

Pasternack

RF Product Guide 2019

Cable Assemblies



Australian Representatives
ROJONE, PTY LTD.
Tel: 02 9829 1555
E: sales@rojone.com.au
www.rojone.com.au

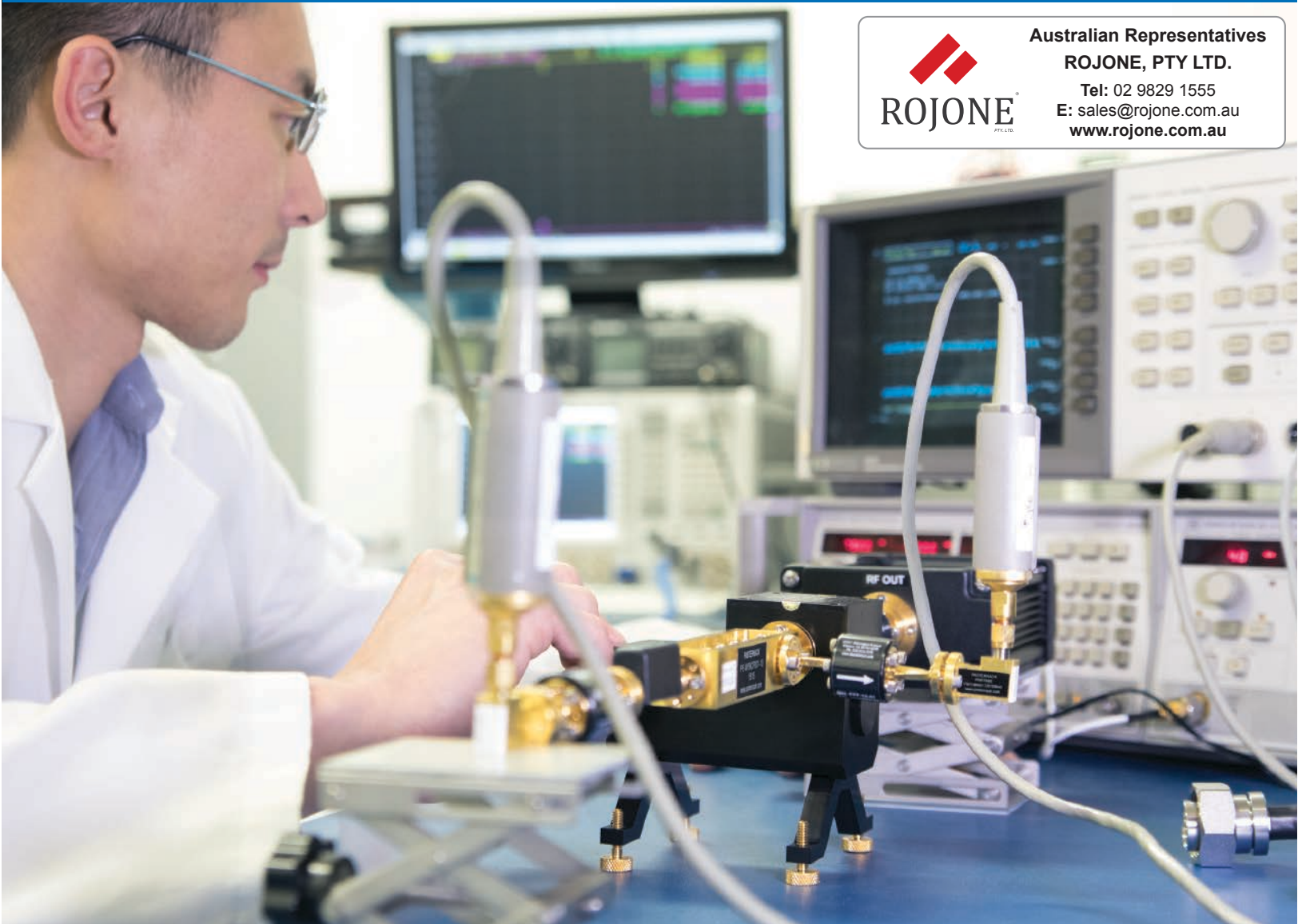

Largest Selection ✓ Same-Day Shipping ✓ Expert Technical Support ✓

866.727.8376 | sales@pasternack.com

PE PASTERNAK®
THE ENGINEER'S RF SOURCE

Coaxial Cable Assemblies Selection Guide

Do you need a cable assembly that isn't in our RF Product Guide?
 Visit our website to view our entire selection of available assemblies or
 to build your own custom length cable assembly!

3 Easy Ways to Find your Product.....

1. Search by PE Part Number

If you know the PE part number you are searching for, please reference our Part Number Index on Page 245

2. Quick Reference Guide

(Page number refers to first appearance of product in the Cable Assemblies Section)

Cable Connector	Page	Cable Connector	Page	Cable Connector	Page	Cable Connector	Page	Cable Connector	Page
1.0/2.3	76	7/16 DIN	78	95 Ohm 3/4"-20 Twinax	103	MMBX	82	SMA	87
1.0mm	76	75 Ohm BNC	102	BMA	78	MMCX	81	SMB	99
1.85mm	76	75 Ohm F	102	BNC	78	N	82	SMC	99
10-32	78	75 Ohm Mini SMB	103	FAKRA	80	QMA	86	SMP	100
2.4mm	76	75 Ohm N	103	HN	80	QN	86	SSMB	100
2.92mm	76	75 Ohm SMB	103	LC	81	Reverse Polarity SMA	98	TNC	100
3.5mm	77	75 Ohm TNC	103	MCX	81	Reverse Polarity TNC	101	UHF	101
4.3-10	78	78 Ohm BNC Twinax	103	MHV	81	SHV	86	UMCX	101

Cable Assemblies

3. Cable Assembly Locator

(Cable Assembly Locator on Page [74-75](#) to locate the Cable Assembly you need by either connector end.)



SMA Female Bulkhead to MCX Plug Right Angle
 PE39421-12

SMA FEMALE BULKHEAD TO:	EXAMPLE	MCX PLUG RIGHT ANGLE TO:	EXAMPLE
MCX PLUG RIGHT ANGLE..... 23		MCX PLUG.....	78
MMCX PLUG RIGHT ANGLE.....	23	MCX PLUG RIGHT ANGLE.....	79
SMA FEMALE BULKHEAD.....	43	N FEMALE BULKHEAD.....	25
SMA MALE.....	17,23,31,32	SMA FEMALE BULKHEAD..... 23	
SMA MALE RIGHT ANGLE.....	17,23,40,41	TNC FEMALE BULKHEAD.....	27
UMCX PLUG.....	76	UMCX PLUG.....	76

The Cable Assembly Locator example above includes Between-Series Cable Assembly part numbers in two configurations: **Connector 1 to Connector 2 as well as Connector 2 to Connector 1 will be found in the same location.**

Products can only be found under the first instance of the series combination. As an example, PE39421-12 above will be found in only one location in the Cable Assembly Section.

All Pasternack coaxial cable assembly part number indicate the length of the assembly (in inches) following the hyphen. Example: PE300-24 and PE300-26.5 are 24 inches and 26.5 inches in length respectively

NOTE: All cable assemblies have a length tolerance of 1.5% or ± 3/8", whichever is greater.



Free Shipping Available
 via UPS Ground
 to USA & Canada



Technical
 Support
 (866) 727-8376



Same-Day Shipping,
 Even Custom
 Cable Assemblies

Cable Assembly Locator

Connector Type	Page
1.0/2.3 Plug Right Angle To:	
BNC MALE.....	76
1.0mm Male To:	
1.0mm MALE.....	76
1.85mm Male To:	
1.85mm FEMALE.....	76
1.85mm MALE.....	76
10-32 Male To:	
10-32 MALE.....	78
2.4mm Male To:	
2.4mm FEMALE.....	76
2.4mm MALE.....	76
2.92mm MALE.....	76
2.92mm Male To:	
2.92mm FEMALE.....	77
2.92mm MALE.....	76
2.92mm MALE.....	77
3.5mm Female To:	
3.5mm FEMALE.....	77
3.5mm Male To:	
3.5mm FEMALE.....	77
3.5mm MALE.....	77
4.3-10 Male To:	
4.3-10 MALE.....	78
7/16 DIN Male To:	
7/16 DIN FEMALE.....	78
7/16 DIN MALE.....	78
7/16 DIN MALE RIGHT ANGLE.....	78
SC MALE.....	78
75 Ohm BNC Male Right Angle To:	
75 Ohm BNC MALE RIGHT ANGLE.....	102
75 Ohm BNC Male To:	
75 Ohm BNC FEMALE.....	102
75 Ohm BNC FEMALE BULKHEAD.....	102
75 Ohm BNC MALE.....	102
75 Ohm BNC MALE RIGHT ANGLE.....	102
75 Ohm F Male To:	
75 Ohm BNC MALE.....	102

Connector Type	Page
75 Ohm F FEMALE BULKHEAD.....	103
75 Ohm F MALE.....	103
75 Ohm Mini SMB Plug To:	
75 Ohm BNC MALE.....	103
75 Ohm MINI SMB PLUG.....	103
75 Ohm N Male To:	
75 Ohm BNC MALE.....	103
75 Ohm SMB Jack To:	
75 Ohm F FEMALE BULKHEAD.....	103
75 Ohm SMB Plug To:	
75 Ohm BNC MALE.....	103
75 Ohm TNC Male To:	
75 Ohm BNC MALE.....	103
78 Ohm BNC Twinax Plug To:	
78 Ohm BNC TWINAX PLUG.....	103
95 Ohm 3/4"-20 Twinax Male To:	
95 Ohm 3/4"-20 TWINAX MALE.....	103
BMA Plug Bulkhead To:	
SMA MALE RIGHT ANGLE.....	78
BNC Female To:	
BNC FEMALE.....	80
BNC Male Right Angle To:	
BNC FEMALE BULKHEAD.....	80
BNC MALE RIGHT ANGLE.....	79
BNC Male To:	
BNC FEMALE.....	79
BNC FEMALE BULKHEAD.....	79
BNC MALE.....	78
BNC MALE.....	79
BNC MALE RIGHT ANGLE.....	79
Cut Lead Sexless.....	102
N MALE.....	79
FAKRA Jack To:	
FAKRA JACK.....	80
FAKRA Plug To:	
FAKRA JACK.....	80
HN Male Right Angle To:	
HN FEMALE.....	80

Connector Type	Page
HN Male To:	
HN MALE.....	80
LC Male To:	
LC MALE.....	81
MCX Plug To:	
75 Ohm BNC MALE.....	102
BNC MALE.....	81
MCX PLUG.....	81
MCX PLUG RIGHT ANGLE.....	81
MHV Male To:	
MHV MALE.....	81
SHV PLUG.....	81
MMBX Plug Right Angle To:	
SMA FEMALE BULKHEAD.....	82
MMCX Plug Right Angle To:	
BNC FEMALE BULKHEAD.....	81
MMCX Plug To:	
MMCX PLUG RIGHT ANGLE.....	81
N Female Bulkhead To:	
QMA MALE RIGHT ANGLE.....	86
REVERSE POLARITY SMA MALE RIGHT ANGLE.....	86
N Female To:	
TNC MALE.....	86
N Male Right Angle To:	
N FEMALE BULKHEAD.....	86
N MALE RIGHT ANGLE.....	85
TNC MALE.....	86
N Male To:	
4.3-10 MALE.....	82
7/16 DIN MALE.....	82
BNC MALE.....	82
N FEMALE.....	84
N FEMALE BULKHEAD.....	84
N MALE.....	82
N MALE.....	83
N MALE.....	84
N MALE RIGHT ANGLE.....	84
SMA FEMALE.....	85

Cable Assembly Locator

Connector Type	Page
N Male To:	
SMA MALE.....	84
SMA MALE.....	85
TNC MALE.....	85
QMA Male To:	
QMA MALE.....	86
QN Male Right Angle To:	
N FEMALE.....	86
Reverse Polarity SMA Female Bulkhead To:	
HMCX32 1.2 PLUG.....	98
MMCX PLUG RIGHT ANGLE.....	98
Reverse Polarity TNC Female Bulkhead To:	
MMCX PLUG.....	101
UMCX PLUG.....	101
SHV Plug To:	
SHV JACK BULKHEAD.....	87
SHV PLUG.....	86
SHV PLUG.....	87
SMA Female 2 Hole Flange To:	
SMP FEMALE.....	98
SMA Female Bulkhead To:	
MCX PLUG RIGHT ANGLE.....	97
MMCX PLUG.....	97
MMCX PLUG RIGHT ANGLE.....	98
SMP FEMALE.....	98
SMP FEMALE RIGHT ANGLE.....	98
UMCX 2.5 PLUG.....	98
UMCX PLUG RIGHT ANGLE.....	98
SMA Female To:	
FAKRA JACK.....	97
N MALE.....	97
SMA FEMALE.....	97
TNC MALE.....	97
Trimmed Lead Sexless.....	102
SMA Male Right Angle To:	
BNC FEMALE BULKHEAD.....	95
BNC MALE.....	94
BNC MALE.....	95
N FEMALE BULKHEAD.....	95

Connector Type	Page
N MALE RIGHT ANGLE.....	95
SMA FEMALE.....	96
SMA FEMALE BULKHEAD.....	96
SMA FEMALE BULKHEAD.....	97
SMA MALE.....	95
SMA MALE RIGHT ANGLE.....	95
SMA MALE RIGHT ANGLE.....	96
SMB PLUG.....	97
SMC PLUG RIGHT ANGLE.....	97
TNC FEMALE BULKHEAD.....	97
TNC MALE RIGHT ANGLE.....	97
SMA Male To:	
BNC MALE.....	87
BNC MALE RIGHT ANGLE.....	87
FAKRA JACK.....	87
MCX PLUG.....	87
MCX PLUG RIGHT ANGLE.....	88
MMCX PLUG.....	88
MMCX PLUG RIGHT ANGLE.....	88
N FEMALE BULKHEAD.....	89
N MALE.....	88
N MALE.....	89
N MALE RIGHT ANGLE.....	89
REVERSE POLARITY SMA MALE.....	93
REVERSE POLARITY TNC MALE.....	94
SMA FEMALE.....	92
SMA FEMALE BULKHEAD.....	92
SMA FEMALE BULKHEAD.....	93
SMA MALE.....	89
SMA MALE.....	90
SMA MALE.....	91
SMA MALE RIGHT ANGLE.....	91
SMA MALE RIGHT ANGLE.....	92
SMB PLUG.....	93
SMP FEMALE.....	93
SMP FEMALE RIGHT ANGLE.....	93
SSMA MALE.....	93
TNC FEMALE BULKHEAD.....	94
TNC MALE.....	94
TNC MALE RIGHT ANGLE.....	94
UMCX 2.5 PLUG.....	94

Connector Type	Page
SMB Jack To:	
BNC MALE.....	99
SMB Plug Right Angle To:	
SMB JACK BULKHEAD.....	99
SMB Plug To:	
BNC MALE.....	99
SMB JACK BULKHEAD.....	99
SMB PLUG.....	99
SMB PLUG RIGHT ANGLE.....	99
SMC Plug Right Angle To:	
BNC MALE.....	100
SMC Plug To:	
SMC PLUG.....	99
SMC PLUG RIGHT ANGLE.....	100
SMP Female Right Angle To:	
MMCX PLUG RIGHT ANGLE.....	100
SMP FEMALE RIGHT ANGLE.....	100
SMP Female To:	
SMP FEMALE.....	100
SSMB Plug Right Angle To:	
SSMB PLUG RIGHT ANGLE.....	100
SSMB Plug To:	
BNC MALE.....	100
TNC Female Bulkhead To:	
TNC MALE.....	101
TNC Male Right Angle To:	
TNC MALE RIGHT ANGLE.....	101
TNC Male To:	
BNC MALE.....	100
TNC MALE.....	100
TNC MALE.....	101
TNC MALE RIGHT ANGLE.....	101
UHF Male To:	
BNC MALE.....	101
UHF MALE.....	101
UMCX Plug Right Angle To:	
MMCX PLUG RIGHT ANGLE.....	101



Free Shipping Available
via UPS Ground
to USA & Canada



Technical
Support
(866) 727-8376



Same-Day Shipping,
Even Custom
Cable Assemblies

For our complete selection of cable assemblies, please visit our website

1.0/2.3 PLUG RIGHT ANGLE TO BNC MALE



Standard Flexible Cable Assemblies

RG316/U Coax, 50 Ohm

Part No. PE3C3469		Cable Dia.	Attn. @1GHz	Power@1GHz		
1 piece price shown. See web or call for volume pricing.		0.102" dia.	38 dB/100ft	160 W		
12"	24"	36"	48"	60"	72"	Custom Len.
\$44.27	\$47.19	\$50.11	\$53.03	\$55.95	\$58.87	See Web

1.0MM MALE TO 1.0MM MALE



Precision Flexible Cable Assemblies

PE-TC110 Coax, 50 Ohm

Part No. PE3TC1220		Cable Dia.	Attn. @1GHz	Power@1GHz		
1 piece price shown. See web or call for volume pricing.		* dia.	dB/100ft	W		
6"	12"	24"	-	-	-	Custom Len.
\$5,658.24	\$7,571.85					See Web

1.85MM MALE TO 1.85MM MALE



Precision Flexible Cable Assemblies

PE-VNA-HF Coax, 50 Ohm

Part No. PE3TC0800		Cable Dia.	Attn. @1GHz	Power@1GHz		
1 piece price shown. See web or call for volume pricing.		0.270" dia.	dB/100ft	W		
24"	36"	48"	500CM	-	-	Custom Len.
\$2,884.71	\$3,268.73	\$3,024.63	\$4,448.62			See Web

Standard Flexible Cable Assemblies

PE-P086 Coax, 50 Ohm

Part No. PE3C0752		Cable Dia.	Attn. @1GHz	Power@1GHz		
1 piece price shown. See web or call for volume pricing.		0.100" dia.	23 dB/100ft	160 W		
12"	24"	36"	48"	60"	50CM	Custom Len.
\$204.69	\$209.96	\$215.23	\$220.50	\$225.76	\$208.06	See Web

Standard Semi-Rigid Cable Assemblies

RG405/U Coax, 50 Ohm

Part No. PE36523		Cable Dia.	Attn. @1GHz	Power@1GHz		
1 piece price shown. See web or call for volume pricing.		* dia.	22 dB/100ft	130 W		
6"	12"	18"	24"	36"	48"	Custom Len.
\$319.65	\$319.65	\$322.95	\$326.26	\$332.87	\$339.48	See Web

1.85MM MALE TO 1.85MM FEMALE



Precision Flexible Cable Assemblies

PE-VNA-HF Coax, 50 Ohm

Part No. PE3TC0900		Cable Dia.	Attn. @1GHz	Power@1GHz		
1 piece price shown. See web or call for volume pricing.		0.270" dia.	dB/100ft	W		
24"	36"	48"	-	-	-	Custom Len.
\$2,884.71		\$3,024.63				See Web

2.4MM MALE TO 2.4MM MALE



Test Flexible Cable Assemblies

PE-P160 Coax, 50 Ohm

Part No. PE363		Cable Dia.	Attn. @1GHz	Power@1GHz		
1 piece price shown. See web or call for volume pricing.		0.160" dia.	13 dB/100ft	W		
12"	24"	36"	48"	60"	50CM	Custom Len.
\$276.74	\$301.65	\$326.58	\$351.50	\$357.85	\$276.57	See Web

PE-P102 Coax, 50 Ohm

Part No. PE373		Cable Dia.	Attn. @1GHz	Power@1GHz		
1 piece price shown. See web or call for volume pricing.		0.102" dia.	29 dB/100ft	W		
12"	24"	36"	48"	60"	50CM	Custom Len.
\$244.57	\$269.53	\$294.48	\$319.43	\$344.39	\$260.57	See Web

Standard Flexible Cable Assemblies

PE-VNA-R Coax, 50 Ohm

Part No. PE3VNA4004		Cable Dia.	Attn. @1GHz	Power@1GHz		
1 piece price shown. See web or call for volume pricing.		0.430" dia.	dB/100ft	W		
24"	48"	-	-	-	-	Custom Len.
\$1,972.35	\$2,175.54					See Web

PE-P086HF Coax, 50 Ohm

Part No. PE3C0728		Cable Dia.	Attn. @1GHz	Power@1GHz		
1 piece price shown. See web or call for volume pricing.		0.104" dia.	23 dB/100ft	160 W		
6"	6"	12"	12"	18"	18"	Custom Len.
\$200.06	\$200.06	\$200.06	\$200.06	\$202.69	\$202.69	See Web

Standard Semi-Rigid Cable Assemblies

PE-SR405AL Coax, 50 Ohm

Part No. PE35672LF		Cable Dia.	Attn. @1GHz	Power@1GHz		
1 piece price shown. See web or call for volume pricing.		* dia.	23 dB/100ft	130 W		
6"	12"	18"	24"	36"	48"	Custom Len.
\$150.33	\$150.33	\$154.49	\$158.65	\$166.98	\$175.29	See Web

PE-SR405AL Coax, 50 Ohm

Part No. PE35672		Cable Dia.	Attn. @1GHz	Power@1GHz		
1 piece price shown. See web or call for volume pricing.		* dia.	23 dB/100ft	130 W		
6"	12"	18"	24"	36"	48"	Custom Len.
\$150.33	\$150.33	\$154.49	\$158.65	\$166.98	\$175.29	See Web

2.4MM MALE TO 2.4MM FEMALE



Precision Flexible Cable Assemblies

PE-VNA-HF Coax, 50 Ohm

Part No. PE3TC0600		Cable Dia.	Attn. @1GHz	Power@1GHz		
1 piece price shown. See web or call for volume pricing.		0.270" dia.	dB/100ft	W		
24"	36"	48"	-	-	-	Custom Len.
\$2,789.44		\$2,932.19				See Web

Standard Flexible Cable Assemblies

PE-VNA-R Coax, 50 Ohm

Part No. PE3VNA4005		Cable Dia.	Attn. @1GHz	Power@1GHz		
1 piece price shown. See web or call for volume pricing.		0.430" dia.	dB/100ft	W		
24"	48"	-	-	-	-	Custom Len.
\$2,034.87	\$2,238.06					See Web

2.4MM MALE TO 2.92MM MALE



Standard Flexible Cable Assemblies

PE-P086 Coax, 50 Ohm

Part No. PE3C0747		Cable Dia.	Attn. @1GHz	Power@1GHz		
1 piece price shown. See web or call for volume pricing.		0.104" dia.	23 dB/100ft	160 W		
12"	24"	36"	48"	60"	72"	Custom Len.
\$221.50	\$226.77	\$232.04	\$237.31	\$242.58	\$239.62	See Web

PE-P086 Coax, 50 Ohm

Part No. PE3C0747LF		Cable Dia.	Attn. @1GHz	Power@1GHz		
1 piece price shown. See web or call for volume pricing.		0.104" dia.	dB/100ft	W		
12"	24"	36"	48"	60"	72"	Custom Len.
\$221.50	\$226.77	\$232.04	\$237.31	\$242.58	\$239.62	See Web

2.92MM MALE TO 2.92MM MALE



Test Flexible Cable Assemblies

PE-P160 Coax, 50 Ohm

Part No. PE360		Cable Dia.	Attn. @1GHz	Power@1GHz		
1 piece price shown. See web or call for volume pricing.		0.155" dia.	13 dB/100ft	1070 W		
12"	24"	36"	48"	60"	72"	Custom Len.
\$220.33	\$241.12	\$261.92	\$282.71	\$303.50	\$314.08	See Web

Cable Assemblies

See Our Website For Current Pricing & Real-Time Stock Availability!

*Coax Performance at 1 GHz Notes: Cable assembly max frequency may be lower than connector or coax max frequency

For our complete selection of cable assemblies, please visit our website

PE-VNA Coax, 50 Ohm						
Part No. PE319		Cable Dia.		Attn. @1 GHz		Power@1GHz
1 piece price shown. See web or call for volume pricing.						
20"	24"	36"	48"	60"	72"	Custom Len.
\$1,140.71	\$1,036.63	\$1,234.66	\$1,271.36	\$1,551.06	\$1,769.09	See Web

Standard Formable Cable Assemblies						
PE-SR402FL Coax, 50 Ohm						
Part No. PE34733		Cable Dia.		Attn. @1 GHz		Power@1GHz
1 piece price shown. See web or call for volume pricing.						
6"	12"	18"	24"	36"	48"	Custom Len.
\$122.55	\$122.55	\$126.18	\$129.81	\$137.07	\$144.32	See Web

PE-SR405FL Coax, 50 Ohm						
Part No. PE3C1377		Cable Dia.		Attn. @1 GHz		Power@1GHz
1 piece price shown. See web or call for volume pricing.						
6"	12"	18"	24"	36"	48"	Custom Len.
\$161.53	\$161.53	\$166.67	\$171.81	\$182.10	\$192.40	See Web

Standard Flexible Cable Assemblies						
PE-P086 Coax, 50 Ohm						
Part No. PE3C0666		Cable Dia.		Attn. @1 GHz		Power@1GHz
1 piece price shown. See web or call for volume pricing.						
6"	12"	18"	24"	36"	48"	Custom Len.
\$154.95	\$154.95	\$157.58	\$160.21	\$165.49	\$170.76	See Web

PE-P102 Coax, 50 Ohm						
Part No. PE371		Cable Dia.		Attn. @1 GHz		Power@1GHz
1 piece price shown. See web or call for volume pricing.						
12"	24"	36"	48"	60"	50CM	Custom Len.
\$232.74	\$257.68	\$282.64	\$307.59	\$332.55	\$248.72	See Web

PE-VNA-R Coax, 50 Ohm						
Part No. PE3VNA4001		Cable Dia.		Attn. @1 GHz		Power@1GHz
1 piece price shown. See web or call for volume pricing.						
120"	24"	48"	-	-	-	Custom Len.
\$2,981.75	\$1,925.46	\$2,128.65	-	-	-	See Web

Standard Semi-Rigid Cable Assemblies						
PE-118SR Coax, 50 Ohm						
Part No. PE34739		Cable Dia.		Attn. @1 GHz		Power@1GHz
1 piece price shown. See web or call for volume pricing.						
6"	12"	18"	24"	36"	48"	Custom Len.
\$185.84	\$185.84	\$203.64	\$221.44	\$257.04	\$292.64	See Web

PE-118SR Coax, 50 Ohm						
Part No. PE34739LF		Cable Dia.		Attn. @1 GHz		Power@1GHz
1 piece price shown. See web or call for volume pricing.						
6"	12"	18"	24"	36"	48"	Custom Len.
\$189.41	\$189.41	\$207.22	\$225.01	\$260.61	\$296.21	See Web

PE-SR402AL Coax, 50 Ohm						
Part No. PE34731LF		Cable Dia.		Attn. @1 GHz		Power@1GHz
1 piece price shown. See web or call for volume pricing.						
6"	12"	18"	24"	36"	48"	Custom Len.
\$124.43	\$124.43	\$128.96	\$133.50	\$142.55	\$151.61	See Web

PE-SR402AL Coax, 50 Ohm						
Part No. PE34731		Cable Dia.		Attn. @1 GHz		Power@1GHz
1 piece price shown. See web or call for volume pricing.						
6"	12"	18"	24"	36"	48"	Custom Len.
\$124.43	\$124.43	\$128.96	\$133.50	\$142.55	\$151.61	See Web

RG402/U Coax, 50 Ohm						
Part No. PE34729		Cable Dia.		Attn. @1 GHz		Power@1GHz
1 piece price shown. See web or call for volume pricing.						
6"	12"	18"	24"	36"	48"	Custom Len.
\$122.36	\$122.36	\$125.87	\$129.39	\$136.41	\$143.45	See Web

2.92MM MALE TO 2.92MM FEMALE



Test Flexible Cable Assemblies

PE-P160 Coax, 50 Ohm						
Part No. PE361		Cable Dia.		Attn. @1 GHz		Power@1GHz
1 piece price shown. See web or call for volume pricing.						
36"	48"	100CM	150CM	200CM	12"	Custom Len.
\$307.65	\$332.57	\$314.65	\$355.54	\$396.41	\$257.81	See Web

Standard Flexible Cable Assemblies						
PE-VNA-R Coax, 50 Ohm						
Part No. PE3VNA4002		Cable Dia.		Attn. @1 GHz		Power@1GHz
1 piece price shown. See web or call for volume pricing.						
24"	48"	-	-	-	-	Custom Len.
\$1,987.98	\$2,191.17	-	-	-	-	See Web

3.5MM MALE TO 3.5MM MALE



Test Flexible Cable Assemblies

PE-P160 Coax, 50 Ohm						
Part No. PE369		Cable Dia.		Attn. @1 GHz		Power@1GHz
1 piece price shown. See web or call for volume pricing.						
12"	24"	36"	48"	60"	50CM	Custom Len.
\$246.62	\$271.54	\$296.45	\$321.38	\$346.30	\$240.67	See Web

PE-VNA Coax, 50 Ohm						
Part No. PE315		Cable Dia.		Attn. @1 GHz		Power@1GHz
1 piece price shown. See web or call for volume pricing.						
24"	36"	48"	60"	72"	-	Custom Len.
\$856.00	\$1,037.47	\$1,095.15	\$1,200.30	\$1,337.68	-	See Web

Standard Flexible Cable Assemblies						
PE-VNA-R Coax, 50 Ohm						
Part No. PE3VNA2603		Cable Dia.		Attn. @1 GHz		Power@1GHz
1 piece price shown. See web or call for volume pricing.						
24"	48"	-	-	-	-	Custom Len.
\$1,406.82	\$1,593.08	-	-	-	-	See Web

Standard Semi-Rigid Cable Assemblies						
PE-SR402AL Coax, 50 Ohm						
Part No. PE34572		Cable Dia.		Attn. @1 GHz		Power@1GHz
1 piece price shown. See web or call for volume pricing.						
6"	12"	18"	24"	36"	48"	Custom Len.
\$207.59	\$207.59	\$212.12	\$216.65	\$225.71	\$234.77	See Web

RG405/U Coax, 50 Ohm						
Part No. PE34574		Cable Dia.		Attn. @1 GHz		Power@1GHz
1 piece price shown. See web or call for volume pricing.						
6"	12"	18"	24"	36"	48"	Custom Len.
\$214.89	\$214.89	\$218.19	\$221.49	\$228.11	\$234.72	See Web

3.5MM MALE TO 3.5MM FEMALE



Test Flexible Cable Assemblies

PE-VNA Coax, 50 Ohm						
Part No. PE317		Cable Dia.		Attn. @1 GHz		Power@1GHz
1 piece price shown. See web or call for volume pricing.						
24"	36"	48"	60"	72"	-	Custom Len.
\$925.34	\$980.53	\$1,189.95	\$1,146.25	\$1,375.38	-	See Web

Standard Flexible Cable Assemblies						
PE-FF430 Coax, 50 Ohm						
Part No. PE3C4012		Cable Dia.		Attn. @1 GHz		Power@1GHz
1 piece price shown. See web or call for volume pricing.						
100CM	100CM	-	-	-	-	Custom Len.
\$839.41	\$839.41	-	-	-	-	See Web

3.5MM FEMALE TO 3.5MM FEMALE



Standard Flexible Cable Assemblies

PE-FF430 Coax, 50 Ohm						
Part No. PE3C4013		Cable Dia.		Attn. @1 GHz		Power@1GHz
1 piece price shown. See web or call for volume pricing.						
100CM	-	-	-	-	-	Custom Len.
\$839.41	-	-	-	-	-	See Web

For Custom Lengths, Metric Lengths or Special Configurations, Please call (949) 261-1920



Free Shipping Available
via UPS Ground
to USA & Canada



Technical
Support
(866) 727-8376



Same-Day Shipping,
Even Custom
Cable Assemblies

Cable Assemblies

See Our Website For Current Pricing & Real-Time Stock Availability!

For our complete selection of cable assemblies, please visit our website

4.3-10 MALE TO 4.3-10 MALE



Low PIM Corrugated Cable Assemblies

SPP-250-LLPL Coax, 50 Ohm

Part No. PE3C4142				Cable Dia.	Attn. @1 GHz	Power@1GHz
1 piece price shown. See web or call for volume pricing.				0.280" dia.	dB/100ft	W
100CM	200CM	-	-	-	-	Custom Len.
\$96.92	\$136.66					See Web

7/16 DIN MALE TO 7/16 DIN MALE



Standard Flexible Cable Assemblies

RG393/U Coax, 50 Ohm

Part No. PE3205				Cable Dia.	Attn. @1 GHz	Power@1GHz
1 piece price shown. See web or call for volume pricing.				0.390" dia.	8 dB/100ft	1700 W
12"	24"	36"	48"	60"	72"	Custom Len.
\$262.28	\$277.17	\$292.05	\$306.94	\$321.83	\$336.71	See Web

RG393/U Coax, 50 Ohm

Part No. PE3205LF				Cable Dia.	Attn. @1 GHz	Power@1GHz
1 piece price shown. See web or call for volume pricing.				0.390" dia.	8 dB/100ft	1700 W
12"	24"	36"	48"	60"	72"	Custom Len.
\$262.28	\$277.17	\$292.05	\$306.94	\$321.83	\$336.71	See Web

7/16 DIN MALE TO 7/16 DIN MALE RIGHT ANGLE



Standard Flexible Cable Assemblies

RG393/U Coax, 50 Ohm

Part No. PE32057				Cable Dia.	Attn. @1 GHz	Power@1GHz
1 piece price shown. See web or call for volume pricing.				0.390" dia.	9 dB/100ft	1700 W
12"	24"	36"	48"	60"	-	Custom Len.
\$282.66	\$297.55	\$312.43	\$327.32	\$342.20		See Web

7/16 DIN MALE TO 7/16 DIN FEMALE



Standard Flexible Cable Assemblies

RG393/U Coax, 50 Ohm

Part No. PE327450				Cable Dia.	Attn. @1 GHz	Power@1GHz
1 piece price shown. See web or call for volume pricing.				0.390" dia.	9 dB/100ft	1700 W
12"	24"	36"	48"	60"	-	Custom Len.
\$271.76	\$286.64	\$301.53	\$316.42	\$331.30		See Web

7/16 DIN MALE TO SC MALE



Standard Flexible Cable Assemblies

RG393/U Coax, 50 Ohm

Part No. PE327497				Cable Dia.	Attn. @1 GHz	Power@1GHz
1 piece price shown. See web or call for volume pricing.				0.390" dia.	9 dB/100ft	1700 W
12"	24"	36"	48"	60"	72"	Custom Len.
\$214.72	\$230.05	\$245.38	\$260.71	\$276.04	\$291.37	See Web

10-32 MALE TO 10-32 MALE



Standard Flexible Cable Assemblies

RG174A/U Coax, 50 Ohm

Part No. PE36520				Cable Dia.	Attn. @1 GHz	Power@1GHz
1 piece price shown. See web or call for volume pricing.				0.100" dia.	32 dB/100ft	16 W
12"	24"	36"	48"	60"	72"	Custom Len.
\$61.43	\$61.85	\$62.27	\$62.69	\$63.11	\$63.53	See Web

BMA PLUG BULKHEAD TO SMA MALE RIGHT ANGLE

SEE MOUNTING HOLE SECTION ON PAGE 259



Flexible Cable Assemblies

RG316/U Coax, 50 Ohm

Part No. PE3C4386				Cable Dia.	Attn. @1 GHz	Power@1GHz
1 piece price shown. See web or call for volume pricing.				0.098" dia.	58 dB/100ft	160 W
6"	12"	24"	36"	60"	-	Custom Len.
\$84.00	\$85.36	\$88.04	\$90.74	\$96.14		See Web

BNC MALE TO BNC MALE



Standard Flexible Cable Assemblies

RG58C/U Coax, 50 Ohm

Part No. PE3067				Cable Dia.	Attn. @1 GHz	Power@1GHz
1 piece price shown. See web or call for volume pricing.				0.195" dia.	20 dB/100ft	80 W
12"	18"	24"	30"	36"	48"	Custom Len.
\$30.03	\$30.38	\$30.73	\$31.08	\$31.43	\$32.14	See Web

RG142B/U Coax, 50 Ohm

Part No. PE3495				Cable Dia.	Attn. @1 GHz	Power@1GHz
1 piece price shown. See web or call for volume pricing.				0.195" dia.	dB/100ft	650 W
12"	24"	36"	48"	60"	72"	Custom Len.
\$29.47	\$34.98	\$40.50	\$46.02	\$51.53	\$57.05	See Web

RG142B/U Coax, 50 Ohm

Part No. PE3495LF				Cable Dia.	Attn. @1 GHz	Power@1GHz
1 piece price shown. See web or call for volume pricing.				0.195" dia.	dB/100ft	650 W
12"	24"	36"	48"	60"	72"	Custom Len.
\$32.16	\$37.67	\$43.20	\$48.71	\$54.23	\$59.74	See Web

RG174A/U Coax, 50 Ohm

Part No. PE3C2295				Cable Dia.	Attn. @1 GHz	Power@1GHz
1 piece price shown. See web or call for volume pricing.				0.110" dia.	32 dB/100ft	17 W
12"	24"	36"	48"	60"	72"	Custom Len.
\$32.87	\$33.26	\$33.71	\$34.10	\$34.54	\$34.92	See Web

RG174A/U Coax, 50 Ohm

Part No. PE3C2295LF				Cable Dia.	Attn. @1 GHz	Power@1GHz
1 piece price shown. See web or call for volume pricing.				0.110" dia.	32 dB/100ft	17 W
12"	24"	36"	48"	60"	72"	Custom Len.
\$34.19	\$34.61	\$35.03	\$35.44	\$35.86	\$36.29	See Web

RG178B/U Coax, 50 Ohm

Part No. PE33130				Cable Dia.	Attn. @1 GHz	Power@1GHz
1 piece price shown. See web or call for volume pricing.				0.072" dia.	44 dB/100ft	78 W
12"	24"	36"	48"	60"	-	Custom Len.
\$59.18	\$60.11	\$61.02	\$61.95	\$62.87		See Web

RG188A/U Coax, 50 Ohm

Part No. PE3C2034				Cable Dia.	Attn. @1 GHz	Power@1GHz
1 piece price shown. See web or call for volume pricing.				0.110" dia.	26 dB/100ft	160 W
12"	24"	36"	48"	60"	72"	Custom Len.
\$34.43	\$36.43	\$38.37	\$40.38	\$42.38	\$44.32	See Web

RG188A/U Coax, 50 Ohm

Part No. PE3C2034LF				Cable Dia.	Attn. @1 GHz	Power@1GHz
1 piece price shown. See web or call for volume pricing.				0.110" dia.	26 dB/100ft	160 W
12"	24"	36"	48"	60"	72"	Custom Len.
\$34.43	\$36.43	\$38.37	\$40.38	\$42.38	\$44.32	See Web

RG213/U Coax, 50 Ohm

Part No. PE32749				Cable Dia.	Attn. @1 GHz	Power@1GHz
1 piece price shown. See web or call for volume pricing.				0.405" dia.	8 dB/100ft	190 W
12"	24"	36"	48"	60"	72"	Custom Len.
\$74.39	\$76.00	\$77.59	\$79.20	\$80.79	\$82.40	See Web

Cable Assemblies

See Our Website For Current Pricing & Real-Time Stock Availability!

*Coax Performance at 1 GHz Notes: Cable assembly max frequency may be lower than connector or coax max frequency

For our complete selection of cable assemblies, please visit our website

RG223/U Coax, 50 Ohm						
Part No. PE3087		Cable Dia.	Attn. @1 GHz	Power@1GHz		
1 piece price shown. See web or call for volume pricing.						
12"	24"	36"	48"	60"	72"	Custom Len.
\$28.87	\$31.78	\$34.69	\$37.60	\$40.51	\$43.42	See Web
RG316/U Coax, 50 Ohm						
Part No. PE3C2416		Cable Dia.	Attn. @1 GHz	Power@1GHz		
1 piece price shown. See web or call for volume pricing.						
12"	24"	36"	48"	60"	72"	Custom Len.
\$35.26	\$38.04	\$40.82	\$41.13	\$43.01	\$45.78	See Web
RG316/U Coax, 50 Ohm						
Part No. PE3C2416LF		Cable Dia.	Attn. @1 GHz	Power@1GHz		
1 piece price shown. See web or call for volume pricing.						
12"	24"	36"	48"	60"	72"	Custom Len.
\$35.26	\$38.04	\$40.82	\$43.60	\$46.37	\$49.16	See Web
RG400/U Coax, 50 Ohm						
Part No. PE3582LF		Cable Dia.	Attn. @1 GHz	Power@1GHz		
1 piece price shown. See web or call for volume pricing.						
12"	24"	36"	48"	60"	72"	Custom Len.
\$39.94	\$46.66	\$53.37	\$60.08	\$66.78	\$73.49	See Web
RG400/U Coax, 50 Ohm						
Part No. PE3582		Cable Dia.	Attn. @1 GHz	Power@1GHz		
1 piece price shown. See web or call for volume pricing.						
12"	24"	36"	48"	60"	72"	Custom Len.
\$37.41	\$44.12	\$50.82	\$57.53	\$64.24	\$70.95	See Web
PE-C195 Coax, 50 Ohm						
Part No. PE36066		Cable Dia.	Attn. @1 GHz	Power@1GHz		
1 piece price shown. See web or call for volume pricing.						
12"	24"	36"	48"	60"	-	Custom Len.
\$25.16	\$25.85	\$26.53	\$27.22	\$28.44	-	See Web
PE-P195 Coax, 50 Ohm						
Part No. PE34035		Cable Dia.	Attn. @1 GHz	Power@1GHz		
1 piece price shown. See web or call for volume pricing.						
12"	24"	36"	48"	60"	-	Custom Len.
\$29.18	\$37.45	\$50.39	\$58.24	\$66.11	-	See Web
LMR-195 Coax, 50 Ohm						
Part No. PE3C0054		Cable Dia.	Attn. @1 GHz	Power@1GHz		
1 piece price shown. See web or call for volume pricing.						
12"	24"	36"	48"	60"	-	Custom Len.
\$24.61	\$25.33	\$26.04	\$26.76	\$27.48	-	See Web
LMR-200-UF Coax, 50 Ohm						
Part No. PE3C2220		Cable Dia.	Attn. @1 GHz	Power@1GHz		
1 piece price shown. See web or call for volume pricing.						
12"	24"	36"	48"	60"	72"	Custom Len.
\$45.90	\$47.99	\$50.08	\$52.17	\$54.26	\$56.35	See Web
RG59B/U Coax, 75 Ohm						
Part No. PE3075		Cable Dia.	Attn. @1 GHz	Power@1GHz		
1 piece price shown. See web or call for volume pricing.						
12"	18"	24"	30"	36"	48"	Custom Len.
\$25.67	\$26.13	\$26.59	\$27.06	\$27.51	\$28.44	See Web
RG59B/U Coax, 75 Ohm						
Part No. PE3075LF		Cable Dia.	Attn. @1 GHz	Power@1GHz		
1 piece price shown. See web or call for volume pricing.						
12"	18"	24"	30"	36"	48"	Custom Len.
\$31.10	\$31.56	\$32.02	\$32.48	\$32.94	\$33.86	See Web
RG62A/U Coax, 93 Ohm						
Part No. PE3081LF		Cable Dia.	Attn. @1 GHz	Power@1GHz		
1 piece price shown. See web or call for volume pricing.						
12"	24"	36"	48"	60"	72"	Custom Len.
\$30.97	\$32.29	\$33.61	\$34.93	\$36.25	\$37.57	See Web

BNC MALE TO BNC MALE RIGHT ANGLE



Standard Flexible Cable Assemblies

RG58C/U Coax, 50 Ohm

Part No. PE3020		Cable Dia.	Attn. @1 GHz	Power@1GHz		
1 piece price shown. See web or call for volume pricing.						
12"	24"	36"	48"	60"	72"	Custom Len.
\$47.51	\$48.21	\$48.92	\$49.63	\$50.33	\$51.04	See Web

RG223/U Coax, 50 Ohm						
Part No. PE3689		Cable Dia.	Attn. @1 GHz	Power@1GHz		
1 piece price shown. See web or call for volume pricing.						
12"	24"	36"	48"	60"	72"	Custom Len.
\$42.10	\$44.89	\$47.69	\$50.48	\$53.26	\$56.05	See Web

BNC MALE TO BNC FEMALE



Standard Flexible Cable Assemblies

RG58C/U Coax, 50 Ohm

Part No. PE3047		Cable Dia.	Attn. @1 GHz	Power@1GHz		
1 piece price shown. See web or call for volume pricing.						
12"	24"	36"	48"	60"	72"	Custom Len.
\$35.03	\$35.74	\$36.44	\$37.15	\$37.86	\$38.57	See Web

RG58C/U Coax, 50 Ohm

Part No. PE3047LF		Cable Dia.	Attn. @1 GHz	Power@1GHz		
1 piece price shown. See web or call for volume pricing.						
12"	24"	36"	48"	60"	72"	Custom Len.
\$35.03	\$35.74	\$36.44	\$37.15	\$37.86	\$38.57	See Web

BNC MALE TO BNC FEMALE BULKHEAD

SEE MOUNTING HOLE SECTION ON PAGE 259



Standard Flexible Cable Assemblies

RG223/U Coax, 50 Ohm

Part No. PE3557		Cable Dia.	Attn. @1 GHz	Power@1GHz		
1 piece price shown. See web or call for volume pricing.						
12"	24"	36"	48"	60"	72"	Custom Len.
\$41.77	\$44.56	\$47.34	\$50.14	\$52.93	\$55.72	See Web

RG316/U Coax, 50 Ohm

Part No. PE3C3446		Cable Dia.	Attn. @1 GHz	Power@1GHz		
1 piece price shown. See web or call for volume pricing.						
12"	24"	36"	48"	60"	72"	Custom Len.
\$41.33	\$44.10	\$46.88	\$49.67	\$52.45	\$55.22	See Web

BNC MALE TO N MALE



Standard Flexible Cable Assemblies

RG142B/U Coax, 50 Ohm

Part No. PE3061		Cable Dia.	Attn. @1 GHz	Power@1GHz		
1 piece price shown. See web or call for volume pricing.						
12"	24"	36"	48"	60"	72"	Custom Len.
\$39.69	\$45.22	\$50.73	\$56.24	\$61.76	\$67.28	See Web

BNC MALE RIGHT ANGLE TO BNC MALE RIGHT ANGLE



Standard Flexible Cable Assemblies

RG58C/U Coax, 50 Ohm

Part No. PE3025		Cable Dia.	Attn. @1 GHz	Power@1GHz		
1 piece price shown. See web or call for volume pricing.						
12"	24"	36"	48"	60"	72"	Custom Len.
\$65.03	\$65.73	\$66.44	\$67.15	\$67.86	\$68.57	See Web

RG58C/U Coax, 50 Ohm

Part No. PE3025LF		Cable Dia.	Attn. @1 GHz	Power@1GHz		
1 piece price shown. See web or call for volume pricing.						
12"	24"	36"	48"	60"	72"	Custom Len.
\$74.54	\$75.25	\$75.96	\$76.66	\$77.37	\$78.08	See Web

For Custom Lengths, Metric Lengths or Special Configurations, Please call (949) 261-1920



Free Shipping Available via UPS Ground to USA & Canada



Technical Support (866) 727-8376



Same-Day Shipping, Even Custom Cable Assemblies

Cable Assemblies

See Our Website For Current Pricing & Real-Time Stock Availability!

For our complete selection of cable assemblies, please visit our website

BNC MALE RIGHT ANGLE TO BNC FEMALE BULKHEAD

SEE MOUNTING HOLE SECTION ON PAGE 259



Standard Flexible Cable Assemblies

RG58C/U Coax, 50 Ohm

Part No. PE33189		Cable Dia.	Attn. @1GHz	Power@1GHz
1 piece price shown. See web or call for volume pricing.				
12"	24"	36"	48"	60"
\$58.03	\$58.74	\$59.45	\$60.16	\$60.87
Custom Len.		See Web		

RG400/U Coax, 50 Ohm

Part No. PE3C3314		Cable Dia.	Attn. @1GHz	Power@1GHz
1 piece price shown. See web or call for volume pricing.				
12"	24"	36"	48"	60"
\$72.74	\$79.65	\$86.56	\$93.47	\$100.38
Custom Len.		See Web		

BNC FEMALE TO BNC FEMALE



Standard Flexible Cable Assemblies

RG174A/U Coax, 50 Ohm

Part No. PE3604LF		Cable Dia.	Attn. @1GHz	Power@1GHz
1 piece price shown. See web or call for volume pricing.				
12"	24"	36"	48"	60"
\$47.36	\$47.78	\$48.20	\$48.61	\$49.03
Custom Len.		See Web		

RG174A/U Coax, 50 Ohm

Part No. PE3604		Cable Dia.	Attn. @1GHz	Power@1GHz
1 piece price shown. See web or call for volume pricing.				
12"	24"	36"	48"	60"
\$47.36	\$47.78	\$48.20	\$48.61	\$49.03
Custom Len.		See Web		

FAKRA PLUG TO FAKRA JACK

SEE FAKRA SPECIFICATION ON PAGE 261



Standard Flexible Cable Assemblies

RG174A/U Coax, 50 Ohm

Part No. PE38752K		Cable Dia.	Attn. @1GHz	Power@1GHz
1 piece price shown. See web or call for volume pricing.				
12"	24"	36"	48"	60"
\$27.67	\$28.09	\$28.50	\$28.93	\$29.35
Custom Len.		See Web		

RG174A/U Coax, 50 Ohm

Part No. PE38752Z		Cable Dia.	Attn. @1GHz	Power@1GHz
1 piece price shown. See web or call for volume pricing.				
12"	24"	36"	48"	60"
\$27.67	\$28.09	\$28.50	\$28.93	\$29.35
Custom Len.		See Web		

PE-C100-LSZH Coax, 50 Ohm

Part No. PE38748Z		Cable Dia.	Attn. @1GHz	Power@1GHz
1 piece price shown. See web or call for volume pricing.				
12"	24"	36"	48"	60"
\$23.61	\$24.76	\$25.93	\$27.63	\$29.60
Custom Len.		See Web		

FAKRA JACK TO FAKRA JACK

SEE FAKRA SPECIFICATION ON PAGE 261



Standard Flexible Cable Assemblies

RG174A/U Coax, 50 Ohm

Part No. PE38750A		Cable Dia.	Attn. @1GHz	Power@1GHz
1 piece price shown. See web or call for volume pricing.				
12"	24"	36"	48"	60"
\$28.18	\$28.60	\$29.02	\$29.44	\$29.86
Custom Len.		See Web		

RG174A/U Coax, 50 Ohm

Part No. PE38750Z		Cable Dia.	Attn. @1GHz	Power@1GHz
1 piece price shown. See web or call for volume pricing.				
12"	24"	36"	48"	60"
\$27.16	\$27.58	\$27.99	\$28.41	\$28.84
Custom Len.		See Web		

RG316/U Coax, 50 Ohm

Part No. PE38754Z		Cable Dia.	Attn. @1GHz	Power@1GHz
1 piece price shown. See web or call for volume pricing.				
12"	24"	36"	48"	60"
\$30.16	\$32.94	\$35.71	\$38.50	\$41.28
Custom Len.		See Web		

PE-C100-LSZH Coax, 50 Ohm

Part No. PE38746Z		Cable Dia.	Attn. @1GHz	Power@1GHz
1 piece price shown. See web or call for volume pricing.				
12"	24"	36"	48"	60"
\$23.17	\$24.34	\$25.72	\$27.63	\$29.60
Custom Len.		See Web		

HN MALE TO HN MALE



Standard Flexible Cable Assemblies

RG8A/U Coax, 50 Ohm

Part No. PE33304		Cable Dia.	Attn. @1GHz	Power@1GHz
1 piece price shown. See web or call for volume pricing.				
12"	24"	36"	48"	60"
\$107.49	\$110.22	\$112.95	\$115.67	\$118.40
Custom Len.		See Web		

RG213/U Coax, 50 Ohm

Part No. PE3038		Cable Dia.	Attn. @1GHz	Power@1GHz
1 piece price shown. See web or call for volume pricing.				
12"	24"	36"	48"	60"
\$106.37	\$107.98	\$109.57	\$111.18	\$112.77
Custom Len.		See Web		

RG213/U Coax, 50 Ohm

Part No. PE3038LF		Cable Dia.	Attn. @1GHz	Power@1GHz
1 piece price shown. See web or call for volume pricing.				
12"	24"	36"	48"	60"
\$106.37	\$107.98	\$109.57	\$111.18	\$112.77
Custom Len.		See Web		

RG214/U Coax, 50 Ohm

Part No. PE3095		Cable Dia.	Attn. @1GHz	Power@1GHz
1 piece price shown. See web or call for volume pricing.				
12"	24"	36"	48"	60"
\$114.34	\$121.39	\$128.44	\$135.50	\$142.54
Custom Len.		See Web		

RG217/U Coax, 50 Ohm

Part No. PE33370LF		Cable Dia.	Attn. @1GHz	Power@1GHz
1 piece price shown. See web or call for volume pricing.				
12"	24"	36"	48"	60"
\$118.87	\$123.11	\$127.35	\$131.59	\$135.83
Custom Len.		See Web		

RG217/U Coax, 50 Ohm

Part No. PE33370		Cable Dia.	Attn. @1GHz	Power@1GHz
1 piece price shown. See web or call for volume pricing.				
12"	24"	36"	48"	60"
\$116.63	\$120.87	\$125.11	\$129.35	\$133.58
Custom Len.		See Web		

RG393/U Coax, 50 Ohm

Part No. PE3340LF		Cable Dia.	Attn. @1GHz	Power@1GHz
1 piece price shown. See web or call for volume pricing.				
12"	24"	36"	48"	60"
\$118.30	\$133.19	\$148.07	\$162.96	\$177.85
Custom Len.		See Web		

RG393/U Coax, 50 Ohm

Part No. PE3340		Cable Dia.	Attn. @1GHz	Power@1GHz
1 piece price shown. See web or call for volume pricing.				
12"	24"	36"	48"	60"
\$118.30	\$133.19	\$148.07	\$162.96	\$177.85
Custom Len.		See Web		

HN MALE RIGHT ANGLE TO HN FEMALE



Standard Flexible Cable Assemblies

RG213/U Coax, 50 Ohm

Part No. PE3W05081		Cable Dia.	Attn. @1GHz	Power@1GHz
1 piece price shown. See web or call for volume pricing.				
12"	24"	36"	48"	60"
\$132.25	\$133.92	\$135.59	\$137.26	\$138.93
Custom Len.		See Web		

Cable Assemblies

See Our Website For Current Pricing & Real-Time Stock Availability!

*Coax Performance at 1 GHz Notes: Cable assembly max frequency may be lower than connector or coax max frequency

For our complete selection of cable assemblies, please visit our website

LC MALE TO LC MALE



Standard Flexible Cable Assemblies

RG218/U Coax, 50 Ohm						
Part No. PE3960LF		Cable Dia.	Attn. @1 GHz	Power@1GHz		
1 piece price shown. See web or call for volume pricing.						
60"	72"	84"	96"	108"	120"	Custom Len.
\$479.37	\$490.43	\$501.50	\$512.56	\$523.62	\$534.69	See Web

RG218/U Coax, 50 Ohm						
Part No. PE3960		Cable Dia.	Attn. @1 GHz	Power@1GHz		
1 piece price shown. See web or call for volume pricing.						
60"	72"	84"	96"	108"	120"	Custom Len.
\$479.37	\$490.43	\$501.50	\$512.56	\$523.62	\$534.69	See Web

RG393/U Coax, 50 Ohm						
Part No. PE33539		Cable Dia.	Attn. @1 GHz	Power@1GHz		
1 piece price shown. See web or call for volume pricing.						
60"	72"	84"	96"	108"	120"	Custom Len.
\$400.66	\$415.55	\$430.43	\$445.32	\$460.20	\$475.09	See Web

MCX PLUG TO BNC MALE



Standard Flexible Cable Assemblies

RG174A/U Coax, 50 Ohm						
Part No. PE3C3387		Cable Dia.	Attn. @1 GHz	Power@1GHz		
1 piece price shown. See web or call for volume pricing.						
12"	24"	36"	48"	60"	72"	Custom Len.
\$35.02	\$35.56	\$36.10	\$36.64	\$37.18	\$37.72	See Web

RG316/U Coax, 50 Ohm						
Part No. PE3W01612		Cable Dia.	Attn. @1 GHz	Power@1GHz		
1 piece price shown. See web or call for volume pricing.						
12"	24"	36"	48"	60"	72"	Custom Len.
\$41.58	\$44.50	\$47.42	\$50.34	\$53.26	\$56.18	See Web

MCX PLUG TO MCX PLUG



Standard Flexible Cable Assemblies

RG316/U Coax, 50 Ohm						
Part No. PE3297		Cable Dia.	Attn. @1 GHz	Power@1GHz		
1 piece price shown. See web or call for volume pricing.						
12"	24"	36"	48"	60"	72"	Custom Len.
\$46.44	\$49.21	\$51.99	\$54.77	\$57.55	\$60.34	See Web

RG316/U Coax, 50 Ohm						
Part No. PE3297LF		Cable Dia.	Attn. @1 GHz	Power@1GHz		
1 piece price shown. See web or call for volume pricing.						
12"	24"	36"	48"	60"	72"	Custom Len.
\$46.44	\$49.21	\$51.99	\$54.77	\$57.55	\$60.34	See Web

MCX PLUG TO MCX PLUG RIGHT ANGLE



Standard Flexible Cable Assemblies

RG316/U Coax, 50 Ohm						
Part No. PE3316LF		Cable Dia.	Attn. @1 GHz	Power@1GHz		
1 piece price shown. See web or call for volume pricing.						
12"	24"	36"	48"	60"	72"	Custom Len.
\$49.56	\$52.33	\$55.12	\$57.90	\$60.68	\$63.46	See Web

MHV MALE TO MHV MALE



Standard Flexible Cable Assemblies

RG58C/U Coax, 50 Ohm						
Part No. PE3516		Cable Dia.	Attn. @1 GHz	Power@1GHz		
1 piece price shown. See web or call for volume pricing.						
12"	24"	36"	48"	60"	72"	Custom Len.
\$70.61	\$71.32	\$72.03	\$72.74	\$73.45	\$74.15	See Web

RG58C/U Coax, 50 Ohm						
Part No. PE3516LF		Cable Dia.	Attn. @1 GHz	Power@1GHz		
1 piece price shown. See web or call for volume pricing.						
12"	24"	36"	48"	60"	72"	Custom Len.
\$69.28	\$69.99	\$70.69	\$71.40	\$72.11	\$72.82	See Web

RG174A/U Coax, 50 Ohm						
Part No. PE34427		Cable Dia.	Attn. @1 GHz	Power@1GHz		
1 piece price shown. See web or call for volume pricing.						
12"	24"	36"	48"	60"	72"	Custom Len.
\$94.38	\$94.80	\$95.21	\$95.64	\$96.06	\$96.47	See Web

RG214/U Coax, 50 Ohm						
Part No. PE3735		Cable Dia.	Attn. @1 GHz	Power@1GHz		
1 piece price shown. See web or call for volume pricing.						
12"	24"	36"	48"	60"	72"	Custom Len.
\$96.97	\$104.02	\$111.07	\$118.13	\$125.18	\$132.22	See Web

RG400/U Coax, 50 Ohm						
Part No. PE34425LF		Cable Dia.	Attn. @1 GHz	Power@1GHz		
1 piece price shown. See web or call for volume pricing.						
12"	24"	36"	48"	60"	72"	Custom Len.
\$64.66	\$71.37	\$78.08	\$84.78	\$91.49	\$98.20	See Web

RG59B/U Coax, 75 Ohm						
Part No. PE3542LF		Cable Dia.	Attn. @1 GHz	Power@1GHz		
1 piece price shown. See web or call for volume pricing.						
12"	24"	36"	48"	60"	72"	Custom Len.
\$42.88	\$43.81	\$44.74	\$45.66	\$46.58	\$47.50	See Web

MHV MALE TO SHV PLUG



Standard Flexible Cable Assemblies

RG58C/U Coax, 50 Ohm						
Part No. PE3950		Cable Dia.	Attn. @1 GHz	Power@1GHz		
1 piece price shown. See web or call for volume pricing.						
12"	24"	36"	48"	60"	72"	Custom Len.
\$85.63	\$86.33	\$87.04	\$87.75	\$88.46	\$89.17	See Web

MMCX PLUG TO MMCX PLUG RIGHT ANGLE

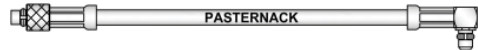

Standard Flexible Cable Assemblies

RG174A/U Coax, 50 Ohm						
Part No. PE34881		Cable Dia.	Attn. @1 GHz	Power@1GHz		
1 piece price shown. See web or call for volume pricing.						
12"	24"	36"	48"	60"	72"	Custom Len.
\$54.99	\$55.41	\$55.84	\$56.25	\$56.67	\$57.09	See Web

RG178B/U Coax, 50 Ohm						
Part No. PE34883		Cable Dia.	Attn. @1 GHz	Power@1GHz		
1 piece price shown. See web or call for volume pricing.						
12"	24"	36"	48"	60"	72"	Custom Len.
\$59.89	\$60.81	\$61.73	\$62.66	\$63.58	\$64.50	See Web

MMCX PLUG RIGHT ANGLE TO BNC FEMALE BULKHEAD

SEE MOUNTING HOLE SECTION ON PAGE 259



Standard Flexible Cable Assemblies

RG174A/U Coax, 50 Ohm						
Part No. PE36738		Cable Dia.	Attn. @1 GHz	Power@1GHz		
1 piece price shown. See web or call for volume pricing.						
12"	24"	36"	48"	60"	-	Custom Len.
\$52.75	\$53.17	\$53.58	\$54.01	\$54.43	-	See Web

For Custom Lengths, Metric Lengths or Special Configurations, Please call (949) 261-1920



Free Shipping Available via UPS Ground to USA & Canada



Technical Support (866) 727-8376



Same-Day Shipping, Even Custom Cable Assemblies

Cable Assemblies

See Our Website For Current Pricing & Real-Time Stock Availability!

For our complete selection of cable assemblies, please visit our website

MMBX PLUG RIGHT ANGLE TO SMA FEMALE BULKHEAD

SEE MOUNTING HOLE SECTION ON PAGE 259



Standard Flexible Cable Assemblies

RG178B/U Coax, 50 Ohm

Part No. PE3C4807		Cable Dia.	Attn. @1GHz	Power@1GHz		
1 piece price shown. See web or call for volume pricing.		0.072" dia.	44 dB/100ft	55 W		
12"	24"	36"	48"	60"	72"	Custom Len.
\$67.03	\$68.02	\$69.01	\$70.00	\$70.99	\$71.98	See Web

N MALE TO 4.3-10 MALE



Low PIM Corrugated Cable Assemblies

SPP-250-LLPL Coax, 50 Ohm

Part No. PE3C4141		Cable Dia.	Attn. @1GHz	Power@1GHz		
1 piece price shown. See web or call for volume pricing.		0.280" dia.	dB/100ft	W		
100CM	100CM	200CM	-	-	-	Custom Len.
\$94.79	\$94.79	\$134.53				See Web

N MALE TO 7/16 DIN MALE



Low PIM Corrugated Cable Assemblies

SPP-250-LLPL Coax, 50 Ohm

Part No. PE3C4132		Cable Dia.	Attn. @1GHz	Power@1GHz		
1 piece price shown. See web or call for volume pricing.		0.280" dia.	dB/100ft	W		
100CM	200CM	-	-	-	-	Custom Len.
\$96.92	\$136.66					See Web

Standard Flexible Cable Assemblies

RG214/U Coax, 50 Ohm

Part No. PE3218		Cable Dia.	Attn. @1GHz	Power@1GHz		
1 piece price shown. See web or call for volume pricing.		0.425" dia.	7 dB/100ft	190 W		
12"	24"	36"	48"	60"	72"	Custom Len.
\$160.40	\$167.44	\$174.50	\$181.55	\$188.61	\$195.65	See Web

N MALE TO BNC MALE



Flexible Cable Assemblies

LMR-195 Coax, 50 Ohm

Part No. PE3C1349LF		Cable Dia.	Attn. @1GHz	Power@1GHz		
1 piece price shown. See web or call for volume pricing.		0.195" dia.	12 dB/100ft	W		
12"	24"	36"	48"	60"	72"	Custom Len.
\$30.04	\$30.74	\$31.44	\$32.14	\$32.84	\$33.54	See Web

Standard Flexible Cable Assemblies

RG58C/U Coax, 50 Ohm

Part No. PE3042		Cable Dia.	Attn. @1GHz	Power@1GHz		
1 piece price shown. See web or call for volume pricing.		0.195" dia.	20 dB/100ft	44 W		
12"	24"	36"	48"	60"	72"	Custom Len.
\$38.94	\$39.65	\$40.36	\$41.07	\$41.78	\$42.49	See Web

RG223/U Coax, 50 Ohm

Part No. PE3476		Cable Dia.	Attn. @1GHz	Power@1GHz		
1 piece price shown. See web or call for volume pricing.		0.210" dia.	13 dB/100ft	53 W		
12"	24"	36"	48"	60"	72"	Custom Len.
\$36.30	\$39.09	\$41.88	\$44.68	\$47.47	\$50.25	See Web

PE-C240 Coax, 50 Ohm

Part No. PE35269		Cable Dia.	Attn. @1GHz	Power@1GHz		
1 piece price shown. See web or call for volume pricing.		0.240" dia.	9 dB/100ft	250 W		
12"	24"	36"	48"	60"	-	Custom Len.
\$46.69	\$47.62	\$49.47	\$52.12	\$54.85		See Web

LMR-240-UF Coax, 50 Ohm

Part No. PE3C2404		Cable Dia.	Attn. @1GHz	Power@1GHz		
1 piece price shown. See web or call for volume pricing.		0.240" dia.	9 dB/100ft	W		
12"	24"	36"	48"	60"	72"	Custom Len.
\$36.74	\$38.01	\$39.28	\$40.55	\$41.82	\$43.09	See Web

N MALE TO N MALE



Flexible Cable Assemblies

LMR-240 Coax, 50 Ohm

Part No. PE3C0053		Cable Dia.	Attn. @1GHz	Power@1GHz		
1 piece price shown. See web or call for volume pricing.		0.240" dia.	8 dB/100ft	W		
12"	24"	36"	48"	60"	72"	Custom Len.
\$51.34	\$52.28	\$53.21	\$54.15	\$55.07		See Web

LMR-400-UF Coax, 50 Ohm

Part No. PE3C2183LF		Cable Dia.	Attn. @1GHz	Power@1GHz		
1 piece price shown. See web or call for volume pricing.		0.405" dia.	5 dB/100ft	W		
12"	24"	36"	48"	60"	72"	Custom Len.
\$48.21	\$50.67	\$53.13	\$55.59	\$58.05	\$60.51	See Web

Low Loss Flexible Cable Assemblies

PE-P142LL Coax, 50 Ohm

Part No. PE3C0231		Cable Dia.	Attn. @1GHz	Power@1GHz		
1 piece price shown. See web or call for volume pricing.		0.320" dia.	7 dB/100ft	W		
24"	36"	48"	60"	72"	120"	Custom Len.
\$319.87	\$360.95	\$405.02	\$436.07	\$454.62	\$652.55	See Web

Low Loss Test Flexible Cable Assemblies

PE-P300LL Coax, 50 Ohm

Part No. PE330		Cable Dia.	Attn. @1GHz	Power@1GHz		
1 piece price shown. See web or call for volume pricing.		0.300" dia.	5 dB/100ft	W		
12"	24"	36"	48"	60"	50CM	Custom Len.
\$259.98	\$284.95	\$309.92	\$334.87	\$359.84	\$275.98	See Web

Standard Formable Cable Assemblies

LMR-SW540 Coax, 50 Ohm

Part No. PE3C0142		Cable Dia.	Attn. @1GHz	Power@1GHz		
1 piece price shown. See web or call for volume pricing.		" dia.	2 dB/100ft	W		
12"	24"	36"	48"	60"	-	Custom Len.
\$81.04	\$83.55	\$86.06	\$88.57	\$91.09		See Web

Standard Flexible Cable Assemblies

RG8A/U Coax, 50 Ohm

Part No. PE3570		Cable Dia.	Attn. @1GHz	Power@1GHz		
1 piece price shown. See web or call for volume pricing.		0.405" dia.	8 dB/100ft	190 W		
12"	24"	36"	48"	60"	72"	Custom Len.
\$59.41	\$62.14	\$64.86	\$67.59	\$70.32	\$73.04	See Web

RG58C/U Coax, 50 Ohm

Part No. PE3441LF		Cable Dia.	Attn. @1GHz	Power@1GHz		
1 piece price shown. See web or call for volume pricing.		0.195" dia.	20 dB/100ft	44 W		
12"	24"	36"	48"	60"	72"	Custom Len.
\$46.86	\$47.57	\$48.28	\$48.99	\$49.70	\$50.41	See Web

RG58C/U Coax, 50 Ohm

Part No. PE3441		Cable Dia.	Attn. @1GHz	Power@1GHz		
1 piece price shown. See web or call for volume pricing.		0.195" dia.	20 dB/100ft	44 W		
12"	24"	36"	48"	60"	72"	Custom Len.
\$44.21	\$44.96	\$45.66	\$46.34	\$47.04	\$47.73	See Web

RG141A/U Coax, 50 Ohm

Part No. PE36589		Cable Dia.	Attn. @1GHz	Power@1GHz		
1 piece price shown. See web or call for volume pricing.		0.190" dia.	13 dB/100ft	650 W		
12"	24"	36"	48"	60"	-	Custom Len.
\$58.63	\$64.84	\$71.06	\$77.27	\$83.48		See Web

RG142B/U Coax, 50 Ohm

Part No. PE3455		Cable Dia.	Attn. @1GHz	Power@1GHz		
1 piece price shown. See web or call for volume pricing.		0.195" dia.	13 dB/100ft	650 W		
6"	12"	18"	24"	30"	36"	Custom Len.
\$46.95	\$46.95	\$49.70	\$52.46	\$55.22	\$57.98	See Web

RG142B/U Coax, 50 Ohm

Part No. PE3455LF		Cable Dia.	Attn. @1GHz	Power@1GHz		
1 piece price shown. See web or call for volume pricing.		0.195" dia.	13 dB/100ft	650 W		
6"	12"	18"	24"	30"	36"	Custom Len.
\$47.84	\$47.84	\$50.60	\$53.37	\$56.13	\$58.88	See Web

Cable Assemblies

See Our Website For Current Pricing & Real-Time Stock Availability!

*Coax Performance at 1 GHz Notes: Cable assembly max frequency may be lower than connector or coax max frequency

For our complete selection of cable assemblies, please visit our website

RG178B/U Coax, 50 Ohm							
Part No. PE33527				Cable Dia.	Attn. @1 GHz	Power@1GHz	
1 piece price shown. See web or call for volume pricing.							
12"	24"	36"	48"	0.072" dia.	44 dB/100ft	78 W	36
\$69.52	\$70.43	\$71.37	\$72.28	\$73.21	\$74.12	See Web	
RG213/U Coax, 50 Ohm							
Part No. PE3496				Cable Dia.	Attn. @1 GHz	Power@1GHz	
1 piece price shown. See web or call for volume pricing.							
12"	24"	36"	48"	0.405" dia.	8 dB/100ft	190 W	37
\$58.38	\$59.97	\$61.57	\$63.17	\$64.77	\$66.37	See Web	
RG214/U Coax, 50 Ohm							
Part No. PE3062				Cable Dia.	Attn. @1 GHz	Power@1GHz	
1 piece price shown. See web or call for volume pricing.							
12"	24"	36"	48"	0.425" dia.	7 dB/100ft	190 W	38
\$61.46	\$68.52	\$75.57	\$82.61	\$89.67	\$96.72	See Web	
RG214/U Coax, 50 Ohm							
Part No. PE3062LF				Cable Dia.	Attn. @1 GHz	Power@1GHz	
1 piece price shown. See web or call for volume pricing.							
12"	24"	36"	48"	0.425" dia.	7 dB/100ft	190 W	39
\$62.65	\$69.69	\$76.75	\$83.80	\$90.86	\$97.90	See Web	
RG217/U Coax, 50 Ohm							
Part No. PE3997				Cable Dia.	Attn. @1 GHz	Power@1GHz	
1 piece price shown. See web or call for volume pricing.							
12"	24"	36"	48"	0.545" dia.	6 dB/100ft	260 W	40
\$89.88	\$94.12	\$98.35	\$102.60	\$106.87	\$111.16	See Web	
RG223/U Coax, 50 Ohm							
Part No. PE3447				Cable Dia.	Attn. @1 GHz	Power@1GHz	
1 piece price shown. See web or call for volume pricing.							
6"	12"	18"	24"	0.210" dia.	13 dB/100ft	53 W	41
\$44.30	\$44.30	\$45.70	\$47.09	\$48.49	\$49.89	See Web	
RG225/U Coax, 50 Ohm							
Part No. PE33269				Cable Dia.	Attn. @1 GHz	Power@1GHz	
1 piece price shown. See web or call for volume pricing.							
12"	24"	36"	48"	0.430" dia.	dB/100ft	1700 W	42
\$84.41	\$116.74	\$149.08	\$181.42	\$213.76	-	See Web	
RG393/U Coax, 50 Ohm							
Part No. PE3607				Cable Dia.	Attn. @1 GHz	Power@1GHz	
1 piece price shown. See web or call for volume pricing.							
12"	24"	36"	48"	0.390" dia.	9 dB/100ft	1700 W	43
\$73.86	\$88.75	\$103.63	\$118.52	\$133.41	\$148.29	See Web	
RG393/U Coax, 50 Ohm							
Part No. PE3607LF				Cable Dia.	Attn. @1 GHz	Power@1GHz	
1 piece price shown. See web or call for volume pricing.							
12"	24"	36"	48"	0.390" dia.	9 dB/100ft	1700 W	44
\$69.42	\$84.30	\$99.19	\$114.08	\$131.02	\$146.05	See Web	
RG400/U Coax, 50 Ohm							
Part No. PE3653LF				Cable Dia.	Attn. @1 GHz	Power@1GHz	
1 piece price shown. See web or call for volume pricing.							
12"	24"	36"	48"	0.195" dia.	15 dB/100ft	650 W	45
\$55.50	\$62.21	\$68.91	\$75.62	\$82.33	\$89.04	See Web	
RG400/U Coax, 50 Ohm							
Part No. PE3653				Cable Dia.	Attn. @1 GHz	Power@1GHz	
1 piece price shown. See web or call for volume pricing.							
12"	24"	36"	48"	0.195" dia.	15 dB/100ft	650 W	46
\$55.50	\$62.21	\$68.91	\$75.62	\$82.33	\$89.04	See Web	
PE-160 Series Coax, 50 Ohm							
Part No. PE302				Cable Dia.	Attn. @1 GHz	Power@1GHz	
1 piece price shown. See web or call for volume pricing.							
12"	24"	36"	48"	0.163" dia.	dB/100ft	W	47
\$157.38	\$167.68	\$177.99	\$188.29	\$198.60	\$208.89	See Web	
PE-P141 Coax, 50 Ohm							
Part No. PE352				Cable Dia.	Attn. @1 GHz	Power@1GHz	
1 piece price shown. See web or call for volume pricing.							
12"	24"	36"	48"	0.163" dia.	11 dB/100ft	600 W	48
\$114.70	\$124.70	\$134.70	\$144.71	\$154.92	\$164.71	See Web	
PE-P195 Coax, 50 Ohm							
Part No. PE33377				Cable Dia.	Attn. @1 GHz	Power@1GHz	
1 piece price shown. See web or call for volume pricing.							
12"	24"	36"	48"	0.195" dia.	13 dB/100ft	650 W	49
\$50.91	\$59.43	\$67.95	\$76.48	\$85.00	-	See Web	

LMR-240 Coax, 50 Ohm							
Part No. PE3C0039				Cable Dia.	Attn. @1 GHz	Power@1GHz	
1 piece price shown. See web or call for volume pricing.							
12"	24"	36"	48"	0.240" dia.	8 dB/100ft	W	50
\$38.56	\$39.49	\$40.42	\$41.36	\$42.29	-	See Web	
LMR-240 Coax, 50 Ohm							
Part No. PE3C0101				Cable Dia.	Attn. @1 GHz	Power@1GHz	
1 piece price shown. See web or call for volume pricing.							
12"	24"	36"	48"	0.240" dia.	8 dB/100ft	W	51
\$42.30	\$43.23	\$44.16	\$45.09	\$46.03	-	See Web	
LMR-400 Coax, 50 Ohm							
Part No. PE3C0033				Cable Dia.	Attn. @1 GHz	Power@1GHz	
1 piece price shown. See web or call for volume pricing.							
12"	24"	36"	48"	0.405" dia.	4 dB/100ft	W	52
\$44.82	\$46.14	\$47.46	\$48.78	\$50.10	-	See Web	
LMR-400 Coax, 50 Ohm							
Part No. PE3C0046				Cable Dia.	Attn. @1 GHz	Power@1GHz	
1 piece price shown. See web or call for volume pricing.							
12"	24"	36"	48"	0.405" dia.	4 dB/100ft	W	53
\$45.96	\$47.28	\$48.59	\$49.92	\$51.24	-	See Web	
LMR-400 Coax, 50 Ohm							
Part No. PE3C0105				Cable Dia.	Attn. @1 GHz	Power@1GHz	
1 piece price shown. See web or call for volume pricing.							
12"	24"	36"	48"	0.405" dia.	4 dB/100ft	W	54
\$74.64	\$75.97	\$77.28	\$78.60	\$79.93	-	See Web	
LMR-400-UF Coax, 50 Ohm							
Part No. PE3C0218				Cable Dia.	Attn. @1 GHz	Power@1GHz	
1 piece price shown. See web or call for volume pricing.							
12"	24"	36"	48"	0.405" dia.	5 dB/100ft	W	55
\$49.84	\$52.30	\$54.76	\$57.22	\$59.68	\$62.14	See Web	
LMR-600 Coax, 50 Ohm							
Part No. PE3C0048				Cable Dia.	Attn. @1 GHz	Power@1GHz	
1 piece price shown. See web or call for volume pricing.							
12"	24"	36"	48"	0.590" dia.	3 dB/100ft	W	56
\$129.50	\$132.23	\$134.95	\$137.68	\$140.40	-	See Web	
LMR-600 Coax, 50 Ohm							
Part No. PE3C0062				Cable Dia.	Attn. @1 GHz	Power@1GHz	
1 piece price shown. See web or call for volume pricing.							
12"	24"	36"	48"	0.590" dia.	3 dB/100ft	W	57
\$126.15	\$128.87	\$131.60	\$134.33	\$137.05	-	See Web	
LMR-600 Coax, 50 Ohm							
Part No. PE3C0110				Cable Dia.	Attn. @1 GHz	Power@1GHz	
1 piece price shown. See web or call for volume pricing.							
12"	24"	36"	48"	0.590" dia.	3 dB/100ft	W	58
\$102.88	\$105.61	\$108.34	\$111.06	\$113.79	-	See Web	
LMR-600 Coax, 50 Ohm							
Part No. PE3C0112				Cable Dia.	Attn. @1 GHz	Power@1GHz	
1 piece price shown. See web or call for volume pricing.							
12"	24"	36"	48"	0.590" dia.	3 dB/100ft	W	59
\$71.05	\$73.78	\$76.51	\$79.23	\$81.96	-	See Web	
PE-P142LL Coax, 50 Ohm							
Part No. PE343				Cable Dia.	Attn. @1 GHz	Power@1GHz	
1 piece price shown. See web or call for volume pricing.							
12"	24"	36"	48"	0.195" dia.	7 dB/100ft	W	60
\$115.70	\$131.32	\$146.95	\$162.58	\$178.20	\$125.71	See Web	
PE-FF430 Coax, 50 Ohm							
Part No. PE3C4002				Cable Dia.	Attn. @1 GHz	Power@1GHz	
1 piece price shown. See web or call for volume pricing.							
60"	144"	-	-	0.430" dia.	dB/100ft	W	61
\$476.20	\$702.46	-	-	-	-	See Web	
PE-FF430 Coax, 50 Ohm							
Part No. PE3C4005				Cable Dia.	Attn. @1 GHz	Power@1GHz	
1 piece price shown. See web or call for volume pricing.							
60"	100CM	-	-	0.430" dia.	dB/100ft	W	62
\$613.15	-	-	-	-	-	See Web	
PE-VNA-R Coax, 50 Ohm							
Part No. PE3VNA1803				Cable Dia.	Attn. @1 GHz	Power@1GHz	
1 piece price shown. See web or call for volume pricing.							
24"	48"	-	-	0.430" dia.	dB/100ft	W	63
\$762.08	\$847.53	-	-	-	-	See Web	

Cable Assemblies

See Our Website For Current Pricing & Real-Time Stock Availability!

Standard Corrugated Cable Assemblies

Continued on Next Page

For Custom Lengths, Metric Lengths or Special Configurations, Please call (949) 261-1920



Free Shipping Available via UPS Ground to USA & Canada



Technical Support (866) 727-8376



Same-Day Shipping, Even Custom Cable Assemblies

For our complete selection of cable assemblies, please visit our website

Cable Assemblies

See Our Website For Current Pricing & Real-Time Stock Availability!

PE-1/4SFHC Coax, 50 Ohm						
Part No. PE3C0124		Cable Dia.	Attn. @1 GHz	Power @1 GHz		
1 piece price shown. See web or call for volume pricing.						
12"	24"	36"	48"	60"	60CM	Custom Len.
\$123.73	\$126.41	\$129.10	\$131.78	\$134.46		See Web



Flexible Cable Assemblies						
PE-P142LL Coax, 50 Ohm						
Part No. PE345		Cable Dia.	Attn. @1 GHz	Power @1 GHz		
1 piece price shown. See web or call for volume pricing.						
12"	24"	36"	48"	60"	50CM	Custom Len.
\$214.31	\$229.93	\$245.56	\$261.19	\$276.81	\$224.33	See Web

Low Loss Test Flexible Cable Assemblies						
PE-P300LL Coax, 50 Ohm						
Part No. PE3C3240		Cable Dia.	Attn. @1 GHz	Power @1 GHz		
1 piece price shown. See web or call for volume pricing.						
12"	24"	36"	48"	60"	50CM	Custom Len.
\$241.43	\$266.39	\$291.35	\$316.31	\$341.28	\$257.42	See Web

Standard Flexible Cable Assemblies						
RG8A/U Coax, 50 Ohm						
Part No. PE3699		Cable Dia.	Attn. @1 GHz	Power @1 GHz		
1 piece price shown. See web or call for volume pricing.						
12"	24"	36"	48"	60"	72"	Custom Len.
\$78.89	\$81.62	\$84.34	\$87.07	\$89.80	\$92.52	See Web

RG58C/U Coax, 50 Ohm						
Part No. PE3143		Cable Dia.	Attn. @1 GHz	Power @1 GHz		
1 piece price shown. See web or call for volume pricing.						
12"	24"	36"	48"	60"	72"	Custom Len.
\$59.31	\$60.01	\$60.72	\$61.43	\$62.13	\$62.84	See Web

RG142B/U Coax, 50 Ohm						
Part No. PE3726		Cable Dia.	Attn. @1 GHz	Power @1 GHz		
1 piece price shown. See web or call for volume pricing.						
12"	24"	36"	48"	60"	72"	Custom Len.
\$60.76	\$66.28	\$71.80	\$77.31	\$82.82	\$88.35	See Web

RG213/U Coax, 50 Ohm						
Part No. PE3797		Cable Dia.	Attn. @1 GHz	Power @1 GHz		
1 piece price shown. See web or call for volume pricing.						
12"	24"	36"	48"	60"	72"	Custom Len.
\$79.26	\$80.85	\$82.46	\$84.05	\$85.66	\$87.25	See Web

RG214/U Coax, 50 Ohm						
Part No. PE3071		Cable Dia.	Attn. @1 GHz	Power @1 GHz		
1 piece price shown. See web or call for volume pricing.						
12"	24"	36"	48"	60"	72"	Custom Len.
\$90.70	\$97.76	\$104.80	\$111.85	\$118.91	\$125.96	See Web

RG393/U Coax, 50 Ohm						
Part No. PE3255		Cable Dia.	Attn. @1 GHz	Power @1 GHz		
1 piece price shown. See web or call for volume pricing.						
12"	24"	36"	48"	60"	72"	Custom Len.
\$93.34	\$108.23	\$123.12	\$138.00	\$152.89	\$167.78	See Web

RG400/U Coax, 50 Ohm						
Part No. PE33321		Cable Dia.	Attn. @1 GHz	Power @1 GHz		
1 piece price shown. See web or call for volume pricing.						
12"	24"	36"	48"	60"	72"	Custom Len.
\$69.58	\$76.29	\$83.00	\$89.71	\$96.41	\$103.12	See Web

PE-C400 Coax, 50 Ohm						
Part No. PE37946		Cable Dia.	Attn. @1 GHz	Power @1 GHz		
1 piece price shown. See web or call for volume pricing.						
36"	48"	60"	72"	120"	-	Custom Len.
\$80.08	\$81.34	\$85.06	\$89.46	\$103.09		See Web

LMR-400 Coax, 50 Ohm						
Part No. PE3C0041		Cable Dia.	Attn. @1 GHz	Power @1 GHz		
1 piece price shown. See web or call for volume pricing.						
12"	24"	36"	48"	60"	-	Custom Len.
\$70.88	\$72.21	\$73.52	\$74.84	\$76.16		See Web

LMR-400 Coax, 50 Ohm						
Part No. PE3C0106		Cable Dia.	Attn. @1 GHz	Power @1 GHz		
1 piece price shown. See web or call for volume pricing.						
12"	24"	36"	48"	60"	60"	Custom Len.
\$75.24	\$76.56	\$77.88	\$79.20	\$80.52		See Web

LMR-400-UF Coax, 50 Ohm						
Part No. PE3C3643		Cable Dia.	Attn. @1 GHz	Power @1 GHz		
1 piece price shown. See web or call for volume pricing.						
12"	24"	36"	48"	60"	72"	Custom Len.
\$53.55	\$56.01	\$58.47	\$60.93	\$63.39	\$65.85	See Web

LMR-600 Coax, 50 Ohm						
Part No. PE3C0050		Cable Dia.	Attn. @1 GHz	Power @1 GHz		
1 piece price shown. See web or call for volume pricing.						
12"	24"	36"	48"	60"	-	Custom Len.
\$102.51	\$105.24	\$107.97	\$110.69	\$113.42		See Web



Standard Flexible Cable Assemblies						
RG223/U Coax, 50 Ohm						
Part No. PE3667		Cable Dia.	Attn. @1 GHz	Power @1 GHz		
1 piece price shown. See web or call for volume pricing.						
12"	24"	36"	48"	60"	72"	Custom Len.
\$45.14	\$47.94	\$50.73	\$53.52	\$56.30	\$59.10	See Web

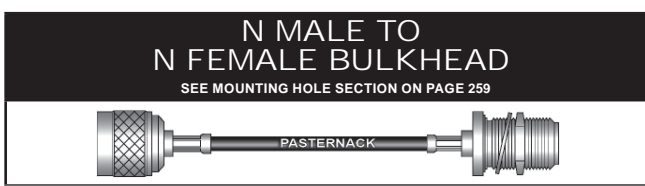

Standard Formable Cable Assemblies						
PE-SR402FL Coax, 50 Ohm						
Part No. PE3488		Cable Dia.	Attn. @1 GHz	Power @1 GHz		
1 piece price shown. See web or call for volume pricing.						
6"	12"	18"	24"	36"	48"	Custom Len.
\$88.26	\$88.26	\$91.89	\$95.51	\$102.77	\$110.03	See Web

Standard Flexible Cable Assemblies						
RG214/U Coax, 50 Ohm						
Part No. PE3217LF		Cable Dia.	Attn. @1 GHz	Power @1 GHz		
1 piece price shown. See web or call for volume pricing.						
12"	24"	36"	48"	60"	72"	Custom Len.
\$63.21	\$70.27	\$77.31	\$84.37	\$91.42	\$98.46	See Web

PE-P141 Coax, 50 Ohm						
Part No. PE3C3255		Cable Dia.	Attn. @1 GHz	Power @1 GHz		
1 piece price shown. See web or call for volume pricing.						
12"	24"	36"	48"	60"	72"	Custom Len.
\$90.84	\$101.45	\$112.06	\$122.67	\$133.28	\$143.89	See Web

PE-P142LL Coax, 50 Ohm						
Part No. PE344		Cable Dia.	Attn. @1 GHz	Power @1 GHz		
1 piece price shown. See web or call for volume pricing.						
12"	24"	36"	48"	60"	50CM	Custom Len.
\$175.96	\$191.59	\$207.22	\$222.84	\$238.47	\$185.97	See Web

Standard Semi-Rigid Cable Assemblies						
RG402/U Coax, 50 Ohm						
Part No. PE3C3286		Cable Dia.	Attn. @1 GHz	Power @1 GHz		
1 piece price shown. See web or call for volume pricing.						
12"	24"	36"	48"	60"	72"	Custom Len.
\$74.95	\$82.26	\$89.57	\$96.88	\$104.19	\$111.50	See Web



Flexible Cable Assemblies						
LMR-240 Coax, 50 Ohm						
Part No. PE3C1982		Cable Dia.	Attn. @1 GHz	Power @1 GHz		
1 piece price shown. See web or call for volume pricing.						
12"	24"	36"	48"	60"	72"	Custom Len.
\$37.93	\$38.84	\$39.75	\$40.66	\$41.57	\$42.48	See Web

*Coax Performance at 1 GHz Notes: Cable assembly max frequency may be lower than connector or coax max frequency

For our complete selection of cable assemblies, please visit our website

N MALE RIGHT ANGLE TO N FEMALE BULKHEAD

SEE MOUNTING HOLE SECTION ON PAGE 259



Flexible Cable Assemblies

LMR-400 Coax, 50 Ohm

Part No. PE3W03991		Cable Dia.	Attn. @1 GHz	Power@1GHz		
1 piece price shown. See web or call for volume pricing.		0.405" dia.	4 dB/100ft	W		
12"	24"	36"	48"	60"	72"	Custom Len.
\$71.80	\$73.09	\$74.38	\$75.67	\$76.96	\$78.25	See Web

Low Loss Flexible Cable Assemblies

PE-P142LL Coax, 50 Ohm

Part No. PE3C0673		Cable Dia.	Attn. @1 GHz	Power@1GHz		
1 piece price shown. See web or call for volume pricing.		0.195" dia.	10 dB/100ft	W		
12"	24"	36"	48"	60"	50CM	Custom Len.
\$253.85	\$269.02	\$284.18	\$299.35	\$314.51	\$263.57	See Web

N MALE RIGHT ANGLE TO TNC MALE



Flexible Cable Assemblies

LMR-600-DB Coax, 50 Ohm

Part No. PE3C4750		Cable Dia.	Attn. @1 GHz	Power@1GHz		
1 piece price shown. See web or call for volume pricing.		0.590" dia.	3 dB/100ft	W		
12"	24"	36"	48"	60"	72"	Custom Len.
\$80.05	\$82.90	\$85.75	\$88.60	\$91.45	\$94.30	See Web

N FEMALE TO TNC MALE



Low Loss Test Flexible Cable Assemblies

PE-P300LL Coax, 50 Ohm

Part No. PE3C3244		Cable Dia.	Attn. @1 GHz	Power@1GHz		
1 piece price shown. See web or call for volume pricing.		0.300" dia.	6 dB/100ft	W		
12"	24"	36"	48"	60"	50CM	Custom Len.
\$235.74	\$259.99	\$284.25	\$308.51	\$332.77	\$251.27	See Web

N FEMALE BULKHEAD TO QMA MALE RIGHT ANGLE

SEE MOUNTING HOLE SECTION ON PAGE 259



Standard Flexible Cable Assemblies

RG316/U Coax, 50 Ohm

Part No. PE3C4238		Cable Dia.	Attn. @1 GHz	Power@1GHz		
1 piece price shown. See web or call for volume pricing.		0.098" dia.	58 dB/100ft	160 W		
12"	24"	36"	48"	60"	72"	Custom Len.
\$65.57	\$68.49	\$71.41	\$74.33	\$77.25	\$80.17	See Web

N FEMALE BULKHEAD TO REVERSE POLARITY SMA MALE RIGHT ANGLE

SEE MOUNTING HOLE SECTION ON PAGE 259



Standard Flexible Cable Assemblies

RG400/U Coax, 50 Ohm

Part No. PE3C5030		Cable Dia.	Attn. @1 GHz	Power@1GHz		
1 piece price shown. See web or call for volume pricing.		0.195" dia.	15 dB/100ft	600 W		
12"	24"	36"	48"	60"	72"	Custom Len.
\$82.85	\$89.76	\$96.67	\$103.58	\$110.49	\$117.40	See Web

QMA MALE TO QMA MALE



Standard Flexible Cable Assemblies

LMR-100A-PVC Coax, 50 Ohm

Part No. PE3W01141		Cable Dia.	Attn. @1 GHz	Power@1GHz		
1 piece price shown. See web or call for volume pricing.		0.110" dia.	24 dB/100ft	W		
12"	24"	36"	48"	60"	72"	Custom Len.
\$47.40	\$48.11	\$48.82	\$49.53	\$50.24	\$50.95	See Web

QN MALE RIGHT ANGLE TO N FEMALE



Flexible Cable Assemblies

LMR-400 Coax, 50 Ohm

Part No. PE3W04619		Cable Dia.	Attn. @1 GHz	Power@1GHz		
1 piece price shown. See web or call for volume pricing.		0.405" dia.	4 dB/100ft	W		
12"	24"	36"	48"	60"	72"	Custom Len.
\$85.59	\$86.88	\$88.17	\$89.46	\$90.75	\$92.04	See Web

SHV PLUG TO SHV PLUG



Standard Flexible Cable Assemblies

RG8A/U Coax, 50 Ohm

Part No. PE33068LF		Cable Dia.	Attn. @1 GHz	Power@1GHz		
1 piece price shown. See web or call for volume pricing.		0.405" dia.	8 dB/100ft	W		
12"	24"	36"	48"	60"	72"	Custom Len.
\$93.50	\$96.22	\$98.95	\$101.67	\$104.40	\$107.13	See Web

RG58C/U Coax, 50 Ohm

Part No. PE3815LF		Cable Dia.	Attn. @1 GHz	Power@1GHz		
1 piece price shown. See web or call for volume pricing.		0.195" dia.	20 dB/100ft	44 W		
12"	24"	36"	48"	60"	72"	Custom Len.
\$97.38	\$98.09	\$98.80	\$99.51	\$100.21	\$100.92	See Web

RG58C/U Coax, 50 Ohm

Part No. PE3815		Cable Dia.	Attn. @1 GHz	Power@1GHz		
1 piece price shown. See web or call for volume pricing.		0.195" dia.	20 dB/100ft	44 W		
12"	24"	36"	48"	60"	72"	Custom Len.
\$95.55	\$96.25	\$96.96	\$97.67	\$98.38	\$99.09	See Web

RG141A/U Coax, 50 Ohm

Part No. PE34428		Cable Dia.	Attn. @1 GHz	Power@1GHz		
1 piece price shown. See web or call for volume pricing.		0.190" dia.	13 dB/100ft	650 W		
12"	24"	36"	48"	60"	72"	Custom Len.
\$111.19	\$117.40	\$123.62	\$129.83	\$136.04	\$142.26	See Web

RG213/U Coax, 50 Ohm

Part No. PE35384		Cable Dia.	Attn. @1 GHz	Power@1GHz		
1 piece price shown. See web or call for volume pricing.		0.405" dia.	8 dB/100ft	190 W		
12"	24"	36"	48"	60"	-	Custom Len.
\$91.73	\$93.33	\$94.92	\$96.53	\$98.12		See Web

RG214/U Coax, 50 Ohm

Part No. PE3117		Cable Dia.	Attn. @1 GHz	Power@1GHz		
1 piece price shown. See web or call for volume pricing.		0.425" dia.	7 dB/100ft	170 W		
12"	24"	36"	48"	60"	72"	Custom Len.
\$101.73	\$108.78	\$115.82	\$122.88	\$129.93	\$136.99	See Web

RG214/U Coax, 50 Ohm

Part No. PE3117LF		Cable Dia.	Attn. @1 GHz	Power@1GHz		
1 piece price shown. See web or call for volume pricing.		0.425" dia.	7 dB/100ft	190 W		
12"	24"	36"	48"	60"	72"	Custom Len.
\$101.73	\$108.78	\$115.82	\$122.88	\$129.93	\$136.99	See Web

RG223/U Coax, 50 Ohm

Part No. PE3992LF		Cable Dia.	Attn. @1 GHz	Power@1GHz		
1 piece price shown. See web or call for volume pricing.		0.210" dia.	13 dB/100ft	53 W		
12"	24"	36"	48"	60"	72"	Custom Len.
\$84.80	\$87.60	\$90.39	\$93.18	\$95.97	\$98.76	See Web

Cable Assemblies

See Our Website For Current Pricing & Real-Time Stock Availability!

*Coax Performance at 1 GHz Notes: Cable assembly max frequency may be lower than connector or coax max frequency

For our complete selection of cable assemblies, please visit our website

RG223/U Coax, 50 Ohm							
Part No. PE3992				Cable Dia.	Attn. @1 GHz	Power@1GHz	
1 piece price shown. See web or call for volume pricing.				0.210" dia.	13 dB/100ft	53 W	
12"	24"	36"	48"	60"	72"	Custom Len.	
\$84.80	\$87.60	\$90.39	\$93.18	\$95.97	\$98.76	See Web	

RG59B/U Coax, 75 Ohm							
Part No. PE3895LF				Cable Dia.	Attn. @1 GHz	Power@1GHz	
1 piece price shown. See web or call for volume pricing.				0.242" dia.	12 dB/100ft	77 W	
12"	24"	36"	48"	60"	72"	Custom Len.	
\$86.48	\$87.41	\$88.32	\$89.25	\$90.18	\$91.10	See Web	

RG59B/U Coax, 75 Ohm							
Part No. PE3895				Cable Dia.	Attn. @1 GHz	Power@1GHz	
1 piece price shown. See web or call for volume pricing.				0.242" dia.	12 dB/100ft	77 W	
12"	24"	36"	48"	60"	72"	Custom Len.	
\$93.67	\$94.60	\$95.51	\$96.44	\$97.37	\$98.29	See Web	

RG62A/U Coax, 93 Ohm							
Part No. PE3857				Cable Dia.	Attn. @1 GHz	Power@1GHz	
1 piece price shown. See web or call for volume pricing.				0.242" dia.	13 dB/100ft	77 W	
12"	24"	36"	48"	60"	72"	Custom Len.	
\$88.55	\$89.88	\$91.19	\$92.51	\$93.84	\$95.15	See Web	

RG178B/U Coax, 50 Ohm							
Part No. PE33258				Cable Dia.	Attn. @1 GHz	Power@1GHz	
1 piece price shown. See web or call for volume pricing.				0.072" dia.	44 dB/100ft	78 W	
12"	24"	36"	48"	60"	72"	Custom Len.	
\$60.15	\$61.08	\$61.99	\$62.92	\$63.85	\$64.77	See Web	

RG223/U Coax, 50 Ohm							
Part No. PE3562LF				Cable Dia.	Attn. @1 GHz	Power@1GHz	
1 piece price shown. See web or call for volume pricing.				0.210" dia.	13 dB/100ft	53 W	
12"	24"	36"	48"	60"	72"	Custom Len.	
\$35.68	\$38.48	\$41.26	\$44.05	\$46.84	\$49.64	See Web	

RG223/U Coax, 50 Ohm							
Part No. PE3562				Cable Dia.	Attn. @1 GHz	Power@1GHz	
1 piece price shown. See web or call for volume pricing.				0.210" dia.	13 dB/100ft	53 W	
12"	24"	36"	48"	60"	72"	Custom Len.	
\$36.60	\$39.39	\$42.19	\$44.98	\$47.76	\$50.55	See Web	

RG316/U Coax, 50 Ohm							
Part No. PE3C2360LF				Cable Dia.	Attn. @1 GHz	Power@1GHz	
1 piece price shown. See web or call for volume pricing.				0.102" dia.	38 dB/100ft	160 W	
12"	24"	36"	48"	60"	72"	Custom Len.	
\$39.56	\$42.34	\$45.12	\$47.91	\$50.68	\$53.46	See Web	

Cable Assemblies

SHV PLUG TO SHV JACK BULKHEAD

SEE MOUNTING HOLE SECTION ON PAGE 259



Standard Flexible Cable Assemblies

RG59B/U Coax, 75 Ohm							
Part No. PE33018				Cable Dia.	Attn. @1 GHz	Power@1GHz	
1 piece price shown. See web or call for volume pricing.				0.242" dia.	12 dB/100ft	77 W	
12"	24"	36"	48"	60"	-	Custom Len.	
\$98.19	\$99.11	\$100.04	\$100.96	\$101.88	-	See Web	

RG316/U Coax, 50 Ohm							
Part No. PE3C2360				Cable Dia.	Attn. @1 GHz	Power@1GHz	
1 piece price shown. See web or call for volume pricing.				0.098" dia.	58 dB/100ft	160 W	
12"	24"	36"	48"	60"	72"	Custom Len.	
\$37.32	\$40.10	\$42.87	\$45.66	\$48.44	\$51.22	See Web	

PE-P195 Coax, 50 Ohm							
Part No. PE33989				Cable Dia.	Attn. @1 GHz	Power@1GHz	
1 piece price shown. See web or call for volume pricing.				0.195" dia.	13 dB/100ft	650 W	
12"	24"	36"	48"	60"	-	Custom Len.	
\$44.94	\$53.46	\$61.98	\$70.50	\$79.02	-	See Web	

LMR-195 Coax, 50 Ohm							
Part No. PE3C0051				Cable Dia.	Attn. @1 GHz	Power@1GHz	
1 piece price shown. See web or call for volume pricing.				0.195" dia.	12 dB/100ft	W	
12"	24"	36"	48"	60"	-	Custom Len.	
\$29.51	\$30.23	\$30.95	\$31.67	\$32.39	-	See Web	

See Our Website For Current Pricing & Real-Time Stock Availability!

SMA MALE TO BNC MALE



Flexible Cable Assemblies

LMR-240 Coax, 50 Ohm							
Part No. PE3C1830				Cable Dia.	Attn. @1 GHz	Power@1GHz	
1 piece price shown. See web or call for volume pricing.				0.240" dia.	8 dB/100ft	W	
12"	24"	36"	48"	60"	72"	Custom Len.	
\$37.93	\$38.84	\$39.75	\$40.66	\$41.57	\$42.48	See Web	

RG58C/U Coax, 50 Ohm							
Part No. PE3615LF				Cable Dia.	Attn. @1 GHz	Power@1GHz	
1 piece price shown. See web or call for volume pricing.				0.195" dia.	20 dB/100ft	44 W	
12"	24"	36"	48"	60"	72"	Custom Len.	
\$37.64	\$38.35	\$39.06	\$39.77	\$40.48	\$41.18	See Web	

RG58C/U Coax, 50 Ohm							
Part No. PE3615				Cable Dia.	Attn. @1 GHz	Power@1GHz	
1 piece price shown. See web or call for volume pricing.				0.195" dia.	20 dB/100ft	44 W	
12"	24"	36"	48"	60"	72"	Custom Len.	
\$36.94	\$37.65	\$38.36	\$39.07	\$39.78	\$40.49	See Web	

RG142B/U Coax, 50 Ohm							
Part No. PE3696				Cable Dia.	Attn. @1 GHz	Power@1GHz	
1 piece price shown. See web or call for volume pricing.				0.195" dia.	13 dB/100ft	650 W	
12"	24"	36"	48"	60"	72"	Custom Len.	
\$37.77	\$43.28	\$48.80	\$54.31	\$59.84	\$65.35	See Web	

RG174A/U Coax, 50 Ohm							
Part No. PE3C3328				Cable Dia.	Attn. @1 GHz	Power@1GHz	
1 piece price shown. See web or call for volume pricing.				0.110" dia.	32 dB/100ft	17 W	
12"	24"	36"	48"	60"	72"	Custom Len.	
\$37.79	\$38.20	\$38.62	\$39.05	\$39.47	\$39.88	See Web	

RG174A/U Coax, 50 Ohm							
Part No. PE3C3328LF				Cable Dia.	Attn. @1 GHz	Power@1GHz	
1 piece price shown. See web or call for volume pricing.				0.110" dia.	32 dB/100ft	17 W	
12"	24"	24"	36"	48"	60"	Custom Len.	
\$37.79	\$38.20	\$38.20	\$38.62	\$39.05	\$39.47	See Web	

SMA MALE TO BNC MALE RIGHT ANGLE

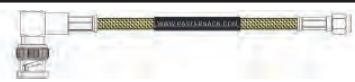

Standard Flexible Cable Assemblies

LMR-195 Coax, 50 Ohm							
Part No. PE3C0040				Cable Dia.	Attn. @1 GHz	Power@1GHz	
1 piece price shown. See web or call for volume pricing.				0.195" dia.	12 dB/100ft	W	
12"	24"	36"	48"	60"	-	Custom Len.	
\$43.34	\$44.06	\$44.78	\$45.50	\$46.22	-	See Web	

SMA MALE TO FAKRA JACK							
SEE FAKRA SPECIFICATION ON PAGE 261							
1 piece price shown. See web or call for volume pricing.				0.109" dia.	25 dB/100ft	W	
12"	24"	36"	48"	60"	-	Custom Len.	
\$32.34	\$33.51	\$34.66	\$35.82	\$36.98	-	See Web	

SMA MALE TO MCX PLUG							
Part No. PE3W02270LF				Cable Dia.	Attn. @1 GHz	Power@1GHz	
1 piece price shown. See web or call for volume pricing.				0.102" dia.	38 dB/100ft	160 W	
-	-	-	-	-	-	Custom Len.	
-	-	-	-	-	-	See Web	

For Custom Lengths, Metric Lengths or Special Configurations, Please call (949) 261-1920



Free Shipping Available via UPS Ground to USA & Canada



Technical Support (866) 727-8376



Same-Day Shipping, Even Custom Cable Assemblies

SMA MALE TO MCX PLUG RIGHT ANGLE



Standard Formable Cable Assemblies

PE-SR405FLJ Coax, 50 Ohm

Part No. PE3C2679LF		Cable Dia.	Attn. @1GHz	Power@1GHz	
1 piece price shown. See web or call for volume pricing.					
12"	24"	36"	48"	60"	72"
\$73.71	\$81.69	\$89.67	\$97.65	\$105.63	\$113.61

Standard Flexible Cable Assemblies

RG316-DS Coax, 50 Ohm

Part No. PE35437LF		Cable Dia.	Attn. @1GHz	Power@1GHz	
1 piece price shown. See web or call for volume pricing.					
12"	24"	36"	48"	60"	72"
\$47.97	\$50.89	\$53.81	\$56.73	\$59.65	\$62.57

SMA MALE TO MMCX PLUG



Standard Flexible Cable Assemblies

RG174A/U Coax, 50 Ohm

Part No. PE34069		Cable Dia.	Attn. @1GHz	Power@1GHz	
1 piece price shown. See web or call for volume pricing.					
12"	24"	36"	48"	60"	72"
\$47.18	\$47.59	\$48.01	\$48.44	\$48.85	\$49.27

RG178B/U Coax, 50 Ohm

Part No. PE34374		Cable Dia.	Attn. @1GHz	Power@1GHz	
1 piece price shown. See web or call for volume pricing.					
12"	24"	36"	48"	60"	72"
\$54.31	\$55.23	\$56.16	\$57.08	\$58.00	\$58.92

RG316/U Coax, 50 Ohm

Part No. PE34122LF		Cable Dia.	Attn. @1GHz	Power@1GHz	
1 piece price shown. See web or call for volume pricing.					
12"	24"	36"	48"	60"	72"
\$49.91	\$52.69	\$55.46	\$58.24	\$61.02	\$63.81

SMA MALE TO MMCX PLUG RIGHT ANGLE



Semi-Rigid Cable Assemblies

PE-047SR Coax, 50 Ohm

Part No. PE37927LF		Cable Dia.	Attn. @1GHz	Power@1GHz	
1 piece price shown. See web or call for volume pricing.					
12"	24"	36"	48"	60"	72"
\$88.24	\$98.58	\$108.92	\$119.26	\$129.60	\$139.94

Standard Formable Cable Assemblies

PE-SR405FLJ Coax, 50 Ohm

Part No. PE39564		Cable Dia.	Attn. @1GHz	Power@1GHz	
1 piece price shown. See web or call for volume pricing.					
6"	9"	12"	18"	24"	-
\$37.71	\$42.77	\$37.71	\$46.17	\$46.20	-

Standard Flexible Cable Assemblies

RG178B/U Coax, 50 Ohm

Part No. PE34777		Cable Dia.	Attn. @1GHz	Power@1GHz	
1 piece price shown. See web or call for volume pricing.					
12"	24"	36"	48"	60"	-
\$61.19	\$62.11	\$63.04	\$63.96	\$64.88	-

SMA MALE TO N MALE



Flexible Cable Assemblies

LMR-195 Coax, 50 Ohm

Part No. PE3C0121		Cable Dia.	Attn. @1GHz	Power@1GHz	
1 piece price shown. See web or call for volume pricing.					
12"	24"	36"	48"	60"	-
\$45.43	\$46.14	\$46.86	\$47.58	\$48.30	-

Precision Formable Cable Assemblies

PE-80TEST Coax, 50 Ohm

Part No. PE3TC0105		Cable Dia.	Attn. @1GHz	Power@1GHz	
1 piece price shown. See web or call for volume pricing.					
24"	48"	72"	-	-	-
\$317.40	\$399.92	\$482.45	-	-	-

Low Loss Flexible Cable Assemblies

PE-P142LL Coax, 50 Ohm

Part No. PE3C0689		Cable Dia.	Attn. @1GHz	Power@1GHz	
1 piece price shown. See web or call for volume pricing.					
12"	24"	36"	48"	60"	72"
\$123.45	\$139.08	\$154.70	\$170.33	\$185.96	\$133.46

Standard Flexible Cable Assemblies

RG58C/U Coax, 50 Ohm

Part No. PE3662LF		Cable Dia.	Attn. @1GHz	Power@1GHz	
1 piece price shown. See web or call for volume pricing.					
12"	24"	36"	48"	60"	72"
\$45.01	\$45.72	\$46.43	\$47.13	\$47.84	\$48.55

RG142B/U Coax, 50 Ohm

Part No. PE3568		Cable Dia.	Attn. @1GHz	Power@1GHz	
1 piece price shown. See web or call for volume pricing.					
12"	24"	36"	48"	60"	72"
\$45.22	\$50.74	\$56.25	\$61.76	\$67.29	\$72.80

RG142B/U Coax, 50 Ohm

Part No. PE3568LF		Cable Dia.	Attn. @1GHz	Power@1GHz	
1 piece price shown. See web or call for volume pricing.					
12"	24"	36"	48"	60"	72"
\$45.22	\$50.74	\$56.25	\$61.76	\$67.29	\$72.80

RG214/U Coax, 50 Ohm

Part No. PE3422LF		Cable Dia.	Attn. @1GHz	Power@1GHz	
1 piece price shown. See web or call for volume pricing.					
12"	24"	36"	48"	60"	72"
\$118.38	\$125.49	\$132.59	\$139.70	\$146.79	\$153.91

RG223/U Coax, 50 Ohm

Part No. PE3519		Cable Dia.	Attn. @1GHz	Power@1GHz	
1 piece price shown. See web or call for volume pricing.					
12"	24"	36"	48"	60"	72"
\$41.72	\$44.51	\$47.30	\$50.09	\$52.89	\$55.67

RG400/U Coax, 50 Ohm

Part No. PE3614		Cable Dia.	Attn. @1GHz	Power@1GHz	
1 piece price shown. See web or call for volume pricing.					
12"	24"	36"	48"	60"	72"
\$52.88	\$59.58	\$66.29	\$73.00	\$79.71	\$86.41

PE-160 Series Coax, 50 Ohm

Part No. PE304		Cable Dia.	Attn. @1GHz	Power@1GHz	
1 piece price shown. See web or call for volume pricing.					
12"	24"	36"	48"	60"	72"
\$149.09	\$159.40	\$169.71	\$180.01	\$190.31	\$200.61

PE-P195 Coax, 50 Ohm

Part No. PE3318		Cable Dia.	Attn. @1GHz	Power@1GHz	
1 piece price shown. See web or call for volume pricing.					
12"	24"	36"	48"	60"	72"
\$54.10	\$62.62	\$71.14	\$79.67	\$88.18	\$96.70

LMR-240 Coax, 50 Ohm

Part No. PE3C0044		Cable Dia.	Attn. @1GHz	Power@1GHz	
1 piece price shown. See web or call for volume pricing.					
12"	24"	36"	48"	60"	-
\$49.52	\$50.46	\$51.39	\$52.32	\$53.26	-

LMR-240 Coax, 50 Ohm

Part No. PE3C0102		Cable Dia.	Attn. @1GHz	Power@1GHz	
1 piece price shown. See web or call for volume pricing.					
12"	24"	36"	48"	60"	-
\$38.80	\$39.74	\$40.66	\$41.60	\$42.53	-

LMR-240-DB Coax, 50 Ohm

Part No. PE3C3354		Cable Dia.	Attn. @1GHz	Power@1GHz	
1 piece price shown. See web or call for volume pricing.					
12"	24"	36"	48"	60"	72"
\$38.04	\$39.11	\$40.18	\$41.25	\$42.32	\$43.39

Standard Semi-Rigid Cable Assemblies

*Coax Performance at 1 GHz Notes: Cable assembly max frequency may be lower than connector or coax max frequency

For our complete selection of cable assemblies, please visit our website

RG402/U Coax, 50 Ohm						
Part No. PE3887		Cable Dia.		Attn. @1 GHz		Power@1GHz
1 piece price shown. See web or call for volume pricing.						
6"	12"	18"	24"	36"	48"	Custom Len.
\$64.93	\$64.93	\$68.45	\$71.97	\$78.99	\$86.02	See Web

SMA MALE TO N MALE RIGHT ANGLE



Low Loss Flexible Cable Assemblies						
PE-P142LL Coax, 50 Ohm						
Part No. PE3C1037		Cable Dia.		Attn. @1 GHz		Power@1GHz
1 piece price shown. See web or call for volume pricing.						
12"	24"	36"	48"	60"	50CM	Custom Len.
\$216.56	\$232.19	\$247.81	\$263.44	\$279.07	\$226.58	See Web

SMA MALE TO N FEMALE BULKHEAD

SEE MOUNTING HOLE SECTION ON PAGE 259



Low Loss Flexible Cable Assemblies						
PE-P142LL Coax, 50 Ohm						
Part No. PE3C2162		Cable Dia.		Attn. @1 GHz		Power@1GHz
1 piece price shown. See web or call for volume pricing.						
12"	24"	36"	48"	60"	50CM	Custom Len.
\$172.97	\$188.60	\$204.22	\$219.85	\$235.48	\$182.98	See Web

Low Loss Test Flexible Cable Assemblies						
PE-P300LL Coax, 50 Ohm						
Part No. PE3C3246		Cable Dia.		Attn. @1 GHz		Power@1GHz
1 piece price shown. See web or call for volume pricing.						
12"	24"	36"	48"	60"	50CM	Custom Len.
\$283.05	\$307.31	\$331.57	\$355.83	\$380.08	\$298.59	See Web

Standard Formable Cable Assemblies						
PE-SR402FL Coax, 50 Ohm						
Part No. PE33996		Cable Dia.		Attn. @1 GHz		Power@1GHz
1 piece price shown. See web or call for volume pricing.						
6"	12"	18"	24"	36"	48"	Custom Len.
\$74.17	\$74.17	\$77.81	\$81.44	\$88.69	\$95.94	See Web

Standard Flexible Cable Assemblies						
RG58C/U Coax, 50 Ohm						
Part No. PE3013		Cable Dia.		Attn. @1 GHz		Power@1GHz
1 piece price shown. See web or call for volume pricing.						
6"	12"	18"	24"	36"	48"	Custom Len.
\$55.39	\$55.39	\$55.74	\$56.10	\$56.80	\$57.51	See Web

RG58C/U Coax, 50 Ohm						
Part No. PE3013LF		Cable Dia.		Attn. @1 GHz		Power@1GHz
1 piece price shown. See web or call for volume pricing.						
6"	12"	18"	24"	36"	48"	Custom Len.
\$55.39	\$55.39	\$55.74	\$56.10	\$56.80	\$57.51	See Web

RG142B/U Coax, 50 Ohm						
Part No. PE3345		Cable Dia.		Attn. @1 GHz		Power@1GHz
1 piece price shown. See web or call for volume pricing.						
6"	12"	18"	24"	36"	48"	Custom Len.
\$49.44	\$49.44	\$52.20	\$54.95	\$60.47	\$65.98	See Web

RG178B/U Coax, 50 Ohm						
Part No. PE34174LF		Cable Dia.		Attn. @1 GHz		Power@1GHz
1 piece price shown. See web or call for volume pricing.						
6"	12"	18"	24"	36"	48"	Custom Len.
\$63.74	\$63.74	\$64.20	\$64.66	\$65.59	\$66.51	See Web

RG316/U Coax, 50 Ohm						
Part No. PE33555		Cable Dia.		Attn. @1 GHz		Power@1GHz
1 piece price shown. See web or call for volume pricing.						
6"	12"	18"	24"	36"	48"	Custom Len.
\$59.72	\$59.72	\$61.11	\$62.50	\$65.28	\$68.06	See Web

SMA MALE TO SMA MALE



Flexible Cable Assemblies						
LMR-195 Coax, 50 Ohm						
Part No. PE3C0038		Cable Dia.		Attn. @1 GHz		Power@1GHz
1 piece price shown. See web or call for volume pricing.						
12"	24"	36"	48"	60"	-	Custom Len.
\$33.36	\$34.08	\$34.80	\$35.52	\$36.24	-	See Web

Precision Formable Cable Assemblies						
PE-80TEST Coax, 50 Ohm						
Part No. PE3TC0101		Cable Dia.		Attn. @1 GHz		Power@1GHz
1 piece price shown. See web or call for volume pricing.						
24"	48"	72"	-	-	-	Custom Len.
\$301.77	\$384.29	\$466.82	-	-	-	See Web

PE-90TEST Coax, 50 Ohm						
Part No. PE3TC0301		Cable Dia.		Attn. @1 GHz		Power@1GHz
1 piece price shown. See web or call for volume pricing.						
6"	16"	18"	24"	48"	72"	Custom Len.
\$211.92	\$231.98	\$231.98	\$221.95	\$315.73	\$390.75	See Web

PE-90TEST Coax, 50 Ohm						
Part No. PE3TC0401		Cable Dia.		Attn. @1 GHz		Power@1GHz
1 piece price shown. See web or call for volume pricing.						
24"	48"	72"	-	-	-	Custom Len.
\$376.17	\$451.19	\$526.21	-	-	-	See Web

Low Loss Flexible Cable Assemblies						
PE-P142LL Coax, 50 Ohm						
Part No. PE3C0230		Cable Dia.		Attn. @1 GHz		Power@1GHz
1 piece price shown. See web or call for volume pricing.						
12"	24"	36"	48"	60"	72"	Custom Len.
\$238.00	\$272.33	\$313.15	\$344.21	\$365.19	\$395.42	See Web

Test Flexible Cable Assemblies						
PE-P160 Coax, 50 Ohm						
Part No. PE366		Cable Dia.		Attn. @1 GHz		Power@1GHz
1 piece price shown. See web or call for volume pricing.						
12"	24"	36"	48"	60"	50CM	Custom Len.
\$240.84	\$260.25	\$315.11	\$340.02	\$318.49	\$281.23	See Web

Low Loss Test Flexible Cable Assemblies						
PE-P300LL Coax, 50 Ohm						
Part No. PE3C3235		Cable Dia.		Attn. @1 GHz		Power@1GHz
1 piece price shown. See web or call for volume pricing.						
12"	24"	36"	48"	60"	50CM	Custom Len.
\$147.98	\$172.22	\$196.45	\$220.69	\$244.93	\$163.52	See Web

PE-P300LL Coax, 50 Ohm						
Part No. PE333		Cable Dia.		Attn. @1 GHz		Power@1GHz
1 piece price shown. See web or call for volume pricing.						
12"	24"	36"	48"	60"	50CM	Custom Len.
\$234.86	\$259.83	\$284.79	\$309.76	\$334.73	\$250.87	See Web

PE-P300LL Coax, 50 Ohm						
Part No. PE336		Cable Dia.		Attn. @1 GHz		Power@1GHz
1 piece price shown. See web or call for volume pricing.						
12"	24"	36"	48"	60"	72"	Custom Len.
\$226.90	\$251.87	\$276.83	\$306.98	\$326.76	\$362.84	See Web

PE-P142LL Coax, 50 Ohm						
Part No. PE341		Cable Dia.		Attn. @1 GHz		Power@1GHz
1 piece price shown. See web or call for volume pricing.						
12"	24"	24"	36"	48"	60"	Custom Len.
\$107.73	\$123.36	\$123.36	\$138.98	\$154.61	\$170.24	See Web

Standard Formable Cable Assemblies						
PE-SR402FL Coax, 50 Ohm						
Part No. PE3481LF		Cable Dia.		Attn. @1 GHz		Power@1GHz
1 piece price shown. See web or call for volume pricing.						
6"	12"	18"	24"	36"	48"	Custom Len.
\$52.04	\$52.04	\$55.68	\$59.31	\$66.56	\$73.81	See Web

PE-SR402FL Coax, 50 Ohm						
Part No. PE39423		Cable Dia.		Attn. @1 GHz		Power@1GHz
1 piece price shown. See web or call for volume pricing.						
3"	6"	9"	12"	18"	24"	Custom Len.
\$42.19	\$42.19	\$42.19	\$42.19	\$45.82	\$49.45	See Web

Cable Assemblies

See Our Website For Current Pricing & Real-Time Stock Availability!

For Custom Lengths, Metric Lengths or Special Configurations, Please call (949) 261-1920



Free Shipping Available via UPS Ground to USA & Canada



Technical Support (866) 727-8376



Same-Day Shipping, Even Custom Cable Assemblies

For our complete selection of cable assemblies, please visit our website

Cable Assemblies

See Our Website For Current Pricing & Real-Time Stock Availability!

PE-SR402FL Coax, 50 Ohm						
Part No. PE3481		Cable Dia.	Attn. @1 GHz	Power@1GHz		
1 piece price shown. See web or call for volume pricing.						
6"	12"	18"	24"	36"	48"	Custom Len.
\$51.08	\$51.08	\$54.71	\$58.34	\$65.60	\$72.85	See Web
PE-SR402FLJ Coax, 50 Ohm						
Part No. PE39437		Cable Dia.	Attn. @1 GHz	Power@1GHz		
1 piece price shown. See web or call for volume pricing.						
6"	9"	12"	18"	24"	-	Custom Len.
\$53.44	\$53.44	\$53.44	\$57.06	\$60.70	-	See Web
PE-SR405FL Coax, 50 Ohm						
Part No. PE39415		Cable Dia.	Attn. @1 GHz	Power@1GHz		
1 piece price shown. See web or call for volume pricing.						
6"	9"	12"	18"	24"	-	Custom Len.
\$47.92	\$47.92	\$47.92	\$53.06	\$58.21	-	See Web
PE-SR405FL Coax, 50 Ohm						
Part No. PE3867LF		Cable Dia.	Attn. @1 GHz	Power@1GHz		
1 piece price shown. See web or call for volume pricing.						
6"	12"	18"	24"	36"	48"	Custom Len.
\$51.81	\$51.81	\$56.96	\$62.11	\$72.39	\$82.69	See Web
PE-SR405FL Coax, 50 Ohm						
Part No. PE3867		Cable Dia.	Attn. @1 GHz	Power@1GHz		
1 piece price shown. See web or call for volume pricing.						
6"	12"	18"	24"	36"	48"	Custom Len.
\$50.85	\$50.85	\$56.00	\$61.14	\$71.43	\$81.73	See Web
PE-SR405FLJ Coax, 50 Ohm						
Part No. PE39429		Cable Dia.	Attn. @1 GHz	Power@1GHz		
1 piece price shown. See web or call for volume pricing.						
6"	9"	12"	18"	24"	-	Custom Len.
\$36.33	\$36.33	\$36.33	\$40.05	\$43.78	-	See Web
Standard Flexible Cable Assemblies						
RG58C/U Coax, 50 Ohm						
Part No. PE3369		Cable Dia.	Attn. @1 GHz	Power@1GHz		
1 piece price shown. See web or call for volume pricing.						
6"	12"	18"	24"	36"	48"	Custom Len.
\$41.41	\$41.41	\$41.77	\$42.12	\$42.83	\$43.54	See Web
RG58C/U Coax, 50 Ohm						
Part No. PE3369LF		Cable Dia.	Attn. @1 GHz	Power@1GHz		
1 piece price shown. See web or call for volume pricing.						
6"	12"	18"	24"	36"	48"	Custom Len.
\$42.20	\$42.20	\$42.55	\$42.90	\$43.61	\$44.32	See Web
RG142B/U Coax, 50 Ohm						
Part No. PE3385		Cable Dia.	Attn. @1 GHz	Power@1GHz		
1 piece price shown. See web or call for volume pricing.						
6"	12"	18"	24"	36"	48"	Custom Len.
\$47.79	\$47.79	\$50.55	\$53.30	\$58.83	\$64.34	See Web
RG142B/U Coax, 50 Ohm						
Part No. PE3385LF		Cable Dia.	Attn. @1 GHz	Power@1GHz		
1 piece price shown. See web or call for volume pricing.						
6"	12"	18"	24"	36"	48"	Custom Len.
\$48.70	\$48.70	\$51.45	\$54.21	\$59.72	\$65.24	See Web
RG174A/U Coax, 50 Ohm						
Part No. PE3353		Cable Dia.	Attn. @1 GHz	Power@1GHz		
1 piece price shown. See web or call for volume pricing.						
6"	12"	18"	24"	36"	48"	Custom Len.
\$44.48	\$44.48	\$44.69	\$44.89	\$45.31	\$45.74	See Web
RG174A/U Coax, 50 Ohm						
Part No. PE3353LF		Cable Dia.	Attn. @1 GHz	Power@1GHz		
1 piece price shown. See web or call for volume pricing.						
6"	12"	18"	24"	36"	48"	Custom Len.
\$44.48	\$44.48	\$44.69	\$44.89	\$45.31	\$45.74	See Web
RG178B/U Coax, 50 Ohm						
Part No. PE3574		Cable Dia.	Attn. @1 GHz	Power@1GHz		
1 piece price shown. See web or call for volume pricing.						
6"	12"	18"	24"	36"	48"	Custom Len.
\$61.06	\$61.06	\$61.51	\$61.98	\$62.90	\$63.83	See Web
RG188A/U Coax, 50 Ohm						
Part No. PE3361LF		Cable Dia.	Attn. @1 GHz	Power@1GHz		
1 piece price shown. See web or call for volume pricing.						
6"	12"	18"	24"	36"	48"	Custom Len.
\$43.32	\$43.32	\$44.39	\$45.46	\$47.59	\$49.73	See Web

RG188A/U Coax, 50 Ohm						
Part No. PE3361		Cable Dia.	Attn. @1 GHz	Power@1GHz		
1 piece price shown. See web or call for volume pricing.						
6"	12"	18"	24"	36"	48"	Custom Len.
\$46.84	\$46.84	\$47.92	\$48.98	\$51.12	\$53.25	See Web
RG188-DS Coax, 50 Ohm						
Part No. PE3778		Cable Dia.	Attn. @1 GHz	Power@1GHz		
1 piece price shown. See web or call for volume pricing.						
12"	24"	36"	48"	60"	-	Custom Len.
\$49.39	\$52.66	\$55.94	\$59.21	\$62.48	-	See Web
RG223/U Coax, 50 Ohm						
Part No. PE3377		Cable Dia.	Attn. @1 GHz	Power@1GHz		
1 piece price shown. See web or call for volume pricing.						
6"	12"	18"	24"	36"	48"	Custom Len.
\$37.08	\$37.08	\$38.48	\$39.87	\$42.66	\$45.45	See Web
RG223/U Coax, 50 Ohm						
Part No. PE3377LF		Cable Dia.	Attn. @1 GHz	Power@1GHz		
1 piece price shown. See web or call for volume pricing.						
6"	12"	18"	24"	36"	48"	Custom Len.
\$36.39	\$36.39	\$37.79	\$39.18	\$41.98	\$44.77	See Web
RG316/U Coax, 50 Ohm						
Part No. PE3573LF		Cable Dia.	Attn. @1 GHz	Power@1GHz		
1 piece price shown. See web or call for volume pricing.						
6"	12"	18"	24"	36"	48"	Custom Len.
\$46.79	\$46.79	\$48.18	\$49.56	\$52.34	\$55.13	See Web
RG316/U Coax, 50 Ohm						
Part No. PE3573		Cable Dia.	Attn. @1 GHz	Power@1GHz		
1 piece price shown. See web or call for volume pricing.						
6"	12"	18"	24"	36"	48"	Custom Len.
\$46.79	\$46.79	\$48.18	\$49.56	\$52.34	\$55.13	See Web
RG316-DS Coax, 50 Ohm						
Part No. PE3704		Cable Dia.	Attn. @1 GHz	Power@1GHz		
1 piece price shown. See web or call for volume pricing.						
12"	24"	36"	48"	60"	-	Custom Len.
\$44.87	\$47.68	\$50.48	\$53.28	\$56.09	-	See Web
RG400/U Coax, 50 Ohm						
Part No. PE3500LF		Cable Dia.	Attn. @1 GHz	Power@1GHz		
1 piece price shown. See web or call for volume pricing.						
6"	12"	18"	24"	36"	48"	Custom Len.
\$51.18	\$51.18	\$54.53	\$57.89	\$64.60	\$71.31	See Web
RG400/U Coax, 50 Ohm						
Part No. PE3500		Cable Dia.	Attn. @1 GHz	Power@1GHz		
1 piece price shown. See web or call for volume pricing.						
6"	12"	18"	24"	36"	48"	Custom Len.
\$50.23	\$50.23	\$53.58	\$56.94	\$63.65	\$70.36	See Web
PE-C100-LSZH Coax, 50 Ohm						
Part No. PE37908		Cable Dia.	Attn. @1 GHz	Power@1GHz		
1 piece price shown. See web or call for volume pricing.						
12"	24"	36"	48"	60"	-	Custom Len.
\$43.32	\$44.49	\$45.64	\$46.80	\$47.96	-	See Web
PE-C195 Coax, 50 Ohm						
Part No. PE35784		Cable Dia.	Attn. @1 GHz	Power@1GHz		
1 piece price shown. See web or call for volume pricing.						
12"	24"	36"	48"	60"	-	Custom Len.
\$35.90	\$36.59	\$37.27	\$37.95	\$38.64	-	See Web
PE-P086EAM Coax, 50 Ohm						
Part No. PE3CA1039		Cable Dia.	Attn. @1 GHz	Power@1GHz		
1 piece price shown. See web or call for volume pricing.						
12"	24"	36"	50CM	100CM	-	Custom Len.
\$55.79	\$68.18	\$81.28	\$67.86	\$89.58	-	See Web
PE-P141 Coax, 50 Ohm						
Part No. PE300		Cable Dia.	Attn. @1 GHz	Power@1GHz		
1 piece price shown. See web or call for volume pricing.						
12"	24"	36"	48"	60"	72"	Custom Len.
\$110.58	\$120.88	\$131.18	\$141.49	\$151.79	\$162.10	See Web
PE-P141 Coax, 50 Ohm						
Part No. PE350		Cable Dia.	Attn. @1 GHz	Power@1GHz		
1 piece price shown. See web or call for volume pricing.						
12"	24"	36"	48"	60"	72"	Custom Len.
\$87.23	\$97.23	\$107.24	\$117.24	\$127.24	\$137.25	See Web

*Coax Performance at 1 GHz Notes: Cable assembly max frequency may be lower than connector or coax max frequency

For our complete selection of cable assemblies, please visit our website

PE-P195 Coax, 50 Ohm						
Part No. PE3138	Cable Dia.	Attn. @1 GHz	Power @1 GHz	1 piece price shown. See web or call for volume pricing.		
6"	12"	18"	24"	0.195" dia.	13 dB/100ft	650 W
\$64.60	\$64.60	\$68.86	\$73.12	\$81.65	\$90.16	See Web

PE-P195 Coax, 50 Ohm						
Part No. PE3138LF	Cable Dia.	Attn. @1 GHz	Power @1 GHz	1 piece price shown. See web or call for volume pricing.		
6"	12"	18"	24"	0.195" dia.	13 dB/100ft	650 W
\$54.35	\$54.35	\$58.61	\$62.87	\$71.39	\$79.92	See Web

LMR-100A-PVC Coax, 50 Ohm						
Part No. PE3C0057	Cable Dia.	Attn. @1 GHz	Power @1 GHz	1 piece price shown. See web or call for volume pricing.		
12"	24"	36"	48"	0.110" dia.	24 dB/100ft	W
\$43.13	\$43.86	\$44.59	\$45.32	\$46.05	-	See Web

LMR-100A-PVC Coax, 50 Ohm						
Part No. PE3C0113	Cable Dia.	Attn. @1 GHz	Power @1 GHz	1 piece price shown. See web or call for volume pricing.		
12"	24"	36"	48"	0.110" dia.	24 dB/100ft	W
\$40.64	\$41.38	\$42.11	\$42.84	\$43.57	-	See Web

LMR-240 Coax, 50 Ohm						
Part No. PE3C0052	Cable Dia.	Attn. @1 GHz	Power @1 GHz	1 piece price shown. See web or call for volume pricing.		
12"	24"	36"	48"	0.240" dia.	8 dB/100ft	W
\$47.23	\$48.17	\$49.10	\$50.03	\$50.97	-	See Web

LMR-240 Coax, 50 Ohm						
Part No. PE3C0103	Cable Dia.	Attn. @1 GHz	Power @1 GHz	1 piece price shown. See web or call for volume pricing.		
12"	24"	36"	48"	0.240" dia.	8 dB/100ft	W
\$35.69	\$36.63	\$37.56	\$38.50	\$39.43	-	See Web

PE-P141FLX Coax, 50 Ohm						
Part No. PE3CA1035	Cable Dia.	Attn. @1 GHz	Power @1 GHz	1 piece price shown. See web or call for volume pricing.		
72"	120"	50CM	12"	0.163" dia.	dB/100ft	W
\$210.82	\$328.27	\$74.62	\$65.69	\$86.28	\$106.27	See Web

PE-VNA-R Coax, 50 Ohm						
Part No. PE3VNA1801	Cable Dia.	Attn. @1 GHz	Power @1 GHz	1 piece price shown. See web or call for volume pricing.		
24"	48"	-	-	0.430" dia.	dB/100ft	W
\$747.75	\$833.72	-	-	-	-	See Web

RG405/U Coax, 50 Ohm						
Part No. PE3818	Cable Dia.	Attn. @1 GHz	Power @1 GHz	1 piece price shown. See web or call for volume pricing.		
6"	12"	18"	24"	* dia.	22 dB/100ft	130 W
\$46.17	\$46.17	\$49.47	\$52.77	\$59.39	\$65.99	See Web

RG405/U Coax, 50 Ohm						
Part No. PE3818LF	Cable Dia.	Attn. @1 GHz	Power @1 GHz	1 piece price shown. See web or call for volume pricing.		
6"	12"	18"	24"	* dia.	22 dB/100ft	130 W
\$47.94	\$47.94	\$51.24	\$54.55	\$61.16	\$67.78	See Web

Standard Flexible Cable Assemblies						
RG179B/U Coax, 75 Ohm						
Part No. PE3739	Cable Dia.	Attn. @1 GHz	Power @1 GHz	1 piece price shown. See web or call for volume pricing.		
6"	12"	18"	24"	0.100" dia.	25 dB/100ft	200 W
\$43.58	\$43.58	\$44.72	\$45.86	\$48.13	\$50.41	See Web

SMA MALE TO SMA MALE RIGHT ANGLE

PASTERNAK

Flexible Cable Assemblies

LMR-240 Coax, 50 Ohm						
Part No. PE3C0055LF	Cable Dia.	Attn. @1 GHz	Power @1 GHz	1 piece price shown. See web or call for volume pricing.		
12"	24"	36"	48"	0.240" dia.	8 dB/100ft	W
\$54.33	\$55.24	\$56.15	\$57.06	\$57.97	\$58.88	See Web

Precision Formable Cable Assemblies

PE-SR402FL Coax, 50 Ohm						
Part No. PE39425	Cable Dia.	Attn. @1 GHz	Power @1 GHz	1 piece price shown. See web or call for volume pricing.		
6"	9"	12"	18"	24"	-	Custom Len.
\$39.22	\$39.22	\$39.22	\$42.84	\$46.48	-	See Web

Precision Flexible Cable Assemblies

PE-P141 Coax, 50 Ohm						
Part No. PE351	Cable Dia.	Attn. @1 GHz	Power @1 GHz	1 piece price shown. See web or call for volume pricing.		
6"	12"	24"	36"	48"	60"	Custom Len.
\$157.74	\$157.74	\$168.05	\$178.34	\$188.65	\$198.95	See Web

Low Loss Test Flexible Cable Assemblies

PE-P300LL Coax, 50 Ohm						
Part No. PE3C1722	Cable Dia.	Attn. @1 GHz	Power @1 GHz	1 piece price shown. See web or call for volume pricing.		
12"	24"	36"	48"	60"	50CM	Custom Len.
\$251.18	\$276.15	\$301.10	\$326.07	\$351.03	\$267.17	See Web

Standard Formable Cable Assemblies

PE-SR401FL Coax, 50 Ohm						
Part No. PE34202	Cable Dia.	Attn. @1 GHz	Power @1 GHz	1 piece price shown. See web or call for volume pricing.		
6"	12"	18"	24"	* dia.	8 dB/100ft	1400 W
\$139.20	\$139.20	\$146.60	\$154.01	\$168.83	\$183.66	See Web

PE-SR402FL Coax, 50 Ohm						
Part No. PE3483	Cable Dia.	Attn. @1 GHz	Power @1 GHz	1 piece price shown. See web or call for volume pricing.		
6"	12"	18"	24"	36"	48"	Custom Len.
\$62.48	\$62.48	\$66.11	\$69.74	\$76.99	\$84.25	See Web

PE-SR405FL Coax, 50 Ohm						
Part No. PE39417	Cable Dia.	Attn. @1 GHz	Power @1 GHz	1 piece price shown. See web or call for volume pricing.		
6"	9"	12"	18"	24"	-	Custom Len.
\$41.90	\$41.90	\$41.90	\$47.05	\$52.20	-	See Web

PE-SR405FL Coax, 50 Ohm						
Part No. PE3958LF	Cable Dia.	Attn. @1 GHz	Power @1 GHz	1 piece price shown. See web or call for volume pricing.		
6"	12"	18"	24"	36"	48"	Custom Len.
\$71.42	\$71.42	\$76.57	\$81.72	\$92.01	\$102.31	See Web

PE-SR405FL Coax, 50 Ohm						
Part No. PE3958	Cable Dia.	Attn. @1 GHz	Power @1 GHz	1 piece price shown. See web or call for volume pricing.		
6"	12"	18"	24"	36"	48"	Custom Len.
\$71.42	\$71.42	\$76.57	\$81.72	\$92.01	\$102.31	See Web

Cable Assemblies

See Our Website For Current Pricing & Real-Time Stock Availability!

For Custom Lengths, Metric Lengths or Special Configurations, Please call (949) 261-1920

Free Shipping Available via UPS Ground to USA & Canada

Technical Support (866) 727-8376

Same-Day Shipping, Even Custom Cable Assemblies

91

For our complete selection of cable assemblies, please visit our website

Cable Assemblies

See Our Website For Current Pricing & Real-Time Stock Availability!

Standard Flexible Cable Assemblies						
RG58C/U Coax, 50 Ohm						
Part No. PE3319		Cable Dia.	Attn. @1GHz	Power@1GHz		
1 piece price shown. See web or call for volume pricing.						
6"	12"	18"	24"	36"	48"	Custom Len.
\$49.88	\$49.88	\$50.23	\$50.58	\$51.29	\$52.00	See Web
RG58C/U Coax, 50 Ohm						
Part No. PE3319LF		Cable Dia.	Attn. @1GHz	Power@1GHz		
1 piece price shown. See web or call for volume pricing.						
6"	12"	18"	24"	36"	48"	Custom Len.
\$50.80	\$50.80	\$51.16	\$51.51	\$52.22	\$52.93	See Web
RG142B/U Coax, 50 Ohm						
Part No. PE3512LF		Cable Dia.	Attn. @1GHz	Power@1GHz		
1 piece price shown. See web or call for volume pricing.						
6"	12"	18"	24"	36"	48"	Custom Len.
\$50.42	\$50.42	\$53.18	\$55.94	\$61.45	\$66.97	See Web
RG142B/U Coax, 50 Ohm						
Part No. PE3512		Cable Dia.	Attn. @1GHz	Power@1GHz		
1 piece price shown. See web or call for volume pricing.						
6"	12"	18"	24"	36"	48"	Custom Len.
\$49.50	\$49.50	\$52.26	\$55.02	\$60.53	\$66.06	See Web
RG174A/U Coax, 50 Ohm						
Part No. PE3420		Cable Dia.	Attn. @1GHz	Power@1GHz		
1 piece price shown. See web or call for volume pricing.						
6"	12"	18"	24"	36"	48"	Custom Len.
\$58.23	\$58.23	\$58.45	\$58.66	\$59.08	\$59.49	See Web
RG188A/U Coax, 50 Ohm						
Part No. PE3510LF		Cable Dia.	Attn. @1GHz	Power@1GHz		
1 piece price shown. See web or call for volume pricing.						
6"	12"	18"	24"	36"	48"	Custom Len.
\$61.16	\$61.16	\$62.22	\$63.30	\$65.43	\$67.57	See Web
RG223/U Coax, 50 Ohm						
Part No. PE3429		Cable Dia.	Attn. @1GHz	Power@1GHz		
1 piece price shown. See web or call for volume pricing.						
6"	12"	18"	24"	36"	48"	Custom Len.
\$52.77	\$52.77	\$54.16	\$55.55	\$58.35	\$61.14	See Web
RG316/U Coax, 50 Ohm						
Part No. PE3513LF		Cable Dia.	Attn. @1GHz	Power@1GHz		
1 piece price shown. See web or call for volume pricing.						
6"	12"	18"	24"	36"	48"	Custom Len.
\$60.91	\$60.91	\$62.31	\$63.69	\$66.47	\$69.26	See Web
RG316/U Coax, 50 Ohm						
Part No. PE3513		Cable Dia.	Attn. @1GHz	Power@1GHz		
1 piece price shown. See web or call for volume pricing.						
6"	12"	18"	24"	36"	48"	Custom Len.
\$60.91	\$60.91	\$62.31	\$63.69	\$66.47	\$69.26	See Web
RG316-DS Coax, 50 Ohm						
Part No. PE3344		Cable Dia.	Attn. @1GHz	Power@1GHz		
1 piece price shown. See web or call for volume pricing.						
6"	12"	18"	24"	36"	48"	Custom Len.
\$54.48	\$54.48	\$55.88	\$57.27	\$60.08	\$62.88	See Web
RG316-DS Coax, 50 Ohm						
Part No. PE3344LF		Cable Dia.	Attn. @1GHz	Power@1GHz		
1 piece price shown. See web or call for volume pricing.						
6"	12"	18"	24"	36"	48"	Custom Len.
\$55.52	\$55.52	\$56.92	\$58.33	\$61.13	\$63.93	See Web
RG400/U Coax, 50 Ohm						
Part No. PE3003		Cable Dia.	Attn. @1GHz	Power@1GHz		
1 piece price shown. See web or call for volume pricing.						
6"	12"	18"	24"	36"	48"	Custom Len.
\$62.36	\$62.36	\$65.71	\$69.07	\$75.78	\$82.48	See Web
PE-P086EAM Coax, 50 Ohm						
Part No. PE3CA1040		Cable Dia.	Attn. @1GHz	Power@1GHz		
1 piece price shown. See web or call for volume pricing.						
12"	12"	24"	36"	50CM	100CM	Custom Len.
\$60.20	\$60.20	\$71.99	\$83.76	\$67.67	\$87.06	See Web
LMR-240 Coax, 50 Ohm						
Part No. PE3C0104		Cable Dia.	Attn. @1GHz	Power@1GHz		
1 piece price shown. See web or call for volume pricing.						
12"	24"	36"	48"	60"	-	Custom Len.
\$39.06	\$39.99	\$40.92	\$41.85	\$42.79	-	See Web

PE-047SR Coax, 50 Ohm						
Part No. PE3230		Cable Dia.	Attn. @1GHz	Power@1GHz		
1 piece price shown. See web or call for volume pricing.						
6"	12"	18"	24"	36"	48"	Custom Len.
\$118.87	\$118.87	\$123.79	\$128.72	\$138.57	\$148.43	See Web



Standard Formable Cable Assemblies						
PE-SR402FLJ Coax, 50 Ohm						
Part No. PE39440		Cable Dia.	Attn. @1GHz	Power@1GHz		
1 piece price shown. See web or call for volume pricing.						
6"	9"	12"	18"	24"	-	Custom Len.
\$35.77	\$35.77	\$35.77	\$39.39	\$43.03	-	See Web

Standard Flexible Cable Assemblies						
RG58C/U Coax, 50 Ohm						
Part No. PE3078LF		Cable Dia.	Attn. @1GHz	Power@1GHz		
1 piece price shown. See web or call for volume pricing.						
6"	12"	18"	24"	36"	48"	Custom Len.
\$51.10	\$51.10	\$51.46	\$51.81	\$52.52	\$53.23	See Web

RG142B/U Coax, 50 Ohm						
Part No. PE3611		Cable Dia.	Attn. @1GHz	Power@1GHz		
1 piece price shown. See web or call for volume pricing.						
6"	12"	18"	24"	36"	48"	Custom Len.
\$47.62	\$47.62	\$50.39	\$53.14	\$58.66	\$64.17	See Web

RG174A/U Coax, 50 Ohm						
Part No. PE3715		Cable Dia.	Attn. @1GHz	Power@1GHz		
1 piece price shown. See web or call for volume pricing.						
6"	12"	18"	24"	36"	48"	Custom Len.
\$51.18	\$51.18	\$51.39	\$51.59	\$52.02	\$52.44	See Web

RG316/U Coax, 50 Ohm						
Part No. PE3832		Cable Dia.	Attn. @1GHz	Power@1GHz		
1 piece price shown. See web or call for volume pricing.						
6"	12"	18"	24"	36"	48"	Custom Len.
\$53.87	\$53.87	\$55.26	\$56.65	\$59.43	\$62.21	See Web

RG316-DS Coax, 50 Ohm						
Part No. PE3171		Cable Dia.	Attn. @1GHz	Power@1GHz		
1 piece price shown. See web or call for volume pricing.						
6"	12"	18"	24"	36"	48"	Custom Len.
\$57.62	\$57.62	\$59.02	\$60.42	\$63.22	\$66.03	See Web

RG400/U Coax, 50 Ohm						
Part No. PE3864		Cable Dia.	Attn. @1GHz	Power@1GHz		
1 piece price shown. See web or call for volume pricing.						
6"	12"	18"	24"	36"	48"	Custom Len.
\$55.55	\$55.55	\$58.91	\$62.26	\$68.97	\$75.68	See Web

PE-P142LL Coax, 50 Ohm						
Part No. PE340		Cable Dia.	Attn. @1GHz	Power@1GHz		
1 piece price shown. See web or call for volume pricing.						
12"	24"	36"	48"	60"	50CM	Custom Len.
\$145.76	\$161.39	\$177.02	\$192.64	\$208.27	\$155.77	See Web

Standard Semi-Rigid Cable Assemblies						
PE-SR402AL Coax, 50 Ohm						
Part No. PE34235		Cable Dia.	Attn. @1GHz	Power@1GHz		
1 piece price shown. See web or call for volume pricing.						
6"	12"	18"	24"	36"	48"	Custom Len.
\$57.28	\$57.28	\$61.81	\$66.34	\$75.39	\$84.46	See Web

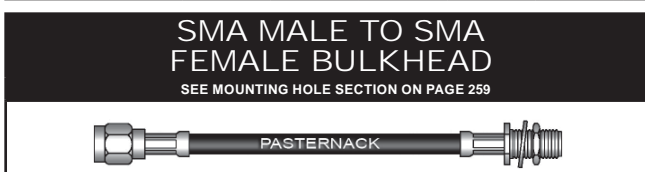

Standard Formable Cable Assemblies						
PE-SR402FL Coax, 50 Ohm						
Part No. PE3468LF		Cable Dia.	Attn. @1GHz	Power@1GHz		
1 piece price shown. See web or call for volume pricing.						
6"	12"	18"	24"	36"	48"	Custom Len.
\$56.29	\$56.29	\$59.92	\$63.56	\$70.81	\$78.06	See Web

*Coax Performance at 1 GHz Notes: Cable assembly max frequency may be lower than connector or coax max frequency

For our complete selection of cable assemblies, please visit our website

PE-SR405FL Coax, 50 Ohm						
Part No. PE39419		Cable Dia.		Attn. @1 GHz	Power@1GHz	
1 piece price shown. See web or call for volume pricing.						
6"	9"	12"	18"	24"	-	Custom Len.
\$48.11	\$48.11	\$48.11	\$53.26	\$58.41		See Web

PE-SR405FLJ Coax, 50 Ohm						
Part No. PE39433		Cable Dia.		Attn. @1 GHz	Power@1GHz	
1 piece price shown. See web or call for volume pricing.						
6"	9"	12"	18"	24"	-	Custom Len.
\$31.35	\$39.46	\$17.66	\$38.56	\$42.13		See Web

Standard Flexible Cable Assemblies

RG178B/U Coax, 50 Ohm						
Part No. PE3959LF		Cable Dia.		Attn. @1 GHz	Power@1GHz	
1 piece price shown. See web or call for volume pricing.						
6"	12"	18"	24"	36"	48"	Custom Len.
\$50.26	\$50.26	\$50.72	\$51.19	\$52.10	\$53.03	See Web

RG316/U Coax, 50 Ohm						
Part No. PE3835		Cable Dia.		Attn. @1 GHz	Power@1GHz	
1 piece price shown. See web or call for volume pricing.						
6"	12"	18"	24"	36"	48"	Custom Len.
\$49.06	\$49.06	\$50.46	\$51.84	\$54.63	\$57.41	See Web

RG179B/U Coax, 75 Ohm						
Part No. PE3967		Cable Dia.		Attn. @1 GHz	Power@1GHz	
1 piece price shown. See web or call for volume pricing.						
6"	12"	18"	24"	36"	48"	Custom Len.
\$55.69	\$55.69	\$56.84	\$57.97	\$60.24	\$62.51	See Web

SMA MALE TO REVERSE POLARITY SMA MALE



Standard Flexible Cable Assemblies

RG223/U Coax, 50 Ohm						
Part No. PE34398		Cable Dia.		Attn. @1 GHz	Power@1GHz	
1 piece price shown. See web or call for volume pricing.						
12"	24"	36"	48"	60"	72"	Custom Len.
\$46.63	\$49.43	\$52.21	\$55.00	\$57.79	\$60.59	See Web

SMA MALE TO SMB PLUG



Standard Flexible Cable Assemblies

RG58C/U Coax, 50 Ohm						
Part No. PE3172		Cable Dia.		Attn. @1 GHz	Power@1GHz	
1 piece price shown. See web or call for volume pricing.						
6"	12"	18"	24"	36"	48"	Custom Len.
\$49.53	\$49.53	\$49.88	\$50.23	\$50.94	\$51.65	See Web

RG142B/U Coax, 50 Ohm						
Part No. PE3181		Cable Dia.		Attn. @1 GHz	Power@1GHz	
1 piece price shown. See web or call for volume pricing.						
6"	12"	18"	24"	36"	48"	Custom Len.
\$48.06	\$48.06	\$50.82	\$53.58	\$59.10	\$64.61	See Web

RG174A/U Coax, 50 Ohm						
Part No. PE3908LF		Cable Dia.		Attn. @1 GHz	Power@1GHz	
1 piece price shown. See web or call for volume pricing.						
6"	12"	18"	24"	36"	48"	Custom Len.
\$42.57	\$42.57	\$42.78	\$42.99	\$43.40	\$43.83	See Web

RG174A/U Coax, 50 Ohm						
Part No. PE3908		Cable Dia.		Attn. @1 GHz	Power@1GHz	
1 piece price shown. See web or call for volume pricing.						
6"	12"	18"	24"	36"	48"	Custom Len.
\$42.57	\$42.57	\$42.78	\$42.99	\$43.40	\$43.83	See Web

RG178B/U Coax, 50 Ohm						
Part No. PE3548LF		Cable Dia.		Attn. @1 GHz	Power@1GHz	
1 piece price shown. See web or call for volume pricing.						
6"	12"	18"	24"	36"	48"	Custom Len.
\$55.23	\$55.23	\$55.69	\$56.16	\$57.08	\$58.00	See Web

RG316/U Coax, 50 Ohm						
Part No. PE3810LF		Cable Dia.		Attn. @1 GHz	Power@1GHz	
1 piece price shown. See web or call for volume pricing.						
6"	12"	18"	24"	36"	48"	Custom Len.
\$45.25	\$45.25	\$46.63	\$48.03	\$50.81	\$53.58	See Web

RG316/U Coax, 50 Ohm						
Part No. PE3810		Cable Dia.		Attn. @1 GHz	Power@1GHz	
1 piece price shown. See web or call for volume pricing.						
6"	12"	18"	24"	36"	48"	Custom Len.
\$44.42	\$44.42	\$45.80	\$47.19	\$49.97	\$52.75	See Web

RG316-DS Coax, 50 Ohm						
Part No. PE33657LF		Cable Dia.		Attn. @1 GHz	Power@1GHz	
1 piece price shown. See web or call for volume pricing.						
6"	12"	18"	24"	36"	48"	Custom Len.
\$40.45	\$40.45	\$41.85	\$43.25	\$46.05	\$48.85	See Web

SMA MALE TO SMP FEMALE



Standard Formable Cable Assemblies

PE-SR047FL Coax, 50 Ohm						
Part No. PE36164LF		Cable Dia.		Attn. @1 GHz	Power@1GHz	
1 piece price shown. See web or call for volume pricing.						
12"	24"	36"	48"	60"	72"	Custom Len.
\$84.04	\$91.14	\$98.23	\$105.32	\$112.42	\$119.51	See Web

PE-SR405FL Coax, 50 Ohm						
Part No. PE36168		Cable Dia.		Attn. @1 GHz	Power@1GHz	
1 piece price shown. See web or call for volume pricing.						
12"	24"	36"	48"	60"	72"	Custom Len.
\$77.09	\$87.39	\$97.68	\$107.97	\$118.26	\$128.56	See Web

PE-SR405FL Coax, 50 Ohm						
Part No. PE36168LF		Cable Dia.		Attn. @1 GHz	Power@1GHz	
1 piece price shown. See web or call for volume pricing.						
12"	24"	36"	48"	60"	72"	Custom Len.
\$61.63	\$71.92	\$82.22	\$92.51	\$102.80	\$113.09	See Web

Standard Semi-Rigid Cable Assemblies

RG405/U Coax, 50 Ohm						
Part No. PE36166		Cable Dia.		Attn. @1 GHz	Power@1GHz	
1 piece price shown. See web or call for volume pricing.						
12"	24"	36"	48"	60"	72"	Custom Len.
\$57.84	\$64.44	\$71.06	\$77.67	\$84.28	\$90.89	See Web

SMA MALE TO SMP FEMALE RIGHT ANGLE



Standard Flexible Cable Assemblies

RG316/U Coax, 50 Ohm						
Part No. PE3C3028		Cable Dia.		Attn. @1 GHz	Power@1GHz	
1 piece price shown. See web or call for volume pricing.						
12"	24"	36"	48"	60"	72"	Custom Len.
\$52.59	\$55.51	\$58.43	\$61.35	\$64.27	\$67.19	See Web

SMA MALE TO SSMA MALE



Standard Flexible Cable Assemblies

RG316/U Coax, 50 Ohm						
Part No. PE3669LF		Cable Dia.		Attn. @1 GHz	Power@1GHz	
1 piece price shown. See web or call for volume pricing.						
6"	12"	18"	24"	36"	48"	Custom Len.
\$57.92	\$57.92	\$59.31	\$60.69	\$63.47	\$66.26	See Web

For Custom Lengths, Metric Lengths or Special Configurations, Please call (949) 261-1920



Free Shipping Available via UPS Ground to USA & Canada



Technical Support (866) 727-8376



Same-Day Shipping, Even Custom Cable Assemblies

Cable Assemblies

See Our Website For Current Pricing & Real-Time Stock Availability!

For our complete selection of cable assemblies, please visit our website

**SMA MALE TO
TNC MALE**



Low Loss Flexible Cable Assemblies

PE-P142LL Coax, 50 Ohm

Part No. PE3C0847				Cable Dia.	Attn. @1 GHz	Power@1GHz
1 piece price shown. See web or call for volume pricing.				0.195" dia.	7 dB/100ft	W
12"	24"	36"	48"	60"	50CM	Custom Len.
\$138.96	\$154.59	\$170.22	\$185.84	\$201.47	\$148.97	See Web

Standard Formable Cable Assemblies

PE-SR402FL Coax, 50 Ohm

Part No. PE33928				Cable Dia.	Attn. @1 GHz	Power@1GHz
1 piece price shown. See web or call for volume pricing.				" dia.	12 dB/100ft	450 W
6"	12"	18"	24"	36"	48"	Custom Len.
\$71.40	\$71.40	\$75.03	\$78.66	\$85.92	\$93.17	See Web

Standard Flexible Cable Assemblies

RG58C/U Coax, 50 Ohm

Part No. RG3154				Cable Dia.	Attn. @1 GHz	Power@1GHz
1 piece price shown. See web or call for volume pricing.				0.195" dia.	20 dB/100ft	44 W
12"	24"	36"	48"	60"	72"	Custom Len.
\$38.27	\$38.98	\$39.68	\$40.39	\$41.10	\$41.81	See Web

RG142B/U Coax, 50 Ohm

Part No. PE3664				Cable Dia.	Attn. @1 GHz	Power@1GHz
1 piece price shown. See web or call for volume pricing.				0.195" dia.	13 dB/100ft	650 W
12"	24"	36"	48"	60"	72"	Custom Len.
\$43.75	\$49.27	\$54.78	\$60.31	\$65.82	\$71.34	See Web

RG316/U Coax, 50 Ohm

Part No. PE3174				Cable Dia.	Attn. @1 GHz	Power@1GHz
1 piece price shown. See web or call for volume pricing.				0.098" dia.	38 dB/100ft	160 W
12"	24"	36"	48"	60"	72"	Custom Len.
\$52.94	\$55.72	\$58.49	\$61.27	\$64.06	\$66.84	See Web

RG400/U Coax, 50 Ohm

Part No. PE33948				Cable Dia.	Attn. @1 GHz	Power@1GHz
1 piece price shown. See web or call for volume pricing.				0.195" dia.	15 dB/100ft	650 W
12"	24"	36"	48"	60"	72"	Custom Len.
\$52.50	\$59.21	\$65.92	\$72.63	\$79.34	\$86.04	See Web

LMR-200 Coax, 50 Ohm

Part No. PE3W02192				Cable Dia.	Attn. @1 GHz	Power@1GHz
1 piece price shown. See web or call for volume pricing.				0.195" dia.	11 dB/100ft	W
12"	24"	36"	48"	60"	72"	Custom Len.
\$42.32	\$43.09	\$43.86	\$44.63	\$45.40	\$46.17	See Web

Standard Semi-Rigid Cable Assemblies

RG402/U Coax, 50 Ohm

Part No. PE3089				Cable Dia.	Attn. @1 GHz	Power@1GHz
1 piece price shown. See web or call for volume pricing.				" dia.	12 dB/100ft	650 W
6"	12"	18"	24"	36"	48"	Custom Len.
\$68.58	\$68.58	\$72.09	\$75.60	\$82.64	\$89.67	See Web

Standard Flexible Cable Assemblies

RG59B/U Coax, 75 Ohm

Part No. PE36848				Cable Dia.	Attn. @1 GHz	Power@1GHz
1 piece price shown. See web or call for volume pricing.				0.242" dia.	12 dB/100ft	77 W
12"	24"	36"	48"	60"	-	Custom Len.
\$46.81	\$47.73	\$48.66	\$49.57	\$50.50	-	See Web

**SMA MALE TO
TNC MALE RIGHT ANGLE**



Low Loss Flexible Cable Assemblies

PE-P142LL Coax, 50 Ohm

Part No. PE3C0780				Cable Dia.	Attn. @1 GHz	Power@1GHz
1 piece price shown. See web or call for volume pricing.				0.195" dia.	7 dB/100ft	W
12"	24"	36"	48"	60"	50CM	Custom Len.
\$216.56	\$232.19	\$247.81	\$263.44	\$279.07	\$226.58	See Web

**SMA MALE TO
TNC FEMALE BULKHEAD**

SEE MOUNTING HOLE SECTION ON PAGE 259



Precision Formable Cable Assemblies

PE-SR402FL Coax, 50 Ohm

Part No. PE39483				Cable Dia.	Attn. @1 GHz	Power@1GHz
1 piece price shown. See web or call for volume pricing.				" dia.	12 dB/100ft	450 W
6"	9"	12"	18"	24"	-	Custom Len.
\$43.81	\$43.81	\$43.81	\$52.67	\$56.93	-	See Web

PE-SR405FLJ Coax, 50 Ohm

Part No. PE39489				Cable Dia.	Attn. @1 GHz	Power@1GHz
1 piece price shown. See web or call for volume pricing.				0.098" dia.	20 dB/100ft	130 W
6"	9"	12"	18"	24"	-	Custom Len.
\$43.45	\$43.45	\$43.45	\$47.18	\$68.91	-	See Web

Low Loss Flexible Cable Assemblies

PE-P142LL Coax, 50 Ohm

Part No. PE3C2449				Cable Dia.	Attn. @1 GHz	Power@1GHz
1 piece price shown. See web or call for volume pricing.				0.195" dia.	10 dB/100ft	W
12"	24"	36"	48"	60"	50CM	Custom Len.
\$172.04	\$187.67	\$203.29	\$218.92	\$234.55	\$182.05	See Web

Standard Formable Cable Assemblies

PE-SR402FLJ Coax, 50 Ohm

Part No. PE39497				Cable Dia.	Attn. @1 GHz	Power@1GHz
1 piece price shown. See web or call for volume pricing.				0.161" dia.	12 dB/100ft	303 W
6"	9"	12"	18"	24"	-	Custom Len.
\$49.70	\$49.70	\$49.70	\$53.33	\$56.96	-	See Web

**SMA MALE TO
REVERSE POLARITY TNC MALE**



Standard Flexible Cable Assemblies

LMR-195-FR Coax, 50 Ohm

Part No. PE3W02436LF				Cable Dia.	Attn. @1 GHz	Power@1GHz
1 piece price shown. See web or call for volume pricing.				0.195" dia.	12 dB/100ft	W
12"	24"	36"	48"	60"	50CM	Custom Len.
\$39.33	\$40.30	\$41.27	\$42.24	\$43.21	\$39.95	See Web

**SMA MALE TO
UMCX 2.5 PLUG**



Standard Flexible Cable Assemblies

PE-137mm Coax, 50 Ohm

Part No. PE3CA1025				Cable Dia.	Attn. @1 GHz	Power@1GHz
1 piece price shown. See web or call for volume pricing.				0.053" dia.	dB/100ft	W
3"	6"	12"	-	-	-	Custom Len.
\$14.57	\$12.93	\$12.93	-	-	-	See Web

**SMA MALE RIGHT ANGLE
TO BNC MALE**



Standard Flexible Cable Assemblies

RG58C/U Coax, 50 Ohm

Part No. PE3850LF				Cable Dia.	Attn. @1 GHz	Power@1GHz
1 piece price shown. See web or call for volume pricing.				0.195" dia.	20 dB/100ft	44 W
6"	12"	18"	24"	36"	48"	Custom Len.
\$50.58	\$50.58	\$50.94	\$51.29	\$52.00	\$52.71	See Web

Cable Assemblies

See Our Website For Current Pricing & Real-Time Stock Availability!

*Coax Performance at 1 GHz Notes: Cable assembly max frequency may be lower than connector or coax max frequency

For our complete selection of cable assemblies, please visit our website

RG174A/U Coax, 50 Ohm							
Part No. PE3C3448		Cable Dia.	Attn. @1 GHz	Power@1GHz			
1 piece price shown. See web or call for volume pricing.							
6"	12"	18"	24"	36"	48"	Custom Len.	
\$49.61	\$49.82	\$50.05	\$50.22	\$50.67	\$51.05	See Web	

RG174A/U Coax, 50 Ohm							
Part No. PE3C3448LF		Cable Dia.	Attn. @1 GHz	Power@1GHz			
1 piece price shown. See web or call for volume pricing.							
6"	12"	18"	24"	36"	48"	Custom Len.	
\$53.81	\$53.81	\$54.02	\$54.23	\$54.65	\$55.06	See Web	

RG188A/U Coax, 50 Ohm							
Part No. PE3C3437		Cable Dia.	Attn. @1 GHz	Power@1GHz			
1 piece price shown. See web or call for volume pricing.							
6"	12"	18"	24"	36"	48"	Custom Len.	
\$49.85	\$49.85	\$50.92	\$51.99	\$54.13	\$56.26	See Web	

RG223/U Coax, 50 Ohm							
Part No. PE3733		Cable Dia.	Attn. @1 GHz	Power@1GHz			
1 piece price shown. See web or call for volume pricing.							
6"	12"	18"	24"	36"	48"	Custom Len.	
\$53.74	\$53.74	\$55.14	\$56.53	\$59.33	\$62.12	See Web	

RG400/U Coax, 50 Ohm							
Part No. PE3642		Cable Dia.	Attn. @1 GHz	Power@1GHz			
1 piece price shown. See web or call for volume pricing.							
6"	12"	18"	24"	36"	48"	Custom Len.	
\$57.92	\$57.92	\$61.27	\$64.63	\$71.34	\$78.04	See Web	

SMA MALE RIGHT ANGLE TO BNC FEMALE BULKHEAD

SEE MOUNTING HOLE SECTION ON PAGE 259



Standard Flexible Cable Assemblies

RG316/U Coax, 50 Ohm							
Part No. PE3681		Cable Dia.	Attn. @1 GHz	Power@1GHz			
1 piece price shown. See web or call for volume pricing.							
12"	24"	36"	48"	60"	-	Custom Len.	
\$59.96	\$62.74	\$65.53	\$68.31	\$71.08		See Web	

RG400/U Coax, 50 Ohm							
Part No. PE34957		Cable Dia.	Attn. @1 GHz	Power@1GHz			
1 piece price shown. See web or call for volume pricing.							
12"	24"	36"	48"	60"	-	Custom Len.	
\$68.17	\$74.88	\$81.58	\$88.29	\$95.00		See Web	

SMA MALE RIGHT ANGLE TO N MALE RIGHT ANGLE



Low Loss Flexible Cable Assemblies

PE-P142LL Coax, 50 Ohm							
Part No. PE3C1528		Cable Dia.	Attn. @1 GHz	Power@1GHz			
1 piece price shown. See web or call for volume pricing.							
12"	24"	36"	48"	60"	50CM	Custom Len.	
\$292.91	\$308.53	\$324.16	\$339.79	\$355.41	\$302.92	See Web	

PE-P300LL Coax, 50 Ohm							
Part No. PE3C3249		Cable Dia.	Attn. @1 GHz	Power@1GHz			
1 piece price shown. See web or call for volume pricing.							
12"	24"	36"	48"	60"	50CM	Custom Len.	
\$434.60	\$458.86	\$483.12	\$507.38	\$531.63	\$450.14	See Web	

SMA MALE RIGHT ANGLE TO N FEMALE BULKHEAD

SEE MOUNTING HOLE SECTION ON PAGE 259



Precision Formable Cable Assemblies

PE-SR402FLJ Coax, 50 Ohm							
Part No. PE39470		Cable Dia.	Attn. @1 GHz	Power@1GHz			
1 piece price shown. See web or call for volume pricing.							
6"	9"	12"	18"	24"	-	Custom Len.	
\$50.31	\$50.31	\$50.31	\$53.94	\$57.58		See Web	

Standard Flexible Cable Assemblies							
RG316/U Coax, 50 Ohm							
Part No. PE33014		Cable Dia.	Attn. @1 GHz	Power@1GHz			
1 piece price shown. See web or call for volume pricing.							
12"	24"	36"	48"	60"	-	Custom Len.	
\$70.04	\$72.82	\$75.60	\$78.37	\$81.16		See Web	

RG400/U Coax, 50 Ohm							
Part No. PE3179		Cable Dia.	Attn. @1 GHz	Power@1GHz			
1 piece price shown. See web or call for volume pricing.							
12"	24"	36"	48"	60"	-	Custom Len.	
\$70.45	\$77.17	\$83.88	\$90.59	\$97.29		See Web	

SMA MALE RIGHT ANGLE TO SMA MALE



Standard Flexible Cable Assemblies

PE-P142LL Coax, 50 Ohm							
Part No. PE342		Cable Dia.	Attn. @1 GHz	Power@1GHz			
1 piece price shown. See web or call for volume pricing.							
12"	24"	36"	48"	60"	50CM	Custom Len.	
\$188.80	\$204.43	\$220.05	\$235.68	\$251.31	\$198.82	See Web	

SMA MALE RIGHT ANGLE TO SMA MALE RIGHT ANGLE



Precision Formable Cable Assemblies

PE-SR402FLJ Coax, 50 Ohm							
Part No. PE39438		Cable Dia.	Attn. @1 GHz	Power@1GHz			
1 piece price shown. See web or call for volume pricing.							
6"	9"	12"	18"	24"	-	Custom Len.	
\$30.97	\$36.61	\$28.56	\$41.89	\$64.92		See Web	

Low Loss Flexible Cable Assemblies

PE-P142LL Coax, 50 Ohm							
Part No. PE3C1425		Cable Dia.	Attn. @1 GHz	Power@1GHz			
1 piece price shown. See web or call for volume pricing.							
12"	24"	36"	48"	60"	50CM	Custom Len.	
\$272.21	\$287.84	\$303.47	\$319.09	\$334.72	\$282.22	See Web	

Standard Formable Cable Assemblies

PE-SR402FL Coax, 50 Ohm							
Part No. PE3417		Cable Dia.	Attn. @1 GHz	Power@1GHz			
1 piece price shown. See web or call for volume pricing.							
6"	12"	18"	24"	36"	48"	Custom Len.	
\$78.53	\$78.53	\$82.16	\$85.79	\$93.05	\$100.30	See Web	

PE-SR405FL Coax, 50 Ohm

Part No. PE3646		Cable Dia.	Attn. @1 GHz	Power@1GHz			
1 piece price shown. See web or call for volume pricing.							
6"	12"	18"	24"	36"	48"	Custom Len.	
\$96.28	\$96.28	\$101.42	\$106.57	\$116.85	\$127.15	See Web	

PE-SR405FL Coax, 50 Ohm

Part No. PE3646LF		Cable Dia.	Attn. @1 GHz	Power@1GHz			
1 piece price shown. See web or call for volume pricing.							
6"	12"	18"	24"	36"	48"	Custom Len.	
\$87.60	\$92.57	\$97.53	\$102.55	\$112.54	\$122.48	See Web	

Standard Flexible Cable Assemblies

RG58C/U Coax, 50 Ohm							
Part No. PE3655LF		Cable Dia.	Attn. @1 GHz	Power@1GHz			
1 piece price shown. See web or call for volume pricing.							
6"	12"	18"	24"	36"	48"	Custom Len.	
\$57.62	\$57.62	\$57.97	\$58.33	\$59.03	\$59.74	See Web	

For Custom Lengths, Metric Lengths or Special Configurations, Please call (949) 261-1920



Free Shipping Available via UPS Ground to USA & Canada



Technical Support (866) 727-8376



Same-Day Shipping, Even Custom Cable Assemblies

Cable Assemblies

See Our Website For Current Pricing & Real-Time Stock Availability!

Cable Assemblies

See Our Website For Current Pricing & Real-Time Stock Availability!

RG58C/U Coax, 50 Ohm							
Part No.	PE3655				Cable Dia.	Attn. @1 GHz	Power@1GHz
1 piece price shown. See web or call for volume pricing.							
6"	12"	18"	24"	36"	48"	Custom Len.	
\$52.99	\$53.34	\$53.69	\$54.03	\$54.72	\$55.41	See Web	
RG142B/U Coax, 50 Ohm							
Part No.	PE3514				Cable Dia.	Attn. @1 GHz	Power@1GHz
1 piece price shown. See web or call for volume pricing.							
6"	6"	12"	12"	18"	18"	Custom Len.	
\$61.85	\$61.85	\$61.85	\$61.85	\$64.61	\$64.61	See Web	
RG174A/U Coax, 50 Ohm							
Part No.	PE3775LF				Cable Dia.	Attn. @1 GHz	Power@1GHz
1 piece price shown. See web or call for volume pricing.							
6"	12"	18"	24"	36"	48"	Custom Len.	
\$60.99	\$60.99	\$61.20	\$61.41	\$61.83	\$62.24	See Web	
RG174A/U Coax, 50 Ohm							
Part No.	PE3775				Cable Dia.	Attn. @1 GHz	Power@1GHz
1 piece price shown. See web or call for volume pricing.							
6"	12"	18"	24"	36"	48"	Custom Len.	
\$59.84	\$59.84	\$60.05	\$60.26	\$60.68	\$61.10	See Web	
RG178B/U Coax, 50 Ohm							
Part No.	PE3876				Cable Dia.	Attn. @1 GHz	Power@1GHz
1 piece price shown. See web or call for volume pricing.							
6"	12"	18"	24"	36"	48"	Custom Len.	
\$79.01	\$79.01	\$79.47	\$79.93	\$80.85	\$81.77	See Web	
RG188A/U Coax, 50 Ohm							
Part No.	PE3511				Cable Dia.	Attn. @1 GHz	Power@1GHz
1 piece price shown. See web or call for volume pricing.							
6"	12"	18"	24"	36"	48"	Custom Len.	
\$63.76	\$63.76	\$64.83	\$65.90	\$68.04	\$70.17	See Web	
RG188-DS Coax, 50 Ohm							
Part No.	PE3347				Cable Dia.	Attn. @1 GHz	Power@1GHz
1 piece price shown. See web or call for volume pricing.							
6"	12"	18"	24"	36"	48"	Custom Len.	
\$66.60	\$66.60	\$68.24	\$69.87	\$73.14	\$76.41	See Web	
RG223/U Coax, 50 Ohm							
Part No.	PE3428				Cable Dia.	Attn. @1 GHz	Power@1GHz
1 piece price shown. See web or call for volume pricing.							
6"	12"	18"	24"	36"	48"	Custom Len.	
\$58.01	\$58.01	\$59.40	\$60.80	\$63.59	\$66.38	See Web	
RG316/U Coax, 50 Ohm							
Part No.	PE3515				Cable Dia.	Attn. @1 GHz	Power@1GHz
1 piece price shown. See web or call for volume pricing.							
6"	12"	18"	24"	36"	48"	Custom Len.	
\$62.30	\$62.30	\$63.69	\$65.08	\$67.86	\$70.64	See Web	
RG316/U Coax, 50 Ohm							
Part No.	PE3515LF				Cable Dia.	Attn. @1 GHz	Power@1GHz
1 piece price shown. See web or call for volume pricing.							
6"	12"	18"	24"	36"	48"	Custom Len.	
\$63.49	\$63.49	\$64.89	\$66.28	\$69.06	\$71.84	See Web	
RG316-DS Coax, 50 Ohm							
Part No.	PE3987LF				Cable Dia.	Attn. @1 GHz	Power@1GHz
1 piece price shown. See web or call for volume pricing.							
6"	12"	18"	24"	36"	48"	Custom Len.	
\$64.98	\$64.98	\$66.39	\$67.79	\$70.59	\$73.39	See Web	
RG316-DS Coax, 50 Ohm							
Part No.	PE3987				Cable Dia.	Attn. @1 GHz	Power@1GHz
1 piece price shown. See web or call for volume pricing.							
6"	12"	18"	24"	36"	48"	Custom Len.	
\$63.76	\$63.76	\$65.16	\$66.57	\$69.36	\$72.16	See Web	
RG400/U Coax, 50 Ohm							
Part No.	PE3713				Cable Dia.	Attn. @1 GHz	Power@1GHz
1 piece price shown. See web or call for volume pricing.							
6"	12"	18"	24"	36"	48"	Custom Len.	
\$70.94	\$70.94	\$74.30	\$77.65	\$84.37	\$91.08	See Web	
Standard Semi-Rigid Cable Assemblies							
RG402/U Coax, 50 Ohm							
Part No.	PE3819				Cable Dia.	Attn. @1 GHz	Power@1GHz
1 piece price shown. See web or call for volume pricing.							
6"	12"	18"	24"	36"	48"	Custom Len.	
\$79.87	\$79.87	\$83.40	\$86.91	\$93.94	\$100.96	See Web	
Standard Flexible Cable Assemblies							

RG180B/U Coax, 95 Ohm							
Part No.	PE3141				Cable Dia.	Attn. @1 GHz	Power@1GHz
1 piece price shown. See web or call for volume pricing.							
6"	12"	18"	24"	36"	48"	Custom Len.	
\$62.26	\$62.26	\$64.19	\$66.11	\$69.95	\$73.80	See Web	
RG180B/U Coax, 95 Ohm							
Part No.	PE3141LF				Cable Dia.	Attn. @1 GHz	Power@1GHz
1 piece price shown. See web or call for volume pricing.							
6"	12"	18"	24"	36"	48"	Custom Len.	
\$62.26	\$62.26	\$64.19	\$66.11	\$69.95	\$73.80	See Web	

SMA MALE RIGHT ANGLE TO SMA FEMALE



Low Loss Flexible Cable Assemblies

PE-P142LL Coax, 50 Ohm							
Part No.	PE3C2305				Cable Dia.	Attn. @1 GHz	Power@1GHz
1 piece price shown. See web or call for volume pricing.							
12"	24"	36"	48"	60"	50CM	Custom Len.	
\$217.41	\$233.04	\$248.67	\$264.30	\$279.92	\$227.43	See Web	

SMA MALE RIGHT ANGLE TO SMA FEMALE BULKHEAD

SEE MOUNTING HOLE SECTION ON PAGE 259



Precision Formable Cable Assemblies

PE-SR405FL Coax, 50 Ohm							
Part No.	PE39420				Cable Dia.	Attn. @1 GHz	Power@1GHz
1 piece price shown. See web or call for volume pricing.							
6"	12"	18"	24"	36"	48"	Custom Len.	
\$48.98	\$48.98	\$48.98	\$54.13	\$59.27	-	See Web	

PE-SR405FLJ Coax, 50 Ohm							
Part No.	PE39434				Cable Dia.	Attn. @1 GHz	Power@1GHz
1 piece price shown. See web or call for volume pricing.							
6"	9"	12"	18"	24"	-	Custom Len.	
\$16.61	\$54.64	\$54.64	\$58.37	\$62.10	-	See Web	

Standard Flexible Cable Assemblies

RG58C/U Coax, 50 Ohm							
Part No.	PE3156LF				Cable Dia.	Attn. @1 GHz	Power@1GHz
1 piece price shown. See web or call for volume pricing.							
6"	12"	18"	24"	36"	48"	Custom Len.	
\$57.30	\$57.30	\$57.66	\$58.01	\$58.72	\$59.43	See Web	

RG178B/U Coax, 50 Ohm							
Part No.	PE3152				Cable Dia.	Attn. @1 GHz	Power@1GHz
1 piece price shown. See web or call for volume pricing.							
6"	12"	18"	24"	36"	48"	Custom Len.	
\$64.13	\$64.13	\$64.59	\$65.06	\$65.97	\$66.90	See Web	

RG316/U Coax, 50 Ohm							
Part No.	PE3836LF				Cable Dia.	Attn. @1 GHz	Power@1GHz
1 piece price shown. See web or call for volume pricing.							
6"	12"	18"	24"	36"	48"	Custom Len.	
\$64.50	\$64.50	\$65.89	\$67.29	\$70.06	\$72.84	See Web	

RG316/U Coax, 50 Ohm							
Part No.	PE3836				Cable Dia.	Attn. @1 GHz	Power@1GHz
1 piece price shown. See web or call for volume pricing.							
6"	12"	18"	24"	36"	48"	Custom Len.	
\$64.50	\$64.50	\$65.89	\$67.29	\$70.06	\$72.84	See Web	

RG316-DS Coax, 50 Ohm							
Part No.	PE34061				Cable Dia.	Attn. @1 GHz	Power@1GHz
1 piece price shown. See web or call for volume pricing.							
6"	12"	18"	24"	36"	48"	Custom Len.	
\$65.12	\$65.12	\$66.53	\$67.92	\$70.73	\$73.53	See Web	

Standard Semi-Rigid Cable Assemblies

For our complete selection of cable assemblies, please visit our website

PE-SR402AL Coax, 50 Ohm							
Part No. PE34297				Cable Dia.	Attn. @1 GHz	Power@1GHz	
1 piece price shown. See web or call for volume pricing.							
6"	12"	18"	24"	36"	48"	Custom Len.	52
\$61.25	\$65.64	\$70.04	\$74.42	\$83.20	\$91.98	See Web	

SMA MALE RIGHT ANGLE TO SMB PLUG



Standard Flexible Cable Assemblies

RG174A/U Coax, 50 Ohm							
Part No. PE33482				Cable Dia.	Attn. @1 GHz	Power@1GHz	
1 piece price shown. See web or call for volume pricing.							
12"	24"	36"	48"	60"	-	Custom Len.	53
\$59.24	\$59.66	\$60.08	\$60.49	\$60.91		See Web	

SMA MALE RIGHT ANGLE TO SMC PLUG RIGHT ANGLE



Standard Flexible Cable Assemblies

RG316/U Coax, 50 Ohm							
Part No. PE3740				Cable Dia.	Attn. @1 GHz	Power@1GHz	
1 piece price shown. See web or call for volume pricing.							
12"	24"	36"	48"	60"	72"	Custom Len.	54
\$57.94	\$60.86	\$63.78	\$66.70	\$69.62	\$72.54	See Web	

SMA MALE RIGHT ANGLE TO TNC MALE RIGHT ANGLE



Low Loss Flexible Cable Assemblies

PE-P142LL Coax, 50 Ohm							
Part No. PE3C1409				Cable Dia.	Attn. @1 GHz	Power@1GHz	
1 piece price shown. See web or call for volume pricing.							
12"	24"	36"	48"	60"	50CM	Custom Len.	55
\$292.91	\$308.53	\$324.16	\$339.79	\$355.41	\$302.92	See Web	

SMA MALE RIGHT ANGLE TO TNC FEMALE BULKHEAD

SEE MOUNTING HOLE SECTION ON PAGE 259



Standard Flexible Cable Assemblies

RG316/U Coax, 50 Ohm							
Part No. PE33073				Cable Dia.	Attn. @1 GHz	Power@1GHz	
1 piece price shown. See web or call for volume pricing.							
12"	24"	36"	48"	60"	-	Custom Len.	56
\$72.77	\$75.54	\$78.32	\$81.10	\$83.89		See Web	

SMA FEMALE TO FAKRA JACK

SEE FAKRA SPECIFICATION ON PAGE 261



Standard Flexible Cable Assemblies

PE-C100-LSZH Coax, 50 Ohm							
Part No. PE39349D				Cable Dia.	Attn. @1 GHz	Power@1GHz	
1 piece price shown. See web or call for volume pricing.							
12"	24"	36"	48"	60"	-	Custom Len.	57
\$35.40	\$36.56	\$37.73	\$38.88	\$40.04		See Web	

SMA FEMALE TO N MALE



Precision Flexible Cable Assemblies

PE-P141 Coax, 50 Ohm							
Part No. PE356				Cable Dia.	Attn. @1 GHz	Power@1GHz	
1 piece price shown. See web or call for volume pricing.							
12"	24"	36"	48"	60"	72"	Custom Len.	58
\$158.19	\$168.50	\$178.79	\$189.10	\$199.40	\$209.71	See Web	

SMA FEMALE TO SMA FEMALE



Standard Semi-Rigid Cable Assemblies

PE-047SR Coax, 50 Ohm							
Part No. PE3758				Cable Dia.	Attn. @1 GHz	Power@1GHz	
1 piece price shown. See web or call for volume pricing.							
6"	12"	18"	24"	36"	48"	Custom Len.	59
\$103.38	\$103.38	\$108.31	\$113.24	\$123.09	\$132.94	See Web	

RG405/U Coax, 50 Ohm

Part No. PE3109							
1 piece price shown. See web or call for volume pricing.				Cable Dia.	Attn. @1 GHz	Power@1GHz	
6"	12"	18"	24"	36"	48"	Custom Len.	60
\$60.36	\$60.36	\$63.67	\$66.97	\$73.58	\$80.20	See Web	

SMA FEMALE TO TNC MALE



Standard Flexible Cable Assemblies

LMR-195-FR Coax, 50 Ohm							
Part No. PE3W02435LF				Cable Dia.	Attn. @1 GHz	Power@1GHz	
1 piece price shown. See web or call for volume pricing.							
12"	24"	36"	48"	60"	50CM	Custom Len.	61
\$62.91	\$63.88	\$64.85	\$65.82	\$66.79	\$63.54	See Web	

SMA FEMALE BULKHEAD TO MCX PLUG RIGHT ANGLE

SEE MOUNTING HOLE SECTION ON PAGE 259



Precision Formable Cable Assemblies

PE-SR405FLJ Coax, 50 Ohm							
Part No. PE39435				Cable Dia.	Attn. @1 GHz	Power@1GHz	
1 piece price shown. See web or call for volume pricing.							
6"	9"	12"	18"	24"	-	Custom Len.	62
\$33.97	\$33.97	\$33.97	\$37.70	\$57.48		See Web	

SMA FEMALE BULKHEAD TO MMCX PLUG

SEE MOUNTING HOLE SECTION ON PAGE 259



Standard Flexible Cable Assemblies

RG316/U Coax, 50 Ohm							
Part No. PE35575				Cable Dia.	Attn. @1 GHz	Power@1GHz	
1 piece price shown. See web or call for volume pricing.							
12"	24"	36"	48"	60"	-	Custom Len.	63
\$52.80	\$55.59	\$58.37	\$61.15	\$63.92		See Web	

Cable Assemblies

See Our Website For Current Pricing & Real-Time Stock Availability!

For Custom Lengths, Metric Lengths or Special Configurations, Please call (949) 261-1920



Free Shipping Available
via UPS Ground
to USA & Canada



Technical Support
(866) 727-8376



Same-Day Shipping,
Even Custom
Cable Assemblies

For our complete selection of cable assemblies, please visit our website

SMA FEMALE BULKHEAD TO MMCX PLUG RIGHT ANGLE

SEE MOUNTING HOLE SECTION ON PAGE 259



Precision Formable Cable Assemblies

PE-SR405FL Coax, 50 Ohm

Part No. PE39422	Cable Dia.	Attn. @1GHz	Power@1GHz	
1 piece price shown. See web or call for volume pricing.				
6"	9"	12"	18"	24"
\$38.43	\$38.43	\$38.43	\$43.58	\$55.04
Custom Len. See Web				

Standard Formable Cable Assemblies

PE-SR405FLJ Coax, 50 Ohm

Part No. PE39436	Cable Dia.	Attn. @1GHz	Power@1GHz	
1 piece price shown. See web or call for volume pricing.				
6"	9"	12"	18"	24"
\$53.14	\$53.14	\$53.14	\$56.87	\$60.60
Custom Len. See Web				

Standard Flexible Cable Assemblies

RG178B/U Coax, 50 Ohm

Part No. PE3C3821	Cable Dia.	Attn. @1GHz	Power@1GHz	
1 piece price shown. See web or call for volume pricing.				
12"	24"	36"	48"	60"
\$59.37	\$60.36	\$61.35	\$62.34	\$63.33
Custom Len. See Web				

RG316/U Coax, 50 Ohm

Part No. PE3C1081	Cable Dia.	Attn. @1GHz	Power@1GHz	
1 piece price shown. See web or call for volume pricing.				
12"	24"	36"	48"	60"
\$56.26	\$59.18	\$62.10	\$65.02	\$67.94
Custom Len. See Web				

RG316/U Coax, 50 Ohm

Part No. PE34686	Cable Dia.	Attn. @1GHz	Power@1GHz	
1 piece price shown. See web or call for volume pricing.				
12"	24"	36"	48"	60"
\$54.64	\$57.42	\$60.20	\$62.97	\$65.76
Custom Len. See Web				

SMA FEMALE BULKHEAD TO SMP FEMALE

SEE MOUNTING HOLE SECTION ON PAGE 259



Standard Formable Cable Assemblies

PE-SR405FL Coax, 50 Ohm

Part No. PE3W00474LF	Cable Dia.	Attn. @1GHz	Power@1GHz	
1 piece price shown. See web or call for volume pricing.				
12"	24"	36"	48"	60"
\$56.87	\$67.46	\$78.06	\$88.66	\$99.26
Custom Len. See Web				

Standard Flexible Cable Assemblies

PE-P086 Coax, 50 Ohm

Part No. PE3C5233	Cable Dia.	Attn. @1GHz	Power@1GHz	
1 piece price shown. See web or call for volume pricing.				
12"	24"	36"	48"	60"
\$66.93	\$74.35	\$81.77	\$89.19	\$96.61
Custom Len. See Web				

SMA FEMALE BULKHEAD TO SMP FEMALE RIGHT ANGLE

SEE MOUNTING HOLE SECTION ON PAGE 259



Low Loss Flexible Cable Assemblies

LMR-100A-PVC Coax, 50 Ohm

Part No. PE3C3937	Cable Dia.	Attn. @1GHz	Power@1GHz	
1 piece price shown. See web or call for volume pricing.				
12"	24"	36"	48"	60"
\$47.15	\$47.86	\$48.57	\$49.28	\$49.99
Custom Len. See Web				

SMA FEMALE BULKHEAD TO UMCX PLUG RIGHT ANGLE

SEE MOUNTING HOLE SECTION ON PAGE 259



Standard Flexible Cable Assemblies

RG178B/U Coax, 50 Ohm

Part No. PE38299	Cable Dia.	Attn. @1GHz	Power@1GHz	
1 piece price shown. See web or call for volume pricing.				
3"	6"	9"	12"	18"
\$66.53	\$66.53	\$66.53	\$66.53	\$70.07
Custom Len. See Web				

SMA FEMALE BULKHEAD TO UMCX 2.5 PLUG

SEE MOUNTING HOLE SECTION ON PAGE 259



Standard Flexible Cable Assemblies

PE-113mm Coax, 50 Ohm

Part No. PE3CA1001	Cable Dia.	Attn. @1GHz	Power@1GHz	
1 piece price shown. See web or call for volume pricing.				
3"	6"	9"	12"	18"
\$14.28	\$12.38	\$11.21	\$12.38	\$12.38
Custom Len. See Web				

REVERSE POLARITY SMA FEMALE BULKHEAD TO MMCX PLUG RIGHT ANGLE

SEE MOUNTING HOLE SECTION ON PAGE 259



Standard Flexible Cable Assemblies

RG316/U Coax, 50 Ohm

Part No. PE34728LF	Cable Dia.	Attn. @1GHz	Power@1GHz	
1 piece price shown. See web or call for volume pricing.				
12"	24"	36"	48"	60"
\$59.39	\$62.31	\$65.23	\$68.15	\$71.07
Custom Len. See Web				

REVERSE POLARITY SMA FEMALE BULKHEAD TO HMCX32 1.2 PLUG

SEE MOUNTING HOLE SECTION ON PAGE 259



Standard Flexible Cable Assemblies

PE-81mm Coax, 50 Ohm

Part No. PE3CA1022	Cable Dia.	Attn. @1GHz	Power@1GHz	
1 piece price shown. See web or call for volume pricing.				
3"	6"	12"	-	-
\$12.93	\$12.93	\$12.38	-	-
Custom Len. See Web				

SMA FEMALE 2 HOLE FLANGE TO SMP FEMALE



Standard Semi-Rigid Cable Assemblies

PE-047SR Coax, 50 Ohm

Part No. PE3W05930	Cable Dia.	Attn. @1GHz	Power@1GHz	
1 piece price shown. See web or call for volume pricing.				
12"	24"	36"	48"	60"
\$86.89	\$97.23	\$107.57	\$117.91	\$128.25
Custom Len. See Web				

Cable Assemblies

See Our Website For Current Pricing & Real-Time Stock Availability!

*Coax Performance at 1 GHz Notes: Cable assembly max frequency may be lower than connector or coax max frequency

For our complete selection of cable assemblies, please visit our website

SMB PLUG TO BNC MALE



Standard Flexible Cable Assemblies

RG58C/U Coax, 50 Ohm

Part No. PE3242		Cable Dia.	Attn. @1 GHz	Power@1GHz
1 piece price shown. See web or call for volume pricing.				
12"	24"	36"	48"	60"
\$44.07	\$44.78	\$45.49	\$46.20	\$46.91

RG174A/U Coax, 50 Ohm

Part No. PE3C3318		Cable Dia.	Attn. @1 GHz	Power@1GHz
1 piece price shown. See web or call for volume pricing.				
12"	24"	36"	48"	60"
\$35.82	\$36.27	\$36.65	\$37.10	\$37.49

RG174A/U Coax, 50 Ohm

Part No. PE3C3318LF		Cable Dia.	Attn. @1 GHz	Power@1GHz
1 piece price shown. See web or call for volume pricing.				
12"	24"	36"	48"	60"
\$36.09	\$36.51	\$36.93	\$37.35	\$37.77

RG178B/U Coax, 50 Ohm

Part No. PE33825		Cable Dia.	Attn. @1 GHz	Power@1GHz
1 piece price shown. See web or call for volume pricing.				
12"	24"	36"	48"	60"
\$53.62	\$54.53	\$55.46	\$56.38	\$57.30

RG223/U Coax, 50 Ohm

Part No. PE3236		Cable Dia.	Attn. @1 GHz	Power@1GHz
1 piece price shown. See web or call for volume pricing.				
12"	24"	36"	48"	60"
\$39.72	\$42.51	\$45.29	\$48.08	\$50.88

SMB PLUG TO SMB PLUG



Standard Flexible Cable Assemblies

RG174A/U Coax, 50 Ohm

Part No. PE3853LF		Cable Dia.	Attn. @1 GHz	Power@1GHz
1 piece price shown. See web or call for volume pricing.				
12"	24"	36"	48"	60"
\$43.58	\$44.00	\$44.43	\$44.84	\$45.26

RG174A/U Coax, 50 Ohm

Part No. PE3853		Cable Dia.	Attn. @1 GHz	Power@1GHz
1 piece price shown. See web or call for volume pricing.				
12"	24"	36"	48"	60"
\$42.78	\$43.20	\$43.61	\$44.03	\$44.45

RG178B/U Coax, 50 Ohm

Part No. PE33165		Cable Dia.	Attn. @1 GHz	Power@1GHz
1 piece price shown. See web or call for volume pricing.				
12"	24"	36"	48"	60"
\$51.70	\$52.63	\$53.54	\$54.47	\$55.40

RG188A/U Coax, 50 Ohm

Part No. PE3587		Cable Dia.	Attn. @1 GHz	Power@1GHz
1 piece price shown. See web or call for volume pricing.				
12"	24"	36"	48"	60"
\$45.33	\$47.47	\$49.60	\$51.74	\$53.88

RG188A/U Coax, 50 Ohm

Part No. PE3587LF		Cable Dia.	Attn. @1 GHz	Power@1GHz
1 piece price shown. See web or call for volume pricing.				
12"	24"	36"	48"	60"
\$45.33	\$47.47	\$49.60	\$51.74	\$53.88

RG316/U Coax, 50 Ohm

Part No. PE3915LF		Cable Dia.	Attn. @1 GHz	Power@1GHz
1 piece price shown. See web or call for volume pricing.				
12"	24"	36"	48"	60"
\$45.34	\$48.12	\$50.90	\$53.68	\$56.46

RG316/U Coax, 50 Ohm

Part No. PE3915		Cable Dia.	Attn. @1 GHz	Power@1GHz
1 piece price shown. See web or call for volume pricing.				
12"	24"	36"	48"	60"
\$45.34	\$48.12	\$50.90	\$53.68	\$56.46

RG316-DS Coax, 50 Ohm

Part No. PE33704		Cable Dia.	Attn. @1 GHz	Power@1GHz
1 piece price shown. See web or call for volume pricing.				
12"	24"	36"	48"	60"
\$46.12	\$48.93	\$51.73	\$54.53	\$57.34

SMB PLUG TO SMB PLUG RIGHT ANGLE



Standard Flexible Cable Assemblies

RG174A/U Coax, 50 Ohm

Part No. PE33175LF		Cable Dia.	Attn. @1 GHz	Power@1GHz
1 piece price shown. See web or call for volume pricing.				
12"	24"	36"	48"	60"
\$54.22	\$54.65	\$55.06	\$55.48	\$55.90

SMB PLUG TO SMB JACK BULKHEAD

SEE MOUNTING HOLE SECTION ON PAGE 259



Standard Flexible Cable Assemblies

RG174A/U Coax, 50 Ohm

Part No. PE33674LF		Cable Dia.	Attn. @1 GHz	Power@1GHz
1 piece price shown. See web or call for volume pricing.				
12"	24"	36"	48"	60"
\$46.69	\$47.11	\$47.53	\$47.95	\$48.36

RG174A/U Coax, 50 Ohm

Part No. PE33674		Cable Dia.	Attn. @1 GHz	Power@1GHz
1 piece price shown. See web or call for volume pricing.				
12"	24"	36"	48"	60"
\$46.69	\$47.11	\$47.53	\$47.95	\$48.36

SMB PLUG RIGHT ANGLE TO SMB JACK BULKHEAD

SEE MOUNTING HOLE SECTION ON PAGE 259



Standard Flexible Cable Assemblies

RG316/U Coax, 50 Ohm

Part No. PE33675LF		Cable Dia.	Attn. @1 GHz	Power@1GHz
1 piece price shown. See web or call for volume pricing.				
12"	24"	36"	48"	60"
\$57.94	\$60.72	\$63.50	\$66.29	\$69.06

SMB JACK TO BNC MALE



Standard Flexible Cable Assemblies

RG174A/U Coax, 50 Ohm

Part No. PE3W01494LF		Cable Dia.	Attn. @1 GHz	Power@1GHz
1 piece price shown. See web or call for volume pricing.				
12"	24"	36"	48"	60"
\$34.67	\$35.20	\$35.74	\$36.27	\$36.80

SMC PLUG TO SMC PLUG



Standard Flexible Cable Assemblies

RG316/U Coax, 50 Ohm

Part No. PE3808LF		Cable Dia.	Attn. @1 GHz	Power@1GHz
1 piece price shown. See web or call for volume pricing.				
12"	24"	36"	48"	60"
\$46.20	\$48.98	\$51.75	\$54.53	\$57.31

For Custom Lengths, Metric Lengths or Special Configurations, Please call (949) 261-1920



Free Shipping Available via UPS Ground to USA & Canada



Technical Support (866) 727-8376



Same-Day Shipping, Even Custom Cable Assemblies

Cable Assemblies

See Our Website For Current Pricing & Real-Time Stock Availability!

For our complete selection of cable assemblies, please visit our website

SMC PLUG TO SMC PLUG RIGHT ANGLE



Standard Flexible Cable Assemblies

RG316/U Coax, 50 Ohm

Part No. PE33363LF		Cable Dia.	Attn. @1 GHz	Power@1GHz		
1 piece price shown. See web or call for volume pricing.		0.098" dia.	38 dB/100ft	160 W		
12"	24"	36"	48"	60"	72"	Custom Len.
\$57.17	\$59.95	\$62.72	\$65.51	\$68.29	\$71.07	See Web

SMC PLUG RIGHT ANGLE TO BNC MALE



Standard Flexible Cable Assemblies

RG174A/U Coax, 50 Ohm

Part No. PE3C1988		Cable Dia.	Attn. @1 GHz	Power@1GHz		
1 piece price shown. See web or call for volume pricing.		0.110" dia.	32 dB/100ft	17 W		
12"	24"	36"	48"	60"	72"	Custom Len.
\$45.01	\$45.55	\$46.09	\$46.63	\$47.17	\$47.71	See Web

SMP FEMALE TO SMP FEMALE



Standard Flexible Cable Assemblies

PE-P047 Coax, 50 Ohm

Part No. PE3C0757		Cable Dia.	Attn. @1 GHz	Power@1GHz		
1 piece price shown. See web or call for volume pricing.		0.056" dia.	35 dB/100ft	43 W		
12"	24"	36"	48"	60"	72"	Custom Len.
\$69.47	\$76.95	\$84.43	\$91.91	\$99.39	\$106.87	See Web

SMP FEMALE RIGHT ANGLE TO MMCX PLUG RIGHT ANGLE



Standard Formable Cable Assemblies

PE-SR405FLJ Coax, 50 Ohm

Part No. PE3C3221		Cable Dia.	Attn. @1 GHz	Power@1GHz		
1 piece price shown. See web or call for volume pricing.		0.098" dia.	20 dB/100ft	130 W		
12"	24"	36"	48"	60"	72"	Custom Len.
\$73.13	\$81.11	\$89.09	\$97.07	\$105.05	\$113.03	See Web

SMP FEMALE RIGHT ANGLE TO SMP FEMALE RIGHT ANGLE

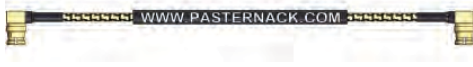

Standard Flexible Cable Assemblies

PE-P047 Coax, 50 Ohm

Part No. PE3C4969		Cable Dia.	Attn. @1 GHz	Power@1GHz		
1 piece price shown. See web or call for volume pricing.		0.056" dia.	35 dB/100ft	43 W		
12"	24"	36"	48"	60"	72"	Custom Len.
\$102.59	\$110.07	\$117.55	\$125.03	\$132.51	\$139.99	See Web

SSMB PLUG TO BNC MALE



Standard Flexible Cable Assemblies

RG316/U Coax, 50 Ohm

Part No. PE3C3408LF		Cable Dia.	Attn. @1 GHz	Power@1GHz		
1 piece price shown. See web or call for volume pricing.		0.102" dia.	38 dB/100ft	160 W		
12"	24"	36"	48"	60"	72"	Custom Len.
\$53.58	\$56.50	\$59.42	\$62.34	\$65.26	\$68.18	See Web

SSMB PLUG RIGHT ANGLE TO SSMB PLUG RIGHT ANGLE



Standard Flexible Cable Assemblies

RG178B/U Coax, 50 Ohm

Part No. PE3C4801		Cable Dia.	Attn. @1 GHz	Power@1GHz		
1 piece price shown. See web or call for volume pricing.		0.072" dia.	44 dB/100ft	55 W		
12"	24"	36"	48"	60"	72"	Custom Len.
\$52.51	\$53.50	\$54.49	\$55.48	\$56.47	\$57.46	See Web

TNC MALE TO BNC MALE



Standard Flexible Cable Assemblies

RG58C/U Coax, 50 Ohm

Part No. PE3497		Cable Dia.	Attn. @1 GHz	Power@1GHz		
1 piece price shown. See web or call for volume pricing.		0.195" dia.	20 dB/100ft	44 W		
12"	24"	36"	48"	60"	72"	Custom Len.
\$33.71	\$34.42	\$35.13	\$35.84	\$36.55	\$37.26	See Web

TNC MALE TO TNC MALE



Low Loss Test Flexible Cable Assemblies

PE-P300LL Coax, 50 Ohm

Part No. PE3334		Cable Dia.	Attn. @1 GHz	Power@1GHz		
1 piece price shown. See web or call for volume pricing.		0.300" dia.	5 dB/100ft	W		
12"	24"	36"	48"	60"	50CM	Custom Len.
\$302.25	\$327.21	\$352.18	\$377.15	\$402.10	\$318.25	See Web

PE-P142LL Coax, 50 Ohm

Part No. PE347		Cable Dia.	Attn. @1 GHz	Power@1GHz		
1 piece price shown. See web or call for volume pricing.		0.195" dia.	7 dB/100ft	W		
12"	24"	36"	48"	60"	50CM	Custom Len.
\$150.00	\$165.63	\$181.26	\$196.88	\$212.51	\$160.01	See Web

Standard Formable Cable Assemblies

PE-SR401FL Coax, 50 Ohm

Part No. PE34282		Cable Dia.	Attn. @1 GHz	Power@1GHz		
1 piece price shown. See web or call for volume pricing.		" dia.	8 dB/100ft	1400 W		
6"	12"	18"	24"	36"	48"	Custom Len.
\$164.18	\$164.18	\$171.60	\$179.01	\$193.83	\$208.66	See Web

Standard Flexible Cable Assemblies

RG58C/U Coax, 50 Ohm

Part No. PE3394		Cable Dia.	Attn. @1 GHz	Power@1GHz		
1 piece price shown. See web or call for volume pricing.		0.195" dia.	20 dB/100ft	44 W		
12"	18"	24"	30"	36"	48"	Custom Len.
\$34.29	\$34.64	\$35.00	\$35.35	\$35.70	\$36.41	See Web

RG58C/U Coax, 50 Ohm

Part No. PE3394LF		Cable Dia.	Attn. @1 GHz	Power@1GHz		
1 piece price shown. See web or call for volume pricing.		0.195" dia.	20 dB/100ft	44 W		
12"	18"	24"	30"	36"	48"	Custom Len.
\$34.29	\$34.64	\$35.00	\$35.35	\$35.70	\$36.41	See Web

RG142B/U Coax, 50 Ohm

Part No. PE3544		Cable Dia.	Attn. @1 GHz	Power@1GHz		
1 piece price shown. See web or call for volume pricing.		0.195" dia.	13 dB/100ft	650 W		
12"	24"	36"	48"	60"	72"	Custom Len.
\$44.20	\$49.71	\$55.22	\$60.74	\$66.26	\$71.78	See Web

RG214/U Coax, 50 Ohm

Part No. PE3435		Cable Dia.	Attn. @1 GHz	Power@1GHz		
1 piece price shown. See web or call for volume pricing.		0.425" dia.	7 dB/100ft	190 W		
12"	24"	36"	48"	60"	72"	Custom Len.
\$86.61	\$93.66	\$100.71	\$107.76	\$114.81	\$121.87	See Web

Cable Assemblies

See Our Website For Current Pricing & Real-Time Stock Availability!

*Coax Performance at 1 GHz Notes: Cable assembly max frequency may be lower than connector or coax max frequency

For our complete selection of cable assemblies, please visit our website

RG223/U Coax, 50 Ohm							
Part No. PE3414				Cable Dia.	Attn. @1 GHz	Power@1GHz	
1 piece price shown. See web or call for volume pricing.							
12"	24"	36"	48"	0.210" dia.	13 dB/100ft	53 W	12
\$41.46	\$44.25	\$47.04	\$49.83	\$52.62	\$55.41	See Web	

RG393/U Coax, 50 Ohm							
Part No. PE33185				Cable Dia.	Attn. @1 GHz	Power@1GHz	
1 piece price shown. See web or call for volume pricing.							
12"	24"	36"	48"	0.390" dia.	8 dB/100ft	1700 W	13
\$86.78	\$101.66	\$116.55	\$131.44	\$146.32	-	See Web	

RG400/U Coax, 50 Ohm							
Part No. PE3608				Cable Dia.	Attn. @1 GHz	Power@1GHz	
1 piece price shown. See web or call for volume pricing.							
12"	24"	36"	48"	0.195" dia.	15 dB/100ft	650 W	14
\$52.90	\$59.61	\$66.31	\$73.02	\$79.73	\$86.44	See Web	

RG400/U Coax, 50 Ohm							
Part No. PE3608LF				Cable Dia.	Attn. @1 GHz	Power@1GHz	
1 piece price shown. See web or call for volume pricing.							
12"	24"	36"	48"	0.195" dia.	15 dB/100ft	650 W	15
\$52.90	\$59.61	\$66.31	\$73.02	\$79.73	\$86.44	See Web	

RG59B/U Coax, 75 Ohm							
Part No. PE3402				Cable Dia.	Attn. @1 GHz	Power@1GHz	
1 piece price shown. See web or call for volume pricing.							
12"	18"	24"	30"	0.242" dia.	12 dB/100ft	77 W	16
\$36.02	\$36.49	\$36.94	\$37.40	\$37.87	\$38.79	See Web	

RG179B/U Coax, 75 Ohm							
Part No. PE3430				Cable Dia.	Attn. @1 GHz	Power@1GHz	
1 piece price shown. See web or call for volume pricing.							
12"	24"	36"	48"	0.100" dia.	25 dB/100ft	200 W	17
\$61.03	\$63.32	\$65.59	\$67.86	\$70.14	\$72.41	See Web	

TNC MALE TO TNC MALE RIGHT ANGLE



Low Loss Test Flexible Cable Assemblies

PE-P142LL Coax, 50 Ohm							
Part No. PE3436				Cable Dia.	Attn. @1 GHz	Power@1GHz	
1 piece price shown. See web or call for volume pricing.							
12"	24"	36"	48"	0.195" dia.	7 dB/100ft	W	18
\$230.35	\$245.97	\$261.60	\$277.23	\$292.85	\$240.36	See Web	

TNC MALE RIGHT ANGLE TO TNC MALE RIGHT ANGLE



Low Loss Flexible Cable Assemblies

PE-P142LL Coax, 50 Ohm							
Part No. PE3C1144				Cable Dia.	Attn. @1 GHz	Power@1GHz	
1 piece price shown. See web or call for volume pricing.							
12"	24"	36"	48"	0.195" dia.	7 dB/100ft	W	19
\$313.61	\$329.24	\$344.85	\$360.48	\$376.11	\$323.62	See Web	

TNC FEMALE BULKHEAD TO TNC MALE

SEE MOUNTING HOLE SECTION ON PAGE 259



Standard Flexible Cable Assemblies

PE-P142LL Coax, 50 Ohm							
Part No. PE3438				Cable Dia.	Attn. @1 GHz	Power@1GHz	
1 piece price shown. See web or call for volume pricing.							
12"	24"	36"	48"	0.195" dia.	10 dB/100ft	W	20
\$191.47	\$207.09	\$222.72	\$238.35	\$253.97	\$201.49	See Web	

REVERSE POLARITY TNC FEMALE BULKHEAD TO MMCX PLUG

SEE MOUNTING HOLE SECTION ON PAGE 259



Standard Flexible Cable Assemblies

LMR-100A-PVC Coax, 50 Ohm							
Part No. PE3W01379				Cable Dia.	Attn. @1 GHz	Power@1GHz	
1 piece price shown. See web or call for volume pricing.							
12"	24"	36"	48"	0.110" dia.	dB/100ft	W	21
\$75.71	\$76.41	\$77.12	\$77.83	\$78.54	\$76.16	See Web	

REVERSE POLARITY TNC FEMALE BULKHEAD TO UMCX PLUG

SEE MOUNTING HOLE SECTION ON PAGE 259



Standard Flexible Cable Assemblies

RG178B/U Coax, 50 Ohm							
Part No. PE38303				Cable Dia.	Attn. @1 GHz	Power@1GHz	
1 piece price shown. See web or call for volume pricing.							
12"	3"	6"	9"	0.072" dia.	dB/100ft	W	22
\$51.55	\$51.55	\$51.55	\$51.55	\$51.55	\$55.09	See Web	

UHF MALE TO BNC MALE



Standard Flexible Cable Assemblies

RG58C/U Coax, 50 Ohm							
Part No. PE3057				Cable Dia.	Attn. @1 GHz	Power@1GHz	
1 piece price shown. See web or call for volume pricing.							
12"	24"	36"	48"	0.195" dia.	20 dB/100ft	44 W	23
\$33.71	\$34.42	\$35.13	\$35.84	\$36.55	\$37.26	See Web	

UHF MALE TO UHF MALE



Standard Flexible Cable Assemblies

RG393/U Coax, 50 Ohm							
Part No. PE33267				Cable Dia.	Attn. @1 GHz	Power@1GHz	
1 piece price shown. See web or call for volume pricing.							
12"	24"	36"	48"	0.390" dia.	8 dB/100ft	1700 W	24
\$65.12	\$80.01	\$94.89	\$109.78	\$124.67	\$139.55	See Web	

UMCX PLUG RIGHT ANGLE TO MMCX PLUG RIGHT ANGLE



Standard Flexible Cable Assemblies

RG178B/U Coax, 50 Ohm							
Part No. PE39078				Cable Dia.	Attn. @1 GHz	Power@1GHz	
1 piece price shown. See web or call for volume pricing.							
3"	6"	9"	12"	0.072" dia.	44 dB/100ft	78 W	25
\$61.74	\$61.74	\$61.74	\$61.74	\$65.29	\$68.83	See Web	

MCX PLUG TO 75 OHM BNC MALE



Standard Flexible Cable Assemblies

Continued on Next Page

Cable Assemblies

See Our Website For Current Pricing & Real-Time Stock Availability!

For Custom Lengths, Metric Lengths or Special Configurations, Please call (949) 261-1920



Free Shipping Available
via UPS Ground
to USA & Canada



Technical Support
(866) 727-8376



Same-Day Shipping,
Even Custom
Cable Assemblies

For our complete selection of cable assemblies, please visit our website

RG187A/U Coax, 75 Ohm							
Part No. PE3C5491				Cable Dia.	Attn. @1 GHz	Power@1GHz	26
1 piece price shown. See web or call for volume pricing.				0.102" dia.	25 dB/100ft	200 W	
12"	24"	36"	48"	60"	72"	Custom Len.	
\$46.11	\$49.68	\$53.25	\$56.82	\$60.39	\$63.96	See Web	

BNC MALE TO CUT LEAD SEXLESS



Standard Flexible Cable Assemblies

RG188A/U Coax, 50 Ohm							
Part No. PE3C3583				Cable Dia.	Attn. @1 GHz	Power@1GHz	27
1 piece price shown. See web or call for volume pricing.				0.110" dia.	26 dB/100ft	160 W	
12"	24"	36"	48"	60"	72"	Custom Len.	
\$24.62	\$26.95	\$29.28	\$31.61	\$33.94	\$36.27	See Web	

SMA FEMALE TO TRIMMED LEAD SEXLESS



Standard Semi-Rigid Cable Assemblies

PE-020SR Coax, 50 Ohm							
Part No. PE3CA1104				Cable Dia.	Attn. @1 GHz	Power@1GHz	28
1 piece price shown. See web or call for volume pricing.				0.020" dia.	dB/100ft	W	
3"	6"	9"	12"	-	-	Custom Len.	
\$91.67	\$108.51	\$125.36	\$142.20	-	-	See Web	

PE-SR047TN Coax, 50 Ohm

Part No. PE3CA1106				Cable Dia.	Attn. @1 GHz	Power@1GHz	29
1 piece price shown. See web or call for volume pricing.				0.047" dia.	dB/100ft	W	
3"	6"	9"	12"	-	-	Custom Len.	
\$35.34	\$40.38	\$45.43	\$50.46	-	-	See Web	

75 OHM BNC MALE TO 75 OHM BNC MALE



Standard Flexible Cable Assemblies

RG6A/U Coax, 75 Ohm							
Part No. PE33197				Cable Dia.	Attn. @1 GHz	Power@1GHz	30
1 piece price shown. See web or call for volume pricing.				0.332" dia.	11 dB/100ft	125 W	
12"	24"	36"	48"	60"	72"	Custom Len.	
\$41.06	\$43.63	\$46.21	\$48.79	\$51.37	\$53.94	See Web	

RG59B/U Coax, 75 Ohm

Part No. PE33188				Cable Dia.	Attn. @1 GHz	Power@1GHz	31
1 piece price shown. See web or call for volume pricing.				0.242" dia.	12 dB/100ft	77 W	
12"	24"	36"	48"	60"	72"	Custom Len.	
\$36.78	\$37.70	\$38.62	\$39.55	\$40.48	\$41.39	See Web	

RG179B/U Coax, 75 Ohm

Part No. PE33401LF				Cable Dia.	Attn. @1 GHz	Power@1GHz	32
1 piece price shown. See web or call for volume pricing.				0.100" dia.	25 dB/100ft	200 W	
12"	24"	36"	48"	60"	72"	Custom Len.	
\$46.00	\$48.28	\$50.55	\$52.83	\$55.11	\$57.38	See Web	

RG179B/U Coax, 75 Ohm

Part No. PE33401				Cable Dia.	Attn. @1 GHz	Power@1GHz	33
1 piece price shown. See web or call for volume pricing.				0.100" dia.	25 dB/100ft	200 W	
12"	24"	36"	48"	60"	72"	Custom Len.	
\$46.00	\$48.28	\$50.55	\$52.83	\$55.11	\$57.38	See Web	

PE-B150 Coax, 75 Ohm

Part No. PE33405				Cable Dia.	Attn. @1 GHz	Power@1GHz	34
1 piece price shown. See web or call for volume pricing.				0.150" dia.	20 dB/100ft	25 W	
12"	24"	36"	48"	60"	72"	Custom Len.	
\$54.87	\$55.63	\$56.39	\$57.16	\$57.92	\$58.68	See Web	

75 OHM BNC MALE TO 75 OHM BNC MALE RIGHT ANGLE



Standard Flexible Cable Assemblies

RG179B/U Coax, 75 Ohm							
Part No. PE33412				Cable Dia.	Attn. @1 GHz	Power@1GHz	35
1 piece price shown. See web or call for volume pricing.				0.100" dia.	25 dB/100ft	200 W	
12"	24"	36"	48"	60"	72"	Custom Len.	
\$56.61	\$58.88	\$61.16	\$63.43	\$65.70	\$67.99	See Web	

75 OHM BNC MALE TO 75 OHM BNC FEMALE



Standard Flexible Cable Assemblies

RG6A/U Coax, 75 Ohm							
Part No. PE33437				Cable Dia.	Attn. @1 GHz	Power@1GHz	36
1 piece price shown. See web or call for volume pricing.				0.332" dia.	11 dB/100ft	125 W	
12"	24"	36"	48"	60"	72"	Custom Len.	
\$75.72	\$78.29	\$80.86	\$83.44	\$86.02	\$88.60	See Web	

75 OHM BNC MALE TO 75 OHM BNC FEMALE BULKHEAD

SEE MOUNTING HOLE SECTION ON PAGE 259



Standard Flexible Cable Assemblies

RG59B/U Coax, 75 Ohm							
Part No. PE33179LF				Cable Dia.	Attn. @1 GHz	Power@1GHz	37
1 piece price shown. See web or call for volume pricing.				0.242" dia.	12 dB/100ft	77 W	
12"	24"	36"	48"	60"	72"	Custom Len.	
\$52.25	\$53.18	\$54.10	\$55.02	\$55.95	\$56.87	See Web	

75 OHM BNC MALE RIGHT ANGLE TO 75 OHM BNC MALE RIGHT ANGLE



Standard Flexible Cable Assemblies

RG187A/U Coax, 75 Ohm							
Part No. PE33434				Cable Dia.	Attn. @1 GHz	Power@1GHz	38
1 piece price shown. See web or call for volume pricing.				0.110" dia.	25 dB/100ft	200 W	
12"	24"	36"	48"	60"	72"	Custom Len.	
\$66.95	\$70.23	\$73.50	\$76.78	\$80.05	\$83.32	See Web	

75 OHM F MALE TO 75 OHM BNC MALE



Standard Flexible Cable Assemblies

RG6-CATV Coax, 75 Ohm							
Part No. PE36145				Cable Dia.	Attn. @1 GHz	Power@1GHz	39
1 piece price shown. See web or call for volume pricing.				0.275" dia.	7 dB/100ft	7 W	
12"	24"	36"	48"	60"	72"	Custom Len.	
\$29.79	\$30.79	\$31.79	\$32.79	\$33.78	\$34.78	See Web	

Cable Assemblies

See Our Website For Current Pricing & Real-Time Stock Availability!

*Coax Performance at 1 GHz Notes: Cable assembly max frequency may be lower than connector or coax max frequency

For our complete selection of cable assemblies, please visit our website

75 OHM F MALE TO 75 OHM F MALE



Standard Flexible Cable Assemblies

RG59B/U Coax, 75 Ohm

Part No. PE36141		Cable Dia.	Attn. @1 GHz	Power@1GHz	40	
1 piece price shown. See web or call for volume pricing.		0.242" dia.	12 dB/100ft	77 W		
12"	24"	36"	48"	60"	72"	Custom Len.
\$14.88	\$15.81	\$16.73	\$17.66	\$18.58	\$19.50	See Web

75 OHM F MALE TO 75 OHM F FEMALE BULKHEAD

SEE MOUNTING HOLE SECTION ON PAGE 259



Standard Flexible Cable Assemblies

RG179B/U Coax, 75 Ohm

Part No. PE36344		Cable Dia.	Attn. @1 GHz	Power@1GHz	41	
1 piece price shown. See web or call for volume pricing.		0.100" dia.	25 dB/100ft	200 W		
12"	24"	36"	48"	60"	72"	Custom Len.
\$25.89	\$28.17	\$30.44	\$32.71	\$35.00		See Web

75 OHM MINI SMB PLUG TO 75 OHM BNC MALE



Standard Flexible Cable Assemblies

RG179B/U Coax, 75 Ohm

Part No. PE34703		Cable Dia.	Attn. @1 GHz	Power@1GHz	42	
1 piece price shown. See web or call for volume pricing.		0.100" dia.	25 dB/100ft	200 W		
12"	24"	36"	48"	60"	72"	Custom Len.
\$48.58	\$50.87	\$53.14	\$55.41	\$57.69	\$59.96	See Web

75 OHM MINI SMB PLUG TO 75 OHM MINI SMB PLUG



Standard Flexible Cable Assemblies

RG179B/U Coax, 75 Ohm

Part No. PE34683LF		Cable Dia.	Attn. @1 GHz	Power@1GHz	43	
1 piece price shown. See web or call for volume pricing.		0.100" dia.	25 dB/100ft	200 W		
12"	24"	36"	48"	60"	72"	Custom Len.
\$50.49	\$52.76	\$55.03	\$57.31	\$59.59	\$61.86	See Web

PE-B159-BL Coax, 75 Ohm

Part No. PE38139		Cable Dia.	Attn. @1 GHz	Power@1GHz	44	
1 piece price shown. See web or call for volume pricing.		0.159" dia.	11 dB/100ft	W		
12"	24"	36"	48"	60"	72"	Custom Len.
\$66.40	\$67.84	\$69.28	\$70.73	\$72.16	\$73.61	See Web

75 OHM N MALE TO 75 OHM BNC MALE



Standard Flexible Cable Assemblies

RG6A/U Coax, 75 Ohm

Part No. PE33341		Cable Dia.	Attn. @1 GHz	Power@1GHz	45	
1 piece price shown. See web or call for volume pricing.		0.332" dia.	11 dB/100ft	125 W		
12"	24"	36"	48"	60"	72"	Custom Len.
\$51.06	\$53.65	\$56.22	\$58.79	\$61.37	\$63.94	See Web

RG179B/U Coax, 75 Ohm

Part No. PE3398LF		Cable Dia.	Attn. @1 GHz	Power@1GHz	46	
1 piece price shown. See web or call for volume pricing.		0.100" dia.	25 dB/100ft	200 W		
12"	24"	36"	48"	60"	72"	Custom Len.
\$53.40	\$55.70	\$58.01	\$60.27	\$62.58	\$64.84	See Web

75 OHM SMB PLUG TO 75 OHM BNC MALE



Standard Flexible Cable Assemblies

RG179B/U Coax, 75 Ohm

Part No. PE33247LF		Cable Dia.	Attn. @1 GHz	Power@1GHz	47	
1 piece price shown. See web or call for volume pricing.		0.100" dia.	25 dB/100ft	200 W		
12"	24"	36"	48"	60"	72"	Custom Len.
\$50.23	\$52.51	\$54.78	\$57.05	\$59.34	\$61.61	See Web

75 OHM SMB JACK TO 75 OHM F FEMALE BULKHEAD

SEE MOUNTING HOLE SECTION ON PAGE 259



Standard Flexible Cable Assemblies

RG179B/U Coax, 75 Ohm

Part No. PE3W04888		Cable Dia.	Attn. @1 GHz	Power@1GHz	48	
1 piece price shown. See web or call for volume pricing.		0.100" dia.	29 dB/100ft	W		
12"	24"	36"	48"	60"	72"	Custom Len.
\$55.76	\$58.15	\$60.54	\$62.93	\$65.32	\$67.71	See Web

75 OHM TNC MALE TO 75 OHM BNC MALE



Standard Flexible Cable Assemblies

RG6A/U Coax, 75 Ohm

Part No. PE35350LF		Cable Dia.	Attn. @1 GHz	Power@1GHz	49	
1 piece price shown. See web or call for volume pricing.		0.332" dia.	11 dB/100ft	125 W		
12"	24"	36"	48"	60"	72"	Custom Len.
\$45.20	\$47.77	\$50.35	\$52.93	\$55.50	\$58.08	See Web

BNC TWINAX PLUG TO BNC TWINAX PLUG



Standard Flexible Cable Assemblies

RG108A/U Coax, 78 Ohm

Part No. PE3480LF		Cable Dia.	Attn. @1 GHz	Power@1GHz	50	
1 piece price shown. See web or call for volume pricing.		0.235" dia.	26 dB/100ft	30 W		
18"	36"	60"	90"	120"	180"	Custom Len.
\$77.79	\$81.23	\$85.79	\$91.51	\$97.22	\$108.65	See Web

RG108A/U Coax, 78 Ohm

Part No. PE3480		Cable Dia.	Attn. @1 GHz	Power@1GHz	51	
1 piece price shown. See web or call for volume pricing.		0.235" dia.	26 dB/100ft	30 W		
18"	36"	60"	90"	120"	180"	Custom Len.
\$92.23	\$95.66	\$100.23	\$105.96	\$111.67	\$123.10	See Web

3/4" -20 TWINAX MALE TO 3/4" -20 TWINAX MALE



Standard Flexible Cable Assemblies

PE-S330 Coax, 100 Ohm

Part No. PE3930LF		Cable Dia.	Attn. @1 GHz	Power@1GHz	52	
1 piece price shown. See web or call for volume pricing.		0.330" dia.	dB/100ft	W		
18"	36"	60"	90"	120"	180"	Custom Len.
\$75.12	\$78.96	\$84.06	\$90.45	\$96.84	\$109.61	See Web

Cable Assemblies

See Our Website For Current Pricing & Real-Time Stock Availability!

For Custom Lengths, Metric Lengths or Special Configurations, Please call (949) 261-1920



Free Shipping Available via UPS Ground to USA & Canada



Technical Support (866) 727-8376



Same-Day Shipping, Even Custom Cable Assemblies

PASTERNAK ENTERPRISES -- REACH PRODUCT COMPLIANCE PROGRAM

What is REACH Compliance?

Regulation (EC) No. 1907/2006 of the European Parliament and of the Council of 18 December 2006 is commonly referred to as REACH (Registration, Evaluation, Authorization, and Restriction of Chemicals). The REACH regulation became effective on June 1, 2007 to streamline and improve the former legislative framework for chemicals available in the European Union (EU) and European Economic Area (EEA) countries.

The objective of REACH is to improve protection of human health and the protection of the environment from the exposure to chemicals. REACH compliance is mandatory for products manufactured in, or imported into the European Union (EU).

As outlined by the REACH regulation, any organization manufacturing, importing, using or placing a substance, mixture, article or product on the EU market will be responsible for ensuring that the component substances are in compliance with REACH regulations.

Determining REACH Compliance of Pasternack Products:

Pasternack Enterprises does not currently either manufacture or import any chemical substances into the EU on their own or in articles (products) in quantities of 1 ton or more per year. In addition, products imported by Pasternack Enterprises' customers do not contain chemical substances intended to be released during the normal and reasonably foreseeable conditions of the product's use as defined by the REACH regulation and existing guidance.

However, under REACH, there is an obligation to ensure that articles do not contain <0.1% by weight of Substances of Very High Concern (SVHCs). SVHCs are substances that may cause cancer or other serious health or environmental effects and thus face restriction or outright bans, and are listed in a regularly-updated 'Candidate list'. The current Candidate list can be downloaded from the European Chemicals Agency (ECHA) website:

http://echa.europa.eu/chem_data/authorisation_process/candidate_list_table_en.asp

For each part that has been found to comply with the REACH SVHC reporting requirements, we show an indication of compliance adjacent to the part number using this symbol:



All products displaying this symbol on our website are assured to contain no SVHCs as defined by the Candidate List displayed on the Pasternack REACH certificate. When you locate the product you need on our website, please click on the "Product ID or Part Number". You will see the "REACH symbol" for the specific part. Click on this symbol to view the Certificate of REACH Compliance (printable if needed) for the specific product as well as the applicable ECHA SVHC Candidate list Date.

Pasternack Enterprises - REACH Product Compliance Program:

At Pasternack Enterprises, we recognize our responsibility as a worldwide supplier of RF, Microwave and Fiber Optic Products subject to the REACH regulations. We have completed a comprehensive effort internally and with our supply chain to determine the REACH compliance of our products. You will find our Reach Symbol adjacent to all products on our website that have been determined by Pasternack and our supply chain to contain less than 0.1% by weight of the REACH substances. You will also see the applicable ECHA SVHC Candidate List Date. "Please refer to our website at www.Pasternack.com.

The Pasternack Enterprises REACH Product Compliance Program is implemented in accordance with Regulation No. 1907/2006 of the European Parliament and the Council of 18 December 2006. Pasternack has implemented a REACH compliance program to address this legislation. Pasternack Enterprises does not currently either manufacture or import any chemical substances into the EU on their own or in articles (products) in quantities of 1 ton or more per year. In addition, products imported by Pasternack Enterprises' customers do not contain chemical substances intended to be released during the normal and reasonably foreseeable conditions of the product's use as defined by the REACH regulation and existing guidance. Thus, Pasternack Enterprises does not currently have a direct REACH obligation to pre-register substances. Pasternack's REACH Product Compliance is determined by a certification from our supply chain. A Pasternack product is deemed to be REACH compliant when it does not contain Substances of Very High Concern (SVHCs) beyond the specified concentration limits of less than 0.1% by weight as outlined in REACH 1907/2006/EU regulation.

Need More Information?

If you have questions regarding REACH Product Certification on Pasternack's products, please contact the Pasternack REACH Compliance Team via email at REACH@Pasternack.com or by calling Toll-Free within North America at 1-866-PASTERNAK (1-866-727-8376). International customers, please call +1-949-261-1920.



Free Shipping Available
via UPS Ground
to USA & Canada



Technical
Support
(866) 727-8376



Same-Day Shipping,
Even Custom
Cable Assemblies

PASTERNAK ENTERPRISES ROHS COMPLIANCE PROGRAM

Lead-free solder is now available for all cable assemblies upon request or online at www.Pasternack.com.

Our Commitment

At Pasternack, we recognize our responsibility as an international supplier of RF, Microwave and Millimeter wave electronics products to maintain a comprehensive RoHS compliance program. We are fully committed to offering RoHS compliance on the majority of our products and posting accurate RoHS compliance status for all of our products. We have posted this data on our website so that it can be easily found for each part number within our on-line catalogue.

What is RoHS Compliance?

The European Union set forth the RoHS (Restriction of Hazardous Substances) Directive to establish environmental guidelines and legislation to reduce the presence of six (6) materials deemed hazardous to the environment. To comply, products entering the EU must not have a homogeneous presence of these materials above the following levels by weight percentage

- Lead (Pb) < 0.1%
- Mercury (Hg) < 0.1%
- Cadmium (Cd) < 0.01%
- Hexavalent Chromium (CrVI) < 0.1%
- Polybrominated Biphenyls (PBB) < 0.1%
- Polybrominated Diphenyl Esters (PBDE) < 0.1%

Determining Pasternack RoHS Compliance

All products displaying this symbol on our website have been certified as RoHS Compliant. Click on the symbol to view the Certificate of RoHS Compliance for that product.



Lead Free Cable Assemblies

Many of Pasternack's cable assemblies are built with leaded solder. If so, the part will not be RoHS compliant and a certificate will not be found on the product page for that assembly. However, many of these assemblies can be brought into RoHS compliance through the use of Lead-Free solder. If the assembly you desire is not RoHS compliant, there may be a RoHS compliant version with a similar part number. If so, you will see an "LF" contained in the basic part number (example PE3067LF-24 is the lead free version of PE3067-24). Please note: the "LF" designation is used only when the base part number is not RoHS compliant. Many assemblies do not include "LF" and are compliant because they are only offered in a RoHS compliant configuration.

For More Information

Please direct any questions to Pasternack Enterprises Technical Support via email at TechSupport@Pasternack.com or by calling Toll-Free within North America at 1-866-PASTERNAK (866-727-8376). International customers, please use +1-949-261-1920.

MAILING LIST CHANGES

If you receive more than one RF Product Guide with the same name and address, please notify Pasternack and pass the RF Product Guide along to a friend. Also, if you do not require multiple copies to the same company address, contact a sales representative to verify and modify your mailing information. A forms-based communications method to add, delete or modify mailing information is available at www.pasternack.com. By clicking "Contact Us", and then clicking "Remove Name from Mailing List", you may complete the form to request a change to your mailing preferences. In addition, by clicking "RF Product Guide", and then clicking "Request a Printed RF Product Guide", you may add your contact information to our mailing list. Please note service opt-in and opt-out options located on the forms. Alternatively, you may mail, email, telephone or fax Pasternack your request.

PLACING YOUR ORDER

► **By Telephone: 866-PASTERNAK (866-727-8376)
US & Canada, or 949-261-1920**

Our friendly sales representatives are ready to serve you from 5:00am to 5:30pm Pacific Standard Time (PST), Monday through Friday. For the most efficient service, please have ready a list of quantities and part numbers and, if paying by credit card, your MasterCard, VISA, American Express or Discover card. Note: Calls may be recorded or monitored for quality and training purposes.

► **By Fax: 949-261-7451**

Our fax lines can be accessed 7 days a week, 24 hours a day. Orders received after 4:00pm PST will be promptly processed and shipped the next business day. Please include your daytime phone number and/or email address in case we have any questions about your order.

► **By Internet: www.Pasternack.com
or Email: sales@pasternack.com**

Order online 7 days a week, 24 hours a day using our online ordering system. Just search for the items you want and add them to your shopping cart. Internet orders entered after 4:00 pm PST will be promptly processed and shipped the next business day.

► **By Mail: Simply Mail Your Order To:
Pasternack Enterprises, Inc.
17802 Fitch
PO Box 16759
Irvine, CA 92623-6759 USA**

International customers, please see "International Orders" below for additional information.

Terms and Conditions of Sale:

The following from Pasternack's Binding Terms and Conditions of Sale are provided for your convenience. A complete documentation of the Binding Terms and Conditions of Sale may be found in the back of the RF Product Guide, or on Pasternack's website at <http://www.pasternack.com/t-terms-of-sale.aspx>. Any questions or clarifications may be answered by contacting Customer Service at (+1) 949-261-1920 or by any of the methods listed above.

No Minimum Order Requirement

Ground Freight is Free:

On UPS Ground orders, there is no charge for shipping for USA & Canada orders of \$100.00 or greater. Otherwise, shipping or freight charges and insurance will be paid by the customer. All sales are made FOB Point (as defined by the INCOTERMS 2000) in Irvine, CA USA. Shipping or freight charges from Pasternack's Irvine, CA factory are prepaid and added to the invoice or billed collect.

Same-Day Shipment:

Same-day shipment will apply to orders received Monday through Friday, prior to 4:00pm PST.

- All UPS air and surface options
- All FedEx air options (with an approved account number)
- Most other shipping options, including DHL (with an approved account number) and USPS

Counter-to-Counter Shipping:

For your urgent order requiring our fastest shipping method, we will place your order on the next available flight from Santa Ana-Orange County John Wayne International Airport (Airport code: SNA) to the destination you specify. Please call for details.

Payment Terms:

Pasternack offers a number of convenient payment methods:

For United States customers, we offer check, money order, MasterCard, VISA, American Express, Discover, and C.O.D. as well as open account credit to qualified institutions and businesses. Payment must be made in US Dollars.

For Canadian customers, we offer all of the above payment options except C.O.D.

For International customers, see **International Orders**.

Open Account Credit:

Net 30 Days terms are available to businesses, schools and agencies subject to credit approval. Approval can begin by submitting a completed Credit Application, which can be found online at:

www.Pasternack.com/t-CreditApplication.aspx

EFT/Wire Transfers:

Please contact us for details. We will inform you of the total amount which will include shipping charges and any applicable wire transfer fees. Orders will not be accepted until funds have been received in full.

WELLS FARGO BANK
420 Montgomery St.
San Francisco, CA 94104 USA
Account Number: 4270 0000 0000 0000 1
Routing Number: 121000248
SWIFT Number: WFBUS6S

International Orders:

In addition to the United States and its territories, Pasternack accepts international orders. All orders of international origin are exported from the US in accordance with the Export Administration Regulations. Diversion contrary to US Law is prohibited. Please see Pasternack's Binding Terms and Conditions of Sale for full details.

Pasternack has international distributors for the following countries:

Africa: Namibia, South Africa

Asia-Pacific: Australia, China PRC, India, Indonesia, Japan, Malaysia, New Zealand, Singapore, South Korea, Thailand

Europe: Austria, Belgium, Czech Republic, Denmark, Finland, France, Germany, Ireland, Italy, Kazakhstan, Luxembourg, Netherlands, Norway, Poland, Portugal, Russia, Slovakia, Spain, Sweden, Switzerland, Turkey, United Kingdom

Middle East: Israel

South America: Brazil

To access their complete contact information, please see our International Distributors section in this RF Product Guide. (inside back cover)

International Shipping Charges:

Shipping or freight charges and insurance will be paid by the customer. All sales are made FOB Point (as defined by the INCOTERMS 2000) in Irvine, CA USA.

We ship orders by UPS, FedEx (with an approved account number), or DHL (with approved account number) with delivery in 2 to 3 days to most locations worldwide.

International Taxes and Duties:

Customer is responsible for duties and taxes.



Free Shipping Available
via UPS Ground
to USA & Canada



Technical
Support
(866) 727-8376



Same-Day Shipping,
Even Custom
Cable Assemblies

BINDING TERMS AND CONDITIONS OF SALE

The following are the terms and conditions ("Terms and Conditions") for the sale of products ("Products") by Pasternack Enterprises, Inc. ("Pasternack") to Pasternack's customers ("Customers"). Please read this agreement carefully. Any different or additional terms set forth in customer's purchase order or similar communication are objected to and shall not be binding on the company unless a separate agreement has been signed by an authorized officer of the company. By placing an order for products from the company, or by accepting delivery of the products described on the applicable packing slip, bill of lading and/or invoice received with the products, you agree to be bound by and accept these terms and conditions of sale.

1. ACCEPTANCE AND CANCELLATION OF ORDERS

All orders are subject to acceptance by Pasternack in writing by a duly authorized agent of Pasternack; any written acknowledgement of receipt of an order shall not, in and of itself, constitute such acceptance. Orders accepted and processed by Pasternack may not be cancelled by Customer except as covered by the Limited Warranty. All sales are final. Cable Assemblies and Non-Standard Products are also Non-Cancelable/Non-Refundable ("NC/NR"). Non-Standard Parts are defined as Products which are special orders, custom orders, orders for non-standard products, products not customarily in stock or orders for value-added products. In the event of cancellation or other withdrawal of an order for any reason and without limiting any other remedy which Pasternack may have as a result of such cancellation or other withdrawal, reasonable cancellation or restocking charges, which shall include all expenses then incurred and commitments made by Pasternack, shall be paid by Customer to Pasternack. Customer requests to reschedule are subject to acceptance by Pasternack in its sole discretion. Orders may not be rescheduled after the order has been submitted by Pasternack to the shipment carrier.

2. PRICES

Orders are billed at the prices (in US dollars) in effect at the time of shipment. Prices will be as specified by Pasternack and will be applicable for the period specified in Pasternack's quote. If no period is specified, quoted prices will be applicable for thirty (30) days. The website contains the most current pricing and is the price reference for orders. Pricing included in the catalog is for reference only and final pricing is determined by the published website price. Prices shown in the RF Product Guide (Catalog) and on the website are subject to change without notice. Prices are exclusive of taxes, impositions and other charges, including: sales, use, excise, value added and similar taxes or charges imposed by any government authority, international shipping charges, forwarding agent's and broker's fees, bank fees, consular fees, document fees and import duties.

3. TERMS OF PAYMENT

All payments must be in US Dollars, or will be converted to US Dollars using the available exchange rate at the time of purchase.

MasterCard, VISA, Discover, and American Express credit cards, purchase cards and major bank debit cards are accepted. Payment via net thirty (30) days is available to businesses, schools and agencies or as otherwise specified by Pasternack subject to credit approval.

For International Orders

MasterCard, VISA, and American Express credit cards are accepted. Payment via open credit account with Net thirty (30) days may be established for companies having three U.S. references accepted to Pasternack. Prepaid Wire Transfer: You can wire the funds to our bank. We will contact you with the total amount, which will include shipping charges and a \$40 wire transfer fee. Orders will not be accepted until funds have been received in full and the Purchase Order (PO) has been received. Customer is responsible for sales, use, excise, value added and similar taxes or charges imposed by any government authority, international shipping charges, forwarding agent's and broker's fees, bank fees, consular fees, document fees and import duties.

4. SALES TAX

California residents are required to remit sales tax. Pasternack does not remit sales tax to states other than California. Any sales tax due that is not collected by Pasternack is the responsibility of the customer.

5. TOLERANCES

All coaxial cable assemblies displayed in the Pasternack catalog and website have a standard cable length tolerance of $\pm 1.5\%$ or 3/8 inches (0.375"), whichever is greater. Cable Assemblies in excess of this tolerance factor are eligible for repair and/or replacement under the terms of the Pasternack Limited Warranty.

6. DELIVERY AND TITLE

Shipping or freight charges and insurance will be paid by the customer. All sales are made FCA Shipping Point (as defined by the INCOTERMS 2000) in Irvine, CA USA. Shipping or freight charges from Pasternack's Irvine, CA facility are prepaid and added to the invoice, or billed collect. Subject to Pasternack's right of stoppage in transit, delivery of the Products to the carrier will constitute delivery to Customer and title and risk of loss will pass to Customer. Pasternack will make reasonable efforts to initiate shipment and schedule delivery as close as possible to Customer's requested delivery date(s). Customer acknowledges that delivery dates provided by Pasternack are estimates only and that Pasternack will not be liable for failure to deliver on such dates. Selection of the carrier and delivery route will be made by Pasternack unless specifically designated by Customer. Pasternack reserves the right to make deliveries in installments. Delay in delivery of one installment will not entitle Customer to cancel any other installment(s). Delivery of any installment of Products within thirty (30) days after the date requested will constitute a

timely delivery. Delivery of a quantity that varies from the quantity specified shall not relieve Customer of the obligation to accept delivery and pay for the Products delivered.

7. PASTERNAK'S LIMITED WARRANTY

All products are covered by a LIMITED WARRANTY for a period of one (1) year from the date of shipment when purchased from Pasternack Enterprises, Inc. Customer must notify Pasternack within one (1) year from date of shipment of any defective product. An approved Return Material Authorization (RMA) number must first be obtained from Pasternack prior to the return of any merchandise to Pasternack for inspection under warranty. Shipping charges for all materials returned under this Limited Warranty are to be prepaid by the Customer. This warranty is limited to the original purchaser. Pasternack's liability arising out of any sale of products to Customer is expressly limited to either (1) Credit for the purchase price paid by Customer for such products (without interest), or (2) Repair and/or replacement of such products, found to be defective after inspection by Pasternack, and such remedies shall be exclusive and in lieu of all others. THIS WARRANTY IS IN LIEU OF ANY AND ALL OTHER WARRANTIES, WHETHER ORAL, WRITTEN, EXPRESSED, IMPLIED OR STATUTORY. ANY IMPLIED WARRANTIES OF MERCHANTABILITY, FITNESS FOR A PARTICULAR PURPOSE AND NON-INFRINGEMENT ARE HEREBY DISCLAIMED. Further, no warranty will apply if the Product has been subject to misuse, neglect, accident or modification, or has been soldered or altered in any way.

All returns must be shipped to: Pasternack Enterprises, Inc.
17802 Fitch
Irvine, CA 92614 USA

8. LIMITATION OF LIABILITIES

In no event shall Pasternack be liable for any special, incidental or consequential damages of any nature including, but not limited to, damages resulting from loss of profit or revenue, recall costs, claims for service interruptions or failure to supply downtime, testing, installations or removal costs, costs of substitute products, property damage, personal injury, death or legal expenses. Customer's recovery from Pasternack for any claim shall not exceed the purchase price paid by Customer for the goods, irrespective of the nature of the claim, whether in warrant, contract or otherwise. CUSTOMER SHALL INDEMNIFY, DEFEND AND HOLD PASTERNAK HARMLESS FROM ANY CLAIMS brought by any party regarding products supplied by Pasternack and incorporated into the customer's product.

9. STATEMENTS AND ADVICE

If statements or advice, technical or otherwise, are offered or given to Customer, such statements or advice will be deemed to be given as an accommodation to Customer and without charge and Pasternack shall have no responsibility or liability for the content or use of such statements or advice.

10. EXPORT CONTROL AND EMBARGOES

Products purchased or received under these Terms and Conditions are subject to export control and economic sanctions laws, restrictions, regulations and orders of the United States. Customer agrees to comply with all applicable export control laws, restrictions and regulations of the United States and shall not export, or transfer for the purpose of re-export, any product to any embargoed country or region, including but not limited to Cuba, the Crimean Region of Ukraine, Iran, North Korea, Sudan, and Syria, or to any denied, blocked, or designated person or entity as mentioned in any such United States or foreign law or regulation. Customer represents and warrants that it is not on the Denied Persons, Specially Designated Nationals or Debarred Persons List (as identified by the U.S. Treasury Office of Foreign Asset Control (OFAC) and by the U.S. Department of Commerce, Bureau of Industry and Security (BIS), or any other United States list of prohibited persons; is not owned or controlled by any person that is on one of those lists, or is otherwise prohibited by United States or other law from purchasing the products or services hereunder. Customer shall be solely responsible to obtain any license to export, re-export or import as may be required. Customer also agrees that it will not use these products in connection with the proliferation of weapons of mass destruction, including missiles, nuclear, chemical or biological weapons.

11. GENERAL

The Terms and Conditions may not be modified or cancelled without Pasternack's written agreement. Accordingly, goods furnished and services rendered by Pasternack are sold only on the terms and conditions stated herein. The Terms and Conditions will be governed by and construed in accordance with the laws of the State of California and the applicable laws of the United States of America. If Customer chooses to access the Pasternack website from outside the United States, Customer does so on their own initiative and is responsible for compliance with all applicable local laws.

12. INTELLECTUAL PROPERTY

The drawings, text, product depictions, logos, content, product descriptions, and organization and taxonomy of Pasternack's RF Product Guide and website and of the described content within the RF Product Guide and website are proprietary to Pasternack and protected by intellectual property laws, including but not limited to United States Copyright law and United States Trademark law. Pasternack owns copyrights in these referenced works as well as the selection, arrangement, coordination and structure of the arranged content and works within their RF Product Guide and website. Use of the RF Product Guide/website does not give you any right to modify, reproduce, transmit, publish, publicly display, adapt, or create derivative works or in any way exploit any of the materials and content of Pasternack's RF Product Guide or website.

WARNING: Products in this catalog can expose you to chemicals including phthalates, which are known to the State of California to cause cancer and birth defects or other reproductive harm. For more information, go to www.P65Warnings.ca.gov. For specific products impacted, please visit www.pasternack.com.

50-OHM CONVERSION TABLE

(dBm - volts- watts)

dBm	V	Po
+53	100.0	200W
+50	70.7	100W
+49	64.0	80W
+48	58.0	64W
+47	50.0	50W
+46	44.5	40W
+45	40.0	32W
+44	32.5	25W
+43	32.0	20W
+42	28.0	16W
+41	26.2	12.5W
+40	22.5	10W
+39	20.0	8W
+38	18.0	6.4W
+37	16.0	5W
+36	14.1	4W
+35	12.5	3.2W
+34	11.5	2.5W
+33	10.0	2W
+32	9.0	1.6W
+31	8.0	1.25W
+30	7.10	1.0W
+29	6.40	800 mW
+28	5.80	640 mW
+27	5.00	500 mW
+26	4.45	400 mW
+25	4.00	320 mW
+24	3.55	250 mW
+23	3.20	200 mW
+22	2.80	160 mW
+21	2.52	125 mW
+20	2.25	100 mW
+19	2.00	80 mW
+18	1.80	64 mW
+17	1.60	50 mW
+16	1.41	40 mW
+15	1.25	32 mW
+14	1.15	25 mW
+13	1.00	20 mW
+12	0.90	16 mW
+11	0.80	12.5 mW
+10	0.71	10 mW
+9	0.64	8 mW
+8	0.58	6.4 mW
+7	0.50	5 mW
+6	0.45	4 mW
+5	0.40	3.2 mW
+4	0.36	2.5 mW
+3	0.32	2.0 mW

dBm	V	Po
+2	0.28	1.6 mW
+1	0.25	1.25 mW
0	0.23	1.0 mW
-1	0.20	.80 mW
-2	0.18	.64 mW
-3	0.16	.50 mW
-4	0.14	.40 mW
-5	0.13	.32 mW
-6	0.12	.25 mW
-7	0.10	.20 mW
-8	0.09	.16 mW
-9	0.08	.125 mW
-10	0.07	.10 mW
-11	0.06	
-12	0.06	
-13	0.05	
-14	0.05	
-15	0.04	
-16	0.0355	
dBm	mV	Po
-17	31.5	
-18	28.5	
-19	25.1	
-20	22.5	.01 mW
-21	20.0	
-22	17.9	
-23	15.9	
-24	14.1	
-25	12.8	
-26	11.5	
-27	10.0	
-28	8.9	
-29	8.0	
-30	7.1	.001 mW
-31	6.25	
-32	5.8	
-33	5.0	
-34	4.5	
-35	4.0	
-36	3.5	
-37	3.2	
-38	2.85	
-39	2.5	
-40	2.25	.1 μ W
-41	2.0	
-42	1.8	
-43	1.6	
-44	1.4	
-45	1.25	

dBm	mV	Po
-46	1.18	
-47	1.0	
-48	0.9	
-49	0.8	
-50	0.71	.01 μ W
-51	0.64	
-52	0.57	
-53	0.5	
-54	0.45	
-55	0.4	
-56	0.351	
-57	0.32	
-58	0.286	
-59	0.251	
-60	0.225	.001 μ W
-61	0.2	
-62	0.18	
-63	0.16	
-64	0.141	
dBm	μ V	Po
-65	128	
-66	115	
-67	100	
-68	90	
-69	80	
-70	71	.1 nW
-71	65	
-72	58	
-73	50	
-74	45	
-75	40	
-76	35	
-77	32	
-78	29	
-79	25	
-80	22.5	.01 nW
-81	20	
-82	18	
-83	16	
-84	11.1	
-85	12.9	
-86	11.5	
-87	10.0	
-88	9.0	
-89	8.0	
-90	7.1	.001 nW
-91	6.1	
-92	5.75	
-93	5.0	

dBm	μ V	Po
-94	4.5	
-95	4.0	
-96	3.51	
-97	3.2	
-98	2.9	
-99	2.51	
-100	2.25	.1 pW
-101	2.0	
-102	1.8	
-103	1.6	
-104	1.41	
-105	1.27	
-106	1.18	
dBm	nV	Po
-107	1000	
-108	900	
-109	800	
-110	710	.01 pW
-109	640	
-112	580	
-113	500	
-114	450	
-115	400	
-116	355	
-117	825	
-118	285	
-119	251	
-120	225	.001 pW
-121	200	
-122	180	
-123	160	
-124	141	
-125	128	
-126	117	
-127	100	
-128	90	
-129	80	
-130	71	.1 fW
-131	61	
-132	58	
-133	50	
-134	45	
-135	40	
-136	35	
-137	33	
-138	29	
-139	25	
-140	23	.01 fW



Free Shipping Available
via UPS Ground to
USA & Canada



Technical
Support
(866) 727-8376



Same-Day Shipping,
Even Custom
Cable Assemblies

RETURN LOSS CONVERSION TABLE

Return Loss (dBm)	VSWR	Return Loss (dBm)	VSWR	Return Loss (dBm)	VSWR	Return Loss (dBm)	VSWR	Return Loss (dBm)	VSWR
46.064	1.01	13.842	1.51	9.485	2.01	7.327	2.51	5.999	3.01
40.086	1.02	13.708	1.52	9.428	2.02	7.294	2.52	5.970	3.02
36.607	1.03	13.577	1.53	9.372	2.03	7.262	2.53	5.956	3.03
34.151	1.04	13.449	1.54	9.317	2.04	7.230	2.54	5.935	3.04
32.256	1.05	13.324	1.55	9.262	2.05	7.198	2.55	5.914	3.05
30.714	1.06	13.201	1.56	9.208	2.06	7.167	2.56	5.893	3.06
29.417	1.07	13.081	1.57	9.155	2.07	7.135	2.57	5.872	3.07
28.299	1.08	12.964	1.58	9.103	2.08	7.105	2.58	5.852	3.08
27.318	1.09	12.849	1.59	9.051	2.09	7.074	2.59	5.832	3.09
26.444	1.10	12.736	1.60	8.999	2.10	7.044	2.60	5.811	3.10
25.658	1.11	12.625	1.61	8.949	2.11	7.014	2.61	5.791	3.11
24.943	1.12	12.518	1.62	8.899	2.12	6.984	2.62	5.771	3.12
24.289	1.13	12.412	1.63	8.849	2.13	6.954	2.63	5.751	3.13
23.686	1.14	12.308	1.64	8.800	2.14	6.925	2.64	5.732	3.14
23.127	1.15	12.207	1.65	8.752	2.15	6.896	2.65	5.712	3.15
22.607	1.16	12.107	1.66	8.705	2.16	6.867	2.66	5.693	3.16
22.120	1.17	12.009	1.67	8.657	2.17	6.839	2.67	5.674	3.17
21.664	1.18	11.913	1.68	8.611	2.18	6.811	2.68	5.654	3.18
21.234	1.19	11.818	1.69	8.565	2.19	6.783	2.69	5.635	3.19
20.828	1.20	11.725	1.70	8.519	2.20	6.755	2.70	5.617	3.20
20.443	1.21	11.634	1.71	8.474	2.21	6.728	2.71	5.598	3.21
20.079	1.22	11.545	1.72	8.430	2.22	6.700	2.72	5.579	3.22
19.732	1.23	11.457	1.73	8.386	2.23	6.673	2.73	5.561	3.23
19.401	1.24	11.370	1.74	8.342	2.24	6.646	2.74	5.542	3.24
19.085	1.25	11.285	1.75	8.299	2.25	6.620	2.75	5.524	3.25
18.783	1.26	11.202	1.76	8.257	2.26	6.594	2.76	5.506	3.26
18.493	1.27	11.120	1.77	8.215	2.27	6.567	2.77	5.488	3.27
18.216	1.28	11.039	1.78	8.173	2.28	6.541	2.78	5.470	3.28
17.949	1.29	10.960	1.79	8.138	2.29	6.516	2.79	5.452	3.29
17.690	1.30	10.881	1.80	8.091	2.30	6.490	2.80	5.435	3.30
17.445	1.31	10.804	1.81	8.051	2.31	6.465	2.81	5.417	3.31
17.207	1.32	10.729	1.82	8.011	2.32	6.440	2.82	5.400	3.32
16.977	1.33	10.654	1.83	7.972	2.33	6.415	2.83	5.383	3.33
16.755	1.34	10.581	1.84	7.933	2.34	6.390	2.84	5.365	3.34
16.540	1.35	10.509	1.85	7.894	2.35	6.366	2.85	5.348	3.35
16.332	1.36	10.437	1.86	7.856	2.36	6.341	2.86	5.331	3.36
16.131	1.37	10.367	1.87	7.818	2.37	6.317	2.87	5.315	3.37
15.936	1.38	10.298	1.88	7.781	2.38	6.293	2.88	5.298	3.38
15.747	1.39	10.230	1.89	7.744	2.39	6.270	2.89	5.281	3.39
15.563	1.40	10.163	1.90	7.707	2.40	6.246	2.90	5.265	3.40
15.385	1.41	10.097	1.91	7.671	2.41	6.223	2.91	5.248	3.41
15.211	1.42	10.032	1.92	7.635	2.42	6.200	2.92	5.232	3.42
15.043	1.43	9.968	1.93	7.599	2.43	6.177	2.93	5.216	3.43
14.879	1.44	9.904	1.94	7.564	2.44	6.154	2.94	5.200	3.44
14.719	1.45	9.842	1.95	7.529	2.45	6.131	2.95	5.184	3.45
14.564	1.46	9.780	1.96	7.494	2.46	6.109	2.96	5.168	3.46
14.412	1.47	9.720	1.97	7.460	2.47	6.086	2.97	5.152	3.47
14.264	1.48	9.660	1.98	7.426	2.48	6.064	2.98	5.137	3.48
14.120	1.49	9.601	1.99	7.393	2.49	6.042	2.99	5.121	3.49
13.979	1.50	9.542	2.00	7.360	2.50	6.021	3.00	5.105	3.50

MOUNTING HOLES

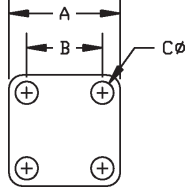

CODE	A	B	C
A01	.500	.340	.102
A02	.687	.500	.109
A03	.687	.500	#3-56 TAP
A04	.687	.500	.125
A05	1.000	.718	.125
A06	.750	.531	.140
A07	.750	.531	.125
A08	1.190	.906	.125
A09	.687	.500	#4-40 TAP
A10	.687	.500	.136
A11	1.250	.975	.147
A12	2.000	1.440	.257
A13	1.000	.718	.141
A14	1.000	.718	.144
A15	.687	.500	.104
A16	.750	.531	.136
A17	.375	.232	.067
A18	.625	.437	.094
A19	1.000	.718	#6-32 TAP
A20	.500	.340	#2-56 TAP
A21	1.250	.975	.142
A22	.375	.232	.093

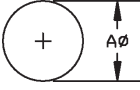

CODE	A
F01	.250
F02	.500
F03	.630
F04	1.200
F05	.380
F06	.450
F07	.200
F08	.362
F09	.220
F10	.317
F11	4.83mm
F12	.390

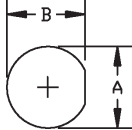

CODE	A	B
B01	.195	.177
B02	.250	.235
B03	.330	.295
B04	.380	.350
B05	.440	.410
B06	.512	.480
B07	.760	.720
B08	.565	.537
B09	.314	.296
B10	.140	.126
B11	.695	.655
B12	.625	.575
B13	.405	.361
B14	.277	.252
B15	.630	.596
B16	.317	.285
B17	.284	.268

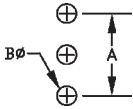

CODE	A	B
J01	.200	.046

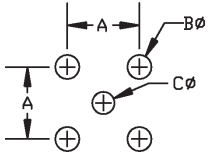

CODE	A	B	C
D01	.200	.067	.062
D02	.200	.067	.046
D03	.100	.031	.031
D04	.200	.052	.052
D05	.260	.067	.043
D06	.200	.052	.047
D07	.200	.055	.043
D08	.200	.067	.035
D09	.200	.055	.028
D10	.200	.055	.035
D11	.320	.091	.031
D12	.400	.062	.062
D13	.320	.091	.091
D14	.340	.091	.043
D15	.164	.067	.091
D16	.500	.126	.440
D17	.380	.083	.043

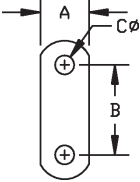

CODE	A	B	C
C01	.223	.481	.102
C02	.260	.481	.102
C03	.192	.328	.067
C04	.640	1.000	.125
C05	.275	.481	.102
C06	.230	.354	.067
C07	.188	.328	.093

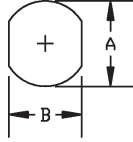

CODE	A	B
G01	.640	.546
G02	.380	.340
G03	.765	.712
G04	.362	.323
G05	.236	.197
G06	.217	.177
G07	.380	.310
G08	1.161	1.000

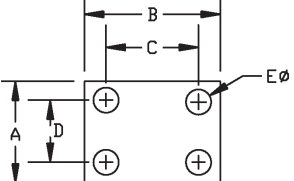

CODE	A	B	C	D	E
E01	.375	.500	.340	.222	.093

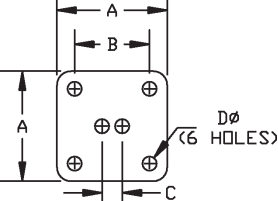

CODE	A	B	C	D
H01	.687	.500	.125	.045



Free Shipping Available
via UPS Ground to
USA & Canada



Technical
Support
(866) 727-8376



Same-Day Shipping,
Even Custom
Cable Assemblies

CONNECTOR IDENTIFIER

SPECIFICATIONS SHOWN ARE INTENDED FOR IDENTIFICATION PURPOSES ONLY











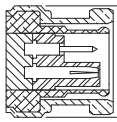
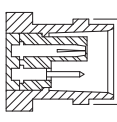
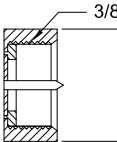
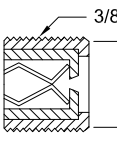
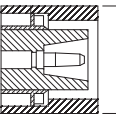
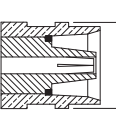
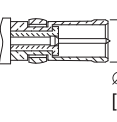
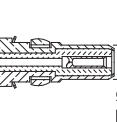
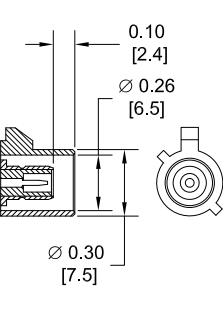
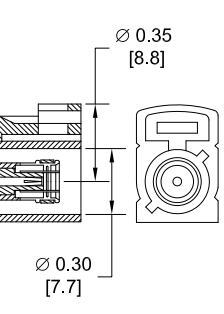





1.0/2.3 SLIDE ON	PLUG	
	JACK	
1.85 mm**	MALE	
	FEMALE	
2.4 mm**	MALE	
	FEMALE	
2.92 mm*	MALE	
	FEMALE	
3.5 mm*	MALE	
	FEMALE	
7 mm	MALE	
	FEMALE	
1.6/56	PLUG	
	JACK	
3/4-20 TWINAX	MALE	
	FEMALE	
10 - 32	MALE	
	FEMALE	
BANANA	PLUG	
	JACK	
BNC	MALE	
	FEMALE	
REVERSE POLARITY BNC	MALE	
	FEMALE	
75 OHM BNC	MALE	
	FEMALE	

*SMA, 2.92mm, & 3.5mm CONNECTORS WILL MATE MECHANICALLY & ELECTRICALLY TO EACH OTHER.

**1.85mm & 2.4mm CONNECTORS WILL MATE MECHANICALLY & ELECTRICALLY TO EACH OTHER.

CONNECTOR IDENTIFIER

SPECIFICATIONS SHOWN ARE INTENDED FOR IDENTIFICATION PURPOSES ONLY

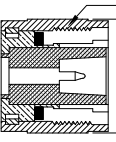
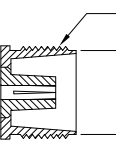
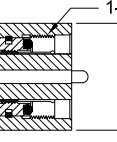
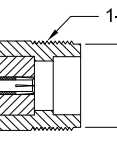
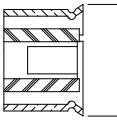
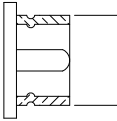
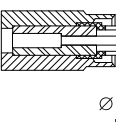
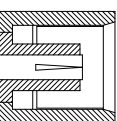
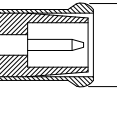
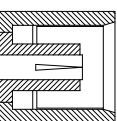
BNC TWINAX	PLUG	 Ø 0.57" [14.5mm]				
	JACK	 Ø 0.44" [11.1mm]				
F	MALE	 3/8-32 7/16 HEX				
	FEMALE	 3/8-32 Ø 0.34 [8.5]				
C	MALE	 Ø 0.75" [19.1mm]				
	FEMALE	 Ø 0.60" [15.2mm]				
D SUBMINIATURE	PLUG	 Ø 0.19" [4.8mm]				
	RECEPTACLE	 Ø 0.15" [3.9mm]				
FAKRA	PLUG	 0.10 [2.4] Ø 0.26 [6.5] Ø 0.30 [7.5]				
	JACK	 Ø 0.35 [8.8] Ø 0.30 [7.7]				
FAKRA	COMPLETE KEY CODE INFO	CODE	JACK	PLUG	COLOR	APPLICATION
		A			BLACK	RADIO WITH PHANTOM SUPPLY
		B			WHITE	RADIO WITHOUT PHANTOM SUPPLY
		C			BLUE	GPS: TELEMATICS OR NAVIGATION
D			BORDEAUX	GSM: CELLULAR PHONE		
H			VIOLET	GPS: TELEMATICS AND NAVIGATION		
I			BEIGE	BLUETOOTH		
K			CURRY	RADIO WITH I.F. OUTPUT (ANTENNA DIVERSITY)		
Z			WATER BLUE	NEUTRAL CODING		
GR874	MALE	 3/4-20 Ø 0.90 [22.9]				
	FEMALE	 3/4-20 Ø 0.67 [17.1]				
LC	MALE	 1-1/4-18 1-1/2 HEX				
	FEMALE	 1-1/4-18 Ø 1.17 [29.6]				
UMCX	PLUG	 Ø 0.10 [2.5]				
	JACK	 Ø 0.08 [2.0]				
MC-CARD	PLUG	 Ø 0.087 [2.2]				
	JACK	 Ø 0.20 [5.0]				
MCX	PLUG	 Ø 0.15 [3.7]				
	JACK	 Ø 0.20 [5.0]				



CONNECTOR IDENTIFIER

SPECIFICATIONS SHOWN ARE INTENDED FOR IDENTIFICATION PURPOSES ONLY

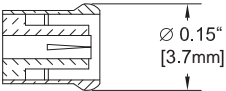
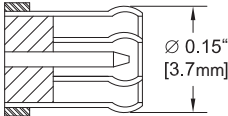
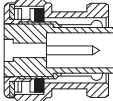
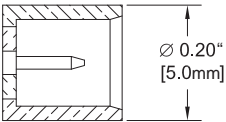
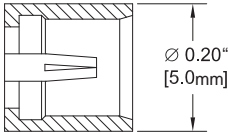
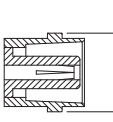
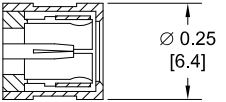
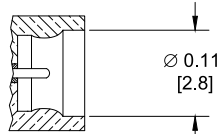
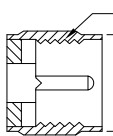
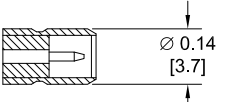
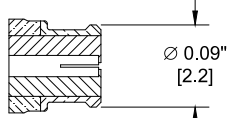
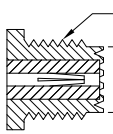
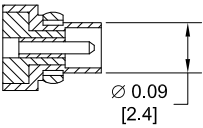
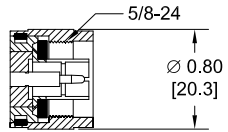
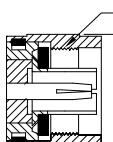
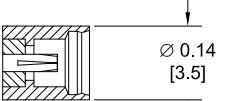
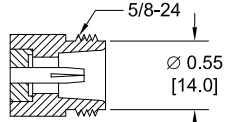
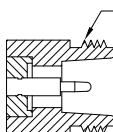
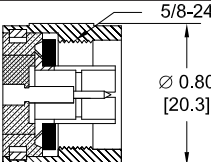
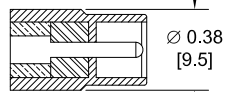
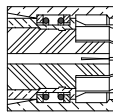
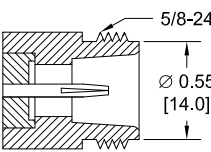
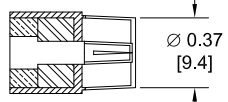
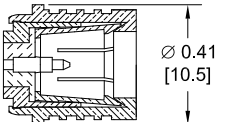
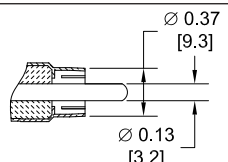
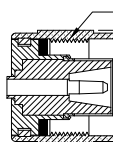
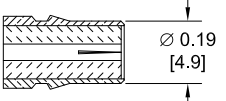
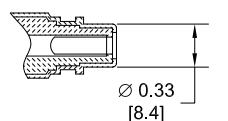
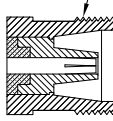
REVERSE POLARITY MCX	PLUG	 Ø 0.15" [3.7mm]	75 OHM MCX	PLUG	 Ø 0.15" [3.7mm]	MHV	MALE	 Ø 0.57" [14.5mm]
	JACK	 Ø 0.20" [5.0mm]		JACK	 Ø 0.20" [5.0mm]		FEMALE	 Ø 0.44" [11.1mm]
MINI 75 OHM SMB	PLUG	 Ø 0.25 [6.4]	MINI SMP	MALE	 Ø 0.11" [2.8]	MINI-UHF	MALE	 3/8-24 Ø 0.45 [11.5]
	JACK	 Ø 0.14 [3.7]		FEMALE	 Ø 0.09" [2.2]		FEMALE	 3/8-24 Ø 0.31 [7.8]
MMCX	PLUG	 Ø 0.09 [2.4]	N	MALE	 5/8-24 Ø 0.80 [20.3]	REVERSE POLARITY N	MALE	 5/8-24 Ø 0.80 [20.3]
	JACK	 Ø 0.14 [3.5]		FEMALE	 5/8-24 Ø 0.55 [14.0]		FEMALE	 5/8-24 Ø 0.55 [14.0]
75 OHM N	MALE	 5/8-24 Ø 0.80 [20.3]	PAL	PLUG	 Ø 0.38 [9.5]	POSITIVE SNAP	 Ø 0.39 [9.9]	
	FEMALE	 5/8-24 Ø 0.55 [14.0]		JACK	 Ø 0.37 [9.4]			
OMA	MALE	 Ø 0.41 [10.5]	RCA	PLUG	 Ø 0.37 [9.3] Ø 0.13 [3.2]	SC	MALE	 11/16-24 Ø 0.80 [20.3]
	FEMALE	 Ø 0.19 [4.9]		JACK	 Ø 0.33 [8.4]		FEMALE	 11/16-24 Ø 0.63 [15.9]

CONNECTOR IDENTIFIER

SPECIFICATIONS SHOWN ARE INTENDED FOR IDENTIFICATION PURPOSES ONLY

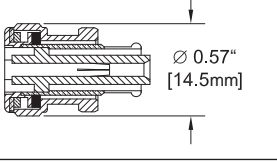
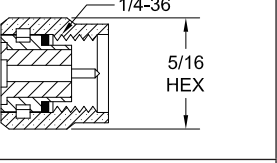
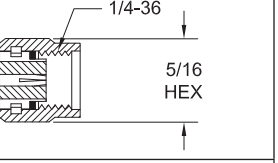
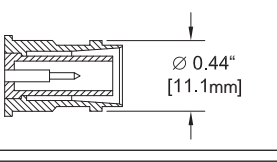
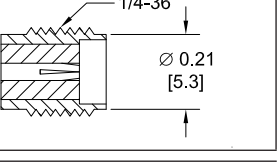
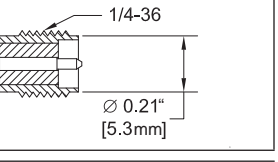
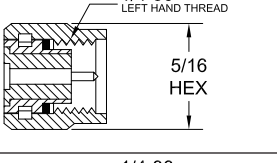
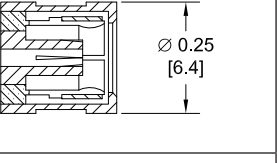
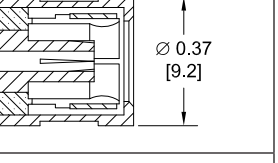
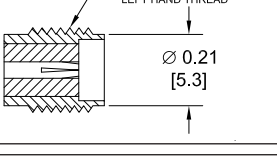
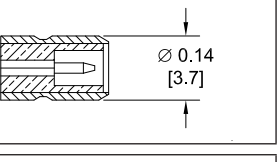
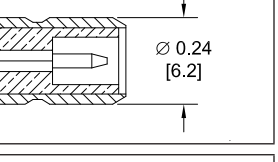
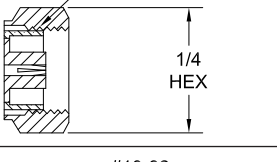
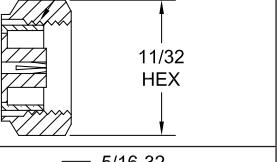
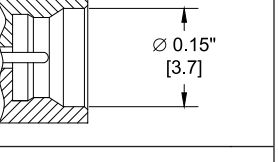
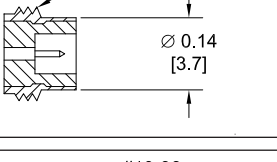
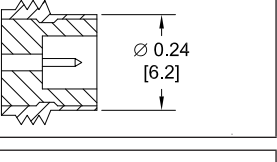
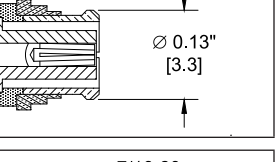
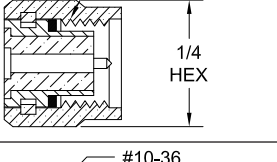
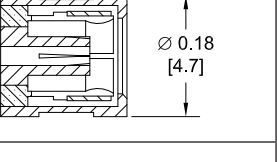
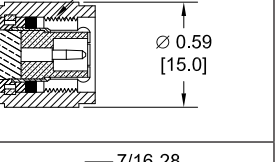
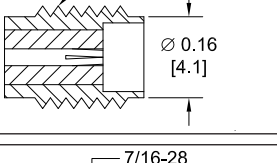
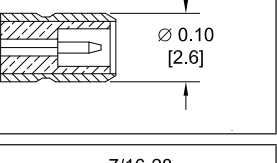
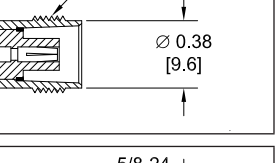
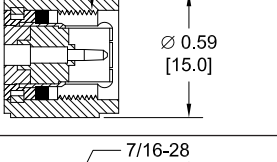
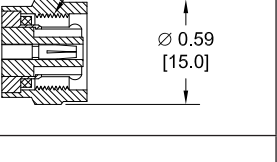
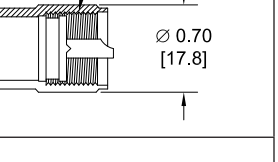
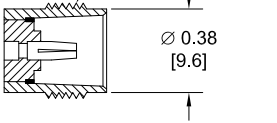
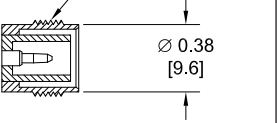
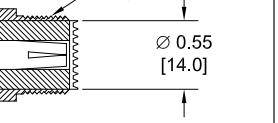
SHV	PLUG	 Ø 0.57" [14.5mm]	SMA*	MALE	 1/4-36 5/16 HEX	REVERSE POLARITY SMA	MALE	 1/4-36 5/16 HEX
	JACK	 Ø 0.44" [11.1mm]		FEMALE	 1/4-36 Ø 0.21 [5.3]		FEMALE	 1/4-36 Ø 0.21" [5.3mm]
SMA REVERSE THREAD	MALE	 1/4-36 LEFT HAND THREAD 5/16 HEX	SMB	PLUG	 Ø 0.25 [6.4]	75 OHM SMB	PLUG	 Ø 0.37 [9.2]
	FEMALE	 1/4-36 LEFT HAND THREAD Ø 0.21 [5.3]		JACK	 Ø 0.14 [3.7]		JACK	 Ø 0.24 [6.2]
SMC	PLUG	 #10-32 1/4 HEX	75 OHM SMC	PLUG	 5/16-32 11/32 HEX	SMP	MALE	 Ø 0.15" [3.7]
	JACK	 #10-32 Ø 0.14 [3.7]		JACK	 5/16-32 Ø 0.24 [6.2]		FEMALE	 Ø 0.13" [3.3]
SSMA	MALE	 #10-36 1/4 HEX	SSMB	PLUG	 Ø 0.18 [4.7]	TNC	MALE	 7/16-28 Ø 0.59 [15.0]
	FEMALE	 #10-36 Ø 0.16 [4.1]		JACK	 Ø 0.10 [2.6]		FEMALE	 7/16-28 Ø 0.38 [9.6]
75 OHM TNC	MALE	 7/16-28 Ø 0.59 [15.0]	REVERSE POLARITY TNC	MALE	 7/16-28 Ø 0.59 [15.0]	UHF	MALE	 5/8-24 Ø 0.70 [17.8]
	FEMALE	 7/16-28 Ø 0.38 [9.6]		FEMALE	 7/16-28 Ø 0.38 [9.6]		FEMALE	 5/8-24 Ø 0.55 [14.0]

*SMA, 2.92mm & 3.5mm CONNECTORS WILL MATE MECHANICALLY & ELECTRICALLY TO EACH OTHER.



Free Shipping Available
via UPS Ground to
USA & Canada



Technical
Support
(866) 727-8376



Same-Day Shipping,
Even Custom
Cable Assemblies

CONNECTOR FREQUENCY RANGE CHART

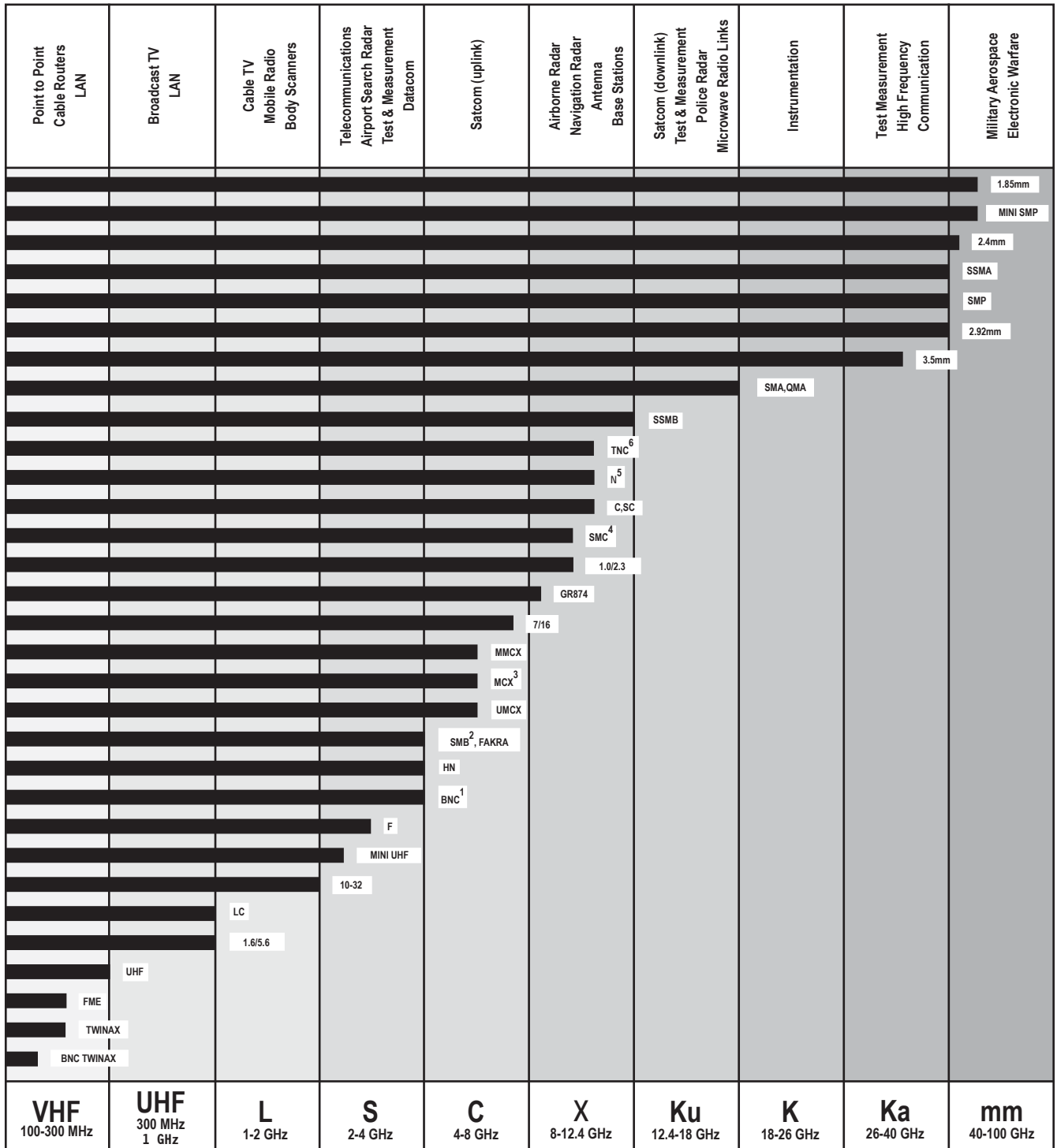

Notes:

- 1: BNC-75 Ohm connectors operate up to 1 GHz
- 2: SMB-75 Ohm & Mini SMB-75 Ohm connectors operate up to 4 GHz
- 3: MCX-75 Ohm connectors operate up to 6 GHz
- 4: SMC-75 Ohm connectors operate up to 10 GHz
- 5: N-75 Ohm connectors operate up to 1.5 GHz
- 6: TNC-75 Ohm connectors operate up to 1 GHz



Australian Representatives
ROJONE, PTY LTD.
Tel: 02 9829 1555
E: sales@rojone.com.au
www.rojone.com.au