

NAVAIR 01-1A-23
NAVSEA SE004-AK-TRS-010/2M
MARINE CORPS TM 5895-45/1E
USAF T.O. 00-25-259

CURRENT SUPPLEMENTS
00-25-259E

15 October 2013

REVISION 4

TECHNICAL MANUAL

**STANDARD MAINTENANCE PRACTICES
MINIATURE/MICROMINIATURE (2M)
ELECTRONIC ASSEMBLY REPAIR**

ORGANIZATIONAL/INTERMEDIATE/DEPOT LEVEL

This manual supersedes
NAVAIR 01-1A-23, dated 01 October 2006
NAVSEA SE004-AK-TRS-010/2M, dated 01 October 2006
MARINE CORPS TM 5895-45/1C, dated 01 October 2006
USAF T.O. 00-25-259, dated 01 October 2006

DISTRIBUTION STATEMENT A. Approved for public release; distribution is unlimited.

BASIC AND ALL UPDATES AND SUPPLMENTS HAVE BEEN
MERGED TO MAKE THIS A COMPLETE PUBLICATION.

Published by Direction of Commander, Naval Air Systems Command

2: 23NR; : 64387

15 October 2013

NUMERICAL INDEX OF EFFECTIVE WORK PACKAGES/PAGES

LIST OF CURRENT CHANGES

Original 01 February 1994
 Revision 1 01 September 1999
 Revision 2 01 October 2003
 Revision 3 01 October 2006

Only those work packages/pages assigned to the manual are listed in this index. If changed pages are issued to a work package, insert the changed pages in the applicable work package. The portion of text affected in a changed or revised work package is indicated by change bars or the change symbol "R" in the outer margin of each column of text. Changes to illustrations are indicated by pointing hands or change bars, as applicable.

Number	Title	Number	Title
Page A	Numerical Index of Effective Work Packages/Pages		
HMWS	Hazardous Materials Warning Summary	WP 011 00	Laminate
WP 001 00	Alphabetical Index	WP 012 00	Conductors, Pads, and Lands
WP 002 00	General Information	WP 013 00	Flex Print
WP 003 00	Technical Information	WP 014 00	Welded Leads
WP 004 00	Electrostatic Discharge (ESD)	WP 015 00	Multilayer
WP 005 00	High Reliability Soldering	WP 016 00	Plastic Panel
WP 006 00	Conformal Coating	WP 017 00	(deleted)
WP 007 00	Through Hole Components	WP 018 00	Surface Mount Devices
WP 008 00	Terminals	WP 019 00	Jumper Wires
WP 009 00	Solder Cups	WP 020 00	Lead-Free Solder
WP 010 00	Wire Repair	WP 021 00	Connectors

Total number of pages in this manual is 890 consisting of the following:

WP/Page No. Change No.	WP/Page No. Change No.	WP/Page No. Change No.
Title0	WP 006 00/1-34.....0	WP 014 00/1-10 0
A-B [B Blank]0	WP 007 00/1-124.....0	WP 015 00/1-18 0
HMWS/1-60	WP 008 00/1-62.....0	WP 016 00/1-28 0
WP 001 00/1-80	WP 009 00/1-36.....0	WP 017 00/1-2 0
WP 002 00/1-440	WP 010 00/1-20.....0	WP 018 00/1-106 0
WP 003 00/1-640	WP 011 00/1-48.....0	WP 019 00/1-26 0
WP 004 00/1-320	WP 012 00/1-96.....0	WP 020 00/1-20 0
WP 005 00/1-340	WP 013 00/1-26.....0	WP 021 00/1-42 0

NAVAIR 01-1A-23
NAVSEA SE004-AK-TRS-010/2M
MARINE CORPS TM 5895-45/1E
USAF T.O. 00-25-259

Page B

This page is intentionally blank.

15 October 2013

HAZARDOUS MATERIALS WARNING SUMMARY

EXPLANATIONS OF WARNINGS

Warnings in this manual alert personnel to hazards associated with the use of some materials in 2M.

Additional information related to hazardous materials (HAZMAT) is provided in OPNAVINST 5100.23, Navy Occupational Safety and Health (NAVOSH) Program Manual, and NAVSUPINST 5100.27, Navy Hazardous Material Control Program publications.

For each hazardous material used, a Material Safety Data Sheet (MSDS) is required to be provided and available for review by users.

Consult your local safety and health staff concerning any questions regarding HAZMAT, MSDS, personnel protective equipment requirements, appropriate handling and emergency procedures, and disposal guidance.

Under the heading “HAZARDOUS MATERIALS WARNING”, complete warnings, including related icon(s) and numeric identifier, are provided for HAZMAT used in this manual.

In the text of this manual, the caption “WARNING” is not used for hazardous material warnings.

Hazards are cited before the start of each procedure with appropriate icon(s), the nomenclature of the HAZMAT, and the numeric identifier relating to the complete warnings.

Users of HAZMAT shall refer to the complete warnings as necessary.

EXPLANATIONS OF HAZARDOUS MATERIALS ICONS



Chemical—The symbol of a liquid dripping onto a hand shows the material will cause burns or irritation to human skin or tissue.



Explosion—The rapidly expanding symbol shows the material may explode if subjected to high temperature, sources of ignition, or high pressure.



Eye Protection—The symbol of a person wearing goggles shows the material will injure your eyes.



Fire—The symbol of a fire shows the material may ignite and cause burns.



Poison—The skull and crossbones symbol shows the material is poisonous or is a danger to life.



Vapor—The symbol of a human figure in a cloud shows material vapors present a danger to life or health.

HAZARDOUS MATERIALS WARNINGS

The following HAZMAT and related icons were assigned on the basis of information obtained in “Dangerous Properties of Industrial Materials”; by N. Irving Sax and Richard J. Lewis, Sr.; Van Nostrand Reinhold, 7th edition, 1989.



Acrylic Resin, MIL-I-46058

3

Acrylic Resin—Causes severe irritation to eyes, if not washed out immediately.

Will cause tissue damage, which may be permanent.

Frequent and/or prolonged contact may irritate skin and cause dermatitis.

High vapor concentrations are irritating to the respiratory tract

Can cause nausea, headaches, and dizziness (effects of overexposure).

Avoid contact with eyes, skin, and clothing and use only in well-ventilated areas.

Vapor is flammable and heavier than air and may travel to source of ignition and flash back.
Keep away from heat, sparks, and open flames.



Alcohol, Isopropyl

1

Alcohol, Isopropyl—Flammable and mildly toxic to eyes, skin, and respiratory tract.

Skin and eye protection is required.

Avoid repeated and/or prolonged contact.

Use only in well-ventilated areas.

Keep away from open flames or other sources of ignition.

A poison when ingested.



Dichloromethane (methylene chloride), ASTM-D4701 10

Dichloromethane—Methylene chloride can affect you when breathed and by passing through skin.

Methylene chloride should be handled as a carcinogen with extreme caution. Exposure to high concentrations causes unconsciousness and even death. Lower exposures can cause headaches, fatigue, unsteadiness, and “drunken” behavior.

Exposure can irritate the lungs causing a build-up of fluid (pulmonary edema), a medical emergency.

Long-term exposure may damage the liver and brain.

Methylene chloride is not combustible but may form a flammable mixture with air.



Epoxy, 0151

4

Epoxy—A poison by inhalation, skin contact, and ingestion.

Is corrosive to skin.

May cause chemical burns to eyes and skin. Skin and eye protection is required.

Heating mixed adhesive may result in excessive heat build-up, releasing toxic gases.



Flux (Soldering)

8

Flux (Soldering)—Flux fumes during soldering may cause irritation to the eyes.

Soldering flux may also cause irritation to the skin and respiratory system.

Containers may burst at elevated temperatures.

Avoid breathing vapors.

Avoid skin and eye contact.

Use only in well ventilated areas.

Keep away from heat, sparks, flames, and incompatible materials.



Lead (Solder)

9

Lead (Solder)—A poison by unspecified route.

Skin, eye, and respiratory irritant. Skin and eye protection required.

Do not breathe smoke during soldering.

High temperatures may produce heavy metal fumes, dust, and/or vapor.



Paint, Acrylic, L300/K-685

11

Paint, Acrylic—Breathing of high vapor concentrations may produce narcosis.

Liquid may cause minor skin irritation and definite eye irritation.

Sufficient ventilation, in volume and pattern, should be provided to keep air contamination below current applicable OSHA permissible exposure limit.

Store away from heat, sparks, and open flame.



Polyurethane Resin, MIL-I-46058

5

Polyurethane Resin—Overexposure will cause irritation of the nose, throat, eyes, lungs, and skin.

Irritation may be accompanied by coughing, choking, and/or labored breathing. Asthma like breathing may be a delayed reaction.

May cause lung irritation, allergic response (dermatitis), and/or cardiac abnormalities.

Avoid contact with eyes and skin.

Do not breathe vapors.

Wash hands thoroughly after handling.

Use only in well ventilated areas.

Vapors heavier than air and can travel a long distance along the ground and flashback.

Containers may explode in heat and fire.



Silicone Resin, MIL-I-46058

6

Silicone Resin—Overexposure will cause slight irritation with redness and swelling to the eyes.

A single short exposure causes no effect to the skin. Several repeated prolonged exposures might irritate. No injury is likely from relatively short exposures.

Ingestion of large amounts may cause digestive discomfort.

Product liberates methyl alcohol when exposed to water or humid air. Provide ventilation during use to control methyl alcohol.

Avoid heat, sparks, and open flames.

15 October 2013

WP 001 00 Alphabetical Index

01-1 PURPOSE

List the work packages in alphabetical order.

List the 2M repair procedures in alphabetical order.

List the workmanship standards in alphabetical order.

01-2 INDEX

Paragraph	Subject	Page
01-1	Purpose	1
01-2	Index	1
01-3	Alphabetical Indexes.....	1
01-3.1	Work Packages.....	1
01-3.2	2M Repair Procedures	2
01-3.3	Workmanship Standards	6

01-3 ALPHABETICAL INDEXES

Three alphabetical indexes are provided: Work Packages, 2M Repair Procedures, and Workmanship Standards.

01-3.1 Work Packages

Title	WP
Alphabetical Index.....	WP 001 00
Conductors, Pads, and Lands	WP 012 00
Conformal Coating	WP 006 00
Connectors	WP 021 00
Electrostatic Discharge (ESD)	WP 004 00
Flex Print.....	WP 013 00
General Information.....	WP 002 00
High Reliability Soldering.....	WP 005 00
Jumper Wires	WP 019 00
Laminate.....	WP 011 00

Title	WP
Lead-Free Solder	WP 020 00
Multilayer	WP 015 00
Plastic Panel.....	WP 016 00
Solder Cups.....	WP 009 00
Surface Mount Devices	WP 018 00
Technical Information	WP 003 00
Terminals	WP 008 00
Through Hole Components	WP 007 00
Welded Leads.....	WP 014 00
Wire Repair.....	WP 010 00

01-3.2 2M Repair Procedures

Title	WP	Paragraph
Automatic Solder Paste Dispensing Procedure.....	WP 018 00	18-5.10.2
Axial Lead Horizontal Flush Mount Procedure.....	WP 007 00	07-5.10.1
Axial Lead Horizontal Mount with Stress Relief Procedure	WP 007 00	07-5.10.2
Axial Lead Standoff Mount Procedure	WP 007 00	07-5.10.3
Axial Lead Vertical Mount Procedure.....	WP 007 00	07-5.10.4
Component Lead and Wire Tinning using Solder Pot Procedure...	WP 003 00	03-5.11
Conductive Preheating Procedure	WP 018 00	18-5.2.2
Conductor Fabrication Procedure	WP 012 00	12-5.13
Conductor Repair, Clinched Staple Procedure	WP 012 00	12-5.5
Conductor Repair, Lap Solder Procedure	WP 012 00	12-5.4
Conductor Repair, Solder Bridge Procedure	WP 012 00	12-5.6
Conformal Coating Identification Procedure	WP 006 00	06-5.2
Conformal Coating Removal (thick) using Motorized Abrasion Procedure	WP 006 00	06-5.4.6
Conformal Coating Removal (thin) using Manual Abrasion Procedure	WP 006 00	06-5.4.5
Conformal Coating Removal (thin) using Motorized Abrasion Procedure	WP 006 00	06-5.4.7
Conformal Coating Removal Chemical (Isopropyl Alcohol) Procedure	WP 006 00	06-5.4.1
Conformal Coating Removal using Cut and Peel Method Procedure	WP 006 00	06-5.4.4
Conformal Coating Removal using Thermal Parting Tool Procedure	WP 006 00	06-5.4.3
Conformal Coating Removal with Hot Air Jet Procedure	WP 006 00	06-5.4.2
Conformal Coating Replacement Procedure.....	WP 006 00	06-5.5
Connector (Coaxial with Soldered Center Pin) Fabrication Procedure	WP 021 00	21-5.2
Connector (Cannon Plug) Fabrication Procedure.....	WP 021 00	21-5.4

Title	WP	Paragraph
Connector (Coaxial with Crimped Center Pin) Fabrication Procedure	WP 021 00	21-5.1
Connector (D-subminiature) Fabrication Procedure.....	WP 021 00	21-5.5
Connector (Molex) Fabrication Procedure.....	WP 021 00	21-5.6
Connector (PL-259 Coaxial with Soldered Center Pin) Fabrication Procedure	WP 021 00	21-5.3
Connector (RJ-45 and RJ-11) Fabrication Procedure.....	WP 021 00	21-5.7
Connector, Cannon Plug Fabrication Procedure	WP 009 00	09-5.5
Connector, DIN Fabrication Procedure	WP 009 00	09-5.6
Continuous Vacuum Extraction Procedure	WP 007 00	07-5.2.1
Continuous Vacuum Extraction with Auxiliary Heating Procedure	WP 007 00	07-5.2.2
Convective Preheating Procedure.....	WP 018 00	18-5.2.1
Cracked Conductor Repair Procedure	WP 012 00	12-5.3
Desoldering Components from Double-Sided CCAs Procedure.....	WP 007 00	07-5.4
Desoldering Components from Single-Sided CCAs Procedure.....	WP 007 00	07-5.3
Destructive Discrete Component Removal Procedure	WP 007 00	07-5.6
Destructive Dual In-Line Package Removal Procedure	WP 007 00	07-5.7
Discrete Component Lead Preparation Procedure	WP 007 00	07-5.9.1
Double-Sided Pad Preparation Procedure	WP 007 00	07-5.8.2
Double-Sided Soldering Procedure	WP 007 00	07-5.12.2
Dual In-Line Package Lead Preparation Procedure	WP 007 00	07-5.9.2
Dual In-Line Package Mounting Procedure.....	WP 007 00	07-5.10.7
ESD Ground Location Procedure	WP 004 00	04-5.1
ESD Workstation Grounding Test Procedure	WP 004 00	04-5.2
Eyelet Repair Procedure.....	WP 012 00	12-5.2
Flat Pack Lead Preparation (Lead Wiping Method) Procedure.....	WP 018 00	18-5.7
Flex Print Conductor Removal and Replacement Procedure.....	WP 013 00	13-5.5
Flex Print Hairline Crack Repair Procedure	WP 013 00	13-5.4
Flex Print Laminate Removal Procedure	WP 013 00	13-5.3
Flex Print Laminate Replacement Procedure.....	WP 013 00	13-5.6
Full Clinch Lead Termination Procedure	WP 007 00	07-5.11.3
General Inspection Procedure.....	WP 003 00	03-5.12
Installation of Chip Components, MELFs, and SOTs with Hot Air Jet Procedure.....	WP 018 00	18-5.8.2
Installation of Chip Components, MELFs, and SOTs with Soldering Iron Procedure	WP 018 00	18-5.8.1
Installation of Gull Wing and J-Leaded SMDs with Point-to-Point Soldering Procedure	WP 018 00	18-5.8.3
Installation of Gull Wing, J-Leaded, and Leadless SMDs with Drag Soldering Procedure	WP 018 00	18-5.8.4
Installation of J-Lead SMDs with Knife Tip Drag Soldering Procedure	WP 018 00	18-5.8.5
Installation of Multilead SMDs with Hot Air Jet Procedure	WP 018 00	18-5.8.6

Title	WP	Paragraph
Insulated Wire Tinning Procedure.....	WP 008 00	08-5.4
Isolated Pad/Land Repair Procedure.....	WP 012 00	12-5.7
Jumper Wire Preparation Procedure	WP 019 00	19-5.3
Jumper Wire Termination and Soldering Procedure.....	WP 019 00	19-5.4
Laminate Repair, Broken Procedure	WP 011 00	11-5.9
Laminate Repair, Edge Delamination Procedure	WP 011 00	11-5.6
Laminate Repair, Interior Delamination Procedure.....	WP 011 00	11-5.5
Laminate Repair, Surface Crack.....	WP 011 00	11-5.7
Laminate Repair, Surface Patch Procedure.....	WP 011 00	11-5.2
Laminate Repair, Through-the-Board Crack.....	WP 011 00	11-5.8
Laminate Repair, Through-the-Board Patch Procedure.....	WP 011 00	11-5.3
Laminate Repair, Through-the-Board Plug Procedure	WP 011 00	11-5.4
Laminate Repair, Warped Procedure.....	WP 011 00	11-5.10
Land and Conductor Repair Procedure	WP 012 00	12-5.8
Land Preparation (Individual) using Continuous Vacuum Extraction Procedure.....	WP 018 00	18-5.5.3
Land Preparation (Individual) using Wicking Material Procedure	WP 018 00	18-5.5.1
Land Preparation (Multiple) using Wicking Material Procedure ...	WP 018 00	18-5.5.2
Lead-Free General High Reliability Soldering Procedure	WP 020 00	20-5.1
Manual Solder Paste Dispensing Procedure	WP 018 00	18-5.10.4
Manual Vacuum Extraction Procedure	WP 007 00	07-5.2.4
Mechanical Wire Stripping Procedure	WP 008 00	08-5.3.2
Microscope Focusing Procedure	WP 003 00	03-5.2
Middle of Conductor Delamination Repair Procedure.....	WP 012 00	12-5.10
Multilayer Subsurface Conductor Replacement Procedure.....	WP 015 00	15-5.2
Offset Pad Lead Termination Procedure.....	WP 007 00	07-5.11.4
Pad and Conductor Delamination Repair Procedure	WP 012 00	12-5.11
Pad and Conductor Repair Procedure.....	WP 012 00	12-5.9
Pad, Land, and/or Conductor Salvage Procedure	WP 012 00	12-5.12
Plastic Panel (Broken) Repair Procedure.....	WP 016 00	16-5.3
Plastic Panel (Cracked) Repair Procedure	WP 016 00	16-5.2
Plastic Panel Bulb Removal and Replacement Procedure	WP 016 00	16-5.4
Plastic Panel Paint Restoration Procedure.....	WP 016 00	16-5.6
Plastic Panel Surface Restoration Procedure	WP 016 00	16-5.5
Plated-Through Hole Repair Procedure	WP 012 00	12-5.1
Procedural Analysis and Feasibility of Repair Procedure	WP 003 00	03-5.1
Radial Lead Horizontal Mount Procedure.....	WP 007 00	07-5.10.6
Radial Lead Vertical Mount Procedure	WP 007 00	07-5.10.5
Reflowing a Solder Joint Procedure	WP 003 00	03-5.5
Removal (Point-to-Point) of Gull Wing SMDs Procedure.....	WP 018 00	18-5.4.3
Removal of Four-Sided SMDs with Box Tip Procedure	WP 018 00	18-5.4.4
Removal of SMDs with Bifurcated or Tunnel Tip Procedure.....	WP 018 00	18-5.4.1
Removal of SMDs with Thermal Tweezers Procedure	WP 018 00	18-5.4.2

Title	WP	Paragraph
Repaired Conductor Encapsulation Procedure	WP 012 00	12-5.14
Semi-Automatic Solder Paste Dispensing Procedure.....	WP 018 00	18-5.10.3
Semi-Clinch Lead Termination Procedure.....	WP 007 00	07-5.11.2
Single-Sided Pad Preparation Procedure	WP 007 00	07-5.8.1
Single-Sided Soldering Procedure	WP 007 00	07-5.12.1
SMD Preparation for Removal, Bridge Fill Method Procedure	WP 018 00	18-5.3.2
SMD Preparation for Removal, Solder Wrap Method Procedure	WP 018 00	18-5.3.1
Solder Bridge Removal Procedure.....	WP 018 00	18-5.9
Solder Cup Wire Installation (Resistive Tweezers) Procedure	WP 009 00	09-5.4
Solder Cup Wire Installation (Soldering Iron) Procedure	WP 009 00	09-5.3
Solder Cup Wire Removal (Resistive Tweezers) Procedure	WP 009 00	09-5.2
Solder Cup Wire Removal (Soldering Iron) Procedure.....	WP 009 00	09-5.1
Solder Extractor (SX-70) Glass Solder Trap Cleaning Procedure	WP 003 00	03-5.10
Solder Extractor Glass Solder Trap Cleaning Procedure	WP 003 00	03-5.8
Solder Extractor Paper Solder Trap Replacement Procedure	WP 003 00	03-5.9
Solder Extractor Readiness Test Procedure	WP 003 00	03-5.6
Solder Extractor Vacuum Test and Heater Element Cleaning Procedure	WP 003 00	03-5.7
Solder Paste Test Procedure	WP 018 00	18-5.10.1
Stencil Solder Paste Dispensing Procedure.....	WP 018 00	18-5.10.5
Straight Through Lead Termination Procedure.....	WP 007 00	07-5.11.1
Terminal Preparation for Soldering Procedure	WP 008 00	08-5.5
Terminal Removal and Installation Procedure.....	WP 008 00	08-5.8
Terminal Soldering Procedure.....	WP 008 00	08-5.7
Thermal Wire Stripping Procedure.....	WP 008 00	08-5.3.1
Through-Hole Component Removal Procedure.....	WP 007 00	07-5.5
Tip Preparation Procedure	WP 003 00	03-5.3
Tip Temperature Procedure.....	WP 003 00	03-5.4
Welded Lead Component Removal and Replacement Procedure.....	WP 014 00	14-5.1
Wicking Procedure	WP 007 00	07-5.2.3
Wire Forming for Bottom Entry Bifurcated Terminals Procedure	WP 008 00	08-5.6.5
Wire Forming for Pierced Tab Terminals Procedure.....	WP 008 00	08-5.6.3
Wire Forming for Round Terminals using Pliers Procedure	WP 008 00	08-5.6.1
Wire Forming for Side Entry Bifurcated Terminals Procedure.....	WP 008 00	08-5.6.4
Wire Forming for Top Entry Bifurcated Terminals Procedure	WP 008 00	08-5.6.6
Wire Forming on Round Terminal Procedure	WP 008 00	08-5.6.2
Wire Removal from Terminal Procedure	WP 008 00	08-5.2
Wire Repair (Mesh Splice) Procedure	WP 010 00	10-5.4
Wire Repair (Wrap Splice) Procedure	WP 010 00	10-5.3
Wire Replacement Procedure	WP 010 00	10-5.2

01-3.3 Workmanship Standards

Title	WP	Paragraph
Axial Leaded Component Installed on Terminal with Stress Relief.....	WP 008 00	08-6.11
Buttercoat	WP 011 00	11-6.4
Clinched Staple	WP 012 00	12-6.3
Coaxial Cable Stripping.....	WP 021 00	21-6.1
Component Lead Forming.....	WP 007 00	07-6.8
Component Lead Tinning	WP 007 00	07-6.3
Component Leads Crossing Conductors.....	WP 007 00	07-6.7
Component Mounting Dual In-Line Package (DIP).....	WP 007 00	07-6.15
Component Mounting Horizontal, Axial Leaded.....	WP 007 00	07-6.10
Component Mounting Horizontal, Axial Leaded with Stress Relief.....	WP 007 00	07-6.11
Component Mounting Horizontal, Radial Leaded.....	WP 007 00	07-6.12
Component Mounting Vertical, Axial Leaded	WP 007 00	07-6.13
Component Mounting Vertical, Radial Leaded	WP 007 00	07-6.14
Component Orientation	WP 007 00	07-6.9
Component Sleeving (Buffer Material)	WP 007 00	07-6.6
Conductor Encapsulation	WP 012 00	12-6.5
Conductors, Pads, and Lands	WP 012 00	12-6.1
Conformal Coating Removal.....	WP 006 00	06-6.1
Conformal Coating Replacement	WP 006 00	06-6.2
Connector Center Pin Position	WP 021 00	21-6.6
Connector Pins, Crimped.....	WP 021 00	21-6.3
Connector Pins, Soldered	WP 021 00	21-6.2
Discrete Component Body	WP 007 00	07-6.2
Discrete Component Leads	WP 007 00	07-6.1
Epoxy Fill.....	WP 011 00	11-6.3
Eyeletting.....	WP 012 00	12-6.2
Flat Pack Lead Forming and Termination.....	WP 018 00	18-6.6
Flex Print.....	WP 013 00	13-6.1
Flex Print Conductor Removal and Replacement.....	WP 013 00	13-6.3
Flex Print Laminate Removal.....	WP 013 00	13-6.2
Flex Print Polyimide Tape Method of Laminate Replacement.....	WP 013 00	13-6.5
Flex Print RTV Method of Laminate Replacement	WP 013 00	13-6.4
Full Clinch Lead Terminations	WP 007 00	07-6.18
General Solder Acceptability.....	WP 005 00	05-6.1
Heat Sink Acceptability Requirements.....	WP 007 00	07-6.4
Heat Sink Insulators and Thermal Compounds.....	WP 007 00	07-6.5
High Voltage Component Soldering.....	WP 007 00	07-6.21
Insulated Wire Stripping.....	WP 008 00	08-6.2
Insulated Wire Tinning	WP 008 00	08-6.3
Insulation Clearance.....	WP 008 00	08-6.4

Title	WP	Paragraph
Insulation Sleeving Replacement	WP 010 00	10-6.4
Insulation Sleeving Replacement	WP 008 00	08-6.13
Jumper Wire Bonding.....	WP 019 00	19-6.11
Jumper Wire Routing.....	WP 019 00	19-6.2
Jumper Wire Selection and Preparation	WP 019 00	19-6.1
Jumper Wire Solder Acceptability.....	WP 019 00	19-6.3
Jumper Wire Terminated in a Plated-Through Hole	WP 019 00	19-6.4
Jumper Wire Terminated to a Gull Wing Lead	WP 019 00	19-6.8
Jumper Wire Terminated to a J-Lead	WP 019 00	19-6.9
Jumper Wire Terminated to a Land Containing a Chip Component.....	WP 019 00	19-6.7
Jumper Wire Terminated to a Lead in a	WP 019 00	19-6.5
Jumper Wire Terminated to a Vacant Land	WP 019 00	19-6.10
Jumper Wire with a Lap Solder Termination.....	WP 019 00	19-6.6
Laminate.....	WP 011 00	11-6.1
Laminate Excavation	WP 011 00	11-6.2
Lap Solder Repair.....	WP 012 00	12-6.4
Multilayer CCA Excavation	WP 015 00	15-6.1
Multilayer Conductor Replacement (All Replacement Conductors).....	WP 015 00	15-6.2
Multilayer Conductor Replacement, Beveled End Soldered.....	WP 015 00	15-6.4
Multilayer Conductor Replacement, Lap Soldered	WP 015 00	15-6.3
Offset Pad Terminations.....	WP 007 00	07-6.19
Plastic Panel (Cracked or Broken) Repair	WP 016 00	16-6.1
Plastic Panel Bulb Replacement	WP 016 00	16-6.3
Plastic Panel Conductor Replacement	WP 016 00	16-6.4
Plastic Panel Excavation	WP 016 00	16-6.2
Plastic Panel Excavation Fill.....	WP 016 00	16-6.5
Plastic Panel Surface Restoration.....	WP 016 00	16-6.6
Post-Solder Joint Cleanliness.....	WP 005 00	05-6.2
Semi-Clinch Lead Terminations	WP 007 00	07-6.17
Shield Termination of Braid Clamp	WP 021 00	21-6.4
Shield Termination of Crimped Ferrule.....	WP 021 00	21-6.5
Solder Acceptability for Through-Hole Components	WP 007 00	07-6.20
Solder Cup Solder Acceptability	WP 009 00	09-6.1
Straight-Through Lead Terminations	WP 007 00	07-6.16
Surface Mount Circuit Card Assembly Lands and Conductors.....	WP 018 00	18-6.3
Surface Mount Device Leads.....	WP 018 00	18-6.2
Surface Mount Device Mounting	WP 018 00	18-6.4
Surface Mount Device Positioning and Soldering.....	WP 018 00	18-6.5
Surface Mount Devices	WP 018 00	18-6.1
Surface Mount Soldering Anomalies.....	WP 018 00	18-6.7
Terminal Installation	WP 008 00	08-6.14
Terminal Installation Soldering	WP 008 00	08-6.15

Title	WP	Paragraph
Terminal Solder Acceptability	WP 008 00	08-6.12
Terminals Connected By a Bus Wire (All Terminals)	WP 008 00	08-6.10
Welded Lead Component Removal.....	WP 014 00	14-6.1
Wire Forming for Bifurcated Terminals.....	WP 008 00	08-6.8
Wire Forming for Hook Terminals.....	WP 008 00	08-6.6
Wire Forming for Pierced Tab Terminals	WP 008 00	08-6.7
Wire Forming for Turret Terminals	WP 008 00	08-6.5
Wire Forming for Wires AWG 30 and Smaller (All Terminals)	WP 008 00	08-6.9
Wire Replacement.....	WP 010 00	10-6.1
Wire Service Loop Stress Relief	WP 010 00	10-6.5
Wire Splice Forming	WP 010 00	10-6.2
Wire Splice Soldering.....	WP 010 00	10-6.3
Wires	WP 008 00	08-6.1

15 October 2013

WP 002 00 General Information

See SUPP E

02-1 PURPOSE AND SCOPE

This manual was developed per the policies of the Miniature/Microminiature (2M) Module Test and Repair (MTR) Program established per NAVSEAINST 4790.17.

Naval Aviation implementation is per COMNAVAIRFORINST 4790.2 (NAMP).

This manual contains instructions to perform Organizational, Intermediate and Depot level maintenance and repair on electronic assemblies (modules, circuit cards, interconnecting wiring, or group of subassemblies manufactured to perform a designed electronic function) under the cognizance of the Naval Air Systems Command (NAVAIR), the Naval Sea Systems Command (NAVSEA), the Space and Naval Warfare Systems Command (SPAWAR), the Marine Corps (MARCOR) Systems Command, the United States Coast Guard (USCG) and the United States Air Force (USAF).

Each work package contains data and procedures necessary to perform a particular task.

This manual is to be used whenever repair procedures are not specified in the equipment technical manuals, and is not to be used in place of those technical manuals.

- In cases where a repair procedure is not specified in the equipment technical manual or this manual, a procedure may be used provided it is approved by the appropriate system engineer.

The procedures in this manual are not to be used to perform unapproved modifications to electronic circuit card assemblies (CCA).

This manual provides guidelines for the Electrostatic Discharge (ESD) Control Program in accordance with ANSI/ESD S20.20-2007 for any activity that tests, manufactures, repairs, assembles, installs, packages, labels, stores, or otherwise handles items containing electrical components, electronic components or devices susceptible to damage caused by the discharge of static electricity.

02-2 INDEX

Paragraph	Subject	Page
02-1	Purpose and Scope	1
02-2	Index	2
02-3	Arrangement of the Manual	2
02-4	Manual Publication Date	2
02-5	Distribution of the Manual	2
02-5.1	NAVAIR Distribution.....	3
02-5.2	NAVSEA and U.S. Coast Guard Distribution.....	3
02-5.3	U.S. Marine Corps Distribution	4
02-5.4	U.S. Air Force Distribution	4
02-6	Reference Material	4
02-7	Acronyms, Abbreviations, and Definitions	6

02-3 ARRANGEMENT OF THE MANUAL

This manual is comprised of work packages (WP). A work package is defined as an independent, self-contained set of data or procedures necessary to support a functional task.

The Numerical Index of Effective Work Packages/Pages (page A) contains a listing, in numerical sequence, of all work packages in this manual. A permanent number identifies each work package. Work package numbers are used for referencing work packages within the manual. Work package numbers are in Arabic numerals beginning with the number WP 001 00. The Alphabetical Index is WP 001 00 and General Information is WP 002 00. Technical Information about 2M is WP 003 00. Electrostatic Discharge (ESD) is WP 004 00. The technical content work packages are WP 005 00 and subsequent. The last two digits of the work packages would identify subordinate work packages, which are currently not used.

02-4 MANUAL PUBLICATION DATE

The publication date shown on the manual title page is the copy freeze date. The copy freeze date is the date established after which no additional information or changes will be incorporated into the manual. Additions, deletions, and changes required after the copy freeze date will be held for the next change or revision.

02-5 DISTRIBUTION OF THE MANUAL

Distribution of this Technical Manual varies by activity. Refer to the applicable distribution requirements below.

02-5.1 NAVAIR Distribution

Procedures to be used by naval activities and other Department of Defense activities requiring NAVAIR technical manuals are defined in NAVAIR 00-25-100.

To receive automatically future changes and revisions to NAVAIR technical manuals, an activity must be established on the Automatic Distribution Requirements List (ADRL) or the Enhanced Library Management Systems (ELMS) maintained by the Naval Air Technical Data and Engineering Services Command (NATEC). To become established on the ADRL, notify your activity central technical publications librarian. If your activity does not have a library, you must request an Initial Outfitting List (IOL) with your activity's distribution requirements by contacting:

Commanding Officer
Naval Air Technical Data and Engineering Services Command
Attn: IOL
NAS North Island, Bldg 90
P.O. Box 357031
San Diego, CA 92135-7031

Annual reconfirmation of these requirements is necessary to remain on automatic distribution. Please use your NATEC assigned account number whenever referring to automatic distribution requirements.

02-5.2 NAVSEA and U.S. Coast Guard Distribution

Ships, training activities, supply points, depots, naval shipyards, and Supervisors of Shipbuilding are requested to arrange for the maximum practical use and evaluation of NAVSEA technical manuals.

All errors, omissions, discrepancies, and suggestions for improvements to NAVSEA technical manuals shall be reported, using NAVSEA Technical Manual Deficiency/Evaluation Report (NAVSEA Form 9086/10), to:

Commander
Code 310 TMDER, Bldg 1388
NAVSURFWARCENDIV NSDSA
4363 Missile Way
Port Hueneme, CA 93043-4307

A NAVSEA Technical Manual Deficiency/Evaluation Reports (TMDER) may also be submitted electronically through the Naval Systems Data Support Activity (NSDSA) Website by using the following URL: <https://nsdsa.nmci.navy.mil/tmder/tmdp.asp>.

02-5.3 U.S. Marine Corps Distribution

Marine Corps organizations needing to order additional manuals or to receive automatically future changes or revisions to this manual should ensure their requirements are loaded to the Marine Corps Publications Distribution System (MCPDS) for their particular unit's Individual Activity Address Code (IAAC).

Procedures to be used are defined in the MCPDS User Manual UM-MCPDS 5605.

02-5.4 U.S. Air Force Distribution

Requests for and questions concerning this document shall be referred to:

WR-ALC/LYGN
Robins AFB GA 31098

02-6 REFERENCE MATERIAL

The references listed form a part of this manual to the extent specified herein.

In the event of a conflict between the text of this document and the references cited herein, the text of this document takes precedence.

A-A-3129 – Cushioning Material, Flexible Open Cell Plastic Film (for Packaging Applications)

A-A-59135 – Packaging Material, Sheet

A-A-59136 – Cushioning Material, Packaging, Closed Cell Foam Plank

ANSI S1.4-1983(R2006) – American National Standard Specification for Sound Level Meters

ANSI/ESD S20.20-2007 – ESD Association Standard for the development of an Electrostatic Discharge Control Program for Protection of Electrical and Electronic Parts, Assemblies and Equipment (Excluding Electrically Initiated Explosive Devices)

ANSI/J-STD-004 (Series) – Requirements for Soldering Fluxes

ASTM D257-99 – Standard Test Methods for D.C. Resistance or Conductance of Insulating Materials

ASTM-D4701 – Methylene Chloride, Technical Grade

COMNAVAIRFORINST 4790.2 (Series) – Naval Aviation Maintenance Program (NAMP)

COMUSFLTFORCOMINST 4790.3 (Series) – Joint Fleet Maintenance Manual (JFMM)

IPC-4101 (Series) – Specification for Base Materials for Rigid and Multilayer Printed Boards

IPC-A-610 (Series) – Acceptability for Electronic Assemblies

IPC/EIA J-STD-001 (Series) – Requirements for Soldered Electrical and Electronic Assemblies

IPC/JEDEC J-STD-033 – Handling, Packing, Shipping and Use of Moisture/Reflow Sensitive Surface Mount Devices

IPC/JEDEC J-STD-609 – Lead-Free and Leaded Marking, Symbols and Labels

MIL-DTL-117 (Series) – Bags, Heat-Sealable

MIL-DTL-81997 (Series) – Pouches, Cushioned, Flexible, Electrostatic-Free Reclosable, Transparent

MIL-I-46058 (Series) – Insulating Compound, Electrical

MIL-PRF-81705 (Series) – Barrier Materials, Flexible, Electrostatic Protective, Heat Sealable

MIL-STD-129 (Series) – Military Marking for Shipment and Storage

MIL-STD-1686 (Series) – Electrostatic Discharge Control Program for Protection of Electrical and Electronic Parts, Assemblies and Equipment (Excluding Electrically Initiated Explosive Devices)

N. Irving Sax and Richard J. Lewis, Sr.; Van Nostrand Reinhold, 7th edition, 1989 – Dangerous Properties of Industrial Materials

NAVAIR 00-25-100 – Naval Air Systems Command Technical Manual Program

NAVSEAINST 4790.17 (Series) – Fleet Test and Repair of Shipboard Electronic Equipment

NAVSEA S9086-KC-STM-010 (Series) – Naval Ships' Technical Manual, Chapter 300, Electric Plant - General

NAVSEA S9665-CY-OMP-010/PRC-2000/U//NAVAIR 17-15-99 (Series) – PRC-2000-2M System
Electronic Rework Power Unit

NAVSEA TE000-AA-MAN-010/2M//NAVAIR SE-004-PQS-000 – Certification Manual For
Miniature/Microminiature (2M) Module Test And Repair (MTR) Program

NAVSUPINST 5100.27 – Navy Hazardous Material Control Program

OPNAVINST 5100.19 (Series) – Navy Occupational Safety and Health (NAVOSH) Program
Manual for Forces Afloat

OPNAVINST 5100.23 (Series) – Navy Occupational Safety and Health (NAVOSH) Program
Manual

PPP-C-795 – Cushioning Material, Packaging (Flexible Closed Cell Plastic Film, for Long
Distribution Cycles)

PPP-C-1797 – Cushioning Material, Resilient, Low Density, Unicellular, Polypropylene Foam

SAE-AMS-I-23053/3 – Insulation Sleeving, Electrical, Heat Shrinkable, Polyvinyl Chloride, Semi
Rigid, Crosslinked and Non-Crosslinked

UM-MCPDS 5605 – Marine Corps Publications Distribution System (MCPDS) User's Manual

02-7 ACRONYMS, ABBREVIATIONS, AND DEFINITIONS

2M – Miniature/Microminiature

2M MTR – Miniature/Microminiature (2M) Module Test and Repair (MTR)

°C – Degrees Celsius

°F – Degrees Fahrenheit

μA – Microampere

μBGA – Micro Ball Grid Array – A polyimide film and metal layer tape form the interconnect
leads for μBGA packages.

Ω – Ohms

A B C D E F G H I J K L M N O P Q R S T U V W X Y Z

A

Abrasion – The mechanical removal of material.

Abrasive – A substance used for cleaning or grinding.

AC – Alternating current

Accelerator – A chemical used to initiate or increase the speed of the reaction between a resin and a curing agent.

Acceptable Condition – A condition, while not necessarily perfect, will maintain the integrity and reliability of the assembly in its service environment.

Acid Flux – A solution of an acid and an inorganic, organic, or water-soluble organic flux. Acid flux is NOT approved for 2M use.

Acid-Core Solder – Wire solder with a self-contained acid flux. Acid-core solder is NOT approved for 2M use.

Activated Rosin Flux – A mixture of rosin and small amounts of organic-halide or organic-acid activators.

Activator – A substance that improves the ability of a flux to remove surface oxides from the surfaces being joined.

Active Device – An electronic component whose basic character changes while operating on an applied signal. (This includes diodes, transistors, thyristors, and integrated circuits used in analog or digital circuits in either monolithic or hybrid form.)

Adhesion Promotion – The chemical process of preparing a surface to enhance its ability to be bonded to another surface or to accept an over-plate.

Adhesive – A substance such as glue or cement used to fasten objects together.

Adhesive Staking – The bonding or attaching of components, or component elements, to a surface by the application of small quantities of adhesive material.

ADRL – Automatic Distribution Requirements List

AEL – Allowance Equipage List

Ag – Silver

A B C D E F G H I J K L M N O P Q R S T U V W X Y Z

AIMD – Aircraft Intermediate Maintenance Department

Alignment Mark – A stylized pattern selectively positioned on a base material to assist in alignment of components.

Alumina Substrate – Aluminum oxide used as a ceramic substrate material.

Ambient – The surrounding area or environment of the system or component in question.

Amp – Ampere

Annular Ring – The portion of conductor material surrounding a hole.

Anomaly – A deviation or departure from the normal order, form, or rule; something irregular or abnormal.

ANSI – American National Standards Institute

Anti-Wicking – Preventing solder from flowing up a wire from the normal wicking action of stranded wire.

APL – Allowance Parts List (NAVSEA/USCG)

Aqueous Flux – An organic chemical soldering flux that is soluble in water.

AR – Acrylic Resin Conformal Coating

Array – A group of elements or circuits arranged in rows and columns on a base material.

Assembly – A functional subdivision of a component, consisting of parts or subassemblies that perform functions necessary for the operation of the component as a whole, e.g., circuit card assembly, power amplifier assembly, gyro assembly.

ASTM – American Standard Test Method

Au – Gold

Auxiliary Ground – A separate supplemental grounding conductor (for use other than general equipment grounding) bonded to the equipment grounding conductor.

AWG – American Wire Gauge – A standardized wire gauge measurement system. Note the smaller the gauge number, the larger the diameter of the wire.

A B C D E F G H I J K L M N O P Q R S T U V W X Y Z

Axial Lead – A lead wire extending from a component body along its longitudinal axis.

B

b0 – Bare circuit card surface finish containing Pb, traditional SnPb, hot air level or solder reflow [J-STD-609]

b1 – Bare circuit card surface finish lead- free HASL (Sn alloys with no Bi or Zn) [J-STD-609]

b2 – Bare circuit card surface finish I-Ag [J-STD-609]

b3 – Bare circuit card surface finish Sn (electrolytic or immersion) [J-STD-609]

b4 – Bare circuit card surface finish Au (immersion or electrolytic), ENIG, NiAu [J-STD-609]

b5 – Bare circuit card surface finish screened carbon (carbon ink) [J-STD-609]

b6 – Bare circuit card surface finish OSP (organic solder preservative) [J-STD-609]

b7 – Bare circuit card surface finish unassigned category [J-STD-609]

b8 – Bare circuit card surface finish unassigned category [J-STD-609]

b9 – Bare circuit card surface finish unassigned category [J-STD-609]

Backlighting – Viewing or photographing by placing an object between a light source and the eye or recording medium.

Baking – Subjecting an assembly to an elevated temperature in order to remove moisture and unwanted gasses prior to certain steps in the repair process or prior to final coating.

Ball Grid Array – See BGA.

Barrel – The plated tube that is connected to and extends between the pads of a plated-through hole.

Barrier Strip – A device or apparatus consisting of a metal strip and connectors or screws that allows the termination and connection of wires or conductors from various components of an ESD protection station. See Bus Bar.

Base Material – The insulating material upon which a conductive pattern may be formed. The base material may be rigid or flexible, or both. It also may be a dielectric or insulated metal sheet. See Laminate.

A B C D E F G H I J K L M N O P Q R S T U V W X Y Z

Base Metal – A metal upon which coatings are deposited.

Base of Terminal – The bottom most flat portion of a terminal on which the wire rests.

Best Practice – A practice that is most appropriate under the circumstances; a technique or methodology that, through experience and research, has reliably led to a desired or optimum result.

Bevel – An angle cut on a conductor or abraded on a laminate surface to facilitate repair.

BGA – Ball Grid Array – A component package having a grid of solder balls attached to lands on the underside of the package. The package is normally attached to a CCA by reflowing the solder balls to the lands on the CCA.

Bi – Bismuth

Bifurcated Terminal – A terminal with a slot or slit opening through which one or more wires are placed prior to soldering.

Birdcaging – A disturbance of the natural lay of the strands in a stranded wire.

Blind Via – A via extending only to one surface of a CCA. See Via.

Blister – Delamination in the form of a localized swelling and separation between any of the layers of a laminate material, between a laminate and a conductive foil, or between a laminate and the conformal coating.

Blowhole – A void in a solder connection caused by outgassing of flux or moisture.

BNC – Bayonet Neill-Concelman (connector) – 0.598 in. diameter plug.

Board Thickness – See Laminate Thickness.

Bond/Bonding – An interconnection that performs a permanent electrical and/or mechanical function.

Bow – The deviation from flatness of a CCA characterized by a roughly cylindrical or spherical curvature. See Twist.

BQFP – Bumped Quad Flat Pack – A QFP with bumpers located on each corner to protect the gull wing leads and assist with proper alignment.

A B C D E F G H I J K L M N O P Q R S T U V W X Y Z

Breakout – Ragged or jagged edges surrounding a drilled hole in laminate or conductor material.

Bridging – The formation of a conductive path between conductors. See Solder Bridge.

Buffer Material – A resilient material used to protect a crack-sensitive component from the stresses generated by a conformal coating.

Bump (Die) – A raised metal feature on a die land or tape carrier that facilitates inner-lead bonding. See Flip Chip.

Buried Via – A via that does not extend to the surface of a CCA. See Via.

Bus – One or more conductors used for transmitting data signals or power.

Bus Bar – (1) A metal strip or bar to which several conductors may be bonded. See Barrier Strip. (2) A conduit, such as a component or conductor, on a CCA used for distributing electrical energy.

Bus Wire – A solid conductor used for interconnections.

Buttercoat – A thin external layer of epoxy applied over a laminate repair to cap exposed fibers.

C

CAGE (code) – Commercial and Government Entity

Capillary Action – The movement of a liquid (solder) along the surface of a solid (such as a small wire or wicking material).

Castellation – A recessed metallized feature on the edge of a leadless chip carrier used to interconnect a conducting surface or conducting planes within or on the chip carrier.

Catalyst (Resin) – A chemical used to initiate the reaction or to increase the speed of the reaction between a resin and a curing agent.

CBGA – Ceramic Ball Grid Array – Hermetically sealed ball grid array packages of cofired alumina substrate allowing various lid sealing and encapsulation techniques. Typically found in military or other high operational stress applications.

A B C D E F G H I J K L M N O P Q R S T U V W X Y Z

CCA – Circuit Card Assembly – The general term for completely processed circuit and printed wiring configurations (this includes single-sided, double-sided, and multilayer CCAs with rigid, flexible, and rigid-flex laminate materials).

CCGA – Ceramic Column Grid Array – A ceramic array with solder columns replacing the solder balls.

Center Conductor – Innermost conductor in coaxial cable.

Center Pin – Point crimped or soldered onto the center conductor end.

Center-to-Center Spacing – See Pitch.

Ceramic Ball Grid Array – See CBGA.

Ceramic Column Grid Array – See CCGA.

Ceramic Quad Flat Pack – See CQFP.

Certification – The verification that specified training or testing has been performed and the required proficiency or parameter values have been attained.

Chemical Wire Stripping – The process of removing insulation from a wire using chemical compounds.

Chip Carrier – A low profile, usually square, SMD package whose die cavity or die mounting area is a large fraction of the package size and whose external connections are usually on all four sides of the package (it may be leaded or leadless).

Chip Scale Package – See CSP.

Chip Style Components – Passive surface mount devices usually made of ceramic material with metallized end caps providing a solderable contact.

Circuit – A number of electrical elements and devices interconnected to perform a desired electrical or electronic function.

Circuit Card Assembly – See CCA.

Circumferential Separation – A crack or void in the plating extending around the entire circumference of a plated-through hole, a solder fillet around a lead wire or eyelet, or the interface between a solder fillet and a land.

A B C D E F G H I J K L M N O P Q R S T U V W X Y Z

Circumferential Wetting – The measurement of solder wetting (measured in ° degrees) that extends around the circumference of cylindrical solderable surfaces typically measured between a component lead and the barrel of a plated-through hole or pad.

Clad – A condition of the base material to which a relatively thin layer or sheet of metal foil has been bonded to one or both of its sides, e.g., metal-clad base material.

Clinched Lead – A component lead inserted through a hole in a CCA and then formed to retain the component in place.

Clinched Staple – A method using a clinched-wire-through connection to repair a damaged conductor.

Cm – Centimeter

CMOS – Complementary Metal Oxide Semiconductor

CMS – Constant Monitoring System

Coaxial Cable – A type of cable that has a center conductor surrounded by a tubular dielectric, surrounded by a tubular conducting shield, which is usually braided. Many coaxial cables also have an insulating outer sheath or jacket. The term coaxial comes from the center conductor and the outer shield sharing the same geometric axis

Coefficient of Thermal Expansion – See CTE.

Coined Lead – The end of a round lead that has been formed to have parallel surfaces that approximate the shape of a ribbon lead.

Cold Solder Joint – A solder joint exhibiting poor wetting and characterized by a grayish porous appearance due to excessive impurities in the solder, inadequate cleaning prior to soldering, and/or the insufficient application of heat during the soldering process.

Common Point Ground – (1) A grounded device where two or more conductors are bonded.
(2) A system or method for connecting two or more grounding conductors to the same electrical potential.

COMNAVAIRFORINST – Commander Naval Air Forces Command Instruction

A B C D E F G H I J K L M N O P Q R S T U V W X Y Z

Component – An electronic component is any basic device in an electronic system used to affect electrons or their associated fields. Electronic components have two or more leads usually soldered to a CCA to create an electronic circuit. See Discrete Component and Integrated Circuit.

Component Lead – The conductor that extends from a component to serve as a mechanical or electrical connector, or both.

Component Mounting – The act of attaching components to a CCA, the manner in which components are attached to a CCA, or both.

Component Mounting Orientation – The direction in which the components on a CCA are lined up electrically with respect to the polarity of polarized components, with respect to one another, and/or with respect to the CCA outline.

Component Side – The side of a CCA that contains the most complex, or the most number of components. See Primary Side.

Compression Seal – A tight joint made between a component package and its leads that is formed as heated metal cools and shrinks around a glass insulator.

COMUSFLTFORCOMINST – Commander U.S. Fleet Forces Command Instruction

Concave – Curved as the inside of a sphere.

Conductive – A material that has a surface resistivity of less than $1 \times 10^5 \Omega$ per square or a volume resistivity less than $1 \times 10^4 \Omega\text{-cm}$.

Conductive Foil – A thin sheet of metal intended for forming a conductive pattern on a laminate material.

Conductive Pattern – The configuration or design of the conductive material on a laminate material. This includes conductors, pads, vias, heat sinks, and passive components when these are an integral part of the CCA manufacturing process.

Conductor – A conductive material or object that permits an electric current to flow easily.

Conductor Side – The side of a single-sided CCA that contains the conductive pattern.

Conductor Spacing – The observable distance between adjacent edges (not center-to-center spacing) of isolated conductive patterns in a conductive layer.

A B C D E F G H I J K L M N O P Q R S T U V W X Y Z

Conductor Thickness – The thickness of a conductor including all metallic coatings and excluding all protective coatings.

Conductor Width – The observable width of a conductor at any point chosen at random on a CCA as viewed from directly above unless otherwise specified.

Conformal Coating – An insulating protective covering that conforms to the configuration of the objects coated (e.g., CCAs), providing a protective barrier against adverse effects from environmental conditions.

Connector – A device used to provide mechanical connect/disconnect for electrical circuits.

Connector Contact – The conducting member of a connecting device that provides a separable connection.

Connector Housing – A plastic shell that holds electrical contacts in a specific field pattern that may also have polarization/keying bosses or slots.

Connector Pin – A terminal used in a cable assembly (connector cup).

Constraining Core – A supporting plane internal to a packaging and interconnecting structure.

Contact Angle, Soldering – The angle of a solder fillet in relation to the materials being soldered i.e. a pad and a lead.

Contaminate – The introduction of foreign material into the repair process.

Convex – Curving outward like the outside of a sphere.

Cooling Line – See Stress Line.

Coplanarity (Coplanar Leads) – The condition where all leads and terminations of a component rest on the same plane.

Corrosion (Chemical/Electrolytic) – The attack of chemicals, flux, and flux residues on base metals.

Corrosive Flux – Flux that contains levels of halides, amines, or organic acids that causes corrosion of copper. Corrosive Flux is NOT authorized for 2M use.

COSAL – Coordinated Shipboard Allowance List

A B C D E F G H I J K L M N O P Q R S T U V W X Y Z

CQFP – Ceramic Quad Flat Pack – Ceramic-bodied quad flat packs used mainly in aerospace and military applications.

Crazing – An internal condition, caused by mechanically induced stress, which occurs in reinforced laminate material whereby glass fibers are separated from the resin at the weave intersections. This condition manifests itself primarily in the form of connected white crosses (spots) on or below the surface of the laminate material.

Crimp Contact – A type of connector contact whose non-mating end is a hollow cylinder that can be crimped onto a wire inserted within it.

CSP– Chip Scale Package – An integrated circuit package where the package is no larger than 1.5 times the die itself, typically a ball grid array package.

CTE – Coefficient of Thermal Expansion – The rate that a material expands or contracts in relation to temperature change.

CTK – Consolidated Tool Kit (US Air Force)

Cu – Copper

Cure – A chemical reaction that changes the physical properties of a substance (such as an adhesive).

Curing Temperature – The temperature at which a material is subject to curing.

Curing Time – The time at which the ultimate physical properties of a curing thermosetting plastic composition are reached.

D

D – Depot (maintenance level)

dB – Decibel (loudness)

DC – Direct current

Defect Condition – A condition insufficient to ensure the form, fit or function of an assembly in its end use environment.

Degradation – A decrease in the performance characteristics or the service life of an assembly.

A B C D E F G H I J K L M N O P Q R S T U V W X Y Z

Delamination – A separation between layers within a laminate material, between a laminate material and a conductive foil, or any other planar separation within a CCA. See Blister.

Dendritic Growth – Metallic filaments that grow between conductors in the presence of condensed moisture and an electric bias. See Whisker.

Desoldering – The process of removing solder to enable removal of a component, wire or conductor.

Deviation – A specific authorization granted before the fact, to depart from a particular requirement of specification or related document.

Dewetting, Solder – A condition that results when molten solder coats a surface and then recedes to leave irregularly shaped mounds of solder separated by areas covered with a thin film of solder and with the base metal or surrounding finish not exposed.

Die – In the context of integrated circuits, a die is a small block of semiconducting material, on which a given functional circuit is fabricated.

Dielectric – (1) Insulating material around center conductor. (2) A material with a high resistance to the flow of current, and which is capable of being polarized by an electrical field.

Dielectric Strength – The maximum voltage that a dielectric can withstand under specified conditions without resulting in a voltage breakdown, usually expressed as volts per unit dimension.

DIN (Connector)– *Deutsches Institut für Normung* (German national standards organization)

DIP – Dual Inline Package – A rectangular integrated circuit package used for through-hole applications with two parallel rows of leads extending from the package downward through the CCA.

Discrete Component – A separate part of a CCA that performs a circuit function, e.g., a resistor, a capacitor, or a transistor.

Disturbed Solder Joint – A solder joint characterized by the appearance that there was motion between the metals being joined while the solder was solidifying.

DoD – Department of Defense

A B C D E F G H I J K L M N O P Q R S T U V W X Y Z

Double-Sided CCA – A CCA with a conductive pattern on both sides.

Drag Soldering – A method of soldering multiple leads by drawing the soldering iron tip across the row of leads in a single motion.

Dross – Oxide and other contaminants that form on the surface of molten solder.

Dual Inline Package – See DIP.

Dwell Time – The amount of time that heat is applied to form a solder joint.

E

e0 – Contains intentionally added Pb (includes traditional SnPb solder) [J-STD-609]

e1 – SnAgCu with Ag content greater than 1.5% and no other intentionally added elements) [J-STD-609]

e2 – Sn alloys with no Bi or Zn, excluding SnAgCu alloys in e1 and e8 [J-STD-609]

e3 – Sn [J-STD-609]

e4 – Precious metal (Ag, Au, NiPd, NiPdAu) [no Sn] [J-STD-609]

e5 – SnZn, SnZnX (all other alloys containing Sn and Zn and not containing Bi) [J-STD-609]

e6 – Contains Bi [J-STD-609]

e7 – Low temperature solder (≤ 302 °F [150 °C]) containing In (no Bi) [J-STD-609]

e8 – SnAgCu with silver content less than or equal to 1.5%, with or without intentionally added alloying elements (this category does not include any alloys described by e1 and e2 or containing Bi or Zn in any quantity) [J-STD-609]

e9 – Symbol unassigned [J-STD-609]

ECL – Emitter Coupled Logic

Edge-Board Connector – A connector used specifically for making non-permanent interconnections with the edge-board contacts on a CCA.

Edge-Board Contact – A printed contact on or near any edge of a CCA used specifically for mating with an edge-board connector.

A B C D E F G H I J K L M N O P Q R S T U V W X Y Z

EIA – Electronics Industry Alliance [now the Electronic Components Industry Association (ECIA)].

Electromagnetic Interference – See EMI.

Electronic Assembly – A module, circuit card, interconnecting wiring, or group of subassemblies manufactured to perform a designed electronic function.

Electrostatic Discharge – See ESD.

Electrostatic Discharge Protected Area – See EPA.

Electrostatic Field – A voltage gradient between an electrostatically charged surface and another surface of a different electrostatic potential.

ELMS – Enhanced Library Management Systems

Embedded Component – A discrete component fabricated as an integral part of the circuit card laminate.

EMI – Electromagnetic Interference – Unwanted radiated electromagnetic energy that couples into electrical conductors.

Encapsulate – To enclose an electronic circuit or device within a protective mass of material, such as epoxy, plastic, or silicone.

ENIG – Electroless Nickel/Immersion Gold

EPA – Electrostatic Protected Area (or ESD Protected Area) – a designated area configured and maintained to protect electrical and electronic components, enclosures, assemblies, subassemblies, and modules from ESD damage during repair, calibration, inspection, routine maintenance, packaging and shipping.

Epoxy/glass Laminate – CCA material constructed by using epoxy glass resin reinforced by layers of woven glass fiber.

Epoxy Resin – A resin that polymerizes spontaneously when its components are mixed, forming a strong, hard, resistant adhesive.

EPROM – Erasable Programmable Read-Only Memory

A B C D E F G H I J K L M N O P Q R S T U V W X Y Z

Equipment Ground – (1) The ground point at which the equipment grounding conductor is bonded to any piece of equipment at the equipment end of the conductor. (2) The third wire (green) terminal of a receptacle. (3) The entire low impedance path from a piece of electrical equipment to a hard ground electrode.

ER – Epoxy Resin Conformal Coating

ESD – Electrostatic Discharge – The transfer of an electrostatic charge between objects at different potentials caused by direct contact or induced by an electrostatic field.

ESD Ground – The point, electrodes, a bus bar, metal strips, or other system of conductors that form a path from a statically charged person or object to ground.

ESD Protective – A property of materials capable of one or more of the following: preventing the generation of static electricity, dissipating an electrostatic charge, or providing shielding from ESD or electrostatic fields.

ESD Protective Work Surface – A work surface that dissipates the electrostatic charge from materials placed on the surface or from the surface itself.

ESD Protective Workstation – An area constructed and equipped with the necessary protective materials and equipment to limit damage to ESD susceptible items handled therein.

ESDS – Electrostatic Discharge Sensitive – Electrical and electronic parts, assemblies, and equipment sensitive to ESD voltages and resultant damage.

Eutectic Alloy – As applied to solder, the composition of metal that changes from a solid to a liquid state without an intermediary plastic state.

Excess Solder Joint – A solder joint characterized by the complete obscuring of the surfaces of the connected metals and/or by the presence of solder beyond the joint.

Eyelet – A short metallic tube, the ends of which can be formed outward in order to fasten it within a hole in a material such as a CCA.

F

FA – Flange Angle (eyelet)

FD – Flange Diameter (eyelet)

Ferrule – Metal sleeve used to clamp or bind parts.

A B C D E F G H I J K L M N O P Q R S T U V W X Y Z

Flat Pack – A rectangular or square integrated circuit package used in a surface mount application that has two rows of flat leads extending from opposite sides of its body.

Flexible Printed Circuit Card Assembly – A CCA partially or completely constructed using a flexible laminate.

Flexible Printed Conductor – A patterned arrangement of printed wiring that utilizes flexible base material with or without a flexible cover lay.

Flip Chip – A leadless monolithic, circuit element structure that electrically and mechanically interconnects to a base material using conductive bumps.

Flux – A chemically and physically active compound that, when heated, promotes the wetting of a base metal surface by molten solder by removing minor surface oxidation and other surface films and by protecting the surfaces from reoxidation during a soldering operation.

Flux Activation Temperature – The temperature at which flux becomes active and removes oxides from the metals being joined.

Flux Activity – The degree or efficiency with which flux promotes wetting of a surface with molten solder.

Flux Residue – Flux present on or near the surface of a solder connection.

Flux-Cored Solder – Wire solder that contains one or more continuous flux-filled cavities along its length.

Foot-Candle – A unit of illuminance or light intensity. One foot-candle is equal to one lumen per square foot or approximately 10.764 lux.

Form, Fit, and Function – Items, components, and/or processes sufficient to enable physical and functional operation.

FR – Flame Retardant

Fractured Solder Joint – A solder joint that displays a physical crack.

FRC – Fleet Readiness Center

FSSG – Force Service Support Group

A B C D E F G H I J K L M N O P Q R S T U V W X Y Z

Full Array Pattern – Grid pattern that covers nearly the entire area of the termination side of an array package. A full balanced pattern has an equal number of terminations in each row and column. A full staggered pattern has one less termination in alternating rows.

Full Clinched Lead – Lead terminations that make complete contact with the pad and conductor, normally at a 90° bend. Full-clinch lead termination style is used with both supported holes and unsupported holes. Clinched leads are used to provide component stability during the installation process. See Semi-Clinched Lead.

Fusing – The combination of metals by melting, blending, and solidification.

G

GaAsFET – Gallium Arsenide Field Effect Transistor

GAO – Government Accountability Office

GFCI – Ground-Fault Circuit Interrupter – A device intended for the protection of personnel that functions to de-energize a circuit, or portion thereof, within an established period of time. It is activated when a current difference between the neutral and hot conductors exceeds some predetermined value less than that required to operate the overcurrent protective device of the supply circuit. The current difference is usually caused by a current to ground.

GHz – Gigahertz

Glass Transition Temperature – See Tg.

Gold Embrittlement – Gold plating dissolving into the bulk solder during reflow causing a frosty appearance and a brittle connection.

Gp – Groundable Point – A designated connection location or assembly used on an ESD protective material or device intended to accommodate electrical connection from the device to an appropriate ground.

Ground – The common reference point for electrical circuit returns, or shielding.

Ground Plane – A conductor layer, or portion thereof, that serves as a common reference for electrical circuit returns, shielding, or heat sinking.

A B C D E F G H I J K L M N O P Q R S T U V W X Y Z

Grounded – Connected to earth or some other conducting body that serves in place of the earth.

Ground-Fault Circuit Interrupter – See GFCI.

Grounding Conductor – A conductor used to connect equipment or the ground circuit of a wiring system to a ground electrode or electrodes.

Grounding Resistance – The total resistance from any given point in an electrically conductive path to the grounding electrode.

Gull Wing Lead – A surface mount technology lead form that extends horizontally from the component body centerline that bends downward and then outward forming the shape of a gull's wing.

H

Haloing – Mechanically induced fracturing or delamination on or below the surface of a laminate material usually exhibited by a light area around holes or other machined features.

Hard Ground – A connection to ground through a wire or other conductor that has very little or nearly no resistance (impedance) to ground.

Hardener – A chemical substance that reacts with a resin to physically harden the resin.

HASL – Hot Air Solder Leveling

Haywire – A discrete electrical connection added to a CCA in order to modify the basic conductive pattern formed on the assembly.

HAZMAT – Hazardous Materials (HAZMAT) – Hazardous and toxic substances are those chemicals present in the workplace, which are capable of causing harm (OSHA definition). The HAZMAT used in this Technical Manual are identified in the HMWS.

Heat Bridge – A heat bridge is formed by placing a properly sized soldering tip to the junction of the materials being soldered at the point of maximum thermal mass and simultaneously applying properly sized solder.

Heat Sink – A mechanical device that dissipates heat.

A B C D E F G H I J K L M N O P Q R S T U V W X Y Z

Heat Transfer – Inducing an increase in temperature from one surface to another, e.g., transferring heat from a soldering iron tip to a component lead.

HF – Halogen Free

Hg – Mercury

HMWS – Hazardous Material Warning Summary

Hz – Hertz

I

I – Intermediate (maintenance level)

I/O – input/output

I/O Count – The quantity of input/output nodes on an integrated circuit.

IAAC – Individual Activity Address Code

I-Ag – Immersion Silver

I-Au – Immersion Gold

IC – Integrated Circuit – A combination of associated circuit elements formed in place and interconnected on or within a single base material to perform a microcircuit function.

Icicle – See Solder Projection.

ID – Inside Diameter (eyelet)

Idle Temperature – The temperature of a soldering iron while sitting unused.

Impedance – A measure of the total opposition (ohmic resistance and reactance) a circuit offers to the flow of alternating current. Impedance is measured in ohms.

IMRL – Individual Material Readiness List (NAVAIR)

In – Indium

IN – Inorganic (Flux)

in. – inch or inches

A B C D E F G H I J K L M N O P Q R S T U V W X Y Z

Inner Layer Connection – A conductor that connects conductive patterns on internal layers of a multilayer CCA, e.g., via.

Inorganic Flux – An aqueous flux solution of inorganic acids and halides. Inorganic flux is NOT authorized for 2M use. See Acid Flux.

Inspection Hole – A hole drilled in the side at the bottom of crimped connector pins to allow for visual verification of wire and connector pin contact.

Inspection Window – A hole drilled in the side at the bottom of soldered RF connector pins to allow for visual verification of the soldered connection.

Insufficient Solder Joint – A solder joint characterized by the incomplete coverage of one or more of the surfaces of the connected metals and/or by the presence of incomplete solder fillets.

Insulated Conductor – A conductor encased within a material whose composition and thickness is recognized as electrical insulation. See Wire.

Insulation Clearance – The distance between the terminal or terminal area and the wire insulation.

Integrated Circuit – See IC.

Interfacial Connection – A conductor that connects conductive patterns on both sides of a CCA, e.g., plated-through hole, via, solder plug, soldered wire.

Internal Layer – A conductive pattern contained entirely within a multilayer CCA.

Inward L-Leads – Leads that cover the ends and are bent under the body of a surface mount device.

IOL – Initial Outfitting List

IPB – Illustrated Parts Breakdown

IPC – Association of Connecting Electronics Industries

Isolated Ground Receptacle – A grounding type receptacle in which the equipment grounding conductor contact and terminal are electrically isolated from the receptacle mounting means.

A B C D E F G H I J K L M N O P Q R S T U V W X Y Z

Isolated Pad – A pad on a circuit card assembly that is used to attach a component, but is not electrically connected to the conductive pattern.

J

JEDEC – Joint Electron Device Engineering Council

JFET – Junction Field Effect Transistor

JFMM – Joint Fleet Maintenance Manual

J-Leads – SMD leads rolled under the body of a component package in the shape of a “J”. J-leads are typically used on a PLCC.

Jumper Wire – A discrete electrical connection that is part of the original design and is used to bridge portions of the basic conductive pattern on a CCA. See Haywire.

Jumper Wire Bonding – use of an adhesive to attach jumper wires to an electronic assembly.

K

L

Laminate – A product made by bonding together two or more layers of material.

Laminate Material – The insulating material upon which a conductor pattern may be formed. The laminate material may be rigid, flexible, or both. It may also be a dielectric or insulated metal sheet.

Laminate Thickness – The thickness of single- or double-sided metal-clad laminate material prior to any subsequent processing.

Land – A portion of a conductive pattern in surface mount applications usually used for making electrical connections, for component attachment, or for both.

Large Scale Integration – See LSI.

Layer – The conductive and insulated layers of a CCA. Layers are differentiated according to their function (conductor layer, insulating layer) and their location.

LCC – Leadless Chip Carrier—A chip carrier whose external connections consist of metallized terminations (castellations) that are an integral part of the component body.

A B C D E F G H I J K L M N O P Q R S T U V W X Y Z

LCCC – Leadless Ceramic Chip Carrier–Ceramic leadless chip carriers are hermetically sealed, rugged, and typically used for military and aerospace applications.

LCD – Liquid Crystal Display

Leaching Metallization – The loss or removal of a base metal or coating during a soldering operation.

Lead – A length of insulated or uninsulated metallic conductor used for electrical interconnections. See Termination.

Lead Deviation – The deviation of a conductor from its intended axis.

Lead Pitch – See Pitch.

Lead Projection – The distance a component lead protrudes through the side of a CCA opposite from the one upon which the component is mounted.

Lead Seal – A tight joint made between a component package and its leads formed as heated metal cools and shrinks around a glass insulator. See Compression Seal.

Lead-Free – contains less than 0.1% lead (Pb) by weight.

Lead-Free Solder – Any metal alloy used for solder that contains less than 0.1% lead (Pb) by weight.

Leadless Ceramic Chip Carrier – See LCCC.

Leadless Chip Carrier – See LCC.

LED – Light Emitting Diode

Lifted Land – A land that has fully or partially separated (lifted) from the laminate material, whether or not any resin is lifted with the land. See Delamination.

L-Leads – Leads that cover the ends and are bent outward from the body of a surface mount device.

LQFP – Low Profile Quad Flat Pack – 1.4 mm thick, rectangular or square-bodied quad flat packs.

LSI – Large Scale Integration – An integrated circuit with over 100 gates.

A B C D E F G H I J K L M N O P Q R S T U V W X Y Z

LUF – Length Under Flange (eyelet)

lm – Lumen – A measure of the total “amount” of visible light emitted by a source.

lx – Lux – One lux is equal to one lumen per square meter ($1 \text{ lx} = 1 \text{ lm/m}^2$).

M

m – Meter

mA – Milliampere

Main Bonding Jumper – The connection between the grounded circuit conductor and the equipment grounding conductor at the service.

MARCOR – Marine Corps

MCLB – Marine Corps Logistic Base

MCPDS – Marine Corps Publications Distribution System

Measling – A condition, caused by thermally induced stress, which occurs in laminate material in which internal glass fibers are separated from the resin at the weave intersection. This condition manifests itself primarily in the form of white spots (crosses) below the surface of the laminate material.

MELF – Metal Electrode Face – Small cylindrical surface mount device with a solderable metallized end cap on each end.

Meniscus – Sealant or encapsulant on a lead, protruding from the lead seal of the component. This includes materials such as ceramic, epoxy or other composites, and flash form molded components.

Metal-Clad Laminate Material – Laminate material covered with metal on one or both sides.

Metallization – A deposited or plated thin metallic film used for its protective and/or electrical properties.

Micro Ball Grid Array – See μ BGA.

A B C D E F G H I J K L M N O P Q R S T U V W X Y Z

Microcircuit – A high-density combination of equivalent circuit elements interconnected to perform as an individual electronic circuit component, e.g., DIP, SOIC, PQFP, BGA.

Microelectronics – The area of electronic technology with, or applied to, the realization of electronic systems from extremely small electronic elements, devices, or parts.

Mil – A unit of length measured in thousandths of an inch.

MIL – Military (standards)

Minimum Electrical Clearance – The minimum allowable distance between adjacent conductors, at a given voltage and altitude, sufficient to prevent dielectric breakdown, corona, or both, from occurring between the conductors. For 2M purposes minimum electrical clearance equals $\frac{1}{16}$ in.

Mixed Technology (Component Mounting) – A component mounting technology that uses both through-hole and surface mount technologies on the same packaging and interconnecting structure.

mm – Millimeter

Moisture Resistant – The ability of a material not to absorb moisture either from air or when immersed in water.

Molex – Molex Connector Company

Molex Connector – the vernacular term for a two-piece pin and socket interconnection.

MOS – Military Occupational Specialty

MOSFET – Metal Oxide Field Effect Transistor

Mounting Hole – A hole used for mechanically mounting a CCA or for mechanically attaching components to a CCA.

MSDS – Material Safety Data Sheet

MTR – Module Test and Repair

Multilayer CCA – A CCA that consists of three or more printed wiring and/or printed circuit layers that have been bonded together and electrically interconnected.

MΩ – Megohms

A B C D E F G H I J K L M N O P Q R S T U V W X Y Z

N

N or Type "N" Connector – Neill connector – 0.827 in. diameter plug.

NAMP – Naval Aviation Maintenance Program

NASA – National Aeronautics and Space Administration

NATEC – Naval Air Technical Data and Engineering Services Command

NAVAIR – Naval Air Systems Command

NAVAIRINST – NAVAIR Instruction

NAVOSH – Navy Occupational Safety and Health

NAVSEA – Naval Sea Systems Command

NAVSEAINST – NAVSEA Instruction

NAVSUP – Naval Supply Systems Command

NAVSUPINST – NAVSUP Instruction

NAVSURFWARCENDIV – Naval Surface Warfare Center Division

Ni – Nickel

Nick – A cut or notch in a wire or in the edge of a conductor.

Nonwetting, Solder – The inability of molten solder to form a metallic bond with the base metal or surface finish.

NSDSA – Naval Systems Data Support Activity

NSN – National Stock Number

O

O – Organizational (maintenance level)

OD – Outside Diameter (eyelet)

Offset Pad – A pad not in physical contact with its associated component hole.

A B C D E F G H I J K L M N O P Q R S T U V W X Y Z

OP AMP – Operational Amplifier

OPNAV – Office of the Chief of Naval Operations

OPNAVINST – OPNAV Instruction

OR – Organic (Flux)

Organic – Composed of matter originating in plant or animal life; or composed of chemicals of hydrocarbon origin, either natural or synthetic.

Orientation – The alignment of a component according to its polarity or electronic properties, e.g., pin one to pad one.

OSHA – Occupational Safety and Health Administration

OSP – Organic Solderability Preservative

Outgassing – The gaseous emission from a laminate CCA or component when the laminate or CCA is exposed to heat, to reduced air pressure, or to both.

Outlet – (1) A receptacle connected to a power supply and equipped with a socket for a plug, or (2) A point on a wiring system at which current is taken to supply equipment.

Overheated Solder Joint – A solder joint characterized by solder surfaces that are dull, chalky, grainy, and porous or pitted.

P

P/N – Part Number

Package – The container for circuit components used to protect its contents and to provide terminals for making connections to the rest of the circuit.

Pad – A portion of a conductive pattern in through-hole applications usually used for making electrical connections, for component attachment, or for both.

Part – An element of a component, assembly, or subassembly not normally subject to further subdivision or disassembly without destruction of designed use.

Passive Component (Element) – A discrete electronic device whose basic character does not change while it processes an applied signal. Passive elements include components such as resistors, capacitors, and inductors.

A B C D E F G H I J K L M N O P Q R S T U V W X Y Z

Paste Flux – A flux formulated in the form of a paste to facilitate its application. Paste flux is NOT authorized for 2M use.

Pb – Lead

Pb-Free – Lead-free

PBGA – Plastic Ball Grid Array – A ball grid array package that consists of an overmolded plastic cover and an array of solder balls providing the interconnection to the CCA.

Pd – Palladium

Perimeter Array Pattern – A grid pattern that covers the perimeter area of the termination side of an array package, leaving the center area of the package without terminations. A perimeter balanced pattern has an equal number of terminations in each row.

PGA – Pin Grid Array – A plated-through hole package with a large array of leads protruding perpendicular to one side of a component package.

Phenolic laminate – A type of laminate material derived from coal tar.

Pierced Tab Terminal – A flat metal terminal with an opening through which one or more wires are placed prior to soldering.

Pin – Point crimped or soldered onto a conductor end

Pin Grid Array – See PGA.

Pinhole – An imperfection in the form of a small hole that penetrates entirely through a layer of material. See Pit.

Pit – An imperfection in the form of a small hole that does not penetrate entirely through a layer of material. See Pinhole.

Pitch – The nominal center-to-center distance of adjacent leads. When the leads are of equal size and their spacing is uniform, the pitch is usually measured from the reference edge of the adjacent lead.

Plastic Ball Grid Array – See PBGA.

Plastic Quad Flat Pack – See PQFP.

Plastic State – The condition of solder between the solid and liquid states.

A B C D E F G H I J K L M N O P Q R S T U V W X Y Z

Plated-Through Hole – See PTH.

Plating – The chemically- or electrochemically-deposited metal on a surface.

PLCC – Plastic Leaded Chip Carrier – A plastic integrated circuit package for surface mount applications that has leads, generally J-Leads, on all four sides.

Polyimide Tape – A material resistant to high temperatures, wear, radiation, and many chemicals.

Polymer – A compound of high molecular weight derived from either joining of many small similar or dissimilar molecules or by the condensation of many small molecules by the elimination of water, alcohol, or some other solvent.

Popcorning – Delamination and/or internal cracks in a plastic bodied component caused by the expansion of trapped moisture.

Potting Compound – A nonconductive material, usually organic, used to encapsulate components and wires.

PPE – Personal Protective Equipment

PQFP – Plastic Quad Flat Pack – Plastic bodied chip carriers with gull wing leads located around all four sides.

Preheating – A preliminary phase of a process during which the product is heated at a predetermined rate from ambient temperature to a desired elevated temperature. Raising the temperature of a material(s) above the ambient temperature reduces thermal shock and influences the dwell time during subsequent elevated-temperature processing.

Primary Side – The side of a CCA so defined on the master drawing. Usually the primary side contains the most complex, or the most number of components. This side is sometimes referred to as the component side in through-hole mounting technology. See Secondary Side.

Printed Wiring – A conductive pattern that provides point-to-point connections, but not printed components, in a predetermined arrangement on a common base.

PSI – Pounds per Square Inch

A B C D E F G H I J K L M N O P Q R S T U V W X Y Z

PTH – Plated-Through Hole – A hole with plating on its walls that makes an electrical connection between conductive patterns on internal layers, on external layers, or on both, of a CCA.

PVC – Polyvinyl Chloride

Q

QFP – Quad Flat Pack – A flat pack with gull wing leads on four sides.

QPL – Qualified Part List

R

R – Rosin (Flux)

RA – Rosin, Activated (Flux) [obsolete]

Radial – Radiating from or converging to a common center.

RE – Resin (Flux) – Composed of natural resins other than rosin types, and/or synthetic resins.

Receptacle – A contact device installed at the outlet for the connection of an attachment plug.

Reflow Line – See Stress Line.

Reflow Soldering – The joining of surfaces that have been pretinned and/or have solder between them, placing them together, heating them until the solder flows, and allowing the surface and the solder to cool in the joined position.

Release Material – A polymer-based non-adhering material used to protect and strengthen during a laminate repair process, e.g., Teflon®.

Reliability – The probability that a component, device, or assembly will function properly under the influence of specific environmental and operational conditions.

Repair – An operation that restores the function of a defective assembly without necessarily restoring its original configuration, e.g., conductor repair, laminate repair, or installation of an eyelet.

Residue – Any visual or measurable process-related contamination.

A B C D E F G H I J K L M N O P Q R S T U V W X Y Z

Resistance Soldering – Soldering by a combination of pressure and heat generated by passing a high current through two mechanically joined conductors.

Rework – An operation that returns a CCA to its original configuration, e.g., removal and installation of a discrete component.

RF – Radio Frequency

RG – Radio Grade

Rigid-Flex Circuit Card Assembly – A CCA with both rigid and flexible laminate materials.

RJ – Registered Jack

RMA – Rosin, Mildly Activated (Flux)

RO – Rosin (Flux) – Flux composed of natural resin extracted from the oleoresin of pine trees and refined. The most common flux used in electronic soldering is a solution of pure rosin dissolved in a suitable solvent.

RoHS – Reduction of Hazardous Substances

ROL1 – Rosin (RO) Low Activity (L1: <0.05% Halide)

ROLØ – Rosin (RO) Low Activity (LØ: 0% Halide)

Rosin Core Solder – Wire solder that has its core(s) filled with rosin flux.

RTV – Room Temperature Vulcanizing (Silicone Resin)

S

SAC – Tin (Sn)-Silver (Ag)-Copper (Cu) lead-free solder

SAC105 – Sn98.5 / Ag1.0 / Cu0.5 lead-free solder

SAC305 – Sn96.5 / Ag3.0 / Cu0.5 lead-free solder

SAW – Surface Acoustic Wave

Sb – Antimony

SCR – Silicon-Controlled Rectifier

A B C D E F G H I J K L M N O P Q R S T U V W X Y Z

Scratch – A narrow furrow or groove in a surface. It is usually shallow and caused by the marking or rasping of the surface with a pointed or sharp object.

Seasoning – The process of adding a small amount of solder to a soldering iron or solder extractor tip to protect the tip from oxidation.

Secondary Side – The side of a CCA opposite the primary side. The secondary side is sometimes referred to as the solder side or termination side in through-hole mounting technology.

Semi-Clinched Lead – A lead termination that is bent to a 45° angle. Semi-clinch lead termination style is used with both supported holes and unsupported holes. Semi-clinch leads may be used with an isolated pad. Clinched leads are used to provide component stability during the installation process. See Full Clinched Lead.

Service Equipment – The necessary equipment, usually consisting of a circuit breaker or switch and fuses, and their accessories located near the point of entrance of supply conductors to a building or other structure, or an otherwise defined area, and intended to constitute the main control and means of cutoff of the supply.

Service Loop – An amount of slack left in a wire when soldered to a termination, normally used with bundled wire, to allow for future repairs.

Shield – Outermost conductor of a coaxial cable.

Shielding – A physical barrier, usually electrically conductive, that reduces the interaction of electric or magnetic fields upon devices, circuits, or portions of circuits.

Shotgun Pattern – A soldering/desoldering process for multilead components that applies heat to non-adjacent leads/pads to avoid heat buildup in the component or laminate. See the Continuous Vacuum Extraction Procedure step 12 in WP 007 00 (paragraph 07-5.2.1) for an example of a shotgun pattern.

Single-Sided CCA – A CCA with a conductive pattern on one side.

SL – Stock List (Marine Corps)

SM&R – Source Maintenance and Recoverability

SMD –Surface Mount Device – A leaded or leadless component (device) capable of being attached to a CCA by surface mounting.

A B C D E F G H I J K L M N O P Q R S T U V W X Y Z

SMT – Surface Mount Technology – The electrical and mechanical connection of parts to the surface of a conductive land pattern on a CCA that does not use part lead holes or terminals.

Sn – Tin

SnPb – Tin-Lead

SO – Small Outline – Used for SMD packages having a DIP or discrete transistor/diode equivalents. SO packages occupy an area about 30–50% less with a typical thickness that is 70% less than the equivalents.

SOIC – Small Outline Integrated Circuit – A plastic small outline integrated circuit package for surface mount applications that has leads on two opposite sides.

SOJ – Small Outline J-Lead – A small outline integrated circuit package with J-Leads vice gull wing leads.

Solder – A metal alloy with a melting temperature below 800°F (427°C) used to join metallic surfaces.

Solder Ball – (1) A small sphere of solder adhering to a laminate, resist, or conductor surface. This generally occurs after wave or reflow soldering. (2) A tiny globe of solder providing contact between the chip package and the CCA. See Solder Bump.

Solder Bridge – The unwanted formation of a conductive path of solder between conductors.

Solder Bump – A round ball of solder used to make interconnections between a flip chip component and a base material during controlled-collapse soldering.

Solder Connection – An electrical/mechanical connection that employs solder for the joining of two or more metal surfaces. See Solder Joint.

Solder Cup – A cylindrical solder terminal with a hollow opening into which one or more wires are inserted prior to soldering.

Solder Fillet – A normally concave surface of solder at the intersection of the metal surfaces of a soldered connection.

Solder Fines – Unreflowed solder paste that remains on a CCA.

A B C D E F G H I J K L M N O P Q R S T U V W X Y Z

Solder Joint – An electrical/mechanical connection that employs solder for the joining of two or more metal surfaces.

Solder Mask – A heat-resisting coating material applied to selected areas of a CCA to prevent the deposition of solder upon those areas during subsequent soldering.

Solder Paste – Finely divided particles of solder, with additives to promote wetting and to control viscosity, tackiness, slumping, drying rate, etc., suspended in a cream flux.

Solder Plug – A core of solder in a plated-through hole.

Solder Pot – A thermally controlled container used to melt solder.

Solder Projection – An undesirable protrusion of solder from a solidified solder connection or coating.

Solder Resist – See Solder Mask.

Solder Spillage – Any quantity of solder outside of the intended solder joint.

Solder Webbing – A continuous film or curtain of solder parallel to, but not necessarily adhering to, a surface that should be free of solder.

Solder Wicking – The capillary movement of solder between metal surfaces, such as strands of wire.

Solderability – The ability of a metal to be wetted by molten solder.

Soldering – The joining of metallic surfaces with solder.

Solderless Wrap (Wire Wrap) – The connecting of a solid wire to a square, rectangular, or v-shaped terminal by tightly wrapping a solid-conductor wire around the terminal with a special tool.

SOLIC – Small Outline Large Integrated Circuit

Solvent – A non-reactive liquid substance capable of dissolving another substance.

SOT – Small Outline Transistor – A plastic small outline leaded package for diodes and transistors used in surface mount applications.

SPAWAR – Space and Naval Warfare Systems Command

A B C D E F G H I J K L M N O P Q R S T U V W X Y Z

SR – Silicone Resin Conformal Coating

SSOP – Shrink Small Outline Package – Small Outline packages with a compressed body and lead structure.

Static Dissipative – A material that has a surface resistivity of at least $1 \times 10^5 \Omega/\text{square}$ or $1 \times 10^4 \Omega\text{-cm}$ volume resistivity, but less than $1 \times 10^{12} \Omega/\text{square}$ surface resistivity or $1 \times 10^{11} \Omega\text{-cm}$ volume resistivity.

STD – Standard

Step Soldering – The making of soldered connections by sequentially using solder alloys with successively lower melting temperatures.

Straight-Through Lead – A component lead that extends through a hole and is terminated without subsequent forming.

Stress – The force producing or tending to produce deformation in a body, measured by the force applied per unit area.

Stress Line – A visible line in the surface of a solder connection caused by uneven cooling.

Stress Relief – The portion of a component lead or wire lead formed in such a way as to minimize mechanical stresses after the lead is terminated.

Substrate – See Laminate Material.

Supported Hole – A hole in a CCA that has its inside surfaces plated or otherwise reinforced.

Surface Mount Device – See SMD.

Surface Mount Technology – See SMT.

Surface Mounting – The electrical connection of components to the surface of a conductive pattern that does not utilize component holes.

Surface Resistivity – An inverse measure of the conductivity of a material and equal to the ratio of the potential gradient to the surface, where the potential gradient is measured in the direction of current flow in the material. Surface resistivity of a material is numerically equal to the surface resistance between two electrodes forming opposite sides of a square. The size of the square is immaterial. Surface resistivity applies to both surface and volume conductive materials and has the value of ohms per square.

A B C D E F G H I J K L M N O P Q R S T U V W X Y Z

Surface Tension – The natural, inward, molecular-attractive force that inhibits the spread of a liquid at its interface with a solid material and makes the liquid assume the shape having the least surface area.

Swaged Lead – A component lead that extends through a hole in a CCA and is flattened (swaged) to secure the component to the CCA during manufacturing operations.

Sweat Joint – A paper-thin solder joint formed by a minute amount of solder remaining on conductor lead surfaces that cannot be removed by extraction or wicking.

T

Tantalum – A hard, heavy metallic element exceptionally resistant to chemical corrosion below 302°F (150°C) and is used to make electronic components (electrolytic capacitors) and surgical instruments.

Target Condition – A condition that is close to perfect. It is a desirable condition, not always achievable and may not be necessary to ensure reliability of the assembly in its service environment.

TBGA – Tape Ball Grid Array – Similar to CSPs. TBGAs have a die-up, wire bonded configuration with a flexible circuit substrate and an over-molded body.

Terminal – A metallic device used for making electrical connections.

Termination – A conductive surface on a component used for making an electrical connection. See Lead.

Termination Side – The side of a CCA opposite of the component side. The side of a CCA that contains the least complex, or the least number of components. See Secondary Side.

Tg – Glass Transition Temperature – The temperature at which an amorphous polymer (e.g., laminate material, epoxy, or conformal coating) or the amorphous regions in a partially crystalline polymer, changes from being in a hard and relatively brittle condition to being in a viscous or rubbery condition.

Thermal Conductivity – The property of a material that describes the rate at which heat will be conducted through a unit area of the material for a given driving force.

Thermal Expansion – The absolute geometric increase or decrease due to a change in temperature, it is equal to the CTE multiplied by the change in temperature.

A B C D E F G H I J K L M N O P Q R S T U V W X Y Z

Thermal Mass – The measure of the ability of a material to transfer heat. The thermal mass of an object depends on its composition and physical mass. An object with a higher thermal mass will transfer more heat before dropping in temperature.

Thermal Shunt – See Heat Sink.

Thermal Stripper – A device used to remove insulation from wires by heat.

Thermally Shock – A procedure of reducing a soldering iron tip temperature rapidly to cause solidification of the contaminants for thorough cleaning.

Through-Hole Component – The electrical connection of components to a conductive pattern by the use of holes in the laminate material.

Tin Whiskers – Electrically conductive, crystalline structures of tin that sometimes grow from surfaces where tin (especially electroplated tin) is used as a final finish on CCAs.

Tinning – The application of molten solder to a base metal in order to increase its solderability.

TMDER – Technical Manual Deficiency/Evaluation Reports

TNC – Threaded Neill-Concelman (connector) – 0.571 in. diameter plug.

Toe Overhang – The condition of a leaded surface mount device when the end of a lead(s) extends beyond the end of the land(s) due to component misalignment, improper lead forming, or improper lead length.

Tombstoning – A defect condition whereby a leadless device has only one of its metallized terminations soldered to a land and has the other metallized termination elevated and not soldered to its land.

TQFP – Thin Quad Flat Pack – One millimeter thick, square-bodied QFP.

Triboelectric – Pertaining to electricity generated by friction.

TSOP – Thin Small Outline Package – Small, thin (1 mm), rectangular, low profile packages, normally used in high-density applications. Leads extend from two of the sides. Type I TSOP leads extend from the ends or short sides of the package. Type II TSOP leads extend from the long sides of the package.

TTL – Transistor-to-Transistor Logic

A B C D E F G H I J K L M N O P Q R S T U V W X Y Z

Turret Terminal – A round post-type solder terminal with one or more pads to which one or more wires are attached prior to soldering.

Twist – The deformation of a CCA occurring when one of the corners is not in the plane as the other three corners. See Bow.

U

UHF – Ultra-High Frequency

UHF Connector – Ultra-High Frequency connector – 0.735 in. diameter plug.

UM – User Manual

Unsupported Hole – A hole in a CCA that does not contain plating or other type of conductive reinforcement.

UR – Polyurethane Resin Conformal Coating

URL – Uniform Resource Locator

USAF – United States Air Force

USCG – United States Coast Guard

USMC – United States Marine Corps

V

V – Volts

VAC – Voltage AC

Via – A plated-through hole used as an interfacial connection or an inner layer connection, but in which there is no intention to insert a component lead or other reinforcing material.

VMOS – Vertical Metal Oxide Field Effect Transistor

Void – The absence of any substances in a localized area.

W

Wave Soldering – A process wherein an assembled CCA is brought in contact with the surface of a continuously flowing and circulating mass of solder.

A B C D E F G H I J K L M N O P Q R S T U V W X Y Z

Weave Exposure – A laminate material surface condition in which unbroken fibers of woven glass cloth are not completely covered by resin.

Welded Leads – Component leads welded to the conductive pattern of the CCA. This technique is often used in the automated assembly of flat packs to the CCA.

Wetting Action – The ability of solder to readily flow over the surfaces of the materials being soldered.

Wetting, Solder – The formation of a relatively uniform, smooth, unbroken, and adherent film of solder to a solderable material.

Whisker – A slender, needle-shaped metallic growth between a conductor and a pad.

Wicking – The capillary absorption of liquid (solder) along the fibers of a base material (wicking material).

Wicking Material – Finely stranded copper braiding saturated with liquid flux used to remove solder as part of the wicking process.

Wire – A typically cylindrical, elongated strand of drawn metal (solid wire) or a group of strands, twisted together (stranded wire). Wires are encased in plastic or another insulating material and are used to carry electrical energy.

Wire Diameter – The overall diameter of a wire excluding insulation. See AWG.

WP – Work Package

wt% – weight percent

X

X-Axis – The horizontal or left-to-right direction in a two-dimensional system of coordinates. The X-Axis is perpendicular to the Y-Axis.

XRF – X-Ray Fluorescence

XY – Paraxylylene Conformal Coating

Y

Y-Axis – The vertical or bottom-to-top direction in a two-dimensional system of coordinates.

A B C D E F G H I J K L M N O P Q R S T U V W X Y Z

Z

Z-Axis – The axis perpendicular to the plane formed by the X-Axis and Y-Axis. This axis usually represents the thickness of the CCA.

Zn – Zinc

15 October 2013

WP 003 00 Technical Information

03-1 PURPOSE

Identify 2M technician skill levels, 2M repair limitations, and general 2M repair procedures.

Identify 2M facilities requirements, 2M workstation requirements, and equipment and material requirements.

Identify 2M repair workmanship standards and handling practices for electronic assemblies.

Identify the concepts of maintenance and repair and Levels of Maintenance used in DoD.

Identify additional technical information relative to 2M repair, including classification of electronic assemblies and counterfeit components.

03-2 INDEX

Paragraph	Subject	Page
03-1	Purpose	1
03-2	Index	1
03-3	General Safety Precautions.....	2
03-4	2M Program Information and Requirements	4
03-4.1	2M Technician Skill Levels.....	4
03-4.1.1	Microminiature Electronic Repair.....	5
03-4.1.1	Microminiature Electronic Repair.....	5
03-4.1.2	2M Repair Limitations.....	5
03-4.2	Concepts of Maintenance and Repair	6
03-4.3	Levels of Maintenance	7
03-4.3.1	Organizational (O) Level Maintenance	7
03-4.3.2	Intermediate (I) Level Maintenance	7
03-4.3.3	Depot (D) Level Maintenance	7
03-4.3.4	Marine Corps Maintenance	8
03-4.4	2M Facilities Requirements	8
03-4.5	2M Workstation	10
03-4.6	Equipment and Material Requirements	13
03-4.6.1	Equipment Required	13
03-4.6.2	Additional Support Items.....	20
03-4.6.3	Material Required.....	20
03-4.6.4	Handling Practices.....	23
03-5	Repair Procedures.....	24
03-5.1	Procedural Analysis and Feasibility of Repair Procedure	25

Paragraph	Subject	Page
03-5.2	Microscope Focusing Procedure.....	28
03-5.3	Tip Preparation Procedure.....	29
03-5.4	Tip Temperature Procedure	31
03-5.5	Reflowing a Solder Joint Procedure	33
03-5.6	Solder Extractor Readiness Test Procedure.....	35
03-5.7	Solder Extractor Vacuum Test and Heater Element Cleaning Procedure.....	36
03-5.8	Solder Extractor Glass Solder Trap Cleaning Procedure	39
03-5.9	Solder Extractor Paper Solder Trap Replacement Procedure.....	41
03-5.10	Solder Extractor (SX-70) Glass Solder Trap Cleaning Procedure	43
03-5.11	Component Lead and Wire Tinning using Solder Pot Procedure	45
03-5.12	General Inspection Procedure	49
03-6	Workmanship Standards	51
03-7	Additional Technical Information	52
03-7.1	Classification of Electronic Assemblies	52
03-7.2	Counterfeit Components	53

03-3 GENERAL SAFETY PRECAUTIONS

Observe all the following precautions while performing 2M repair procedures:

- Electronic equipment must be de- energized during removal and installation of CCAs
- Personnel are required to wear a properly grounded ESD wrist strap and cord while working in or around the Electrostatic Protected Areas (EPA)
- ESD can destroy components—protect ESD Sensitive (ESDS) devices during handling and repair to prevent ESD damage (Refer to WP 004 00)
- Isopropyl alcohol is flammable; do not use in the presence of sparks, heat, flame, or synthetic cloth
- Soldering handpieces (e.g., soldering irons, solder extractors, hot air jets) produce extreme heat—exercise care when these tools are out of their stands
- Avoid direct inhalation of fumes during a soldering operation because there is a possibility these fumes could cause occupational asthma
- The lead contained in solder is a source of lead oxide, which the human body cannot dissipate (accumulation of lead oxide in the body over a period of years can result in a serious health hazard)

- Contact with solder by holding in the mouth, smoking, or eating during or immediately after soldering is a potential means of ingesting trace amounts of lead oxide
- Avoid oral contact with hands during or immediately after solder operations
- Wash hands following any solder operation
- Wear approved personal protective equipment (PPE) whenever pouring or handling molten metals or corrosive liquids and solids; and cutting, drilling, grinding, milling, chipping and other dust and debris producing operations
- When handling solder paste avoid skin contact by wearing the Glove, Chemical Protective (blue nitrile) and wash hands immediately following use
- Use adequate ventilation during thermal wire stripping operations because wire insulation may emit toxic fumes during thermal stripping
- Follow manufacturer's safety instructions for using chemical wire strippers
- Use chemical wire strippers only in well-vented areas, wear prescribed PPE, and avoid contact with skin and eyes
- Do not use wire with polyvinyl chloride (PVC) [plastic] insulation to replace or repair installed military equipment wiring
- Some conformal coating materials are flammable; do not use in the presence of open flames or sparks
- Avoid inhalation of conformal coating fumes, vapors, or spray
- Keep conformal coatings away from the face and eyes
- Apply and cure conformal coatings only in ventilated areas; adequate ventilation shall be provided during and immediately following application
- Avoid excessive skin contact with conformal coatings; if skin contact occurs, wash with soap and water
- Polyurethane resins normally contain traces of free toluene diisocyanates, monomeric isocyanate, or polymeric isocyanates; prevent polyurethane resin vapor or spray mist contact with the eyes and skin
- Always follow the manufacturer's instructions and warnings when using conformal coating products

- Follow manufacturer's safety instructions when using resins and catalysts
- Follow manufacturer's safety instructions when mixing filler material
- Use of eye protection is required and nitrile gloves optional when handling acrylic filler materials
- Follow manufacturer's directions for the mixing, use, and curing of bonding agents

03-4 2M PROGRAM INFORMATION AND REQUIREMENTS

The Miniature and Microminiature (2M) Electronic Repair Program gives military personnel the capability to repair electronics enhancing self-sustainability and avoiding the costs associated with replacing equipment or a failed CCA.

03-4.1 2M Technician Skill Levels

2M electronic repair is divided into two distinct capability levels—Miniature Electronic Repair and Microminiature Electronic Repair:

NOTE

**MINIATURE ELECTRONIC REPAIR DOES NOT INCLUDE REPAIR ON MULTILAYER CCAS.
REPAIR OF FLAT PACKS IS NOW A MICROMINIATURE ELECTRONIC REPAIR.**

- Wiring and soldering of terminals and connectors (wires AWG 26 and larger)
- Removal and replacement of discrete components and integrated circuits on through-hole single- and double-sided CCAs
- Removal and replacement of conformal coatings on through-hole single- and double-sided CCAs
- Removal and replacement of damaged pads and conductors on through-hole single- and double-sided CCAs
- Removal and replacement of damaged laminate through-hole single- and double-sided CCAs
- ESD familiarization and handling procedures

03-4.1.1 Microminiature Electronic Repair

Microminiature electronic repair includes the following techniques and processes on electrical and electronic enclosures, assemblies, subassemblies, and modules:

- All Miniature Electronic Repair techniques and processes
- Wiring and soldering of terminals and connectors (wires AWG 28 and smaller)
- Removal and replacement of discrete components and integrated circuits on multilayer CCAs
- Removal and replacement of damaged conductors and laminate on multilayer CCAs
- Repairs to CCAs constructed of ceramic laminates and their associated parts
- Installation and repair of jumper wires
- Removal and replacement of flat packs
- Disassembly and repair of flexible printed circuitry assemblies
- Repair of edge-lighted (plastic) panels
- Removal and replacement of components with welded leads
- Removal and replacement of surface mount devices
- Removal and replacement of damaged laminate, lands, and conductors on surface mount technology CCAs

03-4.1.2 2M Repair Limitations

NOTE

THESE REPAIRS ARE NOT AUTHORIZED AT ORGANIZATIONAL (O) LEVEL MAINTENANCE OR INTERMEDIATE (I) LEVEL MAINTENANCE.

2M repair limitations include:

- Internal repairs to special components
- Repairs to assemblies that are critically sensitive to frequency, voltage, or temperature

- Repairs requiring special calibration equipment
- Repairs requiring equipment beyond that defined in the 2M MTR Certification Manual (Appendix F)
- Plated-through hole (eyeleting) repair on multilayer CCAs

03-4.2 Concepts of Maintenance and Repair

The concepts of maintenance and repair as they relate to this manual are strictly defined so all personnel know their exact mission and the scope of the 2M Program.

The maintenance of electronic equipment is divided into two main categories: preventive maintenance and corrective maintenance (Figure 03-1).

Preventive Maintenance—Preventive maintenance consists of the routine inspection and upkeep performed on systems and equipment.

Corrective Maintenance—Corrective maintenance consists of the procedures used for correcting equipment failure. Corrective maintenance is divided into two distinct actions: diagnostics (troubleshooting and trouble isolation) and repair. Diagnostics determines the actual cause and effect of equipment failure. Repair is the physical action that returns the equipment to its original function and reliability. This manual identifies standard repair procedures only; therefore, preventive maintenance and the diagnostic level of corrective maintenance are not included.

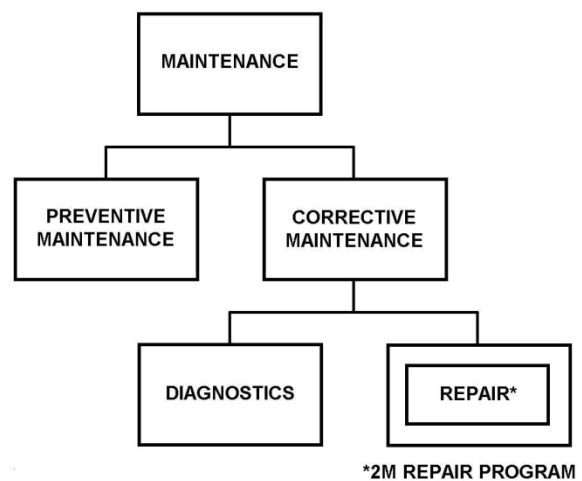

Figure 03-1 Concepts of Maintenance and Repair

NOTE

FOR NAVY SHIPS AND SHORE FACILITIES UNDER THE COGNIZANCE OF NAVSEA, THE JOINT FLEET MAINTENANCE MANUAL (JFMM), COMUSFLTFORCOMINST 4790.3 REQUIRES 2M TECHNICIANS TO SCREEN AND ATTEMPT REPAIR OF ALL CCA/ELECTRONIC ASSEMBLIES WITHIN THEIR TRAINING AND CAPABILITY, REGARDLESS OF COGNIZANCE OR SM&R CODE.

Source, Maintenance and Recoverability (SM&R) Codes—The Allowance Parts List (APL), Allowance Equipage List (AEL) and Illustrated Parts Breakdown (IPB) are technical documents prepared for equipment components. These allowance lists identify all maintenance significant repair parts associated with a specific piece of equipment. To determine the availability of repair parts, the 2M Technician must be familiar with these documents. SM&R codes, found in the APL, AEL, and IPB, determine where repair parts can be obtained, who is authorized to make the repair, and at what maintenance level the item may be recovered or condemned.

03-4.3 Levels of Maintenance

Users of this manual typically utilize the following levels of maintenance:

03-4.3.1 Organizational (O) Level Maintenance

Organizational level maintenance is performed by a using organization on its assigned equipment. O-level maintenance normally consists of inspecting, servicing, lubricating, adjusting, and replacing parts, minor assemblies, and subassemblies. This maintenance normally is shipboard maintenance of ship equipment or aircraft squadron maintenance of aircraft and aeronautical equipment, including corrective and scheduled preventive maintenance.

03-4.3.2 Intermediate (I) Level Maintenance

Intermediate level maintenance is performed by designated maintenance activities in direct support of using organizations. I-level maintenance normally consists of calibration, repair, or replacement of damaged or unserviceable parts, components, or assemblies; the emergency manufacture of unavailable parts; and the provision of technical assistance to using organizations. Intermediate maintenance for naval aircraft is performed by Aircraft Intermediate Maintenance Departments (AIMD) aboard carriers and shore-based activities.

03-4.3.3 Depot (D) Level Maintenance

Depot level maintenance is performed by designated maintenance activities to augment stocks of serviceable material and to support organizational maintenance and intermediate maintenance activities. D-level maintenance employs more extensive shop facilities, equipment, and personnel of higher technical skill than are available at the lower levels of maintenance.

It normally consists of inspection, test, repair, modification, alteration, modernization, conversion, overhaul, reclamation, or rebuilding of parts, assemblies, subassemblies, components, equipment end items, and defense systems; the manufacture of critical unavailable parts; and technical assistance to intermediate maintenance organizations and other activities.

D-level maintenance is normally accomplished in fixed shops, shipyards, Fleet Readiness Centers (FRC), and contractor shore-based facilities or by depot field teams.

03-4.3.4 Marine Corps Maintenance

The Marine Corps divides maintenance among the following five maintenance echelons for ground-employed systems and equipment:

NOTE

MARINE CORPS ECHELONS 1 AND 2 ARE ORGANIZATIONAL LEVEL MAINTENANCE. ECHELONS 3 AND 4 ARE INTERMEDIATE LEVEL MAINTENANCE. ECHELON 5 IS DEPOT LEVEL MAINTENANCE.

Echelon 1—Maintenance by equipment operators in a company or battery.

Echelon 2—Maintenance by maintenance personnel assigned to a company, battery, or squadron.

Echelon 3—Maintenance by personnel of certain Military Occupational Specialties (MOS) at a Force Service Support Group (FSSG).

Echelon 4—Maintenance by personnel of certain other MOSs at an FSSG.

Echelon 5—Maintenance by personnel of the Marine Corps Logistics Bases (MCLB) at Albany, Georgia, and Barstow, California.

03-4.4 2M Facilities Requirements

The requirements for 2M Repair Facilities are as follows:

03-4.4.1 ESD

All 2M work areas shall meet the requirements of WP 004 00.

03-4.4.2 Cleanliness See SUPP E

Work areas and tools shall be maintained in a clean and orderly condition. There shall be no visible foreign material including dirt, chips, grease, silicones, flux residue, solder splatter, solder balls, insulation residue, and wire clippings at any 2M Workstation. Containers of hand creams, ointments, perfumes, cosmetics, and other materials not essential to the repair operation, except hand creams approved and controlled for use in electronic areas, are prohibited at the 2M Workstation.

03-4.4.3 Temperature and Humidity

The temperature should be maintained between 65°F (18°C) and 80°F (27°C), and the relative humidity should not exceed 70%. Shipboard temperature controlled spaces shall be considered as meeting the temperature and humidity requirements.

03-4.4.4 Ventilation

Onboard naval ships, local exhaust ventilation (i.e., a fume extracting hood) is not required for any 2M Workstation. Questions concerning the adequacy of the ventilation of any specific 2M repair facility should be directed to a local industrial hygienist or to the Navy Environmental Health Center for review.

03-4.4.5 Electrical Requirements

There should be a minimum of four 115 VAC, single phase, 60 Hz, 15 amp outlets. Standard electrical safety precautions shall be observed.

03-4.4.6 Noise

The Navy Occupational Exposure Limit for noise is 84 dB (A weighted) for an 8-hour time-weighted average in any 24-hour period when measured with a sound level meter that conforms, at a minimum, to ANSI S1.4-1983(R2006). Personnel are required to wear hearing protection devices where operations generate sound levels greater than the A weighted sound pressure level of 84 dB.

03-4.4.7 Lighting

Illumination at the surface of 2M Workstations shall be 1000 lx minimum (93 foot-candles). The surface shall be defined as a circle, 8 inches in diameter, on the 2M Workstation where the repair work is actually accomplished. The surface does not include the peripheral areas where the 2M Power Units or auxiliary equipment is placed. The light measured can be any combination of ambient (overhead) and supplemental lighting as long as it is at least the required 1000 lx minimum (93 foot-candles) at the surface.

The supplemental lighting source may be placed no closer than 8 inches above the surface to allow sufficient room to work. A fully functioning fiber optic light source or a fully functioning high intensity light with proper bulbs (one spot and one flood type) will provide the minimum lighting level required.

03-4.4.8 Eyewash Station

Shore facilities shall meet eyewash station requirements in accordance with OPNAVINST 5100.23, Chapter 1902. Shipboard facilities shall meet eyewash station requirements in accordance with OPNAVINST 5100.19, Volume I, Chapter B0508.

03-4.4.9 Habitat

Eating, drinking, use of tobacco products, and use of personal grooming items at a 2M workstation is prohibited.

03-4.4.10 Compressed Air

The use of compressed air is limited to NAVAIR facilities only. Compressed air should be oilless, with less than 0.25% moisture. Use a maximum of 10 PSI to remove matter from CCAs. Observe all applicable safety precautions when using compressed air.

03-4.5 2M Workstation

A 2M workstation encompasses the area used to perform Miniature Electronic Repair and Microminiature Electronic Repair.

WARNING

A 2M WORKSTATION SHALL NOT BE USED TO PERFORM MAINTENANCE ON ENERGIZED ELECTRONIC EQUIPMENT.

A mechanical workbench should be used for 2M repair. (An electrically safe workbench is not required per NAVSEA S9086-KC-STM-010, paragraph 300-H.1.1.)

The repair area is defined as the portion of a work surface where repairs are performed. The repair area of the workbench should be burn resistant and shall provide ESD protection. The repair area should be a minimum of 24 in. deep by 30 in. wide.

The 2M workstation must provide for technician comfort. The technician must be able to sit with their legs under the workbench to operate properly footswitches, which are on the deck or on a permanently installed stable platform.

The workbench should have an easily cleanable surface with secure and lockable tool storage. The core of the 2M workstation is the 2M workbench (Figure 03-2).

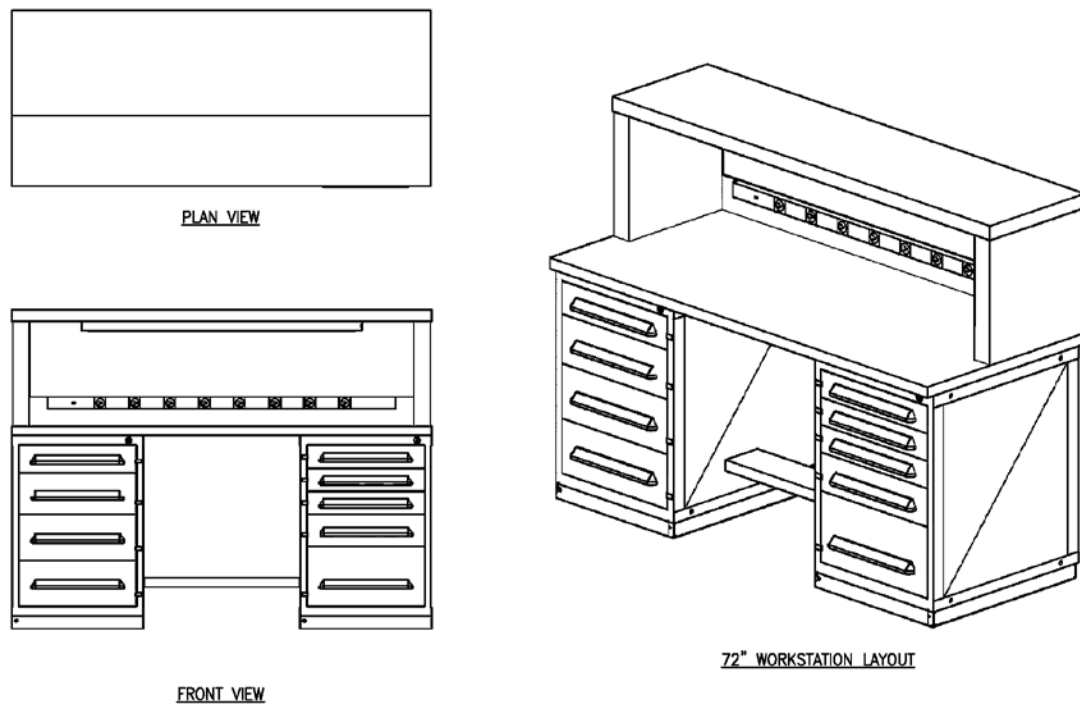

Figure 03-2 2M Workbench

Table 03-1 is the standard configuration for a 2M workbench.

Table 03-1 2M Workbench Configuration

ITEM	QTY	PART NUMBER	NOMENCLATURE
1	1	WSS7218A1AAO	Riser Shelf
2	1	EOS48P	Power Strip
3	1	BS372	Backstop
4	1	PLR72	Tabletop
5	1	SV0175 MAL	Cabinet
6	1	SV0175 MLL	Cabinet
7	1	FL04807200	Light

Shipboard 2M workstations and some shore sites will also include a 2M piece parts cabinet (Figure 03-3) with an array of ship class specific components for 2M repair.

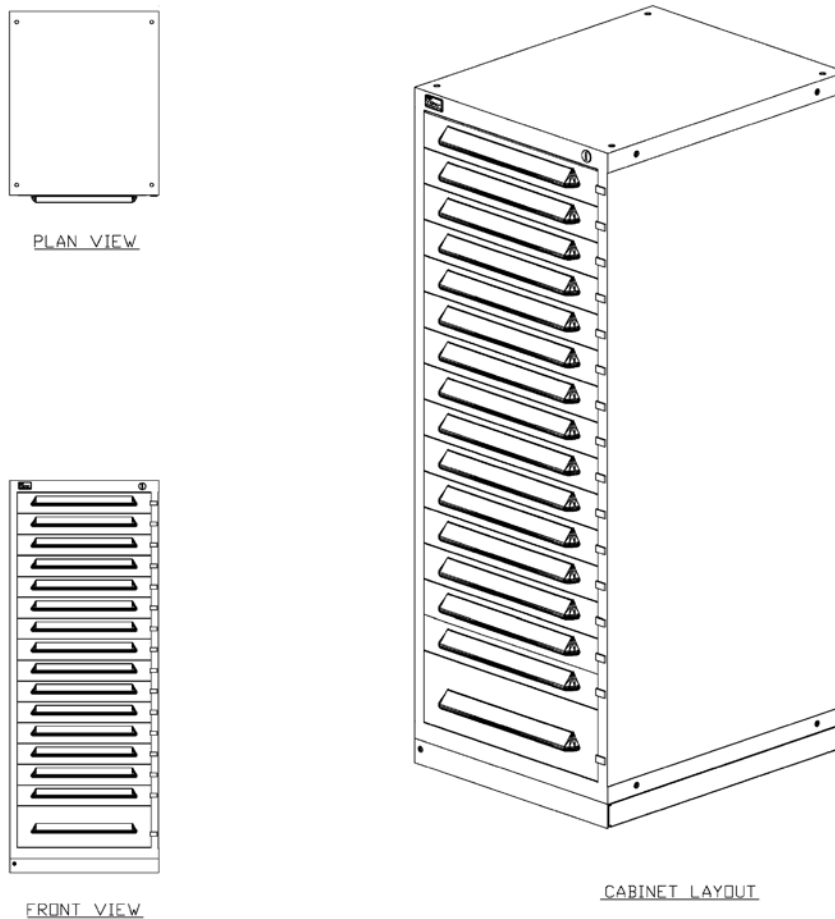

Figure 03-3 2M Piece Parts Cabinet

Table 03-2 is the standard configuration for a 2M piece parts cabinet.

Table 03-2 2M Piece Part Cabinet Configuration

ITEM	QTY	PART NUMBER	NOMENCLATURE
1	1	SGSV0340	Cabinet
2	15	SGSV20SGSV33	Drawer
3	1	SGSV40SGSV33	Drawer

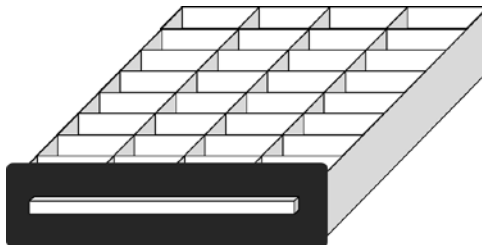

Figure 03-4 2M Piece Parts Cabinet Drawer Configuration

03-4.6 Equipment and Material Requirements

Equipment and materials listed here are required to perform the procedures in this manual. Refer to specific Work Packages for applicability of each item.

03-4.6.1 Equipment Required

The 2M Workstation equipment consists of special electrical and mechanical units, tools, and materials to perform miniature and microminiature repair on electronic assemblies. The basic repair station contains a power unit, handpieces, and auxiliary equipment.

Table 03-3 lists the authorized 2M Power Units for 2M repair.

Table 03-3 Authorized 2M Power Units See SUPP E

	Nomenclature	Part #/Type Designation	CAGE
NAVAIR/NAVSEA/USAF/USCG/USMC	PRC-2000-SMT	8007-0161	00WU8
NAVSEA/USCG	PRC-2000-TH	8007-0138	00WU8
NAVSEA/USCG	MBT-250-SD*	8007-0203	17794
USMC	MBT-350*	7008-0280	17794
NAVSEA	ST-25*	8007-0501	17794

* Limited capability in this manual

03-4.6.1.1 2M Power Units

2M power units provide electrical and mechanical (PRC-2000 only) power for operating the various handpieces (Figure 03-5 and Figure 03-6).

PRC-2000 provides AC (pulse) and DC electrical power, pneumatic power, and mechanical grinding capability to accomplish 2M repairs.



Figure 03-5 2M Power Unit (PRC-2000)

NAVSEA S9665-CY-OMP-010/PRC-2000/U//NAVAIR 17-15-99 is the technical manual for the PRC-2000 providing additional information on its operation.

The MBT-250 (NAVSEA) and the MBT-350 (MARCOR ground) provides DC electrical power and pneumatic capability.

The ST-25 (NAVSEA) provides DC electrical power only.



MBT-250



MBT-350



ST-25

Figure 03-6 Other Power Units used in 2M

Primary heating methods of the 2M power units are those methods responsible for achieving solder reflow during a component installation or removal process.

The primary heating methods are:

- **Conductive**—heating by contact
- **Convective**—heating by gas or air flow

03-4.6.1.2 Conductive Handpieces

NOTE

IF MORE THAN ONE AIR-OPERATED HANDPIECE IS CONNECTED TO THE THERMAL MANAGEMENT CENTER, ENSURE THAT ONLY ONE OF THE AIR HOSES IS CONNECTED TO EITHER THE SNAP-VAC PORT OR CONTROLLABLE PRESSURE PORT. ATTACHMENT TO BOTH SIMULTANEOUSLY WILL CAUSE DETERIORATION IN PERFORMANCE.

Conductive heating is accomplished with continuously heated devices such as soldering irons, solder extractors, and thermal tweezers. These devices may be held at selected idle tip temperatures prior to use. Continuously heated devices generally employ tinnable tips to optimize heat transfer to the work. 2M workstation conductive handpieces include a soldering iron (Figure 03-7) and a solder extractor (Figure 03-8).



Figure 03-7 Soldering Iron



Figure 03-8 Solder Extractor

Continuously heated devices offer the following potential advantages:

- Effective at transferring a large amount of heat to a targeted area rapidly
- Controlled heat delivery with variable tip temperature and dwell time
- Safe access to hard-to-reach places and space-limited areas
- Control of heating pattern based on proper tip selection and use
- Adjacent laminates and components stay cooler during surface mount component installation and removal

NOTE

ALL CONDUCTIVE TIPS USED WITH THE PRC-2000 AND MBT-250 ELECTRONIC REWORK POWER UNITS HAVE AN OFFSET TEMPERATURE IDENTIFIED TO ACCURATELY MAINTAIN DESIRED TIP TEMPERATURE. CONSULT TIP AND SELECTION CHART FOR OFFSET TEMPERATURES OF EACH TIP. APPROPRIATE TEMPERATURE ADJUSTMENTS MUST BE MADE PRIOR TO EACH OPERATION.

The following guidelines and precautions should be observed for continuously heated devices:

- A high-efficiency, temperature controlled handpiece that maintains sufficient thermal output to keep up with thermal load of the work and duty cycle of the application is recommended
- The tip temperature can drop below desired level during heavy, continuous use if the handpiece has insufficient thermal output
- For effective heat transfer there must be good thermal linkage between the tip and solder joint
- The appropriate tip geometry (shape) must be utilized
- The tip and rework area must be free of oxides, contaminants and conformal coating
- The tip must be tinned, as applicable
- Flux or additional solder may be necessary to achieve effective heat transfer
- A precise match between tip and component geometry may be required for effective heat transfer to all solder joints during surface mount component removal
- Contact may disturb component lead-to-land alignment, especially during SMD installation or re-alignment operations
- Heat may be transferred too rapidly for use with sensitive components

03-4.6.1.3 Convective Handpieces

NOTE

IF MORE THAN ONE AIR-OPERATED HANDPIECE IS CONNECTED TO THE THERMAL MANAGEMENT CENTER, ENSURE THAT ONLY ONE OF THE AIR HOSES IS CONNECTED TO EITHER THE SNAP-VAC PORT OR CONTROLLABLE PRESSURE PORT. ATTACHMENT TO BOTH SIMULTANEOUSLY WILL CAUSE DETERIORATION IN PERFORMANCE.

Convective heating methods are found in devices such as hot air jet handpieces. Convective heating is an inefficient means of primary heat delivery when compared to conductive heating methods. 2M workstation convective handpieces include a hot air jet (Figure 03-9).



Figure 03-9 Hot Air Jet

Convective heating devices offer the following potential advantages:

- The ability to install and remove components whose solder connections are not directly accessible by conductive heating methods, e.g., BGAs
- A non-contact process that does not disturb connections or obstruct view
- Ability to re-align slightly skewed (misaligned) surface mount components without component removal
- Flux or tinning is generally not necessary to aid thermal transfer
- Leaves less residue and solder than conductive heating methods for surface mount component removal
- Works well with solder paste under most conditions

With convective heating devices, the following guidelines and precautions should be observed:

- Properly focus and control heated gas or airflow to minimize errant heating of laminate, adjacent components and their solder joints
- Control exit gas or air velocity (via pressure or flow rate) to avoid displacement of applied solder paste and/or disturbance of the lead/land alignment of surface mount components during installation or re-alignment

03-4.6.1.4 Pulse Heated Devices

2M workstation pulse heated devices (PRC-2000 only) include a lap flow tool (Figure 03-10), resistance tweezers (Figure 03-11), and thermal strippers (Figure 03-12).



Figure 03-10 Lap Flow Tool



Figure 03-11 Resistance Tweezers



Figure 03-12 Thermal Stripper

03-4.6.1.5 Motor Driven Handpieces

2M workstation rotary handpieces include a power unit driven handpiece (PRC-2000 only) [Figure 03-13] and rechargeable handpiece (2M Portable Kit only) [Figure 03-14].



Figure 03-13 Rotary Handpiece (power unit driven)



Figure 03-14 Rotary Handpiece (rechargeable)

03-4.6.1.6 Microminiature Specific Handpieces

2M workstation microminiature specific handpieces (PRC-2000 only) include thermal tweezers (Figure 03-15) and a vacuum pick device (Figure 03-16).



Figure 03-15 Thermal Tweezers



Figure 03-16 Vacuum Pick Device

03-4.6.1.7 Shadowboxed Drawers

The 2M workstation may include a workbench with shadowboxed drawers (Figure 03-17) containing consumables, tools, and materials.



Figure 03-17 2M Workbench “Narrow” Shadowboxed Drawers

03-4.6.1.8 Fiber Optic Light

2M workstation lighting includes fiber optic light source (Figure 03-18) with attaching light pipes.



Figure 03-18 2M Fiber Optic Light

03-4.6.1.9 Microscope

The 2M workstation includes a stereo zoom microscope (Figure 03-19).



Figure 03-19 2M Microscope

03-4.6.1.10 Oven

The 2M workstation may include an optional mechanical or gravity-convection oven (Figure 03-20) for drying CCAs and curing conformal coatings and adhesives.



Figure 03-20 Typical 2M Oven

03-4.6.1.11 ESD Protective Equipment

For ESD protective equipment refer to WP 004 00.

03-4.6.2 Additional Support Items

For additional information regarding items of support and support equipment, refer to:

- **NAVSEA/NAVAIR/USCG**—2M MTR Certification Manual
- **NAVSEA/USCG**—Allowance Parts List (APL) 000A8423
- **USMC**—Stock List SL-3-09458A
- **USAF**—the Consolidated Tool Kit (CTK)

03-4.6.3 Material Required

Table 03-4 lists the materials required to perform the procedures in this manual.

- **NAVSEA** and **USCG** units should use Table 03-4, the 2M MTR Certification Manual, and the latest version of APL 000A8423
- **USMC** units should use Table 03-4 and the latest version of SL-3-09458A

See SUPP E • **USAF** units should use Table 03-4 and the latest version of the Consolidated Tool Kit (CTK)

- **NAVAIR** units should use Table 03-4 and the 2M MTR Certification Manual

The list of consumable materials required (Table 03-4) is not mandatory for certification for each location, nor is it an all-inclusive list. Refer to the 2M MTR Certification Manual for certification requirements.

When storing consumable materials, consideration shall be given to shelf life, flammability, and contamination of the material. All consumables such as flux, solvents, and solders shall be labeled with type and expiration date per local HAZMAT requirements.

Table 03-4 Material Required for 2M

Nomenclature	Specification No. /Part No.	National Stock Number*
Adhesive (Epoxy Patch Kit)	EPK 0151	8040-00-061-8303
Adhesive (jumper wire bonding)	Tak Pak 444	8040-01-148-9262
Antistatic and Cleaner Compound	6001	6850-01-283-9966
Applicator, Disposable (cotton-tipped)	362	6515-01-234-6838
Bag, Plastic (ESD) [4x8]	7100408ZL	8105-01-386-3874
Bag, Plastic (ESD) [8x10]	7100810ZL	8105-01-386-3899
Bag, Plastic (ESD) [12x16]	7101216ZL	8105-01-386-3868
Caps, ESD, Round	M5501/31†	
Caps, ESD, "D" Shell	M5501/32†	
Desoldering Wick (#1)	50-1-5	3439-00-545-3396
Desoldering Wick (#2)	50-2-5	3439-01-324-8208
Desoldering Wick (#3)	40-3-5	3439-00-009-2334
Dichloromethane, Technical	ASTM-D4701	6810-00-122-3963
Eraser, Rubber	ZZ-E-00661	7510-00-223-7046
Eyelet, Metallic	CME15	5325-00-139-0328

Nomenclature	Specification No. /Part No.	National Stock Number*
Eyelet, Metallic	CME26C	5325-00-234-7913
Eyelet, Metallic	CME36C	5325-00-558-1785
Eyelet, Metallic	CME46C	5325-01-076-9499
Flux, Soldering	FORMULA 197 1QT	3439-00-069-5815
Glove, Chemical Protective (blue nitrile)	BQF09-L	8415-01-563-5208
Hand Lotion, Static Dissipative	ICL-16-ESD	8510-01-492-3313
Heat Sink Compound	52022IJ	6850-01-143-4853
Insulating Compound (AR conformal coating)	1B31	5970-01-029-7961
Insulating Compound (UR conformal coating)	1A33	5970-01-013-8611
Insulating Compound, Electrical (SR conformal coating)	RTV-3140	5970-01-363-8394
Insulation Sleeving Kit, Electrical	12-1080‡	5970-01-051-4706
Isopropyl Alcohol, Technical	TT-I-735	6810-00-983-8551
Label (ESD Warning)	L-81	7690-01-077-4894
Lacquer (black acrylic)	700B20	8010-00-830-1822
Lacquer (white acrylic)	700W14	8010-00-068-8778
Orangewood Stick	SH-83	5120-01-596-0413
Paper, Abrasive (400 grit sandpaper)	ANSI B74.18	5350-00-224-7201
Paper, Abrasive (600 grit sandpaper)	ANSI B74.18	5350-00-224-7215
Pipet, Measuring (Pipette)	37019	6640-00-290-6890
Plate, Instruction (ESD Caution Sign)	3870-1	9905-01-342-3044
Resin, Acrylic, Dental Kit	651011	6520-01-061-0664
Solder, Paste	6-SN63-211A	3439-01-384-2071

Nomenclature	Specification No. /Part No.	National Stock Number*
Solder, Tin Alloy (0.015 in.)	24-6337-9703	3439-01-510-5302
Solder, Tin Alloy (0.028 in.)	SN63WRMAP3	3439-01-008-7577
Solder, Tin Alloy (0.031 in.)	24-6337-9710	3439-01-510-6209
Solder, Tin Alloy (0.063 in.)	SN63WRMAP3	3439-00-473-2000
Solder, Tin Alloy (0.090 in.)	SN63WRMAP3	3439-01-146-6953
Strip, Metal (copper foil)	QQ-C-576	9535-00-268-9571
Tape Dot, 6.5 mm (jumper wire bonding)	310-0651	OPEN PURCHASE
Tape Dot, 10 mm (jumper wire bonding)	310-1001	OPEN PURCHASE
Tape, Pressure Sensitive (Kapton®)	5413 ½ in.	7510-01-377-9992
Toothpick	A-A-1056‡	7350-00-838-3919
Towel, Paper (Kimwipe®)	900S‡	7920-00-721-8884
Wipes, Staticide®	SW-12ND	7920-01-295-8918
Wire, Electrical (Solid)	A-A-59551	VARIOUS

* National Stock Number was current at time of publication, please verify before ordering

† Family part number

‡ Substitution of equivalent material is acceptable

03-4.6.4 Handling Practices

Proper handling is needed to ensure there is no damage to the CCA or the soldering surfaces become contaminated.

Physical Damage—Improper handling can readily damage components and assemblies (e.g., cracked, chipped, or broken components and connectors; bent or broken terminals; and badly scratched laminate, conductors, pads, and lands).

- Minimize the handling of CCAs to prevent damage
- Never stack CCAs or physical damage may occur

Contamination—Avoid contaminating solderable surfaces prior to soldering.

Whatever contacts the solderable surfaces must be clean. Contamination by handling with bare hands or fingers may cause soldering and coating problems. Body salts and oils, and unauthorized hand creams are typical contaminants. Body oils and acids reduce solderability; promote corrosion and dendritic growth; and cause poor adhesion of subsequent coatings or encapsulates.

Normal cleaning procedures will not always remove such contaminants.

- When gloves are used to handle assemblies, the gloves need to be changed as frequently as necessary to prevent contamination

After soldering and cleaning operations, the handling of electronic assemblies still requires great care.

- Handle the CCA with clean hands by its edges

03-5 REPAIR PROCEDURES



PROTECT STATIC SENSITIVE DEVICES DURING HANDLING AND REPAIR TO PREVENT ESD DAMAGE (REFER TO WP 004 00).

Equipment Required Listed below are the authorized Power Units* for 2M repair:

- **NAVAIR/NAVSEA/USMC/USAF/USCG—PRC-2000-SMT**
- **NAVSEA/USCG—PRC-2000-TH**
- **NAVSEA/USCG—MBT-250-SD**
- **USMC—MBT-350**
- **NAVSEA—ST-25**

* Refer to Table 03-3 for Power Unit Part No., and CAGE Code

Additional Support Items

For additional information regarding items of support and support equipment refer to:

- **NAVSEA/NAVAIR/USCG**—2M MTR Certification Manual
- **NAVSEA/USCG**—Allowance Parts List (APL) 000A8423
- **USMC**—Stock List SL-3-09458A
- **USAF**—the Consolidated Tool Kit (CTK)

Material Required

Listed below are the materials required* for the procedures in this WP:

- Flux, Soldering
- Isopropyl Alcohol, Technical
- Solder, Tin Alloy†
- Toothpick‡
- Towel, Paper (Kimwipe®)‡

* Refer to Table 03-4 for Specification No., Part No., and NSN

† Select size appropriate for application

‡ Substitution of equivalent material is acceptable

03-5.1 Procedural Analysis and Feasibility of Repair Procedure

A procedural analysis shall be conducted prior to performing most 2M repair procedures. A procedural analysis is performed by identifying CCA characteristics and by determining and/or special equipment needed.

Personnel Hazards



Lead (Solder)

Procedural Analysis and Feasibility of Repair Procedure

Step	Action
	<div style="text-align: center;"> <div style="border: 3px double black; padding: 5px; display: inline-block;"> WARNING </div> <p>USE APPROVED SAFETY EYEWEAR WHEN PERFORMING THIS PROCEDURE.</p> <p>COMPLY WITH ALL LOCAL REQUIREMENTS FOR PPE.</p> </div>

Procedural Analysis and Feasibility of Repair Procedure

Step	Action
	<p style="text-align: center;">CAUTION</p> <p style="text-align: center;">DON A PROPERLY GROUNDED ESD WRIST STRAP BEFORE STARTING THIS PROCEDURE.</p> <p style="text-align: center;">NOTE</p> <p style="text-align: center;">TO ALLEVIATE SOLDERABILITY PROBLEMS CAUSED BY OXIDATION AND DAMAGE TO THE ASSEMBLY DURING STORAGE, DO NOT START THE REPAIR PROCESS BEFORE ALL PARTS AND MATERIAL ARE AVAILABLE.</p> <p style="text-align: center;">AS THE REPAIR PROGRESSES, CORRECTIONS MAY HAVE TO BE MADE TO THE PROCEDURAL ANALYSIS OUTLINE. REVIEW THE OUTLINE WHEN REPAIR IS COMPLETE TO DETERMINE WHY THESE CORRECTIONS WERE NEEDED. THIS WILL HELP IN DEVELOPING FUTURE PROCEDURAL OUTLINES.</p>
1	Evaluate and record the type(s) and extent of damage to the CCA.
2	Evaluate and record the type(s) of repair required.
3	Determine and record the base laminate: epoxy/glass, polyimide/glass, phenolic, ceramic, constraining core, or flex print.
4	Determine and record the CCA circuitry style: single-sided CCA, double-sided CCA, or multilayer CCA.
5	Determine and record the component mounting style(s): horizontal axial-leaded, horizontal radial-leaded, vertical axial-leaded, vertical radial leaded, stress relief, and/or surface mount.
6	Determine and record the lead termination style(s): straight-through, semi-clinch, full clinch, offset pad, and/or swaged leads (spaded).
7	Determine and record the component type(s): discrete component and/or integrated circuit.
8	Determine and record the hole reinforcement styles: no hole support, plated-through holes, eyelets, interfacial connections, and/or vias.
9	Determine and record if there are welded leads.

Procedural Analysis and Feasibility of Repair Procedure

Step	Action
10	Determine and record the conformal coating type: no conformal coating, Acrylic Resin (AR), Epoxy Resin (ER), Silicone Resin (SR), Polyurethane Resin (UR), or Paraxylylene (XY) [paralene].

NOTE

THE TYPE AND EXTENT OF LAMINATE, CONDUCTOR AND COMPONENT DAMAGE MUST BE EVALUATED BEFORE A PROPER METHOD AND PROPER LEVEL OF REPAIR CAN BE DETERMINED.

11	Determine and record the type and extent of laminate damage.
12	Determine and record the type and extent of conductor damage.
13	Determine and record the type and extent of component damage.
14	Determine that all required tools and equipment to perform the repair are available.
15	Determine any special and/or additional tool and material requirements.
16	Determine the skill level required to perform the repair.
17	Determine the availability of a technician with the required skill level to perform the repair.
18	Determine that the parts and consumable materials required for the repair are available.
19	Determine the time and cost of the required repairs.
20	Determine the impact to operational/mission needs if repair is/is not attempted.
21	Determine and record the area and method of conformal coating removal.
22	Determine and record the components to be removed and the desoldering methods of component removal.
23	Determine and record the area and method of laminate repair.
24	Determine and record the area and method of conductor repair.

Procedural Analysis and Feasibility of Repair Procedure

Step	Action
25	Determine and record the components to be installed and the installation methods.
26	Determine and record the area and method of conformal coating application.

03-5.2 Microscope Focusing Procedure

It is necessary to adjust the microscope so the focus remains sharp throughout the range of zoom magnification and the image is equally sharp in both the left and right eyepieces.

Personnel Hazards No HAZMAT identified in the HMWS is used in this procedure.

Microscope Focusing Procedure

Step	Action
	<div style="border: 2px solid black; padding: 5px; display: inline-block;">CAUTION</div> DON A PROPERLY GROUNDED ESD WRIST STRAP BEFORE STARTING.
1	<p>Move the eyepiece tubes in and out horizontally to find the place where the distance between the eyepiece centers matches the distance between the pupils of the operator.</p> <p>Note: This is the interpupillary distance and will vary from operator to operator. The operator sees one central image when these distances match.</p>
2	<p>Set the eyepiece diopters to zero.</p> 
3	<p>Set the microscope magnification to the highest power (4.5X) by turning the zoom control knob fully away from the operator.</p>

Microscope Focusing Procedure

Step	Action
4	Focus sharply on the object.
5	Set the microscope magnification to the lowest power by turning the zoom control knob fully toward the operator. Note: <u>DO NOT</u> adjust the focusing controls at this time.
6	Looking with the right eye only, through the right-hand eyepiece, turn the eyepiece's diopter adjustment ring until the image is precisely in focus.
7	Looking with the left eye only, through the left-hand eyepiece, turn the eyepiece's diopter adjustment ring until the image is precisely in focus.
8	While looking through both eyepieces, the fused microscope image should now be uniformly sharp throughout the zoom range and without refocusing.

03-5.3 Tip Preparation Procedure

Use this procedure before any soldering or desoldering operation to maximize effectiveness of the procedure.

Personnel Hazards





Lead (Solder)

9

Tip Preparation Procedure

Step	Action
	<div style="border: 2px solid black; padding: 5px; display: inline-block;"> WARNING </div> USE APPROVED SAFETY EYEWEAR WHEN PERFORMING THIS PROCEDURE. COMPLY WITH ALL LOCAL REQUIREMENTS FOR PPE.

Tip Preparation Procedure

Step	Action	
	<div style="border: 2px solid black; padding: 5px; display: inline-block; margin-bottom: 10px;">CAUTION</div> <p>DON A PROPERLY GROUNDED ESD WRIST STRAP BEFORE STARTING THIS PROCEDURE.</p>	
1	<p>Select a soldering iron or solder extractor tip that maximizes heat transfer per WP 005 00 (paragraph 05-5.3.3) and contact area with the surfaces to be soldered.</p>	
2	<p>Set the soldering iron tip temperature to 600°F (316°C) [700°F (371°C) for a solder extractor] and adjust as necessary per the Tip Temperature Procedure (paragraph 03-5.4).</p>	
3	<p>Remove the seasoning (all solder) from the soldering iron or solder extractor tip. Note: If the handpiece has idled for some time, add fresh solder before wiping off the excess.</p>	
4	<p>Thermally shock the soldering iron or solder extractor tip on a damp, well-maintained sponge.</p>	
5	<p>Perform the soldering/desoldering operation.</p>	
6	<p>Season the tip (load the tip with solder) and place the handpiece into its stand.</p>	

03-5.4 Tip Temperature Procedure

Use this procedure to adjust the temperature of a soldering/desoldering tip should solder melt not occur within 2 to 3 seconds.

Additional information on tip temperature is in WP 005 00 (paragraph 05-5.3.4).



Personnel Hazards





Lead (Solder)

9

Tip Temperature Procedure

Step	Action
	<p style="text-align: center;">WARNING</p> <p style="text-align: center;"><i>USE APPROVED SAFETY EYEWEAR WHEN PERFORMING THIS PROCEDURE.</i></p> <p style="text-align: center;"><i>COMPLY WITH ALL LOCAL REQUIREMENTS FOR PPE.</i></p> <p style="text-align: center;">CAUTION</p> <p style="text-align: center;">DON A PROPERLY GROUNDED ESD WRIST STRAP BEFORE STARTING THIS PROCEDURE.</p>
1	Remove the tip.
2	Unplug the soldering iron or solder extractor from the power unit.
3	<p>Clean the soldering iron or solder extractor heating element with a 3/16 in. wire brush while cold.</p> 
4	<p>Install the soldering iron or solder extractor tip.</p> 

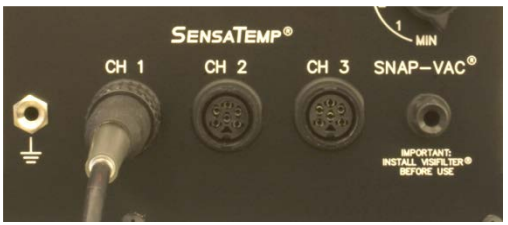
Tip Temperature Procedure

Step	Action
5	Plug the soldering iron or solder extractor cable into the power unit. 
6	Verify and set the temperature on the power unit to 600°F (316°C) [700°F (371°C) for some solder extractor procedures]. 
7	Verify and adjust tip offset temperature as needed. 
8	Perform the soldering or desoldering operation to the step where solder melt should occur.
9	If solder melt occurs, continue the soldering or desoldering operation.
10	If solder melt does not occur in 2-3 seconds, remove the tip from the workpiece.
11	Tin the tip to verify it will accept solder; if the tip accepts solder, skip to step 15.

Tip Temperature Procedure

Step	Action
12	If the tip does not accept solder, clean the tip with a brass plater's brush and re-tin the tip to verify it will accept solder. 
13	if the tip accepts solder, skip to step 15.
14	If the tip still will not accept solder, replace the tip.
15	Perform the soldering or desoldering operation to the step where solder melt should occur.
16	If solder melt occurs, continue the soldering or desoldering operation.
17	If solder melt does not occur, increase the temperature setting by 50°F (27°C).
18	Perform the soldering or desoldering operation to the step where solder melt should occur.
19	If solder melt occurs, continue the soldering or desoldering operation.
20	If solder melt does not occur in 2-3 seconds, remove the tip from the workpiece and repeat steps 17 through 20.

03-5.5 Reflowing a Solder Joint Procedure

Use this procedure to reflow a defective solder joint. DO NOT reflow acceptable solder joints.

Personnel Hazards



Alcohol, Isopropyl

1



Flux (Soldering)

8



Lead (Solder)

Reflowing a Solder Joint Procedure

Step	Action
	<p style="text-align: center;">WARNING</p> <p style="text-align: center;"><i>USE APPROVED SAFETY EYEWEAR WHEN PERFORMING THIS PROCEDURE. COMPLY WITH ALL LOCAL REQUIREMENTS FOR PPE.</i></p> <p style="text-align: center;">CAUTION</p> <p style="text-align: center;">DON A PROPERLY GROUNDED ESD WRIST STRAP BEFORE STARTING THIS PROCEDURE.</p> <p style="text-align: center;">UNNECESSARY APPLICATIONS OF HEAT (REFLOWS OR TOUCH-UPS) SHALL BE AVOIDED. ADDITIONAL APPLICATIONS OF HEAT CAN NEGATIVELY AFFECT THE RELIABILITY OF THE SOLDER JOINT AND MAY LEAD TO CCA AND/OR COMPONENT DAMAGE.</p>
1	Clean the area to be soldered with isopropyl alcohol using an acid brush and blot dry with a clean, lint-free tissue.
2	Apply flux SPARINGLY to the solder joint to be reflowed. Note: Use a toothpick or flux pen to control the volume of flux applied. Heavy flux volume impairs cleaning and may affect reliability.
3	Remove the seasoning (all solder) from the soldering iron tip.
4	Thermally shock the soldering iron tip on a damp sponge.
5	<p style="text-align: center;">CAUTION</p> <p style="text-align: center;">DO NOT APPLY PRESSURE WITH THE SOLDERING IRON.</p> <p>Place the soldering iron tip on the solder joint at the point of maximum thermal mass.</p>

Reflowing a Solder Joint Procedure

Step	Action
6	<div style="text-align: center; border: 2px solid black; padding: 5px; margin: 0 auto; width: fit-content;">CAUTION</div> <p style="text-align: center;">IF SOLDER MELT DOES NOT OCCUR WITHIN TWO SECONDS, STOP THIS PROCEDURE AND ADJUST TIP TEMPERATURE PER THE TIP TEMPERATURE PROCEDURE (PARAGRAPH 03-5.4).</p> <p>Allow the solder joint to reflow completely.</p>
7	Remove the soldering iron tip from the solder joint.
8	Season the tip and place the soldering iron into its stand.
9	Allow the solder joint to cool completely before cleaning.
10	Clean the solder joint with isopropyl alcohol using an acid brush to remove all flux residue and blot dry with a clean, lint-free tissue.
11	<p><i>Inspect per the General Inspection Procedure (paragraph 03-5.12) to all applicable WORKMANSHIP STANDARDS, including:</i></p> <ul style="list-style-type: none"> • <i>General Solder Acceptability in WP 005 00 (paragraph 05-6.1)</i> • <i>Post-Solder Joint Cleanliness in WP 005 00 (paragraph 05-6.2)</i> • <i>Other applicable Workmanship Standards as required</i>
12	Dispose of all HAZMAT following local procedures.

03-5.6 Solder Extractor Readiness Test Procedure

Perform this procedure before each use of the solder extractor.

Personnel Hazards



Alcohol, Isopropyl

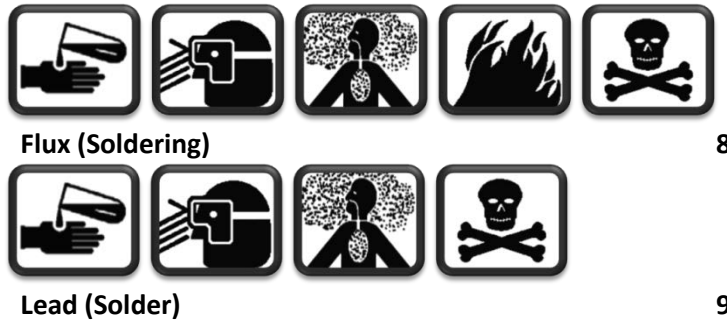















Solder Extractor Readiness Test Procedure

Step	Action
	<p style="text-align: center;">WARNING</p> <p style="text-align: center;"><i>USE APPROVED SAFETY EYEWEAR WHEN PERFORMING THIS PROCEDURE.</i></p> <p style="text-align: center;"><i>COMPLY WITH ALL LOCAL REQUIREMENTS FOR PPE.</i></p> <p style="text-align: center;">CAUTION</p> <p style="text-align: center;">DON A PROPERLY GROUNDED ESD WRIST STRAP BEFORE STARTING THIS PROCEDURE.</p>
<p style="text-align: center;">1</p>	<p>Place a clean tissue on a heat resistant surface and test the solder extractor by actuating vacuum to pick up the tissue.</p> <p>Note: If the solder extractor vacuum is insufficient to pick up the tissue, stop this procedure and perform the Solder Extractor Vacuum Test and Heater Element Cleaning Procedure (paragraph 03-5.7).</p>
<p style="text-align: center;">2</p>	<p><i>There are no WORKMANSHIP STANDARDS specific to this procedure.</i></p>

03-5.7 Solder Extractor Vacuum Test and Heater Element Cleaning Procedure

Perform this procedure if the solder extractor fails the Solder Extractor Readiness Test Procedure (paragraph 03-5.6).

Personnel Hazards

					
Alcohol, Isopropyl					1
					
Flux (Soldering)					8
					
Lead (Solder)					9

Solder Extractor Vacuum Test and Heater Element Cleaning Procedure

Step	Action
	<div style="border: 1px solid black; padding: 5px; margin: 10px auto; width: 150px;">WARNING</div> <p style="text-align: center;">USE APPROVED SAFETY EYEWEAR WHEN PERFORMING THIS PROCEDURE.</p> <p style="text-align: center;">COMPLY WITH ALL LOCAL REQUIREMENTS FOR PPE.</p> <div style="border: 1px solid black; padding: 5px; margin: 10px auto; width: 150px;">CAUTION</div> <p style="text-align: center;">DON A PROPERLY GROUNDED ESD WRIST STRAP BEFORE STARTING THIS PROCEDURE.</p>
1	Remove the solder extractor air hose from female quick-connect fitting attached to the in-line flux filter on the power unit.
2	Attach the compound pressure/vacuum gage to the in-line flux filter assembly using nonmetallic tubing and a male quick-connect fitting.
3	<p>Actuate the solder extractor vacuum.</p> <ul style="list-style-type: none"> • If the gauge reads less than 12" Hg, replace the in-line flux filter element and repeat steps 2 and 3. • If the gauge reads less than 12" Hg after the in-line flux filter element has been replaced, stop this procedure and refer to the appropriate 2M power units' Operation and Maintenance Manual for troubleshooting procedures.
4	Reattach the solder extractor air hose through an in-line flux filter to the power unit.

Solder Extractor Vacuum Test and Heater Element Cleaning Procedure















Step	Action
5	Set the solder extractor tip temperature to 700°F (371°C).
6	Clean the tip and tin the tip with solder if a tip is installed.
7	Loosen the heater element setscrew and remove the tip using the tip tool or the rubber tip removal pad.
8	Place the tip in the tip rack or in the tip slot on the solder extractor stand.
9	With the solder extractor in a vertical position with the heater element pointing up, actuate the solder extractor vacuum for five seconds to remove any loose solder from the heater element into the solder collection chamber.
10	Grasp the 3/16 in. wire brush with pliers and insert the wire brush into the heater element to clear the heater element of any remaining solder and/or desoldering debris.
11	Remove the 3/16 in. wire brush from the heater element and place the brush on a heat resistant surface to allow the brush to cool.
12	Reinstall the solder extractor tip into the solder extractor.
13	<p>Place a clean tissue on a heat resistant surface and test the solder extractor by actuating vacuum to pick up the tissue.</p> <p>Note: If the solder extractor vacuum is sufficient to pick up the tissue return to the parent procedure.</p> <p>Note: If the solder extractor vacuum is insufficient to pick up the tissue continue to the Solder Extractor Glass Solder Trap Cleaning Procedure (paragraph 03-5.8), the Solder Extractor Paper Solder Trap Replacement Procedure (paragraph 03-5.9), or the Solder Extractor (SX-70) Glass Solder Trap Cleaning Procedure (paragraph 03-5.10) below, as applicable.</p>
14	<i>There are no WORKMANSHIP STANDARDS specific to this procedure.</i>

03-5.8 Solder Extractor Glass Solder Trap Cleaning Procedure

Perform when the SX-80, SX-90, or SX-100 solder extractor with a glass tube installed fails the Solder Extractor Vacuum Test and Heater Element Cleaning Procedure (paragraph 03-5.7).

Use the Solder Extractor (SX-70) Glass Solder Trap Cleaning Procedure (paragraph 03-5.10) for the SX-70 solder extractor.

Personnel Hazards

					
Alcohol, Isopropyl					1
					
Flux (Soldering)					8
					
Lead (Solder)					9

Solder Extractor Glass Solder Trap Cleaning Procedure

Step	Action
	<div style="border: 1px solid black; padding: 5px; margin-bottom: 10px;">WARNING</div> <p>USE APPROVED SAFETY EYEWEAR WHEN PERFORMING THIS PROCEDURE.</p> <p>COMPLY WITH ALL LOCAL REQUIREMENTS FOR PPE.</p> <p>THE GLASS SOLDER TRAP WILL RETAIN HEAT MUCH LONGER THAN THE SOLDER EXTRACTOR AND THE EXTRACTOR TIP. USE THE RUBBER HEAT RESISTANT PAD TO REMOVE AND HANDLE THE GLASS SOLDER TRAP THROUGHOUT THE CLEANING PROCESS.</p> <div style="border: 1px solid black; padding: 5px; margin-bottom: 10px;">CAUTION</div> <p>DON A PROPERLY GROUNDED ESD WRIST STRAP BEFORE STARTING THIS PROCEDURE.</p>
1	Turn off the power unit and allow the solder extractor to cool.

Solder Extractor Glass Solder Trap Cleaning Procedure

Step	Action
2	Hold the solder extractor securely with the tip facing away. Pull the plunger lock on the rear of the solder extractor. With the plunger lock extended, turn the plunger lock counterclockwise until it is in a secure open position.
3	Using the recessed finger grips in the glass tube door assembly, pull the glass tube door assembly out of the solder extractor.
4	Remove the rubber end seal from the glass tube, if necessary.
5	Using the rubber heat resistant pad, remove the glass tube from the door assembly.
6	Use a nonmetallic tool to push the filter and V-baffle (or S-baffle) out of the glass tube and onto a heat resistant surface.
7	Properly dispose of the used filter.
8	Ensure the V-baffle (or S-baffle) is cool to the touch.
9	Clean the V-baffle (or S-baffle) with a clean tissue and isopropyl alcohol, ensure all solder debris and flux residue is removed.
10	Grasp and lift the glass tube with the rubber heat resistant pad; clean the inside of the glass tube with a bristle brush to remove any solder debris and flux residue. Note: If required, use a clean tissue and isopropyl alcohol to facilitate removal of solder debris and flux residue.
11	Once the V-baffle (or S-baffle) and glass solder trap are clean and dry, use a cotton-tipped applicator to apply a very thin coat of mineral oil to both the V-baffle (or S-baffle) and glass tube.
12	Reinstall the S-baffle and a clean filter into the glass tube. Ensure the filter is installed between the markings labeled "FILTER" on the back of the glass tube and the V-baffle (or S-baffle) is installed in front of the filter with the "V" pointing toward front of the glass tube.
13	Reinsert the glass tube into the door assembly; insert the glass tube filter end first, in the opposite direction of the arrows marked on the door assembly.
14	Reinsert the rubber end seal into the front of the glass tube, if necessary.

Solder Extractor Glass Solder Trap Cleaning Procedure















Step	Action
15	Reinsert the glass tube/door assembly into the solder extractor and reengage the plunger lock assembly. Ensure the glass tube/door assembly is securely held in place.
16	Turn on the power unit and allow the solder extractor to heat to selected temperature.
17	Place a clean tissue on a heat resistant surface and test the solder extractor by actuating vacuum to pick up the tissue. Note: If the solder extractor vacuum is insufficient to pick up the tissue, stop this procedure and troubleshoot the solder extractor and connecting hardware for air leaks, cracked seals, and/or any obstruction preventing airflow.
18	<i>There are no WORKMANSHIP STANDARDS specific to this procedure.</i>

03-5.9 Solder Extractor Paper Solder Trap Replacement Procedure

Perform when the SX-80, SX-90, or SX-100 solder extractor with a paper solder trap installed fails the Solder Extractor Vacuum Test and Heater Element Cleaning Procedure (paragraph 03-5.7).

Use the Solder Extractor (SX-70) Glass Solder Trap Cleaning Procedure (paragraph 03-5.10) for the SX-70 solder extractor.

Personnel Hazards

					
Alcohol, Isopropyl					1
					
Flux (Soldering)					8
					
Lead (Solder)					9

Solder Extractor Paper Solder Trap Replacement Procedure

Step	Action
	<p style="text-align: center;">WARNING</p> <p style="text-align: center;"><i>USE APPROVED SAFETY EYEWEAR WHEN PERFORMING THIS PROCEDURE. COMPLY WITH ALL LOCAL REQUIREMENTS FOR PPE.</i></p> <p style="text-align: center;">CAUTION</p> <p style="text-align: center;">DON A PROPERLY GROUNDED ESD WRIST STRAP BEFORE STARTING THIS PROCEDURE.</p>
1	Turn off the power unit and allow the solder extractor to cool.
2	Hold the solder extractor securely with the tip facing away. Pull the plunger lock on the rear of the solder extractor. With the plunger lock extended, turn the plunger lock counterclockwise until it is in a secure open position.
3	Using the recessed finger grips in the solder trap door assembly, pull the solder trap/door assembly out of the solder extractor.
4	Hold the solder trap/door assembly in the palm of the hand with the solder trap facing up.
5	Use a new, unused paper solder trap to push the used solder trap out of the solder trap/door assembly. Note: Make sure the arrows on the replacement paper solder trap point toward the solder extractor heater element when it is placed into the solder extractor.
6	Reinsert the solder trap/door assembly into the solder extractor and reengage the plunger lock assembly. Ensure the solder trap/door assembly is securely held in place.
7	Properly dispose of the used paper solder trap.
8	Turn on the power unit and allow the solder extractor to heat to selected temperature.

Solder Extractor Paper Solder Trap Replacement Procedure

Step	Action
9	Place a clean tissue on a heat resistant surface and test the solder extractor by actuating vacuum to pick up the tissue. Note: If the solder extractor vacuum is insufficient to pick up the tissue, stop this procedure and troubleshoot the solder extractor and connecting hardware for air leaks, cracked seals, and/or any obstruction preventing airflow.
10	<i>There are no WORKMANSHIP STANDARDS specific to this procedure.</i>

03-5.10 Solder Extractor (SX-70) Glass Solder Trap Cleaning Procedure

Perform when the SX-70 solder extractor fails the Solder Extractor Vacuum Test and Heater Element Cleaning Procedure (paragraph 03-5.7).

Personnel Hazards

					1
Alcohol, Isopropyl					
					8
Flux (Soldering)					
					9
Lead (Solder)					

Solder Extractor (SX-70) Glass Solder Trap Cleaning Procedure

Step	Action
	<p style="text-align: center;">WARNING</p> <p style="text-align: center;">USE APPROVED SAFETY EYEWEAR WHEN PERFORMING THIS PROCEDURE.</p> <p style="text-align: center;">COMPLY WITH ALL LOCAL REQUIREMENTS FOR PPE.</p> <p style="text-align: center;">THE GLASS SOLDER TRAP WILL RETAIN HEAT MUCH LONGER THAN THE SOLDER EXTRACTOR AND THE EXTRACTOR TIP. USE THE RUBBER HEAT RESISTANT PAD TO REMOVE AND HANDLE THE GLASS SOLDER TRAP THROUGHOUT THE CLEANING PROCESS.</p> <p style="text-align: center;">CAUTION</p> <p style="text-align: center;">DON A PROPERLY GROUNDED ESD WRIST STRAP BEFORE STARTING THIS PROCEDURE.</p>
1	Turn off the power unit and allow the solder extractor to cool.
2	Hold the solder extractor securely, push in the rear seal assembly clip, and turn the clip counterclockwise to release the glass tube assembly.
3	Remove the rear seal assembly and glass tube from the front seal assembly and the solder extractor.
4	Remove the glass tube from the rear seal assembly.
5	Use a nonmetallic tool to push the filter and S-baffle out of the glass tube and onto a heat resistant surface.
6	Properly dispose of the used filter.
7	Ensure that the S-baffle is cool to the touch.
8	Clean the S-baffle with a clean tissue and isopropyl alcohol, ensure all solder debris and flux residue are removed.
9	Grasp and lift the glass tube with the rubber heat resistant pad; clean the inside of the glass tube with a bristle brush to remove any solder debris and flux residue. Note: If required, use a clean tissue and isopropyl alcohol to facilitate removal of solder debris and flux residue.

Solder Extractor (SX-70) Glass Solder Trap Cleaning Procedure

Step	Action
10	Once the S-baffle and glass tube are clean and dry, use a cotton-tipped applicator to apply a thin coat of mineral oil to both the S-baffle and glass tube.
11	Reinstall the S-baffle and a clean cotton filter into the glass tube. Ensure that the cotton filter is installed between the S-baffle and where the glass tube will attach to the rear seal assembly.
12	Attach the rear seal assembly into the glass tube and reinstall the glass tube and rear seal assembly into the solder extractor.
13	Turn on the power unit and allow the solder extractor to heat to selected temperature.
14	Place a clean tissue on a heat resistant surface and test the solder extractor by actuating vacuum to pick up the tissue. Note: If the solder extractor vacuum is insufficient to pick up the tissue, stop this procedure and troubleshoot the solder extractor and connecting hardware for air leaks, cracked seals, and/or any obstruction preventing airflow.
15	<i>There are no WORKMANSHIP STANDARDS specific to this procedure.</i>

03-5.11 Component Lead and Wire Tinning using Solder Pot Procedure

Use this procedure to tin stripped wires or to tin discrete component leads.

The 2M workstation may include an optional solder pot (Figure 03-21).

A solder pot is a thermally controlled container used to melt solder.

When the use of a solder pot is required, the operating temperature should be a minimum 475°F (246°C) to a maximum of 525°F (274°C).



Figure 03-21 Solder Pot

Solder pots should maintain the solder temperature within $\pm 9^{\circ}\text{F}$ (5°C) of the selected temperature.

Solder pots are to be grounded.

Due to their lack of mobility, solder pots are normally used for tinning a group of conductors that are not an integral part of the equipment, e.g., cable repair/ manufacture, component leads.

Over time, the solder in solder pots becomes contaminated e.g., gold, cadmium, and copper. When these contaminants exceed a certain percentage, solder joints will take on certain undesirable characteristics.

- Excessive gold contaminates in the solder will cause the solder to be grainy and brittle.
- Excessive copper levels will cause sluggish solder flow and solder will be hard and brittle.

Most activities do not have access to laboratory facilities to test solder for contamination, so:

- The solder pots containing three pounds or less of solder should be discarded after every 30 operating periods
- Discard the solder every 60 operating periods for pots containing more than three pounds of solder

NOTE

AN OPERATING PERIOD CONSTITUTES ANY PERIOD OF TIME THE SOLDER IS LIQUEFIED AND USED.

Use only bar or ingot solder to fill solder pots.

- Never use flux-cored solder in a solder pot

The dross that forms on the solder surface must be skimmed prior to tinning a wire or component lead.















- Only skim an area large enough to place the component or wire

If large amounts of components with gold are to be tinned, the use of two pots should be considered.

- The first pot is to be used for removing most of the gold plating and the second pot is to be used to complete the tinning operation.

- The solder in the first pot should be changed as soon as signs of gold contamination are noticed.



Personnel Hazards

					
Alcohol, Isopropyl					1
					
Flux (Soldering)					8
					
Lead (Solder)					9

Component Lead and Wire Tinning using Solder Pot Procedure

Step	Action
	<div style="border: 1px solid black; padding: 5px; margin-bottom: 10px;">WARNING</div> <p>USE APPROVED SAFETY EYEWEAR WHEN PERFORMING THIS PROCEDURE.</p> <p>COMPLY WITH ALL LOCAL REQUIREMENTS FOR PPE.</p> <div style="border: 1px solid black; padding: 5px; margin-bottom: 10px;">CAUTION</div> <p>DON A PROPERLY GROUNDED ESD WRIST STRAP BEFORE STARTING THIS PROCEDURE.</p>
	<div style="border: 1px solid black; padding: 5px; margin-bottom: 10px;">CAUTION</div> <p>SOLDER POTS ARE NOT AUTHORIZED FOR SHIPBOARD USE OR OTHER SITES WHERE SPILLAGE IS LIKELY.</p>
1	Set the solder pot temperature to 511°F (266°C) [without digital readout, follow manufacturer’s directions] and adjust as necessary.
2	Ensure the wire was stripped using the proper procedure from Insulated Wire Stripping in WP 008 00 (paragraph 08-5.3).

Component Lead and Wire Tinning using Solder Pot Procedure

Step	Action
3	Clean the wire or component lead with isopropyl alcohol and wipe dry with a clean, lint-free tissue.
4	Select the appropriate size anti-wicking tweezers to match wire or component lead gauge.
5	Clean the anti-wicking tweezers with isopropyl alcohol and wipe dry with a clean, lint-free tissue.
6	<p>Insert the stripped wire or component lead into the anti-wicking tweezers with the wire insulation or component body flat against the inner face of the tweezers.</p> 
7	<p style="text-align: center;">NOTE</p> <p style="text-align: center;">THE USE OF EXTERNAL FLUX WILL INCREASE THE CHANCE OF SOLDER WICKING UNDER THE INSULATION OF THE WIRE.</p> <p>Apply flux SPARINGLY to the lower half of the wire or component lead.</p>
8	Remove the dross from surface of the solder using a tongue depressor.
9	<p>Slowly insert the wire or component lead into the solder pot up to the junction of the wire or component lead and the anti-wicking tweezers.</p> 
10	Hesitate approximately one second to overcome the heat sinking effect.

Component Lead and Wire Tinning using Solder Pot Procedure

Step	Action
11	Slowly remove the wire or component lead from the solder pot.
12	Allow wire or component lead to cool completely before cleaning.
13	Clean the tinned wire or component lead with isopropyl alcohol and a clean, lint-free tissue.
14	Clean the anti-wicking tweezers with isopropyl alcohol using an acid brush and wipe dry with a clean, lint-free tissue.
15	<p><i>Inspect per the General Inspection Procedure (paragraph 03-5.12) to all applicable WORKMANSHIP STANDARDS, including:</i></p> <ul style="list-style-type: none"> • <i>Component Lead Tinning in WP 007 00 (paragraph 07-6.3), as required</i> • <i>Insulated Wire Tinning in WP 008 00 (paragraph 08-6.3), as required</i>
16	Dispose of all HAZMAT following local procedures.

03-5.12 General Inspection Procedure

Inspection is performed to locate defects that may affect the performance or reliability of the assembly.

Inspect the assembly per the inspection magnification guidelines listed in Table 03-5. Supplemental lighting may be necessary to assist in visual assessment.

Table 03-5 Inspection Magnification Guidelines

Conductor Widths / Pad Diameters	Inspection Magnification Power
>1/16 in.	1.75X
>1/32 to 1/16 in.	4X
1/64 to 1/32 in.	10X
<1/64 in.	20X

Personnel Hazards



Lead (Solder)

General Inspection Procedure

Step	Action
	<div style="border: 2px solid black; padding: 5px; display: inline-block; margin-bottom: 10px;">CAUTION</div> <p>DON A PROPERLY GROUNDED ESD WRIST STRAP BEFORE STARTING THIS PROCEDURE.</p>
1	Verify the correct component is installed.
2	<i>Inspect for: proper orientation of polarized and multilead components; components terminate to the correct pads; and component markings and polarization symbols are visible; per the applicable Workmanship Standards.</i>
3	<i>Inspect the component forming, positioning, mounting, and termination per the applicable Workmanship Standards.</i>
4	<i>Inspect the quality of the solder, i.e., smooth, shiny, mirror-like appearance; parts are discernible, feathered edge, dewetting, nonwetting, pits, protrusions, disturbed, cold, and/or fractured per General Solder Acceptability in WP 005 00 (paragraph 05-6.1).</i>
5	<i>Inspect the quantity of the solder, i.e., concave, convex, insufficient, or excessive per General Solder Acceptability in WP 005 00 (paragraph 05-6.1).</i>
6	<i>Inspect the cleanliness of the assembly, i.e., clean, flux residue, contaminants, particulate matter, and/or white residue per the Post-Solder Joint Cleanliness in WP 005 00 (paragraph 05-6.2).</i>
7	<i>Inspect for collateral damage to surrounding components per Discrete Component Leads in WP 007 00 (paragraph 07-6.1) and Discrete Component Body in WP 007 00 (paragraph 07-6.2) or per Surface Mount Devices (paragraph 18-6.1) and Surface Mount Device Leads (paragraph 18-6.2)</i>
8	<i>Inspect for laminate damage per Laminate in WP 011 00 (paragraph 11-6.1).</i>



General Inspection Procedure

Step	Action
9	<i>Inspect for conductor damage per Conductors, Pads, and Lands in WP 012 00 (paragraph 12-6.1).</i>
10	<i>Inspect for the proper application of conformal coating and damage per Conformal Coating Replacement in WP 006 00 (paragraph 06-6.2).</i>
11	Restart the repair process or submit for disposition items identified as defective.

03-6 WORKMANSHIP STANDARDS

Workmanship standards are defined by three conditions: target, acceptable, and defect.

03-6.1 Target Condition

A condition that is close to perfect. It is a desirable condition, not always achievable and may not be necessary to ensure reliability of the assembly in its service environment.

03-6.2 Acceptable Condition

A condition that will maintain the integrity and reliability of the assembly in its service environment. An acceptable condition does not require additional repair.

03-6.3 Defect Condition

A condition insufficient to ensure the fit, form, or function of the assembly in its end use environment. A defect condition must be repaired or scrapped.

03-6.4 Unspecified Anomalies

Unspecified anomalies are considered an acceptable condition unless it can be established that the condition affects the fit, form, or function of the assembly. Any unspecified anomaly that adversely affects the fit, form, or function of an assembly is considered a defect.

Workmanship Standards for:

- General Solder Acceptability and Post-Solder Joint Cleanliness are in WP 005 00 (paragraph 05-6)
- Conformal Coating in WP 006 00 (paragraph 06-6)
- Through Hole Components in WP 007 00 (paragraph 07-6)
- Terminals in WP 008 00 (paragraph 08-6)
- Solder Cups in WP 009 00 (paragraph 09-6)
- Wire Repair in WP 010 00 (paragraph 10-6)
- Laminate in WP 011 00 (paragraph 11-6)
- Conductors, Pads, and Lands in WP 012 00 (paragraph 12-6)
- Flex Print in WP 013 00 (paragraph 13-6)
- Welded Leads in WP 014 00 (paragraph 14-6)
- Multilayer in WP 015 00 (paragraph 15-6)
- Plastic Panel in WP 016 00 (paragraph 16-6)
- Surface Mount Devices in WP 018 00 (paragraph 18-6)
- Jumper Wires in WP 019 00 (paragraph 19-6), and
- Connectors in WP 021 00 (paragraph 21-6)

03-7 ADDITIONAL TECHNICAL INFORMATION

This section contains ancillary and amplifying information pertinent to the procedures contained within this document.

03-7.1 Classification of Electronic Assemblies

IPC/EIA J-STD-001 recognizes electrical and electronic assemblies are subject to classifications by intended end-item use.

Three general end-product classes have been established to reflect differences in producibility, complexity, functional performance requirements, and verification (inspection/test) frequency:

Class 1—General Electronic Products: Includes products suitable for applications where the major requirement is function of the completed assembly.

Class 2—Dedicated Service Electronic Products: Includes products where continued performance and extended life is required, and for which uninterrupted service is desired but not critical. Typically, the end-use environment would not cause failures.

Class 3—High Performance Electronic Products: Includes products where continued high performance or performance-on-demand is critical, equipment downtime cannot be tolerated, end-use environment may be uncommonly harsh and the equipment must function when required, such as life support or other critical systems.

03-7.2 Counterfeit Components

Counterfeit components fall into one of two categories.

- An unauthorized copy of an authentic product.
- Previously used components, refurbished to appear as new components and sold as new.

03-7.2.1 The Counterfeit Component Threat

In recent years, there has been a drastic increase in counterfeit electronic components into DoD supply chains, resulting in an ever increasing threat to national security programs.

On 21 May 2012, the United States Senate Committee on Armed Services released the report, "Inquiry into Counterfeit Electronic Parts in the Department of Defense Supply Chain."ⁱ This report focused on previous findings from a 2010 U.S. Department of Commerce study performed per the request of NAVAIRⁱⁱ and a 2012 Government Accountability Office (GAO) report.ⁱⁱⁱ The report also addressed specific case studies, traced counterfeit components back to the original seller/country of origin, and addressed deficiencies in DoD procedures for dealing with the counterfeit component threat.

These combined reports presented shocking findings.

The Department of Commerce study revealed a 142% increase in detected suspect counterfeit components from 2005 to 2008, as shown in Figure 03-22. The increased rate was attributed to improved detection and tracking methods as well as an increase in the number of counterfeit components.

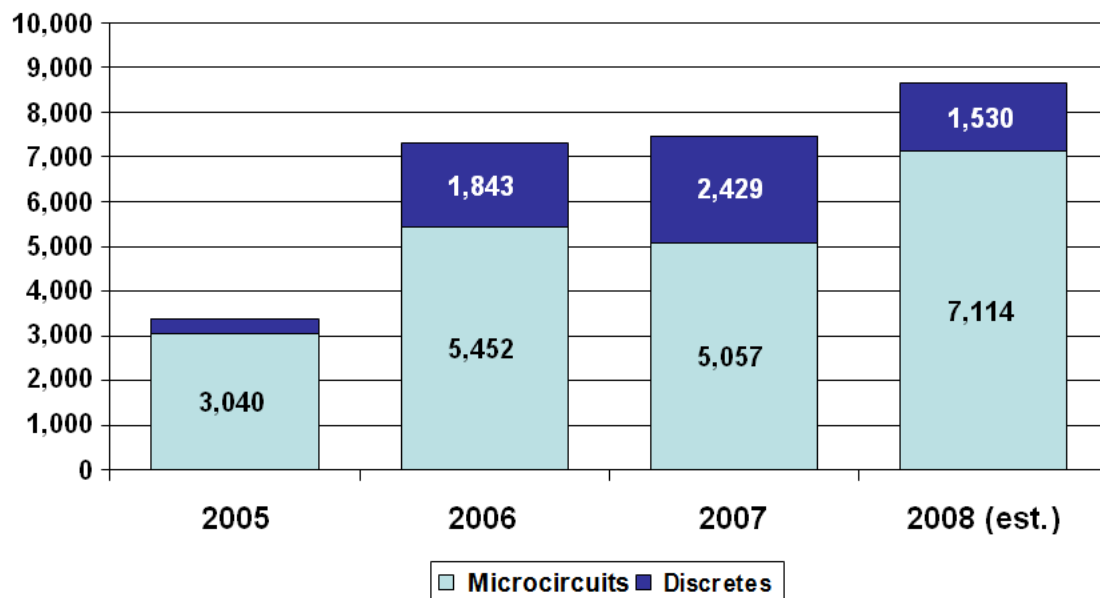

Figure 03-22: Total detected counterfeit incidents per year from 2005 to 2008. The rise in incidents is attributed to an increase in the number of counterfeit components, improved detection, and tracking methods. Figure taken *Defense Industrial Base Assessment: Counterfeit Electronics* report from the U.S. Department of Commerce, released January 2010.

The Department of Commerce study also showed that in 2008, a vast majority of counterfeit microcircuits where either previously used products are re-marked to appear new and of higher quality, or new products re-marked to appear of higher quality, as shown in Figure 03-23.

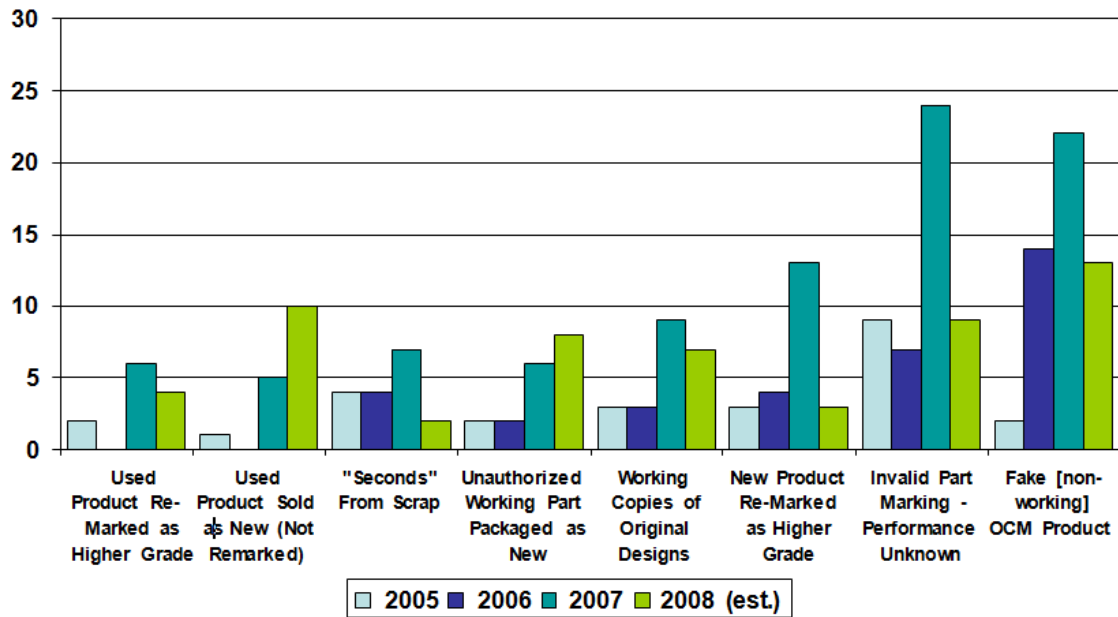

Figure 03-23: Counterfeit microcircuits by year and counterfeit type. Figure taken *Defense Industrial Base Assessment: Counterfeit Electronics* report from the U.S. Department of Commerce, released January 2010.

These two categories would initially result in a functional CCA, but a premature failure of the CCA would follow.

The GAO study highlighted the likelihood of receiving a counterfeit component by procuring electronic components from lowest price vendors.

- A shell company requested specific electronic components. These components included legitimate part numbers and date codes, legitimate part numbers with illegitimate date codes, and illegitimate part number and date codes.
- All orders were filled and all components received were suspect counterfeit.
- Of particular concern were the received components with illegitimate part numbers and date codes emphasizing the, "willingness to sell parts that do not technically exist."

The Senate Armed Services Committee report showed how counterfeit components are affecting Defense systems.

- Suspect counterfeit components were installed in the Navy's P-8A Poseidon aircraft, the US Air Force's C130J and C-27J aircraft, thermal weapon sights for the Army, and on telemetry boxes and missile interceptors for the Missile Defense Agency. The counterfeit components had major impacts on these systems.

- The counterfeit components installed in Air Force aircraft resulted in failing displays, with a rate of failure triple that of authentic components.
- The reliability of ice detection systems on the Navy's P-8A was severely reduced.

The Missile Defense Agency spent \$2.1 million to correct counterfeit component issues.

- Result: In many of these cases, notification of the suspect counterfeit components was greatly delayed on a timescale measured in months to years, allowing more components to enter the supply chain and increasing the risks from these components.

Reducing the risk from counterfeit components requires knowledge of counterfeiting process and detection methods, as well as constant vigilance.

It is just as important that suspect counterfeit components be properly reported in a timely matter.

This work package outlines the counterfeiting process and identifies how visual inspection methods may detect some suspect counterfeit components.

Additional information is provided for correctly reporting suspect counterfeit components.

03-7.2.2 The Counterfeit Process

Understanding how counterfeit components are created and where counterfeit component come from helps a technician identify counterfeit components.

The findings from the Senate Armed Services report showed nearly all suppliers of counterfeit components are independent electronic parts distributors, with a vast majority (80%) of those located or having a business presence in the United States.

Further investigation showed these parts brokers were reselling components purchased from China, the United Kingdom, and Canada, with a vast majority (>70%) purchased from China.

Some cases of counterfeit components coming from the United Kingdom and Canada showed another step in the supply chain with components originating from China. Counterfeit components coming from China are a by-product of recycling electronics waste, or e-waste. Pallets of used circuit card assemblies are received and components are removed using harsh methods, such as reflowing solder over an open fire followed by mechanical agitation, i.e., beating the CCA over a parts bucket.

Loose components are refurbished to look new by straightening and tinning leads, resurfacing the component top (black-topping), and painting new markings. The new marking may falsely identify the component as a new component of the same type, a higher reliability component of the same type, or a completely different component. Figure 03-24 and Figure 03-25 show the scope of counterfeiting operations with pallets full of bags, full of electronic components.



Figure 03-24: Pallets of harvested electronic components for counterfeiting operations. Figure provide by SMT Corp.



Figure 03-25: A bag full of harvested electronic components to be used in counterfeiting operations. Figure provided by SMT Corp.

Counterfeit operations take advantage of weakness in the supply chain to sell counterfeit components. First-tier suppliers sell components directly to manufactures or governmental entities, but these first-tier supplies may purchase components from second-tier suppliers. Second-tier suppliers may have purchased components from third-tier suppliers, and so on.

The longer and more convoluted the supply chain, the greater the probability for counterfeit components.

This is evidenced by the Senate Armed Services report showing that 80% of first-tier counterfeit component suppliers had a U.S. presence, but most were being supplied by second-tier suppliers based in China.

03-7.2.3 Preventing Counterfeit Components

The most effective method of avoiding counterfeit components is to procure components through trusted sources.

In 2009, the Defense Logistics Agency established a list of qualified suppliers for electronic components, and this list is maintained by traceability requirements and audits.

Similarly, the MTR Program Office has a piece part procurement process designed to avoid counterfeit components.

- **For these reasons, 2M Technicians shall use the MTR Program Office or stock system to procure electronic components.**
- **Tantalum capacitors for Phase-Shift Driver CCA repairs shall be procured through the 2M Project Office at NAVSURFWARCENDIV Crane.**

To reduce further the risks, technicians shall also evaluate electronic components for indications of counterfeiting.

The primary method for technician to identify counterfeit components is through visual inspection. This method was effective in the GAO study as all suspect counterfeit components failed visual examination, as shown in Figure 03-26 and Figure 03-27.

Category 1							
Requested authentic part numbers for obsolete and rare parts							
Analysis performed	DAA6	DAA6	IHH1	MLL1	MLL1	YCC7	YCC7
Visual Inspection	Fail	Fail	Fail	Fail	Fail	Fail	Fail
Resistance to Solvents (RTS) and Scrape Test	N/A	N/A	Fail	N/A	N/A	Pass	Pass
Package Configuration and Dimensions	Pass	Pass	Pass	Pass	Pass	Pass	Fail
X-Ray Florescence Elemental Analysis	Fail	Fail	Pass	Fail	Fail	Pass	Pass
Real-Time X-ray Analysis	Pass	Fail	Pass	Pass	Pass	Fail	Pass
Scanning Electron Microscopy (SEM) Analysis	Fail	Fail	Fail	Pass	Pass	Fail	Fail
Solderability Test	Pass	Pass	Pass	Pass	Pass	Pass	Pass
Dynasolve Test	N/A	N/A	Fail	N/A	N/A	N/A	Fail
Delidding and Die Microscopy	Fail	Fail	Fail	Fail	Fail	Fail	Pass
Suspect counterfeit	Yes	Yes	Yes	Yes	Yes	Yes	Yes

Figure 03-26: Test results for suspect counterfeit components containing legitimate part numbers and date codes. Note all components failed visual inspection. Figure taken from "Suspect Counterfeit Electronic Parts can be Found on Internet Purchasing Platforms" by the Government Accountability Office, released February 2012.

Category 2					
Requested authentic part numbers with postproduction date codes (date codes after the last date the part was manufactured)					
Analysis performed	DAA6	IHH1	MLL1	YCC7	YCC7
Visual Inspection	Fail	Fail	Fail	Fail	Fail
Resistance to Solvents (RTS) and Scrape Test	N/A	Fail	N/A	Fail	Fail
Package Configuration and Dimensions	Pass	Pass	Pass	Pass	Pass
X-Ray Florescence Elemental Analysis	Fail	Pass	Fail	Pass	Pass
Real-Time X-ray Analysis	Pass	Fail	Pass	Pass	Pass
Scanning Electron Microscopy (SEM) Analysis	Fail	Fail	Fail	Fail	Fail
Solderability Test	Pass	Fail	Pass	Pass	Pass
Dynasolve Test	N/A	Fail	N/A	N/A	Pass
Delidding and Die Microscopy	Fail	Fail	Fail	Pass	Pass
Suspect counterfeit	Yes	Yes	Yes	Yes	Yes

Figure 03-27: Test results for suspect counterfeit components containing legitimate part numbers and illegitimate date codes. Note all components failed visual inspection. Figure taken from "Suspect Counterfeit Electronic Parts can be Found on Internet Purchasing Platforms" by the Government Accountability Office, released February 2012.

The primary visual indications of counterfeit components include:

- General “used” or low quality appearance
- Refurbished or re-plated leads with dents and/or bends deviating from the manufacturing process (Figure 03-28)
- Component with identical part numbers and date codes but different indents (Figure 03-29)
- Deep surface scratches, cracks, or abrasion marks
- Scuff marks from re-tooling
- Inconsistent, questionable, misspelled, or meaningless part markings
- Evidence of blacktopping/re-marking
- Sanding resulting in scratches all running in the same direction (Figure 03-30)
- Evidence of previous markings (Figure 03-31)
- Partially filled indents (Figure 03-32)
- Indents with marking inside (Figure 03-33)



Figure 03-28: Component leads showing either evidence of previous component use and retinning (top) or incorrect lead finish (bottom).

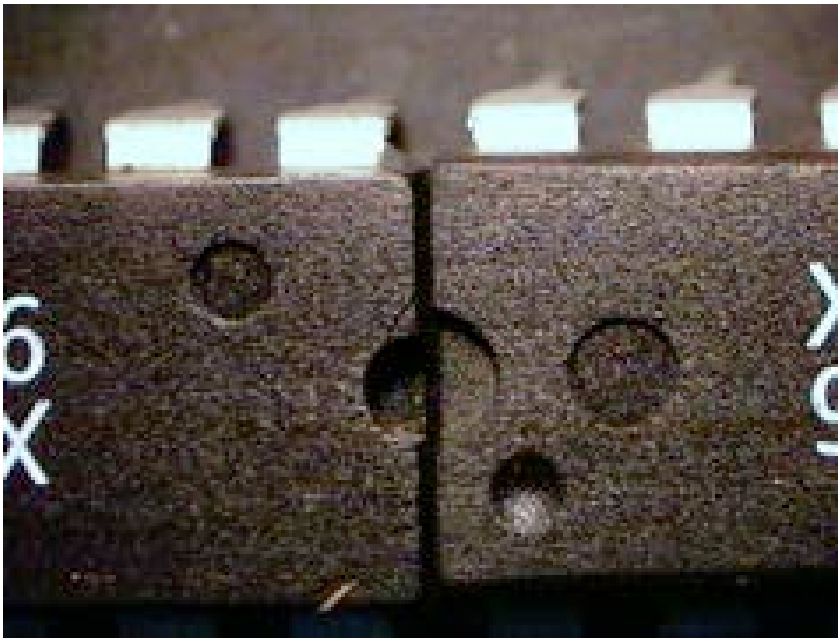

Figure 03-29: Components with the same part number and date code but with inconsistent indents indicating suspect counterfeit components.

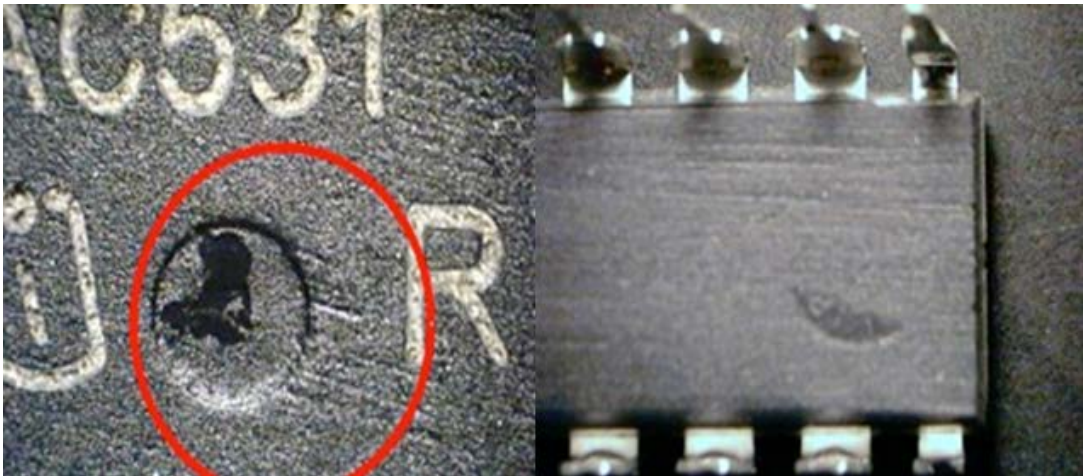

Figure 03-30: Suspect counterfeit components exhibiting unidirectional scratches indicating sanding.

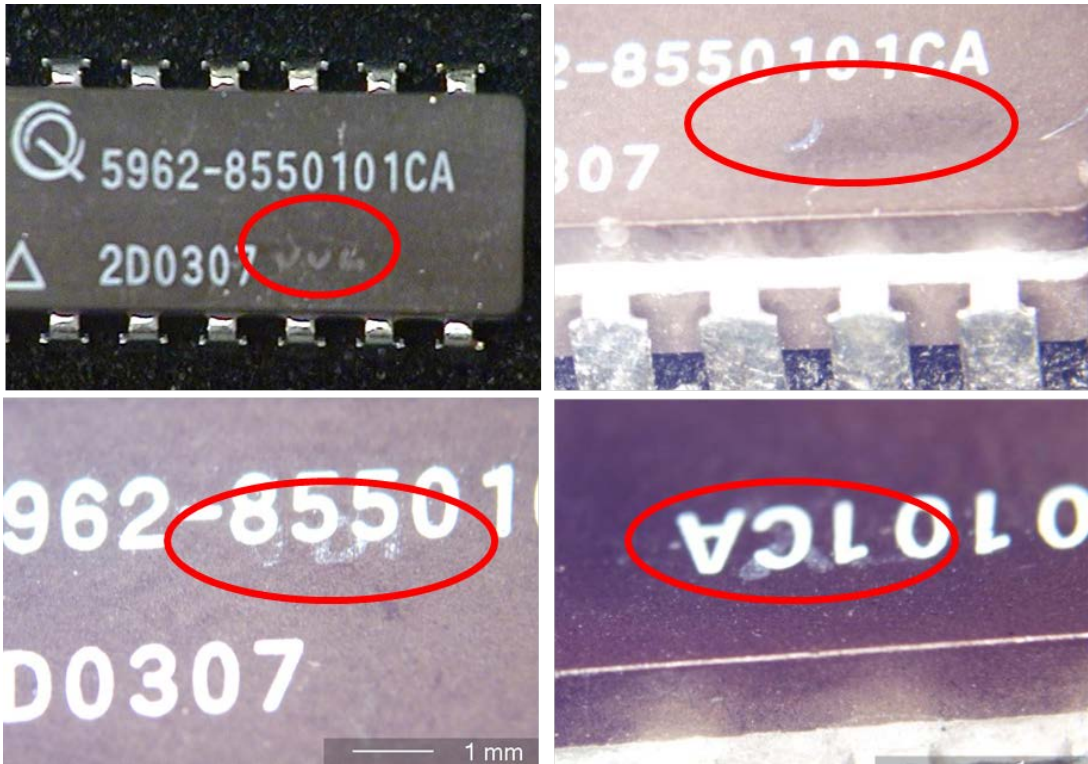

Figure 03-31: Electronic components showing evidence of re-marking. The re-marked area is circled in red.



Figure 03-32: Material in the indent indicating blacktopping.



Figure 03-33: Suspect counterfeit component identified by a marking inside the indent.

03-7.2.4 Documenting Suspect Counterfeit Material

Documenting suspect counterfeit components in a timely manner is essential in minimizing the impact of counterfeit components. If a component is suspect counterfeit, a technician shall document the component and notify the appropriate people by:

- Contacting the 2M or MTR help desks at Cran_2M_Help@navy.mil or partshelp@navy.mil
- Notifying your chain of command
- Saving the suspect counterfeit material and all packaging, paperwork, and certificate of conformance
- Quarantining the suspect counterfeit materials so it can be tested and validated

ⁱⁱⁱ *Inquiry into Counterfeit Electronic Parts in the Department of Defense Supply Chain*. United States Senate Committee on Armed Services. URL: <http://www.armed-services.senate.gov/Publications/Counterfeit%20Electronic%20Parts.pdf>. 21 May 2012.

ⁱⁱ *Defense Industrial Base Assessment: Counterfeit Electronics*. United States Department of Commerce. URL: http://www.bis.doc.gov/defenseindustrialbaseprograms/osies/defmarketresearchrpts/final_counterfeit_electronics_report.pdf. January 2010.

ⁱⁱⁱ *Suspect Counterfeit Electronic Parts can be Found on Internet Purchasing Platforms*. Government Accountability Office. URL: <http://www.gao.gov/assets/590/588736.pdf>. February 2012.

This page is intentionally blank.

15 October 2013

WP 004 00 Electrostatic Discharge (ESD)

04-1 PURPOSE

Identify the technical information relative to ESD.

Specify the ESD control measures that shall be employed to minimize the impact of ESD damage to electrical and electronic parts, assemblies and equipment.

Specify the measures to be taken by all personnel that handle, package, transport, inspect, repair, test, operate, and otherwise maintain items susceptible to damage from ESD.

Specify the ESD Procedures for establishing a proper ESD ground.

04-2 INDEX

Paragraph	Subject	Page
04-1	Purpose	1
04-2	Index	1
04-3	General Safety Precautions.....	2
04-4	Technical Information.....	2
04-4.1	The Nature of Static Electricity	3
04-4.2	Triboelectric Series	3
04-4.3	Prime Sources of Static Electricity	4
04-4.4	Susceptibility of Components to ESD.....	6
04-4.5	Types of ESD Failure.....	7
04-4.6	Electrostatic Protected Areas (EPA).....	8
04-4.6.1	Grounded Static Dissipative Work Surface ESD Mats and Workstations .	9
04-4.6.2	ESD Constant Monitor and Remote Input Jack.....	10
04-4.6.3	ESD Wrist Straps and Cords	11
04-4.6.4	EPA Workstation Grounding.....	12
04-4.6.5	EPA Sign	13
04-4.6.6	Field Maintenance	13
04-4.7	ESD Protective Materials	13
04-4.7.1	Electrostatic Protection	13
04-4.7.2	Classification of ESD Protective Materials.....	14
04-4.7.3	ESD Protective Packaging.....	15
04-4.7.4	ESD Warning Labels	16
04-4.8	ESD Protective Equipment.....	18
04-4.8.1	Personnel Apparel.....	18
04-4.8.2	Soldering Irons, Solder Pots, and Curing Ovens.....	18

Paragraph	Subject	Page
04-4.8.3	ESD Protective Floor Mats	19
04-4.8.4	Ionizers.....	19
04-4.8.5	Relative Humidity.....	19
04-4.8.6	Shunting Bars, Clips, and Conductive Foams.....	19
04-4.9	Grounding	20
04-4.10	Basic Rules for ESD Handling	23
04-4.11	Common ESD Myths	25
04-5	ESD Procedures.....	27
04-5.1	ESD Ground Location Procedure	29
04-5.2	ESD Workstation Grounding Test Procedure.....	31

04-3 GENERAL SAFETY PRECAUTIONS



DO NOT USE ESD WRIST STRAPS AND CORDS, GROUNDED ESD MATS, CONSTANT MONITORING SYSTEMS, OR OTHER ESD PROTECTIVE EQUIPMENT WHEN WORKING ON EXPOSED ENERGIZED PARTS, ASSEMBLIES, AND EQUIPMENT. THIS REQUIREMENT DOES NOT APPLY WHEN WORKING WITH POWERED EQUIPMENT (E.G., SOLDERING STATION, FIBER OPTIC LIGHT, PREHEATER) WHEN CONTACT WITH LIVE VOLTAGE AND/OR CURRENT IS NOT POSSIBLE.

Observe all the following precautions while performing 2M repair procedures:

- Electronic equipment must be de-energized during removal and installation of CCAs
- Personnel are required to wear a properly grounded ESD wrist strap and cord while working in or around the EPA
- ESD can destroy components—protect ESDS devices during handling and repair to prevent ESD damage

04-4 TECHNICAL INFORMATION

Electrostatic discharge is a known cause of failures in electronics.

A thorough understanding of the principles of ESD is necessary to ensure the proper steps are taken to avoid the potential of ESD induced failures.

04-4.1 The Nature of Static Electricity

Static electricity is an electrical charge at rest.

When two materials of any type are separated, one material will gain electrons and the other material will lose electrons creating electrical charges on the surfaces of the separated materials. The electrical charge generated is due to the transfer of electrons from one material to another.

The magnitude of the static charge developed is dependent on the size, shape, composition, and electrical properties of the substances that make up the materials. The materials may be similar or dissimilar although dissimilar materials tend to generate higher levels of static charges.

A material with an excess of electrons is charged negatively and a material with an electron deficit is charged positively. Whether a material will charge positively or negatively depends on the material with which it contacts and from which it separates.

The amount of charge that accumulates is dependent on the contacting material, intimacy of contact, speed of separation, cleanliness of surfaces, and other physical and chemical factors.

Charges on conductive materials will distribute rapidly over the surface of the conductor and the surfaces of other conductive materials they contact.

Insulative or nonconductive materials do not allow the flow of electrons across their surfaces; therefore, both positive and negative charges can reside on insulative or nonconductive surfaces at the same time due to the nonconductive nature of the materials.

Electrostatic fields and their associated lines of force are present and emanate from these charged materials. When conductive materials enter or pass through the electrostatic fields present on charged materials, the conductive materials are charged by induction without contacting the charged material. Insulative or nonconductive materials cannot be charged by induction.

04-4.2 Triboelectric Series

Generating static electricity by rubbing or separating materials is called the triboelectric effect.

The triboelectric series is a list of materials in an order of positive to negative. A triboelectric series is provided in Figure 04-1.

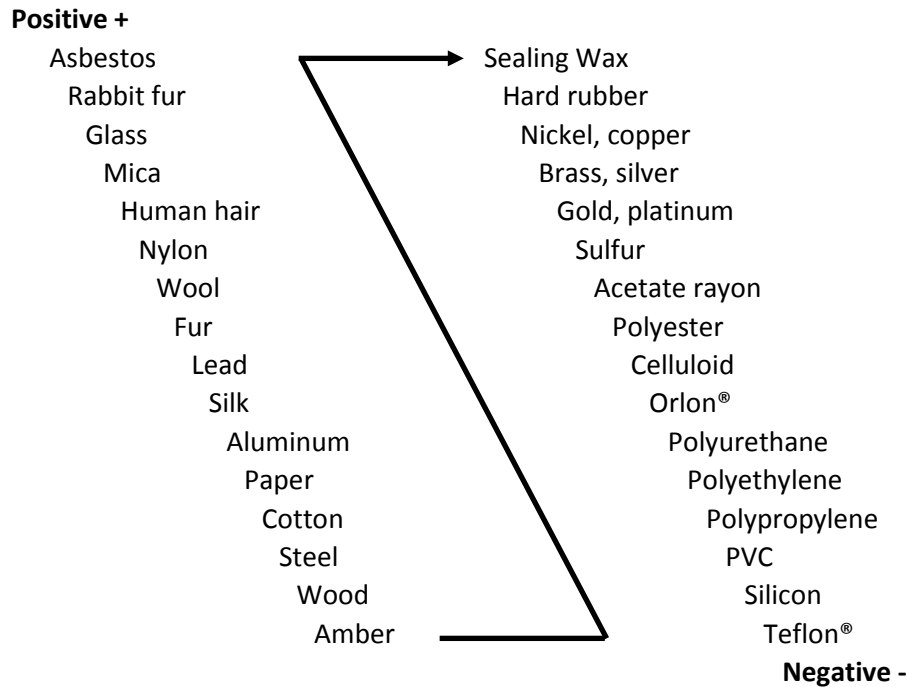

Figure 04-1 Triboelectric Series

Materials higher on the list tend to charge positively (lose electrons) when compared with materials lower on the list (which gain electrons). However, the order of ranking in a triboelectric series is not always constant or repetitive.

The distance between two substances in the triboelectric series does not necessarily affect the magnitude of the charge. The order in the series and magnitude of the charges is dependent on the properties of the material.

04-4.3 Prime Sources of Static Electricity

The prime sources of static electricity are essentially insulators and are typically synthetic materials.

Prime sources of static electricity commonly encountered in the work environment are listed in Table 04-1.

Table 04-1 Prime Sources of Static Electricity

Object or Process	Material or Activity
Work Surfaces	Common Vinyl and Plastics Finished Wood Waxed, Painted, or Varnished Surfaces
Floors	Carpeted Surfaces Common Vinyl Tile or Sheeting High Pressure Laminates made from Insulative Materials Sealed Concrete Waxed, Finished Wood
Clothes	Common Synthetic Clean Room Smocks Common Synthetic Personal Garments Non-Conductive or Synthetic Shoe Soles Virgin Cotton (at low humidity < 30%)
Chairs	Fiberglass Finished Wood Synthetic Fabric Vinyl and Plastic
Packaging and Handling	Aged or Worn Treated Anti-Static Bags, Wraps, Envelopes Common Bubble Wrap or Foam Common Plastic Bags, Wraps, Envelopes Common Plastic Connector Caps or Plugs Common Plastic Trays, Tote Boxes, Vials, Parts Bins Paper Products Tapes, Tape Dispensers, Stickers
Assemble, Clean, Test and Repair	Ball-Point Pens Common Plexiglas and Styrofoam Materials Common Polyethylene Bags and Pouches Copier Equipment Drying, Vacuuming, or Spraying using Plastic Nozzles Laminated Papers Monitors / Computer Screens / Televisions Plastic Desoldering Tools Plastic Syringes Plastic Tool Handles Solvent Brushes (with Synthetic Bristles) Spray Cleaners Ungrounded Soldering Tools

It should be understood any object, material, or person could be a source of static electricity. Remove the unnecessary prime sources and nonconductors from the Electrostatic Protective Area (EPA) and, replace the required nonconductive materials within the EPA with static dissipative or conductive materials.

Table 04-2 shows the typical electrostatic voltages that can be generated by personnel in the EPA at different humidity levels.

Table 04-2 Typical Electrostatic Voltages

Means of Static Generation	Percent Relative Humidity	
	20%	60-90%
Walking Across Carpet	35,000V	1,500V
Walking Across Vinyl Floor	12,000V	250V
Technician At Bench	6,000V	100V
Using Vinyl Envelopes At Bench	7,000V	600V
Common Poly Bag Picked Up From Bench	20,000V	1,200V
Sitting And Standing In Polyurethane Chair	18,000V	1,500V

04-4.4 Susceptibility of Components to ESD

Electrostatic Discharge Susceptibility (ESDS) parts can be destroyed by an ESD event whenever an ESD event occurs across their terminals or when electronic parts are exposed to electrostatic fields.

Components found to be susceptible to ESD include microelectronic devices, film resistors, resistor chips, discrete semiconductors, other thick- and thin-film devices, and piezoelectric crystals.

Subassemblies and modules containing ESDS parts are usually as sensitive as the most sensitive ESDS components they contain.

Some known ESDS component types and their relative sensitivities are listed in Table 04-3.

Table 04-3 Components and Ranges of ESD Susceptibility

Device Type	Range of Susceptibility (Volts)
VMOS	30 to 1800
MOSFET	100 to 200
GaAsFET	100 to 300
EPROM	100 +
JFET	140 to 7000
SAW	150 to 500
OP AMP	190 to 5000
CMOS	250 to 3000
Schottky Diodes	300 to 2500
Film Resistors (Thick, Thin)	300 to 3000
Bipolar Transistors	380 to 7800
ECL	500 to 1500
SCR	680 to 1000
Schottky TTL	100 to 2500

04-4.5 Types of ESD Failure

ESD can cause intermittent , latent and catastrophic failures.

04-4.5.1 Intermittent Failures

Intermittent failures can be the result of an ESD spark occurring near the equipment. The electromagnetic pulse generated by the spark causes the equipment to pick up false signals.

Intermittent failures can also occur by the direct, capacitive, or inductive coupling of an ESD pulse through a signal path.

Intermittent failures that occur on Large-Scale Integration (LSI) memories and chips are characterized by a loss of information or temporary distortion of equipment functions occurring when equipment is in operation.

04-4.5.2 Latent Failures

Latent failures, caused by ESD discharges, do not affect the function of the device immediately, but occurs later (perhaps years).

Latent damage is cumulative in that every time a discharge hits the device, it becomes weaker and more prone to catastrophic failure.

No apparent hardware damage occurs and proper operation resumes automatically after re-entering the information or restarting the equipment.

04-4.5.3 Catastrophic Failures

While intermittent failures normally occur during operation, catastrophic failures can occur any time.

Catastrophic failures can be the result of a discharge from a person or object, an electrostatic field, or a high voltage discharge.

04-4.6 Electrostatic Protected Areas (EPA)

An EPA is a designated area configured and maintained to protect electrical and electronic components, enclosures, assemblies, subassemblies, and modules from ESD damage during repair, calibration, inspection, routine maintenance, packaging, and shipping.

An EPA may be a permanent workstation within a room or an entire shop. An EPA may also be portable and used in a field service situation.

The use of an EPA is required whenever ESDS items are handled outside of their ESD protective packaging to prevent electrostatic charges from damaging ESDS items. For example, an EPA in an Intermediate Maintenance Activity (IMA) or depot facility could include humidity controls, an ESD constant monitor system, a grounded static dissipative ESD mat, personnel ESD wrist straps and cords, static dissipative flooring, air ionizers, and other ESD protective equipment.

The use of prime static generators in an EPA is prohibited. Personnel shall be restricted from entering the EPA with prime static generators.

Access to EPAs shall be restricted to ESD trained personnel. All untrained personnel shall be escorted, cautioned in ESD protective procedures, and restricted from contacting any ESDS items.

The key to a successful ESD control program is the use of identified EPAs and an EPA workstation including the items described below.

Figure 04-2 shows a typical 2M workbench with the proper ESD protection installed.

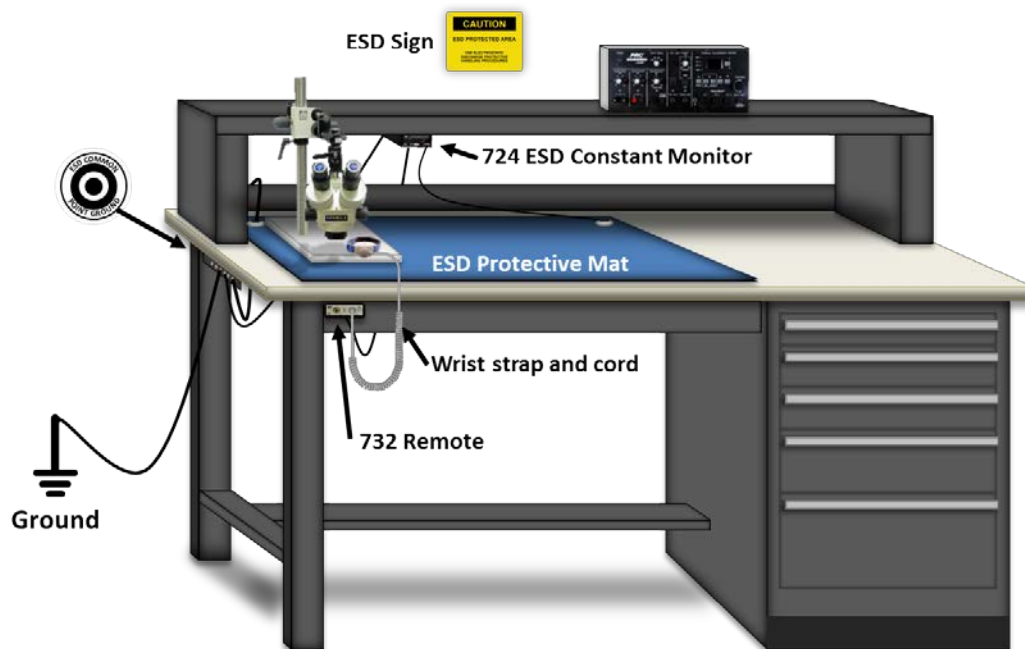

Figure 04-2 Typical ESD Protected 2M Workbench

04-4.6.1 Grounded Static Dissipative Work Surface ESD Mats and Workstations

WARNING

THE USE OF CONDUCTIVE ESD MATS IS NOT AUTHORIZED.

Use either a soft or rigid static dissipative laminate or a portable static dissipative mat (Figure 04-3).

ESD mats and ESD workstations that contact ESDS items and personnel shall have static dissipative work surfaces where ESDS items will be placed.



Figure 04-3 ESD Static Dissipative Work Surfaces

04-4.6.2 ESD Constant Monitor and Remote Input Jack¹

An ESD Constant Monitoring Systems (CMS) continuously tests the connection integrity of the entire ground loop including the person the wristband and the coil cord as well as the bench mat. This system is fully automatic and activates when a wrist strap and cord is plugged into the monitor unit.

The ESD CMS provides a green light for a safe condition and a red (or yellow) light and tone for an unsafe condition.

The most commonly used ESD CMS in the 2M Program is the 3M™ Model 724 Work Station Monitor (Figure 04-4). The 724 is designed to monitor the operation of the wrist strap grounding systems of two operators. To accomplish this, the 724 uses a DC source to measure a loop electrical resistance.



Figure 04-4 3M™ Model 724 Work Station Monitor

The Model 724 monitor performs a resistance measurement by applying an electrical current of less than 3 μ A approximately every 2.0 seconds for 0.2 of a second in duration. The path for the current is through one conductor of the ground cord containing a current-limiting resistor, through one side of the wristband, through the skin of the wearer under the band, through the second side of the wristband, through the second conductor of the ground cord containing a current-limiting resistor and finally back to the monitor.

¹ Source: 3M Model 724 Work Station Monitor Instructions

The wrist strap monitoring function is activated by plugging a wrist strap dual conductor ground cord into either one of the jacks on the 3M™ Models 732/733 Dual Conductor Remote Input Jack (Figure 04-5).



Figure 04-5 3M™ Models 732/733
Dual Conductor Remote Input Jack

If the resistance of the wrist strap loop is within the limits of the selected range (1.5 to 10 MΩ or 1.5 to 35 MΩ ±15%) on the Model 724 Monitor the cord the wristband and the contact to the arm of the wearer it is considered to be functioning correctly.

At this time, one of the (OK) green lamps (1 or 2) will be illuminated on the front of the monitor.

If the resistance of the wrist strap loop is higher than the selected range (10 MΩ or 35 MΩ ±15%) on the 724 monitor, an (OK) wrist strap green lamp (1 or 2) extinguishes and a high wrist strap red lamp (H) illuminates with an audible alarm. This is an indication of a high resistance in the cord band or poor contact between arm and band.

If the resistance in the loop is under 1.5 MΩ (±15%), it is an indication of a low resistance meaning one or both current-limiting resistors are bypassed. The low yellow lamp (L) will flash and an (OK) green lamp (1 or 2) will remain illuminated.

The wrist strap of a second operator is measured in the same way.

Operators are identified by the two (OK) green lamps (1 & 2). The same high wrist strap red lamp (H) and low yellow (L) lamps illuminate when a fault is detected. The green lamp that extinguishes identifies the operator experiencing the fault condition.

04-4.6.3 ESD Wrist Straps and Cords

Personnel working within the EPA shall wear a properly grounded ESD wrist strap with an ESD wrist strap ground cord. The ESD wrist strap and cord dissipates static charges safely to ground and equalizes static levels between the wearer and the ESD work surface.

The ESD wrist strap and cord shall have a total resistance of 800,000Ω to 2 MΩ based on limiting current for personnel to 5mA.

The three common types of ESD wrist straps available are cloth, metal bands, or thermoplastic.

The wrist strap and cord shall be connected to the common point ground terminal where the ESD mat or ESD workstation common point ground cable to ground is connected.

The ground cord shall contain a banana (single wire system) [Figure 04-6 and Figure 04-7] or stereo plug (dual wire system) [Figure 04-8 and Figure 04-9] so the wrist strap ground cord can be released in emergencies with a slight pull without injuring the person.



Figure 04-6 Single Wire Cloth Wrist Strap and Cord



Figure 04-7 Single Wire Metal Wrist Strap and Cord



Figure 04-8 Dual Wire Wrist Strap and Cord



Figure 04-9 Dual Wire Wrist Strap (Metal Band)

The wrist strap shall also have an easy release connection (snap) at the point of contact to the wrist as an added safety precaution.

04-4.6.4 EPA Workstation Grounding

The ESD workstation ground shall be connected to the ESD common point ground through a grounding conductor.

The resistance for the ESD mat or ESD bench top ground cable should be located at or near the point of contact with the ESD mat or ESD bench top and should be high enough to limit any leakage current to 5 mA or less, considering the highest voltage source within reach of grounded personnel and all other parallel resistances to ground such as ESD wrist straps and cords.

Work surfaces shall be individually grounded through an 800,000 Ω to 2 M Ω resistor.

04-4.6.5 EPA Sign

All EPAs and EPA workstations will be identified by signs (Figure 04-10) indicating the workspace is an EPA.



Figure 04-10 ESD Protected Area Caution Sign

04-4.6.6 Field Maintenance EPA

The EPA used for field maintenance shall also be kept free from prime static generators and the technician shall wear an ESD wrist strap attached to a grounded ESD wrist strap ground cord and, work on a grounded portable static dissipative ESD mat.

04-4.7 ESD Protective Materials

ESD protective materials provide ESD protection from electrostatic fields and prevent damaging discharges from contact with charged individuals or charged objects.

ESD protective material should also provide protection against triboelectric charge generation. A few materials will have all of these properties.

Often, a combination of different protective materials is required to achieve the desired results.

04-4.7.1 Electrostatic Protection

All ESDS components, devices, CCAs, and electronic modules shall be protected from ESD damage before leaving the EPA by using one of the following:

- ESD barrier sheet material or an ESD barrier bag conforming to MIL-PRF-81705 TYPE III Class I (Figure 04-11)
- Bagged or wrapped in material conforming to MIL-PRF-81705, type II (pink poly or blue anti-static material), or cushioned in material conforming to A-A-3129, type I or II, style A or B (pink or blue poly anti-static bubble), and then packed in ESD barrier bags conforming to MIL-DTL-117, type I class F, style I (heavy duty, water/vapor proof, electrostatic, and electromagnetic shielding) containing a metal conductive layer
- Bagged or wrapped in material conforming to MIL-DTL-81997, type I (a reclosable bag or material having a pink or blue poly anti-static bubble inside layer with ESD barrier material as an outer layer)
- Provide an ESD barrier or complete the conductive layer for “black boxes” by affixing conductive caps to all the connectors



Figure 04-11 ESD Barrier Bag

04-4.7.2 Classification of ESD Protective Materials

For the purposes of this work package, ESD protective materials are classified as conductive, dissipative, or antistatic.

04-4.7.2.1 Conductive ESD Protective Materials

Provide shielding from electrostatic and electric fields and have a surface resistivity of less than $1 \times 10^5 \Omega$ per square.

Conductive materials are primarily used as outer layer ESD barrier protective packaging.

04-4.7.2.2 Dissipative ESD Protective Materials

Dissipate an electrostatic charge and have a surface resistivity greater than $1 \times 10^5 \Omega$ per square but less than $1 \times 10^{11} \Omega$ per square.

Dissipative materials are primarily used for ESD mats.

04-4.7.2.3 Antistatic ESD Protective Materials

Materials that limit the generation of electrostatic charge (low charging) (Figure 04-12).



Figure 04-12 Antistatic ESD Protective Material (Pink Poly)

- Materials that resist triboelectric charge generation caused by antistatic materials contacting and separating from one another
- Antistatic behavior of these materials is not necessarily predicted by surface or volume resistance measurements
- Antistatic materials are primarily used as inner layer packaging material
- Antistatic materials may or may not be static dissipative (although many are)
- Antistatic materials may be used in EPAs because they do not generate static charges

04-4.7.3 ESD Protective Packaging

The use of ESD protective packaging for repair parts and spares is required (Figure 04-13).

ESD protective packaging shall be in accordance with MIL-STD-1686.

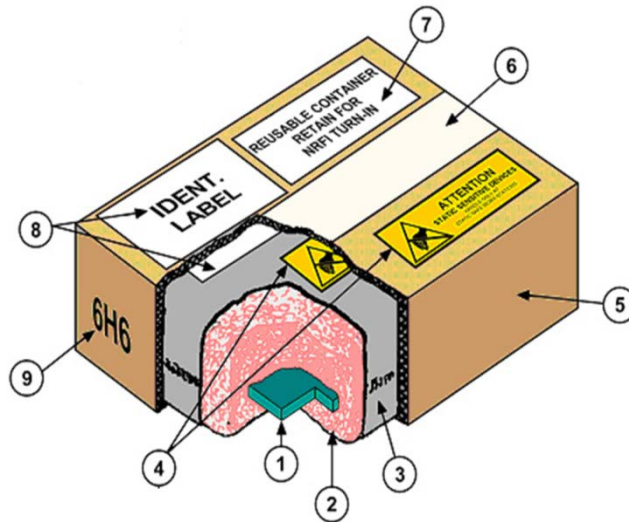

Figure 04-13 ESD Protective Packaging

1. Item
2. Wrap, cushioning or pouch
 - a. Wrap – Use material in accordance with MIL-PRF-81705, Type II or Type III, Class 1, or
 - b. Cushioning – Use material in accordance with PPP-C-795, Class 2; A-A-59135/A-A-59136, Type VII, Class 1, Grade B; PPP-C-1797, Type II; or A-A-3129, Type III, Style A or B, or
 - c. Pouches – Use pouches fabricated in accordance with MIL-DTL-81997, Type I or Type II
3. Sealed bag – In accordance with MIL-DTL-117, Type I, Class F, Style 1 (Fabricated using MIL-PRF-81705, Type I material)
4. Label – Sensitive electronic device label
5. Fiberboard box
6. Tape
7. Special markings on box only
8. Contents labels
9. Print NSN or local control number on one end of box

04-4.7.4 ESD Warning Labels

ESD warning labels are on devices, assemblies, equipment, packages, and in technical publications to alert personnel to the possibility of inflicting ESD or electrical overstress damage to the devices they are handling.

The most frequently encountered symbols/labels are listed below:

An **ESD Susceptibility Symbol** (Figure 04-14) is a triangle with a reaching hand and a slash across it.

This symbol is used to indicate an electrical or electronic device or assembly is susceptible to damage from an ESD event.



Figure 04-14 ESD Susceptibility Symbol

An **ESD Protective Symbol** (Figure 04-15) is used to identify materials specifically designed to provide ESD protection for ESDS assemblies and devices.

Examples of these are ESD packaging, ESD protective clothing, personnel grounding equipment, EPA equipment, trash can liners, and chairs.

This symbol differs from the ESD susceptibility symbol having an arc around the outside of the triangle and no slash across the hand.

The ESD protective symbol is to be used on items ESD protective or non-ESD generative by design.



Figure 04-15 ESD Protective Symbol

An **ESDS Devices Attention Symbol and Label for Unit Packs** (Figure 04-16) is used in accordance with MIL-STD-129 to mark all unit packs containing ESDS devices with the ESD sensitive device symbol (triangle and reaching hand), the words “ATTENTION, STATIC SENSITIVE DEVICES” and the statement “HANDLE ONLY AT STATIC SAFE WORKSTATIONS.”



Figure 04-16 ESD Label for Unit Packs

An **ESDS Devices Attention Label for Intermediate and Exterior Containers** (Figure 04-17) is used in accordance with MIL-STD-129 to mark intermediate and exterior containers with the ESD Sensitive Devices Attention Label.

The ESDS devices symbol and the words “ATTENTION OBSERVE PRECAUTIONS FOR HANDLING ELECTROSTATIC DISCHARGE SENSITIVE DEVICES” shall be marked in black on a yellow background.



Figure 04-17 ESD Label for Intermediate and Exterior Containers

An **ESD Common Point Ground Symbol** (Figure 04-18) is used to identify a grounded device where two or more conductors are bonded together or the verified ESD common point ground for the EPA.



Figure 04-18 ESD Common Point Ground Symbol

Old ESDS Devices Attention Labels/Symbols (Figure 04-19) have been replaced by Figure 04-17 ESD Label for Intermediate and Exterior Containers.

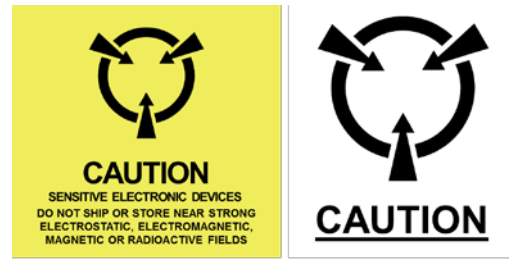

Figure 04-19 Old ESD Sensitive Devices Attention Label/Symbol

04-4.8 ESD Protective Equipment

ESD protective equipment provides ESD protection from electrostatic fields and prevents damaging discharges from contact with CCAs and other electronic equipment.

04-4.8.1 Personnel Apparel

Personnel handling ESDS items may wear ESD protective smocks or clothing.

Some working situations could require additional protection.

Protective apparel shall be checked frequently, especially after cleaning to ascertain proper performance.

Finger cots or gloves, where used, shall also be made of ESD protective materials.

04-4.8.2 Soldering Irons, Solder Pots, and Curing Ovens

Soldering irons, solder pots, and curing ovens shall be properly grounded.

The resistance reading from the tip of a hot soldering iron to common point ground shall not exceed 5 Ω .

The resistance reading between the metal case of solder pots and curing ovens to ground shall measure less than 1 Ω .

Other electrical power equipment, which may contact ESDS items, shall also be properly grounded.

04-4.8.3 ESD Protective Floor Mats

If used, ESD protective floor mats shall be made of a static dissipative material.

ESD floor mats are designed for temporary or semi-permanent installation over existing flooring.

ESD floor mats should be grounded through a 1 M Ω resistor and are effective only when considered as part of a system consisting of the static dissipative ESD floor mat and ESD protective footwear or heel grounders.

04-4.8.4 Ionizers

Ionizers neutralize electrostatic charges by ionizing air molecules, forming both positive and negative ions.

The positive ions are attracted to negatively charged bodies and negative ions to positively charged bodies; this exchange results in charge neutralization.

Ionized air can be used where grounding cannot be accomplished to bleed-off static charges or to neutralize charges on insulators or isolated conductors within the EPA.

Follow the manufacturer's instructions for the periodic cleaning and maintenance of ionizers.

04-4.8.5 Relative Humidity

Humid air helps to dissipate electrostatic charges by keeping surfaces moist, therefore increasing surface conductivity.

Substantial electrostatic voltage levels can accumulate with a decrease in relative humidity (refer to Table 04-2).

It is evident from Table 04-2 that significant electrostatic voltages can still be generated with relative humidity as high as 90%.

Relative humidity between 40% and 60% in ESD protective areas is desirable.

04-4.8.6 Shunting Bars, Clips, and Conductive Foams

During shipping and storage, terminals of ESDS items should be shorted together using conductive shunting bars, conductive clips, or non-corrosive conductive foams.

04-4.9 Grounding

WARNING

USERS OF THIS DOCUMENT ARE RESPONSIBLE FOR SELECTING EQUIPMENT THAT COMPLIES WITH APPLICABLE LAWS, REGULATORY CODES AND BOTH EXTERNAL AND INTERNAL POLICY.

USERS ARE CAUTIONED THAT THIS DOCUMENT CANNOT REPLACE OR SUPERSEDE ANY REQUIREMENTS FOR PERSONNEL SAFETY.

ELECTRICAL HAZARD REDUCTION PRACTICES SHALL BE EXERCISED AND PROPER GROUNDING INSTRUCTIONS FOR EQUIPMENT SHALL BE FOLLOWED.

Protection of ESDS is accomplished by providing a path to bring static dissipative materials, conductive materials, and personnel to the same electrical potential, i.e., to ground.

Every element to be grounded at an ESD protected workstation shall be connected to the same common point ground.

Figure 04-20 shows a typical ESD protective station grounding system.

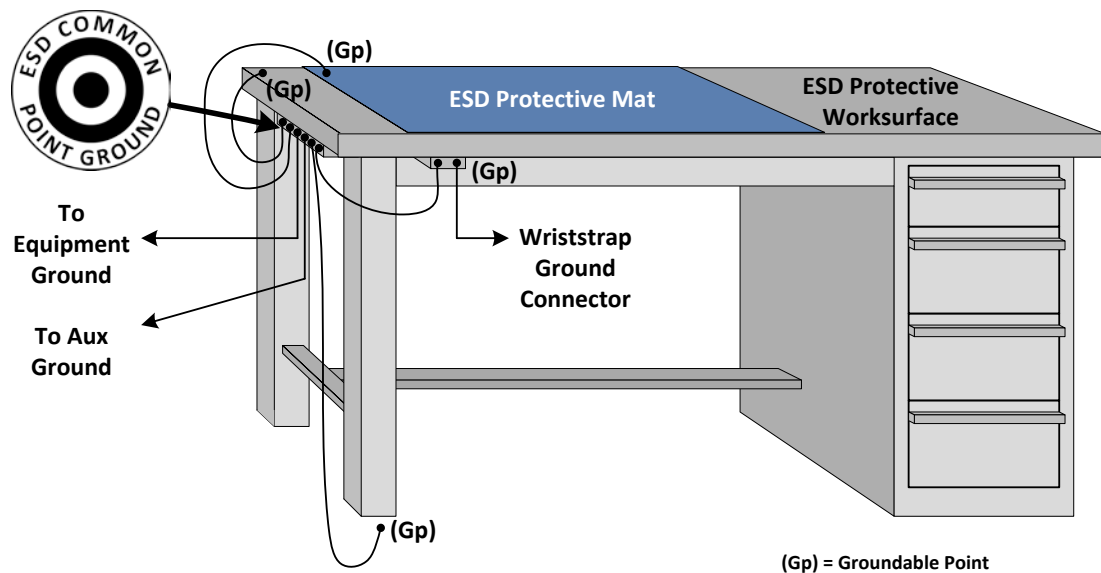

Figure 04-20 Typical ESD Protective Station Grounding System

Figure 04-21 shows a typical common point ground barrier strip.

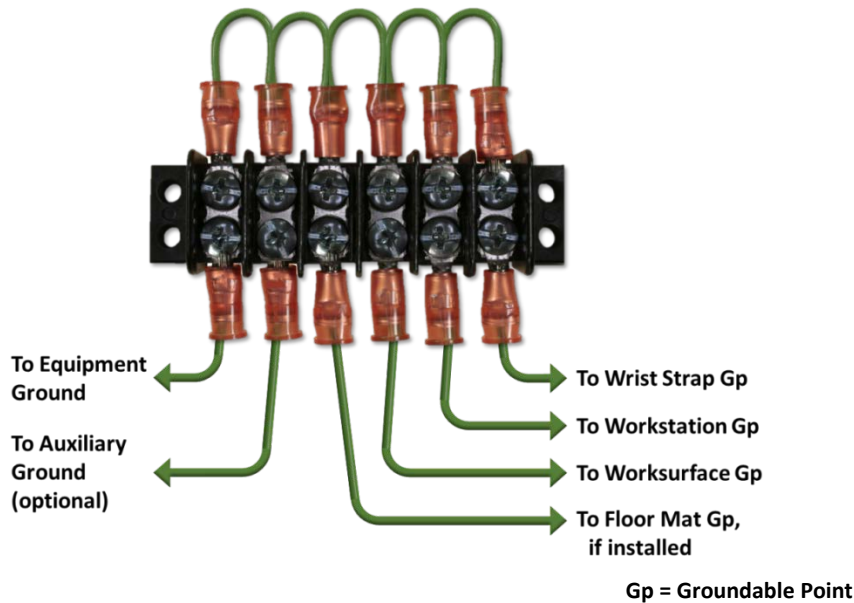

Figure 04-21 Typical Common Point Ground Barrier Strip

Figure 04-22 is an example of a single wire wrist strap ground connector.

When a separate grounding electrode (auxiliary ground) is present or used in addition to the grounding conductor, the grounding electrode shall be bonded to the equipment ground at each ESD protective station to minimize the difference in potential.

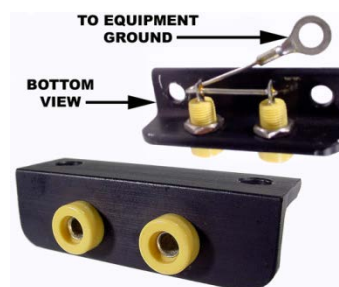

Figure 04-22 Single Wire Wrist Strap Ground Connector

ESD protected workstations **shall not** be tied together electrically in series.

The electrical system of vehicles such as ships, aircraft, spacecraft, and surface vehicles have a ground bus and grounding conductors providing a path to ground.

This ground system is acceptable for ESD control within the scope of this document.

NOTE

THE MULTIMETER USED FOR MEASUREMENT SHALL BE CAPABLE OF MEASURING A DC RESISTANCE OF 0.1 Ω THROUGH 1 M Ω \pm 10% WITH AN OPEN CIRCUIT VOLTAGE GREATER THAN 1.5 V.

NOTE

THE GROUND CIRCUIT TESTER USED SHALL BE CAPABLE OF MEASURING IMPEDANCE OF THE EQUIPMENT GROUNDING CONDUCTOR. MEASUREMENT RANGE OF THE METER SHALL BE UP TO 1 Ω . THE METER SHALL ALSO VERIFY WIRING CONFIGURATION.

The resistance of the conductor from the groundable point of the work surface, chair, wrist strap, walking surface, or other items to the common point ground shall not be greater than 1 Ω .

Where a resistor is used in the circuit, the total resistance includes the value of the resistor.

The resistance of the conductor from the common point ground to the equipment grounding conductor shall not be greater than 1 Ω .

The impedance of the equipment grounding conductor from the common point ground to the neutral bond at the main service equipment shall not be greater than 1 Ω , refer to Figure 04-23 and Figure 04-24.

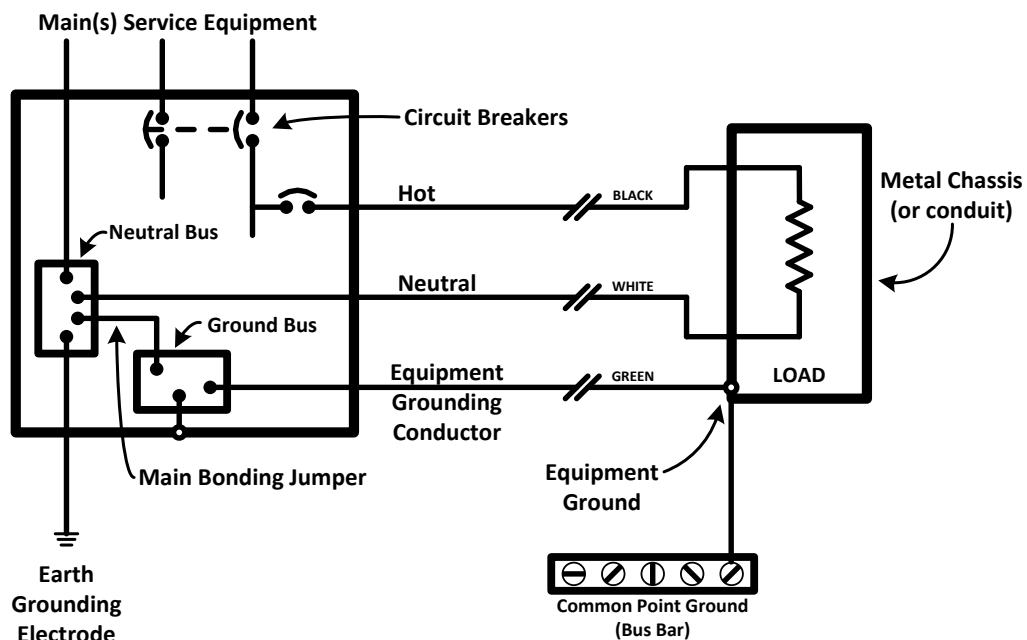

Figure 04-23 Main(s) Service Equipment Single Phase

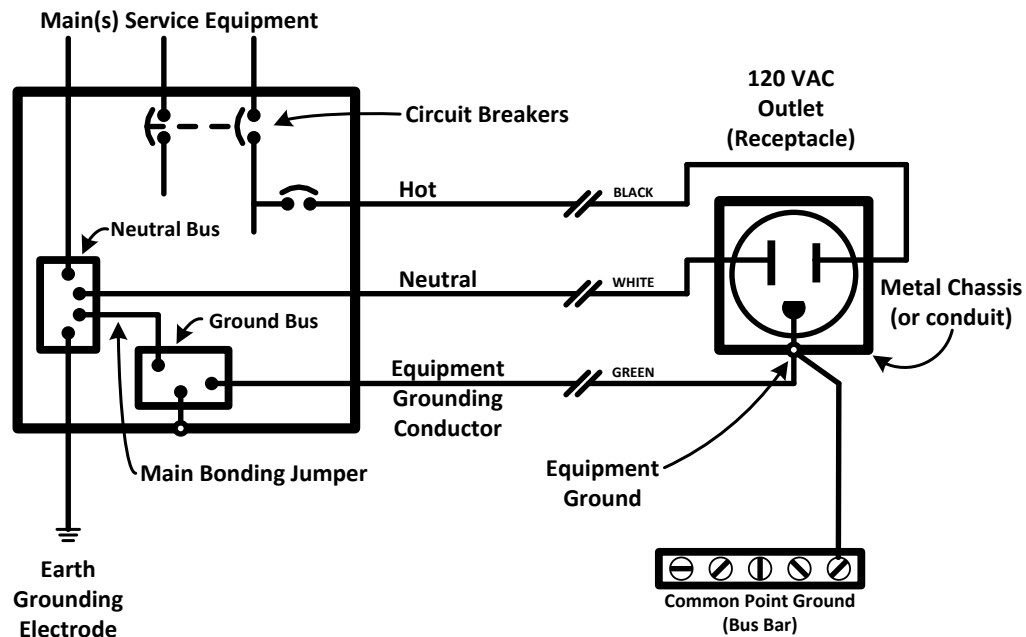

Figure 04-24 Typical Ground Connection and Main(s) Service Equipment

The wire used to connect the common point ground to equipment shall be insulated and mechanically supported to physical structures to prevent mechanical damage.

04-4.10 Basic Rules for ESD Handling

Follow these basic rules to ensure CCAs are not damaged by ESD:

- Do not touch or handle electrical or electronic components and CCAs unless you are wearing a properly grounded ESD wrist strap and cord
- Transport and store ESDS items in ESD protective packaging.
- When transporting ESDS items in or out of an EPA all ESDS items including CCAs must be protected by either a MIL-PRF-81705, Type III approved, sealable, static shielding bag or with approved protective packaging materials in accordance with Electrostatic Protection (paragraph 04-4.7.1)
- Provide an ESD barrier or complete the conductive layer of “black boxes” by placing conductive ESD caps or metal caps on all connectors
- When working in or at any ESD workstation, a properly grounded ESD wrist strap and cord shall be worn on the wrist at all times

- The ESD wrist strap only works when there is constant contact between the skin and the inside surface of the strap and it is connected to ground through an ESD wrist strap ground cord
- Individuals with dry skin should use Hand Lotion, Static Dissipative (Figure 04-25) on their wrist where ESD wrist strap contacts their skin
- The ESD wrist strap and cord must be checked regularly and prior to each use if not used in conjunction with an ESD CMS



Figure 04-25 ESD Lotion

- The Model 722 and 724 CMS shall be connected as shown in the following diagram (Figure 04-26)

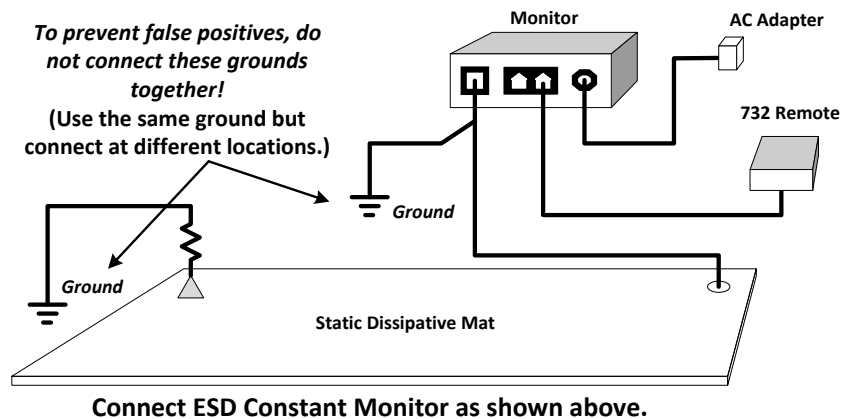

Figure 04-26 Model 722 or 724 CMS Block Diagram

- Use only approved animal hair acid brushes, anti-static document holders, static dissipative or conductive containers and materials in EPAs
- Use Staticide® (Figure 04-27) on monitor screens, oscilloscope screens, and essential nonconductors and insulators required to accomplish assigned tasks within the EPA

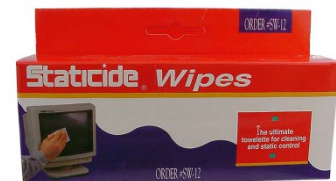

Figure 04-27 Staticide® Wipes

- Keep personal hygiene items, cups, bottles, food or liquids at least two feet from the EPA or from the vicinity of ESDS items
- Hold CCAs by the edges and do not touch contacts

- Never stack unprotected CCAs on top of each other
- Do not place CCAs on top of an ESD bag
- Store CCAs in a closed ESD barrier bag
- Never leave anything, including hand tools, on CCAs
- Clean ESD mats and ESD bench surfaces daily with anti-static and cleaning compound (Figure 04-28)



Figure 04-28 Antistatic
Cleaning Compound

04-4.11 Common ESD Myths

Myth: Touching the equipment before working on the equipment is sufficient for ESD protection.

- **TRUTH:** This method is probably sufficient until the technician moves or rocks enough to generate more damaging static charges. The wearing of a properly grounded ESD wrist strap ensures static charges will dissipate to ground.

Myth: Once ESDS components are mounted to the circuit cards, they are no longer susceptible to ESD.

- **TRUTH:** The chance for damaging CCA mounted components actually increases because the conductors and leads act as antennas to funnel the static charge directly to the device. It is also difficult to handle CCAs without touching the leads and conductors. Protect the CCA by keeping it in a closed or sealed ESD barrier bag.

Myth: The only CCAs requiring ESD protection are those with CMOS devices.

- **TRUTH:** Most CCAs have CMOS devices since nearly half of the devices manufactured are a variation of CMOS. Protect each CCA as ESD susceptible, and consider all component types just as sensitive to ESD damage as CMOS devices.

Myth: You must actually touch the item or component to cause ESD damage.

- **TRUTH:** Many devices are voltage sensitive, particularly the CMOS variety; therefore, simple exposure of these devices to the electrostatic fields surrounding a charged object can break down the component.

Protection by wearing a grounded ESD wrist strap is required when handling ESD susceptible items. All non-conductors and insulators must be kept at least two feet from the EPA.

Myth: CCAs that bench test as good after improper handling have not been damaged.

- **TRUTH:** ESDS items can be partially damaged or weakened by exposure to static charges. Damaged or weakened devices can pass operational tests and specifications only to fail prematurely or perform erratically in the field under operational stresses.

Myth: Shipping and storing CCAs in pink anti-static polyethylene (“pink-poly”) will provide complete and effective static protection.

- **TRUTH:** Antistatic materials only prevent static charge buildup, but fail to protect “pink poly” wrapped or bagged CCAs from external static sources. CCAs packaged with “pink poly” must be placed within an approved ESD barrier material or outer conductive container providing complete static protection.

Myth: Only electronic equipment installed in carpeted areas requires ESD protection.

- **TRUTH:** Walking across a carpet can create large static charges; tile flooring can also create large static charges and has the same damaging effect to ESDS items. ESD protective equipment and materials shall always be used when handling ESDS items.

Myth: Keeping humidity high around electronic equipment will eliminate static problems.

- **TRUTH:** The higher the humidity, the less static charge generation.

High humidity however does not prevent static charging from occurring. Heating and air conditioning makes the air drier within controlled environments, maintaining high humidity in conditioned environments requires special equipment.

Myth: Topical antistatic sprays, waxes, or wipes are permanent and provide complete ESD protection.

- **TRUTH:** Topical antistats (Staticide®) initially provide a limited amount of slow static discharge draining through low-level conductivity on the surface of the items treated. Topical antistats do not provide static shielding or protection against the damaging effects of ESD fields. Topical antistats are not permanent; they wear out and require reapplication. When using topical antistats be careful not to leave untreated bare spots on the materials being treated. Do not use topical antistatic sprays, waxes, or wipes on test probes or test probe cords.

Myth: Using the correct materials and equipment alone can prevent ESD damage.

- **TRUTH:** The ESD control and prevention materials and equipment are useless without properly trained personnel and a continuous ESD awareness program.

Myth: Placing ESDS devices and or CCAs on the surface of an ESD barrier bag will provide the same ESD protection as a grounded ESD mat.

- **TRUTH:** ESD barrier bags do not provide ESD protection to items placed on their surface. Only by keeping ESDS devices and or CCAs inside a closed or sealed ESD barrier bag will complete ESD protection be provided.

Myth: ESD grid tape provides the required level of ESD protection

- **TRUTH:** ESD grid tape does not provide any ESD protection and shall not be used in lieu of conductive caps, ESD bags, or other approved ESD protective material.

04-5 ESD PROCEDURES

WARNING

***THE PROCEDURES DESCRIBED IN THIS SECTION MAY EXPOSE PERSONNEL TO
HAZARDOUS ELECTRICAL CONDITIONS.***

COMPLY WITH ALL LOCAL REQUIREMENTS FOR ELECTRICAL CIRCUIT TESTING.

Equipment Required

Listed below is the ESD equipment authorized for 2M repair:

- **NAVAIR/NAVSEA/USMC/USAF/USCG**—ESD Continuous Monitor (part no. 724)
 - **NAVAIR/NAVSEA/USMC/USAF/USCG**—ESD Wrist Strap Dual Conductor (part no. 4720)
 - **NAVAIR/NAVSEA/USMC/USAF/USCG**—ESD Dual Conductor Cord (part no. 2360)
 - **NAVAIR/NAVSEA/USMC/USAF/USCG**—ESD Soft Static Control Mat (part no. 8811)
 - **NAVAIR/NAVSEA/USMC/USAF/USCG**—ESD Rigid Static Control Mat (part no. 8353)
 - **NAVAIR/NAVSEA/USMC/USAF/USCG**—Watch, Static, Large (part no. SWB40-LC7)
 - **NAVAIR/NAVSEA/USMC/USAF/USCG**—Watch, Static, Medium (part no. SWB40-MC7)
-

-
- **NAVAIR/NAVSEA/USMC/USAF/USCG**—Ground Circuit Tester (part no. PGT-601A)

Additional Support Items

For additional information regarding items of support and support equipment refer to:

- **NAVSEA/NAVAIR/USCG**—2M MTR Certification Manual
- **NAVSEA/USCG**—Allowance Parts List (APL) 000A8423
- **USMC**—Stock List SL-3-09458A
- **USAF**—the Consolidated Tool Kit (CTK)

Material Required

Listed below are the ESD materials* authorized for 2M repair:

- Antistatic and Cleaner Compound
- Bag, Plastic (ESD)†
- Caps, ESD
- Hand Lotion, Static Dissipative
- Label (ESD Warning)
- Plate, Instruction (ESD Caution Sign)
- Wipes, Staticide®

* Refer to Table 03-4 for Specification No., Part No., and NSN

† Select size appropriate for application

04-5.1 ESD Ground Location Procedure

WARNING

THIS PROCEDURE MAY EXPOSE PERSONNEL TO HAZARDOUS ELECTRICAL CONDITIONS.

USERS OF THIS DOCUMENT ARE RESPONSIBLE FOR SELECTING EQUIPMENT THAT COMPLIES WITH APPLICABLE LAWS, REGULATORY CODES AND BOTH EXTERNAL AND INTERNAL POLICY.

USERS ARE CAUTIONED THAT THIS DOCUMENT CANNOT REPLACE OR SUPERSEDE ANY REQUIREMENTS FOR PERSONNEL SAFETY.

GROUND FAULT CIRCUIT INTERRUPTERS (GFCI) AND OTHER SAFETY PROTECTION SHOULD BE USED WHENEVER PERSONNEL MIGHT CONTACT ELECTRICAL SOURCES.

ELECTRICAL HAZARD REDUCTION PRACTICES SHALL BE EXERCISED AND PROPER GROUNDING INSTRUCTIONS FOR EQUIPMENT SHALL BE FOLLOWED.

Use the following flow chart (Figure 04-29) below to establish the proper ground when an ESD ground has not been established for an electrostatic protected workstation.

The equipment grounding conductor at the ESD protective station or other work areas is the ESD measurement reference point.

When no equipment ground is available, an earth ground grounding electrode (such as a post, rod, or continuous metal water pipe in contact with the conductive vehicle frame, etc.) shall be the ESD measurement basic reference point.

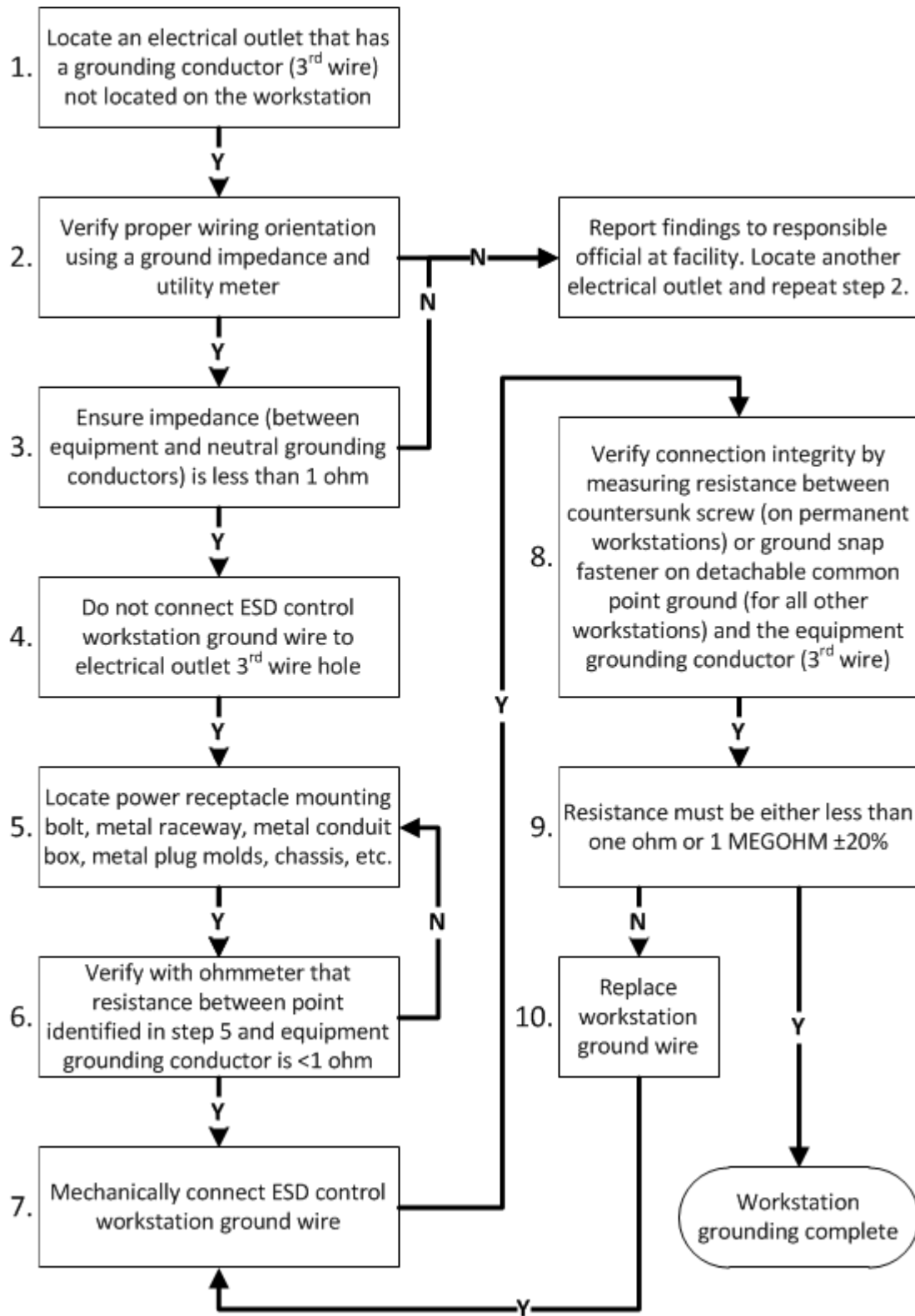

Figure 04-29 ESD Ground Location Flow Chart

04-5.2 ESD Workstation Grounding Test Procedure

WARNING

THIS PROCEDURE MAY EXPOSE PERSONNEL TO HAZARDOUS ELECTRICAL CONDITIONS.

USERS OF THIS DOCUMENT ARE RESPONSIBLE FOR SELECTING EQUIPMENT THAT COMPLIES WITH APPLICABLE LAWS, REGULATORY CODES AND BOTH EXTERNAL AND INTERNAL POLICY.

USERS ARE CAUTIONED THAT THIS DOCUMENT CANNOT REPLACE OR SUPERSEDE ANY REQUIREMENTS FOR PERSONNEL SAFETY.

GROUND FAULT CIRCUIT INTERRUPTERS (GFCI) AND OTHER SAFETY PROTECTION SHOULD BE USED WHENEVER PERSONNEL MIGHT CONTACT ELECTRICAL SOURCES.

ELECTRICAL HAZARD REDUCTION PRACTICES SHALL BE EXERCISED AND PROPER GROUNDING INSTRUCTIONS FOR EQUIPMENT SHALL BE FOLLOWED.

CAUTION

WHEN A SEPARATE GROUNDING ELECTRODE (AUXILIARY GROUND) IS PRESENT OR USED IN ADDITION TO THE EQUIPMENT GROUNDING CONDUCTOR IT SHALL BE BONDED TO THE EQUIPMENT GROUND AT EACH ELECTROSTATIC PROTECTED WORKSTATION TO MINIMIZE THE DIFFERENCE IN POTENTIAL (REFER TO PARAGRAPH 04-4.9).

The following tests are intended to check the integrity and adequacy of the electrostatic protected workstation ground system (refer to Figure 04-20).

Connect the ohmmeter between the common point ground on the electrostatic protected workstation and previously tested equipment grounding conductor (Figure 04-30).

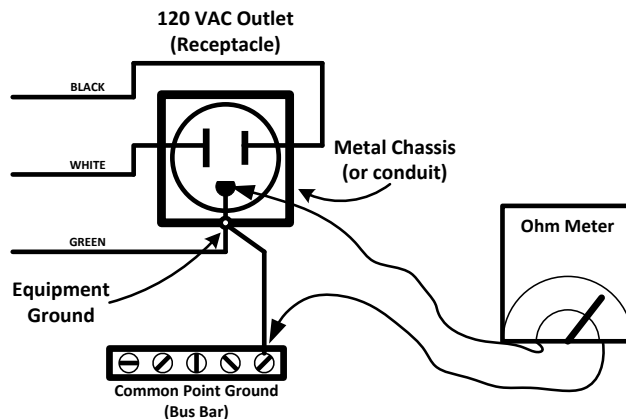

Figure 04-30 Common Point Ground Resistance Measurement Example

- The measurement probes shall be placed to include the grounding resistance of all the interconnecting and securing devices
- Maximum value shall not be greater than 1 Ω

Connect the ohmmeter between the common point ground on the electrostatic protected workstation and the groundable point of ESD equipment (Figure 04-20).

- The measurement probes shall be placed to include the resistance of all of the securing devices related to the ground path

Maximum value shall not be greater than 1 Ω .

If a resistor is used in the circuit, the resistance value shall include the value of the resistor.

15 October 2013

WP 005 00 High Reliability Soldering

05-1 PURPOSE

Identify the technical information relative to high reliability soldering, including solder fillet shape, solder fillet appearance, and cleanliness of the solder joint, plus identification of solder joint anomalies.

Outline the basic procedure and scientific principles of high reliability soldering.

Identify the workmanship standards for high reliability soldering, including general solder acceptability and post-solder joint cleanliness.

Identify additional technical information relative to high reliability soldering, including solder, flux, and finish (plating).

05-2 INDEX

Paragraph	Subject	Page
05-1	Purpose.....	1
05-2	Index.....	1
05-3	General Safety Precautions.....	2
05-4	Technical Information.....	3
05-4.1	Characteristics of a Reliable Solder Joint.....	4
05-4.1.1	Solder Fillet Shape.....	5
05-4.1.2	Appropriate Amount of Solder.....	6
05-4.1.3	Solder Fillet Appearance.....	6
05-4.2	Solder Joint Anomalies.....	6
05-5	High Reliability Soldering.....	13
05-5.1	Procedural Analysis and Feasibility of Repair.....	13
05-5.2	Baking.....	14
05-5.3	Thermal Management.....	14
05-5.3.1	Heat Sinks.....	14
05-5.3.2	Preheating.....	15
05-5.3.3	Soldering Iron Tip Selection.....	16
05-5.3.4	Soldering Iron Tip Temperature.....	17
05-5.4	Pre-Soldering Cleaning.....	17
05-5.5	Application of Flux.....	18
05-5.6	Soldering Iron Tip Maintenance.....	19
05-5.7	Heat Bridge.....	20
05-5.8	Application of Solder.....	21

Paragraph	Subject	Page
05-5.9	Reflowing a Solder Joint	21
05-5.10	Post Soldering Cleaning	22
05-5.11	Inspection	23
05-6	Workmanship Standards	23
05-6.1	General Solder Acceptability	24
05-6.2	Post-Solder Joint Cleanliness	27
05-7	Additional Technical Information	28
05-7.1	Solder	28
05-7.2	Flux	32
05-7.3	Finish (Plating)	33

05-3 GENERAL SAFETY PRECAUTIONS

Observe all the following precautions while performing high reliability soldering:

- Electronic equipment must be de-energized during removal and installation of CCAs
- Personnel are required to wear a properly grounded ESD wrist strap and cord while working in or around the EPA
- ESD can destroy components—protect ESD Sensitive (ESDS) devices during handling and repair to prevent ESD damage (Refer to WP 004 00)
- Isopropyl alcohol is flammable; do not use in the presence of sparks, heat, flame, or synthetic cloth
- Soldering handpieces (e.g., soldering irons, solder extractors, hot air jets) produce extreme heat—exercise care when these tools are out of their stands
- Avoid direct inhalation of fumes during a soldering operation because there is a possibility these fumes could cause occupational asthma
- The lead contained in solder is a source of lead oxide, which the human body cannot dissipate (accumulation of lead oxide in the body over a period of years can result in a serious health hazard)
- Contact with solder by holding in the mouth, smoking, or eating during or immediately after soldering is a potential means of ingesting trace amounts of lead oxide
- Avoid oral contact with hands during or immediately after solder operations
- Wash hands following any solder operation

- Wear approved PPE whenever pouring or handling molten metals or corrosive liquids and solids; and cutting, drilling, grinding, milling, chipping and other dust and debris producing operations

05-4 TECHNICAL INFORMATION

The soldering process has been used for thousands of years to join metal surfaces. Soldering is not the only process that can be used to join two surfaces, but the inherent properties of soldering make this process a natural fit for the assembly and repair of electronics. Compared to welding, the low temperatures required by soldering are less likely to damage heat sensitive electronic components. Compared to chemical adhesives, soldering creates a strong and electrically conductive metallic bond between the two surfaces. Soldering allows for simple and effective means of electronics repair, requiring the joint simply to be heated above solder melt temperatures.

Typical soldering in the 2M Program joins two copper surfaces by melting and solidifying eutectic tin-lead (SnPb) solder between the two surfaces:

- The copper base metal of the component lead is joined to the copper of a plated-through hole of the CCA (WP 007 00).
- The copper termination of a surface mount device is joined to a copper land on a CCA (WP 018 00).
- The copper of a stranded wire is joined to the copper of a terminal (WP 008 00).

Soldering is unique in that a metallic bond is created between the two copper surfaces without actually melting the copper surfaces. In order to create this metallic bond, copper atoms from the base metal must mix with the solder atoms. This mixing occurs while the solder is molten. Copper atoms are dissolved from the base metal into the solder. These copper atoms form an alloy class consisting of copper and tin called an intermetallic. For this reason, the bond between the solder and copper is commonly referred to as the intermetallic bond.

The intermetallic bond is critical for the formation of a solder joint, but is only one aspect of the reliability of the solder joint along with the overall reliability of the electronic assembly. The solder must readily flow over, or wet, the surfaces to be joined. The amount of solder used to form the solder joint must also be considered, with both too much solder and too little solder negatively influencing reliability. Repeated or extended applications of heat can degrade the epoxy joining traces to the CCA and otherwise damage the assembly. Scratches through conductors can change the current carrying capabilities of a circuit. Contamination may lead to corrosion.

The procedures and inspection criteria outlined in this manual are designed to maximize the reliability of the repaired electronic assembly. The procedures are designed to help the technician create a reliable repair the first time, every time. The inspection criteria enable a technician to evaluate critically their work to ensure a repair is reliable.

This work package explains the scientific principles of soldering to assist the technician in successfully creating a reliable solder joint. Understanding these principles will explain the importance of the steps in a procedure and will show how visual inspection criteria indicate if a repair is reliable. Understanding these principles will also help a technician improve their own skills as non-target conditions are often an indication of a process that should be improved. The goal for every technician should be to create a reliable repair the first time, every time.

05-4.1 Characteristics of a Reliable Solder Joint

The procedures outlined in this manual require a technician to inspect visually the characteristics of the solder joint.

When inspecting a solder joint, the technician will observe:

- The shape of the solder fillet
- The appearance of the solder fillet
- The parts being joined are discernible in the solder
- The cleanliness of the solder joint and surrounding areas

These characteristics are used to evaluate the reliability of the solder joint as they indicate:

- The solder readily flowed over, or wetted, the surfaces to be soldered
- The appropriate amount of solder was used
- The solder was molten long enough to form a good intermetallic bond
- The parts were disturbed while the solder was solidifying
- There is contamination in the solder joint decreasing the mechanical integrity of the solder joint
- There is contamination that can lead to corrosion

05-4.1.1 Solder Fillet Shape

The shape of the solder fillet is a prime visual indication of the reliability of the solder joint. A solder fillet is the surface of the solder between the connected surfaces. The surface can be:

- **Concave**—A concave fillet is curved inward toward the soldered surfaces
- **Convex**—A convex fillet is curved outward away from the soldered surfaces

A concave solder joint (Figure 05-1) is the reliable solder joint. It indicates:

- The solder has wet the soldered surfaces
- The appropriate amount of solder was used

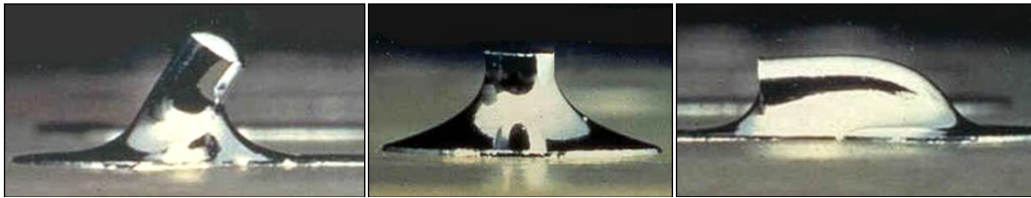

Figure 05-1 Concave Solder Fillets

Molten solder must readily flow over the surfaces to be soldered. This phenomenon, known as wetting, is indicated by the angle between the solder fillet and the soldered surface.

If the angle between the solder fillet and soldered surface, or contact angle, is less than 90° , then the solder has wet the surface. The resulting fillet will be concave.

If the surface prevents the flow of solder, then the contact angle will be greater than 90° resulting in a convex solder fillet (Figure 05-2).



Figure 05-2 Convex Solder Fillet

Figure 05-3 shows an example of the contact angle for solder that has wet the pad versus solder that has not wet the pad. The inability of solder to flow to a required area is known as nonwetting.

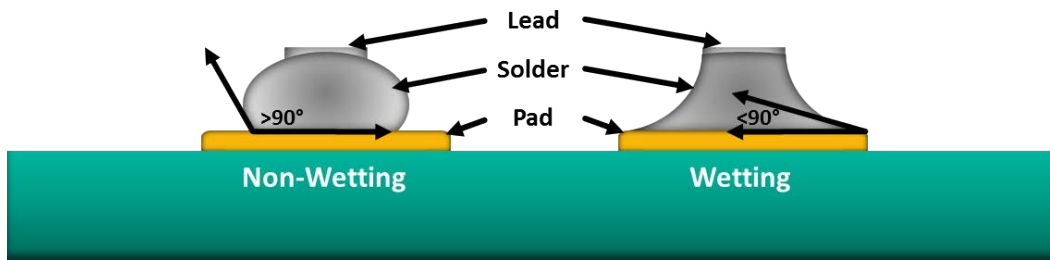

Figure 05-3 Contact Angle

05-4.1.2 Appropriate Amount of Solder

An appropriate amount of solder must also be used when forming a reliable solder joint. The appropriate amount of solder depends on the application, but the pad or land should be completely wet, and the component termination should be wet to meet applicable workmanship standards. Too little solder decreases mechanical integrity of the solder joint. Too much solder does not make the solder joint stronger and may hide solder joint characteristics, which could influence reliability. Figure 05-4 shows an example excessive solder.

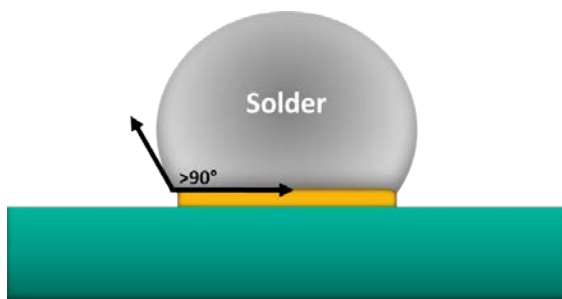

Figure 05-4 Excessive Solder

05-4.1.3 Solder Fillet Appearance

The appearance and surface texture are indicators of a reliable solder joint. Soldering using tin-lead solder should result in fillets that are smooth and shiny. Smooth and shiny fillets indicate the soldering process has been executed properly. Figure 05-1 shows examples of smooth and shiny fillets.

05-4.2 Solder Joint Anomalies

Solder joint anomalies are irregularities or differences from what is considered a target condition. Some anomalies are an acceptable condition and do not require rework. Anomalies that are defects must be reworked.

05-4.2.1 Dewetting

Dewetting (Figure 05-5) is a condition that results when molten solder coats a surface and then recedes to leave irregularly shaped solder fillets separated by areas covered with a thin film of solder and with the base metal or surrounding finish not exposed. Dewetting is an acceptable condition if minimum solder coverage requirements are met.

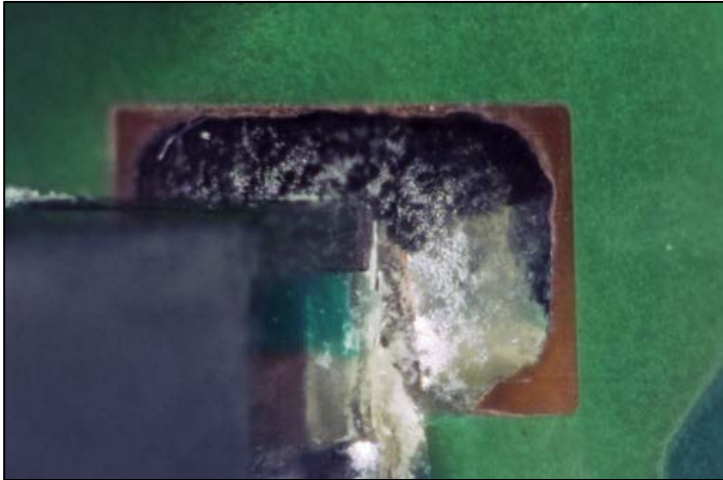

Figure 05-5 Dewetting

05-4.2.2 Nonwetting

Nonwetting (Figure 05-6) is the inability of molten solder to form a metallic bond with the base metal or surface finish. Nonwetting is characterized by areas of the solder fillet where solder does not wet, resulting in a contact angle greater than 90°. Nonwetting is a defect condition; the solder must be removed, and the joint reflowed.



Figure 05-6 Nonwetting

05-4.2.3 Stress Lines (Cooling Lines)

Stress lines (Figure 05-7) indicate uneven cooling of the solder joint. Stress lines occur most often when soldering oddly shaped joints. Stress lines are an acceptable condition and do not require rework.



Figure 05-7 Stress Line

05-4.2.4 Fractured Solder Joint

A fractured solder joint (Figure 05-8) has minute fractures or cracks within the solder or between the solder and the parts being joined. A disturbed solder joint is characterized by a wrinkled texture throughout the solder joint. Movement in the solder joint during cooling causes both of these conditions. Fractured and/or disturbed solder joints are defects and must be reflowed.



Figure 05-8 Fractured Solder Joint

05-4.2.5 Overheated Solder Joint

An overheated solder joint (Figure 05-9) has a dull surface and a rough, grainy, or sandy appearance. Overheated solder is caused by excessively long dwell times causing the solder to oxidize. This condition is a defect; the solder must be removed and the joint resoldered.



Figure 05-9 Overheated Solder Joint

05-4.2.6 Heavily Oxidized Solder Joint

A heavily oxidized solder joint (Figure 05-10) has a crusty, wrinkled appearance. The solder is dark in color and contains light and dark streaks indicating heavy oxidation. This is caused by excessively long dwell times and/or repeated reflow of the solder joint. This condition is a defect; the solder must be removed and the joint resoldered.



Figure 05-10 Heavily Oxidized Solder Joint

05-4.2.7 Pits

Pits (Figure 05-11) are irregular conical indentations in the solder fillet, where the bottom of the indentation can be seen. Pits can be caused by contamination, by uneven cooling, or other anomalies. Pits are an acceptable condition and do not require rework.



Figure 05-11 Pit

05-4.2.8 Pinholes

Pinholes (Figure 05-12) are similar to pits, where the bottom of the indentation cannot be seen. Pinholes are caused by contamination or flux outgassing. Pinholes are a defect condition because it is unknown how large the void may be beneath the surface of the solder; the solder must be removed and the joint resoldered.

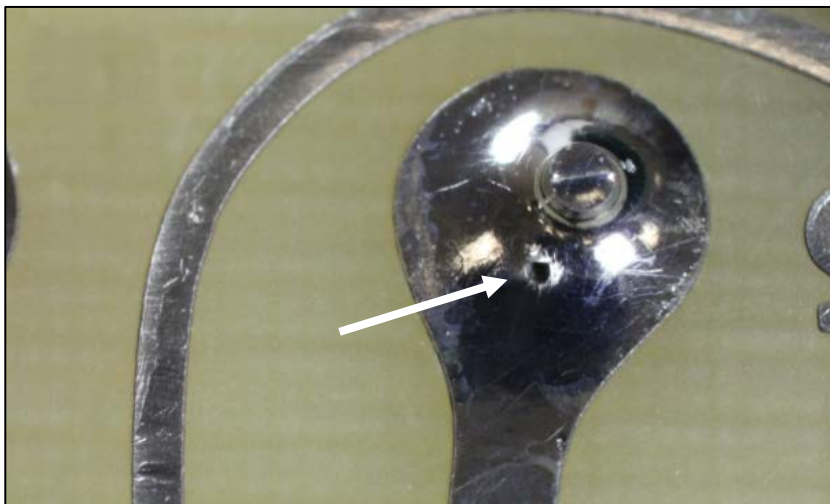

Figure 05-12 Pinhole

05-4.2.9 Blowholes

Blowholes (Figure 05-13) are large pinholes caused by flux outgassing. Blowholes are a defect condition; the solder must be removed and the joint resoldered.



Figure 05-13 Blowhole

05-4.2.10 Excessive Solder

Excessive solder (Figure 05-14) being applied to the solder joint results in the parts being joined not being visible in the solder. Excessive solder is a defect condition; the solder must be removed and the joint resoldered.



Figure 05-14 Excessive Solder

05-4.2.11 Solder Bridging

Solder bridging (Figure 05-15) is the unwanted formation of a conductive path of solder between conductors (leads) while soldering. Solder bridging is a defect and the bridging must be removed.

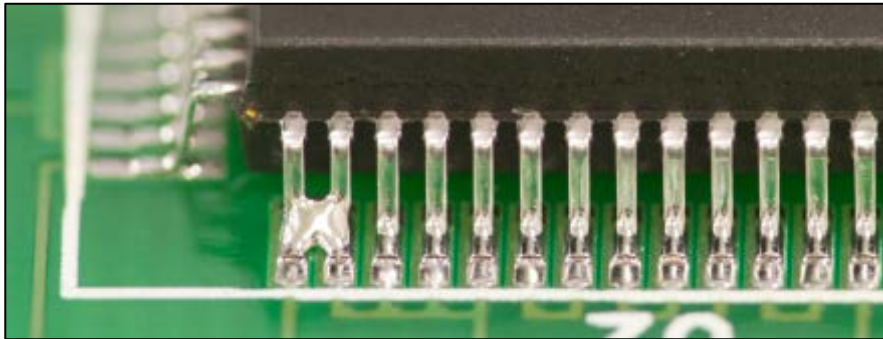

Figure 05-15 Solder Bridging

05-4.2.12 Solder Projection

A solder projection (Figure 05-16) is a protrusion of solder extending from the solder joint. It is caused by removing the soldering iron from the joint before the solder is removed or by reflowing a solder joint without using flux. A solder projection is a defect condition and must be reflowed.



Figure 05-16 Solder Projection

05-5 HIGH RELIABILITY SOLDERING

The procedures and workmanship standards outlined in this manual are designed to maximize the reliability of a repaired assembly. 2M soldering procedures require the use of tin-lead solder, rosin-based, low activity fluxes, and isopropyl alcohol cleaning solvent. Some CCA and lead finishes require additional preparation procedures.

Recommendations are given for choosing the correct soldering iron tip and selecting the correct tip temperature. Techniques are described for protecting electronic components and the workpiece from thermally induced damage.

Most soldering processes follow the same general soldering procedure. This basic procedure is as follows:

- Clean the area to be soldered
- Apply flux
- Create a heat (solder) bridge by applying flux-cored solder to the junction of the iron tip and the surfaces to be soldered
- Paint solder to form the fillets between the surfaces being soldered
- Remove the soldering iron and solder from the joint simultaneously
- Clean the area of all flux residue
- Inspect the solder joint

The soldering action should be completed within two to three seconds for through-hole applications and one to two seconds for surface mount applications.

05-5.1 Procedural Analysis and Feasibility of Repair

An evaluation of the CCA, the repair to be made, and the feasibility of the repair shall be completed before any 2M repair is started. The CCA is evaluated and if required mapped for its construction, the component(s) to be replaced and additional damage that may require repair. Evaluation of the skill level required to perform the repair, the availability of repair parts, and the cost of repair versus assembly replacement shall be completed before repair is started. The Procedural Analysis and Feasibility of Repair Procedure is in WP 003 00 (paragraph 03-5.1).

05-5.2 Baking

Baking of electronic assemblies and some replacement components (IPC/JEDEC J-STD-033) is used to eliminate absorbed moisture. If the repair facility has an oven, CCAs should be baked before soldering, desoldering, and conformal coating operations to prevent delamination, measling, or other laminate degradation. Components marked as moisture-sensitive shall be baked before installation to prevent delamination (popcorning) of the part.

Work processes should begin as soon as possible after removal from the oven to avoid moisture re-absorption. Refer to Table 05-1 for the recommended baking times and temperatures.

Table 05-1 Recommended Baking Times and Temperatures

Baking Temperature	Baking Time
248°F (120°C)	3.5 to 7 hours
212°F (100°C)	8 to 16 hours
176°F (80°C)	18 to 48 hours

05-5.3 Thermal Management

Proper thermal management is necessary to protect the CCA from thermal damage, maximize the lifespan of the soldering iron tip, and to maximize the mechanical integrity of the solder joint. Tip size and temperature selection is one critical element of thermal management. Other elements include heat sinks to protect heat sensitive components from thermal damage, preheating CCAs to prevent damage from thermal shock, and minimizing the number of heat applications.

05-5.3.1 Heat Sinks

A heat sink is used to direct heat away from a component or wire. Heat sinks must be a good conductor of heat, such as a metal clip or tweezers. Figure 05-17 shows examples of heat sinks.

Heat sinks are applied to heat sensitive components before the application of heat. Heat sinks are placed between the heat source and the component to be protected from heat. For example, anti-wicking tweezers may be positioned between the exposed end of a wire and the insulation. A metal clip may be positioned between the end of a lead and the body of a heat-sensitive component, such as a glass diodes and glass capacitors.

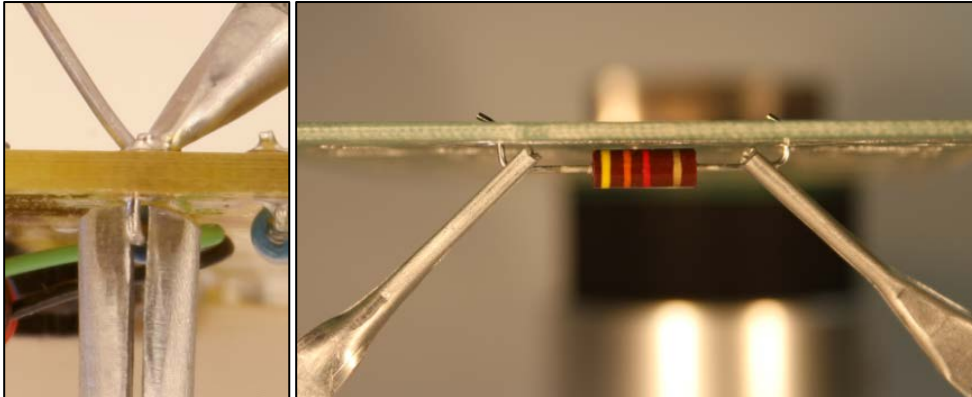

Figure 05-17 Heat Sinks

05-5.3.2 Preheating

All surface mount assemblies shall be preheated before all soldering and desoldering operations. All assemblies should be preheated before soldering and desoldering operations, and most assemblies with large (heavy) ground planes, thick laminates, and/or constraining cores require preheating to enable efficient soldering and desoldering.

Preheating a CCA decreases the risk of thermal shock. Thermal shock, or a sudden change in temperature, can damage a CCA. The susceptibility to thermal shock depends on a number of factors, including the change in temperature, how quickly the temperature changes, the ability of the material to transfer heat, the coefficient of thermal expansion (CTE) (how much the material expands when the temperature is increased), and brittleness of the material.

Damage from thermal shock occurs when a sudden change in temperature causes the assembly to contract or expand at different rates. Thermal shock may cause fractures to certain laminates, conductors, interconnections to mounted components, and individual components. An increase in temperature will cause the assembly to expand. A decrease in temperature will cause the assembly to contract. The risk of thermal shock increases with larger and faster changes in temperature.

A temperature gradient forms in the CCA when heat is applied. The area in contact with the soldering iron tip is the hottest and the temperature decreases as the distance from the soldering iron tip increases. The amount the CCA expands depends on the temperature, so the differences in temperature create differences in expansion. The differences in expansion create stress in the CCA, which can cause damage to the CCA.

Different materials also expand different amounts when heated. For example, the laminate of the CCA will expand more than the copper traces. This creates stresses in both the laminate and copper material, especially when soldering through-hole components.

The expansion of the laminate along the axis of the through-hole is known as Z-Axis expansion. Given the same change in temperature, the Z-Axis expansion of the laminate will be three to four times the expansion of the copper through-hole. The copper through-hole prevents the laminate from expanding this much, creating stress on both the laminate material and copper through-hole. Multiple heat cycles, such as those from multiple reworks, can then cause cracks in the copper through-hole.

A technician only has control over the change in temperature, and how quickly the temperature changes. When working with a CCA at high risk for thermal shock damage, such as a ceramic CCA, allow the assembly to air cool before cleaning as the isopropyl alcohol can result in a sudden decrease in temperature. Slowly preheating the CCA will decrease the change in temperature due to soldering.

Recommended preheat ranges are as follows:

- 171-181°F (77-83°C) for simple hole single- and double-sided CCAs
- 207-217°F (97-103°C) for SMD or through-hole multilayer CCAs with up to six internal layers
- 243-253°F (117-123°C) for high mass multilayer CCAs with seven or more internal layers, ceramic laminates, and CCAs with large ground planes

The Convective Preheating Procedure is in WP 018 00 (paragraph 18-5.2.1) and the Conductive Preheating Procedure is in WP 018 00 (paragraph 18-5.2.2).

05-5.3.3 Soldering Iron Tip Selection

Selecting the correct soldering iron tip and temperature will optimize heat transfer, minimize the amount of time spent creating a reliable solder joint, and minimize the risk of damage to the workpiece. When selecting a soldering iron tip, observe the following guidelines:

- The tip should be as large as possible without overlapping onto the laminate surface or adjacent areas to maximize the thermal mass of the tip
- The tip should provide easy access to the solder joint
- The taper of the tip should be as short as possible to achieve optimal heat transfer
- Larger shank diameters are preferred as they sustain the set temperature better than a smaller shank diameter

The soldering iron tip should always be fully inserted, touching the bottom of the heating element and locked in place with a setscrew. This maximizes heat transfer from the heating element to the tip.

05-5.3.4 Soldering Iron Tip Temperature

When selecting a soldering iron tip temperature, observe the following guidelines:

- A starting point of 600°F is recommended for general soldering procedures using tin-lead solder
- A starting point of 550°F is recommended for low thermal mass soldering operations, such as surface mount soldering
- Preheating the CCA will allow for lower soldering iron tip temperatures
- Solder melt should occur in two to three seconds after heat is applied

NOTE

IF SOLDER MELT DOES NOT OCCUR IN TWO TO THREE SECONDS AFTER HEAT IS APPLIED, ENSURE THE TIP AND SOLDER JOINT ARE CLEAN BEFORE INCREASING THE TEMPERATURE OF THE TIP.

The correct tip preparation, maintenance, and temperature selections will maximize the life of the tip and minimize the risk of damage to the CCA.

The procedure for setting and adjusting tip temperature is the Tip Temperature Procedure in WP 003 00 (paragraph 03-5.4).

05-5.4 Pre-Soldering Cleaning

NOTE

**ISOPROPYL ALCOHOL IS THE ONLY CLEANING SOLVENT AUTHORIZED FOR 2M REPAIR.
USE OF OTHER CLEANING SOLVENTS IS BEYOND THE SCOPE OF THIS MANUAL.**

Cleaning is required before soldering to maximize the solderability of the materials.

Foreign debris contamination, such as flux residue and oils from handling, lead to the formation of voids in a solder joint, entrapped foreign matter, and a corrosive environment. These undesirable outcomes all negatively affect the reliability of the soldered joint.

Foreign debris contamination also decreases the solderability of leads and pads. Solder is less likely to wet a surface contaminated with oxidation and oils. Failure for the solder to wet the surface results in a defective solder joint.

Component leads and terminations, pads, lands, wires, terminals and/or conductors shall be cleaned with isopropyl alcohol before all soldering and desoldering operations. Cleaning is performed using an acid brush to apply and agitate isopropyl alcohol in the repair area. Isopropyl alcohol shall be blotted dry with a clean, lint-free tissue (KimWipe®). Contaminates in the isopropyl alcohol, if left to dry, will remain on the assembly if not removed.

All flux residue, alcohol, and other contaminants shall be removed from the repair area before soldering and desoldering operations.

05-5.5 Application of Flux

NOTE

ROSIN-BASED, LOW ACTIVITY FLUXES (LABELED ROLØ, ROL1, OR RMA) ARE THE ONLY FLUXES AUTHORIZED FOR 2M REPAIR. USE OF OTHER FLUXES IS BEYOND THE SCOPE OF THIS MANUAL.

Flux is used in soldering to facilitate rapid heat transfer and to remove surface oxidation from both the solder and the surface being soldered. Both are essential for high reliability soldering with rapid heat transfer minimizing the amount of heat put into the CCA, and removal of oxidation promoting proper wetting.

CAUTION

FLUX NOT ACTIVATED BY THE SOLDERING PROCESS (HEATED) REMAINS CORROSIVE AND MAY AFFECT RELIABILITY OF THE ASSEMBLY.

When activated by heat, flux removes the oxidation layer on top of the base metal, allowing the solder to react with the metal and form a metallic bond. Molten solder is denser than flux. This allows the solder to displace the flux as it flows over the base metal.

This results in direct contact between the molten solder and base metal with no oxide layer in between. Atoms from the base metal can then freely mix with solder, resulting in a metallic bond.

When applying flux, it is important to use it sparingly. The minimum amount of flux necessary to solder should be applied to the work. If necessary, use a toothpick or flux pen to control the volume of flux applied.

Improper use of flux can result in non-target conditions. Too little flux or no flux will not remove the necessary surface oxide and the solder may not wet the surface. Contamination on the surfaces to be soldered will prevent the activated flux from removing the surface oxide, and solder may not flow into these areas. If flux is trapped under the molten solder, the flux will boil and the escaping vapor can result in a blowhole in the solder surface.

Following soldering, all flux residue, including “No Clean” fluxes, shall be cleaned from the work. This is critical for high reliability soldering. Residual flux may be electrically conductive, may result in corrosion of the workpiece, or lead to other detrimental effects.

05-5.6 Soldering Iron Tip Maintenance

Proper soldering iron tip maintenance will prolong the life of a tip. A soldering iron tip is typically copper with a layer of iron on the outside. This iron protects the copper from being eroded by multiple applications of solder, but is also prone to oxidation.

Figure 05-18 is an illustration of a soldering iron tip (cross-section).

To season a new soldering iron tip, upon reaching solder melt temperature, flow new solder onto the shaped surface and then let the iron idle for approximately two minutes until it reaches full operating temperature, then add more solder to the tip.

Leave solder on the tip if the soldering iron will not be used immediately. Oxides will form on hot tips. Tips seasoned with a layer of solder are protected from oxides by this additional solder.

Before using the soldering iron, use a solder removal tool or KimWipe® to remove excess solder from the tip.

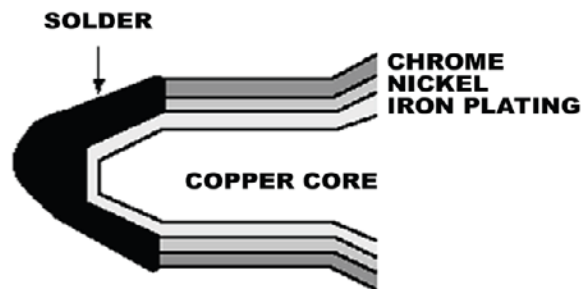

Figure 05-18 Soldering Iron Tip Cross-Section (not to scale)

Perform this operation over a solder catch to prevent solder to splash onto the assembly or on the ESD mat. If the soldering iron has idled for some time, add fresh solder before wiping off excess solder, this ensures impurities flow to the surface and are removed during the wiping action.

After removing the excess solder, immediately before the soldering operation, thermally shock the soldering iron tip on a clean, wet sponge to provide a clean, dry tip. Thermally shocking the tip removes impurities that may remain on the tip after the removing the seasoning. Thermally shocking the tip is accomplished by gently wiping the tip on a damp sponge.

A bright, thin, continuous solder surface should be maintained on the tip's working surface for all soldering operations. This ensures proper heat transfer and avoids transfer of impurities to the joint.

After each soldering operation, season the tip by loading the tip with solder and returning the soldering iron to its stand.

05-5.7 Heat Bridge

The purpose of a heat bridge (Figure 05-19) is to bring rapidly the materials being soldered to soldering temperatures.

A heat bridge is formed by positioning a properly sized soldering tip to the junction of the materials being soldered and simultaneously applying properly sized solder.

The soldering iron tip shall be applied at the point of maximum thermal mass.



Figure 05-19 Heat Bridge

The soldering iron tip shall not be moved at any point during the soldering process. Exceptions are lap soldering, because the soldering iron must move along the length of the lap joint, or drag soldering surface mount devices.

Once the materials being soldered approach solder melt temperature, the flux will activate and remove oxides from the surfaces being soldered and the solder will melt and wet the surfaces. Flux activation and solder flow should occur within two seconds of the application of heat.

05-5.8 Application of Solder

Once the heat bridge is formed, flux is activated, and solder begins to wet the surfaces, apply solder to the cut end of component leads or wires to cover the exposed base metal.

Next, paint the fillets between the surfaces being soldered moving the solder as necessary to form the joint. Once the proper fillets have been formed, remove the soldering iron and the solder from the joint at the same time.

If the iron is removed before the solder, the solder will “stick” to the joint and require an unnecessary application of heat to remove the solder from the joint. If the solder is removed before the soldering iron, the soldering iron tip will pull solder away from the joint, forming projections, or icicles to form on the surface of joint. This also will require an unnecessary application of heat to reflow the solder joint to remove the projection.

The entire soldering operation should be completed in two to three seconds.

05-5.9 Reflowing a Solder Joint

CAUTION

ADDITIONAL APPLICATIONS OF HEAT CAN NEGATIVELY AFFECT THE RELIABILITY OF THE SOLDER JOINT AND MAY LEAD TO CCA AND/OR COMPONENT DAMAGE.

UNNECESSARY APPLICATIONS OF HEAT (REFLOWS OR TOUCH-UPS) SHALL BE AVOIDED.

The goal when soldering is to create a reliable solder joint the first time. Occasionally, a solder joint may require rework.

When possible, reflowing the solder joint is preferred over reworking the solder joint. Reworking requires the existing solder to be extracted and then additional solder be added. This represents two applications of heat instead of just one application when reflowing.

- **Solder joints meeting the acceptability criteria shall not be reflowed or otherwise corrected.**
- **Solder joints shall only be reflowed or reworked to correct a defect condition.**

With experience, a technician will be able to tell if the solder joint that does not meet acceptability criteria, needs to be completely reworked, or if reflowing the solder joint (remelting the solder joint without extracting the solder) will correct the defect conditions.

Every effort should be made to minimize additional applications of heat. If reflow will correct the defect condition, use the Reflowing a Solder Joint Procedure in WP 003 00 (paragraph 03-5.5), including cleaning, application of flux, application of heat, and inspection. Additional solder is typically not required for this procedure.

Multiple reflows of the same solder joint shall be avoided.

Multiple reflows may:

- Contaminate the solder joint with foreign matter
- Break intermetallic particles away from the interface and contaminate the body of the solder joint
- Overcure the epoxy holding conductors to the CCA
- Cause damage to conductors and through-holes due to thermal shock (e.g. Z-Axis expansion cracking of copper through-holes)
- Heavily oxidize the solder

05-5.10 Post Soldering Cleaning

Cleaning is required after soldering to remove contaminants left by the soldering process.

NOTE

**ISOPROPYL ALCOHOL IS THE ONLY CLEANING SOLVENT AUTHORIZED FOR 2M REPAIR.
USE OF OTHER CLEANING SOLVENTS IS BEYOND THE SCOPE OF THIS MANUAL.**

Component leads and terminations, pads, lands, wires, terminals and/or conductors shall be cleaned with isopropyl alcohol after all soldering and desoldering operations to remove all flux residue and other contaminants.

Cleaning is performed using an acid brush to apply and agitate isopropyl alcohol in the repair area. Isopropyl alcohol shall be blotted dry with a clean, lint-free tissue (KimWipe®). Contaminants become suspended in the isopropyl alcohol and if left to dry will remain on the CCA reducing its reliability.

Cleaning is also important for the proper application of conformal coating. Residual contamination can prevent the conformal coating from adhering to the CCA.

05-5.11 Inspection

Inspection is performed to locate defects that may affect the performance or reliability of the assembly. The 2M Technician shall inspect all repairs to all applicable workmanship standards. These standards ensure the repairs are reliable.

This basic inspection procedure is as follows:

- Verify the correct part has been installed
- Verify the part is oriented correctly, terminates to the correct pads and if possible, the component markings are visible
- Inspect the quality and quantity of the solder joints
- Inspect the cleanliness of the CCA
- Inspect for collateral damage that may have been caused during the repair

The procedure for inspection is the General Inspection Procedure in WP 003 00 (paragraph 03-5.12).

05-6 WORKMANSHIP STANDARDS



Refer to WP 003 00 (paragraph 03-6) for definitions of Workmanship Standards.

NOTE

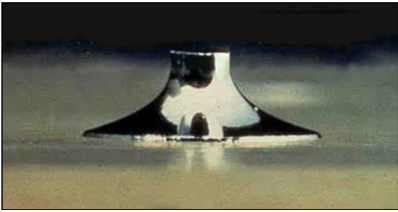

WORKMANSHIP STANDARDS FOR CONFORMAL COATING ARE IN WP 006 00 (PARAGRAPH 06-6), THROUGH HOLE COMPONENTS IN WP 007 00 (PARAGRAPH 07-6), TERMINALS IN WP 008 00 (PARAGRAPH 08-6), SOLDER CUPS IN WP 009 00 (PARAGRAPH 09-6), WIRE REPAIR IN WP 010 00 (PARAGRAPH 10-6), LAMINATE IN WP 011 00 (PARAGRAPH 11-6), CONDUCTORS, PADS, AND LANDS IN WP 012 00 (PARAGRAPH 12-6), FLEX PRINT IN WP 013 00 (PARAGRAPH 13-6), WELDED LEADS IN WP 014 00 (PARAGRAPH 14-6), MULTILAYER IN WP 015 00 (PARAGRAPH 15-6), PLASTIC PANEL IN WP 016 00 (PARAGRAPH 16-6), SURFACE MOUNT DEVICES IN WP 018 00 (PARAGRAPH 18-6), JUMPER WIRES IN WP 019 00 (PARAGRAPH 19-6), AND CONNECTORS IN WP 021 00 (PARAGRAPH 21-6).

05-6.1 General Solder Acceptability

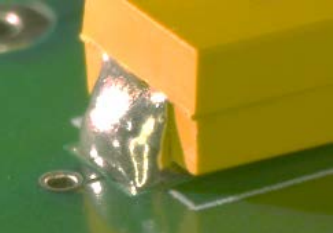

General Solder Acceptability

Target Condition	Acceptable Condition	Defect Condition
<p>The solder fillet exhibits a smooth, shiny, mirror-like appearance.</p> 		
<p>The fillet is concave in shape forming a contact angle less than 90°.</p> 		<p>The fillet is convex and forms a contact angle greater than 90°.</p> 
<p>The soldered parts are discernible in the solder.</p> 		<p>The outline of the soldered parts is not discernible in the solder joint.</p> 
	<p>There is a pit in the solder joint provided the bottom of the pit is visible.</p>	<p>There is a pit the solder joint where the bottom of the pit is not visible.</p>
		<p>There is a pinhole, blowhole, or void in the solder joint.</p>

General Solder Acceptability

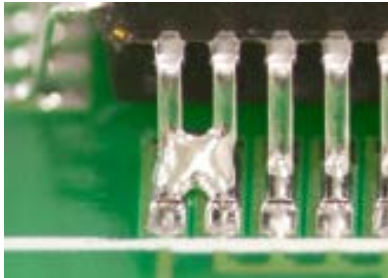
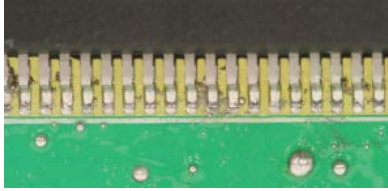

Target Condition	Acceptable Condition	Defect Condition
The fillet exhibits good wetting, creating a feathered edge at the parts being joined.		There is no feathered edge apparent in the solder joint.
	The solder joint shows evidence of dewetting, provided all other solder joint wetting criteria have been met.	Dewetting prevents solder joint wetting criteria to be met.
		There is evidence of nonwetting.
Terminated wire and lead ends are covered with solder.	There is exposed base metal on terminated wire or lead ends after the soldering process.	There is exposed base metal on the horizontal surfaces of conductors, pads, or lands. 
		The solder joint has been disturbed.
		There is evidence of a cold solder joint.
		The solder joint is fractured. 

General Solder Acceptability

Target Condition	Acceptable Condition	Defect Condition
		<p data-bbox="1019 422 1414 489">There are solder splashes on the assembly.</p> 
		<p data-bbox="1019 751 1386 819">Solder has bridged conductors that should not be connected.</p> 
		<p data-bbox="1019 1144 1393 1211">There are solder balls resulting from the repair process.</p> 
		<p data-bbox="1019 1440 1357 1507">There is a solder projection, protrusion, or icicle.</p> 

05-6.2 Post-Solder Joint Cleanliness

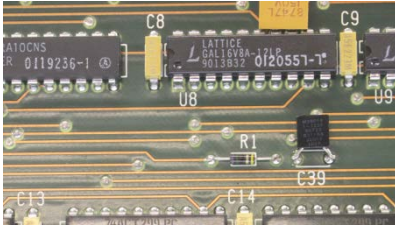
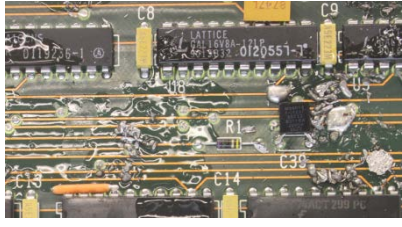
Post-Solder Joint Cleanliness

Target Condition	Acceptable Condition	Defect Condition
<p>The assembly is clean.</p> 		<p>There is particulate matter on the assembly, e.g., dust, lint, dross, metallic particles, etc.</p> 
		<p>There is flux residue discernible (viewed without magnification) on the assembly.</p> 
		<p>There are white residues on or around the solder joint and assembly surface.</p> 

05-7 ADDITIONAL TECHNICAL INFORMATION

05-7.1 Solder

Solder is characterized by a low melting temperature when compared to other pure metals and metal alloys. This is important for soldering electronics because the melting temperature must be low enough to prevent thermal damage to the electronic components and the CCA. In addition to having a low melting temperature, solder must also be electrically conductive.

05-7.1.1 Solder Alloys

NOTE

SN63PB37 AND SN60PB40 ARE THE ONLY SOLDER ALLOYS AUTHORIZED FOR 2M REPAIR. USE OF OTHER SOLDER ALLOYS IS BEYOND THE SCOPE OF THIS MANUAL.

The solder used in the manufacture and repair of military electronic assemblies is primarily an alloy consisting of tin (Sn) and lead (Pb). Tin is alloyed with lead to lower the melting temperature and promote good wetting. The ratio of tin to lead is a percentage with the tin content given first. Eutectic tin-lead solder is an alloy of 63% tin, 37% lead, and is labeled as Sn63Pb37.

There are many available tin-lead solders with different ratios of tin to lead. The solder alloy Sn63Pb37 is the eutectic composition for tin and lead, meaning it transitions from a solid to a liquid, or a liquid to a solid, at a single temperature of 361°F [183°C]. The solder alloy Sn60Pb40, is not eutectic, and transitions from a solid to a liquid between 361-375°F [183-191°C]. Figure 05-20 shows the effect of the ratio of tin to lead on the melting temperature and the solid to liquid range in temperature.

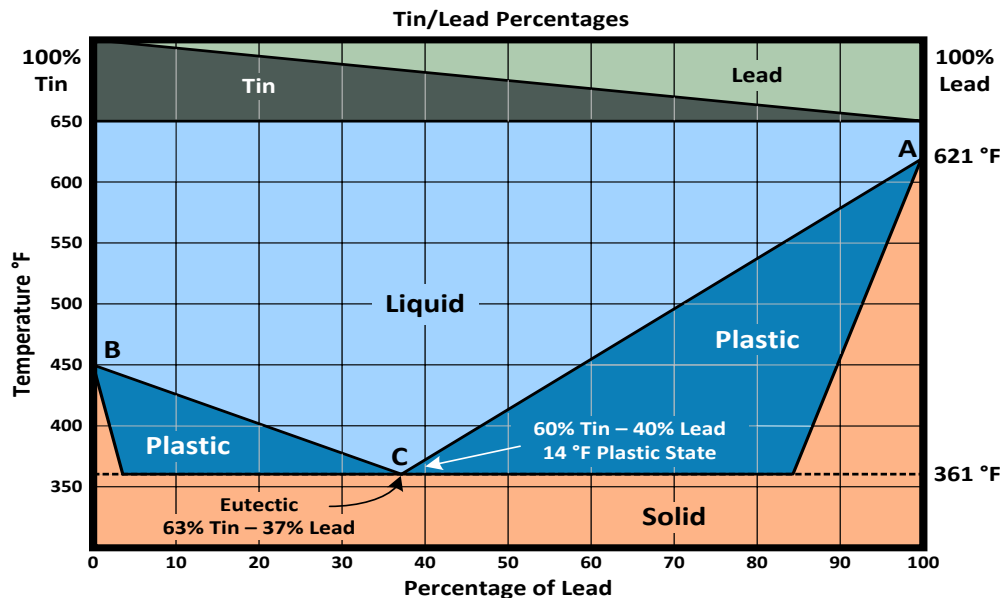

Figure 05-20 Tin-Lead Phase Diagram

There are many other solder compositions, including a class of solders that do not contain any lead. These solders, including lead-free, are beyond the scope of this manual. Use requires authorization by the technical documentation for the CCA under repair and/or as directed by the cognizant technical authority. Further information regarding lead-free solders is in WP 020 00.

05-7.1.2 Intermetallic Formation

A concave solder fillet shows that solder has properly wet the surfaces to be soldered. This is important when soldering because the solder must interact with the surfaces to maximize the strength and minimize the electrical resistance of the solder joint. Failure of the solder to wet the surface indicates that contamination, oxidation, or insufficient heat is preventing the solder from interacting with the base metal.

Because a non-wetted surface indicates that solder is not interacting with the base metal to be soldered, it also indicates that there may not be a strong metallic bond between the solder and surface. In order for solder to form a metallic bond with the surface, atoms from the solder must mix with atoms from the surface. This mixing occurs while soldering as atoms from the surface dissolve into the solder while atoms from the solder diffuse into the surface. The result is a continuous metallic bond between the solder and the base metal once the solder solidifies.

Figure 05-21 illustrates the intermetallic layer between solder and the copper.

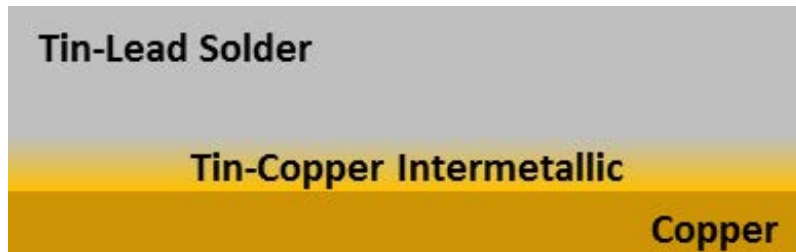

Figure 05-21 Tin/Copper Intermetallic Bond

If the solder is molten for too long, then the intermetallic will become too thick. The intermetallic is brittle compared to the solder, so a thicker intermetallic layer makes the solder joint brittle.

Figure 05-22 illustrates there is an optimum intermetallic thickness where the layer is continuous across the entire solder joint but not so thick that the solder joint becomes brittle.

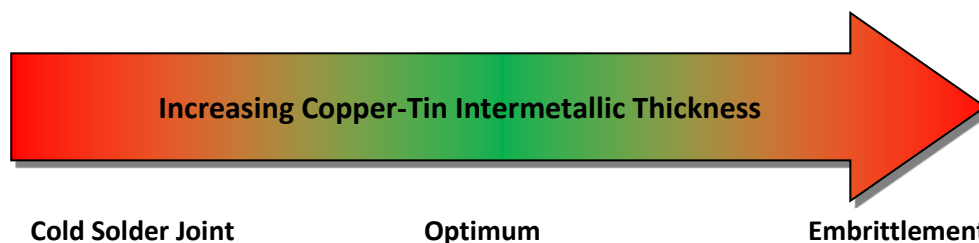

Figure 05-22 Optimal Copper-Tin Intermetallic Thickness

The intermetallic layer is too thin to be seen with the naked eye and is hidden between the copper and solder. A technician should still consider the effect of their repairs on the thickness of the intermetallic. The solder must be molten long enough for the solder to interact with the copper, but repeated heat cycles should be avoided.

05-7.1.3 Solder Forms

Solder comes in a variety of forms, including wire, bar, and paste. The form of solder a technician will use depends on the application and procedure. Figure 05-23 shows many of the solder forms available.



Figure 05-23 Solder and Flux Forms

Flux-core wire solder contains flux inside the wire, surrounded by solder. Most 2M hand soldering applications use flux-core wire solder. However, not all wire solder contains flux. Typical wire solder diameters range between 0.015 and 0.062 in.

Bar solder is a large ingot of solder, sold by the pound. Within the 2M Program, Sn63Pb37 bar solder is used to fill solder pots.

Solder paste contains solder powder, suspended in a thick liquid consisting of flux and other additives. Solder paste is heated with hot air (hot gas) to solder surface mount devices. The size of the solder powder is categorized by a mesh size. A manufacturer will typically use two mesh numbers to identify a powder size, identifying the range in expected particle sizes. The recommended mesh size depends on component lead pitch. Table 05-2 is a summary of recommended mesh sizes and a paste dispenser tip selection chart.

Table 05-2 Solder Paste and Tip Selection Chart

Lead Pitch	Recommended Powder Type	Mesh Size	Recommended Tip Size
50 mil	2	-200/+325	21 or less
25 mil	3	-325/+500	23 or less
20 mil	3	-325/+500	23 or less
16 mil	3 or 4	-325/+500 or -400/+500	25 or less
12 mil	4	400/+500	25 or less

05-7.2 Flux

Flux is a chemically and physically active compound that, when heated, promotes the wetting of a base metal surface by molten solder by removing minor surface oxidation and other surface films and by protecting the surfaces from reoxidation during a soldering operation.

05-7.2.1 Flux Types

The standard for flux, ANSI/J-STD-004, identifies flux by composition and activity. The categories for composition include rosin (RO), resin (RE), organic (OR), and inorganic (IN). The categories for activity include low (LØ or L1), moderate (MØ or M1), and high (HØ or H1).

The classification of flux is given by combining the composition classification with the activity classification. For example, a rosin-based flux with low activity would be classified by ROLØ or ROL1. Within the 2M Program, only rosin-based, low activity (ROLØ, ROL1, or RMA) fluxes are approved for use. Non-ROLØ, ROL1, or RMA fluxes may be used only if authorized in the technical documentation for the CCA under repair or as directed by the cognizant technical authority.

Flux residue can be corrosive, especially inorganic or acid-based fluxes such as zinc chloride. The residue from rosin-based fluxes is the least corrosive, which is why only rosin-based, low activity fluxes are approved for 2M use.

Many common fluxes use natural rosin as a base. Rosin-based flux is derived from pine tree sap and typically has a light-brown appearance. Rosin (RO) based fluxes were previously classified as rosin (R), rosin mildly activated (RMA) or rosin activated (RA).

They are inert until heated, but when heated, activate and remove surface oxides. The residue from these fluxes is non-conductive and minimally corrosive, making them ideal for electronics soldering.

Flux is an essential element in high reliability soldering. How a technician uses flux depends on the form of the flux and application. Since all flux residue must be removed from the workpiece after soldering, the amount applied shall be kept to a minimum.

05-7.2.2 Flux Forms

WARNING

PASTE FLUXES CONTAINING ZINC CHLORIDE AS AN ACTIVATING ADDITIVE (MARKED ON THEIR CONTAINERS) GIVE OFF TOXIC FUMES WHEN HEATED TO SOLDERING TEMPERATURES.

CAUTION

PASTE FLUXES CONTAINING ZINC CHLORIDE AS AN ACTIVATING ADDITIVE (MARKED ON THEIR CONTAINERS) ARE HIGHLY CORROSIVE AND MAY DAMAGE THE CCA.

ZINC CHLORIDE PASTE FLUXES SHALL NOT BE USED FOR 2M SOLDERING.

Flux comes in several forms, including liquid, solid, or paste. There are no requirements within the 2M Program for which flux form shall be used. Most repairs will be performed using liquid flux.

Flux containing zinc chloride is highly corrosive and shall not be used for 2M soldering.

Typically, wire solder will have a flux core. Flux-core solder used in 2M shall have ROLØ or ROL1 flux. Depending on the application, additional flux may be added to aid in soldering

05-7.3 Finish (Plating)

The finish of a component or a circuit card refers to a thin metallic layer covering the base metal. This layer is also called the plating when it is deposited using electroplating. Typical finishes include tin (Sn), tin-lead (SnPb), silver (Ag), and gold (Au).

Most components and circuit assemblies have a finish. The purpose of the finish includes:

- Preventing oxidation of the base metal to maximize solderability
- Making it possible to solder to a surface that would otherwise be non-solderable

If possible, a 2M Technician should identify the finish material and the base material to maximize the reliability of the solder joint. The two main concerns are:

- Is the base metal solderable?
- Does the finish contain gold?

Some base metals are not easily solderable. For example, DIP leads made of Dumet or Kovar® are non-solderable. Do not mechanically abrade a finish if it is covering a non-solderable surface. Instead, use a tinning method to clean the surface.

Gold finishes shall be double-tinned before installation. Double tinning reduces the amount of gold absorbed by the solder. The first tinning operation removes most of the gold from the surface. The second application wets the base metal. Failure to double tin the surface may result in a less reliable solder joint because gold reacts with the solder to form brittle intermetallics. This condition is known as gold embrittlement.

15 October 2013

WP 006 00 Conformal Coating

06-1 PURPOSE

Identify the technical information relative to conformal coating, including conformal coating characteristics and types of conformal coating.

Specify the repair procedures for conformal coating identification.

Specify the repair procedures for conformal coating removal.

Specify the repair procedures for conformal coating replacement.

Identify the workmanship standards for conformal coating.

06-2 INDEX

Paragraph	Subject	Page
06-1	Purpose	1
06-2	Index	1
06-3	General Safety Precautions.....	2
06-4	Technical Information.....	3
06-4.1	Conformal Coating Characteristics	3
06-4.2	Types of Conformal Coating.....	6
06-4.2.1	Acrylic Resin	7
06-4.2.2	Epoxy Resin (ER).....	8
06-4.2.3	Silicone Resin (SR).....	8
06-4.2.4	Polyurethane Resin (UR).....	9
06-4.2.5	Paraxylylene (XY)	9
06-4.3	Solder Mask	9
06-5	Repair Procedures.....	10
06-5.1	Procedural Analysis and Feasibility of Repair	11
06-5.2	Conformal Coating Identification Procedure.....	11
06-5.3	Conformal Coating Removal Requirements	12
06-5.4	Conformal Coating Removal Methods.....	13
06-5.4.1	Conformal Coating Removal Chemical (Isopropyl Alcohol) Procedure	14
06-5.4.2	Conformal Coating Removal with Hot Air Jet Procedure	16
06-5.4.3	Conformal Coating Removal using Thermal Parting Tool Procedure	18
06-5.4.4	Conformal Coating Removal using Cut and Peel Method Procedure.....	20
06-5.4.5	Conformal Coating Removal (thin) using Manual Abrasion Procedure....	22
06-5.4.6	Conformal Coating Removal (thick) using Motorized Abrasion Procedure.....	23

Paragraph	Subject	Page
06-5.4.7	Conformal Coating Removal (thin) using Motorized Abrasion Procedure.....	25
06-5.5	Conformal Coating Replacement Procedure	27
06-6	Workmanship Standards	32
06-6.1	Conformal Coating Removal	32
06-6.2	Conformal Coating Replacement.....	33

06-3 GENERAL SAFETY PRECAUTIONS

Observe all the following precautions while removing and replacing conformal coating:

- Electronic equipment must be de-energized during removal and installation of CCAs
- Personnel are required to wear a properly grounded ESD wrist strap and cord while working in or around the EPA
- ESD can destroy components—protect ESDS devices during handling and repair to prevent ESD damage (Refer to WP 004 00)
- Isopropyl alcohol is flammable; do not use in the presence of sparks, heat, flame, or synthetic cloth
- Soldering handpieces (e.g., hot air jets, lap flow tools) produce extreme heat—exercise care when these tools are out of their stands
- Wear approved PPE whenever pouring or handling molten metals or corrosive liquids and solids; and cutting, drilling, grinding, milling, chipping and other dust and debris producing operations
- Some conformal coating materials are flammable; do not use in the presence of open flames or sparks
- Avoid inhalation of conformal coating fumes, vapors, or spray
- Keep conformal coatings away from the face and eyes
- Apply and cure conformal coatings only in ventilated areas; adequate ventilation shall be provided during and immediately following application
- Avoid excessive skin contact with conformal coatings; if skin contact occurs, wash with soap and water

- Polyurethane resins normally contain traces of free toluene diisocyanates, monomeric isocyanate, or polymeric isocyanates; prevent polyurethane resin vapor or spray mist contact with the eyes and skin
- Always follow the manufacturer's instructions and warnings when using conformal coating products

06-4 TECHNICAL INFORMATION

Conformal coating is applied to the CCA to protect it from environmental stress, vibration, corrosion, moisture, and fungus.

Most conformal coatings consist of a synthetic resin dissolved in a volatile solvent. When properly applied to a clean surface, the solvent evaporates, leaving a layer of solid resins.

Before beginning the repair process, the technician shall determine if the CCA has a protective coating. Coatings shall be removed and the surface properly cleaned before repair can be performed.

There are five primary conformal coatings:

- Acrylic Resin (AR)
- Epoxy Resin (ER)
- Silicone Resin (SR)
- Polyurethane Resin (UR)
- Paraxylylene (XY)

06-4.1 Conformal Coating Characteristics

Conformal coatings may have one or more of the following characteristics:

- Thermal heat conductivity to dissipate heat from components
- Low shrinkage factors during application and curing to prevent coatings from applying stress to laminates or components
- Resilience, hardness, and strength to support and protect components
- Low moisture absorption

- Inorganic composition to prevent fungus growth
- Qualities of electrical insulation

Conformal coatings also have specific physical characteristics of hardness, transparency, thickness, solubility, adhesion, thermal properties, and texture. Table 06-1 lists these characteristics for each specific coating type:

Table 06-1 Conformal Coating Characteristics

Characteristics	Conformal Coating Type				
	Acrylic	Epoxy	Silicone	Polyurethane	Paraxylylene
Hard		X		X	X
Medium Hard	X			X	
Soft			X	X	
Heat Reaction	X	X		X	
Surface Bond-Very Strong		X	X		X
Surface Bond-Strong	X		X		
Surface Bond-Medium			X	X	
Surface Bond-Light			X		
Solvent Reaction	X				
Smooth	X	X	X	X	X
Lumpy	X (Varnish)				
Glossy	X	X		X	
Semi-glossy		X	X		
Dull or Matte			X		X
Rubbery			X		
Brittle	X	X			
Chips	X	X			

Characteristics	Conformal Coating Type				
	Acrylic	Epoxy	Silicone	Polyurethane	Paraxylylene
Peels and Flakes	X			X	X
Stretches			X	X	
Scratch, Dent, Bend, Tear			X	X	X

06-4.1.1 Hardness

Conformal coating hardness may be determined by applying pressure to the coating with an orangewood stick or spudger. Coatings may range from soft to hard.

06-4.1.2 Transparency

Conformal coating transparency is determined by visual inspection. Coatings range from transparent to opaque. Transparent coatings are more easily removed than opaque coatings because they allow the technician to see the elements during removal.

06-4.1.3 Thickness

Conformal coating thickness is determined by visual inspection. Thin coatings show sharp outlines of the components and almost no fillet at intersection points of part leads to the CCA. (Coatings 0.025 in. (~1/32 in.) or less are considered thin). Thick coatings reduce these sharp outlines and show fillets where part leads intersect with the CCA. (Coatings thicker than 0.025 in. are considered thick).

06-4.1.4 Solubility

CAUTION

UNLESS DIRECTED BY OTHER MAINTENANCE ACTIONS, THE SOLUBILITY TEST AND SOLVENT USE SHALL BE LIMITED TO ISOPROPYL ALCOHOL

Most coatings are soluble. The solvent required to dissolve a specific coating may damage the CCA and/or components. Test coating by applying a small quantity of isopropyl alcohol in the repair area and observe reaction.

06-4.1.5 Adhesion

Conformal coating adhesion is the degree to which the coating material has bonded itself to the elements of the assembly. Adhesion strength varies widely between coating types and may vary with age. Adhesion is determined by applying light pressure to the coating with a mechanical aid in the repair area and observing reaction.

06-4.1.6 Thermal Properties

Conformal coating thermal properties relate to their reaction to heat. Coatings react differently to the application of controlled heat and abrasion. The coating may have no reaction, overcure and turn to a white powder, or soften and turn gummy. Test the coating surface in the repair area at or below solder melt temperature (361°F) and observe reaction.

06-4.1.7 Texture

Conformal coating texture is determined by visual inspection and/or touch. Coating textures range from smooth, shiny, glossy to dull, matte, or rubbery.

06-4.2 Types of Conformal Coating

The following paragraphs discuss the characteristics of the five primary conformal coatings:

- Acrylic Resin (AR)
- Epoxy Resin (ER)
- Silicone Resin (SR)
- Polyurethane Resin (UR)
- Paraxylylene (XY)

The characteristics of the five primary conformal coatings are summarized in Table 06-1.

Representative types of coatings, manufacturers, and CAGE codes are given in Table 06-2.

NOTE

TABLE 06-2 IS NOT AN ALL-INCLUSIVE LIST AND IS SUBJECT TO CHANGE.

Table 06-2 Representative Major Resins by Manufacturer

Major Resin	Manufacturer's Designation	Manufacturer	CAGE
Acrylic Resin (AR)	CE-1170	Cytec Olean Inc.	16245
	1B31 1B73	Humiseal Division	99109
	18893	Henkel-Loctite	04347
	2103-12S, 2108-12S	Techspray	
Epoxy Resin (ER)	2A53	Humiseal Division	99109
	0151	Hysol Division	04347
Silicone Resin (SR)	3140 RTV with 1204 Primer	Dow Corning	71984
	1C49, 1C49LV, 1C51, 1C55	Humiseal Division	99109
	2102-P	Techspray	
Polyurethane Resin (UR)	CE-1155 (2 Part), CE-1170	Cytec Olean Inc.	16245
	1A20, 1A27, 1A33, , 2A64	Humiseal Division	99109
	PC18M, PC29M	Hysol Division	04347
	2104-12S	Techspray	
Paraxylylene (XY)	Parylene C, N, D, E, C Fluorescent	Union Carbide Corp	0AFL3
	DIX C	Uniglobe Kisco, Inc.	1RV89

06-4.2.1 Acrylic Resin (AR)

Acrylics, though relatively hard, thin, and similar in appearance to epoxies, yield more readily to scraping and cutting.

Acrylics are normally smooth, nonporous, and moderately hard with a glossy finish similar to automotive lacquer paint.

Acrylics form a surface bond that often yields to chipping and flaking.

Heat applied at or below solder melt temperature (361°F) softens most acrylics, making a gummy residue.

Most acrylic resins may be dissolved by isopropyl alcohol and easily blotted away.

06-4.2.1.1 Varnish

Varnish is a type of acrylic resin.

The hardness of varnish varies with age (New varnish is hard and tough while old varnish is brittle).

Varnish has a surface bond that peels, cracks, and flakes.

Varnish has a semi-gloss finish and is often lumpy.

Isopropyl alcohol will dissolve varnish leaving a gummy residue on the CCA after evaporation.

Application of heat at or below solder melt temperature (361°F) liquefies varnish resulting in a strong, distinctive odor of linseed oil.

06-4.2.2 Epoxy Resin (ER)

Epoxy is a hard thick or thin coating that forms a very strong surface adhesive bond. Because of this adhesion, epoxy will not chip, peel, or crack under physical stress.

The texture is smooth, glossy, and nonporous.

Application of controlled heat, at or below solder melt temperature (361°F), and abrasion overcures epoxy resulting in a powdery substance.

06-4.2.3 Silicone Resin (SR)

Silicone coatings are rubbery and pliable and can be applied as a thin or thick coat.

Their adhesive strengths range from readily peelable to tightly bonded.

Silicone coatings are not brittle and bend very easily.

Their texture is smooth, dull, and rubbery.

Isopropyl alcohol has no effect on these coatings, although it may cause the surface to feel slick or greasy.

Application of heat, at or below solder melt temperature (361°F), has no effect on most silicone coatings.

06-4.2.4 Polyurethane Resin (UR)

Polyurethane coatings range from very hard (similar to epoxies) to relatively soft (similar to a silicone compound).

Polyurethanes can be thick or thin coatings and will normally form a medium-strength bond that often peels in pieces larger than those of acrylics do.

The flexibility of polyurethanes allows these coatings to tear or stretch rather than crack or break.

The texture is normally smooth, glossy, and nonporous; however, the surface may be dented or scratched when light pressure is applied.

Isopropyl alcohol has no effect on polyurethanes.

Application of controlled heat, at or below solder melt temperature (361°F/183°C), and abrasion tends to soften polyurethanes, making them pliable with a putty-like consistency.

06-4.2.5 Paraxylylene (XY)

Paraxylylene is a thin, tough, nonporous, pin hole-free coating of uniform thickness.

Paraxylylene coatings form a very strong surface bond but bend and peel easily after the surface bond has been broken.

The texture of paraxylylene can range from smooth and shiny to dull and matte.

Paraxylylene does not react to isopropyl alcohol.

Although not the preferred method, heat applied at temperatures of approximately 480°F to 500°F (249°C to 260°C) with a thermal parting method will remove paraxylylene.

06-4.3 Solder Mask

Solder mask or solder resist is a polymer coating applied to the surface of a CCA to physically and electrically mask the portions of the circuit where solder or soldering is not required.

With the increased circuit density, decreasing lead pitch and fine lines and spacing of traces and conductors of surface mount technology, solder mask typically covers the entire CCA surface except the pads/lands requiring solder. This eliminates solder bridging between non-electrically common conductors.

While solder mask is a polymer coating with insulating properties, it does not insulate the soldered areas of the completed assembly. Conformal coating is necessary to provide the required environmental protection and insulating properties needed in harsh and high-humidity environments.

Solder mask damaged during a 2M repair process should be replaced with Hysol® 0151 epoxy. Color additives shall not be added. The appropriate conformal coating should be applied after the epoxy is fully cured, if applicable.

06-5 REPAIR PROCEDURES



PROTECT STATIC SENSITIVE DEVICES DURING HANDLING AND REPAIR TO PREVENT ESD DAMAGE (REFER TO WP 004 00).

Equipment Required Listed below are the authorized 2M Power Units* for removal and replacement of conformal coating:

- **NAVAIR/NAVSEA/USMC/USAF/USCG—PRC-2000-SMT**
- **NAVSEA/USCG—PRC-2000-TH**
- **NAVSEA/USCG—MBT-250-SD†**
- **USMC—MBT-350†**
- **NAVSEA—ST-25†**

* Refer to Table 03-3 for Power Unit Part No., and CAGE Code

† Limited capability in this WP

Additional Support Items For additional information regarding items of support and support equipment refer to:

- **NAVSEA/NAVAIR/USCG—2M MTR Certification Manual**
 - **NAVSEA/USCG—Allowance Parts List (APL) 000A8423**
 - **USMC—Stock List SL-3-09458A**
-

-
- **USAF**—the Consolidated Tool Kit (CTK)
-

Material Required Listed below are the materials required* for removal and replacement of conformal coating:

- Applicator, Disposable (cotton-tipped)
- Insulating Compound (conformal coating)
- Isopropyl Alcohol, Technical
- Pipet, Measuring (Pipette)
- Towel, Paper (Kimwipe®)‡

* Refer to Table 03-4 for Specification No., Part No., and NSN

† Select size appropriate for application

‡ Substitution of equivalent material is acceptable

06-5.1 Procedural Analysis and Feasibility of Repair

Perform the Procedural Analysis and Feasibility of Repair Procedure in WP 003 00 (paragraph 03-5.1).

06-5.2 Conformal Coating Identification Procedure

The conformal coating type must be identified before removal so the appropriate removal technique can be used. The Conformal Coating Identification Flowchart (Figure 06-1) aids in identification decision-making and Table 06-1 lists conformal coating characteristics.

NOTE

COATINGS MIGHT DISPLAY CHARACTERISTICS OTHER THAN THOSE LISTED FOR THE FIVE PRIMARY TYPES.

VARIATIONS IN FORMULATIONS, AGE, AND ENVIRONMENTAL FACTORS AFFECT HOW A PARTICULAR COATING REACTS TO EACH TEST.

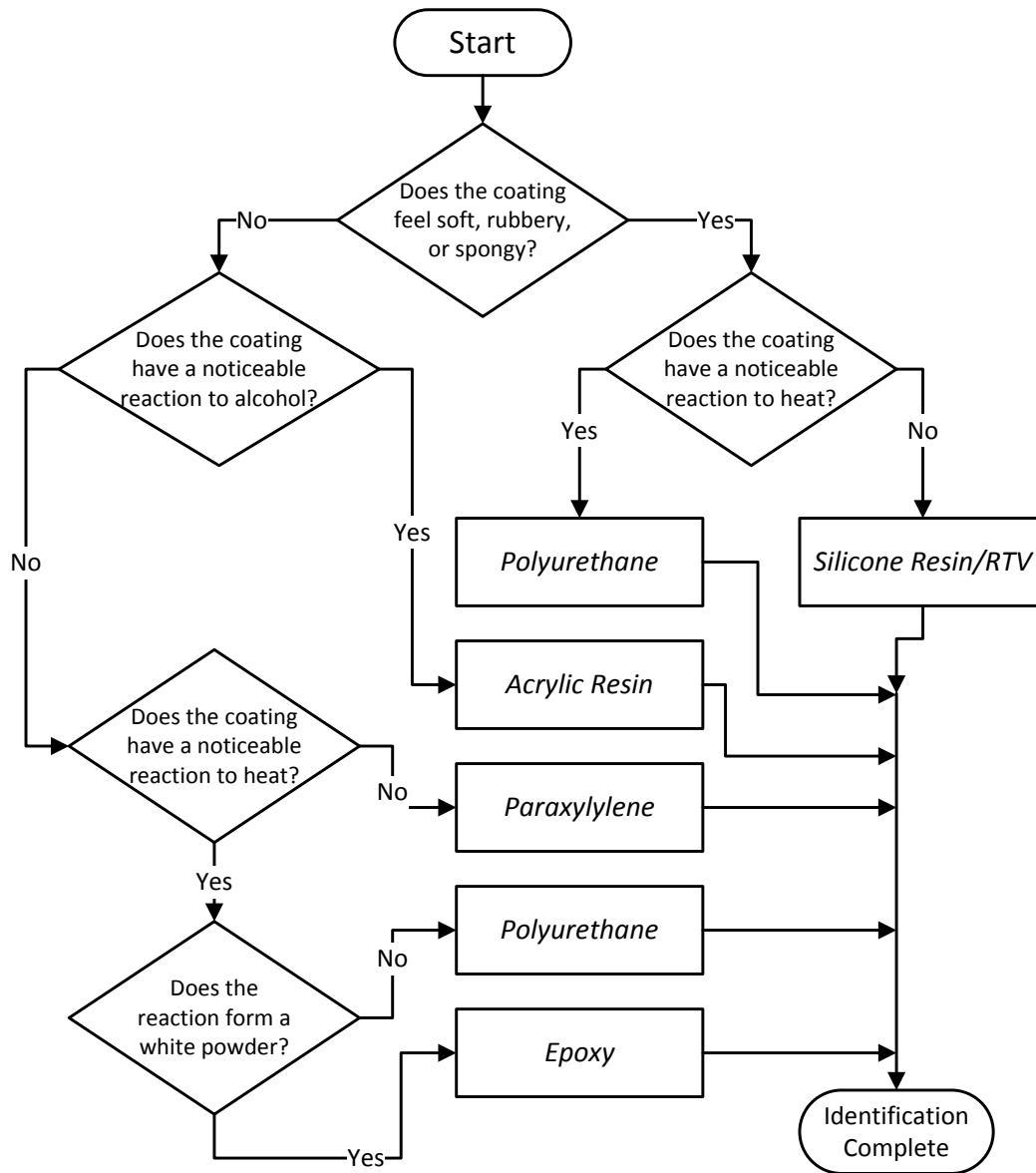

Figure 06-1 Conformal Coating Identification Flowchart

06-5.3 Conformal Coating Removal Requirements

Conformal coatings shall be removed before the desoldering operations.

Conformal coatings may be removed chemically, thermally, or mechanically. The removal method depends on the type, thickness, and condition of the coating; the components; and the laminate material.

Remove only the coating necessary to perform the repair. To prevent damage to the CCA do not attempt to remove all of the coating from the CCA surface.

Conformal coating shall be removed from all accessible lead and pad areas of discrete components (Figure 06-2) to allow free airflow through the mounting holes during solder extraction.

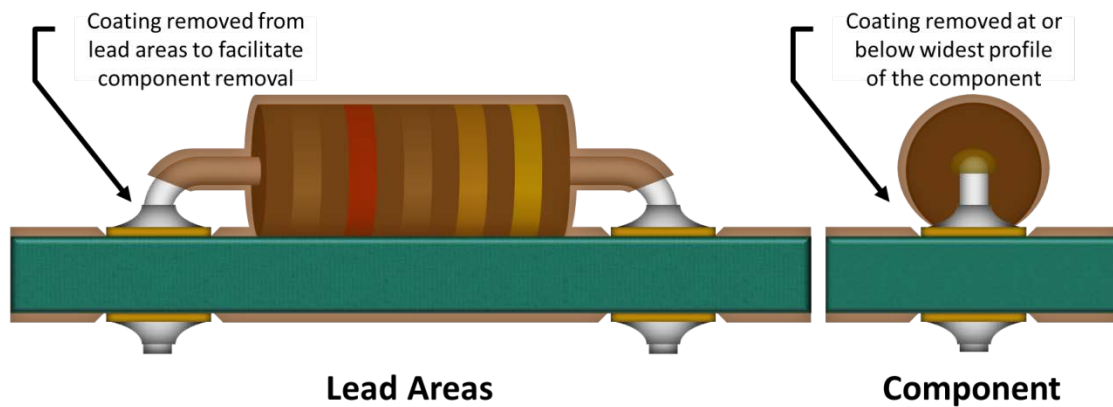

Figure 06-2 Conformal Coating Removal from Encapsulated Discrete Components

Conformal coating shall be removed from the accessible leads/terminations and pad/land areas of dual in-line packages and surface mount devices.

Sufficient conformal coating shall be removed from around the component body to facilitate removal.

06-5.4 Conformal Coating Removal Methods

Conformal coatings may be removed chemically (solvent), thermally (hot air or thermal parting) or mechanically (hand tool or power tool).

Table 06-3 shows each coating and the recommended methods for removal.

Table 06-3 Conformal Coating Removal Methods

Types of Conformal Coating	Solvent	Controlled Heat		Abrasion			
	Isopropyl Alcohol	Hot Air Jet Method and Orangewood Stick	Thermal Parting Tool / Modified Tip	Cutting and Peeling	Manual, Dental Tools / Ball Mill in Pin Vise	Motorized, Ball Mills, etc.	Rotary Bristle Brush
Acrylic Resin (AR)	1*	2			3 ^b		4 ^{a&c}
Epoxy Resin (ER)		1*	2*		3 ^b	4 ^{a&c}	
Silicone Resin (SR)				1*	2 ^b		3 ^c
Polyurethane Resin (UR)		1*	2*		3 ^b	4 ^{a&c}	
Paraxyllylene (XY)				2	1		

- * Method that positively identifies type of conformal coating
- a. For thick coatings only (0.025 in. and thicker)
- b. For thin coatings only
- c. Do not attempt to remove to CCA surface with this method

The preferred order for individual removal techniques to specific coatings is numerically indicated.

These removal techniques are listed in ascending order of their susceptibility to damage the CCA under repair.

Any of the methods listed in Table 06-3 may cause damage if not used with care.

06-5.4.1 Conformal Coating Removal Chemical (Isopropyl Alcohol) Procedure

This procedure is the preferred method for removing Acrylic Resin (AR) conformal coatings.

Personnel Hazards



Alcohol, Isopropyl

Conformal Coating Removal Chemical (Isopropyl Alcohol) Procedure

Step	Action
	<p style="text-align: center;">WARNING</p> <p style="text-align: center;">USE APPROVED SAFETY EYEWEAR WHEN PERFORMING THIS PROCEDURE.</p> <p style="text-align: center;">COMPLY WITH ALL LOCAL REQUIREMENTS FOR PPE.</p> <p style="text-align: center;">CAUTION</p> <p style="text-align: center;">DON A PROPERLY GROUNDED ESD WRIST STRAP BEFORE STARTING THIS PROCEDURE.</p>
<p>1</p>	<p style="text-align: center;">CAUTION</p> <p style="text-align: center;">ISOPROPYL ALCOHOL WILL DISSOLVE ACRYLIC RESIN COATING. USE CARE IN APPLICATION TO CONTROL THE AMOUNT OF COATING REMOVED.</p> <p>Apply a controlled amount of isopropyl alcohol with an acid brush or cotton-tipped applicator to the area from which the coating must be removed to facilitate the repair.</p> 
<p>2</p>	<p>Blot the dissolved coating from the removal area with a clean, dry, lint-free tissue.</p>
<p>3</p>	<p>Rub the repair area carefully with the wooden end of a cotton-tipped applicator, a toothpick, or an orangewood stick to dislodge coating in the repair area that will not easily dissolve.</p>
<p>4</p>	<p>Carefully remove any residue using a dry acid brush, clean lint-free tissue, or cotton-tipped applicator.</p>
<p>5</p>	<p><i>Visually inspect the area to ensure all coating necessary to facilitate the repair and all damaged coating has been removed.</i></p>
<p>6</p>	<p>Repeat steps 1 through 5 as necessary to remove sufficient coating.</p>
<p>7</p>	<p><i>Inspect per the General Inspection Procedure in WP 003 00 (paragraph 03-5.12) to all applicable WORKMANSHIP STANDARDS, including:</i></p> <ul style="list-style-type: none"> • <i>Conformal Coating Removal (paragraph 06-6.1)</i>

Conformal Coating Removal Chemical (Isopropyl Alcohol) Procedure

Step	Action
8	Dispose of all HAZMAT following local procedures.

06-5.4.2 Conformal Coating Removal with Hot Air Jet Procedure

This procedure is the preferred method for removing Epoxy Resin (ER) and Polyurethane Resin (UR) conformal coatings. This procedure is an alternate method for removing Acrylic Resin (AR) conformal coatings.

The hot air jet method of coating removal uses controlled, temperature-regulated hot air in conjunction with abrasion to remove the coating.

The softening or breakdown point varies with the specific coating and is a concern when using this method. Ideally, the softening point is below the solder melt temperature. However, when the softening point is equal to or above the solder melting point, care must be taken when applying heat in the solder joint or component areas to avoid damage to the workpiece.

By controlling the temperature, air pressure, and distance to the workpiece, coatings may be removed without damage.

Personnel Hazards





Alcohol, Isopropyl

1

Conformal Coating Removal with Hot Air Jet Procedure

Step	Action
	<div style="border: 2px solid black; padding: 5px; display: inline-block;"> WARNING </div> <p>USE APPROVED SAFETY EYEWEAR WHEN PERFORMING THIS PROCEDURE.</p> <p>COMPLY WITH ALL LOCAL REQUIREMENTS FOR PPE.</p>

Conformal Coating Removal with Hot Air Jet Procedure

Step	Action
	<p style="text-align: center;">CAUTION</p> <p style="text-align: center;">DON A PROPERLY GROUNDED ESD WRIST STRAP BEFORE STARTING THIS PROCEDURE.</p> <p style="text-align: center;">APPLY HEAT ONLY TO THE COATING TO BE REMOVED.</p> <p style="text-align: center;">PERFORM THE WORK ACTION RAPIDLY TO LIMIT THE HEATING OF THE AREA INVOLVED AND TO PREVENT DAMAGE TO THE CCA AND OTHER COMPONENTS.</p>
1	Select and install the proper tip into the hot air jet.
2	Set the hot air jet tip temperature to 900°F (482°C).
3	Adjust pressure output so the hot air burns a light brown line on a tissue from approximately 1/8-1/4 in. 
4	Position the end of the hot air jet tip to a distance of approximately one inch from the surface of the coating to be removed.
5	Heat the surface of the coating to be removed using a circular or sweeping motion. Note: Varying the distance of the tip to the workpiece will control the temperature and amount of hot air applied to the repair area.
6	Push the softened coating away from the removal area using an orangewood stick or spudger. 

Conformal Coating Removal with Hot Air Jet Procedure

Step	Action
7	<div style="text-align: center; border: 2px solid black; padding: 5px; margin-bottom: 10px;">CAUTION</div> <p>ISOPROPYL ALCOHOL WILL DISSOLVE ACRYLIC RESIN COATING. USE CARE IN APPLICATION TO CONTROL THE AMOUNT OF COATING REMOVED.</p> <p>Clean with isopropyl alcohol using an acid brush to remove any contaminants and blot dry with a clean, lint-free tissue when sufficient coating has been removed from the repair area per Conformal Coating Removal Requirements (paragraph 06-5.3).</p>
8	<p><i>Visually inspect the area to ensure all coating necessary to facilitate the repair and all damaged coating has been removed.</i></p>
9	<p>Repeat steps 4 through 8 as necessary to remove sufficient coating.</p>
10	<p><i>Inspect per the General Inspection Procedure in WP 003 00 (paragraph 03-5.12) to all applicable WORKMANSHIP STANDARDS, including:</i></p> <ul style="list-style-type: none"> • <i>Conformal Coating Removal (paragraph 06-6.1)</i>
11	<p>Dispose of all HAZMAT following local procedures.</p>

06-5.4.3 Conformal Coating Removal using Thermal Parting Tool Procedure

This procedure is an alternate method for removing Epoxy Resin (ER) and Polyurethane Resin (UR) conformal coatings.

The lap flow handpiece and thermal parting tip allows for efficient coating removal. The tip cools quickly due to its small thermal mass and special alloy material designed to dissipate residual heat.

Modified soldering iron tips or modified ball mills heated in soldering irons are effective for removal of thin conformal coatings and for confined working areas.

Personnel Hazards



Alcohol, Isopropyl

Conformal Coating Removal using Thermal Parting Tool Procedure

Step	Action
	<p style="text-align: center;">WARNING</p> <p style="text-align: center;">USE APPROVED SAFETY EYEWEAR WHEN PERFORMING THIS PROCEDURE.</p> <p style="text-align: center;">COMPLY WITH ALL LOCAL REQUIREMENTS FOR PPE.</p> <p style="text-align: center;">CAUTION</p> <p style="text-align: center;">DON A PROPERLY GROUNDED ESD WRIST STRAP BEFORE STARTING THIS PROCEDURE.</p> <p style="text-align: center;">IF SCORCHING OR CHARRING OCCURS, THE TIP IS TOO HOT AND THE TEMPERATURE SHOULD BE DECREASED.</p> <p style="text-align: center;">DO NOT REMOVE COATING TO THE CCA SURFACE.</p>
1	Attach the thermal parting tip to the lap flow handpiece or install a modified ball mill in the soldering iron.
2	Set the tip temperature by melting solder on the thermal parting tip and then lowering the setting to below solder melt temperature.
3	Apply the tip to the coating to be removed using light pressure.
4	If required, slowly increase the temperature of the tip until the coating begins to react. Note: Epoxy resin coating will overcure into a white powder. Polyurethane and acrylic resin will overcure and soften.
5	Gradually abrade the coating and reduce the thickness of the coating in the repair area. 
6	Remove the overcured coating to allow visual inspection of the component area.

Conformal Coating Removal using Thermal Parting Tool Procedure

Step	Action
7	<div style="text-align: center; border: 2px solid black; padding: 5px; margin-bottom: 10px;">CAUTION</div> <p>ISOPROPYL ALCOHOL WILL DISSOLVE ACRYLIC RESIN COATING. USE CARE IN APPLICATION TO CONTROL THE AMOUNT OF COATING REMOVED.</p> <p>Clean with isopropyl alcohol using an acid brush to remove any contaminants and blot dry with a clean, lint-free tissue when sufficient coating has been removed from the repair area per Conformal Coating Removal Requirements (paragraph 06-5.3).</p>
8	<p><i>Visually inspect the area to ensure all coating necessary to facilitate the repair and all damaged coating has been removed.</i></p>
9	<p>Repeat steps 5 through 8 as necessary to remove sufficient coating.</p>
10	<p><i>Inspect per the General Inspection Procedure in WP 003 00 (paragraph 03-5.12) to all applicable WORKMANSHIP STANDARDS, including:</i></p> <ul style="list-style-type: none"> • <i>Conformal Coating Removal (paragraph 06-6.1)</i>
11	<p>Dispose of all HAZMAT following local procedures.</p>

06-5.4.4 Conformal Coating Removal using Cut and Peel Method Procedure

This procedure is the preferred method for removing Silicone Resin (SR) conformal coatings.

This procedure is an alternate method for removing Paraxylylene (XY) conformal coatings.

Personnel Hazards No HAZMAT identified in the HMWS is used in this procedure.

Conformal Coating Removal using Cut and Peel Method Procedure

Step	Action
	<div style="text-align: center; border: 3px double black; padding: 10px; margin-bottom: 10px;">WARNING</div> <p>USE APPROVED SAFETY EYEWEAR WHEN PERFORMING THIS PROCEDURE.</p> <p>COMPLY WITH ALL LOCAL REQUIREMENTS FOR PPE.</p>

Conformal Coating Removal using Cut and Peel Method Procedure

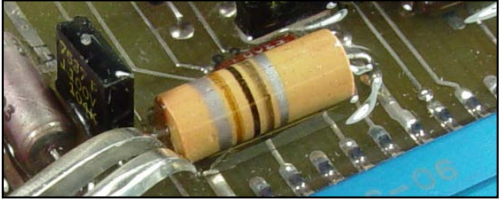
Step	Action
	<p style="text-align: center;">CAUTION</p> <p style="text-align: center;">DON A PROPERLY GROUNDED ESD WRIST STRAP BEFORE STARTING THIS PROCEDURE.</p>
1	<p>Select and install the appropriate scalpel blade.</p>
2	<p style="text-align: center;">WARNING</p> <p style="text-align: center;">DO NOT APPLY LATERAL PRESSURE TO THE SCALPEL. THE BLADE IS EXTREMELY FRAGILE AND CAN CAUSE SERIOUS INJURY TO PERSONNEL IF BROKEN.</p> <p>Penetrate the coating with the cutting side of the scalpel blade facing up and allow the bottom of the blade to contact the CCA surface.</p> 
3	<p>Carefully cut around the component and pad/land areas where the coating will be removed.</p>
4	<p>Peel the coating from the repair area using tweezers.</p> 
5	<p>Remove all loose coating from the repair area.</p>
6	<p><i>Visually inspect the area to ensure all coating necessary to facilitate the repair and all damaged coating has been removed.</i></p>
7	<p>Repeat steps 2 through 6 as necessary to remove sufficient coating.</p>
8	<p><i>Inspect per the General Inspection Procedure in WP 003 00 (paragraph 03-5.12) to all applicable WORKMANSHIP STANDARDS, including:</i></p> <ul style="list-style-type: none"> • <i>Conformal Coating Removal (paragraph 06-6.1)</i>
9	<p>Dispose of all HAZMAT following local procedures.</p>

06-5.4.5 Conformal Coating Removal (thin) using Manual Abrasion Procedure

This procedure is the preferred method for removing Paraxylylene (XY) conformal coatings.

Manual abrasion with dental carvers and chisels (scraping) is effective on thin, soft to semi-hard Silicone Resin (SR), Acrylic Resin (AR), Epoxy Resin (ER), and Polyurethane Resin (UR) coatings where the removal area is very small.

Personnel Hazards



Alcohol, Isopropyl

1

Conformal Coating Removal (thin) using Manual Abrasion Procedure

Step	Action
	<div style="text-align: center;"> <div style="border: 2px solid black; padding: 5px; margin-bottom: 10px;">WARNING</div> <p>USE APPROVED SAFETY EYEWEAR WHEN PERFORMING THIS PROCEDURE.</p> <p>COMPLY WITH ALL LOCAL REQUIREMENTS FOR PPE.</p> <div style="border: 2px solid black; padding: 5px; margin-bottom: 10px;">CAUTION</div> <p>DON A PROPERLY GROUNDED ESD WRIST STRAP BEFORE STARTING THIS PROCEDURE.</p> </div>
1	Select the appropriate dental tool.
2	Carefully abrade the conformal coating from the repair area. <div style="float: right; text-align: center;">  </div>

Conformal Coating Removal (thin) using Manual Abrasion Procedure

Step	Action
3	<div style="text-align: center; border: 2px solid black; padding: 5px; margin-bottom: 10px;">CAUTION</div> <p>ISOPROPYL ALCOHOL WILL DISSOLVE ACRYLIC RESIN COATING. USE CARE IN APPLICATION TO CONTROL THE AMOUNT OF COATING REMOVED.</p> <p>Clean with isopropyl alcohol using an acid brush to remove any contaminants and blot dry with a clean, lint-free tissue when sufficient coating has been removed from the repair area per Conformal Coating Removal Requirements (paragraph 06-5.3).</p>
4	<p><i>Visually inspect the area to ensure all coating necessary to facilitate the repair and all damaged coating has been removed.</i></p>
5	<p>Repeat steps 2 through 4 as necessary to remove sufficient coating.</p>
6	<p><i>Inspect per the General Inspection Procedure in WP 003 00 (paragraph 03-5.12) to all applicable WORKMANSHIP STANDARDS, including:</i></p> <ul style="list-style-type: none"> • <i>Conformal Coating Removal (paragraph 06-6.1)</i>
7	<p>Dispose of all HAZMAT following local procedures.</p>

06-5.4.6 Conformal Coating Removal (thick) using Motorized Abrasion Procedure

Motorized abrasion using ball mills or dental burs is effective on thick Epoxy Resin (ER) and Polyurethane Resin (UR) coatings.

The ball mill design places the most efficient cutting area on the side of the ball rather than at the end. Different ball mill sizes can be used to enter smaller areas where thick coatings will be removed.

Personnel Hazards No HAZMAT identified in the HMWS is used in this procedure.

Conformal Coating Removal (thick) using Motorized Abrasion Procedure

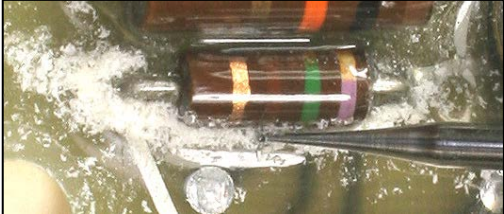
Step	Action
	<p style="text-align: center;">WARNING</p> <p style="text-align: center;">USE APPROVED SAFETY EYEWEAR WHEN PERFORMING THIS PROCEDURE.</p> <p style="text-align: center;">COMPLY WITH ALL LOCAL REQUIREMENTS FOR PPE.</p> <p style="text-align: center;">CAUTION</p> <p style="text-align: center;">DON A PROPERLY GROUNDED ESD WRIST STRAP BEFORE STARTING THIS PROCEDURE.</p>
	<p style="text-align: center;">CAUTION</p> <p style="text-align: center;">MOTORIZED GRINDING GENERATES HEAT THAT WILL SOFTEN EPOXY AND DAMAGE LAMINATE; LIMIT THE TIME AND THE PRESSURE WHEN USING THESE TECHNIQUES.</p>
1	Attach the appropriate ball mill or dental bur to the motorized handpiece.
2	Activate the motorized handpiece.
3	<p style="text-align: center;">CAUTION</p> <p style="text-align: center;">MOVE THE TOOL IN A CONTINUOUS CIRCULAR MOTION TO MINIMIZE LOCALIZED HEATING AND AVOID INADVERTENT DAMAGE TO UNDERLYING MATERIALS.</p> <p>Make contact with the coating while applying varying amounts of pressure to test the rate of coating removal.</p> <p>Note: Set the rotation speed of the handpiece to provide the best control and desired rate of coating removal.</p>
4	Apply the tip to the coating to be removed using light pressure.
5	<p>Continue to remove the coating using smaller ball mills, as the coating gets thinner or when removing coating from small areas.</p> 

Conformal Coating Removal (thick) using Motorized Abrasion Procedure

Step	Action
6	Remove the waste coatings by periodically brushing with a dry acid brush to prevent inadvertent damage to the laminate material and to allow visual inspection of the work surface.
7	Use either the Conformal Coating Removal (thin) using Manual Abrasion Procedure (paragraph 06-5.4.5) or the Conformal Coating Removal (thin) using Motorized Abrasion Procedure (paragraph 06-5.4.7) to continue the removal process once the coating in the repair area has been reduced to a thin layer.
8	<i>Inspect per the General Inspection Procedure in WP 003 00 (paragraph 03-5.12) to all applicable WORKMANSHIP STANDARDS, including:</i> <ul style="list-style-type: none"> • <i>Conformal Coating Removal (paragraph 06-6.1)</i>
9	Dispose of all HAZMAT following local procedures.

06-5.4.7 Conformal Coating Removal (thin) using Motorized Abrasion Procedure

Mechanical removal of coatings using grinding (round wooden toothpick, bullet wheels, abrasive disks, rubberized wheels, or rotary bristle brushes) can be used on thin (equal to or less than 1/32 in.) Silicone Resin (SR) and Acrylic Resin (AR) coatings.

Rubberized abrasives are ideally suited for removing thin, hard coatings from flat surfaces.

Soft coatings adhere and coat the abrasive causing it to become ineffective.

Rotary bristle brushes perform better than rubberized abrasives on contoured or irregular surfaces such as soldered connections because the bristles conform to surface irregularities.

A variable speed motorized handpiece permits fingertip control, proper speed and torque to ease the removal of soft coatings.

Personnel Hazards



Alcohol, Isopropyl

Conformal Coating Removal (thin) using Motorized Abrasion Procedure

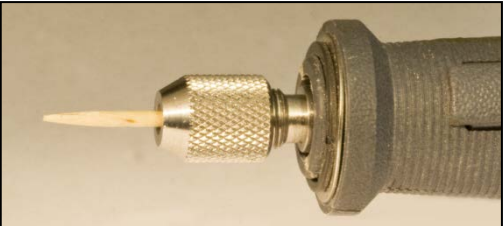
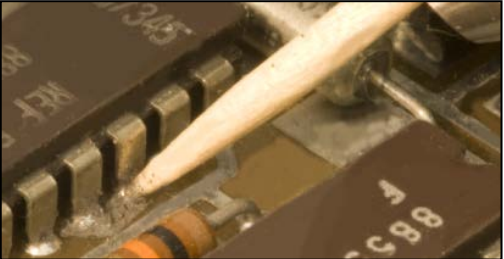
Step	Action
	<p style="text-align: center;">WARNING</p> <p style="text-align: center;">USE APPROVED SAFETY EYEWEAR WHEN PERFORMING THIS PROCEDURE.</p> <p style="text-align: center;">COMPLY WITH ALL LOCAL REQUIREMENTS FOR PPE.</p> <p style="text-align: center;">CAUTION</p> <p style="text-align: center;">DON A PROPERLY GROUNDED ESD WRIST STRAP BEFORE STARTING THIS PROCEDURE.</p> <p style="text-align: center;">MOTORIZED GRINDING GENERATES HEAT THAT WILL SOFTEN EPOXY AND DAMAGE LAMINATE; LIMIT THE TIME AND THE PRESSURE WHEN USING THESE TECHNIQUES.</p>
1	<p>Attach the appropriate abrasive tool to the motorized handpiece.</p> 
2	<p>Activate the motorized handpiece.</p>
3	<p style="text-align: center;">CAUTION</p> <p style="text-align: center;">MOVE THE TOOL IN A CONTINUOUS CIRCULAR MOTION TO MINIMIZE LOCALIZED HEATING AND AVOID INADVERTENT DAMAGE TO UNDERLYING MATERIALS.</p> <p>Make contact with the coating while applying varying amounts of pressure to test the rate of coating removal.</p>
4	<p>Continue to remove coating using appropriate pressure.</p> 

Conformal Coating Removal (thin) using Motorized Abrasion Procedure

Step	Action
5	<div style="text-align: center; border: 2px solid black; padding: 5px; width: fit-content; margin: 0 auto;">CAUTION</div> <p>ISOPROPYL ALCOHOL WILL DISSOLVE ACRYLIC RESIN COATING. USE CARE IN APPLICATION TO CONTROL THE AMOUNT OF COATING REMOVED.</p> <p>Clean with isopropyl alcohol using an acid brush to remove any contaminants and blot dry with a clean, lint-free tissue when sufficient coating has been removed from the repair area per Conformal Coating Removal Requirements (paragraph 06-5.3).</p>
6	<i>Visually inspect the area to ensure all coating necessary to facilitate the repair and all damaged coating has been removed.</i>
7	Repeat steps 2 through 6 as necessary to remove sufficient coating.
8	<p><i>Inspect per the General Inspection Procedure in WP 003 00 (paragraph 03-5.12) to all applicable WORKMANSHIP STANDARDS, including:</i></p> <ul style="list-style-type: none"> • <i>Conformal Coating Removal (paragraph 06-6.1)</i>
9	Dispose of all HAZMAT following local procedures.

06-5.5 Conformal Coating Replacement Procedure

Table 06-4 lists the approved conformal coatings, which are recommended for 2M repair in accordance with the QPL [46058](#).

Table 06-4 Replacement Conformal Coatings























Conformal Coating Type	NSN	Part No.	Manufacturer	CAGE
Acrylic Resin (AR)	5970-01-029-7961	1B31	Humiseal (Chase)	99109
Epoxy Resin (ER)	8040-00-061-8303	EPK 0151	Henkel Loctite	04347
Silicone Resin (SR)	5970-01-363-8394	RTV-3140	Dow Corning	71984
Polyurethane Resin (UR)	5970-01-013-8611	PC18M	Henkel Loctite	04347

The replacement coating will be of the same generic type as the original, except Paraxylylene (XY). Application of paraxylylene coatings is beyond the scope of this manual due to the specialized equipment and materials required. Paraxylylene shall be replaced with Acrylic Resin (AR), Epoxy Resin (ER), or Polyurethane Resin (UR).

- Apply an acrylic resin for best adhesion
- Epoxy and polyurethane resin can be used, but will not adhere as well as acrylic resin

Consult the equipment manual or other technical documentation to determine the original conformal coating used, as needed. If no information can be found in equipment manuals or other technical documentation, replace the coating with an equivalent resin.

Personnel Hazards

					
Alcohol, Isopropyl					1
					
Acrylic Resin, MIL-I-46058					3
					
Epoxy, 0151					4
					
Polyurethane Resin, MIL-I-46058					5
					
Silicone Resin, MIL-I-46058					6

Conformal Coating Replacement Procedure

Step	Action
	<p style="text-align: center;">WARNING</p> <p style="text-align: center;"><i>USE APPROVED SAFETY EYEWEAR WHEN PERFORMING THIS PROCEDURE. COMPLY WITH ALL LOCAL REQUIREMENTS FOR PPE.</i></p> <p style="text-align: center;">CAUTION</p> <p style="text-align: center;">DON A PROPERLY GROUNDED ESD WRIST STRAP BEFORE STARTING THIS PROCEDURE.</p> <p style="text-align: center;">NOTES</p> <p style="text-align: center;">APPLICATION OF PARAXYLYLENE IS BEYOND THE SCOPE OF THIS MANUAL. PARAXYLYLENE-COATED ASSEMBLIES REQUIRE SPECIAL PROCESSES AND EQUIPMENT FOR PROPER APPLICATION.</p> <p style="text-align: center;">THE ADJUSTABLE PORTION OF ADJUSTABLE COMPONENTS, AS WELL AS ELECTRICAL AND MECHANICAL MATING SURFACES SUCH AS TEST POINTS, SCREW THREADS, AND BEARING SURFACES (E.G., CARD GUIDES) WILL BE LEFT UNCOATED.</p> <p style="text-align: center;">MATING CONNECTOR SURFACES OF CCAS MUST NOT BE COATED WITH CONFORMAL COATING.</p> <p style="text-align: center;">EXCESS CONFORMAL COATING MAY PRODUCE AN UNDESIRABLE ELECTRICAL BARRIER AT CONNECTOR/CCA INTERFACE AREAS.</p>
1	<p style="text-align: center;">CAUTION</p> <p style="text-align: center;">THE CURED PROPERTIES OF CONFORMAL COATINGS ARE DEPENDENT ON THE MIX RATIO OF THEIR MATERIALS; ANY ATTEMPT TO INCREASE OR DECREASE THE CURE RATE BY ADDING MORE OR LESS OF THE HARDENER OR THE RESIN WILL RESULT IN THE DEGRADATION OF THE CURED PROPERTIES.</p> <p>Mix conformal coatings as required in accordance with manufacturer's directions.</p> <p>Note: Some resin compounds must be measured and mixed properly by weight, not volume.</p>

Conformal Coating Replacement Procedure

Step	Action
2	<p style="text-align: center;">CAUTION</p> <p style="text-align: center;">ISOPROPYL ALCOHOL WILL DISSOLVE ACRYLIC RESIN COATING. USE CARE IN APPLICATION TO PREVENT UNNECESSARY COATING REMOVAL.</p> <p>Clean with isopropyl alcohol using an acid brush to remove any contaminants and blot dry with a clean, lint-free tissue.</p>
3	<p>Allow the CCA to stabilize at room temperature for one hour.</p>
4	<p>Store the cleaned and dried CCA in a clean ESD MIL-PRF-81705 Type III bag if conformal coating will not be reapplied within 30 minutes after stabilization.</p> <p>Note: Do not store CCAs in the open or in cardboard containers.</p>
5	<p>If the CCA has been in storage, perform steps 2 through 3.</p>
6	<p>Apply the primer according to the manufacturer's directions, if required.</p>
7	<p style="text-align: center;">WARNING</p> <p style="text-align: center;"><i>FOLLOW LOCAL ENVIRONMENTAL INSTRUCTIONS FOR USE OF AEROSOLS WHEN SPRAYING REPLACEMENT CONFORMAL COATING.</i></p> <p style="text-align: center;">CAUTION</p> <p style="text-align: center;">APPLYING CONFORMAL COATING IN THICK COATS WILL NOT ALLOW THE SOLVENTS TO EVAPORATE, TRAPPING THESE SOLVENTS IN THE RESINS. TRAPPED SOLVENTS WILL CAUSE BUBBLES AND PIN HOLES.</p> <p>Brush, spray, or use a pipette to apply the replacement conformal coating in a series of uniform thin coats or applications. Allow the coating to cure according to the manufacturer's directions between coats.</p> <p>Note: Apply the coating to extend at least ½ in. beyond the repaired section to assure the dielectric and hermetic integrity of the recoated area.</p> <p>Note: Apply the conformal coating to the level of the original coating.</p>

Conformal Coating Replacement Procedure

Step	Action
8	<p><i>Visually inspect to ensure uniform coating distribution over the entire replacement area.</i></p> <p>Note: The coating shall be free of voids, bubbles, adhesion loss, or foreign material, which exposes component conductors, printed wiring conductors (including ground planes), or other conductors.</p> <p>Note: Waves or ripples in the conformal coatings must not reduce the thickness below minimum requirements.</p>
9	<div style="text-align: center; border: 1px solid black; padding: 5px; width: fit-content; margin: 0 auto;">CAUTION</div> <p style="text-align: center;">BUBBLES WILL DETERIORATE THE COATING'S SURFACE ADHESION AND ELECTRICAL PROPERTIES.</p> <p>Remove the bubbles and/or foreign material with a dental explorer before curing.</p> <p>Note: The formation of bubbles is a problem commonly encountered because of the mixing process.</p>
10	<div style="text-align: center; border: 1px solid black; padding: 5px; width: fit-content; margin: 0 auto;">WARNING</div> <p style="text-align: center;">CONFORMAL COATINGS CONTAIN FLAMMABLE SOLVENTS. THESE SOLVENTS SHALL NOT BE ALLOWED TO ESCAPE UNDER THE HEAT OF A CURING OVEN.</p> <p>Allow the CCA to air dry at room temperature for at least 30 minutes for the evaporation of solvents (flash-off).</p>
11	<p>Cure the conformal coating in accordance with the manufacturer's directions.</p>
12	<p><i>Inspect per the General Inspection Procedure in WP 003 00 (paragraph 03-5.12) to all applicable WORKMANSHIP STANDARDS, including:</i></p> <ul style="list-style-type: none"> • Conformal Coating Replacement (<i>paragraph 06-6.2</i>)
13	<p>Place the CCA in a clean ESD MIL-PRF-81705 Type III bag if the inspection is satisfactory.</p>
14	<p>Dispose of all HAZMAT following local procedures.</p>

06-6 WORKMANSHIP STANDARDS

Refer to WP 003 00 (paragraph 03-6) for definitions of Workmanship Standards.

NOTE

WORKMANSHIP STANDARDS FOR POST-SOLDER JOINT CLEANLINESS IS IN WP 005 00 (PARAGRAPH 05-6), THROUGH HOLE COMPONENTS IN WP 007 00 (PARAGRAPH 07-6), TERMINALS IN WP 008 00 (PARAGRAPH 08-6), LAMINATE IN WP 011 00 (PARAGRAPH 11-6), CONDUCTORS, PADS, AND LANDS IN WP 012 00 (PARAGRAPH 12-6), WELDED LEADS IN WP 014 00 (PARAGRAPH 14-6), MULTILAYER IN WP 015 00 (PARAGRAPH 15-6), PLASTIC PANEL IN WP 016 00 (PARAGRAPH 16-6), AND SURFACE MOUNT DEVICES IN WP 018 00 (PARAGRAPH 18-6)

06-6.1 Conformal Coating Removal

Conformal Coating Removal

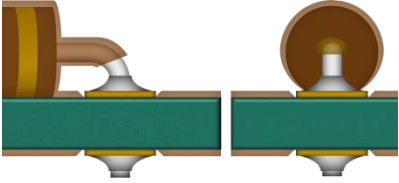
Target Condition	Acceptable Condition	Defect Condition
<p>The conformal coating necessary to facilitate the repair has been removed.</p> 		<p>Insufficient conformal coating has been removed to facilitate the repair.</p>
<p>The conformal coating is completely removed from the accessible leads/terminations and pad/land areas.</p> 		<p>Incomplete conformal coating removal from the accessible leads/terminations and pad/land areas.</p>

Conformal Coating Removal

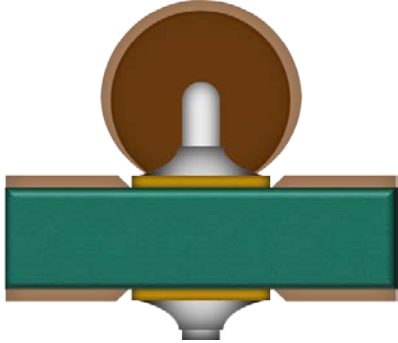
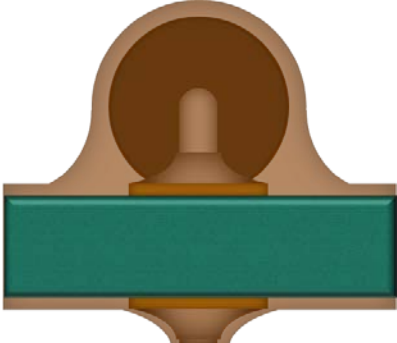
Target Condition	Acceptable Condition	Defect Condition
<p>Thick conformal coating is removed at or below the widest profile of the component body.</p> 		<p>Thick conformal coating is not removed at or below the widest profile of the component body.</p> 
<p>All damaged conformal coating is removed.</p>		<p>Evidence of burnt, charred, or discolored conformal coating.</p>

06-6.2 Conformal Coating Replacement

Conformal Coating Replacement

Target Condition	Acceptable Condition	Defect Condition
		<p>CCA requiring conformal coating is not conformally coated.</p>
<p>The replacement conformal coating is applied over the entire repair area (including the component) and extends onto the original coating.</p>		<p>The replacement conformal coating has not been applied over the entire repair area (including the component) or does not extend onto the original coating.</p>
<p>The replacement conformal coating is applied at or above the level of the original coating.</p>		<p>The replacement conformal coating is not applied at or above the level of the original coating.</p>

Conformal Coating Replacement

Target Condition	Acceptable Condition	Defect Condition
The replacement conformal coating is completely cured and uniformly applied.	The replacement conformal coating is not uniformly applied, but is completely cured	The replacement conformal coating is not completely cured.
The replacement conformal coating is of the same type as the original coating.	The replacement coating is not of the same type as the original coating.	
	The replacement conformal coating shows a loss of adhesion adjacent to masking.	
	The replacement conformal coating exhibits voids, dewetting, ripples, fisheyes, and/or orange peel that does not expose circuitry, bridge pads or bridge adjacent conductive surfaces.	<p>The conformal coating exhibits voids, bubbles, adhesion loss, dewetting, ripples, fisheyes, or orange peel that exposes circuitry, bridges pads, or bridges adjacent conductive surfaces.</p> 
		Foreign material in the replacement conformal coating.
		The replacement conformal coating is applied to the adjustable portion of adjustable components.
		The replacement conformal coating is applied to electrical and mechanical mating surfaces such as test points, screw threads, or bearing surfaces (e.g., card guides, connectors).

15 October 2013

WP 007 00 Through Hole Components

07-1 PURPOSE

Identify the technical information relative to through hole components, including circuit card assembly circuitry styles, hole reinforcement styles, through-hole component form factors, and component lead termination styles.

Specify the repair procedures for desoldering through-hole components.

Specify the repair procedures for CCA preparation for component installation.

Specify the repair procedures for component lead preparation for installation.

Specify the repair procedures for lead forming and component mounting.

Specify the repair procedures for lead terminations.

Specify the repair procedures for component soldering.

Identify the workmanship standards for through hole components.

07-2 INDEX

Paragraph	Subject	Page
07-1	Purpose	1
07-2	Index	1
07-3	General Safety Precautions.....	3
07-4	Technical Information.....	4
07-4.1	Circuit Card Assembly Circuitry Styles	4
07-4.2	Hole Reinforcement Styles	5
07-4.3	Through-Hole Components	10
07-4.4	Component Lead Termination Styles.....	11
07-5	Repair Procedures.....	12
07-5.1	Procedural Analysis and Feasibility of Repair	13
07-5.2	Desoldering Through-Hole Components	13
07-5.2.1	Continuous Vacuum Extraction Procedure.....	13
07-5.2.2	Continuous Vacuum Extraction with Auxiliary Heating Procedure	19
07-5.2.3	Wicking Procedure.....	21
07-5.2.4	Manual Vacuum Extraction Procedure.....	24
07-5.3	Desoldering Components from Single-Sided CCAs Procedure	28
07-5.4	Desoldering Components from Double-Sided CCAs Procedure	31

Paragraph	Subject	Page
07-5.5	Through-Hole Component Removal Procedure	35
07-5.6	Destructive Discrete Component Removal Procedure	37
07-5.7	Destructive Dual In-Line Package Removal Procedure	42
07-5.8	Circuit Card Assembly Preparation for Component Installation	47
07-5.8.1	Single-Sided Pad Preparation Procedure	47
07-5.8.2	Double-Sided Pad Preparation Procedure	51
07-5.9	Component Lead Preparation for Installation	55
07-5.9.1	Discrete Component Lead Preparation Procedure	51
07-5.9.2	Dual In-Line Package Lead Preparation Procedure	59
07-5.10	Lead Forming and Component Mounting	62
07-5.10.1	Axial Lead Horizontal Flush Mount Procedure	62
07-5.10.2	Axial Lead Horizontal Mount with Stress Relief Procedure	64
07-5.10.3	Axial Lead Standoff Mount Procedure	67
07-5.10.4	Axial Lead Vertical Mount Procedure	70
07-5.10.5	Radial Lead Vertical Mount Procedure	73
07-5.10.6	Radial Lead Horizontal Mount Procedure	74
07-5.10.7	Dual In-Line Package Mounting Procedure	76
07-5.11	Lead Terminations	78
07-5.11.1	Straight Through Lead Termination Procedure	79
07-5.11.2	Semi-Clinch Lead Termination Procedure	80
07-5.11.3	Full Clinch Lead Termination Procedure	82
07-5.11.4	Offset Pad Lead Termination Procedure	84
07-5.12	Component Soldering	86
07-5.12.1	Single-Sided Soldering Procedure	86
07-5.12.2	Double-Sided Soldering Procedure	90
07-6	Workmanship Standards	96
07-6.1	Discrete Component Leads	96
07-6.2	Discrete Component Body	97
07-6.3	Component Lead Tinning	98
07-6.4	Heat Sink Acceptability Requirements	99
07-6.5	Heat Sink Insulators and Thermal Compounds	100
07-6.6	Component Sleeving (Buffer Material)	100
07-6.7	Component Leads Crossing Conductors	101
07-6.8	Component Lead Forming	102
07-6.9	Component Orientation	103
07-6.10	Component Mounting Horizontal, Axial Leded	105
07-6.11	Component Mounting Horizontal, Axial Leded with Stress Relief	107
07-6.12	Component Mounting Horizontal, Radial Leded	108
07-6.13	Component Mounting Vertical, Axial Leded	109
07-6.14	Component Mounting Vertical, Radial Leded	112
07-6.15	Component Mounting Dual In-Line Package (DIP)	115
07-6.16	Straight-Through Lead Terminations	116
07-6.17	Semi-Clinch Lead Terminations	117
07-6.18	Full Clinch Lead Terminations	118

Paragraph	Subject	Page
07-6.19	Offset Pad Terminations	120
07-6.20	Solder Acceptability for Through-Hole Components.....	121
07-6.21	High Voltage Component Soldering.....	123

07-3 GENERAL SAFETY PRECAUTIONS

Observe all the following precautions while removing and replacing through-hole components:

- Electronic equipment must be de-energized during removal and installation of CCAs
- Personnel are required to wear a properly grounded ESD wrist strap and cord while working in or around the EPA
- ESD can destroy components—protect ESDS devices during handling and repair to prevent ESD damage (Refer to WP 004 00)
- Isopropyl alcohol is flammable; do not use in the presence of sparks, heat, flame, or synthetic cloth
- Soldering handpieces (e.g., soldering irons, solder extractors, hot air jets) produce extreme heat—exercise care when these tools are out of their stands
- Avoid direct inhalation of fumes during a soldering operation because there is a possibility these fumes could cause occupational asthma
- The lead contained in solder is a source of lead oxide, which the human body cannot dissipate (accumulation of lead oxide in the body over a period of years can result in a serious health hazard)
- Contact with solder by holding in the mouth, smoking, or eating during or immediately after soldering is a potential means of ingesting trace amounts of lead oxide
- Avoid oral contact with hands during or immediately after solder operations
- Wash hands following any solder operation
- Wear approved PPE whenever pouring or handling molten metals or corrosive liquids and solids; and cutting, drilling, grinding, milling, chipping and other dust and debris producing operations
- Always follow the manufacturer’s instructions and warnings when using conformal coating products
- Follow manufacturer’s directions for the mixing, use, and curing of bonding agents

07-4 TECHNICAL INFORMATION

Through-hole component removal and replacement is one of the more common tasks a repair technician performs.

During the repair process, there are several considerations:

- Circuit Card Assembly Circuitry Styles
- Laminate material (WP 011 00)
- Hole Reinforcement Styles
- Through-Hole Component Form Factors
- Component Lead Termination Styles

07-4.1 Circuit Card Assembly Circuitry Styles

CCA circuitry styles consist of single-sided, double-sided, and multilayer CCAs. CCA circuitry style is the easiest characteristic to recognize.

A **single-sided CCA** (Figure 07-1) has surface conductors on only one side.



Figure 07-1 Single-Sided CCA (cross-section)

A **double-sided CCA** (Figure 07-2 and Figure 07-3) has conductors on both sides.



Figure 07-2 Double-Sided Non-Plated-Through Hole CCA (cross-section)



Figure 07-3 Double-Sided Plated-Through Hole CCA (cross-section)

A **multilayer CCA** (Figure 07-4) has both surface and internal conductors.

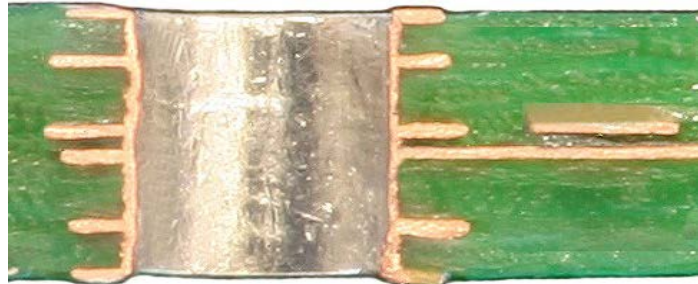

Figure 07-4 Multilayer CCA (cross-section)

07-4.2 Hole Reinforcement Styles

Hole reinforcement styles are generally the most difficult to identify because they are often hidden beneath the solder.

07-4.2.1 No Hole Support

The cross-section of circuitry shows a hole with no reinforcing support.

The component lead is bonded by solder to the copper circuitry on one side of a single-sided CCA with no hole support (Figure 07-5).

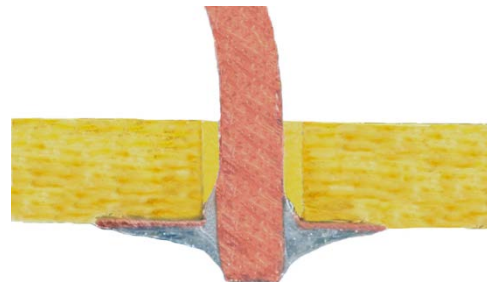

Figure 07-5 Single-Sided CCA with No Hole Support (cross-section)

Solder forms a bond with the component leads on both sides of the CCA on a double-sided CCA with no hole support (Figure 07-6).

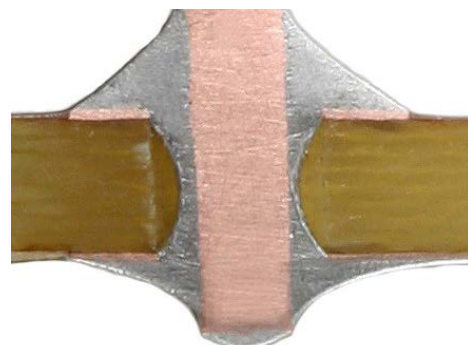

Figure 07-6 Double-Sided CCA with No Hole Support (cross-section)

07-4.2.2 Plated-Through Holes

A plated-through hole (Figure 07-7) provides extra support for the circuit pads, the hole and the lead by providing continuous solder adherence from one side of the CCA to the other.

The hole is lined with copper providing a continuous electrical path through the CCA.

Plated-through holes are normally found on double-sided CCAs and multilayer CCAs.

Plated-through holes, being somewhat fragile, can be one of the more difficult parts of the circuit card to remove components from or to repair.

Plated-through holes are usually formed in a circuit card after drilling, by electroless copper deposition followed by electrolytic copper plating.

With multilayer CCAs, the layers of the circuit card are pressed together and then precision drilled. If the layers of the CCA are not precisely aligned, or if the drill bits are dull, problems may develop affecting the probability of a successful repair. For example, if misalignment of the layers occurs, the contact area between the plated-through hole and the conductor will be decreased.

If the drill bits are dull, fibers may be left in the hole, causing problems during the plating process and if undiscovered will cause voids, blowholes, and poor solder flow in the plated-through hole.

Another area of concern is the knee of the plated-through hole (Figure 07-7). This is the weakest area of any plated-through hole; the weakness is caused by the copper being thinner as it forms across the sharp edge of the CCA laminate. This weakness is the major reason why eyelets are not used in the repair of plated-through holes on multilayer CCAs. As the eyelet is compressed to make contact with the pad, the compression can cause the knee of the plated-through hole to break.

Severe compression can also break the connections to the plated-through hole from the conductor paths in the sub-layers of the multilayer CCA. If the knee of the plated-through hole breaks on a multilayer CCA, contact can also be lost between the top and bottom conductors and the sub-layer conductors.

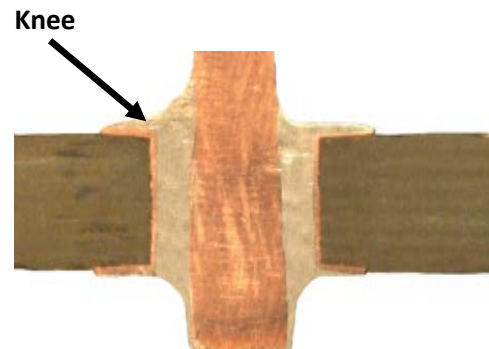

Figure 07-7 Plated-Through Hole (cross-section)

The knee of the plated-through hole can also be easily broken when using the wicking method to remove solder. 2M Technicians frequently put the solder wick on top of the plated-through hole, apply the soldering iron tip to on top of the wicking material, and then apply pressure to remove the solder. Besides pressure, some technicians will also twist the solder wick, the pressure, twisting action could easily cause the plated-through hole to crack at the knee, and the pad will break away from the plated-through hole. When using the wicking method to remove solder, do not apply pressure or twist the wicking material to prevent damage to the plated-through hole.

Vacuum extractor tips can also be a source of plated-through hole failures. If the end of the extractor tip is worn, exposing the edge of the plating material, a very sharp, jagged edge is formed. This jagged edge can cut the pad or catch the copper and twist the plated-through hole, causing the plated-through hole to break at the knee. Frequently inspect solder extractor tips, as the tip is an area exposed to rapid heating and cooling. The heating and cooling, caused by movement of air over the tip during resoldering can cause rapid failure of the metal.

07-4.2.3 Eyelets

Eyelets are used as hole reinforcements during the repair process.

Eyelets are tubular fasteners and are categorized by the outside diameter (OD), the inside diameter (ID), the flange diameter (FD), and the length under the flange (LUF) [see Figure 07-8].

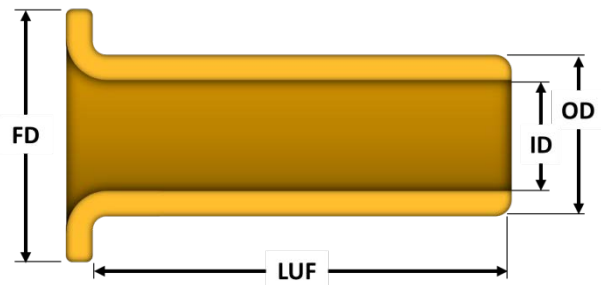

Figure 07-8 Eyelet Specifications

The flange angle (FA) further identifies the eyelet with a flanged head (Figure 07-10 Funnelet).

These hole-reinforcing devices are usually made of pure copper and are often plated with gold, tin, or a tin-lead alloy. The copper-based eyelet is pliable and prevents CCA damage when set.

Eyelets may be one of four different types: flat-set, funnelet, roll-set, or petal-set (controlled split).

A flat-set eyelet (Figure 07-9) is the industry standard and sits flat on the circuit pad when installed.

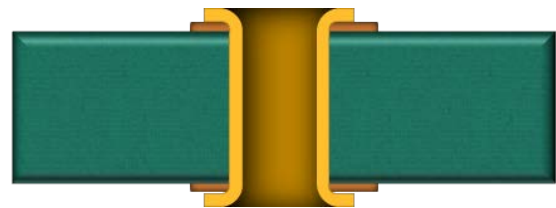

Figure 07-9 Flat-Set Eyelets

Unlike the flat-set eyelet, the funnelet (Figure 07-10) has an angled flange.

The funnel shape permits a solder fillet between the underside of the flange and the remaining pad area.

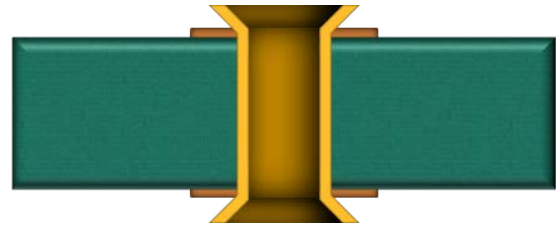

Figure 07-10 Funnelet

Funnelets may be used for 2M repair if the flange is flattened before installation.

A roll-set eyelet (Figure 07-11) is similar in appearance to the flat-set, except for a slight arc in the flange area.

Special dies are required to roll-set an eyelet; therefore, this configuration is not duplicated in the repair process.

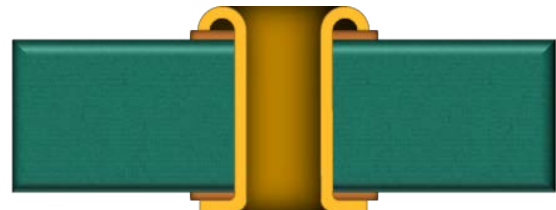

Figure 07-11 Roll-Set Eyelet

Repair and replacement criteria for roll-set eyelets are the same as for flat-set eyelets.

A **Funnel-Set Controlled Split (Petal-Set)** eyelet [not shown] has a barrel scored and designed to split into equal size "petals" when set flat on the pad.

Funnelets, roll-set and petal-set eyelets shall not be used for 2M repair.

07-4.2.4 Vias

A via is a small plated-through hole used as an interlayer connection, but is not designed for a component lead or other reinforcing material.

Figure 07-12 shows the three types of vias:

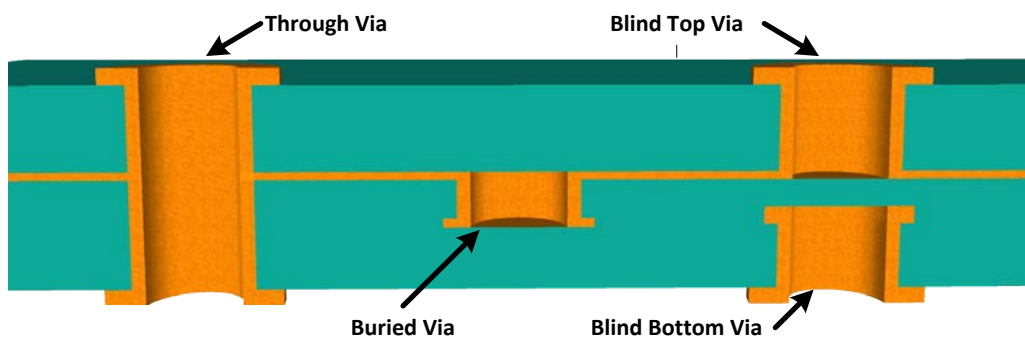

Figure 07-12 Three Types of Vias

A **through via** (or through-hole, feed-through) extends completely through the CCA and has access to both external layers.

A **blind via** does not extend completely through the CCA and has access to only one external layer.

A **buried via** provides connection within the inner layers of a CCA and has no access to the external layers.

07-4.2.5 Interfacial Connections

The following methods interconnect circuitry on one side of the CCA with the circuitry on the other side to establish electrical continuity.

Most common method of interconnect circuitry is a plated-through hole (Figure 07-13)

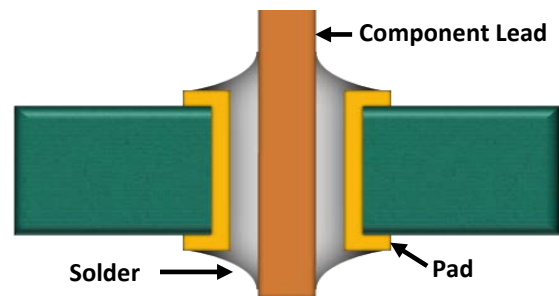

Figure 07-13 Plated-Through Hole

The second type is a plated-through hole filled with a solder plug (Figure 07-14).

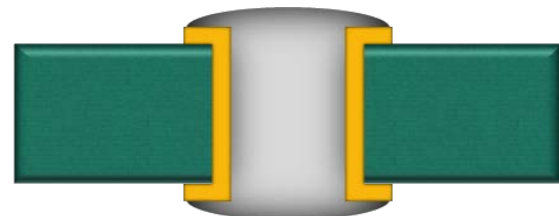

Figure 07-14 Soldered Plug

The third type uses an eyelet soldered to both sides of the CCA to form an interfacial connection.

The flat-set eyelet (Figure 07-9) provides reinforcement for the pads on both sides of the CCA and reinforces the hole itself. The design of the flanged head of the funnelet (Figure 07-10) and the roll-set eyelet (Figure 07-11) does not allow for this type of support.

For information on eyeleting requirements and specifications, refer to Eyeleting in WP 012 00 (paragraph 12-6.2).

The fourth type (for an unsupported hole) has a jumper of copper wire (Figure 07-15) clinched on both sides and soldered in place.

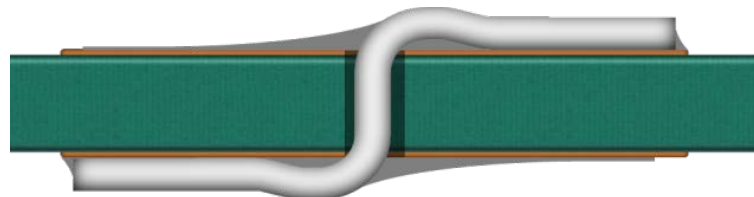

Figure 07-15 Soldered Wire

07-4.3 Through-Hole Components

Through-hole component types are discrete components (axial or radial leaded) and integrated circuits.

Axial leaded discrete components (Figure 07-16) are single-function devices and normally have two leads extending along their longitudinal axis, e.g., resistors, capacitors, or diodes.

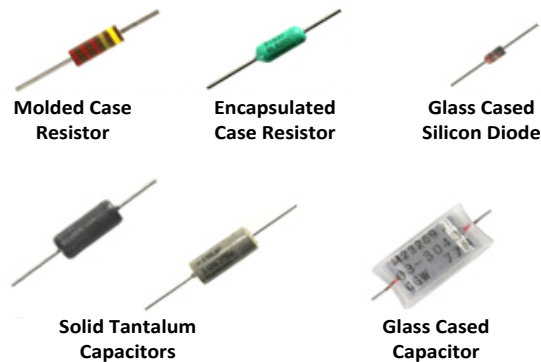

Figure 07-16 Axial Leaded Discrete Components

Radial leaded discrete components (Figure 07-17) are single function transistors, radial capacitors, and light emitting diodes (LED) having leads that converge to a common center.

The leads of discrete components are normally round.

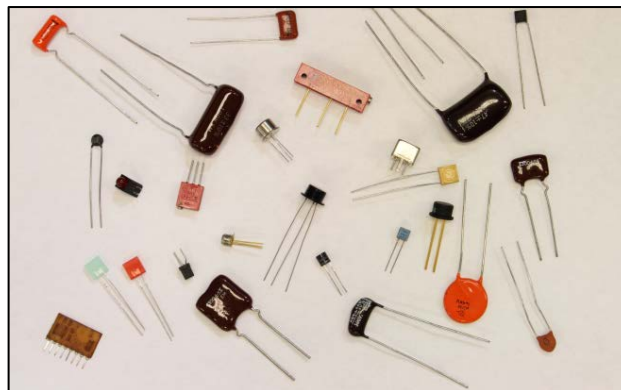

Figure 07-17 Radial Leaded Discrete Components

Integrated Circuits (IC) are multifunction devices and have several leads, such as TO 5 packages (transistor outline cans) and DIPs (Figure 07-18).

With the exception of can packages, most ICs will have flat or ribbon leads.

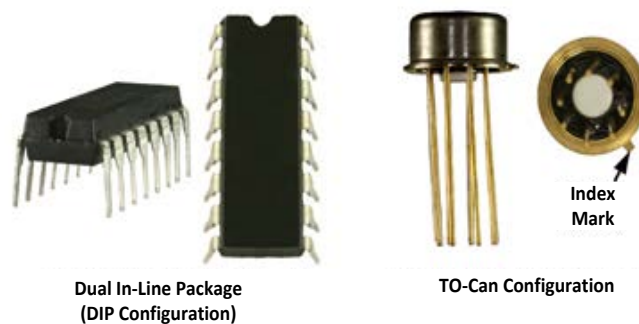

Figure 07-18 Integrated Circuits

07-4.4 Component Lead Termination Styles

Component lead termination styles consist of straight-through, semi-clinch, full clinch, and offset pad. The finished CCA consists of conductive paths, pads, and drilled holes with components and/or wires assembled directly to it. The CCA uses holes or pads as anchoring or termination points for leads (Figure 07-19).

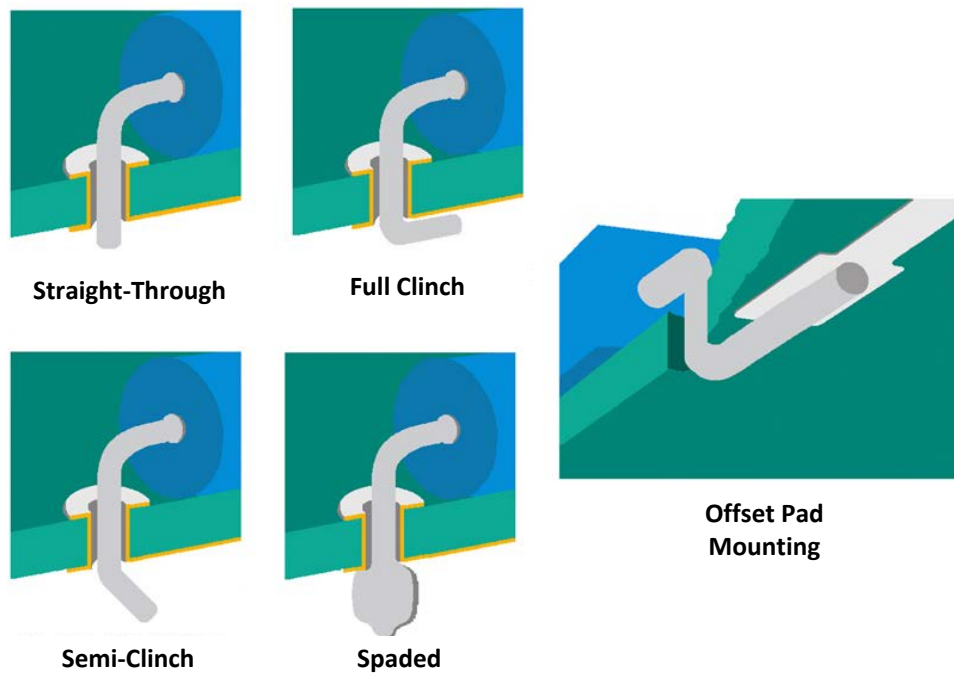

Figure 07-19 Lead Termination Styles

Straight-Through lead terminations are used when the termination stability is not of prime consideration. The straight-through termination is the easiest to remove and repair.

Semi-Clinch lead terminations are bent to a 45° angle and may be used with an isolated pad. Semi-clinch lead termination style is used with both supported and unsupported holes. Clinched leads are used to provide component stability during the installation process.

Full Clinch lead terminations make complete contact with the pad and conductor, normally at a 90° bend. Full-clinch lead termination style is used with both supported and unsupported holes. Clinched leads are used to provide component stability during the installation process.

Offset Pad terminations are a variation of the clinched lead device. The pad is set off from the centerline of the hole. The lead clinch is also offset from the hole centerline so it will contact the pad. Inspect offset pad lead terminations using the workmanship standards for surface mount round or flattened (coined) leads in WP 018 00 (paragraph 18-6.5).

07-5 REPAIR PROCEDURES



PROTECT STATIC SENSITIVE DEVICES DURING HANDLING AND REPAIR TO PREVENT ESD DAMAGE (REFER TO WP 004 00).

Equipment Required Listed below are the authorized 2M Power Units* for removal and replacement of through hole components:

- **NAVAIR/NAVSEA/USMC/USAF/USCG—PRC-2000-SMT**
- **NAVSEA/USCG—PRC-2000-TH**
- **NAVSEA/USCG—MBT-250-SD**
- **USMC—MBT-350**
- **NAVSEA—ST-25**

* Refer to Table 03-3 for Power Unit Part No., and CAGE Code

Additional Support Items For additional information regarding items of support and support equipment refer to:

- **NAVSEA/NAVAIR/USCG—2M MTR Certification Manual**
 - **NAVSEA/USCG—Allowance Parts List (APL) 000A8423**
 - **USMC—Stock List SL-3-09458A**
 - **USAF—the Consolidated Tool Kit (CTK)**
-

Material Required

Listed below are the materials required* for removal and replacement of through hole components:

- Adhesive (Epoxy Patch Kit) [bonding]
- Desoldering Wick†
- Eraser, Rubber
- Flux, Soldering
- Heat Sink Compound
- Insulating Compound (conformal coating)
- Insulation Sleeving Kit, Electrical‡
- Isopropyl Alcohol, Technical
- Solder, Tin Alloy†
- Towel, Paper (Kimwipe®)‡

* Refer to Table 03-4 for Specification No., Part No., and NSN

† Select size appropriate for application

‡ Substitution of equivalent material is acceptable

07-5.1 Procedural Analysis and Feasibility of Repair

Perform the Procedural Analysis and Feasibility of Repair Procedure in WP 003 00 (paragraph 03-5.1).

07-5.2 Desoldering Through-Hole Components

During repair, most damage to the CCA occurs in the desoldering process. To remove components for repair or replacement, the 2M Technician must first determine the type of hole reinforcement, and then select the most effective method for desoldering.

The three methods of solder removal are the Continuous Vacuum Extraction Procedure, the Wicking Procedure, and the Manual Vacuum Extraction Procedure.

07-5.2.1 Continuous Vacuum Extraction Procedure

The most effective method for solder removal is continuous vacuum extraction, which provides controlled combinations of heat and vacuum for solder removal. Continuous vacuum allows for solder removal with a single heat application.

A typical continuous vacuum extraction desoldering operation should be completed in less than five seconds.















2M power units provide variable temperature control for the solder extractor. The vacuum is controlled by a handpiece vacuum control switch or a foot pedal.

The solder extractor consists of a hollow-tipped heating element, transfer tube, and collecting chamber in the handle that collects the waste solder. The extraction tip and heat source, combined in one tool, eliminate time lag between removal of the iron tip and application of the manual vacuum solder extractor tip in the manual vacuum extraction method.

The solder extractor is provided with various sized tips. The solder extractor tip is the primary means of transferring heat to melt the solder. Selection of the proper sized solder extractor tip is essential for successful solder removal. The inside diameter of the tip must be large enough to fit over the lead while permitting airflow through the tip. The outside diameter of the tip must not exceed the pad diameter.

The component lead in a plated-through hole solder joint usually rests against the sidewall of the hole. When the molten solder is removed by vacuum, residual solder between the lead and sidewalls may cause a sweat joint to form. A sweat joint is a paper-thin solder connection formed by a minute amount of solder remaining on the conductor/lead surfaces not removed by vacuum extraction. To prevent a sweat joint, "stir" the lead with the tip while applying the vacuum. This permits cool air to flow into and around the lead and the hole sidewalls causing them to cool.

Personnel Hazards

					
Alcohol, Isopropyl					1
					
Flux (Soldering)					8
					
Lead (Solder)					9

Continuous Vacuum Extraction Procedure

Step	Action
	<p style="text-align: center;">WARNING</p> <p style="text-align: center;"><i>USE APPROVED SAFETY EYEWEAR WHEN PERFORMING THIS PROCEDURE.</i></p> <p style="text-align: center;"><i>COMPLY WITH ALL LOCAL REQUIREMENTS FOR PPE.</i></p> <p style="text-align: center;">CAUTION</p> <p style="text-align: center;">DON A PROPERLY GROUNDED ESD WRIST STRAP BEFORE STARTING THIS PROCEDURE.</p>
1	Select a solder extractor tip with an inside diameter that easily fits over the lead termination and its outside diameter is smaller than the pad.
2	Set the solder extractor tip temperature to 700°F (371°C).
3	Place a clean tissue on a heat resistant surface and test the solder extractor by actuating vacuum to pick up the tissue. Note: If the solder extractor vacuum is insufficient to pick up the tissue, stop this procedure and perform the Solder Extractor Vacuum Test and Heater Element Cleaning Procedure in WP 003 00 (paragraph 03-5.7).
4	Clean the repair area with isopropyl alcohol using an acid brush and blot dry with a clean, lint-free tissue.
5	Apply flux SPARINGLY to the solder joint (both sides of a double-sided CCA). Note: Use a toothpick or flux pen to control the volume of flux applied. Heavy flux volume impairs cleaning and may affect reliability.
6	Position the CCA vertically in a circuit card holder, if feasible.
7	Remove the seasoning (all solder) from the solder extractor tip.
8	Thermally shock the solder extractor tip on a damp sponge.

Continuous Vacuum Extraction Procedure

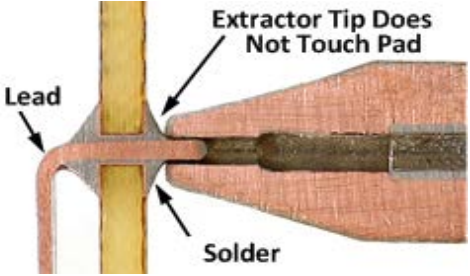
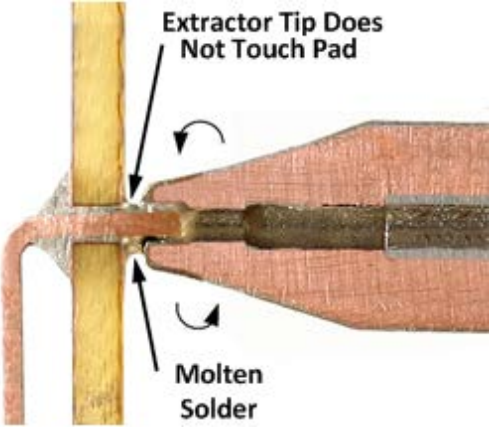
Step	Action
9	<p style="text-align: center;">CAUTION</p> <p style="text-align: center;">DO NOT APPLY PRESSURE WITH THE SOLDER EXTRACTOR.</p> <p>Position the solder extractor tip so the tip contacts only the solder and the lead.</p> <p>Note: Heat transfer is through the molten solder and the lead, not through the pad or the plating.</p> 
10	<p style="text-align: center;">CAUTION</p> <p style="text-align: center;">IF SOLDER MELT DOES NOT OCCUR WITHIN TWO SECONDS, STOP THIS PROCEDURE AND ADJUST TIP TEMPERATURE PER THE TIP TEMPERATURE PROCEDURE IN WP 003 00 (PARAGRAPH 03-5.4).</p> <p>Observe COMPLETE solder melt; then actuate vacuum using the handpiece vacuum control switch or the foot pedal and begin a stirring motion.</p> <p>Note: To prevent a sweat joint, a circular stirring motion shall be used for round leads, or a back and forth stirring motion shall be used for flat leads.</p> <p>Note: If the thermal mass of the solder joint is too large to allow for solder melt, use the Continuous Vacuum Extraction with Auxiliary Heating Procedure (paragraph 07-5.2.2).</p> 

Continuous Vacuum Extraction Procedure

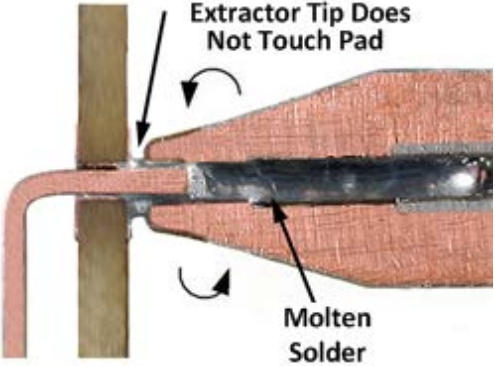
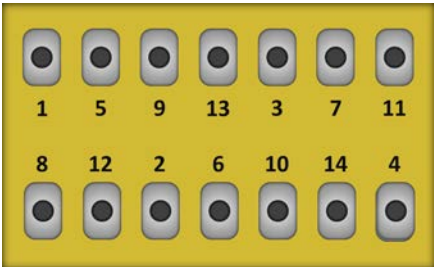
Step	Action
11	<p>Maintain the stirring motion throughout the entire vacuum application.</p> 
12	<p>After complete solder extraction, remove the solder extractor tip from the solder joint allowing the solder extractor vacuum to run continuously for an additional five seconds to draw the molten solder completely into the solder trap.</p>
13	<p style="text-align: center;">CAUTION</p> <p style="text-align: center;">USE A SHOTGUN PATTERN LIKE THAT SHOWN BELOW TO PREVENT EXCESSIVE HEAT BUILDUP WHEN DESOLDERING MULTILEAD COMPONENTS.</p>  <p>Repeat steps 4 through 11 for each lead of the component.</p>
14	<p>Season the tip and place the solder extractor into its stand.</p>
15	<p>Allow the pad areas to cool completely before cleaning.</p>
16	<p>Clean the pad areas on both sides of the CCA with isopropyl alcohol using an acid brush to remove all flux residue and blot dry with a clean, lint-free tissue.</p>

Continuous Vacuum Extraction Procedure

Step	Action
17	<p style="text-align: center;">CAUTION</p> <p style="text-align: center;">DO NOT BREAK THE SWEAT JOINT REMAINING IN THE BARREL OF A PLATED-THROUGH HOLE.</p> <p>Break the surface sweat joint at the shoulder of a DIP using an orangewood stick or spudger.</p>
18	<p>Determine if all the leads move freely by nudging each lead with an orangewood stick or spudger. If all leads move freely, go to step 32; otherwise, perform steps 18 through 31.</p>
19	<p>Select a soldering iron tip that maximizes heat transfer and contact area with the component lead.</p>
20	<p>Set the soldering iron tip temperature to 600°F (316°C).</p>
21	<p>Clean the solder with isopropyl alcohol and wipe dry with a clean, lint-free tissue.</p>
22	<p>Apply flux SPARINGLY to the lead(s) that does move freely in the hole.</p>
23	<p>Remove the seasoning (all solder) from the soldering iron tip.</p>
24	<p>Thermally shock the soldering iron tip on a damp sponge.</p>
25	<p style="text-align: center;">CAUTION</p> <p style="text-align: center;">DO NOT APPLY PRESSURE WITH THE SOLDERING IRON.</p> <p>Place the soldering iron tip on the pad contacting the lead at the point of maximum thermal mass.</p>
26	<p style="text-align: center;">CAUTION</p> <p style="text-align: center;">IF SOLDER MELT DOES NOT OCCUR WITHIN TWO SECONDS, STOP THIS PROCEDURE AND ADJUST TIP TEMPERATURE PER THE TIP TEMPERATURE PROCEDURE IN WP 003 00 (PARAGRAPH 03-5.4).</p> <p>Form a heat bridge between the soldering iron tip and the surfaces to be soldered using clean solder.</p>















Continuous Vacuum Extraction Procedure

Step	Action
27	Add solder to fill completely the pad areas on both sides of the CCA.
28	Remove the solder and the soldering iron tip simultaneously.
29	Season the tip and place the soldering iron into its stand.
30	Allow the solder joint to cool completely before cleaning.
31	Clean the solder joint with isopropyl alcohol using an acid brush to remove all flux residue and blot dry with a clean, lint-free tissue.
32	Repeat steps 23 through 31 for each lead that does not move freely in the hole.
32	Repeat solder extraction for the leads that have been resoldered using steps 4 through 17.
33	Break any remaining surface sweat joints with orangewood stick or spudger.
34	<p><i>Inspect per the General Inspection Procedure in WP 003 00 (paragraph 03-5.12) to all applicable WORKMANSHIP STANDARDS, including:</i></p> <ul style="list-style-type: none"> • <i>Discrete Component Leads (paragraph 07-6.1)</i> • <i>Discrete Component Body (paragraph 07-6.2)</i> • <i>Laminate in WP 011 00 (paragraph 11-6.1)</i> • <i>Conductors, Pads, and Lands in WP 012 00 (paragraph 12-6.1)</i> • <i>Other applicable Workmanship Standards as required</i>
35	Dispose of all HAZMAT following local procedures.

07-5.2.2 Continuous Vacuum Extraction with Auxiliary Heating Procedure

Auxiliary heating may be required on solder joints when solder melt is not attainable using the Continuous Vacuum Extraction Procedure (paragraph 07-5.2.1).



Personnel Hazards

					
Alcohol, Isopropyl					1
					
Flux (Soldering)					8
					
Lead (Solder)					9

Continuous Vacuum Extraction with Auxiliary Heating Procedure

Step	Action
	<p style="text-align: center;">WARNING</p> <p style="text-align: center;"><i>USE APPROVED SAFETY EYEWEAR WHEN PERFORMING THIS PROCEDURE.</i></p> <p style="text-align: center;"><i>COMPLY WITH ALL LOCAL REQUIREMENTS FOR PPE.</i></p> <p style="text-align: center;">CAUTION</p> <p style="text-align: center;">DON A PROPERLY GROUNDED ESD WRIST STRAP BEFORE STARTING THIS PROCEDURE.</p> <p style="text-align: center;">ATTENTION MUST BE GIVEN TO EXTRACTION TIME AND TEMPERATURES TO PREVENT DAMAGE TO THE CCA WHEN USING AUXILIARY HEATING.</p>
1	Select a soldering iron tip no larger than the component side pad to maximize heat transfer and contact area with the solder joint.
2	Set both the solder extractor tip temperature and the soldering iron tip temperature to <u>600°F (316°C)</u> .
3	Apply flux SPARINGLY to the solder joint (both sides of a double-sided CCA).
4	Remove the seasoning (all solder) from the solder extractor and soldering iron tips.
5	Thermally shock the solder extractor tip and the soldering iron tip on a damp sponge.

Continuous Vacuum Extraction with Auxiliary Heating Procedure

Step	Action
6	<p>Place the soldering iron at the junction of the lead and solder joint on the component side of the CCA.</p> 
7	<div style="text-align: center; border: 1px solid black; padding: 5px; margin-bottom: 10px;">CAUTION</div> <p>DO NOT APPLY PRESSURE WITH THE SOLDERING IRON OR SOLDER EXTRACTOR.</p> <p>Position the solder extractor tip so the tip contacts only the solder and the lead.</p> 
8	<p>Continue with step 9 of the Continuous Vacuum Extraction Procedure (paragraph 07-5.2.1).</p>

07-5.2.3 Wicking Procedure

The combination of heat, molten solder, and airspaces in the wicking material creates a capillary action and causes the solder to be drawn into the wicking material.

The wicking material is applied to a solder joint between the solder and a heated soldering iron tip (Figure 07-20).

This method should be used to remove surface solder joints only, such as those found on single- double-sided CCAs with non-plated-through holes or to remove excessive solder from any flat surface.

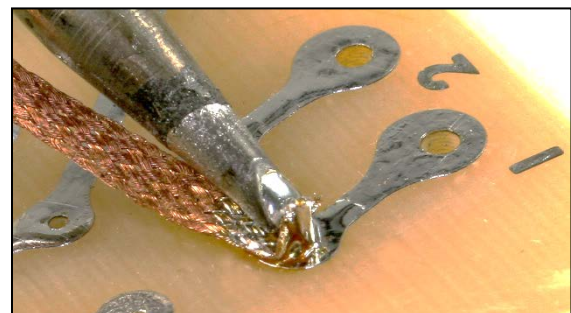















Figure 07-20 Wicking Method Desoldering

Through-hole solder joints cannot be completely removed by this method because the capillary action of the wicking material does not overcome the surface tension of the molten solder.

Personnel Hazards

					
Alcohol, Isopropyl					1
					
Flux (Soldering)					8
					
Lead (Solder)					9

Wicking Procedure

Step	Action
	<p style="text-align: center;">WARNING</p> <p style="text-align: center;"><i>USE APPROVED SAFETY EYEWEAR WHEN PERFORMING THIS PROCEDURE.</i></p> <p style="text-align: center;"><i>COMPLY WITH ALL LOCAL REQUIREMENTS FOR PPE.</i></p> <p style="text-align: center;">CAUTION</p> <p style="text-align: center;">DON A PROPERLY GROUNDED ESD WRIST STRAP BEFORE STARTING THIS PROCEDURE.</p>
1	Select a soldering iron tip that maximizes heat transfer and contact area with the pad without touching the CCA surface.
2	Set the soldering iron tip temperature to 600°F (316°C).
3	Clean the solder joint with isopropyl alcohol using an acid brush and blot dry with a clean, lint-free tissue.
4	Select a wicking material size that fits the pad without overlapping the CCA surface. Note: If corroded, clean the wicking material with isopropyl alcohol and blot dry with a clean, lint-free tissue.
5	Apply flux to the wicking material.

Wicking Procedure

Step	Action
6	Position the wicking material on the solder joint.
7	Remove the seasoning (all solder) from the soldering iron tip.
8	Thermally shock the soldering iron tip on a damp sponge.
9	<p style="text-align: center;">CAUTION</p> <p style="text-align: center;">DO NOT APPLY PRESSURE WITH THE SOLDERING IRON.</p> <p>Place the soldering iron tip on the wicking material.</p>
10	<p style="text-align: center;">CAUTION</p> <p style="text-align: center;">IF SOLDER MELT DOES NOT OCCUR WITHIN FOUR SECONDS, STOP THIS PROCEDURE AND ADJUST TIP TEMPERATURE PER THE TIP TEMPERATURE PROCEDURE IN WP 003 00 (PARAGRAPH 03-5.4).</p> <p>Observe the capillary action (solder flow) into the wicking material; when solder flow stops, remove the soldering iron and the wicking material.</p> 
11	Season the tip and place the soldering iron into its stand.
12	Remove the used portion of wicking material from the spool using utility cutters.
13	Allow the pad area to cool completely before cleaning.
14	Clean the pad area with isopropyl alcohol using an acid brush to remove all flux residue and blot dry with a clean, lint-free tissue.
15	Repeat steps 5 through 14 as necessary to remove any remaining solder.
16	Break any remaining surface sweat joints with orangewood stick or spudger.

Wicking Procedure

Step	Action
17	<p><i>Inspect per the General Inspection Procedure in WP 003 00 (paragraph 03-5.12) to all applicable WORKMANSHIP STANDARDS, including:</i></p> <ul style="list-style-type: none"> • <i>Discrete Component Leads (paragraph 07-6.1)</i> • <i>Discrete Component Body (paragraph 07-6.2)</i> • <i>Laminate in WP 011 00 (paragraph 11-6.1)</i> • <i>Conductors, Pads, and Lands in WP 012 00 (paragraph 12-6.1)</i> • <i>Other applicable Workmanship Standards as required</i>
18	<p>Dispose of all HAZMAT following local procedures.</p>

07-5.2.4 Manual Vacuum Extraction Procedure

This method involves a manually controlled and operated, conductive (ESD safe), one-shot vacuum source using a plunger mechanism with a conductive tip (Figure 07-21).

The vacuum is applied through the tip.



Figure 07-21 Manual Vacuum Solder Extractor

This technique involves melting the solder joint and placing the manual solder extractor tip on the molten solder. The plunger is then released, creating a short period of vacuum to extract the molten solder.















Although this method offers a positive vacuum rather than the capillary action of the wicking method, it has limited applications:

- This method may not remove an adequate quantity of solder and may cause pad lifting
- This extraction method is not usually successful and is not recommended for a plated-through solder joints

Use Manual Vacuum Extraction only for single-sided straight through terminations.

Manual Vacuum Extraction is not recommended for clinched leads.

Personnel Hazards

					
Alcohol, Isopropyl					1
					
Flux (Soldering)					8
					
Lead (Solder)					9

Manual Vacuum Extraction Procedure

Step	Action
	<div style="border: 1px solid black; padding: 5px; margin: 10px auto; width: 150px;">WARNING</div> <p><i>USE APPROVED SAFETY EYEWEAR WHEN PERFORMING THIS PROCEDURE.</i></p> <p><i>COMPLY WITH ALL LOCAL REQUIREMENTS FOR PPE.</i></p> <div style="border: 1px solid black; padding: 5px; margin: 10px auto; width: 150px;">CAUTION</div> <p>DON A PROPERLY GROUNDED ESD WRIST STRAP BEFORE STARTING THIS PROCEDURE.</p> <p>MANUAL VACUUM SOLDER EXTRACTORS MAY CAUSE HIGH ELECTROSTATIC DISCHARGE (ESD) POTENTIALS.</p> <p>USE ONLY APPROVED, ESD SAFE MANUAL SOLDER EXTRACTORS.</p>
1	Select a soldering iron tip that maximizes heat transfer and contact area with the solder joint.
2	Set the soldering iron tip temperature to 600°F (316°C).
3	Clean the solder joint with isopropyl alcohol using an acid brush and blot dry with a clean, lint-free tissue.
4	Apply flux SPARINGLY to the solder joint. Note: Use a toothpick or flux pen to control the volume of flux applied. Heavy flux volume impairs cleaning and may affect reliability.

Manual Vacuum Extraction Procedure

Step	Action
5	<p style="text-align: center;">CAUTION</p> <p style="text-align: center;">TO AVOID DEPOSITING SOLDER DEBRIS, DO NOT DEPRESS THE PLUNGER OF THE MANUAL SOLDER EXTRACTOR OVER THE WORKPIECE.</p> <p>Lock the manual solder extractor plunger in the compressed position.</p>
6	Remove the seasoning (all solder) from the soldering iron tip.
7	Thermally shock the soldering iron tip on a damp sponge.
8	<p style="text-align: center;">CAUTION</p> <p style="text-align: center;">DO NOT APPLY PRESSURE WITH THE SOLDERING IRON.</p> <p>Simultaneously apply the soldering iron tip to the solder joint and place the tip of the manual solder extractor directly beside the solder joint.</p> 

Manual Vacuum Extraction Procedure















Step	Action
9	<div style="text-align: center; border: 1px solid black; padding: 5px; margin-bottom: 10px;">CAUTION</div> <p style="text-align: center;">IF SOLDER MELT DOES NOT OCCUR WITHIN TWO SECONDS, STOP THIS PROCEDURE AND ADJUST TIP TEMPERATURE PER THE TIP TEMPERATURE PROCEDURE (PARAGRAPH 03-5.4).</p> <p>Observe COMPLETE solder melt; then remove the iron and quickly place the tip over the solder joint at a 90° angle, and press the release trigger.</p> <p>Note: The solder extractor must be held firmly to minimize recoil that may cause the solder extractor tip to jump away from the solder joint and result in incomplete extraction.</p> 
10	Season the tip and place the soldering iron into its stand.
11	Allow the pad to cool completely before cleaning.
12	Clean the pad area with isopropyl alcohol using an acid brush to remove all flux residue and blot dry with a clean, lint-free tissue.
13	Repeat steps 4 through 12 as necessary to remove any remaining solder.
14	Break any remaining surface sweat joints with orangewood stick.
15	<p><i>Inspect per the General Inspection Procedure in WP 003 00 (paragraph 03-5.12) to all applicable WORKMANSHIP STANDARDS, including:</i></p> <ul style="list-style-type: none"> • <i>Discrete Component Leads (paragraph 07-6.1)</i> • <i>Discrete Component Body (paragraph 07-6.2)</i> • <i>Laminate in WP 011 00 (paragraph 11-6.1)</i> • <i>Conductors, Pads, and Lands in WP 012 00 (paragraph 12-6.1)</i> • <i>Other applicable Workmanship Standards as required</i>
16	Dispose of all HAZMAT following local procedures.

07-5.3 Desoldering Components from Single-Sided CCAs Procedure

Use this procedure for desoldering components from single-sided CCAs.

Use the Desoldering Components from Double-Sided CCAs Procedure (paragraph 07-5.4) for double-sided CCAs.

Personnel Hazards

					
Alcohol, Isopropyl					1
					
Flux (Soldering)					8
					
Lead (Solder)					9



Desoldering Components from Single-Sided CCAs Procedure

Step	Action
	<div style="border: 1px solid black; padding: 5px; margin-bottom: 10px;">WARNING</div> <p>USE APPROVED SAFETY EYEWEAR WHEN PERFORMING THIS PROCEDURE.</p> <p>COMPLY WITH ALL LOCAL REQUIREMENTS FOR PPE.</p> <div style="border: 1px solid black; padding: 5px; margin-bottom: 10px;">CAUTION</div> <p>DON A PROPERLY GROUNDED ESD WRIST STRAP BEFORE STARTING THIS PROCEDURE.</p>

Desoldering Components from Single-Sided CCAs Procedure

Step	Action												
1	<p style="text-align: center;">CAUTION</p> <p style="text-align: center;">BEGIN THE REPAIR PROCESS AS SOON AS POSSIBLE AFTER REMOVAL FROM THE OVEN TO AVOID MOISTURE RE-ABSORPTION.</p> <table border="1" style="width: 100%; border-collapse: collapse;"> <tr> <td style="width: 60%; vertical-align: top;"> Bake the CCA, if feasible, in accordance with the table to the right before soldering, desoldering, and conformal coating removal procedures to prevent delamination, measling, or other laminate degradation. </td> <td style="width: 20%; text-align: center; vertical-align: top;">Baking Temp.</td> <td style="width: 20%; text-align: center; vertical-align: top;">Baking Time</td> </tr> <tr> <td></td> <td style="text-align: center;">248°F (120°C)</td> <td style="text-align: center;">3.5 to 7 hours</td> </tr> <tr> <td></td> <td style="text-align: center;">212°F (100°C)</td> <td style="text-align: center;">8 to 16 hours</td> </tr> <tr> <td></td> <td style="text-align: center;">176°F (80°C)</td> <td style="text-align: center;">18 to 48 hours</td> </tr> </table>	Bake the CCA, if feasible, in accordance with the table to the right before soldering, desoldering, and conformal coating removal procedures to prevent delamination, measling, or other laminate degradation.	Baking Temp.	Baking Time		248°F (120°C)	3.5 to 7 hours		212°F (100°C)	8 to 16 hours		176°F (80°C)	18 to 48 hours
Bake the CCA, if feasible, in accordance with the table to the right before soldering, desoldering, and conformal coating removal procedures to prevent delamination, measling, or other laminate degradation.	Baking Temp.	Baking Time											
	248°F (120°C)	3.5 to 7 hours											
	212°F (100°C)	8 to 16 hours											
	176°F (80°C)	18 to 48 hours											
2	Remove any conformal coating from the repair area using one of the Conformal Coating Removal Methods in WP 006 00 (paragraph 06-5.4).												
3	Cut swaged leads using flush cut pliers to remove the swaged portion, if required.												
4	<p style="text-align: center;">CAUTION</p> <p style="text-align: center;">HEAT SINKS ARE PLACED BETWEEN THE HEAT SOURCE AND THE COMPONENT BODY TO PROTECT THE COMPONENT FROM THE HEAT OF THE DESOLDERING PROCESS.</p> <p>Install heat sinks, as needed.</p>												
5	For clinched leads, perform steps 6 through 8 before desoldering; otherwise, go to step 9.												
6	<p style="text-align: center;">CAUTION</p> <p style="text-align: center;">USE A SHOTGUN PATTERN TO PREVENT EXCESSIVE HEAT BUILDUP WHEN DESOLDERING MULTILEAD COMPONENTS.</p> <p>Use the Wicking Procedure (paragraph 07-5.2.3) to remove surface solder until only a sweat joint remains.</p>												

Desoldering Components from Single-Sided CCAs Procedure

Step	Action
7	<p style="text-align: center;">CAUTION</p> <p style="text-align: center;">USE EXTREME CAUTION WHEN FREEING A CLINCHED LEAD FROM AN ISOLATED PAD.</p> <p style="text-align: center;">DO NOT ROTATE THE LEAD WHEN DESOLDERING DIP CLINCHED LEADS.</p> <p>Break the surface sweat joint by using duckbill pliers to rotate the clinched lead 15°.</p> 
8	<p>Straighten the component lead using a non-metallic tool.</p> <p>Go to step 11.</p> 
9	<p style="text-align: center;">CAUTION</p> <p style="text-align: center;">USE A SHOTGUN PATTERN TO PREVENT EXCESSIVE HEAT BUILDUP WHEN DESOLDERING MULTILEAD COMPONENTS.</p> <p>Remove solder using the Continuous Vacuum Extraction Procedure (paragraph 07-5.2.1). The Wicking Procedure (paragraph 07-5.2.3) is an acceptable alternative.</p>
10	<p>Break any remaining surface sweat joints with orangewood stick or spudger.</p>
11	<p>Remove the component per the Component Removal Procedure (paragraph 07-5.5).</p>

Desoldering Components from Single-Sided CCAs Procedure

Step	Action
12	<p><i>Inspect per the General Inspection Procedure in WP 003 00 (paragraph 03-5.12) to all applicable WORKMANSHIP STANDARDS, including:</i></p> <ul style="list-style-type: none"> • <i>Discrete Component Leads (paragraph 07-6.1)</i> • <i>Discrete Component Body (paragraph 07-6.2)</i> • <i>Laminate in WP 011 00 (paragraph 11-6.1)</i> • <i>Conductors, Pads, and Lands in WP 012 00 (paragraph 12-6.1)</i> • <i>Other applicable Workmanship Standards as required</i>
13	Dispose of all HAZMAT following local procedures.

07-5.4 Desoldering Components from Double-Sided CCAs Procedure

Use this procedure for desoldering components from double-sided CCAs.

Use the Desoldering Components from Single-Sided CCAs Procedure (paragraph 07-5.3) for single-sided CCAs.

Personnel Hazards

					1
Alcohol, Isopropyl					
					8
Flux (Soldering)					
					9
Lead (Solder)					

Desoldering Components from Double-Sided CCAs Procedure

Step	Action										
	<p style="text-align: center;">WARNING</p> <p style="text-align: center;">USE APPROVED SAFETY EYEWEAR WHEN PERFORMING THIS PROCEDURE.</p> <p style="text-align: center;">COMPLY WITH ALL LOCAL REQUIREMENTS FOR PPE.</p> <p style="text-align: center;">CAUTION</p> <p style="text-align: center;">DON A PROPERLY GROUNDED ESD WRIST STRAP BEFORE STARTING THIS PROCEDURE.</p>										
<p>1</p>	<p style="text-align: center;">CAUTION</p> <p style="text-align: center;">BEGIN THE REPAIR PROCESS AS SOON AS POSSIBLE AFTER REMOVAL FROM THE OVEN TO AVOID MOISTURE RE-ABSORPTION.</p> <table border="1" style="width: 100%; border-collapse: collapse;"> <tr> <td style="width: 50%; vertical-align: top;"> Bake the CCA, if feasible, in accordance with the table to the right before soldering, desoldering, and conformal coating removal procedures to prevent delamination, measling, or other laminate degradation. </td> <td style="width: 50%; text-align: center;"> <table border="1" style="width: 100%; border-collapse: collapse;"> <thead> <tr> <th style="text-align: left;">Baking Temp.</th> <th style="text-align: left;">Baking Time</th> </tr> </thead> <tbody> <tr> <td>248°F (120°C)</td> <td>3.5 to 7 hours</td> </tr> <tr> <td>212°F (100°C)</td> <td>8 to 16 hours</td> </tr> <tr> <td>176°F (80°C)</td> <td>18 to 48 hours</td> </tr> </tbody> </table> </td> </tr> </table>	Bake the CCA, if feasible, in accordance with the table to the right before soldering, desoldering, and conformal coating removal procedures to prevent delamination, measling, or other laminate degradation.	<table border="1" style="width: 100%; border-collapse: collapse;"> <thead> <tr> <th style="text-align: left;">Baking Temp.</th> <th style="text-align: left;">Baking Time</th> </tr> </thead> <tbody> <tr> <td>248°F (120°C)</td> <td>3.5 to 7 hours</td> </tr> <tr> <td>212°F (100°C)</td> <td>8 to 16 hours</td> </tr> <tr> <td>176°F (80°C)</td> <td>18 to 48 hours</td> </tr> </tbody> </table>	Baking Temp.	Baking Time	248°F (120°C)	3.5 to 7 hours	212°F (100°C)	8 to 16 hours	176°F (80°C)	18 to 48 hours
Bake the CCA, if feasible, in accordance with the table to the right before soldering, desoldering, and conformal coating removal procedures to prevent delamination, measling, or other laminate degradation.	<table border="1" style="width: 100%; border-collapse: collapse;"> <thead> <tr> <th style="text-align: left;">Baking Temp.</th> <th style="text-align: left;">Baking Time</th> </tr> </thead> <tbody> <tr> <td>248°F (120°C)</td> <td>3.5 to 7 hours</td> </tr> <tr> <td>212°F (100°C)</td> <td>8 to 16 hours</td> </tr> <tr> <td>176°F (80°C)</td> <td>18 to 48 hours</td> </tr> </tbody> </table>	Baking Temp.	Baking Time	248°F (120°C)	3.5 to 7 hours	212°F (100°C)	8 to 16 hours	176°F (80°C)	18 to 48 hours		
Baking Temp.	Baking Time										
248°F (120°C)	3.5 to 7 hours										
212°F (100°C)	8 to 16 hours										
176°F (80°C)	18 to 48 hours										
<p>2</p>	<p>Remove any conformal coating from the repair area using one of the Conformal Coating Removal Methods in WP 006 00 (paragraph 06-5.4).</p>										
<p>3</p>	<p>Cut swaged leads using flush cut pliers to remove the swaged portion, if required.</p>										
<p>4</p>	<p style="text-align: center;">CAUTION</p> <p style="text-align: center;">HEAT SINKS ARE PLACED BETWEEN THE HEAT SOURCE AND THE COMPONENT BODY TO PROTECT THE COMPONENT FROM THE HEAT OF THE DESOLDERING PROCESS.</p> <p>Install heat sinks, as needed.</p>										

Desoldering Components from Double-Sided CCAs Procedure

Step	Action
5	Preheat the CCA per the Convective Preheating Procedure in WP 018 00 (paragraph 18-5.2.1) or the Conductive Preheating Procedure (paragraph 18-5.2.2) for: <ul style="list-style-type: none"> • CCAs with large (heavy) ground planes • CCAs with large thermal mass (thick laminate, constraining core)
6	For clinched leads, perform steps 7 through 22 before desoldering.
7	Use the Wicking Procedure (paragraph 07-5.2.3) or the Continuous Vacuum Extraction Procedure (paragraph 07-5.2.1) to remove surface solder until only a sweat joint remains.
8	<div style="text-align: center; border: 2px solid black; padding: 5px; margin: 10px auto; width: fit-content;"> CAUTION </div> <p style="text-align: center;">DO NOT BREAK THE SWEAT JOINT REMAINING IN THE BARREL OF A PLATED-THROUGH HOLE.</p> <p style="text-align: center;">USE EXTREME CAUTION WHEN FREEING A CLINCHED LEAD FROM AN ISOLATED PAD.</p> <p style="text-align: center;">DO NOT ROTATE THE LEAD WHEN DESOLDERING DIP CLINCHED LEADS.</p> <p>Break the surface sweat joint by using duckbill pliers to rotate the clinched lead 15°.</p>
9	Straighten the component lead using a non-metallic tool, being careful not to apply pressure to the plated-through hole.
10	Select a soldering iron tip that maximizes heat transfer and contact area with the pad.
11	Set the soldering iron tip temperature to 600°F (316°C).
12	Clean the solder with isopropyl alcohol and wipe dry with a clean, lint-free tissue.
13	Apply flux SPARINGLY to the area to be soldered.
14	Remove the seasoning (all solder) from the soldering iron tip.
15	Thermally shock the soldering iron tip on a damp sponge.

Desoldering Components from Double-Sided CCAs Procedure

Step	Action
16	<p style="text-align: center;">CAUTION</p> <p style="text-align: center;">USE A SHOTGUN PATTERN TO PREVENT EXCESSIVE HEAT BUILDUP WHEN DESOLDERING MULTILEAD COMPONENTS.</p> <p style="text-align: center;">DO NOT APPLY PRESSURE WITH THE SOLDERING IRON.</p> <p>Place the soldering iron tip on the solder joint at the point of maximum thermal mass.</p>
17	<p style="text-align: center;">CAUTION</p> <p style="text-align: center;">IF SOLDER MELT DOES NOT OCCUR WITHIN TWO SECONDS, STOP THIS PROCEDURE AND ADJUST TIP TEMPERATURE PER THE TIP TEMPERATURE PROCEDURE IN WP 003 00 (PARAGRAPH 03-5.4).</p> <p>Form a heat bridge between the soldering iron tip and the surfaces to be soldered using clean solder.</p>
18	Add solder to fill completely the pad areas on both sides of the CCA.
19	Remove the solder and the soldering iron tip simultaneously.
20	Season the tip and place the soldering iron into its stand.
21	Allow the solder joints to cool completely before cleaning.
22	Clean the solder joints with isopropyl alcohol using an acid brush to remove all flux residue and blot dry with a clean, lint-free tissue.
23	<p style="text-align: center;">CAUTION</p> <p style="text-align: center;">USE A SHOTGUN PATTERN TO PREVENT EXCESSIVE HEAT BUILDUP WHEN DESOLDERING MULTILEAD COMPONENTS.</p> <p>Remove solder using the Continuous Vacuum Extraction Procedure (paragraph 07-5.2.1).</p>
24	Remove the component per the Component Removal Procedure (paragraph 07-5.5).

Desoldering Components from Double-Sided CCAs Procedure

Step	Action
25	<p><i>Inspect per the General Inspection Procedure in WP 003 00 (paragraph 03-5.12) to all applicable WORKMANSHIP STANDARDS, including:</i></p> <ul style="list-style-type: none"> • <i>Discrete Component Leads (paragraph 07-6.1)</i> • <i>Discrete Component Body (paragraph 07-6.2)</i> • <i>Laminate in WP 011 00 (paragraph 11-6.1)</i> • <i>Conductors, Pads, and Lands in WP 012 00 (paragraph 12-6.1)</i> • <i>Other applicable Workmanship Standards as required</i>
26	Dispose of all HAZMAT following local procedures.

07-5.5 Through-Hole Component Removal Procedure

Use this procedure to remove components after they were desoldered using either the Desoldering Components from Single-Sided CCAs Procedure (paragraph 07-5.3) or the Desoldering Components from Double-Sided CCAs Procedure (paragraph 07-5.4).

Personnel Hazards



Lead (Solder)

Through-Hole Component Removal Procedure

Step	Action
	<div style="text-align: center;"> <div style="border: 2px solid black; padding: 5px; display: inline-block;">WARNING</div> <p>USE APPROVED SAFETY EYEWEAR WHEN PERFORMING THIS PROCEDURE.</p> <p>COMPLY WITH ALL LOCAL REQUIREMENTS FOR PPE.</p> </div>

Through-Hole Component Removal Procedure

Step	Action
	<p style="text-align: center;">CAUTION</p> <p style="text-align: center;">DON A PROPERLY GROUNDED ESD WRIST STRAP BEFORE STARTING THIS PROCEDURE.</p>
<p style="text-align: center;">1</p>	<p>Record the mounting hardware, heat sinks, insulation sleeving, etc. that will have to be attached to the replacement component.</p> <p>Note: The replacement component should be mounted in the same manner as the original component.</p>
<p style="text-align: center;">2</p>	<p style="text-align: center;">CAUTION</p> <p style="text-align: center;">DAMAGE TO THE PLATED-THROUGH HOLES CAN RESULT IF REMOVAL OF THE COMPONENT IS INITIATED BEFORE COMPLETE SOLDER REMOVAL.</p> <p>Ensure the leads are free and straight and remove the component from the CCA.</p> <p>Note: If the leads are not free and straight, repeat either the Desoldering Components from Single-Sided CCAs Procedure (paragraph 07-5.3) or the Desoldering Components from Double-Sided CCAs Procedure (paragraph 07-5.4), as applicable.</p> <p>Note: If the component is bonded to the CCA by adhesive or conformal coating, perform steps 3 through 8; otherwise, go to step 9.</p>
<p style="text-align: center;">3</p>	<p>Install the single jet tip into the hot air jet.</p>
<p style="text-align: center;">4</p>	<p>Set the hot air jet tip temperature to 900°F (482°C).</p>
<p style="text-align: center;">5</p>	<p>Adjust pressure output so the hot air burns a light brown line on a tissue from approximately 1/8-1/4 in.</p> 
<p style="text-align: center;">6</p>	<p>Position the end of the hot air jet tip to a distance of approximately one inch from the component.</p>

Through-Hole Component Removal Procedure

Step	Action
7	Heat the component body to soften any residual coating or adhesive that may bond the component to the CCA using a circular or sweeping motion. Note: Varying the distance of the tip to the workpiece will control the temperature and amount of hot air applied to the repair area.
8	Move the component in a side-to-side rocking motion using a non-metallic tool until the component is free.
9	Remove the component.
10	Remove any residual conformal coating from the repair area using one of the Conformal Coating Removal Methods in WP 006 00 (paragraph 06-5.4).
11	<i>Inspect per the General Inspection Procedure in WP 003 00 (paragraph 03-5.12) to all applicable WORKMANSHIP STANDARDS, including:</i> <ul style="list-style-type: none">• <i>Discrete Component Leads (paragraph 07-6.1)</i>• <i>Discrete Component Body (paragraph 07-6.2)</i>• <i>Laminate in WP 011 00 (paragraph 11-6.1)</i>• <i>Conductors, Pads, and Lands in WP 012 00 (paragraph 12-6.1)</i>• <i>Other applicable Workmanship Standards as required</i>
12	Dispose of all HAZMAT following local procedures.

07-5.6 Destructive Discrete Component Removal Procedure

NOTE

**DESTRUCTIVE COMPONENT REMOVAL SHALL ONLY BE USED WHEN
NON-DESTRUCTIVE REMOVAL PROCEDURES HAVE PROVEN TO BE INEFFECTIVE.**

Use this procedure to remove discrete components.

Use the Destructive Dual In-Line Package Removal Procedure (paragraph 07-5.7) for DIPs.



Personnel Hazards



Lead (Solder)

9



Destructive Discrete Component Removal Procedure

Step	Action
	<div style="text-align: center;"> <div style="border: 2px solid black; padding: 5px; width: fit-content; margin: 0 auto;">WARNING</div> <p>USE APPROVED SAFETY EYEWEAR WHEN PERFORMING THIS PROCEDURE.</p> <p>COMPLY WITH ALL LOCAL REQUIREMENTS FOR PPE.</p> <div style="border: 2px solid black; padding: 5px; width: fit-content; margin: 0 auto;">CAUTION</div> <p>DON A PROPERLY GROUNDED ESD WRIST STRAP BEFORE STARTING THIS PROCEDURE.</p> </div>
<p style="text-align: center;">1</p>	<p>Record the mounting hardware, heat sinks, insulation sleeving, etc. that will have to be attached to the replacement component.</p> <p>Note: The replacement component should be mounted in the same manner as the original component.</p>
<p style="text-align: center;">2</p>	<p>Remove any conformal coating from the repair area using one of the Conformal Coating Removal Methods in WP 006 00 (paragraph 06-5.4).</p>
<p style="text-align: center;">3</p>	<p>Cut the leads above the solder joint or laminate surface on the component side of the CCA.</p> 
<p style="text-align: center;">4</p>	<p>Remove the component body.</p> <p>Note: If the component is bonded to the CCA by adhesive or conformal coating, perform steps 5 through 11; otherwise, go to step 12.</p> 

Destructive Discrete Component Removal Procedure

Step	Action
5	Install the single jet tip into the hot air jet.
6	Set the hot air jet tip temperature to 900°F (482°C).
7	Adjust pressure output so the hot air burns a light brown line on a tissue from approximately 1/8-1/4 in. 
8	Position the end of the hot air jet tip to a distance of approximately one inch from the component.
9	Heat the component body to soften any residual coating or adhesive that may bond the component to the CCA using a circular or sweeping motion. Note: Varying the distance of the tip to the workpiece will control the temperature and amount of hot air applied to the repair area.
10	Move the component in a side-to-side rocking motion using a non-metallic tool until the component is free.
11	Remove the component.
12	Remove any residual conformal coating from the repair area using one of the Conformal Coating Removal Methods in WP 006 00 (paragraph 06-5.4).
13	For clinched leads on a double-sided CCA, perform steps 14 through 17 before desoldering; otherwise, go to step 18.
14	Use the Wicking Procedure (paragraph 07-5.2.3) to remove the surface solder from each lead.

Destructive Discrete Component Removal Procedure

Step	Action
15	<p>Break the sweat joint by using duckbill pliers to rotate the clinched lead 15°.</p> 
16	<p>Straighten the component leads using a non-metallic tool, being careful not to apply pressure on a plated-through hole.</p> 
17	<p>Add solder to each pad and lead straightened.</p>
18	<p>Select a solder extractor tip with an inside diameter that easily fits over the lead termination and its outside diameter is smaller than the pad.</p>
19	<p>Set the solder extractor tip temperature to <u>700°F (371°C)</u>.</p>
20	<p>Place a clean tissue on a heat resistant surface and test the solder extractor by actuating vacuum to pick up the tissue.</p> <p>Note: If the solder extractor vacuum is insufficient to pick up the tissue, stop this procedure and perform the Solder Extractor Vacuum Test and Heater Element Cleaning Procedure in WP 003 00 (paragraph 03-5.7).</p>
21	<p>Clean the repair area with isopropyl alcohol using an acid brush and blot dry with a clean, lint-free tissue.</p>
22	<p>Apply flux SPARINGLY to each pad/lead area.</p>
23	<p>Position the CCA vertically in a circuit card holder, if feasible.</p>
24	<p>Remove the seasoning (all solder) from the solder extractor tip.</p>

Destructive Discrete Component Removal Procedure

Step	Action
25	Thermally shock the solder extractor tip on a damp sponge.
26	<p data-bbox="799 499 1029 562" style="text-align: center;">CAUTION</p> <p data-bbox="565 583 1263 615" style="text-align: center;">DO NOT APPLY PRESSURE WITH THE SOLDER EXTRACTOR.</p> <p data-bbox="396 772 894 873">Position the solder extractor tip so the tip contacts only the solder and the lead on the termination side of the CCA.</p> 
27	<p data-bbox="799 1031 1029 1094" style="text-align: center;">CAUTION</p> <p data-bbox="472 1115 1357 1215" style="text-align: center;">IF SOLDER MELT DOES NOT OCCUR WITHIN TWO SECONDS, STOP THIS PROCEDURE AND ADJUST TIP TEMPERATURE PER THE TIP TEMPERATURE PROCEDURE IN WP 003 00 (PARAGRAPH 03-5.4).</p> <p data-bbox="396 1255 1398 1318">Observe COMPLETE solder melt; then use curved point tweezers to remove the lead from the component side of the CCA, while extracting the solder.</p>
28	Repeat step 27 on the remaining leads until all leads and solder are removed.
29	Season the tip and place the solder extractor into its stand.
30	Allow the repair area to cool completely before cleaning.
31	Clean the repair area with isopropyl alcohol using an acid brush to remove all flux residue and blot dry with a clean, lint-free tissue.
32	Remove any residual conformal coating from the repair area.

Destructive Discrete Component Removal Procedure

Step	Action
33	<p><i>Inspect per the General Inspection Procedure in WP 003 00 (paragraph 03-5.12) to all applicable WORKMANSHIP STANDARDS, including:</i></p> <ul style="list-style-type: none"> • <i>Discrete Component Leads (paragraph 07-6.1)</i> • <i>Discrete Component Body (paragraph 07-6.2)</i> • <i>Laminate in WP 011 00 (paragraph 11-6.1)</i> • <i>Conductors, Pads, and Lands in WP 012 00 (paragraph 12-6.1)</i> • <i>Other applicable Workmanship Standards as required</i>
34	Dispose of all HAZMAT following local procedures.

07-5.7 Destructive Dual In-Line Package Removal Procedure

NOTE

DESTRUCTIVE COMPONENT REMOVAL SHALL ONLY BE USED WHEN NON-DESTRUCTIVE REMOVAL PROCEDURES HAVE PROVEN TO BE INEFFECTIVE.

Use this procedure for Dual Inline Package (DIP) removal.

Use the Destructive Discrete Component Removal Procedure (paragraph 07-5.6) for discrete components.

Personnel Hazards



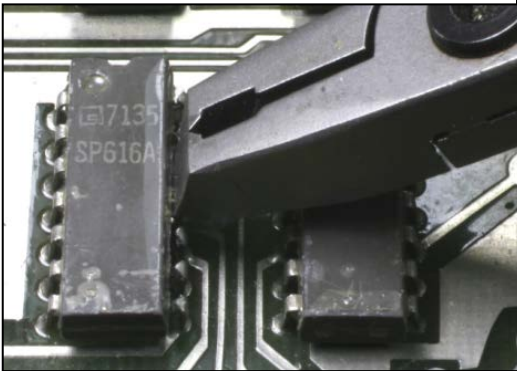

Lead (Solder)

Destructive Dual In-Line Package Removal Procedure

Step	Action								
	<p style="text-align: center;">WARNING</p> <p style="text-align: center;"><i>USE APPROVED SAFETY EYEWEAR WHEN PERFORMING THIS PROCEDURE. COMPLY WITH ALL LOCAL REQUIREMENTS FOR PPE.</i></p> <p style="text-align: center;">CAUTION</p> <p style="text-align: center;">DON A PROPERLY GROUNDED ESD WRIST STRAP BEFORE STARTING THIS PROCEDURE.</p>								
<p>1</p>	<p style="text-align: center;">CAUTION</p> <p style="text-align: center;">BEGIN THE REPAIR PROCESS AS SOON AS POSSIBLE AFTER REMOVAL FROM THE OVEN TO AVOID MOISTURE RE-ABSORPTION.</p> <p>Bake the CCA, if feasible, in accordance with the table to the right before soldering, desoldering, and conformal coating removal procedures to prevent delamination, measling, or other laminate degradation.</p> <table border="1" data-bbox="928 1010 1427 1220"> <thead> <tr> <th>Baking Temp.</th> <th>Baking Time</th> </tr> </thead> <tbody> <tr> <td>248°F (120°C)</td> <td>3.5 to 7 hours</td> </tr> <tr> <td>212°F (100°C)</td> <td>8 to 16 hours</td> </tr> <tr> <td>176°F (80°C)</td> <td>18 to 48 hours</td> </tr> </tbody> </table>	Baking Temp.	Baking Time	248°F (120°C)	3.5 to 7 hours	212°F (100°C)	8 to 16 hours	176°F (80°C)	18 to 48 hours
Baking Temp.	Baking Time								
248°F (120°C)	3.5 to 7 hours								
212°F (100°C)	8 to 16 hours								
176°F (80°C)	18 to 48 hours								
<p>2</p>	<p>Remove any conformal coating from the repair area using one of the Conformal Coating Removal Methods in WP 006 00 (paragraph 06-5.4).</p>								
<p>3</p>	<p>Cut the leads from the DIP at the lead seal.</p> 								

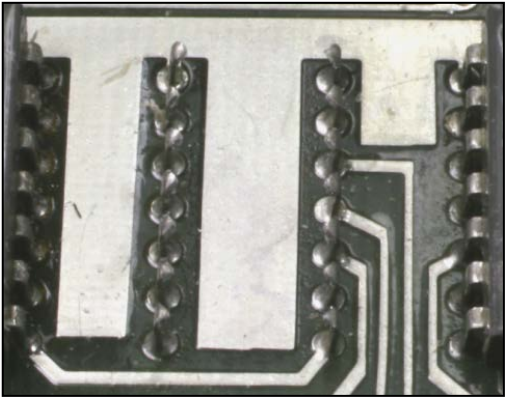

Destructive Dual In-Line Package Removal Procedure

Step	Action
4	<p>Remove the DIP body.</p> <p>Note: If the DIP is bonded to the CCA by adhesive or conformal coating, perform steps 5 through 11; otherwise, go to step 12.</p> 
5	Install the single jet tip into the hot air jet.
6	Set the hot air jet tip temperature to 900°F (482°C).
7	<p>Adjust pressure output so the hot air burns a light brown line on a tissue from approximately 1/8-1/4 in.</p> 
8	Position the end of the hot air jet tip to a distance of approximately one inch from the DIP.
9	<p>Heat the DIP body to soften any residual coating or adhesive that may bond the component to the CCA using a circular or sweeping motion.</p> <p>Note: Varying the distance of the tip to the workpiece will control the temperature and amount of hot air applied to the DIP.</p>
10	Move the DIP in a side-to-side rocking motion using a non-metallic tool until the component is free.
11	Remove the DIP.

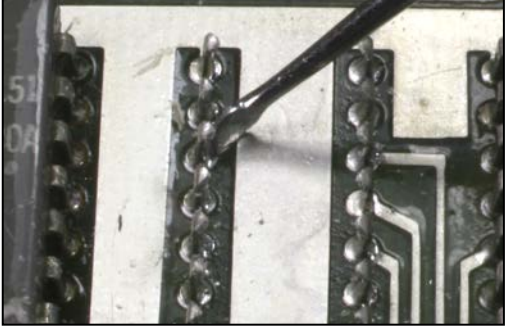
Destructive Dual In-Line Package Removal Procedure

Step	Action
12	<p>Remove any residual conformal coating from the pads on both sides of the CCA using one of the Conformal Coating Removal Methods in WP 006 00 (paragraph 06-5.4).</p> 
13	<p>For clinched leads, perform steps 14 through 16 before desoldering; otherwise, go to step 17.</p>
14	<p style="text-align: center;">CAUTION</p> <p style="text-align: center;">USE A SHOTGUN PATTERN TO PREVENT EXCESSIVE HEAT BUILDUP WHEN WICKING MULTILEAD COMPONENTS.</p> <p>Use the Wicking Procedure (paragraph 07-5.2.3) to remove surface solder from each lead.</p>
15	<p style="text-align: center;">CAUTION</p> <p style="text-align: center;">DO NOT ROTATE THE LEAD WHEN DESOLDERING DIP CLINCHED LEADS.</p> <p>Straighten the DIP leads using a non-metallic tool, being careful not to apply pressure to the plated-through hole.</p>
16	<p>Add solder to each pad and lead straightened.</p>
17	<p>Select a solder extractor tip with an inside diameter that easily fits over the lead termination and its outside diameter is smaller than the pad.</p>
18	<p>Set the solder extractor tip temperature to <u>700°F (371°C)</u>.</p>
19	<p>Place a clean tissue on a heat resistant surface and test the solder extractor by actuating vacuum to pick up the tissue.</p> <p>Note: If the solder extractor vacuum is insufficient to pick up the tissue, stop this procedure and perform the Solder Extractor Vacuum Test and Heater Element Cleaning Procedure in WP 003 00 (paragraph 03-5.7).</p>

Destructive Dual In-Line Package Removal Procedure

Step	Action
20	Clean the repair area with isopropyl alcohol using an acid brush and blot dry with a clean, lint-free tissue.
21	Apply flux SPARINGLY to each pad/lead area.
22	Position the CCA vertically in a circuit card holder, if feasible.
23	Remove the seasoning (all solder) from the solder extractor tip.
24	Thermally shock the solder extractor tip on a damp sponge.
25	<p style="text-align: center;">CAUTION</p> <p style="text-align: center;">USE A SHOTGUN PATTERN TO PREVENT EXCESSIVE HEAT BUILDUP WHEN DESOLDERING MULTILEAD COMPONENTS.</p> <p style="text-align: center;">DO NOT APPLY PRESSURE WITH THE SOLDER EXTRACTOR.</p> <p>Position the solder extractor tip so the tip contacts only the solder and the lead on the termination side of the CCA.</p>
26	<p style="text-align: center;">CAUTION</p> <p style="text-align: center;">IF SOLDER MELT DOES NOT OCCUR WITHIN TWO SECONDS, STOP THIS PROCEDURE AND ADJUST TIP TEMPERATURE PER THE TIP TEMPERATURE PROCEDURE IN WP 003 00 (PARAGRAPH 03-5.4).</p> <p>Observe COMPLETE solder melt; then use curved point tweezers to remove the lead from the component side of the CCA, while extracting the solder.</p> <div style="display: flex; justify-content: space-around;">   </div>

Destructive Dual In-Line Package Removal Procedure

Step	Action
27	Repeat step 26 until all leads and solder are removed.
28	Season the tip and place the solder extractor into its stand.
29	Allow the repair area to cool completely before cleaning.
30	Clean the repair area with isopropyl alcohol using an acid brush to remove all flux residue and blot dry with a clean, lint-free tissue.
31	Remove any residual conformal coating from the repair area.
32	<i>Inspect per the General Inspection Procedure in WP 003 00 (paragraph 03-5.12) to all applicable WORKMANSHIP STANDARDS, including:</i> <ul style="list-style-type: none">• <i>Discrete Component Leads (paragraph 07-6.1)</i>• <i>Discrete Component Body (paragraph 07-6.2)</i>• <i>Laminate in WP 011 00 (paragraph 11-6.1)</i>• <i>Conductors, Pads, and Lands in WP 012 00 (paragraph 12-6.1)</i>• <i>Other applicable Workmanship Standards as required</i>
33	Dispose of all HAZMAT following local procedures.

07-5.8 Circuit Card Assembly Preparation for Component Installation















If needed, prepare CCA pads for component installation using either the Single-Sided Pad Preparation Procedure (paragraph 07-5.8.1) or the Double-Sided Pad Preparation Procedure (paragraph 07-5.8.2) as appropriate.

07-5.8.1 Single-Sided Pad Preparation Procedure

Use this procedure to prepare pads on single-sided CCAs.

Use the Double-Sided Pad Preparation Procedure (paragraph 07-5.8.2) for double-sided CCAs.

Personnel Hazards

					
Alcohol, Isopropyl					1
					
Flux (Soldering)					8
					
Lead (Solder)					9

Single-Sided Pad Preparation Procedure

Step	Action												
	<p style="text-align: center;">WARNING</p> <p style="text-align: center;"><i>USE APPROVED SAFETY EYEWEAR WHEN PERFORMING THIS PROCEDURE.</i></p> <p style="text-align: center;"><i>COMPLY WITH ALL LOCAL REQUIREMENTS FOR PPE.</i></p> <p style="text-align: center;">CAUTION</p> <p style="text-align: center;">DON A PROPERLY GROUNDED ESD WRIST STRAP BEFORE STARTING THIS PROCEDURE.</p>												
<p>1</p>	<p style="text-align: center;">CAUTION</p> <p style="text-align: center;">BEGIN THE REPAIR PROCESS AS SOON AS POSSIBLE AFTER REMOVAL FROM THE OVEN TO AVOID MOISTURE RE-ABSORPTION.</p> <table border="1" data-bbox="381 1522 1409 1732"> <thead> <tr> <th data-bbox="381 1522 909 1570">Bake the CCA, if feasible, in accordance with the table to the right before soldering, desoldering, and conformal coating removal procedures to prevent delamination, measing, or other laminate degradation.</th> <th data-bbox="909 1522 1161 1570">Baking Temp.</th> <th data-bbox="1161 1522 1409 1570">Baking Time</th> </tr> </thead> <tbody> <tr> <td></td> <td data-bbox="909 1570 1161 1619">248°F (120°C)</td> <td data-bbox="1161 1570 1409 1619">3.5 to 7 hours</td> </tr> <tr> <td></td> <td data-bbox="909 1619 1161 1667">212°F (100°C)</td> <td data-bbox="1161 1619 1409 1667">8 to 16 hours</td> </tr> <tr> <td></td> <td data-bbox="909 1667 1161 1724">176°F (80°C)</td> <td data-bbox="1161 1667 1409 1724">18 to 48 hours</td> </tr> </tbody> </table>	Bake the CCA, if feasible, in accordance with the table to the right before soldering, desoldering, and conformal coating removal procedures to prevent delamination, measing, or other laminate degradation.	Baking Temp.	Baking Time		248°F (120°C)	3.5 to 7 hours		212°F (100°C)	8 to 16 hours		176°F (80°C)	18 to 48 hours
Bake the CCA, if feasible, in accordance with the table to the right before soldering, desoldering, and conformal coating removal procedures to prevent delamination, measing, or other laminate degradation.	Baking Temp.	Baking Time											
	248°F (120°C)	3.5 to 7 hours											
	212°F (100°C)	8 to 16 hours											
	176°F (80°C)	18 to 48 hours											
<p>2</p>	<p>Select a soldering iron tip that maximizes heat transfer and contact area with the pad without extending beyond the edge of the pad.</p>												

Single-Sided Pad Preparation Procedure

Step	Action
3	Set the soldering iron tip temperature to 600°F (316°C).
4	Clean the solder with isopropyl alcohol and wipe dry with a clean, lint-free tissue.
5	Apply flux SPARINGLY to the pad area. Note: Use a toothpick or flux pen to control the volume of flux applied. Heavy flux volume impairs cleaning and may affect reliability.
6	Remove the seasoning (all solder) from the soldering iron tip.
7	Thermally shock the soldering iron tip on a damp sponge.
8	<p style="text-align: center;">CAUTION</p> <p style="text-align: center;">DO NOT APPLY PRESSURE WITH THE SOLDERING IRON.</p> Place the soldering iron on the pad on the termination side of the CCA.
9	<p style="text-align: center;">CAUTION</p> <p style="text-align: center;">IF SOLDER MELT DOES NOT OCCUR WITHIN TWO SECONDS, STOP THIS PROCEDURE AND ADJUST TIP TEMPERATURE PER THE TIP TEMPERATURE PROCEDURE IN WP 003 00 (PARAGRAPH 03-5.4).</p> Form a heat bridge between the soldering iron tip and the pad using clean solder.
10	Cover the pad area with solder.
11	Season the tip and place the soldering iron into its stand.
12	Allow the pad area to cool completely before cleaning.
13	Clean the pad area with isopropyl alcohol using an acid brush to remove all flux residue and blot dry with a clean, lint-free tissue.
14	Select a wicking material size that fits the pad without overlapping the CCA surface. Note: If corroded, clean the wicking material with isopropyl alcohol and blot dry with a clean, lint-free tissue.

Single-Sided Pad Preparation Procedure

Step	Action
15	Apply flux SPARINGLY to the wicking material.
16	Position the wicking material on the pad.
17	Remove the seasoning from the soldering iron tip.
18	Thermally shock the soldering iron tip on a damp sponge.
19	<p style="text-align: center;">CAUTION</p> <p style="text-align: center;">DO NOT APPLY PRESSURE WITH THE SOLDERING IRON.</p> <p>Place the soldering iron tip on the wicking material/pad.</p>
20	<p style="text-align: center;">CAUTION</p> <p style="text-align: center;">IF SOLDER MELT DOES NOT OCCUR WITHIN FOUR SECONDS, STOP THIS PROCEDURE AND ADJUST TIP TEMPERATURE PER THE TIP TEMPERATURE PROCEDURE IN WP 003 00 (PARAGRAPH 03-5.4).</p> <p>Observe the capillary action (solder flow) into the wicking material; when solder flow stops, remove the soldering iron and the wicking material simultaneously.</p>
21	Season the tip and place the soldering iron into its stand.
22	Remove the used portion of wicking material from the spool using utility cutters.
23	Allow the pad area to cool completely before cleaning.
24	<p>Clean the pad area with isopropyl alcohol using an acid brush to remove all flux residue and blot dry with a clean, lint-free tissue.</p> <p>Note: Take precautions to prevent bare skin contact before the component is soldered. Skin contact leaves contaminants on the pads.</p>
25	Repeat steps 15 through 24 as necessary to remove any remaining solder.

Single-Sided Pad Preparation Procedure















Step	Action
26	<p><i>Inspect per the General Inspection Procedure in WP 003 00 (paragraph 03-5.12) to all applicable WORKMANSHIP STANDARDS, including:</i></p> <ul style="list-style-type: none"> • <i>Post-Solder Joint Cleanliness in WP 005 00 (paragraph 05-6.2)</i> • <i>Discrete Component Leads (paragraph 07-6.1)</i> • <i>Discrete Component Body (paragraph 07-6.2)</i> • <i>Laminate in WP 011 00 (paragraph 11-6.1)</i> • <i>Conductors, Pads, and Lands in WP 012 00 (paragraph 12-6.1)</i> • <i>Other applicable Workmanship Standards as required</i>
27	Dispose of all HAZMAT following local procedures.

07-5.8.2 Double-Sided Pad Preparation Procedure

Use this procedure to prepare pads on double-sided CCAs.

Use the Single-Sided Pad Preparation Procedure (paragraph 07-5.8.1) for single-sided CCAs.

Personnel Hazards

					1
Alcohol, Isopropyl					
					8
Flux (Soldering)					
					9
Lead (Solder)					

Double-Sided Pad Preparation Procedure

Step	Action										
	<p style="text-align: center;">WARNING</p> <p style="text-align: center;"><i>USE APPROVED SAFETY EYEWEAR WHEN PERFORMING THIS PROCEDURE. COMPLY WITH ALL LOCAL REQUIREMENTS FOR PPE.</i></p> <p style="text-align: center;">CAUTION</p> <p style="text-align: center;">DON A PROPERLY GROUNDED ESD WRIST STRAP BEFORE STARTING THIS PROCEDURE.</p>										
<p>1</p>	<p style="text-align: center;">CAUTION</p> <p style="text-align: center;">BEGIN THE REPAIR PROCESS AS SOON AS POSSIBLE AFTER REMOVAL FROM THE OVEN TO AVOID MOISTURE RE-ABSORPTION.</p> <table border="1" data-bbox="381 1010 1414 1220"> <tr> <td data-bbox="381 1010 911 1220"> Bake the CCA, if feasible, in accordance with the table to the right before soldering, desoldering, and conformal coating removal procedures to prevent delamination, measling, or other laminate degradation. </td> <td data-bbox="911 1010 1162 1220"> <table border="1"> <thead> <tr> <th>Baking Temp.</th> <th>Baking Time</th> </tr> </thead> <tbody> <tr> <td>248°F (120°C)</td> <td>3.5 to 7 hours</td> </tr> <tr> <td>212°F (100°C)</td> <td>8 to 16 hours</td> </tr> <tr> <td>176°F (80°C)</td> <td>18 to 48 hours</td> </tr> </tbody> </table> </td> </tr> </table>	Bake the CCA, if feasible, in accordance with the table to the right before soldering, desoldering, and conformal coating removal procedures to prevent delamination, measling, or other laminate degradation.	<table border="1"> <thead> <tr> <th>Baking Temp.</th> <th>Baking Time</th> </tr> </thead> <tbody> <tr> <td>248°F (120°C)</td> <td>3.5 to 7 hours</td> </tr> <tr> <td>212°F (100°C)</td> <td>8 to 16 hours</td> </tr> <tr> <td>176°F (80°C)</td> <td>18 to 48 hours</td> </tr> </tbody> </table>	Baking Temp.	Baking Time	248°F (120°C)	3.5 to 7 hours	212°F (100°C)	8 to 16 hours	176°F (80°C)	18 to 48 hours
Bake the CCA, if feasible, in accordance with the table to the right before soldering, desoldering, and conformal coating removal procedures to prevent delamination, measling, or other laminate degradation.	<table border="1"> <thead> <tr> <th>Baking Temp.</th> <th>Baking Time</th> </tr> </thead> <tbody> <tr> <td>248°F (120°C)</td> <td>3.5 to 7 hours</td> </tr> <tr> <td>212°F (100°C)</td> <td>8 to 16 hours</td> </tr> <tr> <td>176°F (80°C)</td> <td>18 to 48 hours</td> </tr> </tbody> </table>	Baking Temp.	Baking Time	248°F (120°C)	3.5 to 7 hours	212°F (100°C)	8 to 16 hours	176°F (80°C)	18 to 48 hours		
Baking Temp.	Baking Time										
248°F (120°C)	3.5 to 7 hours										
212°F (100°C)	8 to 16 hours										
176°F (80°C)	18 to 48 hours										
<p>2</p>	<p>Select a soldering iron tip that maximizes heat transfer and contact area with the pads without extending beyond the pad edges.</p>										
<p>3</p>	<p>Set the soldering iron tip temperature to 600°F (316°C).</p>										
<p>4</p>	<p>Clean the solder with isopropyl alcohol and wipe dry with a clean, lint-free tissue.</p>										
<p>5</p>	<p>Apply flux SPARINGLY to the pad areas.</p> <p>Note: Use a toothpick or flux pen to control the volume of flux applied. Heavy flux volume impairs cleaning and may affect reliability.</p>										
<p>6</p>	<p>Remove the seasoning (all solder) from the soldering iron tip.</p>										
<p>7</p>	<p>Thermally shock the soldering iron tip on a damp sponge.</p>										

Double-Sided Pad Preparation Procedure

Step	Action
8	<p style="text-align: center;">CAUTION</p> <p style="text-align: center;">DO NOT APPLY PRESSURE WITH THE SOLDERING IRON.</p> <p>Place the soldering iron on a pad on the termination side of the CCA.</p>
9	<p style="text-align: center;">CAUTION</p> <p style="text-align: center;">IF SOLDER MELT DOES NOT OCCUR WITHIN TWO SECONDS, STOP THIS PROCEDURE AND ADJUST TIP TEMPERATURE PER THE TIP TEMPERATURE PROCEDURE IN WP 003 00 (PARAGRAPH 03-5.4).</p> <p>Form a heat bridge between the soldering iron tip and the pad using clean solder.</p>
10	<p>Apply solder to the pad area filling the plated through-hole and covering the pad from the termination side.</p>
11	<p style="text-align: center;">CAUTION</p> <p style="text-align: center;">USE A SHOTGUN PATTERN TO PREVENT EXCESSIVE HEAT BUILDUP WHEN SOLDERING MULTILEAD CONDUCTIVE PATTERNS.</p> <p>Repeat steps 8 through 10 for each pad.</p>
12	<p>Season the tip and place the soldering iron into its stand.</p>
13	<p>Allow the pad areas to cool completely before cleaning.</p>
14	<p>Clean the pad areas on both sides of the CCA with isopropyl alcohol using an acid brush to remove all flux residue and blot dry with a clean, lint-free tissue.</p>
15	<p>Select a solder extractor tip with an outside diameter smaller than the pads.</p>
16	<p>Set the solder extractor tip temperature to 600°F (316°C).</p>
17	<p>Place a clean tissue on a heat resistant surface and test the solder extractor by actuating vacuum to pick up the tissue.</p> <p>Note: If the solder extractor vacuum is insufficient to pick up the tissue, stop this procedure and perform the Solder Extractor Vacuum Test and Heater Element Cleaning Procedure in WP 003 00 (paragraph 03-5.7).</p>

Double-Sided Pad Preparation Procedure

Step	Action
18	Apply flux SPARINGLY to the pad areas on both sides of the CCA.
19	Remove the seasoning from the solder extractor tip.
20	Thermally shock the solder extractor tip on a damp sponge.
21	<p style="text-align: center;">CAUTION</p> <p style="text-align: center;">DO NOT APPLY PRESSURE WITH THE SOLDER EXTRACTOR.</p> <p>Place solder extractor tip on the component side of the pad area contacting only the solder, not the pad.</p>
22	<p style="text-align: center;">CAUTION</p> <p style="text-align: center;">IF SOLDER MELT DOES NOT OCCUR WITHIN TWO SECONDS, STOP THIS PROCEDURE AND ADJUST TIP TEMPERATURE PER THE TIP TEMPERATURE PROCEDURE IN WP 003 00 (PARAGRAPH 03-5.4).</p> <p>Observe COMPLETE solder melt; then actuate vacuum using the handpiece vacuum control switch or the foot pedal switch.</p>
23	After complete solder extraction, remove the solder extractor tip from the solder joint allowing the solder extractor vacuum to run continuously for an additional five seconds to draw the molten solder completely into the solder trap.
24	<p style="text-align: center;">CAUTION</p> <p style="text-align: center;">USE A SHOTGUN PATTERN TO PREVENT EXCESSIVE HEAT BUILDUP WHEN DESOLDERING MULTILEAD CONDUCTIVE PATTERNS.</p> <p>Repeat steps 8 through 22 for each pad.</p>
25	Season the tip and place the soldering iron into its stand.
26	Allow the pad areas to cool completely before cleaning.
27	Clean the pad areas on both sides of the CCA with isopropyl alcohol using an acid brush to remove all flux residue and blot dry with a clean, lint-free tissue.

Double-Sided Pad Preparation Procedure

Step	Action
28	Repeat steps 5 through 27 as necessary to remove any remaining solder.
29	<p><i>Inspect per the General Inspection Procedure in WP 003 00 (paragraph 03-5.12) to all applicable WORKMANSHIP STANDARDS, including:</i></p> <ul style="list-style-type: none"> • <i>Post-Solder Joint Cleanliness in WP 005 00 (paragraph 05-6.2)</i> • <i>Discrete Component Leads (paragraph 07-6.1)</i> • <i>Discrete Component Body (paragraph 07-6.2)</i> • <i>Laminate in WP 011 00 (paragraph 11-6.1)</i> • <i>Conductors, Pads, and Lands in WP 012 00 (paragraph 12-6.1)</i> • <i>Other applicable Workmanship Standards as required</i>
30	Dispose of all HAZMAT following local procedures.

07-5.9 Component Lead Preparation for Installation

Prepare component leads for installation using either the Discrete Component Lead Preparation Procedure (paragraph 07-5.9.1) or the Dual In-Line Package Lead Preparation Procedure (paragraph 07-5.9.2).

07-5.9.1 Discrete Component Lead Preparation Procedure

Use this procedure to prepare discrete component leads for installation.

Use the Dual In-Line Package Lead Preparation Procedure (paragraph 07-5.9.2) for DIPs.

Personnel Hazards



Alcohol, Isopropyl

1



Flux (Soldering)

8



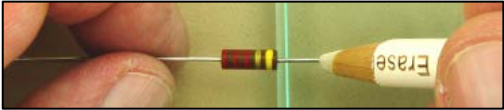

Lead (Solder)

Discrete Component Lead Preparation Procedure

Step	Action
	<p style="text-align: center;">WARNING</p> <p style="text-align: center;"><i>USE APPROVED SAFETY EYEWEAR WHEN PERFORMING THIS PROCEDURE.</i></p> <p style="text-align: center;"><i>COMPLY WITH ALL LOCAL REQUIREMENTS FOR PPE.</i></p> <p style="text-align: center;">CAUTION</p> <p style="text-align: center;">DON A PROPERLY GROUNDED ESD WRIST STRAP BEFORE STARTING THIS PROCEDURE.</p> <p style="text-align: center;">ALL GOLD LEADS SHALL BE DOUBLE-TINNED TO PREVENT GOLD EMBRITTLEMENT.</p> <p style="text-align: center;">NOTE</p> <p style="text-align: center;">REFER TO WP 003 00 (PARAGRAPH 03-5.11) FOR THE SOLDER POT TINNING PROCEDURE.</p>
1	Select a soldering iron tip that maximizes heat transfer and contact area with the component leads.
2	Set the soldering iron tip temperature to 600°F (316°C).
3	Straighten the component leads by using duckbill pliers or by rolling between two non-marring surfaces e.g., tongue depressor and glass slab.
4	Remove oxidization from the leads using an eraser, working away from the component body. 
5	Clean the component lead terminations with isopropyl alcohol using an acid brush and wipe dry with a clean, lint-free tissue.
6	Apply a clean heat sink, such as anti-wicking tweezers, at the base of the component body to the component lead.

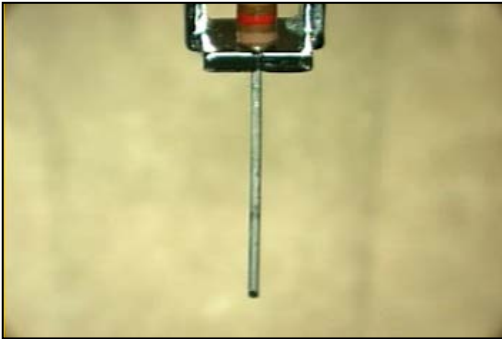
Discrete Component Lead Preparation Procedure

Step	Action
7	Secure the component in a holding device, slanting downward if possible. 
8	Clean the solder with isopropyl alcohol and wipe dry with a clean, lint-free tissue.
9	Apply flux SPARINGLY to the component lead.
10	Remove the seasoning (all solder) from the soldering iron tip.
11	Thermally shock the soldering iron tip on a damp sponge.
12	<p style="text-align: center;">CAUTION</p> <p style="text-align: center;">DO NOT APPLY PRESSURE WITH THE SOLDERING IRON.</p> Place the soldering iron tip behind and in contact with the lead, midway down the lead from the heat sink.
13	<p style="text-align: center;">CAUTION</p> <p style="text-align: center;">IF SOLDER MELT DOES NOT OCCUR WITHIN TWO SECONDS, STOP THIS PROCEDURE AND ADJUST TIP TEMPERATURE PER THE TIP TEMPERATURE PROCEDURE IN WP 003 00 (PARAGRAPH 03-5.4).</p> Form a heat bridge between the soldering iron tip and the lead using clean solder. 

Discrete Component Lead Preparation Procedure

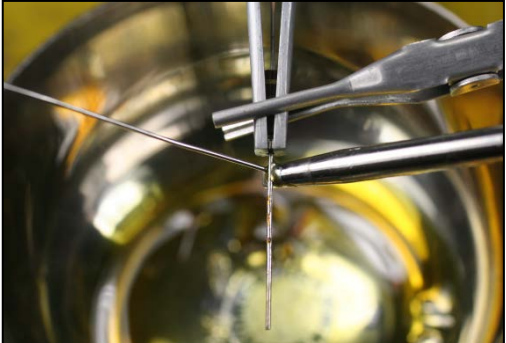
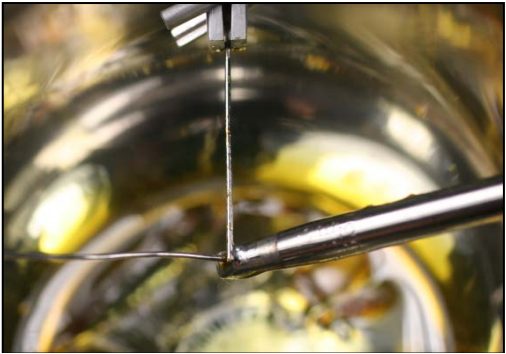
Step	Action
14	<p>Encapsulate the lead with solder and move the soldering iron tip and the solder up the lead toward the heat sink.</p> <p>Note: Continuously add solder throughout the entire tinning process.</p>
15	<p>Hesitate briefly at the junction of the lead and the heat sink, while continuing to flow solder into the lead.</p> 
16	<p>Move the soldering iron tip and solder down and past the end of the lead simultaneously.</p> 
17	<p>Repeat steps 11 through 16 for each lead.</p>
18	<p>Season the tip and place the soldering iron into its stand.</p>
19	<p>Allow the leads to cool completely before cleaning.</p>
20	<p>Clean the leads with isopropyl alcohol using an acid brush to remove all flux residue and wipe dry with a clean, lint-free tissue.</p> <p>Note: Take precautions to prevent bare skin contact before the component is soldered. Skin contact leaves contaminants on the leads.</p>

Discrete Component Lead Preparation Procedure















Step	Action
21	<p><i>Inspect per the General Inspection Procedure in WP 003 00 (paragraph 03-5.12) to all applicable WORKMANSHIP STANDARDS, including:</i></p> <ul style="list-style-type: none"> • <i>Discrete Component Leads (paragraph 07-6.1)</i> • <i>Discrete Component Body (paragraph 07-6.2)</i> • <i>Component Lead Tinning (paragraph 07-6.3)</i> • <i>Other applicable Workmanship Standards as required</i>
22	Clean the holding device with isopropyl alcohol.
23	Dispose of all HAZMAT following local procedures.

07-5.9.2 Dual In-Line Package Lead Preparation Procedure

Use this procedure to prepare Dual Inline Package (DIP) leads for installation.

Use the Discrete Component Lead Preparation Procedure (paragraph 07-5.9.1) for discrete components.

Personnel Hazards

					1
Alcohol, Isopropyl					
					8
Flux (Soldering)					
					9
Lead (Solder)					

Dual In-Line Package Lead Preparation Procedure

Step	Action
	<p style="text-align: center;">WARNING</p> <p style="text-align: center;">USE APPROVED SAFETY EYEWEAR WHEN PERFORMING THIS PROCEDURE.</p> <p style="text-align: center;">COMPLY WITH ALL LOCAL REQUIREMENTS FOR PPE.</p> <p style="text-align: center;">CAUTION</p> <p style="text-align: center;">DON A PROPERLY GROUNDED ESD WRIST STRAP BEFORE STARTING THIS PROCEDURE.</p> <p style="text-align: center;">ALL GOLD LEADS SHALL BE DOUBLE-TINNED TO PREVENT GOLD EMBRITTLEMENT.</p> <p style="text-align: center;">NOTE</p> <p style="text-align: center;">REFER TO WP 003 00 (PARAGRAPH 03-5.11) FOR THE SOLDER POT TINNING PROCEDURE.</p>
1	Select a soldering iron tip that maximizes heat transfer and contact area with the DIP leads.
2	Set the soldering iron tip temperature to <u>500°F (260°C)</u> .
3	<p style="text-align: center;">CAUTION</p> <p style="text-align: center;">AVOID ABRASIVE METHODS (I.E., INK ERASER) TO CLEAN DIP LEADS.</p> <p style="text-align: center;">ABRASION MAY EXPOSE NON-SOLDERABLE BASE MATERIAL.</p> <p>Place the DIP in a holding device.</p>
4	Clean the solder with isopropyl alcohol and wipe dry with a clean, lint-free tissue.
5	Apply flux SPARINGLY to each lead. Note: Use a toothpick or flux pen to control the volume of flux applied. Heavy flux volume impairs cleaning and may affect reliability.
6	Remove the seasoning (all solder) from the soldering iron tip.
7	Thermally shock the soldering iron tip on a damp sponge.

Dual In-Line Package Lead Preparation Procedure

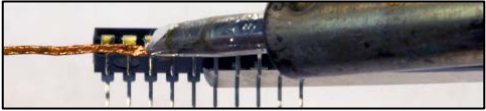
Step	Action
8	Place the soldering iron tip behind and in contact with the lead.
9	<div style="text-align: center; border: 2px solid black; padding: 5px; margin-bottom: 10px;">CAUTION</div> <p style="text-align: center;">IF SOLDER MELT DOES NOT OCCUR WITHIN TWO SECONDS, STOP THIS PROCEDURE AND ADJUST TIP TEMPERATURE PER THE TIP TEMPERATURE PROCEDURE IN WP 003 00 (PARAGRAPH 03-5.4).</p> <p>Form a heat bridge between the soldering iron tip and a DIP lead using clean solder.</p>
10	Slide the soldering and solder together off the end the lead.
11	Repeat steps 8 through 10 for each lead.
12	Season the tip and place the soldering iron into its stand.
13	Allow the DIP to cool completely before cleaning.
14	Clean the DIP body and the leads with isopropyl alcohol using an acid brush to remove all flux residue and blot dry with a clean, lint-free tissue.
15	<p>Wick off any excess solder from the DIP leads using the Wicking Procedure (paragraph 07-5.2.3), if necessary.</p> 
16	<p>After wicking, clean the DIP body and the leads again with isopropyl alcohol using an acid brush to remove all flux residue and blot dry with a clean, lint-free tissue.</p> <p>Note: Take precautions to prevent bare skin contact before the component is soldered. Skin contact leaves contaminants on the leads.</p>
17	<p><i>Inspect per the General Inspection Procedure in WP 003 00 (paragraph 03-5.12) to all applicable WORKMANSHIP STANDARDS, including:</i></p> <ul style="list-style-type: none"> • <i>Discrete Component Leads (paragraph 07-6.1)</i> • <i>Discrete Component Body (paragraph 07-6.2)</i> • <i>Component Lead Tinning (paragraph 07-6.3)</i> • <i>Other applicable Workmanship Standards as required</i>
18	Dispose of all HAZMAT following local procedures.

07-5.10 Lead Forming and Component Mounting

Form the leads and mount the component using the Axial Lead Horizontal Flush Mount Procedure (paragraph 07-5.10.1), the Axial Lead Horizontal Mount with Stress Relief Procedure (paragraph 07-5.10.2), the Axial Lead Standoff Mount Procedure (paragraph 07-5.10.3), the Axial Lead Vertical Mount Procedure (paragraph 07-5.10.4), the Radial Lead Vertical Mount Procedure (paragraph 07-5.10.5), the Radial Lead Horizontal Mount Procedure (paragraph 07-5.10.6), or the Dual In-Line Package Mounting Procedure (paragraph 07-5.10.7), as applicable to the component mounting requirements.

07-5.10.1 Axial Lead Horizontal Flush Mount Procedure

Use this procedure to mount an axial leaded component horizontally, flush to the CCA.

Personnel Hazards



Lead (Solder)

9

Axial Lead Horizontal Flush Mount Procedure

Step	Action
	<div style="text-align: center;"> <div style="border: 2px solid black; padding: 5px; margin-bottom: 10px;">WARNING</div> <p>USE APPROVED SAFETY EYEWEAR WHEN PERFORMING THIS PROCEDURE.</p> <p>COMPLY WITH ALL LOCAL REQUIREMENTS FOR PPE.</p> <div style="border: 2px solid black; padding: 5px; margin-bottom: 10px;">CAUTION</div> <p>DON A PROPERLY GROUNDED ESD WRIST STRAP BEFORE STARTING THIS PROCEDURE.</p> </div>
1	<p>Orient the component so the identification markings will be visible after the installation.</p> <p>Priority of component markings is as follows:</p> <ul style="list-style-type: none"> (1) electrical value (2) reliability level (3) part number <p>Non-polarized components shall read from left-to-right.</p>

Axial Lead Horizontal Flush Mount Procedure

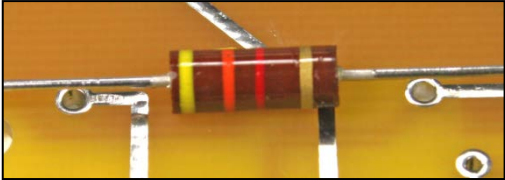
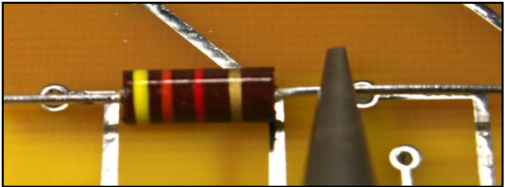
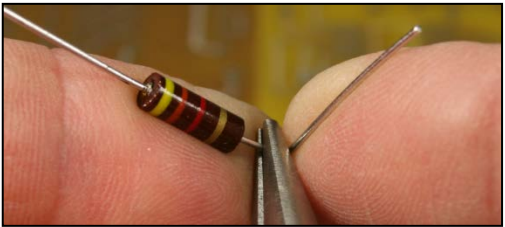
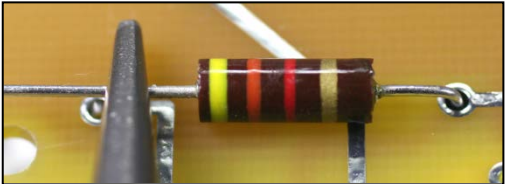
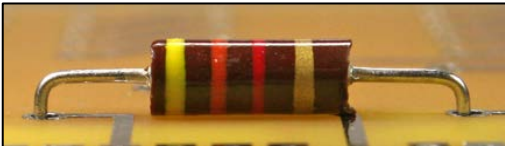
Step	Action
2	Install insulation sleeving and mounting hardware over the lead or over the component before forming the leads, if required.
3	Center the component between the mounting holes on the termination side of the CCA. 
4	Grasp the component lead between the component body and the mounting hole at the inside edge of the mounting hole conforming to lead bend requirements. 
5	Holding the forming tool stationary, bend the lead 90° around the forming tool. Note: The inside bend radius shall be greater than or equal to one lead diameter (rectangular leads use the thickness of the lead). 
6	Insert the formed lead into the mounting hole.
7	Grasp the unformed component lead between the component body and the mounting hole at the inside edge of the mounting hole, conforming to lead bend requirements. 
8	Remove the component from the CCA and bend the lead 90° around the forming tool.
9	Mount the component so the entire length of the component body is in contact with the CCA surface. Note: In cases where space between the laminate and the component is required for heat dissipation, use the Axial Lead Standoff Mount Procedure (paragraph 07-5.10.3) Note: Polarized components must be oriented correctly. 

Axial Lead Horizontal Flush Mount Procedure

Step	Action
10	<p><i>Inspect per the General Inspection Procedure in WP 003 00 (paragraph 03-5.12) to all applicable WORKMANSHIP STANDARDS, including:</i></p> <ul style="list-style-type: none"> • <i>Discrete Component Leads (paragraph 07-6.1)</i> • <i>Discrete Component Body (paragraph 07-6.2)</i> • <i>Component Sleeving (Buffer Material) (paragraph 07-6.6) as required</i> • <i>Component Leads Crossing Conductors (paragraph 07-6.7) as required</i> • <i>Component Lead Forming (paragraph 07-6.8)</i> • <i>Component Orientation (paragraph 07-6.9)</i> • <i>Component Mounting Horizontal, Axial Leaded (paragraph 07-6.10)</i> • <i>Other applicable Workmanship Standards as required</i>

07-5.10.2 Axial Lead Horizontal Mount with Stress Relief Procedure

Use this procedure to mount an axial leaded component horizontally with stress relief.

Personnel Hazards





Lead (Solder)

9

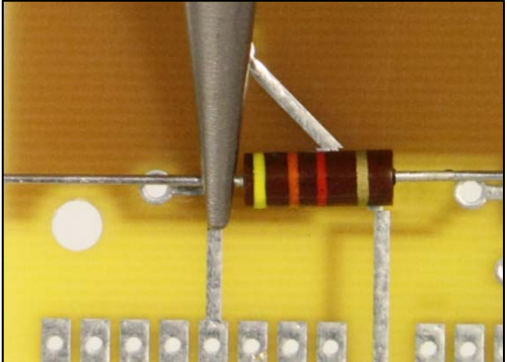

Axial Lead Horizontal Mount with Stress Relief Procedure

Step	Action
	<div style="text-align: center;"> <div style="border: 2px solid black; padding: 5px; width: fit-content; margin: 0 auto;">WARNING</div> <p>USE APPROVED SAFETY EYEWEAR WHEN PERFORMING THIS PROCEDURE.</p> <p>COMPLY WITH ALL LOCAL REQUIREMENTS FOR PPE.</p> <div style="border: 2px solid black; padding: 5px; width: fit-content; margin: 0 auto;">CAUTION</div> <p>DON A PROPERLY GROUNDED ESD WRIST STRAP BEFORE STARTING THIS PROCEDURE.</p> </div>

Axial Lead Horizontal Mount with Stress Relief Procedure

Step	Action
1	<p>Orient the component so the identification markings will be visible after the installation.</p> <p>Priority of component markings is as follows:</p> <ul style="list-style-type: none"> (1) electrical value (2) reliability level (3) part number <p>Non-polarized components shall read from left-to-right.</p>
2	<p>Install insulation sleeving and mounting hardware over the lead or over the component before forming the leads, if required.</p>
3	<p>Center the component between the mounting holes on the termination side of the CCA.</p>
4	<p>Grasp the component lead at a point one plier width from the inside of the mounting hole conforming to lead bend requirements.</p> 
5	<p>Holding the forming tool stationary, bend the lead 90° around the forming tool.</p> <p>Note: The inside bend radius shall be greater than or equal to one lead diameter (rectangular leads use the thickness of the lead).</p> 
6	<p>Release the forming tool and remove the component lead, rotate the forming tool 90° and grasp the lead at the formed bend.</p>

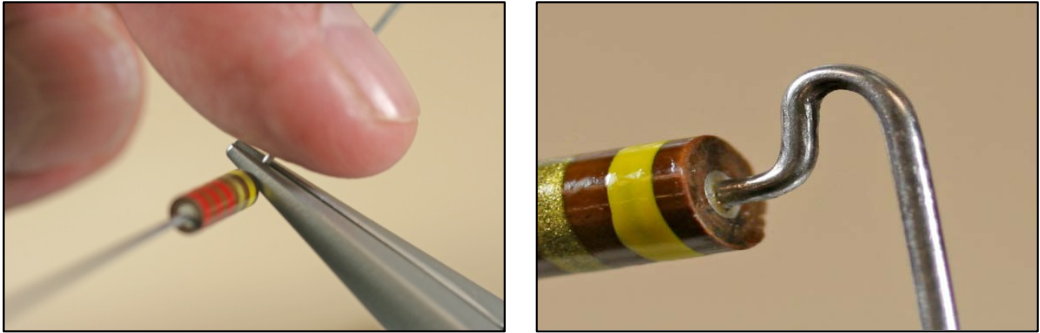
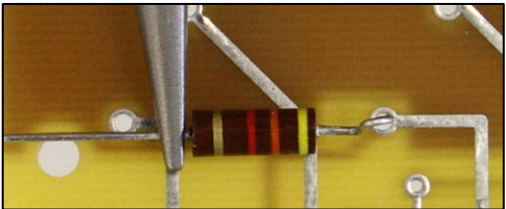
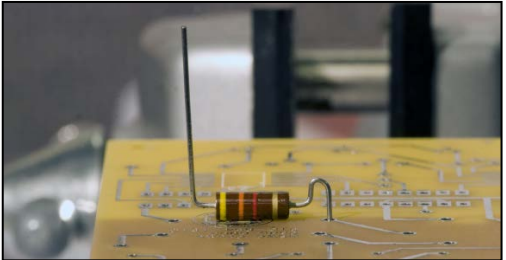
Axial Lead Horizontal Mount with Stress Relief Procedure

Step	Action
7	<p>Bend the lead down and around the pliers forming the second (180°) bend.</p> 
8	<p>Insert the formed lead into the mounting hole and grasp the component lead at a point one plier width from the inside of the mounting hole conforming to lead bend requirements.</p> 
9	<p>Holding the forming tool stationary, bend the lead 90° around the forming tool, toward the top of the component.</p> <p>Note: The inside bend radius shall be greater than or equal to one lead diameter (rectangular leads use the thickness of the lead).</p> 
10	<p>Release the forming tool and remove the component lead, rotate the forming tool 90° and grasp the lead at the formed bend.</p> 
11	<p>Bend the lead down and around the pliers forming the second (180°) bend.</p>
12	<p>Mount the component so the entire length of the component body is in contact with the CCA surface.</p> <p>Note: Polarized components must be oriented correctly.</p>

Axial Lead Horizontal Mount with Stress Relief Procedure

Step	Action
13	<p><i>Inspect per the General Inspection Procedure in WP 003 00 (paragraph 03-5.12) to all applicable WORKMANSHIP STANDARDS, including:</i></p> <ul style="list-style-type: none"> • <i>Discrete Component Leads (paragraph 07-6.1)</i> • <i>Discrete Component Body (paragraph 07-6.2)</i> • <i>Component Sleeving (Buffer Material) (paragraph 07-6.6) as required</i> • <i>Component Leads Crossing Conductors (paragraph 07-6.7) as required</i> • <i>Component Lead Forming (paragraph 07-6.8)</i> • <i>Component Orientation (paragraph 07-6.9)</i> • <i>Component Mounting Horizontal, Axial Leaded with Stress Relief (paragraph 07-6.11)</i> • <i>Other applicable Workmanship Standards as required</i>

07-5.10.3 Axial Lead Standoff Mount Procedure

Use this procedure to standoff mount an axial leaded component usually a one watt or greater resistor.

Personnel Hazards



Lead (Solder)

Axial Lead Standoff Mount Procedure



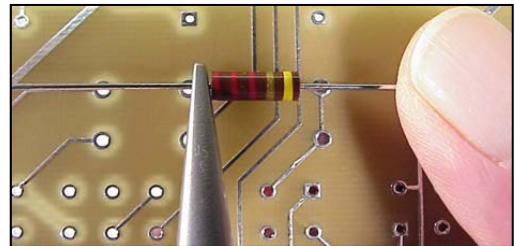

Step	Action
	<div style="text-align: center;"> <div style="border: 3px double black; padding: 5px; display: inline-block;"> WARNING </div> <p>USE APPROVED SAFETY EYEWEAR WHEN PERFORMING THIS PROCEDURE.</p> <p>COMPLY WITH ALL LOCAL REQUIREMENTS FOR PPE.</p> </div>

Axial Lead Standoff Mount Procedure

Step	Action
	<div style="border: 2px solid black; padding: 5px; display: inline-block; margin-bottom: 10px;">CAUTION</div> <p>DON A PROPERLY GROUNDED ESD WRIST STRAP BEFORE STARTING THIS PROCEDURE.</p>
1	<p>Orient the component so the identification markings will be visible after the installation.</p> <p>Priority of component markings is as follows:</p> <ul style="list-style-type: none"> (1) electrical value (2) reliability level (3) part number <p>Non-polarized components shall read from left-to-right.</p>
2	<p>Install insulation sleeving and mounting hardware over the lead or over the component before forming the leads, if required.</p>
3	<p>Center the component between the mounting holes on the termination side of the CCA.</p>
4	<p>Grasp the component lead between the component body and the mounting hole at the inside edge of the mounting hole conforming to lead bend requirements.</p>
5	<p>Bracing the component body, bend the lead 90° around the forming tool.</p> <p>Note: The inside bend radius shall be greater than or equal to one lead diameter (rectangular leads use the thickness of the lead).</p>
6	<p>Insert the formed lead into the mounting hole, repeat steps 4 and 5 for the other component lead.</p>

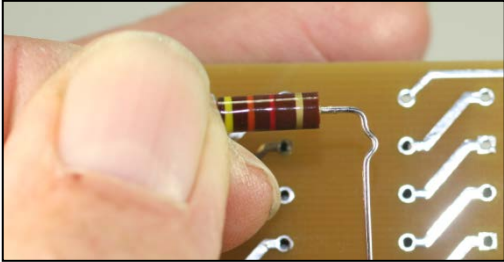
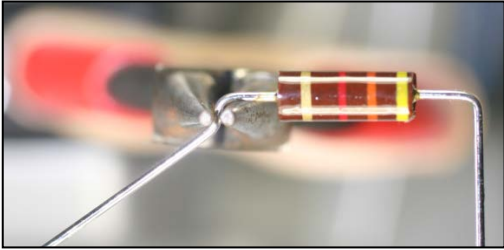

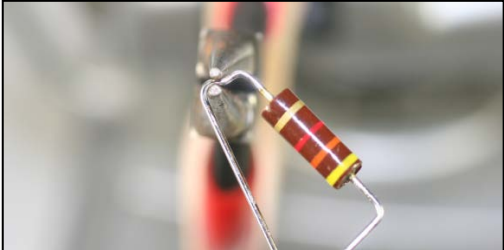
Axial Lead Standoff Mount Procedure

Step	Action
7	<p>For components to be mounted to single-sided CCAs, perform steps 8 through 12 to make a lead form (small 180° bend) on both leads at the CCA surface to prevent lifting the pads.</p> 
8	<p>Grasp the lead at a point even with the bottom of the component body and form the lead outward to a 45° angle.</p> 
9	<p>Reposition the pliers to the opposite side of the bend.</p> 
10	<p>Bend the lead 180° around the pliers.</p> 
11	<p>Reposition the pliers to the bottom of the 180° bend.</p> 

Axial Lead Standoff Mount Procedure

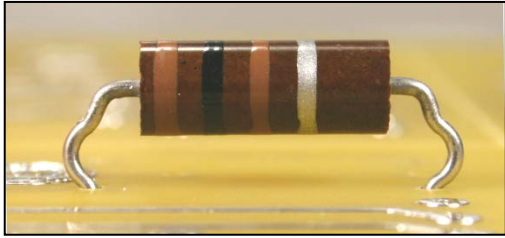
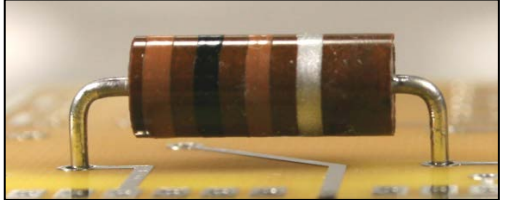
Step	Action
12	<p>Form the lead downward 45° so the lead will be perpendicular as it enters the mounting hole.</p> <p>Note: The component shall be mounted so the lead forms contact the CCA surface.</p> <div style="display: flex; justify-content: space-around;">   </div>
13	<p>Mount the component so the component body is at least 1/16 in. above the CCA surface.</p> <p>Note: Polarized components must be oriented correctly.</p> <div style="text-align: right;">  </div>
14	<p><i>Inspect per the General Inspection Procedure in WP 003 00 (paragraph 03-5.12) to all applicable WORKMANSHIP STANDARDS, including:</i></p> <ul style="list-style-type: none"> • <i>Discrete Component Leads (paragraph 07-6.1)</i> • <i>Discrete Component Body (paragraph 07-6.2)</i> • <i>Component Sleeving (Buffer Material) (paragraph 07-6.6) as required</i> • <i>Component Leads Crossing Conductors (paragraph 07-6.7) as required</i> • <i>Component Lead Forming (paragraph 07-6.8)</i> • <i>Component Orientation (paragraph 07-6.9)</i> • <i>Component Mounting Horizontal, Axial Leaded (paragraph 07-6.10)</i> • <i>Other applicable Workmanship Standards as required</i>

07-5.10.4 Axial Lead Vertical Mount Procedure

Use this procedure to mount an axial leaded component vertically.

Personnel Hazards



Lead (Solder)

9

Axial Lead Vertical Mount Procedure

Step	Action
	<div style="text-align: center;"> <div style="border: 2px solid black; padding: 5px; margin-bottom: 10px;">WARNING</div> <p>USE APPROVED SAFETY EYEWEAR WHEN PERFORMING THIS PROCEDURE.</p> <p>COMPLY WITH ALL LOCAL REQUIREMENTS FOR PPE.</p> <div style="border: 2px solid black; padding: 5px; margin-bottom: 10px;">CAUTION</div> <p>DON A PROPERLY GROUNDED ESD WRIST STRAP BEFORE STARTING THIS PROCEDURE.</p> </div>
<p>1</p>	<p>Orient the component so the identification markings will be visible after the installation.</p> <p>Priority of component markings is as follows:</p> <ul style="list-style-type: none"> (1) electrical value (2) reliability level (3) part number <p>Non-polarized components shall read from top-to-bottom.</p>
<p>2</p>	<p>Install insulation sleeving and mounting hardware over the lead or over the component before forming the leads, if required.</p>
<p>3</p>	<p>Grasp the component lead 1/16 in. from the component lead seal, solder bead, or lead weld.</p>
<p>4</p>	<p>Bracing the component body, bend the lead 90° around the forming tool.</p> <p>Note: The inside bend radius shall be greater than or equal to one lead diameter (rectangular leads use the thickness of the lead).</p>

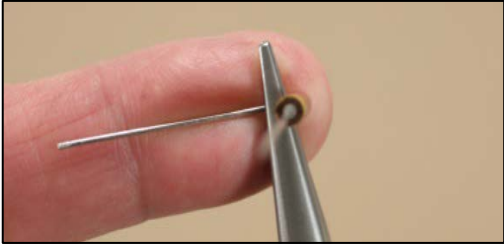

Axial Lead Vertical Mount Procedure

Step	Action
5	Center the bend over one of the mounting holes.
6	<p>Put unformed lead into mounting hole and grasp the component lead at the inside edge of the other mounting hole.</p> 
7	<p>Bend the lead 90° around the forming tool to form a second bend.</p> <p>Note: The inside bend radius shall be greater than or equal to one lead diameter (rectangular leads use the thickness of the lead).</p> 
8	<p>Mount the component so the component body is 1/16 in. above and perpendicular to the CCA surface.</p> <p>Note: Polarized components must be oriented correctly.</p> <p>Note: For axial lead vertical mount on single sided CCAs, replicate the original mounting configuration.</p>
9	<p><i>Inspect per the General Inspection Procedure in WP 003 00 (paragraph 03-5.12) to all applicable WORKMANSHIP STANDARDS, including:</i></p> <ul style="list-style-type: none"> • <i>Discrete Component Leads (paragraph 07-6.1)</i> • <i>Discrete Component Body (paragraph 07-6.2)</i> • <i>Component Sleeving (Buffer Material) (paragraph 07-6.6) as required</i> • <i>Component Leads Crossing Conductors (paragraph 07-6.7) as required</i> • <i>Component Lead Forming (paragraph 07-6.8)</i> • <i>Component Orientation (paragraph 07-6.9)</i> • <i>Component Mounting Vertical, Axial Leaded (paragraph 07-6.13)</i> • <i>Other applicable Workmanship Standards as required</i>

07-5.10.5 Radial Lead Vertical Mount Procedure

Use this procedure to mount a radial leaded component vertically.

Personnel Hazards



Lead (Solder)

9

Radial Lead Vertical Mount Procedure

Step	Action
	<div style="text-align: center;"> <div style="border: 2px solid black; padding: 5px; margin-bottom: 10px;">WARNING</div> <p>USE APPROVED SAFETY EYEWEAR WHEN PERFORMING THIS PROCEDURE.</p> <p>COMPLY WITH ALL LOCAL REQUIREMENTS FOR PPE.</p> <div style="border: 2px solid black; padding: 5px; margin-bottom: 10px;">CAUTION</div> <p>DON A PROPERLY GROUNDED ESD WRIST STRAP BEFORE STARTING THIS PROCEDURE.</p> </div>
1	Install insulation sleeving and mounting hardware, if required.
2	Insert the component into the mounting holes, ensuring proper orientation. Note: Spacers shall be oriented properly and in full contact with the CCA surface and the component body.
3	Form the leads with dual 45° bends to fit the mounting holes when the component lead spacing is less than mounting hole spacing.
4	For components mounted above single-sided CCAs without mounting hardware, install per original configuration.

Radial Lead Vertical Mount Procedure

Step	Action
5	<p><i>Inspect per the General Inspection Procedure in WP 003 00 (paragraph 03-5.12) to all applicable WORKMANSHIP STANDARDS, including:</i></p> <ul style="list-style-type: none"> • <i>Discrete Component Leads (paragraph 07-6.1)</i> • <i>Discrete Component Body (paragraph 07-6.2)</i> • <i>Heat Sink Acceptability Requirements (paragraph 07-6.4) as required</i> • <i>Heat Sink Insulators and Thermal Compounds (paragraph 07-6.5) as required</i> • <i>Component Sleeving (Buffer Material) (paragraph 07-6.6) as required</i> • <i>Component Leads Crossing Conductors (paragraph 07-6.7) as required</i> • <i>Component Lead Forming (paragraph 07-6.8)</i> • <i>Component Orientation (paragraph 07-6.9)</i> • <i>Component Mounting Vertical, Radial Leaded (paragraph 07-6.14)</i> • <i>Other applicable Workmanship Standards as required</i>

07-5.10.6 Radial Lead Horizontal Mount Procedure

Use this procedure to mount a radial leaded component horizontally.

Personnel Hazards



Lead (Solder)

Radial Lead Horizontal Mount Procedure

Step	Action
	<div style="text-align: center;"> <div style="border: 2px solid black; padding: 5px; display: inline-block;"> WARNING </div> <p>USE APPROVED SAFETY EYEWEAR WHEN PERFORMING THIS PROCEDURE.</p> <p>COMPLY WITH ALL LOCAL REQUIREMENTS FOR PPE.</p> </div>

Radial Lead Horizontal Mount Procedure

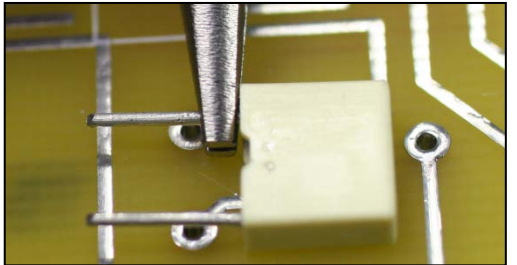
Step	Action
	<div style="border: 2px solid black; padding: 5px; display: inline-block; margin-bottom: 10px;">CAUTION</div> <p>DON A PROPERLY GROUNDED ESD WRIST STRAP BEFORE STARTING THIS PROCEDURE.</p>
1	<p>Orient the component so the identification markings will be visible after the installation.</p> <p>Priority of component markings is as follows:</p> <ul style="list-style-type: none"> (1) electrical value (2) reliability level (3) part number <p>Non-polarized components shall read from left-to-right.</p>
2	<p>Install insulation sleeving and mounting hardware over the lead or over the component before forming the leads, if required.</p>
3	<p>Position the component body on the CCA with the leads centered over the mounting holes.</p>
4	<p>Grasp a component lead at the inside edge of the mounting hole.</p>
	
5	<p>Bend the lead 90° around the forming tool.</p> <p>Note: The inside bend radius shall be greater than or equal to one lead diameter (rectangular leads use the thickness of the lead).</p>
6	<p>Insert the formed lead into the mounting hole and repeat steps 4 and 5 for the other component lead(s).</p>
7	<p>Mount the component so the component body is in full contact with the CCA surface.</p> <p>Note: Polarized component must be oriented correctly.</p> <p>Note: If required, apply bonding material.</p>

Radial Lead Horizontal Mount Procedure

Step	Action
8	<p><i>Inspect per the General Inspection Procedure in WP 003 00 (paragraph 03-5.12) to all applicable WORKMANSHIP STANDARDS, including:</i></p> <ul style="list-style-type: none"> • <i>Discrete Component Leads (paragraph 07-6.1)</i> • <i>Discrete Component Body (paragraph 07-6.2)</i> • <i>Heat Sink Acceptability Requirements (paragraph 07-6.4) as required</i> • <i>Heat Sink Insulators and Thermal Compounds (paragraph 07-6.5) as required</i> • <i>Component Sleeving (Buffer Material) (paragraph 07-6.6) as required</i> • <i>Component Leads Crossing Conductors (paragraph 07-6.7) as required</i> • <i>Component Lead Forming (paragraph 07-6.8)</i> • <i>Component Orientation (paragraph 07-6.9)</i> • <i>Component Mounting Horizontal, Radial Leaded (paragraph 07-6.12)</i> • <i>Other applicable Workmanship Standards as required</i>

07-5.10.7 Dual In-Line Package Mounting Procedure

Use this procedure to mount DIPs.

Personnel Hazards



Lead (Solder)

Dual In-Line Package Mounting Procedure

Step	Action
	<div style="text-align: center;"> <div style="border: 2px solid black; padding: 5px; display: inline-block;"> WARNING </div> <p>USE APPROVED SAFETY EYEWEAR WHEN PERFORMING THIS PROCEDURE.</p> <p>COMPLY WITH ALL LOCAL REQUIREMENTS FOR PPE.</p> </div>

Dual In-Line Package Mounting Procedure

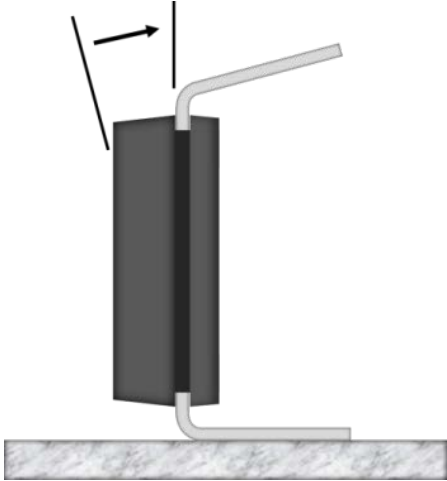
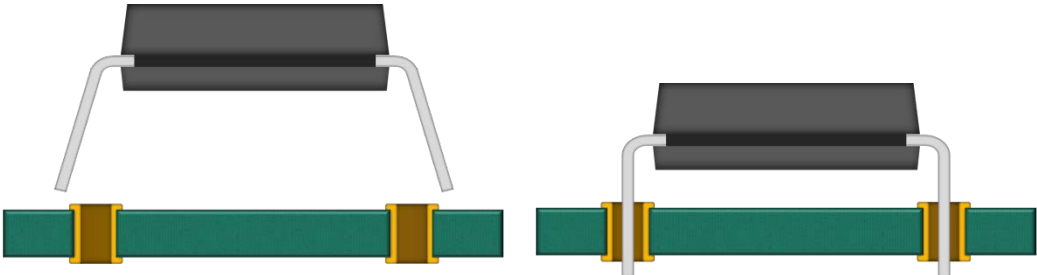
Step	Action
	<div style="text-align: center;">CAUTION</div> <p>DON A PROPERLY GROUNDED ESD WRIST STRAP BEFORE STARTING THIS PROCEDURE.</p>
1	Position the DIP on a smooth, flat surface.
2	Gently roll the DIP to form a 90° angle between the DIP body and the leads. 
3	Insert the DIP into the CCA mounting holes. Note: After forming, the DIP should drop freely into the mounting holes without force. 

Dual In-Line Package Mounting Procedure

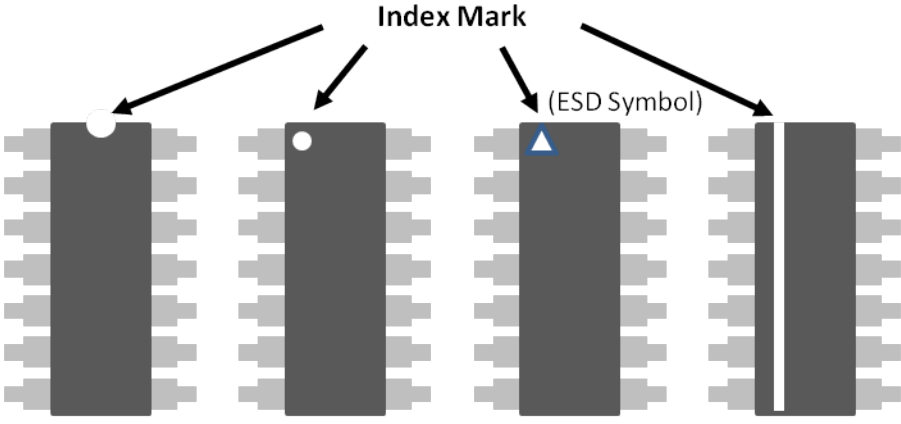
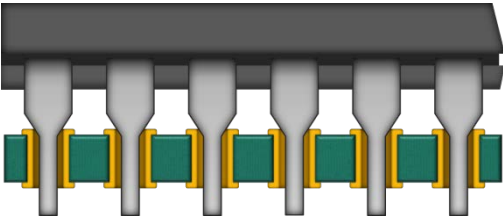
Step	Action
4	<p>Orient the DIP correctly (pin 1 to pad 1).</p>  <p style="text-align: center;">Top View</p>
5	<p>Position the DIP on the CCA so the lead shoulder is in contact with the mounting pads.</p> 
6	<p><i>Inspect per the General Inspection Procedure in WP 003 00 (paragraph 03-5.12) to all applicable WORKMANSHIP STANDARDS, including:</i></p> <ul style="list-style-type: none"> • <i>Discrete Component Leads (paragraph 07-6.1)</i> • <i>Discrete Component Body (paragraph 07-6.2)</i> • <i>Component Orientation (paragraph 07-6.9)</i> • <i>Component Mounting Dual In-Line Package (DIP) (paragraph 07-6.15)</i> • <i>Other applicable Workmanship Standards as required</i>

07-5.11 Lead Terminations

Terminate component leads using the Straight Through Lead Termination Procedure (paragraph 07-5.11.1), the Semi-Clinch Lead Termination Procedure (paragraph 07-5.11.2), the Full Clinch Lead Termination Procedure (paragraph 07-5.11.3), or the Offset Pad Lead Termination Procedure (paragraph 07-5.11.4) as applicable for the application.

07-5.11.1 Straight Through Lead Termination Procedure

Use this procedure to terminate straight through component leads.

Personnel Hazards



Lead (Solder)

9

Straight Through Lead Termination Procedure

Step	Action
	<p style="text-align: center;">WARNING</p> <p style="text-align: center;">USE APPROVED SAFETY EYEWEAR WHEN PERFORMING THIS PROCEDURE.</p> <p style="text-align: center;">COMPLY WITH ALL LOCAL REQUIREMENTS FOR PPE.</p> <p style="text-align: center;">CAUTION</p> <p style="text-align: center;">DON A PROPERLY GROUNDED ESD WRIST STRAP BEFORE STARTING THIS PROCEDURE.</p>
<p style="text-align: center;">1</p>	<p style="text-align: center;">CAUTION</p> <p style="text-align: center;">SHOCK FROM THE CUTTING ACTION SHALL NOT BE IMPARTED TO THE COMPONENT BODY, AS THIS COULD DAMAGE THE COMPONENT/LEAD SEAL.</p> <p style="text-align: center;">KEEP THE FLUSH SIDE OF THE CUTTERS TOWARD THE CCA SURFACE AND DO NOT PULL ON THE LEAD.</p> <p style="text-align: center;">DIP LEADS SHALL NOT BE TERMINATED UNLESS NECESSARY DUE TO THE POSSIBILITY OF EXPOSING A NON-SOLDERABLE BASE MATERIAL.</p> <p>Terminate the component lead to a length of one lead diameter, perpendicular to the lead axis using flush cut pliers.</p> 

Straight Through Lead Termination Procedure

Step	Action
2	<div style="text-align: center;">  <p>← One Lead Diameter →</p> </div> <p><i>Inspect per the General Inspection Procedure in WP 003 00 (paragraph 03-5.12) to all applicable WORKMANSHIP STANDARDS, including:</i></p> <ul style="list-style-type: none"> • <i>Discrete Component Leads (paragraph 07-6.1)</i> • <i>Discrete Component Body (paragraph 07-6.2)</i> • <i>Straight-Through Lead Terminations (paragraph 07-6.16)</i>

07-5.11.2 Semi-Clinch Lead Termination Procedure

Use this procedure to terminate semi-clinched component leads.

Personnel Hazards



Lead (Solder)

Semi-Clinch Lead Termination Procedure

Step	Action
	<div style="text-align: center;"> <div style="border: 2px solid black; padding: 5px; width: fit-content; margin: 0 auto;">WARNING</div> <p>USE APPROVED SAFETY EYEWEAR WHEN PERFORMING THIS PROCEDURE.</p> <p>COMPLY WITH ALL LOCAL REQUIREMENTS FOR PPE.</p> <div style="border: 2px solid black; padding: 5px; width: fit-content; margin: 0 auto;">CAUTION</div> <p>DON A PROPERLY GROUNDED ESD WRIST STRAP BEFORE STARTING THIS PROCEDURE.</p> </div>

Semi-Clinch Lead Termination Procedure

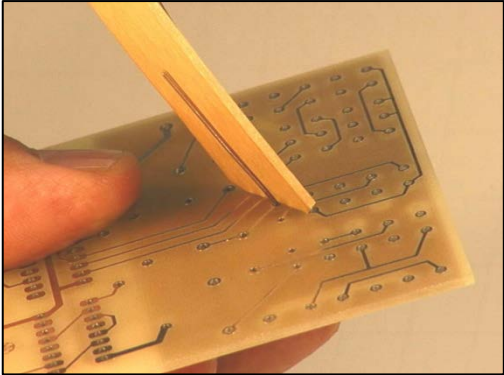
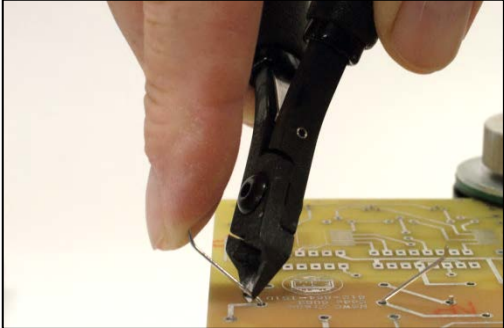
Step	Action
	<p style="text-align: center;">NOTE</p> <p style="text-align: center;">USE A SEMI-CLINCH TERMINATION WHEN REPLACING COMPONENTS THAT HAD FULL-CLINCHED TERMINATIONS ON ISOLATED PADS.</p>
<p style="text-align: center;">1</p>	<p>Bend the lead to a 45° angle in the direction of the conductor (if present) using an orangewood stick, tongue depressor, or other non-damaging tool.</p> 
<p style="text-align: center;">2</p>	<p style="text-align: center;">CAUTION</p> <p style="text-align: center;">SHOCK FROM THE CUTTING ACTION SHALL NOT BE IMPARTED TO THE COMPONENT BODY, AS THIS COULD DAMAGE THE COMPONENT/LEAD SEAL.</p> <p style="text-align: center;">KEEP THE FLUSH SIDE OF THE CUTTERS TOWARD THE CCA SURFACE AND DO NOT PULL ON THE LEAD.</p> <p>Terminate the component lead to a length of one pad diameter, perpendicular to the lead axis using flush cut pliers.</p> 

Semi-Clinch Lead Termination Procedure

Step	Action
3	<div data-bbox="553 426 1243 705" data-label="Image"> </div> <p data-bbox="381 726 1393 795"><i>Inspect per the General Inspection Procedure in WP 003 00 (paragraph 03-5.12) to all applicable WORKMANSHIP STANDARDS, including:</i></p> <ul data-bbox="431 821 1089 953" style="list-style-type: none"> • <i>Discrete Component Leads (paragraph 07-6.1)</i> • <i>Discrete Component Body (paragraph 07-6.2)</i> • <i>Semi-Clinch Lead Terminations (paragraph 07-6.17)</i>

07-5.11.3 Full Clinch Lead Termination Procedure

Use this procedure to terminate full-clinched component leads.

Personnel Hazards



Lead (Solder)

9



Full Clinch Lead Termination Procedure

Step	Action
	<div data-bbox="776 1556 1024 1629" data-label="Text" style="border: 2px solid black; padding: 5px; text-align: center;"> <p>WARNING</p> </div> <p data-bbox="453 1650 1344 1682"><i>USE APPROVED SAFETY EYEWEAR WHEN PERFORMING THIS PROCEDURE.</i></p> <p data-bbox="583 1703 1214 1734"><i>COMPLY WITH ALL LOCAL REQUIREMENTS FOR PPE.</i></p>

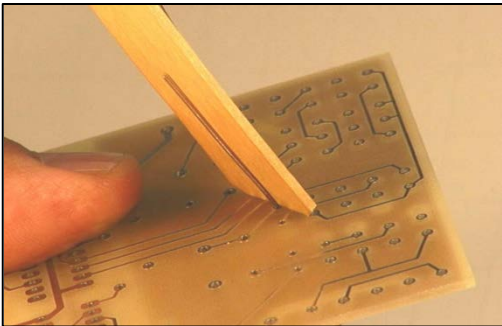
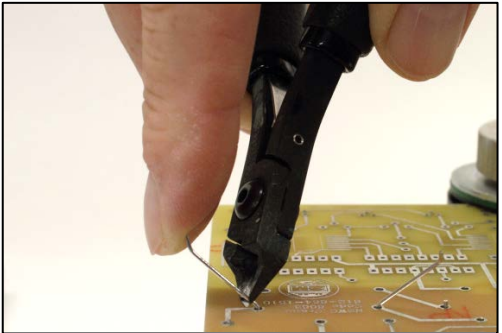
Full Clinch Lead Termination Procedure

Step	Action
	<p style="text-align: center;">CAUTION</p> <p style="text-align: center;">DON A PROPERLY GROUNDED ESD WRIST STRAP BEFORE STARTING THIS PROCEDURE.</p> <p style="text-align: center;">NOTE</p> <p style="text-align: center;">WHEN AN ISOLATED PAD IS ON THE LEAD TERMINATION SIDE OF THE CCA, FULL CLINCHING IS UNACCEPTABLE.</p>
<p style="text-align: center;">1</p>	<p>Bend the lead to a 45° angle in the direction of the conductor (if present) using an orangewood stick, tongue depressor, or other non-damaging tool.</p> 
<p style="text-align: center;">2</p>	<p style="text-align: center;">CAUTION</p> <p style="text-align: center;">SHOCK FROM THE CUTTING ACTION SHALL NOT BE IMPARTED TO THE COMPONENT BODY, AS THIS COULD DAMAGE THE COMPONENT/LEAD SEAL.</p> <p style="text-align: center;">KEEP THE FLUSH SIDE OF THE CUTTERS TOWARD THE CCA SURFACE AND DO NOT PULL ON THE LEAD.</p> <p>Terminate the component lead to a length of one pad diameter, perpendicular to the lead axis using flush cut pliers.</p> <p>Note: The best practice to avoid potential damage is to cut the lead with the cutter oriented so the resulting protrusion does not contact the pad when the lead is fully clinched.</p> 

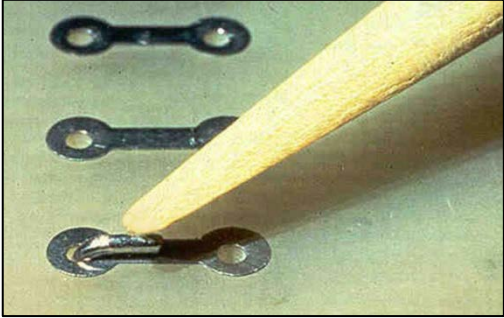
Full Clinch Lead Termination Procedure

Step	Action
3	<p>Complete the clinch by bending the lead to a 90° angle using an orangewood stick.</p> <p>Note: A slight gap due to springback is considered a target condition when further clinching would cause potential damage to the conductor, to the pad, or to the printed circuitry.</p> 
4	 <p><i>Inspect per the General Inspection Procedure in WP 003 00 (paragraph 03-5.12) to all applicable WORKMANSHIP STANDARDS, including:</i></p> <ul style="list-style-type: none"> • <i>Discrete Component Leads (paragraph 07-6.1)</i> • <i>Discrete Component Body (paragraph 07-6.2)</i> • <i>Full Clinch Lead Terminations (paragraph 07-6.18)</i>

07-5.11.4 Offset Pad Lead Termination Procedure

Use this procedure to terminate component leads on offset pads.

Personnel Hazards



Lead (Solder)

Offset Pad Lead Termination Procedure

Step	Action
	<p style="text-align: center;">WARNING</p> <p style="text-align: center;"><i>USE APPROVED SAFETY EYEWEAR WHEN PERFORMING THIS PROCEDURE. COMPLY WITH ALL LOCAL REQUIREMENTS FOR PPE.</i></p> <p style="text-align: center;">CAUTION</p> <p style="text-align: center;">DON A PROPERLY GROUNDED ESD WRIST STRAP BEFORE STARTING THIS PROCEDURE.</p>
1	<p>Bend the lead to a 45° angle in the direction of the pad using an orangewood stick.</p>
2	<p style="text-align: center;">CAUTION</p> <p style="text-align: center;">SHOCK FROM THE CUTTING ACTION SHALL NOT BE IMPARTED TO THE COMPONENT BODY, AS THIS COULD DAMAGE THE COMPONENT/LEAD SEAL. KEEP THE FLUSH SIDE OF THE CUTTERS TOWARD THE CCA SURFACE AND DO NOT PULL ON THE LEAD.</p> <p>Terminate the component lead to the length of the pad, perpendicular to the pad axis using flush cut pliers.</p> <p>Note: The best practice to avoid potential damage is to cut the lead with the cutter oriented so the resulting protrusion does not contact the pad when the lead is fully clinched.</p>
3	<p>Complete the clinch by bending the lead to a 90° angle using an orangewood stick.</p> <p>Note: A slight gap due to springback is considered a target condition when further clinching would cause potential damage to the conductor, to the pad, or to the printed circuitry.</p>
4	<p><i>Inspect per the General Inspection Procedure in WP 003 00 (paragraph 03-5.12) to all applicable WORKMANSHIP STANDARDS, including:</i></p> <ul style="list-style-type: none"> • <i>Discrete Component Leads (paragraph 07-6.1)</i> • <i>Discrete Component Body (paragraph 07-6.2)</i> • <i>Offset Pad Terminations (paragraph 07-6.19)</i>















07-5.12 Component Soldering

For component soldering, use either the Single-Sided Soldering Procedure (paragraph 07-5.12.1) or the Double-Sided Soldering Procedure (paragraph 07-5.12.2) as applicable for the application.

07-5.12.1 Single-Sided Soldering Procedure

Use this procedure to solder components to single-sided CCAs.

Personnel Hazards

					
Alcohol, Isopropyl					1
					
Flux (Soldering)					8
					
Lead (Solder)					9

Single-Sided Soldering Procedure

Step	Action
	<div style="text-align: center;"> <div style="border: 1px solid black; padding: 5px; display: inline-block; margin-bottom: 10px;">WARNING</div> <p>USE APPROVED SAFETY EYEWEAR WHEN PERFORMING THIS PROCEDURE.</p> <p>COMPLY WITH ALL LOCAL REQUIREMENTS FOR PPE.</p> <div style="border: 1px solid black; padding: 5px; display: inline-block; margin-bottom: 10px;">CAUTION</div> <p>DON A PROPERLY GROUNDED ESD WRIST STRAP BEFORE STARTING THIS PROCEDURE.</p> </div>

Single-Sided Soldering Procedure

Step	Action								
1	<p style="text-align: center;">CAUTION</p> <p style="text-align: center;">BEGIN THE REPAIR PROCESS AS SOON AS POSSIBLE AFTER REMOVAL FROM THE OVEN TO AVOID MOISTURE RE-ABSORPTION.</p> <p>Bake the CCA, if feasible, in accordance with the table to the right before soldering, desoldering, and conformal coating removal procedures to prevent delamination, measling, or other laminate degradation.</p> <table border="1" data-bbox="928 611 1427 821"> <thead> <tr> <th>Baking Temp.</th> <th>Baking Time</th> </tr> </thead> <tbody> <tr> <td>248°F (120°C)</td> <td>3.5 to 7 hours</td> </tr> <tr> <td>212°F (100°C)</td> <td>8 to 16 hours</td> </tr> <tr> <td>176°F (80°C)</td> <td>18 to 48 hours</td> </tr> </tbody> </table>	Baking Temp.	Baking Time	248°F (120°C)	3.5 to 7 hours	212°F (100°C)	8 to 16 hours	176°F (80°C)	18 to 48 hours
Baking Temp.	Baking Time								
248°F (120°C)	3.5 to 7 hours								
212°F (100°C)	8 to 16 hours								
176°F (80°C)	18 to 48 hours								
2	<p style="text-align: center;">CAUTION</p> <p style="text-align: center;">HEAT SINKS ARE PLACED BETWEEN THE HEAT SOURCE AND THE COMPONENT BODY TO PROTECT THE COMPONENT FROM THE HEAT OF THE SOLDERING PROCESS.</p> <p>Install heat sinks, as needed.</p>								
3	<p>Select a soldering iron tip that maximizes heat transfer and contact area with the pad.</p> 								
4	<p>Set the soldering iron tip temperature to 600°F (316°C).</p>								
5	<p>Ensure the Single-Sided Pad Preparation Procedure (paragraph 07-5.8.1) and the appropriate Component Lead Preparation for Installation (paragraph 07-5.9), Lead Forming and Component Mounting (paragraph 07-5.10), and Lead Terminations (paragraph 07-5.11) procedures were completed.</p>								
6	<p>Clean the component lead terminations and pads with isopropyl alcohol using an acid brush and blot dry with a clean, lint-free tissue.</p> <p>Note: Take precautions to prevent bare skin contact before the component is soldered. Skin contact leaves contaminants on the leads and/or pads.</p>								
7	<p>Clean the solder with isopropyl alcohol and wipe dry with a clean, lint-free tissue.</p>								

Single-Sided Soldering Procedure

Step	Action
8	Apply flux SPARINGLY to the areas to be soldered. Note: Use a toothpick or flux pen to control the volume of flux applied. Heavy flux volume impairs cleaning and may affect reliability.
9	Remove the seasoning (all solder) from the soldering iron tip.
10	Thermally shock the soldering iron tip on a damp sponge.
11	<div style="text-align: center; border: 1px solid black; padding: 5px; margin-bottom: 10px;">CAUTION</div> <p>DO NOT APPLY PRESSURE WITH THE SOLDERING IRON.</p> Place the soldering iron tip on the pad contacting the lead at the point of maximum thermal mass.
12	<div style="text-align: center; border: 1px solid black; padding: 5px; margin-bottom: 10px;">CAUTION</div> <p>IF SOLDER MELT DOES NOT OCCUR WITHIN TWO SECONDS, STOP THIS PROCEDURE AND ADJUST TIP TEMPERATURE PER THE TIP TEMPERATURE PROCEDURE IN WP 003 00 (PARAGRAPH 03-5.4).</p> <p>DO NOT MOVE THE SOLDERING IRON DURING THE SOLDERING OPERATION.</p> <div style="text-align: center; margin: 10px 0;">NOTE</div> <p>DO NOT MELT SOLDER ONTO THE SOLDERING IRON TIP AND TRANSFER IT TO THE SOLDER JOINT.</p> <p>Form a heat bridge between the soldering iron tip and the surfaces to be soldered using clean solder.</p> 
13	Touch the solder to the cut end of the lead to tin the exposed copper.
14	Form the fillets by painting solder along the sides of the lead. Note: High voltage solder joints require all sharp edges of the component lead to be completely covered with a continuous smooth rounded layer of solder forming a ball of solder.

Single-Sided Soldering Procedure

Step	Action
15	Remove the solder and the soldering iron tip simultaneously.
16	Repeat steps 10 through 15 for each lead termination.
17	Season the tip and place the soldering iron into its stand.
18	<div style="text-align: center; border: 1px solid black; padding: 5px; margin-bottom: 10px;">CAUTION</div> <p>ALLOW THE SOLDER JOINTS TO COOL WITHOUT MECHANICAL MOVEMENT OR DISTURBANCE.</p> <p>DO NOT PULL OR PUSH ON THE SOLDER JOINTS FOR INSPECTION.</p> <p>DO NOT BLOW ON THE SOLDER JOINTS TO SPEED COOLING.</p> <p>Allow the solder joints to cool completely before cleaning.</p>
19	Clean the solder joints with isopropyl alcohol using an acid brush to remove all flux residue and blot dry with a clean, lint-free tissue.
20	<div style="text-align: center;">  </div> <p><i>Inspect per the General Inspection Procedure in WP 003 00 (paragraph 03-5.12) to all applicable WORKMANSHIP STANDARDS, including:</i></p> <ul style="list-style-type: none"> • <i>General Solder Acceptability in WP 005 00 (paragraph 05-6.1)</i> • <i>Post-Solder Joint Cleanliness in WP 005 00 (paragraph 05-6.2)</i> • <i>Solder Acceptability for Through-Hole Components (paragraph 07-6.20)</i> • <i>High Voltage Component Soldering (paragraph 07-6.21), as applicable)</i> • <i>Laminate in WP 011 00 (paragraph 11-6.1)</i> • <i>Conductors, Pads, and Lands in WP 012 00 (paragraph 12-6.1)</i> • <i>Other applicable Workmanship Standards as required</i>

Single-Sided Soldering Procedure











Step	Action
21	<div style="text-align: center; border: 2px solid black; padding: 5px; margin-bottom: 10px;">CAUTION</div> <p>ALWAYS EXERCISE EXTREME CAUTION WHEN APPLYING HEAT TO SHRINKABLE INSULATION SLEEVING, AS DAMAGE TO THE JOINT, SLEEVING, AND ADJACENT AREAS MAY RESULT. EXCESS HEAT CAUSES GREATER DAMAGE THAN INSUFFICIENT HEAT.</p> <p>For heat-shrinkable insulation sleeving, apply heat to shrink the sleeving to a snug fit, if needed.</p> <p>Note: The preferred method of shrinking insulation sleeving is a radiant heat gun. However, a hot air jet may be used, provided extreme caution is exercised.</p>
22	Replace the conformal coating per the Conformal Coating Replacement Procedure in WP 006 00 (paragraph 06-5.5), as needed.
23	<i>Inspect to the Conformal Coating Replacement WORKMANSHIP STANDARD in WP 006 00 (paragraph 06-6.2), as required.</i>
24	Dispose of all HAZMAT following local procedures.

07-5.12.2 Double-Sided Soldering Procedure

Use this procedure to solder components to double-sided CCAs.

Use the Single-Sided Soldering Procedure (paragraph 07-5.12.1) for single-sided CCAs.

Personnel Hazards

					
Alcohol, Isopropyl					1
					
Flux (Soldering)					8



Lead (Solder)

Double-Sided Soldering Procedure

Step	Action										
	<p style="text-align: center;">WARNING</p> <p style="text-align: center;"><i>USE APPROVED SAFETY EYEWEAR WHEN PERFORMING THIS PROCEDURE. COMPLY WITH ALL LOCAL REQUIREMENTS FOR PPE.</i></p> <p style="text-align: center;">CAUTION</p> <p style="text-align: center;">DON A PROPERLY GROUNDED ESD WRIST STRAP BEFORE STARTING THIS PROCEDURE.</p>										
<p>1</p>	<p style="text-align: center;">CAUTION</p> <p style="text-align: center;">BEGIN THE REPAIR PROCESS AS SOON AS POSSIBLE AFTER REMOVAL FROM THE OVEN TO AVOID MOISTURE RE-ABSORPTION.</p> <table border="1" style="width: 100%; border-collapse: collapse;"> <tr> <td style="width: 50%; vertical-align: top;"> Bake the CCA, if feasible, in accordance with the table to the right before soldering, desoldering, and conformal coating removal procedures to prevent delamination, measling, or other laminate degradation. </td> <td style="width: 50%; text-align: center;"> <table border="1" style="width: 100%; border-collapse: collapse;"> <thead> <tr> <th style="text-align: left;">Baking Temp.</th> <th style="text-align: left;">Baking Time</th> </tr> </thead> <tbody> <tr> <td>248°F (120°C)</td> <td>3.5 to 7 hours</td> </tr> <tr> <td>212°F (100°C)</td> <td>8 to 16 hours</td> </tr> <tr> <td>176°F (80°C)</td> <td>18 to 48 hours</td> </tr> </tbody> </table> </td> </tr> </table>	Bake the CCA, if feasible, in accordance with the table to the right before soldering, desoldering, and conformal coating removal procedures to prevent delamination, measling, or other laminate degradation.	<table border="1" style="width: 100%; border-collapse: collapse;"> <thead> <tr> <th style="text-align: left;">Baking Temp.</th> <th style="text-align: left;">Baking Time</th> </tr> </thead> <tbody> <tr> <td>248°F (120°C)</td> <td>3.5 to 7 hours</td> </tr> <tr> <td>212°F (100°C)</td> <td>8 to 16 hours</td> </tr> <tr> <td>176°F (80°C)</td> <td>18 to 48 hours</td> </tr> </tbody> </table>	Baking Temp.	Baking Time	248°F (120°C)	3.5 to 7 hours	212°F (100°C)	8 to 16 hours	176°F (80°C)	18 to 48 hours
Bake the CCA, if feasible, in accordance with the table to the right before soldering, desoldering, and conformal coating removal procedures to prevent delamination, measling, or other laminate degradation.	<table border="1" style="width: 100%; border-collapse: collapse;"> <thead> <tr> <th style="text-align: left;">Baking Temp.</th> <th style="text-align: left;">Baking Time</th> </tr> </thead> <tbody> <tr> <td>248°F (120°C)</td> <td>3.5 to 7 hours</td> </tr> <tr> <td>212°F (100°C)</td> <td>8 to 16 hours</td> </tr> <tr> <td>176°F (80°C)</td> <td>18 to 48 hours</td> </tr> </tbody> </table>	Baking Temp.	Baking Time	248°F (120°C)	3.5 to 7 hours	212°F (100°C)	8 to 16 hours	176°F (80°C)	18 to 48 hours		
Baking Temp.	Baking Time										
248°F (120°C)	3.5 to 7 hours										
212°F (100°C)	8 to 16 hours										
176°F (80°C)	18 to 48 hours										
<p>2</p>	<p style="text-align: center;">CAUTION</p> <p style="text-align: center;">HEAT SINKS ARE PLACED BETWEEN THE HEAT SOURCE AND THE COMPONENT BODY TO PROTECT THE COMPONENT FROM THE HEAT OF THE SOLDERING PROCESS.</p> <p>Install heat sinks, as needed.</p>										

Double-Sided Soldering Procedure

Step	Action
3	<p>Preheat the CCA per the Convective Preheating Procedure in WP 018 00 (paragraph 18-5.2.1) or the Conductive Preheating Procedure (paragraph 18-5.2.2) for:</p> <ul style="list-style-type: none"> • CCAs with large (heavy) ground plane • CCAs with large thermal mass (thick laminate, constraining core)
4	<p>Select a soldering iron tip that maximizes heat transfer and contact area with the pad.</p> 
5	<p>Set the soldering iron tip temperature to 600°F (316°C).</p>
6	<p>Ensure the Double-Sided Pad Preparation Procedure (paragraph 07-5.8.2) and the appropriate Component Lead Preparation for Installation (paragraph 07-5.9), Lead Forming and Component Mounting (paragraph 07-5.10), and Lead Terminations (paragraph 07-5.11) procedures were completed.</p>
7	<p>Clean the component lead terminations and pads with isopropyl alcohol using an acid brush and blot dry with a clean, lint-free tissue.</p> <p>Note: Take precautions to prevent bare skin contact before the component is soldered. Skin contact leaves contaminants on the leads and/or pads.</p>
8	<p>Clean the solder with isopropyl alcohol and wipe dry with a clean, lint-free tissue.</p>
9	<p>Apply flux SPARINGLY to the areas to be soldered.</p> <p>Note: Use a toothpick or flux pen to control the volume of flux applied. Heavy flux volume impairs cleaning and may affect reliability.</p>
10	<p>Remove the seasoning (all solder) from the soldering iron tip.</p>
11	<p>Thermally shock the soldering iron tip on a damp sponge.</p>
12	<div style="text-align: center; border: 2px solid black; padding: 5px; width: fit-content; margin: 0 auto;"> CAUTION </div> <p style="text-align: center;">DO NOT APPLY PRESSURE WITH THE SOLDERING IRON.</p> <p>Place the soldering iron tip on the pad contacting the lead at the point of maximum thermal mass.</p>

Double-Sided Soldering Procedure

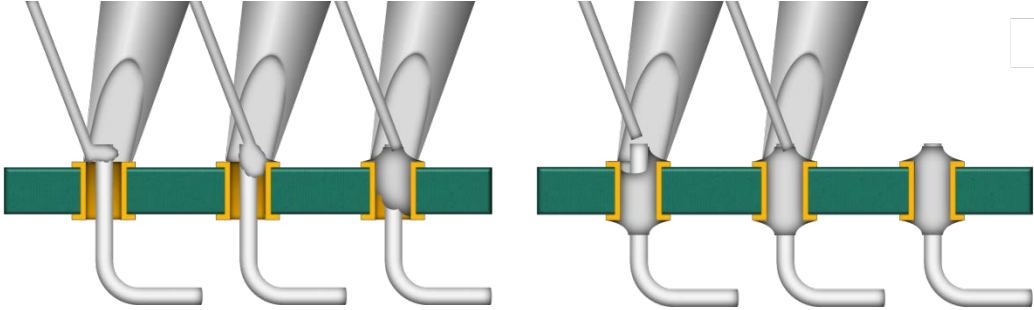
Step	Action
13	<div style="text-align: center; border: 1px solid black; padding: 5px; margin-bottom: 10px;">CAUTION</div> <p style="text-align: center;">IF SOLDER MELT DOES NOT OCCUR WITHIN TWO SECONDS, STOP THIS PROCEDURE AND ADJUST TIP TEMPERATURE PER THE TIP TEMPERATURE PROCEDURE IN WP 003 00 (PARAGRAPH 03-5.4).</p> <p style="text-align: center;">DO NOT MOVE THE SOLDERING IRON DURING THE SOLDERING OPERATION.</p> <div style="text-align: center; margin-top: 20px;">NOTE</div> <p style="text-align: center;">DO NOT MELT SOLDER ONTO THE SOLDERING IRON TIP AND TRANSFER IT TO THE SOLDER JOINT.</p> <p>Form a heat bridge between the soldering iron tip and the surfaces to be soldered using clean solder.</p> 
14	Touch the solder to the cut end of the lead to tin the exposed copper.
15	<p>Apply enough solder to the joint for the solder to flow through the hole and complete the joint on both sides of the CCA in a single operation.</p> <p>Note: Typically, solder will build up on only one side at first; the soldering iron tip must be kept on the joint until the solder pool drops, indicating the solder has flowed through the hole. After flow-through, a small amount of solder is added to form the proper fillets.</p>  <p>Note: High voltage solder joints require all sharp edges of the component lead to be completely covered with a continuous smooth rounded layer of solder forming a ball of solder.</p>

Double-Sided Soldering Procedure

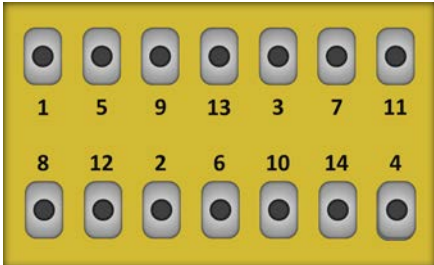
Step	Action
16	Remove the solder and the soldering iron tip simultaneously.
17	<p style="text-align: center;">CAUTION</p> <p style="text-align: center;">USE A SHOTGUN PATTERN LIKE THAT SHOWN BELOW TO PREVENT EXCESSIVE HEAT BUILDUP WHEN SOLDERING MULTILEAD COMPONENTS.</p> <div style="text-align: center;">  </div> <p>Repeat step 11 through 16 for each lead termination.</p>
18	Season the tip and place the soldering iron into its stand.
19	<p style="text-align: center;">CAUTION</p> <p style="text-align: center;">ALLOW THE SOLDER JOINTS TO COOL WITHOUT MECHANICAL MOVEMENT OR DISTURBANCE.</p> <p style="text-align: center;">DO NOT PULL OR PUSH ON THE SOLDER JOINTS FOR INSPECTION.</p> <p style="text-align: center;">DO NOT BLOW ON THE SOLDER JOINTS TO SPEED COOLING.</p> <p>Allow the solder joints to cool completely before cleaning.</p>
20	Clean the solder joints with isopropyl alcohol using an acid brush to remove all flux residue and blot dry with a clean, lint-free tissue.

Double-Sided Soldering Procedure

Step	Action
21	 <p><i>Inspect per the General Inspection Procedure in WP 003 00 (paragraph 03-5.12) to all applicable WORKMANSHIP STANDARDS, including:</i></p> <ul style="list-style-type: none"> • <i>General Solder Acceptability in WP 005 00 (paragraph 05-6.1)</i> • <i>Post-Solder Joint Cleanliness in WP 005 00 (paragraph 05-6.2)</i> • <i>Solder Acceptability for Through-Hole Components (paragraph 07-6.20)</i> • <i>High Voltage Component Soldering (paragraph 07-6.21), as applicable)</i> • <i>Laminate in WP 011 00 (paragraph 11-6.1)</i> • <i>Conductors, Pads, and Lands in WP 012 00 (paragraph 12-6.1)</i> • <i>Other applicable Workmanship Standards as required</i>
22	<div style="text-align: center; border: 2px solid black; padding: 5px; width: fit-content; margin: 0 auto;">CAUTION</div> <p>ALWAYS EXERCISE EXTREME CAUTION WHEN APPLYING HEAT TO SHRINKABLE INSULATION SLEEVING, AS DAMAGE TO THE JOINT, SLEEVING, AND ADJACENT AREAS MAY RESULT. EXCESS HEAT CAUSES GREATER DAMAGE THAN INSUFFICIENT HEAT.</p> <p>For heat-shrinkable insulation sleeving, apply heat to shrink the sleeving to a snug fit, if needed.</p> <p>Note: The preferred method of shrinking insulation sleeving is a radiant heat gun. However, a hot air jet may be used, provided extreme caution is exercised.</p>
23	<p>Replace the conformal coating per the Conformal Coating Replacement Procedure in WP 006 00 (paragraph 06-5.5), as needed.</p>
24	<p><i>Inspect to the Conformal Coating Replacement WORKMANSHIP STANDARD in WP 006 00 (paragraph 06-6.2), as required.</i></p>
25	<p>Dispose of all HAZMAT following local procedures.</p>

07-6 WORKMANSHIP STANDARDS

Refer to WP 003 00 (paragraph 03-6) for definitions of Workmanship Standards.

NOTE

WORKMANSHIP STANDARDS FOR GENERAL SOLDER ACCEPTABILITY AND POST-SOLDER JOINT CLEANLINESS ARE IN WP 005 00 (PARAGRAPH 05-6), CONFORMAL COATING IN WP 006 00 (PARAGRAPH 06-6), TERMINALS IN WP 008 00 (PARAGRAPH 08-6), LAMINATE IN WP 011 00 (PARAGRAPH 11-6), CONDUCTORS, PADS, AND LANDS IN WP 012 00 (PARAGRAPH 12-6), MULTILAYER IN WP 015 00 (PARAGRAPH 15-6), AND SURFACE MOUNT DEVICES IN WP 018 00 (PARAGRAPH 18-6).

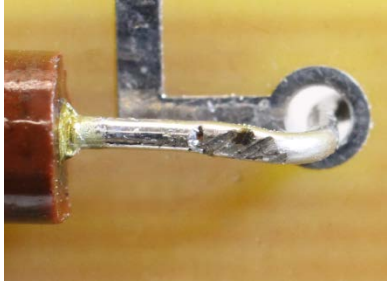

07-6.1 Discrete Component Leads

Discrete Component Leads

Target Condition	Acceptable Condition	Defect Condition
	<p>The component lead has exposed base metal, scrapes, nicks, deformation, or tool marks that do not exceed 10% of the diameter, width, length, or thickness of the lead.</p>	<p>The lead damage exceeds 10% of the lead diameter, the width, or the thickness of the lead.</p> 
		<p>The lead is deformed from repeated or careless bending or forming.</p>

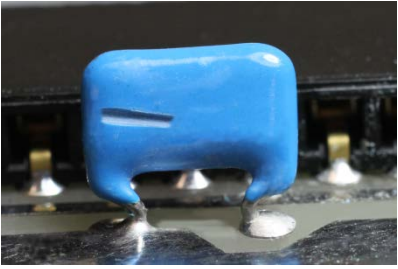

07-6.2 Discrete Component Body

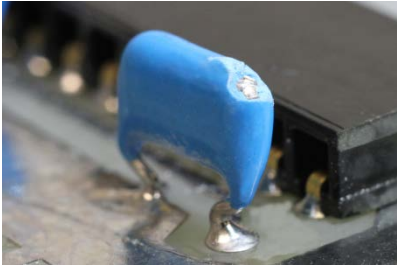
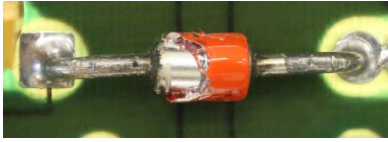
Discrete Component Body

Target Condition	Acceptable Condition	Defect Condition
<p>The component identification markings are legible.</p>	<p>The component identification markings are not legible.</p>	
	<p>There are minor surface scratches, cuts, or chips in the component surface or meniscus, provided the internal functional element is not exposed.</p>  	<p>Surface scratches, cuts, or chips in the component surface or meniscus, that expose the internal functional element or compromise the integrity of the component.</p>  
	<p>A chip-out or crack that does not enter into the lead seal or the lid seal of the component.</p>	<p>A chip-out or crack enters into the lead seal or the lid seal of the component.</p> <p>Any chip or crack in the glass body, glass seal (bead), or glass insulator of a glass-bodied component.</p> 



07-6.3 Component Lead Tinning

Component Lead Tinning

Target Condition	Acceptable Condition	Defect Condition
<p>The component leads are pre-tinned on all portions of the lead coming into contact with the soldered area.</p> 		<p>The component leads are not pre-tinned on all portions of the lead coming into contact with the soldered area.</p>
<p>All excess solder is removed, leaving a smooth, shiny, uniform tinning on the component leads.</p>		<p>All excess solder has not been removed from the component lead, leaving solder spillage on the component leads.</p> 
		<p>The component lead exhibits nonwetting or dewetting in the area to be soldered.</p> 

07-6.4 Heat Sink Acceptability Requirements

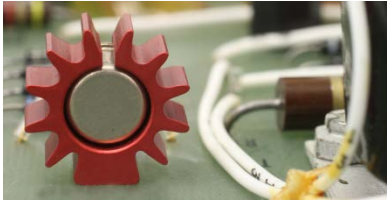
Heat Sink Acceptability Requirements

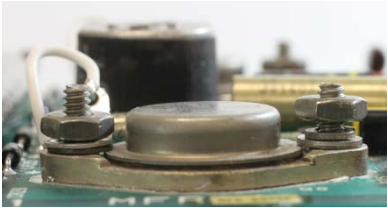
Target Condition	Acceptable Condition	Defect Condition
<p>The heat sink is mounted flush to the CCA surface.</p> 		
<p>The component is in full contact with the heat sink.</p> 	<p>The component is not in full contact with the heat sink, but has greater than or equal to 75% contact with the heat sink.</p>	<p>The component has less than 75% contact with the heat sink.</p>
<p>The heat sink hardware and the component are installed in the proper sequence.</p>		<p>The heat sink is mounted on the wrong side of the CCA, or installed in incorrect sequence.</p>
<p>If required, the heat sink hardware meets specific mounting torque requirements.</p>		<p>The heat sink hardware is loose and can be easily moved.</p> 
		<p>The heat sink is bent.</p>
		<p>There are fins missing from the heat sink.</p>

07-6.5 Heat Sink Insulators and Thermal Compounds

Heat Sink Insulators and Thermal Compounds

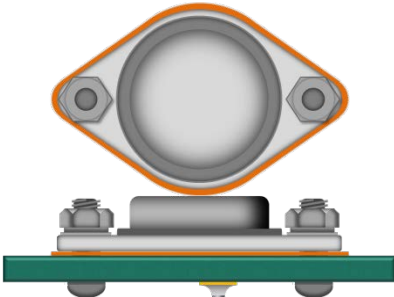
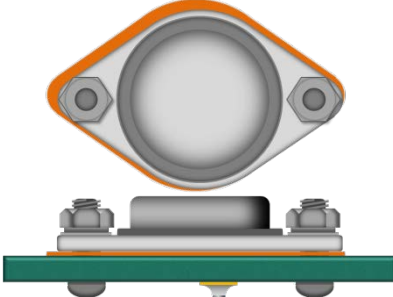
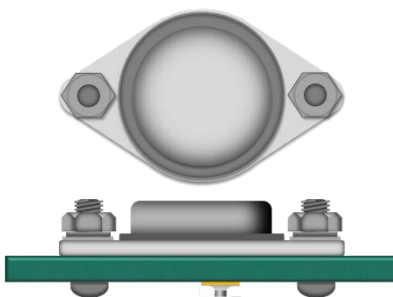
Target Condition	Acceptable Condition	Defect Condition
<p>If insulation is required, a uniform border of mica, plastic film, or thermal compound is visible around the edges of the component.</p> 	<p>If insulation is required, a non-uniform border is showing provided there is evidence of mica, plastic film, or thermal compound around the edges of the component.</p> 	<p>If insulation is required, there is no evidence of insulating materials or thermal compound.</p> 

07-6.6 Component Slewing (Buffer Material)

Component Slewing (Buffer Material)

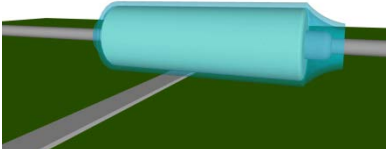
Target Condition	Acceptable Condition	Defect Condition
<p>For components requiring buffer material (slewing), the buffer material covers the entire component and does not extend over the component by more than 1/16 in. at each end.</p> 		<p>If required, the buffer material does not cover the entire component or extends over the component by more than 1/16 in.</p>

Component Slewing (Buffer Material)

Target Condition	Acceptable Condition	Defect Condition
The buffer material is compatible with the conformal coating.		The buffer material is incompatible with the conformal coating.

07-6.7 Component Leads Crossing Conductors

Component Leads Crossing Conductors

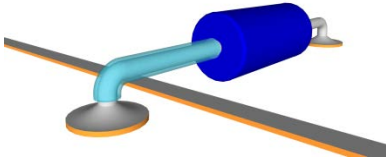
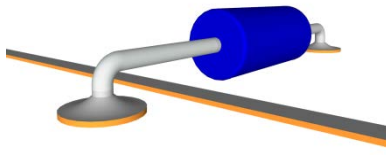
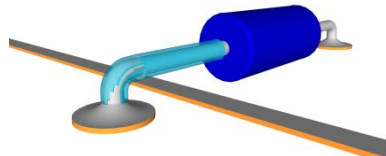
Target Condition	Acceptable Condition	Defect Condition
<p>The sleeving covers the area of designated protection.</p> 		<p>The component leads specified to have sleeving are not sleeved.</p> 
		<p>The sleeving is split or unraveled.</p> 
		<p>Damaged or insufficient sleeving no longer provides protection from shorting.</p>

07-6.8 Component Lead Forming

Component Lead Forming

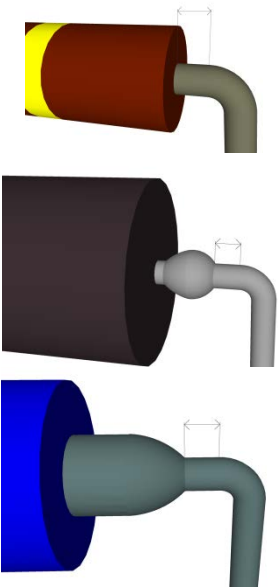
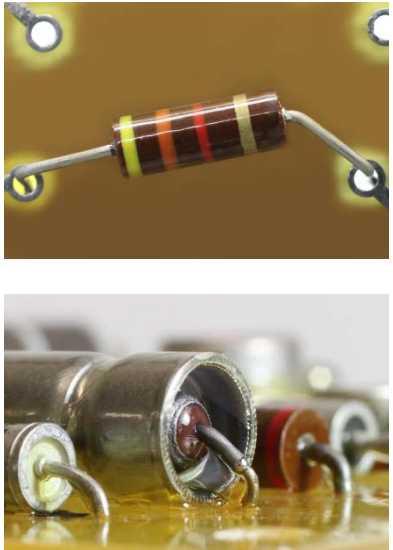
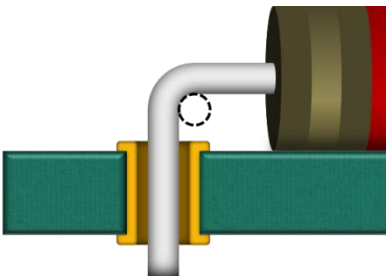
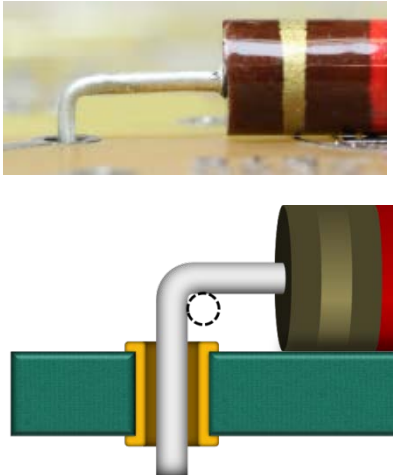
Target Condition	Acceptable Condition	Defect Condition
<p>The leads extend at least 1/32 in. from the body, from the solder bead, or from the lead weld before the first bend.</p> 		<p>The lead bend is less than 1/32 in. from the component body, solder bead, or component body lead seal.</p> 
<p>The inside bend radius of the component lead is greater than or equal to one lead diameter.</p> 		<p>The inside bend radius is less than one lead diameter.</p> 

Component Lead Forming

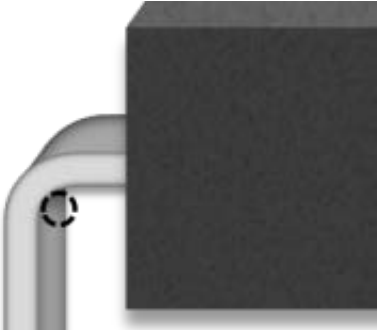
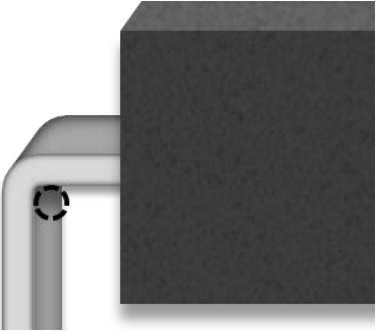
Target Condition	Acceptable Condition	Defect Condition
<p>For rectangular leads, the inside bend radius of the component lead is greater than or equal to the thickness of the lead.</p> 		<p>For rectangular leads, the inside bend radius is less than one lead thickness.</p> 
		<p>The lead weld, the solder bead, or the component body lead seal is fractured.</p>
		<p>The lead is kinked or cracked.</p>

07-6.9 Component Orientation

Component Orientation

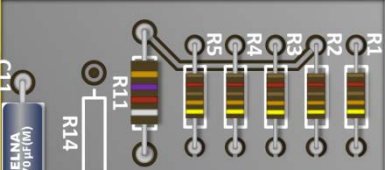
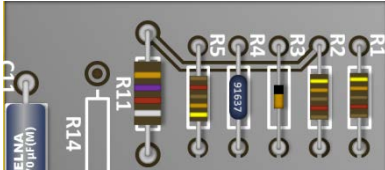

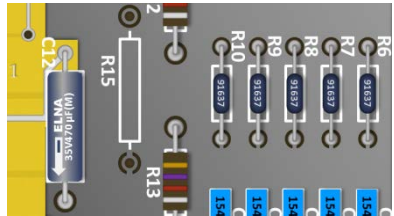
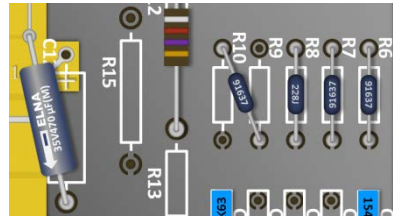
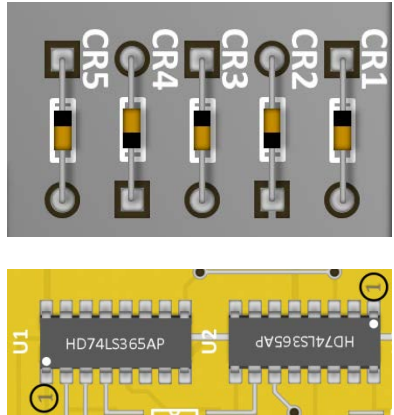
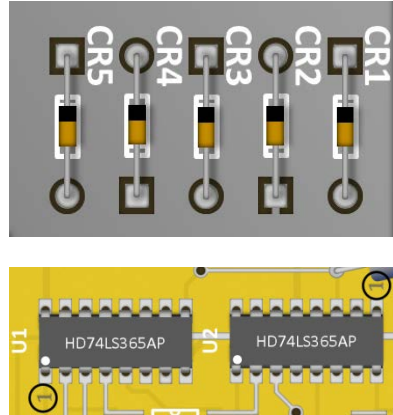

Target Condition	Acceptable Condition	Defect Condition
<p>The component markings and polarization symbols are discernible.</p>	<p>The component markings and polarization symbols are not discernible.</p>	
<p>All components are as specified, i.e. the correct part is installed.</p> 		<p>A component is not as specified, i.e. the wrong part is installed.</p> 

Component Orientation



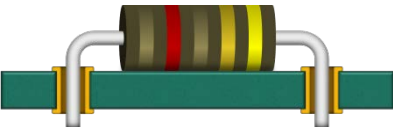
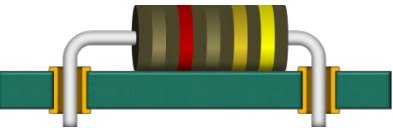
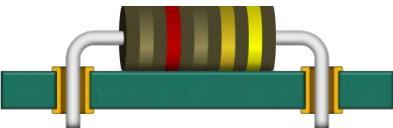
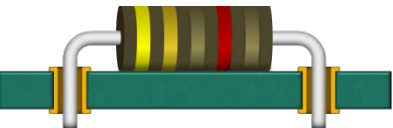

Target Condition	Acceptable Condition	Defect Condition
<p>All components terminate to the correct pads.</p> 		<p>A component is not mounted in the correct holes.</p> 
<p>Polarized and multilead components are oriented correctly.</p> 		<p>A polarized or a multilead component is not oriented correctly.</p> 

07-6.10 Component Mounting Horizontal, Axial Leaded

Component Mounting Horizontal, Axial Leaded

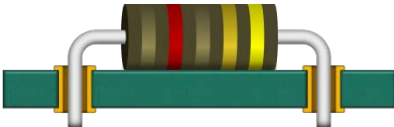

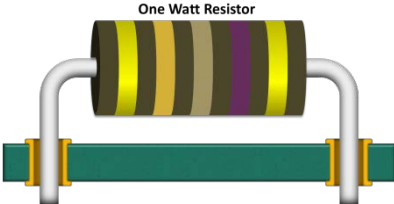
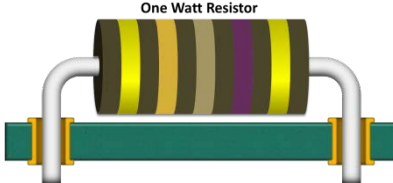
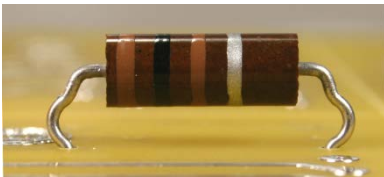
Target Condition	Acceptable Condition	Defect Condition
<p>The component leads emerge straight from the component, parallel to the body axis and the component is mounted utilizing 90° lead bends.</p> 		<p>A component lead does not emerge straight from the component, parallel to the body axis, creating stress at the body or at the lead seal.</p> 
<p>The component lead is perpendicular to the CCA surface as it enters the mounting hole.</p> 	<p>The component lead is not perpendicular to the CCA surface as it enters the hole.</p> 	
<p>The component is centered between the mounting holes.</p> 	<p>The component is not centered between the mounting holes.</p> 	
<p>Horizontal non-polarized components are oriented so the markings all read left-to-right.</p> 	<p>Horizontal non-polarized components are not oriented so the markings all read left-to-right.</p> 	

Component Mounting Horizontal, Axial Leaded

Target Condition	Acceptable Condition	Defect Condition
<p>The component is in full contact with the CCA surface.</p> 	<p>The component is not flush and the space between the component body and the CCA surface is less than 1/32 in., except for resistors one watt or greater.</p> 	<p>The space between the component body and the CCA surface is 1/32 in. or greater, except for resistors greater than one watt.</p> 
<p>Components that are required to be mounted off the CCA (resistors, one watt or greater) are mounted 1/16 in. or greater above the CCA surface.</p> 		<p>A component that is required to be mounted above the CCA surface is mounted less than 1/16 in. above the CCA surface.</p> 
<p>Components required to be mounted above the CCA surface in unsupported holes must be provided with lead forms at the CCA surface or other mechanical support to prevent lifting of the solder pad.</p> 		<p>A component that is required to be mounted above the CCA surface in unsupported holes is not provided with lead forms at the CCA surface or is not provided with other mechanical support to prevent lifting of the solder pad.</p> 

07-6.11 Component Mounting Horizontal, Axial Leaded with Stress Relief

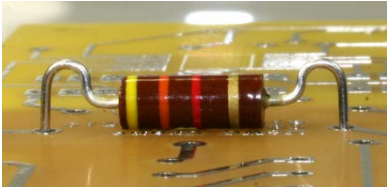
Component Mounting Horizontal, Axial Leaded with Stress Relief

Target Condition	Acceptable Condition	Defect Condition
<p>The component is mounted with camel hump stress relief bends.</p> 	<p>The component is not centered or the stress relief bends are not same size.</p> 	<p>Component requiring stress relief is not mounted with stress relief bends.</p>
<p>A configuration incorporating a single camel hump bend may have the body of the component positioned off-center.</p>		
<p>The component is mounted with loop bends or other alternative stress relief bends if the locations of the mounting holes prevent the use of a standard stress relief bend provided the inside bend diameter of the loop is at least four lead diameters.</p> 		<p>The inside bend radius of a stress relief loop is less than four lead diameters.</p>
		<p>A looped stress relief bend of a component comes closer than 1/16 in. to any adjacent lead or conductor.</p>

07-6.12 Component Mounting Horizontal, Radial Leaded





NOTE

WHEN REQUIRED, A COMPONENT MAY BE EITHER SIDE MOUNTED OR END MOUNTED.

THE SIDE OR SURFACE OF THE BODY, OR AT LEAST ONE POINT OF ANY IRREGULARLY CONFIGURED COMPONENT (SUCH AS CERTAIN POCKETBOOK CAPACITORS), NEEDS TO BE IN FULL CONTACT WITH THE CCA.

THE BODY SHALL BE BONDED OR OTHERWISE RETAINED TO THE CCA TO PREVENT DAMAGE WHEN VIBRATION AND SHOCK FORCES ARE APPLIED.

Component Mounting Horizontal, Radial Leaded

Target Condition	Acceptable Condition	Defect Condition
<p>The component body is in flat contact with the CCA surface.</p> 	<p>The component is in contact with the CCA on at least one side or surface.</p> 	<p>An unbonded component body is not in contact with the mounting surface.</p> 
<p>The component leads emerge straight from the component, parallel to the body axis and the component is mounted utilizing 90° lead bends.</p>		<p>The leads do not emerge straight from the component, parallel to the body axis and create stress at the component body/lead seal.</p> 

Component Mounting Horizontal, Radial Leaded

Target Condition	Acceptable Condition	Defect Condition
<p>The component lead is perpendicular to the CCA surface as it enters the mounting hole.</p> 	<p>The component lead is not perpendicular to the CCA surface as it enters the hole.</p> 	
<p>If required, bonding material is present.</p>		<p>If required, the bonding material is not present.</p>

07-6.13 Component Mounting Vertical, Axial Leaded

Component Mounting Vertical, Axial Leaded

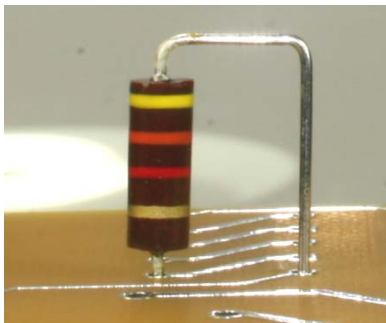
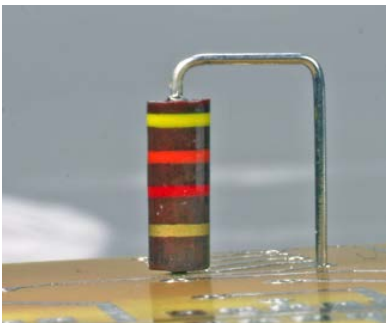
Target Condition	Acceptable Condition	Defect Condition
<p>The height of the component body above the CCA is 1/16 in.</p> 	<p>The height of the component body above the CCA is greater than 1/32 in. but less than 1/16 in.</p>	<p>The height of the component body above the CCA is less than 1/32 in. or the height of the installed component exceeds the height of the highest component on the CCA.</p> 

Component Mounting Vertical, Axial Leaded

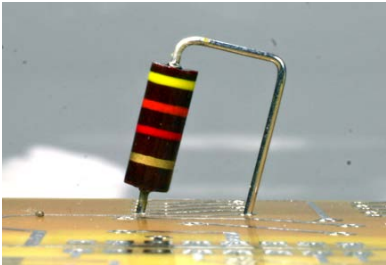
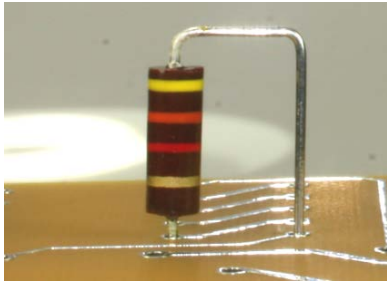
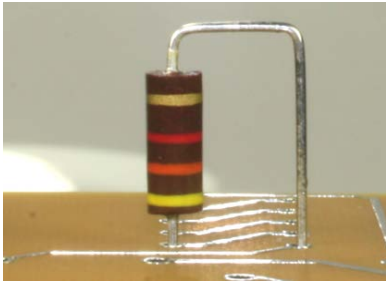
Target Condition	Acceptable Condition	Defect Condition
<p>The component lead is perpendicular to the CCA surface as it enters the mounting hole.</p>	<p>The component lead is not perpendicular to the CCA surface as it enters the hole.</p> 	
<p>The component leads emerge straight from the component, parallel to the body axis.</p>		<p>The leads do not emerge straight from the component, parallel to the body axis and create stress at the component body/lead seal.</p>
<p>The component body is perpendicular to the CCA.</p>	<p>The angle by which the component body deviates from the perpendicular does not allow the component lead to come closer than 1/16 in. to any adjacent lead or conductor.</p>	<p>The angle by which the component body deviates from the perpendicular allows the component lead to come closer than 1/16 in. to any adjacent lead or adjacent conductor.</p>
<p>Vertical, non-polarized component markings read from the top down.</p> 	<p>A vertical, non-polarized component's markings read from the bottom to the top.</p> 	

Component Mounting Vertical, Axial Leaded

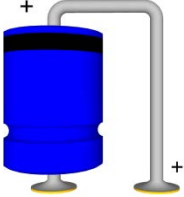
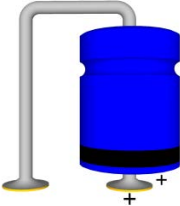
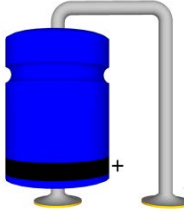
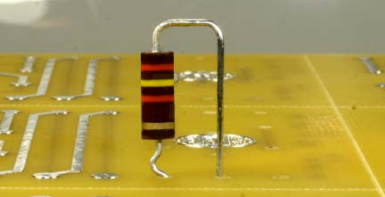
Target Condition	Acceptable Condition	Defect Condition
<p>The vertical components' polarized markings are located on top.</p> 	<p>A vertical polarized component is mounted with a long ground lead.</p> 	<p>A polarized component is mounted backwards.</p> 
	<p>A vertical component's polarized marking is hidden.</p>	
<p>Components that are mounted above the CCA surface in unsupported holes are provided with lead forms or other mechanical support to prevent lifting of the pad.</p> 		<p>Components that are required to be mounted off the CCA in unsupported holes are not provided with lead forms at the CCA surface or other mechanical support to prevent lifting of the solder pad.</p>

07-6.14 Component Mounting Vertical, Radial Leaded

NOTE

SOME COMPONENTS CANNOT BE TILTED DUE TO MATING REQUIREMENTS WITH ENCLOSURES OR PANELS, FOR EXAMPLE TOGGLE SWITCHES, POTENTIOMETERS, LCDS, AND LEDS.

Component Mounting Vertical, Radial Leaded

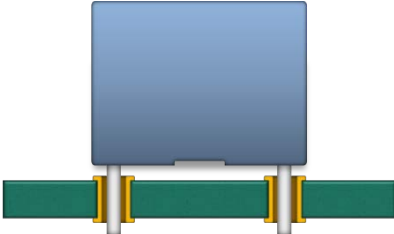
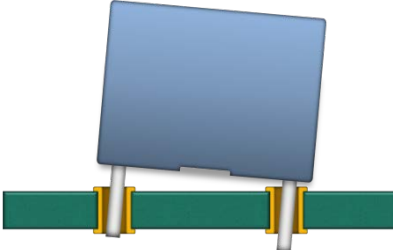
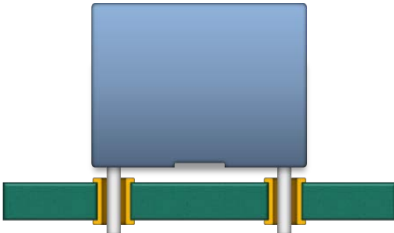
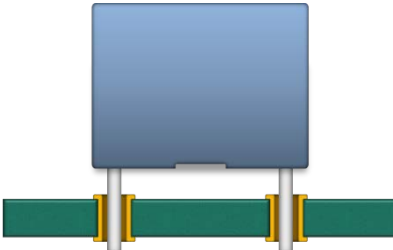
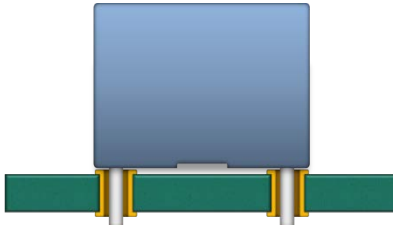
Target Condition	Acceptable Condition	Defect Condition
<p>The component is perpendicular to and the base is parallel to the CCA.</p> 	<p>The angle by which the component body deviates from the perpendicular does not allow the component lead to come closer than 1/16 in. to any adjacent lead or conductor.</p> 	<p>The angle by which the component body deviates from the perpendicular allows the component lead to come closer than 1/16 in. to any adjacent lead or conductor.</p>
<p>For components mounted without dual 45° bends and without spacers, the space between the base (or meniscus) of the component and the CCA surface is between 1/64 and 1/16 in.</p> 	<p>For components mounted without 45° bends and without spacers, the space between component base (or component meniscus) and the CCA surface is greater than 1/16 in.</p> 	<p>For components mounted without dual 45° bends and without spacers, the space between the component base (or component meniscus) and the CCA surface is less than 1/64 in.</p> 

Component Mounting Vertical, Radial Leaded

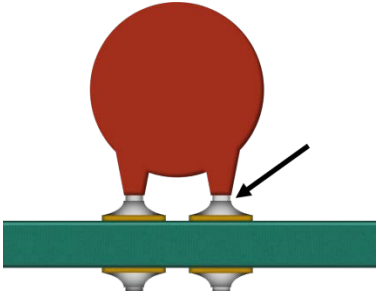
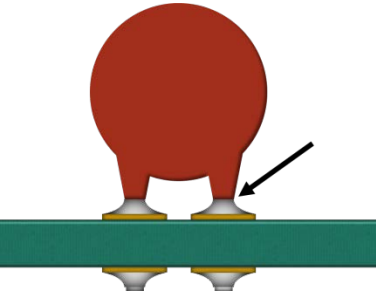
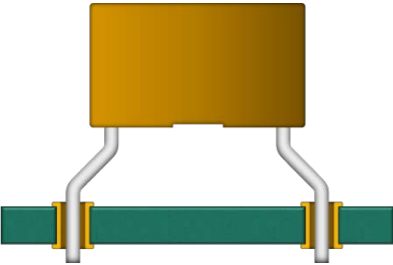
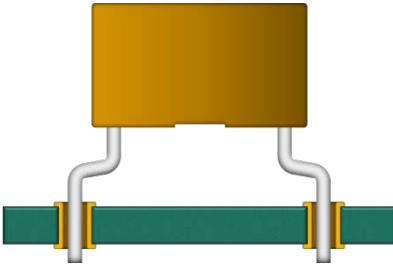
Target Condition	Acceptable Condition	Defect Condition
<p>For components with a coating meniscus, there is discernible clearance between the coating meniscus and the subsequent solder fillet.</p> 		<p>For components with a coating meniscus, the coating meniscus is in contact with the solder fillet.</p> 
<p>Components that are formed to meet hole spacing requirements have dual 45° lead bends and the first bend is 1/16 in. above the CCA.</p> 	<p>Components formed to meet hole spacing requirements have other than dual 45° bends.</p> 	<p>For components formed to meet hole spacing requirements, the lead bend contacts the CCA.</p>
		<p>The height of the installed component exceeds the height of the highest component on the CCA, unless required by the original configuration.</p>

Component Mounting Vertical, Radial Leaded

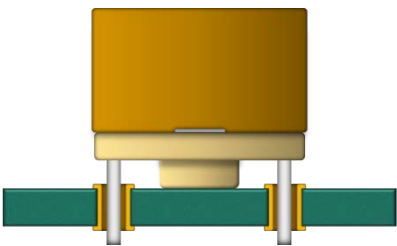
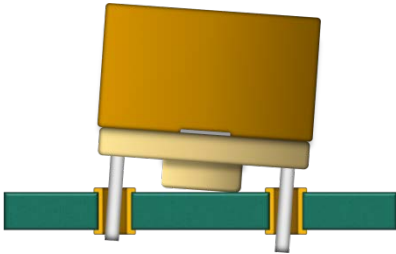
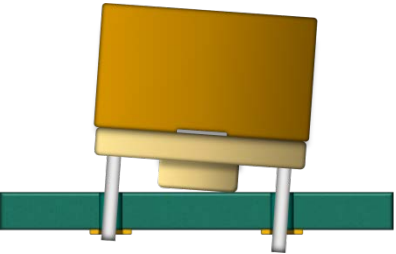
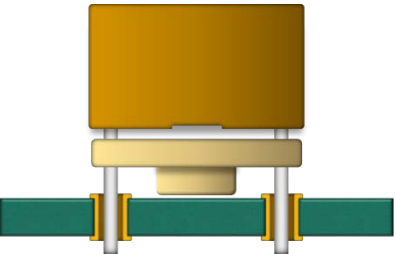
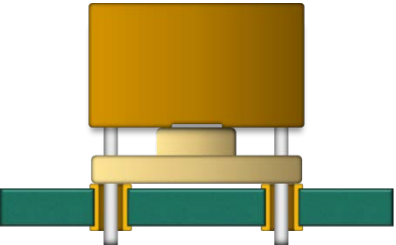
Target Condition	Acceptable Condition	Defect Condition
<p>For components mounted with spacers, the spacer is in full contact with both the component and the CCA.</p> 	<p>For components mounted with spacers, the spacer is in partial contact with the component or the CCA, provided the component is mounted in a supported hole.</p> 	<p>For components mounted with spacers, the spacer is in partial contact with the component or the CCA on a component mounted in an unsupported hole.</p> 
		<p>For components mounted with spacers, the spacer is not in contact with the component or the CCA.</p> 
		<p>For components mounted with spacers, the spacer is inverted.</p> 

07-6.15 Component Mounting Dual In-Line Package (DIP)

Component Mounting Dual In-Line Package (DIP)

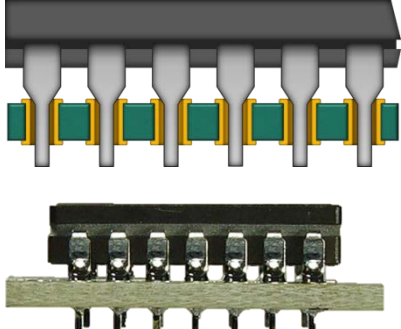
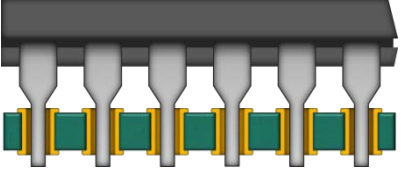
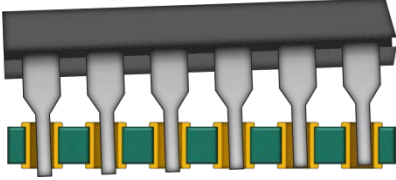



Target Condition	Acceptable Condition	Defect Condition
<p>All lead shoulders contact a pad.</p> 	<p>A lead shoulder does not contact a pad, provided the component height does not exceed the height of the highest component on the CCA and the lead protrusion is visible in the solder joint.</p> 	<p>The tilt of the component causes the component height to exceed the height of the highest component on the CCA or the lead protrusion not to be visible in the solder.</p> 

07-6.16 Straight-Through Lead Terminations

CAUTION



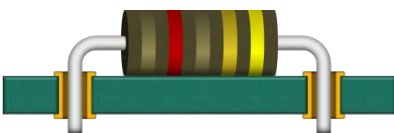
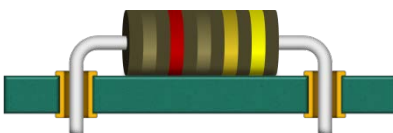
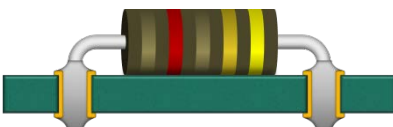



DIP LEADS SHALL NOT BE TERMINATED UNLESS ABSOLUTELY NECESSARY DUE TO THE POSSIBILITY OF EXPOSING A NONSOLDERABLE BASE MATERIAL.

Straight-Through Lead Terminations

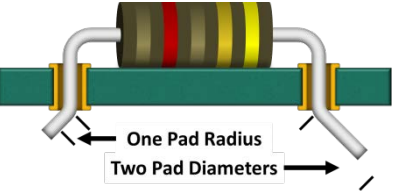
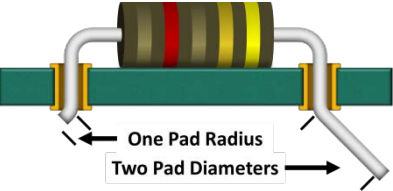
Target Condition	Acceptable Condition	Defect Condition
<p>The lead length after termination is one lead diameter (one lead width for rectangular leads).</p> 	<p>After termination, the lead length is less than or equal to two lead diameters (two lead widths for rectangular leads).</p> 	<p>The lead protrusion is greater than two lead diameters.</p> 
<p>The cut end of the termination is perpendicular to the lead.</p> 	<p>The cut end of the termination is not perpendicular to the lead.</p> 	
	<p>The lead end is visible in the solder joint.</p> 	<p>The lead end is not visible in the solder joint.</p> 
		<p>A lead in an unsupported hole is not clinched.</p> 

07-6.17 Semi-Clinch Lead Terminations

Semi-Clinch Lead Terminations

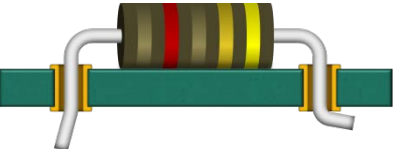

Target Condition	Acceptable Condition	Defect Condition
<p>The lead length after termination is equal to one pad diameter.</p> 	<p>The lead length after termination is at least one pad radius and less than or equal to two pad diameters.</p> 	<p>The lead length after termination is less than one pad radius or greater than two pad diameters.</p> 
		<p>The clinched lead comes closer than 1/16 in. to any adjacent lead or adjacent conductor.</p>
<p>The cut end of the termination is perpendicular to the lead.</p> 	<p>The cut end of the termination is not perpendicular to the lead.</p> 	
		<p>A lead in an unsupported hole is not clinched.</p> 
<p>The clinch angle is 45°.</p> 	<p>The clinch angle is greater than or equal to 30° and less than or equal to 75°.</p> 	<p>The clinch angle is less than 30° or greater than 75°.</p> 

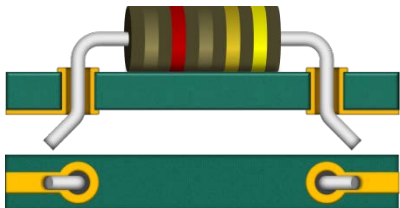
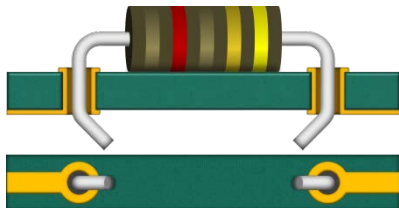
Semi-Clinch Lead Terminations





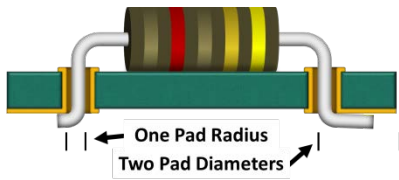
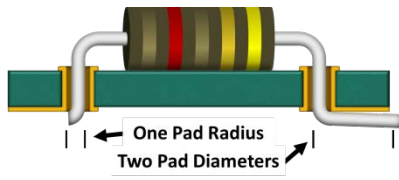

Target Condition	Acceptable Condition	Defect Condition
		
<p>If the pad has a connecting conductor, the clinched lead is formed in the direction of the connecting conductor.</p> 	<p>If the pad has a connecting conductor, the clinched lead is not formed in the direction of the connecting conductor.</p> 	

07-6.18 Full Clinch Lead Terminations

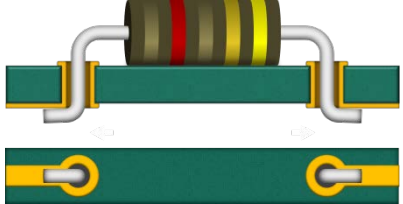
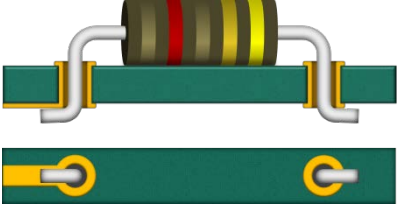
Full Clinch Lead Terminations

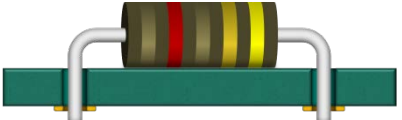
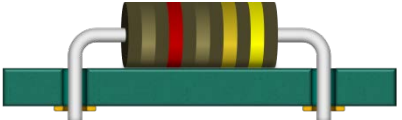

Target Condition	Acceptable Condition	Defect Condition
<p>The lead length after termination equal to one pad diameter.</p>  	<p>The lead length after termination is greater than or equal to one pad radius and less than or equal to two pad diameters.</p> 	<p>The lead length after termination is less than one pad radius or greater than two pad diameters.</p> 

Full Clinch Lead Terminations

Target Condition	Acceptable Condition	Defect Condition
<p>The clinched lead is formed in the direction of the connecting conductor.</p> 		<p>A clinched lead extends beyond the edge of the pad or the edge of a connecting conductor.</p> 
<p>The cut end of the termination is perpendicular to the lead.</p> 	<p>The cut end of the termination is not perpendicular to the lead.</p> 	
<p>The clinch angle is 90° (A slight gap between the lead end and the pad or conductor due to spring back is considered a target condition).</p> 	<p>The clinch angle is greater than or equal to 75° but less than 90°.</p> 	<p>A required full clinch is less than 75°.</p> 
		<p>A lead in an unsupported hole is not clinched.</p> 
		<p>A lead terminating on an isolated pad is fully clinched.</p> 



07-6.19 Offset Pad Terminations

Offset Pad Terminations



Target Condition	Acceptable Condition	Defect Condition
<p>The clinched lead is centered on the pad.</p> 	<p>The clinched lead is not centered, but does not overhang the side of the pad.</p> 	<p>The clinched lead overhangs the side of the pad.</p> 
<p>The lead to pad contact length is 80% of the diameter of the pad.</p>	<p>The lead to pad contact length is greater than 50% of the diameter of the pad, but does not overhang the end of the pad.</p>	<p>The lead to pad contact length is less than 50% of the diameter of the pad or overhangs the end of the pad.</p>
<p>The cut end of the termination is perpendicular to the lead.</p>	<p>The cut end of the termination is not perpendicular to the lead.</p>	
<p>The clinch angle is 90° (A slight gap between the lead end and the pad or conductor due to spring back is considered a target condition).</p>	<p>The clinch angle is greater than or equal to 75° but less than 90°.</p>	<p>The clinch angle is less than 75°.</p>

07-6.20 Solder Acceptability for Through-Hole Components

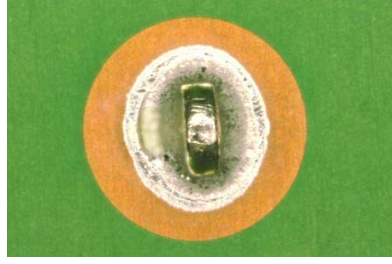
Solder Acceptability for Through-Hole Components

Target Condition	Acceptable Condition	Defect Condition
<p>The lead and barrel of the plated-through hole have 360° of circumferential wetting.</p> 		<p>The lead and barrel of the plated-through hole have less than 360° of circumferential wetting.</p> 
<p>Unsupported holes have 360° of circumferential wetting between the lead and the pad.</p>		<p>Unsupported holes have less than 360° of circumferential wetting between the lead and the pad.</p>
<p>The pad area on the termination side of plated-through and unsupported holes is 100% covered with wetted solder.</p> 	<p>The pad area on the termination side of plated-through and unsupported holes is 75% covered with wetted solder.</p>	<p>The pad area on the termination side of plated-through and unsupported holes is less than 75% covered with wetted solder.</p> 
<p>The pad area on the component side of the plated-through hole is 100% covered with wetted solder.</p>	<p>The pad area on the component side of the plated-through hole shows evidence of wetting.</p>	<p>The pad area on the component side of the plated-through hole shows no evidence of wetting.</p>

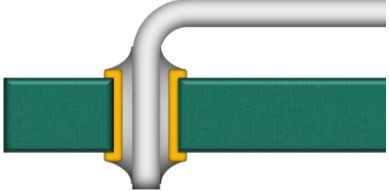
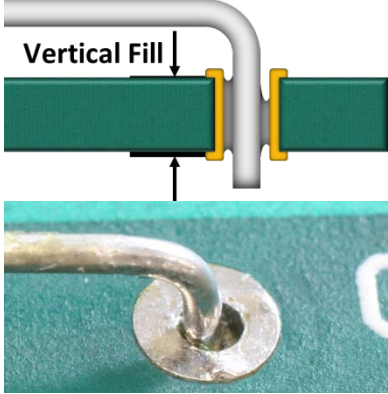
Solder Acceptability for Through-Hole Components

Target Condition	Acceptable Condition	Defect Condition
<p>The vertical fill of the plated-through hole is 100%.</p> 		<p>The vertical fill of the plated-through hole is less than 100%.</p> 
		<p>Solder fillet extends into the lead bend, or contacts component body, or end seal.</p>
<p>100% solder fillet exists between a full clinched lead and a connecting conductor.</p> 	<p>Wetting is evident between the full clinched lead and the connecting conductor.</p>	<p>No wetting is evident between the full clinched lead and the connecting conductor.</p> 

07-6.21 High Voltage Component Soldering

NOTE

THESE SPECIFICATIONS ARE GENERAL REQUIREMENTS FOR HIGH VOLTAGE
SOLDERING.

HIGH-VOLTAGE JOINTS WHERE CORONA SUPPRESSION IS NECESSARY SHALL BE AS
DEFINED ON THE ENGINEERING DOCUMENTATION.

High Voltage Component Soldering

Target Condition	Acceptable Condition	Defect Condition
All sharp edges of the component lead are completely covered with a continuous smooth rounded layer of solder forming a ball of solder. 		The solder joint is not smooth and round.
		There is evidence of a solder protrusion.
		The component lead is discernible in the solder joint.
		The solder joint profile has a teardrop shape.

This page is intentionally blank.

15 October 2013

WP 008 00 Terminals

08-1 PURPOSE

Identify the technical information relative to terminals.

Specify the repair procedures for desoldering and removing wires from terminals.

Specify the repair procedures for insulated wire stripping.

Specify the repair procedures for insulated wire tinning.

Specify the repair procedures for wire forming.

Specify the repair procedures soldering wires to terminals.

Identify the workmanship standards for terminals.

08-2 INDEX

Paragraph	Subject	Page
08-1	Purpose	1
08-2	Index	1
08-3	General Safety Precautions.....	2
08-4	Technical Information.....	3
08-5	Repair Procedures.....	5
08-5.1	Procedural Analysis and Feasibility of Repair	6
08-5.2	Wire Removal from Terminal Procedure.....	6
08-5.3	Insulated Wire Stripping	8
08-5.3.1	Thermal Wire Stripping Procedure	9
08-5.3.2	Mechanical Wire Stripping Procedure.....	12
08-5.3.3	Chemical Wire Stripping	14
08-5.4	Insulated Wire Tinning Procedure	15
08-5.5	Terminal Preparation for Soldering Procedure.....	19
08-5.6	Wire Forming	22
08-5.6.1	Wire Forming for Round Terminals using Pliers Procedure	22
08-5.6.2	Wire Forming on Round Terminal Procedure.....	25
08-5.6.3	Wire Forming for Pierced Tab Terminals Procedure	28
08-5.6.4	Wire Forming for Side Entry Bifurcated Terminals Procedure	30
08-5.6.5	Wire Forming for Bottom Entry Bifurcated Terminals Procedure.....	32
08-5.6.6	Wire Forming for Top Entry Bifurcated Terminals Procedure	34
08-5.7	Terminal Soldering Procedure	36

Paragraph	Subject	Page
08-5.8	Terminal Removal and Installation Procedure	42
08-6	Workmanship Standards	47
08-6.1	Wires	48
08-6.2	Insulated Wire Stripping	49
08-6.3	Insulated Wire Tinning	50
08-6.4	Insulation Clearance	50
08-6.5	Wire Forming for Turret Terminals.....	51
08-6.6	Wire Forming for Hook Terminals	53
08-6.7	Wire Forming for Pierced Tab Terminals	54
08-6.8	Wire Forming for Bifurcated Terminals	55
08-6.9	Wire Forming for Wires AWG 30 and Smaller (All Terminals).....	57
08-6.10	Terminals Connected By a Bus Wire (All Terminals).....	57
08-6.11	Axial Leaded Component Installed on Terminal with Stress Relief	58
08-6.12	Terminal Solder Acceptability	59
08-6.13	Insulation Sleeving Replacement.....	60
08-6.14	Terminal Installation	61
08-6.15	Terminal Installation Soldering	62

08-3 GENERAL SAFETY PRECAUTIONS

Observe all the following precautions while removing and installing wires to terminals:

- Electronic equipment must be de-energized during removal and installation of CCAs
- Personnel are required to wear a properly grounded ESD wrist strap and cord while working in or around the EPA
- ESD can destroy components—protect ESDS devices during handling and repair to prevent ESD damage (Refer to WP 004 00)
- Isopropyl alcohol is flammable; do not use in the presence of sparks, heat, flame, or synthetic cloth
- Soldering handpieces (e.g., soldering irons, solder extractors) produce extreme heat—exercise care when these tools are out of their stands
- Avoid direct inhalation of fumes during a soldering operation because there is a possibility these fumes could cause occupational asthma
- The lead contained in solder is a source of lead oxide, which the human body cannot dissipate (accumulation of lead oxide in the body over a period of years can result in a serious health hazard)

- Contact with solder by holding in the mouth, smoking, or eating during or immediately after soldering is a potential means of ingesting trace amounts of lead oxide
- Avoid oral contact with hands during or immediately after solder operations
- Wash hands following any solder operation
- Wear approved PPE whenever pouring or handling molten metals or corrosive liquids and solids; and cutting, drilling, grinding, milling, chipping and other dust and debris producing operations
- Use adequate ventilation during thermal wire stripping operations because wire insulation may emit toxic fumes during thermal stripping
- Follow manufacturer's safety instructions for using chemical wire strippers
- Use chemical wire strippers only in well-vented areas, wear prescribed PPE, and avoid contact with skin and eyes
- Do not use wire with PVC [plastic] insulation to replace or repair installed military equipment wiring
- Always follow the manufacturer's instructions and warnings when using conformal coating products

08-4 TECHNICAL INFORMATION

Terminals are used for a variety of applications, such as interconnect wiring between assemblies, wiring internal to an assembly, daughter boards, relays, and edge connectors.

The size and shape of the terminal is based on the number of interconnects, wire size, current handling capability, and space required.

The use of a CCA determines the types of terminals and wires installed.

Turret terminals (Figure 08-1) are single-post terminals, which may or may not be insulated, solid or hollow, stud or feed-through.

Stud terminals protrude from one side of the CCA.



Figure 08-1 Turret Terminals

Feed-through terminals protrude from both sides of the CCA.

Hook terminals (Figure 08-2) are made of cylindrical stock formed into the shape of a hook (a common terminal for relays).

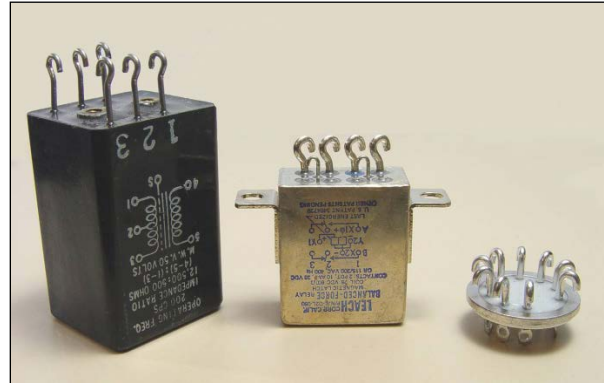

Figure 08-2 Hook Terminals

Perforated or **pierced tab terminals** (Figure 08-3) use a hole pierced in flat metal for termination (e.g., terminal lugs).

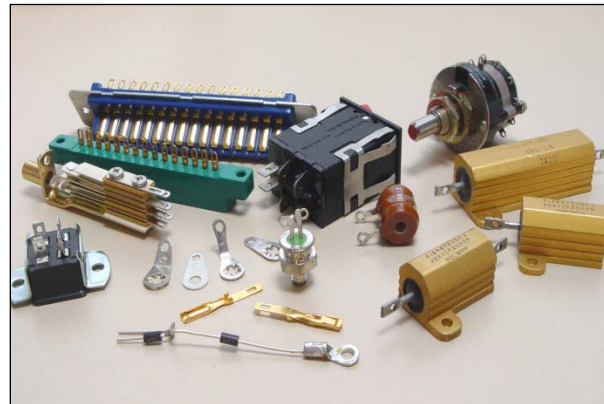

Figure 08-3 Pierced Tab Terminals

Bifurcated or fork terminals (Figure 08-4) are solid or hollow double-post terminals.

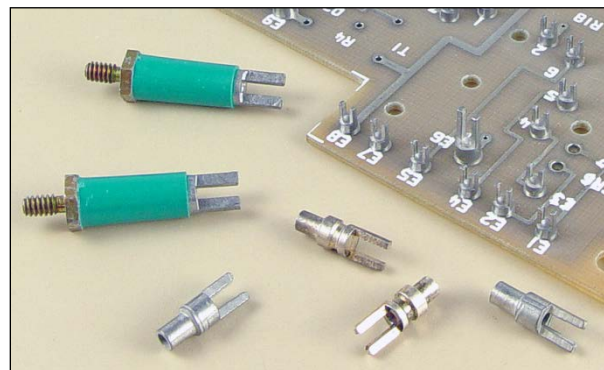

Figure 08-4 Bifurcated Terminals

08-5 REPAIR PROCEDURES



PROTECT STATIC SENSITIVE DEVICES DURING HANDLING AND REPAIR TO PREVENT ESD DAMAGE (REFER TO WP 004 00).

Equipment Required Listed below are the authorized 2M Power Units* for soldering wires to terminals:

- **NAVAIR/NAVSEA/USMC/USAF/USCG**—PRC-2000-SMT
- **NAVSEA/USCG**—PRC-2000-TH
- **NAVSEA/USCG**—MBT-250-SD†
- **USMC**—MBT-350†
- **NAVSEA**—ST-25†

* Refer to Table 03-3 for Power Unit Part No., and CAGE Code
† Limited capability in this WP

Additional Support Items For additional information regarding items of support and support equipment refer to:

- **NAVSEA/NAVAIR/USCG**—2M MTR Certification Manual
- **NAVSEA/USCG**—Allowance Parts List (APL) 000A8423
- **USMC**—Stock List SL-3-09458A
- **USAF**—the Consolidated Tool Kit (CTK)

Material Required Listed below are the materials required* for soldering wires to terminals:

- Desoldering Wick†
 - Flux, Soldering
 - Insulation Sleeving Kit, Electrical‡
 - Isopropyl Alcohol, Technical
 - Solder, Tin Alloy†
-

- Towel, Paper (Kimwipe®)‡

* Refer to Table 03-4 for Specification No., Part No., and NSN

† Select size appropriate for application

‡ Substitution of equivalent material is acceptable

08-5.1 Procedural Analysis and Feasibility of Repair

Perform the Procedural Analysis and Feasibility of Repair Procedure in WP 003 00 (paragraph 03-5.1).















08-5.2 Wire Removal from Terminal Procedure

The proper method to be used in desoldering of wires from terminals will be determined by the solder joint, wire termination, and the amount of solder to be removed.

It is difficult to remove wires with a bend of more than 180° without damage to the wire (e.g., birdcaging, disturbing the lay of the wire, or insulation damage).

Solder must be completely reflowed throughout the joint before attempting to remove the wire.

Personnel Hazards

					
Alcohol, Isopropyl					1
					
Flux (Soldering)					8
					
Lead (Solder)					9

Wire Removal from Terminal Procedure

Step	Action
	<p style="text-align: center;">WARNING</p> <p style="text-align: center;"><i>USE APPROVED SAFETY EYEWEAR WHEN PERFORMING THIS PROCEDURE. COMPLY WITH ALL LOCAL REQUIREMENTS FOR PPE.</i></p> <p style="text-align: center;">CAUTION</p> <p style="text-align: center;">DON A PROPERLY GROUNDED ESD WRIST STRAP BEFORE STARTING THIS PROCEDURE.</p>
1	Remove any conformal coating from the repair area using one of the Conformal Coating Removal Methods in WP 006 00 (paragraph 06-5.4).
2	<p style="text-align: center;">CAUTION</p> <p style="text-align: center;">AVOID DAMAGING THE WIRE OR THE TERMINAL WHILE REMOVING INSULATION SLEEVING.</p> <p>Slide rigid insulation sleeving above the solder joint or cut and remove heat shrinkable sleeving from the solder joint.</p>
3	Select a soldering iron tip that maximizes heat transfer and contact area with the terminal.
4	Set the soldering iron tip temperature to 600°F (316°C).
5	Clean the terminal with isopropyl alcohol using an acid brush and blot dry with a clean, lint-free tissue.
6	Apply flux SPARINGLY to the terminal. Note: Use a toothpick or flux pen to control the volume of flux applied. Heavy flux volume impairs cleaning and may affect reliability.
7	Remove the seasoning (all solder) from the soldering iron tip.
8	Thermally shock the soldering iron tip on a damp sponge.
9	Hold the insulated portion of the wire.

Wire Removal from Terminal Procedure

Step	Action
10	<p style="text-align: center;">CAUTION</p> <p style="text-align: center;">DO NOT APPLY PRESSURE TO THE TERMINAL OR THE WIRE.</p> <p>Place the soldering iron tip on the terminal contacting the wire at the point of maximum thermal mass.</p>
11	<p style="text-align: center;">CAUTION</p> <p style="text-align: center;">IF SOLDER MELT DOES NOT OCCUR WITHIN TWO SECONDS, STOP THIS PROCEDURE AND ADJUST TIP TEMPERATURE PER THE TIP TEMPERATURE PROCEDURE IN WP 003 00 (PARAGRAPH 03-5.4).</p> <p>Observe solder melt and then remove the wire from the terminal.</p>
12	Season the tip and place the soldering iron into its stand.
13	Allow the terminal to cool completely before cleaning.
14	Clean the terminal with isopropyl alcohol using an acid brush to remove all flux residue and blot dry with a clean, lint-free tissue.
15	<p><i>Inspect per the General Inspection Procedure in WP 003 00 (paragraph 03-5.12) to all applicable WORKMANSHIP STANDARDS, including:</i></p> <ul style="list-style-type: none"> • <i>Wires (paragraph 08-6.1)</i> • <i>Post-Solder Joint Cleanliness in WP 005 00 (paragraph 05-6.2)</i> • <i>Laminate in WP 011 00 (paragraph 11-6.1)</i> • <i>Other applicable Workmanship Standards as required</i>
16	Dispose of all HAZMAT following local procedures.

08-5.3 Insulated Wire Stripping

Thermal stripping is the preferred method of insulated wire stripping. Use thermal strippers whenever possible to reduce the risk of wire damage.

Do not use mechanical strippers on wire sizes AWG-22 or smaller. The pulling action of the stripper may stretch the smaller-sized wires.

08-5.3.1 Thermal Wire Stripping Procedure

Thermal wire stripping can be used for any gauge of insulated wire. The insulation types that can be removed effectively include Teflon®, neoprene, Kel-F®, vinyl, rubber, Hypalon®, nylon, and plastic. Coaxial insulations can also be thermally stripped.

Thermal wire strippers are shown in Figure 08-5.



Figure 08-5 Thermal Wire Strippers

Personnel Hazards





Lead (Solder)

9

Thermal Wire Stripping Procedure

Step	Action
	<div style="text-align: center;"> <div style="border: 2px solid black; padding: 5px; margin-bottom: 10px;">WARNING</div> <p><i>USE APPROVED SAFETY EYEWEAR WHEN PERFORMING THIS PROCEDURE.</i></p> <p><i>COMPLY WITH ALL LOCAL REQUIREMENTS FOR PPE.</i></p> <p><i>USE THERMAL STRIPPERS ONLY IN A WELL-VENTILATED AREA TO AVOID TOXIC FUMES FROM WIRE INSULATION.</i></p> <div style="border: 2px solid black; padding: 5px; margin-bottom: 10px;">CAUTION</div> <p><i>DON A PROPERLY GROUNDED ESD WRIST STRAP BEFORE STARTING THIS PROCEDURE.</i></p> </div>

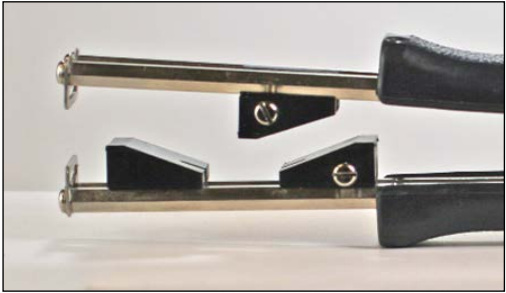
Thermal Wire Stripping Procedure

Step	Action
1	Seat the universal power cord fully into the thermal strippers. 
2	Adjust the thermal strippers' stops for depth of jaw closure and desired strip length. 
3	<div style="text-align: center; border: 1px solid black; padding: 5px; margin-bottom: 10px;">CAUTION</div> <p style="text-align: center;">VISUALLY CHECK TO ENSURE MELTING THROUGH INSULATION AND NOT BURNING.</p> Perform a "test melt" at the end of the insulation by setting the Pulse Heat control to zero (0), apply power to the thermal strippers using the foot switch, and increase the voltage slowly until the insulation melts cleanly and evenly. 
4	Insert the wire into the jaws of the thermal strippers to the stop.
5	<div style="text-align: center; border: 1px solid black; padding: 5px; margin-bottom: 10px;">CAUTION</div> <p style="text-align: center;">EXCESSIVE PRESSURE MAY RESULT IN DEFORMING THE WIRE STRANDS. DO NOT MAR OR CRUSH WIRE DURING THIS PROCESS.</p> Close the jaws carefully on the insulation and apply power to the thermal strippers.

Thermal Wire Stripping Procedure

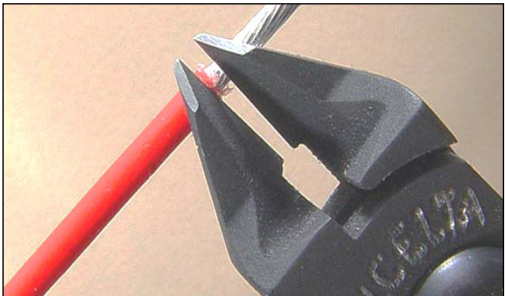
Step	Action
6	<p>When the insulation melts, turn the wire (or the tool) 180° creating a complete melt around the circumference of the wire.</p> 
7	Remove the power from the thermal strippers.
8	Open the jaws of the thermal strippers.
9	Remove the wire from the thermal strippers.
10	Allow the insulation and the wire to cool completely.
11	Remove the stripped insulation from the wire with your fingers allowing the insulation to turn following the natural lay of the wire strands.
12	<p>Trim the insulation evenly, 360° around the wire using flush-cutting pliers.</p> 
13	<p><i>Inspect per the General Inspection Procedure in WP 003 00 (paragraph 03-5.12) to all applicable WORKMANSHIP STANDARDS, including:</i></p> <ul style="list-style-type: none"> • <i>Wires (paragraph 08-6.1)</i> • <i>Insulated Wire Stripping (paragraph 08-6.2)</i> • <i>Other applicable Workmanship Standards as required</i>
14	Dispose of all HAZMAT following local procedures.

08-5.3.2 Mechanical Wire Stripping Procedure

Use mechanical wire strippers only when thermal strippers are not available or thermal wire stripping is not feasible.

The 2M approved mechanical wire stripper (Figure 08-6) has factory-set, non-adjustable, self-aligning precision blades to provide reliable wire stripping.



Figure 08-6 Approved Mechanical Stripper and Blades

Other mechanical strippers such as the old “Miller” strippers and the combination stripper, crimper, and bolt cutter are likely to cause wire damage and are not approved for 2M repair (Figure 08-7).



Figure 08-7 Strippers NOT Approved for 2M Repair

Personnel Hazards





Lead (Solder)

Mechanical Wire Stripping Procedure

Step	Action
	<div style="text-align: center;"> <div style="border: 2px solid black; padding: 5px; display: inline-block;">WARNING</div> <p>USE APPROVED SAFETY EYEWEAR WHEN PERFORMING THIS PROCEDURE.</p> <p>COMPLY WITH ALL LOCAL REQUIREMENTS FOR PPE.</p> </div>

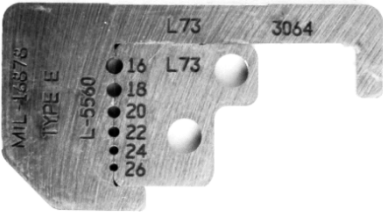
Mechanical Wire Stripping Procedure

Step	Action
	<div style="text-align: center; border: 2px solid black; padding: 5px; width: fit-content; margin: 0 auto;">CAUTION</div> <p style="text-align: center;">DON A PROPERLY GROUNDED ESD WRIST STRAP BEFORE STARTING THIS PROCEDURE.</p> <p style="text-align: center;">DO NOT USE MECHANICAL STRIPPERS ON WIRE SIZES AWG-22 OR SMALLER. THE PULLING ACTION OF THE STRIPPER MAY STRETCH THESE WIRES.</p>
1	<p>Install the correct blades into the approved mechanical strippers.</p> 
2	<p>Adjust the mechanical strippers' stop for a strip length approximately ¼ in. longer than required for the solder joint.</p>
3	<p>If the wire size is unknown, start with the largest notch and move to the smaller notches until the wire strips cleanly without scraping the wire strands.</p>
4	<p>Insert the wire perpendicular through the locking jaws and into the cutting notch that matches the wire size.</p> 
5	<p>Squeeze the handles until the insulation is cut and begins to separate.</p> 
6	<p>Slowly release the pressure on the handles.</p>
7	<p>Remove the wire from the mechanical strippers.</p>
8	<p>Reestablish the natural lay of the wire strands if straightened.</p>



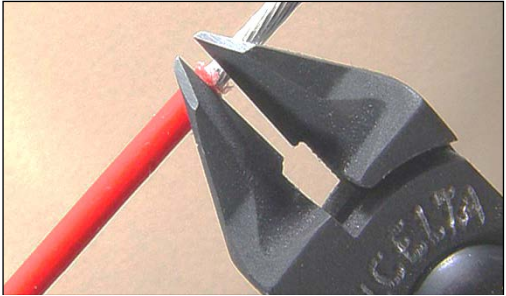











Mechanical Wire Stripping Procedure

Step	Action
9	Remove the stripped insulation from the wire with your fingers allowing the insulation to turn following the natural lay of the wire strands.
10	Trim the insulation evenly, 360° around the wire using flush-cutting pliers. 
11	<p><i>Inspect per the General Inspection Procedure in WP 003 00 (paragraph 03-5.12) to all applicable WORKMANSHIP STANDARDS, including:</i></p> <ul style="list-style-type: none"> • <i>Wires (paragraph 08-6.1)</i> • <i>Insulated Wire Stripping (paragraph 08-6.2)</i> • <i>Other applicable Workmanship Standards as required</i>
12	Dispose of all HAZMAT following local procedures.

08-5.3.3 Chemical Wire Stripping

Chemical wire strippers use a caustic chemical to strip the wire insulation.

Personnel Hazards

					
Alcohol, Isopropyl					1
					
Lead (Solder)					9
					
Chemical Wire Stripper					

Removing thin insulations (such as enamel, varnish, or similar insulating coatings used on motor windings, etc.) by scraping or burning, methods can be detrimental to maintaining the high-reliability requirement.

Scraping can easily cause nicking and subsequent vibration failure; burning can cause the wire to become brittle.

Chemical strippers designed to remove these coatings without marring shall be used.

WARNING

CHEMICAL STRIPPER IS CAUSTIC; FOLLOW MANUFACTURER'S SAFETY INSTRUCTIONS AND LOCAL PROCEDURES.

Chemical stripping typically includes dipping the wire into a caustic chemical mixture.

Be sure to follow the manufacturer's directions and local procedures that apply.

Dispose of all HAZMAT following local requirements.

08-5.4 Insulated Wire Tinning Procedure

Once a wire is exposed to the environment, oxidation begins to take place.

The tinning of wires is important to ensure a reliable solder joint.

Tinning stranded wire reduces the probability of wire damage.

Tinning prevents birdcaging during the forming operation and enhances solder flow.















The use of anti-wicking tweezers during wire tinning operations limits solder wicking under the insulation due to capillary action.

Wires are tinned so the solder wets the tinned portion of the wire and penetrates to the inner strands of the stranded wire (Figure 08-8).



Figure 08-8 Solder Penetration on Tinned Wire

Personnel Hazards

					
Alcohol, Isopropyl					1
					
Flux (Soldering)					8
					
Lead (Solder)					9



Insulated Wire Tinning Procedure

Step	Action
	<p style="text-align: center;">WARNING</p> <p style="text-align: center;"><i>USE APPROVED SAFETY EYEWEAR WHEN PERFORMING THIS PROCEDURE.</i></p> <p style="text-align: center;"><i>COMPLY WITH ALL LOCAL REQUIREMENTS FOR PPE.</i></p> <p style="text-align: center;">CAUTION</p> <p style="text-align: center;">DON A PROPERLY GROUNDED ESD WRIST STRAP BEFORE STARTING THIS PROCEDURE.</p>
1	Ensure the wire was stripped using the appropriate Insulated Wire Stripping procedure (paragraph 08-5.3).
2	Select a soldering iron tip that maximizes heat transfer and contact area with the wire.
3	Set the soldering iron tip temperature to 600°F (316°C).
4	Select anti-wicking tweezers to match the wire gauge.
5	Clean the wire with isopropyl alcohol using an acid brush and blot dry with a clean, lint-free tissue.
6	Clean the anti-wicking tweezers with isopropyl alcohol and wipe dry with a clean, lint-free tissue.

Insulated Wire Tinning Procedure

Step	Action
7	Insert the stripped wire into the anti-wicking tweezers with the wire insulation flat against the inner face of the tweezers.
8	Place the anti-wicking tweezers in a holding device and slant downward, if possible.
9	Clean the solder with isopropyl alcohol and wipe dry with a clean, lint-free tissue.
10	Apply flux SPARINGLY to the lower half of the wire.
11	Remove the seasoning (all solder) from the soldering iron tip.
12	Thermally shock the soldering iron tip on a damp sponge.
13	Place the soldering iron tip behind and in contact with the wire, midway down the wire from the anti-wicking tweezers.
14	<div style="text-align: center; border: 1px solid black; padding: 5px; margin-bottom: 10px;">CAUTION</div> <p>IF SOLDER MELT DOES NOT OCCUR WITHIN TWO SECONDS, STOP THIS PROCEDURE AND ADJUST TIP TEMPERATURE PER THE TIP TEMPERATURE PROCEDURE IN WP 003 00 (PARAGRAPH 03-5.4).</p> <p>Form a heat bridge between the soldering iron tip and the wire using clean solder.</p> 
15	<p>Encapsulate the wire with solder moving the soldering iron tip and the solder up the wire toward the anti-wicking tweezers.</p> <p>Note: Continuously add solder throughout the entire tinning process.</p>

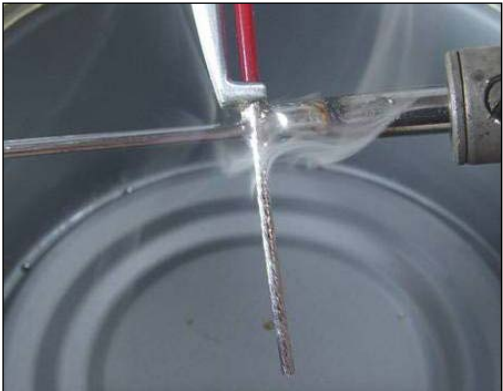













Insulated Wire Tinning Procedure

Step	Action
16	<p>Hesitate briefly at the junction of the wire and the anti-wicking tweezers while continuing to flow solder into the wire.</p> 
17	<p>Move the soldering iron tip and solder down and past the end of the wire simultaneously.</p> 
18	<p>Season the tip and place the soldering iron into its stand.</p>
19	<p>Allow the wire to cool completely before cleaning.</p>
20	<p>Clean the tinned wire with isopropyl alcohol using a clean, lint-free tissue to remove all flux residue.</p>
21	<p>Clean the anti-wicking tweezers with isopropyl alcohol using an acid brush and wipe dry with a clean, lint-free tissue.</p>
22	<p><i>Inspect per the General Inspection Procedure in WP 003 00 (paragraph 03-5.12) to all applicable WORKMANSHIP STANDARDS, including:</i></p> <ul style="list-style-type: none"> • <i>Wires (paragraph 08-6.1)</i> • <i>Insulated Wire Stripping (paragraph 08-6.2)</i> • <i>Insulated Wire Tinning (paragraph 08-6.3)</i> • <i>Other applicable Workmanship Standards as required</i>
23	<p>Dispose of all HAZMAT following local procedures.</p>

08-5.5 Terminal Preparation for Soldering Procedure

Use this procedure to prepare the terminal for installation of wires.

Personnel Hazards

					
Alcohol, Isopropyl					1
					
Flux (Soldering)					8
					
Lead (Solder)					9



Terminal Preparation for Soldering Procedure

Step	Action
	<div style="border: 1px solid black; padding: 5px; margin-bottom: 10px;">WARNING</div> <p style="text-align: center;">USE APPROVED SAFETY EYEWEAR WHEN PERFORMING THIS PROCEDURE.</p> <p style="text-align: center;">COMPLY WITH ALL LOCAL REQUIREMENTS FOR PPE.</p> <div style="border: 1px solid black; padding: 5px; margin-bottom: 10px;">CAUTION</div> <p style="text-align: center;">DON A PROPERLY GROUNDED ESD WRIST STRAP BEFORE STARTING THIS PROCEDURE.</p>
1	Select a soldering iron tip that maximizes heat transfer and contact area with the terminal.
2	Set the soldering iron tip temperature to 600°F (316°C).
3	Clean the terminal with isopropyl alcohol using an acid brush and blot dry with a clean, lint-free tissue.
4	Clean the solder with isopropyl alcohol and wipe dry with a clean, lint-free tissue.

Terminal Preparation for Soldering Procedure

Step	Action
5	Apply flux SPARINGLY to the terminal. Note: Use a toothpick or flux pen to control the volume of flux applied. Heavy flux volume impairs cleaning and may affect reliability.
6	Remove the seasoning (all solder) from the soldering iron tip.
7	Thermally shock the soldering iron tip on a damp sponge.
8	<div style="text-align: center; border: 2px solid black; padding: 5px; margin: 0 auto; width: fit-content;">CAUTION</div> <p style="text-align: center;">DO NOT APPLY PRESSURE WITH THE SOLDERING IRON.</p> Place the soldering iron tip on the terminal at the point of maximum thermal mass.
9	<div style="text-align: center; border: 2px solid black; padding: 5px; margin: 0 auto; width: fit-content;">CAUTION</div> <p style="text-align: center;">IF SOLDER MELT DOES NOT OCCUR WITHIN TWO SECONDS, STOP THIS PROCEDURE AND ADJUST TIP TEMPERATURE PER THE TIP TEMPERATURE PROCEDURE IN WP 003 00 (PARAGRAPH 03-5.4).</p> Form a heat bridge between the soldering iron tip and the terminal using clean solder.
10	Flow fresh solder onto the terminal tinning all areas where the wire will contact.
11	Remove the solder and the soldering iron tip simultaneously.
12	Season the tip and place the soldering iron into its stand.
13	Allow the terminal to cool completely before cleaning.
14	Clean the terminal with isopropyl alcohol using an acid brush to remove all flux residue and blot dry with a clean, lint-free tissue.
15	Select wicking material needed to remove excess solder from the terminal. Note: If corroded, clean the wicking material with isopropyl alcohol and blot dry with a clean, lint-free tissue.
16	Apply flux to the wicking material.

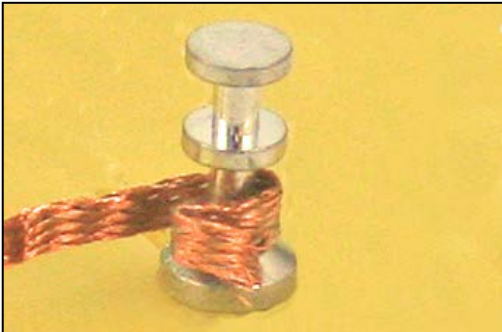
Terminal Preparation for Soldering Procedure

Step	Action
17	Position the wicking material on the terminal. 
18	Remove the seasoning from the soldering iron tip.
19	Thermally shock the soldering iron tip on a damp sponge.
20	<p style="text-align: center;">CAUTION</p> <p style="text-align: center;">DO NOT APPLY PRESSURE WITH THE SOLDERING IRON TO THE TERMINAL.</p> Place soldering iron tip on the wicking material.
21	<p style="text-align: center;">CAUTION</p> <p style="text-align: center;">IF SOLDER MELT DOES NOT OCCUR WITHIN FOUR SECONDS, STOP THIS PROCEDURE AND ADJUST TIP TEMPERATURE PER THE TIP TEMPERATURE PROCEDURE IN WP 003 00 (PARAGRAPH 03-5.4).</p> Observe the capillary action (solder flow) into the wicking material; when solder flow stops, remove the soldering iron and the wicking material. 
22	Season the tip and place the soldering iron into its stand.

Terminal Preparation for Soldering Procedure

Step	Action
23	Remove the used portion of wicking material from the spool using utility cutters.
24	Allow the terminal to cool completely before cleaning.
25	Clean the terminal with isopropyl alcohol using an acid brush to remove all flux residue and blot dry with a clean, lint-free tissue.
26	Repeat steps 15 to 25 as necessary until only a bright, shiny, tinned surface remains on the terminal. Note: Extremely oxidized or otherwise contaminated terminals may require multiple applications of solder to remove non-metallic oxides.
27	<i>Inspect per the General Inspection Procedure in WP 003 00 (paragraph 03-5.12) to all applicable WORKMANSHIP STANDARDS, including:</i> <ul style="list-style-type: none"> • <i>General Solder Acceptability in WP 005 00 (paragraph 05-6.1)</i> • <i>Post-Solder Joint Cleanliness in WP 005 00 (paragraph 05-6.2)</i> • <i>Laminate in WP 011 00 (paragraph 11-6.1)</i> • <i>Other applicable Workmanship Standards as required</i>
28	Dispose of all HAZMAT following local procedures.

08-5.6 Wire Forming

Form all wires before attaching the wire to the terminal.

Determine the routing and positioning requirements of the wire before forming wires for soldering to terminals in accordance with the Workmanship Standards: Insulation Clearance (paragraph 08-6.4); and Wire Forming for Turret Terminals (paragraph 08-6.5), Wire Forming for Hook Terminals (paragraph 08-6.6), Wire Forming for Pierced Tab Terminals (paragraph 08-6.7), or Wire Forming for Bifurcated Terminals (paragraph 08-6.8), as applicable.

08-5.6.1 Wire Forming for Round Terminals using Pliers Procedure

Use this procedure or the Wire Forming on Round Terminal Procedure (paragraph 08-5.6.2) for hook and turret terminals.

Personnel Hazards



Alcohol, Isopropyl

1





Lead (Solder)

9

Wire Forming for Round Terminals using Pliers Procedure

Step	Action
	<p style="text-align: center;">WARNING</p> <p style="text-align: center;"><i>USE APPROVED SAFETY EYEWEAR WHEN PERFORMING THIS PROCEDURE.</i></p> <p style="text-align: center;"><i>COMPLY WITH ALL LOCAL REQUIREMENTS FOR PPE.</i></p> <p style="text-align: center;">CAUTION</p> <p style="text-align: center;">DON A PROPERLY GROUNDED ESD WRIST STRAP BEFORE STARTING THIS PROCEDURE.</p>
1	Ensure the wire was stripped using the appropriate Insulated Wire Stripping procedure (paragraph 08-5.3).
2	Ensure the wire was tinned using the Insulated Wire Tinning Procedure (paragraph 08-5.4).
3	Cut a 4-6 in. piece of medium sized solder from the roll of solder.
4	<p>Bend the solder around the terminal 180° to determine the radius for the wire to be soldered to the terminal.</p> 
5	Remove the piece of solder from the terminal, maintaining the bend radius.

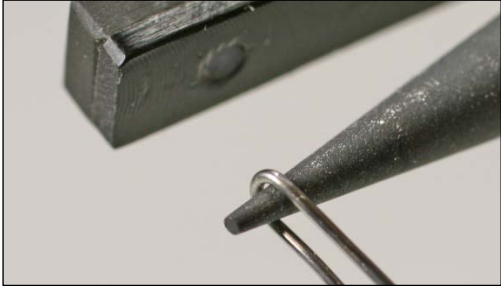
Wire Forming for Round Terminals using Pliers Procedure

Step	Action
6	<p>Slide the piece of solder onto the round jaw of the pliers (forming, chain nose, or round nose) until the solder is flush with the surface of the round jaw.</p> 
7	<p>Mark or note the point on the round jaw of the pliers where the bend will be made.</p>
8	<p>Insert the tinned wire into the pliers at the mark maintaining insulation clearance for the terminal to be soldered.</p> <p>Note: See the Workmanship Standard: Insulation Clearance (paragraph 08-6.4) for specifics on insulation clearance.</p> 
9	<p>Close the pliers to hold the wire in place.</p> <p>Note: Do not to flatten the wire in the pliers.</p>
10	<p>Bend the wire 180° around the pliers' jaw.</p>
11	<p>Open the pliers and remove the wire.</p>
12	<p>Terminate the wire using flush cutting pliers so the wire makes a 180° bend on the terminal.</p> 

Wire Forming for Round Terminals using Pliers Procedure

Step	Action
13	Clean the terminal and the wire with isopropyl alcohol using an acid brush and blot dry with a clean, lint-free tissue.
14	<p><i>Inspect per the General Inspection Procedure in WP 003 00 (paragraph 03-5.12) to all applicable WORKMANSHIP STANDARDS, including:</i></p> <ul style="list-style-type: none"> • <i>Wires (paragraph 08-6.1)</i> • <i>Insulated Wire Stripping (paragraph 08-6.2)</i> • <i>Insulated Wire Tinning (paragraph 08-6.3)</i> • <i>Insulation Clearance (paragraph 08-6.4)</i> • <i>Wire Forming for Turret Terminals (paragraph 08-6.5)</i> • <i>Wire Forming for Hook Terminals (paragraph 08-6.6)</i> • <i>Other applicable Workmanship Standards as required</i>
15	Dispose of all HAZMAT following local procedures.

08-5.6.2 Wire Forming on Round Terminal Procedure

Use this procedure or the Wire Forming for Round Terminals using Pliers Procedure (paragraph 08-5.6.1) for hook and turret terminals.

Personnel Hazards



Alcohol, Isopropyl

1





Lead (Solder)

9

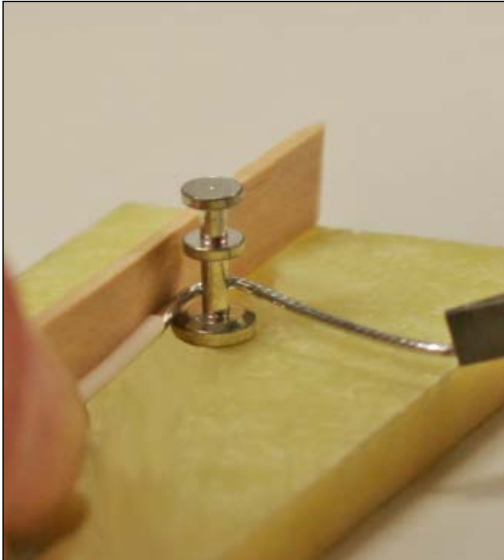
Wire Forming on Round Terminal Procedure

Step	Action
	<p style="text-align: center;">WARNING</p> <p style="text-align: center;"><i>USE APPROVED SAFETY EYEWEAR WHEN PERFORMING THIS PROCEDURE. COMPLY WITH ALL LOCAL REQUIREMENTS FOR PPE.</i></p> <p style="text-align: center;">CAUTION</p> <p style="text-align: center;">DON A PROPERLY GROUNDED ESD WRIST STRAP BEFORE STARTING THIS PROCEDURE.</p>
1	Ensure the wire was stripped using the appropriate Insulated Wire Stripping procedure (paragraph 08-5.3).
2	Ensure the wire was tinned using the Insulated Wire Tinning Procedure (paragraph 08-5.4).
3	Insert the tinned wire onto the terminal maintaining insulation clearance for the terminal to be soldered. Note: See the Workmanship Standard: Insulation Clearance (paragraph 08-6.4) for specifics on insulation clearance.
4	Brace the wire using a tongue depressor or other suitable tool to protect the wire from birdcaging. 

Wire Forming on Round Terminal Procedure

Step	Action
5	Bend the wire 180° around the terminal post. 
6	Terminate the wire, using flush cutting pliers, perpendicular to the terminal so the wire contacts the terminal for 180°. 
7	Clean the terminal and the wire with isopropyl alcohol using an acid brush and blot dry with a clean, lint-free tissue.
8	<i>Inspect per the General Inspection Procedure in WP 003 00 (paragraph 03-5.12) to all applicable WORKMANSHIP STANDARDS, including:</i> <ul style="list-style-type: none">• <i>Wires (paragraph 08-6.1)</i>• <i>Insulated Wire Stripping (paragraph 08-6.2)</i>• <i>Insulated Wire Tinning (paragraph 08-6.3)</i>• <i>Insulation Clearance (paragraph 08-6.4)</i>• <i>Wire Forming for Turret Terminals (paragraph 08-6.5)</i>• <i>Wire Forming for Hook Terminals (paragraph 08-6.6)</i>• <i>Other applicable Workmanship Standards as required</i>
9	Dispose of all HAZMAT following local procedures.

08-5.6.3 Wire Forming for Pierced Tab Terminals Procedure

Use this procedure for pierced tab terminals.

Personnel Hazards



Alcohol, Isopropyl

1





Lead (Solder)

9

Wire Forming for Pierced Tab Terminals Procedure

Step	Action
	<p style="text-align: center;">WARNING</p> <p style="text-align: center;"><i>USE APPROVED SAFETY EYEWEAR WHEN PERFORMING THIS PROCEDURE. COMPLY WITH ALL LOCAL REQUIREMENTS FOR PPE.</i></p> <p style="text-align: center;">CAUTION</p> <p style="text-align: center;">DON A PROPERLY GROUNDED ESD WRIST STRAP BEFORE STARTING THIS PROCEDURE.</p>
1	Ensure the wire was stripped using the appropriate Insulated Wire Stripping procedure (paragraph 08-5.3).
2	Ensure the wire was tinned using the Insulated Wire Tinning Procedure (paragraph 08-5.4).
3	Insert the tinned wire into the duckbill pliers maintaining insulation clearance for the pierced tab terminal to be soldered. Note: See the Workmanship Standard: Insulation Clearance (paragraph 08-6.4) for specifics on insulation clearance.
4	Close the pliers to hold the wire in place. Note: Do not to flatten the wire in the pliers.

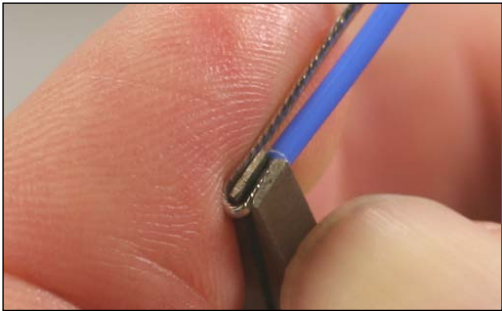
Wire Forming for Pierced Tab Terminals Procedure

Step	Action
5	Bend the wire 180° around the pliers' jaw. 
6	Open the pliers and remove the wire.
7	Insert the wire through the eye of the tab terminal.
8	Form the wire to terminal dimensions.
9	Terminate the wire using flush cutting pliers so the cut end of the wire is flush with the terminal edge. 
10	Clean the terminal and the wire with isopropyl alcohol using an acid brush and blot dry with a clean, lint-free tissue.
11	<i>Inspect per the General Inspection Procedure in WP 003 00 (paragraph 03-5.12) to all applicable WORKMANSHIP STANDARDS, including:</i> <ul style="list-style-type: none"> • <i>Wires (paragraph 08-6.1)</i> • <i>Insulated Wire Stripping (paragraph 08-6.2)</i> • <i>Insulated Wire Tinning (paragraph 08-6.3)</i> • <i>Insulation Clearance (paragraph 08-6.4)</i> • <i>Wire Forming for Pierced Tab Terminals (paragraph 08-6.7)</i> • <i>Other applicable Workmanship Standards as required</i>
12	Dispose of all HAZMAT following local procedures.

08-5.6.4 Wire Forming for Side Entry Bifurcated Terminals Procedure

Use this procedure for side entry bifurcated terminals.

Use the Wire Forming for Bottom Entry Bifurcated Terminals Procedure (paragraph 08-5.6.5) for bottom entry bifurcated terminals or the Wire Forming for Top Entry Bifurcated Terminals Procedure (paragraph 08-5.6.6) for top entry bifurcated terminals.

Personnel Hazards



Alcohol, Isopropyl

1



Lead (Solder)

9

Wire Forming for Side Entry Bifurcated Terminals Procedure

Step	Action
	<p style="text-align: center;">WARNING</p> <p style="text-align: center;"><i>USE APPROVED SAFETY EYEWEAR WHEN PERFORMING THIS PROCEDURE.</i></p> <p style="text-align: center;"><i>COMPLY WITH ALL LOCAL REQUIREMENTS FOR PPE.</i></p> <p style="text-align: center;">CAUTION</p> <p style="text-align: center;">DON A PROPERLY GROUNDED ESD WRIST STRAP BEFORE STARTING THIS PROCEDURE.</p>
1	Ensure the wire was stripped using the appropriate Insulated Wire Stripping procedure (paragraph 08-5.3).
2	Ensure the wire was tinned using the Insulated Wire Tinning Procedure (paragraph 08-5.4).
3	Insert the tinned wire into the duckbill pliers maintaining insulation clearance for the bifurcated terminal to be soldered. Note: See the Workmanship Standard: Insulation Clearance (paragraph 08-6.4) for specifics on insulation clearance.

Wire Forming for Side Entry Bifurcated Terminals Procedure

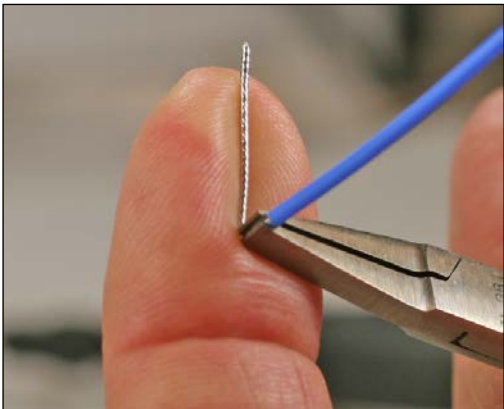
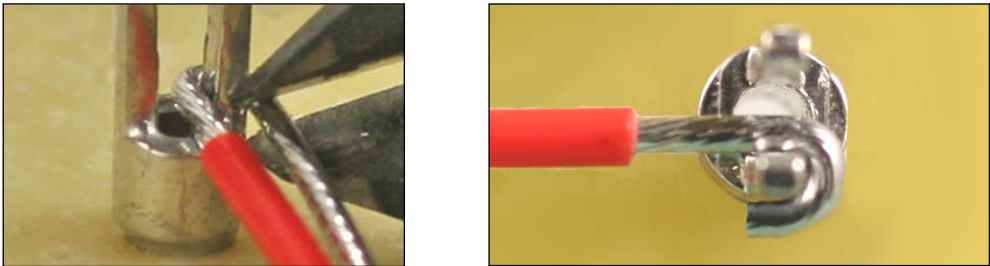
Step	Action
4	Close the pliers to hold the wire in place. Note: Do not to flatten the wire in the pliers.
5	Bend the wire 90° around the pliers' jaw. 
6	Open the pliers and remove the wire.
7	Insert the wire between the posts of the bifurcated terminal.
8	Brace the wire using a tongue depressor or other suitable tool to protect the wire from birdcaging.
9	Bend the wire 180° around the terminal post.
10	Terminate the wire using flush cutting pliers so the cut end of the wire is flush with the edge of the post. 
11	Clean the terminal and the wire with isopropyl alcohol using an acid brush and blot dry with a clean, lint-free tissue.

Wire Forming for Side Entry Bifurcated Terminals Procedure

Step	Action
12	<p><i>Inspect per the General Inspection Procedure in WP 003 00 (paragraph 03-5.12) to all applicable WORKMANSHIP STANDARDS, including:</i></p> <ul style="list-style-type: none"> • <i>Wires (paragraph 08-6.1)</i> • <i>Insulated Wire Stripping (paragraph 08-6.2)</i> • <i>Insulated Wire Tinning (paragraph 08-6.3)</i> • <i>Insulation Clearance (paragraph 08-6.4)</i> • <i>Wire Forming for Bifurcated Terminals (paragraph 08-6.8)</i> • <i>Other applicable Workmanship Standards as required</i>
13	<p>Dispose of all HAZMAT following local procedures.</p>

08-5.6.5 Wire Forming for Bottom Entry Bifurcated Terminals Procedure

Use this procedure for bottom entry bifurcated terminals.

Use the Wire Forming for Side Entry Bifurcated Terminals Procedure (paragraph 08-5.6.4) for side entry bifurcated terminals or the Wire Forming for Top Entry Bifurcated Terminals Procedure (paragraph 08-5.6.6) for top entry bifurcated terminals.

Personnel Hazards



Alcohol, Isopropyl

1



Lead (Solder)

9

Wire Forming for Bottom Entry Bifurcated Terminals Procedure

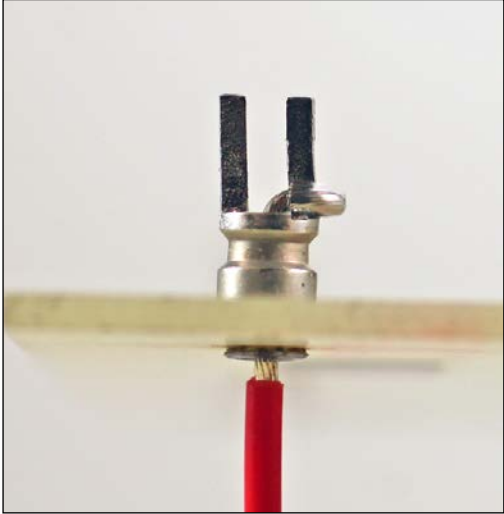
Step	Action
	<p style="text-align: center;">WARNING</p> <p style="text-align: center;"><i>USE APPROVED SAFETY EYEWEAR WHEN PERFORMING THIS PROCEDURE. COMPLY WITH ALL LOCAL REQUIREMENTS FOR PPE.</i></p> <p style="text-align: center;">CAUTION</p> <p style="text-align: center;">DON A PROPERLY GROUNDED ESD WRIST STRAP BEFORE STARTING THIS PROCEDURE.</p>
1	Ensure the wire was stripped using the appropriate Insulated Wire Stripping procedure (paragraph 08-5.3).
2	Ensure the wire was tinned using the Insulated Wire Tinning Procedure (paragraph 08-5.4).
3	<p>Insert the tinned wire through the terminal base maintaining insulation clearance for the bifurcated terminal to be soldered.</p> <p>Note: See the Workmanship Standard: Insulation Clearance (paragraph 08-6.4) for specifics on insulation clearance.</p> 
4	Bend the wire 90° at the base of the terminal so the wire is centered and perpendicular to the posts.
5	Brace the wire using a tongue depressor or other suitable tool to protect the wire from birdcaging.
6	Bend the wire 180° around the terminal post.

Wire Forming for Bottom Entry Bifurcated Terminals Procedure

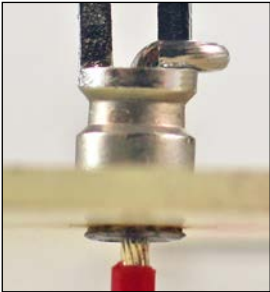
Step	Action
7	<p>Terminate the wire using flush cutting pliers so the cut end of the wire is flush with the edge of the post.</p> <div style="display: flex; justify-content: space-around; align-items: center;">   </div>
8	<p>Clean the terminal and the wire with isopropyl alcohol using an acid brush and blot dry with a clean, lint-free tissue.</p>
9	<p><i>Inspect per the General Inspection Procedure in WP 003 00 (paragraph 03-5.12) to all applicable WORKMANSHIP STANDARDS, including:</i></p> <ul style="list-style-type: none"> • <i>Wires (paragraph 08-6.1)</i> • <i>Insulated Wire Stripping (paragraph 08-6.2)</i> • <i>Insulated Wire Tinning (paragraph 08-6.3)</i> • <i>Insulation Clearance (paragraph 08-6.4)</i> • <i>Wire Forming for Bifurcated Terminals (paragraph 08-6.8)</i> • <i>Other applicable Workmanship Standards as required</i>
10	<p>Dispose of all HAZMAT following local procedures.</p>

08-5.6.6 Wire Forming for Top Entry Bifurcated Terminals Procedure

Use this procedure for top entry bifurcated terminals.

Use the Wire Forming for Side Entry Bifurcated Terminals Procedure (paragraph 08-5.6.4) for side entry bifurcated terminals or the Wire Forming for Bottom Entry Bifurcated Terminals Procedure (paragraph 08-5.6.5) for bottom entry bifurcated terminals.

Personnel Hazards



Alcohol, Isopropyl

1



Lead (Solder)

9

Wire Forming for Top Entry Bifurcated Terminals Procedure

Step	Action
	<p style="text-align: center;">WARNING</p> <p style="text-align: center;"><i>USE APPROVED SAFETY EYEWEAR WHEN PERFORMING THIS PROCEDURE.</i></p> <p style="text-align: center;"><i>COMPLY WITH ALL LOCAL REQUIREMENTS FOR PPE.</i></p> <p style="text-align: center;">CAUTION</p> <p style="text-align: center;">DON A PROPERLY GROUNDED ESD WRIST STRAP BEFORE STARTING THIS PROCEDURE.</p>
1	Ensure the wire was stripped using the appropriate Insulated Wire Stripping procedure (paragraph 08-5.3).
2	Ensure the wire was tinned using the Insulated Wire Tinning Procedure (paragraph 08-5.4).
3	<p>Insert the tinned wire between the terminal posts so the cut end is flush with the terminal base and maintaining insulation clearance for the bifurcated terminal to be soldered.</p> <p>Note: See the Workmanship Standard: Insulation Clearance (paragraph 08-6.4) for specifics on insulation clearance.</p>
4	<p>If the wire does not fill the space between the posts, either bend the wire back onto itself or use a filler wire to fill the space.</p> 

Wire Forming for Top Entry Bifurcated Terminals Procedure

Step	Action
5	Terminate, using flush cutting pliers, the wire bent back onto itself or the filler wire so the cut end of the wire is flush with the top of the terminal post, if required. 
6	Clean the terminal and the wire with isopropyl alcohol using an acid brush and blot dry with a clean, lint-free tissue.
7	<i>Inspect per the General Inspection Procedure in WP 003 00 (paragraph 03-5.12) to all applicable WORKMANSHIP STANDARDS, including:</i> <ul style="list-style-type: none"> • <i>Wires (paragraph 08-6.1)</i> • <i>Insulated Wire Stripping (paragraph 08-6.2)</i> • <i>Insulated Wire Tinning (paragraph 08-6.3)</i> • <i>Insulation Clearance (paragraph 08-6.4)</i> • <i>Wire Forming for Bifurcated Terminals (paragraph 08-6.8)</i> • <i>Other applicable Workmanship Standards as required</i>
8	Dispose of all HAZMAT following local procedures.

08-5.7 Terminal Soldering Procedure

Use this procedure for soldering wires to terminals.

Personnel Hazards



Alcohol, Isopropyl

1



Flux (Soldering)

8



Lead (Solder)

Terminal Soldering Procedure

Step	Action
	<p style="text-align: center;">WARNING</p> <p style="text-align: center;"><i>USE APPROVED SAFETY EYEWEAR WHEN PERFORMING THIS PROCEDURE. COMPLY WITH ALL LOCAL REQUIREMENTS FOR PPE.</i></p> <p style="text-align: center;">CAUTION</p> <p style="text-align: center;">DON A PROPERLY GROUNDED ESD WRIST STRAP BEFORE STARTING THIS PROCEDURE.</p>
1	Ensure the wire was stripped using the appropriate Insulated Wire Stripping procedure (paragraph 08-5.3).
2	Ensure the wire was tinned using the Insulated Wire Tinning Procedure (paragraph 08-5.4).
3	Ensure the terminal was prepared for soldering using the Terminal Preparation for Soldering Procedure (paragraph 08-5.5).
4	If required, slide the appropriate length and size of heat-shrinkable insulation sleeving onto the wire before forming the wire.
5	Ensure the wires were formed using the appropriate Wire Forming procedure (paragraph 08-5.6) for the terminal type.
6	Select a soldering iron tip that maximizes heat transfer and contact area with the terminal.
7	Set the soldering iron tip temperature to 600°F (316°C).

Terminal Soldering Procedure

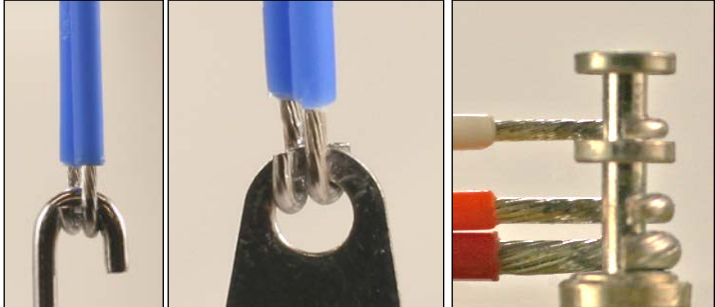
Step	Action
8	<p>Place the wires on the terminal and mechanically secure the wires before soldering.</p> 
9	<p style="text-align: center;">CAUTION</p> <p style="text-align: center;">HEAT SINKS ARE PLACED BETWEEN THE HEAT SOURCE AND THE WIRE TO PROTECT FROM THE HEAT OF THE SOLDERING PROCESS.</p> <p>Install heat sinks, as needed.</p>
10	<p>Clean all wires and the terminal with isopropyl alcohol using an acid brush and blot dry with a clean, lint-free tissue.</p> <p>Note: Take precautions to prevent bare skin contact before the wire is soldered. Skin contact leaves contaminants on the wires and/or terminals.</p>
11	<p>Clean the solder with isopropyl alcohol and wipe dry with a clean, lint-free tissue.</p>
12	<p>Apply flux SPARINGLY to the area to be soldered, if required.</p> <p>Note: Use a toothpick or flux pen to control the volume of flux applied. Heavy flux volume impairs cleaning and may affect reliability.</p>
13	<p>Remove the seasoning (all solder) from the soldering iron tip.</p>
14	<p>Thermally shock the soldering iron tip on a damp sponge.</p>
15	<p style="text-align: center;">CAUTION</p> <p style="text-align: center;">DO NOT APPLY PRESSURE TO THE TERMINAL OR THE WIRE.</p> <p>Place the soldering iron tip on the terminal contacting the wire.</p>

Terminal Soldering Procedure

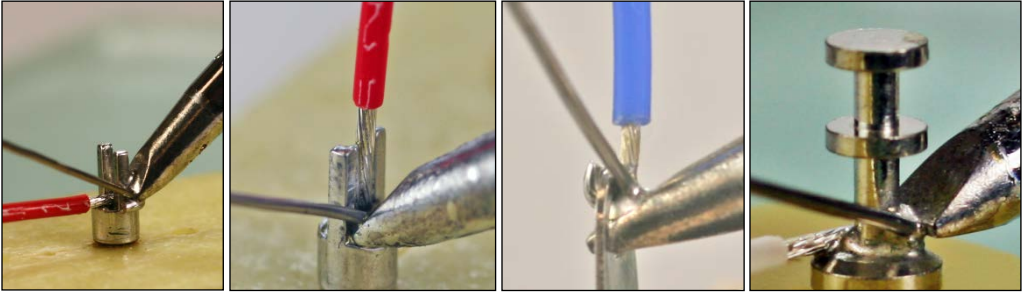
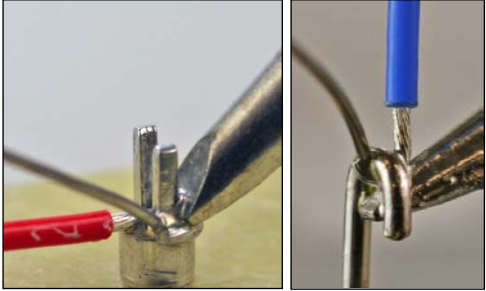
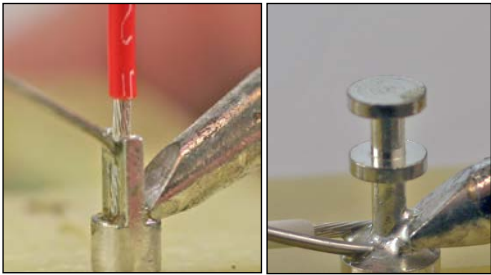
Step	Action
16	<div style="text-align: center; border: 2px solid black; padding: 5px; margin-bottom: 10px;">CAUTION</div> <p style="text-align: center;">IF SOLDER MELT DOES NOT OCCUR WITHIN TWO SECONDS, STOP THIS PROCEDURE AND ADJUST TIP TEMPERATURE PER THE TIP TEMPERATURE PROCEDURE IN WP 003 00 (PARAGRAPH 03-5.4).</p> <p>Form a heat bridge between the soldering iron tip and the terminal/wire using clean solder.</p> 
17	<p>Touch the solder to the cut end of the wire to tin the exposed copper.</p> 
18	<p>Form the fillet between the start of the wire bend and the terminal where the wire enters the terminal.</p> 

Terminal Soldering Procedure

Step	Action
19	<p style="text-align: center;">CAUTION</p> <p style="text-align: center;">WHEN SOLDERING MULTIPLE WIRES, COMPLETE ALL SOLDERING BEFORE REMOVING THE SOLDERING IRON TIP FROM ITS ORIGINAL POSITION ON THE TERMINAL.</p> <p>Repeat steps 17 through 18 for each wire to be soldered.</p>
20	Remove the solder and the soldering iron tip simultaneously.
21	Season the tip and place the soldering iron into its stand.
22	Allow the terminal and solder joint to cool completely before cleaning.
23	Clean the terminal and solder joint with isopropyl alcohol using an acid brush to remove all flux residue and blot dry with a clean, lint-free tissue.
24	<p>Slide insulation sleeving over the terminal ensuring the wire insulation is also covered, if required.</p> <p>Note: Ensure wire identification is replaced or markings are replicated.</p>
25	<p style="text-align: center;">CAUTION</p> <p style="text-align: center;">ALWAYS EXERCISE EXTREME CAUTION WHEN APPLYING HEAT TO SHRINKABLE SLEEVING, AS DAMAGE TO THE JOINT, SLEEVING, AND ADJACENT AREAS MAY RESULT. EXCESS HEAT CAUSES GREATER DAMAGE THAN INSUFFICIENT HEAT.</p> <p>For heat-shrinkable sleeving, apply heat to shrink the sleeving to a snug fit over the joint and the wire insulation.</p> <p>Note: The preferred method of shrinking insulation sleeving is a radiant heat gun. However, a hot air jet may be used, provided extreme caution is exercised.</p>

Terminal Soldering Procedure

Step	Action
<p>26</p>	<div style="display: flex; flex-wrap: wrap; justify-content: space-around;">   </div> <p><i>Inspect per the General Inspection Procedure in WP 003 00 (paragraph 03-5.12) to all applicable WORKMANSHIP STANDARDS, including:</i></p> <ul style="list-style-type: none"> • <i>General Solder Acceptability in WP 005 00 (paragraph 05-6.1)</i> • <i>Post-Solder Joint Cleanliness in WP 005 00 (paragraph 05-6.2)</i> • <i>Terminal Solder Acceptability (paragraph 08-6.12)</i> • <i>Wires (paragraph 08-6.1)</i> • <i>Insulated Wire Stripping (paragraph 08-6.2)</i> • <i>Insulated Wire Tinning (paragraph 08-6.3)</i> • <i>Insulation Clearance (paragraph 08-6.4)</i> • <i>Wire Forming for Turret Terminals (paragraph 08-6.5)</i> • <i>Wire Forming for Hook Terminals (paragraph 08-6.6)</i> • <i>Wire Forming for Pierced Tab Terminals (paragraph 08-6.7)</i> • <i>Wire Forming for Bifurcated Terminals (paragraph 08-6.8)</i> • <i>Insulation Sleeving Replacement (paragraph 08-6.13)</i> • <i>Other applicable Workmanship Standards as required</i>

Terminal Soldering Procedure















Step	Action
27	Replace the conformal coating per the Conformal Coating Replacement Procedure in WP 006 00 (paragraph 06-5.5), as needed.
28	<i>Inspect to the Conformal Coating Replacement WORKMANSHIP STANDARD in WP 006 00 (paragraph 06-6.2), as required.</i>
29	Dispose of all HAZMAT following local procedures.

08-5.8 Terminal Removal and Installation Procedure

This procedure is limited to the installation of flared flange terminals only.

Installation of rolled flange terminals is beyond the scope of this manual.

Personnel Hazards

					
Alcohol, Isopropyl					1
					
Flux (Soldering)					8
					
Lead (Solder)					9

Terminal Removal and Installation Procedure

Step	Action
	<div style="border: 2px solid black; padding: 5px; display: inline-block;"> WARNING </div> <p>USE APPROVED SAFETY EYEWEAR WHEN PERFORMING THIS PROCEDURE.</p> <p>COMPLY WITH ALL LOCAL REQUIREMENTS FOR PPE.</p>

Terminal Removal and Installation Procedure

Step	Action
	<p style="text-align: center;">CAUTION</p> <p style="text-align: center;">DON A PROPERLY GROUNDED ESD WRIST STRAP BEFORE STARTING THIS PROCEDURE.</p> <p style="text-align: center;">TERMINALS WITH A FUNNEL SHOULDER ON THE COMPONENT SIDE OF THE CCA SHALL NOT BE USED BECAUSE OF STRESSES IMPARTED TO THE KNEE OF THE MOUNTING HOLE. THESE STRESSES COULD CAUSE EXTENSIVE LAMINATE DAMAGE SUCH AS CRAZING, DELAMINATION, AND POSSIBLE CRACKING OF THE HOLE.</p>
1	Select a solder extractor tip that maximizes contact area, heat transfer, and airflow.
2	Set the extractor tip temperature to 700°F (371°C).
3	<p>Place a clean tissue on a heat resistant surface and test the solder extractor by actuating vacuum to pick up the tissue.</p> <p>Note: If the solder extractor vacuum is insufficient to pick up the tissue, stop this procedure and perform the Solder Extractor Vacuum Test and Heater Element Cleaning Procedure in WP 003 00 (paragraph 03-5.7).</p>
4	Clean the terminal with isopropyl alcohol using an acid brush and blot dry with a clean, lint-free tissue.
5	<p>Apply flux SPARINGLY to the solder joint.</p> <p>Note: Use a toothpick or flux pen to control the volume of flux applied. Heavy flux volume impairs cleaning and may affect reliability.</p>
6	Remove the seasoning (all solder) from the solder extractor tip.
7	Thermally shock the solder extractor tip on a damp sponge.
8	<p style="text-align: center;">CAUTION</p> <p style="text-align: center;">DO NOT APPLY PRESSURE WITH SOLDER EXTRACTOR ON THE TERMINAL.</p> <p>Place extractor tip on the solder joint.</p>

Terminal Removal and Installation Procedure

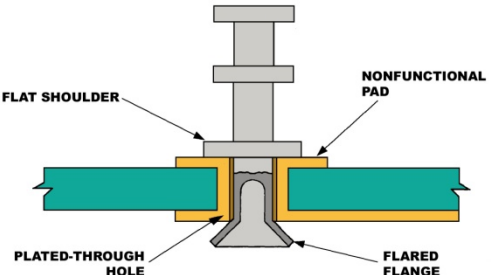
Step	Action
9	<div style="text-align: center; border: 2px solid black; padding: 5px; margin-bottom: 10px;">CAUTION</div> <p style="text-align: center;">IF SOLDER MELT DOES NOT OCCUR WITHIN TWO SECONDS, STOP THIS PROCEDURE AND ADJUST TIP TEMPERATURE PER THE TIP TEMPERATURE PROCEDURE IN WP 003 00 (PARAGRAPH 03-5.4).</p> <p>Observe COMPLETE solder melt; then actuate vacuum using the handpiece vacuum control switch or the foot pedal switch.</p>
10	<p>After complete solder extraction, remove the solder extractor tip from the solder joint allowing the solder extractor vacuum to run continuously for an additional five seconds to draw the molten solder completely into the solder trap.</p>
11	<p>Season the tip and place the solder extractor into its stand.</p>
12	<p>Allow the terminal to cool completely before cleaning.</p>
13	<p>Clean the terminal with isopropyl alcohol using an acid brush to remove all flux residue and blot dry with a clean, lint-free tissue.</p>
14	<p>Select a replacement terminal.</p> <p>Note: Terminals with flared flanges shall be mounted in plated-through holes with a non-functional pad on the component side, provided the mounting is in conjunction with a pad or ground plane on the flared side as shown.</p> <div style="text-align: center;">  </div>
15	<p>Select the proper diameter ball mill or drill bit matching the outside diameter (OD) of the replacement terminal to drill out the swaged area.</p> <p>Note: Determine the size of the drill bit or ball mill by sizing the selected terminal in a drill gauge and selecting the corresponding size drill bit or ball mill.</p>

Terminal Removal and Installation Procedure

Step	Action
16	<p>Use the ball mill/drill bit in a pin vise to remove the swaged area of the terminal.</p> <p>Note: The terminal mounting hole shall be drilled to a diameter sufficient to permit the replacement terminal shank to be pressed through the CCA.</p> <p>Note: A press fit is not necessary, but the replacement terminal shall be tight enough not to fall out when CCA is inverted.</p> <p>Note: Ensure the mounting hole is drilled perpendicular to the CCA surface.</p> <p>Note: Ensure the barrel drilled hole is rounded and smooth.</p>
17	Remove the terminal from the CCA.
18	Clean the repair area with isopropyl alcohol using an acid brush and blot dry with a clean, lint-free tissue.
19	<p>Align and press the replacement terminal shank through the CCA.</p> <p>Note: Maintain 360° contact between the terminal mounting shoulder and the CCA.</p>
20	<p>Use a center punch to swage the terminal until the swaged end of the terminal is in direct contact with the metal foil terminal pad, as required.</p> <p>Note: Swaging is the process by which the terminal shank is flared or expanded to secure the terminal in the mounting hole.</p>
21	Select a soldering iron tip that maximizes heat transfer and contact area with the terminal.
22	Set the soldering iron tip temperature to 600°F (316°C).
23	Clean the terminal with isopropyl alcohol using an acid brush and blot dry with a clean, lint-free tissue.
24	Clean the solder with isopropyl alcohol and wipe dry with a clean, lint-free tissue.

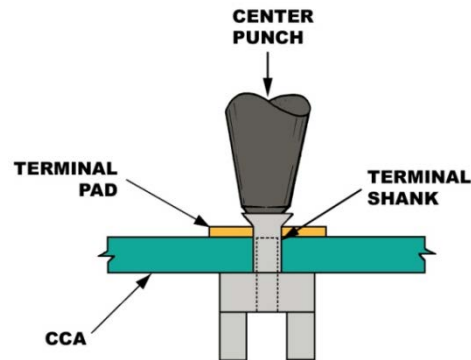

Terminal Removal and Installation Procedure

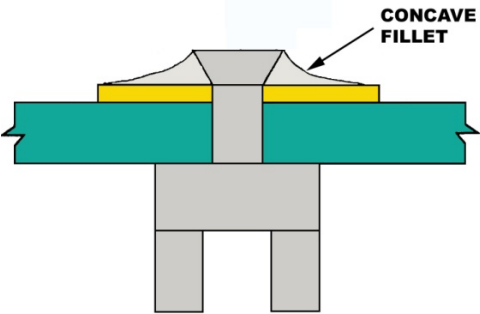
Step	Action
25	Apply flux SPARINGLY to the terminal flange. Note: Use a toothpick or flux pen to control the volume of flux applied. Heavy flux volume impairs cleaning and may affect reliability.
26	Remove the seasoning (all solder) from the soldering iron tip.
27	Thermally shock the soldering iron tip on a damp sponge.
28	<div style="text-align: center; border: 2px solid black; padding: 5px; width: fit-content; margin: 0 auto;">CAUTION</div> <p style="text-align: center;">DO NOT APPLY PRESSURE WITH THE SOLDERING IRON ON THE TERMINAL.</p> Place the soldering iron tip on the pad contacting the terminal at the point of maximum thermal mass.
29	<div style="text-align: center; border: 2px solid black; padding: 5px; width: fit-content; margin: 0 auto;">CAUTION</div> <p style="text-align: center;">IF SOLDER MELT DOES NOT OCCUR WITHIN TWO SECONDS, STOP THIS PROCEDURE AND ADJUST TIP TEMPERATURE PER THE TIP TEMPERATURE PROCEDURE IN WP 003 00 (PARAGRAPH 03-5.4).</p> Form a heat bridge between the soldering iron tip and the terminal/pad using clean solder.
30	Solder the terminal in place. <div style="text-align: right; margin-top: 20px;">  </div>
31	Remove the solder and the soldering iron tip simultaneously.
32	Season the tip and place the soldering iron into its stand.
33	Allow the terminal to cool completely before cleaning.

Terminal Removal and Installation Procedure

Step	Action
34	Clean the terminal with isopropyl alcohol using an acid brush to remove all flux residue and blot dry with a clean, lint-free tissue.
35	<p><i>Inspect per the General Inspection Procedure in WP 003 00 (paragraph 03-5.12) to all applicable WORKMANSHIP STANDARDS, including:</i></p> <ul style="list-style-type: none"> • <i>General Solder Acceptability in WP 005 00 (paragraph 05-6.1)</i> • <i>Post-Solder Joint Cleanliness in WP 005 00 (paragraph 05-6.2)</i> • <i>Terminal Installation (paragraph 08-6.14)</i> • <i>Terminal Installation Soldering (paragraph 08-6.15)</i> • <i>Other applicable Workmanship Standards as required</i>
36	Replace the conformal coating per the Conformal Coating Replacement Procedure in WP 006 00 (paragraph 06-5.5), as needed.
37	<i>Inspect to the Conformal Coating Replacement WORKMANSHIP STANDARD in WP 006 00 (paragraph 06-6.2), as required.</i>
38	Dispose of all HAZMAT following local procedures.

08-6 WORKMANSHIP STANDARDS

Refer to WP 003 00 (paragraph 03-6) for definitions of Workmanship Standards.

NOTE

WORKMANSHIP STANDARDS FOR GENERAL SOLDER ACCEPTABILITY AND POST-SOLDER JOINT CLEANLINESS ARE IN WP 005 00 (PARAGRAPH 05-6), WIRE REPAIR IN WP 010 00 (PARAGRAPH 10-6), LAMINATE IN WP 011 00 (PARAGRAPH 11-6), AND CONDUCTORS, PADS, AND LANDS IN WP 012 00 (PARAGRAPH 12-6).

08-6.1 Wires

Wires

Target Condition	Acceptable Condition	Defect Condition
The original spiral lay of the wire strands has been maintained.	The spiral lay of the wire strands has been restored.	The spiral lay of the wire strands has not been maintained.
		The wire is kinked.
		The insulation is split or cracked.
	The wire has nicks, scrapes, scratches, or missing strands that do not exceed the limits of Table 08-1. 	The wire has nicks, scrapes, scratches, or missing strands that exceed the limits of Table 08-1.
	The wire has heavy indentations or tool marks that reduce the wire diameter 10% or less.	The wire has heavy indentations or tool marks that reduce the wire diameter more than 10%.
	The insulation has damage that reduces the thickness 20% or less.	The insulation has damage that reduces the thickness more than 20%.

Table 08-1 Wire Strand Damage (from Table 5-1 of J-STD-001E)

Number of Strands	Maximum Allowable Strands, Scraped, Nicked, or Severed for Wires that will not be Tinned before Installation	Maximum Allowable Strands, Scraped, Nicked or Severed for Wires that will be Tinned before Installation
2-6	0	0
7-15	0	1
16-25	0	2
26-40	3	3
41-60	4	4
61-120	5	5
121 or more	5%	5%

Note 1: No damaged strands for wires used at a potential for 6 kV or greater.







Note 2: For plated wires, a visual anomaly that does not expose basis metal is not considered to be strand damage.

Note 3: Damaged strands have nicks or scrapes exceeding 10% of cross sectional area.

A damaged strand is defined as having a nick or scrape exceeding 10% of the cross-sectional area of that strand.

08-6.2 Insulated Wire Stripping

Insulated Wire Stripping

Target Condition	Acceptable Condition	Defect Condition
<p>The original spiral lay of the wire strands has been maintained.</p>	<p>The spiral lay of the wire strands has been restored.</p>	<p>The spiral lay of the wire strands has not been maintained.</p> 
	<p>There is a slight, uniform impression in the insulation from the gripping of mechanical strippers.</p> 	
	<p>Thermally stripped insulation shows slight discoloration.</p> 	<p>Thermally stripped insulation shows charring or burning.</p> 
<p>The insulation has been neatly and uniformly trimmed.</p> 	<p>The insulation is not uniformly trimmed; the insulation edge is uneven or frayed.</p>	<p>The length of uneven or ragged insulation exceeds 50% of the wire diameter (including insulation).</p> 
		<p>The insulation is damaged to the extent of exposing the wire.</p> 
		<p>Wire is degraded from the use of chemical stripper.</p>
		<p>Insulation is melted into the wire strands.</p>

08-6.3 Insulated Wire Tinning

Insulated Wire Tinning

Target Condition	Acceptable Condition	Defect Condition
Stranded wires are tinned to a point equal to one wire diameter (including insulation) from the insulation. 	The stranded wires are tinned on all portions of the wire coming into contact with the soldered area.	The stranded wires are not tinned on all portions of the wire coming into contact with the soldered area.
The tin line is even around the circumference of the wire.	The tin line is not even around the circumference of the wire. The wire is wicked, but wicking does not cause the insulation to bulge or become discolored.	Wicking causes the insulation to bulge or become discolored.
Stranded wire is fully wetted.		The stranded wire is not fully wetted.
The individual strands of the wire are visible.	Some of the wire strands are not visible in the solder, provided the form, fit, or function of the wire is not affected.	No wire strands are visible in the solder.

08-6.4 Insulation Clearance

Insulation Clearance

Target Condition	Acceptable Condition	Defect Condition
		The insulation clearance permits the wire to short to adjacent wires.
		The insulation contacts the terminal.

Insulation Clearance

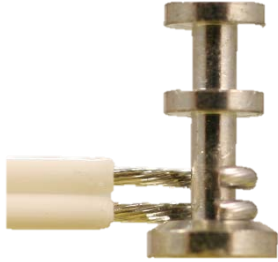
Target Condition	Acceptable Condition	Defect Condition
<p>There is an insulation clearance of one wire diameter (including insulation) between the end of the insulation and the outside edge of the terminal.</p> 	<p>The insulation clearance is two wire diameters (including insulation) or less than one wire diameter between the end of the insulation and the outside edge of the terminal.</p>	<p>The insulation clearance is greater than two wire diameters (including insulation) between the end of the insulation and the outside edge of the terminal.</p>

08-6.5 Wire Forming for Turret Terminals

Wire Forming for Turret Terminals

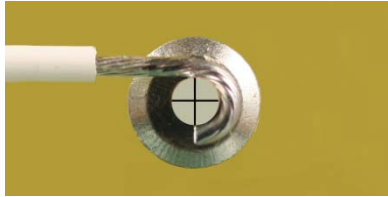
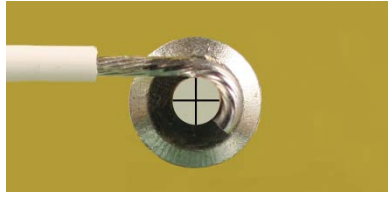



Target Condition	Acceptable Condition	Defect Condition
<p>The wire contacts the terminal post for 180°.</p> 	<p>The wire contact of the terminal post is greater than 180°, provided the wire does not overlap itself.</p>	<p>The wire has less than 180° of contact between the wire and the terminal post or overlaps itself on the terminal.</p> 
<p>The cut end of the wire is cut perpendicular to the axis of the wire.</p>	<p>The cut end of the wire is not perpendicular to the terminal.</p>	

Wire Forming for Turret Terminals

Target Condition	Acceptable Condition	Defect Condition
Multiple wires are wrapped parallel with the terminal base and each other.	Multiple wires are not wrapped parallel with the terminal base and each other provide they do not overlap or crossover each other.	Multiple wires crossover or overlap each other on the terminal.
Single wire installation is in contact with the base for the full 180° bend.		Single wire installation is not in contact with the base for the full 180° bend.
<p>On multiple wire installations, subsequent wires are mounted as close to the base as allowed by the insulation.</p> 	On multiple wire installations, subsequent wires are not in contact with the previously installed wire.	
The cut end of the wire contacts the post.	The cut end of the wire extends beyond the edge of the terminal one wire diameter or less (not including insulation).	The wire end extends beyond the edge of the terminal more than one wire diameter (not including insulation).

08-6.6 Wire Forming for Hook Terminals

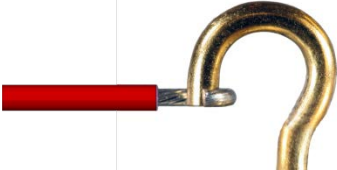
Wire Forming for Hook Terminals

Target Condition	Acceptable Condition	Defect Condition
<p>The wire contacts terminal for 180°.</p> 	<p>The wire contacts terminal for greater than 180° provided the wire does not overlap itself.</p> 	<p>The wire contacts the terminal for less than 180° or overlaps itself.</p>
<p>The wires are attached within the 180° arc of the hook.</p>	<p>Wires are attached greater than or equal to two wire diameters (including insulation) from the base of the terminal or one wire diameter (including insulation) or greater from the end of the hook.</p>	<p>The wire is attached less than two wire diameters (including insulation) from the base of the terminal, one wire diameter (including insulation) from the end of the hook, or outside the arc of the hook.</p> 
<p>Multiple wires are attached in alternating directions.</p> 	<p>Multiple wires are not attached in alternating directions.</p>	

Wire Forming for Hook Terminals

Target Condition	Acceptable Condition	Defect Condition
The cut end of the wire contacts the hook.	The wire cut end extends beyond the edge of the terminal less than one wire diameter (not including insulation).	The wire end extends beyond the edge of the terminal more than one wire diameter (not including insulation).
		Multiple wires overlap each other on the terminal.

08-6.7 Wire Forming for Pierced Tab Terminals

Wire Forming for Pierced Tab Terminals

Target Condition	Acceptable Condition	Defect Condition
<p>The wire contacts two parallel sides (180° bend) of the terminal.</p> 	The wire to terminal contact is greater than or equal to 90°, provided the wire does not overlap itself.	The wire to terminal contact is less than 90° or the wire overlaps itself.
The wire passes through the eye of the terminal.		The wire does not pass through the eye of the terminal.
		Multiple wires overlap each other on the terminal.
The cut end of the wire contacts the terminal.	The wire end extends beyond the edge of the terminal one wire diameter or less (not including insulation).	The wire extends beyond the edge of the terminal more than one wire diameter (not including insulation).

Wire Forming for Pierced Tab Terminals

Target Condition	Acceptable Condition	Defect Condition
<p>Multiple wires are attached in alternating directions.</p> 	<p>Multiple wires are not attached in alternating directions.</p>	

08-6.8 Wire Forming for Bifurcated Terminals

Wire Forming for Bifurcated Terminals

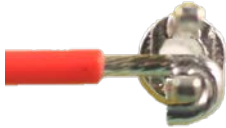
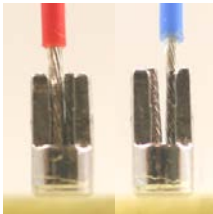
Target Condition	Acceptable Condition	Defect Condition
<p>Side entry wire contacts two parallel faces (180° bend) of the terminal post.</p> 	<p>Side entry wire passes through the slot and makes positive contact with at least two sides (90°) of the post.</p>	<p>Side entry wire does not pass through the slot</p> <p>Side entry wire contacts the terminal for less than 90°</p> <p>Side entry wire overlaps itself.</p>
<p>The cut end of the wire contacts the terminal.</p>	<p>The wire end extends beyond the base of the terminal one wire diameter or less (not including insulation).</p>	<p>The wire end extends beyond the base of the terminal more than one wire diameter (not including insulation).</p>
<p>Top entry wire has the space between the posts filled with a separate filler wire or with a wire that has been bent double.</p> 		<p>Top entry wire is not supported with filler wire or has not been bent double.</p>

Wire Forming for Bifurcated Terminals

Target Condition	Acceptable Condition	Defect Condition
Bottom entry wire contacts two parallel sides of the post (180° bend).	Bottom entry wire passes through the slot and makes positive contact with at least two sides (90°) of the post.	Bottom entry wire contacts the terminal for less than 90°.
<p>The bottom entry wire is in full contact with and extends to the edge of the base of the terminal.</p> 		The bottom entry wire does not contact the terminal base.
Single side and bottom entry wires are in contact with the base of the terminal.		Single side and bottom entry wires are not in contact with the base of the terminal.
		Any portion of the side entry wire extends beyond the top of the terminal post.
		Bottom or top entry wire insulation enters the base or the posts of the terminal.
Multiple side entry wires are mounted as close to the base as allowed by the insulation.	Multiple side entry wires are not in contact with the previously installed wire.	Multiple side entry wires overlap each other on the terminal.
Multiple side entry wires are placed on the terminal in ascending order with the largest wire on the bottom.		Multiple side entry wires are not placed on the terminal in ascending order with the largest wire on the bottom.
Multiple side entry wire attachments alternate terminal posts.	Multiple side entry wire attachments do not alternate terminal posts.	

08-6.9 Wire Forming for Wires AWG 30 and Smaller (All Terminals)

Wire Forming for Wires AWG 30 and Smaller (All Terminals)

Target Condition	Acceptable Condition	Defect Condition
The wire contacts the terminal for two wraps.	The wire has one to three wraps.	The wire to terminal contact is less than one wrap or greater than three wraps.

08-6.10 Terminals Connected By a Bus Wire (All Terminals)

Terminals Connected By a Bus Wire (All Terminals)

Target Condition	Acceptable Condition	Defect Condition
For three or more terminals connected by a common bus wire, if space permits, the wire between the terminals has stress relief.		For three or more terminals connected by a common bus wire, if space permits, there is no stress relief in the wire between any two terminals.
For three or more terminals connected by a common bus wire, the first and last terminals meet the required wrap for individual terminals.		For three or more terminals connected by a common bus wire, the first and last terminals do not meet the required wrap for individual terminals.
For three or more hook terminals connected by a common bus wire, the wire is wrapped 360° around each intermediate terminal.		For three or more hook terminals connected by a common bus wire, the wire is not wrapped 360° around each intermediate terminal.
For three or more turret terminals in a row connected by a common bus wire, for each intermediate terminal, the wire wraps around or interweaves the terminal.		For three or more turret terminals connected by a common bus wire, the wire is not wrapped around or does not interweave each terminal.

Terminals Connected By a Bus Wire (All Terminals)

Target Condition	Acceptable Condition	Defect Condition
For three or more pierced tab terminals connected by a common bus wire, for each intermediate terminal, the wire is in contact with at least two nonadjacent contact surfaces of the intermediate terminal.		For three or more pierced tab terminals connected by a common bus wire, for each intermediate terminal, the wire is not in contact with at least two nonadjacent contact surfaces of each intermediate terminal.
For three or more bifurcated terminals in a row connected by a common bus wire, the wire passes through the slot and is in contact with the base of the terminal or with a previously installed wire.		For three or more bifurcated terminals in a row connected by a common bus wire, for each intermediate terminal, the wire does not pass through the slot or is not in contact with the base of the terminal or a previously installed wire

08-6.11 Axial Leaded Component Installed on Terminal with Stress Relief

Axial Leaded Component Installed on Terminal with Stress Relief

Target Condition	Acceptable Condition	Defect Condition
The component body centerline to the terminal edge is at least one-half (50%) the component diameter; for components less than ¼ in. diameter, the measurement is to the far edge of the terminal.		

Axial Leaded Component Installed on Terminal with Stress Relief

Target Condition	Acceptable Condition	Defect Condition
Both component leads have stress relief.	One component lead has a stress relief bend, provided the component is not clip mounted, not adhesive mounted and that the assembly is not conformally coated.	The component has no stress relief. Only one lead has stress relief on clip-mounted components, adhesive mounted components or on conformally coated assemblies.

08-6.12 Terminal Solder Acceptability

Terminal Solder Acceptability

Target Condition	Acceptable Condition	Defect Condition
The solder fillet exhibits complete wetting, creating a feathered edge.	The solder fillet exhibits minor dewetting from the terminal surface that does not contact the wire to terminal interface.	The solder fillet exhibits dewetting that contacts the wire to terminal interface.
Discernible solder fillet covers 100% of the wire and terminal contact area. 		The solder fillet covers less than 100% of the wire and terminal contact area.

Terminal Solder Acceptability

Target Condition	Acceptable Condition	Defect Condition
The contour of the wire is discernible in the solder.		The contour of the wire is not discernible in the solder.
	The wire is wicked, but the wicking does not cause the wire to bulge or become discolored.	Wicking causes the insulation to bulge or become discolored.
		The wire insulation is charred.
	Solder spillage does not change the contour of the terminal.	Solder spillage changes the contour of the terminal.

08-6.13 Insulation Sleeving Replacement

NOTE



THESE STANDARDS APPLY ONLY IF INSULATION SLEEVING REPLACEMENT IS REQUIRED.

Insulation Sleeving Replacement

Target Condition	Acceptable Condition	Defect Condition
The shrink sleeving fits snugly on the wire and terminal.		The sleeving is loose on the wire or terminal.
The sleeving overlaps the terminal and extends over the wire insulation four wire diameters (including insulation).	The sleeving overlaps the terminal and extends over the wire insulation two or more wire diameters (including insulation).	The sleeving overlap of the wire insulation is less than two wire diameters (including insulation).
	Insulation sleeving is one wire diameter (including insulation) from the base of the terminal.	Insulation sleeving is more than one wire diameter (including insulation) from the base of the terminal.
		Insulation is split, charred, cracked, torn, has pinholes, or is otherwise damaged.

08-6.14 Terminal Installation

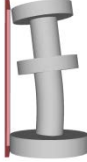
Terminal Installation

Target Condition	Acceptable Condition	Defect Condition
The terminal is intact.		A bifurcated terminal post or turret terminal is broken.
<p>The terminal is mounted perpendicular to the assembly surface.</p> 	<p>The terminal is bent, provided the top edge of the terminal does not extend beyond the base of the terminal.</p> 	<p>The top edge of the terminal is bent beyond the edge of the base of the terminal.</p> 
The flared flange is formed to an angle of between 35° and 120°.		Flared flanges have been formed to an angle less than 35° or greater than 120°.
The flared flanges extend between 1/64 and 1/16 in. beyond the surface of the pad or conductor.		Flared flanges extend less than 1/64 in.) or greater than 1/16 in. beyond the surface of the pad or conductor.
The flange flare diameter does not exceed the diameter of the pad or width of conductor.		The flared flange diameter exceeds the diameter of the pad or width of the conductor.
The flange is swaged sufficiently tight to prevent the terminal from movement in the Z-Axis.		The flange is not swaged sufficiently tight allowing the terminal movement in the Z-Axis.
	Three or less radial splits or cracks in the terminal flange separated by at least 90°.	Three or more splits or cracks in the terminal flange.
		Any two radial splits in the flange are separated by less than 90°.

Terminal Installation

Target Condition	Acceptable Condition	Defect Condition
		The terminal shank has circumferential cracks or splits.
		The flared flange area of the terminal has circumferential splits or cracks.
		The flared flange has missing pieces
		A split in the flange enters into the barrel of the terminal.
		The terminal center post is cracked.

08-6.15 Terminal Installation Soldering

Terminal Installation Soldering

Target Condition	Acceptable Condition	Defect Condition
Solder flows 360° around the flange of the terminal.	Solder flows greater than or equal to 330° but less than 360° around the flange of the terminal.	Solder flows less than 330° around the flange of the terminal.
Complete wetting of the flange and terminal area.	Solder fillet height is greater than or equal to 75% of the flange height.	Solder fillet height is less than 75% of the flange height.

15 October 2013

WP 009 00 Solder Cups

09-1 PURPOSE

Identify the technical information relative to solder cups.

Specify the repair procedures for removing and installing wires in solder cups.

Specify the repair procedures for fabricating connectors with solder cups.

Identify the workmanship standards for solder cups.

09-2 INDEX

Paragraph	Subject	Page
09-1	Purpose	1
09-2	Index	1
09-3	General Safety Precautions.....	1
09-4	Technical Information.....	2
09-5	Repair Procedures.....	4
09-5.1	Solder Cup Wire Removal (Soldering Iron) Procedure	5
09-5.2	Solder Cup Wire Removal (Resistive Tweezers) Procedure.....	7
09-5.3	Solder Cup Wire Installation (Soldering Iron) Procedure	10
09-5.4	Solder Cup Wire Installation (Resistive Tweezers) Procedure.....	17
09-5.5	Connector, Cannon Plug Fabrication Procedure	25
09-5.6	Connector, DIN Fabrication Procedure.....	31
09-6	Workmanship Standards	34
09-6.1	Solder Cup Solder Acceptability.....	34

09-3 GENERAL SAFETY PRECAUTIONS

Observe all the following precautions while removing and installing wires in solder cups:

- Electronic equipment must be de-energized during removal and installation of CCAs
- Personnel are required to wear a properly grounded ESD wrist strap and cord while working in or around the EPA
- ESD can destroy components—protect ESDS devices during handling and repair to prevent ESD damage (Refer to WP 004 00)

- Isopropyl alcohol is flammable; do not use in the presence of sparks, heat, flame, or synthetic cloth
- Soldering handpieces (e.g., soldering irons, solder extractors, hot air jets) produce extreme heat—exercise care when these tools are out of their stands
- Avoid direct inhalation of fumes during a soldering operation because there is a possibility these fumes could cause occupational asthma
- The lead contained in solder is a source of lead oxide, which the human body cannot dissipate (accumulation of lead oxide in the body over a period of years can result in a serious health hazard)
- Contact with solder by holding in the mouth, smoking, or eating during or immediately after soldering is a potential means of ingesting trace amounts of lead oxide
- Avoid oral contact with hands during or immediately after solder operations
- Wash hands following any solder operation
- Wear approved PPE whenever pouring or handling molten metals or corrosive liquids and solids; and cutting, drilling, grinding, milling, chipping and other dust and debris producing operations
- Use adequate ventilation during thermal wire stripping operations because wire insulation may emit toxic fumes during thermal stripping
- Follow manufacturer's safety instructions for using chemical wire strippers
- Use chemical wire strippers only in well-vented areas, wear prescribed PPE, and avoid contact with skin and eyes
- Do not use wire with PVC [plastic] insulation to replace or repair installed military equipment wiring

09-4 TECHNICAL INFORMATION

Solder cups are cylindrical solder terminals with a hollow opening into which one or more wires are inserted prior to soldering.

Solder cups are normally gold plated to reduce oxidation and come in a wide range of sizes to accommodate current handling requirements.

Solder cups can be used in special design connectors and are easily removed or replaced with an appropriate insertion or extraction tool.

09-4.1 Solder Cup Types:

Connector Type solder cups are identified by a smooth cutout section on the face of the cup (Figure 09-1).



Figure 09-1 Connector Type Solder Cups

Swaged Type solder cups (Figure 09-2) are hollow cylindrical cups mounted on the CCA.



Figure 09-2 Swaged Type Solder Cup

Connector Pins (Figure 09-3) are small cylindrical cups used primarily in connector assemblies.



Figure 09-3 Connector Pins

Connector pins serve not only as quick, easy disconnect points for disassembly of units, but also allow passage of signals and voltages through airtight bulkheads.

Connector pins normally encountered are designed to accommodate wires between AWG-28 and AWG-14.

Solderable connector pins can normally be identified by a curved cutout on one side at the cup end of the pin.

Connector pins having an inspection hole drilled in the side at the bottom of the wire socket are designed for crimping. Exceptions are connector pins used on RF connectors, which have an inspection window and are designed to be soldered.

09-5 REPAIR PROCEDURES



PROTECT STATIC SENSITIVE DEVICES DURING HANDLING AND REPAIR TO PREVENT ESD DAMAGE (REFER TO WP 004 00).

Equipment Required Listed below are the authorized 2M Power Units* for removing and installing wires in solder cups:

- **NAVAIR/NAVSEA/USMC/USAF/USCG—PRC-2000-SMT**
- **NAVSEA/USCG—PRC-2000-TH**
- **NAVSEA/USCG—MBT-250-SD†**
- **USMC—MBT-350†**
- **NAVSEA—ST-25†**

* Refer to Table 03-3 for Power Unit Part No., and CAGE Code
† Limited capability in this WP

Additional Support Items For additional information regarding items of support and support equipment refer to:

- **NAVSEA/NAVAIR/USCG—2M MTR Certification Manual**
- **NAVSEA/USCG—Allowance Parts List (APL) 000A8423**
- **USMC—Stock List SL-3-09458A**
- **USAF—the Consolidated Tool Kit (CTK)**

Material Required Listed below are the materials required* for removing and installing wires in solder cups:

- **Desoldering Wick†**
 - **Flux, Soldering**
 - **Insulation Sleeving Kit, Electrical†**
 - **Isopropyl Alcohol, Technical**
-

- Paper, Abrasive (sandpaper)
- Solder, Tin Alloy†
- Towel, Paper (Kimwipe®)‡

* Refer to Table 03-4 for Specification No., Part No., and NSN

† Select size appropriate for application















‡ Substitution of equivalent material is acceptable

09-5.1 Solder Cup Wire Removal (Soldering Iron) Procedure

Use this procedure for wire removal from easily accessible solder cups.

Use the Solder Cup Wire Removal (Resistive Tweezers) Procedure (paragraph 09-5.2) for tightly spaced solder cups.

Personnel Hazards

					
Alcohol, Isopropyl					1
					
Flux (Soldering)					8
					
Lead (Solder)					9

Solder Cup Wire Removal (Soldering Iron) Procedure

Step	Action
	<div style="border: 2px solid black; padding: 5px; width: fit-content; margin: 0 auto;"> <p>WARNING</p> </div> <p style="text-align: center;">USE APPROVED SAFETY EYEWEAR WHEN PERFORMING THIS PROCEDURE.</p> <p style="text-align: center;">COMPLY WITH ALL LOCAL REQUIREMENTS FOR PPE.</p>

Solder Cup Wire Removal (Soldering Iron) Procedure

Step	Action
	<p style="text-align: center;">CAUTION</p> <p style="text-align: center;">DON A PROPERLY GROUNDED ESD WRIST STRAP BEFORE STARTING THIS PROCEDURE.</p> <p style="text-align: center;">THE SOLDER CUP MAY HAVE BEEN SOLDERED TO THE CCA USING HIGH TEMPERATURE SOLDER.</p>
1	Perform the Procedural Analysis and Feasibility of Repair Procedure in WP 003 00 (paragraph 03-5.1).
2	Select a soldering iron tip that maximizes heat transfer and contact area with the solder cup.
3	Set the soldering iron tip temperature to 600°F (316°C).
4	Clean the solder cup and the soldered portion of the wire with isopropyl alcohol using an acid brush and blot dry with a clean, lint-free tissue.
5	Apply flux SPARINGLY to the face of the solder cup.
6	Remove the seasoning (all solder) from the soldering iron tip.
7	Thermally shock the soldering iron tip on a damp sponge.
8	<p style="text-align: center;">CAUTION</p> <p style="text-align: center;">DO NOT APPLY PRESSURE WITH THE SOLDERING IRON TO THE SOLDER CUP.</p> <p style="text-align: center;">IMPROPER PLACEMENT OF THE SOLDERING IRON MAY BURN SURROUNDING WIRES AND INSULATION.</p> <p>Place the soldering iron against the back of the solder cup using the flat portion of the soldering iron tip.</p>

Solder Cup Wire Removal (Soldering Iron) Procedure

Step	Action
9	<div style="text-align: center; border: 2px solid black; padding: 5px; margin-bottom: 10px;">CAUTION</div> <p>IF SOLDER MELT DOES NOT OCCUR WITHIN TWO SECONDS, STOP THIS PROCEDURE AND ADJUST TIP TEMPERATURE PER THE TIP TEMPERATURE PROCEDURE IN WP 003 00 (PARAGRAPH 03-5.4).</p> <p>Observe COMPLETE solder melt; then remove the wire from the solder cup.</p> <p>Note: Do not remove the soldering iron until the wire is completely removed from the cup.</p>
10	Season the tip and place the soldering iron into its stand.
11	Allow the solder cup to cool completely before cleaning.
12	Clean the wire and solder cup with isopropyl alcohol using an acid brush to remove all flux residue and blot dry with a clean, lint-free tissue.
13	<p><i>Inspect per the General Inspection Procedure in WP 003 00 (paragraph 03-5.12) to all applicable WORKMANSHIP STANDARDS, including:</i></p> <ul style="list-style-type: none"> • <i>Post-Solder Joint Cleanliness in WP 005 00 (paragraph 05-6.2)</i> • <i>Wires in WP 008 00 (paragraph 08-6.1)</i> • <i>Other applicable Workmanship Standards as required</i>
14	Dispose of all HAZMAT following local procedures.

09-5.2 Solder Cup Wire Removal (Resistive Tweezers) Procedure

Use this procedure for wire removal from tightly spaced solder cups.

Use the Solder Cup Wire Removal (Soldering Iron) Procedure (paragraph 09-5.1) For easily accessible solder cups.

Personnel Hazards



Alcohol, Isopropyl



Solder Cup Wire Removal (Resistive Tweezers) Procedure

Step	Action
	<p style="text-align: center;">WARNING</p> <p style="text-align: center;"><i>USE APPROVED SAFETY EYEWEAR WHEN PERFORMING THIS PROCEDURE. COMPLY WITH ALL LOCAL REQUIREMENTS FOR PPE.</i></p> <p style="text-align: center;">CAUTION</p> <p style="text-align: center;">DON A PROPERLY GROUNDED ESD WRIST STRAP BEFORE STARTING THIS PROCEDURE.</p> <p style="text-align: center;">THE SOLDER CUP MAY HAVE BEEN SOLDERED TO THE CCA USING HIGH TEMPERATURE SOLDER.</p>
1	Perform the Procedural Analysis and Feasibility of Repair Procedure in WP 003 00 (paragraph 03-5.1).
2	Clean the resistive tweezers tips with a plater's brush or 400-600 grit sandpaper to remove surface oxides and ensure good electrical contact.
3	Set the AC power control to the lowest setting.
4	Clean the solder cup and the soldered portion of the wire with isopropyl alcohol using an acid brush and blot dry with a clean, lint-free tissue.

Solder Cup Wire Removal (Resistive Tweezers) Procedure

Step	Action
5	<p style="text-align: center;">CAUTION</p> <p style="text-align: center;">ALWAYS PLACE THE RESISTIVE TWEEZERS TIPS IN CONTACT WITH THE SOLDER CUP BEFORE APPLYING POWER TO PREVENT ARCING AND BURNING.</p> <p style="text-align: center;">CONTACT BETWEEN THE RESISTIVE TWEEZERS TIPS AND THE SOLDER CUP MUST BE MAINTAINED WHENEVER POWER IS APPLIED TO THE TWEEZERS</p> <p>Place the resistive tweezers tips low on the solder cup.</p>
6	<p style="text-align: center;">CAUTION</p> <p style="text-align: center;">EXERCISE CARE WHEN ADJUSTING THE CURRENT LEVEL BECAUSE MOST RESISTIVE HEATING SOURCES ARE CAPABLE OF SOLDER CUP DESTRUCTION BY OVERHEATING IF THE CURRENT LEVEL IS SET TOO HIGH.</p> <p>Actuate the foot pedal to apply power to the resistive tweezers and slowly increase the AC power to the tweezers until the solder in the cup begins to melt.</p>
7	<p>Observe COMPLETE solder melt; then remove the wire from the solder cup.</p> <p>Note: Do not remove AC power until the wire is completely removed from the cup.</p>
8	<p style="text-align: center;">CAUTION</p> <p style="text-align: center;">ALWAYS REMOVE POWER FROM RESISTIVE TWEEZERS TIPS PRIOR TO REMOVING THE TIPS FROM THE SOLDER CUP TO PREVENT ARCING AND BURNING.</p> <p>Release the foot pedal and remove the resistive tweezers tips from the solder cup.</p>
9	<p>Allow the solder cup to cool completely before cleaning.</p>
10	<p>Clean the wire and solder cup with isopropyl alcohol using an acid brush to remove all flux residue and blot dry with a clean, lint-free tissue.</p>
11	<p><i>Inspect per the General Inspection Procedure in WP 003 00 (paragraph 03-5.12) to all applicable WORKMANSHIP STANDARDS, including:</i></p> <ul style="list-style-type: none"> • <i>Post-Solder Joint Cleanliness in WP 005 00 (paragraph 05-6.2)</i> • <i>Wires in WP 008 00 (paragraph 08-6.1)</i> • <i>Other applicable Workmanship Standards as required</i>

Solder Cup Wire Removal (Resistive Tweezers) Procedure

Step	Action
12	Dispose of all HAZMAT following local procedures.

09-5.3 Solder Cup Wire Installation (Soldering Iron) Procedure

Use this procedure for wire installation in easily accessible solder cups.

Use the Solder Cup Wire Installation (Resistive Tweezers) Procedure (paragraph 09-5.4) for tightly spaced solder cups.

Personnel Hazards

Alcohol, Isopropyl					1
Flux (Soldering)					8
Lead (Solder)					9

Solder Cup Wire Installation (Soldering Iron) Procedure

Step	Action
	<div style="text-align: center;"> <div style="border: 2px solid black; padding: 5px; width: fit-content; margin: 0 auto;">WARNING</div> <p>USE APPROVED SAFETY EYEWEAR WHEN PERFORMING THIS PROCEDURE.</p> <p>COMPLY WITH ALL LOCAL REQUIREMENTS FOR PPE.</p> <div style="border: 2px solid black; padding: 5px; width: fit-content; margin: 0 auto;">CAUTION</div> <p>DON A PROPERLY GROUNDED ESD WRIST STRAP BEFORE STARTING THIS PROCEDURE.</p> </div>



Solder Cup Wire Installation (Soldering Iron) Procedure

Step	Action
1	Ensure the wire was stripped using the appropriate Insulated Wire Stripping procedure in WP 008 00 (paragraph 08-5.3).
2	Ensure the wire was tinned using the Insulated Wire Tinning Procedure in WP 008 00 (paragraph 08-5.4).
3	<p><i>Inspect per the General Inspection Procedure in WP 003 00 (paragraph 03-5.12) to all applicable WORKMANSHIP STANDARDS, including:</i></p> <ul style="list-style-type: none"> • <i>Wires in WP 008 00 (paragraph 08-6.1)</i> • <i>Insulated Wire Stripping in WP 008 00 (paragraph 08-6.2)</i> • <i>Insulated Wire Tinning in WP 008 00 (paragraph 08-6.3)</i>
4	Select a soldering iron tip that maximizes heat transfer and contact area with the solder cup.
5	Set the soldering iron tip temperature to 600°F (316°C).
6	Clean the solder with isopropyl alcohol and wipe dry with a clean, lint-free tissue.
7	<p>Clean the solder cup with isopropyl alcohol.</p> <p>Note: The application of external flux could promote solder spillage and should not be used.</p>
8	Remove the seasoning (all solder) from the soldering iron tip.
9	Thermally shock the soldering iron tip on a damp sponge.
10	<div style="text-align: center; border: 2px solid black; padding: 5px; margin: 10px auto; width: fit-content;"> CAUTION </div> <p style="text-align: center;">DO NOT APPLY PRESSURE WITH THE SOLDERING IRON TO THE SOLDER CUP. IMPROPER PLACEMENT OF THE SOLDERING IRON MAY BURN SURROUNDING WIRES AND INSULATION.</p> <p>Place the soldering iron tip as low as possible on the back of the solder cup using the flat portion of the soldering iron tip.</p>



Solder Cup Wire Installation (Soldering Iron) Procedure

Step	Action
11	<p style="text-align: center;">CAUTION</p> <p style="text-align: center;">IF SOLDER MELT DOES NOT OCCUR WITHIN TWO SECONDS, STOP THIS PROCEDURE AND ADJUST TIP TEMPERATURE PER THE TIP TEMPERATURE PROCEDURE IN WP 003 00 (PARAGRAPH 03-5.4).</p> <p>Add solder to the solder cup until the face of the cup is filled with solder.</p>
12	Remove the solder and the soldering iron tip simultaneously.
13	Season the tip and place the soldering iron into its stand.
14	Allow the solder cup to cool completely before cleaning.
15	Clean the solder cup with isopropyl alcohol using an acid brush to remove all flux residue and blot dry with a clean, lint-free tissue.
16	<p>Select the largest size of wicking material that can be loosely twisted and still fit inside of the solder cup.</p> <p>Note: If corroded, clean the wicking material with isopropyl alcohol and blot dry with a clean, lint-free tissue.</p>
17	Loosely twist the wicking material.
18	Apply flux SPARINGLY to the wicking material.
19	Remove the seasoning (all solder) from the soldering iron tip.
20	Thermally shock the soldering iron tip on a damp sponge.
21	<p style="text-align: center;">CAUTION</p> <p style="text-align: center;">DO NOT APPLY PRESSURE WITH THE SOLDERING IRON TO THE SOLDER CUP. IMPROPER PLACEMENT OF THE SOLDERING IRON MAY BURN SURROUNDING WIRES AND INSULATION.</p> <p>Place the soldering iron tip as low as possible on the back of the solder cup using the flat portion of the soldering iron tip.</p>

Solder Cup Wire Installation (Soldering Iron) Procedure

Step	Action
22	<div style="text-align: center; border: 1px solid black; padding: 5px; margin-bottom: 10px;">CAUTION</div> <p style="text-align: center;">IF SOLDER MELT DOES NOT OCCUR WITHIN FOUR SECONDS, STOP THIS PROCEDURE AND ADJUST TIP TEMPERATURE PER THE TIP TEMPERATURE PROCEDURE IN WP 003 00 (PARAGRAPH 03-5.4).</p> <p>Begin to apply the wicking material to the solder in the cup at solder melt.</p> 
23	Observe the capillary action (solder flow) into the wicking material; when solder flow stops, remove the soldering iron and the wicking material.
24	Season the tip and place the soldering iron into its stand.
25	Remove the used portion of wicking material from the spool using utility cutters.
26	Allow the solder cup to cool completely before cleaning.
27	Clean the solder cup with isopropyl alcohol to remove all flux residue.
28	<p>Repeat steps 7 through 27 once for gold plated solder cups and until the interior, the milled face, and the corners of the solder cup are clean, shiny and covered with a thin layer of solder.</p> <p>Note: Double tin gold plated solder cups to ensure removal of the gold plating.</p> 
29	Determine the routing and positioning requirements of the wire.
30	<p>Insert the wire into the solder cup to measure the length of wire needed.</p> <p>Note: Ensure the solder cup used as a depth gauge is completely empty of solder.</p>

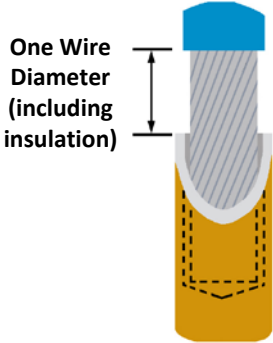
Solder Cup Wire Installation (Soldering Iron) Procedure

Step	Action
31	<p>Terminate the wire, using flush cutting pliers, so there is one wire diameter (including insulation) clearance between the end of the insulation and the top edge of the solder cup where the wire first makes contact.</p> <p>Note: After the first wire is terminated, it can be used as a gauge for terminating other wires.</p> 
32	<p style="text-align: center;">CAUTION</p> <p style="text-align: center;">USE INSULATION SLEEVING ON ALL SOLDER CUPS IN CLOSE PROXIMITY TO EACH OTHER DUE TO THE DANGER OF ELECTRICAL SHORT CIRCUITS.</p> <p>If required, insert insulation sleeving over the wire.</p> <p>Note: The sleeving may be either fixed-size or heat-shrinkable; however, heat-shrinkable sleeving is recommended because it provides good insulation with less bulk and is not subject to slipping off the joint.</p>
33	<p>Select a solder size to snugly fit into the solder cup and cut to length.</p> <p>Note: Smaller sizes of solder may be twisted together to provide the proper fill of the solder cup.</p> 
34	Clean the solder with isopropyl alcohol and wipe dry with a clean, lint-free tissue.
35	Place the proper amount of solder into the solder cup.
36	Tilt the solder cup to approximately 45° with the cup opening facing up, if feasible.
37	Remove the seasoning from the soldering iron tip.
38	Thermally shock the soldering iron tip on a damp sponge.

Solder Cup Wire Installation (Soldering Iron) Procedure

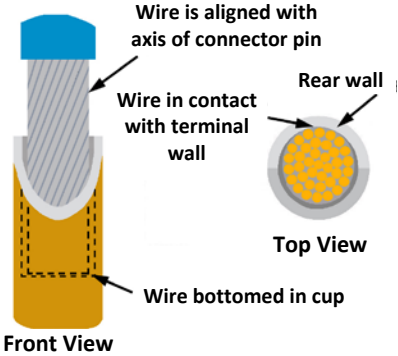
Step	Action
39	<p style="text-align: center;">CAUTION</p> <p style="text-align: center;">DO NOT APPLY PRESSURE WITH THE SOLDERING IRON TO THE SOLDER CUP. IMPROPER PLACEMENT OF THE SOLDERING IRON MAY BURN SURROUNDING WIRES AND INSULATION.</p> <p>Place the soldering iron tip as low as possible on the back of the solder cup using the flat portion of the soldering iron tip.</p>
40	<p style="text-align: center;">CAUTION</p> <p style="text-align: center;">IF SOLDER MELT DOES NOT OCCUR WITHIN TWO SECONDS, STOP THIS PROCEDURE AND ADJUST TIP TEMPERATURE PER THE TIP TEMPERATURE PROCEDURE IN WP 003 00 (PARAGRAPH 03-5.4).</p> <p>Observe the cup for solder melt.</p>
41	<p>Upon solder melt, immediately insert the tip of the wire partially into the solder cup at an angle.</p> 
42	<p>Hesitate momentarily to overcome the heat-sinking action.</p>
43	<p>After the solder melts again, move the wire slowly to the back of the cup wall and to the bottom of the solder cup.</p> <p>Note: Multiple wires are placed as close to each other as possible without bending or birdcaging of the wires.</p> 
44	<p>Remove the soldering iron tip from the solder cup.</p>

Solder Cup Wire Installation (Soldering Iron) Procedure

Step	Action
45	<p style="text-align: center;">CAUTION</p> <p style="text-align: center;">DO NOT USE PRESSURE OR ALLOW MOVEMENT OF THE WIRE DURING THE SOLDER COOLING PROCESS.</p> <p>Allow the wire to rest in cup until the solder solidifies.</p>
46	Season the tip and place the soldering iron into its stand.
47	Allow the wire and solder cup to cool completely before cleaning.
48	Clean the wire and solder cup with isopropyl alcohol using an acid brush to remove all flux residue and blot dry with a clean, lint-free tissue.
49	<p><i>Inspect per the General Inspection Procedure in WP 003 00 (paragraph 03-5.12) to all applicable WORKMANSHIP STANDARDS, including:</i></p> <ul style="list-style-type: none"> • <i>General Solder Acceptability in WP 005 00 (paragraph 05-6.1)</i> • <i>Post-Solder Joint Cleanliness in WP 005 00 (paragraph 05-6.2)</i> • <i>Solder Cup Solder Acceptability (paragraph 09-6.1)</i> • <i>Other applicable Workmanship Standards as required</i>
50	Slide the insulation sleeving over the solder cup ensuring the wire insulation is also covered, if required.
51	<p style="text-align: center;">CAUTION</p> <p style="text-align: center;">ALWAYS EXERCISE EXTREME CAUTION WHEN APPLYING HEAT TO SHRINKABLE SLEEVING, AS DAMAGE TO THE JOINT, SLEEVING, AND ADJACENT AREAS MAY RESULT. EXCESS HEAT CAUSES GREATER DAMAGE THAN INSUFFICIENT HEAT.</p> <p>For heat-shrinkable sleeving, apply heat to shrink the sleeving to a snug fit over the joint and the wire insulation.</p> <p>Note: The preferred method of shrinking insulation sleeving is a radiant heat gun. However, a hot air jet may be used, provided extreme caution is exercised.</p>

Solder Cup Wire Installation (Soldering Iron) Procedure















Step	Action
52	<p><i>Inspect per the General Inspection Procedure in WP 003 00 (paragraph 03-5.12) to all applicable WORKMANSHIP STANDARDS, including:</i></p> <ul style="list-style-type: none"> <i>Insulation Sleeving Replacement in WP 008 00 (paragraph 08-6.13)</i> <i>Other applicable Workmanship Standards as required</i>
53	Dispose of all HAZMAT following local procedures.

09-5.4 Solder Cup Wire Installation (Resistive Tweezers) Procedure

Use this procedure for wire installation in tightly spaced solder cups.

Use the Solder Cup Wire Installation (Soldering Iron) Procedure (paragraph 09-5.3) for easily accessible solder cups.

Personnel Hazards

					
Alcohol, Isopropyl					1
					
Flux (Soldering)					8
					
Lead (Solder)					9

Solder Cup Wire Installation (Resistive Tweezers) Procedure

Step	Action
	<div style="border: 2px solid black; padding: 5px; display: inline-block;"> WARNING </div> <p>USE APPROVED SAFETY EYEWEAR WHEN PERFORMING THIS PROCEDURE.</p> <p>COMPLY WITH ALL LOCAL REQUIREMENTS FOR PPE.</p>

Solder Cup Wire Installation (Resistive Tweezers) Procedure

Step	Action
	<div style="border: 2px solid black; padding: 5px; display: inline-block; margin-bottom: 10px;">CAUTION</div> <p>DON A PROPERLY GROUNDED ESD WRIST STRAP BEFORE STARTING THIS PROCEDURE.</p>
1	Ensure the wire was stripped using the appropriate Insulated Wire Stripping procedure in WP 008 00 (paragraph 08-5.3).
2	Ensure the wire was tinned using the Insulated Wire Tinning Procedure in WP 008 00 (paragraph 08-5.4).
3	<p><i>Inspect per the General Inspection Procedure in WP 003 00 (paragraph 03-5.12) to all applicable WORKMANSHIP STANDARDS, including:</i></p> <ul style="list-style-type: none"> • <i>Wires in WP 008 00 (paragraph 08-6.1)</i> • <i>Insulated Wire Stripping in WP 008 00 (paragraph 08-6.2)</i> • <i>Insulated Wire Tinning in WP 008 00 (paragraph 08-6.3)</i>
4	Clean the resistive tweezers tips with a plater's brush or 400-600 grit sandpaper to remove surface oxides and wipe with a tissue.
5	Set the AC power control to the lowest setting.
6	Clean the solder with isopropyl alcohol and wipe dry with a clean, lint-free tissue.
7	Clean the solder cup with isopropyl alcohol.
8	<p>Cut a length of solder equal to the depth of the cup and place it in the solder cup.</p> <p>Note: The application of external flux could promote solder spillage and should not be used.</p>



Solder Cup Wire Installation (Resistive Tweezers) Procedure

Step	Action
9	<p style="text-align: center;">CAUTION</p> <p style="text-align: center;">ALWAYS PLACE THE RESISTIVE TWEEZERS TIPS IN CONTACT WITH THE SOLDER CUP BEFORE APPLYING POWER TO PREVENT ARCING AND BURNING.</p> <p style="text-align: center;">CONTACT BETWEEN THE RESISTIVE TWEEZERS TIPS AND THE SOLDER CUP MUST BE MAINTAINED WHENEVER POWER IS APPLIED TO THE TWEEZERS.</p> <p>Place the resistive tweezers tips low on the solder cup.</p> 
10	<p style="text-align: center;">CAUTION</p> <p style="text-align: center;">EXERCISE CARE WHEN ADJUSTING THE CURRENT LEVEL BECAUSE MOST RESISTIVE HEATING SOURCES ARE CAPABLE OF SOLDER CUP DESTRUCTION BY OVERHEATING IF THE CURRENT LEVEL IS SET TOO HIGH.</p> <p>Actuate the foot pedal to apply power to the resistive tweezers and slowly increase the AC power to the tweezers until the solder in the cup begins to melt.</p>
11	<p>When the solder in the cup melts, add additional solder to the cup until filled as required.</p>
12	<p style="text-align: center;">CAUTION</p> <p style="text-align: center;">ALWAYS REMOVE POWER FROM RESISTIVE TWEEZERS TIPS BEFORE REMOVING THE TIPS FROM THE SOLDER CUP TO PREVENT ARCING AND BURNING.</p> <p>Release the foot pedal and remove the resistive tweezers tips from the solder cup.</p>
13	<p>Allow the solder cup to cool completely before cleaning.</p>
14	<p>Clean the solder cup with isopropyl alcohol using an acid brush to remove all flux residue and blot dry with a clean, lint-free tissue.</p>

Solder Cup Wire Installation (Resistive Tweezers) Procedure

Step	Action
15	Select the largest size of wicking material that can be loosely twisted and still fit inside of the solder cup. Note: If corroded, clean the wicking material with isopropyl alcohol and blot dry with a clean, lint-free tissue.
16	Loosely twist the wicking material.
17	Apply flux SPARINGLY to the wicking material.
18	Clean the resistive tweezers tips with a plater's brush or 400-600 grit sandpaper to remove surface oxides and wipe with a tissue.
19	Maintain the AC power control setting.
20	<div style="text-align: center;">CAUTION</div> <p>ALWAYS PLACE THE RESISTIVE TWEEZERS TIPS IN CONTACT WITH THE SOLDER CUP BEFORE APPLYING POWER TO PREVENT ARCING AND BURNING.</p> <p>CONTACT BETWEEN THE RESISTIVE TWEEZERS TIPS AND THE SOLDER CUP MUST BE MAINTAINED WHENEVER POWER IS APPLIED TO THE TWEEZERS.</p> <p>Place the resistive tweezers tips low on the solder cup.</p>
21	Actuate the foot pedal to apply power to the resistive tweezers.
22	Apply the wicking material to the solder in the cup at solder melt. 
23	Observe the capillary action (solder flow) into the wicking material; when solder flow stops, remove the wicking material.

Solder Cup Wire Installation (Resistive Tweezers) Procedure

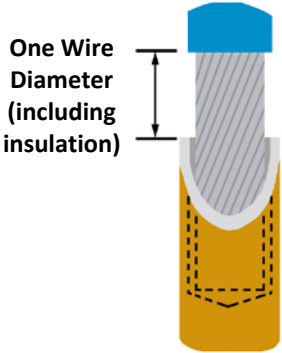
Step	Action
24	<div style="text-align: center; border: 2px solid black; padding: 5px; margin-bottom: 10px;">CAUTION</div> <p>ALWAYS REMOVE POWER FROM RESISTIVE TWEEZERS TIPS PRIOR TO REMOVING THE TIPS FROM THE SOLDER CUP TO PREVENT ARCING AND BURNING.</p> <p>Release the foot pedal and remove the resistive tweezers tips from the solder cup.</p>
25	Remove the used portion of wicking material from the spool using utility cutters.
26	Allow the solder cup to cool completely before cleaning.
27	Clean the solder cup with isopropyl alcohol to remove all flux residue.
28	<p>Repeat steps 7 through 27 once for gold plated solder cups and until the interior, the milled face, and the corners of the solder cup are clean, shiny and covered with a thin layer of solder.</p> <p>Note: Double tin gold plated solder cups to ensure removal of the gold plating.</p> 
29	Determine the routing and positioning requirements of the wire.
30	<p>Insert the wire into the solder cup to measure the length of wire needed.</p> <p>Note: Ensure the solder cup used as a depth gauge is completely empty of solder.</p>
31	<p>Terminate the wire, using flush cutting pliers, so there is one wire diameter (including insulation) clearance between the end of the insulation and the top edge of the solder cup where the wire first makes contact.</p> <p>Note: After the first wire is terminated, it can be used as a gauge for terminating other wires.</p> 

Solder Cup Wire Installation (Resistive Tweezers) Procedure

Step	Action
32	<p style="text-align: center;">CAUTION</p> <p style="text-align: center;">USE INSULATION SLEEVING ON ALL SOLDER CUPS IN CLOSE PROXIMITY TO EACH OTHER DUE TO THE DANGER OF ELECTRICAL SHORT CIRCUITS.</p> <p>If required, insert insulation sleeving over the wire.</p> <p>Note: The sleeving may be either fixed-size or heat-shrinkable; however, heat-shrinkable sleeving is recommended because it provides good insulation with less bulk and is not subject to slipping off the joint.</p>
33	<p>Select a solder size to snugly fit into the solder cup and cut to length.</p> <p>Note: Smaller sizes of solder may be twisted together to provide the proper fill of the solder cup.</p> 
34	Clean the solder with isopropyl alcohol and wipe dry with a clean, lint-free tissue.
35	Place the proper amount of solder into the solder cup.
36	Clean the resistive tweezers tips with a plater's brush or 400-600 grit sandpaper and wipe with a tissue.
37	Maintain the AC power control setting.
38	If feasible, tilt the solder cup to approximately 45° with the cup opening facing up.
39	<p style="text-align: center;">CAUTION</p> <p style="text-align: center;">ALWAYS PLACE THE RESISTIVE TWEEZERS TIPS IN CONTACT WITH THE SOLDER CUP BEFORE APPLYING POWER TO PREVENT ARCING AND BURNING.</p> <p style="text-align: center;">CONTACT BETWEEN THE RESISTIVE TWEEZERS TIPS AND THE SOLDER CUP MUST BE MAINTAINED WHENEVER POWER IS APPLIED TO THE TWEEZERS.</p> <p>Place the resistive tweezers tips low on the solder cup.</p>
40	Actuate the foot pedal to apply power to the resistive tweezers.
41	Observe the cup for solder melt.

Solder Cup Wire Installation (Resistive Tweezers) Procedure

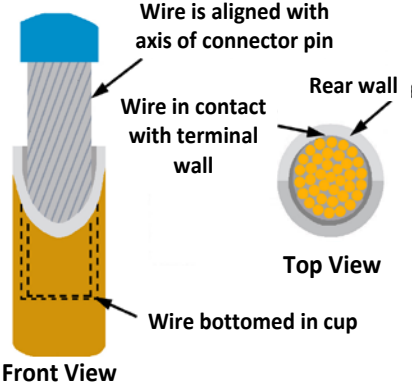
Step	Action
42	<p>Upon solder melt, immediately insert the tip of the wire partially into the solder cup at an angle.</p> 
43	<p>Hesitate momentarily to overcome the heat-sinking action.</p>
44	<p>After the solder melts again, move the wire slowly to the back of the cup wall and to the bottom of the solder cup.</p> <p>Note: Multiple wires are placed as close to each other as possible without bending or birdcaging of the wires.</p> 
45	<p style="text-align: center;">CAUTION</p> <p style="text-align: center;">ALWAYS REMOVE POWER FROM RESISTIVE TWEEZERS TIPS PRIOR TO REMOVING THE TIPS FROM THE SOLDER CUP TO PREVENT ARCING AND BURNING.</p> <p>Release the foot pedal and remove the resistive tweezers tips from the solder cup.</p>
46	<p style="text-align: center;">CAUTION</p> <p style="text-align: center;">DO NOT USE PRESSURE OR ALLOW MOVEMENT OF THE WIRE WHILE COOLING.</p> <p>Allow the wire to rest in cup until the solder solidifies.</p>
47	<p>Clean the resistive tweezers tips with a plater's brush or 400-600 grit sandpaper and wipe with a tissue.</p>

Solder Cup Wire Installation (Resistive Tweezers) Procedure

Step	Action
48	Allow the wire and solder cup to cool completely before cleaning.
49	Clean the wire and solder cup with isopropyl alcohol using an acid brush to remove all flux residue and blot dry with a clean, lint-free tissue.
50	<p><i>Inspect per the General Inspection Procedure in WP 003 00 (paragraph 03-5.12) to all applicable WORKMANSHIP STANDARDS, including:</i></p> <ul style="list-style-type: none"> • <i>General Solder Acceptability in WP 005 00 (paragraph 05-6.1)</i> • <i>Post-Solder Joint Cleanliness in WP 005 00 (paragraph 05-6.2)</i> • <i>Solder Cup Solder Acceptability (paragraph 09-6.1)</i> • <i>Other applicable Workmanship Standards as required</i>
51	Slide the insulation sleeving over the solder cup ensuring the wire insulation is also covered, if required.
52	<div style="text-align: center; border: 2px solid black; padding: 5px; width: fit-content; margin: 0 auto;">CAUTION</div> <p>ALWAYS EXERCISE EXTREME CAUTION WHEN APPLYING HEAT TO SHRINKABLE SLEEVING, AS DAMAGE TO THE JOINT, SLEEVING, AND ADJACENT AREAS MAY RESULT. EXCESS HEAT CAUSES GREATER DAMAGE THAN INSUFFICIENT HEAT.</p> <p>For heat-shrinkable sleeving, apply heat to shrink the sleeving to a snug fit over the joint and the wire insulation.</p> <p>Note: The preferred method of shrinking insulation sleeving is a radiant heat gun. However, a hot air jet may be used, provided extreme caution is exercised.</p>
53	<p><i>Inspect per the General Inspection Procedure in WP 003 00 (paragraph 03-5.12) to all applicable WORKMANSHIP STANDARDS, including:</i></p> <ul style="list-style-type: none"> • <i>Insulation Sleeving Replacement in WP 008 00 (paragraph 08-6.13)</i> • <i>Other applicable Workmanship Standards as required</i>
54	Dispose of all HAZMAT following local procedures.

09-5.5 Connector, Cannon Plug Fabrication Procedure

Follow the directions in the replacement connector package (if available) for specific installation requirements.

The following three kits (Figure 09-4, Figure 09-5, and Figure 09-6) make up the components for a typical Cannon Plug replacement:

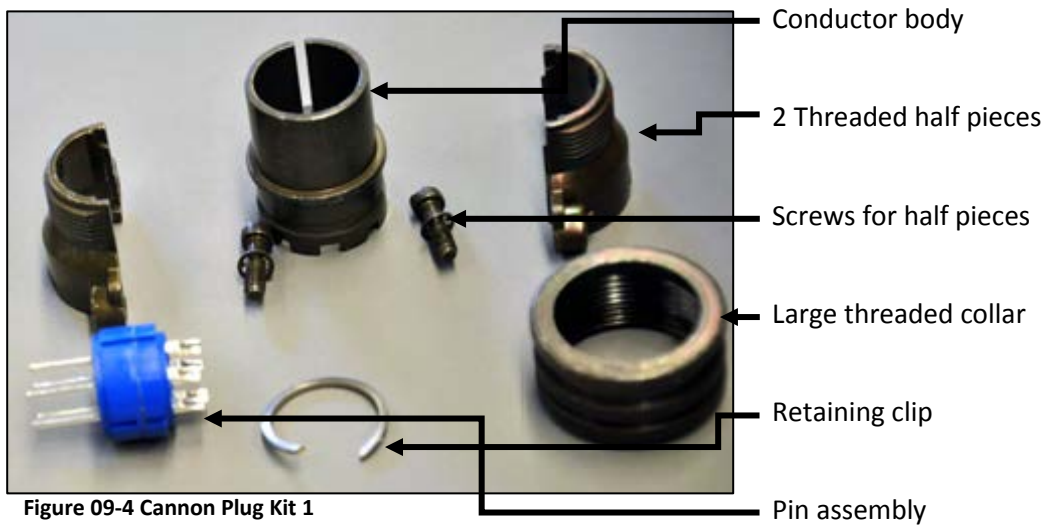

Figure 09-4 Cannon Plug Kit 1

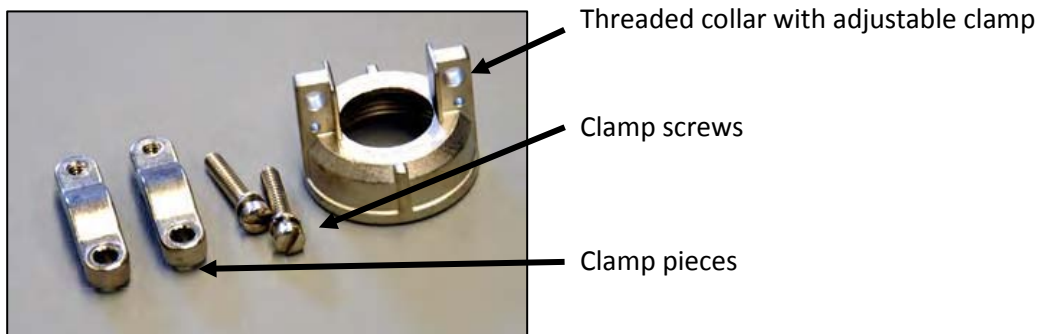















Figure 09-5 Cannon Plug Kit 2



Figure 09-6 Cannon Plug Kit 3



Personnel Hazards

					
Alcohol, Isopropyl					1
					
Flux (Soldering)					8
					
Lead (Solder)					9

Connector, Cannon Plug Fabrication Procedure

Step	Action
	<p style="text-align: center;">WARNING</p> <p style="text-align: center;"><i>USE APPROVED SAFETY EYEWEAR WHEN PERFORMING THIS PROCEDURE.</i></p> <p style="text-align: center;"><i>COMPLY WITH ALL LOCAL REQUIREMENTS FOR PPE.</i></p> <p style="text-align: center;">CAUTION</p> <p style="text-align: center;">DON A PROPERLY GROUNDED ESD WRIST STRAP BEFORE STARTING THIS PROCEDURE.</p>
1	Perform the Procedural Analysis and Feasibility of Repair Procedure in WP 003 00 (paragraph 03-5.1).
2	<p>Inventory the Cannon Plug Kit from three different kits (see Figure 09-4, Figure 09-5, and Figure 09-6):</p> <ul style="list-style-type: none"> • large threaded collar • connector body • threaded half piece collars • 1 retaining clip • screws • pin assembly • one piece threaded collar with adjustable clamp • clamp screws • clamp pieces • stress boot

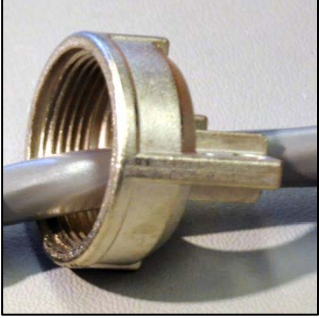

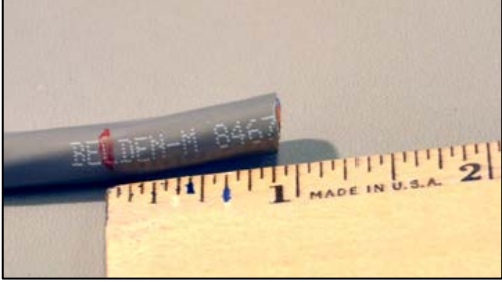
Connector, Cannon Plug Fabrication Procedure

Step	Action
3	<p>Slide the large threaded collar with the clamp onto the cable, with the threaded side toward the connector body.</p> 
4	<p>Slide the stress boot onto the cable, with the tapered end away from the connector body.</p> 
5	<p>Slide the large threaded collar onto the cable (open end toward the connector body).</p> 
6	<p>Measure 7/8 in. from the end of the cable and make a mark on the cable.</p> 
7	<p>Strip the outer jacket.</p>
8	<p>Separate the wires, and strip 5/16 in. from each wire per the appropriate Insulated Wire Stripping procedure in WP 008 00 (paragraph 08-5.3).</p>

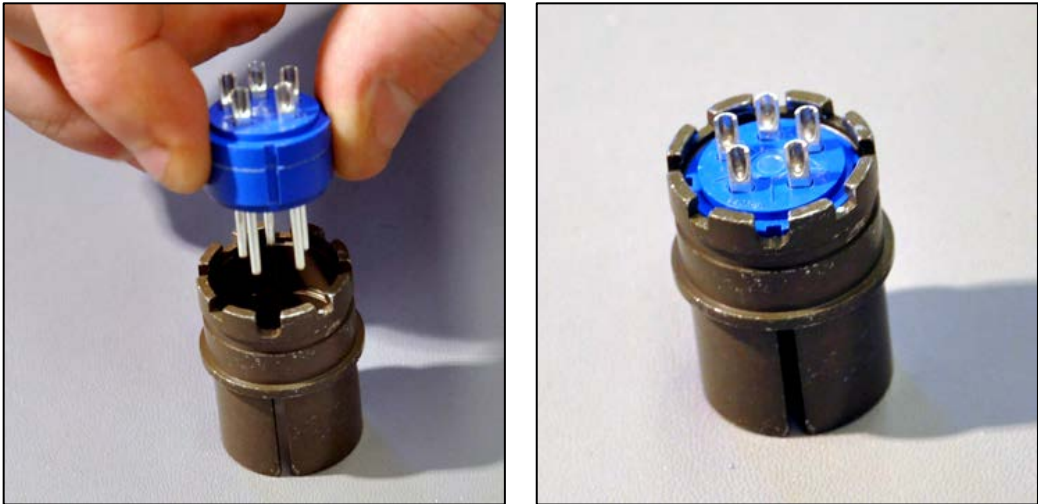

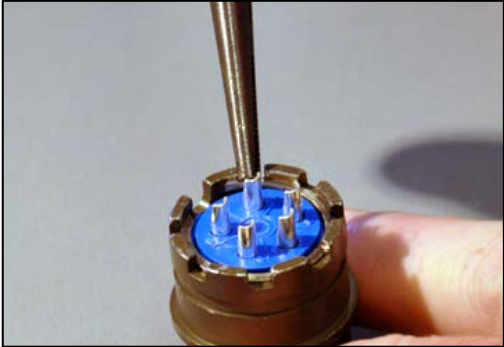

Connector, Cannon Plug Fabrication Procedure

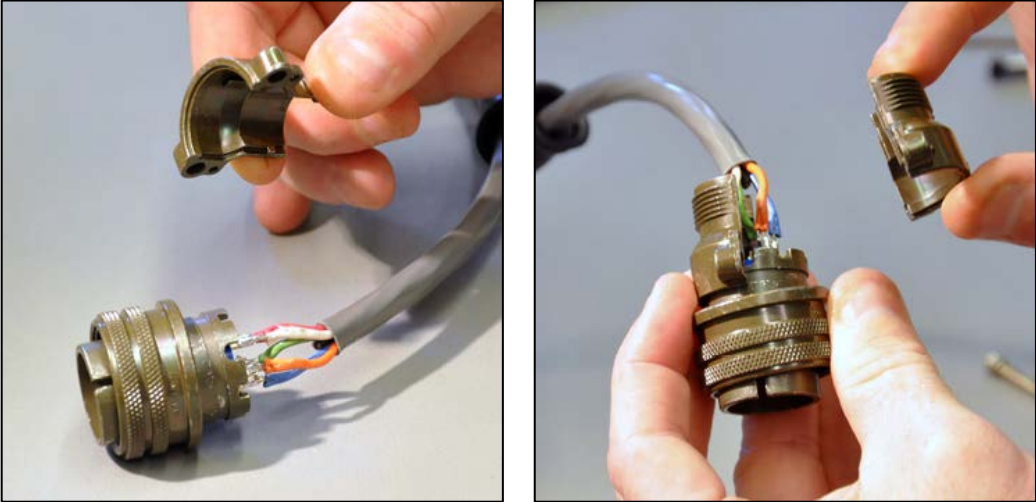
Step	Action
9	<p>Tin each wire per the Insulated Wire Tinning Procedure in WP 008 00 (paragraph 08-5.4).</p> 
10	<p><i>Inspect per the General Inspection Procedure in WP 003 00 (paragraph 03-5.12) to all applicable WORKMANSHIP STANDARDS, including:</i></p> <ul style="list-style-type: none">• <i>Wires in WP 008 00 (paragraph 08-6.1)</i>• <i>Insulated Wire Stripping in WP 008 00 (paragraph 08-6.2)</i>• <i>Insulated Wire Tinning in WP 008 00 (paragraph 08-6.3)</i>
11	<p>Insert the pin assembly into the connector body.</p> 

Connector, Cannon Plug Fabrication Procedure

Step	Action
12	Insert the retaining clip into the connector body to hold pin assembly in place. 
13	Solder the wires into the Cannon Plug solder cups per the Solder Cup Wire Installation (Soldering Iron) Procedure (paragraph 09-5.3) or the Solder Cup Wire Installation (Resistive Tweezers) Procedure (paragraph 09-5.4).
14	Slide threaded collar up onto the connector body. 
15	Install the two half-piece collars to the connector body, and hold them together with the two screws so the collar holds the threaded collar in place on the connector body. 

Connector, Cannon Plug Fabrication Procedure

Step	Action
16	<p>Slide the stress boot up to the solder cups so the boot lines up with the indentation of half collar.</p> 
17	<p>Screw the two half-piece collars together.</p> 
18	<p>Assemble the clamp pieces onto the clamp collar, then slide the remaining collar up to the two-piece collar, and thread them together.</p> 
19	<p>Tighten the clamp on the last collar to the outer jacket of the cable.</p> 

Connector, Cannon Plug Fabrication Procedure

Step	Action
20	Test connector strength using a pull test. 
21	Test the cable for continuity using a multimeter.
22	Dispose of all <i>HAZMAT</i> following local procedures.

09-5.6 Connector, DIN Fabrication Procedure

DIN stands for *Deutsches Institut für Normung*, the German national standards organization.

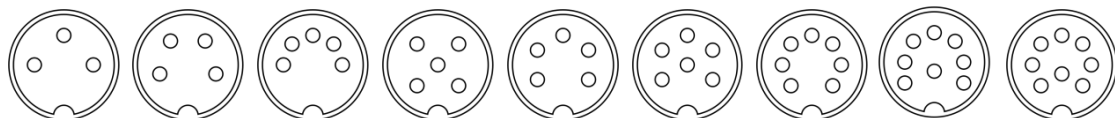

DIN connectors are used for analog audio signals and have been used in analog video applications. The term DIN connector applies to a large number of different connectors. The pin-outs for a common DIN connector are shown below:



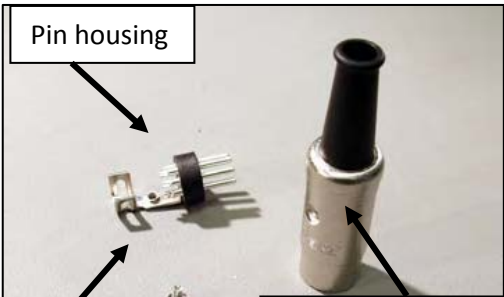

Follow the directions in the replacement connector package (if available) for specific installation requirements.

Personnel Hazards No HAZMAT identified in the HMWS is used in this procedure.

Connector, DIN Fabrication Procedure

Step	Action
	<p style="text-align: center;">WARNING</p> <p style="text-align: center;"><i>USE APPROVED SAFETY EYEWEAR WHEN PERFORMING THIS PROCEDURE.</i></p> <p style="text-align: center;"><i>COMPLY WITH ALL LOCAL REQUIREMENTS FOR PPE.</i></p> <p style="text-align: center;">CAUTION</p> <p style="text-align: center;">DON A PROPERLY GROUNDED ESD WRIST STRAP BEFORE STARTING THIS PROCEDURE.</p>
1	<p>Perform the Procedural Analysis and Feasibility of Repair Procedure in WP 003 00 (paragraph 03-5.1).</p>
2	<p>Inventory DIN connector kit for the following pieces:</p> <ul style="list-style-type: none"> • pin housing • screw for connecting pin housing to main body • main body with stress relief <div style="display: flex; justify-content: space-around; align-items: center;">  </div>
3	<p>Slip the main body with stress relief onto the multi-wire cable</p> <div style="display: flex; justify-content: center; align-items: center;">  </div>

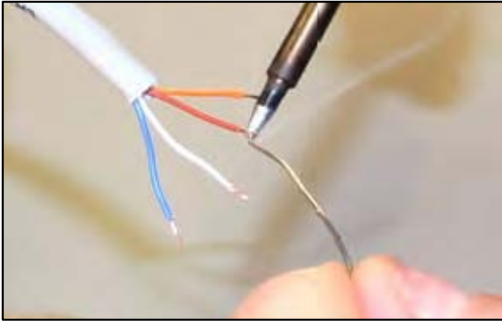
Connector, DIN Fabrication Procedure

Step	Action
4	<p>Strip the outer jacket.</p> <p>Note: Remove enough to work with the wires, but keep in mind the tension clamp in the connector body must bite into the outer jacket.</p> 
5	<p>Strip ¼ in. from the end of each wire per the appropriate Insulated Wire Stripping procedure in WP 008 00 (paragraph 08-5.3).</p>
6	<p>Tin each wire per the Insulated Wire Tinning Procedure in WP 008 00 (paragraph 08-5.4).</p> 
7	<p><i>Inspect per the General Inspection Procedure in WP 003 00 (paragraph 03-5.12) to all applicable WORKMANSHIP STANDARDS, including:</i></p> <ul style="list-style-type: none"> • <i>Wires in WP 008 00 (paragraph 08-6.1)</i> • <i>Insulated Wire Stripping in WP 008 00 (paragraph 08-6.2)</i> • <i>Insulated Wire Tinning in WP 008 00 (paragraph 08-6.3)</i>
8	<p>Solder the wires into the DIN connector solder cups per the Solder Cup Wire Installation (Soldering Iron) Procedure (paragraph 09-5.3) or the Solder Cup Wire Installation (Resistive Tweezers) Procedure (paragraph 09-5.4).</p>
9	<p>Slide the pin housing into the connector body.</p> 

Connector, DIN Fabrication Procedure

Step	Action
10	Insert retaining screw and tighten into the main body to hold together with pin housing 
11	Test the cable for continuity using a multimeter.
12	Dispose of all <i>HAZMAT</i> following local procedures.

09-6 WORKMANSHIP STANDARDS

Refer to WP 003 00 (paragraph 03-6) for definitions of Workmanship Standards.

NOTE



WORKMANSHIP STANDARDS FOR GENERAL SOLDER ACCEPTABILITY AND POST-SOLDER JOINT CLEANLINESS ARE IN WP 005 00 (PARAGRAPH 05-6), TERMINALS IN WP 008 00 (PARAGRAPH 08-6), WIRE REPAIR IN WP 010 00 (PARAGRAPH 10-6), AND CONNECTORS IN WP 021 00 (PARAGRAPH 21-6).

09-6.1 Solder Cup Solder Acceptability

Solder Cup Solder Acceptability

Target Condition	Acceptable Condition	Defect Condition
	Slight melting or discoloration of the insulation caused by the soldering operation is visible.	The wire insulation is burned.
The wire is inserted straight into the solder cup (along the solder cup axis).	The wire is not inserted straight into the solder cup.	

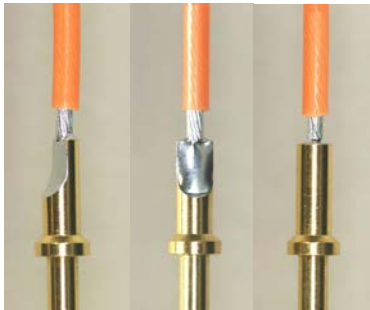
Solder Cup Solder Acceptability

Target Condition	Acceptable Condition	Defect Condition
<p>The wire contacts the back wall of the solder cup or contacts other inserted wires for the full depth of the cup.</p>	<p>The wire does not contact the back wall of the solder cup, provided the wire is inserted for the full depth of the solder cup.</p>	<p>The wire is not inserted for the full depth of the solder cup.</p>
<p>There is an insulation clearance of one wire diameter (including insulation) between the end of the insulation and the top edge of the solder cup where the wire first makes contact.</p>	<p>The insulation clearance is two wire diameters or less (including insulation) between the end of the insulation and the top edge of the solder cup where the wire first makes contact.</p>	<p>The wire insulation contacts the solder fillet or is greater than two wire diameters (including insulation).</p>
<p>Solder vertical fill is 100% of the cutout section of the face of the cup, complete wetting between the wire and the cup, forming a concave fillet between the wire and the top of the solder cup.</p> 	<p>Solder vertical fill is greater than or equal to 75%, but less than 100%, of the cutout section of the face of the cup and complete wetting is evident between the wire and the solder cup.</p>	<p>Solder vertical fill is less than 75% of the cutout section of the face of the cup or complete wetting is not evident between the wire and the solder cup.</p> 
<p>For wires installed in RF connector pins, solder is visible in the inspection window hole.</p> 		<p>For wires installed in RF connector pins, solder is not visible in the inspection window hole.</p>
	<p>There is evidence of arcing on the side of the solder cup caused by improper use of the resistance soldering tools.</p>	<p>The solder cup has been perforated, split, cracked, or otherwise deformed.</p>

Solder Cup Solder Acceptability

Target Condition	Acceptable Condition	Defect Condition
	<p>A thin film of solder (that does not change the contour of the cup) present on the outside of the cup.</p>	<p>There is solder spillage that changes the contour of the solder cup.</p> 

15 October 2013

WP 010 00 Wire Repair

10-1 PURPOSE

Identify the technical information relative to wire repair.

Specify the methods for determining the type and extent of wire damage.

Specify the repair procedures for wire repair.

Identify the workmanship standards for wire repair.

10-2 INDEX

Paragraph	Subject	Page
10-1	Purpose	1
10-2	Index	1
10-3	General Safety Precautions.....	1
10-4	Technical Information.....	2
10-5	Repair Procedures.....	3
10-5.1	Wire Repair Procedural Analysis and Feasibility of Repair	4
10-5.2	Wire Replacement Procedure.....	5
10-5.3	Wire Repair (Wrap Splice) Procedure.....	5
10-5.4	Wire Repair (Mesh Splice) Procedure.....	12
10-6	Workmanship Standards	16
10-6.1	Wire Replacement	16
10-6.2	Wire Splice Forming.....	17
10-6.3	Wire Splice Soldering.....	18
10-6.4	Insulation Sleeving Replacement.....	19
10-6.5	Wire Service Loop Stress Relief	19

10-3 GENERAL SAFETY PRECAUTIONS

Observe all the following precautions while repairing wires:

- Electronic equipment must be de-energized during removal and installation of CCAs
- Personnel are required to wear a properly grounded ESD wrist strap and cord while working in or around the EPA

- ESD can destroy components—protect ESDS devices during handling and repair to prevent ESD damage (Refer to WP 004 00)
- Isopropyl alcohol is flammable; do not use in the presence of sparks, heat, flame, or synthetic cloth
- Soldering handpieces (e.g., soldering irons, hot air jets) produce extreme heat—exercise care when these tools are out of their stands
- Avoid direct inhalation of fumes during a soldering operation because there is a possibility these fumes could cause occupational asthma
- The lead contained in solder is a source of lead oxide, which the human body cannot dissipate (accumulation of lead oxide in the body over a period of years can result in a serious health hazard)
- Contact with solder by holding in the mouth, smoking, or eating during or immediately after soldering is a potential means of ingesting trace amounts of lead oxide
- Avoid oral contact with hands during or immediately after solder operations
- Wash hands following any solder operation
- Wear approved PPE whenever pouring or handling molten metals or corrosive liquids and solids; and cutting, drilling, grinding, milling, chipping and other dust and debris producing operations
- Use adequate ventilation during thermal wire stripping operations because wire insulation may emit toxic fumes during thermal stripping
- Follow manufacturer’s safety instructions for using chemical wire strippers
- Use chemical wire strippers only in well-vented areas, wear prescribed PPE, and avoid contact with skin and eyes
- Do not use wire with PVC [plastic] insulation to replace or repair installed military equipment wiring

10-4 TECHNICAL INFORMATION

There are two types of wire splices used in 2M:

10-4.1 Wrap Splice

Wrap splices require a length of wire adequate to complete the splice and result in a splice diameter equal to two times the diameter of the wire used. The wrap splice is reliable and requires the wires to be wrapped around each other.

10-4.2 Mesh Splice

Mesh splices require the shortest wire length to complete the splice and result in a splice diameter only slightly larger than the diameter of the wire used. The mesh splice is the weakest of the two splices and should not be used where mechanical stress is involved.

10-5 REPAIR PROCEDURES



PROTECT STATIC SENSITIVE DEVICES DURING HANDLING AND REPAIR TO PREVENT ESD DAMAGE (REFER TO WP 004 00).

Equipment Required Listed below are the authorized 2M Power Units* for wire repair:

- **NAVAIR/NAVSEA/USMC/USAF/USCG—PRC-2000-SMT**
- **NAVSEA/USCG—PRC-2000-TH**
- **NAVSEA/USCG—MBT-250-SD**
- **USMC—MBT-350**
- **NAVSEA—ST-25**

* Refer to Table 03-3 for Power Unit Part No., and CAGE Code

Additional Support Items For additional information regarding items of support and support equipment refer to:

- **NAVSEA/NAVAIR/USCG**—2M MTR Certification Manual
- **NAVSEA/USCG**—Allowance Parts List (APL) 000A8423
- **USMC**—Stock List SL-3-09458A
- **USAF**—the Consolidated Tool Kit (CTK)

Material Required Listed below are the materials required* for wire repair:

- Flux, Soldering
- Insulation Sleeving Kit, Electrical‡
- Isopropyl Alcohol, Technical
- Solder, Tin Alloy†
- Towel, Paper (Kimwipe®)‡

* Refer to Table 03-4 for Specification No., Part No., and NSN
 † Select size appropriate for application
 ‡ Substitution of equivalent material is acceptable

10-5.1 Wire Repair Procedural Analysis and Feasibility of Repair

Perform this procedure before any other step.

Personnel Hazards No HAZMAT identified in the HMWS is used in this procedure.

Wire Repair Procedural Analysis and Feasibility of Repair

Step	Action
	<div style="text-align: center;"> <div style="border: 2px solid black; padding: 5px; width: fit-content; margin: 0 auto;">WARNING</div> <p>USE APPROVED SAFETY EYEWEAR WHEN PERFORMING THIS PROCEDURE.</p> <p>COMPLY WITH ALL LOCAL REQUIREMENTS FOR PPE.</p> <div style="border: 2px solid black; padding: 5px; width: fit-content; margin: 0 auto;">CAUTION</div> <p>DON A PROPERLY GROUNDED ESD WRIST STRAP BEFORE STARTING THIS PROCEDURE.</p> </div>

Wire Repair Procedural Analysis and Feasibility of Repair

Step	Action
1	<div style="text-align: center; border: 3px double black; padding: 5px; margin: 0 auto; width: fit-content;"> WARNING </div> <p style="text-align: center;"><i>ENSURE LOCK OUT/TAG OUT WAS PERFORMED PER LOCAL PROCEDURES.</i></p> <p>Locate the damaged wire.</p>
2	Isolate the damaged area by using point-to-point resistance measurements.
3	Determine if both wire ends are accessible.
4	If both wire ends are accessible, perform the Wire Replacement Procedure (paragraph 10-5.2).
5	If only one wire end is accessible, replace one end of the wire using the Wire Repair (Wrap Splice) Procedure (paragraph 10-5.3).
6	If neither wire end is accessible, replace the damaged section of the wire using the Wire Repair (Wrap Splice) Procedure (paragraph 10-5.3).

10-5.2 Wire Replacement Procedure

Replacement is the preferred wire repair method.

Use the Wire Repair (Wrap Splice) Procedure (paragraph 10-5.3) or the Wire Repair (Mesh Splice) Procedure (paragraph 10-5.4) only when wire replacement is not feasible.

Personnel Hazards No HAZMAT identified in the HMWS is used in this procedure.

Wire Replacement Procedure

Step	Action
	<div style="text-align: center; border: 3px double black; padding: 5px; margin: 0 auto; width: fit-content;"> WARNING </div> <p style="text-align: center;"><i>USE APPROVED SAFETY EYEWEAR WHEN PERFORMING THIS PROCEDURE.</i></p> <p style="text-align: center;"><i>COMPLY WITH ALL LOCAL REQUIREMENTS FOR PPE.</i></p>

Wire Replacement Procedure

Step	Action
	<p style="text-align: center;">CAUTION</p> <p style="text-align: center;">DON A PROPERLY GROUNDED ESD WRIST STRAP BEFORE STARTING THIS PROCEDURE.</p>
1	Perform the Wire Repair Procedural Analysis and Feasibility of Repair (paragraph 10-5.1) above, if not already completed.
2	Select a replacement wire having the same insulation type, gauge, and color-coding as the original wire.
3	Replace the wire identification or replicate the wire markings.
4	<p>Position the wire designation sleeve within one inch of the termination when the replacement wire does not have the same gauge, insulation type, and color-coding as the original wire.</p> <p>Note: Install insulation sleeving over the wire prior to soldering (as required).</p>
5	Solder the replacement wire to a terminal per the Terminal Soldering Procedure in WP 008 00 (paragraph 08-5.7) or to a solder cup per the Solder Cup Wire Installation (Soldering Iron) Procedure in WP 009 00 (paragraph 09-5.3), as appropriate.
6	Return the spliced wire to the wire bundle ensuring the wire designation sleeve is positioned on the exterior of the wire bundle and are clearly visible, if required.
7	<p style="text-align: center;">CAUTION</p> <p style="text-align: center;">DO NOT REPLACE LACING TWINE WITH PLASTIC TIE WRAPS ON CABLE BUNDLES THAT MUST FLEX. WIRING MAY BREAK AT TIE POINTS.</p> <p>Secure the wire bundle as in original configuration with lacing twine, spot ties, tie wraps, cord, or other mechanical devices, if required.</p>
8	Route and position the wire bundle to its original position.















Wire Replacement Procedure

Step	Action
9	<p><i>Inspect per the General Inspection Procedure in WP 003 00 (paragraph 03-5.12) to all applicable WORKMANSHIP STANDARDS, including:</i></p> <ul style="list-style-type: none"> • <i>Wire Replacement (paragraph 10-6.1)</i> • <i>Wire Service Loop Stress Relief (paragraph 10-6.5), if required</i> • <i>Other applicable Workmanship Standards as required</i>
10	Dispose of all HAZMAT following local procedures.

10-5.3 Wire Repair (Wrap Splice) Procedure

Use this procedure only when the preferred the Wire Replacement Procedure (paragraph 10-5.2) is not feasible.

Personnel Hazards

					
Alcohol, Isopropyl					1
					
Flux (Soldering)					8
					
Lead (Solder)					9



Wire Repair (Wrap Splice) Procedure

Step	Action
	<div style="border: 2px solid black; padding: 5px; display: inline-block;">WARNING</div> <p>USE APPROVED SAFETY EYEWEAR WHEN PERFORMING THIS PROCEDURE.</p> <p>COMPLY WITH ALL LOCAL REQUIREMENTS FOR PPE.</p>

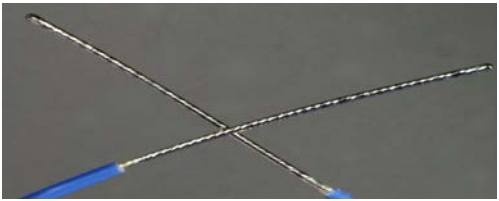

Wire Repair (Wrap Splice) Procedure

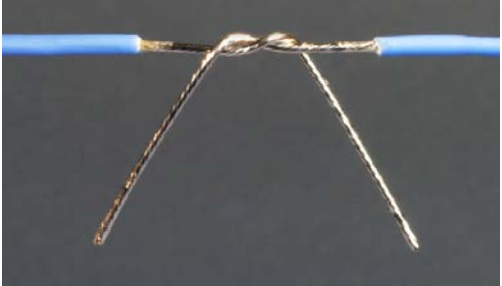
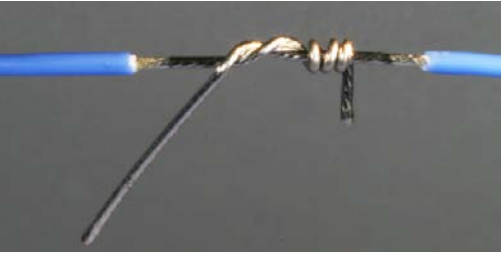
Step	Action
	<p style="text-align: center;">CAUTION</p> <p style="text-align: center;">DON A PROPERLY GROUNDED ESD WRIST STRAP BEFORE STARTING THIS PROCEDURE.</p>
1	<p>Perform the Wire Repair Procedural Analysis and Feasibility of Repair (paragraph 10-5.1) above, if not already completed.</p>
2	<p style="text-align: center;">CAUTION</p> <p style="text-align: center;">THE SPLICED WIRE REPAIR METHOD EXPLAINED IN THIS PROCEDURE IS USED ONLY WHEN THE COMPLETE REMOVAL AND REPLACEMENT OF THE ENTIRE WIRE IS NOT FEASIBLE.</p> <p>Obtain proper authorization to perform this splice, as required.</p>
3	<p>Select a replacement wire having the same insulation type, gauge, and color-coding as the original wire.</p>
4	<p>Select a soldering iron tip that maximizes heat transfer and contact area with the wire.</p>
5	<p>Set the soldering iron tip temperature to 600°F (316°C).</p>
6	<p>If required, slide the appropriate length and size of heat-shrinkable insulation sleeving onto the wire before forming the splice.</p> <p>Note: The insulation sleeving must extend over the wire insulation a minimum of two wire diameters (including insulation) or ¼ in., whichever is greater, on both sides of the splice.</p>
7	<p>Replace the wire identification or replicate the wire markings.</p>
8	<p>Strip and tin both ends of the wire per an Insulated Wire Stripping procedure in WP 008 00 (paragraph 08-5.3) and the Insulated Wire Tinning Procedure in WP 008 00 (paragraph 08-5.4).</p>
9	<p>Lay the two tinned wires across each other in an "X" pattern.</p> 

Wire Repair (Wrap Splice) Procedure

Step	Action
10	<p>Form the splice by wrapping, not twisting, each wire around the other wire.</p> <p>Note: For strength and reliability, both wires must wrap.</p> 
11	<p>Continue wrapping a minimum of three wraps.</p> 
12	<p>Flush cut the ends of the wires.</p> <p>Note: The wrapped portion of the wires shall be tight with the cut end, shall be flush cut, and shall not protrude from the splice.</p> 
13	<p>Clean the splice with isopropyl alcohol using an acid brush and blot dry with a clean, lint-free tissue.</p> <p>Note: Take precautions to prevent bare skin contact before the splice is soldered. Skin contact leaves contaminants on the splice.</p>
14	<p>Clean the solder with isopropyl alcohol and wipe dry with a clean, lint-free tissue.</p>
15	<p>Remove the seasoning (all solder) from the soldering iron tip.</p>
16	<p>Thermally shock the soldering iron tip on a damp sponge.</p>
17	<p style="text-align: center;">CAUTION</p> <p style="text-align: center;">DO NOT APPLY PRESSURE WITH THE SOLDERING IRON TO THE SPLICE.</p> <p>Place the soldering iron tip on the splice at the point of maximum thermal mass.</p>

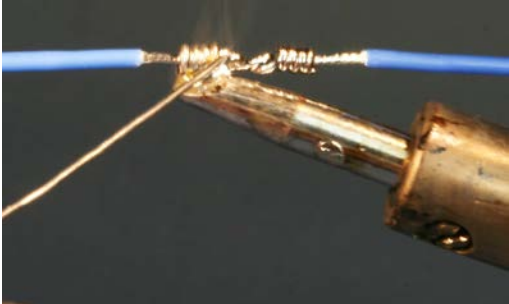
Wire Repair (Wrap Splice) Procedure

Step	Action
<p>18</p>	<div style="text-align: center; border: 1px solid black; padding: 5px; margin-bottom: 10px;"> CAUTION </div> <p style="text-align: center;">IF SOLDER MELT DOES NOT OCCUR WITHIN TWO SECONDS, STOP THIS PROCEDURE AND ADJUST TIP TEMPERATURE PER THE TIP TEMPERATURE PROCEDURE IN WP 003 00 (PARAGRAPH 03-5.4).</p> <p>Form a heat bridge between the soldering iron tip and the splice using clean solder.</p> 
<p>19</p>	<p>Apply solder only until the splice is fully wetted with solder.</p> 
<p>20</p>	<p>Remove the solder and the soldering iron tip simultaneously.</p>
<p>21</p>	<p>Season the tip and place the soldering iron into its stand.</p>
<p>22</p>	<p>Repeat steps 6 through 21 when more than one splice is needed.</p>
<p>23</p>	<p>Allow the splice to cool completely before cleaning.</p>
<p>24</p>	<p>Clean the splice with isopropyl alcohol using an acid brush to remove all flux residue and blot dry with a clean, lint-free tissue.</p>
<p>25</p>	<p>Position the insulation sleeving on the replacement wire ensuring the sleeving overlaps the wire insulation and the solder joint.</p>

Wire Repair (Wrap Splice) Procedure















Step	Action
26	<p style="text-align: center;">CAUTION</p> <p>ALWAYS EXERCISE EXTREME CAUTION WHEN APPLYING HEAT TO SHRINKABLE SLEEVING, AS DAMAGE TO THE JOINT, SLEEVING, AND ADJACENT AREAS MAY RESULT. EXCESS HEAT CAUSES GREATER DAMAGE THAN INSUFFICIENT HEAT.</p> <p>For heat-shrinkable sleeving, apply heat to shrink the sleeving to a snug fit over the joint and the wire insulation.</p> <p>Note: The preferred method of shrinking insulation sleeving is a radiant heat gun. However, a hot air jet may be used, provided extreme caution is exercised.</p>
27	<p>Position the wire designation sleeve within one inch of the termination when the replacement wire does not have the same gauge, insulation type, or color-coding as the original wire.</p>
28	<p>Return the spliced wire to the wire bundle ensuring the wire designation sleeve is positioned on the exterior of the wire bundle and are clearly visible, if required.</p>
29	<p style="text-align: center;">CAUTION</p> <p>DO NOT REPLACE LACING TWINE WITH PLASTIC TIE WRAPS ON CABLE BUNDLES THAT MUST FLEX. WIRING MAY BREAK AT TIE POINTS.</p> <p>Secure the wire bundle as in original configuration with lacing twine, spot ties, tie wraps, cord, or other mechanical devices, if required.</p>
30	<p>Route and position the wire bundle to its original position.</p>
31	<p><i>Inspect per the General Inspection Procedure in WP 003 00 (paragraph 03-5.12) to all applicable WORKMANSHIP STANDARDS, including:</i></p> <ul style="list-style-type: none"> • <i>Wire Replacement (paragraph 10-6.1)</i> • <i>Wire Splice Forming (paragraph 10-6.2)</i> • <i>Wire Splice Soldering (paragraph 10-6.3)</i> • <i>Insulation Sleeving Replacement (paragraph 10-6.4)</i> • <i>Wire Service Loop Stress Relief (paragraph 10-6.5), if required</i> • <i>Other applicable Workmanship Standards as required</i>
32	<p>Dispose of all HAZMAT following local procedures.</p>

10-5.4 Wire Repair (Mesh Splice) Procedure

Use this procedure only when the preferred the Wire Replacement Procedure (paragraph 10-5.2) is not feasible.

The procedure is an alternate method to the Wire Repair (Wrap Splice) Procedure (paragraph 10-5.3).

Personnel Hazards

					
Alcohol, Isopropyl					1
					
Flux (Soldering)					8
					
Lead (Solder)					9

Wire Repair (Mesh Splice) Procedure

Step	Action
	<p style="text-align: center;">WARNING</p> <p style="text-align: center;">USE APPROVED SAFETY EYEWEAR WHEN PERFORMING THIS PROCEDURE.</p> <p style="text-align: center;">COMPLY WITH ALL LOCAL REQUIREMENTS FOR PPE.</p> <p style="text-align: center;">CAUTION</p> <p style="text-align: center;">DON A PROPERLY GROUNDED ESD WRIST STRAP BEFORE STARTING THIS PROCEDURE.</p>
1	Perform the Wire Repair Procedural Analysis and Feasibility of Repair (paragraph 10-5.1) above, if not already completed.

Wire Repair (Mesh Splice) Procedure

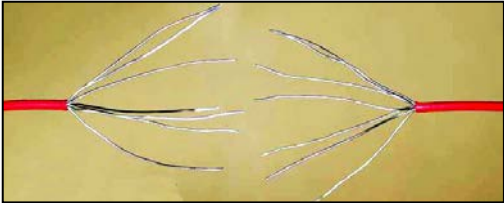
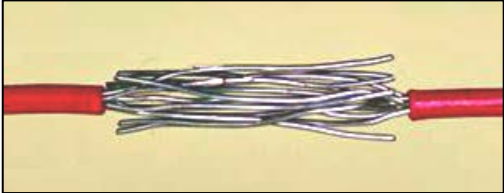
Step	Action
2	<div style="text-align: center; border: 2px solid black; padding: 5px; margin: 0 auto; width: fit-content;">CAUTION</div> <p style="text-align: center;">THE SPLICED WIRE REPAIR METHOD EXPLAINED IN THIS PROCEDURE IS USED ONLY WHEN THE COMPLETE REMOVAL AND REPLACEMENT OF THE ENTIRE WIRE IS NOT FEASIBLE.</p> <p>Obtain proper authorization to perform this splice, as required.</p>
3	Select a replacement wire having the same insulation type, gauge, and color-coding as the original wire.
4	Select a soldering iron tip that maximizes heat transfer and contact area with the wire.
5	Set the soldering iron tip temperature to 600°F (316°C).
6	<p>If required, slide the appropriate length and size of heat-shrinkable insulation sleeving onto the wire before forming the splice.</p> <p>Note: The insulation sleeving must extend over the wire insulation a minimum of two wire diameters (including insulation) or ¼ in., whichever is greater, on both sides of the splice.</p>
7	Replace the wire identification or replicate the wire markings.
8	<p>Strip each wire to be spliced approximately ½ in. per Insulated Wire Stripping in WP 008 00 (paragraph 08-5.3).</p> <p>Note: Do not tin wires prior to forming mesh splice.</p>
9	<p>Use a nonmetallic tool, such as a wooden toothpick, to spread and funnel the strands of the wire.</p> 
10	<p>Smooth the wire strands together.</p> 

Wire Repair (Mesh Splice) Procedure

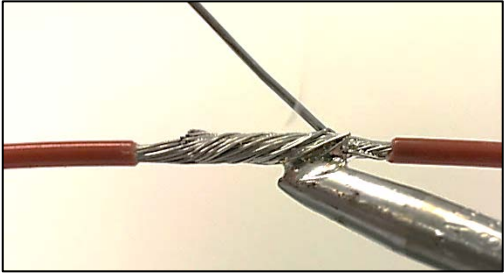
Step	Action
11	Form and gently twist the funneled strands together to replicate the original lay of the wire until they form a bundle approximately two thicknesses of the wire (including insulation). 
12	Clean the splice with isopropyl alcohol using an acid brush and blot dry with a clean, lint-free tissue. Note: Take precautions to prevent bare skin contact before the splice is soldered. Skin contact leaves contaminants on the splice.
13	Clean the solder with isopropyl alcohol and wipe dry with a clean, lint-free tissue.
14	Remove the seasoning (all solder) from the soldering iron tip.
15	Thermally shock the soldering iron tip on a damp sponge.
16	<div style="text-align: center;"> <div style="border: 2px solid black; padding: 5px; display: inline-block;">CAUTION</div> <p>DO NOT APPLY PRESSURE WITH THE SOLDERING IRON TO THE SPLICE.</p> Place the soldering iron tip on the splice at the point of maximum thermal mass. </div>
17	<div style="text-align: center;"> <div style="border: 2px solid black; padding: 5px; display: inline-block;">CAUTION</div> <p>IF SOLDER MELT DOES NOT OCCUR WITHIN TWO SECONDS, STOP THIS PROCEDURE AND ADJUST TIP TEMPERATURE PER THE TIP TEMPERATURE PROCEDURE IN WP 003 00 (PARAGRAPH 03-5.4).</p> </div> Form a heat bridge between the soldering iron tip and the splice using clean solder. 
18	Apply solder only until the splice is fully wetted with solder.

Wire Repair (Mesh Splice) Procedure

Step	Action
19	Remove the solder and the soldering iron tip simultaneously.
20	Season the tip and place the soldering iron into its stand.
21	Repeat steps 6 through 20 when more than one splice is needed.
22	Allow the splice to cool completely before cleaning.
23	Clean the splice with isopropyl alcohol using an acid brush to remove all flux residue and blot dry with a clean, lint-free tissue.
24	Position the insulation sleeving on the replacement wire ensuring the sleeving overlaps the wire insulation and the solder joint.
25	<p style="text-align: center;">CAUTION</p> <p>ALWAYS EXERCISE EXTREME CAUTION WHEN APPLYING HEAT TO SHRINKABLE SLEEVING, AS DAMAGE TO THE JOINT, SLEEVING, AND ADJACENT AREAS MAY RESULT. EXCESS HEAT CAUSES GREATER DAMAGE THAN INSUFFICIENT HEAT.</p> <p>For heat-shrinkable sleeving, apply heat to shrink the sleeving to a snug fit over the joint and the wire insulation.</p> <p>Note: The preferred method of shrinking insulation sleeving is a radiant heat gun. However, a hot air jet may be used, provided extreme caution is exercised.</p>
26	Position the wire designation sleeve within one inch of the termination when the replacement wire does not have the same gauge, insulation type, or color-coding as the original wire.
27	Return the spliced wire to the wire bundle ensuring the wire designation sleeve is positioned on the exterior of the wire bundle and are clearly visible, if required.
28	<p style="text-align: center;">CAUTION</p> <p>DO NOT REPLACE LACING TWINE WITH PLASTIC TIE WRAPS ON CABLE BUNDLES THAT MUST FLEX. WIRING MAY BREAK AT TIE POINTS.</p> <p>Secure the wire bundle as in original configuration with lacing twine, spot ties, tie wraps, cord, or other mechanical devices, if required.</p>

Wire Repair (Mesh Splice) Procedure

Step	Action
29	Route and position the wire bundle to its original position.
30	<p><i>Inspect per the General Inspection Procedure in WP 003 00 (paragraph 03-5.12) to all applicable WORKMANSHIP STANDARDS, including:</i></p> <ul style="list-style-type: none"> • <i>Wire Replacement (paragraph 10-6.1)</i> • <i>Wire Splice Forming (paragraph 10-6.2)</i> • <i>Wire Splice Soldering (paragraph 10-6.3)</i> • <i>Insulation Sleeving Replacement (paragraph 10-6.4)</i> • <i>Wire Service Loop Stress Relief (paragraph 10-6.5), if required</i> • <i>Other applicable Workmanship Standards as required</i>
31	Dispose of all HAZMAT following local procedures.

10-6 WORKMANSHIP STANDARDS

Refer to WP 003 00 (paragraph 03-6) for definitions of Workmanship Standards.

NOTE

WORKMANSHIP STANDARDS FOR GENERAL SOLDER ACCEPTABILITY AND POST-SOLDER JOINT CLEANLINESS ARE IN WP 005 00 (PARAGRAPH 05-6), TERMINALS IN WP 008 00 (PARAGRAPH 08-6), SOLDER CUPS IN WP 009 00 (PARAGRAPH 09-6), AND CONNECTORS IN WP 021 00 (PARAGRAPH 21-6).

10-6.1 Wire Replacement

Wire Replacement

Target Condition	Acceptable Condition	Defect Condition
The replacement wire is of the same insulation type as the original wire.	The replacement wire is not of the same insulation type, if wire of the same insulation type is not available.	

Wire Replacement



Target Condition	Acceptable Condition	Defect Condition
The replacement wire is the same size as the original wire.	The replacement wire is not of the same size, provided the replacement wire is larger than the original wire	The replacement wire is smaller than the original wire.
The color-coding (wire designation) of the insulation of the replacement wire is the same as the original wire.	The color-coding or wire designation of the insulation of the replacement wire is not the same as the original wire, provided a wire designation sleeve is installed over the wire in either within one inch of the termination(s) of that wire or one inch of the splice area.	The color-coding or wire designation of the insulation of the replacement wire is not the same as the original wire, and a wire designation sleeve is not installed over the wire in either within one inch of the termination(s) of that wire or one inch of the splice area.

10-6.2 Wire Splice Forming

Wire Splice Forming

Target Condition	Acceptable Condition	Defect Condition
The insulation clearance is one wire diameter (including insulation) between the wire insulation and the beginning of the splice.	The insulation clearance is greater than one and less than or equal to two wire diameters (including insulation) between the wire insulation and the start of the splice.	The insulation clearance is greater than two or less than one wire diameters (including insulation) between the wire insulation and the start of the splice.
The overall length of the splice does not exceed ¾-in. for wires AWG 16 or smaller.		The overall length of the splice exceeds ¾-in. for wires AWG 16 or smaller.
If more than one wire is to be spliced, the spliced areas shall be staggered to keep the wire bundle diameter close to the original diameter.	If more than one wire has been spliced, the spliced areas are not staggered to keep the wire bundle diameter close to the original diameter.	

Wire Splice Forming

Target Condition	Acceptable Condition	Defect Condition
<p>For wrap splices, the two wires are wrapped greater than or equal to three turns of each wire.</p> 		<p>For wrap splices, there is less than three wraps of each wire.</p>
<p>For Mesh Splices, wire strands are interlaced at least ½ in.</p> 		<p>For Mesh Splices, the contact area (interlace) between the two wires is less than three wire diameters.</p>



10-6.3 Wire Splice Soldering

Wire Splice Soldering

Target Condition	Acceptable Condition	Defect Condition
<p>Both wires are 100% wetted with solder in the areas being joined.</p>		<p>Both wires are not 100% wetted with solder in the areas being joined.</p>
<p>The wires are wetted to each other.</p>		<p>The wires are not wetted to each other.</p>
<p>The contour of the wires is discernible in the solder.</p>		<p>The contour of the wires is not discernible in the solder.</p>
		<p>There is evidence of wicking of the solder underneath the wire insulation.</p>
		<p>The wire insulation contacts the wire splice.</p>
	<p>Slight melting of insulation is visible.</p>	<p>The wire insulation is burned.</p>

10-6.4 Insulation Sleeving Replacement

Insulation Sleeving Replacement



Target Condition	Acceptable Condition	Defect Condition
<p>The insulation sleeving fits snugly on the wire.</p> 		<p>The insulation sleeving is loose on the wire.</p> 
<p>The insulation sleeving overlaps the splice area greater than or equal to two wire diameters (including insulation).</p>		<p>The insulation sleeving overlap of the splice area is less than two wire diameters.</p> 
	<p>The wire bulges the insulation sleeving but does not pierce it.</p>	<p>The wire strands pierce the insulation sleeving.</p>
		<p>There are sharp points or projections from the splice visible in the insulation sleeving.</p>
		<p>The splice area is exposed.</p>

10-6.5 Wire Service Loop Stress Relief

Wire Service Loop Stress Relief

Target Condition	Acceptable Condition	Defect Condition
<p>Replacement wire length is sufficient to allow one field repair to be made.</p>		<p>Replacement wire is too short to allow an additional repair, (no service loop).</p>

Wire Service Loop Stress Relief

Target Condition	Acceptable Condition	Defect Condition
<p>The wire approaches the terminal with a bend sufficient to relieve any tension on the joint during thermal or vibration stress.</p> 		<p>The wire does not approach the terminal with a service loop or a bend sufficient to relieve any tension on the joint during thermal or vibration stress.</p>
		<p>The wire is formed around the terminal opposite to the feed-in direction.</p> 
<p>The direction of the stress-relief service loop places no strain on the mechanical wrap or on the solder joint.</p>		<p>The wire is under stress at the wrap.</p>
<p>The bend not touching the terminal has a radius of greater than or equal to two wire diameters</p>		<p>The bend not touching the terminal has a radius of less than two wire diameters (B).</p>
<p>The wire is straight between the joints with no loop or no bend, but wire is not taut.</p>		<p>The wire is stretched taut between the terminals (A).</p>

15 October 2013

WP 011 00 Laminate

NOTE

THIS WP IS LIMITED TO 0.050 LAMINATES OR THICKER.

REPAIR OF CERAMIC OR CONSTRAINING CORE LAMINATE MATERIAL IS BEYOND THE SCOPE OF THIS MANUAL.

11-1 PURPOSE

Identify the technical information relative to laminate repair.

Specify the methods for determining the type and extent of laminate damage.

Specify the methods for selecting laminate repair procedures.

Specify the repair procedures for the repair of laminate.

Identify the workmanship standards for laminate repair.

11-2 INDEX

Paragraph	Subject	Page
11-1	Purpose	1
11-2	Index	1
11-3	General Safety Precautions.....	2
11-4	Technical Information.....	2
11-5	Repair Procedures.....	7
11-5.1	Laminate Procedural Analysis and Feasibility of Repair	8
11-5.2	Laminate Repair, Surface Patch Procedure	13
11-5.3	Laminate Repair, Through-the-Board Patch Procedure	18
11-5.4	Laminate Repair, Through-the-Board Plug Procedure	23
11-5.5	Laminate Repair, Interior Delamination Procedure	30
11-5.6	Laminate Repair, Edge Delamination Procedure	31
11-5.7	Laminate Repair, Surface Crack	34
11-5.8	Laminate Repair, Through-the-Board Crack	34
11-5.9	Laminate Repair, Broken Procedure.....	34
11-5.10	Laminate Repair, Warped Procedure	39
11-6	Workmanship Standards	42
11-6.1	Laminate	43
11-6.2	Laminate Excavation	43

Paragraph	Subject	Page
11-6.3	Epoxy Fill	45
11-6.4	Buttercoat	46

11-3 GENERAL SAFETY PRECAUTIONS

Observe all the following precautions while repairing laminate:

- Electronic equipment must be de-energized during removal and installation of CCAs
- Personnel are required to wear a properly grounded ESD wrist strap and cord while working in or around the EPA
- ESD can destroy components—protect ESDS devices during handling and repair to prevent ESD damage (Refer to WP 004 00)
- Isopropyl alcohol is flammable; do not use in the presence of sparks, heat, flame, or synthetic cloth
- Wear approved PPE whenever pouring or handling molten metals or corrosive liquids and solids; and cutting, drilling, grinding, milling, chipping and other dust and debris producing operations
- Always follow the manufacturer’s instructions and warnings when using conformal coating products
- Follow manufacturer’s safety instructions when using resins and catalysts

11-4 TECHNICAL INFORMATION

It is important for the repair technician to be familiar with the different materials used in CCA fabrication.

11-4.1 Types of Laminate

The following information covers types of laminate materials:

11-4.1.1 Epoxy/Glass

Epoxy/glass laminate (Figure 11-1) is constructed using epoxy resin reinforced with layers of woven glass fiber.

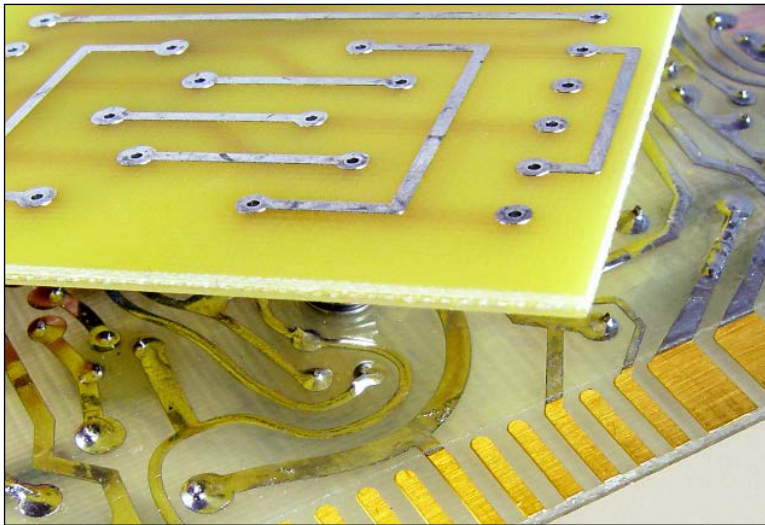

Figure 11-1 Epoxy / Glass Laminate

The natural color of epoxy/glass laminate typically produces a translucent CCA. The solder mask, when used, gives the CCA its color. Epoxy/glass laminates are widely used throughout the electronics industry.

Applications for epoxy/glass electronic assemblies include single-sided, double-sided, and multilayer CCAs.

Advantages of epoxy/glass are a wide selection of flame retardant (FR) resin formulations with glass fiber constructions to meet special electronic assembly applications, available in many sizes, lightweight, relatively low cost per square foot, and suitable for high reliability electronic assembly applications.

Disadvantages are high Z-Axis coefficient of thermal expansion (CTE) [this attribute stresses plated-through holes during thermal excursions such as soldering], low thermal conductivity (this presents poor heat sinking ability for high power dissipation devices), high dielectric constant (limits high frequency operation), and lower temperature operating environment than polyimide/glass laminates.

11-4.1.2 Polyimide/Glass

Polyimide/glass laminate (Figure 11-2) is constructed using a polyimide resin reinforced with layers of woven glass fiber.

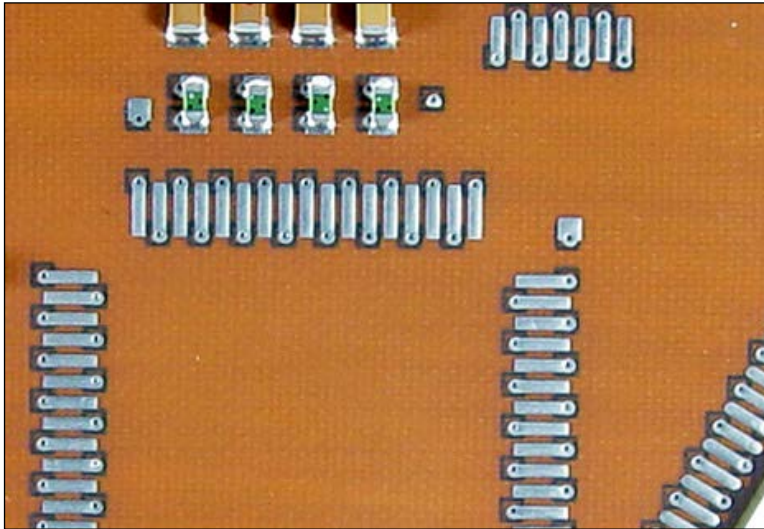

Figure 11-2 Polyimide / Glass Laminate

The natural color of polyimide/glass typically produces a CCA with a brown color.

Polyimide/glass applications for electronic assemblies include single-sided, double-sided, and multilayer CCAs.

Advantages of polyimide/glass include suitable for higher temperature applications than epoxy/glass laminates, low Z-Axis CTE, available in many sizes, light weight, high dielectric strength and suitable for high reliability electronic assembly applications.

Disadvantages are high moisture absorption (baking is often required before soldering to prevent delamination), cost of polyimide/glass laminate is higher than epoxy/glass laminate, low thermal conductivity, and high dielectric constant.

11-4.1.3 Phenolic

Phenolic laminate (Figure 11-3) is composed of a flame retardant phenolic resin that typically uses a reinforcement media such as cellulose paper or a woven fabric.

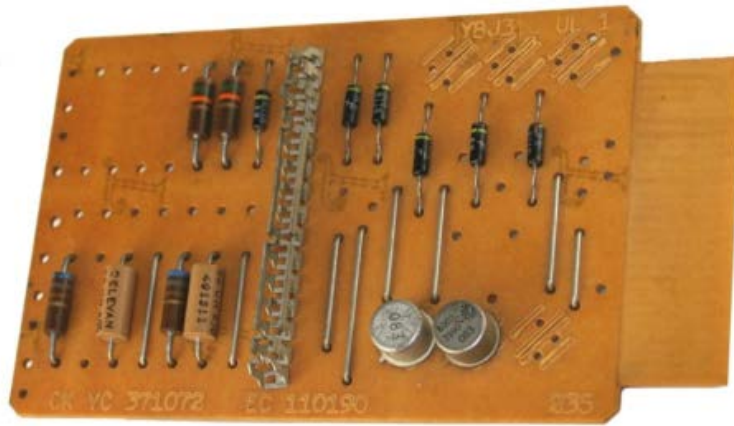

Figure 11-3 Phenolic Laminate

When no reinforcement media is used then it is referred to as cast phenolic laminate. Generally, phenolic type laminates are seldom used in high reliability electronic assembly applications.

Advantages of phenolic laminates are low cost, availability in many sizes and lightweight.

Disadvantages are high moisture absorption, high dielectric constant, low thermal conductivity and a lower temperature-operating environment than epoxy/glass laminates.

11-4.1.4 Ceramic

Ceramic laminate (Figure 11-4) is constructed with ceramic materials and conductive interconnects that may be configured for single-sided, double-sided or multilayer conductive patterns.

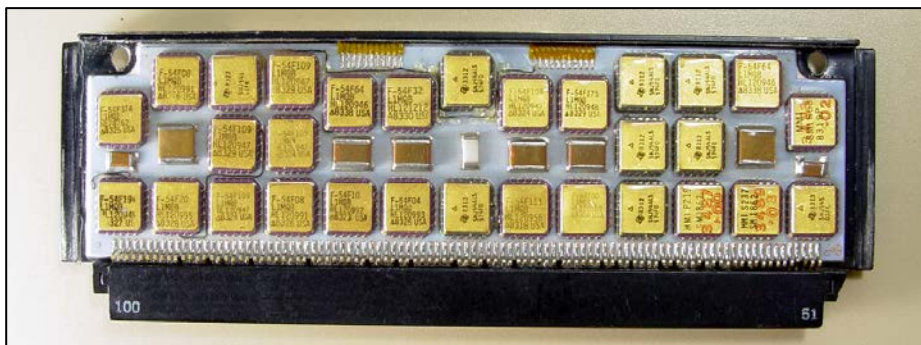

Figure 11-4 Ceramic Laminate

Electrical interconnection of double-sided and multilayer conductive patterns is an integral part of the sequential dielectric layer and conductive layer fabrication process. There are no plated-through holes in a conventional ceramic CCA.

Ceramic laminates are typically used for surface mount technology electronic applications.

Advantages include a low CTE in all axes, high thermal conductivity, suitable for higher temperature applications than polyimide/glass, low moisture absorption and suitable for high reliability electronic assembly applications.

Disadvantages are high cost, restrictions on available size, heavy weight, fragility, and limited repairability.

11-4.1.5 Constraining Core

Constraining core laminate (Figure 11-5) is a multilayer CCA with a metal core.

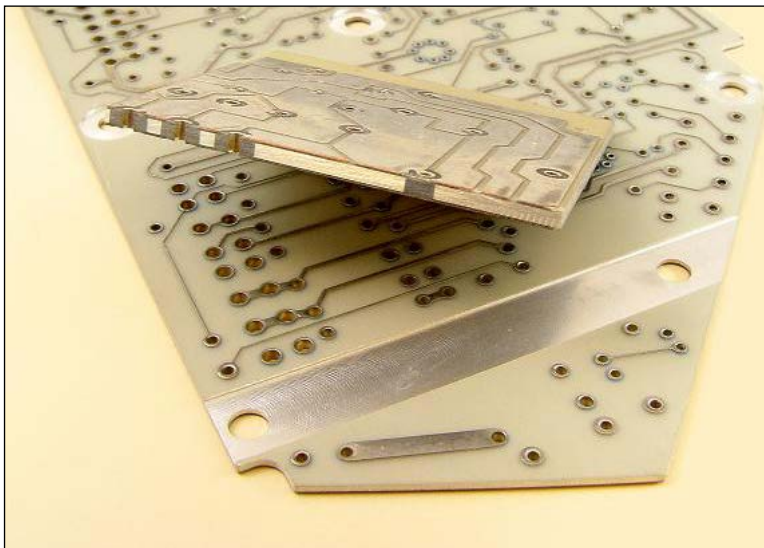

Figure 11-5 Constraining Core Laminate

The most common constraining core materials used are copper-invar-copper and copper-molybdenum-copper. The constraining core either is located in the center of a multilayer CCA buildup or toward the outer surface (one core) or surfaces (two cores). Typical laminates used with constraining core technology are epoxy/glass and polyimide/glass.

Major advantages of a constraining core are controlled CTE (improves solder interconnection reliability of SMDs) and enhanced thermal sinking capability.

Disadvantages are higher processing cost and heavier weight than traditional multilayer CCAs.

11-4.1.6 Flexible

For information on flexible laminates refer to Flex Print (WP 013 00).

11-5 REPAIR PROCEDURES



PROTECT STATIC SENSITIVE DEVICES DURING HANDLING AND REPAIR TO PREVENT ESD DAMAGE (REFER TO WP 004 00).

Equipment Required Listed below are the authorized 2M Power Units* for laminate repair:

- **NAVAIR/NAVSEA/USMC/USAF/USCG**—PRC-2000-SMT
- **NAVSEA/USCG**—PRC-2000-TH
- **NAVSEA/USCG**—MBT-250-SD
- **USMC**—MBT-350
- **NAVSEA**—ST-25

* Refer to Table 03-3 for Power Unit Part No., and CAGE Code

Additional Support Items For additional information regarding items of support and support equipment refer to:

- **NAVSEA/NAVAIR/USCG**—2M MTR Certification Manual
- **NAVSEA/USCG**—Allowance Parts List (APL) 000A8423
- **USMC**—Stock List SL-3-09458A
- **USAF**—the Consolidated Tool Kit (CTK)

Material Required Listed below are the materials required* for laminate repair:

- Applicator, Disposable (cotton-tipped)
- Isopropyl Alcohol, Technical
- Towel, Paper (Kimwipe®)‡

* Refer to Table 03-4 for Specification No., Part No., and NSN

‡ Substitution of equivalent material is acceptable

11-5.1 Laminate Procedural Analysis and Feasibility of Repair

WARNING

USE APPROVED SAFETY EYEWEAR WHEN PERFORMING THIS PROCEDURE.

COMPLY WITH ALL LOCAL REQUIREMENTS FOR PPE.

CAUTION

DON A PROPERLY GROUNDED ESD WRIST STRAP BEFORE STARTING THIS PROCEDURE.

Inspect the CCA per the General Inspection Procedure in WP 003 00 (paragraph 03-5.12) to the Laminate Workmanship Standard (paragraph 11-6.1).

The final decision to repair CCA laminate depends on factors other than type and extent of laminate damage. Other factors that must be considered include:

- Other types of damage
- Repair capability
- Availability of material
- Time and cost of repair
- Operational and mission needs

Include inspecting for the laminate conditions listed below:

11-5.1.1 Measling

Measling (Figure 11-6) is a condition caused by thermally induced stress occurring in laminate material in which internal glass fibers are separated from the resin at the weave intersection. This condition primarily manifests itself in the form of white spots (crosses) below the surface of the laminate material.

- Repair measling only if the assembly is not functional

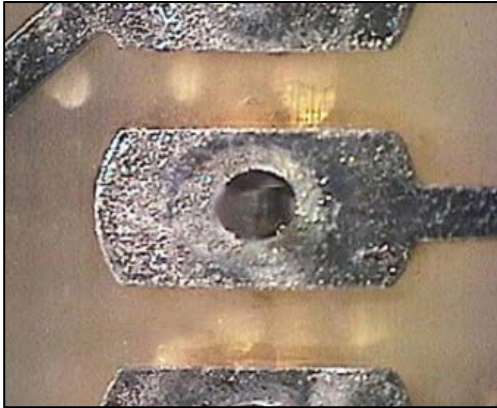

Figure 11-6 Measling

11-5.1.2 Crazing

Crazing (Figure 11-7) is an internal condition caused by mechanically induced stress occurring in reinforced laminate material whereby glass fibers are separated from the resin at the weave intersections. This condition primarily manifests itself in the form of connected white crosses (spots) on or below the surface of the laminate material.

- Repair crazing only if the assembly is not functional



Figure 11-7 Crazing

11-5.1.3 Burned

Burned laminate (Figure 11-8) is a scorched, charred, or deeply burned CCAs identified by blackened or discolored laminate and/or components. The depth of the damage may range from a slight surface discoloration to a hole burnt through the CCA.

- Repair all burns that physically damage the surface of the laminate or the CCA
- Repair all through-the-board burns

- Slight discoloration of the laminate is acceptable and does not require repair

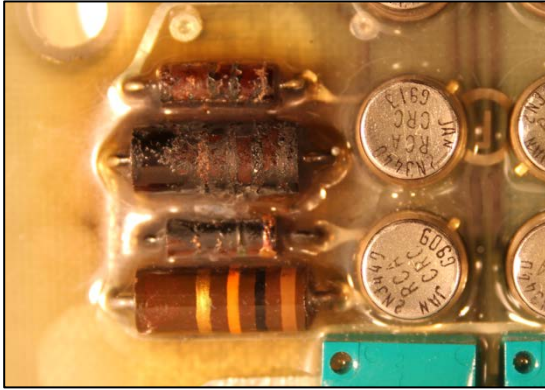
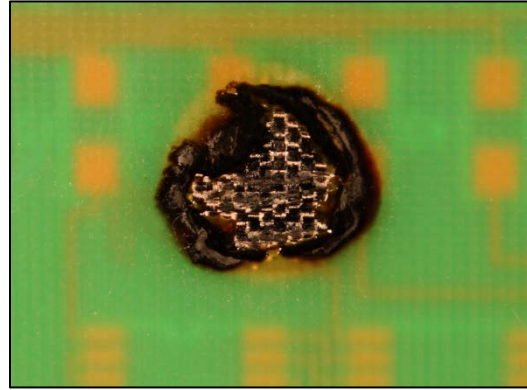

Figure 11-8 Burned Laminate



11-5.1.4 Delamination

Delamination (Figure 11-9) is a debonding of the fiberglass layers of the CCA caused by heat, shock, stress, or thermal cycling. Delamination appears as a blister or raised area.

- Repair any delamination bridging more than 25% of the distance between plated-through holes or conductors

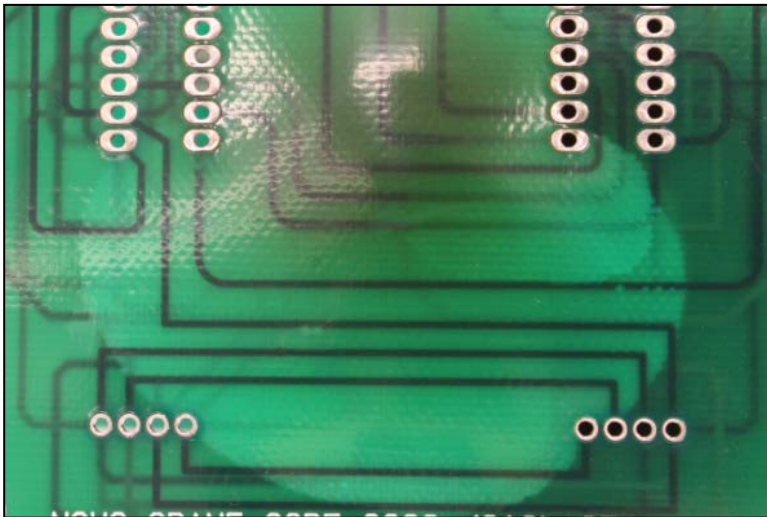

Figure 11-9 Delamination

11-5.1.5 Edge Delamination

Edge delamination (Figure 11-10) will appear as a physical separation of the CCA or frayed edge.

- Repair any edge delamination reducing the edge spacing (distance between the edge of the laminate and outermost conductor) by more than 50%



Figure 11-10 Edge Delamination

11-5.1.6 Cracked

Cracked laminate damage (Figure 11-11) consists of surface scratches, cracks, nicks, or pinholes.

- Repair any crack, scratch, or pinhole exposing the glass fiber weave

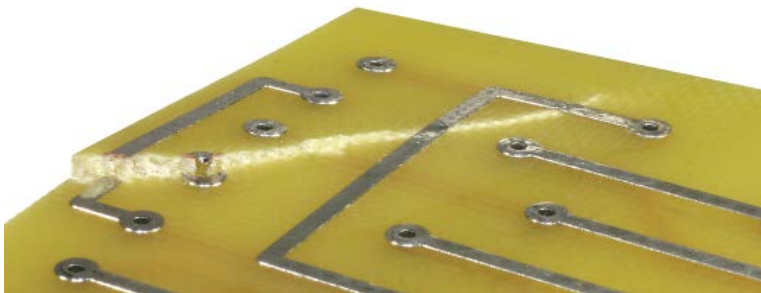

Figure 11-11 Cracked Laminate

11-5.1.7 Broken

Broken laminate damage (Figure 11-12) consists of one or more broken laminate pieces with none of the pieces missing. Examine broken CCAs to determine: if the broken pieces may be rejoined reliably or if new pieces must be manufactured

- Repair all broken laminate, if feasible

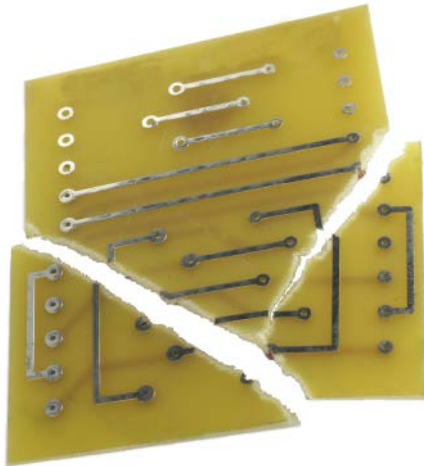

Figure 11-12 Broken Laminate

11-5.1.8 Incomplete Broken

Incomplete broken laminate (Figure 11-13) consists of a broken CCA with one or more pieces missing. Fit the pieces of the laminate together, noting the number and size of missing pieces. Refer to the technical manual of the item being repaired to identify missing components and conductors.

- Repair all incomplete broken laminate, if feasible.

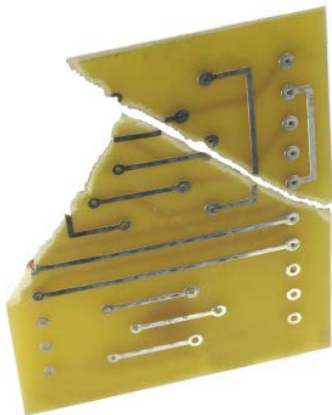

Figure 11-13 Incomplete Broken Laminate

11-5.1.9 Warped

Warped (bowed and twisted) laminate damage (Figure 11-14) consists of a bow and/or twist (warped and/or bent) in the CCA.

- Repair warped laminate only if the assembly is not functional

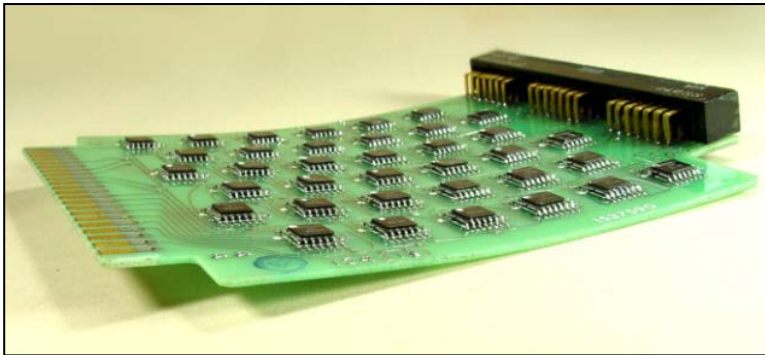

Figure 11-14 Warped Laminate

11-5.2 Laminate Repair, Surface Patch Procedure

If the damage does not extend through the laminate, use this procedure.

If the damage extends through the laminate and is less or equal to one inch in any dimension, use the Laminate Repair, Through-the-Board Patch Procedure (paragraph 11-5.3).

If the damage extends through the laminate and is greater than one inch in any dimension, use the Laminate Repair, Through-the-Board Plug Procedure (paragraph 11-5.4).

Personnel Hazards



Alcohol, Isopropyl

1



Epoxy, 0151

4



Laminate Repair, Surface Patch Procedure

Step	Action
	<div style="text-align: center;"> <div data-bbox="792 1646 1037 1717" style="border: 2px solid black; padding: 5px; display: inline-block;"> WARNING </div> <p data-bbox="467 1738 1360 1770" style="margin-top: 10px;">USE APPROVED SAFETY EYEWEAR WHEN PERFORMING THIS PROCEDURE.</p> <p data-bbox="597 1791 1230 1822" style="margin-top: 10px;">COMPLY WITH ALL LOCAL REQUIREMENTS FOR PPE.</p> </div>



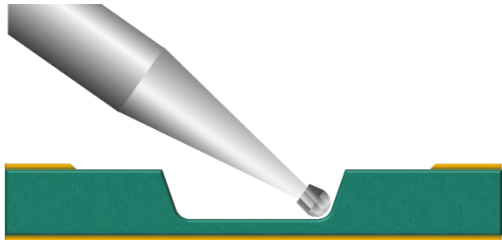

Laminate Repair, Surface Patch Procedure

Step	Action								
	<p style="text-align: center;">CAUTION</p> <p style="text-align: center;">DON A PROPERLY GROUNDED ESD WRIST STRAP BEFORE STARTING THIS PROCEDURE.</p>								
1	<p>Perform the Laminate Procedural Analysis and Feasibility of Repair (paragraph 11-5.1) above, if not already completed.</p>								
2	<p style="text-align: center;">CAUTION</p> <p style="text-align: center;">TO AVOID ESD AND EMI DAMAGE, DO NOT USE A PHOTOCOPIER OR SCANNER TO MAP CCAS.</p> <p>Diagram the CCA features by noting the component locations, types, values, orientation, and part numbers before removing any components or conductors from the CCA.</p> <p>Note: Technical manuals or manufacturer’s specification drawings usually provide this information. If drawings are not available, make a sketch or take a digital photograph of the assembly showing component locations, conductor locations, and CCA markings.</p>								
3	<p style="text-align: center;">CAUTION</p> <p style="text-align: center;">BEGIN THE REPAIR PROCESS AS SOON AS POSSIBLE AFTER REMOVAL FROM THE OVEN TO AVOID MOISTURE RE-ABSORPTION.</p> <p>Bake the CCA, if feasible, in accordance with the table to the right before soldering, desoldering, and conformal coating removal procedures to prevent delamination, measling, or other laminate degradation.</p> <table border="1" data-bbox="915 1373 1411 1583"> <thead> <tr> <th data-bbox="915 1373 1162 1423">Baking Temp.</th> <th data-bbox="1162 1373 1411 1423">Baking Time</th> </tr> </thead> <tbody> <tr> <td data-bbox="915 1423 1162 1474">248°F (120°C)</td> <td data-bbox="1162 1423 1411 1474">3.5 to 7 hours</td> </tr> <tr> <td data-bbox="915 1474 1162 1524">212°F (100°C)</td> <td data-bbox="1162 1474 1411 1524">8 to 16 hours</td> </tr> <tr> <td data-bbox="915 1524 1162 1575">176°F (80°C)</td> <td data-bbox="1162 1524 1411 1575">18 to 48 hours</td> </tr> </tbody> </table>	Baking Temp.	Baking Time	248°F (120°C)	3.5 to 7 hours	212°F (100°C)	8 to 16 hours	176°F (80°C)	18 to 48 hours
Baking Temp.	Baking Time								
248°F (120°C)	3.5 to 7 hours								
212°F (100°C)	8 to 16 hours								
176°F (80°C)	18 to 48 hours								
4	<p>Remove any conformal coating from the repair area using one of the Conformal Coating Removal Methods in WP 006 00 (paragraph 06-5.4).</p>								
5	<p>Remove the components necessary to provide access to the repair area (WP 007 00 for Through Hole Components or WP 018 00 for Surface Mount Devices).</p>								

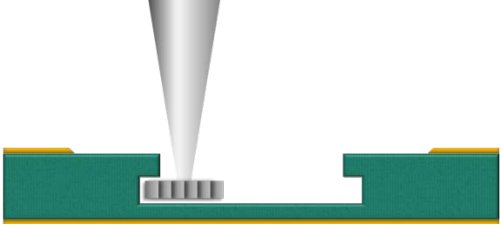
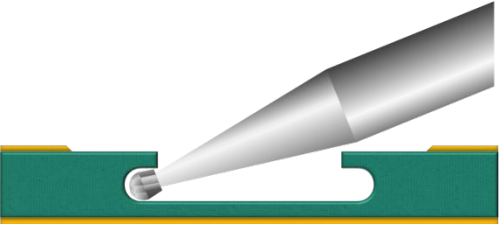

Laminate Repair, Surface Patch Procedure

Step	Action
6	<p>Map the conductor and plated-through hole patterns by tracing them onto paper or copper foil.</p> <p>Note: If the circuitry is missing, replicate the original pattern as close as possible.</p>
7	<p>Remove the surface conductors and pads necessary to facilitate this repair.</p>
8	<div style="text-align: center; border: 1px solid black; padding: 5px; margin-bottom: 10px;"> WARNING </div> <p style="text-align: center;">ENSURE ALL BALL MILLS, SLOTTING SAWS, DENTAL BURS, ETC., ARE PROPERLY SECURED IN THE MOTORIZED HANDPIECE.</p> <div style="text-align: center; border: 1px solid black; padding: 5px; margin-bottom: 10px;"> CAUTION </div> <p style="text-align: center;">MOTORIZED ABRASION GENERATES HEAT THAT WILL SOFTEN EPOXY AND DAMAGE LAMINATE.</p> <p style="text-align: center;">LIMIT THE TIME AND THE PRESSURE WHEN USING THESE TECHNIQUES.</p> <p style="text-align: center;">OBSERVE THE SPEED OF ROTATION OF THE BALL MILL TO PREVENT DAMAGE TO THE WORKPIECE.</p> <p>Excavate damaged laminated material using a ball mill or other suitable tool, working across the surface in one direction, then turning the CCA 90° making a crosshatch pattern. Repeat until all damaged laminate material is removed.</p> <div style="display: flex; align-items: center;"> <div style="flex: 1;"> <p>Note: If a crack is present, excavate the crack along its entire length.</p> <p>Note: To facilitate the undercut the excavation must be at least 75% of the thickness of the laminate.</p> <p>Note: Use backlighting frequently to check progress of damage removal.</p> </div> <div style="flex: 1; text-align: center;">  </div> </div>
9	<p>Straight wall the excavation area (cut the inner walls of the excavation perpendicular to the CCA surface) using and inverted cone, fissure cutter, or other suitable tool.</p> <div style="display: flex; align-items: center;"> <div style="flex: 1;"> <p>Note: If a crack is present, excavate the crack along its entire length.</p> <p>Note: To facilitate the undercut the excavation must be at least 75% of the thickness of the laminate.</p> <p>Note: Use backlighting frequently to check progress of damage removal.</p> </div> <div style="flex: 1; text-align: center;">  </div> </div>

Laminate Repair, Surface Patch Procedure

Step	Action
10	<p>Undercut the excavated area on the damaged laminate using a slotting saw. The undercut should be centered in the straight wall of the excavation.</p> 
11	<p>Enlarge the undercut to a depth and width of approximately 50% of the laminate thickness with a ball mill in a pin vise.</p> 
12	<p>Bevel the top edges of the excavated area to a width equal to the laminate thickness.</p> 
13	<p>Clean the excavated area with isopropyl alcohol using an acid brush to remove any loose particles and blot dry with a clean, lint-free tissue.</p>
14	<p><i>Inspect to the Laminate (paragraph 11-6.1) and the Laminate Excavation (paragraph 11-6.2) WORKMANSHIP STANDARDS.</i></p>
15	<p>If feasible, bake the CCA in accordance with the table in step 3 to remove moisture absorbed during the excavation process.</p>
16	<p>Prepare epoxy according to the manufacturer's directions.</p>
17	<p>Fill the undercut with bubble-free epoxy.</p> 
18	<p>Fill the excavated area with epoxy, overfilling the repair area by about 5% of the laminate thickness and covering the entire bevel area.</p> 

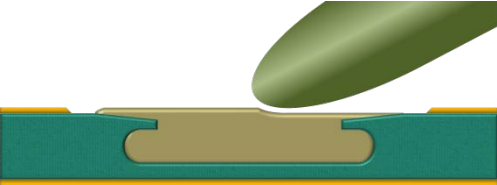
Laminate Repair, Surface Patch Procedure

Step	Action
19	<p>Remove any voids and/or bubbles in the epoxy.</p> <p>Note: An option is to roll clean polyethylene release material (e.g., coffee can lid) onto the epoxy fill to flatten the top of the fill.</p> <p>Note: Allow the release material to remain in place while the epoxy cures.</p> 
20	<p>Cure the epoxy according to the manufacturer's directions.</p>
21	<p>Restore the fill area to the original laminate level using abrasive methods.</p> 
22	<p>Clean the repaired area with isopropyl alcohol and blot dry with a clean, lint-free tissue.</p>
23	<p><i>Inspect to the Epoxy Fill WORKMANSHIP STANDARD (paragraph 11-6.3).</i></p>
24	<p>Apply a thin layer of epoxy (buttercoat) to the repair area covering and overlapping the exposed fiber weave in the repair area.</p> 
25	<p>Cure the epoxy (buttercoat) according to the manufacturer's directions.</p> 
26	<p><i>Inspect to the Buttercoat WORKMANSHIP STANDARD (paragraph 11-6.4).</i></p>
27	<p>Replace the surface conductors removed to facilitate this repair (WP 012 00 Conductors, Pads, and Lands).</p>
28	<p>Replace the components removed to facilitate this repair (WP 007 00 for Through Hole Components or WP 018 00 for Surface Mount Devices).</p>

Laminate Repair, Surface Patch Procedure

Step	Action
29	<i>Inspect per the General Inspection Procedure in WP 003 00 (paragraph 03-5.12) to all applicable WORKMANSHIP STANDARDS, including:</i> <ul style="list-style-type: none"> • <i>Through Hole Components in WP 007 00 (paragraph 07-6), as applicable</i> • <i>Conductors, Pads, and Lands in WP 012 00 (paragraph 12-6.1)</i> • <i>Surface Mount Devices in WP 018 00 (paragraph 18-6), as applicable</i> • <i>Other applicable Workmanship Standards as required</i>
30	Replace the conformal coating per the Conformal Coating Replacement Procedure in WP 006 00 (paragraph 06-5.5), as needed.
31	<i>Inspect to the Conformal Coating Replacement WORKMANSHIP STANDARD in WP 006 00 (paragraph 06-6.2), as required.</i>
32	Dispose of all HAZMAT following local procedures.

11-5.3 Laminate Repair, Through-the-Board Patch Procedure

If the damage extends through the laminate and is less or equal to one inch in any dimension, use this procedure.

If the damage extends through the laminate and is greater than one inch in any dimension, use the Laminate Repair, Through-the-Board Plug Procedure (paragraph 11-5.4).

If the damage does not extend through the laminate, use the Laminate Repair, Surface Patch Procedure (paragraph 11-5.2).

Personnel Hazards



Alcohol, Isopropyl

1





Epoxy, 0151

4





Laminate Repair, Through-the-Board Patch Procedure

Step	Action								
	<p style="text-align: center;">WARNING</p> <p style="text-align: center;"><i>USE APPROVED SAFETY EYEWEAR WHEN PERFORMING THIS PROCEDURE. COMPLY WITH ALL LOCAL REQUIREMENTS FOR PPE.</i></p> <p style="text-align: center;">CAUTION</p> <p style="text-align: center;">DON A PROPERLY GROUNDED ESD WRIST STRAP BEFORE STARTING THIS PROCEDURE.</p>								
1	<p>Perform the Laminate Procedural Analysis and Feasibility of Repair (paragraph 11-5.1) above, if not already completed.</p>								
2	<p style="text-align: center;">CAUTION</p> <p style="text-align: center;">TO AVOID ESD AND EMI DAMAGE, DO NOT USE A PHOTOCOPIER OR SCANNER TO MAP CCAS.</p> <p>Diagram the CCA features by noting the component locations, types, values, orientation, and part numbers before removing any components or conductors from the CCA.</p> <p>Note: Technical manuals or manufacturer’s specification drawings usually provide this information. If drawings are not available, make a sketch or take a digital photograph of the assembly showing component locations, conductor locations, and CCA markings.</p>								
3	<p style="text-align: center;">CAUTION</p> <p style="text-align: center;">BEGIN THE REPAIR PROCESS AS SOON AS POSSIBLE AFTER REMOVAL FROM THE OVEN TO AVOID MOISTURE RE-ABSORPTION.</p> <p>Bake the CCA, if feasible, in accordance with the table to the right before soldering, desoldering, and conformal coating removal procedures to prevent delamination, measling, or other laminate degradation.</p> <table border="1" data-bbox="928 1583 1425 1793" style="margin-left: auto; margin-right: auto;"> <thead> <tr> <th style="text-align: center;">Baking Temp.</th> <th style="text-align: center;">Baking Time</th> </tr> </thead> <tbody> <tr> <td style="text-align: center;">248°F (120°C)</td> <td style="text-align: center;">3.5 to 7 hours</td> </tr> <tr> <td style="text-align: center;">212°F (100°C)</td> <td style="text-align: center;">8 to 16 hours</td> </tr> <tr> <td style="text-align: center;">176°F (80°C)</td> <td style="text-align: center;">18 to 48 hours</td> </tr> </tbody> </table>	Baking Temp.	Baking Time	248°F (120°C)	3.5 to 7 hours	212°F (100°C)	8 to 16 hours	176°F (80°C)	18 to 48 hours
Baking Temp.	Baking Time								
248°F (120°C)	3.5 to 7 hours								
212°F (100°C)	8 to 16 hours								
176°F (80°C)	18 to 48 hours								



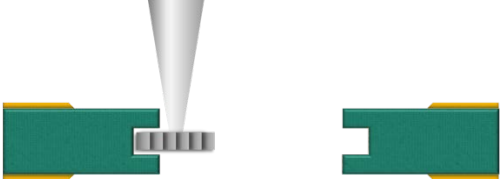
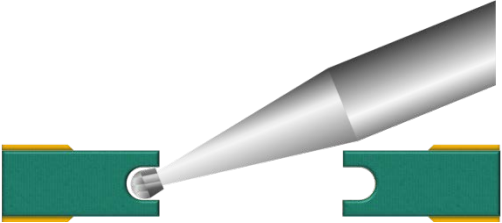
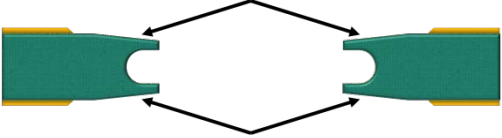

Laminate Repair, Through-the-Board Patch Procedure

Step	Action
4	Remove any conformal coating from the repair area using one of the Conformal Coating Removal Methods in WP 006 00 (paragraph 06-5.4).
5	Remove the components necessary to provide access to the repair area (WP 007 00 for Through Hole Components or WP 018 00 for Surface Mount Devices).
6	Map the conductor and plated-through hole patterns by tracing them onto paper or copper foil. Note: If the circuitry is missing, replicate the original pattern as close as possible.
7	Remove the surface conductors and pads necessary to facilitate this repair.
8	<div style="text-align: center; border: 1px solid black; padding: 5px; margin-bottom: 10px;">WARNING</div> <p style="text-align: center;"><i>ENSURE ALL BALL MILLS, SLOTTING SAWS, DENTAL BURS, ETC., ARE PROPERLY SECURED IN THE MOTORIZED HANDPIECE.</i></p> <div style="text-align: center; border: 1px solid black; padding: 5px; margin-bottom: 10px;">CAUTION</div> <p style="text-align: center;">MOTORIZED ABRASION GENERATES HEAT THAT WILL SOFTEN EPOXY AND DAMAGE LAMINATE.</p> <p style="text-align: center;">LIMIT THE TIME AND THE PRESSURE WHEN USING THESE TECHNIQUES.</p> <p style="text-align: center;">OBSERVE THE SPEED OF ROTATION OF THE BALL MILL TO PREVENT DAMAGE TO THE WORKPIECE.</p> <p>Remove all damaged laminate material using a ball mill or other suitable tool.</p> <p>Note: If a crack is present, excavate the crack along its entire length.</p> 
9	<p>Straight wall the excavation area (cut the inner walls of the excavation perpendicular to the CCA surface) using and inverted cone, fissure cutter, or other suitable tool.</p> 

Laminate Repair, Through-the-Board Patch Procedure

Step	Action
10	Undercut the excavated area on the damaged laminate using a slotting saw. The undercut should be centered in the straight wall of the excavation. 
11	Enlarge the undercut to a depth and width of approximately 50% of the laminate thickness with a ball mill in a pin vise. 
12	Bevel the top and bottom edges of the excavated area to a width equal to the laminate thickness. 
13	Clean the excavated area with isopropyl alcohol using an acid brush to remove any loose particles and blot dry with a clean, lint-free tissue.
14	<i>Inspect to the Laminate (paragraph 11-6.1) and the Laminate Excavation (paragraph 11-6.2) WORKMANSHIP STANDARDS.</i>
15	If feasible, bake the CCA in accordance with the table in step 3 to remove moisture absorbed during the excavation process.
16	Prepare epoxy according to the manufacturer's directions.
17	Fill the undercut of the excavated area with bubble-free epoxy. 
18	Apply epoxy to the beveled edge of the excavated area on the termination side of the CCA. 
19	Place clean, polyethylene release material (e.g., coffee can lid) on the termination side of the CCA. 

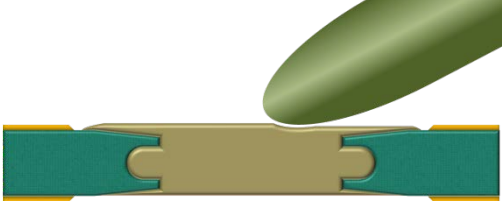
Laminate Repair, Through-the-Board Patch Procedure

Step	Action
20	Fill the excavated area with epoxy, overfilling the repair area by about 5% of the laminate thickness and covering the entire bevel area. 
21	Remove any voids and/or bubbles in the epoxy. Note: An option is to roll clean polyethylene release material (e.g., coffee can lid) onto the epoxy fill to flatten the top of the fill. Note: Allow the release material to remain in place while the epoxy cures. 
22	Cure the epoxy according to the manufacturer's directions. 
23	Restore the fill area to the original laminate level on both sides of the CCA using abrasive methods. 
24	Clean the repaired area with isopropyl alcohol and blot dry with a clean, lint-free tissue.
25	<i>Inspect to the Epoxy Fill WORKMANSHIP STANDARD (paragraph 11-6.3).</i>
26	Apply a thin layer of epoxy (buttercoat) to the repair area covering and overlapping the exposed fiber weave in the repair area. 
27	Cure the epoxy (buttercoat) according to the manufacturer's directions. 
28	<i>Inspect to the Buttercoat WORKMANSHIP STANDARD (paragraph 11-6.4).</i>
29	Replace the surface conductors removed to facilitate this repair (WP 012 00 Conductors, Pads, and Lands).

Laminate Repair, Through-the-Board Patch Procedure

Step	Action
30	Replace the components removed to facilitate this repair (WP 007 00 for Through Hole Components or WP 018 00 for Surface Mount Devices).
31	<p><i>Inspect per the General Inspection Procedure in WP 003 00 (paragraph 03-5.12) to all applicable WORKMANSHIP STANDARDS, including:</i></p> <ul style="list-style-type: none"> • <i>Through Hole Components in WP 007 00 (paragraph 07-6), as applicable</i> • <i>Conductors, Pads, and Lands in WP 012 00 (paragraph 12-6.1)</i> • <i>Surface Mount Devices in WP 018 00 (paragraph 18-6), as applicable</i> • <i>Other applicable Workmanship Standards as required</i>
32	Replace the conformal coating per the Conformal Coating Replacement Procedure in WP 006 00 (paragraph 06-5.5), as needed.
33	<i>Inspect to the Conformal Coating Replacement WORKMANSHIP STANDARD in WP 006 00 (paragraph 06-6.2), as required.</i>
34	Dispose of all HAZMAT following local procedures.

11-5.4 Laminate Repair, Through-the-Board Plug Procedure

If the damage extends through the laminate and the damage area is greater than one inch in any dimension, use this procedure.

If the damage extends through the laminate and is less or equal to one inch in any dimension, use the Laminate Repair, Through-the-Board Patch Procedure (paragraph 11-5.3).

If the damage does not extend through the laminate, use the Laminate Repair, Surface Patch Procedure (paragraph 11-5.2).

Personnel Hazards



Alcohol, Isopropyl



Epoxy, 0151

4





Laminate Repair, Through-the-Board Plug Procedure

Step	Action
	<p style="text-align: center;">WARNING</p> <p style="text-align: center;"><i>USE APPROVED SAFETY EYEWEAR WHEN PERFORMING THIS PROCEDURE.</i></p> <p style="text-align: center;"><i>COMPLY WITH ALL LOCAL REQUIREMENTS FOR PPE.</i></p> <p style="text-align: center;">CAUTION</p> <p style="text-align: center;">DON A PROPERLY GROUNDED ESD WRIST STRAP BEFORE STARTING THIS PROCEDURE.</p>
<p style="text-align: center;">1</p>	<p>Perform the Laminate Procedural Analysis and Feasibility of Repair (paragraph 11-5.1) above, if not already completed.</p>
<p style="text-align: center;">2</p>	<p style="text-align: center;">CAUTION</p> <p style="text-align: center;">TO AVOID ESD AND EMI DAMAGE, DO NOT USE A PHOTOCOPIER OR SCANNER TO MAP CCAS.</p> <p>Diagram the CCA features by noting the component locations, types, values, orientation, and part numbers before removing any components or conductors from the CCA.</p> <p>Note: Technical manuals or manufacturer’s specification drawings usually provide this information. If drawings are not available, make a sketch or take a digital photograph of the assembly showing component locations, conductor locations, and CCA markings.</p>



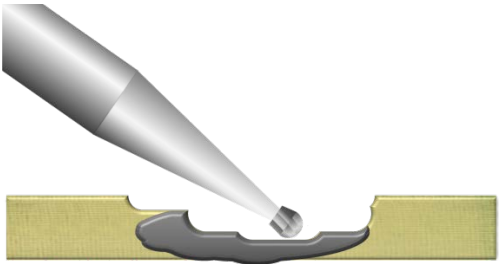

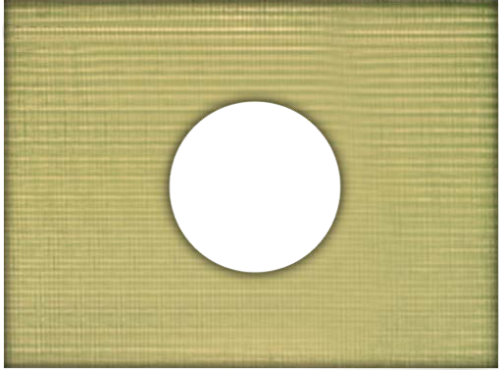
Laminate Repair, Through-the-Board Plug Procedure

Step	Action								
3	<p style="text-align: center;">CAUTION</p> <p style="text-align: center;">BEGIN THE REPAIR PROCESS AS SOON AS POSSIBLE AFTER REMOVAL FROM THE OVEN TO AVOID MOISTURE RE-ABSORPTION.</p> <p>Bake the CCA, if feasible, in accordance with the table to the right before soldering, desoldering, and conformal coating removal procedures to prevent delamination, measling, or other laminate degradation.</p> <table border="1" data-bbox="928 611 1430 821"> <thead> <tr> <th data-bbox="928 611 1177 667">Baking Temp.</th> <th data-bbox="1177 611 1430 667">Baking Time</th> </tr> </thead> <tbody> <tr> <td data-bbox="928 667 1177 716">248°F (120°C)</td> <td data-bbox="1177 667 1430 716">3.5 to 7 hours</td> </tr> <tr> <td data-bbox="928 716 1177 764">212°F (100°C)</td> <td data-bbox="1177 716 1430 764">8 to 16 hours</td> </tr> <tr> <td data-bbox="928 764 1177 821">176°F (80°C)</td> <td data-bbox="1177 764 1430 821">18 to 48 hours</td> </tr> </tbody> </table>	Baking Temp.	Baking Time	248°F (120°C)	3.5 to 7 hours	212°F (100°C)	8 to 16 hours	176°F (80°C)	18 to 48 hours
	Baking Temp.	Baking Time							
	248°F (120°C)	3.5 to 7 hours							
	212°F (100°C)	8 to 16 hours							
176°F (80°C)	18 to 48 hours								
4	Remove any conformal coating from the repair area using one of the Conformal Coating Removal Methods in WP 006 00 (paragraph 06-5.4).								
5	Remove the components necessary to provide access to the repair area (WP 007 00 for Through Hole Components or WP 018 00 for Surface Mount Devices).								
6	<p>Map the conductor and plated-through hole patterns by tracing them onto paper or copper foil.</p> <p>Note: If the circuitry is missing, replicate the original pattern as close as possible.</p>								
7	Remove the surface conductors and pads necessary to facilitate this repair.								



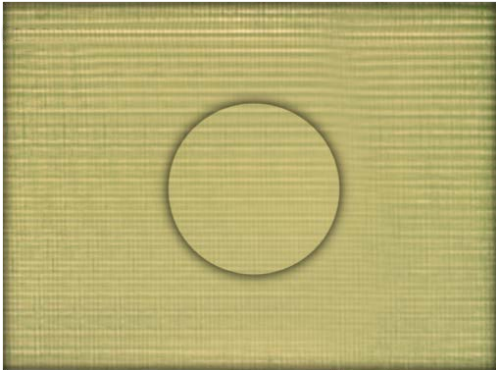
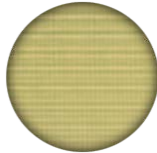

Laminate Repair, Through-the-Board Plug Procedure

Step	Action
8	<div style="text-align: center; border: 2px solid black; padding: 5px; margin-bottom: 10px;">WARNING</div> <p style="text-align: center;">ENSURE ALL BALL MILLS, SLOTTING SAWS, DENTAL BURS, ETC., ARE PROPERLY SECURED IN THE MOTORIZED HANDPIECE.</p> <div style="text-align: center; border: 2px solid black; padding: 5px; margin-bottom: 10px;">CAUTION</div> <p style="text-align: center;">MOTORIZED ABRASION GENERATES HEAT THAT WILL SOFTEN EPOXY AND DAMAGE LAMINATE.</p> <p style="text-align: center;">LIMIT THE TIME AND THE PRESSURE WHEN USING THESE TECHNIQUES.</p> <p style="text-align: center;">OBSERVE THE SPEED OF ROTATION OF THE BALL MILL TO PREVENT DAMAGE TO THE WORKPIECE.</p> <p>Remove all damaged laminate material using a ball mill or other suitable tool.</p> 
9	<p>Straight wall the excavation area (cut the inner walls of the excavation perpendicular to the CCA surface) using an inverted cone, fissure cutter, or other suitable tool.</p>  
10	<p>Obtain a piece of laminate material of the same type and thickness and, if possible, color as the damaged laminate.</p> 



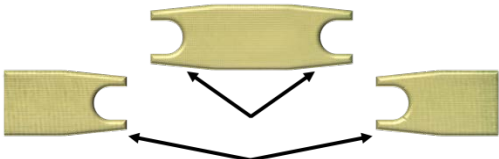
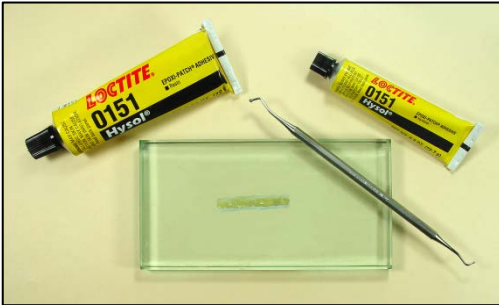

Laminate Repair, Through-the-Board Plug Procedure

Step	Action
11	<p>Lay the damaged CCA on top of the replacement laminate material and align the weave patterns.</p> 
12	<p>Trace the shape of the missing area onto the replacement laminate material maintaining clearance between 1/16 and 1/8 in.</p>
13	<p>Cut the replacement laminate plug just outside the trace line on the replacement laminate material.</p> 
14	<p>Check the fit of the replacement plug. Note: Clearance between the finished replacement plug and excavated CCA is 1/16 to 1/8 in.</p> 
15	<p>Undercut the excavated area on the damaged laminate using a slotting saw. The undercut should be centered in the straight wall of the excavation.</p> 
16	<p>Undercut the replacement laminate plug using a slotting saw. The undercut should be centered in the straight wall of the plug.</p> 

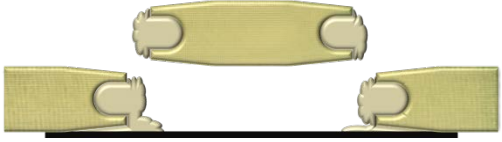

Laminate Repair, Through-the-Board Plug Procedure

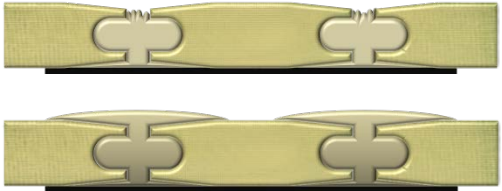
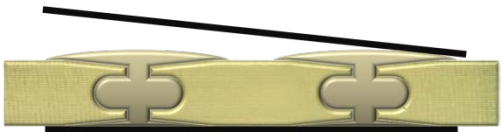
Step	Action
17	<p>Enlarge both undercuts to a depth and width of approximately 50% of the laminate thickness with a ball mill in a pin vise.</p> 
18	<p>Bevel the top and bottom edges of the excavated area and the replacement plug to a width equal to the laminate thickness.</p> 
19	<p>Clean the excavated area with isopropyl alcohol using an acid brush to remove any loose particles and blot dry with a clean, lint-free tissue.</p>
20	<p><i>Inspect to the Laminate (paragraph 11-6.1) and the Laminate Excavation (paragraph 11-6.2) WORKMANSHIP STANDARDS.</i></p>
21	<p>If feasible, bake the CCA in accordance with the table in step 3 to remove moisture absorbed during the excavation process.</p>
22	<p>Prepare epoxy according to the manufacturer's directions.</p> 
23	<p>Fill the undercut of the excavated area with bubble-free epoxy.</p> 
24	<p>Apply epoxy to the beveled edge of the excavated area on the termination side of the CCA.</p> 
25	<p>Place clean, polyethylene release material (e.g., coffee can lid) on the termination side of the CCA.</p> 

Laminate Repair, Through-the-Board Plug Procedure

Step	Action
26	Fill the undercut of the replacement plug with bubble-free epoxy. 
27	Apply epoxy to the beveled edge on the termination side of the replacement plug. 
28	Place the replacement plug into the repair area aligning the weave pattern with the CCA. 
29	Fill the remaining area between the CCA and replacement plug with epoxy, overfilling the repair area by approximately 5% of the laminate thickness and covering the entire bevel area. 
30	Remove any voids and/or bubbles in the epoxy. Note: An option is to roll clean polyethylene release material (e.g., coffee can lid) onto the epoxy fill to flatten the top of the fill. Note: Allow the release material to remain in place while the epoxy cures. 
31	Cure the epoxy according to the manufacturer's directions.
32	Restore the fill area to the original laminate level on both sides of the CCA using abrasive methods. 
33	Clean the repaired area with isopropyl alcohol and blot dry with a clean, lint-free tissue.

Laminate Repair, Through-the-Board Plug Procedure

Step	Action
34	<i>Inspect to the Epoxy Fill WORKMANSHIP STANDARD (paragraph 11-6.3).</i>
35	Apply a thin layer of epoxy (buttercoat) to the repair area covering and overlapping the exposed fiber weave in the repair area. 
36	Cure the epoxy (buttercoat) according to the manufacturer's directions. 
37	<i>Inspect to the Buttercoat WORKMANSHIP STANDARD (paragraph 11-6.4).</i>
38	Replace the surface conductors removed to facilitate this repair (WP 012 00 Conductors, Pads, and Lands).
39	Replace the components removed to facilitate this repair (WP 007 00 for Through Hole Components or WP 018 00 for Surface Mount Devices).
40	<i>Inspect per the General Inspection Procedure in WP 003 00 (paragraph 03-5.12) to all applicable WORKMANSHIP STANDARDS, including:</i> <ul style="list-style-type: none"> • <i>Through Hole Components in WP 007 00 (paragraph 07-6), as applicable</i> • <i>Conductors, Pads, and Lands in WP 012 00 (paragraph 12-6.1)</i> • <i>Surface Mount Devices in WP 018 00 (paragraph 18-6), as applicable</i> • <i>Other applicable Workmanship Standards as required</i>
41	Replace the conformal coating per the Conformal Coating Replacement Procedure in WP 006 00 (paragraph 06-5.5), as needed.
42	<i>Inspect to the Conformal Coating Replacement WORKMANSHIP STANDARD in WP 006 00 (paragraph 06-6.2), as required.</i>
43	Dispose of all HAZMAT following local procedures.

11-5.5 Laminate Repair, Interior Delamination Procedure

Use the Laminate Repair, Surface Patch Procedure (paragraph 11-5.2) to repair interior delamination.

11-5.6 Laminate Repair, Edge Delamination Procedure

Use this procedure to repair laminate separation (delamination) on the edge of a CCA.

Personnel Hazards



Alcohol, Isopropyl

1





Epoxy, 0151

4

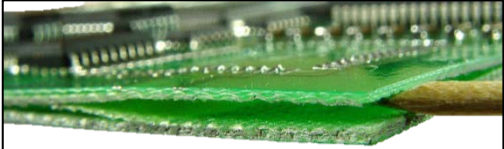

Laminate Repair, Edge Delamination Procedure

Step	Action
	<p style="text-align: center;">WARNING</p> <p style="text-align: center;"><i>USE APPROVED SAFETY EYEWEAR WHEN PERFORMING THIS PROCEDURE.</i></p> <p style="text-align: center;"><i>COMPLY WITH ALL LOCAL REQUIREMENTS FOR PPE.</i></p> <p style="text-align: center;">CAUTION</p> <p style="text-align: center;">DON A PROPERLY GROUNDED ESD WRIST STRAP BEFORE STARTING THIS PROCEDURE.</p>
1	<p>Perform the Laminate Procedural Analysis and Feasibility of Repair (paragraph 11-5.1) above, if not already completed.</p>
2	<p style="text-align: center;">CAUTION</p> <p style="text-align: center;">TO AVOID ESD AND EMI DAMAGE, DO NOT USE A PHOTOCOPIER OR SCANNER TO MAP CCAS.</p> <p>Diagram the CCA features by noting the component locations, types, values, orientation, and part numbers before removing any components or conductors from the CCA.</p> <p>Note: Technical manuals or manufacturer's specification drawings usually provide this information. If not available, make a sketch or take a digital photograph of the assembly showing component locations, conductor locations, and CCA markings.</p>

Laminate Repair, Edge Delamination Procedure

Step	Action								
3	<p style="text-align: center;">CAUTION</p> <p style="text-align: center;">BEGIN THE REPAIR PROCESS AS SOON AS POSSIBLE AFTER REMOVAL FROM THE OVEN TO AVOID MOISTURE RE-ABSORPTION.</p> <table border="1" data-bbox="914 611 1414 821"> <thead> <tr> <th data-bbox="914 611 1162 663">Baking Temp.</th> <th data-bbox="1162 611 1414 663">Baking Time</th> </tr> </thead> <tbody> <tr> <td data-bbox="914 663 1162 716">248°F (120°C)</td> <td data-bbox="1162 663 1414 716">3.5 to 7 hours</td> </tr> <tr> <td data-bbox="914 716 1162 768">212°F (100°C)</td> <td data-bbox="1162 716 1414 768">8 to 16 hours</td> </tr> <tr> <td data-bbox="914 768 1162 821">176°F (80°C)</td> <td data-bbox="1162 768 1414 821">18 to 48 hours</td> </tr> </tbody> </table> <p>Bake the CCA, if feasible, in accordance with the table to the right before soldering, desoldering, and conformal coating removal procedures to prevent delamination, measling, or other laminate degradation.</p>	Baking Temp.	Baking Time	248°F (120°C)	3.5 to 7 hours	212°F (100°C)	8 to 16 hours	176°F (80°C)	18 to 48 hours
	Baking Temp.	Baking Time							
	248°F (120°C)	3.5 to 7 hours							
	212°F (100°C)	8 to 16 hours							
176°F (80°C)	18 to 48 hours								
4	Remove any conformal coating from the repair area using one of the Conformal Coating Removal Methods in WP 006 00 (paragraph 06-5.4).								
5	Remove the components necessary to provide access to the repair area (WP 007 00 for Through Hole Components or WP 018 00 for Surface Mount Devices).								
6	<p>Map the conductor and plated-through hole patterns by tracing them onto paper or copper foil.</p> <p>Note: If the circuitry is missing, replicate the original pattern as close as possible.</p>								
7	Remove the surface conductors and pads necessary to facilitate this repair.								
8	<p>Clean the delamination with isopropyl alcohol using an acid brush to remove any loose particles and allow drying.</p> 								
9	If feasible, bake the CCA in accordance with the table in step 3 to remove moisture absorbed during the excavation process.								
10	Prepare epoxy according to the manufacturer's directions.								
11	<p>Apply the epoxy between the delaminated layers.</p> 								
12	<p>Place clean, polyethylene release material (e.g., coffee can lid) on both sides of the repair area.</p> 								

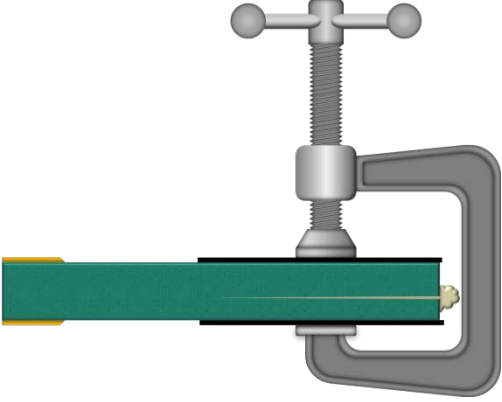
Laminate Repair, Edge Delamination Procedure

Step	Action
13	Clamp the upper and lower release material against the repair area. 
14	Wipe off excess epoxy from edges of CCA.
15	Cure the epoxy according to the manufacturer's directions.
16	Restore the edge to the original laminate level on both sides of the CCA using abrasive methods. 
17	Clean the repaired area with isopropyl alcohol and blot dry with a clean, lint-free tissue.
18	<i>Inspect to the Epoxy Fill WORKMANSHIP STANDARD (paragraph 11-6.3).</i>
19	Replace the surface conductors removed to facilitate this repair (WP 012 00 Conductors, Pads, and Lands).
20	Replace the components removed to facilitate this repair (WP 007 00 for Through Hole Components or WP 018 00 for Surface Mount Devices).
21	<i>Inspect per the General Inspection Procedure in WP 003 00 (paragraph 03-5.12) to all applicable WORKMANSHIP STANDARDS, including:</i> <ul style="list-style-type: none"> • <i>Through Hole Components in WP 007 00 (paragraph 07-6), as applicable</i> • <i>Conductors, Pads, and Lands in WP 012 00 (paragraph 12-6.1)</i> • <i>Surface Mount Devices in WP 018 00 (paragraph 18-6), as applicable</i> • <i>Other applicable Workmanship Standards as required</i>

Laminate Repair, Edge Delamination Procedure

Step	Action
22	Replace the conformal coating per the Conformal Coating Replacement Procedure in WP 006 00 (paragraph 06-5.5), as needed.
23	<i>Inspect to the Conformal Coating Replacement WORKMANSHIP STANDARD in WP 006 00 (paragraph 06-6.2), as required.</i>
24	Dispose of all HAZMAT following local procedures.

11-5.7 Laminate Repair, Surface Crack

Use the Laminate Repair, Surface Patch Procedure (paragraph 11-5.2) to repair surface cracks in the laminate.

11-5.8 Laminate Repair, Through-the-Board Crack

If the crack extends through the laminate, but the sections are not detached, use the Laminate Repair, Through-the-Board Patch Procedure (paragraph 11-5.3).

If the crack does not extend through the laminate, use the Laminate Repair, Surface Patch Procedure (paragraph 11-5.2).

If the laminate is broken through, use the Laminate Repair, Broken Procedure (paragraph 11-5.9).

11-5.9 Laminate Repair, Broken Procedure

If the laminate is broken through, use this procedure. If the laminate is cracked, but not detached, use the Laminate Repair, Through-the-Board Patch Procedure (paragraph 11-5.3).

Personnel Hazards



Alcohol, Isopropyl

1



Epoxy, 0151

4

Laminate Repair, Broken Procedure

Step	Action
	<p style="text-align: center;">WARNING</p> <p style="text-align: center;"><i>USE APPROVED SAFETY EYEWEAR WHEN PERFORMING THIS PROCEDURE.</i></p> <p style="text-align: center;"><i>COMPLY WITH ALL LOCAL REQUIREMENTS FOR PPE.</i></p> <p style="text-align: center;">CAUTION</p> <p style="text-align: center;">DON A PROPERLY GROUNDED ESD WRIST STRAP BEFORE STARTING THIS PROCEDURE.</p>
1	<p>Perform the Laminate Procedural Analysis and Feasibility of Repair (paragraph 11-5.1) above, if not already completed.</p>
2	<p style="text-align: center;">CAUTION</p> <p style="text-align: center;">TO AVOID ESD AND EMI DAMAGE, DO NOT USE A PHOTOCOPIER OR SCANNER TO MAP CCAS.</p> <p>Diagram the CCA features by noting the component locations, types, values, orientation, and part numbers before removing any components or conductors from the CCA.</p> <p>Note: Technical manuals or manufacturer’s specification drawings usually provide this information. If drawings are not available, make a sketch or take a digital photograph of the assembly showing component locations, conductor locations, and CCA markings.</p>

Laminate Repair, Broken Procedure

Step	Action										
3	<p style="text-align: center;">CAUTION</p> <p style="text-align: center;">BEGIN THE REPAIR PROCESS AS SOON AS POSSIBLE AFTER REMOVAL FROM THE OVEN TO AVOID MOISTURE RE-ABSORPTION.</p> <table border="1" style="width: 100%; border-collapse: collapse;"> <tr> <td style="width: 50%; vertical-align: top;"> Bake the CCA, if feasible, in accordance with the table to the right before soldering, desoldering, and conformal coating removal procedures to prevent delamination, measling, or other laminate degradation. </td> <td style="width: 50%; text-align: center;"> <table border="1" style="width: 100%; border-collapse: collapse;"> <thead> <tr> <th style="border: none;">Baking Temp.</th> <th style="border: none;">Baking Time</th> </tr> </thead> <tbody> <tr> <td style="border: none;">248°F (120°C)</td> <td style="border: none;">3.5 to 7 hours</td> </tr> <tr> <td style="border: none;">212°F (100°C)</td> <td style="border: none;">8 to 16 hours</td> </tr> <tr> <td style="border: none;">176°F (80°C)</td> <td style="border: none;">18 to 48 hours</td> </tr> </tbody> </table> </td> </tr> </table>	Bake the CCA, if feasible, in accordance with the table to the right before soldering, desoldering, and conformal coating removal procedures to prevent delamination, measling, or other laminate degradation.	<table border="1" style="width: 100%; border-collapse: collapse;"> <thead> <tr> <th style="border: none;">Baking Temp.</th> <th style="border: none;">Baking Time</th> </tr> </thead> <tbody> <tr> <td style="border: none;">248°F (120°C)</td> <td style="border: none;">3.5 to 7 hours</td> </tr> <tr> <td style="border: none;">212°F (100°C)</td> <td style="border: none;">8 to 16 hours</td> </tr> <tr> <td style="border: none;">176°F (80°C)</td> <td style="border: none;">18 to 48 hours</td> </tr> </tbody> </table>	Baking Temp.	Baking Time	248°F (120°C)	3.5 to 7 hours	212°F (100°C)	8 to 16 hours	176°F (80°C)	18 to 48 hours
Bake the CCA, if feasible, in accordance with the table to the right before soldering, desoldering, and conformal coating removal procedures to prevent delamination, measling, or other laminate degradation.	<table border="1" style="width: 100%; border-collapse: collapse;"> <thead> <tr> <th style="border: none;">Baking Temp.</th> <th style="border: none;">Baking Time</th> </tr> </thead> <tbody> <tr> <td style="border: none;">248°F (120°C)</td> <td style="border: none;">3.5 to 7 hours</td> </tr> <tr> <td style="border: none;">212°F (100°C)</td> <td style="border: none;">8 to 16 hours</td> </tr> <tr> <td style="border: none;">176°F (80°C)</td> <td style="border: none;">18 to 48 hours</td> </tr> </tbody> </table>	Baking Temp.	Baking Time	248°F (120°C)	3.5 to 7 hours	212°F (100°C)	8 to 16 hours	176°F (80°C)	18 to 48 hours		
Baking Temp.	Baking Time										
248°F (120°C)	3.5 to 7 hours										
212°F (100°C)	8 to 16 hours										
176°F (80°C)	18 to 48 hours										
4	Remove any conformal coating from the repair area using one of the Conformal Coating Removal Methods in WP 006 00 (paragraph 06-5.4).										
5	Remove the components necessary to provide access to the repair area (WP 007 00 for Through Hole Components or WP 018 00 for Surface Mount Devices).										
6	Map the conductor and plated-through hole patterns by tracing them onto paper or copper foil. Note: If the circuitry is missing, replicate the original pattern as close as possible.										
7	Remove the surface conductors and pads necessary to facilitate this repair.										
8	<p style="text-align: center;">WARNING</p> <p style="text-align: center;">ENSURE ALL BALL MILLS, SLOTTING SAWS, DENTAL BURS, ETC., ARE PROPERLY SECURED IN THE MOTORIZED HANDPIECE.</p> <p style="text-align: center;">CAUTION</p> <p style="text-align: center;">MOTORIZED ABRASION GENERATES HEAT THAT WILL SOFTEN EPOXY AND DAMAGE LAMINATE.</p> <p style="text-align: center;">LIMIT THE TIME AND THE PRESSURE WHEN USING THESE TECHNIQUES.</p> <p style="text-align: center;">OBSERVE THE SPEED OF ROTATION OF THE BALL MILL TO PREVENT DAMAGE TO THE WORKPIECE.</p> <p>Excavate all broken edges to remove damaged (ragged, frayed, crazed) laminate material using a ball mill or other suitable tool.</p>										

Laminate Repair, Broken Procedure

Step	Action
9	Straight wall the broken edges (cut the walls perpendicular to the CCA surface) using and inverted cone, fissure cutter, or other suitable tool.
10	If pieces of the broken laminates are missing, perform steps 11 through 15; otherwise go to step 16.
11	Obtain a piece of laminate of the same type and thickness and, if possible, color as the damaged laminate.
12	Lay the damaged CCA on top of the replacement laminate and align the weave patterns, if possible.
13	Trace the shape of the missing area onto the replacement laminate maintaining clearance between 1/16 and 1/8 in.
14	Cut the replacement laminate just outside the trace line.
15	Check the fit of the replacement laminate to the original laminate and the other pieces. Note: Clearance between the replacement laminate and the original CCA and/or other pieces is 1/16 and 1/8 in.
16	Undercut the edges on the original laminate and all pieces including the replacement laminate, if used, with a slotting saw.
17	Enlarge the undercuts to a depth and width of approximately 50% of the laminate thickness with a ball mill in a pin vise.
18	Bevel the top and bottom edges of the excavated areas to a width equal to the laminate thickness.
19	Clean the excavated areas with isopropyl alcohol using an acid brush to remove any loose particles and blot dry with a clean, lint-free tissue.
20	<i>Inspect to the Laminate (paragraph 11-6.1) and the Laminate Excavation (paragraph 11-6.2) WORKMANSHIP STANDARDS.</i>
21	If feasible, bake the CCA in accordance with the table in step 3 to remove moisture absorbed during the excavation process.
22	Prepare epoxy according to the manufacturer's directions.

Laminate Repair, Broken Procedure

Step	Action
23	Fill the undercut of the original CCA with bubble-free epoxy.
24	Apply epoxy to the beveled edge of the excavated area on the termination side of the CCA.
25	Place clean, polyethylene release material (e.g., coffee can lid) on the termination side of the CCA.
26	Fill the undercut of the broken pieces including the replacement laminate, if used, with bubble-free epoxy.
27	Apply epoxy to the beveled edge of the termination side of all pieces to be joined.
28	Position and secure all pieces 1/16 in. apart on the release material.
29	Fill the excavated area with epoxy, overfilling the repair area by approximately 5% of the laminate thickness and covering the entire bevel area.
30	Remove any voids and/or bubbles in the epoxy.
31	Place clean, polyethylene release material on the component side and a hard backing material on both sides of the CCA covering the repair area and clamp in place.
32	Cure the epoxy according to the manufacturer's directions.
33	Restore the fill area to the original laminate level on both sides of the CCA using abrasive methods.
34	Clean the repaired area with isopropyl alcohol and blot dry with a clean, lint-free tissue.
35	<i>Inspect to the Epoxy Fill WORKMANSHIP STANDARD (paragraph 11-6.3).</i>
36	Apply a thin layer of epoxy (buttercoat) to the repair area covering and overlapping the exposed fiber weave in the repair area.
37	Cure the epoxy (buttercoat) according to the manufacturer's directions.
38	<i>Inspect to the Buttercoat WORKMANSHIP STANDARD (paragraph 11-6.4).</i>

Laminate Repair, Broken Procedure

Step	Action
39	Replace the surface conductors removed to facilitate this repair (WP 012 00 Conductors, Pads, and Lands).
40	Replace the components removed to facilitate this repair (WP 007 00 for Through Hole Components or WP 018 00 for Surface Mount Devices).
41	<p><i>Inspect per the General Inspection Procedure in WP 003 00 (paragraph 03-5.12) to all applicable WORKMANSHIP STANDARDS, including:</i></p> <ul style="list-style-type: none"> • <i>Through Hole Components in WP 007 00 (paragraph 07-6), as applicable</i> • <i>Conductors, Pads, and Lands in WP 012 00 (paragraph 12-6.1)</i> • <i>Surface Mount Devices in WP 018 00 (paragraph 18-6), as applicable</i> • <i>Other applicable Workmanship Standards as required</i>
42	Replace the conformal coating per the Conformal Coating Replacement Procedure in WP 006 00 (paragraph 06-5.5), as needed.
43	<i>Inspect to the Conformal Coating Replacement WORKMANSHIP STANDARD in WP 006 00 (paragraph 06-6.2), as required.</i>
44	Dispose of all HAZMAT following local procedures.

11-5.10 Laminate Repair, Warped Procedure

Repair of warped laminate is performed when the CCA is not functional or the deflection (Figure 11-15) prevents the CCA from being installed in the chassis.

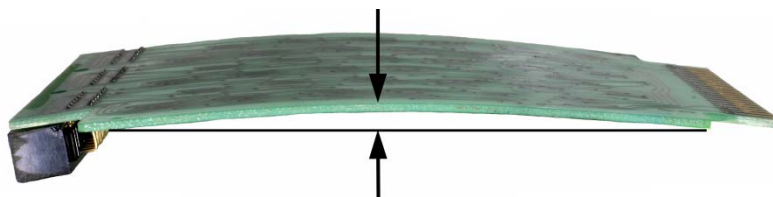

Figure 11-15 Wrapped CCA Deflection

A bowed CCA is warped only in one plane.

A twisted CCA is warped in multiple planes.

Personnel Hazards No HAZMAT identified in the HMWS is used in this procedure.

Laminate Repair, Warped Procedure

Step	Action
	<p style="text-align: center;">WARNING</p> <p style="text-align: center;">USE APPROVED SAFETY EYEWEAR WHEN PERFORMING THIS PROCEDURE.</p> <p style="text-align: center;">COMPLY WITH ALL LOCAL REQUIREMENTS FOR PPE.</p> <p style="text-align: center;">CAUTION</p> <p style="text-align: center;">DON A PROPERLY GROUNDED ESD WRIST STRAP BEFORE STARTING THIS PROCEDURE.</p>
1	<p>Perform the Laminate Procedural Analysis and Feasibility of Repair (paragraph 11-5.1) above, if not already completed.</p>
2	<p style="text-align: center;">CAUTION</p> <p style="text-align: center;">TO AVOID ESD AND EMI DAMAGE, DO NOT USE A PHOTOCOPIER OR SCANNER TO MAP CCAS.</p> <p>Diagram the CCA features by noting the component locations, types, values, orientation, and part numbers before removing any components or conductors from the CCA.</p> <p>Note: Technical manuals or manufacturer’s specification drawings usually provide this information. If drawings are not available, make a sketch or take a digital photograph of the assembly showing component locations, conductor locations, and CCA markings.</p>
3	<p>Remove any conformal coating from the repair area using one of the Conformal Coating Removal Methods in WP 006 00 (paragraph 06-5.4).</p>
4	<p>Remove the components necessary to provide access to the repair area for a bowed CCA or remove all components for a twisted CCA (WP 007 00 for Through Hole Components or WP 018 00 for Surface Mount Devices).</p>
5	<p>Set the oven temperature to 257°F (125°C).</p>

Laminate Repair, Warped Procedure

Step	Action
<p>6</p>	<p>Clamp the bowed edges between two rigid metallic devices.</p> <p>or</p> <p>Clamp the bowed and twisted CCA between two rigid metallic surfaces.</p> <div data-bbox="922 415 1429 1180"> </div>
<p>7</p>	<p>Place the clamped CCA into the oven.</p>
<p>8</p>	<p>Bake the clamped CCA for one hour.</p>
<p>9</p>	<p>After the one-hour bake cycle, turn off the oven leaving the clamped CCA inside. Note: This allows the CCA to slowly cool to room temperature improving stress relief.</p>
<p>10</p>	<p>After the oven and the clamped CCA have returned to room temperature, remove the clamped CCA from the oven.</p>
<p>11</p>	<p>Remove the clamp(s) and the metallic surfaces.</p>
<p>12</p>	<p><i>Inspect to determine if the warp has been reduced sufficiently to restore functionality.</i></p>
<p>13</p>	<p>Repeat steps 7 through 13 until the warp has been reduced sufficiently to restore functionality.</p>

Laminate Repair, Warped Procedure

Step	Action
14	Clean the CCA with isopropyl alcohol and blot dry with a clean, lint-free tissue.
15	Replace the components removed to facilitate this repair (WP 007 00 for Through Hole Components or WP 018 00 for Surface Mount Devices).
16	<p><i>Inspect per the General Inspection Procedure in WP 003 00 (paragraph 03-5.12) to all applicable WORKMANSHIP STANDARDS, including:</i></p> <ul style="list-style-type: none"> • <i>Through Hole Components in WP 007 00 (paragraph 07-6), as applicable</i> • <i>Conductors, Pads, and Lands in WP 012 00 (paragraph 12-6.1)</i> • <i>Surface Mount Devices in WP 018 00 (paragraph 18-6), as applicable</i> • <i>Other applicable Workmanship Standards as required</i>
17	Replace the conformal coating per the Conformal Coating Replacement Procedure in WP 006 00 (paragraph 06-5.5), as needed.
18	<i>Inspect to the Conformal Coating Replacement WORKMANSHIP STANDARD in WP 006 00 (paragraph 06-6.2), as required.</i>
19	Dispose of all HAZMAT following local procedures.

11-6 WORKMANSHIP STANDARDS

Refer to WP 003 00 (paragraph 03-6) for definitions of Workmanship Standards.

NOTE

WORKMANSHIP STANDARDS FOR GENERAL SOLDER ACCEPTABILITY AND POST-SOLDER JOINT CLEANLINESS ARE IN WP 005 00 (PARAGRAPH 05-6), CONFORMAL COATING IN WP 006 00 (PARAGRAPH 06-6), THROUGH HOLE COMPONENTS IN WP 007 00 (PARAGRAPH 07-6), CONDUCTORS, PADS, AND LANDS IN WP 012 00 (PARAGRAPH 12-6), AND SURFACE MOUNT DEVICES IN WP 018 00 (PARAGRAPH 18-6).

11-6.1 Laminate

Laminate



Target Condition	Acceptable Condition	Defect Condition
	Occurrence of measling or crazing in the laminate provided the CCA is functional.	The assembly is not functional due to excessive measling or crazing.
	Occurrence of bow and twist (warped) laminate provided the CCA is functional.	The assembly is not functional due to bow and twist.
	Delamination is 25% or less of the distance between plated-through holes or conductors.	Delamination exceeds 25% of the distance between plated-through holes or conductors.
	Edge delamination reduces the edge spacing (distance between the edge of the laminate and outermost conductor) by 50% or less.	Edge delamination reduces the edge spacing by more than 50%.
	Discoloration of the laminate provided there are no burns evident.	Burns that physically damage the surface of or extend through the laminate.
		Scratches or cracks in the laminate that expose the laminate fiber weave.

11-6.2 Laminate Excavation

Laminate Excavation

Target Condition	Acceptable Condition	Defect Condition
All burnt or delaminated laminate material is completely removed.		All burnt or delaminated laminate material is not completely removed.

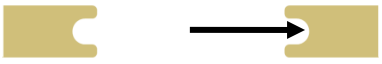
Laminate Excavation



Target Condition	Acceptable Condition	Defect Condition
If present, a crack has been excavated along its entire length.		A crack has not been excavated along its entire length.
For a surface patch, the depth of the excavation is 75% of the laminate thickness.		For a surface patch, the depth of the excavation is less than 75% of the laminate thickness.
For a surface patch, the floor of the excavation is flat.	For a surface patch, the floor of the excavation is not flat.	
All excavated walls are straight and perpendicular to the laminate surface.	An excavated wall is not straight or perpendicular to the laminate surface.	
		The CCA does not fit due to the replacement laminate or broken laminate pieces being misaligned.
The depth and width of the undercuts are approximately 50% of the CCA thickness.		The depth or width of an undercut is not approximately 50% of the laminate thickness.
The undercuts are centered throughout the straight-wall of the excavation.	An undercut is not centered throughout the straight-wall of the excavation.	
<p>The corners of the undercut are rounded.</p> 		<p>A corner of the undercut is not rounded.</p> 
The widths of the bevels are equal to one laminate thickness.	The width of a bevel is greater than one laminate thickness.	The width of a bevel is less than one laminate thickness.
		The angle of the bevel forms a knife-edge at an undercut.

Laminate Excavation

Target Condition	Acceptable Condition	Defect Condition
		A surrounding component or conductor has been damaged during the repair processes.
The replacement laminate is the same type, color, and thickness as the original CCA.	The replacement laminate is not the same color as the original CCA.	The replacement laminate is not the same type or not the same thickness as the original CCA.
If the original laminate has a weave pattern, the replacement laminate's weave pattern is aligned to the weave of the original CCA.	The replacement laminate's weave pattern is not aligned to the weave of the original CCA.	
The clearance between the original laminate and replacement laminate or broken laminate pieces is 1/16 in. or greater and 1/8 in. or less at all points along the repair.		The clearance between the original laminate and replacement laminate or broken laminate pieces is less than 1/16 in. or greater than 1/8 in. at any point along the repair.

11-6.3 Epoxy Fill

Epoxy Fill

Target Condition	Acceptable Condition	Defect Condition
<p>After the resurfacing process, the fill area has been restored to the original laminate level.</p> <p>Restored Surface Original Laminate</p> 		<p>The fill area has not been restored to the original laminate level.</p> <p>Restored Surface Original Laminate</p> 
		There are contaminants in the epoxy fill.

Epoxy Fill

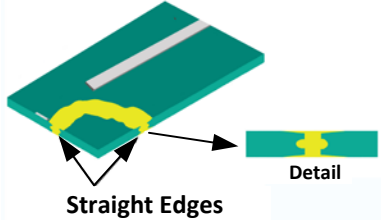
Target Condition	Acceptable Condition	Defect Condition
	There are voids or air bubbles smaller than or equal to 20% of the laminate thickness in the fill area.	There are voids or air bubbles that are larger than 20% of the laminate thickness in the fill area.
	The volume of bubbles in the fill area is equal to or less than 5% of the volume of the fill area.	The volume of bubbles in the fill area is greater than 5% of the volume of the fill area.
<p>For edge delamination, broken laminate, and incomplete broken laminate repair, the fill area edges have been restored to the original laminate edges.</p>  <p>Straight Edges</p> <p>Detail</p>		For edge delamination repair, broken laminate repair, and incomplete broken laminate repair, the fill area edges have not been restored to the original laminate edges.
		There is uncured epoxy in the fill area.
		Surrounding components or conductors have been damaged during the resurfacing process.

11-6.4 Buttercoat

Buttercoat

Target Condition	Acceptable Condition	Defect Condition
The buttercoat is a thin, smooth continuous layer of epoxy.	The buttercoat is not a thin, smooth continuous layer of epoxy.	

Buttercoat

Target Condition	Acceptable Condition	Defect Condition
The buttercoat covers and overlaps the exposed fiber weave in the repair area.		The buttercoat does not cover and overlap the exposed fiber weave in the repair area.
		There are contaminants in the buttercoat.
		There are voids or air bubbles in the buttercoat.
		There is uncured epoxy in the buttercoat.

This page is intentionally blank.

15 October 2013

WP 012 00 Conductors, Pads, and Lands

12-1 PURPOSE

Identify the technical information relative to conductors, pads, and lands.

Specify the methods for determining the type and extent of conductor, pad, or land damage.

Specify the repair procedures for the repair of conductors, pads, and lands.

Identify the workmanship standards for conductors, pads, and lands.

12-2 INDEX

Paragraph	Subject	Page
12-1	Purpose	1
12-2	Index	1
12-3	General Safety Precautions.....	2
12-4	Technical Information.....	2
12-5	Repair Procedures.....	4
12-5.1	Plated-Through Hole Repair Procedure.....	6
12-5.2	Eyelet Repair Procedure	12
12-5.3	Cracked Conductor Repair Procedure	22
12-5.4	Conductor Repair, Lap Solder Procedure	27
12-5.5	Conductor Repair, Clinched Staple Procedure	35
12-5.6	Conductor Repair, Solder Bridge Procedure.....	43
12-5.7	Isolated Pad/Land Repair Procedure	46
12-5.8	Land and Conductor Repair Procedure.....	52
12-5.9	Pad and Conductor Repair Procedure	59
12-5.10	Middle of Conductor Delamination Repair Procedure	71
12-5.11	Pad and Conductor Delamination Repair Procedure.....	74
12-5.12	Pad, Land, and/or Conductor Salvage Procedure	82
12-5.13	Conductor Fabrication Procedure.....	85
12-5.14	Repaired Conductor Encapsulation Procedure.....	88
12-6	Workmanship Standards	89
12-6.1	Conductors, Pads, and Lands	90
12-6.2	Eyeletting	90
12-6.3	Clinched Staple	92
12-6.4	Lap Solder Repair	93
12-6.5	Conductor Encapsulation.....	95

12-3 GENERAL SAFETY PRECAUTIONS

Observe all the following precautions while repairing conductors, pads, and lands:

- Electronic equipment must be de-energized during removal and installation of CCAs
- Personnel are required to wear a properly grounded ESD wrist strap and cord while working in or around the EPA
- ESD can destroy components—protect ESDS devices during handling and repair to prevent ESD damage (Refer to WP 004 00)
- Isopropyl alcohol is flammable; do not use in the presence of sparks, heat, flame, or synthetic cloth
- Soldering handpieces (e.g., soldering irons, solder extractors) produce extreme heat—exercise care when these tools are out of their stands
- Avoid direct inhalation of fumes during a soldering operation because there is a possibility these fumes could cause occupational asthma
- The lead contained in solder is a source of lead oxide, which the human body cannot dissipate (accumulation of lead oxide in the body over a period of years can result in a serious health hazard)
- Contact with solder by holding in the mouth, smoking, or eating during or immediately after soldering is a potential means of ingesting trace amounts of lead oxide
- Avoid oral contact with hands during or immediately after solder operations
- Wash hands following any solder operation
- Wear approved PPE whenever pouring or handling molten metals or corrosive liquids and solids; and cutting, drilling, grinding, milling, chipping and other dust and debris producing operations
- Always follow the manufacturer's instructions and warnings when using conformal coating products
- Follow manufacturer's safety instructions when using resins and catalysts

12-4 TECHNICAL INFORMATION

Conductor and pad damage are common repair problems.

The repair techniques discussed in this work package will restore functional capability.

12-4.1 Types of Conductor and Pad Damage

The four most common types of damage to conductors are:

12-4.1.1 Burned Conductors

Burned conductors (Figure 12-1) are caused by overcurrent situations (e.g., thermal runaway, shorts) where there is insufficient circuit protection. The excessive current causes the conductor to overheat and burn destroying the conductor.



Figure 12-1 Burned Conductor

12-4.1.2 Cracked Conductors and Pads

Cracked conductors and pads have cracked, nicked, scratched, or torn conductors (Figure 12-2); cracked or damaged plated-through holes; or cracked or damaged eyelets (Figure 12-3).

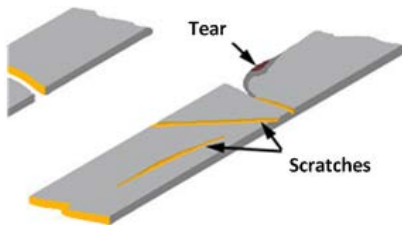

Figure 12-2 Scratched and Torn Conductors



Figure 12-3 Damaged Eyelets

12-4.1.3 Damaged Conductors and Pads

Damaged conductors and pads have pads or conductors completely missing from the CCA or conductors and pads are damaged beyond a crack.

12-4.1.4 Delaminated Conductors and Pads

Delaminated conductors and pads (Figure 12-4) are classified as any portion of the conductor no longer bonded to the CCA surface.

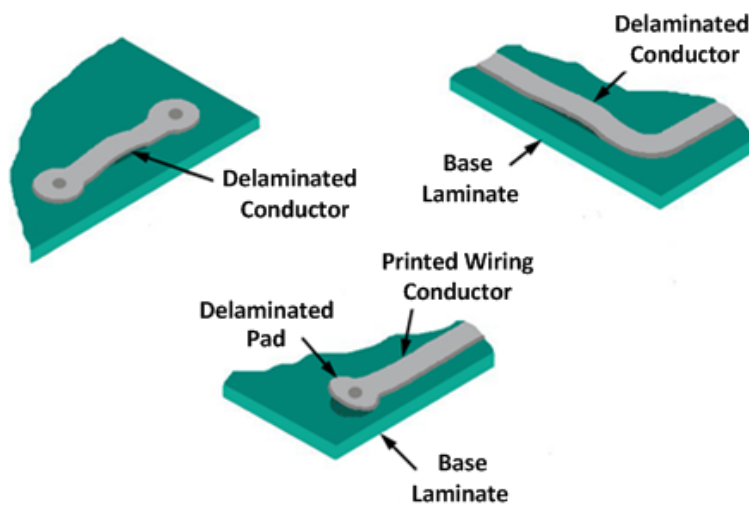

Figure 12-4 Delaminated Conductors and Pads

12-5 REPAIR PROCEDURES



PROTECT STATIC SENSITIVE DEVICES DURING HANDLING AND REPAIR TO PREVENT ESD DAMAGE (REFER TO WP 004 00).

Equipment Required Listed below are the authorized 2M Power Units* for repair of conductors, pads, and lands:

- **NAVAIR/NAVSEA/USMC/USAF/USCG**—PRC-2000-SMT
- **NAVSEA/USCG**—PRC-2000-TH
- **NAVSEA/USCG**—MBT-250-SD
- **USMC**—MBT-350
- **NAVSEA**—ST-25

* Refer to Table 03-3 for Power Unit Part No., and CAGE Code

Additional Support Items For additional information regarding items of support and support equipment refer to:

- **NAVSEA/NAVAIR/USCG**—2M MTR Certification Manual
- **NAVSEA/USCG**—Allowance Parts List (APL) 000A8423
- **USMC**—Stock List SL-3-09458A
- **USAF**—the Consolidated Tool Kit (CTK)

Material Required Listed below are the materials required* for repair of conductors, pads, and lands:

- Adhesive (Epoxy Patch Kit)
- Desoldering Wick†
- Eyelet, Metallic†
- Flux, Soldering
- Insulation Sleeving Kit, Electrical‡
- Isopropyl Alcohol, Technical
- Orangewood Stick
- Solder, Tin Alloy†
- Strip, Metal (copper foil)
- Toothpick‡
- Towel, Paper (Kimwipe®)‡

* Refer to Table 03-4 for Specification No., Part No., and NSN

† Select size appropriate for application















‡ Substitution of equivalent material is acceptable

12-5.1 Plated-Through Hole Repair Procedure

Use this procedure to repair damaged plated-through holes by eyeleting on single- and double-sided CCAs.

The use of eyelets to repair plated-through holes on multilayer CCAs is prohibited due to the possibility of damaging multiple interfacial connections. Repair of damaged plated-through holes on multilayer CCAs are beyond the scope of this manual.



Personnel Hazards

					
Alcohol, Isopropyl					1
					
Flux (Soldering)					8
					
Lead (Solder)					9

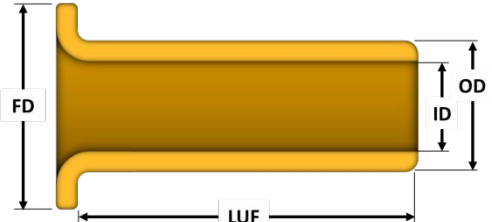

Plated-Through Hole Repair Procedure

Step	Action
	<p style="text-align: center;">WARNING</p> <p style="text-align: center;"><i>USE APPROVED SAFETY EYEWEAR WHEN PERFORMING THIS PROCEDURE.</i></p> <p style="text-align: center;"><i>COMPLY WITH ALL LOCAL REQUIREMENTS FOR PPE.</i></p> <p style="text-align: center;">CAUTION</p> <p style="text-align: center;">THE USE OF EYELETS TO REPAIR MULTILAYER CCAS IS PROHIBITED DUE TO THE POSSIBILITY OF DAMAGING MULTIPLE INTERFACIAL CONNECTIONS.</p> <p style="text-align: center;">DON A PROPERLY GROUNDED ESD WRIST STRAP BEFORE STARTING THIS PROCEDURE.</p>
1	Perform the Procedural Analysis and Feasibility of Repair Procedure in WP 003 00 (paragraph 03-5.1).

Plated-Through Hole Repair Procedure

Step	Action								
2	<div style="text-align: center; border: 2px solid black; padding: 5px; margin-bottom: 10px;">CAUTION</div> <p style="text-align: center;">BEGIN THE REPAIR PROCESS AS SOON AS POSSIBLE AFTER REMOVAL FROM THE OVEN TO AVOID MOISTURE RE-ABSORPTION.</p> <table border="1" style="width: 100%; border-collapse: collapse;"> <thead> <tr> <th style="width: 50%; text-align: left;">Baking Temp.</th> <th style="width: 50%; text-align: left;">Baking Time</th> </tr> </thead> <tbody> <tr> <td>248°F (120°C)</td> <td>3.5 to 7 hours</td> </tr> <tr> <td>212°F (100°C)</td> <td>8 to 16 hours</td> </tr> <tr> <td>176°F (80°C)</td> <td>18 to 48 hours</td> </tr> </tbody> </table> <p>Bake the CCA, if feasible, in accordance with the table to the right before soldering, desoldering, and conformal coating removal procedures to prevent delamination, measling, or other laminate degradation.</p>	Baking Temp.	Baking Time	248°F (120°C)	3.5 to 7 hours	212°F (100°C)	8 to 16 hours	176°F (80°C)	18 to 48 hours
Baking Temp.	Baking Time								
248°F (120°C)	3.5 to 7 hours								
212°F (100°C)	8 to 16 hours								
176°F (80°C)	18 to 48 hours								
3	Remove any conformal coating from the repair area using one of the Conformal Coating Removal Methods in WP 006 00 (paragraph 06-5.4).								
4	Remove the components necessary to provide access to the repair area (WP 007 00 for Through Hole Components or WP 018 00 for Surface Mount Devices).								
5	<p>Select an eyelet with:</p> <ul style="list-style-type: none"> • A barrel inside diameter (ID) large enough to accommodate the component lead to be installed in the hole. • An ID matching, as closely as possible, the inside diameter of the plated-through hole to be repaired. • A flange diameter (FD) of the eyelet providing 50 to 80% pad coverage. • A length under the flange (LUF) to provide 50 to 80% pad coverage after the eyelet is set. <div style="text-align: center;">  </div> <p>Note: Only flat-set eyelets are authorized for 2M repair. Flattened funnelets are also acceptable.</p>								
6	<p>Select the proper diameter drill bit matching the outside diameter (OD) of the selected eyelet to enlarge the existing hole.</p> <div style="text-align: center;">  </div> <p>Note: Determine the size of the drill bit by sizing the selected eyelet in a drill gauge and selecting the corresponding size drill bit or ball mill.</p>								

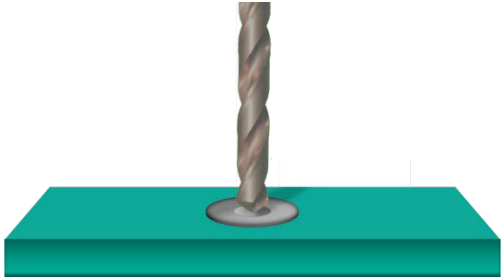

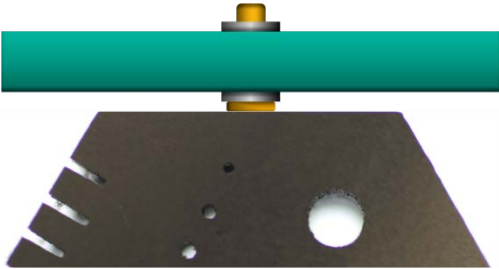
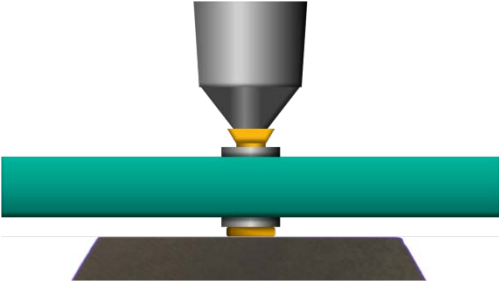
Plated-Through Hole Repair Procedure

Step	Action
7	<p style="text-align: center;">CAUTION</p> <p style="text-align: center;">WHEN ENLARGING THE HOLE, DO NOT DRILL HOLE AT AN ANGLE.</p> <p>Starting on termination side of CCA, use the drill bit in a pin vise to enlarge the existing hole.</p> <p>Note: Drill only half way through the CCA to avoid breakout.</p> 
8	Turn the CCA over and complete the drilling process from the component side.
9	Clean the eyelet and repair area with isopropyl alcohol using an acid brush and blot dry with a clean, lint-free tissue.
10	<p>Insert the eyelet into the hole with the preformed head on the component side of the CCA.</p> <p>Note: The preformed head shall not be installed to a bare laminate surface.</p> 
11	<p>Brace the preformed head of the eyelet against a flat, solid surface such as a jeweler's anvil.</p> <p>Note: In confined places on the CCA, it may be necessary to insert a pin punch into the anvil and use the flat surface of the punch handle as a solid surface.</p> 
12	<p>Flare the unformed end of the eyelet to approximately 45°, using a circular motion with a center punch.</p> 

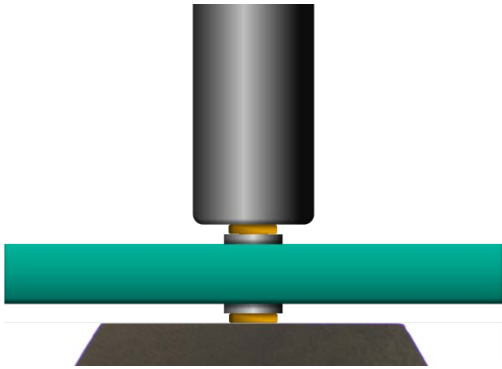
Plated-Through Hole Repair Procedure

Step	Action
13	<div style="text-align: center; border: 2px solid black; padding: 5px; margin-bottom: 10px;">CAUTION</div> <p style="text-align: center;">WHEN SETTING AN EYELET, EXCESSIVE FORCE WILL DAMAGE BOTH THE EYELET AND THE CCA.</p> <p>Set the flared end of the eyelet flat by gently tapping the flat pin punch with a machinist's hammer.</p> <p>Note: A single tap should be sufficient to set the eyelet properly.</p> <p>Note: To provide proper mechanical support the eyelet shall not rotate in the hole.</p> 
14	<p><i>Inspect to the Eyeletting WORKMANSHIP STANDARD (paragraph 12-6.2).</i></p>
15	<p>Select a soldering iron tip that maximizes heat transfer and contact area with the eyelet and the pad.</p>
16	<p>Set the soldering iron tip temperature to 600°F (316°C).</p>
17	<p>Clean the set eyelet with isopropyl alcohol using an acid brush and blot dry with a clean, lint-free tissue.</p> <p>Note: Take precautions to prevent bare skin contact on the eyelet before soldering. Skin contact leaves contaminants on the surfaces to be soldered.</p>
18	<p>Clean the solder with isopropyl alcohol and wipe dry with a clean, lint-free tissue.</p>
19	<p>Apply flux SPARINGLY to the eyelet.</p> <p>Note: Use a toothpick or flux pen to control the volume of flux applied. Heavy flux volume impairs cleaning and may affect reliability.</p>
20	<p>Remove the seasoning (all solder) from the soldering iron tip.</p>
21	<p>Thermally shock the soldering iron tip on a damp sponge.</p>

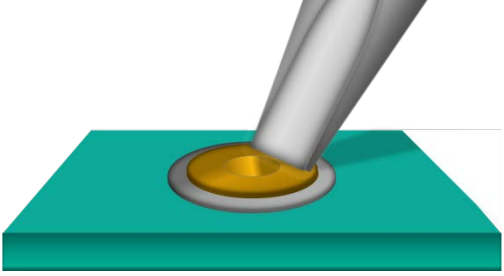
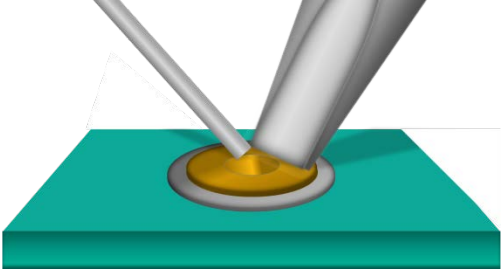
Plated-Through Hole Repair Procedure

Step	Action
22	<p style="text-align: center;">CAUTION</p> <p style="text-align: center;">DO NOT APPLY PRESSURE WITH THE SOLDERING IRON.</p> <p>Place the soldering iron tip on eyelet at the point of maximum thermal mass on the termination side of the CCA.</p> 
23	<p style="text-align: center;">CAUTION</p> <p style="text-align: center;">IF SOLDER MELT DOES NOT OCCUR WITHIN TWO SECONDS, STOP THIS PROCEDURE AND ADJUST TIP TEMPERATURE PER THE TIP TEMPERATURE PROCEDURE IN WP 003 00 (PARAGRAPH 03-5.4).</p> <p>Form a heat bridge between the soldering iron tip and the eyelet using clean solder.</p> 
24	<p>Apply solder to the pad area filling the eyelet and both pad areas from the termination side.</p> 
25	<p>Remove the solder and the soldering iron tip simultaneously.</p>
26	<p>Season the tip and place the soldering iron into its stand.</p>
27	<p>Allow the eyelet to cool completely before cleaning.</p>
28	<p>Clean the eyelet on both sides of the CCA with isopropyl alcohol using an acid brush to remove all flux residue and blot dry with a clean, lint-free tissue.</p>

Plated-Through Hole Repair Procedure

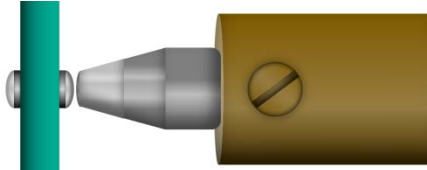
Step	Action
29	Select a solder extractor tip with an outside diameter smaller than eyelet.
30	Set the solder extractor tip temperature to 600°F (316°C).
31	Place a clean tissue on a heat resistant surface and test the solder extractor by actuating vacuum to pick up the tissue. Note: If the solder extractor vacuum is insufficient to pick up the tissue, stop this procedure and perform the Solder Extractor Vacuum Test and Heater Element Cleaning Procedure in WP 003 00 (paragraph 03-5.7).
32	Apply flux SPARINGLY to the eyelet on both sides of the CCA.
33	Position the CCA vertically in a circuit cardholder, if feasible.
34	Remove the seasoning from the solder extractor tip.
35	Thermally shock the solder extractor tip on a damp sponge.
36	<p style="text-align: center;">CAUTION</p> <p style="text-align: center;">DO NOT APPLY PRESSURE WITH THE SOLDER EXTRACTOR.</p> <p>Place solder extractor tip on the component side of the eyelet contacting only the solder fillet, not the eyelet.</p> 
37	<p style="text-align: center;">CAUTION</p> <p style="text-align: center;">IF SOLDER MELT DOES NOT OCCUR WITHIN TWO SECONDS, STOP THIS PROCEDURE AND ADJUST TIP TEMPERATURE PER THE TIP TEMPERATURE PROCEDURE IN WP 003 00 (PARAGRAPH 03-5.4).</p> <p>Observe COMPLETE solder melt; then actuate vacuum using the handpiece vacuum control switch or the foot pedal switch.</p>
38	After complete solder extraction, remove the solder extractor tip from the solder joint allowing the solder extractor vacuum to run continuously for an additional five seconds to draw the molten solder completely into the solder trap.

Plated-Through Hole Repair Procedure















Step	Action
39	Season the tip and place the solder extractor into its stand.
40	Allow the eyelet to cool completely before cleaning.
41	Clean the eyelet on both sides of the CCA with isopropyl alcohol using an acid brush to remove all flux residue and blot dry with a clean, lint-free tissue.
42	Replace the components removed to facilitate this repair (WP 007 00 for Through Hole Components or WP 018 00 for Surface Mount Devices).
43	<p><i>Inspect per the General Inspection Procedure in WP 003 00 (paragraph 03-5.12) to all applicable WORKMANSHIP STANDARDS, including:</i></p> <ul style="list-style-type: none"> • <i>General Solder Acceptability in WP 005 00 (paragraph 05-6.1)</i> • <i>Post-Solder Joint Cleanliness in WP 005 00 (paragraph 05-6.2)</i> • <i>Laminate in WP 011 00 (paragraph 11-6.1)</i> • <i>Through Hole Components in WP 007 00 (paragraph 07-6), as applicable</i> • <i>Surface Mount Devices in WP 018 00 (paragraph 18-6), as applicable</i> • <i>Other applicable Workmanship Standards, as required</i>
44	Replace the conformal coating per the Conformal Coating Replacement Procedure in WP 006 00 (paragraph 06-5.5), as needed.
45	<i>Inspect to the Conformal Coating Replacement WORKMANSHIP STANDARD in WP 006 00 (paragraph 06-6.2), as required.</i>
46	Dispose of all HAZMAT following local procedures.

12-5.2 Eyelet Repair Procedure

Use this procedure to repair damaged eyelets by replacing the eyelet on single- and double-sided CCAs.

Eyelet repair on multilayer CCAs is prohibited due to the possibility of damaging multiple interfacial connections. The repair of damaged eyelets on multilayer CCAs is beyond the scope of this manual.

Personnel Hazards

					
Alcohol, Isopropyl					1
					
Flux (Soldering)					8
					
Lead (Solder)					9

Eyelet Repair Procedure

Step	Action
	<div style="border: 1px solid black; padding: 5px; margin-bottom: 10px;">WARNING</div> <p>USE APPROVED SAFETY EYEWEAR WHEN PERFORMING THIS PROCEDURE.</p> <p>COMPLY WITH ALL LOCAL REQUIREMENTS FOR PPE.</p> <div style="border: 1px solid black; padding: 5px; margin-bottom: 10px;">CAUTION</div> <p>THE USE OF EYELETS TO REPAIR MULTILAYER CCAS IS PROHIBITED DUE TO THE POSSIBILITY OF DAMAGING MULTIPLE INTERFACIAL CONNECTIONS.</p> <p>DON A PROPERLY GROUNDED ESD WRIST STRAP BEFORE STARTING THIS PROCEDURE.</p>
1	Perform the Procedural Analysis and Feasibility of Repair Procedure in WP 003 00 (paragraph 03-5.1).

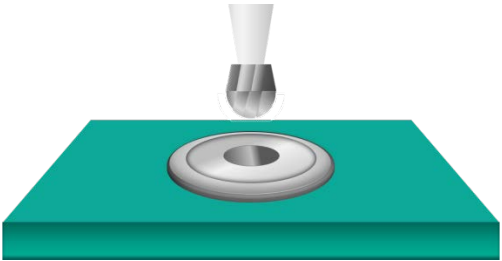
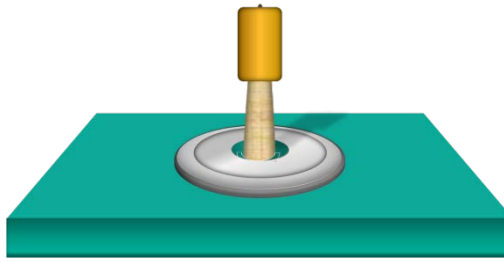

Eyelet Repair Procedure

Step	Action								
2	<div style="text-align: center; border: 2px solid black; padding: 5px; margin-bottom: 10px;">CAUTION</div> <p style="text-align: center;">BEGIN THE REPAIR PROCESS AS SOON AS POSSIBLE AFTER REMOVAL FROM THE OVEN TO AVOID MOISTURE RE-ABSORPTION.</p> <table border="1" style="width: 100%; border-collapse: collapse;"> <thead> <tr> <th style="width: 60%; text-align: left;">Baking Temp.</th> <th style="width: 40%; text-align: left;">Baking Time</th> </tr> </thead> <tbody> <tr> <td>248°F (120°C)</td> <td>3.5 to 7 hours</td> </tr> <tr> <td>212°F (100°C)</td> <td>8 to 16 hours</td> </tr> <tr> <td>176°F (80°C)</td> <td>18 to 48 hours</td> </tr> </tbody> </table> <p>Bake the CCA, if feasible, in accordance with the table to the right before soldering, desoldering, and conformal coating removal procedures to prevent delamination, measling, or other laminate degradation.</p>	Baking Temp.	Baking Time	248°F (120°C)	3.5 to 7 hours	212°F (100°C)	8 to 16 hours	176°F (80°C)	18 to 48 hours
	Baking Temp.	Baking Time							
248°F (120°C)	3.5 to 7 hours								
212°F (100°C)	8 to 16 hours								
176°F (80°C)	18 to 48 hours								
3	Remove any conformal coating from the repair area using one of the Conformal Coating Removal Methods in WP 006 00 (paragraph 06-5.4).								
4	Remove the components necessary to provide access to the repair area (WP 007 00 for Through Hole Components or WP 018 00 for Surface Mount Devices).								
5	Select a ball mill slightly larger than the inside diameter of the barrel of the damaged eyelet and install into a pin vise.								
6	<p>Mill the both flanges from the barrel of the damaged eyelet without enlarging the hole.</p> 								
7	<p>Use a toothpick to push the barrel of the damaged eyelet from the CCA.</p> 								
8	Select a soldering iron tip that maximizes heat transfer and contact area with the eyelet.								
9	Set the soldering iron tip temperature to 600°F (316°C).								

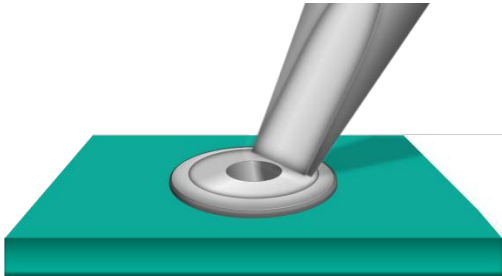
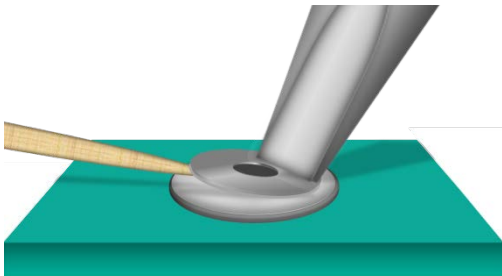
Eyelet Repair Procedure

Step	Action
10	Remove the seasoning (all solder) from the soldering iron tip.
11	Thermally shock the soldering iron tip on a damp sponge.
12	<p style="text-align: center;">CAUTION</p> <p style="text-align: center;">CARE MUST BE TAKEN WHEN REMOVING THE FLANGES FROM THE PADS AS EXCESSIVE HEAT OR PRESSURE WILL DELAMINATE THE PADS.</p> <p>Place the soldering iron tip on the eyelet flange at the point of maximum thermal mass.</p> 
13	<p style="text-align: center;">CAUTION</p> <p style="text-align: center;">IF SOLDER MELT DOES NOT OCCUR WITHIN TWO SECONDS, STOP THIS PROCEDURE AND ADJUST TIP TEMPERATURE PER THE TIP TEMPERATURE PROCEDURE IN WP 003 00 (PARAGRAPH 03-5.4).</p> <p>Heat each flange with a soldering iron and lift them from the pads.</p> 
14	Season the tip and place the soldering iron into its stand.
15	Allow the pad areas to cool completely before cleaning.
16	Clean both pad areas with isopropyl alcohol using an acid brush and blot dry with a clean, lint-free tissue.

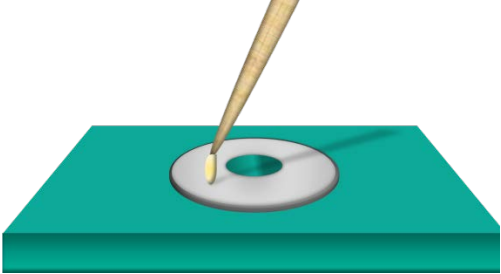

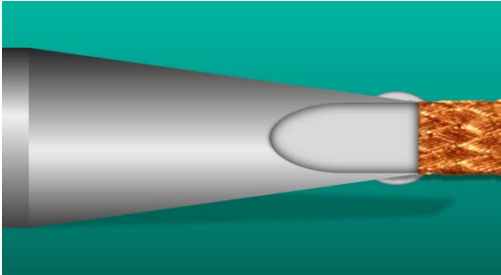
Eyelet Repair Procedure

Step	Action
17	Apply flux SPARINGLY to the pad areas. 
18	Select wicking material smaller than the pad diameters. Note: If corroded, clean the wicking material with isopropyl alcohol and blot dry with a clean, lint-free tissue.
19	Apply flux SPARINGLY to the wicking material.
20	Position the wicking material on a pad. 
21	Remove the seasoning from the soldering iron tip.
22	Thermally shock the soldering iron tip on a damp sponge.
23	<div data-bbox="784 1356 1015 1423" style="border: 2px solid black; padding: 5px; text-align: center;">CAUTION</div> <p data-bbox="566 1444 1232 1472" style="text-align: center;">DO NOT APPLY PRESSURE WITH THE SOLDERING IRON.</p> <p data-bbox="383 1612 883 1682">Place the soldering iron tip on the wicking material over the pad area. </p>

Eyelet Repair Procedure

Step	Action
24	<div style="text-align: center; border: 2px solid black; padding: 5px; margin: 0 auto; width: fit-content;">CAUTION</div> <p style="text-align: center;">IF SOLDER MELT DOES NOT OCCUR WITHIN FOUR SECONDS, STOP THIS PROCEDURE AND ADJUST TIP TEMPERATURE PER THE TIP TEMPERATURE PROCEDURE IN WP 003 00 (PARAGRAPH 03-5.4).</p> <p>Observe the capillary action (solder flow) into the wicking material; when solder flow stops, remove the soldering iron and the wicking material.</p>
25	Remove the used portion of wicking material from the spool using utility cutters.
26	Repeat steps 19 through 25 for the pad on the opposite side.
27	Season the tip and place the soldering iron into its stand.
28	Allow the pad areas to cool completely before cleaning.
29	Clean both pad areas with isopropyl alcohol using an acid brush to remove all flux residue and blot dry with a clean, lint-free tissue.
30	<p><i>Inspect per the General Inspection Procedure in WP 003 00 (paragraph 03-5.12) to:</i></p> <ul style="list-style-type: none"> • <i>Post-Solder Joint Cleanliness in WP 005 00 (paragraph 05-6.2)</i> • <i>Laminate in WP 011 00 (paragraph 11-6.1)</i> • <i>Conductors, Pads, and Lands in WP 012 00 (paragraph 12-6.1)</i>

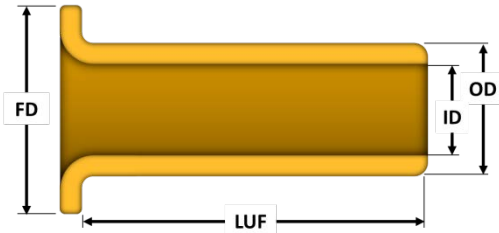
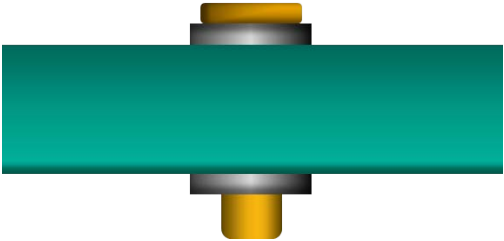

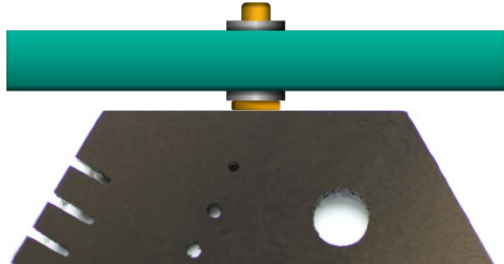
Eyelet Repair Procedure

Step	Action
<p>31</p>	<p>Select an eyelet with:</p> <ul style="list-style-type: none"> • A barrel inside diameter (ID) large enough to accommodate the component lead to be installed in the hole. • An ID matching, as closely as possible, the inside diameter of the plated-through hole to be repaired. • A flange diameter (FD) of the eyelet providing 50 to 80% pad coverage. • A length under the flange (LUF) to provide 50 to 80% pad coverage after the eyelet is set. <p>Note: Only flat-set eyelets are authorized for 2M repair. Flattened funnelets are also acceptable.</p> <div style="display: flex; align-items: center;">  </div> <div style="display: flex; align-items: center; margin-top: 20px;">  </div>
<p>32</p>	<p>Clean the eyelet and repair area with isopropyl alcohol using an acid brush and blot dry with a clean, lint-free tissue.</p>
<p>33</p>	<p>Insert the eyelet into the hole with the preformed head on the component side of the CCA.</p> <p>Note: The preformed head shall not be installed to a bare laminate surface.</p> <div style="display: flex; align-items: center;">  </div>
<p>34</p>	<p>Brace the preformed head of the eyelet against a flat, solid surface such as a jeweler's anvil.</p> <p>Note: In confined places on the CCA, it may be necessary to insert a pin punch into the anvil and use the flat surface of the punch handle as a solid surface.</p> <div style="display: flex; align-items: center;">  </div>

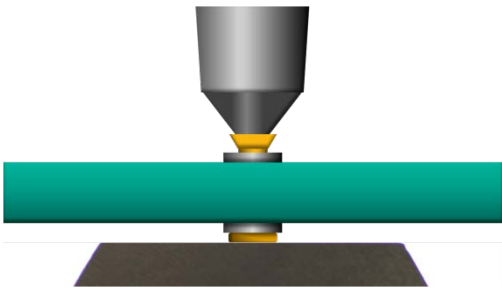
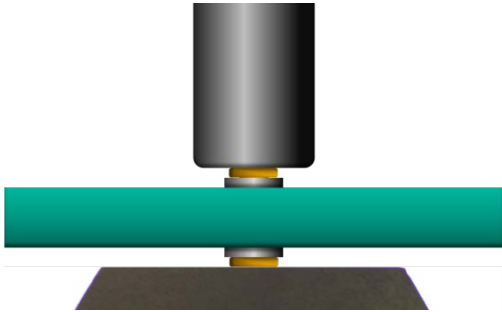
Eyelet Repair Procedure

Step	Action
35	<p>Flare the unformed end of the eyelet to approximately 45°, using a circular motion with a center punch.</p> 
36	<p style="text-align: center;">CAUTION</p> <p style="text-align: center;">WHEN SETTING AN EYELET, EXCESSIVE FORCE WILL DAMAGE BOTH THE EYELET AND THE CCA.</p> <p>Set the flared end of the eyelet flat by gently tapping the flat pin punch with a machinist’s hammer.</p> <p>Note: A single tap should be sufficient to set the eyelet properly.</p> <p>Note: To provide proper mechanical support the eyelet shall not rotate in the hole.</p> 
37	<p><i>Inspect to the Eyeletting WORKMANSHIP STANDARD (paragraph 12-6.2).</i></p>
38	<p>Clean the set eyelet with isopropyl alcohol using an acid brush and blot dry with a clean, lint-free tissue.</p> <p>Note: Take precautions to prevent bare skin contact on the eyelet before soldering. Skin contact leaves contaminants on the surfaces to be soldered.</p>
39	<p>Clean the solder with isopropyl alcohol and wipe dry with a clean, lint-free tissue.</p>
40	<p>Apply flux SPARINGLY to the eyelet.</p> <p>Note: Use a toothpick or flux pen to control the volume of flux applied. Heavy flux volume impairs cleaning and may affect reliability.</p>
41	<p>Remove the seasoning from the soldering iron tip.</p>
42	<p>Thermally shock the soldering iron tip on a damp sponge.</p>

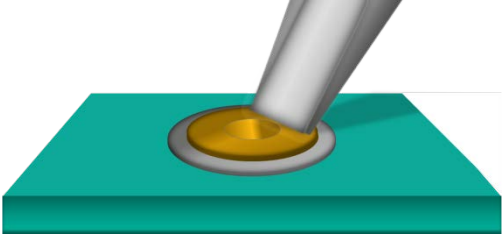
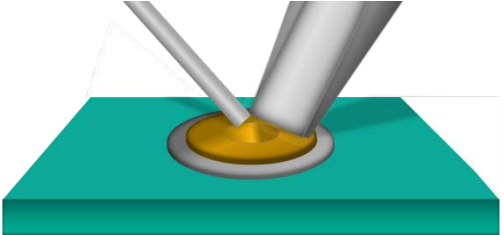
Eyelet Repair Procedure

Step	Action
43	<p style="text-align: center;">CAUTION</p> <p style="text-align: center;">DO NOT APPLY PRESSURE WITH THE SOLDERING IRON.</p> <p>Place the soldering iron tip on eyelet at the point of maximum thermal mass on the termination side of the CCA.</p> 
44	<p style="text-align: center;">CAUTION</p> <p style="text-align: center;">IF SOLDER MELT DOES NOT OCCUR WITHIN TWO SECONDS, STOP THIS PROCEDURE AND ADJUST TIP TEMPERATURE PER THE TIP TEMPERATURE PROCEDURE IN WP 003 00 (PARAGRAPH 03-5.4).</p> <p>Form a heat bridge between the soldering iron tip and the eyelet using clean solder.</p> 
45	<p>Apply solder to the pad area filling the eyelet and both pad areas from the termination side.</p> 
46	<p>Remove the solder and the soldering iron tip simultaneously.</p>
47	<p>Season the tip and place the soldering iron into its stand.</p>
48	<p>Allow the eyelet to cool completely before cleaning.</p>
49	<p>Clean the eyelet on both sides of the CCA with isopropyl alcohol using an acid brush to remove all flux residue and blot dry with a clean, lint-free tissue.</p>
50	<p>Select a solder extractor tip with an outside diameter smaller than eyelet.</p>

Eyelet Repair Procedure

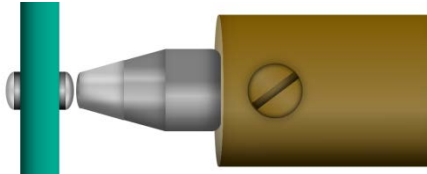
Step	Action
51	Set the solder extractor tip temperature to 600°F (316°C).
52	Place a clean tissue on a heat resistant surface and test the solder extractor by actuating vacuum to pick up the tissue. Note: If the solder extractor vacuum is insufficient to pick up the tissue, stop this procedure and perform the Solder Extractor Vacuum Test and Heater Element Cleaning Procedure in WP 003 00 (paragraph 03-5.7).
53	Apply flux SPARINGLY to the eyelet on both sides of the CCA.
54	Position the CCA vertically in a circuit cardholder, if feasible.
55	Remove the seasoning from the solder extractor tip.
56	Thermally shock the solder extractor tip on a damp sponge.
57	<p style="text-align: center;">CAUTION</p> <p style="text-align: center;">DO NOT APPLY PRESSURE WITH THE SOLDER EXTRACTOR.</p> <p>Place solder extractor tip on the component side of the eyelet contacting only the solder fillet, not the eyelet.</p> 
58	<p style="text-align: center;">CAUTION</p> <p style="text-align: center;">IF SOLDER MELT DOES NOT OCCUR WITHIN TWO SECONDS, STOP THIS PROCEDURE AND ADJUST TIP TEMPERATURE PER THE TIP TEMPERATURE PROCEDURE IN WP 003 00 (PARAGRAPH 03-5.4).</p> <p>Observe COMPLETE solder melt; then actuate vacuum using the handpiece vacuum control switch or the foot pedal switch.</p>
59	After complete solder extraction, remove the solder extractor tip from the solder joint allowing the solder extractor vacuum to run continuously for an additional five seconds to draw the molten solder completely into the solder trap.
60	Season the tip and place the solder extractor into its stand.

Eyelet Repair Procedure

Step	Action
61	Allow the eyelet to cool completely before cleaning.
62	Clean the eyelet on both sides of the CCA with isopropyl alcohol using an acid brush to remove all flux residue and blot dry with a clean, lint-free tissue.
63	Replace the components removed to facilitate this repair (WP 007 00 for Through Hole Components or WP 018 00 for Surface Mount Devices).
64	<p><i>Inspect per the General Inspection Procedure in WP 003 00 (paragraph 03-5.12) to all applicable WORKMANSHIP STANDARDS, including:</i></p> <ul style="list-style-type: none"> • <i>General Solder Acceptability in WP 005 00 (paragraph 05-6.1)</i> • <i>Post-Solder Joint Cleanliness in WP 005 00 (paragraph 05-6.2)</i> • <i>Laminate in WP 011 00 (paragraph 11-6.1)</i> • <i>Through Hole Components in WP 007 00 (paragraph 07-6), as applicable</i> • <i>Surface Mount Devices in WP 018 00 (paragraph 18-6), as applicable</i> • <i>Other applicable Workmanship Standards, as required</i>
65	Replace the conformal coating per the Conformal Coating Replacement Procedure in WP 006 00 (paragraph 06-5.5), as needed.
66	<i>Inspect to the Conformal Coating Replacement WORKMANSHIP STANDARD in WP 006 00 (paragraph 06-6.2), as required.</i>
67	Dispose of all HAZMAT following local procedures.













12-5.3 Cracked Conductor Repair Procedure

Use this procedure to repair hairline conductor cracks on all CCAs.

Personnel Hazards



Alcohol, Isopropyl

				
Epoxy, 0151				4
				
Flux (Soldering)				8
				
Lead (Solder)				9

Cracked Conductor Repair Procedure

Step	Action										
	<div style="border: 1px solid black; padding: 5px; margin-bottom: 10px;">WARNING</div> <p>USE APPROVED SAFETY EYEWEAR WHEN PERFORMING THIS PROCEDURE.</p> <p>COMPLY WITH ALL LOCAL REQUIREMENTS FOR PPE.</p> <div style="border: 1px solid black; padding: 5px; margin-bottom: 10px;">CAUTION</div> <p>DON A PROPERLY GROUNDED ESD WRIST STRAP BEFORE STARTING THIS PROCEDURE.</p>										
1	Perform the Procedural Analysis and Feasibility of Repair Procedure in WP 003 00 (paragraph 03-5.1).										
2	<div style="text-align: center; border: 1px solid black; padding: 5px; margin-bottom: 10px;">CAUTION</div> <p style="text-align: center;">BEGIN THE REPAIR PROCESS AS SOON AS POSSIBLE AFTER REMOVAL FROM THE OVEN TO AVOID MOISTURE RE-ABSORPTION.</p> <table border="0" style="width: 100%;"> <tr> <td style="width: 50%; vertical-align: top;"> Bake the CCA, if feasible, in accordance with the table to the right before soldering, desoldering, and conformal coating removal procedures to prevent delamination, measling, or other laminate degradation. </td> <td style="width: 50%; border-collapse: collapse;"> <table border="1" style="width: 100%; border-collapse: collapse;"> <thead> <tr> <th style="text-align: center;">Baking Temp.</th> <th style="text-align: center;">Baking Time</th> </tr> </thead> <tbody> <tr> <td style="text-align: center;">248°F (120°C)</td> <td style="text-align: center;">3.5 to 7 hours</td> </tr> <tr> <td style="text-align: center;">212°F (100°C)</td> <td style="text-align: center;">8 to 16 hours</td> </tr> <tr> <td style="text-align: center;">176°F (80°C)</td> <td style="text-align: center;">18 to 48 hours</td> </tr> </tbody> </table> </td> </tr> </table>	Bake the CCA, if feasible, in accordance with the table to the right before soldering, desoldering, and conformal coating removal procedures to prevent delamination, measling, or other laminate degradation.	<table border="1" style="width: 100%; border-collapse: collapse;"> <thead> <tr> <th style="text-align: center;">Baking Temp.</th> <th style="text-align: center;">Baking Time</th> </tr> </thead> <tbody> <tr> <td style="text-align: center;">248°F (120°C)</td> <td style="text-align: center;">3.5 to 7 hours</td> </tr> <tr> <td style="text-align: center;">212°F (100°C)</td> <td style="text-align: center;">8 to 16 hours</td> </tr> <tr> <td style="text-align: center;">176°F (80°C)</td> <td style="text-align: center;">18 to 48 hours</td> </tr> </tbody> </table>	Baking Temp.	Baking Time	248°F (120°C)	3.5 to 7 hours	212°F (100°C)	8 to 16 hours	176°F (80°C)	18 to 48 hours
Bake the CCA, if feasible, in accordance with the table to the right before soldering, desoldering, and conformal coating removal procedures to prevent delamination, measling, or other laminate degradation.	<table border="1" style="width: 100%; border-collapse: collapse;"> <thead> <tr> <th style="text-align: center;">Baking Temp.</th> <th style="text-align: center;">Baking Time</th> </tr> </thead> <tbody> <tr> <td style="text-align: center;">248°F (120°C)</td> <td style="text-align: center;">3.5 to 7 hours</td> </tr> <tr> <td style="text-align: center;">212°F (100°C)</td> <td style="text-align: center;">8 to 16 hours</td> </tr> <tr> <td style="text-align: center;">176°F (80°C)</td> <td style="text-align: center;">18 to 48 hours</td> </tr> </tbody> </table>	Baking Temp.	Baking Time	248°F (120°C)	3.5 to 7 hours	212°F (100°C)	8 to 16 hours	176°F (80°C)	18 to 48 hours		
Baking Temp.	Baking Time										
248°F (120°C)	3.5 to 7 hours										
212°F (100°C)	8 to 16 hours										
176°F (80°C)	18 to 48 hours										



Cracked Conductor Repair Procedure

Step	Action
3	Remove any conformal coating from the repair area using one of the Conformal Coating Removal Methods in WP 006 00 (paragraph 06-5.4).
4	Remove the components necessary to provide access to the repair area (WP 007 00 for Through Hole Components or WP 018 00 for Surface Mount Devices).
5	<p>Obtain a replacement conductor from a scrap CCA using the Pad, Land, and/or Conductor Salvage Procedure (paragraph 12-5.12), from a track repair kit, or by manufacturing a replacement from copper foil using the Conductor Fabrication Procedure (paragraph 12-5.13).</p> <ul style="list-style-type: none"> • The replacement conductor shall be the same or slightly larger in width and thickness as the original conductor. • The replacement conductor must be long enough to overlap the original conductor a minimum of two conductor widths on each side of the crack.
6	Remove the adhesive from the underside of the replacement conductor, if required.
7	Select a soldering iron tip that maximizes heat transfer and contact area with the replacement conductor.
8	Set the soldering iron tip temperature to 600°F (316°C).
9	<p>Clean the original conductor where the lap solder joint will be made and the underside of the replacement conductor with isopropyl alcohol using an acid brush and blot dry with a clean, lint-free tissue.</p> <p>Note: Take precautions to prevent bare skin contact on the replacement conductor before soldering. Skin contact leaves contaminants on the leads and/or pads.</p>
10	Clean the solder with isopropyl alcohol and wipe dry with a clean, lint-free tissue.
11	<p>Apply flux SPARINGLY to the original conductor in area to be soldered and to the replacement conductor.</p> <p>Note: Use a toothpick or flux pen to control the volume of flux applied. Heavy flux volume impairs cleaning and may affect reliability.</p>
12	Remove the seasoning (all solder) from the soldering iron tip.
13	Thermally shock the soldering iron tip on a damp sponge.

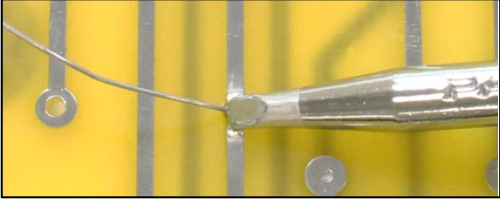
Cracked Conductor Repair Procedure

Step	Action
14	<p style="text-align: center;">CAUTION</p> <p style="text-align: center;">DO NOT APPLY PRESSURE WITH THE SOLDERING IRON.</p> <p>Place the soldering iron tip on the original conductor.</p> 
15	<p style="text-align: center;">CAUTION</p> <p style="text-align: center;">IF SOLDER MELT DOES NOT OCCUR WITHIN TWO SECONDS, STOP THIS PROCEDURE AND ADJUST TIP TEMPERATURE PER THE TIP TEMPERATURE PROCEDURE IN WP 003 00 (PARAGRAPH 03-5.4).</p> <p>Form a heat bridge between the soldering iron tip and the original conductor using clean solder.</p> 
16	Tin the original conductor in the solder area.
17	Tin the underside of the replacement conductor.
18	Remove the solder and the soldering iron tip simultaneously.
19	Season the tip and place the soldering iron into its stand.
20	Allow the original and the replacement conductor to cool completely before cleaning.
21	Clean the original and the replacement conductor with isopropyl alcohol using an acid brush to remove all flux residue and blot dry with a clean, lint-free tissue.
22	Apply flux SPARINGLY to the original conductor using a toothpick or flux pen.
23	Center the replacement conductor on the original conductor, ensuring there is a minimum of two conductor widths of overlap on each side of the crack.

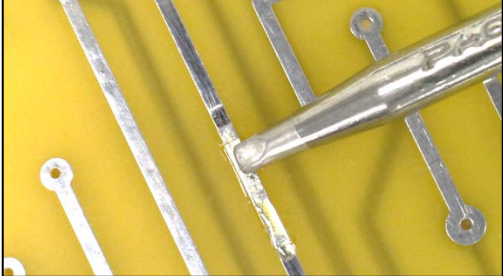
Cracked Conductor Repair Procedure

Step	Action
24	Remove the seasoning from the soldering iron tip.
25	Thermally shock the soldering iron tip on a damp sponge.
26	<p style="text-align: center;">CAUTION</p> <p style="text-align: center;">DO NOT APPLY PRESSURE WITH THE SOLDERING IRON.</p> <p>Place the soldering iron tip on the replacement conductor at one end.</p> 
27	<p style="text-align: center;">CAUTION</p> <p style="text-align: center;">IF SOLDER MELT DOES NOT OCCUR WITHIN TWO SECONDS, STOP THIS PROCEDURE AND ADJUST TIP TEMPERATURE PER THE TIP TEMPERATURE PROCEDURE IN WP 003 00 (PARAGRAPH 03-5.4).</p> <p>Draw the solder the length of the replacement conductor by moving the soldering iron tip toward and off the opposite end.</p> <p>Note: Follow the soldering iron tip with an orangewood stick to hold the conductor in place.</p> 
28	Season the tip and place the soldering iron into its stand.
29	Allow the repaired area to cool completely before cleaning.
30	Clean the soldered area with isopropyl alcohol using an acid brush and blot dry with a clean, lint-free tissue.

Cracked Conductor Repair Procedure

Step	Action
31	<p><i>Inspect per the General Inspection Procedure in WP 003 00 (paragraph 03-5.12) to:</i></p> <ul style="list-style-type: none"> • <i>General Solder Acceptability in WP 005 00 (paragraph 05-6.1)</i> • <i>Post-Solder Joint Cleanliness in WP 005 00 (paragraph 05-6.2)</i> • <i>Conductors, Pads, and Lands (paragraph 12-6.1)</i> • <i>Lap Solder Repair (paragraph 12-6.4)</i>
32	<p>Encapsulate the repair area with epoxy using the Repaired Conductor Encapsulation Procedure (paragraph 12-5.14) if the repair area was not originally conformally coated.</p>
33	<p>Replace the components removed to facilitate this repair (WP 007 00 for Through Hole Components or WP 018 00 for Surface Mount Devices).</p>
34	<p><i>Inspect per the General Inspection Procedure in WP 003 00 (paragraph 03-5.12) to all applicable WORKMANSHIP STANDARDS, including:</i></p> <ul style="list-style-type: none"> • <i>Laminate in WP 011 00 (paragraph 11-6.1)</i> • <i>Through Hole Components in WP 007 00 (paragraph 07-6), as applicable</i> • <i>Surface Mount Devices in WP 018 00 (paragraph 18-6), as applicable</i> • <i>Other applicable Workmanship Standards, as required</i>
35	<p>Replace the conformal coating per the Conformal Coating Replacement Procedure in WP 006 00 (paragraph 06-5.5), as needed.</p>
36	<p><i>Inspect to the Conformal Coating Replacement WORKMANSHIP STANDARD in WP 006 00 (paragraph 06-6.2), as required.</i></p>
37	<p>Dispose of all HAZMAT following local procedures.</p>

12-5.4 Conductor Repair, Lap Solder Procedure

Use this procedure to repair surface conductors on all CCAs.

If a lap solder repair is not feasible, use the Conductor Repair, Clinched Staple Procedure (paragraph 12-5.5).

If the damaged area includes a plated-through hole, perform the Pad and Conductor Repair Procedure (paragraph 12-5.9).



Personnel Hazards

					
Alcohol, Isopropyl					1
					
Epoxy, 0151					4
					
Flux (Soldering)					8
					
Lead (Solder)					9

Conductor Repair, Lap Solder Procedure

Step	Action
	<p style="text-align: center;">WARNING</p> <p style="text-align: center;"><i>USE APPROVED SAFETY EYEWEAR WHEN PERFORMING THIS PROCEDURE. COMPLY WITH ALL LOCAL REQUIREMENTS FOR PPE.</i></p> <p style="text-align: center;">CAUTION</p> <p style="text-align: center;">DON A PROPERLY GROUNDED ESD WRIST STRAP BEFORE STARTING THIS PROCEDURE.</p>
1	Perform the Procedural Analysis and Feasibility of Repair Procedure in WP 003 00 (paragraph 03-5.1).

Conductor Repair, Lap Solder Procedure

Step	Action								
2	<p style="text-align: center;">CAUTION</p> <p style="text-align: center;">BEGIN THE REPAIR PROCESS AS SOON AS POSSIBLE AFTER REMOVAL FROM THE OVEN TO AVOID MOISTURE RE-ABSORPTION.</p> <table border="1" data-bbox="928 611 1427 821"> <thead> <tr> <th data-bbox="928 611 1177 667">Baking Temp.</th> <th data-bbox="1177 611 1427 667">Baking Time</th> </tr> </thead> <tbody> <tr> <td data-bbox="928 667 1177 716">248°F (120°C)</td> <td data-bbox="1177 667 1427 716">3.5 to 7 hours</td> </tr> <tr> <td data-bbox="928 716 1177 764">212°F (100°C)</td> <td data-bbox="1177 716 1427 764">8 to 16 hours</td> </tr> <tr> <td data-bbox="928 764 1177 821">176°F (80°C)</td> <td data-bbox="1177 764 1427 821">18 to 48 hours</td> </tr> </tbody> </table> <p>Bake the CCA, if feasible, in accordance with the table to the right before soldering, desoldering, and conformal coating removal procedures to prevent delamination, measling, or other laminate degradation.</p>	Baking Temp.	Baking Time	248°F (120°C)	3.5 to 7 hours	212°F (100°C)	8 to 16 hours	176°F (80°C)	18 to 48 hours
Baking Temp.	Baking Time								
248°F (120°C)	3.5 to 7 hours								
212°F (100°C)	8 to 16 hours								
176°F (80°C)	18 to 48 hours								
3	Remove any conformal coating from the repair area using one of the Conformal Coating Removal Methods in WP 006 00 (paragraph 06-5.4).								
4	Remove the components necessary to provide access to the repair area (WP 007 00 for Through Hole Components or WP 018 00 for Surface Mount Devices).								
5	<p style="text-align: center;">WARNING</p> <p style="text-align: center;">DO NOT APPLY LATERAL PRESSURE TO THE SCALPEL. THE BLADE IS EXTREMELY FRAGILE AND CAN CAUSE SERIOUS INJURY IF BROKEN.</p> <p>Cut the conductor perpendicular to the conductor axis with a 45° bevel on each side of the damage using a scalpel or chisel.</p> 								
6	<p>Remove the damaged portion by cold-peeling the conductor from the laminate surface.</p> 								
7	Repair the laminate using the appropriate repair procedure in WP 011 00 (paragraph 11-4), as needed.								

Conductor Repair, Lap Solder Procedure

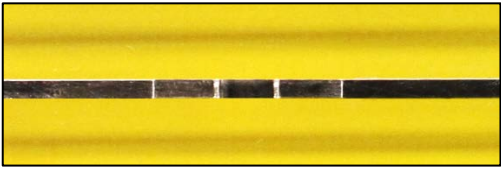
Step	Action
8	<p>Obtain a replacement conductor from a scrap CCA using the Pad, Land, and/or Conductor Salvage Procedure (paragraph 12-5.12), from a track repair kit, or by manufacturing a replacement from copper foil using the Conductor Fabrication Procedure (paragraph 12-5.13).</p> <ul style="list-style-type: none"> • The replacement conductor shall be the same or slightly larger in width and thickness as the original conductor. • The replacement conductor must be long enough to overlap the original conductor a minimum of two conductor widths on each side of the crack.
9	<p>Center the replacement conductor over the removed damage on the original conductor.</p>
10	<p>Form the replacement conductor to the 45° bevels in the original conductor using an orangewood stick or spudger.</p> 
11	<p style="text-align: center;">NOTE</p> <p style="text-align: center;">DO NOT REMOVE THE CUPRIC OXIDE OR OTHER ADHESIVE COATING FROM THE UNDERSIDE OF SALVAGED CONDUCTORS, EXCEPT AT THE AREAS TO BE SOLDERED. THE CUPRIC OXIDE OR ADHESIVE COATING WILL ENHANCE THE SURFACE ADHESION OF THE REPLACEMENT CONDUCTOR.</p> <p>Remove the adhesive from the underside of the replacement conductor in the bevel and overlap areas, if required.</p>
12	<p>Select a soldering iron tip that maximizes heat transfer and contact area with the replacement conductor.</p>
13	<p>Set the soldering iron tip temperature to 600°F (316°C).</p>
14	<p>Clean the original conductor where the lap solder joint will be made and the underside of the replacement conductor with isopropyl alcohol using an acid brush and blot dry with a clean, lint-free tissue.</p> <p>Note: Take precautions to prevent bare skin contact on the replacement conductor before soldering. Skin contact leaves contaminants on the surfaces to be soldered.</p>
15	<p>Clean the solder with isopropyl alcohol and wipe dry with a clean, lint-free tissue.</p>

Conductor Repair, Lap Solder Procedure

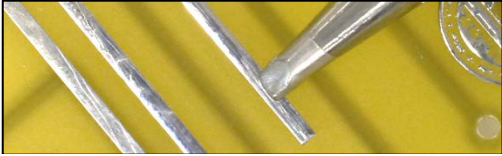
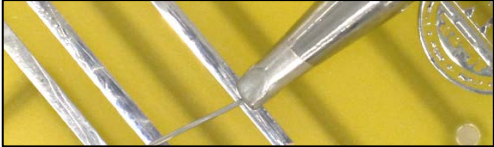
Step	Action
16	Apply flux SPARINGLY to the beveled end of the original conductor and to one of the overlap areas of the replacement conductor. Note: Use a toothpick or flux pen to control the volume of flux applied. Heavy flux volume impairs cleaning and may affect reliability.
17	Remove the seasoning (all solder) from the soldering iron tip.
18	Thermally shock the soldering iron tip on a damp sponge.
19	<div style="text-align: center; border: 1px solid black; padding: 5px; margin-bottom: 10px;">CAUTION</div> <p style="text-align: center;">DO NOT APPLY PRESSURE WITH THE SOLDERING IRON.</p> Place the soldering iron tip on the original conductor. 
20	<div style="text-align: center; border: 1px solid black; padding: 5px; margin-bottom: 10px;">CAUTION</div> <p style="text-align: center;">IF SOLDER MELT DOES NOT OCCUR WITHIN TWO SECONDS, STOP THIS PROCEDURE AND ADJUST TIP TEMPERATURE PER THE TIP TEMPERATURE PROCEDURE IN WP 003 00 (PARAGRAPH 03-5.4).</p> Form a heat bridge between the soldering iron tip and the original conductor using clean solder. 
21	Tin the original conductor at the bevel ends and in the overlap areas.
22	Tin the underside of replacement conductor at the bevels and in the overlap areas.
23	Remove the solder and the soldering iron tip simultaneously.
24	Season the tip and place the soldering iron into its stand.
25	Allow the original and the replacement conductors to cool completely before cleaning.

Conductor Repair, Lap Solder Procedure

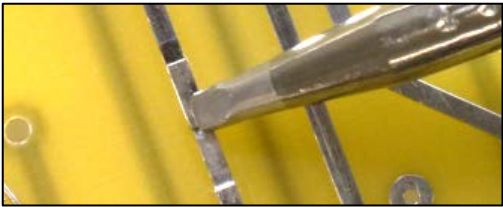
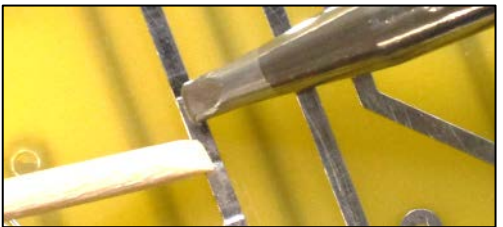
Step	Action
26	Roughen the underside of the replacement conductor and the laminate surface to aid in adhesion.
27	Clean the original and the replacement conductors with isopropyl alcohol using an acid brush to remove all flux residue and blot dry with a clean, lint-free tissue.
28	Apply flux SPARINGLY to one beveled end of the original conductor using a toothpick or flux pen. Note: Do not allow the flux to contact the laminate between the bevels.
29	Position the replacement conductor on the original conductor so the bevels and overlap areas are aligned.
30	Remove the seasoning from the soldering iron tip.
31	Thermally shock the soldering iron tip on a damp sponge.
32	<div style="text-align: center; border: 1px solid black; padding: 5px; margin-bottom: 10px;">CAUTION</div> <p>DO NOT APPLY PRESSURE WITH THE SOLDERING IRON.</p> <p>Place the soldering iron tip on the replacement conductor at the bevel on where the flux has been applied.</p> 
33	<div style="text-align: center; border: 1px solid black; padding: 5px; margin-bottom: 10px;">CAUTION</div> <p>IF SOLDER MELT DOES NOT OCCUR WITHIN TWO SECONDS, STOP THIS PROCEDURE AND ADJUST TIP TEMPERATURE PER THE TIP TEMPERATURE PROCEDURE IN WP 003 00 (PARAGRAPH 03-5.4).</p> <p>Draw the solder the length of the overlap by moving the soldering iron tip toward and off the cut end.</p> <p>Note: Follow the soldering iron tip with an orangewood stick to hold the conductor in place.</p> 

Conductor Repair, Lap Solder Procedure

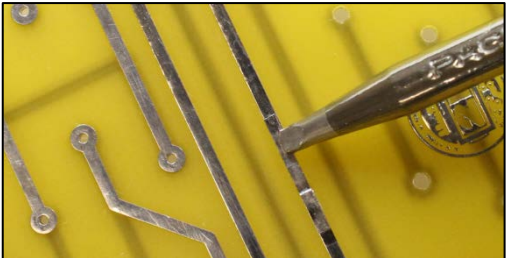
Step	Action
34	Season the tip and place the soldering iron into its stand.
35	Allow the repaired area to cool completely before continuing.
36	<p style="text-align: center;">CAUTION</p> <p style="text-align: center;">TO PREVENT CONTAMINATION OF THE EPOXY, DO NOT CLEAN THE LAP SOLDER JOINT WITH ISOPROPYL ALCOHOL AT THIS TIME.</p> <p>Wipe the lap solder joint with a dry, clean, lint-free tissue.</p>
37	Prepare the epoxy according to the manufacturer's directions.
38	Apply epoxy SPARINGLY to the laminate surface OR to the underside of the replacement conductor.
39	Roll the replacement conductor onto the laminate surface.
40	Remove any excess epoxy with a dry tissue or cotton-tipped applicator.
41	<p>Apply flux SPARINGLY to unsoldered bevel and overlap of the original conductor using a toothpick or flux pen.</p> <p>Note: Do not allow the flux to contact the epoxy.</p>
42	Remove the seasoning from the soldering iron tip.
43	Thermally shock the soldering iron tip on a damp sponge.
44	<p style="text-align: center;">CAUTION</p> <p style="text-align: center;">DO NOT APPLY PRESSURE WITH THE SOLDERING IRON.</p> <p>Place the soldering iron tip on the replacement conductor at the bevel on the unsoldered overlap.</p> 

Conductor Repair, Lap Solder Procedure

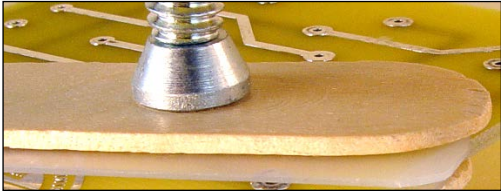
Step	Action
45	<div style="text-align: center; border: 1px solid black; padding: 5px; margin-bottom: 10px;">CAUTION</div> <p style="text-align: center;">IF SOLDER MELT DOES NOT OCCUR WITHIN TWO SECONDS, STOP THIS PROCEDURE AND ADJUST TIP TEMPERATURE PER THE TIP TEMPERATURE PROCEDURE IN WP 003 00 (PARAGRAPH 03-5.4).</p> <p>Draw the solder the length of the overlap by moving the soldering iron tip toward and off the cut end.</p> <p>Note: Follow the soldering iron tip with an orangewood stick to hold the conductor in place.</p> 
46	Season the tip and place the soldering iron into its stand.
47	Allow the repaired area to cool completely before continuing.
48	Place polyethylene release material (e.g., coffee can lid) over the repair area on both sides of the CCA.
49	<p>Clamp release material in place.</p> 
50	Cure the epoxy according to the manufacturer's directions.
51	Remove the clamp and the release material.
52	Clean the repair area with isopropyl alcohol using an acid brush to remove all flux residue and blot dry with a clean, lint-free tissue.
53	<p><i>Inspect per the General Inspection Procedure in WP 003 00 (paragraph 03-5.12) to:</i></p> <ul style="list-style-type: none"> • <i>General Solder Acceptability in WP 005 00 (paragraph 05-6.1)</i> • <i>Post-Solder Joint Cleanliness in WP 005 00 (paragraph 05-6.2)</i> • <i>Conductors, Pads, and Lands (paragraph 12-6.1)</i> • <i>Lap Solder Repair (paragraph 12-6.4)</i>

Conductor Repair, Lap Solder Procedure

Step	Action
54	Encapsulate the repair area with epoxy using the Repaired Conductor Encapsulation Procedure (paragraph 12-5.14) if the repair area was not originally conformally coated.
55	Replace the components removed to facilitate this repair (WP 007 00 for Through Hole Components or WP 018 00 for Surface Mount Devices).
56	<p><i>Inspect per the General Inspection Procedure in WP 003 00 (paragraph 03-5.12) to all applicable WORKMANSHIP STANDARDS, including:</i></p> <ul style="list-style-type: none"> • <i>Laminate in WP 011 00 (paragraph 11-6.1)</i> • <i>Through Hole Components in WP 007 00 (paragraph 07-6), as applicable</i> • <i>Surface Mount Devices in WP 018 00 (paragraph 18-6), as applicable</i> • <i>Other applicable Workmanship Standards, as required</i>
57	Replace the conformal coating per the Conformal Coating Replacement Procedure in WP 006 00 (paragraph 06-5.5), as needed.
58	<i>Inspect to the Conformal Coating Replacement WORKMANSHIP STANDARD in WP 006 00 (paragraph 06-6.2), as required.</i>
59	Dispose of all HAZMAT following local procedures.

12-5.5 Conductor Repair, Clinched Staple Procedure

Use this procedure to repair conductors on single- and double-sided CCAs if the Conductor Repair, Lap Solder Procedure (paragraph 12-5.4) is not feasible and the circuitry and conductors will not interfere with the repair.

The repair of multilayer CCAs using a clinched staple is beyond the scope of this manual.

Personnel Hazards



Alcohol, Isopropyl

1



Flux (Soldering)

8



Lead (Solder)

Conductor Repair, Clinched Staple Procedure

Step	Action										
	<p style="text-align: center;">WARNING</p> <p style="text-align: center;"><i>USE APPROVED SAFETY EYEWEAR WHEN PERFORMING THIS PROCEDURE.</i></p> <p style="text-align: center;"><i>COMPLY WITH ALL LOCAL REQUIREMENTS FOR PPE.</i></p> <p style="text-align: center;">CAUTION</p> <p style="text-align: center;">DON A PROPERLY GROUNDED ESD WRIST STRAP BEFORE STARTING THIS PROCEDURE.</p>										
<p style="text-align: center;">1</p>	<p>Perform the Procedural Analysis and Feasibility of Repair Procedure in WP 003 00 (paragraph 03-5.1).</p> <p>Note: Examine both sides of the CCA to determine if any conductor damage, component damage, or shorting will result from the installation of a clinched staple.</p>										
<p style="text-align: center;">2</p>	<p style="text-align: center;">CAUTION</p> <p style="text-align: center;">BEGIN THE REPAIR PROCESS AS SOON AS POSSIBLE AFTER REMOVAL FROM THE OVEN TO AVOID MOISTURE RE-ABSORPTION.</p> <table border="1" style="width: 100%; border-collapse: collapse;"> <tr> <td style="width: 50%; vertical-align: top;"> Bake the CCA, if feasible, in accordance with the table to the right before soldering, desoldering, and conformal coating removal procedures to prevent delamination, measling, or other laminate degradation. </td> <td style="width: 50%; text-align: center;"> <table border="1" style="width: 100%; border-collapse: collapse;"> <thead> <tr> <th style="text-align: left;">Baking Temp.</th> <th style="text-align: left;">Baking Time</th> </tr> </thead> <tbody> <tr> <td>248°F (120°C)</td> <td>3.5 to 7 hours</td> </tr> <tr> <td>212°F (100°C)</td> <td>8 to 16 hours</td> </tr> <tr> <td>176°F (80°C)</td> <td>18 to 48 hours</td> </tr> </tbody> </table> </td> </tr> </table>	Bake the CCA, if feasible, in accordance with the table to the right before soldering, desoldering, and conformal coating removal procedures to prevent delamination, measling, or other laminate degradation.	<table border="1" style="width: 100%; border-collapse: collapse;"> <thead> <tr> <th style="text-align: left;">Baking Temp.</th> <th style="text-align: left;">Baking Time</th> </tr> </thead> <tbody> <tr> <td>248°F (120°C)</td> <td>3.5 to 7 hours</td> </tr> <tr> <td>212°F (100°C)</td> <td>8 to 16 hours</td> </tr> <tr> <td>176°F (80°C)</td> <td>18 to 48 hours</td> </tr> </tbody> </table>	Baking Temp.	Baking Time	248°F (120°C)	3.5 to 7 hours	212°F (100°C)	8 to 16 hours	176°F (80°C)	18 to 48 hours
Bake the CCA, if feasible, in accordance with the table to the right before soldering, desoldering, and conformal coating removal procedures to prevent delamination, measling, or other laminate degradation.	<table border="1" style="width: 100%; border-collapse: collapse;"> <thead> <tr> <th style="text-align: left;">Baking Temp.</th> <th style="text-align: left;">Baking Time</th> </tr> </thead> <tbody> <tr> <td>248°F (120°C)</td> <td>3.5 to 7 hours</td> </tr> <tr> <td>212°F (100°C)</td> <td>8 to 16 hours</td> </tr> <tr> <td>176°F (80°C)</td> <td>18 to 48 hours</td> </tr> </tbody> </table>	Baking Temp.	Baking Time	248°F (120°C)	3.5 to 7 hours	212°F (100°C)	8 to 16 hours	176°F (80°C)	18 to 48 hours		
Baking Temp.	Baking Time										
248°F (120°C)	3.5 to 7 hours										
212°F (100°C)	8 to 16 hours										
176°F (80°C)	18 to 48 hours										
<p style="text-align: center;">3</p>	<p>Remove any conformal coating from the repair area using one of the Conformal Coating Removal Methods in WP 006 00 (paragraph 06-5.4).</p>										
<p style="text-align: center;">4</p>	<p>Remove the components necessary to provide access to the repair area (WP 007 00 for Through Hole Components or WP 018 00 for Surface Mount Devices).</p>										

Conductor Repair, Clinched Staple Procedure

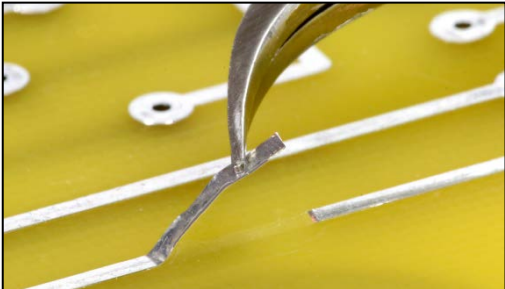
Step	Action												
5	<div style="text-align: center; border: 2px solid black; padding: 5px; margin-bottom: 10px;">WARNING</div> <p><i>DO NOT APPLY LATERAL PRESSURE TO THE SCALPEL. THE BLADE IS EXTREMELY FRAGILE AND CAN CAUSE SERIOUS INJURY IF BROKEN.</i></p> <p>Cut the conductor perpendicular to the conductor axis with a 45° bevel on each side of the damage using a scalpel or chisel.</p> 												
6	<p>Remove the damaged portion by cold-peeling the conductor from the laminate surface.</p> 												
7	<p>Repair the laminate using the appropriate repair procedure in WP 011 00 (paragraph 11-4), as needed.</p>												
8	<p>Measure the conductor width.</p>												
9	<table border="1" style="width: 100%; border-collapse: collapse;"> <thead> <tr> <th style="width: 50%;"></th> <th style="text-align: center;">Conductor Width in Inches</th> <th style="text-align: center;">Equivalent Solid Wire Diameter</th> </tr> </thead> <tbody> <tr> <td rowspan="4" style="vertical-align: top;">Select a solid wire or component lead equaling 50 to 60% of the conductor width in accordance with the table to the right.</td> <td style="text-align: center;">0.03125 (1/32)</td> <td style="text-align: center;">#25/#26</td> </tr> <tr> <td style="text-align: center;">0.06250 (1/16)</td> <td style="text-align: center;">#19/#20</td> </tr> <tr> <td style="text-align: center;">0.09375 (3/32)</td> <td style="text-align: center;">#16</td> </tr> <tr> <td style="text-align: center;">0.12500 (1/8)</td> <td style="text-align: center;">#13/#14</td> </tr> </tbody> </table>		Conductor Width in Inches	Equivalent Solid Wire Diameter	Select a solid wire or component lead equaling 50 to 60% of the conductor width in accordance with the table to the right.	0.03125 (1/32)	#25/#26	0.06250 (1/16)	#19/#20	0.09375 (3/32)	#16	0.12500 (1/8)	#13/#14
	Conductor Width in Inches	Equivalent Solid Wire Diameter											
Select a solid wire or component lead equaling 50 to 60% of the conductor width in accordance with the table to the right.	0.03125 (1/32)	#25/#26											
	0.06250 (1/16)	#19/#20											
	0.09375 (3/32)	#16											
	0.12500 (1/8)	#13/#14											
10	<p>Strip the solid wire using the Thermal Wire Stripping Procedure in WP 008 00 (paragraph 08-5.3.1), if needed.</p>												
11	<p>Select a soldering iron tip that maximizes heat transfer and contact area with the conductor and the solid wire or component lead.</p>												
12	<p>Set the soldering iron tip temperature to 600°F (316°C).</p>												

Conductor Repair, Clinched Staple Procedure

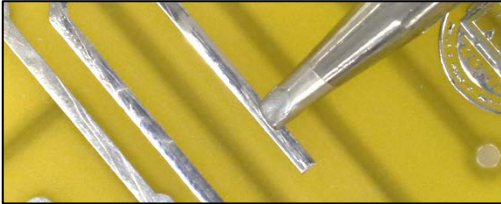
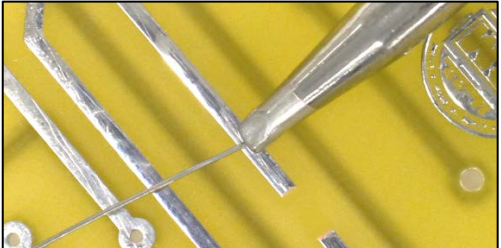
Step	Action
13	Clean the original conductor at the bevel and the wire or lead with isopropyl alcohol using an acid brush and blot dry with a clean, lint-free tissue. Note: Take precautions to prevent bare skin contact on the conductor or wire/lead before soldering. Skin contact leaves contaminants on the surfaces to be soldered.
14	Clean the solder with isopropyl alcohol and wipe dry with a clean, lint-free tissue.
15	Apply flux SPARINGLY to the beveled ends of the conductor and to the wire. Note: Use a toothpick or flux pen to control the volume of flux applied. Heavy flux volume impairs cleaning and may affect reliability.
16	Remove the seasoning (all solder) from the soldering iron tip.
17	Thermally shock the soldering iron tip on a damp sponge.
18	<div style="text-align: center; border: 1px solid black; padding: 5px; margin-bottom: 10px;">CAUTION</div> <p style="text-align: center;">DO NOT APPLY PRESSURE WITH THE SOLDERING IRON.</p> <div style="display: flex; justify-content: space-between;"> <div style="width: 45%;"> <p>Place the soldering iron tip on the original conductor at one beveled end.</p> </div> <div style="width: 45%; text-align: right;">  </div> </div>
19	<div style="text-align: center; border: 1px solid black; padding: 5px; margin-bottom: 10px;">CAUTION</div> <p style="text-align: center;">IF SOLDER MELT DOES NOT OCCUR WITHIN TWO SECONDS, STOP THIS PROCEDURE AND ADJUST TIP TEMPERATURE PER THE TIP TEMPERATURE PROCEDURE IN WP 003 00 (PARAGRAPH 03-5.4).</p> <div style="display: flex; justify-content: space-between;"> <div style="width: 45%;"> <p>Form a heat bridge between the soldering iron tip and the original conductor using clean solder.</p> </div> <div style="width: 45%; text-align: right;">  </div> </div>

Conductor Repair, Clinched Staple Procedure

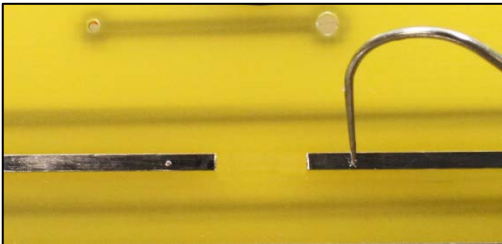
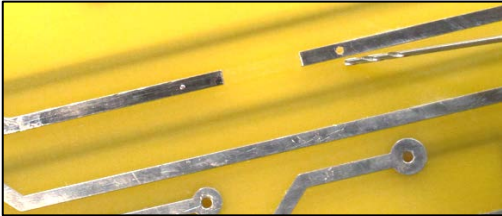
Step	Action
20	Tin the original conductor at the bevel ends.
21	Tin the solid wire or component lead.
22	Remove the solder and the soldering iron tip simultaneously.
23	Season the tip and place the soldering iron into its stand.
24	Allow the wire/lead and conductor to cool completely before cleaning.
25	Clean the wire/lead and conductor with isopropyl alcohol using an acid brush to remove all flux residue and blot dry with a clean, lint-free tissue.
26	Select a drill bit slightly larger than the tinned wire/lead diameter. Note: Determine the size of the drill bit by sizing the wire/lead in a drill gauge and selecting the corresponding size drill bit.
27	Install selected drill bit into a pin vise.
28	Use a #½ ball mill, center punch, or #6 explorer to make a small conical impression in the center of the conductor where the holes will be drilled. 
29	<div style="text-align: center; border: 2px solid black; padding: 5px; margin-bottom: 10px;">CAUTION</div> <p>DRILLING HOLES INTO CONDUCTORS REQUIRES SPECIAL ATTENTION DUE TO THE FLEXIBILITY OF SMALL DRILL BITS AND THE NEED TO PREVENT ADDITIONAL CONDUCTOR DAMAGE.</p> Drill a hole, centered on the conductor, a minimum of two conductor widths from the end of one bevel using the selected drill bit in a pin vise. Note: Drill only until a white dot appears in the laminate on the opposite side. 

Conductor Repair, Clinched Staple Procedure

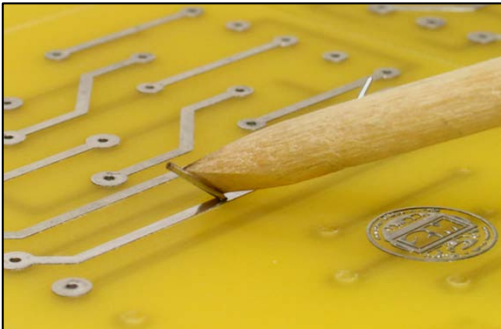
Step	Action
30	Drill a second hole, centered on the conductor, a minimum of two conductor widths from the end of the other bevel.
31	Turn the CCA over and complete the drilling process by drilling directly into each white dot appearing in the laminate.
32	<div style="text-align: center; border: 2px solid black; padding: 5px; margin: 0 auto; width: fit-content;"> CAUTION </div> <p style="text-align: center; margin: 5px 0;">WIRE MUST BE SLEEVED IF IT CROSSES OTHER CONDUCTORS OR LEADS.</p> <p>Slide insulation sleeving over the solid wire/lead, as needed.</p>
33	Center the wire/lead in the repair area ensuring there is enough exposed wire to form clinches at both ends.
34	<p>Grasp the wire/lead at the edge of a mounting hole, wipe the wire/lead around the forming tool to a 90° bend.</p> <p>Note: The inside bend radius shall be greater than or equal to one lead diameter.</p>
35	Insert the formed wire/lead into a hole and repeat step 34 for the opposite end.
36	Insert the ends of the formed staple into the drilled holes from the component side of CCA.
37	<p>Bend each end to a 45° angle in the direction of the conductor, away from the damaged area, using an orangewood stick.</p> 

Conductor Repair, Clinched Staple Procedure

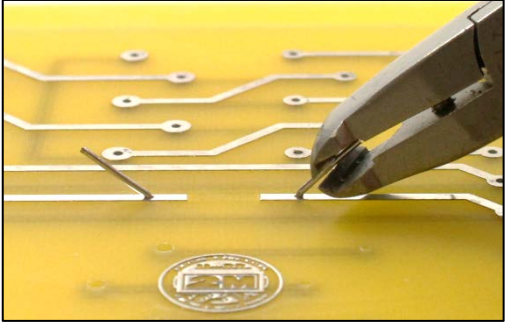
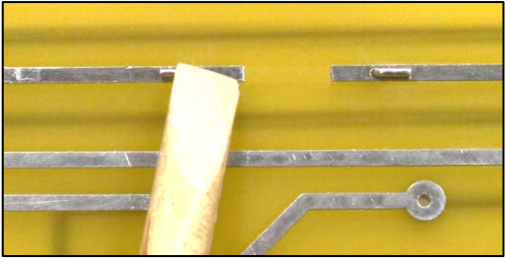
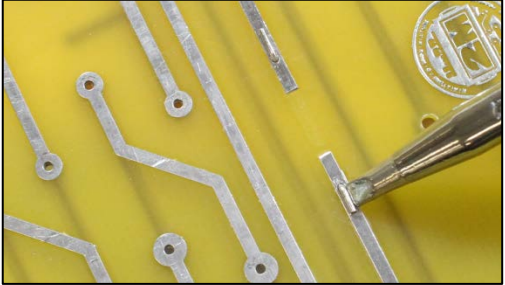
Step	Action
38	<p>Terminate each wire/lead to a length of two conductor widths, perpendicular to the wire axis using flush cut pliers, keeping the flush side of the cutters toward the CCA surface.</p> <p>Note: Avoid potential damage by orienting the flush cutter so the resulting protrusion does not contact the conductor when fully clinched.</p> 
39	<p>Complete each clinch by bending the wire to a 90° angle using an orangewood stick.</p> <p>Note: A slight gap due to springback is considered a target condition when further clinching would cause potential damage to the conductor, to the pad, or to the printed circuitry.</p> 
40	<p>Clean all surfaces to be soldered with isopropyl alcohol using an acid brush to remove all flux residue and blot dry with a clean, lint-free tissue.</p>
41	<p>Apply flux SPARINGLY to each termination.</p>
42	<p>Remove the seasoning from the soldering iron tip.</p>
43	<p>Thermally shock the soldering iron tip on a damp sponge.</p>
44	<div style="text-align: center; border: 2px solid black; padding: 5px; margin-bottom: 10px;"> CAUTION </div> <p>DO NOT APPLY PRESSURE WITH THE SOLDERING IRON.</p> <p>Place the soldering iron tip on the termination at the point of maximum thermal mass.</p> 

Conductor Repair, Clinched Staple Procedure

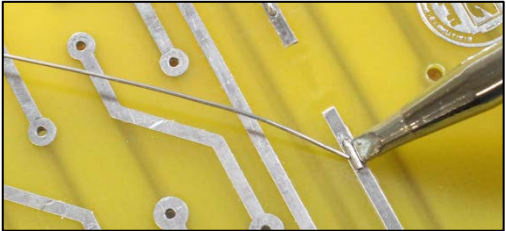
Step	Action
45	<div style="text-align: center; border: 2px solid black; padding: 5px; margin-bottom: 10px;">CAUTION</div> <p style="text-align: center;">IF SOLDER MELT DOES NOT OCCUR WITHIN TWO SECONDS, STOP THIS PROCEDURE AND ADJUST TIP TEMPERATURE PER THE TIP TEMPERATURE PROCEDURE IN WP 003 00 (PARAGRAPH 03-5.4).</p> <p style="text-align: center;">NOTE</p> <p style="text-align: center;">DO NOT MELT SOLDER ONTO THE SOLDERING IRON TIP AND TRANSFER IT TO THE SOLDER JOINT.</p> <p>Form a heat bridge between the soldering iron tip, the conductor, and the clinched staple using clean solder.</p> 
46	Touch the solder to the cut end of the wire to tin the exposed copper.
47	Form the fillets by painting solder along the sides of the lead.
48	Remove the solder and the soldering iron tip simultaneously.
49	Repeat steps 44 through 48 for the opposite termination.
50	Season the tip and place the soldering iron into its stand.
51	Allow the terminations to cool completely before cleaning.
52	Clean the terminations with isopropyl alcohol using an acid brush to remove all flux residue and blot dry with a clean, lint-free tissue.
53	<p><i>Inspect per the General Inspection Procedure in WP 003 00 (paragraph 03-5.12) to:</i></p> <ul style="list-style-type: none"> • <i>General Solder Acceptability in WP 005 00 (paragraph 05-6.1)</i> • <i>Post-Solder Joint Cleanliness in WP 005 00 (paragraph 05-6.2)</i> • <i>Conductors, Pads, and Lands (paragraph 12-6.1)</i> • <i>Lap Solder Repair (paragraph 12-6.4)</i>















Conductor Repair, Clinched Staple Procedure

Step	Action
54	Replace the components removed to facilitate this repair (WP 007 00 for Through Hole Components or WP 018 00 for Surface Mount Devices).
55	<p><i>Inspect per the General Inspection Procedure in WP 003 00 (paragraph 03-5.12) to all applicable WORKMANSHIP STANDARDS, including:</i></p> <ul style="list-style-type: none"> • <i>Laminate in WP 011 00 (paragraph 11-6.1)</i> • <i>Through Hole Components in WP 007 00 (paragraph 07-6), as applicable</i> • <i>Surface Mount Devices in WP 018 00 (paragraph 18-6), as applicable</i> • <i>Other applicable Workmanship Standards, as required</i>
56	Replace the conformal coating per the Conformal Coating Replacement Procedure in WP 006 00 (paragraph 06-5.5), as needed.
57	<i>Inspect to the Conformal Coating Replacement WORKMANSHIP STANDARD in WP 006 00 (paragraph 06-6.2), as required.</i>
58	Dispose of all HAZMAT following local procedures.

12-5.6 Conductor Repair, Solder Bridge Procedure

Use this procedure to repair surface nicks or scratches on all CCAs provided the damage does not exceed 20% of the cross-sectional area of the conductor.

Personnel Hazards

					
Alcohol, Isopropyl					1
					
Flux (Soldering)					8
					
Lead (Solder)					9

Conductor Repair, Solder Bridge Procedure

Step	Action									
	<p style="text-align: center;">WARNING</p> <p style="text-align: center;"><i>USE APPROVED SAFETY EYEWEAR WHEN PERFORMING THIS PROCEDURE. COMPLY WITH ALL LOCAL REQUIREMENTS FOR PPE.</i></p> <p style="text-align: center;">CAUTION</p> <p style="text-align: center;">DON A PROPERLY GROUNDED ESD WRIST STRAP BEFORE STARTING THIS PROCEDURE.</p>									
1	Perform the Procedural Analysis and Feasibility of Repair Procedure in WP 003 00 (paragraph 03-5.1).									
2	<p style="text-align: center;">CAUTION</p> <p style="text-align: center;">BEGIN THE REPAIR PROCESS AS SOON AS POSSIBLE AFTER REMOVAL FROM THE OVEN TO AVOID MOISTURE RE-ABSORPTION.</p> <table border="1" data-bbox="381 1115 1409 1325"> <tr> <td data-bbox="381 1115 911 1325" rowspan="4">Bake the CCA, if feasible, in accordance with the table to the right before soldering, desoldering, and conformal coating removal procedures to prevent delamination, measling, or other laminate degradation.</td> <td data-bbox="911 1115 1162 1167" style="text-align: center;">Baking Temp.</td> <td data-bbox="1162 1115 1409 1167" style="text-align: center;">Baking Time</td> </tr> <tr> <td data-bbox="911 1167 1162 1220" style="text-align: center;">248°F (120°C)</td> <td data-bbox="1162 1167 1409 1220" style="text-align: center;">3.5 to 7 hours</td> </tr> <tr> <td data-bbox="911 1220 1162 1272" style="text-align: center;">212°F (100°C)</td> <td data-bbox="1162 1220 1409 1272" style="text-align: center;">8 to 16 hours</td> </tr> <tr> <td data-bbox="911 1272 1162 1325" style="text-align: center;">176°F (80°C)</td> <td data-bbox="1162 1272 1409 1325" style="text-align: center;">18 to 48 hours</td> </tr> </table>	Bake the CCA, if feasible, in accordance with the table to the right before soldering, desoldering, and conformal coating removal procedures to prevent delamination, measling, or other laminate degradation.	Baking Temp.	Baking Time	248°F (120°C)	3.5 to 7 hours	212°F (100°C)	8 to 16 hours	176°F (80°C)	18 to 48 hours
Bake the CCA, if feasible, in accordance with the table to the right before soldering, desoldering, and conformal coating removal procedures to prevent delamination, measling, or other laminate degradation.	Baking Temp.		Baking Time							
	248°F (120°C)		3.5 to 7 hours							
	212°F (100°C)		8 to 16 hours							
	176°F (80°C)	18 to 48 hours								
3	Remove any conformal coating from the repair area using one of the Conformal Coating Removal Methods in WP 006 00 (paragraph 06-5.4).									
4	Remove the components necessary to provide access to the repair area (WP 007 00 for Through Hole Components or WP 018 00 for Surface Mount Devices).									
5	Select a soldering iron tip that maximizes heat transfer and contact area with the scratched conductor.									
6	Set the soldering iron tip temperature to 600°F (316°C).									
7	<p>Clean the scratched conductor with isopropyl alcohol using an acid brush and blot dry with a clean, lint-free tissue.</p> <p>Note: Take precautions to prevent bare skin contact on the conductor.</p>									

Conductor Repair, Solder Bridge Procedure

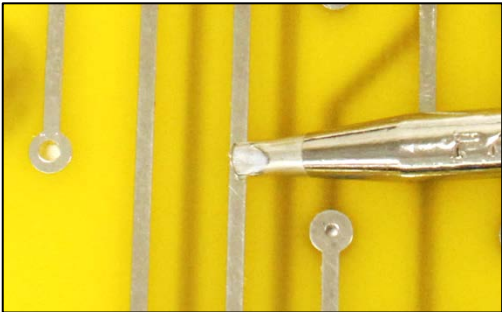
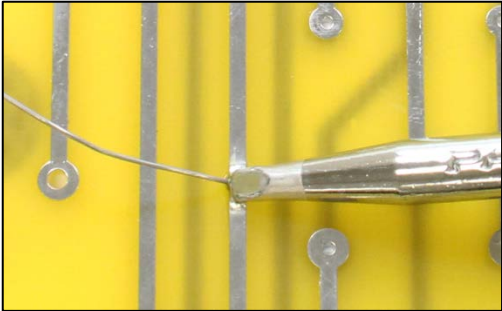
Step	Action
8	Clean the solder with isopropyl alcohol and wipe dry with a clean, lint-free tissue.
9	Apply flux SPARINGLY to the surface nick or scratch. Note: Use a toothpick or <i>flux pen</i> to control the volume of flux applied. Heavy flux volume impairs cleaning and may affect reliability.
10	Remove the seasoning (all solder) from the soldering iron tip.
11	Thermally shock the soldering iron tip on a damp sponge.
12	<p style="text-align: center;">CAUTION</p> <p style="text-align: center;">DO NOT APPLY PRESSURE WITH THE SOLDERING IRON.</p> <p>Place the soldering iron tip on the scratch.</p> 
13	<p style="text-align: center;">CAUTION</p> <p style="text-align: center;">IF SOLDER MELT DOES NOT OCCUR WITHIN TWO SECONDS, STOP THIS PROCEDURE AND ADJUST TIP TEMPERATURE PER THE TIP TEMPERATURE PROCEDURE IN WP 003 00 (PARAGRAPH 03-5.4).</p> <p>Form a heat bridge between the soldering iron tip and the scratched conductor using clean solder.</p> 

Conductor Repair, Solder Bridge Procedure

Step	Action
14	Flow solder until the scratch is filled.
15	Remove the solder and the soldering iron tip simultaneously.
16	Season the tip and place the soldering iron into its stand.
17	Allow the soldered area to cool completely before cleaning.
18	Clean the soldered area with isopropyl alcohol using an acid brush to remove all flux residue and blot dry with a clean, lint-free tissue.
19	Replace the components removed to facilitate this repair (WP 007 00 for Through Hole Components or WP 018 00 for Surface Mount Devices).
20	<p><i>Inspect per the General Inspection Procedure in WP 003 00 (paragraph 03-5.12) to all applicable WORKMANSHIP STANDARDS, including:</i></p> <ul style="list-style-type: none"> • <i>General Solder Acceptability in WP 005 00 (paragraph 05-6.1)</i> • <i>Post-Solder Joint Cleanliness in WP 005 00 (paragraph 05-6.2)</i> • <i>Laminate in WP 011 00 (paragraph 11-6.1)</i> • <i>Through Hole Components in WP 007 00 (paragraph 07-6), as applicable</i> • <i>Surface Mount Devices in WP 018 00 (paragraph 18-6), as applicable</i> • <i>Other applicable Workmanship Standards, as required</i>
21	Replace the conformal coating per the Conformal Coating Replacement Procedure in WP 006 00 (paragraph 06-5.5), as needed.
22	<i>Inspect to the Conformal Coating Replacement WORKMANSHIP STANDARD in WP 006 00 (paragraph 06-6.2), as required.</i>
23	Dispose of all HAZMAT following local procedures.

12-5.7 Isolated Pad/Land Repair Procedure

Use this procedure to repair isolated lands on surface mount CCAs, isolated pads on single-sided CCAs, and double-sided CCAs without hole support.

Use the Plated-Through Hole Repair Procedure (paragraph 12-5.1) for double-sided CCAs with plated-through holes.

Repair of plated-through holes on multilayer CCAs is beyond the scope of this manual.

Personnel Hazards

					
Alcohol, Isopropyl					1
					
Epoxy, 0151					4
					
Flux (Soldering)					8
					
Lead (Solder)					9



Isolated Pad/Land Repair Procedure

Step	Action
	<div style="text-align: center;"> <div style="border: 1px solid black; padding: 5px; margin-bottom: 10px;">WARNING</div> <p>USE APPROVED SAFETY EYEWEAR WHEN PERFORMING THIS PROCEDURE.</p> <p>COMPLY WITH ALL LOCAL REQUIREMENTS FOR PPE.</p> <div style="border: 1px solid black; padding: 5px; margin-bottom: 10px;">CAUTION</div> <p>DON A PROPERLY GROUNDED ESD WRIST STRAP BEFORE STARTING THIS PROCEDURE.</p> </div>
1	Perform the Procedural Analysis and Feasibility of Repair Procedure in WP 003 00 (paragraph 03-5.1).

Isolated Pad/Land Repair Procedure

Step	Action								
2	<div style="text-align: center; border: 2px solid black; padding: 5px; margin-bottom: 10px;">CAUTION</div> <p style="text-align: center;">BEGIN THE REPAIR PROCESS AS SOON AS POSSIBLE AFTER REMOVAL FROM THE OVEN TO AVOID MOISTURE RE-ABSORPTION.</p> <table border="1" style="width: 100%; border-collapse: collapse;"> <thead> <tr> <th style="width: 60%; text-align: left;">Baking Temp.</th> <th style="width: 40%; text-align: left;">Baking Time</th> </tr> </thead> <tbody> <tr> <td>248°F (120°C)</td> <td>3.5 to 7 hours</td> </tr> <tr> <td>212°F (100°C)</td> <td>8 to 16 hours</td> </tr> <tr> <td>176°F (80°C)</td> <td>18 to 48 hours</td> </tr> </tbody> </table> <p>Bake the CCA, if feasible, in accordance with the table to the right before soldering, desoldering, and conformal coating removal procedures to prevent delamination, measling, or other laminate degradation.</p>	Baking Temp.	Baking Time	248°F (120°C)	3.5 to 7 hours	212°F (100°C)	8 to 16 hours	176°F (80°C)	18 to 48 hours
Baking Temp.	Baking Time								
248°F (120°C)	3.5 to 7 hours								
212°F (100°C)	8 to 16 hours								
176°F (80°C)	18 to 48 hours								
3	Remove any conformal coating from the repair area using one of the Conformal Coating Removal Methods in WP 006 00 (paragraph 06-5.4).								
4	Remove the components necessary to provide access to the repair area (WP 007 00 for Through Hole Components or WP 018 00 for Surface Mount Devices).								
5	<p>Obtain a replacement conductor from a scrap CCA using the Pad, Land, and/or Conductor Salvage Procedure (paragraph 12-5.12), from a track repair kit, or by manufacturing a replacement from copper foil using the Conductor Fabrication Procedure (paragraph 12-5.13).</p> 								
6	Select a soldering iron tip that maximizes heat transfer and contact area with the replacement land.								
7	Set the soldering iron tip temperature to 600°F (316°C).								
8	<p>Clean the replacement land or isolated pad with isopropyl alcohol using an acid brush and blot dry with a clean, lint-free tissue.</p> <p>Note: Take precautions to prevent bare skin contact on the replacement land before soldering. Skin contact leaves contaminants on the surfaces to be soldered.</p>								
9	Clean the solder with isopropyl alcohol and wipe dry with a clean, lint-free tissue.								

Isolated Pad/Land Repair Procedure

Step	Action
10	Apply flux SPARINGLY to the replacement land or isolated pad. Note: Use a toothpick or flux pen to control the volume of flux applied. Heavy flux volume impairs cleaning and may affect reliability.
11	Remove the seasoning (all solder) from the soldering iron tip.
12	Thermally shock the soldering iron tip on a damp sponge.
13	<div style="text-align: center; border: 1px solid black; padding: 5px; margin-bottom: 10px;">CAUTION</div> <p style="text-align: center;">DO NOT APPLY PRESSURE WITH THE SOLDERING IRON.</p> <div style="display: flex; justify-content: space-between;"> <div style="width: 60%;">Place the soldering iron tip on the replacement land or isolated pad.</div> <div style="width: 35%; text-align: right;">  </div> </div>
14	<div style="text-align: center; border: 1px solid black; padding: 5px; margin-bottom: 10px;">CAUTION</div> <p style="text-align: center;">IF SOLDER MELT DOES NOT OCCUR WITHIN TWO SECONDS, STOP THIS PROCEDURE AND ADJUST TIP TEMPERATURE PER THE TIP TEMPERATURE PROCEDURE IN WP 003 00 (PARAGRAPH 03-5.4).</p> <div style="display: flex; justify-content: space-between;"> <div style="width: 60%;">Form a heat bridge between the soldering iron tip and the replacement land or isolated pad using clean solder.</div> <div style="width: 35%; text-align: right;">  </div> </div>
15	Tin only the top side of the replacement land or isolated pad.
16	Remove the solder and the soldering iron tip simultaneously.
17	Season the tip and place the soldering iron into its stand.
18	Allow the replacement land or isolated pad to cool completely before continuing.

Isolated Pad/Land Repair Procedure

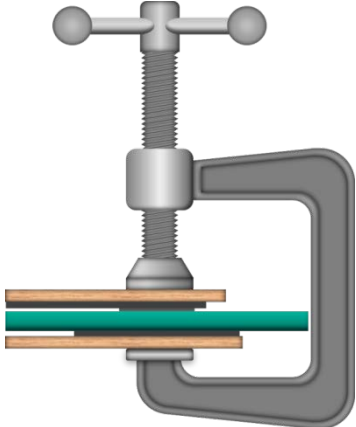
Step	Action
19	Roughen the underside of the replacement land or isolated pad and the laminate surface to aid in adhesion.
20	<div style="text-align: center; border: 2px solid black; padding: 5px; margin-bottom: 10px;">CAUTION</div> <p>TO PREVENT CONTAMINATION OF THE EPOXY, DO NOT CLEAN THE REPLACEMENT LAND WITH ISOPROPYL ALCOHOL.</p> <p>Wipe the replacement land or isolated pad <i>with</i> a clean, lint-free tissue.</p>
21	<p><i>Inspect per the General Inspection Procedure in WP 003 00 (paragraph 03-5.12) to:</i></p> <ul style="list-style-type: none"> • <i>General Solder Acceptability in WP 005 00 (paragraph 05-6.1)</i> • <i>Post-Solder Joint Cleanliness in WP 005 00 (paragraph 05-6.2)</i> • <i>Conductors, Pads, and Lands (paragraph 12-6.1)</i>
22	Prepare the epoxy according to the manufacturer’s directions.
23	Apply epoxy SPARINGLY to the underside of the replacement land or isolated pad.
24	Position the replacement land flat on the laminate surface.
25	Remove any excess epoxy with a dry tissue.
26	Place polyethylene release material (e.g., coffee can lid) over the repair area on both sides of the CCA.
27	<p>Clamp release material in place.</p> <div style="text-align: right; margin-top: 20px;">  </div>

Isolated Pad/Land Repair Procedure

Step	Action
28	Cure the epoxy according to the manufacturer's directions.
29	Remove the clamp and the release material.
30	Clean the repair area with isopropyl alcohol using an acid brush and blot dry with a clean, lint-free tissue.
31	Replace the components removed to facilitate this repair (WP 007 00 for Through Hole Components or WP 018 00 for Surface Mount Devices).
32	<p><i>Inspect per the General Inspection Procedure in WP 003 00 (paragraph 03-5.12) to all applicable WORKMANSHIP STANDARDS, including:</i></p> <ul style="list-style-type: none"> • <i>Laminate in WP 011 00 (paragraph 11-6.1)</i> • <i>Conductors, Pads, and Lands (paragraph 12-6.1)</i> • <i>Through Hole Components in WP 007 00 (paragraph 07-6), as applicable</i> • <i>Surface Mount Devices in WP 018 00 (paragraph 18-6), as applicable</i> • <i>Other applicable Workmanship Standards, as required</i>
33	Replace the conformal coating per the Conformal Coating Replacement Procedure in WP 006 00 (paragraph 06-5.5), as needed.
34	<i>Inspect to the Conformal Coating Replacement WORKMANSHIP STANDARD in WP 006 00 (paragraph 06-6.2), as required.</i>
35	Dispose of all HAZMAT following local procedures.

12-5.8 Land and Conductor Repair Procedure

Use this procedure to repair lands connected to conductors on surface mount CCAs.

Personnel Hazards

					
Alcohol, Isopropyl					1
					
Epoxy, 0151					4
					
Flux (Soldering)					8
					
Lead (Solder)					9



Land and Conductor Repair Procedure

Step	Action
	<div style="border: 1px solid black; padding: 5px; margin: 0 auto; width: 150px;">WARNING</div> <p style="text-align: center;">USE APPROVED SAFETY EYEWEAR WHEN PERFORMING THIS PROCEDURE.</p> <p style="text-align: center;">COMPLY WITH ALL LOCAL REQUIREMENTS FOR PPE.</p> <div style="border: 1px solid black; padding: 5px; margin: 0 auto; width: 150px;">CAUTION</div> <p style="text-align: center;">DON A PROPERLY GROUNDED ESD WRIST STRAP BEFORE STARTING THIS PROCEDURE.</p>

Land and Conductor Repair Procedure

Step	Action								
	<p style="text-align: center;">NOTE</p> <p style="text-align: center;">THE LAP SOLDER JOINT SHALL BE A MINIMUM OF TWO LAND LENGTHS FROM ANY SOLDERABLE AREA (I.E., LAND, COMPONENT LEAD, OR WIRE) TO PREVENT LAP JOINTS FROM DESOLDERING WHEN SOLDERING A COMPONENT ONTO THE CCA. IF THESE CRITERIA CANNOT BE MET, BOTH LANDS AND THE CONNECTING CONDUCTOR MUST BE REPLACED.</p>								
1	<p>Perform the Procedural Analysis and Feasibility of Repair Procedure in WP 003 00 (paragraph 03-5.1).</p>								
2	<p style="text-align: center;">CAUTION</p> <p style="text-align: center;">BEGIN THE REPAIR PROCESS AS SOON AS POSSIBLE AFTER REMOVAL FROM THE OVEN TO AVOID MOISTURE RE-ABSORPTION.</p> <p>Bake the CCA, if feasible, in accordance with the table to the right before soldering, desoldering, and conformal coating removal procedures to prevent delamination, measling, or other laminate degradation.</p> <table border="1" data-bbox="928 991 1425 1201"> <thead> <tr> <th data-bbox="928 991 1179 1045">Baking Temp.</th> <th data-bbox="1179 991 1425 1045">Baking Time</th> </tr> </thead> <tbody> <tr> <td data-bbox="928 1045 1179 1100">248°F (120°C)</td> <td data-bbox="1179 1045 1425 1100">3.5 to 7 hours</td> </tr> <tr> <td data-bbox="928 1100 1179 1155">212°F (100°C)</td> <td data-bbox="1179 1100 1425 1155">8 to 16 hours</td> </tr> <tr> <td data-bbox="928 1155 1179 1201">176°F (80°C)</td> <td data-bbox="1179 1155 1425 1201">18 to 48 hours</td> </tr> </tbody> </table>	Baking Temp.	Baking Time	248°F (120°C)	3.5 to 7 hours	212°F (100°C)	8 to 16 hours	176°F (80°C)	18 to 48 hours
Baking Temp.	Baking Time								
248°F (120°C)	3.5 to 7 hours								
212°F (100°C)	8 to 16 hours								
176°F (80°C)	18 to 48 hours								
3	<p>Remove any conformal coating from the repair area using one of the Conformal Coating Removal Methods in WP 006 00 (paragraph 06-5.4).</p>								
4	<p>Remove the components necessary to provide access to the repair area (WP 018 00 for Surface Mount Devices).</p>								
5	<p>Obtain a replacement conductor from a scrap CCA using the Pad, Land, and/or Conductor Salvage Procedure (paragraph 12-5.12), from a track repair kit, or by manufacturing a replacement from copper foil using the Conductor Fabrication Procedure (paragraph 12-5.13).</p> <ul style="list-style-type: none"> • The replacement conductor shall be the same or slightly larger in width and thickness as the original conductor. • The replacement conductor must be long enough to overlap the original conductor a minimum of two conductor widths on each side of the crack. 								

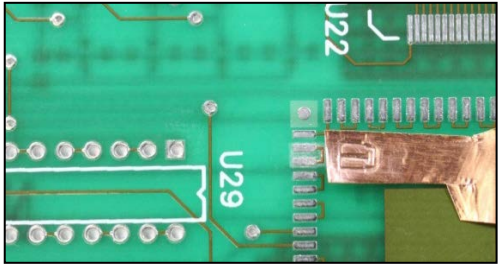
Land and Conductor Repair Procedure

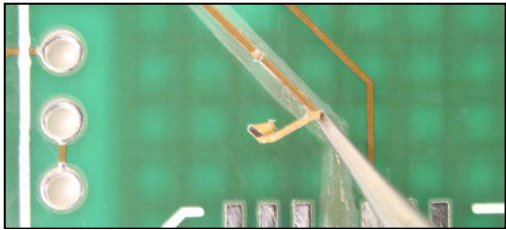
Step	Action
6	<p>Map the shape of the damaged conductor by tracing onto the copper foil using an orangewood stick or spudger if the conductor is to be manufactured.</p> 
7	<div style="text-align: center;"> <p>WARNING</p> <p>DO NOT APPLY LATERAL PRESSURE TO THE SCALPEL. THE BLADE IS EXTREMELY FRAGILE AND CAN CAUSE SERIOUS INJURY IF BROKEN.</p> <p>CAUTION</p> <p>TO PREVENT CRAZING, DO NOT APPLY EXCESSIVE PRESSURE WITH SCALPEL OR CHISEL WHEN CUTTING THE CONDUCTOR.</p> </div> <p>Cut the conductor perpendicular to the conductor axis with a 45° bevel using a scalpel or chisel ensuring the lap solder joint will be a minimum of two land <u>lengths</u> from either land. The length of solderable overlap shall be a minimum of two land <u>widths</u>.</p> 
8	<p>Remove the damaged portion by cold-peeling the land/conductor from the laminate surface.</p> 
9	<p>Repair the laminate using the appropriate repair procedure in WP 011 00 (paragraph 11-4), as needed.</p>
10	<p>Position the replacement land/conductor over the land area and the original conductor.</p>
11	<p>Form the replacement land/conductor to the 45° bevel in the original conductor using a toothpick.</p>

Land and Conductor Repair Procedure

Step	Action
12	<p style="text-align: center;">NOTE</p> <p style="text-align: center;">DO NOT REMOVE THE CUPRIC OXIDE OR OTHER ADHESIVE COATING FROM THE UNDERSIDE OF SALVAGED CONDUCTORS, EXCEPT AT THE AREAS TO BE SOLDERED. THE CUPRIC OXIDE OR ADHESIVE COATING WILL ENHANCE THE SURFACE ADHESION OF THE REPLACEMENT CONDUCTOR.</p> <p>Remove the adhesive from the underside of the replacement land/conductor in the overlap area, if required.</p>
13	<p>Select a soldering iron tip that maximizes heat transfer and contact area with the replacement land/conductor.</p>
14	<p>Set the soldering iron tip temperature to 600°F (316°C).</p>
15	<p>Clean the original conductor where the lap solder joint will be made and the underside of the replacement land/conductor with isopropyl alcohol using an acid brush and blot dry with a clean, lint-free tissue.</p> <p>Note: Take precautions to prevent bare skin contact on the replacement land/conductor before soldering. Skin contact leaves contaminants on the surfaces to be soldered.</p>
16	<p>Clean the solder with isopropyl alcohol and wipe dry with a clean, lint-free tissue.</p>
17	<p>Apply flux SPARINGLY to the beveled end of the original conductor and to the replacement land/conductor.</p> <p>Note: Use a toothpick or flux pen to control the volume of flux applied. Heavy flux volume impairs cleaning and may affect reliability.</p>
18	<p>Remove the seasoning (all solder) from the soldering iron tip.</p>
19	<p>Thermally shock the soldering iron tip on a damp sponge.</p>
20	<p style="text-align: center;">CAUTION</p> <p style="text-align: center;">DO NOT APPLY PRESSURE WITH THE SOLDERING IRON.</p> <p>Place the soldering iron tip on the original conductor.</p>

Land and Conductor Repair Procedure

Step	Action
21	<div style="text-align: center; border: 2px solid black; padding: 5px; margin-bottom: 10px;">CAUTION</div> <p style="text-align: center;">IF SOLDER MELT DOES NOT OCCUR WITHIN TWO SECONDS, STOP THIS PROCEDURE AND ADJUST TIP TEMPERATURE PER THE TIP TEMPERATURE PROCEDURE IN WP 003 00 (PARAGRAPH 03-5.4).</p> <p>Form a heat bridge between the soldering iron tip and the original conductor using clean solder.</p>
22	Tin the original conductor at the bevel and in the overlap area.
23	Tin the underside of replacement land/conductor at the bevel and in the overlap area.
24	Remove the solder and the soldering iron tip simultaneously.
25	Season the tip and place the soldering iron into its stand.
26	Allow the original conductor and the replacement land/conductor to cool completely before continuing.
27	Roughen the underside of the replacement land/conductor and the laminate surface to aid in adhesion.
28	Clean the original conductor and the replacements with isopropyl alcohol using an acid brush to remove all flux residue and blot dry with a clean, lint-free tissue.
29	<p>Apply flux SPARINGLY to the beveled end of the original conductor using a toothpick or flux pen.</p> <p>Note: Do not allow the flux to contact the laminate.</p>
30	Position the replacement land/conductor on the original conductor.
31	Remove the seasoning from the soldering iron tip.
32	Thermally shock the soldering iron tip on a damp sponge.

Land and Conductor Repair Procedure

Step	Action
33	<p style="text-align: center;">CAUTION</p> <p style="text-align: center;">DO NOT APPLY PRESSURE WITH THE SOLDERING IRON.</p> <p>Place the soldering iron tip on the replacement land/conductor at the bevel.</p>
34	<p style="text-align: center;">CAUTION</p> <p style="text-align: center;">IF SOLDER MELT DOES NOT OCCUR WITHIN TWO SECONDS, STOP THIS PROCEDURE AND ADJUST TIP TEMPERATURE PER THE TIP TEMPERATURE PROCEDURE IN WP 003 00 (PARAGRAPH 03-5.4).</p> <p>Draw the solder the length of the lap by moving the soldering iron tip toward and off the cut end.</p> <p>Note: Follow the soldering iron tip with an orangewood stick to hold the conductor.</p>
35	Season the tip and place the soldering iron into its stand.
36	Allow the repaired area to cool completely before continuing.
37	<p style="text-align: center;">CAUTION</p> <p style="text-align: center;">TO PREVENT CONTAMINATION OF THE EPOXY, DO NOT CLEAN THE LAP SOLDER JOINT WITH ISOPROPYL ALCOHOL AT THIS TIME.</p> <p>Wipe the lap solder joint with a dry, clean, lint-free tissue.</p>
38	<p><i>Inspect per the General Inspection Procedure in WP 003 00 (paragraph 03-5.12) to:</i></p> <ul style="list-style-type: none"> • <i>General Solder Acceptability in WP 005 00 (paragraph 05-6.1)</i> • <i>Post-Solder Joint Cleanliness in WP 005 00 (paragraph 05-6.2)</i> • <i>Conductors, Pads, and Lands (paragraph 12-6.1)</i> • <i>Lap Solder Repair (paragraph 12-6.4)</i>
39	Prepare the epoxy according to the manufacturer's directions.
40	Apply epoxy SPARINGLY to the laminate surface OR to the underside of the replacement land/conductor.
41	Position the replacement land/conductor flat on the laminate surface.

Land and Conductor Repair Procedure

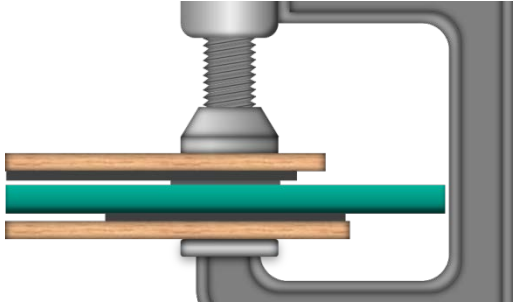
Step	Action
42	Remove any excess epoxy with a dry tissue.
43	Place polyethylene release material (e.g., coffee can lid) over the repair area on both sides of the CCA.
44	Clamp release material in place. 
45	Cure the epoxy according to the manufacturer's directions.
46	Remove the clamp and the release material.
47	Clean the repaired area with isopropyl alcohol using an acid brush and blot dry with a clean, lint-free tissue.
48	Encapsulate the repair area with epoxy using the Repaired Conductor Encapsulation Procedure (paragraph 12-5.14) if the repair area was not originally conformally coated.
49	Replace the components removed to facilitate this repair (WP 018 00 for Surface Mount Devices).
50	<i>Inspect per the General Inspection Procedure in WP 003 00 (paragraph 03-5.12) to all applicable WORKMANSHIP STANDARDS, including:</i> <ul style="list-style-type: none"> • <i>General Solder Acceptability in WP 005 00 (paragraph 05-6.1)</i> • <i>Post-Solder Joint Cleanliness in WP 005 00 (paragraph 05-6.2)</i> • <i>Laminate in WP 011 00 (paragraph 11-6.1)</i> • <i>Conductors, Pads, and Lands (paragraph 12-6.1)</i> • <i>Surface Mount Devices in WP 018 00 (paragraph 18-6), as applicable</i> • <i>Other applicable Workmanship Standards, as required</i>
51	Replace the conformal coating per the Conformal Coating Replacement Procedure in WP 006 00 (paragraph 06-5.5), as needed.

Land and Conductor Repair Procedure









Step	Action
52	Inspect to the Conformal Coating Replacement WORKMANSHIP STANDARD in WP 006 00 (paragraph 06-6.2), as required.
53	Dispose of all HAZMAT following local procedures.

12-5.9 Pad and Conductor Repair Procedure

Use this procedure to repair pads connected to conductors on single- and double-sided CCAs.

Repair of pads connected to conductors on multilayer CCAs is beyond the scope of this manual.



Personnel Hazards

					
Alcohol, Isopropyl					1
					
Epoxy, 0151					4
					
Flux (Soldering)					8
					
Lead (Solder)					9

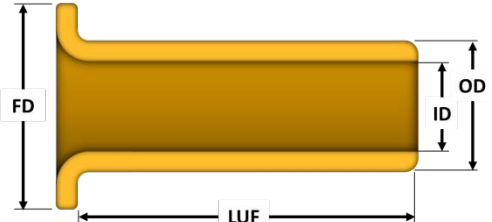

Pad and Conductor Repair Procedure

Step	Action
	<p style="text-align: center;">WARNING</p> <p style="text-align: center;"><i>USE APPROVED SAFETY EYEWEAR WHEN PERFORMING THIS PROCEDURE.</i></p> <p style="text-align: center;"><i>COMPLY WITH ALL LOCAL REQUIREMENTS FOR PPE.</i></p> <p style="text-align: center;">CAUTION</p> <p style="text-align: center;">DON A PROPERLY GROUNDED ESD WRIST STRAP BEFORE STARTING THIS PROCEDURE.</p> <p style="text-align: center;">NOTE</p> <p style="text-align: center;">THE LAP SOLDER JOINT SHALL BE A MINIMUM OF THREE PAD DIAMETERS FROM ANY SOLDERABLE AREA (I.E., PAD, COMPONENT LEAD, OR WIRE) TO PREVENT LAP JOINTS FROM DESOLDERING WHEN SOLDERING A COMPONENT ONTO THE CCA. IF THESE CRITERIA CANNOT BE MET DUE TO CIRCUIT CONFIGURATION, THEN THE LAP AREA MUST HAVE AN EYELET SET.</p>
<p style="text-align: center;">1</p>	<p>Perform the Procedural Analysis and Feasibility of Repair Procedure in WP 003 00 (paragraph 03-5.1).</p> <p>Note: Examine both sides of the CCA to determine if any conductor damage, component damage, or shorting will result from the installation of the eyelet.</p>
<p style="text-align: center;">2</p>	<p>Obtain a detailed drawing of the CCA showing components and conductors before removing any components or conductors from the CCA.</p> <p>Note: Technical manuals or specification drawings usually provide this information.</p>
<p style="text-align: center;">3</p>	<p style="text-align: center;">CAUTION</p> <p style="text-align: center;">TO AVOID ESD AND EMI DAMAGE, DO NOT USE A PHOTOCOPIER OR SCANNER TO MAP CCAS.</p> <p>Make a sketch or take a digital photograph of the assembly showing component locations, conductor locations, and CCA markings if drawings are not available.</p>

Pad and Conductor Repair Procedure

Step	Action								
4	<div style="text-align: center; border: 2px solid black; padding: 5px; margin-bottom: 10px;">CAUTION</div> <p style="text-align: center;">BEGIN THE REPAIR PROCESS AS SOON AS POSSIBLE AFTER REMOVAL FROM THE OVEN TO AVOID MOISTURE RE-ABSORPTION.</p> <table border="1" style="width: 100%; border-collapse: collapse;"> <thead> <tr> <th style="width: 50%; text-align: left;">Baking Temp.</th> <th style="width: 50%; text-align: left;">Baking Time</th> </tr> </thead> <tbody> <tr> <td>248°F (120°C)</td> <td>3.5 to 7 hours</td> </tr> <tr> <td>212°F (100°C)</td> <td>8 to 16 hours</td> </tr> <tr> <td>176°F (80°C)</td> <td>18 to 48 hours</td> </tr> </tbody> </table> <p>Bake the CCA, if feasible, in accordance with the table to the right before soldering, desoldering, and conformal coating removal procedures to prevent delamination, measling, or other laminate degradation.</p>	Baking Temp.	Baking Time	248°F (120°C)	3.5 to 7 hours	212°F (100°C)	8 to 16 hours	176°F (80°C)	18 to 48 hours
Baking Temp.	Baking Time								
248°F (120°C)	3.5 to 7 hours								
212°F (100°C)	8 to 16 hours								
176°F (80°C)	18 to 48 hours								
5	Remove any conformal coating from the repair area using one of the Conformal Coating Removal Methods in WP 006 00 (paragraph 06-5.4).								
6	Remove the components necessary to provide access to the repair area (WP 007 00 for Through Hole Components or WP 018 00 for Surface Mount Devices).								
7	<p>Select an eyelet with:</p> <ul style="list-style-type: none"> • A barrel inside diameter (ID) large enough to accommodate the component lead to be installed in the hole. • An ID matching, as closely as possible, the inside diameter of the plated-through hole to be repaired. • A flange diameter (FD) of the eyelet providing 50 to 80% pad coverage. • A length under the flange (LUF) to provide 50 to 80% pad coverage after the eyelet is set. <div style="text-align: center;">  </div> <p>Note: Only flat-set eyelets (or flattened funnelets) are authorized for 2M repair.</p>								
8	<p>Select the proper diameter drill bit matching the outside diameter (OD) of the selected eyelet to enlarge the existing hole.</p> <div style="text-align: center;">  </div> <p>Note: Determine the size of the drill bit by sizing the selected eyelet in a drill gauge and selecting the corresponding size drill bit or ball mill.</p>								

Pad and Conductor Repair Procedure

Step	Action
<p>9</p>	<div style="text-align: center; border: 1px solid black; padding: 5px; margin-bottom: 10px;">CAUTION</div> <p style="text-align: center;">WHEN ENLARGING THE HOLE, DO NOT DRILL HOLE AT AN ANGLE.</p> <p>Starting on termination side of CCA, use the drill bit in a pin vise to enlarge the existing hole.</p> <p>Note: Drill only half way through the CCA to avoid breakout.</p> 
<p>10</p>	<p>Turn the CCA over and complete the drilling process from the component side.</p>
<p>11</p>	<p>Obtain a replacement conductor from a scrap CCA using the Pad, Land, and/or Conductor Salvage Procedure (paragraph 12-5.12), from a track repair kit, or by manufacturing a replacement from copper foil using the Conductor Fabrication Procedure (paragraph 12-5.13).</p> <ul style="list-style-type: none"> • The replacement conductor shall be the same or slightly larger in width and thickness as the original conductor. • The replacement conductor must be long enough to overlap the original conductor a minimum of two conductor widths on each side of the crack.
<p>12</p>	<div style="text-align: center; border: 1px solid black; padding: 5px; margin-bottom: 10px;">WARNING</div> <p style="text-align: center;">DO NOT APPLY LATERAL PRESSURE TO THE SCALPEL. THE BLADE IS EXTREMELY FRAGILE AND CAN CAUSE SERIOUS INJURY IF BROKEN.</p> <div style="text-align: center; border: 1px solid black; padding: 5px; margin-bottom: 10px;">CAUTION</div> <p style="text-align: center;">TO PREVENT CRAZING, DO NOT APPLY EXCESSIVE PRESSURE WITH SCALPEL OR CHISEL WHEN CUTTING THE CONDUCTOR.</p> <p>Cut the damaged conductor perpendicular to the conductor axis with a 45° bevel using a scalpel or chisel ensuring the lap solder joint will be a minimum of three pad diameters from any solderable area (i.e., pad, component lead, or wire).</p> 
<p>13</p>	<p>Prepare the conductor to be removed by lifting the corners with a scalpel or chisel.</p>

Pad and Conductor Repair Procedure

Step	Action
14	Remove the damaged portion by cold-peeling the pad/conductor from the laminate surface.
15	Repair the laminate using the appropriate repair procedure in WP 011 00 (paragraph 11-4), as needed.
16	Position the replacement pad/conductor over the pad area and the original conductor.
17	Form the replacement pad/conductor to the 45° bevel in the original conductor using an orangewood stick or spudger.
18	<p style="text-align: center;">NOTE</p> <p style="text-align: center;">DO NOT REMOVE THE CUPRIC OXIDE OR OTHER ADHESIVE COATING FROM THE UNDERSIDE OF SALVAGED CONDUCTORS, EXCEPT AT THE AREAS TO BE SOLDERED. THE CUPRIC OXIDE OR ADHESIVE COATING WILL ENHANCE THE SURFACE ADHESION OF THE REPLACEMENT CONDUCTOR.</p> <p>Remove the adhesive from the underside of the replacement pad/conductor in the bevel and overlap areas, if required.</p>
19	Terminate the replacement conductor to ensure an overlap length of at least two conductor widths.
20	Select a soldering iron tip that maximizes heat transfer and contact area with the replacement pad/conductor.
21	Set the soldering iron tip temperature to 600°F (316°C).
22	<p>Clean the original conductor where the lap solder joint will be made and the underside of the replacement pad/conductor with isopropyl alcohol using an acid brush and blot dry with a clean, lint-free tissue.</p> <p>Note: Take precautions to prevent bare skin contact on the replacement pad/conductor before soldering.</p>
23	Clean the solder with isopropyl alcohol and wipe dry with a clean, lint-free tissue.
24	<p>Apply flux SPARINGLY to the beveled end of the original conductor and to the replacement pad/conductor in the overlap area.</p> <p>Note: Use a toothpick or flux pen to control the volume of flux applied. Heavy flux volume impairs cleaning and may affect reliability.</p>

Pad and Conductor Repair Procedure

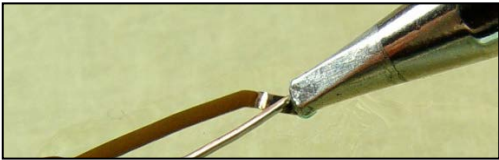
Step	Action
25	Remove the seasoning (all solder) from the soldering iron tip.
26	Thermally shock the soldering iron tip on a damp sponge.
27	<p style="text-align: center;">CAUTION</p> <p style="text-align: center;">DO NOT APPLY PRESSURE WITH THE SOLDERING IRON.</p> <p>Place the soldering iron tip on the original conductor.</p>
28	<p style="text-align: center;">CAUTION</p> <p style="text-align: center;">IF SOLDER MELT DOES NOT OCCUR WITHIN TWO SECONDS, STOP THIS PROCEDURE AND ADJUST TIP TEMPERATURE PER THE TIP TEMPERATURE PROCEDURE IN WP 003 00 (PARAGRAPH 03-5.4).</p> <p>Form a heat bridge between the soldering iron tip and the original conductor using clean solder.</p>
29	Tin the original conductor at the bevel and in the overlap area.
30	<p>Tin the underside of replacement pad/conductor at the bevel and in the overlap area.</p> 
31	Remove the solder and the soldering iron tip simultaneously.
32	Season the tip and place the soldering iron into its stand.
33	Allow the original conductor and the replacement pad/conductor to cool completely before continuing.
34	Roughen the underside of the replacement pad/conductor and the laminate surface to aid in adhesion.
35	Clean the original conductor and the replacement pad/ conductor with isopropyl alcohol using an acid brush to remove all flux residue and blot dry with a clean, lint-free tissue.

Pad and Conductor Repair Procedure

Step	Action
36	Apply flux SPARINGLY to the beveled end of the original conductor using a toothpick or flux pen. Note: Do not allow the flux to contact the laminate between the bevel and the hole.
37	Position the replacement pad/conductor on the original conductor.
38	Remove the seasoning from the soldering iron tip.
39	Thermally shock the soldering iron tip on a damp sponge.
40	<div style="text-align: center; border: 2px solid black; padding: 5px; width: fit-content; margin: 0 auto;">CAUTION</div> <p style="text-align: center;">DO NOT APPLY PRESSURE WITH THE SOLDERING IRON.</p> Place the soldering iron tip on the replacement pad/conductor at the bevel.
41	<div style="text-align: center; border: 2px solid black; padding: 5px; width: fit-content; margin: 0 auto;">CAUTION</div> <p style="text-align: center;">IF SOLDER MELT DOES NOT OCCUR WITHIN TWO SECONDS, STOP THIS PROCEDURE AND ADJUST TIP TEMPERATURE PER THE TIP TEMPERATURE PROCEDURE IN WP 003 00 (PARAGRAPH 03-5.4).</p> Draw the solder the length of the lap by moving the soldering iron tip toward and off the cut end. Note: Follow the soldering iron tip with an orangewood stick to hold the conductor in place.
42	Season the tip and place the soldering iron into its stand.
43	Allow the repaired area to cool completely before continuing.
44	<div style="text-align: center; border: 2px solid black; padding: 5px; width: fit-content; margin: 0 auto;">CAUTION</div> <p style="text-align: center;">TO PREVENT CONTAMINATION OF THE EPOXY, DO NOT CLEAN THE LAP SOLDER JOINT WITH ISOPROPYL ALCOHOL AT THIS TIME.</p> Wipe the lap solder joint with a dry, clean, lint-free tissue.

Pad and Conductor Repair Procedure

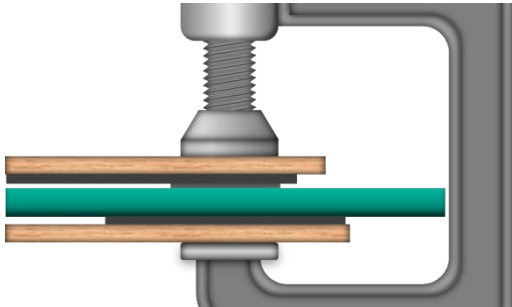
Step	Action
45	<p><i>Inspect per the General Inspection Procedure in WP 003 00 (paragraph 03-5.12) to:</i></p> <ul style="list-style-type: none"> • <i>General Solder Acceptability in WP 005 00 (paragraph 05-6.1)</i> • <i>Post-Solder Joint Cleanliness in WP 005 00 (paragraph 05-6.2)</i> • <i>Conductors, Pads, and Lands (paragraph 12-6.1)</i> • <i>Lap Solder Repair (paragraph 12-6.4)</i>
46	Prepare the epoxy according to the manufacturer's directions.
47	Apply epoxy SPARINGLY to the laminate surface OR to the underside of the replacement pad/conductor.
48	Roll the replacement pad/conductor down onto the CCA.
49	<p>Use a toothpick to align the holes in the pad and in the laminate.</p> <p>Note: Cut both ends of the toothpick flush with the pad/laminate to facilitate clamping.</p>
50	Remove any excess epoxy with a dry tissue or cotton-tipped applicator.
51	Place polyethylene release material (e.g., coffee can lid) over the repair area on both sides of the CCA.
52	<p>Clamp release material in place.</p> 
53	Cure the epoxy according to the manufacturer's directions.
54	Remove the clamp and the release material.
55	Clean the repaired area with isopropyl alcohol using an acid brush and blot dry with a clean, lint-free tissue.

Pad and Conductor Repair Procedure

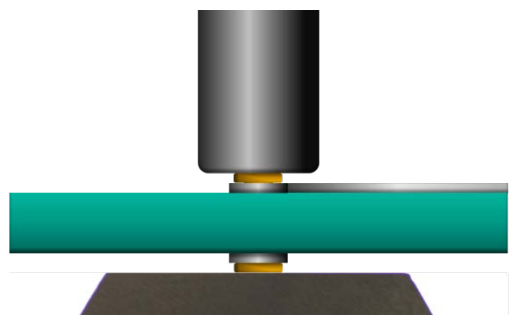
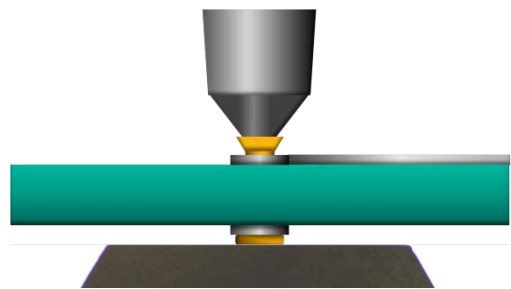
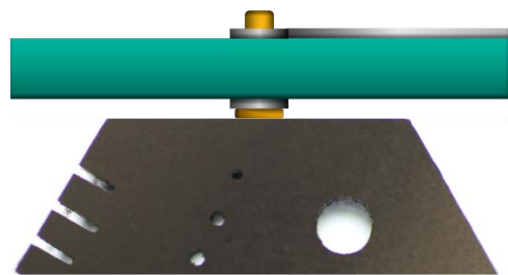
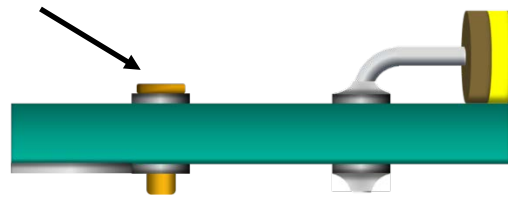

Step	Action
56	<i>Inspect to the Conductors, Pads, and Lands WORKMANSHIP STANDARD (paragraph 12-6.1).</i>
57	<p>Insert the eyelet into the hole with the preformed head on the component side of the CCA.</p> <p>Note: The preformed head shall not be installed to a bare laminate surface.</p>
58	<p>Brace the preformed head of the eyelet against a flat, solid surface such as a jeweler's anvil.</p> <p>Note: In confined places on the CCA, it may be necessary to insert a pin punch into the anvil and use the flat surface of the punch handle as a solid surface.</p>
59	<p>Flare the unformed end of the eyelet to approximately 45°, using a circular motion with a center punch.</p>
60	<div style="text-align: center; border: 1px solid black; padding: 5px; margin-bottom: 10px;">CAUTION</div> <p>WHEN SETTING AN EYELET, EXCESSIVE FORCE WILL DAMAGE BOTH THE EYELET AND THE CCA.</p> <p>Set the flared end of the eyelet flat by gently tapping the flat pin punch with a machinist's hammer.</p> <p>Note: A single tap should be sufficient to set the eyelet properly.</p> <p>Note: To provide proper mechanical support the eyelet shall not rotate in the hole.</p>

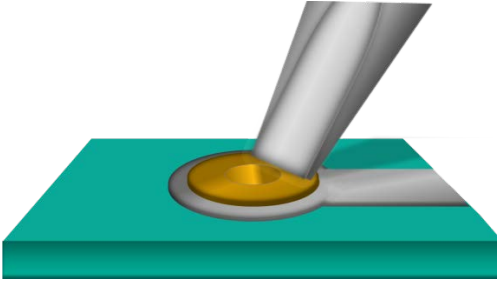
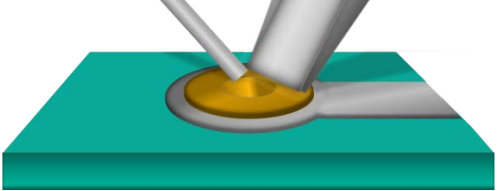

Pad and Conductor Repair Procedure

Step	Action
61	<i>Inspect to the Eyeletting WORKMANSHIP STANDARD (paragraph 12-6.2).</i>
62	Verify the soldering iron tip maximizes heat transfer and contact area with the eyelet and the replacement pad/conductor and change as needed.
63	Clean the set eyelet with isopropyl alcohol using an acid brush and blot dry with a clean, lint-free tissue. Note: Take precautions to prevent bare skin contact on the eyelet before soldering. Skin contact leaves contaminants on the surfaces to be soldered.
64	Apply flux SPARINGLY to the eyelet.
65	Remove the seasoning from the soldering iron tip.
66	Thermally shock the soldering iron tip on a damp sponge.
67	<p style="text-align: center;">CAUTION</p> <p style="text-align: center;">DO NOT APPLY PRESSURE WITH THE SOLDERING IRON.</p> <p>Place the soldering iron tip on the eyelet at the point of maximum thermal mass on the termination side of the CCA.</p> 
68	<p style="text-align: center;">CAUTION</p> <p style="text-align: center;">IF SOLDER MELT DOES NOT OCCUR WITHIN TWO SECONDS, STOP THIS PROCEDURE AND ADJUST TIP TEMPERATURE PER THE TIP TEMPERATURE PROCEDURE IN WP 003 00 (PARAGRAPH 03-5.4).</p> <p>Form a heat bridge between the soldering iron tip and the eyelet using clean solder.</p> 

Pad and Conductor Repair Procedure

Step	Action
69	Apply solder to the pad area filling the eyelet and both pad areas from the termination side. 
70	Remove the solder and the soldering iron tip simultaneously.
71	Season the tip and place the soldering iron into its stand.
72	Allow the eyelet to cool completely before cleaning.
73	Clean the eyelet on both sides of the CCA with isopropyl alcohol using an acid brush to remove all flux residue and blot dry with a clean, lint-free tissue.
74	Select a solder extractor tip with an outside diameter smaller than eyelet.
75	Set the solder extractor tip temperature to 600°F (316°C).
76	Place a clean tissue on a heat resistant surface and test the solder extractor by actuating vacuum to pick up the tissue. Note: If the solder extractor vacuum is insufficient to pick up the tissue, stop this procedure and perform the Solder Extractor Vacuum Test and Heater Element Cleaning Procedure in WP 003 00 (paragraph 03-5.7).
77	Apply flux SPARINGLY to the eyelet on both sides of the CCA.
78	Position the CCA vertically in a circuit cardholder, if feasible.
79	Remove the seasoning from the solder extractor tip.
80	Thermally shock the solder extractor tip on a damp sponge.
81	<div style="text-align: center;"> <div data-bbox="797 1577 1029 1640" style="border: 2px solid black; padding: 5px; display: inline-block;">CAUTION</div> <p data-bbox="565 1661 1263 1692">DO NOT APPLY PRESSURE WITH THE SOLDER EXTRACTOR.</p> </div> Place solder extractor tip on the component side of the eyelet contacting only the solder fillet, not the eyelet. 

Pad and Conductor Repair Procedure

Step	Action
82	<div style="text-align: center; border: 2px solid black; padding: 5px; margin-bottom: 10px;">CAUTION</div> <p style="text-align: center;">IF SOLDER MELT DOES NOT OCCUR WITHIN TWO SECONDS, STOP THIS PROCEDURE AND ADJUST TIP TEMPERATURE PER THE TIP TEMPERATURE PROCEDURE IN WP 003 00 (PARAGRAPH 03-5.4).</p> <p>Observe COMPLETE solder melt; then actuate vacuum using the handpiece vacuum control switch or the foot pedal switch.</p>
83	After complete solder extraction, remove the solder extractor tip from the solder joint allowing the solder extractor vacuum to run continuously for an additional five seconds to draw the molten solder completely into the solder trap.
84	Season the tip and place the solder extractor into its stand.
85	Allow the eyelet to cool completely before cleaning.
86	Clean the eyelet with isopropyl alcohol using an acid brush to remove all flux residue and blot dry with a clean, lint-free tissue.
87	Encapsulate the repair area with epoxy using the Repaired Conductor Encapsulation Procedure (paragraph 12-5.14) if the repair area was not originally conformally coated.
88	Replace the components removed to facilitate this repair (WP 007 00 for Through Hole Components or WP 018 00 for Surface Mount Devices).
89	<p><i>Inspect per the General Inspection Procedure in WP 003 00 (paragraph 03-5.12) to all applicable WORKMANSHIP STANDARDS, including:</i></p> <ul style="list-style-type: none"> • <i>General Solder Acceptability in WP 005 00 (paragraph 05-6.1)</i> • <i>Post-Solder Joint Cleanliness in WP 005 00 (paragraph 05-6.2)</i> • <i>Laminate in WP 011 00 (paragraph 11-6.1)</i> • <i>Conductors, Pads, and Lands (paragraph 12-6.1)</i> • <i>Through Hole Components in WP 007 00 (paragraph 07-6), as applicable</i> • <i>Surface Mount Devices in WP 018 00 (paragraph 18-6), as applicable</i> • <i>Other applicable Workmanship Standards, as required</i>
90	Replace the conformal coating per the Conformal Coating Replacement Procedure in WP 006 00 (paragraph 06-5.5), as needed.

Pad and Conductor Repair Procedure

Step	Action
91	Inspect to the Conformal Coating Replacement WORKMANSHIP STANDARD in WP 006 00 (paragraph 06-6.2), as required.
92	Dispose of all HAZMAT following local procedures.

12-5.10 Middle of Conductor Delamination Repair Procedure

Use this procedure to rebond conductors on all CCAs.

Personnel Hazards



Alcohol, Isopropyl

1



Epoxy, 0151

4

Middle of Conductor Delamination Repair Procedure

Step	Action
	<div style="border: 1px solid black; padding: 5px; width: fit-content; margin: 0 auto;">WARNING</div> <p>USE APPROVED SAFETY EYEWEAR WHEN PERFORMING THIS PROCEDURE.</p> <p>COMPLY WITH ALL LOCAL REQUIREMENTS FOR PPE.</p> <div style="border: 1px solid black; padding: 5px; width: fit-content; margin: 10px auto;">CAUTION</div> <p>DON A PROPERLY GROUNDED ESD WRIST STRAP BEFORE STARTING THIS PROCEDURE.</p>
1	Perform the Procedural Analysis and Feasibility of Repair Procedure in WP 003 00 (paragraph 03-5.1).

Middle of Conductor Delamination Repair Procedure

Step	Action								
2	<p style="text-align: center;">CAUTION</p> <p style="text-align: center;">BEGIN THE REPAIR PROCESS AS SOON AS POSSIBLE AFTER REMOVAL FROM THE OVEN TO AVOID MOISTURE RE-ABSORPTION.</p> <table border="1" data-bbox="915 611 1414 821"> <thead> <tr> <th data-bbox="915 611 1162 663">Baking Temp.</th> <th data-bbox="1162 611 1414 663">Baking Time</th> </tr> </thead> <tbody> <tr> <td data-bbox="915 663 1162 716">248°F (120°C)</td> <td data-bbox="1162 663 1414 716">3.5 to 7 hours</td> </tr> <tr> <td data-bbox="915 716 1162 768">212°F (100°C)</td> <td data-bbox="1162 716 1414 768">8 to 16 hours</td> </tr> <tr> <td data-bbox="915 768 1162 821">176°F (80°C)</td> <td data-bbox="1162 768 1414 821">18 to 48 hours</td> </tr> </tbody> </table> <p>Bake the CCA, if feasible, in accordance with the table to the right before soldering, desoldering, and conformal coating removal procedures to prevent delamination, measling, or other laminate degradation.</p>	Baking Temp.	Baking Time	248°F (120°C)	3.5 to 7 hours	212°F (100°C)	8 to 16 hours	176°F (80°C)	18 to 48 hours
Baking Temp.	Baking Time								
248°F (120°C)	3.5 to 7 hours								
212°F (100°C)	8 to 16 hours								
176°F (80°C)	18 to 48 hours								
3	Remove any conformal coating from the repair area using one of the Conformal Coating Removal Methods in WP 006 00 (paragraph 06-5.4).								
4	Remove the components necessary to provide access to the repair area (WP 007 00 for Through Hole Components or WP 018 00 for Surface Mount Devices).								
5	Roughen the underside of the conductor and the laminate surface to aid in adhesion.								
6	<p style="text-align: center;">CAUTION</p> <p style="text-align: center;">TO PREVENT CONTAMINATION OF THE EPOXY, DO NOT CLEAN THE PAD/CONDUCTOR OR LAMINATE WITH ISOPROPYL ALCOHOL.</p> <p>Wipe the conductor and laminate with a clean, lint-free tissue.</p>								
7	Prepare the epoxy according to the manufacturer's directions.								
8	<p>Apply epoxy SPARINGLY to the laminate surface OR to the underside of the conductor.</p> 								

Middle of Conductor Delamination Repair Procedure

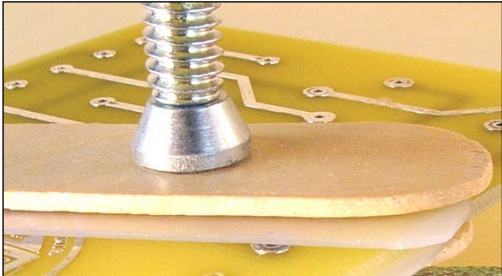
Step	Action
9	Position the conductor flat onto the laminate surface.
10	Place polyethylene release material (e.g., coffee can lid) over the repair area on both sides of the CCA.
11	Clamp release material in place. 
12	Cure the epoxy according to the manufacturer's directions.
13	Remove the clamp and the release material.
14	Clean the repaired area with isopropyl alcohol using an acid brush and blot dry with a clean, lint-free tissue.
15	Encapsulate the repair area with epoxy using the Repaired Conductor Encapsulation Procedure (paragraph 12-5.14) if the repair area was not originally conformally coated.
16	Replace the components removed to facilitate this repair (WP 007 00 for Through Hole Components or WP 018 00 for Surface Mount Devices).
17	<i>Inspect per the General Inspection Procedure in WP 003 00 (paragraph 03-5.12) to all applicable WORKMANSHIP STANDARDS, including:</i> <ul style="list-style-type: none"> • <i>Laminate in WP 011 00 (paragraph 11-6.1)</i> • <i>Conductors, Pads, and Lands (paragraph 12-6.1)</i> • <i>Through Hole Components in WP 007 00 (paragraph 07-6), as applicable</i> • <i>Surface Mount Devices in WP 018 00 (paragraph 18-6), as applicable</i> • <i>Other applicable Workmanship Standards, as required</i>
18	Replace the conformal coating per the Conformal Coating Replacement Procedure in WP 006 00 (paragraph 06-5.5), as needed.

Middle of Conductor Delamination Repair Procedure

Step	Action
19	Inspect to the Conformal Coating Replacement WORKMANSHIP STANDARD in WP 006 00 (paragraph 06-6.2), as required.
20	Dispose of all HAZMAT following local procedures.

12-5.11 Pad and Conductor Delamination Repair Procedure

Use this procedure to repair pads and conductors single- and double-sided CCAs.

Pad/conductor repair on multilayer CCAs is beyond the scope of this manual.

Personnel Hazards

					
Alcohol, Isopropyl					1
					
Epoxy, 0151					4
					
Flux (Soldering)					8
					
Lead (Solder)					9

Pad and Conductor Delamination Repair Procedure

Step	Action
	<div style="border: 2px solid black; padding: 5px; display: inline-block;"> WARNING </div> <p>USE APPROVED SAFETY EYEWEAR WHEN PERFORMING THIS PROCEDURE.</p> <p>COMPLY WITH ALL LOCAL REQUIREMENTS FOR PPE.</p>



Pad and Conductor Delamination Repair Procedure

Step	Action										
	<p style="text-align: center;">CAUTION</p> <p style="text-align: center;">DON A PROPERLY GROUNDED ESD WRIST STRAP BEFORE STARTING THIS PROCEDURE.</p>										
1	<p>Perform the Procedural Analysis and Feasibility of Repair Procedure in WP 003 00 (paragraph 03-5.1).</p>										
2	<p style="text-align: center;">CAUTION</p> <p style="text-align: center;">BEGIN THE REPAIR PROCESS AS SOON AS POSSIBLE AFTER REMOVAL FROM THE OVEN TO AVOID MOISTURE RE-ABSORPTION.</p> <table border="1" data-bbox="396 898 1443 1115"> <tr> <td data-bbox="396 898 922 1115" rowspan="3"> Bake the CCA, if feasible, in accordance with the table to the right before soldering, desoldering, and conformal coating removal procedures to prevent delamination, measling, or other laminate degradation. </td> <td data-bbox="922 898 1177 953" style="text-align: center;">Baking Temp.</td> <td data-bbox="1177 898 1443 953" style="text-align: center;">Baking Time</td> </tr> <tr> <td data-bbox="922 953 1177 1008" style="text-align: center;">248°F (120°C)</td> <td data-bbox="1177 953 1443 1008" style="text-align: center;">3.5 to 7 hours</td> </tr> <tr> <td data-bbox="922 1008 1177 1062" style="text-align: center;">212°F (100°C)</td> <td data-bbox="1177 1008 1443 1062" style="text-align: center;">8 to 16 hours</td> </tr> <tr> <td data-bbox="922 1062 1177 1115" style="text-align: center;">176°F (80°C)</td> <td data-bbox="1177 1062 1443 1115" style="text-align: center;">18 to 48 hours</td> <td></td> </tr> </table>	Bake the CCA, if feasible, in accordance with the table to the right before soldering, desoldering, and conformal coating removal procedures to prevent delamination, measling, or other laminate degradation.	Baking Temp.	Baking Time	248°F (120°C)	3.5 to 7 hours	212°F (100°C)	8 to 16 hours	176°F (80°C)	18 to 48 hours	
Bake the CCA, if feasible, in accordance with the table to the right before soldering, desoldering, and conformal coating removal procedures to prevent delamination, measling, or other laminate degradation.	Baking Temp.		Baking Time								
	248°F (120°C)		3.5 to 7 hours								
	212°F (100°C)	8 to 16 hours									
176°F (80°C)	18 to 48 hours										
3	<p>Remove any conformal coating from the repair area using one of the Conformal Coating Removal Methods in WP 006 00 (paragraph 06-5.4).</p>										
4	<p>Remove the components necessary to provide access to the repair area (WP 007 00 for Through Hole Components).</p>										
5	<p>Roughen the underside of the pad/conductor and the laminate surface to aid adhesion.</p>										
6	<p style="text-align: center;">CAUTION</p> <p style="text-align: center;">TO PREVENT CONTAMINATION OF THE EPOXY, DO NOT CLEAN THE PAD/CONDUCTOR OR LAMINATE WITH ISOPROPYL ALCOHOL.</p> <p>Wipe the pad/conductor and laminate with a clean, lint-free tissue.</p>										
7	<p>Prepare the epoxy according to the manufacturer's directions.</p>										

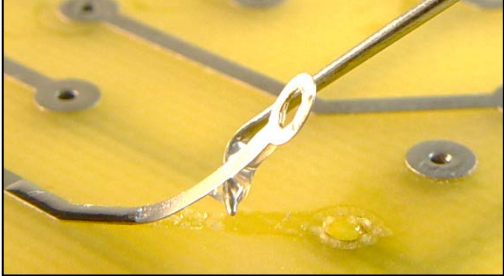
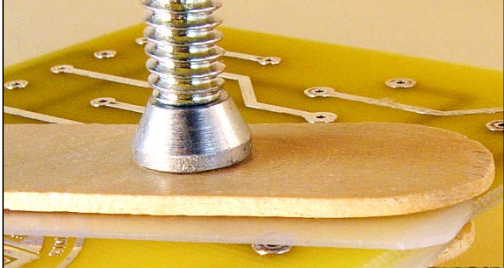
Pad and Conductor Delamination Repair Procedure

Step	Action
8	Apply epoxy SPARINGLY to the laminate surface OR to the underside of the conductor. 
9	Roll the pad/conductor flat onto the laminate surface.
10	Use a toothpick to align the holes in the pad and in the laminate. Note: Cut both ends of the toothpick flush with the pad/laminate to facilitate clamping.
11	Place polyethylene release material (e.g., coffee can lid) over the repair area on both sides of the CCA.
12	Clamp release material in place. 
13	Cure the epoxy according to the manufacturer's directions.
14	Remove the clamp and the release material.
15	Clean the repaired area with isopropyl alcohol using an acid brush and blot dry with a clean, lint-free tissue.
16	<i>Inspect to the Conductors, Pads, and Lands WORKMANSHIP STANDARD (paragraph 12-6.1).</i>

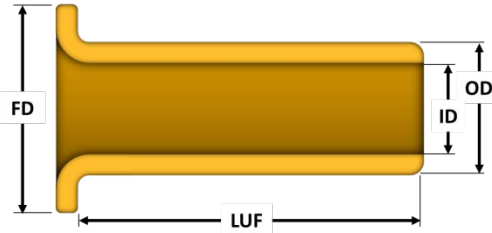
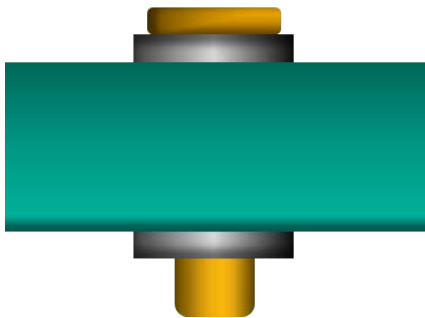
Pad and Conductor Delamination Repair Procedure

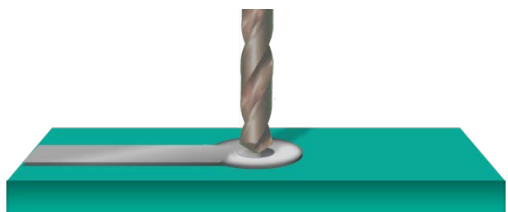
Step	Action
17	<p>Select an eyelet with:</p> <ul style="list-style-type: none"> • A barrel inside diameter (ID) large enough to accommodate the component lead to be installed in the hole. • An ID matching, as closely as possible, the inside diameter of the plated-through hole to be repaired. • A flange diameter (FD) of the eyelet providing 50 to 80% pad coverage. • A length under the flange (LUF) to provide 50 to 80% pad coverage after the eyelet is set. <p>Note: Only flat-set eyelets are authorized for 2M repair. Flattened funnelets are also acceptable.</p>  
18	<p>Select the proper diameter drill bit matching the outside diameter (OD) of the selected eyelet to enlarge the existing hole.</p> <p>Note: Determine the size of the drill bit by sizing the selected eyelet in a drill gauge and selecting the corresponding size drill bit or ball mill.</p> 
19	<div style="text-align: center; border: 1px solid black; padding: 5px; margin-bottom: 10px;">CAUTION</div> <p style="text-align: center;">WHEN ENLARGING THE HOLE, DO NOT DRILL HOLE AT AN ANGLE.</p> <p>Starting on termination side of CCA, use the drill bit in a pin vise to enlarge the existing hole.</p> <p>Note: Drill only half way through the CCA to avoid breakout.</p> 
20	<p>Turn the CCA over and complete the drilling process from the component side.</p>

Pad and Conductor Delamination Repair Procedure

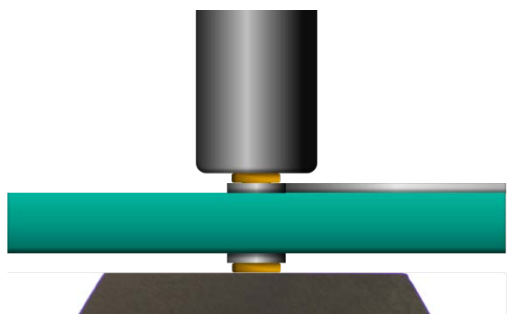
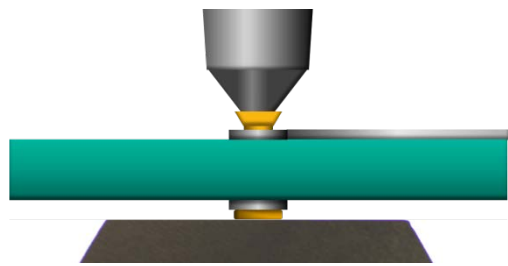
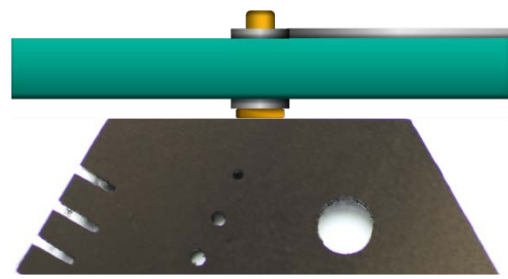
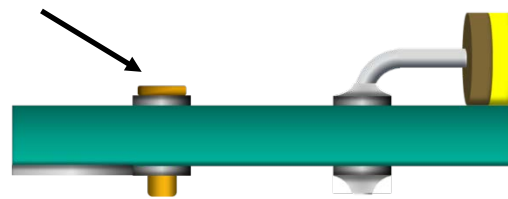

Step	Action
21	Clean the eyelet with isopropyl alcohol using an acid brush and blot dry with a clean, lint-free tissue.
22	Insert the eyelet into the hole with the preformed head on the component side of the CCA. Note: The preformed head shall not be installed to a bare laminate surface.
23	Brace the preformed head of the eyelet against a flat, solid surface such as a jeweler's anvil. Note: In confined places on the CCA, it may be necessary to insert a pin punch into the anvil and use the flat surface of the punch handle as a solid surface.
24	Flare the unformed end of the eyelet to approximately 45°, using a circular motion with a center punch.
25	<div style="text-align: center; border: 1px solid black; padding: 5px; margin-bottom: 10px;">CAUTION</div> <p>WHEN SETTING AN EYELET, EXCESSIVE FORCE WILL DAMAGE BOTH THE EYELET AND THE CCA.</p> Set the flared end of the eyelet flat by gently tapping the flat pin punch with a machinist's hammer. Note: A single tap should be sufficient to set the eyelet properly. Note: To provide proper mechanical support the eyelet shall not rotate in the hole.

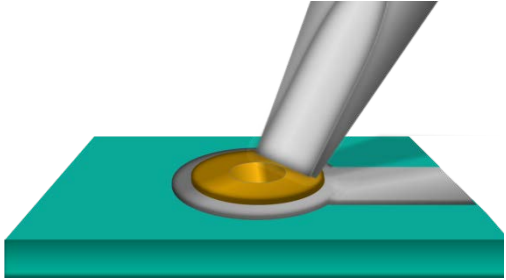

Pad and Conductor Delamination Repair Procedure

Step	Action
26	<i>Inspect to the Eyeletting WORKMANSHIP STANDARD (paragraph 12-6.2).</i>
27	Select a soldering iron tip that maximizes heat transfer and contact area with the eyelet.
28	Set the soldering iron tip temperature to 600°F (316°C).
29	Clean the set eyelet with isopropyl alcohol using an acid brush and blot dry with a clean, lint-free tissue. Note: Take precautions to prevent bare skin contact on the eyelet before soldering. Skin contact leaves contaminants on the surfaces to be soldered.
30	Clean the solder with isopropyl alcohol and wipe dry with a clean, lint-free tissue.
31	Apply flux SPARINGLY to the eyelet. Note: Use a toothpick or flux pen to control the volume of flux applied. Heavy flux volume impairs cleaning and may affect reliability.
32	Remove the seasoning (all solder) from the soldering iron tip.
33	Thermally shock the soldering iron tip on a damp sponge.
34	<div style="text-align: center; border: 1px solid black; padding: 5px; margin-bottom: 10px;">CAUTION</div> <p>DO NOT APPLY PRESSURE WITH THE SOLDERING IRON.</p> <p>Place the soldering iron tip on eyelet at the point of maximum thermal mass on the termination side of the CCA.</p> 

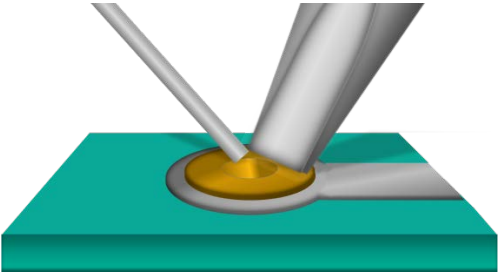
Pad and Conductor Delamination Repair Procedure

Step	Action
35	<div style="text-align: center; border: 1px solid black; padding: 5px; margin-bottom: 10px;">CAUTION</div> <p style="text-align: center;">IF SOLDER MELT DOES NOT OCCUR WITHIN TWO SECONDS, STOP THIS PROCEDURE AND ADJUST TIP TEMPERATURE PER THE TIP TEMPERATURE PROCEDURE IN WP 003 00 (PARAGRAPH 03-5.4).</p> <p>Form a heat bridge between the soldering iron tip and the eyelet using clean solder.</p> 
36	<p>Apply solder to the pad area filling the eyelet and both pad areas from the termination side.</p> 
37	Remove the solder and the soldering iron tip simultaneously.
38	Season the tip and place the soldering iron into its stand.
39	Allow the eyelet to cool completely before cleaning.
40	Clean the eyelet on both sides of the CCA with isopropyl alcohol using an acid brush to remove all flux residue and blot dry with a clean, lint-free tissue.
41	Select a solder extractor tip with an outside diameter smaller than eyelet.
42	Set the solder extractor tip temperature to 600°F (316°C).
43	<p>Place a clean tissue on a heat resistant surface and test the solder extractor by actuating vacuum to pick up the tissue.</p> <p>Note: If the solder extractor vacuum is insufficient to pick up the tissue, stop this procedure and perform the Solder Extractor Vacuum Test and Heater Element Cleaning Procedure in WP 003 00 (paragraph 03-5.7).</p>
44	Apply flux SPARINGLY to the eyelet on both sides of the CCA.

Pad and Conductor Delamination Repair Procedure

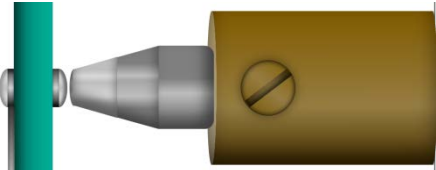
Step	Action
45	Position the CCA vertically in a circuit cardholder, if feasible.
46	Remove the seasoning from the solder extractor tip.
47	Thermally shock the solder extractor tip on a damp sponge.
48	<p style="text-align: center;">CAUTION</p> <p style="text-align: center;">DO NOT APPLY PRESSURE WITH THE SOLDER EXTRACTOR.</p> <p>Place solder extractor tip on the component side of the eyelet contacting only the solder fillet, not the eyelet.</p> 
49	<p style="text-align: center;">CAUTION</p> <p style="text-align: center;">IF SOLDER MELT DOES NOT OCCUR WITHIN TWO SECONDS, STOP THIS PROCEDURE AND ADJUST TIP TEMPERATURE PER THE TIP TEMPERATURE PROCEDURE IN WP 003 00 (PARAGRAPH 03-5.4).</p> <p>Observe COMPLETE solder melt; then actuate vacuum using the handpiece vacuum control switch or the foot pedal switch.</p>
50	After complete solder extraction, remove the solder extractor tip from the solder joint allowing the solder extractor vacuum to run continuously for an additional five seconds to draw the molten solder completely into the solder trap.
50	Season the tip and place the solder extractor into its stand.
51	Allow the eyelet to cool completely before cleaning.
52	Clean the eyelet with isopropyl alcohol using an acid brush and blot dry with a clean, lint-free tissue.
54	Encapsulate the conductor outside solderable area with epoxy using the Repaired Conductor Encapsulation Procedure (paragraph 12-5.14) if the repair area was not originally conformally coated.

Pad and Conductor Delamination Repair Procedure

Step	Action
55	Replace the components removed to facilitate this repair (WP 007 00 for Through Hole Components).
56	<p><i>Inspect per the General Inspection Procedure in WP 003 00 (paragraph 03-5.12) to all applicable WORKMANSHIP STANDARDS, including:</i></p> <ul style="list-style-type: none"> • <i>General Solder Acceptability in WP 005 00 (paragraph 05-6.1)</i> • <i>Post-Solder Joint Cleanliness in WP 005 00 (paragraph 05-6.2)</i> • <i>Laminate in WP 011 00 (paragraph 11-6.1)</i> • <i>Through Hole Components in WP 007 00 (paragraph 07-6), as applicable</i> • <i>Other applicable Workmanship Standards, as required</i>
57	Replace the conformal coating per the Conformal Coating Replacement Procedure in WP 006 00 (paragraph 06-5.5), as needed.
58	<i>Inspect to the Conformal Coating Replacement WORKMANSHIP STANDARD in WP 006 00 (paragraph 06-6.2), as required.</i>
59	Dispose of all HAZMAT following local procedures.

12-5.12 Pad, Land, and/or Conductor Salvage Procedure

Use this procedure to salvage lands, pads, and/or conductors from all CCAs.

Personnel Hazards



Alcohol, Isopropyl

1



Lead (Solder)

9

Pad, Land, and/or Conductor Salvage Procedure

Step	Action
	<div style="text-align: center;"> <div style="border: 3px double black; padding: 5px; width: fit-content; margin: 0 auto;">WARNING</div> <p>USE APPROVED SAFETY EYEWEAR WHEN PERFORMING THIS PROCEDURE.</p> <p>COMPLY WITH ALL LOCAL REQUIREMENTS FOR PPE.</p> <div style="border: 3px double black; padding: 5px; width: fit-content; margin: 0 auto;">CAUTION</div> <p>DON A PROPERLY GROUNDED ESD WRIST STRAP BEFORE STARTING THIS PROCEDURE.</p> </div>
1	<p>Select a scrap assembly with a replacement conductor having the following dimensions:</p> <ul style="list-style-type: none"> • Equal to or slightly wider than the damaged section of the conductor. • Equal to or slightly thicker than the damaged section of the conductor. • The pad size of the replacement pad is the same or slightly larger than the original pad. • The land size of the replacement land is the same or slightly larger than the original land. • The length of the salvaged conductor must overlap onto the original conductor a distance at least two times the width of the conductor.
2	<p>Remove any conformal coating from the repair area using one of the Conformal Coating Removal Methods in WP 006 00 (paragraph 06-5.4).</p>
3	<p>Remove the components necessary to provide access to the repair area (WP 007 00 for Through Hole Components or WP 018 00 for Surface Mount Devices).</p>
4	<p>Select the 1/8 in. chisel soldering iron tip.</p>
5	<p>Set the soldering iron tip temperature to <u>700°F (371°C)</u>.</p>
6	<p>Select a ball mill just large enough to break the interfacial connection between the salvage pad and the barrel of the plated-through hole, as needed.</p>
7	<p>Use the ball mill in a pin vise to sever the salvage pad from the plated-through hole, as needed.</p>

Pad, Land, and/or Conductor Salvage Procedure

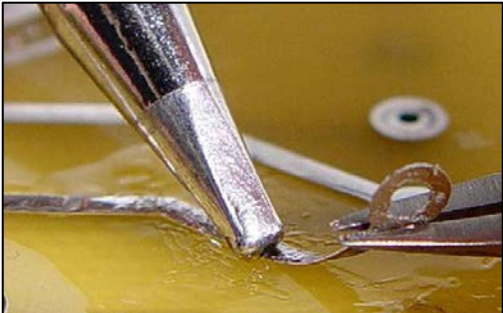
Step	Action
8	Mark a sufficient length of conductor to be salvaged.
9	<div style="text-align: center; border: 1px solid black; padding: 5px; margin-bottom: 10px;">WARNING</div> <p>DO NOT APPLY LATERAL PRESSURE TO THE SCALPEL. THE BLADE IS EXTREMELY FRAGILE AND CAN CAUSE SERIOUS INJURY IF BROKEN.</p> <p>Cut the salvage pad/conductor at the ends perpendicular to the conductor axis with no bevel using a scalpel or chisel.</p>
10	Apply flux SPARINGLY to the salvage pad/conductor.
11	Remove the seasoning (all solder) from the soldering iron tip.
12	Thermally shock the soldering iron tip on a damp sponge.
13	<div style="text-align: center; border: 1px solid black; padding: 5px; margin-bottom: 10px;">CAUTION</div> <p>CONDUCTOR STRETCHING WILL OCCUR IF COLD-PEELING OF THE CONDUCTOR IS ATTEMPTED.</p> <p>Use a soldering iron and tweezers to hot-peel the pad/conductor from the laminate.</p> 
14	Season the tip and place the soldering iron into its stand.
15	Allow the salvaged pad/conductor to cool completely before cleaning.
16	<p>Clean the salvaged pad/conductor with isopropyl alcohol using an acid brush and blot dry with a clean, lint-free tissue.</p> <p>Note: Take precautions to prevent bare skin contact on the salvaged pad/conductor before soldering. Skin contact leaves contaminants on the surfaces to be soldered.</p>















Pad, Land, and/or Conductor Salvage Procedure

Step	Action
17	<p><i>Inspect per the General Inspection Procedure in WP 003 00 (paragraph 03-5.12) to all applicable WORKMANSHIP STANDARDS, including:</i></p> <ul style="list-style-type: none"> • <i>Post-Solder Joint Cleanliness in WP 005 00 (paragraph 05-6.2)</i> • <i>Conductors, Pads, and Lands (paragraph 12-6.1)</i> • <i>Other applicable Workmanship Standards, as required</i>
18	Dispose of all HAZMAT following local procedures.

12-5.13 Conductor Fabrication Procedure

Use this procedure to manufacture replacement conductors.



Personnel Hazards

					
Alcohol, Isopropyl					1
					
Flux (Soldering)					8
					
Lead (Solder)					9

Conductor Fabrication Procedure

Step	Action
	<div style="border: 2px solid black; padding: 5px; display: inline-block;">WARNING</div> <p>USE APPROVED SAFETY EYEWEAR WHEN PERFORMING THIS PROCEDURE.</p> <p>COMPLY WITH ALL LOCAL REQUIREMENTS FOR PPE.</p>

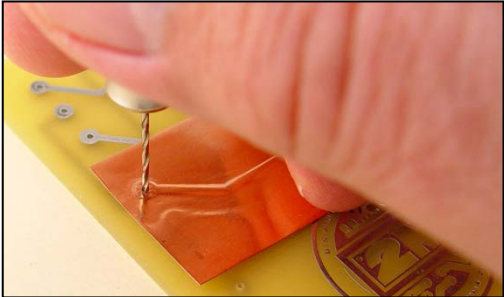
Conductor Fabrication Procedure

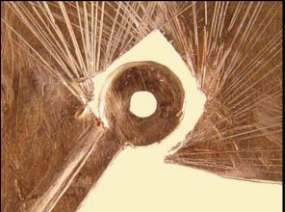
Step	Action
	<p style="text-align: center;">CAUTION</p> <p style="text-align: center;">DON A PROPERLY GROUNDED ESD WRIST STRAP BEFORE STARTING THIS PROCEDURE.</p>
1	Perform the Procedural Analysis and Feasibility of Repair Procedure in WP 003 00 (paragraph 03-5.1).
2	Obtain copper foil of equal or greater thickness than the damaged conductor.
3	<p>Trace the shape of the damaged conductor onto the copper foil using an orangewood stick or spudger.</p> 
4	<p>If the fabricated conductor will include a pad, drill a hole the size of the outside diameter of the replacement eyelet into the pad area of the fabricated conductor.</p> 
5	<p style="text-align: center;">WARNING</p> <p style="text-align: center;">DO NOT APPLY LATERAL PRESSURE TO THE SCALPEL. THE BLADE IS EXTREMELY FRAGILE AND CAN CAUSE SERIOUS INJURY IF BROKEN.</p> <p>Cut and shape the copper foil into a replacement conductor using a scalpel.</p> <p>Note: The dimensions of the fabricated replacement conductor shall be the same or slightly wider than the conductor being replaced.</p>  

Conductor Fabrication Procedure

Step	Action
6	Select a soldering iron tip that maximizes heat transfer and contact area with the area to be soldered.
7	Set the soldering iron tip temperature to 600°F (316°C).
8	Clean the fabricated conductor with isopropyl alcohol using an acid brush and blot dry with a clean, lint-free tissue. Note: Take precautions to prevent bare skin contact on the fabricated conductor before soldering. Skin contact leaves contaminants on the surfaces to be soldered.
9	Clean the solder with isopropyl alcohol and wipe dry with a clean, lint-free tissue.
10	Apply flux SPARINGLY to the fabricated conductor. Note: Use a toothpick or flux pen to control the volume of flux applied. Heavy flux volume impairs cleaning and may affect reliability.
11	Remove the seasoning (all solder) from the soldering iron tip.
12	Thermally shock the soldering iron tip on a damp sponge.
13	<div style="text-align: center; border: 2px solid black; padding: 5px; margin: 0 auto; width: fit-content;">CAUTION</div> <p style="text-align: center;">DO NOT APPLY PRESSURE WITH THE SOLDERING IRON.</p> Place the soldering iron tip on the fabricated conductor.
14	<div style="text-align: center; border: 2px solid black; padding: 5px; margin: 0 auto; width: fit-content;">CAUTION</div> <p style="text-align: center;">IF SOLDER MELT DOES NOT OCCUR WITHIN TWO SECONDS, STOP THIS PROCEDURE AND ADJUST TIP TEMPERATURE PER THE TIP TEMPERATURE PROCEDURE IN WP 003 00 (PARAGRAPH 03-5.4).</p> Form a heat bridge between the soldering iron tip and the fabricated conductor using clean solder.
15	Tin the top surface of the fabricated conductor.
16	Remove the solder and the soldering iron tip simultaneously.
17	Season the tip and place the soldering iron into its stand.

Conductor Fabrication Procedure

Step	Action
18	Allow the fabricated conductor to cool completely before cleaning.
19	Clean the fabricated conductor with isopropyl alcohol using an acid brush to remove all flux residue and blot dry with a clean, lint-free tissue.
20	<i>Inspect per the General Inspection Procedure in WP 003 00 (paragraph 03-5.12) to all applicable WORKMANSHIP STANDARDS, including:</i> <ul style="list-style-type: none"> • <i>Post-Solder Joint Cleanliness in WP 005 00 (paragraph 05-6.2)</i> • <i>Conductors, Pads, and Lands (paragraph 12-6.1)</i> • <i>Other applicable Workmanship Standards, as required</i>
21	Dispose of all HAZMAT following local procedures.

12-5.14 Repaired Conductor Encapsulation Procedure

Use this procedure to encapsulate repaired conductors with epoxy.

Encapsulation shall be done when the original CCA is not conformally coated.

Encapsulation improves the conductor's adhesion and increases its resistance to damage.

Personnel Hazards



Alcohol, Isopropyl

1



Epoxy, 0151

4

Repaired Conductor Encapsulation Procedure

Step	Action
	<div style="text-align: center;"> <div style="border: 3px double black; padding: 5px; width: fit-content; margin: 0 auto;">WARNING</div> <p>USE APPROVED SAFETY EYEWEAR WHEN PERFORMING THIS PROCEDURE.</p> <p>COMPLY WITH ALL LOCAL REQUIREMENTS FOR PPE.</p> <div style="border: 3px double black; padding: 5px; width: fit-content; margin: 0 auto;">CAUTION</div> <p>DON A PROPERLY GROUNDED ESD WRIST STRAP BEFORE STARTING THIS PROCEDURE.</p> </div>
1	Prepare the epoxy according to the manufacturer's directions.
2	Apply a thin coating of epoxy conforming to the shape of the conductor up to one pad diameter from a solderable area.
3	Feather the encapsulation beyond the conductor edge a distance of ½ of the conductor width in all directions, or to the edge of an adjacent conductor, whichever is less.
4	Remove any voids and/or bubbles in the epoxy.
5	Cure the epoxy according to the manufacturer's directions.
6	Clean the repaired area with isopropyl alcohol and blot dry with a clean, lint-free tissue.
7	<p><i>Inspect per the General Inspection Procedure in WP 003 00 (paragraph 03-5.12) to all applicable WORKMANSHIP STANDARDS, including:</i></p> <ul style="list-style-type: none"> • <i>Conductor Encapsulation (paragraph 12-6.5)</i> • <i>Other applicable Workmanship Standards, as required</i>
8	Dispose of all HAZMAT following local procedures.

12-6 WORKMANSHIP STANDARDS



Refer to WP 003 00 (paragraph 03-6) for definitions of Workmanship Standards.

NOTE

WORKMANSHIP STANDARDS FOR GENERAL SOLDER ACCEPTABILITY AND POST-SOLDER JOINT CLEANLINESS ARE IN WP 005 00 (PARAGRAPH 05-6), CONFORMAL COATING IN WP 006 00 (PARAGRAPH 06-6), THROUGH HOLE COMPONENTS IN WP 007 00 (PARAGRAPH 07-6), LAMINATE IN WP 011 00 (PARAGRAPH 11-6), MULTILAYER IN WP 015 00 (PARAGRAPH 15-6), SURFACE MOUNT DEVICES IN WP 018 00 (PARAGRAPH 18-6), AND JUMPER WIRES IN WP 019 00 (PARAGRAPH 19-6).

12-6.1 Conductors, Pads, and Lands

Conductors, Pads, and Lands

Target Condition	Acceptable Condition	Defect Condition
The conductors, pads, and lands are in full contact with the laminate surface.		A conductor, pad, or land is separated either partially or totally from the laminate surface.
	A conductor, pad, or land has damage that does not reduce its cross-sectional area by more than 20%. 	A conductor, pad, or land has damage that reduces its cross-sectional area by more than 20%. 
		There is a missing conductor, pad, or land.

12-6.2 Eyeletting

Eyeletting

Target Condition	Acceptable Condition	Defect Condition
Eyelet flanges are in full contact with the pad or conductor.		Eyelet flanges are not in full contact with the pad or conductor.

Eyeleting

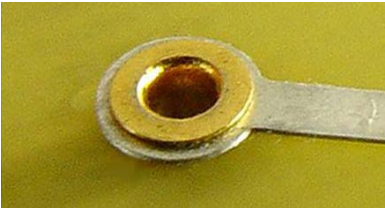
Target Condition	Acceptable Condition	Defect Condition
		The eyelet is split or cracked.
<p>Solder flows 100% around the flange of the eyelet.</p> 		Solder flows less than 100% around the flange of the eyelet.
Pad Eyeleting		
The pad is in full contact with the laminate surface.		
<p>The flange of the set eyelet provides 50-80% pad coverage.</p> 	The flange of the set eyelet provides greater than 80% but there is area outside of the set eyelet to make a solder fillet.	The flange of the set eyelet provides less than 50% or there is no area outside of the set eyelet to make a solder fillet.
Conductor Eyeleting		
The flange diameter of the set eyelet is 50-80% the conductor width.	The flange diameter of the set eyelet is greater than 80% but less than 100% of the conductor width.	The flange diameter of the set eyelet is less than 50% of, equal to, or greater than the width of the conductor.
The outside diameter of the eyelet is 50% or less than the conductor width.		The outside diameter of the eyelet exceeds 50% of the conductor width.

12-6.3 Clinched Staple

Clinched Staple

Target Condition	Acceptable Condition	Defect Condition
The holes are drilled a minimum of two conductor widths from the damaged area.		Either hole is drilled less than two conductor widths from the damaged area.
The solid-wire or component lead diameter is in accordance with paragraph 12-5.5, step 9 or between 50 and 80% of the conductor width.		The solid-wire or component lead diameter is not in accordance with paragraph 12-5.5, step 9 or is less than 50% or greater than 80% of the conductor width.
Insulation sleeving is installed on the replacement conductor that crosses other conductors or leads.		Insulation sleeving is not installed on a replacement conductor that crosses other conductors or leads.
The termination length of both clinched lead ends is at greater than two times the conductor width.		The termination length of either clinched lead is less than two times the conductor width.
The lead ends are clinched 90°. A slight gap between the lead end and the conductor due to springback is considered a target condition.	A lead end is clinched between 75° and 90°.	A lead end is clinched less than 75°.
The lead ends are clinched in the direction away from the damage.		A lead end is clinched in the direction towards the damage.
		A clinched lead that extends beyond the edge of the connecting conductor.
The ends of the conductors are cut 90° degrees perpendicular to the conductor axis.	The end of the conductor is cut at an angle other than 90° degrees perpendicular to the conductor axis.	

Clinched Staple

Target Condition	Acceptable Condition	Defect Condition
The ends of the conductors are beveled at a 45° angle.	The end of a conductor is beveled at an angle less than 90°.	An end of a conductor is not beveled.

12-6.4 Lap Solder Repair

Lap Solder Repair

Target Condition	Acceptable Condition	Defect Condition
The ends of the conductors where the damage was removed are cut perpendicular to the conductor axis.	The end of a conductor where the damage was removed is not perpendicular to the conductor axis.	
The ends of the conductors where the damage is removed are beveled at a 45° angle.	The end of a conductor where the damage was removed is beveled at an angle less than 90°.	An end of the conductor where the damage was removed is not beveled.
The replacement conductor is the same thickness, width, and shape as the original conductor.		The replacement conductor is narrower or thinner as the original conductor.
	The replacement conductor is slightly larger in width, thickness, and/or shape as the original conductor provided the solder joint is visible.	The replacement conductor is significantly larger in width, thickness, and/or shape as the original conductor or the solder joint is not visible.
		The overall width (overhang) of the replacement conductor precludes proper inspection of the solder fillet.
The cut ends of the replacement conductor are perpendicular in respect to the original conductor.	A cut end of the replacement conductor is not perpendicular in respect to the original conductor.	

Lap Solder Repair

Target Condition	Acceptable Condition	Defect Condition
The replacement conductor overlaps the original conductor two conductor widths or greater at each end.		The replacement conductor overlaps original conductor less than two conductor widths at either end.
The replacement conductor lays flat on the original conductor in the overlap area.		The replacement conductor does not lay flat on the original conductor in the overlap areas.
The replacement conductor is formed to the beveled ends of the original conductor in the repair area.	The replacement conductor is formed but does not provide an exact fit with the beveled ends of the original conductor.	The replacement conductor is not formed to the bevels of the original conductor.
<p>The overlap area shows evidence of complete wetting (solder seam).</p> 		There is evidence of nonwetting or dewetting in an overlap area.
The overlap area has a concave fillet at the end of the overlap.		The overlap area is not wetted with solder or has a convex fillet at the end of the overlap.
The lap solder joint is a minimum of three pad diameters from any solderable area (i.e., pad, component lead, or wire).	The lap solder joint is less than three pad diameters from any solderable area and an eyelet is installed in the lap joint.	The lap solder joint is less than three pad diameters from any solderable area (i.e. pad, component lead, or wire) and an eyelet is not installed in the lap joint.
	There is exposed base metal on any surface conductor.	

12-6.5 Conductor Encapsulation

Conductor Encapsulation

Target Condition	Acceptable Condition	Defect Condition
Pad/conductor repair encapsulation extends one pad diameter from the edge of the pad to one conductor width or greater past the lap joint.	The encapsulation is closer than one pad diameter from the pad, provided it does not contact the solder joint.	Pad/conductor encapsulation contacts the component solder joint or overlaps the lap joint less than one conductor width.
Middle of conductor repair encapsulation overlaps the repair one conductor width or greater at each end.		Middle of conductor repair encapsulation overlaps the repair less than one conductor width at each end.
The encapsulation is feathered beyond the conductor edge a distance of 1/2 of the conductor width in all directions. 		The encapsulation is not feathered beyond the conductor edge a distance of 1/2 of the conductor width in all directions.
The encapsulation is smooth.	The encapsulation contains lumps, ridges, streaks, or protrusions.	
		Evidence of contamination in the encapsulation.
	Voids or air bubbles in the encapsulation are 20% or less of the encapsulation thickness.	Voids or air bubbles in the encapsulation are greater than 20% of the encapsulation thickness.
	Volume of bubbles in the encapsulation is 5% or less of the volume of the encapsulation.	Volume of bubbles in the encapsulation is greater than 5% of the volume of the encapsulation.
		Evidence of uncured epoxy.

This page is intentionally blank.

15 October 2013

WP 013 00 Flex Print

CAUTION

**FLEX PRINT REPAIR IS TO BE USED ONLY IN EMERGENCIES (MISSION CRITICAL).
REPLACE REPAIRED FLEX PRINT ASSEMBLIES WITH A NEW ASSEMBLY AS SOON AS
POSSIBLE.**

13-1 PURPOSE

Identify the technical information relative to flex print.

Specify the methods for determining the type and extent of laminate and conductor damage for flex print assemblies.

Specify the repair procedures for the temporary repair of flex print.

Identify the workmanship standards for flex print repair.

13-2 INDEX

Paragraph	Subject	Page
13-1	Purpose	1
13-2	Index	1
13-3	General Safety Precautions.....	2
13-4	Technical Information.....	2
13-5	Repair Procedures.....	3
13-5.1	Types of Flex Print Damage	4
13-5.2	Flex Print Procedural Analysis and Feasibility of Repair	5
13-5.3	Flex Print Laminate Removal Procedure.....	5
13-5.4	Flex Print Hairline Crack Repair Procedure.....	8
13-5.5	Flex Print Conductor Removal and Replacement Procedure	13
13-5.6	Flex Print Laminate Replacement Procedure	20
13-6	Workmanship Standards	22
13-6.1	Flex Print	23
13-6.2	Flex Print Laminate Removal	23
13-6.3	Flex Print Conductor Removal and Replacement	24
13-6.4	Flex Print RTV Method of Laminate Replacement.....	26
13-6.5	Flex Print Polyimide Tape Method of Laminate Replacement	26

13-3 GENERAL SAFETY PRECAUTIONS

Observe all the following precautions while repairing flex print:

- Electronic equipment must be de-energized during removal and installation of CCAs
- Personnel are required to wear a properly grounded ESD wrist strap and cord while working in or around the EPA
- ESD can destroy components—protect ESDS devices during handling and repair to prevent ESD damage (Refer to WP 004 00)
- Isopropyl alcohol is flammable; do not use in the presence of sparks, heat, flame, or synthetic cloth
- Soldering handpieces (e.g., soldering irons) produce extreme heat—exercise care when these tools are out of their stands
- Avoid direct inhalation of fumes during a soldering operation because there is a possibility these fumes could cause occupational asthma
- The lead contained in solder is a source of lead oxide, which the human body cannot dissipate (accumulation of lead oxide in the body over a period of years can result in a serious health hazard)
- Contact with solder by holding in the mouth, smoking, or eating during or immediately after soldering is a potential means of ingesting trace amounts of lead oxide
- Avoid oral contact with hands during or immediately after solder operations
- Wash hands following any solder operation
- Wear approved PPE whenever pouring or handling molten metals or corrosive liquids and solids; and cutting, drilling, grinding, milling, chipping and other dust and debris producing operations
- Always follow the manufacturer's instructions and warnings when using conformal coating products

13-4 TECHNICAL INFORMATION

Flexible laminates (Figure 13-1) used in the fabrication of flex CCAs are primarily made from two dielectric materials.

Polyimide film and polyester film are the two most common flex laminate materials used as the dielectric film.

Polyimide film is typically used in high reliability applications and polyester film in the remainder of the applications.

Flexible laminates are available with copper bonded to the polyimide film with and without adhesive.

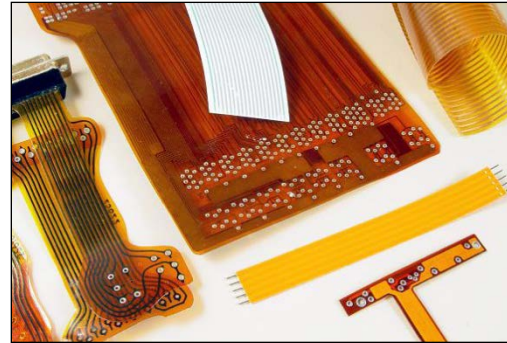

Figure 13-1 Flexible Laminates

The most common types of film used for bonding applications of flexible laminates are modified acrylic, epoxy, polyimide, and polyester. Polyimide film material characteristics include nonflammable, dimensionally stable, has a high tear strength and capable of withstanding solder temperatures. Polyester film also known as polyethylene terephthalate when compared to polyimide film has a lower dielectric constant and absorbs less moisture, but is not as thermally resistant.

Flexible laminates are used in single-sided, double-sided, and multilayer applications.

13-5 REPAIR PROCEDURES



PROTECT STATIC SENSITIVE DEVICES DURING HANDLING AND REPAIR TO PREVENT ESD DAMAGE (REFER TO WP 004 00).

Equipment Required Listed below is the authorized 2M Power Unit* for flex print repair:

- **NAVAIR/NAVSEA/USMC/USAF/USCG—PRC-2000-SMT**

* Refer to Table 03-3 for Power Unit Part No., and CAGE Code

Additional Support Items	For additional information regarding items of support and support equipment refer to: <ul style="list-style-type: none">• NAVSEA/NAVAIR/USCG—2M MTR Certification Manual• NAVSEA/USCG—Allowance Parts List (APL) 000A8423• USMC—Stock List SL-3-09458A• USAF—the Consolidated Tool Kit (CTK)
---------------------------------	---

Material Required	Listed below are the materials required* for flex print repair: <ul style="list-style-type: none">• Flux, Soldering• Insulating Compound (conformal coating)• Isopropyl Alcohol, Technical• Orangewood Stick• Paper, Abrasive (sandpaper)• Solder, Tin Alloy†• Strip, Metal (copper foil)• Tape, Pressure Sensitive (Kapton®)• Toothpick‡• Towel, Paper (Kimwipe®)‡ <p>* Refer to Table 03-4 for Specification No., Part No., and NSN † Select size appropriate for application ‡ Substitution of equivalent material is acceptable</p>
--------------------------	--

13-5.1 Types of Flex Print Damage

13-5.1.1 Laminate and Conductor Damage

Laminate and conductor damage (Figure 13-2) can usually be located by visual inspection since most flex print is translucent.



Figure 13-2 Flex Print Damage

13-5.1.2 Hairline Cracks

Hairline cracks in the conductors are the most difficult to locate, but can normally be located by backlighting and gently flexing the circuitry.

13-5.1.3 Conductor Damage

CAUTION

WHEN TESTING OR REPAIRING ESDS DEVICES, USE OF A HIGH INPUT IMPEDANCE MULTIMETER IS REQUIRED.

Conductor damage can also be located by point-to-point continuity testing using a high input impedance multimeter.

13-5.2 Flex Print Procedural Analysis and Feasibility of Repair

The final decision to repair flex print assemblies depends on factors other than type and extent of damage. Other factors that must be considered include:

- Other types of damage
- Repair capability
- Availability of material
- Time and cost of repair
- Operational and mission needs

13-5.3 Flex Print Laminate Removal Procedure



Use this procedure to remove damaged laminate on a flex print assembly.

Personnel Hazards No HAZMAT identified in the HMWS is used in this procedure.



Flex Print Laminate Removal Procedure

Step	Action
	<p style="text-align: center;">WARNING</p> <p style="text-align: center;">USE APPROVED SAFETY EYEWEAR WHEN PERFORMING THIS PROCEDURE.</p> <p style="text-align: center;">COMPLY WITH ALL LOCAL REQUIREMENTS FOR PPE.</p> <p style="text-align: center;">CAUTION</p> <p style="text-align: center;">DON A PROPERLY GROUNDED ESD WRIST STRAP BEFORE STARTING THIS PROCEDURE.</p> <p style="text-align: center;">CAUTION</p> <p style="text-align: center;">FLEX PRINT REPAIR IS TO BE USED ONLY IN EMERGENCIES (MISSION CRITICAL).</p> <p style="text-align: center;">REPLACE REPAIRED FLEX PRINT ASSEMBLIES WITH A NEW ASSEMBLY AS SOON AS POSSIBLE.</p> <p style="text-align: center;">THE REPAIR METHODS DESCRIBED IN THIS PROCEDURE APPLY TO FLEX PRINT ASSEMBLIES ONLY.</p> <p style="text-align: center;">NOTE</p> <p style="text-align: center;">USE OF A MICROSCOPE IS REQUIRED WHEN PERFORMING THESE FLEX PRINT REPAIR TECHNIQUES.</p>
1	Perform the Procedural Analysis and Feasibility of Repair Procedure in WP 003 00 (paragraph 03-5.1).
2	Mark the area of the laminate to be removed. Note: Remove only enough laminate to facilitate the repair.
3	Support the flex print on a flat, smooth surface such as a dental mixing slab. Note: A firm base will keep the assembly from moving while repairing the damaged area.
4	Turn the assembly so the thinnest side of the flex print is facing up.

Flex Print Laminate Removal Procedure

Step	Action
5	<div style="text-align: center; border: 1px solid black; padding: 5px; margin-bottom: 10px;"> WARNING </div> <p style="text-align: center;">TO ENSURE PERSONNEL SAFETY AND PREVENT WORKPIECE DAMAGE, SPOT TOOLS UNDER THE MICROSCOPE IN THE WORK AREA BEFORE LOOKING THROUGH THE MICROSCOPE.</p> <div style="text-align: center; border: 1px solid black; padding: 5px; margin-bottom: 10px;"> CAUTION </div> <p style="text-align: center;">EXCESSIVE PRESSURE WITH TOOLS CAN CAUSE ADDITIONAL DAMAGE TO THE LAMINATE.</p> <p>Cut the laminate at a 45° angle along each side of the damaged conductor using a scalpel or dental tool.</p> <p>Note: Laminate can also be removed by using a light abrasive such as a pumice wheel or rotary bristle brush in the motorized handpiece.</p> 
6	<p>Cut the ends of the laminate to be removed perpendicular to the conductor axis with no bevel.</p> <p>Note: The length of the laminate removed shall allow a minimum of ½ in. overlap on both sides of the damaged conductor area plus room for the end fillets on both ends of the replacement conductor.</p> <p style="text-align: center;"><i>Laminate removed = damaged area + end fillets + one inch</i></p>
7	<p>Remove the cut portion of laminate.</p> <p>Note: If adhesive between the laminate and conductor surface is present, a hot-peel technique (steps 8 through 14) maybe used to soften the adhesive.</p> 
8	<p>Select a soldering iron tip that maximizes heat transfer and contact area with the laminate to be removed.</p>
9	<p>Set the soldering iron tip temperature to <u>361°F (183°C)</u>.</p>
10	<p>Remove the seasoning (all solder) from the soldering iron tip.</p>

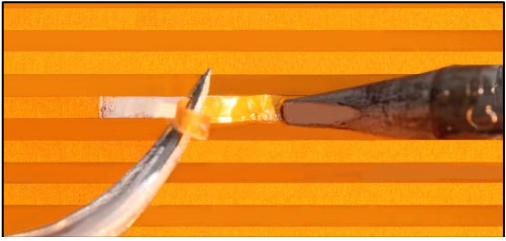













Flex Print Laminate Removal Procedure

Step	Action
11	Thermally shock the soldering iron tip on a damp sponge.
12	<p>Use the soldering iron and tweezers to hot-peel the cut portion of laminate from the flex print.</p> <p>Note: A wet tissue may be placed under the laminate to help dissipate heat.</p> 
13	Season the tip and place the soldering iron into its stand.
14	Allow the flex print to cool completely before continuing.
15	<p>Use light abrasion (e.g. orangewood stick, rotary bristle brush, eraser) to remove the adhesive from the repair area.</p> 
16	Clean the repaired area with isopropyl alcohol using an acid brush and blot dry with a clean, lint-free tissue.
17	<p><i>Inspect per the General Inspection Procedure in WP 003 00 (paragraph 03-5.12) to all applicable WORKMANSHIP STANDARDS, including:</i></p> <ul style="list-style-type: none"> • <i>Flex Print (paragraph 13-6.1)</i> • <i>Flex Print Laminate Removal (paragraph 13-6.2)</i> • <i>Other applicable Workmanship Standards, as required</i>
18	Perform the Flex Print Laminate Replacement Procedure (paragraph 13-5.6), if the conductor is not damaged and only the laminate requires replacement.
19	Dispose of all HAZMAT following local procedures.

13-5.4 Flex Print Hairline Crack Repair Procedure

Use this procedure to repair hairline cracks in flex print conductors.

Personnel Hazards

					
Alcohol, Isopropyl					1
					
Flux (Soldering)					8
					
Lead (Solder)					9

Flex Print Hairline Crack Repair Procedure

Step	Action
	<div style="border: 1px solid black; padding: 5px; margin-bottom: 10px;">WARNING</div> <p><i>USE APPROVED SAFETY EYEWEAR WHEN PERFORMING THIS PROCEDURE. COMPLY WITH ALL LOCAL REQUIREMENTS FOR PPE.</i></p> <div style="border: 1px solid black; padding: 5px; margin-bottom: 10px;">CAUTION</div> <p>DON A PROPERLY GROUNDED ESD WRIST STRAP BEFORE STARTING THIS PROCEDURE.</p> <p>FLEX PRINT REPAIR IS TO BE USED ONLY IN EMERGENCIES (MISSION CRITICAL). REPLACE REPAIRED FLEX PRINT ASSEMBLIES WITH A NEW ASSEMBLY AS SOON AS POSSIBLE.</p> <p>THE REPAIR METHODS DESCRIBED IN THIS PROCEDURE APPLY TO FLEX PRINT ASSEMBLIES ONLY.</p> <p style="text-align: center;">NOTE</p> <p>USE OF A MICROSCOPE IS REQUIRED WHEN PERFORMING THESE FLEX PRINT REPAIR TECHNIQUES.</p>
1	Perform the Procedural Analysis and Feasibility of Repair Procedure in WP 003 00 (paragraph 03-5.1).

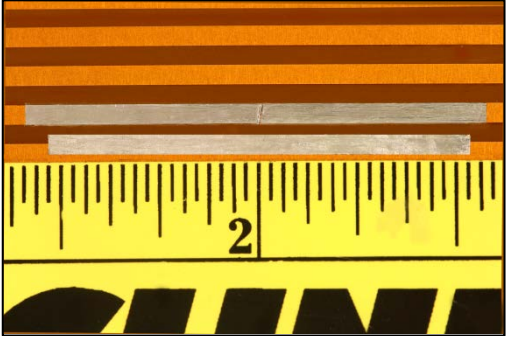

Flex Print Hairline Crack Repair Procedure

Step	Action
2	<p>Obtain a replacement conductor from a similar flex print assembly, from a track repair kit, or by manufacturing a replacement from copper foil using the Conductor Fabrication Procedure in WP 012 00 (paragraph 12-5.13).</p> <p>Note: The replacement conductor shall overlap a minimum of ½ in. on both sides of the damage.</p> 
3	Remove the adhesive from the underside of the replacement conductor, if required.
4	Select a soldering iron tip that maximizes heat transfer and contact area with the replacement conductor.
5	Set the soldering iron tip temperature to 600°F (316°C).
6	<p>Clean the original and replacement conductor with isopropyl alcohol using an acid brush and blot dry with a clean, lint-free tissue.</p> <p>Note: Take precautions to prevent bare skin contact on the replacement conductor before soldering. Skin contact leaves contaminants on the leads and/or pads.</p>
7	Clean the solder with isopropyl alcohol and wipe dry with a clean, lint-free tissue.
8	<p>Apply flux SPARINGLY to the original and replacement conductor.</p> <p>Note: Use a toothpick or flux pen to control the volume of flux applied. Heavy flux volume impairs cleaning and may affect reliability.</p>
9	Remove the seasoning (all solder) from the soldering iron tip.
10	Thermally shock the soldering iron tip on a damp sponge.
11	<p style="text-align: center;">CAUTION</p> <p style="text-align: center;">DO NOT APPLY PRESSURE WITH THE SOLDERING IRON.</p> <p>Place the soldering iron tip on the original conductor.</p>

Flex Print Hairline Crack Repair Procedure

Step	Action
12	<div style="text-align: center; border: 1px solid black; padding: 5px; margin-bottom: 10px;">CAUTION</div> <p style="text-align: center;">IF SOLDER MELT DOES NOT OCCUR WITHIN TWO SECONDS, STOP THIS PROCEDURE AND ADJUST TIP TEMPERATURE PER THE TIP TEMPERATURE PROCEDURE IN WP 003 00 (PARAGRAPH 03-5.4).</p> <p>Form a heat bridge between the soldering iron tip and the original conductor using clean solder.</p> 
13	Tin the original conductor in the solder area.
14	Tin both sides and ends of the replacement conductor.
15	Remove the solder and the soldering iron tip simultaneously.
16	Season the tip and place the soldering iron into its stand.
17	Allow the original and replacement conductor to cool completely before cleaning.
18	Clean the original and replacement conductor with isopropyl alcohol using an acid brush to remove all flux residue and blot dry with a clean, lint-free tissue.
19	Apply flux SPARINGLY to the original conductor using a toothpick or flux pen.
20	Center the replacement conductor on the original conductor over the hairline crack allowing at least ½ in. overlap on each side.
21	Remove the seasoning from the soldering iron tip.
22	Thermally shock the soldering iron tip on a damp sponge.

Flex Print Hairline Crack Repair Procedure

Step	Action
23	<p style="text-align: center;">CAUTION</p> <p style="text-align: center;">DO NOT APPLY PRESSURE WITH THE SOLDERING IRON.</p> <p>Place the soldering iron tip on the replacement conductor at one end.</p> <p>Note: Hold the replacement conductor in place with an orangewood stick.</p> 
24	<p style="text-align: center;">CAUTION</p> <p style="text-align: center;">IF SOLDER MELT DOES NOT OCCUR WITHIN TWO SECONDS, STOP THIS PROCEDURE AND ADJUST TIP TEMPERATURE PER THE TIP TEMPERATURE PROCEDURE IN WP 003 00 (PARAGRAPH 03-5.4).</p> <p>Tack solder the replacement conductor.</p>
25	<p>Place the soldering iron tip on the replacement conductor at the opposite end.</p> <p>Note: Hold the replacement conductor in place with an orangewood stick.</p>
26	<p>Solder the replacement conductor by moving the soldering iron tip toward and off the opposite end.</p> <p>Note: Follow the movement of the soldering iron tip with a tool such as an orangewood stick or toothpick to hold the conductor in place.</p> 
27	<p>Season the tip and place the soldering iron into its stand.</p>
28	<p>Allow the repaired area to cool completely before cleaning.</p>
29	<p>Clean the repaired area with isopropyl alcohol using an acid brush and blot dry with a clean, lint-free tissue.</p>

Flex Print Hairline Crack Repair Procedure

Step	Action
30	<p><i>Inspect per the General Inspection Procedure in WP 003 00 (paragraph 03-5.12) to all applicable WORKMANSHIP STANDARDS, including:</i></p> <ul style="list-style-type: none"> • <i>General Solder Acceptability in WP 005 00 (paragraph 05-6.1)</i> • <i>Post-Solder Joint Cleanliness in WP 005 00 (paragraph 05-6.2)</i> • <i>Flex Print Conductor Removal and Replacement (paragraph 13-6.3)</i> • <i>Other applicable Workmanship Standards, as required</i>
31	Perform the Flex Print Laminate Replacement Procedure (paragraph 13-5.6).
32	Dispose of all HAZMAT following local procedures.

13-5.5 Flex Print Conductor Removal and Replacement Procedure

Use this procedure to remove and replace damaged conductors on a flex print assembly.

Personnel Hazards

					1
Alcohol, Isopropyl					
					8
Flux (Soldering)					
					9
Lead (Solder)					

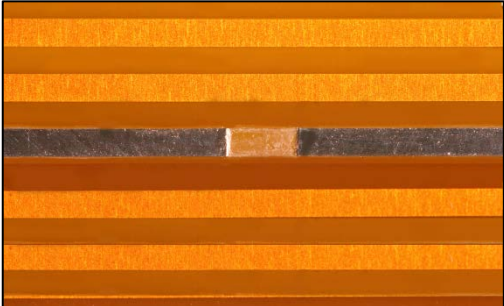

Flex Print Conductor Removal and Replacement Procedure

Step	Action
	<p style="text-align: center;">WARNING</p> <p style="text-align: center;"><i>USE APPROVED SAFETY EYEWEAR WHEN PERFORMING THIS PROCEDURE. COMPLY WITH ALL LOCAL REQUIREMENTS FOR PPE.</i></p> <p style="text-align: center;">CAUTION</p> <p style="text-align: center;">DON A PROPERLY GROUNDED ESD WRIST STRAP BEFORE STARTING THIS PROCEDURE.</p>
1	<p>Perform the Flex Print Laminate Removal Procedure (paragraph 13-5.3).</p>
2	<p style="text-align: center;">WARNING</p> <p style="text-align: center;"><i>DO NOT APPLY LATERAL PRESSURE TO THE SCALPEL. THE BLADE IS EXTREMELY FRAGILE AND CAN CAUSE SERIOUS INJURY IF BROKEN.</i></p> <p>Remove the damage by cutting with a scalpel or chisel making the cuts perpendicular to the conductor axis with a 45° bevel.</p> <p>Note: In order to have at least ½-in. overlap, additional laminate material may have to be removed.</p> 
3	<p>Grasp the damaged conductor with tweezers and remove.</p> <p>Note: If adhesive between the laminate and conductor surface is present, a hot-peel technique (steps 4 through 10) maybe used to soften the adhesive.</p> 
4	<p>Select a soldering iron tip that maximizes heat transfer and contact area with the conductor to be removed.</p>
5	<p>Set the soldering iron tip temperature to 361°F (183°C).</p>

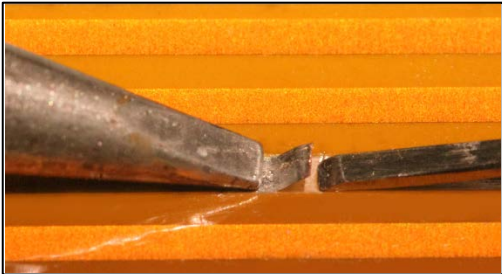
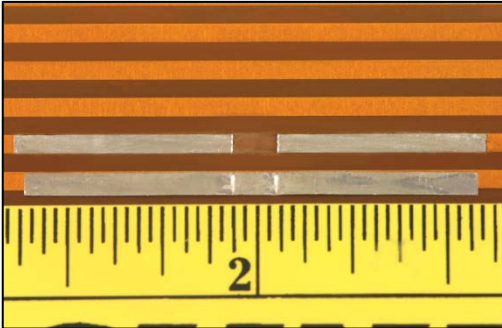
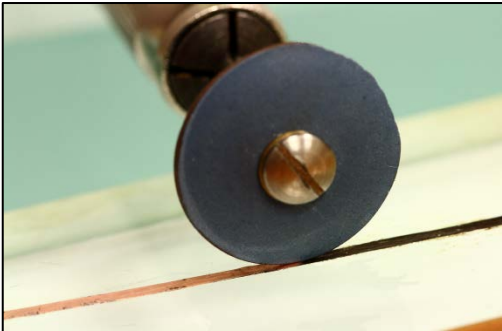
Flex Print Conductor Removal and Replacement Procedure

Step	Action
6	Remove the seasoning (all solder) from the soldering iron tip.
7	Thermally shock the soldering iron tip on a damp sponge.
8	<p>Use the soldering iron and tweezers or chisel to hot-peel the cut portion of the original conductor from the flex print.</p> <p>Note: A wet tissue may be placed under the laminate to help dissipate heat.</p> 
9	Season the tip and place the soldering iron into its stand.
10	Allow the flex print to cool completely before continuing.
11	<p>Obtain a replacement conductor from a similar flex print assembly, from a track repair kit, or by manufacturing a replacement from copper foil using the Conductor Fabrication Procedure in WP 012 00 (paragraph 12-5.13).</p> <p>Note: The replacement conductor shall overlap a minimum of ½ in. on both sides of the damage.</p> 
12	<p>Remove the adhesive from the underside of the replacement conductor, if required.</p> 
13	Center the replacement conductor over the original conductor.

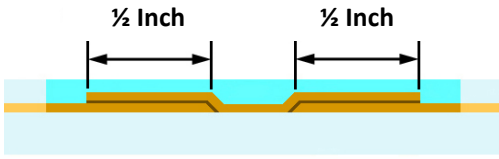

Flex Print Conductor Removal and Replacement Procedure

Step	Action
<p>14</p>	<p>Form the replacement conductor to the 45° bevels in the original conductor using an orangewood stick or spudger.</p>  <p>Note: The replacement conductor shall overlap the original area at least ½ in. on each side of the damaged area to provide strength and allow for flexing of the circuit.</p> 
<p>15</p>	<p>Select a soldering iron tip that maximizes heat transfer and contact area with the replacement conductor.</p>
<p>16</p>	<p>Set the soldering iron tip temperature to 600°F (316°C).</p>
<p>17</p>	<p>Clean the original conductor where the lap solder joint will be made and the underside of the replacement conductor with isopropyl alcohol using an acid brush and blot dry with a clean, lint-free tissue.</p> <p>Note: Take precautions to prevent bare skin contact with the replacement conductor before soldering. Skin contact leaves contaminants on the leads and/or pads.</p>
<p>18</p>	<p>Clean the solder with isopropyl alcohol and wipe dry with a clean, lint-free tissue.</p>
<p>19</p>	<p>Apply flux SPARINGLY to the beveled ends and overlap areas of the original conductor.</p> <p>Note: Use a toothpick or flux pen to control the volume of flux applied. Heavy flux volume impairs cleaning and may affect reliability.</p>
<p>20</p>	<p>Remove the seasoning from the soldering iron tip.</p>
<p>21</p>	<p>Thermally shock the soldering iron tip on a damp sponge.</p>

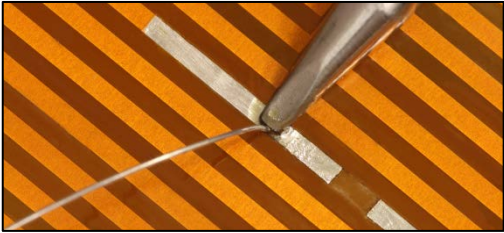
Flex Print Conductor Removal and Replacement Procedure

Step	Action
22	<p style="text-align: center;">CAUTION</p> <p style="text-align: center;">DO NOT APPLY PRESSURE WITH THE SOLDERING IRON. AVOID APPLYING EXCESSIVE HEAT TO CONDUCTORS AS THE LAMINATE SURROUNDING THE REPAIR AREA MAY BE DAMAGED.</p> <p>Place the soldering iron tip on the original conductor.</p> <p>Note: A wet tissue may be placed under the laminate to help dissipate heat while tinning the conductor.</p> 
23	<p style="text-align: center;">CAUTION</p> <p style="text-align: center;">IF SOLDER MELT DOES NOT OCCUR WITHIN TWO SECONDS, STOP THIS PROCEDURE AND ADJUST TIP TEMPERATURE PER THE TIP TEMPERATURE PROCEDURE IN WP 003 00 (PARAGRAPH 03-5.4).</p> <p>Form a heat bridge between the soldering iron tip and the original conductor using clean solder.</p> 
24	Tin the original conductor in the solder area.
25	Tin the underside of the replacement conductor at the bevels and in the overlap areas and along the length of the top surface.
26	Remove the solder and the soldering iron tip simultaneously.
27	Season the tip and place the soldering iron into its stand.
28	Allow the original and replacement conductor to cool completely before cleaning.

Flex Print Conductor Removal and Replacement Procedure

Step	Action
29	Clean the original and replacement conductor with isopropyl alcohol using an acid brush to remove all flux residue and blot dry with a clean, lint-free tissue.
30	Apply flux SPARINGLY to the original conductor using a toothpick or flux pen.
31	Position the replacement conductor on the original conductor. 
32	Remove the seasoning from the soldering iron tip.
33	Thermally shock the soldering iron tip on a damp sponge.
34	<p style="text-align: center;">CAUTION</p> <p style="text-align: center;">DO NOT APPLY PRESSURE WITH THE SOLDERING IRON.</p> Place the soldering iron tip on the replacement conductor at one end. Note: Hold the replacement conductor in place with an orangewood stick.
35	<p style="text-align: center;">CAUTION</p> <p style="text-align: center;">IF SOLDER MELT DOES NOT OCCUR WITHIN TWO SECONDS, STOP THIS PROCEDURE AND ADJUST TIP TEMPERATURE PER THE TIP TEMPERATURE PROCEDURE IN WP 003 00 (PARAGRAPH 03-5.4).</p> Tack solder one end of the replacement conductor to the original conductor. 

Flex Print Conductor Removal and Replacement Procedure

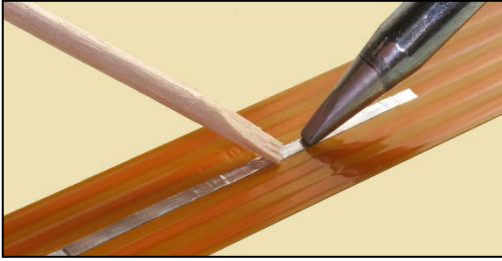
Step	Action
36	<p>Place the soldering iron tip on the replacement conductor at the bevel that is NOT tack soldered.</p> 
37	<p>Solder the replacement conductor by moving the soldering iron tip toward and off the cut end.</p> <p>Note: Follow the movement of the soldering iron tip with a tool such as an orangewood stick or toothpick to hold the conductor in place.</p> 
38	<p>Place the soldering iron tip on the replacement conductor at the bevel of the replacement conductor that is tack soldered.</p>
39	<p>Solder the replacement conductor by moving the soldering iron tip toward and off the cut end.</p> <p>Note: Follow the movement of the soldering iron tip with a tool such as an orangewood stick or toothpick to hold the conductor in place.</p>
40	<p>Season the tip and place the soldering iron into its stand.</p>
41	<p>Allow the repaired area to cool completely before cleaning.</p>
42	<p>Clean the soldered area with isopropyl alcohol using an acid brush to remove all flux residue and blot dry with a clean, lint-free tissue.</p>
43	<p><i>Inspect per the General Inspection Procedure in WP 003 00 (paragraph 03-5.12) to all applicable WORKMANSHIP STANDARDS, including:</i></p> <ul style="list-style-type: none"> • <i>General Solder Acceptability in WP 005 00 (paragraph 05-6.1)</i> • <i>Post-Solder Joint Cleanliness in WP 005 00 (paragraph 05-6.2)</i> • <i>Flex Print Conductor Removal and Replacement (paragraph 13-6.3)</i> • <i>Other applicable Workmanship Standards, as required</i>

Flex Print Conductor Removal and Replacement Procedure

Step	Action
44	Perform the Flex Print Laminate Replacement Procedure (paragraph 13-5.6).
45	Dispose of all HAZMAT following local procedures.

13-5.6 Flex Print Laminate Replacement Procedure

Use this procedure to replace damaged laminate on a flex print assembly.

Personnel Hazards



Alcohol, Isopropyl

1



Silicone Resin, MIL-I-46058

6

Flex Print Laminate Replacement Procedure

Step	Action
	<p style="text-align: center;">WARNING</p> <p style="text-align: center;"><i>USE APPROVED SAFETY EYEWEAR WHEN PERFORMING THIS PROCEDURE. COMPLY WITH ALL LOCAL REQUIREMENTS FOR PPE.</i></p> <p style="text-align: center;">CAUTION</p> <p style="text-align: center;">DON A PROPERLY GROUNDED ESD WRIST STRAP BEFORE STARTING THIS PROCEDURE.</p>
1	<p>Use 600 grit sandpaper to roughen the laminate surface in the repair area and to smooth any nicks along the outer edges of the laminate.</p> <p>Note: Roughening the laminate surface facilitates the reliable bonding of the replacement coating.</p>

Flex Print Laminate Replacement Procedure

Step	Action
2	Clean the repair area with isopropyl alcohol using an acid brush and blot dry with a clean, lint-free tissue.
3	Dry the flex print assembly in a curing oven or on a preheater set at 130°F (54°C) for a minimum of one hour.
4	<div style="text-align: center; border: 1px solid black; padding: 5px; margin-bottom: 10px;">WARNING</div> <p style="text-align: center;"><i>READ THE MANUFACTURERS' WARNING LABELS AND INSTRUCTIONS; FOLLOW ALL SAFETY REQUIREMENTS AND PROCEDURES WHILE HANDLING 3140 RTV (SILICONE RESIN).</i></p> <p>Use a dental tool to apply a thin coat of 3140 RTV (silicone resin) to bring the level of the repair area to the level of the original laminate.</p> <p>Note: If 3140 RTV is not available, use polyimide tape (Kapton®) to restore the repair area to the original laminate level by completing steps 8 through 10.</p>
5	<p>Feather the coating out on the sides of the repair approximately ¼ in.</p> <p>Note: Apply a thin coat of 3140 RTV as necessary to restore laminate integrity on the opposite side should break through occur during the laminate removal process.</p> <p>Note: Air bubbles or voids in the coating shall not exceed 25% of the conductor spacing.</p>
6	Cure 3140 RTV in accordance with the manufacturer's specifications.
7	Clean the repair area with isopropyl alcohol using an acid brush and blot dry with a clean, lint-free tissue.
8	If 3140 RTV is not available, cut a piece of polyimide tape to a length to allow for a minimum of ¼ in. overlap onto the laminate on each side of the repair area.
9	<p>Use a scalpel or scissors to round the corners of the tape.</p> <p>Note: Do not stretch the tape.</p>

Flex Print Laminate Replacement Procedure

Step	Action
10	<div style="text-align: center; border: 1px solid black; padding: 5px; margin-bottom: 10px;">CAUTION</div> <p style="text-align: center;">BEFORE APPLYING POLYIMIDE TAPE, ENSURE THE ASSEMBLY IS FREE FROM ALL DEBRIS AND RESIDUES THAT WOULD INTERFERE WITH THE TAPE BONDING TO THE REPAIR AREA.</p> <p>Press the polyimide tape over the repair area with the adhesive side of the tape next to the conductor.</p> 
11	<p>Repeat steps 8 through 10 as necessary to restore the repair area to the level of the original laminate.</p> <p>Note: Use steps 8 through 10 as necessary to restore laminate integrity on the opposite side should break through occur during the laminate removal process.</p>
12	<p><i>Inspect per the General Inspection Procedure in WP 003 00 (paragraph 03-5.12) to all applicable WORKMANSHIP STANDARDS, including:</i></p> <ul style="list-style-type: none"> • <i>Flex Print RTV Method of Laminate Replacement (paragraph 13-6.4)</i> • <i>Flex Print Polyimide Tape Method of Laminate Replacement (paragraph 13-6.5)</i> • <i>Other applicable Workmanship Standards, as required</i>
13	<p>Dispose of all HAZMAT following local procedures.</p>

13-6 WORKMANSHIP STANDARDS

Refer to WP 003 00 (paragraph 03-6) for definitions of Workmanship Standards.

NOTE

WORKMANSHIP STANDARDS FOR GENERAL SOLDER ACCEPTABILITY AND POST-SOLDER JOINT CLEANLINESS ARE IN WP 005 00 (PARAGRAPH 05-6) AND CONDUCTORS, PADS, AND LANDS IN WP 012 00 (PARAGRAPH 12-6).

13-6.1 Flex Print

Flex Print

Target Condition	Acceptable Condition	Defect Condition
	Discoloration of the laminate provided there are no burns evident.	There is burned, charred, or damaged laminate.
		There is damage to a conductor.

13-6.2 Flex Print Laminate Removal

Flex Print Laminate Removal

Target Condition	Acceptable Condition	Defect Condition
All damaged laminate has been removed.		Evidence of damaged laminate.
The length of laminate removed allows room for the end fillets on both ends of the replacement conductor.		The length of laminate removed does not allow room for the end fillets on both sides of the replacement conductor.
The length of laminate removed allows a minimum of ½-in. overlap on both sides of the damaged conductor area.		The length of laminate removed does not allow a minimum of ½-in. overlap on both sides of the damaged conductor area.
The laminate removed is cut at a 45° angle along the bottom edge of the damaged conductor.	The removed laminate is not cut at a 45° angle along the bottom edge of the damaged conductor.	The laminate is not removed to the bottom edge of the damaged conductor.
The ends of the removed laminate are cut out at a 90° angle perpendicular to the conductor.	The ends of the removed laminate are not cut out at a 90° angle perpendicular to the conductor.	The conductor has been damaged when cutting the ends of the removed laminate.

Flex Print Laminate Removal

Target Condition	Acceptable Condition	Defect Condition
	The cut made during the laminate removal process breaks through the laminate to the other side.	

13-6.3 Flex Print Conductor Removal and Replacement

Flex Print Conductor Removal and Replacement

Target Condition	Acceptable Condition	Defect Condition
The ends of the original conductor where the damage was removed are cut perpendicular to the conductor axis.	The ends of the original conductor where the damage was removed are not perpendicular to the conductor axis.	
The ends of the original conductor where the damage was removed are beveled at a 45° angle.	The ends of the original conductor where the damage was removed are beveled.	The ends of the original conductor where the damage was removed are not beveled.
The replacement conductor is the same width and same thickness as the original conductor.	The replacement conductor is slightly larger in width than the original conductor is if the overall width (overhang) reduces spacing between adjacent conductors by 50% or less, provided the solder seam is visible.	The overall width (overhang) of the replacement conductor reduces the spacing between adjacent conductors by more than 50% or the solder seam is not visible.
	The replacement conductor is slightly thicker than the original conductor is.	The replacement conductor is narrower or thinner than the original conductor is.
The replacement conductor overlaps the original conductor a minimum of ½ in. at each end.		The replacement conductor does not overlap the original conductor a minimum of ½ in. at each end.

Flex Print Conductor Removal and Replacement

Target Condition	Acceptable Condition	Defect Condition
The cut ends of the replacement conductor are perpendicular and 90° in respect to the original conductor.	The cut ends of the replacement conductor are not perpendicular and 90° in respect to the original conductor.	
The replacement conductor lays flat on the original conductor in the overlap area.		The replacement conductor does not lay flat on the original conductor in the overlap area.
The replacement conductor is formed and beveled to provide an exact fit with the beveled ends of the original conductor in the repair area.		The replacement conductor is not formed and beveled to conform to the original conductor.
	A conductor, pad, or land has damage that does not reduce its cross-sectional area more than 20%.	A conductor, pad, or land has damage that reduces its cross-sectional area more than 20%.
The adhesive is removed from the replacement conductor.		The adhesive is not removed from the replacement conductor.
The overlap area shows evidence of complete wetting (solder seam).		There is nonwetting or dewetting in the overlap area.
The overlap area has a concave fillet at the end of the overlap.		
		There is exposed copper on the replacement conductor.

13-6.4 Flex Print RTV Method of Laminate Replacement

Flex Print RTV Method of Laminate Replacement

Target Condition	Acceptable Condition	Defect Condition
The applied coating brings the level of the repair area at least to the level of the original laminate.		Coating applied does not bring the level of the repair area to the level of the original laminate.
The coating fill overlaps the repair area ¼-in. on all sides.	The coating fill overlaps the repair area more than ¼-in. on any side.	The coating fill overlaps the repair area less than ¼-in. on any side.
		There are contaminants in the coating fill.
	There are voids or air bubbles that are less than or equal to 20% of the thickness of the coating fill.	There are voids or air bubbles in the coating that exceed 20% of the coating thickness of the coating fill.
	The volume of bubbles in the coating fill is less than or equal to 5% of the coating fill volume.	The volume of bubbles in the coating fill is greater than 5% of the coating fill volume.
		There is uncured coating.

13-6.5 Flex Print Polyimide Tape Method of Laminate Replacement

Flex Print Polyimide Tape Method of Laminate Replacement

Target Condition	Acceptable Condition	Defect Condition
The polyimide tape is bonded to all parts of the repair area.		The polyimide tape is not bonded to all parts of the repair area.
The polyimide tape overlaps the repair area ¼-in. on all sides.	The polyimide tape overlaps the repair area more than ¼-in. on any side.	The polyimide tape overlaps the repair area less than ¼-in. on any side.

15 October 2013

WP 014 00 Welded Leads

14-1 PURPOSE

Identify the technical information relative to welded leads.

Specify the repair procedures for welded leads.

Identify the workmanship standards for repair of welded leads.

14-2 INDEX

Paragraph	Subject	Page
14-1	Purpose	1
14-2	Index	1
14-3	General Safety Precautions.....	1
14-4	Technical Information.....	2
14-5	Repair Procedures.....	3
14-5.1	Welded Lead Component Removal and Replacement Procedure	4
14-6	Workmanship Standards	8
14-6.1	Welded Lead Component Removal	9

14-3 GENERAL SAFETY PRECAUTIONS

Observe all the following precautions while repairing welded leads:

- Electronic equipment must be de-energized during removal and installation of CCAs
- Personnel are required to wear a properly grounded ESD wrist strap and cord while working in or around the EPA
- ESD can destroy components—protect ESDS devices during handling and repair to prevent ESD damage (Refer to WP 004 00)
- Isopropyl alcohol is flammable; do not use in the presence of sparks, heat, flame, or synthetic cloth
- Soldering handpieces (e.g., soldering irons) produce extreme heat—exercise care when these tools are out of their stands

- Avoid direct inhalation of fumes during a soldering operation because there is a possibility these fumes could cause occupational asthma
- The lead contained in solder is a source of lead oxide, which the human body cannot dissipate (accumulation of lead oxide in the body over a period of years can result in a serious health hazard)
- Contact with solder by holding in the mouth, smoking, or eating during or immediately after soldering is a potential means of ingesting trace amounts of lead oxide
- Avoid oral contact with hands during or immediately after solder operations
- Wash hands following any solder operation
- Wear approved PPE whenever pouring or handling molten metals or corrosive liquids and solids; and cutting, drilling, grinding, milling, chipping and other dust and debris producing operations
- Always follow the manufacturer's instructions and warnings when using conformal coating products

14-4 TECHNICAL INFORMATION

Welding is a process using heat to join two pieces of metal together. Resistance welding is commonly used in electronics and is similar in principle to resistance soldering. The resistance of the materials being joined produces heat when electric current is applied. Fusion takes place when the temperature produced at the connection interface is high enough to cause the materials to melt.

There are two common methods of resistance welding used in electronic manufacturing:

Opposed Electrode Welding—is used when the electrodes approach the parts to be welded from directly opposite sides and the current flows from one electrode, through the part, to the other electrode. Identifying this type of weld requires careful inspection, as the weld exists between the two metals.

Parallel Electrode Welding—is used for welding components such as flat packs onto circuit card assemblies. The electrodes contact the workpiece from one side, positioned close together so only one weld is made between the two electrodes. It is readily seen as a silver or black line across the leads of the component and no solder is visible.

14-5 REPAIR PROCEDURES



PROTECT STATIC SENSITIVE DEVICES DURING HANDLING AND REPAIR TO PREVENT ESD DAMAGE (REFER TO WP 004 00).

Equipment Required Listed below is the authorized 2M Power Unit* for repair of welded leads:

- **NAVAIR/NAVSEA/USMC/USAF/USCG**—PRC-2000-SMT

* Refer to Table 03-3 for Power Unit Part No., and CAGE Code

Additional Support Items For additional information regarding items of support and support equipment refer to:

- **NAVSEA/NAVAIR/USCG**—2M MTR Certification Manual
- **NAVSEA/USCG**—Allowance Parts List (APL) 000A8423
- **USMC**—Stock List SL-3-09458A
- **USAF**—the Consolidated Tool Kit (CTK)

Material Required Listed below are the materials required* for repair of welded leads:

- Flux, Soldering
- Isopropyl Alcohol, Technical
- Orangewood Stick
- Solder, Tin Alloy†
- Toothpick‡
- Towel, Paper (Kimwipe®)‡

* Refer to Table 03-4 for Specification No., Part No., and NSN















† Select size appropriate for application

‡ Substitution of equivalent material is acceptable

14-5.1 Welded Lead Component Removal and Replacement Procedure

In this procedure, the failed component body is removed leaving a portion of the leads intact on the lands to be used as solderable areas (new land) for installing a new component.

Personnel Hazards

					
Alcohol, Isopropyl					1
					
Flux (Soldering)					8
					
Lead (Solder)					9

Welded Lead Component Removal and Replacement Procedure

Step	Action
	<div style="border: 2px solid black; padding: 5px; margin-bottom: 10px;">WARNING</div> <p>USE APPROVED SAFETY EYEWEAR WHEN PERFORMING THIS PROCEDURE.</p> <p>COMPLY WITH ALL LOCAL REQUIREMENTS FOR PPE.</p> <p>SPOT TOOLS UNDER THE MICROSCOPE IN THE WORK AREA BEFORE LOOKING THROUGH THE MICROSCOPE.</p> <div style="border: 2px solid black; padding: 5px; margin-bottom: 10px;">CAUTION</div> <p>DON A PROPERLY GROUNDED ESD WRIST STRAP BEFORE STARTING THIS PROCEDURE.</p> <p>NEVER ATTEMPT TO REMOVE A WELDED LEAD USING HEAT OR PRESSURE.</p>
1	Perform the Procedural Analysis and Feasibility of Repair Procedure in WP 003 00 (paragraph 03-5.1).

Welded Lead Component Removal and Replacement Procedure

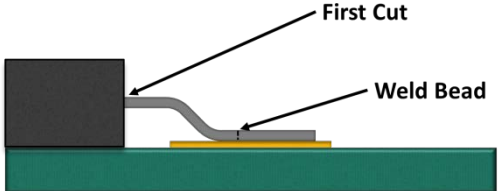
Step	Action								
2	<p style="text-align: center;">CAUTION</p> <p style="text-align: center;">BEGIN THE REPAIR PROCESS AS SOON AS POSSIBLE AFTER REMOVAL FROM THE OVEN TO AVOID MOISTURE RE-ABSORPTION.</p> <table border="1" style="width: 100%; border-collapse: collapse;"> <thead> <tr> <th style="width: 50%; text-align: left;">Baking Temp.</th> <th style="width: 50%; text-align: left;">Baking Time</th> </tr> </thead> <tbody> <tr> <td>248°F (120°C)</td> <td>3.5 to 7 hours</td> </tr> <tr> <td>212°F (100°C)</td> <td>8 to 16 hours</td> </tr> <tr> <td>176°F (80°C)</td> <td>18 to 48 hours</td> </tr> </tbody> </table> <p>Bake the CCA, if feasible, in accordance with the table to the right before soldering, desoldering, and conformal coating removal procedures to prevent delamination, measling, or other laminate degradation.</p>	Baking Temp.	Baking Time	248°F (120°C)	3.5 to 7 hours	212°F (100°C)	8 to 16 hours	176°F (80°C)	18 to 48 hours
Baking Temp.	Baking Time								
248°F (120°C)	3.5 to 7 hours								
212°F (100°C)	8 to 16 hours								
176°F (80°C)	18 to 48 hours								
3	Remove any conformal coating from the repair area using one of the Conformal Coating Removal Methods in WP 006 00 (paragraph 06-5.4).								
4	Preheat the CCA per the Convective Preheating Procedure in WP 018 00 (paragraph 18-5.2.1) or the Conductive Preheating Procedure (paragraph 18-5.2.2).								
5	Select a soldering iron tip that maximizes heat transfer and contact area with the lead.								
6	Set the soldering iron tip temperature to 600°F (316°C).								
7	<p style="text-align: center;">CAUTION</p> <p style="text-align: center;">DAMAGE TO THE WELD AREA MAY OCCUR IF EXCESSIVE PRESSURE IS APPLIED TO THE WELD AREA WHEN CUTTING A WELDED LEAD.</p> <p style="text-align: center;">ENSURE THE SHOCK GENERATED BY THE CUTTING ACTION IS TRANSMITTED TOWARD THE COMPONENT BODY, NOT THE WELD BEAD.</p> <p>Use flush cutters to cut the component leads flush at the failed component body.</p> <p>Note: Use a toothpick or orangewood stick used to stabilize the weld beads while cutting the leads.</p> 								
8	<p>Remove the component.</p> <p>Note: If the component is attached to the CCA with adhesive, use the Component Removal Procedure in WP 007 00 (paragraph 07-5.5).</p>								

Welded Lead Component Removal and Replacement Procedure

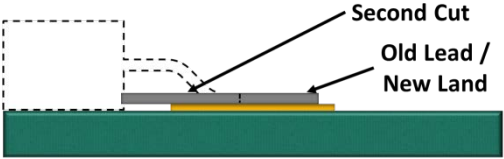
Step	Action
9	Place an orangewood stick or spudger firmly against the land of the existing welded lead.
10	Straighten the component lead until it is on the same plane as the land of the welded lead.
11	<div style="text-align: center; border: 2px solid black; padding: 5px; margin-bottom: 10px;">WARNING</div> <p style="text-align: center;">DO NOT APPLY LATERAL PRESSURE TO THE SCALPEL. THE BLADE IS EXTREMELY FRAGILE AND CAN CAUSE SERIOUS INJURY IF BROKEN.</p> <p>Use a scalpel to cut the welded lead to a length to make a new land area.</p> 
12	<div style="text-align: center; border: 2px solid black; padding: 5px; margin-bottom: 10px;">CAUTION</div> <p style="text-align: center;">USE CARE WHEN BURNISHING, AS THE BURNISHING TOOL MAY CAUSE THE WELD BEAD TO SPREAD OUT OR EXPAND.</p> <p>Burnish the weld bead as necessary until it is level with the land.</p>
13	<p>Clean the land with isopropyl alcohol using an acid brush and blot dry with a clean, lint-free tissue.</p> <p>Note: Take precautions to prevent bare skin contact with the land before soldering. Skin contact leaves contaminants on the lands.</p>
14	Clean the solder with isopropyl alcohol and wipe dry with a clean, lint-free tissue.
15	<p>Apply flux SPARINGLY to the land.</p> <p>Note: Use a toothpick or flux pen to control the volume of flux applied. Heavy flux volume impairs cleaning and may affect reliability.</p>
16	Remove the seasoning (all solder) from the soldering iron tip.
17	Thermally shock the soldering iron tip on a damp sponge.

Welded Lead Component Removal and Replacement Procedure

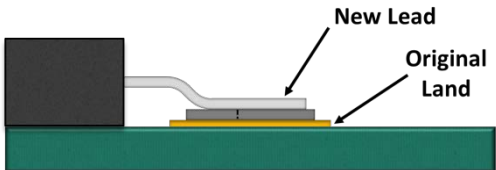
Step	Action
18	<p style="text-align: center;">CAUTION</p> <p style="text-align: center;">DO NOT APPLY PRESSURE WITH THE SOLDERING IRON.</p> <p>Place the soldering iron tip on the connection at the point of maximum thermal mass.</p>
19	<p style="text-align: center;">CAUTION</p> <p style="text-align: center;">IF SOLDER MELT DOES NOT OCCUR WITHIN TWO SECONDS, STOP THIS PROCEDURE AND ADJUST TIP TEMPERATURE PER THE TIP TEMPERATURE PROCEDURE IN WP 003 00 (PARAGRAPH 03-5.4).</p> <p>Form a heat bridge between the soldering iron tip and the surfaces to be soldered using clean solder.</p>
20	<p>Tin the lead/land areas.</p> <p>Note: A small amount of dewetting at the weld bead is acceptable.</p>
21	<p>Remove the solder and the soldering iron tip simultaneously.</p>
22	<p>Season the tip and place the soldering iron into its stand.</p>
23	<p>Allow the lands to cool completely before cleaning.</p>
24	<p>Clean the lands with isopropyl alcohol using an acid brush to remove all flux residue and blot dry with a clean, lint-free tissue.</p>
25	<p>Install the component using one of the Surface Mount Device Installation procedures in WP 018 00 (paragraph 18-5.8).</p> 

Welded Lead Component Removal and Replacement Procedure

Step	Action
26	<p><i>Inspect per the General Inspection Procedure in WP 003 00 (paragraph 03-5.12) to all applicable WORKMANSHIP STANDARDS, including:</i></p> <ul style="list-style-type: none"> • <i>General Solder Acceptability in WP 005 00 (paragraph 05-6.1)</i> • <i>Post-Solder Joint Cleanliness in WP 005 00 (paragraph 05-6.2)</i> • <i>Laminate in WP 011 00 (paragraph 11-6.1)</i> • <i>Conductors, Pads, and Lands in WP 012 00 (paragraph 12-6.1)</i> • <i>Welded Lead Component Removal (paragraph 14-6.1)</i> • <i>Surface Mount Devices Workmanship Standards in WP 018 00 (paragraph 18-6), as applicable</i> • <i>Other applicable Workmanship Standards, as required</i>
27	<p>Replace the conformal coating per the Conformal Coating Replacement Procedure in WP 006 00 (paragraph 06-5.5), as needed.</p>
28	<p><i>Inspect to the Conformal Coating Replacement WORKMANSHIP STANDARD in WP 006 00 (paragraph 06-6.2), as required.</i></p>
29	<p>Dispose of all HAZMAT following local procedures.</p>

14-6 WORKMANSHIP STANDARDS

Refer to WP 003 00 (paragraph 03-6) for definitions of Workmanship Standards.

NOTE

WORKMANSHIP STANDARDS FOR GENERAL SOLDER ACCEPTABILITY AND POST-SOLDER JOINT CLEANLINESS ARE IN WP 005 00 (PARAGRAPH 05-6), CONFORMAL COATING IN WP 006 00 (PARAGRAPH 06-6), THROUGH HOLE COMPONENTS IN WP 007 00 (PARAGRAPH 07-6), LAMINATE IN WP 011 00 (PARAGRAPH 11-6), CONDUCTORS, PADS, AND LANDS IN WP 012 00 (PARAGRAPH 12-6), AND SURFACE MOUNT DEVICES IN WP 018 00 (PARAGRAPH 18-6).

14-6.1 Welded Lead Component Removal

Welded Lead Component Removal

Target Condition	Acceptable Condition	Defect Condition
The land is in full contact with the laminate surface.		The land is separated either partially or totally from the laminate surface.
The lead is in full contact with the land area.		The lead is not in full contact with the land area.
The lead contact length is approximately 80% of the land area.	The existing lead contact length is greater than or equal to one lead width provided there is room to form proper fillets between the new and original lands.	The existing lead contact length is less than one lead width.
The cut end of the lead is perpendicular and 90° with respect to the original land.	The cut end of the existing lead is not perpendicular with respect to the original land.	
The weld bead is burnished flush with the lead surface.		The weld bead is not burnished flush with the lead surface.
	There is evidence of exposed base metal on the lead or land.	
	The lead has nicks or deformation not exceeding 10% of the width of the lead.	
	A small dewetted area exists at the weld bead.	
	The land has damage that does not reduce its cross-sectional area by more than 20%.	
		The weld bead is spread beyond the outer edge of the lead.

This page is intentionally blank.

15 October 2013

WP 015 00 Multilayer

NOTE

USE WP 019 00 JUMPER WIRES AS THE PREFERRED METHOD FOR SUBSURFACE CONDUCTOR REPAIR.

USE THIS WORK PACKAGE ONLY IF THE DAMAGE MAKES JUMPER WIRES NOT FEASIBLE.

15-1 PURPOSE

Identify the technical information relative to multilayer CCAs.

Specify the methods for determining the type and extent of laminate and conductor damage for multilayer CCAs.

Specify the repair procedures for multilayer CCAs.

Identify the workmanship standards for multilayer CCAs.

15-2 INDEX

Paragraph	Subject	Page
15-1	Purpose	1
15-2	Index	1
15-3	General Safety Precautions.....	1
15-4	Technical Information.....	2
15-5	Repair Procedures.....	3
15-5.1	Multilayer CCA Procedural Analysis and Feasibility of Repair	4
15-5.2	Multilayer Subsurface Conductor Replacement Procedure	5
15-6	Workmanship Standards	14
15-6.1	Multilayer CCA Excavation.....	14
15-6.2	Multilayer Conductor Replacement (All Replacement Conductors)	16
15-6.3	Multilayer Conductor Replacement, Lap Soldered.....	16
15-6.4	Multilayer Conductor Replacement, Beveled End Soldered	17

15-3 GENERAL SAFETY PRECAUTIONS

Observe all the following precautions while performing multilayer repair:

- Electronic equipment must be de-energized during removal and installation of CCAs
- Personnel are required to wear a properly grounded ESD wrist strap and cord while working in or around the EPA
- ESD can destroy components—protect ESDS devices during handling and repair to prevent ESD damage (Refer to WP 004 00)
- Isopropyl alcohol is flammable; do not use in the presence of sparks, heat, flame, or synthetic cloth
- Soldering handpieces (e.g., soldering irons, solder extractors, hot air jets) produce extreme heat—exercise care when these tools are out of their stands
- Avoid direct inhalation of fumes during a soldering operation because there is a possibility these fumes could cause occupational asthma
- The lead contained in solder is a source of lead oxide, which the human body cannot dissipate (accumulation of lead oxide in the body over a period of years can result in a serious health hazard)
- Contact with solder by holding in the mouth, smoking, or eating during or immediately after soldering is a potential means of ingesting trace amounts of lead oxide
- Avoid oral contact with hands during or immediately after solder operations
- Wash hands following any solder operation
- Wear approved PPE whenever pouring or handling molten metals or corrosive liquids and solids; and cutting, drilling, grinding, milling, chipping and other dust and debris producing operations
- Always follow the manufacturer’s instructions and warnings when using conformal coating products
- Follow manufacturer’s safety instructions when using resins and catalysts

15-4 TECHNICAL INFORMATION

Additional technical information on multilayer CCA laminate and conductor repair is in the Technical Information of WP 011 00 (paragraph 11-4) and WP 012 00 (paragraph 12-4).

Multilayer CCAs utilize one or more internal conductor planes sandwiched between the layers of the CCA (Figure 15-1).

These conductor planes are connected in many locations to the plated-through holes in the CCA and circuitry on both outside surfaces of the CCA.

Multilayer CCAs consist of rigid or flexible insulation materials and used primarily for high-density applications.

Repair of internal layers is a tedious process and requires patience and skill.

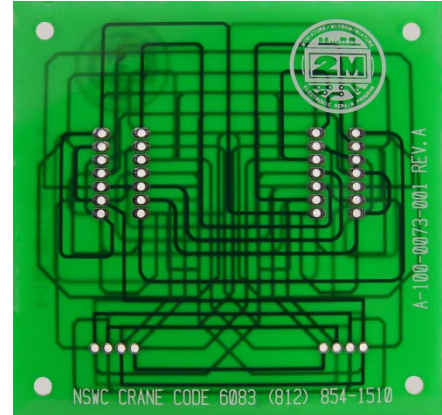

Figure 15-1 Multilayer CCA

15-5 REPAIR PROCEDURES



PROTECT STATIC SENSITIVE DEVICES DURING HANDLING AND REPAIR TO PREVENT ESD DAMAGE (REFER TO WP 004 00).

Equipment Required Listed below is the authorized 2M Power Unit* for multilayer repair:

- **NAVAIR/NAVSEA/USMC/USAF/USCG—PRC-2000-SMT**

* Refer to Table 03-3 for Power Unit Part No., and CAGE Code

Additional Support Items For additional information regarding items of support and support equipment refer to:

- **NAVSEA/NAVAIR/USCG—2M MTR Certification Manual**
 - **NAVSEA/USCG—Allowance Parts List (APL) 000A8423**
 - **USMC—Stock List SL-3-09458A**
 - **USAF—the Consolidated Tool Kit (CTK)**
-

Material Required Listed below are the materials required* for multilayer repair:

- Adhesive (Epoxy Patch Kit)
- Adhesive (jumper wire bonding)
- Flux, Soldering
- Isopropyl Alcohol, Technical
- Paper, Abrasive (sandpaper)
- Solder, Tin Alloy†
- Towel, Paper (Kimwipe®)‡

* Refer to Table 03-4 for Specification No., Part No., and NSN

† Select size appropriate for application

‡ Substitution of equivalent material is acceptable

15-5.1 Multilayer CCA Procedural Analysis and Feasibility of Repair

CAUTION

CARE MUST BE USED TO PREVENT ADDITIONAL DAMAGE TO THE CCA COMPONENTS AND CONDUCTORS DURING INSPECTION OF THE DAMAGED AREAS.

NOTE

ORGANIZATIONAL LEVEL AND INTERMEDIATE LEVEL REPAIR OF PLATED-THROUGH HOLES IN MULTILAYER CCAS IS AUTHORIZED ONLY IF THE TECHNICIAN CAN VERIFY THERE ARE NO INTERNAL CONNECTIONS TO THE PLATED-THROUGH HOLE.

Identifying the source of the failure and repairing multilayer CCAs requires the fault be isolated to as small and exact a point on the CCA as possible to eliminate unnecessary CCA excavation during the repair process.

To determine the ***extent of laminate damage***, refer to Laminate Procedural Analysis and Feasibility of Repair in WP 011 00 (paragraph 11-5.1).

To determine the ***extent of conductor damage***, use one of the following methods:

- Backlighting the CCA.

NOTE

WHEN TESTING/REPAIRING ESDS DEVICES, USE OF A HIGH INPUT IMPEDANCE MULTIMETER IS REQUIRED.

- Point to point continuity testing.

The final decision to repair multilayer laminate and conductors depends on factors other than type and extent of damage. Other factors that must be considered include:















- Other types of damage
- Repair capability
- Availability of material
- Time and cost of repair
- Operational and mission needs

15-5.2 Multilayer Subsurface Conductor Replacement Procedure

Use WP 019 00 Jumper Wires as the preferred method for subsurface conductor repair.

Use this procedure only if making a jumper wire repair is not feasible.

Personnel Hazards

					
Alcohol, Isopropyl					1
					
Epoxy, 0151					4
					
Flux (Soldering)					8
					
Lead (Solder)					9

Multilayer Subsurface Conductor Replacement Procedure

Step	Action									
	<p style="text-align: center;">WARNING</p> <p style="text-align: center;"><i>USE APPROVED SAFETY EYEWEAR WHEN PERFORMING THIS PROCEDURE.</i></p> <p style="text-align: center;"><i>COMPLY WITH ALL LOCAL REQUIREMENTS FOR PPE.</i></p> <p style="text-align: center;">CAUTION</p> <p style="text-align: center;">DON A PROPERLY GROUNDED ESD WRIST STRAP BEFORE STARTING THIS PROCEDURE.</p>									
1	<p>Perform the Multilayer CCA Procedural Analysis and Feasibility of Repair (paragraph 15-5.1), if not already completed.</p>									
2	<p>Obtain a detailed drawing of the CCA showing components and conductors before removing any components or conductors from the CCA.</p> <p>Note: Technical manuals or manufacturer’s specification drawings usually provide this information.</p>									
3	<p style="text-align: center;">CAUTION</p> <p style="text-align: center;">TO AVOID ESD AND EMI DAMAGE, DO NOT USE A PHOTOCOPIER OR SCANNER TO MAP CCAS.</p> <p>Make a sketch or take a digital photograph of the assembly showing component locations, conductor locations, and CCA markings if drawings are not available.</p>									
4	<p style="text-align: center;">CAUTION</p> <p style="text-align: center;">BEGIN THE REPAIR PROCESS AS SOON AS POSSIBLE AFTER REMOVAL FROM THE OVEN TO AVOID MOISTURE RE-ABSORPTION.</p> <table border="1" data-bbox="381 1612 1409 1822"> <tr> <td data-bbox="381 1612 912 1822" rowspan="4"> Bake the CCA, if feasible, in accordance with the table to the right before soldering, desoldering, and conformal coating removal procedures to prevent delamination, measling, or other laminate degradation. </td> <td data-bbox="912 1612 1162 1665" style="text-align: center;">Baking Temp.</td> <td data-bbox="1162 1612 1409 1665" style="text-align: center;">Baking Time</td> </tr> <tr> <td data-bbox="912 1665 1162 1717" style="text-align: center;">248°F (120°C)</td> <td data-bbox="1162 1665 1409 1717" style="text-align: center;">3.5 to 7 hours</td> </tr> <tr> <td data-bbox="912 1717 1162 1770" style="text-align: center;">212°F (100°C)</td> <td data-bbox="1162 1717 1409 1770" style="text-align: center;">8 to 16 hours</td> </tr> <tr> <td data-bbox="912 1770 1162 1822" style="text-align: center;">176°F (80°C)</td> <td data-bbox="1162 1770 1409 1822" style="text-align: center;">18 to 48 hours</td> </tr> </table>	Bake the CCA, if feasible, in accordance with the table to the right before soldering, desoldering, and conformal coating removal procedures to prevent delamination, measling, or other laminate degradation.	Baking Temp.	Baking Time	248°F (120°C)	3.5 to 7 hours	212°F (100°C)	8 to 16 hours	176°F (80°C)	18 to 48 hours
Bake the CCA, if feasible, in accordance with the table to the right before soldering, desoldering, and conformal coating removal procedures to prevent delamination, measling, or other laminate degradation.	Baking Temp.		Baking Time							
	248°F (120°C)		3.5 to 7 hours							
	212°F (100°C)		8 to 16 hours							
	176°F (80°C)	18 to 48 hours								

Multilayer Subsurface Conductor Replacement Procedure

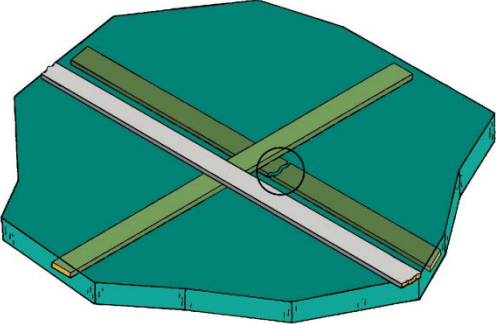
Step	Action
5	Remove any conformal coating from the repair area using one of the Conformal Coating Removal Methods in WP 006 00 (paragraph 06-5.4).
6	Remove the components necessary to provide access to the repair area(WP 007 00 for Through Hole Components or WP 018 00 for Surface Mount Devices).
7	Mark the location of the damaged conductor. 
8	Mark the excavation area to allow a stair-stepped excavation down to the damaged conductor layer.
9	Select a soldering iron tip that maximizes heat transfer and contact area with the surface/subsurface conductors to be removed.
10	Set the soldering iron tip temperature to 600°F (316°C).
11	Clean the solder with isopropyl alcohol and wipe dry with a clean, lint-free tissue.

Multilayer Subsurface Conductor Replacement Procedure

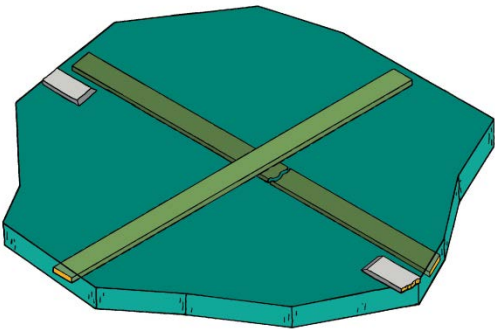
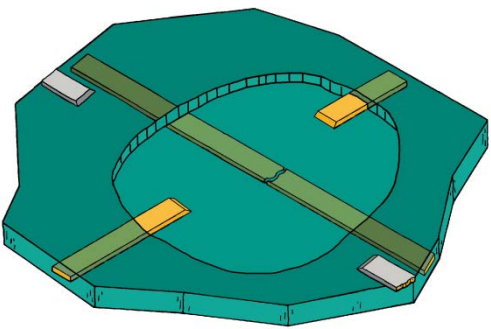
Step	Action
12	<div style="text-align: center; border: 2px solid black; padding: 5px; margin-bottom: 10px;"> WARNING </div> <p style="text-align: center;">DO NOT APPLY LATERAL PRESSURE TO THE SCALPEL. THE BLADE IS EXTREMELY FRAGILE AND CAN CAUSE SERIOUS INJURY IF BROKEN.</p> <p>Cut the ends of a surface/subsurface conductor perpendicular to the conductor axis with a 45° bevel using a scalpel or chisel.</p> <div style="display: flex; justify-content: space-around; align-items: center;">   </div>
13	Apply flux SPARINGLY to the conductor
14	Remove the seasoning (all solder) from the soldering iron tip.
15	Thermally shock the soldering iron tip on a damp sponge.
16	<div style="text-align: center; border: 2px solid black; padding: 5px; margin-bottom: 10px;"> CAUTION </div> <p style="text-align: center;">CONDUCTOR STRETCHING WILL OCCUR IF COLD-PEELING OF THE CONDUCTOR IS ATTEMPTED.</p> <p>Use a soldering iron and tweezers to hot-peel the conductor from the laminate.</p> <p>Note: Set the removed conductor aside for potential use as a replacement conductor at a subsurface level.</p>
17	Season the tip and place the soldering iron into its stand.
18	Allow the both conductors to cool completely before cleaning.



Multilayer Subsurface Conductor Replacement Procedure

Step	Action
19	Clean both conductors with isopropyl alcohol using an acid brush and blot dry with a clean, lint-free tissue. Note: Take precautions to prevent bare skin contact on the conductors before soldering. Skin contact leaves contaminants on the surfaces to be soldered.
20	Apply flux SPARINGLY to the ends of the original and removed conductors. Note: Use a toothpick or flux pen to control the volume of flux applied. Heavy flux volume impairs cleaning and may affect reliability.
21	Remove the seasoning from the soldering iron tip.
22	Thermally shock the soldering iron tip on a damp sponge.
23	<div style="text-align: center;"> <div style="border: 2px solid black; padding: 5px; display: inline-block;">CAUTION</div> DO NOT APPLY PRESSURE WITH THE SOLDERING IRON. </div> Place the soldering iron tip at the bevel cut on one end of the original conductor.
24	<div style="text-align: center;"> <div style="border: 2px solid black; padding: 5px; display: inline-block;">CAUTION</div> IF SOLDER MELT DOES NOT OCCUR WITHIN TWO SECONDS, STOP THIS PROCEDURE AND ADJUST TIP TEMPERATURE PER THE TIP TEMPERATURE PROCEDURE IN WP 003 00 (PARAGRAPH 03-5.4). </div> Form a heat bridge between the soldering iron tip and the original conductor using clean solder.
25	Heavily tin the original conductor at the bevel ends.
26	Remove the solder and the soldering iron tip simultaneously.
27	Season the tip and place the soldering iron into its stand.
28	Allow the conductors to cool completely before cleaning.
29	Clean the conductors with isopropyl alcohol using an acid brush to remove all flux residue and blot dry with a clean, lint-free tissue.

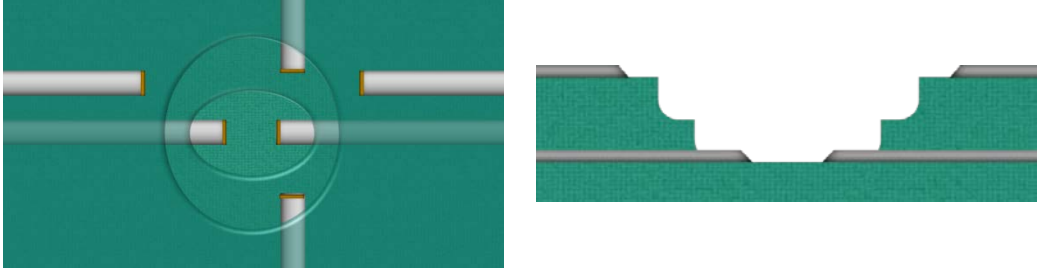
Multilayer Subsurface Conductor Replacement Procedure

Step	Action
30	<p style="text-align: center;">WARNING</p> <p style="text-align: center;">ENSURE ALL BALL MILLS, SLOTTING SAWS, DENTAL BURS, ETC., ARE PROPERLY SECURED IN THE MOTORIZED HANDPIECE.</p> <p style="text-align: center;">CAUTION</p> <p style="text-align: center;">MOTORIZED ABRASION GENERATES HEAT THAT WILL SOFTEN EPOXY AND DAMAGE LAMINATE.</p> <p style="text-align: center;">LIMIT THE TIME AND THE PRESSURE WHEN USING THESE TECHNIQUES.</p> <p style="text-align: center;">OBSERVE THE SPEED OF ROTATION OF THE BALL MILL TO PREVENT DAMAGE TO THE WORKPIECE.</p> <p>Excavate the laminated material using a ball mill or other suitable tool, working across the surface in one direction, then turning the CCA 90° making a crosshatch pattern. Repeat until all laminate material is removed to the bottom of the conductor on each level.</p> <p>Note: A minimum of one conductor width of CCA material shall be exposed between the cut end of the conductor and the excavated layer walls to facilitate leveling of layers and soldering of existing/replacement conductor.</p>
31	<p>Round the walls of the excavation using a ball mill in a pin vise, ensuring all corners of the excavation are rounded.</p> 
32	<p>Clean the excavated area with isopropyl alcohol using an acid brush to remove any loose particles and blot dry with a clean, lint-free tissue.</p>
33	<p><i>Inspect to the Laminate WORKMANSHIP STANDARD in WP 011 00 (paragraph 11-6.1) and the Multilayer CCA Excavation WORKMANSHIP STANDARD (paragraph 15-6.1).</i></p>

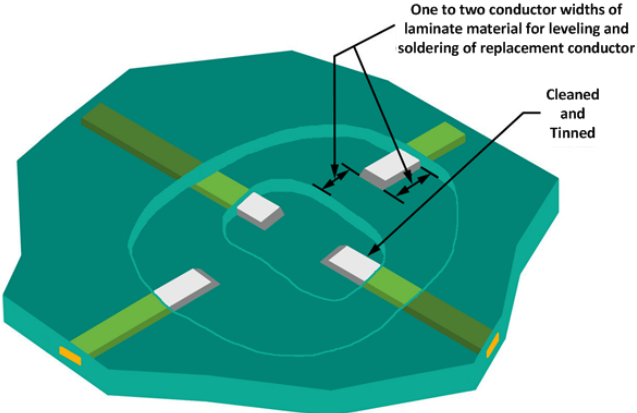
Multilayer Subsurface Conductor Replacement Procedure

Step	Action
34	<p>Repeat steps 12 through 33 for each laminated conductor layer until the damaged conductor has been excavated and removed.</p> 
35	<p>Obtain a replacement conductor from a removed surface/subsurface conductor, a scrap CCA using the Pad, Land, and/or Conductor Salvage Procedure in WP 012 00 (paragraph 12-5.12), from a track repair kit, or by manufacturing a replacement from copper foil using the Conductor Fabrication Procedure (paragraph 12-5.13).</p> <ul style="list-style-type: none"> The replacement conductor shall be the same or slightly larger in width and thickness as the original conductor. <p>Note: The replacement conductor can be sanded to achieve the correct thickness.</p>
36	<p>Reverse bevel the replacement conductor and cut to provide an exact fit with the original conductor.</p> 
37	<p>Clean both the replacement and original conductors with isopropyl alcohol using an acid brush to remove all flux residue and blot dry with a clean, lint-free tissue.</p>
38	<p>Use steps 20 through 29 to tin the replacement conductor and the beveled ends of the original conductor.</p>
39	<p>Align the replacement conductor with the original conductor.</p>
40	<p>Apply flux SPARINGLY to the beveled ends of the original conductor.</p>
41	<p>Remove the seasoning from the soldering iron tip.</p>
42	<p>Thermally shock the soldering iron tip on a damp sponge.</p>

Multilayer Subsurface Conductor Replacement Procedure

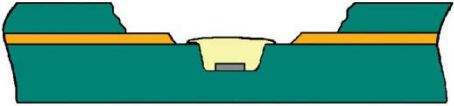
Step	Action
43	<p style="text-align: center;">CAUTION</p> <p style="text-align: center;">DO NOT APPLY PRESSURE WITH THE SOLDERING IRON.</p> <p>Place the soldering iron tip at a bevel end of the original conductor using a soldering aid to hold the conductor in place.</p>
44	<p style="text-align: center;">CAUTION</p> <p style="text-align: center;">IF SOLDER MELT DOES NOT OCCUR WITHIN TWO SECONDS, STOP THIS PROCEDURE AND ADJUST TIP TEMPERATURE PER THE TIP TEMPERATURE PROCEDURE IN WP 003 00 (PARAGRAPH 03-5.4).</p> <p>Form a heat bridge between the soldering iron tip and the original conductor using clean solder.</p>
45	<p>Solder the bevel end connections in place.</p> <p>Note: Ensure no further laminate damage is caused by excessive heat.</p>
46	<p>Remove the soldering iron tip, while holding the conductor in place until the solder solidifies.</p>
47	<p>Season the tip and place the soldering iron into its stand.</p>
48	<p>Allow the repair area to cool completely before continuing.</p>
49	<p>Clean the repair area with isopropyl alcohol using an acid brush to remove all flux residue and blot dry with a clean, lint-free tissue.</p>
50	<p>Remove excess solder using abrasive methods to level the repaired conductor with the original conductor.</p>
51	<p><i>Inspect to the Multilayer Conductor Replacement, Beveled End Soldered WORKMANSHIP STANDARD (paragraph 15-6.4).</i></p>
52	<p>Prepare epoxy according to the manufacturer's directions.</p>
53	<p>Fill the excavated area with epoxy up to or slightly above the next laminate level.</p> 

Multilayer Subsurface Conductor Replacement Procedure

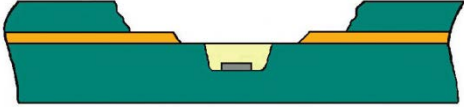
Step	Action
54	Remove any voids and/or bubbles from the epoxy.
55	Cure the epoxy according to the manufacturer's directions.
56	<p>Restore the fill area to the original laminate level using abrasive methods.</p> <p>Note: An alternative method to complete resurfacing is to excavate a trough in the cured epoxy so that the conductor will lay flat on the respective level when soldered.</p> 
57	<i>Inspect to the Epoxy Fill WORKMANSHIP STANDARD in WP 011 00 (paragraph 11-6.3).</i>
58	Repeat steps 35 through 57 for each laminated conductor layer until the CCA has been restored to its original dimensions.
59	Apply a thin layer of epoxy (buttercoat) to the repair area covering and overlapping the exposed fiber weave in the repair area.
60	Cure the epoxy (buttercoat) according to the manufacturer's directions.
61	<i>Inspect to the Buttercoat WORKMANSHIP STANDARD in WP 011 00 (paragraph 11-6.4).</i>
62	Replace the surface conductors removed to facilitate this repair per the appropriate repair procedure in WP 012 00 (paragraph 12-5).
63	Replace the components removed to facilitate this repair(WP 007 00 for Through Hole Components or WP 018 00 for Surface Mount Devices).
64	<p><i>Inspect per the General Inspection Procedure in WP 003 00 (paragraph 03-5.12) to all applicable WORKMANSHIP STANDARDS, including:</i></p> <ul style="list-style-type: none"> • <i>Through Hole Components in WP 007 00 (paragraph 07-6), as applicable</i> • <i>Surface Mount Devices in WP 018 00 (paragraph 18-6), as applicable</i> • <i>Other applicable Workmanship Standards, as required</i>
65	Replace the conformal coating per the Conformal Coating Replacement Procedure in WP 006 00 (paragraph 06-5.5), as needed.

Multilayer Subsurface Conductor Replacement Procedure

Step	Action
66	Inspect to the Conformal Coating Replacement WORKMANSHIP STANDARD in WP 006 00 (paragraph 06-6.2), as required.
67	Dispose of all HAZMAT following local procedures.

15-6 WORKMANSHIP STANDARDS

Refer to WP 003 00 (paragraph 03-6) for definitions of Workmanship Standards.

NOTE

WORKMANSHIP STANDARDS FOR GENERAL SOLDER ACCEPTABILITY AND POST-SOLDER JOINT CLEANLINESS ARE IN WP 005 00 (PARAGRAPH 05-6), CONFORMAL COATING IN WP 006 00 (PARAGRAPH 06-6), THROUGH HOLE COMPONENTS IN WP 007 00 (PARAGRAPH 07-6), LAMINATE IN WP 011 00 (PARAGRAPH 11-6), CONDUCTORS, PADS, AND LANDS IN WP 012 00 (PARAGRAPH 12-6), SURFACE MOUNT DEVICES IN WP 018 00 (PARAGRAPH 18-6), AND JUMPER WIRES IN WP 019 00 (PARAGRAPH 19-6).

15-6.1 Multilayer CCA Excavation

Multilayer CCA Excavation

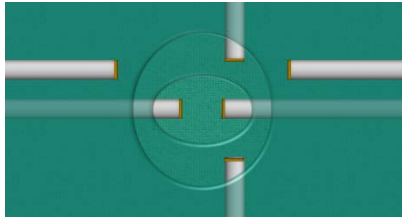
Target Condition	Acceptable Condition	Defect Condition
Each excavation layer has rounded corners. 		An excavation layer has squared corners.
The floor of each excavation level is flat.	All floors of the excavation are not flat.	

Multilayer CCA Excavation

Target Condition	Acceptable Condition	Defect Condition
<p>The walls of each excavation level are straight and perpendicular to the laminate surface.</p>	<p>All walls of the excavation are not straight or perpendicular to the laminate surface.</p>	
<p>The transition from the straight wall to the floor is rounded.</p> 		<p>The transition from the straight wall to the floor is 90° (not rounded).</p>
<p>The laminate is removed to the bottom of the conductor on each level.</p>		<p>The laminate is not removed to the bottom of the conductor on each level.</p>
		<p>The excavation of any layer exposes the next layer conductor.</p>
<p>The width of laminate material exposed between the cut end of the conductor and each excavated layer wall is greater than or equal to one conductor width.</p>		<p>There is less than one conductor width of laminate material exposed between the cut end of a conductor and any excavated layer wall.</p>
<p>The cut ends of the original conductors are beveled at a 45° angle.</p>	<p>The cuts ends of the original conductor are beveled at an angle less than 90°.</p>	<p>The cut ends of the original conductors are not beveled.</p>
<p>The cut ends of the original conductors are cut perpendicular to the conductor axis.</p>	<p>The cut ends of the original conductors are not cut perpendicular to the conductor axis.</p>	
<p>The excavation layers are stair-stepped and the stair-step is maintained completely around (360°) the excavated area.</p>		<p>The stair-step is not maintained completely around (360°) the excavated area.</p>

Multilayer CCA Excavation

Target Condition	Acceptable Condition	Defect Condition
There is a distance greater than or equal to two conductor widths between the walls of adjacent excavation layers.		There is less than two conductor widths distance between the walls of adjacent excavation layers.
		Surrounding components or conductors have been damaged during the excavation process.

15-6.2 Multilayer Conductor Replacement (All Replacement Conductors)

Multilayer Conductor Replacement (All Replacement Conductors)

Target Condition	Acceptable Condition	Defect Condition
The replacement conductor is the same thickness and width as the original conductor.	The replacement conductor is slightly larger in width and/or thickness than the original conductor.	The replacement conductor is narrower or thinner or significantly larger in width and/or thickness than the original conductor.
	There is exposed base metal on any surface conductor.	

15-6.3 Multilayer Conductor Replacement, Lap Soldered

Multilayer Conductor Replacement, Lap Soldered

Target Condition	Acceptable Condition	Defect Condition
	The overall width (overhang) of the replacement conductor does not come closer than 1/16 in. to any adjacent lead or conductor.	The overall width (overhang) of the replacement conductor comes closer than 1/16 in. to any adjacent lead or conductor.

Multilayer Conductor Replacement, Lap Soldered

Target Condition	Acceptable Condition	Defect Condition
The cut ends of the replacement conductor are perpendicular in respect to the original conductor.	A cut end of the replacement conductor is not perpendicular in respect to the original conductor.	
The replacement conductor overlaps the original conductor two conductor widths or greater at each end.		The replacement conductor overlaps original conductor less than two conductor widths at either end.
The replacement conductor lays flat on the original conductor in the overlap area.		The replacement conductor does not lay flat on the original conductor in the overlap areas.
The replacement conductor is formed to the beveled ends of the original conductor in the repair area.	The replacement conductor is formed but does not provide an exact fit with the beveled ends of the original conductor.	The replacement conductor is not formed to the bevels of the original conductor.
The overlap area shows evidence of complete wetting (solder seam).		There is evidence of nonwetting or dewetting in an overlap area.
The overlap area has a concave fillet at the end of the overlap.		The overlap area is not wetted with solder or has a convex fillet at the end of the overlap.

15-6.4 Multilayer Conductor Replacement, Beveled End Soldered

Multilayer Conductor Replacement, Beveled End Soldered

Target Condition	Acceptable Condition	Defect Condition
The replacement conductor is reverse beveled and cut to provide an exact fit with the original conductor.		The replacement conductor is not reverse beveled and cut to provide an exact fit with the original conductor.

Multilayer Conductor Replacement, Beveled End Soldered

Target Condition	Acceptable Condition	Defect Condition
The replacement conductor lays flat on the laminate surface in the repair area.		The replacement conductor does not lay flat on the laminate surface in the repair area.
		The replacement conductor overlaps the original conductor.
		The replacement conductor skews from the axis of the original conductor.
There is complete wetting between the joined conductors.		There is nonwetting or dewetting between the soldered conductors.
The outline of the conductors is visible in the solder joint.	The outline of the original conductors is not visible provided the solder joint is completely wetted.	
	Excess solder has been mechanically removed.	The soldered replacement conductor is not level with the original conductor due to excessive solder.

15 October 2013

WP 016 00 Plastic Panel

16-1 PURPOSE

Identify the technical information relative to plastic panels.

Specify the methods for determining the type and extent of plastic panel damage.

Specify the repair procedures for plastic panel repair and restoration.

Identify the workmanship standards for plastic panel repair.

16-2 INDEX

Paragraph	Subject	Page
16-1	Purpose	1
16-2	Index	1
16-3	General Safety Precautions.....	1
16-4	Technical Information.....	2
16-5	Repair Procedures.....	3
16-5.1	Plastic Panel Procedural Analysis and Feasibility of Repair	4
16-5.2	Plastic Panel (Cracked) Repair Procedure.....	5
16-5.3	Plastic Panel (Broken) Repair Procedure	6
16-5.4	Plastic Panel Bulb Removal and Replacement Procedure	12
16-5.5	Plastic Panel Surface Restoration Procedure.....	19
16-5.6	Plastic Panel Paint Restoration Procedure	21
16-6	Workmanship Standards	22
16-6.1	Plastic Panel (Cracked or Broken) Repair.....	23
16-6.2	Plastic Panel Excavation.....	24
16-6.3	Plastic Panel Bulb Replacement.....	25
16-6.4	Plastic Panel Conductor Replacement.....	26
16-6.5	Plastic Panel Excavation Fill	26
16-6.6	Plastic Panel Surface Restoration	27

16-3 GENERAL SAFETY PRECAUTIONS

Observe all the following precautions while repairing plastic panels:

- Electronic equipment must be de-energized during removal and installation of CCAs

- Personnel are required to wear a properly grounded ESD wrist strap and cord while working in or around the EPA
- ESD can destroy components—protect ESDS devices during handling and repair to prevent ESD damage (Refer to WP 004 00)
- Isopropyl alcohol is flammable; do not use in the presence of sparks, heat, flame, or synthetic cloth
- Soldering handpieces (e.g., soldering irons) produce extreme heat—exercise care when these tools are out of their stands
- Avoid direct inhalation of fumes during a soldering operation because there is a possibility these fumes could cause occupational asthma
- The lead contained in solder is a source of lead oxide, which the human body cannot dissipate (accumulation of lead oxide in the body over a period of years can result in a serious health hazard)
- Contact with solder by holding in the mouth, smoking, or eating during or immediately after soldering is a potential means of ingesting trace amounts of lead oxide
- Avoid oral contact with hands during or immediately after solder operations
- Wash hands following any solder operation
- Wear approved PPE whenever pouring or handling molten metals or corrosive liquids and solids; and cutting, drilling, grinding, milling, chipping and other dust and debris producing operations
- Follow manufacturer’s safety instructions when mixing filler material
- Use of eye protection is required and nitrile gloves optional when handling acrylic filler materials
- Follow manufacturer’s directions for the mixing, use, and curing of bonding agents

16-4 TECHNICAL INFORMATION

Plastic lighting panels employ diffused light within an acrylic plastic panel to light a switch or function legends of electronic assemblies. Any scratches, breaks, cracks, or lamp failures within the lighting panel will cause unwanted lighting degradation.

Lighting may be accomplished by one of three basic designs:

- **Internally Lighted Panel**—The lamps and power conductors are cast as an integral part of the acrylic panel
- **Externally Lighted Panel**—The lamps are mounted in filter inserts screwed into the lighting panel
- **Recessed Panel**—The lamp sockets and wiring are mounted on a metal backing plate with the bulb holes are recessed in the lighting panel and the backing plate is mated with the lighting panel to provide panel lighting

16-5 REPAIR PROCEDURES



PROTECT STATIC SENSITIVE DEVICES DURING HANDLING AND REPAIR TO PREVENT ESD DAMAGE (REFER TO WP 004 00).

Equipment Required Listed below is the authorized 2M Power Unit* for repair of plastic panels:

- **NAVAIR/NAVSEA/USMC/USAF/USCG**—PRC-2000-SMT

* Refer to Table 03-3 for Power Unit Part No., and CAGE Code

Additional Support Items For additional information regarding items of support and support equipment refer to:

- **NAVSEA/NAVAIR/USCG**—2M MTR Certification Manual
 - **NAVSEA/USCG**—Allowance Parts List (APL) 000A8423
 - **USMC**—Stock List SL-3-09458A
 - **USAF**—the Consolidated Tool Kit (CTK)
-

Material Required Listed below are the materials required* for repair of plastic panels:

- Applicator, Disposable (cotton-tipped)
- Desoldering Wick†
- Dichloromethane, Technical
- Flux, Soldering
- Glove, Chemical Protective (blue nitrile)
- Isopropyl Alcohol, Technical
- Lacquer (black or white acrylic)
- Paper, Abrasive (sandpaper)
- Pipet, Measuring (Pipette)
- Resin, Acrylic, Dental Kit
- Solder, Tin Alloy†
- Toothpick‡
- Towel, Paper (Kimwipe®)‡

* Refer to Table 03-4 for Specification No., Part No., and NSN

† Select size appropriate for application

‡ Substitution of equivalent material is acceptable

16-5.1 Plastic Panel Procedural Analysis and Feasibility of Repair

The extent of damage must be determined before feasibility and proper method of repair can be determined.

The extent of cracks or breaks in plastic panels can be determined by visual inspection.

CAUTION

APPLICATION OF EXCESSIVE VOLTAGE MAY DAMAGE PANELS.

THE CORRECT VOLTAGE MAY BE FOUND IN THE APPLICABLE TECHNICAL MANUAL FOR THE SYSTEM.

Defective bulbs may be found by visual inspection after applying voltage to the electrical connections.

Defective bulbs and conductors may be located by point-to-point continuity testing and/or excavation of the panel.

The final decision to repair a plastic panel assembly depends on factors other than type and extent of plastic panel damage.

Other factors that must be considered include:

- Other types of damage
- Repair capability
- Availability of material
- Time and cost of repair
- Operational and mission needs

16-5.2 Plastic Panel (Cracked) Repair Procedure

Use this procedure to repair cracked plastic panels.

If the plastic panel is broken, use the Plastic Panel (Broken) Repair Procedure (paragraph 16-5.3).

Personnel Hazards



Alcohol, Isopropyl

1

Plastic Panel (Cracked) Repair Procedure

Step	Action
	<div style="text-align: center;"> <div data-bbox="789 1556 1037 1631" style="border: 2px solid black; padding: 5px; display: inline-block;"> WARNING </div> <p data-bbox="467 1650 1360 1682">USE APPROVED SAFETY EYEWEAR WHEN PERFORMING THIS PROCEDURE.</p> <p data-bbox="599 1703 1227 1734">COMPLY WITH ALL LOCAL REQUIREMENTS FOR PPE.</p> </div>

Plastic Panel (Cracked) Repair Procedure

Step	Action
	<div style="border: 2px solid black; padding: 5px; display: inline-block; margin-bottom: 10px;">CAUTION</div> <p>DON A PROPERLY GROUNDED ESD WRIST STRAP BEFORE STARTING THIS PROCEDURE.</p>
1	Perform the Plastic Panel Procedural Analysis and Feasibility of Repair (paragraph 16-5.1), if not already completed.
2	Excavate the crack to widen slightly and to provide a flat floor using a toothpick in a rotary handpiece.
3	Clean the excavation with isopropyl alcohol using a cotton-tipped applicator and blot dry with a clean, lint-free tissue.
4	<i>Inspect per the General Inspection Procedure in WP 003 00 (paragraph 03-5.12) to all applicable WORKMANSHIP STANDARDS, including:</i> <ul style="list-style-type: none"> • Plastic Panel (Cracked or Broken) Repair (<i>paragraph 16-6.1</i>) • <i>Other applicable Workmanship Standards, as required</i>
5	Dispose of all HAZMAT following local procedures.
6	Use the Plastic Panel Surface Restoration Procedure (paragraph 16-5.5) below to complete the repair

16-5.3 Plastic Panel (Broken) Repair Procedure

Use this procedure to repair broken plastic panels.

If the plastic panel is only cracked, use the Plastic Panel (Cracked) Repair Procedure (paragraph 16-5.2).

Personnel Hazards



Alcohol, Isopropyl

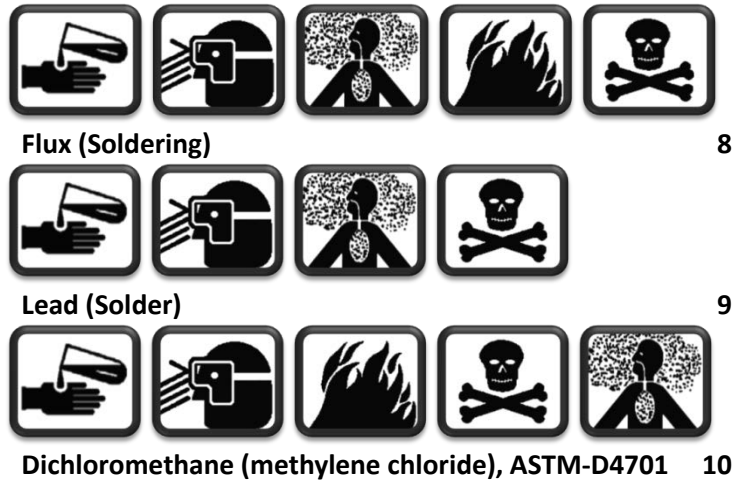

Plastic Panel (Broken) Repair Procedure

Step	Action
	<p style="text-align: center;">WARNING</p> <p style="text-align: center;"><i>USE APPROVED SAFETY EYEWEAR WHEN PERFORMING THIS PROCEDURE. COMPLY WITH ALL LOCAL REQUIREMENTS FOR PPE.</i></p> <p style="text-align: center;">CAUTION</p> <p style="text-align: center;">DON A PROPERLY GROUNDED ESD WRIST STRAP BEFORE STARTING THIS PROCEDURE.</p>
1	Perform the Plastic Panel Procedural Analysis and Feasibility of Repair (paragraph 16-5.1), if not already completed.
2	Assemble all of the pieces of the broken panel and inspect for broken or deformed bus wires.
3	Cut broken or deformed bus wires slightly below the panel edges prior to repairing the broken panel. Note: Bus wire repair is performed after the broken panel has bonded.

Plastic Panel (Broken) Repair Procedure

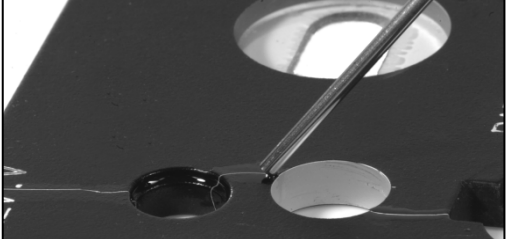
Step	Action
4	<p data-bbox="784 422 1015 489" style="text-align: center;">CAUTION</p> <p data-bbox="431 508 1369 611" style="text-align: center;">DO NOT ABRADE THE BROKEN PANEL EDGES BECAUSE THE PIECES MUST PRESENT A CLOSE FIT FOR THE SOLVENT ACTION OF THE ADHESIVE TO WORK PROPERLY.</p> <div data-bbox="389 653 1411 777" style="text-align: center;"><p data-bbox="561 745 654 772" style="text-align: center;">Correct</p><p data-bbox="1122 745 1239 772" style="text-align: center;">Incorrect</p></div> <p data-bbox="383 789 1352 856">Clean the edges of the broken pieces with isopropyl alcohol using a cotton-tipped applicator and blot dry with a clean, lint-free tissue.</p>
5	<p data-bbox="383 892 774 919">Thoroughly dry the panel pieces.</p> <p data-bbox="383 942 1179 970">Note: The adhesive will not properly adhere if moisture is present.</p>
6	<p data-bbox="784 1010 1015 1077" style="text-align: center;">CAUTION</p> <p data-bbox="423 1096 1377 1163" style="text-align: center;">DO NOT CLAMP THE PANEL PIECES TOGETHER BECAUSE THE BOND IS FORMED THROUGH CAPILLARY FLOW BETWEEN THE PIECES.</p> <p data-bbox="383 1199 1081 1226">Align and position the pieces on a flat, non-porous surface.</p>
7	<p data-bbox="784 1268 1015 1335" style="text-align: center;">WARNING</p> <p data-bbox="472 1360 1331 1428" style="text-align: center;"><i>DICHLOROMETHANE IS FLAMMABLE AND TOXIC. PROVIDE ADEQUATE VENTILATION AND AVOID SKIN CONTACT.</i></p> <p data-bbox="453 1451 1349 1551" style="text-align: center;"><i>ENSURE DICHLOROMETHANE DOES NOT COME IN DIRECT CONTACT WITH OXIDIZING MATERIALS SUCH AS ALUMINUM, POTASSIUM, SODIUM, MAGNESIUM, ALUMINUM SPRAY EQUIPMENT, AROMATIC SOLVENTS.</i></p> <p data-bbox="446 1572 1352 1600" style="text-align: center;"><i>ANY CONTACT WITH THESE MATERIALS MAY CAUSE HAZARDOUS VAPORS.</i></p> <p data-bbox="383 1675 870 1843">Apply the bonding adhesive (Dichloromethane, Technical, ASTM-D4701) to the cracks with a measuring pipette until the cement is no longer drawn into the cracks by capillary action.</p> <div data-bbox="917 1640 1419 1877" style="text-align: right;"></div>

Plastic Panel (Broken) Repair Procedure

Step	Action
8	Cure adhesive according to manufacturer's directions (adhesive cures at room temperature in approximately 20 minutes).
9	Remove paint from the panel to expose location of lighting bus. Feather (transition) the edge of the paint removal so each color (layer) of paint is visible.
10	<div style="text-align: center; border: 2px solid black; padding: 5px; margin: 0 auto; width: fit-content;"> CAUTION </div> <p style="text-align: center; margin: 10px 0;">USE EXTREME CARE IN EXCAVATING AROUND THE LIGHTING BUS. THE WIRE IS SMALL AND DAMAGE TO THE WIRE MAY REQUIRE REPLACING A SECTION OF THE LIGHTING BUS.</p> <p>Excavate the area around where the lighting bus wire was cut at the panel broken edges using rotary abrasion (rotary bristle brush, ball mill, round toothpick, etc.) or controlled heat and dental tools.</p>
11	Clean the excavation with isopropyl alcohol using a cotton-tipped applicator and blot dry with a clean, lint-free tissue.
12	Ensure the excavation is completely dry and free of contaminants.
13	Select a soldering iron tip that maximizes heat transfer and contact area.
14	Set the soldering iron tip temperature to 600°F (316°C).
15	Obtain a replacement conductor the same or slightly larger in diameter than the existing conductor and long enough to wrap around the original lighting bus a minimum of 180° at each end.
16	<p>Clean the replacement conductor and the exposed original lighting bus with isopropyl alcohol using a cotton-tipped applicator and blot dry with a clean, lint-free tissue.</p> <p>Note: Take precautions to prevent bare skin contact before the conductors are soldered. Skin contact leaves contaminants on the conductors.</p>
17	Clean the solder with isopropyl alcohol and wipe dry with a clean, lint-free tissue.

Plastic Panel (Broken) Repair Procedure

Step	Action
18	Apply flux SPARINGLY to each end of the replacement conductor and the original lighting bus. Note: Use a toothpick or flux pen to control the volume of flux applied. Heavy flux volume impairs cleaning and may affect reliability.
19	Remove the seasoning (all solder) from the soldering iron tip.
20	Thermally shock the soldering iron tip on a damp sponge.
21	<p style="text-align: center;">CAUTION</p> <p style="text-align: center;">DO NOT APPLY PRESSURE WITH THE SOLDERING IRON.</p> Place the soldering iron tip on the original lighting bus.
22	<p style="text-align: center;">CAUTION</p> <p style="text-align: center;">IF SOLDER MELT DOES NOT OCCUR WITHIN TWO SECONDS, STOP THIS PROCEDURE AND ADJUST TIP TEMPERATURE PER THE TIP TEMPERATURE PROCEDURE IN WP 003 00 (PARAGRAPH 03-5.4).</p> Form a heat bridge between the soldering iron tip and the original lighting bus using clean solder.
23	Tin the ends of the original lighting bus and the replacement conductor.
24	Remove the solder and the soldering iron tip simultaneously.
25	Season the tip and place the soldering iron into its stand.
26	Allow the original lighting bus and the replacement conductor to cool completely before cleaning.
27	Form hook terminations with the original bus wires and replacement conductor terminated at 180°.
28	Clean the hook terminations with isopropyl alcohol using a cotton-tipped applicator to remove all flux residue and blot dry with a clean, lint-free tissue.

Plastic Panel (Broken) Repair Procedure

Step	Action
29	Position the replacement conductor on the original lighting bus.
30	Apply flux SPARINGLY to the hook terminations using a toothpick or flux pen.
31	Remove the seasoning from the soldering iron tip.
32	Thermally shock the soldering iron tip on a damp sponge.
33	<p style="text-align: center;">CAUTION</p> <p style="text-align: center;">DO NOT APPLY PRESSURE WITH THE SOLDERING IRON.</p> <p>Place the soldering iron tip on the joint at the point of maximum thermal mass.</p>
34	<p style="text-align: center;">CAUTION</p> <p style="text-align: center;">IF SOLDER MELT DOES NOT OCCUR WITHIN TWO SECONDS, STOP THIS PROCEDURE AND ADJUST TIP TEMPERATURE PER THE TIP TEMPERATURE PROCEDURE IN WP 003 00 (PARAGRAPH 03-5.4).</p> <p>Form a heat bridge between the soldering iron tip and the hook terminations using clean solder.</p>
35	Solder the replacement conductor leads to the lighting buses.
	
36	Remove the solder and the soldering iron tip simultaneously.
37	Season the tip and place the soldering iron into its stand.
38	Allow the joints to cool completely before cleaning.
39	Clean the solder joints with isopropyl alcohol using a cotton-tipped applicator to remove all flux residue and blot dry with a clean, lint-free tissue.
40	Verify operation by applying power to the input connections of the panel.

Plastic Panel (Broken) Repair Procedure

Step	Action
41	<p><i>Inspect per the General Inspection Procedure in WP 003 00 (paragraph 03-5.12) to all applicable WORKMANSHIP STANDARDS, including:</i></p> <ul style="list-style-type: none"> • <i>General Solder Acceptability in WP 005 00 (paragraph 05-6.1)</i> • <i>Post-Solder Joint Cleanliness in WP 005 00 (paragraph 05-6.2)</i> • <i>Plastic Panel (Cracked or Broken) Repair (paragraph 16-6.1)</i> • <i>Plastic Panel Excavation (paragraph 16-6.2)</i> • <i>Plastic Panel Conductor Replacement (paragraph 16-6.4)</i> • <i>Other applicable Workmanship Standards, as required</i>
42	Dispose of all HAZMAT following local procedures.
43	Go to the Plastic Panel Surface Restoration Procedure (paragraph 16-5.5) below.



16-5.4 Plastic Panel Bulb Removal and Replacement Procedure

Use this procedure to remove and replace defective bulbs in plastic panels.

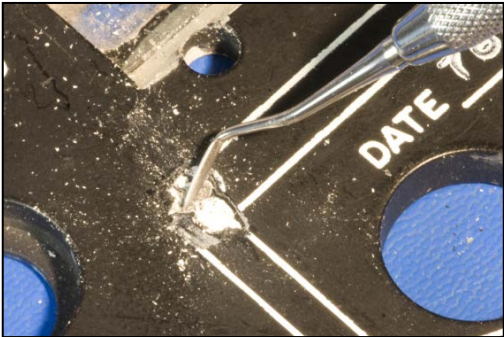

Personnel Hazards

					1
Alcohol, Isopropyl					
					8
Flux (Soldering)					
				9	
Lead (Solder)					
					10
Dichloromethane (methylene chloride), ASTM-D4701					

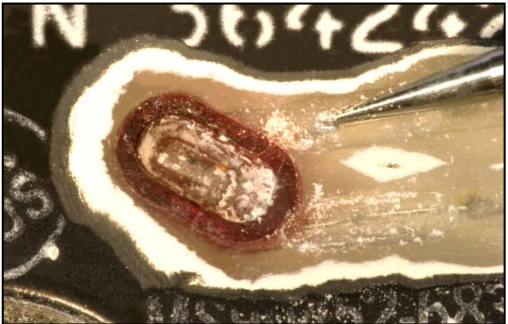

Plastic Panel Bulb Removal and Replacement Procedure

Step	Action
	<div style="text-align: center;"> <div style="border: 2px solid black; padding: 5px; display: inline-block; margin-bottom: 10px;">WARNING</div> <p>USE APPROVED SAFETY EYEWEAR WHEN PERFORMING THIS PROCEDURE.</p> <p>COMPLY WITH ALL LOCAL REQUIREMENTS FOR PPE.</p> <div style="border: 2px solid black; padding: 5px; display: inline-block; margin-bottom: 10px;">CAUTION</div> <p>DON A PROPERLY GROUNDED ESD WRIST STRAP BEFORE STARTING THIS PROCEDURE.</p> </div>
1	<p>Perform the Plastic Panel Procedural Analysis and Feasibility of Repair (paragraph 16-5.1), if not already completed.</p>
2	<p>Remove paint from backside of the panel to expose location of defective bulb and leads. Feather (transition) the edge of the paint removal so each color (layer) of paint is visible.</p> 
3	<p>Working from the backside of the panel, excavate the bulb using rotary abrasion (rotary bristle brush, ball mill, round toothpick, etc.), or controlled heat and dental tools.</p> <p>Note: Excavation is complete when the plastic is removed down to the widest portion of the bulb.</p> 

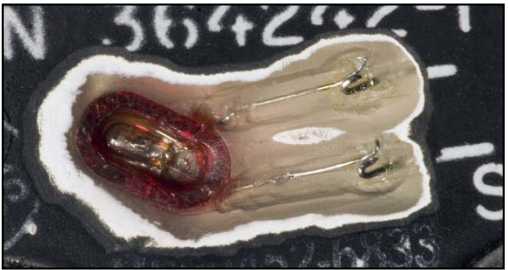
Plastic Panel Bulb Removal and Replacement Procedure

Step	Action
4	<p style="text-align: center;">CAUTION</p> <p style="text-align: center;">USE EXTREME CARE IN EXCAVATING AROUND THE LIGHTING BUS. THE WIRE IS SMALL AND DAMAGE TO THE WIRE MAY REQUIRE REPLACING A SECTION OF THE LIGHTING BUS.</p> <p>Excavate the area around the bulb leads using rotary abrasion (rotary bristle brush, ball mill, round toothpick, etc.) or controlled heat and dental tools.</p> 
5	<p>Excavate the bulb leads to the solder joint or to one in. from the filter insert, whichever is closest to the bulb.</p> <p>Note: If the solder joint is further than one in. from the filter insert, cut the lead and use the existing lead as the new solder joint point.</p> 
6	<p>Desolder the bulb from the lighting buses.</p> 

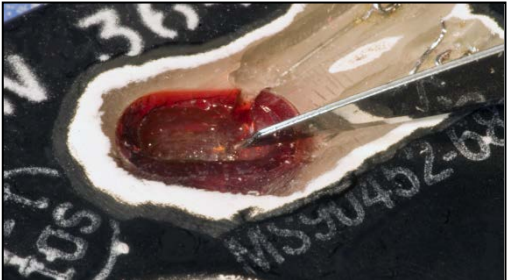

Plastic Panel Bulb Removal and Replacement Procedure

Step	Action
7	<p style="text-align: center;">WARNING</p> <p style="text-align: center;">DO NOT APPLY ANY LATERAL PRESSURE TO THE SCALPEL WHEN OPENING THE FILTER INSERT. THE BLADE IS EXTREMELY FRAGILE AND IF BROKEN CAN CAUSE SERIOUS INJURY TO PERSONNEL.</p> <p>Use a scalpel to reopen the wire access slots to facilitate removal of bulb leads without damaging the filter insert.</p> 
8	<p style="text-align: center;">CAUTION</p> <p style="text-align: center;">USE CARE IN REMOVING THE BULB SO AS NOT TO DAMAGE THE FILTER INSERT IF THE BULB IS SEATED IN A COLORED OR CLEAR FILTER INSERT.</p> <p>Lift the bulb from the filter insert or plastic panel.</p> <p>Note: If required, use a hot air jet to debond the bulb from the filter insert or plastic panel.</p> <p>Note: If the filter insert has been damaged during bulb removal, replace the filter insert or use a colored bulb.</p>
9	<p>Ensure the excavation is completely dry and free of contaminants.</p> 
10	Replace the reflector with aluminum foil if it has been damaged.

Plastic Panel Bulb Removal and Replacement Procedure

Step	Action
11	Clean the seat with isopropyl alcohol using a cotton-tipped applicator and blot dry with a clean, lint-free tissue.
12	Select a soldering iron tip that maximizes heat transfer and contact area.
13	Set the soldering iron tip temperature to 600°F (316°C).
14	Obtain a replacement bulb having the same electrical rating and physical size as the damaged bulb.
15	Clean the replacement bulb leads and the exposed original lighting bus with isopropyl alcohol using a cotton-tipped applicator and blot dry with a clean, lint-free tissue. Note: Take precautions to prevent bare skin contact before the conductors are soldered. Skin contact leaves contaminants on the conductors.
16	Clean the solder with isopropyl alcohol and wipe dry with a clean, lint-free tissue.
17	Apply flux SPARINGLY to each lead of the replacement bulb and to the ends of the original lighting bus. Note: Use a toothpick or flux pen to control the volume of flux applied. Heavy flux volume impairs cleaning and may affect reliability.
18	Remove the seasoning (all solder) from the soldering iron tip.
19	Thermally shock the soldering iron tip on a damp sponge.
20	<div data-bbox="784 1392 1015 1459" style="border: 2px solid black; padding: 5px; text-align: center;">CAUTION</div> <p style="text-align: center;">DO NOT APPLY PRESSURE WITH THE SOLDERING IRON.</p> Place the soldering iron tip on the original lighting bus.

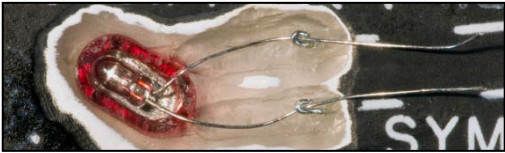
Plastic Panel Bulb Removal and Replacement Procedure

Step	Action
21	<div style="text-align: center; border: 2px solid black; padding: 5px; margin-bottom: 10px;">CAUTION</div> <p>IF SOLDER MELT DOES NOT OCCUR WITHIN TWO SECONDS, STOP THIS PROCEDURE AND ADJUST TIP TEMPERATURE PER THE TIP TEMPERATURE PROCEDURE IN WP 003 00 (PARAGRAPH 03-5.4).</p> <p>Form a heat bridge between the soldering iron tip and the original lighting bus using clean solder.</p>
22	Tin the ends of the original lighting bus.
23	Tin the leads of the replacement bulb.
24	Remove the solder and the soldering iron tip simultaneously.
25	Season the tip and place the soldering iron into its stand.
26	Allow the original lighting bus and the replacement bulb to cool completely before continuing.
27	<p>Position the replacement bulb in the filter insert.</p> 
28	<p>Form hook terminations with the original bus wires and replacement bulb terminated at 180°.</p> 
29	Clean the hook terminations with isopropyl alcohol using a cotton-tipped applicator to remove all flux residue and blot dry with a clean, lint-free tissue.
30	Position the replacement conductor on the original lighting bus.
31	Apply flux SPARINGLY to the hook terminations using a toothpick or flux pen.

Plastic Panel Bulb Removal and Replacement Procedure

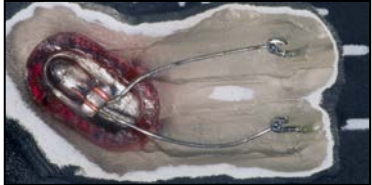
Step	Action
32	Remove the seasoning from the soldering iron tip.
33	Thermally shock the soldering iron tip on a damp sponge.
34	<p style="text-align: center;">CAUTION</p> <p style="text-align: center;">DO NOT APPLY PRESSURE WITH THE SOLDERING IRON.</p> <p>Place the soldering iron tip on the joint at the point of maximum thermal mass.</p>
35	<p style="text-align: center;">CAUTION</p> <p style="text-align: center;">IF SOLDER MELT DOES NOT OCCUR WITHIN TWO SECONDS, STOP THIS PROCEDURE AND ADJUST TIP TEMPERATURE PER THE TIP TEMPERATURE PROCEDURE IN WP 003 00 (PARAGRAPH 03-5.4).</p> <p>Form a heat bridge between the soldering iron tip and the hook terminations using clean solder.</p>
36	<p>Solder the replacement bulb leads to the lighting buses.</p> <div style="display: flex; justify-content: space-around;">   </div>
37	Remove the solder and the soldering iron tip simultaneously.
38	Season the tip and place the soldering iron into its stand.
39	Allow the joints to cool completely before cleaning.
40	Clean the solder joints with isopropyl alcohol using a cotton-tipped applicator to remove all flux residue and blot dry with a clean, lint-free tissue.
41	Verify bulb operation by applying lamp power to the input connections of the lighting panel.

Plastic Panel Bulb Removal and Replacement Procedure

Step	Action
42	<p><i>Inspect per the General Inspection Procedure in WP 003 00 (paragraph 03-5.12) to all applicable WORKMANSHIP STANDARDS, including:</i></p> <ul style="list-style-type: none"> • <i>General Solder Acceptability in WP 005 00 (paragraph 05-6.1)</i> • <i>Post-Solder Joint Cleanliness in WP 005 00 (paragraph 05-6.2)</i> • <i>Plastic Panel Excavation (paragraph 16-6.2)</i> • <i>Plastic Panel Bulb Replacement (paragraph 16-6.3)</i> • <i>Plastic Panel Conductor Replacement (paragraph 16-6.4)</i> • <i>Other applicable Workmanship Standards, as required</i>
43	Dispose of all HAZMAT following local procedures.
44	Go to the Plastic Panel Surface Restoration Procedure (paragraph 16-5.5) below.

16-5.5 Plastic Panel Surface Restoration Procedure

Use this procedure to restore the surface of repaired plastic panel.

Personnel Hazards



Acrylic Resin, MIL-I-46058

3

Plastic Panel Surface Restoration Procedure

Step	Action
	<div style="border: 2px solid black; padding: 5px; text-align: center; margin: 0 auto; width: 150px;"> <p>WARNING</p> </div> <p style="text-align: center;">USE APPROVED SAFETY EYEWEAR WHEN PERFORMING THIS PROCEDURE.</p> <p style="text-align: center;">COMPLY WITH ALL LOCAL REQUIREMENTS FOR PPE.</p>

Plastic Panel Surface Restoration Procedure

Step	Action
	<p style="text-align: center;">CAUTION</p> <p style="text-align: center;">DON A PROPERLY GROUNDED ESD WRIST STRAP BEFORE STARTING THIS PROCEDURE.</p>
1	Ensure the repair area is completely dry and free of contaminants.
2	<p style="text-align: center;">WARNING</p> <p style="text-align: center;">ACRYLIC RESIN FILLER MATERIAL IS FLAMMABLE.</p> <p style="text-align: center;">DO NOT USE IN THE PRESENCE OF EXTREME HEAT, SPARKS OR OPEN FLAME.</p> <p style="text-align: center;">ENSURE ADEQUATE VENTILATION, AVOID PROLONGED BREATHING OF VAPOR, AND AVOID SKIN CONTACT.</p> <p>Fill the repair area with orthodontic resin by moistening the surfaces of the excavation with the monomer (fluid) using the pipette.</p> <p>Note: Refer to Resin, Acrylic, Dental Kit, P/N 651011.</p>
3	Dispense the polymer (powder) from the squeeze bottle and dust the wet surface with a uniformly thin layer.
4	Using the pipette, apply additional liquid to wet thoroughly all powder particles until the liquid stops absorbing into the powder.
5	Repeat steps 2 through 4 until the excavation is filled, extending slightly above the surface of the panel and slightly beyond the repair area.
6	Cure the filler per manufacturer's directions.
7	Resurface the fill area to the level of the original surface using mechanical abrasion.
8	Smooth the fill area using very fine, wet sandpaper to feather the original paint around the perimeter of the fill area.

Plastic Panel Surface Restoration Procedure

Step	Action
9	<p><i>Inspect per the General Inspection Procedure in WP 003 00 (paragraph 03-5.12) to all applicable WORKMANSHIP STANDARDS, including:</i></p> <ul style="list-style-type: none"> • <i>Plastic Panel Excavation Fill (paragraph 16-6.5)</i> • <i>Plastic Panel Surface Restoration (paragraph 16-6.6)</i> • <i>Other applicable Workmanship Standards, as required</i>
10	Dispose of all HAZMAT following local procedures.
11	Go to the Plastic Panel Paint Restoration Procedure (paragraph 16-5.6) below.

16-5.6 Plastic Panel Paint Restoration Procedure

Use this procedure to restore the paint of repaired plastic panel.

Personnel Hazards



Paint, Acrylic, L300/K-685

11

Plastic Panel Paint Restoration Procedure

Step	Action
	<p style="text-align: center;">WARNING</p> <p style="text-align: center;">USE APPROVED SAFETY EYEWEAR WHEN PERFORMING THIS PROCEDURE.</p> <p style="text-align: center;">COMPLY WITH ALL LOCAL REQUIREMENTS FOR PPE.</p> <p style="text-align: center;">CAUTION</p> <p style="text-align: center;">DON A PROPERLY GROUNDED ESD WRIST STRAP BEFORE STARTING THIS PROCEDURE.</p>
1	Clean the restored surface with isopropyl alcohol using a cotton-tipped applicator and blot dry with a clean, lint-free tissue.

Plastic Panel Paint Restoration Procedure

Step	Action
2	<div style="text-align: center; border: 2px solid black; padding: 5px; margin-bottom: 10px;">CAUTION</div> <p style="text-align: center;">SOME PAINTS CONTAIN ORGANIC SOLVENTS HARMFUL TO PLASTIC AND MAY CAUSE CRAZING.</p> <p style="text-align: center;">ACRYLIC BASE PAINTS ARE RECOMMENDED BECAUSE OF THEIR COMPATIBILITY WITH ACRYLIC RESINS.</p> <p>Apply two coats of white acrylic paint to the repaired area and allow complete drying between coats.</p>
3	Apply a thin coat of black acrylic paint to the repaired area and let dry.
4	Re-stencil the locations of the bulb and the conductor bus wires on the backside of the panel using white paint and an artist's brush.
5	<p>Carefully etch the lettering or numbering on the front side until the underlying white paint appears using a dental tool or a small ball mill.</p> <p>Note: Do not completely remove the white paint.</p> 
6	Apply lamp power and verify the function legend is legible and there is no light leakage.
7	Touch-up the paint as necessary.
8	<p><i>Inspect per the General Inspection Procedure in WP 003 00 (paragraph 03-5.12) to all applicable WORKMANSHIP STANDARDS, including:</i></p> <ul style="list-style-type: none"> • <i>Plastic Panel Surface Restoration (paragraph 16-6.6)</i> • <i>Other applicable Workmanship Standards, as required</i>
9	Dispose of all HAZMAT following local procedures.

16-6 WORKMANSHIP STANDARDS

Refer to WP 003 00 (paragraph 03-6) for definitions of Workmanship Standards.

NOTE

WORKMANSHIP STANDARDS FOR GENERAL SOLDER ACCEPTABILITY AND POST-SOLDER JOINT CLEANLINESS ARE IN WP 005 00 (PARAGRAPH 05-6).

16-6.1 Plastic Panel (Cracked or Broken) Repair

Plastic Panel (Cracked or Broken) Repair

Target Condition	Acceptable Condition	Defect Condition
The repaired edges and surfaces are aligned and restored to the original configuration.		The repaired edges and surfaces are not aligned and restored to the original configuration.
The repaired area is restored to the original panel level.		The repaired area is not restored to the original panel level.
		The repaired crack or break shows evidence of voids or areas that have not adhered.
		There is evidence of uncured adhesive or uncured filler.
	There are pinholes in the painted surface provided the pinholes do not allow any stray light leakage.	Any stray light leakage.
The painted surface is smooth and feathered at the edges.	The painted surface is not smooth and feathered at the edges.	The paint is blistered.
	There is evidence of paint runs or drips.	
The location of conductors and bulbs are replaced on the panel with white acrylic paint.		The location of the conductors and bulbs are not replaced on the panel with white acrylic paint.
		The panel is not labeled as the original panel.

Plastic Panel (Cracked or Broken) Repair

Target Condition	Acceptable Condition	Defect Condition
Etched letters and numbers are legible.		Etched letters or numbers are not legible.

16-6.2 Plastic Panel Excavation

Plastic Panel Excavation

Target Condition	Acceptable Condition	Defect Condition
Only the acrylic material required to facilitate bulb or conductor removal is removed.		
	The acrylic material shows slight discoloration.	There are burns that physically damage the acrylic material.
		The jumper wire is routed over or under a component.
		The bulb is damaged.
	A bulb lead has nicks or deformation that is less than or equal to 10% of the diameter of the lead.	A bulb lead has nicks or deformation greater than 10% of the diameter of the lead.
	A bus wire has nicks or deformation less than or equal to 10% of the diameter of the lead.	A bus wire has nicks or deformation greater than 10% of the diameter of the wire.
	There is damage to the filter insert provided there is no stray light leakage.	The filter insert has damage that allows stray light leakage.
	There is damage to the light reflector provided there is no stray light leakage.	The light reflector has damage that allows stray light leakage.

16-6.3 Plastic Panel Bulb Replacement

Plastic Panel Bulb Replacement

Target Condition	Acceptable Condition	Defect Condition
The replacement bulb is positioned in the filter insert.		The replacement bulb is not positioned in the filter insert.
The bus wires, bulb leads, and replacement bulb are positioned below the original panel surface.		The bus wires, bulb leads, or replacement bulb is not positioned below the original panel surface.
The bulb leads are soldered to the bus wire using 180° hook terminations.	The bulb leads are soldered to the bus wire using hook terminations that are greater than 180° but less than or equal to 270°.	The bulb leads are soldered to the bus wire using hook terminations that are less than 180° or greater than 270°.
		The bulb leads are not soldered to the bus wire using hook terminations.
		The bulb is damaged.
	A bulb lead has nicks or deformation less than or equal to 10% of the diameter of the leads.	A bulb lead has nicks or deformation greater than 10% of the diameter of the lead.
	A bus wire has nicks or deformation less than or equal to 10% of the diameter of the wires.	A bus wire has nicks or deformation greater than 10% of the diameter of the wire.
	There is damage to the filter insert provided there is no stray light leakage.	The filter insert has damage that allows stray light leakage.
	There is damage to the light reflector provided there is no stray light leakage.	The light reflector has damage that allows stray light leakage.

16-6.4 Plastic Panel Conductor Replacement

Plastic Panel Conductor Replacement

Target Condition	Acceptable Condition	Defect Condition
The bus wires and replacement conductor are positioned below the original panel surface.		The bus wires and replacement conductor are not positioned below the original panel surface.
The replacement conductor leads are soldered to the bus wires using 180° hook terminations.	The replacement conductor is soldered to the bus wires using hook terminations that are greater than 180° but less than or equal to 270°.	The replacement conductor is soldered to the bus wires using hook terminations that are less than 180° or greater than 270°.
	The replacement conductor has nicks or deformation less than or equal to 10% of the diameter of the conductor.	The replacement conductor has nicks or deformation greater than 10% of the diameter of the conductor.
	A bus wire has nicks or deformation less than or equal to 10% of the diameter of the wire.	A bus wire has nicks or deformation greater than 10% of the diameter of the lead or bus wire.

16-6.5 Plastic Panel Excavation Fill

Plastic Panel Excavation Fill

Target Condition	Acceptable Condition	Defect Condition
The filler extends above the panel.		The filler does not extend above the panel.
The filler extends slightly beyond the repair area.		The filler does not extend beyond the repair area.
		There are contaminants in the filler.

Plastic Panel Excavation Fill

Target Condition	Acceptable Condition	Defect Condition
There are air bubbles in the fill area that are less than 10% of the volume of the fill area, viewed without magnification.		The air bubbles in the fill area are equal to or greater than 10% of the volume of the fill area, viewed without magnification.
		There is evidence of uncured filler.

16-6.6 Plastic Panel Surface Restoration

Plastic Panel Surface Restoration

Target Condition	Acceptable Condition	Defect Condition
The repair area is restored to the original panel level.		The repaired area is not restored to the original panel level.
	There are pinholes in the painted surface, provided the pinholes do not allow stray light leakage.	Any stray light leakage.
The painted surface is smooth and feathered at the edges.	The painted surface is not smooth and feathered at the edges.	The paint is blistered.
	There is evidence of paint runs or drips.	
The panel is labeled as the original panel.		Etched letters or numbers are not labeled as the original panel.
The location of the conductors and bulbs are replaced on the panel with white acrylic paint.		The location of conductors and bulbs are not replaced on the panel with white acrylic paint.
Etched letters or numbers are legible.		Etched letters or numbers are not legible.

This page is intentionally blank.

NAVAIR 01-1A-23
NAVSEA SE004-AK-TRS-010/2M
MARINE CORPS TM 5895-45/1E
USAF T.O. 00-25-259

017 00
Page 1 of 2

15 October 2013

WP 017 00 (deleted)

This page is intentionally blank.

15 October 2013

WP 018 00 Surface Mount Devices

18-1 PURPOSE

Identify the technical information relative to 2M surface mount device (SMD) repair, including SMD classification, termination styles, and repair considerations.

Specify the procedures for preheating.

Specify the repair procedures for SMD removal.

Specify the repair procedures for CCA preparation.

Specify the repair procedures for SMD preparation for installation.

Specify the repair procedures for flat pack lead preparation.

Specify the repair procedures for SMD installation.

Specify the repair procedures for using solder paste.

Identify the workmanship standards for SMDs.

Identify additional technical information relative to 2M SMD repair, including the form factors.

18-2 INDEX

Paragraph	Subject	Page
18-1	Purpose	1
18-2	Index	1
18-3	General Safety Precautions.....	3
18-4	Technical Information.....	4
18-4.1	Surface Mount Device Classification	4
18-4.2	Surface Mount Device Termination Styles	4
18-4.2.1	End Caps.....	5
18-4.2.2	Inward Formed L-Shaped Ribbon Leads	5
18-4.2.3	Gull Wing Leads	5
18-4.2.4	J-Leads.....	6
18-4.2.5	Castellations.....	6
18-4.2.6	Compliant Leads.....	6
18-4.3	Surface Mount Repair Considerations.....	7
18-4.3.1	Coefficient of Thermal Expansion (CTE).....	7

Paragraph	Subject	Page
18-4.3.2	Glass Transition Temperature (T_g).....	8
18-4.3.3	Lead Pitch.....	8
18-4.3.4	Component	9
18-5	Repair Procedures.....	9
18-5.1	Procedural Analysis and Feasibility of Repair	10
18-5.2	Preheating.....	10
18-5.2.1	Convective Preheating Procedure	11
18-5.2.2	Conductive Preheating Procedure	14
18-5.3	Surface Mount Device Preparation for Removal	16
18-5.3.1	SMD Preparation for Removal, Solder Wrap Method Procedure	16
18-5.3.2	SMD Preparation for Removal, Bridge Fill Method Procedure.....	17
18-5.4	Surface Mount Device Removal.....	19
18-5.4.1	Removal of SMDs with Bifurcated or Tunnel Tip Procedure	20
18-5.4.2	Removal of SMDs with Thermal Tweezers Procedure.....	24
18-5.4.3	Removal (Point-to-Point) of Gull Wing SMDs Procedure	29
18-5.4.4	Removal of Four-Sided SMDs with Box Tip Procedure	32
18-5.5	Circuit Card Assembly Preparation for SMD Installation.....	36
18-5.5.1	Land Preparation (Individual) using Wicking Material Procedure.....	36
18-5.5.2	Land Preparation (Multiple) using Wicking Material Procedure	40
18-5.5.3	Land Preparation (Individual) using Continuous Vacuum Extraction Procedure.....	44
18-5.6	Surface Mount Device Preparation for Installation	47
18-5.7	Flat Pack Lead Preparation (Lead Wiping Method) Procedure	48
18-5.8	Surface Mount Device Installation.....	50
18-5.8.1	Installation of Chip Components, MELFs, and SOTs with Soldering Iron Procedure.....	51
18-5.8.2	Installation of Chip Components, MELFs, and SOTs with Hot Air Jet Procedure.....	55
18-5.8.3	Installation of Gull Wing and J-Leaded SMDs with Point-to-Point Soldering Procedure	59
18-5.8.4	Installation of Gull Wing, J-Leaded, and Leadless SMDs with Drag Soldering Procedure	63
18-5.8.5	Installation of J-Lead SMDs with Knife Tip Drag Soldering Procedure	68
18-5.8.6	Installation of Multilead SMDs with Hot Air Jet Procedure.....	73
18-5.9	Solder Bridge Removal Procedure	78
18-5.10	Solder Paste	81
18-5.10.1	Solder Paste Test Procedure.....	81
18-5.10.2	Automatic Solder Paste Dispensing Procedure	83
18-5.10.3	Semi-Automatic Solder Paste Dispensing Procedure	85
18-5.10.4	Manual Solder Paste Dispensing Procedure.....	87
18-5.10.5	Stencil Solder Paste Dispensing Procedure	89
18-6	Workmanship Standards	90
18-6.1	Surface Mount Devices	90
18-6.2	Surface Mount Device Leads	91

Paragraph	Subject	Page
18-6.3	Surface Mount Circuit Card Assembly Lands and Conductors	91
18-6.4	Surface Mount Device Mounting.....	92
18-6.5	Surface Mount Device Positioning and Soldering.....	93
18-6.6	Flat Pack Lead Forming and Termination	96
18-6.7	Surface Mount Soldering Anomalies	97
18-7	Additional Technical Information	99
18-7.1	Chip Style Components.....	99
18-7.2	Metal Electrode Face (MELF) Components	99
18-7.3	Leaded Surface Mount Devices	100
18-7.4	Leadless Ceramic Chip Carrier (LCCC)	103
18-7.5	Surface Mount Devices, Array Packages.....	103

18-3 GENERAL SAFETY PRECAUTIONS

Observe all the following precautions while removing and replacing SMDs:

- Electronic equipment must be de-energized during removal and installation of CCAs
- Personnel are required to wear a properly grounded ESD wrist strap and cord while working in or around the EPA
- ESD can destroy components—protect ESDS devices during handling and repair to prevent ESD damage (Refer to WP 004 00)
- Isopropyl alcohol is flammable; do not use in the presence of sparks, heat, flame, or synthetic cloth
- Soldering handpieces (e.g., soldering irons, solder extractors, hot air jets) produce extreme heat—exercise care when these tools are out of their stands
- Avoid direct inhalation of fumes during a soldering operation because there is a possibility these fumes could cause occupational asthma
- The lead contained in solder is a source of lead oxide, which the human body cannot dissipate (accumulation of lead oxide in the body over a period of years can result in a serious health hazard)
- Contact with solder by holding in the mouth, smoking, or eating during or immediately after soldering is a potential means of ingesting trace amounts of lead oxide
- Avoid oral contact with hands during or immediately after solder operations

- Wash hands following any solder operation
- Wear approved PPE whenever pouring or handling molten metals or corrosive liquids and solids; and cutting, drilling, grinding, milling, chipping and other dust and debris producing operations
- When handling solder paste avoid skin contact by wearing the Glove, Chemical Protective (blue nitrile) and wash hands immediately following use
- Always follow the manufacturer's instructions and warnings when using conformal coating products

18-4 TECHNICAL INFORMATION

Surface mount technology (SMT) in electronics manufacturing has many advantages over the use of through-hole technology.

These advantages include smaller, lighter, and higher performance components.

Surface mount devices (SMDs) have led to higher density assemblies utilizing a smaller footprint.

SMT rework and repair processes require specialized tools, equipment, and techniques than those used for through-hole processes.

The processes described herein provide high reliability rework and repair of SMT CCAs.

18-4.1 Surface Mount Device Classification

SMDs are classified as:

- **Active Components**—Components that process a signal
- **Passive Components**—Components that do not process (pass through) a signal

18-4.2 Surface Mount Device Termination Styles

SMD termination styles include end caps, inward formed L-shaped ribbon leads, gull wing leads, J-leads, castellations, and compliant leads.

18-4.2.1 End Caps

End caps are normally associated with planar mount resistor and capacitor chips.

The lead construction is sintered (caused to become a coherent mass) precious metal, usually silver or gold, with a nickel-plated barrier to reduce dissolution (leaching) of the precious metal.

The number of termination faces varies with component types—capacitors typically have a 5-sided end cap while resistors have a 3-sided end cap (Figure 18-1).

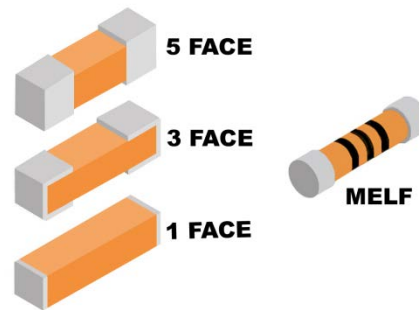

Figure 18-1 End Caps

18-4.2.2 Inward Formed L-Shaped Ribbon Leads

Inward L-leads (Figure 18-2) are leads extending horizontally from the component body centerline, are bent downward immediately past the body, and then bent inward underneath the bottom of the body.

These leads are typically used on tantalum capacitors.



Figure 18-2 Inward L-Shaped Ribbon Leads

18-4.2.3 Gull Wing Leads

Gull Wing Leads (Figure 18-3) are leads extending horizontally from the component body centerline, are bent downward immediately past the body, and then bent outward just below the bottom of the body, forming the shape of a gull's wing.

Gull wing leads are typically used in Small Outline (SO) and quad packages.

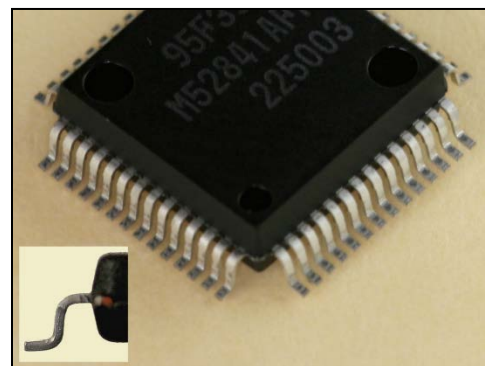

Figure 18-3 Gull Wing Leads

18-4.2.4 J-Leads

J-leads (Figure 18-4) are leads rolled under the body of the package in the shape of a “J.”

These leads are typically used on a PLCC.

J-leads are more robust and durable and have a smaller footprint than a similarly configured Gull wing leaded component.



Figure 18-4 J-Leads

18-4.2.5 Castellations

A recessed metallized feature on the edge of a leadless chip carrier (LCC) used to interconnect conducting surface or planes within or on the chip carrier (Figure 18-5).

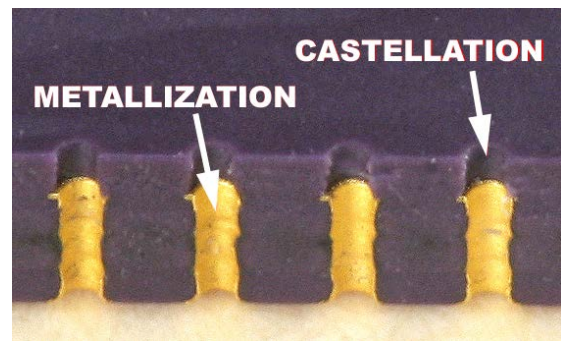

Figure 18-5 Castellations

18-4.2.6 Compliant Leads

Some ceramic chip carriers have compliant leads attached by the vendor to provide stress relief. They are either top brazed or attached to the castellations.

Compliant leads (Figure 18-6) are straight and attached to a common bar. The leads can be cut and formed to a gull wing lead, S, L-lead, or J-lead configuration.

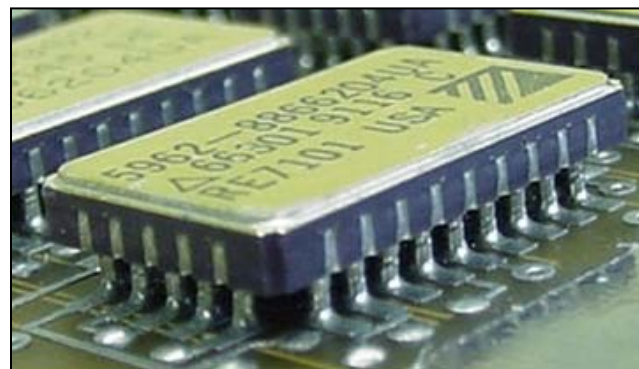

Figure 18-6 Compliant Leads

18-4.3 Surface Mount Repair Considerations

There are several considerations involved in SMT rework and repair.

The primary areas of concern are the coefficient of thermal expansion (CTE) of the CCA and the components, the glass transition temperature (T_g) of the laminate material, the package material, the style and pitch of the leads, and component orientation.

18-4.3.1 Coefficient of Thermal Expansion (CTE)

CTE is the linear dimensional change of a material per unit change in temperature. In other words, when heated, materials will expand or contract proportional to the amount of temperature change (Figure 18-7).

The CTE indicates how much a material will expand or contract for each degree of temperature change (measured on the Celsius scale).

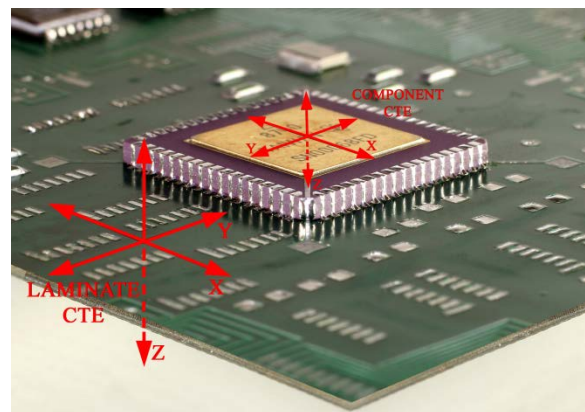

Figure 18-7 Coefficient of Thermal Expansion

All materials have their own CTE rate. The expansion and contraction are generally smaller in the horizontal directions (X-Axis and Y-Axis) than the vertical direction (Z-Axis). The X-Axis is the plane from left to right, the Y-Axis is the plane from front to back and the Z-Axis is the vertical plane (thickness) [Figure 18-7].

CTE differences between the CCA and the component cause stress to build in the solder joints or constraint points. The components on an SMT CCA are selected to match as closely as possible the CTE of the CCA. If the components and CCA are mismatched, solder cracks, component cracking, and land damage can result.

The expansion and contraction problems usually arise after many thermal cycles, but can happen in just a few cycles.

Solder quantities on component leads should be equal, uneven amounts will cause cracks in the solder joints after the CCA has been thermally cycled.

Leadless SMDs are more susceptible to damage due to CTE mismatch because the solder joints themselves provide the only stress relief. Leaded SMDs are less susceptible due to the stress relief provided by the leads.

18-4.3.2 Glass Transition Temperature (T_g)

Most laminates contain polymers that undergo structural changes at T_g of the laminate. When the T_g of a laminate is exceeded the physical structure of the laminate changes from hard, brittle, or glass-like to soft and rubbery.

18-4.3.3 Lead Pitch

Lead pitch is an important factor in the reduction of size of electronic circuits.

Lead pitch is defined as the nominal distance from center-to-center of adjacent leads.

When the conductors are of equal size and their spacing is uniform, the pitch is usually measured from the reference edge of the adjacent conductors.

Examples are shown in Figure 18-8 and in Figure 18-9.

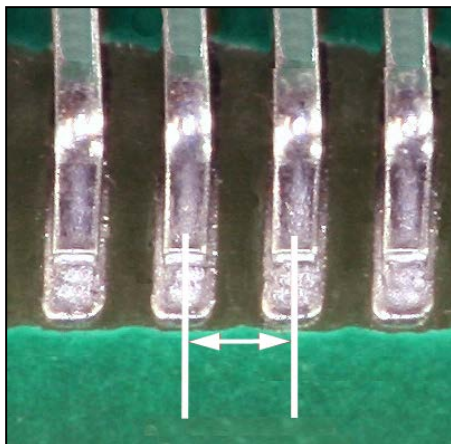

Figure 18-8 Gull Wing Lead Pitch

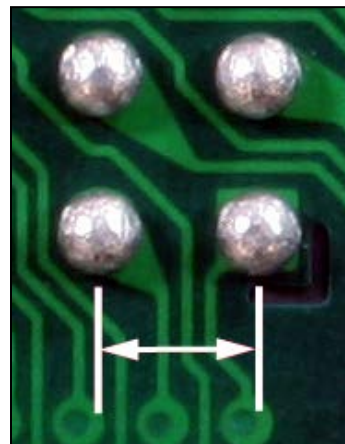

Figure 18-9 BGA Pitch

Lead pitch is normally expressed in mils, a term reflecting the approximate measurement in thousandths of an inch.

As lead pitch is reduced, component placement becomes more critical. Fine pitch (20-mil or less) components are more susceptible to excess solder, bridging, and solder ball formation. It is very important to adjust the amount of solder and/or solder paste to accommodate pitch size.

Table 18-1 lists the actual measurements of various lead pitches.

Table 18-1 Lead Pitch

Lead Pitch	Pitch in Inches	Pitch in Millimeters
50-mil	0.0500 in.	1.27 mm
30-mil	0.0314 in.	0.8 mm
25-mil	0.0256 in.	0.65 mm
20-mil	0.0197 in.	0.5 mm
15-mil	0.0157 in.	0.4 mm
12-mil	0.0118 in.	0.3 mm

18-4.3.4 Component Orientation

SMDs must be oriented correctly. Both component and CCA manufacturers mark their assemblies so correct orientation is easily determined. Common component markings include a small circle molded into the body, a dot, a beveled edge, or combination thereof over the number one lead. An end notch or stripe on the component body or a tang on the number one component lead may also be used.

The component footprint on the CCA is also typically marked with a dot adjacent to land one, a silk-screened silhouette of the component outline, or the lands may be numbered. The land outline on the number one land may also differ in size or shape for recognition.

The leads are numbered counterclockwise from pin one when viewing the component from the top.

18-5 REPAIR PROCEDURES



CAUTION

PROTECT STATIC SENSITIVE DEVICES DURING HANDLING AND REPAIR TO PREVENT ESD DAMAGE (REFER TO WP 004 00).

Equipment Required Listed below is the authorized 2M Power Unit* for removal and replacement of surface mount devices:

- **NAVAIR/NAVSEA/USMC/USAF/USCG—PRC-2000-SMT**

* Refer to Table 03-3 for Power Unit Part No., and CAGE Code

Additional Support Items For additional information regarding items of support and support equipment refer to:

- **NAVSEA/NAVAIR/USCG—2M MTR Certification Manual**
- **NAVSEA/USCG—Allowance Parts List (APL) 000A8423**
- **USMC—Stock List SL-3-09458A**
- **USAF—the Consolidated Tool Kit (CTK)**

Material Required Listed below are the materials required* for removal and replacement of surface mount devices:

- Desoldering Wick†
- Flux, Soldering
- Isopropyl Alcohol, Technical
- Solder, Paste
- Solder, Tin Alloy†
- Towel, Paper (Kimwipe®)‡

* Refer to Table 03-4 for Specification No., Part No., and NSN

† Select size appropriate for application

‡ Substitution of equivalent material is acceptable

18-5.1 Procedural Analysis and Feasibility of Repair

Perform the Procedural Analysis and Feasibility of Repair Procedure in WP 003 00 (paragraph 03-5.1).

18-5.2 Preheating

NOTE

PREHEATING IS REQUIRED FOR EVERY SMT REPAIR PROCESS.

Preheating minimizes the risk of thermal shock to the laminate and components.

The technician must employ a preheat method which heats the rework and adjacent areas of the assembly as evenly as possible.

Preheating is typically accomplished from the bottom side of the CCA by either a temperature controlled conductive heating plate, a controlled convective heating device, or a system combining both.

Controlling both the rate of temperature ramp up as well as the soak temperature is critical to avoiding damage and optimizing the component installation or removal process. The assembly is ramped at an acceptably safe rate until it reaches a target temperature at which it is thermally soaked or evenly heated. To avoid thermal shock, the ramp rate should be between 4 to 9°F (2 to 5°C) per second until the appropriate temperature is reached.

Replacement components should be preheated along with the CCA to the recommended levels.

Use a thermocouple and a digital thermometer to determine CCA surface temperature.

Recommended soak temperatures are as follows:

- 176°F (80°C) for simple, single- and double-sided CCAs
- 212°F (100°C) for epoxy/glass and SMT through-hole CCAs with up to six internal layers
- 248°F (120°C) for ceramic, polyimide and high mass CCAs with seven or more internal layers

Preheating accomplishes the following objectives:

- Minimizes thermal shock by elevating the assembly temperature to a level closer to solder melt temperature
- Minimizes solder reflow time
- Overcomes the heat dissipation characteristics of the assembly
- Avoids adjacent solder joint reflow on densely populated assemblies

18-5.2.1 Convective Preheating Procedure

Use this procedure if the repair site has an ST-400 or similar preheater.

Personnel Hazards





Lead (Solder)

9

Convective Preheating Procedure

Step	Action										
	<p style="text-align: center;">WARNING</p> <p style="text-align: center;"><i>USE APPROVED SAFETY EYEWEAR WHEN PERFORMING THIS PROCEDURE.</i></p> <p style="text-align: center;"><i>COMPLY WITH ALL LOCAL REQUIREMENTS FOR PPE.</i></p> <p style="text-align: center;"><i>THE PREHEATER PRODUCES EXTREME HEAT. EXERCISE CARE WHEN OPERATING THIS EQUIPMENT.</i></p> <p style="text-align: center;">CAUTION</p> <p style="text-align: center;">DON A PROPERLY GROUNDED ESD WRIST STRAP BEFORE STARTING THIS PROCEDURE.</p>										
<p style="text-align: center;">1</p>	<p>Turn the power switch on the front panel of the preheater to the OFF position.</p> <div style="text-align: right;">  </div>										
<p style="text-align: center;">2</p>	<table border="1" style="width: 100%; border-collapse: collapse;"> <thead> <tr> <th style="width: 30%;"></th> <th style="text-align: center;">CCA Type</th> <th style="text-align: center;">Preheat Temperature</th> </tr> </thead> <tbody> <tr> <td rowspan="3" style="vertical-align: top;">Determine the CCA construction and set the preheater in accordance with the table to the right.</td> <td>Simple, single and double-sided CCAs</td> <td style="text-align: center;">194°F (90°C)</td> </tr> <tr> <td>Epoxy/glass through-hole and SMD CCAs with up to six internal layers</td> <td style="text-align: center;">266°F (130°C)</td> </tr> <tr> <td>Ceramic, polyimide/glass, constraining core (metal-clad), and CCAs with seven or more internal layers</td> <td style="text-align: center;">320°F (160°C)</td> </tr> </tbody> </table>		CCA Type	Preheat Temperature	Determine the CCA construction and set the preheater in accordance with the table to the right.	Simple, single and double-sided CCAs	194°F (90°C)	Epoxy/glass through-hole and SMD CCAs with up to six internal layers	266°F (130°C)	Ceramic, polyimide/glass, constraining core (metal-clad), and CCAs with seven or more internal layers	320°F (160°C)
	CCA Type	Preheat Temperature									
Determine the CCA construction and set the preheater in accordance with the table to the right.	Simple, single and double-sided CCAs	194°F (90°C)									
	Epoxy/glass through-hole and SMD CCAs with up to six internal layers	266°F (130°C)									
	Ceramic, polyimide/glass, constraining core (metal-clad), and CCAs with seven or more internal layers	320°F (160°C)									

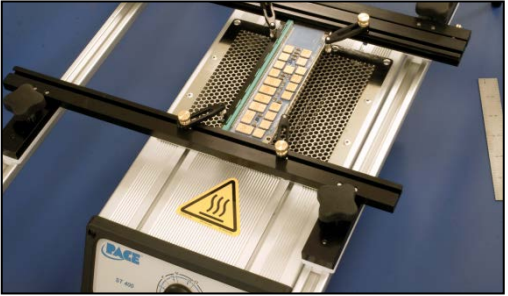
Convective Preheating Procedure

Step	Action	
<p>3 Adjust the circuit board holder in accordance with the table to the right.</p>	<p>CCA Type</p>	<p>Distance above Preheater</p>
	<p>Simple, single and double-sided CCAs</p>	<p>Two inches</p>
	<p>Epoxy/glass through-hole and SMD CCAs with up to six internal layers</p>	<p>Two inches</p>
	<p>Ceramic, polyimide/glass, constraining core (metal-clad), and CCAs with seven or more internal layers</p>	<p>One inch</p>
<p>4</p>	<p>Place the CCA between the holder rails in the slots, and tighten adjustment hardware.</p>	
<p>5</p>	<p>Align repair area of the CCA over the center of the heater grille.</p>	
<p>6</p>	<p>Turn the power switch on the front panel of the preheater to the ON position.</p> <p>Note: It will take 10-15 minutes for the CCA to ramp to the required temperature and stabilize.</p>	
		

Convective Preheating Procedure

Step	Action		
7	Use a thermocouple and a calibrated digital thermometer to verify the temperature on the surface of the CCA in the repair area. Adjust the preheater temperature as required to achieve temperature in accordance with the table to the right. Note: Allow ten minutes for temperature to stabilize after adjustment is made.	CCA Type	Top Side CCA Temperature
		Simple, single and double-sided CCAs	176°F (80°C)
		Epoxy/glass through-hole and SMD CCAs with up to six internal layers	212°F (100°C)
		Ceramic, polyimide/glass, constraining core (metal-clad), and CCAs with seven or more internal layers	248°F (120°C)
8	Begin the next step in the parent procedure.		

18-5.2.2 Conductive Preheating Procedure

Use this procedure if repair site has an HS-150 or similar preheater.

Personnel Hazards



Lead (Solder)

Conductive Preheating Procedure

Step	Action
	<div style="border: 2px solid black; padding: 5px; display: inline-block;"> WARNING </div> USE APPROVED SAFETY EYEWEAR WHEN PERFORMING THIS PROCEDURE. COMPLY WITH ALL LOCAL REQUIREMENTS FOR PPE. THE PREHEATER PRODUCES EXTREME HEAT. EXERCISE CARE WHEN OPERATING THIS EQUIPMENT.

Conductive Preheating Procedure

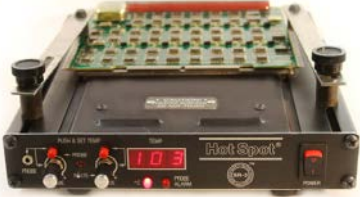
Step	Action										
	<div style="border: 2px solid black; padding: 5px; display: inline-block; margin-bottom: 10px;">CAUTION</div> <p>DON A PROPERLY GROUNDED ESD WRIST STRAP BEFORE STARTING THIS PROCEDURE.</p>										
1	Ensure the front panel power switch is in the OFF position, and the heater plate is at room temperature.										
2	Place the CCA on the heater plate with the repair area centered on the plate.										
3	<p>Lock the CCA in place with the vertical clamps on each side of the preheater.</p> 										
4	Turn the power switch on the front panel of the preheater to the ON position.										
5	<table border="1" style="width: 100%; border-collapse: collapse;"> <thead> <tr> <th style="width: 40%;"></th> <th style="width: 30%; text-align: center;">CCA Type</th> <th style="width: 30%; text-align: center;">Top Side CCA Temperature</th> </tr> </thead> <tbody> <tr> <td rowspan="3" style="vertical-align: top;"> Determine the CCA construction and set the preheater in accordance with the table to the right. Note: It will take approximately 15 minutes for the CCA to ramp to the required temperature and stabilize. </td> <td style="text-align: center;">Simple, single and double-sided CCAs</td> <td style="text-align: center;">176°F (80°C)</td> </tr> <tr> <td style="text-align: center;">Epoxy/glass through-hole and SMD CCAs with up to six internal layers</td> <td style="text-align: center;">212°F (100°C)</td> </tr> <tr> <td style="text-align: center;">Ceramic, polyimide/glass, constraining core (metal-clad), and CCAs with seven or more internal layers</td> <td style="text-align: center;">248°F (120°C)</td> </tr> </tbody> </table>		CCA Type	Top Side CCA Temperature	Determine the CCA construction and set the preheater in accordance with the table to the right. Note: It will take approximately 15 minutes for the CCA to ramp to the required temperature and stabilize.	Simple, single and double-sided CCAs	176°F (80°C)	Epoxy/glass through-hole and SMD CCAs with up to six internal layers	212°F (100°C)	Ceramic, polyimide/glass, constraining core (metal-clad), and CCAs with seven or more internal layers	248°F (120°C)
	CCA Type	Top Side CCA Temperature									
Determine the CCA construction and set the preheater in accordance with the table to the right. Note: It will take approximately 15 minutes for the CCA to ramp to the required temperature and stabilize.	Simple, single and double-sided CCAs	176°F (80°C)									
	Epoxy/glass through-hole and SMD CCAs with up to six internal layers	212°F (100°C)									
	Ceramic, polyimide/glass, constraining core (metal-clad), and CCAs with seven or more internal layers	248°F (120°C)									
6	<p>If available, use a thermocouple and a calibrated digital thermometer to verify the temperature on the surface of the CCA in the repair area.</p> <p>Adjust the preheater temperature as required to achieve temperature in accordance with the table in step 5.</p> <p>Note: Allow ten minutes for temperature to stabilize after adjustment is made.</p>										
7	Begin the next step in the parent procedure.										

18-5.3 Surface Mount Device Preparation for Removal

NOTE

USE FOR MULTILEAD SMDs ONLY.

Select the proper procedure based on the SMD and the handpiece being used. Do not use Bridge Fill Method for leadless SMDs.

The point-to-point method of removing of gull wing leaded SMDs does not require device preparation.

18-5.3.1 SMD Preparation for Removal, Solder Wrap Method Procedure

Use this procedure on gull wing leads, J-leaded and leadless SMDs.

Personnel Hazards



Lead (Solder)

9

SMD Preparation for Removal, Solder Wrap Method Procedure

Step	Action
	<div style="text-align: center;"> <div style="border: 2px solid black; padding: 5px; margin-bottom: 10px;">WARNING</div> <p>USE APPROVED SAFETY EYEWEAR WHEN PERFORMING THIS PROCEDURE.</p> <p>COMPLY WITH ALL LOCAL REQUIREMENTS FOR PPE.</p> <div style="border: 2px solid black; padding: 5px; margin-bottom: 10px;">CAUTION</div> <p>DON A PROPERLY GROUNDED ESD WRIST STRAP BEFORE STARTING THIS PROCEDURE.</p> </div>
1	Select a sufficient amount of large diameter (0.062" or larger) solder to encircle the SMD.
2	Clean the solder with isopropyl alcohol and wipe dry with a clean, lint-free tissue.

SMD Preparation for Removal, Solder Wrap Method Procedure

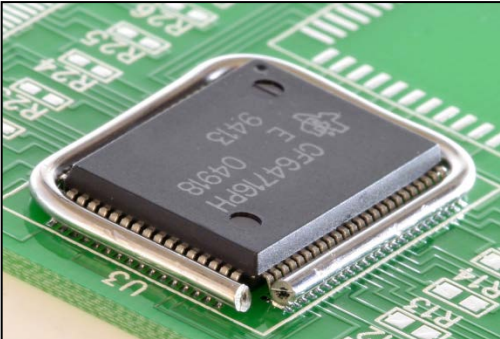
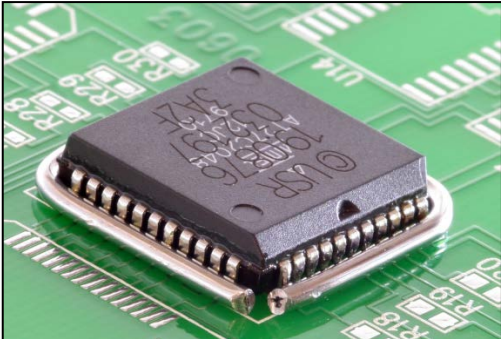
Step	Action
3	<p>Form the large diameter solder around the SMD lead pattern ensuring solder is in contact with all leads and lands.</p> <div style="display: flex; justify-content: space-around;">   </div> <div style="display: flex; justify-content: space-around; margin-top: 5px;"> <p data-bbox="444 869 854 894">Solder Wrap Method on Gull Wing Leads</p> <p data-bbox="1019 869 1338 894">Solder Wrap Method on J-Leads</p> </div>
4	Dispose of all HAZMAT following local procedures.
5	Begin the next step in the parent procedure.

18-5.3.2 SMD Preparation for Removal, Bridge Fill Method Procedure

Use this procedure on gull wing leaded and J-leaded SMDs only.

Use the Solder Wrap Method Procedure (paragraph 18-5.3.1) for leadless SMDs.

Personnel Hazards



Flux (Soldering)

8



Lead (Solder)

9

SMD Preparation for Removal, Bridge Fill Method Procedure

Step	Action
	<p style="text-align: center;">WARNING</p> <p style="text-align: center;"><i>USE APPROVED SAFETY EYEWEAR WHEN PERFORMING THIS PROCEDURE.</i></p> <p style="text-align: center;"><i>COMPLY WITH ALL LOCAL REQUIREMENTS FOR PPE.</i></p> <p style="text-align: center;">CAUTION</p> <p style="text-align: center;">DON A PROPERLY GROUNDED ESD WRIST STRAP BEFORE STARTING THIS PROCEDURE.</p>
1	Preheat the CCA per the Convective Preheating Procedure (paragraph 18-5.2.1) or the Conductive Preheating Procedure (paragraph 18-5.2.2).
2	Select a soldering iron tip that maximizes heat transfer and contact area with the SMD leads.
3	Set the soldering iron tip temperature to 600°F (316°C).
4	Select a sufficient amount of large diameter (0.062 or larger) solder to encircle the SMD.
5	Clean the solder with isopropyl alcohol and wipe dry with a clean, lint-free tissue.
6	Remove the seasoning (all solder) from the soldering iron tip.
7	Thermally shock the soldering iron tip on a damp sponge.
8	<p style="text-align: center;">CAUTION</p> <p style="text-align: center;">DO NOT APPLY PRESSURE WITH THE SOLDERING IRON.</p> <p>Place the soldering iron tip on one of the SMD leads at the point of maximum thermal mass.</p>

SMD Preparation for Removal, Bridge Fill Method Procedure

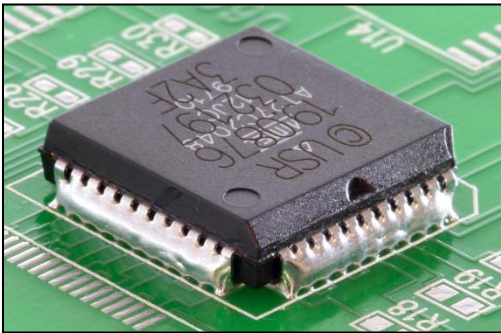
Step	Action
9	<div style="text-align: center; border: 2px solid black; padding: 5px; margin-bottom: 10px;">CAUTION</div> <p>IF SOLDER MELT DOES NOT OCCUR WITHIN TWO SECONDS, STOP THIS PROCEDURE AND ADJUST TIP TEMPERATURE PER THE TIP TEMPERATURE PROCEDURE IN WP 003 00 (PARAGRAPH 03-5.4).</p> <p>Melt the solder onto the SMD leads in a sufficient quantity to bridge fill all adjoining leads.</p>
10	Remove the solder and the soldering iron tip simultaneously.
11	Season the tip and place the soldering iron into its stand.
12	<p><i>Inspect to verify all leads have been bridged.</i></p> <div style="display: flex; justify-content: space-around; align-items: center;"> <div style="text-align: center;">  <p>Bridge Fill Method on Gull Wing Leads</p> </div> <div style="text-align: center;">  <p>Bridge Fill Method on J-Leads</p> </div> </div>
13	Dispose of all HAZMAT following local procedures.
14	Begin the next step in the parent procedure.

18-5.4 Surface Mount Device Removal

Ensure a Procedural Analysis and Feasibility of Repair Procedure in WP 003 00 (paragraph 03-5.1) was completed before starting a SMD removal procedure.















Select a SMD removal procedure based on configuration of the SMD to be removed:

- For chip style components, MELFs, or SOTs, use Removal of SMDs with Bifurcated or Tunnel Tip Procedure [Bifurcated Tip] (paragraph 18-5.4.1) or the Removal of SMDs with Thermal Tweezers Procedure [Paddle Tips] (paragraph 18-5.4.2)
- For SOICs, use the Removal of SMDs with Bifurcated or Tunnel Tip Procedure [Tunnel Tip] (paragraph 18-5.4.1) or the Removal of SMDs with Thermal Tweezers Procedure [Paddle Tips] (paragraph 18-5.4.2)
- For four-sided gull wing leaded SMDs, use the Removal of SMDs with Thermal Tweezers Procedure [Split Box] (paragraph 18-5.4.2), Removal (Point-to-Point) of Gull Wing SMDs Procedure (paragraph 18-5.4.3), or the Removal of Four-Sided SMDs with Box Tip Procedure (paragraph 18-5.4.4)
- For J-leaded SMDs, use the Removal of SMDs with Thermal Tweezers Procedure [Split Box] (paragraph 18-5.4.2) or Removal of Four-Sided SMDs with Box Tip Procedure (paragraph 18-5.4.4)
- For SMDs with castellations, use the Removal of SMDs with Thermal Tweezers Procedure [Split Box] (paragraph 18-5.4.2) or the Removal of Four-Sided SMDs with Box Tip Procedure (paragraph 18-5.4.4)

18-5.4.1 Removal of SMDs with Bifurcated or Tunnel Tip Procedure

Use this procedure to remove chip style components, MELFs, SOTs, or SOICs.





Personnel Hazards

					
Alcohol, Isopropyl					1
					
Flux (Soldering)					8
					
Lead (Solder)					9

Removal of SMDs with Bifurcated or Tunnel Tip Procedure

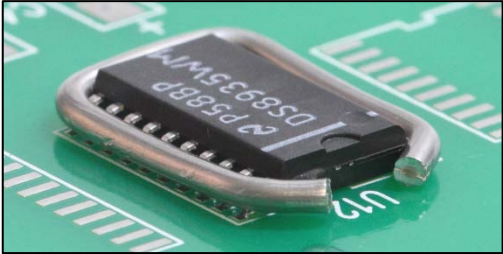
Step	Action										
	<p style="text-align: center;">WARNING</p> <p style="text-align: center;"><i>USE APPROVED SAFETY EYEWEAR WHEN PERFORMING THIS PROCEDURE. COMPLY WITH ALL LOCAL REQUIREMENTS FOR PPE.</i></p> <p style="text-align: center;">CAUTION</p> <p style="text-align: center;">DON A PROPERLY GROUNDED ESD WRIST STRAP BEFORE STARTING THIS PROCEDURE.</p> <p style="text-align: center;">SOLDER MUST BE COMPLETELY REFLOWED BEFORE ANY REMOVAL ATTEMPTS ARE MADE—REMOVAL OF THE SMD BEFORE COMPLETE REFLOW WILL CAUSE EXTENSIVE DAMAGE TO THE SURFACE LAMINATE AND THE SURROUNDING LAMINATE.</p> <p style="text-align: center;">NOTE</p> <p style="text-align: center;">SMDS SHOULD NOT BE REUSED AFTER REMOVAL—THE HIGH TEMPERATURES IMPOSED ON THE DEVICES DURING REMOVAL LEAD TO CRACKING AND FATIGUE OF THE CONNECTION BETWEEN THE SMD LEAD AND THE INTERIOR OF THE SMD.</p>										
<p>1</p>	<p style="text-align: center;">CAUTION</p> <p style="text-align: center;">BEGIN THE REPAIR PROCESS AS SOON AS POSSIBLE AFTER REMOVAL FROM THE OVEN TO AVOID MOISTURE RE-ABSORPTION.</p> <table border="1" style="width: 100%; border-collapse: collapse;"> <tr> <td style="width: 50%; vertical-align: top;"> Bake the CCA, if feasible, in accordance with the table to the right before soldering, desoldering, and conformal coating removal procedures to prevent delamination, measling, or other laminate degradation. </td> <td style="width: 50%; text-align: center;"> <table border="1" style="width: 100%; border-collapse: collapse;"> <thead> <tr> <th style="text-align: left;">Baking Temp.</th> <th style="text-align: left;">Baking Time</th> </tr> </thead> <tbody> <tr> <td>248°F (120°C)</td> <td>3.5 to 7 hours</td> </tr> <tr> <td>212°F (100°C)</td> <td>8 to 16 hours</td> </tr> <tr> <td>176°F (80°C)</td> <td>18 to 48 hours</td> </tr> </tbody> </table> </td> </tr> </table>	Bake the CCA, if feasible, in accordance with the table to the right before soldering, desoldering, and conformal coating removal procedures to prevent delamination, measling, or other laminate degradation.	<table border="1" style="width: 100%; border-collapse: collapse;"> <thead> <tr> <th style="text-align: left;">Baking Temp.</th> <th style="text-align: left;">Baking Time</th> </tr> </thead> <tbody> <tr> <td>248°F (120°C)</td> <td>3.5 to 7 hours</td> </tr> <tr> <td>212°F (100°C)</td> <td>8 to 16 hours</td> </tr> <tr> <td>176°F (80°C)</td> <td>18 to 48 hours</td> </tr> </tbody> </table>	Baking Temp.	Baking Time	248°F (120°C)	3.5 to 7 hours	212°F (100°C)	8 to 16 hours	176°F (80°C)	18 to 48 hours
Bake the CCA, if feasible, in accordance with the table to the right before soldering, desoldering, and conformal coating removal procedures to prevent delamination, measling, or other laminate degradation.	<table border="1" style="width: 100%; border-collapse: collapse;"> <thead> <tr> <th style="text-align: left;">Baking Temp.</th> <th style="text-align: left;">Baking Time</th> </tr> </thead> <tbody> <tr> <td>248°F (120°C)</td> <td>3.5 to 7 hours</td> </tr> <tr> <td>212°F (100°C)</td> <td>8 to 16 hours</td> </tr> <tr> <td>176°F (80°C)</td> <td>18 to 48 hours</td> </tr> </tbody> </table>	Baking Temp.	Baking Time	248°F (120°C)	3.5 to 7 hours	212°F (100°C)	8 to 16 hours	176°F (80°C)	18 to 48 hours		
Baking Temp.	Baking Time										
248°F (120°C)	3.5 to 7 hours										
212°F (100°C)	8 to 16 hours										
176°F (80°C)	18 to 48 hours										
<p>2</p>	<p>Remove any conformal coating from the repair area using one of the Conformal Coating Removal Methods in WP 006 00 (paragraph 06-5.4).</p>										
<p>3</p>	<p>Clean the repair area with isopropyl alcohol using an acid brush and blot dry with a clean, lint-free tissue.</p>										

Removal of SMDs with Bifurcated or Tunnel Tip Procedure

Step	Action
4	<p>Prepare a multilead SMD for removal using the Solder Wrap Method Procedure (paragraph 18-5.3.1).</p> <p>Note: The Bridge Fill Method Procedure (paragraph 18-5.3.2) procedure is an acceptable alternative, but does require an additional heat cycle.</p> 
5	<p>Apply flux SPARINGLY to the solder joints for <u>chip components, MELFs, or SOTs</u> only.</p> <p>Note: Use a toothpick or flux pen to control the volume of flux applied. Heavy flux volume impairs cleaning and may affect reliability.</p>
6	<p>Preheat the CCA per the Convective Preheating Procedure (paragraph 18-5.2.1) or the Conductive Preheating Procedure (paragraph 18-5.2.2).</p>
7	<p>Select and install the proper bifurcated/slotted or tunnel tip sized for the SMD into the soldering iron.</p> <p>Note: The tip must easily contact the lead/land junctions without touching the CCA laminate, adjacent components, or adjacent solder joints.</p>
8	<p>Set the soldering iron tip temperature to 600°F (316°C) and set the tip offset temperature per the Tip Temperature Chart, as required.</p>
9	<p>Remove the seasoning (all solder) from the bifurcated or tunnel tip.</p>
10	<p>Tin the bottom and inside edges of the slotted tip with solder for a SOT.</p> 
	<p>Apply solder to inside of the bifurcated tip, forming a crown of solder for a chip component or MELF.</p> 
	<p>Heavily tin the bottom and inside edges of the tunnel tip with solder.</p> 

Removal of SMDs with Bifurcated or Tunnel Tip Procedure

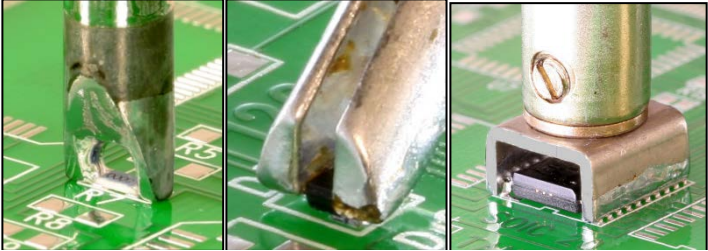
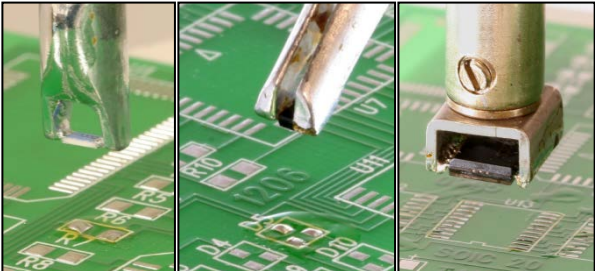
Step	Action
11	<p style="text-align: center;">CAUTION</p> <p style="text-align: center;">DO NOT APPLY PRESSURE WITH THE SOLDERING IRON.</p> <p>Lower the tip over the SMD gently contacting all of the leads or terminations.</p> 
12	<p style="text-align: center;">CAUTION</p> <p style="text-align: center;">IF SOLDER MELT DOES NOT OCCUR WITHIN TWO SECONDS, STOP THIS PROCEDURE AND ADJUST TIP TEMPERATURE PER THE TIP TEMPERATURE PROCEDURE IN WP 003 00 (PARAGRAPH 03-5.4).</p> <p>Observe COMPLETE solder melt.</p>
13	<p>Sweep the SMD from the CCA.</p> <p>Note: If an adhesive is holding the SMD in place, the bond must be broken with a slight twisting motion after solder melt.</p> <p>Note: The surface tension of the solder will retain the SMD in the tip as it is swept from the CCA.</p> 
14	Release the SMD from the tip by wiping across a heat resistant surface.
15	Season the tip and place the soldering iron into its stand.















Removal of SMDs with Bifurcated or Tunnel Tip Procedure

Step	Action
16	Turn the preheater power switch to the OFF position.
17	Allow the CCA to cool completely before cleaning.
18	Clean the repair area with isopropyl alcohol using an acid brush to remove all flux residue and blot dry with a clean, lint-free tissue.
19	<p><i>Inspect per the General Inspection Procedure in WP 003 00 (paragraph 03-5.12) to all applicable WORKMANSHIP STANDARDS, including:</i></p> <ul style="list-style-type: none"> • <i>Post-Solder Joint Cleanliness in WP 005 00 (paragraph 05-6.2)</i> • <i>Laminate in WP 011 00 (paragraph 11-6.1)</i> • <i>Surface Mount Circuit Card Assembly Lands and Conductors (paragraph 18-6.3)</i> • <i>Other applicable Workmanship Standards as required</i>
20	Dispose of all HAZMAT following local procedures.

18-5.4.2 Removal of SMDs with Thermal Tweezers Procedure

procedure to remove chip style components, MELFs, SOTs, and two-sided or four-sided SMDs.



Personnel Hazards

					
Alcohol, Isopropyl					1
					
Flux (Soldering)					8
					
Lead (Solder)					9



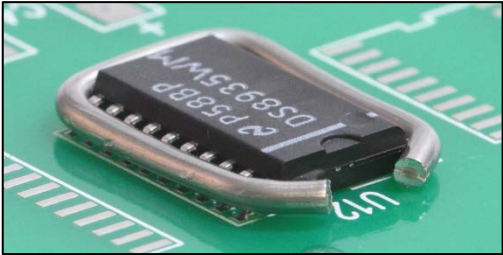

Removal of SMDs with Thermal Tweezers Procedure

Step	Action										
	<p style="text-align: center;">WARNING</p> <p style="text-align: center;"><i>USE APPROVED SAFETY EYEWEAR WHEN PERFORMING THIS PROCEDURE. COMPLY WITH ALL LOCAL REQUIREMENTS FOR PPE.</i></p> <p style="text-align: center;">CAUTION</p> <p style="text-align: center;">DON A PROPERLY GROUNDED ESD WRIST STRAP BEFORE STARTING THIS PROCEDURE.</p> <p style="text-align: center;">SOLDER MUST BE COMPLETELY REFLOWED BEFORE ANY REMOVAL ATTEMPTS ARE MADE—REMOVAL OF THE SMD BEFORE COMPLETE REFLOW WILL CAUSE EXTENSIVE DAMAGE TO THE SURFACE LAMINATE AND THE SURROUNDING LAMINATE.</p> <p style="text-align: center;">NOTE</p> <p style="text-align: center;">SMDS SHOULD NOT BE REUSED AFTER REMOVAL—THE HIGH TEMPERATURES IMPOSED ON THE DEVICES DURING REMOVAL LEAD TO CRACKING AND FATIGUE OF THE CONNECTION BETWEEN THE SMD LEAD AND THE INTERIOR OF THE SMD.</p>										
<p style="text-align: center;">1</p>	<p style="text-align: center;">CAUTION</p> <p style="text-align: center;">BEGIN THE REPAIR PROCESS AS SOON AS POSSIBLE AFTER REMOVAL FROM THE OVEN TO AVOID MOISTURE RE-ABSORPTION.</p> <table border="1" style="width: 100%; border-collapse: collapse;"> <tr> <td style="width: 50%; vertical-align: top;"> Bake the CCA, if feasible, in accordance with the table to the right before soldering, desoldering, and conformal coating removal procedures to prevent delamination, measling, or other laminate degradation. </td> <td style="width: 50%; text-align: center;"> <table border="1" style="width: 100%; border-collapse: collapse;"> <thead> <tr> <th style="text-align: left;">Baking Temp.</th> <th style="text-align: left;">Baking Time</th> </tr> </thead> <tbody> <tr> <td>248°F (120°C)</td> <td>3.5 to 7 hours</td> </tr> <tr> <td>212°F (100°C)</td> <td>8 to 16 hours</td> </tr> <tr> <td>176°F (80°C)</td> <td>18 to 48 hours</td> </tr> </tbody> </table> </td> </tr> </table>	Bake the CCA, if feasible, in accordance with the table to the right before soldering, desoldering, and conformal coating removal procedures to prevent delamination, measling, or other laminate degradation.	<table border="1" style="width: 100%; border-collapse: collapse;"> <thead> <tr> <th style="text-align: left;">Baking Temp.</th> <th style="text-align: left;">Baking Time</th> </tr> </thead> <tbody> <tr> <td>248°F (120°C)</td> <td>3.5 to 7 hours</td> </tr> <tr> <td>212°F (100°C)</td> <td>8 to 16 hours</td> </tr> <tr> <td>176°F (80°C)</td> <td>18 to 48 hours</td> </tr> </tbody> </table>	Baking Temp.	Baking Time	248°F (120°C)	3.5 to 7 hours	212°F (100°C)	8 to 16 hours	176°F (80°C)	18 to 48 hours
Bake the CCA, if feasible, in accordance with the table to the right before soldering, desoldering, and conformal coating removal procedures to prevent delamination, measling, or other laminate degradation.	<table border="1" style="width: 100%; border-collapse: collapse;"> <thead> <tr> <th style="text-align: left;">Baking Temp.</th> <th style="text-align: left;">Baking Time</th> </tr> </thead> <tbody> <tr> <td>248°F (120°C)</td> <td>3.5 to 7 hours</td> </tr> <tr> <td>212°F (100°C)</td> <td>8 to 16 hours</td> </tr> <tr> <td>176°F (80°C)</td> <td>18 to 48 hours</td> </tr> </tbody> </table>	Baking Temp.	Baking Time	248°F (120°C)	3.5 to 7 hours	212°F (100°C)	8 to 16 hours	176°F (80°C)	18 to 48 hours		
Baking Temp.	Baking Time										
248°F (120°C)	3.5 to 7 hours										
212°F (100°C)	8 to 16 hours										
176°F (80°C)	18 to 48 hours										
<p style="text-align: center;">2</p>	<p>Remove any conformal coating from the repair area using one of the Conformal Coating Removal Methods in WP 006 00 (paragraph 06-5.4).</p>										
<p style="text-align: center;">3</p>	<p>Clean the repair area with isopropyl alcohol using an acid brush and blot dry with a clean, lint-free tissue.</p>										

Removal of SMDs with Thermal Tweezers Procedure

Step	Action
4	<p>Prepare a multilead SMD for removal using the Solder Wrap Method Procedure (paragraph 18-5.3.1).</p> <p>Note: The Bridge Fill Method Procedure (paragraph 18-5.3.2) procedure is an acceptable alternative, but does require an additional heat cycle.</p> 
5	<p>Apply flux SPARINGLY to the solder joints for <u>chip components, MELFs, or SOTs</u> only.</p> <p>Note: Use a toothpick or flux pen to control the volume of flux applied. Heavy flux volume impairs cleaning and may affect reliability.</p>
6	<p>Preheat the CCA per the Convective Preheating Procedure (paragraph 18-5.2.1) or the Conductive Preheating Procedure (paragraph 18-5.2.2).</p>
7	<p>Select and install the proper split box, paddles, or angled fine point conical tips sized for the SMD into the thermal tweezers.</p> <p>Note: The tips must easily contact the lead/land junctions without touching the CCA laminate, adjacent components, or adjacent solder joints.</p>
8	<p>Align the tips in the thermal tweezers.</p> 
9	<p>Set the tip temperature to 600°F (316°C) and set the tip offset temperature per the Tip Temperature Chart, as required.</p>

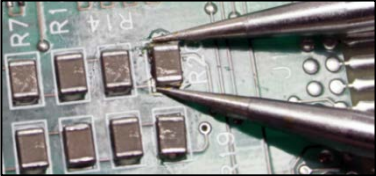
Removal of SMDs with Thermal Tweezers Procedure

Step	Action
10	<p>Tin the inside edges of the fine point conical and chip removal paddle tips.</p>  <p>Heavily tin the bottom and inside edges of the split box and paddle tips with solder.</p> 
11	<p style="text-align: center;">CAUTION</p> <p style="text-align: center;">DO NOT APPLY PRESSURE WITH THE THERMAL TWEEZERS.</p> <p>Place the thermal tweezers tips over the SMD and gently squeeze to contact all leads with the tips.</p>  
12	<p style="text-align: center;">CAUTION</p> <p style="text-align: center;">IF SOLDER MELT DOES NOT OCCUR WITHIN TWO SECONDS, STOP THIS PROCEDURE AND ADJUST TIP TEMPERATURE PER THE TIP TEMPERATURE PROCEDURE IN WP 003 00 (PARAGRAPH 03-5.4).</p> <p>Observe complete solder melt.</p>

Removal of SMDs with Thermal Tweezers Procedure

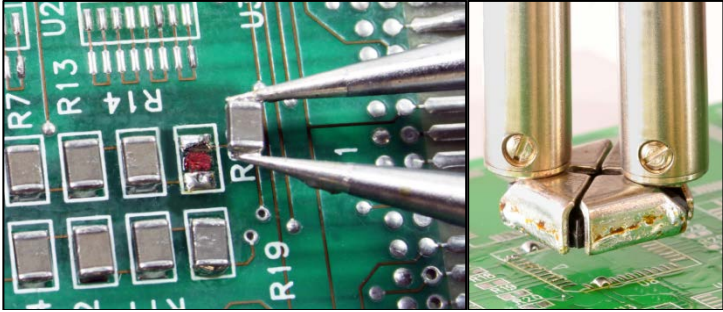













Step	Action
13	<p>Lift the SMD from the CCA.</p> <p>Note: If an adhesive is holding the SMD in place, the bond must be broken with a slight twisting motion after solder melt.</p> 
14	Release the onto a heat resistant surface.
15	Season the tips and place the thermal tweezers into its stand.
16	Turn the preheater power switch to the OFF position.
17	Allow the CCA to cool completely before cleaning.
18	Clean the repair area with isopropyl alcohol using an acid brush to remove all flux residue and blot dry with a clean, lint-free tissue.
19	<p><i>Inspect per the General Inspection Procedure in WP 003 00 (paragraph 03-5.12) to all applicable WORKMANSHIP STANDARDS, including:</i></p> <ul style="list-style-type: none"> • <i>Post-Solder Joint Cleanliness in WP 005 00 (paragraph 05-6.2)</i> • <i>Laminate in WP 011 00 (paragraph 11-6.1)</i> • <i>Surface Mount Circuit Card Assembly Lands and Conductors (paragraph 18-6.3)</i> • <i>Other applicable Workmanship Standards as required</i>
20	Dispose of all HAZMAT following local procedures.

18-5.4.3 Removal (Point-to-Point) of Gull Wing SMDs Procedure

Use this procedure only for removal of gull wing leaded SMDs.

Use the Removal of SMDs with Thermal Tweezers Procedure (paragraph 18-5.4.2) or Removal of Four-Sided SMDs with Box Tip Procedure (paragraph 18-5.4.4) for other multilead SMDs.

Personnel Hazards

					
Alcohol, Isopropyl					1
					
Flux (Soldering)					8
					
Lead (Solder)					9

Removal (Point-to-Point) of Gull Wing SMDs Procedure

Step	Action
	<div style="border: 1px solid black; padding: 5px; margin-bottom: 10px;">WARNING</div> <p>USE APPROVED SAFETY EYEWEAR WHEN PERFORMING THIS PROCEDURE.</p> <p>COMPLY WITH ALL LOCAL REQUIREMENTS FOR PPE.</p> <div style="border: 1px solid black; padding: 5px; margin-bottom: 10px;">CAUTION</div> <p>DON A PROPERLY GROUNDED ESD WRIST STRAP BEFORE STARTING THIS PROCEDURE.</p> <p>NOTE</p> <p>SMDS SHOULD NOT BE REUSED AFTER REMOVAL—THE HIGH TEMPERATURES IMPOSED ON THE DEVICES DURING REMOVAL LEAD TO CRACKING AND FATIGUE OF THE CONNECTION BETWEEN THE SMD LEAD AND THE INTERIOR OF THE SMD.</p>

Removal (Point-to-Point) of Gull Wing SMDs Procedure

Step	Action												
<p>1</p>	<div style="text-align: center; border: 2px solid black; padding: 5px; margin-bottom: 10px;"> <p>CAUTION</p> </div> <p style="text-align: center;">BEGIN THE REPAIR PROCESS AS SOON AS POSSIBLE AFTER REMOVAL FROM THE OVEN TO AVOID MOISTURE RE-ABSORPTION.</p> <table border="1" style="width: 100%; border-collapse: collapse;"> <thead> <tr> <th style="width: 60%;"></th> <th style="width: 20%; text-align: center;">Baking Temp.</th> <th style="width: 20%; text-align: center;">Baking Time</th> </tr> </thead> <tbody> <tr> <td>Bake the CCA, if feasible, in accordance with the table to the right before soldering, desoldering, and conformal coating removal procedures to prevent delamination, measling, or other laminate degradation.</td> <td style="text-align: center;">248°F (120°C)</td> <td style="text-align: center;">3.5 to 7 hours</td> </tr> <tr> <td></td> <td style="text-align: center;">212°F (100°C)</td> <td style="text-align: center;">8 to 16 hours</td> </tr> <tr> <td></td> <td style="text-align: center;">176°F (80°C)</td> <td style="text-align: center;">18 to 48 hours</td> </tr> </tbody> </table>		Baking Temp.	Baking Time	Bake the CCA, if feasible, in accordance with the table to the right before soldering, desoldering, and conformal coating removal procedures to prevent delamination, measling, or other laminate degradation.	248°F (120°C)	3.5 to 7 hours		212°F (100°C)	8 to 16 hours		176°F (80°C)	18 to 48 hours
		Baking Temp.	Baking Time										
	Bake the CCA, if feasible, in accordance with the table to the right before soldering, desoldering, and conformal coating removal procedures to prevent delamination, measling, or other laminate degradation.	248°F (120°C)	3.5 to 7 hours										
		212°F (100°C)	8 to 16 hours										
	176°F (80°C)	18 to 48 hours											
<p>2</p>	<p>Remove any conformal coating from the repair area using one of the Conformal Coating Removal Methods in WP 006 00 (paragraph 06-5.4).</p>												
<p>3</p>	<p>Clean the repair area with isopropyl alcohol using an acid brush and blot dry with a clean, lint-free tissue.</p>												
<p>4</p>	<p>Apply flux SPARINGLY to the gull wing leads.</p> <p>Note: Use a toothpick or flux pen to control the volume of flux applied. Heavy flux volume impairs cleaning and may affect reliability.</p>												
<p>5</p>	<p>Preheat the CCA per the Convective Preheating Procedure (paragraph 18-5.2.1) or the Conductive Preheating Procedure (paragraph 18-5.2.2).</p>												
<p>6</p>	<p>Select a soldering iron tip that maximizes heat transfer and contact area with the gull wing leads.</p> <p>Note: The tip must easily contact the lead/land junction without touching the CCA laminate, adjacent components, or other solder joints.</p>												
<p>7</p>	<p>Set the soldering iron tip temperature to 600°F (316°C).</p>												
<p>8</p>	<p>Remove the seasoning (all solder) from the soldering iron tip.</p>												
<p>9</p>	<p>Thermally shock the soldering iron tip on a damp sponge.</p>												

Removal (Point-to-Point) of Gull Wing SMDs Procedure

Step	Action
10	<p style="text-align: center;">CAUTION</p> <p style="text-align: center;">DO NOT APPLY PRESSURE WITH THE SOLDERING IRON.</p> <p>Place the soldering iron tip on a lead/land junction at the point of maximum thermal mass.</p>
11	<p style="text-align: center;">CAUTION</p> <p style="text-align: center;">IF SOLDER MELT DOES NOT OCCUR WITHIN TWO SECONDS, STOP THIS PROCEDURE AND ADJUST TIP TEMPERATURE PER THE TIP TEMPERATURE PROCEDURE IN WP 003 00 (PARAGRAPH 03-5.4).</p> <p>Observe complete solder melt.</p>
12	<p style="text-align: center;">CAUTION</p> <p style="text-align: center;">LIFTING OF THE LEAD BEFORE COMPLETE SOLDER MELT MAY CAUSE THE LAND TO BE DAMAGED. FOOTPRINTS (LEAD INDENTATIONS) LEFT IN THE SOLDER ARE AN INDICATION OF LIFTING THE LEAD BEFORE COMPLETE SOLDER MELT.</p> <p>Lift the lead from the land using a dental tool or toothpick.</p>
13	Repeat steps 10 through 12 on all remaining lead/land junctions.
14	Lift the SMD from the CCA using tweezers once all leads have been desoldered. Note: If an adhesive is holding the SMD in place, use a hot air jet to heat the component body and break the bond with a slight twisting motion.
15	Release the SMD onto a heat resistant surface.
16	Season the tip and place the soldering iron into its stand.
17	Turn the preheater power switch to the OFF position.
18	Allow the CCA to cool completely before cleaning.
19	Clean the repair area with isopropyl alcohol using an acid brush to remove all flux residue and blot dry with a clean, lint-free tissue.

Removal (Point-to-Point) of Gull Wing SMDs Procedure

Step	Action
20	<p><i>Inspect per the General Inspection Procedure in WP 003 00 (paragraph 03-5.12) to all applicable WORKMANSHIP STANDARDS, including:</i></p> <ul style="list-style-type: none"> • <i>Post-Solder Joint Cleanliness in WP 005 00 (paragraph 05-6.2)</i> • <i>Laminate in WP 011 00 (paragraph 11-6.1)</i> • <i>Surface Mount Circuit Card Assembly Lands and Conductors (paragraph 18-6.3)</i> • <i>Other applicable Workmanship Standards as required</i>
21	Dispose of all HAZMAT following local procedures.

18-5.4.4 Removal of Four-Sided SMDs with Box Tip Procedure

Use this procedure only for four-sided SMDs.

Use the Removal of SMDs with Thermal Tweezers Procedure (paragraph 18-5.4.2) or the Removal (Point-to-Point) of Gull Wing SMDs Procedure (paragraph 18-5.4.3) for other multilead SMDs.

Personnel Hazards

					1
Alcohol, Isopropyl					
					8
Flux (Soldering)					
					9
Lead (Solder)					

Removal of Four-Sided SMDs with Box Tip Procedure

Step	Action										
	<p style="text-align: center;">WARNING</p> <p style="text-align: center;"><i>USE APPROVED SAFETY EYEWEAR WHEN PERFORMING THIS PROCEDURE. COMPLY WITH ALL LOCAL REQUIREMENTS FOR PPE.</i></p> <p style="text-align: center;">CAUTION</p> <p style="text-align: center;">DON A PROPERLY GROUNDED ESD WRIST STRAP BEFORE STARTING THIS PROCEDURE.</p> <p style="text-align: center;">SOLDER MUST BE COMPLETELY REFLOWED BEFORE ANY REMOVAL ATTEMPTS ARE MADE—REMOVAL OF THE SMD BEFORE COMPLETE REFLOW WILL CAUSE EXTENSIVE DAMAGE TO THE SURFACE LAMINATE AND THE SURROUNDING LAMINATE.</p> <p style="text-align: center;">NOTE</p> <p style="text-align: center;">SMDS SHOULD NOT BE REUSED AFTER REMOVAL—THE HIGH TEMPERATURES IMPOSED ON THE DEVICES DURING REMOVAL LEAD TO CRACKING AND FATIGUE OF THE CONNECTION BETWEEN THE SMD LEAD AND THE INTERIOR OF THE SMD.</p>										
<p>1</p>	<p style="text-align: center;">CAUTION</p> <p style="text-align: center;">BEGIN THE REPAIR PROCESS AS SOON AS POSSIBLE AFTER REMOVAL FROM THE OVEN TO AVOID MOISTURE RE-ABSORPTION.</p> <table border="1" style="width: 100%; border-collapse: collapse;"> <tr> <td style="width: 50%; vertical-align: top;"> Bake the CCA, if feasible, in accordance with the table to the right before soldering, desoldering, and conformal coating removal procedures to prevent delamination, measling, or other laminate degradation. </td> <td style="width: 50%; text-align: center;"> <table border="1" style="width: 100%; border-collapse: collapse;"> <thead> <tr> <th style="text-align: left;">Baking Temp.</th> <th style="text-align: left;">Baking Time</th> </tr> </thead> <tbody> <tr> <td>248°F (120°C)</td> <td>3.5 to 7 hours</td> </tr> <tr> <td>212°F (100°C)</td> <td>8 to 16 hours</td> </tr> <tr> <td>176°F (80°C)</td> <td>18 to 48 hours</td> </tr> </tbody> </table> </td> </tr> </table>	Bake the CCA, if feasible, in accordance with the table to the right before soldering, desoldering, and conformal coating removal procedures to prevent delamination, measling, or other laminate degradation.	<table border="1" style="width: 100%; border-collapse: collapse;"> <thead> <tr> <th style="text-align: left;">Baking Temp.</th> <th style="text-align: left;">Baking Time</th> </tr> </thead> <tbody> <tr> <td>248°F (120°C)</td> <td>3.5 to 7 hours</td> </tr> <tr> <td>212°F (100°C)</td> <td>8 to 16 hours</td> </tr> <tr> <td>176°F (80°C)</td> <td>18 to 48 hours</td> </tr> </tbody> </table>	Baking Temp.	Baking Time	248°F (120°C)	3.5 to 7 hours	212°F (100°C)	8 to 16 hours	176°F (80°C)	18 to 48 hours
Bake the CCA, if feasible, in accordance with the table to the right before soldering, desoldering, and conformal coating removal procedures to prevent delamination, measling, or other laminate degradation.	<table border="1" style="width: 100%; border-collapse: collapse;"> <thead> <tr> <th style="text-align: left;">Baking Temp.</th> <th style="text-align: left;">Baking Time</th> </tr> </thead> <tbody> <tr> <td>248°F (120°C)</td> <td>3.5 to 7 hours</td> </tr> <tr> <td>212°F (100°C)</td> <td>8 to 16 hours</td> </tr> <tr> <td>176°F (80°C)</td> <td>18 to 48 hours</td> </tr> </tbody> </table>	Baking Temp.	Baking Time	248°F (120°C)	3.5 to 7 hours	212°F (100°C)	8 to 16 hours	176°F (80°C)	18 to 48 hours		
Baking Temp.	Baking Time										
248°F (120°C)	3.5 to 7 hours										
212°F (100°C)	8 to 16 hours										
176°F (80°C)	18 to 48 hours										
<p>2</p>	<p>Remove any conformal coating from the repair area using one of the Conformal Coating Removal Methods in WP 006 00 (paragraph 06-5.4).</p>										
<p>3</p>	<p>Clean the repair area with isopropyl alcohol using an acid brush and blot dry with a clean, lint-free tissue.</p>										

Removal of Four-Sided SMDs with Box Tip Procedure

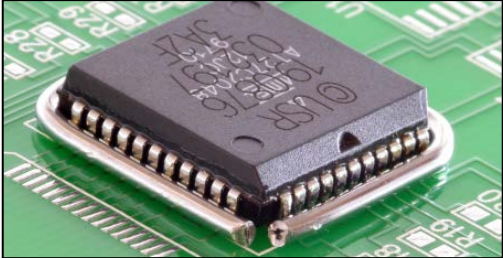
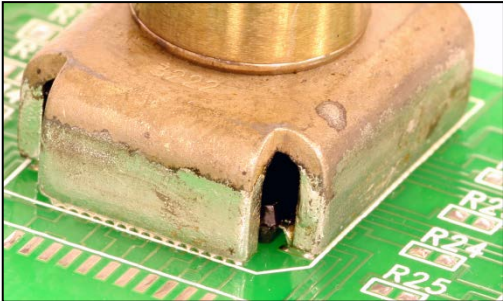
Step	Action
4	<p>Prepare a multilead SMD for removal using the Solder Wrap Method Procedure (paragraph 18-5.3.1).</p> <p>Note: The Bridge Fill Method Procedure (paragraph 18-5.3.2) procedure is an acceptable alternative, but does require an additional heat cycle.</p> 
5	<p>Preheat the CCA per the Convective Preheating Procedure (paragraph 18-5.2.1) or the Conductive Preheating Procedure (paragraph 18-5.2.2).</p>
6	<p>Select and install the proper box tip sized for the SMD into the solder extractor.</p>
7	<p>Install the vacuum cup onto the vacuum tube of the solder extractor.</p>
8	<p>Set the box tip temperature to 700°F (371°C) and set the tip offset per the Tip Temperature Chart, if required.</p>
9	<p>Heavily tin the bottom and inside edges of the box tip with solder.</p>
10	<div style="text-align: center; border: 2px solid black; padding: 5px; margin-bottom: 10px;">CAUTION</div> <p style="text-align: center;">DO NOT APPLY PRESSURE WITH THE SOLDER EXTRACTOR.</p> <p>Place the box tip over the SMD contacting all leads.</p> 
11	<div style="text-align: center; border: 2px solid black; padding: 5px; margin-bottom: 10px;">CAUTION</div> <p style="text-align: center;">IF SOLDER MELT DOES NOT OCCUR WITHIN TWO SECONDS, STOP THIS PROCEDURE AND ADJUST TIP TEMPERATURE PER THE TIP TEMPERATURE PROCEDURE IN WP 003 00 (PARAGRAPH 03-5.4).</p> <p>Observe complete solder melt.</p>

Removal of Four-Sided SMDs with Box Tip Procedure

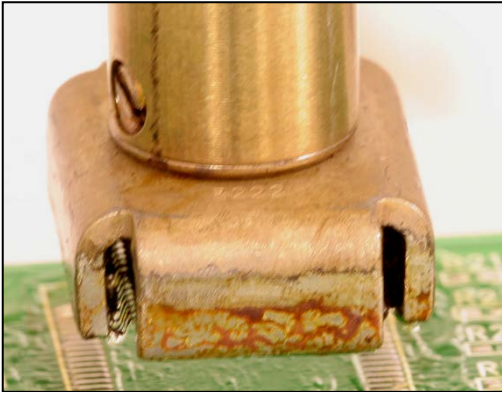
Step	Action
12	Actuate the solder extractor vacuum.
13	<p>Lift the SMD from the CCA.</p> <p>Note: If an adhesive is holding the SMD in place, the bond must be broken with a slight twisting motion after solder melt.</p> 
14	Release the SMD onto a heat resistant surface.
15	Season the tip and place the handpiece into its stand.
16	Turn the preheater power switch to the OFF position.
17	Allow the CCA to cool completely before cleaning.
18	Clean the repair area with isopropyl alcohol using an acid brush to remove all flux residue and blot dry with a clean, lint-free tissue.
19	<p><i>Inspect per the General Inspection Procedure in WP 003 00 (paragraph 03-5.12) to all applicable WORKMANSHIP STANDARDS, including:</i></p> <ul style="list-style-type: none"> • <i>Post-Solder Joint Cleanliness in WP 005 00 (paragraph 05-6.2)</i> • <i>Laminate in WP 011 00 (paragraph 11-6.1)</i> • <i>Surface Mount Circuit Card Assembly Lands and Conductors (paragraph 18-6.3)</i> • <i>Other applicable Workmanship Standards as required</i>
20	Dispose of all HAZMAT following local procedures.

18-5.5 Circuit Card Assembly Preparation for SMD Installation

Surface mount land preparation shall be performed before the installation of a new SMD.

It is critical to avoid thermal and/or mechanical damage to the land and to the laminate.















The two primary steps are to thoroughly clean all land areas and to remove old solder using one of the following methods.

18-5.5.1 Land Preparation (Individual) using Wicking Material Procedure

Use this procedure to wick individual lands.

Use the Land Preparation (Multiple) using Wicking Material Procedure (paragraph 18-5.5.2) to wick multiple lands.

Personnel Hazards

					
Alcohol, Isopropyl					1
					
Flux (Soldering)					8
					
Lead (Solder)					9

Land Preparation (Individual) using Wicking Material Procedure

Step	Action
	<div style="border: 2px solid black; padding: 5px; display: inline-block;"> WARNING </div> <p>USE APPROVED SAFETY EYEWEAR WHEN PERFORMING THIS PROCEDURE.</p> <p>COMPLY WITH ALL LOCAL REQUIREMENTS FOR PPE.</p>

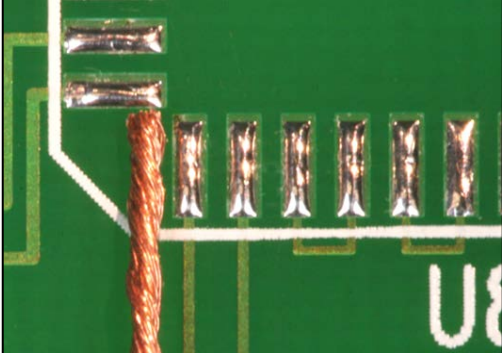

Land Preparation (Individual) using Wicking Material Procedure

Step	Action								
	<p style="text-align: center;">CAUTION</p> <p style="text-align: center;">DON A PROPERLY GROUNDED ESD WRIST STRAP BEFORE STARTING THIS PROCEDURE.</p>								
<p>1</p>	<p style="text-align: center;">CAUTION</p> <p style="text-align: center;">BEGIN THE REPAIR PROCESS AS SOON AS POSSIBLE AFTER REMOVAL FROM THE OVEN TO AVOID MOISTURE RE-ABSORPTION.</p> <p>Bake the CCA, if feasible, in accordance with the table to the right before soldering, desoldering, and conformal coating removal procedures to prevent delamination, measling, or other laminate degradation.</p> <table border="1" data-bbox="928 793 1425 1003"> <thead> <tr> <th data-bbox="928 793 1177 848">Baking Temp.</th> <th data-bbox="1177 793 1425 848">Baking Time</th> </tr> </thead> <tbody> <tr> <td data-bbox="928 848 1177 900">248°F (120°C)</td> <td data-bbox="1177 848 1425 900">3.5 to 7 hours</td> </tr> <tr> <td data-bbox="928 900 1177 953">212°F (100°C)</td> <td data-bbox="1177 900 1425 953">8 to 16 hours</td> </tr> <tr> <td data-bbox="928 953 1177 1003">176°F (80°C)</td> <td data-bbox="1177 953 1425 1003">18 to 48 hours</td> </tr> </tbody> </table>	Baking Temp.	Baking Time	248°F (120°C)	3.5 to 7 hours	212°F (100°C)	8 to 16 hours	176°F (80°C)	18 to 48 hours
Baking Temp.	Baking Time								
248°F (120°C)	3.5 to 7 hours								
212°F (100°C)	8 to 16 hours								
176°F (80°C)	18 to 48 hours								
<p>2</p>	<p>Remove any conformal coating from the repair area using one of the Conformal Coating Removal Methods in WP 006 00 (paragraph 06-5.4).</p>								
<p>3</p>	<p>Clean the repair area with isopropyl alcohol using an acid brush and blot dry with a clean, lint-free tissue.</p>								
<p>4</p>	<p>Apply flux SPARINGLY to the lands.</p> <p>Note: Use a toothpick or flux pen to control the volume of flux applied. Heavy flux volume impairs cleaning and may affect reliability.</p>								
<p>5</p>	<p>Preheat the CCA per the Convective Preheating Procedure (paragraph 18-5.2.1) or the Conductive Preheating Procedure (paragraph 18-5.2.2).</p>								
<p>6</p>	<p>Select the proper size wicking material to fit the size of the lands.</p> <p>Note: The wicking material may need to be twisted so it will fit the land properly.</p> <p>Note: If corroded, clean the wicking material with alcohol and blot dry with a clean, lint-free tissue.</p> 								

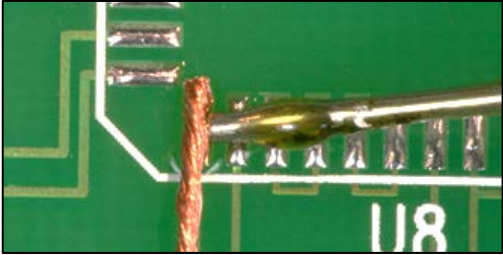
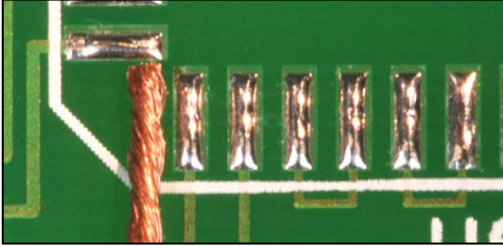
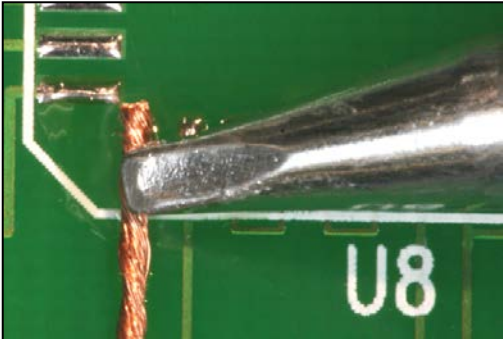
Land Preparation (Individual) using Wicking Material Procedure

Step	Action
7	Select a soldering iron tip that maximizes heat transfer and contact area with the wicking material.
8	Set the soldering iron tip temperature to 600°F (316°C).
9	Use a drag soldering technique to overfill the lands with solder.
10	Apply flux SPARINGLY to the wicking material. 
11	Position the wicking material on the land. 
12	Remove the seasoning (all solder) from the soldering iron tip.
13	Thermally shock the soldering iron tip on a damp sponge.
14	<p style="text-align: center;">CAUTION</p> <p style="text-align: center;">DO NOT APPLY PRESSURE WITH THE SOLDERING IRON.</p> <p>Place the soldering iron tip on the wicking material. </p>

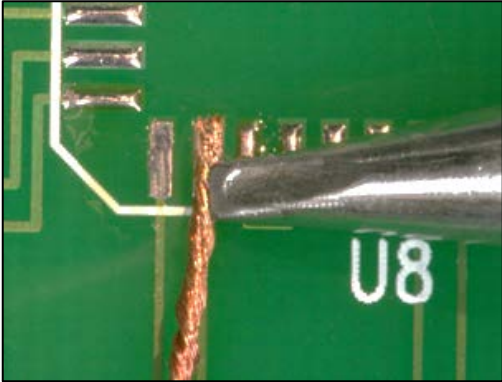
Land Preparation (Individual) using Wicking Material Procedure

Step	Action
15	<p style="text-align: center;">CAUTION</p> <p style="text-align: center;">IF SOLDER MELT DOES NOT OCCUR WITHIN FOUR SECONDS, STOP THIS PROCEDURE AND ADJUST TIP TEMPERATURE PER THE TIP TEMPERATURE PROCEDURE IN WP 003 00 (PARAGRAPH 03-5.4).</p> <p>Observe the capillary action (solder flow) into the wicking material; when solder flow stops, remove the soldering iron and the wicking material.</p>
16	Remove the used portion of wicking material from the spool using utility cutters.
17	<p>Repeat steps 14 through 16 for the remaining lands.</p> 
18	Season the tip and place the soldering iron into its stand.
19	Turn the preheater power switch to the OFF position.
20	Allow the CCA to cool completely before cleaning.
21	<p>Clean the lands with isopropyl alcohol using an acid brush to remove all flux residue and blot dry with a clean, lint-free tissue.</p> <p>Note: Take precautions to prevent bare skin contact before the component is soldered. Skin contact leaves contaminants on the leads and/or pads.</p> 

Land Preparation (Individual) using Wicking Material Procedure

Step	Action
22	<p><i>Inspect per the General Inspection Procedure in WP 003 00 (paragraph 03-5.12) to all applicable WORKMANSHIP STANDARDS, including:</i></p> <ul style="list-style-type: none"> • <i>Post-Solder Joint Cleanliness in WP 005 00 (paragraph 05-6.2)</i> • <i>Laminate in WP 011 00 (paragraph 11-6.1)</i> • <i>Surface Mount Circuit Card Assembly Lands and Conductors (paragraph 18-6.3)</i> • <i>Other applicable Workmanship Standards as required</i>
23	Dispose of all HAZMAT following local procedures.

18-5.5.2 Land Preparation (Multiple) using Wicking Material Procedure

Use this procedure to wick multiple lands.

Use the Land Preparation (Individual) using Wicking Material Procedure (paragraph 18-5.5.1) to wick individual lands.

Personnel Hazards

					1
Alcohol, Isopropyl					
					8
Flux (Soldering)					
					9
Lead (Solder)					

Land Preparation (Multiple) using Wicking Material Procedure

Step	Action										
	<p style="text-align: center;">WARNING</p> <p style="text-align: center;"><i>USE APPROVED SAFETY EYEWEAR WHEN PERFORMING THIS PROCEDURE. COMPLY WITH ALL LOCAL REQUIREMENTS FOR PPE.</i></p> <p style="text-align: center;">CAUTION</p> <p style="text-align: center;">DON A PROPERLY GROUNDED ESD WRIST STRAP BEFORE STARTING THIS PROCEDURE.</p>										
<p>1</p>	<p style="text-align: center;">CAUTION</p> <p style="text-align: center;">BEGIN THE REPAIR PROCESS AS SOON AS POSSIBLE AFTER REMOVAL FROM THE OVEN TO AVOID MOISTURE RE-ABSORPTION.</p> <table border="1" style="width: 100%; border-collapse: collapse;"> <tr> <td style="width: 50%; vertical-align: top;"> Bake the CCA, if feasible, in accordance with the table to the right before soldering, desoldering, and conformal coating removal procedures to prevent delamination, measling, or other laminate degradation. </td> <td style="width: 50%; text-align: center;"> <table border="1" style="width: 100%; border-collapse: collapse;"> <thead> <tr> <th style="text-align: left;">Baking Temp.</th> <th style="text-align: left;">Baking Time</th> </tr> </thead> <tbody> <tr> <td>248°F (120°C)</td> <td>3.5 to 7 hours</td> </tr> <tr> <td>212°F (100°C)</td> <td>8 to 16 hours</td> </tr> <tr> <td>176°F (80°C)</td> <td>18 to 48 hours</td> </tr> </tbody> </table> </td> </tr> </table>	Bake the CCA, if feasible, in accordance with the table to the right before soldering, desoldering, and conformal coating removal procedures to prevent delamination, measling, or other laminate degradation.	<table border="1" style="width: 100%; border-collapse: collapse;"> <thead> <tr> <th style="text-align: left;">Baking Temp.</th> <th style="text-align: left;">Baking Time</th> </tr> </thead> <tbody> <tr> <td>248°F (120°C)</td> <td>3.5 to 7 hours</td> </tr> <tr> <td>212°F (100°C)</td> <td>8 to 16 hours</td> </tr> <tr> <td>176°F (80°C)</td> <td>18 to 48 hours</td> </tr> </tbody> </table>	Baking Temp.	Baking Time	248°F (120°C)	3.5 to 7 hours	212°F (100°C)	8 to 16 hours	176°F (80°C)	18 to 48 hours
Bake the CCA, if feasible, in accordance with the table to the right before soldering, desoldering, and conformal coating removal procedures to prevent delamination, measling, or other laminate degradation.	<table border="1" style="width: 100%; border-collapse: collapse;"> <thead> <tr> <th style="text-align: left;">Baking Temp.</th> <th style="text-align: left;">Baking Time</th> </tr> </thead> <tbody> <tr> <td>248°F (120°C)</td> <td>3.5 to 7 hours</td> </tr> <tr> <td>212°F (100°C)</td> <td>8 to 16 hours</td> </tr> <tr> <td>176°F (80°C)</td> <td>18 to 48 hours</td> </tr> </tbody> </table>	Baking Temp.	Baking Time	248°F (120°C)	3.5 to 7 hours	212°F (100°C)	8 to 16 hours	176°F (80°C)	18 to 48 hours		
Baking Temp.	Baking Time										
248°F (120°C)	3.5 to 7 hours										
212°F (100°C)	8 to 16 hours										
176°F (80°C)	18 to 48 hours										
<p>2</p>	<p>Remove any conformal coating from the repair area using one of the Conformal Coating Removal Methods in WP 006 00 (paragraph 06-5.4).</p>										
<p>3</p>	<p>Clean the repair area with isopropyl alcohol using an acid brush and blot dry with a clean, lint-free tissue.</p>										
<p>4</p>	<p>Apply flux SPARINGLY to the lands.</p> <p>Note: Use a toothpick or flux pen to control the volume of flux applied. Heavy flux volume impairs cleaning and may affect reliability.</p>										
<p>5</p>	<p>Preheat the CCA per the Convective Preheating Procedure (paragraph 18-5.2.1) or the Conductive Preheating Procedure (paragraph 18-5.2.2).</p>										
<p>6</p>	<p>Select a soldering iron tip that maximizes heat transfer and contact area with the lands.</p>										
<p>7</p>	<p>Set the soldering iron tip temperature to 600°F (316°C).</p>										

Land Preparation (Multiple) using Wicking Material Procedure

Step	Action
8	Use a drag soldering technique to overfill the lands with solder.
9	<p>Select the proper size wicking material to fit the size of the lands.</p> <p>Note: If corroded, clean the wicking material with alcohol and blot dry with a clean, lint-free tissue.</p>
10	<p>Select a soldering iron blade tip that maximizes heat transfer and contact area with the wicking material.</p>
11	Set the soldering iron tip temperature to 600°F (316°C) and set the tip offset temperature per the Tip Temperature Chart, as required.
12	<p>Apply flux SPARINGLY to the wicking material.</p>
13	Position the wicking material on the lands.
14	Remove the seasoning (all solder) from the soldering iron tip.
15	Thermally shock the soldering iron tip on a damp sponge.

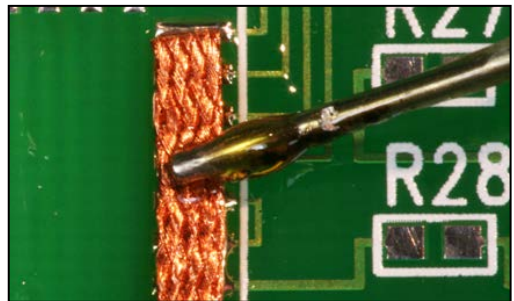
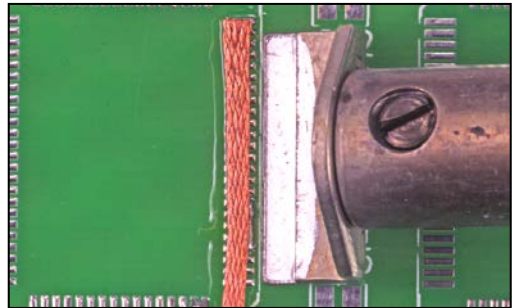
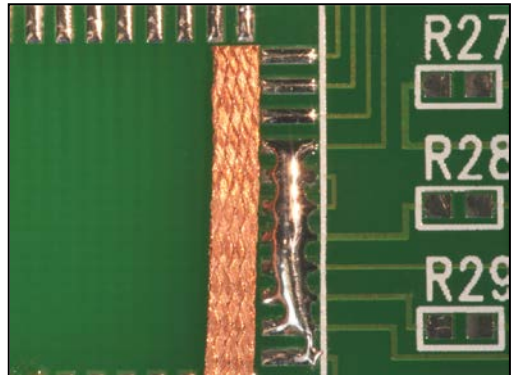

Land Preparation (Multiple) using Wicking Material Procedure

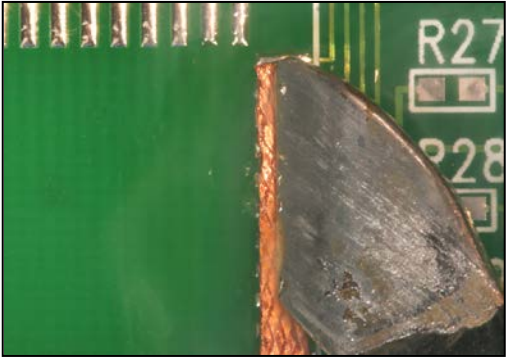
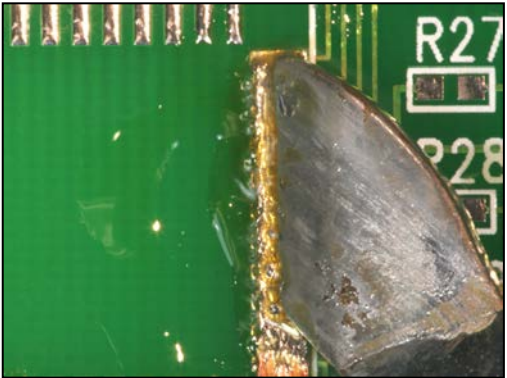
Step	Action
16	<p style="text-align: center;">CAUTION</p> <p style="text-align: center;">DO NOT APPLY PRESSURE WITH THE SOLDERING IRON.</p> <p>Place the soldering iron tip on the wicking material.</p> 
17	<p style="text-align: center;">CAUTION</p> <p style="text-align: center;">IF SOLDER MELT DOES NOT OCCUR WITHIN FOUR SECONDS, STOP THIS PROCEDURE AND ADJUST TIP TEMPERATURE PER THE TIP TEMPERATURE PROCEDURE IN WP 003 00 (PARAGRAPH 03-5.4).</p> <p>Observe the capillary action (solder flow) into the wicking material; when solder flow stops, remove the soldering iron and the wicking material.</p> 
18	Remove the used portion of wicking material from the spool using utility cutters.
19	Repeat steps 13 through 18 for the remaining rows of lands.
20	Season the tip and place the soldering iron into its stand.
21	Turn the preheater power switch to the OFF position.

Land Preparation (Multiple) using Wicking Material Procedure

Step	Action
22	Allow the CCA to cool completely before cleaning.
23	<p>Clean the lands with isopropyl alcohol using an acid brush to remove all flux residue and blot dry with a clean, lint-free tissue.</p> <p>Note: Take precautions to prevent bare skin contact before the component is soldered. Skin contact leaves contaminants on the leads and/or pads.</p> 
24	<p><i>Inspect per the General Inspection Procedure in WP 003 00 (paragraph 03-5.12) to all applicable WORKMANSHIP STANDARDS, including:</i></p> <ul style="list-style-type: none"> • <i>Post-Solder Joint Cleanliness in WP 005 00 (paragraph 05-6.2)</i> • <i>Laminate in WP 011 00 (paragraph 11-6.1)</i> • <i>Surface Mount Circuit Card Assembly Lands and Conductors (paragraph 18-6.3)</i> • <i>Other applicable Workmanship Standards as required</i>
25	Dispose of all HAZMAT following local procedures.

18-5.5.3 Land Preparation (Individual) using Continuous Vacuum Extraction Procedure

Use this procedure to individually prepare SMD lands.

Personnel Hazards



Alcohol, Isopropyl

1



Flux (Soldering)

8



Lead (Solder)

Land Preparation (Individual) using Continuous Vacuum Extraction Procedure

Step	Action										
	<p style="text-align: center;">WARNING</p> <p style="text-align: center;"><i>USE APPROVED SAFETY EYEWEAR WHEN PERFORMING THIS PROCEDURE.</i></p> <p style="text-align: center;"><i>COMPLY WITH ALL LOCAL REQUIREMENTS FOR PPE.</i></p> <p style="text-align: center;">CAUTION</p> <p style="text-align: center;">DON A PROPERLY GROUNDED ESD WRIST STRAP BEFORE STARTING THIS PROCEDURE.</p>										
<p>1</p>	<p style="text-align: center;">CAUTION</p> <p style="text-align: center;">BEGIN THE REPAIR PROCESS AS SOON AS POSSIBLE AFTER REMOVAL FROM THE OVEN TO AVOID MOISTURE RE-ABSORPTION.</p> <table border="1" style="width: 100%; border-collapse: collapse;"> <tr> <td style="width: 50%; vertical-align: top;"> Bake the CCA, if feasible, in accordance with the table to the right before soldering, desoldering, and conformal coating removal procedures to prevent delamination, measling, or other laminate degradation. </td> <td style="width: 50%; text-align: center;"> <table border="1" style="width: 100%; border-collapse: collapse;"> <thead> <tr> <th style="text-align: left;">Baking Temp.</th> <th style="text-align: left;">Baking Time</th> </tr> </thead> <tbody> <tr> <td>248°F (120°C)</td> <td>3.5 to 7 hours</td> </tr> <tr> <td>212°F (100°C)</td> <td>8 to 16 hours</td> </tr> <tr> <td>176°F (80°C)</td> <td>18 to 48 hours</td> </tr> </tbody> </table> </td> </tr> </table>	Bake the CCA, if feasible, in accordance with the table to the right before soldering, desoldering, and conformal coating removal procedures to prevent delamination, measling, or other laminate degradation.	<table border="1" style="width: 100%; border-collapse: collapse;"> <thead> <tr> <th style="text-align: left;">Baking Temp.</th> <th style="text-align: left;">Baking Time</th> </tr> </thead> <tbody> <tr> <td>248°F (120°C)</td> <td>3.5 to 7 hours</td> </tr> <tr> <td>212°F (100°C)</td> <td>8 to 16 hours</td> </tr> <tr> <td>176°F (80°C)</td> <td>18 to 48 hours</td> </tr> </tbody> </table>	Baking Temp.	Baking Time	248°F (120°C)	3.5 to 7 hours	212°F (100°C)	8 to 16 hours	176°F (80°C)	18 to 48 hours
Bake the CCA, if feasible, in accordance with the table to the right before soldering, desoldering, and conformal coating removal procedures to prevent delamination, measling, or other laminate degradation.	<table border="1" style="width: 100%; border-collapse: collapse;"> <thead> <tr> <th style="text-align: left;">Baking Temp.</th> <th style="text-align: left;">Baking Time</th> </tr> </thead> <tbody> <tr> <td>248°F (120°C)</td> <td>3.5 to 7 hours</td> </tr> <tr> <td>212°F (100°C)</td> <td>8 to 16 hours</td> </tr> <tr> <td>176°F (80°C)</td> <td>18 to 48 hours</td> </tr> </tbody> </table>	Baking Temp.	Baking Time	248°F (120°C)	3.5 to 7 hours	212°F (100°C)	8 to 16 hours	176°F (80°C)	18 to 48 hours		
Baking Temp.	Baking Time										
248°F (120°C)	3.5 to 7 hours										
212°F (100°C)	8 to 16 hours										
176°F (80°C)	18 to 48 hours										
<p>2</p>	<p>Remove any conformal coating from the repair area using one of the Conformal Coating Removal Methods in WP 006 00 (paragraph 06-5.4).</p>										
<p>3</p>	<p>Clean the repair area with isopropyl alcohol using an acid brush and blot dry with a clean, lint-free tissue.</p>										
<p>4</p>	<p>Apply flux SPARINGLY to the lands.</p> <p>Note: Use a toothpick or flux pen to control the volume of flux applied. Heavy flux volume impairs cleaning and may affect reliability.</p>										
<p>5</p>	<p>Preheat the CCA per the Convective Preheating Procedure (paragraph 18-5.2.1) or the Conductive Preheating Procedure (paragraph 18-5.2.2).</p>										

Land Preparation (Individual) using Continuous Vacuum Extraction Procedure

Step	Action
6	Select a soldering iron tip that maximizes heat transfer and contact area with the lands.
7	Set the soldering iron tip temperature to 600°F (316°C).
8	Use a drag soldering technique to overfill the lands with solder.
9	Select a solder extractor tip whose outer diameter closely matches the land width.
10	Set the solder extractor tip temperature to 700°F (371°C).
11	Place a clean tissue on a heat resistant surface and test the solder extractor by actuating vacuum to pick up the tissue. Note: If the solder extractor vacuum is insufficient to pick up the tissue, stop this procedure and perform the Solder Extractor Vacuum Test and Heater Element Cleaning Procedure in WP 003 00 (paragraph 03-5.7).
12	Remove the seasoning (all solder) from the solder extractor tip.
13	Thermally shock the solder extractor tip on a damp sponge.
14	<div style="text-align: center; border: 2px solid black; padding: 5px; width: fit-content; margin: 0 auto;">CAUTION</div> <p style="text-align: center;">DO NOT APPLY PRESSURE WITH THE SOLDER EXTRACTOR.</p> <p>Place the solder extractor tip on one land contacting only the solder.</p>
15	<div style="text-align: center; border: 2px solid black; padding: 5px; width: fit-content; margin: 0 auto;">CAUTION</div> <p style="text-align: center;">IF SOLDER MELT DOES NOT OCCUR WITHIN TWO SECONDS, STOP THIS PROCEDURE AND ADJUST TIP TEMPERATURE PER THE TIP TEMPERATURE PROCEDURE IN WP 003 00 (PARAGRAPH 03-5.4).</p> <p>Observe COMPLETE solder melt; then actuate vacuum using the handpiece vacuum control switch or the foot pedal switch.</p>
16	After complete solder extraction, remove the solder extractor tip from the solder joint allowing the solder extractor vacuum to run continuously for an additional five seconds to draw the molten solder completely into the solder collection tube.

Land Preparation (Individual) using Continuous Vacuum Extraction Procedure

Step	Action
17	Repeat steps 14 through 16 for the remaining lands.
18	Season the tip and place the handpiece into its stand.
19	Turn the preheater power switch to the OFF position.
20	Allow the CCA to cool completely before cleaning.
21	<p>Clean the lands with isopropyl alcohol using an acid brush to remove all flux residue and blot dry with a clean, lint-free tissue.</p> <p>Note: Take precautions to prevent bare skin contact before the component is soldered. Skin contact leaves contaminants on the leads and/or pads.</p> 
22	<p><i>Inspect per the General Inspection Procedure in WP 003 00 (paragraph 03-5.12) to all applicable WORKMANSHIP STANDARDS, including:</i></p> <ul style="list-style-type: none"> • <i>Post-Solder Joint Cleanliness in WP 005 00 (paragraph 05-6.2)</i> • <i>Laminate in WP 011 00 (paragraph 11-6.1)</i> • <i>Surface Mount Circuit Card Assembly Lands and Conductors (paragraph 18-6.3)</i> • <i>Other applicable Workmanship Standards as required</i>
23	Dispose of all HAZMAT following local procedures.

18-5.6 Surface Mount Device Preparation for Installation

CAUTION

USE A DOUBLE TINNING PROCESS ON SMDS WITH GOLD-PLATED LEADS OR GOLD-PLATED CASTELLATIONS TO PREVENT GOLD EMBRITTLEMENT.

TIN ALL LEADS ON SMDS MARKED AS LEAD-FREE (SEE WP 020 00).

Most SMDs are pretinned by the manufacturer and packaged to protect the SMD from the environment.

Cleaning and tinning of SMDs (except for flat packs) is not normally performed due to the high probability of disturbing lead positioning and damaging the SMD.

18-5.7 Flat Pack Lead Preparation (Lead Wiping Method) Procedure

Flat pack leads must be tinned, formed, and terminated before installation (Figure 18-10).

Ensure the flat pack is oriented properly before forming the leads.

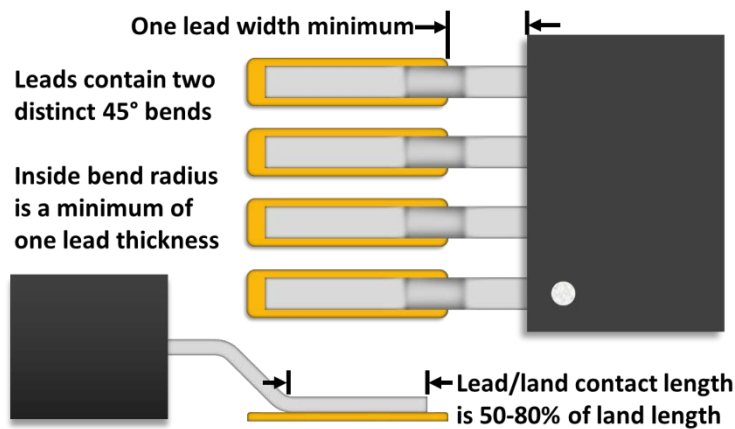

Figure 18-10 Flat Pack Lead Forming

Personnel Hazards



Lead (Solder)

9

Flat Pack Lead Preparation (Lead Wiping Method) Procedure

Step	Action
	<div style="text-align: center;"> <div style="border: 2px solid black; padding: 5px; display: inline-block;">WARNING</div> <p>USE APPROVED SAFETY EYEWEAR WHEN PERFORMING THIS PROCEDURE.</p> <p>COMPLY WITH ALL LOCAL REQUIREMENTS FOR PPE.</p> </div>

Flat Pack Lead Preparation (Lead Wiping Method) Procedure

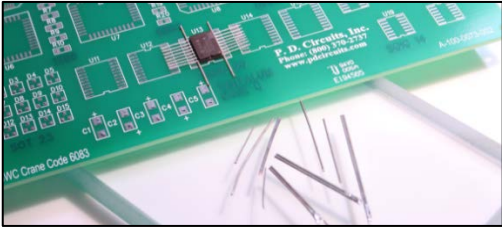
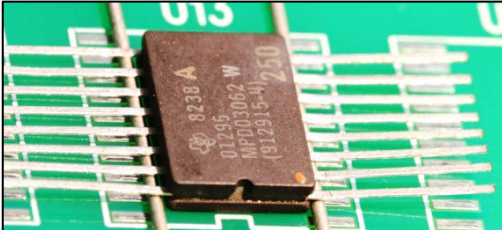
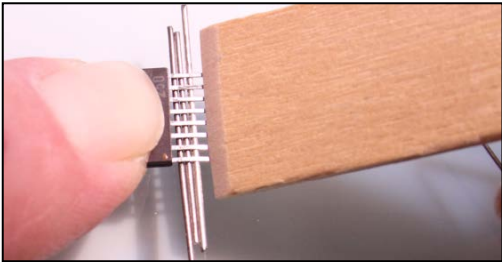
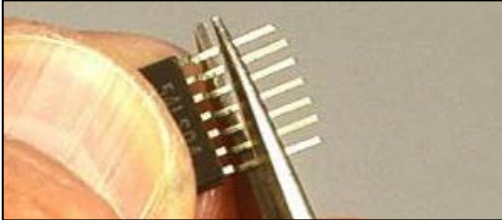
Step	Action
	<div style="border: 2px solid black; padding: 5px; display: inline-block; margin-bottom: 10px;">CAUTION</div> <p>DON A PROPERLY GROUNDED ESD WRIST STRAP BEFORE STARTING THIS PROCEDURE.</p>
1	Tin the leads.
2	Position the flat pack on a hard, flat surface, such as a glass slab.
3	<p>Select spacer(s) [component leads or drill bits] whose diameter is equal to the distance between the bottom of the leads and the bottom of the flat pack body.</p> 
4	<p>Place the spacer(s) flush against flat pack body underneath the leads.</p> <p>Note: The number of spacers used determines the distance of the bends from the flat pack body.</p> 
5	<p>Use an orangewood stick, spudger, or tongue depressor to press in and down on flat pack leads where they contact the spacer.</p> 
6	Wipe the tool along the length of the leads, in a motion parallel to the leads.
7	<p>Use scissors to terminate the leads to length.</p> 

Flat Pack Lead Preparation (Lead Wiping Method) Procedure

Step	Action
8	Repeat steps 2 through 7 on the leads on the opposite side of the flat pack.
9	Clean the flat pack leads with isopropyl alcohol using an acid brush to remove all flux residue and blot dry with a clean, lint-free tissue.
10	<i>Inspect per the General Inspection Procedure in WP 003 00 (paragraph 03-5.12) to all applicable WORKMANSHIP STANDARDS, including:</i> <ul style="list-style-type: none">• <i>Flat Pack Lead Forming and Termination (paragraph 18-6.6)</i>• <i>Other applicable Workmanship Standards, as required</i>
11	Dispose of all HAZMAT following local procedures.

18-5.8 Surface Mount Device Installation















Ensure a Circuit Card Assembly Preparation for SMD Installation procedure (paragraph 18-5.5) was completed before starting a SMD installation procedure.

- For chip style components, MELFs, or SOTs, use the Installation of Chip Components, MELFs, and SOTs with Soldering Iron Procedure (paragraph 18-5.8.1) or the Installation of Chip Components, MELFs, and SOTs with Hot Air Jet Procedure (paragraph 18-5.8.2)
- For gull wing leaded SMDs, use the Installation of Gull Wing and J-Leaded SMDs with Point-to-Point Soldering Procedure (paragraph 18-5.8.3), the Installation of Gull Wing, J-Leaded, and Leadless SMDs with Drag Soldering Procedure (paragraph 18-5.8.4), or the Installation of Multilead SMDs with Hot Air Jet Procedure (paragraph 18-5.8.6)
- For J-leaded SMDs, use the Installation of Gull Wing and J-Leaded SMDs with Point-to-Point Soldering Procedure (paragraph 18-5.8.3), the Installation of Gull Wing, J-Leaded, and Leadless SMDs with Drag Soldering Procedure (paragraph 18-5.8.4), the Installation of J-Lead SMDs with Knife Tip Drag Soldering Procedure (paragraph 18-5.8.5), or the Installation of Multilead SMDs with Hot Air Jet Procedure (paragraph 18-5.8.6)
- For SMDs with castellations, use the Installation of Gull Wing, J-Leaded, and Leadless SMDs with Drag Soldering Procedure (paragraph 18-5.8.4), or the Installation of Multilead SMDs with Hot Air Jet Procedure (paragraph 18-5.8.6)

18-5.8.1 Installation of Chip Components, MELFs, and SOTs with Soldering Iron Procedure

Use this procedure to install chip style components, MELFs, or SOTs.

Personnel Hazards

					
Alcohol, Isopropyl					1
					
Flux (Soldering)					8
					
Lead (Solder)					9



Installation of Chip Components, MELFs, and SOTs with Soldering Iron Procedure

Step	Action
	<div style="border: 1px solid black; padding: 5px; margin-bottom: 10px;">WARNING</div> <p>USE APPROVED SAFETY EYEWEAR WHEN PERFORMING THIS PROCEDURE.</p> <p>COMPLY WITH ALL LOCAL REQUIREMENTS FOR PPE.</p> <div style="border: 1px solid black; padding: 5px; margin-bottom: 10px;">CAUTION</div> <p>DON A PROPERLY GROUNDED ESD WRIST STRAP BEFORE STARTING THIS PROCEDURE.</p>
1	Ensure a Circuit Card Assembly Preparation for SMD Installation procedure (paragraph 18-5.5) was completed.
2	Apply flux SPARINGLY to the lands. Note: Use a toothpick or flux pen to control the volume of flux applied. Heavy flux volume impairs cleaning and may affect reliability.
3	Preheat the CCA and replacement SMDs per the Convective Preheating Procedure (paragraph 18-5.2.1) or the Conductive Preheating Procedure (paragraph 18-5.2.2).

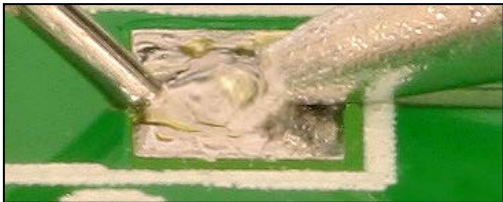
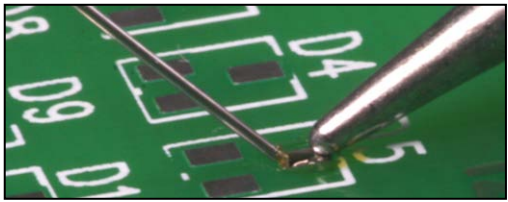
Installation of Chip Components, MELFs, and SOTs with Soldering Iron Procedure

Step	Action
4	Select a soldering iron tip that maximizes heat transfer and contact area with the lead termination and the land.
5	Set the soldering iron tip temperature to 600°F (316°C).
6	Clean the solder with isopropyl alcohol and wipe dry with a clean, lint-free tissue.
7	Remove the seasoning (all solder) from the soldering iron tip.
8	Thermally shock the soldering iron tip on a damp sponge.
9	<p style="text-align: center;">CAUTION</p> <p style="text-align: center;">DO NOT APPLY PRESSURE WITH THE SOLDERING IRON.</p> <p>Place the soldering iron tip on one land.</p>
10	<p style="text-align: center;">CAUTION</p> <p style="text-align: center;">IF SOLDER MELT DOES NOT OCCUR WITHIN TWO SECONDS, STOP THIS PROCEDURE AND ADJUST TIP TEMPERATURE PER THE TIP TEMPERATURE PROCEDURE IN WP 003 00 (PARAGRAPH 03-5.4).</p> <p>Form a heat bridge between the soldering iron tip and a land using clean solder.</p>
11	<p>Prefill one land with solder.</p> <div style="display: flex; justify-content: space-around;">   </div>
12	Remove the solder and the soldering iron tip simultaneously.
13	Season the tip and place the soldering iron into its stand.

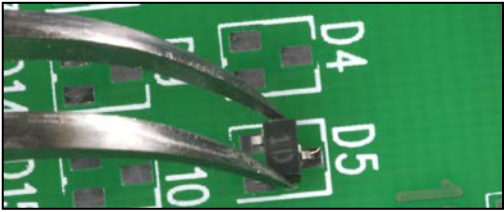
Installation of Chip Components, MELFs, and SOTs with Soldering Iron Procedure

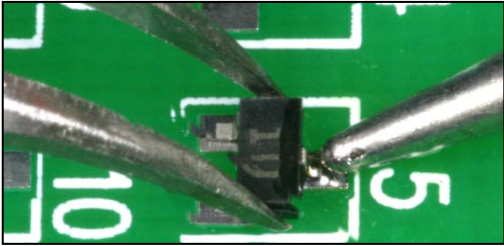
Step	Action
14	<p>Center the SMD on the lands with identifying marks visible and properly oriented for polarity.</p> 
15	<p>Remove the seasoning from the soldering iron tip.</p>
16	<p>Thermally shock the soldering iron tip on a damp sponge.</p>
17	<p>Use tweezers or a soldering aid to hold the SMD in place.</p>
18	<p style="text-align: center;">CAUTION</p> <p style="text-align: center;">DO NOT APPLY PRESSURE WITH THE SOLDERING IRON. DO NOT TOUCH THE END CAP OF CHIP COMPONENT WITH THE SOLDERING IRON.</p> <p>Place the soldering iron on the prefilled land.</p> 
19	<p style="text-align: center;">CAUTION</p> <p style="text-align: center;">IF SOLDER MELT DOES NOT OCCUR WITHIN TWO SECONDS, STOP THIS PROCEDURE AND ADJUST TIP TEMPERATURE PER THE TIP TEMPERATURE PROCEDURE IN WP 003 00 (PARAGRAPH 03-5.4).</p> <p>Reflow the solder in the prefilled land joint.</p> 

Installation of Chip Components, MELFs, and SOTs with Soldering Iron Procedure

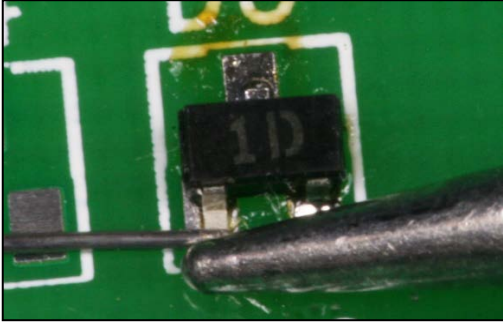
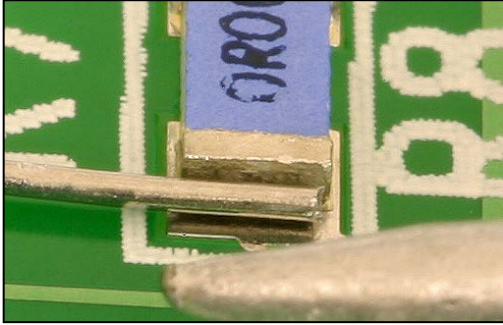
Step	Action
20	<p style="text-align: center;">CAUTION</p> <p style="text-align: center;">DO NOT TOUCH THE END CAP OF CHIP COMPONENT WITH THE SOLDERING IRON.</p> <p>Solder the remaining joint(s) using clean solder.</p> <div style="display: flex; justify-content: space-around;"></div>
21	Remove the solder and the soldering iron tip simultaneously.
22	Season the tip and place the soldering iron into its stand.
23	Turn the preheater power switch to the OFF position.
24	<p style="text-align: center;">CAUTION</p> <p style="text-align: center;">FAILURE TO ALLOW THE CCA TO COOL COMPLETELY MAY RESULT IN DAMAGE TO THE CCA; ESPECIALLY FOR CERAMIC CCAS, WHICH ARE SUBJECT TO THERMAL SHOCK AND CRACKING.</p> <p>Allow the CCA to cool completely before cleaning.</p>
25	Clean the repair area with isopropyl alcohol using an acid brush to remove all flux residue and blot dry with a clean, lint-free tissue.

Installation of Chip Components, MELFs, and SOTs with Soldering Iron Procedure

Step	Action
26	<p><i>Inspect per the General Inspection Procedure in WP 003 00 (paragraph 03-5.12) to all applicable WORKMANSHIP STANDARDS, including:</i></p> <ul style="list-style-type: none"> • <i>General Solder Acceptability in WP 005 00 (paragraph 05-6.1)</i> • <i>Post-Solder Joint Cleanliness in WP 005 00 (paragraph 05-6.2)</i> • <i>Laminate in WP 011 00 (paragraph 11-6.1)</i> • <i>Surface Mount Devices (paragraph 18-6.1)</i> • <i>Surface Mount Device Leads (paragraph 18-6.2)</i> • <i>Surface Mount Circuit Card Assembly Lands and Conductors (paragraph 18-6.3)</i> • <i>Surface Mount Device Mounting (paragraph 18-6.4)</i> • <i>Surface Mount Device Positioning and Soldering (paragraph 18-6.5)</i> • <i>Surface Mount Soldering Anomalies (paragraph 18-6.7)</i> • <i>Other applicable Workmanship Standards as required</i>
27	<p>Replace the conformal coating per the Conformal Coating Replacement Procedure in WP 006 00 (paragraph 06-5.5), as needed.</p>
28	<p><i>Inspect to the Conformal Coating Replacement WORKMANSHIP STANDARD in WP 006 00 (paragraph 06-6.2), as required.</i></p>
29	<p>Dispose of all HAZMAT following local procedures.</p>

18-5.8.2 Installation of Chip Components, MELFs, and SOTs with Hot Air Jet Procedure

Use this procedure to install chip style components, MELFs, or SOTs.

This procedure requires the use of solder paste.

Personnel Hazards



Alcohol, Isopropyl



Flux (Soldering)

8



Lead (Solder)

9

Installation of Chip Components, MELFs, and SOTs with Hot Air Jet Procedure

Step	Action
	<p style="text-align: center;">WARNING</p> <p style="text-align: center;"><i>USE APPROVED SAFETY EYEWEAR WHEN PERFORMING THIS PROCEDURE. COMPLY WITH ALL LOCAL REQUIREMENTS FOR PPE.</i></p> <p style="text-align: center;">CAUTION</p> <p style="text-align: center;">DON A PROPERLY GROUNDED ESD WRIST STRAP BEFORE STARTING THIS PROCEDURE.</p> <p style="text-align: center;">NOTE</p> <p style="text-align: center;">DO NOT USE EXTERNAL FLUX IN CONJUNCTION WITH SOLDER PASTE. THE FLUX CONTAINED IN THE SOLDER PASTE IS SUFFICIENT TO REMOVE THE OXIDATION AND REDUCE THE SURFACE TENSION TO ALLOW THE SOLDER TO WET ALL OF THE ELEMENTS OF THE JOINT.</p>
1	Ensure a Circuit Card Assembly Preparation for SMD Installation procedure (paragraph 18-5.5) was completed.
2	Preheat the CCA and replacement SMDs per the Convective Preheating Procedure (paragraph 18-5.2.1) or the Conductive Preheating Procedure (paragraph 18-5.2.2).
3	Select and install the proper tip into the hot air jet.
4	Set the hot air jet tip temperature to 900°F (482°C).

Installation of Chip Components, MELFs, and SOTs with Hot Air Jet Procedure

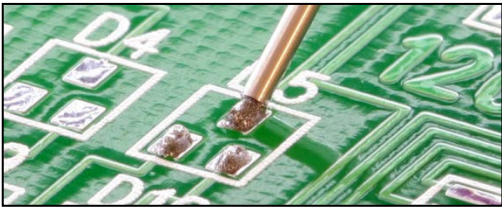
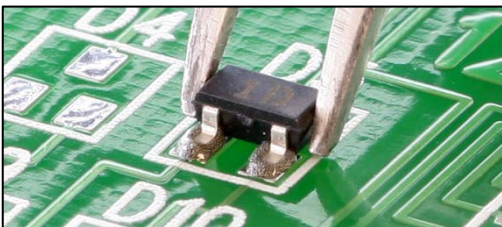
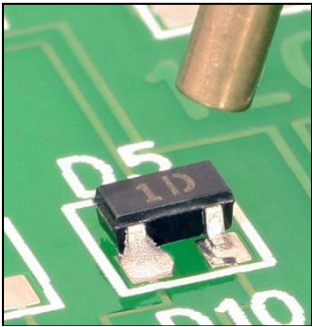
Step	Action
5	Adjust pressure output so the hot air burns a light brown line on a tissue from approximately 1/8-1/4 in. 
6	Select and install the proper tip into the paste dispenser.
7	Dispense solder paste by applying a bead to each land. Note: Adjust solder bead size as required for proper solder joint formation. 
8	Center the SMD on the lands with identifying marks visible and properly oriented for polarity. 
9	Bring the end of the hot air jet tip to a distance of approximately one inch from the SMD leads/terminations.
10	Activate airflow to the hot air jet.
11	Direct the heated air evenly over all lands using a circular motion.
12	Observe the drying of the solder paste (changes color to a dull gray).
13	Lower the hot air jet tip to begin solder reflow. Note: Varying the distance of the tip to the workpiece will control the temperature and amount of hot air applied to the repair area. 















Installation of Chip Components, MELFs, and SOTs with Hot Air Jet Procedure

Step	Action
14	Maintain all solder joints in reflow state for approximately five seconds.
15	Remove hot air jet from workpiece, deactivate, and place into its stand.
16	Turn the preheater power switch to the OFF position.
17	Allow the CCA to cool completely before cleaning.
18	Clean the repair area with isopropyl alcohol using an acid brush to remove all flux residue and blot dry with a clean, lint-free tissue.
19	<p><i>Inspect per the General Inspection Procedure in WP 003 00 (paragraph 03-5.12) to all applicable WORKMANSHIP STANDARDS, including:</i></p> <ul style="list-style-type: none"> • <i>General Solder Acceptability in WP 005 00 (paragraph 05-6.1)</i> • <i>Post-Solder Joint Cleanliness in WP 005 00 (paragraph 05-6.2)</i> • <i>Laminate in WP 011 00 (paragraph 11-6.1)</i> • <i>Surface Mount Devices (paragraph 18-6.1)</i> • <i>Surface Mount Device Leads (paragraph 18-6.2)</i> • <i>Surface Mount Circuit Card Assembly Lands and Conductors (paragraph 18-6.3)</i> • <i>Surface Mount Device Mounting (paragraph 18-6.4)</i> • <i>Surface Mount Device Positioning and Soldering (paragraph 18-6.5)</i> • <i>Surface Mount Soldering Anomalies (paragraph 18-6.7)</i> • <i>Other applicable Workmanship Standards as required</i>
20	Replace the conformal coating per the Conformal Coating Replacement Procedure in WP 006 00 (paragraph 06-5.5), as needed.
21	<i>Inspect to the Conformal Coating Replacement WORKMANSHIP STANDARD in WP 006 00 (paragraph 06-6.2), as required.</i>
22	Dispose of all HAZMAT following local procedures.

18-5.8.3 Installation of Gull Wing and J-Leaded SMDs with Point-to-Point Soldering Procedure

Use this procedure to install gull wing leaded and J-Leaded SMDs.



Personnel Hazards

					
Alcohol, Isopropyl					1
					
Flux (Soldering)					8
					
Lead (Solder)					9

Installation of Gull Wing and J-Leaded SMDs with Point-to-Point Soldering Procedure

Step	Action
	<div style="border: 1px solid black; padding: 5px; margin-bottom: 10px;">WARNING</div> <p>USE APPROVED SAFETY EYEWEAR WHEN PERFORMING THIS PROCEDURE.</p> <p>COMPLY WITH ALL LOCAL REQUIREMENTS FOR PPE.</p> <div style="border: 1px solid black; padding: 5px; margin-bottom: 10px;">CAUTION</div> <p>DON A PROPERLY GROUNDED ESD WRIST STRAP BEFORE STARTING THIS PROCEDURE.</p>
1	Ensure a Circuit Card Assembly Preparation for SMD Installation procedure (paragraph 18-5.5) and, if required, a Flat Pack Lead Preparation (Lead Wiping Method) Procedure (paragraph 18-5.7) were completed.

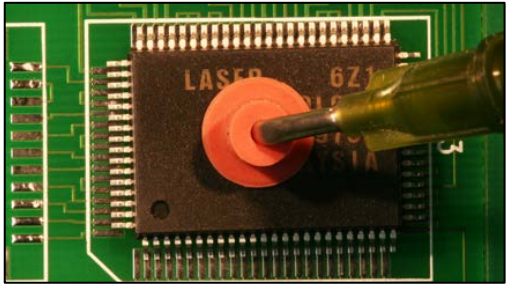
Installation of Gull Wing and J-Leaded SMDs with Point-to-Point Soldering Procedure

Step	Action
2	<p>Position the replacement SMD onto the CCA using a vacuum holding device or tweezers.</p> <p>Note: Center the SMD leads on the lands with the SMD properly oriented (pin one to land one).</p> 
3	<p>Apply flux SPARINGLY to the leads and the lands.</p> <p>Note: Use a toothpick or flux pen to control the volume of flux applied. Heavy flux volume impairs cleaning and may affect reliability.</p>
4	<p>Preheat the CCA and replacement SMDs per the Convective Preheating Procedure (paragraph 18-5.2.1) or the Conductive Preheating Procedure (paragraph 18-5.2.2).</p>
5	<p>Select a soldering iron tip that maximizes heat transfer and contact area with the lead termination and the land.</p>
6	<p>Set the soldering iron tip temperature to 600°F (316°C).</p>
7	<p>Clean the solder with isopropyl alcohol and wipe dry with a clean, lint-free tissue.</p>
8	<p>Remove the seasoning (all solder) from the soldering iron tip.</p>
9	<p>Thermally shock the soldering iron tip on a damp sponge.</p>
10	<div style="text-align: center; border: 1px solid black; padding: 5px; margin-bottom: 10px;"> CAUTION </div> <p>DO NOT APPLY PRESSURE WITH THE SOLDERING IRON.</p> <p>Place the soldering iron tip on a lead at the end of one row of leads.</p> 

Installation of Gull Wing and J-Leaded SMDs with Point-to-Point Soldering Procedure

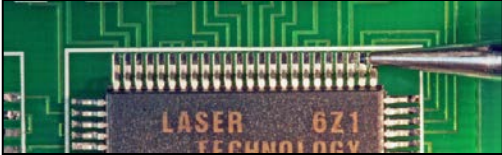
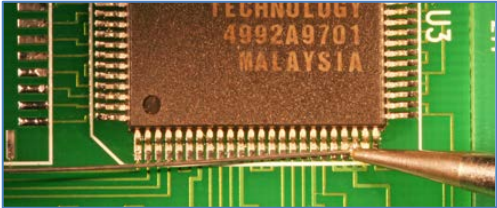
Step	Action
11	<p style="text-align: center;">CAUTION</p> <p style="text-align: center;">IF SOLDER MELT DOES NOT OCCUR WITHIN TWO SECONDS, STOP THIS PROCEDURE AND ADJUST TIP TEMPERATURE PER THE TIP TEMPERATURE PROCEDURE IN WP 003 00 (PARAGRAPH 03-5.4).</p> <p>Tack solder the lead.</p>
12	<p>Tack solder the lead at the opposite corner.</p> 
13	Remove the solder and the soldering iron tip simultaneously.
14	Season the tip and place the soldering iron into its stand.
15	Remove the seasoning from the soldering iron tip.
16	Thermally shock the soldering iron tip on a damp sponge.
17	<p style="text-align: center;">CAUTION</p> <p style="text-align: center;">DO NOT APPLY PRESSURE WITH THE SOLDERING IRON.</p> <p>Place the soldering iron on a lead not tacked.</p>
18	<p style="text-align: center;">CAUTION</p> <p style="text-align: center;">IF SOLDER MELT DOES NOT OCCUR WITHIN TWO SECONDS, STOP THIS PROCEDURE AND ADJUST TIP TEMPERATURE PER THE TIP TEMPERATURE PROCEDURE IN WP 003 00 (PARAGRAPH 03-5.4).</p> <p>Form a heat bridge and add solder to form heel and toe fillets.</p> 

Installation of Gull Wing and J-Leaded SMDs with Point-to-Point Soldering Procedure

Step	Action
19	Remove the solder and the soldering iron tip simultaneously.
20	Repeat steps 17 through 19 for each lead.
21	Season the tip and place the soldering iron into its stand.
22	Remove any solder bridges using the Solder Bridge Removal Procedure (paragraph 18-5.9), as needed.
23	Turn the preheater power switch to the OFF position.
24	Allow the CCA to cool completely before cleaning.
25	Clean the repair area with isopropyl alcohol using an acid brush to remove all flux residue and blot dry with a clean, lint-free tissue.
26	<p><i>Inspect per the General Inspection Procedure in WP 003 00 (paragraph 03-5.12) to all applicable WORKMANSHIP STANDARDS, including:</i></p> <ul style="list-style-type: none"> • <i>General Solder Acceptability in WP 005 00 (paragraph 05-6.1)</i> • <i>Post-Solder Joint Cleanliness in WP 005 00 (paragraph 05-6.2)</i> • <i>Laminate in WP 011 00 (paragraph 11-6.1)</i> • <i>Surface Mount Devices (paragraph 18-6.1)</i> • <i>Surface Mount Device Leads (paragraph 18-6.2)</i> • <i>Surface Mount Circuit Card Assembly Lands and Conductors (paragraph 18-6.3)</i> • <i>Surface Mount Device Mounting (paragraph 18-6.4)</i> • <i>Surface Mount Device Positioning and Soldering (paragraph 18-6.5)</i> • <i>Flat Pack Lead Forming and Termination (paragraph 18-6.6), as applicable</i> • <i>Surface Mount Soldering Anomalies (paragraph 18-6.7)</i> • <i>Other applicable Workmanship Standards as required</i>
27	Replace the conformal coating per the Conformal Coating Replacement Procedure in WP 006 00 (paragraph 06-5.5), as needed.















Installation of Gull Wing and J-Leaded SMDs with Point-to-Point Soldering Procedure

Step	Action
28	Inspect to the Conformal Coating Replacement WORKMANSHIP STANDARD in WP 006 00 (paragraph 06-6.2), as required.
29	Dispose of all HAZMAT following local procedures.

18-5.8.4 Installation of Gull Wing, J-Leaded, and Leadless SMDs with Drag Soldering Procedure

Use this procedure to install gull wing leaded, J-leaded, and castellated SMDs when drag soldering is feasible.



Personnel Hazards

					
Alcohol, Isopropyl					1
					
Flux (Soldering)					8
					
Lead (Solder)					9

Installation of Gull Wing, J-Leaded, and Leadless SMDs with Drag Soldering Procedure

Step	Action
	<div style="border: 2px solid black; padding: 5px; display: inline-block;">WARNING</div> USE APPROVED SAFETY EYEWEAR WHEN PERFORMING THIS PROCEDURE. COMPLY WITH ALL LOCAL REQUIREMENTS FOR PPE.

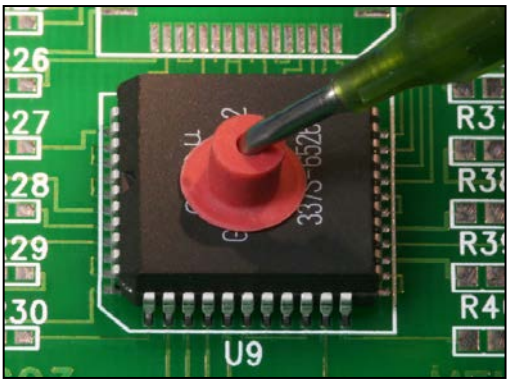
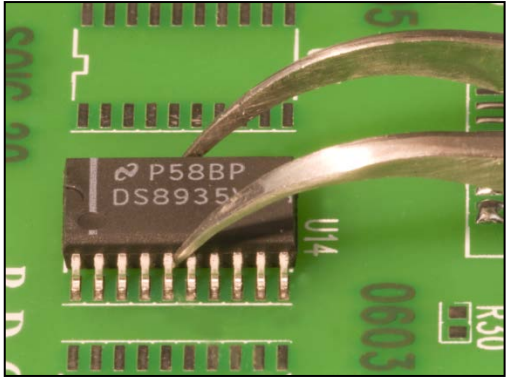
Installation of Gull Wing, J-Leaded, and Leadless SMDs with Drag Soldering Procedure



Step	Action
	<div style="border: 2px solid black; padding: 5px; display: inline-block; margin-bottom: 10px;">CAUTION</div> <p>DON A PROPERLY GROUNDED ESD WRIST STRAP BEFORE STARTING THIS PROCEDURE.</p>
1	<p>Ensure a Circuit Card Assembly Preparation for SMD Installation procedure (paragraph 18-5.5) and, if required, a Flat Pack Lead Preparation (Lead Wiping Method) Procedure (paragraph 18-5.7) were completed.</p>
2	<p>Position the replacement SMD onto the CCA using a vacuum holding device or tweezers.</p> <p>Note: Center the SMD leads (or castellations) on the lands with the SMD properly oriented (pin one to land one).</p> <div style="display: flex; justify-content: space-around;">   </div>
3	<p>Apply flux SPARINGLY to the leads and the lands.</p> <p>Note: Use a toothpick or flux pen to control the volume of flux applied. Heavy flux volume impairs cleaning and may affect reliability.</p>
4	<p>Preheat the CCA and replacement SMDs per the Convective Preheating Procedure (paragraph 18-5.2.1) or the Conductive Preheating Procedure (paragraph 18-5.2.2).</p>
5	<p>Install a single-sided chisel or wave tip into the soldering iron.</p> <div style="text-align: right;">  </div>

Installation of Gull Wing, J-Leaded, and Leadless SMDs with Drag Soldering Procedure

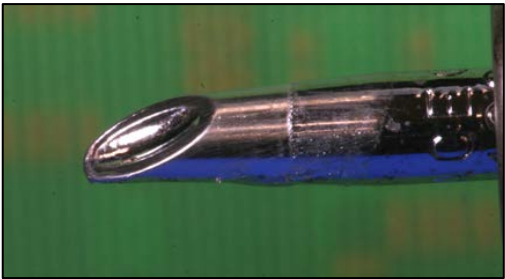
Step	Action
6	Set the soldering iron tip temperature to 600°F (316°C).
7	Clean the solder with isopropyl alcohol and wipe dry with a clean, lint-free tissue.
8	Remove the seasoning (all solder) from the soldering iron tip.
9	Thermally shock the soldering iron tip on a damp sponge.
10	<p style="text-align: center;">CAUTION</p> <p style="text-align: center;">DO NOT APPLY PRESSURE WITH THE SOLDERING IRON.</p> <p>Place the soldering iron tip on one lead (or castellation) at the end of a row of leads.</p> 
11	Tack solder the lead (castellation).
12	Tack solder the lead (castellation) at the opposite corner.
13	Remove the solder and the soldering iron tip simultaneously.
14	Season the tip and place the soldering iron into its stand.
15	Remove the seasoning from the soldering iron tip.

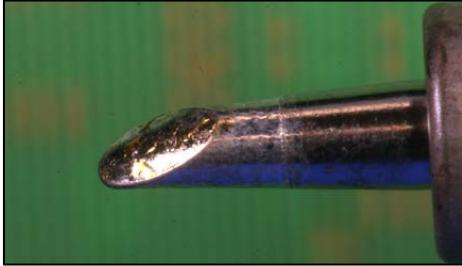

Installation of Gull Wing, J-Leaded, and Leadless SMDs with Drag Soldering Procedure

Step	Action
16	Thermally shock the soldering iron tip on a damp sponge.
17	<p>Apply solder to the flat end of the single-sided chisel or wave tip, forming a bead of solder across the tip surface.</p> <div style="display: flex; justify-content: space-around;">   </div>
18	<div style="text-align: center; border: 1px solid black; padding: 5px; width: fit-content; margin: 0 auto;">CAUTION</div> <p style="text-align: center;">DO NOT APPLY PRESSURE WITH THE SOLDERING IRON.</p> <p>Place the single-sided chisel or wave tip on the end of the row to be soldered.</p> <p>Note: The tip should sit flat on the lead or land with the iron oriented at a 30° angle to the row being soldered.</p> <p>Note: For a <u>four-sided</u> SMD, start the soldering process with a row of leads that has not been tack soldered.</p> <p>Note: For a <u>two-sided</u> SMD start the soldering process on an end opposite of the tack soldered joint.</p> 

Installation of Gull Wing, J-Leaded, and Leadless SMDs with Drag Soldering Procedure

Step	Action
19	<div style="text-align: center; border: 1px solid black; padding: 5px; margin-bottom: 10px;">CAUTION</div> <p style="text-align: center;">IF SOLDER MELT DOES NOT OCCUR WITHIN TWO SECONDS, STOP THIS PROCEDURE AND ADJUST TIP TEMPERATURE PER THE TIP TEMPERATURE PROCEDURE IN WP 003 00 (PARAGRAPH 03-5.4).</p> <p>Slowly drag the tip (toward the tacked lead on their rows) along remaining lead (castellation) and land junctions to form proper solder fillets at each joint.</p> <p>Note: For gull wing leaded SMDs, drag the tip across the foot of the leads or across the lead/land junctions.</p> <p>Note: For J-leaded SMDs, drag the tip across the land at the lead/land junctions.</p> <p>Note: For castellations drag the tip across the exposed lands.</p> <p>Note: Solder bridges may form if excess solder is applied to the tip in step 17 or if speed of tip movement is too fast or too slow.</p> 
20	Repeat steps 15 through 19 for the remaining rows to be soldered.
21	Season the tip and place the soldering iron into its stand.
22	Remove any solder bridges using the Solder Bridge Removal Procedure (paragraph 18-5.9), as needed.
23	Turn the preheater power switch to the OFF position.
24	Allow the CCA to cool completely before cleaning.
25	Clean the repair area with isopropyl alcohol using an acid brush to remove all flux residue and blot dry with a clean, lint-free tissue.

Installation of Gull Wing, J-Leaded, and Leadless SMDs with Drag Soldering Procedure

Step	Action
26	<p><i>Inspect per the General Inspection Procedure in WP 003 00 (paragraph 03-5.12) to all applicable WORKMANSHIP STANDARDS, including:</i></p> <ul style="list-style-type: none"> • <i>General Solder Acceptability in WP 005 00 (paragraph 05-6.1)</i> • <i>Post-Solder Joint Cleanliness in WP 005 00 (paragraph 05-6.2)</i> • <i>Laminate in WP 011 00 (paragraph 11-6.1)</i> • <i>Surface Mount Devices (paragraph 18-6.1)</i> • <i>Surface Mount Device Leads (paragraph 18-6.2)</i> • <i>Surface Mount Circuit Card Assembly Lands and Conductors (paragraph 18-6.3)</i> • <i>Surface Mount Device Mounting (paragraph 18-6.4)</i> • <i>Surface Mount Device Positioning and Soldering (paragraph 18-6.5)</i> • <i>Flat Pack Lead Forming and Termination (paragraph 18-6.6), as applicable</i> • <i>Surface Mount Soldering Anomalies (paragraph 18-6.7)</i> • <i>Other applicable Workmanship Standards as required</i>
27	<p>Replace the conformal coating per the Conformal Coating Replacement Procedure in WP 006 00 (paragraph 06-5.5), as needed.</p>
28	<p><i>Inspect to the Conformal Coating Replacement WORKMANSHIP STANDARD in WP 006 00 (paragraph 06-6.2), as required.</i></p>
29	<p>Dispose of all HAZMAT following local procedures.</p>

18-5.8.5 Installation of J-Lead SMDs with Knife Tip Drag Soldering Procedure

Use this procedure to install J-leaded SMDs only.

Personnel Hazards



Alcohol, Isopropyl

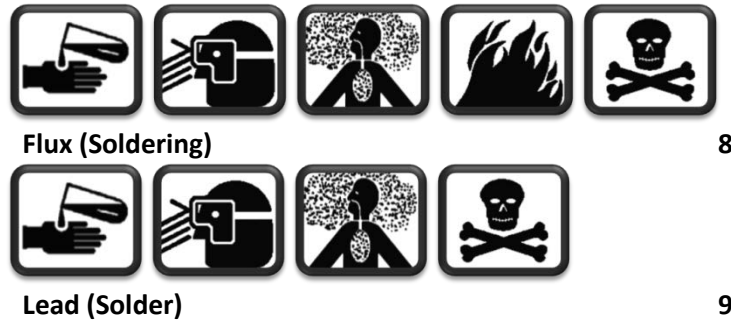

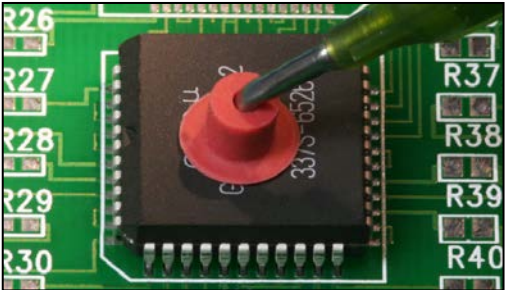

Installation of J-Lead SMDs with Knife Tip Drag Soldering Procedure

Step	Action
	<p style="text-align: center;">WARNING</p> <p style="text-align: center;"><i>USE APPROVED SAFETY EYEWEAR WHEN PERFORMING THIS PROCEDURE. COMPLY WITH ALL LOCAL REQUIREMENTS FOR PPE.</i></p> <p style="text-align: center;">CAUTION</p> <p style="text-align: center;">DON A PROPERLY GROUNDED ESD WRIST STRAP BEFORE STARTING THIS PROCEDURE.</p>
1	<p>Ensure a Circuit Card Assembly Preparation for SMD Installation procedure (paragraph 18-5.5) was completed.</p>
2	<p>Position the replacement SMD onto the CCA using a vacuum holding device or tweezers.</p> <p>Note: Center the leads on the lands with the SMD properly oriented (pin one to land one).</p> 
3	<p>Apply flux SPARINGLY to the area to be soldered.</p> <p>Note: Use a toothpick or flux pen to control the volume of flux applied. Heavy flux volume impairs cleaning and may affect reliability.</p>
4	<p>Preheat the CCA and replacement SMDs per the Convective Preheating Procedure (paragraph 18-5.2.1) or the Conductive Preheating Procedure (paragraph 18-5.2.2).</p>

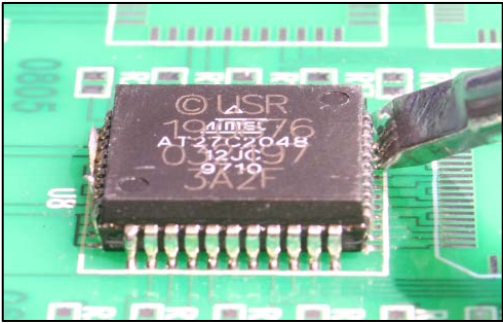
Installation of J-Lead SMDs with Knife Tip Drag Soldering Procedure

Step	Action
5	Install the knife tip into the soldering iron.
6	Set the soldering iron tip temperature to 600°F (316°C) and set the tip offset temperature per the Tip Temperature Chart, as required.
7	Clean the solder with isopropyl alcohol and wipe dry with a clean, lint-free tissue.
8	Remove the seasoning (all solder) from the soldering iron tip.
9	Thermally shock the soldering iron tip on a damp sponge.
10	<p style="text-align: center;">CAUTION</p> <p style="text-align: center;">DO NOT APPLY PRESSURE WITH THE SOLDERING IRON.</p> <p>Place the soldering iron tip on end of one of a row of leads.</p> 
11	Tack solder the lead.
12	Tack solder the lead at the opposite corner.
13	Remove the solder and the soldering iron tip simultaneously.
14	Season the tip and place the soldering iron into its stand.

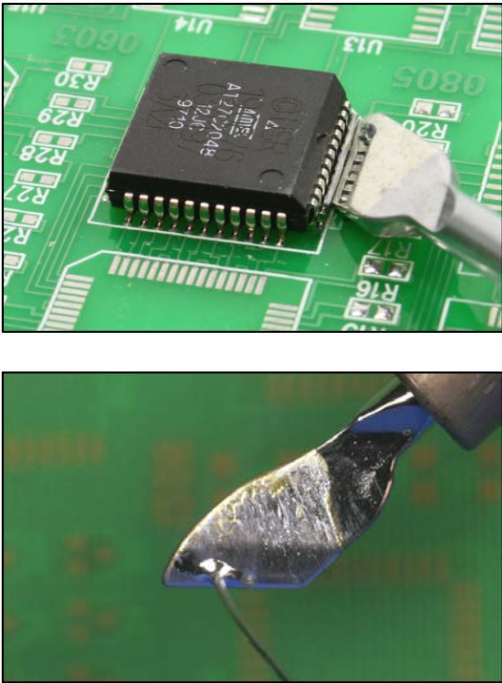
Installation of J-Lead SMDs with Knife Tip Drag Soldering Procedure

Step	Action
<p>15</p>	<p>Cut and place a piece of flux-cored solder (0.028 diameter) approximately 3/4 the length of the row of leads/lands to be soldered.</p> <p>Note: An alternative method is to preload a clean, thermally shocked knife tip with an equivalent amount of solder.</p> 
<p>16</p>	<p>Remove the seasoning from the soldering iron tip.</p>
<p>17</p>	<p>Thermally shock the soldering iron tip on a damp sponge.</p>
<p>18</p>	<div style="text-align: center; border: 1px solid black; padding: 5px; margin-bottom: 10px;"> <p>CAUTION</p> </div> <p>DO NOT APPLY PRESSURE WITH THE SOLDERING IRON.</p> <p>Place the knife tip on the row to be soldered.</p> <p>Note: For a <u>four-sided</u> SMD, start the soldering process with a row of leads that has not been tack soldered.</p> <p>Note: For a <u>two-sided</u> SMD start the soldering process on an end opposite of the tack soldered joint.</p> 

Installation of J-Lead SMDs with Knife Tip Drag Soldering Procedure

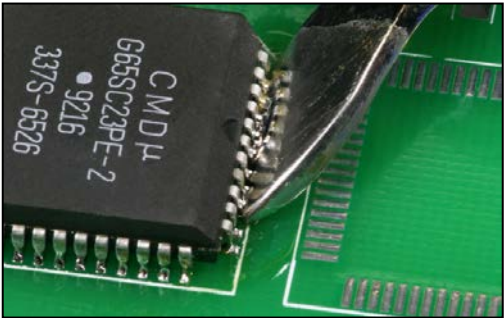
Step	Action
<p>19</p>	<div style="text-align: center; border: 1px solid black; padding: 5px; margin-bottom: 10px;"> CAUTION </div> <p style="text-align: center;">IF SOLDER MELT DOES NOT OCCUR WITHIN TWO SECONDS, STOP THIS PROCEDURE AND ADJUST TIP TEMPERATURE PER THE TIP TEMPERATURE PROCEDURE IN WP 003 00 (PARAGRAPH 03-5.4).</p> <p>Slowly drag the tip (toward the tacked lead on their rows) along remaining lead and land junctions to form proper solder fillets at each joint.</p> <p>Note: Solder bridges may form if excess solder is applied to the tip in step 15 or if speed of tip movement is too fast or too slow.</p> 
<p>20</p>	<p>Repeat steps 15 through 19 for the remaining rows to be soldered.</p>
<p>21</p>	<p>Season the tip and place the soldering iron into its stand.</p>
<p>22</p>	<p>Remove any solder bridges using the Solder Bridge Removal Procedure (paragraph 18-5.9), as needed.</p>
<p>23</p>	<p>Turn the preheater power switch to the OFF position.</p>
<p>24</p>	<p>Allow the CCA to cool completely before cleaning.</p>
<p>25</p>	<p>Clean the repair area with isopropyl alcohol using an acid brush to remove all flux residue and blot dry with a clean, lint-free tissue.</p>

Installation of J-Lead SMDs with Knife Tip Drag Soldering Procedure

Step	Action
26	<p><i>Inspect per the General Inspection Procedure in WP 003 00 (paragraph 03-5.12) to all applicable WORKMANSHIP STANDARDS, including:</i></p> <ul style="list-style-type: none"> • <i>General Solder Acceptability in WP 005 00 (paragraph 05-6.1)</i> • <i>Post-Solder Joint Cleanliness in WP 005 00 (paragraph 05-6.2)</i> • <i>Laminate in WP 011 00 (paragraph 11-6.1)</i> • <i>Surface Mount Devices (paragraph 18-6.1)</i> • <i>Surface Mount Device Leads (paragraph 18-6.2)</i> • <i>Surface Mount Circuit Card Assembly Lands and Conductors (paragraph 18-6.3)</i> • <i>Surface Mount Device Mounting (paragraph 18-6.4)</i> • <i>Surface Mount Device Positioning and Soldering (paragraph 18-6.5)</i> • <i>Surface Mount Soldering Anomalies (paragraph 18-6.7)</i> • <i>Other applicable Workmanship Standards as required</i>
27	<p>Replace the conformal coating per the Conformal Coating Replacement Procedure in WP 006 00 (paragraph 06-5.5), as needed.</p>
28	<p><i>Inspect to the Conformal Coating Replacement WORKMANSHIP STANDARD in WP 006 00 (paragraph 06-6.2), as required.</i></p>
29	<p>Dispose of all HAZMAT following local procedures.</p>

18-5.8.6 Installation of Multilead SMDs with Hot Air Jet Procedure

Use this procedure install gull wing leaded, J-leaded, and castellated SMDs.

This procedure requires the use of solder paste.

Personnel Hazards





Alcohol, Isopropyl

	8
Flux (Soldering)	
	9
Lead (Solder)	

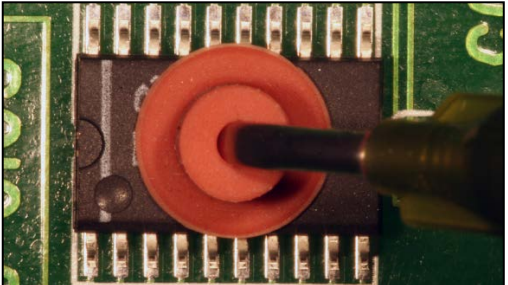
Installation of Multilead SMDs with Hot Air Jet Procedure

Step	Action
	<div style="border: 1px solid black; padding: 5px; margin-bottom: 10px;">WARNING</div> <p>USE APPROVED SAFETY EYEWEAR WHEN PERFORMING THIS PROCEDURE.</p> <p>COMPLY WITH ALL LOCAL REQUIREMENTS FOR PPE.</p> <div style="border: 1px solid black; padding: 5px; margin-bottom: 10px;">CAUTION</div> <p>DON A PROPERLY GROUNDED ESD WRIST STRAP BEFORE STARTING THIS PROCEDURE.</p> <p style="text-align: center;">NOTE</p> <p>DO NOT USE EXTERNAL FLUX IN CONJUNCTION WITH SOLDER PASTE. THE FLUX CONTAINED IN THE SOLDER PASTE IS SUFFICIENT TO REMOVE THE OXIDATION AND REDUCE THE SURFACE TENSION TO ALLOW THE SOLDER TO WET ALL OF THE ELEMENTS OF THE JOINT.</p>
1	<p>Ensure a Circuit Card Assembly Preparation for SMD Installation procedure (paragraph 18-5.5) and, if required, a Flat Pack Lead Preparation (Lead Wiping Method) Procedure (paragraph 18-5.7) were completed.</p>
2	<p>Position the replacement SMD onto the CCA using a vacuum holding device or tweezers.</p> <p>Note: Center the SMD leads/castellations on the lands with the SMD properly oriented (pin one to land one).</p> <div style="text-align: right;">  </div>

Installation of Multilead SMDs with Hot Air Jet Procedure

Step	Action
3	Preheat the CCA and replacement SMDs per the Convective Preheating Procedure (paragraph 18-5.2.1) or the Conductive Preheating Procedure (paragraph 18-5.2.2).
4	Select a soldering iron tip that maximizes heat transfer and contact area with the SMD lead.
5	Set the soldering iron tip temperature to 600°F (316°C).
6	Clean the solder with isopropyl alcohol and wipe dry with a clean, lint-free tissue.
7	Remove the seasoning (all solder) from the soldering iron tip.
8	Thermally shock the soldering iron tip on a damp sponge.
9	<div style="text-align: center;"> <div data-bbox="797 932 1027 999" style="border: 2px solid black; padding: 5px; display: inline-block;">CAUTION</div> DO NOT APPLY PRESSURE WITH THE SOLDERING IRON. </div> Place the soldering iron tip on one end of a lead row. <div data-bbox="932 1085 1432 1337" style="float: right; text-align: center;">  </div>
10	Tack solder the lead.
11	Tack solder the lead at the opposite corner. <div data-bbox="932 1451 1432 1692" style="float: right; text-align: center;">  </div>
12	Remove the solder and the soldering iron tip simultaneously.
13	Season the tip and place the soldering iron into its stand.

Installation of Multilead SMDs with Hot Air Jet Procedure

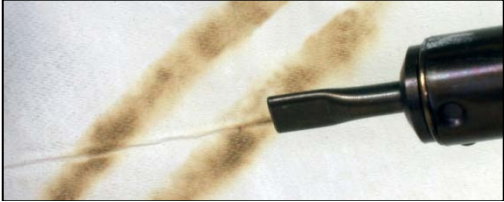
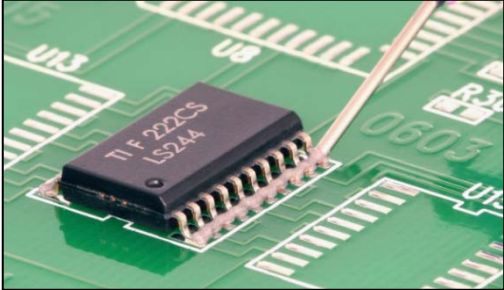
Step	Action
14	Select and install the proper tip into the hot air jet.
15	Set the hot air jet tip temperature to 900°F (482°C).
16	<p>Adjust pressure output so the hot air burns a light brown line on a tissue from approximately 1/8-1/4 in.</p> 
17	Select and install the proper tip into the paste dispenser.
18	<p>Dispense solder paste by applying a continuous bead of paste to each row.</p> <p>Note: Adjust solder bead size and length as required for proper solder joint formation.</p> 
19	<p>Bring the end of the hot air jet tip to a distance of approximately one inch from the row to be soldered.</p> <p>Note: For a <u>four-sided</u> SMD, start the soldering process with a row of leads that has not been tack soldered.</p> <p>Note: For a <u>two-sided</u> SMD start the soldering process on an end opposite of the tack soldered joint.</p>
20	Activate airflow to the hot air jet.
21	Direct the heated air evenly over the row using a sweeping (or circular on very small SMDs) motion.
22	Observe the drying of the solder paste (changes color to a dull gray).
23	<p>Lower the hot air jet tip to begin solder reflow at one end of the row.</p> <p>Note: Varying the distance of the tip to the workpiece will control the temperature and amount of hot air applied to the repair area.</p>

Installation of Multilead SMDs with Hot Air Jet Procedure

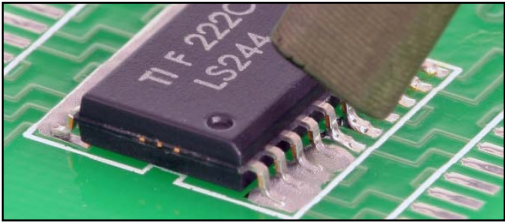
Step	Action
24	<p>Slowly move tip down the row while maintaining each solder joint in reflow state for approximately five seconds.</p> 
25	Repeat steps 19 through 24 for the remaining rows to be soldered.
26	Remove hot air jet from workpiece, deactivate, and place into hot stand.
27	Remove any solder bridges using the Solder Bridge Removal Procedure (paragraph 18-5.9), as needed.
28	Turn the preheater power switch to the OFF position.
29	Allow the CCA to cool completely before cleaning.
30	Clean the repair area with isopropyl alcohol using an acid brush to remove all flux residue and blot dry with a clean, lint-free tissue.
31	<p><i>Inspect per the General Inspection Procedure in WP 003 00 (paragraph 03-5.12) to all applicable WORKMANSHIP STANDARDS, including:</i></p> <ul style="list-style-type: none"> • <i>General Solder Acceptability in WP 005 00 (paragraph 05-6.1)</i> • <i>Post-Solder Joint Cleanliness in WP 005 00 (paragraph 05-6.2)</i> • <i>Laminate in WP 011 00 (paragraph 11-6.1)</i> • <i>Surface Mount Devices (paragraph 18-6.1)</i> • <i>Surface Mount Device Leads (paragraph 18-6.2)</i> • <i>Surface Mount Circuit Card Assembly Lands and Conductors (paragraph 18-6.3)</i> • <i>Surface Mount Device Mounting (paragraph 18-6.4)</i> • <i>Surface Mount Device Positioning and Soldering (paragraph 18-6.5)</i> • <i>Flat Pack Lead Forming and Termination (paragraph 18-6.6), as applicable</i> • <i>Surface Mount Soldering Anomalies (paragraph 18-6.7)</i> • <i>Other applicable Workmanship Standards as required</i>















Installation of Multilead SMDs with Hot Air Jet Procedure

Step	Action
32	Replace the conformal coating per the Conformal Coating Replacement Procedure in WP 006 00 (paragraph 06-5.5), as needed.
33	<i>Inspect to the Conformal Coating Replacement WORKMANSHIP STANDARD in WP 006 00 (paragraph 06-6.2), as required.</i>
34	Dispose of all HAZMAT following local procedures.

18-5.9 Solder Bridge Removal Procedure

Use this procedure to remove any solder bridges that may have occurred from the installation of SMDs.

Personnel Hazards

					
Alcohol, Isopropyl					1
					
Flux (Soldering)					8
					
Lead (Solder)					9

Solder Bridge Removal Procedure

Step	Action
	<div style="border: 2px solid black; padding: 5px; display: inline-block;">WARNING</div> USE APPROVED SAFETY EYEWEAR WHEN PERFORMING THIS PROCEDURE. COMPLY WITH ALL LOCAL REQUIREMENTS FOR PPE.

Solder Bridge Removal Procedure

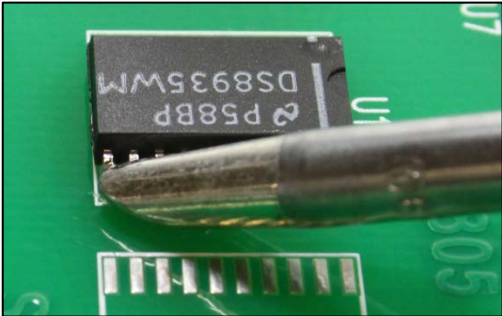
Step	Action
	<p style="text-align: center;">CAUTION</p> <p style="text-align: center;">DON A PROPERLY GROUNDED ESD WRIST STRAP BEFORE STARTING THIS PROCEDURE.</p>
1	Select a soldering iron tip that that will cover the width of at least two leads and lands.
2	Set the soldering iron tip temperature to 600°F (316°C).
3	Clean the bridged areas with isopropyl alcohol using an acid brush and blot dry with a clean, lint-free tissue.
4	<p style="text-align: center;">CAUTION</p> <p style="text-align: center;">DO NOT APPLY FLUX TO A PREHEATED CERAMIC CCA; THE THERMAL SHOCK FROM THE COLD FLUX MAY CRACK THE CCA.</p> <p>Apply flux SPARINGLY to the bridged area.</p>
5	Remove the seasoning (all solder) from the soldering iron tip.
6	Thermally shock the soldering iron tip on a damp sponge.
7	<p style="text-align: center;">CAUTION</p> <p style="text-align: center;">DO NOT APPLY PRESSURE WITH THE SOLDERING IRON.</p> <p>Place the soldering iron tip on the bridged leads close to the SMD body.</p> 

Solder Bridge Removal Procedure

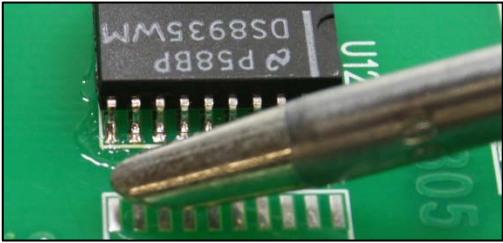
Step	Action
8	<div style="text-align: center; border: 1px solid black; padding: 5px; margin-bottom: 10px;">CAUTION</div> <p style="text-align: center;">IF SOLDER MELT DOES NOT OCCUR WITHIN TWO SECONDS, STOP THIS PROCEDURE AND ADJUST TIP TEMPERATURE PER THE TIP TEMPERATURE PROCEDURE IN WP 003 00 (PARAGRAPH 03-5.4).</p> <p>Draw the soldering iron tip along the lead, straight off the lead and land ends.</p> <p>Note: Use of wicking material is an acceptable alternative.</p> 
9	Season the tip and place the soldering iron into its stand.
10	Repeat steps 4 through 9 as necessary to remove all remaining solder bridges.
11	Allow the CCA to cool completely before cleaning.
12	Clean the repair area with isopropyl alcohol using an acid brush to remove all flux residue and blot dry with a clean, lint-free tissue.
13	<p><i>Inspect per the General Inspection Procedure in WP 003 00 (paragraph 03-5.12) to all applicable WORKMANSHIP STANDARDS, including:</i></p> <ul style="list-style-type: none"> • <i>General Solder Acceptability in WP 005 00 (paragraph 05-6.1)</i> • <i>Post-Solder Joint Cleanliness in WP 005 00 (paragraph 05-6.2)</i> • <i>Laminate in WP 011 00 (paragraph 11-6.1)</i> • <i>Surface Mount Device Positioning and Soldering (paragraph 18-6.5)</i> • <i>Surface Mount Soldering Anomalies (paragraph 18-6.7)</i> • <i>Other applicable Workmanship Standards as required</i>
14	Dispose of all HAZMAT following local procedures.

18-5.10 Solder Paste

Solder paste is finely divided particles of solder, with additives to promote wetting and to control viscosity, tackiness, slumping, drying rate, etc., suspended in a cream flux.

Ensure the solder paste is fresh, has been stored properly, and is at room temperature prior to use. If cold paste is used, moisture from the air will condense on the paste and cause splatter when the paste is heated.

The recommended method of dispensing solder paste is using an automatic dispensing unit.

Follow manufacturer's instructions for proper setup and operation of each dispensing unit.

18-5.10.1 Solder Paste Test Procedure

Use this procedure to provide an indication of solder paste usability.

Personnel Hazards

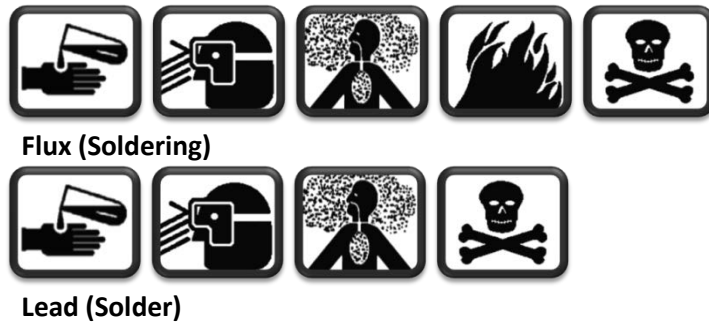

Solder Paste Test Procedure

Step	Action
	<div style="text-align: center;"> <div style="border: 2px solid black; padding: 5px; margin-bottom: 10px;">WARNING</div> <p>USE APPROVED SAFETY EYEWEAR WHEN PERFORMING THIS PROCEDURE.</p> <p>COMPLY WITH ALL LOCAL REQUIREMENTS FOR PPE.</p> <div style="border: 2px solid black; padding: 5px; margin-bottom: 10px;">CAUTION</div> <p>DON A PROPERLY GROUNDED ESD WRIST STRAP BEFORE STARTING THIS PROCEDURE.</p> </div>

Solder Paste Test Procedure

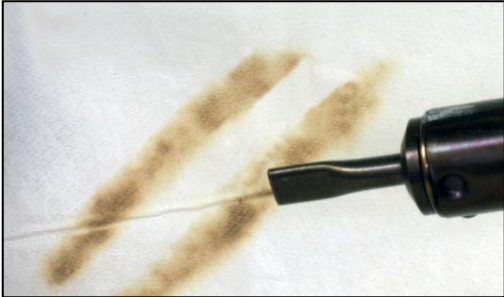
Step	Action
1	Dispense a single or double dot of solder paste ¼ to ½ inch in diameter and approximately 0.10 in. high on a piece of clean laminate material.
2	Preheat the laminate per the Convective Preheating Procedure (paragraph 18-5.2.1) or the Conductive Preheating Procedure (paragraph 18-5.2.2).
3	Install a fan tip into the hot air jet handpiece.
4	Set the hot air jet tip temperature to 900°F (482°C).
5	<p>Adjust the hot air jet pressure output so the hot air burns a light brown line on a tissue from approximately ⅛ to ¼ in.</p> 
6	Slowly direct hot air over the solder paste starting with the tip at a distance of one to two inches until the pastes turns a dull gray.
7	Move the tip to a distance of ⅛ to ¼ in. until the paste is fully reflowed.
8	Observe how the paste reflows and how the solder coalesces.
9	Remove the laminate material from the preheater as soon as the paste is fully reflowed.
10	<p><i>Inspect the solder paste.</i></p> <p>Note: Good, fresh solder paste will have a single large solidified solder pool or “bull’s-eye” with three or less stray solder balls.</p> <p>It is recommended to not use solder paste that forms more than three stray solder balls in addition to the single large solidified pool. This result indicates that the solder paste has deteriorated in quality.</p>

18-5.10.2 Automatic Solder Paste Dispensing Procedure

Use this procedure to dispense solder paste when installing SMDs per the Installation of Chip Components, MELFs, and SOTs with Hot Air Jet Procedure (paragraph 18-5.8.2) or the Installation of Multilead SMDs with Hot Air Jet Procedure (paragraph 18-5.8.6).

With the automatic method, the time and pressure is machine controlled, allowing for precise dispensing on each land.

Personnel Hazards



Flux (Soldering)

8



Lead (Solder)

9

Automatic Solder Paste Dispensing Procedure

Step	Action
	<div style="text-align: center;"> <div style="border: 2px solid black; padding: 5px; display: inline-block; margin-bottom: 10px;">WARNING</div> <p>USE APPROVED SAFETY EYEWEAR WHEN PERFORMING THIS PROCEDURE.</p> <p>COMPLY WITH ALL LOCAL REQUIREMENTS FOR PPE.</p> <div style="border: 2px solid black; padding: 5px; display: inline-block; margin-bottom: 10px;">CAUTION</div> <p>DON A PROPERLY GROUNDED ESD WRIST STRAP BEFORE STARTING THIS PROCEDURE.</p> <p>NOTE</p> <p>FOLLOW THE MANUFACTURER'S INSTRUCTIONS FOR PROPER SETUP AND OPERATION OF THE SPECIFIC SOLDER PASTE DISPENSING UNIT.</p> </div>
1	Set the air pressure in accordance with the manufacturer's recommendations (normally 40 to 50 psi).

Automatic Solder Paste Dispensing Procedure

Step	Action																								
2	<p style="text-align: center;">NOTE</p> <p>The dispensing tip may be clogged with material used in a previous application, ensure the dispensing tip is clean prior to use.</p> <p>Select and install the appropriate gauge dispensing tip to match the application as per Table 18-2.</p> <div data-bbox="915 579 1416 743" style="text-align: right;"> </div> <p style="text-align: center;">Table 18-2 Solder Paste Dispensing Tip Recommendations</p> <table border="1" style="width: 100%; border-collapse: collapse;"> <thead> <tr> <th style="width: 25%;">Lead Pitch</th> <th style="width: 25%;">Recommended Powder Type</th> <th style="width: 25%;">Mesh Size</th> <th style="width: 25%;">Recommended Tip Size</th> </tr> </thead> <tbody> <tr> <td>50-mil</td> <td>2</td> <td>-200/+325</td> <td>21 or less</td> </tr> <tr> <td>25-mil</td> <td>3</td> <td>-325/+500</td> <td>23 or less</td> </tr> <tr> <td>20-mil</td> <td>3</td> <td>-325/+500</td> <td>23 or less</td> </tr> <tr> <td>16-mil</td> <td>3 or 4</td> <td>-325/+500 or -400/+500</td> <td>25 or less</td> </tr> <tr> <td>12-mil</td> <td>4</td> <td>-400/+500</td> <td>25 or less</td> </tr> </tbody> </table>	Lead Pitch	Recommended Powder Type	Mesh Size	Recommended Tip Size	50-mil	2	-200/+325	21 or less	25-mil	3	-325/+500	23 or less	20-mil	3	-325/+500	23 or less	16-mil	3 or 4	-325/+500 or -400/+500	25 or less	12-mil	4	-400/+500	25 or less
Lead Pitch	Recommended Powder Type	Mesh Size	Recommended Tip Size																						
50-mil	2	-200/+325	21 or less																						
25-mil	3	-325/+500	23 or less																						
20-mil	3	-325/+500	23 or less																						
16-mil	3 or 4	-325/+500 or -400/+500	25 or less																						
12-mil	4	-400/+500	25 or less																						
3	Set the rework power unit to the paste dispense mode.																								
4	Set the timer control to the continuous position.																								
5	<p>While holding the syringe at a 45° angle, rest the tip on a tissue and depress the footswitch to dispense about one inch of paste.</p> <p>Note: This initial dispensing will fill the tip with paste and give an indication of paste quality.</p>																								
6	Wipe any paste residue from the end of the tip with a tissue.																								
7	Set timer control to the timed mode.																								

Automatic Solder Paste Dispensing Procedure

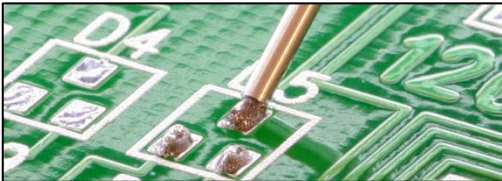
Step	Action
8	<p>Select a tip/time combination that dispenses appropriate sized dots.</p> <p>Note: Use of the timed mode in this manner can eliminate frequent tip changes and dispense cycle time adjustments.</p> <p>These dots may be dispensed in multiples to provide the amount of solder paste required.</p> <p>Solder paste should cover 50% to 70% of the land.</p> <p>Larger land areas may require more solder paste. If this is the case, the dots should be evenly spaced apart on the land and not dispensed on top of each other.</p>
9	<p>Position the syringe tip on the center of the land at a 45° angle to the workpiece.</p>
10	<p>Depress the footswitch to dispense paste.</p> <p>Note: The paste will be dispensed for the time selected.</p> 
11	<p>At the end of each cycle, lift the dispensing tip straight up from the land.</p>

18-5.10.3 Semi-Automatic Solder Paste Dispensing Procedure

Use this procedure to dispense solder paste when the Automatic Solder Paste Dispensing Procedure (paragraph 18-5.10.2) is not feasible.

With the semi-automatic dispensing method, the pressure is machine controlled and the time is operator controlled.

Personnel Hazards



Flux (Soldering)

8



Lead (Solder)

9

Semi-Automatic Solder Paste Dispensing Procedure

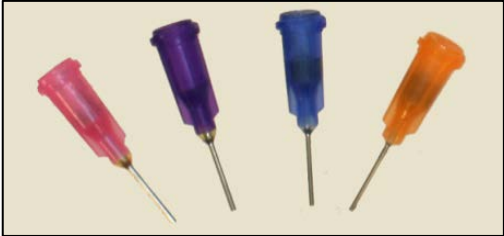
Step	Action
	<p style="text-align: center;">WARNING</p> <p style="text-align: center;"><i>USE APPROVED SAFETY EYEWEAR WHEN PERFORMING THIS PROCEDURE. COMPLY WITH ALL LOCAL REQUIREMENTS FOR PPE.</i></p> <p style="text-align: center;">CAUTION</p> <p style="text-align: center;">DON A PROPERLY GROUNDED ESD WRIST STRAP BEFORE STARTING THIS PROCEDURE.</p> <p style="text-align: center;">NOTE</p> <p style="text-align: center;">FOLLOW THE MANUFACTURER’S INSTRUCTIONS FOR PROPER SETUP AND OPERATION OF THE SPECIFIC SOLDER PASTE DISPENSING UNIT.</p>
1	Set the air pressure in accordance with the manufacturer’s recommendations (normally 40 to 50 psi).
2	<p>Select and install the appropriate gauge dispensing tip to match the application per Table 18-2.</p> 
3	Set the rework power unit to the paste dispense mode.
4	Set the timer control to the continuous position.
5	<p>While holding the syringe at a 45° angle, rest the tip on a tissue and depress the footswitch to dispense about one inch of paste.</p> <p>Note: This initial dispensing will fill the tip with paste and give an indication of paste quality.</p>
6	Wipe any paste residue from the end of the tip with a tissue.

Semi-Automatic Solder Paste Dispensing Procedure

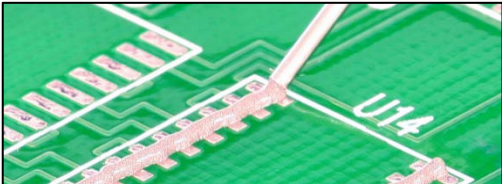
Step	Action
7	<p>Depress the footswitch to dispense paste.</p> <p>Note: Solder paste will be dispensed in a continuous bead until the footswitch is released.</p> 
8	At the end of each cycle, lift the dispensing tip straight up from the land.

18-5.10.4 Manual Solder Paste Dispensing Procedure

Use this procedure to dispense solder paste when the Automatic Solder Paste Dispensing Procedure (paragraph 18-5.10.2) or the Semi-Automatic Solder Paste Dispensing Procedure (paragraph 18-5.10.3) are not feasible.

With manual solder paste dispensing methods, both time and pressure are operator controlled.

Dispensing guns and syringes are typically used for manual solder paste dispensing.

Personnel Hazards



Flux (Soldering)

8



Lead (Solder)

9

Manual Solder Paste Dispensing Procedure

Step	Action
	<div style="border: 2px solid black; padding: 5px; display: inline-block;"> WARNING </div> <p>USE APPROVED SAFETY EYEWEAR WHEN PERFORMING THIS PROCEDURE.</p> <p>COMPLY WITH ALL LOCAL REQUIREMENTS FOR PPE.</p>

Manual Solder Paste Dispensing Procedure

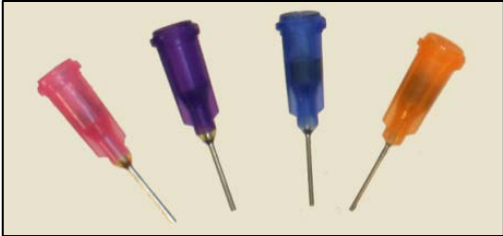
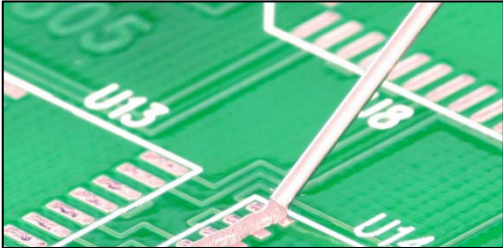
Step	Action
	<p style="text-align: center;">CAUTION</p> <p style="text-align: center;">DON A PROPERLY GROUNDED ESD WRIST STRAP BEFORE STARTING THIS PROCEDURE.</p> <p style="text-align: center;">NOTE</p> <p style="text-align: center;">FOLLOW THE MANUFACTURER'S INSTRUCTIONS FOR PROPER SETUP AND OPERATION OF THE SPECIFIC SOLDER PASTE DISPENSING UNIT.</p>
1	<p>Select and install the appropriate gauge dispensing tip to match the application per Table 18-2.</p> 
2	<p>Insert the plunger into the syringe or attach the syringe to the gun as applicable.</p>
3	<p>While holding the syringe at a 45° angle, rest the tip on a tissue and dispense about one inch of paste.</p> <p>Note: This initial dispensing will fill the tip with paste and give an indication of paste quality.</p>
4	<p>Wipe any paste residue from the end of the tip with a tissue.</p>
5	<p>Position the syringe tip on the center of the land at a 45° angle to the workpiece.</p> 
6	<p>Dispense the proper quantity of solder paste.</p> <p>Note: The pressure applied and time of application is controlled by the operator.</p>
7	<p>At the end of each cycle, lift the dispensing tip straight up from the land.</p>

18-5.10.5 Stencil Solder Paste Dispensing Procedure

Use this procedure to dispense solder paste on lands using a stencil.

The stencil method is typically used for applying solder paste to individual component sites when using an automated convective installation process.

Personnel Hazards

	8
Flux (Soldering)	
	9
Lead (Solder)	

Stencil Solder Paste Dispensing Procedure

Step	Action
	<div style="border: 1px solid black; padding: 5px; margin-bottom: 10px;">WARNING</div> <p style="text-align: center;">USE APPROVED SAFETY EYEWEAR WHEN PERFORMING THIS PROCEDURE.</p> <p style="text-align: center;">COMPLY WITH ALL LOCAL REQUIREMENTS FOR PPE.</p> <div style="border: 1px solid black; padding: 5px; margin-bottom: 10px;">CAUTION</div> <p style="text-align: center;">DON A PROPERLY GROUNDED ESD WRIST STRAP BEFORE STARTING THIS PROCEDURE.</p>
1	Remove any conformal coating from the repair area using one of the Conformal Coating Removal Methods in WP 006 00 (paragraph 06-5.4).
2	Remove the SMDs necessary to provide access to the repair area using the appropriate Surface Mount Device Removal procedure (paragraph 18-5.4).
3	Set the stencil over the device footprint ensuring that the stencil is precisely aligned on the lands.
4	Apply solder paste to one end of the stencil.

Stencil Solder Paste Dispensing Procedure

Step	Action
5	Use a squeegee at a 45° angle, to pull the solder paste across the stencil, filling the land openings in the stencil with paste. Note: Do not allow the paste to be pushed off the side of the stencil onto the CCA.
6	After all land openings have been filled to the top of the stencil, carefully lift the stencil straight up and away from the CCA.
7	Inspect solder paste for accurate alignment. Note: Improper alignment requires removal of solder paste and restenciling.

18-6 WORKMANSHIP STANDARDS

Refer to WP 003 00 (paragraph 03-6) for definitions of Workmanship Standards.

NOTE

WORKMANSHIP STANDARDS FOR GENERAL SOLDER ACCEPTABILITY AND POST-SOLDER JOINT CLEANLINESS ARE IN WP 005 00 (PARAGRAPH 05-6), CONFORMAL COATING IN WP 006 00 (PARAGRAPH 06-6), THROUGH HOLE COMPONENTS IN WP 007 00 (PARAGRAPH 07-6), LAMINATE IN WP 011 00 (PARAGRAPH 11-6), CONDUCTORS, PADS, AND LANDS IN WP 012 00 (PARAGRAPH 12-6), MULTILAYER IN WP 015 00 (PARAGRAPH 15-6), AND JUMPER WIRES IN WP 019 00 (PARAGRAPH 19-6).

18-6.1 Surface Mount Devices

Surface Mount Devices

Target Condition	Acceptable Condition	Defect Condition
	Minor surface scratches.	Any nick, dent, burn, crack, chip-out, or stress fracture.
		Any metallization loss on end cap or castellation of SMD.

18-6.2 Surface Mount Device Leads

Surface Mount Device Leads

Target Condition	Acceptable Condition	Defect Condition
	An SMD lead has nicks or deformation that is 10% or less of the diameter or the width of the lead.	An SMD lead has nicks or deformation that is greater than 10% of the diameter or the width of the lead.
	There is exposed base metal on a lead.	
		A lead is kinked.
		A lead is cracked.

18-6.3 Surface Mount Circuit Card Assembly Lands and Conductors

Surface Mount Circuit Card Assembly Lands and Conductors

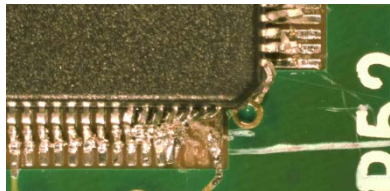
Target Condition	Acceptable Condition	Defect Condition
Each land and conductor is in full contact with the laminate surface.	There are footprints (impressions in the land caused by lifting of the lead before complete solder melt). 	A land or conductor is separated either partially or totally from the laminate surface. 
	A land or conductor has damage that reduces the cross-sectional area by 20% or less.	A land or conductor has damage that reduces the cross-sectional area by greater than 20%.
	There is exposed base metal on a land or conductor.	
		A land or conductor is missing.



18-6.4 Surface Mount Device Mounting

Surface Mount Device Mounting

Target Condition	Acceptable Condition	Defect Condition
All SMDs are as specified (correct part).		An SMD is not as specified (wrong part).
All SMDs terminate to the correct lands.		An SMD is not mounted on the correct lands.
Polarized SMDs are oriented correctly.		A polarized SMD is mounted backwards.
Multilead SMDs are oriented correctly (pin one to land one)		A multileaded SMD is not oriented correctly.
Non-polarized SMDs are oriented so that their markings all read the same way (left-to-right).	Non-polarized SMDs are not oriented so that their markings all read the same way.	
The SMD markings and polarization symbols are discernible.	SMD markings and polarization symbols are not discernible.	
If required, staking adhesive is centered between the lands.		A land or termination is contaminated with staking adhesive.

18-6.5 Surface Mount Device Positioning and Soldering

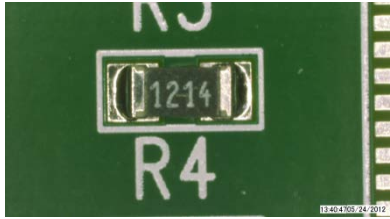
Surface Mount Device Positioning and Soldering

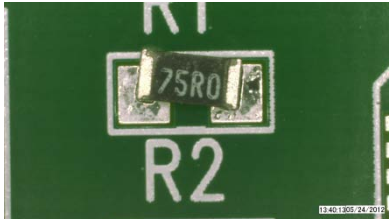
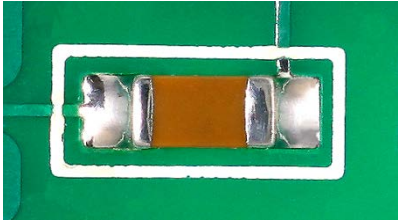
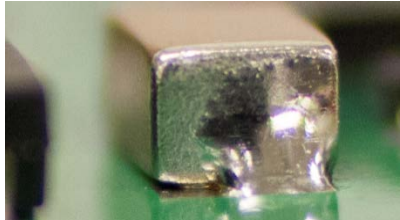
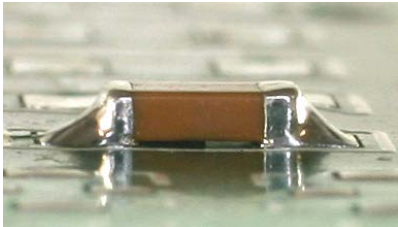
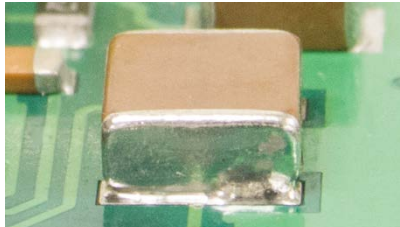
Target Condition	Acceptable Condition	Defect Condition
<p>The end cap, lead, or castellation is centered on the lands.</p> 	<p>The end cap, lead, or castellation is not centered on the lands, provided the end cap, lead or castellation does not overhang the land.</p> 	<p>The end cap, lead, or castellation overhangs the land.</p> 
<p>Chip resistors are mounted with resistive element away from the CCA.</p>		<p>A chip resistor is mounted with resistive element toward the CCA (upside down).</p>
<p>100% solder fillet between the interface of all lands and the SMD leads or terminations.</p> 		<p>Less than 100% solder fillet between the interface of a land and SMD lead or termination.</p> 
<p>The fillet height is 100% of the chip or MELF termination height.</p> 	<p>The fillet height is 25%, or greater, of the chip or MELF termination height.</p>	<p>The fillet height is less than 25% of the chip or MELF termination height.</p> 

Surface Mount Device Positioning and Soldering

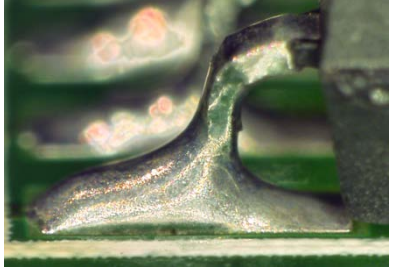
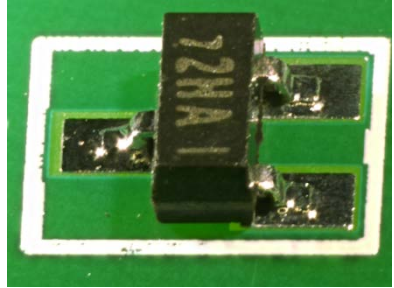
Target Condition	Acceptable Condition	Defect Condition
<p>The solder fillet is concave.</p> 		<p>The solder fillet is convex or overhangs the land.</p> 
		<p>The lead or termination is not visible in the solder.</p> 
	<p>The solder fillet contacts the body of a low profile SMD.</p>	<p>The solder fillet contacts the SMD body, except for low profile SMDs.</p>
<p>The Flat Ribbon, L, Inward L, Gull Wing, Round, or Flattened (Coined) Lead heel fillet extends above the lead thickness, does not fill the upper lead bend, and the lead is visible in the solder.</p> 	<p>The Flat Ribbon, L, Inward L, Gull Wing, Round, or Flattened (Coined) Leads heel fillet height is equal to the lead thickness at the joint side.</p>	<p>The Flat Ribbon, L, Inward L, Gull Wing, Round, or Flattened (Coined) Leads heel fillet height is less than the lead thickness at the joint side.</p>

Surface Mount Device Positioning and Soldering

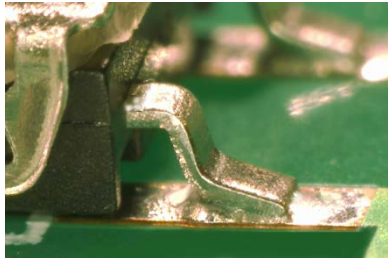
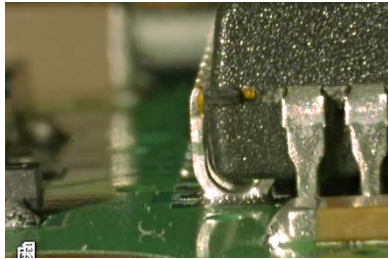
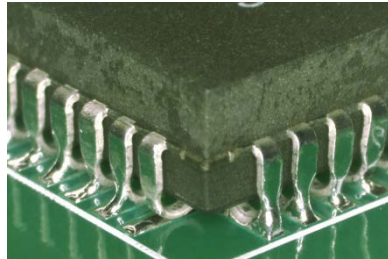
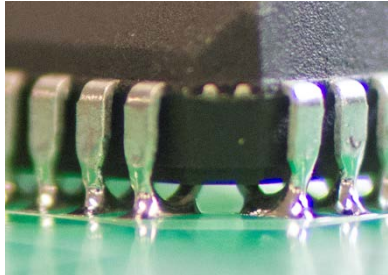
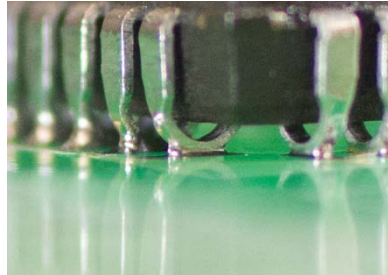
Target Condition	Acceptable Condition	Defect Condition
<p>In the case of a toe down configuration, the Flat Ribbon, Gull Wing, Round, or Flattened (Coined) Lead heel fillet extends slightly beyond the mid-point of the outside lead bend, does not fill the upper lead bend, and the lead is visible in the solder.</p> 	<p>In the case of a toe down configuration, the Flat Ribbon, Gull Wing, Round, or Flattened (Coined) Lead heel fillet extends to the mid-point of the outside lead bend.</p>	<p>In the case of a toe-down configuration, the Flat Ribbon, Gull Wing, Round, or Flattened (Coined) Lead heel fillet does not extend to the mid-point of the outside lead, the fillet fills the upper lead bend, or the lead is not visible in the solder.</p>
<p>The J-lead side fillet length is 200%, or greater, of the lead width.</p> 	<p>The J-lead side fillet length is 150%, or greater, of the lead width.</p>	<p>The J-lead side fillet length is less than 150% of the lead width.</p> 
<p>The J-lead heel fillet height exceeds the lead thickness.</p> 	<p>The J-lead heel fillet height is equal to the lead thickness.</p>	<p>The J-lead heel fillet height is less than the lead thickness.</p> 

Surface Mount Device Positioning and Soldering

Target Condition	Acceptable Condition	Defect Condition
The leadless SMD solder fillet extends from the back of the castellation to the end of the land.	The leadless SMD solder fillet extends from the back of the castellation onto the land at or beyond the edge of the SMD.	The leadless SMD solder fillet does not extend from the back of the castellation onto the land at or beyond the edge of the SMD.
The leadless SMD fillet height is 100% of the castellation height.	The leadless SMD fillet height is 25% or greater, of the castellation height or the solder fillet extends past the top of the castellation provided it does not contact the SMD body.	The leadless SMD fillet height is less than 25% of the castellation height or the solder fillet contacts the SMD body.

18-6.6 Flat Pack Lead Forming and Termination

NOTE

ALL GULL WING WORKMANSHIP STANDARDS APPLY TO THE INSTALLATION OF FLAT PACKS WITH THE FOLLOWING ADDITIONAL FLAT PACK LEAD FORMING AND FLAT PACK TERMINATION STANDARDS.

Flat Pack Lead Forming and Termination

Target Condition	Acceptable Condition	Defect Condition
The leads extend at least one lead width from the flat pack body before the start of the first bend.		The leads do not extend at least one lead width from the flat pack body before the start of the first bend.
The inside bend radius of the flat pack lead is at least one lead thickness.		The inside bend radius of the flat pack lead is less than one lead thickness.
The leads contain two distinct 45° or 90° bends.	The leads do not contain two distinct 45° or 90° bends.	

Flat Pack Lead Forming and Termination

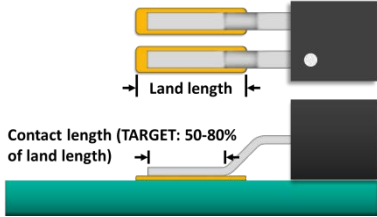

Target Condition	Acceptable Condition	Defect Condition
<p>The lead length is 50-80% of the land length.</p> 	<p>The lead length is less than 50% and greater than the lead width or the lead length is greater than 80% provided the toe of the lead does not overhang the land.</p>	<p>The lead length is less than the lead width or the toe of the lead overhangs the land.</p>

18-6.7 Surface Mount Soldering Anomalies

NOTE

SURFACE MOUNT SOLDERING ANOMALIES ARE NORMALLY A DEFECT CONDITION, ONLY THOSE ANOMALIES WITH AN ACCEPTABLE CONDITION ARE SO LISTED.

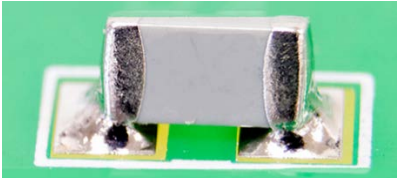
Surface Mount Soldering Anomalies

Target Condition	Acceptable Condition	Defect Condition
		<p>A chip component is side-mounted (billboarding).</p> 
		<p>A chip component is standing on its terminal end (tombstoning) and one termination joint does not contact the solder joint.</p> 

Surface Mount Soldering Anomalies

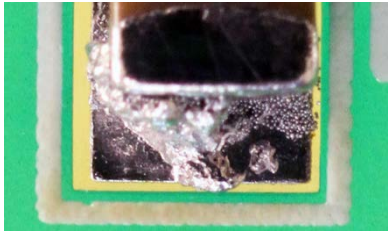
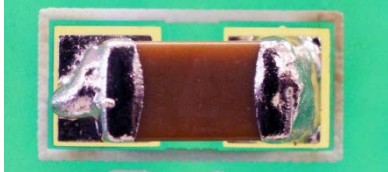
Target Condition	Acceptable Condition	Defect Condition
	<p>One lead, end cap, or series of leads, on an SMD is out of alignment, provided all of the leads or end caps have solder fillets that make contact with their respective land.</p> 	<p>One lead, end cap, or series of leads on an SMD is out of alignment and the solder fillet fails to make contact with the land.</p>
		<p>Incomplete reflow of solder paste.</p> 
		<p>Solder has not wetted to a land or termination.</p> 

NOTE

SOLDER FINES ARE TYPICALLY SMALL BALLS OF THE ORIGINAL SOLDER PASTE THAT HAVE SPLATTERED AROUND THE JOINT DURING THE REFLOW PROCESS.

		<p>Any solder fines resulting from the soldering process.</p> 
--	--	---

18-7 ADDITIONAL TECHNICAL INFORMATION

SMDs comprise many form factors: Chip Style Components; Metal Electrode Face (MELF) Components; Leaded Surface Mount Devices, including Flat Packs; Leadless Ceramic Chip Carrier (LCCC); Surface Mount Devices, Array Packages.

18-7.1 Chip Style Components

Chip Style Components (Figure 18-11) are passive components such as a resistor or capacitor.



Figure 18-11 Chip Style Components

Chip style components are usually made of ceramic material with metallized end caps providing a solderable contact.

18-7.2 Metal Electrode Face (MELF) Components

MELFs (Figure 18-12) are small cylindrical parts with a solderable terminal on each end.



Figure 18-12 MELFs

18-7.3 Leaded Surface Mount Devices

Leaded Surface Mount Devices include Flat Pack, Quad Flat Pack (QFP), Plastic Quad Flat Pack (PQFP), Bumped Quad Flat Pack (BQFP), Ceramic Quad Flat Pack (CQFP), Thin Quad Flat Pack (TQFP), Low Profile Quad Flat Pack (LQFP), Plastic Leaded Chip Carrier (PLCC), Small Outline Integrated Circuit (SOIC), Small Outline J-Lead (SOJ), Shrink Small Outline Package (SSOP), Thin Small Outline Package (TSOP), and Small Outline Transistor (SOT).

18-7.3.1 Flat Pack

Flat Packs (Figure 18-13) are rectangular component packages having two or more rows of gull wing shaped leads extending from each of the sides of its body.

The rows of leads are parallel to the base of the flat pack.

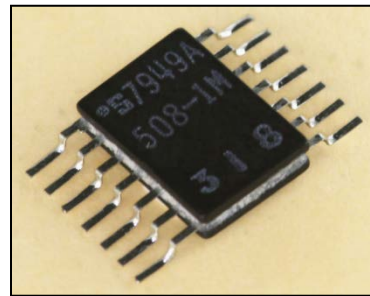

Figure 18-13 Flat Pack

18-7.3.2 Quad Flat Pack (QFP)

This class of packages includes a wide variety of pin counts, lead pitches, component thicknesses, and fabrication materials.

QFPs may be square or rectangular, but all have gull wing leads exiting from all four sides of the component.

18-7.3.3 Plastic Quad Flat Pack (PQFP)

PQFPs (Figure 18-14) are bodied chip carriers with gull wing leads located around all four sides.

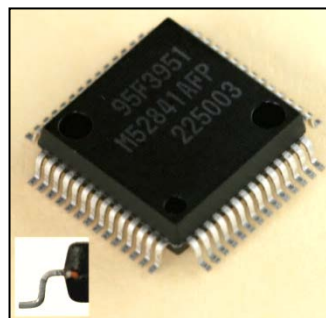

Figure 18-14 Plastic Quad Flat Pack

18-7.3.4 Bumpered Quad Flat Pack (BQFP)

BQFPs (Figure 18-15) are distinguishable by the bumpers located on each of the four corners protecting the gull wing leads and assisting with proper alignment.



Figure 18-15 Bumpered Quad Flat Pack

18-7.3.5 Ceramic Quad Flat Pack (CQFP)

CQFPs have ceramic-bodies and are used mainly in aerospace and military applications.

18-7.3.6 Thin Quad Flat Pack (TQFP)

TQFPs are one mm thick, with lead counts from 32 to 176 and lead pitch varying from 15 to 30-mils. The component body of a TQFP is square.

18-7.3.7 Low Profile Quad Flat Pack (LQFP)

LQFPs are 1.4 mm thick with lead counts from 32 to 256 and lead pitch varying from 12.5 to 30-mils. The component body of a LQFP may be rectangular or square.

18-7.3.8 Plastic Leaded Chip Carrier (PLCC)

PLCCs (Figure 18-16) are leaded SMDs with plastic bodies whose external connections consist of J-lead terminations located around all four sides.

PLCCs are typically 50-mil pitch with lead counts ranging from 20 to 84.

PLCC packages are normally square but can be rectangular.

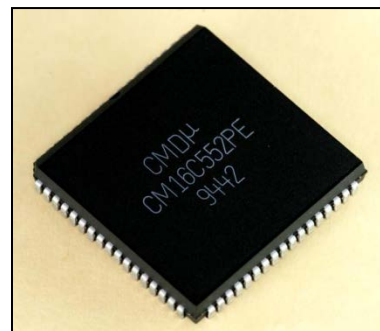

Figure 18-16 Plastic Leaded Chip Carrier

18-7.3.9 Small Outline Integrated Circuit (SOIC)

SOICs (Figure 18-17) are a family of components consisting of many styles and lead counts.

Each is a small rectangular circuit package usually constructed of a plastic body with gull wing leads extending from each of the long sides.

SOICs are normally 50 or 25-mil pitch and lead counts vary from 8 to 86.

SOICs are the surface mount equivalent of a dual in-line package.

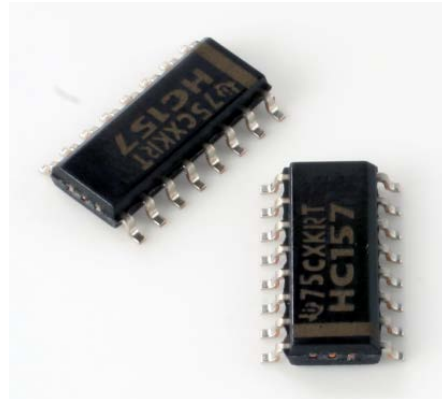

Figure 18-17 Small Outline Integrated Circuit

18-7.3.10 Small Outline J-Lead (SOJ)

SOJs are SOIC packages with J-leads vice gull wing leads. SOJs are normally 50-mil pitch and lead counts vary from 16 to 40.

18-7.3.11 Shrink Small Outline Package (SSOP)

SSOPs have a compressed body and lead structure. SSOPs are normally 25-mil pitch and lead counts vary from 8 to 64.

18-7.3.12 Thin Small Outline Package (TSOP)

TSOPs are small, thin (1.0 mm), low profile packages, attractive for use in high-density applications.

Like an SOIC, there are leads extending from two of the sides.

In the Type I TSOP (Figure 18-18), the leads extend from the ends or short sides and are typically 20-mil pitch with lead counts from 20 to 56.



Figure 18-18 Type I Thin Small Outline Package

The Type II TSOP (Figure 18-19) looks more like a conventional SOIC with leads extending from the long sides and lead pitches vary from 30 to 50-mil pitch with lead counts from 20 to 86.

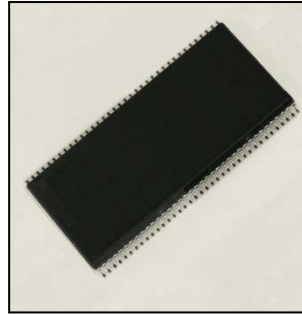

Figure 18-19 Type II Thin Small Outline Package

18-7.3.13 Small Outline Transistor (SOT)

SOTs (Figure 18-20) are rectangular surface mount transistors or diodes with three or more gull wing leads extending from the two longer sides.

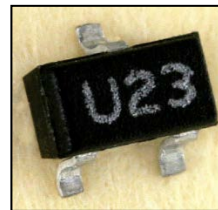

Figure 18-20 Small Outline Transistor

18-7.4 Leadless Ceramic Chip Carrier (LCCC)

LCCCs (Figure 18-21) have external connections (castellations) consisting of metallized terminations integral with the component body.

LCCCs are typically 50-mil pitch with lead counts from 16 to 124.

LCCCs are hermetically sealed, rugged and are typically used for military and aerospace applications.

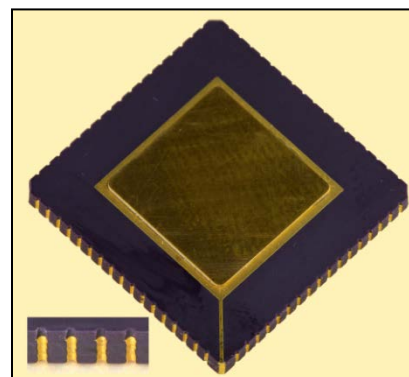

Figure 18-21 Leadless Ceramic Chip Carrier

18-7.5 Surface Mount Devices, Array Packages

Array packages are a group of elements or circuits arranged in rows and columns on a base material.

The full array pattern grid covers nearly the entire area of the termination side of the package. A **full balanced pattern** (Figure 18-22) has an equal number of terminations in each row and column and a **full staggered pattern** (Figure 18-23) has one less termination in alternating rows.

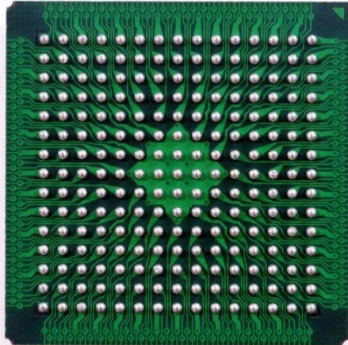

Figure 18-22 Full Balanced Pattern

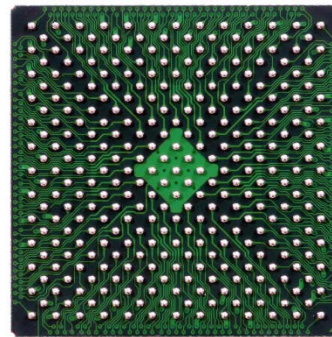

Figure 18-23 Full Staggered Pattern

The **Perimeter Array Pattern Grid** (Figure 18-24) covers the perimeter area of the termination side of the package, leaving the center area of the package without terminations.

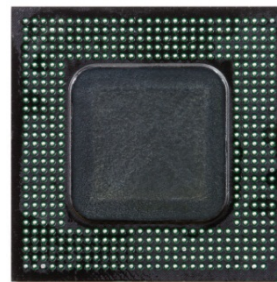

Figure 18-24 Perimeter Balanced Array Pattern

Ball Grid Array (BGA) packages have a grid of solder balls attached to lands on the underside of the package. Depending on the package type, the solder balls will be either eutectic or a high temperature solder. The package is attached to a CCA by reflowing the solder balls to the lands on the CCA. In the case of high temperature solder balls, solder paste is applied to the CCA and paste is reflowed to the solder balls, the balls themselves do not reflow.

18-7.5.1 Plastic Ball Grid Array (PBGA)

PBGAs (Figure 18-25) are the most common type of BGA.

PBGA packages consist of a laminate with an overmolded plastic cover and an array of eutectic solder balls providing the interconnection to the CCA.

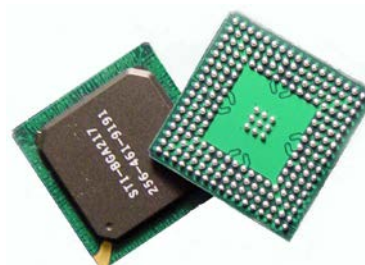

Figure 18-25 Plastic Ball Grid Array

These balls reflow during package and CCA assembly and provide a 50 mm gap or standoff between the chip carrier and the CCA.

Common pitches are 1.0, 1.27, and 1.5 mm. Body sizes can range from 13 to 45 mm. Array patterns include full grid, perimeter and staggered. I/O counts can vary from less than 100 to more than 1,000.

18-7.5.2 Ceramic Ball Grid Array (CBGA)

CBGAs (Figure 18-26) are hermetically sealed packages of co-fired alumina substrate allowing various lid sealing and encapsulation techniques.

CBGAs are typically found in military or other high operational stress applications.

The CBGA uses high temperature solder balls that do not melt in the reflow process.

Solder paste is required to attach the high temperature solder balls to the lands on the CCA.

CBGAs are the same as PBGAs in size, pitch, and I/O counts.



Figure 18-26 Ceramic Ball Grid Array

18-7.5.3 Ceramic Column Grid Array (CCGA)

CCGAs are ceramic BGAs with solder columns replacing the solder balls.

18-7.5.4 Tape Ball Grid Array (TBGA)

TBGAs (Figure 18-27) are similar to a Chip Scale Package (CSP).

A TBGA has a die-up, wire bonded configuration with a flexible circuit substrate and an over-molded body.

TBGAs are typically 50-mil pitch with I/O counts ranging from 48 to 256.

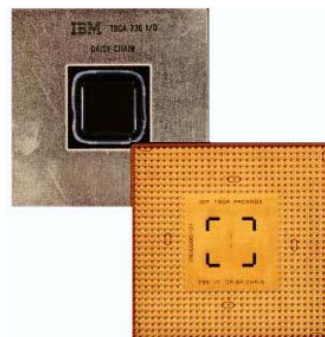

Figure 18-27 Tape Ball Grid Array

18-7.5.5 Micro Ball Grid Array (μ BGA)

A polyimide film and metal layer tape form the interconnect leads for μ BGA packages. The package is attached to the tape by a low stress elastomeric adhesive. The leads are bonded from the tape in an "S" shape to chip bond pads. A low stress encapsulate covers the bond leads, and eutectic solder balls are attached to pads on the tape. μ BGAs are typically 25 to 30-mil pitch.

18-7.5.6 Chip Scale Package (CSP)

CSPs are integrated circuits where the package is no larger than 1.5 times the die itself. In order to maintain the CSP die to package ratio the CSP is generally a ball grid array.

18-7.5.7 Flip Chip

Flip chip describes the method of electrically connecting the die to the package carrier. The package carrier, either substrate or lead frame, provides the connection from the die to the exterior of the package. The interconnection between die and carrier in flip chip packaging is made through a conductive bump placed directly on the die surface. The bumped die is then flipped over and placed face down with the bumps connecting to the carrier. After the die is soldered, underfill is applied between the die and the substrate, around the solder bumps. The underfill is designed to contract the stress in the solder joints caused by the difference in thermal expansion between the silicon die and carrier.

18-7.5.8 Pin Grid Array (PGA)

PGAs are plated-through hole packages with a large array of leads protruding perpendicular to one side of a component package.

15 October 2013

WP 019 00 Jumper Wires

19-1 PURPOSE

Identify the technical information relative to jumper wires.

Specify the repair procedures for the routing, termination, and bonding of jumper wires.

Identify the workmanship standards for jumper wires.

19-2 INDEX

Paragraph	Subject	Page
19-1	Purpose	1
19-2	Index	1
19-3	General Safety Precautions.....	1
19-4	Technical Information.....	3
19-5	Repair Procedures.....	4
19-5.1	Jumper Wire Procedural Analysis and Feasibility of Repair	5
19-5.2	Jumper Wire Routing Guidelines	5
19-5.3	Jumper Wire Preparation Procedure.....	6
19-5.4	Jumper Wire Termination and Soldering Procedure	11
19-5.5	Jumper Wire Bonding Guidelines	15
19-6	Workmanship Standards	16
19-6.1	Jumper Wire Selection and Preparation.....	16
19-6.2	Jumper Wire Routing	18
19-6.3	Jumper Wire Solder Acceptability	19
19-6.4	Jumper Wire Terminated in a Plated-Through Hole.....	19
19-6.5	Jumper Wire Terminated to a Lead in a	20
19-6.6	Jumper Wire with a Lap Solder Termination	21
19-6.7	Jumper Wire Terminated to a Land Containing a Chip Component.....	23
19-6.8	Jumper Wire Terminated to a Gull Wing Lead	23
19-6.9	Jumper Wire Terminated to a J-Lead.....	23
19-6.10	Jumper Wire Terminated to a Vacant Land	24
19-6.11	Jumper Wire Bonding	25

19-3 GENERAL SAFETY PRECAUTIONS

Observe all the following precautions while installing jumper wires:

- Electronic equipment must be de-energized during removal and installation of CCAs
- Personnel are required to wear a properly grounded ESD wrist strap and cord while working in or around the EPA
- ESD can destroy components—protect ESDS devices during handling and repair to prevent ESD damage (Refer to WP 004 00)
- Isopropyl alcohol is flammable; do not use in the presence of sparks, heat, flame, or synthetic cloth
- Soldering handpieces (e.g., soldering irons) produce extreme heat—exercise care when these tools are out of their stands
- Avoid direct inhalation of fumes during a soldering operation because there is a possibility these fumes could cause occupational asthma
- The lead contained in solder is a source of lead oxide, which the human body cannot dissipate (accumulation of lead oxide in the body over a period of years can result in a serious health hazard)
- Contact with solder by holding in the mouth, smoking, or eating during or immediately after soldering is a potential means of ingesting trace amounts of lead oxide
- Avoid oral contact with hands during or immediately after solder operations
- Wash hands following any solder operation
- Wear approved PPE whenever pouring or handling molten metals or corrosive liquids and solids; and cutting, drilling, grinding, milling, chipping and other dust and debris producing operations
- Use adequate ventilation during thermal wire stripping operations because wire insulation may emit toxic fumes during thermal stripping
- Follow manufacturer's safety instructions for using chemical wire strippers
- Use chemical wire strippers only in well-vented areas, wear prescribed PPE, and avoid contact with skin and eyes
- Do not use wire with PVC [plastic] insulation to replace or repair installed military equipment wiring

- Always follow the manufacturer's instructions and warnings when using conformal coating products
- Follow manufacturer's directions for the mixing, use, and curing of bonding agents

19-4 TECHNICAL INFORMATION

There are two types of discrete electrical connections (wires) added to a CCA: Jumper wires and Haywires.

Jumper Wires—are part of the original design used to bridge portions of the basic conductor pattern formed on a CCA. Engineering instructions or drawing notations document the routing, termination, and bonding of jumper wires installed during the manufacturing process. Replacement jumper wires shall be routed and terminated in the same manner in which the original jumper wire was installed.

Haywires—are added to a CCA in order to modify the basic conductor pattern formed on the assembly. Engineering change notice instructions or drawing notations determine the routing, termination and bonding of haywires added after the manufacturing process to effect a change or modification. The 2M Technician will determine the routing, termination, and bonding of haywires to be installed to repair a defective assembly where no other repair procedures exist, i.e., a multilayer plated-through hole repair.

NOTE

THE REQUIREMENTS RELATIVE TO WIRE TYPE, WIRE ROUTING, BONDING (STAKING) AND SOLDERING ARE THE SAME FOR BOTH HAYWIRES AND JUMPER WIRES.

FOR THE SAKE OF SIMPLICITY, THE MORE COMMON TERM "JUMPER WIRE" IS USED IN THE REMAINDER OF THIS WORK PACKAGE; HOWEVER, THE MAINTENANCE PROCEDURES AND WORKMANSHIP STANDARDS OUTLINED IN THIS WORK PACKAGE APPLY TO BOTH HAYWIRES AND JUMPER WIRES.

19-5 REPAIR PROCEDURES



PROTECT STATIC SENSITIVE DEVICES DURING HANDLING AND REPAIR TO PREVENT ESD DAMAGE (REFER TO WP 004 00).

Equipment Required Listed below is the authorized 2M Power Unit* for repairs using jumper wires:

- **NAVAIR/NAVSEA/USMC/USAF/USCG**—PRC-2000-SMT

* Refer to Table 03-3 for Power Unit Part No., and CAGE Code

Additional Support Items For additional information regarding items of support and support equipment refer to:

- **NAVSEA/NAVAIR/USCG**—2M MTR Certification Manual
- **NAVSEA/USCG**—Allowance Parts List (APL) 000A8423
- **USMC**—Stock List SL-3-09458A
- **USAF**—the Consolidated Tool Kit (CTK)

Material Required Listed below are the materials required* for repairs using jumper wires:

- Adhesive (jumper wire bonding)
- Flux, Soldering
- Insulating Compound (conformal coating)
- Insulation Sleeving Kit, Electrical‡
- Isopropyl Alcohol, Technical
- Solder, Tin Alloy†
- Tape Dot†
- Towel, Paper (Kimwipe®)‡
- Wire, Electrical (Solid)

* Refer to Table 03-4 for Specification No., Part No., and NSN

† Select size appropriate for application

‡ Substitution of equivalent material is acceptable

19-5.1 Jumper Wire Procedural Analysis and Feasibility of Repair

Jumper wires are **not** authorized for use in lieu of other repair procedures included in this manual.

Jumper wires are authorized for use in the following applications:

- Repair of an installed jumper wire
- Installation of a Field Change, an Engineering Change Notice, or an Ordnance Alteration
- A multilayer plated-through hole repair
- In lieu of a multilayer subsurface conductor repair

CAUTION

A JUMPER WIRE WITH A NICKED OR DAMAGED CONDUCTOR CANNOT BE USED.

Solid (not stranded) copper wire is required.

The smallest diameter wire that will carry the required current load shall be used.

All jumper wires longer than one inch must be insulated.

19-5.2 Jumper Wire Routing Guidelines

The following guidelines apply to the routing of jumper wires:

- Jumper wire routing on assemblies having the same part number shall have the same routing pattern
- The jumper wire shall be installed on the component side of the CCA, unless otherwise specified by technical direction
- The jumper wire shall be routed along the X-Axis and/or the Y-Axis, as directly as feasible, making as few bends as possible (Figure 19-1)

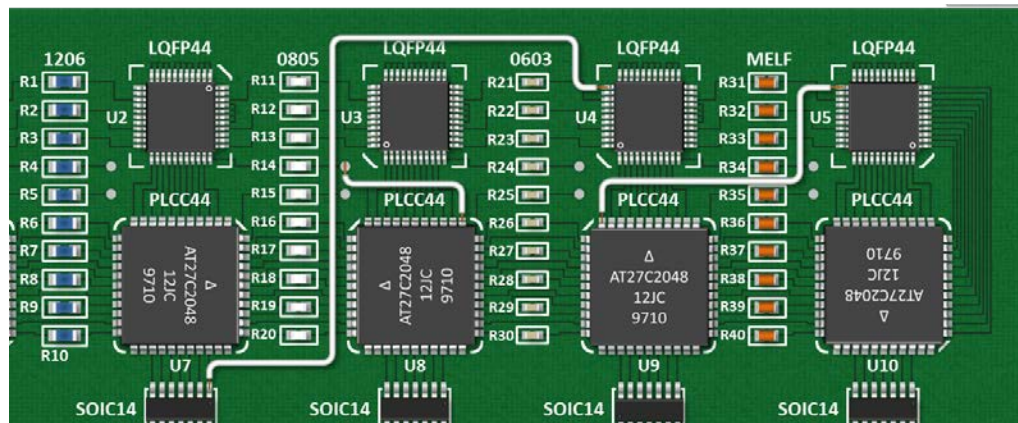

Figure 19-1 Jumper Wire Routing

- The jumper wire shall not be raised more than the height of adjacent components when pulled taut
- The jumper wire may pass over pads and/or lands provided sufficient slack is available so the wire can be moved away from the pad or the land for component replacement
- The jumper wire shall not be routed over vias or over conductive patterns being used as test points
- The jumper wire shall have stress relief
- The jumper wire shall not be routed under or over component leads or component bodies
- The jumper wire may be routed through plated-through holes, provided the wire is insulated and that insulation sleeving is placed in the hole
- Jumper wire contact with heat sinks shall be avoided

19-5.3 Jumper Wire Preparation Procedure

The length and gauge of the jumper wire is critical. All wires have an electrical resistance (impedance); this impedance is important to electronic circuitry. Always refer to engineering instructions, drawing notations and wiring lists for specific jumper wire requirements.















Thermal wire stripping can be used for any gage of insulated wire.

Use precision strippers (Figure 19-2) only when thermal strippers are not available.



Figure 19-2 Precision Strippers

Personnel Hazards

					
Alcohol, Isopropyl					1
					
Flux (Soldering)					8
					
Lead (Solder)					9

Jumper Wire Preparation Procedure

Step	Action
	<div style="text-align: center; border: 1px solid black; padding: 5px; margin-bottom: 10px;"> WARNING </div> <p style="text-align: center;">USE APPROVED SAFETY EYEWEAR WHEN PERFORMING THIS PROCEDURE.</p> <p style="text-align: center;">COMPLY WITH ALL LOCAL REQUIREMENTS FOR PPE.</p> <p style="text-align: center;">USE THERMAL STRIPPERS ONLY IN A WELL-VENTILATED AREA TO AVOID TOXIC FUMES FROM WIRE INSULATION.</p> <div style="text-align: center; border: 1px solid black; padding: 5px; margin-bottom: 10px;"> CAUTION </div> <p style="text-align: center;">DON A PROPERLY GROUNDED ESD WRIST STRAP BEFORE STARTING THIS PROCEDURE.</p>

Jumper Wire Preparation Procedure

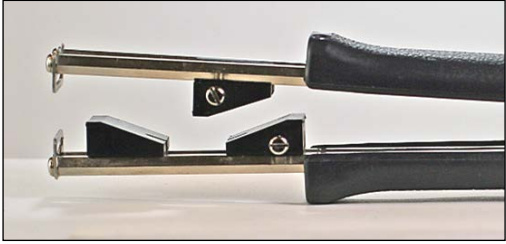
Step	Action
1	Perform the Jumper Wire Procedural Analysis and Feasibility of Repair (paragraph 19-5.1), if not already completed.
2	Cut a length jumper wire approximately ½ in. longer than the estimated length required.
3	Seat the universal power cord fully into the thermal strippers. 
4	Adjust the thermal strippers' stops for depth of jaw closure and strip length ~¼ in. longer than required for the termination. 
5	<div style="text-align: center; border: 2px solid black; padding: 5px; margin-bottom: 10px;">CAUTION</div> <p style="text-align: center;">VISUALLY CHECK TO ENSURE MELTING THROUGH INSULATION AND NOT BURNING.</p> Perform a “test melt” at the end of the insulation by setting the Pulse Heat control to zero (0), apply power to the thermal strippers using the foot switch, and increase the voltage slowly until the insulation melts cleanly and evenly.
6	Insert an end of the wire into the jaws of the thermal strippers to the stop.
7	<div style="text-align: center; border: 2px solid black; padding: 5px; margin-bottom: 10px;">CAUTION</div> <p style="text-align: center;">EXCESSIVE PRESSURE MAY RESULT IN DEFORMING THE WIRE STRANDS. DO NOT MAR OR CRUSH WIRE DURING THIS PROCESS.</p> Close the jaws carefully on the insulation and apply power to the thermal strippers.

Jumper Wire Preparation Procedure

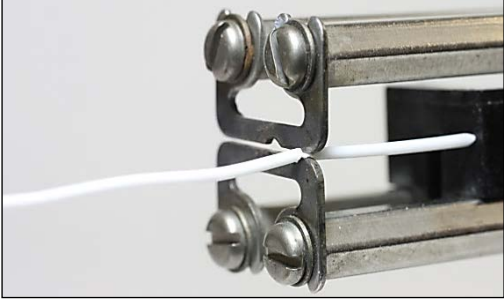
Step	Action
8	<p>When the insulation melts, turn the wire 180° creating a complete melt around the circumference of the wire.</p> 
9	Remove the power from the thermal strippers.
10	Open the jaws of the thermal strippers.
11	Remove the wire from the thermal strippers.
12	Allow the insulation and the wire to cool completely.
13	Remove the stripped insulation from the wire with your fingers.
14	Trim the insulation evenly, 360° around the wire using flush-cutting pliers.
15	Repeat steps 6 through 14 for the other end of the wire.
16	<p><i>Inspect per the General Inspection Procedure in WP 003 00 (paragraph 03-5.12) to all applicable WORKMANSHIP STANDARDS, including:</i></p> <ul style="list-style-type: none"> • <i>Wires in WP 008 00 (paragraph 08-6.1)</i> • <i>Insulated Wire Stripping in WP 008 00 (paragraph 08-6.2)</i> • <i>Jumper Wire Selection and Preparation (paragraph 19-6.1)</i> • <i>Other applicable Workmanship Standards, as required</i>
17	Select a soldering iron tip that maximizes heat transfer and contact area with the stripped jumper wire.
18	Set the soldering iron tip temperature to 600°F (316°C).
19	Clean both stripped ends of the jumper wire with isopropyl alcohol using an acid brush and wipe dry with a clean, lint-free tissue.

Jumper Wire Preparation Procedure

Step	Action
20	Clean the solder with isopropyl alcohol and wipe dry with a clean, lint-free tissue.
21	Place an end of the wire in a holding device and slant downward, if possible.
22	Apply flux SPARINGLY to the lower half of the wire.
23	Remove the seasoning (all solder) from the soldering iron tip.
24	Thermally shock the soldering iron tip on a damp sponge.
25	<p style="text-align: center;">CAUTION</p> <p style="text-align: center;">DO NOT APPLY PRESSURE WITH THE SOLDERING IRON.</p> <p>Place the soldering iron tip behind and in contact with the wire, midway down the wire.</p>
26	<p style="text-align: center;">CAUTION</p> <p style="text-align: center;">IF SOLDER MELT DOES NOT OCCUR WITHIN TWO SECONDS, STOP THIS PROCEDURE AND ADJUST TIP TEMPERATURE PER THE TIP TEMPERATURE PROCEDURE IN WP 003 00 (PARAGRAPH 03-5.4).</p> <p>Form a heat bridge between the soldering iron tip and the jumper wire using clean solder.</p>
27	Encapsulate the wire with solder moving the soldering iron tip and the solder up the wire.
28	Move the soldering iron tip and solder down and past the end of the wire simultaneously.
29	Season the tip and place the soldering iron into its stand.
30	Repeat steps 21 through 29 for the other end of the wire.
31	Allow the wire to cool completely before cleaning.
32	Clean the tinned wire with isopropyl alcohol using an acid brush and wipe dry with a clean, lint-free tissue.

Jumper Wire Preparation Procedure

Step	Action
33	<p><i>Inspect per the General Inspection Procedure in WP 003 00 (paragraph 03-5.12) to all applicable WORKMANSHIP STANDARDS, including:</i></p> <ul style="list-style-type: none"> • <i>General Solder Acceptability in WP 005 00 (paragraph 05-6.1)</i> • <i>Post-Solder Joint Cleanliness in WP 005 00 (paragraph 05-6.2)</i> • <i>Insulated Wire Tinning in WP 008 00 (paragraph 08-6.3)</i> • <i>Other applicable Workmanship Standards, as required</i>
34	Dispose of all HAZMAT following local procedures.

19-5.4 Jumper Wire Termination and Soldering Procedure

Use this procedure only after completing the Jumper Wire Preparation Procedure (paragraph 19-5.3).

Personnel Hazards

					1
Alcohol, Isopropyl					
Flux (Soldering)					
				9	
Lead (Solder)					

Jumper Wire Termination and Soldering Procedure

Step	Action
	<p style="text-align: center;">WARNING</p> <p style="text-align: center;">USE APPROVED SAFETY EYEWEAR WHEN PERFORMING THIS PROCEDURE.</p> <p style="text-align: center;">COMPLY WITH ALL LOCAL REQUIREMENTS FOR PPE.</p> <p style="text-align: center;">CAUTION</p> <p style="text-align: center;">DON A PROPERLY GROUNDED ESD WRIST STRAP BEFORE STARTING THIS PROCEDURE.</p>
1	Perform Insulated Wire Stripping in WP 008 00 (paragraph 08-5.3), if not already completed.
2	Select a soldering iron tip that maximizes heat transfer and contact area with terminated jumper wire.
3	Set the soldering iron tip temperature to 600°F (316°C).
4	Clean the solder with isopropyl alcohol and wipe dry with a clean, lint-free tissue.
5	<p style="text-align: center;">CAUTION</p> <p style="text-align: center;">DO NOT BEND THE WIRE TIGHTER THAN A RADIUS OF THREE TIMES THE CONDUCTOR DIAMETER.</p> <p>Form the wire as needed to solder the first termination.</p>
6	<p>Position the wire depending on the wire termination style.</p> <ul style="list-style-type: none"> • For a jumper wire installed on a land or pad, center the wire on the land or pad, so the wire will not overhang sides of the land or pad • For a jumper wire soldered to a round pin, round terminal, or round component lead, wrap the wire a minimum of 180° • For a jumper wire soldered to a flat pin, flat terminal, or flat component lead, wrap the wire a minimum of 90°, <u>or</u> • Lap solder the jumper wire to a flat component lead provided the wire extends above the knee of the component lead and that the wire does not extend past the top of the component

Jumper Wire Termination and Soldering Procedure

Step	Action
7	Terminate one end the jumper wire.
8	Clean the terminated end of the jumper wire with isopropyl alcohol using an acid brush and wipe dry with a clean, lint-free tissue.
9	Apply flux SPARINGLY to the area to terminated end of the jumper wire. Note: Use a toothpick or flux pen to control the volume of flux applied. Heavy flux volume impairs cleaning and may affect reliability.
10	Remove the seasoning (all solder) from the soldering iron tip.
11	Thermally shock the soldering iron tip on a damp sponge.
12	<div style="text-align: center; border: 2px solid black; padding: 5px; margin: 0 auto; width: fit-content;">CAUTION</div> <p>DO NOT APPLY PRESSURE WITH THE SOLDERING IRON.</p> <p>Place the soldering iron tip on a terminated end of the jumper wire at the point of maximum thermal mass.</p>
13	<div style="text-align: center; border: 2px solid black; padding: 5px; margin: 0 auto; width: fit-content;">CAUTION</div> <p>IF SOLDER MELT DOES NOT OCCUR WITHIN TWO SECONDS, STOP THIS PROCEDURE AND ADJUST TIP TEMPERATURE PER THE TIP TEMPERATURE PROCEDURE IN WP 003 00 (PARAGRAPH 03-5.4).</p> <p>Form a heat bridge between the soldering iron tip the terminated jumper wire using clean solder.</p>
14	Solder the terminated end of the jumper wire.
15	Remove the solder and the soldering iron tip simultaneously.
16	Season the tip and place the soldering iron into its stand.
17	Allow the solder joint to cool completely before cleaning.
18	Clean the solder joint with isopropyl alcohol using an acid brush to remove all flux residue and blot dry with a clean, lint-free tissue.

Jumper Wire Termination and Soldering Procedure

Step	Action
19	<div style="text-align: center; border: 2px solid black; padding: 5px; margin-bottom: 10px;">CAUTION</div> <p>DO NOT BEND THE WIRE TIGHTER THAN A RADIUS OF THREE TIMES THE CONDUCTOR DIAMETER.</p> <p>Bend the wire as needed and route the wire along the CCA surface to the second termination point per the Jumper Wire Routing Guidelines (paragraph 19-5.2).</p>
20	Terminate the second end of the jumper wire.
21	Perform steps 8 through 18 to solder the second termination.
22	<p><i>Inspect per the General Inspection Procedure in WP 003 00 (paragraph 03-5.12) to all applicable WORKMANSHIP STANDARDS, including:</i></p> <ul style="list-style-type: none"> • <i>General Solder Acceptability in WP 005 00 (paragraph 05-6.1)</i> • <i>Post-Solder Joint Cleanliness in WP 005 00 (paragraph 05-6.2)</i> • <i>Jumper Wire Routing (paragraph 19-6.2)</i> • <i>Jumper Wire Solder Acceptability (paragraph 19-6.3)</i> • <i>Jumper Wire Terminated in a Plated-Through Hole (paragraph 19-6.4), if applicable</i> • <i>Jumper Wire Terminated to a Lead in a Plated-Through Hole (paragraph 19-6.5), if applicable</i> • <i>Jumper Wire with a Lap Solder Termination (paragraph 19-6.6), if applicable</i> • <i>Jumper Wire Terminated to a Land Containing a Chip Component (paragraph 19-6.7), if applicable</i> • <i>Jumper Wire Terminated to a Gull Wing Lead (paragraph 19-6.8), if applicable</i> • <i>Jumper Wire Terminated to a J-Lead (paragraph 19-6.9), if applicable</i> • <i>Jumper Wire Terminated to a Vacant Land (paragraph 19-6.10), if applicable</i> • <i>Other applicable Workmanship Standards, as required</i>
23	Bond the jumper wire to the CCA per the Jumper Wire Bonding Guidelines (paragraph 19-5.5).
24	<i>Inspect per the Jumper Wire Bonding WORKMANSHIP STANDARD (paragraph 19-6.11)</i>

Jumper Wire Termination and Soldering Procedure

Step	Action
25	Dispose of all HAZMAT following local procedures.

19-5.5 Jumper Wire Bonding Guidelines

After the jumper wire has been soldered at both ends and cleaned, the jumper wire shall be bonded to the CCA surface (Figure 19-3).

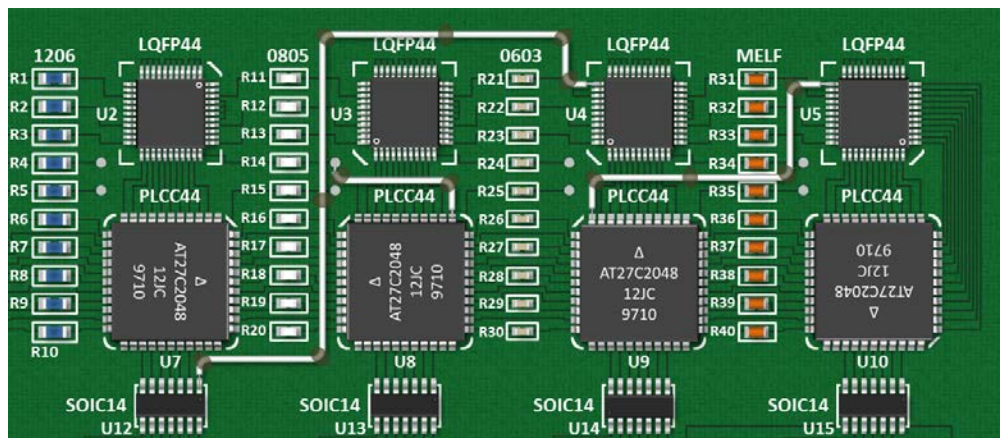

Figure 19-3 Jumper Wire Bonding

The jumper wire may be bonded to the CCA laminate (or to an integral thermal mounting plate or to hardware) by adhesive or tape (dots or strips).

When adhesive is used, it is to be mixed and cured in accordance with manufacturer’s instructions.

- All adhesive must be fully cured before returning CCA to service.

Consider the end-use product environment as well as subsequent process compatibility when selecting the appropriate bonding method.

Some jumper wire is manufactured with a special thermally set adhesive coating and is bonded to the CCA surface with a special tool.

The following guidelines apply to jumper wire bonding:

- Bond the jumper wire using tape dots, tape strips, quick set adhesive or hot melt adhesive.

- Spot bond the jumper wire so the bond fillet is sufficient to secure the wire with no excessive spillover onto adjacent pads, lands, or components.
- Do not bond the jumper wire to a removable or socketed component.
- The jumper wire shall not be raised more than the height of adjacent components when pulled taut.
- The jumper wire is not to be bonded to, or allowed to touch, any moving parts.
- Bond the jumper wire as close to the solder joint as possible.
- Bond the jumper wire at intervals not less than one inch on straight runs.
- Bond the jumper wire within the radius of each bend for each change of direction.
- Bond the jumper wire so the bonding tape or the bonding adhesive does not overhang the edge of the CCA.

19-6 WORKMANSHIP STANDARDS

Refer to WP 003 00 (paragraph 03-6) for definitions of Workmanship Standards.

NOTE

WORKMANSHIP STANDARDS FOR GENERAL SOLDER ACCEPTABILITY AND POST-SOLDER JOINT CLEANLINESS ARE IN WP 005 00 (PARAGRAPH 05-6).

19-6.1 Jumper Wire Selection and Preparation

Jumper Wire Selection and Preparation

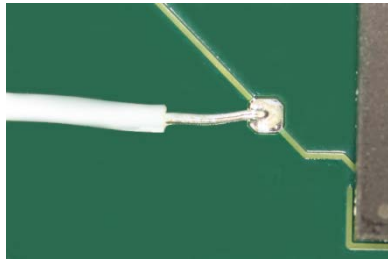

Target Condition	Acceptable Condition	Defect Condition
The jumper wire is insulated if it is greater than one inch in length.		An uninsulated jumper wire is greater than one inch in length.

Jumper Wire Selection and Preparation

Target Condition	Acceptable Condition	Defect Condition
The jumper wire is insulated if the bare wire would come closer than 1/16 in. to adjacent pads, lands or component leads.		An uninsulated jumper wire comes closer than 1/16 in. to an adjacent lead or an adjacent conductor.
The jumper wire is solid, copper wire.		The jumper wire is other than solid, copper wire (i.e. stranded wire).
The insulation has been trimmed neatly.	The insulation has not been trimmed neatly.	
The jumper wire is tinned in all areas of the wire that contacts the solder joint.		The jumper wire is not tinned in all of the areas that contacts the solder joint.
	Thermally stripped insulation shows slight discoloration.	Thermally stripped insulation shows charring or burning.
<p>The insulation clearance is equal to one wire diameter (including insulation) between the end of the insulation and the edge of the pad, land, lead, or termination where the wire first makes contact.</p> 	<p>The insulation clearance is two wire diameters (including insulation) or less between the end of the insulation and the edge of the pad, land, lead, or termination where the wire first makes contact.</p>	<p>The insulation clearance is greater than two wire diameters, the insulation clearance allows shorting to adjacent leads or adjacent conductors, or the insulation contacts the solder joint.</p> 
		The insulation is damaged to the extent of exposing the wire.
		There are cuts, nicks, scrapes or other damage to the wire conductor.

19-6.2 Jumper Wire Routing

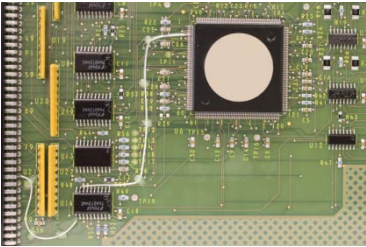
Jumper Wire Routing

Target Condition	Acceptable Condition	Defect Condition
<p>The jumper wire is routed in an XY pattern, using the shortest route.</p>	<p>The jumper wire is not routed in the shortest route.</p> <p>The jumper wire is not routed in an XY pattern.</p> 	
	<p>A jumper wire that is routed across pads or lands has sufficient slack to allow for relocation of the wire during component replacement.</p>	<p>A jumper wire that is routed across pads or lands does not have sufficient slack to allow for relocation of the wire during component replacement.</p>
		<p>The jumper wire is routed over or under a component.</p> 
		<p>The jumper wire is routed over vias or over conductive patterns that are used as test points.</p>

19-6.3 Jumper Wire Solder Acceptability

Jumper Wire Solder Acceptability

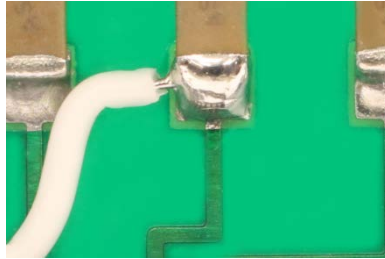
Target Condition	Acceptable Condition	Defect Condition
<p>The wire contour and the wire cut end are visible in the solder joint.</p> 		<p>Either the wire cut end or the wire contour are not visible in the solder joint.</p> 

19-6.4 Jumper Wire Terminated in a Plated-Through Hole

Jumper Wire Terminated in a Plated-Through Hole

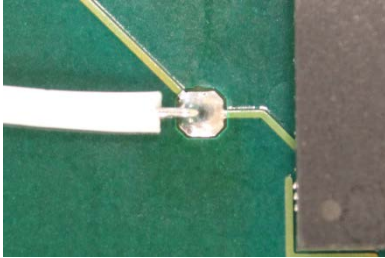
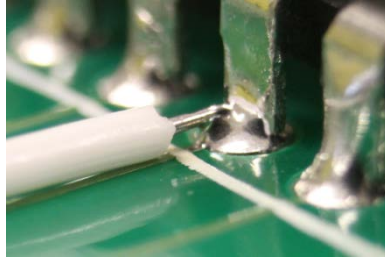
Target Condition	Acceptable Condition	Defect Condition
<p>The jumper wire is soldered into a plated-through hole or via, provided there is no component lead in the plated-through hole.</p> 		<p>The jumper wire is soldered into a plated-through hole that contains a component lead.</p> 

19-6.5 Jumper Wire Terminated to a Lead in a Plated-Through Hole

Jumper Wire Terminated to a Lead in a

Target Condition	Acceptable Condition	Defect Condition
<p>The jumper wire wraps the component lead for 180°.</p>	<p>The jumper wire is wrapped greater than 180°, provided the wire wrap does not overlap itself.</p> 	<p>The jumper wire is wrapped less than 180° on a round lead or less than 90° on a flat lead.</p>
		<p>The jumper wire wrap overlaps itself.</p>
	<p>The jumper wire overhangs the component termination, provided the wire does not come closer than 1/16 in. to an adjacent lead, land, pad, or conductor.</p>	<p>The jumper wire overhangs the solder termination and the wire comes closer than 1/16 in. to an adjacent lead, land, pad, or conductor.</p>

19-6.6 Jumper Wire with a Lap Solder Termination

Jumper Wire with a Lap Solder Termination

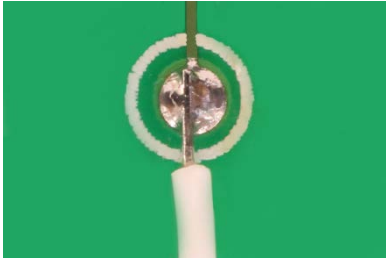
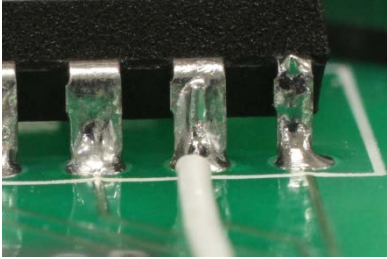
Target Condition	Acceptable Condition	Defect Condition
<p>The jumper wire is lap soldered to a via/PTH for 100% of the pad diameter.</p> 	<p>The jumper wire is lap soldered to a via/PTH for 75% or greater, but less than 100%, of the pad diameter.</p>	<p>The jumper wire is lap soldered to a via/PTH for less than 75% of the pad diameter.</p>
<p>The jumper wire is lap soldered to a flat component lead for 100% of the vertical portion of the lead.</p>	<p>The jumper wire is lap soldered to a flat component lead for 75% or greater, but less than 100%, of the vertical portion of the lead.</p> 	<p>The jumper wire is lap soldered to a flat component lead for less than 75% of the vertical portion of the lead.</p>
		<p>The end of jumper wire overhangs the pad.</p>
		<p>The jumper wire is lap soldered to a round component lead.</p>

19-6.7 Jumper Wire Terminated to a Land Containing a Chip Component

Jumper Wire Terminated to a Land Containing a Chip Component

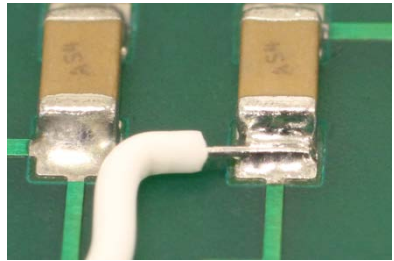
Target Condition	Acceptable Condition	Defect Condition
<p>The jumper wire is positioned parallel to the component termination.</p> 		
<p>The solder joint length is equal to 100% of the land width.</p>	<p>The solder joint length is 50% or greater, but less than 100% of the land width.</p>	<p>The solder joint length is less than 50% of the land width.</p>
<p>The jumper wire contacts the land for 100% of the width of the solder joint.</p>		<p>The jumper wire contacts the land for less than 100% of the width of the solder joint.</p>
	<p>The jumper wire overhangs land, provided the wire does not come closer than 1/16 in. to an adjacent lead, adjacent land, adjacent termination, or adjacent conductor.</p>	<p>The jumper wire overhangs land and the wire comes closer than 1/16 in. to an adjacent lead, adjacent land, adjacent termination, or adjacent conductor.</p>

19-6.8 Jumper Wire Terminated to a Gull Wing Lead

Jumper Wire Terminated to a Gull Wing Lead

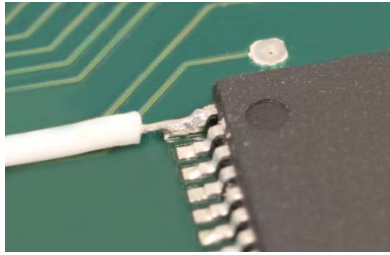
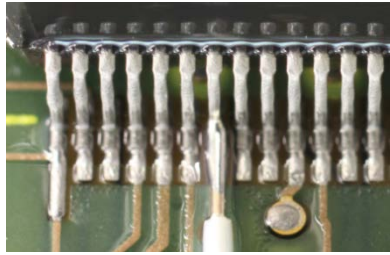
Target Condition	Acceptable Condition	Defect Condition
<p>The solder joint length is 100% of the length from the toe to the knee of the lead.</p>	<p>The solder joint length is 75% or greater, but less than 100%, of the length from the toe to the knee of the lead.</p> 	<p>The solder joint length is less than 75% of the length from the toe to the heel of the lead.</p> 
	<p>The jumper wire extends above the knee of the lead, provided the wire does not touch the component body or extend past the top of the component body.</p>	<p>The jumper wire touches the component body or extends past the top of the component body.</p>

19-6.9 Jumper Wire Terminated to a J-Lead

Jumper Wire Terminated to a J-Lead

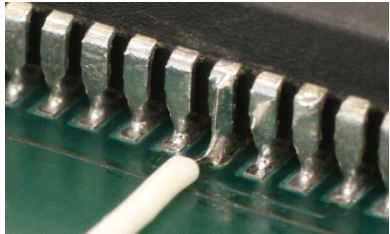
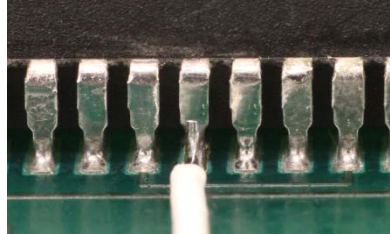
Target Condition	Acceptable Condition	Defect Condition
<p>The solder joint length is equal to 100% of the lead height.</p>	<p>The solder joint length is 75% or greater, but less than 100%, of the lead height.</p> 	<p>The solder joint length is less than 75% of the lead height.</p> 

Jumper Wire Terminated to a J-Lead

Target Condition	Acceptable Condition	Defect Condition
	The jumper wire extends beyond the top of the lead, provided the wire does not extend beyond the top of the component body.	The jumper wire extends beyond the top of the component body.

19-6.10 Jumper Wire Terminated to a Vacant Land

Jumper Wire Terminated to a Vacant Land

Target Condition	Acceptable Condition	Defect Condition
The jumper wire is positioned parallel to the longest dimension of the land.		
The jumper wire contacts the land for 100% of the land length.		
The solder joint length is equal to the 100% of the land length.	The solder joint length is greater than or equal to 50% of the land length.	The solder joint length is less than 50% of the land length.
	The jumper wire extends beyond the edge of the land, provided the wire does not come closer than 1/16 in. to an adjacent land, adjacent lead, adjacent termination, or adjacent conductor.	The jumper wire extends beyond the edge of the land and the wire comes closer than 1/16 in. to an adjacent land, adjacent lead, adjacent termination, or adjacent conductor.

19-6.11 Jumper Wire Bonding

Jumper Wire Bonding

Target Condition	Acceptable Condition	Defect Condition
The jumper wire is bonded as close to the solder joint as possible.		The jumper wire is not bonded as close to the solder joint as possible.
The jumper wire is bonded at intervals of one inch on straight runs.	The jumper wire is bonded at intervals less than one inch on straight runs.	The jumper wire is bonded at intervals greater than one inch on straight runs.
<p>The jumper wire is bonded within the radius of each bend for each change of direction.</p> 		The jumper wire is not bonded within the radius of each bend for each change of direction.
		The jumper wire extends above the height of adjacent components when pulled taut.
		The jumper wire is bonded to a removable or socketed component.
		The jumper wire is bonded to or in contact with a moving part.
		The jumper wire or bonding material overhangs the board edge.
		The bonding material overhangs the board edge.
		The bonding adhesive is not completely cured before the CCA is returned to service.

This page is intentionally blank.

15 October 2013

WP 020 00 Lead-Free Solder

20-1 PURPOSE

Identify the technical information relative to lead-free solder; including 2M lead-free policy, lead-free concerns, and identifying lead-free.

Specify the repair procedures for using lead-free solder.

Identify the workmanship standards for lead-free solder.

20-2 INDEX

Paragraph	Subject	Page
20-1	Purpose	1
20-2	Index	1
20-3	General Safety Precautions.....	1
20-4	Technical Information.....	2
20-4.1	2M Lead-Free Policy.....	3
20-4.2	Lead-Free Concerns	4
20-4.3	Identifying Lead-Free	8
20-5	Repair Procedures.....	15
20-5.1	Lead-Free General High Reliability Soldering Procedure.....	16
20-6	Workmanship Standards	20

20-3 GENERAL SAFETY PRECAUTIONS

Observe all the following precautions while using lead-free solder:

- Electronic equipment must be de-energized during removal and installation of CCAs
- Personnel are required to wear a properly grounded ESD wrist strap and cord while working in or around the EPA
- ESD can destroy components—protect ESDS devices during handling and repair to prevent ESD damage (Refer to WP 004 00)
- Isopropyl alcohol is flammable; do not use in the presence of sparks, heat, flame, or synthetic cloth

- Soldering handpieces (e.g., soldering irons, solder extractors, hot air jets) produce extreme heat—exercise care when these tools are out of their stands
- Avoid direct inhalation of fumes during a soldering operation because there is a possibility these fumes could cause occupational asthma
- The lead contained in solder is a source of lead oxide, which the human body cannot dissipate (accumulation of lead oxide in the body over a period of years can result in a serious health hazard)
- Contact with solder by holding in the mouth, smoking, or eating during or immediately after soldering is a potential means of ingesting trace amounts of lead oxide
- Avoid oral contact with hands during or immediately after solder operations
- Wash hands following any solder operation
- Wear approved PPE whenever pouring or handling molten metals or corrosive liquids and solids; and cutting, drilling, grinding, milling, chipping and other dust and debris producing operations
- When handling solder paste avoid skin contact by wearing the Glove, Chemical Protective (blue nitrile) and wash hands immediately following use

20-4 TECHNICAL INFORMATION

Tin-lead (SnPb) solder has been the primary method of attaching components to CCAs in electronics manufacturing for over 60 years.

The tin-lead soldering process is a mature technology with well-documented engineering characteristics and reliability data.

However, lead in some forms has long been known as a hazard to humans and the environment and has been banned in plumbing, coatings, gasoline, paint, and some ammunition.

Although solder used in electronics accounts for only 0.49% of the worldwide use of lead; litigation, legislation, and environmental mandates have increasingly sought to remove lead from the electronics market.

In 2003, the European Union (EU) passed the Waste Electrical and Electronic Equipment (WEEE) and Reduction of Hazardous Substances (RoHS) directives, essentially banning the use of lead and five other substances used in electronics.

Similar legislation was adopted by other countries.

The United States has not adopted yet similar legislation, but commercial markets drive demand and lead-free electronics have proliferated worldwide, including into military supply chains.

20-4.1 2M Lead-Free Policy

Despite the proliferation of lead-free solders in the commercial market, the reliability of lead-free in military environments remains unproven. Until this occurs, the policy regarding the use of lead-free is as follows:

Organizational (O) Level—Tin-lead solder shall be used for all soldering processes.

Intermediate (I) Level—Tin-lead solder shall be used for all soldering process with the following exception: I-level facilities collocated with a depot having approved lead-free procedures shall defer the repair to the depot.

Depot (D) Level—Tin-lead CCAs shall be repaired with tin-lead solders using the processes in this manual. Lead-free solder shall be used only where approved lead-free procedures are in place. Tin-lead solder shall be used where the solder alloy is not identified or lead-free procedures are not in place. Tin-lead CCAs **shall not** be repaired with lead-free solder.

20-4.1.1 Segregation of Soldering Materials

Depots having approved lead-free repair procedures **shall** maintain separate tin-lead and lead-free repair stations.

A wide-ranging variety of reliability issues have been proven when lead-free alloys are contaminated with varying amounts of tin-lead. Each lead-free alloy has its own characteristics and reacts differently when contaminated with lead.

With lead contamination issues, and the incompatibility of some lead-free alloys when intermixed, each solder alloy type shall have its own set of tools and equipment. This requirement is to preclude cross-contamination of assemblies through use of common soldering and desoldering tips and materials.

Segregation of soldering materials includes but is not limited to soldering iron tips, extractor tips, tool stand sponges, tip-cleaning tools and dressings, wire solder, and solder paste. This list should also include hand and supporting tools, e.g., acid brushes and wooden alignment tools, that cannot be cleaned effectively of all residual solder.

20-4.1.2 Lead Free Soldering Acceptance Criteria

Soldering acceptance criteria have traditionally been based on tin-lead solders. These standards are being revised to reflect the different appearance and wetting properties of lead-free alloys.

IPC-A-610 includes lead-free information on the difference in lead-free appearance caused primarily by poor wetting resulting in steeper fillets. However, the specifications have not changed, and **lead-free solder joints must meet the same specifications as tin-lead solders.**

20-4.2 Lead-Free Concerns

The reliability of lead-free solder is a complex and application specific task and has been proven for many consumer electronics products. Cell phones, televisions, digital recorders, and other consumer electronics have been manufactured with lead-free alloys for a many years with good reliability.

What is unknown is the reliability of lead-free solders in high performance environments, due to the lack of thorough testing of the many possible combinations of laminates, circuit card finishes, component types, component lead finishes, and solder alloys completed to date.

Studies to date suggest tin-lead solder provides generally higher reliability in high stress environments while lead-free solder provides higher reliability in low stress environments. Further studies must be completed using high reliability criteria before official policy on lead-free solder can be completed.

Further information concerning lead-free solder standards and policy is available on the Defense Acquisition University website, <https://acc.dau.mil/leadfree>.

20-4.2.1 Tin Whiskers

A move away from over 60 years of knowledge and proven engineering data in tin-lead soldering processes raises significant technical concerns. Solder joint reliability baselines, proven processes, and test procedures that have been established and validated over the years are no longer useful. Possibly more problematic is the reemergence of tin whiskers, which have been successfully suppressed for decades by the addition of at least 3% lead to the tin plating used in high reliability applications.

Tin whiskers (Figure 20-1) are electrically conductive, crystalline structures of tin that sometimes grow from surfaces where tin (especially electroplated tin) is used as a final finish.

Numerous electronic system failures have been attributed to short circuits caused by tin whiskers that bridge closely spaced circuit elements maintained at different electrical potentials.

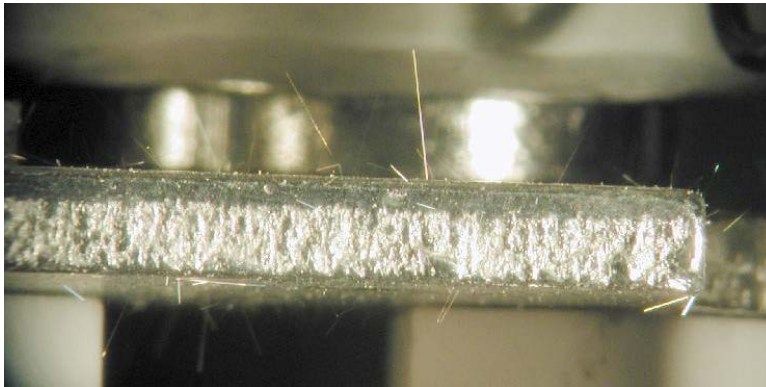

Figure 20-1 Tin Whiskers

Tin whiskers are not a new phenomenon. The first published reports of tin whiskers date back to the 1940s. Tin is only one of several metals known to be capable of growing whiskers. Other examples of metals that may form whiskers include zinc, cadmium, indium, and antimony.

The mechanisms by which tin whiskers grow have been studied for many years. A single accepted explanation of the mechanisms has **NOT** been established. Some theories suggest that tin whiskers may grow in response to a mechanism of stress relief (especially, compressive stress) within the tin plating.

Tin whiskers pose a serious reliability risk to electronic assemblies. There are reports of at least three tin whisker induced short circuits that resulted in complete failure of on-orbit commercial satellites.

The general risks from tin whiskers fall into four categories:

- **Stable Short Circuit**—In low current circuits insufficient current exists to fuse the whisker open resulting in a stable short circuit result. Depending on the diameter and length of the whisker, it can take more than 50 mA to fuse open a tin whisker.
- **Transient Short Circuit**—At atmospheric pressure, if current exceeds the fusing current of the whisker, the circuit will experience a transient glitch as the whisker fuses open.
- **Metal Vapor Arc**—If a tin whisker initiates a short in an application environment possessing high levels of current and voltage, then a very destructive phenomenon known as a metal vapor arc can occur.

In a metal vapor arc, the solid metal whisker is vaporized into a plasma of highly conductive metal ions (more conductive than the solid whisker itself). This plasma can form an arc capable of carrying hundreds of amperes.

Metal vapor arcs in a vacuum are reported to have occurred on at least three commercial satellites resulting in blown fuses that rendered the spacecraft non-operational.

- **Debris / Contamination**—Whiskers or parts of whiskers may break loose and bridge isolated conductors or interfere with optical surfaces.

20-4.2.2 Mechanical Failure

Lead-free solders have different mechanical properties than SnPb solders. In general, lead-free solders tend to be stiffer than eutectic SnPb solder. The increased stiffness of lead-free solders results in assemblies not as reliable in high stress, high vibration environments.

These types of mechanical failures may be characterized by a crack that propagates through the entire solder joint or pad createring, where the entire pad and some connecting laminate material is lifted with the lead.

20-4.2.3 Copper Dissolution

Lead-free solders tend to have a high tin content, greater than 90%. The increased amount of tin results in a high rate of dissolution of the copper traces into the molten solder.

If solder is heated for too long or reflowed multiple times, the entire trace may be dissolved into the solder. This is a particular concern for wave soldering operations.

20-4.2.4 Process Incompatibilities

Lead-free solders tend to have higher melting temperatures than eutectic SnPb solder. The increased melting temperature may affect the heat sensitive components. Laminate material may be degraded, delaminate, or warp.

A greater change in temperature increases the Z-Axis expansion for plated-through holes, increasing the stress and chance of cracking.

Lead-free solders may also require different fluxes. These fluxes tend to be more active than fluxes for eutectic SnPb solder. Increased activity of flux increases the potential for flux induced corrosion.

20-4.2.5 Corrosion

Some lead-free solders corrode more readily than eutectic SnPb solders. If not properly removed during cleaning, the more active fluxes can further increase the rate of corrosion. Corrosion decreases the mechanical reliability of a solder joint, increases the electrical resistance, and, in some cases, increase the potential for tin whisker growth.

20-4.2.6 Cross Contamination

Research on lead-free solders has been on going from prior to the implementation of lead-free legislation in 2003 to present time. Initially, as many as 100 combinations of lead-free alloys have been studied and tested by manufacturers to replace tin-lead solder with varying results. The drive for so many alloys included scientific and economic forces.

Some alloys perform better in particular applications or are easier to process. Some alloys allow a manufacture to patent a particular chemistry for profit. While no drop-in replacement exists for tin-lead solder, the tin (Sn)-silver (Ag)-copper (Cu) [SAC] family has emerged as the leading candidate to replace tin-lead solders for general use.

Two common alloys include SAC305 (sack-three-oh-five) and SAC105. These alloys are primarily tin, with SAC305 being 96.5% tin, 3 percent silver, and 0.5% copper. SAC105 is 98.5% Sn, 1% silver, and 0.5% copper.

There are many other solder alloys. Most alloys are some combination of the following elements:

- Tin (Sn) provides good strength and wetting
- Lead (Pb) adds needed ductility to solder and retards growth of tin whiskers
- Silver (Ag) commonly added to solder to retard silver washing when soldering silver plated materials
- Antimony (Sb) added some solders to increase strength without affecting wetting
- Bismuth (Bi) significantly lowers the melting point and improves wetting
- Copper (Cu) lowers the melting point and improves wetting properties of the molten solder and slows the rate of copper dissolution from the CCA and part leads in the liquid solder
- Nickel (Ni) used to stabilize SnCu lead -free solder alloys to slow the effects of copper erosion

- Indium (In) a very ductile metal used primarily to create solders with a low melting temperature

Table 20-1 is a partial list of lead-free solder alloys.

Table 20-1 Examples of Lead-Free Solders

Solder Alloy	Composition/Wt%	Melting Range °F/°C
Tin-Indium (Sn/In)	Sn/52In	244°F / 118°C
Tin-Bismuth (Sn/Bi)	Sn/58Bi	280°F / 138°C
Tin-Lead (Sn/Pb)*	Sn/37Pb	361°F / 183°C
Tin-Zinc (Sn/Zn)	Sn/9Zn	388°F / 198°C
Tin-Silver-Copper (Sn/Ag/Cu)	Sn/3.8Ag/0.5Cu	423°F / 217°C
Tin-Silver (Sn/Ag)	Sn/20Ag	430-439°F / 221-226°C
Tin-Silver (Sn/Ag)	Sn/3.5Ag	430°F / 221°C
Tin-Copper (Sn/Cu)	Sn/0.7Cu	441°F / 227°C
Tin-Antimony (Sn/Sb)	Sn/5Sb	450-464°F / 232-240°C
Tin-Silver-Copper-Antimony (Sn/Ag/Cu/Sb)	Sn/2Ag/0.8Cu/0.5Sb	421-432°F / 216-222°C

*Tin-lead solder is listed for comparison purposes

A key issue is that each of the proposed alternative solder compositions has potential advantages and disadvantages. Their suitability can vary from application to application and furthermore individual companies have developed different processing solutions for each type of solder and composition.

Not all elements are compatible. Mixing particular solder chemistries may result in undesirable compounds. For example, mixing tin, lead, and small amounts of bismuth results in portions of the solder joint melting below typical operating temperatures will decrease the mechanical integrity of the solder joint.

20-4.3 Identifying Lead-Free

All touch-up, rework, or repair of printed circuit assemblies should be performed with the solder and component finish composition used to manufacture the original assembly. Any deviation may result in mixing of incompatible metals reducing the reliability of the assembly.

Positive identification of the solder cannot be made through visual inspection alone.

While most lead-free solder joints exhibit steeper wetting angles, reduced wetting and less shiny appearance when compared to tin-lead, these visual characteristics will not lead to the positive identification of the solder type used.

In manufacturing facilities, solders used in assembly should be well documented with information available to make an informed decision. In situations where the repair technician does not have access to assembly documentation, the lead-free alloy used in assembly may be very difficult to determine. Rework technicians should always consult with the technical documentation of the assembly to determine solder alloy used in assembly. If technical documentation is not available, consult with your supervisor or quality assurance department for direction.

20-4.3.1 Component Part Numbers

As a result of RoHS and the global lead-free movement, the majority of component manufacturers have moved away from tin-lead component finishes in favor of lead-free finishes. A high percentage of component manufacturers will not be changing component part numbers as part of the transition to lead-free, creating a high probability of uncertainty as to the component lead finish on some components. Companies not introducing new part numbers are identifying lead-free status using date codes or lot numbers on component packaging. This could prove to be a problem to the military supply chain and to the 2M repair process. Without specific lead-free component part numbers or identification on packaging, lead-free parts will unknowingly be installed into military systems. This could cause compatibility issues affecting the reliability of high reliability electronics.

20-4.3.2 Lead Detection Using X-Ray Fluorescence (XRF)

XRF is the primary technology used in industry to identify positively the constituent metals of a solder alloy or lead finishes. XRF equipment is available in both handheld and desktop models, is very expensive, and probably not well suited to the 2M Program use due to cost, space requirements, and the safety concerns associated with the x-ray emission.

20-4.3.3 Lead Detection Using LeadCheck® Swabs

LeadCheck® Swabs are an inexpensive method of providing a go/no go test for lead presence to a claimed 0.1% accuracy.

LeadCheck® Swabs identify only lead, so it may be a useful tool for determining if a solder alloy or lead finish is lead-free, but is not useful to determine the constituent metals in a lead-free alloy.

When LeadCheck® Swabs are used; a pink color specific for lead develops within 30 seconds and is stable for hours (Figure 20-2).



Figure 20-2 LeadCheck® Swabs

LeadCheck® Swabs have an indefinite shelf life, provide rapid results, and are low cost, non-destructive, and non-hazardous.

A package of 16 LeadCheck® Swabs can be ordered under P/N PB-2M16, NSN 8010-01-359-9241. A package of 48 LeadCheck® Swabs can be ordered under P/N PB-2M48CB.

20-4.3.4 IPC/JEDEC J-STD-609—Lead-Free and Leaded Marking, Symbols and Labels

J-STD-609 provides those personnel performing assembly, rework, and repair a means of determining the lead-free or lead-containing materials used in assembly and the ability to distinguish between lead-free materials and traditional tin-lead solder.

J-STD-609 will also assist in end of life cycle recycling requirements.

The marking and labeling requirements of J-STD-609 will only appear on assemblies where this standard was invoked in the manufacturing contract.

J-STD-609 provides a labeling system that aids in assembly, rework, repair, and recycling and provides for the identification of:

- Those assemblies that are assembled with lead-containing or lead-free solder alloys and components
- The terminal finish of components and the maximum processing temperature that a component can endure during assembly or rework processing
- The lead-free solder family used for circuit card assembly (intended to identify the solder and to distinguish such solders from tin-lead solders)

- The base materials used in the CCA construction, including those CCAs that use halogen-free resin
- The surface finish of unpopulated CCAs

20-4.3.5 J-STD-609 Symbols and Labels

Material Category Symbol. This symbol (Figure 20-3) is used to identify the terminal finish or material.

It is to be marked on components and assemblies.

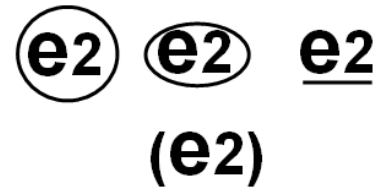

Figure 20-3 Example of Marks Indicating Material Category 2

Lead-Free Symbol. This symbol (Figure 20-4) can be used in addition to, or instead of the phrase “Lead-Free” on labels, components, circuit cards, or assemblies.



Figure 20-4 Lead-Free Symbol

Lead-Free Identification Label. This label (Figure 20-5) may be used only when the component or assembly itself is lead-free.

It may be affixed to intermediate boxes or other containers not otherwise identified as lead-free.



Figure 20-5 Lead-Free Identification Label

Second Level Interconnect Component Label. These labels (Figure 20-6 and Figure 20-7) indicate that the 2nd level interconnect (CCA level solder connection) terminal finish/material is lead-free (or lead-containing).

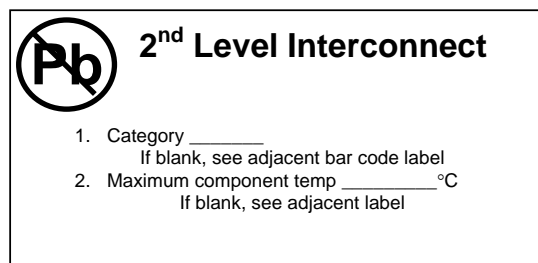

Figure 20-6 Second Level Lead-Free Interconnect Component Label

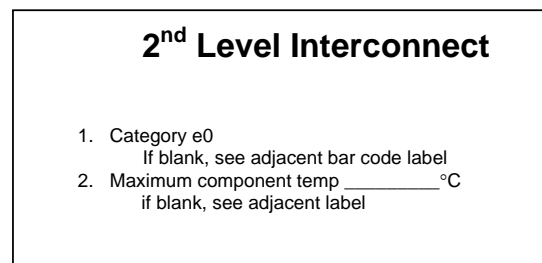

Figure 20-7 Second Level Interconnect Component Label for Lead-Containing Coatings and Finishes

This label shall be placed/printed on the lowest level shipping container and any ESD, dry pack, or other bag/box, excluding tubes, trays, reels, or other carriers, within the lowest level shipping container.

20-4.3.6 J-STD-609 Marking/Labeling Categories

Halogen-Free Laminate Resin Category—If the base resin and reinforcement matrix used in making the bare printed circuit card are halogen free (HF), the label/markings “HF” shall be noted on the bare printed circuit card identification label.

If no “HF” is present, a halogen-containing base resin and reinforcement matrix are assumed.

Solder Material Categories—The following categories describe the terminal finish or solder ball material of components, or describe the solder paste or solder used in circuit card assembly:

- **e0**—contains intentionally added Pb (includes traditional SnPb solder)
- **e1**—SnAgCu with Ag content greater than 1.5% and no other intentionally added elements
- **e2**—Sn alloys with no Bi or Zn, excluding SnAgCu alloys in e1 and e8
- **e3**—Sn
- **e4**—precious metal (e.g. Ag, Au, NiPd, NiPdAu) [no Sn]
- **e5**—SnZn, SnZnX (all other alloys containing Sn and Zn and not containing Bi)
- **e6**—contains Bi
- **e7**—low temperature solder (≤ 302 °F [150 °C]) containing In (no Bi)
- **e8**—SnAgCu with silver content less than or equal to 1.5%, with or without intentionally added alloying elements (this category does not include any alloys described by e1 and e2 or containing Bi or Zn in any quantity)
- **e9**—unassigned

Conformal Coating Categories—The following categories describe the conformal coatings, if used:

- Acrylic Resin (AR)

- Epoxy Resin (ER)
- Silicone Resin (SR)
- Polyurethane Resin (UR)
- Paraxylylene (XY)

Bare Circuit Card Surface Finish Categories—The following codes shall be used to describe the surface finish on the bare circuit card (prior to assembly):

- **b0**—contains Pb, traditional SnPb, hot air level or solder reflow
- **b1**—lead-free HASL (Sn alloys with no Bi or Zn)
- **b2**—I-Ag
- **b3**—Sn (electrolytic or immersion)
- **b4**—Au (immersion or electrolytic), ENIG, NiAu
- **b5**—screened carbon (carbon ink)
- **b6**—OSP (organic solder preservative)
- **b7, b8** and **b9** are unassigned

Bare Printed Circuit Card Material Categories. The bare circuit card base materials may be identified by using the classification system found in IPC-4101, where a unique specification sheet (slash-sheet) number identifies a specific grade of material.

Table 20-2 is a list of the more common base materials expected to be used on the majority of the CCAs, which will be marked or labeled per this specification; however, other grades of base materials are possible.

Table 20-2 J-STD-609 Laminates (Sample List)

Slash No.	Resin System	FR Mechanism	ID References	Tg in °F/°C
/14	Epoxy	Phosphorus	CEM-3	N/A
/92	Epoxy	Phosphorus	FR-4	230-302/110-150
/93	Epoxy	Aluminum hydroxide	FR-4	230-302/110-150
/94	Epoxy	Phosphorus	FR-4	302-392/150-200
/95	Epoxy	Aluminum hydroxide	FR-4	302-392/150-200

Slash No.	Resin System	FR Mechanism	ID References	Tg in °F/°C
/97	Epoxy	Bromine	FR-4	230/110 minimum
/98	Epoxy	Bromine	FR-4	302/150 minimum
/99	Epoxy	Bromine	FR-4/99	302/150 minimum
/101	Difunctional Epoxy	Bromine	FR-4/101	230/110 minimum
/126	Epoxy	Bromine	FR-4/126	338/170 minimum

CCAs made with more than one grade of materials shall be marked or labeled with the slash-sheet of the material with the lowest temperature rating.

Component Marking. On a component with normal marking, if space permits, the individual component shall be marked with the material category designation enclosed within a circle, ellipse, underlined, or parentheses on the top side (Figure 20-8).



Figure 20-8 Example of Component Markings

20-4.3.7 Category Hierarchy

If two or more solder alloy categories are used (e.g., reflow, wave, and other solders use different category solder alloys), the category of the solders used shall be shown in the following sequence—reflow, wave, and other (hand soldering).

Marking Location—The preferred location for marking the material categories on the circuit card is on CCA layer 1 (topside) at the lower right-hand segment, next to the part/serial number on the circuit card, or next to the company logo (Figure 20-9).

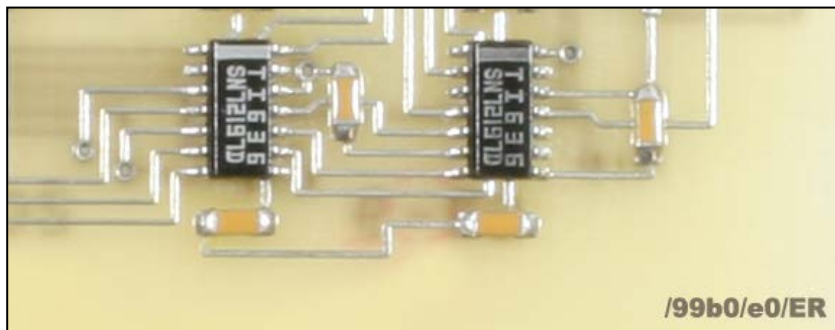

Figure 20-9 CCA Marking

Marking Sequence—The sequence of marking shall be as follows:

- Base material slash sheet number
- Halogen-free (HF) [if applicable]
- Bare circuit card surface finish
- Reflow, wave, and other solders
- Conformal coating (if applicable)

Examples of marking sequences and the definition of the markings:

- **/95 HF b2 e1 e2** or **/95-HF-b2-e1-e2** or **/95/HF/b2/e1/e2**

Multifunctional epoxy, halogen-free FR-4 laminate CCA with I-Ag finish; assembled with SnAgCu solder for reflow and a Sn alloy for wave attachments; no conformal coating.

- **/99 b0 e0 ER** or **/99-b0-e0-ER** or **/99/b0/e0/ER**

Halogen containing epoxy lead-free FR-4 laminate CCA with SnPb finish; assembled with SnPb solder in both reflow and wave; with epoxy conformal coating.

Rework or Repair Marking—Repairs to assemblies with a material finish category code shall be made with the same solder code category or a compatible solder code category.

If different repair solder is used, the marking sequence shall be modified.

20-5 REPAIR PROCEDURES



PROTECT STATIC SENSITIVE DEVICES DURING HANDLING AND REPAIR TO PREVENT ESD DAMAGE (REFER TO WP 004 00).

Equipment Required Listed below are the authorized 2M Power Units* for repair with lead-free solder:

- **NAVAIR/NAVSEA/USMC/USAF/USCG**—PRC-2000-SMT
- **NAVSEA/USCG**—PRC-2000-TH
- **NAVSEA/USCG**—MBT-250-SD
- **USMC**—MBT-350
- **NAVSEA**—ST-25

* Refer to Table 03-3 for Power Unit Part No., and CAGE Code

Additional Support Items For additional information regarding items of support and support equipment refer to:

- **NAVSEA/NAVAIR/USCG**—2M MTR Certification Manual
- **NAVSEA/USCG**—Allowance Parts List (APL) 000A8423
- **USMC**—Stock List SL-3-09458A
- **USAF**—the Consolidated Tool Kit (CTK)

Material Required Listed below are the materials required* for repair with lead-free solder:

- Flux, Soldering
- Isopropyl Alcohol, Technical
- Lead-free Solder alloy†
- Towel, Paper (Kimwipe®)‡

* Refer to Table 03-4 for Specification No., Part No., and NSN

† Select size appropriate for application

‡ Substitution of equivalent material is acceptable

20-5.1 Lead-Free General High Reliability Soldering Procedure

Repair of lead-free is beyond the scope of this manual. This procedure is provided for informational purposes only.

There are some notable differences between tin-lead and lead-free hand soldering. Tin-lead eutectic solder melts at 361°F (183°C). The leading group of SAC and SnCu lead-free solders melts between 423°F (217°C) and 441°F (227°C). This 62-79°F (34-44°C) difference in melting points (compared to SnPb) may require higher initial soldering iron temperatures and/or longer dwell times on the assembly.

Personnel Hazards



Alcohol, Isopropyl

1



Flux (Soldering)

8

Lead-Free General High Reliability Soldering Procedure

Step	Action												
	<p style="text-align: center;">WARNING</p> <p style="text-align: center;"><i>USE APPROVED SAFETY EYEWEAR WHEN PERFORMING THIS PROCEDURE.</i></p> <p style="text-align: center;"><i>COMPLY WITH ALL LOCAL REQUIREMENTS FOR PPE.</i></p> <p style="text-align: center;">CAUTION</p> <p style="text-align: center;">DON A PROPERLY GROUNDED ESD WRIST STRAP BEFORE STARTING THIS PROCEDURE.</p>												
<p style="text-align: center;">1</p>	<p>Perform the Procedural Analysis and Feasibility of Repair Procedure in WP 003 00 (paragraph 03-5.1).</p>												
<p style="text-align: center;">2</p>	<p style="text-align: center;">CAUTION</p> <p style="text-align: center;">BEGIN THE REPAIR PROCESS AS SOON AS POSSIBLE AFTER REMOVAL FROM THE OVEN TO AVOID MOISTURE RE-ABSORPTION.</p> <table border="1" style="width: 100%; border-collapse: collapse;"> <tr> <td style="width: 50%; vertical-align: top;"> Bake the CCA, if feasible, in accordance with the table to the right before soldering, desoldering, and conformal coating removal procedures to prevent delamination, measling, or other laminate degradation. </td> <td style="width: 25%; text-align: center;"> Baking Temp. </td> <td style="width: 25%; text-align: center;"> Baking Time </td> </tr> <tr> <td></td> <td style="text-align: center;">248°F (120°C)</td> <td style="text-align: center;">3.5 to 7 hours</td> </tr> <tr> <td></td> <td style="text-align: center;">212°F (100°C)</td> <td style="text-align: center;">8 to 16 hours</td> </tr> <tr> <td></td> <td style="text-align: center;">176°F (80°C)</td> <td style="text-align: center;">18 to 48 hours</td> </tr> </table>	Bake the CCA, if feasible, in accordance with the table to the right before soldering, desoldering, and conformal coating removal procedures to prevent delamination, measling, or other laminate degradation.	Baking Temp.	Baking Time		248°F (120°C)	3.5 to 7 hours		212°F (100°C)	8 to 16 hours		176°F (80°C)	18 to 48 hours
Bake the CCA, if feasible, in accordance with the table to the right before soldering, desoldering, and conformal coating removal procedures to prevent delamination, measling, or other laminate degradation.	Baking Temp.	Baking Time											
	248°F (120°C)	3.5 to 7 hours											
	212°F (100°C)	8 to 16 hours											
	176°F (80°C)	18 to 48 hours											
<p style="text-align: center;">3</p>	<p>Remove any conformal coating from the repair area using one of the Conformal Coating Removal Methods in WP 006 00 (paragraph 06-5.4).</p>												

Lead-Free General High Reliability Soldering Procedure

Step	Action
4	<div style="text-align: center; border: 2px solid black; padding: 5px; margin-bottom: 10px;">CAUTION</div> <p style="text-align: center;">HEAT SINKS ARE PLACED BETWEEN THE HEAT SOURCE AND THE COMPONENT BODY TO PROTECT THE COMPONENT FROM THE HEAT OF THE SOLDERING PROCESS.</p> <p>Install heat sinks, as needed.</p>
5	<p>Preheat the CCA per the Convective Preheating Procedure in WP 018 00 (paragraph 18-5.2.1) or the Conductive Preheating Procedure (paragraph 18-5.2.2) for:</p> <ul style="list-style-type: none"> • All surface mount CCAs • CCAs with large (heavy) ground planes • CCAs with large thermal mass (thick laminate, constraining core)
6	<p>Select a soldering iron tip that maximizes heat transfer and contact area with the area to be soldered.</p>
7	<p>Set the soldering iron tip temperature to 600°F (316°C).</p>
8	<p>Clean the area to be soldered with isopropyl alcohol using an acid brush and blot dry with a clean, lint-free tissue.</p> <p>Note: Take precautions to prevent bare skin contact before the component is soldered. Skin contact leaves contaminants on the leads and/or pads.</p>
9	<p>Clean the solder with isopropyl alcohol and wipe dry with a clean, lint-free tissue.</p>
10	<p>Apply flux SPARINGLY to the area to be soldered.</p> <p>Note: Use a toothpick or flux pen to control the volume of flux applied. Heavy flux volume impairs cleaning and may affect reliability.</p>
11	<p>Remove the seasoning (all solder) from the soldering iron tip.</p>
12	<p>Thermally shock the soldering iron tip on a damp sponge.</p>
13	<div style="text-align: center; border: 2px solid black; padding: 5px; margin-bottom: 10px;">CAUTION</div> <p style="text-align: center;">DO NOT APPLY PRESSURE WITH THE SOLDERING IRON.</p> <p>Place the soldering iron tip on the joint at the point of maximum thermal mass.</p>

Lead-Free General High Reliability Soldering Procedure

Step	Action
14	<div style="text-align: center; border: 2px solid black; padding: 5px; margin: 0 auto; width: fit-content;">CAUTION</div> <p style="text-align: center;">IF SOLDER MELT DOES NOT OCCUR WITHIN TWO SECONDS, STOP THIS PROCEDURE AND ADJUST TIP TEMPERATURE PER THE TIP TEMPERATURE PROCEDURE IN WP 003 00 (PARAGRAPH 03-5.4).</p> <p>Form a heat bridge between the soldering iron tip and the surfaces to be soldered using clean solder.</p>
15	Flow solder to form fillets.
16	Remove the solder and the soldering iron tip simultaneously.
17	Season the tip and place the soldering iron into its stand.
18	Allow the joint to cool completely before cleaning.
19	Clean the soldered area with isopropyl alcohol using an acid brush to remove all flux residue and blot dry with a clean, lint-free tissue.
20	<p><i>Inspect per the General Inspection Procedure in WP 003 00 (paragraph 03-5.12) to all applicable WORKMANSHIP STANDARDS, including:</i></p> <ul style="list-style-type: none"> • <i>General Solder Acceptability in WP 005 00 (paragraph 05-6.1)</i> • <i>Post-Solder Joint Cleanliness in WP 005 00 (paragraph 05-6.2)</i> • <i>Laminate in WP 011 00 (paragraph 11-6.1)</i> • <i>Conductors, Pads, and Lands in WP 012 00 (paragraph 12-6.1)</i> • <i>Other applicable Workmanship Standards as required</i>
21	Replace the conformal coating per the Conformal Coating Replacement Procedure in WP 006 00 (paragraph 06-5.5), as needed.
22	<i>Inspect to the Conformal Coating Replacement WORKMANSHIP STANDARD in WP 006 00 (paragraph 06-6.2), as required.</i>
23	Dispose of all HAZMAT following local procedures.

20-6 WORKMANSHIP STANDARDS

Refer to WP 003 00 (paragraph 03-6) for definitions of Workmanship Standards. There are currently no workmanship standards specific to lead-free connections.

The primary difference between the solder connections created with processes using tin-lead alloys and processes using lead-free alloys is related to the visual appearance of the solder. Acceptable lead-free connections may exhibit similar appearances but lead-free alloys are more likely to have dull or grainy surface appearance and greater wetting contact angles. All other solder fillet criteria are the same.

NOTE

WORKMANSHIP STANDARDS FOR GENERAL SOLDER ACCEPTABILITY AND POST-SOLDER JOINT CLEANLINESS ARE IN WP 005 00 (PARAGRAPH 05-6), CONFORMAL COATING IN WP 006 00 (PARAGRAPH 06-6), THROUGH HOLE COMPONENTS IN WP 007 00 (PARAGRAPH 07-6), TERMINALS IN WP 008 00 (PARAGRAPH 08-6), SOLDER CUPS IN WP 009 00 (PARAGRAPH 09-6), WIRE REPAIR IN WP 010 00 (PARAGRAPH 10-6), LAMINATE IN WP 011 00 (PARAGRAPH 11-6), CONDUCTORS, PADS, AND LANDS IN WP 012 00 (PARAGRAPH 12-6), MULTILAYER IN WP 015 00 (PARAGRAPH 15-6), PLASTIC PANEL IN WP 016 00 (PARAGRAPH 16-6), SURFACE MOUNT DEVICES IN WP 018 00 (PARAGRAPH 18-6), AND JUMPER WIRES IN WP 019 00 (PARAGRAPH 19-6).

15 October 2013

WP 021 00 Connectors

21-1 PURPOSE

Identify the technical information relative to connectors.

Specify the repair procedures for fabricating connectors.

Identify the workmanship standards for connectors.

NOTE

THE MATERIAL IN THIS WORK PACKAGE WAS PROVIDED BY
THE USCG TRAINING CENTER, PETALUMA, CA.

21-2 INDEX

Paragraph	Subject	Page
21-1	Purpose	1
21-2	Index	1
21-3	General Safety Precautions.....	2
21-4	Technical Information.....	3
21-5	Repair Procedures.....	3
21-5.1	Connector (Coaxial with Crimped Center Pin) Fabrication Procedure	4
21-5.2	Connector (Coaxial with Soldered Center Pin) Fabrication Procedure.....	8
21-5.3	Connector (PL-259 Coaxial with Soldered Center Pin) Fabrication Procedure.....	15
21-5.4	Connector (Cannon Plug) Fabrication Procedure	21
21-5.5	Connector (D-subminiature) Fabrication Procedure	21
21-5.6	Connector (Molex) Fabrication Procedure	28
21-5.7	Connector (RJ-45 and RJ-11) Fabrication Procedure	32
21-6	Workmanship Standards	36
21-6.1	Coaxial Cable Stripping	37
21-6.2	Connector Pins, Soldered.....	38
21-6.3	Connector Pins, Crimped	39
21-6.4	Shield Termination of Braid Clamp	40
21-6.5	Shield Termination of Crimped Ferrule	41
21-6.6	Connector Center Pin Position.....	41

21-3 GENERAL SAFETY PRECAUTIONS

Observe all the following precautions while installing connectors:

- Electronic equipment must be de-energized during removal and installation of CCAs
- Personnel are required to wear a properly grounded ESD wrist strap and cord while working in or around the EPA
- ESD can destroy components—protect ESDS devices during handling and repair to prevent ESD damage (Refer to WP 004 00)
- Isopropyl alcohol is flammable; do not use in the presence of sparks, heat, flame, or synthetic cloth
- Soldering handpieces (e.g., soldering irons, hot air jets) produce extreme heat—exercise care when these tools are out of their stands
- Avoid direct inhalation of fumes during a soldering operation because there is a possibility these fumes could cause occupational asthma
- The lead contained in solder is a source of lead oxide, which the human body cannot dissipate (accumulation of lead oxide in the body over a period of years can result in a serious health hazard)
- Contact with solder by holding in the mouth, smoking, or eating during or immediately after soldering is a potential means of ingesting trace amounts of lead oxide
- Avoid oral contact with hands during or immediately after solder operations
- Wash hands following any solder operation
- Wear approved PPE whenever pouring or handling molten metals or corrosive liquids and solids; and cutting, drilling, grinding, milling, chipping and other dust and debris producing operations
- Use adequate ventilation during thermal wire stripping operations because wire insulation may emit toxic fumes during thermal stripping
- Follow manufacturer's safety instructions for using chemical wire strippers
- Use chemical wire strippers only in well-vented areas, wear prescribed PPE, and avoid contact with skin and eyes

- Do not use wire with PVC [plastic] insulation to replace or repair installed military equipment wiring

21-4 TECHNICAL INFORMATION

Each connector fabrication procedure contains the technical information specific to that connector type.

Information and the Connector, Cannon Plug Fabrication Procedure is in WP 009 00 (paragraph 09-5.5)

Information and the Connector, DIN Fabrication Procedure is in WP 009 00 (paragraph 09-5.6)

21-5 REPAIR PROCEDURES



PROTECT STATIC SENSITIVE DEVICES DURING HANDLING AND REPAIR TO PREVENT ESD DAMAGE (REFER TO WP 004 00):

Equipment Required Listed below are the authorized 2M Power Units* for installation of connectors.

- **NAVAIR/NAVSEA/USMC/USAF/USCG—PRC-2000-SMT**
- **NAVSEA/USCG—PRC-2000-TH**
- **NAVSEA/USCG—MBT-250-SD**
- **USMC—MBT-350**
- **NAVSEA—ST-25**

* Refer to Table 03-3 for Power Unit Part No., and CAGE Code

Additional Support Items	For additional information regarding items of support and support equipment refer to: <ul style="list-style-type: none">• NAVSEA/NAVAIR/USCG—2M MTR Certification Manual• NAVSEA/USCG—Allowance Parts List (APL) 000A8423• USMC—Stock List SL-3-09458A• USAF—the Consolidated Tool Kit (CTK)
---------------------------------	---

Material Required	Listed below are the materials required* for installation of connectors: <ul style="list-style-type: none">• Flux, Soldering• Isopropyl Alcohol, Technical• Solder, Tin Alloy†• Towel, Paper (Kimwipe®)‡ <p>* Refer to Table 03-4 for Specification No., Part No., and NSN † Select size appropriate for application ‡ Substitution of equivalent material is acceptable</p>
--------------------------	---

21-5.1 Connector (Coaxial with Crimped Center Pin) Fabrication Procedure

Follow the directions in the replacement connector (if available) for specific installation requirements.

The following procedure is for typical coaxial connectors with crimped center pin replacement:

The **BNC Connector** is a miniature, quick connect/disconnect RF connector used for coaxial cable. BNC Connectors feature two bayonet lugs on the female connector; mating is achieved with only a quarter turn of the coupling nut. BNCs are ideally suited for cable termination for miniature-to-subminiature coaxial cable (e.g., RG-58, 59, to RG-179, RG-316).

The **TNC Connector** is a threaded version of the BNC Connector.



The **Type “N” Connector** is a threaded RF connector used to join coaxial cables. Type “N” was one of the first connectors capable of carrying microwave-frequency signals.

The **Mini-UHF Connector** is a miniaturized version of UHF connector designed primarily for use in mobile phones and similar applications where size is an important consideration. Mini-UHF has a 3/8-24 thread size and operates up to 2.5 GHz.

The **TNC Connector** is shown in this procedure.

Personnel Hazards No HAZMAT identified in the HMWS is used in this procedure.

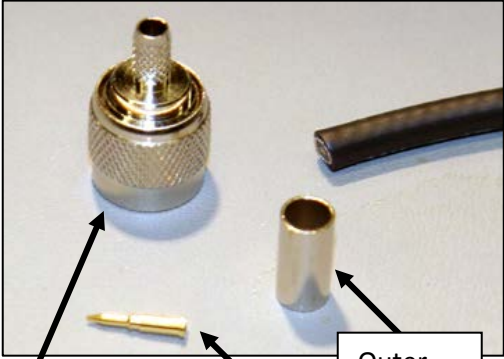
Connector (Coaxial with Crimped Center Pin) Fabrication Procedure



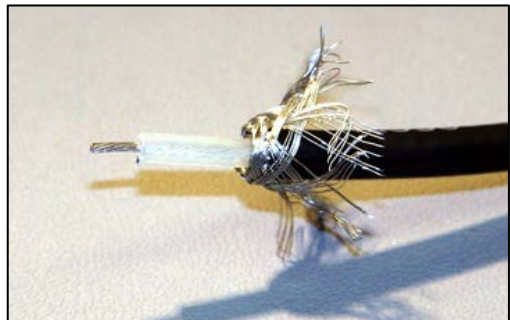
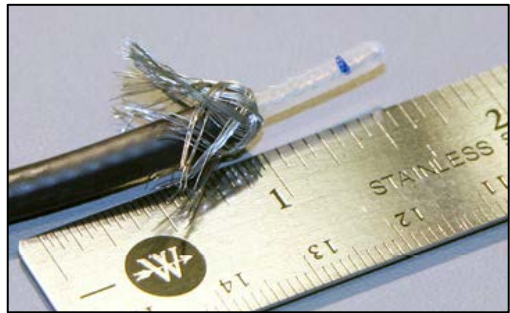
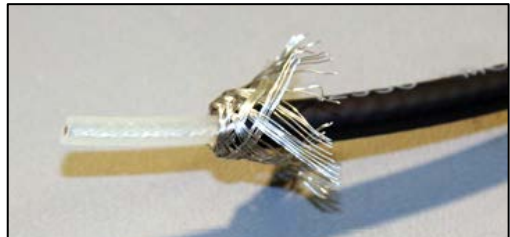
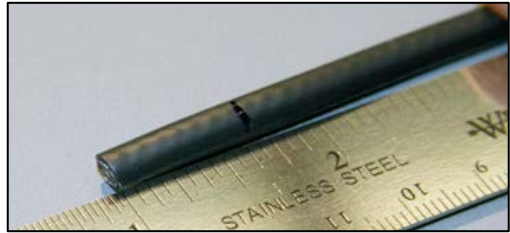

Step	Action
	<div style="text-align: center;"> <div style="border: 2px solid black; padding: 5px; width: fit-content; margin: 0 auto;">WARNING</div> <p>USE APPROVED SAFETY EYEWEAR WHEN PERFORMING THIS PROCEDURE.</p> <p>COMPLY WITH ALL LOCAL REQUIREMENTS FOR PPE.</p> <div style="border: 2px solid black; padding: 5px; width: fit-content; margin: 0 auto;">CAUTION</div> <p>DON A PROPERLY GROUNDED ESD WRIST STRAP BEFORE STARTING THIS PROCEDURE.</p> </div>
<p>1</p>	<p>Perform the Procedural Analysis and Feasibility of Repair Procedure in WP 003 00 (paragraph 03-5.1).</p>
<p>2</p>	<p>Inventory the connector kit for the following pieces:</p> <ul style="list-style-type: none"> • Main body • Pin • Outer ferrule <div style="text-align: right;">  </div>
<p>3</p>	<p>Slip the outer ferrule onto the cable.</p> <div style="text-align: right;">  </div>

Connector (Coaxial with Crimped Center Pin) Fabrication Procedure



Step	Action
4	<p>Measure 5/8 in. down from the top of the cable, and strip outer jacket of the coaxial cable without damaging the metallic shielding.</p> <p>Note: The amount to be stripped may vary pending specific connector configuration.</p>
5	<p>Remove the excess outer jacket and re-measure to ensure 5/8 in. removed.</p>
6	<p>Flare the braided shield away from the dielectric and down around the outer jacket.</p>
7	<p>Measure 7/16 in. from the end of the outer jacket to the end of the dielectric.</p> <p>Note: The amount stripped may vary pending specific connector configuration.</p>
8	<p>Strip off the dielectric, exposing center conductor per the Mechanical Wire Stripping Procedure in WP 008 00 (paragraph 08-5.3.2).</p>



Connector (Coaxial with Crimped Center Pin) Fabrication Procedure

Step	Action
9	<p>Slide the pin on for dry-fit measurement, ensuring there is no space between the base of the pin and the dielectric.</p> 
10	<p>Trim the excess conductor, if any exists after dry-fit measurement.</p> 
11	<p>Position the center pin on the center conductor.</p> 
12	<p>Crimp the pin to the conductor, ensuring the pin touches the dielectric.</p> 
13	<p>Slide the main body of the connector on until it locks in place.</p> <p>Note: The tip of the pin should be even with the end of the inner ferrule.</p> 

Connector (Coaxial with Crimped Center Pin) Fabrication Procedure

Step	Action
14	Fold the metallic shielding to the main body.
15	Trim the metallic shielding so it is no longer than the neck of the connector body. 
16	Bring the outer ferrule up to the main body, and crimp it into place. 
17	Test the connector strength using a pull test. 
18	Test the cable for continuity using a multimeter.
19	Dispose of all <i>HAZMAT</i> following local procedures.

21-5.2 Connector (Coaxial with Soldered Center Pin) Fabrication Procedure















Follow the directions in the replacement connector package (if available) for specific installation requirements. The following procedure is for a typical coaxial connector replacement.

The following components (Figure 21-1) make up the contents of the typical coaxial connector with soldered pin kit:



Figure 21-1 Coaxial Connector Kit Components



Personnel Hazards

					
Alcohol, Isopropyl					1
					
Flux (Soldering)					8
					
Lead (Solder)					9





Connector (Coaxial with Soldered Center Pin) Fabrication Procedure

Step	Action
	<div style="text-align: center;"> <div style="border: 2px solid black; padding: 5px; display: inline-block;">WARNING</div> <p>USE APPROVED SAFETY EYEWEAR WHEN PERFORMING THIS PROCEDURE.</p> <p>COMPLY WITH ALL LOCAL REQUIREMENTS FOR PPE.</p> </div>



Connector (Coaxial with Soldered Center Pin) Fabrication Procedure

Step	Action
	<div style="border: 2px solid black; padding: 5px; display: inline-block; margin-bottom: 10px;">CAUTION</div> <p>DON A PROPERLY GROUNDED ESD WRIST STRAP BEFORE STARTING THIS PROCEDURE.</p>
1	Perform the Procedural Analysis and Feasibility of Repair Procedure in WP 003 00 (paragraph 03-5.1).
2	<p>Inventory the connector kit for the following (see Figure 21-1):</p> <ul style="list-style-type: none"> <li style="display: inline-block; width: 45%; vertical-align: top;"> <ul style="list-style-type: none"> • pin • connector body • clamp nut • dielectric bushing • braid clamp <li style="display: inline-block; width: 45%; vertical-align: top;"> <ul style="list-style-type: none"> • rubber gasket • metal washer • metal bushing • connector body center dielectric bushing
3	<p>Slip the clamp nut, metal washer, and rubber gasket onto the cable in this order.</p> <p>Note: The threaded portion of the clamp nut should be positioned toward the connector end, and the smooth side of the rubber gasket should be positioned toward the clamp nut.</p>
	
4	<p>Measure 3/8 in. down from the top of the cable, and strip outer jacket of the coaxial cable without damaging the metallic shielding.</p> <p>Note: The amount stripped may vary pending specific connector configuration.</p>
	
5	Remove the excess outer jacket.
	

Connector (Coaxial with Soldered Center Pin) Fabrication Procedure

Step	Action
6	<p>Slide the braid clamp down over the metallic shield.</p> <p>Note: The outer jacket will stop the braid clamp.</p> 
7	<p>Flare the braided shield away from the dielectric and down over the braid clamp.</p> 
8	<p>Trim the shielding at the centerline of the braid clamp.</p>
9	<p>Remove all but 1/8 in. of the dielectric per the Mechanical Wire Stripping Procedure in WP 008 00 (paragraph 08-5.3.2).</p> <p>Note: The amount stripped may vary pending specific connector configuration.</p> 
10	<p>Reestablish natural lay of the center conductor strands as needed.</p> 
11	<p>Tin the center conductor per the Insulated Wire Tinning Procedure in WP 008 00 (paragraph 08-5.4).</p> <p>Note: Be sure not to increase the diameter of the center conductor.</p>



Connector (Coaxial with Soldered Center Pin) Fabrication Procedure

Step	Action
12	<p><i>Inspect per the General Inspection Procedure in WP 003 00 (paragraph 03-5.12) to all applicable WORKMANSHIP STANDARDS, including:</i></p> <ul style="list-style-type: none"> • <i>Wires in WP 008 00 (paragraph 08-6.1)</i> • <i>Insulated Wire Stripping in WP 008 00 (paragraph 08-6.2)</i> • <i>Insulated Wire Tinning in WP 008 00 (paragraph 08-6.3)</i>
13	<p>Test fit the center pin on the center conductor.</p> <p>Note: The center pin should lay flush against the dielectric. Ensure no tinned conductor shows. Trim if necessary.</p> 
14	<p>Place the metal bushing over the dielectric, ensuring it sits flush on the braid.</p> 
15	<p>Slide the dielectric bushing and pin onto the center conductor, flush with the metal bushing, and with side A up and side B down.</p> 
16	<p>Select a soldering iron tip that maximizes heat transfer and contact area with the center conductor.</p>
17	<p>Set the soldering iron tip temperature to 600°F (316°C).</p>
18	<p>Clean the center pin with isopropyl alcohol using an acid brush and blot dry with a clean, lint-free tissue.</p>
19	<p>Clean the solder with isopropyl alcohol and wipe dry with a clean, lint-free tissue.</p>



Connector (Coaxial with Soldered Center Pin) Fabrication Procedure

Step	Action
20	Remove the seasoning (all solder) from the soldering iron tip.
21	Thermally shock the soldering iron tip on a damp sponge.
22	<p style="text-align: center;">CAUTION</p> <p style="text-align: center;">DO NOT APPLY PRESSURE WITH THE SOLDERING IRON.</p> <p>Place the soldering iron tip on the center pin opposite side from the inspection window.</p>
23	<p style="text-align: center;">CAUTION</p> <p style="text-align: center;">IF SOLDER MELT DOES NOT OCCUR WITHIN TWO SECONDS, STOP THIS PROCEDURE AND ADJUST TIP TEMPERATURE PER THE TIP TEMPERATURE PROCEDURE IN WP 003 00 (PARAGRAPH 03-5.4).</p> <p style="text-align: center;">DO NOT APPLY HEAT TOO LONG OR THE DIELECTRIC BUSHING COULD WARP.</p> <p>Carefully add solder sparingly to the inspection window.</p> 
24	Remove the solder and the soldering iron tip simultaneously.
25	Season the tip and place the soldering iron into its stand.
26	Allow the center pin to cool completely before cleaning.
27	Clean the center pin with isopropyl alcohol using an acid brush to remove all flux residue and blot dry with a clean, lint-free tissue.

Connector (Coaxial with Soldered Center Pin) Fabrication Procedure

Step	Action
28	<i>Visually inspect the inspection window to ensure it is soldered and there is no spillage on the center pin.</i>
29	Slide the connector body's bushing over the pin, if applicable. The bushing should sit flush against the dielectric bushing. 
30	Slide the metal connector body over the entire assembly. 
31	Secure the washer and rubber gasket with the camp nut. 

Connector (Coaxial with Soldered Center Pin) Fabrication Procedure















Step	Action
32	<div data-bbox="797 422 1029 489" style="border: 2px solid black; padding: 5px; text-align: center; margin-bottom: 10px;">CAUTION</div> <p data-bbox="477 510 1352 537" style="text-align: center;">DO NOT ALLOW THE CONNECTOR BODY MOVE RELATIVE TO THE CABLE.</p> <p data-bbox="396 751 867 821">Hand-tighten the clamp nut, then finish tightening with wrenches.</p> 
33	<p data-bbox="396 1125 867 1194">Test the connector strength using a pull test.</p> 
34	<p data-bbox="396 1325 971 1352">Test the cable for continuity using a multimeter.</p>
35	<p data-bbox="396 1398 997 1425">Dispose of all <i>HAZMAT</i> following local procedures.</p>

21-5.3 Connector (PL-259 Coaxial with Soldered Center Pin) Fabrication Procedure



Follow the directions in the replacement connector packaging (if available) for specific installation requirements.

The following procedure is for a typical PL-259 coaxial connector replacement:



Personnel Hazards

					
Alcohol, Isopropyl					1
					
Flux (Soldering)					8
					
Lead (Solder)					9

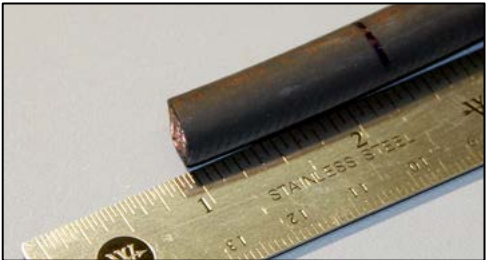

Connector (PL-259 Coaxial with Soldered Center Pin) Fabrication Procedure

Step	Action
	<p style="text-align: center;">WARNING</p> <p style="text-align: center;"><i>USE APPROVED SAFETY EYEWEAR WHEN PERFORMING THIS PROCEDURE. COMPLY WITH ALL LOCAL REQUIREMENTS FOR PPE.</i></p> <p style="text-align: center;">CAUTION</p> <p style="text-align: center;">DON A PROPERLY GROUNDED ESD WRIST STRAP BEFORE STARTING THIS PROCEDURE.</p>
1	Perform the Procedural Analysis and Feasibility of Repair Procedure in WP 003 00 (paragraph 03-5.1).
2	<p>Inventory the PL-259 connector kit contents: threaded collar and main body with pin.</p> <div style="text-align: right; margin-top: 10px;">  <div style="display: flex; justify-content: space-around; margin-top: 5px;"> <div style="text-align: center;">  Threaded collar </div> <div style="text-align: center;">  Main body with pin </div> </div> </div>

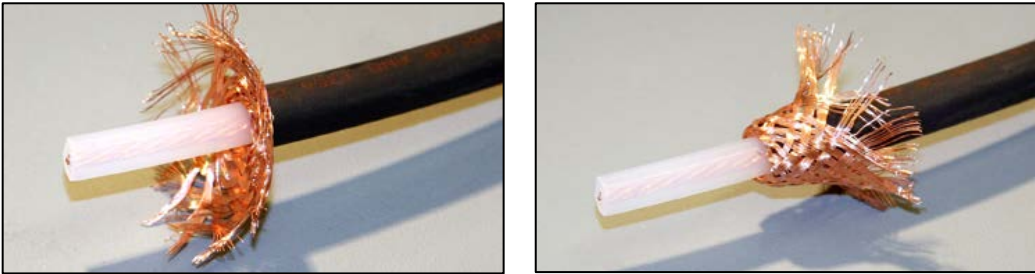
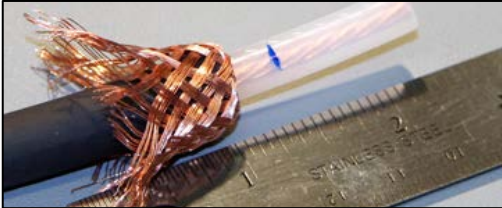

Connector (PL-259 Coaxial with Soldered Center Pin) Fabrication Procedure

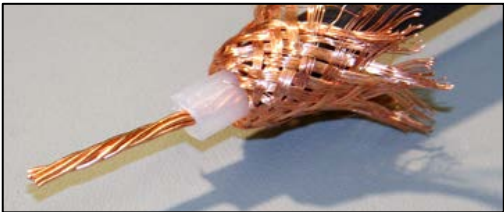
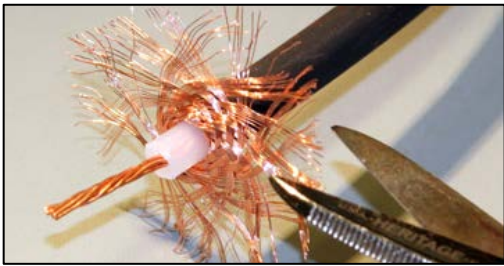
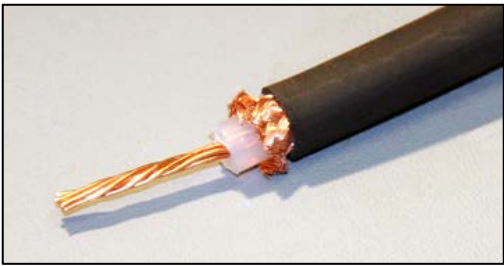
Step	Action
3	<p>Slip the threaded collar over the cable with the threaded side towards the connector end of the cable.</p> 
4	<p>Measure 1 ¼ in. down from the top of the cable, and strip outer jacket of the coaxial cable without damaging the metallic shielding.</p> <p>Note: The amount stripped may vary pending specific connector configuration.</p> 
5	<p>Remove the outer jacket.</p> 
6	<p>Flare the braided shield away from the dielectric and down around the outer jacket.</p> 
7	<p>Measure 5/16 in. from the end of the outer jacket to the end of the dielectric and mark on the outer jacket.</p> <p>Note: The amount stripped may vary pending specific connector configuration.</p> 

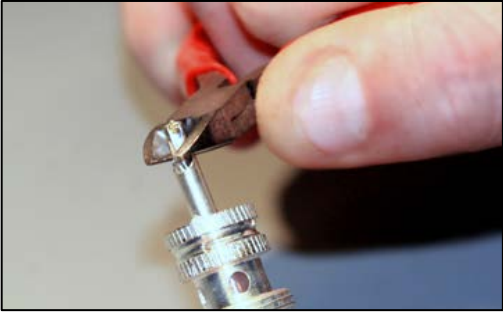

Connector (PL-259 Coaxial with Soldered Center Pin) Fabrication Procedure

Step	Action
8	<p>Strip off dielectric exposing center conductor per the Mechanical Wire Stripping Procedure in WP 008 00 (paragraph 08-5.3.2).</p> 
9	<p>Trim the metallic shielding. The shielding needs to be shorter than the exposed dielectric and must not contact the center conductor.</p>  
10	<p>Tin the center conductor per the Insulated Wire Tinning Procedure in WP 008 00 (paragraph 08-5.4).</p>
11	<p>Clean the center conductor with isopropyl alcohol and wipe dry with a clean, lint-free tissue.</p>
12	<p><i>Inspect per the General Inspection Procedure in WP 003 00 (paragraph 03-5.12) to all applicable WORKMANSHIP STANDARDS, including:</i></p> <ul style="list-style-type: none"> • <i>Wires in WP 008 00 (paragraph 08-6.1)</i> • <i>Insulated Wire Stripping in WP 008 00 (paragraph 08-6.2)</i> • <i>Insulated Wire Tinning in WP 008 00 (paragraph 08-6.3)</i>
13	<p>Slide the main body with the pin on (the main body is threaded, so it will screw onto the outer jacket).</p> 

Connector (PL-259 Coaxial with Soldered Center Pin) Fabrication Procedure

Step	Action
14	View the braided shield through the holes in the main body to verify the main body is fully seated. 
15	Trim the excess conductor so it is flush with the end of the pin.  
16	Select a soldering iron tip that maximizes heat transfer and contact area with the center pin.
17	Set the soldering iron tip temperature to 600°F (316°C).
18	Clean the solder with isopropyl alcohol and wipe dry with a clean, lint-free tissue.
19	Apply flux SPARINGLY to the end of the center pin. Note: Use a toothpick or flux pen to control the volume of flux applied. Heavy flux volume impairs cleaning and may affect reliability.
20	Remove the seasoning (all solder) from the soldering iron tip.
21	Thermally shock the soldering iron tip on a damp sponge.
22	<div style="border: 2px solid black; padding: 5px; display: inline-block; margin-bottom: 10px;">CAUTION</div> <p>DO NOT APPLY PRESSURE WITH THE SOLDERING IRON.</p> <p>Place the soldering iron tip on the bottom side of the center pin.</p>

Connector (PL-259 Coaxial with Soldered Center Pin) Fabrication Procedure

Step	Action
23	<div style="text-align: center; border: 1px solid black; padding: 5px; margin-bottom: 10px;">CAUTION</div> <p style="text-align: center;">IF SOLDER MELT DOES NOT OCCUR WITHIN TWO SECONDS, STOP THIS PROCEDURE AND ADJUST TIP TEMPERATURE PER THE TIP TEMPERATURE PROCEDURE IN WP 003 00 (PARAGRAPH 03-5.4).</p> <p>Apply solder to the cut out portion of the pin.</p> <div style="display: flex; justify-content: space-around;">   </div>
24	Remove the solder and the soldering iron tip simultaneously.
25	Season the tip and place the soldering iron into its stand.
26	Allow the center pin to cool completely before cleaning.
27	<p>Clean the center pin with isopropyl alcohol using an acid brush to remove all flux residue and blot dry with a clean, lint-free tissue.</p> 
28	<p><i>Inspect per the General Inspection Procedure in WP 003 00 (paragraph 03-5.12) to all applicable WORKMANSHIP STANDARDS, including:</i></p> <ul style="list-style-type: none"> • <i>General Solder Acceptability in WP 005 00 (paragraph 05-6.1)</i> • <i>Post-Solder Joint Cleanliness in WP 005 00 (paragraph 05-6.2)</i> • <i>Other applicable Workmanship Standards as required</i>

Connector (PL-259 Coaxial with Soldered Center Pin) Fabrication Procedure

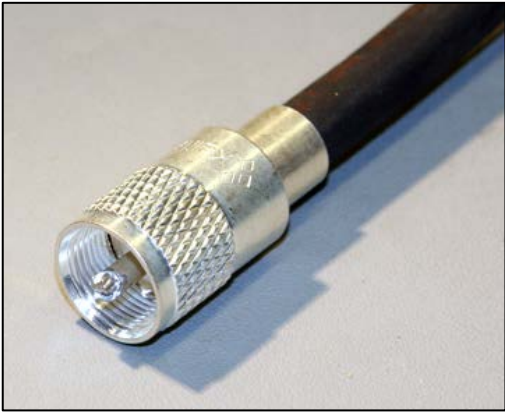
Step	Action
29	Test the connector strength using a pull test. 
30	Test the cable for continuity using a multimeter.
31	Dispose of all <i>HAZMAT</i> following local procedures.

21-5.4 Connector (Cannon Plug) Fabrication Procedure

Use the Connector, Cannon Plug Fabrication Procedure in WP 009 00 (paragraph 09-5.5) to install a Cannon Plug connector.

21-5.5 Connector (D-subminiature) Fabrication Procedure

A D-subminiature connector contains two or more parallel rows of pins or sockets usually surrounded by a D-shaped metal shield providing mechanical support, ensure correct orientation, and may screen against electromagnetic interference.

Examples of D-subminiature connectors are shown on the right.

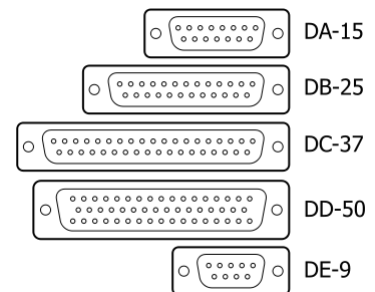

A DB-25 Connector Kit is shown in Figure 21-2.

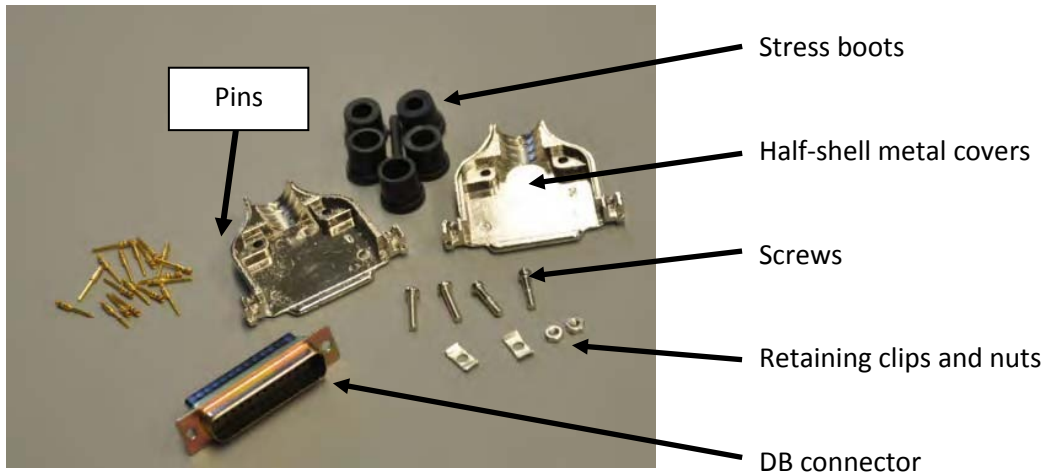





Figure 21-2 DB-25 Connector Kit

Personnel Hazards No HAZMAT identified in the HMWS is used in this procedure.



Connector (D-subminiature) Fabrication Procedure

Step	Action
	<div style="text-align: center;"> <div style="border: 2px solid black; padding: 5px; margin-bottom: 10px;">WARNING</div> <p>USE APPROVED SAFETY EYEWEAR WHEN PERFORMING THIS PROCEDURE. COMPLY WITH ALL LOCAL REQUIREMENTS FOR PPE.</p> <div style="border: 2px solid black; padding: 5px; margin-bottom: 10px;">CAUTION</div> <p>DON A PROPERLY GROUNDED ESD WRIST STRAP BEFORE STARTING THIS PROCEDURE.</p> </div>
1	Perform the Procedural Analysis and Feasibility of Repair Procedure in WP 003 00 (paragraph 03-5.1).
2	Inventory the DB connector kit for the following pieces: <ul style="list-style-type: none"> • 2 half shell metal covers • stress boot • 4 screws • 2 retaining clips • 2 nuts.

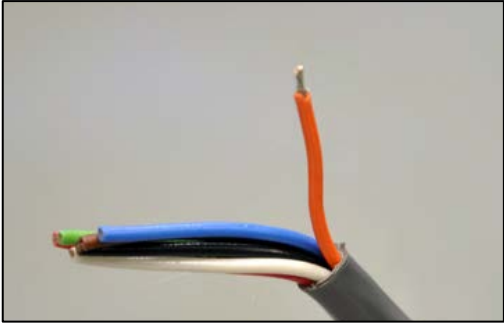
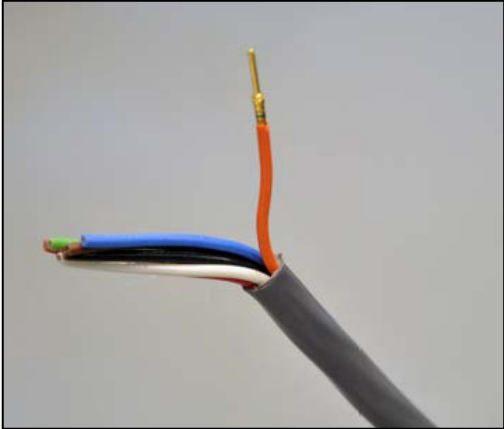

Connector (D-subminiature) Fabrication Procedure

Step	Action
	<p>The following pieces are separate from the kit:</p> <ul style="list-style-type: none">• DB connector and pins.
3	<p>Slip the stress boot onto the multi-wire cable (with the ridged side away from the connector).</p> 
4	<p>Measure 1 ¼ in. down from the top of the cable, and strip the outer jacket off the coaxial cable without damaging the inner wires.</p> 
5	<p>Remove the excess outer jacket.</p> 

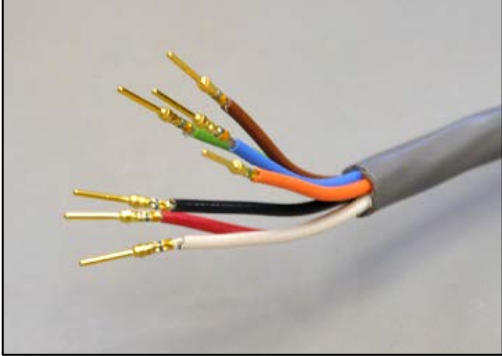
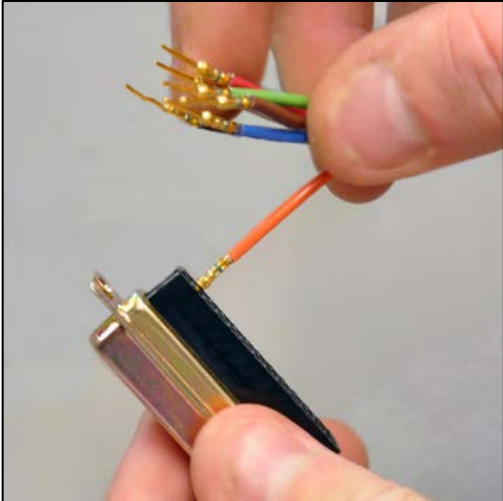
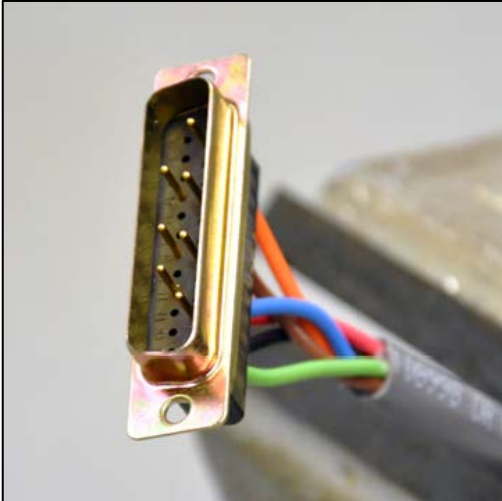

Connector (D-subminiature) Fabrication Procedure

Step	Action
6	<p>Strip ¼ in. off the end of each wire per the Mechanical Wire Stripping Procedure in WP 008 00 (paragraph 08-5.3.2).</p> <div style="display: flex; justify-content: space-around;">   </div>
7	<p>Position a pin on a conductor.</p> <div style="display: flex; justify-content: space-around;">  </div>
8	<p>Crimp the pin to the wire using the connector DB connector crimper.</p> <div style="display: flex; justify-content: space-around;">  </div>

Connector (D-subminiature) Fabrication Procedure

Step	Action
9	<p>Repeat steps 7 and 8 until all the wires have pins.</p> 
10	<p>Insert the pins with wires attached into the connector.</p>  
11	<p>Set one metal cover half on the desk.</p> 

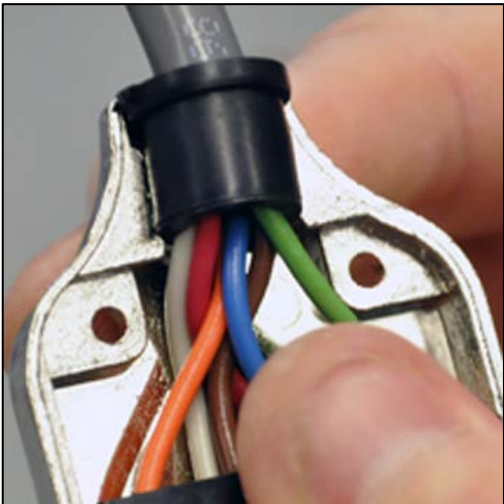

Connector (D-subminiature) Fabrication Procedure

Step	Action
12	<p>Slide the stress boot to $\frac{3}{4}$ in. from the pin housing.</p> 
13	<p>Insert the pin housing into the cutout of the metal cover.</p> 
14	<p>Insert the stress boot into the cutout of the metal cover (adjust the boot position on the cable if needed).</p> 

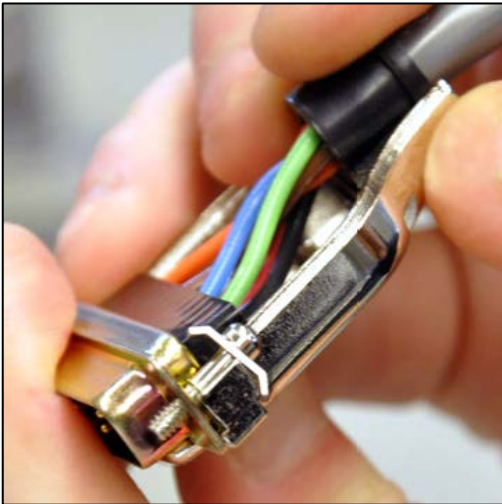
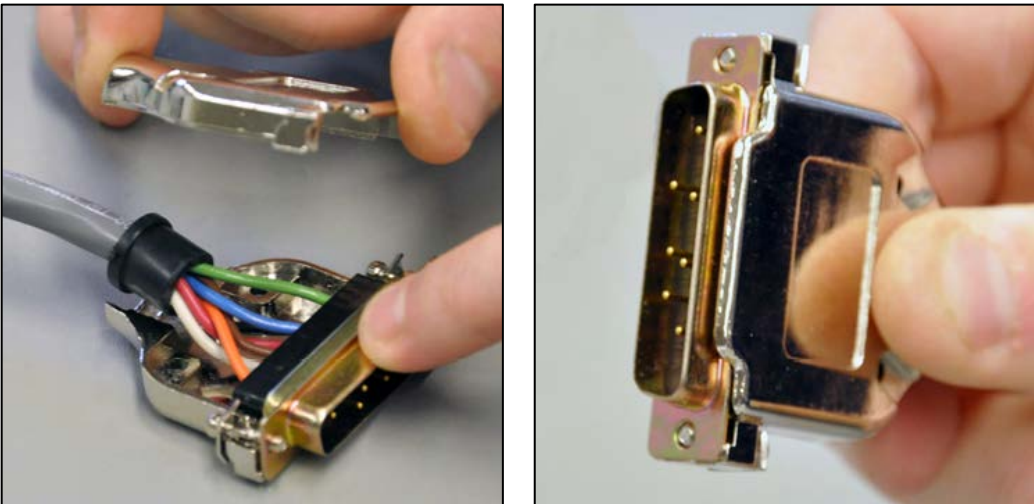
Connector (D-subminiature) Fabrication Procedure

Step	Action
15	<p>Take the two screws that have threads halfway up the screw post, and insert them into the two angled retaining clips.</p> 
16	<p>Insert the two screws with retaining clips into the holes in the pin housing and the cutouts in the metal cover.</p> 
17	<p>Line up the two metal cover halves, and place together.</p> 

Connector (D-subminiature) Fabrication Procedure

Step	Action
18	<p>Insert the two nuts and two screws into the cover, and tighten the DB connector.</p> 
19	<p>Test the connector strength using a pull test.</p> 
20	<p>Test the cable for continuity using a multimeter.</p>
21	<p>Dispose of all HAZMAT following local procedures.</p>

21-5.6 Connector (Molex) Fabrication Procedure

Follow the directions in the replacement connector (if available) for specific installation requirements.

The following procedure is for a typical Molex Connector replacement.

Molex Connectors have cylindrical spring-metal pins fitting into cylindrical spring-metal sockets.

The pins and sockets are held in a rectangular matrix in a nylon shell.

The connector typically has 2 to 24 contacts and is polarized or keyed to ensure correct orientation.





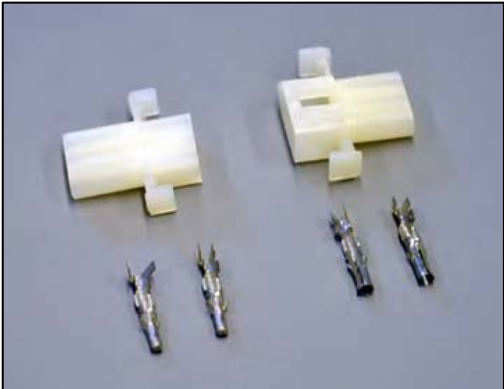

Pins and sockets can be arranged in any combination in a single housing, which can be either male or female.

Personnel Hazards No HAZMAT identified in the HMWS is used in this procedure.

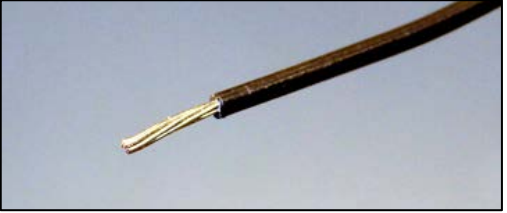

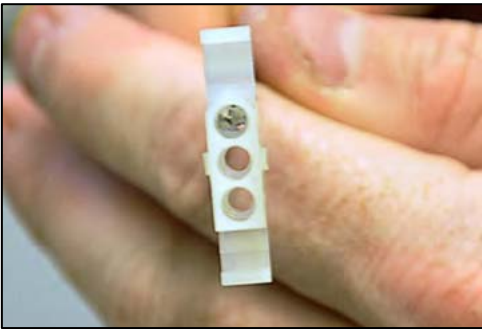

Connector (Molex) Fabrication Procedure

Step	Action
	<div style="text-align: center;"> <div style="border: 2px solid black; padding: 5px; display: inline-block; margin-bottom: 10px;">WARNING</div> <p>USE APPROVED SAFETY EYEWEAR WHEN PERFORMING THIS PROCEDURE.</p> <p>COMPLY WITH ALL LOCAL REQUIREMENTS FOR PPE.</p> <div style="border: 2px solid black; padding: 5px; display: inline-block; margin-bottom: 10px;">CAUTION</div> <p>DON A PROPERLY GROUNDED ESD WRIST STRAP BEFORE STARTING THIS PROCEDURE.</p> </div>
1	Perform the Procedural Analysis and Feasibility of Repair Procedure in WP 003 00 (paragraph 03-5.1).
2	<p>Inventory the Molex connector kit for the following pieces:</p> <ul style="list-style-type: none"> • male plug • female plug • male pin(s) • female pin(s) <div style="text-align: right;">  </div>

Connector (Molex) Fabrication Procedure

Step	Action	
Steps for Plug		
3	Strip ¼ in. off the end of the wire.	
4	Place the end of the wire into the male terminal.	
5	Crimp in place.	
		
6	Insert the pin into the plug using the pin out in the equipment technical manual.	
		
7	Repeat steps 3 through 6 until complete.	

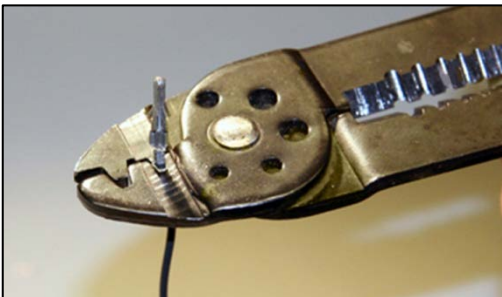
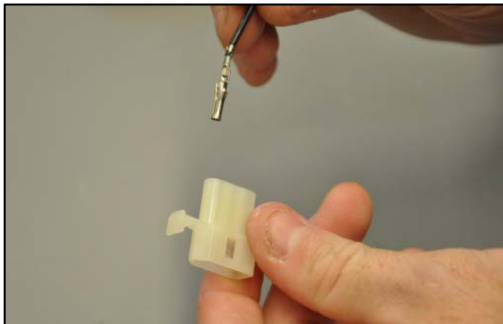
Connector (Molex) Fabrication Procedure

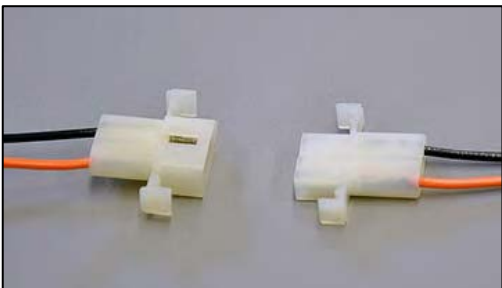
Step	Action
Steps for Receptacle	
8	<p>Strip ¼ in. off the end of the wire per the Mechanical Wire Stripping Procedure in WP 008 00 (paragraph 08-5.3.2) and place the end of the wire into the female terminal.</p> 
9	<p>Crimp in place.</p>  
10	<p>Insert the pin into the receptacle.</p>  
11	<p>Repeat steps 8 through 10 until complete.</p> 

Connector (Molex) Fabrication Procedure

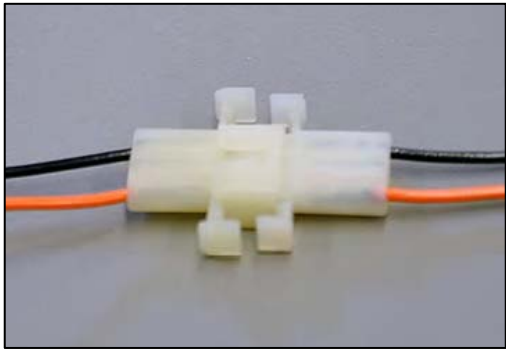
Step	Action
12	Test the connector strength by putting male and female ends together and using a pull test. 
13	Test the cable for continuity using a multimeter.
14	Dispose of all HAZMAT following local procedures.

21-5.7 Connector (RJ-45 and RJ-11) Fabrication Procedure

Follow the directions in the replacement connector (if available) for specific installation requirements.

The following procedure is for a typical RJ-45 connector replacement. RJ (Registered Jack) connectors are used for telecommunication and computer applications. RJ-11, a four- or six-wire connector, is used primarily to connect telephone equipment. RJ-45, an eight-wire connector used commonly to connect computers to local-area networks (LAN), especially Ethernets. RJ-45 connectors look similar to the ubiquitous RJ-11 connectors used for connecting telephone equipment, but they are somewhat wider.

NOTE

STRAIGHT-THROUGH HAS (A) PINOUT ON BOTH ENDS OF THE CABLE. CROSSOVER HAS (A) ON ONE END OF THE CABLE AND (B) ON THE OTHER END OF THE CABLE. THE COLOR CODE FOR PINOUT (B) IS STRIPED ORANGE, SOLID ORANGE, STRIPED GREEN, SOLID BLUE, STRIPED BLUE, SOLID GREEN, STRIPED BROWN, SOLID BROWN.

Personnel Hazards No HAZMAT identified in the HMWS is used in this procedure.

Connector (RJ-45 and RJ-11) Fabrication Procedure

Step	Action
	<p style="text-align: center;">WARNING</p> <p style="text-align: center;"><i>USE APPROVED SAFETY EYEWEAR WHEN PERFORMING THIS PROCEDURE. COMPLY WITH ALL LOCAL REQUIREMENTS FOR PPE.</i></p> <p style="text-align: center;">CAUTION</p> <p style="text-align: center;">DON A PROPERLY GROUNDED ESD WRIST STRAP BEFORE STARTING THIS PROCEDURE.</p>
1	Perform the Procedural Analysis and Feasibility of Repair Procedure in WP 003 00 (paragraph 03-5.1).
2	Inventory the RJ-45 connector kit for the connector. 
3	Strip 1½ to 2 in. from the outer jacket of the wire, being careful not to damage the wires.

Connector (RJ-45 and RJ-11) Fabrication Procedure

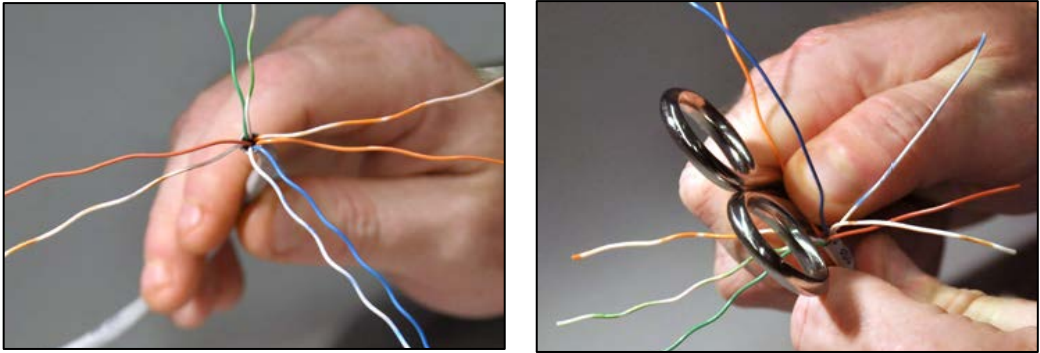
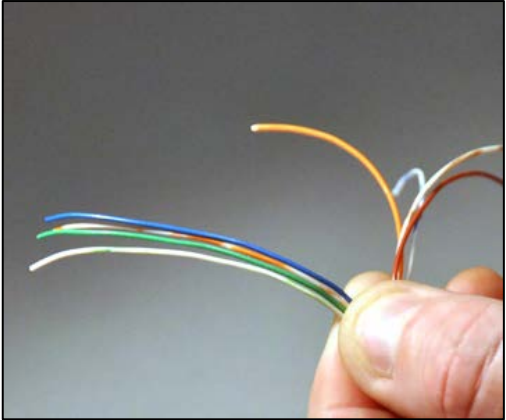
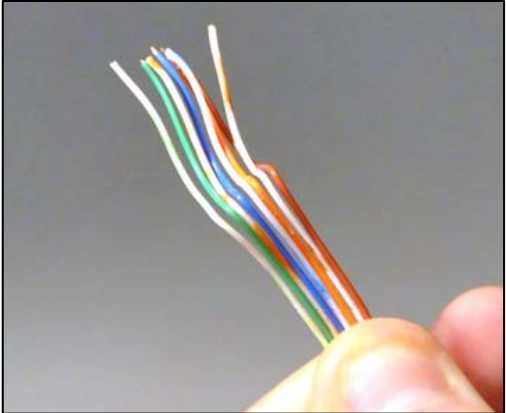
Step	Action
4	<p>Separate the twisted wire pairs, and, using the smooth side of your scissors, place the wire between the scissors and your thumb, and pull to smooth out ripples in the wire.</p> 
5	<p>Align the individual wires in the following order for the standard pinout (A):</p> <ul style="list-style-type: none">• striped green• solid green• striped orange• solid blue• striped blue• solid orange• striped brown• solid brown 
6	<p>Flatten the wires into a “ribbon” so they will easily slip into the connector and into the individual channeled areas.</p> 

Connector (RJ-45 and RJ-11) Fabrication Procedure

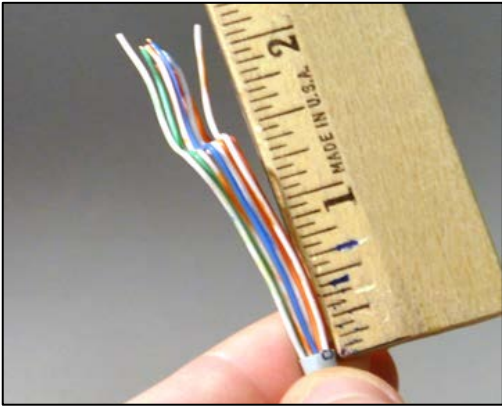
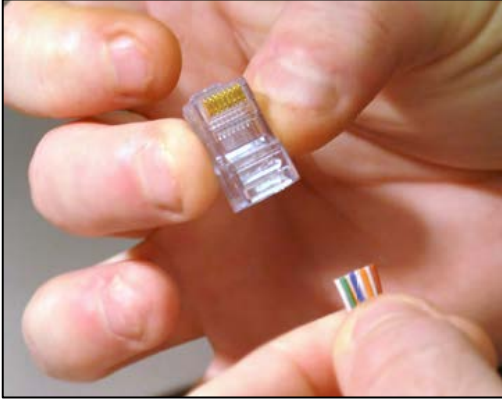
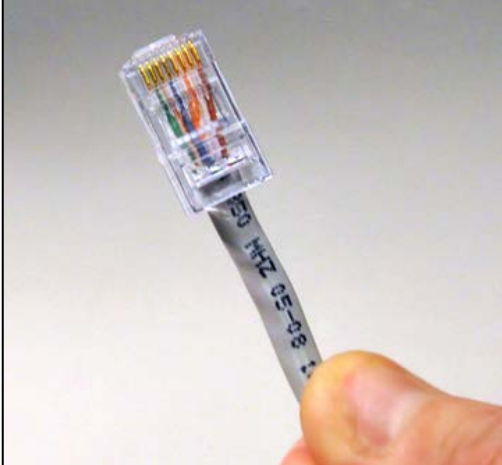
Step	Action
7	<p>Trim off the wire ends to ½ in. in length.</p> 
8	<p>Insert the wires all at once into the connector while holding them in the order outlined in step 4; each wire should feed into its individual channel.</p> 
9	<p>Ensure the wire extends all the way to the end of the connector underneath the brass connectors.</p>
10	<p>Press the cable and the jacket into the connector firmly so the jacket will be crimped by the plastic wedge near the rear of the connector.</p> 

Connector (RJ-45 and RJ-11) Fabrication Procedure

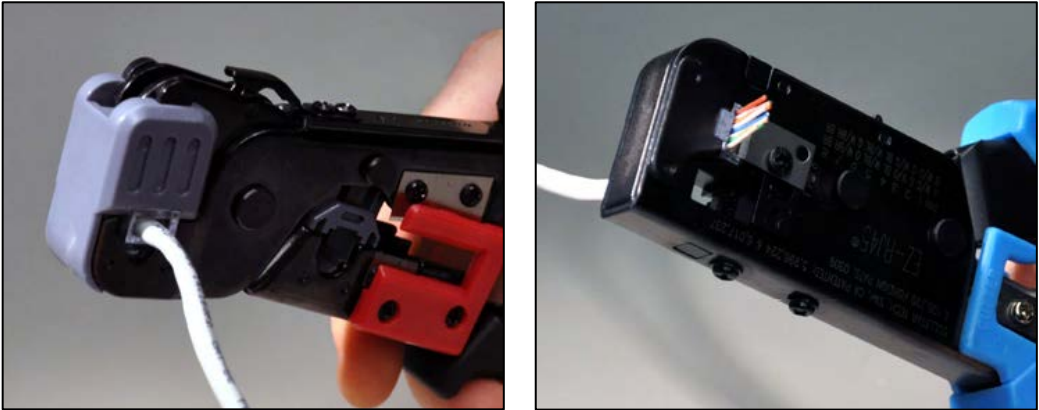
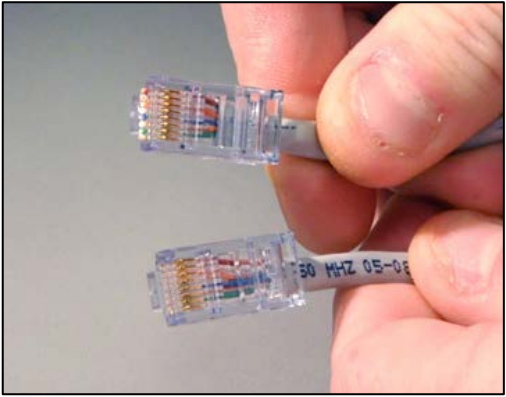
Step	Action
11	<p>Crimp the cable, using a crimping tool.</p> 
12	<p>Repeat steps 3 through 11 for the other end of the cable for a standard straight-through Ethernet cable.</p>
13	<p>Test the connector strength using a pull test.</p> 
14	<p>Test the cable for continuity using a multimeter.</p>
15	<p>Dispose of all HAZMAT following local procedures.</p>

21-6 WORKMANSHIP STANDARDS

Refer to WP 003 00 (paragraph 03-6) for definitions of Workmanship Standards.

NOTE

WORKMANSHIP STANDARDS FOR GENERAL SOLDER ACCEPTABILITY AND POST-SOLDER JOINT CLEANLINESS ARE IN WP 005 00 (PARAGRAPH 05-6), TERMINALS IN WP 008 00 (PARAGRAPH 08-6), AND SOLDER CUPS IN WP 009 00 (PARAGRAPH 09-6).

21-6.1 Coaxial Cable Stripping

Coaxial Cable Stripping

Target Condition	Acceptable Condition	Defect Condition
Smooth, clean cut; no jagged edges.	Slight marks on dielectric.	Any cuts or breaks in outer jacket.
		Outer jacket thickness is reduced greater than 20%.
		Uneven or ragged pieces (frays, tails, tags) of outer jacket are greater than 50% of the outer jacket thickness or 1 mm whichever is more.
	Slight discoloration on dielectric from thermal stripping.	Burns or melted areas on dielectric.
		Damage to center dielectric reducing insulation diameter by more than 10%.
Braid/shield cut even.		Uneven cut on braid; any long strands.
Braid lies smooth and flat after cut .	Minor unraveling of braid.	Braid twisted/birdcaged.
	Damaged or missing braid does not exceed allowance of Table 21-1.	Missing or damaged braid exceeds the allowance of Table 21-1.
		Discernible nicks or cuts in center conductor.

Table 21-1 Coax Cable Strand Damage

Number of Strands	Maximum Allowable Strands Scraped, Nicked or Severed		
	Shield Braid	Center Conductor	
		Crimped Terminations	Soldered Terminations
Less than 7	0	0	0
7-15	1	0	1
16-25	3	0	2
26-40	4	3	3
41-60	5	4	4
61-120	6	5	5
121 or more	6%	5%	5%

21-6.2 Connector Pins, Soldered

Connector Pins, Soldered

Target Condition	Acceptable Condition	Defect Condition
During assembly center conductor visible across full diameter of inspection window.		Prior to soldering, center conductor not visible in inspection window.
The inspection window is filled with solder.		Solder not visible in inspection window.
	Minor flare of dielectric due to heat from solder does not interfere with assembly of connector.	Damage to dielectric due to heat from soldering process interferes with the assembly of the connector.
Solder is confined to the inside of the terminal.	Solder slightly protrudes from inspection window, but will not interfere with assembly.	Excess solder prevents proper assembly of connector and electrical impedance of the connector.

Connector Pins, Soldered

Target Condition	Acceptable Condition	Defect Condition
Solder is wetted to both the terminal and the conductor.		No discernible solder fillet or wetting between terminal and conductor.
		Solder on mating surface of contact.
Terminal is flush against dielectric.	Terminal is less than or equal to 1/8 inch from dielectric	Terminal embedded into dielectric or greater than 1/8 inch from dielectric.
		Strand(s) of center conductor not captured in terminal.
		Braid extends into barrel of terminal.

21-6.3 Connector Pins, Crimped

Connector Pins, Crimped

Target Condition	Acceptable Condition	Defect Condition
Crimp is centered on crimp area of terminal.	Crimp is not centered on crimp area of terminal, but does not cause damage to terminal.	Crimp is not centered in crimp area of terminal and causes damage to terminal.
Equal compression on all crimp surfaces.		Terminal damaged by crimp.
		Crimp loose - does not hold terminal.
	Dielectric does not enter barrel of terminal.	
		Conductor strand(s) not captured in terminal.

Connector Pins, Crimped

Target Condition	Acceptable Condition	Defect Condition
		Pin shows "dog ear" of excess material.
		Braid strand(s) caught in terminal.

21-6.4 Shield Termination of Braid Clamp

Shield Termination of Braid Clamp

Target Condition	Acceptable Condition	Defect Condition
Braid/shield evenly distributed around the braid clamp.	Shield strands not uniformly distributed around the braid clamp.	
Shield strands are close to, but not in contact with, the outer shoulder flange of the braid clamp.	Shield strands contact outer shoulder flange of the braid clamp but do not impede assembly of the connector.	
Shield ground strands hold the braid clamp in tight contact with the cable outer jacket.		Shield strands do not hold the braid clamp in tight contact with the cable outer jacket.
		Cable is displaced from position on ferrule and/or connector after crimping.

21-6.5 Shield Termination of Crimped Ferrule

Shield Termination of Crimped Ferrule

Target Condition	Acceptable Condition	Defect Condition
Crimp on ferrule located tight against connector body.	Distance between connector body and start of crimp is equal to or less than 0.030 in.	Distance between connector body and crimp is more 0.030 in.
		Crimp extends over the cable jacket.
		Double crimps.
Ferrule butted up tight to connector body.	Gap between connector body and ferrule is less than 0.030 in.	Gap between crimp and connector body is more than 0.030 in.
		Ferrule shows "dog ear" of excess material; cross-section example of "dog ear."
		Connector and/or ferrule turns or moves on cable after crimping.

21-6.6 Connector Center Pin Position

Connector Center Pin Position

Target Condition	Acceptable Condition	Defect Condition
Center pin fully seated into housing of connector.		Center pin not fully seated into housing of connector.
Center pin is straight.		Center pin is bent.
Center pin extends to proper length.		Center pin extends beyond proper length.

This page is intentionally blank.

SUPPLEMENT TECHNICAL MANUAL

STANDARD MAINTENANCE PRACTICES MINIATURE/MICROMINIATURE (2M) ELECTRONIC ASSEMBLY REPAIR

ORGANIZATIONAL/INTERMEDIATE/DEPOT LEVEL

This manual supplements TO-00-25-259 dated, 15 October 2013 and supersedes TO-00-25-259D dated, 1 October 2019.

COMMANDERS ARE RESPONSIBLE FOR BRINGING THIS SUPPLEMENT TO THE ATTENTION OF ALL AFFECTED PERSONNEL.

DISTRIBUTION STATEMENT A - Approved for public release; distribution is unlimited. PA Case Number 78ABW-2019-0111 (19-09347). Other requests for this document shall be referred to 406 SCMS/GUEE, Robins AFB, GA 31098. Questions concerning technical content shall be referred to AFLCMC/EZSS.

Published under authority of the Secretary of the Air Force

16 JANUARY 2021

1 WP 002 00, page 1, paragraph 02-1, of the basic manual, is amended to add a sentence at the end of the paragraph as follows:

All Air Force activities will refer to TO 00-25-234 for Electrostatic Discharge Control guidelines.

2 WP 003 00, page 9, paragraph 03-4.4.2 Cleanliness, of the basic manual, is amended to read as follows:

Work areas and tools shall be maintained in a clean and orderly condition. There shall be no visible foreign material including dirt, chips, grease, silicones, flux residue, solder splatter, solder balls, insulation residue, and wire clippings at any 2M Workstation. The use of shoe cleaners with a self-contained vacuum system (or external vacuum system) are recommended (not mandatory) and should be located where they will be most effective in reducing contamination that might be carried into the 2M repair area. Containers of hand creams, ointments, perfumes, cosmetics, and other materials not essential to the repair operation, except hand creams approved and controlled for use in electronic areas, are prohibited at the 2M Workstation.

3 WP 003 00, page 13, table 03-3, of the basic manual is amended to read as follows:

Table 03-3. Authorized 2M Power Units

	Nomenclature	Part #/Type Designation	CAGE
NAVAIR/NAVSEA/USAF/USCG/USMC	PRC-2000-SMT/TH	8007-0132	17794
NAVAIR/NAVSEA/USAF/USCG/USMC	PRC-2000-SMT**	8007-0161	17794
NAVSEA/USAF/USCG	PRC-2000-TH	8007-0138	17794
NAVSEA/USAF/USCG	MBT-250-SD*	8007-0203	17794
USMC/USAF	MBT-350*	7008-0280	17794
NAVSEA/USAF	ST-25*	8007-0501	17794
*Limited capability in this manual **No longer procurable			

4 WP 003 00, page 21, paragraph 03-4.6.3, third bullet, of the basic manual is amended to read as follows:

TO 00-25-259E

•USAF units should use Table 03-4, 2M MTR Certification Manual and the latest version of the Consolidated Tool Kit (CTK)

5 WP 003 00, page 22, table 03-4, of the basic manual is amended to add the following entries as follows:

Flux, Soldering or Flux, Soldering (64 oz. bottle)	FLUX RMA 1QT ± 186	3439-00-069-5815 3439-01-459-2000
Flux, Soldering (Flux Pen)	8310000186	3439-01-510-2558