

CONTENTS

5		UP TO 40KG	6		UP TO 35KG	6		UP TO 40KG	7		UP TO 100KG
	FURNITURE CASTORS			DESK CASTORS			BED LEG CASTORS			FURNITURE DOLLIE	
7		UP TO 300KG	8		UP TO 95KG	9		UP TO 50KG	10		UP TO 70KG
	HEAVY DUTY DOLLIE			STYLER CASTORS			DESIGNR CASTORS			UTILITY SERIES BOLT CASTORS	
11		UP TO 70KG	12		UP TO 100KG	13		UP TO 125KG	14		UP TO 100KG
	UTILITY SERIES PLATE CASTORS			UTILITY SERIES TWIN WHEEL CASTORS			LIGHT INDUSTRIAL SERIES CASTORS			ZINC DUROLITE SINGLE BOLT CASTORS	
15		UP TO 125KG	16		UP TO 125KG	17		UP TO 125KG	18		UP TO 300KG
	ZINC DUROLITE SERIES PLATE CASTORS			CHROME DUROLITE SERIES SINGLE BOLT CASTORS			CHROME DUROLITE SERIES PLATE CASTORS			300 SERIES BOLT HOLE CASTORS	
19		UP TO 200KG	20		UP TO 300KG	21			22		UP TO 180KG
	300 SERIES PLATE CASTORS (100-125MM)			300 SERIES PLATE CASTORS (150-200MM)			SELF-ALIGNING CASTOR FRAME			PNEUMATIC/PUNCTURE PROOF CASTORS	
23		UP TO 500KG	25		UP TO 400KG	26		UP TO 500KG	27		UP TO 500KG
	HEAVY INDUSTRIAL SERIES CASTORS			HEAVY DUTY WELDED SERIES CASTORS			WASTE BIN CASTORS			500 SERIES CASTORS	
28		UP TO 1T	29		UP TO 1.5T	30		UP TO 3T	31		UP TO 1.5T
	1000 SERIES CASTORS			FORGED HEAD SERIES CASTORS			3000 SERIES CASTORS			HIGH PERFORMANCE SERIES CASTORS	
32		UP TO 5T	33		UP TO 3T	34		UP TO 10T	35		UP TO 20T
	SINGLE WHEEL EXTRA HIGH PERFORMANCE CASTORS			TWIN WHEEL EXTRA HIGH PERFORMANCE CASTORS			10 TONNE CASTOR			CONTAINER LOCKING CASTOR KIT	

CONTENTS

36		UP TO 2.25T	37		UP TO 20T	38		UP TO 200KG	39		
	TOWMASTER CASTORS			AVIATION PRODUCTS			CARGO SERIES CASTORS			SPRING LOADED CASTORS	
40		UP TO 100KG	41		UP TO 100KG	42		UP TO 300KG	43		UP TO 400KG
	STAINLESS STEEL ELITE BOLT SERIES CASTORS			STAINLESS STEEL ELITE PLATE SERIES CASTORS			STAINLESS STEEL EXCEL BOLT HOLE SERIES CASTORS			STAINLESS STEEL EXCEL PLATE SERIES CASTORS	
44		UP TO 110KG	45		UP TO 150KG	45		UP TO 120KG	46		UP TO 80KG
	MEDI TWIN SERIES			ABS CENTRAL LOCKING TWIN WHEEL SERIES			CENTRAL LOCKING MEDICAL SERIES CASTORS			REFRIGERATION CASTORS	
47		UP TO 400KG	47			48		UP TO 20KG	49		UP TO 700KG
	ADJUSTABLE STAINLESS STEEL CATERING LEGS			THREADED BASEPLATES			GATE & UNIVERSAL SPRING LOADED CASTORS			TUBE TYPE SCAFFOLD CASTOR	
50		UP TO 350KG	51		UP TO 200KG	52		UP TO 200 KG	53		UP TO 300KG
	JOCKEY WHEELS			PUNCTURE PROOF WHEELS			PLASTIC CENTRED PNEUMATIC WHEELS			STEEL CENTRED PNEUMATIC WHEELS	
54		UP TO 100KG	54		UP TO 180KG	55		UP TO 1.07T	56		UP TO 925KG
	OFFSET PUNCTURE PROOF WHEELS			OFFSET PNEUMATIC WHEELS			LAWN AND GARDEN EQUIPMENT TYRES			LIGHT TRUCK AND TRAILER TYRES	
57			58			58			59		UP TO 50KG
	LAWN AND GARDEN EQUIPMENT, LIGHT TRUCK AND TRAILER TUBES			INDUSTRIAL TUBES			INDUSTRIAL TYRES			RUBBER TYRED NYLON CENTRED WHEELS	
59		UP TO 70KG	60		UP TO 50KG	61		UP TO 250KG	61		UP TO 250KG
	SEMI PNEUMATIC RUBBER TYRED WHEELS			RUBBER / PVC TYRED WHEELS			RUBBER TYRED NYLON WHEELS			RUBBER TYRED CAST IRON CENTRED WHEELS	

CONTENTS

62		UP TO 100KG	62		UP TO 100KG	63		UP TO 350KG	63		UP TO 250KG
	INSTITUTIONAL RUBBER WHEELS			ANTI-STATIC RUBBER WHEELS			REBOUND RUBBER WHEELS			ELASTIC RUBBER TYRED WHEELS	
64		UP TO 300KG	64		UP TO 1.05T	65		UP TO 300KG	65		UP TO 350KG
	CUSHION RUBBER WHEELS			SOLID PNEUMATIC WHEELS			REBOUND POLYURETHANE TYRED WHEELS			SOLID POLYURETHANE WHEELS	
66		UP TO 600KG	67		UP TO 5T	68		UP TO 5T	69		UP TO 600KG
	POLYURETHANE TYRED NYLON CENTRED WHEELS			POLYURETHANE TYRED CAST IRON CENTRED WHEELS			DRIVE WHEELS			HIGH/LOW TEMPERATURE WHEELS	
70		UP TO 400KG	71		UP TO 500KG	72		UP TO 800KG	73		UP TO 5T
	BLACK SOLID NYLON WHEELS			WHITE SOLID NYLON WHEELS			POLYURETHANE & NYLON ROLLERS			CAST IRON & SG IRON WHEELS	
74			75		UP TO 4T	76		UP TO 5T	76		UP TO 500KG
	CONCRETE AGITATOR ROLLERS			TRACK WHEELS - SINGLE FLANGE			TRACK WHEELS - DOUBLE FLANGE			TRACK WHEELS - BEAM TROLLEY	
77		UP TO 5T	77		UP TO 1.5T	78		UP TO 420KG	79		UP TO 227KG
	TRACK WHEELS - V GROOVE			TRACK WHEELS - ROPE GROOVE			TRACK WHEELS - C GROOVE			BALL TRANSFERS	
80			80		UP TO 1.4T	81		UP TO 120KG	83		
	FLOW RAIL			SKATE RAIL			CONVEYOR ROLLERS			FLOOR LOCKS	
84		UP TO 150KG	85		UP TO 1.5T	90		UP TO 250KG	90		
	LONG THREADED TUBE ENDS			ADJUSTING FEET			LEVELING STAND CASTOR			LOCKING KNOBS	

CONTENTS

<p>91</p>  <p>ROUND & SQUARE TUBE ENDS</p>	<p>92</p>  <p>PINTLE PARTS</p>	<p>93</p>  <p>SLEEVES & TOP HATS</p>	<p>94</p>  <p>BEARINGS & AXLES</p>
<p>95</p>  <p>BASE PLATE MOUNTS/STILLAGE FEET</p>	<p>96</p>  <p>BUFFERS</p>	<p>97</p>  <p>WHEEL & CASTOR PRODUCT GUIDE</p>	<p>98</p>  <p>ROLLING RESISTANCE & CASTOR MOUNTING OPTIONS</p>
<p>99</p>  <p>RICHMOND ENGINEERING</p>	<p>100</p>  <p>RICHMOND PIPE ROLLERS</p>		

COME AND VISIT OUR SHOWROOMS!



UP TO 40KG / CASTOR

FURNITURE CASTORS

Richmond's Furniture Castor range is made to suit most office furniture including chairs, trolleys and light duty cabinets such as TV units and display racking.

An economic and attractive twin wheel hooded design which is perfect for DIY retro fitting and to return rolling functionality to your furniture.

Available with a range of fittings to suit your application these castors are hard wearing, easily rolling over carpeted surfaces without pulling the pile.



SPECIFICATIONS & FITTINGS

TWIN WHEEL PLATE CASTOR

Diameter (mm)	Width (mm)	Wheel Type	Bearing Type	Load Capacity	Height (mm)	Swivel Radius	Swivel Code
50	43	Nylon	Plain	40/25	63	50	S50PT

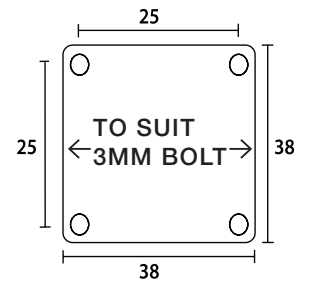

TWIN WHEEL GRIP NECK CASTOR

Diameter (mm)	Width (mm)	Wheel Type	Bearing Type	Load Capacity	Height (mm)	Swivel Radius	Swivel Code
50	43	Nylon	Plain	40/25	63	50	S51GN

The GN stem furniture castor is made to fit knock-in sockets



TWIN WHEEL THREADED STEM CASTOR

Diameter (mm)	Width (mm)	Wheel Type	Bearing Type	Load Capacity	Height (mm)	Swivel Radius	Swivel Code
50	43	Nylon	Plain	40/25	63	50	S52TH

The threaded stem furniture castor is made with a 3/8" (D) x 3/4" (L) BSW thread (suitable for most Australian beds)



TWIN WHEEL FRICTION STEM CASTOR

Diameter (mm)	Width (mm)	Wheel Type	Bearing Type	Load Capacity	Height (mm)	Swivel Radius	Swivel Code
50	43	Nylon	Plain	40/25	63	50	S53WC

The friction stem on this castor measures 11mm (D) x 25mm (L) (fits most office chairs)



Pintle	Pintle Code	Pintle Type	To Suit Castor
	PINTLER01	For 12.7mm ID Round Tube	S51GN
	PINTLER03	For 19.0mm ID Round Tube	S51GN
	PINTLER04	For 22.0mm ID Round Tube	S51GN
	PINTLER07	For 16.0mm ID Round Tube	S51GN
	PINTLER05	Grip Neck to suit Timber	S51GN
	PINTLES01	For 16.0mm ID Square Tube	S51GN
	PINTLES02	For 22.0mm ID Square Tube	S51GN
	PINTLER02	For 19.0mm ID Round Tube C/W 3/8" BSW Thread	S52TH
	PINTLER06	For 22.0mm ID Round Tube C/W 3/8" BSW Thread	S52TH
	PINTLES03	For 22.0mm ID Square Tube C/W 3/8" BSW Thread	S52TH
	PINTLES04	For 19.0mm ID Square Tube C/W 3/8" BSW Thread	S52TH

DESK CASTORS

UP TO 35KG / CASTOR

Richmond's Desk Castors are made to suit most office furniture including light duty cabinets and display units. The 'U' shape mounting makes fixing the castor to 16mm-19mm thick MDF, chipboard & timber desks quick and simple, whilst providing a sturdy fit and full maneuverability of the swivel.

This castor is perfect for DIY retro fitting and to return rolling functionality to your furniture.



S54

SPECIFICATIONS

Diameter (mm)	Width (mm)	Height (mm)	Wheel Type	Load Capacity (kg)	Swivel Radius	U Bracket Size (mm)	Swivel Code
50	46	61	Nylon	35/20	68	16 x 35	S54
50	46	61	Nylon	35/20	68	19 x 35	S57

To order castor with brake add B to the end of the swivel code, eg. S54B indicates brake castor
As a rule of thumb if a standard HB hex pencil slides into the threaded hole in the bed, it is 3/8

BED LEG CASTORS

UP TO 40KG / CASTOR

Suitable to fit most major beds, Richmond's range of Bed Castors, Lockable Bed Castors and Glides provide an economical solution to reinvigorate the life of your bed base.

This range is hard wearing and durable, easily rolling over carpeted surfaces without pulling the pile. These castors are also an ideal addition to furniture and can provide additional clearance to allow storage under a TV or display unit.

Available with two different thread options for simple installation.

Warning - May mark soft floors.



BEDLEG001

SPECIFICATIONS

Part Type	Height (mm)	Thread Length (mm)	Thread Type	Load Capacity (kg)	Part Number
CASTOR	135	28	5/16 BSW	40	BEDLEG001
CASTOR w/ BRAKE	135	28	5/16 BSW	40	BEDLEG002
CASTOR	135	28	3/8 BSW	40	BEDLEG003
CASTOR w/ BRAKE	135	28	3/8 BSW	40	BEDLEG004
GLIDE	135	28	5/16 BSW	40	BEDLEG005
GLIDE	135	28	3/8 BSW	40	BEDLEG006



BEDLEG004



BEDLEG005

As a rule of thumb if a standard HB hex pencil slides into the threaded hole in the bed, it is 3/8.

UP TO 100KG / DOLLIE

FURNITURE DOLLIE

These dollies are specifically designed for moving furniture, appliances and more.

Features include a concave centre that makes moving items with legs easier and a padded surface to protect objects from damage. Constructed using three 1½” swivel castors, providing easy mobility for oversized objects.



TRICASTOR30

SPECIFICATIONS & FITTINGS

Wheel Diameter (mm)	Wheel Type	Bearing Type	Load Capacity	Height (mm)	Swivel Radius	Product Code
32	Polypropylene	Plain	100	50	135	TRICASTOR30

HEAVY DUTY DOLLIE

UP TO 300KG / DOLLIE

With a heavy duty, robust top plate and a high load capacity, these dollies can maneuver heavy loads with ease, even in tight spaces.

Ideal for theatrical and stage equipment, this heavy duty dolly has a load capacity of 300kg.

Richmond can custom design and manufacture heavy duty dollies up to 20 tonne to suit to customers requirements.



TRICASTOR7

SPECIFICATIONS & FITTINGS

Wheel Diameter (mm)	Wheel Type	Bearing Type	Load Capacity	Height (mm)	Swivel Radius	Product Code
100	Poly Nylon	Ball	300	170	190	TRICASTOR7

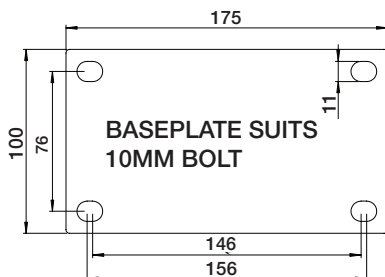

12 TONNE MECHANICAL SKATE DOLLIE
600SKATE5-12TON

UP TO 95KG / CASTOR

styleR CASTORS











The styleR range of castors are perfect for light duty applications that require your castors to be the star of the show.

Featuring a bright chrome finish, these clear wheel polyurethane castors can hold up to 95kg each, making them ideal for use at home, in the office or in the hospitality industry. Non-marking wheels ensure that soft and timber floors are not damaged.



S2032

SPECIFICATIONS & FITTINGS - PLATE TYPE

 Diameter (mm)	 Width (mm)	 Wheel Type	 Wheel Code	 Bearing Type	 Load Capacity	 Height (mm)	 Swivel Radius (mm)	 With Brake (mm)	 Swivel Code
50	20	PU/Clear	N/A	Plain	40kg	65	42	55	S2032
75	23	PU/Clear	N/A	Plain	80kg	100	60	75	S3044
100	25	PU/Clear	N/A	Plain	95kg	125	80	85	S4242

To order castor with brake add B to the end of the swivel code, eg. S2032B indicates brake castor. *Wheel brake only

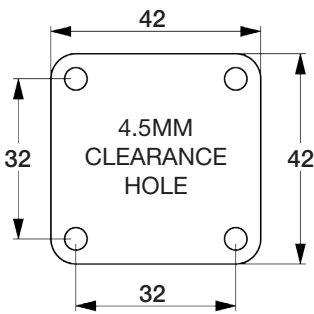

50mm swivel castor

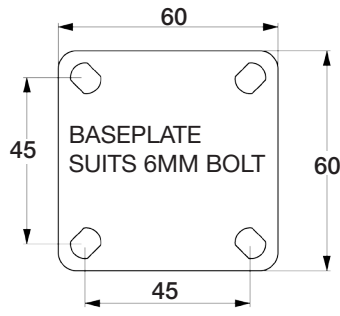

75mm & 100mm swivel castor













S3044B



S3042B

SPECIFICATIONS & FITTINGS - BOLT TYPE

 Diameter (mm)	 Width (mm)	 Wheel Type	 Wheel Code	 Bearing Type	 Load Capacity	 Height (mm)	 Swivel Radius (mm)	 With Brake (mm)	 Thread Size (mm)	 Swivel Code
50	20	PU/Clear	N/A	Plain	40kg	67	42	55	M10x15	S2030
75	23	PU/Clear	N/A	Plain	80kg	100	60	75	M10x15	S3042

To order castor with brake add B to the end of the swivel code, eg. S2030B indicates brake castor. *Wheel brake only











The designR range of castors are perfect for applications that require your castors to be on display.

Richmond's new light duty designR range have a maximum load capacity of 55kg per castor, making them ideal for use on furniture in the home or office. Offering a distinct smooth and modern polished chrome finish with a non-marking polyurethane wheel, these designR castors will compliment any interior.













S3036B

SPECIFICATIONS & FITTINGS - PLATE TYPE

									
Diameter (mm)	Width (mm)	Wheel Type	Wheel Code	Bearing Type	Load Capacity	Height (mm)	Swivel Radius	With Brake	Swivel Code
60	13	PU/Grey	N/A	Ball	40kg	95	60	60	S3036
75	13	PU/Red	N/A	Ball	55kg	110	75	75	S3040

To order castor with Swivel Lock & Brake, add B to the end of the Swivel Code, eg S3036B indicates a brake castor.

SPECIFICATIONS & FITTINGS - BOLT TYPE

										
Diameter (mm)	Width (mm)	Wheel Type	Wheel Code	Bearing Type	Load Capacity	Height (mm)	Swivel Radius	With Brake	Thread (mm)	Swivel Code
60	13	PU/Grey	N/A	Ball	40kg	90	60	60	M10 x 15	S3034
75	13	PU/Red	N/A	Ball	55kg	105	75	75	M10 x 15	S3038

To order castor with Swivel Lock & Brake, add B to the end of the Swivel Code, eg S3034B indicates a brake castor.

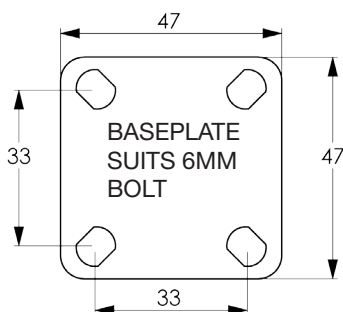

S3040B



S3038B



S3034B

UP TO 70KG / CASTOR

UTILITY SERIES BOLT CASTORS

Ideal for light duty applications including wire baskets, display equipment and light trolley applications, Richmond's Utility Series Bolt Castors offers a corrosion resistant attractive zinc plated finish in a pressed metal construction.





A choice of a nylon wheel or non-marking grey rubber adds to the versatility of this castor.

The ability to add various pintle fittings for round or square tubing ensures maximum functionality and performance.



S3714B

SPECIFICATIONS & FITTINGS

 Diameter (mm)	 Width (mm)	 Wheel Type	 Wheel Code	 Bearing Type	 Load Capacity	 Height (mm)	 Swivel Radius	 With Brake	 Bolt Size (mm)	 Swivel Code
50	20	Inst Rubber	-	Ball	30/20	68	49	75	10	S2714
50	20	Nylon	-	Plain	30/20	68	49	75	10	S2712
75	25	Inst Rubber	IR3301	Ball	50/40	98	65	85	10	S3714
75	25	Nylon	NY3324	Plain	50/40	98	65	85	10	S3712
100	25	Inst Rubber	IR4401	Ball	70/60	131	90	100	10	S4714
100	25	Nylon	NY4415	Plain	70/60	131	90	100	10	S4712

To order castor with Swivel Lock & Brake, add B to the end of the Swivel Code, eg. S3714B indicates a brake castor. See page 92 for Solid and Threaded pintle options

NYLON EXPANDING PINTLES

Pintle	Pintle Code	Pintle Type
	UT110-P1	For 19mm ID Round Tube
	UT110-P2	For 22mm ID Round Tube
	UT110-P3	For 28.5mm ID Round Tube
	UT110-P4	For 19mm ID Square Tube
	UT110-P5	For 22mm ID Square Tube
	UT110-P6	For 28.5mm ID Square Tube
	Single Bolt Fitting 10mm Various Bolt Lengths Available	



S2714

S3712

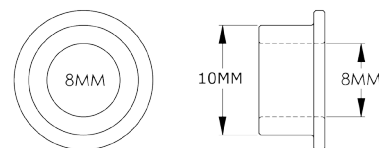

Reduction bush available to suit 8mm fittings, code 100RED1008UTI

CASTOR FITTING REQUIREMENTS

To fit this castor to a 20mm thick base requires a 40mm x 10mm set screw

UP TO 70KG / CASTOR

UTILITY SERIES PLATE CASTORS











Plate mounted, Richmond's Utility Castor has endless light duty applications, adding mobility to many useful items including wire baskets, display equipment and light trolley applications.

Its zinc plated, pressed metal construction provides an attractive corrosion resistant finish. Together with a choice of nylon or grey non-marking wheels, this castor is truly a utility by name and nature, a must have for all small fabricating, retail and home handy man purposes.



S3710B

SPECIFICATIONS & FITTINGS

 Diameter (mm)	 Width (mm)	 Wheel Type	 Wheel Code	 Bearing Type	 Load Capacity	 Height (mm)	 Swivel Radius	 With Brake	 Rigid Code	 Swivel Code
50	20	Inst Rubber	-	Ball	30/25	69	50	77	R2711	S2710
50	20	Nylon	-	Plain	30/25	69	50	77	R2709	S2708
75	25	Inst Rubber	IR3301	Ball	50/40	98	65	85	R3711	S3710
75	25	Nylon	NY3324	Plain	50/40	98	65	85	R3709	S3708
100	25	Inst Rubber	IR4401	Ball	70/60	134	90	100	R4711	S4710
100	25	Nylon	NY4415	Plain	70/60	134	90	100	R4717	S4716

To order castor with Swivel Lock & Brake, add B to the end of the Swivel Code, eg S3708B indicates a brake castor.

BASEPLATE DIMENSIONS & DRILLING PATTERNS FOR SWIVEL & RIGID CASTORS

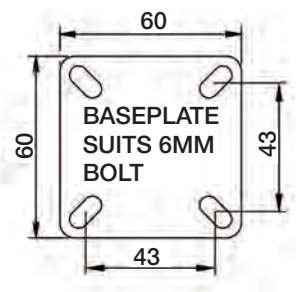

50MM & 75MM SWIVEL & RIGID

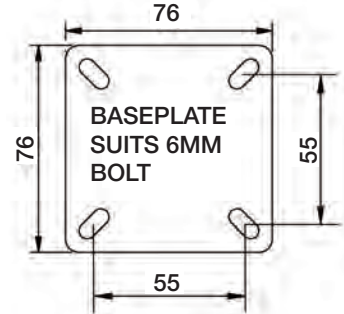

100MM SWIVEL & RIGID



S3708B

UTILITY SERIES TWIN WHEEL CASTORS

UP TO 100KG / CASTOR

The twin wheel low profile design not only increases maneuverability but also load capacity of the Richmond Utility Castor.

Available in a plate or bolt fitting this castor is commonly used in shop fitting applications, light duty cabinets, home entertainment units and other furniture.

Its zinc plated, pressed metal construction provides an attractive corrosion resistant finish and is available with the choice of nylon or grey non-marking wheels.



S2718

S3722B

SPECIFICATIONS & FITTINGS

TWIN WHEEL BOLT CASTOR

Diameter (mm)	Width (mm)	Wheel Type	Wheel Code	Bearing Type	Load Capacity	Height (mm)	Swivel Radius	With Brake	Bolt Size (mm)	Swivel Code
50	2 x 20	Rubber	-	Ball	70/60	71	60	83	10	S2722
50	2 x 17	Nylon	-	Plain	70/60	71	60	83	10	S2720
75	2 x 25	Rubber	-	Ball	100/90	98	70	100	12	S3722
75	2 x 25	Nylon	-	Plain	100/90	98	70	100	12	S3720

TWIN WHEEL PLATE CASTOR

Diameter (mm)	Width (mm)	Wheel Type	Wheel Code	Bearing Type	Load Capacity	Height (mm)	Swivel Radius	With Brake	Swivel Code
50	2 x 20	Rubber	-	Ball	70/60	71	60	80	S2718
50	2 x 17	Nylon	-	Plain	70/60	71	60	80	S2716
75	2 x 25	Rubber	-	Ball	100/90	101	70	100	S3718
75	2 x 25	Nylon	-	Plain	100/90	101	70	100	S3716

To order castor with Swivel Lock & Brake, add B to the end of the Swivel Code, eg S2716B indicates a brake castor.

NYLON EXPANDING PINTLES

Pintle	Pintle Code	Pintle Type	Pintle	Pintle Code	Pintle Type
	UTI10-P1	For 19mm ID Round Tube		S2722-WC	Friction Stem
	UTI10-P2	For 22mm ID Round Tube			
	UTI10-P3	For 28.5mm ID Round Tube			
	UTI10-P4	For 19mm ID Square Tube		S2722-GN	Grip Neck
	UTI10-P5	For 22mm ID Square Tube			
	UTI10-P6	For 28.5mm ID Square Tube			

CASTOR FITTING REQUIREMENTS

To fit this castor to a 20mm thick base requires a 40mm x 10mm set screw. Reduction bush 100RED1008UTI available to fit castors with an 8mm set screw

*Also see page 92 for Solid and Threaded pintle options

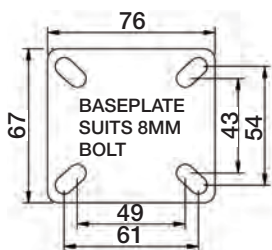

75MM TWIN WHEEL SWIVEL

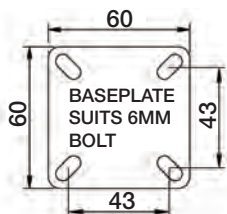

50MM SWIVEL

LIGHT INDUSTRIAL SERIES CASTORS

UP TO 125KG / CASTOR

Available with a large variety of wheels each designed to suit different floor surfaces, applications and load requirements – Richmond’s Light Industrial Series castors are ideal for use on mobile equipment, in hospitals, nurseries, shops and general industry.











The light industrial series is the castor of choice for produce bins used by green grocers, market stalls and others as it provides an economical hard wearing reliable castor. It combines a zinc plated corrosion resistant frame and a robust twin race swivel which ensures a long and productive life.



MOUNTING PLATES AVAILABLE IF REQUIRED
page 95

S4404B

SPECIFICATIONS & FITTINGS

 Diameter (mm)	 Width (mm)	 Wheel Type	 Wheel Code	 Bearing Type	 Load Capacity	 Height (mm)	 Swivel Radius	 With Brake	 Rigid Code	 Swivel Code
75	32	Inst Rubber	IR3008	Ball	80/45	108	71	108	R3313	S3312
75	32	Reb Rubber	RR3348	Ball	80/45	108	71	108	R3351	S3350
75	32	Poly Nylon	PU3344	Ball	80/45	108	71	108	R3311	S3310
75	30	Nylon	NY3321	Plain	125/100	108	71	108	R3305	S3304
75	32	Cast Iron	CI3340	Plain	125/100	108	71	-	R3307	S3306*
100	32	Inst Rubber	IR4007	Ball	100/80	131	84	110	R4426	S4425
100	32	Reb Rubber	RR4473	Ball	100/80	131	84	110	R4405	S4404
100	32	Poly Nylon	PU4444	Ball	100/80	131	84	110	R4423	S4422
100	30	Nylon	NY4417	Plain	125/100	131	84	110	R4407	S4406
100	30	GF Nylon	GF4420	Plain	125/100	131	84	-	R4403	S4402*
100	36	Aluminium	AL472	Oilless Bush	125/100	131	84	-	R4381	S4380
100	36	Aluminium	AL471	Bronze Bush	125/100	131	84	-	R4415	S4414
125	32	Inst Rubber	IR5007	Ball	100/80	160	100	110	R5526	S5525
125	32	Reb Rubber	RR5573	Ball	100/80	160	100	110	R5505	S5504
125	32	Poly Nylon	PU5555	Ball	100/80	160	100	110	R5523	S5522
125	30	Nylon	NY5517	Plain	125/100	160	100	110	R5507	S5506

To order castor with Swivel Lock & Brake, add B to the end of the Swivel Code, eg S5504B indicates a brake castor. Castors marked * are not available with brakes.  Indicates castors suitable for high/low temperature applications.

BASEPLATE DIMENSIONS & DRILLING PATTERNS FOR LIGHT INDUSTRIAL CASTORS

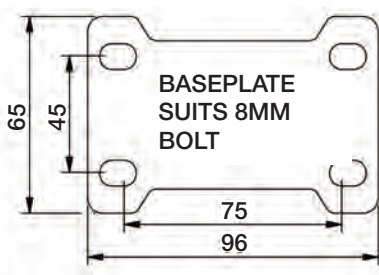

75 -125MM RIGID CASTOR

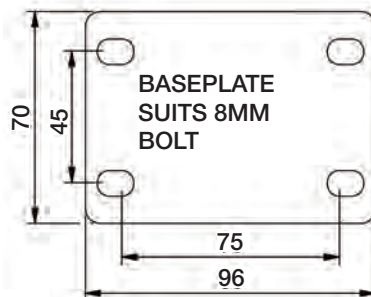

75 -125MM SWIVEL CASTOR



IDEAL FOR HIGH/LOW TEMPERATURE APPLICATIONS

S4380

ZINC DUROLITE SERIES SINGLE BOLT AND PLATE CASTORS

UP TO 100KG / CASTOR

Available with a wide range of wheels, the Zinc DuroLite Series is commonly used on a vast array of mobile equipment. The castors are enhanced by a twin swivel race ensuring longevity and making them ideal for use in hospitals, retail shops and general industry.

Zinc DuroLite Series castors feature a bolt hole for bolt or pintle fitting or baseplate designed for flexibility, with the bolt holes being slotted on an angle to give users a multitude of mounting options. This allows the castors to be matched with American and imported castors. The baseplate design also matches European standards for a growing number of uses and equipment.





S6081B

SPECIFICATIONS & FITTINGS

Diameter (mm)	Width (mm)	Wheel Type	Wheel Code	Bearing Type	Load Capacity	Height (mm)	Swivel Radius	With Brake	Bolt Size (mm)	Swivel Code
75	32	Inst Rubber	IR3008	Ball	80/45	107	71	105	12	S3080 #
75	32	Reb Rubber	RR3348	Ball	80/45	107	71	105	12	S3355 #
75	32	Poly Nylon	PU3344	Ball	80/45	107	71	105	12	S3330 #
75	30	Nylon	NY3321	Plain	80/45	107	71	105	12	S3326 #
100	32	Inst Rubber	IR4007	Ball	100/80	133	90	106	12	S4080
100	32	Anti Static	AS4005	Ball	100/80	133	90	106	12	S4493
100	32	Reb Rubber	RR4473	Ball	100/80	133	90	106	12	S4483
100	32	Poly Nylon	PU4444	Ball	100/80	133	90	106	12	S4484
100	30	Nylon	NY4417	Plain	100/80	133	90	106	12	S4485
125	32	Inst Rubber	IR5007	Ball	100/80	159	102	106	12	S5080
125	32	Anti Static	AS5005	Ball	100/80	159	102	106	12	S5593
125	32	Reb Rubber	RR5573	Ball	100/80	159	102	106	12	S5583
125	27	Poly Nylon	PU5555	Ball	100/80	159	102	106	12	S5584
125	30	Nylon	NY5517	Plain	100/80	159	102	106	12	S5585
150	32	Inst Rubber	IR6009	Ball	100/80	187	125	125	12	S6080
150	30	Poly Nylon	PU6660	Ball	100/80	187	125	125	12	S6081

To order castor with Red Brake (BR) or Green Directional Lock (D) add BR or D to the end of the Swivel Code., EG S6080BR indicates red brake castor. All brakes are Swivel, Lock & Brake. Castors marked # are not available with directional lock.

NYLON EXPANDING PINTLES

Pintle	Pintle Code	Pintle Type
	OBT12-P1	For 19mm ID Round Tube
	OBT12-P2	For 22mm ID Round Tube
	OBT12-P3	For 28.5mm ID Round Tube
	OBT12-P4	For 19mm ID Square Tube
	OBT12-P5	For 22mm ID Square Tube
	OBT12-P6	For 28.5mm ID Square Tube

*Also see page 92 for Solid and Threaded pintle options

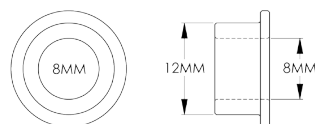

Reduction bushes available to suit 8mm fittings, code 100RED12080BT

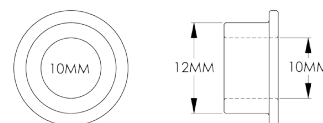

Reduction bushes available to suit 10mm fittings, code 100RED12100BT



S4483

CASTOR FITTING REQUIREMENTS

To fit this castor to a 20mm thick base requires a 50mm x 12mm set screw. Reduction bush 100RED12100BT available to allow fitting with 10mm set screw.

ZINC DUROLITE SERIES PLATE CASTORS

UP TO 125KG / CASTOR



S3102















S4110B



S5104

SPECIFICATIONS & FITTINGS

 Diameter (mm)	 Width (mm)	 Wheel Type	 Wheel Code	 Bearing Type	 Load Capacity	 Height (mm)	 Swivel Radius	 With Brake	 Rigid Code	 Swivel Code
75	32	Inst Rubber	IR3008	Ball	80/45	107	71	105	R3105	S3104 #
75	32	Reb Rubber	RR3348	Ball	80/45	107	71	105	R3117	S3116 #
75	32	Poly Nylon	PU3344	Ball	80/45	107	71	105	R3107	S3106 #
75	30	Nylon	NY3321	Plain	80/45	107	71	105	R3103	S3102 #
100	32	Inst Rubber	IR4007	Ball	100/80	135	90	106	R4105	S4104
100	32	Anti Static	AS4005	Ball	100/80	135	90	106	R4121	S4120
100	32	Reb Rubber	RR4473	Ball	100/80	135	90	106	R4111	S4110
100	32	Poly Nylon	PU4444	Ball	100/80	135	90	106	R4107	S4106
100	30	Nylon	NY4417	Plain	100/80	135	90	106	R4103	S4102
100	36	Aluminium	AL472	Oilless bush	125/100	133	90	-	R4113	S4112 *
125	32	Inst Rubber	IR5007	Ball	100/80	161	102	106	R5105	S5104
125	32	Anti Static	AS5005	Ball	100/80	161	102	106	R5121	S5120
125	32	Reb Rubber	RR5573	Ball	100/80	161	102	106	R5111	S5110
125	32	Poly Nylon	PU5555	Ball	100/80	161	102	106	R5107	S5106
125	30	Nylon	NY5517	Plain	100/80	161	102	106	R5103	S5102
150	32	Inst Rubber	IR6009	Ball	100/80	190	125	125	R6105	S6104
150	30	Poly Nylon	PU6660	Ball	100/80	190	125	125	R6107	S6106

To order castor with a Swivel Lock & Brake (B) or Green Directional Lock (D) to the end of the Swivel Code, eg S4110B indicates a brake castor. Castors marked # are not available with Directional Locks. Castors marked * are not available with brakes.
 Indicates castors suitable for high/low temperature applications.

BASEPLATE DIMENSIONS & DRILLING PATTERNS FOR ZINC DUROLITE CASTORS

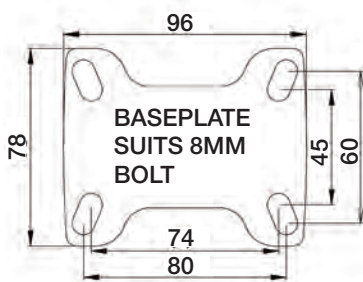

RIGID

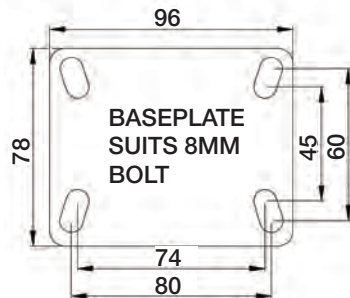

SWIVEL



R4113

**MOUNTING
PLATES
AVAILABLE IF
REQUIRED**
page 95

CHROME DUROLITE SERIES SINGLE BOLT CASTORS

UP TO 125KG / CASTOR

Truly the best looking durable castor in its class. Richmond's Chrome Durolite Series is ideal for use in hospitals, institutions, nursing homes and an attractive addition to furniture and retail displays.











The pressed metal frame and chrome finish combines both strength and corrosion resistance.

A robust twin swivel race design provides durability and longevity in the workplace.





S5569

SPECIFICATIONS & FITTINGS

 Diameter (mm)	 Width (mm)	 Wheel Type	 Wheel Code	 Bearing Type	 Load Capacity	 Height (mm)	 Swivel Radius	 With Brake	 Bolt Size (mm)	 Swivel Code
75	30	Inst Rubber	IR3008	Ball	80/45	105	76	105	12	S3380 #
75	30	Poly Nylon	PU3344	Ball	80/45	105	76	105	12	S3381 #
100	32	Inst Rubber	IR4007	Ball	100/80	133	90	106	12	S4386
100	32	Inst Rubber	IR4004	Ball	100/80	133	90	106	12	S4480
100	32	Anti Static	AS4005	Ball	100/80	135	90	106	12	S4469
100	27	Poly Nylon	PU4444	Ball	100/80	135	90	106	12	S4481
125	32	Inst Rubber	IR5007	Ball	100/80	159	102	106	12	S5386
125	32	Inst Rubber	IR5004	Ball	100/80	159	102	106	12	S5580
125	32	Anti Static	AS5005	Ball	100/80	159	102	106	12	S5569
125	27	Poly Nylon	PU5554	Ball	100/80	159	102	106	12	S5581
150	32	Inst Rubber	IR6009	Ball	100/80	187	125	125	12	S6680
150	30	Poly Nylon	PU6660	Ball	100/80	187	125	125	12	S6681
150	30	Nylon	NY6617	Plain	125/100	187	125	125	12	S6682

To order castor with Red Brake (BR) Grey Brake (BG) or Green Directional Lock (D) add BR or D to the end of the Swivel Code e.g. S6682BR indicates red brake castor. Castors marked # are not available with Directional Locks. Grey plastic brake available. All brakes are Swivel, Lock & Brake.

NYLON EXPANDING PINTLES

Pintle	Pintle Code	Pintle Type
	IPN12-P1	For 19mm ID Round Tube
	IPN12-P2	For 22mm ID Round Tube
	IPN12-P3	For 28.5mm ID Round Tube
	INP12-P4	For 19mm ID Square Tube
	IPN12-P5	For 22mm ID Square Tube
	IPN12-P6	For 28.5mm ID Square Tube
	Single Bolt Fitting Various bolt lengths available	

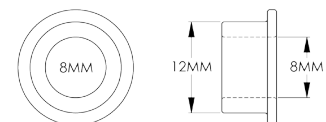

Reduction bushes available to suit 8mm fittings, code 100RED12080BT

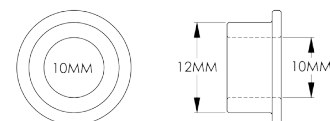

Reduction bushes available to suit 10mm fittings, code 100RED12100BT

*Also see page 92 for Solid and Threaded pintle options

CHROME DUROLITE SERIES PLATE CASTORS

UP TO 125KG / CASTOR

**MOUNTING
PLATES
AVAILABLE IF
REQUIRED
page 95**



S4486BR













S5574



R5575

SPECIFICATIONS & FITTINGS

 Diameter (mm)	 Width (mm)	 Wheel Type	 Wheel Code	 Bearing Type	 Load Capacity	 Height (mm)	 Swivel Radius	 With Brake	 Rigid Code	 Swivel Code
75	32	Inst Rubber	IR3008	Ball	80/45	107	70	105	R3375	S3374 #
75	32	Poly Nylon	PU3344	Ball	80/45	107	70	105	R3373	S3372 #
100	32	Inst Rubber	IR4004	Ball	100/80	135	90	106	R4475	S4474
100	32	Anti Static	AS4005	Ball	100/80	135	90	106	R4509	S4508
100	32	Poly Nylon	PU4444	Ball	100/80	135	90	106	R4487	S4486
125	32	Inst Rubber	IR5004	Ball	100/80	161	102	106	R5575	S5574
125	32	Anti Static	AS5006	Ball	100/80	161	102	106	R5565	S5564
125	32	Poly Nylon	PU5555	Ball	100/80	161	102	106	R5587	S5586
150	32	Inst Rubber	IR6009	Ball	100/80	190	125	125	R6675	S6674
150	30	Poly Nylon	PU6660	Ball	100/80	190	125	125	R6689	S6688
150	30	Nylon	NY6617	Ball	125/100	190	125	125	R6685	S6684

To order castor with Red Brake (BR), Grey Brake (BG) or Green Directional Lock (D) add BR, CH or D to the end of the Swivel Code. Eg S6688BR indicates red brake castor. Castors marked # are not available with Directional Locks. All brakes are Swivel, Lock & Brake.

BASEPLATE DIMENSIONS & DRILLING PATTERNS FOR CHROME DUROLITE CASTORS

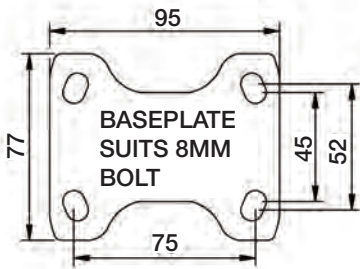

RIGID

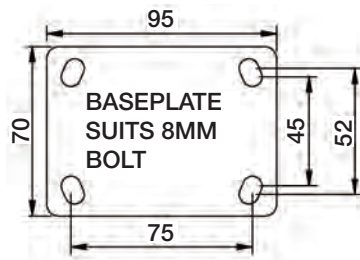

SWIVEL



S6688B

300 SERIES BOLT HOLE AND PLATE CASTORS

UP TO 300KG / CASTOR

Meeting and exceeding all performance standards due to its higher load bearing capacity, the 300 Series has a wide range of uses. A sturdy pressed metal castor with a variety of wheel fitting options, it can be purchased with belt/pintle fitting or M2 plate. Richmond can also help identify the correct wheel for your application and environment.

A nylon wheel in the 300 series is most common for industrial and trolley applications, a rebound rubber wheel is ideal for road cases and transportable crates whilst a poly nylon wheel is best suited for undercover and showroom displays. Cast Iron, Poly Cast Iron and Aluminium wheels are other choices available within this series.



S5218B

SPECIFICATIONS & FITTINGS

 Diameter (mm)	 Width (mm)	 Wheel Type	 Wheel Code	 Bearing Type	 Load Capacity	 Height (mm)	 Swivel Radius	 With Brake	 Bolt Size (mm)	 Swivel Code
100	35	Reb Rubber	RR4077	Ball	150/110	130	90	125	12	S4214
100	35	Reb Poly	RP4072	Roller	150/110	130	90	125	12	S4216
100	35	Poly Nylon	PU4408	Roller	200/150	130	90	125	12	S4218
100	38	Poly Ci	PU449	Ball	200/150	130	90	125	12	S4220
100	35	Nylon	NY401	Plain	200/150	130	90	125	12	S4222
100	35	Nylon	NY413	Ball	200/150	130	90	125	12	S4224
100	35	Nylon	NY403	Roller	200/150	130	90	125	12	S4226
100	35	Glass Nylon	GF414	Plain	200/150	130	90	125	12	S4228
100	36	Aluminium	AL474	AL Bronze Bush	200/150	130	90	125	12	S4230 *
100	36	Aluminium	AL473	Oilless bush	200/150	130	90	125	12	S4232 *
100	38	Cast Iron	Ci421	Plain	200/150	130	90	125	12	S4234 *
100	38	Cast Iron	Ci400	Ball	200/150	130	90	125	12	S4236 *
125	35	Reb Rubber	RR5077	Ball	200/150	157	112	125	12	S5214
125	35	Reb Poly	RP5072	Roller	200/150	157	112	125	12	S5216
125	35	Poly Nylon	PU5508	Roller	200/150	157	112	125	12	S5218
125	35	Poly Ci	PU549	Ball	200/150	157	112	125	12	S5220
125	35	Nylon	NY501	Plain	200/150	157	112	125	12	S5222
125	35	Nylon	NY513	Ball	200/150	157	112	125	12	S5224
125	35	Nylon	NY503	Roller	200/150	157	112	125	12	S5226
150	50	Nylon	NY652	Plain	300/250	181	125	150	12	S6222
150	50	Nylon	NY613	Ball	300/250	181	125	150	12	S6224
150	45	Reb Rubber	RR6677	Ball	225/200	181	125	150	12	S6228
150	40	Reb Poly	RP6072	Roller	300/250	181	125	150	12	S6216



To order castor with Swivel Lock & Brake, add B to the end of the Swivel Code, eg S4214B indicates a brake castor. Castors marked * are not available with a brakes.  Indicates castors suitable for high/low temperature applications.

CASTOR FITTING REQUIREMENTS

To fit this castor to a 20mm thick base requires a 50mm x 12mm set screw

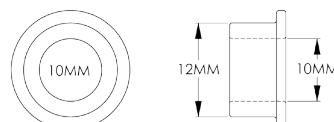

Reduction bushes available to suit 10mm fittings, code 100RED12100BT

*Also see page 92 for Solid and Threaded pintle options

300 SERIES PLATE CASTORS (100-125MM)

UP TO 200KG / CASTOR



S4048



R4053



S4042B

MOUNTING
PLATES
AVAILABLE IF
REQUIRED
page 95

SPECIFICATIONS & FITTINGS

 Diameter (mm)	 Width (mm)	 Wheel Type	 Wheel Code	 Bearing Type	 Load Capacity	 Height (mm)	 Swivel Radius	 With Brake	 Rigid Code	 Swivel Code
100	35	Reb Rubber	RR4077	Ball	150/110	130	90	125	R4043	S4042
100	35	Reb Poly	RP4072	Roller	150/110	130	90	125	R4055	S4054
100	35	Poly Nylon	PU4408	Roller	200/150	130	90	125	R4045	S4044
100	38	Poly Ci	PU449	Ball	200/150	130	90	125	R4049	S4048
100	35	Nylon	NY401	Plain	200/150	130	90	125	R4033	S4032
100	35	Nylon	NY413	Ball	200/150	130	90	125	R4035	S4034
100	35	Nylon	NY403	Roller	200/150	130	90	125	R4047	S4046
100	35	Glass Nylon	GF412	Plain	200/150	130	90	125	R4061	S4060
100	36	Aluminium	AL474	AL Bronze Bush	200/150	130	90	-	R4067	S4066 *
100	36	Aluminium	AL473	Oilless bush	200/150	130	90	-	R4059	S4058 *
100	38	Cast Iron	Ci421	Plain	200/150	130	90	-	R4051	S4050 *
100	38	Cast Iron	Ci400	Ball	200/150	130	90	125	R4053	S4052
125	35	Reb Rubber	RR5077	Ball	200/150	157	112	125	R5043	S5042
125	35	Reb Poly	RP5072	Roller	200/150	157	112	125	R5055	S5054
125	35	Poly Nylon	PU5508	Roller	200/150	157	112	125	R5045	S5044
125	35	Poly Ci	PU549	Ball	200/150	157	112	125	R5049	S5048
125	35	Nylon	NY501	Plain	200/150	157	112	125	R5033	S5032
125	35	Nylon	NY513	Ball	200/150	157	112	125	R5035	S5034
125	35	Nylon	NY503	Roller	200/150	157	112	125	R5037	S5036



To order castor with Swivel Lock & Brake, add B to the end of the Swivel Code, eg S4044B indicates a brake castor. Castors marked * are not available with a brakes.  Indicates castors suitable for high/low temperature applications.

BASEPLATE DIMENSIONS & DRILLING PATTERNS FOR 300 SERIES CASTORS

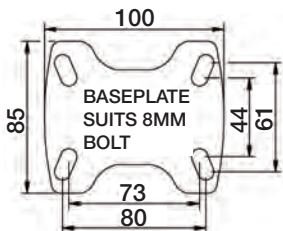

RIGID CASTOR

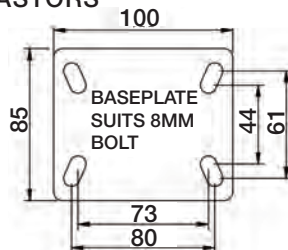

SWIVEL CASTOR



S4044B



S4066

300 SERIES PLATE CASTORS (150-200MM)

UP TO 300KG / CASTOR



R6036













S6044



S8040

MOUNTING
PLATES
AVAILABLE IF
REQUIRED
page 95

SPECIFICATIONS & FITTINGS

 Diameter (mm)	 Width (mm)	 Wheel Type	 Wheel Code	 Bearing Type	 Load Capacity	 Height (mm)	 Swivel Radius	 With Brake	 Rigid Code	 Swivel Code
150	45	Reb Rubber	RR6677	Ball	225/200	187	127	170	R6043	S6042
150	50	Rubber	RT6642	Roller	225/200	187	127	170	R6041	S6040
150	50	Poly Nylon	PU6071	Ball	300/225	187	127	170	R6045	S6044
150	50	Nylon	NY652	Plain	300/225	187	127	170	R6033	S6032
150	50	Nylon	NY613	Ball	300/225	187	127	170	R6036	S6035
150	45	Cast Iron	CI611	Plain	300/225	187	127	NA	R6051	S6050 *
200	45	Reb Rubber	RR8871	Ball	250/225	237	156	170	R8043	S8042
200	50	Reb Poly	RP8072	SS Roller	250/225	237	156	170	R8055	S8054
200	50	Rubber	RT8842	Roller	250/225	237	156	170	R8041	S8040
200	45	Rubber	RN8875	Roller	200/175	237	156	170	R8047	S8046
200	50	Poly Nylon	PU8071	Ball	300/225	237	156	170	R8045	S8044
200	50	Nylon	NY800	Plain	300/225	237	156	170	R8033	S8032

To order castor with Swivel Lock & Brake, add B to the end of the Swivel Code, eg S6042B indicates a brake castor. Castors marked * are not available with brakes.  Indicates castors suitable for high/low temperature applications.

BASEPLATE DIMENSIONS & DRILLING PATTERNS FOR 300 SERIES CASTORS

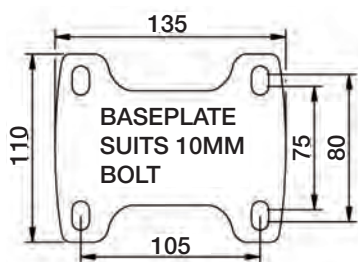

RIGID CASTOR

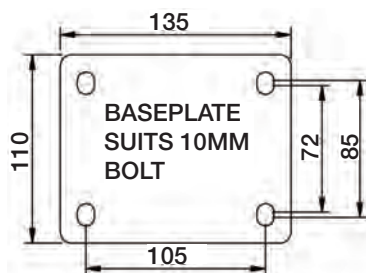

SWIVEL CASTOR



R6041



S8054B

SELF-ALIGNING CASTOR FRAME



The self-aligning function is available on all 6" and 8" 300 series and excel series castors with a swivel, brake or directional lock. The purpose of the self-alignment function is to eliminate free spinning of the swivel castor as the wheel becomes airborne in applications such as AGV trolley transportation in hospitals, factories, warehouses and more. This prevents the castor from becoming jammed when it returns to the ground. The self-aligning function does not affect the overall height of the castor, and can be used with conductive or anti-static wheels.



Diameter
(mm)

Width
(mm)

Wheel
Type

Wheel
Code

Bearing
Type

Load
Capacity

Swivel
Code

200

45

Rebound Rubber

RR8871

Ball

250-225

S8042SA

200

45

Poly/Nylon

PU8071

Ball

300-225

S8044SA

200

45

Rebound Poly

RP8072

Ball

300-250

S8144SA



THE PURPOSE OF THE SELF-ALIGNMENT FUNCTION IS TO ELIMINATE FREE SPINNING OF THE SWIVEL CASTOR. THE SPRINGS WILL RETURN THE CASTOR BACK TO DEFAULT FORWARD POSITION.

PNEUMATIC/PUNCTURE PROOF CASTORS

UP TO 180KG / CASTOR

Ideal for outdoor use, whether used over soft or hard ground, a pneumatic castor features a cushioned comfortable ride characteristic to protect the load.

Richmond Pneumatic Castors are fitted with the highest quality rubber tyres and sealed bearings, increasing water resistance and decreasing rolling resistance.











Pneumatic castors are ideal for use on agricultural equipment and for making sports equipment such as batting cages, nets and equipment trolleys more mobile on soft ground.













MOUNTING PLATES AVAILABLE IF REQUIRED
page 95

S8861

PNEUMATIC SERIES

 Diameter (mm)	 Width (mm)	 Wheel Type	 Wheel Code	 Bearing Type	 Load Capacity	 Height (mm)	 Swivel Radius	 Rigid Code	 Swivel Code
220	60	Pneumatic	PN8860	Ball	100	260	160	R8862	S8861
255	85	Pneumatic	PN1066	Ball	180	315	200	R1068	S1067

PUNCTURE PROOF SERIES

 Diameter (mm)	 Width (mm)	 Wheel Type	 Wheel Code	 Bearing Type	 Load Capacity	 Height (mm)	 Swivel Radius	 Rigid Code	 Swivel Code
215	55	Puncture Proof	PF8881	Ball	70	245	160	R8835	S8834
255	83	Puncture Proof	PF1084	Ball	100	305	200	R1089	S1088

- WHEELS ALL HAVE SEALED PRECISION BALL BEARINGS FOR LONG LIFE.

BASEPLATE DIMENSIONS & DRILLING PATTERNS FOR PNEUMATIC CASTORS

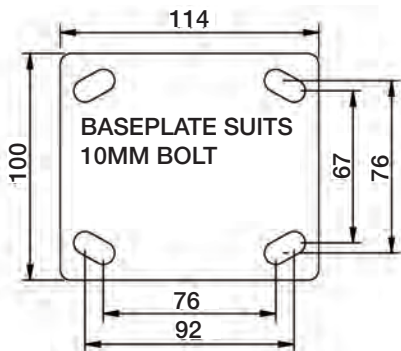

R8862



S1067B

*SHOWN WITH OPTIONAL BAND BRAKE

HEAVY INDUSTRIAL SERIES CASTORS

UP TO 400KG / CASTOR

Richmond Heavy Industrial Series castors have been developed to meet the exacting demands of customers wanting castors capable of being transported long distances.

Logistics, manufacturing, display and exhibition services are just some of the common businesses relying on our heavy industrial series castors daily.











The castor is zinc plated to provide corrosion resistance and includes a grease nipple to help maintain smooth operation. Its industry leading swivel lock and brake design combined with its sturdy 6mm thick steel construction provides uncompromised strength and flex resistance making it ideal for road transport.



MOUNTING PLATES AVAILABLE IF REQUIRED
page 95

S4448SLB

SPECIFICATIONS & FITTINGS

 Diameter (mm)	 Width (mm)	 Wheel Type	 Wheel Code	 Bearing Type	 Load Capacity	 Height (mm)	 Swivel Radius	 With Brake	 Rigid Code	 Swivel Code
100	35	Reb Rubber	RR4077	Ball	150/110	142	84	145	R4457	S4456
100	35	Reb Poly	RP4072	Roller	150/110	142	84	145	R4441	S4440
100	35	Poly Nylon	PU4408	Roller	250/200	142	84	145	R4438	S4437
100	38	Poly Ci	PU449	Ball	330/250	142	84	145	R4449	S4448
100	35	Nylon	NY401	Plain	300/200	142	84	145	R4434	S4433
100	35	Nylon	NY403	Roller	300/200	142	84	145	R4446	S4445
100	35	Nylon	NY413	Ball	300/200	142	84	145	R4436	S4435
100	35	GF Nylon	GF412	Plain	200/150	142	84	145	R4455	S4454
100	36	Aluminium	AL474	AL bronze bush	180/150	142	84	145	R4467	S4466 *
100	36	Aluminium	AL473	Oilless bush	180/150	142	84	145	R4397	S4396 *
100	38	Cast Iron	Ci421	Plain	300/225	142	84	145	R4451	S4450
100	38	Cast Iron	Ci400	Ball	400/300	142	84	145	R4453	S4452
100	36	Cast Iron	VG459	Ball	280/250	142	84	145	R4444	S4443 *
100	50	Cast Iron	VG461	Roller	280/250	142	84	145	R4497	S4496 *
125	35	Reb Rubber	RR5077	Ball	200/150	165	100	145	R5545	S5544
125	35	Reb Poly	RP5072	Roller	200/150	165	100	145	R5441	S5440
125	35	Poly Nylon	PU5508	Roller	250/200	165	100	145	R5543	S5542
125	38	Poly Ci	PU549	Ball	330/250	165	100	145	R5549	S5548
125	35	Nylon	NY501	Plain	330/250	165	100	145	R5534	S5533
125	35	Nylon	NY503	Roller	330/250	165	100	145	R5538	S5537
125	35	Nylon	NY513	Ball	330/250	165	100	145	R5536	S5535
125	38	Cast Iron	Ci532	Plain	380/280	165	100	145	R5551	S5550

Available with a standard baseplate or M3 (Metric) baseplate. To order castor with Wheel Brake & or Directional Lock add B or D to the end of the Swivel Code e.g. S5542BD indicates a brake castor with directional lock. To order castor with Swivel Lock & Brake (SLB) add SLB to the end of the Swivel Code e.g. S4448SLB indicates a swivel lock & brake castor. Castors marked * are not available with brakes.  Indicates castors suitable for high/low temperature applications.

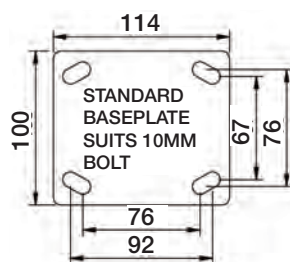
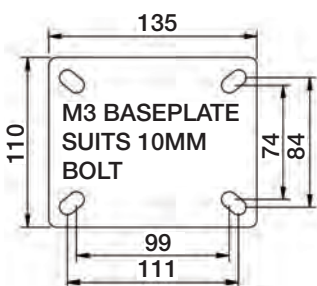

BASEPLATE DIMENSIONS & DRILLING PATTERNS FOR HEAVY INDUSTRIAL CASTORS

HEAVY INDUSTRIAL SERIES CASTORS

UP TO 500KG / CASTOR



S6602SLB













S6440D



S6644SLB

**MOUNTING
PLATES
AVAILABLE IF
REQUIRED**
page 95

SPECIFICATIONS & FITTINGS

 Diameter (mm)	 Width (mm)	 Wheel Type	 Wheel Code	 Bearing Type	 Load Capacity	 Height (mm)	 Swivel Radius	 With Brake	 Rigid Code	 Swivel Code
100	50	Rubber	RT4447	Roller	110/80	142	84	160	R4431	S4432
100	50	Poly Nylon	PU4409	Ball	250/200	142	84	160	R4411	S4410
100	50	Poly Ci	PU424	Roller	250/200	142	84	160	R4401	S4400
100	50	Poly Ci	PU425	Ball	500/380	142	84	160	R4389	S4388
100	50	Solid Poly	PS4479	Roller	350/300	142	84	160	R4495	S4494
125	50	Rubber	RT5547	Roller	180/130	165	100	160	R5503	S5502
125	50	Poly Nylon	PU5509	Ball	350/300	165	100	160	R5511	S5510
125	50	Poly Ci	PU524	Roller	350/300	165	100	160	R5531	S5530
125	50	Solid Poly	PS5579	Ball	350/300	165	100	160	R5595	S5594
150	45	Reb Rubber	RR6677	Ball	225/200	190	124	160	R6631	S6632
150	50	Rubber	RT6642	Roller	225/200	190	124	160	R6641	S6640
150	50	Rubber	RT6647	Roller	225/200	190	124	160	R6603	S6602
150	50	Reb Poly	RP6072	Roller	300/250	190	124	160	R6441	S6440
150	50	Poly Nylon	PU6071	Ball	400/300	190	124	160	R6645	S6644
150	50	Poly Ci	PU614	Roller	250/200	190	124	160	R6656	S6655
150	50	Poly Ci	PU649	Ball	500/380	190	124	160	R6649	S6648
150	50	Nylon	NY652	Plain	400/300	190	124	160	R6634	S6633
150	50	Nylon	NY613	Ball	400/300	190	124	160	R6636	S6635
150	50	Cast Iron	VG661	Roller	400/300	190	124	160	R6697	S6696 *
150	45	Cast Iron	Ci611	Plain	500/380	190	124	160	R6651	S6650
150	45	Cast Iron	Ci601	Ball	500/380	190	124	160	R6653	S6652
200	45	Reb Rubber	RR8871	Ball	250/225	241	156	160	R8831	S8832
200	35	Rubber	RN8875	Roller	200/150	241	156	160	R8873	S8872
200	50	Rubber	RT8842	Roller	250/225	241	156	160	R8841	S8840
200	50	Rubber	RT8847	Roller	250/225	241	156	160	R8803	S8802
200	50	Poly Nylon	PU8071	Ball	400/300	241	156	160	R8850	S8849
200	50	Poly Ci	PU849	Ball	500/380	241	156	160	R8852	S8851
200	50	Nylon	NY800	Plain	400/300	241	156	160	R8844	S8843
200	50	Cast Iron	Ci842	Plain	500/380	241	156	160	R8854	S8853
200	50	Cast Iron	Ci841	Ball	500/380	241	156	160	R8856	S8855
200	50	Nylon	NY830	Ball	400/300	241	156	160	R8846	S8845

Available with a standard baseplate or M3 (Metric) baseplate Add M3 to the end of the code. To order castor with Swivel Lock & Brake (SLB), Directional Lock (D) or Side Brake (WB) add SLB, D or WB to the end of the Swivel Code e.g. S6644SLB indicates a swivel lock & brake castor.

*S6696 not available with brake

HEAVY DUTY WELDED SERIES CASTORS

UP TO 400KG / CASTOR

Precision built for durability under extreme working conditions, the Heavy Duty Welded Series is ideal for the exhaustive demands of industrial environments when a low profile high load bearing castor is required.











Featuring a precision machined swivel ball race providing an unrivalled ultra smooth swivel action and a kingpin made of high tensile steel made to withstand high side impact loads.

Finished in an attractive zinc plating to provide corrosion resistance, Richmond can also supply the heavy duty welded series in stainless steel for use in very corrosive environments.



S547

SPECIFICATIONS & FITTINGS

 Diameter (mm)	 Width (mm)	 Wheel Type	 Wheel Code	 Bearing Type	 Load Capacity	 Height (mm)	 Swivel Radius	 Rigid Code	 Swivel Code
75	25	Poly Ci	PU350	Ball	240/180	114	76	R328	S327
75	30	Nylon	NY3321	Plain	125/100	114	76	R321	S323
100	38	Poly Ci	PU449	Ball	330/250	132	90	R448	S447
100	35	Nylon	NY401	SS Sleeve	300/200	132	90	R402	S406
100	35	Nylon	NY413	Ball	300/200	132	90	R415	S416
100	35	Cast Iron	SGi421	Plain	300/225	132	90	R423	S422
100	38	Cast Iron	Ci400	Ball	400/300	132	90	R440	S470
100	36	Cast Iron	VG459	Ball	280	132	90	R466	S465
125	35	Poly Ci	PU549	Ball	330/250	159	102	R548	S547
125	35	Nylon	NY501	SS Sleeve	330/250	159	102	R502	S506
125	35	Nylon	NY513	Ball	330/250	159	102	R515	S516
125	38	Cast Iron	Ci532	Plain	380/280	159	102	R534	S533

To order castor with Brake and/or 4 Way Directional Lock, add B and/or D to the end of Swivel Code .
e.g. S422B indicates a brake castor.  Indicates castors suitable for high/low temperature applications.

BASEPLATE DIMENSIONS & DRILLING PATTERNS FOR HEAVY DUTY WELDED CASTORS

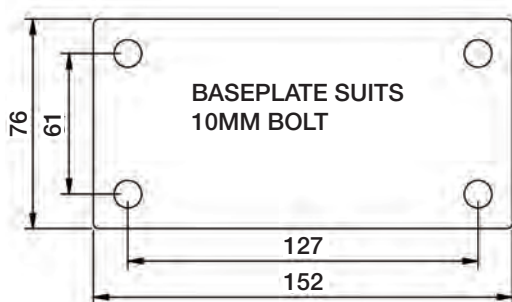

Optional baseplate sizing available.
Enquire at sales@richmondau.com

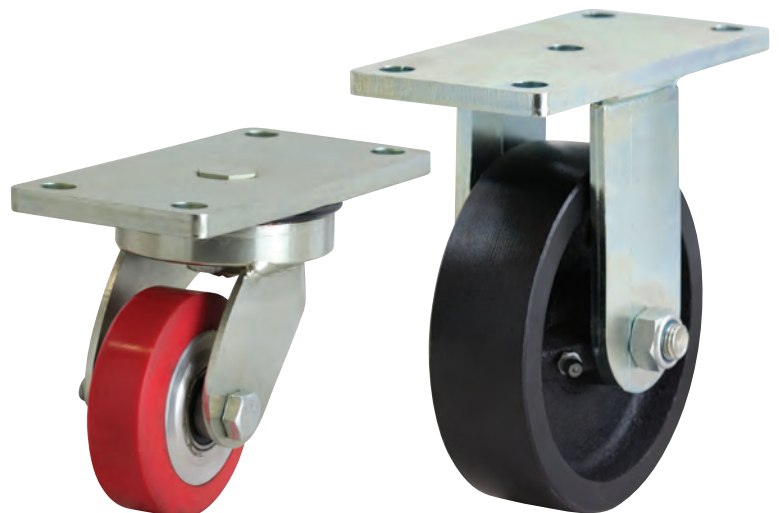

S327

R534

UP TO 500KG / CASTOR

WASTE BIN CASTORS

- A heavier load bearing castor than most with a load capacity up to 500kg
- High tensile steel kingpin to help withstand any high impact loads
- Precision machined ball race



S6012SLB

S6010B

CASTORS - SPECIFICATIONS & FITTINGS

Diameter (mm)	Wheel Type	Bearing Type	Load Capacity(kg)	Height (mm)	Wheel Code	Rigid Code	Swivel Code
150	SG Iron	Plain	500/400	194	SG608	R6011	S6010
150	Rubber Ci	Roller	225/200	194	RT6647	R6015	S6014
150	Poly Ci	Roller	250/200	194	PU614	S6013	S6012

Brake Options:

B = Wheel Brake Only

SLB = Brakes Wheel & Swivel Rotating Simultaneously

To order castors with B or SLB add B or SLB to end of swivel code eg S6010SLB.

COMPLETE SETS - SPECIFICATIONS & FITTINGS

Diameter (mm)	Swivel	Swivel, brake	Swivel, lock & brake	Rigid	Wheel Type	Bearing	Set Code
150	2	-	-	2	SG Iron	Plain	WASTESETT
150	2	-	-	2	Rubber Ci	Roller	WASTESETT-2
150	4	-	-	-	SG Iron	Plain	WASTESETT-3
150	2	-	-	2	Poly Ci	Roller	WASTESETT-5
150	-	-	2	2	Poly Ci	Roller	WASTESETT-7
150	1	-	1	2	SG Iron	Plain	WASTESETT-8
150	-	2	-	2	SG Iron	Plain	WASTESETT-9
150	-	2	-	2	Poly Ci	Roller	WASTESETT-10
150	4	-	-	-	Poly Ci	Roller	WASTESETT-12
150	-	-	2	2	Rubber Ci	Roller	WASTESETT-13

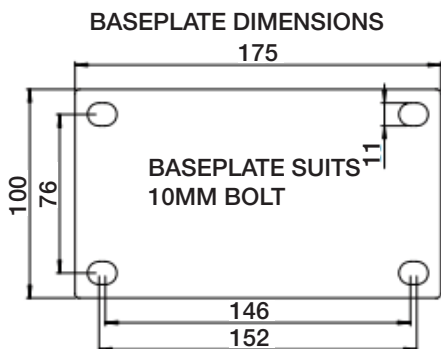

S6012



S6010

500 SERIES CASTORS

AVAILABLE
IN STAINLESS
STEEL

UP TO 500KG / CASTOR

The 500 Series is designed and manufactured for heavy duty applications including low speed, medium weight towing up to a maximum speed of 6kph. A sealed precision machined ball race ensures the swivel movement is kept clean and smooth.











Complete with a high tensile kingpin to withstand high impact side loads, Richmond's 500 Series moves high demand industries such as; Automotive, Steel Manufacture and Rapid Moving production lines, all due to the reliability and performance of this robust castor.





MOUNTING
PLATES
AVAILABLE IF
REQUIRED
page 95

S6270SLB

SPECIFICATIONS & FITTINGS

 Diameter (mm)	 Width (mm)	 Wheel Type	 Wheel Code	 Bearing Type	 Load Capacity	 Height (mm)	 Swivel Radius	 Rigid Code	 Swivel Code
100	50	Cast Iron	Ci464	Ball	500	139	108	R4211	S4210 *
100	50	Rubber	RT4447	Ball	110/80	139	108	R4213	S4212
100	50	Poly Ci	PU425	Ball	500/380	139	108	R4271	S4270 *
100	50	Cast Iron	Ci464	Ball	500	139	108	R4861	S4860 *
125	45	Cast Iron	Ci520	Ball	500	166	108	R5211	S5210 *
125	50	Rubber	RT5547	Ball	180/130	166	120	-	S5212 *
125	50	Poly Ci	PU525	Ball	500/380	166	120	R5271	S5270 *
150	50	Rubber	RT6642	Roller	225/200	194	130	R6761	S6760
150	50	Poly Nylon	PU6071	Ball	400/300	194	130	R6215	S6214
150	50	Poly Ci	PU614	Roller	250/200	194	130	R6013	S6012
150	50	Poly Ci	PU649	Ball	500/380	194	130	R6271	S6270
150	50	Nylon	NY652	SS Sleeve	400/300	194	130	R6061	S6060
150	50	Nylon	NY613	Ball	400/300	194	130	R6121	S6120
150	45	Cast Iron	SG611	Plain	500/380	194	130	R6711	S6710 !
150	45	Cast Iron	SG601	Ball	500/380	194	130	R6241	S6240 !
150	38	Cast Iron	VG609	Ball	500/380	194	130	R6451	S6450 *
200	45	Resilient Rubber	RR8871	Ball	350/300	248	155	R8071	S8070
200	50	Rubber	RT8842	Roller	250/225	248	155	R8231	S8230
200	50	Poly Nylon	PU8071	Ball	400/300	248	155	R8215	S8214
200	50	Poly Nylon	PU815	Ball	500/380	248	155	R8261	S8260
200	50	Poly Ci	PU849	Ball	500/380	248	155	R8471	S8470
200	50	Nylon	NY800	SS Sleeve	400/300	248	155	R8281	S8280
200	50	Nylon	NY830	Ball	400/300	248	155	R8121	S8120
200	50	Cast Iron	Ci842	Plain	500/250	248	155	R8451	S8450 !
200	50	Cast Iron	Ci852	Ball	500/300	248	155	R8431	S8430 !
200	52	V-Groove	VG839	Ball	500	248	155	R8507	S8506 *
210	60	Pneumatic	PN8860	Ball	100	250	155	R8711	S8710
230	40	Cushion Rubber	CR9000	Ball	220/180	294	175	R9011	S9010
250	50	Cushion Rubber	CR1060	Ball	300/250	302	184	R1026	S1025
250	50	Poly Ci Doughnut	PU1056	Ball	500	302	180	R1039	S1038 *
250	50	Poli Ci	PU1056	Ball	500	302	180	R1052	S1051

To order castor with SLB and/ or 4 Way Directional Lock, add SLB and/or D to the end of Swivel Code e.g. S8120SLB indicates a brake castor.  denotes towable castors. ! denotes castor available with wheel brake only.  Indicates castors for high/low temperature applications. * Indicates castors not available with brake.

UP TO 1000KG / CASTOR

1000 SERIES CASTORS

The 1000 Series 1000kg load rating provides an economical alternative to heavier load bearing castors. The ability to be towed at a 6kph by tugs and tractors enables this castor to be used on mobile platforms, aviation trolleys, automotive assembly lines and production manufacturing plants.

















The polyurethane cast iron wheel type with a rolling diameter of up to 300mm not only enhances maneuverability but decreases rolling resistance. Like most Richmond heavy duty castors, our 1000 series has a precision machined ball race and high tensile steel kingpin to withstand side impact loads.



MOUNTING PLATES AVAILABLE IF REQUIRED
page 95

S6338SLB

SPECIFICATIONS & FITTINGS

 Diameter (mm)	 Width (mm)	 Wheel Type	 Wheel Code	 Bearing Type	 Load Capacity	 Height (mm)	 Swivel Radius	 Rigid Code	 Swivel Code	
150	50	Poly Ci	PU659	Ball	900/700	194	130	R6339	S6338	
150	45	Cast Iron	Ci601	Ball	1000/500	194	130	R6319	S6318	
200	50	Poly Ci	PU876	Ball	1000/750	248	155	R8069	S8068	
200	50	Cast Iron	Ci852	Ball	1000/500	248	155	R8089	S8088	
250	50	Poly Ci	PU1056	Ball	1000/750	300	180	R1020	S1019	
300	50	Poly Ci	PU1218	Ball	1000/750	360	215	R1205	S1204	

To order castor with Brake and/ or 4 Way Directional Lock, add B and/or D to the end of Swivel Code e.g. S6138B indicates a brake castor.  denotes towable castors. Also available with Swivel Lock and Brake add SLB to the end of the Swivel Code e.g. S6138SLB.

BASEPLATE DIMENSIONS & DRILLING PATTERNS FOR 1000 SERIES CASTORS

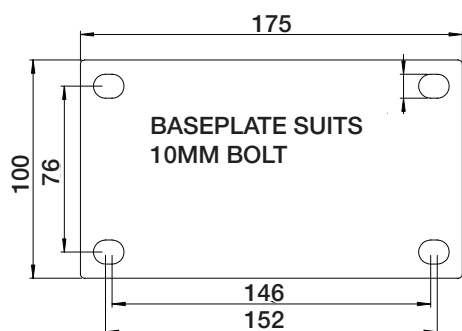

R6319

S1019

FORGED HEAD SERIES CASTORS

UP TO 1500KG / CASTOR



















Applications including transport and logistics, heavy machinery, warehousing equipment and mobile platforms rely on the extreme shock loading, robust durable kingpin and drop forged steel baseplate of Richmond's Forged Head Series for loads up to 1500kg.

Truly a great all round castor for those heavy duty applications requiring a towable option, zinc plated for corrosion resistance and the ability to withstand daily abuse that will not compromise performance.



S8002B

SPECIFICATIONS & FITTINGS

 Diameter (mm)	 Width (mm)	 Wheel Type	 Wheel Code	 Bearing Type	 Load Capacity	 Height (mm)	 Swivel Radius	 Rigid Code	 Swivel Code	
200	75	Poly	PU824	Ball	1500/1200	268	156	R8003	S8002	
200	75	SG Iron	SG822	Ball	1500/1200	268	156	R8001	S8000	
250	75	Poly	PU1030	Ball	1500/1200	317	194	R1035	S1034	
250	75	SG Iron	SG1027	Ball	1500/1200	317	194	R1033	S1032	
250	75	Solid PN	SN1005	Ball	260/200	317	194	R1045	S1044	
300	75	Poly	PU1217	Ball	1500/1200	370	234	R1235	S1234	
300	75	Solid PN	SN1295	Ball	540-400	370	234	R1245	S1244	

To order castor with Brake B or Directional Lock D add B or D to the end of the Swivel Code e.g. S8002B indicates a swivel brake castor. To order castor with Directional Lock add D to the end of Swivel Code e.g. S8002D indicates a brake castor.  denotes towable castors.

BASEPLATE DIMENSIONS & DRILLING PATTERNS FOR FORGED HEAD SERIES CASTORS

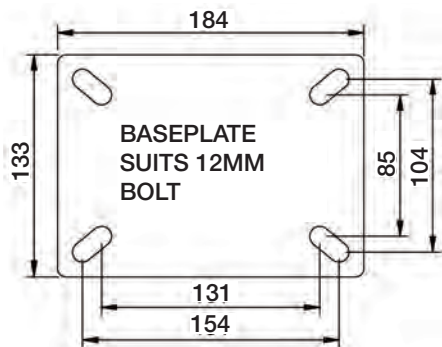

S1034

R1033

3000 SERIES CASTORS

UP TO 3000KG / CASTOR











This Extra Heavy Duty range has been precisely engineered and custom built to excel under the hardest conditions.

Richmond's 3000 Series picks up applications that our 1000 Series cannot. Increased towing capacity and towing speed, increases the possibility for rolling solutions for the most arduous of towing applications.



S10902

SPECIFICATIONS & FITTINGS

									
Diameter (mm)	Width (mm)	Wheel Type	Wheel Code	Bearing Type	Load Capacity	Height (mm)	Swivel Radius	Rigid Code	Swivel Code
200	76	Poly	PU823	Ball	2000/1700	260	167	R8905	S8904
200	76	SG Iron	SG834	Ball	2000/1700	260	167	R8903	S8902
200	75	V-Groove	VG836	Ball	2000/1700	260	167	-	S8912
250	76	Poly	PU1209	Ball	2500/2000	310	190	R10905	S10904
250	76	SG Iron	SG1028	Ball	3000/2500	310	190	R10903	S10902
250	70	Solid Pneumatic	SN1005	Ball	260/200	310	190	R1909	S10908
250	100	Poly	PU1048	Ball	3000/2000	310	190	R10913	S10912
300	76	Poly	PU1217	Ball	3000/2500	364	228	R12905	S12904
300	85	Solid Pneumatic	SN1295	Ball	540/400	364	228	R12909	S12908
300	100	Poly	PU1224	Ball	3000/2500	364	228	R12913	S12912
400	100	Solid Pneumatic	SN1612	Ball	950/730	462	293	R16901	S16902
400	100	Pneumatic	PN1616	Ball	300/250	462	293	R16903	S16904

To order castor with Brake and/or 4 Way Directional Lock, add B and/or D to the end of Swivel Code e.g. S8904B indicates a brake castor.  denotes towable castors. Add OP to end of castor code to specify Optional Baseplate e.g. S8904OP.

STANDARD BASEPLATE DIMENSIONS & DRILLING PATTERNS FOR 3000 SERIES CASTORS

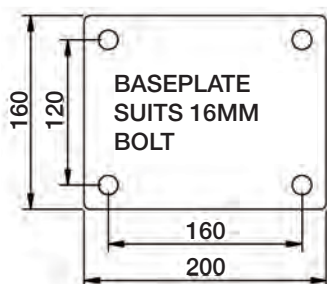

OPTIONAL BASEPLATE DIMENSIONS & DRILLING PATTERNS FOR 3000 SERIES CASTORS

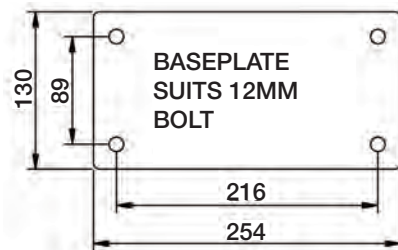

HIGH PERFORMANCE SERIES CASTORS

UP TO 1500KG / CASTOR

When performance and endurance are key concerns, the High Performance castor is world class. Large opposed taper roller bearings in the swivel head mean the castor can be power towed at speeds up to 12kph over flat surfaces without obstructions.











The passivated zinc plated frame is robot welded with a fully sealed greasable precision taper roller bearing swivel head ensuring a high performance. Richmond's High Performance Series is custom designed and manufactured in-house to a Richmond designed specification.



CUSTOM DESIGN

S810

SPECIFICATIONS & FITTINGS

 Diameter (mm)	 Width (mm)	 Wheel Type	 Wheel Code	 Bearing Type	 Load Capacity	 Height (mm)	 Swivel Radius	 Rigid Code	 Swivel Code
150	50	Poly Ci	PU659	Ball	900/700	214	135	R634	S633
150	75	Poly Ci	PU615	Ball	1100/750	214	135	R656	S657
150	45	Cast Iron	Ci601	Ball	1500/500	214	135	R632	S631
150	75	Cast Iron	Ci689	Ball	1500/500	214	135	R691	S690
200	50	Poly Ci	PU876	Ball	1200/900	264	172	R811	S810
200	50 x 2	TW Poly Ci	PU876 x 2	Ball	1200/900	264	172	R873	S872
200	75	Poly Ci	PU896	Ball	1300/750	264	172	R898	S897
200	50	SG Iron	SG835	Ball	1500/500	264	172	R819	S818
200	75	SG Iron	SG834	Ball	1500/500	264	172	R838	S837
250	75	Poly Ci	PU1076	Ball	1300/1000	312	210	R1018	S1017
250	75 x 2	TW Poly Ci	PU1076 x 2	Ball	1300/1000	312	210	R1091	S1090
250	75	SG Iron	SG1040	Ball	1500/1000	312	210	R1042	S1043
300	75	Poly Ci	PU1217	Ball	1500/1000	375	240	R1229	S1228
300	100	Poly Ci	PU1224	Ball	1500/1000	375	240	R1226	S1225
400	100	Pneumatic	PN1616	Ball	300	475	295	R1602	S1601
400	100	Solid Pneumatic	SN1612	Ball	950/730	475	295	R1649	S1650

To order castor with Brake and/or 4 Way Directional Lock, add B and/or D to the end of Swivel Code e.g. S633B indicates a brake castor.  denotes towable castors.

BASEPLATE DIMENSIONS & DRILLING PATTERNS FOR HIGH PERFORMANCE CASTORS

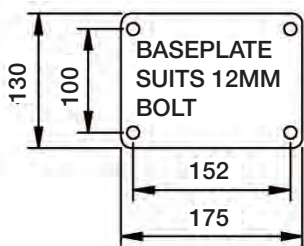

STANDARD HP BASE PLATE

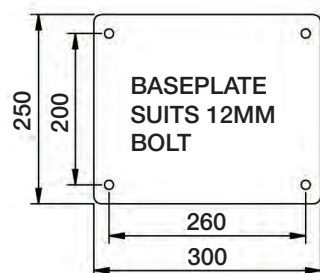

STANDARD TWIN WHEEL RIGID BASE PLATE



R656

S818

UP TO 5000KG / CASTOR

SINGLE WHEEL EXTRA HIGH PERFORMANCE CASTORS











Designed by Richmond over 30 years ago, this series remains the best Extra Heavy Duty towing castor in the world. Suitable for speeds up to 16kph on good surfaces with loads up to 5000kg per castor.

Features a well sealed precision swivel head with high rigidity combined with super tough wheels.



S1093B

SPECIFICATIONS & FITTINGS

 Diameter (mm)	 Width (mm)	 Wheel Type	 Wheel Code	 Bearing Type	 Load Capacity	 Height (mm)	 Swivel Radius	 Rigid Code	 Swivel Code
200	75	Steel	SG836	Taper	5000/3750	320	172	R865	S866
250	100	Poly Ci	PU1049	Taper	5000/3750	370	210	R1092	S1093
300	100	Poly Ci	PU1224	Ball	2500/1875	420	240	R1221	S1222
300	100	Poly Ci	PU1203	Taper	5000/3750	420	240	R1223	S1224
400	125	Poly Ci	PU1606	Taper	5000/3750	520	295	R1607	S1608



To order castor with Brake and/ or 4 Way Directional Lock, add B and/or D to the end of Swivel Code e.g. S886B indicates a brake castor.  denotes towable castors.

BASEPLATE DIMENSIONS & DRILLING PATTERNS FOR 5000 SERIES CASTORS

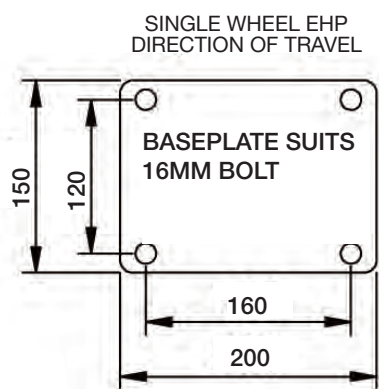

S1093



“Australian made by Richmond ensures the best you can get”

- Ray Winslow, Chairman

TWIN WHEEL EXTRA HIGH PERFORMANCE CASTORS

UP TO 3000KG / CASTOR

In a class of its own, the EHP series outperforms all rivals no matter how tough the circumstances.

Developed using Richmond's 55+ years of castor know-how, features include a large opposed taper roller bearing swivel head with a precision robot welded fully sealed construction ensuring a long life without costly breakdowns.

The EHP series are fully towable at speeds up to 16kph on flat surfaces without obstacles, making them ideal for work with heavy duty applications.











The castor's twin wheel design not only increases surface contact but controls the rolling speed of each wheel when turning and maneuvering.

Custom designed and manufactured in-house, we challenge you to find a better castor.



S1241

SPECIFICATIONS & FITTINGS

 Diameter (mm)	 Width (mm)	 Wheel Type	 Wheel Code	 Bearing Type	 Load Capacity	 Height (mm)	 Swivel Radius	 Rigid Code	 Swivel Code
250	50 x 2	TW Poly Ci	PU1061 x 2	Taper	2000/1500	370	210	R1062	S1063
250	75 x 2	TW Poly Ci	PU1076 x 2	Taper	2000/1500	370	210	R1064	S1065
300	50 x 2	TW Poly Ci	PU1218 x 2	Taper	2500/1875	420	240	R1236	S1237
300	100 x 2	TW Poly Ci	PU1203 x 2	Taper	3000/2250	420	240	R1240	S1241
350	100 x 2	TW Poly Ci	PU1408 x 2	Taper	3000/2250	470	290	R1409	S1410

To order castor with Brake and/ or 4 Way Directional Lock, add B and/or D to the end of Swivel Code e.g. S1063B indicates a brake castor.  denotes towable castors.

BASEPLATE DIMENSIONS & DRILLING PATTERNS FOR TWIN WHEEL EHP CASTORS

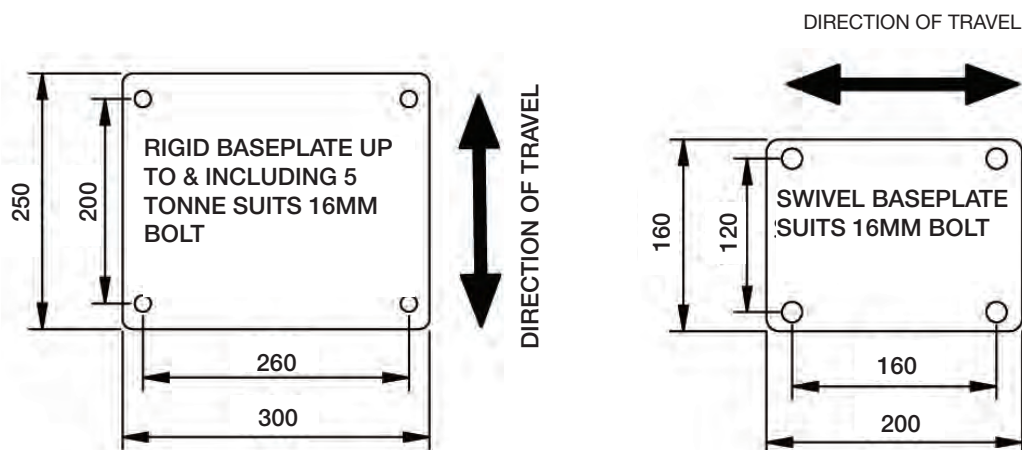

10 TONNE CASTOR

UP TO 10000KG / CASTOR





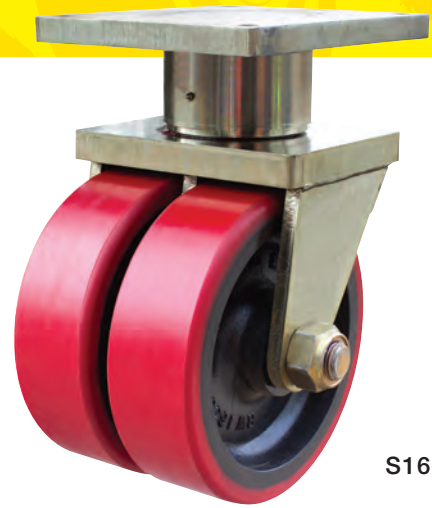





This Richmond design surpasses anything available on the world castor market, immensely rugged and precision built.

Our 10 tonner easily moves the biggest loads, and the tyre formulation can be varied for different applications to further improve performance.



S1652

SPECIFICATIONS & FITTINGS

 Diameter (mm)	 Width (mm)	 Wheel Type	 Wheel Code	 Bearing Type	 Load Capacity	 Height (mm)	 Swivel Radius	 Rigid Code	 Swivel Code
400	125 x 2	TW Poly Ci	PU1606 x 2	Taper	10000/7500	610	318	R1653	S1652

To order castor with Brake and/ or 4 Way Directional Lock, add B and/or D to the end of Swivel Code e.g. S1652B indicates a brake castor.  denotes towable castors.

FOR CASTORS ABOVE 10 TONNE CONTACT OUR ENGINEERING DEPARTMENT FOR A CUSTOM SOLUTION!

TWIN WHEEL BASEPLATE DIMENSIONS

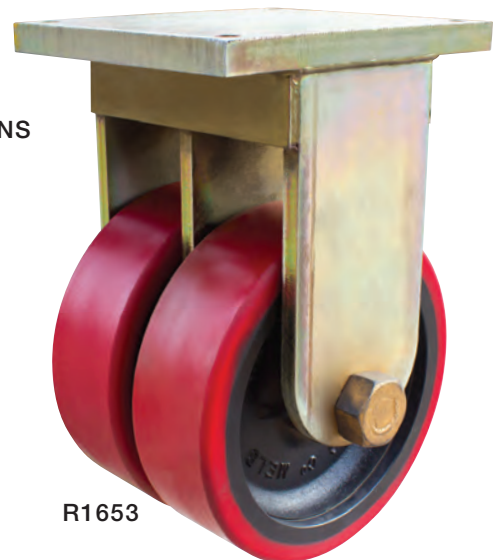
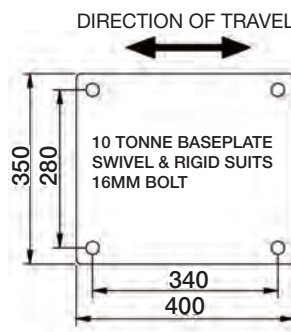

R1653



"Australian made by Richmond ensures the best you can get"

- Ray Winslow, Chairman

CONTAINER LOCKING CASTOR KIT

These kits once fitted to each castor, are then mounted onto each corner of the container, thus making the container mobile.

Fitting requires using two left-hand and two right-hand kits.

Using 3000 Series castors allows a maximum total of 12 tonne loading at 8KPH and EHP castors will allow 20 tonne loading. Please note some castors in each range have lower capacities and this must be allowed for.

Shipping containers have 2 left and right fittings, so to order the correct fittings to move a container, order 2 x 195CONT-LOCKITL, 2 x 195CONT-LOCKITR and 4 x castors.



KIT CONTENTS

- 1 x Left or right corner fitting
- 1 x Locating bush
- 1 x M30 bolt
- 1 x Flat washer
- 4 x M30 Spring washers & fasteners

**ALSO
AVAILABLE
FOR RENTAL!**

**CALL
1300 4 RICHMOND**

To move a container order 2 x 195CONT-LOCKITL, 2 x 195CONT-LOCKITR + 4 castors.



5000kg capacity kit
using EHP Series



3000kg capacity kit
using 3000 Series



UP TO 2250KG / CASTOR

TOWMASTER CASTORS











At the forefront of castor design, the Towmaster was conceived, designed and manufactured in-house. Initially designed for airport ground support dollies and suitable for speeds up to 24kph, it can also be found in use in container handling areas, wharves and manufacturing plants.

Its robust nature, precision steering combined with its towable capacity makes this the castor of choice at airports for tarmac use. The Towmaster can be customised to suit specifications allowing for changes in load capacities and tow speeds. Richmond offer a full maintenance and service program on this castor series.



S1622

SPECIFICATIONS & FITTINGS

 Diameter (mm)	 Width (mm)	 Wheel Type	 Wheel Code	 Bearing Type	 Load Capacity	 Height (mm)	 Swivel Radius	 Rigid Code	 Swivel Code
406	125 x 2	TW Cushion Rubber	SN1615 x 2	Ball	2250	460	322	R1625	S1624
406	125 x 2	TW Solid Pneumatic	SN1615 x 2	Ball	2250	460	322	R1623	S1622
406	110 x 2	TW Solid Pneumatic	SN1612 x 2	Ball	1900	465	310	R1639	S1638

To order castor with Brake and/ or 4 Way Directional Lock, add B and/or D to the end of Swivel Code e.g. S1622B indicates a brake castor.  denotes towable castors.

BASEPLATE DIMENSIONS & DRILLING PATTERNS FOR TOWMASTER CASTORS

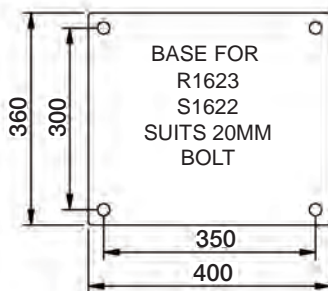
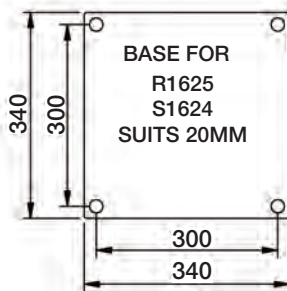
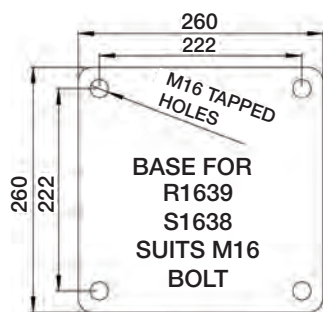

Richmond has now manufactured an alternative/replacement Towmaster castor (R1639 & S1638) suitable for fully imported ground support container trailers. This high quality product fits directly to the trolley and is backed by Richmond's service and spare parts program.

BASEPLATES CAN BE CUSTOMIZED TO YOUR REQUIREMENTS

AVIATION PRODUCTS

Richmond offers a vast range of spare parts to suit all makes and models of airport ground support trailers & commander loaders.

With our inhouse polyurethane moulding facilities, Richmond can recoat worn out rubber coated Commander castor wheels & drive rollers with a much longer lasting, hard wearing poly material.

Please phone our technical staff for more information.



**PU1209
COMMANDER WHEEL**



COMMANDER ROLLERS

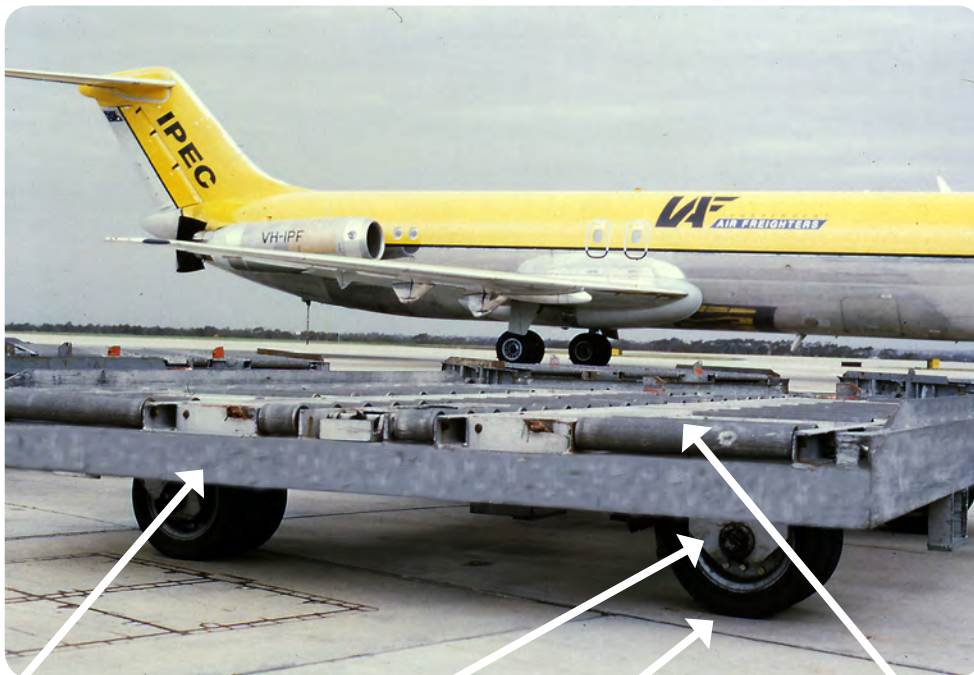

Replacement swivel & rigid frames

Replacement steel rims

Replacement cushion solid tyres

Replacement steel rollers

UP TO 200KG / CASTOR

CARGO SERIES CASTORS







The unique upside down nature of the Cargo castor was conceived for use on cargo handling systems and specifically for airport applications.

The heavy load carrying capacity, maintenance free precision ball bearing for low rolling and swivel resistance coupled with the anti-corrosion coating ensure this castors' longevity. Other features include a robust pressed steel fork combined with integrated plastic sealing.



S2446

SPECIFICATIONS & FITTINGS

 Diameter (mm)	 Width (mm)	 Wheel Type	 Bearing Type	 Load Capacity	 Height (mm)	 Swivel Code
58	35	Nylon	Ball	200	96	S2334
70	35	Nylon	Ball	200	102	S2446



BASEPLATE DIMENSIONS & DRILLING PATTERNS FOR CARGO CASTORS

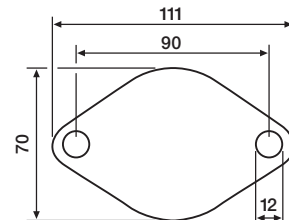

* Richmond Cargo Castors at work in Airport cargo handling systems

SPRING LOADED CASTORS

Richmond can custom engineer Spring Loaded Castors to suit any requirements.

- Substantial noise reduction
- Shock absorption protects the cargo from unwanted shock & vibrations
- Ideal for power towing applications

Contact your store for design details. Designs can be tuned to fit your load and speed requirements.



S8262SPR



S6644SPR



S6338SPR



S9010SPR



S8904SPR



R12907SPR

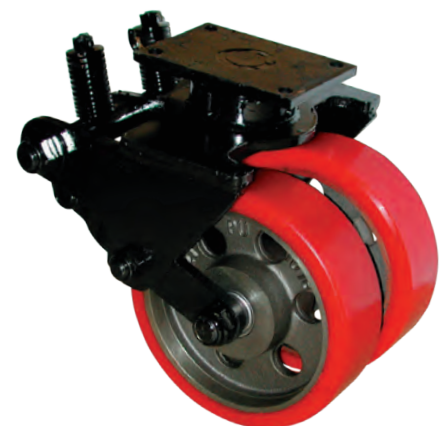

S1090SPR

RICHMOND
WheelMakers for Industry

STAINLESS STEEL ELITE BOLT SERIES

UP TO 100KG / CASTOR

Richmond's Stainless Steel Elite castors are manufactured from Grade 304 stainless steel to provide uncompromised durability when hygiene and health are important, they are highly suited to medical or laboratory equipment.

Featuring a stainless steel double ball race swivel head contributing to maintenance free life, fitted with an attractive stainless steel thread guard on the 100 and 125mm or plastic thread guards on the 75mm castors these castors can be fitted to food carts that are constantly moved through cool rooms and steamy kitchens. They can also be hose cleaned.











A full range of round and square pintle options are available through your local Richmond supplier.



S3390B







SUITABLE FOR WET ENVIRONMENTS
FULL STAINLESS CONSTRUCTION

SPECIFICATIONS & FITTINGS

 Diameter (mm)	 Width (mm)	 Wheel Type	 Wheel Code	 Bearing Type	 Load Capacity	 Height (mm)	 Swivel Radius	 With Brake	 Bolt Size (mm)	 Swivel Code
75	30	Poly Nylon	PU3345	SS Ball	80/45	105	70	105	12	S3384 #
75	30	Nylon	NY3321	Plain	80/45	105	70	105	12	S3390 #
100	27	Poly Nylon	PU4439	SS Ball	100/80	133	90	106	12	S4478
100	30	Nylon	NY4417	Plain	100/80	133	90	106	12	S4490
125	27	Poly Nylon	PU5539	SS Ball	100/80	159	102	106	12	S5578
125	30	Nylon	NY5517	Plain	100/80	159	102	106	12	S5590
125	32	Poly Nylon	PU5555	Ball	100/80	159	-	106	12	S5571B

To order castor with Swivel Lock & Brake (B) or Directional Lock (D) add B or D to the end of the Swivel Code e.g. S5578B indicates a brake castor. Castors marked # are not available with directional locks.

NYLON EXPANDING PINTLES

Pintle	Pintle Code	Pintle Type
	IPN12-P1	For 19mm ID Round Tube
	IPN12-P2	For 22mm ID Round Tube
	IPN12-P3	For 28.5mm ID Round Tube
	INP12-P4	For 19mm ID Square Tube
	INP12-P5	For 22mm ID Square Tube
	INP12-P6	For 28.5mm ID Square Tube
Single Bolt Fitting Various bolt lengths available		

*Also see page 92 for Solid and Threaded pintle options

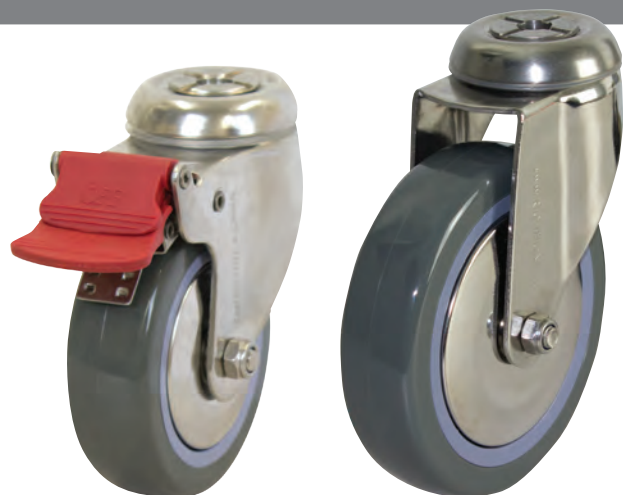

S4478B

S5578

CASTOR FITTING REQUIREMENTS

To fit this castor to a 20mm thick base requires a 50mm x 12mm stainless steel set screw. Can be fitted with a 10mm set screw using a 100RED1208SS Reducer.

STAINLESS STEEL ELITE PLATE SERIES

UP TO 100KG / CASTOR



S4476B













S4488



S4488B

SUITABLE FOR WET ENVIRONMENTS
FULL STAINLESS CONSTRUCTION

SPECIFICATIONS & FITTINGS

 Diameter (mm)	 Width (mm)	 Wheel Type	 Wheel Code	 Bearing Type	 Load Capacity	 Height (mm)	 Swivel Radius	 With Brake	 Rigid Code	 Swivel Code
75	30	Poly Nylon	PU3345	SS Ball	80/45	107	70	105	R3383	S3382 #
75	30	Nylon	NY3321	Plain	80/45	107	70	105	R3389	S3388 #
100	27	Poly Nylon	PU4439	SS Ball	100/80	135	90	106	R4477	S4476
100	30	Nylon	NY4417	Plain	100/80	135	90	106	R4489	S4488
125	27	Poly Nylon	PU5539	SS Ball	100/80	161	102	106	R5577	S5576
125	30	Nylon	NY5517	Plain	100/80	161	102	106	R5589	S5588

To order castor with Swivel Lock & Brake (B) or Directional Lock (D) add B or D to the end of the Swivel Code e.g. S4476B indicates a brake castor. Castors marked # are not available with directional locks.

BASEPLATE DIMENSIONS & DRILLING PATTERNS FOR STAINLESS STEEL ELITE CASTORS

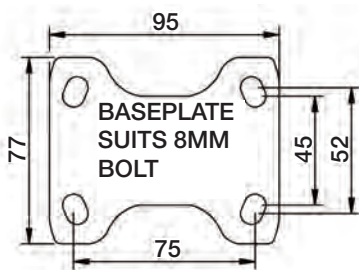

RIGID

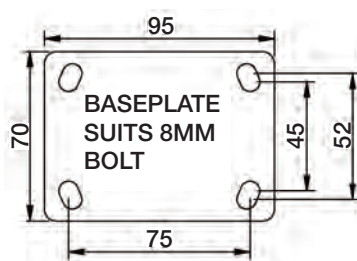

SWIVEL



R4477

UP TO 300KG / CASTOR

STAINLESS STEEL EXCEL BOLT HOLE SERIES

Heavy duty pressed stainless steel frame combined with full stainless componentry make the Excel Series the ideal choice for use in wet areas, frequent wash down applications and food and health industries.











When hygiene is of the utmost importance, the castor has the ability to be fitted to an array of equipment and trolleys with various fittings including; pre fitted threaded inserts, solid drilled metal pintles, expanding pintles or a single bolt or plate style.



S4146B



SUITABLE FOR WET ENVIRONMENTS
FULL STAINLESS CONSTRUCTION

SPECIFICATIONS & FITTINGS

 Diameter (mm)	 Width (mm)	 Wheel Type	 Wheel Code	 Bearing Type	 Load Capacity	 Height (mm)	 Swivel Radius	 With Brake	 Bolt Size (mm)	 Swivel Code
100	35	Reb Poly	RP4072	SS Roller	150/110	130	90	125	12	S4148
100	35	GF Nylon	GF412	Plain	200/150	130	90	125	12	S4136
100	35	Nylon	NY401	Plain	200/110	130	90	125	12	S4146
125	35	Reb Poly	RP5072	SS Roller	200/150	157	112	125	12	S5148
125	35	Nylon	NY501	Plain	200/150	157	112	125	12	S5146
150	40	Reb Poly	RP6072	SS Roller	300/225	183	127	127	12	S6148
150	50	Nylon	NY652	Plain	300/225	183	127	127	12	S6146
150	50	Nylon	NY655	SS Roller	300/225	183	127	150	12	S6150

To order castor with Swivel Lock & Brake, add B to the end of the Swivel Code, eg S4146B indicates a brake castor.
 Indicates castor suitable for high/low temperature applications.

NYLON EXPANDING PINTLES

Pintle	Pintle Code	Pintle Type
	IPN12-P1	For 19mm ID Round Tube
	IPN12-P2	For 22mm ID Round Tube
	IPN12-P3	For 28.5mm ID Round Tube
	INP12-P4	For 19mm ID Square Tube
	IPN12-P5	For 22mm ID Square Tube
	IPN12-P6	For 28.5mm ID Square Tube
	Single Bolt Fitting Various bolt lengths available	

*Also see page 92 for Solid and Threaded pintle options



S4148B

S6146

CASTOR FITTING REQUIREMENTS

To fit to 20mm thick base requires a 50mm x 12mm stainless steel set screw.

STAINLESS STEEL EXCEL PLATE SERIES

UP TO 400KG / CASTOR



S4144B













S4114



S5142B

SUITABLE FOR WET ENVIRONMENTS
FULL STAINLESS CONSTRUCTION

SPECIFICATIONS & FITTINGS

 Diameter (mm)	 Width (mm)	 Wheel Type	 Wheel Code	 Bearing Type	 Load Capacity	 Height (mm)	 Swivel Radius	 With Brake	 Rigid Code	 Swivel Code
100	35	Reb Poly	RP4072	SS Roller	140/100	133	92	115	R4145	S4144
100	35	Nylon	NY401	Plain	200/150	133	92	115	R4143	S4142
100	36	Aluminium	AL473	Plain	180/150	133	92	-	R4115	S4114 *
100	36	Aluminium	AL474	Plain	180/150	133	92	-	R4141	S4140
100	35	GF Nylon	GF412	Plain	200/150	133	92	115	R4139	S4138
125	35	Reb Poly	RP5072	SS Roller	180/150	158	158	120	R5145	S5144
125	35	Nylon	NY501	Plain	200/150	158	158	120	R5143	S5142
150	50	Reb Poly	RP6074	SS Roller	300/250	187	127	160	R6137	S6136
150	40	Reb Poly	RP6072	SS Roller	300/250	187	127	160	R6145	S6144
150	50	Nylon	NY652	Plain	300/250	187	127	160	R6143	S6142
150	50	Nylon	NY655	SS Roller	300/250	187	127	160	R6141	S6140
200	50	Reb Poly	RP8072	SS Roller	300/250	237	156	170	R8145	S8144
200	45	Nylon	NY800	Plain	380/350	237	156	170	R8143	S8142
200	50	Nylon	NY802	SS Roller	380/350	237	156	170	R8141	S8140
200	43	GF Nylon	GF800	Plain	400/300	237	156	170	R8149	S8148

To order castor with Swivel Lock & Brake (B), add B to the end of the Swivel Code e.g. S5144B indicates a brake castor. *S4114 not available with brake.
Indicates castor suitable for high/low temperature applications.

Part numbers denoted in red indicate M2 Baseplate. Part numbers denoted in black indicate M3 Baseplate.

BASEPLATE DIMENSIONS & DRILLING PATTERNS FOR RIGID STAINLESS STEEL EXCEL CASTORS

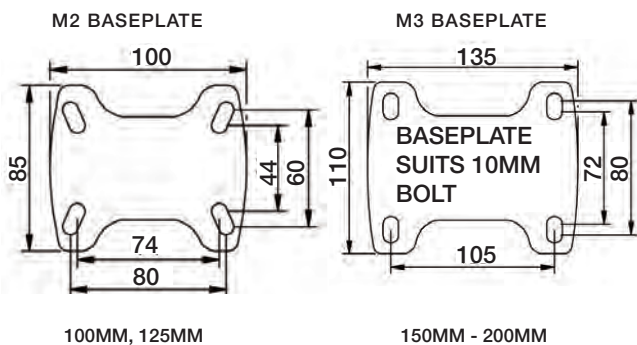

BASEPLATE DIMENSIONS & DRILLING PATTERNS FOR SWIVEL STAINLESS STEEL EXCEL CASTORS

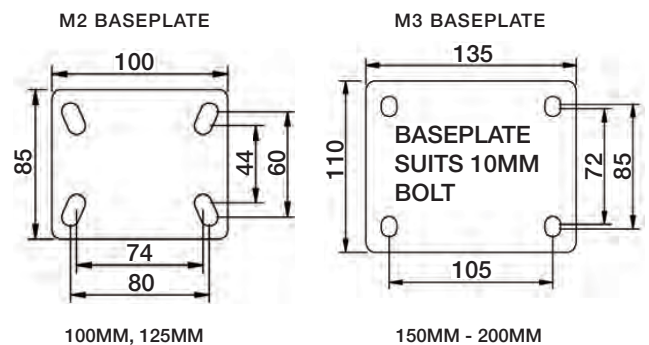

MEDI TWIN SERIES

UP TO 110KG / CASTOR

The Medi Twin is a non-marking, modern designed medical castor fitted with precision ball bearings. Its stylish appearance and polyurethane tyres provide a smooth ride. A directional lock is available for straight line tracking or free movement when unlocked.

Richmond's Medi Twin castor is suited to top of the range medical carts and monitor trolleys.



S4312B

SPECIFICATIONS & FITTINGS

 Diameter (mm)	 Width (mm)	 Wheel Type	 Thread Size	 Bearing Type	 Load Capacity	 Height (mm)	 Swivel Radius	 With Brake	 Swivel Code
100	2 x 16	Polyurethane	M12 x 25mm	Ball	80/60	123	80	120	S4312
125	2 x 18	Polyurethane	M12 x 25mm	Ball	110/80	148	102	148	S5312

To order castor with Swivel Lock & Brake (B), add B to the end of the Swivel Code e.g. S4312B indicates a brake castor. To order castor with Directional lock (D) add D to the end of the Swivel e.g. S4312D

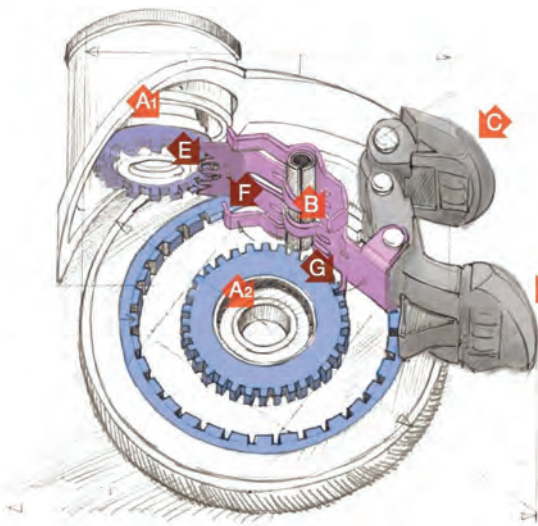

TOTAL LOCKING

Locks swivel head and two wheels simultaneously.

DIRECTIONAL LOCK

Swivel head lock for straight line tracking. Unlock for free movement.

*** DIRECTIONAL LOCK THREAD SIZE IN ALL MODELS IS M16 x 25mm LONG**

A1-2: Precision ball bearings at swivel head & wheel axis

B: Stainless steel brake spring

C: Release Pedal

D: Brake Pedal

E: Swivel Lock

F: External wheel lock

G: Internal wheel lock



ABS CENTRAL LOCKING TWIN WHEEL SERIES

UP TO 150KG / CASTOR

Suitable for patient beds requiring one point locking and require minimal maintenance the larger rolling diameter of the Central Locking Twin Wheel Castors performs on both hard and carpeted surfaces.

The stylish ABS cover and precision ball bearing swivel head assist in swivelling the castor, making beds and stretchers easier to position at any time. An increased load capacity of 150kg and positive brake performance increase the value this Richmond castor adds to hospital beds.



S6296B

SPECIFICATIONS & FITTINGS

Diameter (mm)	Width (mm)	Wheel Type	Bearing Type	Load Capacity (KG)	Height (mm)	Swivel Radius	Swivel Code
125	2x15	Polyurethane	Ball	120/90	165	102	S5296
150	2x18	Polyurethane	Ball	150/120	189	115	S6296

To order castor with Total Lock & Brake (B), or Directional Lock,(D) add B or D to the end of the Swivel Code e.g. S5295B indicates a brake castor.

CENTRAL LOCKING MEDICAL SERIES CASTORS

UP TO 120KG / CASTOR

Patient comfort is vital in the health care industry and also the ease at which medical personnel can move equipment and patients to and from procedure rooms.

Richmond Central Locking Castors address that both patient and personnel are both equally as important. These castors offer smooth running, positive brake performance, quiet motion and an attractive chrome finish.



S8293B

SPECIFICATIONS & FITTINGS

Diameter (mm)	Width (mm)	Wheel Type	Bearing Type	Load Capacity (KG)	Height (mm)	Swivel Radius	Swivel Code
100	32	Grey Rubber	Ball	100/90	142	80	S4293
125	32	Grey Rubber	Ball	100/90	164	102	S5293
150	32	Grey Rubber	Ball	120/100	192	125	S6293
200	32	Grey Rubber	Ball	120/100	240	157	S8293

To order castor with Total Lock & Brake (B), or Directional Lock,(D) add B or D to the end of the Swivel Code e.g. S4293B indicates a brake castor

UP TO 80KG / CASTOR







REFRIGERATION CASTORS

Designed specifically for use on catering refrigeration units, merchandisers, food serveries and preparation counters. Richmond Refrigeration Castors are designed to be a compatible replacement product for most commercial equipment.



S3300B

SPECIFICATIONS & FITTINGS

 Diameter (mm)	 Width (mm)	 Wheel Type	 Bearing Type	 Load Capacity	 Height (mm)	 Swivel Radius	 With Brake	 Thread Size (mm)	 Swivel Code
75	30	Nylon	Plain	80/60	100	62	65	3/4" BSW	S3298
75	30	Nylon	Plain	80/60	107	71	105	3/4" BSW	S3300
75	30	Nylon	Plain	80/60	90	62	65	Plate	S3296

To order castor with wheel Brake, add B to the end of the Swivel Code, eg S3296B indicates a brake castor.



S3296B



S3300



S3298B

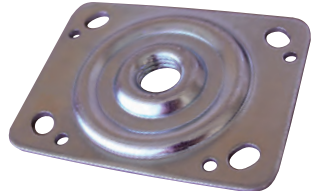

REFPL10983

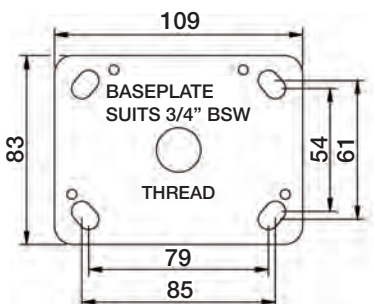

ADJUSTABLE STAINLESS STEEL CATERING LEGS

Made mainly for catering equipment such as display fridges and bain maries, Richmond's stainless steel adjustable catering legs are interchangeable with all leading manufacturers.

Catering legs allow for easy access under equipment to ensure a clean and hygienic environment. Simple adjustability allows levelling of the unit and is quick and accurate whilst providing stability.

Catering legs are designed for easy installation when incorporated with the matching thread baseplate, also available from Richmond.



REFADJLEG146

SPECIFICATIONS & FITTINGS

Height (mm) (A)	Adjustment Height (mm) (B)	Tube Diameter (C)	Flange (D)	Thread (E)	Load (kg)	Product Code
120	25-55	50	60	3/4 BSW	400	REFADJLEG146



THREADED BASE PLATES

Allows for easy installation of castors or adjustable legs. Simply weld or bolt the plate into position, select the castor or adjustable leg and screw into place.

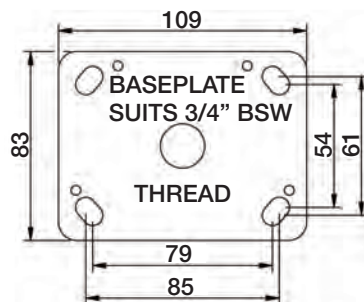
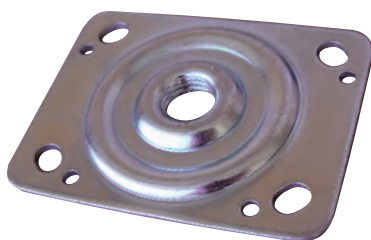
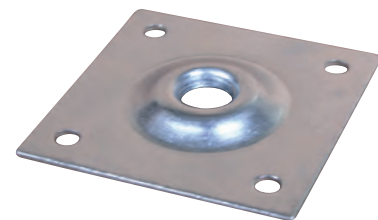

REFPLT10983

Compatible with SKOPE brand display fridge units and bain maries

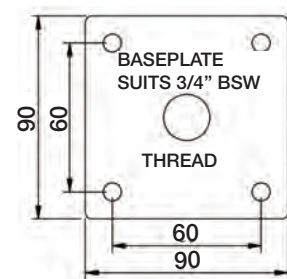

REFPLT09090

Compatible with all major manufacturers of display fridges, preparation benches, bain maries, display cabinets etc

UP TO 20KG / CASTOR

SPRING LOADED UNIVERSAL & GATE CASTORS

Richmond's Spring Loaded Universal & Gate Castors are designed to make opening and closing of residential gates easier.

The spring loaded design provides shock absorption features specifically for use on uneven surfaces. The gate mount is integrated into the frame of the castor for ease of fixing to any gate system.



S4022

SPECIFICATIONS

Diameter (mm) A	Width (mm)	Wheel Type	Wheel Code	Bearing Type	Load Capacity (kg)	Height (mm) B	Swivel Radius C	Swivel Code
75	30	Reb Rubber	RR3348	Ball	20	259	175	S3022
75	30	Nylon	NY3321	Plain	20	259	175	S3024
75	25	Nylon	NY3324	Plain	25	100	65	S3712SPR
100	30	Reb Rubber	RR4473	Ball	20	285	190	S4022
100	30	Nylon	NY4417	Plain	20	285	190	S4024
125	30	Reb Rubber	RR5573	Ball	20	311	205	S5022

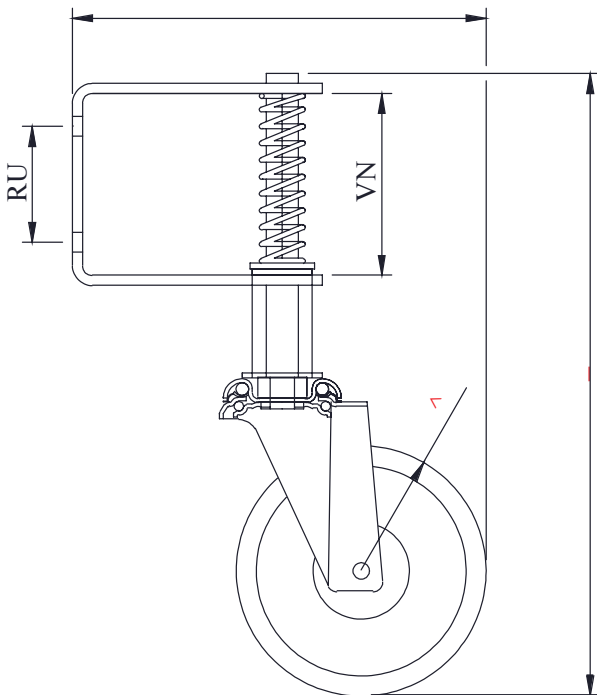

S3712SPR



S3022

UP TO 700KG / CASTOR

TUBE TYPE SCAFFOLD CASTOR

The Tube Type Scaffold Castor has a tube stem to fit 50mm OD scaffold tubing.

The advanced design which eliminates the kingpin features a zinc passivated steel frame for rigidity and a longer working life.

Richmond Tube Type Scaffold Castors are tested and approved to AS/NZS 1576.2:2009



TESTED & APPROVED
To AS/NZS 1576.2:2009

SPECIFICATIONS & FITTINGS

 Diameter (mm)	 Width (mm)	 Wheel Type	 Wheel Code	 Bearing Type	 Load Capacity	 Swivel Code
200	50	Poly Nylon	-	Roller	700	S883B

RICHMOND CAN SUPPLY MANY OTHER SOCKET AND PIN SIZES - 1300 4 RICHMOND or email sales@richmondau.com



TESTED & APPROVED
To AS/NZS 1576.2:2009

S879B

SPECIFICATIONS & FITTINGS

Tube Type to Suit 48mm OD Tube

 Diameter (mm)	 Width (mm)	 Wheel Type	 Wheel Code	 Bearing Type	 Load Capacity	 Swivel Code
200	50	Poly Nylon	-	Roller	700	S879B

RICHMOND CAN SUPPLY MANY OTHER SOCKET AND PIN SIZES - 1300 4 RICHMOND or email sales@richmondau.com

UP TO 350KG / WHEEL

JOCKEY WHEELS









Richmond Jockey Wheels are suitable for use on Caravans, Campers, Boat Trailers and a whole range of Trailers used for transporting goods for leisure or business.

- Available in two different wheel sizes - 150mm or 200mm.
- Replacing the traditional black rubber wheel with a superior rebound rubber product greatly improves the rolling and maneuverability of these products.
- Swing mounting option - pull the handle, unit swings up and locks into position against the draw bar.
- Clamp mounting option - for easy removal.



S6026SW

SPECIFICATIONS & FITTINGS

 Diameter (mm)	 Width (mm)	 Wheel Type	 Wheel Code	 Bearing Type	 Load Capacity	 Raised Height (mm)	 Lowered Height (mm)	 Swivel Code
150	40	Solid Rubber	-	Plain	350	760	500	S6026CL
150	45	Reb Rubber	RR6677	Ball	350	760	500	S6052CL
150	45	Reb Rubber	RR6677	Ball	350	760	500	S6062SW
150	40	Solid Rubber	-	Plain	350	760	500	S6066SW
200	55	Rubber Tyred	-	Plain	350	815	555	S8026CL
200	45	Reb Rubber	RR8871	Ball	350	815	555	S8052CL
ADJUSTABLE STAND WITH PLATE AND CLAMP								
-	-	-	-	-	350	640	315	S6028CL

Important Note: When moving equipment best performance is achieved with jockey wheel being at a lowest position. Moving equipment with jockey wheel in a high position is not safe or advised. All load capacities are based on smooth concrete or asphalt surfaces.

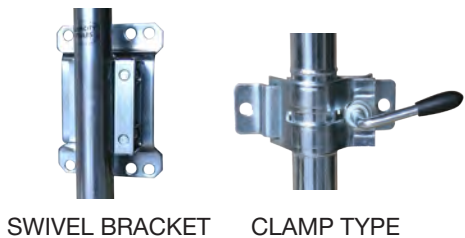

SWIVEL BRACKET CLAMP TYPE

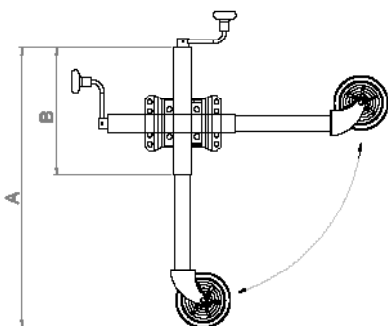

SWING MODEL SHOWN

A - RAISED
B - LOWERED



S6026CL



S6028CL

UP TO 200KG / WHEEL

PUNCTURE PROOF WHEELS

Why buy a pneumatic wheel when there is a better option? Richmond's fully puncture proof wheels eliminate flat tyres and replace the need for tubes.

With high load capacities suited to hand trucks, nursery equipment, industrial and agricultural equipment Richmond's puncture proof wheels combine the strength and stability of a solid rubber wheel with the smooth cushioned ride of a pneumatic wheel.



PF1628



PF1275



PF1124













PF1084



PF8881

SPECIFICATIONS

 Nom Wheel Diameter (mm)	 Tyre Width (mm)	 Boss Width (mm)	 Axle Diameter	 Bearing Type	 Tyre Size	 Tyre Tread Pattern	 Load Capacity	 Wheel Centre	 Wheel Code
215	55	60	5/8", 3/4" or 20mm	Ball	2.50 - 4	Lug	100	Steel	PF8881
255	83	60	5/8", 3/4" or 20mm	Ball	4.10/3.50-4	Industrial	100	Steel	PF1084
280	60	60	3/4"	Flange	2.50-6	Industrial	100	Steel	PF1124
310	81	62	1"	Flange	4.10/3.50-6	Diamond	180	Steel	PF1273
310	103	62	1"	Flange	13/5.00-6	Turf	200	Steel	PF1275
400	150	102	1"	Flange	16x6.50-8	Turf	200	Plastic	PF1628*
400	93	76	1"	Flange	4.00-8	Industrial	200	Steel	PF1632
400	150	102	1"	Nylon Bush	16x6.50-8	Turf	200	Steel	PF1629
400	93	76	1"	Nylon Bush	4.00-8	Industrial	200	Steel	PF1641

* Denotes plastic centre



PF1628 IN USE ON A WHEELBARROW

UP TO 200KG / WHEEL

PLASTIC CENTRED PNEUMATIC WHEELS

Richmond's plastic centred pneumatic wheels feature a quality corrosion and rust resistant plastic rim, making them ideal for applications in wet or damp environments.

Use Richmond's plastic centred pneumatic wheels on nursery trolleys, hand trucks, agricultural equipment and more as an economical alternative to steel rimmed pneumatics.



PN1610











PN1075



PN8865

SPECIFICATIONS

 Nom Wheel Diameter (mm)	 Tyre Width (mm)	 Boss Width (mm)	 Axle Diameter	 Bearing Type	 Tyre Size	 Tyre Tread Pattern	 Load Capacity	 Wheel Code
215	60	62	3/4"	Nylon Bush	2.50-4	Lug	100	PN8864
215	60	62	5/8 or 3/4"	Flange	2.50-4	Lug	100	PN8865
265	88	60	3/4" or 20mm	Nylon Bush	4.10/3.50-4	Diamond	100	PN1074
265	88	60	5/8 or 3/4"	Flange	4.10/3.50-4	Diamond	100	PN1075
420	150	106	1"	Nylon Bush	16x6.50-8	Turf	200	PN1604
420	150	106	1"	Flange	16x6.50-8	Turf	200	PN1610
400	100	105	1"	Nylon Bush	4.00-8	Knobby	200	PN1603
400	100	105	1"	Flange	4.00-8	Knobby	200	PN1627



DIAMOND TREAD



TURF TREAD



LUG TREAD



KNOBBY TREAD

UP TO 300KG / WHEEL

STEEL CENTRED PNEUMATIC WHEELS

These steel centred pneumatic wheels are ideal for use in garden, industrial and agricultural equipment, as well as concrete mixers.

The three piece rims are zinc plated and fitted with rubber sealed precision bearings, which provide longer life, and two piece rims are enamel plated and fitted with flange ball bearings.

Grey non-marking tyres are also available where indicated #, as well as Richmond puncture proof wheels.



PN1608



PN1066

SPECIFICATIONS

Nom Wheel Diameter (mm)	Tyre Width (mm)	Boss Width (mm)	Axle Diameter	Bearing Type	Tyre Size	Tyre Tread Pattern	Load Capacity (kg)	Wheel Code
210	60	60	5/8", 3/4" or 20mm	Ball	2.50-4	Lug	100	PN8860 *
215	60	60	5/8", 3/4" or 20mm	Ball	2.50-4	Lug	100	PN8870 #
260	83	60	5/8", 3/4" or 20mm	Ball	4.10/3.50-4	Highway	180	PN1066 *
260	85	60	5/8", 3/4" or 20mm	Ball	4.10/3.50-4	Saw Tooth	180	PN1050 #
260	85	54 (offset)	5/8" or 3/4"	Ball	4.10/3.50-4	Diamond	100	PN1070
280	60	60	3/4"	Flange	2.50-6	Industrial	150	PN1100
320	83	60	1"	Flange Ball	4.10/3.50-6	Highway	180	PN1271
320	120	60	1"	Flange Ball	13/5.00-6	Diamond	200	PN1272
400	100	75	1"	Flange Ball	4.00-8	Knobby	200	PN1608
400	100	94	20mm, 1" or 25mm	Ball	4.00-8	Highway	300	PN1616 *
400	100	100	25mm	Taper	4.00-8	Highway	300	PN1616TR *

Wheel codes marked with * indicate 3 piece rim. All other rims are 2 piece. Recommended max pressure 35psi. Wheel Codes marked # are Grey Non Marking



Knobby Tread



Lug Tread



Diamond Tread



Highway Tread



Saw Tooth



PN1070 in use on a hand trolley

UP TO 100KG / WHEEL

OFFSET PUNCTURE PROOF WHEEL

Eliminates flat tyres, combining the strength and stability of a solid rubber wheel with the smooth cushioned ride of a pneumatic wheel, Richmond's puncture proof foam filled wheel is unrivaled in performance. The combination of this unique wheel compound with its offset hub fits this wheel to most hand trolleys requiring offset hubs.









3 piece zinc plated rim & rubber sealed precision bearings mean a longer life, ultimately reducing down time and increasing performance.



PF1047



SPECIFICATIONS

 Nom Wheel Diameter (mm)	 Tyre Width (mm)	 Boss Width (mm)	 Axle Diameter	 Bearing Type	 Tyre Size	 Tyre Tread Pattern	 Load Capacity	 Wheel Code
215	55	60 offset	5/8", 3/4" or 20mm	Ball	2.50 - 4	Lug	100	PF8881
260	80	54 offset	5/8", 3/4" or 20mm	Ball	4.10/3.50-4	Industrial	100	PF1047
280	60	60 offset	3/4"	Flange	2.50-6	Industrial	100	PF1124

UP TO 180KG / WHEEL

OFFSET PNEUMATIC WHEEL

Suitable for most hand trolleys requiring an offset wheel, Richmond's offset pneumatic wheel clearly stands alone as the best in the Australian market.

Fitted with the highest quality tough rubber tyre, 3 piece zinc plated rim and rubber sealed precision bearings to provide a longer life, ultimately reducing down time and increasing performance.











PN1070



REVERSE VIEW

SPECIFICATIONS

 Nom Wheel Diameter (mm)	 Tyre Width (mm)	 Boss Width (mm)	 Axle Diameter	 Bearing Type	 Tyre Size	 Tyre Tread Pattern	 Load Capacity	 Wheel Code
210	60	60 offset	3/4"	Ball	2.50-4	Lug	100	PN8872
260	85	54 offset	5/8", 3/4" or 20mm	Ball	4.10/3.50-4	Highway	180	PN1070
260	85	54 offset	5/8"	Flange	4.10/3.50-4	Industrial	180	PN1071
280	60	60 offset	3/4"	Flange	2.50-6	Industrial	150	PN1100

LG TYRES

LAWN AND GARDEN EQUIPMENT TYRES



UP TO 1070KG / WHEEL



Image	Tyre Diameter	Ply Rating	PSI Rating	Tube Type	Tyre Width	Tyre & Tube Size	Tread Pattern	Load Capacity	Tyre Code
	229mm	4	50	TL	88.9mm	9x3.50-4	Smooth	105kg	LG935004SM
	279mm	4	46	TL	101.6mm	11x4.00-5	Smooth	150kg	LG114005SM
	330mm	4	40	TL	127mm	13x5.00-6	Block Turf	200kg	LG135006BT
	330mm	4	28	TL	165.1mm	13x6.50-6	Block Turf	210kg	LG136506BT
	381mm	4	30	TL	152.4mm	15x6.00-6	Block Turf	260kg	LG156006BT
	406mm	4	28	TL	165.1mm	16x6.50-8	Block Turf	350kg	LG166508BT
	457mm	6	34	TL	215.9mm	18x8.50-8	Block Turf	475kg	LG188508BT
	559mm	4	14.5	TL	241.3mm	22x9.50-10	Tough Turf	473kg	LG229510TT
	610mm	4	14.5	TL	304.8mm	24x12.00-10	Tough Turf	473kg	LG241210TT
	610mm	6	32	TL	304.8mm	24x12.00-12	Tough Turf	1070kg	LG241212TT
	635mm	4	14.5	TL	304.8mm	25x12.00-9	Tough Turf	478kg	LG251209TT
	330mm	4	28	TL	165.1mm	13x6.50.6	Driver Turf	210kg	LG136506DT
	381mm	4	30	TL	152.4mm	15x6.00-6	Driver Turf	260kg	LG156006DT
	406mm	6	42	TL	165.1mm	16x6.50-8	Driver Turf	353kg	LG166508DT
	457mm	4	28	TL	165.1mm	18x6.50-8	Driver Turf	350kg	LG186508DT
	457mm	6	34	TL	215.9mm	18x8.50-8	Driver Turf	475kg	LG188508DT
	457mm	6	38	TL	215.9mm	18x8.50-10	Driver Turf	475kg	LG188610DT
	457mm	6	36	TL	241.3mm	18x9.50-8	Driver Turf	595kg	LG189508DT
	508mm	6	34	TL	254mm	20x10.00-8	Driver Turf	700kg	LG201008DT
	508mm	6	32	TL	254mm	20x10.00-10	Driver Turf	659kg	LG201110DT
	584mm	6	32	TL	266.7mm	23x10.50-12	Driver Turf	800kg	LG231012DT
	584mm	6	34	TL	215.9mm	23x8.50-12	Driver Turf	655kg	LG238512DT
	660mm	6	30	TL	304.8mm	26x12.00-12	Driver Turf	1070kg	LG261212DT
	559mm	4	14.5	TL	279.4mm	22x11.00-10	Aggressive Turf	150kg	LG221110AT
	559mm	4	14.5	TL	241.3mm	22x9.50-10	Aggressive Turf	293kg	LG229510AT
	584mm	4	14.5	TL	266.7mm	23x10.50-12	Aggressive Turf	195kg	LG231012AT
	610mm	4	14.5	TL	266.7mm	24x10.50-10	Aggressive Turf	401kg	LG241010AT
	610mm	4	14.5	TL	241.3mm	24x9.50-10	Aggressive Turf	145kg	LG249510AT
	635mm	4	14.5	TL	330.2mm	25x13.00-9	Aggressive Turf	494kg	LG251309AT
	457mm	4	22	TL	215.9mm	18x8.50-8	Golf Kart	815kg	LG185508GK
	459mm	4	30	TL	205mm	205/50-10	Golf Kart	665kg	LG205510GK



LT TYRES

LIGHT TRUCK AND TRAILER TYRES



UP TO 925KG / WHEEL



Image	Tyre Diameter	Ply Rating	PSI Rating	Tube Type	Tyre Width	Tyre & Tube Size	Tread Pattern	Load Capacity	Tyre Code
	508mm	105/103N	65	TL	195mm	195R14	Highway	925kg	LT2020RD
	508mm	102/100N	65	TL	185mm	185R14	Highway	850kg	LT2085RD
	533mm	8	58	TT	114.3mm	4.50-12	Highway	415kg	LT2112HW
	559mm	6	60	TT	152.4mm	6.00-9	Highway	500kg	LT2209HW
	559mm	8	72	TT	127mm	5.00-10	Highway	500kg	LT2210HW



TUBES AVAILABLE FOR ALL WHEELS
FULL DETAILS AT WWW.RICHMONDAU.COM

TYRE FITTING & BALANCING IN ALL STORES



LG & LT TUBES



LAWN AND GARDEN EQUIPMENT, LIGHT TRUCK AND TRAILER TUBES

SPECIFICATIONS

Tube Size	Valve	Code
9X3.50-4	TR87	LG0924-TUBE87
11x4.00-5	TR13	LG1140-TUBE13
11x4.00-5	TR87	LG 1140-TUBE87
13x5.00-6	TR13	LG1350-TUBE13
13x5.00-6	TR87	LG1350-TUBE87
13x6.50-6	TR13	LG1365-TUBE13
13x6.50-6	TR87	LG1365-TUBE87
15x6.00-6	TR13	LG1560-TUBE13
15X6.00-6	TR87	LG1560-TUBE87
16x6.50-8	TR13	LG1665-TUBE13
16x6.50-8	TR87	LG1665-TUBE87
18x8.50-8	TR13	LG1885-TUBE13
18x8.50-8	TR87	LG1885-TUBE87
20x10.00-10	TR13	LG2010-TUBE13
20x10.00-8	TR87	LG201008-TUBE87
20x10.00-8	TR13	LG201008-TUBE13
22x9.50-10	TR13	LG2295-TUBE13
23x10.50-12	TR13	LG2310-TUBE13
24x12.00-10	TR13	LG2412-TUBE13
24x9.50-10	TR13	LG2495-TUBE13
25x12.00-9	TR13	LG2512-TUBE13
25x13.00-9	TR13	LG2513-TUBE13
195R14	TR13	LT2020-TUBE13
185R14	TR13	LT2085-TUBE13
6.00-9	TR13	LT2209-TUBE13
5.00-10	TR13	LT2210-TUBE13

VALVE OPTIONS



TUBE13
STRAIGHT VALVE



TUBE87
BENT VALVE



LG1365-TUBE13



LG2295-TUBE13



LG2495-TUBE13



Available in hangable packaging, perfect for showrooms and display.

INDUSTRIAL TUBES



TUBE2.50-4



TUBE3.00/3.50-4



TUBE5.00-6



TUBE3.50-6



TUBE4.80/4.00-8

All pictured with bent valves, however straight valves are available.



TUBES AVAILABLE FOR ALL WHEELS
FULL DETAILS AT WWW.RICHMONDAU.COM

INDUSTRIAL TYRES

Tyre	Size	Tread
PN8860TYR	2.50 - 4	LUG
PN1066TYR	4.10/3.50 - 4	HIGHWAY
PN1271TYR	4.10/3.50 - 6	HIGHWAY
PN1272TYR	13 x 5.00 - 6	DIAMOND
PN1608TYR	4.00 - 8	KNOBBY
PN1610TYR	16 x 6.50 - 8	TURF

TREAD PATTERNS



TURF TREAD



KNOBBY TREAD



LUG TREAD



DIAMOND TREAD



HIGHWAY TREAD

RUBBER TYRED NYLON CENTRED WHEELS









UP TO 50KG / WHEEL



RN6661

Rubber Tyred Nylon Centred Wheels are plain bore, rust free wheels suitable for permanent outdoor settings. Applications include outdoor furniture, barbecue, nursery trolleys and more.

SPECIFICATIONS

 Diameter (mm)	 Tyre Width (mm)	 Boss Width (mm)	 Axle Diameter	 Bearing Type	 Load Capacity	 Wheel Colour	 Wheel Code
150	37	37	1/2"	Plain	50/35	Black	RN6661
200	42	37	1/2"	Plain	50/35	Black	RN8874

SEMI PNEUMATIC RUBBER TYRED WHEELS

UP TO 70KG / WHEEL









SP6663

Semi Pneumatic Rubber Tyred Wheels are an attractive steel centred shock absorbing and puncture proof wheel.

They feature a low rolling resistance and quiet operation, perfect for use in applications where ease of use is important. Perfect for portable equipment, steam cleaners, nursery trolleys, compressors and portable welders.

SPECIFICATIONS

 Diameter (mm)	 Tyre Width (mm)	 Boss Width (mm)	 Axle Diameter	 Bearing Type	 Load Capacity	 Wheel Code
150	35	40	1/2"	Flange Ball	45/30	SP6663
200	42	51	1/2"	Flange Ball	70/45	SP8885

UP TO 50KG / WHEEL

RUBBER/PVC TYRED WHEELS

Richmond's range of Rubber/PVC tyred wheels are an excellent low cost, lightweight and durable solution for outdoor use.

These wheels are non-marking, feature plastic centres, and are water resistant, making them ideal for any wash down equipment and prolonged outdoor exposure. They are the ideal solution for barbecues, lawn mowers, billy carts, children's buggies and much more.



Knock on retaining axle caps are available and provide an easy fixing arrangement.

To suit 3/8 shaft: 100AXLECAP350
 To suit 5/8 shaft: 100AXLECAP625
 To suit 3/4 shaft: 100AXLECAP750
 To suit 1/2 shaft: 100AXLECAP50



RN4068-08 RN4069-10 RN5041-10



RN6629-50 RN6630-50









RN1206-50 RN1024-20



RN8830-50 RN8884-50

SPECIFICATIONS

 Wheel Diameter (mm)	 Tyre Width (mm)	 Boss Width (mm)	 Axle Diameter	 Bearing Type	 Load Capacity (kg)	 Wheel Code
95	30	29	8mm	Plain	10	RN4068-08
107	30	30	10mm	Plain	12	RN4069-10
130	21	29	10mm	Plain	15	RN5041-10
155	42	37	1/2"	Plain	25	RN6629-50
150	42	40	1/2"	Flange	35	RN6630-50
180	35	35	1/2"	Plain	35	RN8830-50
197	45	40	1/2"	Flange	40	RN8884-50
245	68	57	20mm	Plain	50	RN1024-20
295	43	43	1/2"	Flange	50	RN1206-50

UP TO 200KG / WHEEL

RUBBER TYRED NYLON WHEELS











RN8875

RN8876

Rubber Tyred Nylon Wheels are a low cost alternative to rubber tyred cast iron wheels. They are hard wearing, with a high resistance to corrosion and lightweight whilst still boasting a high load bearing capacity.

SPECIFICATIONS

 Diameter (mm)	 Tyre Width (mm)	 Boss Width (mm)	 Axle Diameter (mm)	 Bearing Type	 Load Capacity	 Tyre Colour	 Wheel Code
200	35	58	1/2" or 20mm	Roller	200/175	Black	RN8875
200	35	58	1/2" or 20mm	Roller	200/175	Grey	RN8876

RUBBER TYRED CAST IRON CENTRED WHEELS

UP TO 250KG / WHEEL











RT6642

RT5547

These wheels are cast iron centred for extra strength and ease of movement. They offer a cushioned ride, are quiet and shock absorbing, and are fitted with roller bearings for ease of rolling.

Blue tyres are non-marking with high resilience, and black tyres have are harder wearing and therefore last longer than blue tyres.

SPECIFICATIONS

 Diameter (mm)	 Tyre Width (mm)	 Boss Width (mm)	 Axle Diameter	 Bearing Type	 Load Capacity	 Tyre Colour	 Wheel Code
100	50	60	1/2" or 3/4"	Roller	110/80	Black	RT4447
125	50	60	1/2" or 3/4"	Roller	180/130	Black	RT5547
150	50	60	1/2" or 3/4"	Roller	225/200	Blue	RT6642
150	50	60	1/2" or 3/4"	Roller	225/200	Black	RT6647
200	50	60	1/2" or 3/4"	Roller	250/225	Blue	RT8842
200	50	60	1/2" or 3/4"	Roller	250/225	Black	RT8847

UP TO 100KG / WHEEL

INSTITUTIONAL RUBBER WHEELS







Richmond's Institutional Rubber Wheels are attractive grey wheels with non-marking rubber tyres.

Features include sealed bearing and matching grey nylon threadguards for added protection. Models marked with * come with chrome threadguards which are ideal for use in hospitals, schools, home use & light industrial applications.



IR4007

SPECIFICATIONS

 Diameter (mm)	 Tyre Width (mm)	 Boss Width (mm)	 Axle Diameter	 Bearing Type	 Load Capacity	 Wheel Code
75	30	41	5/16" or 3/8"	Ball	80/45	IR3008
75	25	25	1/4"	Ball	100/80	IR3301
100	32	41	5/16" or 3/8"	Ball	100/80	IR4007
100	27	27	5/16" or 8mm	Ball	100/80	IR4401*
125	27	27	5/16"	Ball	100/80	IR5004*
125	32	41	5/16" or 3/8"	Ball	100/80	IR5007
150	32	39.6	5/16"	Ball	100/80	IR6009

ANTI-STATIC (CONDUCTIVE) RUBBER WHEELS

UP TO 100KG / WHEEL

Anti-Static Rubber Wheels provide a surface resistivity of less than 10,000 Ω (OHM). The resistance can increase as a result of mechanical influence. The wheels conform to AS 2050 1978.

We also produce a large range of anti-static (conductive) polyurethane wheels.



AS5005

SPECIFICATIONS

 Diameter (mm)	 Tyre Width (mm)	 Boss Width (mm)	 Axle Diameter	 Bearing Type	 Load Capacity	 Wheel Code
100	32	41	5/16"	Ball	100/80	AS4005
125	32	41	5/16"	Ball	100/80	AS5005

REBOUND RUBBER TYRED WHEELS

UP TO 350KG / WHEEL







Rebound Rubber Tyred Wheels are non-marking, quiet and shock absorbing with a low rolling resistance. They are perfect for moving lightly loaded equipment over uneven ground, and protect the load from shocks.

They roll over small obstructions easily, and are ideal for waste bins, laundry trolleys, electrical equipment and other "handle with care" goods.



RR4077

SPECIFICATIONS

 Diameter (mm)	 Tyre Width (mm)	 Boss Width (mm)	 Axle Diameter	 Bearing Type	 Load Capacity	 Wheel Code
75	32	40	8mm or 3/8"	Ball	100/80	RR3348
100	30	40	8mm or 3/8"	Ball	100/80	RR4473
100	35	48	8mm, 3/8" or 12mm	Ball	150/110	RR4077
125	32	40	8mm or 3/8"	Ball	100/80	RR5573
125	35	48	8mm, 3/8" or 12mm	Ball	150/110	RR5077
150	45	63	1/2" or 20mm	Ball	350/300	RR6677
200	45	63	1/2", 20mm or 3/4"	Ball	350/300	RR8871

ELASTIC RUBBER TYRED WHEELS

UP TO 250KG / WHEEL







Richmond's Elastic Rubber Tyred Wheels are quiet in operation and resilient, maneuvering well over small obstacles. They are shock absorbing, providing a cushioned ride for fragile loads, and boast a good resistance to wear and tear.

Not recommended for applications where solvents are present.



ER1006

SPECIFICATIONS

 Diameter (mm)	 Tyre Width (mm)	 Boss Width (mm)	 Axle Diameter	 Bearing Type	 Load Capacity	 Wheel Code
250	50	56 offset	5/8", 3/4" or 20mm	Flange Ball	250/225	ER1006

UP TO 300KG / WHEEL







CUSHION RUBBER WHEELS

Cushion Rubber Wheels offer a soft ride while having the ability to withstand high impact. A steel centre offers additional strength and load bearing capacity, with quality elastic rubber compound tyres which offer a softer, shock absorbing ride.



CR1060

SPECIFICATIONS

 Diameter (mm)	 Tyre Width (mm)	 Boss Width (mm)	 Axle Diameter	 Bearing Type	 Load Capacity	 Wheel Code
230	40	50	20mm or 25mm	Ball	220/180	CR9000
250	50	55	12mm, 20mm or 25mm	Ball	300/250	CR1060
280	50	53	20mm, 25mm or 1"	Ball	200/170	CR1110

UP TO 1050KG / WHEEL

SOLID PNEUMATIC WHEELS







The unique formulation of these solid pneumatic wheels provides a pneumatic tyre performance with a much higher load capacity, towable up to 24KPH and ideal for tarmac use. They are puncture proof for long wear, and feature split pins with rugged bolt on hubs.

Spare tyres stocked and fitted.



SN1612

SPECIFICATIONS

 Diameter (mm)	 Tyre Width (mm)	 Boss Width (mm)	 Axle Diameter	 Bearing Type	 Load Capacity	 Wheel Code
250	75	93	20mm	Ball	260/200	SN1005
300	83	93	20mm or 25mm	Ball	540/400	SN1295
400	110	94	20mm, 25mm or 1"	Ball	950/730	SN1612
400	123	PCD	N/A	Ball	1050/810	SN1619

REBOUND POLYURETHANE TYRED WHEELS

UP TO 300KG / WHEEL









RP8072

Rebound Polyurethane Tyred wheels are a softer than normal tyre, which provides a smoother, quieter ride than most polyurethane or nylon wheels.

The attractive sky blue tyre will remain cleaner than other types, and when combined with stainless steel bearings, these wheels are suitable for clean rooms and other applications where aesthetics and performance are crucial.

Premium stainless steel bearing model is also available.

SPECIFICATIONS

 Diameter (mm)	 Tyre Width (mm)	 Boss Width (mm)	 Axle Diameter	 Bearing Type	 Load Capacity	 Wheel Code
100	35	47	15mm or 3/8"	SS Roller	140/110	RP4072
100	35	47	15mm or 3/8"	SS Ball	140/110	RP4075
125	35	47	15mm or 3/8"	SS Roller	180/150	RP5072
125	35	47	15mm or 3/8"	SS Ball	180/150	RP5075
150	40	63	20mm or 1/2"	SS Roller	300/250	RP6072
150	40	63	20mm or 1/2"	SS Ball	300/250	RP6075
200	50	63	20mm or 1/2"	SS Roller	300/250	RP8072
200	50	63	20mm or 1/2"	SS Ball	300/250	RP8075

SOLID POLYURETHANE WHEELS

UP TO 350KG / WHEEL









PS4479

On the Shore D Scale, these solid polyurethane wheels have a hardness of 64. They feature excellent wear resistance, quiet operation and low rolling resistance, providing an effortless ride.

They have a hygienic appearance, and are suitable for food and medical industries.

Richmond's standard polyurethane wheels are suitable for intermittent usage. If your application requires continuous running usage, please contact our engineering department for more suitable polyurethane tyres.

SPECIFICATIONS

 Diameter (mm)	 Tyre Width (mm)	 Boss Width (mm)	 Axle Diameter	 Bearing Type	 Load Capacity	 Wheel Code
100	50	60	1/2" or 3/4"	Roller	350/300	PS4479
125	50	60	1/2" or 3/4"	Roller	350/300	PS5579

UP TO 600KG / WHEEL







POLYURETHANE TYRED NYLON CENTRED WHEELS

These tyres are manufactured from injection moulded polyurethane around a nylon hub. They are hard wearing, non-marking and long lasting with high load carrying capabilities.

Richmond's standard polyurethane wheels are suitable for intermittent usage. If your application requires continuous running usage, please contact our engineering department for more suitable polyurethane tyres.



SPECIFICATIONS

 Diameter (mm)	 Tyre Width (mm)	 Boss Width (mm)	 Axle Diameter	 Bearing Type	 Load Capacity	 Wheel Code
75	32	41	8mm	SS Ball	80/45	PU3345
75	32	41	8mm or 10mm	Ball	80/45	PU3344
100	32	41	8mm	SS Ball	100/80	PU4439
100	32	41	8mm or 3/8"	Ball	100/80	PU4444
100	35	47	3/4"	SS Roller	250/200	PU4070
100	35	47	1/2" or 3/4"	Roller	250/200	PU4408
100	50	62	1/2", 3/4" or 20mm	Ball	250/200	PU4409
125	32	41	8mm	SS Ball	100/80	PU5539
125	32	41	8mm or 3/8"	Ball	100/80	PU5555
125	35	47	3/4"	SS Roller	250/200	PU5070
125	35	47	3/4", 3/8" or 1/2"	Roller	250/200	PU5508
125	50	62	1/2", 3/4" or 20mm	Ball	350/300	PU5509
150	30	41	8mm	Ball	100/80	PU6660
150	50	62	1/2", 3/4" or 20mm	Ball	400/300	PU6071
200	50	63	1/2", 3/4" or 20mm	Ball	400/300	PU8071
200	50	48	20mm, 25mm or 1"	Ball	600/500	PU8074

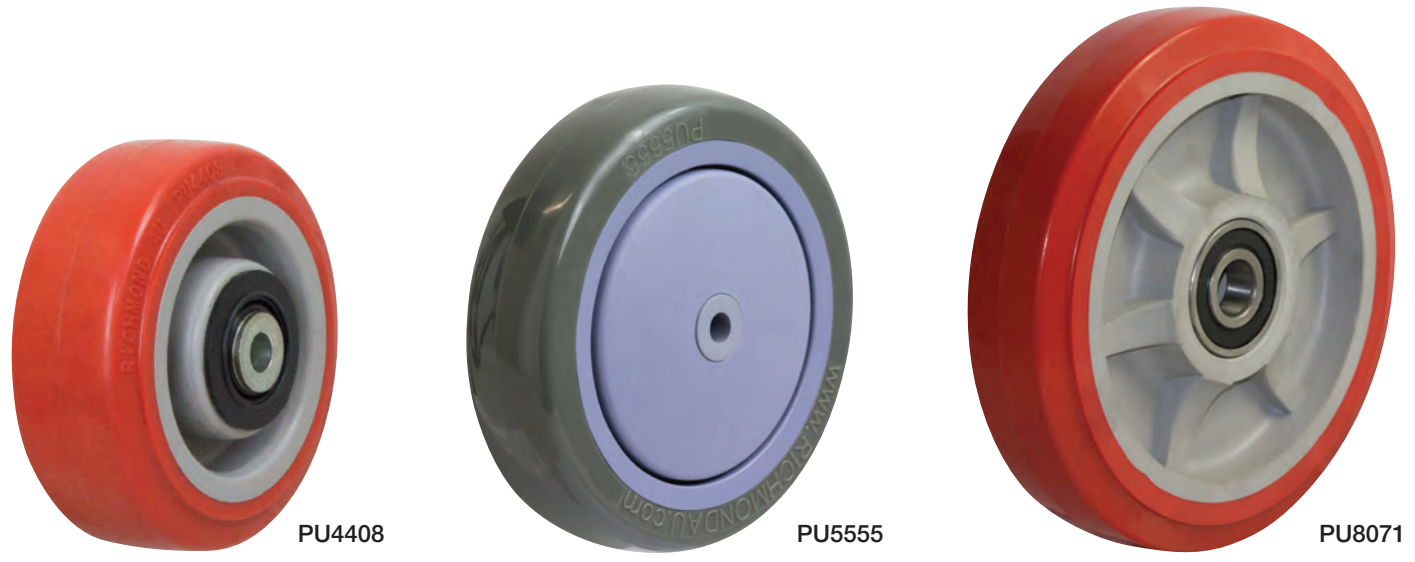

POLYURETHANE TYRED CAST IRON CENTRED WHEELS

UP TO 5000KG / WHEEL

These Polyurethane Tyred Cast Iron Centred Wheels have a hardness ranging from 60A to 75D on the shore scale.





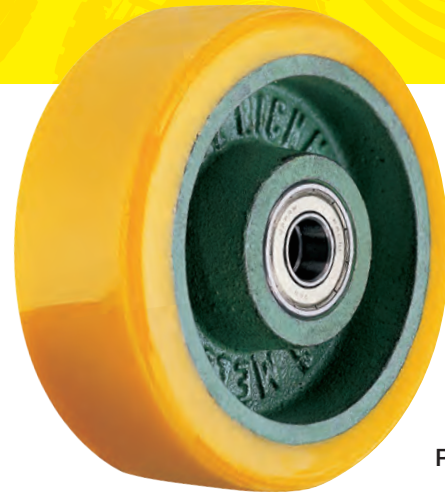

Special tyres and other polyurethane parts are manufactured in house.

Richmond's standard polyurethane wheels are suitable for intermittent usage. If your application requires continuous running usage, please contact our engineering department for more suitable polyurethane tyres.



PU449

SPECIFICATIONS

 Diameter (mm)	 Tyre Width (mm)	 Boss Width (mm)	 Axle Diameter	 Bearing Type	 Load Capacity	 Wheel Code
75	25	29	1/2"	Ball	240/180	PU350
100	50	60	1/2" or 3/4"	Roller	250/200	PU424
100	50	57	1/2", 3/4", 5/8", 17mm or 20mm	Ball	500/380	PU425
100	38	41	3/8" or 1/2"	Ball	330/250	PU449
125	50	60	1/2" or 3/4"	Roller	250/200	PU524
125	50	57	1/2", 3/4", 5/8" or 20mm	Ball	500/380	PU525
125	35	41	3/8" or 1/2"	Ball	330/250	PU549
150	50	60	1/2" or 3/4"	Roller	250/200	PU614
150	75	76	20mm, 25mm or 1"	Ball	1100/900	PU615
150	50	63	1/2", 5/8" or 20mm	Ball	600/450	PU649
150	50	63	20mm, 25mm, 50mm or 1"	Ball	900/700	PU659
200	50	63	1/2", 3/4", 5/8" or 20mm	Ball	600/450	PU849
200	50	63	20mm, 25mm, 30mm, 50mm or 1"	Ball	1200/700	PU876
200	75	76	20mm, 25mm, 30mm, 40mm or 1"	Ball	1300/750	PU896
200	75	90	20mm	Ball	1500/1200	PU824
200	75	82	20mm	Ball	2000/1700	PU823
200	75	96	40mm	Taper	5000/3750	PU892
250	50	60	20mm, 25mm or 50mm	Ball	1200/900	PU1056
250	75	76	20mm, 25mm, 30mm, 35mm or 1"	Ball	1300/1000	PU1076
250	75	90	20mm	Ball	1500/1200	PU1030
250	75	82	20mm	Ball	2000/1700	PU1029
250	100	112	40mm	Ball	5000/3750	PU1048
250	100	112	40mm	Ball	5000/3750	PU1049
300	100	102	50mm	Ball	4000/3000	PU1207
300	75	82	20mm	Ball	2500/2000	PU1216
300	72	76	20mm or 25mm	Ball	1800/1350	PU1217
300	50	60	20mm	Ball	1300/1000	PU1218
300	100	102	25mm, 30mm or 40mm	Ball	2500/2000	PU1224
300	100	102	35mm	Ball	5000/3750	PU1203
300	100	112	40mm	Ball	5000/3750	PU1203
300	100	112	40mm	Ball	5000/3750	PU1238
400	125	137	40mm	Taper	5000/3750	PU1606

UP TO 5000KG / WHEEL

DRIVE WHEELS

Richmond's Drive Wheels are polyurethane tyred with a hardness of 85 Shore A. The Cast Iron centre is bored to provide a transition fit onto a shaft.







Drive wheels are stocked without keyways cut. Please enquire if you wish us to supply with keyways.

Richmond's standard polyurethane wheels are suitable for intermittent usage. If your application requires continuous running usage, please contact our engineering department for more suitable polyurethane tyres.



PU1800DV

SPECIFICATIONS

 Diameter (mm)	 Tyre Width (mm)	 Boss Width (mm)	 Axle Diameter	 Bearing Type	 Load Capacity	 Wheel Code
150	75	76	25mm transition fit	Plain	200	PU615DV
150	50	60	25mm	Plain	500	PU659DV
200	50	60	25mm	Plain	700	PU876DV
200	75	76	25mm or 40mm	Plain	900	PU896DV
250	100	112	50mm	Plain	5000/3750	PU1049DV
200	50	60	50mm	Plain	1200/900	PU1056DV
250	75	76	25mm or 40mm	Plain	1100	PU1076DV
300	100	102	50mm	Plain	2000	PU1207DV
300	75	76	50mm	Plain	1000	PU1217DV
400	125	127	50mm	Plain	2800	PU1606DV
450	150	152	50mm	Plain	3500	PU1800DV

Richmond are specialist manufacturers of polyurethane tyred wheels and rollers. We use many grades of polyurethane and can advise, design and manufacture to suit your application. 1300 4 RICHMOND or email sales@richmondau.com

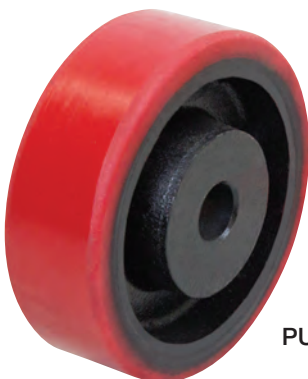

PU659DV



PU876DV

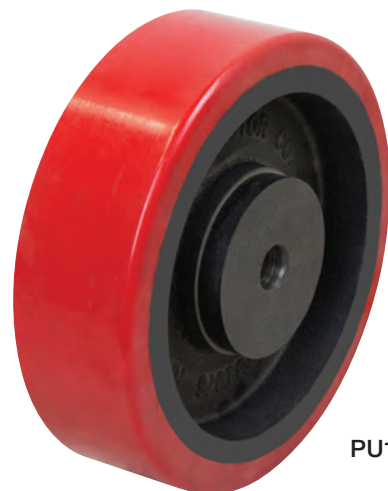

PU1076DV

HIGH/LOW TEMPERATURE WHEELS



UP TO 600KG / WHEEL

Richmond's High/Low Temperature wheels are glass-filled nylon and aluminium wheels suitable for use in bakery ovens, smoke houses, chillers or applications where there is temperature fluctuation and exposure from -30° to +350°C with peaks up to 400°C.









Aluminium wheels AL472 and AL473 are fitted with DU Teflon bushes for noiseless ease of use, while AL471 and AL474 are fitted with aluminium bronze bushes for extremely high temperatures.

All wheels can be fitted to a variety of our castor frames. Please phone for more comprehensive advice.



Aluminium AL473

SPECIFICATIONS

 Diameter (mm)	 Tyre Width (mm)	 Boss Width (mm)	 Axle Diameter	 Bearing Type	 Load Capacity	 Temp Range	 Wheel Code
75	32	38	1/2"	Plain	150/100	-30° to 300°C	Ci3340
100	35	45	20mm	Plain	200/150	-30° to 240°C	GF412
100	30	37	1/2"	Plain	200/150	-30° to 240°C	GF4420
100	36	45	5/16", 1/2"	AL bronze bush	180/150	-30° to 400°C	AL471
100	36	41	5/16", 1/2"	DU Teflon bush	180/150	-30° to 280°C	AL472
100	36	46	3/8", 1/2"	DU Teflon bush	180/150	-30° to 280°C	AL473
100	36	46	3/8", 1/2"	AL bronze bush	180/150	-30° to 400°C	AL474
100	38	45	1/2"	Plain	300/225	-30° to 300°C	Ci421
125	38	45	1/2"	Plain	380/280	-30° to 300°C	Ci532
150	45	57	3/4"	Plain	400/300	-30° to 240°C	GF652
150	45	60	1/2", 3/4"	Plain	600/450	-30° to 300°C	Ci611
150	50	60	5/8"	Plain	500/400	-30° to 300°C	SG608
200	43	60	20mm	Plain	400/300	-30° to 240°C	GF800
200	50	60	3/4"	Plain	600/450	-30° to 300°C	Ci842
250	50	60	30mm	Ball	500/400	-30° to 240°C	GF1023

Castors using High/Low Temperature Wheels can be found in this catalogue conveniently marked with a  Temperature Symbol.

Please Note: When we fit these wheels to our castors, we remove the castor headseal and lubricate with high temperature grease (Food grade lubricants are available).



SG Iron SG608



Glass Filled Nylon GF652



Glass Filled Nylon GF412



Cast Iron Ci421



Aluminium AL471

UP TO 400KG / WHEEL

BLACK SOLID NYLON WHEELS

Black Solid Nylon Wheels are virgin nylon, fully conditioned in an industrial sauna for maximum strength.

They are an easy to maintain durable wheel with low rolling resistance and are high wearing when compared to equivalent sized rubber wheels.









NY830

NY613

NY413

STAINLESS STEEL BEARING OPTIONS AVAILABLE

SPECIFICATIONS

 Diameter (mm)	 Tyre Width (mm)	 Boss Width (mm)	 Axle Diameter	 Bearing Type	 Load Cap	 Wheel Code
75	25	28 incl. sleeve	6 or 8mm	Plain	50/40	NY3324
100	26	33.5 incl. sleeve	8mm	Plain	70/60	NY4415
100	35	43	1/2" or 3/4"	Plain	300/200	NY401
100	35	44	12mm	Roller	300/200	NY403
100	35	48	3/8" or 1/2"	Ball	300/200	NY413
125	35	46	1/2" or 3/4"	Plain	350/250	NY501
125	35	48	3/4"	Roller	330/250	NY503
125	35	50	3/8" or 1/2"	Ball	330/250	NY513
150	50	60	3/4", 20mm or 7/8"	Plain	400/300	NY652
150	50	63	1/2", 5/8", 3/4" or 20mm	Ball	400/300	NY613
150	50	63	1/2" or 20mm	SS Ball	400/300	NY635
200	45	60	3/4", 20mm or 7/8"	Plain	400/300	NY800
200	50	63	1/2", 5/8", 3/4" or 20mm	Ball	400/300	NY830
200	50	63	1/2" or 20mm	SS Ball	400/300	NY854

Quantities of 1000 or more available in your nominated colour.

UP TO 500KG / WHEEL

WHITE SOLID NYLON WHEELS

Richmond's range of White Solid Nylon Wheels are high quality virgin nylon, fully conditioned in an industrial sauna for maximum strength.

They are an easy to maintain and durable wheel with a low rolling resistance and are high wearing compared to equivalent sized rubber wheels.









NY800

NY655

NY401

STAINLESS STEEL BEARING OPTIONS AVAILABLE

SPECIFICATIONS

 Diameter (mm)	 Tyre Width (mm)	 Boss Width (mm)	 Axle Diameter	 Bearing Type	 Load Cap	 Wheel Code
50	20	22	5/16"	Plain	50/35	NY204
75	30	39	5/16" or 1/2"	Plain	125/100	NY3321
100	35	43	1/2"	Plain	300/200	NY401
100	32	39	5/16" or 1/2"	Plain	125/100	NY4417
125	35	46	1/2" or 3/4"	Plain	350/250	NY501
125	32	39	5/16" or 1/2"	Plain	125/100	NY5517
150	50	60	3/4", 20mm or 7/8"	Plain	400/300	NY652
150	45	45	3/4"	Plain	250/200	NY653
150	50	62	20mm	SS Roller	400/300	NY655
200	45	60	3/4", 20mm or 7/8"	Plain	400/300	NY800
200	50	60	20mm	SS Roller	500/400	NY802

Quantities of 1000 or more available in your nominated colour.

UP TO 800KG / WHEEL

POLYURETHANE & NYLON ROLLERS









Richmond's standard nylon and polyurethane roller range offer good wear resistance.

These are often used as replacement parts for pallet jacks and other applicable equipment. Richmond can also custom make rollers for printing and press applications.



PU8074

SPECIFICATIONS

 Diameter (mm)	 Tyre Width (mm)	 Boss Width (mm)	 Wheel Type	 Axle Diameter	 Bearing Type	 Load Capacity	 Wheel Code
80	96	96	Polyurethane	20mm	Ball	800/700	PU324
80	96	96	Nylon	20mm	Ball	800/700	NY335
82	100	100	Polyurethane	20 or 25mm	Ball	500/375	PU326
82	82	82	Polyurethane	20 or 25mm	Ball	450/340	PU341
82	75	75	Polyurethane	20 or 25mm	Ball	450/340	PU325
82	65	65	Polyurethane	20 or 25mm	Ball	400/300	PU340
82	100	100	Nylon	20 or 25mm	Ball	800/700	NY417
82	82	82	Nylon	20 or 25mm	Ball	600/500	NY418
100	75	75	Polyurethane	20 or 25mm	Ball	600/450	PU410
200	50	48	Polyurethane	20 or 25mm	Ball	600/500	PU8074
200	50	48	Nylon	20 or 25mm	Ball	600/500	NY832
200	50	56	Polyurethane	20mm	Ball	600/500	PU820
200	50	56	Nylon	20mm or 25mm	Ball	600/500	NY833



NY417

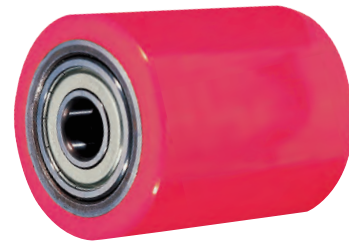

PU326

CAST IRON & SG IRON WHEELS

UP TO 5000KG / WHEEL

Both Cast Iron & Spheroidal Graphite Iron wheels provide high capacity with low rolling resistance. They are hard wearing, as well as abrasive and heat resistant.

They can be used for high load bearing applications in which loads are left standing for extended periods as they will always be ready to roll as they have low rolling resistance.









SG1040







Ci842

SPECIFICATIONS

CAST IRON WHEELS

 Diameter (mm)	 Tyre Width (mm)	 Boss Width (mm)	 Axle Diameter	 Bearing Type	 Load Capacity	 Wheel Code
75	32	38	1/2"	Plain	150/100	Ci3340
100	38	45	1/2"	Plain	300/225	Ci421
100	50	60	1/2" or 5/8"	Ball	750/560	Ci464 *
100	38	41	1/2" or 3/8"	Ball	400/300	Ci400
125	38	45	1/2"	Plain	380/280	Ci532
125	45	60	5/8"	Ball	660/500	Ci520
150	45	60	1/2", 3/4"	Plain	600/450	Ci611
150	75	76	20 or 25 mm	Ball	1675/1250	Ci689
150	45	60	1/2", 5/8", 3/4" & 20mm	Ball	1000/500	Ci601
200	50	60	3/4"	Plain	600/450	Ci842
200	50	60	1/2", 20 or 25mm	Ball	1800/750	Ci852

SG IRON WHEELS

 Diameter (mm)	 Tyre Width (mm)	 Boss Width (mm)	 Axle Diameter	 Bearing Type	 Load Capacity	 Wheel Code
150	50	60	5/8"	Plain	500/400	SG608
200	75	90	20mm	Ball	1500/1200	SG822
200	75	76	20mm	Ball	3000/2500	SG834
200	50	60	20 or 25mm	Ball	1800/1350	SG835 *
200	75	90	20mm	Ball	2000/1700	SG821
200	75	96	40mm	Taper	5000/3750	SG836 *
250	75	90	20mm	Ball	1500/1200	SG1027
250	75	76	20 or 25 mm	Ball	1800/1350	SG1040
250	75	90	20mm	Ball	2000/1700	SG1028

Wheels marked * are manufactured from K1045 Steel

CONCRETE AGITATOR ROLLERS

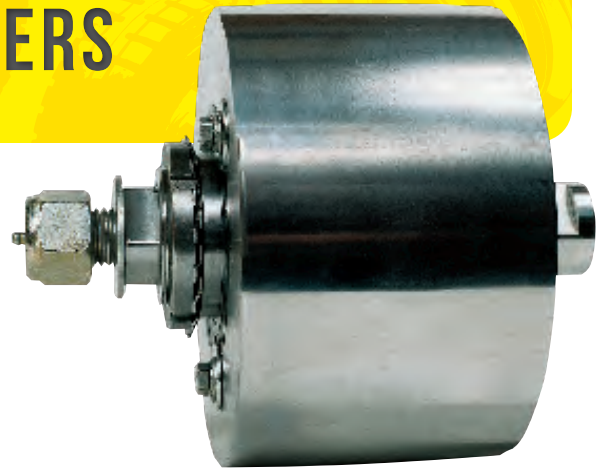









Richmond stock a full range of concrete agitator rollers for small to large concrete trucks. They are suitable for all trommel applications, with nylon and aluminium rollers made to order.

A full range of spare parts are available for these rollers.

SPECIFICATIONS









MINI ROLLER

Used for 3 metre Mini Concrete Trucks

							
Roller Diameter (mm)	Rim Width (mm)	Dist b/w Flats (mm)	Flat Width (mm)	Flat Depth (mm)	Flat Diameter (mm)	Axle Length (mm)	Roller Code
152	75	105	10	5	26.5	154	MINIROLLER









JTY ROLLER

Used for 4 to 6 metre Mini Concrete Trucks

							
Roller Diameter (mm)	Rim Width (mm)	Dist b/w Flats (mm)	Flat Width (mm)	Flat Depth (mm)	Flat Diameter (mm)	Axle Length (mm)	Roller Code
208	92	158.5	12.75	5.5	32.5	216	JTYROLLER

MAXI ROLLER

Used for 6 to 8 metre Large Concrete Trucks

							
Roller Diameter (mm)	Rim Width (mm)	Dist b/w Flats (mm)	Flat Width (mm)	Flat Depth (mm)	Flat Diameter (mm)	Axle Length (mm)	Roller Code
197	121	160	18	4.45	31.8	237	MAXIROLLER

UP TO 4000KG / WHEEL

TRACK WHEELS - SINGLE FLANGE

Single flange wheels are designed to run on railway line. They are made from cast iron to suit your application, with axle shafts available.











Track wheels can be flame hardened to increase wear resistance, and are also available as drive wheels. Can be used on other sections such as RHS.



SF1099

SF697

SPECIFICATIONS

									
Wheel Diameter (mm)	Rim Width (mm)	Flange Width (mm)	Flange Diameter (mm)	Boss Width (mm)	Boss Diameter (mm)	Axle Diameter	Bearing Type	Load Capacity (kg)	Wheel Code
75	45	10	100	55	Solid	20 or 25mm	Ball	750	SF399
100	25	10	120	42	40	3/4"	Plain	375	SF499
100	50	20	130	70	Solid	20 or 25mm	Ball	1300	SF492
100	25	10	120	42	40	1/2"	Ball	375	SF499
150	40	9	175	53	62	3/4" or 25mm	Plain	1000	SF699
154	50	20	192	76	Solid	25mm	Ball	2000	SF697
150	40	9	175	53	62	5/8" or 20mm	Ball	1000	SF699
200	50	14	225	64	Solid	25 or 50mm	Plain	3000	SF899
200	39	16	228	55	101	35mm	Ball	1100	SF891
200	50	14	225	64	Solid	20 or 25mm	Ball	1500	SF899
250	50	15	290	65	Solid	25 or 50mm	Plain	1800	SF1099
250	52	12	285	75	125	45mm	Ball	2400	SF1098
250	50	15	290	65	Solid	25mm	Ball	1800	SF1099
300	52	14	360	95	150	50mm	Ball	4000	SF1299



UP TO 5000KG / WHEEL

TRACK WHEELS - DOUBLE FLANGE













DF698

Double flange wheels are often used where accurate tracking is needed. They are manufactured with K1045 Steel, and can be matched with a flat rim wheel to guide on one side of the track only. Axle shafts are available upon request.

Can be flame hardened to increase wear resistance, and are also available as drive wheels.

SPECIFICATIONS

 Wheel Diameter (mm)	 Rim Width (mm)	 Flange Width (mm)	 Flange Diameter (mm)	 Boss Width (mm)	 Boss Diameter (mm)	 Axle Diameter	 Bearing Type	 Load Capacity (kg)	 Wheel Code
125	27	15	150	60	70	20 or 25mm	Ball	1300	DF698
150	52	10.5	178	74	Solid	30mm	Ball	1800	DF795
175	52	12	200	76	Solid	30mm	Ball	2800	DF895
225	52	14	250	80	Solid	30 or 50mm	Ball	4000	DF1095
250	62	19	300	100	Solid	50mm	Ball	5000	DF1295

UP TO 500KG / WHEEL











TRACK WHEELS - BEAM TROLLEY



BT80

This range of beam trolley wheels has been designed to fit standard channel and beam sections. All beam trolley wheels in the range are CNC machined in-house from the highest quality K1045 Steel, making them strong and reliable track wheels.

SPECIFICATIONS

 Wheel Diameter (mm)	 Rim Width (mm)	 Flange Width (mm)	 Flange Diameter (mm)	 Axle Length (mm)	 Shoulder Length (mm)	 Axle Diameter	 Bearing Type	 Load Capacity	 Wheel Code
48	14	5	61	17	2	1/2" UNF	Ball	65	BT481
58	27	12	79	25	3	16mm (M16)	Ball	200	BT581
80	27	12	100	30	3	20mm (M20)	Ball	250	BT80
100	32	8	134	35	3	24mm (M24)	Ball	500	BT493

UP TO 5000KG / WHEEL

TRACK WHEELS - V GROOVE











CNC Machined from Cast Iron, K1045 Steel or SG Iron, these are for running track wheels on bars, pipes, angle iron or rope. Capacities can be increased with changes to bearing and shaft configurations.

Custom design to your specifications available.



VG459

SPECIFICATIONS

									
Wheel Diameter (mm)	Rim Width (mm)	Boss Width (mm)	Groove Width (mm)	Groove Depth (mm)	Axle Diameter	Bearing Type	Wheel Type	Load Capacity	Wheel Code
75	32	38	22	10.8	1/2"	Plain	Ci	65	VG360
100	36	41	22	10.8	3/4"	Plain	Ci	280	VG459
100	36	41	22	10.8	3/8" or 1/2"	Ball	Ci	280	VG459
100	50	60	22	12.0	1/2" or 3/4"	Roller	Ci	300/250	VG461
150	38	60	22	10.8	5/8" or 20mm	Ball	Ci	650	VG609
150	50	60	22	12.0	1/2" or 3/4"	Roller	Ci	450/400	VG661
200	52	60	30	14.7	20 or 25mm	Ball	SG Iron	1300	VG839
200	75	96	30	14.7	40mm	Taper	K1045 Steel	5000	VG836
250	52	60	30	14.7	25 or 30mm	Ball	K1045 Steel	1800	VG1059

TRACK WHEELS - ROPE GROOVE

UP TO 1500KG / WHEEL





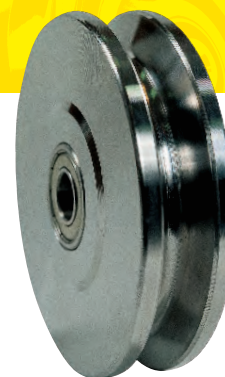



CNC Machined from Cast Iron, K1045 Steel or SG Iron, these are for running track wheels on bars, pipes, angle iron or rope. Capacities can be increased with changes to bearing and shaft configurations.

Custom design to your specifications available.



RG458

SPECIFICATIONS

							
Wheel Diameter (mm)	Rim Width (mm)	Boss Width (mm)	Suit Rope Diameter (mm)	Axle Diameter (mm)	Bearing Type	Load Capacity	Wheel Code
100	25	27	8mm	1/2", 5/8" or 20mm	Ball	500	RG458
150	32	34	12mm	20mm or 25mm	Ball	1500	RG658

UP TO 420KG / WHEEL

TRACK WHEELS - C GROOVE









CNC Machined from Cast Iron, K1045 Steel or SG Iron, these are for running track wheels on bars, pipes, angle iron or rope. Capacities can be increased with changes to bearing and shaft configurations.
Custom design to your specifications available.



CG459

CG462

SPECIFICATIONS

 Wheel Diameter (mm)	 Rim Width (mm)	 Boss Width (mm)	 Suit Bar	 Axle Diameter	 Bearing Type	 Wheel Type	 Load Capacity	 Wheel Code
78	28	34	20	14	Ball	K1045 Steel	350	CG361
88	28	34	20	14	Ball	K1045 Steel	380	CG462
98	28	34	20	14	Ball	K1045 Steel	400	CG463
100	36	41	16 or 20	3/8" or 1/2"	Ball	Ci Iron	280	CG459
116	28	34	20	14	Ball	K1045 Steel	420	CG560

EXTERNAL TRACK WHEEL - Capacity up to 200kg per wheel

A (mm)	B (mm)	C (mm)	D (mm)	D1 (mm)	E (mm)	F (mm)	G (mm)	Code
25	83	20	78	60	37	90	116	R329

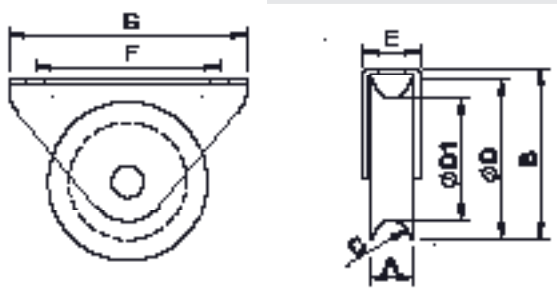

Suits 20mm Round Bar. Round profile track available from Richmond in 3 meter lengths with a zinc plated finish.



R329

RECESS TRACK WHEEL - Capacity up to 200kg per wheel

A (mm)	B (mm)	C (mm)	D (mm)	D1 (mm)	E (mm)	F (mm)	G (mm)	H (mm)	Code
24	30	20	78	63	32	110	130	51	R331
24	37	20	88	70	34	120	155	62	R467

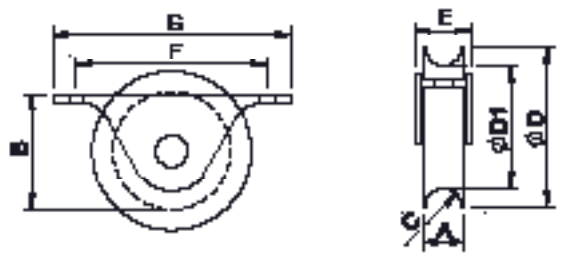

Suits 20mm Round Bar. Round profile track available from Richmond in 3 meter lengths with a zinc plated finish.

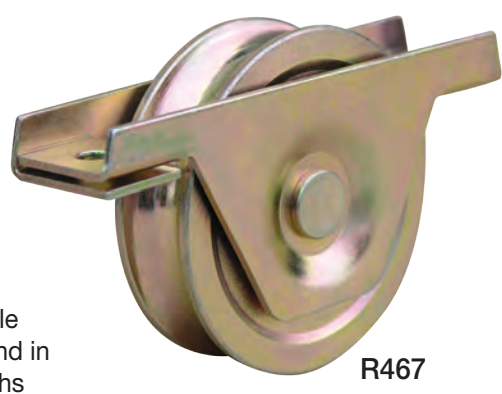

R467

BALL TRANSFERS

Commonly used around presses, guillotines and packing machines, Richmond's Ball Transfers enable smooth and simple transfers of objects in any direction. Multi directional movement is essential where the need to move heavy loads is paramount.

Consisting of a large load bearing roller sitting upon many smaller balls encapsulated in a cup the engineering in this design makes for a perfect transfer station from one conveyor to another. Richmond can customise ball transfer tables to suit your application whether the requirement is for a recessed transfer table or a multiple ball transfers in a designated area.



BTR001

LOAD CAPACITY: 45kg
BALL DIAMETER: 25.4mm
BALL MATERIAL: Mild Steel
HOLE CENTRE: 55.7mm



BTR003

LOAD CAPACITY: 15kg
BALL DIAMETER: 15.8mm
BALL MATERIAL: Carbon Steel
HOLE CENTRE: 33mm



BTR005

LOAD CAPACITY: 50kg
BALL DIAMETER: 25.4mm
BALL MATERIAL: Carbon Steel
THREAD: M6 x 17mm long



BTR006

LOAD CAPACITY: 50kg
BALL DIAMETER: 25.4mm
BALL MATERIAL: Carbon



BTR020

LOAD CAPACITY: 45kg
BALL DIAMETER: 25.4mm
BALL MATERIAL: Stainless Steel
HOLE CENTRE: 70mm

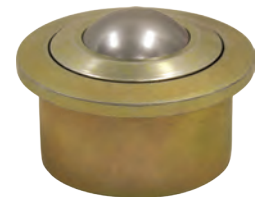

BTR021

LOAD CAPACITY: 227kg
BALL DIAMETER: 30mm
BALL MATERIAL: Stainless Steel

RICHMOND CAN CUSTOM DESIGN & MANUFACTURE SPECIFIC SIZED TRANSFER TABLES TO SUIT YOUR REQUIREMENTS

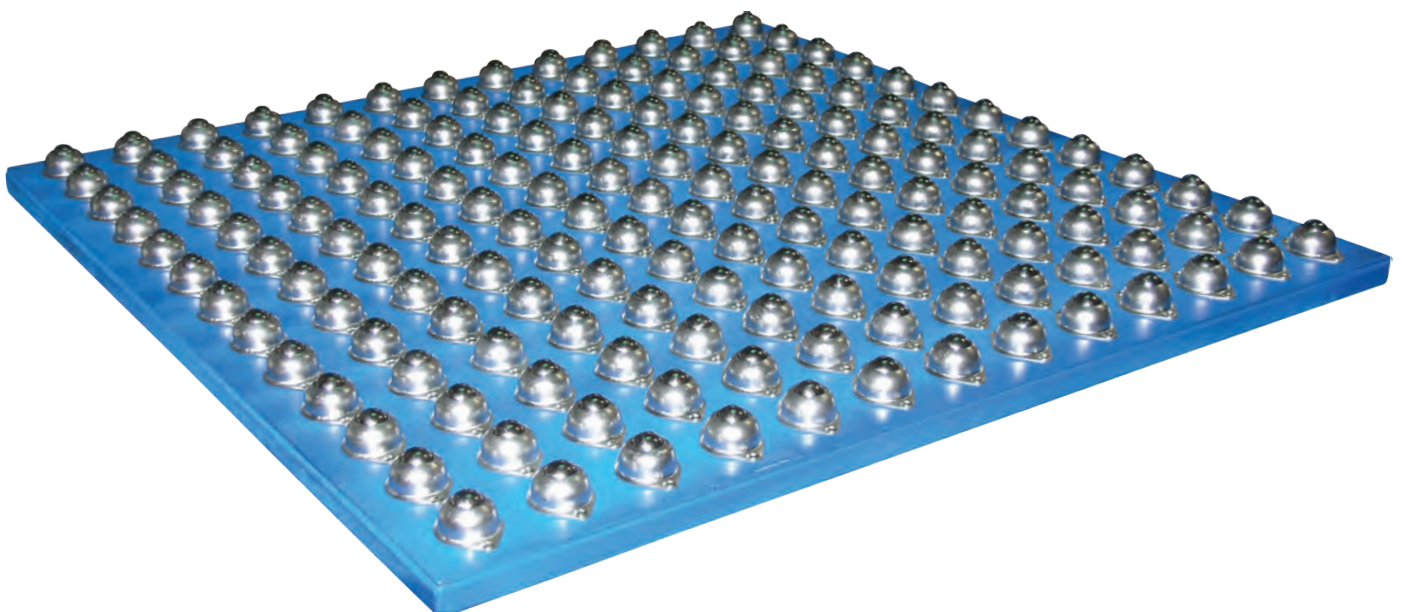

FLOW RAIL

Flow Rail systems can be manufactured to suit each and every warehouse, gravity driven, the flow rail is ideal for applications where picking and stock turnover is frequent.

Presenting on a stock rotation basis as inventory flows on a first in first out system, Richmond's flow rails allow for more efficient operation to personnel by reducing manual handling. Easily incorporated into racking or custom framing, flow rail can provide unlimited solutions in the manufacturing industry.

Setting us apart from our competitors, Richmond's Flow Rail features high quality nylon rollers that are securely riveted, thereby creating a strengthened rigid smooth operation giving consistent rollability.



FRR002

SPECIFICATIONS

Model Number	Length (m)	Roller Diameter (mm)	Roller Width (mm)	Frame Width (mm)	Overall Height (mm)	Skate Type	Load Capacity Per Metre (kg)
FRR002	3	32	25	36	36	Nylon	60

SKATE RAILS

When a higher capacity, free flowing, gravity track system is required in warehouse storage or line applications Richmond's Skate Rail is the answer.

Designed to reduce costs by relieving manual handling, guaranteed rollability in both the dual and single skate rails. This product is a heavy duty alternative to the lighter Flow Rail. Skate Rail is ideal for heavy industrial loads, pallets and larger robust cartons.

Easily mounted and maintenance free, Richmond's Skate Rail makes for easy movement of an endless variety of products.



FRR005



FRR004



FRR003

SPECIFICATIONS

Model Number	Length (m)	Diameter (mm)	Width (mm)	Pitch (mm)	Skate Type	Load Capacity (kg)
FRR005	3	50	16	Single 75	Nylon	700 *
FRR004	3	50	16	Single 75	Steel	1400
FRR003	3	50	16	Double 75	Steel	1400 *

* Load Capacity is based on the skate rail supported every metre

CONVEYOR ROLLERS

UP TO 120KG

Suitable for loads up to 120kg, Richmond Gravity Conveyor Rollers allow free moving, efficient and safe transportation of goods at any operational stage of a conveyor line. Producing movement via natural forces, gravity conveyors are an economical material handling solution used in many industries for simplicity and functionality.

Spring loaded shafts not only provide hassle free maintenance and simple installation they also ensure secure attachment to the conveyor frame (channel) maximizing roller and bearing function and performance. Rollers are available in zinc plated steel, nylon and stainless steel for wash down applications.

It is recommended that there be a minimum of three rollers under the goods being transported at any one time. The size of the object being transported can help determine the roller pitch on your conveyor system applying the three roller rule.

Richmond can custom manufacture gravity conveyor rollers to length, diameter and shaft requirements.



SPECIFICATIONS

Model Number	Face Width (mm) A	Over Bearing Width (mm) B	Diameter (mm) C	Material Type (mm)	Load Capacity (kg)	To Suit Overall Conveyor Width (mm)
CRR002	217	227	50	Steel	120	290
CRR500	206	227	48	Nylon	40	290
CRR007	377	387	50	Steel	120	450
CRR501	366	387	48	Nylon	30	450
CRR014	527	537	50	Steel	120	600
CRR502	516	537	48	Nylon	20	600

RICHMOND MAKE ROLLERS TO SIZE - CONTACT OUR TECHNICAL SALES STAFF FOR MORE INFO!

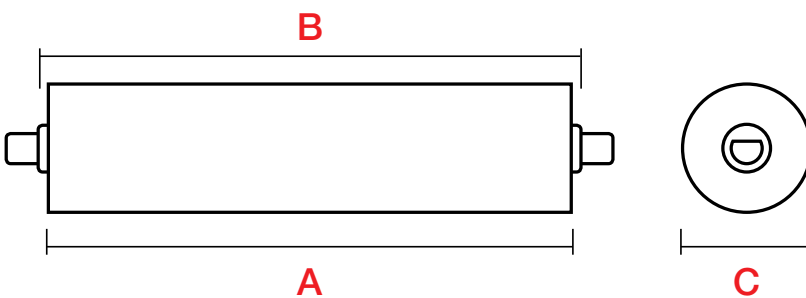

10MM SHAFT WITH 8MM FLATS



CONVEYOR ROLLER FAX ORDER FORM

ROLLER CONFIRMATION SHEET

ROLLER SPECIFICATION

ROLLER SERIES

TUBE DIAMETER

WALL THICKNESS

TUBE SPECIFICATION

M/S GALVANISED

M/S ZINC PLATED

M/S BLACK

STAINLESS STEEL

PVC

OTHER

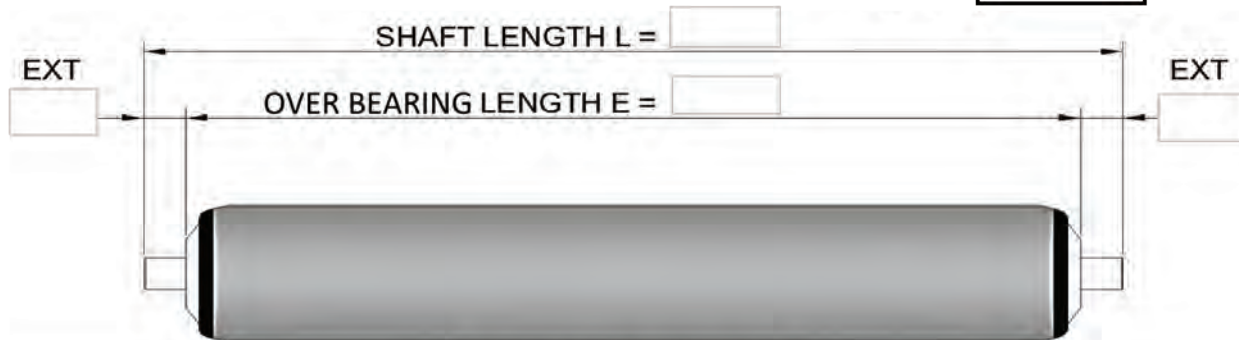

SHAFT SPECIFICATION

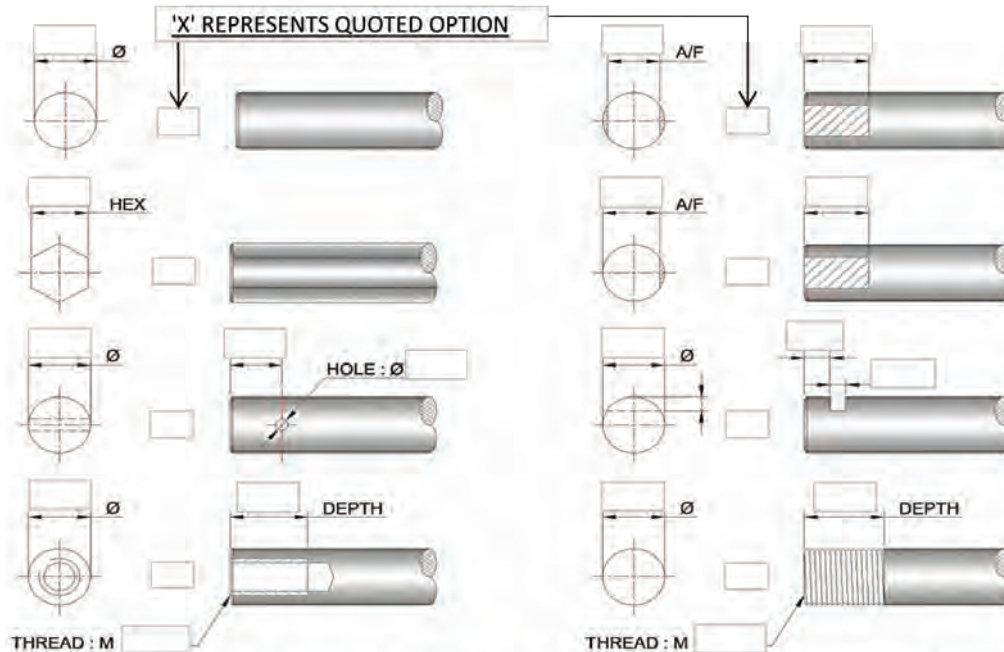

SHAFT MATERIAL

MILD STEEL

ZINC PLATED

STAINLESS

OTHER

SHAFT FIXING

SPRING LOADED

LOOSE

FIXED

NO SHAFT

BEARING DETAIL

PRECISION

SEMI PRECISION

M/S or S/S

QTY :

QUOTED PRICE (EX GST)

TOTAL \$

GENERAL NOTES :

PLEASE SIGN AND FAX OR E-MAIL BACK FOR YOUR APPROVAL.

SIGNED : PRINT NAME : DATE :/...../.....

NOTE: MANUFACTURE OF THE ROLLERS WILL NOT COMMENCE UNTIL A SIGNED COPY IS RETURNED WITH COMPANY ORDER NUMBER.

FLOOR LOCKS

Richmond's Floor Locks are designed to stop portable equipment and trolleys from moving. They are foot operated, and feature a long lasting resilient polyurethane pad and swivel base for uneven floors.

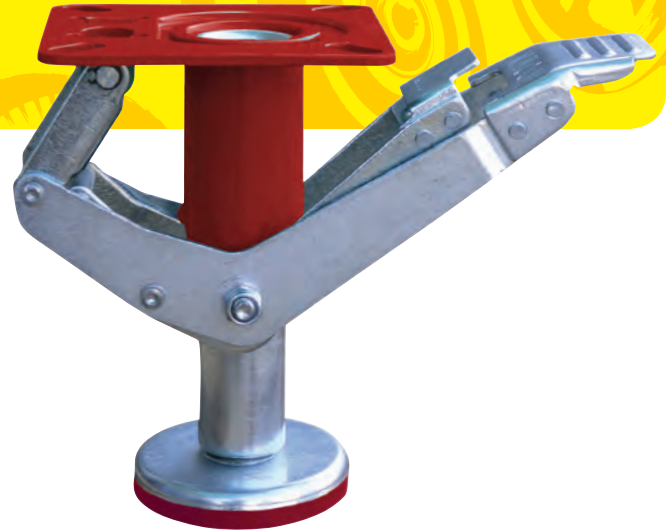

SPECIFICATIONS & FITTINGS

Extended Height (mm)	Retracted Height (mm)	Stroke (mm)	Pedal Length (mm)	Floor Lock Code
155	130	25	140	900-2
215	170	45	145	900-4

CROSS SECTION

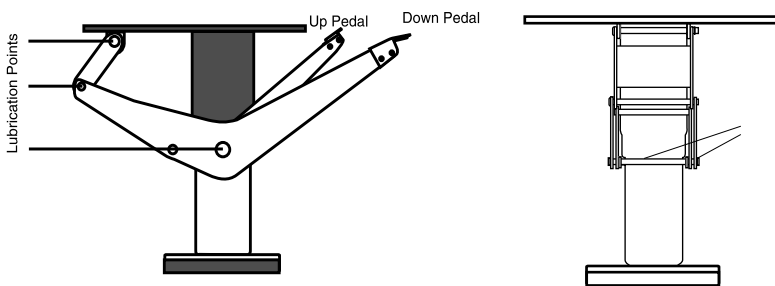

BASEPLATE DIMENSIONS

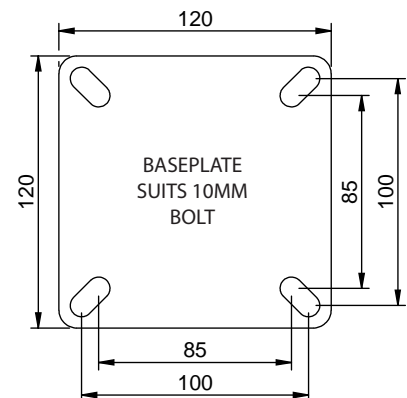

FLOOR LOCK OPERATION

- 1 Depress the down pedal as far as it will go. The lock is now set.
- 2 To unlock, press the up pedal until it is level with the down pedal. Release. The base will then retract from the floor

SELECTING & INSTALLING FLOOR LOCKS

It is important to select a model which clears the floor when retracted.

To adapt a floor lock to your current equipment, select a model with an extended height 1.6 mm to 6mm greater than the overall height of the castors.

The lock must be centred between castors

When installed the floor lock must be set 5mm from ground level when in the UP position



GLASS-FILLED NYLON CONSTRUCTION

SQUARE							
Part Number	Description	Base Width (A)	Shank Width (F)	Shank Length (C)	Overall Length (D)	Thread (B)	Load Capacity
TIR19SQM08	FITS 19mm O.D SQUARE TUBE 1.2-1.6mm WALL	19mm	17mm	28mm	31mm	M8	50kg
TIR25SQM08	FITS 25.4mm O.D SQUARE TUBE 1.2-1.6mm WALL	25mm	23.8mm	39.6mm	46.6mm	M8	250kg
TIR25SQM10	FITS 25.4mm O.D SQUARE TUBE 1.2-1.6mm WALL	25mm	23.8mm	39.6mm	46.6mm	M10	250kg
TIR25SQM12	FITS 25.4mm O.D SQUARE TUBE 1.2-1.6mm WALL	25mm	23.8mm	39.6mm	46.6mm	M12	250kg
TIR32SQM08	FITS 31.8mm O.D SQUARE TUBE 1.2-1.6mm WALL	32mm	30mm	38.4mm	46.4mm	M8	350kg
TIR32SQM10	FITS 31.8mm O.D SQUARE TUBE 1.2-1.6mm WALL	32mm	30mm	38.4mm	46.4mm	M10	350kg
TIR32SQM12	FITS 31.8mm O.D SQUARE TUBE 1.2-1.6mm WALL	32mm	30mm	38.4mm	46.4mm	M12	350kg
TIR38SQM10	FITS 38mm O.D SQUARE TUBE 1.2-1.6mm WALL	38mm	36.1mm	38.1mm	46.1mm	M10	500kg
TIR38SQM12	FITS 38mm O.D SQUARE TUBE 1.2-1.6mm WALL	38mm	36.1mm	38.1mm	46.1mm	M12	500kg
TIR38SQM16	FITS 38mm O.D SQUARE TUBE 1.2-1.6mm WALL	38mm	36.1mm	38.1mm	46.1mm	M16	500kg
TIR40SQM10	FITS 40mm O.D SQUARE TUBE 1.2-1.6mm WALL	40mm	36.8mm	38.1mm	47.1mm	M10	500kg
TIR40SQM12	FITS 40mm O.D SQUARE TUBE 1.2-1.6mm WALL	40mm	36.8mm	38.1mm	47.1mm	M12	500kg
TIR40SQM16	FITS 40mm O.D SQUARE TUBE 1.2-1.6mm WALL	40mm	36.8mm	38.1mm	47.1mm	M16	500kg
TIR51SQM10	FITS 50mm O.D SQUARE TUBE 1.2-1.6mm WALL	51mm	47.9mm	36.9mm	46.9mm	M10	750kg
TIR51SQM12	FITS 50mm O.D SQUARE TUBE 1.2-1.6mm WALL	51mm	47.9mm	36.9mm	46.9mm	M12	750kg
TIR51SQM16	FITS 50mm O.D SQUARE TUBE 1.2-1.6mm WALL	51mm	47.9mm	36.9mm	46.9mm	M16	750kg
TIR51SQM20	FITS 50mm O.D SQUARE TUBE 1.2-1.6mm WALL	51mm	47.9mm	36.9mm	46.9mm	M20	750kg

For stainless steel option add SS to the part number, eg. TIR19SQM08SS

ROUND							
Part Number	Description	Diameter (A)	Shank Diameter (F)	Shank Length (C)	Overall Length (D)	Thread (B)	Load Capacity
TIR25R0M08	FITS 25.4mm O.D ROUND TUBE 1.2-1.6mm WALL	25mm	22.9mm	37.4mm	45.8mm	M8	100kg
TIR25R0M10	FITS 25.4mm O.D ROUND TUBE 1.2-1.6mm WALL	25mm	22.9mm	37.4mm	45.8mm	M10	100kg
TIR25R0M12	FITS 25.4mm O.D ROUND TUBE 1.2-1.6mm WALL	25mm	22.9mm	37.4mm	45.8mm	M12	100kg
TIR32R0M10	FITS 31.8mm O.D ROUND TUBE 1.2-1.6mm WALL	32mm	29.5mm	39.2mm	45.3mm	M10	250kg
TIR32R0M12	FITS 31.8mm O.D ROUND TUBE 1.2-1.6mm WALL	32mm	29.5mm	39.2mm	45.3mm	M12	250kg
TIR32R0M16	FITS 31.8mm O.D ROUND TUBE 1.2-1.6mm WALL	32mm	29.5mm	39.2mm	45.3mm	M16	250kg
TIR38R0M10	FITS 38mm O.D ROUND TUBE 1.2-1.6mm WALL	38mm	35.3mm	39.4mm	45.6mm	M10	300kg
TIR38R0M12	FITS 38mm O.D ROUND TUBE 1.2-1.6mm WALL	38mm	35.3mm	39.4mm	45.6mm	M12	300kg
TIR38R0M16	FITS 38mm O.D ROUND TUBE 1.2-1.6mm WALL	38mm	35.3mm	39.4mm	45.6mm	M16	300kg
TIR51R0M10	FITS 51mm O.D ROUND TUBE 1.2-1.6mm WALL	51mm	48.5mm	39.2mm	47.4mm	M10	450kg
TIR51R0M12	FITS 51mm O.D ROUND TUBE 1.2-1.6mm WALL	51mm	48.5mm	39.2mm	47.4mm	M12	450kg
TIR51R0M16	FITS 51mm O.D ROUND TUBE 1.2-1.6mm WALL	51mm	48.5mm	39.2mm	47.4mm	M16	450kg
TIR51R0M20	FITS 51mm O.D ROUND TUBE 1.2-1.6mm WALL	51mm	48.5mm	39.2mm	47.4mm	M20	450kg

For stainless steel option add SS to the part number, eg. TIR25R0M08SS

WHEN ASSEMBLING INTO HEAVY DUTY WALL TUBE, INSERT MAY REQUIRE TRIMMING

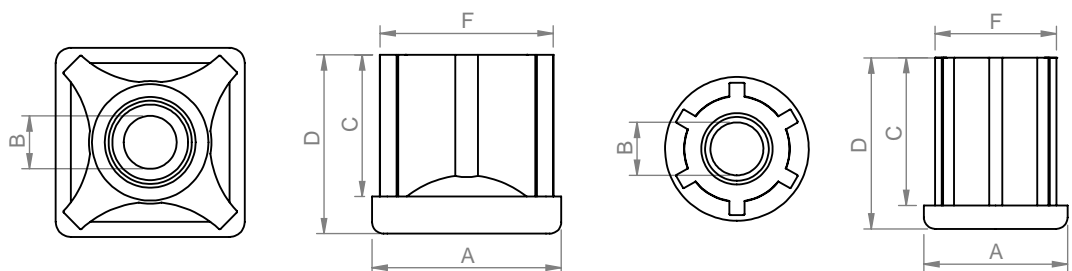

SQUARE THREADED TUBE ENDS

ROUND THREADED TUBE ENDS

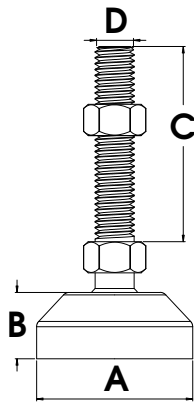

LVR7020100FRU
FIXED - RUBBER BASE

FIXED - RUBBER BASE

Part Number	Size	Base Diameter (A)	Base Height (B)	Thread Length (C)	Thread (D)	Load Capacity
LVR601050FRU	60 x M10	60mm	25mm	50mm	M10	1000kg
LVR6010100FRU	60 x M10	60mm	25mm	100mm	M10	1000kg
LVR601250FRU	60 x M12	60mm	25mm	50mm	M12	1000kg
LVR6012100FRU	60 x M12	60mm	25mm	100mm	M12	1000kg
LVR7016100FRU	70 x M16	70mm	29mm	100mm	M16	1500kg
LVR7016150FRU	70 x M16	70mm	29mm	150mm	M16	1500kg
LVR7020100FRU	70 x M20	70mm	29mm	100mm	M20	1500kg
LVR7020150FRU	70 x M20	70mm	29mm	150mm	M20	1500kg

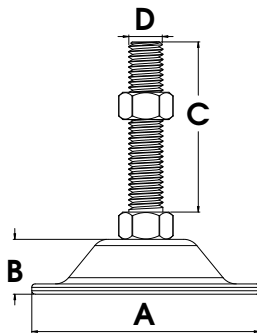

LVR6012100FST
FIXED - STEEL BASE

FIXED - STEEL BASE

Part Number	Size	Base Diameter (A)	Base Height (B)	Thread Length (C)	Thread (D)	Load Capacity
LVR380850FST	38 x M8	38mm	11mm	50mm	M8	150kg
LVR3808100FST	38 x M8	38mm	11mm	100mm	M8	150kg
LVR381050FST	38 x M10	38mm	11mm	50mm	M10	150kg
LVR3810100FST	38 x M10	38mm	11mm	100mm	M10	150kg
LVR601050FST	60 x M10	60mm	11mm	50mm	M10	300kg
LVR6010100FST	60 x M10	60mm	11mm	100mm	M10	300kg
LVR601250FST	60 x M12	60mm	11mm	50mm	M12	300kg
LVR6012100FST	60 x M12	60mm	11mm	100mm	M12	300kg
LVR8016100FST	80 x M16	80mm	13mm	100mm	M16	500kg
LVR8016150FST	80 x M16	80mm	13mm	150mm	M16	500kg
LVR8020100FST	80 x M20	80mm	13mm	100mm	M20	500kg
LVR8020150FST	80 x M20	80mm	13mm	150mm	M20	500kg
LVR10020100FST	100 x M20	100mm	20mm	100mm	M20	700kg
LVR10020150FST	100 x M20	100mm	20mm	150mm	M20	700kg

levelR LEVELING FEET

UP TO 1000KG



LVR8012100B
BOLT DOWN FOOT

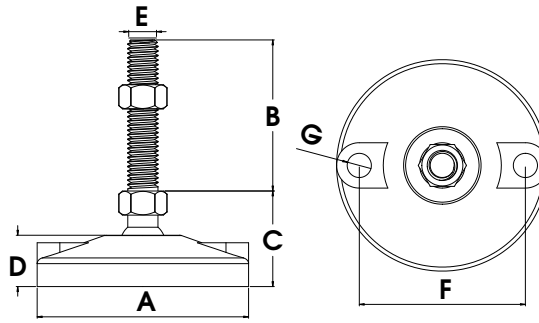

BOLT DOWN

Part Number	Size	Base Diameter (A)	Thread Height (B)	Base Thread Height (C)	Base Height (D)	Thread (E)	Hole Centres (F)	Hole Diameter (G)	Load Capacity
LVR8008100B	80 x M8	80mm	100mm	35mm	18mm	M8	56mm	10mm	350kg
LVR8010100B	80 x M10	80mm	100mm	32mm	18mm	M10	56mm	10mm	500kg
LVR8012100B*	80 x M12	80mm	100mm	33mm	18mm	M12	56mm	10mm	800kg
LVR8012150B	80 x M12	80mm	150mm	35mm	18mm	M12	56mm	10mm	800kg
LVR10012100B	100 x M12	100mm	100mm	41mm	29mm	M12	73mm	13mm	800kg
LVR10012150B	100 x M12	100mm	150mm	44mm	29mm	M12	73mm	13mm	800kg
LVR10016150B	100 x M16	100mm	150mm	45mm	28mm	M16	73mm	13mm	1000kg
LVR12716150B	127 x M16	127mm	150mm	47mm	29mm	M16	102mm	13mm	1000kg
LVR12720150B	127 x M20	127mm	150mm	47mm	30mm	M20	102mm	13mm	1000kg

For stainless steel option add SS to the part number, eg. LVR8008100BSS. Models marked * not available in stainless steel



LVR500850F
FIXED FOOT

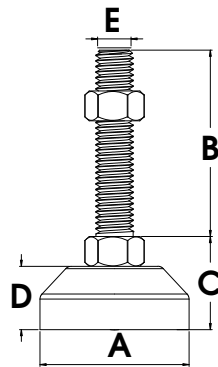

FIXED

Part Number	Size	Base Diameter (A)	Thread Height (B)	Base Thread Height (C)	Base Height (D)	Thread (E)	Load Capacity
LVR500850F	50 x M8	50mm	50mm	31mm	23mm	M8	350kg
LVR501050F	50 x M10	50mm	50mm	31mm	23mm	M10	500kg
LVR601250F	60 x M12	60mm	50mm	33mm	25mm	M12	800kg
LVR6012100F	60 x M12	60mm	100mm	33mm	25mm	M12	800kg
LVR6016150F	60 x M16	60mm	150mm	35mm	25mm	M16	1000kg
LVR6020150F	60 x M20	60mm	150mm	35mm	25mm	M20	1000kg
LVR8012100F*	80 x M12	80mm	100mm	40mm	30mm	M12	500kg
LVR8012150F	80 x M12	80mm	150mm	40mm	30mm	M12	500kg
LVR8016150F*	80 x M16	80mm	150mm	40mm	30mm	M16	800kg
LVR8020150F	80 x M20	80mm	150mm	40mm	30mm	M20	1000kg

For stainless steel option add SS to the part number, eg. LVR500850FSS. Models marked * not available in stainless steel

levelR LEVELING FEET

UP TO 1000KG



LVR8020150S
BALL JOINTED
FOOT

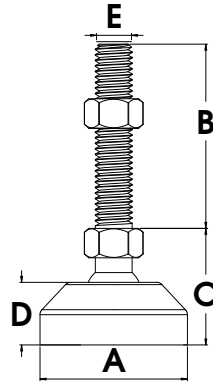

BALL JOINTED

Part Number	Size	Base Diameter (A)	Thread Height (B)	Base Thread Height (C)	Base Height (D)	Thread (E)	Load Capacity
LVR400850S	40 x M8	40mm	50mm	30mm	17mm	M8	350kg
LVR4008100S	40 x M8	40mm	100mm	33mm	17mm	M8	350kg
LVR401050S	40 x M10	40mm	50mm	30mm	16mm	M10	500kg
LVR4010100S	40 x M10	40mm	100mm	32mm	18mm	M10	500kg
LVR600850S	60 x M8	60mm	50mm	36mm	24mm	M8	350kg
LVR601050S	60 x M10	60mm	50mm	36mm	24mm	M10	500kg
LVR6010100S	60 x M10	60mm	100mm	38mm	24mm	M10	500kg
LVR601250S	60 x M12	60mm	50mm	36mm	24mm	M12	800kg
LVR6012100S	60 x M12	60mm	100mm	36mm	24mm	M12	800kg
LVR801250S	80 x M12	80mm	50mm	36mm	24mm	M12	800kg
LVR8012100S	80 x M12	80mm	100mm	36mm	24mm	M12	800kg
LVR8016100S	80 x M16	80mm	100mm	38mm	23mm	M16	1000kg
LVR8016150S	80 x M16	80mm	150mm	38mm	24mm	M16	1000kg
LVR8020100S	80 x M20	80mm	100mm	42mm	23mm	M20	1000kg
LVR8020150S	80 x M20	80mm	150mm	42mm	24mm	M20	1000kg

For stainless steel option add SS to the part number, eg. LVR400850SSS



LVR400850S
BALL JOINTED FOOT



LVR500850F
FIXED FOOT



LVR10012150B
BOLT DOWN FOOT

LEVELING FEET

UP TO 1000KG

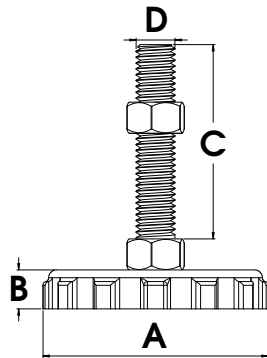

LFR250838FNK
FIXED - NYLON KNOB FOOT

FIXED - NYLON KNOB						
Part Number	Size	Base Diameter (A)	Base Height (B)	Thread Length (C)	Thread (D)	Load Capacity
LFR250638FNK	25 x M6	25mm	10mm	38mm	M6	100kg
LFR250650FNK	25 x M6	25mm	10mm	50mm	M6	100kg
LFR250838FNK	25 x M8	25mm	10mm	38mm	M8	100kg
LFR250850FNK	25 x M8	25mm	10mm	50mm	M8	100kg
LFR380838FNK	38 x M8	38mm	10mm	38mm	M8	200kg
LFR380850FNK	38 x M8	38mm	10mm	50mm	M8	200kg
LFR381050FNK	38 x M10	38mm	10mm	50mm	M10	200kg
LFR3810100FNK	38 x M10	38mm	10mm	100mm	M10	200kg
LFR501050FNK	50 x M10	50mm	10mm	50mm	M10	300kg
LFR5010100FNK	50 x M10	50mm	10mm	100mm	M10	300kg
LFR501250FNK	50 x M12	50mm	10mm	50mm	M12	300kg
LFR5012100FNK	50 x M12	50mm	10mm	100mm	M12	300kg
LFR631050FNK	63 x M10	63mm	10mm	50mm	M10	500kg
LFR6310100FNK	63 x M10	63mm	10mm	100mm	M10	500kg
LFR631250FNK	63 x M12	63mm	10mm	50mm	M12	500kg
LFR6312100FNK	63 x M12	63mm	10mm	100mm	M12	500kg

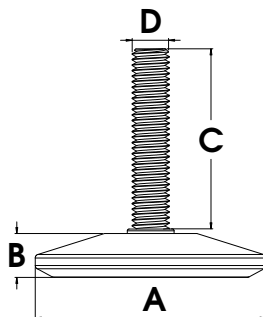

LFR400850FNC
FIXED - NYLON CONE FOOT

FIXED - NYLON CONE						
Part Number	Size	Base Diameter (A)	Base Height (B)	Thread Length (C)	Thread (D)	Load Capacity
LFR400850FNC	40 x M8	40mm	13mm	50mm	M8	100kg
LFR501050FNC	50 x M10	50mm	13mm	50mm	M10	150kg
LFR601250FNC	60 x M12	60mm	13mm	50mm	M12	200kg

LEVELING FEET

UP TO 600KG

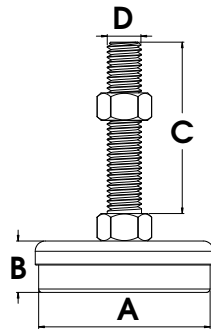

LFR601050FSR
FIXED - STEEL/RUBBER FOOT

FIXED - STEEL/RUBBER

Part Number	Size	Base Diameter (A)	Base Height (B)	Thread Length (C)	Thread (D)	Load Capacity
LFR300650FSR	30 x M6	30mm	15mm	50mm	M6	200kg
LFR300850FSR	30 x M8	30mm	15mm	50mm	M8	200kg
LFR400850FSR	40 x M8	40mm	17mm	50mm	M8	300kg
LFR4008100FSR	40 x M8	40mm	17mm	100mm	M8	300kg
LFR401050FSR	40 x M10	40mm	17mm	50mm	M10	300kg
LFR4010100FSR	40 x M10	40mm	17mm	100mm	M10	300kg
LFR501050FSR	50 x M10	50mm	17mm	50mm	M10	450kg
LFR5010100FSR	50 x M10	50mm	17mm	100mm	M10	450kg
LFR501250FSR	50 x M12	50mm	17mm	50mm	M12	450kg
LFR5012100FSR	50 x M12	50mm	17mm	100mm	M12	450kg
LFR601050FSR	60 x M10	60mm	20mm	50mm	M10	600kg
LFR6010100FSR	60 x M10	60mm	20mm	100mm	M10	600kg
LFR601250FSR	60 x M12	60mm	20mm	50mm	M12	600kg
LFR6012100FSR	60 x M12	60mm	20mm	100mm	M12	600kg

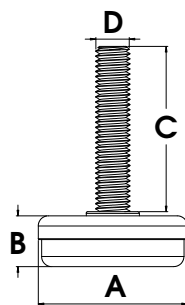

FIXED - STEEL/NYLON FOOT
LFR361045FSN



FIXED- STEEL/NYLON

Part Number	Size	Base Diameter (A)	Base Height (B)	Thread Length (C)	Thread (D)	Load Capacity
LFR250825FSN	25 x M8	25mm	10mm	25mm	M8	200kg
LFR361045FSN	36 x M10	36mm	12mm	45mm	M10	350kg
LFR421045FSN	42 x M10	42mm	14mm	45mm	M10	500kg

levelR LEVELING STAND CASTOR

The Leveling Stand Castor is an adjustable castor with multifunctional and multipurpose useage. It allows for easy moving, setting and leveling adjustment up to 10mm over the total height of the castor.

Do you need to move your equipment into position, level it and make it immobile? This castor will do it.



SPECIFICATIONS

Wheel Diameter (mm)	Wheel Width (mm)	Overall Height (mm)	Wheel Type	Bearing Type	Load Capacity (kg)	Product Code
50	24	82	Polyurethane	Ball	250	S55 LEVELR

LOCKING KNOBS

A quick and easy way to ensure products remain firmly in place. Eliminates the need for spanners and bolts by simply twisting and tightening by hand.



LCKNOB.37

SPECIFICATIONS & FITTINGS

Overall Size (mm) (A)	Thread Length (mm) (B)	Thread Type (C)	Product Code
47	19	5/16" BSW	LCKNOB.31
47	19	3/8" BSW	LCKNOB.37

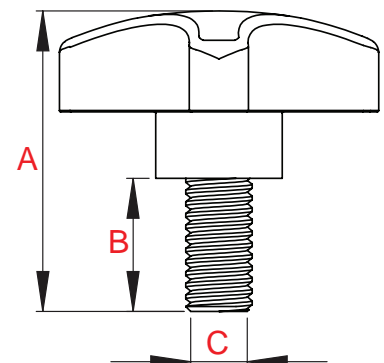

SQUARE TUBE END CAPS

Square tube end caps insert to fit light wall square tubes. They feature a ribbed design for a safe and secure fit.

Standard sizes are listed, additional sizes available on request.



ENDCPSQ381.6

SPECIFICATIONS & FITTINGS

Overall Size (mm) (A)	Thickness (mm) (B)	Insert Length (mm) (C)	Insert Width (mm) (D)	Product Code
22	4	12	20	ENDCPSQ221.6
25	3	12	24	ENDCPSQ251.6
31	3	12	29.6	ENDCPSQ321.6
38	2.9	15.5	35	ENDCPSQ381.6
50	3.5	24	47	ENDCPSQ501.6

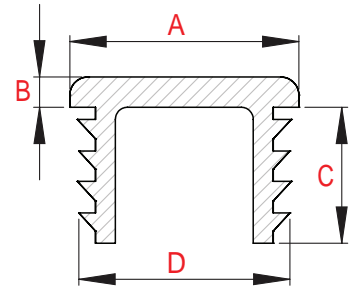

ROUND TUBE END CAPS

Round tube end caps insert to fit light wall square tubes. They feature a ribbed design for a safe and secure fit.

Standard sizes are listed, additional sizes available on request.



ENDCPRD381.6

SPECIFICATIONS & FITTINGS

Overall Size (mm) (A)	Thickness (mm) (B)	Insert Length (mm) (C)	Insert Width (mm) (D)	Product Code
22	4	12	20	ENDCPRD221.6
25	4	12	23	ENDCPRD251.6
32	4	12	29	ENDCPRD321.6
38	3	12	35	ENDCPRD381.6
50	5	19	49	ENDCPRD501.6

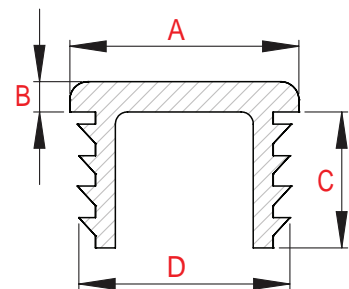

PINTLE PARTS

Solid metal pintles are used to ensure castors and securely fastened into position. Solid pintles are maintenance free, and both solid and threaded metal pintles fit all of our pintle castors.

Threaded metal pintles are used when a variety of thread sizes are required. Other sizes available for quantity order.



ROUND



SQUARE

**NEW DESIGN
COMING
SOON!**

SPECIFICATIONS & FITTINGS

EXPANDING PINTLES

Pintle Code	Pintle Part Type
P1	For 19mm ID Round Tube
P2	For 22mm ID Round Tube
P3	For 28.5mm ID Round Tube
P4	For 19mm ID Square Tube
P5	For 22mm ID Square Tube
P6	For 28.5mm ID Square Tube
P10	For 20.6mm ID Round Tube
P12	For 22mm ID Round Tube



EXPANDING

SOLID METAL PINTLE PARTS

Pintle Code	Pintle Part Type
P7	For 25mm ID Round Tube
P8	For 28.5mm ID Square Tube
P9	For 28.5mm ID Round Tube
P12	For 22mm ID Round Tube
P13	For 19mm ID Round Tube
P15	For 22mm ID Square Tube









SOLID

THREADED METAL PINTLE PARTS

Pintle Code	Pintle Part Type
TH1	For 12mm Thread 30mm Long
TH2	For 16mm Thread 30mm Long
TH3	For 3/4" BSW Thread 16mm Long
TH4	For 1/2" UNF Thread 30mm Long
TH5	For 1/2" BSW Thread 40mm Long
TH6	For 5/8" UNC Thread 40mm Long



THREADED

Pintle	Pintle Code	Pintle Type	Pintle	Pintle Code	Pintle Type
	OBT12-P1	For 19mm ID Round Tube		S2722-WC	Friction Stem
	OBT12-P2	For 22mm ID Round Tube			
	OBT12-P3	For 28.5mm ID Round Tube			
	OBT12-P4	For 19mm ID Square Tube			
	OBT12-P5	For 22mm ID Square Tube		S2722-GN	Grip Neck
	OBT12-P6	For 28.5mm ID Square Tube			

**AVAILABLE
IN
STAINLESS
STEEL**

SLEEVES & TOP HATS

Richmond's range of sleeves are most commonly used inside roller bearings or plain bore wheels for castors.

A range of top hats are available to reduce precision bearing sizes.

Mild steel axles are available from Richmond to suit our wheel range. Axles are easily cut to length to suit any application.



TOP HAT

SLEEVE

SPECIFICATIONS & FITTINGS

SLEEVES - MILD STEEL

OD (A)	ID (B)	Length (mm) (C)	Product Code
3/4"	9.8mm	48.5	SL137
3/4"	1/2"	63.5	SL142
3/4"	1/2"	101	SL143
3/4"	1/2"	82	SL144
20mm	1/2"	62.2	SL154
1/2"	3/8"	48	SL165UG

SLEEVES - STAINLESS STEEL

OD (A)	ID (B)	Length (mm) (C)	Product Code
1/2"	8mm	41	SL099
1/2"	3/8"	49.5	SL101
20mm	1/2"	63.5	SL105
3/4"	1/2"	48.5	SL106
3/4"	1/2"	63.5	SL107
3/4"	5/8"	63.4	SL108
15mm	10mm	46.5	SL118

TOP HATS - ZINC PLATED MILD STEEL

OD	ID	Length (mm)	Product Code
1/2	3/8	20	RED.5.375
5/8	1/2	28.2	RED.625.5
20mm	1/2	29.1	RED2012.8
30mm	20mm	37.5	RED3020
25.4	3/4	20	RED25-4-19
25.4	16	20	RED25-4-16
25.4	20	20	RED25-4-20

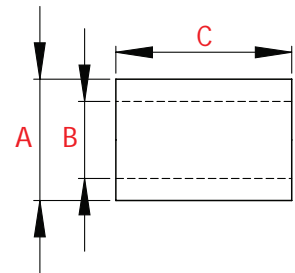
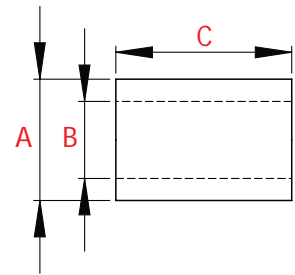

RED.5.375

BEARINGS & AXLES

Richmond can supply a full range of bearings, axles and fasteners including bolts, nuts and washers to suit all castors.



BUSH20MMBRG



BUSH25MMBRG

SPECIFICATIONS & FITTINGS

FLANGE BEARINGS

Diameter	Bore	Width	Product Code
1 1/4"	1/2"	5/16"	FLANGE BRG 1/2
1 7/8"	3/4"	7/16"	FLANGE BRG 3/4
2"	1"	7/16"	FLANGE BRG 1 INCH



PRECISION BALL BEARINGS

Diameter	Bore	Width	Product Code
1 1/8"	1/2"	5/6"	R8ZZ
40mm	5/8"	12mm	6203/10-2RS
40mm	3/4"	12mm	620312-2RS
47mm	20mm	14mm	6204-ZRS
52mm	20mm	15mm	6304-ZRS
52mm	25mm	15mm	6205-ZRS
62mm	30mm	16mm	6206-ZRS

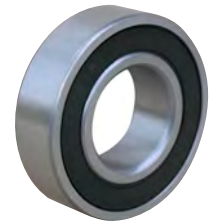

ROLLER BEARINGS

Diameter	Bore	Width	Product Code
1 3/16"	3/4"	36mm	ROLLER BRG 75X30X34
1 3/16"	3/4"	46.5mm	ROLLER BRG 75X30X48



AXLES

Diameter	Length (mm)	Product Code
1/2"	900	AXLE-50X900
5/8"	900	AXLE-62X900
3/4"	900	AXLE-75X900
1"	900	AXLE-1 INCH

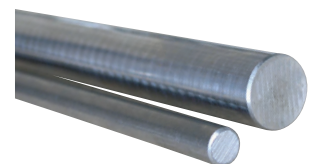

BEARING KITS

Description	Kit Code
To suit 20mm axle, fits any wheel with a 40mm I.D. bearing pocket	BUSH20MMBRG
To suit 25mm axle, fits any wheel with a 2" I.D. bearing pocket	BUSH25MMBRG

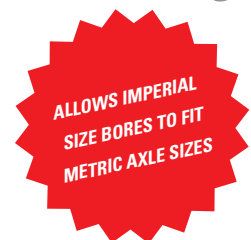

Other bearing sizes available on request. Axles above 900mm in length can be cut to suit your requirements. Contact your local Richmond supplier for options.

BASE PLATE MOUNTS / STILLAGE FEET

Richmond has a range of Mounting Plates to suit most castors. These are ideal for welding to your base frame.

These mounting plates correctly support the castor base plate, remove the need to weld in order to mount castors and save time for repair and maintenance.

Stillage feet are primarily designed for stillages and crates that need to be stackable. They have a heavy duty press steel construction, a square base for stability and are unpainted, ready to weld.

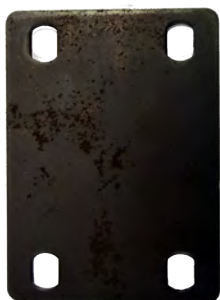

BPR001
Base plate size: 96 x 70
Hole centres: 75 x 45
Suits bolt size: 8mm
Series: Light Industrial



BPR02
Base plate size: 96 x 78
Hole centres: 80 x 60
Suits bolt size: 8mm
Series: Zinc Durolite + 300



BPR04
Base plate size: 114 x 100
Hole centres: 76 x 67/92 x 76
Suits bolt size: 3/8
Series: Heavy Industrial



BPR05
Base plate size: 130 x 110
Hole centres: 105 x 80
Suits bolt size: 3/8
Series: Heavy Industrial M3



BPR07
Base plate size: 177 x 100
Hole centres: 152 x 76
Suits bolt size: 10mm
Series: 500 + 1000



STILLFEET
Base plate size: 130 x 130

BUFFERS

These non-marking round corner and D section buffers are a great way to protect doors and corridor walls. Round buffers are fitted onto a round/square RHS tube and Corner and D section buffers are fitted using self tapering screws.

Ideal for use on flat bed trolleys, mobile tables, as well as hospital beds and equipment. We can also manufacture different shapes and sizes in polyurethane to suit your requirements.

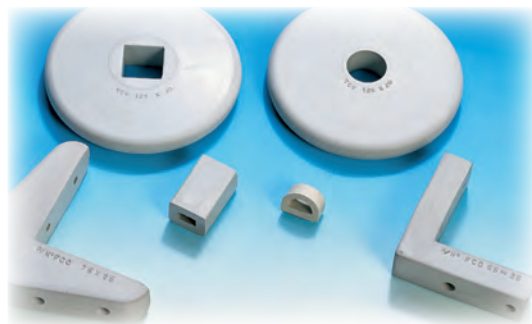

SPECIFICATIONS & FITTINGS

PVC ROUND BUFFERS - ROUND & SQUARE TUBE FITTING

Buffer Description	Measurement	Product Code	
Round Buffer	Suit 25mm SQUARE x 125 DIA	BUFFER12	 BUFFER12 with dress cap
Round Buffer	Suit 25mm ROUND x 125 DIA	BUFFER13	
Round Buffer	Suit 32mm ROUND x 125 DIA	BUFFER14	

Fitted to square or round tubular trolley legs before castors, the buffer sits loosely on top of the castor, absorbing and reducing damage.

ROUND BUFFERS - ROUND & SQUARE TUBE FITTING

Buffer Description	Measurement	Product Code	
Round Buffer	Suit 25mm SQUARE x 125 DIA	BUFFER02	 BUFFER02
Round Buffer	Suit 25mm ROUND x 125 DIA	BUFFER06	

Fitted to square or round tubular trolley legs before castors, the buffer sits loosely on top of the castor, absorbing and reducing damage.

CORNER BUFFERS

Buffer Description	Measurement	Product Code	
Small Corner Buffer	50mm x 19mm	BUFFER04	 BUFFER05
Medium Corner Buffer	65mm x 25mm	BUFFER05	
Large Corner Buffer	75mm x 25mm	BUFFER01	

Corner buffers are fitted to the square edges of new or existing trolleys to cushion impact against walls and doors.

D SECTION BUFFER

Buffer Description	Measurement	Product Code	
D Section Buffer	20mm x 30mm W x 7 MTR	BUFFER07	

D Section buffers are used to run along trolley edges between corner buffers.

WHEEL & CASTOR PRODUCT GUIDE





THINGS TO LOOK FOR WHEN CHOOSING YOUR PRODUCTS

ROLLING RESISTANCE

The ease of moving a piece of equipment is determined by the resistance of the wheels to rolling (known as Rolling Resistance). Rolling resistance is described as “that effort required to move the equipment from rest and keep it moving.” The easiest rolling is achieved by **hard tyred wheels** on a hard smooth surface. However, if the wheels must overcome obstacles from rest, then the effort required includes the force needed to lift the wheels over the obstructions. **Resilient tyred wheels** (e.g. pneumatic tyred wheels) roll over these obstructions more easily, while both **bearing wheels** and **larger wheels** make it more and more easier.

With so many variations to consider, the only realistic measurement of rolling resistance is actual site testing. Wheels are usually much cheaper to replace than the floors they run on. **Cast iron wheels** can damage concrete, especially if rolled over the same area. **Nylon wheels** are a good compromise and are long lasting. **Rubber tyred wheels** offer good protection, but are unable to carry the higher loads required of modern equipment. **Polyurethane tyred wheels** will not damage or mark floors and can carry high loads. Both **cast iron** and **nylon wheels** can often be noisy in operation. In areas where low noise levels are important, **rubber** or **polyurethane tyred wheels** are the best choice.

BEARINGS

PLAIN		Plain bore wheels are normally polypropylene, nylon or cast iron and are suitable for lighter loads where rolling resistance is not as important. They are used in very wet, corrosive or high heat conditions where better bearings would not survive.
ROLLER		Roller bearings are suitable for medium duty applications. If kept well greased, they can cope with some dirt or water. Best service is given on hardened axles. These bearings do not require axial adjustment.
PRECISION BALL		Precision deep groove ball bearings are fitted to most of our heavy duty wheels. Such wheels have very low rolling resistance and are normally provided with double seal bearings that are ‘sealed for life.’ If the application required regular greasing, grease nipples can be fitted.
TAPER ROLLER		Taper roller bearings are the best choice for power towing applications and have the highest carrying capacity. All wheels with taper roller bearings are fitted with oil seal sleeves. The axle design must allow for fine adjustment of distance between bearing cones

LOAD RATINGS

Our load capacities are based upon ideal / average working conditions. These ratings are for normal use. If the castors or wheels are in continuous use (e.g. as 24 hour a day drive wheels) these ratings would have to be downgraded. **Ideal** load ratings mean that the floor must be smooth and there is no chance of overloading the castor. **Average** load ratings are used when conditions are not perfect (i.e. probably on most sites where castors are used). It may be necessary to underate castors to ensure ease of use, especially under harsh conditions. Our castors are tested on a concrete floor free of door sills, breaks, rails etc and capacities are based on ‘hand operation’ except where otherwise designated.

DIMENSIONS

All dimensions in this catalogue are approximate. They are subject to change without notice, especially due to improvements or new designs.

Please contact us for information relevant to your own needs.

CASTOR SELECTION

There are many questions to consider when choosing a castor:

How much load will it carry? Will there be shock loads?

What is the condition of the running surface? How often is the castor in operation?

Will the castor be towed and if so at what speed? Do height restrictions apply?

How easily must the load be moved and does the floor need protection?

Is wheel noise likely to be a problem? Is the wheel in danger from a harsh environment?

Our staff can help you answer all these questions and more! phone us if you have any queries.

DEFINITIONS & CODE ABBREVIATIONS

CASTORS: **Rigid Castor:** Non-swivelling castor

Swivel Castor: Swivel rotates without restriction

BRAKES: **Wheel Brake:** Prevents the wheel from rotating

Directional Lock: Locks the swivel in any direction

Swivel Lock & Brake: Simultaneously brakes the wheel and locks the swivel in any direction

4WD	4 Way Directional Lock	AS	Anti Static	B	Brake or Swivel Lock & Brake	BT	Beam Trolley
CI	Cast Iron	CG	C Groove	CR	Cushion Rubber	D	Directional Lock
DF	Double Flange	DV	Drive Wheel	ER	Elastic Rubber	IR	Institutional Rubber
NY	Nylon	PU	Polyurethane	PN	Pneumatic	RG	Rope Groove
PS	Solid Polyurethane	RR	Rebound Rubber	R	Rigid	SLB	Swivel Lock & Brake (Total Brake)
RN	Rubber on Nylon	SF	Single Flange	RT	Rubber Tyre on Cast Iron	TG	Threadguard
S	Swivel	SP	Semi Pneumatic	SG	Spheroidal Graphite Iron		
SN	Solid Pneumatic						
VG	V Groove						

WARRANTY: Please see www.richmondau.com for warranty document as well as Conditions of Use, Fitting, and Maintenance Guidelines.

ROLLING RESISTANCE & CASTOR MOUNTING OPTIONS

FORCE REQUIRED FOR MOVEMENT

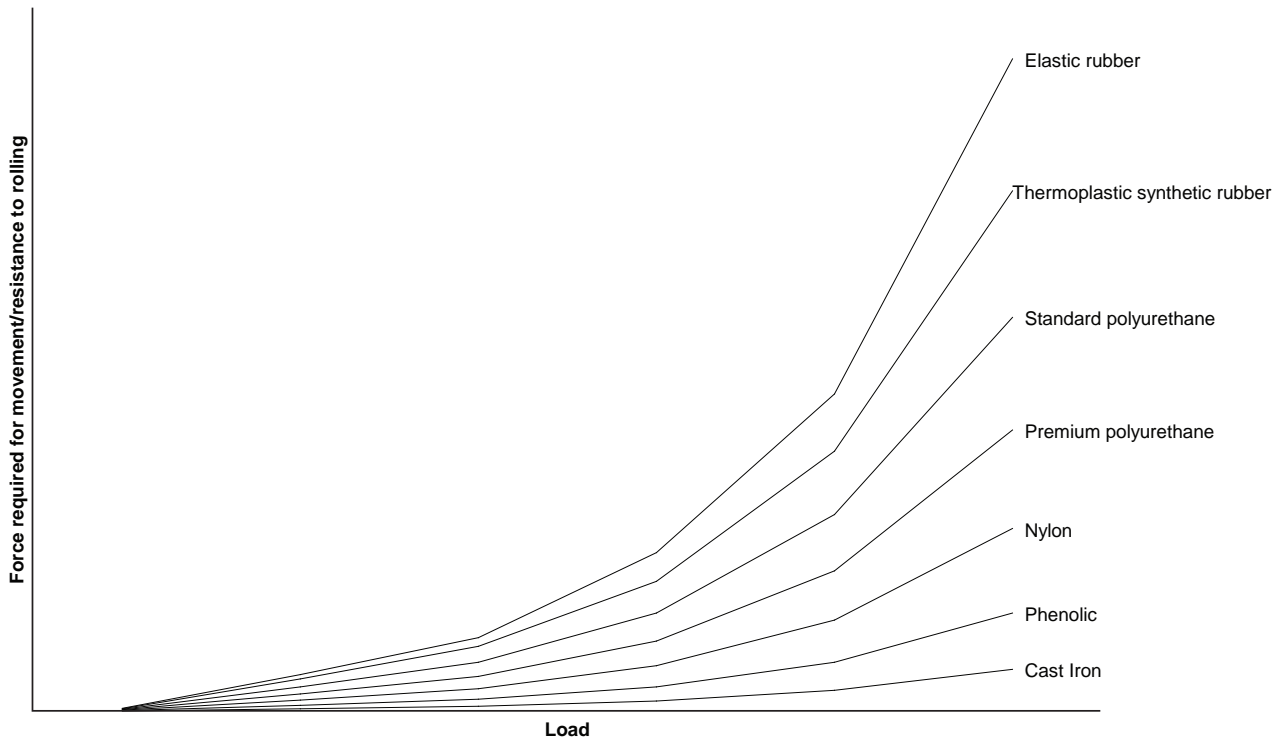

NOTE: Graph provides relative differences between wheel types assuming 150mm diameter wheels with precision ball bearings. Detailed advice can be given on request as many other factors need to be taken into account.

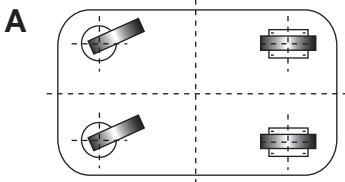

Swivel castors / fixed castors

This solution offers excellent load bearing capacity and manoeuvrability and eliminates the danger of overturning uneven loads.

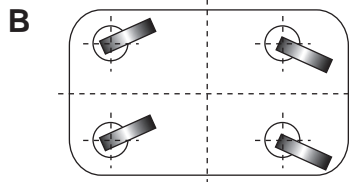

Swivel castors

This solution is recommended for trolleys which will be required to work in confined spaces and will be pushed or pulled from all sides. It offers the advantage of excellent manoeuvrability and load capacity.

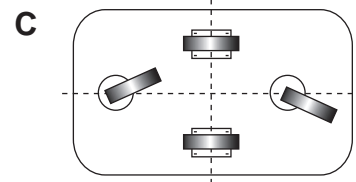

Swivel castors / fixed castors

This solution combines an excellent load capacity with equally good manoeuvrability. The load is borne by the two central fixed wheels and the pivoting wheels. There is a danger of overturning if the load is off centre and the trolley is pulled from the side.

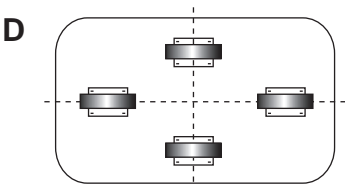

Fixed castors

This solution is recommended for medium-sized loads and trolleys moved predominantly in a straight line. With no rotating parts on the castors, maintenance is kept to a minimum.

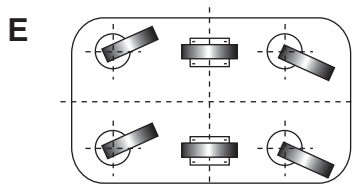

Swivel castors / fixed castors

This is the best solution for large trolleys intended for heavy loads. It offers excellent load capacity and manoeuvrability with perfect stability. The trolley may be pushed or pulled from either of the ends with pivoting castors will pivot on half in length.