

# SYNERGY TELECOM

## CATALOG

Vikaspuri, New Delhi-110018, India.

Mobile 91-98101 38894, Fax -91 11 2853 1435

pradeep@rfconnectorhouse.com <http://www.rfconnectorhouse.com/>

Skype Accout - pradeepag, My trademanager ID -synergytelecom;

# CATALOG SECTION INDEX

Use this Section Index to find product categories quickly.  
Turn the page to the Table of Contents to find individual products,  
or use the Part Number Index to find product page by Part Number.

## New Products

Precision Test Cable Assemblies; VNA Cables; QMA & QN Connectors, Cable Assemblies & Adapters; LFU Connectors & Cable Assemblies; HD Connectors & Cable Assemblies; PE-BYR940 Coaxial Cable; Mobile & Stationary Antennas; Antenna NMO Mounts; Antenna Cable Assemblies; N Connectors & Cable Assemblies; 7/16 Din Connectors & Cable Assemblies; 3.5mm & N Type VNA Calibration Kits; 3-Port Calibration Tools

New  
Products

## Coaxial & Twinax Cable Assemblies

N Type & 3.5mm VNA Calibration Kits; VNA Test Cable Assemblies; 3-Port Field Calibration tools; High-Frequency Assemblies; Flexible Assemblies; Semi-Rigid & Re-Shapable Assemblies; Single Wire Patch Cords; Breakouts; Twinax (Cable Assemblies & Connectors); 3/4"-20 Twinax; BNC Twinax

Cable  
Assemblies

## Coaxial Connectors

1.0/2.3 Snap On; 1.6/5.6; 1.85mm; 2.4mm; 2.92mm; 3.5mm; 7/16 DIN; 10-32; BNC; BNC-75 Ohm; BNC-Reverse Polarity; Banana Plugs; C; D-Subminiature; F; FME; GR874; HN; LC; LFU; MC-Card; MCX; MCX-75 Ohm; MCX-Reverse Polarity; MMCX; N; N-75 Ohm; N-Reverse Polarity; Positive Snap; QMA; QN; SC; SHV; SMA; SMA-Reverse Polarity; SMA-Reverse Thread; SMB; SMB-75 Ohm; Mini-75 Ohm SMB; SMC; SMC-75 Ohm; SMP; MINI SMP; SSMA; SSMB; TNC; TNC-75 Ohm; UHF; Mini UHF

Connectors

## Adapters

Adapter Selection List (Part Number Identifier); Adapters to all Connectors above

Adapters

## Additional Products

Attenuators (Programmable, Fixed, Rotary, Pushbutton, Toggle, & Continuously Variable); Impedance Matching Pads; Terminations; Directional Couplers (Octave, Broadband, Dual, 90° Hybrid & High Power); Power Dividers; Ferrite Isolators & Circulators; Phase Shifters; Phase Trimmers; DC Blocks; Bias "Tee"; Caps & Shorts; Surge Protectors; Coaxial Relay & Transfer Switches; Noise Generators; Amplifiers (In-line, LNA & Power); Schottky Diode Detectors & Limiters; Double Balanced Mixers; Frequency Doublers; Standard Gain Horns; Waveguide-to-Coax Adapters; Waveguide Terminations; Mobile & Stationary Antennas; Antenna NMO Mounts; Antenna Cable Assemblies

Attenuators /  
RF Components

## Fiber Optics

Cable Assemblies; Adapters; Attenuators

Fiber Optics

## Tools & Bulk Cable

Coax Crimping Tools; Preset Torque Wrenches; Coax Compression Tool; Cable Cutting Tools; Bulk Coaxial Cable

Tools &  
Bulk Cable

# TABLE OF CONTENTS

## PAGES

90° HYBRID .....	236
<b>NEW</b> ADAPTERS .....	199 THRU 223
ADAPTER SELECTION LIST .....	195 THRU 198
<b>NEW</b> AMPLIFIERS .....	238
<b>NEW</b> ANTENNAS, MOBILE & STATIONARY .....	252 & 253
<b>NEW</b> ANTENNAS, MOBILE MOUNTS .....	254
<b>NEW</b> ANTENNA CABLE ASSEMBLIES .....	254 & 255
ATTENUATORS, COUNTINUOUSLY VARIABLE .....	231
<b>NEW</b> ATTENUATORS, FIXED .....	227 THRU 230
ATTENUATORS, PROGRAMMABLE .....	233
ATTENUATORS, PUSHBUTTON .....	233
ATTENUATORS, ROTARY .....	232
ATTENUATORS, TOGGLE .....	233
BIAS "TEE" .....	242
BREAKOUTS .....	146
<b>NEW</b> CALIBRATION KIT.....	28
CAPS .....	242
CIRCULATORS, FERRITE .....	241
COAX CABLE ASSEMBLY SELECTION LIST ....	25 THRU 27
<b>NEW</b> COAXIAL CABLE ASSEMBLIES .....	29 THRU 144
<b>NEW</b> COAXIAL CABLE (BULK) .....	261 THRU 263
COAXIAL CONNECTORS .....	147 THRU 194
1.0/2.3 SNAP ON .....	178
1.6/5.6, 75 OHM .....	178
1.85mm .....	166
2.4mm .....	166
2.92mm .....	165
3.5mm .....	165
<b>NEW</b> 7/16 DIN .....	152 & 153
3/4"-20 TWINAX .....	193
10-32 .....	151
BNC .....	170 & 171
BNC TWINAX .....	193
<b>NEW</b> BNC, 75 OHM .....	179 THRU 181
BANANA PLUGS .....	192
C .....	169
D SUBMINIATURE .....	192
<b>NEW</b> F .....	182 & 186
FME .....	149
GR874 .....	193
<b>NEW</b> HN .....	152
LC .....	150
<b>NEW</b> LFU .....	174
MC-CARD .....	174
MCX .....	175 & 176
MCX, 75 OHM .....	185
MHV .....	167
MINI UHF .....	150
MMCX .....	174
<b>NEW</b> N .....	154 THRU 156
N, 75 OHM .....	186
<b>NEW</b> QMA .....	177
<b>NEW</b> QN .....	176
RCA .....	181
REVERSE POLARITY BNC .....	188
REVERSE POLARITY N .....	189
REVERSE POLARITY SMA .....	191

## PAGES

REVERSE POLARITY TNC .....	189 & 190
REVERSE POLARITY MCX .....	189
REVERSE THREAD SMA .....	190
SC .....	151
<b>NEW</b> SHV .....	168
SMA .....	160 THRU 163
SMA FIELD REPLACEABLE .....	164
<b>NEW</b> SMB .....	173
SMB, 75 OHM & MINI 75 OHM SMB ...	182,183 & 184
SMC .....	158
SMC, 75 OHM .....	187
SMP .....	178
MINI SMP .....	178
SSMA .....	159
SSMB .....	172
TNC .....	157
TNC, 75 OHM .....	185
UHF .....	149
CONNECTOR IDENTIFIER .....	19 THRU 24
D.C. BLOCKS .....	241
DETECTORS (BNC, LOG & SCHOTTKY).....	246 & 247
DIRECTIONAL COUPLERS .....	237 THRU 239
<b>NEW</b> DISTRIBUTORS, INTERNATIONAL .....	10
FIBER OPTIC ADAPTERS .....	259 & 260
FIBER OPTIC ATTENUATORS .....	260
FIBER OPTIC CABLE ASSEMBLIES .....	256 THRU 258
FREQUENCY DOUBLERS .....	248
FUSE HOLDERS .....	243
HOW TO PLACE YOUR ORDER .....	2
IMPEDANCE MATCHING PADS .....	234
ISOLATORS, FERRITE .....	241
LIMITERS .....	247
MAILING LIST CHANGE FORM .....	267
MIXERS, DOUBLE BALANCED .....	248
MOUNTING HOLE LAYOUTS .....	266
NOISE GENERATORS .....	245 & 246
ORDER FORM .....	272
PHASE TRIMMERS .....	241
PHASE SHIFTERS .....	241
POWER DIVIDERS .....	240
ROHS COMPLIANCE PROGRAM.....	269
SCREWS & NUTS .....	264
SHORTS .....	242
SINGLE WIRE PATCH CORDS .....	145
STANDARD GAIN HORNS .....	249
SURGE PROTECTORS .....	243
<b>NEW</b> SWITCHES, COAXIAL .....	243 & 244
TERMINATIONS .....	234 THRU 236
TERMS & CONDITIONS .....	271
<b>NEW</b> TOOL, CABLE CUTTING .....	264
TOOL, COMPRESSION .....	264
TOOLS, CRIMPING .....	265
TOOLS, PRESET TORQUE WRENCHES .....	264
<b>NEW</b> TWINAX CABLE ASSEMBLIES .....	138
VNA TEST CABLE .....	31
WAVEGUIDE TO COAX ADAPTERS .....	250 & 251
WAVEGUIDE TERMINATIONS .....	248 & 250

# INDEX

Model No.	Page No.	Model No.	Page No.	Model No.	Page No.	Model No.	Page No.
PE1001 THRU PE1003	164	PE3133 & PE3134	100	PE3293 THRU PE3301	101	PE3420	58
PE1004 THRU PE1009	264	PE3137	58	PE3302	74	PE3421	112
PE1510 THRU PE1525	245	PE3138	56	PE3304 & PE3306	101	PE3422	74
PE1603 THRU PE1618	242	PE3139	100	PE3307	108	PE3423	49
PE2000 THRU PE2049	240	PE3141	60	PE3309 THRU PE3316	101	PE3425	112
PE2050 THRU PE2060	236	PE3143	78	PE3318	74	PE3427	49
PE2061 THRU PE2069	240	PE3145	100	PE3319	58	PE3428	60
PE2200 THRU PE2207	238	PE3147	61	PE3320	82	PE3429	58
PE2208 THRU PE2216	237	PE3149 & PE3152	66	PE3321 & PE3323	74	PE3430	112
PE2217 THRU PE2236	239	PE3154	120	PE3325 THRU PE3332	46	PE3431	49
PE300 THRU PE303	28	PE3156	66	PE3333	62	PE3434 & PE3435	112
PE304 THRU PE309	29	PE3157 & PE3158	100	PE3334	127	PE3436	49
PE310	31	PE3159	53	PE3338	90	PE3437	52
PE311 & PE312	30	PE3160	62	PE3340	91	PE3440	49
PE315 THRU PE321	32	PE3164	142	PE3341	108	PE3441	76
PE3000	143	PE3166	92	PE3343	123	PE3442	49
PE3003	58	PE3168	78	PE3344	58	PE3443	63
PE3005	143	PE3170	100	PE3345	72	PE3444	60
PE3010	142	PE3171	62	PE3346	142	PE3445	45
PE3013	72	PE3172	97	PE3347	60	PE3446	49
PE3015	53	PE3174 THRU PE3178	120	PE3348	127	PE3447	76
PE3020	46	PE3181	97	PE3349	52	PE3448	75
PE3023	122	PE3182	100	PE3351	47	PE3450	49
PE3025	47	PE3183	102	PE3352	58	PE3451	89
PE3034	82	PE3184	64	PE3353	56	PE3454	49
PE3038	91	PE3185	102	PE3354	48	PE3455	76
PE3041	98	PE3187	97	PE3355	46	PE3457	123
PE3042	51	PE3188	63	PE3357	91	PE3458	47
PE3044	47	PE3189	102	PE3358	46	PE3459	58
PE3047	48	PE3190	100	PE3360	48	PE3460	46
PE3050	66	PE3192	102	PE3361	56	PE3462	45
PE3051	64	PE3193	72	PE3362	98	PE3466	113
PE3052	50	PE3199	102	PE3364	50	PE3468	65
PE3054	46	PE3200	100	PE3365	89	PE3470	44
PE3056	62	PE3205	102	PE3366	47	PE3472	77
PE3057	126	PE3207	103	PE3367	73	PE3476 & PE3477	51
PE3058	125	PE3210	119	PE3368	48	PE3479	54
PE3061	51	PE3211	100	PE3369	56	PE3480	138
PE3062	76	PE3214	119	PE3370	47	PE3481	57
PE3067	44	PE3216	103	PE3371	48	PE3483	59
PE3071	78	PE3217	82	PE3373	47	PE3485	81
PE3074	113	PE3218	103	PE3375	48	PE3487	76
PE3075	44	PE3221	104	PE3376	98	PE3488	83
PE3078	62	PE3223	70	PE3377	56	PE3490	114
PE3079	48	PE3224	104	PE3378	47	PE3492	57
PE3081	44	PE3226	119	PE3380	60	PE3494	64
PE3082	46	PE3227	82	PE3381	47	PE3495	44
PE3083	91	PE3230	59	PE3382	65	PE3496	76
PE3085	89	PE3231	126	PE3384	47	PE3497 & PE3498	122
PE3087	44	PE3232	80	PE3385	56	PE3500	56
PE3088	50	PE3233	104	PE3387	57	PE3501 & PE3502	142
PE3089	121	PE3234	74	PE3388	98	PE3504	112
PE3093	62	PE3236 THRU PE3244	52	PE3389	47	PE3505	50
PE3094	50	PE3246 THRU PE3252	51	PE3393	59	PE3508	46
PE3095	91	PE3253	63	PE3394	112	PE3510	58
PE3097	51	PE3254	51	PE3395	127	PE3511	60
PE3098	88	PE3255	78	PE3396 THRU PE3400	108	PE3512 & PE3513	58
PE3100	98	PE3256	51	PE3402	112	PE3514 & PE3515	60
PE3102	62	PE3258	107	PE3404	108	PE3516 & PE3517	88
PE3103	49	PE3259	61	PE3405	62	PE3518	123
PE3104	127	PE3261	51	PE3407	86	PE3519	74
PE3108	89	PE3263 & PE3265	107	PE3408	112	PE3520	69
PE3109	68	PE3268	79	PE3409	127	PE3521	68
PE3112	98	PE3269 & PE3271	107	PE3411	58	PE3522	123
PE3113 & PE3116	46	PE3272	79	PE3412	79	PE3524	68
PE3117	90	PE3273 THRU PE3278	107	PE3413	49	PE3525	70
PE3120	123	PE3279	76	PE3414	112	PE3528	108
PE3121	56	PE3280 THRU PE3288	107	PE3416	127	PE3530	52
PE3122	100	PE3290	101	PE3417	61	PE3531	65
PE3130	95	PE3291	74	PE3418	112	PE3534	68

# INDEX

Model No.	Page No.	Model No.	Page No.	Model No.	Page No.	Model No.	Page No.
PE3535	120	PE3673	125	PE3830	83	PE3982	87
PE3538	44	PE3674	48	PE3832	62	PE3983	83
PE3539	54	PE3675	50	PE3835	64	PE3986	80
PE3542	88	PE3678	45	PE3836	66	PE3987	60
PE3543	126	PE3679	67	PE3842	47	PE3988	81
PE3544	112	PE3684	113	PE3843	90	PE3989 & PE3991	87
PE3545	123	PE3686	82	PE3845	53	PE3992	90
PE3548	97	PE3689	46	PE3849	52	PE3993	83
PE3551	122	PE3693	79	PE3850	53	PE3995	77
PE3553	64	PE3694	88	PE3852	91	PE3996	80
PE3557	49	PE3696	54	PE3853	92	PE3997	76
PE3561	119	PE3697	62	PE3854	49	PE33001	75
PE3562	54	PE3698	79	PE3857	90	PE33003	57
PE3568	74	PE3699	78	PE3858	60	PE33009	144
PE3570	76	PE3705	44	PE3864	62	PE33011	80
PE3571	142	PE3706	62	PE3865	58	PE33021	86
PE3572 THRU PE3574	56	PE3713	60	PE3867	57	PE33068	90
PE3577	88	PE3714	80	PE3871	64	PE33071	125
PE3580	53	PE3715	62	PE3874	51	PE33098	123
PE3581	108	PE3721	92	PE3876	60	PE33117	72
PE3582 THRU PE3584	44	PE3722	97	PE3882	79	PE33121	94
PE3587 & PE3588	92	PE3726	78	PE3883	114	PE33122	87
PE3589 & PE3590	94	PE3733	53	PE3885	54	PE33143	93
PE3591	95	PE3735	88	PE3886	53	PE33144	103
PE3592 & PE3593	93	PE3736	119	PE3887	75	PE33154	114
PE3594	96	PE3739	56	PE3895	90	PE33165	92
PE3595 & PE3596	114	PE3745	54	PE3898	126	PE33168	79
PE3597 & PE3598	116	PE3746	52	PE3899	56	PE33175	93
PE3600 & PE3601	115	PE3747	112	PE3901	48	PE33176	69
PE3602	117	PE3749	44	PE3902	114	PE33178	86
PE3604	50	PE3750	51	PE3903	69	PE33179	110
PE3605	123	PE3755	97	PE3904	122	PE33188	109
PE3606	48	PE3756	53	PE3906	44	PE33191	70
PE3607	76	PE3758	68	PE3908	97	PE33196 & PE33197	109
PE3608	112	PE3759	66	PE3911	74	PE33231 THRU PE33233	33
PE3611	62	PE3764	69	PE3914	88	PE33236	76
PE3612	108	PE3765	116	PE3915	92	PE33247	98
PE3613	54	PE3769	73	PE3916 & PE3917	94	PE33258	54
PE3614	74	PE3775	60	PE3918 & PE3919	116	PE33261	96
PE3615	54	PE3776	45	PE3920	77	PE33267	53
PE3616	108	PE3777	48	PE3921	81	PE33270	98
PE3617	80	PE3779	58	PE3922	83	PE33304	91
PE3618	108	PE3780	53	PE3924	64	PE33316	123
PE3623	53	PE3781	79	PE3925	67	PE33321	78
PE3626	54	PE3782	77	PE3929	69	PE33330	98
PE3627	48	PE3790	36	PE3930	138	PE33349	96
PE3634	69	PE3792	48	PE3931	68	PE33350	94
PE3635	53	PE3794	69	PE3932	69	PE33352	118
PE3641	52	PE3796	53	PE3935	47	PE33356	93
PE3642	53	PE3797	78	PE3940	64	PE33361	120
PE3644	87	PE3799	64	PE3944	119	PE33363	115
PE3646	61	PE3800	66	PE3949	48	PE33370	91
PE3649	49	PE3803	126	PE3950	89	PE33383	122
PE3650	80	PE3806	64	PE3953	50	PE33391	113
PE3651	63	PE3807	44	PE3954	142	PE33399 THRU PE33416	109
PE3652	87	PE3808	114	PE3956	64	PE33417 & PE33419	110
PE3653	76	PE3809	119	PE3957	74	PE33420	121
PE3654	74	PE3810	97	PE3958	59	PE33421 THRU PE33436	110
PE3655	60	PE3811	53	PE3959	64	PE33437	111
PE3656	57	PE3814	56	PE3960	50	PE33438	126
PE3657	75	PE3815	90	PE3961	65	PE33439	111
PE3658	54	PE3816	47	PE3962	78	PE33440	143
PE3660	52	PE3818	57	PE3963	77	PE33441	111
PE3661	87	PE3819 & PE3820	61	PE3965	81	PE33442	143
PE3662	74	PE3821 & PE3822	59	PE3966	82	PE33443	111
PE3664	120	PE3823 & PE3824	63	PE3967	64	PE33444	143
PE3665 & PE3666	87	PE3825 & PE3826	65	PE3971	83	PE33445	111
PE3667	80	PE3827	77	PE3973	64	PE33446	143
PE3669	125	PE3828	75	PE3977	80	PE33447 & PE33448	111
PE3671 & PE3672	52	PE3829	81	PE3979	81	PE33449	143

# INDEX

Model No.	Page No.	Model No.	Page No.	Model No.	Page No.	Model No.	Page No.
PE33450 THRU PE33452	111	PE33974	79	PE34213	61	PE34407	89
PE33454	143	PE33984	89	PE34214	86	PE34408	121
PE33455	87	PE33996	73	PE34215	61	PE34409	89
PE33456	111	PE34023	50	PE34216	86	PE34410	121
PE33457	87	PE34061	66	PE34217	61	PE34411	89
PE33458	111	PE34069	128	PE34218	86	PE34412	121
PE33476	94	PE34070 & PE34071	69	PE34219	61	PE34413	89
PE33481	72	PE34078	117	PE34220	59	PE34414	121
PE33491	50	PE34098	103	PE34221	86	PE34415	89
PE33502	70	PE34116	132	PE34222	79	PE34416	121
PE33516	89	PE34122	128	PE34223	61	PE34417	89
PE33518	69	PE34135	66	PE34224	63	PE34418	121
PE33519 THRU PE33523	54	PE34138 & PE34140	77	PE34225	86	PE34419	89
PE33525 & PE33527	76	PE34141	66	PE34226	63	PE34420	121
PE33528	86	PE34142	77	PE34227	86	PE34421	90
PE33530	82	PE34143	73	PE34228	63	PE34422	121
PE33532	86	PE34144 & PE34146	77	PE34229	86	PE34423	88
PE33534	82	PE34148	73	PE34230	63	PE34424	90
PE33535	122	PE34149	77	PE34231	79	PE34425 & PE34427	88
PE33536	86	PE34150	83	PE34233	63	PE34428	90
PE33537 THRU PE33541	50	PE34151	73	PE34234	79	PE34429	88
PE33543	82	PE34152	83	PE34235	63	PE34430	90
PE33545	86	PE34153	73	PE34236	79	PE34431	88
PE33546 THRU PE33554	144	PE34154	83	PE34237	63	PE34432	90
PE33555	72	PE34155	73	PE34238	79	PE34433	88
PE33556	115	PE34156	83	PE34240	128	PE34434	91
PE33557 THRU PE33567	144	PE34157	73	PE34241 & PE34243	65	PE34435	123
PE33580	118	PE34158	83	PE34244	142	PE34436	91
PE33583	91	PE34159	73	PE34245	65	PE34437	123
PE33586	98	PE34160	66	PE34246	120	PE34438	91
PE33605	108	PE34161	83	PE34247	65	PE34439	127
PE33615	87	PE34162	45	PE34248	120	PE34440	123
PE33641	114	PE34163	73	PE34249	65	PE34441	127
PE33643	116	PE34164 THRU PE34168	45	PE34250	120	PE34442	123
PE33644	98	PE34169	72	PE34252	65	PE34443 THRU PE34447	127
PE33645	116	PE34170	45	PE34253	120	PE34448	97
PE33646	98	PE34171	72	PE34254	65	PE34449	127
PE33647	114	PE34173	45	PE34255	120	PE34450	119
PE33649	116	PE34174	72	PE34256	65	PE34451	127
PE33650 & PE33652	92	PE34175	45	PE34257 THRU PE34265	75	PE34452	97
PE33654 & PE33656	94	PE34176	72	PE34266	87	PE34453	127
PE33657	97	PE34177	45	PE34268	75	PE34454	119
PE33658 & PE33660	115	PE34178	72	PE34269	92	PE34455	97
PE33662	123	PE34179	66	PE34270	75	PE34456 & PE34458	119
PE33664	115	PE34180	57	PE34271	113	PE34459	116
PE33666 THRU PE33672	93	PE34181	82	PE34272	87	PE34460	119
PE33673	120	PE34182	57	PE34273	113	PE34461	94
PE33674	95	PE34183	72	PE34274	80	PE34462	116
PE33675	96	PE34184	57	PE34275	113	PE34463	94
PE33676 & PE33680	95	PE34185	72	PE34276	80	PE34464	116
PE33682	96	PE34186 THRU PE34191	57	PE34277 THRU PE34280	113	PE34465	94
PE33686 THRU PE33690	118	PE34192	66	PE34281	80	PE34466	116
PE33692	117	PE34193	57	PE34282	113	PE34467 & PE34469	96
PE33701	122	PE34194	82	PE34283	80	PE34470	117
PE33704	92	PE34195	59	PE34284	113	PE34471	96
PE33706	90	PE34196	82	PE34285	81	PE34472	117
PE33728	80	PE34197	59	PE34286	36	PE34473	96
PE33749	66	PE34198	82	PE34287 THRU PE34291	81	PE34474	117
PE33762	125	PE34199 & PE34200	59	PE34292	68	PE34475	96
PE33778	91	PE34201	82	PE34293 & PE34296	81	PE34476	117
PE33789	69	PE34202	59	PE34297 THRU PE34321	67	PE34477	96
PE33844	73	PE34203	78	PE34331	132	PE34478	117
PE33864	69	PE34204	59	PE34357 & PE34359	103	PE34479	96
PE33896	63	PE34205	78	PE34360	102	PE34480	117
PE33928	121	PE34206	59	PE34361	129	PE34481	93
PE33929	72	PE34207	78	PE34374	128	PE34482	117
PE33938	91	PE34208 & PE34209	61	PE34396 & PE34397	130	PE34483	95
PE33948	120	PE34210	78	PE34398	132	PE34484	117
PE33964	68	PE34211	61	PE34405	68	PE34485	93
PE33969	122	PE34212	78	PE34406	121	PE34486	117

# INDEX

Model No.	Page No.	Model No.	Page No.	Model No.	Page No.	Model No.	Page No.
PE34487	95	PE35210	132	PE35475	37	PE36164	135
PE34488	92	PE35211	129	PE35591 THRU PE35611	38	PE36165	104
PE34489	95	PE35212	132	PE35639 THRU PE35672	42	PE36166	135
PE34490	93	PE35213	129	PE35900	102	PE36167	104
PE34491	95	PE35214	132	PE35952	34	PE36168	135
PE34492	115	PE35215	129	PE35953	134	PE36169	104
PE34493	95	PE35216	132	PE35954	34	PE36170	103
PE34494	114	PE35217	129	PE35955	134	PE36171	104
PE34495	95	PE35218	132	PE35956	34	PE36172	103
PE34496	115	PE35219	129	PE35957	134	PE36173	104
PE34497	95	PE35220	132	PE35958	34	PE36174 & PE36178	103
PE34498	118	PE35221	129	PE35959 & PE35962	134	PE36519	43
PE34499	115	PE35222	132	PE35963	103	PE36520	124
PE34500	118	PE35223	129	PE35964	134	PE36521	43
PE34501	114	PE35224	132	PE35965	103	PE36522	124
PE34502	115	PE35225	129	PE36108	136	PE36523	43
PE34503	118	PE35226	132	PE36109	137	PE36524	124
PE34504	122	PE35227	129	PE36110	136	PE36525	43
PE34505	118	PE35228	130	PE36111	137	PE36526	124
PE34506	122	PE35229	131	PE36112	136	PE36527	43
PE34507	118	PE35230	130	PE36113	137	PE36528	124
PE34508	122	PE35231	131	PE36114	136	PE36529	43
PE34509	118	PE35232	130	PE36115	137	PE36530	124
PE34510	122	PE35233	131	PE36116	136	PE36531	43
PE34511	118	PE35234	130	PE36117	137	PE36532	124
PE34512	122	PE35235	131	PE36118	136	PE36533	43
PE34518	115	PE35236	130	PE36119	137	PE36534	124
PE34520	131	PE35237	131	PE36120	136	PE36535	43
PE34532 THRU PE34536	142	PE35238	130	PE36121	137	PE36536	124
PE34538	50	PE35239	131	PE36122	136	PE36537	43
PE34554	131	PE35240	130	PE36123	137	PE36538	124
PE34570 & PE34572	40	PE35241	131	PE36124	136	PE36539	43
PE34573	131	PE35242	130	PE36125	137	PE36540	124
PE34574 & PE34576	40	PE35243	131	PE36126	136	PE36541	43
PE34577	126	PE35244	130	PE36127	137	PE36542	124
PE34578	40	PE35245	131	PE36128	136	PE36569 THRU PE36574	125
PE34579	126	PE35246	130	PE36129	137	PE36674 THRU PE36678	39
PE34580	40	PE35247 & PE35249	131	PE36130	136	PE36689 & PE36690	35
PE34581	126	PE35284	103	PE36131	137	PE37840 & PE37841	254
PE34582	40	PE35348	71	PE36132	138	PE37842 THRU PE37851	255
PE34583	126	PE35349	133	PE36134	102	PE37940 THRU PE37951	106
PE34584	40	PE35350	71	PE36135	138	PE37952 THRU PE37963	105
PE34585	126	PE35351	133	PE36136	102	PE37968 THRU PE37973	141
PE34586	40	PE35352	71	PE36137	138	PE38040	140
PE34587	126	PE35353	133	PE36138	102	PE38052 & PE38116	55
PE34588	40	PE35354	71	PE36139	138	PE38130 THRU PE38132	140
PE34589	126	PE35355	133	PE36140	102	PE38133 THRU PE38135	141
PE34590	40	PE35356	71	PE36141	138	PE38136 THRU PE38141	140
PE34591	126	PE35357	133	PE36142	102	PE38161 THRU PE38278	55
PE34592	40	PE35358	71	PE36143	138	PE38295 THRU PE38304	139
PE34593 THRU PE34597	143	PE35359	133	PE36144	102	PE38446 THRU PE38457	84
PE34598	128	PE35360	71	PE36145	138	PE38485 THRU PE38496	85
PE34600 THRU PE34604	143	PE35361	133	PE36146	135	PE30000 THRU PE300011	256
PE34614	132	PE35362	71	PE36147	138	PE300012 THRU PE300023	257
PE34681 THRU PE34705	99	PE35363	133	PE36148	135	PE300024 THRU PE300035	258
PE34709	69	PE35364	71	PE36149	138	PE4000 & PE4001	162
PE34721	114	PE35365	133	PE36150	135	PE4002 & PE4003	160
PE34727	129	PE35366	71	PE36151	138	PE4004	162
PE34729 THRU PE34751	41	PE35367	133	PE36152	135	PE4005	160
PE34770	129	PE35368	71	PE36153	138	PE4006	155
PE34833 THRU PE34836	68	PE35369	133	PE36154	135	PE4007 THRU PE4009	160
PE34853 & PE34854	130	PE35370	71	PE36155	138	PE4010 & PE4011	171
PE34856 THRU PE34866	134	PE35371 THRU PE35375	133	PE36156	135	PE4012	149
PE34879 THRU PE34895	128	PE35418	36	PE36157	104	PE4013	156
PE34917	68	PE35419	35	PE36158	135	PE4014 & PE4015	171
PE35028	33	PE35420	36	PE36159	104	PE4016	170
PE35064 THRU PE35154	70	PE35421 & PE35422	37	PE36160	135	PE4017	172
PE35207	129	PE35423	35	PE36161	104	PE4018	170
PE35208	132	PE35424	37	PE36162	135	PE4019	172
PE35209	129	PE35430	125	PE36163	104	PE4020 THRU PE4022	149

# INDEX

Model No.	Page No.	Model No.	Page No.	Model No.	Page No.	Model No.	Page No.
PE4023 & PE4024	170	PE4157	183	PE4266 & PE4267	187	PE4373	167
PE4025 THRU PE4031	160	PE4158	187	PE4268 & PE4269	173	PE4374 & PE4375	169
PE4032 THRU PE4035	161	PE4159	173	PE4270 & PE4271	158	PE4376	155
PE4036 THRU PE4041	160	PE4160	158	PE4272 & PE4273	183	PE4377 THRU PE4393	170
PE4042	155	PE4161	183	PE4274 & PE4275	187	PE4394 & PE4395	171
PE4043 & PE4044	170	PE4162	187	PE4276 & PE4277	173	PE4396 & PE4397	170
PE4045	158	PE4163	183	PE4278 & PE4279	158	PE4398 THRU PE4418	160
PE4046	173	PE4164	187	PE4280 & PE4281	183	PE4419 THRU PE4428	161
PE4047	157	PE4165	183	PE4282 & PE4283	187	PE4429 THRU PE4443	155
PE4048	155	PE4166	187	PE4284	173	PE4444	156
PE4049	171	PE4167	173	PE4285	158	PE4445	169
PE4050	192	PE4168	183	PE4286	183	PE4446 THRU PE4471	157
PE4051	158	PE4169	187	PE4287	187	PE4472	183
PE4052	173	PE4170	173	PE4288	173	PE4473 THRU PE4481	152
PE4053	170	PE4171	158	PE4289	158	PE4482 THRU PE4485	155
PE4054	157	PE4172	183	PE4290	183	PE4486 THRU PE4492	156
PE4055 & PE4056	171	PE4173	187	PE4291	187	PE4493 THRU PE4495	167
PE4057 & PE4058	170	PE4174	173	PE4292	183	PE4496 THRU PE4501	168
PE4059	155	PE4175	158	PE4293	187	PE4502 THRU PE4516	186
PE4060	156	PE4176	187	PE4294	160	PE4517 & PE4518	169
PE4061 & PE4062	155	PE4177	173	PE4295	149	PE4519 & PE4520	151
PE4063 THRU PE4068	157	PE4178	158	PE4296	160	PE4521	150
PE4069	149	PE4179	183	PE4297	155	PE4522 & PE4523	173
PE4070	170	PE4180	187	PE4298	170	PE4524 THRU PE4529	162
PE4071	157	PE4181	167	PE4299	167	PE4530 THRU PE4541	163
PE4072	155	PE4182 & PE4183	152	PE4300	162	PE4542 & PE4543	161
PE4073	149	PE4184	159	PE4301	192	PE4544 THRU PE4546	163
PE4074	158	PE4186	162	PE4302 THRU PE4306	157	PE4547 & PE4548	161
PE4075 & PE4076	167	PE4187 & PE4188	161	PE4307 THRU PE4310	170	PE4549	163
PE4077	171	PE4189 & PE4190	162	PE4311 THRU PE4314	167	PE4550	155
PE4078 & PE4079	170	PE4191	155	PE4315 & PE4316	168	PE4551 THRU PE4556	175
PE4080	173	PE4192	150	PE4317 & PE4318	171	PE4557 & PE4558	158
PE4081	155	PE4193	167	PE4319 THRU PE4321	170	PE4559 THRU PE4562	175
PE4082	171	PE4194	168	PE4322	151	PE4563 THRU PE4565	150
PE4083	160	PE4195	170	PE4323	150	PE4566 THRU PE4575	152
PE4084	170	PE4196 & PE4197	161	PE4324	193	PE4576 THRU PE4580	160
PE4085	160	PE4198	152	PE4325 THRU PE4327	160	PE4581	161
PE4088	157	PE4199	159	PE4328	156	PE4587 THRU PE4592	160
PE4089	192	PE4200	173	PE4329 THRU PE4331	155	PE4593	173
PE4091	171	PE4201 & PE4202	158	PE4332	160	PE4594	158
PE4092	170	PE4203	183	PE4333	168	PE4595	173
PE4093	167	PE4204 THRU PE4210	170	PE4334 THRU PE4341	172	PE4596	158
PE4094 & PE4095	158	PE4211	171	PE4342	150	PE4597 THRU PE4626	179
PE4096 & PE4097	173	PE4212	170	PE4343	168	PE4627 THRU PE4631	180
PE4098	167	PE4213 THRU PE4215	160	PE4344	155	PE4632	170
PE4099	162	PE4216 THRU PE4220	162	PE4345	170	PE4633 THRU PE4642	179
PE4100	168	PE4221 THRU PE4224	155	PE4346 THRU PE4348	193	PE4643	170
PE4101	162	PE4225 THRU PE4228	167	PE4349	168	PE4644	150
PE4102	170	PE4229 & PE4230	152	PE4350	167	PE4645 THRU PE4647	155
PE4104 & PE4105	193	PE4231 & PE4232	151	PE4351	170	PE4648 & PE4649	157
PE4106	170	PE4233 THRU PE4238	193	PE4352	193	PE4650 & PE4651	170
PE4107	158	PE4239	168	PE4353	161	PE4652 THRU PE4655	155
PE4108	160	PE4240 THRU PE4244	169	PE4354	162	PE4656	186
PE4109	170	PE4245	173	PE4355	156	PE4657	167
PE4110	183	PE4246	158	PE4356	173	PE4658	187
PE4112	160	PE4247	170	PE4357	158	PE4659 THRU PE4682	189
PE4113 & PE4114	155	PE4248	183	PE4358	173	PE4683 THRU PE4708	190
PE4115 & PE4116	160	PE4249	187	PE4359	158	PE4709 & PE4710	167
PE4117 & PE4118	162	PE4250	173	PE4360	173	PE4711 THRU PE4765	188
PE4119 THRU PE4122	161	PE4251	183	PE4361	158	PE4766 THRU PE4799	191
PE4123 THRU PE4128	162	PE4252	187	PE4362	173	PE4804 THRU PE4849	192
PE4129 & PE4130	155	PE4253	183	PE4363	158	PE4850 THRU PE4875	191
PE4131	156	PE4254	187	PE4364	173	PE4876 THRU PE4890	175
PE4132 THRU PE4136	155	PE4255	183	PE4365	158	PE4891 THRU PE4895	176
PE4137	156	PE4256	187	PE4366	173	PE4896 THRU PE4905	174
PE4138	155	PE4257	183	PE4367	158	PE4906	187
PE4139	156	PE4258 & PE4259	187	PE4368	183	PE4907	160
PE4140	155	PE4260 & PE4261	173	PE4369	187	PE4908	170
PE4141	156	PE4262 & PE4263	158	PE4370	162	PE4909	157
PE4142 THRU PE4156	157	PE4264 & PE4265	183	PE4371 & PE4372	155	PE4910 & PE4911	163



# INDEX

Model No.	Page No.	Model No.	Page No.	Model No.	Page No.	Model No.	Page No.
PE4912 THRU PE4914	161	PE44204 THRU PE44214	161	PE51015 THRU PE51019	253	PE7061 THRU PE7065	231
PE4915 & PE4916	170	PE44215 THRU PE44226	166	PE51020 THRU PE51022	254	PE7066 THRU PE7083	234
PE4917 THRU PE4922	160	PE44227 THRU PE44234	165	PE6000 & PE6001	236	PE7100 THRU PE7103	243
PE4923 & PE4924	161	PE44235 THRU PE44241	163	PE6002 & PE6003	235	PE7104 THRU PE7138	244
PE4925	183	PE44242 THRU PE44261	172	PE6006 & PE6007	242	PE7139 & PE7140	243
PE4926	173	PE44262 THRU PE44275	178	PE6008 & PE6009	235	PE7141 THRU PE7160	244
PE4927	158	PE44276 THRU PE44292	152	PE6011	236	PE7161 & PE7162	226
PE4928	183	PE44293	157	PE6012 THRU PE6024	242	PE7300 & PE7301	243
PE4929	187	PE44294	170	PE6026	235	PE700000 THRU PE700003	260
PE4930	160	PE44295 THRU PE44297	149	PE6027 THRU PE6029	236	PE8000 THRU PE8009	246
PE4931	161	PE44298 THRU PE44307	185	PE6030 & PE6031	242	PE8010 THRU PE8038	247
PE4932	160	PE44308 THRU PE44311	174	PE6032 & PE6033	235	PE8040	246
PE4933	167	PE44312 THRU PE44334	186	PE6034 THRU PE6043	234	PE8200 THRU PE8406	241
PE4934 THRU PE4946	155	PE44335 THRU PE44339	166	PE6044 & PE6045	236	PE8500 THRU PE8504	246
PE4949 THRU PE4973	169	PE44340 THRU PE44344	163	PE6046	242	PE8505 THRU PE8509	245
PE4974	170	PE44345 & PE44346	166	PE6047 THRU PE6056	236	PE8600 THRU PE8654	248
PE4975	157	PE44347	165	PE6057 THRU PE6059	242	PE9000 THRU PE9080	199
PE4976 THRU PE4980	151	PE44348	178	PE6061 THRU PE6068	236	PE9081 THRU PE9111	200
PE4981 THRU PE4992	165	PE44349 & PE44350	155	PE6069 THRU PE6092	235	PE9112 THRU PE9143	201
PE4993 THRU PE4998	184	PE44351 THRU PE44368	151	PE6093 & PE6094	236	PE9144 THRU PE9180	202
PE44000 THRU PE44032	164	PE44369 THRU PE44377	189	PE6095 THRU PE6107	234	PE9181 THRU PE9214	203
PE44033 THRU PE44039	192	PE44378 THRU PE44395	159	PE6108 THRU PE6111	242	PE9215 THRU PE9244	204
PE44040 THRU PE44042	170	PE44396 THRU PE44398	156	PE6112	234	PE9245 THRU PE9274	205
PE44043 THRU PE44046	155	PE44401 THRU PE44441	159	PE6113 THRU PE6136	242	PE9275 THRU PE9304	206
PE44047	158	PE44442 THRU PE44446	184	PE6137 THRU PE6141	234	PE9305 THRU PE9335	207
PE44048	173	PE44447 THRU PE44451	150	PE6142	235	PE9336 THRU PE9365	208
PE44049	168	PE44452	186	PE6143 & PE6144	242	PE9366 THRU PE9395	209
PE44050 THRU PE44060	149	PE44453	174	PE6145 THRU PE6147	236	PE9396 THRU PE9425	210
PE44061 THRU PE44064	157	PE44454	155	PE6148 THRU PE6158	235	PE9426 THRU PE9455	211
PE44065 THRU PE44079	156	PE44455	172	PE6159	236	PE9456 THRU PE9485	212
PE44080	168	PE44456 THRU PE44459	174	PE6160 THRU PE6165	235	PE9486 THRU PE9515	213
PE44081 THRU PE44092	150	PE44460	161	PE6800 THRU PE6808	250	PE9516 THRU PE9545	214
PE44093	168	PE44470 THRU PE44478	189	PE6809 THRU PE6835	248	PE9546 THRU PE9575	215
PE44094	173	PE44480 THRU PE44483	178	PE7000	230	PE9576 THRU PE9605	216
PE44095	158	PE44484 THRU PE44488	31	PE7001	226	PE9606 THRU PE9635	217
PE44096 THRU PE44099	169	PE44489 THRU PE44494	178	PE7002	227	PE9636 THRU PE9665	218
PE44100 THRU PE44113	167	PE44495 THRU PE44513	177	PE7003	228	PE9666 THRU PE9695	219
PE44114 THRU PE44116	193	PE44520 THRU PE44535	154	PE7004	227	PE9696 THRU PE9725	220
PE44117	169	PE44536 THRU PE44551	153	PE7005	226	PE9726 THRU PE9755	221
PE44118	168	PE44552 THRU PE44556	154	PE7006 & PE7007	234	PE9756 THRU PE9786	222
PE44119	173	PE44557 THRU PE44561	153	PE7008	233	PE9787 THRU PE9789	223
PE44120	158	PE44562 THRU PE44566	154	PE7009	230	PE9800 THRU PE9843	251
PE44121	173	PE44567 THRU PE44571	153	PE7010	227	PE9844 THRU PE9849	250
PE44122	158	PE44572 & PE44573	182	PE7011	233	PE9850 THRU PE9864	249
PE44123	173	PE44574 THRU PE44578	181	PE7013 & PE7014	227	PE9865 THRU PE9870	250
PE44124	158	PE44579	182	PE7015	228	PE9900 THRU PE9917	146
PE44125	184	PE44580 & PE44581	181	PE7016	227	PE9918	222
PE44126	173	PE44582	182	PE7017	228	PE9930 THRU PE9936	145
PE44127	158	PE44583 & PE44584	181	PE7018	227	PE9950 THRU PE9967	146
PE44128	184	PE44585	182	PE7019	228	PE900001 THRU PE900023	259
PE44129	173	PE44586 & PE44587	181	PE7020	227	PE900025 THRU PE900039	260
PE44130	158	PE44588 THRU PE44590	182,184	PE7021	228		
PE44131	184	PE44592	152	PE7022	227		
PE44132	173	PE44593	163	PE7023 & PE7024	226		
PE44133	158	PE44594	174	PE7025 & PE7026	230		
PE44134	184	PE44595 THRU PE44613	176	PE7027 & PE7028	234		
PE44135	173	PE44615	156	PE7029	230		
PE44136	158	PE44616 & PE44618	171	PE7030 THRU PE7032	228		
PE44137	173	PE44619 & PE44620	180	PE7033 THRU PE7035	232		
PE44138	158	PE44622 THRU PE44624	181	PE7036 THRU PE7038	233		
PE44139	173	PE44625 THRU PE44628	179	PE7039 THRU PE7043	229		
PE44140	158	PE44629 THRU PE44632	181	PE7044	230		
PE44141	184	PE44633	155	PE7045 & PE7046	226		
PE44142	173	PE5001 THRU PE5010	265	PE7047	227		
PE44143	158	PE5011 THRU PE5200	264	PE7048	228		
PE44145	192	PE5500 & PE5501	30	PE7049 & PE7050	230		
PE44146 THRU PE44149	149	PE5510 THRU PE5515	31	PE7051	228		
PE44161 THRU PE44181	185	PE51000 THRU PE51010	252	PE7052 THRU PE7056	229		
PE44182 THRU PE44202	190	PE51011 & PE51012	253	PE7057	230		
PE44203	160	PE51013 & PE51014	252	PE7058 & PE7059	232		

# NEW PRODUCTS

## PRECISION TEST CABLE ASSEMBLIES

### 18 GHz TEST CABLES

Wideband Coverage DC - 18 GHz @ 50 Ohms RoHS Compliant. Flexible For Easy Connection and Bend Radius, in a Triple Shielded Cable. Extra Rugged Construction with Molded Strain Relief and Passivated Stainless Steel Connectors for Extra Durability and Longer Life. Custom Lengths Also Ship Same-Day!



SEE PAGE 28 FOR MORE DETAILS

PRICING FROM: \$82.35

### 26.5 GHz ARMORED TEST CABLES

The PE315 & PE317 Series 26.5 GHz Test Cables are highly suitable for severe test environments where rugged construction is necessary, or in any location where higher phase stability must be assured. Their low-loss PTFE and solid center conductor ensure low insertion loss and outstanding phase & amplitude stability. Durable Passivated Stainless Steel connectors ensure secure matings over and over again, while external armoring limits excessive bending radius. Temperature performance from -55°C to +165°C makes these test cables perfect for environmental test systems.



SEE PAGE 32 FOR MORE DETAILS

PRICING FROM: \$595.00

### 40 GHz ARMORED TEST CABLES

The PE319 & PE321 Series 40 GHz Test Cables are suitable for severe test environments where rugged construction is a must, or wherever the highest phase stability must be assured. Their low-loss PTFE and solid center conductor ensure low insertion loss and outstanding phase & amplitude stability. Durable Passivated Stainless Steel connectors ensure secure matings over and over again, while external armoring limits excessive bending radius. Temperature performance from -55°C to +165°C makes these test cables perfect for environmental test systems.



SEE PAGE 32 FOR MORE DETAILS

PRICING FROM: \$745.00

### PE310-KIT VNA Test Cable Set

Pasternack Microwave test cables are designed for a broad range of VNA models with 3.5mm NMD connector ports, including Agilent and Anritsu equipment! These highly flexible test cables have excellent electrical characteristics with outstanding phase and amplitude stability.

The unique interchangeable connector head can be configured for DUT applications that require Precision 7mm (PC-7), N, 3.5mm, SMA or 2.92mm connectors. Two Test cables per set, packaged in a durable, protective wood box.

#### Features:

- Broad VNA Coverage, Including Agilent & Anritsu
- DC to 26.5 GHz.
- End A: 3.5mm NMD Connector.
- End B: Interchangeable Connector Head, see details for selection.



SEE PAGE 31 FOR MORE DETAILS

PRICING: \$3,695.00

# NEW PRODUCTS

## QUICK-LOCK (QLF®) COMPLIANT

### QMA and QN CONNECTORS AND CABLE ASSEMBLIES

Pasternack introduces our new line of QMA and QN connectors and cable assemblies. Compliant to QLF® specifications, the connectors provide fast, easy and secure matings with minimal space requirements. (Quick Lock Formula® and the QLF® logo are registered trademarks of Huber+Suhner AG and Radiall SA.)

**QMA Connectors are snap-on versions of SMA Connectors.** Designed for DC to 18 GHz, these connectors can mount in a few seconds. No torque wrench is needed, making them excellent for field applications. Connectors can be spaced closer together for this same reason. The cabled connector plug can rotate freely 360° around the jack, easing installation again while reducing stress on the cable and any return loss due to bending.

#### ADAPTERS

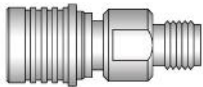

PE9786



PE44499



PE44503

#### CONNECTORS



PE44506



#### CABLE ASSEMBLIES

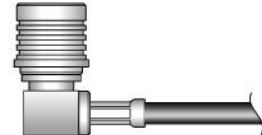

See Page 222 for Adapters  
Pricing From: \$39.95

See Page 177 for Connectors  
Pricing From: \$8.30

See Page 55 for Cable Assemblies  
Pricing From: \$36.65

**QN Connectors are snap-on versions of N Connectors.** Designed for DC to 11 GHz, these connectors can mount in a few seconds. No torque wrench is needed, making them excellent for field applications. Connectors can be spaced closer together for this same reason. The cabled connector plug can rotate freely 360° around the jack, easing installation again while reducing stress on the cable and any return loss due to bending.

#### ADAPTERS

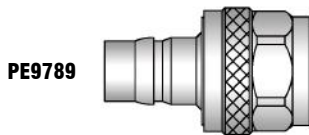

PE9789

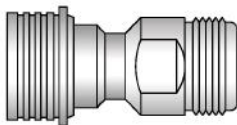

PE9788



PE44596

#### CONNECTORS

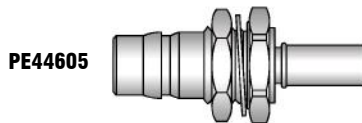

PE44605

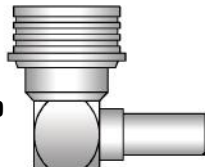

PE44600

#### CABLE ASSEMBLIES

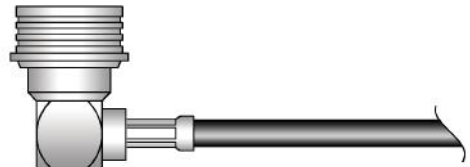
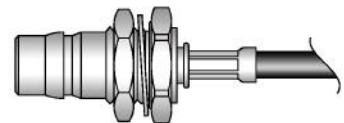

See Page 223 for Adapters  
Pricing From: \$22.33

See Page 176 for Connectors  
Pricing From: \$19.95

See Page 84 for Cable Assemblies  
Pricing From: \$38.95

# NEW PRODUCTS

## Pasternack introduces its new line of LFU Connectors and Cable Assemblies

Compatible with Hirose U.FL™ connectors, these connectors and cable assemblies are typically used in mobile phone, radio communication, measurement, GPS, wireless LAN and Bluetooth applications.

Pasternack's LFU Connectors offer an extremely small footprint and low profile, making them one of the world's smallest and lightest coaxial connectors. Pasternack offers both pigtail and complete cable assemblies that come with standard terminations of SMA, MCX, and TNC, or can be terminated with other standard Coaxial connectors upon request. Our cables are especially helpful for testing PC boards that utilize the Surface Mount Pasternack LFU and Hirose U.FL™ series connectors. The cable assemblies utilize 1.13mm coax or RG178B/U coaxial cable. A Tactile locking mechanism allows mating connectors to snap into place. These ultra-miniature connectors provide operation up to 6GHz at 50 Ohms.

See Page 139 for LFU Cable Assemblies  
Prices Starting at \$4.95

See Page 174 for LFU Connectors

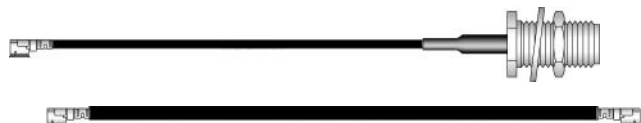

Note: U.FL™ is Registered Trademark of Hirose Electric Group

## HIGH DEFINITION CONNECTORS AND CABLE ASSEMBLIES

Stay ahead of the digital revolution! The US Congress approved a "hard date" deadline of February 17, 2009 to turn off analog NTSC broadcasts, which means after that date, all broadcasts will use the ATSC digital broadcast programming standard. Upgrade your equipment now and get some spares!

### HD CONNECTORS: PE44572 thru PE44592

The new HD series is a professional-grade, 75 Ohm connector line designed for applications that include HDTV, satellite communications, and digital broadcast. The HD series connectors are designed around the popular Mini-59 type coaxial cables, such as Pasternack's new PE-BYR940. The HD Precision connectors are designed specifically for Pasternack's PE-BYR940 and Belden's 1855A cables, while the HD Universal connectors are designed for generic 75 Ohm cables with a 23, 24 or 25 AWG center conductor.

See Page 181 & 182 for HD Connectors  
Prices Starting at \$2.95

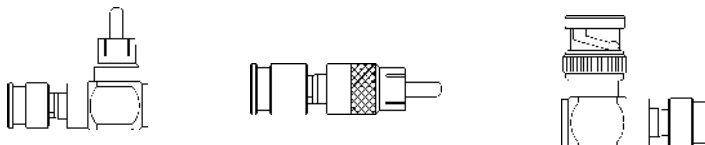

### HD PRECISION CABLE ASSEMBLIES

The HD Precision 75 Ohm cable assemblies are recommended for demanding applications where signal integrity is critical. The assemblies are designed around Pasternack's new PE-BYR940 Mini-59 coax cable, which provides improved impedance and phase stability over standard RG type assemblies.

See Page 140 & 141 for HD Precision Cable Assemblies  
Prices Starting at \$12.45

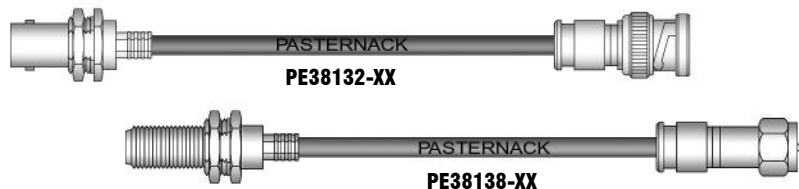

### PE-BYR940 Coaxial Cable

PE-BYR940 Mini-59 coax cable provides improved impedance and phase stability over standard RG type coax. The 6 available colors (Black, White, Red, Green, Blue and Yellow) define a pallet for typical color-coding applications. Black is also suitable for both indoor and outdoor-aerial application.

See Page 262 for PE-BYR940 Mini-59 coax cable  
Prices Starting at \$0.95 per foot



# NEW PRODUCTS

## MOBILE & STATIONARY ANTENNAS FOR LAND MOBILE RADIO APPLICATIONS

Pasternack introduces our newest product line to make it even easier to find all the RF coaxial products you need in one location. Our wideband antenna solutions operate across multiple frequencies, which helps alleviate the interoperability problems that can occur during crisis and emergency situations.

Our Mobile Antennas are compatible with 1-1/8"-18 thread mounts, including the industry standard 3/4 inch hole mounts, so installation or replacement of existing antennas on public safety and emergency response vehicles is both easy and cost-effective.

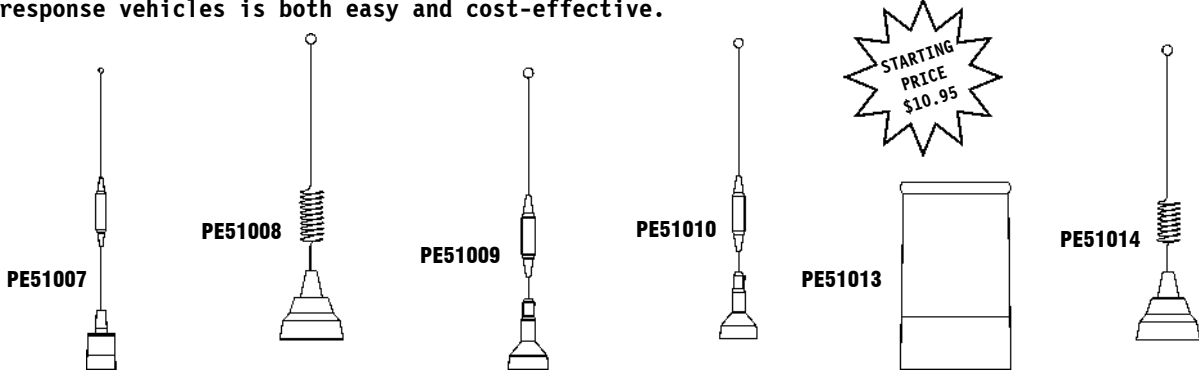

SEE PAGE 252 FOR DETAILS

Our Antennas for LMR and Base Station applications also come ready-to-install for both indoor and outdoor environments, and even for extreme weather situations. Of these antennas, three come equipped with coaxial cable that can be terminated with your choice of connector for a customized solution that can be shipped the same day you place your order!

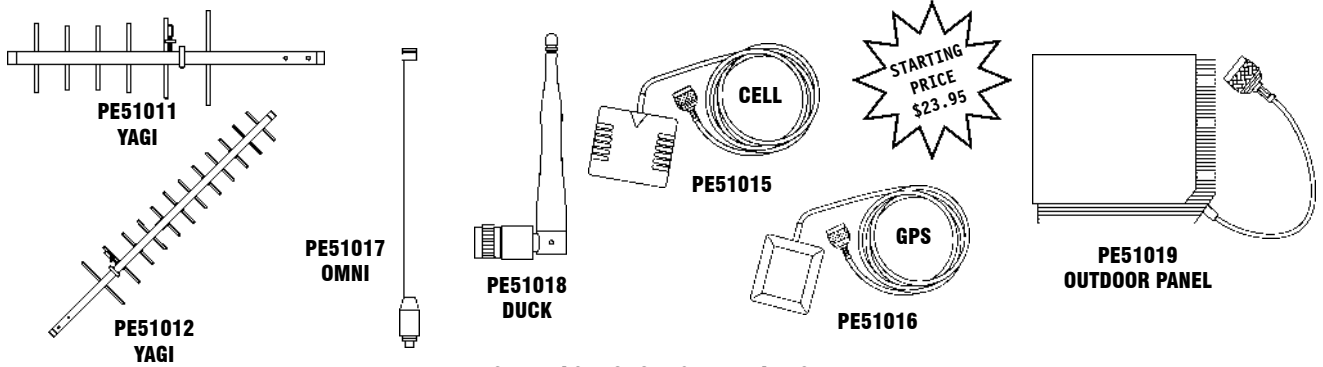

SEE PAGE 253 FOR DETAILS

To complete your installation, Pasternack also offers our complete line of Antenna mounts, NMO cable assemblies and jumpers. These can be easily customized to your specifications, no matter which connector termination or length you need. Pasternack has it all in-stock and ready to ship the same day.

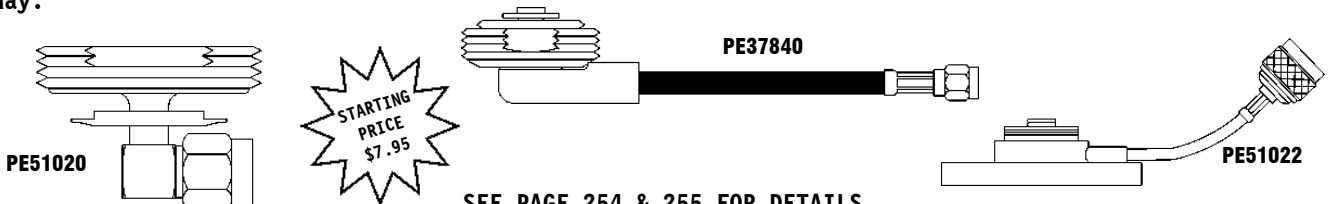

SEE PAGE 254 & 255 FOR DETAILS

Full technical specifications and drawings are available at [www.Pasternack.com](http://www.Pasternack.com), or by calling our Technical Support department toll-free at 866-727-8376 (US & Canada) or +1-949-261-1920.

# NEW PRODUCTS

## MOBILE & STATIONARY ANTENNAS

### FOR LAND MOBILE RADIO APPLICATIONS

New Products

#### Wireless Data Jumper Assemblies - 1/2" Helical Flexible Cable

This water-proof series of Jumper Assemblies are ideal where PIM (Passive Intermodulation Distortion) is a concern, such as WiFi or GSM base station applications. White Bronze-plated brass connectors and silver-plated contact pins provide greater durability and corrosion-resistance. In standard 3 or 6 foot lengths, our Jumpers are 100% water-proof and use a unique double-solder technique to give excellent system performance.

Available in following configurations:

##### N-Type Connectors

- N Male to: N Male
- N Male R/A
- N Female



See Page 141 for Wireless Jumper Assemblies

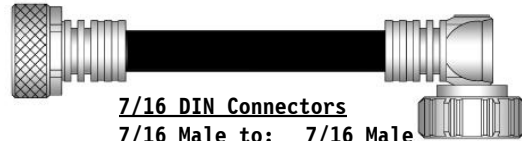

##### 7/16 DIN Connectors

- 7/16 Male to: 7/16 Male
- 7/16 Male R/A
- 7/16 Female

Prices Starting at \$81.55

#### Type N and 7/16 DIN Connectors and Cable Assemblies for LMR Applications

Pasternack's new line of low PIM (Passive Intermodulation Distortion) Type N connector is designed for applications where intermodulation distortion is a concern. The connector body is Brass with White Bronze plating for greater durability and corrosion-resistance, and the contacts are Gold-plated with no Nickel undercoat. These lightweight, low-loss 50 Ohm connectors are now widely used in Wireless, WiFi, and GSM base station applications, and are fully interchangeable with Type N connectors designed to the MIL-C39012 specification. The cables are fully interchangeable with standard Type N jumpers, and are equivalent to LMR® type 195, 200, 240, 400, and 600 cables, as well as 1/2" or 7/8" Annular or Helical cables.

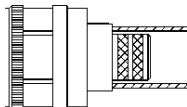

SEE PAGE 154 FOR CONNECTORS  
PRICING: \$9.95



SEE PAGE 106 FOR CABLE ASSEMBLIES  
PRICING: \$30.85

Pasternack's new line of low PIM (Passive Intermodulation Distortion) 7/16 DIN connector is designed for applications where intermodulation distortion is a concern. The connector body is Brass with White Bronze plating for greater durability and corrosion-resistance, and the contacts are Silver-plated with no Nickel undercoat. These lightweight, low-loss 50 Ohm connectors are now widely used in Wireless, WiFi, and GSM base station applications, and are fully interchangeable with all 7/16 DIN connectors designed to IEC 169-4, CECC 22-190, DIN 47223 and VG 95250 specifications. The cables are fully interchangeable with standard 7/16 DIN jumpers, and are equivalent to LMR® type 195, 200, 240, 400, and 600 cables, as well as 1/2" or 7/8" Annular or Helical cables.

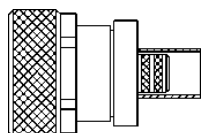

SEE PAGE 153 FOR CONNECTORS  
PRICING: \$29.95



SEE PAGE 105 FOR CABLE ASSEMBLIES  
PRICING: \$82.35

# NEW PRODUCTS

## TEST & MEASUREMENT CALIBRATION KITS

Your VNA provides you with the most accurate measurements only if calibrated against known standards. Pasternack VNA Calibration Kits and Tools incorporate accurate, stable, and precise calibration standards designed for a broad range of vector network analyzers models, including Agilent and Anritsu!

### PE5500-KIT 3.5mm Standard VNA Calibration Kit

With this kit you can make error-corrected measurements of devices supplied with either 3.5mm or SMA connectors from DC to 26.5 GHz. This kit contains both Male (Plug) and Female (Jack) connector interfaces to perform full Two-Port error corrections. This yields the most complete calibration because it accounts for the three major sources of systematic error addressed by one-port calibration at both ports of a two-port DUT. The short, open, load, and thru standards make up the calibration kit. The most common thru used is the test ports connected directly together.



SEE PAGE 30 FOR MORE DETAILS

PRICING: \$3,495.00

### PE5501-KIT N-Type Standard VNA Calibration Kit

Your VNA provides you with the most accurate measurements only if calibrated against known standards. Pasternack VNA calibration kits incorporate accurate, stable, and precise calibration standards designed for a broad range of vector network analyzers models, including Agilent and Anritsu!



With this kit you can make error-corrected measurements of devices supplied with N-Type connectors from DC to 18 GHz. This kit contains both Male (Plug) and Female (Jack) connector interfaces to perform full Two-Port error corrections. This yields the most complete calibration because it accounts for the three major sources of systematic error addressed by one-port calibration at both ports of a two-port DUT. The short, open, load, and thru standards make up the calibration kit. The most common thru used is the test ports connected directly together.

SEE PAGE 30 FOR MORE DETAILS

PRICING: \$4,495.00

### 3-PORT FIELD CALIBRATION TOOLS

With these 3-Port Field Calibration Tools you can make error-corrected measurements of devices supplied with 3.5mm, N-Type, or 7/16 DIN connectors. Also called "Bones", these tools are very effective when needing to make field calibrations as they are lightweight and portable. These tools are ideal to use with Anritsu® SiteMaster™ analyzers and other equivalent devices. Each tool has either Male (Plug) or Female (Jack) connector interfaces to perform Short, Open, and Load measurements on the cable assembly, antenna, or other device you are evaluating. RoHS Compliant.

PE5510



PE5512



PE5514

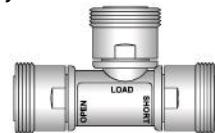

PE5511



PE5513

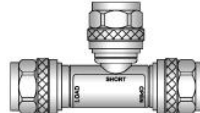

PE5515

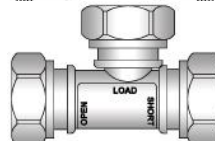

SEE PAGE 31 FOR MORE DETAILS

PRICING FROM: \$595.95

# WAREHOUSE CLEARANCE

THE ITEMS BELOW ARE SUBJECT TO PRIOR SALE & SUPPLY ON HAND AS OF August 18, 2008! ALL SALES ARE FINAL!

## PE4000-SF

### SMA FEMALE, 4 HOLE PANEL MOUNT SOLDER CUP CONTACT

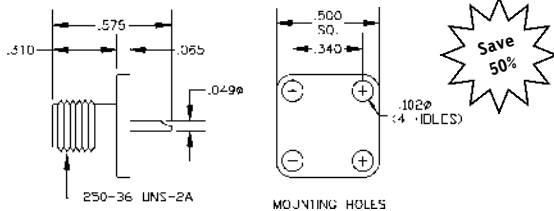

#### SPECIFICATIONS

BODY: PASSIVATED STAINLESS STEEL  
CONTACT: GOLD PLATED  
INSULATOR: PTFE

PRICE  
1-99 \$3.25  
100-999 \$2.95

## PE7059-1

### 26.5 GHz SINGLE STAGE BENCH MOUNT ROTARY ATTENUATOR



PRICE  
\$1595.00

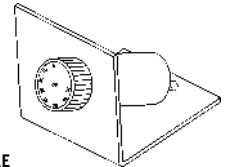

#### SPECIFICATIONS

IMPEDANCE: 50 OHMS  
FREQUENCY RANGE: DC-26.5 GHz  
CONNECTOR TYPE: 2.92mm FEMALE  
POWER RATING: 2 WATTS AVERAGE  
200 WATTS PEAK

OPERATING TEMP: 0° C TO 54° C  
ATTENUATION RANGE: 0-9 dB IN 1 dB STEPS

OVERALL: ±.5 dB  
VSWR: DC TO 18 GHz 1.45:1 MAX.  
18 GHz TO 26.5 GHz 1.70:1 MAX.

## PE4099-SF

### SMA FEMALE, 4 HOLE PANEL MOUNT STUB CONTACT, .590 EXTENDED DIELECTRIC

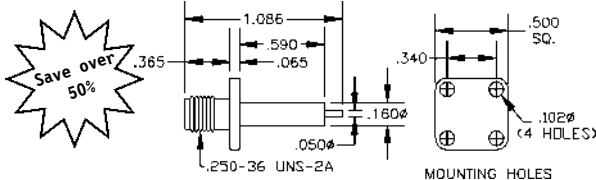

#### SPECIFICATIONS

BODY: PASSIVATED STAINLESS STEEL  
CONTACT: GOLD PLATED  
INSULATOR: PTFE

PRICE  
1-99 \$3.25  
100-999 \$2.95

## DC TO 500 MHz N ATTENUATORS

#### SPECIFICATIONS

AVERAGE POWER HANDLING CAPABILITY: 1 WATT  
IMPEDANCE: 50 OHMS  
ACCURACY: 1,2,3 & 10 ±.3 dB  
VSWR: 1.20:1 MAX.

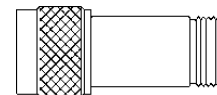

\*PE7002-30-SP05

DC TO 250 MHz  
ACCURACY: ±.5 dB  
VSWR: 1.12:1 MAX.

AVERAGE POWER HANDLING CAPABILITY: 1 WATT

MODEL NO.	ATTENUATION	PRICE
PE7002-1-SP05	1 dB	\$21.95
PE7002-2-SP05	2 dB	21.95
PE7002-3-SP05	3 dB	21.95
PE7002-10-SP05	10 dB	19.95
PE7002-30-SP05*	30 dB	14.95

## PE4128-SF

### SMA FEMALE, 2 HOLE PANEL MOUNT STUB CONTACT, .590 EXTENDED DIELECTRIC

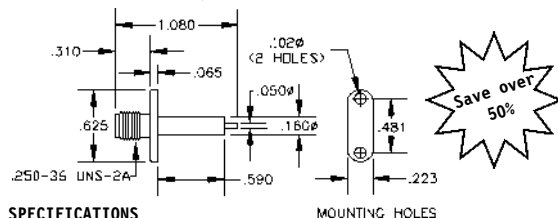

#### SPECIFICATIONS

BODY: PASSIVATED STAINLESS STEEL  
CONTACT: GOLD PLATED  
INSULATOR: PTFE

PRICE  
1-99 \$3.25  
100-999 \$2.95

## PE4118-SP98

### 50 OHM, SMA FEMALE RIGHT ANGLE PRINTED CIRCUIT MOUNT

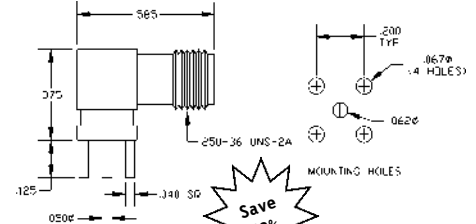

#### SPECIFICATIONS

BODY: BRASS GOLD PLATED  
CONTACT: GOLD PLATED  
INSULATOR: PTFE

PRICE  
1-999 \$3.50  
1000+ \$2.95

## PE4189-SF

### SMA FEMALE BULKHEAD .050 DIA. STUB CONTACT

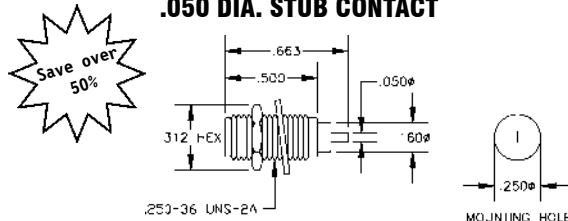

#### SPECIFICATIONS

BODY: PASSIVATED STAINLESS STEEL  
CONTACT: GOLD PLATED  
INSULATOR: PTFE

PRICE  
1-99 \$3.25  
100-999 \$2.95

## 50 OHM, SMA MALE TERMINATION

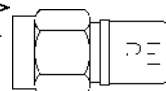

PE6002-2SP02  
DC - 2.5 GHz  
PRICE  
1-99 \$3.00  
100-999 \$2.50

PE6002-8SP02  
DC - 8 GHz  
PRICE  
1-99 \$5.00  
100-999 \$4.50

#### SPECIFICATIONS

POWER  
AVERAGE: 1 WATT  
PEAK: 500 WATTS MAX. (1uSec Pulse, .01% Duty Cycle)  
BODY: GOLD PLATED  
CONTACT: GOLD PLATED

VSWR: 1.10:1 MAX.

VSWR: 1.15:1 MAX.



# CONNECTOR FREQUENCY RANGE CHART

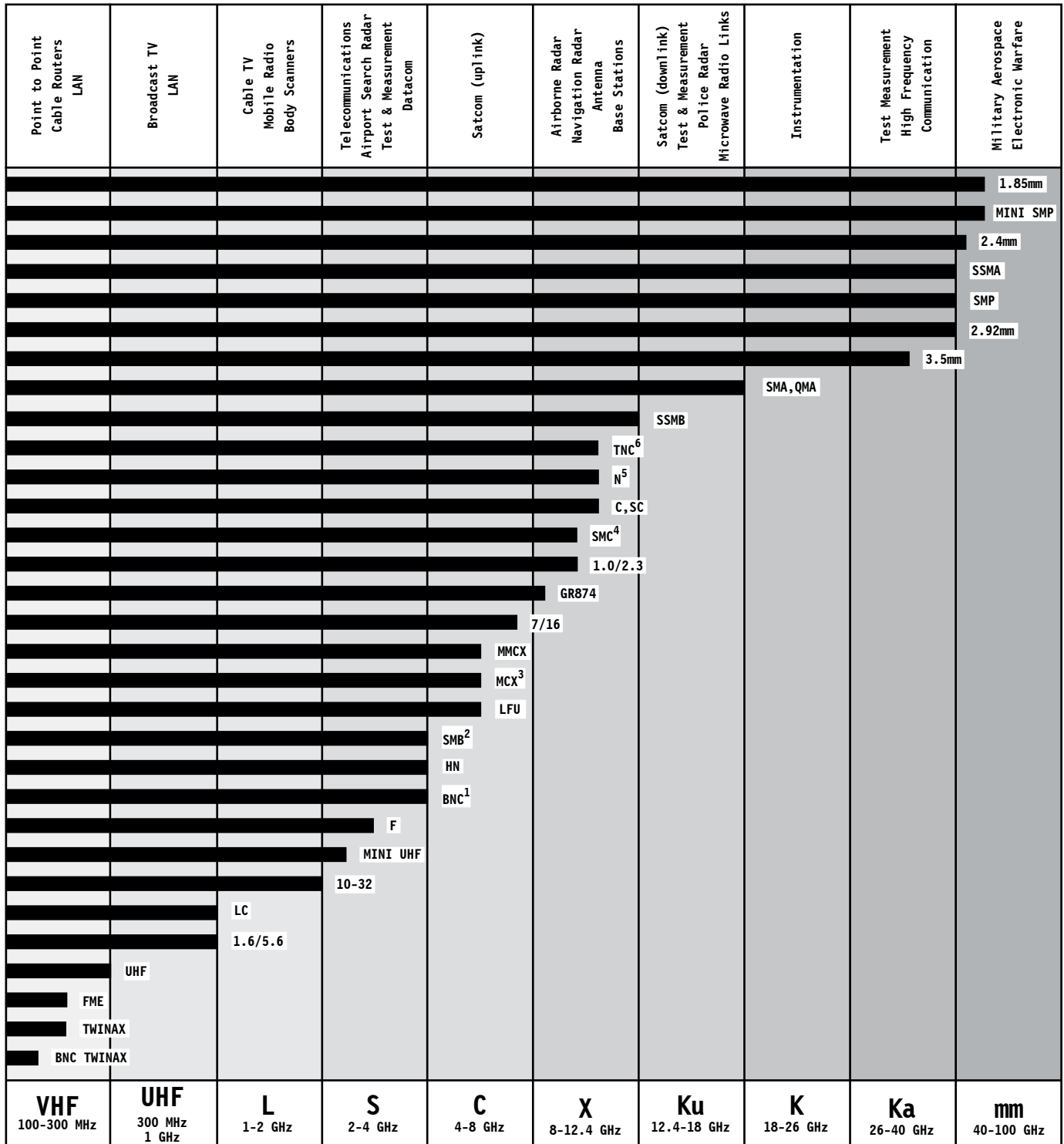

## Notes:

- 1: BNC-75 Ohm connectors operate up to 1 GHz
- 2: SMB-75 Ohm & Mini SMB-75 Ohm connectors operate up to 4 GHz
- 3: MCX-75 Ohm connectors operate up to 6 GHz
- 4: SMC-75 Ohm connectors operate up to 10 GHz
- 5: N-75 Ohm connectors operate up to 1.5 GHz
- 6: TNC-75 Ohm connectors operate up to 1 GHz

# CONNECTOR IDENTIFIER

DIMENSIONS IN INCHES UNLESS NOTED OTHERWISE

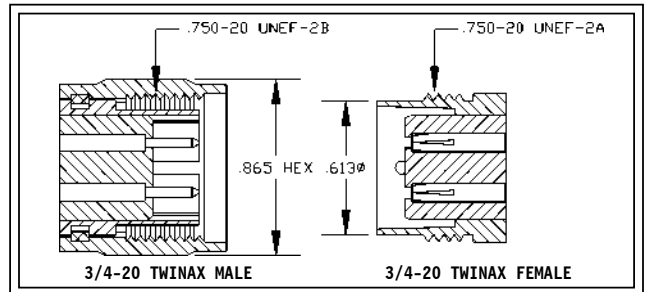
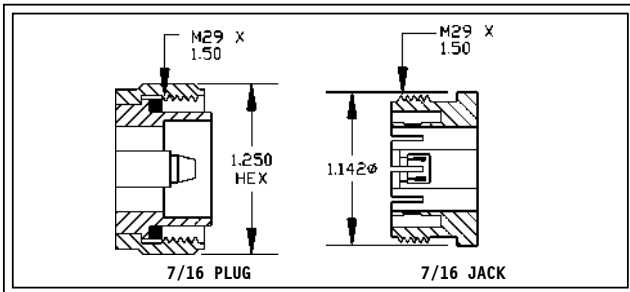
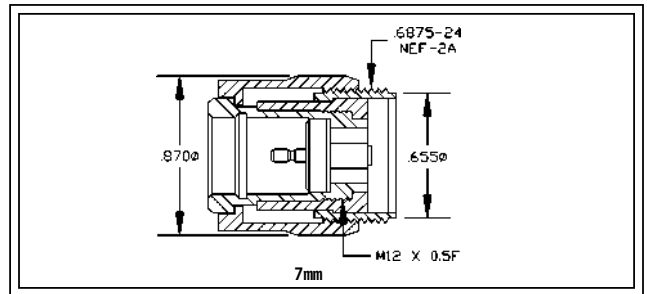
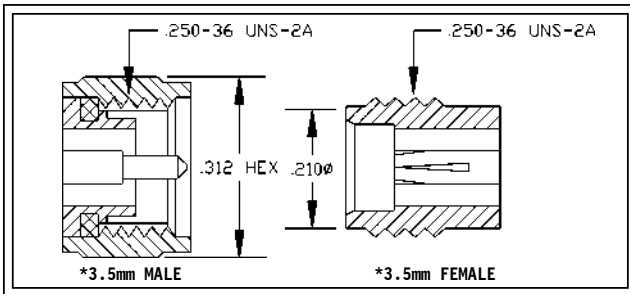
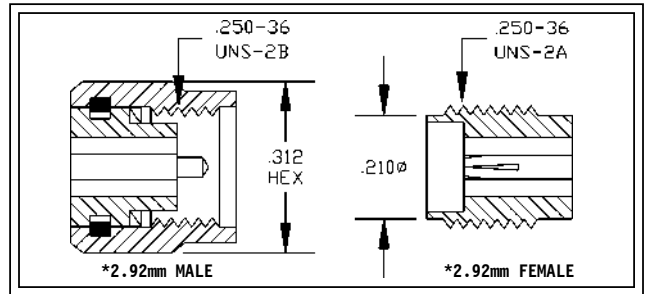
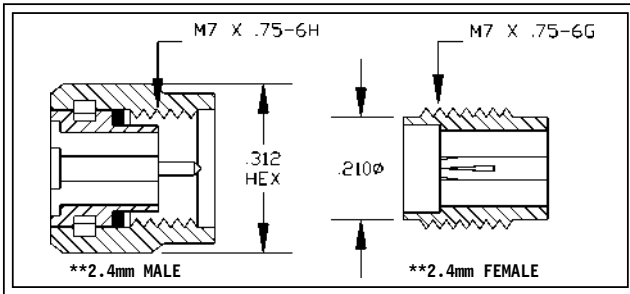
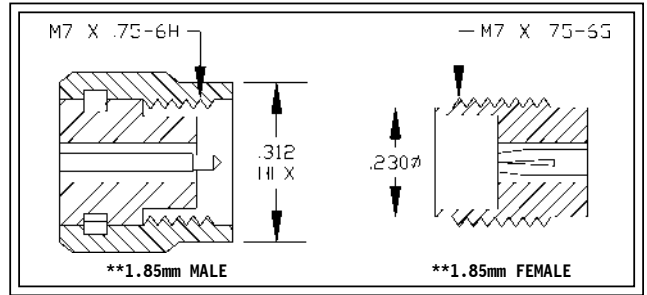
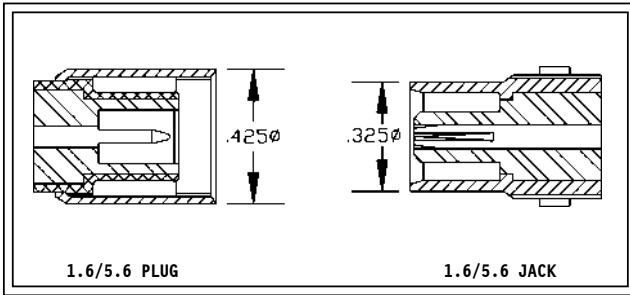
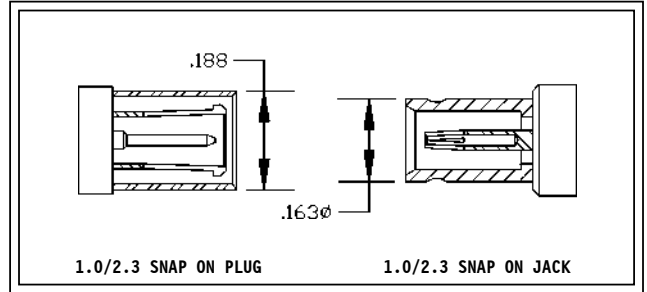
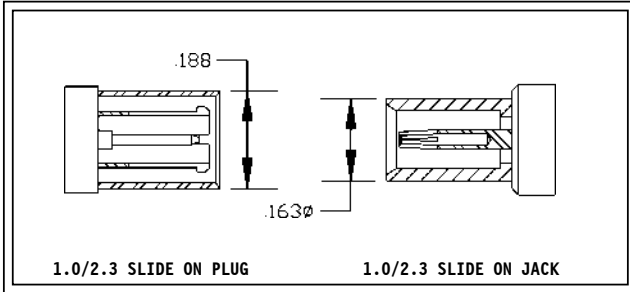

\*SMA, 2.92mm, 3.5mm & K CONNECTORS WILL MATE MECHANICALLY & ELECTRICALLY TO EACH OTHER. THE K CONNECTOR IS A TRADEMARK OF THE ANRITSU COMPANY.  
 \*\*1.85mm, 2.4mm & V CONNECTORS WILL MATE MECHANICALLY & ELECTRICALLY TO EACH OTHER. THE V CONNECTOR IS A TRADEMARK OF THE ANRITSU COMPANY.

**SPECIFICATIONS SHOWN ARE INTENDED FOR IDENTIFICATION PURPOSES ONLY**

# CONNECTOR IDENTIFIER

DIMENSIONS IN INCHES UNLESS NOTED OTHERWISE

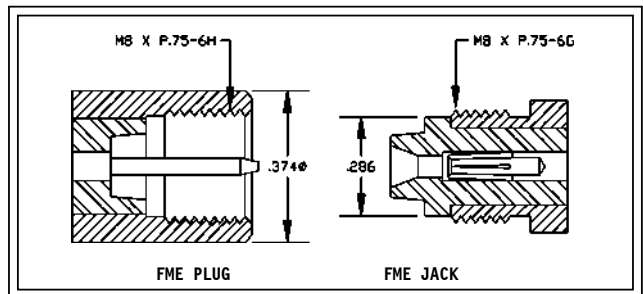
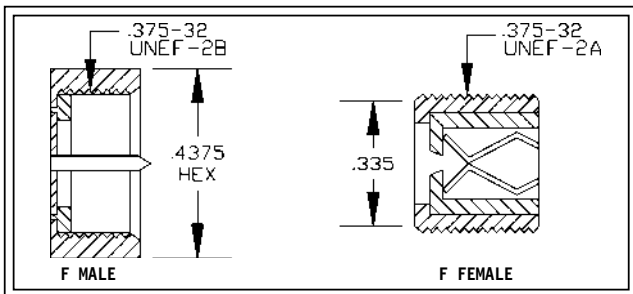
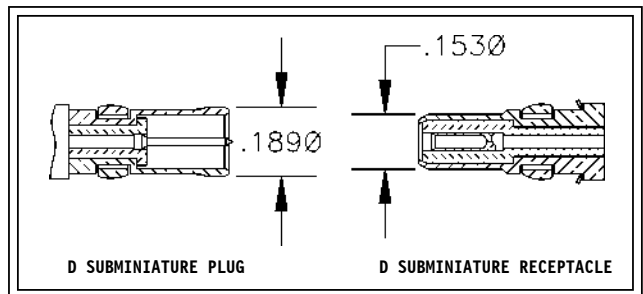
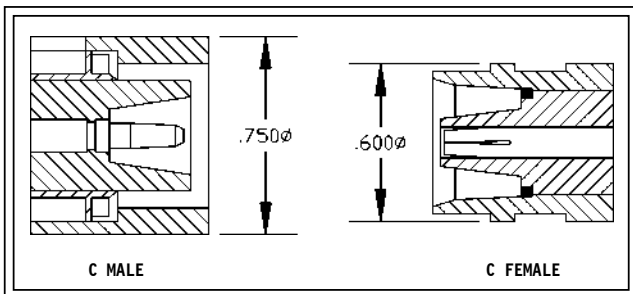
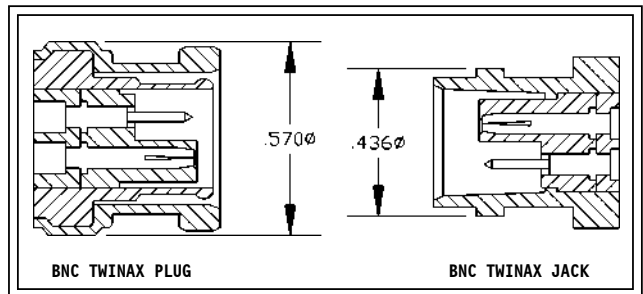
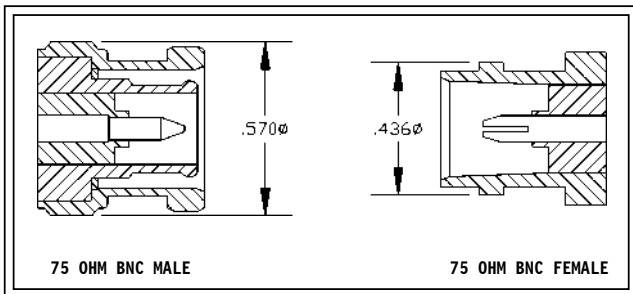
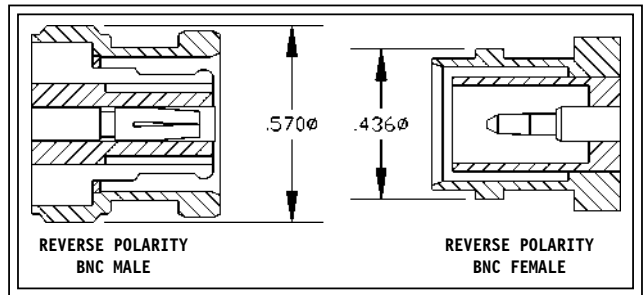
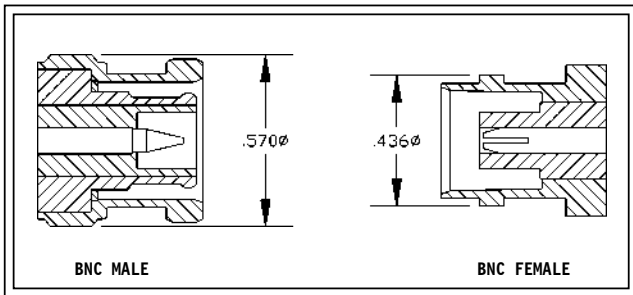
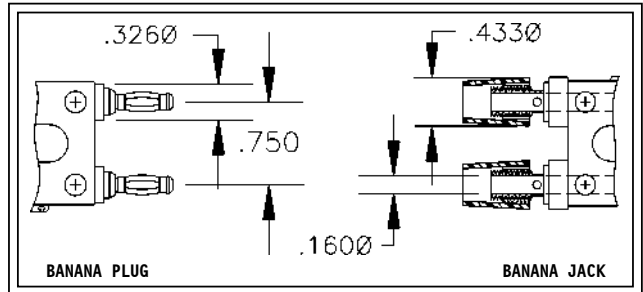
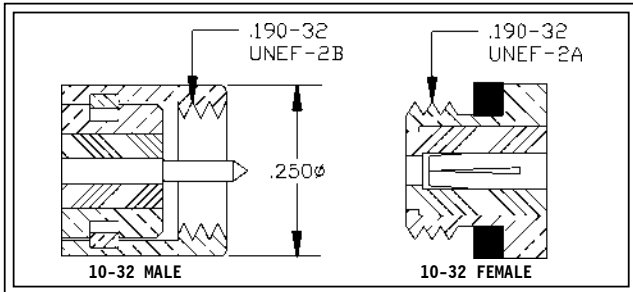

\*SMA, 2.92mm, 3.5mm & K CONNECTORS WILL MATE MECHANICALLY & ELECTRICALLY TO EACH OTHER. THE K CONNECTOR IS A TRADEMARK OF THE ANRITSU COMPANY.  
 \*\*1.85mm, 2.4mm & V CONNECTORS WILL MATE MECHANICALLY & ELECTRICALLY TO EACH OTHER. THE V CONNECTOR IS A TRADEMARK OF THE ANRITSU COMPANY.

**SPECIFICATIONS SHOWN ARE INTENDED FOR IDENTIFICATION PURPOSES ONLY**

# CONNECTOR IDENTIFIER

DIMENSIONS IN INCHES UNLESS NOTED OTHERWISE

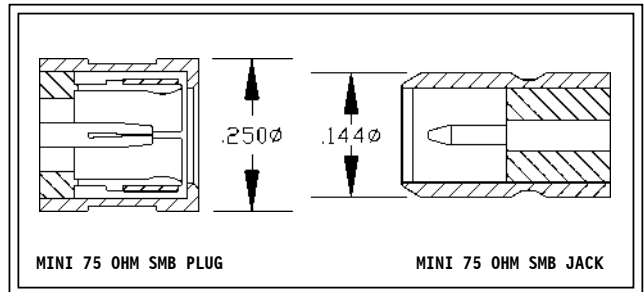
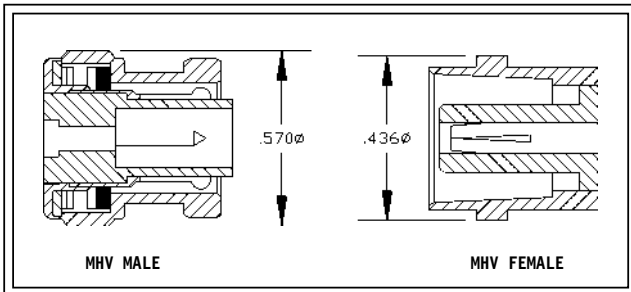
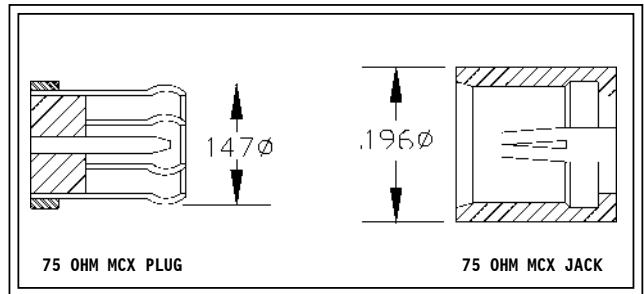
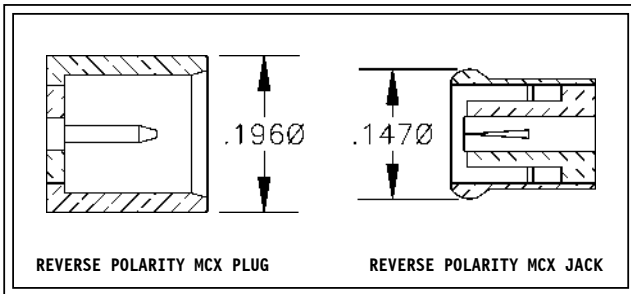
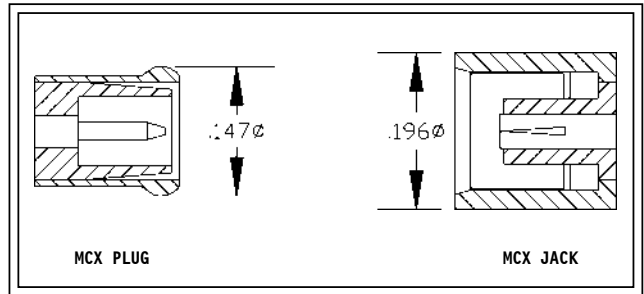
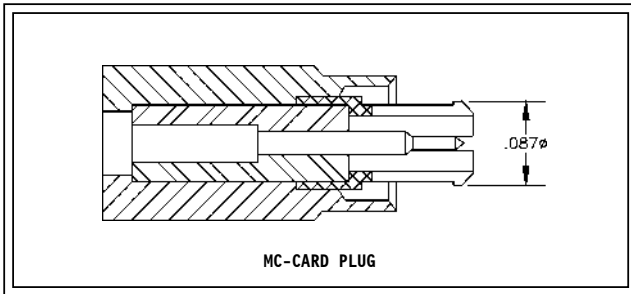
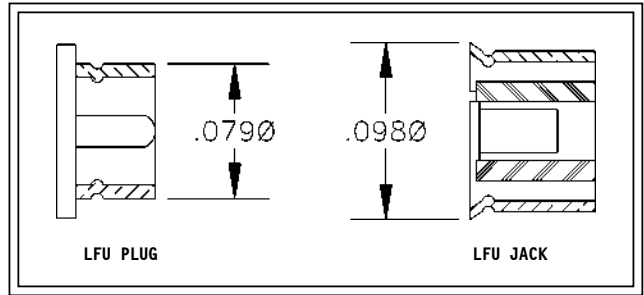
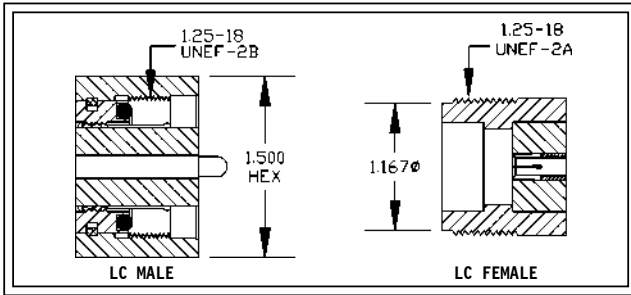
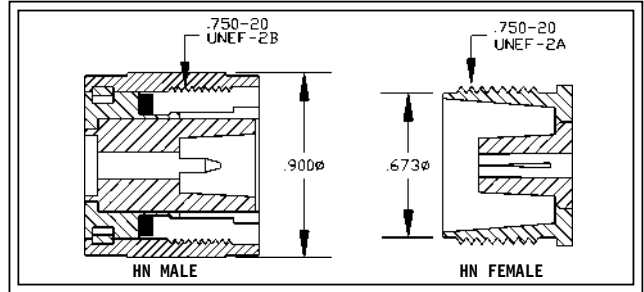
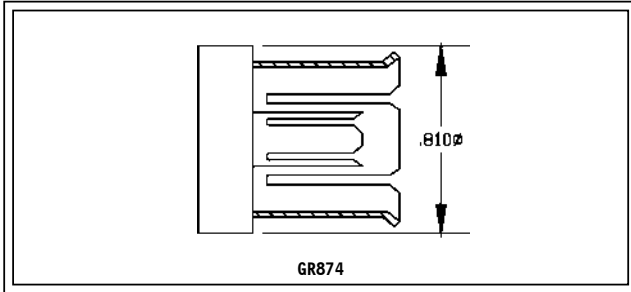

\*SMA, 2.92mm, 3.5mm & K CONNECTORS WILL MATE MECHANICALLY & ELECTRICALLY TO EACH OTHER. THE K CONNECTOR IS A TRADEMARK OF THE ANRITSU COMPANY.

**SPECIFICATIONS SHOWN ARE INTENDED FOR IDENTIFICATION PURPOSES ONLY**

# CONNECTOR IDENTIFIER

DIMENSIONS IN INCHES UNLESS NOTED OTHERWISE

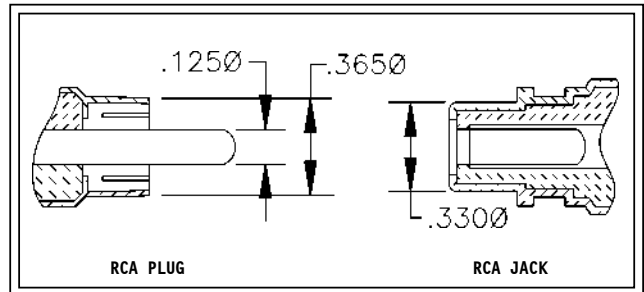
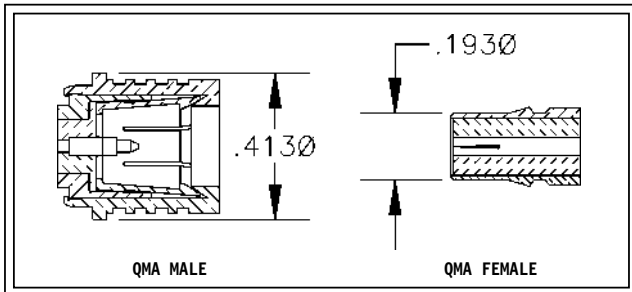
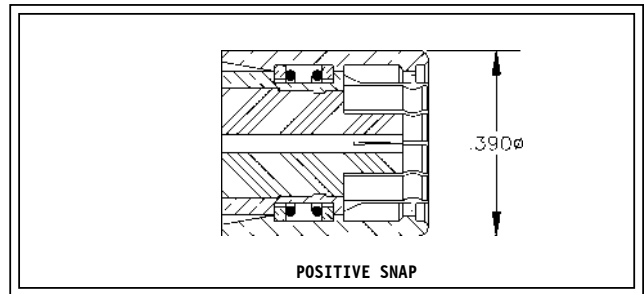
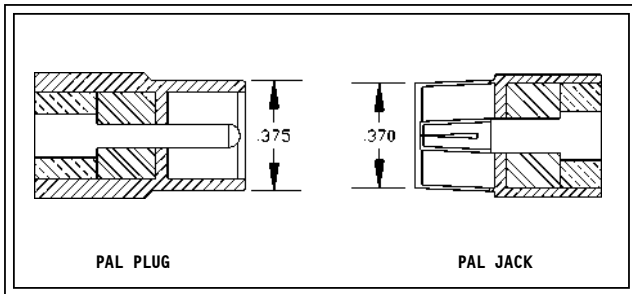
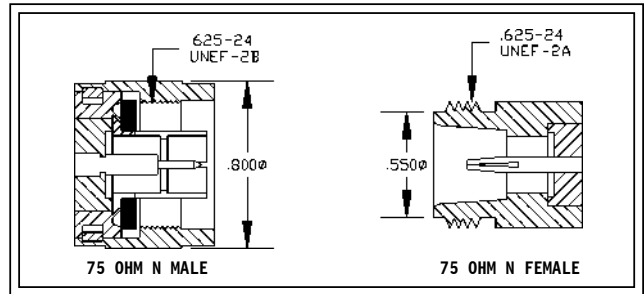
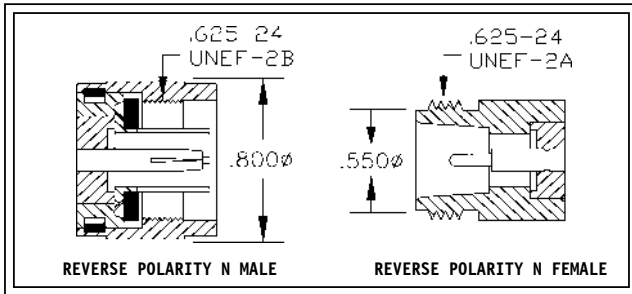
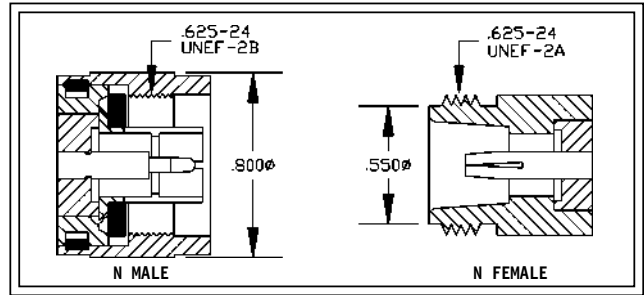
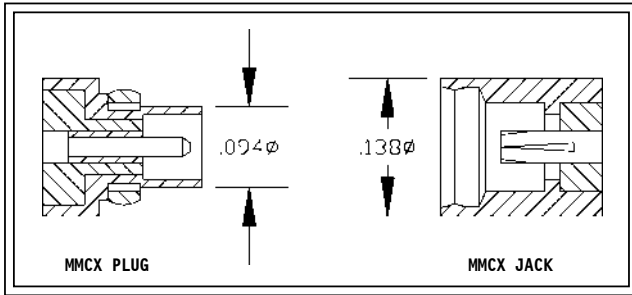
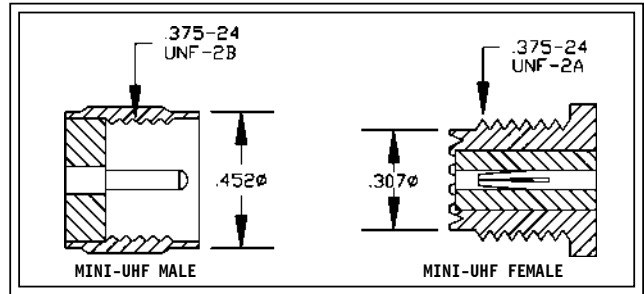
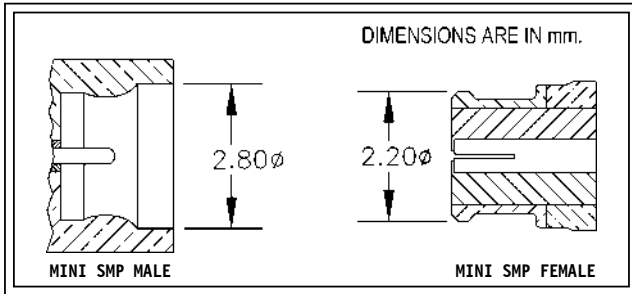

\*SMA, 2.92mm, 3.5mm & K CONNECTORS WILL MATE MECHANICALLY & ELECTRICALLY TO EACH OTHER. THE K CONNECTOR IS A TRADEMARK OF THE ANRITSU COMPANY.

**SPECIFICATIONS SHOWN ARE INTENDED FOR IDENTIFICATION PURPOSES ONLY**

# CONNECTOR IDENTIFIER

DIMENSIONS IN INCHES UNLESS NOTED OTHERWISE

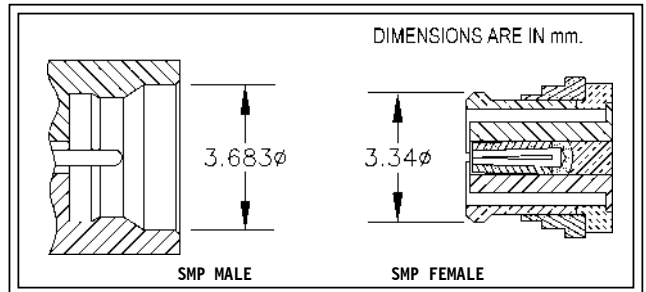
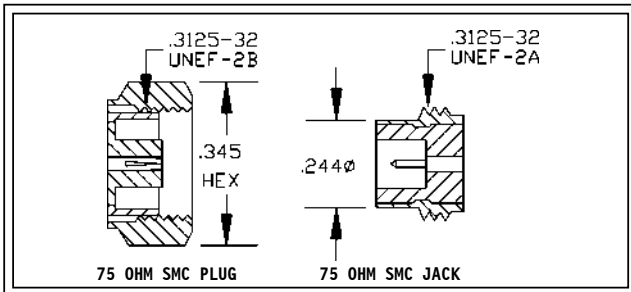
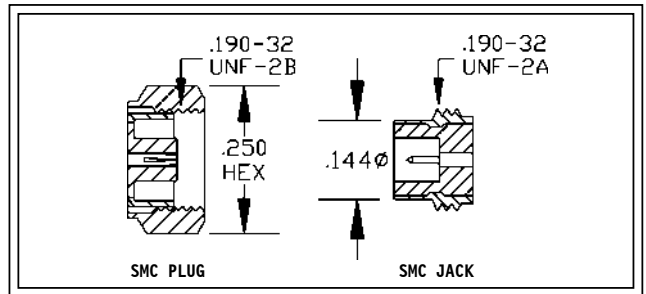
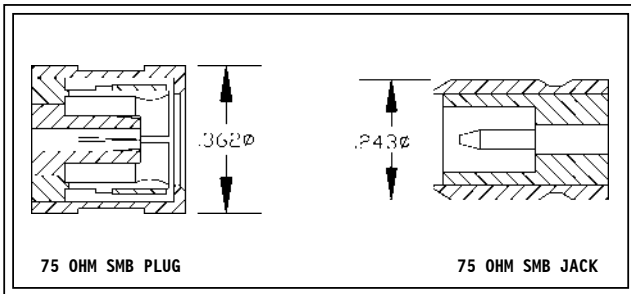
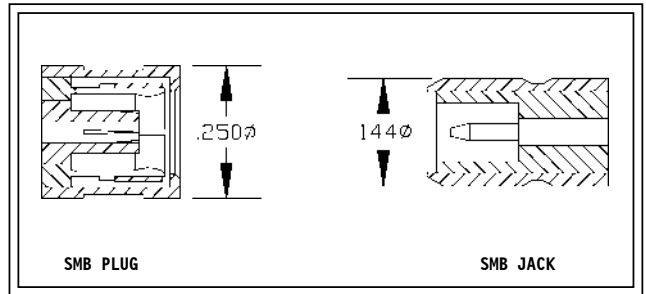
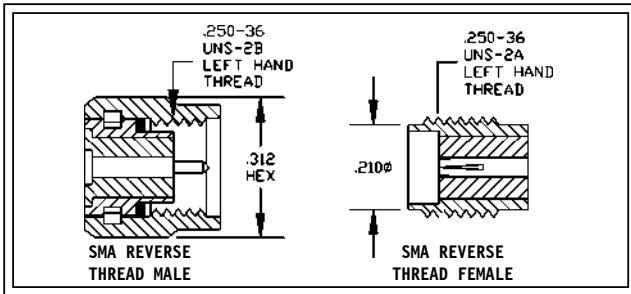
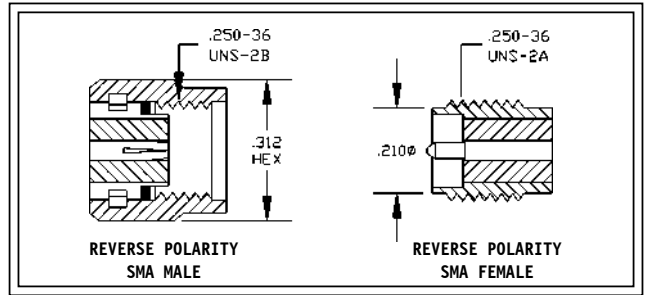
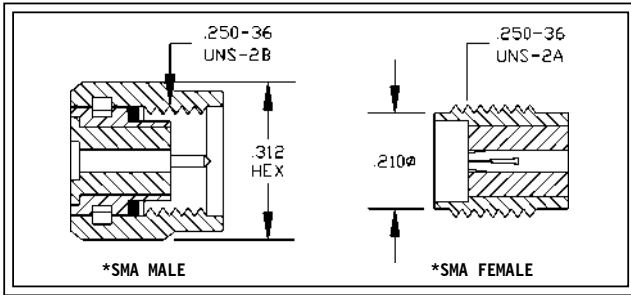
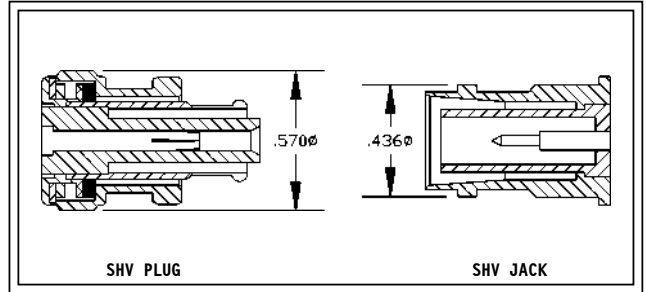
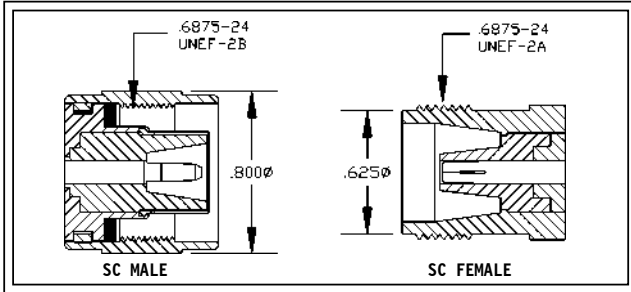

\*SMA, 2.92mm, 3.5mm & K CONNECTORS WILL MATE MECHANICALLY & ELECTRICALLY TO EACH OTHER. THE K CONNECTOR IS A TRADEMARK OF THE ANRITSU COMPANY.

**SPECIFICATIONS SHOWN ARE INTENDED FOR IDENTIFICATION PURPOSES ONLY**

# CONNECTOR IDENTIFIER

DIMENSIONS IN INCHES UNLESS NOTED OTHERWISE

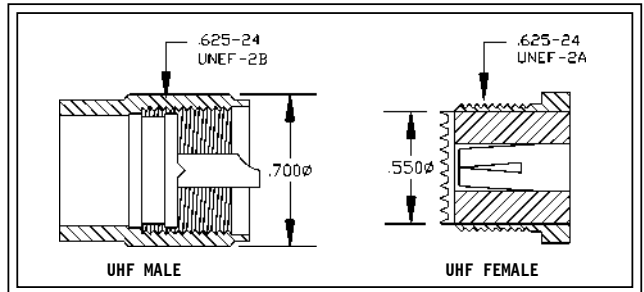
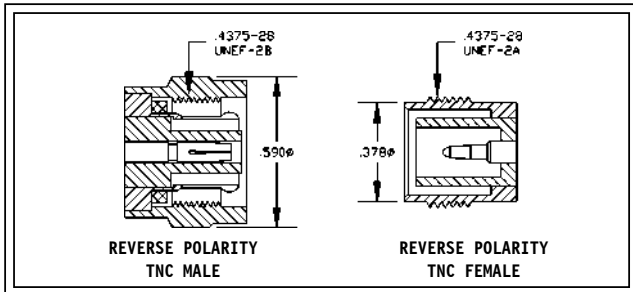
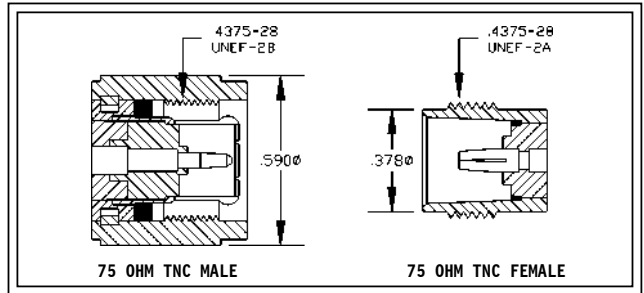
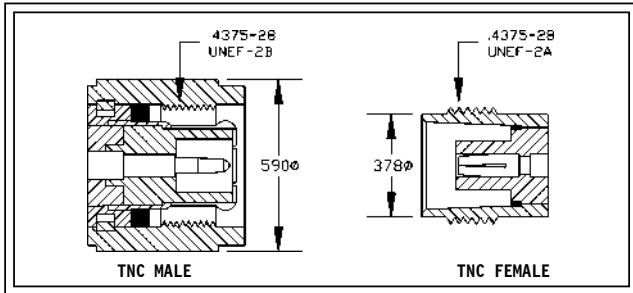
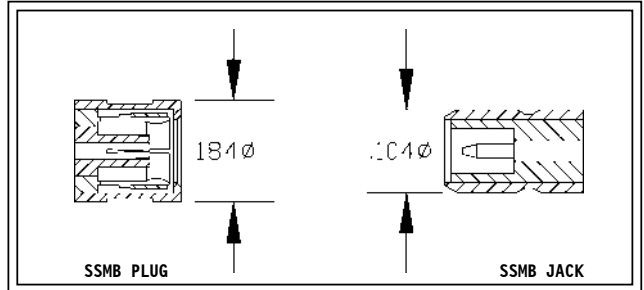
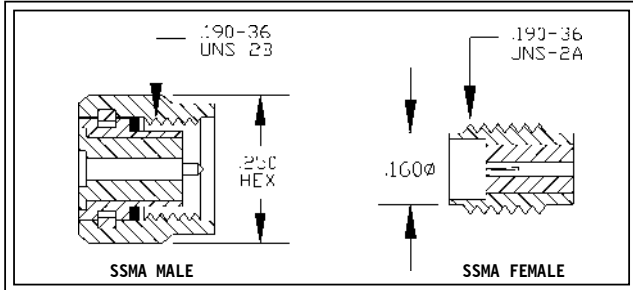

\*SMA, 2.92mm, 3.5mm & K CONNECTORS WILL MATE MECHANICALLY & ELECTRICALLY TO EACH OTHER. THE K CONNECTOR IS A TRADEMARK OF THE ANRITSU COMPANY.

# INDEX GUIDE TO COAXIAL CABLE ASSEMBLIES

**GUIDE: ALL COAXIAL CABLE ASSEMBLIES INDICATE THE LENGTH OF THE ASSEMBLY (IN INCHES) FOLLOWING THE HYPHEN.**

**EXAMPLE: PE3000-24 AND PE3000-26.5 ARE 24 INCHES AND 26.5 INCHES IN LENGTH, RESPECTIVELY.**

**NEW PRODUCTS AND CATEGORIES ARE IDENTIFIED WITH THE **NEW** SYMBOL.**

## **PRECISION TEST CABLE ASSEMBLIES**

<b>NEW</b>	18 GHz TEST CABLE ASSEMBLIES.....	28 & 29
<b>NEW</b>	N TYPE & 3.5mm VNA CALIBRATION KITS.....	30
<b>NEW</b>	VNA TEST CABLE SET.....	31
<b>NEW</b>	3-PORT FIELD CALIBRATION TOOLS.....	31
<b>NEW</b>	26.5 & 40 GHz PRECISION TEST CABLE ASSEMBLIES.....	32
	18 GHz FLEXIBLE CABLE ASSEMBLIES.....	33 THRU 35
	QUICK-DISCONNECT QD-SMA CABLE ASSEMBLIES.....	35
	26.5 GHz FLEXIBLE CABLE ASSEMBLIES.....	36 & 37
	40-65 GHz FLEXIBLE CABLE ASSEMBLIES.....	38 & 39
	 FLEXIBLE, SEMI-RIGID & RE-SHAPEABLE CABLE ASSEMBLIES.....	 40 THRU 144
	 TWINAX CABLE ASSEMBLIES.....	 138
	SINGLE WIRE PATCH CORDS.....	145
	BREAKOUT TEST LEADS & ASSEMBLIES.....	146

**PLEASE USE THE COAXIAL CABLE ASSEMBLY SELECTION LIST ON THE NEXT PAGE TO LOCATE THE CABLE ASSEMBLY YOU NEED BY CONNECTOR END.**

## **CUSTOM CABLE ASSEMBLIES**

**WE CAN PROVIDE CABLE ASSEMBLIES BUILT TO YOUR SPECIFIC LENGTH, AND THEY WILL SHIP THE SAME DAY YOU ORDER THEM IF ORDERED BY 3:00 P.M. PST.**

**YOU CAN ORDER CUSTOM LENGTH CABLE ASSEMBLIES ON OUR WEBSITE AT [www.pasternack.com](http://www.pasternack.com).**

**IF YOU CANNOT FIND THE CABLE ASSEMBLY YOU NEED, YOU CAN ORDER A SPECIAL CABLE ASSEMBLY BY CONTACTING OUR ENGINEERING DEPARTMENT AT (949) 261-1920 EXT. 3, OR BY EMAIL AT [techsupport@pasternack.com](mailto:techsupport@pasternack.com).**

### **NOTE:**

All cable assemblies have a standard cable length tolerance of 1.5% or  $\pm 3/8$ ", whichever is greater.



# COAXIAL CABLE ASSEMBLY SELECTION LIST

Cable Assemblies

<b>1.6/5.6 PLUG RIGHT ANGLE TO:</b>	
1.6/5.6 PLUG .....	137
1.6/5.6 PLUG RIGHT ANGLE .....	137
<b>1.6/5.6 PLUG TO:</b>	
1.6/5.6 PLUG .....	137
1.6/5.6 PLUG RIGHT ANGLE .....	137
75 OHM BNC MALE .....	137
<b>1.85mm MALE TO:</b>	
1.85mm MALE .....	39,43
2.4mm MALE .....	39,43
2.92mm MALE .....	39,43
3.5mm MALE .....	43
SMA MALE .....	43
<b>2.4mm FEMALE TO:</b>	
2.4mm MALE .....	42
<b>2.4mm MALE TO:</b>	
1.85mm MALE .....	39,43
2.4mm FEMALE .....	42
2.4mm MALE .....	38,42
2.92mm MALE .....	38,42
SMA MALE .....	42
<b>2.92mm FEMALE TO:</b>	
2.92mm MALE .....	32,35
<b>2.92mm FEMALE BULKHEAD TO:</b>	
2.92mm MALE .....	41
<b>2.92mm MALE TO:</b>	
1.85mm MALE .....	39,43
2.4mm MALE .....	38,42
2.92mm FEMALE .....	32,35
2.92mm FEMALE BULKHEAD .....	41
2.92mm MALE .....	32,35,38,41
<b>3.5mm FEMALE BULKHEAD TO:</b>	
3.5mm MALE .....	40
<b>3.5mm FEMALE TO:</b>	
3.5mm MALE .....	32,35,40
<b>3.5mm MALE TO:</b>	
1.85mm MALE .....	43
3.5mm FEMALE .....	32,35,40
3.5mm FEMALE BULKHEAD .....	40
3.5mm MALE .....	32,35,40
<b>3/4"-20 TWINAXIAL MALE TO:</b>	
3/4"-20 TWINAXIAL MALE .....	138
<b>7/16 DIN FEMALE TO:</b>	
7/16 DIN MALE .....	105,141
<b>7/16 DIN MALE RIGHT ANGLE TO:</b>	
7/16 DIN MALE .....	105,141
<b>7/16 DIN MALE TO:</b>	
7/16 DIN FEMALE .....	105,141
7/16 DIN MALE .....	102,105,141
7/16 DIN MALE RIGHT ANGLE .....	105,141
N MALE .....	103
SMA MALE .....	104
<b>10-32 MALE RIGHT ANGLE TO:</b>	
10-32 MALE .....	124
10-32 MALE RIGHT ANGLE .....	124
<b>10-32 MALE TO:</b>	
10-32 MALE .....	124
10-32 MALE RIGHT ANGLE .....	124
BNC MALE .....	124
<b>75 OHM BNC FEMALE BULKHEAD TO:</b>	
75 OHM BNC MALE .....	110,140
<b>75 OHM BNC FEMALE TO:</b>	
75 OHM BNC FEMALE .....	111
75 OHM BNC MALE .....	111
<b>75 OHM BNC MALE RIGHT ANGLE TO:</b>	
75 OHM BNC MALE .....	109,140
75 OHM BNC MALE RIGHT ANGLE .....	110

<b>75 OHM BNC MALE TO:</b>	
1.6/5.6 PLUG .....	137
75 OHM BNC FEMALE .....	111
75 OHM BNC FEMALE BULKHEAD .....	110
75 OHM BNC MALE .....	110,140
75 OHM BNC MALE RIGHT ANGLE .....	109,140
75 OHM N MALE .....	108
75 OHM SMB PLUG .....	98
75 OHM SMC PLUG .....	98
75 OHM TNC MALE .....	71
F MALE .....	138
MINI 75 OHM SMB PLUG .....	99,140
<b>75 OHM N MALE TO:</b>	
75 OHM BNC MALE .....	108
75 OHM N MALE .....	108
<b>75 OHM SMB PLUG TO:</b>	
75 OHM BNC MALE .....	98
75 OHM SMB PLUG .....	98
<b>75 OHM SMC PLUG TO:</b>	
75 OHM BNC MALE .....	98
75 OHM SMC PLUG .....	98
<b>75 OHM TNC MALE TO:</b>	
75 OHM BNC MALE .....	71
75 OHM TNC MALE .....	71
<b>ALLIGATOR CLIPS TO:</b>	
BANANA PLUG .....	142
BNC MALE .....	142
<b>BANANA PLUG TO:</b>	
ALLIGATOR CLIPS .....	142
BANANA PLUG .....	143
BNC MALE .....	143
UHF MALE .....	142
<b>BNC FEMALE BULKHEAD TO:</b>	
BNC MALE .....	49
<b>BNC FEMALE TO:</b>	
BNC FEMALE .....	50
BNC MALE .....	48
NMO MOUNT .....	255
<b>BNC MALE RIGHT ANGLE TO:</b>	
BNC MALE .....	46
BNC MALE RIGHT ANGLE .....	47
<b>BNC MALE TO:</b>	
10-32 MALE .....	124
ALLIGATOR CLIPS .....	142
BANANA PLUG .....	143
BNC FEMALE .....	48
BNC FEMALE BULKHEAD .....	49
BNC MALE .....	44,45
BNC MALE RIGHT ANGLE .....	46
FME JACK .....	134
FME PLUG .....	134
GR874 .....	100
MINIATURE ALLIGATOR CLIPS .....	144
MINIATURE STACKING BANANA PLUGS .....	144
N MALE .....	51
NMO MOUNT .....	255
REVERSE POLARITY SMA MALE .....	129
REVERSE POLARITY TNC MALE .....	131
SAFETY HOOKS .....	144
SMA MALE .....	54
SMA MALE RIGHT ANGLE .....	53
SMB PLUG .....	52
SMC PLUG .....	52
STACKING TIP PLUGS .....	144
STANDARD STACKING BANANA PLUGS .....	144
TNC MALE .....	122
UHF MALE .....	126
UNTERMINATED WIRES .....	144
<b>BNC TWINAX MALE TO:</b>	
BNC TWINAX MALE .....	138
<b>C MALE TO:</b>	
C MALE .....	123
<b>F FEMALE BULKHEAD TO:</b>	
F MALE .....	140

<b>F MALE RIGHT ANGLE TO:</b>	
F MALE .....	140
<b>F MALE TO:</b>	
75 OHM BNC MALE .....	138
F FEMALE BULKHEAD .....	140
F MALE .....	138,140
F MALE RIGHT ANGLE .....	140
<b>FME JACK TO:</b>	
BNC MALE .....	134
FME JACK .....	134
NMO MOUNT .....	255
<b>FME PLUG TO:</b>	
BNC MALE .....	134
FME PLUG .....	134
NMO MOUNT .....	255
<b>GR874 TO:</b>	
BNC MALE .....	100
GR874 .....	100
N MALE .....	100
<b>HN MALE TO:</b>	
HN MALE .....	91
<b>LFU PLUG TO:</b>	
LFU PLUG .....	139
MCX JACK BULKHEAD .....	139
REV. POLARITY MCX JACK BULKHEAD .....	139
REV. POLARITY SMA FEMALE BULKHEAD .....	139
REV. POLARITY TNC FEMALE BULKHEAD .....	139
REV. THREAD SMA FEMALE BULKHEAD .....	139
SMA FEMALE BULKHEAD .....	139
TNC FEMALE BULKHEAD .....	139
<b>LC MALE TO:</b>	
LC MALE .....	50
<b>MC-CARD PLUG RIGHT ANGLE TO:</b>	
MC-CARD PLUG .....	136
MC-CARD PLUG RIGHT ANGLE .....	136
<b>MC-CARD PLUG TO:</b>	
MC-CARD PLUG .....	136
MC-CARD PLUG RIGHT ANGLE .....	136
SMA MALE .....	136
<b>MCX JACK BULKHEAD TO:</b>	
LFU .....	139
<b>MCX PLUG RIGHT ANGLE TO:</b>	
MCX PLUG .....	101
MCX PLUG RIGHT ANGLE .....	101
<b>MCX PLUG TO:</b>	
MCX PLUG .....	101
MCX PLUG RIGHT ANGLE .....	101
<b>MHV MALE TO:</b>	
MHV MALE .....	88
SHV PLUG .....	89
<b>MINI 75 OHM SMB JACK TO:</b>	
MINI 75 OHM SMB PLUG .....	140
<b>MINI 75 OHM SMB PLUG RIGHT ANGLE TO:</b>	
MINI 75 OHM SMB PLUG .....	99,140
MINI 75 OHM SMB PLUG RIGHT ANGLE .....	99
<b>MINI 75 OHM SMB PLUG TO:</b>	
75 OHM BNC MALE .....	99
MINI 75 OHM SMB JACK .....	140
MINI 75 OHM SMB PLUG .....	99,140
MINI 75 OHM SMB PLUG RIGHT ANGLE .....	99,140
<b>MINI UHF FEMALE TO:</b>	
NMO MOUNT .....	255
<b>MINI UHF MALE TO:</b>	
MINI UHF MALE .....	107
N MALE .....	107
NMO MOUNT .....	255
SMA MALE .....	107
<b>MINIATURE ALLIGATOR CLIPS TO:</b>	
BNC MALE .....	144

# COAXIAL CABLE ASSEMBLY SELECTION LIST (CONT'D)

<b>MINIATURE STACKING BANANA PLUGS TO:</b>	
BNC MALE .....	144
<b>MMCX PLUG RIGHT ANGLE TO:</b>	
MMCX PLUG .....	128
<b>MMCX PLUG TO:</b>	
MMCX PLUG .....	128
MMCX PLUG RIGHT ANGLE .....	128
SMA MALE .....	128
<b>N FEMALE BULKHEAD TO:</b>	
N MALE .....	34,82,83
N MALE RIGHT ANGLE .....	86
SMA MALE .....	34,72,73
<b>N FEMALE TO:</b>	
N MALE .....	80,81,106,141
NMO MOUNT .....	255
QN MALE .....	84
QN MALE RIGHT ANGLE .....	85
<b>N MALE RIGHT ANGLE TO:</b>	
N FEMALE BULKHEAD .....	86
N MALE .....	78,106,141
N MALE RIGHT ANGLE .....	79
<b>N MALE TO:</b>	
7/16 DIN MALE .....	103
BNC MALE .....	51
GR874 .....	100
MINI UHF MALE .....	107
N FEMALE .....	80,81,106,141
N FEMALE BULKHEAD .....	34,82,83
N MALE .....	29,33,76,77,106,141
N MALE RIGHT ANGLE .....	29,78,106,141
NMO MOUNT .....	255
QN MALE .....	84
QN MALE RIGHT ANGLE .....	85
REVERSE POLARITY SMA MALE .....	129
REVERSE POLARITY TNC MALE .....	131
SMA FEMALE .....	30
SMA MALE .....	30,33,74,75
TNC MALE .....	87
<b>NMO (ANTENNA) MOUNTS TO:</b>	
BNC FEMALE .....	255
BNC MALE .....	255
FME JACK .....	255
FME PLUG .....	255
MINI UHF FEMALE .....	255
MINI UHF MALE .....	255
N FEMALE .....	255
N MALE .....	255
SMA FEMALE .....	254
SMA MALE .....	254
TNC FEMALE .....	255
TNC MALE .....	255
<b>QMA MALE TO:</b>	
QMA MALE .....	55
SMA FEMALE .....	55
SMA MALE .....	55
<b>QN MALE TO:</b>	
N FEMALE .....	84
N MALE .....	84
QN MALE .....	84
<b>QN MALE RIGHT ANGLE TO:</b>	
N FEMALE .....	85
N MALE .....	85
QN MALE .....	85
<b>QUICK DISCONNECT SMA MALE TO:</b>	
QUICK DISCONNECT SMA MALE .....	35
SMA MALE .....	35
<b>REVERSE POLARITY MCX JACK BULKHEAD TO:</b>	
LFU .....	139
<b>REVERSE POLARITY SMA FEMALE BULKHEAD TO:</b>	
LFU .....	139
<b>REVERSE POLARITY SMA MALE TO:</b>	
BNC MALE .....	129
N MALE .....	129
SMA MALE .....	132
TNC MALE .....	132

<b>REVERSE POLARITY TNC FEMALE BULKHEAD TO:</b>	
LFU .....	139
<b>REVERSE POLARITY TNC MALE TO:</b>	
BNC MALE .....	131
N MALE .....	131
SMA MALE .....	130
TNC MALE .....	130
<b>REVERSE THREAD SMA FEMALE BULKHEAD TO:</b>	
LFU .....	139
<b>REVERSE THREAD SMA MALE TO:</b>	
REVERSE THREAD SMA MALE .....	133
SMA MALE .....	133
<b>RCA FEMALE BULKHEAD TO:</b>	
RCA MALE .....	141
<b>RCA MALE RIGHT ANGLE TO:</b>	
RCA MALE .....	141
<b>RCA MALE TO:</b>	
RCA FEMALE BULKHEAD .....	141
RCA MALE .....	141
RCA MALE RIGHT ANGLE .....	141
<b>SAFETY HOOKS TO:</b>	
BNC MALE .....	144
<b>SC MALE TO:</b>	
SC MALE .....	127
<b>SHV PLUG TO:</b>	
MHV MALE .....	89
SHV PLUG .....	90
<b>SMA FEMALE 2 HOLE PANEL MOUNT TO:</b>	
SMA FEMALE 2 HOLE PANEL MOUNT .....	70
<b>SMA FEMALE 4 HOLE PANEL MOUNT TO:</b>	
SMA FEMALE 4 HOLE PANEL MOUNT .....	70
<b>SMA FEMALE BULKHEAD TO:</b>	
LFU .....	139
SMA FEMALE BULKHEAD .....	69
SMA MALE .....	37,64,65
SMA MALE RIGHT ANGLE .....	37,66,67
<b>SMA FEMALE TO:</b>	
N MALE .....	30
NMO MOUNT .....	254
QMA MALE .....	55
SMA FEMALE .....	68
SMA MALE .....	62,63
<b>SMA MALE RIGHT ANGLE TO:</b>	
BNC MALE .....	53
SMA FEMALE BULKHEAD .....	37,66,67
SMA MALE .....	29,36,58,59
SMA MALE RIGHT ANGLE .....	37,60,61
<b>SMA MALE TO:</b>	
1.85mm MALE .....	43
2.4mm MALE .....	42
7/16 DIN MALE .....	104
BNC MALE .....	54
MC-CARD PLUG .....	136
MINI UHF MALE .....	107
MMCX PLUG .....	128
N FEMALE BULKHEAD .....	34,72,73
N MALE .....	30,33,74,75
NMO MOUNT .....	254
QMA MALE .....	55
REVERSE POLARITY SMA MALE .....	132
REVERSE POLARITY TNC MALE .....	130
REVERSE THREAD SMA MALE .....	133
SMA FEMALE .....	62,63
SMA FEMALE BULKHEAD .....	37,64,65
PUSH ON SMA MALE .....	30
SMA MALE .....	29,36,54,57
SMA MALE, PUSH ON .....	30
SMA MALE, QUICK DISCONNECT .....	30,35
SMA MALE RIGHT ANGLE .....	36,58,59
SMB PLUG .....	97
SMC PLUG .....	119
SMP FEMALE .....	135
SSMA MALE .....	125
TNC MALE .....	30,35,120,121

<b>SMB JACK BULKHEAD TO:</b>	
SMB PLUG .....	95
SMB PLUG RIGHT ANGLE .....	96
<b>SMB PLUG RIGHT ANGLE TO:</b>	
SMB JACK BULKHEAD .....	96
SMB PLUG .....	93
SMB PLUG RIGHT ANGLE .....	94
<b>SMB PLUG TO:</b>	
BNC MALE .....	52
SMA MALE .....	97
SMB JACK BULKHEAD .....	95
SMB PLUG .....	92
SMB PLUG RIGHT ANGLE .....	93
<b>SMC JACK BULKHEAD TO:</b>	
SMC PLUG .....	118
SMC PLUG RIGHT ANGLE .....	117
<b>SMC PLUG RIGHT ANGLE TO:</b>	
SMC JACK BULKHEAD .....	117
SMC PLUG .....	115
SMC PLUG RIGHT ANGLE .....	116
<b>SMC PLUG TO:</b>	
BNC MALE .....	52
SMA MALE .....	119
SMC JACK BULKHEAD .....	118
SMC PLUG .....	114
SMC PLUG RIGHT ANGLE .....	115
<b>SMP FEMALE RIGHT ANGLE TO:</b>	
SMP FEMALE .....	135
<b>SMP FEMALE TO:</b>	
SMA MALE .....	135
SMP FEMALE .....	135
SMP FEMALE RIGHT ANGLE .....	135
<b>SSMA MALE RIGHT ANGLE TO:</b>	
SSMA MALE .....	125
SSMA MALE RIGHT ANGLE .....	125
<b>SSMA MALE TO:</b>	
SMA MALE .....	125
SSMA MALE .....	125
SSMA MALE RIGHT ANGLE .....	125
<b>SSMB PLUG RIGHT ANGLE TO:</b>	
SSMB PLUG RIGHT ANGLE .....	100
<b>SSMB PLUG TO:</b>	
SSMB PLUG .....	100
<b>STACKING TIP PLUGS TO:</b>	
BNC MALE .....	144
<b>STANDARD STACKING BANANA PLUGS TO:</b>	
BNC MALE .....	144
<b>TNC FEMALE BULKHEAD TO:</b>	
LFU .....	139
<b>TNC FEMALE TO:</b>	
NMO MOUNT .....	255
<b>TNC MALE TO:</b>	
BNC MALE .....	122
N MALE .....	87
NMO MOUNT .....	255
REVERSE POLARITY SMA MALE .....	132
REVERSE POLARITY TNC MALE .....	130
SMA MALE .....	30,35,120,121
TNC MALE .....	35,112,113
<b>UHF MALE TO:</b>	
BANANA PLUG .....	142
BNC MALE .....	143
UHF MALE .....	53
<b>UNTERMINATED WIRES TO:</b>	
BNC MALE .....	144
BREAKOUTS .....	144
SINGLE WIRE PATCH CORD .....	144

Cable Assemblies

**NEW**

# 18 GHZ TEST CABLE ASSEMBLIES

- WIDEBAND COVERAGE DC-18 GHZ TEST CABLES
- ROHS COMPLIANT
- FLEXIBLE FOR EASY CONNECTION AND BEND RADIUS
- TRIPLE SHIELDED CABLE AND STAINLESS STEEL CONNECTORS PROVIDE EXCELLENT PERFORMANCE OVER LONGER LIFE
- EXTRA RUGGED CONSTRUCTION WITH MOLDED STRAIN RELIEF FOR EXTRA DURABILITY

## ELECTRICAL PROPERTIES

Impedance	50 OHMS
Velocity of Propagation	70.0%
Max Operating Voltage	1000 Volts RMS
Nominal Capacitance	29.4 pf/ft
RF Shielding	100 dB Min
Electrical Delay	1.43 ns/ft.

## MECHANICAL PROPERTIES

Bend Radius	Minimum .750 Inch
Weight	.47 oz/ft
Temp Range	-65°C/+ 125°C
Inner Conductor	Silver Plated Copper Clad Steel .035" Dia.
Dielectric	PTFE .120" Dia.
Outer Conductor 1	Silver Plated Copper Braid
Outer Conductor 2	Silver Plated Copper Tape
Jacket	FEP .163" Dia.

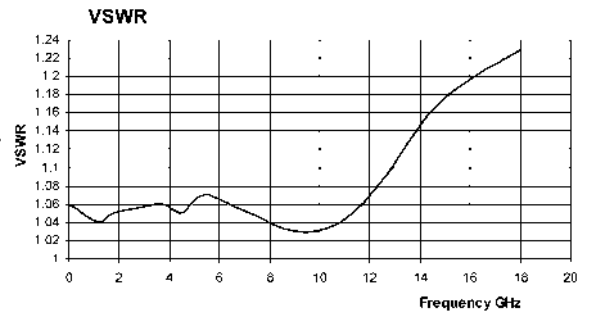
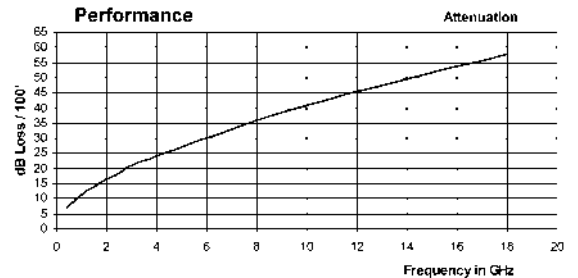

## SMA MALE TO SMA MALE

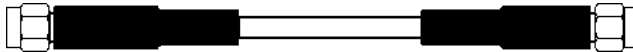

VSWR MAX  
DC-2 GHz, 1.06:1  
2-8 GHz, 1.09:1  
8-18 GHz, 1.30:1

Model No.	Length	1-9	10-24	25 +
PE300-24	24"	\$82.35	\$76.59	\$70.82
PE300-36	36"	85.90	79.89	73.87
PE300-48	48"	89.40	83.14	76.88
PE300-60	60"	89.10	82.86	76.63
PE300-72	72"	94.15	87.56	80.97
PE300-120	120"	137.70	128.06	118.42

PE300-XX Custom Lengths Ship 3 Days ARO, See Website For Pricing

## SMA MALE TO SMA MALE RIGHT ANGLE

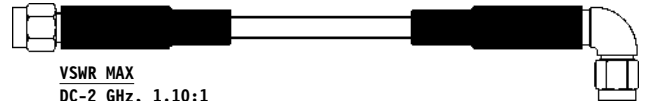

VSWR MAX  
DC-2 GHz, 1.10:1  
2-8 GHz, 1.15:1  
8-18 GHz, 1.30:1

Model No.	Length	1-9	10-24	25 +
PE301-24	24"	\$104.95	\$97.60	\$90.26
PE301-36	36"	109.50	101.84	98.00
PE301-48	48"	113.95	105.97	98.00
PE301-60	60"	116.95	108.76	100.58
PE301-72	72"	119.95	111.55	103.16
PE301-120	120"	175.50	163.22	150.93

PE301-XX Custom Lengths Ship 3 Days ARO, See Website For Pricing

## N MALE TO N MALE

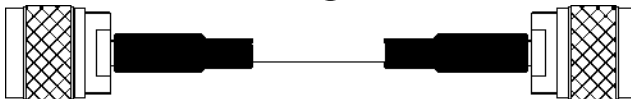

VSWR MAX  
DC-2 GHz, 1.08:1  
2-12.4 GHz, 1.20:1  
12.4-18 GHz, 1.33:1

Model No.	Length	1-9	10-24	25 +
PE302-24	24"	\$118.40	\$110.11	\$101.82
PE302-36	36"	121.85	113.32	104.79
PE302-48	48"	125.35	116.58	107.80
PE302-60	60"	127.60	118.67	109.74
PE302-72	72"	129.90	120.81	107.80
PE302-120	120"	145.10	134.94	124.79

PE302-XX Custom Lengths Ship 3 Days ARO, See Website For Pricing

## N MALE TO N MALE RIGHT ANGLE



VSWR MAX  
DC-2 GHz, 1.08:1  
2-12.4 GHz, 1.20:1  
12.4-18 GHz, 1.33:1

Model No.	Length	1-9	10-24	25 +
PE303-24	24"	\$129.95	\$120.85	\$111.76
PE303-36	36"	133.70	124.34	114.98
PE303-48	48"	137.50	127.88	118.25
PE303-60	60"	140.10	130.29	120.49
PE303-72	72"	142.60	132.62	122.64
PE303-120	120"	164.00	152.52	141.04

PE303-XX Custom Lengths Ship 3 Days ARO, See Website For Pricing

**NEW**

# 18 GHZ TEST CABLE ASSEMBLIES

- WIDEBAND COVERAGE DC-18 GHZ TEST CABLES
- ROHS COMPLIANT
- FLEXIBLE FOR EASY CONNECTION AND BEND RADIUS
- TRIPLE SHIELDED CABLE AND STAINLESS STEEL CONNECTORS PROVIDE EXCELLENT PERFORMANCE OVER LONGER LIFE
- EXTRA RUGGED CONSTRUCTION WITH MOLDED STRAIN RELIEF FOR EXTRA DURABILITY

## SMA MALE TO N MALE

**VSWR MAX**

DC-2 GHz, 1.08:1  
 2-12.4 GHz, 1.20:1  
 12.4-18 GHz, 1.33:1

Model No.	Length	1-9	10-24	25 +
PE304-24	24"	\$113.25	\$105.32	\$97.40
PE304-36	36"	117.85	109.60	101.35
PE304-48	48"	122.35	113.79	105.22
PE304-60	60"	126.85	117.97	109.09
PE304-72	72"	131.35	122.16	112.96
PE304-120	120"	142.95	132.94	122.94

PE304-XX Custom Lengths Ship 3 Days ARO, See Website For Pricing

## SMA FEMALE TO N MALE

**VSWR MAX**

DC-2 GHz, 1.08:1  
 2-12.4 GHz, 1.20:1  
 12.4-18 GHz, 1.33:1

Model No.	Length	1-9	10-24	25 +
PE306-24	24"	\$139.00	\$129.27	\$119.54
PE306-36	36"	140.60	130.76	120.92
PE306-48	48"	151.80	141.17	130.55
PE306-60	60"	158.60	147.50	126.88
PE306-72	72"	163.10	151.68	140.27
PE306-120	120"	179.95	167.35	154.76

PE306-XX Custom Lengths Ship 3 Days ARO, See Website For Pricing

**Cable Assemblies**

## SMA MALE TO TNC MALE

**VSWR MAX**

DC-2 GHz, 1.10:1  
 2-8 GHz, 1.18:1  
 8-18 GHz, 1.40:1

Model No.	Length	1-9	10-24	25 +
PE308-24	24"	\$118.40	\$110.11	\$101.82
PE308-36	36"	121.85	113.32	104.79
PE308-48	48"	125.35	116.58	107.80
PE308-60	60"	127.60	118.67	109.74
PE308-72	72"	129.90	120.81	111.71
PE308-120	120"	145.10	134.94	124.79

PE308-XX Custom Lengths Ship 3 Days ARO, See Website For Pricing

## SMA MALE TO TNC MALE RIGHT ANGLE

**VSWR MAX**

DC-2 GHz, 1.10:1  
 2-8 GHz, 1.25:1  
 8-18 GHz, 1.40:1

Model No.	Length	1-9	10-24	25 +
PE309-24	24"	\$134.95	\$125.50	\$116.06
PE309-36	36"	138.90	129.18	119.45
PE309-48	48"	142.80	132.80	122.81
PE309-60	60"	145.40	135.22	125.04
PE309-72	72"	148.10	137.73	127.37
PE309-120	120"	170.30	158.38	146.46

PE309-XX Custom Lengths Ship 3 Days ARO, See Website For Pricing

## SMA MALE TO PUSH ON SMA MALE

**VSWR MAX**

DC-1 GHz, 1.10:1  
 1-10 GHz, 1.15:1  
 10-18 GHz, 1.20:1

Model No.	Length	1-9	10-24	25 +
PE311-24	24"	\$99.95	\$92.95	\$85.96
PE311-36	36"	103.45	96.21	88.97
PE311-48	48"	106.95	99.46	91.98
PE311-60	60"	110.45	102.72	94.99
PE311-72	72"	113.95	105.97	98.00
PE311-120	120"	127.95	118.99	110.04

PE311-XX Custom Lengths Ship 3 Days ARO, See Website For Pricing

## SMA MALE TO QD SMA MALE

**VSWR MAX**

DC-1 GHz, 1.10:1  
 1-10 GHz, 1.15:1  
 10-18 GHz, 1.20:1

Model No.	Length	1-9	10-24	25 +
PE312-24	24"	\$99.95	\$92.95	\$85.96
PE312-36	36"	103.45	96.21	88.97
PE312-48	48"	106.95	99.46	91.98
PE312-60	60"	110.45	102.72	94.99
PE312-72	72"	113.95	105.97	98.00
PE312-120	120"	127.95	118.99	110.04

PE312-XX Custom Lengths Ship 3 Days ARO, See Website For Pricing

**NEW**

# N TYPE VNA CALIBRATION KITS

The N-Type Standard Calibration kit is designed for use with a broad range of vector network analyzers (VNAs) that utilize a Short-Open-Load calibration technique. With this kit you can make error-corrected measurements of devices supplied with N-Type connectors from DC to 18 GHz. This kit contains both Male (Plug) and Female (Jack) connector interfaces to perform full Two-Port error corrections.

**FEATURES:**

- Broad VNA Coverage, Including Agilent & Anritsu
- Open, Short, Fixed Broadband Load Configurations
- DC to 18 GHz



Specifications	Units	Value	Description
Impedance	Ohms	50	
Frequency	GHz	18	DC to 18 GHz
Open Return Loss(1)	dB	≤ 0.10	≤ 4 GHz
	dB	≤ 0.20	> 4GHz to ≤ 18 GHz
Short Return Loss(1)	dB	≤ 0.10	≤ 4 GHz
	dB	≤ 0.15	> 4GHz and ≤ 18 GHz
Load Return Loss(1)	dB	≥ 40	≤ 4 GHz
	dB	≥ 30	> 4GHz and ≤ 18 GHz
Open Phase Deviation(1)	degs.	≤ 1.2°	≤ 4 GHz
	degs.	≤ 3.0°	> 4GHz and ≤ 18 GHz
Short Phase Deviation(1)	degs.	≤ 1.2°	≤ 4 GHz
	degs.	≤ 2.5°	> 4GHz and ≤ 18 GHz
Load Resistance	Ohms	50 ± 0.25	
Load Power Handling	Watts	≤ 0.5	At 18 GHz, 0°-50° C

Model No.	Description	P R I C E
PE5501-KIT	N-Type Standard Calibration Kit	\$4495.00
PE5501-1	Open Circuit, Male (Plug)	Included
PE5501-2	Open Circuit, Female (Jack)	Included
PE5501-3	Short Circuit, Male (Plug)	Included
PE5501-4	Short Circuit, Female (Jack)	Included
PE5501-5	Broadband Load, Male (Plug)	Included
PE5501-6	Broadband Load, Female (Jack)	Included
PE5011-7	Type N Torque Wrench	Included

(1) Specifications are for both Male (Plug) and Female (Jack) components.

# NEW 3.5mm VNA CALIBRATION KITS

The 3.5mm Standard Calibration kit is designed for use with a broad range of vector network analyzers (VNAs) that utilize a Short-Open-Load calibration technique. With this kit you can make error-corrected measurements of devices supplied with either 3.5mm or SMA connectors from DC to 26.5 GHz. This kit contains both Male (Plug) and Female (Jack) connector interfaces to perform full Two-Port error corrections.

**FEATURES:**

- Broad VNA Coverage, including Agilent® & Anritsu®
- Open, Short, Fixed Broadband Load Configurations
- DC To 26.5 GHz
- In-Series Phase Matched Adapters Available



Specifications	Units	Value	Description	Model No.	Description	P R I C E
Connector Type	mm	3.5	Male and Female	PE5500-KIT	3.5mm Standard Calibration Kit	\$3495.00
Max Frequency	GHz	26.5	DC to 26.5 GHz	PE5500-1	Open Circuit, Male	Included
Open Return Loss	dB	<0.2	At 26.5 GHz	PE5500-2	Open Circuit, Female	Included
Open Phase Deviation	degrees	<3.5°	Nominal @ 26.5 GHz	PE5500-3	Short Circuit, Male	Included
Short Return Loss	dB	<0.15	At 26.5 GHz	PE5500-4	Short Circuit, Female	Included
Short Phase Deviation	degrees	<3.0°	Nominal @ 26.5 GHz	PE5500-5	Broadband Load, Male	Included
Load Return Loss	dB	>30	At 26.5 GHz	PE5500-6	Broadband Load, Female	Included
Load Impedance	Ohms	50.0 ± 0.5	At DC	PE5011-1	3.5mm/SMA Preset Torque Wrench	Included
Load Power Handling	Watts	0.5	At 26.5 GHz			

\*\*ROHS COMPLIANT & CUSTOM-LENGTH CABLE ASSEMBLIES MAY BE ORDERED ON OUR WEBSITE.\*\*

**NEW**

# VNA TEST CABLE ASSEMBLIES

Pasternack introduces its new Microwave test cables for Agilent® and Anritsu® VNA's and additional test equipment with 3.5mm NMD connector ports. These highly flexible test cables have excellent electrical characteristics with outstanding phase and amplitude stability. The unique interchangeable connector head can be configured for DUT applications that require Precision 7mm (PC-7), N, 3.5mm, SMA or 2.92mm connectors.



Specifications	Units	Value	Description
Impedance	Ohms	50Ω	
Frequency	GHz	26.5	DC to 26.5 GHz
Insertion Loss	dB	<1.5	At 26.5 GHz
Amplitude Stability	dB	<0.05	At 26.5 GHz
Phase stability	degree	≤3.0°	At 26.5 GHz, after 90°degree bend
Return Loss	dB	>20dB	At 26.5 GHz
Return Loss Stability	dB	>40 dB	At 26.5 GHz
Cable Length	cm	60	
Minimum bend radius	mm	25	
Connector A		3.5mm NMD	VNA compatible
Connector B		Interchangeable	
Oper. Temperature	Celsius	-40° to +85°	

**Cable Assemblies**

Model No.	Description	P R I C E	
		1-9	10 +
PE310-KIT	VNA Test Cable Set in a protective wood box. Two cables in set Note: Must order companion Connector for each cable (see below)	\$3695.00	\$3436.35
PE44484	One Precision 7mm (PC-7) Connector for PE310 VNA Test Cable	261.20	242.92
PE44485	One N Male Connector for PE310 VNA Test Cable	261.20	242.92
PE44486	One N Female Connector for PE310 VNA Test Cable	261.20	242.92
PE44487	One 3.5mm Male Connector for PE310 VNA Test Cable	261.20	242.92
PE44488	One 3.5mm Female Connector for PE310 VNA Test Cable	261.20	242.92

**NEW**

## 3-PORT FIELD CALIBRATION TOOLS

With these 3-Port Field Calibration Tools you can make error-corrected measurements of devices supplied with 3.5mm, N-Type, or 7/16 DIN connectors. Also called "Bones", these tools are very effective when needing to make field calibrations as they are lightweight and portable. These tools are ideal to use with Anritsu® SiteMaster™ analyzers and other equivalent devices. Each tool has either Male (Plug) or Female (Jack) connector interfaces to perform Short, Open, and Load measurements on the cable assembly, antenna, or other device you are evaluating. RoHS Compliant.



PE5510- FEMALE



PE5512- FEMALE



PE5514- FEMALE



PE5511- MALE

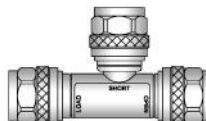

PE5513- MALE

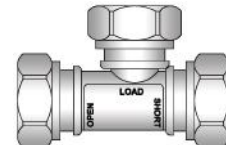

PE5515- DIN MALE

Data	3.5mm Tool	N Type Tool	7/16 DIN Tool
Impedance	50Ω ± 0.5Ω	50Ω	50Ω
Frequency	DC – 26.5 GHz	DC – 6 GHz	DC – 6 GHz
Open Return Loss	≤ 0.15 dB, DC – 4 GHz ≤ 0.30 dB, 4 GHz – 26.5 GHz	≤ 0.1 dB, DC – 6 GHz	≤ 0.15 dB, DC – 6 GHz
Short Return Loss	≤ 0.10 dB, DC – 4 GHz ≤ 0.20 dB, 4 GHz – 26.5 GHz	≤ 0.1 dB, DC – 6 GHz	≤ 0.15 dB, DC – 6 GHz
Load Return Loss	≤ 40.0 dB, DC – 4 GHz ≤ 30.0 dB, 4 GHz – 26.5 GHz	≥ 42 dB to 2.5 GHz ≥ 38 dB 2.5 GHz – 6 GHz	≥ 40 dB to 2.5 GHz ≥ 38 dB 2.5 GHz – 6 GHz
Power Handling	0.5 W	1.0 W	1.0 W
Temp Range	-40°C to +70°C	-40°C to +85°C	-65°C to +85°C
Price (1-9 pcs)	\$995.00	\$595.00	\$695.00

Vikaspuri, New Delhi-110018, India.  
 Email-pradeep@rfconnectorhouse.com  
 Skype Accout - pradeepag

Mobile 91-98101 38894, Fax -91 11 2853 1435  
 Website-http://www.rfconnectorhouse.com/  
 My trademanager ID -synergytelecom;

Our Precision Test Cables are highly suitable for severe test environments where rugged construction is necessary, or in any location where higher phase stability must be assured. Their low-loss PTFE and solid center conductor ensure low insertion loss and outstanding phase & amplitude stability. Durable Passivated Stainless Steel connectors ensure secure matings over and over again, while external armoring removes excessive bending radius. Temperature performance from -55°C to +165°C makes these test cables perfect for environmental test systems.

**NEW**

## 26.5 GHZ PRECISION TEST CABLES

### ELECTRICAL PROPERTIES

Impedance 50 OHMS  
 Velocity of Propagation 77.0%  
 Max Operating Voltage 1000 Volts RMS  
 Phase Stability 1.82° @ 26.5 GHz  
 RF Shielding 100 dB Min  
 Power Rating 286 watts @ 10 GHz

### MECHANICAL PROPERTIES

Bend Radius Minimum 1.38 Inch  
 Temp Range -55°C/+ 165°C  
 Jacket Armored 0.47" Dia.  
 Flex Life Bending 10K Min.  
 Mating Torque 8 Inch Pounds  
 Inner Conductor Gold Plated Copper

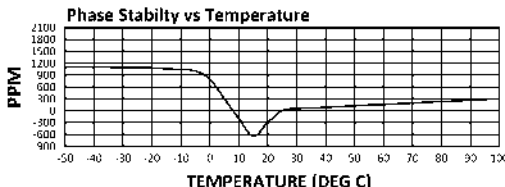
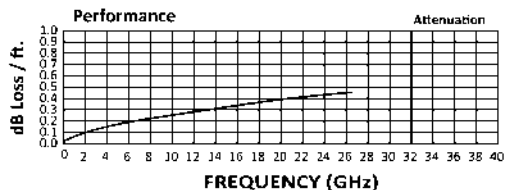

### 3.5mm MALE TO 3.5mm MALE



#### VSWR MAX

DC-10 GHz, 1.15:1  
 10-18 GHz, 1.20:1  
 18-26.5 GHz, 1.35:1

Model No.	Length	1-9	10-24	25 +
PE315-24	24"	\$595.00	\$553.35	\$511.70
PE315-36	36"	695.00	646.35	597.70
PE315-72	72"	995.00	925.35	855.70

### 3.5mm MALE TO 3.5mm FEMALE



#### VSWR MAX

DC-10 GHz, 1.15:1  
 10-18 GHz, 1.20:1  
 18-26.5 GHz, 1.35:1

Model No.	Length	1-9	10-24	25 +
PE317-24	24"	\$645.00	\$599.85	\$554.70
PE317-36	36"	745.00	692.85	640.70
PE317-72	72"	1045.00	971.85	898.70

**NEW**

## 40 GHZ PRECISION TEST CABLES

### ELECTRICAL PROPERTIES

Impedance 50 OHMS  
 Velocity of Propagation 77.0%  
 Max Operating Voltage 1000 Volts RMS  
 Phase Stability 2.44° @ 40 GHz  
 RF Shielding 100 dB Min  
 Power Rating 286 watts @ 10 GHz

### MECHANICAL PROPERTIES

Bend Radius Minimum 1.38 Inch  
 Temp Range -55°C/+ 165°C  
 Jacket Armored 0.47" Dia.  
 Flex Life Bending 10K Min.  
 Mating Torque 8 Inch Pounds  
 Inner Conductor Gold Plated Copper

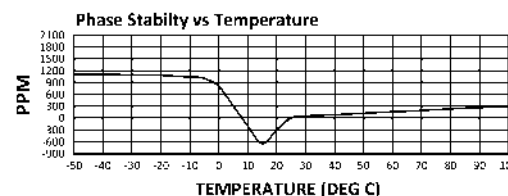
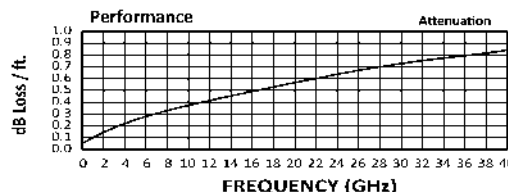

### 2.92mm MALE TO 2.92mm MALE



#### VSWR MAX

DC-18 GHz, 1.20:1  
 18-26 GHz, 1.25:1  
 26-40 GHz, 1.35:1

Model No.	Length	1-9	10-24	25 +
PE319-24	24"	\$745.00	\$692.85	\$640.70
PE319-36	36"	885.00	823.05	761.10
PE319-72	72"	1305.00	1213.65	1122.30

### 2.92mm MALE TO 2.92mm FEMALE



#### VSWR MAX

DC-18 GHz, 1.20:1  
 18-26 GHz, 1.25:1  
 26-40 GHz, 1.35:1

Model No.	Length	1-9	10-24	25 +
PE321-24	24"	\$795.00	\$739.35	\$683.70
PE321-36	36"	935.00	869.55	804.10
PE321-72	72"	1355.00	1260.15	1165.30

# 18 GHZ FLEXIBLE CABLE ASSEMBLIES

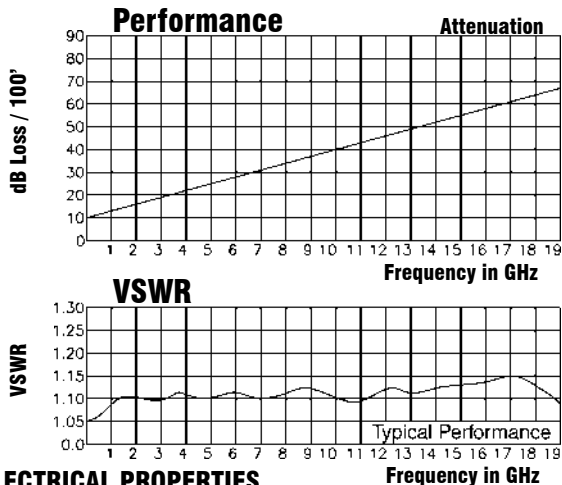

## ELECTRICAL PROPERTIES

Impedance	50 OHMS
Velocity of Propagation	69.5%
Cut Off Frequency	35.0 GHz
Max Operating Voltage	1900 Volts RMS
Nominal Capacitance	29.4 pf/ft
RF Shielding	Greater than 90 dB

## MECHANICAL PROPERTIES

Bend Radius	Minimum 1.0 Inch
Weight	.4 oz/ft
Temp Range	-55°F + 400°F
Inner Conductor	SIL PLT CU Clad Steel .036" Dia.
Dielectric	PTFE .116" Dia.
Outer Conductor	SIL PLT Copper Ribbon .125" Dia.
Jacket	FEP .150" Dia.

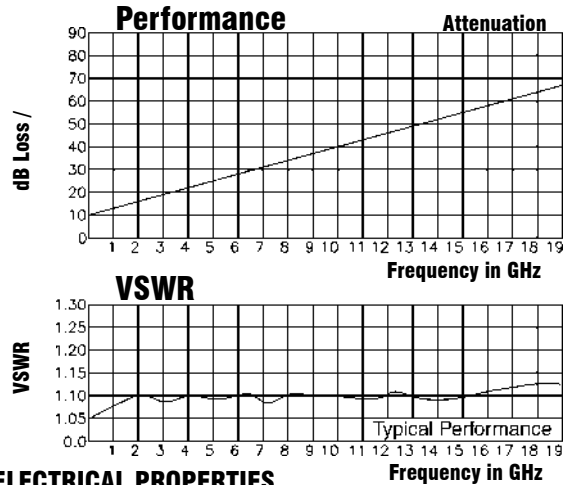

## ELECTRICAL PROPERTIES

Impedance	50 OHMS
Velocity of Propagation	69.5%
Cut Off Frequency	35.0 GHz
Max Operating Voltage	1900 Volts RMS
Nominal Capacitance	29.4 pf/ft
RF Shielding	Greater than 90 dB

## MECHANICAL PROPERTIES

Bend Radius	Minimum 1.0 Inch
Weight	.6 oz/ft
Temp Range	-55°F + 400°F
Inner Conductor	SIL PLT Beryllium CU .036" Dia.
Dielectric	PTFE .116" Dia.
Outer Conductor	SIL PLT Copper Ribbon .140" Dia.
Jacket	FEP .165" Dia.

Cable Assemblies

## N MALE TO SMA MALE

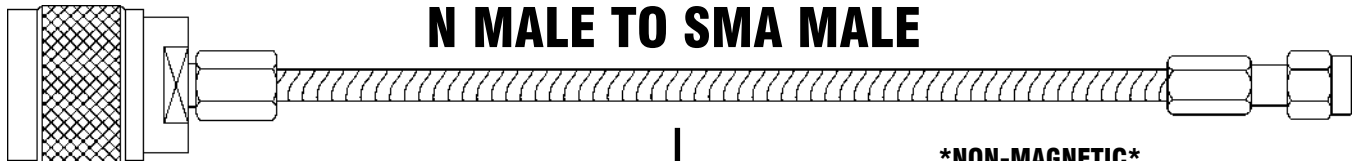

Model No.	Length	1-24	25-49	50-99	100 +
PE33231-6	6"	\$73.20	\$68.08	\$62.95	\$58.56
PE33231-12	12"	75.85	70.54	65.23	60.68
PE33231-18	18"	78.50	73.01	67.51	62.80
PE33231-24	24"	81.10	75.42	69.75	64.88
PE33231-30	30"	83.75	77.89	72.03	67.00
PE33231-36	36"	86.45	80.40	74.35	69.16
PE33231-48	48"	91.75	85.33	78.91	73.40
PE33231-60	60"	102.35	95.19	88.02	81.88
PE33231-72	72"	102.35	95.19	88.02	81.88

PE33231-XX Custom Lengths Ship 3 Days ARO, See Website For Pricing

### \*NON-MAGNETIC\*

Model No.	Length	1-24	25-49	50-99	100 +
PE33233-6	6"	\$98.70	\$91.79	\$84.88	\$78.96
PE33233-12	12"	103.65	96.39	89.14	82.92
PE33233-18	18"	108.65	101.04	93.44	86.92
PE33233-24	24"	113.60	105.65	97.70	90.88
PE33233-30	30"	123.30	114.67	106.04	98.64
PE33233-36	36"	123.45	114.81	106.17	98.76
PE33233-48	48"	133.30	123.97	114.64	106.64
PE33233-60	60"	144.80	134.66	124.53	115.84
PE33233-72	72"	153.00	142.29	131.58	122.40

PE33233-XX Custom Lengths Ship 3 Days ARO, See Website For Pricing

## N MALE TO N MALE

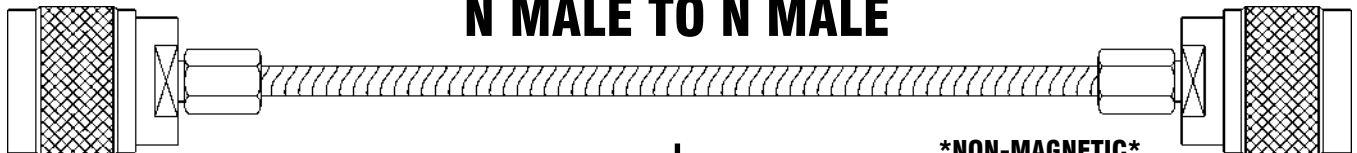

Model No.	Length	1-24	25-49	50-99	100 +
PE33232-6	6"	\$83.55	\$77.70	\$71.85	\$66.84
PE33232-12	12"	86.35	80.31	74.26	69.08
PE33232-18	18"	89.15	82.91	76.67	71.32
PE33232-24	24"	91.95	85.51	79.08	73.56
PE33232-30	30"	94.70	88.07	81.44	75.76
PE33232-36	36"	97.50	90.68	83.85	78.00
PE33232-48	48"	103.00	95.79	88.58	82.40
PE33232-60	60"	108.65	101.04	93.44	86.92
PE33232-72	72"	114.15	106.16	98.17	91.32

PE33232-XX Custom Lengths Ship 3 Days ARO, See Website For Pricing

### \*NON-MAGNETIC\*

Model No.	Length	1-24	25-49	50-99	100 +
PE35028-6	6"	\$109.30	\$101.65	\$94.00	\$87.44
PE35028-12	12"	114.35	106.35	98.34	91.48
PE35028-18	18"	119.35	111.00	102.64	95.48
PE35028-24	24"	124.40	115.69	106.98	99.52
PE35028-30	30"	129.45	120.39	111.33	103.56
PE35028-36	36"	134.55	125.13	115.71	107.64
PE35028-48	48"	144.60	134.48	124.36	115.68
PE35028-60	60"	156.25	145.31	134.38	125.00
PE35028-72	72"	166.30	154.66	143.02	133.04

PE35028-XX Custom Lengths Ship 3 Days ARO, See Website For Pricing



# 18 GHZ FLEXIBLE CABLE ASSEMBLIES

**Performance**

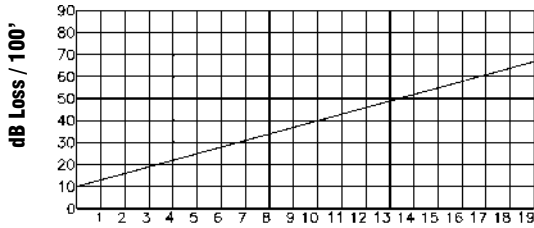

**Attenuation**

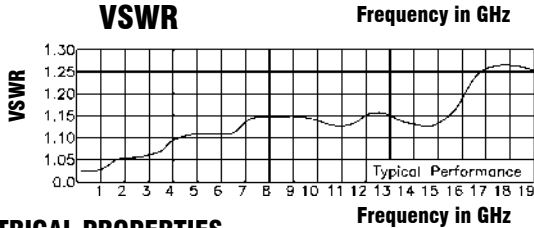

**Performance**

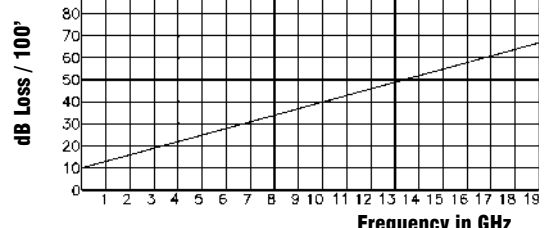

**Attenuation**

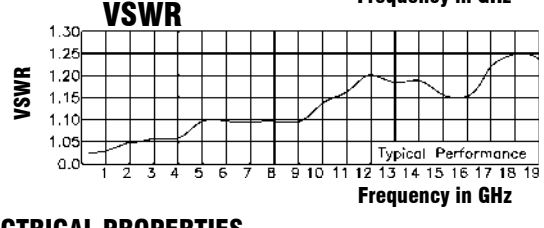

Cable Assemblies

**ELECTRICAL PROPERTIES**

Impedance 50 OHMS  
 Velocity of Propagation 69.5%  
 Cut Off Frequency 35.0 GHz  
 Max Operating Voltage 1900 Volts RMS  
 Nominal Capacitance 29.4 pf/ft  
 RF Shielding Greater than 90 dB

**MECHANICAL PROPERTIES**

Bend Radius Minimum 1.0 Inch  
 Weight .4 oz/ft  
 Temp Range -55°F + 400°F  
 Inner Conductor SIL PLT CU Clad Steel .036" Dia.  
 Dielectric PTFE .116" Dia.  
 Outer Conductor SIL PLT Copper Ribbon .125" Dia.  
 Jacket FEP .150" Dia.

**ELECTRICAL PROPERTIES**

**NON-MAGNETIC**  
 Impedance 50 OHMS  
 Velocity of Propagation 69.5%  
 Cut Off Frequency 35.0 GHz  
 Max Operating Voltage 1900 Volts RMS  
 Nominal Capacitance 29.4 pf/ft  
 RF Shielding Greater than 90 dB

**MECHANICAL PROPERTIES**

Bend Radius Minimum 1.0 Inch  
 Weight .6 oz/ft  
 Temp Range -55°F + 400°F  
 Inner Conductor SIL PLT Beryllium CU .036" Dia.  
 Dielectric PTFE .116" Dia.  
 Outer Conductor SIL PLT Copper Ribbon .140" Dia.  
 Jacket FEP .165" Dia.

## N MALE TO N FEMALE BULKHEAD

USE MOUNTING HOLE G01 ON PAGE 266

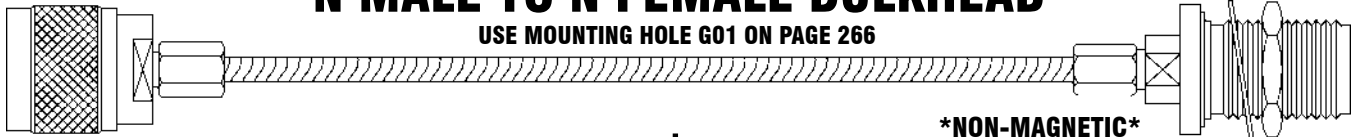

Model No.	Length	1-24	25-49	50-99	100 +
PE35952-6	6"	\$94.70	\$88.07	\$81.44	\$75.76
PE35952-12	12"	97.40	90.58	83.76	77.92
PE35952-18	18"	100.10	93.09	86.09	80.08
PE35952-24	24"	102.75	95.56	88.37	82.20
PE35952-30	30"	105.35	97.98	90.60	84.28
PE35952-36	36"	108.10	100.53	92.97	86.48
PE35952-48	48"	113.65	105.69	97.74	90.92
PE35952-60	60"	119.05	110.72	102.38	95.24
PE35952-72	72"	124.40	115.69	106.98	99.52
PE35952-XX	Custom Lengths	Ship 3 Days ARO, See Website For Pricing			

**\*NON-MAGNETIC\***

Model No.	Length	1-24	25-49	50-99	100 +
PE35956-6	6"	\$125.15	\$116.39	\$107.63	\$100.12
PE35956-12	12"	128.40	119.41	110.42	102.72
PE35956-18	18"	131.80	122.57	113.35	105.44
PE35956-24	24"	135.20	125.74	116.27	108.16
PE35956-30	30"	138.50	128.81	119.11	110.80
PE35956-36	36"	141.90	131.97	122.03	113.52
PE35956-48	48"	148.55	138.15	127.75	118.84
PE35956-60	60"	155.20	144.34	133.47	124.16
PE35956-72	72"	161.85	150.52	139.19	129.48
PE35956-XX	Custom Lengths	Ship 3 Days ARO, See Website For Pricing			

## SMA MALE TO N FEMALE BULKHEAD

USE MOUNTING HOLE G01 ON PAGE 266

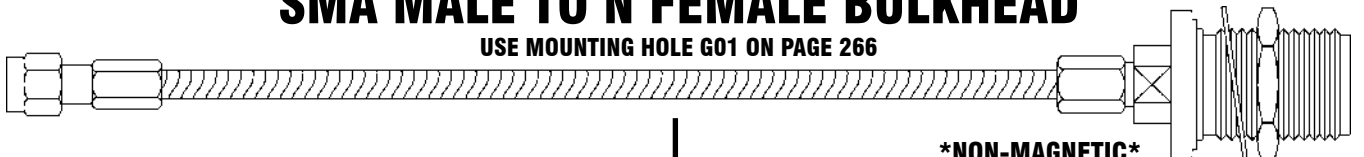

Model No.	Length	1-24	25-49	50-99	100 +
PE35954-6	6"	\$84.20	\$78.31	\$72.41	\$67.36
PE35954-12	12"	86.80	80.72	74.65	69.44
PE35954-18	18"	89.40	83.14	76.88	71.52
PE35954-24	24"	91.95	85.51	79.08	73.56
PE35954-30	30"	94.45	87.84	81.23	75.56
PE35954-36	36"	97.05	90.26	83.46	77.64
PE35954-48	48"	102.25	95.09	87.94	81.80
PE35954-60	60"	107.45	99.93	92.41	85.96
PE35954-72	72"	112.60	104.72	96.84	90.08
PE35954-XX	Custom Lengths	Ship 3 Days ARO, See Website For Pricing			

**\*NON-MAGNETIC\***

Model No.	Length	1-24	25-49	50-99	100 +
PE35958-6	6"	\$104.65	\$97.32	\$90.00	\$83.72
PE35958-12	12"	107.55	100.02	92.49	86.04
PE35958-18	18"	110.55	102.81	95.07	88.44
PE35958-24	24"	113.60	105.65	97.70	90.88
PE35958-30	30"	116.60	108.44	100.28	93.28
PE35958-36	36"	119.55	111.18	102.81	95.64
PE35958-48	48"	125.55	116.76	107.97	100.44
PE35958-60	60"	131.50	122.30	113.09	105.20
PE35958-72	72"	137.55	127.92	118.29	110.04
PE35958-XX	Custom Lengths	Ship 3 Days ARO, See Website For Pricing			

# 18 GHZ FLEXIBLE CABLE ASSEMBLIES

## ELECTRICAL PROPERTIES

Impedance	50 OHMS
Velocity of Propagation	69.5%
Cut Off Frequency	35.0 GHz
Max Operating Voltage	1900 Volts RMS
Nominal Capacitance	29.4 pf/ft
RF Shielding	Greater than 90 dB

## MECHANICAL PROPERTIES

Bend Radius	Minimum 1.0 Inch
Weight	.4 oz/ft
Temp Range	-55°F + 400°F
Inner Conductor	SIL PLT CU Clad Steel .036" Dia.
Dielectric	PTFE .116" Dia.
Outer Conductor	SIL PLT Copper Ribbon .125" Dia.
Jacket FEP	.150" Dia.

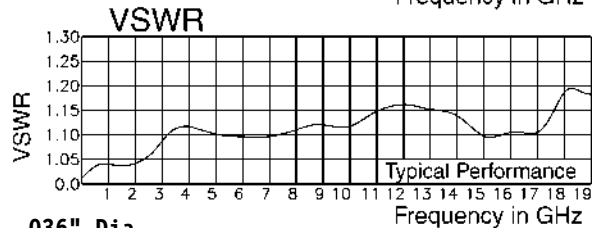
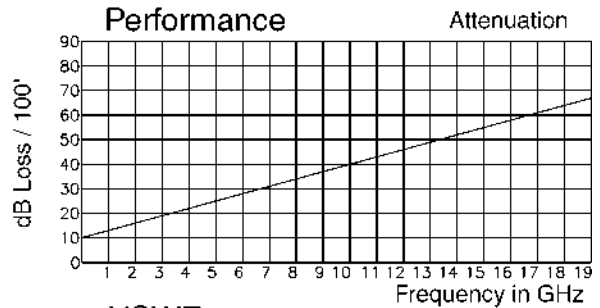

## TNC MALE TO TNC MALE

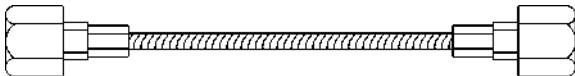

Model No.	Length	1-24	25-49	50-99	100 +
PE35423-6	6"	\$99.65	\$92.67	\$85.70	\$79.72
PE35423-12	12"	102.50	95.33	88.15	82.00
PE35423-18	18"	105.25	97.88	90.52	84.20
PE35423-24	24"	108.15	100.58	93.01	86.52
PE35423-30	30"	111.00	103.23	95.46	88.80
PE35423-36	36"	113.85	105.88	97.91	91.08
PE35423-48	48"	119.55	111.18	102.81	95.64
PE35423-60	60"	125.30	116.53	107.76	100.24
PE35423-72	72"	130.95	121.78	112.62	104.76
PE35423-XX	Custom Lengths	Ship 3 Days ARO, See Website For Pricing			

## TNC MALE TO SMA MALE



Model No.	Length	1-24	25-49	50-99	100 +
PE35419-6	6"	\$88.40	\$82.21	\$76.02	\$70.72
PE35419-12	12"	91.45	85.05	78.65	73.16
PE35419-18	18"	94.35	87.75	81.14	75.48
PE35419-24	24"	97.35	90.54	83.72	77.88
PE35419-30	30"	100.30	93.28	86.26	80.24
PE35419-36	36"	103.20	95.98	88.75	82.56
PE35419-48	48"	109.05	101.42	93.78	87.24
PE35419-60	60"	115.05	107.00	98.94	92.04
PE35419-72	72"	120.85	112.39	103.93	96.68
PE35419-XX	Custom Lengths	Ship 3 Days ARO, See Website For Pricing			

## NEW QUICK-DISCONNECT QD-SMA CABLE ASSEMBLIES

Pasternack's Quick-Disconnect Cable Assemblies are designed for Test environments that require rapid SMA connections. The QD-SMA is designed to push on and lock in place by sliding the shroud over the connector. Where enhanced VSWR measurements are required, an additional 1/8 turn of the QD-SMA will ensure lower VSWR performance. The QD-SMA Connector can be quickly removed by pulling on the shroud and sliding off the QD-SMA connector.

### QD SMA MALE TO SMA MALE



#### NEW 50 OHM, RG58C/U COAX

Model No.	Length	1-24	25-49	50-99	100 +
PE36689-24	24"	\$57.75	\$53.71	\$49.67	\$46.20
PE36689-36	36"	60.90	56.64	52.37	48.72
PE36689-48	48"	64.05	59.57	55.08	51.24
PE36689-72	72"	68.25	63.47	58.70	54.60
PE36689-XX	Any	Same-Day Shipment / Call for Pricing			

### QD SMA MALE TO QD SMA MALE



#### NEW 50 OHM, RG58C/U COAX

Model No.	Length	1-24	25-49	50-99	100 +
PE36690-24	24"	\$68.25	\$63.47	\$58.70	\$54.60
PE36690-36	36"	71.40	66.40	61.40	57.12
PE36690-48	48"	74.55	69.33	64.11	59.64
PE36690-72	72"	78.75	73.24	67.73	63.00
PE36690-XX	Any	Same-Day Shipment / Call for Pricing			

Cable Assemblies

# 26.5 GHz FLEXIBLE CABLE ASSEMBLIES

THE CABLE BECOMES AN INTEGRAL PART OF THE SMA CONNECTOR RESULTING IN NO DISCONTINUITIES FOR BETTER ELECTRICAL PERFORMANCE THRU 26.5 GHz (35.0 GHz WHEN MATED WITH A \*K CONNECTOR.)

\*THE K CONNECTOR IS A REGISTERED TRADEMARK OF THE ANRITSU COMPANY.

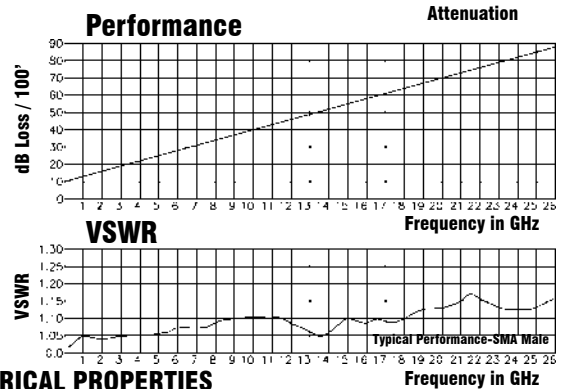
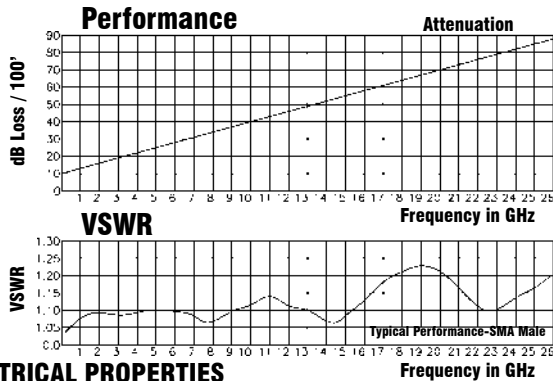

Cable Assemblies

## ELECTRICAL PROPERTIES

Impedance 50 OHMS  
 Velocity of Propagation 69.5%  
 Cut Off Frequency 35.0 GHz  
 Max Operating Voltage 1900 Volts RMS  
 Nominal Capacitance 29.4 pf/ft  
 RF Shielding Greater than 90 dB

## MECHANICAL PROPERTIES

Bend Radius Minimum 1.0 Inch  
 Weight .4 oz/ft  
 Temp Range -55°F + 400°F  
 Inner Conductor SIL PLT CU Clad Steel .036" Dia.  
 Dielectric PTFE .116" Dia.  
 Outer Conductor SIL PLT Copper Ribbon .125" Dia.  
 Jacket FEP .150" Dia.

## ELECTRICAL PROPERTIES

**NON-MAGNETIC**  
 Impedance 50 OHMS  
 Velocity of Propagation 69.5%  
 Cut Off Frequency 35.0 GHz  
 Max Operating Voltage 1900 Volts RMS  
 Nominal Capacitance 29.4 pf/ft  
 RF Shielding Greater than 90 dB

## MECHANICAL PROPERTIES

Bend Radius Minimum 1.0 Inch  
 Weight .6 oz/ft  
 Temp Range -55°F + 400°F  
 Inner Conductor SIL PLT Beryllium CU .036" Dia.  
 Dielectric PTFE .116" Dia.  
 Outer Conductor SIL PLT Copper Ribbon .140" Dia.  
 Jacket FEP .165" Dia.

## SMA MALE TO SMA MALE



Model No.	Length	1-24	25-49	50-99	100 +
PE34286-6	6"	\$56.45	\$52.50	\$48.55	\$45.16
PE34286-12	12"	59.30	55.15	51.00	47.44
PE34286-18	18"	62.05	57.71	53.36	49.64
PE34286-20	20"	63.50	59.06	54.61	50.80
PE34286-24	24"	64.85	60.31	55.77	51.88
PE34286-30	30"	67.80	63.05	58.31	54.24
PE34286-36	36"	70.55	65.61	60.67	56.44
PE34286-40	40"	73.35	68.22	63.08	58.68
PE34286-48	48"	76.15	70.82	65.49	60.92
PE34286-60	60"	81.80	76.07	70.35	65.44
PE34286-72	72"	87.40	81.28	75.16	69.92
PE34286-84	84"	104.70	97.37	90.04	83.76
PE34286-96	96"	107.90	100.35	92.79	86.32
PE34286-108	108"	117.65	109.41	101.18	94.12
PE34286-120	120"	110.05	102.35	94.64	88.04

Model No.	Length	1-24	25-49	50-99	100 +
PE3790-6	6"	\$82.55	\$76.77	\$70.99	\$66.04
PE3790-12	12"	87.40	81.28	75.16	69.92
PE3790-18	18"	92.40	85.93	79.46	73.92
PE3790-20	20"	95.70	89.00	82.30	76.56
PE3790-24	24"	97.35	90.54	83.72	77.88
PE3790-30	30"	102.25	95.09	87.94	81.80
PE3790-36	36"	107.35	99.84	92.32	85.88
PE3790-40	40"	115.55	107.46	99.37	92.44
PE3790-48	48"	117.20	109.00	100.79	93.76
PE3790-60	60"	127.05	118.16	109.26	101.64
PE3790-72	72"	137.00	127.41	117.82	109.60
PE3790-84	84"	155.10	144.24	133.39	124.08
PE3790-96	96"	171.60	159.59	147.58	137.28
PE3790-108	108"	188.10	174.93	161.77	150.48
PE3790-120	120"	204.60	190.28	175.96	163.68

## SMA MALE TO SMA MALE RIGHT ANGLE



Model No.	Length	1-24	25-49	50-99	100 +
PE35418-6	6"	\$98.25	\$91.37	\$84.50	\$78.60
PE35418-12	12"	101.50	94.40	87.29	81.20
PE35418-18	18"	104.85	97.51	90.17	83.88
PE35418-24	24"	108.15	100.58	93.01	86.52
PE35418-30	30"	111.50	103.70	95.89	89.20
PE35418-36	36"	114.75	106.72	98.69	91.80
PE35418-48	48"	121.20	112.72	104.23	96.96
PE35418-60	60"	127.80	118.85	109.91	102.24
PE35418-72	72"	134.30	124.90	115.50	107.44

Model No.	Length	1-24	25-49	50-99	100 +
PE35420-6	6"	\$126.40	\$117.55	\$108.70	\$101.12
PE35420-12	12"	131.15	121.97	112.79	104.92
PE35420-18	18"	135.90	126.39	116.87	108.72
PE35420-24	24"	140.60	130.76	120.92	112.48
PE35420-30	30"	145.35	135.18	125.00	116.28
PE35420-36	36"	150.10	139.59	129.09	120.08
PE35420-48	48"	159.65	148.47	137.30	127.72
PE35420-60	60"	167.65	155.91	144.18	134.12
PE35420-72	72"	178.55	166.05	153.55	142.84

# 26.5 GHZ FLEXIBLE CABLE ASSEMBLIES SMA MALE RIGHT ANGLE TO SMA MALE RIGHT ANGLE

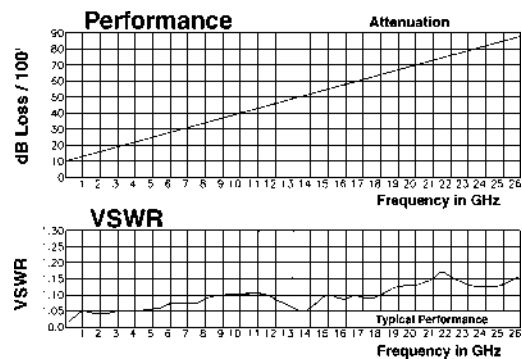
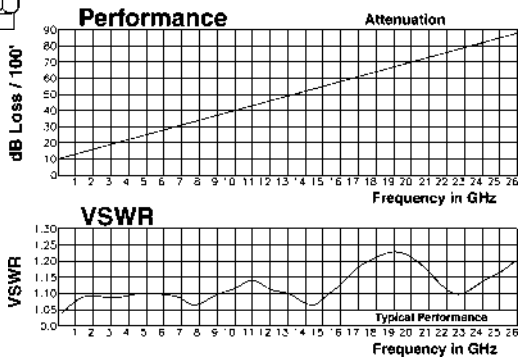
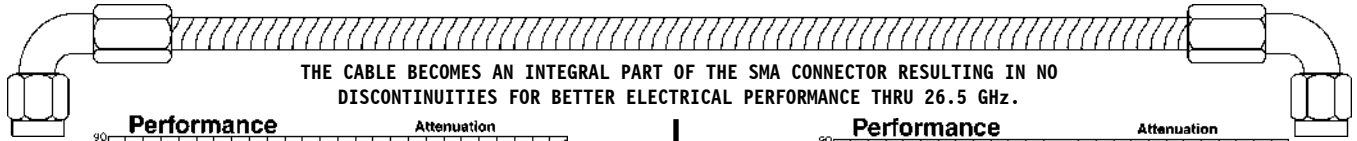

### ELECTRICAL PROPERTIES

Impedance: 50 OHMS  
Velocity of Propagation: 69.5%  
Cut Off Frequency: 35.0 GHz  
Max Operating Voltage: 1900 Volts RMS  
Nominal Capacitance: 29.4 pf/ft  
RF Shielding: Greater than 90 dB

### MECHANICAL PROPERTIES

Bend Radius: Minimum 1.0 Inch  
Weight: .4 oz/ft  
Temp Range: -55°F + 400°F  
Inner Conductor: SIL PLT CU Clad Steel .036" Dia.  
Dielectric: PTFE .116" Dia.  
Outer Conductor: SIL PLT Copper Ribbon .125" Dia.  
Jacket: FEP .150" Dia.

### ELECTRICAL PROPERTIES

**NON-MAGNETIC**  
Impedance: 50 OHMS  
Velocity of Propagation: 69.5%  
Cut Off Frequency: 35.0 GHz  
Max Operating Voltage: 1900 Volts RMS  
Nominal Capacitance: 29.4 pf/ft  
RF Shielding: Greater than 90 dB

### MECHANICAL PROPERTIES

Bend Radius: Minimum 1.0 Inch  
Weight: .6 oz/ft  
Temp Range: -55°F + 400°F  
Inner Conductor: SIL PLT Beryllium CU .036" Dia.  
Dielectric: PTFE .116" Dia.  
Outer Conductor: SIL PLT Copper Ribbon .140" Dia.  
Jacket: FEP .165" Dia.

### \*NON-MAGNETIC\*

Model No.	Length	1-24	25-49	50-99	100 +
PE35422-6	6"	\$130.70	\$121.55	\$112.40	\$104.56
PE35422-12	12"	134.10	124.71	115.33	107.28
PE35422-18	18"	137.30	127.69	118.08	109.84
PE35422-24	24"	140.60	130.76	120.92	112.48
PE35422-30	30"	143.90	133.83	123.75	115.12
PE35422-36	36"	147.20	136.90	126.59	117.76
PE35422-48	48"	153.65	142.89	132.14	122.92
PE35422-60	60"	160.15	148.94	137.73	128.12
PE35422-72	72"	166.70	155.03	143.36	133.36
PE35422-XX	Custom Lengths	Ship 3 Days ARO, See Website For Pricing			

Model No.	Length	1-24	25-49	50-99	100 +
PE35424-6	6"	\$158.95	\$147.82	\$136.70	\$127.16
PE35424-12	12"	163.75	152.29	140.83	131.00
PE35424-18	18"	168.25	156.47	144.70	134.60
PE35424-24	24"	173.10	160.98	148.87	138.48
PE35424-30	30"	177.85	165.40	152.95	142.28
PE35424-36	36"	182.45	169.68	156.91	145.96
PE35424-48	48"	191.85	178.42	164.99	153.48
PE35424-60	60"	201.20	187.12	173.03	160.96
PE35424-72	72"	210.50	195.77	181.03	168.40
PE35424-XX	Custom Lengths	Ship 3 Days ARO, See Website For Pricing			

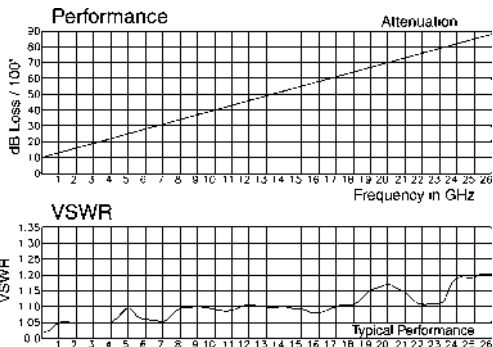

### ELECTRICAL PROPERTIES

Impedance: 50 OHMS  
Velocity of Propagation: 69.5%  
Cut Off Frequency: 35.0 GHz  
Max Operating Voltage: 1900 Volts RMS  
Nominal Capacitance: 29.4 pf/ft  
RF Shielding: Greater than 90 dB

### MECHANICAL PROPERTIES

Bend Radius: Minimum 1.0 Inch  
Weight: .4 oz/ft  
Temp Range: -55°F + 400°F  
Inner Conductor: SIL PLT CU Clad Steel .036" Dia.  
Dielectric: PTFE .116" Dia.  
Outer Conductor: SIL PLT Copper Ribbon .125" Dia.  
Jacket: FEP .150" Dia.

## SMA MALE TO SMA FEMALE BULKHEAD USE MOUNTING HOLE B02 ON PAGE 266

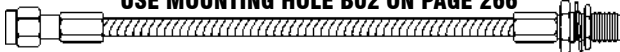

Model No.	Length	1-24	25-49	50-99	100 +
PE35475-6	6"	\$73.20	\$68.08	\$62.95	\$58.56
PE35475-12	12"	75.85	70.54	65.23	60.68
PE35475-18	18"	78.50	73.01	67.51	62.80
PE35475-24	24"	81.10	75.42	69.75	64.88
PE35475-30	30"	83.75	77.89	72.03	67.00
PE35475-36	36"	86.45	80.40	74.35	69.16
PE35475-48	48"	91.75	85.33	78.91	73.40
PE35475-60	60"	97.05	90.26	83.46	77.64
PE35475-72	72"	102.35	95.19	88.02	81.88
PE35475-XX	Custom Lengths	Ship 3 Days ARO, See Website For Pricing			

## SMA MALE RIGHT ANGLE TO SMA FEMALE BULKHEAD USE MOUNTING HOLE B02 ON PAGE 266

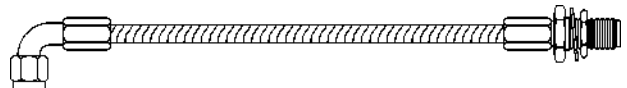

Model No.	Length	1-24	25-49	50-99	100 +
PE35421-6	6"	\$99.65	\$92.67	\$85.70	\$79.72
PE35421-12	12"	102.50	95.33	88.15	82.00
PE35421-18	18"	105.25	97.88	90.52	84.20
PE35421-24	24"	108.15	100.58	93.01	86.52
PE35421-30	30"	111.05	103.28	95.50	88.84
PE35421-36	36"	113.85	105.88	97.91	91.08
PE35421-48	48"	119.55	111.18	102.81	95.64
PE35421-60	60"	125.30	116.53	107.76	100.24
PE35421-72	72"	130.95	121.78	112.62	104.76
PE35421-XX	Custom Lengths	Ship 3 Days ARO, See Website For Pricing			

Cable Assemblies

# 40 GHz FLEXIBLE CABLE ASSEMBLIES

## ELECTRICAL PROPERTIES

Impedance	50 OHMS
Velocity of Propagation	69.5%
Cut Off Frequency	60.0 GHz
Max Operating Voltage	1500 Volts RMS
Nominal Capacitance	29.4 pf/ft
RF Shielding	Greater than 90 dB

## MECHANICAL PROPERTIES

Bend Radius	Minimum 1/2 Inch
Weight	.175 oz/ft
Temp Range	-55°F + 400°F
Inner Conductor	SIL PLT CU Clad Steel .020" Dia.
Dielectric	PTFE .066" Dia.
Outer Conductor	SIL PLT CU Ribbon & BRAID .080" Dia.
Jacket	FEP .095" Dia.

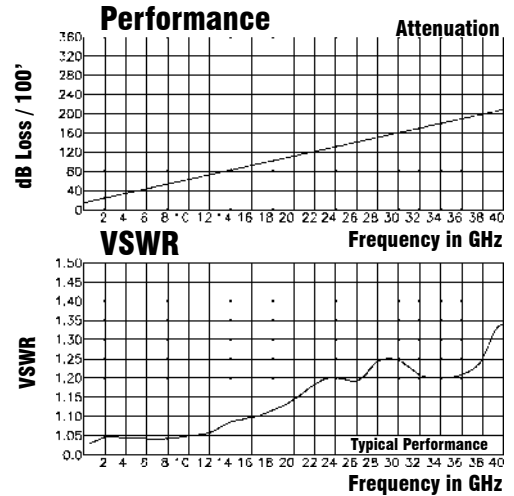

## 2.92mm MALE TO 2.92mm MALE

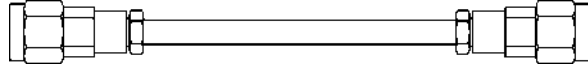

Model No.	Length	1-24	25-49	50-99	100 +
PE35591-6	6"	\$103.20	\$95.98	\$88.75	\$82.56
PE35591-12	12"	106.60	99.14	91.68	85.28
PE35591-18	18"	110.15	102.44	94.73	88.12
PE35591-24	24"	113.60	105.65	97.70	90.88
PE35591-30	30"	117.00	108.81	100.62	93.60
PE35591-36	36"	120.45	112.02	103.59	96.36
PE35591-48	48"	127.30	118.39	109.48	101.84
PE35591-60	60"	134.20	124.81	115.41	107.36
PE35591-72	72"	141.00	131.13	121.26	112.80
PE35591-XX	Custom Lengths Ship 3 Days ARO, See Website For Pricing				

## 2.92mm MALE TO 2.4mm MALE

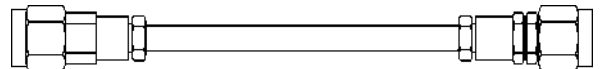

Model No.	Length	1-24	25-49	50-99	100 +
PE35606-6	6"	\$109.05	\$101.42	\$93.78	\$87.24
PE35606-12	12"	112.40	104.53	96.66	89.92
PE35606-18	18"	115.65	107.55	99.46	92.52
PE35606-24	24"	119.00	110.67	102.34	95.20
PE35606-30	30"	125.55	116.76	107.97	100.44
PE35606-36	36"	128.90	119.88	110.85	103.12
PE35606-48	48"	132.10	122.85	113.61	105.68
PE35606-60	60"	138.80	129.08	119.37	111.04
PE35606-72	72"	145.45	135.27	125.09	116.36
PE35606-XX	Custom Lengths Ship 3 Days ARO, See Website For Pricing				

# 50 GHz FLEXIBLE CABLE ASSEMBLIES

## 2.4mm MALE TO 2.4mm MALE

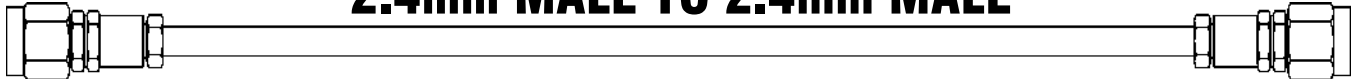

## ELECTRICAL PROPERTIES

Impedance	50 OHMS
Velocity of Propagation	69.5%
Cut Off Frequency	60.0 GHz
Max Operating Voltage	1500 Volts RMS
Nominal Capacitance	29.4 pf/ft
RF Shielding	Greater than 90 dB

## MECHANICAL PROPERTIES

Bend Radius	Minimum 1/2 Inch
Weight	.175 oz/ft
Temp Range	-55°F + 400°F
Inner Conductor	SIL PLT CU Clad Steel .020" Dia.
Dielectric	PTFE .066" Dia.
Outer Conductor	SIL PLT CU Ribbon & BRAID .080" Dia.
Jacket	FEP .095" Dia.

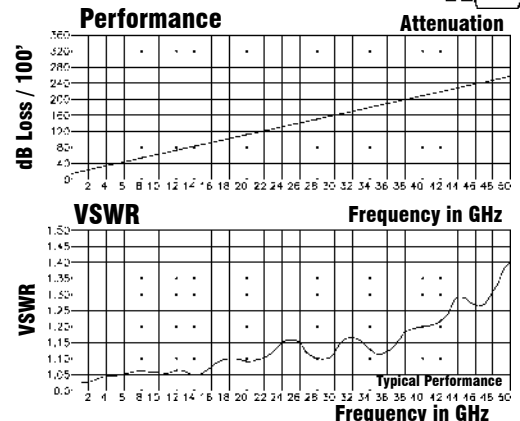

Model No.	Length	1-24	25-49	50-99	100 +
PE35611-6	6"	\$114.60	\$106.58	\$98.56	\$91.68
PE35611-12	12"	117.80	109.55	101.31	94.24
PE35611-18	18"	121.05	112.58	104.10	96.84
PE35611-24	24"	124.40	115.69	106.98	99.52
PE35611-30	30"	134.20	124.81	115.41	107.36
PE35611-36	36"	135.85	126.34	116.83	108.68
PE35611-48	48"	137.55	127.92	118.29	110.04
PE35611-60	60"	144.00	133.92	123.84	115.20
PE35611-72	72"	150.65	140.10	129.56	120.52
PE35611-XX	Custom Lengths Ship 3 Days ARO, See Website For Pricing				

# FLEXIBLE CABLE ASSEMBLIES

## ELECTRICAL PROPERTIES

Impedance	50 OHMS
Velocity of Propagation	69.5%
Cut Off Frequency	65.0 GHz
Max Operating Voltage	700 Volts RMS
Nominal Capacitance	29.4 pf/ft
RF Shielding	Greater than 90 dB

## MECHANICAL PROPERTIES

Bend Radius	Minimum 1/2 Inch
Weight	.175 oz/ft
Temp Range	-55°F + 400°F
Inner Conductor	SIL PLT CU Clad Steel .020" Dia.
Dielectric	PTFE .062" Dia.
Outer Conductor	SIL PLT CU Ribbon & BRAID .080" Dia.
Jacket	FEP .095" Dia.

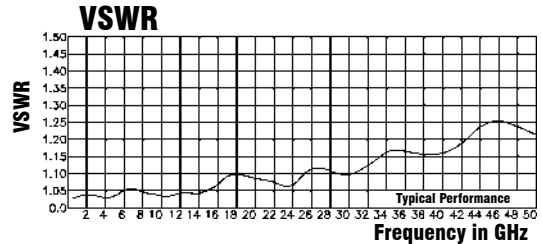
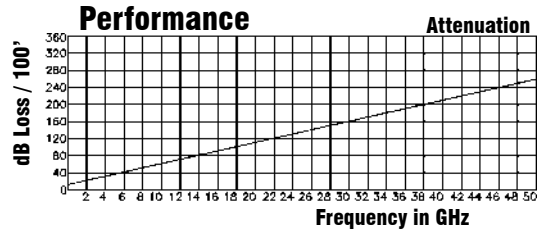

## 40 GHZ

### 1.85mm MALE TO 2.92mm MALE

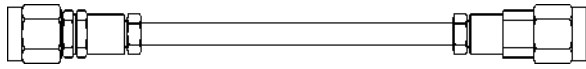

Model No.	Length	1-24	25-49	50-99	100 +
PE36674-6	6"	\$114.60	\$106.58	\$98.56	\$91.68
PE36674-12	12"	117.80	109.55	101.31	94.24
PE36674-18	18"	121.05	112.58	104.10	96.84
PE36674-24	24"	124.40	115.69	106.98	99.52
PE36674-30	30"	127.70	118.76	109.82	102.16
PE36674-36	36"	130.95	121.78	112.62	104.76
PE36674-48	48"	137.55	127.92	118.29	110.04
PE36674-60	60"	144.00	133.92	123.84	115.20
PE36674-72	72"	150.65	140.10	129.56	120.52

## 50 GHZ

### 1.85mm MALE TO 2.4mm MALE



Model No.	Length	1-24	25-49	50-99	100 +
PE36676-6	6"	\$120.15	\$111.74	\$103.33	\$96.12
PE36676-12	12"	123.30	114.67	106.04	98.64
PE36676-18	18"	126.60	117.74	108.88	101.28
PE36676-24	24"	129.80	120.71	111.63	103.84
PE36676-30	30"	133.00	123.69	114.38	106.40
PE36676-36	36"	136.35	126.81	117.26	109.08
PE36676-48	48"	142.85	132.85	122.85	114.28
PE36676-60	60"	149.35	138.90	128.44	119.48
PE36676-72	72"	155.75	144.85	133.95	124.60

## 65 GHZ FLEXIBLE CABLE ASSEMBLIES

### 1.85mm MALE TO 1.85mm MALE

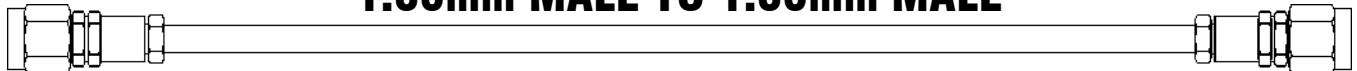

## ELECTRICAL PROPERTIES

Impedance	50 OHMS
Velocity of Propagation	69.5%
Cut Off Frequency	65.0 GHz
Max Operating Voltage	700 Volts RMS
Nominal Capacitance	29.4 pf/ft
RF Shielding	Greater than 90 dB

## MECHANICAL PROPERTIES

Bend Radius	Minimum 1/2 Inch
Weight	.175 oz/ft
Temp Range	-55°F + 400°F
Inner Conductor	SIL PLT CU Clad Steel .020" Dia.
Dielectric	PTFE .062" Dia.
Outer Conductor	SIL PLT CU Ribbon & BRAID .080" Dia.
Jacket	FEP .095" Dia.

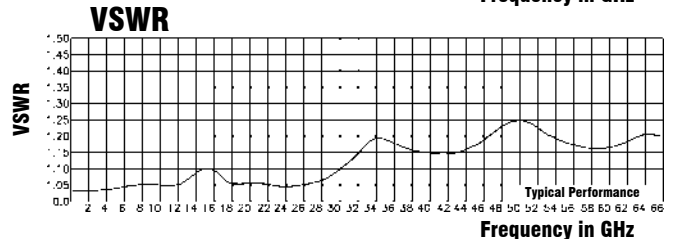
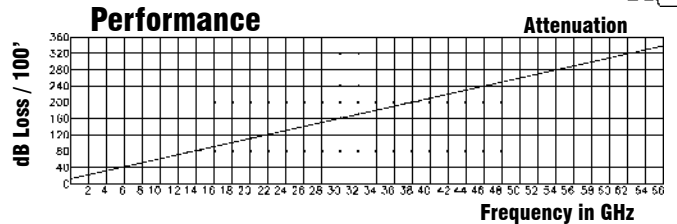

Model No.	Length	1-24	25-49	50-99	100 +
PE36678-6	6"	\$130.50	\$121.37	\$112.23	\$104.40
PE36678-12	12"	133.80	124.43	115.07	107.04
PE36678-18	18"	137.20	127.60	117.99	109.76
PE36678-24	24"	140.60	130.76	120.92	112.48
PE36678-30	30"	143.95	133.87	123.80	115.16
PE36678-36	36"	147.30	136.99	126.68	117.84
PE36678-48	48"	153.95	143.17	132.40	123.16
PE36678-60	60"	160.70	149.45	138.20	128.56
PE36678-72	72"	167.45	155.73	144.01	133.96

Cable Assemblies

## SEMI-RIGID & RE-SHAPEABLE CABLE ASSEMBLIES

# 3.5mm MALE TO 3.5mm MALE



### 50 OHM, RG402/U (.141" BARE COPPER)

Model No.	Length	1-24	25-49	50-99	100 +
PE34570-12	12"	\$110.25	\$102.53	\$94.82	\$88.20
PE34570-24	24"	116.15	108.02	99.89	92.92
PE34570-36	36"	119.75	111.37	102.99	95.80
PE34570-48	48"	121.15	112.67	104.19	96.92
PE34570-60	60"	125.90	117.09	108.27	100.72
PE34570-XX	Any	Same-Day Shipment / Call for Pricing			

### 50 OHM, PE-SR402AL (.141" TINNED ALUMINUM)

Model No.	Length	1-24	25-49	50-99	100 +
PE34572-12	12"	\$113.90	\$105.93	\$97.95	\$91.12
PE34572-24	24"	117.50	109.28	101.05	94.00
PE34572-36	36"	121.15	112.67	104.19	96.92
PE34572-48	48"	124.75	116.02	107.29	99.80
PE34572-60	60"	128.30	119.32	110.34	102.64
PE34572-XX	Any	Same-Day Shipment / Call for Pricing			

### 50 OHM, RG405/U (.085" BARE COPPER)

Model No.	Length	1-24	25-49	50-99	100 +
PE34574-12	12"	\$112.65	\$104.76	\$96.88	\$90.12
PE34574-24	24"	116.25	108.11	99.98	93.00
PE34574-36	36"	119.85	111.46	103.07	95.88
PE34574-48	48"	123.60	114.95	106.30	98.88
PE34574-60	60"	127.20	118.30	109.39	101.76
PE34574-XX	Any	Same-Day Shipment / Call for Pricing			

### 50 OHM, PE-SR405AL (.085" TINNED ALUMINUM)

Model No.	Length	1-24	25-49	50-99	100 +
PE34576-12	12"	\$116.25	\$108.11	\$99.98	\$93.00
PE34576-24	24"	119.85	111.46	103.07	95.88
PE34576-36	36"	123.60	114.95	106.30	98.88
PE34576-48	48"	127.20	118.30	109.39	101.76
PE34576-60	60"	130.80	121.64	112.49	104.64
PE34576-XX	Any	Same-Day Shipment / Call for Pricing			

# 3.5mm MALE TO 3.5mm FEMALE



### 50 OHM, RG402/U (.141" BARE COPPER)

Model No.	Length	1-24	25-49	50-99	100+
PE34578-12	12"	\$116.25	\$108.11	\$99.98	\$93.00
PE34578-24	24"	119.85	111.46	103.07	95.88
PE34578-36	36"	123.60	114.95	106.30	98.88
PE34578-48	48"	127.20	118.30	109.39	101.76
PE34578-60	60"	130.80	121.64	112.49	104.64
PE34578-XX	Any	Same-Day Shipment / Call for Pricing			

### 50 OHM, PE-SR402AL (.141" TINNED ALUMINUM)

Model No.	Length	1-24	25-49	50-99	100+
PE34580-12	12"	\$119.85	\$111.46	\$103.07	\$95.88
PE34580-24	24"	123.60	114.95	106.30	98.88
PE34580-36	36"	127.20	118.30	109.39	101.76
PE34580-48	48"	130.80	121.64	112.49	104.64
PE34580-60	60"	134.45	125.04	115.63	107.56
PE34580-XX	Any	Same-Day Shipment / Call for Pricing			

### 50 OHM, RG405/U (.085" BARE COPPER)

Model No.	Length	1-24	25-49	50-99	100 +
PE34582-12	12"	\$119.85	\$111.46	\$103.07	\$95.88
PE34582-24	24"	123.60	114.95	106.30	98.88
PE34582-36	36"	127.20	118.30	109.39	101.76
PE34582-48	48"	130.80	121.64	112.49	104.64
PE34582-60	60"	134.45	125.04	115.63	107.56
PE34582-XX	Any	Same-Day Shipment / Call for Pricing			

### 50 OHM, PE-SR405AL (.085" TINNED ALUMINUM)

Model No.	Length	1-24	25-49	50-99	100 +
PE34584-12	12"	\$123.60	\$114.95	\$106.30	\$98.88
PE34584-24	24"	127.20	118.30	109.39	101.76
PE34584-36	36"	130.80	121.64	112.49	104.64
PE34584-48	48"	134.45	125.04	115.63	107.56
PE34584-60	60"	138.00	128.34	118.68	110.40
PE34584-XX	Any	Same-Day Shipment / Call for Pricing			

# 3.5mm MALE TO 3.5mm FEMALE BULKHEAD



USE MOUNTING HOLE B02 ON PAGE 266

### 50 OHM, RG402/U (.141" BARE COPPER)

Model No.	Length	1-24	25-49	50-99	100 +
PE34586-12	12"	\$128.30	\$119.32	\$110.34	\$102.64
PE34586-24	24"	131.95	122.71	113.48	105.56
PE34586-36	36"	135.55	126.06	116.57	108.44
PE34586-48	48"	139.20	129.46	119.71	111.36
PE34586-60	60"	142.85	132.85	122.85	114.28
PE34586-XX	Any	Same-Day Shipment / Call for Pricing			

### 50 OHM, PE-SR402AL (.141" TINNED ALUMINUM)

Model No.	Length	1-24	25-49	50-99	100 +
PE34588-12	12"	\$131.95	\$122.71	\$113.48	\$105.56
PE34588-24	24"	135.55	126.06	116.57	108.44
PE34588-36	36"	139.20	129.46	119.71	111.36
PE34588-48	48"	142.85	132.85	122.85	114.28
PE34588-60	60"	146.45	136.20	125.95	117.16
PE34588-XX	Any	Same-Day Shipment / Call for Pricing			

### 50 OHM, RG405/U (.085" BARE COPPER)

Model No.	Length	1-24	25-49	50-99	100 +
PE34590-12	12"	\$130.80	\$121.64	\$112.49	\$104.64
PE34590-24	24"	134.45	125.04	115.63	107.56
PE34590-36	36"	138.00	128.34	118.68	110.40
PE34590-48	48"	141.70	131.78	121.86	113.36
PE34590-60	60"	145.30	135.13	124.96	116.24
PE34590-XX	Any	Same-Day Shipment / Call for Pricing			

### 50 OHM, PE-SR405AL (.085" TINNED ALUMINUM)

Model No.	Length	1-24	25-49	50-99	100 +
PE34592-12	12"	\$134.45	\$125.04	\$115.63	\$107.56
PE34592-24	24"	138.00	128.34	118.68	110.40
PE34592-36	36"	141.70	131.78	121.86	113.36
PE34592-48	48"	145.30	135.13	124.96	116.24
PE34592-60	60"	148.85	138.43	128.01	119.08
PE34592-XX	Any	Same-Day Shipment / Call for Pricing			

\*\*ROHS COMPLIANT & CUSTOM-LENGTH CABLE ASSEMBLIES MAY BE ORDERED ON OUR WEBSITE.\*\*

# SEMI-RIGID & RE-SHAPEABLE CABLE ASSEMBLIES 2.92mm MALE TO 2.92mm MALE



### 50 OHM, RG402/U (.141" BARE COPPER)

Model No.	Length	1-24	25-49	50-99	100 +
PE34729-12	12"	\$59.65	\$55.47	\$51.30	\$47.72
PE34729-24	24"	63.30	58.87	54.44	50.64
PE34729-36	36"	66.85	62.17	57.49	53.48
PE34729-48	48"	70.50	65.57	60.63	56.40
PE34729-60	60"	74.10	68.91	63.73	59.28
PE34729-XX	Any	Same-Day Shipment / Call for Pricing			

### 50 OHM, PE-SR402AL (.141" TINNED ALUMINUM)

Model No.	Length	1-24	25-49	50-99	100 +
PE34731-12	12"	\$62.00	\$57.66	\$53.32	\$49.60
PE34731-24	24"	65.70	61.10	56.50	52.56
PE34731-36	36"	69.30	64.45	59.60	55.44
PE34731-48	48"	72.90	67.80	62.69	58.32
PE34731-60	60"	76.55	71.19	65.83	61.24
PE34731-XX	Any	Same-Day Shipment / Call for Pricing			

### 50 OHM, PE-SR402FL (.141" RE-SHAPEABLE)

Model No.	Length	1-24	25-49	50-99	100 +
PE34733-12	12"	\$62.00	\$57.66	\$53.32	\$49.60
PE34733-24	24"	65.70	61.10	56.50	52.56
PE34733-36	36"	69.30	64.45	59.60	55.44
PE34733-48	48"	72.90	67.80	62.69	58.32
PE34733-60	60"	76.55	71.19	65.83	61.24
PE34733-XX	Any	Same-Day Shipment / Call for Pricing			

### 50 OHM, RG405/U (.085" BARE COPPER)

Model No.	Length	1-24	25-49	50-99	100 +
PE34735-12	12"	\$62.00	\$57.66	\$53.32	\$49.60
PE34735-24	24"	65.70	61.10	56.50	52.56
PE34735-36	36"	69.30	64.45	59.60	55.44
PE34735-48	48"	72.90	67.80	62.69	58.32
PE34735-60	60"	76.55	71.19	65.83	61.24
PE34735-XX	Any	Same-Day Shipment / Call for Pricing			

### 50 OHM, PE-SR405FL (.085" RE-SHAPEABLE)

Model No.	Length	1-24	25-49	50-99	100 +
PE34737-12	12"	\$64.50	\$59.99	\$55.47	\$51.60
PE34737-24	24"	68.10	63.33	58.57	54.48
PE34737-36	36"	71.70	66.68	61.66	57.36
PE34737-48	48"	75.40	70.12	64.84	60.32
PE34737-60	60"	78.95	73.42	67.90	63.16
PE34737-XX	Any	Same-Day Shipment / Call for Pricing			

### 50 OHM, PE-118SR (.118" BARE COPPER)

Model No.	Length	1-24	25-49	50-99	100 +
PE34739-12	12"	\$78.35	\$72.87	\$67.38	\$62.68
PE34739-24	24"	90.40	84.07	77.74	72.32
PE34739-36	36"	102.50	95.33	88.15	82.00
PE34739-48	48"	114.45	106.44	98.43	91.56
PE34739-60	60"	126.55	117.69	108.83	101.24
PE34739-XX	Any	Same-Day Shipment / Call for Pricing			

# SEMI-RIGID & RE-SHAPEABLE CABLE ASSEMBLIES 2.92mm MALE TO 2.92mm FEMALE BULKHEAD



USE MOUNTING HOLE B02 ON PAGE 266

### 50 OHM, RG402/U (.141" BARE COPPER)

Model No.	Length	1-24	25-49	50-99	100 +
PE34741-12	12"	\$74.10	\$68.91	\$63.73	\$59.28
PE34741-24	24"	77.70	72.26	66.82	62.16
PE34741-36	36"	81.35	75.66	69.96	65.08
PE34741-48	48"	85.00	79.05	73.10	68.00
PE34741-60	60"	88.60	82.40	76.20	70.88
PE34741-XX	Any	Same-Day Shipment / Call for Pricing			

### 50 OHM, PE-SR402AL (.141" TINNED ALUMINUM)

Model No.	Length	1-24	25-49	50-99	100 +
PE34743-12	12"	\$76.55	\$71.19	\$65.83	\$61.24
PE34743-24	24"	80.15	74.54	68.93	64.12
PE34743-36	36"	83.75	77.89	72.03	67.00
PE34743-48	48"	87.35	81.24	75.12	69.88
PE34743-60	60"	91.00	84.63	78.26	72.80
PE34743-XX	Any	Same-Day Shipment / Call for Pricing			

### 50 OHM, PE-SR402FL (.141" RE-SHAPEABLE)

Model No.	Length	1-24	25-49	50-99	100 +
PE34745-12	12"	\$76.55	\$71.19	\$65.83	\$61.24
PE34745-24	24"	80.15	74.54	68.93	64.12
PE34745-36	36"	83.75	77.89	72.03	67.00
PE34745-48	48"	87.35	81.24	75.12	69.88
PE34745-60	60"	91.00	84.63	78.26	72.80
PE34745-XX	Any	Same-Day Shipment / Call for Pricing			

### 50 OHM, RG405/U (.085" BARE COPPER)

Model No.	Length	1-24	25-49	50-99	100 +
PE34747-12	12"	\$76.55	\$71.19	\$65.83	\$61.24
PE34747-24	24"	80.15	74.54	68.93	64.12
PE34747-36	36"	83.75	77.89	72.03	67.00
PE34747-48	48"	87.35	81.24	75.12	69.88
PE34747-60	60"	91.00	84.63	78.26	72.80
PE34747-XX	Any	Same-Day Shipment / Call for Pricing			

### 50 OHM, PE-SR405FL (.085" RE-SHAPEABLE)

Model No.	Length	1-24	25-49	50-99	100 +
PE34749-12	12"	\$78.95	\$73.42	\$67.90	\$63.16
PE34749-24	24"	82.55	76.77	70.99	66.04
PE34749-36	36"	86.20	80.17	74.13	68.96
PE34749-48	48"	89.75	83.47	77.19	71.80
PE34749-60	60"	93.40	86.86	80.32	74.72
PE34749-XX	Any	Same-Day Shipment / Call for Pricing			

### 50 OHM, PE-118SR (.118" BARE COPPER)

Model No.	Length	1-24	25-49	50-99	100 +
PE34751-12	12"	\$92.75	\$86.26	\$79.77	\$74.20
PE34751-24	24"	104.85	97.51	90.17	83.88
PE34751-36	36"	116.90	108.72	100.53	93.52
PE34751-48	48"	129.05	120.02	110.98	103.24
PE34751-60	60"	141.05	131.18	121.30	112.84
PE34751-XX	Any	Same-Day Shipment / Call for Pricing			

\*\*ROHS COMPLIANT & CUSTOM-LENGTH CABLE ASSEMBLIES MAY BE ORDERED ON OUR WEBSITE.\*\*



## SEMI-RIGID & RE-SHAPEABLE 2.4mm MALE TO 2.4mm MALE



### 50 OHM, RG405/U (.085" BARE COPPER)

Model No.	Length	1-24	25-49	50-99	100 +
PE35639-12	12"	\$69.30	\$64.45	\$59.60	\$55.44
PE35639-24	24"	72.90	67.80	62.69	58.32
PE35639-36	36"	76.55	71.19	65.83	61.24
PE35639-48	48"	80.15	74.54	68.93	64.12
PE35639-60	60"	83.75	77.89	72.03	67.00
PE35639-XX	Any	Same-Day Shipment / Call for Pricing			

### 50 OHM, PE-SR405AL (.085" TINNED ALUMINUM)

Model No.	Length	1-24	25-49	50-99	100 +
PE35672-12	12"	\$71.70	\$66.68	\$61.66	\$57.36
PE35672-24	24"	75.40	70.12	64.84	60.32
PE35672-36	36"	78.95	73.42	67.90	63.16
PE35672-48	48"	82.55	76.77	70.99	66.04
PE35672-60	60"	86.20	80.17	74.13	68.96
PE35672-XX	Any	Same-Day Shipment / Call for Pricing			

### 50 OHM, PE-SR405FL (.085" RE-SHAPEABLE)

Model No.	Length	1-24	25-49	50-99	100 +
PE35652-12	12"	\$71.70	\$66.68	\$61.66	\$57.36
PE35652-24	24"	75.40	70.12	64.84	60.32
PE35652-36	36"	78.95	73.42	67.90	63.16
PE35652-48	48"	82.55	76.77	70.99	66.04
PE35652-60	60"	86.20	80.17	74.13	68.96
PE35652-XX	Any	Same-Day Shipment / Call for Pricing			

## SEMI-RIGID & RE-SHAPEABLE 2.4mm MALE TO 2.92mm MALE



### 50 OHM, RG405/U (.085" BARE COPPER)

Model No.	Length	1-24	25-49	50-99	100 +
PE35660-12	12"	\$65.70	\$61.10	\$56.50	\$52.56
PE35660-24	24"	69.30	64.45	59.60	55.44
PE35660-36	36"	72.90	67.80	62.69	58.32
PE35660-48	48"	76.55	71.19	65.83	61.24
PE35660-60	60"	80.15	74.54	68.93	64.12
PE35660-XX	Any	Same-Day Shipment / Call for Pricing			

### 50 OHM, PE-SR405AL (.085" TINNED ALUMINUM)

Model No.	Length	1-24	25-49	50-99	100 +
PE35662-12	12"	\$68.10	\$63.33	\$58.57	\$54.48
PE35662-24	24"	71.70	66.68	61.66	57.36
PE35662-36	36"	75.40	70.12	64.84	60.32
PE35662-48	48"	78.95	73.42	67.90	63.16
PE35662-60	60"	82.55	76.77	70.99	66.04
PE35662-XX	Any	Same-Day Shipment / Call for Pricing			

### 50 OHM, PE-SR405FL (.085" RE-SHAPEABLE)

Model No.	Length	1-24	25-49	50-99	100 +
PE35664-12	12"	\$68.10	\$63.33	\$58.57	\$54.48
PE35664-24	24"	71.70	66.68	61.66	57.36
PE35664-36	36"	75.40	70.12	64.84	60.32
PE35664-48	48"	78.95	73.42	67.90	63.16
PE35664-60	60"	82.55	76.77	70.99	66.04
PE35664-XX	Any	Same-Day Shipment / Call for Pricing			

## SEMI-RIGID & RE-SHAPEABLE 2.4mm MALE TO 2.4mm FEMALE



### 50 OHM, RG405/U (.085" BARE COPPER)

Model No.	Length	1-24	25-49	50-99	100 +
PE35654-12	12"	\$74.10	\$68.91	\$63.73	\$59.28
PE35654-24	24"	77.70	72.26	66.82	62.16
PE35654-36	36"	81.35	75.66	69.96	65.08
PE35654-48	48"	85.00	79.05	73.10	68.00
PE35654-60	60"	88.60	82.40	76.20	70.88
PE35654-XX	Any	Same-Day Shipment / Call for Pricing			

### 50 OHM, PE-SR405AL (.085" TINNED ALUMINUM)

Model No.	Length	1-24	25-49	50-99	100 +
PE35656-12	12"	\$76.55	\$71.19	\$65.83	\$61.24
PE35656-24	24"	80.15	74.54	68.93	64.12
PE35656-36	36"	83.75	77.89	72.03	67.00
PE35656-48	48"	87.35	81.24	75.12	69.88
PE35656-60	60"	91.00	84.63	78.26	72.80
PE35656-XX	Any	Same-Day Shipment / Call for Pricing			

### 50 OHM, PE-SR405FL (.085" RE-SHAPEABLE)

Model No.	Length	1-24	25-49	50-99	100 +
PE35658-12	12"	\$76.55	\$71.19	\$65.83	\$61.24
PE35658-24	24"	80.15	74.54	68.93	64.12
PE35658-36	36"	83.75	77.89	72.03	67.00
PE35658-48	48"	87.35	81.24	75.12	69.88
PE35658-60	60"	91.00	84.63	78.26	72.80
PE35658-XX	Any	Same-Day Shipment / Call for Pricing			

## SEMI-RIGID & RE-SHAPEABLE 2.4mm MALE TO SMA MALE



### 50 OHM, RG405/U (.085" BARE COPPER)

Model No.	Length	1-24	25-49	50-99	100 +
PE35666-12	12"	\$62.00	\$57.66	\$53.32	\$49.60
PE35666-24	24"	65.70	61.10	56.50	52.56
PE35666-36	36"	69.30	64.45	59.60	55.44
PE35666-48	48"	72.90	67.80	62.69	58.32
PE35666-60	60"	76.55	71.19	65.83	61.24
PE35666-XX	Any	Same-Day Shipment / Call for Pricing			

### 50 OHM, PE-SR405AL (.085" TINNED ALUMINUM)

Model No.	Length	1-24	25-49	50-99	100 +
PE35668-12	12"	\$64.50	\$59.99	\$55.47	\$51.60
PE35668-24	24"	68.10	63.33	58.57	54.48
PE35668-36	36"	71.70	66.68	61.66	57.36
PE35668-48	48"	75.40	70.12	64.84	60.32
PE35668-60	60"	78.95	73.42	67.90	63.16
PE35668-XX	Any	Same-Day Shipment / Call for Pricing			

### 50 OHM, PE-SR405FL (.085" RE-SHAPEABLE)

Model No.	Length	1-24	25-49	50-99	100 +
PE35670-12	12"	\$64.50	\$59.99	\$55.47	\$51.60
PE35670-24	24"	68.10	63.33	58.57	54.48
PE35670-36	36"	71.70	66.68	61.66	57.36
PE35670-48	48"	75.40	70.12	64.84	60.32
PE35670-60	60"	78.95	73.42	67.90	63.16
PE35670-XX	Any	Same-Day Shipment / Call for Pricing			

\*\*ROHS COMPLIANT & CUSTOM-LENGTH CABLE ASSEMBLIES MAY BE ORDERED ON OUR WEBSITE.\*\*

## SEMI-RIGID & RE-SHAPEABLE CABLE ASSEMBLIES 1.85mm MALE TO 1.85mm MALE



### 50 OHM, PE-047SR (.047" BARE COPPER)

Model No.	Length	1-24	25-49	50-99	100 +
PE36519-12	12"	\$242.85	\$225.85	\$208.85	\$194.28
PE36519-24	24"	246.50	229.25	211.99	197.20
PE36519-36	36"	250.10	232.59	215.09	200.08
PE36519-48	48"	253.75	235.99	218.23	203.00
PE36519-60	60"	257.35	239.34	221.32	205.88
PE36519-XX	Any	Same-Day Shipment / Call for Pricing			

### 50 OHM, PE-SR047FL (.047" RE-SHAPEABLE)

Model No.	Length	1-24	25-49	50-99	100 +
PE36521-12	12"	\$242.85	\$225.85	\$208.85	\$194.28
PE36521-24	24"	246.50	229.25	211.99	197.20
PE36521-36	36"	250.10	232.59	215.09	200.08
PE36521-48	48"	253.75	235.99	218.23	203.00
PE36521-60	60"	257.35	239.34	221.32	205.88
PE36521-XX	Any	Same-Day Shipment / Call for Pricing			

### 50 OHM, RG405/U (.085" BARE COPPER)

Model No.	Length	1-24	25-49	50-99	100 +
PE36523-12	12"	\$230.85	\$214.69	\$198.53	\$184.68
PE36523-24	24"	234.45	218.04	201.63	187.56
PE36523-36	36"	238.05	221.39	204.72	190.44
PE36523-48	48"	241.65	224.73	207.82	193.32
PE36523-60	60"	245.25	228.08	210.92	196.20
PE36523-XX	Any	Same-Day Shipment / Call for Pricing			

### 50 OHM, PE-SR405FL (.085" RE-SHAPEABLE)

Model No.	Length	1-24	25-49	50-99	100 +
PE36525-12	12"	\$230.85	\$214.69	\$198.53	\$184.68
PE36525-24	24"	234.45	218.04	201.63	187.56
PE36525-36	36"	238.05	221.39	204.72	190.44
PE36525-48	48"	241.65	224.73	207.82	193.32
PE36525-60	60"	245.25	228.08	210.92	196.20
PE36525-XX	Any	Same-Day Shipment / Call for Pricing			

**Cable Assemblies**

## SEMI-RIGID & RE-SHAPEABLE CABLE ASSEMBLIES 1.85mm MALE TO 2.4mm MALE



### 50 OHM, RG405/U (.085" BARE COPPER)

Model No.	Length	1-24	25-49	50-99	100 +
PE36527-12	12"	\$182.55	\$169.77	\$156.99	\$146.04
PE36527-24	24"	186.20	173.17	160.13	148.96
PE36527-36	36"	189.80	176.51	163.23	151.84
PE36527-48	48"	193.40	179.86	166.32	154.72
PE36527-60	60"	197.05	183.26	169.46	157.64
PE36527-XX	Any	Same-Day Shipment / Call for Pricing			

### 50 OHM, PE-SR405FL (.085" RE-SHAPEABLE)

Model No.	Length	1-24	25-49	50-99	100 +
PE36529-12	12"	\$182.55	\$169.77	\$156.99	\$146.04
PE36529-24	24"	186.20	173.17	160.13	148.96
PE36529-36	36"	189.80	176.51	163.23	151.84
PE36529-48	48"	193.40	179.86	166.32	154.72
PE36529-60	60"	197.05	183.26	169.46	157.64
PE36529-XX	Any	Same-Day Shipment / Call for Pricing			

## SEMI-RIGID & RE-SHAPEABLE CABLE ASSEMBLIES 1.85mm MALE TO 2.92mm MALE



### 50 OHM, RG405/U (.085" BARE COPPER)

Model No.	Length	1-24	25-49	50-99	100 +
PE36531-12	12"	\$182.55	\$169.77	\$156.99	\$146.04
PE36531-24	24"	186.20	173.17	160.13	148.96
PE36531-36	36"	189.80	176.51	163.23	151.84
PE36531-48	48"	193.40	179.86	166.32	154.72
PE36531-60	60"	197.05	183.26	169.46	157.64
PE36531-XX	Any	Same-Day Shipment / Call for Pricing			

### 50 OHM, PE-SR405FL (.085" RE-SHAPEABLE)

Model No.	Length	1-24	25-49	50-99	100 +
PE36533-12	12"	\$182.55	\$169.77	\$156.99	\$146.04
PE36533-24	24"	186.20	173.17	160.13	148.96
PE36533-36	36"	189.80	176.51	163.23	151.84
PE36533-48	48"	193.40	179.86	166.32	154.72
PE36533-60	60"	197.05	183.26	169.46	157.64
PE36533-XX	Any	Same-Day Shipment / Call for Pricing			

## SEMI-RIGID & RE-SHAPEABLE CABLE ASSEMBLIES 1.85mm MALE TO 3.5mm MALE



### 50 OHM, RG405/U (.085" BARE COPPER)

Model No.	Length	1-24	25-49	50-99	100 +
PE36535-12	12"	\$218.75	\$203.44	\$188.13	\$175.00
PE36535-24	24"	222.35	206.79	191.22	177.88
PE36535-36	36"	225.95	210.13	194.32	180.76
PE36535-48	48"	229.60	213.53	197.46	183.68
PE36535-60	60"	233.20	216.88	200.55	186.56
PE36535-XX	Any	Same-Day Shipment / Call for Pricing			

### 50 OHM, PE-SR405FL (.085" RE-SHAPEABLE)

Model No.	Length	1-24	25-49	50-99	100 +
PE36537-12	12"	\$218.75	\$203.44	\$188.13	\$175.00
PE36537-24	24"	222.35	206.79	191.22	177.88
PE36537-36	36"	225.95	210.13	194.32	180.76
PE36537-48	48"	229.60	213.53	197.46	183.68
PE36537-60	60"	233.20	216.88	200.55	186.56
PE36537-XX	Any	Same-Day Shipment / Call for Pricing			

## SEMI-RIGID & RE-SHAPEABLE CABLE ASSEMBLIES 1.85mm MALE TO SMA MALE



### 50 OHM, RG405/U (.085" BARE COPPER)

Model No.	Length	1-24	25-49	50-99	100 +
PE36539-12	12"	\$158.50	\$147.41	\$136.31	\$126.80
PE36539-24	24"	162.20	150.85	139.49	129.76
PE36539-36	36"	165.75	154.15	142.55	132.60
PE36539-48	48"	169.35	157.50	145.64	135.48
PE36539-60	60"	173.00	160.89	148.78	138.40
PE36539-XX	Any	Same-Day Shipment / Call for Pricing			

### 50 OHM, PE-SR405FL (.085" RE-SHAPEABLE)

Model No.	Length	1-24	25-49	50-99	100 +
PE36541-12	12"	\$158.50	\$147.41	\$136.31	\$126.80
PE36541-24	24"	162.20	150.85	139.49	129.76
PE36541-36	36"	165.75	154.15	142.55	132.60
PE36541-48	48"	169.35	157.50	145.64	135.48
PE36541-60	60"	173.00	160.89	148.78	138.40
PE36541-XX	Any	Same-Day Shipment / Call for Pricing			

\*\*ROHS COMPLIANT & CUSTOM-LENGTH CABLE ASSEMBLIES MAY BE ORDERED ON OUR WEBSITE.\*\*

# BNC MALE TO BNC MALE

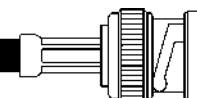
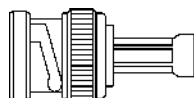

ALL CABLE ASSEMBLIES ON THIS PAGE UTILIZE STANDARD 50 OHM INTERFACE CONNECTORS

## 52 OHM, RG8A/U COAX

Model No.	Length	1-24	25-49	50-99	100 +
PE3807-12	12"	\$34.50	\$32.09	\$29.67	\$27.60
PE3807-24	24"	35.45	32.97	30.49	28.36
PE3807-36	36"	36.50	33.95	31.39	29.20
PE3807-48	48"	37.50	34.88	32.25	30.00
PE3807-60	60"	38.50	35.81	33.11	30.80
PE3807-XX	Any	Same-Day Shipment / Call for Pricing			

## 53.5 OHM, RG55B/U COAX, DOUBLE SHIELDED

Model No.	Length	1-24	25-49	50-99	100 +
PE3583-12	12"	\$21.20	\$19.72	\$18.23	\$16.96
PE3583-24	24"	21.95	20.41	18.88	17.56
PE3583-36	36"	22.70	21.11	19.52	18.16
PE3583-48	48"	23.35	21.72	20.08	18.68
PE3583-60	60"	24.05	22.37	20.68	19.24
PE3583-XX	Any	Same-Day Shipment / Call for Pricing			

## 50 OHM, RG58C/U COAX

Model No.	Length	1-24	25-49	50-99	100 +
PE3067-12	12"	\$15.90	\$14.79	\$13.67	\$12.72
PE3067-24	24"	16.30	15.16	14.02	13.04
PE3067-36	36"	16.75	15.58	14.41	13.40
PE3067-48	48"	17.20	16.00	14.79	13.76
PE3067-60	60"	17.55	16.32	15.09	14.04
PE3067-XX	Any	Same-Day Shipment / Call for Pricing			

## 75 OHM, RG59B/U COAX

Model No.	Length	1-24	25-49	50-99	100 +
PE3075-12	12"	\$17.25	\$16.04	\$14.84	\$13.80
PE3075-24	24"	17.65	16.41	15.18	14.12
PE3075-36	36"	18.00	16.74	15.48	14.40
PE3075-48	48"	18.45	17.16	15.87	14.76
PE3075-60	60"	18.80	17.48	16.17	15.04
PE3075-XX	Any	Same-Day Shipment / Call for Pricing			

## 93 OHM, RG62A/U COAX

Model No.	Length	1-24	25-49	50-99	100 +
PE3081-12	12"	\$19.90	\$18.51	\$17.11	\$15.92
PE3081-24	24"	20.30	18.88	17.46	16.24
PE3081-36	36"	20.70	19.25	17.80	16.56
PE3081-48	48"	21.10	19.62	18.15	16.88
PE3081-60	60"	21.50	20.00	18.49	17.20
PE3081-XX	Any	Same-Day Shipment / Call for Pricing			

## 50 OHM, RG142B/U COAX, DOUBLE SHIELDED

Model No.	Length	1-24	25-49	50-99	100 +
PE3495-12	12"	\$21.20	\$19.72	\$18.23	\$16.96
PE3495-24	24"	23.85	22.18	20.51	19.08
PE3495-36	36"	26.50	24.65	22.79	21.20
PE3495-48	48"	29.15	27.11	25.07	23.32
PE3495-60	60"	31.80	29.57	27.35	25.44
PE3495-XX	Any	Same-Day Shipment / Call for Pricing			

## 75 OHM, RG179B/U COAX

Model No.	Length	1-24	25-49	50-99	100 +
PE3705-12	12"	\$21.20	\$19.72	\$18.23	\$16.96
PE3705-24	24"	22.20	20.65	19.09	17.76
PE3705-36	36"	23.10	21.48	19.87	18.48
PE3705-48	48"	24.05	22.37	20.68	19.24
PE3705-60	60"	25.10	23.34	21.59	20.08
PE3705-XX	Any	Same-Day Shipment / Call for Pricing			

## 50 OHM, RG174A/U COAX

Model No.	Length	1-24	25-49	50-99	100 +
PE3538-12	12"	\$21.20	\$19.72	\$18.23	\$16.96
PE3538-24	24"	21.45	19.95	18.45	17.16
PE3538-36	36"	21.75	20.23	18.71	17.40
PE3538-48	48"	22.05	20.51	18.96	17.64
PE3538-60	60"	22.30	20.74	19.18	17.84
PE3538-XX	Any	Same-Day Shipment / Call for Pricing			

## 50 OHM, RG188A/U COAX

Model No.	Length	1-24	25-49	50-99	100 +
PE3470-12	12"	\$21.20	\$19.72	\$18.23	\$16.96
PE3470-24	24"	22.20	20.65	19.09	17.76
PE3470-36	36"	23.10	21.48	19.87	18.48
PE3470-48	48"	24.05	22.37	20.68	19.24
PE3470-60	60"	25.10	23.34	21.59	20.08
PE3470-XX	Any	Same-Day Shipment / Call for Pricing			

## 50 OHM, RG213/U COAX

Model No.	Length	1-24	25-49	50-99	100 +
PE3749-12	12"	\$34.50	\$32.09	\$29.67	\$27.60
PE3749-24	24"	35.45	32.97	30.49	28.36
PE3749-36	36"	36.50	33.95	31.39	29.20
PE3749-48	48"	37.50	34.88	32.25	30.00
PE3749-60	60"	38.50	35.81	33.11	30.80
PE3749-XX	Any	Same-Day Shipment / Call for Pricing			

## 50 OHM, RG214/U COAX, DOUBLE SHIELDED

Model No.	Length	1-24	25-49	50-99	100 +
PE3906-12	12"	\$38.40	\$35.71	\$33.02	\$30.72
PE3906-24	24"	42.10	39.15	36.21	33.68
PE3906-36	36"	45.65	42.45	39.26	36.52
PE3906-48	48"	49.25	45.80	42.36	39.40
PE3906-60	60"	52.90	49.20	45.49	42.32
PE3906-XX	Any	Same-Day Shipment / Call for Pricing			

## 50 OHM, RG223/U COAX, DOUBLE SHIELDED

Model No.	Length	1-24	25-49	50-99	100 +
PE3087-12	12"	\$21.20	\$19.72	\$18.23	\$16.96
PE3087-24	24"	22.50	20.93	19.35	18.00
PE3087-36	36"	23.85	22.18	20.51	19.08
PE3087-48	48"	25.20	23.44	21.67	20.16
PE3087-60	60"	26.50	24.65	22.79	21.20
PE3087-XX	Any	Same-Day Shipment / Call for Pricing			

## 50 OHM, RG316/U COAX

Model No.	Length	1-24	25-49	50-99	100 +
PE3584-12	12"	\$21.20	\$19.72	\$18.23	\$16.96
PE3584-24	24"	22.20	20.65	19.09	17.76
PE3584-36	36"	23.10	21.48	19.87	18.48
PE3584-48	48"	24.05	22.37	20.68	19.24
PE3584-60	60"	25.10	23.34	21.59	20.08
PE3584-XX	Any	Same-Day Shipment / Call for Pricing			

## 50 OHM, RG400/U COAX, DOUBLE SHIELDED

Model No.	Length	1-24	25-49	50-99	100 +
PE3582-12	12"	\$21.20	\$19.72	\$18.23	\$16.96
PE3582-24	24"	23.85	22.18	20.51	19.08
PE3582-36	36"	26.50	24.65	22.79	21.20
PE3582-48	48"	29.15	27.11	25.07	23.32
PE3582-60	60"	31.80	29.57	27.35	25.44
PE3582-XX	Any	Same-Day Shipment / Call for Pricing			

\*\*ROHS COMPLIANT & CUSTOM-LENGTH CABLE ASSEMBLIES MAY BE ORDERED ON OUR WEBSITE.\*\*

# SEMI-RIGID & RE-SHAPEABLE CABLE ASSEMBLIES

## BNC MALE TO BNC MALE

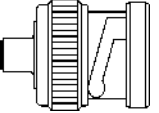
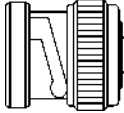

### 50 OHM, RG402/U (.141" BARE COPPER)

Model No.	Length	1-24	25-49	50-99	100 +
PE3445-12	12"	\$45.55	\$42.36	\$39.17	\$36.44
PE3445-24	24"	49.15	45.71	42.27	39.32
PE3445-36	36"	52.80	49.10	45.41	42.24
PE3445-48	48"	56.35	52.41	48.46	45.08
PE3445-60	60"	60.00	55.80	51.60	48.00
PE3445-XX	Any	Same-Day Shipment / Call for Pricing			

### 50 OHM, PE-SR402AL (.141" TINNED ALUMINUM)

Model No.	Length	1-24	25-49	50-99	100 +
PE34164-12	12"	\$50.85	\$47.29	\$43.73	\$40.68
PE34164-24	24"	54.45	50.64	46.83	43.56
PE34164-36	36"	58.10	54.03	49.97	46.48
PE34164-48	48"	61.65	57.33	53.02	49.32
PE34164-60	60"	65.30	60.73	56.16	52.24
PE34164-XX	Any	Same-Day Shipment / Call for Pricing			

### 50 OHM, PE-SR402FL (.141" RE-SHAPEABLE)

Model No.	Length	1-24	25-49	50-99	100 +
PE3462-12	12"	\$50.85	\$47.29	\$43.73	\$40.68
PE3462-24	24"	54.45	50.64	46.83	43.56
PE3462-36	36"	58.10	54.03	49.97	46.48
PE3462-48	48"	61.65	57.33	53.02	49.32
PE3462-60	60"	65.30	60.73	56.16	52.24
PE3462-XX	Any	Same-Day Shipment / Call for Pricing			

### 50 OHM, PE-047SR (.047" BARE COPPER)

Model No.	Length	1-24	25-49	50-99	100 +
PE34177-12	12"	\$54.85	\$51.01	\$47.17	\$43.88
PE34177-24	24"	58.45	54.36	50.27	46.76
PE34177-36	36"	62.00	57.66	53.32	49.60
PE34177-48	48"	65.70	61.10	56.50	52.56
PE34177-60	60"	69.30	64.45	59.60	55.44
PE34177-XX	Any	Same-Day Shipment / Call for Pricing			

### 50 OHM, PE-SR047AL (.047" TINNED ALUMINUM)

Model No.	Length	1-24	25-49	50-99	100 +
PE34168-12	12"	\$61.45	\$57.15	\$52.85	\$49.16
PE34168-24	24"	65.10	60.54	55.99	52.08
PE34168-36	36"	68.70	63.89	59.08	54.96
PE34168-48	48"	72.25	67.19	62.14	57.80
PE34168-60	60"	75.90	70.59	65.27	60.72
PE34168-XX	Any	Same-Day Shipment / Call for Pricing			

### 50 OHM, PE-SR047FL (.047" RE-SHAPEABLE)

Model No.	Length	1-24	25-49	50-99	100 +
PE34173-12	12"	\$61.45	\$57.15	\$52.85	\$49.16
PE34173-24	24"	65.10	60.54	55.99	52.08
PE34173-36	36"	68.70	63.89	59.08	54.96
PE34173-48	48"	72.25	67.19	62.14	57.80
PE34173-60	60"	75.90	70.59	65.27	60.72
PE34173-XX	Any	Same-Day Shipment / Call for Pricing			

### 50 OHM, RG405/U (.085" BARE COPPER)

Model No.	Length	1-24	25-49	50-99	100 +
PE3678-12	12"	\$46.90	\$43.62	\$40.33	\$37.52
PE3678-24	24"	50.50	46.97	43.43	40.40
PE3678-36	36"	54.10	50.31	46.53	43.28
PE3678-48	48"	57.75	53.71	49.67	46.20
PE3678-60	60"	61.35	57.06	52.76	49.08
PE3678-XX	Any	Same-Day Shipment / Call for Pricing			

### 50 OHM, PE-SR405AL (.085" TINNED ALUMINUM)

Model No.	Length	1-24	25-49	50-99	100 +
PE34162-12	12"	\$52.20	\$48.55	\$44.89	\$41.76
PE34162-24	24"	55.80	51.89	47.99	44.64
PE34162-36	36"	59.40	55.24	51.08	47.52
PE34162-48	48"	63.05	58.64	54.22	50.44
PE34162-60	60"	66.65	61.98	57.32	53.32
PE34162-XX	Any	Same-Day Shipment / Call for Pricing			

### 50 OHM, PE-SR405FL (.085" RE-SHAPEABLE)

Model No.	Length	1-24	25-49	50-99	100 +
PE3776-12	12"	\$52.20	\$48.55	\$44.89	\$41.76
PE3776-24	24"	55.80	51.89	47.99	44.64
PE3776-36	36"	59.40	55.24	51.08	47.52
PE3776-48	48"	63.05	58.64	54.22	50.44
PE3776-60	60"	66.65	61.98	57.32	53.32
PE3776-XX	Any	Same-Day Shipment / Call for Pricing			

### 50 OHM, RG401/U (.250" BARE COPPER)

Model No.	Length	1-24	25-49	50-99	100 +
PE34170-12	12"	\$76.30	\$70.96	\$65.62	\$61.04
PE34170-24	24"	89.10	82.86	76.63	71.28
PE34170-36	36"	101.95	94.81	87.68	81.56
PE34170-48	48"	114.75	106.72	98.69	91.80
PE34170-60	60"	127.55	118.62	109.69	102.04
PE34170-XX	Any	Same-Day Shipment / Call for Pricing			

### 50 OHM, PE-SR401AL (.250" TINNED ALUMINUM)

Model No.	Length	1-24	25-49	50-99	100 +
PE34175-12	12"	\$81.05	\$75.38	\$69.70	\$64.84
PE34175-24	24"	88.65	82.44	76.24	70.92
PE34175-36	36"	96.35	89.61	82.86	77.08
PE34175-48	48"	104.00	96.72	89.44	83.20
PE34175-60	60"	111.60	103.79	95.98	89.28
PE34175-XX	Any	Same-Day Shipment / Call for Pricing			

### 50 OHM, PE-SR401FL (.250" RE-SHAPEABLE)

Model No.	Length	1-24	25-49	50-99	100 +
PE34166-12	12"	\$81.05	\$75.38	\$69.70	\$64.84
PE34166-24	24"	88.65	82.44	76.24	70.92
PE34166-36	36"	96.35	89.61	82.86	77.08
PE34166-48	48"	104.00	96.72	89.44	83.20
PE34166-60	60"	111.60	103.79	95.98	89.28
PE34166-XX	Any	Same-Day Shipment / Call for Pricing			

\*\*ROHS COMPLIANT & CUSTOM-LENGTH CABLE ASSEMBLIES MAY BE ORDERED ON OUR WEBSITE.\*\*

# BNC MALE TO BNC MALE RIGHT ANGLE



ALL CABLE ASSEMBLIES ON THIS PAGE UTILIZE STANDARD 50 OHM INTERFACE CONNECTORS

## 52 OHM, RG8A/U COAX

Model No.	Length	1-24	25-49	50-99	100 +
PE3327-12	12"	\$43.75	\$40.69	\$37.63	\$35.00
PE3327-24	24"	44.80	41.66	38.53	35.84
PE3327-36	36"	45.75	42.55	39.35	36.60
PE3327-48	48"	46.80	43.52	40.25	37.44
PE3327-60	60"	47.85	44.50	41.15	38.28
PE3327-XX	Any	Same-Day Shipment / Call for Pricing			

## 50 OHM, RG58C/U COAX

Model No.	Length	1-24	25-49	50-99	100 +
PE3020-12	12"	\$25.20	\$23.44	\$21.67	\$20.16
PE3020-24	24"	25.60	23.81	22.02	20.48
PE3020-36	36"	26.00	24.18	22.36	20.80
PE3020-48	48"	26.40	24.55	22.70	21.12
PE3020-60	60"	26.85	24.97	23.09	21.48
PE3020-XX	Any	Same-Day Shipment / Call for Pricing			

## 75 OHM, RG59B/U COAX

Model No.	Length	1-24	25-49	50-99	100 +
PE3508-12	12"	\$27.85	\$25.90	\$23.95	\$22.28
PE3508-24	24"	28.25	26.27	24.30	22.60
PE3508-36	36"	28.65	26.64	24.64	22.92
PE3508-48	48"	29.05	27.02	24.98	23.24
PE3508-60	60"	29.45	27.39	25.33	23.56
PE3508-XX	Any	Same-Day Shipment / Call for Pricing			

## 50 OHM, RG142B/U COAX, DOUBLE SHIELDED

Model No.	Length	1-24	25-49	50-99	100 +
PE3082-12	12"	\$33.15	\$30.83	\$28.51	\$26.52
PE3082-24	24"	35.80	33.29	30.79	28.64
PE3082-36	36"	38.40	35.71	33.02	30.72
PE3082-48	48"	41.10	38.22	35.35	32.88
PE3082-60	60"	43.75	40.69	37.63	35.00
PE3082-XX	Any	Same-Day Shipment / Call for Pricing			

## 50 OHM, RG174A/U COAX

Model No.	Length	1-24	25-49	50-99	100 +
PE3460-12	12"	\$34.50	\$32.09	\$29.67	\$27.60
PE3460-24	24"	34.75	32.32	29.89	27.80
PE3460-36	36"	35.00	32.55	30.10	28.00
PE3460-48	48"	35.25	32.78	30.32	28.20
PE3460-60	60"	35.55	33.06	30.57	28.44
PE3460-XX	Any	Same-Day Shipment / Call for Pricing			

## 75 OHM, RG179B/U COAX

Model No.	Length	1-24	25-49	50-99	100 +
PE3054-12	12"	\$35.80	\$33.29	\$30.79	\$28.64
PE3054-24	24"	36.75	34.18	31.61	29.40
PE3054-36	36"	37.75	35.11	32.47	30.20
PE3054-48	48"	38.65	35.94	33.24	30.92
PE3054-60	60"	39.70	36.92	34.14	31.76
PE3054-XX	Any	Same-Day Shipment / Call for Pricing			

## 50 OHM, RG188A/U COAX

Model No.	Length	1-24	25-49	50-99	100 +
PE3113-12	12"	\$35.80	\$33.29	\$30.79	\$28.64
PE3113-24	24"	36.75	34.18	31.61	29.40
PE3113-36	36"	37.75	35.11	32.47	30.20
PE3113-48	48"	38.65	35.94	33.24	30.92
PE3113-60	60"	39.70	36.92	34.14	31.76
PE3113-XX	Any	Same-Day Shipment / Call for Pricing			

## 50 OHM, RG188-DS COAX, DOUBLE SHIELDED

Model No.	Length	1-24	25-49	50-99	100 +
PE3330-12	12"	\$45.10	\$41.94	\$38.79	\$36.08
PE3330-24	24"	47.50	44.18	40.85	38.00
PE3330-36	36"	49.95	46.45	42.96	39.96
PE3330-48	48"	52.35	48.69	45.02	41.88
PE3330-60	60"	54.65	50.82	47.00	43.72
PE3330-XX	Any	Same-Day Shipment / Call for Pricing			

## 50 OHM, RG213/U COAX

Model No.	Length	1-24	25-49	50-99	100 +
PE3355-12	12"	\$43.75	\$40.69	\$37.63	\$35.00
PE3355-24	24"	44.80	41.66	38.53	35.84
PE3355-36	36"	45.75	42.55	39.35	36.60
PE3355-48	48"	46.80	43.52	40.25	37.44
PE3355-60	60"	47.85	44.50	41.15	38.28
PE3355-XX	Any	Same-Day Shipment / Call for Pricing			

## 50 OHM, RG214/U COAX, DOUBLE SHIELDED

Model No.	Length	1-24	25-49	50-99	100 +
PE3325-12	12"	\$45.10	\$41.94	\$38.79	\$36.08
PE3325-24	24"	48.70	45.29	41.88	38.96
PE3325-36	36"	52.35	48.69	45.02	41.88
PE3325-48	48"	55.90	51.99	48.07	44.72
PE3325-60	60"	59.55	55.38	51.21	47.64
PE3325-XX	Any	Same-Day Shipment / Call for Pricing			

## 50 OHM, RG223/U COAX, DOUBLE SHIELDED

Model No.	Length	1-24	25-49	50-99	100 +
PE3689-12	12"	\$31.80	\$29.57	\$27.35	\$25.44
PE3689-24	24"	33.15	30.83	28.51	26.52
PE3689-36	36"	34.50	32.09	29.67	27.60
PE3689-48	48"	35.80	33.29	30.79	28.64
PE3689-60	60"	37.15	34.55	31.95	29.72
PE3689-XX	Any	Same-Day Shipment / Call for Pricing			

## 50 OHM, RG316/U COAX

Model No.	Length	1-24	25-49	50-99	100 +
PE3332-12	12"	\$35.80	\$33.29	\$30.79	\$28.64
PE3332-24	24"	36.75	34.18	31.61	29.40
PE3332-36	36"	37.75	35.11	32.47	30.20
PE3332-48	48"	38.65	35.94	33.24	30.92
PE3332-60	60"	39.70	36.92	34.14	31.76
PE3332-XX	Any	Same-Day Shipment / Call for Pricing			

## 50 OHM, RG316-DS COAX, DOUBLE SHIELDED

Model No.	Length	1-24	25-49	50-99	100 +
PE3358-12	12"	\$45.10	\$41.94	\$38.79	\$36.08
PE3358-24	24"	47.50	44.18	40.85	38.00
PE3358-36	36"	49.95	46.45	42.96	39.96
PE3358-48	48"	52.35	48.69	45.02	41.88
PE3358-60	60"	54.65	50.82	47.00	43.72
PE3358-XX	Any	Same-Day Shipment / Call for Pricing			

## 50 OHM, RG400/U COAX, DOUBLE SHIELDED

Model No.	Length	1-24	25-49	50-99	100 +
PE3116-12	12"	\$33.15	\$30.83	\$28.51	\$26.52
PE3116-24	24"	35.80	33.29	30.79	28.64
PE3116-36	36"	38.40	35.71	33.02	30.72
PE3116-48	48"	41.10	38.22	35.35	32.88
PE3116-60	60"	43.75	40.69	37.63	35.00
PE3116-XX	Any	Same-Day Shipment / Call for Pricing			

\*\*ROHS COMPLIANT & CUSTOM-LENGTH CABLE ASSEMBLIES MAY BE ORDERED ON OUR WEBSITE.\*\*

# BNC MALE RIGHT ANGLE TO BNC MALE RIGHT ANGLE

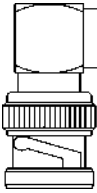

ALL CABLE ASSEMBLIES ON THIS PAGE UTILIZE STANDARD 50 OHM INTERFACE CONNECTORS

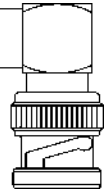

## 52 OHM, RG8A/U COAX

Model No.	Length	1-24	25-49	50-99	100 +
PE3378-12	12"	\$53.00	\$49.29	\$45.58	\$42.40
PE3378-24	24"	54.05	50.27	46.48	43.24
PE3378-36	36"	55.10	51.24	47.39	44.08
PE3378-48	48"	56.05	52.13	48.20	44.84
PE3378-60	60"	57.10	53.10	49.11	45.68
PE3378-XX	Any	Same-Day Shipment / Call for Pricing			

## 50 OHM, RG58C/U COAX

Model No.	Length	1-24	25-49	50-99	100 +
PE3025-12	12"	\$34.50	\$32.09	\$29.67	\$27.60
PE3025-24	24"	34.85	32.41	29.97	27.88
PE3025-36	36"	35.30	32.83	30.36	28.24
PE3025-48	48"	35.70	33.20	30.70	28.56
PE3025-60	60"	36.15	33.62	31.09	28.92
PE3025-XX	Any	Same-Day Shipment / Call for Pricing			

## 75 OHM, RG59B/U COAX

Model No.	Length	1-24	25-49	50-99	100 +
PE3935-12	12"	\$37.15	\$34.55	\$31.95	\$29.72
PE3935-24	24"	37.55	34.92	32.29	30.04
PE3935-36	36"	37.95	35.29	32.64	30.36
PE3935-48	48"	38.35	35.67	32.98	30.68
PE3935-60	60"	38.70	35.99	33.28	30.96
PE3935-XX	Any	Same-Day Shipment / Call for Pricing			

## 50 OHM, RG142B/U COAX, DOUBLE SHIELDED

Model No.	Length	1-24	25-49	50-99	100 +
PE3044-12	12"	\$41.10	\$38.22	\$35.35	\$32.88
PE3044-24	24"	43.75	40.69	37.63	35.00
PE3044-36	36"	46.35	43.11	39.86	37.08
PE3044-48	48"	49.05	45.62	42.18	39.24
PE3044-60	60"	51.70	48.08	44.46	41.36
PE3044-XX	Any	Same-Day Shipment / Call for Pricing			

## 50 OHM, RG174A/U COAX

Model No.	Length	1-24	25-49	50-99	100 +
PE3373-12	12"	\$45.10	\$41.94	\$38.79	\$36.08
PE3373-24	24"	45.35	42.18	39.00	36.28
PE3373-36	36"	45.60	42.41	39.22	36.48
PE3373-48	48"	45.80	42.59	39.39	36.64
PE3373-60	60"	46.10	42.87	39.65	36.88
PE3373-XX	Any	Same-Day Shipment / Call for Pricing			

## 75 OHM, RG179B/U COAX

Model No.	Length	1-24	25-49	50-99	100 +
PE3366-12	12"	\$43.75	\$40.69	\$37.63	\$35.00
PE3366-24	24"	44.75	41.62	38.49	35.80
PE3366-36	36"	45.65	42.45	39.26	36.52
PE3366-48	48"	46.70	43.43	40.16	37.36
PE3366-60	60"	47.60	44.27	40.94	38.08
PE3366-XX	Any	Same-Day Shipment / Call for Pricing			

## 50 OHM, RG188A/U COAX

Model No.	Length	1-24	25-49	50-99	100 +
PE3351-12	12"	\$43.75	\$40.69	\$37.63	\$35.00
PE3351-24	24"	44.75	41.62	38.49	35.80
PE3351-36	36"	45.65	42.45	39.26	36.52
PE3351-48	48"	46.70	43.43	40.16	37.36
PE3351-60	60"	47.60	44.27	40.94	38.08
PE3351-XX	Any	Same-Day Shipment / Call for Pricing			

## 50 OHM, RG188-DS COAX, DOUBLE SHIELDED

Model No.	Length	1-24	25-49	50-99	100 +
PE3381-12	12"	\$49.05	\$45.62	\$42.18	\$39.24
PE3381-24	24"	51.45	47.85	44.25	41.16
PE3381-36	36"	53.90	50.13	46.35	43.12
PE3381-48	48"	56.25	52.31	48.38	45.00
PE3381-60	60"	58.75	54.64	50.53	47.00
PE3381-XX	Any	Same-Day Shipment / Call for Pricing			

## 50 OHM, RG213/U COAX

Model No.	Length	1-24	25-49	50-99	100 +
PE3384-12	12"	\$53.00	\$49.29	\$45.58	\$42.40
PE3384-24	24"	54.05	50.27	46.48	43.24
PE3384-36	36"	55.10	51.24	47.39	44.08
PE3384-48	48"	56.05	52.13	48.20	44.84
PE3384-60	60"	57.10	53.10	49.11	45.68
PE3384-XX	Any	Same-Day Shipment / Call for Pricing			

## 50 OHM, RG214/U COAX, DOUBLE SHIELDED

Model No.	Length	1-24	25-49	50-99	100 +
PE3370-12	12"	\$53.00	\$49.29	\$45.58	\$42.40
PE3370-24	24"	56.60	52.64	48.68	45.28
PE3370-36	36"	60.25	56.03	51.82	48.20
PE3370-48	48"	63.85	59.38	54.91	51.08
PE3370-60	60"	67.45	62.73	58.01	53.96
PE3370-XX	Any	Same-Day Shipment / Call for Pricing			

## 50 OHM, RG223/U COAX, DOUBLE SHIELDED

Model No.	Length	1-24	25-49	50-99	100 +
PE3816-12	12"	\$39.80	\$37.01	\$34.23	\$31.84
PE3816-24	24"	41.10	38.22	35.35	32.88
PE3816-36	36"	42.45	39.48	36.51	33.96
PE3816-48	48"	43.75	40.69	37.63	35.00
PE3816-60	60"	45.10	41.94	38.79	36.08
PE3816-XX	Any	Same-Day Shipment / Call for Pricing			

## 50 OHM, RG316/U COAX

Model No.	Length	1-24	25-49	50-99	100 +
PE3842-12	12"	\$43.75	\$40.69	\$37.63	\$35.00
PE3842-24	24"	44.75	41.62	38.49	35.80
PE3842-36	36"	45.65	42.45	39.26	36.52
PE3842-48	48"	46.70	43.43	40.16	37.36
PE3842-60	60"	47.60	44.27	40.94	38.08
PE3842-XX	Any	Same-Day Shipment / Call for Pricing			

## 50 OHM, RG316-DS COAX, DOUBLE SHIELDED

Model No.	Length	1-24	25-49	50-99	100 +
PE3389-12	12"	\$49.05	\$45.62	\$42.18	\$39.24
PE3389-24	24"	51.45	47.85	44.25	41.16
PE3389-36	36"	53.90	50.13	46.35	43.12
PE3389-48	48"	56.25	52.31	48.38	45.00
PE3389-60	60"	58.75	54.64	50.53	47.00
PE3389-XX	Any	Same-Day Shipment / Call for Pricing			

## 50 OHM, RG400/U COAX, DOUBLE SHIELDED

Model No.	Length	1-24	25-49	50-99	100 +
PE3458-12	12"	\$41.10	\$38.22	\$35.35	\$32.88
PE3458-24	24"	43.75	40.69	37.63	35.00
PE3458-36	36"	46.35	43.11	39.86	37.08
PE3458-48	48"	49.05	45.62	42.18	39.24
PE3458-60	60"	51.70	48.08	44.46	41.36
PE3458-XX	Any	Same-Day Shipment / Call for Pricing			

\*\*ROHS COMPLIANT & CUSTOM-LENGTH CABLE ASSEMBLIES MAY BE ORDERED ON OUR WEBSITE.\*\*

Cable Assemblies

# BNC MALE TO BNC FEMALE



ALL CABLE ASSEMBLIES ON THIS PAGE UTILIZE STANDARD 50 OHM INTERFACE CONNECTORS

## 52 OHM, RG8A/U COAX

Model No.	Length	1-24	25-49	50-99	100 +
PE3360-12	12"	\$37.15	\$34.55	\$31.95	\$29.72
PE3360-24	24"	38.15	35.48	32.81	30.52
PE3360-36	36"	39.10	36.36	33.63	31.28
PE3360-48	48"	40.15	37.34	34.53	32.12
PE3360-60	60"	41.20	38.32	35.43	32.96
PE3360-XX	Any	Same-Day Shipment / Call for Pricing			

## 53.5 OHM, RG55B/U COAX, DOUBLE SHIELDED

Model No.	Length	1-24	25-49	50-99	100 +
PE3375-12	12"	\$23.85	\$22.18	\$20.51	\$19.08
PE3375-24	24"	24.65	22.92	21.20	19.72
PE3375-36	36"	25.30	23.53	21.76	20.24
PE3375-48	48"	26.00	24.18	22.36	20.80
PE3375-60	60"	26.80	24.92	23.05	21.44
PE3375-XX	Any	Same-Day Shipment / Call for Pricing			

## 50 OHM, RG58C/U COAX

Model No.	Length	1-24	25-49	50-99	100 +
PE3047-12	12"	\$18.55	\$17.25	\$15.95	\$14.84
PE3047-24	24"	18.95	17.62	16.30	15.16
PE3047-36	36"	19.45	18.09	16.73	15.56
PE3047-48	48"	19.80	18.41	17.03	15.84
PE3047-60	60"	20.25	18.83	17.42	16.20
PE3047-XX	Any	Same-Day Shipment / Call for Pricing			

## 75 OHM, RG59B/U COAX

Model No.	Length	1-24	25-49	50-99	100 +
PE3792-12	12"	\$21.20	\$19.72	\$18.23	\$16.96
PE3792-24	24"	21.60	20.09	18.58	17.28
PE3792-36	36"	22.05	20.51	18.96	17.64
PE3792-48	48"	22.45	20.88	19.31	17.96
PE3792-60	60"	22.85	21.25	19.65	18.28
PE3792-XX	Any	Same-Day Shipment / Call for Pricing			

## 93 OHM, RG62A/U COAX

Model No.	Length	1-24	25-49	50-99	100 +
PE3368-12	12"	\$21.20	\$19.72	\$18.23	\$16.96
PE3368-24	24"	21.60	20.09	18.58	17.28
PE3368-36	36"	22.05	20.51	18.96	17.64
PE3368-48	48"	22.45	20.88	19.31	17.96
PE3368-60	60"	22.85	21.25	19.65	18.28
PE3368-XX	Any	Same-Day Shipment / Call for Pricing			

## 50 OHM, RG142B/U COAX, DOUBLE SHIELDED

Model No.	Length	1-24	25-49	50-99	100 +
PE3777-12	12"	\$26.50	\$24.65	\$22.79	\$21.20
PE3777-24	24"	29.15	27.11	25.07	23.32
PE3777-36	36"	31.80	29.57	27.35	25.44
PE3777-48	48"	34.50	32.09	29.67	27.60
PE3777-60	60"	37.15	34.55	31.95	29.72
PE3777-XX	Any	Same-Day Shipment / Call for Pricing			

## 50 OHM, RG174A/U COAX

Model No.	Length	1-24	25-49	50-99	100 +
PE3674-12	12"	\$27.85	\$25.90	\$23.95	\$22.28
PE3674-24	24"	28.10	26.13	24.17	22.48
PE3674-36	36"	28.35	26.37	24.38	22.68
PE3674-48	48"	28.60	26.60	24.60	22.88
PE3674-60	60"	28.90	26.88	24.85	23.12
PE3674-XX	Any	Same-Day Shipment / Call for Pricing			

## 75 OHM, RG179B/U COAX

Model No.	Length	1-24	25-49	50-99	100 +
PE3354-12	12"	\$26.50	\$24.65	\$22.79	\$21.20
PE3354-24	24"	27.50	25.58	23.65	22.00
PE3354-36	36"	28.45	26.46	24.47	22.76
PE3354-48	48"	29.40	27.34	25.28	23.52
PE3354-60	60"	30.40	28.27	26.14	24.32
PE3354-XX	Any	Same-Day Shipment / Call for Pricing			

## 50 OHM, RG188A/U COAX

Model No.	Length	1-24	25-49	50-99	100 +
PE3901-12	12"	\$26.50	\$24.65	\$22.79	\$21.20
PE3901-24	24"	27.50	25.58	23.65	22.00
PE3901-36	36"	28.45	26.46	24.47	22.76
PE3901-48	48"	29.40	27.34	25.28	23.52
PE3901-60	60"	30.40	28.27	26.14	24.32
PE3901-XX	Any	Same-Day Shipment / Call for Pricing			

## 50 OHM, RG213/U COAX

Model No.	Length	1-24	25-49	50-99	100 +
PE3949-12	12"	\$37.15	\$34.55	\$31.95	\$29.72
PE3949-24	24"	38.15	35.48	32.81	30.52
PE3949-36	36"	39.10	36.36	33.63	31.28
PE3949-48	48"	40.15	37.34	34.53	32.12
PE3949-60	60"	41.20	38.32	35.43	32.96
PE3949-XX	Any	Same-Day Shipment / Call for Pricing			

## 50 OHM, RG214/U COAX, DOUBLE SHIELDED

Model No.	Length	1-24	25-49	50-99	100 +
PE3371-12	12"	\$42.45	\$39.48	\$36.51	\$33.96
PE3371-24	24"	46.00	42.78	39.56	36.80
PE3371-36	36"	49.65	46.17	42.70	39.72
PE3371-48	48"	53.30	49.57	45.84	42.64
PE3371-60	60"	56.85	52.87	48.89	45.48
PE3371-XX	Any	Same-Day Shipment / Call for Pricing			

## 50 OHM, RG223/U COAX, DOUBLE SHIELDED

Model No.	Length	1-24	25-49	50-99	100 +
PE3606-12	12"	\$23.85	\$22.18	\$20.51	\$19.08
PE3606-24	24"	25.20	23.44	21.67	20.16
PE3606-36	36"	26.50	24.65	22.79	21.20
PE3606-48	48"	27.85	25.90	23.95	22.28
PE3606-60	60"	29.15	27.11	25.07	23.32
PE3606-XX	Any	Same-Day Shipment / Call for Pricing			

## 50 OHM, RG316/U COAX

Model No.	Length	1-24	25-49	50-99	100 +
PE3079-12	12"	\$26.50	\$24.65	\$22.79	\$21.20
PE3079-24	24"	27.50	25.58	23.65	22.00
PE3079-36	36"	28.45	26.46	24.47	22.76
PE3079-48	48"	29.40	27.34	25.28	23.52
PE3079-60	60"	30.40	28.27	26.14	24.32
PE3079-XX	Any	Same-Day Shipment / Call for Pricing			

## 50 OHM, RG400/U COAX, DOUBLE SHIELDED

Model No.	Length	1-24	25-49	50-99	100 +
PE3627-12	12"	\$26.50	\$24.65	\$22.79	\$21.20
PE3627-24	24"	29.15	27.11	25.07	23.32
PE3627-36	36"	31.80	29.57	27.35	25.44
PE3627-48	48"	34.50	32.09	29.67	27.60
PE3627-60	60"	37.15	34.55	31.95	29.72
PE3627-XX	Any	Same-Day Shipment / Call for Pricing			

\*\*ROHS COMPLIANT & CUSTOM-LENGTH CABLE ASSEMBLIES MAY BE ORDERED ON OUR WEBSITE.\*\*

Cable Assemblies

# BNC MALE TO BNC FEMALE BULKHEAD

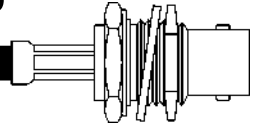
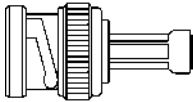

USE MOUNTING HOLE B06 ON PAGE 266

ALL CABLE ASSEMBLIES ON THIS PAGE UTILIZE STANDARD 50 OHM INTERFACE CONNECTORS

## 52 OHM, RG8A/U COAX

Model No.	Length	1-24	25-49	50-99	100 +
PE3440-12	12"	\$43.75	\$40.69	\$37.63	\$35.00
PE3440-24	24"	44.80	41.66	38.53	35.84
PE3440-36	36"	45.75	42.55	39.35	36.60
PE3440-48	48"	46.80	43.52	40.25	37.44
PE3440-60	60"	47.85	44.50	41.15	38.28
PE3440-XX	Any	Same-Day Shipment / Call for Pricing			

## 50 OHM, RG58C/U COAX

Model No.	Length	1-24	25-49	50-99	100 +
PE3649-12	12"	\$25.20	\$23.44	\$21.67	\$20.16
PE3649-24	24"	25.60	23.81	22.02	20.48
PE3649-36	36"	26.00	24.18	22.36	20.80
PE3649-48	48"	26.40	24.55	22.70	21.12
PE3649-60	60"	26.85	24.97	23.09	21.48
PE3649-XX	Any	Same-Day Shipment / Call for Pricing			

## 75 OHM, RG59B/U COAX

Model No.	Length	1-24	25-49	50-99	100 +
PE3103-12	12"	\$26.50	\$24.65	\$22.79	\$21.20
PE3103-24	24"	26.95	25.06	23.18	21.56
PE3103-36	36"	27.35	25.44	23.52	21.88
PE3103-48	48"	27.75	25.81	23.87	22.20
PE3103-60	60"	28.15	26.18	24.21	22.52
PE3103-XX	Any	Same-Day Shipment / Call for Pricing			

## 50 OHM, RG142B/U COAX, DOUBLE SHIELDED

Model No.	Length	1-24	25-49	50-99	100 +
PE3436-12	12"	\$33.15	\$30.83	\$28.51	\$26.52
PE3436-24	24"	35.80	33.29	30.79	28.64
PE3436-36	36"	38.40	35.71	33.02	30.72
PE3436-48	48"	41.10	38.22	35.35	32.88
PE3436-60	60"	43.75	40.69	37.63	35.00
PE3436-XX	Any	Same-Day Shipment / Call for Pricing			

## 50 OHM, RG174A/U COAX

Model No.	Length	1-24	25-49	50-99	100 +
PE3431-12	12"	\$34.50	\$32.09	\$29.67	\$27.60
PE3431-24	24"	34.75	32.32	29.89	27.80
PE3431-36	36"	35.00	32.55	30.10	28.00
PE3431-48	48"	35.25	32.78	30.32	28.20
PE3431-60	60"	35.55	33.06	30.57	28.44
PE3431-XX	Any	Same-Day Shipment / Call for Pricing			

## 75 OHM, RG179B/U COAX

Model No.	Length	1-24	25-49	50-99	100 +
PE3413-12	12"	\$34.50	\$32.09	\$29.67	\$27.60
PE3413-24	24"	35.45	32.97	30.49	28.36
PE3413-36	36"	36.40	33.85	31.30	29.12
PE3413-48	48"	37.40	34.78	32.16	29.92
PE3413-60	60"	38.30	35.62	32.94	30.64
PE3413-XX	Any	Same-Day Shipment / Call for Pricing			

## 50 OHM, RG188A/U COAX

Model No.	Length	1-24	25-49	50-99	100 +
PE3442-12	12"	\$34.50	\$32.09	\$29.67	\$27.60
PE3442-24	24"	35.45	32.97	30.49	28.36
PE3442-36	36"	36.40	33.85	31.30	29.12
PE3442-48	48"	37.40	34.78	32.16	29.92
PE3442-60	60"	38.30	35.62	32.94	30.64
PE3442-XX	Any	Same-Day Shipment / Call for Pricing			

## 50 OHM, RG188-DS COAX, DOUBLE SHIELDED

Model No.	Length	1-24	25-49	50-99	100 +
PE3446-12	12"	\$45.10	\$41.94	\$38.79	\$36.08
PE3446-24	24"	47.50	44.18	40.85	38.00
PE3446-36	36"	49.95	46.45	42.96	39.96
PE3446-48	48"	52.35	48.69	45.02	41.88
PE3446-60	60"	54.65	50.82	47.00	43.72
PE3446-XX	Any	Same-Day Shipment / Call for Pricing			

## 50 OHM, RG213/U COAX

Model No.	Length	1-24	25-49	50-99	100 +
PE3450-12	12"	\$43.75	\$40.69	\$37.63	\$35.00
PE3450-24	24"	44.80	41.66	38.53	35.84
PE3450-36	36"	45.75	42.55	39.35	36.60
PE3450-48	48"	46.80	43.52	40.25	37.44
PE3450-60	60"	47.85	44.50	41.15	38.28
PE3450-XX	Any	Same-Day Shipment / Call for Pricing			

## 50 OHM, RG214/U COAX, DOUBLE SHIELDED

Model No.	Length	1-24	25-49	50-99	100 +
PE3427-12	12"	\$55.70	\$51.80	\$47.90	\$44.56
PE3427-24	24"	59.30	55.15	51.00	47.44
PE3427-36	36"	62.95	58.54	54.14	50.36
PE3427-48	48"	66.50	61.85	57.19	53.20
PE3427-60	60"	70.20	65.29	60.37	56.16
PE3427-XX	Any	Same-Day Shipment / Call for Pricing			

## 50 OHM, RG223/U COAX, DOUBLE SHIELDED

Model No.	Length	1-24	25-49	50-99	100 +
PE3557-12	12"	\$30.50	\$28.37	\$26.23	\$24.40
PE3557-24	24"	31.80	29.57	27.35	25.44
PE3557-36	36"	33.15	30.83	28.51	26.52
PE3557-48	48"	34.50	32.09	29.67	27.60
PE3557-60	60"	35.80	33.29	30.79	28.64
PE3557-XX	Any	Same-Day Shipment / Call for Pricing			

## 50 OHM, RG316/U COAX

Model No.	Length	1-24	25-49	50-99	100 +
PE3854-12	12"	\$34.50	\$32.09	\$29.67	\$27.60
PE3854-24	24"	35.45	32.97	30.49	28.36
PE3854-36	36"	36.40	33.85	31.30	29.12
PE3854-48	48"	37.40	34.78	32.16	29.92
PE3854-60	60"	38.30	35.62	32.94	30.64
PE3854-XX	Any	Same-Day Shipment / Call for Pricing			

## 50 OHM, RG316-DS COAX, DOUBLE SHIELDED

Model No.	Length	1-24	25-49	50-99	100 +
PE3454-12	12"	\$45.10	\$41.94	\$38.79	\$36.08
PE3454-24	24"	47.50	44.18	40.85	38.00
PE3454-36	36"	49.95	46.45	42.96	39.96
PE3454-48	48"	52.35	48.69	45.02	41.88
PE3454-60	60"	54.65	50.82	47.00	43.72
PE3454-XX	Any	Same-Day Shipment / Call for Pricing			

## 50 OHM, RG400/U COAX, DOUBLE SHIELDED

Model No.	Length	1-24	25-49	50-99	100 +
PE3423-12	12"	\$33.15	\$30.83	\$28.51	\$26.52
PE3423-24	24"	35.80	33.29	30.79	28.64
PE3423-36	36"	38.40	35.71	33.02	30.72
PE3423-48	48"	41.10	38.22	35.35	32.88
PE3423-60	60"	43.75	40.69	37.63	35.00
PE3423-XX	Any	Same-Day Shipment / Call for Pricing			

\*\*ROHS COMPLIANT & CUSTOM-LENGTH CABLE ASSEMBLIES MAY BE ORDERED ON OUR WEBSITE.\*\*

Cable Assemblies



# BNC FEMALE TO BNC FEMALE

ALL CABLE ASSEMBLIES ON THIS PAGE UTILIZE STANDARD

50 OHM INTERFACE CONNECTORS



## 50 OHM, RG58C/U COAX

Model No.	Length	1-24	25-49	50-99	100 +
PE3052-12	12"	\$19.90	\$18.51	\$17.11	\$15.92
PE3052-24	24"	20.30	18.88	17.46	16.24
PE3052-36	36"	20.70	19.25	17.80	16.56
PE3052-48	48"	21.10	19.62	18.15	16.88
PE3052-60	60"	21.50	20.00	18.49	17.20
PE3052-XX	Any	Same-Day Shipment / Call for Pricing			

## 75 OHM, RG59B/U COAX

Model No.	Length	1-24	25-49	50-99	100 +
PE3675-12	12"	\$23.85	\$22.18	\$20.51	\$19.08
PE3675-24	24"	24.25	22.55	20.86	19.40
PE3675-36	36"	24.75	23.02	21.29	19.80
PE3675-48	48"	25.10	23.34	21.59	20.08
PE3675-60	60"	25.55	23.76	21.97	20.44
PE3675-XX	Any	Same-Day Shipment / Call for Pricing			

## 50 OHM, RG142B/U COAX, DOUBLE SHIELDED

Model No.	Length	1-24	25-49	50-99	100 +
PE3088-12	12"	\$29.15	\$27.11	\$25.07	\$23.32
PE3088-24	24"	31.80	29.57	27.35	25.44
PE3088-36	36"	34.50	32.09	29.67	27.60
PE3088-48	48"	37.15	34.55	31.95	29.72
PE3088-60	60"	39.80	37.01	34.23	31.84
PE3088-XX	Any	Same-Day Shipment / Call for Pricing			

## 50 OHM, RG174A/U COAX

Model No.	Length	1-24	25-49	50-99	100 +
PE3604-12	12"	\$29.15	\$27.11	\$25.07	\$23.32
PE3604-24	24"	29.45	27.39	25.33	23.56
PE3604-36	36"	29.65	27.57	25.50	23.72
PE3604-48	48"	29.95	27.85	25.76	23.96
PE3604-60	60"	30.25	28.13	26.02	24.20
PE3604-XX	Any	Same-Day Shipment / Call for Pricing			

## 50 OHM, RG188A/U COAX

Model No.	Length	1-24	25-49	50-99	100 +
PE3094-12	12"	\$29.15	\$27.11	\$25.07	\$23.32
PE3094-24	24"	30.15	28.04	25.93	24.12
PE3094-36	36"	31.10	28.92	26.75	24.88
PE3094-48	48"	32.10	29.85	27.61	25.68
PE3094-60	60"	33.00	30.69	28.38	26.40
PE3094-XX	Any	Same-Day Shipment / Call for Pricing			

## 50 OHM, RG214/U COAX, DOUBLE SHIELDED

Model No.	Length	1-24	25-49	50-99	100 +
PE3953-12	12"	\$66.30	\$61.66	\$57.02	\$53.04
PE3953-24	24"	69.90	65.01	60.11	55.92
PE3953-36	36"	73.50	68.36	63.21	58.80
PE3953-48	48"	77.15	71.75	66.35	61.72
PE3953-60	60"	80.80	75.14	69.49	64.64
PE3953-XX	Any	Same-Day Shipment / Call for Pricing			

## 50 OHM, RG223/U COAX, DOUBLE SHIELDED

Model No.	Length	1-24	25-49	50-99	100 +
PE3364-12	12"	\$27.85	\$25.90	\$23.95	\$22.28
PE3364-24	24"	29.15	27.11	25.07	23.32
PE3364-36	36"	30.50	28.37	26.23	24.40
PE3364-48	48"	31.80	29.57	27.35	25.44
PE3364-60	60"	33.15	30.83	28.51	26.52
PE3364-XX	Any	Same-Day Shipment / Call for Pricing			

## 50 OHM, RG316/U COAX

Model No.	Length	1-24	25-49	50-99	100 +
PE3505-12	12"	\$29.15	\$27.11	\$25.07	\$23.32
PE3505-24	24"	30.15	28.04	25.93	24.12
PE3505-36	36"	31.10	28.92	26.75	24.88
PE3505-48	48"	32.10	29.85	27.61	25.68
PE3505-60	60"	33.00	30.69	28.38	26.40
PE3505-XX	Any	Same-Day Shipment / Call for Pricing			

# LC MALE TO LC MALE



## 50 OHM, RG142B/U COAX

Model No.	Length	1-24	25-49	50-99	100 +
PE33541-60	60"	\$265.15	\$246.59	\$228.03	\$212.12
PE33541-72	72"	267.85	249.10	230.35	214.28
PE33541-84	84"	270.40	251.47	232.54	216.32
PE33541-96	96"	273.10	253.98	234.87	218.48
PE33541-108	108"	275.70	256.40	237.10	220.56
PE33541-XXX	Any	Same-Day Shipment / Call for Pricing			

## 50 OHM, RG214/U COAX, DOUBLE SHIELDED

Model No.	Length	1-24	25-49	50-99	100 +
PE33491-60	60"	\$289.20	\$268.96	\$248.71	\$231.36
PE33491-72	72"	292.90	272.40	251.89	234.32
PE33491-84	84"	296.45	275.70	254.95	237.16
PE33491-96	96"	300.10	279.09	258.09	240.08
PE33491-108	108"	303.70	282.44	261.18	242.96
PE33491-XXX	Any	Same-Day Shipment / Call for Pricing			

## 50 OHM, RG217/U COAX

Model No.	Length	1-24	25-49	50-99	100 +
PE33537-60	60"	\$265.15	\$246.59	\$228.03	\$212.12
PE33537-72	72"	267.55	248.82	230.09	214.04
PE33537-84	84"	270.00	251.10	232.20	216.00
PE33537-96	96"	272.45	253.38	234.31	217.96
PE33537-108	108"	274.80	255.56	236.33	219.84
PE33537-XXX	Any	Same-Day Shipment / Call for Pricing			

## 50 OHM, RG218/U COAX

Model No.	Length	1-24	25-49	50-99	100 +
PE3960-60	60"	\$301.30	\$280.21	\$259.12	\$241.04
PE3960-72	72"	307.35	285.84	264.32	245.88
PE3960-84	84"	313.40	291.46	269.52	250.72
PE3960-96	96"	319.35	297.00	274.64	255.48
PE3960-108	108"	325.40	302.62	279.84	260.32
PE3960-XXX	Any	Same-Day Shipment / Call for Pricing			

## 50 OHM, RG219/U COAX

Model No.	Length	1-24	25-49	50-99	100 +
PE34023-60	60"	\$397.75	\$369.91	\$342.07	\$318.20
PE34023-72	72"	421.85	392.32	362.79	337.48
PE34023-84	84"	446.00	414.78	383.56	356.80
PE34023-96	96"	470.05	437.15	404.24	376.04
PE34023-108	108"	494.15	459.56	424.97	395.32
PE34023-XXX	Any	Same-Day Shipment / Call for Pricing			

## 50 OHM, RG225/U COAX, DOUBLE SHIELDED

Model No.	Length	1-24	25-49	50-99	100 +
PE34538-60	60"	\$301.30	\$280.21	\$259.12	\$241.04
PE34538-72	72"	325.45	302.67	279.89	260.36
PE34538-84	84"	349.55	325.08	300.61	279.64
PE34538-96	96"	373.55	347.40	321.25	298.84
PE34538-108	108"	397.75	369.91	342.07	318.20
PE34538-XXX	Any	Same-Day Shipment / Call for Pricing			

## 50 OHM, RG393/U COAX

Model No.	Length	1-24	25-49	50-99	100 +
PE33539-60	60"	\$301.30	\$280.21	\$259.12	\$241.04
PE33539-72	72"	309.75	288.07	266.39	247.80
PE33539-84	84"	318.20	295.93	273.65	254.56
PE33539-96	96"	326.65	303.78	280.92	261.32
PE33539-108	108"	335.00	311.55	288.10	268.00
PE33539-XXX	Any	Same-Day Shipment / Call for Pricing			

\*\*ROHS COMPLIANT & CUSTOM-LENGTH CABLE ASSEMBLIES MAY BE ORDERED ON OUR WEBSITE.\*\*

# BNC MALE TO N MALE

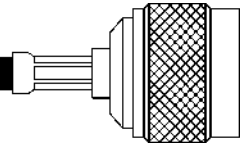
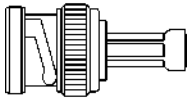

## 52 OHM, RG8A/U COAX

Model No.	Length	1-24	25-49	50-99	100 +
PE3252-12	12"	\$38.40	\$35.71	\$33.02	\$30.72
PE3252-24	24"	39.40	36.64	33.88	31.52
PE3252-36	36"	40.35	37.53	34.70	32.28
PE3252-48	48"	41.40	38.50	35.60	33.12
PE3252-60	60"	42.30	39.34	36.38	33.84
PE3252-XX	Any	Same-Day Shipment / Call for Pricing			

## 53.5 OHM, RG55B/U COAX, DOUBLE SHIELDED

Model No.	Length	1-24	25-49	50-99	100 +
PE3477-12	12"	\$26.50	\$24.65	\$22.79	\$21.20
PE3477-24	24"	27.25	25.34	23.44	21.80
PE3477-36	36"	28.00	26.04	24.08	22.40
PE3477-48	48"	28.65	26.64	24.64	22.92
PE3477-60	60"	29.40	27.34	25.28	23.52
PE3477-XX	Any	Same-Day Shipment / Call for Pricing			

## 50 OHM, RG58C/U COAX

Model No.	Length	1-24	25-49	50-99	100 +
PE3042-12	12"	\$21.20	\$19.72	\$18.23	\$16.96
PE3042-24	24"	21.60	20.09	18.58	17.28
PE3042-36	36"	22.05	20.51	18.96	17.64
PE3042-48	48"	22.45	20.88	19.31	17.96
PE3042-60	60"	22.85	21.25	19.65	18.28
PE3042-XX	Any	Same-Day Shipment / Call for Pricing			

## 50 OHM, RG142B/U COAX, DOUBLE SHIELDED

Model No.	Length	1-24	25-49	50-99	100 +
PE3061-12	12"	\$27.85	\$25.90	\$23.95	\$22.28
PE3061-24	24"	30.50	28.37	26.23	24.40
PE3061-36	36"	33.15	30.83	28.51	26.52
PE3061-48	48"	35.80	33.29	30.79	28.64
PE3061-60	60"	38.40	35.71	33.02	30.72
PE3061-XX	Any	Same-Day Shipment / Call for Pricing			

## 50 OHM, RG174A/U COAX

Model No.	Length	1-24	25-49	50-99	100 +
PE3246-12	12"	\$34.60	\$32.18	\$29.76	\$27.68
PE3246-24	24"	34.85	32.41	29.97	27.88
PE3246-36	36"	35.10	32.64	30.19	28.08
PE3246-48	48"	35.40	32.92	30.44	28.32
PE3246-60	60"	35.70	33.20	30.70	28.56
PE3246-XX	Any	Same-Day Shipment / Call for Pricing			

## 50 OHM, RG188A/U COAX

Model No.	Length	1-24	25-49	50-99	100 +
PE3248-12	12"	\$35.80	\$33.29	\$30.79	\$28.64
PE3248-24	24"	36.75	34.18	31.61	29.40
PE3248-36	36"	37.75	35.11	32.47	30.20
PE3248-48	48"	38.65	35.94	33.24	30.92
PE3248-60	60"	39.70	36.92	34.14	31.76
PE3248-XX	Any	Same-Day Shipment / Call for Pricing			

## 50 OHM, RG213/U COAX

Model No.	Length	1-24	25-49	50-99	100 +
PE3750-12	12"	\$38.40	\$35.71	\$33.02	\$30.72
PE3750-24	24"	39.40	36.64	33.88	31.52
PE3750-36	36"	40.35	37.53	34.70	32.28
PE3750-48	48"	41.40	38.50	35.60	33.12
PE3750-60	60"	42.30	39.34	36.38	33.84
PE3750-XX	Any	Same-Day Shipment / Call for Pricing			

## 50 OHM, RG214/U COAX, DOUBLE SHIELDED

Model No.	Length	1-24	25-49	50-99	100 +
PE3097-12	12"	\$39.80	\$37.01	\$34.23	\$31.84
PE3097-24	24"	43.40	40.36	37.32	34.72
PE3097-36	36"	47.00	43.71	40.42	37.60
PE3097-48	48"	50.60	47.06	43.52	40.48
PE3097-60	60"	54.25	50.45	46.66	43.40
PE3097-XX	Any	Same-Day Shipment / Call for Pricing			

## 50 OHM, RG223/U COAX, DOUBLE SHIELDED

Model No.	Length	1-24	25-49	50-99	100 +
PE3476-12	12"	\$23.85	\$22.18	\$20.51	\$19.08
PE3476-24	24"	25.20	23.44	21.67	20.16
PE3476-36	36"	26.50	24.65	22.79	21.20
PE3476-48	48"	27.85	25.90	23.95	22.28
PE3476-60	60"	29.15	27.11	25.07	23.32
PE3476-XX	Any	Same-Day Shipment / Call for Pricing			

## 50 OHM, RG316/U COAX

Model No.	Length	1-24	25-49	50-99	100 +
PE3250-12	12"	\$35.80	\$33.29	\$30.79	\$28.64
PE3250-24	24"	36.75	34.18	31.61	29.40
PE3250-36	36"	37.75	35.11	32.47	30.20
PE3250-48	48"	38.65	35.94	33.24	30.92
PE3250-60	60"	39.70	36.92	34.14	31.76
PE3250-XX	Any	Same-Day Shipment / Call for Pricing			

## 50 OHM, RG316-DS COAX, DOUBLE SHIELDED

Model No.	Length	1-24	25-49	50-99	100 +
PE3261-12	12"	\$41.00	\$38.13	\$35.26	\$32.80
PE3261-24	24"	43.40	40.36	37.32	34.72
PE3261-36	36"	45.75	42.55	39.35	36.60
PE3261-48	48"	48.25	44.87	41.50	38.60
PE3261-60	60"	50.60	47.06	43.52	40.48
PE3261-XX	Any	Same-Day Shipment / Call for Pricing			

## 50 OHM, RG393/U COAX, DOUBLE SHIELDED

Model No.	Length	1-24	25-49	50-99	100 +
PE3254-12	12"	\$66.30	\$61.66	\$57.02	\$53.04
PE3254-24	24"	74.70	69.47	64.24	59.76
PE3254-36	36"	83.15	77.33	71.51	66.52
PE3254-48	48"	91.60	85.19	78.78	73.28
PE3254-60	60"	100.00	93.00	86.00	80.00
PE3254-XX	Any	Same-Day Shipment / Call for Pricing			

## 50 OHM, RG400/U COAX, DOUBLE SHIELDED

Model No.	Length	1-24	25-49	50-99	100 +
PE3874-12	12"	\$27.85	\$25.90	\$23.95	\$22.28
PE3874-24	24"	30.50	28.37	26.23	24.40
PE3874-36	36"	33.15	30.83	28.51	26.52
PE3874-48	48"	35.80	33.29	30.79	28.64
PE3874-60	60"	38.40	35.71	33.02	30.72
PE3874-XX	Any	Same-Day Shipment / Call for Pricing			

## 50 OHM, PE-B3199, VERY LOW LOSS COAX

Model No.	Length	1-24	25-49	50-99	100 +
PE3256-12	12"	\$38.40	\$35.71	\$33.02	\$30.72
PE3256-24	24"	39.40	36.64	33.88	31.52
PE3256-36	36"	40.35	37.53	34.70	32.28
PE3256-48	48"	41.40	38.50	35.60	33.12
PE3256-60	60"	42.30	39.34	36.38	33.84
PE3256-XX	Any	Same-Day Shipment / Call for Pricing			

\*\*ROHS COMPLIANT & CUSTOM-LENGTH CABLE ASSEMBLIES MAY BE ORDERED ON OUR WEBSITE.\*\*

Cable Assemblies

# BNC MALE TO SMB PLUG



## 50 OHM, RG58C/U COAX

Model No.	Length	1-24	25-49	50-99	100 +
PE3242-12	12"	\$34.50	\$32.09	\$29.67	\$27.60
PE3242-24	24"	34.85	32.41	29.97	27.88
PE3242-36	36"	35.30	32.83	30.36	28.24
PE3242-48	48"	35.70	33.20	30.70	28.56
PE3242-60	60"	36.15	33.62	31.09	28.92
PE3242-XX	Any	Same-Day Shipment / Call for Pricing			

## 50 OHM, RG142B/U COAX, DOUBLE SHIELDED

Model No.	Length	1-24	25-49	50-99	100 +
PE3349-12	12"	\$33.15	\$30.83	\$28.51	\$26.52
PE3349-24	24"	35.80	33.29	30.79	28.64
PE3349-36	36"	38.40	35.71	33.02	30.72
PE3349-48	48"	41.10	38.22	35.35	32.88
PE3349-60	60"	43.75	40.69	37.63	35.00
PE3349-XX	Any	Same-Day Shipment / Call for Pricing			

## 50 OHM, RG174A/U COAX

Model No.	Length	1-24	25-49	50-99	100 +
PE3672-12	12"	\$25.20	\$23.44	\$21.67	\$20.16
PE3672-24	24"	25.50	23.72	21.93	20.40
PE3672-36	36"	25.75	23.95	22.15	20.60
PE3672-48	48"	25.95	24.13	22.32	20.76
PE3672-60	60"	26.25	24.41	22.58	21.00
PE3672-XX	Any	Same-Day Shipment / Call for Pricing			

## 50 OHM, RG188A/U COAX

Model No.	Length	1-24	25-49	50-99	100 +
PE3671-12	12"	\$25.20	\$23.44	\$21.67	\$20.16
PE3671-24	24"	26.20	24.37	22.53	20.96
PE3671-36	36"	27.10	25.20	23.31	21.68
PE3671-48	48"	28.10	26.13	24.17	22.48
PE3671-60	60"	29.00	26.97	24.94	23.20
PE3671-XX	Any	Same-Day Shipment / Call for Pricing			

## 50 OHM, RG223/U COAX, DOUBLE SHIELDED

Model No.	Length	1-24	25-49	50-99	100 +
PE3236-12	12"	\$34.50	\$32.09	\$29.67	\$27.60
PE3236-24	24"	35.80	33.29	30.79	28.64
PE3236-36	36"	37.15	34.55	31.95	29.72
PE3236-48	48"	38.40	35.71	33.02	30.72
PE3236-60	60"	39.80	37.01	34.23	31.84
PE3236-XX	Any	Same-Day Shipment / Call for Pricing			

## 50 OHM, RG316/U COAX

Model No.	Length	1-24	25-49	50-99	100 +
PE3746-12	12"	\$25.20	\$23.44	\$21.67	\$20.16
PE3746-24	24"	26.20	24.37	22.53	20.96
PE3746-36	36"	27.10	25.20	23.31	21.68
PE3746-48	48"	28.10	26.13	24.17	22.48
PE3746-60	60"	29.00	26.97	24.94	23.20
PE3746-XX	Any	Same-Day Shipment / Call for Pricing			

## 50 OHM, RG316-DS COAX, DOUBLE SHIELDED

Model No.	Length	1-24	25-49	50-99	100 +
PE3530-12	12"	\$41.10	\$38.22	\$35.35	\$32.88
PE3530-24	24"	43.50	40.46	37.41	34.80
PE3530-36	36"	45.85	42.64	39.43	36.68
PE3530-48	48"	48.35	44.97	41.58	38.68
PE3530-60	60"	50.75	47.20	43.65	40.60
PE3530-XX	Any	Same-Day Shipment / Call for Pricing			

# BNC MALE TO SMC PLUG



## 50 OHM, RG58C/U COAX

Model No.	Length	1-24	25-49	50-99	100 +
PE3244-12	12"	\$34.50	\$32.09	\$29.67	\$27.60
PE3244-24	24"	34.85	32.41	29.97	27.88
PE3244-36	36"	35.30	32.83	30.36	28.24
PE3244-48	48"	35.70	33.20	30.70	28.56
PE3244-60	60"	36.15	33.62	31.09	28.92
PE3244-XX	Any	Same-Day Shipment / Call for Pricing			

## 50 OHM, RG142B/U COAX, DOUBLE SHIELDED

Model No.	Length	1-24	25-49	50-99	100 +
PE3240-12	12"	\$33.15	\$30.83	\$28.51	\$26.52
PE3240-24	24"	35.80	33.29	30.79	28.64
PE3240-36	36"	38.40	35.71	33.02	30.72
PE3240-48	48"	41.10	38.22	35.35	32.88
PE3240-60	60"	43.75	40.69	37.63	35.00
PE3240-XX	Any	Same-Day Shipment / Call for Pricing			

## 50 OHM, RG174A/U COAX

Model No.	Length	1-24	25-49	50-99	100 +
PE3660-12	12"	\$25.20	\$23.44	\$21.67	\$20.16
PE3660-24	24"	25.50	23.72	21.93	20.40
PE3660-36	36"	25.75	23.95	22.15	20.60
PE3660-48	48"	25.95	24.13	22.32	20.76
PE3660-60	60"	26.25	24.41	22.58	21.00
PE3660-XX	Any	Same-Day Shipment / Call for Pricing			

## 50 OHM, RG188A/U COAX

Model No.	Length	1-24	25-49	50-99	100 +
PE3641-12	12"	\$25.20	\$23.44	\$21.67	\$20.16
PE3641-24	24"	26.20	24.37	22.53	20.96
PE3641-36	36"	27.10	25.20	23.31	21.68
PE3641-48	48"	28.10	26.13	24.17	22.48
PE3641-60	60"	29.00	26.97	24.94	23.20
PE3641-XX	Any	Same-Day Shipment / Call for Pricing			

## 50 OHM, RG223/U COAX, DOUBLE SHIELDED

Model No.	Length	1-24	25-49	50-99	100 +
PE3238-12	12"	\$34.50	\$32.09	\$29.67	\$27.60
PE3238-24	24"	35.80	33.29	30.79	28.64
PE3238-36	36"	37.15	34.55	31.95	29.72
PE3238-48	48"	38.40	35.71	33.02	30.72
PE3238-60	60"	39.80	37.01	34.23	31.84
PE3238-XX	Any	Same-Day Shipment / Call for Pricing			

## 50 OHM, RG316/U COAX

Model No.	Length	1-24	25-49	50-99	100 +
PE3849-12	12"	\$25.20	\$23.44	\$21.67	\$20.16
PE3849-24	24"	26.20	24.37	22.53	20.96
PE3849-36	36"	27.10	25.20	23.31	21.68
PE3849-48	48"	28.10	26.13	24.17	22.48
PE3849-60	60"	29.00	26.97	24.94	23.20
PE3849-XX	Any	Same-Day Shipment / Call for Pricing			

## 50 OHM, RG316-DS COAX, DOUBLE SHIELDED

Model No.	Length	1-24	25-49	50-99	100 +
PE3437-12	12"	\$41.10	\$38.22	\$35.35	\$32.88
PE3437-24	24"	43.50	40.46	37.41	34.80
PE3437-36	36"	45.85	42.64	39.43	36.68
PE3437-48	48"	48.35	44.97	41.58	38.68
PE3437-60	60"	50.75	47.20	43.65	40.60
PE3437-XX	Any	Same-Day Shipment / Call for Pricing			

\*\*ROHS COMPLIANT & CUSTOM-LENGTH CABLE ASSEMBLIES MAY BE ORDERED ON OUR WEBSITE.\*\*

# UHF MALE TO UHF MALE



## 52 OHM, RG8A/U COAX

Model No.	Length	1-24	25-49	50-99	100 +
PE3623-12	12"	\$31.80	\$29.57	\$27.35	\$25.44
PE3623-24	24"	32.85	30.55	28.25	26.28
PE3623-36	36"	33.80	31.43	29.07	27.04
PE3623-48	48"	34.85	32.41	29.97	27.88
PE3623-60	60"	35.85	33.34	30.83	28.68
PE3623-XX	Any	Same-Day Shipment / Call for Pricing			

## 50 OHM, RG58C/U COAX

Model No.	Length	1-24	25-49	50-99	100 +
PE3015-12	12"	\$19.90	\$18.51	\$17.11	\$15.92
PE3015-24	24"	20.30	18.88	17.46	16.24
PE3015-36	36"	20.70	19.25	17.80	16.56
PE3015-48	48"	21.10	19.62	18.15	16.88
PE3015-60	60"	21.50	20.00	18.49	17.20
PE3015-XX	Any	Same-Day Shipment / Call for Pricing			

## 75 OHM, RG59B/U COAX

Model No.	Length	1-24	25-49	50-99	100 +
PE3580-12	12"	\$19.90	\$18.51	\$17.11	\$15.92
PE3580-24	24"	20.30	18.88	17.46	16.24
PE3580-36	36"	20.70	19.25	17.80	16.56
PE3580-48	48"	21.10	19.62	18.15	16.88
PE3580-60	60"	21.50	20.00	18.49	17.20
PE3580-XX	Any	Same-Day Shipment / Call for Pricing			

## 50 OHM, RG213/U COAX

Model No.	Length	1-24	25-49	50-99	100 +
PE3635-12	12"	\$31.80	\$29.57	\$27.35	\$25.44
PE3635-24	24"	32.85	30.55	28.25	26.28
PE3635-36	36"	33.80	31.43	29.07	27.04
PE3635-48	48"	34.85	32.41	29.97	27.88
PE3635-60	60"	35.85	33.34	30.83	28.68
PE3635-XX	Any	Same-Day Shipment / Call for Pricing			

## 50 OHM, RG214/U COAX, DOUBLE SHIELDED

Model No.	Length	1-24	25-49	50-99	100 +
PE3796-12	12"	\$39.80	\$37.01	\$34.23	\$31.84
PE3796-24	24"	43.40	40.36	37.32	34.72
PE3796-36	36"	47.00	43.71	40.42	37.60
PE3796-48	48"	50.60	47.06	43.52	40.48
PE3796-60	60"	54.25	50.45	46.66	43.40
PE3796-XX	Any	Same-Day Shipment / Call for Pricing			

## 50 OHM, RG223/U COAX, DOUBLE SHIELDED

Model No.	Length	1-24	25-49	50-99	100 +
PE3845-12	12"	\$22.50	\$20.93	\$19.35	\$18.00
PE3845-24	24"	23.85	22.18	20.51	19.08
PE3845-36	36"	25.20	23.44	21.67	20.16
PE3845-48	48"	26.50	24.65	22.79	21.20
PE3845-60	60"	27.85	25.90	23.95	22.28
PE3845-XX	Any	Same-Day Shipment / Call for Pricing			

## 50 OHM, RG393/U COAX, DOUBLE SHIELDED

Model No.	Length	1-24	25-49	50-99	100 +
PE33267-12	12"	\$42.45	\$39.48	\$36.51	\$33.96
PE33267-24	24"	50.85	47.29	43.73	40.68
PE33267-36	36"	59.30	55.15	51.00	47.44
PE33267-48	48"	67.80	63.05	58.31	54.24
PE33267-60	60"	76.15	70.82	65.49	60.92
PE33267-XX	Any	Same-Day Shipment / Call for Pricing			

## 50 OHM, PE-B3199, VERY LOW LOSS COAX

Model No.	Length	1-24	25-49	50-99	100 +
PE3159-12	12"	\$30.80	\$28.64	\$26.49	\$24.64
PE3159-24	24"	32.60	30.32	28.04	26.08
PE3159-36	36"	33.25	30.92	28.60	26.60
PE3159-48	48"	34.20	31.81	29.41	27.36
PE3159-60	60"	35.20	32.74	30.27	28.16
PE3159-XX	Any	Same-Day Shipment / Call for Pricing			

# SMA MALE RIGHT ANGLE TO BNC MALE



## 50 OHM, RG58C/U COAX

Model No.	Length	1-24	25-49	50-99	100 +
PE3850-12	12"	\$41.35	\$38.46	\$35.56	\$33.08
PE3850-24	24"	41.70	38.78	35.86	33.36
PE3850-36	36"	42.15	39.20	36.25	33.72
PE3850-48	48"	42.55	39.57	36.59	34.04
PE3850-60	60"	43.00	39.99	36.98	34.40
PE3850-XX	Any	Same-Day Shipment / Call for Pricing			

## 50 OHM, RG142B/U COAX, DOUBLE SHIELDED

Model No.	Length	1-24	25-49	50-99	100 +
PE3780-12	12"	\$43.75	\$40.69	\$37.63	\$35.00
PE3780-24	24"	46.35	43.11	39.86	37.08
PE3780-36	36"	49.05	45.62	42.18	39.24
PE3780-48	48"	51.70	48.08	44.46	41.36
PE3780-60	60"	54.35	50.55	46.74	43.48
PE3780-XX	Any	Same-Day Shipment / Call for Pricing			

## 50 OHM, RG174A/U COAX

Model No.	Length	1-24	25-49	50-99	100 +
PE3886-12	12"	\$41.25	\$38.36	\$35.48	\$33.00
PE3886-24	24"	41.50	38.60	35.69	33.20
PE3886-36	36"	41.75	38.83	35.91	33.40
PE3886-48	48"	42.00	39.06	36.12	33.60
PE3886-60	60"	42.30	39.34	36.38	33.84
PE3886-XX	Any	Same-Day Shipment / Call for Pricing			

## 50 OHM, RG188A/U COAX

Model No.	Length	1-24	25-49	50-99	100 +
PE3756-12	12"	\$40.25	\$37.43	\$34.62	\$32.20
PE3756-24	24"	41.25	38.36	35.48	33.00
PE3756-36	36"	42.20	39.25	36.29	33.76
PE3756-48	48"	43.20	40.18	37.15	34.56
PE3756-60	60"	44.05	40.97	37.88	35.24
PE3756-XX	Any	Same-Day Shipment / Call for Pricing			

## 50 OHM, RG223/U COAX, DOUBLE SHIELDED

Model No.	Length	1-24	25-49	50-99	100 +
PE3733-12	12"	\$43.15	\$40.13	\$37.11	\$34.52
PE3733-24	24"	44.40	41.29	38.18	35.52
PE3733-36	36"	45.70	42.50	39.30	36.56
PE3733-48	48"	47.05	43.76	40.46	37.64
PE3733-60	60"	48.45	45.06	41.67	38.76
PE3733-XX	Any	Same-Day Shipment / Call for Pricing			

## 50 OHM, RG316/U COAX

Model No.	Length	1-24	25-49	50-99	100 +
PE3811-12	12"	\$40.25	\$37.43	\$34.62	\$32.20
PE3811-24	24"	41.25	38.36	35.48	33.00
PE3811-36	36"	42.20	39.25	36.29	33.76
PE3811-48	48"	43.20	40.18	37.15	34.56
PE3811-60	60"	44.05	40.97	37.88	35.24
PE3811-XX	Any	Same-Day Shipment / Call for Pricing			

## 50 OHM, RG400/U COAX, DOUBLE SHIELDED

Model No.	Length	1-24	25-49	50-99	100 +
PE3642-12	12"	\$43.75	\$40.69	\$37.63	\$35.00
PE3642-24	24"	46.35	43.11	39.86	37.08
PE3642-36	36"	49.05	45.62	42.18	39.24
PE3642-48	48"	51.70	48.08	44.46	41.36
PE3642-60	60"	54.35	50.55	46.74	43.48
PE3642-XX	Any	Same-Day Shipment / Call for Pricing			

\*\*ROHS COMPLIANT & CUSTOM-LENGTH CABLE ASSEMBLIES MAY BE ORDERED ON OUR WEBSITE.\*\*

Cable Assemblies

# BNC MALE TO SMA MALE



ALL CABLE ASSEMBLIES ON THIS PAGE UTILIZE STANDARD 50 OHM INTERFACE CONNECTORS

## 53.5 OHM, RG55B/U COAX, DOUBLE SHIELDED

Model No.	Length	1-24	25-49	50-99	100 +
PE3479-12	12"	\$31.80	\$29.57	\$27.35	\$25.44
PE3479-24	24"	32.55	30.27	27.99	26.04
PE3479-36	36"	33.25	30.92	28.60	26.60
PE3479-48	48"	33.95	31.57	29.20	27.16
PE3479-60	60"	34.70	32.27	29.84	27.76
PE3479-XX	Any	Same-Day Shipment / Call for Pricing			

## 50 OHM, RG58C/U COAX

Model No.	Length	1-24	25-49	50-99	100 +
PE3615-12	12"	\$26.50	\$24.65	\$22.79	\$21.20
PE3615-24	24"	26.95	25.06	23.18	21.56
PE3615-36	36"	27.35	25.44	23.52	21.88
PE3615-48	48"	27.75	25.81	23.87	22.20
PE3615-60	60"	28.15	26.18	24.21	22.52
PE3615-XX	Any	Same-Day Shipment / Call for Pricing			

## 75 OHM, RG59B/U COAX

Model No.	Length	1-24	25-49	50-99	100 +
PE3539-12	12"	\$37.15	\$34.55	\$31.95	\$29.72
PE3539-24	24"	37.55	34.92	32.29	30.04
PE3539-36	36"	37.95	35.29	32.64	30.36
PE3539-48	48"	38.35	35.67	32.98	30.68
PE3539-60	60"	38.70	35.99	33.28	30.96
PE3539-XX	Any	Same-Day Shipment / Call for Pricing			

## 50 OHM, RG142B/U COAX, DOUBLE SHIELDED

Model No.	Length	1-24	25-49	50-99	100 +
PE3696-12	12"	\$31.80	\$29.57	\$27.35	\$25.44
PE3696-24	24"	34.50	32.09	29.67	27.60
PE3696-36	36"	37.15	34.55	31.95	29.72
PE3696-48	48"	39.80	37.01	34.23	31.84
PE3696-60	60"	42.45	39.48	36.51	33.96
PE3696-XX	Any	Same-Day Shipment / Call for Pricing			

## 50 OHM, RG174A/U COAX

Model No.	Length	1-24	25-49	50-99	100 +
PE3745-12	12"	\$30.50	\$28.37	\$26.23	\$24.40
PE3745-24	24"	30.80	28.64	26.49	24.64
PE3745-36	36"	31.05	28.88	26.70	24.84
PE3745-48	48"	31.30	29.11	26.92	25.04
PE3745-60	60"	31.50	29.30	27.09	25.20
PE3745-XX	Any	Same-Day Shipment / Call for Pricing			

## 50 OHM, RG178B/U COAX

Model No.	Length	1-24	25-49	50-99	100 +
PE33258-12	12"	\$51.70	\$48.08	\$44.46	\$41.36
PE33258-24	24"	52.70	49.01	45.32	42.16
PE33258-36	36"	53.65	49.89	46.14	42.92
PE33258-48	48"	54.55	50.73	46.91	43.64
PE33258-60	60"	55.60	51.71	47.82	44.48
PE33258-XX	Any	Same-Day Shipment / Call for Pricing			

## 75 OHM, RG179B/U COAX

Model No.	Length	1-24	25-49	50-99	100 +
PE3626-12	12"	\$30.50	\$28.37	\$26.23	\$24.40
PE3626-24	24"	31.45	29.25	27.05	25.16
PE3626-36	36"	32.45	30.18	27.91	25.96
PE3626-48	48"	33.40	31.06	28.72	26.72
PE3626-60	60"	34.35	31.95	29.54	27.48
PE3626-XX	Any	Same-Day Shipment / Call for Pricing			

## 50 OHM, RG188A/U COAX

Model No.	Length	1-24	25-49	50-99	100 +
PE3885-12	12"	\$30.50	\$28.37	\$26.23	\$24.40
PE3885-24	24"	31.45	29.25	27.05	25.16
PE3885-36	36"	32.45	30.18	27.91	25.96
PE3885-48	48"	33.40	31.06	28.72	26.72
PE3885-60	60"	34.35	31.95	29.54	27.48
PE3885-XX	Any	Same-Day Shipment / Call for Pricing			

## 50 OHM, RG196A/U COAX

Model No.	Length	1-24	25-49	50-99	100 +
PE33523-12	12"	\$51.70	\$48.08	\$44.46	\$41.36
PE33523-24	24"	52.70	49.01	45.32	42.16
PE33523-36	36"	53.65	49.89	46.14	42.92
PE33523-48	48"	54.55	50.73	46.91	43.64
PE33523-60	60"	55.60	51.71	47.82	44.48
PE33523-XX	Any	Same-Day Shipment / Call for Pricing			

## 50 OHM, RG214/U COAX, DOUBLE SHIELDED

Model No.	Length	1-24	25-49	50-99	100 +
PE33519-12	12"	\$53.00	\$49.29	\$45.58	\$42.40
PE33519-24	24"	56.60	52.64	48.68	45.28
PE33519-36	36"	60.25	56.03	51.82	48.20
PE33519-48	48"	63.85	59.38	54.91	51.08
PE33519-60	60"	67.45	62.73	58.01	53.96
PE33519-XX	Any	Same-Day Shipment / Call for Pricing			

## 50 OHM, RG223/U COAX, DOUBLE SHIELDED

Model No.	Length	1-24	25-49	50-99	100 +
PE3562-12	12"	\$30.50	\$28.37	\$26.23	\$24.40
PE3562-24	24"	31.80	29.57	27.35	25.44
PE3562-36	36"	33.15	30.83	28.51	26.52
PE3562-48	48"	34.50	32.09	29.67	27.60
PE3562-60	60"	35.80	33.29	30.79	28.64
PE3562-XX	Any	Same-Day Shipment / Call for Pricing			

## 50 OHM, RG316/U COAX

Model No.	Length	1-24	25-49	50-99	100 +
PE3658-12	12"	\$30.50	\$28.37	\$26.23	\$24.40
PE3658-24	24"	31.45	29.25	27.05	25.16
PE3658-36	36"	32.45	30.18	27.91	25.96
PE3658-48	48"	33.40	31.06	28.72	26.72
PE3658-60	60"	34.35	31.95	29.54	27.48
PE3658-XX	Any	Same-Day Shipment / Call for Pricing			

## 50 OHM, RG393/U COAX, DOUBLE SHIELDED

Model No.	Length	1-24	25-49	50-99	100 +
PE33521-12	12"	\$66.30	\$61.66	\$57.02	\$53.04
PE33521-24	24"	74.70	69.47	64.24	59.76
PE33521-36	36"	83.15	77.33	71.51	66.52
PE33521-48	48"	91.60	85.19	78.78	73.28
PE33521-60	60"	100.00	93.00	86.00	80.00
PE33521-XX	Any	Same-Day Shipment / Call for Pricing			

## 50 OHM, RG400/U COAX, DOUBLE SHIELDED

Model No.	Length	1-24	25-49	50-99	100 +
PE3613-12	12"	\$31.80	\$29.57	\$27.35	\$25.44
PE3613-24	24"	34.50	32.09	29.67	27.60
PE3613-36	36"	37.15	34.55	31.95	29.72
PE3613-48	48"	39.80	37.01	34.23	31.84
PE3613-60	60"	42.45	39.48	36.51	33.96
PE3613-XX	Any	Same-Day Shipment / Call for Pricing			

\*\*ROHS COMPLIANT & CUSTOM-LENGTH CABLE ASSEMBLIES MAY BE ORDERED ON OUR WEBSITE.\*\*

**NEW**

# QMA MALE TO QMA MALE



## 50 OHM, RG316/U COAX

Model No.	Length	1-24	25-49	50-99	100 +
PE38270-12	12"	\$48.90	\$45.48	\$42.05	\$39.12
PE38270-24	24"	50.95	47.38	43.82	40.76
PE38270-36	36"	53.00	49.29	45.58	42.40
PE38270-48	48"	55.05	51.20	47.34	44.04
PE38270-60	60"	57.05	53.06	49.06	45.64
PE38270-XX	Any	Same-Day Shipment / Call for Pricing			

## 50 OHM, RG58C/U

Model No.	Length	1-24	25-49	50-99	100 +
PE38271-12	12"	\$48.90	\$45.48	\$42.05	\$39.12
PE38271-24	24"	50.95	47.38	43.82	40.76
PE38271-36	36"	53.00	49.29	45.58	42.40
PE38271-48	48"	55.05	51.20	47.34	44.04
PE38271-60	60"	57.05	53.06	49.06	45.64
PE38271-XX	Any	Same-Day Shipment / Call for Pricing			

## 50 OHM, RG316-DS COAX, DOUBLE SHIELDED

Model No.	Length	1-24	25-49	50-99	100 +
PE38161-12	12"	\$50.95	\$47.38	\$43.82	\$40.76
PE38161-24	24"	54.00	50.22	46.44	43.20
PE38161-36	36"	57.05	53.06	49.06	45.64
PE38161-48	48"	60.15	55.94	51.73	48.12
PE38161-60	60"	63.20	58.78	54.35	50.56
PE38161-XX	Any	Same-Day Shipment / Call for Pricing			

## 50 OHM, PE-T195

Model No.	Length	1-24	25-49	50-99	100 +
PE38272-12	12"	\$50.95	\$47.38	\$43.82	\$40.76
PE38272-24	24"	53.00	49.29	45.58	42.40
PE38272-36	36"	55.05	51.20	47.34	44.04
PE38272-48	48"	57.05	53.06	49.06	45.64
PE38272-60	60"	59.10	54.96	50.83	47.28
PE38272-XX	Any	Same-Day Shipment / Call for Pricing			

**Cable Assemblies****NEW**

# QMA MALE TO SMA MALE



## 50 OHM, RG316/U COAX

Model No.	Length	1-24	25-49	50-99	100 +
PE38273-12	12"	\$36.65	\$34.08	\$31.52	\$29.32
PE38273-24	24"	38.70	35.99	33.28	30.96
PE38273-36	36"	40.75	37.90	35.05	32.60
PE38273-48	48"	42.80	39.80	36.81	34.24
PE38273-60	60"	44.85	41.71	38.57	35.88
PE38273-XX	Any	Same-Day Shipment / Call for Pricing			

## 50 OHM, RG58C/U

Model No.	Length	1-24	25-49	50-99	100 +
PE38275-12	12"	\$36.65	\$34.08	\$31.52	\$29.32
PE38275-24	24"	38.70	35.99	33.28	30.96
PE38275-36	36"	40.75	37.90	35.05	32.60
PE38275-48	48"	42.80	39.80	36.81	34.24
PE38275-60	60"	44.85	41.71	38.57	35.88
PE38275-XX	Any	Same-Day Shipment / Call for Pricing			

## 50 OHM, RG316-DS COAX, DOUBLE SHIELDED

Model No.	Length	1-24	25-49	50-99	100 +
PE38274-12	12"	\$38.70	\$35.99	\$33.28	\$30.96
PE38274-24	24"	41.75	38.83	35.91	33.40
PE38274-36	36"	44.85	41.71	38.57	35.88
PE38274-48	48"	47.90	44.55	41.19	38.32
PE38274-60	60"	50.95	47.38	43.82	40.76
PE38274-XX	Any	Same-Day Shipment / Call for Pricing			

## 50 OHM, PE-T195

Model No.	Length	1-24	25-49	50-99	100 +
PE38116-12	12"	\$38.70	\$35.99	\$33.28	\$30.96
PE38116-24	24"	40.75	37.90	35.05	32.60
PE38116-36	36"	42.80	39.80	36.81	34.24
PE38116-48	48"	44.85	41.71	38.57	35.88
PE38116-60	60"	46.85	43.57	40.29	37.48
PE38116-XX	Any	Same-Day Shipment / Call for Pricing			

**NEW**

# QMA MALE TO SMA FEMALE



## 50 OHM, RG316/U COAX

Model No.	Length	1-24	25-49	50-99	100 +
PE38276-12	12"	\$39.75	\$36.97	\$34.19	\$31.80
PE38276-24	24"	41.75	38.83	35.91	33.40
PE38276-36	36"	43.80	40.73	37.67	35.04
PE38276-48	48"	45.85	42.64	39.43	36.68
PE38276-60	60"	47.90	44.55	41.19	38.32
PE38276-XX	Any	Same-Day Shipment / Call for Pricing			

## 50 OHM, RG58C/U

Model No.	Length	1-24	25-49	50-99	100 +
PE38277-12	12"	\$39.75	\$36.97	\$34.19	\$31.80
PE38277-24	24"	41.75	38.83	35.91	33.40
PE38277-36	36"	43.80	40.73	37.67	35.04
PE38277-48	48"	45.85	42.64	39.43	36.68
PE38277-60	60"	47.90	44.55	41.19	38.32
PE38277-XX	Any	Same-Day Shipment / Call for Pricing			

## 50 OHM, RG316-DS COAX, DOUBLE SHIELDED

Model No.	Length	1-24	25-49	50-99	100 +
PE38052-12	12"	\$41.75	\$38.83	\$35.91	\$33.40
PE38052-24	24"	44.85	41.71	38.57	35.88
PE38052-36	36"	47.90	44.55	41.19	38.32
PE38052-48	48"	50.95	47.38	43.82	40.76
PE38052-60	60"	54.00	50.22	46.44	43.20
PE38052-XX	Any	Same-Day Shipment / Call for Pricing			

## 50 OHM, PE-T195

Model No.	Length	1-24	25-49	50-99	100 +
PE38278-12	12"	\$41.75	\$38.83	\$35.91	\$33.40
PE38278-24	24"	43.80	40.73	37.67	35.04
PE38278-36	36"	45.85	42.64	39.43	36.68
PE38278-48	48"	47.90	44.55	41.19	38.32
PE38278-60	60"	49.95	46.45	42.96	39.96
PE38278-XX	Any	Same-Day Shipment / Call for Pricing			

\*\*ROHS COMPLIANT &amp; CUSTOM-LENGTH CABLE ASSEMBLIES MAY BE ORDERED ON OUR WEBSITE.\*\*

# SMA MALE TO SMA MALE



## 53.5 OHM, RG55B/U COAX, DOUBLE SHIELDED

Model No.	Length	1-24	25-49	50-99	100 +
PE3572-12	12"	\$34.80	\$32.36	\$29.93	\$27.84
PE3572-24	24"	35.60	33.11	30.62	28.48
PE3572-36	36"	36.30	33.76	31.22	29.04
PE3572-48	48"	37.05	34.46	31.86	29.64
PE3572-60	60"	37.75	35.11	32.47	30.20
PE3572-XX	Any	Same-Day Shipment / Call for Pricing			

## 50 OHM, RG58C/U COAX

Model No.	Length	1-24	25-49	50-99	100 +
PE3369-12	12"	\$36.05	\$33.53	\$31.00	\$28.84
PE3369-24	24"	36.40	33.85	31.30	29.12
PE3369-36	36"	36.80	34.22	31.65	29.44
PE3369-48	48"	37.25	34.64	32.04	29.80
PE3369-60	60"	37.70	35.06	32.42	30.16
PE3369-XX	Any	Same-Day Shipment / Call for Pricing			

## 75 OHM, RG59B/U COAX

Model No.	Length	1-24	25-49	50-99	100 +
PE3814-12	12"	\$50.60	\$47.06	\$43.52	\$40.48
PE3814-24	24"	50.95	47.38	43.82	40.76
PE3814-36	36"	51.40	47.80	44.20	41.12
PE3814-48	48"	51.80	48.17	44.55	41.44
PE3814-60	60"	52.30	48.64	44.98	41.84
PE3814-XX	Any	Same-Day Shipment / Call for Pricing			

## 93 OHM, RG62A/U COAX

Model No.	Length	1-24	25-49	50-99	100 +
PE3899-12	12"	\$50.60	\$47.06	\$43.52	\$40.48
PE3899-24	24"	50.95	47.38	43.82	40.76
PE3899-36	36"	51.40	47.80	44.20	41.12
PE3899-48	48"	51.80	48.17	44.55	41.44
PE3899-60	60"	52.30	48.64	44.98	41.84
PE3899-XX	Any	Same-Day Shipment / Call for Pricing			

## 50 OHM, RG142B/U COAX, DOUBLE SHIELDED

Model No.	Length	1-24	25-49	50-99	100 +
PE3385-12	12"	\$39.80	\$37.01	\$34.23	\$31.84
PE3385-24	24"	42.45	39.48	36.51	33.96
PE3385-36	36"	45.10	41.94	38.79	36.08
PE3385-48	48"	47.70	44.36	41.02	38.16
PE3385-60	60"	50.40	46.87	43.34	40.32
PE3385-XX	Any	Same-Day Shipment / Call for Pricing			

## 50 OHM, RG178B/U COAX

Model No.	Length	1-24	25-49	50-99	100 +
PE3574-12	12"	\$50.85	\$47.29	\$43.73	\$40.68
PE3574-24	24"	51.80	48.17	44.55	41.44
PE3574-36	36"	52.80	49.10	45.41	42.24
PE3574-48	48"	53.80	50.03	46.27	43.04
PE3574-60	60"	54.65	50.82	47.00	43.72
PE3574-XX	Any	Same-Day Shipment / Call for Pricing			

## 50 OHM, RG174A/U COAX

Model No.	Length	1-24	25-49	50-99	100 +
PE3353-12	12"	\$36.00	\$33.48	\$30.96	\$28.80
PE3353-24	24"	36.20	33.67	31.13	28.96
PE3353-36	36"	36.45	33.90	31.35	29.16
PE3353-48	48"	36.70	34.13	31.56	29.36
PE3353-60	60"	37.05	34.46	31.86	29.64
PE3353-XX	Any	Same-Day Shipment / Call for Pricing			

## 75 OHM, RG179B/U COAX

Model No.	Length	1-24	25-49	50-99	100 +
PE3739-12	12"	\$36.30	\$33.76	\$31.22	\$29.04
PE3739-24	24"	37.30	34.69	32.08	29.84
PE3739-36	36"	38.20	35.53	32.85	30.56
PE3739-48	48"	39.15	36.41	33.67	31.32
PE3739-60	60"	40.10	37.29	34.49	32.08
PE3739-XX	Any	Same-Day Shipment / Call for Pricing			

## 50 OHM, RG188A/U COAX

Model No.	Length	1-24	25-49	50-99	100 +
PE3361-12	12"	\$36.30	\$33.76	\$31.22	\$29.04
PE3361-24	24"	37.30	34.69	32.08	29.84
PE3361-36	36"	38.20	35.53	32.85	30.56
PE3361-48	48"	39.15	36.41	33.67	31.32
PE3361-60	60"	40.10	37.29	34.49	32.08
PE3361-XX	Any	Same-Day Shipment / Call for Pricing			

## 50 OHM, RG214/U COAX, DOUBLE SHIELDED

Model No.	Length	1-24	25-49	50-99	100 +
PE3121-12	12"	\$107.90	\$100.35	\$92.79	\$86.32
PE3121-24	24"	111.50	103.70	95.89	89.20
PE3121-36	36"	115.10	107.04	98.99	92.08
PE3121-48	48"	118.80	110.48	102.17	95.04
PE3121-60	60"	122.35	113.79	105.22	97.88
PE3121-XX	Any	Same-Day Shipment / Call for Pricing			

## 50 OHM, RG223/U COAX, DOUBLE SHIELDED

Model No.	Length	1-24	25-49	50-99	100 +
PE3377-12	12"	\$36.45	\$33.90	\$31.35	\$29.16
PE3377-24	24"	37.80	35.15	32.51	30.24
PE3377-36	36"	39.10	36.36	33.63	31.28
PE3377-48	48"	40.40	37.57	34.74	32.32
PE3377-60	60"	41.75	38.83	35.91	33.40
PE3377-XX	Any	Same-Day Shipment / Call for Pricing			

## 50 OHM, RG316/U COAX

Model No.	Length	1-24	25-49	50-99	100 +
PE3573-12	12"	\$36.30	\$33.76	\$31.22	\$29.04
PE3573-24	24"	37.30	34.69	32.08	29.84
PE3573-36	36"	38.20	35.53	32.85	30.56
PE3573-48	48"	39.15	36.41	33.67	31.32
PE3573-60	60"	40.10	37.29	34.49	32.08
PE3573-XX	Any	Same-Day Shipment / Call for Pricing			

## 50 OHM, RG400/U COAX, DOUBLE SHIELDED

Model No.	Length	1-24	25-49	50-99	100 +
PE3500-12	12"	\$39.80	\$37.01	\$34.23	\$31.84
PE3500-24	24"	42.45	39.48	36.51	33.96
PE3500-36	36"	45.10	41.94	38.79	36.08
PE3500-48	48"	47.70	44.36	41.02	38.16
PE3500-60	60"	50.40	46.87	43.34	40.32
PE3500-XX	Any	Same-Day Shipment / Call for Pricing			

## 50 OHM, PE-142LL, LOW LOSS, DBL-SHLD COAX

Model No.	Length	1-24	25-49	50-99	100 +
PE3138-12	12"	\$54.85	\$51.01	\$47.17	\$43.88
PE3138-24	24"	58.45	54.36	50.27	46.76
PE3138-36	36"	62.00	57.66	53.32	49.60
PE3138-48	48"	65.70	61.10	56.50	52.56
PE3138-60	60"	69.30	64.45	59.60	55.44
PE3138-XX	Any	Same-Day Shipment / Call for Pricing			

\*\*ROHS COMPLIANT & CUSTOM-LENGTH CABLE ASSEMBLIES MAY BE ORDERED ON OUR WEBSITE.\*\*

# SEMI-RIGID & RE-SHAPEABLE CABLE ASSEMBLIES SMA MALE TO SMA MALE



## 50 OHM, RG402/U (.141" BARE COPPER)

Model No.	Length	1-24	25-49	50-99	100 +
PE3492-12	12"	\$25.70	\$23.90	\$22.10	\$20.56
PE3492-24	24"	29.25	27.20	25.16	23.40
PE3492-36	36"	32.90	30.60	28.29	26.32
PE3492-48	48"	36.50	33.95	31.39	29.20
PE3492-60	60"	40.10	37.29	34.49	32.08
PE3492-XX	Any	Same-Day Shipment / Call for Pricing			

## 50 OHM, PE-SR402AL (.141" TINNED ALUMINUM)

Model No.	Length	1-24	25-49	50-99	100 +
PE34180-12	12"	\$28.30	\$26.32	\$24.34	\$22.64
PE34180-24	24"	32.00	29.76	27.52	25.60
PE34180-36	36"	35.60	33.11	30.62	28.48
PE34180-48	48"	39.15	36.41	33.67	31.32
PE34180-60	60"	42.80	39.80	36.81	34.24
PE34180-XX	Any	Same-Day Shipment / Call for Pricing			

## 50 OHM, PE-SR402FL (.141" RE-SHAPEABLE)

Model No.	Length	1-24	25-49	50-99	100 +
PE3481-12	12"	\$28.30	\$26.32	\$24.34	\$22.64
PE3481-24	24"	32.00	29.76	27.52	25.60
PE3481-36	36"	35.60	33.11	30.62	28.48
PE3481-48	48"	39.15	36.41	33.67	31.32
PE3481-60	60"	42.80	39.80	36.81	34.24
PE3481-XX	Any	Same-Day Shipment / Call for Pricing			

## 50 OHM, PE-047SR (.047" BARE COPPER)

Model No.	Length	1-24	25-49	50-99	100 +
PE3656-12	12"	\$45.55	\$42.36	\$39.17	\$36.44
PE3656-24	24"	49.15	45.71	42.27	39.32
PE3656-36	36"	52.80	49.10	45.41	42.24
PE3656-48	48"	56.35	52.41	48.46	45.08
PE3656-60	60"	60.00	55.80	51.60	48.00
PE3656-XX	Any	Same-Day Shipment / Call for Pricing			

## 50 OHM, PE-SR047AL (.047" TINNED ALUMINUM)

Model No.	Length	1-24	25-49	50-99	100 +
PE3387-12	12"	\$49.45	\$45.99	\$42.53	\$39.56
PE3387-24	24"	53.15	49.43	45.71	42.52
PE3387-36	36"	56.70	52.73	48.76	45.36
PE3387-48	48"	60.35	56.13	51.90	48.28
PE3387-60	60"	64.00	59.52	55.04	51.20
PE3387-XX	Any	Same-Day Shipment / Call for Pricing			

## 50 OHM, PE-SR047FL (.047" RE-SHAPEABLE)

Model No.	Length	1-24	25-49	50-99	100 +
PE34186-12	12"	\$49.45	\$45.99	\$42.53	\$39.56
PE34186-24	24"	53.15	49.43	45.71	42.52
PE34186-36	36"	56.70	52.73	48.76	45.36
PE34186-48	48"	60.35	56.13	51.90	48.28
PE34186-60	60"	64.00	59.52	55.04	51.20
PE34186-XX	Any	Same-Day Shipment / Call for Pricing			

## 50 OHM, PE-020SR (.020" BARE COPPER)

Model No.	Length	1-24	25-49	50-99	100 +
PE34191-12	12"	\$109.70	\$102.02	\$94.34	\$87.76
PE34191-24	24"	116.90	108.72	100.53	93.52
PE34191-36	36"	124.20	115.51	106.81	99.36
PE34191-48	48"	131.40	122.20	113.00	105.12
PE34191-60	60"	138.55	128.85	119.15	110.84
PE34191-XX	Any	Same-Day Shipment / Call for Pricing			

## 50 OHM, RG405/U (.085" BARE COPPER)

Model No.	Length	1-24	25-49	50-99	100 +
PE3818-12	12"	\$28.30	\$26.32	\$24.34	\$22.64
PE3818-24	24"	32.00	29.76	27.52	25.60
PE3818-36	36"	35.60	33.11	30.62	28.48
PE3818-48	48"	39.15	36.41	33.67	31.32
PE3818-60	60"	42.80	39.80	36.81	34.24
PE3818-XX	Any	Same-Day Shipment / Call for Pricing			

## 50 OHM, PE-SR405AL (.085" TINNED ALUMINUM)

Model No.	Length	1-24	25-49	50-99	100 +
PE34182-12	12"	\$31.00	\$28.83	\$26.66	\$24.80
PE34182-24	24"	34.60	32.18	29.76	27.68
PE34182-36	36"	38.20	35.53	32.85	30.56
PE34182-48	48"	41.80	38.87	35.95	33.44
PE34182-60	60"	45.40	42.22	39.04	36.32
PE34182-XX	Any	Same-Day Shipment / Call for Pricing			

## 50 OHM, PE-SR405FL (.085" RE-SHAPEABLE)

Model No.	Length	1-24	25-49	50-99	100 +
PE3867-12	12"	\$31.00	\$28.83	\$26.66	\$24.80
PE3867-24	24"	34.60	32.18	29.76	27.68
PE3867-36	36"	38.20	35.53	32.85	30.56
PE3867-48	48"	41.80	38.87	35.95	33.44
PE3867-60	60"	45.40	42.22	39.04	36.32
PE3867-XX	Any	Same-Day Shipment / Call for Pricing			

## 50 OHM, RG401/U (.250" BARE COPPER)

Model No.	Length	1-24	25-49	50-99	100 +
PE33003-12	12"	\$109.70	\$102.02	\$94.34	\$87.76
PE33003-24	24"	116.90	108.72	100.53	93.52
PE33003-36	36"	124.20	115.51	106.81	99.36
PE33003-48	48"	131.40	122.20	113.00	105.12
PE33003-60	60"	138.55	128.85	119.15	110.84
PE33003-XX	Any	Same-Day Shipment / Call for Pricing			

## 50 OHM, PE-SR401AL (.250" TINNED ALUMINUM)

Model No.	Length	1-24	25-49	50-99	100 +
PE34184-12	12"	\$117.65	\$109.41	\$101.18	\$94.12
PE34184-24	24"	124.85	116.11	107.37	99.88
PE34184-36	36"	132.05	122.81	113.56	105.64
PE34184-48	48"	139.40	129.64	119.88	111.52
PE34184-60	60"	146.55	136.29	126.03	117.24
PE34184-XX	Any	Same-Day Shipment / Call for Pricing			

## 50 OHM, PE-SR401FL (.250" RE-SHAPEABLE)

Model No.	Length	1-24	25-49	50-99	100 +
PE34188-12	12"	\$117.65	\$109.41	\$101.18	\$94.12
PE34188-24	24"	124.85	116.11	107.37	99.88
PE34188-36	36"	132.05	122.81	113.56	105.64
PE34188-48	48"	139.40	129.64	119.88	111.52
PE34188-60	60"	146.55	136.29	126.03	117.24
PE34188-XX	Any	Same-Day Shipment / Call for Pricing			

## 50 OHM, PE-034SR (.034" BARE COPPER)

Model No.	Length	1-24	25-49	50-99	100 +
PE34193-12	12"	\$81.35	\$75.66	\$69.96	\$65.08
PE34193-24	24"	85.00	79.05	73.10	68.00
PE34193-36	36"	88.60	82.40	76.20	70.88
PE34193-48	48"	92.20	85.75	79.29	73.76
PE34193-60	60"	95.90	89.19	82.47	76.72
PE34193-XX	Any	Same-Day Shipment / Call for Pricing			

\*\*ROHS COMPLIANT & CUSTOM-LENGTH CABLE ASSEMBLIES MAY BE ORDERED ON OUR WEBSITE.\*\*



# SMA MALE TO SMA MALE RIGHT ANGLE



## 50 OHM, RG58C/U COAX

Model No.	Length	1-24	25-49	50-99	100 +
PE3319-12	12"	\$42.65	\$39.66	\$36.68	\$34.12
PE3319-24	24"	43.10	40.08	37.07	34.48
PE3319-36	36"	43.45	40.41	37.37	34.76
PE3319-48	48"	43.85	40.78	37.71	35.08
PE3319-60	60"	44.25	41.15	38.06	35.40
PE3319-XX	Any	Same-Day Shipment / Call for Pricing			

## 75 OHM, RG59B/U COAX

Model No.	Length	1-24	25-49	50-99	100 +
PE3137-12	12"	\$57.20	\$53.20	\$49.19	\$45.76
PE3137-24	24"	57.65	53.61	49.58	46.12
PE3137-36	36"	58.05	53.99	49.92	46.44
PE3137-48	48"	58.40	54.31	50.22	46.72
PE3137-60	60"	58.90	54.78	50.65	47.12
PE3137-XX	Any	Same-Day Shipment / Call for Pricing			

## 93 OHM, RG62A/U COAX

Model No.	Length	1-24	25-49	50-99	100 +
PE3411-12	12"	\$57.20	\$53.20	\$49.19	\$45.76
PE3411-24	24"	57.65	53.61	49.58	46.12
PE3411-36	36"	58.05	53.99	49.92	46.44
PE3411-48	48"	58.40	54.31	50.22	46.72
PE3411-60	60"	58.90	54.78	50.65	47.12
PE3411-XX	Any	Same-Day Shipment / Call for Pricing			

## 50 OHM, RG142B/U COAX, DOUBLE SHIELDED

Model No.	Length	1-24	25-49	50-99	100 +
PE3512-12	12"	\$46.35	\$43.11	\$39.86	\$37.08
PE3512-24	24"	49.05	45.62	42.18	39.24
PE3512-36	36"	51.70	48.08	44.46	41.36
PE3512-48	48"	54.35	50.55	46.74	43.48
PE3512-60	60"	57.00	53.01	49.02	45.60
PE3512-XX	Any	Same-Day Shipment / Call for Pricing			

## 50 OHM, RG174A/U COAX

Model No.	Length	1-24	25-49	50-99	100 +
PE3420-12	12"	\$42.60	\$39.62	\$36.64	\$34.08
PE3420-24	24"	42.85	39.85	36.85	34.28
PE3420-36	36"	43.15	40.13	37.11	34.52
PE3420-48	48"	43.35	40.32	37.28	34.68
PE3420-60	60"	43.60	40.55	37.50	34.88
PE3420-XX	Any	Same-Day Shipment / Call for Pricing			

## 50 OHM, RG178B/U COAX

Model No.	Length	1-24	25-49	50-99	100 +
PE3865-12	12"	\$58.85	\$54.73	\$50.61	\$47.08
PE3865-24	24"	59.75	55.57	51.39	47.80
PE3865-36	36"	60.80	56.54	52.29	48.64
PE3865-48	48"	61.65	57.33	53.02	49.32
PE3865-60	60"	62.70	58.31	53.92	50.16
PE3865-XX	Any	Same-Day Shipment / Call for Pricing			

## 75 OHM, RG179B/U COAX

Model No.	Length	1-24	25-49	50-99	100 +
PE3459-12	12"	\$42.95	\$39.94	\$36.94	\$34.36
PE3459-24	24"	43.85	40.78	37.71	35.08
PE3459-36	36"	44.90	41.76	38.61	35.92
PE3459-48	48"	45.75	42.55	39.35	36.60
PE3459-60	60"	46.80	43.52	40.25	37.44
PE3459-XX	Any	Same-Day Shipment / Call for Pricing			

## 95 OHM, RG180B/U COAX

Model No.	Length	1-24	25-49	50-99	100 +
PE3352-12	12"	\$44.35	\$41.25	\$38.14	\$35.48
PE3352-24	24"	45.55	42.36	39.17	36.44
PE3352-36	36"	46.80	43.52	40.25	37.44
PE3352-48	48"	48.00	44.64	41.28	38.40
PE3352-60	60"	49.15	45.71	42.27	39.32
PE3352-XX	Any	Same-Day Shipment / Call for Pricing			

## 50 OHM, RG188A/U COAX

Model No.	Length	1-24	25-49	50-99	100 +
PE3510-12	12"	\$42.95	\$39.94	\$36.94	\$34.36
PE3510-24	24"	43.85	40.78	37.71	35.08
PE3510-36	36"	44.90	41.76	38.61	35.92
PE3510-48	48"	45.75	42.55	39.35	36.60
PE3510-60	60"	46.80	43.52	40.25	37.44
PE3510-XX	Any	Same-Day Shipment / Call for Pricing			

## 50 OHM, RG188-DS COAX, DOUBLE SHIELDED

Model No.	Length	1-24	25-49	50-99	100 +
PE3779-12	12"	\$46.25	\$43.01	\$39.78	\$37.00
PE3779-24	24"	48.70	45.29	41.88	38.96
PE3779-36	36"	51.05	47.48	43.90	40.84
PE3779-48	48"	53.55	49.80	46.05	42.84
PE3779-60	60"	55.90	51.99	48.07	44.72
PE3779-XX	Any	Same-Day Shipment / Call for Pricing			

## 50 OHM, RG223/U COAX, DOUBLE SHIELDED

Model No.	Length	1-24	25-49	50-99	100 +
PE3429-12	12"	\$43.15	\$40.13	\$37.11	\$34.52
PE3429-24	24"	44.40	41.29	38.18	35.52
PE3429-36	36"	45.70	42.50	39.30	36.56
PE3429-48	48"	47.05	43.76	40.46	37.64
PE3429-60	60"	48.45	45.06	41.67	38.76
PE3429-XX	Any	Same-Day Shipment / Call for Pricing			

## 50 OHM, RG316/U COAX

Model No.	Length	1-24	25-49	50-99	100 +
PE3513-12	12"	\$42.95	\$39.94	\$36.94	\$34.36
PE3513-24	24"	43.85	40.78	37.71	35.08
PE3513-36	36"	44.90	41.76	38.61	35.92
PE3513-48	48"	45.75	42.55	39.35	36.60
PE3513-60	60"	46.80	43.52	40.25	37.44
PE3513-XX	Any	Same-Day Shipment / Call for Pricing			

## 50 OHM, RG316-DS COAX, DOUBLE SHIELDED

Model No.	Length	1-24	25-49	50-99	100 +
PE3344-12	12"	\$46.25	\$43.01	\$39.78	\$37.00
PE3344-24	24"	48.70	45.29	41.88	38.96
PE3344-36	36"	51.05	47.48	43.90	40.84
PE3344-48	48"	53.55	49.80	46.05	42.84
PE3344-60	60"	55.90	51.99	48.07	44.72
PE3344-XX	Any	Same-Day Shipment / Call for Pricing			

## 50 OHM, RG400/U COAX, DOUBLE SHIELDED

Model No.	Length	1-24	25-49	50-99	100 +
PE3003-12	12"	\$46.35	\$43.11	\$39.86	\$37.08
PE3003-24	24"	49.05	45.62	42.18	39.24
PE3003-36	36"	51.70	48.08	44.46	41.36
PE3003-48	48"	54.35	50.55	46.74	43.48
PE3003-60	60"	57.00	53.01	49.02	45.60
PE3003-XX	Any	Same-Day Shipment / Call for Pricing			

\*\*ROHS COMPLIANT & CUSTOM-LENGTH CABLE ASSEMBLIES MAY BE ORDERED ON OUR WEBSITE.\*\*

# SEMI-RIGID & RE-SHAPEABLE CABLE ASSEMBLIES

## SMA MALE TO SMA MALE RIGHT ANGLE



### 50 OHM, RG402/U (.141" BARE COPPER)

Model No.	Length	1-24	25-49	50-99	100 +
PE3821-12	12"	\$33.60	\$31.25	\$28.90	\$26.88
PE3821-24	24"	37.30	34.69	32.08	29.84
PE3821-36	36"	40.85	37.99	35.13	32.68
PE3821-48	48"	44.45	41.34	38.23	35.56
PE3821-60	60"	48.10	44.73	41.37	38.48
PE3821-XX	Any	Same-Day Shipment / Call for Pricing			

### 50 OHM, PE-SR402AL (.141" TINNED ALUMINUM)

Model No.	Length	1-24	25-49	50-99	100 +
PE34195-12	12"	\$37.60	\$34.97	\$32.34	\$30.08
PE34195-24	24"	41.25	38.36	35.48	33.00
PE34195-36	36"	44.90	41.76	38.61	35.92
PE34195-48	48"	48.50	45.11	41.71	38.80
PE34195-60	60"	52.10	48.45	44.81	41.68
PE34195-XX	Any	Same-Day Shipment / Call for Pricing			

### 50 OHM, PE-SR402FL (.141" RE-SHAPEABLE)

Model No.	Length	1-24	25-49	50-99	100 +
PE3483-12	12"	\$37.60	\$34.97	\$32.34	\$30.08
PE3483-24	24"	41.25	38.36	35.48	33.00
PE3483-36	36"	44.90	41.76	38.61	35.92
PE3483-48	48"	48.50	45.11	41.71	38.80
PE3483-60	60"	52.10	48.45	44.81	41.68
PE3483-XX	Any	Same-Day Shipment / Call for Pricing			

### 50 OHM, PE-047SR (.047" BARE COPPER)

Model No.	Length	1-24	25-49	50-99	100 +
PE3230-12	12"	\$65.45	\$60.87	\$56.29	\$52.36
PE3230-24	24"	69.05	64.22	59.38	55.24
PE3230-36	36"	72.60	67.52	62.44	58.08
PE3230-48	48"	76.30	70.96	65.62	61.04
PE3230-60	60"	79.90	74.31	68.71	63.92
PE3230-XX	Any	Same-Day Shipment / Call for Pricing			

### 50 OHM, PE-SR047AL (.047" TINNED ALUMINUM)

Model No.	Length	1-24	25-49	50-99	100 +
PE3393-12	12"	\$73.40	\$68.26	\$63.12	\$58.72
PE3393-24	24"	77.00	71.61	66.22	61.60
PE3393-36	36"	80.70	75.05	69.40	64.56
PE3393-48	48"	84.25	78.35	72.46	67.40
PE3393-60	60"	87.85	81.70	75.55	70.28
PE3393-XX	Any	Same-Day Shipment / Call for Pricing			

### 50 OHM, PE-SR047FL (.047" RE-SHAPEABLE)

Model No.	Length	1-24	25-49	50-99	100 +
PE34197-12	12"	\$73.40	\$68.26	\$63.12	\$58.72
PE34197-24	24"	77.00	71.61	66.22	61.60
PE34197-36	36"	80.70	75.05	69.40	64.56
PE34197-48	48"	84.25	78.35	72.46	67.40
PE34197-60	60"	87.85	81.70	75.55	70.28
PE34197-XX	Any	Same-Day Shipment / Call for Pricing			

### 50 OHM, PE-020SR (.020" BARE COPPER)

Model No.	Length	1-24	25-49	50-99	100 +
PE34204-12	12"	\$136.20	\$126.67	\$117.13	\$108.96
PE34204-24	24"	143.45	133.41	123.37	114.76
PE34204-36	36"	150.70	140.15	129.60	120.56
PE34204-48	48"	157.90	146.85	135.79	126.32
PE34204-60	60"	165.15	153.59	142.03	132.12
PE34204-XX	Any	Same-Day Shipment / Call for Pricing			

### 50 OHM, RG405/U (.085" BARE COPPER)

Model No.	Length	1-24	25-49	50-99	100 +
PE3822-12	12"	\$34.95	\$32.50	\$30.06	\$27.96
PE3822-24	24"	38.55	35.85	33.15	30.84
PE3822-36	36"	42.20	39.25	36.29	33.76
PE3822-48	48"	45.75	42.55	39.35	36.60
PE3822-60	60"	49.35	45.90	42.44	39.48
PE3822-XX	Any	Same-Day Shipment / Call for Pricing			

### 50 OHM, PE-SR405AL (.085" TINNED ALUMINUM)

Model No.	Length	1-24	25-49	50-99	100 +
PE34199-12	12"	\$38.90	\$36.18	\$33.45	\$31.12
PE34199-24	24"	42.60	39.62	36.64	34.08
PE34199-36	36"	46.15	42.92	39.69	36.92
PE34199-48	48"	49.80	46.31	42.83	39.84
PE34199-60	60"	53.45	49.71	45.97	42.76
PE34199-XX	Any	Same-Day Shipment / Call for Pricing			

### 50 OHM, PE-SR405FL (.085" RE-SHAPEABLE)

Model No.	Length	1-24	25-49	50-99	100 +
PE3958-12	12"	\$38.90	\$36.18	\$33.45	\$31.12
PE3958-24	24"	42.60	39.62	36.64	34.08
PE3958-36	36"	46.15	42.92	39.69	36.92
PE3958-48	48"	49.80	46.31	42.83	39.84
PE3958-60	60"	53.45	49.71	45.97	42.76
PE3958-XX	Any	Same-Day Shipment / Call for Pricing			

### 50 OHM, RG401/U (.250" BARE COPPER)

Model No.	Length	1-24	25-49	50-99	100 +
PE34220-12	12"	\$136.20	\$126.67	\$117.13	\$108.96
PE34220-24	24"	143.45	133.41	123.37	114.76
PE34220-36	36"	150.70	140.15	129.60	120.56
PE34220-48	48"	157.90	146.85	135.79	126.32
PE34220-60	60"	165.15	153.59	142.03	132.12
PE34220-XX	Any	Same-Day Shipment / Call for Pricing			

### 50 OHM, PE-SR401AL (.250" TINNED ALUMINUM)

Model No.	Length	1-24	25-49	50-99	100 +
PE34200-12	12"	\$149.45	\$138.99	\$128.53	\$119.56
PE34200-24	24"	156.65	145.68	134.72	125.32
PE34200-36	36"	163.95	152.47	141.00	131.16
PE34200-48	48"	171.15	159.17	147.19	136.92
PE34200-60	60"	178.40	165.91	153.42	142.72
PE34200-XX	Any	Same-Day Shipment / Call for Pricing			

### 50 OHM, PE-SR401FL (.250" RE-SHAPEABLE)

Model No.	Length	1-24	25-49	50-99	100 +
PE34202-12	12"	\$149.45	\$138.99	\$128.53	\$119.56
PE34202-24	24"	156.65	145.68	134.72	125.32
PE34202-36	36"	163.95	152.47	141.00	131.16
PE34202-48	48"	171.15	159.17	147.19	136.92
PE34202-60	60"	178.40	165.91	153.42	142.72
PE34202-XX	Any	Same-Day Shipment / Call for Pricing			

### 50 OHM, PE-034SR (.034" BARE COPPER)

Model No.	Length	1-24	25-49	50-99	100 +
PE34206-12	12"	\$107.90	\$100.35	\$92.79	\$86.32
PE34206-24	24"	111.50	103.70	95.89	89.20
PE34206-36	36"	115.10	107.04	98.99	92.08
PE34206-48	48"	118.80	110.48	102.17	95.04
PE34206-60	60"	122.35	113.79	105.22	97.88
PE34206-XX	Any	Same-Day Shipment / Call for Pricing			

\*\*ROHS COMPLIANT & CUSTOM-LENGTH CABLE ASSEMBLIES MAY BE ORDERED ON OUR WEBSITE.\*\*

Cable Assemblies

# SMA MALE RIGHT ANGLE TO SMA MALE RIGHT ANGLE



## 50 OHM, RG58C/U COAX

Model No.	Length	1-24	25-49	50-99	100 +
PE3655-12	12"	\$45.30	\$42.13	\$38.96	\$36.24
PE3655-24	24"	45.65	42.45	39.26	36.52
PE3655-36	36"	46.10	42.87	39.65	36.88
PE3655-48	48"	46.55	43.29	40.03	37.24
PE3655-60	60"	46.95	43.66	40.38	37.56
PE3655-XX	Any	Same-Day Shipment / Call for Pricing			

## 75 OHM, RG59B/U COAX

Model No.	Length	1-24	25-49	50-99	100 +
PE3380-12	12"	\$63.80	\$59.33	\$54.87	\$51.04
PE3380-24	24"	64.30	59.80	55.30	51.44
PE3380-36	36"	64.65	60.12	55.60	51.72
PE3380-48	48"	65.10	60.54	55.99	52.08
PE3380-60	60"	65.45	60.87	56.29	52.36
PE3380-XX	Any	Same-Day Shipment / Call for Pricing			

## 93 OHM, RG62A/U COAX

Model No.	Length	1-24	25-49	50-99	100 +
PE3444-12	12"	\$63.80	\$59.33	\$54.87	\$51.04
PE3444-24	24"	64.30	59.80	55.30	51.44
PE3444-36	36"	64.65	60.12	55.60	51.72
PE3444-48	48"	65.10	60.54	55.99	52.08
PE3444-60	60"	65.45	60.87	56.29	52.36
PE3444-XX	Any	Same-Day Shipment / Call for Pricing			

## 50 OHM, RG142B/U COAX, DOUBLE SHIELDED

Model No.	Length	1-24	25-49	50-99	100 +
PE3514-12	12"	\$49.05	\$45.62	\$42.18	\$39.24
PE3514-24	24"	51.70	48.08	44.46	41.36
PE3514-36	36"	54.35	50.55	46.74	43.48
PE3514-48	48"	57.00	53.01	49.02	45.60
PE3514-60	60"	59.65	55.47	51.30	47.72
PE3514-XX	Any	Same-Day Shipment / Call for Pricing			

## 50 OHM, RG174A/U COAX

Model No.	Length	1-24	25-49	50-99	100 +
PE3775-12	12"	\$45.30	\$42.13	\$38.96	\$36.24
PE3775-24	24"	45.65	42.45	39.26	36.52
PE3775-36	36"	46.10	42.87	39.65	36.88
PE3775-48	48"	46.55	43.29	40.03	37.24
PE3775-60	60"	46.95	43.66	40.38	37.56
PE3775-XX	Any	Same-Day Shipment / Call for Pricing			

## 50 OHM, RG178B/U COAX

Model No.	Length	1-24	25-49	50-99	100 +
PE3876-12	12"	\$62.80	\$58.40	\$54.01	\$50.24
PE3876-24	24"	63.75	59.29	54.83	51.00
PE3876-36	36"	64.70	60.17	55.64	51.76
PE3876-48	48"	65.70	61.10	56.50	52.56
PE3876-60	60"	66.65	61.98	57.32	53.32
PE3876-XX	Any	Same-Day Shipment / Call for Pricing			

## 75 OHM, RG179B/U COAX

Model No.	Length	1-24	25-49	50-99	100 +
PE3858-12	12"	\$45.55	\$42.36	\$39.17	\$36.44
PE3858-24	24"	46.55	43.29	40.03	37.24
PE3858-36	36"	47.50	44.18	40.85	38.00
PE3858-48	48"	48.50	45.11	41.71	38.80
PE3858-60	60"	49.35	45.90	42.44	39.48
PE3858-XX	Any	Same-Day Shipment / Call for Pricing			

## 95 OHM, RG180B/U COAX

Model No.	Length	1-24	25-49	50-99	100 +
PE3141-12	12"	\$47.00	\$43.71	\$40.42	\$37.60
PE3141-24	24"	48.25	44.87	41.50	38.60
PE3141-36	36"	49.35	45.90	42.44	39.48
PE3141-48	48"	50.60	47.06	43.52	40.48
PE3141-60	60"	51.80	48.17	44.55	41.44
PE3141-XX	Any	Same-Day Shipment / Call for Pricing			

## 50 OHM, RG188A/U COAX

Model No.	Length	1-24	25-49	50-99	100 +
PE3511-12	12"	\$45.55	\$42.36	\$39.17	\$36.44
PE3511-24	24"	46.55	43.29	40.03	37.24
PE3511-36	36"	47.50	44.18	40.85	38.00
PE3511-48	48"	48.50	45.11	41.71	38.80
PE3511-60	60"	49.35	45.90	42.44	39.48
PE3511-XX	Any	Same-Day Shipment / Call for Pricing			

## 50 OHM, RG188-DS COAX, DOUBLE SHIELDED

Model No.	Length	1-24	25-49	50-99	100 +
PE3347-12	12"	\$48.95	\$45.52	\$42.10	\$39.16
PE3347-24	24"	51.30	47.71	44.12	41.04
PE3347-36	36"	53.80	50.03	46.27	43.04
PE3347-48	48"	56.15	52.22	48.29	44.92
PE3347-60	60"	58.55	54.45	50.35	46.84
PE3347-XX	Any	Same-Day Shipment / Call for Pricing			

## 50 OHM, RG223/U COAX, DOUBLE SHIELDED

Model No.	Length	1-24	25-49	50-99	100 +
PE3428-12	12"	\$45.70	\$42.50	\$39.30	\$36.56
PE3428-24	24"	47.05	43.76	40.46	37.64
PE3428-36	36"	48.45	45.06	41.67	38.76
PE3428-48	48"	49.75	46.27	42.79	39.80
PE3428-60	60"	51.00	47.43	43.86	40.80
PE3428-XX	Any	Same-Day Shipment / Call for Pricing			

## 50 OHM, RG316/U COAX

Model No.	Length	1-24	25-49	50-99	100 +
PE3515-12	12"	\$45.55	\$42.36	\$39.17	\$36.44
PE3515-24	24"	46.55	43.29	40.03	37.24
PE3515-36	36"	47.50	44.18	40.85	38.00
PE3515-48	48"	48.50	45.11	41.71	38.80
PE3515-60	60"	49.35	45.90	42.44	39.48
PE3515-XX	Any	Same-Day Shipment / Call for Pricing			

## 50 OHM, RG316-DS COAX, DOUBLE SHIELDED

Model No.	Length	1-24	25-49	50-99	100 +
PE3987-12	12"	\$48.95	\$45.52	\$42.10	\$39.16
PE3987-24	24"	51.30	47.71	44.12	41.04
PE3987-36	36"	53.80	50.03	46.27	43.04
PE3987-48	48"	56.15	52.22	48.29	44.92
PE3987-60	60"	58.55	54.45	50.35	46.84
PE3987-XX	Any	Same-Day Shipment / Call for Pricing			

## 50 OHM, RG400/U COAX, DOUBLE SHIELDED

Model No.	Length	1-24	25-49	50-99	100 +
PE3713-12	12"	\$49.05	\$45.62	\$42.18	\$39.24
PE3713-24	24"	51.70	48.08	44.46	41.36
PE3713-36	36"	54.35	50.55	46.74	43.48
PE3713-48	48"	57.00	53.01	49.02	45.60
PE3713-60	60"	59.65	55.47	51.30	47.72
PE3713-XX	Any	Same-Day Shipment / Call for Pricing			

\*\*ROHS COMPLIANT & CUSTOM-LENGTH CABLE ASSEMBLIES MAY BE ORDERED ON OUR WEBSITE.\*\*

# SEMI-RIGID & RE-SHAPEABLE CABLE ASSEMBLIES

## SMA MALE RIGHT ANGLE TO SMA MALE RIGHT ANGLE



### 50 OHM, RG402/U (.141" BARE COPPER)

Model No.	Length	1-24	25-49	50-99	100 +
PE3819-12	12"	\$49.45	\$45.99	\$42.53	\$39.56
PE3819-24	24"	53.15	49.43	45.71	42.52
PE3819-36	36"	56.70	52.73	48.76	45.36
PE3819-48	48"	60.35	56.13	51.90	48.28
PE3819-60	60"	64.00	59.52	55.04	51.20
PE3819-XX	Any	Same-Day Shipment / Call for Pricing			

### 50 OHM, PE-SR402AL (.141" TINNED ALUMINUM)

Model No.	Length	1-24	25-49	50-99	100 +
PE34208-12	12"	\$52.20	\$48.55	\$44.89	\$41.76
PE34208-24	24"	55.80	51.89	47.99	44.64
PE34208-36	36"	59.40	55.24	51.08	47.52
PE34208-48	48"	63.05	58.64	54.22	50.44
PE34208-60	60"	66.65	61.98	57.32	53.32
PE34208-XX	Any	Same-Day Shipment / Call for Pricing			

### 50 OHM, PE-SR402FL (.141" RE-SHAPEABLE)

Model No.	Length	1-24	25-49	50-99	100 +
PE3417-12	12"	\$52.20	\$48.55	\$44.89	\$41.76
PE3417-24	24"	55.80	51.89	47.99	44.64
PE3417-36	36"	59.40	55.24	51.08	47.52
PE3417-48	48"	63.05	58.64	54.22	50.44
PE3417-60	60"	66.65	61.98	57.32	53.32
PE3417-XX	Any	Same-Day Shipment / Call for Pricing			

### 50 OHM, PE-047SR (.047" BARE COPPER)

Model No.	Length	1-24	25-49	50-99	100 +
PE3147-12	12"	\$81.35	\$75.66	\$69.96	\$65.08
PE3147-24	24"	85.00	79.05	73.10	68.00
PE3147-36	36"	88.60	82.40	76.20	70.88
PE3147-48	48"	92.20	85.75	79.29	73.76
PE3147-60	60"	95.90	89.19	82.47	76.72
PE3147-XX	Any	Same-Day Shipment / Call for Pricing			

### 50 OHM, PE-SR047AL (.047" TINNED ALUMINUM)

Model No.	Length	1-24	25-49	50-99	100 +
PE3259-12	12"	\$89.30	\$83.05	\$76.80	\$71.44
PE3259-24	24"	92.90	86.40	79.89	74.32
PE3259-36	36"	96.60	89.84	83.08	77.28
PE3259-48	48"	100.15	93.14	86.13	80.12
PE3259-60	60"	103.80	96.53	89.27	83.04
PE3259-XX	Any	Same-Day Shipment / Call for Pricing			

### 50 OHM, PE-SR047FL (.047" RE-SHAPEABLE)

Model No.	Length	1-24	25-49	50-99	100 +
PE34209-12	12"	\$89.30	\$83.05	\$76.80	\$71.44
PE34209-24	24"	92.90	86.40	79.89	74.32
PE34209-36	36"	96.60	89.84	83.08	77.28
PE34209-48	48"	100.15	93.14	86.13	80.12
PE34209-60	60"	103.80	96.53	89.27	83.04
PE34209-XX	Any	Same-Day Shipment / Call for Pricing			

### 50 OHM, PE-020SR (.020" BARE COPPER)

Model No.	Length	1-24	25-49	50-99	100 +
PE34211-12	12"	\$162.75	\$151.36	\$139.97	\$130.20
PE34211-24	24"	169.95	158.05	146.16	135.96
PE34211-36	36"	177.10	164.70	152.31	141.68
PE34211-48	48"	184.40	171.49	158.58	147.52
PE34211-60	60"	191.60	178.19	164.78	153.28
PE34211-XX	Any	Same-Day Shipment / Call for Pricing			

### 50 OHM, RG405/U (.085" BARE COPPER)

Model No.	Length	1-24	25-49	50-99	100 +
PE3820-12	12"	\$50.85	\$47.29	\$43.73	\$40.68
PE3820-24	24"	54.45	50.64	46.83	43.56
PE3820-36	36"	58.10	54.03	49.97	46.48
PE3820-48	48"	61.65	57.33	53.02	49.32
PE3820-60	60"	65.30	60.73	56.16	52.24
PE3820-XX	Any	Same-Day Shipment / Call for Pricing			

### 50 OHM, PE-SR405AL (.085" TINNED ALUMINUM)

Model No.	Length	1-24	25-49	50-99	100 +
PE34213-12	12"	\$54.85	\$51.01	\$47.17	\$43.88
PE34213-24	24"	58.45	54.36	50.27	46.76
PE34213-36	36"	62.00	57.66	53.32	49.60
PE34213-48	48"	65.70	61.10	56.50	52.56
PE34213-60	60"	69.30	64.45	59.60	55.44
PE34213-XX	Any	Same-Day Shipment / Call for Pricing			

### 50 OHM, PE-SR405FL (.085" RE-SHAPEABLE)

Model No.	Length	1-24	25-49	50-99	100 +
PE3646-12	12"	\$54.85	\$51.01	\$47.17	\$43.88
PE3646-24	24"	58.45	54.36	50.27	46.76
PE3646-36	36"	62.00	57.66	53.32	49.60
PE3646-48	48"	65.70	61.10	56.50	52.56
PE3646-60	60"	69.30	64.45	59.60	55.44
PE3646-XX	Any	Same-Day Shipment / Call for Pricing			

### 50 OHM, RG401/U (.250" BARE COPPER)

Model No.	Length	1-24	25-49	50-99	100 +
PE34223-12	12"	\$159.55	\$148.38	\$137.21	\$127.64
PE34223-24	24"	166.60	154.94	143.28	133.28
PE34223-36	36"	173.65	161.49	149.34	138.92
PE34223-48	48"	180.80	168.14	155.49	144.64
PE34223-60	60"	187.85	174.70	161.55	150.28
PE34223-XX	Any	Same-Day Shipment / Call for Pricing			

### 50 OHM, PE-SR401AL (.250" TINNED ALUMINUM)

Model No.	Length	1-24	25-49	50-99	100 +
PE34215-12	12"	\$186.35	\$173.31	\$160.26	\$149.08
PE34215-24	24"	194.10	180.51	166.93	155.28
PE34215-36	36"	201.70	187.58	173.46	161.36
PE34215-48	48"	209.30	194.65	180.00	167.44
PE34215-60	60"	216.90	201.72	186.53	173.52
PE34215-XX	Any	Same-Day Shipment / Call for Pricing			

### 50 OHM, PE-SR401FL (.250" RE-SHAPEABLE)

Model No.	Length	1-24	25-49	50-99	100 +
PE34217-12	12"	\$186.35	\$173.31	\$160.26	\$149.08
PE34217-24	24"	194.10	180.51	166.93	155.28
PE34217-36	36"	201.70	187.58	173.46	161.36
PE34217-48	48"	209.30	194.65	180.00	167.44
PE34217-60	60"	216.90	201.72	186.53	173.52
PE34217-XX	Any	Same-Day Shipment / Call for Pricing			

### 50 OHM, PE-034SR (.034" BARE COPPER)

Model No.	Length	1-24	25-49	50-99	100 +
PE34219-12	12"	\$134.45	\$125.04	\$115.63	\$107.56
PE34219-24	24"	138.00	128.34	118.68	110.40
PE34219-36	36"	141.70	131.78	121.86	113.36
PE34219-48	48"	145.30	135.13	124.96	116.24
PE34219-60	60"	148.85	138.43	128.01	119.08
PE34219-XX	Any	Same-Day Shipment / Call for Pricing			

\*\*ROHS COMPLIANT & CUSTOM-LENGTH CABLE ASSEMBLIES MAY BE ORDERED ON OUR WEBSITE.\*\*

Cable Assemblies

# SMA MALE TO SMA FEMALE

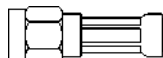

## 53.5 OHM, RG55B/U COAX, DOUBLE SHIELDED

Model No.	Length	1-24	25-49	50-99	100 +
PE3093-12	12"	\$49.35	\$45.90	\$42.44	\$39.48
PE3093-24	24"	50.20	46.69	43.17	40.16
PE3093-36	36"	50.85	47.29	43.73	40.68
PE3093-48	48"	51.55	47.94	44.33	41.24
PE3093-60	60"	52.35	48.69	45.02	41.88
PE3093-XX	Any	Same-Day Shipment / Call for Pricing			

## 50 OHM, RG58C/U COAX

Model No.	Length	1-24	25-49	50-99	100 +
PE3078-12	12"	\$42.65	\$39.66	\$36.68	\$34.12
PE3078-24	24"	\$43.10	40.08	37.07	34.48
PE3078-36	36"	43.45	40.41	37.37	34.76
PE3078-48	48"	43.85	40.78	37.71	35.08
PE3078-60	60"	44.25	41.15	38.06	35.40
PE3078-XX	Any	Same-Day Shipment / Call for Pricing			

## 75 OHM, RG59B/U COAX

Model No.	Length	1-24	25-49	50-99	100 +
PE3333-12	12"	\$57.20	\$53.20	\$49.19	\$45.76
PE3333-24	24"	57.65	53.61	49.58	46.12
PE3333-36	36"	58.05	53.99	49.92	46.44
PE3333-48	48"	58.40	54.31	50.22	46.72
PE3333-60	60"	58.90	54.78	50.65	47.12
PE3333-XX	Any	Same-Day Shipment / Call for Pricing			

## 93 OHM, RG62A/U COAX

Model No.	Length	1-24	25-49	50-99	100 +
PE3405-12	12"	\$57.20	\$53.20	\$49.19	\$45.76
PE3405-24	24"	57.65	53.61	49.58	46.12
PE3405-36	36"	58.05	53.99	49.92	46.44
PE3405-48	48"	58.40	54.31	50.22	46.72
PE3405-60	60"	58.90	54.78	50.65	47.12
PE3405-XX	Any	Same-Day Shipment / Call for Pricing			

## 50 OHM, RG142B/U COAX, DOUBLE SHIELDED

Model No.	Length	1-24	25-49	50-99	100 +
PE3611-12	12"	\$46.35	\$43.11	\$39.86	\$37.08
PE3611-24	24"	49.05	45.62	42.18	39.24
PE3611-36	36"	51.70	48.08	44.46	41.36
PE3611-48	48"	54.35	50.55	46.74	43.48
PE3611-60	60"	57.00	53.01	49.02	45.60
PE3611-XX	Any	Same-Day Shipment / Call for Pricing			

## 50 OHM, RG174A/U COAX

Model No.	Length	1-24	25-49	50-99	100 +
PE3715-12	12"	\$42.60	\$39.62	\$36.64	\$34.08
PE3715-24	24"	42.85	39.85	36.85	34.28
PE3715-36	36"	43.15	40.13	37.11	34.52
PE3715-48	48"	43.35	40.32	37.28	34.68
PE3715-60	60"	43.60	40.55	37.50	34.88
PE3715-XX	Any	Same-Day Shipment / Call for Pricing			

## 50 OHM, RG178B/U COAX

Model No.	Length	1-24	25-49	50-99	100 +
PE3056-12	12"	\$58.85	\$54.73	\$50.61	\$47.08
PE3056-24	24"	59.75	55.57	51.39	47.80
PE3056-36	36"	60.80	56.54	52.29	48.64
PE3056-48	48"	61.65	57.33	53.02	49.32
PE3056-60	60"	62.70	58.31	53.92	50.16
PE3056-XX	Any	Same-Day Shipment / Call for Pricing			

## 75 OHM, RG179B/U COAX

Model No.	Length	1-24	25-49	50-99	100 +
PE3102-12	12"	\$42.95	\$39.94	\$36.94	\$34.36
PE3102-24	24"	43.85	40.78	37.71	35.08
PE3102-36	36"	44.90	41.76	38.61	35.92
PE3102-48	48"	45.75	42.55	39.35	36.60
PE3102-60	60"	46.80	43.52	40.25	37.44
PE3102-XX	Any	Same-Day Shipment / Call for Pricing			

## 50 OHM, RG188A/U COAX

Model No.	Length	1-24	25-49	50-99	100 +
PE3706-12	12"	\$42.95	\$39.94	\$36.94	\$34.36
PE3706-24	24"	43.85	40.78	37.71	35.08
PE3706-36	36"	44.90	41.76	38.61	35.92
PE3706-48	48"	45.75	42.55	39.35	36.60
PE3706-60	60"	46.80	43.52	40.25	37.44
PE3706-XX	Any	Same-Day Shipment / Call for Pricing			

## 50 OHM, RG223/U COAX, DOUBLE SHIELDED

Model No.	Length	1-24	25-49	50-99	100 +
PE3697-12	12"	\$43.15	\$40.13	\$37.11	\$34.52
PE3697-24	24"	44.40	41.29	38.18	35.52
PE3697-36	36"	45.70	42.50	39.30	36.56
PE3697-48	48"	47.05	43.76	40.46	37.64
PE3697-60	60"	48.45	45.06	41.67	38.76
PE3697-XX	Any	Same-Day Shipment / Call for Pricing			

## 50 OHM, RG316/U COAX

Model No.	Length	1-24	25-49	50-99	100 +
PE3832-12	12"	\$42.95	\$39.94	\$36.94	\$34.36
PE3832-24	24"	43.85	40.78	37.71	35.08
PE3832-36	36"	44.90	41.76	38.61	35.92
PE3832-48	48"	45.75	42.55	39.35	36.60
PE3832-60	60"	46.80	43.52	40.25	37.44
PE3832-XX	Any	Same-Day Shipment / Call for Pricing			

## 50 OHM, RG316-DS COAX, DOUBLE SHIELDED

Model No.	Length	1-24	25-49	50-99	100 +
PE3171-12	12"	\$46.25	\$43.01	\$39.78	\$37.00
PE3171-24	24"	48.70	45.29	41.88	38.96
PE3171-36	36"	51.05	47.48	43.90	40.84
PE3171-48	48"	53.55	49.80	46.05	42.84
PE3171-60	60"	55.90	51.99	48.07	44.72
PE3171-XX	Any	Same-Day Shipment / Call for Pricing			

## 50 OHM, RG400/U COAX, DOUBLE SHIELDED

Model No.	Length	1-24	25-49	50-99	100 +
PE3864-12	12"	\$46.35	\$43.11	\$39.86	\$37.08
PE3864-24	24"	49.05	45.62	42.18	39.24
PE3864-36	36"	51.70	48.08	44.46	41.36
PE3864-48	48"	54.35	50.55	46.74	43.48
PE3864-60	60"	57.00	53.01	49.02	45.60
PE3864-XX	Any	Same-Day Shipment / Call for Pricing			

## 50 OHM, PE-142LL, LOW LOSS, DBL-SHLD COAX

Model No.	Length	1-24	25-49	50-99	100 +
PE3160-12	12"	\$60.15	\$55.94	\$51.73	\$48.12
PE3160-24	24"	63.75	59.29	54.83	51.00
PE3160-36	36"	67.30	62.59	57.88	53.84
PE3160-48	48"	71.00	66.03	61.06	56.80
PE3160-60	60"	74.60	69.38	64.16	59.68
PE3160-XX	Any	Same-Day Shipment / Call for Pricing			

\*\*ROHS COMPLIANT & CUSTOM-LENGTH CABLE ASSEMBLIES MAY BE ORDERED ON OUR WEBSITE.\*\*

# SEMI-RIGID & RE-SHAPEABLE CABLE ASSEMBLIES

## SMA MALE TO SMA FEMALE



Cable Assemblies

### 50 OHM, RG402/U (.141" BARE COPPER)

Model No.	Length	1-24	25-49	50-99	100 +
PE3823-12	12"	\$29.65	\$27.57	\$25.50	\$23.72
PE3823-24	24"	33.25	30.92	28.60	26.60
PE3823-36	36"	36.85	34.27	31.69	29.48
PE3823-48	48"	40.45	37.62	34.79	32.36
PE3823-60	60"	44.05	40.97	37.88	35.24
PE3823-XX	Any	Same-Day Shipment / Call for Pricing			

### 50 OHM, PE-SR402AL (.141" TINNED ALUMINUM)

Model No.	Length	1-24	25-49	50-99	100 +
PE34235-12	12"	\$33.60	\$31.25	\$28.90	\$26.88
PE34235-24	24"	37.30	34.69	32.08	29.84
PE34235-36	36"	40.85	37.99	35.13	32.68
PE34235-48	48"	44.45	41.34	38.23	35.56
PE34235-60	60"	48.10	44.73	41.37	38.48
PE34235-XX	Any	Same-Day Shipment / Call for Pricing			

### 50 OHM, PE-SR402FL (.141" RE-SHAPEABLE)

Model No.	Length	1-24	25-49	50-99	100 +
PE3443-12	12"	\$33.60	\$31.25	\$28.90	\$26.88
PE3443-24	24"	37.30	34.69	32.08	29.84
PE3443-36	36"	40.85	37.99	35.13	32.68
PE3443-48	48"	44.45	41.34	38.23	35.56
PE3443-60	60"	48.10	44.73	41.37	38.48
PE3443-XX	Any	Same-Day Shipment / Call for Pricing			

### 50 OHM, PE-047SR (.047" BARE COPPER)

Model No.	Length	1-24	25-49	50-99	100 +
PE3188-12	12"	\$52.20	\$48.55	\$44.89	\$41.76
PE3188-24	24"	55.80	51.89	47.99	44.64
PE3188-36	36"	59.40	55.24	51.08	47.52
PE3188-48	48"	63.05	58.64	54.22	50.44
PE3188-60	60"	66.65	61.98	57.32	53.32
PE3188-XX	Any	Same-Day Shipment / Call for Pricing			

### 50 OHM, PE-SR047AL (.047" TINNED ALUMINUM)

Model No.	Length	1-24	25-49	50-99	100 +
PE3253-12	12"	\$54.85	\$51.01	\$47.17	\$43.88
PE3253-24	24"	58.45	54.36	50.27	46.76
PE3253-36	36"	62.00	57.66	53.32	49.60
PE3253-48	48"	65.70	61.10	56.50	52.56
PE3253-60	60"	69.30	64.45	59.60	55.44
PE3253-XX	Any	Same-Day Shipment / Call for Pricing			

### 50 OHM, PE-SR047FL (.047" RE-SHAPEABLE)

Model No.	Length	1-24	25-49	50-99	100 +
PE34228-12	12"	\$54.85	\$51.01	\$47.17	\$43.88
PE34228-24	24"	58.45	54.36	50.27	46.76
PE34228-36	36"	62.00	57.66	53.32	49.60
PE34228-48	48"	65.70	61.10	56.50	52.56
PE34228-60	60"	69.30	64.45	59.60	55.44
PE34228-XX	Any	Same-Day Shipment / Call for Pricing			

### 50 OHM, PE-020SR (.020" BARE COPPER)

Model No.	Length	1-24	25-49	50-99	100 +
PE34224-12	12"	\$116.25	\$108.11	\$99.98	\$93.00
PE34224-24	24"	123.60	114.95	106.30	98.88
PE34224-36	36"	130.80	121.64	112.49	104.64
PE34224-48	48"	138.00	128.34	118.68	110.40
PE34224-60	60"	145.30	135.13	124.96	116.24
PE34224-XX	Any	Same-Day Shipment / Call for Pricing			

### 50 OHM, RG405/U (.085" BARE COPPER)

Model No.	Length	1-24	25-49	50-99	100 +
PE3824-12	12"	\$31.00	\$28.83	\$26.66	\$24.80
PE3824-24	24"	34.60	32.18	29.76	27.68
PE3824-36	36"	38.20	35.53	32.85	30.56
PE3824-48	48"	41.80	38.87	35.95	33.44
PE3824-60	60"	45.40	42.22	39.04	36.32
PE3824-XX	Any	Same-Day Shipment / Call for Pricing			

### 50 OHM, PE-SR405AL (.085" TINNED ALUMINUM)

Model No.	Length	1-24	25-49	50-99	100 +
PE34237-12	12"	\$34.95	\$32.50	\$30.06	\$27.96
PE34237-24	24"	38.55	35.85	33.15	30.84
PE34237-36	36"	42.20	39.25	36.29	33.76
PE34237-48	48"	45.75	42.55	39.35	36.60
PE34237-60	60"	49.35	45.90	42.44	39.48
PE34237-XX	Any	Same-Day Shipment / Call for Pricing			

### 50 OHM, PE-SR405FL (.085" RE-SHAPEABLE)

Model No.	Length	1-24	25-49	50-99	100 +
PE3651-12	12"	\$34.95	\$32.50	\$30.06	\$27.96
PE3651-24	24"	38.55	35.85	33.15	30.84
PE3651-36	36"	42.20	39.25	36.29	33.76
PE3651-48	48"	45.75	42.55	39.35	36.60
PE3651-60	60"	49.35	45.90	42.44	39.48
PE3651-XX	Any	Same-Day Shipment / Call for Pricing			

### 50 OHM, RG401/U (.250" BARE COPPER)

Model No.	Length	1-24	25-49	50-99	100 +
PE33896-12	12"	\$122.95	\$114.34	\$105.74	\$98.36
PE33896-24	24"	130.15	121.04	111.93	104.12
PE33896-36	36"	137.35	127.74	118.12	109.88
PE33896-48	48"	144.65	134.52	124.40	115.72
PE33896-60	60"	151.90	141.27	130.63	121.52
PE33896-XX	Any	Same-Day Shipment / Call for Pricing			

### 50 OHM, PE-SR401AL (.250" TINNED ALUMINUM)

Model No.	Length	1-24	25-49	50-99	100 +
PE34230-12	12"	\$129.60	\$120.53	\$111.46	\$103.68
PE34230-24	24"	136.80	127.22	117.65	109.44
PE34230-36	36"	144.00	133.92	123.84	115.20
PE34230-48	48"	151.25	140.66	130.08	121.00
PE34230-60	60"	158.50	147.41	136.31	126.80
PE34230-XX	Any	Same-Day Shipment / Call for Pricing			

### 50 OHM, PE-SR401FL (.250" RE-SHAPEABLE)

Model No.	Length	1-24	25-49	50-99	100 +
PE34233-12	12"	\$129.60	\$120.53	\$111.46	\$103.68
PE34233-24	24"	136.80	127.22	117.65	109.44
PE34233-36	36"	144.00	133.92	123.84	115.20
PE34233-48	48"	151.25	140.66	130.08	121.00
PE34233-60	60"	158.50	147.41	136.31	126.80
PE34233-XX	Any	Same-Day Shipment / Call for Pricing			

### 50 OHM, PE-034SR (.034" BARE COPPER)

Model No.	Length	1-24	25-49	50-99	100 +
PE34226-12	12"	\$94.55	\$87.93	\$81.31	\$75.64
PE34226-24	24"	98.25	91.37	84.50	78.60
PE34226-36	36"	101.85	94.72	87.59	81.48
PE34226-48	48"	105.40	98.02	90.64	84.32
PE34226-60	60"	109.05	101.42	93.78	87.24
PE34226-XX	Any	Same-Day Shipment / Call for Pricing			

\*\*ROHS COMPLIANT & CUSTOM-LENGTH CABLE ASSEMBLIES MAY BE ORDERED ON OUR WEBSITE.\*\*

# SMA MALE TO SMA FEMALE BULKHEAD

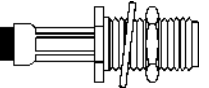
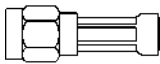

USE MOUNTING HOLE B02 ON PAGE 266

## 53.5 OHM, RG55B/U COAX, DOUBLE SHIELDED

Model No.	Length	1-24	25-49	50-99	100 +
PE3940-12	12"	\$52.10	\$48.45	\$44.81	\$41.68
PE3940-24	24"	52.80	49.10	45.41	42.24
PE3940-36	36"	53.55	49.80	46.05	42.84
PE3940-48	48"	54.25	50.45	46.66	43.40
PE3940-60	60"	54.95	51.10	47.26	43.96
PE3940-XX	Any	Same-Day Shipment / Call for Pricing			

## 50 OHM, RG58C/U COAX

Model No.	Length	1-24	25-49	50-99	100 +
PE3956-12	12"	\$45.30	\$42.13	\$38.96	\$36.24
PE3956-24	24"	45.65	42.45	39.26	36.52
PE3956-36	36"	46.10	42.87	39.65	36.88
PE3956-48	48"	46.55	43.29	40.03	37.24
PE3956-60	60"	46.95	43.66	40.38	37.56
PE3956-XX	Any	Same-Day Shipment / Call for Pricing			

## 75 OHM, RG59B/U COAX

Model No.	Length	1-24	25-49	50-99	100 +
PE3871-12	12"	\$63.80	\$59.33	\$54.87	\$51.04
PE3871-24	24"	64.30	59.80	55.30	51.44
PE3871-36	36"	64.65	60.12	55.60	51.72
PE3871-48	48"	65.10	60.54	55.99	52.08
PE3871-60	60"	65.45	60.87	56.29	52.36
PE3871-XX	Any	Same-Day Shipment / Call for Pricing			

## 93 OHM, RG62A/U COAX

Model No.	Length	1-24	25-49	50-99	100 +
PE3806-12	12"	\$63.80	\$59.33	\$54.87	\$51.04
PE3806-24	24"	64.30	59.80	55.30	51.44
PE3806-36	36"	64.65	60.12	55.60	51.72
PE3806-48	48"	65.10	60.54	55.99	52.08
PE3806-60	60"	65.45	60.87	56.29	52.36
PE3806-XX	Any	Same-Day Shipment / Call for Pricing			

## 50 OHM, RG142B/U COAX, DOUBLE SHIELDED

Model No.	Length	1-24	25-49	50-99	100 +
PE3494-12	12"	\$49.05	\$45.62	\$42.18	\$39.24
PE3494-24	24"	51.70	48.08	44.46	41.36
PE3494-36	36"	54.35	50.55	46.74	43.48
PE3494-48	48"	57.00	53.01	49.02	45.60
PE3494-60	60"	59.65	55.47	51.30	47.72
PE3494-XX	Any	Same-Day Shipment / Call for Pricing			

## 50 OHM, RG174A/U COAX

Model No.	Length	1-24	25-49	50-99	100 +
PE3184-12	12"	\$45.20	\$42.04	\$38.87	\$36.16
PE3184-24	24"	45.45	42.27	39.09	36.36
PE3184-36	36"	45.70	42.50	39.30	36.56
PE3184-48	48"	46.00	42.78	39.56	36.80
PE3184-60	60"	46.25	43.01	39.78	37.00
PE3184-XX	Any	Same-Day Shipment / Call for Pricing			

## 50 OHM, RG178B/U COAX

Model No.	Length	1-24	25-49	50-99	100 +
PE3959-12	12"	\$62.80	\$58.40	\$54.01	\$50.24
PE3959-24	24"	63.75	59.29	54.83	51.00
PE3959-36	36"	64.70	60.17	55.64	51.76
PE3959-48	48"	65.70	61.10	56.50	52.56
PE3959-60	60"	66.65	61.98	57.32	53.32
PE3959-XX	Any	Same-Day Shipment / Call for Pricing			

## 75 OHM, RG179B/U COAX

Model No.	Length	1-24	25-49	50-99	100 +
PE3967-12	12"	\$45.55	\$42.36	\$39.17	\$36.44
PE3967-24	24"	46.55	43.29	40.03	37.24
PE3967-36	36"	47.50	44.18	40.85	38.00
PE3967-48	48"	48.50	45.11	41.71	38.80
PE3967-60	60"	49.35	45.90	42.44	39.48
PE3967-XX	Any	Same-Day Shipment / Call for Pricing			

## 50 OHM, RG188A/U COAX

Model No.	Length	1-24	25-49	50-99	100 +
PE3051-12	12"	\$45.55	\$42.36	\$39.17	\$36.44
PE3051-24	24"	46.55	43.29	40.03	37.24
PE3051-36	36"	47.50	44.18	40.85	38.00
PE3051-48	48"	48.50	45.11	41.71	38.80
PE3051-60	60"	49.35	45.90	42.44	39.48
PE3051-XX	Any	Same-Day Shipment / Call for Pricing			

## 50 OHM, RG223/U COAX, DOUBLE SHIELDED

Model No.	Length	1-24	25-49	50-99	100 +
PE3553-12	12"	\$45.70	\$42.50	\$39.30	\$36.56
PE3553-24	24"	47.05	43.76	40.46	37.64
PE3553-36	36"	48.45	45.06	41.67	38.76
PE3553-48	48"	49.75	46.27	42.79	39.80
PE3553-60	60"	51.00	47.43	43.86	40.80
PE3553-XX	Any	Same-Day Shipment / Call for Pricing			

## 50 OHM, RG316/U COAX

Model No.	Length	1-24	25-49	50-99	100 +
PE3835-12	12"	\$45.55	\$42.36	\$39.17	\$36.44
PE3835-24	24"	46.55	43.29	40.03	37.24
PE3835-36	36"	47.50	44.18	40.85	38.00
PE3835-48	48"	48.50	45.11	41.71	38.80
PE3835-60	60"	49.35	45.90	42.44	39.48
PE3835-XX	Any	Same-Day Shipment / Call for Pricing			

## 50 OHM, RG316-DS COAX, DOUBLE SHIELDED

Model No.	Length	1-24	25-49	50-99	100 +
PE3973-12	12"	\$48.95	\$45.52	\$42.10	\$39.16
PE3973-24	24"	51.30	47.71	44.12	41.04
PE3973-36	36"	53.80	50.03	46.27	43.04
PE3973-48	48"	56.15	52.22	48.29	44.92
PE3973-60	60"	58.55	54.45	50.35	46.84
PE3973-XX	Any	Same-Day Shipment / Call for Pricing			

## 50 OHM, RG400/U COAX, DOUBLE SHIELDED

Model No.	Length	1-24	25-49	50-99	100 +
PE3924-12	12"	\$49.05	\$45.62	\$42.18	\$39.24
PE3924-24	24"	51.70	48.08	44.46	41.36
PE3924-36	36"	54.35	50.55	46.74	43.48
PE3924-48	48"	57.00	53.01	49.02	45.60
PE3924-60	60"	59.65	55.47	51.30	47.72
PE3924-XX	Any	Same-Day Shipment / Call for Pricing			

## 50 OHM, PE-142LL, LOW LOSS, DBL-SHLD COAX

Model No.	Length	1-24	25-49	50-99	100 +
PE3799-12	12"	\$64.15	\$59.66	\$55.17	\$51.32
PE3799-24	24"	67.80	63.05	58.31	54.24
PE3799-36	36"	71.40	66.40	61.40	57.12
PE3799-48	48"	75.00	69.75	64.50	60.00
PE3799-60	60"	78.60	73.10	67.60	62.88
PE3799-XX	Any	Same-Day Shipment / Call for Pricing			

\*\*ROHS COMPLIANT & CUSTOM-LENGTH CABLE ASSEMBLIES MAY BE ORDERED ON OUR WEBSITE.\*\*

# SEMI-RIGID & RE-SHAPEABLE CABLE ASSEMBLIES SMA MALE TO SMA FEMALE BULKHEAD



**USE MOUNTING HOLE B02 ON PAGE 266**

### 50 OHM, RG402/U (.141" BARE COPPER)

Model No.	Length	1-24	25-49	50-99	100 +
PE3825-12	12"	\$37.60	\$34.97	\$32.34	\$30.08
PE3825-24	24"	41.25	38.36	35.48	33.00
PE3825-36	36"	44.90	41.76	38.61	35.92
PE3825-48	48"	48.50	45.11	41.71	38.80
PE3825-60	60"	52.10	48.45	44.81	41.68
PE3825-XX	Any	Same-Day Shipment / Call for Pricing			

### 50 OHM, PE-SR402AL (.141" TINNED ALUMINUM)

Model No.	Length	1-24	25-49	50-99	100 +
PE34252-12	12"	\$40.25	\$37.43	\$34.62	\$32.20
PE34252-24	24"	43.85	40.78	37.71	35.08
PE34252-36	36"	47.50	44.18	40.85	38.00
PE34252-48	48"	51.05	47.48	43.90	40.84
PE34252-60	60"	54.65	50.82	47.00	43.72
PE34252-XX	Any	Same-Day Shipment / Call for Pricing			

### 50 OHM, PE-SR402FL (.141" RE-SHAPEABLE)

Model No.	Length	1-24	25-49	50-99	100 +
PE3468-12	12"	\$40.25	\$37.43	\$34.62	\$32.20
PE3468-24	24"	43.85	40.78	37.71	35.08
PE3468-36	36"	47.50	44.18	40.85	38.00
PE3468-48	48"	51.05	47.48	43.90	40.84
PE3468-60	60"	54.65	50.82	47.00	43.72
PE3468-XX	Any	Same-Day Shipment / Call for Pricing			

### 50 OHM, PE-047SR (.047" BARE COPPER)

Model No.	Length	1-24	25-49	50-99	100 +
PE3531-12	12"	\$60.15	\$55.94	\$51.73	\$48.12
PE3531-24	24"	63.75	59.29	54.83	51.00
PE3531-36	36"	67.30	62.59	57.88	53.84
PE3531-48	48"	71.00	66.03	61.06	56.80
PE3531-60	60"	74.60	69.38	64.16	59.68
PE3531-XX	Any	Same-Day Shipment / Call for Pricing			

### 50 OHM, PE-SR047AL (.047" TINNED ALUMINUM)

Model No.	Length	1-24	25-49	50-99	100 +
PE3382-12	12"	\$64.15	\$59.66	\$55.17	\$51.32
PE3382-24	24"	67.80	63.05	58.31	54.24
PE3382-36	36"	71.40	66.40	61.40	57.12
PE3382-48	48"	75.00	69.75	64.50	60.00
PE3382-60	60"	78.60	73.10	67.60	62.88
PE3382-XX	Any	Same-Day Shipment / Call for Pricing			

### 50 OHM, PE-SR047FL (.047" RE-SHAPEABLE)

Model No.	Length	1-24	25-49	50-99	100 +
PE34245-12	12"	\$64.15	\$59.66	\$55.17	\$51.32
PE34245-24	24"	67.80	63.05	58.31	54.24
PE34245-36	36"	71.40	66.40	61.40	57.12
PE34245-48	48"	75.00	69.75	64.50	60.00
PE34245-60	60"	78.60	73.10	67.60	62.88
PE34245-XX	Any	Same-Day Shipment / Call for Pricing			

### 50 OHM, PE-020SR (.020" BARE COPPER)

Model No.	Length	1-24	25-49	50-99	100 +
PE34241-12	12"	\$129.60	\$120.53	\$111.46	\$103.68
PE34241-24	24"	136.80	127.22	117.65	109.44
PE34241-36	36"	144.00	133.92	123.84	115.20
PE34241-48	48"	151.25	140.66	130.08	121.00
PE34241-60	60"	158.50	147.41	136.31	126.80
PE34241-XX	Any	Same-Day Shipment / Call for Pricing			

### 50 OHM, RG405/U (.085" BARE COPPER)

Model No.	Length	1-24	25-49	50-99	100 +
PE3826-12	12"	\$38.90	\$36.18	\$33.45	\$31.12
PE3826-24	24"	42.60	39.62	36.64	34.08
PE3826-36	36"	46.15	42.92	39.69	36.92
PE3826-48	48"	49.80	46.31	42.83	39.84
PE3826-60	60"	53.45	49.71	45.97	42.76
PE3826-XX	Any	Same-Day Shipment / Call for Pricing			

### 50 OHM, PE-SR405AL (.085" TINNED ALUMINUM)

Model No.	Length	1-24	25-49	50-99	100 +
PE34254-12	12"	\$41.60	\$38.69	\$35.78	\$33.28
PE34254-24	24"	45.20	42.04	38.87	36.16
PE34254-36	36"	48.80	45.38	41.97	39.04
PE34254-48	48"	52.50	48.83	45.15	42.00
PE34254-60	60"	56.05	52.13	48.20	44.84
PE34254-XX	Any	Same-Day Shipment / Call for Pricing			

### 50 OHM, PE-SR405FL (.085" RE-SHAPEABLE)

Model No.	Length	1-24	25-49	50-99	100 +
PE3961-12	12"	\$41.60	\$38.69	\$35.78	\$33.28
PE3961-24	24"	45.20	42.04	38.87	36.16
PE3961-36	36"	48.80	45.38	41.97	39.04
PE3961-48	48"	52.50	48.83	45.15	42.00
PE3961-60	60"	56.05	52.13	48.20	44.84
PE3961-XX	Any	Same-Day Shipment / Call for Pricing			

### 50 OHM, RG401/U (.250" BARE COPPER)

Model No.	Length	1-24	25-49	50-99	100 +
PE34256-12	12"	\$136.20	\$126.67	\$117.13	\$108.96
PE34256-24	24"	143.45	133.41	123.37	114.76
PE34256-36	36"	150.70	140.15	129.60	120.56
PE34256-48	48"	157.90	146.85	135.79	126.32
PE34256-60	60"	165.15	153.59	142.03	132.12
PE34256-XX	Any	Same-Day Shipment / Call for Pricing			

### 50 OHM, PE-SR401AL (.250" TINNED ALUMINUM)

Model No.	Length	1-24	25-49	50-99	100 +
PE34247-12	12"	\$142.85	\$132.85	\$122.85	\$114.28
PE34247-24	24"	150.05	139.55	129.04	120.04
PE34247-36	36"	157.30	146.29	135.28	125.84
PE34247-48	48"	164.55	153.03	141.51	131.64
PE34247-60	60"	171.70	159.68	147.66	137.36
PE34247-XX	Any	Same-Day Shipment / Call for Pricing			

### 50 OHM, PE-SR401FL (.250" RE-SHAPEABLE)

Model No.	Length	1-24	25-49	50-99	100 +
PE34249-12	12"	\$142.85	\$132.85	\$122.85	\$114.28
PE34249-24	24"	150.05	139.55	129.04	120.04
PE34249-36	36"	157.30	146.29	135.28	125.84
PE34249-48	48"	164.55	153.03	141.51	131.64
PE34249-60	60"	171.70	159.68	147.66	137.36
PE34249-XX	Any	Same-Day Shipment / Call for Pricing			

### 50 OHM, PE-034SR (.034" BARE COPPER)

Model No.	Length	1-24	25-49	50-99	100 +
PE34243-12	12"	\$107.90	\$100.35	\$92.79	\$86.32
PE34243-24	24"	111.50	103.70	95.89	89.20
PE34243-36	36"	115.10	107.04	98.99	92.08
PE34243-48	48"	118.80	110.48	102.17	95.04
PE34243-60	60"	122.35	113.79	105.22	97.88
PE34243-XX	Any	Same-Day Shipment / Call for Pricing			

\*\*ROHS COMPLIANT & CUSTOM-LENGTH CABLE ASSEMBLIES MAY BE ORDERED ON OUR WEBSITE.\*\*

Cable Assemblies



# SMA MALE RIGHT ANGLE TO SMA FEMALE BULKHEAD



USE MOUNTING HOLE B02 ON PAGE 266

## 50 OHM, RG58C/U COAX

Model No.	Length	1-24	25-49	50-99	100 +
PE3156-12	12"	\$45.30	\$42.13	\$38.96	\$36.24
PE3156-24	24"	45.65	42.45	39.26	36.52
PE3156-36	36"	46.10	42.87	39.65	36.88
PE3156-48	48"	46.55	43.29	40.03	37.24
PE3156-60	60"	46.95	43.66	40.38	37.56
PE3156-XX	Any	Same-Day Shipment / Call for Pricing			

## 75 OHM, RG59B/U COAX

Model No.	Length	1-24	25-49	50-99	100 +
PE34160-12	12"	\$63.80	\$59.33	\$54.87	\$51.04
PE34160-24	24"	64.30	59.80	55.30	51.44
PE34160-36	36"	64.65	60.12	55.60	51.72
PE34160-48	48"	65.10	60.54	55.99	52.08
PE34160-60	60"	65.45	60.87	56.29	52.36
PE34160-XX	Any	Same-Day Shipment / Call for Pricing			

## 50 OHM, RG142B/U COAX, DOUBLE SHIELDED

Model No.	Length	1-24	25-49	50-99	100 +
PE3759-12	12"	\$49.05	\$45.62	\$42.18	\$39.24
PE3759-24	24"	51.70	48.08	44.46	41.36
PE3759-36	36"	54.35	50.55	46.74	43.48
PE3759-48	48"	57.00	53.01	49.02	45.60
PE3759-60	60"	59.65	55.47	51.30	47.72
PE3759-XX	Any	Same-Day Shipment / Call for Pricing			

## 50 OHM, RG174A/U COAX

Model No.	Length	1-24	25-49	50-99	100 +
PE3149-12	12"	\$45.20	\$42.04	\$38.87	\$36.16
PE3149-24	24"	45.45	42.27	39.09	36.36
PE3149-36	36"	45.70	42.50	39.30	36.56
PE3149-48	48"	46.00	42.78	39.56	36.80
PE3149-60	60"	46.25	43.01	39.78	37.00
PE3149-XX	Any	Same-Day Shipment / Call for Pricing			

## 50 OHM, RG178B/U COAX

Model No.	Length	1-24	25-49	50-99	100 +
PE3152-12	12"	\$62.80	\$58.40	\$54.01	\$50.24
PE3152-24	24"	63.75	59.29	54.83	51.00
PE3152-36	36"	64.70	60.17	55.64	51.76
PE3152-48	48"	65.70	61.10	56.50	52.56
PE3152-60	60"	66.65	61.98	57.32	53.32
PE3152-XX	Any	Same-Day Shipment / Call for Pricing			

## 75 OHM, RG179B/U COAX

Model No.	Length	1-24	25-49	50-99	100
PE34135-12	12"	\$45.55	\$42.36	\$39.17	\$36.44
PE34135-24	24"	46.55	43.29	40.03	37.24
PE34135-36	36"	47.50	44.18	40.85	38.00
PE34135-48	48"	48.50	45.11	41.71	38.80
PE34135-60	60"	49.40	45.94	42.48	39.52
PE34135-XX	Any	Same-Day Shipment / Call for Pricing			

## 50 OHM, RG188A/U COAX

Model No.	Length	1-24	25-49	50-99	100 +
PE3050-12	12"	\$45.55	\$42.36	\$39.17	\$36.44
PE3050-24	24"	46.55	43.29	40.03	37.24
PE3050-36	36"	47.50	44.18	40.85	38.00
PE3050-48	48"	48.50	45.11	41.71	38.80
PE3050-60	60"	49.35	45.90	42.44	39.48
PE3050-XX	Any	Same-Day Shipment / Call for Pricing			

## 50 OHM, RG188-DS COAX, DOUBLE SHIELDED

Model No.	Length	1-24	25-49	50-99	100 +
PE34179-12	12"	\$48.95	\$45.52	\$42.10	\$39.16
PE34179-24	24"	51.30	47.71	44.12	41.04
PE34179-36	36"	53.80	50.03	46.27	43.04
PE34179-48	48"	56.15	52.22	48.29	44.92
PE34179-60	60"	58.55	54.45	50.35	46.84
PE34179-XX	Any	Same-Day Shipment / Call for Pricing			

## 50 OHM, RG196A/U COAX

Model No.	Length	1-24	25-49	50-99	100 +
PE34141-12	12"	\$62.80	\$58.40	\$54.01	\$50.24
PE34141-24	24"	63.75	59.29	54.83	51.00
PE34141-36	36"	64.70	60.17	55.64	51.76
PE34141-48	48"	65.70	61.10	56.50	52.56
PE34141-60	60"	66.65	61.98	57.32	53.32
PE34141-XX	Any	Same-Day Shipment / Call for Pricing			

## 50 OHM, RG223/U COAX, DOUBLE SHIELDED

Model No.	Length	1-24	25-49	50-99	100 +
PE3800-12	12"	\$45.70	\$42.50	\$39.30	\$36.56
PE3800-24	24"	47.05	43.76	40.46	37.64
PE3800-36	36"	48.45	45.06	41.67	38.76
PE3800-48	48"	49.75	46.27	42.79	39.80
PE3800-60	60"	51.00	47.43	43.86	40.80
PE3800-XX	Any	Same-Day Shipment / Call for Pricing			

## 50 OHM, RG316/U COAX

Model No.	Length	1-24	25-49	50-99	100 +
PE3836-12	12"	\$45.55	\$42.36	\$39.17	\$36.44
PE3836-24	24"	46.55	43.29	40.03	37.24
PE3836-36	36"	47.50	44.18	40.85	38.00
PE3836-48	48"	48.50	45.11	41.71	38.80
PE3836-60	60"	49.35	45.90	42.44	39.48
PE3836-XX	Any	Same-Day Shipment / Call for Pricing			

## 50 OHM, RG316-DS COAX, DOUBLE SHIELDED

Model No.	Length	1-24	25-49	50-99	100 +
PE34061-12	12"	\$48.95	\$45.52	\$42.10	\$39.16
PE34061-24	24"	51.30	47.71	44.12	41.04
PE34061-36	36"	53.80	50.03	46.27	43.04
PE34061-48	48"	56.15	52.22	48.29	44.92
PE34061-60	60"	58.55	54.45	50.35	46.84
PE34061-XX	Any	Same-Day Shipment / Call for Pricing			

## 50 OHM, RG400/U COAX, DOUBLE SHIELDED

Model No.	Length	1-24	25-49	50-99	100 +
PE34192-12	12"	\$49.05	\$45.62	\$42.18	\$39.24
PE34192-24	24"	51.70	48.08	44.46	41.36
PE34192-36	36"	54.35	50.55	46.74	43.48
PE34192-48	48"	57.00	53.01	49.02	45.60
PE34192-60	60"	59.65	55.47	51.30	47.72
PE34192-XX	Any	Same-Day Shipment / Call for Pricing			

## 50 OHM, PE-142LL, LOW LOSS, DBL-SHLD COAX

Model No.	Length	1-24	25-49	50-99	100 +
PE33749-12	12"	\$81.35	\$75.66	\$69.96	\$65.08
PE33749-24	24"	85.00	79.05	73.10	68.00
PE33749-36	36"	88.60	82.40	76.20	70.88
PE33749-48	48"	92.20	85.75	79.29	73.76
PE33749-60	60"	95.90	89.19	82.47	76.72
PE33749-XX	Any	Same-Day Shipment / Call for Pricing			

\*\*ROHS COMPLIANT & CUSTOM-LENGTH CABLE ASSEMBLIES MAY BE ORDERED ON OUR WEBSITE.\*\*

# SEMI-RIGID & RE-SHAPEABLE CABLE ASSEMBLIES

## SMA MALE RIGHT ANGLE TO SMA FEMALE BULKHEAD

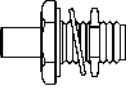
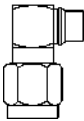

USE MOUNTING HOLE B02 ON PAGE 266

### 50 OHM, RG402/U (.141" BARE COPPER)

Model No.	Length	1-24	25-49	50-99	100 +
PE3679-12	12"	\$49.45	\$45.99	\$42.53	\$39.56
PE3679-24	24"	53.15	49.43	45.71	42.52
PE3679-36	36"	56.70	52.73	48.76	45.36
PE3679-48	48"	60.35	56.13	51.90	48.28
PE3679-60	60"	64.00	59.52	55.04	51.20
PE3679-XX	Any	Same-Day Shipment / Call for Pricing			

### 50 OHM, PE-SR402AL (.141" TINNED ALUMINUM)

Model No.	Length	1-24	25-49	50-99	100 +
PE34297-12	12"	\$52.20	\$48.55	\$44.89	\$41.76
PE34297-24	24"	55.80	51.89	47.99	44.64
PE34297-36	36"	59.40	55.24	51.08	47.52
PE34297-48	48"	63.05	58.64	54.22	50.44
PE34297-60	60"	66.65	61.98	57.32	53.32
PE34297-XX	Any	Same-Day Shipment / Call for Pricing			

### 50 OHM, PE-SR402FL (.141" RE-SHAPEABLE)

Model No.	Length	1-24	25-49	50-99	100 +
PE34299-12	12"	\$52.20	\$48.55	\$44.89	\$41.76
PE34299-24	24"	55.80	51.89	47.99	44.64
PE34299-36	36"	59.40	55.24	51.08	47.52
PE34299-48	48"	63.05	58.64	54.22	50.44
PE34299-60	60"	63.85	59.38	54.91	51.08
PE34299-XX	Any	Same-Day Shipment / Call for Pricing			

### 50 OHM, PE-047SR (.047" BARE COPPER)

Model No.	Length	1-24	25-49	50-99	100 +
PE34303-12	12"	\$81.35	\$75.66	\$69.96	\$65.08
PE34303-24	24"	85.00	79.05	73.10	68.00
PE34303-36	36"	88.60	82.40	76.20	70.88
PE34303-48	48"	92.20	85.75	79.29	73.76
PE34303-60	60"	95.90	89.19	82.47	76.72
PE34303-XX	Any	Same-Day Shipment / Call for Pricing			

### 50 OHM, PE-SR047AL (.047" TINNED ALUMINUM)

Model No.	Length	1-24	25-49	50-99	100 +
PE34305-12	12"	\$89.30	\$83.05	\$76.80	\$71.44
PE34305-24	24"	92.90	86.40	79.89	74.32
PE34305-36	36"	96.60	89.84	83.08	77.28
PE34305-48	48"	100.15	93.14	86.13	80.12
PE34305-60	60"	103.80	96.53	89.27	83.04
PE34305-XX	Any	Same-Day Shipment / Call for Pricing			

### 50 OHM, PE-SR047FL (.047" RE-SHAPEABLE)

Model No.	Length	1-24	25-49	50-99	100 +
PE34307-12	12"	\$89.30	\$83.05	\$76.80	\$71.44
PE34307-24	24"	92.90	86.40	79.89	74.32
PE34307-36	36"	96.60	89.84	83.08	77.28
PE34307-48	48"	100.15	93.14	86.13	80.12
PE34307-60	60"	103.80	96.53	89.27	83.04
PE34307-XX	Any	Same-Day Shipment / Call for Pricing			

### 50 OHM, PE-020SR (.020" BARE COPPER)

Model No.	Length	1-24	25-49	50-99	100 +
PE34309-12	12"	\$162.75	\$151.36	\$139.97	\$130.20
PE34309-24	24"	169.95	158.05	146.16	135.96
PE34309-36	36"	177.10	164.70	152.31	141.68
PE34309-48	48"	184.40	171.49	158.58	147.52
PE34309-60	60"	191.60	178.19	164.78	153.28
PE34309-XX	Any	Same-Day Shipment / Call for Pricing			

### 50 OHM, RG405/U (.085" BARE COPPER)

Model No.	Length	1-24	25-49	50-99	100 +
PE3925-12	12"	\$46.35	\$43.11	\$39.86	\$37.08
PE3925-24	24"	54.45	50.64	46.83	43.56
PE3925-36	36"	58.10	54.03	49.97	46.48
PE3925-48	48"	61.65	57.33	53.02	49.32
PE3925-60	60"	65.30	60.73	56.16	52.24
PE3925-XX	Any	Same-Day Shipment / Call for Pricing			

### 50 OHM, PE-SR405AL (.085" TINNED ALUMINUM)

Model No.	Length	1-24	25-49	50-99	100 +
PE34311-12	12"	\$54.85	\$51.01	\$47.17	\$43.88
PE34311-24	24"	58.45	54.36	50.27	46.76
PE34311-36	36"	62.00	57.66	53.32	49.60
PE34311-48	48"	65.70	61.10	56.50	52.56
PE34311-60	60"	69.30	64.45	59.60	55.44
PE34311-XX	Any	Same-Day Shipment / Call for Pricing			

### 50 OHM, PE-SR405FL (.085" RE-SHAPEABLE)

Model No.	Length	1-24	25-49	50-99	100 +
PE34313-12	12"	\$54.85	\$51.01	\$47.17	\$43.88
PE34313-24	24"	58.45	54.36	50.27	46.76
PE34313-36	36"	62.00	57.66	53.32	49.60
PE34313-48	48"	65.70	61.10	56.50	52.56
PE34313-60	60"	69.30	64.45	59.60	55.44
PE34313-XX	Any	Same-Day Shipment / Call for Pricing			

### 50 OHM, RG401/U (.250" BARE COPPER)

Model No.	Length	1-24	25-49	50-99	100 +
PE34315-12	12"	\$162.75	\$151.36	\$139.97	\$130.20
PE34315-24	24"	169.95	158.05	146.16	135.96
PE34315-36	36"	177.10	164.70	152.31	141.68
PE34315-48	48"	184.40	171.49	158.58	147.52
PE34315-60	60"	191.60	178.19	164.78	153.28
PE34315-XX	Any	Same-Day Shipment / Call for Pricing			

### 50 OHM, PE-SR401AL (.250" TINNED ALUMINUM)

Model No.	Length	1-24	25-49	50-99	100 +
PE34317-12	12"	\$176.00	\$163.68	\$151.36	\$140.80
PE34317-24	24"	183.30	170.47	157.64	146.64
PE34317-36	36"	190.50	177.17	163.83	152.40
PE34317-48	48"	197.70	183.86	170.02	158.16
PE34317-60	60"	204.85	190.51	176.17	163.88
PE34317-XX	Any	Same-Day Shipment / Call for Pricing			

### 50 OHM, PE-SR401FL (.250" RE-SHAPEABLE)

Model No.	Length	1-24	25-49	50-99	100 +
PE34319-12	12"	\$176.00	\$163.68	\$151.36	\$140.80
PE34319-24	24"	183.30	170.47	157.64	146.64
PE34319-36	36"	190.50	177.17	163.83	152.40
PE34319-48	48"	197.70	183.86	170.02	158.16
PE34319-60	60"	204.85	190.51	176.17	163.88
PE34319-XX	Any	Same-Day Shipment / Call for Pricing			

### 50 OHM, PE-034SR (.034" BARE COPPER)

Model No.	Length	1-24	25-49	50-99	100 +
PE34321-12	12"	\$134.45	\$125.04	\$115.63	\$107.56
PE34321-24	24"	138.00	128.34	118.68	110.40
PE34321-36	36"	141.70	131.78	121.86	113.36
PE34321-48	48"	145.30	135.13	124.96	116.24
PE34321-60	60"	148.85	138.43	128.01	119.08
PE34321-XX	Any	Same-Day Shipment / Call for Pricing			

Cable Assemblies

\*\*ROHS COMPLIANT & CUSTOM-LENGTH CABLE ASSEMBLIES MAY BE ORDERED ON OUR WEBSITE.\*\*

# SEMI-RIGID & RE-SHAPEABLE CABLE ASSEMBLIES

## SMA FEMALE TO SMA FEMALE



### 50 OHM, RG402/U (.141" BARE COPPER)

Model No.	Length	1-24	25-49	50-99	100 +
PE3931-12	12"	\$30.75	\$28.60	\$26.45	\$24.60
PE3931-24	24"	34.35	31.95	29.54	27.48
PE3931-36	36"	38.00	35.34	32.68	30.40
PE3931-48	48"	41.60	38.69	35.78	33.28
PE3931-60	60"	45.20	42.04	38.87	36.16
PE3931-XX	Any	Same-Day Shipment / Call for Pricing			

### 50 OHM, PE-SR402AL (.141" TINNED ALUMINUM)

Model No.	Length	1-24	25-49	50-99	100 +
PE34836-12	12"	\$34.70	\$32.27	\$29.84	\$27.76
PE34836-24	24"	38.30	35.62	32.94	30.64
PE34836-36	36"	41.90	38.97	36.03	33.52
PE34836-48	48"	45.55	42.36	39.17	36.44
PE34836-60	60"	49.15	45.71	42.27	39.32
PE34836-XX	Any	Same-Day Shipment / Call for Pricing			

### 50 OHM, PE-SR402FL (.141" RE-SHAPEABLE)

Model No.	Length	1-24	25-49	50-99	100 +
PE33964-12	12"	\$34.70	\$32.27	\$29.84	\$27.76
PE33964-24	24"	38.30	35.62	32.94	30.64
PE33964-36	36"	41.90	38.97	36.03	33.52
PE33964-48	48"	45.55	42.36	39.17	36.44
PE33964-60	60"	49.15	45.71	42.27	39.32
PE33964-XX	Any	Same-Day Shipment / Call for Pricing			

### 50 OHM, PE-047SR (.047" BARE COPPER)

Model No.	Length	1-24	25-49	50-99	100 +
PE3758-12	12"	\$54.85	\$51.01	\$47.17	\$43.88
PE3758-24	24"	58.45	54.36	50.27	46.76
PE3758-36	36"	62.00	57.66	53.32	49.60
PE3758-48	48"	65.70	61.10	56.50	52.56
PE3758-60	60"	69.30	64.45	59.60	55.44
PE3758-XX	Any	Same-Day Shipment / Call for Pricing			

### 50 OHM, PE-SR047AL (.047" TINNED ALUMINUM)

Model No.	Length	1-24	25-49	50-99	100 +
PE34835-12	12"	\$57.55	\$53.52	\$49.49	\$46.04
PE34835-24	24"	61.10	56.82	52.55	48.88
PE34835-36	36"	64.70	60.17	55.64	51.76
PE34835-48	48"	68.40	63.61	58.82	54.72
PE34835-60	60"	71.95	66.91	61.88	57.56
PE34835-XX	Any	Same-Day Shipment / Call for Pricing			

### 50 OHM, PE-SR047FL (.047" RE-SHAPEABLE)

Model No.	Length	1-24	25-49	50-99	100 +
PE34833-12	12"	\$57.55	\$53.52	\$49.49	\$46.04
PE34833-24	24"	61.10	56.82	52.55	48.88
PE34833-36	36"	64.70	60.17	55.64	51.76
PE34833-48	48"	68.40	63.61	58.82	54.72
PE34833-60	60"	71.95	66.91	61.88	57.56
PE34833-XX	Any	Same-Day Shipment / Call for Pricing			

### 50 OHM, PE-020SR (.020" BARE COPPER)

Model No.	Length	1-24	25-49	50-99	100 +
PE34917-12	12"	\$124.20	\$115.51	\$106.81	\$99.36
PE34917-24	24"	131.40	122.20	113.00	105.12
PE34917-36	36"	138.55	128.85	119.15	110.84
PE34917-48	48"	145.85	135.64	125.43	116.68
PE34917-60	60"	153.05	142.34	131.62	122.44
PE34917-XX	Any	Same-Day Shipment / Call for Pricing			

### 50 OHM, RG405/U (.085" BARE COPPER)

Model No.	Length	1-24	25-49	50-99	100 +
PE3109-12	12"	\$32.00	\$29.76	\$27.52	\$25.60
PE3109-24	24"	35.60	33.11	30.62	28.48
PE3109-36	36"	39.15	36.41	33.67	31.32
PE3109-48	48"	42.80	39.80	36.81	34.24
PE3109-60	60"	46.35	43.11	39.86	37.08
PE3109-XX	Any	Same-Day Shipment / Call for Pricing			

### 50 OHM, PE-SR405AL (.085" TINNED ALUMINUM)

Model No.	Length	1-24	25-49	50-99	100 +
PE34834-12	12"	\$35.95	\$33.43	\$30.92	\$28.76
PE34834-24	24"	39.50	36.74	33.97	31.60
PE34834-36	36"	43.20	40.18	37.15	34.56
PE34834-48	48"	46.80	43.52	40.25	37.44
PE34834-60	60"	50.40	46.87	43.34	40.32
PE34834-XX	Any	Same-Day Shipment / Call for Pricing			

### 50 OHM, PE-SR405FL (.085" RE-SHAPEABLE)

Model No.	Length	1-24	25-49	50-99	100 +
PE34292-12	12"	\$35.95	\$33.43	\$30.92	\$28.76
PE34292-24	24"	39.50	36.74	33.97	31.60
PE34292-36	36"	43.20	40.18	37.15	34.56
PE34292-48	48"	46.80	43.52	40.25	37.44
PE34292-60	60"	50.40	46.87	43.34	40.32
PE34292-XX	Any	Same-Day Shipment / Call for Pricing			

### 50 OHM, RG401/U (.250" BARE COPPER)

Model No.	Length	1-24	25-49	50-99	100 +
PE3521-12	12"	\$136.20	\$126.67	\$117.13	\$108.96
PE3521-24	24"	143.45	133.41	123.37	114.76
PE3521-36	36"	150.70	140.15	129.60	120.56
PE3521-48	48"	157.90	146.85	135.79	126.32
PE3521-60	60"	165.15	153.59	142.03	132.12
PE3521-XX	Any	Same-Day Shipment / Call for Pricing			

### 50 OHM, PE-SR401AL (.250" TINNED ALUMINUM)

Model No.	Length	1-24	25-49	50-99	100 +
PE3524-12	12"	\$142.25	\$132.29	\$122.34	\$113.80
PE3524-24	24"	149.45	138.99	128.53	119.56
PE3524-36	36"	156.65	145.68	134.72	125.32
PE3524-48	48"	163.95	152.47	141.00	131.16
PE3524-60	60"	171.15	159.17	147.19	136.92
PE3524-XX	Any	Same-Day Shipment / Call for Pricing			

### 50 OHM, PE-SR401FL (.250" RE-SHAPEABLE)

Model No.	Length	1-24	25-49	50-99	100 +
PE3534-12	12"	\$142.25	\$132.29	\$122.34	\$113.80
PE3534-24	24"	149.45	138.99	128.53	119.56
PE3534-36	36"	156.65	145.68	134.72	125.32
PE3534-48	48"	163.95	152.47	141.00	131.16
PE3534-60	60"	171.15	159.17	147.19	136.92
PE3534-XX	Any	Same-Day Shipment / Call for Pricing			

### 50 OHM, PE-034SR (.034" BARE COPPER)

Model No.	Length	1-24	25-49	50-99	100 +
PE34405-12	12"	\$101.85	\$94.72	\$87.59	\$81.48
PE34405-24	24"	105.40	98.02	90.64	84.32
PE34405-36	36"	109.05	101.42	93.78	87.24
PE34405-48	48"	112.65	104.76	96.88	90.12
PE34405-60	60"	116.25	108.11	99.98	93.00
PE34405-XX	Any	Same-Day Shipment / Call for Pricing			

\*\*ROHS COMPLIANT & CUSTOM-LENGTH CABLE ASSEMBLIES MAY BE ORDERED ON OUR WEBSITE.\*\*

# SEMI-RIGID & RE-SHAPEABLE CABLE ASSEMBLIES

## SMA FEMALE BULKHEAD TO SMA FEMALE BULKHEAD

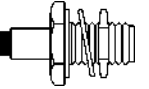
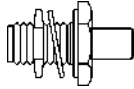

USE MOUNTING HOLE B02 ON PAGE 266

### 50 OHM, RG402/U (.141" BARE COPPER)

Model No.	Length	1-24	25-49	50-99	100 +
PE33518-12	12"	\$41.60	\$38.69	\$35.78	\$33.28
PE33518-24	24"	45.20	42.04	38.87	36.16
PE33518-36	36"	48.80	45.38	41.97	39.04
PE33518-48	48"	52.50	48.83	45.15	42.00
PE33518-60	60"	56.05	52.13	48.20	44.84
PE33518-XX	Any	Same-Day Shipment / Call for Pricing			

### 50 OHM, PE-SR402AL (.141" TINNED ALUMINUM)

Model No.	Length	1-24	25-49	50-99	100 +
PE3903-12	12"	\$44.20	\$41.11	\$38.01	\$35.36
PE3903-24	24"	47.90	44.55	41.19	38.32
PE3903-36	36"	51.45	47.85	44.25	41.16
PE3903-48	48"	55.10	51.24	47.39	44.08
PE3903-60	60"	58.75	54.64	50.53	47.00
PE3903-XX	Any	Same-Day Shipment / Call for Pricing			

### 50 OHM, PE-SR402FL (.141" RE-SHAPEABLE)

Model No.	Length	1-24	25-49	50-99	100 +
PE33864-12	12"	\$44.20	\$41.11	\$38.01	\$35.36
PE33864-24	24"	47.90	44.55	41.19	38.32
PE33864-36	36"	51.45	47.85	44.25	41.16
PE33864-48	48"	55.10	51.24	47.39	44.08
PE33864-60	60"	58.75	54.64	50.53	47.00
PE33864-XX	Any	Same-Day Shipment / Call for Pricing			

### 50 OHM, PE-047SR (.047" BARE COPPER)

Model No.	Length	1-24	25-49	50-99	100 +
PE33789-12	12"	\$74.10	\$68.91	\$63.73	\$59.28
PE33789-24	24"	77.70	72.26	66.82	62.16
PE33789-36	36"	81.35	75.66	69.96	65.08
PE33789-48	48"	85.00	79.05	73.10	68.00
PE33789-60	60"	88.60	82.40	76.20	70.88
PE33789-XX	Any	Same-Day Shipment / Call for Pricing			

### 50 OHM, PE-SR047AL (.047" TINNED ALUMINUM)

Model No.	Length	1-24	25-49	50-99	100 +
PE3929-12	12"	\$79.70	\$74.12	\$68.54	\$63.76
PE3929-24	24"	83.30	77.47	71.64	66.64
PE3929-36	36"	86.90	80.82	74.73	69.52
PE3929-48	48"	90.55	84.21	77.87	72.44
PE3929-60	60"	94.15	87.56	80.97	75.32
PE3929-XX	Any	Same-Day Shipment / Call for Pricing			

### 50 OHM, PE-SR047FL (.047" RE-SHAPEABLE)

Model No.	Length	1-24	25-49	50-99	100 +
PE34709-12	12"	\$79.70	\$74.12	\$68.54	\$63.76
PE34709-24	24"	83.30	77.47	71.64	66.64
PE34709-36	36"	86.90	80.82	74.73	69.52
PE34709-48	48"	90.55	84.21	77.87	72.44
PE34709-60	60"	94.15	87.56	80.97	75.32
PE34709-XX	Any	Same-Day Shipment / Call for Pricing			

### 50 OHM, PE-020SR (.020" BARE COPPER)

Model No.	Length	1-24	25-49	50-99	100 +
PE3932-12	12"	\$136.20	\$126.67	\$117.13	\$108.96
PE3932-24	24"	143.45	133.41	123.37	114.76
PE3932-36	36"	150.70	140.15	129.60	120.56
PE3932-48	48"	157.90	146.85	135.79	126.32
PE3932-60	60"	165.15	153.59	142.03	132.12
PE3932-XX	Any	Same-Day Shipment / Call for Pricing			

### 50 OHM, RG405/U (.085" BARE COPPER)

Model No.	Length	1-24	25-49	50-99	100 +
PE33176-12	12"	\$43.95	\$40.87	\$37.80	\$35.16
PE33176-24	24"	47.60	44.27	40.94	38.08
PE33176-36	36"	51.15	47.57	43.99	40.92
PE33176-48	48"	54.85	51.01	47.17	43.88
PE33176-60	60"	58.45	54.36	50.27	46.76
PE33176-XX	Any	Same-Day Shipment / Call for Pricing			

### 50 OHM, PE-SR405AL (.085" TINNED ALUMINUM)

Model No.	Length	1-24	25-49	50-99	100 +
PE34071-12	12"	\$48.00	\$44.64	\$41.28	\$38.40
PE34071-24	24"	51.55	47.94	44.33	41.24
PE34071-36	36"	55.25	51.38	47.52	44.20
PE34071-48	48"	58.85	54.73	50.61	47.08
PE34071-60	60"	62.40	58.03	53.66	49.92
PE34071-XX	Any	Same-Day Shipment / Call for Pricing			

### 50 OHM, PE-SR405FL (.085" RE-SHAPEABLE)

Model No.	Length	1-24	25-49	50-99	100 +
PE34070-12	12"	\$48.00	\$44.64	\$41.28	\$38.40
PE34070-24	24"	51.55	47.94	44.33	41.24
PE34070-36	36"	55.25	51.38	47.52	44.20
PE34070-48	48"	58.85	54.73	50.61	47.08
PE34070-60	60"	62.40	58.03	53.66	49.92
PE34070-XX	Any	Same-Day Shipment / Call for Pricing			

### 50 OHM, RG401/U (.250" BARE COPPER)

Model No.	Length	1-24	25-49	50-99	100 +
PE3634-12	12"	\$148.25	\$137.87	\$127.50	\$118.60
PE3634-24	24"	155.45	144.57	133.69	124.36
PE3634-36	36"	162.75	151.36	139.97	130.20
PE3634-48	48"	169.95	158.05	146.16	135.96
PE3634-60	60"	177.10	164.70	152.31	141.68
PE3634-XX	Any	Same-Day Shipment / Call for Pricing			

### 50 OHM, PE-SR401AL (.250" TINNED ALUMINUM)

Model No.	Length	1-24	25-49	50-99	100 +
PE3764-12	12"	\$160.30	\$149.08	\$137.86	\$128.24
PE3764-24	24"	167.60	155.87	144.14	134.08
PE3764-36	36"	174.80	162.56	150.33	139.84
PE3764-48	48"	181.95	169.21	156.48	145.56
PE3764-60	60"	189.25	176.00	162.76	151.40
PE3764-XX	Any	Same-Day Shipment / Call for Pricing			

### 50 OHM, PE-SR401FL (.250" RE-SHAPEABLE)

Model No.	Length	1-24	25-49	50-99	100 +
PE3794-12	12"	\$160.30	\$149.08	\$137.86	\$128.24
PE3794-24	24"	167.60	155.87	144.14	134.08
PE3794-36	36"	174.80	162.56	150.33	139.84
PE3794-48	48"	181.95	169.21	156.48	145.56
PE3794-60	60"	189.25	176.00	162.76	151.40
PE3794-XX	Any	Same-Day Shipment / Call for Pricing			

### 50 OHM, PE-034SR (.034" BARE COPPER)

Model No.	Length	1-24	25-49	50-99	100 +
PE3520-12	12"	\$122.35	\$113.79	\$105.22	\$97.88
PE3520-24	24"	125.95	117.13	108.32	100.76
PE3520-36	36"	129.60	120.53	111.46	103.68
PE3520-48	48"	133.15	123.83	114.51	106.52
PE3520-60	60"	136.80	127.22	117.65	109.44
PE3520-XX	Any	Same-Day Shipment / Call for Pricing			

\*\*ROHS COMPLIANT & CUSTOM-LENGTH CABLE ASSEMBLIES MAY BE ORDERED ON OUR WEBSITE.\*\*

Cable Assemblies

## SEMI-RIGID & RE-SHAPEABLE CABLE ASSEMBLIES

### SMA FEMALE 2 HOLE PANEL MOUNT TO SMA FEMALE 2 HOLE PANEL MOUNT



USE MOUNTING HOLE C01 ON PAGE 266

#### 50 OHM, RG402/U (.141" BARE COPPER)

Model No.	Length	1-24	25-49	50-99	100 +
PE3525-12	12"	\$41.60	\$38.69	\$35.78	\$33.28
PE3525-24	24"	45.20	42.04	38.87	36.16
PE3525-36	36"	48.80	45.38	41.97	39.04
PE3525-48	48"	52.50	48.83	45.15	42.00
PE3525-60	60"	56.05	52.13	48.20	44.84
PE3525-XX	Any	Same-Day Shipment / Call for Pricing			

#### 50 OHM, RG405/U (.085" BARE COPPER)

Model No.	Length	1-24	25-49	50-99	100 +
PE33191-12	12"	\$43.95	\$40.87	\$37.80	\$35.16
PE33191-24	24"	47.60	44.27	40.94	38.08
PE33191-36	36"	51.15	47.57	43.99	40.92
PE33191-48	48"	54.85	51.01	47.17	43.88
PE33191-60	60"	58.45	54.36	50.27	46.76
PE33191-XX	Any	Same-Day Shipment / Call for Pricing			

#### 50 OHM, PE-047SR (.047" BARE COPPER)

Model No.	Length	1-24	25-49	50-99	100 +
PE35064-12	12"	\$74.10	\$68.91	\$63.73	\$59.28
PE35064-24	24"	77.70	72.26	66.82	62.16
PE35064-36	36"	81.35	75.66	69.96	65.08
PE35064-48	48"	85.00	79.05	73.10	68.00
PE35064-60	60"	88.60	82.40	76.20	70.88
PE35064-XX	Any	Same-Day Shipment / Call for Pricing			

#### 50 OHM, PE-SR402FL (.141" RE-SHAPEABLE)

Model No.	Length	1-24	25-49	50-99	100 +
PE35108-12	12"	\$44.20	\$41.11	\$38.01	\$35.36
PE35108-24	24"	47.90	44.55	41.19	38.32
PE35108-36	36"	51.45	47.85	44.25	41.16
PE35108-48	48"	55.10	51.24	47.39	44.08
PE35108-60	60"	58.75	54.64	50.53	47.00
PE35108-XX	Any	Same-Day Shipment / Call for Pricing			

#### 50 OHM, PE-SR405FL (.085" RE-SHAPEABLE)

Model No.	Length	1-24	25-49	50-99	100 +
PE35114-12	12"	\$48.00	\$44.64	\$41.28	\$38.40
PE35114-24	24"	51.55	47.94	44.33	41.24
PE35114-36	36"	55.25	51.38	47.52	44.20
PE35114-48	48"	58.85	54.73	50.61	47.08
PE35114-60	60"	62.40	58.03	53.66	49.92
PE35114-XX	Any	Same-Day Shipment / Call for Pricing			

#### 50 OHM, PE-SR047FL (.047" RE-SHAPEABLE)

Model No.	Length	1-24	25-49	50-99	100 +
PE35154-12	12"	\$79.70	\$74.12	\$68.54	\$63.76
PE35154-24	24"	83.30	77.47	71.64	66.64
PE35154-36	36"	86.90	80.82	74.73	69.52
PE35154-48	48"	90.55	84.21	77.87	72.44
PE35154-60	60"	94.15	87.56	80.97	75.32
PE35154-XX	Any	Same-Day Shipment / Call for Pricing			

## SEMI-RIGID & RE-SHAPEABLE CABLE ASSEMBLIES

### SMA FEMALE 4 HOLE PANEL MOUNT TO SMA FEMALE 4 HOLE PANEL MOUNT



USE MOUNTING HOLE A01 ON PAGE 266

#### 50 OHM, RG402/U (.141" BARE COPPER)

Model No.	Length	1-24	25-49	50-99	100 +
PE33502-12	12"	\$47.60	\$44.27	\$40.94	\$38.08
PE33502-24	24"	51.15	47.57	43.99	40.92
PE33502-36	36"	54.85	51.01	47.17	43.88
PE33502-48	48"	58.45	54.36	50.27	46.76
PE33502-60	60"	62.00	57.66	53.32	49.60
PE33502-XX	Any	Same-Day Shipment / Call for Pricing			

#### 50 OHM, RG405/U (.085" BARE COPPER)

Model No.	Length	1-24	25-49	50-99	100 +
PE3223-12	12"	\$50.05	\$46.55	\$43.04	\$40.04
PE3223-24	24"	53.65	49.89	46.14	42.92
PE3223-36	36"	57.25	53.24	49.24	45.80
PE3223-48	48"	60.90	56.64	52.37	48.72
PE3223-60	60"	64.50	59.99	55.47	51.60
PE3223-XX	Any	Same-Day Shipment / Call for Pricing			

#### 50 OHM, PE-047SR (.047" BARE COPPER)

Model No.	Length	1-24	25-49	50-99	100 +
PE35118-12	12"	\$83.75	\$77.89	\$72.03	\$67.00
PE35118-24	24"	87.35	81.24	75.12	69.88
PE35118-36	36"	91.00	84.63	78.26	72.80
PE35118-48	48"	94.55	87.93	81.31	75.64
PE35118-60	60"	98.25	91.37	84.50	78.60
PE35118-XX	Any	Same-Day Shipment / Call for Pricing			

#### 50 OHM, PE-SR402FL (.141" RE-SHAPEABLE)

Model No.	Length	1-24	25-49	50-99	100 +
PE35110-12	12"	\$50.30	\$46.78	\$43.26	\$40.24
PE35110-24	24"	53.90	50.13	46.35	43.12
PE35110-36	36"	57.55	53.52	49.49	46.04
PE35110-48	48"	61.10	56.82	52.55	48.88
PE35110-60	60"	64.70	60.17	55.64	51.76
PE35110-XX	Any	Same-Day Shipment / Call for Pricing			

#### 50 OHM, PE-SR405FL (.085" RE-SHAPEABLE)

Model No.	Length	1-24	25-49	50-99	100 +
PE35116-12	12"	\$54.00	\$50.22	\$46.44	\$43.20
PE35116-24	24"	57.65	53.61	49.58	46.12
PE35116-36	36"	61.20	56.92	52.63	48.96
PE35116-48	48"	64.85	60.31	55.77	51.88
PE35116-60	60"	68.50	63.71	58.91	54.80
PE35116-XX	Any	Same-Day Shipment / Call for Pricing			

#### 50 OHM, PE-SR047FL (.047" RE-SHAPEABLE)

Model No.	Length	1-24	25-49	50-99	100 +
PE35112-12	12"	\$89.30	\$83.05	\$76.80	\$71.44
PE35112-24	24"	92.90	86.40	79.89	74.32
PE35112-36	36"	96.60	89.84	83.08	77.28
PE35112-48	48"	100.15	93.14	86.13	80.12
PE35112-60	60"	103.80	96.53	89.27	83.04
PE35112-XX	Any	Same-Day Shipment / Call for Pricing			

\*\*ROHS COMPLIANT & CUSTOM-LENGTH CABLE ASSEMBLIES MAY BE ORDERED ON OUR WEBSITE.\*\*

## 75 OHM TNC MALE TO 75 OHM TNC MALE



### 75 OHM, RG6A/U COAX

Model No.	Length	1-24	25-49	50-99	100 +
PE35348-12	12"	\$31.30	\$29.11	\$26.92	\$25.04
PE35348-24	24"	32.30	30.04	27.78	25.84
PE35348-36	36"	33.25	30.92	28.60	26.60
PE35348-48	48"	34.20	31.81	29.41	27.36
PE35348-60	60"	35.20	32.74	30.27	28.16
PE35348-XX	Any	Same-Day Shipment / Call for Pricing			

### 75 OHM, RG11A/U COAX

Model No.	Length	1-24	25-49	50-99	100 +
PE35352-12	12"	\$34.95	\$32.50	\$30.06	\$27.96
PE35352-24	24"	35.95	33.43	30.92	28.76
PE35352-36	36"	36.85	34.27	31.69	29.48
PE35352-48	48"	37.90	35.25	32.59	30.32
PE35352-60	60"	38.80	36.08	33.37	31.04
PE35352-XX	Any	Same-Day Shipment / Call for Pricing			

### 75 OHM, RG59B/U COAX

Model No.	Length	1-24	25-49	50-99	100 +
PE35356-12	12"	\$28.90	\$26.88	\$24.85	\$23.12
PE35356-24	24"	29.35	27.30	25.24	23.48
PE35356-36	36"	29.70	27.62	25.54	23.76
PE35356-48	48"	30.20	28.09	25.97	24.16
PE35356-60	60"	30.55	28.41	26.27	24.44
PE35356-XX	Any	Same-Day Shipment / Call for Pricing			

### 75 OHM, RG179B/U COAX

Model No.	Length	1-24	25-49	50-99	100 +
PE35360-12	12"	\$28.90	\$26.88	\$24.85	\$23.12
PE35360-24	24"	29.90	27.81	25.71	23.92
PE35360-36	36"	30.90	28.74	26.57	24.72
PE35360-48	48"	31.80	29.57	27.35	25.44
PE35360-60	60"	32.80	30.50	28.21	26.24
PE35360-XX	Any	Same-Day Shipment / Call for Pricing			

### 75 OHM, RG187A/U COAX

Model No.	Length	1-24	25-49	50-99	100 +
PE35364-12	12"	\$28.90	\$26.88	\$24.85	\$23.12
PE35364-24	24"	29.90	27.81	25.71	23.92
PE35364-36	36"	30.90	28.74	26.57	24.72
PE35364-48	48"	31.80	29.57	27.35	25.44
PE35364-60	60"	32.80	30.50	28.21	26.24
PE35364-XX	Any	Same-Day Shipment / Call for Pricing			

### 75 OHM, RG216/U COAX

Model No.	Length	1-24	25-49	50-99	100 +
PE35368-12	12"	\$34.95	\$32.50	\$30.06	\$27.96
PE35368-24	24"	35.95	33.43	30.92	28.76
PE35368-36	36"	36.85	34.27	31.69	29.48
PE35368-48	48"	37.90	35.25	32.59	30.32
PE35368-60	60"	38.80	36.08	33.37	31.04
PE35368-XX	Any	Same-Day Shipment / Call for Pricing			

## 75 OHM TNC MALE TO 75 OHM BNC MALE



### 75 OHM, RG6A/U COAX

Model No.	Length	1-24	25-49	50-99	100 +
PE35350-12	12"	\$30.15	\$28.04	\$25.93	\$24.12
PE35350-24	24"	31.10	28.92	26.75	24.88
PE35350-36	36"	32.10	29.85	27.61	25.68
PE35350-48	48"	33.00	30.69	28.38	26.40
PE35350-60	60"	33.95	31.57	29.20	27.16
PE35350-XX	Any	Same-Day Shipment / Call for Pricing			

### 75 OHM, RG11A/U COAX

Model No.	Length	1-24	25-49	50-99	100 +
PE35354-12	12"	\$33.75	\$31.39	\$29.03	\$27.00
PE35354-24	24"	34.70	32.27	29.84	27.76
PE35354-36	36"	35.70	33.20	30.70	28.56
PE35354-48	48"	36.60	34.04	31.48	29.28
PE35354-60	60"	37.60	34.97	32.34	30.08
PE35354-XX	Any	Same-Day Shipment / Call for Pricing			

### 75 OHM, RG59B/U COAX

Model No.	Length	1-24	25-49	50-99	100 +
PE35358-12	12"	\$27.70	\$25.76	\$23.82	\$22.16
PE35358-24	24"	28.15	26.18	24.21	22.52
PE35358-36	36"	28.50	26.51	24.51	22.80
PE35358-48	48"	28.95	26.92	24.90	23.16
PE35358-60	60"	29.35	27.30	25.24	23.48
PE35358-XX	Any	Same-Day Shipment / Call for Pricing			

### 75 OHM, RG179B/U COAX

Model No.	Length	1-24	25-49	50-99	100 +
PE35362-12	12"	\$27.70	\$25.76	\$23.82	\$22.16
PE35362-24	24"	28.65	26.64	24.64	22.92
PE35362-36	36"	29.65	27.57	25.50	23.72
PE35362-48	48"	30.60	28.46	26.32	24.48
PE35362-60	60"	31.60	29.39	27.18	25.28
PE35362-XX	Any	Same-Day Shipment / Call for Pricing			

### 75 OHM, RG187A/U COAX

Model No.	Length	1-24	25-49	50-99	100 +
PE35366-12	12"	\$27.70	\$25.76	\$23.82	\$22.16
PE35366-24	24"	28.65	26.64	24.64	22.92
PE35366-36	36"	29.65	27.57	25.50	23.72
PE35366-48	48"	30.60	28.46	26.32	24.48
PE35366-60	60"	31.60	29.39	27.18	25.28
PE35366-XX	Any	Same-Day Shipment / Call for Pricing			

### 75 OHM, RG216/U COAX

Model No.	Length	1-24	25-49	50-99	100 +
PE35370-12	12"	\$33.75	\$31.39	\$29.03	\$27.00
PE35370-24	24"	34.70	32.27	29.84	27.76
PE35370-36	36"	35.70	33.20	30.70	28.56
PE35370-48	48"	36.60	34.04	31.48	29.28
PE35370-60	60"	37.60	34.97	32.34	30.08
PE35370-XX	Any	Same-Day Shipment / Call for Pricing			

\*\*ROHS COMPLIANT & CUSTOM-LENGTH CABLE ASSEMBLIES MAY BE ORDERED ON OUR WEBSITE.\*\*

Cable  
Assemblies

# SMA MALE TO N FEMALE BULKHEAD

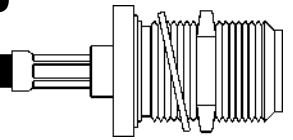
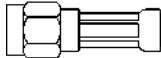

USE MOUNTING HOLE G01 ON PAGE 266

## 53.5 OHM, RG55B/U COAX, DOUBLE SHIELDED

Model No.	Length	1-24	25-49	50-99	100 +
PE34169-12	12"	\$52.10	\$48.45	\$44.81	\$41.68
PE34169-24	24"	52.80	49.10	45.41	42.24
PE34169-36	36"	53.55	49.80	46.05	42.84
PE34169-48	48"	54.25	50.45	46.66	43.40
PE34169-60	60"	54.95	51.10	47.26	43.96
PE34169-XX	Any	Same-Day Shipment / Call for Pricing			

## 50 OHM, RG58C/U COAX

Model No.	Length	1-24	25-49	50-99	100 +
PE3013-12	12"	\$45.30	\$42.13	\$38.96	\$36.24
PE3013-24	24"	45.65	42.45	39.26	36.52
PE3013-36	36"	46.10	42.87	39.65	36.88
PE3013-48	48"	46.55	43.29	40.03	37.24
PE3013-60	60"	46.95	43.66	40.38	37.56
PE3013-XX	Any	Same-Day Shipment / Call for Pricing			

## 50 OHM, RG142B/U COAX, DOUBLE SHIELDED

Model No.	Length	1-24	25-49	50-99	100 +
PE3345-12	12"	\$49.05	\$45.62	\$42.18	\$39.24
PE3345-24	24"	51.70	48.08	44.46	41.36
PE3345-36	36"	54.35	50.55	46.74	43.48
PE3345-48	48"	57.00	53.01	49.02	45.60
PE3345-60	60"	59.65	55.47	51.30	47.72
PE3345-XX	Any	Same-Day Shipment / Call for Pricing			

## 50 OHM, RG174A/U COAX

Model No.	Length	1-24	25-49	50-99	100 +
PE34171-12	12"	\$45.20	\$42.04	\$38.87	\$36.16
PE34171-24	24"	45.45	42.27	39.09	36.36
PE34171-36	36"	45.70	42.50	39.30	36.56
PE34171-48	48"	46.00	42.78	39.56	36.80
PE34171-60	60"	46.25	43.01	39.78	37.00
PE34171-XX	Any	Same-Day Shipment / Call for Pricing			

## 50 OHM, RG178B/U COAX

Model No.	Length	1-24	25-49	50-99	100 +
PE34174-12	12"	\$62.80	\$58.40	\$54.01	\$50.24
PE34174-24	24"	63.75	59.29	54.83	51.00
PE34174-36	36"	64.70	60.17	55.64	51.76
PE34174-48	48"	65.70	61.10	56.50	52.56
PE34174-60	60"	66.65	61.98	57.32	53.32
PE34174-XX	Any	Same-Day Shipment / Call for Pricing			

## 50 OHM, RG188A/U COAX

Model No.	Length	1-24	25-49	50-99	100 +
PE34176-12	12"	\$45.55	\$42.36	\$39.17	\$36.44
PE34176-24	24"	46.55	43.29	40.03	37.24
PE34176-36	36"	47.50	44.18	40.85	38.00
PE34176-48	48"	48.50	45.11	41.71	38.80
PE34176-60	60"	49.35	45.90	42.44	39.48
PE34176-XX	Any	Same-Day Shipment / Call for Pricing			

## 50 OHM, RG213/U COAX

Model No.	Length	1-24	25-49	50-99	100 +
PE34185-12	12"	\$57.60	\$53.57	\$49.54	\$46.08
PE34185-24	24"	58.50	54.41	50.31	46.80
PE34185-36	36"	59.55	55.38	51.21	47.64
PE34185-48	48"	60.60	56.36	52.12	48.48
PE34185-60	60"	61.55	57.24	52.93	49.24
PE34185-XX	Any	Same-Day Shipment / Call for Pricing			

## 50 OHM, RG214/U COAX, DOUBLE SHIELDED

Model No.	Length	1-24	25-49	50-99	100 +
PE33481-12	12"	\$61.45	\$57.15	\$52.85	\$49.16
PE33481-24	24"	65.10	60.54	55.99	52.08
PE33481-36	36"	68.70	63.89	59.08	54.96
PE33481-48	48"	72.25	67.19	62.14	57.80
PE33481-60	60"	75.90	70.59	65.27	60.72
PE33481-XX	Any	Same-Day Shipment / Call for Pricing			

## 50 OHM, RG223/U COAX, DOUBLE SHIELDED

Model No.	Length	1-24	25-49	50-99	100 +
PE3193-12	12"	\$45.70	\$42.50	\$39.30	\$36.56
PE3193-24	24"	47.05	43.76	40.46	37.64
PE3193-36	36"	48.45	45.06	41.67	38.76
PE3193-48	48"	49.75	46.27	42.79	39.80
PE3193-60	60"	51.00	47.43	43.86	40.80
PE3193-XX	Any	Same-Day Shipment / Call for Pricing			

## 50 OHM, RG316/U COAX

Model No.	Length	1-24	25-49	50-99	100 +
PE33555-12	12"	\$45.55	\$42.36	\$39.17	\$36.44
PE33555-24	24"	46.55	43.29	40.03	37.24
PE33555-36	36"	47.50	44.18	40.85	38.00
PE33555-48	48"	48.50	45.11	41.71	38.80
PE33555-60	60"	49.35	45.90	42.44	39.48
PE33555-XX	Any	Same-Day Shipment / Call for Pricing			

## 50 OHM, RG316-DS COAX, DOUBLE SHIELDED

Model No.	Length	1-24	25-49	50-99	100 +
PE33929-12	12"	\$48.95	\$45.52	\$42.10	\$39.16
PE33929-24	24"	51.30	47.71	44.12	41.04
PE33929-36	36"	53.80	50.03	46.27	43.04
PE33929-48	48"	56.15	52.22	48.29	44.92
PE33929-60	60"	58.55	54.45	50.35	46.84
PE33929-XX	Any	Same-Day Shipment / Call for Pricing			

## 50 OHM, RG393/U COAX, DOUBLE SHIELDED

Model No.	Length	1-24	25-49	50-99	100 +
PE34183-12	12"	\$67.90	\$63.15	\$58.39	\$54.32
PE34183-24	24"	76.30	70.96	65.62	61.04
PE34183-36	36"	84.75	78.82	72.89	67.80
PE34183-48	48"	93.20	86.68	80.15	74.56
PE34183-60	60"	101.60	94.49	87.38	81.28
PE34183-XX	Any	Same-Day Shipment / Call for Pricing			

## 50 OHM, RG400/U COAX, DOUBLE SHIELDED

Model No.	Length	1-24	25-49	50-99	100 +
PE33117-12	12"	\$49.05	\$45.62	\$42.18	\$39.24
PE33117-24	24"	51.70	48.08	44.46	41.36
PE33117-36	36"	54.35	50.55	46.74	43.48
PE33117-48	48"	57.00	53.01	49.02	45.60
PE33117-60	60"	59.65	55.47	51.30	47.72
PE33117-XX	Any	Same-Day Shipment / Call for Pricing			

## 50 OHM, PE-142LL, LOW LOSS, DBL-SHLD COAX

Model No.	Length	1-24	25-49	50-99	100 +
PE34178-12	12"	\$64.15	\$59.66	\$55.17	\$51.32
PE34178-24	24"	67.80	63.05	58.31	54.24
PE34178-36	36"	71.40	66.40	61.40	57.12
PE34178-48	48"	75.00	69.75	64.50	60.00
PE34178-60	60"	78.60	73.10	67.60	62.88
PE34178-XX	Any	Same-Day Shipment / Call for Pricing			

\*\*ROHS COMPLIANT & CUSTOM-LENGTH CABLE ASSEMBLIES MAY BE ORDERED ON OUR WEBSITE.\*\*

# SEMI-RIGID & RE-SHAPEABLE CABLE ASSEMBLIES SMA MALE TO N FEMALE BULKHEAD



## 50 OHM, RG402/U (.141" BARE COPPER)

Model No.	Length	1-24	25-49	50-99	100 +
PE3769-12	12"	\$81.35	\$75.66	\$69.96	\$65.08
PE3769-24	24"	85.00	79.05	73.10	68.00
PE3769-36	36"	88.60	82.40	76.20	70.88
PE3769-48	48"	92.20	85.75	79.29	73.76
PE3769-60	60"	95.90	89.19	82.47	76.72
PE3769-XX	Any	Same-Day Shipment / Call for Pricing			

## 50 OHM, RG405/U (.085" BARE COPPER)

Model No.	Length	1-24	25-49	50-99	100 +
PE3367-12	12"	\$82.65	\$76.86	\$71.08	\$66.12
PE3367-24	24"	86.30	80.26	74.22	69.04
PE3367-36	36"	89.85	83.56	77.27	71.88
PE3367-48	48"	93.55	87.00	80.45	74.84
PE3367-60	60"	97.20	90.40	83.59	77.76
PE3367-XX	Any	Same-Day Shipment / Call for Pricing			

## 50 OHM, PE-SR402AL (.141" TINNED ALUMINUM)

Model No.	Length	1-24	25-49	50-99	100 +
PE34143-12	12"	\$85.35	\$79.38	\$73.40	\$68.28
PE34143-24	24"	88.95	82.72	76.50	71.16
PE34143-36	36"	92.55	86.07	79.59	74.04
PE34143-48	48"	96.20	89.47	82.73	76.96
PE34143-60	60"	99.75	92.77	85.79	79.80
PE34143-XX	Any	Same-Day Shipment / Call for Pricing			

## 50 OHM, PE-SR405AL (.085" TINNED ALUMINUM)

Model No.	Length	1-24	25-49	50-99	100 +
PE34155-12	12"	\$86.70	\$80.63	\$74.56	\$69.36
PE34155-24	24"	90.30	83.98	77.66	72.24
PE34155-36	36"	93.90	87.33	80.75	75.12
PE34155-48	48"	97.50	90.68	83.85	78.00
PE34155-60	60"	101.10	94.02	86.95	80.88
PE34155-XX	Any	Same-Day Shipment / Call for Pricing			

## 50 OHM, PE-SR402FL (.141" RE-SHAPEABLE)

Model No.	Length	1-24	25-49	50-99	100 +
PE33996-12	12"	\$85.35	\$79.38	\$73.40	\$68.28
PE33996-24	24"	88.95	82.72	76.50	71.16
PE33996-36	36"	92.55	86.07	79.59	74.04
PE33996-48	48"	96.20	89.47	82.73	76.96
PE33996-60	60"	99.75	92.77	85.79	79.80
PE33996-XX	Any	Same-Day Shipment / Call for Pricing			

## 50 OHM, PE-SR405FL (.085" RE-SHAPEABLE)

Model No.	Length	1-24	25-49	50-99	100 +
PE33844-12	12"	\$86.70	\$80.63	\$74.56	\$69.36
PE33844-24	24"	90.30	83.98	77.66	72.24
PE33844-36	36"	93.90	87.33	80.75	75.12
PE33844-48	48"	97.50	90.68	83.85	78.00
PE33844-60	60"	101.10	94.02	86.95	80.88
PE33844-XX	Any	Same-Day Shipment / Call for Pricing			

## 50 OHM, PE-047SR (.047" BARE COPPER)

Model No.	Length	1-24	25-49	50-99	100 +
PE34148-12	12"	\$94.55	\$87.93	\$81.31	\$75.64
PE34148-24	24"	98.25	91.37	84.50	78.60
PE34148-36	36"	101.85	94.72	87.59	81.48
PE34148-48	48"	105.40	98.02	90.64	84.32
PE34148-60	60"	109.05	101.42	93.78	87.24
PE34148-XX	Any	Same-Day Shipment / Call for Pricing			

## 50 OHM, RG401/U (.250" BARE COPPER)

Model No.	Length	1-24	25-49	50-99	100 +
PE34157-12	12"	\$83.15	\$77.33	\$71.51	\$66.52
PE34157-24	24"	90.40	84.07	77.74	72.32
PE34157-36	36"	97.65	90.81	83.98	78.12
PE34157-48	48"	104.85	97.51	90.17	83.88
PE34157-60	60"	112.10	104.25	96.41	89.68
PE34157-XX	Any	Same-Day Shipment / Call for Pricing			

## 50 OHM, PE-SR047AL (.047" TINNED ALUMINUM)

Model No.	Length	1-24	25-49	50-99	100 +
PE34151-12	12"	\$101.30	\$94.21	\$87.12	\$81.04
PE34151-24	24"	104.85	97.51	90.17	83.88
PE34151-36	36"	108.50	100.91	93.31	86.80
PE34151-48	48"	112.10	104.25	96.41	89.68
PE34151-60	60"	115.65	107.55	99.46	92.52
PE34151-XX	Any	Same-Day Shipment / Call for Pricing			

## 50 OHM, PE-SR401AL (.250" TINNED ALUMINUM)

Model No.	Length	1-24	25-49	50-99	100 +
PE34159-12	12"	\$89.75	\$83.47	\$77.19	\$71.80
PE34159-24	24"	97.00	90.21	83.42	77.60
PE34159-36	36"	104.30	97.00	89.70	83.44
PE34159-48	48"	111.50	103.70	95.89	89.20
PE34159-60	60"	118.80	110.48	102.17	95.04
PE34159-XX	Any	Same-Day Shipment / Call for Pricing			

## 50 OHM, PE-SR047FL (.047" RE-SHAPEABLE)

Model No.	Length	1-24	25-49	50-99	100 +
PE34153-12	12"	\$101.30	\$94.21	\$87.12	\$81.04
PE34153-24	24"	104.85	97.51	90.17	83.88
PE34153-36	36"	108.50	100.91	93.31	86.80
PE34153-48	48"	112.10	104.25	96.41	89.68
PE34153-60	60"	115.65	107.55	99.46	92.52
PE34153-XX	Any	Same-Day Shipment / Call for Pricing			

## 50 OHM, PE-SR401FL (.250" RE-SHAPEABLE)

Model No.	Length	1-24	25-49	50-99	100 +
PE34163-12	12"	\$89.75	\$83.47	\$77.19	\$71.80
PE34163-24	24"	97.00	90.21	83.42	77.60
PE34163-36	36"	104.30	97.00	89.70	83.44
PE34163-48	48"	111.50	103.70	95.89	89.20
PE34163-60	60"	118.80	110.48	102.17	95.04
PE34163-XX	Any	Same-Day Shipment / Call for Pricing			

\*\*ROHS COMPLIANT & CUSTOM-LENGTH CABLE ASSEMBLIES MAY BE ORDERED ON OUR WEBSITE.\*\*

Cable Assemblies



# SMA MALE TO N MALE



## 52 OHM, RG8A/U COAX

Model No.	Length	1-24	25-49	50-99	100 +
PE3323-12	12"	\$86.20	\$80.17	\$74.13	\$68.96
PE3323-24	24"	87.20	81.10	74.99	69.76
PE3323-36	36"	88.20	82.03	75.85	70.56
PE3323-48	48"	89.15	82.91	76.67	71.32
PE3323-60	60"	90.25	83.93	77.62	72.20
PE3323-XX	Any	Same-Day Shipment / Call for Pricing			

## 53.5 OHM, RG55B/U COAX, DOUBLE SHIELDED

Model No.	Length	1-24	25-49	50-99	100 +
PE3654-12	12"	\$29.15	\$27.11	\$25.07	\$23.32
PE3654-24	24"	29.90	27.81	25.71	23.92
PE3654-36	36"	30.60	28.46	26.32	24.48
PE3654-48	48"	31.30	29.11	26.92	25.04
PE3654-60	60"	32.10	29.85	27.61	25.68
PE3654-XX	Any	Same-Day Shipment / Call for Pricing			

## 50 OHM, RG58C/U COAX

Model No.	Length	1-24	25-49	50-99	100 +
PE3662-12	12"	\$31.80	\$29.57	\$27.35	\$25.44
PE3662-24	24"	32.25	29.99	27.74	25.80
PE3662-36	36"	32.65	30.36	28.08	26.12
PE3662-48	48"	33.05	30.74	28.42	26.44
PE3662-60	60"	33.45	31.11	28.77	26.76
PE3662-XX	Any	Same-Day Shipment / Call for Pricing			

## 50 OHM, RG142B/U COAX, DOUBLE SHIELDED

Model No.	Length	1-24	25-49	50-99	100 +
PE3568-12	12"	\$31.80	\$29.57	\$27.35	\$25.44
PE3568-24	24"	34.50	32.09	29.67	27.60
PE3568-36	36"	37.15	34.55	31.95	29.72
PE3568-48	48"	39.80	37.01	34.23	31.84
PE3568-60	60"	42.45	39.48	36.51	33.96
PE3568-XX	Any	Same-Day Shipment / Call for Pricing			

## 50 OHM, RG174A/U COAX

Model No.	Length	1-24	25-49	50-99	100 +
PE3291-12	12"	\$35.80	\$33.29	\$30.79	\$28.64
PE3291-24	24"	36.10	33.57	31.05	28.88
PE3291-36	36"	36.35	33.81	31.26	29.08
PE3291-48	48"	36.60	34.04	31.48	29.28
PE3291-60	60"	36.80	34.22	31.65	29.44
PE3291-XX	Any	Same-Day Shipment / Call for Pricing			

## 50 OHM, RG178B/U COAX

Model No.	Length	1-24	25-49	50-99	100 +
PE3321-12	12"	\$47.70	\$44.36	\$41.02	\$38.16
PE3321-24	24"	48.70	45.29	41.88	38.96
PE3321-36	36"	49.65	46.17	42.70	39.72
PE3321-48	48"	50.60	47.06	43.52	40.48
PE3321-60	60"	51.55	47.94	44.33	41.24
PE3321-XX	Any	Same-Day Shipment / Call for Pricing			

## 50 OHM, RG188A/U COAX

Model No.	Length	1-24	25-49	50-99	100 +
PE3911-12	12"	\$35.80	\$33.29	\$30.79	\$28.64
PE3911-24	24"	36.75	34.18	31.61	29.40
PE3911-36	36"	37.75	35.11	32.47	30.20
PE3911-48	48"	38.65	35.94	33.24	30.92
PE3911-60	60"	39.70	36.92	34.14	31.76
PE3911-XX	Any	Same-Day Shipment / Call for Pricing			

## 50 OHM, RG214/U COAX, DOUBLE SHIELDED

Model No.	Length	1-24	25-49	50-99	100 +
PE3422-12	12"	\$86.20	\$80.17	\$74.13	\$68.96
PE3422-24	24"	89.75	83.47	77.19	71.80
PE3422-36	36"	93.40	86.86	80.32	74.72
PE3422-48	48"	97.00	90.21	83.42	77.60
PE3422-60	60"	100.60	93.56	86.52	80.48
PE3422-XX	Any	Same-Day Shipment / Call for Pricing			

## 50 OHM, RG223/U COAX, DOUBLE SHIELDED

Model No.	Length	1-24	25-49	50-99	100 +
PE3519-12	12"	\$31.80	\$29.57	\$27.35	\$25.44
PE3519-24	24"	33.15	30.83	28.51	26.52
PE3519-36	36"	34.50	32.09	29.67	27.60
PE3519-48	48"	35.80	33.29	30.79	28.64
PE3519-60	60"	37.15	34.55	31.95	29.72
PE3519-XX	Any	Same-Day Shipment / Call for Pricing			

## 50 OHM, RG316/U COAX

Model No.	Length	1-24	25-49	50-99	100 +
PE3234-12	12"	\$35.80	\$33.29	\$30.79	\$28.64
PE3234-24	24"	36.75	34.18	31.61	29.40
PE3234-36	36"	37.75	35.11	32.47	30.20
PE3234-48	48"	38.65	35.94	33.24	30.92
PE3234-60	60"	39.70	36.92	34.14	31.76
PE3234-XX	Any	Same-Day Shipment / Call for Pricing			

## 50 OHM, RG316-DS COAX, DOUBLE SHIELDED

Model No.	Length	1-24	25-49	50-99	100 +
PE3957-12	12"	\$41.10	\$38.22	\$35.35	\$32.88
PE3957-24	24"	43.50	40.46	37.41	34.80
PE3957-36	36"	45.85	42.64	39.43	36.68
PE3957-48	48"	48.35	44.97	41.58	38.68
PE3957-60	60"	50.75	47.20	43.65	40.60
PE3957-XX	Any	Same-Day Shipment / Call for Pricing			

## 50 OHM, RG393/U COAX, DOUBLE SHIELDED

Model No.	Length	1-24	25-49	50-99	100 +
PE3302-12	12"	\$86.20	\$80.17	\$74.13	\$68.96
PE3302-24	24"	94.55	87.93	81.31	75.64
PE3302-36	36"	103.05	95.84	88.62	82.44
PE3302-48	48"	111.50	103.70	95.89	89.20
PE3302-60	60"	119.85	111.46	103.07	95.88
PE3302-XX	Any	Same-Day Shipment / Call for Pricing			

## 50 OHM, RG400/U COAX, DOUBLE SHIELDED

Model No.	Length	1-24	25-49	50-99	100 +
PE3614-12	12"	\$31.80	\$29.57	\$27.35	\$25.44
PE3614-24	24"	34.50	32.09	29.67	27.60
PE3614-36	36"	37.15	34.55	31.95	29.72
PE3614-48	48"	39.80	37.01	34.23	31.84
PE3614-60	60"	42.45	39.48	36.51	33.96
PE3614-XX	Any	Same-Day Shipment / Call for Pricing			

## 50 OHM, PE-142LL, LOW LOSS, DBL-SHLD COAX

Model No.	Length	1-24	25-49	50-99	100 +
PE3318-12	12"	\$53.00	\$49.29	\$45.58	\$42.40
PE3318-24	24"	56.60	52.64	48.68	45.28
PE3318-36	36"	60.25	56.03	51.82	48.20
PE3318-48	48"	63.85	59.38	54.91	51.08
PE3318-60	60"	67.45	62.73	58.01	53.96
PE3318-XX	Any	Same-Day Shipment / Call for Pricing			

\*\*ROHS COMPLIANT & CUSTOM-LENGTH CABLE ASSEMBLIES MAY BE ORDERED ON OUR WEBSITE.\*\*

# SEMI-RIGID & RE-SHAPEABLE CABLE ASSEMBLIES

## SMA MALE TO N MALE



### 50 OHM, RG402/U (.141" BARE COPPER)

Model No.	Length	1-24	25-49	50-99	100 +
PE3887-12	12"	\$45.55	\$42.36	\$39.17	\$36.44
PE3887-24	24"	49.15	45.71	42.27	39.32
PE3887-36	36"	52.80	49.10	45.41	42.24
PE3887-48	48"	56.35	52.41	48.46	45.08
PE3887-60	60"	60.00	55.80	51.60	48.00
PE3887-XX	Any	Same-Day Shipment / Call for Pricing			

### 50 OHM, PE-SR402AL (.141" TINNED ALUMINUM)

Model No.	Length	1-24	25-49	50-99	100 +
PE34265-12	12"	\$50.85	\$47.29	\$43.73	\$40.68
PE34265-24	24"	54.45	50.64	46.83	43.56
PE34265-36	36"	58.10	54.03	49.97	46.48
PE34265-48	48"	61.65	57.33	53.02	49.32
PE34265-60	60"	65.30	60.73	56.16	52.24
PE34265-XX	Any	Same-Day Shipment / Call for Pricing			

### 50 OHM, PE-SR402FL (.141" RE-SHAPEABLE)

Model No.	Length	1-24	25-49	50-99	100 +
PE3448-12	12"	\$50.85	\$47.29	\$43.73	\$40.68
PE3448-24	24"	54.45	50.64	46.83	43.56
PE3448-36	36"	58.10	54.03	49.97	46.48
PE3448-48	48"	61.65	57.33	53.02	49.32
PE3448-60	60"	65.30	60.73	56.16	52.24
PE3448-XX	Any	Same-Day Shipment / Call for Pricing			

### 50 OHM, PE-047SR (.047" BARE COPPER)

Model No.	Length	1-24	25-49	50-99	100 +
PE34257-12	12"	\$54.85	\$51.01	\$47.17	\$43.88
PE34257-24	24"	58.45	54.36	50.27	46.76
PE34257-36	36"	62.00	57.66	53.32	49.60
PE34257-48	48"	65.70	61.10	56.50	52.56
PE34257-60	60"	69.30	64.45	59.60	55.44
PE34257-XX	Any	Same-Day Shipment / Call for Pricing			

### 50 OHM, PE-SR047AL (.047" TINNED ALUMINUM)

Model No.	Length	1-24	25-49	50-99	100 +
PE34261-12	12"	\$61.45	\$57.15	\$52.85	\$49.16
PE34261-24	24"	65.10	60.54	55.99	52.08
PE34261-36	36"	68.70	63.89	59.08	54.96
PE34261-48	48"	72.25	67.19	62.14	57.80
PE34261-60	60"	75.90	70.59	65.27	60.72
PE34261-XX	Any	Same-Day Shipment / Call for Pricing			

### 50 OHM, PE-SR047FL (.047" RE-SHAPEABLE)

Model No.	Length	1-24	25-49	50-99	100 +
PE34268-12	12"	\$61.45	\$57.15	\$52.85	\$49.16
PE34268-24	24"	65.10	60.54	55.99	52.08
PE34268-36	36"	68.70	63.89	59.08	54.96
PE34268-48	48"	72.25	67.19	62.14	57.80
PE34268-60	60"	75.90	70.59	65.27	60.72
PE34268-XX	Any	Same-Day Shipment / Call for Pricing			

### 50 OHM, RG405/U (.085" BARE COPPER)

Model No.	Length	1-24	25-49	50-99	100 +
PE3828-12	12"	\$46.90	\$43.62	\$40.33	\$37.52
PE3828-24	24"	50.50	46.97	43.43	40.40
PE3828-36	36"	54.10	50.31	46.53	43.28
PE3828-48	48"	57.75	53.71	49.67	46.20
PE3828-60	60"	61.35	57.06	52.76	49.08
PE3828-XX	Any	Same-Day Shipment / Call for Pricing			

### 50 OHM, PE-SR405AL (.085" TINNED ALUMINUM)

Model No.	Length	1-24	25-49	50-99	100 +
PE34270-12	12"	\$52.20	\$48.55	\$44.89	\$41.76
PE34270-24	24"	55.80	51.89	47.99	44.64
PE34270-36	36"	59.40	55.24	51.08	47.52
PE34270-48	48"	63.05	58.64	54.22	50.44
PE34270-60	60"	66.65	61.98	57.32	53.32
PE34270-XX	Any	Same-Day Shipment / Call for Pricing			

### 50 OHM, PE-SR405FL (.085" RE-SHAPEABLE)

Model No.	Length	1-24	25-49	50-99	100 +
PE3657-12	12"	\$52.20	\$48.55	\$44.89	\$41.76
PE3657-24	24"	55.80	51.89	47.99	44.64
PE3657-36	36"	59.40	55.24	51.08	47.52
PE3657-48	48"	63.05	58.64	54.22	50.44
PE3657-60	60"	66.65	61.98	57.32	53.32
PE3657-XX	Any	Same-Day Shipment / Call for Pricing			

### 50 OHM, RG401/U (.250" BARE COPPER)

Model No.	Length	1-24	25-49	50-99	100 +
PE33001-12	12"	\$69.90	\$65.01	\$60.11	\$55.92
PE33001-24	24"	77.15	71.75	66.35	61.72
PE33001-36	36"	84.35	78.45	72.54	67.48
PE33001-48	48"	91.60	85.19	78.78	73.28
PE33001-60	60"	98.80	91.88	84.97	79.04
PE33001-XX	Any	Same-Day Shipment / Call for Pricing			

### 50 OHM, PE-SR401AL (.250" TINNED ALUMINUM)

Model No.	Length	1-24	25-49	50-99	100 +
PE34259-12	12"	\$76.55	\$71.19	\$65.83	\$61.24
PE34259-24	24"	83.75	77.89	72.03	67.00
PE34259-36	36"	91.00	84.63	78.26	72.80
PE34259-48	48"	98.25	91.37	84.50	78.60
PE34259-60	60"	105.40	98.02	90.64	84.32
PE34259-XX	Any	Same-Day Shipment / Call for Pricing			

### 50 OHM, PE-SR401FL (.250" RE-SHAPEABLE)

Model No.	Length	1-24	25-49	50-99	100 +
PE34263-12	12"	\$76.55	\$71.19	\$65.83	\$61.24
PE34263-24	24"	83.75	77.89	72.03	67.00
PE34263-36	36"	91.00	84.63	78.26	72.80
PE34263-48	48"	98.25	91.37	84.50	78.60
PE34263-60	60"	105.40	98.02	90.64	84.32
PE34263-XX	Any	Same-Day Shipment / Call for Pricing			

\*\*ROHS COMPLIANT & CUSTOM-LENGTH CABLE ASSEMBLIES MAY BE ORDERED ON OUR WEBSITE.\*\*

Cable Assemblies

# N MALE TO N MALE



## 52 OHM, RG8A/U COAX

Model No.	Length	1-24	25-49	50-99	100 +
PE3570-12	12"	\$34.50	\$32.09	\$29.67	\$27.60
PE3570-24	24"	35.45	32.97	30.49	28.36
PE3570-36	36"	36.50	33.95	31.39	29.20
PE3570-48	48"	37.50	34.88	32.25	30.00
PE3570-60	60"	38.50	35.81	33.11	30.80
PE3570-XX	Any	Same-Day Shipment / Call for Pricing			

## 50 OHM, RG58C/U COAX

Model No.	Length	1-24	25-49	50-99	100 +
PE3441-12	12"	\$23.85	\$22.18	\$20.51	\$19.08
PE3441-24	24"	24.25	22.55	20.86	19.40
PE3441-36	36"	24.75	23.02	21.29	19.80
PE3441-48	48"	25.10	23.34	21.59	20.08
PE3441-60	60"	25.55	23.76	21.97	20.44
PE3441-XX	Any	Same-Day Shipment / Call for Pricing			

## 50 OHM, RG142B/U COAX, DOUBLE SHIELDED

Model No.	Length	1-24	25-49	50-99	100 +
PE3455-12	12"	\$31.80	\$29.57	\$27.35	\$25.44
PE3455-24	24"	34.50	32.09	29.67	27.60
PE3455-36	36"	37.15	34.55	31.95	29.72
PE3455-48	48"	39.80	37.01	34.23	31.84
PE3455-60	60"	42.45	39.48	36.51	33.96
PE3455-XX	Any	Same-Day Shipment / Call for Pricing			

## 50 OHM, RG178B/U COAX

Model No.	Length	1-24	25-49	50-99	100 +
PE33527-12	12"	\$53.00	\$49.29	\$45.58	\$42.40
PE33527-24	24"	54.00	50.22	46.44	43.20
PE33527-36	36"	54.95	51.10	47.26	43.96
PE33527-48	48"	55.90	51.99	48.07	44.72
PE33527-60	60"	56.85	52.87	48.89	45.48
PE33527-XX	Any	Same-Day Shipment / Call for Pricing			

## 50 OHM, RG188A/U COAX

Model No.	Length	1-24	25-49	50-99	100 +
PE33525-12	12"	\$35.80	\$33.29	\$30.79	\$28.64
PE33525-24	24"	36.75	34.18	31.61	29.40
PE33525-36	36"	37.75	35.11	32.47	30.20
PE33525-48	48"	38.65	35.94	33.24	30.92
PE33525-60	60"	39.70	36.92	34.14	31.76
PE33525-XX	Any	Same-Day Shipment / Call for Pricing			

## 50 OHM, RG213/U COAX

Model No.	Length	1-24	25-49	50-99	100 +
PE3496-12	12"	\$34.50	\$32.09	\$29.67	\$27.60
PE3496-24	24"	35.45	32.97	30.49	28.36
PE3496-36	36"	36.50	33.95	31.39	29.20
PE3496-48	48"	37.50	34.88	32.25	30.00
PE3496-60	60"	38.50	35.81	33.11	30.80
PE3496-XX	Any	Same-Day Shipment / Call for Pricing			

## 50 OHM, RG214/U COAX, DOUBLE SHIELDED

Model No.	Length	1-24	25-49	50-99	100 +
PE3062-12	12"	\$38.40	\$35.71	\$33.02	\$30.72
PE3062-24	24"	42.10	39.15	36.21	33.68
PE3062-36	36"	45.65	42.45	39.26	36.52
PE3062-48	48"	49.25	45.80	42.36	39.40
PE3062-60	60"	52.90	49.20	45.49	42.32
PE3062-XX	Any	Same-Day Shipment / Call for Pricing			

## 50 OHM, RG217/U COAX, DOUBLE SHIELDED

Model No.	Length	1-24	25-49	50-99	100 +
PE3997-12	12"	\$74.25	\$69.05	\$63.86	\$59.40
PE3997-24	24"	76.70	71.33	65.96	61.36
PE3997-36	36"	79.05	73.52	67.98	63.24
PE3997-48	48"	81.50	75.80	70.09	65.20
PE3997-60	60"	83.90	78.03	72.15	67.12
PE3997-XX	Any	Same-Day Shipment / Call for Pricing			

## 50 OHM, RG218/U COAX

Model No.	Length	1-24	25-49	50-99	100 +
PE33236-12	12"	\$113.20	\$105.28	\$97.35	\$90.56
PE33236-24	24"	116.10	107.97	99.85	92.88
PE33236-36	36"	117.15	108.95	100.75	93.72
PE33236-48	48"	119.30	110.95	102.60	95.44
PE33236-60	60"	125.40	116.62	107.84	100.32
PE33236-XX	Any	Same-Day Shipment / Call for Pricing			

## 50 OHM, RG223/U COAX, DOUBLE SHIELDED

Model No.	Length	1-24	25-49	50-99	100 +
PE3447-12	12"	\$31.15	\$28.97	\$26.79	\$24.92
PE3447-24	24"	32.50	30.23	27.95	26.00
PE3447-36	36"	33.80	31.43	29.07	27.04
PE3447-48	48"	35.10	32.64	30.19	28.08
PE3447-60	60"	36.45	33.90	31.35	29.16
PE3447-XX	Any	Same-Day Shipment / Call for Pricing			

## 50 OHM, RG316/U COAX

Model No.	Length	1-24	25-49	50-99	100 +
PE3487-12	12"	\$35.80	\$33.29	\$30.79	\$28.64
PE3487-24	24"	36.75	34.18	31.61	29.40
PE3487-36	36"	37.75	35.11	32.47	30.20
PE3487-48	48"	38.65	35.94	33.24	30.92
PE3487-60	60"	39.70	36.92	34.14	31.76
PE3487-XX	Any	Same-Day Shipment / Call for Pricing			

## 50 OHM, RG393/U COAX, DOUBLE SHIELDED

Model No.	Length	1-24	25-49	50-99	100 +
PE3607-12	12"	\$39.80	\$37.01	\$34.23	\$31.84
PE3607-24	24"	48.25	44.87	41.50	38.60
PE3607-36	36"	56.60	52.64	48.68	45.28
PE3607-48	48"	65.10	60.54	55.99	52.08
PE3607-60	60"	73.50	68.36	63.21	58.80
PE3607-XX	Any	Same-Day Shipment / Call for Pricing			

## 50 OHM, RG400/U COAX, DOUBLE SHIELDED

Model No.	Length	1-24	25-49	50-99	100 +
PE3653-12	12"	\$30.50	\$28.37	\$26.23	\$24.40
PE3653-24	24"	33.15	30.83	28.51	26.52
PE3653-36	36"	35.80	33.29	30.79	28.64
PE3653-48	48"	38.40	35.71	33.02	30.72
PE3653-60	60"	41.10	38.22	35.35	32.88
PE3653-XX	Any	Same-Day Shipment / Call for Pricing			

## 50 OHM, PE-B3199, VERY LOW LOSS COAX

Model No.	Length	1-24	25-49	50-99	100 +
PE3279-12	12"	\$45.10	\$41.94	\$38.79	\$36.08
PE3279-24	24"	46.00	42.78	39.56	36.80
PE3279-36	36"	47.00	43.71	40.42	37.60
PE3279-48	48"	48.00	44.64	41.28	38.40
PE3279-60	60"	48.95	45.52	42.10	39.16
PE3279-XX	Any	Same-Day Shipment / Call for Pricing			

\*\*ROHS COMPLIANT & CUSTOM-LENGTH CABLE ASSEMBLIES MAY BE ORDERED ON OUR WEBSITE.\*\*

# SEMI-RIGID & RE-SHAPEABLE CABLE ASSEMBLIES

## N MALE TO N MALE

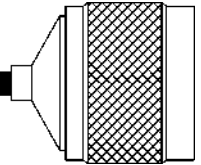
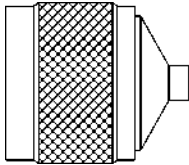

### 50 OHM, RG402/U (.141" BARE COPPER)

Model No.	Length	1-24	25-49	50-99	100 +
PE3827-12	12"	\$52.20	\$48.55	\$44.89	\$41.76
PE3827-24	24"	55.80	51.89	47.99	44.64
PE3827-36	36"	59.40	55.24	51.08	47.52
PE3827-48	48"	63.05	58.64	54.22	50.44
PE3827-60	60"	66.65	61.98	57.32	53.32
PE3827-XX	Any	Same-Day Shipment / Call for Pricing			

### 50 OHM, PE-SR402AL (.141" TINNED ALUMINUM)

Model No.	Length	1-24	25-49	50-99	100 +
PE34138-12	12"	\$54.85	\$51.01	\$47.17	\$43.88
PE34138-24	24"	58.45	54.36	50.27	46.76
PE34138-36	36"	62.00	57.66	53.32	49.60
PE34138-48	48"	65.70	61.10	56.50	52.56
PE34138-60	60"	69.30	64.45	59.60	55.44
PE34138-XX	Any	Same-Day Shipment / Call for Pricing			

### 50 OHM, PE-SR402FL (.141" RE-SHAPEABLE)

Model No.	Length	1-24	25-49	50-99	100 +
PE3472-12	12"	\$54.85	\$51.01	\$47.17	\$43.88
PE3472-24	24"	58.45	54.36	50.27	46.76
PE3472-36	36"	62.00	57.66	53.32	49.60
PE3472-48	48"	65.70	61.10	56.50	52.56
PE3472-60	60"	69.30	64.45	59.60	55.44
PE3472-XX	Any	Same-Day Shipment / Call for Pricing			

### 50 OHM, PE-047SR (.047" BARE COPPER)

Model No.	Length	1-24	25-49	50-99	100 +
PE34142-12	12"	\$68.10	\$63.33	\$58.57	\$54.48
PE34142-24	24"	71.70	66.68	61.66	57.36
PE34142-36	36"	75.40	70.12	64.84	60.32
PE34142-48	48"	78.95	73.42	67.90	63.16
PE34142-60	60"	82.55	76.77	70.99	66.04
PE34142-XX	Any	Same-Day Shipment / Call for Pricing			

### 50 OHM, PE-SR047AL (.047" TINNED ALUMINUM)

Model No.	Length	1-24	25-49	50-99	100 +
PE34144-12	12"	\$74.70	\$69.47	\$64.24	\$59.76
PE34144-24	24"	78.35	72.87	67.38	62.68
PE34144-36	36"	81.95	76.21	70.48	65.56
PE34144-48	48"	85.60	79.61	73.62	68.48
PE34144-60	60"	89.15	82.91	76.67	71.32
PE34144-XX	Any	Same-Day Shipment / Call for Pricing			

### 50 OHM, PE-SR047FL (.047" RE-SHAPEABLE)

Model No.	Length	1-24	25-49	50-99	100 +
PE34146-12	12"	\$74.70	\$69.47	\$64.24	\$59.76
PE34146-24	24"	78.35	72.87	67.38	62.68
PE34146-36	36"	81.95	76.21	70.48	65.56
PE34146-48	48"	85.60	79.61	73.62	68.48
PE34146-60	60"	89.15	82.91	76.67	71.32
PE34146-XX	Any	Same-Day Shipment / Call for Pricing			

### 50 OHM, RG405/U (.085" BARE COPPER)

Model No.	Length	1-24	25-49	50-99	100 +
PE3920-12	12"	\$54.85	\$51.01	\$47.17	\$43.88
PE3920-24	24"	58.45	54.36	50.27	46.76
PE3920-36	36"	62.00	57.66	53.32	49.60
PE3920-48	48"	65.70	61.10	56.50	52.56
PE3920-60	60"	69.30	64.45	59.60	55.44
PE3920-XX	Any	Same-Day Shipment / Call for Pricing			

### 50 OHM, PE-SR405AL (.085" TINNED ALUMINUM)

Model No.	Length	1-24	25-49	50-99	100 +
PE34140-12	12"	\$57.55	\$53.52	\$49.49	\$46.04
PE34140-24	24"	61.10	56.82	52.55	48.88
PE34140-36	36"	64.70	60.17	55.64	51.76
PE34140-48	48"	68.40	63.61	58.82	54.72
PE34140-60	60"	71.95	66.91	61.88	57.56
PE34140-XX	Any	Same-Day Shipment / Call for Pricing			

### 50 OHM, PE-SR405FL (.085" RE-SHAPEABLE)

Model No.	Length	1-24	25-49	50-99	100 +
PE3963-12	12"	\$57.55	\$53.52	\$49.49	\$46.04
PE3963-24	24"	61.10	56.82	52.55	48.88
PE3963-36	36"	64.70	60.17	55.64	51.76
PE3963-48	48"	68.40	63.61	58.82	54.72
PE3963-60	60"	71.95	66.91	61.88	57.56
PE3963-XX	Any	Same-Day Shipment / Call for Pricing			

### 50 OHM, RG401/U (.250" BARE COPPER)

Model No.	Length	1-24	25-49	50-99	100 +
PE3782-12	12"	\$69.90	\$65.01	\$60.11	\$55.92
PE3782-24	24"	77.15	71.75	66.35	61.72
PE3782-36	36"	84.35	78.45	72.54	67.48
PE3782-48	48"	91.60	85.19	78.78	73.28
PE3782-60	60"	98.80	91.88	84.97	79.04
PE3782-XX	Any	Same-Day Shipment / Call for Pricing			

### 50 OHM, PE-SR401AL (.250" TINNED ALUMINUM)

Model No.	Length	1-24	25-49	50-99	100 +
PE3995-12	12"	\$76.55	\$71.19	\$65.83	\$61.24
PE3995-24	24"	83.75	77.89	72.03	67.00
PE3995-36	36"	91.00	84.63	78.26	72.80
PE3995-48	48"	98.25	91.37	84.50	78.60
PE3995-60	60"	105.40	98.02	90.64	84.32
PE3995-XX	Any	Same-Day Shipment / Call for Pricing			

### 50 OHM, PE-SR401FL (.250" RE-SHAPEABLE)

Model No.	Length	1-24	25-49	50-99	100 +
PE34149-12	12"	\$76.55	\$71.19	\$65.83	\$61.24
PE34149-24	24"	83.75	77.89	72.03	67.00
PE34149-36	36"	91.00	84.63	78.26	72.80
PE34149-48	48"	98.25	91.37	84.50	78.60
PE34149-60	60"	105.40	98.02	90.64	84.32
PE34149-XX	Any	Same-Day Shipment / Call for Pricing			

\*\*ROHS COMPLIANT & CUSTOM-LENGTH CABLE ASSEMBLIES MAY BE ORDERED ON OUR WEBSITE.\*\*

# N MALE TO N MALE RIGHT ANGLE



## 52 OHM, RG8A/U COAX

Model No.	Length	1-24	25-49	50-99	100 +
PE3699-12	12"	\$57.00	\$53.01	\$49.02	\$45.60
PE3699-24	24"	58.05	53.99	49.92	46.44
PE3699-36	36"	59.05	54.92	50.78	47.24
PE3699-48	48"	60.05	55.85	51.64	48.04
PE3699-60	60"	61.05	56.78	52.50	48.84
PE3699-XX	Any	Same-Day Shipment / Call for Pricing			

## 50 OHM, RG58C/U COAX

Model No.	Length	1-24	25-49	50-99	100 +
PE3143-12	12"	\$46.35	\$43.11	\$39.86	\$37.08
PE3143-24	24"	46.85	43.57	40.29	37.48
PE3143-36	36"	47.25	43.94	40.64	37.80
PE3143-48	48"	47.65	44.31	40.98	38.12
PE3143-60	60"	48.05	44.69	41.32	38.44
PE3143-XX	Any	Same-Day Shipment / Call for Pricing			

## 50 OHM, RG142B/U COAX, DOUBLE SHIELDED

Model No.	Length	1-24	25-49	50-99	100 +
PE3726-12	12"	\$46.35	\$43.11	\$39.86	\$37.08
PE3726-24	24"	49.05	45.62	42.18	39.24
PE3726-36	36"	51.70	48.08	44.46	41.36
PE3726-48	48"	54.35	50.55	46.74	43.48
PE3726-60	60"	57.00	53.01	49.02	45.60
PE3726-XX	Any	Same-Day Shipment / Call for Pricing			

## 50 OHM, RG174A/U COAX

Model No.	Length	1-24	25-49	50-99	100 +
PE34205-12	12"	\$53.00	\$49.29	\$45.58	\$42.40
PE34205-24	24"	53.30	49.57	45.84	42.64
PE34205-36	36"	53.60	49.85	46.10	42.88
PE34205-48	48"	53.85	50.08	46.31	43.08
PE34205-60	60"	54.10	50.31	46.53	43.28
PE34205-XX	Any	Same-Day Shipment / Call for Pricing			

## 50 OHM, RG188A/U COAX

Model No.	Length	1-24	25-49	50-99	100 +
PE34212-12	12"	\$53.00	\$49.29	\$45.58	\$42.40
PE34212-24	24"	54.00	50.22	46.44	43.20
PE34212-36	36"	54.95	51.10	47.26	43.96
PE34212-48	48"	55.90	51.99	48.07	44.72
PE34212-60	60"	56.85	52.87	48.89	45.48
PE34212-XX	Any	Same-Day Shipment / Call for Pricing			

## 50 OHM, RG213/U COAX

Model No.	Length	1-24	25-49	50-99	100 +
PE3797-12	12"	\$57.00	\$53.01	\$49.02	\$45.60
PE3797-24	24"	58.05	53.99	49.92	46.44
PE3797-36	36"	59.05	54.92	50.78	47.24
PE3797-48	48"	60.05	55.85	51.64	48.04
PE3797-60	60"	61.05	56.78	52.50	48.84
PE3797-XX	Any	Same-Day Shipment / Call for Pricing			

## 50 OHM, RG214/U COAX, DOUBLE SHIELDED

Model No.	Length	1-24	25-49	50-99	100 +
PE3071-12	12"	\$57.00	\$53.01	\$49.02	\$45.60
PE3071-24	24"	60.65	56.40	52.16	48.52
PE3071-36	36"	64.30	59.80	55.30	51.44
PE3071-48	48"	67.90	63.15	58.39	54.32
PE3071-60	60"	71.50	66.50	61.49	57.20
PE3071-XX	Any	Same-Day Shipment / Call for Pricing			

## 50 OHM, RG223/U COAX, DOUBLE SHIELDED

Model No.	Length	1-24	25-49	50-99	100 +
PE3168-12	12"	\$46.35	\$43.11	\$39.86	\$37.08
PE3168-24	24"	47.70	44.36	41.02	38.16
PE3168-36	36"	49.05	45.62	42.18	39.24
PE3168-48	48"	50.40	46.87	43.34	40.32
PE3168-60	60"	51.70	48.08	44.46	41.36
PE3168-XX	Any	Same-Day Shipment / Call for Pricing			

## 50 OHM, RG225/U COAX, DOUBLE SHIELDED

Model No.	Length	1-24	25-49	50-99	100 +
PE34203-12	12"	\$66.30	\$61.66	\$57.02	\$53.04
PE34203-24	24"	90.40	84.07	77.74	72.32
PE34203-36	36"	114.45	106.44	98.43	91.56
PE34203-48	48"	138.55	128.85	119.15	110.84
PE34203-60	60"	162.75	151.36	139.97	130.20
PE34203-XX	Any	Same-Day Shipment / Call for Pricing			

## 50 OHM, RG316/U COAX

Model No.	Length	1-24	25-49	50-99	100 +
PE34210-12	12"	\$53.00	\$49.29	\$45.58	\$42.40
PE34210-24	24"	54.00	50.22	46.44	43.20
PE34210-36	36"	54.95	51.10	47.26	43.96
PE34210-48	48"	55.90	51.99	48.07	44.72
PE34210-60	60"	56.85	52.87	48.89	45.48
PE34210-XX	Any	Same-Day Shipment / Call for Pricing			

## 50 OHM, RG316-DS COAX, DOUBLE SHIELDED

Model No.	Length	1-24	25-49	50-99	100 +
PE34207-12	12"	\$55.70	\$51.80	\$47.90	\$44.56
PE34207-24	24"	58.10	54.03	49.97	46.48
PE34207-36	36"	60.55	56.31	52.07	48.44
PE34207-48	48"	62.95	58.54	54.14	50.36
PE34207-60	60"	65.30	60.73	56.16	52.24
PE34207-XX	Any	Same-Day Shipment / Call for Pricing			

## 50 OHM, RG393/U COAX, DOUBLE SHIELDED

Model No.	Length	1-24	25-49	50-99	100 +
PE3255-12	12"	\$57.00	\$53.01	\$49.02	\$45.60
PE3255-24	24"	65.45	60.87	56.29	52.36
PE3255-36	36"	73.90	68.73	63.55	59.12
PE3255-48	48"	82.30	76.54	70.78	65.84
PE3255-60	60"	90.80	84.44	78.09	72.64
PE3255-XX	Any	Same-Day Shipment / Call for Pricing			

## 50 OHM, RG400/U COAX, DOUBLE SHIELDED

Model No.	Length	1-24	25-49	50-99	100 +
PE33321-12	12"	\$46.35	\$43.11	\$39.86	\$37.08
PE33321-24	24"	49.05	45.62	42.18	39.24
PE33321-36	36"	51.70	48.08	44.46	41.36
PE33321-48	48"	54.35	50.55	46.74	43.48
PE33321-60	60"	57.00	53.01	49.02	45.60
PE33321-XX	Any	Same-Day Shipment / Call for Pricing			

## 50 OHM, PE-B3199, VERY LOW LOSS COAX

Model No.	Length	1-24	25-49	50-99	100 +
PE3962-12	12"	\$50.40	\$46.87	\$43.34	\$40.32
PE3962-24	24"	51.30	47.71	44.12	41.04
PE3962-36	36"	52.35	48.69	45.02	41.88
PE3962-48	48"	53.30	49.57	45.84	42.64
PE3962-60	60"	54.25	50.45	46.66	43.40
PE3962-XX	Any	Same-Day Shipment / Call for Pricing			

\*\*ROHS COMPLIANT & CUSTOM-LENGTH CABLE ASSEMBLIES MAY BE ORDERED ON OUR WEBSITE.\*\*

# N MALE RIGHT ANGLE TO N MALE RIGHT ANGLE



## 52 OHM, RG8A/U COAX

Model No.	Length	1-24	25-49	50-99	100 +
PE33974-12	12"	\$66.30	\$61.66	\$57.02	\$53.04
PE33974-24	24"	67.25	62.54	57.84	53.80
PE33974-36	36"	68.35	63.57	58.78	54.68
PE33974-48	48"	69.35	64.50	59.64	55.48
PE33974-60	60"	70.35	65.43	60.50	56.28
PE33974-XX	Any	Same-Day Shipment / Call for Pricing			

## 50 OHM, RG58C/U COAX

Model No.	Length	1-24	25-49	50-99	100 +
PE3698-12	12"	\$53.00	\$49.29	\$45.58	\$42.40
PE3698-24	24"	53.50	49.76	46.01	42.80
PE3698-36	36"	53.85	50.08	46.31	43.08
PE3698-48	48"	54.25	50.45	46.66	43.40
PE3698-60	60"	54.60	50.78	46.96	43.68
PE3698-XX	Any	Same-Day Shipment / Call for Pricing			

## 50 OHM, RG142B/U COAX, DOUBLE SHIELDED

Model No.	Length	1-24	25-49	50-99	100 +
PE3693-12	12"	\$53.00	\$49.29	\$45.58	\$42.40
PE3693-24	24"	55.70	51.80	47.90	44.56
PE3693-36	36"	58.35	54.27	50.18	46.68
PE3693-48	48"	61.00	56.73	52.46	48.80
PE3693-60	60"	63.65	59.19	54.74	50.92
PE3693-XX	Any	Same-Day Shipment / Call for Pricing			

## 50 OHM, RG174A/U COAX

Model No.	Length	1-24	25-49	50-99	100 +
PE34231-12	12"	\$61.00	\$56.73	\$52.46	\$48.80
PE34231-24	24"	61.25	56.96	52.68	49.00
PE34231-36	36"	61.50	57.20	52.89	49.20
PE34231-48	48"	61.70	57.38	53.06	49.36
PE34231-60	60"	61.95	57.61	53.28	49.56
PE34231-XX	Any	Same-Day Shipment / Call for Pricing			

## 50 OHM, RG188A/U COAX

Model No.	Length	1-24	25-49	50-99	100 +
PE34238-12	12"	\$61.00	\$56.73	\$52.46	\$48.80
PE34238-24	24"	61.90	57.57	53.23	49.52
PE34238-36	36"	62.95	58.54	54.14	50.36
PE34238-48	48"	63.85	59.38	54.91	51.08
PE34238-60	60"	64.85	60.31	55.77	51.88
PE34238-XX	Any	Same-Day Shipment / Call for Pricing			

## 50 OHM, RG213/U COAX

Model No.	Length	1-24	25-49	50-99	100 +
PE3272-12	12"	\$66.30	\$61.66	\$57.02	\$53.04
PE3272-24	24"	67.25	62.54	57.84	53.80
PE3272-36	36"	68.35	63.57	58.78	54.68
PE3272-48	48"	69.35	64.50	59.64	55.48
PE3272-60	60"	70.35	65.43	60.50	56.28
PE3272-XX	Any	Same-Day Shipment / Call for Pricing			

## 50 OHM, RG214/U COAX, DOUBLE SHIELDED

Model No.	Length	1-24	25-49	50-99	100 +
PE3781-12	12"	\$66.30	\$61.66	\$57.02	\$53.04
PE3781-24	24"	69.90	65.01	60.11	55.92
PE3781-36	36"	73.50	68.36	63.21	58.80
PE3781-48	48"	77.15	71.75	66.35	61.72
PE3781-60	60"	80.80	75.14	69.49	64.64
PE3781-XX	Any	Same-Day Shipment / Call for Pricing			

## 50 OHM, RG223/U COAX, DOUBLE SHIELDED

Model No.	Length	1-24	25-49	50-99	100 +
PE3882-12	12"	\$53.00	\$49.29	\$45.58	\$42.40
PE3882-24	24"	54.35	50.55	46.74	43.48
PE3882-36	36"	55.70	51.80	47.90	44.56
PE3882-48	48"	57.00	53.01	49.02	45.60
PE3882-60	60"	58.35	54.27	50.18	46.68
PE3882-XX	Any	Same-Day Shipment / Call for Pricing			

## 50 OHM, RG225/U COAX, DOUBLE SHIELDED

Model No.	Length	1-24	25-49	50-99	100 +
PE34222-12	12"	\$79.55	\$73.98	\$68.41	\$63.64
PE34222-24	24"	103.65	96.39	89.14	82.92
PE34222-36	36"	127.75	118.81	109.87	102.20
PE34222-48	48"	151.90	141.27	130.63	121.52
PE34222-60	60"	176.00	163.68	151.36	140.80
PE34222-XX	Any	Same-Day Shipment / Call for Pricing			

## 50 OHM, RG316/U COAX

Model No.	Length	1-24	25-49	50-99	100 +
PE34236-12	12"	\$61.00	\$56.73	\$52.46	\$48.80
PE34236-24	24"	61.90	57.57	53.23	49.52
PE34236-36	36"	62.95	58.54	54.14	50.36
PE34236-48	48"	63.85	59.38	54.91	51.08
PE34236-60	60"	64.85	60.31	55.77	51.88
PE34236-XX	Any	Same-Day Shipment / Call for Pricing			

## 50 OHM, RG316-DS COAX, DOUBLE SHIELDED

Model No.	Length	1-24	25-49	50-99	100 +
PE34234-12	12"	\$63.65	\$59.19	\$54.74	\$50.92
PE34234-24	24"	66.10	61.47	56.85	52.88
PE34234-36	36"	68.50	63.71	58.91	54.80
PE34234-48	48"	70.85	65.89	60.93	56.68
PE34234-60	60"	73.30	68.17	63.04	58.64
PE34234-XX	Any	Same-Day Shipment / Call for Pricing			

## 50 OHM, RG393/U COAX, DOUBLE SHIELDED

Model No.	Length	1-24	25-49	50-99	100 +
PE3268-12	12"	\$66.30	\$61.66	\$57.02	\$53.04
PE3268-24	24"	74.70	69.47	64.24	59.76
PE3268-36	36"	83.15	77.33	71.51	66.52
PE3268-48	48"	91.60	85.19	78.78	73.28
PE3268-60	60"	100.00	93.00	86.00	80.00
PE3268-XX	Any	Same-Day Shipment / Call for Pricing			

## 50 OHM, RG400/U COAX, DOUBLE SHIELDED

Model No.	Length	1-24	25-49	50-99	100 +
PE3412-12	12"	\$53.00	\$49.29	\$45.58	\$42.40
PE3412-24	24"	55.70	51.80	47.90	44.56
PE3412-36	36"	58.35	54.27	50.18	46.68
PE3412-48	48"	61.00	56.73	52.46	48.80
PE3412-60	60"	63.65	59.19	54.74	50.92
PE3412-XX	Any	Same-Day Shipment / Call for Pricing			

## 50 OHM, PE-B3199, VERY LOW LOSS COAX

Model No.	Length	1-24	25-49	50-99	100 +
PE33168-12	12"	\$57.00	\$53.01	\$49.02	\$45.60
PE33168-24	24"	58.00	53.94	49.88	46.40
PE33168-36	36"	58.95	54.82	50.70	47.16
PE33168-48	48"	59.85	55.66	51.47	47.88
PE33168-60	60"	60.90	56.64	52.37	48.72
PE33168-XX	Any	Same-Day Shipment / Call for Pricing			

\*\*ROHS COMPLIANT & CUSTOM-LENGTH CABLE ASSEMBLIES MAY BE ORDERED ON OUR WEBSITE.\*\*

Cable Assemblies

# N MALE TO N FEMALE

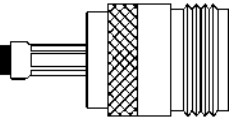
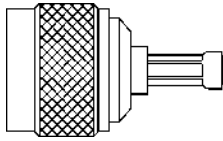

## 50 OHM, RG58C/U COAX

Model No.	Length	1-24	25-49	50-99	100 +
PE3714-12	12"	\$29.15	\$27.11	\$25.07	\$23.32
PE3714-24	24"	29.55	27.48	25.41	23.64
PE3714-36	36"	30.00	27.90	25.80	24.00
PE3714-48	48"	30.40	28.27	26.14	24.32
PE3714-60	60"	30.85	28.69	26.53	24.68
PE3714-XX	Any	Same-Day Shipment / Call for Pricing			

## 50 OHM, RG142B/U COAX, DOUBLE SHIELDED

Model No.	Length	1-24	25-49	50-99	100 +
PE3996-12	12"	\$29.15	\$27.11	\$25.07	\$23.32
PE3996-24	24"	31.80	29.57	27.35	25.44
PE3996-36	36"	34.50	32.09	29.67	27.60
PE3996-48	48"	37.15	34.55	31.95	29.72
PE3996-60	60"	39.80	37.01	34.23	31.84
PE3996-XX	Any	Same-Day Shipment / Call for Pricing			

## 50 OHM, RG188A/U COAX

Model No.	Length	1-24	25-49	50-99	100 +
PE34283-12	12"	\$43.75	\$40.69	\$37.63	\$35.00
PE34283-24	24"	44.75	41.62	38.49	35.80
PE34283-36	36"	45.65	42.45	39.26	36.52
PE34283-48	48"	46.70	43.43	40.16	37.36
PE34283-60	60"	47.60	44.27	40.94	38.08
PE34283-XX	Any	Same-Day Shipment / Call for Pricing			

## 50 OHM, RG213/U COAX

Model No.	Length	1-24	25-49	50-99	100 +
PE3232-12	12"	\$41.10	\$38.22	\$35.35	\$32.88
PE3232-24	24"	42.15	39.20	36.25	33.72
PE3232-36	36"	43.15	40.13	37.11	34.52
PE3232-48	48"	44.10	41.01	37.93	35.28
PE3232-60	60"	45.15	41.99	38.83	36.12
PE3232-XX	Any	Same-Day Shipment / Call for Pricing			

## 50 OHM, RG214/U COAX, DOUBLE SHIELDED

Model No.	Length	1-24	25-49	50-99	100 +
PE3650-12	12"	\$43.75	\$40.69	\$37.63	\$35.00
PE3650-24	24"	47.40	44.08	40.76	37.92
PE3650-36	36"	50.95	47.38	43.82	40.76
PE3650-48	48"	54.55	50.73	46.91	43.64
PE3650-60	60"	58.20	54.13	50.05	46.56
PE3650-XX	Any	Same-Day Shipment / Call for Pricing			

## 50 OHM, RG217/U COAX, DOUBLE SHIELDED

Model No.	Length	1-24	25-49	50-99	100 +
PE34274-12	12"	\$79.55	\$73.98	\$68.41	\$63.64
PE34274-24	24"	81.95	76.21	70.48	65.56
PE34274-36	36"	84.35	78.45	72.54	67.48
PE34274-48	48"	86.80	80.72	74.65	69.44
PE34274-60	60"	89.15	82.91	76.67	71.32
PE34274-XX	Any	Same-Day Shipment / Call for Pricing			

## 50 OHM, RG218/U COAX

Model No.	Length	1-24	25-49	50-99	100 +
PE34276-12	12"	\$106.10	\$98.67	\$91.25	\$84.88
PE34276-24	24"	112.10	104.25	96.41	89.68
PE34276-36	36"	118.05	109.79	101.52	94.44
PE34276-48	48"	124.20	115.51	106.81	99.36
PE34276-60	60"	130.15	121.04	111.93	104.12
PE34276-XX	Any	Same-Day Shipment / Call for Pricing			

## 50 OHM, RG223/U COAX, DOUBLE SHIELDED

Model No.	Length	1-24	25-49	50-99	100 +
PE3667-12	12"	\$29.15	\$27.11	\$25.07	\$23.32
PE3667-24	24"	30.50	28.37	26.23	24.40
PE3667-36	36"	31.80	29.57	27.35	25.44
PE3667-48	48"	33.15	30.83	28.51	26.52
PE3667-60	60"	34.50	32.09	29.67	27.60
PE3667-XX	Any	Same-Day Shipment / Call for Pricing			

## 50 OHM, RG225/U COAX, DOUBLE SHIELDED

Model No.	Length	1-24	25-49	50-99	100 +
PE33728-12	12"	\$53.00	\$49.29	\$45.58	\$42.40
PE33728-24	24"	77.15	71.75	66.35	61.72
PE33728-36	36"	101.30	94.21	87.12	81.04
PE33728-48	48"	125.40	116.62	107.84	100.32
PE33728-60	60"	149.45	138.99	128.53	119.56
PE33728-XX	Any	Same-Day Shipment / Call for Pricing			

## 50 OHM, RG316/U COAX

Model No.	Length	1-24	25-49	50-99	100 +
PE3986-12	12"	\$43.75	\$40.69	\$37.63	\$35.00
PE3986-24	24"	44.75	41.62	38.49	35.80
PE3986-36	36"	45.65	42.45	39.26	36.52
PE3986-48	48"	46.70	43.43	40.16	37.36
PE3986-60	60"	47.60	44.27	40.94	38.08
PE3986-XX	Any	Same-Day Shipment / Call for Pricing			

## 50 OHM, RG316-DS COAX, DOUBLE SHIELDED

Model No.	Length	1-24	25-49	50-99	100 +
PE34281-12	12"	\$47.70	\$44.36	\$41.02	\$38.16
PE34281-24	24"	50.20	46.69	43.17	40.16
PE34281-36	36"	52.60	48.92	45.24	42.08
PE34281-48	48"	54.95	51.10	47.26	43.96
PE34281-60	60"	57.45	53.43	49.41	45.96
PE34281-XX	Any	Same-Day Shipment / Call for Pricing			

## 50 OHM, RG393/U COAX, DOUBLE SHIELDED

Model No.	Length	1-24	25-49	50-99	100 +
PE3977-12	12"	\$43.75	\$40.69	\$37.63	\$35.00
PE3977-24	24"	52.20	48.55	44.89	41.76
PE3977-36	36"	60.65	56.40	52.16	48.52
PE3977-48	48"	69.05	64.22	59.38	55.24
PE3977-60	60"	77.45	72.03	66.61	61.96
PE3977-XX	Any	Same-Day Shipment / Call for Pricing			

## 50 OHM, RG400/U COAX, DOUBLE SHIELDED

Model No.	Length	1-24	25-49	50-99	100 +
PE3617-12	12"	\$29.15	\$27.11	\$25.07	\$23.32
PE3617-24	24"	31.80	29.57	27.35	25.44
PE3617-36	36"	34.50	32.09	29.67	27.60
PE3617-48	48"	37.15	34.55	31.95	29.72
PE3617-60	60"	39.80	37.01	34.23	31.84
PE3617-XX	Any	Same-Day Shipment / Call for Pricing			

## 50 OHM, PE-B3199, VERY LOW LOSS COAX

Model No.	Length	1-24	25-49	50-99	100 +
PE33011-12	12"	\$43.75	\$40.69	\$37.63	\$35.00
PE33011-24	24"	44.75	41.62	38.49	35.80
PE33011-36	36"	45.65	42.45	39.26	36.52
PE33011-48	48"	46.70	43.43	40.16	37.36
PE33011-60	60"	47.60	44.27	40.94	38.08
PE33011-XX	Any	Same-Day Shipment / Call for Pricing			

\*\*ROHS COMPLIANT & CUSTOM-LENGTH CABLE ASSEMBLIES MAY BE ORDERED ON OUR WEBSITE.\*\*

# SEMI-RIGID & RE-SHAPEABLE CABLE ASSEMBLIES

## N MALE TO N FEMALE

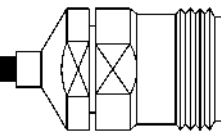
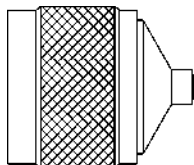

### 50 OHM, RG402/U (.141" BARE COPPER)

Model No.	Length	1-24	25-49	50-99	100 +
PE3829-12	12"	\$60.15	\$55.94	\$51.73	\$48.12
PE3829-24	24"	63.75	59.29	54.83	51.00
PE3829-36	36"	67.30	62.59	57.88	53.84
PE3829-48	48"	71.00	66.03	61.06	56.80
PE3829-60	60"	74.60	69.38	64.16	59.68
PE3829-XX	Any	Same-Day Shipment / Call for Pricing			

### 50 OHM, PE-SR402AL (.141" TINNED ALUMINUM)

Model No.	Length	1-24	25-49	50-99	100 +
PE34289-12	12"	\$64.15	\$59.66	\$55.17	\$51.32
PE34289-24	24"	67.80	63.05	58.31	54.24
PE34289-36	36"	71.40	66.40	61.40	57.12
PE34289-48	48"	75.00	69.75	64.50	60.00
PE34289-60	60"	78.60	73.10	67.60	62.88
PE34289-XX	Any	Same-Day Shipment / Call for Pricing			

### 50 OHM, PE-SR402FL (.141" RE-SHAPEABLE)

Model No.	Length	1-24	25-49	50-99	100 +
PE3485-12	12"	\$64.15	\$59.66	\$55.17	\$51.32
PE3485-24	24"	67.80	63.05	58.31	54.24
PE3485-36	36"	71.40	66.40	61.40	57.12
PE3485-48	48"	75.00	69.75	64.50	60.00
PE3485-60	60"	78.60	73.10	67.60	62.88
PE3485-XX	Any	Same-Day Shipment / Call for Pricing			

### 50 OHM, PE-047SR (.047" BARE COPPER)

Model No.	Length	1-24	25-49	50-99	100 +
PE34287-12	12"	\$88.00	\$81.84	\$75.68	\$70.40
PE34287-24	24"	91.60	85.19	78.78	73.28
PE34287-36	36"	95.15	88.49	81.83	76.12
PE34287-48	48"	98.80	91.88	84.97	79.04
PE34287-60	60"	102.50	95.33	88.15	82.00
PE34287-XX	Any	Same-Day Shipment / Call for Pricing			

### 50 OHM, PE-SR047AL (.047" TINNED ALUMINUM)

Model No.	Length	1-24	25-49	50-99	100 +
PE34296-12	12"	\$94.55	\$87.93	\$81.31	\$75.64
PE34296-24	24"	98.25	91.37	84.50	78.60
PE34296-36	36"	101.85	94.72	87.59	81.48
PE34296-48	48"	105.40	98.02	90.64	84.32
PE34296-60	60"	109.05	101.42	93.78	87.24
PE34296-XX	Any	Same-Day Shipment / Call for Pricing			

### 50 OHM, PE-SR047FL (.047" RE-SHAPEABLE)

Model No.	Length	1-24	25-49	50-99	100 +
PE34291-12	12"	\$94.55	\$87.93	\$81.31	\$75.64
PE34291-24	24"	98.25	91.37	84.50	78.60
PE34291-36	36"	101.85	94.72	87.59	81.48
PE34291-48	48"	105.40	98.02	90.64	84.32
PE34291-60	60"	109.05	101.42	93.78	87.24
PE34291-XX	Any	Same-Day Shipment / Call for Pricing			

### 50 OHM, RG405/U (.085" BARE COPPER)

Model No.	Length	1-24	25-49	50-99	100 +
PE3921-12	12"	\$64.15	\$59.66	\$55.17	\$51.32
PE3921-24	24"	67.80	63.05	58.31	54.24
PE3921-36	36"	71.40	66.40	61.40	57.12
PE3921-48	48"	75.00	69.75	64.50	60.00
PE3921-60	60"	78.60	73.10	67.60	62.88
PE3921-XX	Any	Same-Day Shipment / Call for Pricing			

### 50 OHM, PE-SR405AL (.085" TINNED ALUMINUM)

Model No.	Length	1-24	25-49	50-99	100 +
PE34285-12	12"	\$68.10	\$63.33	\$58.57	\$54.48
PE34285-24	24"	71.70	66.68	61.66	57.36
PE34285-36	36"	75.40	70.12	64.84	60.32
PE34285-48	48"	78.95	73.42	67.90	63.16
PE34285-60	60"	82.55	76.77	70.99	66.04
PE34285-XX	Any	Same-Day Shipment / Call for Pricing			

### 50 OHM, PE-SR405FL (.085" RE-SHAPEABLE)

Model No.	Length	1-24	25-49	50-99	100 +
PE3965-12	12"	\$68.10	\$63.33	\$58.57	\$54.48
PE3965-24	24"	71.70	66.68	61.66	57.36
PE3965-36	36"	75.40	70.12	64.84	60.32
PE3965-48	48"	78.95	73.42	67.90	63.16
PE3965-60	60"	82.55	76.77	70.99	66.04
PE3965-XX	Any	Same-Day Shipment / Call for Pricing			

### 50 OHM, RG401/U (.250" BARE COPPER)

Model No.	Length	1-24	25-49	50-99	100 +
PE3979-12	12"	\$76.55	\$71.19	\$65.83	\$61.24
PE3979-24	24"	83.75	77.89	72.03	67.00
PE3979-36	36"	91.00	84.63	78.26	72.80
PE3979-48	48"	98.25	91.37	84.50	78.60
PE3979-60	60"	105.40	98.02	90.64	84.32
PE3979-XX	Any	Same-Day Shipment / Call for Pricing			

### 50 OHM, PE-SR401AL (.250" TINNED ALUMINUM)

Model No.	Length	1-24	25-49	50-99	100 +
PE3988-12	12"	\$83.15	\$77.33	\$71.51	\$66.52
PE3988-24	24"	90.40	84.07	77.74	72.32
PE3988-36	36"	97.65	90.81	83.98	78.12
PE3988-48	48"	104.85	97.51	90.17	83.88
PE3988-60	60"	112.10	104.25	96.41	89.68
PE3988-XX	Any	Same-Day Shipment / Call for Pricing			

### 50 OHM, PE-SR401FL (.250" RE-SHAPEABLE)

Model No.	Length	1-24	25-49	50-99	100 +
PE34293-12	12"	\$83.15	\$77.33	\$71.51	\$66.52
PE34293-24	24"	90.40	84.07	77.74	72.32
PE34293-36	36"	97.65	90.81	83.98	78.12
PE34293-48	48"	104.85	97.51	90.17	83.88
PE34293-60	60"	112.10	104.25	96.41	89.68
PE34293-XX	Any	Same-Day Shipment / Call for Pricing			

\*\*ROHS COMPLIANT & CUSTOM-LENGTH CABLE ASSEMBLIES MAY BE ORDERED ON OUR WEBSITE.\*\*

Cable Assemblies



# N MALE TO N FEMALE BULKHEAD



USE MOUNTING HOLE G01 ON PAGE 266

## 52 OHM, RG8A/U COAX

Model No.	Length	1-24	25-49	50-99	100 +
PE3966-12	12"	\$54.35	\$50.55	\$46.74	\$43.48
PE3966-24	24"	55.40	51.52	47.64	44.32
PE3966-36	36"	56.35	52.41	48.46	45.08
PE3966-48	48"	57.45	53.43	49.41	45.96
PE3966-60	60"	58.40	54.31	50.22	46.72
PE3966-XX	Any	Same-Day Shipment / Call for Pricing			

## 50 OHM, RG58C/U COAX

Model No.	Length	1-24	25-49	50-99	100 +
PE3320-12	12"	\$45.10	\$41.94	\$38.79	\$36.08
PE3320-24	24"	45.45	42.27	39.09	36.36
PE3320-36	36"	45.85	42.64	39.43	36.68
PE3320-48	48"	46.25	43.01	39.78	37.00
PE3320-60	60"	46.75	43.48	40.21	37.40
PE3320-XX	Any	Same-Day Shipment / Call for Pricing			

## 50 OHM, RG142B/U COAX, DOUBLE SHIELDED

Model No.	Length	1-24	25-49	50-99	100 +
PE3034-12	12"	\$45.10	\$41.94	\$38.79	\$36.08
PE3034-24	24"	47.70	44.36	41.02	38.16
PE3034-36	36"	50.40	46.87	43.34	40.32
PE3034-48	48"	53.00	49.29	45.58	42.40
PE3034-60	60"	55.70	51.80	47.90	44.56
PE3034-XX	Any	Same-Day Shipment / Call for Pricing			

## 50 OHM, RG178B/U COAX

Model No.	Length	1-24	25-49	50-99	100 +
PE34201-12	12"	\$59.65	\$55.47	\$51.30	\$47.72
PE34201-24	24"	60.65	56.40	52.16	48.52
PE34201-36	36"	61.55	57.24	52.93	49.24
PE34201-48	48"	62.60	58.22	53.84	50.08
PE34201-60	60"	63.50	59.06	54.61	50.80
PE34201-XX	Any	Same-Day Shipment / Call for Pricing			

## 50 OHM, RG188A/U COAX

Model No.	Length	1-24	25-49	50-99	100 +
PE34181-12	12"	\$54.35	\$50.55	\$46.74	\$43.48
PE34181-24	24"	55.35	51.48	47.60	44.28
PE34181-36	36"	56.25	52.31	48.38	45.00
PE34181-48	48"	57.25	53.24	49.24	45.80
PE34181-60	60"	58.20	54.13	50.05	46.56
PE34181-XX	Any	Same-Day Shipment / Call for Pricing			

## 50 OHM, RG213/U COAX

Model No.	Length	1-24	25-49	50-99	100 +
PE33543-12	12"	\$54.35	\$50.55	\$46.74	\$43.48
PE33543-24	24"	55.40	51.52	47.64	44.32
PE33543-36	36"	56.35	52.41	48.46	45.08
PE33543-48	48"	57.45	53.43	49.41	45.96
PE33543-60	60"	58.40	54.31	50.22	46.72
PE33543-XX	Any	Same-Day Shipment / Call for Pricing			

## 50 OHM, RG214/U COAX, DOUBLE SHIELDED

Model No.	Length	1-24	25-49	50-99	100 +
PE3217-12	12"	\$54.35	\$50.55	\$46.74	\$43.48
PE3217-24	24"	58.00	53.94	49.88	46.40
PE3217-36	36"	61.55	57.24	52.93	49.24
PE3217-48	48"	65.20	60.64	56.07	52.16
PE3217-60	60"	68.80	63.98	59.17	55.04
PE3217-XX	Any	Same-Day Shipment / Call for Pricing			

## 50 OHM, RG223/U COAX, DOUBLE SHIELDED

Model No.	Length	1-24	25-49	50-99	100 +
PE3686-12	12"	\$45.10	\$41.94	\$38.79	\$36.08
PE3686-24	24"	46.35	43.11	39.86	37.08
PE3686-36	36"	47.70	44.36	41.02	38.16
PE3686-48	48"	49.05	45.62	42.18	39.24
PE3686-60	60"	50.40	46.87	43.34	40.32
PE3686-XX	Any	Same-Day Shipment / Call for Pricing			

## 50 OHM, RG225/U COAX, DOUBLE SHIELDED

Model No.	Length	1-24	25-49	50-99	100 +
PE34194-12	12"	\$66.30	\$61.66	\$57.02	\$53.04
PE34194-24	24"	90.40	84.07	77.74	72.32
PE34194-36	36"	114.45	106.44	98.43	91.56
PE34194-48	48"	138.55	128.85	119.15	110.84
PE34194-60	60"	162.75	151.36	139.97	130.20
PE34194-XX	Any	Same-Day Shipment / Call for Pricing			

## 50 OHM, RG316/U COAX

Model No.	Length	1-24	25-49	50-99	100 +
PE33534-12	12"	\$54.35	\$50.55	\$46.74	\$43.48
PE33534-24	24"	55.35	51.48	47.60	44.28
PE33534-36	36"	56.25	52.31	48.38	45.00
PE33534-48	48"	57.25	53.24	49.24	45.80
PE33534-60	60"	58.20	54.13	50.05	46.56
PE33534-XX	Any	Same-Day Shipment / Call for Pricing			

## 50 OHM, RG316-DS COAX, DOUBLE SHIELDED

Model No.	Length	1-24	25-49	50-99	100 +
PE34198-12	12"	\$54.35	\$50.55	\$46.74	\$43.48
PE34198-24	24"	56.70	52.73	48.76	45.36
PE34198-36	36"	59.20	55.06	50.91	47.36
PE34198-48	48"	61.55	57.24	52.93	49.24
PE34198-60	60"	64.00	59.52	55.04	51.20
PE34198-XX	Any	Same-Day Shipment / Call for Pricing			

## 50 OHM, RG393/U COAX, DOUBLE SHIELDED

Model No.	Length	1-24	25-49	50-99	100 +
PE33530-12	12"	\$54.35	\$50.55	\$46.74	\$43.48
PE33530-24	24"	62.80	58.40	54.01	50.24
PE33530-36	36"	71.30	66.31	61.32	57.04
PE33530-48	48"	79.70	74.12	68.54	63.76
PE33530-60	60"	88.10	81.93	75.77	70.48
PE33530-XX	Any	Same-Day Shipment / Call for Pricing			

## 50 OHM, RG400/U COAX, DOUBLE SHIELDED

Model No.	Length	1-24	25-49	50-99	100 +
PE3227-12	12"	\$45.10	\$41.94	\$38.79	\$36.08
PE3227-24	24"	47.70	44.36	41.02	38.16
PE3227-36	36"	50.40	46.87	43.34	40.32
PE3227-48	48"	53.00	49.29	45.58	42.40
PE3227-60	60"	55.70	51.80	47.90	44.56
PE3227-XX	Any	Same-Day Shipment / Call for Pricing			

## 50 OHM, PE-B3199, VERY LOW LOSS COAX

Model No.	Length	1-24	25-49	50-99	100 +
PE34196-12	12"	\$47.70	\$44.36	\$41.02	\$38.16
PE34196-24	24"	48.70	45.29	41.88	38.96
PE34196-36	36"	49.65	46.17	42.70	39.72
PE34196-48	48"	50.60	47.06	43.52	40.48
PE34196-60	60"	51.55	47.94	44.33	41.24
PE34196-XX	Any	Same-Day Shipment / Call for Pricing			

\*\*ROHS COMPLIANT & CUSTOM-LENGTH CABLE ASSEMBLIES MAY BE ORDERED ON OUR WEBSITE.\*\*

# SEMI-RIGID & RE-SHAPEABLE CABLE ASSEMBLIES

## N MALE TO N FEMALE BULKHEAD

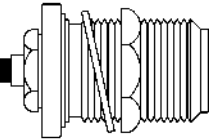
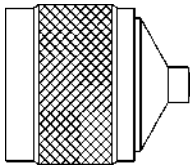

USE MOUNTING HOLE G01 ON PAGE 266

### 50 OHM, RG402/U (.141" BARE COPPER)

Model No.	Length	1-24	25-49	50-99	100 +
PE3830-12	12"	\$81.35	\$75.66	\$69.96	\$65.08
PE3830-24	24"	85.00	79.05	73.10	68.00
PE3830-36	36"	88.60	82.40	76.20	70.88
PE3830-48	48"	92.20	85.75	79.29	73.76
PE3830-60	60"	95.90	89.19	82.47	76.72
PE3830-XX	Any	Same-Day Shipment / Call for Pricing			

### 50 OHM, RG405/U (.085" BARE COPPER)

Model No.	Length	1-24	25-49	50-99	100 +
PE3922-12	12"	\$82.65	\$76.86	\$71.08	\$66.12
PE3922-24	24"	86.30	80.26	74.22	69.04
PE3922-36	36"	89.85	83.56	77.27	71.88
PE3922-48	48"	93.55	87.00	80.45	74.84
PE3922-60	60"	97.20	90.40	83.59	77.76
PE3922-XX	Any	Same-Day Shipment / Call for Pricing			

### 50 OHM, PE-SR402AL (.141" TINNED ALUMINUM)

Model No.	Length	1-24	25-49	50-99	100 +
PE34158-12	12"	\$85.35	\$79.38	\$73.40	\$68.28
PE34158-24	24"	88.95	82.72	76.50	71.16
PE34158-36	36"	92.55	86.07	79.59	74.04
PE34158-48	48"	96.20	89.47	82.73	76.96
PE34158-60	60"	99.75	92.77	85.79	79.80
PE34158-XX	Any	Same-Day Shipment / Call for Pricing			

### 50 OHM, PE-SR405AL (.085" TINNED ALUMINUM)

Model No.	Length	1-24	25-49	50-99	100 +
PE34161-12	12"	\$86.70	\$80.63	\$74.56	\$69.36
PE34161-24	24"	90.30	83.98	77.66	72.24
PE34161-36	36"	93.90	87.33	80.75	75.12
PE34161-48	48"	97.50	90.68	83.85	78.00
PE34161-60	60"	101.10	94.02	86.95	80.88
PE34161-XX	Any	Same-Day Shipment / Call for Pricing			

### 50 OHM, PE-SR402FL (.141" RE-SHAPEABLE)

Model No.	Length	1-24	25-49	50-99	100 +
PE3488-12	12"	\$85.35	\$79.38	\$73.40	\$68.28
PE3488-24	24"	88.95	82.72	76.50	71.16
PE3488-36	36"	92.55	86.07	79.59	74.04
PE3488-48	48"	96.20	89.47	82.73	76.96
PE3488-60	60"	99.75	92.77	85.79	79.80
PE3488-XX	Any	Same-Day Shipment / Call for Pricing			

### 50 OHM, PE-SR405FL (.085" RE-SHAPEABLE)

Model No.	Length	1-24	25-49	50-99	100 +
PE3971-12	12"	\$86.70	\$80.63	\$74.56	\$69.36
PE3971-24	24"	90.30	83.98	77.66	72.24
PE3971-36	36"	93.90	87.33	80.75	75.12
PE3971-48	48"	97.50	90.68	83.85	78.00
PE3971-60	60"	101.10	94.02	86.95	80.88
PE3971-XX	Any	Same-Day Shipment / Call for Pricing			

### 50 OHM, PE-047SR (.047" BARE COPPER)

Model No.	Length	1-24	25-49	50-99	100 +
PE34152-12	12"	\$94.55	\$87.93	\$81.31	\$75.64
PE34152-24	24"	98.25	91.37	84.50	78.60
PE34152-36	36"	101.85	94.72	87.59	81.48
PE34152-48	48"	105.40	98.02	90.64	84.32
PE34152-60	60"	109.05	101.42	93.78	87.24
PE34152-XX	Any	Same-Day Shipment / Call for Pricing			

### 50 OHM, RG401/U (.250" BARE COPPER)

Model No.	Length	1-24	25-49	50-99	100 +
PE3983-12	12"	\$83.15	\$77.33	\$71.51	\$66.52
PE3983-24	24"	90.40	84.07	77.74	72.32
PE3983-36	36"	97.65	90.81	83.98	78.12
PE3983-48	48"	104.85	97.51	90.17	83.88
PE3983-60	60"	112.10	104.25	96.41	89.68
PE3983-XX	Any	Same-Day Shipment / Call for Pricing			

### 50 OHM, PE-SR047AL (.047" TINNED ALUMINUM)

Model No.	Length	1-24	25-49	50-99	100 +
PE34154-12	12"	\$101.30	\$94.21	\$87.12	\$81.04
PE34154-24	24"	104.85	97.51	90.17	83.88
PE34154-36	36"	108.50	100.91	93.31	86.80
PE34154-48	48"	112.10	104.25	96.41	89.68
PE34154-60	60"	115.65	107.55	99.46	92.52
PE34154-XX	Any	Same-Day Shipment / Call for Pricing			

### 50 OHM, PE-SR401AL (.250" TINNED ALUMINUM)

Model No.	Length	1-24	25-49	50-99	100 +
PE3993-12	12"	\$89.75	\$83.47	\$77.19	\$71.80
PE3993-24	24"	97.00	90.21	83.42	77.60
PE3993-36	36"	104.30	97.00	89.70	83.44
PE3993-48	48"	111.50	103.70	95.89	89.20
PE3993-60	60"	118.80	110.48	102.17	95.04
PE3993-XX	Any	Same-Day Shipment / Call for Pricing			

### 50 OHM, PE-SR047FL (.047" RE-SHAPEABLE)

Model No.	Length	1-24	25-49	50-99	100 +
PE34156-12	12"	\$101.30	\$94.21	\$87.12	\$81.04
PE34156-24	24"	104.85	97.51	90.17	83.88
PE34156-36	36"	108.50	100.91	93.31	86.80
PE34156-48	48"	112.10	104.25	96.41	89.68
PE34156-60	60"	115.65	107.55	99.46	92.52
PE34156-XX	Any	Same-Day Shipment / Call for Pricing			

### 50 OHM, PE-SR401FL (.250" RE-SHAPEABLE)

Model No.	Length	1-24	25-49	50-99	100 +
PE34150-12	12"	\$89.75	\$83.47	\$77.19	\$71.80
PE34150-24	24"	97.00	90.21	83.42	77.60
PE34150-36	36"	104.30	97.00	89.70	83.44
PE34150-48	48"	111.50	103.70	95.89	89.20
PE34150-60	60"	118.80	110.48	102.17	95.04
PE34150-XX	Any	Same-Day Shipment / Call for Pricing			

\*\*ROHS COMPLIANT & CUSTOM-LENGTH CABLE ASSEMBLIES MAY BE ORDERED ON OUR WEBSITE.\*\*

Cable Assemblies

**NEW**

# QN MALE TO QN MALE

**50 OHM, RG58C/U COAX**

Model No.	Length	1-24	25-49	50-99	100 +
PE38448-12	12"	\$58.95	\$54.82	\$50.70	\$47.16
PE38448-24	24"	60.95	56.68	52.42	48.76
PE38448-36	36"	62.95	58.54	54.14	50.36
PE38448-48	48"	64.95	60.40	55.86	51.96
PE38448-60	60"	66.95	62.26	57.58	53.56
PE38448-72	72"	67.95	63.19	58.44	54.36
PE38448-120	120"	75.95	70.63	65.32	60.76
PE38448-XX	Any	Same-Day Shipment / Call for Pricing			

**50 OHM, RG213/U COAX**

Model No.	Length	1-24	25-49	50-99	100 +
PE38446-12	12"	\$81.95	\$76.21	\$70.48	\$65.56
PE38446-24	24"	85.95	79.93	73.92	68.76
PE38446-36	36"	89.95	83.65	77.36	71.96
PE38446-48	48"	94.95	88.30	81.66	75.96
PE38446-60	60"	98.95	92.02	85.10	79.16
PE38446-72	72"	102.95	95.74	88.54	82.36
PE38446-120	120"	119.95	111.55	103.16	95.96
PE38446-XX	Any	Same-Day Shipment / Call for Pricing			

**50 OHM, PE-T195**

Model No.	Length	1-24	25-49	50-99	100 +
PE38449-12	12"	\$60.95	\$56.68	\$52.42	\$48.76
PE38449-24	24"	64.95	60.40	55.86	51.96
PE38449-36	36"	68.95	64.12	59.30	55.16
PE38449-48	48"	72.95	67.84	62.74	58.36
PE38449-60	60"	76.95	71.56	66.18	61.56
PE38449-72	72"	80.95	75.28	69.62	64.76
PE38449-120	120"	95.95	89.23	82.52	76.76
PE38449-XX	Any	Same-Day Shipment / Call for Pricing			

**50 OHM, RG223/U COAX, DOUBLE SHIELDED**

Model No.	Length	1-24	25-49	50-99	100 +
PE38447-12	12"	\$64.95	\$60.40	\$55.86	\$51.96
PE38447-24	24"	71.95	66.91	61.88	57.56
PE38447-36	36"	78.95	73.42	67.90	63.16
PE38447-48	48"	85.95	79.93	73.92	68.76
PE38447-60	60"	92.95	86.44	79.94	74.36
PE38447-72	72"	107.95	100.39	92.84	86.36
PE38447-120	120"	128.95	119.92	110.90	103.16
PE38447-XX	Any	Same-Day Shipment / Call for Pricing			

**Cable Assemblies****NEW**

# QN MALE TO N MALE

**50 OHM, RG58C/U COAX**

Model No.	Length	1-24	25-49	50-99	100 +
PE38452-12	12"	\$38.95	\$36.22	\$33.50	\$31.16
PE38452-24	24"	39.95	37.15	34.36	31.96
PE38452-36	36"	41.95	39.01	36.08	33.56
PE38452-48	48"	43.95	40.87	37.80	35.16
PE38452-60	60"	45.95	42.73	39.52	36.76
PE38452-72	72"	47.95	44.59	41.24	38.36
PE38452-120	120"	54.95	51.10	47.26	43.96
PE38452-XX	Any	Same-Day Shipment / Call for Pricing			

**50 OHM, RG213/U COAX**

Model No.	Length	1-24	25-49	50-99	100 +
PE38450-12	12"	\$53.95	\$50.17	\$46.40	\$43.16
PE38450-24	24"	57.95	53.89	49.84	46.36
PE38450-36	36"	61.95	57.61	53.28	49.56
PE38450-48	48"	66.95	62.26	57.58	53.56
PE38450-60	60"	70.95	65.98	61.02	56.76
PE38450-72	72"	74.95	69.70	64.46	59.96
PE38450-120	120"	91.95	85.51	79.08	73.56
PE38450-XX	Any	Same-Day Shipment / Call for Pricing			

**50 OHM, PE-T195**

Model No.	Length	1-24	25-49	50-99	100 +
PE38453-12	12"	\$40.95	\$38.08	\$35.22	\$32.76
PE38453-24	24"	43.95	40.87	37.80	35.16
PE38453-36	36"	47.95	44.59	41.24	38.36
PE38453-48	48"	51.95	48.31	44.68	41.56
PE38453-60	60"	55.95	52.03	48.12	44.76
PE38453-72	72"	59.95	55.75	51.56	47.96
PE38453-120	120"	74.95	69.70	64.46	59.96
PE38453-XX	Any	Same-Day Shipment / Call for Pricing			

**50 OHM, RG223/U COAX, DOUBLE SHIELDED**

Model No.	Length	1-24	25-49	50-99	100 +
PE38451-12	12"	\$43.95	\$40.87	\$37.80	\$35.16
PE38451-24	24"	50.95	47.38	43.82	40.76
PE38451-36	36"	57.95	53.89	49.84	46.36
PE38451-48	48"	64.95	60.40	55.86	51.96
PE38451-60	60"	72.95	67.84	62.74	58.36
PE38451-72	72"	79.95	74.35	68.76	63.96
PE38451-120	120"	108.95	101.32	93.70	87.16
PE38451-XX	Any	Same-Day Shipment / Call for Pricing			

**NEW**

# QN MALE TO N FEMALE

**50 OHM, RG58C/U COAX**

Model No.	Length	1-24	25-49	50-99	100 +
PE38456-12	12"	\$39.95	\$37.15	\$34.36	\$31.96
PE38456-24	24"	41.95	39.01	36.08	33.56
PE38456-36	36"	43.95	40.87	37.80	35.16
PE38456-48	48"	45.95	42.73	39.52	36.76
PE38456-60	60"	46.95	43.66	40.38	37.56
PE38456-72	72"	48.95	45.52	42.10	39.16
PE38456-120	120"	56.95	52.96	48.98	45.56
PE38456-XX	Any	Same-Day Shipment / Call for Pricing			

**50 OHM, RG213/U COAX**

Model No.	Length	1-24	25-49	50-99	100 +
PE38454-12	12"	\$50.95	\$47.38	\$43.82	\$40.76
PE38454-24	24"	54.95	51.10	47.26	43.96
PE38454-36	36"	58.95	54.82	50.70	47.16
PE38454-48	48"	63.95	59.47	55.00	51.16
PE38454-60	60"	67.95	63.19	58.44	54.36
PE38454-72	72"	71.95	66.91	61.88	57.56
PE38454-120	120"	89.95	83.65	77.36	71.96
PE38454-XX	Any	Same-Day Shipment / Call for Pricing			

**50 OHM, PE-T195**

Model No.	Length	1-24	25-49	50-99	100 +
PE38457-12	12"	\$41.95	\$39.01	\$36.08	\$33.56
PE38457-24	24"	45.95	42.73	39.52	36.76
PE38457-36	36"	49.95	46.45	42.96	39.96
PE38457-48	48"	53.95	50.17	46.40	43.16
PE38457-60	60"	56.95	52.96	48.98	45.56
PE38457-72	72"	60.95	56.68	52.42	48.76
PE38457-120	120"	76.95	71.56	66.18	61.56
PE38457-XX	Any	Same-Day Shipment / Call for Pricing			

**50 OHM, RG223/U COAX, DOUBLE SHIELDED**

Model No.	Length	1-24	25-49	50-99	100 +
PE38455-12	12"	\$44.95	\$41.80	\$38.66	\$35.96
PE38455-24	24"	52.95	49.24	45.54	42.36
PE38455-36	36"	59.95	55.75	51.56	47.96
PE38455-48	48"	66.95	62.26	57.58	53.56
PE38455-60	60"	73.95	68.77	63.60	59.16
PE38455-72	72"	80.95	75.28	69.62	64.76
PE38455-120	120"	109.95	102.25	94.56	87.96
PE38455-XX	Any	Same-Day Shipment / Call for Pricing			

**\*\*ROHS COMPLIANT & CUSTOM-LENGTH CABLE ASSEMBLIES MAY BE ORDERED ON OUR WEBSITE.\*\***

# NEW QN MALE RIGHT ANGLE TO QN MALE



## 50 OHM, RG58C/U COAX

Model No.	Length	1-24	25-49	50-99	100 +
PE38485-12	12"	\$62.95	\$58.54	\$54.14	\$50.36
PE38485-24	24"	64.95	60.40	55.86	51.96
PE38485-36	36"	66.95	62.26	57.58	53.56
PE38485-48	48"	68.95	64.12	59.30	55.16
PE38485-60	60"	69.95	65.05	60.16	55.96
PE38485-72	72"	71.95	66.91	61.88	57.56
PE38485-120	120"	79.95	74.35	68.76	63.96
PE38485-XX	Any	Same-Day Shipment / Call for Pricing			

## 50 OHM, PE-T195

Model No.	Length	1-24	25-49	50-99	100 +
PE38486-12	12"	\$64.95	\$60.40	\$55.86	\$51.96
PE38486-24	24"	68.95	64.12	59.30	55.16
PE38486-36	36"	72.95	67.84	62.74	58.36
PE38486-48	48"	76.95	71.56	66.18	61.56
PE38486-60	60"	80.95	75.28	69.62	64.76
PE38486-72	72"	83.95	78.07	72.20	67.16
PE38486-120	120"	99.95	92.95	85.96	79.96
PE38486-XX	Any	Same-Day Shipment / Call for Pricing			

## 50 OHM, RG213/U COAX

Model No.	Length	1-24	25-49	50-99	100 +
PE38487-12	12"	\$83.95	\$78.07	\$72.20	\$67.16
PE38487-24	24"	88.95	82.72	76.50	71.16
PE38487-36	36"	92.95	86.44	79.94	74.36
PE38487-48	48"	96.95	90.16	83.38	77.56
PE38487-60	60"	100.95	93.88	86.82	80.76
PE38487-72	72"	105.95	98.53	91.12	84.76
PE38487-120	120"	122.95	114.34	105.74	98.36
PE38487-XX	Any	Same-Day Shipment / Call for Pricing			

## 50 OHM, RG223/U COAX, DOUBLE SHIELDED

Model No.	Length	1-24	25-49	50-99	100 +
PE38488-12	12"	\$67.95	\$63.19	\$58.44	\$54.36
PE38488-24	24"	75.95	70.63	65.32	60.76
PE38488-36	36"	92.95	86.44	79.94	74.36
PE38488-48	48"	99.95	92.95	85.96	79.96
PE38488-60	60"	101.95	94.81	87.68	81.56
PE38488-72	72"	107.95	100.39	92.84	86.36
PE38488-120	120"	136.95	127.36	117.78	109.56
PE38488-XX	Any	Same-Day Shipment / Call for Pricing			

Cable Assemblies

# NEW QN MALE RIGHT ANGLE TO N MALE

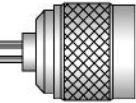
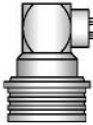

## 50 OHM, RG58C/U COAX

Model No.	Length	1-24	25-49	50-99	100 +
PE38489-12	12"	\$41.95	\$39.01	\$36.08	\$33.56
PE38489-24	24"	43.95	40.87	37.80	35.16
PE38489-36	36"	45.95	42.73	39.52	36.76
PE38489-48	48"	47.95	44.59	41.24	38.36
PE38489-60	60"	49.95	46.45	42.96	39.96
PE38489-72	72"	51.95	48.31	44.68	41.56
PE38489-120	120"	58.95	54.82	50.70	47.16
PE38489-XX	Any	Same-Day Shipment / Call for Pricing			

## 50 OHM, PE-T195

Model No.	Length	1-24	25-49	50-99	100 +
PE38490-12	12"	\$41.95	\$39.01	\$36.08	\$33.56
PE38490-24	24"	43.95	40.87	37.80	35.16
PE38490-36	36"	45.95	42.73	39.52	36.76
PE38490-48	48"	47.95	44.59	41.24	38.36
PE38490-60	60"	49.95	46.45	42.96	39.96
PE38490-72	72"	51.95	48.31	44.68	41.56
PE38490-120	120"	58.95	54.82	50.70	47.16
PE38490-XX	Any	Same-Day Shipment / Call for Pricing			

## 50 OHM, RG213/U COAX

Model No.	Length	1-24	25-49	50-99	100 +
PE38491-12	12"	\$55.95	\$52.03	\$48.12	\$44.76
PE38491-24	24"	60.95	56.68	52.42	48.76
PE38491-36	36"	64.95	60.40	55.86	51.96
PE38491-48	48"	68.95	64.12	59.30	55.16
PE38491-60	60"	72.95	67.84	62.74	58.36
PE38491-72	72"	77.95	72.49	67.04	62.36
PE38491-120	120"	94.95	88.30	81.66	75.96
PE38491-XX	Any	Same-Day Shipment / Call for Pricing			

## 50 OHM, RG223/U COAX, DOUBLE SHIELDED

Model No.	Length	1-24	25-49	50-99	100 +
PE38492-12	12"	\$47.95	\$44.59	\$41.24	\$38.36
PE38492-24	24"	54.95	51.10	47.26	43.96
PE38492-36	36"	61.95	57.61	53.28	49.56
PE38492-48	48"	68.95	64.12	59.30	55.16
PE38492-60	60"	75.95	70.63	65.32	60.76
PE38492-72	72"	83.95	78.07	72.20	67.16
PE38492-120	120"	111.95	104.11	96.28	89.56
PE38492-XX	Any	Same-Day Shipment / Call for Pricing			

# NEW QN MALE RIGHT ANGLE TO N FEMALE

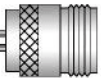

## 50 OHM, RG58C/U COAX

Model No.	Length	1-24	25-49	50-99	100 +
PE38493-12	12"	\$43.95	\$40.87	\$37.80	\$35.16
PE38493-24	24"	45.95	42.73	39.52	36.76
PE38493-36	36"	47.95	44.59	41.24	38.36
PE38493-48	48"	48.95	45.52	42.10	39.16
PE38493-60	60"	50.95	47.38	43.82	40.76
PE38493-72	72"	52.95	49.24	45.54	42.36
PE38493-120	120"	60.95	56.68	52.42	48.76
PE38493-XX	Any	Same-Day Shipment / Call for Pricing			

## 50 OHM, PE-T195

Model No.	Length	1-24	25-49	50-99	100 +
PE38494-12	12"	\$45.95	\$42.73	\$39.52	\$36.76
PE38494-24	24"	49.95	46.45	42.96	39.96
PE38494-36	36"	53.95	50.17	46.40	43.16
PE38494-48	48"	56.95	52.96	48.98	45.56
PE38494-60	60"	60.95	56.68	52.42	48.76
PE38494-72	72"	64.95	60.40	55.86	51.96
PE38494-120	120"	80.95	75.28	69.62	64.76
PE38494-XX	Any	Same-Day Shipment / Call for Pricing			

## 50 OHM, RG213/U COAX

Model No.	Length	1-24	25-49	50-99	100 +
PE38495-12	12"	\$52.95	\$49.24	\$45.54	\$42.36
PE38495-24	24"	57.95	53.89	49.84	46.36
PE38495-36	36"	61.95	57.61	53.28	49.56
PE38495-48	48"	65.95	61.33	56.72	52.76
PE38495-60	60"	70.95	65.98	61.02	56.76
PE38495-72	72"	74.95	69.70	64.46	59.96
PE38495-120	120"	91.95	85.51	79.08	73.56
PE38495-XX	Any	Same-Day Shipment / Call for Pricing			

## 50 OHM, RG223/U COAX, DOUBLE SHIELDED

Model No.	Length	1-24	25-49	50-99	100 +
PE38496-12	12"	\$48.95	\$45.52	\$42.10	\$39.16
PE38496-24	24"	55.95	52.03	48.12	44.76
PE38496-36	36"	63.95	59.47	55.00	51.16
PE38496-48	48"	70.95	65.98	61.02	56.76
PE38496-60	60"	77.95	72.49	67.04	62.36
PE38496-72	72"	84.95	79.00	73.06	67.96
PE38496-120	120"	113.95	105.97	98.00	91.16
PE38496-XX	Any	Same-Day Shipment / Call for Pricing			

\*\*ROHS COMPLIANT & CUSTOM-LENGTH CABLE ASSEMBLIES MAY BE ORDERED ON OUR WEBSITE.\*\*

# N MALE RIGHT ANGLE TO N FEMALE BULKHEAD

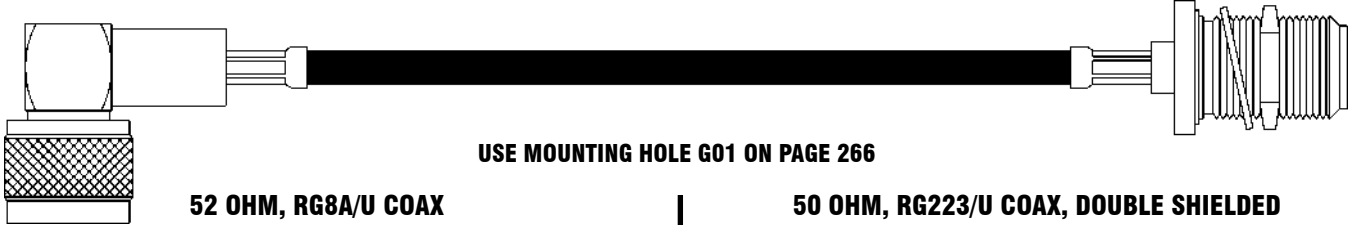

USE MOUNTING HOLE G01 ON PAGE 266

## 52 OHM, RG8A/U COAX

Model No.	Length	1-24	25-49	50-99	100 +
PE34216-12	12"	\$66.30	\$61.66	\$57.02	\$53.04
PE34216-24	24"	67.25	62.54	57.84	53.80
PE34216-36	36"	68.35	63.57	58.78	54.68
PE34216-48	48"	69.35	64.50	59.64	55.48
PE34216-60	60"	70.35	65.43	60.50	56.28
PE34216-XX	Any	Same-Day Shipment / Call for Pricing			

## 50 OHM, RG58C/U COAX

Model No.	Length	1-24	25-49	50-99	100 +
PE3407-12	12"	\$53.00	\$49.29	\$45.58	\$42.40
PE3407-24	24"	53.50	49.76	46.01	42.80
PE3407-36	36"	53.85	50.08	46.31	43.08
PE3407-48	48"	54.25	50.45	46.66	43.40
PE3407-60	60"	54.60	50.78	46.96	43.68
PE3407-XX	Any	Same-Day Shipment / Call for Pricing			

## 50 OHM, RG142B/U COAX, DOUBLE SHIELDED

Model No.	Length	1-24	25-49	50-99	100 +
PE33021-12	12"	\$53.00	\$49.29	\$45.58	\$42.40
PE33021-24	24"	55.70	51.80	47.90	44.56
PE33021-36	36"	58.35	54.27	50.18	46.68
PE33021-48	48"	61.00	56.73	52.46	48.80
PE33021-60	60"	63.65	59.19	54.74	50.92
PE33021-XX	Any	Same-Day Shipment / Call for Pricing			

## 50 OHM, RG174A/U COAX

Model No.	Length	1-24	25-49	50-99	100 +
PE34229-12	12"	\$61.00	\$56.73	\$52.46	\$48.80
PE34229-24	24"	61.25	56.96	52.68	49.00
PE34229-36	36"	61.50	57.20	52.89	49.20
PE34229-48	48"	61.70	57.38	53.06	49.36
PE34229-60	60"	61.95	57.61	53.28	49.56
PE34229-XX	Any	Same-Day Shipment / Call for Pricing			

## 50 OHM, RG188A/U COAX

Model No.	Length	1-24	25-49	50-99	100 +
PE34218-12	12"	\$61.00	\$56.73	\$52.46	\$48.80
PE34218-24	24"	61.90	57.57	53.23	49.52
PE34218-36	36"	62.95	58.54	54.14	50.36
PE34218-48	48"	63.85	59.38	54.91	51.08
PE34218-60	60"	64.85	60.31	55.77	51.88
PE34218-XX	Any	Same-Day Shipment / Call for Pricing			

## 50 OHM, RG213/U COAX

Model No.	Length	1-24	25-49	50-99	100 +
PE33545-12	12"	\$66.30	\$61.66	\$57.02	\$53.04
PE33545-24	24"	67.25	62.54	57.84	53.80
PE33545-36	36"	68.35	63.57	58.78	54.68
PE33545-48	48"	69.35	64.50	59.64	55.48
PE33545-60	60"	70.35	65.43	60.50	56.28
PE33545-XX	Any	Same-Day Shipment / Call for Pricing			

## 50 OHM, RG214/U COAX, DOUBLE SHIELDED

Model No.	Length	1-24	25-49	50-99	100 +
PE33178-12	12"	\$66.30	\$61.66	\$57.02	\$53.04
PE33178-24	24"	69.90	65.01	60.11	55.92
PE33178-36	36"	73.50	68.36	63.21	58.80
PE33178-48	48"	77.15	71.75	66.35	61.72
PE33178-60	60"	80.80	75.14	69.49	64.64
PE33178-XX	Any	Same-Day Shipment / Call for Pricing			

## 50 OHM, RG223/U COAX, DOUBLE SHIELDED

Model No.	Length	1-24	25-49	50-99	100 +
PE33536-12	12"	\$53.00	\$49.29	\$45.58	\$42.40
PE33536-24	24"	54.35	50.55	46.74	43.48
PE33536-36	36"	55.70	51.80	47.90	44.56
PE33536-48	48"	57.00	53.01	49.02	45.60
PE33536-60	60"	58.35	54.27	50.18	46.68
PE33536-XX	Any	Same-Day Shipment / Call for Pricing			

## 50 OHM, RG225/U COAX, DOUBLE SHIELDED

Model No.	Length	1-24	25-49	50-99	100 +
PE34221-12	12"	\$79.55	\$73.98	\$68.41	\$63.64
PE34221-24	24"	103.65	96.39	89.14	82.92
PE34221-36	36"	127.75	118.81	109.87	102.20
PE34221-48	48"	151.90	141.27	130.63	121.52
PE34221-60	60"	176.00	163.68	151.36	140.80
PE34221-XX	Any	Same-Day Shipment / Call for Pricing			

## 50 OHM, RG316/U COAX

Model No.	Length	1-24	25-49	50-99	100 +
PE34214-12	12"	\$61.00	\$56.73	\$52.46	\$48.80
PE34214-24	24"	61.90	57.57	53.23	49.52
PE34214-36	36"	62.95	58.54	54.14	50.36
PE34214-48	48"	63.85	59.38	54.91	51.08
PE34214-60	60"	64.85	60.31	55.77	51.88
PE34214-XX	Any	Same-Day Shipment / Call for Pricing			

## 50 OHM, RG316-DS COAX, DOUBLE SHIELDED

Model No.	Length	1-24	25-49	50-99	100 +
PE34227-12	12"	\$63.65	\$59.19	\$54.74	\$50.92
PE34227-24	24"	66.10	61.47	56.85	52.88
PE34227-36	36"	68.50	63.71	58.91	54.80
PE34227-48	48"	70.85	65.89	60.93	56.68
PE34227-60	60"	73.30	68.17	63.04	58.64
PE34227-XX	Any	Same-Day Shipment / Call for Pricing			

## 50 OHM, RG393/U COAX, DOUBLE SHIELDED

Model No.	Length	1-24	25-49	50-99	100 +
PE33532-12	12"	\$66.30	\$61.66	\$57.02	\$53.04
PE33532-24	24"	74.70	69.47	64.24	59.76
PE33532-36	36"	83.15	77.33	71.51	66.52
PE33532-48	48"	91.60	85.19	78.78	73.28
PE33532-60	60"	100.00	93.00	86.00	80.00
PE33532-XX	Any	Same-Day Shipment / Call for Pricing			

## 50 OHM, RG400/U COAX, DOUBLE SHIELDED

Model No.	Length	1-24	25-49	50-99	100 +
PE33528-12	12"	\$53.00	\$49.29	\$45.58	\$42.40
PE33528-24	24"	55.70	51.80	47.90	44.56
PE33528-36	36"	58.35	54.27	50.18	46.68
PE33528-48	48"	61.00	56.73	52.46	48.80
PE33528-60	60"	63.65	59.19	54.74	50.92
PE33528-XX	Any	Same-Day Shipment / Call for Pricing			

## 50 OHM, PE-B3199, VERY LOW LOSS COAX

Model No.	Length	1-24	25-49	50-99	100 +
PE34225-12	12"	\$57.00	\$53.01	\$49.02	\$45.60
PE34225-24	24"	58.00	53.94	49.88	46.40
PE34225-36	36"	58.95	54.82	50.70	47.16
PE34225-48	48"	59.85	55.66	51.47	47.88
PE34225-60	60"	60.90	56.64	52.37	48.72
PE34225-XX	Any	Same-Day Shipment / Call for Pricing			

\*\*ROHS COMPLIANT & CUSTOM-LENGTH CABLE ASSEMBLIES MAY BE ORDERED ON OUR WEBSITE.\*\*

# N MALE TO TNC MALE



## 52 OHM, RG8A/U COAX

Model No.	Length	1-24	25-49	50-99	100 +
PE33615-12	12"	\$42.45	\$39.48	\$36.51	\$33.96
PE33615-24	24"	43.45	40.41	37.37	34.76
PE33615-36	36"	44.40	41.29	38.18	35.52
PE33615-48	48"	45.45	42.27	39.09	36.36
PE33615-60	60"	46.45	43.20	39.95	37.16
PE33615-XX	Any	Same-Day Shipment / Call for Pricing			

## 50 OHM, RG58C/U COAX

Model No.	Length	1-24	25-49	50-99	100 +
PE3661-12	12"	\$29.15	\$27.11	\$25.07	\$23.32
PE3661-24	24"	29.55	27.48	25.41	23.64
PE3661-36	36"	30.00	27.90	25.80	24.00
PE3661-48	48"	30.40	28.27	26.14	24.32
PE3661-60	60"	30.85	28.69	26.53	24.68
PE3661-XX	Any	Same-Day Shipment / Call for Pricing			

## 50 OHM, RG142B/U COAX, DOUBLE SHIELDED

Model No.	Length	1-24	25-49	50-99	100 +
PE3652-12	12"	\$29.15	\$27.11	\$25.07	\$23.32
PE3652-24	24"	31.80	29.57	27.35	25.44
PE3652-36	36"	34.50	32.09	29.67	27.60
PE3652-48	48"	37.15	34.55	31.95	29.72
PE3652-60	60"	39.80	37.01	34.23	31.84
PE3652-XX	Any	Same-Day Shipment / Call for Pricing			

## 50 OHM, RG174A/U COAX

Model No.	Length	1-24	25-49	50-99	100 +
PE34272-12	12"	\$42.45	\$39.48	\$36.51	\$33.96
PE34272-24	24"	42.70	39.71	36.72	34.16
PE34272-36	36"	43.00	39.99	36.98	34.40
PE34272-48	48"	43.25	40.22	37.20	34.60
PE34272-60	60"	43.50	40.46	37.41	34.80
PE34272-XX	Any	Same-Day Shipment / Call for Pricing			

## 50 OHM, RG178B/U COAX

Model No.	Length	1-24	25-49	50-99	100 +
PE33455-12	12"	\$45.10	\$41.94	\$38.79	\$36.08
PE33455-24	24"	46.00	42.78	39.56	36.80
PE33455-36	36"	47.00	43.71	40.42	37.60
PE33455-48	48"	48.00	44.64	41.28	38.40
PE33455-60	60"	48.95	45.52	42.10	39.16
PE33455-XX	Any	Same-Day Shipment / Call for Pricing			

## 50 OHM, RG188A/U COAX

Model No.	Length	1-24	25-49	50-99	100 +
PE33457-12	12"	\$43.75	\$40.69	\$37.63	\$35.00
PE33457-24	24"	44.75	41.62	38.49	35.80
PE33457-36	36"	45.65	42.45	39.26	36.52
PE33457-48	48"	46.70	43.43	40.16	37.36
PE33457-60	60"	47.60	44.27	40.94	38.08
PE33457-XX	Any	Same-Day Shipment / Call for Pricing			

## 50 OHM, RG213/U COAX

Model No.	Length	1-24	25-49	50-99	100 +
PE3644-12	12"	\$42.45	\$39.48	\$36.51	\$33.96
PE3644-24	24"	43.45	40.41	37.37	34.76
PE3644-36	36"	44.40	41.29	38.18	35.52
PE3644-48	48"	45.45	42.27	39.09	36.36
PE3644-60	60"	46.45	43.20	39.95	37.16
PE3644-XX	Any	Same-Day Shipment / Call for Pricing			

## 50 OHM, RG214/U COAX, DOUBLE SHIELDED

Model No.	Length	1-24	25-49	50-99	100 +
PE3991-12	12"	\$43.75	\$40.69	\$37.63	\$35.00
PE3991-24	24"	47.40	44.08	40.76	37.92
PE3991-36	36"	50.95	47.38	43.82	40.76
PE3991-48	48"	54.55	50.73	46.91	43.64
PE3991-60	60"	58.20	54.13	50.05	46.56
PE3991-XX	Any	Same-Day Shipment / Call for Pricing			

## 50 OHM, RG223/U COAX, DOUBLE SHIELDED

Model No.	Length	1-24	25-49	50-99	100 +
PE3665-12	12"	\$29.15	\$27.11	\$25.07	\$23.32
PE3665-24	24"	30.50	28.37	26.23	24.40
PE3665-36	36"	31.80	29.57	27.35	25.44
PE3665-48	48"	33.15	30.83	28.51	26.52
PE3665-60	60"	34.50	32.09	29.67	27.60
PE3665-XX	Any	Same-Day Shipment / Call for Pricing			

## 50 OHM, RG316/U COAX

Model No.	Length	1-24	25-49	50-99	100 +
PE3989-12	12"	\$43.75	\$40.69	\$37.63	\$35.00
PE3989-24	24"	44.75	41.62	38.49	35.80
PE3989-36	36"	45.65	42.45	39.26	36.52
PE3989-48	48"	46.70	43.43	40.16	37.36
PE3989-60	60"	47.60	44.27	40.94	38.08
PE3989-XX	Any	Same-Day Shipment / Call for Pricing			

## 50 OHM, RG316-DS COAX, DOUBLE SHIELDED

Model No.	Length	1-24	25-49	50-99	100 +
PE34266-12	12"	\$46.35	\$43.11	\$39.86	\$37.08
PE34266-24	24"	48.80	45.38	41.97	39.04
PE34266-36	36"	51.15	47.57	43.99	40.92
PE34266-48	48"	53.65	49.89	46.14	42.92
PE34266-60	60"	56.05	52.13	48.20	44.84
PE34266-XX	Any	Same-Day Shipment / Call for Pricing			

## 50 OHM, RG393/U COAX, DOUBLE SHIELDED

Model No.	Length	1-24	25-49	50-99	100 +
PE3982-12	12"	\$43.75	\$40.69	\$37.63	\$35.00
PE3982-24	24"	52.20	48.55	44.89	41.76
PE3982-36	36"	60.65	56.40	52.16	48.52
PE3982-48	48"	69.05	64.22	59.38	55.24
PE3982-60	60"	77.45	72.03	66.61	61.96
PE3982-XX	Any	Same-Day Shipment / Call for Pricing			

## 50 OHM, RG400/U COAX, DOUBLE SHIELDED

Model No.	Length	1-24	25-49	50-99	100 +
PE3666-12	12"	\$29.15	\$27.11	\$25.07	\$23.32
PE3666-24	24"	31.80	29.57	27.35	25.44
PE3666-36	36"	34.50	32.09	29.67	27.60
PE3666-48	48"	37.15	34.55	31.95	29.72
PE3666-60	60"	39.80	37.01	34.23	31.84
PE3666-XX	Any	Same-Day Shipment / Call for Pricing			

## 50 OHM, PE-B3199, VERY LOW LOSS COAX

Model No.	Length	1-24	25-49	50-99	100 +
PE33122-12	12"	\$42.45	\$39.48	\$36.51	\$33.96
PE33122-24	24"	43.40	40.36	37.32	34.72
PE33122-36	36"	44.35	41.25	38.14	35.48
PE33122-48	48"	45.30	42.13	38.96	36.24
PE33122-60	60"	46.25	43.01	39.78	37.00
PE33122-XX	Any	Same-Day Shipment / Call for Pricing			

\*\*ROHS COMPLIANT & CUSTOM-LENGTH CABLE ASSEMBLIES MAY BE ORDERED ON OUR WEBSITE.\*\*

Cable Assemblies

# MHV MALE TO MHV MALE



## 52 OHM, RG8A/U COAX

Model No.	Length	1-24	25-49	50-99	100 +
PE3098-12	12"	\$66.30	\$61.66	\$57.02	\$53.04
PE3098-24	24"	67.25	62.54	57.84	53.80
PE3098-36	36"	68.35	63.57	58.78	54.68
PE3098-48	48"	69.35	64.50	59.64	55.48
PE3098-60	60"	70.35	65.43	60.50	56.28
PE3098-XX	Any	Same-Day Shipment / Call for Pricing			

## 50 OHM, RG58C/U COAX

Model No.	Length	1-24	25-49	50-99	100 +
PE3516-12	12"	\$39.80	\$37.01	\$34.23	\$31.84
PE3516-24	24"	40.15	37.34	34.53	32.12
PE3516-36	36"	40.60	37.76	34.92	32.48
PE3516-48	48"	41.00	38.13	35.26	32.80
PE3516-60	60"	41.45	38.55	35.65	33.16
PE3516-XX	Any	Same-Day Shipment / Call for Pricing			

## 75 OHM, RG59B/U COAX

Model No.	Length	1-24	25-49	50-99	100 +
PE3542-12	12"	\$45.10	\$41.94	\$38.79	\$36.08
PE3542-24	24"	45.45	42.27	39.09	36.36
PE3542-36	36"	45.85	42.64	39.43	36.68
PE3542-48	48"	46.25	43.01	39.78	37.00
PE3542-60	60"	46.75	43.48	40.21	37.40
PE3542-XX	Any	Same-Day Shipment / Call for Pricing			

## 93 OHM, RG62A/U COAX

Model No.	Length	1-24	25-49	50-99	100 +
PE3517-12	12"	\$45.10	\$41.94	\$38.79	\$36.08
PE3517-24	24"	45.45	42.27	39.09	36.36
PE3517-36	36"	45.85	42.64	39.43	36.68
PE3517-48	48"	46.25	43.01	39.78	37.00
PE3517-60	60"	46.75	43.48	40.21	37.40
PE3517-XX	Any	Same-Day Shipment / Call for Pricing			

## 50 OHM, RG141A/U COAX

Model No.	Length	1-24	25-49	50-99	100 +
PE34429-12	12"	\$43.75	\$40.69	\$37.63	\$35.00
PE34429-24	24"	47.40	44.08	40.76	37.92
PE34429-36	36"	50.95	47.38	43.82	40.76
PE34429-48	48"	54.55	50.73	46.91	43.64
PE34429-60	60"	58.20	54.13	50.05	46.56
PE34429-XX	Any	Same-Day Shipment / Call for Pricing			

## 50 OHM, RG142B/U COAX, DOUBLE SHIELDED

Model No.	Length	1-24	25-49	50-99	100 +
PE3914-12	12"	\$39.80	\$37.01	\$34.23	\$31.84
PE3914-24	24"	42.45	39.48	36.51	33.96
PE3914-36	36"	45.10	41.94	38.79	36.08
PE3914-48	48"	47.70	44.36	41.02	38.16
PE3914-60	60"	50.40	46.87	43.34	40.32
PE3914-XX	Any	Same-Day Shipment / Call for Pricing			

## 50 OHM, RG174A/U COAX

Model No.	Length	1-24	25-49	50-99	100 +
PE34427-12	12"	\$42.45	\$39.48	\$36.51	\$33.96
PE34427-24	24"	42.70	39.71	36.72	34.16
PE34427-36	36"	43.00	39.99	36.98	34.40
PE34427-48	48"	43.25	40.22	37.20	34.60
PE34427-60	60"	43.50	40.46	37.41	34.80
PE34427-XX	Any	Same-Day Shipment / Call for Pricing			

## 50 OHM, RG188A/U COAX

Model No.	Length	1-24	25-49	50-99	100 +
PE34431-12	12"	\$43.75	\$40.69	\$37.63	\$35.00
PE34431-24	24"	44.75	41.62	38.49	35.80
PE34431-36	36"	45.65	42.45	39.26	36.52
PE34431-48	48"	46.70	43.43	40.16	37.36
PE34431-60	60"	47.60	44.27	40.94	38.08
PE34431-XX	Any	Same-Day Shipment / Call for Pricing			

## 50 OHM, RG214/U COAX, DOUBLE SHIELDED

Model No.	Length	1-24	25-49	50-99	100 +
PE3735-12	12"	\$66.30	\$61.66	\$57.02	\$53.04
PE3735-24	24"	69.90	65.01	60.11	55.92
PE3735-36	36"	73.50	68.36	63.21	58.80
PE3735-48	48"	77.15	71.75	66.35	61.72
PE3735-60	60"	80.80	75.14	69.49	64.64
PE3735-XX	Any	Same-Day Shipment / Call for Pricing			

## 50 OHM, RG223/U COAX, DOUBLE SHIELDED

Model No.	Length	1-24	25-49	50-99	100 +
PE3694-12	12"	\$39.80	\$37.01	\$34.23	\$31.84
PE3694-24	24"	41.10	38.22	35.35	32.88
PE3694-36	36"	42.45	39.48	36.51	33.96
PE3694-48	48"	43.75	40.69	37.63	35.00
PE3694-60	60"	45.10	41.94	38.79	36.08
PE3694-XX	Any	Same-Day Shipment / Call for Pricing			

## 50 OHM, RG225/U COAX, DOUBLE SHIELDED

Model No.	Length	1-24	25-49	50-99	100 +
PE34423-12	12"	\$72.90	\$67.80	\$62.69	\$58.32
PE34423-24	24"	97.00	90.21	83.42	77.60
PE34423-36	36"	121.15	112.67	104.19	96.92
PE34423-48	48"	145.30	135.13	124.96	116.24
PE34423-60	60"	169.35	157.50	145.64	135.48
PE34423-XX	Any	Same-Day Shipment / Call for Pricing			

## 50 OHM, RG316/U COAX

Model No.	Length	1-24	25-49	50-99	100 +
PE34433-12	12"	\$43.75	\$40.69	\$37.63	\$35.00
PE34433-24	24"	44.75	41.62	38.49	35.80
PE34433-36	36"	45.65	42.45	39.26	36.52
PE34433-48	48"	46.70	43.43	40.16	37.36
PE34433-60	60"	47.60	44.27	40.94	38.08
PE34433-XX	Any	Same-Day Shipment / Call for Pricing			

## 50 OHM, RG393/U COAX, DOUBLE SHIELDED

Model No.	Length	1-24	25-49	50-99	100 +
PE3577-12	12"	\$66.30	\$61.66	\$57.02	\$53.04
PE3577-24	24"	74.70	69.47	64.24	59.76
PE3577-36	36"	83.15	77.33	71.51	66.52
PE3577-48	48"	91.60	85.19	78.78	73.28
PE3577-60	60"	100.00	93.00	86.00	80.00
PE3577-XX	Any	Same-Day Shipment / Call for Pricing			

## 50 OHM, RG400/U COAX, DOUBLE SHIELDED

Model No.	Length	1-24	25-49	50-99	100 +
PE34425-12	12"	\$39.80	\$37.01	\$34.23	\$31.84
PE34425-24	24"	42.45	39.48	36.51	33.96
PE34425-36	36"	45.10	41.94	38.79	36.08
PE34425-48	48"	47.70	44.36	41.02	38.16
PE34425-60	60"	50.40	46.87	43.34	40.32
PE34425-XX	Any	Same-Day Shipment / Call for Pricing			

\*\*ROHS COMPLIANT & CUSTOM-LENGTH CABLE ASSEMBLIES MAY BE ORDERED ON OUR WEBSITE.\*\*

# MHV MALE TO SHV PLUG



## 52 OHM, RG8A/U COAX

Model No.	Length	1-24	25-49	50-99	100 +
PE3365-12	12"	\$92.75	\$86.26	\$79.77	\$74.20
PE3365-24	24"	93.85	87.28	80.71	75.08
PE3365-36	36"	94.80	88.16	81.53	75.84
PE3365-48	48"	95.90	89.19	82.47	76.72
PE3365-60	60"	96.85	90.07	83.29	77.48
PE3365-XX	Any	Same-Day Shipment / Call for Pricing			

## 50 OHM, RG58C/U COAX

Model No.	Length	1-24	25-49	50-99	100 +
PE3950-12	12"	\$79.55	\$73.98	\$68.41	\$63.64
PE3950-24	24"	79.95	74.35	68.76	63.96
PE3950-36	36"	80.45	74.82	69.19	64.36
PE3950-48	48"	80.80	75.14	69.49	64.64
PE3950-60	60"	81.20	75.52	69.83	64.96
PE3950-XX	Any	Same-Day Shipment / Call for Pricing			

## 75 OHM, RG59B/U COAX

Model No.	Length	1-24	25-49	50-99	100 +
PE3108-12	12"	\$79.55	\$73.98	\$68.41	\$63.64
PE3108-24	24"	79.95	74.35	68.76	63.96
PE3108-36	36"	80.45	74.82	69.19	64.36
PE3108-48	48"	80.80	75.14	69.49	64.64
PE3108-60	60"	81.20	75.52	69.83	64.96
PE3108-XX	Any	Same-Day Shipment / Call for Pricing			

## 93 OHM, RG62A/U COAX

Model No.	Length	1-24	25-49	50-99	100 +
PE3451-12	12"	\$79.55	\$73.98	\$68.41	\$63.64
PE3451-24	24"	79.95	74.35	68.76	63.96
PE3451-36	36"	80.45	74.82	69.19	64.36
PE3451-48	48"	80.80	75.14	69.49	64.64
PE3451-60	60"	81.20	75.52	69.83	64.96
PE3451-XX	Any	Same-Day Shipment / Call for Pricing			

## 50 OHM, RG141A/U COAX

Model No.	Length	1-24	25-49	50-99	100 +
PE34413-12	12"	\$82.20	\$76.45	\$70.69	\$65.76
PE34413-24	24"	85.85	79.84	73.83	68.68
PE34413-36	36"	89.40	83.14	76.88	71.52
PE34413-48	48"	93.10	86.58	80.07	74.48
PE34413-60	60"	96.70	89.93	83.16	77.36
PE34413-XX	Any	Same-Day Shipment / Call for Pricing			

## 50 OHM, RG142B/U COAX, DOUBLE SHIELDED

Model No.	Length	1-24	25-49	50-99	100 +
PE3085-12	12"	\$79.55	\$73.98	\$68.41	\$63.64
PE3085-24	24"	82.20	76.45	70.69	65.76
PE3085-36	36"	84.85	78.91	72.97	67.88
PE3085-48	48"	87.50	81.38	75.25	70.00
PE3085-60	60"	90.20	83.89	77.57	72.16
PE3085-XX	Any	Same-Day Shipment / Call for Pricing			

## 50 OHM, RG174A/U COAX

Model No.	Length	1-24	25-49	50-99	100 +
PE34419-12	12"	\$79.55	\$73.98	\$68.41	\$63.64
PE34419-24	24"	79.80	74.21	68.63	63.84
PE34419-36	36"	80.05	74.45	68.84	64.04
PE34419-48	48"	80.40	74.77	69.14	64.32
PE34419-60	60"	80.65	75.00	69.36	64.52
PE34419-XX	Any	Same-Day Shipment / Call for Pricing			

## 50 OHM, RG188A/U COAX

Model No.	Length	1-24	25-49	50-99	100 +
PE34415-12	12"	\$80.90	\$75.24	\$69.57	\$64.72
PE34415-24	24"	81.80	76.07	70.35	65.44
PE34415-36	36"	82.75	76.96	71.17	66.20
PE34415-48	48"	83.75	77.89	72.03	67.00
PE34415-60	60"	84.75	78.82	72.89	67.80
PE34415-XX	Any	Same-Day Shipment / Call for Pricing			

## 50 OHM, RG214/U COAX, DOUBLE SHIELDED

Model No.	Length	1-24	25-49	50-99	100 +
PE33516-12	12"	\$99.45	\$92.49	\$85.53	\$79.56
PE33516-24	24"	103.05	95.84	88.62	82.44
PE33516-36	36"	106.70	99.23	91.76	85.36
PE33516-48	48"	110.25	102.53	94.82	88.20
PE33516-60	60"	113.90	105.93	97.95	91.12
PE33516-XX	Any	Same-Day Shipment / Call for Pricing			

## 50 OHM, RG223/U COAX, DOUBLE SHIELDED

Model No.	Length	1-24	25-49	50-99	100 +
PE34411-12	12"	\$79.55	\$73.98	\$68.41	\$63.64
PE34411-24	24"	80.90	75.24	69.57	64.72
PE34411-36	36"	82.20	76.45	70.69	65.76
PE34411-48	48"	83.50	77.66	71.81	66.80
PE34411-60	60"	84.85	78.91	72.97	67.88
PE34411-XX	Any	Same-Day Shipment / Call for Pricing			

## 50 OHM, RG225/U COAX, DOUBLE SHIELDED

Model No.	Length	1-24	25-49	50-99	100 +
PE34407-12	12"	\$106.10	\$98.67	\$91.25	\$84.88
PE34407-24	24"	130.15	121.04	111.93	104.12
PE34407-36	36"	154.30	143.50	132.70	123.44
PE34407-48	48"	178.40	165.91	153.42	142.72
PE34407-60	60"	202.45	188.28	174.11	161.96
PE34407-XX	Any	Same-Day Shipment / Call for Pricing			

## 50 OHM, RG316/U COAX

Model No.	Length	1-24	25-49	50-99	100 +
PE34417-12	12"	\$80.90	\$75.24	\$69.57	\$64.72
PE34417-24	24"	81.80	76.07	70.35	65.44
PE34417-36	36"	82.75	76.96	71.17	66.20
PE34417-48	48"	83.75	77.89	72.03	67.00
PE34417-60	60"	84.75	78.82	72.89	67.80
PE34417-XX	Any	Same-Day Shipment / Call for Pricing			

## 50 OHM, RG393/U COAX, DOUBLE SHIELDED

Model No.	Length	1-24	25-49	50-99	100 +
PE33984-12	12"	\$99.45	\$92.49	\$85.53	\$79.56
PE33984-24	24"	107.90	100.35	92.79	86.32
PE33984-36	36"	116.25	108.11	99.98	93.00
PE33984-48	48"	124.75	116.02	107.29	99.80
PE33984-60	60"	133.15	123.83	114.51	106.52
PE33984-XX	Any	Same-Day Shipment / Call for Pricing			

## 50 OHM, RG400/U COAX, DOUBLE SHIELDED

Model No.	Length	1-24	25-49	50-99	100 +
PE34409-12	12"	\$79.55	\$73.98	\$68.41	\$63.64
PE34409-24	24"	82.20	76.45	70.69	65.76
PE34409-36	36"	84.85	78.91	72.97	67.88
PE34409-48	48"	87.50	81.38	75.25	70.00
PE34409-60	60"	90.20	83.89	77.57	72.16
PE34409-XX	Any	Same-Day Shipment / Call for Pricing			

\*\*ROHS COMPLIANT & CUSTOM-LENGTH CABLE ASSEMBLIES MAY BE ORDERED ON OUR WEBSITE.\*\*

Cable Assemblies



# SHV PLUG TO SHV PLUG



## 52 OHM, RG8A/U COAX

Model No.	Length	1-24	25-49	50-99	100 +
PE33068-12	12"	\$92.75	\$86.26	\$79.77	\$74.20
PE33068-24	24"	93.85	87.28	80.71	75.08
PE33068-36	36"	94.80	88.16	81.53	75.84
PE33068-48	48"	95.90	89.19	82.47	76.72
PE33068-60	60"	96.85	90.07	83.29	77.48
PE33068-XX	Any	Same-Day Shipment / Call for Pricing			

## 50 OHM, RG58C/U COAX

Model No.	Length	1-24	25-49	50-99	100 +
PE3815-12	12"	\$79.55	\$73.98	\$68.41	\$63.64
PE3815-24	24"	79.95	74.35	68.76	63.96
PE3815-36	36"	80.45	74.82	69.19	64.36
PE3815-48	48"	80.80	75.14	69.49	64.64
PE3815-60	60"	81.20	75.52	69.83	64.96
PE3815-XX	Any	Same-Day Shipment / Call for Pricing			

## 75 OHM, RG59B/U COAX

Model No.	Length	1-24	25-49	50-99	100 +
PE3895-12	12"	\$79.55	\$73.98	\$68.41	\$63.64
PE3895-24	24"	79.95	74.35	68.76	63.96
PE3895-36	36"	80.45	74.82	69.19	64.36
PE3895-48	48"	80.80	75.14	69.49	64.64
PE3895-60	60"	81.20	75.52	69.83	64.96
PE3895-XX	Any	Same-Day Shipment / Call for Pricing			

## 93 OHM, RG62A/U COAX

Model No.	Length	1-24	25-49	50-99	100 +
PE3857-12	12"	\$79.55	\$73.98	\$68.41	\$63.64
PE3857-24	24"	79.95	74.35	68.76	63.96
PE3857-36	36"	80.45	74.82	69.19	64.36
PE3857-48	48"	80.80	75.14	69.49	64.64
PE3857-60	60"	81.20	75.52	69.83	64.96
PE3857-XX	Any	Same-Day Shipment / Call for Pricing			

## 50 OHM, RG141A/U COAX

Model No.	Length	1-24	25-49	50-99	100 +
PE34428-12	12"	\$82.20	\$76.45	\$70.69	\$65.76
PE34428-24	24"	85.85	79.84	73.83	68.68
PE34428-36	36"	89.40	83.14	76.88	71.52
PE34428-48	48"	93.10	86.58	80.07	74.48
PE34428-60	60"	96.70	89.93	83.16	77.36
PE34428-XX	Any	Same-Day Shipment / Call for Pricing			

## 50 OHM, RG142B/U COAX, DOUBLE SHIELDED

Model No.	Length	1-24	25-49	50-99	100 +
PE3843-12	12"	\$79.55	\$73.98	\$68.41	\$63.64
PE3843-24	24"	82.20	76.45	70.69	65.76
PE3843-36	36"	84.85	78.91	72.97	67.88
PE3843-48	48"	87.50	81.38	75.25	70.00
PE3843-60	60"	90.20	83.89	77.57	72.16
PE3843-XX	Any	Same-Day Shipment / Call for Pricing			

## 50 OHM, RG174A/U COAX

Model No.	Length	1-24	25-49	50-99	100 +
PE33706-12	12"	\$79.55	\$73.98	\$68.41	\$63.64
PE33706-24	24"	79.80	74.21	68.63	63.84
PE33706-36	36"	80.05	74.45	68.84	64.04
PE33706-48	48"	80.40	74.77	69.14	64.32
PE33706-60	60"	80.65	75.00	69.36	64.52
PE33706-XX	Any	Same-Day Shipment / Call for Pricing			

## 50 OHM, RG188A/U COAX

Model No.	Length	1-24	25-49	50-99	100 +
PE34430-12	12"	\$80.90	\$75.24	\$69.57	\$64.72
PE34430-24	24"	81.80	76.07	70.35	65.44
PE34430-36	36"	82.75	76.96	71.17	66.20
PE34430-48	48"	83.75	77.89	72.03	67.00
PE34430-60	60"	84.75	78.82	72.89	67.80
PE34430-XX	Any	Same-Day Shipment / Call for Pricing			

## 50 OHM, RG214/U COAX, DOUBLE SHIELDED

Model No.	Length	1-24	25-49	50-99	100 +
PE3117-12	12"	\$99.45	\$92.49	\$85.53	\$79.56
PE3117-24	24"	103.05	95.84	88.62	82.44
PE3117-36	36"	106.70	99.23	91.76	85.36
PE3117-48	48"	110.25	102.53	94.82	88.20
PE3117-60	60"	113.90	105.93	97.95	91.12
PE3117-XX	Any	Same-Day Shipment / Call for Pricing			

## 50 OHM, RG223/U COAX, DOUBLE SHIELDED

Model No.	Length	1-24	25-49	50-99	100 +
PE3992-12	12"	\$79.55	\$73.98	\$68.41	\$63.64
PE3992-24	24"	80.90	75.24	69.57	64.72
PE3992-36	36"	82.20	76.45	70.69	65.76
PE3992-48	48"	83.50	77.66	71.81	66.80
PE3992-60	60"	84.85	78.91	72.97	67.88
PE3992-XX	Any	Same-Day Shipment / Call for Pricing			

## 50 OHM, RG225/U COAX, DOUBLE SHIELDED

Model No.	Length	1-24	25-49	50-99	100 +
PE34421-12	12"	\$106.10	\$98.67	\$91.25	\$84.88
PE34421-24	24"	130.15	121.04	111.93	104.12
PE34421-36	36"	154.30	143.50	132.70	123.44
PE34421-48	48"	178.40	165.91	153.42	142.72
PE34421-60	60"	202.45	188.28	174.11	161.96
PE34421-XX	Any	Same-Day Shipment / Call for Pricing			

## 50 OHM, RG316/U COAX

Model No.	Length	1-24	25-49	50-99	100 +
PE34432-12	12"	\$80.90	\$75.24	\$69.57	\$64.72
PE34432-24	24"	81.80	76.07	70.35	65.44
PE34432-36	36"	82.75	76.96	71.17	66.20
PE34432-48	48"	83.75	77.89	72.03	67.00
PE34432-60	60"	84.75	78.82	72.89	67.80
PE34432-XX	Any	Same-Day Shipment / Call for Pricing			

## 50 OHM, RG393/U COAX, DOUBLE SHIELDED

Model No.	Length	1-24	25-49	50-99	100 +
PE3338-12	12"	\$99.45	\$92.49	\$85.53	\$79.56
PE3338-24	24"	107.90	100.35	92.79	86.32
PE3338-36	36"	116.25	108.11	99.98	93.00
PE3338-48	48"	124.75	116.02	107.29	99.80
PE3338-60	60"	133.15	123.83	114.51	106.52
PE3338-XX	Any	Same-Day Shipment / Call for Pricing			

## 50 OHM, RG400/U COAX, DOUBLE SHIELDED

Model No.	Length	1-24	25-49	50-99	100 +
PE34424-12	12"	\$79.55	\$73.98	\$68.41	\$63.64
PE34424-24	24"	82.20	76.45	70.69	65.76
PE34424-36	36"	84.85	78.91	72.97	67.88
PE34424-48	48"	87.50	81.38	75.25	70.00
PE34424-60	60"	90.20	83.89	77.57	72.16
PE34424-XX	Any	Same-Day Shipment / Call for Pricing			

\*\*ROHS COMPLIANT & CUSTOM-LENGTH CABLE ASSEMBLIES MAY BE ORDERED ON OUR WEBSITE.\*\*

# HN MALE TO HN MALE



## 52 OHM, RG8A/U COAX

Model No.	Length	1-24	25-49	50-99	100 +
PE33304-12	12"	\$66.30	\$61.66	\$57.02	\$53.04
PE33304-24	24"	67.25	62.54	57.84	53.80
PE33304-36	36"	68.35	63.57	58.78	54.68
PE33304-48	48"	69.35	64.50	59.64	55.48
PE33304-60	60"	70.35	65.43	60.50	56.28
PE33304-XX	Any	Same-Day Shipment / Call for Pricing			

## 50 OHM, RG58C/U COAX

Model No.	Length	1-24	25-49	50-99	100 +
PE3852-12	12"	\$59.65	\$55.47	\$51.30	\$47.72
PE3852-24	24"	60.05	55.85	51.64	48.04
PE3852-36	36"	60.55	56.31	52.07	48.44
PE3852-48	48"	60.90	56.64	52.37	48.72
PE3852-60	60"	61.30	57.01	52.72	49.04
PE3852-XX	Any	Same-Day Shipment / Call for Pricing			

## 75 OHM, RG59B/U COAX

Model No.	Length	1-24	25-49	50-99	100 +
PE34436-12	12"	\$62.30	\$57.94	\$53.58	\$49.84
PE34436-24	24"	62.75	58.36	53.97	50.20
PE34436-36	36"	63.15	58.73	54.31	50.52
PE34436-48	48"	63.55	59.10	54.65	50.84
PE34436-60	60"	63.95	59.47	55.00	51.16
PE34436-XX	Any	Same-Day Shipment / Call for Pricing			

## 93 OHM, RG62A/U COAX

Model No.	Length	1-24	25-49	50-99	100 +
PE34438-12	12"	\$62.30	\$57.94	\$53.58	\$49.84
PE34438-24	24"	62.75	58.36	53.97	50.20
PE34438-36	36"	63.15	58.73	54.31	50.52
PE34438-48	48"	63.55	59.10	54.65	50.84
PE34438-60	60"	63.95	59.47	55.00	51.16
PE34438-XX	Any	Same-Day Shipment / Call for Pricing			

## 50 OHM, RG141A/U COAX

Model No.	Length	1-24	25-49	50-99	100 +
PE34434-12	12"	\$62.30	\$57.94	\$53.58	\$49.84
PE34434-24	24"	65.95	61.33	56.72	52.76
PE34434-36	36"	69.60	64.73	59.86	55.68
PE34434-48	48"	73.20	68.08	62.95	58.56
PE34434-60	60"	76.80	71.42	66.05	61.44
PE34434-XX	Any	Same-Day Shipment / Call for Pricing			

## 50 OHM, RG142B/U COAX, DOUBLE SHIELDED

Model No.	Length	1-24	25-49	50-99	100 +
PE3083-12	12"	\$59.65	\$55.47	\$51.30	\$47.72
PE3083-24	24"	62.30	57.94	53.58	49.84
PE3083-36	36"	64.95	60.40	55.86	51.96
PE3083-48	48"	67.60	62.87	58.14	54.08
PE3083-60	60"	70.30	65.38	60.46	56.24
PE3083-XX	Any	Same-Day Shipment / Call for Pricing			

## 50 OHM, RG213/U COAX

Model No.	Length	1-24	25-49	50-99	100 +
PE3038-12	12"	\$66.30	\$61.66	\$57.02	\$53.04
PE3038-24	24"	67.25	62.54	57.84	53.80
PE3038-36	36"	68.35	63.57	58.78	54.68
PE3038-48	48"	69.35	64.50	59.64	55.48
PE3038-60	60"	70.35	65.43	60.50	56.28
PE3038-XX	Any	Same-Day Shipment / Call for Pricing			

## 50 OHM, RG214/U COAX, DOUBLE SHIELDED

Model No.	Length	1-24	25-49	50-99	100 +
PE3095-12	12"	\$66.30	\$61.66	\$57.02	\$53.04
PE3095-24	24"	69.90	65.01	60.11	55.92
PE3095-36	36"	73.50	68.36	63.21	58.80
PE3095-48	48"	77.15	71.75	66.35	61.72
PE3095-60	60"	80.80	75.14	69.49	64.64
PE3095-XX	Any	Same-Day Shipment / Call for Pricing			

## 50 OHM, RG217/U COAX, DOUBLE SHIELDED

Model No.	Length	1-24	25-49	50-99	100 +
PE33370-12	12"	\$106.10	\$98.67	\$91.25	\$84.88
PE33370-24	24"	108.50	100.91	93.31	86.80
PE33370-36	36"	110.80	103.04	95.29	88.64
PE33370-48	48"	113.30	105.37	97.44	90.64
PE33370-60	60"	115.65	107.55	99.46	92.52
PE33370-XX	Any	Same-Day Shipment / Call for Pricing			

## 50 OHM, RG218/U COAX

Model No.	Length	1-24	25-49	50-99	100 +
PE33583-12	12"	\$159.05	\$147.92	\$136.78	\$127.24
PE33583-24	24"	165.15	153.59	142.03	132.12
PE33583-36	36"	171.15	159.17	147.19	136.92
PE33583-48	48"	177.10	164.70	152.31	141.68
PE33583-60	60"	183.30	170.47	157.64	146.64
PE33583-XX	Any	Same-Day Shipment / Call for Pricing			

## 50 OHM, RG223/U COAX, DOUBLE SHIELDED

Model No.	Length	1-24	25-49	50-99	100 +
PE3357-12	12"	\$59.65	\$55.47	\$51.30	\$47.72
PE3357-24	24"	61.00	56.73	52.46	48.80
PE3357-36	36"	62.30	57.94	53.58	49.84
PE3357-48	48"	63.65	59.19	54.74	50.92
PE3357-60	60"	64.95	60.40	55.86	51.96
PE3357-XX	Any	Same-Day Shipment / Call for Pricing			

## 50 OHM, RG225/U COAX, DOUBLE SHIELDED

Model No.	Length	1-24	25-49	50-99	100 +
PE33778-12	12"	\$71.60	\$66.59	\$61.58	\$57.28
PE33778-24	24"	95.75	89.05	82.35	76.60
PE33778-36	36"	119.75	111.37	102.99	95.80
PE33778-48	48"	143.85	133.78	123.71	115.08
PE33778-60	60"	168.05	156.29	144.52	134.44
PE33778-XX	Any	Same-Day Shipment / Call for Pricing			

## 50 OHM, RG393/U COAX, DOUBLE SHIELDED

Model No.	Length	1-24	25-49	50-99	100 +
PE3340-12	12"	\$66.30	\$61.66	\$57.02	\$53.04
PE3340-24	24"	74.70	69.47	64.24	59.76
PE3340-36	36"	83.15	77.33	71.51	66.52
PE3340-48	48"	91.60	85.19	78.78	73.28
PE3340-60	60"	100.00	93.00	86.00	80.00
PE3340-XX	Any	Same-Day Shipment / Call for Pricing			

## 50 OHM, RG400/U COAX, DOUBLE SHIELDED

Model No.	Length	1-24	25-49	50-99	100 +
PE33938-12	12"	\$59.65	\$55.47	\$51.30	\$47.72
PE33938-24	24"	62.30	57.94	53.58	49.84
PE33938-36	36"	64.95	60.40	55.86	51.96
PE33938-48	48"	67.60	62.87	58.14	54.08
PE33938-60	60"	70.30	65.38	60.46	56.24
PE33938-XX	Any	Same-Day Shipment / Call for Pricing			

\*\*ROHS COMPLIANT & CUSTOM-LENGTH CABLE ASSEMBLIES MAY BE ORDERED ON OUR WEBSITE.\*\*

Cable Assemblies

# SMB PLUG TO SMB PLUG



**WARNING!!! ALL CONNECTORS ON THIS PAGE ARE 50 OHM SMB CONNECTORS AND DO NOT MATE WITH "75 OHM SMB TYPE" CONNECTORS!!!**

## 50 OHM, RG58C/U COAX

Model No.	Length	1-24	25-49	50-99	100 +
PE33650-12	12"	\$34.50	\$32.09	\$29.67	\$27.60
PE33650-24	24"	34.85	32.41	29.97	27.88
PE33650-36	36"	35.30	32.83	30.36	28.24
PE33650-48	48"	35.70	33.20	30.70	28.56
PE33650-60	60"	36.15	33.62	31.09	28.92
PE33650-XX	Any	Same-Day Shipment / Call for Pricing			

## 50 OHM, RG142B/U COAX, DOUBLE SHIELDED

Model No.	Length	1-24	25-49	50-99	100 +
PE33652-12	12"	\$34.50	\$32.09	\$29.67	\$27.60
PE33652-24	24"	37.15	34.55	31.95	29.72
PE33652-36	36"	39.80	37.01	34.23	31.84
PE33652-48	48"	42.45	39.48	36.51	33.96
PE33652-60	60"	45.10	41.94	38.79	36.08
PE33652-XX	Any	Same-Day Shipment / Call for Pricing			

## 50 OHM, RG174A/U COAX

Model No.	Length	1-24	25-49	50-99	100 +
PE3853-12	12"	\$26.50	\$24.65	\$22.79	\$21.20
PE3853-24	24"	26.80	24.92	23.05	21.44
PE3853-36	36"	27.05	25.16	23.26	21.64
PE3853-48	48"	27.35	25.44	23.52	21.88
PE3853-60	60"	27.60	25.67	23.74	22.08
PE3853-XX	Any	Same-Day Shipment / Call for Pricing			

## 50 OHM, RG178B/U COAX

Model No.	Length	1-24	25-49	50-99	100 +
PE33165-12	12"	\$27.85	\$25.90	\$23.95	\$22.28
PE33165-24	24"	28.75	26.74	24.73	23.00
PE33165-36	36"	29.80	27.71	25.63	23.84
PE33165-48	48"	30.75	28.60	26.45	24.60
PE33165-60	60"	31.70	29.48	27.26	25.36
PE33165-XX	Any	Same-Day Shipment / Call for Pricing			

## 50 OHM, RG188A/U COAX

Model No.	Length	1-24	25-49	50-99	100 +
PE3587-12	12"	\$26.50	\$24.65	\$22.79	\$21.20
PE3587-24	24"	27.50	25.58	23.65	22.00
PE3587-36	36"	28.45	26.46	24.47	22.76
PE3587-48	48"	29.40	27.34	25.28	23.52
PE3587-60	60"	30.40	28.27	26.14	24.32
PE3587-XX	Any	Same-Day Shipment / Call for Pricing			

## 50 OHM, RG188-DS COAX, DOUBLE SHIELDED

Model No.	Length	1-24	25-49	50-99	100 +
PE3721-12	12"	\$29.15	\$27.11	\$25.07	\$23.32
PE3721-24	24"	31.60	29.39	27.18	25.28
PE3721-36	36"	33.95	31.57	29.20	27.16
PE3721-48	48"	36.40	33.85	31.30	29.12
PE3721-60	60"	38.80	36.08	33.37	31.04
PE3721-XX	Any	Same-Day Shipment / Call for Pricing			

## 50 OHM, RG196A/U COAX

Model No.	Length	1-24	25-49	50-99	100 +
PE3588-12	12"	\$27.85	\$25.90	\$23.95	\$22.28
PE3588-24	24"	28.75	26.74	24.73	23.00
PE3588-36	36"	29.80	27.71	25.63	23.84
PE3588-48	48"	30.75	28.60	26.45	24.60
PE3588-60	60"	31.70	29.48	27.26	25.36
PE3588-XX	Any	Same-Day Shipment / Call for Pricing			

## 50 OHM, RG223/U COAX, DOUBLE SHIELDED

Model No.	Length	1-24	25-49	50-99	100 +
PE3166-12	12"	\$34.50	\$32.09	\$29.67	\$27.60
PE3166-24	24"	35.80	33.29	30.79	28.64
PE3166-36	36"	37.15	34.55	31.95	29.72
PE3166-48	48"	38.40	35.71	33.02	30.72
PE3166-60	60"	39.80	37.01	34.23	31.84
PE3166-XX	Any	Same-Day Shipment / Call for Pricing			

## 50 OHM, RG316/U COAX

Model No.	Length	1-24	25-49	50-99	100 +
PE3915-12	12"	\$26.50	\$24.65	\$22.79	\$21.20
PE3915-24	24"	27.50	25.58	23.65	22.00
PE3915-36	36"	28.45	26.46	24.47	22.76
PE3915-48	48"	29.40	27.34	25.28	23.52
PE3915-60	60"	30.40	28.27	26.14	24.32
PE3915-XX	Any	Same-Day Shipment / Call for Pricing			

## 50 OHM, RG316-DS COAX, DOUBLE SHIELDED

Model No.	Length	1-24	25-49	50-99	100 +
PE33704-12	12"	\$29.15	\$27.11	\$25.07	\$23.32
PE33704-24	24"	31.60	29.39	27.18	25.28
PE33704-36	36"	33.95	31.57	29.20	27.16
PE33704-48	48"	36.40	33.85	31.30	29.12
PE33704-60	60"	38.80	36.08	33.37	31.04
PE33704-XX	Any	Same-Day Shipment / Call for Pricing			

## 50 OHM, RG400/U COAX, DOUBLE SHIELDED

Model No.	Length	1-24	25-49	50-99	100 +
PE34269-12	12"	\$34.50	\$32.09	\$29.67	\$27.60
PE34269-24	24"	37.15	34.55	31.95	29.72
PE34269-36	36"	39.80	37.01	34.23	31.84
PE34269-48	48"	42.45	39.48	36.51	33.96
PE34269-60	60"	45.10	41.94	38.79	36.08
PE34269-XX	Any	Same-Day Shipment / Call for Pricing			

## 50 OHM, LOW NOISE, PE-B9329 COAX (BELDEN 9329)

Model No.	Length	1-24	25-49	50-99	100 +
PE34488-12	12"	\$30.50	\$28.37	\$26.23	\$24.40
PE34488-24	24"	32.90	30.60	28.29	26.32
PE34488-36	36"	35.30	32.83	30.36	28.24
PE34488-48	48"	37.75	35.11	32.47	30.20
PE34488-60	60"	40.10	37.29	34.49	32.08
PE34488-XX	Any	Same-Day Shipment / Call for Pricing			

**\*\*ROHS COMPLIANT & CUSTOM-LENGTH CABLE ASSEMBLIES MAY BE ORDERED ON OUR WEBSITE.\*\***

# SMB PLUG TO SMB PLUG RIGHT ANGLE



**WARNING!!! ALL CONNECTORS ON THIS PAGE ARE 50 OHM SMB CONNECTORS AND DO NOT MATE WITH "75 OHM SMB TYPE" CONNECTORS!!!**

## 50 OHM, RG58C/U COAX

Model No.	Length	1-24	25-49	50-99	100 +
PE33666-12	12"	\$37.15	\$34.55	\$31.95	\$29.72
PE33666-24	24"	37.55	34.92	32.29	30.04
PE33666-36	36"	37.95	35.29	32.64	30.36
PE33666-48	48"	38.35	35.67	32.98	30.68
PE33666-60	60"	38.70	35.99	33.28	30.96
PE33666-XX	Any	Same-Day Shipment / Call for Pricing			

## 50 OHM, RG142B/U COAX, DOUBLE SHIELDED

Model No.	Length	1-24	25-49	50-99	100 +
PE33668-12	12"	\$41.10	\$38.22	\$35.35	\$32.88
PE33668-24	24"	43.75	40.69	37.63	35.00
PE33668-36	36"	46.35	43.11	39.86	37.08
PE33668-48	48"	49.05	45.62	42.18	39.24
PE33668-60	60"	51.70	48.08	44.46	41.36
PE33668-XX	Any	Same-Day Shipment / Call for Pricing			

## 50 OHM, RG174A/U COAX

Model No.	Length	1-24	25-49	50-99	100 +
PE33175-12	12"	\$35.80	\$33.29	\$30.79	\$28.64
PE33175-24	24"	36.10	33.57	31.05	28.88
PE33175-36	36"	36.35	33.81	31.26	29.08
PE33175-48	48"	36.60	34.04	31.48	29.28
PE33175-60	60"	36.80	34.22	31.65	29.44
PE33175-XX	Any	Same-Day Shipment / Call for Pricing			

## 50 OHM, RG178B/U COAX

Model No.	Length	1-24	25-49	50-99	100 +
PE33356-12	12"	\$34.50	\$32.09	\$29.67	\$27.60
PE33356-24	24"	35.45	32.97	30.49	28.36
PE33356-36	36"	36.40	33.85	31.30	29.12
PE33356-48	48"	37.40	34.78	32.16	29.92
PE33356-60	60"	38.30	35.62	32.94	30.64
PE33356-XX	Any	Same-Day Shipment / Call for Pricing			

## 50 OHM, RG188A/U COAX

Model No.	Length	1-24	25-49	50-99	100 +
PE3592-12	12"	\$33.15	\$30.83	\$28.51	\$26.52
PE3592-24	24"	34.05	31.67	29.28	27.24
PE3592-36	36"	35.05	32.60	30.14	28.04
PE3592-48	48"	36.05	33.53	31.00	28.84
PE3592-60	60"	37.05	34.46	31.86	29.64
PE3592-XX	Any	Same-Day Shipment / Call for Pricing			

## 50 OHM, RG188-DS COAX, DOUBLE SHIELDED

Model No.	Length	1-24	25-49	50-99	100 +
PE33143-12	12"	\$35.80	\$33.29	\$30.79	\$28.64
PE33143-24	24"	38.20	35.53	32.85	30.56
PE33143-36	36"	40.60	37.76	34.92	32.48
PE33143-48	48"	43.05	40.04	37.02	34.44
PE33143-60	60"	45.40	42.22	39.04	36.32
PE33143-XX	Any	Same-Day Shipment / Call for Pricing			

## 50 OHM, RG196A/U COAX

Model No.	Length	1-24	25-49	50-99	100 +
PE3593-12	12"	\$34.50	\$32.09	\$29.67	\$27.60
PE3593-24	24"	35.45	32.97	30.49	28.36
PE3593-36	36"	36.40	33.85	31.30	29.12
PE3593-48	48"	37.40	34.78	32.16	29.92
PE3593-60	60"	38.30	35.62	32.94	30.64
PE3593-XX	Any	Same-Day Shipment / Call for Pricing			

## 50 OHM, RG223/U COAX, DOUBLE SHIELDED

Model No.	Length	1-24	25-49	50-99	100 +
PE33670-12	12"	\$39.80	\$37.01	\$34.23	\$31.84
PE33670-24	24"	41.10	38.22	35.35	32.88
PE33670-36	36"	42.45	39.48	36.51	33.96
PE33670-48	48"	43.75	40.69	37.63	35.00
PE33670-60	60"	45.10	41.94	38.79	36.08
PE33670-XX	Any	Same-Day Shipment / Call for Pricing			

## 50 OHM, RG316/U COAX

Model No.	Length	1-24	25-49	50-99	100 +
PE33672-12	12"	\$33.15	\$30.83	\$28.51	\$26.52
PE33672-24	24"	34.05	31.67	29.28	27.24
PE33672-36	36"	35.05	32.60	30.14	28.04
PE33672-48	48"	36.05	33.53	31.00	28.84
PE33672-60	60"	37.05	34.46	31.86	29.64
PE33672-XX	Any	Same-Day Shipment / Call for Pricing			

## 50 OHM, RG316-DS COAX, DOUBLE SHIELDED

Model No.	Length	1-24	25-49	50-99	100 +
PE34485-12	12"	\$35.80	\$33.29	\$30.79	\$28.64
PE34485-24	24"	38.20	35.53	32.85	30.56
PE34485-36	36"	40.60	37.76	34.92	32.48
PE34485-48	48"	43.05	40.04	37.02	34.44
PE34485-60	60"	45.40	42.22	39.04	36.32
PE34485-XX	Any	Same-Day Shipment / Call for Pricing			

## 50 OHM, RG400/U COAX, DOUBLE SHIELDED

Model No.	Length	1-24	25-49	50-99	100 +
PE34481-12	12"	\$41.10	\$38.22	\$35.35	\$32.88
PE34481-24	24"	43.75	40.69	37.63	35.00
PE34481-36	36"	46.35	43.11	39.86	37.08
PE34481-48	48"	49.05	45.62	42.18	39.24
PE34481-60	60"	51.70	48.08	44.46	41.36
PE34481-XX	Any	Same-Day Shipment / Call for Pricing			

## 50 OHM, LOW NOISE, PE-B9329 COAX (BELDEN 9329)

Model No.	Length	1-24	25-49	50-99	100 +
PE34490-12	12"	\$37.15	\$34.55	\$31.95	\$29.72
PE34490-24	24"	39.50	36.74	33.97	31.60
PE34490-36	36"	41.90	38.97	36.03	33.52
PE34490-48	48"	44.35	41.25	38.14	35.48
PE34490-60	60"	46.80	43.52	40.25	37.44
PE34490-XX	Any	Same-Day Shipment / Call for Pricing			

**\*\*ROHS COMPLIANT & CUSTOM-LENGTH CABLE ASSEMBLIES MAY BE ORDERED ON OUR WEBSITE.\*\***

Cable Assemblies

# SMB PLUG RIGHT ANGLE TO SMB PLUG RIGHT ANGLE



**WARNING!!! ALL CONNECTORS ON THIS PAGE ARE 50 OHM SMB CONNECTORS AND DO NOT MATE WITH "75 OHM SMB TYPE" CONNECTORS!!!**

## 50 OHM, RG58C/U COAX

Model No.	Length	1-24	25-49	50-99	100 +
PE33654-12	12"	\$37.15	\$34.55	\$31.95	\$29.72
PE33654-24	24"	37.55	34.92	32.29	30.04
PE33654-36	36"	37.95	35.29	32.64	30.36
PE33654-48	48"	38.35	35.67	32.98	30.68
PE33654-60	60"	38.70	35.99	33.28	30.96
PE33654-XX	Any	Same-Day Shipment / Call for Pricing			

## 50 OHM, RG142B/U COAX, DOUBLE SHIELDED

Model No.	Length	1-24	25-49	50-99	100 +
PE33656-12	12"	\$41.10	\$38.22	\$35.35	\$32.88
PE33656-24	24"	43.75	40.69	37.63	35.00
PE33656-36	36"	46.35	43.11	39.86	37.08
PE33656-48	48"	49.05	45.62	42.18	39.24
PE33656-60	60"	51.70	48.08	44.46	41.36
PE33656-XX	Any	Same-Day Shipment / Call for Pricing			

## 50 OHM, RG174A/U COAX

Model No.	Length	1-24	25-49	50-99	100 +
PE3916-12	12"	\$35.80	\$33.29	\$30.79	\$28.64
PE3916-24	24"	36.10	33.57	31.05	28.88
PE3916-36	36"	36.35	33.81	31.26	29.08
PE3916-48	48"	36.60	34.04	31.48	29.28
PE3916-60	60"	36.80	34.22	31.65	29.44
PE3916-XX	Any	Same-Day Shipment / Call for Pricing			

## 50 OHM, RG178B/U COAX

Model No.	Length	1-24	25-49	50-99	100 +
PE33350-12	12"	\$37.15	\$34.55	\$31.95	\$29.72
PE33350-24	24"	38.10	35.43	32.77	30.48
PE33350-36	36"	39.05	36.32	33.58	31.24
PE33350-48	48"	40.00	37.20	34.40	32.00
PE33350-60	60"	41.00	38.13	35.26	32.80
PE33350-XX	Any	Same-Day Shipment / Call for Pricing			

## 50 OHM, RG188A/U COAX

Model No.	Length	1-24	25-49	50-99	100 +
PE3589-12	12"	\$35.80	\$33.29	\$30.79	\$28.64
PE3589-24	24"	36.75	34.18	31.61	29.40
PE3589-36	36"	37.75	35.11	32.47	30.20
PE3589-48	48"	38.65	35.94	33.24	30.92
PE3589-60	60"	39.70	36.92	34.14	31.76
PE3589-XX	Any	Same-Day Shipment / Call for Pricing			

## 50 OHM, RG188-DS COAX, DOUBLE SHIELDED

Model No.	Length	1-24	25-49	50-99	100 +
PE34463-12	12"	\$38.40	\$35.71	\$33.02	\$30.72
PE34463-24	24"	40.85	37.99	35.13	32.68
PE34463-36	36"	43.30	40.27	37.24	34.64
PE34463-48	48"	45.65	42.45	39.26	36.52
PE34463-60	60"	48.10	44.73	41.37	38.48
PE34463-XX	Any	Same-Day Shipment / Call for Pricing			

## 50 OHM, RG196A/U COAX

Model No.	Length	1-24	25-49	50-99	100 +
PE3590-12	12"	\$37.15	\$34.55	\$31.95	\$29.72
PE3590-24	24"	38.10	35.43	32.77	30.48
PE3590-36	36"	39.05	36.32	33.58	31.24
PE3590-48	48"	40.00	37.20	34.40	32.00
PE3590-60	60"	41.00	38.13	35.26	32.80
PE3590-XX	Any	Same-Day Shipment / Call for Pricing			

## 50 OHM, RG223/U COAX, DOUBLE SHIELDED

Model No.	Length	1-24	25-49	50-99	100 +
PE33121-12	12"	\$39.80	\$37.01	\$34.23	\$31.84
PE33121-24	24"	41.10	38.22	35.35	32.88
PE33121-36	36"	42.45	39.48	36.51	33.96
PE33121-48	48"	43.75	40.69	37.63	35.00
PE33121-60	60"	45.10	41.94	38.79	36.08
PE33121-XX	Any	Same-Day Shipment / Call for Pricing			

## 50 OHM, RG316/U COAX

Model No.	Length	1-24	25-49	50-99	100 +
PE3917-12	12"	\$35.80	\$33.29	\$30.79	\$28.64
PE3917-24	24"	36.75	34.18	31.61	29.40
PE3917-36	36"	37.75	35.11	32.47	30.20
PE3917-48	48"	38.65	35.94	33.24	30.92
PE3917-60	60"	39.70	36.92	34.14	31.76
PE3917-XX	Any	Same-Day Shipment / Call for Pricing			

## 50 OHM, RG316-DS COAX, DOUBLE SHIELDED

Model No.	Length	1-24	25-49	50-99	100 +
PE33476-12	12"	\$38.40	\$35.71	\$33.02	\$30.72
PE33476-24	24"	40.85	37.99	35.13	32.68
PE33476-36	36"	43.30	40.27	37.24	34.64
PE33476-48	48"	45.65	42.45	39.26	36.52
PE33476-60	60"	48.10	44.73	41.37	38.48
PE33476-XX	Any	Same-Day Shipment / Call for Pricing			

## 50 OHM, RG400/U COAX, DOUBLE SHIELDED

Model No.	Length	1-24	25-49	50-99	100 +
PE34461-12	12"	\$41.10	\$38.22	\$35.35	\$32.88
PE34461-24	24"	43.75	40.69	37.63	35.00
PE34461-36	36"	46.35	43.11	39.86	37.08
PE34461-48	48"	49.05	45.62	42.18	39.24
PE34461-60	60"	51.70	48.08	44.46	41.36
PE34461-XX	Any	Same-Day Shipment / Call for Pricing			

## 50 OHM, LOW NOISE, PE-B9329 COAX (BELDEN 9329)

Model No.	Length	1-24	25-49	50-99	100 +
PE34465-12	12"	\$39.80	\$37.01	\$34.23	\$31.84
PE34465-24	24"	42.20	39.25	36.29	33.76
PE34465-36	36"	44.55	41.43	38.31	35.64
PE34465-48	48"	47.00	43.71	40.42	37.60
PE34465-60	60"	49.35	45.90	42.44	39.48
PE34465-XX	Any	Same-Day Shipment / Call for Pricing			

**\*\*ROHS COMPLIANT & CUSTOM-LENGTH CABLE ASSEMBLIES MAY BE ORDERED ON OUR WEBSITE.\*\***

# SMB PLUG TO SMB JACK BULKHEAD

USE MOUNTING HOLE B01 ON PAGE 266



**WARNING!!! ALL CONNECTORS ON THIS PAGE ARE 50 OHM SMB CONNECTORS AND DO NOT MATE WITH "75 OHM SMB TYPE" CONNECTORS!!!**

## 50 OHM, RG58C/U COAX

Model No.	Length	1-24	25-49	50-99	100 +
PE34493-12	12"	\$42.45	\$39.48	\$36.51	\$33.96
PE34493-24	24"	42.85	39.85	36.85	34.28
PE34493-36	36"	43.25	40.22	37.20	34.60
PE34493-48	48"	43.65	40.59	37.54	34.92
PE34493-60	60"	44.00	40.92	37.84	35.20
PE34493-XX	Any	Same-Day Shipment / Call for Pricing			

## 50 OHM, RG142B/U COAX, DOUBLE SHIELDED

Model No.	Length	1-24	25-49	50-99	100 +
PE34495-12	12"	\$43.75	\$40.69	\$37.63	\$35.00
PE34495-24	24"	46.35	43.11	39.86	37.08
PE34495-36	36"	49.05	45.62	42.18	39.24
PE34495-48	48"	51.70	48.08	44.46	41.36
PE34495-60	60"	54.35	50.55	46.74	43.48
PE34495-XX	Any	Same-Day Shipment / Call for Pricing			

## 50 OHM, RG174A/U COAX

Model No.	Length	1-24	25-49	50-99	100 +
PE33674-12	12"	\$35.80	\$33.29	\$30.79	\$28.64
PE33674-24	24"	36.10	33.57	31.05	28.88
PE33674-36	36"	36.35	33.81	31.26	29.08
PE33674-48	48"	36.60	34.04	31.48	29.28
PE33674-60	60"	36.80	34.22	31.65	29.44
PE33674-XX	Any	Same-Day Shipment / Call for Pricing			

## 50 OHM, RG178B/U COAX

Model No.	Length	1-24	25-49	50-99	100 +
PE33676-12	12"	\$37.15	\$34.55	\$31.95	\$29.72
PE33676-24	24"	38.10	35.43	32.77	30.48
PE33676-36	36"	39.05	36.32	33.58	31.24
PE33676-48	48"	40.00	37.20	34.40	32.00
PE33676-60	60"	41.00	38.13	35.26	32.80
PE33676-XX	Any	Same-Day Shipment / Call for Pricing			

## 50 OHM, RG188A/U COAX

Model No.	Length	1-24	25-49	50-99	100 +
PE3591-12	12"	\$33.15	\$30.83	\$28.51	\$26.52
PE3591-24	24"	34.05	31.67	29.28	27.24
PE3591-36	36"	35.05	32.60	30.14	28.04
PE3591-48	48"	36.05	33.53	31.00	28.84
PE3591-60	60"	37.05	34.46	31.86	29.64
PE3591-XX	Any	Same-Day Shipment / Call for Pricing			

## 50 OHM, RG188-DS COAX, DOUBLE SHIELDED

Model No.	Length	1-24	25-49	50-99	100 +
PE34489-12	12"	\$35.80	\$33.29	\$30.79	\$28.64
PE34489-24	24"	38.20	35.53	32.85	30.56
PE34489-36	36"	40.60	37.76	34.92	32.48
PE34489-48	48"	43.05	40.04	37.02	34.44
PE34489-60	60"	45.40	42.22	39.04	36.32
PE34489-XX	Any	Same-Day Shipment / Call for Pricing			

## 50 OHM, RG196A/U COAX

Model No.	Length	1-24	25-49	50-99	100 +
PE3130-12	12"	\$37.15	\$34.55	\$31.95	\$29.72
PE3130-24	24"	38.10	35.43	32.77	30.48
PE3130-36	36"	39.05	36.32	33.58	31.24
PE3130-48	48"	40.00	37.20	34.40	32.00
PE3130-60	60"	41.00	38.13	35.26	32.80
PE3130-XX	Any	Same-Day Shipment / Call for Pricing			

## 50 OHM, RG223/U COAX, DOUBLE SHIELDED

Model No.	Length	1-24	25-49	50-99	100 +
PE34497-12	12"	\$42.45	\$39.48	\$36.51	\$33.96
PE34497-24	24"	43.75	40.69	37.63	35.00
PE34497-36	36"	45.10	41.94	38.79	36.08
PE34497-48	48"	46.35	43.11	39.86	37.08
PE34497-60	60"	47.70	44.36	41.02	38.16
PE34497-XX	Any	Same-Day Shipment / Call for Pricing			

## 50 OHM, RG316/U COAX

Model No.	Length	1-24	25-49	50-99	100 +
PE33680-12	12"	\$33.15	\$30.83	\$28.51	\$26.52
PE33680-24	24"	34.05	31.67	29.28	27.24
PE33680-36	36"	35.05	32.60	30.14	28.04
PE33680-48	48"	36.05	33.53	31.00	28.84
PE33680-60	60"	37.05	34.46	31.86	29.64
PE33680-XX	Any	Same-Day Shipment / Call for Pricing			

## 50 OHM, RG316-DS COAX, DOUBLE SHIELDED

Model No.	Length	1-24	25-49	50-99	100 +
PE34487-12	12"	\$35.80	\$33.29	\$30.79	\$28.64
PE34487-24	24"	38.20	35.53	32.85	30.56
PE34487-36	36"	40.60	37.76	34.92	32.48
PE34487-48	48"	43.05	40.04	37.02	34.44
PE34487-60	60"	45.40	42.22	39.04	36.32
PE34487-XX	Any	Same-Day Shipment / Call for Pricing			

## 50 OHM, RG400/U COAX, DOUBLE SHIELDED

Model No.	Length	1-24	25-49	50-99	100 +
PE34483-12	12"	\$43.75	\$40.69	\$37.63	\$35.00
PE34483-24	24"	46.35	43.11	39.86	37.08
PE34483-36	36"	49.05	45.62	42.18	39.24
PE34483-48	48"	51.70	48.08	44.46	41.36
PE34483-60	60"	54.35	50.55	46.74	43.48
PE34483-XX	Any	Same-Day Shipment / Call for Pricing			

## 50 OHM, LOW NOISE, PE-B9329 COAX (BELDEN 9329)

Model No.	Length	1-24	25-49	50-99	100 +
PE34491-12	12"	\$37.15	\$34.55	\$31.95	\$29.72
PE34491-24	24"	39.50	36.74	33.97	31.60
PE34491-36	36"	41.90	38.97	36.03	33.52
PE34491-48	48"	44.35	41.25	38.14	35.48
PE34491-60	60"	46.80	43.52	40.25	37.44
PE34491-XX	Any	Same-Day Shipment / Call for Pricing			

\*\*ROHS COMPLIANT & CUSTOM-LENGTH CABLE ASSEMBLIES MAY BE ORDERED ON OUR WEBSITE.\*\*

Cable Assemblies

# SMB PLUG RIGHT ANGLE TO SMB JACK BULKHEAD

USE MOUNTING HOLE B01 ON PAGE 266



**WARNING!!! ALL CONNECTORS ON THIS PAGE ARE 50 OHM SMB CONNECTORS AND DO NOT MATE WITH "75 OHM SMB TYPE" CONNECTORS!!!**

## 50 OHM, RG58C/U COAX

Model No.	Length	1-24	25-49	50-99	100 +
PE34469-12	12"	\$42.45	\$39.48	\$36.51	\$33.96
PE34469-24	24"	42.85	39.85	36.85	34.28
PE34469-36	36"	43.25	40.22	37.20	34.60
PE34469-48	48"	43.65	40.59	37.54	34.92
PE34469-60	60"	44.00	40.92	37.84	35.20
PE34469-XX	Any	Same-Day Shipment / Call for Pricing			

## 50 OHM, RG196A/U COAX

Model No.	Length	1-24	25-49	50-99	100 +
PE33682-12	12"	\$39.80	\$37.01	\$34.23	\$31.84
PE33682-24	24"	40.75	37.90	35.05	32.60
PE33682-36	36"	41.70	38.78	35.86	33.36
PE33682-48	48"	42.70	39.71	36.72	34.16
PE33682-60	60"	43.60	40.55	37.50	34.88
PE33682-XX	Any	Same-Day Shipment / Call for Pricing			

## 50 OHM, RG142B/U COAX, DOUBLE SHIELDED

Model No.	Length	1-24	25-49	50-99	100 +
PE34471-12	12"	\$43.75	\$40.69	\$37.63	\$35.00
PE34471-24	24"	46.35	43.11	39.86	37.08
PE34471-36	36"	49.05	45.62	42.18	39.24
PE34471-48	48"	51.70	48.08	44.46	41.36
PE34471-60	60"	54.35	50.55	46.74	43.48
PE34471-XX	Any	Same-Day Shipment / Call for Pricing			

## 50 OHM, RG223/U COAX, DOUBLE SHIELDED

Model No.	Length	1-24	25-49	50-99	100 +
PE34473-12	12"	\$43.75	\$40.69	\$37.63	\$35.00
PE34473-24	24"	45.10	41.94	38.79	36.08
PE34473-36	36"	46.35	43.11	39.86	37.08
PE34473-48	48"	47.70	44.36	41.02	38.16
PE34473-60	60"	49.05	45.62	42.18	39.24
PE34473-XX	Any	Same-Day Shipment / Call for Pricing			

## 50 OHM, RG174A/U COAX

Model No.	Length	1-24	25-49	50-99	100 +
PE33261-12	12"	\$35.80	\$33.29	\$30.79	\$28.64
PE33261-24	24"	36.10	33.57	31.05	28.88
PE33261-36	36"	36.35	33.81	31.26	29.08
PE33261-48	48"	36.60	34.04	31.48	29.28
PE33261-60	60"	36.80	34.22	31.65	29.44
PE33261-XX	Any	Same-Day Shipment / Call for Pricing			

## 50 OHM, RG316/U COAX

Model No.	Length	1-24	25-49	50-99	100 +
PE33675-12	12"	\$35.80	\$33.29	\$30.79	\$28.64
PE33675-24	24"	36.75	34.18	31.61	29.40
PE33675-36	36"	37.75	35.11	32.47	30.20
PE33675-48	48"	38.65	35.94	33.24	30.92
PE33675-60	60"	39.70	36.92	34.14	31.76
PE33675-XX	Any	Same-Day Shipment / Call for Pricing			

## 50 OHM, RG178B/U COAX

Model No.	Length	1-24	25-49	50-99	100 +
PE34467-12	12"	\$39.80	\$37.01	\$34.23	\$31.84
PE34467-24	24"	40.75	37.90	35.05	32.60
PE34467-36	36"	41.70	38.78	35.86	33.36
PE34467-48	48"	42.70	39.71	36.72	34.16
PE34467-60	60"	43.60	40.55	37.50	34.88
PE34467-XX	Any	Same-Day Shipment / Call for Pricing			

## 50 OHM, RG316-DS COAX, DOUBLE SHIELDED

Model No.	Length	1-24	25-49	50-99	100 +
PE33349-12	12"	\$38.40	\$35.71	\$33.02	\$30.72
PE33349-24	24"	40.85	37.99	35.13	32.68
PE33349-36	36"	43.30	40.27	37.24	34.64
PE33349-48	48"	45.65	42.45	39.26	36.52
PE33349-60	60"	48.10	44.73	41.37	38.48
PE33349-XX	Any	Same-Day Shipment / Call for Pricing			

## 50 OHM, RG188A/U COAX

Model No.	Length	1-24	25-49	50-99	100 +
PE33594-12	12"	\$35.80	\$33.29	\$30.79	\$28.64
PE33594-24	24"	36.75	34.18	31.61	29.40
PE33594-36	36"	37.75	35.11	32.47	30.20
PE33594-48	48"	38.65	35.94	33.24	30.92
PE33594-60	60"	39.70	36.92	34.14	31.76
PE33594-XX	Any	Same-Day Shipment / Call for Pricing			

## 50 OHM, RG400/U COAX, DOUBLE SHIELDED

Model No.	Length	1-24	25-49	50-99	100 +
PE34475-12	12"	\$43.75	\$40.69	\$37.63	\$35.00
PE34475-24	24"	46.35	43.11	39.86	37.08
PE34475-36	36"	49.05	45.62	42.18	39.24
PE34475-48	48"	51.70	48.08	44.46	41.36
PE34475-60	60"	54.35	50.55	46.74	43.48
PE34475-XX	Any	Same-Day Shipment / Call for Pricing			

## 50 OHM, RG188-DS COAX, DOUBLE SHIELDED

Model No.	Length	1-24	25-49	50-99	100 +
PE34477-12	12"	\$38.40	\$35.71	\$33.02	\$30.72
PE34477-24	24"	40.85	37.99	35.13	32.68
PE34477-36	36"	43.30	40.27	37.24	34.64
PE34477-48	48"	45.65	42.45	39.26	36.52
PE34477-60	60"	48.10	44.73	41.37	38.48
PE34477-XX	Any	Same-Day Shipment / Call for Pricing			

## 50 OHM, LOW NOISE, PE-B9329 COAX (BELDEN 9329)

Model No.	Length	1-24	25-49	50-99	100 +
PE34479-12	12"	\$39.80	\$37.01	\$34.23	\$31.84
PE34479-24	24"	42.20	39.25	36.29	33.76
PE34479-36	36"	44.55	41.43	38.31	35.64
PE34479-48	48"	47.00	43.71	40.42	37.60
PE34479-60	60"	49.35	45.90	42.44	39.48
PE34479-XX	Any	Same-Day Shipment / Call for Pricing			

\*\*ROHS COMPLIANT & CUSTOM-LENGTH CABLE ASSEMBLIES MAY BE ORDERED ON OUR WEBSITE.\*\*

# SMA MALE TO SMB PLUG



## 50 OHM, RG58C/U COAX

Model No.	Length	1-24	25-49	50-99	100 +
PE3172-12	12"	\$36.05	\$33.53	\$31.00	\$28.84
PE3172-24	24"	36.40	33.85	31.30	29.12
PE3172-36	36"	36.80	34.22	31.65	29.44
PE3172-48	48"	37.25	34.64	32.04	29.80
PE3172-60	60"	37.70	35.06	32.42	30.16
PE3172-XX	Any	Same-Day Shipment / Call for Pricing			

## 50 OHM, RG142B/U COAX, DOUBLE SHIELDED

Model No.	Length	1-24	25-49	50-99	100 +
PE3181-12	12"	\$39.80	\$37.01	\$34.23	\$31.84
PE3181-24	24"	42.45	39.48	36.51	33.96
PE3181-36	36"	45.10	41.94	38.79	36.08
PE3181-48	48"	47.70	44.36	41.02	38.16
PE3181-60	60"	50.40	46.87	43.34	40.32
PE3181-XX	Any	Same-Day Shipment / Call for Pricing			

## 50 OHM, RG174A/U COAX

Model No.	Length	1-24	25-49	50-99	100 +
PE3908-12	12"	\$36.00	\$33.48	\$30.96	\$28.80
PE3908-24	24"	36.20	33.67	31.13	28.96
PE3908-36	36"	36.45	33.90	31.35	29.16
PE3908-48	48"	36.70	34.13	31.56	29.36
PE3908-60	60"	37.05	34.46	31.86	29.64
PE3908-XX	Any	Same-Day Shipment / Call for Pricing			

## 50 OHM, RG178B/U COAX

Model No.	Length	1-24	25-49	50-99	100 +
PE3548-12	12"	\$50.85	\$47.29	\$43.73	\$40.68
PE3548-24	24"	51.80	48.17	44.55	41.44
PE3548-36	36"	52.80	49.10	45.41	42.24
PE3548-48	48"	53.80	50.03	46.27	43.04
PE3548-60	60"	54.65	50.82	47.00	43.72
PE3548-XX	Any	Same-Day Shipment / Call for Pricing			

## 50 OHM, RG188A/U COAX

Model No.	Length	1-24	25-49	50-99	100 +
PE3755-12	12"	\$36.30	\$33.76	\$31.22	\$29.04
PE3755-24	24"	37.30	34.69	32.08	29.84
PE3755-36	36"	38.20	35.53	32.85	30.56
PE3755-48	48"	39.15	36.41	33.67	31.32
PE3755-60	60"	40.10	37.29	34.49	32.08
PE3755-XX	Any	Same-Day Shipment / Call for Pricing			

## 50 OHM, RG188-DS COAX, DOUBLE SHIELDED

Model No.	Length	1-24	25-49	50-99	100 +
PE3722-12	12"	\$39.70	\$36.92	\$34.14	\$31.76
PE3722-24	24"	42.10	39.15	36.21	33.68
PE3722-36	36"	44.45	41.34	38.23	35.56
PE3722-48	48"	46.90	43.62	40.33	37.52
PE3722-60	60"	49.25	45.80	42.36	39.40
PE3722-XX	Any	Same-Day Shipment / Call for Pricing			

## 50 OHM, RG196A/U COAX

Model No.	Length	1-24	25-49	50-99	100 +
PE34448-12	12"	\$50.85	\$47.29	\$43.73	\$40.68
PE34448-24	24"	51.80	48.17	44.55	41.44
PE34448-36	36"	52.80	49.10	45.41	42.24
PE34448-48	48"	53.80	50.03	46.27	43.04
PE34448-60	60"	54.65	50.82	47.00	43.72
PE34448-XX	Any	Same-Day Shipment / Call for Pricing			

## 50 OHM, RG223/U COAX, DOUBLE SHIELDED

Model No.	Length	1-24	25-49	50-99	100 +
PE3187-12	12"	\$36.45	\$33.90	\$31.35	\$29.16
PE3187-24	24"	37.80	35.15	32.51	30.24
PE3187-36	36"	39.10	36.36	33.63	31.28
PE3187-48	48"	40.40	37.57	34.74	32.32
PE3187-60	60"	41.75	38.83	35.91	33.40
PE3187-XX	Any	Same-Day Shipment / Call for Pricing			

## 50 OHM, RG316/U COAX

Model No.	Length	1-24	25-49	50-99	100 +
PE3810-12	12"	\$36.30	\$33.76	\$31.22	\$29.04
PE3810-24	24"	37.30	34.69	32.08	29.84
PE3810-36	36"	38.20	35.53	32.85	30.56
PE3810-48	48"	39.15	36.41	33.67	31.32
PE3810-60	60"	40.10	37.29	34.49	32.08
PE3810-XX	Any	Same-Day Shipment / Call for Pricing			

## 50 OHM, RG316-DS COAX, DOUBLE SHIELDED

Model No.	Length	1-24	25-49	50-99	100 +
PE33657-12	12"	\$39.70	\$36.92	\$34.14	\$31.76
PE33657-24	24"	42.10	39.15	36.21	33.68
PE33657-36	36"	44.45	41.34	38.23	35.56
PE33657-48	48"	46.90	43.62	40.33	37.52
PE33657-60	60"	49.25	45.80	42.36	39.40
PE33657-XX	Any	Same-Day Shipment / Call for Pricing			

## 50 OHM, RG400/U COAX, DOUBLE SHIELDED

Model No.	Length	1-24	25-49	50-99	100 +
PE34452-12	12"	\$39.80	\$37.01	\$34.23	\$31.84
PE34452-24	24"	42.45	39.48	36.51	33.96
PE34452-36	36"	45.10	41.94	38.79	36.08
PE34452-48	48"	47.70	44.36	41.02	38.16
PE34452-60	60"	50.40	46.87	43.34	40.32
PE34452-XX	Any	Same-Day Shipment / Call for Pricing			

## 50 OHM, LOW NOISE, PE-B9329 COAX (BELDEN 9329)

Model No.	Length	1-24	25-49	50-99	100 +
PE34455-12	12"	\$41.00	\$38.13	\$35.26	\$32.80
PE34455-24	24"	43.40	40.36	37.32	34.72
PE34455-36	36"	45.75	42.55	39.35	36.60
PE34455-48	48"	48.25	44.87	41.50	38.60
PE34455-60	60"	50.60	47.06	43.52	40.48
PE34455-XX	Any	Same-Day Shipment / Call for Pricing			

\*\*ROHS COMPLIANT & CUSTOM-LENGTH CABLE ASSEMBLIES MAY BE ORDERED ON OUR WEBSITE.\*\*

Cable Assemblies



## 75 OHM SMB PLUG TO 75 OHM BNC MALE



### 75 OHM, RG59B/U COAX

Model No.	Length	1-24	25-49	50-99	100 +
PE33270-12	12"	\$39.80	\$37.01	\$34.23	\$31.84
PE33270-24	24"	40.15	37.34	34.53	32.12
PE33270-36	36"	40.60	37.76	34.92	32.48
PE33270-48	48"	41.00	38.13	35.26	32.80
PE33270-60	60"	41.45	38.55	35.65	33.16
PE33270-XX	Any	Same-Day Shipment / Call for Pricing			

### 75 OHM, RG179B/U COAX

Model No.	Length	1-24	25-49	50-99	100 +
PE33247-12	12"	\$39.80	\$37.01	\$34.23	\$31.84
PE33247-24	24"	40.75	37.90	35.05	32.60
PE33247-36	36"	41.70	38.78	35.86	33.36
PE33247-48	48"	42.70	39.71	36.72	34.16
PE33247-60	60"	43.60	40.55	37.50	34.88
PE33247-XX	Any	Same-Day Shipment / Call for Pricing			

### 75 OHM, PE-B8128 COAX (BELDEN 8218)

Model No.	Length	1-24	25-49	50-99	100 +
PE33644-12	12"	\$39.80	\$37.01	\$34.23	\$31.84
PE33644-24	24"	40.35	37.53	34.70	32.28
PE33644-36	36"	41.00	38.13	35.26	32.80
PE33644-48	48"	41.60	38.69	35.78	33.28
PE33644-60	60"	42.20	39.25	36.29	33.76
PE33644-XX	Any	Same-Day Shipment / Call for Pricing			

## 75 OHM SMC PLUG TO 75 OHM BNC MALE



### 75 OHM, RG59B/U COAX

Model No.	Length	1-24	25-49	50-99	100 +
PE33330-12	12"	\$39.80	\$37.01	\$34.23	\$31.84
PE33330-24	24"	40.15	37.34	34.53	32.12
PE33330-36	36"	40.60	37.76	34.92	32.48
PE33330-48	48"	41.00	38.13	35.26	32.80
PE33330-60	60"	41.45	38.55	35.65	33.16
PE33330-XX	Any	Same-Day Shipment / Call for Pricing			

### 75 OHM, RG179B/U COAX

Model No.	Length	1-24	25-49	50-99	100 +
PE33586-12	12"	\$39.80	\$37.01	\$34.23	\$31.84
PE33586-24	24"	40.75	37.90	35.05	32.60
PE33586-36	36"	41.70	38.78	35.86	33.36
PE33586-48	48"	42.70	39.71	36.72	34.16
PE33586-60	60"	43.60	40.55	37.50	34.88
PE33586-XX	Any	Same-Day Shipment / Call for Pricing			

### 75 OHM, PE-B8128 COAX (BELDEN 8218)

Model No.	Length	1-24	25-49	50-99	100 +
PE33646-12	12"	\$39.80	\$37.01	\$34.23	\$31.84
PE33646-24	24"	40.35	37.53	34.70	32.28
PE33646-36	36"	41.00	38.13	35.26	32.80
PE33646-48	48"	41.60	38.69	35.78	33.28
PE33646-60	60"	42.20	39.25	36.29	33.76
PE33646-XX	Any	Same-Day Shipment / Call for Pricing			

**WARNING: ALL SMB AND SMC CONNECTORS ON THIS PAGE ARE STANDARD "75 OHM" CONNECTORS. THESE CONNECTORS WILL NOT MATE TO 50 OHM OR "MINI 75 OHM" CONNECTORS.**

## 75 OHM SMB PLUG TO 75 OHM SMB PLUG



### 75 OHM, RG59B/U COAX

Model No.	Length	1-24	25-49	50-99	100 +
PE3041-12	12"	\$46.35	\$43.11	\$39.86	\$37.08
PE3041-24	24"	46.85	43.57	40.29	37.48
PE3041-36	36"	47.25	43.94	40.64	37.80
PE3041-48	48"	47.65	44.31	40.98	38.12
PE3041-60	60"	48.05	44.69	41.32	38.44
PE3041-XX	Any	Same-Day Shipment / Call for Pricing			

### 75 OHM, RG179B/U COAX

Model No.	Length	1-24	25-49	50-99	100 +
PE3100-12	12"	\$46.35	\$43.11	\$39.86	\$37.08
PE3100-24	24"	47.40	44.08	40.76	37.92
PE3100-36	36"	48.35	44.97	41.58	38.68
PE3100-48	48"	49.25	45.80	42.36	39.40
PE3100-60	60"	50.30	46.78	43.26	40.24
PE3100-XX	Any	Same-Day Shipment / Call for Pricing			

### 75 OHM, PE-B8128 COAX (BELDEN 8218)

Model No.	Length	1-24	25-49	50-99	100 +
PE3112-12	12"	\$46.35	\$43.11	\$39.86	\$37.08
PE3112-24	24"	47.00	43.71	40.42	37.60
PE3112-36	36"	47.60	44.27	40.94	38.08
PE3112-48	48"	48.25	44.87	41.50	38.60
PE3112-60	60"	48.80	45.38	41.97	39.04
PE3112-XX	Any	Same-Day Shipment / Call for Pricing			

## 75 OHM SMC PLUG TO 75 OHM SMC PLUG



### 75 OHM, RG59B/U COAX

Model No.	Length	1-24	25-49	50-99	100 +
PE3362-12	12"	\$46.35	\$43.11	\$39.86	\$37.08
PE3362-24	24"	46.85	43.57	40.29	37.48
PE3362-36	36"	47.25	43.94	40.64	37.80
PE3362-48	48"	47.65	44.31	40.98	38.12
PE3362-60	60"	48.05	44.69	41.32	38.44
PE3362-XX	Any	Same-Day Shipment / Call for Pricing			

### 75 OHM, RG179B/U COAX

Model No.	Length	1-24	25-49	50-99	100 +
PE3376-12	12"	\$46.35	\$43.11	\$39.86	\$37.08
PE3376-24	24"	47.40	44.08	40.76	37.92
PE3376-36	36"	48.35	44.97	41.58	38.68
PE3376-48	48"	49.25	45.80	42.36	39.40
PE3376-60	60"	50.30	46.78	43.26	40.24
PE3376-XX	Any	Same-Day Shipment / Call for Pricing			

### 75 OHM, PE-B8128 COAX (BELDEN 8218)

Model No.	Length	1-24	25-49	50-99	100 +
PE3388-12	12"	\$46.35	\$43.11	\$39.86	\$37.08
PE3388-24	24"	47.00	43.71	40.42	37.60
PE3388-36	36"	47.60	44.27	40.94	38.08
PE3388-48	48"	48.25	44.87	41.50	38.60
PE3388-60	60"	48.80	45.38	41.97	39.04
PE3388-XX	Any	Same-Day Shipment / Call for Pricing			

\*\*ROHS COMPLIANT & CUSTOM-LENGTH CABLE ASSEMBLIES MAY BE ORDERED ON OUR WEBSITE.\*\*

### MINI 75 OHM SMB PLUG TO MINI 75 OHM SMB PLUG



#### 75 OHM, RG59B/U COAX

Model No.	Length	1-24	25-49	50-99	100 +
PE34681-12	12"	\$33.15	\$30.83	\$28.51	\$26.52
PE34681-24	24"	33.55	31.20	28.85	26.84
PE34681-36	36"	33.95	31.57	29.20	27.16
PE34681-48	48"	34.35	31.95	29.54	27.48
PE34681-60	60"	34.80	32.36	29.93	27.84
PE34681-XX	Any	Same-Day Shipment / Call for Pricing			

#### 75 OHM, RG179B/U COAX

Model No.	Length	1-24	25-49	50-99	100 +
PE34683-12	12"	\$30.50	\$28.37	\$26.23	\$24.40
PE34683-24	24"	31.45	29.25	27.05	25.16
PE34683-36	36"	32.45	30.18	27.91	25.96
PE34683-48	48"	33.40	31.06	28.72	26.72
PE34683-60	60"	34.35	31.95	29.54	27.48
PE34683-XX	Any	Same-Day Shipment / Call for Pricing			

#### 75 OHM, RG187A/U COAX

Model No.	Length	1-24	25-49	50-99	100 +
PE34685-12	12"	\$30.50	\$28.37	\$26.23	\$24.40
PE34685-24	24"	31.45	29.25	27.05	25.16
PE34685-36	36"	32.45	30.18	27.91	25.96
PE34685-48	48"	33.40	31.06	28.72	26.72
PE34685-60	60"	34.35	31.95	29.54	27.48
PE34685-XX	Any	Same-Day Shipment / Call for Pricing			

### MINI 75 OHM SMB PLUG RIGHT ANGLE TO MINI 75 OHM SMB PLUG RIGHT ANGLE



#### 75 OHM, RG59B/U COAX

Model No.	Length	1-24	25-49	50-99	100 +
PE34692-12	12"	\$37.15	\$34.55	\$31.95	\$29.72
PE34692-24	24"	37.55	34.92	32.29	30.04
PE34692-36	36"	37.95	35.29	32.64	30.36
PE34692-48	48"	38.35	35.67	32.98	30.68
PE34692-60	60"	38.70	35.99	33.28	30.96
PE34692-XX	Any	Same-Day Shipment / Call for Pricing			

#### 75 OHM, RG179B/U COAX

Model No.	Length	1-24	25-49	50-99	100 +
PE34694-12	12"	\$34.50	\$32.09	\$29.67	\$27.60
PE34694-24	24"	35.45	32.97	30.49	28.36
PE34694-36	36"	36.40	33.85	31.30	29.12
PE34694-48	48"	37.40	34.78	32.16	29.92
PE34694-60	60"	38.30	35.62	32.94	30.64
PE34694-XX	Any	Same-Day Shipment / Call for Pricing			

#### 75 OHM, RG187A/U COAX

Model No.	Length	1-24	25-49	50-99	100 +
PE34696-12	12"	\$34.50	\$32.09	\$29.67	\$27.60
PE34696-24	24"	35.45	32.97	30.49	28.36
PE34696-36	36"	36.40	33.85	31.30	29.12
PE34696-48	48"	37.40	34.78	32.16	29.92
PE34696-60	60"	38.30	35.62	32.94	30.64
PE34696-XX	Any	Same-Day Shipment / Call for Pricing			

**WARNING: ALL SMB CONNECTORS ON THIS PAGE ARE MINI 75 OHM SMB CONNECTORS. THESE CONNECTORS WILL NOT MATE TO STANDARD 75 OHM SMB CONNECTORS.**

### MINI 75 OHM SMB PLUG TO MINI 75 OHM SMB PLUG RIGHT ANGLE



#### 75 OHM, RG59B/U COAX

Model No.	Length	1-24	25-49	50-99	100 +
PE34687-12	12"	\$35.80	\$33.29	\$30.79	\$28.64
PE34687-24	24"	36.25	33.71	31.18	29.00
PE34687-36	36"	36.60	34.04	31.48	29.28
PE34687-48	48"	37.10	34.50	31.91	29.68
PE34687-60	60"	37.45	34.83	32.21	29.96
PE34687-XX	Any	Same-Day Shipment / Call for Pricing			

#### 75 OHM, RG179B/U COAX

Model No.	Length	1-24	25-49	50-99	100 +
PE34689-12	12"	\$33.15	\$30.83	\$28.51	\$26.52
PE34689-24	24"	34.05	31.67	29.28	27.24
PE34689-36	36"	35.05	32.60	30.14	28.04
PE34689-48	48"	36.05	33.53	31.00	28.84
PE34689-60	60"	37.05	34.46	31.86	29.64
PE34689-XX	Any	Same-Day Shipment / Call for Pricing			

#### 75 OHM, RG187A/U COAX

Model No.	Length	1-24	25-49	50-99	100 +
PE34690-12	12"	\$33.15	\$30.83	\$28.51	\$26.52
PE34690-24	24"	34.05	31.67	29.28	27.24
PE34690-36	36"	35.05	32.60	30.14	28.04
PE34690-48	48"	36.05	33.53	31.00	28.84
PE34690-60	60"	37.05	34.46	31.86	29.64
PE34690-XX	Any	Same-Day Shipment / Call for Pricing			

### MINI 75 OHM SMB PLUG TO 75 OHM BNC MALE



#### 75 OHM, RG59B/U COAX

Model No.	Length	1-24	25-49	50-99	100 +
PE34701-12	12"	\$35.80	\$33.29	\$30.79	\$28.64
PE34701-24	24"	36.25	33.71	31.18	29.00
PE34701-36	36"	36.60	34.04	31.48	29.28
PE34701-48	48"	37.10	34.50	31.91	29.68
PE34701-60	60"	37.45	34.83	32.21	29.96
PE34701-XX	Any	Same-Day Shipment / Call for Pricing			

#### 75 OHM, RG179B/U COAX

Model No.	Length	1-24	25-49	50-99	100 +
PE34703-12	12"	\$33.15	\$30.83	\$28.51	\$26.52
PE34703-24	24"	34.05	31.67	29.28	27.24
PE34703-36	36"	35.05	32.60	30.14	28.04
PE34703-48	48"	36.05	33.53	31.00	28.84
PE34703-60	60"	37.05	34.46	31.86	29.64
PE34703-XX	Any	Same-Day Shipment / Call for Pricing			

#### 75 OHM, RG187A/U COAX

Model No.	Length	1-24	25-49	50-99	100 +
PE34705-12	12"	\$33.15	\$30.83	\$28.51	\$26.52
PE34705-24	24"	34.05	31.67	29.28	27.24
PE34705-36	36"	35.05	32.60	30.14	28.04
PE34705-48	48"	36.05	33.53	31.00	28.84
PE34705-60	60"	37.05	34.46	31.86	29.64
PE34705-XX	Any	Same-Day Shipment / Call for Pricing			

\*\*ROHS COMPLIANT & CUSTOM-LENGTH CABLE ASSEMBLIES MAY BE ORDERED ON OUR WEBSITE.\*\*

# GR874 TO GR874



## 50 OHM, RG58C/U COAX

Model No.	Length	1-24	25-49	50-99	100 +
PE3211-12	12"	\$145.85	\$135.64	\$125.43	\$116.68
PE3211-24	24"	146.25	136.01	125.78	117.00
PE3211-36	36"	146.70	136.43	126.16	117.36
PE3211-48	48"	147.10	136.80	126.51	117.68
PE3211-60	60"	147.50	137.18	126.85	118.00
PE3211-XX	Any	Same-Day Shipment / Call for Pricing			

## 50 OHM, RG214/U COAX, DOUBLE SHIELDED

Model No.	Length	1-24	25-49	50-99	100 +
PE3158-12	12"	\$159.05	\$147.92	\$136.78	\$127.24
PE3158-24	24"	162.75	151.36	139.97	130.20
PE3158-36	36"	166.30	154.66	143.02	133.04
PE3158-48	48"	169.95	158.05	146.16	135.96
PE3158-60	60"	173.55	161.40	149.25	138.84
PE3158-XX	Any	Same-Day Shipment / Call for Pricing			

## 50 OHM, RG142B/U COAX, DOUBLE SHIELDED

Model No.	Length	1-24	25-49	50-99	100 +
PE3200-12	12"	\$145.85	\$135.64	\$125.43	\$116.68
PE3200-24	24"	148.45	138.06	127.67	118.76
PE3200-36	36"	151.15	140.57	129.99	120.92
PE3200-48	48"	153.75	142.99	132.23	123.00
PE3200-60	60"	156.45	145.50	134.55	125.16
PE3200-XX	Any	Same-Day Shipment / Call for Pricing			

## 50 OHM, RG223/U COAX, DOUBLE SHIELDED

Model No.	Length	1-24	25-49	50-99	100 +
PE3190-12	12"	\$145.85	\$135.64	\$125.43	\$116.68
PE3190-24	24"	147.20	136.90	126.59	117.76
PE3190-36	36"	148.45	138.06	127.67	118.76
PE3190-48	48"	149.80	139.31	128.83	119.84
PE3190-60	60"	151.15	140.57	129.99	120.92
PE3190-XX	Any	Same-Day Shipment / Call for Pricing			

# GR874 TO BNC MALE



## 50 OHM, RG214/U COAX, DOUBLE SHIELDED

Model No.	Length	1-24	25-49	50-99	100 +
PE3145-12	12"	\$112.65	\$104.76	\$96.88	\$90.12
PE3145-24	24"	116.25	108.11	99.98	93.00
PE3145-36	36"	119.85	111.46	103.07	95.88
PE3145-48	48"	123.60	114.95	106.30	98.88
PE3145-60	60"	127.20	118.30	109.39	101.76
PE3145-XX	Any	Same-Day Shipment / Call for Pricing			

## 50 OHM, RG223/U COAX, DOUBLE SHIELDED

Model No.	Length	1-24	25-49	50-99	100 +
PE3182-12	12"	\$106.10	\$98.67	\$91.25	\$84.88
PE3182-24	24"	107.40	99.88	92.36	85.92
PE3182-36	36"	108.70	101.09	93.48	86.96
PE3182-48	48"	110.05	102.35	94.64	88.04
PE3182-60	60"	111.40	103.60	95.80	89.12
PE3182-XX	Any	Same-Day Shipment / Call for Pricing			

# GR874 TO N MALE



## 50 OHM, RG214/U COAX, DOUBLE SHIELDED

Model No.	Length	1-24	25-49	50-99	100 +
PE3133-12	12"	\$112.65	\$104.76	\$96.88	\$90.12
PE3133-24	24"	116.25	108.11	99.98	93.00
PE3133-36	36"	119.85	111.46	103.07	95.88
PE3133-48	48"	123.60	114.95	106.30	98.88
PE3133-60	60"	127.20	118.30	109.39	101.76
PE3133-XX	Any	Same-Day Shipment / Call for Pricing			

## 50 OHM, RG223/U COAX, DOUBLE SHIELDED

Model No.	Length	1-24	25-49	50-99	100 +
PE3170-12	12"	\$106.10	\$98.67	\$91.25	\$84.88
PE3170-24	24"	107.40	99.88	92.36	85.92
PE3170-36	36"	108.70	101.09	93.48	86.96
PE3170-48	48"	110.05	102.35	94.64	88.04
PE3170-60	60"	111.40	103.60	95.80	89.12
PE3170-XX	Any	Same-Day Shipment / Call for Pricing			

# SSMB PLUG TO SSMB PLUG



## 50 OHM, RG196A/U COAX

Model No.	Length	1-24	25-49	50-99	100 +
PE3122-12	12"	\$41.10	\$38.22	\$35.35	\$32.88
PE3122-24	24"	42.10	39.15	36.21	33.68
PE3122-36	36"	43.05	40.04	37.02	34.44
PE3122-48	48"	43.95	40.87	37.80	35.16
PE3122-60	60"	45.00	41.85	38.70	36.00
PE3122-XX	Any	Same-Day Shipment / Call for Pricing			

## 50 OHM, RG316/U COAX

Model No.	Length	1-24	25-49	50-99	100 +
PE3139-12	12"	\$39.80	\$37.01	\$34.23	\$31.84
PE3139-24	24"	40.75	37.90	35.05	32.60
PE3139-36	36"	41.70	38.78	35.86	33.36
PE3139-48	48"	42.70	39.71	36.72	34.16
PE3139-60	60"	43.60	40.55	37.50	34.88
PE3139-XX	Any	Same-Day Shipment / Call for Pricing			

# SSMB PLUG RIGHT ANGLE TO SSMB PLUG RIGHT ANGLE



## 50 OHM, RG196A/U COAX

Model No.	Length	1-24	25-49	50-99	100 +
PE3134-12	12"	\$47.70	\$44.36	\$41.02	\$38.16
PE3134-24	24"	48.70	45.29	41.88	38.96
PE3134-36	36"	49.65	46.17	42.70	39.72
PE3134-48	48"	50.60	47.06	43.52	40.48
PE3134-60	60"	51.55	47.94	44.33	41.24
PE3134-XX	Any	Same-Day Shipment / Call for Pricing			

## 50 OHM, RG316/U COAX

Model No.	Length	1-24	25-49	50-99	100 +
PE3157-12	12"	\$46.35	\$43.11	\$39.86	\$37.08
PE3157-24	24"	47.40	44.08	40.76	37.92
PE3157-36	36"	48.35	44.97	41.58	38.68
PE3157-48	48"	49.25	45.80	42.36	39.40
PE3157-60	60"	50.30	46.78	43.26	40.24
PE3157-XX	Any	Same-Day Shipment / Call for Pricing			

\*\*ROHS COMPLIANT & CUSTOM-LENGTH CABLE ASSEMBLIES MAY BE ORDERED ON OUR WEBSITE.\*\*

## MCX PLUG TO MCX PLUG



### 50 OHM, RG174A/U COAX

Model No.	Length	1-24	25-49	50-99	100 +
PE3295-12	12"	\$25.20	\$23.44	\$21.67	\$20.16
PE3295-24	24"	25.50	23.72	21.93	20.40
PE3295-36	36"	25.75	23.95	22.15	20.60
PE3295-48	48"	25.95	24.13	22.32	20.76
PE3295-60	60"	26.25	24.41	22.58	21.00
PE3295-XX	Any	Same-Day Shipment / Call for Pricing			

### 50 OHM, RG188A/U COAX

Model No.	Length	1-24	25-49	50-99	100 +
PE3290-12	12"	\$25.20	\$23.44	\$21.67	\$20.16
PE3290-24	24"	26.20	24.37	22.53	20.96
PE3290-36	36"	27.10	25.20	23.31	21.68
PE3290-48	48"	28.10	26.13	24.17	22.48
PE3290-60	60"	29.00	26.97	24.94	23.20
PE3290-XX	Any	Same-Day Shipment / Call for Pricing			

### 50 OHM, RG196A/U COAX

Model No.	Length	1-24	25-49	50-99	100 +
PE3293-12	12"	\$26.50	\$24.65	\$22.79	\$21.20
PE3293-24	24"	27.50	25.58	23.65	22.00
PE3293-36	36"	28.45	26.46	24.47	22.76
PE3293-48	48"	29.40	27.34	25.28	23.52
PE3293-60	60"	30.40	28.27	26.14	24.32
PE3293-XX	Any	Same-Day Shipment / Call for Pricing			

### 50 OHM, RG316/U COAX

Model No.	Length	1-24	25-49	50-99	100 +
PE3297-12	12"	\$25.20	\$23.44	\$21.67	\$20.16
PE3297-24	24"	26.20	24.37	22.53	20.96
PE3297-36	36"	27.10	25.20	23.31	21.68
PE3297-48	48"	28.10	26.13	24.17	22.48
PE3297-60	60"	29.00	26.97	24.94	23.20
PE3297-XX	Any	Same-Day Shipment / Call for Pricing			

## MCX PLUG RIGHT ANGLE TO MCX PLUG RIGHT ANGLE



### 50 OHM, RG174A/U COAX

Model No.	Length	1-24	25-49	50-99	100 +
PE3304-12	12"	\$34.50	\$32.09	\$29.67	\$27.60
PE3304-24	24"	34.75	32.32	29.89	27.80
PE3304-36	36"	35.00	32.55	30.10	28.00
PE3304-48	48"	35.25	32.78	30.32	28.20
PE3304-60	60"	35.55	33.06	30.57	28.44
PE3304-XX	Any	Same-Day Shipment / Call for Pricing			

### 50 OHM, RG188A/U COAX

Model No.	Length	1-24	25-49	50-99	100 +
PE3299-12	12"	\$34.50	\$32.09	\$29.67	\$27.60
PE3299-24	24"	35.45	32.97	30.49	28.36
PE3299-36	36"	36.40	33.85	31.30	29.12
PE3299-48	48"	37.40	34.78	32.16	29.92
PE3299-60	60"	38.30	35.62	32.94	30.64
PE3299-XX	Any	Same-Day Shipment / Call for Pricing			

### 50 OHM, RG196A/U COAX

Model No.	Length	1-24	25-49	50-99	100 +
PE3301-12	12"	\$35.80	\$33.29	\$30.79	\$28.64
PE3301-24	24"	36.75	34.18	31.61	29.40
PE3301-36	36"	37.75	35.11	32.47	30.20
PE3301-48	48"	38.65	35.94	33.24	30.92
PE3301-60	60"	39.70	36.92	34.14	31.76
PE3301-XX	Any	Same-Day Shipment / Call for Pricing			

### 50 OHM, RG316/U COAX

Model No.	Length	1-24	25-49	50-99	100 +
PE3306-12	12"	\$34.50	\$32.09	\$29.67	\$27.60
PE3306-24	24"	35.45	32.97	30.49	28.36
PE3306-36	36"	36.40	33.85	31.30	29.12
PE3306-48	48"	37.40	34.78	32.16	29.92
PE3306-60	60"	38.30	35.62	32.94	30.64
PE3306-XX	Any	Same-Day Shipment / Call for Pricing			

## MCX PLUG RIGHT ANGLE TO MCX PLUG



### 50 OHM, RG174A/U COAX

Model No.	Length	1-24	25-49	50-99	100 +
PE3314-12	12"	\$33.15	\$30.83	\$28.51	\$26.52
PE3314-24	24"	33.40	31.06	28.72	26.72
PE3314-36	36"	33.65	31.29	28.94	26.92
PE3314-48	48"	33.90	31.53	29.15	27.12
PE3314-60	60"	34.20	31.81	29.41	27.36
PE3314-XX	Any	Same-Day Shipment / Call for Pricing			

### 50 OHM, RG188A/U COAX

Model No.	Length	1-24	25-49	50-99	100 +
PE3309-12	12"	\$33.15	\$30.83	\$28.51	\$26.52
PE3309-24	24"	34.05	31.67	29.28	27.24
PE3309-36	36"	35.05	32.60	30.14	28.04
PE3309-48	48"	36.05	33.53	31.00	28.84
PE3309-60	60"	37.05	34.46	31.86	29.64
PE3309-XX	Any	Same-Day Shipment / Call for Pricing			

### 50 OHM, RG196A/U COAX

Model No.	Length	1-24	25-49	50-99	100 +
PE3311-12	12"	\$34.50	\$32.09	\$29.67	\$27.60
PE3311-24	24"	35.45	32.97	30.49	28.36
PE3311-36	36"	36.40	33.85	31.30	29.12
PE3311-48	48"	37.40	34.78	32.16	29.92
PE3311-60	60"	38.30	35.62	32.94	30.64
PE3311-XX	Any	Same-Day Shipment / Call for Pricing			

### 50 OHM, RG316/U COAX

Model No.	Length	1-24	25-49	50-99	100 +
PE3316-12	12"	\$33.15	\$30.83	\$28.51	\$26.52
PE3316-24	24"	34.05	31.67	29.28	27.24
PE3316-36	36"	35.05	32.60	30.14	28.04
PE3316-48	48"	36.05	33.53	31.00	28.84
PE3316-60	60"	37.05	34.46	31.86	29.64
PE3316-XX	Any	Same-Day Shipment / Call for Pricing			

\*\*ROHS COMPLIANT & CUSTOM-LENGTH CABLE ASSEMBLIES MAY BE ORDERED ON OUR WEBSITE.\*\*

Cable Assemblies

# 7/16 DIN MALE TO 7/16 DIN MALE

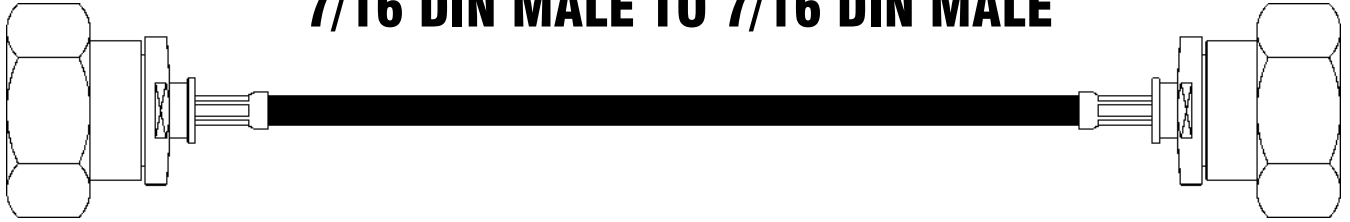

## 50 OHM, RG58C/U COAX

Model No.	Length	1-24	25-49	50-99	100 +
PE3183-12	12"	\$144.90	\$134.76	\$124.61	\$115.92
PE3183-24	24"	145.30	135.13	124.96	116.24
PE3183-36	36"	145.65	135.45	125.26	116.52
PE3183-48	48"	146.05	135.83	125.60	116.84
PE3183-60	60"	146.45	136.20	125.95	117.16
PE3183-XX	Any	Same-Day Shipment / Call for Pricing			

## 50 OHM, RG142B/U COAX, DOUBLE SHIELDED

Model No.	Length	1-24	25-49	50-99	100 +
PE3189-12	12"	\$148.35	\$137.97	\$127.58	\$118.68
PE3189-24	24"	151.05	140.48	129.90	120.84
PE3189-36	36"	153.65	142.89	132.14	122.92
PE3189-48	48"	156.35	145.41	134.46	125.08
PE3189-60	60"	158.95	147.82	136.70	127.16
PE3189-XX	Any	Same-Day Shipment / Call for Pricing			

## 50 OHM, RG213/U COAX

Model No.	Length	1-24	25-49	50-99	100 +
PE3199-12	12"	\$151.15	\$140.57	\$129.99	\$120.92
PE3199-24	24"	152.10	141.45	130.81	121.68
PE3199-36	36"	153.05	142.34	131.62	122.44
PE3199-48	48"	154.00	143.22	132.44	123.20
PE3199-60	60"	155.00	144.15	133.30	124.00
PE3199-XX	Any	Same-Day Shipment / Call for Pricing			

## 50 OHM, RG214/U COAX, DOUBLE SHIELDED

Model No.	Length	1-24	25-49	50-99	100 +
PE3185-12	12"	\$154.85	\$144.01	\$133.17	\$123.88
PE3185-24	24"	158.50	147.41	136.31	126.80
PE3185-36	36"	162.20	150.85	139.49	129.76
PE3185-48	48"	165.75	154.15	142.55	132.60
PE3185-60	60"	169.35	157.50	145.64	135.48
PE3185-XX	Any	Same-Day Shipment / Call for Pricing			

## 50 OHM, RG217/U COAX

Model No.	Length	1-24	25-49	50-99	100 +
PE36134-12	12"	\$206.15	\$191.72	\$177.29	\$164.92
PE36134-24	24"	208.55	193.95	179.35	166.84
PE36134-36	36"	210.95	196.18	181.42	168.76
PE36134-48	48"	213.35	198.42	183.48	170.68
PE36134-60	60"	215.75	200.65	185.55	172.60
PE36134-XX	Any	Same-Day Shipment / Call for Pricing			

## 50 OHM, RG218/U COAX

Model No.	Length	1-24	25-49	50-99	100 +
PE35900-12	12"	\$213.95	\$198.97	\$184.00	\$171.16
PE35900-24	24"	219.95	204.55	189.16	175.96
PE35900-36	36"	225.95	210.13	194.32	180.76
PE35900-48	48"	232.05	215.81	199.56	185.64
PE35900-60	60"	238.05	221.39	204.72	190.44
PE35900-XX	Any	Same-Day Shipment / Call for Pricing			

## 50 OHM, RG223/U COAX, DOUBLE SHIELDED

Model No.	Length	1-24	25-49	50-99	100 +
PE3192-12	12"	\$147.70	\$137.36	\$127.02	\$118.16
PE3192-24	24"	149.00	138.57	128.14	119.20
PE3192-36	36"	150.35	139.83	129.30	120.28
PE3192-48	48"	151.70	141.08	130.46	121.36
PE3192-60	60"	153.00	142.29	131.58	122.40
PE3192-XX	Any	Same-Day Shipment / Call for Pricing			

## 50 OHM, RG225/U COAX, DOUBLE SHIELDED

Model No.	Length	1-24	25-49	50-99	100 +
PE36136-12	12"	\$168.75	\$156.94	\$145.13	\$135.00
PE36136-24	24"	192.85	179.35	165.85	154.28
PE36136-36	36"	216.95	201.76	186.58	173.56
PE36136-48	48"	241.10	224.22	207.35	192.88
PE36136-60	60"	265.15	246.59	228.03	212.12
PE36136-XX	Any	Same-Day Shipment / Call for Pricing			

## 50 OHM, RG393/U COAX, DOUBLE SHIELDED

Model No.	Length	1-24	25-49	50-99	100 +
PE3205-12	12"	\$157.30	\$146.29	\$135.28	\$125.84
PE3205-24	24"	165.75	154.15	142.55	132.60
PE3205-36	36"	174.15	161.96	149.77	139.32
PE3205-48	48"	182.55	169.77	156.99	146.04
PE3205-60	60"	191.05	177.68	164.30	152.84
PE3205-XX	Any	Same-Day Shipment / Call for Pricing			

## 50 OHM, RG400/U COAX, DOUBLE SHIELDED

Model No.	Length	1-24	25-49	50-99	100 +
PE34360-12	12"	\$148.35	\$137.97	\$127.58	\$118.68
PE34360-24	24"	151.05	140.48	129.90	120.84
PE34360-36	36"	153.65	142.89	132.14	122.92
PE34360-48	48"	156.35	145.41	134.46	125.08
PE34360-60	60"	158.95	147.82	136.70	127.16
PE34360-XX	Any	Same-Day Shipment / Call for Pricing			

## 50 OHM, RG401/U (.250" BARE COPPER)

Model No.	Length	1-24	25-49	50-99	100 +
PE36138-12	12"	\$166.30	\$154.66	\$143.02	\$133.04
PE36138-24	24"	173.55	161.40	149.25	138.84
PE36138-36	36"	180.75	168.10	155.45	144.60
PE36138-48	48"	188.00	174.84	161.68	150.40
PE36138-60	60"	195.30	181.63	167.96	156.24
PE36138-XX	Any	Same-Day Shipment / Call for Pricing			

## 50 OHM, PE-SR401FL (.250" RE-SHAPEABLE)

Model No.	Length	1-24	25-49	50-99	100 +
PE36140-12	12"	\$168.75	\$156.94	\$145.13	\$135.00
PE36140-24	24"	176.00	163.68	151.36	140.80
PE36140-36	36"	183.30	170.47	157.64	146.64
PE36140-48	48"	190.50	177.17	163.83	152.40
PE36140-60	60"	197.70	183.86	170.02	158.16
PE36140-XX	Any	Same-Day Shipment / Call for Pricing			

## 50 OHM, RG402/U (.141" BARE COPPER)

Model No.	Length	1-24	25-49	50-99	100 +
PE36142-12	12"	\$164.55	\$153.03	\$141.51	\$131.64
PE36142-24	24"	168.15	156.38	144.61	134.52
PE36142-36	36"	171.70	159.68	147.66	137.36
PE36142-48	48"	175.35	163.08	150.80	140.28
PE36142-60	60"	178.95	166.42	153.90	143.16
PE36142-XX	Any	Same-Day Shipment / Call for Pricing			

## 50 OHM, PE-SR402FL (.141" RE-SHAPEABLE)

Model No.	Length	1-24	25-49	50-99	100 +
PE36144-12	12"	\$166.95	\$155.26	\$143.58	\$133.56
PE36144-24	24"	170.55	158.61	146.67	136.44
PE36144-36	36"	174.15	161.96	149.77	139.32
PE36144-48	48"	177.85	165.40	152.95	142.28
PE36144-60	60"	181.40	168.70	156.00	145.12
PE36144-XX	Any	Same-Day Shipment / Call for Pricing			

\*\*ROHS COMPLIANT & CUSTOM-LENGTH CABLE ASSEMBLIES MAY BE ORDERED ON OUR WEBSITE.\*\*

Cable Assemblies

# 7/16 DIN MALE TO N MALE



## 52 OHM, RG8A/U COAX

Model No.	Length	1-24	25-49	50-99	100 +
PE35284-12	12"	\$90.40	\$84.07	\$77.74	\$72.32
PE35284-24	24"	91.40	85.00	78.60	73.12
PE35284-36	36"	92.35	85.89	79.42	73.88
PE35284-48	48"	93.30	86.77	80.24	74.64
PE35284-60	60"	94.25	87.65	81.06	75.40
PE35284-XX	Any	Same-Day Shipment / Call for Pricing			

## 50 OHM, RG58C/U COAX

Model No.	Length	1-24	25-49	50-99	100 +
PE3207-12	12"	\$86.80	\$80.72	\$74.65	\$69.44
PE3207-24	24"	87.20	81.10	74.99	69.76
PE3207-36	36"	87.60	81.47	75.34	70.08
PE3207-48	48"	88.05	81.89	75.72	70.44
PE3207-60	60"	88.40	82.21	76.02	70.72
PE3207-XX	Any	Same-Day Shipment / Call for Pricing			

## 50 OHM, RG142B/U COAX, DOUBLE SHIELDED

Model No.	Length	1-24	25-49	50-99	100 +
PE3216-12	12"	\$86.80	\$80.72	\$74.65	\$69.44
PE3216-24	24"	89.40	83.14	76.88	71.52
PE3216-36	36"	92.10	85.65	79.21	73.68
PE3216-48	48"	94.75	88.12	81.49	75.80
PE3216-60	60"	97.40	90.58	83.76	77.92
PE3216-XX	Any	Same-Day Shipment / Call for Pricing			

## 50 OHM, RG213/U COAX

Model No.	Length	1-24	25-49	50-99	100 +
PE34098-12	12"	\$90.40	\$84.07	\$77.74	\$72.32
PE34098-24	24"	91.40	85.00	78.60	73.12
PE34098-36	36"	92.35	85.89	79.42	73.88
PE34098-48	48"	93.30	86.77	80.24	74.64
PE34098-60	60"	94.25	87.65	81.06	75.40
PE34098-XX	Any	Same-Day Shipment / Call for Pricing			

## 50 OHM, RG214/U COAX, DOUBLE SHIELDED

Model No.	Length	1-24	25-49	50-99	100 +
PE3218-12	12"	\$90.40	\$84.07	\$77.74	\$72.32
PE3218-24	24"	94.00	87.42	80.84	75.20
PE3218-36	36"	97.65	90.81	83.98	78.12
PE3218-48	48"	101.30	94.21	87.12	81.04
PE3218-60	60"	104.85	97.51	90.17	83.88
PE3218-XX	Any	Same-Day Shipment / Call for Pricing			

## 50 OHM, RG217/U COAX

Model No.	Length	1-24	25-49	50-99	100 +
PE36170-12	12"	\$108.50	\$100.91	\$93.31	\$86.80
PE36170-24	24"	110.80	103.04	95.29	88.64
PE36170-36	36"	113.30	105.37	97.44	90.64
PE36170-48	48"	115.65	107.55	99.46	92.52
PE36170-60	60"	118.05	109.79	101.52	94.44
PE36170-XX	Any	Same-Day Shipment / Call for Pricing			

## 50 OHM, RG218/U COAX

Model No.	Length	1-24	25-49	50-99	100 +
PE36172-12	12"	\$144.65	\$134.52	\$124.40	\$115.72
PE36172-24	24"	150.70	140.15	129.60	120.56
PE36172-36	36"	156.65	145.68	134.72	125.32
PE36172-48	48"	162.75	151.36	139.97	130.20
PE36172-60	60"	168.75	156.94	145.13	135.00
PE36172-XX	Any	Same-Day Shipment / Call for Pricing			

## 50 OHM, RG223/U COAX, DOUBLE SHIELDED

Model No.	Length	1-24	25-49	50-99	100 +
PE33144-12	12"	\$86.80	\$80.72	\$74.65	\$69.44
PE33144-24	24"	88.10	81.93	75.77	70.48
PE33144-36	36"	89.40	83.14	76.88	71.52
PE33144-48	48"	90.80	84.44	78.09	72.64
PE33144-60	60"	92.10	85.65	79.21	73.68
PE33144-XX	Any	Same-Day Shipment / Call for Pricing			

## 50 OHM, RG393/U COAX, DOUBLE SHIELDED

Model No.	Length	1-24	25-49	50-99	100 +
PE34357-12	12"	\$90.40	\$84.07	\$77.74	\$72.32
PE34357-24	24"	98.80	91.88	84.97	79.04
PE34357-36	36"	107.25	99.74	92.24	85.80
PE34357-48	48"	115.65	107.55	99.46	92.52
PE34357-60	60"	124.20	115.51	106.81	99.36
PE34357-XX	Any	Same-Day Shipment / Call for Pricing			

## 50 OHM, RG400/U COAX, DOUBLE SHIELDED

Model No.	Length	1-24	25-49	50-99	100 +
PE34359-12	12"	\$86.80	\$80.72	\$74.65	\$69.44
PE34359-24	24"	89.40	83.14	76.88	71.52
PE34359-36	36"	92.10	85.65	79.21	73.68
PE34359-48	48"	94.75	88.12	81.49	75.80
PE34359-60	60"	97.40	90.58	83.76	77.92
PE34359-XX	Any	Same-Day Shipment / Call for Pricing			

## 50 OHM, RG401/U (.250" BARE COPPER)

Model No.	Length	1-24	25-49	50-99	100 +
PE36174-12	12"	\$102.50	\$95.33	\$88.15	\$82.00
PE36174-24	24"	106.10	98.67	91.25	84.88
PE36174-36	36"	109.70	102.02	94.34	87.76
PE36174-48	48"	113.30	105.37	97.44	90.64
PE36174-60	60"	116.90	108.72	100.53	93.52
PE36174-XX	Any	Same-Day Shipment / Call for Pricing			

## 50 OHM, PE-SR401FL (.250" RE-SHAPEABLE)

Model No.	Length	1-24	25-49	50-99	100 +
PE36178-12	12"	\$104.85	\$97.51	\$90.17	\$83.88
PE36178-24	24"	108.50	100.91	93.31	86.80
PE36178-36	36"	112.10	104.25	96.41	89.68
PE36178-48	48"	115.65	107.55	99.46	92.52
PE36178-60	60"	119.30	110.95	102.60	95.44
PE36178-XX	Any	Same-Day Shipment / Call for Pricing			

## 50 OHM, RG402/U (.141" BARE COPPER)

Model No.	Length	1-24	25-49	50-99	100 +
PE35963-12	12"	\$102.50	\$95.33	\$88.15	\$82.00
PE35963-24	24"	106.10	98.67	91.25	84.88
PE35963-36	36"	109.70	102.02	94.34	87.76
PE35963-48	48"	113.30	105.37	97.44	90.64
PE35963-60	60"	116.90	108.72	100.53	93.52
PE35963-XX	Any	Same-Day Shipment / Call for Pricing			

## 50 OHM, PE-SR402FL (.141" RE-SHAPEABLE)

Model No.	Length	1-24	25-49	50-99	100 +
PE35965-12	12"	\$104.85	\$97.51	\$90.17	\$83.88
PE35965-24	24"	108.50	100.91	93.31	86.80
PE35965-36	36"	112.10	104.25	96.41	89.68
PE35965-48	48"	115.65	107.55	99.46	92.52
PE35965-60	60"	119.30	110.95	102.60	95.44
PE35965-XX	Any	Same-Day Shipment / Call for Pricing			

\*\*ROHS COMPLIANT & CUSTOM-LENGTH CABLE ASSEMBLIES MAY BE ORDERED ON OUR WEBSITE.\*\*

Cable Assemblies

# 7/16 DIN MALE TO SMA MALE



## 52 OHM, RG8A/U COAX

Model No.	Length	1-24	25-49	50-99	100 +
PE36157-12	12"	\$102.50	\$95.33	\$88.15	\$82.00
PE36157-24	24"	103.40	96.16	88.92	82.72
PE36157-36	36"	104.40	97.09	89.78	83.52
PE36157-48	48"	105.30	97.93	90.56	84.24
PE36157-60	60"	106.30	98.86	91.42	85.04
PE36157-XX	Any	Same-Day Shipment / Call for Pricing			

## 50 OHM, RG58C/U COAX

Model No.	Length	1-24	25-49	50-99	100 +
PE3221-12	12"	\$99.45	\$92.49	\$85.53	\$79.56
PE3221-24	24"	99.80	92.81	85.83	79.84
PE3221-36	36"	100.25	93.23	86.22	80.20
PE3221-48	48"	100.60	93.56	86.52	80.48
PE3221-60	60"	101.10	94.02	86.95	80.88
PE3221-XX	Any	Same-Day Shipment / Call for Pricing			

## 50 OHM, RG142B/U COAX, DOUBLE SHIELDED

Model No.	Length	1-24	25-49	50-99	100 +
PE3224-12	12"	\$99.45	\$92.49	\$85.53	\$79.56
PE3224-24	24"	102.10	94.95	87.81	81.68
PE3224-36	36"	104.75	97.42	90.09	83.80
PE3224-48	48"	107.40	99.88	92.36	85.92
PE3224-60	60"	110.05	102.35	94.64	88.04
PE3224-XX	Any	Same-Day Shipment / Call for Pricing			

## 50 OHM, RG213/U COAX

Model No.	Length	1-24	25-49	50-99	100 +
PE36159-12	12"	\$102.50	\$95.33	\$88.15	\$82.00
PE36159-24	24"	103.40	96.16	88.92	82.72
PE36159-36	36"	104.40	97.09	89.78	83.52
PE36159-48	48"	105.30	97.93	90.56	84.24
PE36159-60	60"	106.30	98.86	91.42	85.04
PE36159-XX	Any	Same-Day Shipment / Call for Pricing			

## 50 OHM, RG214/U COAX, DOUBLE SHIELDED

Model No.	Length	1-24	25-49	50-99	100 +
PE3233-12	12"	\$106.10	\$98.67	\$91.25	\$84.88
PE3233-24	24"	109.70	102.02	94.34	87.76
PE3233-36	36"	113.30	105.37	97.44	90.64
PE3233-48	48"	116.90	108.72	100.53	93.52
PE3233-60	60"	120.55	112.11	103.67	96.44
PE3233-XX	Any	Same-Day Shipment / Call for Pricing			

## 50 OHM, RG223/U COAX, DOUBLE SHIELDED

Model No.	Length	1-24	25-49	50-99	100 +
PE36161-12	12"	\$96.40	\$89.65	\$82.90	\$77.12
PE36161-24	24"	97.75	90.91	84.07	78.20
PE36161-36	36"	99.10	92.16	85.23	79.28
PE36161-48	48"	100.35	93.33	86.30	80.28
PE36161-60	60"	101.75	94.63	87.51	81.40
PE36161-XX	Any	Same-Day Shipment / Call for Pricing			

## 50 OHM, RG393/U COAX, DOUBLE SHIELDED

Model No.	Length	1-24	25-49	50-99	100 +
PE36163-12	12"	\$106.10	\$98.67	\$91.25	\$84.88
PE36163-24	24"	114.45	106.44	98.43	91.56
PE36163-36	36"	122.95	114.34	105.74	98.36
PE36163-48	48"	131.40	122.20	113.00	105.12
PE36163-60	60"	139.85	130.06	120.27	111.88
PE36163-XX	Any	Same-Day Shipment / Call for Pricing			

## 50 OHM, RG400/U COAX, DOUBLE SHIELDED

Model No.	Length	1-24	25-49	50-99	100 +
PE36165-12	12"	\$99.45	\$92.49	\$85.53	\$79.56
PE36165-24	24"	102.10	94.95	87.81	81.68
PE36165-36	36"	104.75	97.42	90.09	83.80
PE36165-48	48"	107.40	99.88	92.36	85.92
PE36165-60	60"	110.05	102.35	94.64	88.04
PE36165-XX	Any	Same-Day Shipment / Call for Pricing			

## 50 OHM, RG401/U (.250" BARE COPPER)

Model No.	Length	1-24	25-49	50-99	100 +
PE36167-12	12"	\$102.50	\$95.33	\$88.15	\$82.00
PE36167-24	24"	106.10	98.67	91.25	84.88
PE36167-36	36"	109.70	102.02	94.34	87.76
PE36167-48	48"	113.30	105.37	97.44	90.64
PE36167-60	60"	116.90	108.72	100.53	93.52
PE36167-XX	Any	Same-Day Shipment / Call for Pricing			

## 50 OHM, PE-SR401FL (.250" RE-SHAPEABLE)

Model No.	Length	1-24	25-49	50-99	100 +
PE36169-12	12"	\$104.85	\$97.51	\$90.17	\$83.88
PE36169-24	24"	108.50	100.91	93.31	86.80
PE36169-36	36"	112.10	104.25	96.41	89.68
PE36169-48	48"	115.65	107.55	99.46	92.52
PE36169-60	60"	119.30	110.95	102.60	95.44
PE36169-XX	Any	Same-Day Shipment / Call for Pricing			

## 50 OHM, RG402/U (.141" BARE COPPER)

Model No.	Length	1-24	25-49	50-99	100 +
PE36171-12	12"	\$102.50	\$95.33	\$88.15	\$82.00
PE36171-24	24"	106.10	98.67	91.25	84.88
PE36171-36	36"	109.70	102.02	94.34	87.76
PE36171-48	48"	113.30	105.37	97.44	90.64
PE36171-60	60"	116.90	108.72	100.53	93.52
PE36171-XX	Any	Same-Day Shipment / Call for Pricing			

## 50 OHM, PE-SR402FL (.141" RE-SHAPEABLE)

Model No.	Length	1-24	25-49	50-99	100 +
PE36173-12	12"	\$104.85	\$97.51	\$90.17	\$83.88
PE36173-24	24"	108.50	100.91	93.31	86.80
PE36173-36	36"	112.10	104.25	96.41	89.68
PE36173-48	48"	115.65	107.55	99.46	92.52
PE36173-60	60"	119.30	110.95	102.60	95.44
PE36173-XX	Any	Same-Day Shipment / Call for Pricing			

\*\*ROHS COMPLIANT & CUSTOM-LENGTH CABLE ASSEMBLIES MAY BE ORDERED ON OUR WEBSITE.\*\*

**NEW**

# LMR<sup>®</sup> EQUIVALENT CABLE ASSEMBLIES

The Pasternack Wireless Data jumper series is ideal where PIM (Passive Intermodulation Distortion) is a concern, such as WiFi or GSM base station applications. The connectors are low PIM designs and the coax has a lightweight, low-loss construction. The cables are fully interchangeable with standard 7/16 DIN jumpers.

## 7/16 DIN MALE TO 7/16 DIN MALE

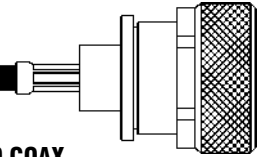
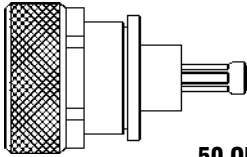

### 50 OHM, PE-T195 COAX

Model No.	Length	1-24	25-49	50-99	100 +
PE37952-36	36"	\$82.35	\$76.59	\$70.82	\$65.88
PE37952-48	48"	83.40	77.56	71.72	66.72
PE37952-60	60"	84.40	78.49	72.58	67.52
PE37952-72	72"	85.45	79.47	73.49	68.36
PE37952-120	120"	89.55	83.28	77.01	71.64
PE37940-XX	Any	Same-Day Shipment / See Website for Pricing			

### 50 OHM, PE-T240 COAX

Model No.	Length	1-24	25-49	50-99	100 +
PE37953-36	36"	\$87.50	\$81.38	\$75.25	\$70.00
PE37953-48	48"	88.75	82.54	76.33	71.00
PE37953-60	60"	89.95	83.65	77.36	71.96
PE37953-72	72"	91.20	84.82	78.43	72.96
PE37953-120	120"	96.15	89.42	82.69	76.92
PE37953-XX	Any	Same-Day Shipment / See Website for Pricing			

### 50 OHM, PE-T400 COAX

Model No.	Length	1-24	25-49	50-99	100 +
PE37954-36	36"	\$92.65	\$86.16	\$79.68	\$74.12
PE37954-48	48"	94.20	87.61	81.01	75.36
PE37954-60	60"	95.75	89.05	82.35	76.60
PE37954-72	72"	97.30	90.49	83.68	77.84
PE37954-120	120"	103.45	96.21	88.97	82.76
PE37954-XX	Any	Same-Day Shipment / See Website for Pricing			

### 50 OHM, PE-T600 COAX

Model No.	Length	1-24	25-49	50-99	100 +
PE37955-36	36"	\$102.95	\$95.74	\$88.54	\$82.36
PE37955-48	48"	106.05	98.63	91.20	84.84
PE37955-60	60"	109.15	101.51	93.87	87.32
PE37955-72	72"	112.20	104.35	96.49	89.76
PE37955-120	120"	124.60	115.88	107.16	99.68
PE37955-XX	Any	Same-Day Shipment / See Website for Pricing			

**Cable Assemblies**

## 7/16 DIN MALE TO 7/16 DIN MALE RIGHT ANGLE

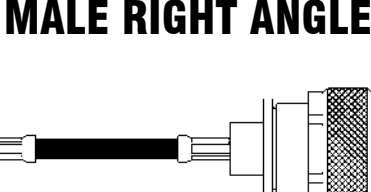
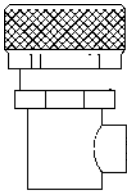

### 50 OHM, PE-T195 COAX

Model No.	Length	1-24	25-49	50-99	100 +
PE37956-36	36"	\$92.65	\$86.16	\$79.68	\$74.12
PE37956-48	48"	93.70	87.14	80.58	74.96
PE37956-60	60"	94.70	88.07	81.44	75.76
PE37956-72	72"	95.75	89.05	82.35	76.60
PE37956-120	120"	99.85	92.86	85.87	79.88
PE37956-XX	Any	Same-Day Shipment / See Website for Pricing			

### 50 OHM, PE-T240 COAX

Model No.	Length	1-24	25-49	50-99	100 +
PE37957-36	36"	\$97.80	\$90.95	\$84.11	\$78.24
PE37957-48	48"	99.05	92.12	85.18	79.24
PE37957-60	60"	100.25	93.23	86.22	80.20
PE37957-72	72"	101.50	94.40	87.29	81.20
PE37957-120	120"	107.70	100.16	92.62	86.16
PE37957-XX	Any	Same-Day Shipment / See Website for Pricing			

### 50 OHM, PE-T400 COAX

Model No.	Length	1-24	25-49	50-99	100 +
PE37958-36	36"	\$102.95	\$95.74	\$88.54	\$82.36
PE37958-48	48"	104.50	97.19	89.87	83.60
PE37958-60	60"	106.05	98.63	91.20	84.84
PE37958-72	72"	107.60	100.07	92.54	86.08
PE37958-120	120"	113.75	105.79	97.83	91.00
PE37958-XX	Any	Same-Day Shipment / See Website for Pricing			

### 50 OHM, PE-T600 COAX

Model No.	Length	1-24	25-49	50-99	100 +
PE37959-36	36"	\$118.40	\$110.11	\$101.82	\$94.72
PE37959-48	48"	121.50	113.00	104.49	97.20
PE37959-60	60"	124.60	115.88	107.16	99.68
PE37959-72	72"	127.65	118.71	109.78	102.12
PE37959-120	120"	140.05	130.25	120.44	112.04
PE37959-XX	Any	Same-Day Shipment / See Website for Pricing			

## 7/16 DIN MALE TO 7/16 DIN FEMALE

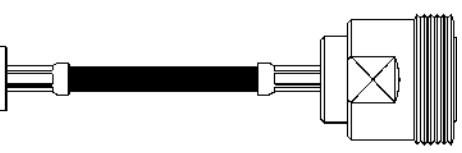
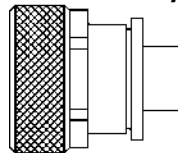

### 50 OHM, PE-T195 COAX

Model No.	Length	1-24	25-49	50-99	100 +
PE37960-36	36"	\$97.80	\$90.95	\$84.11	\$78.24
PE37960-48	48"	98.85	91.93	85.01	79.08
PE37960-60	60"	99.85	92.86	85.87	79.88
PE37960-72	72"	100.90	93.84	86.77	80.72
PE37960-120	120"	105.00	97.65	90.30	84.00
PE37960-XX	Any	Same-Day Shipment / See Website for Pricing			

### 50 OHM, PE-T240 COAX

Model No.	Length	1-24	25-49	50-99	100 +
PE37961-36	36"	\$92.65	\$86.16	\$79.68	\$74.12
PE37961-48	48"	93.90	87.33	80.75	75.12
PE37961-60	60"	95.10	88.44	81.79	76.08
PE37961-72	72"	96.35	89.61	82.86	77.08
PE37961-120	120"	101.30	94.21	87.12	81.04
PE37961-XX	Any	Same-Day Shipment / See Website for Pricing			

### 50 OHM, PE-T400 COAX

Model No.	Length	1-24	25-49	50-99	100 +
PE37962-36	36"	\$97.80	\$90.95	\$84.11	\$78.24
PE37962-48	48"	99.35	92.40	85.44	79.48
PE37962-60	60"	100.35	93.33	86.30	80.28
PE37962-72	72"	102.45	95.28	88.11	81.96
PE37962-120	120"	108.60	101.00	93.40	86.88
PE37962-XX	Any	Same-Day Shipment / See Website for Pricing			

### 50 OHM, PE-T600 COAX

Model No.	Length	1-24	25-49	50-99	100 +
PE37963-36	36"	\$113.25	\$105.32	\$97.40	\$90.60
PE37963-48	48"	116.35	108.21	100.06	93.08
PE37963-60	60"	119.45	111.09	102.73	95.56
PE37963-72	72"	122.50	113.93	105.35	98.00
PE37963-120	120"	134.90	125.46	116.01	107.92
PE37963-XX	Any	Same-Day Shipment / See Website for Pricing			

\*\*ROHS COMPLIANT & CUSTOM-LENGTH CABLE ASSEMBLIES MAY BE ORDERED ON OUR WEBSITE.\*\*



**NEW**

# LMR<sup>®</sup> EQUIVALENT CABLE ASSEMBLIES

The Pasternack Wireless Data jumper series is ideal where PIM (Passive Intermodulation Distortion) is a concern, such as WiFi or GSM base station applications. The connectors are low PIM designs and the coax has a lightweight, low-loss construction. The cables are fully interchangeable with standard Type N jumpers.

## N MALE TO N MALE

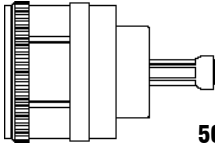

### 50 OHM, PE-T195 COAX

Model No.	Length	1-24	25-49	50-99	100 +
PE37940-36	36"	\$30.85	\$28.69	\$26.53	\$24.68
PE37940-48	48"	31.90	29.67	27.43	25.52
PE37940-60	60"	32.90	30.60	28.29	26.32
PE37940-72	72"	33.95	31.57	29.20	27.16
PE37940-120	120"	38.05	35.39	32.72	30.44
PE37940-XX	Any	Same-Day Shipment / See Website for Pricing			

### 50 OHM, PE-T240 COAX

Model No.	Length	1-24	25-49	50-99	100 +
PE37941-36	36"	\$37.05	\$34.46	\$31.86	\$29.64
PE37941-48	48"	38.25	35.57	32.90	30.60
PE37941-60	60"	39.50	36.74	33.97	31.60
PE37941-72	72"	40.75	37.90	35.05	32.60
PE37941-120	120"	45.70	42.50	39.30	36.56
PE37941-XX	Any	Same-Day Shipment / See Website for Pricing			

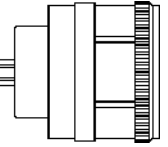

### 50 OHM, PE-T400 COAX

Model No.	Length	1-24	25-49	50-99	100 +
PE37942-36	36"	\$46.30	\$43.06	\$39.82	\$37.04
PE37942-48	48"	47.85	44.50	41.15	38.28
PE37942-60	60"	49.40	45.94	42.48	39.52
PE37942-72	72"	50.95	47.38	43.82	40.76
PE37942-120	120"	57.10	53.10	49.11	45.68
PE37942-XX	Any	Same-Day Shipment / See Website for Pricing			

### 50 OHM, PE-T600 COAX

Model No.	Length	1-24	25-49	50-99	100 +
PE37943-36	36"	\$72.05	\$67.01	\$61.96	\$57.64
PE37943-48	48"	75.15	69.89	64.63	60.12
PE37943-60	60"	78.25	72.77	67.30	62.60
PE37943-72	72"	81.30	75.61	69.92	65.04
PE37943-120	120"	93.70	87.14	80.58	74.96
PE37943-XX	Any	Same-Day Shipment / See Website for Pricing			

## N MALE TO N MALE RIGHT ANGLE



### 50 OHM, PE-T195 COAX

Model No.	Length	1-24	25-49	50-99	100 +
PE37944-36	36"	\$41.15	\$38.27	\$35.39	\$32.92
PE37944-48	48"	42.20	39.25	36.29	33.76
PE37944-60	60"	43.20	40.18	37.15	34.56
PE37944-72	72"	44.25	41.15	38.06	35.40
PE37944-120	120"	48.35	44.97	41.58	38.68
PE37944-XX	Any	Same-Day Shipment / See Website for Pricing			

### 50 OHM, PE-T240 COAX

Model No.	Length	1-24	25-49	50-99	100 +
PE37945-36	36"	\$47.35	\$44.04	\$40.72	\$37.88
PE37945-48	48"	48.55	45.15	41.75	38.84
PE37945-60	60"	49.80	46.31	42.83	39.84
PE37945-72	72"	51.05	47.48	43.90	40.84
PE37945-120	120"	56.00	52.08	48.16	44.80
PE37945-XX	Any	Same-Day Shipment / See Website for Pricing			

### 50 OHM, PE-T400 COAX

Model No.	Length	1-24	25-49	50-99	100 +
PE37946-36	36"	\$57.65	\$53.61	\$49.58	\$46.12
PE37946-48	48"	59.15	55.01	50.87	47.32
PE37946-60	60"	60.70	56.45	52.20	48.56
PE37946-72	72"	62.25	57.89	53.54	49.80
PE37946-120	120"	68.45	63.66	58.87	54.76
PE37946-XX	Any	Same-Day Shipment / See Website for Pricing			

### 50 OHM, PE-T600 COAX

Model No.	Length	1-24	25-49	50-99	100 +
PE37947-36	36"	\$82.35	\$76.59	\$70.82	\$65.88
PE37947-48	48"	85.45	79.47	73.49	68.36
PE37947-60	60"	88.55	82.35	76.15	70.84
PE37947-72	72"	91.60	85.19	78.78	73.28
PE37947-120	120"	104.00	96.72	89.44	83.20
PE37947-XX	Any	Same-Day Shipment / See Website for Pricing			

## N MALE TO N FEMALE



### 50 OHM, PE-T195 COAX

Model No.	Length	1-24	25-49	50-99	100 +
PE37948-36	36"	\$36.00	\$33.48	\$30.96	\$28.80
PE37948-48	48"	37.05	34.46	31.86	29.64
PE37948-60	60"	38.05	35.39	32.72	30.44
PE37948-72	72"	39.10	36.36	33.63	31.28
PE37948-120	120"	43.20	40.18	37.15	34.56
PE37948-XX	Any	Same-Day Shipment / See Website for Pricing			

### 50 OHM, PE-T240 COAX

Model No.	Length	1-24	25-49	50-99	100 +
PE37949-36	36"	\$42.20	\$39.25	\$36.29	\$33.76
PE37949-48	48"	43.40	40.36	37.32	34.72
PE37949-60	60"	44.65	41.52	38.40	35.72
PE37949-72	72"	45.90	42.69	39.47	36.72
PE37949-120	120"	50.85	47.29	43.73	40.68
PE37949-XX	Any	Same-Day Shipment / See Website for Pricing			

### 50 OHM, PE-T400 COAX

Model No.	Length	1-24	25-49	50-99	100 +
PE37950-36	36"	\$51.45	\$47.85	\$44.25	\$41.16
PE37950-48	48"	53.00	49.29	45.58	42.40
PE37950-60	60"	54.55	50.73	46.91	43.64
PE37950-72	72"	56.10	52.17	48.25	44.88
PE37950-120	120"	62.25	57.89	53.54	49.80
PE37950-XX	Any	Same-Day Shipment / See Website for Pricing			

### 50 OHM, PE-T600 COAX

Model No.	Length	1-24	25-49	50-99	100 +
PE37951-36	36"	\$77.20	\$71.80	\$66.39	\$61.76
PE37951-48	48"	80.30	74.68	69.06	64.24
PE37951-60	60"	83.40	77.56	71.72	66.72
PE37951-72	72"	86.45	80.40	74.35	69.16
PE37951-120	120"	98.85	91.93	85.01	79.08
PE37951-XX	Any	Same-Day Shipment / See Website for Pricing			

\*\*ROHS COMPLIANT & CUSTOM-LENGTH CABLE ASSEMBLIES MAY BE ORDERED ON OUR WEBSITE.\*\*

# MINI UHF MALE TO MINI UHF MALE

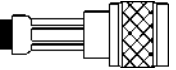
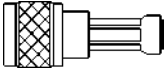

## 50 OHM, RG58C/U COAX

Model No.	Length	1-24	25-49	50-99	100 +
PE3258-12	12"	\$15.90	\$14.79	\$13.67	\$12.72
PE3258-24	24"	16.30	15.16	14.02	13.04
PE3258-36	36"	16.75	15.58	14.41	13.40
PE3258-48	48"	17.20	16.00	14.79	13.76
PE3258-60	60"	17.55	16.32	15.09	14.04
PE3258-XX	Any	Same-Day Shipment / Call for Pricing			

## 50 OHM, RG142B/U COAX, DOUBLE SHIELDED

Model No.	Length	1-24	25-49	50-99	100 +
PE3263-12	12"	\$21.20	\$19.72	\$18.23	\$16.96
PE3263-24	24"	23.85	22.18	20.51	19.08
PE3263-36	36"	26.50	24.65	22.79	21.20
PE3263-48	48"	29.15	27.11	25.07	23.32
PE3263-60	60"	31.80	29.57	27.35	25.44
PE3263-XX	Any	Same-Day Shipment / Call for Pricing			

## 50 OHM, RG223/U COAX, DOUBLE SHIELDED

Model No.	Length	1-24	25-49	50-99	100 +
PE3265-12	12"	\$21.20	\$19.72	\$18.23	\$16.96
PE3265-24	24"	22.50	20.93	19.35	18.00
PE3265-36	36"	23.85	22.18	20.51	19.08
PE3265-48	48"	25.20	23.44	21.67	20.16
PE3265-60	60"	26.50	24.65	22.79	21.20
PE3265-XX	Any	Same-Day Shipment / Call for Pricing			

## 50 OHM, RG400/U COAX, DOUBLE SHIELDED

Model No.	Length	1-24	25-49	50-99	100 +
PE3269-12	12"	\$21.20	\$19.72	\$18.23	\$16.96
PE3269-24	24"	23.85	22.18	20.51	19.08
PE3269-36	36"	26.50	24.65	22.79	21.20
PE3269-48	48"	29.15	27.11	25.07	23.32
PE3269-60	60"	31.80	29.57	27.35	25.44
PE3269-XX	Any	Same-Day Shipment / Call for Pricing			

Cable Assemblies

# MINI UHF MALE TO SMA MALE



## 50 OHM, RG58C/U COAX

Model No.	Length	1-24	25-49	50-99	100 +
PE3273-12	12"	\$26.50	\$24.65	\$22.79	\$21.20
PE3273-24	24"	26.95	25.06	23.18	21.56
PE3273-36	36"	27.35	25.44	23.52	21.88
PE3273-48	48"	27.75	25.81	23.87	22.20
PE3273-60	60"	28.15	26.18	24.21	22.52
PE3273-XX	Any	Same-Day Shipment / Call for Pricing			

## 50 OHM, RG142B/U COAX, DOUBLE SHIELDED

Model No.	Length	1-24	25-49	50-99	100 +
PE3275-12	12"	\$27.85	\$25.90	\$23.95	\$22.28
PE3275-24	24"	30.50	28.37	26.23	24.40
PE3275-36	36"	33.15	30.83	28.51	26.52
PE3275-48	48"	35.80	33.29	30.79	28.64
PE3275-60	60"	38.40	35.71	33.02	30.72
PE3275-XX	Any	Same-Day Shipment / Call for Pricing			

## 50 OHM, RG223/U COAX, DOUBLE SHIELDED

Model No.	Length	1-24	25-49	50-99	100 +
PE3271-12	12"	\$26.50	\$24.65	\$22.79	\$21.20
PE3271-24	24"	27.85	25.90	23.95	22.28
PE3271-36	36"	29.15	27.11	25.07	23.32
PE3271-48	48"	30.50	28.37	26.23	24.40
PE3271-60	60"	31.80	29.57	27.35	25.44
PE3271-XX	Any	Same-Day Shipment / Call for Pricing			

## 50 OHM, RG400/U COAX, DOUBLE SHIELDED

Model No.	Length	1-24	25-49	50-99	100 +
PE3278-12	12"	\$27.85	\$25.90	\$23.95	\$22.28
PE3278-24	24"	30.50	28.37	26.23	24.40
PE3278-36	36"	33.15	30.83	28.51	26.52
PE3278-48	48"	35.80	33.29	30.79	28.64
PE3278-60	60"	38.40	35.71	33.02	30.72
PE3278-XX	Any	Same-Day Shipment / Call for Pricing			

# MINI UHF MALE TO N MALE



## 50 OHM, RG58C/U COAX

Model No.	Length	1-24	25-49	50-99	100 +
PE3282-12	12"	\$26.50	\$24.65	\$22.79	\$21.20
PE3282-24	24"	26.95	25.06	23.18	21.56
PE3282-36	36"	27.35	25.44	23.52	21.88
PE3282-48	48"	27.75	25.81	23.87	22.20
PE3282-60	60"	28.15	26.18	24.21	22.52
PE3282-XX	Any	Same-Day Shipment / Call for Pricing			

## 50 OHM, RG142B/U COAX, DOUBLE SHIELDED

Model No.	Length	1-24	25-49	50-99	100 +
PE3285-12	12"	\$27.85	\$25.90	\$23.95	\$22.28
PE3285-24	24"	30.50	28.37	26.23	24.40
PE3285-36	36"	33.15	30.83	28.51	26.52
PE3285-48	48"	35.80	33.29	30.79	28.64
PE3285-60	60"	38.40	35.71	33.02	30.72
PE3285-XX	Any	Same-Day Shipment / Call for Pricing			

## 50 OHM, RG223/U COAX, DOUBLE SHIELDED

Model No.	Length	1-24	25-49	50-99	100 +
PE3280-12	12"	\$26.50	\$24.65	\$22.79	\$21.20
PE3280-24	24"	27.85	25.90	23.95	22.28
PE3280-36	36"	29.15	27.11	25.07	23.32
PE3280-48	48"	30.50	28.37	26.23	24.40
PE3280-60	60"	31.80	29.57	27.35	25.44
PE3280-XX	Any	Same-Day Shipment / Call for Pricing			

## 50 OHM, RG400/U COAX, DOUBLE SHIELDED

Model No.	Length	1-24	25-49	50-99	100 +
PE3288-12	12"	\$27.85	\$25.90	\$23.95	\$22.28
PE3288-24	24"	30.50	28.37	26.23	24.40
PE3288-36	36"	33.15	30.83	28.51	26.52
PE3288-48	48"	35.80	33.29	30.79	28.64
PE3288-60	60"	38.40	35.71	33.02	30.72
PE3288-XX	Any	Same-Day Shipment / Call for Pricing			

\*\*ROHS COMPLIANT & CUSTOM-LENGTH CABLE ASSEMBLIES MAY BE ORDERED ON OUR WEBSITE.\*\*

# 75 OHM N MALE TO 75 OHM N MALE



## 75 OHM, RG6A/U COAX

Model No.	Length	1-24	25-49	50-99	100 +
PE3612-12	12"	\$42.45	\$39.48	\$36.51	\$33.96
PE3612-24	24"	43.40	40.36	37.32	34.72
PE3612-36	36"	44.35	41.25	38.14	35.48
PE3612-48	48"	45.30	42.13	38.96	36.24
PE3612-60	60"	46.25	43.01	39.78	37.00
PE3612-XX	Any	Same-Day Shipment / Call for Pricing			

## 75 OHM, RG11A/U COAX

Model No.	Length	1-24	25-49	50-99	100 +
PE3616-12	12"	\$47.70	\$44.36	\$41.02	\$38.16
PE3616-24	24"	48.70	45.29	41.88	38.96
PE3616-36	36"	49.65	46.17	42.70	39.72
PE3616-48	48"	50.60	47.06	43.52	40.48
PE3616-60	60"	51.55	47.94	44.33	41.24
PE3616-XX	Any	Same-Day Shipment / Call for Pricing			

## 75 OHM, RG59B/U COAX

Model No.	Length	1-24	25-49	50-99	100 +
PE3528-12	12"	\$43.75	\$40.69	\$37.63	\$35.00
PE3528-24	24"	44.10	41.01	37.93	35.28
PE3528-36	36"	44.55	41.43	38.31	35.64
PE3528-48	48"	45.00	41.85	38.70	36.00
PE3528-60	60"	45.40	42.22	39.04	36.32
PE3528-XX	Any	Same-Day Shipment / Call for Pricing			

## 75 OHM, RG179B/U COAX

Model No.	Length	1-24	25-49	50-99	100 +
PE3307-12	12"	\$49.05	\$45.62	\$42.18	\$39.24
PE3307-24	24"	50.05	46.55	43.04	40.04
PE3307-36	36"	50.95	47.38	43.82	40.76
PE3307-48	48"	52.00	48.36	44.72	41.60
PE3307-60	60"	52.90	49.20	45.49	42.32
PE3307-XX	Any	Same-Day Shipment / Call for Pricing			

## 75 OHM, RG187A/U COAX

Model No.	Length	1-24	25-49	50-99	100 +
PE3581-12	12"	\$49.05	\$45.62	\$42.18	\$39.24
PE3581-24	24"	50.05	46.55	43.04	40.04
PE3581-36	36"	50.95	47.38	43.82	40.76
PE3581-48	48"	52.00	48.36	44.72	41.60
PE3581-60	60"	52.90	49.20	45.49	42.32
PE3581-XX	Any	Same-Day Shipment / Call for Pricing			

## 75 OHM, RG216/U COAX

Model No.	Length	1-24	25-49	50-99	100 +
PE3618-12	12"	\$47.70	\$44.36	\$41.02	\$38.16
PE3618-24	24"	48.70	45.29	41.88	38.96
PE3618-36	36"	49.65	46.17	42.70	39.72
PE3618-48	48"	50.60	47.06	43.52	40.48
PE3618-60	60"	51.55	47.94	44.33	41.24
PE3618-XX	Any	Same-Day Shipment / Call for Pricing			

**WARNING: 75 OHM N CONNECTORS DO NOT MATE WITH STANDARD 50 OHM CONNECTORS. ALL 75 OHM BNC MALES ON THIS PAGE WILL MATE TO STANDARD 50 OHM BNC CONNECTORS.**

# 75 OHM N MALE TO 75 OHM BNC MALE



## 75 OHM, RG6A/U COAX

Model No.	Length	1-24	25-49	50-99	100 +
PE3341-12	12"	\$39.80	\$37.01	\$34.23	\$31.84
PE3341-24	24"	40.75	37.90	35.05	32.60
PE3341-36	36"	41.70	38.78	35.86	33.36
PE3341-48	48"	42.70	39.71	36.72	34.16
PE3341-60	60"	43.60	40.55	37.50	34.88
PE3341-XX	Any	Same-Day Shipment / Call for Pricing			

## 75 OHM, RG11A/U COAX

Model No.	Length	1-24	25-49	50-99	100+
PE3396-12	12"	\$43.75	\$40.69	\$37.63	\$35.00
PE3396-24	24"	44.75	41.62	38.49	35.80
PE3396-36	36"	45.65	42.45	39.26	36.52
PE3396-48	48"	46.70	43.43	40.16	37.36
PE3396-60	60"	47.60	44.27	40.94	38.08
PE3396-XX	Any	Same-Day Shipment / Call for Pricing			

## 75 OHM, RG59B/U COAX

Model No.	Length	1-24	25-49	50-99	100 +
PE33605-12	12"	\$37.15	\$34.55	\$31.95	\$29.72
PE33605-24	24"	37.55	34.92	32.29	30.04
PE33605-36	36"	37.95	35.29	32.64	30.36
PE33605-48	48"	38.35	35.67	32.98	30.68
PE33605-60	60"	38.70	35.99	33.28	30.96
PE33605-XX	Any	Same-Day Shipment / Call for Pricing			

## 75 OHM, RG179B/U COAX

Model No.	Length	1-24	25-49	50-99	100 +
PE3398-12	12"	\$41.10	\$38.22	\$35.35	\$32.88
PE3398-24	24"	42.10	39.15	36.21	33.68
PE3398-36	36"	43.05	40.04	37.02	34.44
PE3398-48	48"	43.95	40.87	37.80	35.16
PE3398-60	60"	45.00	41.85	38.70	36.00
PE3398-XX	Any	Same-Day Shipment / Call for Pricing			

## 75 OHM, RG187A/U COAX

Model No.	Length	1-24	25-49	50-99	100 +
PE3400-12	12"	\$41.10	\$38.22	\$35.35	\$32.88
PE3400-24	24"	42.10	39.15	36.21	33.68
PE3400-36	36"	43.05	40.04	37.02	34.44
PE3400-48	48"	43.95	40.87	37.80	35.16
PE3400-60	60"	45.00	41.85	38.70	36.00
PE3400-XX	Any	Same-Day Shipment / Call for Pricing			

## 75 OHM, RG216/U COAX

Model No.	Length	1-24	25-49	50-99	100 +
PE3404-12	12"	\$43.75	\$40.69	\$37.63	\$35.00
PE3404-24	24"	44.75	41.62	38.49	35.80
PE3404-36	36"	45.65	42.45	39.26	36.52
PE3404-48	48"	46.70	43.43	40.16	37.36
PE3404-60	60"	47.60	44.27	40.94	38.08
PE3404-XX	Any	Same-Day Shipment / Call for Pricing			

\*\*ROHS COMPLIANT & CUSTOM-LENGTH CABLE ASSEMBLIES MAY BE ORDERED ON OUR WEBSITE.\*\*

# 75 OHM BNC MALE TO 75 OHM BNC MALE



## 75 OHM, RG6A/U COAX

Model No.	Length	1-24	25-49	50-99	100 +
PE33197-12	12"	\$29.15	\$27.11	\$25.07	\$23.32
PE33197-24	24"	30.15	28.04	25.93	24.12
PE33197-36	36"	31.10	28.92	26.75	24.88
PE33197-48	48"	32.10	29.85	27.61	25.68
PE33197-60	60"	33.00	30.69	28.38	26.40
PE33197-XX	Any	Same-Day Shipment / Call for Pricing			

## 75 OHM, RG11A/U COAX

Model No.	Length	1-24	25-49	50-99	100 +
PE33399-12	12"	\$33.15	\$30.83	\$28.51	\$26.52
PE33399-24	24"	34.05	31.67	29.28	27.24
PE33399-36	36"	35.05	32.60	30.14	28.04
PE33399-48	48"	36.05	33.53	31.00	28.84
PE33399-60	60"	37.05	34.46	31.86	29.64
PE33399-XX	Any	Same-Day Shipment / Call for Pricing			

## 75 OHM, RG59B/U COAX

Model No.	Length	1-24	25-49	50-99	100 +
PE33188-12	12"	\$26.50	\$24.65	\$22.79	\$21.20
PE33188-24	24"	26.95	25.06	23.18	21.56
PE33188-36	36"	27.35	25.44	23.52	21.88
PE33188-48	48"	27.75	25.81	23.87	22.20
PE33188-60	60"	28.15	26.18	24.21	22.52
PE33188-XX	Any	Same-Day Shipment / Call for Pricing			

## 75 OHM, RG179B/U COAX

Model No.	Length	1-24	25-49	50-99	100 +
PE33401-12	12"	\$26.50	\$24.65	\$22.79	\$21.20
PE33401-24	24"	27.50	25.58	23.65	22.00
PE33401-36	36"	28.45	26.46	24.47	22.76
PE33401-48	48"	29.40	27.34	25.28	23.52
PE33401-60	60"	30.40	28.27	26.14	24.32
PE33401-XX	Any	Same-Day Shipment / Call for Pricing			

## 75 OHM, RG216/U COAX

Model No.	Length	1-24	25-49	50-99	100 +
PE33403-12	12"	\$33.15	\$30.83	\$28.51	\$26.52
PE33403-24	24"	34.05	31.67	29.28	27.24
PE33403-36	36"	35.05	32.60	30.14	28.04
PE33403-48	48"	36.05	33.53	31.00	28.84
PE33403-60	60"	37.05	34.46	31.86	29.64
PE33403-XX	Any	Same-Day Shipment / Call for Pricing			

## 75 OHM, PE-B8128 COAX

Model No.	Length	1-24	25-49	50-99	100 +
PE33405-12	12"	\$26.50	\$24.65	\$22.79	\$21.20
PE33405-24	24"	27.10	25.20	23.31	21.68
PE33405-36	36"	27.70	25.76	23.82	22.16
PE33405-48	48"	28.30	26.32	24.34	22.64
PE33405-60	60"	28.90	26.88	24.85	23.12
PE33405-XX	Any	Same-Day Shipment / Call for Pricing			

# 75 OHM BNC MALE TO 75 OHM BNC MALE RIGHT ANGLE



## 75 OHM, RG6A/U COAX

Model No.	Length	1-24	25-49	50-99	100 +
PE33407-12	12"	\$39.80	\$37.01	\$34.23	\$31.84
PE33407-24	24"	40.75	37.90	35.05	32.60
PE33407-36	36"	41.70	38.78	35.86	33.36
PE33407-48	48"	42.70	39.71	36.72	34.16
PE33407-60	60"	43.60	40.55	37.50	34.88
PE33407-XX	Any	Same-Day Shipment / Call for Pricing			

## 75 OHM, RG11A/U COAX

Model No.	Length	1-24	25-49	50-99	100 +
PE33409-12	12"	\$43.75	\$40.69	\$37.63	\$35.00
PE33409-24	24"	44.75	41.62	38.49	35.80
PE33409-36	36"	45.65	42.45	39.26	36.52
PE33409-48	48"	46.70	43.43	40.16	37.36
PE33409-60	60"	47.60	44.27	40.94	38.08
PE33409-XX	Any	Same-Day Shipment / Call for Pricing			

## 75 OHM, RG59B/U COAX

Model No.	Length	1-24	25-49	50-99	100 +
PE33196-12	12"	\$37.15	\$34.55	\$31.95	\$29.72
PE33196-24	24"	37.55	34.92	32.29	30.04
PE33196-36	36"	37.95	35.29	32.64	30.36
PE33196-48	48"	38.35	35.67	32.98	30.68
PE33196-60	60"	38.70	35.99	33.28	30.96
PE33196-XX	Any	Same-Day Shipment / Call for Pricing			

## 75 OHM, RG179B/U COAX

Model No.	Length	1-24	25-49	50-99	100 +
PE33412-12	12"	\$41.10	\$38.22	\$35.35	\$32.88
PE33412-24	24"	42.10	39.15	36.21	33.68
PE33412-36	36"	43.05	40.04	37.02	34.44
PE33412-48	48"	43.95	40.87	37.80	35.16
PE33412-60	60"	45.00	41.85	38.70	36.00
PE33412-XX	Any	Same-Day Shipment / Call for Pricing			

## 75 OHM, RG187A/U COAX

Model No.	Length	1-24	25-49	50-99	100 +
PE33414-12	12"	\$41.10	\$38.22	\$35.35	\$32.88
PE33414-24	24"	42.10	39.15	36.21	33.68
PE33414-36	36"	43.05	40.04	37.02	34.44
PE33414-48	48"	43.95	40.87	37.80	35.16
PE33414-60	60"	45.00	41.85	38.70	36.00
PE33414-XX	Any	Same-Day Shipment / Call for Pricing			

## 75 OHM, RG216/U COAX

Model No.	Length	1-24	25-49	50-99	100 +
PE33416-12	12"	\$43.75	\$40.69	\$37.63	\$35.00
PE33416-24	24"	44.75	41.62	38.49	35.80
PE33416-36	36"	45.65	42.45	39.26	36.52
PE33416-48	48"	46.70	43.43	40.16	37.36
PE33416-60	60"	47.60	44.27	40.94	38.08
PE33416-XX	Any	Same-Day Shipment / Call for Pricing			

\*\*ROHS COMPLIANT & CUSTOM-LENGTH CABLE ASSEMBLIES MAY BE ORDERED ON OUR WEBSITE.\*\*

# 75 OHM BNC MALE RIGHT ANGLE TO 75 OHM BNC MALE RIGHT ANGLE



## 75 OHM, RG6A/U COAX

Model No.	Length	1-24	25-49	50-99	100 +
PE33426-12	12"	\$46.35	\$43.11	\$39.86	\$37.08
PE33426-24	24"	47.40	44.08	40.76	37.92
PE33426-36	36"	48.35	44.97	41.58	38.68
PE33426-48	48"	49.25	45.80	42.36	39.40
PE33426-60	60"	50.30	46.78	43.26	40.24
PE33426-XX	Any	Same-Day Shipment / Call for Pricing			

## 75 OHM, RG179B/U COAX

Model No.	Length	1-24	25-49	50-99	100 +
PE33432-12	12"	\$51.70	\$48.08	\$44.46	\$41.36
PE33432-24	24"	52.70	49.01	45.32	42.16
PE33432-36	36"	53.65	49.89	46.14	42.92
PE33432-48	48"	54.55	50.73	46.91	43.64
PE33432-60	60"	55.60	51.71	47.82	44.48
PE33432-XX	Any	Same-Day Shipment / Call for Pricing			

## 75 OHM, RG11A/U COAX

Model No.	Length	1-24	25-49	50-99	100 +
PE33428-12	12"	\$50.40	\$46.87	\$43.34	\$40.32
PE33428-24	24"	51.30	47.71	44.12	41.04
PE33428-36	36"	52.35	48.69	45.02	41.88
PE33428-48	48"	53.30	49.57	45.84	42.64
PE33428-60	60"	54.25	50.45	46.66	43.40
PE33428-XX	Any	Same-Day Shipment / Call for Pricing			

## 75 OHM, RG187A/U COAX

Model No.	Length	1-24	25-49	50-99	100 +
PE33434-12	12"	\$51.70	\$48.08	\$44.46	\$41.36
PE33434-24	24"	52.70	49.01	45.32	42.16
PE33434-36	36"	53.65	49.89	46.14	42.92
PE33434-48	48"	54.55	50.73	46.91	43.64
PE33434-60	60"	55.60	51.71	47.82	44.48
PE33434-XX	Any	Same-Day Shipment / Call for Pricing			

## 75 OHM, RG59B/U COAX

Model No.	Length	1-24	25-49	50-99	100 +
PE33430-12	12"	\$47.70	\$44.36	\$41.02	\$38.16
PE33430-24	24"	48.20	44.83	41.45	38.56
PE33430-36	36"	48.55	45.15	41.75	38.84
PE33430-48	48"	48.95	45.52	42.10	39.16
PE33430-60	60"	49.35	45.90	42.44	39.48
PE33430-XX	Any	Same-Day Shipment / Call for Pricing			

## 75 OHM, RG216/U COAX

Model No.	Length	1-24	25-49	50-99	100 +
PE33436-12	12"	\$50.40	\$46.87	\$43.34	\$40.32
PE33436-24	24"	51.30	47.71	44.12	41.04
PE33436-36	36"	52.35	48.69	45.02	41.88
PE33436-48	48"	53.30	49.57	45.84	42.64
PE33436-60	60"	54.25	50.45	46.66	43.40
PE33436-XX	Any	Same-Day Shipment / Call for Pricing			

# 75 OHM BNC MALE TO 75 OHM BNC FEMALE BULKHEAD



USE MOUNTING HOLE B06 ON PAGE 266

## 75 OHM, RG6A/U COAX

Model No.	Length	1-24	25-49	50-99	100 +
PE33417-12	12"	\$42.45	\$39.48	\$36.51	\$33.96
PE33417-24	24"	43.40	40.36	37.32	34.72
PE33417-36	36"	44.35	41.25	38.14	35.48
PE33417-48	48"	45.30	42.13	38.96	36.24
PE33417-60	60"	46.25	43.01	39.78	37.00
PE33417-XX	Any	Same-Day Shipment / Call for Pricing			

## 75 OHM, RG179B/U COAX

Model No.	Length	1-24	25-49	50-99	100 +
PE33421-12	12"	\$49.05	\$45.62	\$42.18	\$39.24
PE33421-24	24"	50.05	46.55	43.04	40.04
PE33421-36	36"	50.95	47.38	43.82	40.76
PE33421-48	48"	52.00	48.36	44.72	41.60
PE33421-60	60"	52.90	49.20	45.49	42.32
PE33421-XX	Any	Same-Day Shipment / Call for Pricing			

## 75 OHM, RG11A/U COAX

Model No.	Length	1-24	25-49	50-99	100 +
PE33419-12	12"	\$47.70	\$44.36	\$41.02	\$38.16
PE33419-24	24"	48.70	45.29	41.88	38.96
PE33419-36	36"	49.65	46.17	42.70	39.72
PE33419-48	48"	50.60	47.06	43.52	40.48
PE33419-60	60"	51.55	47.94	44.33	41.24
PE33419-XX	Any	Same-Day Shipment / Call for Pricing			

## 75 OHM, RG216/U COAX

Model No.	Length	1-24	25-49	50-99	100 +
PE33423-12	12"	\$47.70	\$44.36	\$41.02	\$38.16
PE33423-24	24"	48.70	45.29	41.88	38.96
PE33423-36	36"	49.65	46.17	42.70	39.72
PE33423-48	48"	50.60	47.06	43.52	40.48
PE33423-60	60"	51.55	47.94	44.33	41.24
PE33423-XX	Any	Same-Day Shipment / Call for Pricing			

## 75 OHM, RG59B/U COAX

Model No.	Length	1-24	25-49	50-99	100 +
PE33179-12	12"	\$43.75	\$40.69	\$37.63	\$35.00
PE33179-24	24"	44.10	41.01	37.93	35.28
PE33179-36	36"	44.55	41.43	38.31	35.64
PE33179-48	48"	45.00	41.85	38.70	36.00
PE33179-60	60"	45.40	42.22	39.04	36.32
PE33179-XX	Any	Same-Day Shipment / Call for Pricing			

## 75 OHM, PE-B8128 COAX

Model No.	Length	1-24	25-49	50-99	100 +
PE33425-12	12"	\$46.35	\$43.11	\$39.86	\$37.08
PE33425-24	24"	47.00	43.71	40.42	37.60
PE33425-36	36"	47.60	44.27	40.94	38.08
PE33425-48	48"	48.25	44.87	41.50	38.60
PE33425-60	60"	48.80	45.38	41.97	39.04
PE33425-XX	Any	Same-Day Shipment / Call for Pricing			

\*\*ROHS COMPLIANT & CUSTOM-LENGTH CABLE ASSEMBLIES MAY BE ORDERED ON OUR WEBSITE.\*\*

# 75 OHM BNC MALE TO 75 OHM BNC FEMALE



## 75 OHM, RG6A/U COAX

Model No.	Length	1-24	25-49	50-99	100 +
PE33437-12	12"	\$41.10	\$38.22	\$35.35	\$32.88
PE33437-24	24"	42.10	39.15	36.21	33.68
PE33437-36	36"	43.05	40.04	37.02	34.44
PE33437-48	48"	43.95	40.87	37.80	35.16
PE33437-60	60"	45.00	41.85	38.70	36.00
PE33437-XX	Any	Same-Day Shipment / Call for Pricing			

## 75 OHM, RG11A/U COAX

Model No.	Length	1-24	25-49	50-99	100 +
PE33439-12	12"	\$46.35	\$43.11	\$39.86	\$37.08
PE33439-24	24"	47.40	44.08	40.76	37.92
PE33439-36	36"	48.35	44.97	41.58	38.68
PE33439-48	48"	49.25	45.80	42.36	39.40
PE33439-60	60"	50.30	46.78	43.26	40.24
PE33439-XX	Any	Same-Day Shipment / Call for Pricing			

## 75 OHM, RG59B/U COAX

Model No.	Length	1-24	25-49	50-99	100 +
PE33441-12	12"	\$42.45	\$39.48	\$36.51	\$33.96
PE33441-24	24"	42.85	39.85	36.85	34.28
PE33441-36	36"	43.25	40.22	37.20	34.60
PE33441-48	48"	43.65	40.59	37.54	34.92
PE33441-60	60"	44.00	40.92	37.84	35.20
PE33441-XX	Any	Same-Day Shipment / Call for Pricing			

## 75 OHM, RG179B/U COAX

Model No.	Length	1-24	25-49	50-99	100 +
PE33443-12	12"	\$46.35	\$43.11	\$39.86	\$37.08
PE33443-24	24"	47.40	44.08	40.76	37.92
PE33443-36	36"	48.35	44.97	41.58	38.68
PE33443-48	48"	49.25	45.80	42.36	39.40
PE33443-60	60"	50.30	46.78	43.26	40.24
PE33443-XX	Any	Same-Day Shipment / Call for Pricing			

## 75 OHM, RG187A/U COAX

Model No.	Length	1-24	25-49	50-99	100 +
PE33445-12	12"	\$46.35	\$43.11	\$39.86	\$37.08
PE33445-24	24"	47.40	44.08	40.76	37.92
PE33445-36	36"	48.35	44.97	41.58	38.68
PE33445-48	48"	49.25	45.80	42.36	39.40
PE33445-60	60"	50.30	46.78	43.26	40.24
PE33445-XX	Any	Same-Day Shipment / Call for Pricing			

## 75 OHM, RG216/U COAX

Model No.	Length	1-24	25-49	50-99	100 +
PE33447-12	12"	\$46.35	\$43.11	\$39.86	\$37.08
PE33447-24	24"	47.40	44.08	40.76	37.92
PE33447-36	36"	48.35	44.97	41.58	38.68
PE33447-48	48"	49.25	45.80	42.36	39.40
PE33447-60	60"	50.30	46.78	43.26	40.24
PE33447-XX	Any	Same-Day Shipment / Call for Pricing			

Cable Assemblies

# 75 OHM BNC FEMALE TO 75 OHM BNC FEMALE



## 75 OHM, RG6A/U COAX

Model No.	Length	1-24	25-49	50-99	100 +
PE33448-12	12"	\$42.45	\$39.48	\$36.51	\$33.96
PE33448-24	24"	43.40	40.36	37.32	34.72
PE33448-36	36"	44.35	41.25	38.14	35.48
PE33448-48	48"	45.30	42.13	38.96	36.24
PE33448-60	60"	46.25	43.01	39.78	37.00
PE33448-XX	Any	Same-Day Shipment / Call for Pricing			

## 75 OHM, RG11A/U COAX

Model No.	Length	1-24	25-49	50-99	100 +
PE33450-12	12"	\$47.70	\$44.36	\$41.02	\$38.16
PE33450-24	24"	48.70	45.29	41.88	38.96
PE33450-36	36"	49.65	46.17	42.70	39.72
PE33450-48	48"	50.60	47.06	43.52	40.48
PE33450-60	60"	51.55	47.94	44.33	41.24
PE33450-XX	Any	Same-Day Shipment / Call for Pricing			

## 75 OHM, RG59B/U COAX

Model No.	Length	1-24	25-49	50-99	100 +
PE33452-12	12"	\$43.75	\$40.69	\$37.63	\$35.00
PE33452-24	24"	44.10	41.01	37.93	35.28
PE33452-36	36"	44.55	41.43	38.31	35.64
PE33452-48	48"	45.00	41.85	38.70	36.00
PE33452-60	60"	45.40	42.22	39.04	36.32
PE33452-XX	Any	Same-Day Shipment / Call for Pricing			

## 75 OHM, RG179B/U COAX

Model No.	Length	1-24	25-49	50-99	100 +
PE33451-12	12"	\$49.05	\$45.62	\$42.18	\$39.24
PE33451-24	24"	50.05	46.55	43.04	40.04
PE33451-36	36"	50.95	47.38	43.82	40.76
PE33451-48	48"	52.00	48.36	44.72	41.60
PE33451-60	60"	52.90	49.20	45.49	42.32
PE33451-XX	Any	Same-Day Shipment / Call for Pricing			

## 75 OHM, RG187A/U COAX

Model No.	Length	1-24	25-49	50-99	100 +
PE33456-12	12"	\$49.05	\$45.62	\$42.18	\$39.24
PE33456-24	24"	50.05	46.55	43.04	40.04
PE33456-36	36"	50.95	47.38	43.82	40.76
PE33456-48	48"	52.00	48.36	44.72	41.60
PE33456-60	60"	52.90	49.20	45.49	42.32
PE33456-XX	Any	Same-Day Shipment / Call for Pricing			

## 75 OHM, RG216/U COAX

Model No.	Length	1-24	25-49	50-99	100 +
PE33458-12	12"	\$47.70	\$44.36	\$41.02	\$38.16
PE33458-24	24"	48.70	45.29	41.88	38.96
PE33458-36	36"	49.65	46.17	42.70	39.72
PE33458-48	48"	50.60	47.06	43.52	40.48
PE33458-60	60"	51.55	47.94	44.33	41.24
PE33458-XX	Any	Same-Day Shipment / Call for Pricing			

\*\*ROHS COMPLIANT & CUSTOM-LENGTH CABLE ASSEMBLIES MAY BE ORDERED ON OUR WEBSITE.\*\*

# TNC MALE TO TNC MALE

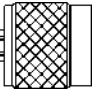

ALL CABLE ASSEMBLIES ON THIS PAGE UTILIZE STANDARD 50 OHM INTERFACE CONNECTORS

## 52 OHM, RG8A/U COAX

Model No.	Length	1-24	25-49	50-99	100 +
PE3418-12	12"	\$51.70	\$48.08	\$44.46	\$41.36
PE3418-24	24"	52.70	49.01	45.32	42.16
PE3418-36	36"	53.65	49.89	46.14	42.92
PE3418-48	48"	54.55	50.73	46.91	43.64
PE3418-60	60"	55.60	51.71	47.82	44.48
PE3418-XX	Any	Same-Day Shipment / Call for Pricing			

## 75 OHM, RG179B/U COAX

Model No.	Length	1-24	25-49	50-99	100 +
PE3430-12	12"	\$27.85	\$25.90	\$23.95	\$22.28
PE3430-24	24"	28.75	26.74	24.73	23.00
PE3430-36	36"	29.80	27.71	25.63	23.84
PE3430-48	48"	30.75	28.60	26.45	24.60
PE3430-60	60"	31.70	29.48	27.26	25.36
PE3430-XX	Any	Same-Day Shipment / Call for Pricing			

## 53.5 OHM, RG55B/U COAX, DOUBLE SHIELDED

Model No.	Length	1-24	25-49	50-99	100 +
PE3504-12	12"	\$26.50	\$24.65	\$22.79	\$21.20
PE3504-24	24"	27.25	25.34	23.44	21.80
PE3504-36	36"	28.00	26.04	24.08	22.40
PE3504-48	48"	28.65	26.64	24.64	22.92
PE3504-60	60"	29.40	27.34	25.28	23.52
PE3504-XX	Any	Same-Day Shipment / Call for Pricing			

## 50 OHM, RG188A/U COAX

Model No.	Length	1-24	25-49	50-99	100 +
PE3434-12	12"	\$27.85	\$25.90	\$23.95	\$22.28
PE3434-24	24"	28.75	26.74	24.73	23.00
PE3434-36	36"	29.80	27.71	25.63	23.84
PE3434-48	48"	30.75	28.60	26.45	24.60
PE3434-60	60"	31.70	29.48	27.26	25.36
PE3434-XX	Any	Same-Day Shipment / Call for Pricing			

## 50 OHM, RG58C/U COAX

Model No.	Length	1-24	25-49	50-99	100 +
PE3394-12	12"	\$22.50	\$20.93	\$19.35	\$18.00
PE3394-24	24"	22.95	21.34	19.74	18.36
PE3394-36	36"	23.30	21.67	20.04	18.64
PE3394-48	48"	23.75	22.09	20.43	19.00
PE3394-60	60"	24.10	22.41	20.73	19.28
PE3394-XX	Any	Same-Day Shipment / Call for Pricing			

## 50 OHM, RG213/U COAX

Model No.	Length	1-24	25-49	50-99	100 +
PE3421-12	12"	\$51.70	\$48.08	\$44.46	\$41.36
PE3421-24	24"	52.70	49.01	45.32	42.16
PE3421-36	36"	53.65	49.89	46.14	42.92
PE3421-48	48"	54.55	50.73	46.91	43.64
PE3421-60	60"	55.60	51.71	47.82	44.48
PE3421-XX	Any	Same-Day Shipment / Call for Pricing			

## 75 OHM, RG59B/U COAX

Model No.	Length	1-24	25-49	50-99	100 +
PE3402-12	12"	\$22.50	\$20.93	\$19.35	\$18.00
PE3402-24	24"	22.95	21.34	19.74	18.36
PE3402-36	36"	23.30	21.67	20.04	18.64
PE3402-48	48"	23.75	22.09	20.43	19.00
PE3402-60	60"	24.10	22.41	20.73	19.28
PE3402-XX	Any	Same-Day Shipment / Call for Pricing			

## 50 OHM, RG214/U COAX, DOUBLE SHIELDED

Model No.	Length	1-24	25-49	50-99	100 +
PE3435-12	12"	\$51.70	\$48.08	\$44.46	\$41.36
PE3435-24	24"	55.35	51.48	47.60	44.28
PE3435-36	36"	58.95	54.82	50.70	47.16
PE3435-48	48"	62.60	58.22	53.84	50.08
PE3435-60	60"	66.20	61.57	56.93	52.96
PE3435-XX	Any	Same-Day Shipment / Call for Pricing			

## 93 OHM, RG62A/U COAX

Model No.	Length	1-24	25-49	50-99	100 +
PE3408-12	12"	\$25.20	\$23.44	\$21.67	\$20.16
PE3408-24	24"	25.60	23.81	22.02	20.48
PE3408-36	36"	26.00	24.18	22.36	20.80
PE3408-48	48"	26.40	24.55	22.70	21.12
PE3408-60	60"	26.85	24.97	23.09	21.48
PE3408-XX	Any	Same-Day Shipment / Call for Pricing			

## 50 OHM, RG223/U COAX, DOUBLE SHIELDED

Model No.	Length	1-24	25-49	50-99	100 +
PE3414-12	12"	\$26.50	\$24.65	\$22.79	\$21.20
PE3414-24	24"	27.85	25.90	23.95	22.28
PE3414-36	36"	29.15	27.11	25.07	23.32
PE3414-48	48"	30.50	28.37	26.23	24.40
PE3414-60	60"	31.80	29.57	27.35	25.44
PE3414-XX	Any	Same-Day Shipment / Call for Pricing			

## 50 OHM, RG142B/U COAX, DOUBLE SHIELDED

Model No.	Length	1-24	25-49	50-99	100 +
PE3544-12	12"	\$26.50	\$24.65	\$22.79	\$21.20
PE3544-24	24"	29.15	27.11	25.07	23.32
PE3544-36	36"	31.80	29.57	27.35	25.44
PE3544-48	48"	34.50	32.09	29.67	27.60
PE3544-60	60"	37.15	34.55	31.95	29.72
PE3544-XX	Any	Same-Day Shipment / Call for Pricing			

## 50 OHM, RG316/U COAX

Model No.	Length	1-24	25-49	50-99	100 +
PE3747-12	12"	\$27.85	\$25.90	\$23.95	\$22.28
PE3747-24	24"	28.75	26.74	24.73	23.00
PE3747-36	36"	29.80	27.71	25.63	23.84
PE3747-48	48"	30.75	28.60	26.45	24.60
PE3747-60	60"	31.70	29.48	27.26	25.36
PE3747-XX	Any	Same-Day Shipment / Call for Pricing			

## 50 OHM, RG174A/U COAX

Model No.	Length	1-24	25-49	50-99	100 +
PE3425-12	12"	\$22.50	\$20.93	\$19.35	\$18.00
PE3425-24	24"	22.80	21.20	19.61	18.24
PE3425-36	36"	23.05	21.44	19.82	18.44
PE3425-48	48"	23.30	21.67	20.04	18.64
PE3425-60	60"	23.55	21.90	20.25	18.84
PE3425-XX	Any	Same-Day Shipment / Call for Pricing			

## 50 OHM, RG400/U COAX, DOUBLE SHIELDED

Model No.	Length	1-24	25-49	50-99	100 +
PE3608-12	12"	\$26.50	\$24.65	\$22.79	\$21.20
PE3608-24	24"	29.15	27.11	25.07	23.32
PE3608-36	36"	31.80	29.57	27.35	25.44
PE3608-48	48"	34.50	32.09	29.67	27.60
PE3608-60	60"	37.15	34.55	31.95	29.72
PE3608-XX	Any	Same-Day Shipment / Call for Pricing			

\*\*ROHS COMPLIANT & CUSTOM-LENGTH CABLE ASSEMBLIES MAY BE ORDERED ON OUR WEBSITE.\*\*

# SEMI-RIGID & RE-SHAPEABLE CABLE ASSEMBLIES

## TNC MALE TO TNC MALE



### 50 OHM, RG402/U (.141" BARE COPPER)

Model No.	Length	1-24	25-49	50-99	100 +
PE3074-12	12"	\$45.55	\$42.36	\$39.17	\$36.44
PE3074-24	24"	49.15	45.71	42.27	39.32
PE3074-36	36"	52.80	49.10	45.41	42.24
PE3074-48	48"	56.35	52.41	48.46	45.08
PE3074-60	60"	60.00	55.80	51.60	48.00
PE3074-XX	Any	Same-Day Shipment / Call for Pricing			

### 50 OHM, PE-SR402AL (.141" TINNED ALUMINUM)

Model No.	Length	1-24	25-49	50-99	100 +
PE34279-12	12"	\$50.85	\$47.29	\$43.73	\$40.68
PE34279-24	24"	54.45	50.64	46.83	43.56
PE34279-36	36"	58.10	54.03	49.97	46.48
PE34279-48	48"	61.65	57.33	53.02	49.32
PE34279-60	60"	65.30	60.73	56.16	52.24
PE34279-XX	Any	Same-Day Shipment / Call for Pricing			

### 50 OHM, PE-SR402FL (.141" RE-SHAPEABLE)

Model No.	Length	1-24	25-49	50-99	100 +
PE3466-12	12"	\$50.85	\$47.29	\$43.73	\$40.68
PE3466-24	24"	54.45	50.64	46.83	43.56
PE3466-36	36"	58.10	54.03	49.97	46.48
PE3466-48	48"	61.65	57.33	53.02	49.32
PE3466-60	60"	65.30	60.73	56.16	52.24
PE3466-XX	Any	Same-Day Shipment / Call for Pricing			

### 50 OHM, PE-047SR (.047" BARE COPPER)

Model No.	Length	1-24	25-49	50-99	100 +
PE34273-12	12"	\$54.85	\$51.01	\$47.17	\$43.88
PE34273-24	24"	58.45	54.36	50.27	46.76
PE34273-36	36"	62.00	57.66	53.32	49.60
PE34273-48	48"	65.70	61.10	56.50	52.56
PE34273-60	60"	69.30	64.45	59.60	55.44
PE34273-XX	Any	Same-Day Shipment / Call for Pricing			

### 50 OHM, PE-SR047AL (.047" TINNED ALUMINUM)

Model No.	Length	1-24	25-49	50-99	100 +
PE34277-12	12"	\$61.45	\$57.15	\$52.85	\$49.16
PE34277-24	24"	65.10	60.54	55.99	52.08
PE34277-36	36"	68.70	63.89	59.08	54.96
PE34277-48	48"	72.25	67.19	62.14	57.80
PE34277-60	60"	75.90	70.59	65.27	60.72
PE34277-XX	Any	Same-Day Shipment / Call for Pricing			

### 50 OHM, PE-SR047FL (.047" RE-SHAPEABLE)

Model No.	Length	1-24	25-49	50-99	100 +
PE34280-12	12"	\$61.45	\$57.15	\$52.85	\$49.16
PE34280-24	24"	65.10	60.54	55.99	52.08
PE34280-36	36"	68.70	63.89	59.08	54.96
PE34280-48	48"	72.25	67.19	62.14	57.80
PE34280-60	60"	75.90	70.59	65.27	60.72
PE34280-XX	Any	Same-Day Shipment / Call for Pricing			

### 50 OHM, RG405/U (.085" BARE COPPER)

Model No.	Length	1-24	25-49	50-99	100 +
PE33391-12	12"	\$46.90	\$43.62	\$40.33	\$37.52
PE33391-24	24"	50.50	46.97	43.43	40.40
PE33391-36	36"	54.10	50.31	46.53	43.28
PE33391-48	48"	57.75	53.71	49.67	46.20
PE33391-60	60"	61.35	57.06	52.76	49.08
PE33391-XX	Any	Same-Day Shipment / Call for Pricing			

### 50 OHM, PE-SR405AL (.085" TINNED ALUMINUM)

Model No.	Length	1-24	25-49	50-99	100 +
PE34284-12	12"	\$52.20	\$48.55	\$44.89	\$41.76
PE34284-24	24"	55.80	51.89	47.99	44.64
PE34284-36	36"	59.40	55.24	51.08	47.52
PE34284-48	48"	63.05	58.64	54.22	50.44
PE34284-60	60"	66.65	61.98	57.32	53.32
PE34284-XX	Any	Same-Day Shipment / Call for Pricing			

### 50 OHM, PE-SR405FL (.085" RE-SHAPEABLE)

Model No.	Length	1-24	25-49	50-99	100 +
PE3684-12	12"	\$52.20	\$48.55	\$44.89	\$41.76
PE3684-24	24"	55.80	51.89	47.99	44.64
PE3684-36	36"	59.40	55.24	51.08	47.52
PE3684-48	48"	63.05	58.64	54.22	50.44
PE3684-60	60"	66.65	61.98	57.32	53.32
PE3684-XX	Any	Same-Day Shipment / Call for Pricing			

### 50 OHM, RG401/U (.250" BARE COPPER)

Model No.	Length	1-24	25-49	50-99	100 +
PE34271-12	12"	\$69.90	\$65.01	\$60.11	\$55.92
PE34271-24	24"	77.15	71.75	66.35	61.72
PE34271-36	36"	84.35	78.45	72.54	67.48
PE34271-48	48"	91.60	85.19	78.78	73.28
PE34271-60	60"	98.80	91.88	84.97	79.04
PE34271-XX	Any	Same-Day Shipment / Call for Pricing			

### 50 OHM, PE-SR401AL (.250" TINNED ALUMINUM)

Model No.	Length	1-24	25-49	50-99	100 +
PE34275-12	12"	\$76.55	\$71.19	\$65.83	\$61.24
PE34275-24	24"	83.75	77.89	72.03	67.00
PE34275-36	36"	91.00	84.63	78.26	72.80
PE34275-48	48"	98.25	91.37	84.50	78.60
PE34275-60	60"	105.40	98.02	90.64	84.32
PE34275-XX	Any	Same-Day Shipment / Call for Pricing			

### 50 OHM, PE-SR401FL (.250" RE-SHAPEABLE)

Model No.	Length	1-24	25-49	50-99	100 +
PE34282-12	12"	\$76.55	\$71.19	\$65.83	\$61.24
PE34282-24	24"	83.75	77.89	72.03	67.00
PE34282-36	36"	91.00	84.63	78.26	72.80
PE34282-48	48"	98.25	91.37	84.50	78.60
PE34282-60	60"	105.40	98.02	90.64	84.32
PE34282-XX	Any	Same-Day Shipment / Call for Pricing			

\*\*ROHS COMPLIANT & CUSTOM-LENGTH CABLE ASSEMBLIES MAY BE ORDERED ON OUR WEBSITE.\*\*



# SMC PLUG TO SMC PLUG



**WARNING!!! ALL CONNECTORS ON THIS PAGE ARE "50 OHM SMC" CONNECTORS AND DO NOT MATE WITH "75 OHM SMC TYPE" CONNECTORS!!!**

## 50 OHM, RG58C/U COAX

Model No.	Length	1-24	25-49	50-99	100 +
PE33641-12	12"	\$34.50	\$32.09	\$29.67	\$27.60
PE33641-24	24"	34.85	32.41	29.97	27.88
PE33641-36	36"	35.30	32.83	30.36	28.24
PE33641-48	48"	35.70	33.20	30.70	28.56
PE33641-60	60"	36.15	33.62	31.09	28.92
PE33641-XX	Any	Same-Day Shipment / Call for Pricing			

## 50 OHM, RG142B/U COAX, DOUBLE SHIELDED

Model No.	Length	1-24	25-49	50-99	100 +
PE3490-12	12"	\$34.50	\$32.09	\$29.67	\$27.60
PE3490-24	24"	37.15	34.55	31.95	29.72
PE3490-36	36"	39.80	37.01	34.23	31.84
PE3490-48	48"	42.45	39.48	36.51	33.96
PE3490-60	60"	45.10	41.94	38.79	36.08
PE3490-XX	Any	Same-Day Shipment / Call for Pricing			

## 50 OHM, RG174A/U COAX

Model No.	Length	1-24	25-49	50-99	100 +
PE3883-12	12"	\$26.50	\$24.65	\$22.79	\$21.20
PE3883-24	24"	26.80	24.92	23.05	21.44
PE3883-36	36"	27.05	25.16	23.26	21.64
PE3883-48	48"	27.35	25.44	23.52	21.88
PE3883-60	60"	27.60	25.67	23.74	22.08
PE3883-XX	Any	Same-Day Shipment / Call for Pricing			

## 50 OHM, RG178B/U COAX

Model No.	Length	1-24	25-49	50-99	100 +
PE3902-12	12"	\$27.85	\$25.90	\$23.95	\$22.28
PE3902-24	24"	28.75	26.74	24.73	23.00
PE3902-36	36"	29.80	27.71	25.63	23.84
PE3902-48	48"	30.75	28.60	26.45	24.60
PE3902-60	60"	31.70	29.48	27.26	25.36
PE3902-XX	Any	Same-Day Shipment / Call for Pricing			

## 50 OHM, RG188A/U COAX

Model No.	Length	1-24	25-49	50-99	100 +
PE3595-12	12"	\$26.50	\$24.65	\$22.79	\$21.20
PE3595-24	24"	27.50	25.58	23.65	22.00
PE3595-36	36"	28.45	26.46	24.47	22.76
PE3595-48	48"	29.40	27.34	25.28	23.52
PE3595-60	60"	30.40	28.27	26.14	24.32
PE3595-XX	Any	Same-Day Shipment / Call for Pricing			

## 50 OHM, RG188-DS COAX, DOUBLE SHIELDED

Model No.	Length	1-24	25-49	50-99	100 +
PE33154-12	12"	\$29.15	\$27.11	\$25.07	\$23.32
PE33154-24	24"	31.60	29.39	27.18	25.28
PE33154-36	36"	33.95	31.57	29.20	27.16
PE33154-48	48"	36.40	33.85	31.30	29.12
PE33154-60	60"	38.80	36.08	33.37	31.04
PE33154-XX	Any	Same-Day Shipment / Call for Pricing			

## 50 OHM, RG196A/U COAX

Model No.	Length	1-24	25-49	50-99	100 +
PE3596-12	12"	\$27.85	\$25.90	\$23.95	\$22.28
PE3596-24	24"	28.75	26.74	24.73	23.00
PE3596-36	36"	29.80	27.71	25.63	23.84
PE3596-48	48"	30.75	28.60	26.45	24.60
PE3596-60	60"	31.70	29.48	27.26	25.36
PE3596-XX	Any	Same-Day Shipment / Call for Pricing			

## 50 OHM, RG223/U COAX, DOUBLE SHIELDED

Model No.	Length	1-24	25-49	50-99	100 +
PE33647-12	12"	\$34.50	\$32.09	\$29.67	\$27.60
PE33647-24	24"	35.80	33.29	30.79	28.64
PE33647-36	36"	37.15	34.55	31.95	29.72
PE33647-48	48"	38.40	35.71	33.02	30.72
PE33647-60	60"	39.80	37.01	34.23	31.84
PE33647-XX	Any	Same-Day Shipment / Call for Pricing			

## 50 OHM, RG316/U COAX

Model No.	Length	1-24	25-49	50-99	100 +
PE3808-12	12"	\$26.50	\$24.65	\$22.79	\$21.20
PE3808-24	24"	27.50	25.58	23.65	22.00
PE3808-36	36"	28.45	26.46	24.47	22.76
PE3808-48	48"	29.40	27.34	25.28	23.52
PE3808-60	60"	30.40	28.27	26.14	24.32
PE3808-XX	Any	Same-Day Shipment / Call for Pricing			

## 50 OHM, RG316-DS COAX, DOUBLE SHIELDED

Model No.	Length	1-24	25-49	50-99	100 +
PE34721-12	12"	\$29.15	\$27.11	\$25.07	\$23.32
PE34721-24	24"	31.60	29.39	27.18	25.28
PE34721-36	36"	33.95	31.57	29.20	27.16
PE34721-48	48"	36.40	33.85	31.30	29.12
PE34721-60	60"	38.80	36.08	33.37	31.04
PE34721-XX	Any	Same-Day Shipment / Call for Pricing			

## 50 OHM, RG400/U COAX, DOUBLE SHIELDED

Model No.	Length	1-24	25-49	50-99	100 +
PE34494-12	12"	\$34.50	\$32.09	\$29.67	\$27.60
PE34494-24	24"	37.15	34.55	31.95	29.72
PE34494-36	36"	39.80	37.01	34.23	31.84
PE34494-48	48"	42.45	39.48	36.51	33.96
PE34494-60	60"	45.10	41.94	38.79	36.08
PE34494-XX	Any	Same-Day Shipment / Call for Pricing			

## 50 OHM, LOW NOISE, PE-B9329 COAX (BELDEN 9329)

Model No.	Length	1-24	25-49	50-99	100 +
PE34501-12	12"	\$30.50	\$28.37	\$26.23	\$24.40
PE34501-24	24"	32.90	30.60	28.29	26.32
PE34501-36	36"	35.30	32.83	30.36	28.24
PE34501-48	48"	37.75	35.11	32.47	30.20
PE34501-60	60"	40.10	37.29	34.49	32.08
PE34501-XX	Any	Same-Day Shipment / Call for Pricing			

**\*\*ROHS COMPLIANT & CUSTOM-LENGTH CABLE ASSEMBLIES MAY BE ORDERED ON OUR WEBSITE.\*\***

# SMC PLUG TO SMC PLUG RIGHT ANGLE



**WARNING!!! ALL CONNECTORS ON THIS PAGE ARE "50 OHM SMC" CONNECTORS AND DO NOT MATE WITH "75 OHM SMC TYPE" CONNECTORS!!!**

## 50 OHM, RG58C/U COAX

Model No.	Length	1-24	25-49	50-99	100 +
PE33658-12	12"	\$37.15	\$34.55	\$31.95	\$29.72
PE33658-24	24"	37.55	34.92	32.29	30.04
PE33658-36	36"	37.95	35.29	32.64	30.36
PE33658-48	48"	38.35	35.67	32.98	30.68
PE33658-60	60"	38.70	35.99	33.28	30.96
PE33658-XX	Any	Same-Day Shipment / Call for Pricing			

## 50 OHM, RG196A/U COAX

Model No.	Length	1-24	25-49	50-99	100 +
PE3601-12	12"	\$34.50	\$32.09	\$29.67	\$27.60
PE3601-24	24"	35.45	32.97	30.49	28.36
PE3601-36	36"	36.40	33.85	31.30	29.12
PE3601-48	48"	37.40	34.78	32.16	29.92
PE3601-60	60"	38.30	35.62	32.94	30.64
PE3601-XX	Any	Same-Day Shipment / Call for Pricing			

## 50 OHM, RG142B/U COAX, DOUBLE SHIELDED

Model No.	Length	1-24	25-49	50-99	100 +
PE33660-12	12"	\$41.10	\$38.22	\$35.35	\$32.88
PE33660-24	24"	43.75	40.69	37.63	35.00
PE33660-36	36"	46.35	43.11	39.86	37.08
PE33660-48	48"	49.05	45.62	42.18	39.24
PE33660-60	60"	51.70	48.08	44.46	41.36
PE33660-XX	Any	Same-Day Shipment / Call for Pricing			

## 50 OHM, RG223/U COAX, DOUBLE SHIELDED

Model No.	Length	1-24	25-49	50-99	100 +
PE33664-12	12"	\$39.80	\$37.01	\$34.23	\$31.84
PE33664-24	24"	41.10	38.22	35.35	32.88
PE33664-36	36"	42.45	39.48	36.51	33.96
PE33664-48	48"	43.75	40.69	37.63	35.00
PE33664-60	60"	45.10	41.94	38.79	36.08
PE33664-XX	Any	Same-Day Shipment / Call for Pricing			

## 50 OHM, RG174A/U COAX

Model No.	Length	1-24	25-49	50-99	100 +
PE33556-12	12"	\$35.80	\$33.29	\$30.79	\$28.64
PE33556-24	24"	36.10	33.57	31.05	28.88
PE33556-36	36"	36.35	33.81	31.26	29.08
PE33556-48	48"	36.60	34.04	31.48	29.28
PE33556-60	60"	36.80	34.22	31.65	29.44
PE33556-XX	Any	Same-Day Shipment / Call for Pricing			

## 50 OHM, RG316/U COAX

Model No.	Length	1-24	25-49	50-99	100 +
PE33363-12	12"	\$33.15	\$30.83	\$28.51	\$26.52
PE33363-24	24"	34.05	31.67	29.28	27.24
PE33363-36	36"	35.05	32.60	30.14	28.04
PE33363-48	48"	36.05	33.53	31.00	28.84
PE33363-60	60"	37.05	34.46	31.86	29.64
PE33363-XX	Any	Same-Day Shipment / Call for Pricing			

## 50 OHM, RG178B/U COAX

Model No.	Length	1-24	25-49	50-99	100 +
PE34492-12	12"	\$34.50	\$32.09	\$29.67	\$27.60
PE34492-24	24"	35.45	32.97	30.49	28.36
PE34492-36	36"	36.40	33.85	31.30	29.12
PE34492-48	48"	37.40	34.78	32.16	29.92
PE34492-60	60"	38.30	35.62	32.94	30.64
PE34492-XX	Any	Same-Day Shipment / Call for Pricing			

## 50 OHM, RG316-DS COAX, DOUBLE SHIELDED

Model No.	Length	1-24	25-49	50-99	100 +
PE34518-12	12"	\$35.80	\$33.29	\$30.79	\$28.64
PE34518-24	24"	38.20	35.53	32.85	30.56
PE34518-36	36"	40.60	37.76	34.92	32.48
PE34518-48	48"	43.05	40.04	37.02	34.44
PE34518-60	60"	45.40	42.22	39.04	36.32
PE34518-XX	Any	Same-Day Shipment / Call for Pricing			

## 50 OHM, RG188A/U COAX

Model No.	Length	1-24	25-49	50-99	100 +
PE3600-12	12"	\$33.15	\$30.83	\$28.51	\$26.52
PE3600-24	24"	34.05	31.67	29.28	27.24
PE3600-36	36"	35.05	32.60	30.14	28.04
PE3600-48	48"	36.05	33.53	31.00	28.84
PE3600-60	60"	37.05	34.46	31.86	29.64
PE3600-XX	Any	Same-Day Shipment / Call for Pricing			

## 50 OHM, RG400/U COAX, DOUBLE SHIELDED

Model No.	Length	1-24	25-49	50-99	100 +
PE34496-12	12"	\$41.10	\$38.22	\$35.35	\$32.88
PE34496-24	24"	43.75	40.69	37.63	35.00
PE34496-36	36"	46.35	43.11	39.86	37.08
PE34496-48	48"	49.05	45.62	42.18	39.24
PE34496-60	60"	51.70	48.08	44.46	41.36
PE34496-XX	Any	Same-Day Shipment / Call for Pricing			

## 50 OHM, RG188-DS COAX, DOUBLE SHIELDED

Model No.	Length	1-24	25-49	50-99	100 +
PE34499-12	12"	\$35.80	\$33.29	\$30.79	\$28.64
PE34499-24	24"	38.20	35.53	32.85	30.56
PE34499-36	36"	40.60	37.76	34.92	32.48
PE34499-48	48"	43.05	40.04	37.02	34.44
PE34499-60	60"	45.40	42.22	39.04	36.32
PE34499-XX	Any	Same-Day Shipment / Call for Pricing			

## 50 OHM, LOW NOISE, PE-B9329 COAX (BELDEN 9329)

Model No.	Length	1-24	25-49	50-99	100 +
PE34502-12	12"	\$37.15	\$34.55	\$31.95	\$29.72
PE34502-24	24"	39.50	36.74	33.97	31.60
PE34502-36	36"	41.90	38.97	36.03	33.52
PE34502-48	48"	44.35	41.25	38.14	35.48
PE34502-60	60"	46.80	43.52	40.25	37.44
PE34502-XX	Any	Same-Day Shipment / Call for Pricing			

\*\*ROHS COMPLIANT & CUSTOM-LENGTH CABLE ASSEMBLIES MAY BE ORDERED ON OUR WEBSITE.\*\*

# SMC PLUG RIGHT ANGLE TO SMC PLUG RIGHT ANGLE



**WARNING!!! ALL CONNECTORS ON THIS PAGE ARE "50 OHM SMC" CONNECTORS AND DO NOT MATE WITH "75 OHM SMC TYPE" CONNECTORS!!!**

## 50 OHM, RG58C/U COAX

Model No.	Length	1-24	25-49	50-99	100 +
PE33643-12	12"	\$37.15	\$34.55	\$31.95	\$29.72
PE33643-24	24"	37.55	34.92	32.29	30.04
PE33643-36	36"	37.95	35.29	32.64	30.36
PE33643-48	48"	38.35	35.67	32.98	30.68
PE33643-60	60"	38.70	35.99	33.28	30.96
PE33643-XX	Any	Same-Day Shipment / Call for Pricing			

## 50 OHM, RG142B/U COAX, DOUBLE SHIELDED

Model No.	Length	1-24	25-49	50-99	100 +
PE33645-12	12"	\$41.10	\$38.22	\$35.35	\$32.88
PE33645-24	24"	43.75	40.69	37.63	35.00
PE33645-36	36"	46.35	43.11	39.86	37.08
PE33645-48	48"	49.05	45.62	42.18	39.24
PE33645-60	60"	51.70	48.08	44.46	41.36
PE33645-XX	Any	Same-Day Shipment / Call for Pricing			

## 50 OHM, RG174A/U COAX

Model No.	Length	1-24	25-49	50-99	100 +
PE3918-12	12"	\$35.80	\$33.29	\$30.79	\$28.64
PE3918-24	24"	36.10	33.57	31.05	28.88
PE3918-36	36"	36.35	33.81	31.26	29.08
PE3918-48	48"	36.60	34.04	31.48	29.28
PE3918-60	60"	36.80	34.22	31.65	29.44
PE3918-XX	Any	Same-Day Shipment / Call for Pricing			

## 50 OHM, RG178B/U COAX

Model No.	Length	1-24	25-49	50-99	100 +
PE3765-12	12"	\$37.15	\$34.55	\$31.95	\$29.72
PE3765-24	24"	38.10	35.43	32.77	30.48
PE3765-36	36"	39.05	36.32	33.58	31.24
PE3765-48	48"	40.00	37.20	34.40	32.00
PE3765-60	60"	41.00	38.13	35.26	32.80
PE3765-XX	Any	Same-Day Shipment / Call for Pricing			

## 50 OHM, RG188A/U COAX

Model No.	Length	1-24	25-49	50-99	100 +
PE3597-12	12"	\$35.80	\$33.29	\$30.79	\$28.64
PE3597-24	24"	36.75	34.18	31.61	29.40
PE3597-36	36"	37.75	35.11	32.47	30.20
PE3597-48	48"	38.65	35.94	33.24	30.92
PE3597-60	60"	39.70	36.92	34.14	31.76
PE3597-XX	Any	Same-Day Shipment / Call for Pricing			

## 50 OHM, RG188-DS COAX, DOUBLE SHIELDED

Model No.	Length	1-24	25-49	50-99	100 +
PE34464-12	12"	\$38.40	\$35.71	\$33.02	\$30.72
PE34464-24	24"	40.85	37.99	35.13	32.68
PE34464-36	36"	43.30	40.27	37.24	34.64
PE34464-48	48"	45.65	42.45	39.26	36.52
PE34464-60	60"	48.10	44.73	41.37	38.48
PE34464-XX	Any	Same-Day Shipment / Call for Pricing			

## 50 OHM, RG196A/U COAX

Model No.	Length	1-24	25-49	50-99	100 +
PE3598-12	12"	\$37.15	\$34.55	\$31.95	\$29.72
PE3598-24	24"	38.10	35.43	32.77	30.48
PE3598-36	36"	39.05	36.32	33.58	31.24
PE3598-48	48"	40.00	37.20	34.40	32.00
PE3598-60	60"	41.00	38.13	35.26	32.80
PE3598-XX	Any	Same-Day Shipment / Call for Pricing			

## 50 OHM, RG223/U COAX, DOUBLE SHIELDED

Model No.	Length	1-24	25-49	50-99	100 +
PE33649-12	12"	\$39.80	\$37.01	\$34.23	\$31.84
PE33649-24	24"	41.10	38.22	35.35	32.88
PE33649-36	36"	42.45	39.48	36.51	33.96
PE33649-48	48"	43.75	40.69	37.63	35.00
PE33649-60	60"	45.10	41.94	38.79	36.08
PE33649-XX	Any	Same-Day Shipment / Call for Pricing			

## 50 OHM, RG316/U COAX

Model No.	Length	1-24	25-49	50-99	100 +
PE3919-12	12"	\$35.80	\$33.29	\$30.79	\$28.64
PE3919-24	24"	36.75	34.18	31.61	29.40
PE3919-36	36"	37.75	35.11	32.47	30.20
PE3919-48	48"	38.65	35.94	33.24	30.92
PE3919-60	60"	39.70	36.92	34.14	31.76
PE3919-XX	Any	Same-Day Shipment / Call for Pricing			

## 50 OHM, RG316-DS COAX, DOUBLE SHIELDED

Model No.	Length	1-24	25-49	50-99	100 +
PE34462-12	12"	\$38.40	\$35.71	\$33.02	\$30.72
PE34462-24	24"	40.85	37.99	35.13	32.68
PE34462-36	36"	43.30	40.27	37.24	34.64
PE34462-48	48"	45.65	42.45	39.26	36.52
PE34462-60	60"	48.10	44.73	41.37	38.48
PE34462-XX	Any	Same-Day Shipment / Call for Pricing			

## 50 OHM, RG400/U COAX, DOUBLE SHIELDED

Model No.	Length	1-24	25-49	50-99	100 +
PE34459-12	12"	\$41.10	\$38.22	\$35.35	\$32.88
PE34459-24	24"	43.75	40.69	37.63	35.00
PE34459-36	36"	46.35	43.11	39.86	37.08
PE34459-48	48"	49.05	45.62	42.18	39.24
PE34459-60	60"	51.70	48.08	44.46	41.36
PE34459-XX	Any	Same-Day Shipment / Call for Pricing			

## 50 OHM, LOW NOISE, PE-B9329 COAX (BELDEN 9329)

Model No.	Length	1-24	25-49	50-99	100 +
PE34466-12	12"	\$39.80	\$37.01	\$34.23	\$31.84
PE34466-24	24"	42.20	39.25	36.29	33.76
PE34466-36	36"	44.55	41.43	38.31	35.64
PE34466-48	48"	47.00	43.71	40.42	37.60
PE34466-60	60"	49.35	45.90	42.44	39.48
PE34466-XX	Any	Same-Day Shipment / Call for Pricing			

\*\*ROHS COMPLIANT & CUSTOM-LENGTH CABLE ASSEMBLIES MAY BE ORDERED ON OUR WEBSITE.\*\*

# SMC PLUG RIGHT ANGLE TO SMC JACK BULKHEAD

USE MOUNTING HOLE B01 ON PAGE 266



**WARNING!!! ALL CONNECTORS ON THIS PAGE ARE "50 OHM SMC" CONNECTORS AND DO NOT MATE WITH "75 OHM SMC TYPE" CONNECTORS!!!**

## 50 OHM, RG58C/U COAX

Model No.	Length	1-24	25-49	50-99	100 +
PE34476-12	12"	\$42.45	\$39.48	\$36.51	\$33.96
PE34476-24	24"	42.85	39.85	36.85	34.28
PE34476-36	36"	43.25	40.22	37.20	34.60
PE34476-48	48"	43.65	40.59	37.54	34.92
PE34476-60	60"	44.00	40.92	37.84	35.20
PE34476-XX	Any	Same-Day Shipment / Call for Pricing			

## 50 OHM, RG142B/U COAX, DOUBLE SHIELDED

Model No.	Length	1-24	25-49	50-99	100 +
PE34478-12	12"	\$43.75	\$40.69	\$37.63	\$35.00
PE34478-24	24"	46.35	43.11	39.86	37.08
PE34478-36	36"	49.05	45.62	42.18	39.24
PE34478-48	48"	51.70	48.08	44.46	41.36
PE34478-60	60"	54.35	50.55	46.74	43.48
PE34478-XX	Any	Same-Day Shipment / Call for Pricing			

## 50 OHM, RG174A/U COAX

Model No.	Length	1-24	25-49	50-99	100 +
PE34078-12	12"	\$35.80	\$33.29	\$30.79	\$28.64
PE34078-24	24"	36.10	33.57	31.05	28.88
PE34078-36	36"	36.35	33.81	31.26	29.08
PE34078-48	48"	36.60	34.04	31.48	29.28
PE34078-60	60"	36.80	34.22	31.65	29.44
PE34078-XX	Any	Same-Day Shipment / Call for Pricing			

## 50 OHM, RG178B/U COAX

Model No.	Length	1-24	25-49	50-99	100 +
PE34470-12	12"	\$39.80	\$37.01	\$34.23	\$31.84
PE34470-24	24"	40.75	37.90	35.05	32.60
PE34470-36	36"	41.70	38.78	35.86	33.36
PE34470-48	48"	42.70	39.71	36.72	34.16
PE34470-60	60"	43.60	40.55	37.50	34.88
PE34470-XX	Any	Same-Day Shipment / Call for Pricing			

## 50 OHM, RG188A/U COAX

Model No.	Length	1-24	25-49	50-99	100 +
PE3602-12	12"	\$35.80	\$33.29	\$30.79	\$28.64
PE3602-24	24"	36.75	34.18	31.61	29.40
PE3602-36	36"	37.75	35.11	32.47	30.20
PE3602-48	48"	38.65	35.94	33.24	30.92
PE3602-60	60"	39.70	36.92	34.14	31.76
PE3602-XX	Any	Same-Day Shipment / Call for Pricing			

## 50 OHM, RG188-DS COAX, DOUBLE SHIELDED

Model No.	Length	1-24	25-49	50-99	100 +
PE34484-12	12"	\$38.40	\$35.71	\$33.02	\$30.72
PE34484-24	24"	40.85	37.99	35.13	32.68
PE34484-36	36"	43.30	40.27	37.24	34.64
PE34484-48	48"	45.65	42.45	39.26	36.52
PE34484-60	60"	48.10	44.73	41.37	38.48
PE34484-XX	Any	Same-Day Shipment / Call for Pricing			

## 50 OHM, RG196A/U COAX

Model No.	Length	1-24	25-49	50-99	100 +
PE33692-12	12"	\$39.80	\$37.01	\$34.23	\$31.84
PE33692-24	24"	40.75	37.90	35.05	32.60
PE33692-36	36"	41.70	38.78	35.86	33.36
PE33692-48	48"	42.70	39.71	36.72	34.16
PE33692-60	60"	43.60	40.55	37.50	34.88
PE33692-XX	Any	Same-Day Shipment / Call for Pricing			

## 50 OHM, RG223/U COAX, DOUBLE SHIELDED

Model No.	Length	1-24	25-49	50-99	100 +
PE34480-12	12"	\$43.75	\$40.69	\$37.63	\$35.00
PE34480-24	24"	45.10	41.94	38.79	36.08
PE34480-36	36"	46.35	43.11	39.86	37.08
PE34480-48	48"	47.70	44.36	41.02	38.16
PE34480-60	60"	49.05	45.62	42.18	39.24
PE34480-XX	Any	Same-Day Shipment / Call for Pricing			

## 50 OHM, RG316/U COAX

Model No.	Length	1-24	25-49	50-99	100 +
PE34472-12	12"	\$35.80	\$33.29	\$30.79	\$28.64
PE34472-24	24"	36.75	34.18	31.61	29.40
PE34472-36	36"	37.75	35.11	32.47	30.20
PE34472-48	48"	38.65	35.94	33.24	30.92
PE34472-60	60"	39.70	36.92	34.14	31.76
PE34472-XX	Any	Same-Day Shipment / Call for Pricing			

## 50 OHM, RG316-DS COAX, DOUBLE SHIELDED

Model No.	Length	1-24	25-49	50-99	100 +
PE34474-12	12"	\$38.40	\$35.71	\$33.02	\$30.72
PE34474-24	24"	40.85	37.99	35.13	32.68
PE34474-36	36"	43.30	40.27	37.24	34.64
PE34474-48	48"	45.65	42.45	39.26	36.52
PE34474-60	60"	48.10	44.73	41.37	38.48
PE34474-XX	Any	Same-Day Shipment / Call for Pricing			

## 50 OHM, RG400/U COAX, DOUBLE SHIELDED

Model No.	Length	1-24	25-49	50-99	100 +
PE34482-12	12"	\$43.75	\$40.69	\$37.63	\$35.00
PE34482-24	24"	46.35	43.11	39.86	37.08
PE34482-36	36"	49.05	45.62	42.18	39.24
PE34482-48	48"	51.70	48.08	44.46	41.36
PE34482-60	60"	54.35	50.55	46.74	43.48
PE34482-XX	Any	Same-Day Shipment / Call for Pricing			

## 50 OHM, LOW NOISE, PE-B9329 COAX (BELDEN 9329)

Model No.	Length	1-24	25-49	50-99	100 +
PE34486-12	12"	\$39.80	\$37.01	\$34.23	\$31.84
PE34486-24	24"	42.20	39.25	36.29	33.76
PE34486-36	36"	44.55	41.43	38.31	35.64
PE34486-48	48"	47.00	43.71	40.42	37.60
PE34486-60	60"	49.35	45.90	42.44	39.48
PE34486-XX	Any	Same-Day Shipment / Call for Pricing			

Cable Assemblies

\*\*ROHS COMPLIANT & CUSTOM-LENGTH CABLE ASSEMBLIES MAY BE ORDERED ON OUR WEBSITE.\*\*

# SMC PLUG TO SMC JACK BULKHEAD

USE MOUNTING HOLE B01 ON PAGE 266



**WARNING!!! ALL CONNECTORS ON THIS PAGE ARE "50 OHM SMC" CONNECTORS AND DO NOT MATE WITH "75 OHM SMC TYPE" CONNECTORS!!!**

## 50 OHM, RG58C/U COAX

Model No.	Length	1-24	25-49	50-99	100 +
PE34503-12	12"	\$42.45	\$39.48	\$36.51	\$33.96
PE34503-24	24"	42.85	39.85	36.85	34.28
PE34503-36	36"	43.25	40.22	37.20	34.60
PE34503-48	48"	43.65	40.59	37.54	34.92
PE34503-60	60"	44.00	40.92	37.84	35.20
PE34503-XX	Any	Same-Day Shipment / Call for Pricing			

## 50 OHM, RG196A/U COAX

Model No.	Length	1-24	25-49	50-99	100 +
PE33688-12	12"	\$37.15	\$34.55	\$31.95	\$29.72
PE33688-24	24"	38.10	35.43	32.77	30.48
PE33688-36	36"	39.05	36.32	33.58	31.24
PE33688-48	48"	40.00	37.20	34.40	32.00
PE33688-60	60"	41.00	38.13	35.26	32.80
PE33688-XX	Any	Same-Day Shipment / Call for Pricing			

## 50 OHM, RG142B/U COAX, DOUBLE SHIELDED

Model No.	Length	1-24	25-49	50-99	100 +
PE34505-12	12"	\$43.75	\$40.69	\$37.63	\$35.00
PE34505-24	24"	46.35	43.11	39.86	37.08
PE34505-36	36"	49.05	45.62	42.18	39.24
PE34505-48	48"	51.70	48.08	44.46	41.36
PE34505-60	60"	54.35	50.55	46.74	43.48
PE34505-XX	Any	Same-Day Shipment / Call for Pricing			

## 50 OHM, RG223/U COAX, DOUBLE SHIELDED

Model No.	Length	1-24	25-49	50-99	100 +
PE34507-12	12"	\$42.45	\$39.48	\$36.51	\$33.96
PE34507-24	24"	43.75	40.69	37.63	35.00
PE34507-36	36"	45.10	41.94	38.79	36.08
PE34507-48	48"	46.35	43.11	39.86	37.08
PE34507-60	60"	47.70	44.36	41.02	38.16
PE34507-XX	Any	Same-Day Shipment / Call for Pricing			

## 50 OHM, RG174A/U COAX

Model No.	Length	1-24	25-49	50-99	100 +
PE33580-12	12"	\$35.80	\$33.29	\$30.79	\$28.64
PE33580-24	24"	36.10	33.57	31.05	28.88
PE33580-36	36"	36.35	33.81	31.26	29.08
PE33580-48	48"	36.60	34.04	31.48	29.28
PE33580-60	60"	36.80	34.22	31.65	29.44
PE33580-XX	Any	Same-Day Shipment / Call for Pricing			

## 50 OHM, RG316/U COAX

Model No.	Length	1-24	25-49	50-99	100 +
PE33690-12	12"	\$33.15	\$30.83	\$28.51	\$26.52
PE33690-24	24"	34.05	31.67	29.28	27.24
PE33690-36	36"	35.05	32.60	30.14	28.04
PE33690-48	48"	36.05	33.53	31.00	28.84
PE33690-60	60"	37.05	34.46	31.86	29.64
PE33690-XX	Any	Same-Day Shipment / Call for Pricing			

## 50 OHM, RG178B/U COAX

Model No.	Length	1-24	25-49	50-99	100 +
PE33352-12	12"	\$37.15	\$34.55	\$31.95	\$29.72
PE33352-24	24"	38.10	35.43	32.77	30.48
PE33352-36	36"	39.05	36.32	33.58	31.24
PE33352-48	48"	40.00	37.20	34.40	32.00
PE33352-60	60"	41.00	38.13	35.26	32.80
PE33352-XX	Any	Same-Day Shipment / Call for Pricing			

## 50 OHM, RG316-DS COAX, DOUBLE SHIELDED

Model No.	Length	1-24	25-49	50-99	100 +
PE34511-12	12"	\$35.80	\$33.29	\$30.79	\$28.64
PE34511-24	24"	38.20	35.53	32.85	30.56
PE34511-36	36"	40.60	37.76	34.92	32.48
PE34511-48	48"	43.05	40.04	37.02	34.44
PE34511-60	60"	45.40	42.22	39.04	36.32
PE34511-XX	Any	Same-Day Shipment / Call for Pricing			

## 50 OHM, RG188A/U COAX

Model No.	Length	1-24	25-49	50-99	100 +
PE33686-12	12"	\$33.15	\$30.83	\$28.51	\$26.52
PE33686-24	24"	34.05	31.67	29.28	27.24
PE33686-36	36"	35.05	32.60	30.14	28.04
PE33686-48	48"	36.05	33.53	31.00	28.84
PE33686-60	60"	37.05	34.46	31.86	29.64
PE33686-XX	Any	Same-Day Shipment / Call for Pricing			

## 50 OHM, RG400/U COAX, DOUBLE SHIELDED

Model No.	Length	1-24	25-49	50-99	100 +
PE34498-12	12"	\$43.75	\$40.69	\$37.63	\$35.00
PE34498-24	24"	46.35	43.11	39.86	37.08
PE34498-36	36"	49.05	45.62	42.18	39.24
PE34498-48	48"	51.70	48.08	44.46	41.36
PE34498-60	60"	54.35	50.55	46.74	43.48
PE34498-XX	Any	Same-Day Shipment / Call for Pricing			

## 50 OHM, RG188-DS COAX, DOUBLE SHIELDED

Model No.	Length	1-24	25-49	50-99	100 +
PE34500-12	12"	\$35.80	\$33.29	\$30.79	\$28.64
PE34500-24	24"	38.20	35.53	32.85	30.56
PE34500-36	36"	40.60	37.76	34.92	32.48
PE34500-48	48"	43.05	40.04	37.02	34.44
PE34500-60	60"	45.40	42.22	39.04	36.32
PE34500-XX	Any	Same-Day Shipment / Call for Pricing			

## 50 OHM, LOW NOISE, PE-B9329 COAX (BELDEN 9329)

Model No.	Length	1-24	25-49	50-99	100 +
PE34509-12	12"	\$37.15	\$34.55	\$31.95	\$29.72
PE34509-24	24"	39.50	36.74	33.97	31.60
PE34509-36	36"	41.90	38.97	36.03	33.52
PE34509-48	48"	44.35	41.25	38.14	35.48
PE34509-60	60"	46.80	43.52	40.25	37.44
PE34509-XX	Any	Same-Day Shipment / Call for Pricing			

\*\*ROHS COMPLIANT & CUSTOM-LENGTH CABLE ASSEMBLIES MAY BE ORDERED ON OUR WEBSITE.\*\*

# SMA MALE TO SMC PLUG



## 50 OHM, RG58C/U COAX

Model No.	Length	1-24	25-49	50-99	100 +
PE3210-12	12"	\$36.05	\$33.53	\$31.00	\$28.84
PE3210-24	24"	36.40	33.85	31.30	29.12
PE3210-36	36"	36.80	34.22	31.65	29.44
PE3210-48	48"	37.25	34.64	32.04	29.80
PE3210-60	60"	37.70	35.06	32.42	30.16
PE3210-XX	Any	Same-Day Shipment / Call for Pricing			

## 50 OHM, RG142B/U COAX, DOUBLE SHIELDED

Model No.	Length	1-24	25-49	50-99	100 +
PE3214-12	12"	\$39.80	\$37.01	\$34.23	\$31.84
PE3214-24	24"	42.45	39.48	36.51	33.96
PE3214-36	36"	45.10	41.94	38.79	36.08
PE3214-48	48"	47.70	44.36	41.02	38.16
PE3214-60	60"	50.40	46.87	43.34	40.32
PE3214-XX	Any	Same-Day Shipment / Call for Pricing			

## 50 OHM, RG174A/U COAX

Model No.	Length	1-24	25-49	50-99	100 +
PE3944-12	12"	\$36.00	\$33.48	\$30.96	\$28.80
PE3944-24	24"	36.20	33.67	31.13	28.96
PE3944-36	36"	36.45	33.90	31.35	29.16
PE3944-48	48"	36.70	34.13	31.56	29.36
PE3944-60	60"	37.05	34.46	31.86	29.64
PE3944-XX	Any	Same-Day Shipment / Call for Pricing			

## 50 OHM, RG178B/U COAX

Model No.	Length	1-24	25-49	50-99	100 +
PE3561-12	12"	\$50.85	\$47.29	\$43.73	\$40.68
PE3561-24	24"	51.80	48.17	44.55	41.44
PE3561-36	36"	52.80	49.10	45.41	42.24
PE3561-48	48"	53.80	50.03	46.27	43.04
PE3561-60	60"	54.65	50.82	47.00	43.72
PE3561-XX	Any	Same-Day Shipment / Call for Pricing			

## 50 OHM, RG188A/U COAX

Model No.	Length	1-24	25-49	50-99	100 +
PE3736-12	12"	\$36.30	\$33.76	\$31.22	\$29.04
PE3736-24	24"	37.30	34.69	32.08	29.84
PE3736-36	36"	38.20	35.53	32.85	30.56
PE3736-48	48"	39.15	36.41	33.67	31.32
PE3736-60	60"	40.10	37.29	34.49	32.08
PE3736-XX	Any	Same-Day Shipment / Call for Pricing			

## 50 OHM, RG188-DS COAX, DOUBLE SHIELDED

Model No.	Length	1-24	25-49	50-99	100 +
PE34458-12	12"	\$39.70	\$36.92	\$34.14	\$31.76
PE34458-24	24"	42.10	39.15	36.21	33.68
PE34458-36	36"	44.45	41.34	38.23	35.56
PE34458-48	48"	46.90	43.62	40.33	37.52
PE34458-60	60"	49.25	45.80	42.36	39.40
PE34458-XX	Any	Same-Day Shipment / Call for Pricing			

## 50 OHM, RG196A/U COAX

Model No.	Length	1-24	25-49	50-99	100 +
PE34450-12	12"	\$50.85	\$47.29	\$43.73	\$40.68
PE34450-24	24"	51.80	48.17	44.55	41.44
PE34450-36	36"	52.80	49.10	45.41	42.24
PE34450-48	48"	53.80	50.03	46.27	43.04
PE34450-60	60"	54.65	50.82	47.00	43.72
PE34450-XX	Any	Same-Day Shipment / Call for Pricing			

## 50 OHM, RG223/U COAX, DOUBLE SHIELDED

Model No.	Length	1-24	25-49	50-99	100 +
PE3226-12	12"	\$36.45	\$33.90	\$31.35	\$29.16
PE3226-24	24"	37.80	35.15	32.51	30.24
PE3226-36	36"	39.10	36.36	33.63	31.28
PE3226-48	48"	40.40	37.57	34.74	32.32
PE3226-60	60"	41.75	38.83	35.91	33.40
PE3226-XX	Any	Same-Day Shipment / Call for Pricing			

## 50 OHM, RG316/U COAX

Model No.	Length	1-24	25-49	50-99	100 +
PE3809-12	12"	\$36.30	\$33.76	\$31.22	\$29.04
PE3809-24	24"	37.30	34.69	32.08	29.84
PE3809-36	36"	38.20	35.53	32.85	30.56
PE3809-48	48"	39.15	36.41	33.67	31.32
PE3809-60	60"	40.10	37.29	34.49	32.08
PE3809-XX	Any	Same-Day Shipment / Call for Pricing			

## 50 OHM, RG316-DS COAX, DOUBLE SHIELDED

Model No.	Length	1-24	25-49	50-99	100 +
PE34456-12	12"	\$39.70	\$36.92	\$34.14	\$31.76
PE34456-24	24"	42.10	39.15	36.21	33.68
PE34456-36	36"	44.45	41.34	38.23	35.56
PE34456-48	48"	46.90	43.62	40.33	37.52
PE34456-60	60"	49.25	45.80	42.36	39.40
PE34456-XX	Any	Same-Day Shipment / Call for Pricing			

## 50 OHM, RG400/U COAX, DOUBLE SHIELDED

Model No.	Length	1-24	25-49	50-99	100 +
PE34454-12	12"	\$39.80	\$37.01	\$34.23	\$31.84
PE34454-24	24"	42.45	39.48	36.51	33.96
PE34454-36	36"	45.10	41.94	38.79	36.08
PE34454-48	48"	47.70	44.36	41.02	38.16
PE34454-60	60"	50.40	46.87	43.34	40.32
PE34454-XX	Any	Same-Day Shipment / Call for Pricing			

## 50 OHM, LOW NOISE, PE-B9329 COAX (BELDEN 9329)

Model No.	Length	1-24	25-49	50-99	100 +
PE34460-12	12"	\$41.00	\$38.13	\$35.26	\$32.80
PE34460-24	24"	43.40	40.36	37.32	34.72
PE34460-36	36"	45.75	42.55	39.35	36.60
PE34460-48	48"	48.25	44.87	41.50	38.60
PE34460-60	60"	50.60	47.06	43.52	40.48
PE34460-XX	Any	Same-Day Shipment / Call for Pricing			

\*\*ROHS COMPLIANT & CUSTOM-LENGTH CABLE ASSEMBLIES MAY BE ORDERED ON OUR WEBSITE.\*\*

# SMA MALE TO TNC MALE



## 53.5 OHM, RG55B/U COAX, DOUBLE SHIELDED

Model No.	Length	1-24	25-49	50-99	100 +
PE34250-12	12"	\$34.50	\$32.09	\$29.67	\$27.60
PE34250-24	24"	35.20	32.74	30.27	28.16
PE34250-36	36"	35.95	33.43	30.92	28.76
PE34250-48	48"	36.60	34.04	31.48	29.28
PE34250-60	60"	37.40	34.78	32.16	29.92
PE34250-XX	Any	Same-Day Shipment / Call for Pricing			

## 50 OHM, RG58C/U COAX

Model No.	Length	1-24	25-49	50-99	100 +
PE3154-12	12"	\$31.80	\$29.57	\$27.35	\$25.44
PE3154-24	24"	32.25	29.99	27.74	25.80
PE3154-36	36"	32.65	30.36	28.08	26.12
PE3154-48	48"	33.05	30.74	28.42	26.44
PE3154-60	60"	33.45	31.11	28.77	26.76
PE3154-XX	Any	Same-Day Shipment / Call for Pricing			

## 50 OHM, RG142B/U COAX, DOUBLE SHIELDED

Model No.	Length	1-24	25-49	50-99	100 +
PE3664-12	12"	\$31.80	\$29.57	\$27.35	\$25.44
PE3664-24	24"	34.50	32.09	29.67	27.60
PE3664-36	36"	37.15	34.55	31.95	29.72
PE3664-48	48"	39.80	37.01	34.23	31.84
PE3664-60	60"	42.45	39.48	36.51	33.96
PE3664-XX	Any	Same-Day Shipment / Call for Pricing			

## 50 OHM, RG174A/U COAX

Model No.	Length	1-24	25-49	50-99	100 +
PE3178-12	12"	\$35.80	\$33.29	\$30.79	\$28.64
PE3178-24	24"	36.10	33.57	31.05	28.88
PE3178-36	36"	36.35	33.81	31.26	29.08
PE3178-48	48"	36.60	34.04	31.48	29.28
PE3178-60	60"	36.80	34.22	31.65	29.44
PE3178-XX	Any	Same-Day Shipment / Call for Pricing			

## 50 OHM, RG178B/U COAX

Model No.	Length	1-24	25-49	50-99	100 +
PE34248-12	12"	\$42.45	\$39.48	\$36.51	\$33.96
PE34248-24	24"	43.40	40.36	37.32	34.72
PE34248-36	36"	44.35	41.25	38.14	35.48
PE34248-48	48"	45.30	42.13	38.96	36.24
PE34248-60	60"	46.25	43.01	39.78	37.00
PE34248-XX	Any	Same-Day Shipment / Call for Pricing			

## 75 OHM, RG179B/U COAX

Model No.	Length	1-24	25-49	50-99	100 +
PE34255-12	12"	\$35.80	\$33.29	\$30.79	\$28.64
PE34255-24	24"	36.75	34.18	31.61	29.40
PE34255-36	36"	37.75	35.11	32.47	30.20
PE34255-48	48"	38.65	35.94	33.24	30.92
PE34255-60	60"	39.70	36.92	34.14	31.76
PE34255-XX	Any	Same-Day Shipment / Call for Pricing			

## 50 OHM, RG188A/U COAX

Model No.	Length	1-24	25-49	50-99	100 +
PE33361-12	12"	\$35.80	\$33.29	\$30.79	\$28.64
PE33361-24	24"	36.75	34.18	31.61	29.40
PE33361-36	36"	37.75	35.11	32.47	30.20
PE33361-48	48"	38.65	35.94	33.24	30.92
PE33361-60	60"	39.70	36.92	34.14	31.76
PE33361-XX	Any	Same-Day Shipment / Call for Pricing			

## 50 OHM, RG213/U COAX

Model No.	Length	1-24	25-49	50-99	100 +
PE33673-12	12"	\$79.55	\$73.98	\$68.41	\$63.64
PE33673-24	24"	80.60	74.96	69.32	64.48
PE33673-36	36"	81.60	75.89	70.18	65.28
PE33673-48	48"	82.55	76.77	70.99	66.04
PE33673-60	60"	83.60	77.75	71.90	66.88
PE33673-XX	Any	Same-Day Shipment / Call for Pricing			

## 50 OHM, RG214/U COAX, DOUBLE SHIELDED

Model No.	Length	1-24	25-49	50-99	100 +
PE3176-12	12"	\$86.20	\$80.17	\$74.13	\$68.96
PE3176-24	24"	89.75	83.47	77.19	71.80
PE3176-36	36"	93.40	86.86	80.32	74.72
PE3176-48	48"	97.00	90.21	83.42	77.60
PE3176-60	60"	100.60	93.56	86.52	80.48
PE3176-XX	Any	Same-Day Shipment / Call for Pricing			

## 50 OHM, RG223/U COAX, DOUBLE SHIELDED

Model No.	Length	1-24	25-49	50-99	100 +
PE3535-12	12"	\$31.80	\$29.57	\$27.35	\$25.44
PE3535-24	24"	33.15	30.83	28.51	26.52
PE3535-36	36"	34.50	32.09	29.67	27.60
PE3535-48	48"	35.80	33.29	30.79	28.64
PE3535-60	60"	37.15	34.55	31.95	29.72
PE3535-XX	Any	Same-Day Shipment / Call for Pricing			

## 50 OHM, RG316/U COAX

Model No.	Length	1-24	25-49	50-99	100 +
PE3174-12	12"	\$35.80	\$33.29	\$30.79	\$28.64
PE3174-24	24"	36.75	34.18	31.61	29.40
PE3174-36	36"	37.75	35.11	32.47	30.20
PE3174-48	48"	38.65	35.94	33.24	30.92
PE3174-60	60"	39.70	36.92	34.14	31.76
PE3174-XX	Any	Same-Day Shipment / Call for Pricing			

## 50 OHM, RG316-DS COAX, DOUBLE SHIELDED

Model No.	Length	1-24	25-49	50-99	100 +
PE34246-12	12"	\$38.40	\$35.71	\$33.02	\$30.72
PE34246-24	24"	40.85	37.99	35.13	32.68
PE34246-36	36"	43.30	40.27	37.24	34.64
PE34246-48	48"	45.65	42.45	39.26	36.52
PE34246-60	60"	48.10	44.73	41.37	38.48
PE34246-XX	Any	Same-Day Shipment / Call for Pricing			

## 50 OHM, RG393/U COAX, DOUBLE SHIELDED

Model No.	Length	1-24	25-49	50-99	100 +
PE34253-12	12"	\$86.20	\$80.17	\$74.13	\$68.96
PE34253-24	24"	94.55	87.93	81.31	75.64
PE34253-36	36"	103.05	95.84	88.62	82.44
PE34253-48	48"	111.50	103.70	95.89	89.20
PE34253-60	60"	119.85	111.46	103.07	95.88
PE34253-XX	Any	Same-Day Shipment / Call for Pricing			

## 50 OHM, RG400/U COAX, DOUBLE SHIELDED

Model No.	Length	1-24	25-49	50-99	100 +
PE33948-12	12"	\$31.80	\$29.57	\$27.35	\$25.44
PE33948-24	24"	34.50	32.09	29.67	27.60
PE33948-36	36"	37.15	34.55	31.95	29.72
PE33948-48	48"	39.80	37.01	34.23	31.84
PE33948-60	60"	42.45	39.48	36.51	33.96
PE33948-XX	Any	Same-Day Shipment / Call for Pricing			

\*\*ROHS COMPLIANT & CUSTOM-LENGTH CABLE ASSEMBLIES MAY BE ORDERED ON OUR WEBSITE.\*\*

# SEMI-RIGID & RE-SHAPEABLE CABLE ASSEMBLIES

## SMA MALE TO TNC MALE



### 50 OHM, RG402/U (.141" BARE COPPER)

Model No.	Length	1-24	25-49	50-99	100 +
PE3089-12	12"	\$52.20	\$48.55	\$44.89	\$41.76
PE3089-24	24"	55.80	51.89	47.99	44.64
PE3089-36	36"	59.40	55.24	51.08	47.52
PE3089-48	48"	63.05	58.64	54.22	50.44
PE3089-60	60"	66.65	61.98	57.32	53.32
PE3089-XX	Any	Same-Day Shipment / Call for Pricing			

### 50 OHM, PE-SR402AL (.141" TINNED ALUMINUM)

Model No.	Length	1-24	25-49	50-99	100 +
PE34406-12	12"	\$54.85	\$51.01	\$47.17	\$43.88
PE34406-24	24"	58.45	54.36	50.27	46.76
PE34406-36	36"	62.00	57.66	53.32	49.60
PE34406-48	48"	65.70	61.10	56.50	52.56
PE34406-60	60"	69.30	64.45	59.60	55.44
PE34406-XX	Any	Same-Day Shipment / Call for Pricing			

### 50 OHM, PE-SR402FL (.141" RE-SHAPEABLE)

Model No.	Length	1-24	25-49	50-99	100 +
PE33928-12	12"	\$54.85	\$51.01	\$47.17	\$43.88
PE33928-24	24"	58.45	54.36	50.27	46.76
PE33928-36	36"	62.00	57.66	53.32	49.60
PE33928-48	48"	65.70	61.10	56.50	52.56
PE33928-60	60"	69.30	64.45	59.60	55.44
PE33928-XX	Any	Same-Day Shipment / Call for Pricing			

### 50 OHM, PE-047SR (.047" BARE COPPER)

Model No.	Length	1-24	25-49	50-99	100 +
PE34408-12	12"	\$68.10	\$63.33	\$58.57	\$54.48
PE34408-24	24"	71.70	66.68	61.66	57.36
PE34408-36	36"	75.40	70.12	64.84	60.32
PE34408-48	48"	78.95	73.42	67.90	63.16
PE34408-60	60"	82.55	76.77	70.99	66.04
PE34408-XX	Any	Same-Day Shipment / Call for Pricing			

### 50 OHM, PE-SR047AL (.047" TINNED ALUMINUM)

Model No.	Length	1-24	25-49	50-99	100 +
PE34410-12	12"	\$74.70	\$69.47	\$64.24	\$59.76
PE34410-24	24"	78.35	72.87	67.38	62.68
PE34410-36	36"	81.95	76.21	70.48	65.56
PE34410-48	48"	85.60	79.61	73.62	68.48
PE34410-60	60"	89.15	82.91	76.67	71.32
PE34410-XX	Any	Same-Day Shipment / Call for Pricing			

### 50 OHM, PE-SR047FL (.047" RE-SHAPEABLE)

Model No.	Length	1-24	25-49	50-99	100 +
PE34412-12	12"	\$74.70	\$69.47	\$64.24	\$59.76
PE34412-24	24"	78.35	72.87	67.38	62.68
PE34412-36	36"	81.95	76.21	70.48	65.56
PE34412-48	48"	85.60	79.61	73.62	68.48
PE34412-60	60"	89.15	82.91	76.67	71.32
PE34412-XX	Any	Same-Day Shipment / Call for Pricing			

### 50 OHM, RG405/U (.085" BARE COPPER)

Model No.	Length	1-24	25-49	50-99	100 +
PE33420-12	12"	\$54.85	\$51.01	\$47.17	\$43.88
PE33420-24	24"	58.45	54.36	50.27	46.76
PE33420-36	36"	62.00	57.66	53.32	49.60
PE33420-48	48"	65.70	61.10	56.50	52.56
PE33420-60	60"	69.30	64.45	59.60	55.44
PE33420-XX	Any	Same-Day Shipment / Call for Pricing			

### 50 OHM, PE-SR405AL (.085" TINNED ALUMINUM)

Model No.	Length	1-24	25-49	50-99	100 +
PE34414-12	12"	\$57.55	\$53.52	\$49.49	\$46.04
PE34414-24	24"	61.10	56.82	52.55	48.88
PE34414-36	36"	64.70	60.17	55.64	51.76
PE34414-48	48"	68.40	63.61	58.82	54.72
PE34414-60	60"	71.95	66.91	61.88	57.56
PE34414-XX	Any	Same-Day Shipment / Call for Pricing			

### 50 OHM, PE-SR405FL (.085" RE-SHAPEABLE)

Model No.	Length	1-24	25-49	50-99	100 +
PE34416-12	12"	\$57.55	\$53.52	\$49.49	\$46.04
PE34416-24	24"	61.10	56.82	52.55	48.88
PE34416-36	36"	64.70	60.17	55.64	51.76
PE34416-48	48"	68.40	63.61	58.82	54.72
PE34416-60	60"	71.95	66.91	61.88	57.56
PE34416-XX	Any	Same-Day Shipment / Call for Pricing			

### 50 OHM, RG401/U (.250" BARE COPPER)

Model No.	Length	1-24	25-49	50-99	100 +
PE34418-12	12"	\$69.90	\$65.01	\$60.11	\$55.92
PE34418-24	24"	77.15	71.75	66.35	61.72
PE34418-36	36"	84.35	78.45	72.54	67.48
PE34418-48	48"	91.60	85.19	78.78	73.28
PE34418-60	60"	98.80	91.88	84.97	79.04
PE34418-XX	Any	Same-Day Shipment / Call for Pricing			

### 50 OHM, PE-SR401AL (.250" TINNED ALUMINUM)

Model No.	Length	1-24	25-49	50-99	100 +
PE34420-12	12"	\$76.55	\$71.19	\$65.83	\$61.24
PE34420-24	24"	83.75	77.89	72.03	67.00
PE34420-36	36"	91.00	84.63	78.26	72.80
PE34420-48	48"	98.25	91.37	84.50	78.60
PE34420-60	60"	105.40	98.02	90.64	84.32
PE34420-XX	Any	Same-Day Shipment / Call for Pricing			

### 50 OHM, PE-SR401FL (.250" RE-SHAPEABLE)

Model No.	Length	1-24	25-49	50-99	100 +
PE34422-12	12"	\$76.55	\$71.19	\$65.83	\$61.24
PE34422-24	24"	83.75	77.89	72.03	67.00
PE34422-36	36"	91.00	84.63	78.26	72.80
PE34422-48	48"	98.25	91.37	84.50	78.60
PE34422-60	60"	105.40	98.02	90.64	84.32
PE34422-XX	Any	Same-Day Shipment / Call for Pricing			

\*\*ROHS COMPLIANT & CUSTOM-LENGTH CABLE ASSEMBLIES MAY BE ORDERED ON OUR WEBSITE.\*\*



# BNC MALE TO TNC MALE



ALL CABLE ASSEMBLIES ON THIS PAGE UTILIZE STANDARD 50 OHM INTERFACE CONNECTORS

## 52 OHM, RG8A/U COAX

Model No.	Length	1-24	25-49	50-99	100 +
PE34504-12	12"	\$51.70	\$48.08	\$44.46	\$41.36
PE34504-24	24"	52.75	49.06	45.37	42.20
PE34504-36	36"	53.75	49.99	46.23	43.00
PE34504-48	48"	54.70	50.87	47.04	43.76
PE34504-60	60"	55.75	51.85	47.95	44.60
PE34504-XX	Any	Same-Day Shipment / Call for Pricing			

## 53.5 OHM, RG55B/U COAX, DOUBLE SHIELDED

Model No.	Length	1-24	25-49	50-99	100 +
PE3904-12	12"	\$26.50	\$24.65	\$22.79	\$21.20
PE3904-24	24"	27.25	25.34	23.44	21.80
PE3904-36	36"	28.00	26.04	24.08	22.40
PE3904-48	48"	28.65	26.64	24.64	22.92
PE3904-60	60"	29.40	27.34	25.28	23.52
PE3904-XX	Any	Same-Day Shipment / Call for Pricing			

## 50 OHM, RG58C/U COAX

Model No.	Length	1-24	25-49	50-99	100 +
PE3497-12	12"	\$22.50	\$20.93	\$19.35	\$18.00
PE3497-24	24"	22.95	21.34	19.74	18.36
PE3497-36	36"	23.30	21.67	20.04	18.64
PE3497-48	48"	23.75	22.09	20.43	19.00
PE3497-60	60"	24.10	22.41	20.73	19.28
PE3497-XX	Any	Same-Day Shipment / Call for Pricing			

## 75 OHM, RG59B/U COAX

Model No.	Length	1-24	25-49	50-99	100 +
PE3023-12	12"	\$22.50	\$20.93	\$19.35	\$18.00
PE3023-24	24"	22.95	21.34	19.74	18.36
PE3023-36	36"	23.30	21.67	20.04	18.64
PE3023-48	48"	23.75	22.09	20.43	19.00
PE3023-60	60"	24.10	22.41	20.73	19.28
PE3023-XX	Any	Same-Day Shipment / Call for Pricing			

## 93 OHM, RG62A/U COAX

Model No.	Length	1-24	25-49	50-99	100 +
PE34508-12	12"	\$25.20	\$23.44	\$21.67	\$20.16
PE34508-24	24"	25.60	23.81	22.02	20.48
PE34508-36	36"	26.00	24.18	22.36	20.80
PE34508-48	48"	26.40	24.55	22.70	21.12
PE34508-60	60"	26.85	24.97	23.09	21.48
PE34508-XX	Any	Same-Day Shipment / Call for Pricing			

## 50 OHM, RG142B/U COAX, DOUBLE SHIELDED

Model No.	Length	1-24	25-49	50-99	100 +
PE3551-12	12"	\$22.50	\$20.93	\$19.35	\$18.00
PE3551-24	24"	25.20	23.44	21.67	20.16
PE3551-36	36"	27.85	25.90	23.95	22.28
PE3551-48	48"	30.50	28.37	26.23	24.40
PE3551-60	60"	33.15	30.83	28.51	26.52
PE3551-XX	Any	Same-Day Shipment / Call for Pricing			

## 50 OHM, RG174A/U COAX

Model No.	Length	1-24	25-49	50-99	100 +
PE34506-12	12"	\$22.50	\$20.93	\$19.35	\$18.00
PE34506-24	24"	22.80	21.20	19.61	18.24
PE34506-36	36"	23.05	21.44	19.82	18.44
PE34506-48	48"	23.30	21.67	20.04	18.64
PE34506-60	60"	23.55	21.90	20.25	18.84
PE34506-XX	Any	Same-Day Shipment / Call for Pricing			

## 75 OHM, RG179B/U COAX

Model No.	Length	1-24	25-49	50-99	100 +
PE34510-12	12"	\$27.85	\$25.90	\$23.95	\$22.28
PE34510-24	24"	28.75	26.74	24.73	23.00
PE34510-36	36"	29.80	27.71	25.63	23.84
PE34510-48	48"	30.75	28.60	26.45	24.60
PE34510-60	60"	31.70	29.48	27.26	25.36
PE34510-XX	Any	Same-Day Shipment / Call for Pricing			

## 50 OHM, RG188A/U COAX

Model No.	Length	1-24	25-49	50-99	100 +
PE34512-12	12"	\$27.85	\$25.90	\$23.95	\$22.28
PE34512-24	24"	28.75	26.74	24.73	23.00
PE34512-36	36"	29.80	27.71	25.63	23.84
PE34512-48	48"	30.75	28.60	26.45	24.60
PE34512-60	60"	31.70	29.48	27.26	25.36
PE34512-XX	Any	Same-Day Shipment / Call for Pricing			

## 50 OHM, RG213/U COAX

Model No.	Length	1-24	25-49	50-99	100 +
PE33969-12	12"	\$51.70	\$48.08	\$44.46	\$41.36
PE33969-24	24"	52.75	49.06	45.37	42.20
PE33969-36	36"	53.75	49.99	46.23	43.00
PE33969-48	48"	54.70	50.87	47.04	43.76
PE33969-60	60"	55.75	51.85	47.95	44.60
PE33969-XX	Any	Same-Day Shipment / Call for Pricing			

## 50 OHM, RG214/U COAX, DOUBLE SHIELDED

Model No.	Length	1-24	25-49	50-99	100 +
PE33701-12	12"	\$51.70	\$48.08	\$44.46	\$41.36
PE33701-24	24"	55.35	51.48	47.60	44.28
PE33701-36	36"	58.95	54.82	50.70	47.16
PE33701-48	48"	62.60	58.22	53.84	50.08
PE33701-60	60"	66.20	61.57	56.93	52.96
PE33701-XX	Any	Same-Day Shipment / Call for Pricing			

## 50 OHM, RG223/U COAX, DOUBLE SHIELDED

Model No.	Length	1-24	25-49	50-99	100 +
PE3498-12	12"	\$22.50	\$20.93	\$19.35	\$18.00
PE3498-24	24"	23.85	22.18	20.51	19.08
PE3498-36	36"	25.20	23.44	21.67	20.16
PE3498-48	48"	26.50	24.65	22.79	21.20
PE3498-60	60"	27.85	25.90	23.95	22.28
PE3498-XX	Any	Same-Day Shipment / Call for Pricing			

## 50 OHM, RG316/U COAX

Model No.	Length	1-24	25-49	50-99	100 +
PE33383-12	12"	\$27.85	\$25.90	\$23.95	\$22.28
PE33383-24	24"	28.75	26.74	24.73	23.00
PE33383-36	36"	29.80	27.71	25.63	23.84
PE33383-48	48"	30.75	28.60	26.45	24.60
PE33383-60	60"	31.70	29.48	27.26	25.36
PE33383-XX	Any	Same-Day Shipment / Call for Pricing			

## 50 OHM, RG400/U COAX, DOUBLE SHIELDED

Model No.	Length	1-24	25-49	50-99	100 +
PE33535-12	12"	\$22.50	\$20.93	\$19.35	\$18.00
PE33535-24	24"	25.20	23.44	21.67	20.16
PE33535-36	36"	27.85	25.90	23.95	22.28
PE33535-48	48"	30.50	28.37	26.23	24.40
PE33535-60	60"	33.15	30.83	28.51	26.52
PE33535-XX	Any	Same-Day Shipment / Call for Pricing			

\*\*ROHS COMPLIANT & CUSTOM-LENGTH CABLE ASSEMBLIES MAY BE ORDERED ON OUR WEBSITE.\*\*

# C MALE TO C MALE



## 52 OHM, RG8A/U COAX

Model No.	Length	1-24	25-49	50-99	100 +
PE33316-12	12"	\$58.35	\$54.27	\$50.18	\$46.68
PE33316-24	24"	59.35	55.20	51.04	47.48
PE33316-36	36"	60.35	56.13	51.90	48.28
PE33316-48	48"	61.35	57.06	52.76	49.08
PE33316-60	60"	62.40	58.03	53.66	49.92
PE33316-XX	Any	Same-Day Shipment / Call for Pricing			

## 50 OHM, RG58C/U COAX

Model No.	Length	1-24	25-49	50-99	100 +
PE3457-12	12"	\$53.00	\$49.29	\$45.58	\$42.40
PE3457-24	24"	53.50	49.76	46.01	42.80
PE3457-36	36"	53.85	50.08	46.31	43.08
PE3457-48	48"	54.25	50.45	46.66	43.40
PE3457-60	60"	54.60	50.78	46.96	43.68
PE3457-XX	Any	Same-Day Shipment / Call for Pricing			

## 75 OHM, RG59B/U COAX

Model No.	Length	1-24	25-49	50-99	100 +
PE33662-12	12"	\$55.70	\$51.80	\$47.90	\$44.56
PE33662-24	24"	56.05	52.13	48.20	44.84
PE33662-36	36"	56.45	52.50	48.55	45.16
PE33662-48	48"	56.85	52.87	48.89	45.48
PE33662-60	60"	57.30	53.29	49.28	45.84
PE33662-XX	Any	Same-Day Shipment / Call for Pricing			

## 93 OHM, RG62A/U COAX

Model No.	Length	1-24	25-49	50-99	100 +
PE34435-12	12"	\$55.70	\$51.80	\$47.90	\$44.56
PE34435-24	24"	56.05	52.13	48.20	44.84
PE34435-36	36"	56.45	52.50	48.55	45.16
PE34435-48	48"	56.85	52.87	48.89	45.48
PE34435-60	60"	57.30	53.29	49.28	45.84
PE34435-XX	Any	Same-Day Shipment / Call for Pricing			

## 50 OHM, RG141A/U COAX

Model No.	Length	1-24	25-49	50-99	100 +
PE34440-12	12"	\$55.70	\$51.80	\$47.90	\$44.56
PE34440-24	24"	59.30	55.15	51.00	47.44
PE34440-36	36"	62.95	58.54	54.14	50.36
PE34440-48	48"	66.50	61.85	57.19	53.20
PE34440-60	60"	70.20	65.29	60.37	56.16
PE34440-XX	Any	Same-Day Shipment / Call for Pricing			

## 50 OHM, RG142B/U COAX, DOUBLE SHIELDED

Model No.	Length	1-24	25-49	50-99	100 +
PE3518-12	12"	\$53.00	\$49.29	\$45.58	\$42.40
PE3518-24	24"	55.70	51.80	47.90	44.56
PE3518-36	36"	58.35	54.27	50.18	46.68
PE3518-48	48"	61.00	56.73	52.46	48.80
PE3518-60	60"	63.65	59.19	54.74	50.92
PE3518-XX	Any	Same-Day Shipment / Call for Pricing			

## 50 OHM, RG213/U COAX

Model No.	Length	1-24	25-49	50-99	100 +
PE3522-12	12"	\$58.35	\$54.27	\$50.18	\$46.68
PE3522-24	24"	59.35	55.20	51.04	47.48
PE3522-36	36"	60.35	56.13	51.90	48.28
PE3522-48	48"	61.35	57.06	52.76	49.08
PE3522-60	60"	62.40	58.03	53.66	49.92
PE3522-XX	Any	Same-Day Shipment / Call for Pricing			

## 50 OHM, RG214/U COAX, DOUBLE SHIELDED

Model No.	Length	1-24	25-49	50-99	100 +
PE3605-12	12"	\$58.35	\$54.27	\$50.18	\$46.68
PE3605-24	24"	61.90	57.57	53.23	49.52
PE3605-36	36"	65.55	60.96	56.37	52.44
PE3605-48	48"	69.20	64.36	59.51	55.36
PE3605-60	60"	72.80	67.70	62.61	58.24
PE3605-XX	Any	Same-Day Shipment / Call for Pricing			

## 50 OHM, RG217/U COAX, DOUBLE SHIELDED

Model No.	Length	1-24	25-49	50-99	100 +
PE34437-12	12"	\$86.20	\$80.17	\$74.13	\$68.96
PE34437-24	24"	88.60	82.40	76.20	70.88
PE34437-36	36"	91.00	84.63	78.26	72.80
PE34437-48	48"	93.40	86.86	80.32	74.72
PE34437-60	60"	95.90	89.19	82.47	76.72
PE34437-XX	Any	Same-Day Shipment / Call for Pricing			

## 50 OHM, RG218/U COAX

Model No.	Length	1-24	25-49	50-99	100 +
PE34442-12	12"	\$132.60	\$123.32	\$114.04	\$106.08
PE34442-24	24"	138.55	128.85	119.15	110.84
PE34442-36	36"	144.65	134.52	124.40	115.72
PE34442-48	48"	150.70	140.15	129.60	120.56
PE34442-60	60"	156.65	145.68	134.72	125.32
PE34442-XX	Any	Same-Day Shipment / Call for Pricing			

## 50 OHM, RG223/U COAX, DOUBLE SHIELDED

Model No.	Length	1-24	25-49	50-99	100 +
PE3343-12	12"	\$53.00	\$49.29	\$45.58	\$42.40
PE3343-24	24"	54.35	50.55	46.74	43.48
PE3343-36	36"	55.70	51.80	47.90	44.56
PE3343-48	48"	57.00	53.01	49.02	45.60
PE3343-60	60"	58.35	54.27	50.18	46.68
PE3343-XX	Any	Same-Day Shipment / Call for Pricing			

## 50 OHM, RG225/U COAX, DOUBLE SHIELDED

Model No.	Length	1-24	25-49	50-99	100 +
PE33098-12	12"	\$64.95	\$60.40	\$55.86	\$51.96
PE33098-24	24"	89.05	82.82	76.58	71.24
PE33098-36	36"	113.20	105.28	97.35	90.56
PE33098-48	48"	137.25	127.64	118.04	109.80
PE33098-60	60"	161.35	150.06	138.76	129.08
PE33098-XX	Any	Same-Day Shipment / Call for Pricing			

## 50 OHM, RG393/U COAX, DOUBLE SHIELDED

Model No.	Length	1-24	25-49	50-99	100 +
PE3120-12	12"	\$58.35	\$54.27	\$50.18	\$46.68
PE3120-24	24"	66.75	62.08	57.41	53.40
PE3120-36	36"	75.20	69.94	64.67	60.16
PE3120-48	48"	83.65	77.79	71.94	66.92
PE3120-60	60"	92.10	85.65	79.21	73.68
PE3120-XX	Any	Same-Day Shipment / Call for Pricing			

## 50 OHM, RG400/U COAX, DOUBLE SHIELDED

Model No.	Length	1-24	25-49	50-99	100 +
PE3545-12	12"	\$53.00	\$49.29	\$45.58	\$42.40
PE3545-24	24"	55.70	51.80	47.90	44.56
PE3545-36	36"	58.35	54.27	50.18	46.68
PE3545-48	48"	61.00	56.73	52.46	48.80
PE3545-60	60"	63.65	59.19	54.74	50.92
PE3545-XX	Any	Same-Day Shipment / Call for Pricing			

\*\*ROHS COMPLIANT & CUSTOM-LENGTH CABLE ASSEMBLIES MAY BE ORDERED ON OUR WEBSITE.\*\*

## 10-32 MALE TO 10-32 MALE



### 50 OHM, RG174A/U COAX

Model No.	Length	1-24	25-49	50-99	100 +
PE36520-12	12"	\$35.95	\$33.43	\$30.92	\$28.76
PE36520-24	24"	36.20	33.67	31.13	28.96
PE36520-36	36"	36.45	33.90	31.35	29.16
PE36520-48	48"	36.70	34.13	31.56	29.36
PE36520-60	60"	37.05	34.46	31.86	29.64
PE36520-XX	Any	Same-Day Shipment / Call for Pricing			

### 50 OHM, RG178B/U COAX

Model No.	Length	1-24	25-49	50-99	100 +
PE36522-12	12"	\$37.15	\$34.55	\$31.95	\$29.72
PE36522-24	24"	38.10	35.43	32.77	30.48
PE36522-36	36"	39.05	36.32	33.58	31.24
PE36522-48	48"	40.00	37.20	34.40	32.00
PE36522-60	60"	41.00	38.13	35.26	32.80
PE36522-XX	Any	Same-Day Shipment / Call for Pricing			

### 50 OHM, RG316/U COAX

Model No.	Length	1-24	25-49	50-99	100 +
PE36524-12	12"	\$35.95	\$33.43	\$30.92	\$28.76
PE36524-24	24"	36.85	34.27	31.69	29.48
PE36524-36	36"	37.90	35.25	32.59	30.32
PE36524-48	48"	38.80	36.08	33.37	31.04
PE36524-60	60"	39.80	37.01	34.23	31.84
PE36524-XX	Any	Same-Day Shipment / Call for Pricing			

## 10-32 MALE TO 10-32 MALE RIGHT ANGLE



### 50 OHM, RG174A/U COAX

Model No.	Length	1-24	25-49	50-99	100 +
PE36526-12	12"	\$40.75	\$37.90	\$35.05	\$32.60
PE36526-24	24"	41.00	38.13	35.26	32.80
PE36526-36	36"	41.30	38.41	35.52	33.04
PE36526-48	48"	41.55	38.64	35.73	33.24
PE36526-60	60"	41.80	38.87	35.95	33.44
PE36526-XX	Any	Same-Day Shipment / Call for Pricing			

### 50 OHM, RG178B/U COAX

Model No.	Length	1-24	25-49	50-99	100 +
PE36528-12	12"	\$41.90	\$38.97	\$36.03	\$33.52
PE36528-24	24"	42.95	39.94	36.94	34.36
PE36528-36	36"	43.85	40.78	37.71	35.08
PE36528-48	48"	44.90	41.76	38.61	35.92
PE36528-60	60"	45.75	42.55	39.35	36.60
PE36528-XX	Any	Same-Day Shipment / Call for Pricing			

### 50 OHM, RG316/U COAX

Model No.	Length	1-24	25-49	50-99	100 +
PE36530-12	12"	\$40.75	\$37.90	\$35.05	\$32.60
PE36530-24	24"	41.70	38.78	35.86	33.36
PE36530-36	36"	42.70	39.71	36.72	34.16
PE36530-48	48"	43.60	40.55	37.50	34.88
PE36530-60	60"	44.55	41.43	38.31	35.64
PE36530-XX	Any	Same-Day Shipment / Call for Pricing			

## 10-32 MALE RIGHT ANGLE TO 10-32 MALE RIGHT ANGLE

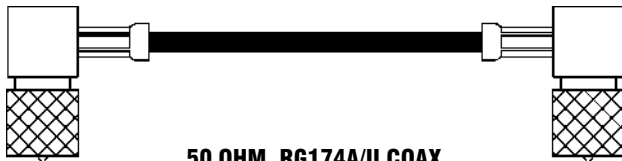

### 50 OHM, RG174A/U COAX

Model No.	Length	1-24	25-49	50-99	100 +
PE36532-12	12"	\$45.55	\$42.36	\$39.17	\$36.44
PE36532-24	24"	45.80	42.59	39.39	36.64
PE36532-36	36"	46.05	42.83	39.60	36.84
PE36532-48	48"	46.30	43.06	39.82	37.04
PE36532-60	60"	46.65	43.38	40.12	37.32
PE36532-XX	Any	Same-Day Shipment / Call for Pricing			

### 50 OHM, RG178B/U COAX

Model No.	Length	1-24	25-49	50-99	100 +
PE36534-12	12"	\$46.80	\$43.52	\$40.25	\$37.44
PE36534-24	24"	47.70	44.36	41.02	38.16
PE36534-36	36"	48.70	45.29	41.88	38.96
PE36534-48	48"	49.65	46.17	42.70	39.72
PE36534-60	60"	50.60	47.06	43.52	40.48
PE36534-XX	Any	Same-Day Shipment / Call for Pricing			

### 50 OHM, RG316/U COAX

Model No.	Length	1-24	25-49	50-99	100 +
PE36536-12	12"	\$45.55	\$42.36	\$39.17	\$36.44
PE36536-24	24"	46.55	43.29	40.03	37.24
PE36536-36	36"	47.50	44.18	40.85	38.00
PE36536-48	48"	48.50	45.11	41.71	38.80
PE36536-60	60"	49.35	45.90	42.44	39.48
PE36536-XX	Any	Same-Day Shipment / Call for Pricing			

## 10-32 MALE TO BNC MALE



### 50 OHM, RG174A/U COAX

Model No.	Length	1-24	25-49	50-99	100 +
PE36538-12	12"	\$40.75	\$37.90	\$35.05	\$32.60
PE36538-24	24"	41.00	38.13	35.26	32.80
PE36538-36	36"	41.30	38.41	35.52	33.04
PE36538-48	48"	41.55	38.64	35.73	33.24
PE36538-60	60"	41.80	38.87	35.95	33.44
PE36538-XX	Any	Same-Day Shipment / Call for Pricing			

### 50 OHM, RG178B/U COAX

Model No.	Length	1-24	25-49	50-99	100 +
PE36540-12	12"	\$41.90	\$38.97	\$36.03	\$33.52
PE36540-24	24"	42.95	39.94	36.94	34.36
PE36540-36	36"	43.85	40.78	37.71	35.08
PE36540-48	48"	44.90	41.76	38.61	35.92
PE36540-60	60"	45.75	42.55	39.35	36.60
PE36540-XX	Any	Same-Day Shipment / Call for Pricing			

### 50 OHM, RG316/U COAX

Model No.	Length	1-24	25-49	50-99	100 +
PE36542-12	12"	\$40.75	\$37.90	\$35.05	\$32.60
PE36542-24	24"	41.70	38.78	35.86	33.36
PE36542-36	36"	42.70	39.71	36.72	34.16
PE36542-48	48"	43.60	40.55	37.50	34.88
PE36542-60	60"	44.55	41.43	38.31	35.64
PE36542-XX	Any	Same-Day Shipment / Call for Pricing			

\*\*ROHS COMPLIANT & CUSTOM-LENGTH CABLE ASSEMBLIES MAY BE ORDERED ON OUR WEBSITE.\*\*

## SSMA MALE TO SSMA MALE



### 50 OHM, RG174A/U COAX

Model No.	Length	1-24	25-49	50-99	100 +
PE3673-12	12"	\$43.50	\$40.46	\$37.41	\$34.80
PE3673-24	24"	43.75	40.69	37.63	35.00
PE3673-36	36"	44.00	40.92	37.84	35.20
PE3673-48	48"	44.30	41.20	38.10	35.44
PE3673-60	60"	44.55	41.43	38.31	35.64
PE3673-XX	Any	Same-Day Shipment / Call for Pricing			

### 50 OHM, RG178B/U COAX

Model No.	Length	1-24	25-49	50-99	100 +
PE33762-12	12"	\$48.70	\$45.29	\$41.88	\$38.96
PE33762-24	24"	49.65	46.17	42.70	39.72
PE33762-36	36"	50.60	47.06	43.52	40.48
PE33762-48	48"	51.55	47.94	44.33	41.24
PE33762-60	60"	52.60	48.92	45.24	42.08
PE33762-XX	Any	Same-Day Shipment / Call for Pricing			

### 50 OHM, RG316/U COAX

Model No.	Length	1-24	25-49	50-99	100 +
PE33071-12	12"	\$43.85	\$40.78	\$37.71	\$35.08
PE33071-24	24"	44.90	41.76	38.61	35.92
PE33071-36	36"	45.75	42.55	39.35	36.60
PE33071-48	48"	46.80	43.52	40.25	37.44
PE33071-60	60"	47.70	44.36	41.02	38.16
PE33071-XX	Any	Same-Day Shipment / Call for Pricing			

## SSMA MALE TO SMA MALE



### 50 OHM, RG174A/U COAX

Model No.	Length	1-24	25-49	50-99	100 +
PE35430-12	12"	\$53.15	\$49.43	\$45.71	\$42.52
PE35430-24	24"	53.50	49.76	46.01	42.80
PE35430-36	36"	53.75	49.99	46.23	43.00
PE35430-48	48"	54.00	50.22	46.44	43.20
PE35430-60	60"	54.20	50.41	46.61	43.36
PE35430-XX	Any	Same-Day Shipment / Call for Pricing			

### 50 OHM, RG178B/U COAX

Model No.	Length	1-24	25-49	50-99	100 +
PE3058-12	12"	\$58.35	\$54.27	\$50.18	\$46.68
PE3058-24	24"	59.30	55.15	51.00	47.44
PE3058-36	36"	60.25	56.03	51.82	48.20
PE3058-48	48"	61.20	56.92	52.63	48.96
PE3058-60	60"	62.10	57.75	53.41	49.68
PE3058-XX	Any	Same-Day Shipment / Call for Pricing			

### 50 OHM, RG316/U COAX

Model No.	Length	1-24	25-49	50-99	100 +
PE3669-12	12"	\$53.55	\$49.80	\$46.05	\$42.84
PE3669-24	24"	54.45	50.64	46.83	43.56
PE3669-36	36"	55.45	51.57	47.69	44.36
PE3669-48	48"	56.35	52.41	48.46	45.08
PE3669-60	60"	57.45	53.43	49.41	45.96
PE3669-XX	Any	Same-Day Shipment / Call for Pricing			

## SSMA MALE RIGHT ANGLE TO SSMA MALE RIGHT ANGLE



### 50 OHM, RG174A/U COAX

Model No.	Length	1-24	25-49	50-99	100 +
PE36570-12	12"	\$62.80	\$58.40	\$54.01	\$50.24
PE36570-24	24"	63.10	58.68	54.27	50.48
PE36570-36	36"	63.35	58.92	54.48	50.68
PE36570-48	48"	63.60	59.15	54.70	50.88
PE36570-60	60"	63.85	59.38	54.91	51.08
PE36570-XX	Any	Same-Day Shipment / Call for Pricing			

### 50 OHM, RG178B/U COAX

Model No.	Length	1-24	25-49	50-99	100 +
PE36572-12	12"	\$68.00	\$63.24	\$58.48	\$54.40
PE36572-24	24"	68.95	64.12	59.30	55.16
PE36572-36	36"	69.90	65.01	60.11	55.92
PE36572-48	48"	70.85	65.89	60.93	56.68
PE36572-60	60"	71.85	66.82	61.79	57.48
PE36572-XX	Any	Same-Day Shipment / Call for Pricing			

### 50 OHM, RG316/U COAX

Model No.	Length	1-24	25-49	50-99	100 +
PE36574-12	12"	\$63.20	\$58.78	\$54.35	\$50.56
PE36574-24	24"	64.15	59.66	55.17	51.32
PE36574-36	36"	65.10	60.54	55.99	52.08
PE36574-48	48"	66.10	61.47	56.85	52.88
PE36574-60	60"	66.95	62.26	57.58	53.56
PE36574-XX	Any	Same-Day Shipment / Call for Pricing			

## SSMA MALE RIGHT ANGLE TO SSMA MALE



### 50 OHM, RG174A/U COAX

Model No.	Length	1-24	25-49	50-99	100 +
PE36569-12	12"	\$53.15	\$49.43	\$45.71	\$42.52
PE36569-24	24"	53.50	49.76	46.01	42.80
PE36569-36	36"	53.75	49.99	46.23	43.00
PE36569-48	48"	54.00	50.22	46.44	43.20
PE36569-60	60"	54.20	50.41	46.61	43.36
PE36569-XX	Any	Same-Day Shipment / Call for Pricing			

### 50 OHM, RG178B/U COAX

Model No.	Length	1-24	25-49	50-99	100 +
PE36571-12	12"	\$58.35	\$54.27	\$50.18	\$46.68
PE36571-24	24"	59.30	55.15	51.00	47.44
PE36571-36	36"	60.25	56.03	51.82	48.20
PE36571-48	48"	61.20	56.92	52.63	48.96
PE36571-60	60"	62.10	57.75	53.41	49.68
PE36571-XX	Any	Same-Day Shipment / Call for Pricing			

### 50 OHM, RG316/U COAX

Model No.	Length	1-24	25-49	50-99	100 +
PE36573-12	12"	\$53.55	\$49.80	\$46.05	\$42.84
PE36573-24	24"	54.45	50.64	46.83	43.56
PE36573-36	36"	55.45	51.57	47.69	44.36
PE36573-48	48"	56.35	52.41	48.46	45.08
PE36573-60	60"	57.45	53.43	49.41	45.96
PE36573-XX	Any	Same-Day Shipment / Call for Pricing			

\*\*ROHS COMPLIANT & CUSTOM-LENGTH CABLE ASSEMBLIES MAY BE ORDERED ON OUR WEBSITE.\*\*

# BNC MALE TO UHF MALE



## 52 OHM, RG8A/U COAX

Model No.	Length	1-24	25-49	50-99	100 +
PE34581-12	12"	\$26.50	\$24.65	\$22.79	\$21.20
PE34581-24	24"	27.55	25.62	23.69	22.04
PE34581-36	36"	28.50	26.51	24.51	22.80
PE34581-48	48"	29.55	27.48	25.41	23.64
PE34581-60	60"	30.55	28.41	26.27	24.44
PE34581-XX	Any	Same-Day Shipment / Call for Pricing			

## 53.5 OHM, RG55B/U COAX, DOUBLE SHIELDED

Model No.	Length	1-24	25-49	50-99	100 +
PE34591-12	12"	\$21.20	\$19.72	\$18.23	\$16.96
PE34591-24	24"	21.95	20.41	18.88	17.56
PE34591-36	36"	22.70	21.11	19.52	18.16
PE34591-48	48"	23.35	21.72	20.08	18.68
PE34591-60	60"	24.05	22.37	20.68	19.24
PE34591-XX	Any	Same-Day Shipment / Call for Pricing			

## 50 OHM, RG58C/U COAX

Model No.	Length	1-24	25-49	50-99	100 +
PE3057-12	12"	\$19.90	\$18.51	\$17.11	\$15.92
PE3057-24	24"	20.30	18.88	17.46	16.24
PE3057-36	36"	20.70	19.25	17.80	16.56
PE3057-48	48"	21.10	19.62	18.15	16.88
PE3057-60	60"	21.50	20.00	18.49	17.20
PE3057-XX	Any	Same-Day Shipment / Call for Pricing			

## 75 OHM, RG59B/U COAX

Model No.	Length	1-24	25-49	50-99	100 +
PE3543-12	12"	\$21.20	\$19.72	\$18.23	\$16.96
PE3543-24	24"	21.60	20.09	18.58	17.28
PE3543-36	36"	22.05	20.51	18.96	17.64
PE3543-48	48"	22.45	20.88	19.31	17.96
PE3543-60	60"	22.85	21.25	19.65	18.28
PE3543-XX	Any	Same-Day Shipment / Call for Pricing			

## 93 OHM, RG62A/U COAX

Model No.	Length	1-24	25-49	50-99	100 +
PE34587-12	12"	\$22.50	\$20.93	\$19.35	\$18.00
PE34587-24	24"	22.95	21.34	19.74	18.36
PE34587-36	36"	23.30	21.67	20.04	18.64
PE34587-48	48"	23.75	22.09	20.43	19.00
PE34587-60	60"	24.10	22.41	20.73	19.28
PE34587-XX	Any	Same-Day Shipment / Call for Pricing			

## 50 OHM, RG142B/U COAX, DOUBLE SHIELDED

Model No.	Length	1-24	25-49	50-99	100 +
PE3898-12	12"	\$29.15	\$27.11	\$25.07	\$23.32
PE3898-24	24"	31.80	29.57	27.35	25.44
PE3898-36	36"	34.50	32.09	29.67	27.60
PE3898-48	48"	37.15	34.55	31.95	29.72
PE3898-60	60"	39.80	37.01	34.23	31.84
PE3898-XX	Any	Same-Day Shipment / Call for Pricing			

## 50 OHM, RG213/U COAX

Model No.	Length	1-24	25-49	50-99	100 +
PE34583-12	12"	\$26.50	\$24.65	\$22.79	\$21.20
PE34583-24	24"	27.55	25.62	23.69	22.04
PE34583-36	36"	28.50	26.51	24.51	22.80
PE34583-48	48"	29.55	27.48	25.41	23.64
PE34583-60	60"	30.55	28.41	26.27	24.44
PE34583-XX	Any	Same-Day Shipment / Call for Pricing			

## 50 OHM, RG214/U COAX, DOUBLE SHIELDED

Model No.	Length	1-24	25-49	50-99	100 +
PE33438-12	12"	\$29.15	\$27.11	\$25.07	\$23.32
PE33438-24	24"	32.80	30.50	28.21	26.24
PE33438-36	36"	36.40	33.85	31.30	29.12
PE33438-48	48"	40.00	37.20	34.40	32.00
PE33438-60	60"	43.60	40.55	37.50	34.88
PE33438-XX	Any	Same-Day Shipment / Call for Pricing			

## 50 OHM, RG223/U COAX, DOUBLE SHIELDED

Model No.	Length	1-24	25-49	50-99	100 +
PE3803-12	12"	\$22.50	\$20.93	\$19.35	\$18.00
PE3803-24	24"	23.85	22.18	20.51	19.08
PE3803-36	36"	25.20	23.44	21.67	20.16
PE3803-48	48"	26.50	24.65	22.79	21.20
PE3803-60	60"	27.85	25.90	23.95	22.28
PE3803-XX	Any	Same-Day Shipment / Call for Pricing			

## 50 OHM, RG225/U COAX, DOUBLE SHIELDED

Model No.	Length	1-24	25-49	50-99	100 +
PE34589-12	12"	\$39.80	\$37.01	\$34.23	\$31.84
PE34589-24	24"	63.85	59.38	54.91	51.08
PE34589-36	36"	88.00	81.84	75.68	70.40
PE34589-48	48"	112.10	104.25	96.41	89.68
PE34589-60	60"	136.20	126.67	117.13	108.96
PE34589-XX	Any	Same-Day Shipment / Call for Pricing			

## 50 OHM, RG393/U COAX, DOUBLE SHIELDED

Model No.	Length	1-24	25-49	50-99	100 +
PE34585-12	12"	\$33.15	\$30.83	\$28.51	\$26.52
PE34585-24	24"	41.60	38.69	35.78	33.28
PE34585-36	36"	50.05	46.55	43.04	40.04
PE34585-48	48"	58.45	54.36	50.27	46.76
PE34585-60	60"	66.85	62.17	57.49	53.48
PE34585-XX	Any	Same-Day Shipment / Call for Pricing			

## 50 OHM, RG400/U COAX, DOUBLE SHIELDED

Model No.	Length	1-24	25-49	50-99	100 +
PE3231-12	12"	\$29.15	\$27.11	\$25.07	\$23.32
PE3231-24	24"	31.80	29.57	27.35	25.44
PE3231-36	36"	34.50	32.09	29.67	27.60
PE3231-48	48"	37.15	34.55	31.95	29.72
PE3231-60	60"	39.80	37.01	34.23	31.84
PE3231-XX	Any	Same-Day Shipment / Call for Pricing			

## 50 OHM, PE-B3199, VERY LOW LOSS CABLE

Model No.	Length	1-24	25-49	50-99	100 +
PE34577-12	12"	\$26.50	\$24.65	\$22.79	\$21.20
PE34577-24	24"	27.50	25.58	23.65	22.00
PE34577-36	36"	28.45	26.46	24.47	22.76
PE34577-48	48"	29.40	27.34	25.28	23.52
PE34577-60	60"	30.40	28.27	26.14	24.32
PE34577-XX	Any	Same-Day Shipment / Call for Pricing			

## 50 OHM, PE-B4199, LOW LOSS COAX

Model No.	Length	1-24	25-49	50-99	100 +
PE34579-12	12"	\$26.50	\$24.65	\$22.79	\$21.20
PE34579-24	24"	27.50	25.58	23.65	22.00
PE34579-36	36"	28.45	26.46	24.47	22.76
PE34579-48	48"	29.40	27.34	25.28	23.52
PE34579-60	60"	30.40	28.27	26.14	24.32
PE34579-XX	Any	Same-Day Shipment / Call for Pricing			

\*\*ROHS COMPLIANT & CUSTOM-LENGTH CABLE ASSEMBLIES MAY BE ORDERED ON OUR WEBSITE.\*\*

# SC MALE TO SC MALE



Cable Assemblies

## 52 OHM, RG8A/U COAX

Model No.	Length	1-24	25-49	50-99	100 +
PE34443-12	12"	\$102.50	\$95.33	\$88.15	\$82.00
PE34443-24	24"	103.45	96.21	88.97	82.76
PE34443-36	36"	104.50	97.19	89.87	83.60
PE34443-48	48"	105.40	98.02	90.64	84.32
PE34443-60	60"	106.50	99.05	91.59	85.20
PE34443-XX	Any	Same-Day Shipment / Call for Pricing			

## 50 OHM, RG58C/U COAX

Model No.	Length	1-24	25-49	50-99	100 +
PE3104-12	12"	\$96.40	\$89.65	\$82.90	\$77.12
PE3104-24	24"	96.85	90.07	83.29	77.48
PE3104-36	36"	97.25	90.44	83.64	77.80
PE3104-48	48"	97.65	90.81	83.98	78.12
PE3104-60	60"	98.00	91.14	84.28	78.40
PE3104-XX	Any	Same-Day Shipment / Call for Pricing			

## 75 OHM, RG59B/U COAX

Model No.	Length	1-24	25-49	50-99	100 +
PE34441-12	12"	\$102.50	\$95.33	\$88.15	\$82.00
PE34441-24	24"	102.85	95.65	88.45	82.28
PE34441-36	36"	103.30	96.07	88.84	82.64
PE34441-48	48"	103.65	96.39	89.14	82.92
PE34441-60	60"	104.10	96.81	89.53	83.28
PE34441-XX	Any	Same-Day Shipment / Call for Pricing			

## 93 OHM, RG62A/U COAX

Model No.	Length	1-24	25-49	50-99	100 +
PE34449-12	12"	\$102.50	\$95.33	\$88.15	\$82.00
PE34449-24	24"	102.85	95.65	88.45	82.28
PE34449-36	36"	103.30	96.07	88.84	82.64
PE34449-48	48"	103.65	96.39	89.14	82.92
PE34449-60	60"	104.10	96.81	89.53	83.28
PE34449-XX	Any	Same-Day Shipment / Call for Pricing			

## 50 OHM, RG141A/U COAX

Model No.	Length	1-24	25-49	50-99	100 +
PE34439-12	12"	\$98.80	\$91.88	\$84.97	\$79.04
PE34439-24	24"	102.50	95.33	88.15	82.00
PE34439-36	36"	106.10	98.67	91.25	84.88
PE34439-48	48"	109.70	102.02	94.34	87.76
PE34439-60	60"	113.30	105.37	97.44	90.64
PE34439-XX	Any	Same-Day Shipment / Call for Pricing			

## 50 OHM, RG142B/U COAX, DOUBLE SHIELDED

Model No.	Length	1-24	25-49	50-99	100 +
PE3334-12	12"	\$96.40	\$89.65	\$82.90	\$77.12
PE3334-24	24"	99.10	92.16	85.23	79.28
PE3334-36	36"	101.75	94.63	87.51	81.40
PE3334-48	48"	104.40	97.09	89.78	83.52
PE3334-60	60"	107.05	99.56	92.06	85.64
PE3334-XX	Any	Same-Day Shipment / Call for Pricing			

## 50 OHM, RG213/U COAX

Model No.	Length	1-24	25-49	50-99	100 +
PE3395-12	12"	\$102.50	\$95.33	\$88.15	\$82.00
PE3395-24	24"	103.45	96.21	88.97	82.76
PE3395-36	36"	104.50	97.19	89.87	83.60
PE3395-48	48"	105.40	98.02	90.64	84.32
PE3395-60	60"	106.50	99.05	91.59	85.20
PE3395-XX	Any	Same-Day Shipment / Call for Pricing			

## 50 OHM, RG214/U COAX, DOUBLE SHIELDED

Model No.	Length	1-24	25-49	50-99	100 +
PE3409-12	12"	\$102.50	\$95.33	\$88.15	\$82.00
PE3409-24	24"	106.10	98.67	91.25	84.88
PE3409-36	36"	109.70	102.02	94.34	87.76
PE3409-48	48"	113.30	105.37	97.44	90.64
PE3409-60	60"	116.90	108.72	100.53	93.52
PE3409-XX	Any	Same-Day Shipment / Call for Pricing			

## 50 OHM, RG217/U COAX, DOUBLE SHIELDED

Model No.	Length	1-24	25-49	50-99	100 +
PE34445-12	12"	\$144.65	\$134.52	\$124.40	\$115.72
PE34445-24	24"	147.10	136.80	126.51	117.68
PE34445-36	36"	149.45	138.99	128.53	119.56
PE34445-48	48"	151.90	141.27	130.63	121.52
PE34445-60	60"	154.30	143.50	132.70	123.44
PE34445-XX	Any	Same-Day Shipment / Call for Pricing			

## 50 OHM, RG218/U COAX

Model No.	Length	1-24	25-49	50-99	100 +
PE34451-12	12"	\$229.05	\$213.02	\$196.98	\$183.24
PE34451-24	24"	235.00	218.55	202.10	188.00
PE34451-36	36"	241.10	224.22	207.35	192.88
PE34451-48	48"	247.10	229.80	212.51	197.68
PE34451-60	60"	253.10	235.38	217.67	202.48
PE34451-XX	Any	Same-Day Shipment / Call for Pricing			

## 50 OHM, RG223/U COAX, DOUBLE SHIELDED

Model No.	Length	1-24	25-49	50-99	100 +
PE3348-12	12"	\$96.40	\$89.65	\$82.90	\$77.12
PE3348-24	24"	97.75	90.91	84.07	78.20
PE3348-36	36"	99.10	92.16	85.23	79.28
PE3348-48	48"	100.35	93.33	86.30	80.28
PE3348-60	60"	101.75	94.63	87.51	81.40
PE3348-XX	Any	Same-Day Shipment / Call for Pricing			

## 50 OHM, RG225/U COAX, DOUBLE SHIELDED

Model No.	Length	1-24	25-49	50-99	100 +
PE34447-12	12"	\$116.90	\$108.72	\$100.53	\$93.52
PE34447-24	24"	141.05	131.18	121.30	112.84
PE34447-36	36"	165.15	153.59	142.03	132.12
PE34447-48	48"	189.25	176.00	162.76	151.40
PE34447-60	60"	213.35	198.42	183.48	170.68
PE34447-XX	Any	Same-Day Shipment / Call for Pricing			

## 50 OHM, RG393/U COAX, DOUBLE SHIELDED

Model No.	Length	1-24	25-49	50-99	100 +
PE3416-12	12"	\$102.50	\$95.33	\$88.15	\$82.00
PE3416-24	24"	110.80	103.04	95.29	88.64
PE3416-36	36"	119.30	110.95	102.60	95.44
PE3416-48	48"	127.75	118.81	109.87	102.20
PE3416-60	60"	136.20	126.67	117.13	108.96
PE3416-XX	Any	Same-Day Shipment / Call for Pricing			

## 50 OHM, RG400/U COAX, DOUBLE SHIELDED

Model No.	Length	1-24	25-49	50-99	100 +
PE34453-12	12"	\$96.40	\$89.65	\$82.90	\$77.12
PE34453-24	24"	99.10	92.16	85.23	79.28
PE34453-36	36"	101.75	94.63	87.51	81.40
PE34453-48	48"	104.40	97.09	89.78	83.52
PE34453-60	60"	107.05	99.56	92.06	85.64
PE34453-XX	Any	Same-Day Shipment / Call for Pricing			

\*\*ROHS COMPLIANT & CUSTOM-LENGTH CABLE ASSEMBLIES MAY BE ORDERED ON OUR WEBSITE.\*\*

# MMCX PLUG TO MMCX PLUG



## 50 OHM, RG174A/U COAX

Model No.	Length	1-24	25-49	50-99	100 +
PE34879-12	12"	\$26.50	\$24.65	\$22.79	\$21.20
PE34879-24	24"	26.80	24.92	23.05	21.44
PE34879-36	36"	27.05	25.16	23.26	21.64
PE34879-48	48"	27.35	25.44	23.52	21.88
PE34879-60	60"	27.60	25.67	23.74	22.08
PE34879-XX	Any	Same-Day Shipment / Call for Pricing			

## 50 OHM, RG178B/U COAX

Model No.	Length	1-24	25-49	50-99	100 +
PE34598-12	12"	\$27.70	\$25.76	\$23.82	\$22.16
PE34598-24	24"	28.65	26.64	24.64	22.92
PE34598-36	36"	29.65	27.57	25.50	23.72
PE34598-48	48"	30.60	28.46	26.32	24.48
PE34598-60	60"	31.60	29.39	27.18	25.28
PE34598-XX	Any	Same-Day Shipment / Call for Pricing			

## 50 OHM, RG188A/U COAX

Model No.	Length	1-24	25-49	50-99	100 +
PE34885-12	12"	\$26.50	\$24.65	\$22.79	\$21.20
PE34885-24	24"	27.50	25.58	23.65	22.00
PE34885-36	36"	28.45	26.46	24.47	22.76
PE34885-48	48"	29.40	27.34	25.28	23.52
PE34885-60	60"	30.40	28.27	26.14	24.32
PE34885-XX	Any	Same-Day Shipment / Call for Pricing			

## 50 OHM, RG196A/U COAX

Model No.	Length	1-24	25-49	50-99	100 +
PE34891-12	12"	\$27.70	\$25.76	\$23.82	\$22.16
PE34891-24	24"	28.65	26.64	24.64	22.92
PE34891-36	36"	29.65	27.57	25.50	23.72
PE34891-48	48"	30.60	28.46	26.32	24.48
PE34891-60	60"	31.60	29.39	27.18	25.28
PE34891-XX	Any	Same-Day Shipment / Call for Pricing			

## 50 OHM, RG316/U COAX

Model No.	Length	1-24	25-49	50-99	100 +
PE34240-12	12"	\$26.50	\$24.65	\$22.79	\$21.20
PE34240-24	24"	27.50	25.58	23.65	22.00
PE34240-36	36"	28.45	26.46	24.47	22.76
PE34240-48	48"	29.40	27.34	25.28	23.52
PE34240-60	60"	30.40	28.27	26.14	24.32
PE34240-XX	Any	Same-Day Shipment / Call for Pricing			

# MMCX PLUG TO MMCX PLUG RIGHT ANGLE



## 50 OHM, RG174A/U COAX

Model No.	Length	1-24	25-49	50-99	100 +
PE34881-12	12"	\$33.75	\$31.39	\$29.03	\$27.00
PE34881-24	24"	33.95	31.57	29.20	27.16
PE34881-36	36"	34.25	31.85	29.46	27.40
PE34881-48	48"	34.55	32.13	29.71	27.64
PE34881-60	60"	34.80	32.36	29.93	27.84
PE34881-XX	Any	Same-Day Shipment / Call for Pricing			

## 50 OHM, RG178B/U COAX

Model No.	Length	1-24	25-49	50-99	100 +
PE34883-12	12"	\$34.95	\$32.50	\$30.06	\$27.96
PE34883-24	24"	35.95	33.43	30.92	28.76
PE34883-36	36"	36.85	34.27	31.69	29.48
PE34883-48	48"	37.90	35.25	32.59	30.32
PE34883-60	60"	38.80	36.08	33.37	31.04
PE34883-XX	Any	Same-Day Shipment / Call for Pricing			

## 50 OHM, RG188A/U COAX

Model No.	Length	1-24	25-49	50-99	100 +
PE34889-12	12"	\$33.75	\$31.39	\$29.03	\$27.00
PE34889-24	24"	34.70	32.27	29.84	27.76
PE34889-36	36"	35.70	33.20	30.70	28.56
PE34889-48	48"	36.60	34.04	31.48	29.28
PE34889-60	60"	37.60	34.97	32.34	30.08
PE34889-XX	Any	Same-Day Shipment / Call for Pricing			

## 50 OHM, RG196A/U COAX

Model No.	Length	1-24	25-49	50-99	100 +
PE34893-12	12"	\$34.95	\$32.50	\$30.06	\$27.96
PE34893-24	24"	35.95	33.43	30.92	28.76
PE34893-36	36"	36.85	34.27	31.69	29.48
PE34893-48	48"	37.90	35.25	32.59	30.32
PE34893-60	60"	38.80	36.08	33.37	31.04
PE34893-XX	Any	Same-Day Shipment / Call for Pricing			

## 50 OHM, RG316/U COAX

Model No.	Length	1-24	25-49	50-99	100 +
PE34895-12	12"	\$33.75	\$31.39	\$29.03	\$27.00
PE34895-24	24"	34.70	32.27	29.84	27.76
PE34895-36	36"	35.70	33.20	30.70	28.56
PE34895-48	48"	36.60	34.04	31.48	29.28
PE34895-60	60"	37.60	34.97	32.34	30.08
PE34895-XX	Any	Same-Day Shipment / Call for Pricing			

# MMCX PLUG TO SMA MALE



## 50 OHM, RG174A/U COAX

Model No.	Length	1-24	25-49	50-99	100 +
PE34069-12	12"	\$33.75	\$31.39	\$29.03	\$27.00
PE34069-24	24"	33.95	31.57	29.20	27.16
PE34069-36	36"	34.25	31.85	29.46	27.40
PE34069-48	48"	34.55	32.13	29.71	27.64
PE34069-60	60"	34.80	32.36	29.93	27.84
PE34069-XX	Any	Same-Day Shipment / Call for Pricing			

## 50 OHM, RG178B/U COAX

Model No.	Length	1-24	25-49	50-99	100 +
PE34374-12	12"	\$34.95	\$32.50	\$30.06	\$27.96
PE34374-24	24"	35.95	33.43	30.92	28.76
PE34374-36	36"	36.85	34.27	31.69	29.48
PE34374-48	48"	37.90	35.25	32.59	30.32
PE34374-60	60"	38.80	36.08	33.37	31.04
PE34374-XX	Any	Same-Day Shipment / Call for Pricing			

## 50 OHM, RG188A/U COAX

Model No.	Length	1-24	25-49	50-99	100 +
PE34887-12	12"	\$33.75	\$31.39	\$29.03	\$27.00
PE34887-24	24"	34.70	32.27	29.84	27.76
PE34887-36	36"	35.70	33.20	30.70	28.56
PE34887-48	48"	36.60	34.04	31.48	29.28
PE34887-60	60"	37.60	34.97	32.34	30.08
PE34887-XX	Any	Same-Day Shipment / Call for Pricing			

## 50 OHM, RG316/U COAX

Model No.	Length	1-24	25-49	50-99	100 +
PE34122-12	12"	\$33.75	\$31.39	\$29.03	\$27.00
PE34122-24	24"	34.70	32.27	29.84	27.76
PE34122-36	36"	35.70	33.20	30.70	28.56
PE34122-48	48"	36.60	34.04	31.48	29.28
PE34122-60	60"	37.60	34.97	32.34	30.08
PE34122-XX	Any	Same-Day Shipment / Call for Pricing			

\*\*ROHS COMPLIANT & CUSTOM-LENGTH CABLE ASSEMBLIES MAY BE ORDERED ON OUR WEBSITE.\*\*

## REVERSE POLARITY SMA MALE TO STANDARD BNC MALE



### 50 OHM, RG58C/U COAX

Model No.	Length	1-24	25-49	50-99	100 +
PE35207-12	12"	\$30.15	\$28.04	\$25.93	\$24.12
PE35207-24	24"	30.55	28.41	26.27	24.44
PE35207-36	36"	30.95	28.78	26.62	24.76
PE35207-48	48"	31.35	29.16	26.96	25.08
PE35207-60	60"	31.75	29.53	27.31	25.40
PE35207-XX	Any	Same-Day Shipment / Call for Pricing			

### 50 OHM, RG142B/U COAX, DOUBLE SHIELDED

Model No.	Length	1-24	25-49	50-99	100 +
PE35209-12	12"	\$34.95	\$32.50	\$30.06	\$27.96
PE35209-24	24"	37.60	34.97	32.34	30.08
PE35209-36	36"	40.25	37.43	34.62	32.20
PE35209-48	48"	42.95	39.94	36.94	34.36
PE35209-60	60"	45.55	42.36	39.17	36.44
PE35209-XX	Any	Same-Day Shipment / Call for Pricing			

### 50 OHM, RG174A/U COAX

Model No.	Length	1-24	25-49	50-99	100 +
PE35211-12	12"	\$33.75	\$31.39	\$29.03	\$27.00
PE35211-24	24"	33.95	31.57	29.20	27.16
PE35211-36	36"	34.25	31.85	29.46	27.40
PE35211-48	48"	34.55	32.13	29.71	27.64
PE35211-60	60"	34.80	32.36	29.93	27.84
PE35211-XX	Any	Same-Day Shipment / Call for Pricing			

### 50 OHM, RG178B/U COAX

Model No.	Length	1-24	25-49	50-99	100 +
PE35213-12	12"	\$54.25	\$50.45	\$46.66	\$43.40
PE35213-24	24"	55.25	51.38	47.52	44.20
PE35213-36	36"	56.15	52.22	48.29	44.92
PE35213-48	48"	57.10	53.10	49.11	45.68
PE35213-60	60"	58.10	54.03	49.97	46.48
PE35213-XX	Any	Same-Day Shipment / Call for Pricing			

### 50 OHM, RG188A/U COAX

Model No.	Length	1-24	25-49	50-99	100 +
PE35215-12	12"	\$33.75	\$31.39	\$29.03	\$27.00
PE35215-24	24"	34.70	32.27	29.84	27.76
PE35215-36	36"	35.70	33.20	30.70	28.56
PE35215-48	48"	36.60	34.04	31.48	29.28
PE35215-60	60"	37.60	34.97	32.34	30.08
PE35215-XX	Any	Same-Day Shipment / Call for Pricing			

### 50 OHM, RG223/U COAX, DOUBLE SHIELDED

Model No.	Length	1-24	25-49	50-99	100 +
PE35217-12	12"	\$34.95	\$32.50	\$30.06	\$27.96
PE35217-24	24"	36.30	33.76	31.22	29.04
PE35217-36	36"	37.60	34.97	32.34	30.08
PE35217-48	48"	38.90	36.18	33.45	31.12
PE35217-60	60"	40.25	37.43	34.62	32.20
PE35217-XX	Any	Same-Day Shipment / Call for Pricing			

### 50 OHM, RG316/U COAX

Model No.	Length	1-24	25-49	50-99	100 +
PE35219-12	12"	\$33.75	\$31.39	\$29.03	\$27.00
PE35219-24	24"	34.70	32.27	29.84	27.76
PE35219-36	36"	35.70	33.20	30.70	28.56
PE35219-48	48"	36.60	34.04	31.48	29.28
PE35219-60	60"	37.60	34.97	32.34	30.08
PE35219-XX	Any	Same-Day Shipment / Call for Pricing			

## REVERSE POLARITY SMA MALE TO STANDARD N MALE



### 50 OHM, RG58C/U COAX

Model No.	Length	1-24	25-49	50-99	100 +
PE34727-12	12"	\$34.95	\$32.50	\$30.06	\$27.96
PE34727-24	24"	35.35	32.88	30.40	28.28
PE34727-36	36"	35.80	33.29	30.79	28.64
PE34727-48	48"	36.20	33.67	31.13	28.96
PE34727-60	60"	36.60	34.04	31.48	29.28
PE34727-XX	Any	Same-Day Shipment / Call for Pricing			

### 50 OHM, RG142B/U COAX, DOUBLE SHIELDED

Model No.	Length	1-24	25-49	50-99	100 +
PE34361-12	12"	\$34.95	\$32.50	\$30.06	\$27.96
PE34361-24	24"	37.60	34.97	32.34	30.08
PE34361-36	36"	40.25	37.43	34.62	32.20
PE34361-48	48"	42.95	39.94	36.94	34.36
PE34361-60	60"	45.55	42.36	39.17	36.44
PE34361-XX	Any	Same-Day Shipment / Call for Pricing			

### 50 OHM, RG174A/U COAX

Model No.	Length	1-24	25-49	50-99	100 +
PE35221-12	12"	\$39.80	\$37.01	\$34.23	\$31.84
PE35221-24	24"	40.05	37.25	34.44	32.04
PE35221-36	36"	40.30	37.48	34.66	32.24
PE35221-48	48"	40.50	37.67	34.83	32.40
PE35221-60	60"	40.80	37.94	35.09	32.64
PE35221-XX	Any	Same-Day Shipment / Call for Pricing			

### 50 OHM, RG178B/U COAX

Model No.	Length	1-24	25-49	50-99	100 +
PE35223-12	12"	\$49.35	\$45.90	\$42.44	\$39.48
PE35223-24	24"	50.40	46.87	43.34	40.32
PE35223-36	36"	51.30	47.71	44.12	41.04
PE35223-48	48"	52.35	48.69	45.02	41.88
PE35223-60	60"	53.30	49.57	45.84	42.64
PE35223-XX	Any	Same-Day Shipment / Call for Pricing			

### 50 OHM, RG188A/U COAX

Model No.	Length	1-24	25-49	50-99	100 +
PE35225-12	12"	\$39.80	\$37.01	\$34.23	\$31.84
PE35225-24	24"	40.75	37.90	35.05	32.60
PE35225-36	36"	41.70	38.78	35.86	33.36
PE35225-48	48"	42.70	39.71	36.72	34.16
PE35225-60	60"	43.60	40.55	37.50	34.88
PE35225-XX	Any	Same-Day Shipment / Call for Pricing			

### 50 OHM, RG223/U COAX, DOUBLE SHIELDED

Model No.	Length	1-24	25-49	50-99	100 +
PE35227-12	12"	\$34.95	\$32.50	\$30.06	\$27.96
PE35227-24	24"	36.30	33.76	31.22	29.04
PE35227-36	36"	37.60	34.97	32.34	30.08
PE35227-48	48"	38.90	36.18	33.45	31.12
PE35227-60	60"	40.25	37.43	34.62	32.20
PE35227-XX	Any	Same-Day Shipment / Call for Pricing			

### 50 OHM, RG316/U COAX

Model No.	Length	1-24	25-49	50-99	100 +
PE34770-12	12"	\$39.80	\$37.01	\$34.23	\$31.84
PE34770-24	24"	40.75	37.90	35.05	32.60
PE34770-36	36"	41.70	38.78	35.86	33.36
PE34770-48	48"	42.70	39.71	36.72	34.16
PE34770-60	60"	43.60	40.55	37.50	34.88
PE34770-XX	Any	Same-Day Shipment / Call for Pricing			

\*\*ROHS COMPLIANT & CUSTOM-LENGTH CABLE ASSEMBLIES MAY BE ORDERED ON OUR WEBSITE.\*\*



## REVERSE POLARITY TNC MALE TO STANDARD TNC MALE



### 50 OHM, RG58C/U COAX

Model No.	Length	1-24	25-49	50-99	100 +
PE35228-12	12"	\$25.30	\$23.53	\$21.76	\$20.24
PE35228-24	24"	25.75	23.95	22.15	20.60
PE35228-36	36"	26.10	24.27	22.45	20.88
PE35228-48	48"	26.55	24.69	22.83	21.24
PE35228-60	60"	26.95	25.06	23.18	21.56
PE35228-XX	Any	Same-Day Shipment / Call for Pricing			

### 50 OHM, RG142B/U COAX, DOUBLE SHIELDED

Model No.	Length	1-24	25-49	50-99	100 +
PE35230-12	12"	\$25.30	\$23.53	\$21.76	\$20.24
PE35230-24	24"	28.00	26.04	24.08	22.40
PE35230-36	36"	30.60	28.46	26.32	24.48
PE35230-48	48"	33.25	30.92	28.60	26.60
PE35230-60	60"	35.95	33.43	30.92	28.76
PE35230-XX	Any	Same-Day Shipment / Call for Pricing			

### 50 OHM, RG213/U COAX

Model No.	Length	1-24	25-49	50-99	100 +
PE35232-12	12"	\$54.25	\$50.45	\$46.66	\$43.40
PE35232-24	24"	55.30	51.43	47.56	44.24
PE35232-36	36"	56.25	52.31	48.38	45.00
PE35232-48	48"	57.25	53.24	49.24	45.80
PE35232-60	60"	58.30	54.22	50.14	46.64
PE35232-XX	Any	Same-Day Shipment / Call for Pricing			

### 50 OHM, RG214/U COAX, DOUBLE SHIELDED

Model No.	Length	1-24	25-49	50-99	100 +
PE35234-12	12"	\$54.25	\$50.45	\$46.66	\$43.40
PE35234-24	24"	57.90	53.85	49.79	46.32
PE35234-36	36"	61.45	57.15	52.85	49.16
PE35234-48	48"	65.10	60.54	55.99	52.08
PE35234-60	60"	68.70	63.89	59.08	54.96
PE35234-XX	Any	Same-Day Shipment / Call for Pricing			

### 50 OHM, RG223/U COAX, DOUBLE SHIELDED

Model No.	Length	1-24	25-49	50-99	100 +
PE35236-12	12"	\$25.30	\$23.53	\$21.76	\$20.24
PE35236-24	24"	26.60	24.74	22.88	21.28
PE35236-36	36"	28.00	26.04	24.08	22.40
PE35236-48	48"	29.25	27.20	25.16	23.40
PE35236-60	60"	30.60	28.46	26.32	24.48
PE35236-XX	Any	Same-Day Shipment / Call for Pricing			

### 50 OHM, RG316/U COAX

Model No.	Length	1-24	25-49	50-99	100 +
PE35238-12	12"	\$31.30	\$29.11	\$26.92	\$25.04
PE35238-24	24"	32.30	30.04	27.78	25.84
PE35238-36	36"	33.25	30.92	28.60	26.60
PE35238-48	48"	34.20	31.81	29.41	27.36
PE35238-60	60"	35.20	32.74	30.27	28.16
PE35238-XX	Any	Same-Day Shipment / Call for Pricing			

### 50 OHM, PE-B3199, VERY LOW LOSS COAX

Model No.	Length	1-24	25-49	50-99	100 +
PE35240-12	12"	\$54.25	\$50.45	\$46.66	\$43.40
PE35240-24	24"	55.25	51.38	47.52	44.20
PE35240-36	36"	56.15	52.22	48.29	44.92
PE35240-48	48"	57.10	53.10	49.11	45.68
PE35240-60	60"	58.10	54.03	49.97	46.48
PE35240-XX	Any	Same-Day Shipment / Call for Pricing			

## REVERSE POLARITY TNC MALE TO STANDARD SMA MALE



### 50 OHM, RG58C/U COAX

Model No.	Length	1-24	25-49	50-99	100 +
PE34853-12	12"	\$34.95	\$32.50	\$30.06	\$27.96
PE34853-24	24"	35.35	32.88	30.40	28.28
PE34853-36	36"	35.80	33.29	30.79	28.64
PE34853-48	48"	36.20	33.67	31.13	28.96
PE34853-60	60"	36.60	34.04	31.48	29.28
PE34853-XX	Any	Same-Day Shipment / Call for Pricing			

### 50 OHM, RG142B/U COAX, DOUBLE SHIELDED

Model No.	Length	1-24	25-49	50-99	100 +
PE34854-12	12"	\$34.95	\$32.50	\$30.06	\$27.96
PE34854-24	24"	37.60	34.97	32.34	30.08
PE34854-36	36"	40.25	37.43	34.62	32.20
PE34854-48	48"	42.95	39.94	36.94	34.36
PE34854-60	60"	45.55	42.36	39.17	36.44
PE34854-XX	Any	Same-Day Shipment / Call for Pricing			

### 50 OHM, RG178B/U COAX

Model No.	Length	1-24	25-49	50-99	100 +
PE35242-12	12"	\$47.00	\$43.71	\$40.42	\$37.60
PE35242-24	24"	48.00	44.64	41.28	38.40
PE35242-36	36"	48.95	45.52	42.10	39.16
PE35242-48	48"	49.95	46.45	42.96	39.96
PE35242-60	60"	50.85	47.29	43.73	40.68
PE35242-XX	Any	Same-Day Shipment / Call for Pricing			

### 50 OHM, RG188A/U COAX

Model No.	Length	1-24	25-49	50-99	100 +
PE35244-12	12"	\$39.80	\$37.01	\$34.23	\$31.84
PE35244-24	24"	40.75	37.90	35.05	32.60
PE35244-36	36"	41.70	38.78	35.86	33.36
PE35244-48	48"	42.70	39.71	36.72	34.16
PE35244-60	60"	43.60	40.55	37.50	34.88
PE35244-XX	Any	Same-Day Shipment / Call for Pricing			

### 50 OHM, RG223/U COAX, DOUBLE SHIELDED

Model No.	Length	1-24	25-49	50-99	100 +
PE34397-12	12"	\$34.95	\$32.50	\$30.06	\$27.96
PE34397-24	24"	36.30	33.76	31.22	29.04
PE34397-36	36"	37.60	34.97	32.34	30.08
PE34397-48	48"	38.90	36.18	33.45	31.12
PE34397-60	60"	40.25	37.43	34.62	32.20
PE34397-XX	Any	Same-Day Shipment / Call for Pricing			

### 50 OHM, RG316/U COAX

Model No.	Length	1-24	25-49	50-99	100 +
PE34396-12	12"	\$39.80	\$37.01	\$34.23	\$31.84
PE34396-24	24"	40.75	37.90	35.05	32.60
PE34396-36	36"	41.70	38.78	35.86	33.36
PE34396-48	48"	42.70	39.71	36.72	34.16
PE34396-60	60"	43.60	40.55	37.50	34.88
PE34396-XX	Any	Same-Day Shipment / Call for Pricing			

### 50 OHM, RG400/U COAX, DOUBLE SHIELDED

Model No.	Length	1-24	25-49	50-99	100 +
PE35246-12	12"	\$34.95	\$32.50	\$30.06	\$27.96
PE35246-24	24"	37.60	34.97	32.34	30.08
PE35246-36	36"	40.25	37.43	34.62	32.20
PE35246-48	48"	42.95	39.94	36.94	34.36
PE35246-60	60"	45.55	42.36	39.17	36.44
PE35246-XX	Any	Same-Day Shipment / Call for Pricing			

\*\*ROHS COMPLIANT & CUSTOM-LENGTH CABLE ASSEMBLIES MAY BE ORDERED ON OUR WEBSITE.\*\*

## REVERSE POLARITY TNC MALE TO STANDARD BNC MALE



### 50 OHM, RG58C/U COAX

Model No.	Length	1-24	25-49	50-99	100 +
PE35229-12	12"	\$25.30	\$23.53	\$21.76	\$20.24
PE35229-24	24"	25.75	23.95	22.15	20.60
PE35229-36	36"	26.10	24.27	22.45	20.88
PE35229-48	48"	26.55	24.69	22.83	21.24
PE35229-60	60"	26.95	25.06	23.18	21.56
PE35229-XX	Any	Same-Day Shipment / Call for Pricing			

### 50 OHM, RG142B/U COAX, DOUBLE SHIELDED

Model No.	Length	1-24	25-49	50-99	100 +
PE35231-12	12"	\$25.30	\$23.53	\$21.76	\$20.24
PE35231-24	24"	28.00	26.04	24.08	22.40
PE35231-36	36"	30.60	28.46	26.32	24.48
PE35231-48	48"	33.25	30.92	28.60	26.60
PE35231-60	60"	35.95	33.43	30.92	28.76
PE35231-XX	Any	Same-Day Shipment / Call for Pricing			

### 50 OHM, RG213/U COAX

Model No.	Length	1-24	25-49	50-99	100 +
PE35233-12	12"	\$54.25	\$50.45	\$46.66	\$43.40
PE35233-24	24"	55.30	51.43	47.56	44.24
PE35233-36	36"	56.25	52.31	48.38	45.00
PE35233-48	48"	57.25	53.24	49.24	45.80
PE35233-60	60"	58.30	54.22	50.14	46.64
PE35233-XX	Any	Same-Day Shipment / Call for Pricing			

### 50 OHM, RG214/U COAX, DOUBLE SHIELDED

Model No.	Length	1-24	25-49	50-99	100 +
PE34520-12	12"	\$54.25	\$50.45	\$46.66	\$43.40
PE34520-24	24"	57.90	53.85	49.79	46.32
PE34520-36	36"	61.45	57.15	52.85	49.16
PE34520-48	48"	65.10	60.54	55.99	52.08
PE34520-60	60"	68.70	63.89	59.08	54.96
PE34520-XX	Any	Same-Day Shipment / Call for Pricing			

### 50 OHM, RG223/U COAX, DOUBLE SHIELDED

Model No.	Length	1-24	25-49	50-99	100 +
PE35235-12	12"	\$25.30	\$23.53	\$21.76	\$20.24
PE35235-24	24"	26.60	24.74	22.88	21.28
PE35235-36	36"	28.00	26.04	24.08	22.40
PE35235-48	48"	29.25	27.20	25.16	23.40
PE35235-60	60"	30.60	28.46	26.32	24.48
PE35235-XX	Any	Same-Day Shipment / Call for Pricing			

### 50 OHM, RG316/U COAX

Model No.	Length	1-24	25-49	50-99	100 +
PE35237-12	12"	\$31.30	\$29.11	\$26.92	\$25.04
PE35237-24	24"	32.30	30.04	27.78	25.84
PE35237-36	36"	33.25	30.92	28.60	26.60
PE35237-48	48"	34.20	31.81	29.41	27.36
PE35237-60	60"	35.20	32.74	30.27	28.16
PE35237-XX	Any	Same-Day Shipment / Call for Pricing			

### 50 OHM, PE-B3199, VERY LOW LOSS COAX

Model No.	Length	1-24	25-49	50-99	100 +
PE35239-12	12"	\$54.25	\$50.45	\$46.66	\$43.40
PE35239-24	24"	55.25	51.38	47.52	44.20
PE35239-36	36"	56.15	52.22	48.29	44.92
PE35239-48	48"	57.10	53.10	49.11	45.68
PE35239-60	60"	58.10	54.03	49.97	46.48
PE35239-XX	Any	Same-Day Shipment / Call for Pricing			

## REVERSE POLARITY TNC MALE TO STANDARD N MALE



### 50 OHM, RG58C/U COAX

Model No.	Length	1-24	25-49	50-99	100 +
PE34554-12	12"	\$32.55	\$30.27	\$27.99	\$26.04
PE34554-24	24"	32.95	30.64	28.34	26.36
PE34554-36	36"	33.30	30.97	28.64	26.64
PE34554-48	48"	33.75	31.39	29.03	27.00
PE34554-60	60"	34.20	31.81	29.41	27.36
PE34554-XX	Any	Same-Day Shipment / Call for Pricing			

### 50 OHM, RG142B/U COAX, DOUBLE SHIELDED

Model No.	Length	1-24	25-49	50-99	100 +
PE34573-12	12"	\$32.55	\$30.27	\$27.99	\$26.04
PE34573-24	24"	35.20	32.74	30.27	28.16
PE34573-36	36"	37.90	35.25	32.59	30.32
PE34573-48	48"	40.45	37.62	34.79	32.36
PE34573-60	60"	43.20	40.18	37.15	34.56
PE34573-XX	Any	Same-Day Shipment / Call for Pricing			

### 50 OHM, RG178B/U COAX

Model No.	Length	1-24	25-49	50-99	100 +
PE35241-12	12"	\$48.25	\$44.87	\$41.50	\$38.60
PE35241-24	24"	49.15	45.71	42.27	39.32
PE35241-36	36"	50.20	46.69	43.17	40.16
PE35241-48	48"	51.05	47.48	43.90	40.84
PE35241-60	60"	52.10	48.45	44.81	41.68
PE35241-XX	Any	Same-Day Shipment / Call for Pricing			

### 50 OHM, RG188A/U COAX

Model No.	Length	1-24	25-49	50-99	100 +
PE35243-12	12"	\$47.00	\$43.71	\$40.42	\$37.60
PE35243-24	24"	48.00	44.64	41.28	38.40
PE35243-36	36"	48.95	45.52	42.10	39.16
PE35243-48	48"	49.95	46.45	42.96	39.96
PE35243-60	60"	50.85	47.29	43.73	40.68
PE35243-XX	Any	Same-Day Shipment / Call for Pricing			

### 50 OHM, RG223/U COAX, DOUBLE SHIELDED

Model No.	Length	1-24	25-49	50-99	100 +
PE35245-12	12"	\$32.55	\$30.27	\$27.99	\$26.04
PE35245-24	24"	33.85	31.48	29.11	27.08
PE35245-36	36"	35.20	32.74	30.27	28.16
PE35245-48	48"	36.50	33.95	31.39	29.20
PE35245-60	60"	37.90	35.25	32.59	30.32
PE35245-XX	Any	Same-Day Shipment / Call for Pricing			

### 50 OHM, RG316/U COAX

Model No.	Length	1-24	25-49	50-99	100 +
PE35247-12	12"	\$47.00	\$43.71	\$40.42	\$37.60
PE35247-24	24"	48.00	44.64	41.28	38.40
PE35247-36	36"	48.95	45.52	42.10	39.16
PE35247-48	48"	49.95	46.45	42.96	39.96
PE35247-60	60"	50.85	47.29	43.73	40.68
PE35247-XX	Any	Same-Day Shipment / Call for Pricing			

### 50 OHM, PE-B3199, VERY LOW LOSS COAX

Model No.	Length	1-24	25-49	50-99	100 +
PE35249-12	12"	\$47.00	\$43.71	\$40.42	\$37.60
PE35249-24	24"	48.00	44.64	41.28	38.40
PE35249-36	36"	48.95	45.52	42.10	39.16
PE35249-48	48"	49.95	46.45	42.96	39.96
PE35249-60	60"	50.85	47.29	43.73	40.68
PE35249-XX	Any	Same-Day Shipment / Call for Pricing			

\*\*ROHS COMPLIANT & CUSTOM-LENGTH CABLE ASSEMBLIES MAY BE ORDERED ON OUR WEBSITE.\*\*

# REVERSE POLARITY SMA MALE TO STANDARD SMA MALE



## 50 OHM, RG58C/U COAX

Model No.	Length	1-24	25-49	50-99	100 +
PE34116-12	12"	\$38.55	\$35.85	\$33.15	\$30.84
PE34116-24	24"	38.95	36.22	33.50	31.16
PE34116-36	36"	39.40	36.64	33.88	31.52
PE34116-48	48"	39.80	37.01	34.23	31.84
PE34116-60	60"	40.20	37.39	34.57	32.16
PE34116-XX	Any	Same-Day Shipment / Call for Pricing			

## 50 OHM, RG142B/U COAX, DOUBLE SHIELDED

Model No.	Length	1-24	25-49	50-99	100 +
PE34614-12	12"	\$41.00	\$38.13	\$35.26	\$32.80
PE34614-24	24"	43.60	40.55	37.50	34.88
PE34614-36	36"	46.25	43.01	39.78	37.00
PE34614-48	48"	48.95	45.52	42.10	39.16
PE34614-60	60"	51.55	47.94	44.33	41.24
PE34614-XX	Any	Same-Day Shipment / Call for Pricing			

## 50 OHM, RG174A/U COAX

Model No.	Length	1-24	25-49	50-99	100 +
PE34331-12	12"	\$39.80	\$37.01	\$34.23	\$31.84
PE34331-24	24"	40.05	37.25	34.44	32.04
PE34331-36	36"	40.30	37.48	34.66	32.24
PE34331-48	48"	40.50	37.67	34.83	32.40
PE34331-60	60"	40.80	37.94	35.09	32.64
PE34331-XX	Any	Same-Day Shipment / Call for Pricing			

## 50 OHM, RG178B/U COAX

Model No.	Length	1-24	25-49	50-99	100 +
PE35208-12	12"	\$53.00	\$49.29	\$45.58	\$42.40
PE35208-24	24"	54.00	50.22	46.44	43.20
PE35208-36	36"	54.95	51.10	47.26	43.96
PE35208-48	48"	55.90	51.99	48.07	44.72
PE35208-60	60"	56.85	52.87	48.89	45.48
PE35208-XX	Any	Same-Day Shipment / Call for Pricing			

## 50 OHM, RG188A/U COAX

Model No.	Length	1-24	25-49	50-99	100 +
PE35210-12	12"	\$39.80	\$37.01	\$34.23	\$31.84
PE35210-24	24"	40.75	37.90	35.05	32.60
PE35210-36	36"	41.70	38.78	35.86	33.36
PE35210-48	48"	42.70	39.71	36.72	34.16
PE35210-60	60"	43.60	40.55	37.50	34.88
PE35210-XX	Any	Same-Day Shipment / Call for Pricing			

## 50 OHM, RG223/U COAX, DOUBLE SHIELDED

Model No.	Length	1-24	25-49	50-99	100 +
PE34398-12	12"	\$39.80	\$37.01	\$34.23	\$31.84
PE34398-24	24"	41.10	38.22	35.35	32.88
PE34398-36	36"	42.45	39.48	36.51	33.96
PE34398-48	48"	43.75	40.69	37.63	35.00
PE34398-60	60"	45.10	41.94	38.79	36.08
PE34398-XX	Any	Same-Day Shipment / Call for Pricing			

## 50 OHM, RG316/U COAX

Model No.	Length	1-24	25-49	50-99	100 +
PE35212-12	12"	\$39.80	\$37.01	\$34.23	\$31.84
PE35212-24	24"	40.75	37.90	35.05	32.60
PE35212-36	36"	41.70	38.78	35.86	33.36
PE35212-48	48"	42.70	39.71	36.72	34.16
PE35212-60	60"	43.60	40.55	37.50	34.88
PE35212-XX	Any	Same-Day Shipment / Call for Pricing			

# REVERSE POLARITY SMA MALE TO STANDARD TNC MALE



## 50 OHM, RG58C/U COAX

Model No.	Length	1-24	25-49	50-99	100 +
PE35214-12	12"	\$34.95	\$32.50	\$30.06	\$27.96
PE35214-24	24"	35.35	32.88	30.40	28.28
PE35214-36	36"	35.80	33.29	30.79	28.64
PE35214-48	48"	36.20	33.67	31.13	28.96
PE35214-60	60"	36.60	34.04	31.48	29.28
PE35214-XX	Any	Same-Day Shipment / Call for Pricing			

## 50 OHM, RG142B/U COAX, DOUBLE SHIELDED

Model No.	Length	1-24	25-49	50-99	100 +
PE35216-12	12"	\$34.95	\$32.50	\$30.06	\$27.96
PE35216-24	24"	37.60	34.97	32.34	30.08
PE35216-36	36"	40.25	37.43	34.62	32.20
PE35216-48	48"	42.95	39.94	36.94	34.36
PE35216-60	60"	45.55	42.36	39.17	36.44
PE35216-XX	Any	Same-Day Shipment / Call for Pricing			

## 50 OHM, RG174A/U COAX

Model No.	Length	1-24	25-49	50-99	100 +
PE35218-12	12"	\$39.80	\$37.01	\$34.23	\$31.84
PE35218-24	24"	40.05	37.25	34.44	32.04
PE35218-36	36"	40.30	37.48	34.66	32.24
PE35218-48	48"	40.50	37.67	34.83	32.40
PE35218-60	60"	40.80	37.94	35.09	32.64
PE35218-XX	Any	Same-Day Shipment / Call for Pricing			

## 50 OHM, RG178B/U COAX

Model No.	Length	1-24	25-49	50-99	100 +
PE35220-12	12"	\$47.00	\$43.71	\$40.42	\$37.60
PE35220-24	24"	48.00	44.64	41.28	38.40
PE35220-36	36"	48.95	45.52	42.10	39.16
PE35220-48	48"	49.95	46.45	42.96	39.96
PE35220-60	60"	50.85	47.29	43.73	40.68
PE35220-XX	Any	Same-Day Shipment / Call for Pricing			

## 50 OHM, RG188A/U COAX

Model No.	Length	1-24	25-49	50-99	100 +
PE35222-12	12"	\$39.80	\$37.01	\$34.23	\$31.84
PE35222-24	24"	40.75	37.90	35.05	32.60
PE35222-36	36"	41.70	38.78	35.86	33.36
PE35222-48	48"	42.70	39.71	36.72	34.16
PE35222-60	60"	43.60	40.55	37.50	34.88
PE35222-XX	Any	Same-Day Shipment / Call for Pricing			

## 50 OHM, RG223/U COAX, DOUBLE SHIELDED

Model No.	Length	1-24	25-49	50-99	100 +
PE35224-12	12"	\$34.95	\$32.50	\$30.06	\$27.96
PE35224-24	24"	36.30	33.76	31.22	29.04
PE35224-36	36"	37.60	34.97	32.34	30.08
PE35224-48	48"	38.90	36.18	33.45	31.12
PE35224-60	60"	40.25	37.43	34.62	32.20
PE35224-XX	Any	Same-Day Shipment / Call for Pricing			

## 50 OHM, RG316/U COAX

Model No.	Length	1-24	25-49	50-99	100 +
PE35226-12	12"	\$39.80	\$37.01	\$34.23	\$31.84
PE35226-24	24"	40.75	37.90	35.05	32.60
PE35226-36	36"	41.70	38.78	35.86	33.36
PE35226-48	48"	42.70	39.71	36.72	34.16
PE35226-60	60"	43.60	40.55	37.50	34.88
PE35226-XX	Any	Same-Day Shipment / Call for Pricing			

\*\*ROHS COMPLIANT & CUSTOM-LENGTH CABLE ASSEMBLIES MAY BE ORDERED ON OUR WEBSITE.\*\*

# REVERSE THREAD SMA MALE TO REVERSE THREAD SMA MALE



## 50 OHM, RG58C/U COAX

Model No.	Length	1-24	25-49	50-99	100 +
PE35349-12	12"	\$41.00	\$38.13	\$35.26	\$32.80
PE35349-24	24"	41.40	38.50	35.60	33.12
PE35349-36	36"	41.80	38.87	35.95	33.44
PE35349-48	48"	42.20	39.25	36.29	33.76
PE35349-60	60"	42.65	39.66	36.68	34.12
PE35349-XX	Any	Same-Day Shipment / Call for Pricing			

## 50 OHM, RG142B/U COAX, DOUBLE SHIELDED

Model No.	Length	1-24	25-49	50-99	100 +
PE35353-12	12"	\$43.40	\$40.36	\$37.32	\$34.72
PE35353-24	24"	46.00	42.78	39.56	36.80
PE35353-36	36"	48.70	45.29	41.88	38.96
PE35353-48	48"	51.30	47.71	44.12	41.04
PE35353-60	60"	54.00	50.22	46.44	43.20
PE35353-XX	Any	Same-Day Shipment / Call for Pricing			

## 50 OHM, RG174A/U COAX

Model No.	Length	1-24	25-49	50-99	100 +
PE35357-12	12"	\$42.20	\$39.25	\$36.29	\$33.76
PE35357-24	24"	42.50	39.53	36.55	34.00
PE35357-36	36"	42.75	39.76	36.77	34.20
PE35357-48	48"	43.00	39.99	36.98	34.40
PE35357-60	60"	43.25	40.22	37.20	34.60
PE35357-XX	Any	Same-Day Shipment / Call for Pricing			

## 50 OHM, RG178B/U COAX

Model No.	Length	1-24	25-49	50-99	100 +
PE35361-12	12"	\$55.45	\$51.57	\$47.69	\$44.36
PE35361-24	24"	56.35	52.41	48.46	45.08
PE35361-36	36"	57.45	53.43	49.41	45.96
PE35361-48	48"	58.35	54.27	50.18	46.68
PE35361-60	60"	59.30	55.15	51.00	47.44
PE35361-XX	Any	Same-Day Shipment / Call for Pricing			

## 50 OHM, RG188A/U COAX

Model No.	Length	1-24	25-49	50-99	100 +
PE35365-12	12"	\$42.20	\$39.25	\$36.29	\$33.76
PE35365-24	24"	43.20	40.18	37.15	34.56
PE35365-36	36"	44.05	40.97	37.88	35.24
PE35365-48	48"	45.10	41.94	38.79	36.08
PE35365-60	60"	46.00	42.78	39.56	36.80
PE35365-XX	Any	Same-Day Shipment / Call for Pricing			

## 50 OHM, RG223/U COAX, DOUBLE SHIELDED

Model No.	Length	1-24	25-49	50-99	100 +
PE35369-12	12"	\$42.20	\$39.25	\$36.29	\$33.76
PE35369-24	24"	43.50	40.46	37.41	34.80
PE35369-36	36"	44.90	41.76	38.61	35.92
PE35369-48	48"	46.15	42.92	39.69	36.92
PE35369-60	60"	47.50	44.18	40.85	38.00
PE35369-XX	Any	Same-Day Shipment / Call for Pricing			

## 50 OHM, RG316/U COAX

Model No.	Length	1-24	25-49	50-99	100 +
PE35373-12	12"	\$42.20	\$39.25	\$36.29	\$33.76
PE35373-24	24"	43.20	40.18	37.15	34.56
PE35373-36	36"	44.05	40.97	37.88	35.24
PE35373-48	48"	45.10	41.94	38.79	36.08
PE35373-60	60"	46.00	42.78	39.56	36.80
PE35373-XX	Any	Same-Day Shipment / Call for Pricing			

# REVERSE THREAD SMA MALE TO STANDARD SMA MALE



## 50 OHM, RG58C/U COAX

Model No.	Length	1-24	25-49	50-99	100 +
PE35351-12	12"	\$39.80	\$37.01	\$34.23	\$31.84
PE35351-24	24"	40.15	37.34	34.53	32.12
PE35351-36	36"	40.60	37.76	34.92	32.48
PE35351-48	48"	41.00	38.13	35.26	32.80
PE35351-60	60"	41.45	38.55	35.65	33.16
PE35351-XX	Any	Same-Day Shipment / Call for Pricing			

## 50 OHM, RG142B/U COAX, DOUBLE SHIELDED

Model No.	Length	1-24	25-49	50-99	100 +
PE35355-12	12"	\$42.20	\$39.25	\$36.29	\$33.76
PE35355-24	24"	44.90	41.76	38.61	35.92
PE35355-36	36"	47.50	44.18	40.85	38.00
PE35355-48	48"	50.20	46.69	43.17	40.16
PE35355-60	60"	52.80	49.10	45.41	42.24
PE35355-XX	Any	Same-Day Shipment / Call for Pricing			

## 50 OHM, RG174A/U COAX

Model No.	Length	1-24	25-49	50-99	100 +
PE35359-12	12"	\$41.00	\$38.13	\$35.26	\$32.80
PE35359-24	24"	41.30	38.41	35.52	33.04
PE35359-36	36"	41.55	38.64	35.73	33.24
PE35359-48	48"	41.80	38.87	35.95	33.44
PE35359-60	60"	42.00	39.06	36.12	33.60
PE35359-XX	Any	Same-Day Shipment / Call for Pricing			

## 50 OHM, RG178B/U COAX

Model No.	Length	1-24	25-49	50-99	100 +
PE35363-12	12"	\$54.25	\$50.45	\$46.66	\$43.40
PE35363-24	24"	55.25	51.38	47.52	44.20
PE35363-36	36"	56.15	52.22	48.29	44.92
PE35363-48	48"	57.10	53.10	49.11	45.68
PE35363-60	60"	58.10	54.03	49.97	46.48
PE35363-XX	Any	Same-Day Shipment / Call for Pricing			

## 50 OHM, RG188A/U COAX

Model No.	Length	1-24	25-49	50-99	100 +
PE35367-12	12"	\$41.00	\$38.13	\$35.26	\$32.80
PE35367-24	24"	41.90	38.97	36.03	33.52
PE35367-36	36"	42.95	39.94	36.94	34.36
PE35367-48	48"	43.85	40.78	37.71	35.08
PE35367-60	60"	44.90	41.76	38.61	35.92
PE35367-XX	Any	Same-Day Shipment / Call for Pricing			

## 50 OHM, RG223/U COAX, DOUBLE SHIELDED

Model No.	Length	1-24	25-49	50-99	100 +
PE35371-12	12"	\$41.00	\$38.13	\$35.26	\$32.80
PE35371-24	24"	42.30	39.34	36.38	33.84
PE35371-36	36"	43.60	40.55	37.50	34.88
PE35371-48	48"	45.00	41.85	38.70	36.00
PE35371-60	60"	46.25	43.01	39.78	37.00
PE35371-XX	Any	Same-Day Shipment / Call for Pricing			

## 50 OHM, RG316/U COAX

Model No.	Length	1-24	25-49	50-99	100 +
PE35375-12	12"	\$41.00	\$38.13	\$35.26	\$32.80
PE35375-24	24"	41.90	38.97	36.03	33.52
PE35375-36	36"	42.95	39.94	36.94	34.36
PE35375-48	48"	43.85	40.78	37.71	35.08
PE35375-60	60"	44.90	41.76	38.61	35.92
PE35375-XX	Any	Same-Day Shipment / Call for Pricing			

Cable  
Assemblies

\*\*ROHS COMPLIANT & CUSTOM-LENGTH CABLE ASSEMBLIES MAY BE ORDERED ON OUR WEBSITE.\*\*

## FME JACK TO FME JACK



### 50 OHM, RG58C/U COAX

Model No.	Length	1-24	25-49	50-99	100 +
PE34856-12	12"	\$14.50	\$13.49	\$12.47	\$11.60
PE34856-24	24"	14.85	13.81	12.77	11.88
PE34856-36	36"	15.30	14.23	13.16	12.24
PE34856-48	48"	15.70	14.60	13.50	12.56
PE34856-60	60"	16.10	14.97	13.85	12.88
PE34856-XX	Any	Same-Day Shipment / Call for Pricing			

### 50 OHM, RG142B/U COAX, DOUBLE SHIELDED

Model No.	Length	1-24	25-49	50-99	100 +
PE34858-12	12"	\$19.35	\$18.00	\$16.64	\$15.48
PE34858-24	24"	21.95	20.41	18.88	17.56
PE34858-36	36"	24.65	22.92	21.20	19.72
PE34858-48	48"	27.25	25.34	23.44	21.80
PE34858-60	60"	29.90	27.81	25.71	23.92
PE34858-XX	Any	Same-Day Shipment / Call for Pricing			

### 50 OHM, RG174A/U COAX

Model No.	Length	1-24	25-49	50-99	100 +
PE34860-12	12"	\$19.35	\$18.00	\$16.64	\$15.48
PE34860-24	24"	19.60	18.23	16.86	15.68
PE34860-36	36"	19.85	18.46	17.07	15.88
PE34860-48	48"	20.05	18.65	17.24	16.04
PE34860-60	60"	20.35	18.93	17.50	16.28
PE34860-XX	Any	Same-Day Shipment / Call for Pricing			

## FME JACK TO BNC MALE



### 50 OHM, RG58C/U COAX

Model No.	Length	1-24	25-49	50-99	100 +
PE34862-12	12"	\$14.50	\$13.49	\$12.47	\$11.60
PE34862-24	24"	14.85	13.81	12.77	11.88
PE34862-36	36"	15.30	14.23	13.16	12.24
PE34862-48	48"	15.70	14.60	13.50	12.56
PE34862-60	60"	16.10	14.97	13.85	12.88
PE34862-XX	Any	Same-Day Shipment / Call for Pricing			

### 50 OHM, RG142B/U COAX, DOUBLE SHIELDED

Model No.	Length	1-24	25-49	50-99	100 +
PE34864-12	12"	\$19.35	\$18.00	\$16.64	\$15.48
PE34864-24	24"	21.95	20.41	18.88	17.56
PE34864-36	36"	24.65	22.92	21.20	19.72
PE34864-48	48"	27.25	25.34	23.44	21.80
PE34864-60	60"	29.90	27.81	25.71	23.92
PE34864-XX	Any	Same-Day Shipment / Call for Pricing			

### 50 OHM, RG174A/U COAX

Model No.	Length	1-24	25-49	50-99	100 +
PE34866-12	12"	\$19.35	\$18.00	\$16.64	\$15.48
PE34866-24	24"	19.60	18.23	16.86	15.68
PE34866-36	36"	19.85	18.46	17.07	15.88
PE34866-48	48"	20.35	18.93	17.50	16.28
PE34866-60	60"	20.60	19.16	17.72	16.48
PE34866-XX	Any	Same-Day Shipment / Call for Pricing			

## FME PLUG TO FME PLUG



### 50 OHM, RG58C/U COAX

Model No.	Length	1-24	25-49	50-99	100 +
PE35953-12	12"	\$14.50	\$13.49	\$12.47	\$11.60
PE35953-24	24"	14.85	13.81	12.77	11.88
PE35953-36	36"	15.30	14.23	13.16	12.24
PE35953-48	48"	15.70	14.60	13.50	12.56
PE35953-60	60"	16.10	14.97	13.85	12.88
PE35953-XX	Any	Same-Day Shipment / Call for Pricing			

### 50 OHM, RG142B/U COAX, DOUBLE SHIELDED

Model No.	Length	1-24	25-49	50-99	100 +
PE35955-12	12"	\$19.35	\$18.00	\$16.64	\$15.48
PE35955-24	24"	21.95	20.41	18.88	17.56
PE35955-36	36"	24.65	22.92	21.20	19.72
PE35955-48	48"	27.25	25.34	23.44	21.80
PE35955-60	60"	29.90	27.81	25.71	23.92
PE35955-XX	Any	Same-Day Shipment / Call for Pricing			

### 50 OHM, RG174A/U COAX

Model No.	Length	1-24	25-49	50-99	100 +
PE35957-12	12"	\$19.35	\$18.00	\$16.64	\$15.48
PE35957-24	24"	19.60	18.23	16.86	15.68
PE35957-36	36"	19.85	18.46	17.07	15.88
PE35957-48	48"	20.05	18.65	17.24	16.04
PE35957-60	60"	20.35	18.93	17.50	16.28
PE35957-XX	Any	Same-Day Shipment / Call for Pricing			

## FME PLUG TO BNC MALE



### 50 OHM, RG58C/U COAX

Model No.	Length	1-24	25-49	50-99	100 +
PE35959-12	12"	\$14.50	\$13.49	\$12.47	\$11.60
PE35959-24	24"	14.85	13.81	12.77	11.88
PE35959-36	36"	15.30	14.23	13.16	12.24
PE35959-48	48"	15.70	14.60	13.50	12.56
PE35959-60	60"	16.10	14.97	13.85	12.88
PE35959-XX	Any	Same-Day Shipment / Call for Pricing			

### 50 OHM, RG142B/U COAX, DOUBLE SHIELDED

Model No.	Length	1-24	25-49	50-99	100 +
PE35962-12	12"	\$19.35	\$18.00	\$16.64	\$15.48
PE35962-24	24"	21.95	20.41	18.88	17.56
PE35962-36	36"	24.65	22.92	21.20	19.72
PE35962-48	48"	27.25	25.34	23.44	21.80
PE35962-60	60"	29.90	27.81	25.71	23.92
PE35962-XX	Any	Same-Day Shipment / Call for Pricing			

### 50 OHM, RG174A/U COAX

Model No.	Length	1-24	25-49	50-99	100 +
PE35964-12	12"	\$19.35	\$18.00	\$16.64	\$15.48
PE35964-24	24"	19.60	18.23	16.86	15.68
PE35964-36	36"	19.85	18.46	17.07	15.88
PE35964-48	48"	20.35	18.93	17.50	16.28
PE35964-60	60"	20.60	19.16	17.72	16.48
PE35964-XX	Any	Same-Day Shipment / Call for Pricing			

\*\*ROHS COMPLIANT & CUSTOM-LENGTH CABLE ASSEMBLIES MAY BE ORDERED ON OUR WEBSITE.\*\*

## SEMI-RIGID & RE-SHAPEABLE CABLE ASSEMBLIES SMP FEMALE TO SMP FEMALE



### 50 OHM, PE-047SR (.047" BARE COPPER)

Model No.	Length	1-24	25-49	50-99	100 +
PE36146-12	12"	\$59.65	\$55.47	\$51.30	\$47.72
PE36146-24	24"	63.30	58.87	54.44	50.64
PE36146-36	36"	66.85	62.17	57.49	53.48
PE36146-48	48"	70.50	65.57	60.63	56.40
PE36146-60	60"	74.10	68.91	63.73	59.28
PE36146-XX	Any	Same-Day Shipment / Call for Pricing			

### 50 OHM, PE-SR047FL (.047 RE-SHAPEABLE)

Model No.	Length	1-24	25-49	50-99	100 +
PE36148-12	12"	\$62.00	\$57.66	\$53.32	\$49.60
PE36148-24	24"	65.70	61.10	56.50	52.56
PE36148-36	36"	69.30	64.45	59.60	55.44
PE36148-48	48"	72.90	67.80	62.69	58.32
PE36148-60	60"	76.55	71.19	65.83	61.24
PE36148-XX	Any	Same-Day Shipment / Call for Pricing			

### 50 OHM, RG405/U (.085" BARE COPPER)

Model No.	Length	1-24	25-49	50-99	100 +
PE36150-12	12"	\$59.65	\$55.47	\$51.30	\$47.72
PE36150-24	24"	63.30	58.87	54.44	50.64
PE36150-36	36"	66.85	62.17	57.49	53.48
PE36150-48	48"	70.50	65.57	60.63	56.40
PE36150-60	60"	74.10	68.91	63.73	59.28
PE36150-XX	Any	Same-Day Shipment / Call for Pricing			

### 50 OHM, PE-SR405FL (.085" RE-SHAPEABLE)

Model No.	Length	1-24	25-49	50-99	100 +
PE36152-12	12"	\$62.00	\$57.66	\$53.32	\$49.60
PE36152-24	24"	65.70	61.10	56.50	52.56
PE36152-36	36"	69.30	64.45	59.60	55.44
PE36152-48	48"	72.90	67.80	62.69	58.32
PE36152-60	60"	76.55	71.19	65.83	61.24
PE36152-XX	Any	Same-Day Shipment / Call for Pricing			

Cable Assemblies

## SEMI-RIGID & RE-SHAPEABLE CABLE ASSEMBLIES SMP FEMALE TO SMP FEMALE RIGHT ANGLE



### 50 OHM, PE-047SR (.047" BARE COPPER)

Model No.	Length	1-24	25-49	50-99	100 +
PE36154-12	12"	\$66.85	\$62.17	\$57.49	\$53.48
PE36154-24	24"	70.50	65.57	60.63	56.40
PE36154-36	36"	74.10	68.91	63.73	59.28
PE36154-48	48"	77.70	72.26	66.82	62.16
PE36154-60	60"	81.35	75.66	69.96	65.08
PE36154-XX	Any	Same-Day Shipment / Call for Pricing			

### 50 OHM, PE-SR047FL (.047 RE-SHAPEABLE)

Model No.	Length	1-24	25-49	50-99	100 +
PE36156-12	12"	\$69.30	\$64.45	\$59.60	\$55.44
PE36156-24	24"	72.90	67.80	62.69	58.32
PE36156-36	36"	76.55	71.19	65.83	61.24
PE36156-48	48"	80.15	74.54	68.93	64.12
PE36156-60	60"	83.75	77.89	72.03	67.00
PE36156-XX	Any	Same-Day Shipment / Call for Pricing			

### 50 OHM, RG405/U (.085" BARE COPPER)

Model No.	Length	1-24	25-49	50-99	100 +
PE36158-12	12"	\$66.85	\$62.17	\$57.49	\$53.48
PE36158-24	24"	70.50	65.57	60.63	56.40
PE36158-36	36"	74.10	68.91	63.73	59.28
PE36158-48	48"	77.70	72.26	66.82	62.16
PE36158-60	60"	81.35	75.66	69.96	65.08
PE36158-XX	Any	Same-Day Shipment / Call for Pricing			

### 50 OHM, PE-SR405FL (.085" RE-SHAPEABLE)

Model No.	Length	1-24	25-49	50-99	100 +
PE36160-12	12"	\$69.30	\$64.45	\$59.60	\$55.44
PE36160-24	24"	72.90	67.80	62.69	58.32
PE36160-36	36"	76.55	71.19	65.83	61.24
PE36160-48	48"	80.15	74.54	68.93	64.12
PE36160-60	60"	83.75	77.89	72.03	67.00
PE36160-XX	Any	Same-Day Shipment / Call for Pricing			

## SEMI-RIGID & RE-SHAPEABLE CABLE ASSEMBLIES SMP FEMALE TO SMA MALE

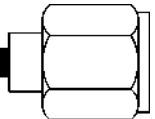

### 50 OHM, PE-047SR (.047" BARE COPPER)

Model No.	Length	1-24	25-49	50-99	100 +
PE36162-12	12"	\$50.05	\$46.55	\$43.04	\$40.04
PE36162-24	24"	53.65	49.89	46.14	42.92
PE36162-36	36"	57.25	53.24	49.24	45.80
PE36162-48	48"	60.90	56.64	52.37	48.72
PE36162-60	60"	64.50	59.99	55.47	51.60
PE36162-XX	Any	Same-Day Shipment / Call for Pricing			

### 50 OHM, PE-SR047FL (.047 RE-SHAPEABLE)

Model No.	Length	1-24	25-49	50-99	100 +
PE36164-12	12"	\$52.50	\$48.83	\$45.15	\$42.00
PE36164-24	24"	56.05	52.13	48.20	44.84
PE36164-36	36"	59.65	55.47	51.30	47.72
PE36164-48	48"	63.30	58.87	54.44	50.64
PE36164-60	60"	66.85	62.17	57.49	53.48
PE36164-XX	Any	Same-Day Shipment / Call for Pricing			

### 50 OHM, RG405/U (.085" BARE COPPER)

Model No.	Length	1-24	25-49	50-99	100 +
PE36166-12	12"	\$50.05	\$46.55	\$43.04	\$40.04
PE36166-24	24"	53.65	49.89	46.14	42.92
PE36166-36	36"	57.25	53.24	49.24	45.80
PE36166-48	48"	60.90	56.64	52.37	48.72
PE36166-60	60"	64.50	59.99	55.47	51.60
PE36166-XX	Any	Same-Day Shipment / Call for Pricing			

### 50 OHM, PE-SR405FL (.085" RE-SHAPEABLE)

Model No.	Length	1-24	25-49	50-99	100 +
PE36168-12	12"	\$52.50	\$48.83	\$45.15	\$42.00
PE36168-24	24"	56.05	52.13	48.20	44.84
PE36168-36	36"	59.65	55.47	51.30	47.72
PE36168-48	48"	63.30	58.87	54.44	50.64
PE36168-60	60"	66.85	62.17	57.49	53.48
PE36168-XX	Any	Same-Day Shipment / Call for Pricing			

\*\*ROHS COMPLIANT & CUSTOM-LENGTH CABLE ASSEMBLIES MAY BE ORDERED ON OUR WEBSITE.\*\*

## MC-CARD PLUG TO MC-CARD PLUG



### 50 OHM, RG174A/U COAX

Model No.	Length	1-24	25-49	50-99	100 +
PE36114-12	12"	\$26.50	\$24.65	\$22.79	\$21.20
PE36114-24	24"	26.80	24.92	23.05	21.44
PE36114-36	36"	27.05	25.16	23.26	21.64
PE36114-48	48"	27.35	25.44	23.52	21.88
PE36114-60	60"	27.60	25.67	23.74	22.08
PE36114-XX	Any	Same-Day Shipment / Call for Pricing			

### 50 OHM, RG178B/U COAX

Model No.	Length	1-24	25-49	50-99	100 +
PE36116-12	12"	\$28.90	\$26.88	\$24.85	\$23.12
PE36116-24	24"	29.90	27.81	25.71	23.92
PE36116-36	36"	30.90	28.74	26.57	24.72
PE36116-48	48"	31.80	29.57	27.35	25.44
PE36116-60	60"	32.80	30.50	28.21	26.24
PE36116-XX	Any	Same-Day Shipment / Call for Pricing			

### 50 OHM, RG316/U COAX

Model No.	Length	1-24	25-49	50-99	100 +
PE36118-12	12"	\$26.50	\$24.65	\$22.79	\$21.20
PE36118-24	24"	27.50	25.58	23.65	22.00
PE36118-36	36"	28.45	26.46	24.47	22.76
PE36118-48	48"	29.40	27.34	25.28	23.52
PE36118-60	60"	30.40	28.27	26.14	24.32
PE36118-XX	Any	Same-Day Shipment / Call for Pricing			

## MC-CARD PLUG TO SMA MALE



### 50 OHM, RG174A/U COAX

Model No.	Length	1-24	25-49	50-99	100 +
PE36112-12	12"	\$33.75	\$31.39	\$29.03	\$27.00
PE36112-24	24"	33.95	31.57	29.20	27.16
PE36112-36	36"	34.25	31.85	29.46	27.40
PE36112-48	48"	34.55	32.13	29.71	27.64
PE36112-60	60"	34.80	32.36	29.93	27.84
PE36112-XX	Any	Same-Day Shipment / Call for Pricing			

### 50 OHM, RG178B/U COAX

Model No.	Length	1-24	25-49	50-99	100 +
PE36110-12	12"	\$36.20	\$33.67	\$31.13	\$28.96
PE36110-24	24"	37.15	34.55	31.95	29.72
PE36110-36	36"	38.10	35.43	32.77	30.48
PE36110-48	48"	39.05	36.32	33.58	31.24
PE36110-60	60"	40.00	37.20	34.40	32.00
PE36110-XX	Any	Same-Day Shipment / Call for Pricing			

### 50 OHM, RG316/U COAX

Model No.	Length	1-24	25-49	50-99	100 +
PE36108-12	12"	\$33.75	\$31.39	\$29.03	\$27.00
PE36108-24	24"	34.70	32.27	29.84	27.76
PE36108-36	36"	35.70	33.20	30.70	28.56
PE36108-48	48"	36.60	34.04	31.48	29.28
PE36108-60	60"	37.60	34.97	32.34	30.08
PE36108-XX	Any	Same-Day Shipment / Call for Pricing			

## MC-CARD PLUG RIGHT ANGLE TO MC-CARD PLUG RIGHT ANGLE



### 50 OHM, RG174A/U COAX

Model No.	Length	1-24	25-49	50-99	100 +
PE36126-12	12"	\$32.55	\$30.27	\$27.99	\$26.04
PE36126-24	24"	32.80	30.50	28.21	26.24
PE36126-36	36"	33.05	30.74	28.42	26.44
PE36126-48	48"	33.30	30.97	28.64	26.64
PE36126-60	60"	33.60	31.25	28.90	26.88
PE36126-XX	Any	Same-Day Shipment / Call for Pricing			

### 50 OHM, RG178B/U COAX

Model No.	Length	1-24	25-49	50-99	100 +
PE36128-12	12"	\$34.95	\$32.50	\$30.06	\$27.96
PE36128-24	24"	35.95	33.43	30.92	28.76
PE36128-36	36"	36.85	34.27	31.69	29.48
PE36128-48	48"	37.90	35.25	32.59	30.32
PE36128-60	60"	38.80	36.08	33.37	31.04
PE36128-XX	Any	Same-Day Shipment / Call for Pricing			

### 50 OHM, RG316/U COAX

Model No.	Length	1-24	25-49	50-99	100 +
PE36130-12	12"	\$32.55	\$30.27	\$27.99	\$26.04
PE36130-24	24"	33.50	31.16	28.81	26.80
PE36130-36	36"	34.50	32.09	29.67	27.60
PE36130-48	48"	35.45	32.97	30.49	28.36
PE36130-60	60"	36.40	33.85	31.30	29.12
PE36130-XX	Any	Same-Day Shipment / Call for Pricing			

## MC-CARD PLUG TO MC-CARD PLUG RIGHT ANGLE



### 50 OHM, RG174A/U COAX

Model No.	Length	1-24	25-49	50-99	100 +
PE36120-12	12"	\$30.15	\$28.04	\$25.93	\$24.12
PE36120-24	24"	30.40	28.27	26.14	24.32
PE36120-36	36"	30.70	28.55	26.40	24.56
PE36120-48	48"	30.95	28.78	26.62	24.76
PE36120-60	60"	31.20	29.02	26.83	24.96
PE36120-XX	Any	Same-Day Shipment / Call for Pricing			

### 50 OHM, RG178B/U COAX

Model No.	Length	1-24	25-49	50-99	100 +
PE36122-12	12"	\$32.55	\$30.27	\$27.99	\$26.04
PE36122-24	24"	33.50	31.16	28.81	26.80
PE36122-36	36"	34.50	32.09	29.67	27.60
PE36122-48	48"	35.45	32.97	30.49	28.36
PE36122-60	60"	36.40	33.85	31.30	29.12
PE36122-XX	Any	Same-Day Shipment / Call for Pricing			

### 50 OHM, RG316/U COAX

Model No.	Length	1-24	25-49	50-99	100 +
PE36124-12	12"	\$30.15	\$28.04	\$25.93	\$24.12
PE36124-24	24"	31.10	28.92	26.75	24.88
PE36124-36	36"	32.10	29.85	27.61	25.68
PE36124-48	48"	33.00	30.69	28.38	26.40
PE36124-60	60"	33.95	31.57	29.20	27.16
PE36124-XX	Any	Same-Day Shipment / Call for Pricing			

\*\*ROHS COMPLIANT & CUSTOM-LENGTH CABLE ASSEMBLIES MAY BE ORDERED ON OUR WEBSITE.\*\*

## 1.6/5.6 PLUG TO 1.6/5.6 PLUG



### 75 OHM, RG59B/U COAX

Model No.	Length	1-24	25-49	50-99	100 +
PE36109-12	12"	\$26.50	\$24.65	\$22.79	\$21.20
PE36109-24	24"	26.95	25.06	23.18	21.56
PE36109-36	36"	27.35	25.44	23.52	21.88
PE36109-48	48"	27.75	25.81	23.87	22.20
PE36109-60	60"	28.15	26.18	24.21	22.52
PE36109-XX	Any	Same-Day Shipment / Call for Pricing			

### 75 OHM, RG179B/U COAX

Model No.	Length	1-24	25-49	50-99	100 +
PE36111-12	12"	\$28.90	\$26.88	\$24.85	\$23.12
PE36111-24	24"	29.90	27.81	25.71	23.92
PE36111-36	36"	30.90	28.74	26.57	24.72
PE36111-48	48"	31.80	29.57	27.35	25.44
PE36111-60	60"	32.80	30.50	28.21	26.24
PE36111-XX	Any	Same-Day Shipment / Call for Pricing			

### 75 OHM, RG187A/U COAX

Model No.	Length	1-24	25-49	50-99	100 +
PE36113-12	12"	\$28.90	\$26.88	\$24.85	\$23.12
PE36113-24	24"	29.90	27.81	25.71	23.92
PE36113-36	36"	30.90	28.74	26.57	24.72
PE36113-48	48"	31.80	29.57	27.35	25.44
PE36113-60	60"	32.80	30.50	28.21	26.24
PE36113-XX	Any	Same-Day Shipment / Call for Pricing			

## 1.6/5.6 PLUG TO 75 OHM BNC MALE



### 75 OHM, RG59B/U COAX

Model No.	Length	1-24	25-49	50-99	100 +
PE36127-12	12"	\$26.50	\$24.65	\$22.79	\$21.20
PE36127-24	24"	26.95	25.06	23.18	21.56
PE36127-36	36"	27.35	25.44	23.52	21.88
PE36127-48	48"	27.75	25.81	23.87	22.20
PE36127-60	60"	28.15	26.18	24.21	22.52
PE36127-XX	Any	Same-Day Shipment / Call for Pricing			

### 75 OHM, RG179B/U COAX

Model No.	Length	1-24	25-49	50-99	100 +
PE36129-12	12"	\$28.90	\$26.88	\$24.85	\$23.12
PE36129-24	24"	29.90	27.81	25.71	23.92
PE36129-36	36"	30.90	28.74	26.57	24.72
PE36129-48	48"	31.80	29.57	27.35	25.44
PE36129-60	60"	32.80	30.50	28.21	26.24
PE36129-XX	Any	Same-Day Shipment / Call for Pricing			

### 75 OHM, RG187A/U COAX

Model No.	Length	1-24	25-49	50-99	100 +
PE36131-12	12"	\$28.90	\$26.88	\$24.85	\$23.12
PE36131-24	24"	29.90	27.81	25.71	23.92
PE36131-36	36"	30.90	28.74	26.57	24.72
PE36131-48	48"	31.80	29.57	27.35	25.44
PE36131-60	60"	32.80	30.50	28.21	26.24
PE36131-XX	Any	Same-Day Shipment / Call for Pricing			

Cable Assemblies

## 1.6/5.6 PLUG RIGHT ANGLE TO 1.6/5.6 PLUG RIGHT ANGLE



### 75 OHM, RG59B/U COAX

Model No.	Length	1-24	25-49	50-99	100 +
PE36121-12	12"	\$33.75	\$31.39	\$29.03	\$27.00
PE36121-24	24"	34.15	31.76	29.37	27.32
PE36121-36	36"	34.60	32.18	29.76	27.68
PE36121-48	48"	34.95	32.50	30.06	27.96
PE36121-60	60"	35.35	32.88	30.40	28.28
PE36121-XX	Any	Same-Day Shipment / Call for Pricing			

### 75 OHM, RG179B/U COAX

Model No.	Length	1-24	25-49	50-99	100 +
PE36123-12	12"	\$36.20	\$33.67	\$31.13	\$28.96
PE36123-24	24"	37.15	34.55	31.95	29.72
PE36123-36	36"	38.10	35.43	32.77	30.48
PE36123-48	48"	39.05	36.32	33.58	31.24
PE36123-60	60"	40.00	37.20	34.40	32.00
PE36123-XX	Any	Same-Day Shipment / Call for Pricing			

### 75 OHM, RG187A/U COAX

Model No.	Length	1-24	25-49	50-99	100 +
PE36125-12	12"	\$36.20	\$33.67	\$31.13	\$28.96
PE36125-24	24"	37.15	34.55	31.95	29.72
PE36125-36	36"	38.10	35.43	32.77	30.48
PE36125-48	48"	39.05	36.32	33.58	31.24
PE36125-60	60"	40.00	37.20	34.40	32.00
PE36125-XX	Any	Same-Day Shipment / Call for Pricing			

## 1.6/5.6 PLUG TO 1.6/5.6 PLUG RIGHT ANGLE



### 75 OHM, RG59B/U COAX

Model No.	Length	1-24	25-49	50-99	100 +
PE36115-12	12"	\$30.15	\$28.04	\$25.93	\$24.12
PE36115-24	24"	30.55	28.41	26.27	24.44
PE36115-36	36"	30.95	28.78	26.62	24.76
PE36115-48	48"	31.35	29.16	26.96	25.08
PE36115-60	60"	31.75	29.53	27.31	25.40
PE36115-XX	Any	Same-Day Shipment / Call for Pricing			

### 75 OHM, RG179B/U COAX

Model No.	Length	1-24	25-49	50-99	100 +
PE36117-12	12"	\$32.55	\$30.27	\$27.99	\$26.04
PE36117-24	24"	33.50	31.16	28.81	26.80
PE36117-36	36"	34.50	32.09	29.67	27.60
PE36117-48	48"	35.45	32.97	30.49	28.36
PE36117-60	60"	36.40	33.85	31.30	29.12
PE36117-XX	Any	Same-Day Shipment / Call for Pricing			

### 75 OHM, RG187A/U COAX

Model No.	Length	1-24	25-49	50-99	100 +
PE36119-12	12"	\$32.55	\$30.27	\$27.99	\$26.04
PE36119-24	24"	33.50	31.16	28.81	26.80
PE36119-36	36"	34.50	32.09	29.67	27.60
PE36119-48	48"	35.45	32.97	30.49	28.36
PE36119-60	60"	36.40	33.85	31.30	29.12
PE36119-XX	Any	Same-Day Shipment / Call for Pricing			

\*\*ROHS COMPLIANT & CUSTOM-LENGTH CABLE ASSEMBLIES MAY BE ORDERED ON OUR WEBSITE.\*\*



# F MALE TO F MALE

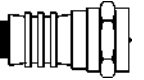
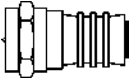

## 75 OHM, RG6-CATV COAX

Model No.	Length	1-24	25-49	50-99	100 +
PE36132-12	12"	\$10.10	\$9.39	\$8.69	\$8.08
PE36132-24	24"	11.00	10.23	9.46	8.80
PE36132-36	36"	12.00	11.16	10.32	9.60
PE36132-48	48"	12.90	12.00	11.09	10.32
PE36132-60	60"	13.95	12.97	12.00	11.16
PE36132-XX	Any	Same-Day Shipment / Call for Pricing			

## 75 OHM, RG11A/U COAX

Model No.	Length	1-24	25-49	50-99	100 +
PE36135-12	12"	\$11.20	\$10.42	\$9.63	\$8.96
PE36135-24	24"	12.25	11.39	10.54	9.80
PE36135-36	36"	13.20	12.28	11.35	10.56
PE36135-48	48"	14.20	13.21	12.21	11.36
PE36135-60	60"	15.15	14.09	13.03	12.12
PE36135-XX	Any	Same-Day Shipment / Call for Pricing			

## 75 OHM, RG59B/U COAX, BLACK

Model No.	Length	1-24	25-49	50-99	100 +
PE36141-12	12"	\$8.60	\$8.00	\$7.40	\$6.88
PE36141-24	24"	9.00	8.37	7.74	7.20
PE36141-36	36"	9.40	8.74	8.08	7.52
PE36141-48	48"	9.85	9.16	8.47	7.88
PE36141-60	60"	10.25	9.53	8.82	8.20
PE36141-XX	Any	Same-Day Shipment / Call for Pricing			

## 75 OHM, RG59B/U COAX, WHITE

Model No.	Length	1-24	25-49	50-99	100 +
PE36143-12	12"	\$8.60	\$8.00	\$7.40	\$6.88
PE36143-24	24"	9.00	8.37	7.74	7.20
PE36143-36	36"	9.40	8.74	8.08	7.52
PE36143-48	48"	9.85	9.16	8.47	7.88
PE36143-60	60"	10.25	9.53	8.82	8.20
PE36143-XX	Any	Same-Day Shipment / Call for Pricing			

## 75 OHM, RG179B/U COAX

Model No.	Length	1-24	25-49	50-99	100 +
PE36137-12	12"	\$12.45	\$11.58	\$10.71	\$9.96
PE36137-24	24"	13.40	12.46	11.52	10.72
PE36137-36	36"	14.45	13.44	12.43	11.56
PE36137-48	48"	15.40	14.32	13.24	12.32
PE36137-60	60"	16.30	15.16	14.02	13.04
PE36137-XX	Any	Same-Day Shipment / Call for Pricing			

## 75 OHM, RG187A/U COAX

Model No.	Length	1-24	25-49	50-99	100 +
PE36139-12	12"	\$12.45	\$11.58	\$10.71	\$9.96
PE36139-24	24"	13.40	12.46	11.52	10.72
PE36139-36	36"	14.45	13.44	12.43	11.56
PE36139-48	48"	15.40	14.32	13.24	12.32
PE36139-60	60"	16.30	15.16	14.02	13.04
PE36139-XX	Any	Same-Day Shipment / Call for Pricing			

Cable Assemblies

# F MALE TO 75 OHM BNC MALE

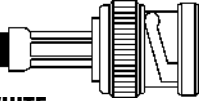
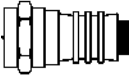

## 75 OHM, RG6-CATV COAX

Model No.	Length	1-24	25-49	50-99	100 +
PE36145-12	12"	\$14.85	\$13.81	\$12.77	\$11.88
PE36145-24	24"	15.85	14.74	13.63	12.68
PE36145-36	36"	16.85	15.67	14.49	13.48
PE36145-48	48"	17.75	16.51	15.27	14.20
PE36145-60	60"	18.70	17.39	16.08	14.96
PE36145-XX	Any	Same-Day Shipment / Call for Pricing			

## 75 OHM, RG11A/U COAX

Model No.	Length	1-24	25-49	50-99	100 +
PE36147-12	12"	\$18.50	\$17.21	\$15.91	\$14.80
PE36147-24	24"	19.50	18.14	16.77	15.60
PE36147-36	36"	20.45	19.02	17.59	16.36
PE36147-48	48"	21.35	19.86	18.36	17.08
PE36147-60	60"	22.35	20.79	19.22	17.88
PE36147-XX	Any	Same-Day Shipment / Call for Pricing			

## 75 OHM, RG59B/U COAX, BLACK

Model No.	Length	1-24	25-49	50-99	100 +
PE36149-12	12"	\$13.35	\$12.42	\$11.48	\$10.68
PE36149-24	24"	13.85	12.88	11.91	11.08
PE36149-36	36"	14.25	13.25	12.26	11.40
PE36149-48	48"	14.65	13.62	12.60	11.72
PE36149-60	60"	15.05	14.00	12.94	12.04
PE36149-XX	Any	Same-Day Shipment / Call for Pricing			

## 75 OHM, RG59B/U COAX, WHITE

Model No.	Length	1-24	25-49	50-99	100 +
PE36151-12	12"	\$13.35	\$12.42	\$11.48	\$10.68
PE36151-24	24"	13.85	12.88	11.91	11.08
PE36151-36	36"	14.25	13.25	12.26	11.40
PE36151-48	48"	14.65	13.62	12.60	11.72
PE36151-60	60"	15.05	14.00	12.94	12.04
PE36151-XX	Any	Same-Day Shipment / Call for Pricing			

## 75 OHM, RG179B/U COAX

Model No.	Length	1-24	25-49	50-99	100 +
PE36153-12	12"	\$16.05	\$14.93	\$13.80	\$12.84
PE36153-24	24"	17.05	15.86	14.66	13.64
PE36153-36	36"	18.00	16.74	15.48	14.40
PE36153-48	48"	18.95	17.62	16.30	15.16
PE36153-60	60"	19.95	18.55	17.16	15.96
PE36153-XX	Any	Same-Day Shipment / Call for Pricing			

## 75 OHM, RG187A/U COAX

Model No.	Length	1-24	25-49	50-99	100 +
PE36155-12	12"	\$16.05	\$14.93	\$13.80	\$12.84
PE36155-24	24"	17.05	15.86	14.66	13.64
PE36155-36	36"	18.00	16.74	15.48	14.40
PE36155-48	48"	18.95	17.62	16.30	15.16
PE36155-60	60"	19.95	18.55	17.16	15.96
PE36155-XX	Any	Same-Day Shipment / Call for Pricing			

# 3/4"-20 THREADED TWINAX MALE TO MALE



## 100 OHM, PE-B7029 TWINAXIAL CABLE

Model No.	Length	1-24	25-49	50-99	100 +
PE3930-18	18"	\$41.00	\$38.13	\$35.26	\$32.80
PE3930-36	36"	42.80	39.80	36.81	34.24
PE3930-60	60"	45.20	42.04	38.87	36.16
PE3930-90	90"	48.25	44.87	41.50	38.60
PE3930-120	120"	51.15	47.57	43.99	40.92
PE3930-180	180"	57.25	53.24	49.24	45.80
PE3930-XXX	Any	Same-Day Shipment / Call for Pricing			

# BNC TWINAX CABLE ASSEMBLIES PLUG TO PLUG



## 78 OHM, RG108A/U TWINAXIAL CABLE

Model No.	Length	1-24	25-49	50-99	100 +
PE3480-18	18"	\$78.35	\$72.87	\$67.38	\$62.68
PE3480-36	36"	79.20	73.66	68.11	63.36
PE3480-60	60"	80.50	74.87	69.23	64.40
PE3480-90	90"	81.95	76.21	70.48	65.56
PE3480-120	120"	83.45	77.61	71.77	66.76
PE3480-180	180"	86.50	80.45	74.39	69.20
PE3480-XXX	Any	Same-Day Shipment / Call for Pricing			

\*\*ROHS COMPLIANT & CUSTOM-LENGTH CABLE ASSEMBLIES MAY BE ORDERED ON OUR WEBSITE.\*\*

# NEW LFU CABLE ASSEMBLIES

## LFU PLUG TO LFU PLUG, 1.13mm COAX



Model No.	Length	1-24	25-49	50-99	100 +
PE38295-3	3"	\$4.95	\$4.60	\$4.26	\$3.96
PE38295-6	6"	5.45	5.07	4.69	4.36
PE38295-12	12"	5.95	5.53	5.12	4.76

Pasternack introduces our New line of LFU connectors and cable assemblies. Similar to U.FL™ connectors\*, these miniature RF Coaxial connectors operate up to 6 GHz at 50 Ohms. The cable assemblies use 1.13mm coax or RG178B/U coax cables as indicated.

## LFU PLUG TO SMA FEMALE BULKHEAD, 1.13mm COAX



Model No.	Length	1-24	25-49	50-99	100 +
PE38297-6	6"	\$14.95	\$13.90	\$12.86	\$11.96
PE38297-12	12"	15.95	14.83	13.72	12.76
PE38297-18	18"	16.95	15.76	14.58	13.56

## LFU PLUG TO MCX JACK BULKHEAD, 1.13mm COAX



Model No.	Length	1-24	25-49	50-99	100 +
PE38298-6	6"	\$14.95	\$13.90	\$12.86	\$11.96
PE38298-12	12"	15.95	14.83	13.72	12.76
PE38298-18	18"	16.95	15.76	14.58	13.56

Cable Assemblies

## LFU PLUG PIGTAIL, RG178B/U COAX



Model No.	Length	1-24	25-49	50-99	100 +
PE38296-6	6"	\$14.95	\$13.90	\$12.86	\$11.96
PE38296-12	12"	15.95	14.83	13.72	12.76
PE38296-24	24"	16.95	15.76	14.58	13.56
PE38296-XX	Any	Same-Day Shipment / Call for Pricing			

## LFU PLUG TO REVERSE THREAD SMA FEMALE BULKHEAD, RG178B/U COAX



Model No.	Length	1-24	25-49	50-99	100 +
PE38301-3	3"	\$34.95	\$32.50	\$30.06	\$27.96
PE38301-6	6"	35.45	32.97	30.49	28.36
PE38301-9	9"	35.95	33.43	30.92	28.76
PE38301-12	12"	36.45	33.90	31.35	29.16
PE38301-18	18"	37.45	34.83	32.21	29.96
PE38301-24	24"	38.45	35.76	33.07	30.76
PE38301-XX	Any	Same-Day Shipment / Call for Pricing			

## LFU PLUG TO REVERSE POLARITY SMA FEMALE BULKHEAD, RG178B/U COAX



Model No.	Length	1-24	25-49	50-99	100 +
PE38300-3	3"	\$29.95	\$27.85	\$25.76	\$23.96
PE38300-6	6"	30.45	28.32	26.19	24.36
PE38300-9	9"	30.95	28.78	26.62	24.76
PE38300-12	12"	31.45	29.25	27.05	25.16
PE38300-18	18"	32.45	30.18	27.91	25.96
PE38300-24	24"	33.95	31.57	29.20	27.16
PE38300-XX	Any	Same-Day Shipment / Call for Pricing			

## LFU PLUG TO REVERSE POLARITY TNC FEMALE BULKHEAD, RG178B/U COAX



Model No.	Length	1-24	25-49	50-99	100 +
PE38303-3	3"	\$29.95	\$27.85	\$25.76	\$23.96
PE38303-6	6"	30.45	28.32	26.19	24.36
PE38303-9	9"	30.95	28.78	26.62	24.76
PE38303-12	12"	31.45	29.25	27.05	25.16
PE38303-18	18"	32.45	30.18	27.91	25.96
PE38303-24	24"	33.95	31.57	29.20	27.16
PE38303-XX	Any	Same-Day Shipment / Call for Pricing			

## LFU PLUG TO REVERSE POLARITY MCX JACK BULKHEAD, RG178B/U COAX



Model No.	Length	1-24	25-49	50-99	100 +
PE38302-3	3"	\$43.95	\$40.87	\$37.80	\$35.16
PE38302-6	6"	44.45	41.34	38.23	35.56
PE38302-9	9"	44.95	41.80	38.66	35.96
PE38302-12	12"	45.45	42.27	39.09	36.36
PE38302-18	18"	45.95	42.73	39.52	36.76
PE38302-24	24"	46.45	43.20	39.95	37.16
PE38302-XX	Any	Same-Day Shipment / Call for Pricing			

## LFU PLUG TO TNC FEMALE BULKHEAD, RG178B/U COAX



Model No.	Length	1-24	25-49	50-99	100 +
PE38304-3	3"	\$29.95	\$27.85	\$25.76	\$23.96
PE38304-6	6"	30.45	28.32	26.19	24.36
PE38304-9	9"	30.95	28.78	26.62	24.76
PE38304-12	12"	31.45	29.25	27.05	25.16
PE38304-18	18"	32.45	30.18	27.91	25.96
PE38304-24	24"	33.95	31.57	29.20	27.16
PE38304-XX	Any	Same-Day Shipment / Call for Pricing			

\*Note: U.FL™ is a Registered Trademark of Hirose Electric Group.

**NEW**

# HIGH DEFINITION (HD) CABLE ASSEMBLIES

The HD Precision 75 Ohm cable assemblies are recommended for demanding applications where signal integrity is critical. The assemblies are designed around Pasternack's new PE-BYR940 Mini-59 coax cable, which provides improved impedance and phase stability over standard RG type assemblies. Typical applications include HDTV, satellite communications, and digital broadcast.

## BNC MALE TO BNC MALE



Model No.	Length	1-24	25-49	50-99	100 +
PE38130-12	12"	\$32.60	\$30.32	\$28.04	\$26.08
PE38130-24	24"	34.65	32.22	29.80	27.72
PE38130-36	36"	36.65	34.08	31.52	29.32
PE38130-48	48"	38.70	35.99	33.28	30.96
PE38130-60	60"	40.75	37.90	35.05	32.60
PE38130-72	72"	42.80	39.80	36.81	34.24
PE38130-120	120"	50.95	47.38	43.82	40.76

## BNC FEMALE BULKHEAD TO BNC MALE



Model No.	Length	1-24	25-49	50-99	100 +
PE38132-12	12"	\$43.80	\$40.73	\$37.67	\$35.04
PE38132-24	24"	45.85	42.64	39.43	36.68
PE38132-36	36"	47.90	44.55	41.19	38.32
PE38132-48	48"	49.95	46.45	42.96	39.96
PE38132-60	60"	51.95	48.31	44.68	41.56
PE38132-72	72"	54.00	50.22	46.44	43.20
PE38132-120	120"	62.15	57.80	53.45	49.72

## F MALE TO F MALE



Model No.	Length	1-24	25-49	50-99	100 +
PE38136-12	12"	\$12.70	\$11.81	\$10.92	\$10.16
PE38136-24	24"	14.25	13.25	12.26	11.40
PE38136-36	36"	15.75	14.65	13.55	12.60
PE38136-48	48"	17.30	16.09	14.88	13.84
PE38136-60	60"	18.80	17.48	16.17	15.04
PE38136-72	72"	20.35	18.93	17.50	16.28
PE38136-120	120"	25.95	24.13	22.32	20.76

## F FEMALE BULKHEAD TO F MALE



Model No.	Length	1-24	25-49	50-99	100 +
PE38138-12	12"	\$16.25	\$15.11	\$13.98	\$13.00
PE38138-24	24"	17.80	16.55	15.31	14.24
PE38138-36	36"	19.35	18.00	16.64	15.48
PE38138-48	48"	20.85	19.39	17.93	16.68
PE38138-60	60"	22.40	20.83	19.26	17.92
PE38138-72	72"	23.90	22.23	20.55	19.12
PE38138-120	120"	30.55	28.41	26.27	24.44

## MINI SMB PLUG TO MINI SMB PLUG



Model No.	Length	1-24	25-49	50-99	100 +
PE38139-12	12"	\$50.95	\$47.38	\$43.82	\$40.76
PE38139-24	24"	44.85	41.71	38.57	35.88
PE38139-36	36"	46.85	43.57	40.29	37.48
PE38139-48	48"	48.90	45.48	42.05	39.12
PE38139-60	60"	50.95	47.38	43.82	40.76
PE38139-72	72"	53.00	49.29	45.58	42.40
PE38139-120	120"	61.15	56.87	52.59	48.92

## BNC MALE RIGHT ANGLE TO BNC MALE



Model No.	Length	1-24	25-49	50-99	100 +
PE38131-12	12"	\$41.75	\$38.83	\$35.91	\$33.40
PE38131-24	24"	43.80	40.73	37.67	35.04
PE38131-36	36"	45.85	42.64	39.43	36.68
PE38131-48	48"	47.90	44.55	41.19	38.32
PE38131-60	60"	49.95	46.45	42.96	39.96
PE38131-72	72"	51.95	48.31	44.68	41.56
PE38131-120	120"	60.15	55.94	51.73	48.12

## BNC MALE TO MINI SMB PLUG

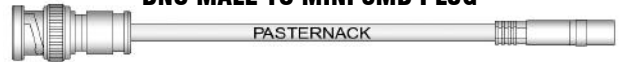

Model No.	Length	1-24	25-49	50-99	100 +
PE38040-12	12"	\$35.65	\$33.15	\$30.66	\$28.52
PE38040-24	24"	36.65	34.08	31.52	29.32
PE38040-36	36"	37.70	35.06	32.42	30.16
PE38040-48	48"	38.70	35.99	33.28	30.96
PE38040-60	60"	39.75	36.97	34.19	31.80
PE38040-72	72"	40.75	37.90	35.05	32.60
PE38040-120	120"	43.80	40.73	37.67	35.04

## F MALE RIGHT ANGLE TO F MALE



Model No.	Length	1-24	25-49	50-99	100 +
PE38137-12	12"	\$20.35	\$18.93	\$17.50	\$16.28
PE38137-24	24"	21.90	20.37	18.83	17.52
PE38137-36	36"	23.40	21.76	20.12	18.72
PE38137-48	48"	24.95	23.20	21.46	19.96
PE38137-60	60"	26.45	24.60	22.75	21.16
PE38137-72	72"	28.00	26.04	24.08	22.40
PE38137-120	120"	34.10	31.71	29.33	27.28

## MINI SMB JACK TO MINI SMB PLUG



Model No.	Length	1-24	25-49	50-99	100 +
PE38141-12	12"	\$40.75	\$37.90	\$35.05	\$32.60
PE38141-24	24"	42.80	39.80	36.81	34.24
PE38141-36	36"	44.85	41.71	38.57	35.88
PE38141-48	48"	46.85	43.57	40.29	37.48
PE38141-60	60"	48.90	45.48	42.05	39.12
PE38141-72	72"	50.95	47.38	43.82	40.76
PE38141-120	120"	59.10	54.96	50.83	47.28

## MINI SMB PLUG RIGHT ANGLE TO MINI SMB PLUG



Model No.	Length	1-24	25-49	50-99	100 +
PE38140-12	12"	\$50.95	\$47.38	\$43.82	\$40.76
PE38140-24	24"	53.00	49.29	45.58	42.40
PE38140-36	36"	55.05	51.20	47.34	44.04
PE38140-48	48"	57.05	53.06	49.06	45.64
PE38140-60	60"	59.10	54.96	50.83	47.28
PE38140-72	72"	61.15	56.87	52.59	48.92
PE38140-120	120"	69.30	64.45	59.60	55.44

Cable Assemblies

# NEW HIGH DEFINITION (HD) CABLE ASSEMBLIES (CONT'D)

## RCA MALE TO RCA MALE



Model No.	Length	1-24	25-49	50-99	100 +
PE38133-12	12"	\$40.75	\$37.90	\$35.05	\$32.60
PE38133-24	24"	42.80	39.80	36.81	34.24
PE38133-36	36"	44.85	41.71	38.57	35.88
PE38133-48	48"	46.85	43.57	40.29	37.48
PE38133-60	60"	48.90	45.48	42.05	39.12
PE38133-72	72"	50.95	47.38	43.82	40.76
PE38133-120	120"	59.10	54.96	50.83	47.28

## RCA FEMALE BULKHEAD TO RCA MALE



Model No.	Length	1-24	25-49	50-99	100 +
PE38135-12	12"	\$45.85	\$42.64	\$39.43	\$36.68
PE38135-24	24"	47.90	44.55	41.19	38.32
PE38135-36	36"	49.95	46.45	42.96	39.96
PE38135-48	48"	51.95	48.31	44.68	41.56
PE38135-60	60"	54.00	50.22	46.44	43.20
PE38135-72	72"	56.05	52.13	48.20	44.84
PE38135-120	120"	64.20	59.71	55.21	51.36

## RCA MALE RIGHT ANGLE TO RCA MALE



Model No.	Length	1-24	25-49	50-99	100 +
PE38134-12	12"	\$49.95	\$46.45	\$42.96	\$39.96
PE38134-24	24"	51.95	48.31	44.68	41.56
PE38134-36	36"	54.00	50.22	46.44	43.20
PE38134-48	48"	56.05	52.13	48.20	44.84
PE38134-60	60"	58.10	54.03	49.97	46.48
PE38134-72	72"	60.15	55.94	51.73	48.12
PE38134-120	120"	68.30	63.52	58.74	54.64

If you need a custom-length cable assembly, you can select your desired length, see pricing, and order online at our 100% secure website: [www.Pasternack.com](http://www.Pasternack.com), or contact Technical Support at (866) 727-8376, or email at [TechSupport@pasternack.com](mailto:TechSupport@pasternack.com).

Cable Assemblies

# NEW 1/2" HELICAL FLEX CABLE ASSEMBLIES

## N MALE TO N MALE, 1/2" HELICAL FLEX



Model No.	Length	1-24	25-49	50-99	100 +
PE37968-36	36"	\$81.55	\$75.84	\$70.13	\$65.24
PE37968-72	72"	101.95	94.81	87.68	81.56

For Additional Lengths, Please Contact Technical Support

## N MALE TO N MALE RIGHT ANGLE 1/2" HELICAL FLEX



Model No.	Length	1-24	25-49	50-99	100 +
PE37970-36	36"	\$101.95	\$94.81	\$87.68	\$81.56
PE37970-72	72"	122.35	113.79	105.22	97.88

For Additional Lengths, Please Contact Technical Support

## N MALE TO N FEMALE, 1/2" HELICAL FLEX



Model No.	Length	1-24	25-49	50-99	100 +
PE37969-36	36"	\$91.75	\$85.33	\$78.91	\$73.40
PE37969-72	72"	112.15	104.30	96.45	89.72

For Additional Lengths, Please Contact Technical Support

## 7/16 DIN MALE TO 7/16 DIN MALE, 1/2" HELICAL FLEX



Model No.	Length	1-24	25-49	50-99	100 +
PE37971-36	36"	\$101.95	\$94.81	\$87.68	\$81.56
PE37971-72	72"	122.35	113.79	105.22	97.88

For Additional Lengths, Please Contact Technical Support

## 7/16 DIN MALE TO 7/16 DIN MALE RIGHT ANGLE 1/2" HELICAL FLEX



Model No.	Length	1-24	25-49	50-99	100 +
PE37973-36	36"	\$122.35	\$113.79	\$105.22	\$97.88
PE37973-72	72"	142.75	132.76	122.77	114.20

For Additional Lengths, Please Contact Technical Support

## 7/16 DIN MALE TO 7/16 DIN FEMALE, 1/2" HELICAL FLEX



Model No.	Length	1-24	25-49	50-99	100 +
PE37972-36	36"	\$112.15	\$104.30	\$96.45	\$89.72
PE37972-72	72"	132.55	123.27	113.99	106.04

For Additional Lengths, Please Contact Technical Support

## ALLIGATOR CLIPS TO BANANA PLUG

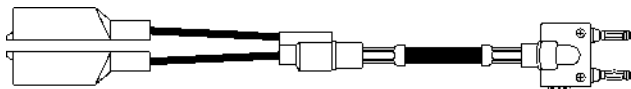

### 50 OHM, RG58C/U COAX

Model No.	Length	1-24	25-49	50-99	100 +
PE3502-12	12"	\$21.20	\$19.72	\$18.23	\$16.96
PE3502-24	24"	21.60	20.09	18.58	17.28
PE3502-36	36"	22.05	20.51	18.96	17.64
PE3502-48	48"	22.45	20.88	19.31	17.96
PE3502-60	60"	22.85	21.25	19.65	18.28
PE3502-XX	Any	Same-Day Shipment / Call for Pricing			

### 50 OHM, RG223/U COAX, DOUBLE SHIELDED

Model No.	Length	1-24	25-49	50-99	100 +
PE3164-12	12"	\$23.85	\$22.18	\$20.51	\$19.08
PE3164-24	24"	25.20	23.44	21.67	20.16
PE3164-36	36"	26.50	24.65	22.79	21.20
PE3164-48	48"	27.85	25.90	23.95	22.28
PE3164-60	60"	29.15	27.11	25.07	23.32
PE3164-XX	Any	Same-Day Shipment / Call for Pricing			

## UHF MALE TO BANANA PLUG



### 50 OHM, RG58C/U COAX

Model No.	Length	1-24	25-49	50-99	100 +
PE3010-12	12"	\$19.90	\$18.51	\$17.11	\$15.92
PE3010-24	24"	20.30	18.88	17.46	16.24
PE3010-36	36"	20.70	19.25	17.80	16.56
PE3010-48	48"	21.10	19.62	18.15	16.88
PE3010-60	60"	21.50	20.00	18.49	17.20
PE3010-XX	Any	Same-Day Shipment / Call for Pricing			

### 50 OHM, RG223/U COAX, DOUBLE SHIELDED

Model No.	Length	1-24	25-49	50-99	100 +
PE34244-12	12"	\$23.85	\$22.18	\$20.51	\$19.08
PE34244-24	24"	25.20	23.44	21.67	20.16
PE34244-36	36"	26.50	24.65	22.79	21.20
PE34244-48	48"	27.85	25.90	23.95	22.28
PE34244-60	60"	29.15	27.11	25.07	23.32
PE34244-XX	Any	Same-Day Shipment / Call for Pricing			

## BNC MALE TO ALLIGATOR CLIPS

CABLE LENGTH IS LENGTH STATED PLUS APPROXIMATELY 6" OF BLACK & RED TEST LEAD

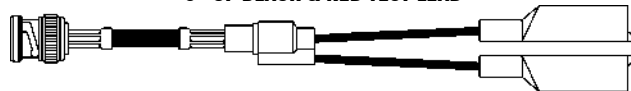

### 53.5 OHM, RG55B/U COAX, DOUBLE SHIELDED

Model No.	Length	1-24	25-49	50-99	100 +
PE34536-12	12"	\$21.20	\$19.72	\$18.23	\$16.96
PE34536-24	24"	21.95	20.41	18.88	17.56
PE34536-36	36"	22.70	21.11	19.52	18.16
PE34536-48	48"	23.35	21.72	20.08	18.68
PE34536-60	60"	24.05	22.37	20.68	19.24
PE34536-XX	Any	Same-Day Shipment / Call for Pricing			

### 50 OHM, RG58C/U COAX

Model No.	Length	1-24	25-49	50-99	100 +
PE3501-12	12"	\$19.90	\$18.51	\$17.11	\$15.92
PE3501-24	24"	20.30	18.88	17.46	16.24
PE3501-36	36"	20.70	19.25	17.80	16.56
PE3501-48	48"	21.10	19.62	18.15	16.88
PE3501-60	60"	21.50	20.00	18.49	17.20
PE3501-XX	Any	Same-Day Shipment / Call for Pricing			

### 75 OHM, RG59B/U COAX

Model No.	Length	1-24	25-49	50-99	100 +
PE3954-12	12"	\$22.50	\$20.93	\$19.35	\$18.00
PE3954-24	24"	22.95	21.34	19.74	18.36
PE3954-36	36"	23.30	21.67	20.04	18.64
PE3954-48	48"	23.75	22.09	20.43	19.00
PE3954-60	60"	24.10	22.41	20.73	19.28
PE3954-XX	Any	Same-Day Shipment / Call for Pricing			

### 93 OHM, RG62A/U COAX

Model No.	Length	1-24	25-49	50-99	100 +
PE34532-12	12"	\$22.50	\$20.93	\$19.35	\$18.00
PE34532-24	24"	22.95	21.34	19.74	18.36
PE34532-36	36"	23.30	21.67	20.04	18.64
PE34532-48	48"	23.75	22.09	20.43	19.00
PE34532-60	60"	24.10	22.41	20.73	19.28
PE34532-XX	Any	Same-Day Shipment / Call for Pricing			

### 50 OHM, RG142B/U COAX, DOUBLE SHIELDED

Model No.	Length	1-24	25-49	50-99	100 +
PE3571-12	12"	\$19.90	\$18.51	\$17.11	\$15.92
PE3571-24	24"	22.50	20.93	19.35	18.00
PE3571-36	36"	25.20	23.44	21.67	20.16
PE3571-48	48"	27.85	25.90	23.95	22.28
PE3571-60	60"	30.50	28.37	26.23	24.40
PE3571-XX	Any	Same-Day Shipment / Call for Pricing			

### 50 OHM, RG223/U COAX, DOUBLE SHIELDED

Model No.	Length	1-24	25-49	50-99	100 +
PE3346-12	12"	\$19.90	\$18.51	\$17.11	\$15.92
PE3346-24	24"	21.20	19.72	18.23	16.96
PE3346-36	36"	22.50	20.93	19.35	18.00
PE3346-48	48"	23.85	22.18	20.51	19.08
PE3346-60	60"	25.20	23.44	21.67	20.16
PE3346-XX	Any	Same-Day Shipment / Call for Pricing			

### 50 OHM, RG400/U COAX, DOUBLE SHIELDED

Model No.	Length	1-24	25-49	50-99	100 +
PE34534-12	12"	\$19.90	\$18.51	\$17.11	\$15.92
PE34534-24	24"	22.50	20.93	19.35	18.00
PE34534-36	36"	25.20	23.44	21.67	20.16
PE34534-48	48"	27.85	25.90	23.95	22.28
PE34534-60	60"	30.50	28.37	26.23	24.40
PE34534-XX	Any	Same-Day Shipment / Call for Pricing			

\*\*ROHS COMPLIANT & CUSTOM-LENGTH CABLE ASSEMBLIES MAY BE ORDERED ON OUR WEBSITE.\*\*

## BNC MALE TO BANANA PLUG

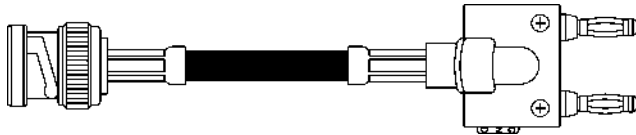

### 50 OHM, RG58C/U COAX

Model No.	Length	1-24	25-49	50-99	100 +
PE3000-12	12"	\$18.55	\$17.25	\$15.95	\$14.84
PE3000-24	24"	18.95	17.62	16.30	15.16
PE3000-36	36"	19.45	18.09	16.73	15.56
PE3000-48	48"	19.80	18.41	17.03	15.84
PE3000-60	60"	20.25	18.83	17.42	16.20
PE3000-XX	Any	Same-Day Shipment / Call for Pricing			

### 50 OHM, RG142B/U COAX, DOUBLE SHIELDED

Model No.	Length	1-24	25-49	50-99	100 +
PE33440-12	12"	\$21.20	\$19.72	\$18.23	\$16.96
PE33440-24	24"	23.85	22.18	20.51	19.08
PE33440-36	36"	26.50	24.65	22.79	21.20
PE33440-48	48"	29.15	27.11	25.07	23.32
PE33440-60	60"	31.80	29.57	27.35	25.44
PE33440-XX	Any	Same-Day Shipment / Call for Pricing			

### 50 OHM, RG174A/U COAX

Model No.	Length	1-24	25-49	50-99	100 +
PE34593-12	12"	\$21.20	\$19.72	\$18.23	\$16.96
PE34593-24	24"	21.45	19.95	18.45	17.16
PE34593-36	36"	21.75	20.23	18.71	17.40
PE34593-48	48"	22.05	20.51	18.96	17.64
PE34593-60	60"	22.30	20.74	19.18	17.84
PE34593-XX	Any	Same-Day Shipment / Call for Pricing			

### 50 OHM, RG223/U COAX, DOUBLE SHIELDED

Model No.	Length	1-24	25-49	50-99	100 +
PE33442-12	12"	\$21.20	\$19.72	\$18.23	\$16.96
PE33442-24	24"	22.50	20.93	19.35	18.00
PE33442-36	36"	23.85	22.18	20.51	19.08
PE33442-48	48"	25.20	23.44	21.67	20.16
PE33442-60	60"	26.50	24.65	22.79	21.20
PE33442-XX	Any	Same-Day Shipment / Call for Pricing			

### 50 OHM, RG316/U COAX

Model No.	Length	1-24	25-49	50-99	100 +
PE34597-12	12"	\$22.50	\$20.93	\$19.35	\$18.00
PE34597-24	24"	23.45	21.81	20.17	18.76
PE34597-36	36"	24.50	22.79	21.07	19.60
PE34597-48	48"	25.45	23.67	21.89	20.36
PE34597-60	60"	26.40	24.55	22.70	21.12
PE34597-XX	Any	Same-Day Shipment / Call for Pricing			

### 50 OHM, RG316-DS COAX, DOUBLE SHIELDED

Model No.	Length	1-24	25-49	50-99	100 +
PE34602-12	12"	\$23.85	\$22.18	\$20.51	\$19.08
PE34602-24	24"	26.30	24.46	22.62	21.04
PE34602-36	36"	28.65	26.64	24.64	22.92
PE34602-48	48"	31.10	28.92	26.75	24.88
PE34602-60	60"	33.50	31.16	28.81	26.80
PE34602-XX	Any	Same-Day Shipment / Call for Pricing			

### 50 OHM, RG400/U COAX, DOUBLE SHIELDED

Model No.	Length	1-24	25-49	50-99	100 +
PE33444-12	12"	\$21.20	\$19.72	\$18.23	\$16.96
PE33444-24	24"	23.85	22.18	20.51	19.08
PE33444-36	36"	26.50	24.65	22.79	21.20
PE33444-48	48"	29.15	27.11	25.07	23.32
PE33444-60	60"	31.80	29.57	27.35	25.44
PE33444-XX	Any	Same-Day Shipment / Call for Pricing			

## BANANA PLUG TO BANANA PLUG



### 50 OHM, RG58C/U COAX

Model No.	Length	1-24	25-49	50-99	100 +
PE3005-12	12"	\$18.55	\$17.25	\$15.95	\$14.84
PE3005-24	24"	18.95	17.62	16.30	15.16
PE3005-36	36"	19.45	18.09	16.73	15.56
PE3005-48	48"	19.80	18.41	17.03	15.84
PE3005-60	60"	20.25	18.83	17.42	16.20
PE3005-XX	Any	Same-Day Shipment / Call for Pricing			

### 50 OHM, RG142B/U COAX, DOUBLE SHIELDED

Model No.	Length	1-24	25-49	50-99	100 +
PE33446-12	12"	\$21.20	\$19.72	\$18.23	\$16.96
PE33446-24	24"	23.85	22.18	20.51	19.08
PE33446-36	36"	26.50	24.65	22.79	21.20
PE33446-48	48"	29.15	27.11	25.07	23.32
PE33446-60	60"	31.80	29.57	27.35	25.44
PE33446-XX	Any	Same-Day Shipment / Call for Pricing			

### 50 OHM, RG174A/U COAX

Model No.	Length	1-24	25-49	50-99	100 +
PE34595-12	12"	\$21.20	\$19.72	\$18.23	\$16.96
PE34595-24	24"	21.45	19.95	18.45	17.16
PE34595-36	36"	21.75	20.23	18.71	17.40
PE34595-48	48"	22.05	20.51	18.96	17.64
PE34595-60	60"	22.30	20.74	19.18	17.84
PE34595-XX	Any	Same-Day Shipment / Call for Pricing			

### 50 OHM, RG223/U COAX, DOUBLE SHIELDED

Model No.	Length	1-24	25-49	50-99	100 +
PE33449-12	12"	\$21.20	\$19.72	\$18.23	\$16.96
PE33449-24	24"	22.50	20.93	19.35	18.00
PE33449-36	36"	23.85	22.18	20.51	19.08
PE33449-48	48"	25.20	23.44	21.67	20.16
PE33449-60	60"	26.50	24.65	22.79	21.20
PE33449-XX	Any	Same-Day Shipment / Call for Pricing			

### 50 OHM, RG316/U COAX

Model No.	Length	1-24	25-49	50-99	100 +
PE34600-12	12"	\$22.50	\$20.93	\$19.35	\$18.00
PE34600-24	24"	23.45	21.81	20.17	18.76
PE34600-36	36"	24.50	22.79	21.07	19.60
PE34600-48	48"	25.45	23.67	21.89	20.36
PE34600-60	60"	26.40	24.55	22.70	21.12
PE34600-XX	Any	Same-Day Shipment / Call for Pricing			

### 50 OHM, RG316-DS COAX, DOUBLE SHIELDED

Model No.	Length	1-24	25-49	50-99	100 +
PE34604-12	12"	\$23.85	\$22.18	\$20.51	\$19.08
PE34604-24	24"	26.30	24.46	22.62	21.04
PE34604-36	36"	28.65	26.64	24.64	22.92
PE34604-48	48"	31.10	28.92	26.75	24.88
PE34604-60	60"	33.50	31.16	28.81	26.80
PE34604-XX	Any	Same-Day Shipment / Call for Pricing			

### 50 OHM, RG400/U COAX, DOUBLE SHIELDED

Model No.	Length	1-24	25-49	50-99	100 +
PE33454-12	12"	\$21.20	\$19.72	\$18.23	\$16.96
PE33454-24	24"	23.85	22.18	20.51	19.08
PE33454-36	36"	26.50	24.65	22.79	21.20
PE33454-48	48"	29.15	27.11	25.07	23.32
PE33454-60	60"	31.80	29.57	27.35	25.44
PE33454-XX	Any	Same-Day Shipment / Call for Pricing			

\*\*ROHS COMPLIANT & CUSTOM-LENGTH CABLE ASSEMBLIES MAY BE ORDERED ON OUR WEBSITE.\*\*

**LENGTH FOR ALL CABLES ON THIS PAGE IS DETERMINED AS FOLLOWS:  
LENGTH STATED PLUS APPROXIMATELY 6" OF RED & BLACK TEST LEAD**

**BNC MALE TO MINIATURE  
ALLIGATOR CLIPS**

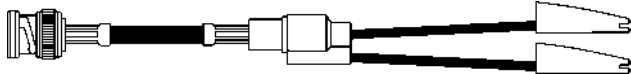

50 OHM, RG58C/U COAX					
Model No.	Length	1-24	25-49	50-99	100 +
PE33546-12	12"	\$24.65	\$22.92	\$21.20	\$19.72
PE33546-24	24"	25.05	23.30	21.54	20.04
PE33546-36	36"	25.45	23.67	21.89	20.36
PE33546-48	48"	25.80	23.99	22.19	20.64
PE33546-60	60"	26.25	24.41	22.58	21.00
PE33546-XX	Any	Same-Day Shipment / Call for Pricing			

75 OHM, RG59B/U COAX					
Model No.	Length	1-24	25-49	50-99	100 +
PE33548-12	12"	\$26.00	\$24.18	\$22.36	\$20.80
PE33548-24	24"	26.45	24.60	22.75	21.16
PE33548-36	36"	26.85	24.97	23.09	21.48
PE33548-48	48"	27.30	25.39	23.48	21.84
PE33548-60	60"	27.65	25.71	23.78	22.12
PE33548-XX	Any	Same-Day Shipment / Call for Pricing			

**BNC MALE TO MINIATURE  
STACKING BANANA PLUGS**

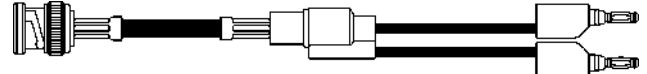

50 OHM, RG58C/U COAX					
Model No.	Length	1-24	25-49	50-99	100 +
PE33557-12	12"	\$24.65	\$22.92	\$21.20	\$19.72
PE33557-24	24"	25.05	23.30	21.54	20.04
PE33557-36	36"	25.45	23.67	21.89	20.36
PE33557-48	48"	25.80	23.99	22.19	20.64
PE33557-60	60"	26.25	24.41	22.58	21.00
PE33557-XX	Any	Same-Day Shipment / Call for Pricing			

75 OHM, RG59B/U COAX					
Model No.	Length	1-24	25-49	50-99	100 +
PE33559-12	12"	\$26.00	\$24.18	\$22.36	\$20.80
PE33559-24	24"	26.45	24.60	22.75	21.16
PE33559-36	36"	26.85	24.97	23.09	21.48
PE33559-48	48"	27.30	25.39	23.48	21.84
PE33559-60	60"	27.65	25.71	23.78	22.12
PE33559-XX	Any	Same-Day Shipment / Call for Pricing			

**BNC MALE TO  
STACKING TIP PLUGS**

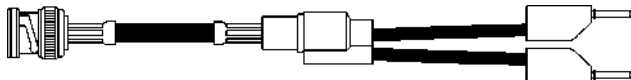

50 OHM, RG58C/U COAX					
Model No.	Length	1-24	25-49	50-99	100 +
PE33009-12	12"	\$24.65	\$22.92	\$21.20	\$19.72
PE33009-24	24"	25.05	23.30	21.54	20.04
PE33009-36	36"	25.45	23.67	21.89	20.36
PE33009-48	48"	25.80	23.99	22.19	20.64
PE33009-60	60"	26.25	24.41	22.58	21.00
PE33009-XX	Any	Same-Day Shipment / Call for Pricing			

75 OHM, RG59B/U COAX					
Model No.	Length	1-24	25-49	50-99	100 +
PE33550-12	12"	\$26.00	\$24.18	\$22.36	\$20.80
PE33550-24	24"	26.45	24.60	22.75	21.16
PE33550-36	36"	26.85	24.97	23.09	21.48
PE33550-48	48"	27.30	25.39	23.48	21.84
PE33550-60	60"	27.65	25.71	23.78	22.12
PE33550-XX	Any	Same-Day Shipment / Call for Pricing			

**BNC MALE TO SAFETY HOOKS**

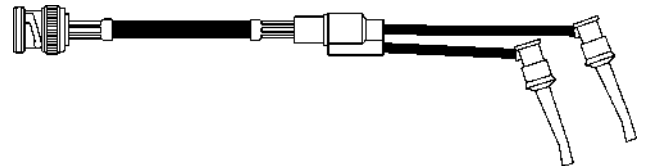

50 OHM, RG58C/U COAX					
Model No.	Length	1-24	25-49	50-99	100 +
PE33561-12	12"	\$24.65	\$22.92	\$21.20	\$19.72
PE33561-24	24"	25.05	23.30	21.54	20.04
PE33561-36	36"	25.45	23.67	21.89	20.36
PE33561-48	48"	25.80	23.99	22.19	20.64
PE33561-60	60"	26.25	24.41	22.58	21.00
PE33561-XX	Any	Same-Day Shipment / Call for Pricing			

75 OHM, RG59B/U COAX					
Model No.	Length	1-24	25-49	50-99	100 +
PE33563-12	12"	\$26.00	\$24.18	\$22.36	\$20.80
PE33563-24	24"	26.45	24.60	22.75	21.16
PE33563-36	36"	26.85	24.97	23.09	21.48
PE33563-48	48"	27.30	25.39	23.48	21.84
PE33563-60	60"	27.65	25.71	23.78	22.12
PE33563-XX	Any	Same-Day Shipment / Call for Pricing			

**BNC MALE TO STANDARD  
STACKING BANANA PLUGS**

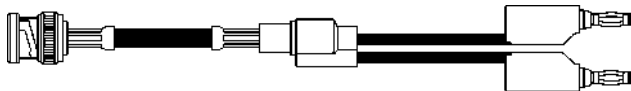

50 OHM, RG58C/U COAX					
Model No.	Length	1-24	25-49	50-99	100 +
PE33552-12	12"	\$24.65	\$22.92	\$21.20	\$19.72
PE33552-24	24"	25.05	23.30	21.54	20.04
PE33552-36	36"	25.45	23.67	21.89	20.36
PE33552-48	48"	25.80	23.99	22.19	20.64
PE33552-60	60"	26.25	24.41	22.58	21.00
PE33552-XX	Any	Same-Day Shipment / Call for Pricing			

75 OHM, RG59B/U COAX					
Model No.	Length	1-24	25-49	50-99	100 +
PE33554-12	12"	\$26.00	\$24.18	\$22.36	\$20.80
PE33554-24	24"	26.45	24.60	22.75	21.16
PE33554-36	36"	26.85	24.97	23.09	21.48
PE33554-48	48"	27.30	25.39	23.48	21.84
PE33554-60	60"	27.65	25.71	23.78	22.12
PE33554-XX	Any	Same-Day Shipment / Call for Pricing			

**BNC MALE TO  
UNTERMINATED WIRES**

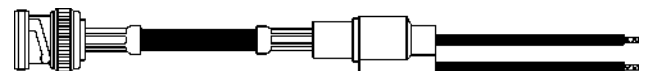

50 OHM, RG58C/U COAX					
Model No.	Length	1-24	25-49	50-99	100 +
PE33565-12	12"	\$23.10	\$21.48	\$19.87	\$18.48
PE33565-24	24"	23.50	21.86	20.21	18.80
PE33565-36	36"	23.90	22.23	20.55	19.12
PE33565-48	48"	24.40	22.69	20.98	19.52
PE33565-60	60"	24.85	23.11	21.37	19.88
PE33565-XX	Any	Same-Day Shipment / Call for Pricing			

75 OHM, RG59B/U COAX					
Model No.	Length	1-24	25-49	50-99	100 +
PE33567-12	12"	\$24.65	\$22.92	\$21.20	\$19.72
PE33567-24	24"	25.05	23.30	21.54	20.04
PE33567-36	36"	25.45	23.67	21.89	20.36
PE33567-48	48"	25.80	23.99	22.19	20.64
PE33567-60	60"	26.25	24.41	22.58	21.00
PE33567-XX	Any	Same-Day Shipment / Call for Pricing			

\*\*ROHS COMPLIANT & CUSTOM-LENGTH CABLE ASSEMBLIES MAY BE ORDERED ON OUR WEBSITE.\*\*

# SINGLE WIRE PATCH CORDS

All of the color coded Patch Cords listed below are rated at 2500 Volts, 5 Amps and +50 °C

STACKING BANANA PLUG TO STACKING BANANA PLUG	BLACK	RED	LENGTH	P R I C E			
	Black Model No.	Red Model No.		1-24	25-49	50-99	100 +
	PE9930-6-B	PE9930-6-R	6"	\$5.75	\$5.35	\$4.95	\$4.60
	PE9930-12-B	PE9930-12-R	12"	5.85	5.44	5.03	4.68
	PE9930-18-B	PE9930-18-R	18"	6.00	5.58	5.16	4.80
	PE9930-24-B	PE9930-24-R	24"	6.10	5.67	5.25	4.88
	PE9930-36-B	PE9930-36-R	36"	6.30	5.86	5.42	5.04
	PE9930-48-B	PE9930-48-R	48"	6.60	6.14	5.68	5.28
	PE9930-60-B	PE9930-60-R	60"	6.80	6.32	5.85	5.44
	PE9930-72-B	PE9930-72-R	72"	7.05	6.56	6.06	5.64

ALLIGATOR CLIP TO STACKING BANANA PLUG	BLACK	RED	LENGTH	P R I C E			
	Black Model No.	Red Model No.		1-24	25-49	50-99	100 +
	PE9931-6-B	PE9931-6-R	6"	\$5.55	\$5.16	\$4.77	\$4.44
	PE9931-12-B	PE9931-12-R	12"	5.65	5.25	4.86	4.52
	PE9931-18-B	PE9931-18-R	18"	5.80	5.39	4.99	4.64
	PE9931-24-B	PE9931-24-R	24"	5.90	5.49	5.07	4.72
	PE9931-36-B	PE9931-36-R	36"	6.10	5.67	5.25	4.88
	PE9931-48-B	PE9931-48-R	48"	6.35	5.91	5.46	5.08
	PE9931-60-B	PE9931-60-R	60"	6.55	6.09	5.63	5.24
	PE9931-72-B	PE9931-72-R	72"	6.80	6.32	5.85	5.44

ALLIGATOR CLIP TO ALLIGATOR CLIP	BLACK	RED	LENGTH	P R I C E			
	Black Model No.	Red Model No.		1-24	25-49	50-99	100 +
	PE9932-6-B	PE9932-6-R	6"	\$5.55	\$5.16	\$4.77	\$4.44
	PE9932-12-B	PE9932-12-R	12"	5.65	5.25	4.86	4.52
	PE9932-18-B	PE9932-18-R	18"	5.80	5.39	4.99	4.64
	PE9932-24-B	PE9932-24-R	24"	5.90	5.49	5.07	4.72
	PE9932-36-B	PE9932-36-R	36"	6.10	5.67	5.25	4.88
	PE9932-48-B	PE9932-48-R	48"	6.35	5.91	5.46	5.08
	PE9932-60-B	PE9932-60-R	60"	6.55	6.09	5.63	5.24
	PE9932-72-B	PE9932-72-R	72"	6.80	6.32	5.85	5.44

MINI ALLIGATOR CLIP TO STACKING BANANA PLUG	BLACK	RED	LENGTH	P R I C E			
	Black Model No.	Red Model No.		1-24	25-49	50-99	100 +
	PE9933-6-B	PE9933-6-R	6"	\$5.55	\$5.16	\$4.77	\$4.44
	PE9933-12-B	PE9933-12-R	12"	5.65	5.25	4.86	4.52
	PE9933-18-B	PE9933-18-R	18"	5.80	5.39	4.99	4.64
	PE9933-24-B	PE9933-24-R	24"	5.90	5.49	5.07	4.72
	PE9933-36-B	PE9933-36-R	36"	6.10	5.67	5.25	4.88
	PE9933-48-B	PE9933-48-R	48"	6.35	5.91	5.46	5.08
	PE9933-60-B	PE9933-60-R	60"	6.55	6.09	5.63	5.24
	PE9933-72-B	PE9933-72-R	72"	6.80	6.32	5.85	5.44

MINI ALLIGATOR CLIP TO MINI ALLIGATOR CLIP	BLACK	RED	LENGTH	P R I C E			
	Black Model No.	Red Model No.		1-24	25-49	50-99	100 +
	PE9934-6-B	PE9934-6-R	6"	\$5.55	\$5.16	\$4.77	\$4.44
	PE9934-12-B	PE9934-12-R	12"	5.65	5.25	4.86	4.52
	PE9934-18-B	PE9934-18-R	18"	5.80	5.39	4.99	4.64
	PE9934-24-B	PE9934-24-R	24"	5.90	5.49	5.07	4.72
	PE9934-36-B	PE9934-36-R	36"	6.10	5.67	5.25	4.88
	PE9934-48-B	PE9934-48-R	48"	6.35	5.91	5.46	5.08
	PE9934-60-B	PE9934-60-R	60"	6.55	6.09	5.63	5.24
	PE9934-72-B	PE9934-72-R	72"	6.80	6.32	5.85	5.44

INSULATED SPADE LUG TO ALLIGATOR CLIP	BLACK	RED	LENGTH	P R I C E			
	Black Model No.	Red Model No.		1-24	25-49	50-99	100 +
	PE9935-6-B	PE9935-6-R	6"	\$5.55	\$5.16	\$4.77	\$4.44
	PE9935-12-B	PE9935-12-R	12"	5.65	5.25	4.86	4.52
	PE9935-18-B	PE9935-18-R	18"	5.80	5.39	4.99	4.64
	PE9935-24-B	PE9935-24-R	24"	5.90	5.49	5.07	4.72
	PE9935-36-B	PE9935-36-R	36"	6.10	5.67	5.25	4.88
	PE9935-48-B	PE9935-48-R	48"	6.35	5.91	5.46	5.08
	PE9935-60-B	PE9935-60-R	60"	6.55	6.09	5.63	5.24
	PE9935-72-B	PE9935-72-R	72"	6.80	6.32	5.85	5.44





INSULATED SPADE LUG TO STACKING BANANA PLUG	BLACK	RED	LENGTH	P R I C E			
	Black Model No.	Red Model No.		1-24	25-49	50-99	100 +
	PE9936-6-B	PE9936-6-R	6"	\$5.55	\$5.16	\$4.77	\$4.44
	PE9936-12-B	PE9936-12-R	12"	5.65	5.25	4.86	4.52
	PE9936-18-B	PE9936-18-R	18"	5.80	5.39	4.99	4.64
	PE9936-24-B	PE9936-24-R	24"	5.90	5.49	5.07	4.72
	PE9936-36-B	PE9936-36-R	36"	6.10	5.67	5.25	4.88
	PE9936-48-B	PE9936-48-R	48"	6.35	5.91	5.46	5.08
	PE9936-60-B	PE9936-60-R	60"	6.55	6.09	5.63	5.24
	PE9936-72-B	PE9936-72-R	72"	6.80	6.32	5.85	5.44

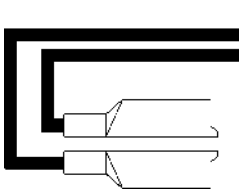
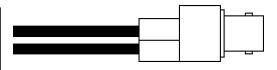
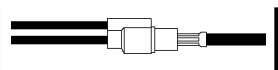
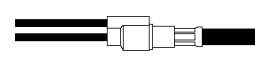
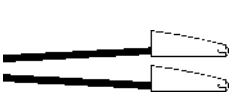
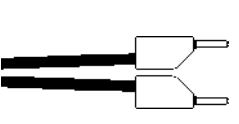
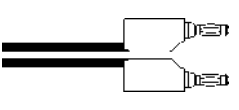

# BREAKOUTS

ALL BREAKOUTS HAVE APPROXIMATELY 6" LONG RED AND BLACK LEADS

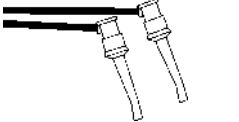
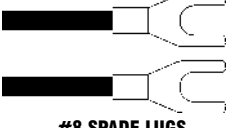
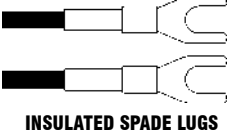
Cable  
Assemblies

 <p><b>STANDARD ALLIGATOR CLIPS</b></p>	<p align="center"><b>BNC MALE</b></p> <p align="center">Model No. <u>PE9900</u></p> <table border="1"> <tr> <td>1-24</td> <td>25-49</td> <td>50-99</td> <td>100 +</td> </tr> <tr> <td>\$12.05</td> <td>\$11.21</td> <td>\$10.36</td> <td>\$9.64</td> </tr> </table>	1-24	25-49	50-99	100 +	\$12.05	\$11.21	\$10.36	\$9.64	 <p align="center"><b>BNC FEMALE</b></p> <p align="center">Model No. <u>PE9909</u></p> <table border="1"> <tr> <td>1-24</td> <td>25-49</td> <td>50-99</td> <td>100 +</td> </tr> <tr> <td>\$10.95</td> <td>\$10.18</td> <td>\$9.42</td> <td>\$8.76</td> </tr> </table>	1-24	25-49	50-99	100 +	\$10.95	\$10.18	\$9.42	\$8.76	 <p align="center"><b>CRIMP ON FOR RG58</b></p> <p align="center">Model No. <u>PE9950</u></p> <table border="1"> <tr> <td>1-24</td> <td>25-49</td> <td>50-99</td> <td>100 +</td> </tr> <tr> <td>\$12.05</td> <td>\$11.21</td> <td>\$10.36</td> <td>\$9.64</td> </tr> </table>	1-24	25-49	50-99	100 +	\$12.05	\$11.21	\$10.36	\$9.64	 <p align="center"><b>CRIMP ON FOR RG59</b></p> <p align="center">Model No. <u>PE9959</u></p> <table border="1"> <tr> <td>1-24</td> <td>25-49</td> <td>50-99</td> <td>100 +</td> </tr> <tr> <td>\$12.05</td> <td>\$11.21</td> <td>\$10.36</td> <td>\$9.64</td> </tr> </table>	1-24	25-49	50-99	100 +	\$12.05	\$11.21	\$10.36	\$9.64
1-24	25-49	50-99	100 +																																	
\$12.05	\$11.21	\$10.36	\$9.64																																	
1-24	25-49	50-99	100 +																																	
\$10.95	\$10.18	\$9.42	\$8.76																																	
1-24	25-49	50-99	100 +																																	
\$12.05	\$11.21	\$10.36	\$9.64																																	
1-24	25-49	50-99	100 +																																	
\$12.05	\$11.21	\$10.36	\$9.64																																	
 <p><b>MINIATURE ALLIGATOR CLIPS</b></p>	<p align="center">Model No. <u>PE9901</u></p> <table border="1"> <tr> <td>1-24</td> <td>25-49</td> <td>50-99</td> <td>100 +</td> </tr> <tr> <td>\$12.05</td> <td>\$11.21</td> <td>\$10.36</td> <td>\$9.64</td> </tr> </table>	1-24	25-49	50-99	100 +	\$12.05	\$11.21	\$10.36	\$9.64	<p align="center">Model No. <u>PE9910</u></p> <table border="1"> <tr> <td>1-24</td> <td>25-49</td> <td>50-99</td> <td>100 +</td> </tr> <tr> <td>\$10.95</td> <td>\$10.18</td> <td>\$9.42</td> <td>\$8.76</td> </tr> </table>	1-24	25-49	50-99	100 +	\$10.95	\$10.18	\$9.42	\$8.76	<p align="center">Model No. <u>PE9951</u></p> <table border="1"> <tr> <td>1-24</td> <td>25-49</td> <td>50-99</td> <td>100 +</td> </tr> <tr> <td>\$10.95</td> <td>\$10.18</td> <td>\$9.42</td> <td>\$8.76</td> </tr> </table>	1-24	25-49	50-99	100 +	\$10.95	\$10.18	\$9.42	\$8.76	<p align="center">Model No. <u>PE9960</u></p> <table border="1"> <tr> <td>1-24</td> <td>25-49</td> <td>50-99</td> <td>100 +</td> </tr> <tr> <td>\$12.05</td> <td>\$11.21</td> <td>\$10.36</td> <td>\$9.64</td> </tr> </table>	1-24	25-49	50-99	100 +	\$12.05	\$11.21	\$10.36	\$9.64
1-24	25-49	50-99	100 +																																	
\$12.05	\$11.21	\$10.36	\$9.64																																	
1-24	25-49	50-99	100 +																																	
\$10.95	\$10.18	\$9.42	\$8.76																																	
1-24	25-49	50-99	100 +																																	
\$10.95	\$10.18	\$9.42	\$8.76																																	
1-24	25-49	50-99	100 +																																	
\$12.05	\$11.21	\$10.36	\$9.64																																	
 <p><b>STACKING TIP PLUGS</b></p>	<p align="center">Model No. <u>PE9902</u></p> <table border="1"> <tr> <td>1-24</td> <td>25-49</td> <td>50-99</td> <td>100 +</td> </tr> <tr> <td>\$14.30</td> <td>\$13.30</td> <td>\$12.30</td> <td>\$11.44</td> </tr> </table>	1-24	25-49	50-99	100 +	\$14.30	\$13.30	\$12.30	\$11.44	<p align="center">Model No. <u>PE9911</u></p> <table border="1"> <tr> <td>1-24</td> <td>25-49</td> <td>50-99</td> <td>100 +</td> </tr> <tr> <td>\$13.20</td> <td>\$12.28</td> <td>\$11.35</td> <td>\$10.56</td> </tr> </table>	1-24	25-49	50-99	100 +	\$13.20	\$12.28	\$11.35	\$10.56	<p align="center">Model No. <u>PE9952</u></p> <table border="1"> <tr> <td>1-24</td> <td>25-49</td> <td>50-99</td> <td>100 +</td> </tr> <tr> <td>\$13.20</td> <td>\$12.28</td> <td>\$11.35</td> <td>\$10.56</td> </tr> </table>	1-24	25-49	50-99	100 +	\$13.20	\$12.28	\$11.35	\$10.56	<p align="center">Model No. <u>PE9961</u></p> <table border="1"> <tr> <td>1-24</td> <td>25-49</td> <td>50-99</td> <td>100 +</td> </tr> <tr> <td>\$14.30</td> <td>\$13.30</td> <td>\$12.30</td> <td>\$11.44</td> </tr> </table>	1-24	25-49	50-99	100 +	\$14.30	\$13.30	\$12.30	\$11.44
1-24	25-49	50-99	100 +																																	
\$14.30	\$13.30	\$12.30	\$11.44																																	
1-24	25-49	50-99	100 +																																	
\$13.20	\$12.28	\$11.35	\$10.56																																	
1-24	25-49	50-99	100 +																																	
\$13.20	\$12.28	\$11.35	\$10.56																																	
1-24	25-49	50-99	100 +																																	
\$14.30	\$13.30	\$12.30	\$11.44																																	
 <p><b>STANDARD STACKING BANANA PLUGS</b></p>	<p align="center">Model No. <u>PE9903</u></p> <table border="1"> <tr> <td>1-24</td> <td>25-49</td> <td>50-99</td> <td>100 +</td> </tr> <tr> <td>\$13.20</td> <td>\$12.28</td> <td>\$11.35</td> <td>\$10.56</td> </tr> </table>	1-24	25-49	50-99	100 +	\$13.20	\$12.28	\$11.35	\$10.56	<p align="center">Model No. <u>PE9912</u></p> <table border="1"> <tr> <td>1-24</td> <td>25-49</td> <td>50-99</td> <td>100 +</td> </tr> <tr> <td>\$12.05</td> <td>\$11.21</td> <td>\$10.36</td> <td>\$9.64</td> </tr> </table>	1-24	25-49	50-99	100 +	\$12.05	\$11.21	\$10.36	\$9.64	<p align="center">Model No. <u>PE9953</u></p> <table border="1"> <tr> <td>1-24</td> <td>25-49</td> <td>50-99</td> <td>100 +</td> </tr> <tr> <td>\$12.05</td> <td>\$11.21</td> <td>\$10.36</td> <td>\$9.64</td> </tr> </table>	1-24	25-49	50-99	100 +	\$12.05	\$11.21	\$10.36	\$9.64	<p align="center">Model No. <u>PE9962</u></p> <table border="1"> <tr> <td>1-24</td> <td>25-49</td> <td>50-99</td> <td>100 +</td> </tr> <tr> <td>\$13.20</td> <td>\$12.28</td> <td>\$11.35</td> <td>\$10.56</td> </tr> </table>	1-24	25-49	50-99	100 +	\$13.20	\$12.28	\$11.35	\$10.56
1-24	25-49	50-99	100 +																																	
\$13.20	\$12.28	\$11.35	\$10.56																																	
1-24	25-49	50-99	100 +																																	
\$12.05	\$11.21	\$10.36	\$9.64																																	
1-24	25-49	50-99	100 +																																	
\$12.05	\$11.21	\$10.36	\$9.64																																	
1-24	25-49	50-99	100 +																																	
\$13.20	\$12.28	\$11.35	\$10.56																																	
 <p><b>MINIATURE STACKING BANANA PLUGS</b></p>	<p align="center">Model No. <u>PE9904</u></p> <table border="1"> <tr> <td>1-24</td> <td>25-49</td> <td>50-99</td> <td>100 +</td> </tr> <tr> <td>\$14.30</td> <td>\$13.30</td> <td>\$12.30</td> <td>\$11.44</td> </tr> </table>	1-24	25-49	50-99	100 +	\$14.30	\$13.30	\$12.30	\$11.44	<p align="center">Model No. <u>PE9913</u></p> <table border="1"> <tr> <td>1-24</td> <td>25-49</td> <td>50-99</td> <td>100 +</td> </tr> <tr> <td>\$13.20</td> <td>\$12.28</td> <td>\$11.35</td> <td>\$10.56</td> </tr> </table>	1-24	25-49	50-99	100 +	\$13.20	\$12.28	\$11.35	\$10.56	<p align="center">Model No. <u>PE9954</u></p> <table border="1"> <tr> <td>1-24</td> <td>25-49</td> <td>50-99</td> <td>100 +</td> </tr> <tr> <td>\$13.20</td> <td>\$12.28</td> <td>\$11.35</td> <td>\$10.56</td> </tr> </table>	1-24	25-49	50-99	100 +	\$13.20	\$12.28	\$11.35	\$10.56	<p align="center">Model No. <u>PE9963</u></p> <table border="1"> <tr> <td>1-24</td> <td>25-49</td> <td>50-99</td> <td>100 +</td> </tr> <tr> <td>\$14.30</td> <td>\$13.30</td> <td>\$12.30</td> <td>\$11.44</td> </tr> </table>	1-24	25-49	50-99	100 +	\$14.30	\$13.30	\$12.30	\$11.44
1-24	25-49	50-99	100 +																																	
\$14.30	\$13.30	\$12.30	\$11.44																																	
1-24	25-49	50-99	100 +																																	
\$13.20	\$12.28	\$11.35	\$10.56																																	
1-24	25-49	50-99	100 +																																	
\$13.20	\$12.28	\$11.35	\$10.56																																	
1-24	25-49	50-99	100 +																																	
\$14.30	\$13.30	\$12.30	\$11.44																																	
 <p><b>SAFETY HOOKS</b></p>	<p align="center">Model No. <u>PE9905</u></p> <table border="1"> <tr> <td>1-24</td> <td>25-49</td> <td>50-99</td> <td>100 +</td> </tr> <tr> <td>\$13.20</td> <td>\$12.28</td> <td>\$11.35</td> <td>\$10.56</td> </tr> </table>	1-24	25-49	50-99	100 +	\$13.20	\$12.28	\$11.35	\$10.56	<p align="center">Model No. <u>PE9914</u></p> <table border="1"> <tr> <td>1-24</td> <td>25-49</td> <td>50-99</td> <td>100 +</td> </tr> <tr> <td>\$12.05</td> <td>\$11.21</td> <td>\$10.36</td> <td>\$9.64</td> </tr> </table>	1-24	25-49	50-99	100 +	\$12.05	\$11.21	\$10.36	\$9.64	<p align="center">Model No. <u>PE9955</u></p> <table border="1"> <tr> <td>1-24</td> <td>25-49</td> <td>50-99</td> <td>100 +</td> </tr> <tr> <td>\$12.05</td> <td>\$11.21</td> <td>\$10.36</td> <td>\$9.64</td> </tr> </table>	1-24	25-49	50-99	100 +	\$12.05	\$11.21	\$10.36	\$9.64	<p align="center">Model No. <u>PE9964</u></p> <table border="1"> <tr> <td>1-24</td> <td>25-49</td> <td>50-99</td> <td>100 +</td> </tr> <tr> <td>\$13.20</td> <td>\$12.28</td> <td>\$11.35</td> <td>\$10.56</td> </tr> </table>	1-24	25-49	50-99	100 +	\$13.20	\$12.28	\$11.35	\$10.56
1-24	25-49	50-99	100 +																																	
\$13.20	\$12.28	\$11.35	\$10.56																																	
1-24	25-49	50-99	100 +																																	
\$12.05	\$11.21	\$10.36	\$9.64																																	
1-24	25-49	50-99	100 +																																	
\$12.05	\$11.21	\$10.36	\$9.64																																	
1-24	25-49	50-99	100 +																																	
\$13.20	\$12.28	\$11.35	\$10.56																																	
 <p><b>#8 SPADE LUGS</b></p>	<p align="center">Model No. <u>PE9906</u></p> <table border="1"> <tr> <td>1-24</td> <td>25-49</td> <td>50-99</td> <td>100 +</td> </tr> <tr> <td>\$10.95</td> <td>\$10.18</td> <td>\$9.42</td> <td>\$8.76</td> </tr> </table>	1-24	25-49	50-99	100 +	\$10.95	\$10.18	\$9.42	\$8.76	<p align="center">Model No. <u>PE9915</u></p> <table border="1"> <tr> <td>1-24</td> <td>25-49</td> <td>50-99</td> <td>100 +</td> </tr> <tr> <td>\$9.90</td> <td>\$9.21</td> <td>\$8.51</td> <td>\$7.92</td> </tr> </table>	1-24	25-49	50-99	100 +	\$9.90	\$9.21	\$8.51	\$7.92	<p align="center">Model No. <u>PE9956</u></p> <table border="1"> <tr> <td>1-24</td> <td>25-49</td> <td>50-99</td> <td>100 +</td> </tr> <tr> <td>\$9.90</td> <td>\$9.21</td> <td>\$8.51</td> <td>\$7.92</td> </tr> </table>	1-24	25-49	50-99	100 +	\$9.90	\$9.21	\$8.51	\$7.92	<p align="center">Model No. <u>PE9965</u></p> <table border="1"> <tr> <td>1-24</td> <td>25-49</td> <td>50-99</td> <td>100 +</td> </tr> <tr> <td>\$10.95</td> <td>\$10.18</td> <td>\$9.42</td> <td>\$8.76</td> </tr> </table>	1-24	25-49	50-99	100 +	\$10.95	\$10.18	\$9.42	\$8.76
1-24	25-49	50-99	100 +																																	
\$10.95	\$10.18	\$9.42	\$8.76																																	
1-24	25-49	50-99	100 +																																	
\$9.90	\$9.21	\$8.51	\$7.92																																	
1-24	25-49	50-99	100 +																																	
\$9.90	\$9.21	\$8.51	\$7.92																																	
1-24	25-49	50-99	100 +																																	
\$10.95	\$10.18	\$9.42	\$8.76																																	
 <p><b>INSULATED SPADE LUGS</b></p>	<p align="center">Model No. <u>PE9907</u></p> <table border="1"> <tr> <td>1-24</td> <td>25-49</td> <td>50-99</td> <td>100 +</td> </tr> <tr> <td>\$12.05</td> <td>\$11.21</td> <td>\$10.36</td> <td>\$9.64</td> </tr> </table>	1-24	25-49	50-99	100 +	\$12.05	\$11.21	\$10.36	\$9.64	<p align="center">Model No. <u>PE9916</u></p> <table border="1"> <tr> <td>1-24</td> <td>25-49</td> <td>50-99</td> <td>100 +</td> </tr> <tr> <td>\$10.95</td> <td>\$10.18</td> <td>\$9.42</td> <td>\$8.76</td> </tr> </table>	1-24	25-49	50-99	100 +	\$10.95	\$10.18	\$9.42	\$8.76	<p align="center">8.51 Model No. <u>PE9957</u></p> <table border="1"> <tr> <td>1-24</td> <td>25-49</td> <td>50-99</td> <td>100 +</td> </tr> <tr> <td>\$10.95</td> <td>\$10.18</td> <td>\$9.42</td> <td>\$8.76</td> </tr> </table>	1-24	25-49	50-99	100 +	\$10.95	\$10.18	\$9.42	\$8.76	<p align="center">Model No. <u>PE9966</u></p> <table border="1"> <tr> <td>1-24</td> <td>25-49</td> <td>50-99</td> <td>100 +</td> </tr> <tr> <td>\$12.05</td> <td>\$11.21</td> <td>\$10.36</td> <td>\$9.64</td> </tr> </table>	1-24	25-49	50-99	100 +	\$12.05	\$11.21	\$10.36	\$9.64
1-24	25-49	50-99	100 +																																	
\$12.05	\$11.21	\$10.36	\$9.64																																	
1-24	25-49	50-99	100 +																																	
\$10.95	\$10.18	\$9.42	\$8.76																																	
1-24	25-49	50-99	100 +																																	
\$10.95	\$10.18	\$9.42	\$8.76																																	
1-24	25-49	50-99	100 +																																	
\$12.05	\$11.21	\$10.36	\$9.64																																	
 <p><b>UN-TERMINATED #20 AWG LEADS</b></p>	<p align="center">Model No. <u>PE9908</u></p> <table border="1"> <tr> <td>1-24</td> <td>25-49</td> <td>50-99</td> <td>100 +</td> </tr> <tr> <td>\$8.65</td> <td>\$8.04</td> <td>\$7.44</td> <td>\$6.92</td> </tr> </table>	1-24	25-49	50-99	100 +	\$8.65	\$8.04	\$7.44	\$6.92	<p align="center">Model No. <u>PE9917</u></p> <table border="1"> <tr> <td>1-24</td> <td>25-49</td> <td>50-99</td> <td>100 +</td> </tr> <tr> <td>\$7.75</td> <td>\$7.21</td> <td>\$6.67</td> <td>\$6.20</td> </tr> </table>	1-24	25-49	50-99	100 +	\$7.75	\$7.21	\$6.67	\$6.20	<p align="center">Model No. <u>PE9958</u></p> <table border="1"> <tr> <td>1-24</td> <td>25-49</td> <td>50-99</td> <td>100 +</td> </tr> <tr> <td>\$7.75</td> <td>\$7.21</td> <td>\$6.67</td> <td>\$6.20</td> </tr> </table>	1-24	25-49	50-99	100 +	\$7.75	\$7.21	\$6.67	\$6.20	<p align="center">Model No. <u>PE9967</u></p> <table border="1"> <tr> <td>1-24</td> <td>25-49</td> <td>50-99</td> <td>100 +</td> </tr> <tr> <td>\$8.65</td> <td>\$8.04</td> <td>\$7.44</td> <td>\$6.92</td> </tr> </table>	1-24	25-49	50-99	100 +	\$8.65	\$8.04	\$7.44	\$6.92
1-24	25-49	50-99	100 +																																	
\$8.65	\$8.04	\$7.44	\$6.92																																	
1-24	25-49	50-99	100 +																																	
\$7.75	\$7.21	\$6.67	\$6.20																																	
1-24	25-49	50-99	100 +																																	
\$7.75	\$7.21	\$6.67	\$6.20																																	
1-24	25-49	50-99	100 +																																	
\$8.65	\$8.04	\$7.44	\$6.92																																	

# INDEX GUIDE TO COAXIAL CONNECTORS

**GUIDE:** CONNECTORS ARE ARRANGED IN THIS SECTION BY GROUP, AND THEN BY INCREASING FREQUENCY RANGE. PLEASE REVIEW THE CONNECTOR FREQUENCY RANGE CHART ON THE NEXT PAGE FOR REFERENCE.

NEW PRODUCTS AND CATEGORIES ARE IDENTIFIED WITH THE **NEW** SYMBOL.

## THREADED CONNECTORS

FME .....	149
UHF .....	149
MINI-UHF.....	150
LC .....	150
10-32 .....	151
SC.....	151
<b>NEW</b> HN .....	152
<b>NEW</b> 7/16 DIN .....	152 & 153
<b>NEW</b> N.....	154 THRU 156
TNC.....	157
SMC.....	158
SSMA .....	159
<b>NEW</b> SMA .....	160 THRU 164
3.5mm .....	165
2.92mm .....	165
2.4mm .....	166
1.85mm .....	166

## PUSH-ON CONNECTORS

MHV.....	167
SHV.....	168
C.....	169
BNC .....	170 & 171
1.0/2.3.....	172
SSMB.....	172
SMB.....	173
MC-CARD.....	174
<b>NEW</b> LFU .....	174
MMCX.....	174
MCX.....	175 & 176
<b>NEW</b> QN .....	176
<b>NEW</b> QMA.....	177
SMP .....	178
MINI SMP .....	178

## 75 OHM CONNECTORS

1.6/5.6-75 OHM .....	178
<b>NEW</b> BNC-75 OHM ..	179 THRU 181
<b>NEW</b> RCA .....	181
SMB-75 OHM.....	183
<b>NEW</b> POSITIVE SNAP .....	184
MINI SMB-75 OHM	182 & 184
MCX-75 OHM .....	185
TNC-75 OHM.....	185
N-75 OHM.....	186
<b>NEW</b> F .....	182 & 186
SMC-75 OHM.....	187

## REVERSE POLARITY & REVERSE THREAD CONNECTORS

RP BNC .....	188
RP MCX .....	189
RP N .....	189
RP TNC .....	189 & 190
RT SMA .....	190
RP SMA.....	191

## TEST & OTHER CONNECTORS

BANANA PLUG .....	192
D-SUBMINIATURE .....	192
GR874.....	193
BNC TWINAX .....	193
3/4"-20 TWINAX.....	193

# CONNECTOR FREQUENCY RANGE CHART

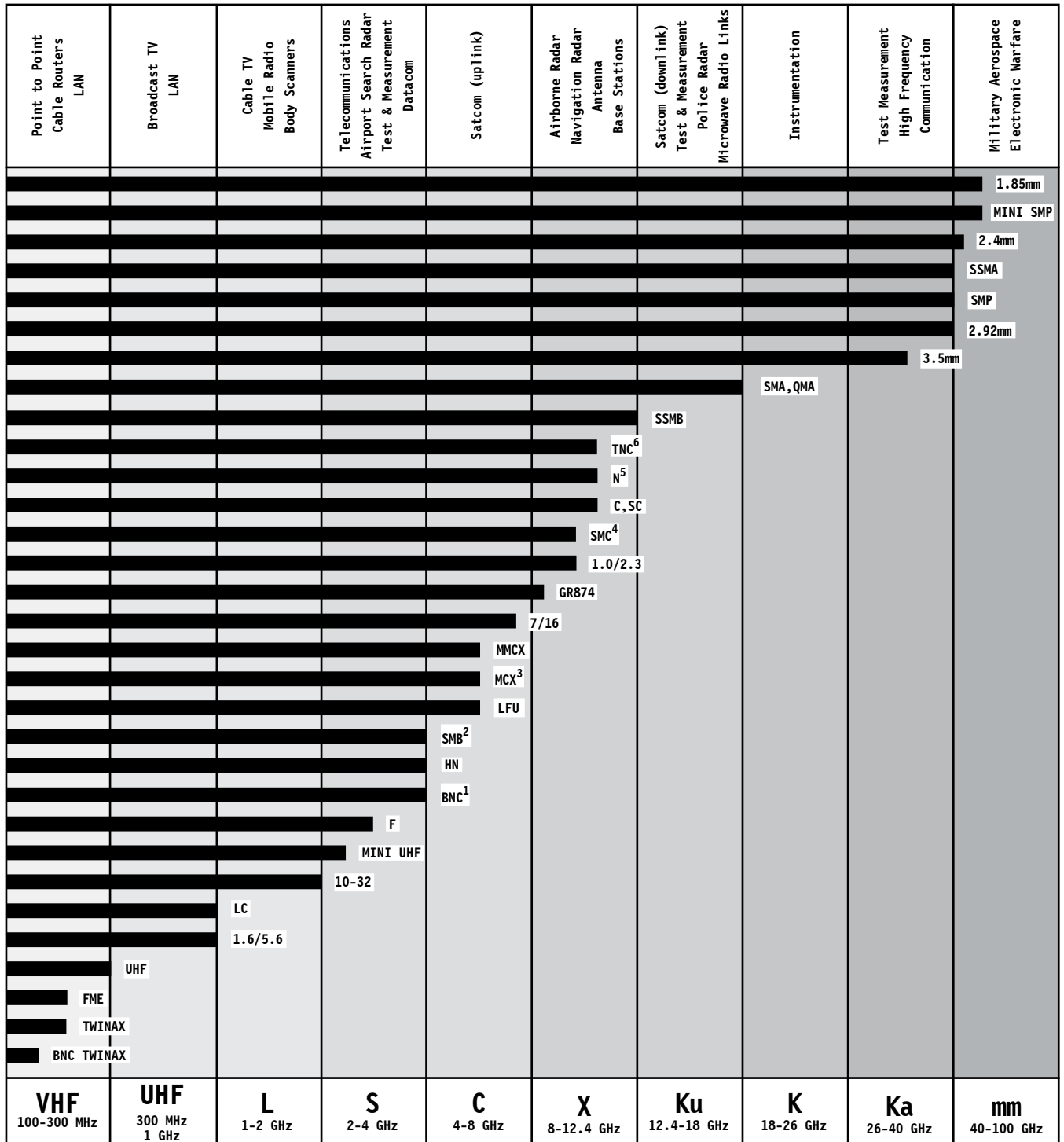

Connectors

**Notes:**

- 1: BNC-75 Ohm connectors operate up to 1 GHz
- 2: SMB-75 Ohm & Mini SMB-75 Ohm connectors operate up to 4 GHz
- 3: MCX-75 Ohm connectors operate up to 6 GHz
- 4: SMC-75 Ohm connectors operate up to 10 GHz
- 5: N-75 Ohm connectors operate up to 1.5 GHz
- 6: TNC-75 Ohm connectors operate up to 1 GHz

# FME CONNECTORS

SEE PAGE 266 FOR MOUNTING HOLES

Model No. PE44146  
FME JACK, CRIMP ATTACHMENT  
FOR RG58

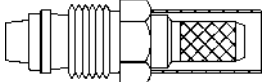

1-24	25-49
\$5.50	\$5.12
50-99	100 +
\$4.73	\$4.40

Model No. PE44147  
FME JACK, CRIMP ATTACHMENT  
FOR RG55, RG142, RG223 &  
RG400

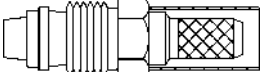

1-24	25-49
\$5.45	\$5.07
50-99	100 +
\$4.69	\$4.36

Model No. PE44148  
FME JACK, CRIMP ATTACHMENT  
FOR RG174, RG188, RG316

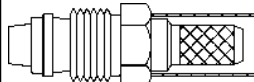

1-24	25-49
\$7.25	\$6.74
50-99	100 +
\$6.24	\$5.80

Model No. PE44149  
FME PLUG BULKHEAD, FRONT  
MOUNT, SOLDER CUP CONTACT  
MOUNTING HOLE B04

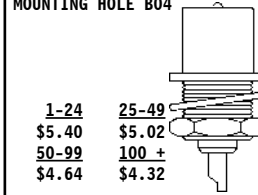

1-24	25-49
\$5.40	\$5.02
50-99	100 +
\$4.64	\$4.32

Model No. PE44295  
FME PLUG CRIMP ATTACHMENT  
FOR RG58

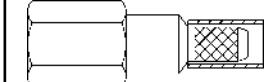

1-24	25-49
\$7.60	\$7.07
50-99	100 +
\$6.54	\$6.08

Model No. PE44296  
FME PLUG CRIMP ATTACHMENT  
FOR RG55, RG142, RG223 &  
RG400

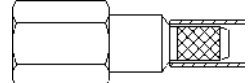

1-24	25-49
\$7.65	\$7.11
50-99	100 +
\$6.58	\$6.12

Model No. PE44297  
FME PLUG CRIMP ATTACHMENT  
FOR RG174, RG188 & RG316

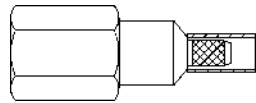

1-24	25-49
\$7.60	\$7.07
50-99	100 +
\$6.54	\$6.08

Connectors

# UHF CONNECTORS

SEE PAGE 266 FOR MOUNTING HOLES

UHF MALE  
FOR CABLE  
ATTACHMENT

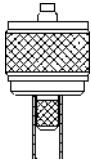

Model No.	FITS MIL SPEC AND EQUIVALENT CABLES	ATTACHMENT METHOD	P R I C E			
PE44050	RG8, RG9, RG11, RG213, RG214, RG225, RG393	CLAMP	1-24	25-49	50-99	100 +
PE4295	RG8, RG213	CRIMP	\$7.75	\$7.21	\$6.67	\$6.20
PE4020	RG8, RG9, RG213, RG214, RG225, RG393	SOLDER (PL259)	9.55	8.88	8.21	7.64
PE44051	RG9, RG214, RG225, RG393	CRIMP	9.35	8.70	8.04	7.48
PE44052	RG55, RG58, RG141, RG142, RG223, RG400	CRIMP	8.80	8.18	7.57	7.04
PE44053	RG55, RG141, RG142, RG223, RG400	CLAMP	7.60	7.07	6.54	6.08
PE4069	RG58	CRIMP	6.20	5.77	5.33	4.96
PE4073	RG59B/U, RG62	CRIMP	4.45	4.14	3.83	3.56
PE44054	BELDEN 9913 & 9914, PE-B3199, PE-B4199, PE-T004RML	CRIMP	5.15	4.79	4.43	4.12

UHF FEMALE  
FOR CABLE  
ATTACHMENT



PE44055	RG8, RG9, RG11, RG213, RG214, RG225, RG393	CLAMP	9.75	9.07	8.39	7.80
PE44056	RG55, RG58, RG141, RG142, RG223, RG400	CLAMP	9.75	9.07	8.39	7.80
PE44057	RG55, RG141, RG142, RG223, RG400	CRIMP	9.90	9.21	8.51	7.92
PE44058	RG58	CRIMP	9.75	9.07	8.39	7.80

Model No. PE4012  
UHF FEMALE PANEL MOUNT  
SOLDER CUP CONTACT  
MOUNTING HOLE A05  
(50-239)

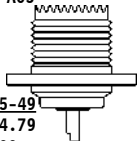

1-24	25-49
\$5.15	\$4.79
50-99	100 +
\$4.43	\$4.12

Model No. PE4021  
UHF ADAPTER FOR USE  
WITH PE4020 FOR RG59B/U

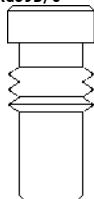

1-24	25-49
\$1.05	\$0.98
50-99	100 +
\$0.90	\$0.84

Model No. PE4022  
UHF ADAPTER FOR USE  
WITH PE4020 FOR RG58

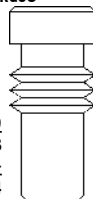

1-24	25-49
\$1.05	\$0.98
50-99	100 +
\$0.90	\$0.84

Model No. PE44059  
UHF FEMALE BULKHEAD, FRONT  
MOUNT, SOLDER CUP CONTACT  
MOUNTING HOLE B12

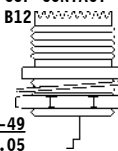

1-24	25-49
\$6.50	\$6.05
50-99	100 +
\$5.59	\$5.20

Model No. PE44060  
UHF FEMALE BULKHEAD, REAR  
MOUNT, SOLDER CUP CONTACT  
MOUNTING HOLE B12

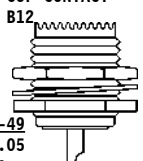





1-24	25-49
\$6.50	\$6.05
50-99	100 +
\$5.59	\$5.20

# MINI UHF CONNECTORS

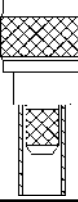
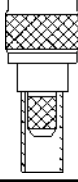
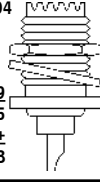
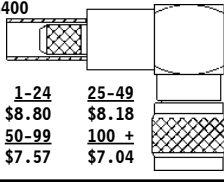
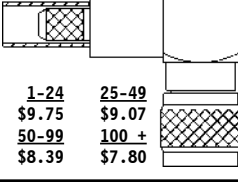
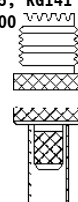
SEE PAGE 266 FOR MOUNTING HOLES

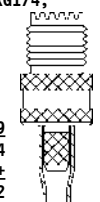
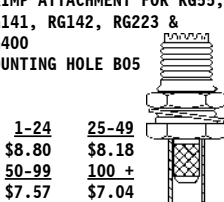
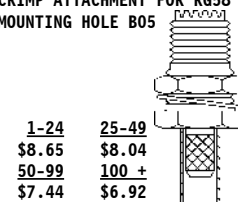
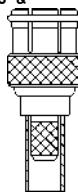
Connectors

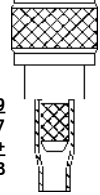
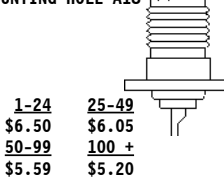
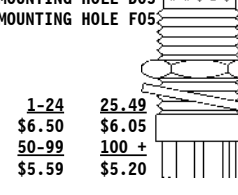
<p><b>Model No. PE4342</b> MINI UHF MALE, CRIMP ATTACHMENT FOR RG58</p>  <table border="1"> <tr><td>1-24</td><td>25-49</td></tr> <tr><td>\$4.45</td><td>\$4.14</td></tr> <tr><td>50-99</td><td>100 +</td></tr> <tr><td>\$3.83</td><td>\$3.56</td></tr> </table>	1-24	25-49	\$4.45	\$4.14	50-99	100 +	\$3.83	\$3.56	<p><b>Model No. PE4521</b> MINI UHF MALE, CRIMP ATTACHMENT FOR RG55, RG141, RG142, RG223 &amp; RG400</p>  <table border="1"> <tr><td>1-24</td><td>25-49</td></tr> <tr><td>\$4.40</td><td>\$4.09</td></tr> <tr><td>50-99</td><td>100 +</td></tr> <tr><td>\$3.78</td><td>\$3.52</td></tr> </table>	1-24	25-49	\$4.40	\$4.09	50-99	100 +	\$3.78	\$3.52	<p><b>Model No. PE4644</b> MINI UHF FEMALE BULKHEAD REAR MOUNT SOLDER CUP CONTACT MOUNTING HOLE B04</p>  <table border="1"> <tr><td>1-24</td><td>25-49</td></tr> <tr><td>\$4.35</td><td>\$4.05</td></tr> <tr><td>50-99</td><td>100 +</td></tr> <tr><td>\$3.74</td><td>\$3.48</td></tr> </table>	1-24	25-49	\$4.35	\$4.05	50-99	100 +	\$3.74	\$3.48	<p><b>Model No. PE44081</b> MINI UHF MALE, RIGHT ANGLE CRIMP ATTACHMENT FOR RG55, RG141, RG142, RG223 &amp; RG400</p>  <table border="1"> <tr><td>1-24</td><td>25-49</td></tr> <tr><td>\$8.80</td><td>\$8.18</td></tr> <tr><td>50-99</td><td>100 +</td></tr> <tr><td>\$7.57</td><td>\$7.04</td></tr> </table>	1-24	25-49	\$8.80	\$8.18	50-99	100 +	\$7.57	\$7.04	<p><b>Model No. PE44082</b> MINI UHF MALE, RIGHT ANGLE CRIMP ATTACHMENT FOR RG58</p>  <table border="1"> <tr><td>1-24</td><td>25-49</td></tr> <tr><td>\$9.75</td><td>\$9.07</td></tr> <tr><td>50-99</td><td>100 +</td></tr> <tr><td>\$8.39</td><td>\$7.80</td></tr> </table>	1-24	25-49	\$9.75	\$9.07	50-99	100 +	\$8.39	\$7.80
1-24	25-49																																											
\$4.45	\$4.14																																											
50-99	100 +																																											
\$3.83	\$3.56																																											
1-24	25-49																																											
\$4.40	\$4.09																																											
50-99	100 +																																											
\$3.78	\$3.52																																											
1-24	25-49																																											
\$4.35	\$4.05																																											
50-99	100 +																																											
\$3.74	\$3.48																																											
1-24	25-49																																											
\$8.80	\$8.18																																											
50-99	100 +																																											
\$7.57	\$7.04																																											
1-24	25-49																																											
\$9.75	\$9.07																																											
50-99	100 +																																											
\$8.39	\$7.80																																											
<p><b>Model No. PE44083</b> MINI UHF FEMALE, CRIMP ATTACHMENT FOR RG55, RG141, RG142, RG223 &amp; RG400</p>  <table border="1"> <tr><td>1-24</td><td>25-49</td></tr> <tr><td>\$7.65</td><td>\$7.11</td></tr> <tr><td>50-99</td><td>100 +</td></tr> <tr><td>\$6.58</td><td>\$6.12</td></tr> </table>	1-24	25-49	\$7.65	\$7.11	50-99	100 +	\$6.58	\$6.12	<p><b>Model No. PE44084</b> MINI UHF FEMALE, CRIMP ATTACHMENT FOR RG58</p>  <table border="1"> <tr><td>1-24</td><td>25-49</td></tr> <tr><td>\$7.60</td><td>\$7.07</td></tr> <tr><td>50-99</td><td>100 +</td></tr> <tr><td>\$6.54</td><td>\$6.08</td></tr> </table>	1-24	25-49	\$7.60	\$7.07	50-99	100 +	\$6.54	\$6.08	<p><b>Model No. PE44085</b> MINI UHF FEMALE, CRIMP ATTACHMENT FOR RG174, RG188 &amp; RG316</p>  <table border="1"> <tr><td>1-24</td><td>25-49</td></tr> <tr><td>\$8.65</td><td>\$8.04</td></tr> <tr><td>50-99</td><td>100 +</td></tr> <tr><td>\$7.44</td><td>\$6.92</td></tr> </table>	1-24	25-49	\$8.65	\$8.04	50-99	100 +	\$7.44	\$6.92	<p><b>Model No. PE44086</b> MINI UHF FEMALE BULKHEAD CRIMP ATTACHMENT FOR RG55, RG141, RG142, RG223 &amp; RG400 MOUNTING HOLE B05</p>  <table border="1"> <tr><td>1-24</td><td>25-49</td></tr> <tr><td>\$8.80</td><td>\$8.18</td></tr> <tr><td>50-99</td><td>100 +</td></tr> <tr><td>\$7.57</td><td>\$7.04</td></tr> </table>	1-24	25-49	\$8.80	\$8.18	50-99	100 +	\$7.57	\$7.04	<p><b>Model No. PE44087</b> MINI UHF FEMALE BULKHEAD CRIMP ATTACHMENT FOR RG58 MOUNTING HOLE B05</p>  <table border="1"> <tr><td>1-24</td><td>25-49</td></tr> <tr><td>\$8.65</td><td>\$8.04</td></tr> <tr><td>50-99</td><td>100 +</td></tr> <tr><td>\$7.44</td><td>\$6.92</td></tr> </table>	1-24	25-49	\$8.65	\$8.04	50-99	100 +	\$7.44	\$6.92
1-24	25-49																																											
\$7.65	\$7.11																																											
50-99	100 +																																											
\$6.58	\$6.12																																											
1-24	25-49																																											
\$7.60	\$7.07																																											
50-99	100 +																																											
\$6.54	\$6.08																																											
1-24	25-49																																											
\$8.65	\$8.04																																											
50-99	100 +																																											
\$7.44	\$6.92																																											
1-24	25-49																																											
\$8.80	\$8.18																																											
50-99	100 +																																											
\$7.57	\$7.04																																											
1-24	25-49																																											
\$8.65	\$8.04																																											
50-99	100 +																																											
\$7.44	\$6.92																																											
<p><b>Model No. PE44088</b> MINI UHF MALE, PUSH ON CRIMP ATTACHMENT FOR RG55, RG141, RG142, RG223 &amp; RG400</p>  <table border="1"> <tr><td>1-24</td><td>25-49</td></tr> <tr><td>\$6.50</td><td>\$6.05</td></tr> <tr><td>50-99</td><td>100 +</td></tr> <tr><td>\$5.59</td><td>\$5.20</td></tr> </table>	1-24	25-49	\$6.50	\$6.05	50-99	100 +	\$5.59	\$5.20	<p><b>Model No. PE44089</b> MINI UHF FEMALE BULKHEAD FRONT MOUNT SOLDER CUP CONTACT MOUNTING HOLE B04</p>  <table border="1"> <tr><td>1-24</td><td>25-49</td></tr> <tr><td>\$4.35</td><td>\$4.05</td></tr> <tr><td>50-99</td><td>100 +</td></tr> <tr><td>\$3.74</td><td>\$3.48</td></tr> </table>	1-24	25-49	\$4.35	\$4.05	50-99	100 +	\$3.74	\$3.48	<p><b>Model No. PE44090</b> MINI UHF MALE, CRIMP ATTACHMENT FOR RG174, RG188 &amp; RG316</p>  <table border="1"> <tr><td>1-24</td><td>25-49</td></tr> <tr><td>\$7.60</td><td>\$7.07</td></tr> <tr><td>50-99</td><td>100 +</td></tr> <tr><td>\$6.54</td><td>\$6.08</td></tr> </table>	1-24	25-49	\$7.60	\$7.07	50-99	100 +	\$6.54	\$6.08	<p><b>Model No. PE44091</b> MINI UHF FEMALE, PANEL MOUNT, SOLDER CUP CONTACT MOUNTING HOLE A18</p>  <table border="1"> <tr><td>1-24</td><td>25-49</td></tr> <tr><td>\$6.50</td><td>\$6.05</td></tr> <tr><td>50-99</td><td>100 +</td></tr> <tr><td>\$5.59</td><td>\$5.20</td></tr> </table>	1-24	25-49	\$6.50	\$6.05	50-99	100 +	\$5.59	\$5.20	<p><b>Model No. PE44092</b> MINI UHF FEMALE BULKHEAD P.C. MOUNT MOUNTING HOLE D05 MOUNTING HOLE F05</p>  <table border="1"> <tr><td>1-24</td><td>25-49</td></tr> <tr><td>\$6.50</td><td>\$6.05</td></tr> <tr><td>50-99</td><td>100 +</td></tr> <tr><td>\$5.59</td><td>\$5.20</td></tr> </table>	1-24	25-49	\$6.50	\$6.05	50-99	100 +	\$5.59	\$5.20
1-24	25-49																																											
\$6.50	\$6.05																																											
50-99	100 +																																											
\$5.59	\$5.20																																											
1-24	25-49																																											
\$4.35	\$4.05																																											
50-99	100 +																																											
\$3.74	\$3.48																																											
1-24	25-49																																											
\$7.60	\$7.07																																											
50-99	100 +																																											
\$6.54	\$6.08																																											
1-24	25-49																																											
\$6.50	\$6.05																																											
50-99	100 +																																											
\$5.59	\$5.20																																											
1-24	25-49																																											
\$6.50	\$6.05																																											
50-99	100 +																																											
\$5.59	\$5.20																																											

# LC CONNECTORS

SEE PAGE 266 FOR MOUNTING HOLES

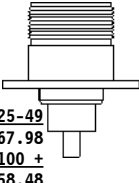
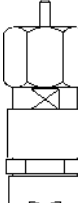
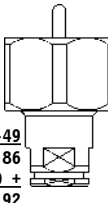
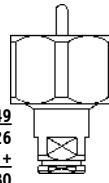
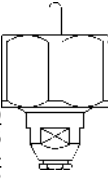
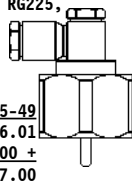
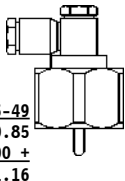
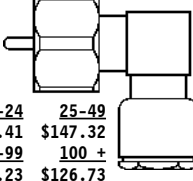
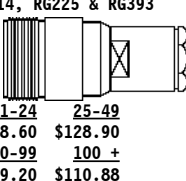
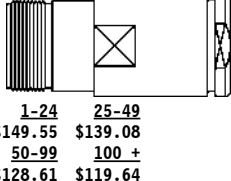
<p><b>Model No. PE4192</b> LC FEMALE, PANEL MOUNT MOUNTING HOLE A12</p>  <table border="1"> <tr><td>1-24</td><td>25-49</td></tr> <tr><td>\$73.10</td><td>\$67.98</td></tr> <tr><td>50-99</td><td>100 +</td></tr> <tr><td>\$62.87</td><td>\$58.48</td></tr> </table>	1-24	25-49	\$73.10	\$67.98	50-99	100 +	\$62.87	\$58.48	<p><b>Model No. PE4323</b> LC MALE, CLAMP ATTACHMENT FOR RG218 &amp; RG219</p>  <table border="1"> <tr><td>1-24</td><td>25-49</td></tr> <tr><td>\$135.80</td><td>\$126.29</td></tr> <tr><td>50-99</td><td>100 +</td></tr> <tr><td>\$116.79</td><td>\$108.64</td></tr> </table>	1-24	25-49	\$135.80	\$126.29	50-99	100 +	\$116.79	\$108.64	<p><b>Model No. PE4563</b> LC MALE, CLAMP ATTACHMENT FOR RG217</p>  <table border="1"> <tr><td>1-24</td><td>25-49</td></tr> <tr><td>\$114.90</td><td>\$106.86</td></tr> <tr><td>50-99</td><td>100 +</td></tr> <tr><td>\$98.81</td><td>\$91.92</td></tr> </table>	1-24	25-49	\$114.90	\$106.86	50-99	100 +	\$98.81	\$91.92	<p><b>Model No. PE4564</b> LC MALE, CLAMP ATTACHMENT FOR RG8, RG9, RG213, RG214, RG225 &amp; RG393</p>  <table border="1"> <tr><td>1-24</td><td>25-49</td></tr> <tr><td>\$103.50</td><td>\$96.26</td></tr> <tr><td>50-99</td><td>100 +</td></tr> <tr><td>\$89.01</td><td>\$82.80</td></tr> </table>	1-24	25-49	\$103.50	\$96.26	50-99	100 +	\$89.01	\$82.80	<p><b>Model No. PE4565</b> LC MALE, CLAMP ATTACHMENT FOR RG55, RG58, RG142, RG223 &amp; RG400</p>  <table border="1"> <tr><td>1-24</td><td>25-49</td></tr> <tr><td>\$114.90</td><td>\$106.86</td></tr> <tr><td>50-99</td><td>100 +</td></tr> <tr><td>\$98.81</td><td>\$91.92</td></tr> </table>	1-24	25-49	\$114.90	\$106.86	50-99	100 +	\$98.81	\$91.92
1-24	25-49																																											
\$73.10	\$67.98																																											
50-99	100 +																																											
\$62.87	\$58.48																																											
1-24	25-49																																											
\$135.80	\$126.29																																											
50-99	100 +																																											
\$116.79	\$108.64																																											
1-24	25-49																																											
\$114.90	\$106.86																																											
50-99	100 +																																											
\$98.81	\$91.92																																											
1-24	25-49																																											
\$103.50	\$96.26																																											
50-99	100 +																																											
\$89.01	\$82.80																																											
1-24	25-49																																											
\$114.90	\$106.86																																											
50-99	100 +																																											
\$98.81	\$91.92																																											
<p><b>Model No. PE44447</b> LC MALE, RIGHT ANGLE, CLAMP ATTACHMENT FOR RG8, RG9, RG213, RG214, RG225, &amp; RG393</p>  <table border="1"> <tr><td>1-24</td><td>25-49</td></tr> <tr><td>\$146.25</td><td>\$136.01</td></tr> <tr><td>50-99</td><td>100 +</td></tr> <tr><td>\$125.78</td><td>\$117.00</td></tr> </table>	1-24	25-49	\$146.25	\$136.01	50-99	100 +	\$125.78	\$117.00	<p><b>Model No. PE44448</b> LC MALE, RIGHT ANGLE, CLAMP ATTACHMENT FOR RG217</p>  <table border="1"> <tr><td>1-24</td><td>25-49</td></tr> <tr><td>\$151.45</td><td>\$140.85</td></tr> <tr><td>50-99</td><td>100 +</td></tr> <tr><td>\$130.25</td><td>\$121.16</td></tr> </table>	1-24	25-49	\$151.45	\$140.85	50-99	100 +	\$130.25	\$121.16	<p><b>Model No. PE44449</b> LC MALE, RIGHT ANGLE, CLAMP ATTACHMENT FOR RG218</p>  <table border="1"> <tr><td>1-24</td><td>25-49</td></tr> <tr><td>\$158.41</td><td>\$147.32</td></tr> <tr><td>50-99</td><td>100 +</td></tr> <tr><td>\$136.23</td><td>\$126.73</td></tr> </table>	1-24	25-49	\$158.41	\$147.32	50-99	100 +	\$136.23	\$126.73	<p><b>Model No. PE44450</b> LC FEMALE, CLAMP ATTACHMENT FOR RG8, RG9, RG213, RG214, RG225 &amp; RG393</p>  <table border="1"> <tr><td>1-24</td><td>25-49</td></tr> <tr><td>\$138.60</td><td>\$128.90</td></tr> <tr><td>50-99</td><td>100 +</td></tr> <tr><td>\$119.20</td><td>\$110.88</td></tr> </table>	1-24	25-49	\$138.60	\$128.90	50-99	100 +	\$119.20	\$110.88	<p><b>Model No. PE44451</b> LC FEMALE, CLAMP ATTACHMENT FOR RG218</p>  <table border="1"> <tr><td>1-24</td><td>25-49</td></tr> <tr><td>\$149.55</td><td>\$139.08</td></tr> <tr><td>50-99</td><td>100 +</td></tr> <tr><td>\$128.61</td><td>\$119.64</td></tr> </table>	1-24	25-49	\$149.55	\$139.08	50-99	100 +	\$128.61	\$119.64
1-24	25-49																																											
\$146.25	\$136.01																																											
50-99	100 +																																											
\$125.78	\$117.00																																											
1-24	25-49																																											
\$151.45	\$140.85																																											
50-99	100 +																																											
\$130.25	\$121.16																																											
1-24	25-49																																											
\$158.41	\$147.32																																											
50-99	100 +																																											
\$136.23	\$126.73																																											
1-24	25-49																																											
\$138.60	\$128.90																																											
50-99	100 +																																											
\$119.20	\$110.88																																											
1-24	25-49																																											
\$149.55	\$139.08																																											
50-99	100 +																																											
\$128.61	\$119.64																																											

# 10-32 CONNECTORS

SEE PAGE 266 FOR MOUNTING HOLES

Model No. PE44351  
10-32 MALE, CRIMP  
ATTACHMENT FOR RG174, RG188  
& RG316



1-24	25-49
\$14.60	\$13.58
50-99	100 +
\$12.56	\$11.68

Model No. PE44352  
10-32 MALE, CRIMP  
ATTACHMENT FOR RG178 &  
RG196



1-24	25-49
\$17.70	\$16.46
50-99	100 +
\$15.22	\$14.16

Model No. PE44353  
10-32 MALE, CLAMP  
ATTACHMENT FOR RG174, RG188  
& RG316



1-24	25-49
\$20.45	\$19.02
50-99	100 +
\$17.59	\$16.36

Model No. PE44354  
10-32 MALE, CLAMP  
ATTACHMENT FOR RG178 & 196



1-24	25-49
\$20.85	\$19.39
50-99	100 +
\$17.93	\$16.68

Model No. PE44355  
10-32 MALE RIGHT ANGLE  
CRIMP ATTACHMENT FOR RG174,  
RG188, RG316

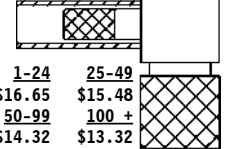

1-24	25-49
\$16.65	\$15.48
50-99	100 +
\$14.32	\$13.32

Model No. PE44356  
10-32 MALE RIGHT ANGLE  
CRIMP ATTACHMENT FOR  
RG178 & RG196

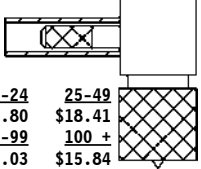

1-24	25-49
\$19.80	\$18.41
50-99	100 +
\$17.03	\$15.84

Model No. PE44357  
10-32 FEMALE BULKHEAD  
FRONT MOUNT  
MOUNTING HOLE B01

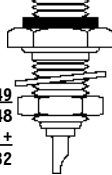

1-24	25-49
\$16.65	\$15.48
50-99	100 +
\$14.32	\$13.32

Model No. PE44358  
10-32 FEMALE BULKHEAD  
REAR MOUNT  
MOUNTING HOLE B03

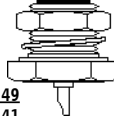

1-24	25-49
\$19.80	\$18.41
50-99	100 +
\$17.03	\$15.84

Model No. PE44359  
10-32 FEMALE, P.C. MOUNT  
MOUNTING HOLE D01

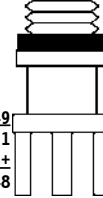

1-24	25-49
\$15.60	\$14.51
50-99	100 +
\$13.42	\$12.48

Model No. PE44360  
10-32 FEMALE RIGHT ANGLE  
P.C. MOUNT  
MOUNTING HOLE D01

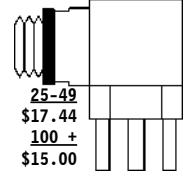

1-24	25-49
\$18.75	\$17.44
50-99	100 +
\$16.13	\$15.00

Model No. PE44361  
10-32 FEMALE, CRIMP  
ATTACHMENT FOR RG174,  
RG188 & RG316

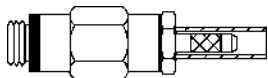

1-24	25-49
\$17.70	\$16.46
50-99	100 +
\$15.22	\$14.16

Model No. PE44362  
10-32 FEMALE, CRIMP  
ATTACHMENT FOR RG178  
& RG196

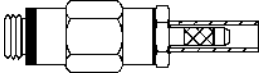

1-24	25-49
\$17.70	\$16.46
50-99	100 +
\$15.22	\$14.16

Model No. PE44363  
10-32 FEMALE, CLAMP  
ATTACHMENT FOR RG174,  
RG188 & RG316

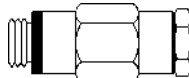

1-24	25-49
\$19.80	\$18.41
50-99	100 +
\$17.03	\$15.84

Model No. PE44364  
10-32 FEMALE, CLAMP  
ATTACHMENT FOR RG178  
& RG196



1-24	25-49
\$19.80	\$18.41
50-99	100 +
\$17.03	\$15.84

Model No. PE44365  
10-32 FEMALE BULKHEAD  
CRIMP ATTACHMENT FOR RG174  
RG188 & RG316  
MOUNTING HOLE B03

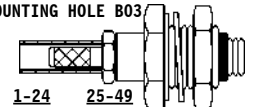

1-24	25-49
\$20.85	\$19.39
50-99	100 +
\$17.93	\$16.68

Model No. PE44366  
10-32 FEMALE BULKHEAD  
CRIMP ATTACHMENT FOR  
RG178 & RG196  
MOUNTING HOLE B03

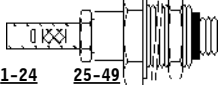

1-24	25-49
\$20.85	\$19.39
50-99	100 +
\$17.93	\$16.68

Model No. PE44367  
10-32 FEMALE BULKHEAD  
CLAMP ATTACHMENT FOR  
RG174, RG188 & RG316  
MOUNTING HOLE B03

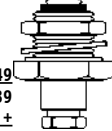

1-24	25-49
\$20.85	\$19.39
50-99	100 +
\$17.93	\$16.68

Model No. PE44368  
10-32 FEMALE BULKHEAD  
CLAMP ATTACHMENT FOR  
RG178 & RG196  
MOUNTING HOLE B03

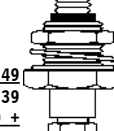

1-24	25-49
\$20.85	\$19.39
50-99	100 +
\$17.93	\$16.68

**PLEASE CONTACT OUR ENGINEERING  
DEPARTMENT FOR ALL YOUR SPECIAL  
REQUIREMENTS AT (866) 727-8376 EXT. 3**

Connectors

# SC CONNECTORS

SEE PAGE 266 FOR MOUNTING HOLES

Model No. PE4231  
SC MALE, CRIMP ATTACHMENT  
FOR RG55, RG141, RG142,  
RG223 & RG400

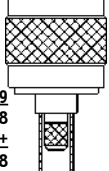

1-24	25-49
\$73.10	\$67.98
50-99	100 +
\$62.87	\$58.48

Model No. PE4232  
SC MALE, CRIMP ATTACHMENT  
FOR RG9, RG214, RG225 &  
RG393

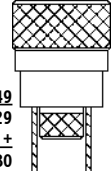

1-24	25-49
\$42.25	\$39.29
50-99	100 +
\$36.34	\$33.80

Model No. PE4232  
SC FEMALE, PANEL MOUNT  
SOLDER CUP CONTACT  
MOUNTING HOLE A13

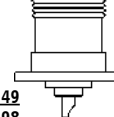

1-24	25-49
\$73.10	\$67.98
50-99	100 +
\$62.87	\$58.48

Model No. PE4519  
SC MALE, CLAMP ATTACHMENT  
FOR RG55, RG58, RG141,  
RG142, RG223 & RG400

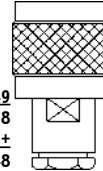

1-24	25-49
\$73.10	\$67.98
50-99	100 +
\$62.87	\$58.48

Model No. PE4520  
SC MALE, CLAMP ATTACHMENT  
FOR RG8, RG9, RG213, RG214,  
RG225 & RG393

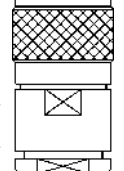

1-24	25-49
\$104.45	\$97.14
50-99	100 +
\$89.83	\$83.56

Model No. PE4976  
SC MALE, CLAMP ATTACHMENT  
FOR RG14 & RG217

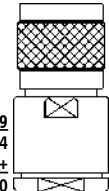

1-24	25-49
\$88.75	\$82.54
50-99	100 +
\$76.33	\$71.00

Model No. PE4977  
SC MALE, CLAMP ATTACHMENT  
FOR RG218



1-24	25-49
\$88.75	\$82.54
50-99	100 +
\$76.33	\$71.00

Model No. PE4978  
SC MALE, RIGHT ANGLE  
CLAMP ATTACHMENT FOR  
RG55, RG58, RG141, RG142,  
RG223 & RG400

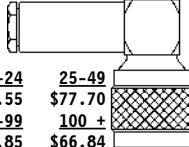

1-24	25-49
\$83.55	\$77.70
50-99	100 +
\$71.85	\$66.84

Model No. PE4979  
SC MALE, RIGHT ANGLE  
CLAMP ATTACHMENT FOR RG8,  
RG9, RG213, RG214, RG225  
& RG393

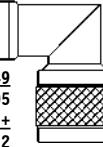

1-24	25-49
\$97.90	\$91.05
50-99	100 +
\$84.19	\$78.32

Model No. PE4980  
SC FEMALE, BULKHEAD  
HERMETICALLY SEALED  
MOUNTING HOLE B11

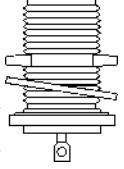

1-24	25-49
\$25.60	\$23.81
50-99	100 +
\$22.02	\$20.48

# HN CONNECTORS

SEE PAGE 266 FOR MOUNTING HOLES

P R I C E

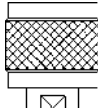
HN MALE FOR CABLE ATTACHMENT	Model No.	FITS MIL SPEC AND EQUIVALENT CABLES	ATTACHMENT METHOD	1-24	25-49	50-99	100 +
	PE4182	RG8, RG9, RG213, RG214, RG225, RG393	CLAMP	\$15.55	\$14.46	\$13.37	\$12.44
	PE4473	RG8, RG213	CRIMP	28.60	26.60	24.60	22.88
	PE4474	RG9, RG214, RG225, RG393	CRIMP	28.90	26.88	24.85	23.12
	PE4475	RG14, RG217	CLAMP	28.90	26.88	24.85	23.12
	PE4476	RG17, RG218	CLAMP	52.20	48.55	44.89	41.76
	PE4198	RG55, RG58, RG141, RG142, RG223, RG400	CLAMP	22.90	21.30	19.69	18.32
	PE4477	RG55, RG142, RG223, RG400	CRIMP	23.90	22.23	20.55	19.12
	PE4478	RG58, RG141	CRIMP	23.10	21.48	19.87	18.48
	PE4479	RG59B/U, RG62	CLAMP	31.30	29.11	26.92	25.04

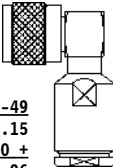
Model No.	PE44592	HN MALE, RIGHT ANGLE CLAMP ATTACHMENT FOR RG217
<b>NEW</b>		
		
1-24	25-49	
\$39.95	\$37.15	
50-99	100 +	
\$34.36	\$31.96	

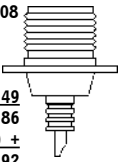
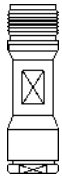
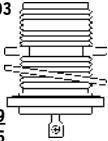
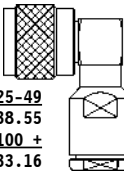
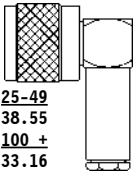
Model No.	PE4183	HN FEMALE, PANEL MOUNT SOLDER CUP CONTACT .125 MOUNTING HOLES MOUNTING HOLE A08	Model No.	PE4229	HN FEMALE, CLAMP ATTACHMENT FOR RG8, RG9, RG213, RG214, RG225 & RG393	Model No.	PE4481	HN FEMALE, BULKHEAD, REAR MOUNT, HERMETICALLY SEALED MOUNTING HOLE G03	Model No.	PE4230	HN MALE, RIGHT ANGLE CLAMP ATTACHMENT FOR RG8, RG9, RG213, RG214, RG225 & RG393	Model No.	PE4480	HN MALE, RIGHT ANGLE CLAMP ATTACHMENT FOR RG55, RG58, RG141, RG142, RG223 & RG400	
															
1-24	25-49	50-99	100 +	1-24	25-49	50-99	100 +	1-24	25-49	50-99	100 +	1-24	25-49	50-99	100 +
\$14.90	\$13.86	\$12.81	\$11.92	\$34.90	\$32.46	\$30.01	\$27.92	\$36.50	\$33.95	\$31.39	\$29.20	\$41.45	\$38.55	\$35.65	\$33.16

# 7/16 DIN CONNECTORS

SEE PAGE 266 FOR MOUNTING HOLES

P R I C E

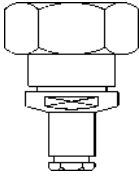
7/16 MALE FOR CABLE ATTACHMENT	Model No.	FITS MIL SPEC AND EQUIVALENT CABLES	ATTACHMENT METHOD	1-24	25-49	50-99	100 +
	PE4567	RG8, RG9, RG213, RG214, RG225, RG393	CLAMP	\$63.25	\$58.82	\$54.40	\$50.60
	PE4570	RG8, RG213	CRIMP	81.45	75.75	70.05	65.16
	PE4571	RG9, RG214, RG225, RG393	CRIMP	77.90	72.45	66.99	62.32
	PE4566	RG55, RG58, RG141, RG142, RG223 & RG400	CLAMP	83.55	77.70	71.85	66.84
	PE4568	RG55, RG142, RG223, RG400	CRIMP	73.10	67.98	62.87	58.48
	PE4569	RG58	CRIMP	73.10	67.98	62.87	58.48
	PE44276	RG217	CLAMP	94.00	87.42	80.84	75.20
	PE44277	RG218	CLAMP	94.00	87.42	80.84	75.20
	PE44278	RG401, PE-SR401AL, PE-SR401FL (.250")	SOLDER/CLAMP	94.00	87.42	80.84	75.20
	PE44279	RG402, PE-SR402AL, PE-SR402FL (.141")	SOLDER/CLAMP	94.00	87.42	80.84	75.20

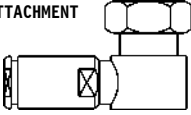
7/16 MALE RIGHT ANGLE FOR CABLE ATTACHMENT	Model No.	FITS MIL SPEC AND EQUIVALENT CABLES	ATTACHMENT METHOD	1-24	25-49	50-99	100 +
	PE44280	RG8, RG9, RG213, RG214, RG225, RG393	CLAMP	103.65	96.39	89.14	82.92
	PE44281	RG55, RG58, RG141, RG142, RG223, RG400	CLAMP	125.35	116.58	107.80	100.28
	PE44282	RG217	CLAMP	125.35	116.58	107.80	100.28

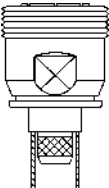
7/16 FEMALE FOR CABLE ATTACHMENT	Model No.	FITS MIL SPEC AND EQUIVALENT CABLES	ATTACHMENT METHOD	1-24	25-49	50-99	100 +
	PE44283	RG8, RG9, RG213, RG214, RG225, RG393	CLAMP	94.00	87.42	80.84	75.20
	PE44284	RG8, RG213	CRIMP	88.75	82.54	76.33	71.00
	PE4575	RG9, RG214, RG225, RG393	CRIMP	88.75	82.54	76.33	71.00
	PE44285	RG55, RG58, RG141, RG142, RG223, RG400	CLAMP	94.00	87.42	80.84	75.20
	PE44286	RG55, RG142, RG223, RG400	CRIMP	79.35	73.80	68.24	63.48
	PE44287	RG58	CRIMP	77.15	71.75	66.35	61.72
	PE44288	RG217	CLAMP	87.75	81.61	75.47	70.20
	PE44289	RG401, PE-SR401AL, PE-SR401FL (.250")	SOLDER/CLAMP	88.75	82.54	76.33	71.00
	PE44290	RG402, PE-SR402AL, PE-SR402FL (.141")	SOLDER/CLAMP	88.75	82.54	76.33	71.00

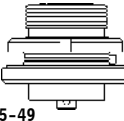
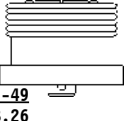
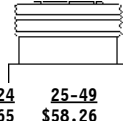
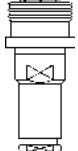
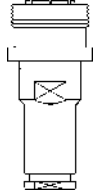
Model No.	PE4572	7/16 FEMALE BULKHEAD REAR MOUNT, SOLDER CUP CONTACT	Model No.	PE4573	7/16 FEMALE, 4 HOLE PANEL MOUNT, SOLDER CUP CONTACT MOUNTING HOLE A21	Model No.	PE4574	7/16 FEMALE, 4 HOLE PANEL MOUNT, WITH THREADED CONTACT, MOUNTING HOLE A21	Model No.	PE44291	7/16 FEMALE, 4 HOLE PANEL MOUNT, CLAMP ATTACHMENT FOR RG8, RG9 RG213, RG214, RG225 & RG393 MOUNTING HOLE A21	Model No.	PE44292	7/16 FEMALE, 4 HOLE PANEL MOUNT, CLAMP ATTACHMENT FOR RG217 MOUNTING HOLE A21	
															
1-24	25-49	50-99	100 +	1-24	25-49	50-99	100 +	1-24	25-49	50-99	100 +	1-24	25-49	50-99	100 +
\$104.45	\$97.14	\$89.83	\$83.56	\$62.65	\$58.26	\$53.88	\$50.12	\$62.65	\$58.26	\$53.88	\$50.12	\$104.45	\$97.14	\$89.83	\$83.56

**NEW**

# 7/16 DIN CONNECTORS

**SEE PAGE 266 FOR MOUNTING HOLES**

The Pasternack 7/16 DIN line of low PIM (Passive Intermodulation Distortion) connectors is designed for applications where intermodulation distortion is a concern. The connector bodies are brass with White Bronze plating, and the contacts are silver plated with no nickel undercoat. Pasternack's low PIM connectors are fully interchangeable with 7/16 DIN connectors designed to IEC 169-4, CECC 22-190, DIN 47223 and VG 95250 specifications.

7/16 MALE  
FOR CABLE  
ATTACHMENT

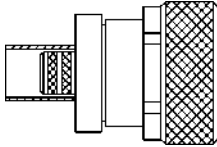

Model No.  
PE44536  
PE44537  
PE44538  
PE44539

FITS MIL-SPEC AND  
EQUIVALENT CABLES  
PE-T195\*, LMR195\*\*  
PE-T240\*, LMR240\*\*  
PE-T400\*, LMR400\*\*  
PE-T600\*, LMR600\*\*

ATTACHMENT  
METHOD  
CRIMP  
CRIMP  
CRIMP  
CRIMP

P R I C E			
1-24	25-49	50-99	100 +
\$29.95	\$27.85	\$25.76	\$23.96
29.95	27.85	25.76	23.96
34.95	32.50	30.06	27.96
39.95	37.15	34.36	31.96

7/16 MALE  
RIGHT ANGLE  
FOR CABLE  
ATTACHMENT

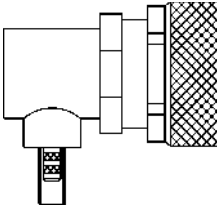

PE44540  
PE44541  
PE44542  
PE44543

PE-T195\*, LMR195\*\*  
PE-T240\*, LMR240\*\*  
PE-T400\*, LMR400\*\*  
PE-T600\*, LMR600\*\*

CRIMP  
CRIMP  
CRIMP  
CRIMP

39.95	37.15	34.36	31.96
39.95	37.15	34.36	31.96
44.95	41.80	38.66	35.96
49.95	46.45	42.96	39.96

7/16 MALE  
FOR CABLE  
ATTACHMENT

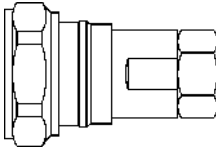

PE44567  
PE44567  
PE44568  
PE44568

1/2" ANNULAR  
1/2" HELICAL  
7/8" ANNULAR  
7/8" HELICAL

CLAMP  
CLAMP  
CLAMP  
CLAMP

39.95	37.15	34.36	31.96
40.95	38.08	35.22	32.76
54.95	51.10	47.26	43.96
54.95	51.10	47.26	43.96

7/16 MALE  
RIGHT ANGLE  
FOR CABLE  
ATTACHMENT

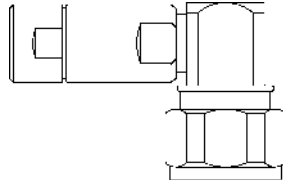

PE44569  
PE44559

1/2" ANNULAR  
1/2" HELICAL

CLAMP  
CLAMP

49.95	46.45	42.96	39.96
49.95	46.45	42.96	39.96

7/16 FEMALE  
FOR CABLE  
ATTACHMENT

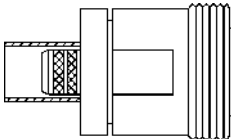

PE44544  
PE44545  
PE44546  
PE44547

PE-T195\*, LMR195\*\*  
PE-T240\*, LMR240\*\*  
PE-T400\*, LMR400\*\*  
PE-T600\*, LMR600\*\*

CRIMP  
CRIMP  
CRIMP  
CRIMP

39.95	37.15	34.36	31.96
39.95	37.15	34.36	31.96
44.95	41.80	38.66	35.96
49.95	46.45	42.96	39.96

7/16 FEMALE  
BULKHEAD FOR  
CABLE ATTACHMENT

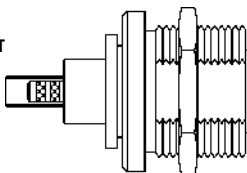

PE44548  
PE44549  
PE44550  
PE44551

PE-T195\*, LMR195\*\*  
PE-T240\*, LMR240\*\*  
PE-T400\*, LMR400\*\*  
PE-T600\*, LMR600\*\*

CRIMP  
CRIMP  
CRIMP  
CRIMP

44.95	41.80	38.66	35.96
44.95	41.80	38.66	35.96
49.95	46.45	42.96	39.96
54.95	51.10	47.26	43.96

**MOUNTING HOLE G08**

7/16 FEMALE  
FOR CABLE  
ATTACHMENT

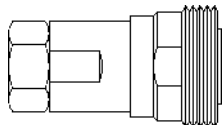

PE44570  
PE44560  
PE44571  
PE44561

1/2" ANNULAR  
1/2" HELICAL  
7/8" ANNULAR  
7/8" HELICAL

CLAMP  
CLAMP  
CLAMP  
CLAMP

39.95	37.15	34.36	31.96
44.95	41.80	38.66	35.96
49.95	46.45	42.96	39.96
54.95	51.10	47.26	43.96

\* PE-T SERIES COAX IS FUNCTIONALLY EQUIVALENT TO TIMES MICROWAVE LMR® SERIES COAX  
\*\* LMR® IS A REGISTERED TRADEMARK OF TIMES MICROWAVE SYSTEMS



**NEW**

# 50 OHM N CONNECTORS

**THESE CONNECTORS WILL NOT MATE WITH 75 OHM N CONNECTORS****SEE PAGE 266 FOR MOUNTING HOLES**

The Pasternack Type N line of low PIM (Passive Intermodulation Distortion) connectors is designed for applications where intermodulation distortion is a concern. The connector bodies are brass with White Bronze plating, and the contacts are gold plated with no nickel undercoat. Pasternack's low PIM connectors are fully interchangeable with Type N connectors designed to the MIL-C39012 specifications.

N MALE  
FOR CABLE  
ATTACHMENT

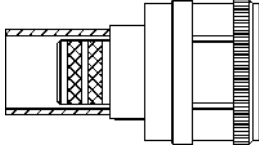

Model No.  
PE44520  
PE44521  
PE44522  
PE44523

**FITS MIL-SPEC AND  
EQUIVALENT CABLES**  
PE-T195\*, LMR195\*\*  
PE-T240\*, LMR240\*\*  
PE-T400\*, LMR400\*\*  
PE-T600\*, LMR600\*\*

**ATTACHMENT  
METHOD**  
CRIMP  
CRIMP  
CRIMP  
CRIMP

**P R I C E**  
1-24    25-49    50-99    100 +  
\$9.95    \$9.25    \$8.56    \$7.96  
9.95    9.25    8.56    7.96  
10.95    10.18    9.42    8.76  
19.95    18.55    17.16    15.96

N MALE  
RIGHT ANGLE  
FOR CABLE  
ATTACHMENT

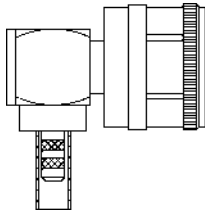

PE44524  
PE44525  
PE44526  
PE44527

PE-T195\*, LMR195\*\*  
PE-T240\*, LMR240\*\*  
PE-T400\*, LMR400\*\*  
PE-T600\*, LMR600\*\*

CRIMP  
CRIMP  
CRIMP  
CRIMP

17.95    16.69    15.44    14.36  
19.95    18.55    17.16    15.96  
24.95    23.20    21.46    19.96  
29.95    27.85    25.76    23.96

N MALE  
FOR CABLE  
ATTACHMENT

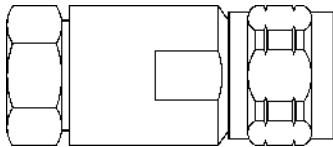

PE44562  
PE44552  
PE44563  
PE44553

1/2" ANNULAR  
1/2" HELICAL  
7/8" ANNULAR  
7/8" HELICAL

CLAMP  
CLAMP  
CLAMP  
CLAMP

39.95    37.15    34.36    31.96  
39.95    37.15    34.36    31.96  
49.95    46.45    42.96    39.96  
49.95    46.45    42.96    39.96

N MALE  
RIGHT ANGLE  
FOR CABLE  
ATTACHMENT

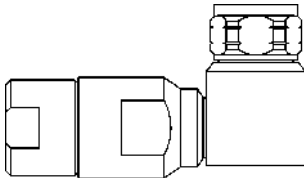

PE44564  
PE44554

1/2" ANNULAR  
1/2" HELICAL

CLAMP  
CLAMP

48.95    45.52    42.10    39.16  
45.95    42.73    39.52    36.76

N FEMALE  
BULKHEAD  
FOR CABLE  
ATTACHMENT

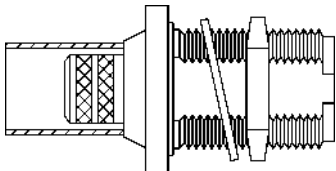

PE44528  
PE44529  
PE44530  
PE44531

PE-T195\*, LMR195\*\*  
PE-T240\*, LMR240\*\*  
PE-T400\*, LMR400\*\*  
PE-T600\*, LMR600\*\*

CRIMP  
CRIMP  
CRIMP  
CRIMP

10.95    10.18    9.42    8.76  
10.95    10.18    9.42    8.76  
14.95    13.90    12.86    11.96  
24.95    23.20    21.46    19.96

**MOUNTING HOLE G01**

N FEMALE  
FOR CABLE  
ATTACHMENT

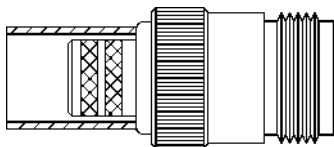

PE44532  
PE44533  
PE44534  
PE44535

PE-T195\*, LMR195\*\*  
PE-T240\*, LMR240\*\*  
PE-T400\*, LMR400\*\*  
PE-T600\*, LMR600\*\*

CRIMP  
CRIMP  
CRIMP  
CRIMP

11.95    11.11    10.28    9.56  
11.95    11.11    10.28    9.56  
14.95    13.90    12.86    11.96  
29.95    27.85    25.76    23.96

N FEMALE  
FOR CABLE  
ATTACHMENT

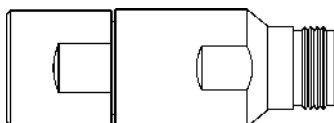

PE44565  
PE44555  
PE44566  
PE44556

1/2" ANNULAR  
1/2" HELICAL  
7/8" ANNULAR  
7/8" HELICAL

CLAMP  
CLAMP  
CLAMP  
CLAMP

39.95    37.15    34.36    31.96  
39.95    37.15    34.36    31.96  
49.95    46.45    42.96    39.96  
49.95    46.45    42.96    39.96

\* PE-T SERIES COAX IS FUNCTIONALLY EQUIVALENT TO TIMES MICROWAVE LMR® SERIES COAX

\*\* LMR® IS A REGISTERED TRADEMARK OF TIMES MICROWAVE SYSTEMS

# 50 OHM N CONNECTORS

## THESE CONNECTORS WILL NOT MATE WITH 75 OHM N CONNECTORS

**SEE PAGE 266 FOR MOUNTING HOLES**

P R I C E

**N MALE  
FOR CABLE  
ATTACHMENT**

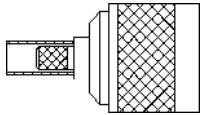
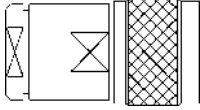

Model No.	FITS MIL SPEC AND EQUIVALENT CABLES	ATTACHMENT METHOD	1-24	25-49	50-99	100 +
PE4062	RG8, RG9, RG11, RG213, RG214, RG225, RG393	CLAMP	\$9.20	\$8.56	\$7.91	\$7.36
PE4132	RG8, RG9, RG11, RG213, RG214, RG225, RG393	CLAMP (CAPTIVE CONTACT)	9.75	9.07	8.39	7.80
PE4430	RG8, RG213	CRIMP	11.45	10.65	9.85	9.16
PE4431	RG8X, PE-T042RML	CRIMP	9.90	9.21	8.51	7.92
PE4344	RG8X, PE-T042RML	CRIMP	14.60	13.58	12.56	11.68
PE4048	RG9, RG214, RG225, RG393	CRIMP	10.60	9.86	9.12	8.48
PE4221	RG14, RG217	CLAMP	20.70	19.25	17.80	16.56
PE4081	RG55, RG58, RG141, RG142, RG223, RG400	CLAMP	7.75	7.21	6.67	6.20
PE4042	RG55, RG141, RG142, RG223, RG400	CRIMP	10.00	9.30	8.60	8.00
PE4329	RG58	CRIMP	9.90	9.21	8.51	7.92
PE4331	RG59B/U, RG62	CLAMP	11.65	10.83	10.02	9.32
PE4432	RG59B/U, RG62	CRIMP	9.75	9.07	8.39	7.80
PE4224	RG174, RG188, RG316	CLAMP	12.05	11.21	10.36	9.64
PE4429	RG174, RG188, RG316	CRIMP	11.10	10.32	9.55	8.88
PE4647	RG178, RG196	CRIMP	18.75	17.44	16.13	15.00
PE4433	RG218	CLAMP	62.65	58.26	53.88	50.12
PE4434	RG401, PE-SR401AL, PE-SR401FL (.250" SEMI-RIGID)	SOLDER/CLAMP	14.30	13.30	12.30	11.44
PE4376	RG401, PE-SR401AL, PE-SR401FL (.250" SEMI-RIGID)	SOLDER-PRECISION TYPE	28.15	26.18	24.21	22.52
PE4006	RG402, PE-SR402AL, PE-SR402FL (.141" SEMI-RIGID)	SOLDER/CLAMP	14.30	13.30	12.30	11.44
PE4140	RG402, PE-SR402AL, PE-SR402FL (.141" SEMI-RIGID)	SOLDER-PRECISION TYPE	16.60	15.44	14.28	13.28
PE4129	RG405, PE-SR405AL, PE-SR405FL (.085" SEMI-RIGID)	SOLDER/CLAMP	14.30	13.30	12.30	11.44
PE4222	RG405, PE-SR405AL, PE-SR405FL (.085" SEMI-RIGID)	SOLDER-PRECISION TYPE	25.05	23.30	21.54	20.04
PE4133	BELDEN 9913 & 9914, PE-B3199, PE-B4199, PE-T004RML	CLAMP	12.50	11.63	10.75	10.00
PE4550	BELDEN 9913 & 9914, PE-B3199, PE-B4199, PE-T004RML	CRIMP	10.45	9.72	8.99	8.36
PE4934	PE-047SR, PE-SR047AL, PE-SR047FL (.047" SEMI-RIGID)	SOLDER	20.70	19.25	17.80	16.56
PE44043	PE-T002RML	CLAMP	9.90	9.21	8.51	7.92
PE44044	PE-T002RML	CRIMP	10.95	10.18	9.42	8.76
PE44045	PE-T003RML	CLAMP	14.60	13.58	12.56	11.68
PE44046	PE-T005RML	CLAMP	20.70	19.25	17.80	16.56
PE44349	PE-T006RML	CLAMP	39.25	36.50	33.76	31.40
PE44454	PE-T006RML	CRIMP	34.90	32.46	30.01	27.92

**N MALE  
RIGHT ANGLE  
FOR CABLE  
ATTACHMENT**

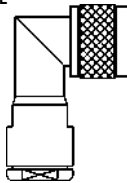

PE4136	RG8, RG9, RG213, RG214, RG225, RG393	CLAMP	16.60	15.44	14.28	13.28
PE4482	RG8, RG213	CRIMP	25.35	23.58	21.80	20.28
PE4483	RG9, RG214, RG225, RG393	CRIMP	25.60	23.81	22.02	20.48
PE4135	RG55, RG58, RG141, RG142, RG223, RG400	CLAMP	14.40	13.39	12.38	11.52
PE4484	RG55, RG141, RG142, RG223, RG400	CRIMP	18.85	17.53	16.21	15.08
PE4485	RG58	CRIMP	18.70	17.39	16.08	14.96
PE4935	RG401, PE-SR401AL, PE-SR401FL (.250" SEMI-RIGID)	SOLDER/CLAMP	20.85	19.39	17.93	16.68
PE4936	RG402, PE-SR402AL, PE-SR402FL (.141" SEMI-RIGID)	SOLDER	16.15	15.02	13.89	12.92
PE4937	RG405, PE-SR405AL, PE-SR405FL (.085" SEMI-RIGID)	SOLDER	16.65	15.48	14.32	13.32
PE4938	BELDEN 9913 & 9914, PE-B3199, PE-B4199, PE-T004RML	CLAMP	19.80	18.41	17.03	15.84
PE4939	BELDEN 9913 & 9914, PE-B3199, PE-B4199, PE-T004RML	CRIMP	29.75	27.67	25.59	23.80

**N FEMALE  
FOR CABLE  
ATTACHMENT**

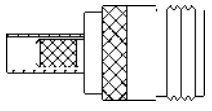
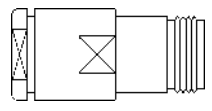

PE4061	RG8, RG9, RG11, RG213, RG214, RG225, RG393	CLAMP	11.45	10.65	9.85	9.16
PE4059	RG8, RG9, RG11, RG213, RG214, RG225, RG393	CLAMP (CAPTIVE CONTACT)	17.85	16.60	15.35	14.28
PE4435	RG8, RG213	CRIMP	10.95	10.18	9.42	8.76
PE4191	RG9, RG214, RG225, RG393	CRIMP	11.10	10.32	9.55	8.88
PE4645	RG14, RG217	CLAMP	36.50	33.95	31.39	29.20
PE4072	RG55, RG58, RG141, RG142, RG223, RG400	CLAMP	11.10	10.32	9.55	8.88
PE4134	RG55, RG141, RG142, RG223, RG400	CRIMP	11.10	10.32	9.55	8.88
PE4436	RG58	CRIMP	10.95	10.18	9.42	8.76
PE4330	RG59B/U, RG62	CLAMP	10.85	10.09	9.33	8.68
PE4437	RG174, RG188, RG316	CLAMP	13.55	12.60	11.65	10.84
PE4438	RG174, RG188, RG316	CRIMP	14.15	13.16	12.17	11.32
PE4646	RG218	CLAMP	38.60	35.90	33.20	30.88
PE4439	RG401, PE-SR401AL, PE-SR401FL (.250" SEMI-RIGID)	SOLDER/CLAMP	16.45	15.30	14.15	13.16
PE4138	RG402, PE-SR402AL, PE-SR402FL (.141" SEMI-RIGID)	SOLDER/CLAMP	14.30	13.30	12.30	11.44
PE4652	RG402, PE-SR402AL, PE-SR402FL (.141" SEMI-RIGID)	SOLDER-PRECISION TYPE	20.85	19.39	17.93	16.68
PE4130	RG405, PE-SR405AL, PE-SR405FL (.085" SEMI-RIGID)	SOLDER/CLAMP	14.30	13.30	12.30	11.44
PE4653	RG405, PE-SR405AL, PE-SR405FL (.085" SEMI-RIGID)	SOLDER-PRECISION TYPE	18.75	17.44	16.13	15.00
PE4945	PE-047SR, PE-SR047AL, PE-SR047FL (.047" SEMI-RIGID)	SOLDER-PRECISION TYPE	41.75	38.83	35.91	33.40
PE4372	BELDEN 9913 & 9914, PE-B3199, PE-B4199, PE-T004RML	CLAMP	17.85	16.60	15.35	14.28
PE44350	PE-T006RML	CLAMP	46.95	43.66	40.38	37.56

**N FEMALE  
BULKHEAD  
FOR CABLE  
ATTACHMENT**

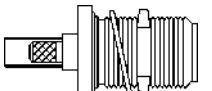

**NEW**

**MOUNTING HOLE G01**

PE4223	RG8, RG9, RG11, RG213, RG214, RG225, RG393	CLAMP	16.30	15.16	14.02	13.04
PE4940	RG8, RG213	CRIMP	20.85	19.39	17.93	16.68
PE4941	RG9, RG214, RG225, RG393	CRIMP	20.70	19.25	17.80	16.56
PE4114	RG55, RG58, RG141, RG142, RG223, RG400	CLAMP	12.75	11.86	10.97	10.20
PE4371	RG55, RG141, RG142, RG223, RG400	CRIMP	12.75	11.86	10.97	10.20
PE4440	RG58	CRIMP	12.05	11.21	10.36	9.64
PE4297	RG59B/U, RG62	CLAMP	19.80	18.41	17.03	15.84
PE4441	RG174, RG188, RG316	CLAMP	15.30	14.23	13.16	12.24
PE4442	RG174, RG188, RG316	CRIMP	18.10	16.83	15.57	14.48
PE44633	RG178	CLAMP	15.30	14.23	13.16	12.24
PE4942	RG401, PE-SR401AL, PE-SR401FL (.250" SEMI-RIGID)	SOLDER/CLAMP	17.55	16.32	15.09	14.04
PE4113	RG402, PE-SR402AL, PE-SR402FL (.141" SEMI-RIGID)	SOLDER/CLAMP	14.30	13.30	12.30	11.44
PE4654	RG402, PE-SR402AL, PE-SR402FL (.141" SEMI-RIGID)	SOLDER-PRECISION TYPE	22.20	20.65	19.09	17.76
PE4443	RG405, PE-SR405AL, PE-SR405FL (.085" SEMI-RIGID)	SOLDER/CLAMP	14.30	13.30	12.30	11.44
PE4655	RG405, PE-SR405AL, PE-SR405FL (.085" SEMI-RIGID)	SOLDER-PRECISION TYPE	22.90	21.30	19.69	18.32
PE4946	PE-047SR, PE-SR047AL, PE-SR047FL (.047" SEMI-RIGID)	SOLDER-PRECISION TYPE	36.50	33.95	31.39	29.20
PE4943	BELDEN 9913 & 9914, PE-B3199, PE-B4199, PE-T004RML	CLAMP	17.40	16.18	14.96	13.92
PE4944	BELDEN 9913 & 9914, PE-B3199, PE-B4199, PE-T004RML	CRIMP	20.85	19.39	17.93	16.68

**Connectors**

# 50 OHM N CONNECTORS

## THESE CONNECTORS WILL NOT MATE WITH 75 OHM N CONNECTORS

**SEE PAGE 266 FOR MOUNTING HOLES**

P R I C E

N FEMALE  
PANEL MOUNT  
FOR CABLE  
ATTACHMENT

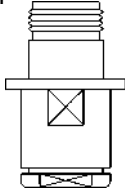

Model No.	FITS MIL SPEC AND EQUIVALENT CABLES		ATTACHMENT METHOD	1-24	25-49	50-99	100 +
PE4060	RG8, RG9, RG11, RG213, RG214, RG225, RG393		CLAMP (CAPTIVE CONTACT)	\$16.15	\$15.02	\$13.89	\$12.92
PE44065	RG8, RG213		CRIMP	15.40	14.32	13.24	12.32
PE44066	RG9, RG214, RG225, RG393		CRIMP	15.25	14.18	13.12	12.20
PE4141	RG55, RG58, RG141, RG142, RG223, RG400		CLAMP	10.85	10.09	9.33	8.68
PE44068	RG55, RG141, RG142, RG223, RG400		CRIMP	15.55	14.46	13.37	12.44
PE44069	RG58		CRIMP	15.40	14.32	13.24	12.32
PE44070	RG174, RG188, RG316		CLAMP	13.20	12.28	11.35	10.56
PE44071	RG401, PE-SR401AL, PE-SR401FL (.250" SEMI-RIGID)		SOLDER/CLAMP	17.55	16.32	15.09	14.04
PE44072	RG402, PE-SR402AL, PE-SR402FL (.141" SEMI-RIGID)		SOLDER/CLAMP	17.55	16.32	15.09	14.04
PE44073	RG405, PE-SR405AL, PE-SR405FL (.085" SEMI-RIGID)		SOLDER/CLAMP	17.55	16.32	15.09	14.04

**MOUNTING HOLE A05**

Model No. PE4013  
N FEMALE, PANEL MOUNT  
SOLDER CUP CONTACT  
MOUNTING HOLE A05

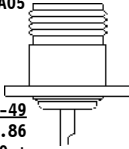

1-24	25-49
\$8.45	\$7.86
50-99	100 +
\$7.27	\$6.76

Model No. PE4131  
N MALE, PANEL MOUNT  
SOLDER CUP CONTACT  
MOUNTING HOLE A05



1-24	25-49
\$9.75	\$9.07
50-99	100 +
\$8.39	\$7.80

Model No. PE4137  
N FEMALE BULKHEAD, FRONT  
MOUNT, SOLDER CUP CONTACT  
HERMETICALLY SEALED  
MOUNTING HOLE G01



1-24	25-49
\$11.10	\$10.32
50-99	100 +
\$9.55	\$8.88

Model No. PE4139  
N FEMALE BULKHEAD  
REAR MOUNT  
HALF MOON CONTACT  
MOUNTING HOLE G01



1-24	25-49
\$7.60	\$7.07
50-99	100 +
\$6.54	\$6.08

Model No. PE4328  
N FEMALE, PANEL MOUNT  
.590" EXTENDED DIELECTRIC  
1" SQ. FLANGE SIZE  
.384" DIELECTRIC DIAMETER  
.120" CONTACT DIAMETER  
MOUNTING HOLE A05

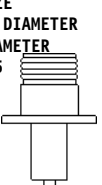

1-24	25-49
\$13.05	\$12.14
50-99	100 +
\$11.22	\$10.44

Model No. PE4355  
N FEMALE, PANEL MOUNT  
.590" EXTENDED DIELECTRIC  
.500" SQ. FLANGE SIZE  
.162" DIELECTRIC DIAMETER  
.050" CONTACT DIAMETER  
MOUNTING HOLE A01



1-24	25-49
\$13.05	\$12.14
50-99	100 +
\$11.22	\$10.44

Model No. PE4444  
N FEMALE, PANEL MOUNT  
.590" EXTENDED DIELECTRIC  
.687" SQ. FLANGE SIZE  
.162" DIELECTRIC DIAMETER  
.050" CONTACT DIAMETER  
MOUNTING HOLE A04

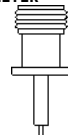

1-24	25-49
\$13.30	\$12.37
50-99	100 +
\$11.44	\$10.64

Model No. PE4486  
N FEMALE RIGHT ANGLE  
PANEL MOUNT, SOLDER CUP  
CONTACT, MOUNTING HOLE A05

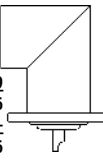

1-24	25-49
\$29.20	\$27.16
50-99	100 +
\$25.11	\$23.36

Model No. PE4487  
N FEMALE, PANEL MOUNT  
HERMETICALLY SEALED WITH  
O-RING, SOLDER CUP CONTACT  
MOUNTING HOLE A05

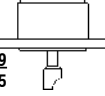

1-24	25-49
\$36.50	\$33.95
50-99	100 +
\$31.39	\$29.20

Model No. PE4488  
N FEMALE BULKHEAD, FRONT  
MOUNT, SOLDER CUP CONTACT  
MOUNTING HOLE F05

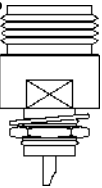

1-24	25-49
\$9.75	\$9.07
50-99	100 +
\$8.39	\$7.80

Model No. PE4489  
N MALE BULKHEAD, FRONT  
MOUNT, SOLDER CUP CONTACT  
MOUNTING HOLE G01



1-24	25-49
\$21.90	\$20.37
50-99	100 +
\$18.83	\$17.52

Model No. PE4490  
N MALE BULKHEAD, FRONT  
MOUNT, SOLDER CUP CONTACT  
MOUNTING HOLE B04

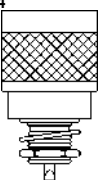

1-24	25-49
\$19.80	\$18.41
50-99	100 +
\$17.03	\$15.84

Model No. PE4491  
N MALE, PANEL MOUNT  
.330" EXTENDED DIELECTRIC  
MOUNTING HOLE A05

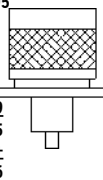

1-24	25-49
\$20.70	\$19.25
50-99	100 +
\$17.80	\$16.56

Model No. PE4492  
N FEMALE, PANEL MOUNT  
CAPTURED TAB CONTACT  
.100" LONG, .005" THICK  
BY .120" WIDE  
MOUNTING HOLE A05

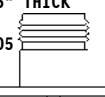

1-24	25-49
\$16.65	\$15.48
50-99	100 +
\$14.32	\$13.32

Model No. PE44074  
N FEMALE, PRESS MOUNT  
.050" DIAMETER CONTACT  
MOUNTING HOLE F02

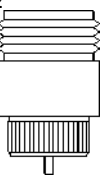

1-24	25-49
\$16.65	\$15.48
50-99	100 +
\$14.32	\$13.32

Model No. PE44075  
N FEMALE, PRESS MOUNT  
TAB CONTACT .005" THICK  
BY .120" WIDE  
MOUNTING HOLE F02

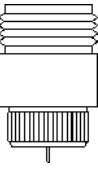

1-24	25-49
\$18.75	\$17.44
50-99	100 +
\$16.13	\$15.00

Model No. PE44076  
N FEMALE, PRESS MOUNT  
SOLDER CUP CONTACT  
MOUNTING HOLE F02



1-24	25-49
\$9.75	\$9.07
50-99	100 +
\$8.39	\$7.80

Model No. PE44077  
N FEMALE, 2 HOLE PANEL  
MOUNT, SOLDER CUP CONTACT  
MOUNTING HOLE C04



1-24	25-49
\$16.30	\$15.16
50-99	100 +
\$14.02	\$13.04

Model No. PE44078  
N FEMALE, 2 HOLE PANEL  
MOUNT, TAB CONTACT  
.005" THICK BY .120" WIDE  
MOUNTING HOLE C04

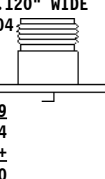

1-24	25-49
\$18.75	\$17.44
50-99	100 +
\$16.13	\$15.00

Model No. PE44079  
N FEMALE, 2 HOLE PANEL  
MOUNT, .590" EXTENDED  
DIELECTRIC  
.162" DIELECTRIC DIAMETER  
.050" CONTACT DIAMETER  
MOUNTING HOLE C04

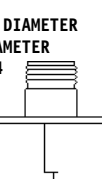

1-24	25-49
\$26.05	\$24.23
50-99	100 +
\$22.40	\$20.84

Model No. PE44396  
N FEMALE, P.C. MOUNT  
MOUNTING HOLE D12

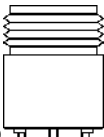

1-24	25-49
\$16.65	\$15.48
50-99	100 +
\$14.32	\$13.32

Model No. PE44397  
N FEMALE BULKHEAD  
P.C. MOUNT  
MOUNTING HOLE D12  
MOUNTING HOLE G01

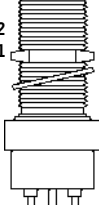

1-24	25-49
\$20.85	\$19.39
50-99	100 +
\$17.93	\$16.68

Model No. PE44398  
N FEMALE BULKHEAD  
RIGHT ANGLE, P.C. MOUNT  
MOUNTING HOLE D12  
MOUNTING HOLE B15

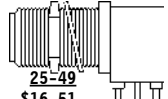

1-24	25-49
\$17.75	\$16.51
50-99	100 +
\$15.27	\$14.20

Model No. PE44615  
N FEMALE, PCB-GRIP  
EDGE LAUNCH  
MOUNTING HOLE G01

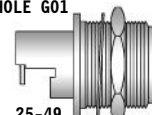

1-24	25-49
\$18.95	\$17.62
50-99	100 +
\$16.30	\$15.16

**NEW**

**PLEASE CONTACT OUR  
ENGINEERING DEPARTMENT  
FOR ALL YOUR SPECIAL  
REQUIREMENTS AT  
(866) 727-8376 EXT. 3**

# 50 OHM TNC CONNECTORS

SEE PAGE 266 FOR MOUNTING HOLES

TNC MALE FOR CABLE ATTACHMENT	Model No.	FITS MIL SPEC AND EQUIVALENT CABLES	ATTACHMENT METHOD	PRICE			
				1-24	25-49	50-99	100 +
	PE4088	RG8, RG9, RG11, RG213, RG214, RG225, RG393	CLAMP	\$12.60	\$11.72	\$10.84	\$10.08
	PE4446	RG8, RG213	CRIMP	13.20	12.28	11.35	10.56
	PE44063	RG8X, PE-T042RML	CLAMP	11.95	11.11	10.28	9.56
	PE4447	RG9, RG214, RG225, RG393	CRIMP	17.30	16.09	14.88	13.84
	PE4067	RG55, RG58, RG141, RG142, RG223, RG400	CLAMP	7.75	7.21	6.67	6.20
	PE4047	RG55, RG141, RG142, RG223, RG400	CRIMP	7.80	7.25	6.71	6.24
	PE4156	RG58	CRIMP	7.65	7.11	6.58	6.12
	PE4154	RG59B/U, RG62	CLAMP	10.00	9.30	8.60	8.00
	PE4071	RG59B/U, RG62	CRIMP	7.75	7.21	6.67	6.20
	PE4303	RG174, RG188, RG316	CLAMP	10.95	10.18	9.42	8.76
	PE4302	RG174, RG188, RG316	CRIMP	13.80	12.83	11.87	11.04
	PE4448	RG178, RG196	CLAMP	13.20	12.28	11.35	10.56
	PE4909	RG401, PE-SR401AL, PE-SR401FL (.250" SEMI-RIGID)	DIRECT SOLDER	38.60	35.90	33.20	30.88
	PE4143	RG402, PE-SR402AL, PE-SR402FL (.141" SEMI-RIGID)	SOLDER/CLAMP	15.40	14.32	13.24	12.32
	PE4648	RG402, PE-SR402AL, PE-SR402FL (.141" SEMI-RIGID)	SOLDER	19.10	17.76	16.43	15.28
	PE4142	RG405, PE-SR405AL, PE-SR405FL (.085" SEMI-RIGID)	SOLDER/CLAMP	15.40	14.32	13.24	12.32
	PE4649	RG405, PE-SR405AL, PE-SR405FL (.085" SEMI-RIGID)	SOLDER	18.50	17.21	15.91	14.80
	PE4975	PE-047SR, PE-SR047AL, PE-SR047FL (.047" SEMI-RIGID)	DIRECT SOLDER	17.40	16.18	14.96	13.92
	PE4449	BELDEN 9913 & 9914, PE-B3199, PE-B4199, PE-T004RML	CLAMP	14.15	13.16	12.17	11.32
	PE44293	BELDEN 9913 & 9914, PE-B3199, PE-B4199, PE-T004RML	CRIMP	20.85	19.39	17.93	16.68
	PE44061	PE-T002RML	CLAMP	12.05	11.21	10.36	9.64
	PE44062	PE-T002RML	CRIMP	12.05	11.21	10.36	9.64
	PE44064	PE-T003RML	CLAMP	13.20	12.28	11.35	10.56

TNC MALE RIGHT ANGLE FOR CABLE ATTACHMENT	Model No.	FITS MIL SPEC AND EQUIVALENT CABLES	ATTACHMENT METHOD	PRICE			
				1-24	25-49	50-99	100 +
	PE4146	RG8, RG9, RG11, RG213, RG214, RG225, RG393	CLAMP	22.90	21.30	19.69	18.32
	PE4054	RG55, RG58, RG141, RG142, RG223, RG400	CLAMP	17.40	16.18	14.96	13.92
	PE4450	RG55, RG141, RG142, RG223, RG400	CRIMP	18.75	17.44	16.13	15.00
	PE4451	RG58	CRIMP	15.95	14.83	13.72	12.76
	PE4452	RG59B/U, RG62	CLAMP	18.50	17.21	15.91	14.80
	PE4453	RG59B/U, RG62	CRIMP	15.25	14.18	13.12	12.20
	PE4454	RG174, RG188, RG316	CLAMP	15.40	14.32	13.24	12.32
	PE4455	RG174, RG188, RG316	CRIMP	16.30	15.16	14.02	13.04
	PE4456	RG178, RG196	CLAMP	18.70	17.39	16.08	14.96

TNC FEMALE FOR CABLE ATTACHMENT	Model No.	FITS MIL SPEC AND EQUIVALENT CABLES	ATTACHMENT METHOD	PRICE			
				1-24	25-49	50-99	100 +
	PE4155	RG8, RG9, RG11, RG213, RG214, RG225, RG393	CLAMP	22.90	21.30	19.69	18.32
	PE4068	RG55, RG58, RG141, RG142, RG223, RG400	CLAMP	8.65	8.04	7.44	6.92
	PE4457	RG55, RG141, RG142, RG223, RG400	CRIMP	10.40	9.67	8.94	8.32
	PE4458	RG58	CRIMP	9.55	8.88	8.21	7.64
	PE4459	RG59B/U, RG62	CRIMP	9.75	9.07	8.39	7.80
	PE4460	RG59B/U, RG62	CLAMP	9.75	9.07	8.39	7.80
	PE4461	RG174, RG188, RG316	CLAMP	10.95	10.18	9.42	8.76
	PE4462	RG174, RG188, RG316	CRIMP	12.50	11.63	10.75	10.00
	PE4463	RG178, RG196	CLAMP	12.05	11.21	10.36	9.64
	PE4145	RG402, PE-SR402AL, PE-SR402FL (.141" SEMI-RIGID)	SOLDER/CLAMP	15.40	14.32	13.24	12.32
	PE4144	RG405, PE-SR405AL, PE-SR405FL (.085" SEMI-RIGID)	SOLDER/CLAMP	15.40	14.32	13.24	12.32

TNC FEMALE BULKHEAD FOR CABLE ATTACHMENT MOUNTING HOLE B06	Model No.	FITS MIL SPEC AND EQUIVALENT CABLES	ATTACHMENT METHOD	PRICE			
				1-24	25-49	50-99	100 +
	PE4152	RG55, RG58, RG141, RG142, RG223, RG400	CLAMP	13.05	12.14	11.22	10.44
	PE4153	RG55, RG141, RG142, RG223, RG400	CRIMP	13.55	12.60	11.65	10.84
	PE4151	RG58	CRIMP	12.75	11.86	10.97	10.20
	PE4464	RG59B/U, RG62	CLAMP	18.75	17.44	16.13	15.00
	PE4465	RG59B/U, RG62	CRIMP	15.25	14.18	13.12	12.20
	PE4304	RG174, RG188, RG316	CLAMP	15.40	14.32	13.24	12.32
	PE4466	RG174, RG188, RG316	CRIMP	15.55	14.46	13.37	12.44
	PE4467	RG178, RG196	CLAMP	15.40	14.32	13.24	12.32
	PE4148	RG402, PE-SR402AL, PE-SR402FL (.141" SEMI-RIGID)	SOLDER-PRECISION	41.75	38.83	35.91	33.40
	PE4150	RG402, PE-SR402AL, PE-SR402FL (.141" SEMI-RIGID)	SOLDER/CLAMP	18.70	17.39	16.08	14.96
	PE4147	RG405, PE-SR405AL, PE-SR405FL (.085" SEMI-RIGID)	SOLDER-PRECISION	44.90	41.76	38.61	35.92
	PE4149	RG405, PE-SR405AL, PE-SR405FL (.085" SEMI-RIGID)	SOLDER/CLAMP	18.70	17.39	16.08	14.96

Model No. PE4063  
TNC FEMALE BULKHEAD SOLDER CUP CONTACT MOUNTING HOLE B05

1-24	25-49
\$13.30	\$12.37
50-99	100 +
\$11.44	\$10.64

Model No. PE4064  
TNC FEMALE, PANEL MOUNT #3-56 TAPPED HOLES SOLDER CUP CONTACT MOUNTING HOLE A03

1-24	25-49
\$8.85	\$8.23
50-99	100 +
\$7.61	\$7.08

Model No. PE4065  
TNC FEMALE BULKHEAD SOLDER CUP CONTACT MOUNTING HOLE B04

1-24	25-49
\$8.65	\$8.04
50-99	100 +
\$7.44	\$6.92

Model No. PE4066  
TNC FEMALE, PANEL MOUNT CLAMP ATTACHMENT FOR RG55, RG58, RG141, RG142, RG223 & RG400 #3-56 TAPPED HOLES MOUNTING HOLE A03

1-24	25-49
\$10.85	\$10.09
50-99	100 +
\$9.33	\$8.68

Model No. PE4305  
TNC FEMALE BULKHEAD, FRONT MOUNT, HERMETICALLY SEALED MOUNTING HOLE B04

1-24	25-49
\$20.85	\$19.39
50-99	100 +
\$17.93	\$16.68

Model No. PE4306  
TNC FEMALE BULKHEAD ISOLATED GROUND SOLDER CUP CONTACT MOUNTING HOLE B04

1-24	25-49
\$9.75	\$9.07
50-99	100 +
\$8.39	\$7.80

Model No. PE4468  
TNC FEMALE BULKHEAD ISOLATED GROUND SOLDER CUP CONTACT MOUNTING HOLE B06

1-24	25-49
\$10.85	\$10.09
50-99	100 +
\$9.33	\$8.68

Model No. PE4469  
TNC FEMALE BULKHEAD, REAR MOUNT, HERMETICALLY SEALED MOUNTING HOLE B06

1-24	25-49
\$26.05	\$24.23
50-99	100 +
\$22.40	\$20.84

Model No. PE4470  
TNC MALE, PANEL MOUNT SOLDER CUP CONTACT MOUNTING HOLE A07

1-24	25-49
\$13.05	\$12.14
50-99	100 +
\$11.22	\$10.44

Model No. PE4471  
TNC FEMALE, RIGHT ANGLE BULKHEAD, SOLDER CUP CONTACT, MOUNTING HOLE B13

1-24	25-49
\$18.50	\$17.21
50-99	100 +
\$15.91	\$14.80

Connectors

# SMC CONNECTORS

## STANDARD 50 OHM M39012 INTERFACE

SEE PAGE 266 FOR MOUNTING HOLES

These 50 Ohm SMC connectors will interface with all M39012 50 Ohm SMC connectors. These will NOT mate with any 75 Ohm SMC connectors. JACK=MALE contact, PLUG=FEMALE contact

		Model No.	FITS MIL SPEC AND EQUIVALENT CABLES		P R I C E				
			1-24	25-49	50-99	100 +			
PLUG, CRIMP ATTACHMENT		PE4558 PE4594 PE4045 PE4074	RG58 RG55, RG142, RG223, RG400 RG174, RG188, RG316 RG178, RG196	15.60 15.60 7.75 11.10	14.51 14.51 7.21 10.32	13.42 13.42 6.67 9.55	12.48 12.48 6.20 8.88		
PLUG, CLAMP ATTACHMENT		PE4201 PE4202 PE4357	RG174, RG188, RG316 RG178, RG196 RG405, PE-SR405AL, PE-SR405FL (SEMI-RIGID)	8.65 11.45 13.55	8.04 10.65 12.60	7.44 9.85 11.65	6.92 9.16 10.84		
PLUG, RIGHT ANGLE, CRIMP ATTACHMENT		PE4557 PE4596 PE4051 PE4160	RG58 RG55, RG142, RG223, RG400 RG174, RG188, RG316 RG178, RG196	14.15 14.30 11.10 10.85	13.16 13.30 10.32 10.09	12.17 12.30 9.55 9.33	11.32 11.44 8.88 8.68		
PLUG, RIGHT ANGLE, CLAMP ATTACHMENT		PE4262 PE4263 PE4359	RG174, RG188, RG316 RG178, RG196 RG405, PE-SR405AL, PE-SR405FL (SEMI-RIGID)	10.00 10.40 15.60	9.30 9.67 14.51	8.60 8.94 13.42	8.00 8.32 12.48		
JACK, CRIMP ATTACHMENT		PE4094 PE4927	RG174, RG188, RG316 RG178, RG196	10.40 11.45	9.67 10.65	8.94 9.85	8.32 9.16		
JACK, CLAMP ATTACHMENT		PE4270 PE4271 PE4361	RG174, RG188, RG316 RG178, RG196 RG405, PE-SR405AL, PE-SR405FL (SEMI-RIGID)	18.75 18.75 18.75	17.44 17.44 17.44	16.13 16.13 16.13	15.00 15.00 15.00		
JACK, BULKHEAD CRIMP ATTACHMENT		PE44047 PE44095 PE4095 PE4365	RG55, RG142, RG223, RG400 RG58 RG174, RG188, RG316 RG178, RG196	18.75 18.75 10.40 19.80	17.44 17.44 9.67 18.41	16.13 16.13 8.94 17.03	15.00 15.00 8.32 15.84		
JACK, BULKHEAD CLAMP ATTACHMENT		PE4278 PE4279 PE4363	RG174, RG188, RG316 RG178, RG196 RG405, PE-SR405AL, PE-SR405FL (SEMI-RIGID)	20.85 20.85 20.85	19.39 19.39 19.39	17.93 17.93 17.93	16.68 16.68 16.68		

Model No. PE4107 SMC JACK BULKHEAD RECEPTACLE REAR MOUNT, SOLDER CUP CONTACT, MOUNTING HOLE B01		1-24 \$8.30 50-99 \$7.14	25-49 \$7.72 100 + \$6.64
Model No. PE4171 SMC JACK BULKHEAD RECEPTACLE FRONT MOUNT, SOLDER CUP CONTACT, MOUNTING HOLE B1		1-24 \$8.30 50-99 \$7.14	25-49 \$7.72 100 + \$6.64
Model No. PE4285 SMC JACK BULKHEAD RECEPTACLE RIGHT ANGLE SOLDER CUP CONTACT MOUNTING HOLE B01		1-24 \$17.70 50-99 \$15.22	25-49 \$16.46 100 + \$14.16

Connectors

Model No. PE4289 SMC PLUG BULKHEAD RECEPTACLE SOLDER CUP CONTACT MOUNTING HOLE B01		1-24 \$13.55 50-99 \$11.65	25-49 \$12.60 100 + \$10.84
Model No. PE4175 SMC JACK, PRINTED CIRCUIT MOUNT, MOUNTING HOLE D02		1-24 \$5.90 50-99 \$5.07	25-49 \$5.49 100 + \$4.72
Model No. PE4367 SMC PLUG, PRINTED CIRCUIT MOUNT, MOUNTING HOLE D02		1-24 \$9.35 50-99 \$8.04	25-49 \$8.70 100 + \$7.48
Model No. PE4178 SMC JACK, RIGHT ANGLE PRINTED CIRCUIT MOUNT MOUNTING HOLE D02		1-24 \$9.35 50-99 \$8.04	25-49 \$8.70 100 + \$7.48
Model No. PE4246 SMC PLUG, RIGHT ANGLE PRINTED CIRCUIT MOUNT MOUNTING HOLE D02		1-24 \$18.75 50-99 \$16.13	25-49 \$17.44 100 + \$15.00
Model No. PE44120 SMC JACK, SURFACE MOUNT		1-24 \$10.40 50-99 \$8.94	25-49 \$9.67 100 + \$8.32
Model No. PE44122 SMC JACK, RIGHT ANGLE SURFACE MOUNT		1-24 \$8.65 50-99 \$7.44	25-49 \$8.04 100 + \$6.92
Model No. PE44124 SMC JACK BULKHEAD P.C. MOUNT MOUNTING HOLE B01 & D02		1-24 \$17.70 50-99 \$15.22	25-49 \$16.46 100 + \$14.16
Model No. PE44127 SMC JACK BULKHEAD RIGHT ANGLE, P.C. MOUNT MOUNTING HOLE B01 & D02		1-24 \$14.15 50-99 \$12.17	25-49 \$13.16 100 + \$11.32
Model No. PE44130 SMC JACK, END LAUNCH FOR .062" THICK BOARD ROUND CONTACT		1-24 \$31.30 50-99 \$26.92	25-49 \$29.11 100 + \$25.04
Model No. PE44133 SMC JACK, END LAUNCH FOR .042" THICK BOARD ROUND CONTACT		1-24 \$16.65 50-99 \$14.32	25-49 \$15.48 100 + \$13.32
Model No. PE44136 SMC JACK, END LAUNCH FOR .062" THICK BOARD TAB CONTACT		1-24 \$15.60 50-99 \$13.42	25-49 \$14.51 100 + \$12.48
Model No. PE44138 SMC JACK, END LAUNCH FOR .042" THICK BOARD TAB CONTACT		1-24 \$16.65 50-99 \$14.32	25-49 \$15.48 100 + \$13.32
Model No. PE44140 SMC JACK, 2 HOLE FLANGE SOLDER CUP CONTACT MOUNTING HOLE C07		1-24 \$13.55 50-99 \$11.65	25-49 \$12.60 100 + \$10.84
Model No. PE44143 SMC JACK, 4 HOLE FLANGE SOLDER CUP CONTACT MOUNTING HOLE A22		1-24 \$13.55 50-99 \$11.65	25-49 \$12.60 100 + \$10.84

# SSMA CONNECTORS

SEE PAGE 266 FOR MOUNTING HOLES

		FITs MIL SPEC AND EQUIVALENT CABLES		ATTACHMENT METHOD	P R I C E			
					1-24	25-49	50-99	100 +
SSMA MALE FOR CABLE ATTACHMENT	Model No. PE44379	RG174, RG188, RG316		CRIMP	\$15.55	\$14.46	\$13.37	\$12.44
	PE4184	RG174, RG188, RG316		SOLDER	17.70	16.46	15.22	14.16
	PE44416	RG188-DS, RG316-DS		CRIMP	16.45	15.30	14.15	13.16
	PE44417	RG188-DS, RG316-DS		SOLDER	17.55	16.32	15.09	14.04
	PE44381	RG178, RG196		CRIMP	17.70	16.46	15.22	14.16
	PE4199	RG178, RG196		SOLDER	20.85	19.39	17.93	16.68
	PE44382	RG405, PE-SR405AL, PE-SR405FL (.085" SEMI-RIGID)		SOLDER(WITHOUT CONTACT)	17.70	16.46	15.22	14.16
	PE44383	RG405, PE-SR405AL, PE-SR405FL (.085" SEMI-RIGID)		SOLDER(WITH CONTACT)	17.70	16.46	15.22	14.16
	PE44440	PE-034SR (.034" SEMI-RIGID)		SOLDER	18.75	17.44	16.13	15.00
	PE44441	PE-047SR, PE-SR047AL, PE-SR047FL (.047" SEMI-RIGID)		SOLDER	18.75	17.44	16.13	15.00
SSMA MALE RIGHT ANGLE FOR CABLE ATTACHMENT	PE44378	RG174, RG188, RG316		CRIMP	18.75	17.44	16.13	15.00
	PE44401	RG174, RG188, RG316		SOLDER	24.95	23.20	21.46	19.96
	PE44418	RG188-DS, RG316-DS		CRIMP	20.90	19.44	17.97	16.72
	PE44419	RG188-DS, RG316-DS		SOLDER	20.85	19.39	17.93	16.68
	PE44380	RG178, RG196		CRIMP	20.85	19.39	17.93	16.68
	PE44402	RG178, RG196		SOLDER	20.85	19.39	17.93	16.68
	PE44384	RG405, PE-SR405AL, PE-SR405FL (.085")		SOLDER	20.85	19.39	17.93	16.68
	PE44420	PE-034SR (.034" SEMI-RIGID)		SOLDER	29.20	27.16	25.11	23.36
	PE44421	PE-047SR, PE-SR047AL, PE-SR047FL (.047" SEMI-RIGID)		SOLDER	29.20	27.16	25.11	23.36
	SSMA FEMALE FOR CABLE ATTACHMENT	PE44385	RG174, RG188, RG316		CRIMP	17.40	16.18	14.96
PE44403		RG174, RG188, RG316		SOLDER	18.70	17.39	16.08	14.96
PE44422		RG188-DS, RG315-DS		CRIMP	19.80	18.41	17.03	15.84
PE44423		RG188-DS, RG316-DS		SOLDER	20.85	19.39	17.93	16.68
PE44386		RG178, RG196		CRIMP	30.10	27.99	25.89	24.08
PE44404		RG178, RG196		SOLDER	18.70	17.39	16.08	14.96
PE44387		RG405, PE-SR405AL, PE-SR405FL (.085")		SOLDER	17.40	16.18	14.96	13.92
PE44424		PE-034SR (.034" SEMI-RIGID)		SOLDER	22.90	21.30	19.69	18.32
PE44425		PE-047SR, PE-SR047AL, PE-SR047FL (.047" SEMI-RIGID)		SOLDER	21.80	20.27	18.75	17.44
SSMA FEMALE BULKHEAD FOR CABLE ATTACHMENT		PE44388	RG174, RG188, RG316		CRIMP	24.00	22.32	20.64
	PE44405	RG174, RG188, RG316		SOLDER	19.80	18.41	17.03	15.84
	PE44426	RG188-DS, RG316-DS		CRIMP	20.85	19.39	17.93	16.68
	PE44427	RG188-DS, RG316-DS		SOLDER	19.80	18.41	17.03	15.84
	PE44389	RG178, RG196		CRIMP	21.95	20.41	18.88	17.56
	PE44406	RG178, RG196		SOLDER	19.80	18.41	17.03	15.84
	PE44390	RG405, PE-SR405AL, PE-SR405FL (.085")		SOLDER	19.80	18.41	17.03	15.84
	PE44428	PE-034SR (.034" SEMI-RIGID)		SOLDER	28.30	26.32	24.34	22.64
	PE44429	PE-047SR, PE-SR047AL, PE-SR047FL (.047" SEMI-RIGID)		SOLDER	28.30	26.32	24.34	22.64

Connectors

## USE MOUNTING HOLE B01

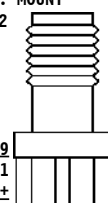
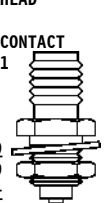
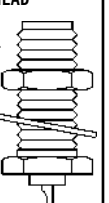
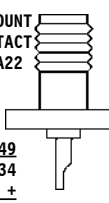
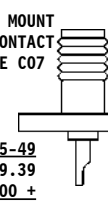
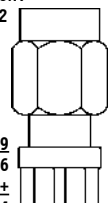
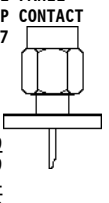
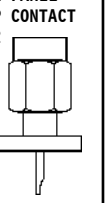
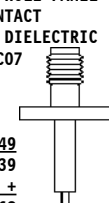
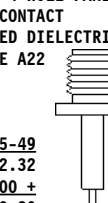
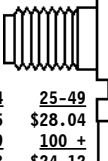
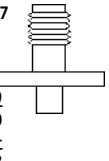
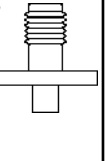
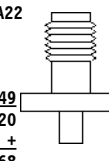
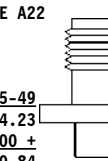
<p>Model No. PE44391 SSMA FEMALE, P.C. MOUNT MOUNTING HOLE D02</p>  <table border="1"> <tr> <td>1-24</td> <td>25-49</td> </tr> <tr> <td>\$19.80</td> <td>\$18.41</td> </tr> <tr> <td>50-99</td> <td>100 +</td> </tr> <tr> <td>\$17.03</td> <td>\$15.84</td> </tr> </table>	1-24	25-49	\$19.80	\$18.41	50-99	100 +	\$17.03	\$15.84	<p>Model No. PE44392 SSMA FEMALE BULKHEAD FRONT MOUNT TURRET TERMINAL CONTACT MOUNTING HOLE B01</p>  <table border="1"> <tr> <td>1-24</td> <td>25-49</td> </tr> <tr> <td>\$20.85</td> <td>\$19.39</td> </tr> <tr> <td>50-99</td> <td>100 +</td> </tr> <tr> <td>\$17.93</td> <td>\$16.68</td> </tr> </table>	1-24	25-49	\$20.85	\$19.39	50-99	100 +	\$17.93	\$16.68	<p>Model No. PE44393 SSMA FEMALE BULKHEAD REAR MOUNT MOUNTING HOLE B01</p>  <table border="1"> <tr> <td>1-24</td> <td>25-49</td> </tr> <tr> <td>\$18.75</td> <td>\$17.44</td> </tr> <tr> <td>50-99</td> <td>100 +</td> </tr> <tr> <td>\$16.13</td> <td>\$15.00</td> </tr> </table>	1-24	25-49	\$18.75	\$17.44	50-99	100 +	\$16.13	\$15.00	<p>Model No. PE44394 SSMA FEMALE 4 HOLE PANEL MOUNT SOLDER CUP CONTACT MOUNTING HOLE A22</p>  <table border="1"> <tr> <td>1-24</td> <td>25-49</td> </tr> <tr> <td>\$22.95</td> <td>\$21.34</td> </tr> <tr> <td>50-99</td> <td>100 +</td> </tr> <tr> <td>\$19.74</td> <td>\$18.36</td> </tr> </table>	1-24	25-49	\$22.95	\$21.34	50-99	100 +	\$19.74	\$18.36	<p>Model No. PE44395 SSMA FEMALE 2 HOLE PANEL MOUNT SOLDER CUP CONTACT MOUNTING HOLE C07</p>  <table border="1"> <tr> <td>1-24</td> <td>25-49</td> </tr> <tr> <td>\$20.85</td> <td>\$19.39</td> </tr> <tr> <td>50-99</td> <td>100 +</td> </tr> <tr> <td>\$17.93</td> <td>\$16.68</td> </tr> </table>	1-24	25-49	\$20.85	\$19.39	50-99	100 +	\$17.93	\$16.68
1-24	25-49																																											
\$19.80	\$18.41																																											
50-99	100 +																																											
\$17.03	\$15.84																																											
1-24	25-49																																											
\$20.85	\$19.39																																											
50-99	100 +																																											
\$17.93	\$16.68																																											
1-24	25-49																																											
\$18.75	\$17.44																																											
50-99	100 +																																											
\$16.13	\$15.00																																											
1-24	25-49																																											
\$22.95	\$21.34																																											
50-99	100 +																																											
\$19.74	\$18.36																																											
1-24	25-49																																											
\$20.85	\$19.39																																											
50-99	100 +																																											
\$17.93	\$16.68																																											
<p>Model No. PE44430 SSMA MALE, PC MOUNT MOUNTING HOLE D02</p>  <table border="1"> <tr> <td>1-24</td> <td>25-49</td> </tr> <tr> <td>\$16.30</td> <td>\$15.16</td> </tr> <tr> <td>50-99</td> <td>100 +</td> </tr> <tr> <td>\$14.02</td> <td>\$13.04</td> </tr> </table>	1-24	25-49	\$16.30	\$15.16	50-99	100 +	\$14.02	\$13.04	<p>Model No. PE44431 SSMA MALE, 2 HOLE PANEL MOUNT, SOLDER CUP CONTACT MOUNTING HOLE C07</p>  <table border="1"> <tr> <td>1-24</td> <td>25-49</td> </tr> <tr> <td>\$20.85</td> <td>\$19.39</td> </tr> <tr> <td>50-99</td> <td>100 +</td> </tr> <tr> <td>\$17.93</td> <td>\$16.68</td> </tr> </table>	1-24	25-49	\$20.85	\$19.39	50-99	100 +	\$17.93	\$16.68	<p>Model No. PE44432 SSMA MALE, 4 HOLE PANEL MOUNT, SOLDER CUP CONTACT MOUNTING HOLE A22</p>  <table border="1"> <tr> <td>1-24</td> <td>25-49</td> </tr> <tr> <td>\$20.85</td> <td>\$19.39</td> </tr> <tr> <td>50-99</td> <td>100 +</td> </tr> <tr> <td>\$17.93</td> <td>\$16.68</td> </tr> </table>	1-24	25-49	\$20.85	\$19.39	50-99	100 +	\$17.93	\$16.68	<p>Model No. PE44433 SSMA FEMALE, 2 HOLE PANEL MOUNT, STUB CONTACT .375" EXTENDED DIELECTRIC MOUNTING HOLE C07</p>  <table border="1"> <tr> <td>1-24</td> <td>25-49</td> </tr> <tr> <td>\$20.85</td> <td>\$19.39</td> </tr> <tr> <td>50-99</td> <td>100 +</td> </tr> <tr> <td>\$17.93</td> <td>\$16.68</td> </tr> </table>	1-24	25-49	\$20.85	\$19.39	50-99	100 +	\$17.93	\$16.68	<p>Model No. PE44434 SSMA FEMALE, 4 HOLE PANEL MOUNT, STUB CONTACT .375" EXTENDED DIELECTRIC MOUNTING HOLE A22</p>  <table border="1"> <tr> <td>1-24</td> <td>25-49</td> </tr> <tr> <td>\$24.00</td> <td>\$22.32</td> </tr> <tr> <td>50-99</td> <td>100 +</td> </tr> <tr> <td>\$20.64</td> <td>\$19.20</td> </tr> </table>	1-24	25-49	\$24.00	\$22.32	50-99	100 +	\$20.64	\$19.20
1-24	25-49																																											
\$16.30	\$15.16																																											
50-99	100 +																																											
\$14.02	\$13.04																																											
1-24	25-49																																											
\$20.85	\$19.39																																											
50-99	100 +																																											
\$17.93	\$16.68																																											
1-24	25-49																																											
\$20.85	\$19.39																																											
50-99	100 +																																											
\$17.93	\$16.68																																											
1-24	25-49																																											
\$20.85	\$19.39																																											
50-99	100 +																																											
\$17.93	\$16.68																																											
1-24	25-49																																											
\$24.00	\$22.32																																											
50-99	100 +																																											
\$20.64	\$19.20																																											
<p>Model No. PE44435 SSMA FEMALE RIGHT ANGLE P.C. MOUNT MOUNTING HOLE D02</p>  <table border="1"> <tr> <td>1-24</td> <td>25-49</td> </tr> <tr> <td>\$30.15</td> <td>\$28.04</td> </tr> <tr> <td>50-99</td> <td>100 +</td> </tr> <tr> <td>\$25.93</td> <td>\$24.12</td> </tr> </table>	1-24	25-49	\$30.15	\$28.04	50-99	100 +	\$25.93	\$24.12	<p>Model No. PE44436 SSMA FEMALE, 2 HOLE PANEL MOUNT FOR PE-047SR, PE-SR047AL &amp; PE-SR047FL MOUNTING HOLE C07</p>  <table border="1"> <tr> <td>1-24</td> <td>25-49</td> </tr> <tr> <td>\$22.90</td> <td>\$21.30</td> </tr> <tr> <td>50-99</td> <td>100 +</td> </tr> <tr> <td>\$19.69</td> <td>\$18.32</td> </tr> </table>	1-24	25-49	\$22.90	\$21.30	50-99	100 +	\$19.69	\$18.32	<p>Model No. PE44437 SSMA FEMALE, 2 HOLE PANEL MOUNT FOR RG405, PE-SR405AL &amp; PE-SR405FL MOUNTING HOLE C07</p>  <table border="1"> <tr> <td>1-24</td> <td>25-49</td> </tr> <tr> <td>\$25.10</td> <td>\$23.34</td> </tr> <tr> <td>50-99</td> <td>100 +</td> </tr> <tr> <td>\$21.59</td> <td>\$20.08</td> </tr> </table>	1-24	25-49	\$25.10	\$23.34	50-99	100 +	\$21.59	\$20.08	<p>Model No. PE44438 SSMA FEMALE, 4 HOLE PANEL MOUNT FOR PE-047SR, PE-SR047FL &amp; PE-SR047FL MOUNTING HOLE A22</p>  <table border="1"> <tr> <td>1-24</td> <td>25-49</td> </tr> <tr> <td>\$27.10</td> <td>\$25.20</td> </tr> <tr> <td>50-99</td> <td>100 +</td> </tr> <tr> <td>\$23.31</td> <td>\$21.68</td> </tr> </table>	1-24	25-49	\$27.10	\$25.20	50-99	100 +	\$23.31	\$21.68	<p>Model No. PE44439 SSMA FEMALE, 4 HOLE PANEL MOUNT FOR RG405, PE-SR405AL &amp; PE-SR405FL MOUNTING HOLE A22</p>  <table border="1"> <tr> <td>1-24</td> <td>25-49</td> </tr> <tr> <td>\$26.05</td> <td>\$24.23</td> </tr> <tr> <td>50-99</td> <td>100 +</td> </tr> <tr> <td>\$22.40</td> <td>\$20.84</td> </tr> </table>	1-24	25-49	\$26.05	\$24.23	50-99	100 +	\$22.40	\$20.84
1-24	25-49																																											
\$30.15	\$28.04																																											
50-99	100 +																																											
\$25.93	\$24.12																																											
1-24	25-49																																											
\$22.90	\$21.30																																											
50-99	100 +																																											
\$19.69	\$18.32																																											
1-24	25-49																																											
\$25.10	\$23.34																																											
50-99	100 +																																											
\$21.59	\$20.08																																											
1-24	25-49																																											
\$27.10	\$25.20																																											
50-99	100 +																																											
\$23.31	\$21.68																																											
1-24	25-49																																											
\$26.05	\$24.23																																											
50-99	100 +																																											
\$22.40	\$20.84																																											

# SMA CONNECTORS

## SMA MALE FOR CABLE ATTACHMENT

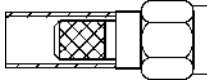
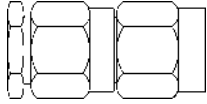

Model No.	FITS MIL SPEC AND EQUIVALENT CABLES	ATTACHMENT METHOD	1-24	25-49	50-99	100 +
PE4332	RG8, RG9, RG11, RG213, RG214, RG225, RG393	CLAMP	\$53.40	\$49.66	\$45.92	\$42.72
PE4027	RG55, RG58, RG142, RG223, RG400	CLAMP	17.70	16.46	15.22	14.16
PE4008	RG55, RG142, RG223, RG400	CRIMP	9.00	8.37	7.74	7.20
PE4576	RG55, RG142, RG223, RG400	CRIMP(CAPTIVE CONTACT)	15.60	14.51	13.42	12.48
PE4587	RG55, RG58, RG142, RG223, RG400	SOLDER(CAPTIVE CONTACT)	12.75	11.86	10.97	10.20
PE4037	RG55, RG58, RG142, RG223, RG400	SOLDER	11.20	10.42	9.63	8.96
PE4215	RG58	CRIMP	8.30	7.72	7.14	6.64
PE4577	RG58	CRIMP(CAPTIVE CONTACT)	15.60	14.51	13.42	12.48
PE4294	RG59B/U, RG62	CRIMP	17.75	16.51	15.27	14.20
PE4026	RG174, RG188, RG316	CLAMP	17.40	16.18	14.96	13.92
PE4003	RG174, RG188, RG316	CRIMP	11.10	10.32	9.55	8.88
PE4036	RG174, RG188, RG316	SOLDER	9.50	8.84	8.17	7.60
PE4589	RG174, RG188, RG316	CRIMP(CAPTIVE CONTACT)	11.95	11.11	10.28	9.56
PE4590	RG174, RG188, RG316	SOLDER(CAPTIVE CONTACT)	12.05	11.21	10.36	9.64
PE4214	RG178, RG196	CLAMP	33.40	31.06	28.72	26.72
PE4398	RG178, RG196	CRIMP	13.30	12.37	11.44	10.64
PE4213	RG178, RG196	SOLDER	13.20	12.28	11.35	10.56
PE4399	RG180, RG195	CLAMP	13.55	12.60	11.65	10.84
PE4578	RG180, RG195	CRIMP	15.60	14.51	13.42	12.48
PE4400	RG188-DS, RG316-DS	CLAMP	19.95	18.55	17.16	15.96
PE4401	RG188-DS, RG316-DS	CRIMP	10.40	9.67	8.94	8.32
PE4402	RG188-DS, RG316-DS	SOLDER	10.95	10.18	9.42	8.76
PE4403	RG401, PE-SR401AL, PE-SR401FL (.250")	SOLDER/CLAMP	30.85	28.69	26.53	24.68
PE4907	RG401, PE-SR401AL, PE-SR401FL (.250")	DIRECT SOLDER	31.30	29.11	26.92	25.04
PE4007	RG402, PE-SR402AL, PE-SR402FL (.141")	SOLDER(WITHOUT CONTACT)	5.50	5.12	4.73	4.40
PE4112	RG402, PE-SR402AL, PE-SR402FL (.141")	SOLDER(WITH CONTACT)	6.60	6.14	5.68	5.28
PE4005	RG405, PE-SR405AL, PE-SR405FL (.085")	SOLDER	5.90	5.49	5.07	4.72
PE4918	PE-020SR (.020" SEMI-RIGID)	SOLDER	28.30	26.32	24.34	22.64
PE4917	PE-034SR (.034" SEMI-RIGID)	SOLDER	35.25	32.78	30.32	28.20
PE4404	PE-047SR, PE-SR047AL, PE-SR047FL (.047")	SOLDER	16.60	15.44	14.28	13.28
PE44203	PE-142LL	CRIMP	10.00	9.30	8.60	8.00
PE4085	PE-142SLL	CRIMP	15.60	14.51	13.42	12.48

Connectors

## SMA MALE RIGHT ANGLE FOR CABLE ATTACHMENT

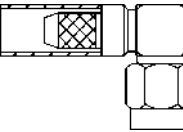
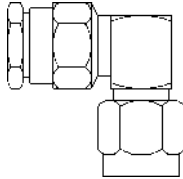

PE4029	RG55, RG58, RG142, RG223, RG400	CLAMP	18.50	17.21	15.91	14.80
PE4002	RG55, RG142, RG223, RG400	CRIMP	13.30	12.37	11.44	10.64
PE4039	RG55, RG58, RG142, RG223, RG400	SOLDER	13.20	12.28	11.35	10.56
PE4405	RG58	CRIMP	13.20	12.28	11.35	10.56
PE4327	RG59B/U, RG62	CRIMP	21.80	20.27	18.75	17.44
PE4028	RG174, RG188, RG316	CLAMP	21.00	19.53	18.06	16.80
PE4009	RG174, RG188, RG316	CRIMP	13.30	12.37	11.44	10.64
PE4038	RG174, RG188, RG316	SOLDER	13.20	12.28	11.35	10.56
PE4108	RG178, RG196	CLAMP	13.05	12.14	11.22	10.44
PE4296	RG178, RG196	CRIMP	18.10	16.83	15.57	14.48
PE4406	RG178, RG196	SOLDER	17.55	16.32	15.09	14.04
PE4579	RG180, RG195	CLAMP	16.30	15.16	14.02	13.04
PE4580	RG180, RG195	CRIMP	16.30	15.16	14.02	13.04
PE4407	RG188-DS, RG316-DS	CLAMP	19.60	18.23	16.86	15.68
PE4408	RG188-DS, RG316-DS	CRIMP	15.40	14.32	13.24	12.32
PE4409	RG188-DS, RG316-DS	SOLDER	15.40	14.32	13.24	12.32
PE4932	RG401, PE-SR401AL, PE-SR401FL (.250")	SOLDER	34.30	31.90	29.50	27.44
PE4083	RG402, PE-SR402AL, PE-SR402FL (.141")	SOLDER	18.85	17.53	16.21	15.08
PE4025	RG405, PE-SR405AL, PE-SR405FL (.085")	SOLDER	20.00	18.60	17.20	16.00
PE4920	PE-020SR (.020" SEMI-RIGID)	SOLDER	38.60	35.90	33.20	30.88
PE4919	PE-034SR (.034" SEMI-RIGID)	SOLDER	36.50	33.95	31.39	29.20
PE4410	PE-047SR, PE-SR047AL, PE-SR047FL (.047")	SOLDER	40.20	37.39	34.57	32.16

## SMA FEMALE FOR CABLE ATTACHMENT

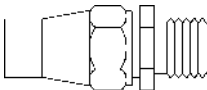

PE4411	RG8, RG9, RG11, RG213, RG214, RG225, RG393	CLAMP	36.50	33.95	31.39	29.20
PE4031	RG55, RG58, RG142, RG223, RG400	CLAMP	26.05	24.23	22.40	20.84
PE4412	RG55, RG142, RG223, RG400	CRIMP	11.10	10.32	9.55	8.88
PE4041	RG55, RG58, RG142, RG223, RG400	SOLDER	10.95	10.18	9.42	8.76
PE4413	RG58	CRIMP	13.55	12.60	11.65	10.84
PE4326	RG59B/U, RG62	CRIMP	17.70	16.46	15.22	14.16
PE4030	RG174, RG188, RG316	CLAMP	18.75	17.44	16.13	15.00
PE4414	RG174, RG188, RG316	CRIMP	11.10	10.32	9.55	8.88
PE4040	RG174, RG188, RG316	SOLDER	10.95	10.18	9.42	8.76
PE4325	RG178, RG196	CRIMP	18.35	17.07	15.78	14.68
PE4591	RG178, RG196	CLAMP	18.75	17.44	16.13	15.00
PE4592	RG178, RG196	SOLDER	16.45	15.30	14.15	13.16
PE4415	RG188-DS, RG316-DS	CLAMP	18.75	17.44	16.13	15.00
PE4416	RG188-DS, RG316-DS	CRIMP	13.55	12.60	11.65	10.84
PE4417	RG188-DS, RG316-DS	SOLDER	12.05	11.21	10.36	9.64
PE4930	RG401, PE-SR401AL, PE-SR401FL (.250")	SOLDER	17.40	16.18	14.96	13.92
PE4115	RG402, PE-SR402AL, PE-SR402FL (.141")	SOLDER	8.85	8.23	7.61	7.08
PE4116	RG405, PE-SR405AL, PE-SR405FL (.085")	SOLDER	15.55	14.46	13.37	12.44
PE4922	PE-020SR (.020" SEMI-RIGID)	SOLDER	35.50	33.02	30.53	28.40
PE4921	PE-034SR (.034" SEMI-RIGID)	SOLDER	36.50	33.95	31.39	29.20
PE4418	PE-047SR, PE-SR047AL, PE-SR047FL (.047")	SOLDER	23.70	22.04	20.38	18.96

# SMA CONNECTORS

SEE PAGE 266 FOR MOUNTING HOLES

SMA FEMALE  
BULKHEAD  
FOR CABLE  
ATTACHMENT

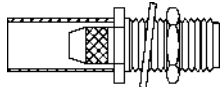
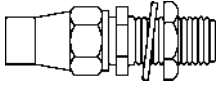

Model No.	FITS MIL SPEC AND EQUIVALENT CABLES	ATTACHMENT METHOD	PRICE			
			1-24	25-49	50-99	100 +
PE4033	RG55, RG58, RG142, RG223, RG400	CLAMP	\$20.85	\$19.39	\$17.93	\$16.68
PE4419	RG55, RG142, RG223, RG400	CRIMP	13.30	12.37	11.44	10.64
PE4353	RG55, RG58, RG142, RG223, RG400	SOLDER	13.55	12.60	11.65	10.84
PE4420	RG58	CRIMP	13.20	12.28	11.35	10.56
PE4914	RG59B/U, RG62	CRIMP	17.40	16.18	14.96	13.92
PE4032	RG174, RG188, RG316	CLAMP	19.80	18.41	17.03	15.84
PE4427	RG174, RG188, RG316	CRIMP	13.80	12.83	11.87	11.04
PE4188	RG174, RG188, RG316	SOLDER	13.20	12.28	11.35	10.56
PE4187	RG174, RG188, RG316	CRIMP(CAPTIVE CONTACT)	14.15	13.16	12.17	11.32
PE4428	RG174, RG188, RG316	SOLDER(CAPTIVE CONTACT)	14.60	13.58	12.56	11.68
PE4421	RG178, RG196	CLAMP	19.80	18.41	17.03	15.84
PE4422	RG178, RG196	CRIMP	18.50	17.21	15.91	14.80
PE4423	RG178, RG196	SOLDER	18.70	17.39	16.08	14.96
PE4424	RG188-DS, RG316-DS	CLAMP	26.05	24.23	22.40	20.84
PE4425	RG188-DS, RG316-DS	CRIMP	15.65	14.55	13.46	12.52
PE4426	RG188-DS, RG316-DS	SOLDER	14.30	13.30	12.30	11.44
PE4931	RG401, PE-SR401AL, PE-SR401FL (.250")	SOLDER	22.95	21.34	19.74	18.36
PE4120	RG402, PE-SR402AL, PE-SR402FL (.141")	SOLDER	10.00	9.30	8.60	8.00
PE4119	RG405, PE-SR405AL, PE-SR405FL (.085")	SOLDER	11.45	10.65	9.85	9.16
PE4924	PE-020SR (.020" SEMI-RIGID)	SOLDER	38.15	35.48	32.81	30.52
PE4923	PE-034SR (.034" SEMI-RIGID)	SOLDER	39.65	36.87	34.10	31.72
PE4581	PE-047SR, PE-SR047AL, PE-SR047FL (.047")	SOLDER	32.70	30.41	28.12	26.16

## MOUNTING HOLE B02

SMA MALE  
QUICK  
DISCONNECT

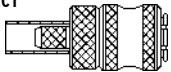

PE44460	RG58, RG141 & RG303	CRIMP	41.75	38.83	35.91	33.40
---------	---------------------	-------	-------	-------	-------	-------

SMA FEMALE  
2 HOLE  
PANEL MOUNT  
ATTACHMENT

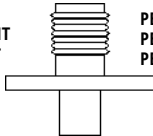

PE4196	RG402, PE-SR402AL, PE-SR402FL (.141")	SOLDER	15.60	14.51	13.42	12.48
PE4197	RG405, PE-SR405AL, PE-SR405FL (.085")	SOLDER	15.60	14.51	13.42	12.48
PE4547	PE-047SR, PE-SR047AL, PE-SR047FL (.047")	SOLDER	17.70	16.46	15.22	14.16

## MOUNTING HOLE C01

SMA FEMALE  
4 HOLE  
PANEL MOUNT  
ATTACHMENT

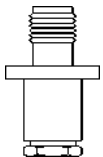

PE4034	RG174, RG188, RG316	CLAMP	36.50	33.95	31.39	29.20
PE4035	RG55, RG58, RG141, RG142, RG223, RG400	CLAMP	36.50	33.95	31.39	29.20
PE4121	RG402, PE-SR402AL, PE-SR402FL (.141")	SOLDER	21.85	20.32	18.79	17.48
PE4122	RG405, PE-SR405AL, PE-SR405FL (.085")	SOLDER	18.75	17.44	16.13	15.00
PE4548	PE-047SR, PE-SR047AL, PE-SR047FL (.047")	SOLDER	24.00	22.32	20.64	19.20

## MOUNTING HOLE A01

SMA FEMALE  
END LAUNCH

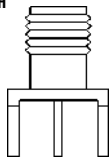

Model No.	BOARD THICKNESS	CONTACT SIZE	1-24	25-49	50-99	100 +
PE44206	.031"	.030" ROUND	\$12.75	\$11.86	\$10.97	\$10.20
PE44204	.042"	.030" ROUND	15.60	14.51	13.42	12.48
PE44205	.047"	.030" ROUND	15.60	14.51	13.42	12.48
PE4542	.062"	.030" ROUND	12.50	11.63	10.75	10.00
PE44207	.042"	.020" X .010" TAB	16.65	15.48	14.32	13.32
PE44208	.047"	.020" X .010" TAB	17.40	16.18	14.96	13.92
PE4543	.062"	.020" X .010" TAB	12.25	11.39	10.54	9.80

SMA FEMALE  
BULKHEAD  
END LAUNCH



PE44211	.042"	.030" ROUND	16.65	15.48	14.32	13.32
PE44212	.062"	.030" ROUND	16.65	15.48	14.32	13.32
PE44213	.042"	.020" X .010" TAB	16.65	15.48	14.32	13.32
PE44214	.062"	.020" X .010" TAB	16.65	15.48	14.32	13.32

## MOUNTING HOLE F01

SMA MALE  
END LAUNCH

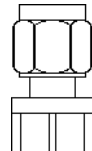

PE44209	.042"	.030" ROUND	19.80	18.41	17.03	15.84
PE4912	.062"	.030" ROUND	16.30	15.16	14.02	13.04
PE44210	.042"	.020" X .010" TAB	19.80	18.41	17.03	15.84
PE4913	.062"	.020" X .010" TAB	18.75	17.44	16.13	15.00

Connectors



# SMA CONNECTORS

SEE PAGE 266 FOR MOUNTING HOLES

Connectors

### Model No. PE4000

SMA FEMALE, 4 HOLE PANEL MOUNT, SOLDER CUP CONTACT MOUNTING HOLE A01

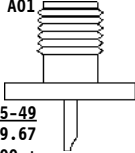

1-24	25-49
\$10.40	\$9.67
50-99	100 +
\$8.94	\$8.32

### Model No. PE4001

SMA FEMALE, 2 HOLE PANEL MOUNT, STUB CONTACT EXTENDED DIELECTRIC MOUNTING HOLE C01

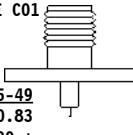

1-24	25-49
\$11.65	\$10.83
50-99	100 +
\$10.02	\$9.32

### Model No. PE4004

SMA FEMALE, 2 HOLE PANEL MOUNT, SOLDER CUP CONTACT MOUNTING HOLE C01

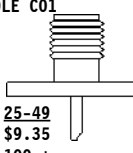

1-24	25-49
\$10.05	\$9.35
50-99	100 +
\$8.64	\$8.04

### Model No. PE4099

SMA FEMALE, 4 HOLE PANEL MOUNT, STUB CONTACT .590" EXTENDED DIELECTRIC MOUNTING HOLE A01

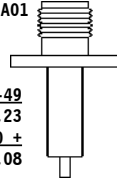

1-24	25-49
\$8.85	\$8.23
50-99	100 +
\$7.61	\$7.08

### Model No. PE4101

SMA FEMALE BULKHEAD, REAR MOUNT, SOLDER CUP CONTACT MOUNTING HOLE B02

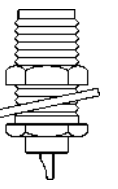

1-24	25-49
\$8.85	\$8.23
50-99	100 +
\$7.61	\$7.08

### Model No. PE4117

SMA FEMALE, P.C. MOUNT MOUNTING HOLE D01

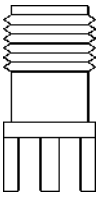

1-24	25-49
\$11.10	\$10.32
50-99	100 +
\$9.55	\$8.88

### Model No. PE4118

SMA FEMALE, RIGHT ANGLE P.C. MOUNT MOUNTING HOLE D01

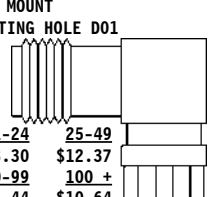

1-24	25-49
\$13.30	\$12.37
50-99	100 +
\$11.44	\$10.64

### Model No. PE4123

SMA FEMALE, RIGHT ANGLE 4 HOLE PANEL MOUNT SOLDER CUP CONTACT MOUNTING HOLE A01

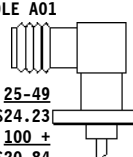

1-24	25-49
\$26.05	\$24.23
50-99	100 +
\$22.40	\$20.84

### Model No. PE4124

SMA MALE, 4 HOLE PANEL MOUNT, SOLDER CUP CONTACT MOUNTING HOLE A01

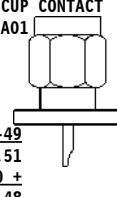

1-24	25-49
\$15.60	\$14.51
50-99	100 +
\$13.42	\$12.48

### Model No. PE4125

SMA MALE, 2 HOLE PANEL MOUNT, SOLDER CUP CONTACT MOUNTING HOLE C01

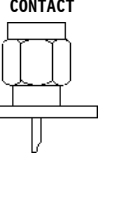

1-24	25-49
\$17.95	\$16.69
50-99	100 +
\$15.44	\$14.36

### Model No. PE4126

SMA MALE, 4 HOLE PANEL MOUNT, STUB CONTACT .330" EXTENDED DIELECTRIC MOUNTING HOLE A01

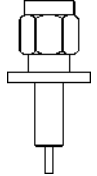

1-24	25-49
\$15.25	\$14.18
50-99	100 +
\$13.12	\$12.20

### Model No. PE4127

SMA MALE, 2 HOLE PANEL MOUNT, STUB CONTACT .330" EXTENDED DIELECTRIC MOUNTING HOLE C02

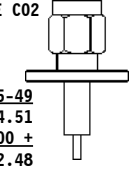

1-24	25-49
\$15.60	\$14.51
50-99	100 +
\$13.42	\$12.48

### Model No. PE4128

SMA FEMALE, 2 HOLE PANEL MOUNT, STUB CONTACT .590" EXTENDED DIELECTRIC MOUNTING HOLE C01

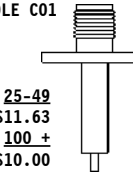

1-24	25-49
\$12.50	\$11.63
50-99	100 +
\$10.75	\$10.00

### Model No. PE4186

SMA FEMALE, 4 HOLE PANEL MOUNT, FLUSH DIELECTRIC REMOVABLE TAB CONTACT MOUNTING HOLE A01

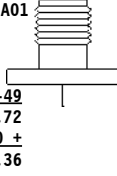

1-24	25-49
\$10.45	\$9.72
50-99	100 +
\$8.99	\$8.36

### Model No. PE4189

SMA FEMALE BULKHEAD .050" DIA. STUB CONTACT MOUNTING HOLE F01

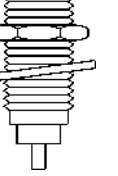

1-24	25-49
\$9.75	\$9.07
50-99	100 +
\$8.39	\$7.80

### Model No. PE4190

SMA FEMALE, STRIPLINE END LAUNCH, CAPTIVE TAB CONTACT, 1/8" GROUND PLANE SPACING

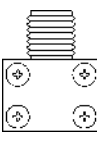

1-24	25-49
\$30.90	\$28.74
50-99	100 +
\$26.57	\$24.72

### Model No. PE4216

SMA FEMALE, 4 HOLE PANEL MOUNT, 1" FLANGE, .012" WIDTH SLOT IN CONTACT MOUNTING HOLE A05

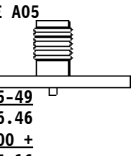

1-24	25-49
\$17.70	\$16.46
50-99	100 +
\$15.22	\$14.16

### Model No. PE4217

SMA FEMALE, 4 HOLE PANEL MOUNT, .5" FLANGE, .012" WIDTH SLOT IN CONTACT MOUNTING HOLE A01

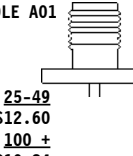

1-24	25-49
\$13.55	\$12.60
50-99	100 +
\$11.65	\$10.84

### Model No. PE4218

SMA FEMALE, 4 HOLE PANEL MOUNT, 1" FLANGE SOLDER CUP CONTACT MOUNTING HOLE A05

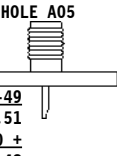

1-24	25-49
\$15.60	\$14.51
50-99	100 +
\$13.42	\$12.48

### Model No. PE4219

SMA FEMALE BULKHEAD FRONT MOUNT SOLDER CUP CONTACT MOUNTING HOLE B02

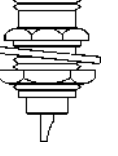

1-24	25-49
\$8.65	\$8.04
50-99	100 +
\$7.44	\$6.92

### Model No. PE4220

SMA FEMALE, RADIUS RIGHT ANGLE, 4 HOLE PANEL MOUNT SOLDER CUP CONTACT MOUNTING HOLE A01

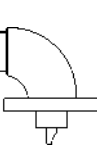

1-24	25-49
\$41.75	\$38.83
50-99	100 +
\$35.91	\$33.40

### Model No. PE4300

SMA FEMALE, RIGHT ANGLE BULKHEAD, SOLDER CUP CONTACT MOUNTING HOLE B02

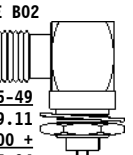

1-24	25-49
\$31.30	\$29.11
50-99	100 +
\$26.92	\$25.04

### Model No. PE4354

SMA MALE BULKHEAD, FRONT MOUNT, SOLDER CUP CONTACT MOUNTING HOLE B02

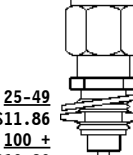

1-24	25-49
\$12.75	\$11.86
50-99	100 +
\$10.97	\$10.20

### Model No. PE4370

SMA FEMALE, 2 HOLE PANEL MOUNT, FLUSH DIELECTRIC REMOVABLE TAB CONTACT MOUNTING HOLE C01

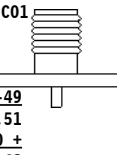

1-24	25-49
\$15.60	\$14.51
50-99	100 +
\$13.42	\$12.48

### Model No. PE4524

SMA FEMALE BULKHEAD P.C. MOUNT MOUNTING HOLE D01 MOUNTING HOLE B02

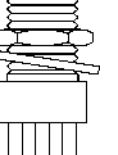

1-24	25-49
\$12.25	\$11.39
50-99	100 +
\$10.54	\$9.80

### Model No. PE4525

SMA MALE, P.C. MOUNT MOUNTING HOLE D01

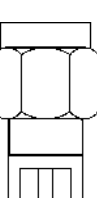

1-24	25-49
\$13.05	\$12.14
50-99	100 +
\$11.22	\$10.44

### Model No. PE4526

SMA MALE, RIGHT ANGLE P.C. MOUNT MOUNTING HOLE D01

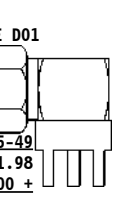

1-24	25-49
\$23.63	\$21.98
50-99	100 +
\$20.32	\$18.90

### Model No. PE4527

SMA FEMALE, 4 HOLE PANEL MOUNT, .687" FLANGE SOLDER CUP CONTACT MOUNTING HOLE A04

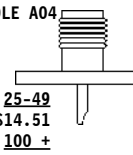

1-24	25-49
\$15.60	\$14.51
50-99	100 +
\$13.42	\$12.48

### Model No. PE4528

SMA FEMALE BULKHEAD REAR MOUNT, .020" DIA. STUB CONTACT, HERMETICALLY SEALED WITH O-RING MOUNTING HOLE B02

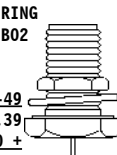

1-24	25-49
\$20.85	\$19.39
50-99	100 +
\$17.93	\$16.68

### Model No. PE4529



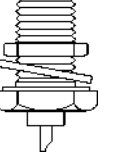





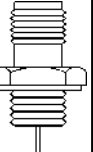
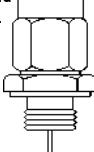

SMA FEMALE BULKHEAD, REAR MOUNT, SOLDER CUP CONTACT WITH O-RING MOUNTING HOLE B02

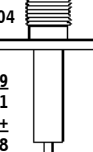
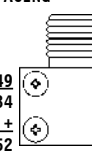
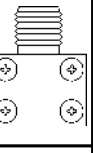
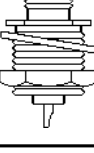
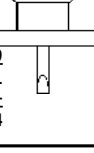
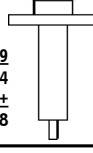
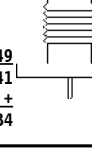
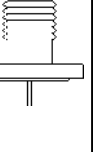
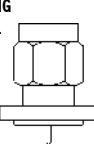
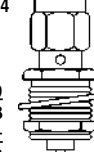

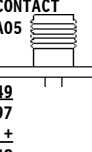
1-24	25-49
\$13.55	\$12.60
50-99	100 +
\$11.65	\$10.84

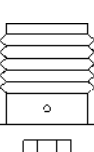
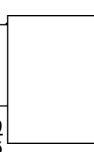
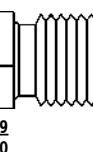
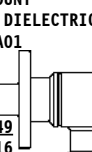
# SMA CONNECTORS

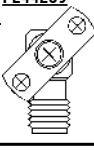
SEE PAGE 266 FOR MOUNTING HOLES

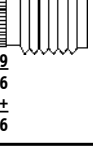
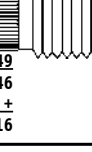
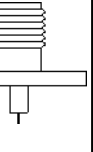
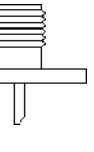
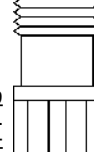
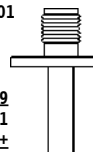
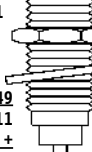
<p>Model No. PE4530 SMA FEMALE BULKHEAD, FRONT MOUNT, .020" DIA. STUB CONTACT, HERMETICALLY SEALED WITH O-RING MOUNTING HOLE F01</p>  <table border="1"> <tr><td>1-24</td><td>25-49</td></tr> <tr><td>\$21.90</td><td>\$20.37</td></tr> <tr><td>50-99</td><td>100 +</td></tr> <tr><td>\$18.83</td><td>\$17.52</td></tr> </table>	1-24	25-49	\$21.90	\$20.37	50-99	100 +	\$18.83	\$17.52	<p>Model No. PE4531 SMA MALE BULKHEAD, FRONT MOUNT, .020" DIA. STUB CONTACT, HERMETICALLY SEALED WITH O-RING MOUNTING HOLE F01</p>  <table border="1"> <tr><td>1-24</td><td>25-49</td></tr> <tr><td>\$24.00</td><td>\$22.32</td></tr> <tr><td>50-99</td><td>100 +</td></tr> <tr><td>\$20.64</td><td>\$19.20</td></tr> </table>	1-24	25-49	\$24.00	\$22.32	50-99	100 +	\$20.64	\$19.20	<p>Model No. PE4532 SMA FEMALE BULKHEAD .020" DIA. STUB CONTACT HERMETICALLY SEALED MOUNTING HOLE F01</p>  <table border="1"> <tr><td>1-24</td><td>25-49</td></tr> <tr><td>\$17.70</td><td>\$16.46</td></tr> <tr><td>50-99</td><td>100 +</td></tr> <tr><td>\$15.22</td><td>\$14.16</td></tr> </table>	1-24	25-49	\$17.70	\$16.46	50-99	100 +	\$15.22	\$14.16	<p>Model No. PE4533 SMA FEMALE, 4 HOLE PANEL MOUNT, .687" FLANGE, STUB CONTACT, .590" EXTENDED DIELECTRIC MOUNTING HOLE A04</p>  <table border="1"> <tr><td>1-24</td><td>25-49</td></tr> <tr><td>\$15.60</td><td>\$14.51</td></tr> <tr><td>50-99</td><td>100 +</td></tr> <tr><td>\$13.42</td><td>\$12.48</td></tr> </table>	1-24	25-49	\$15.60	\$14.51	50-99	100 +	\$13.42	\$12.48	<p>Model No. PE4534 SMA FEMALE, STRIPLINE END LAUNCH, CAPTIVE TAB CONTACT, 1/16" GROUND PLANE SPACING</p>  <table border="1"> <tr><td>1-24</td><td>25-49</td></tr> <tr><td>\$29.40</td><td>\$27.34</td></tr> <tr><td>50-99</td><td>100 +</td></tr> <tr><td>\$25.28</td><td>\$23.52</td></tr> </table>	1-24	25-49	\$29.40	\$27.34	50-99	100 +	\$25.28	\$23.52
1-24	25-49																																											
\$21.90	\$20.37																																											
50-99	100 +																																											
\$18.83	\$17.52																																											
1-24	25-49																																											
\$24.00	\$22.32																																											
50-99	100 +																																											
\$20.64	\$19.20																																											
1-24	25-49																																											
\$17.70	\$16.46																																											
50-99	100 +																																											
\$15.22	\$14.16																																											
1-24	25-49																																											
\$15.60	\$14.51																																											
50-99	100 +																																											
\$13.42	\$12.48																																											
1-24	25-49																																											
\$29.40	\$27.34																																											
50-99	100 +																																											
\$25.28	\$23.52																																											
<p>Model No. PE4535 SMA FEMALE, STRIPLINE END LAUNCH, CAPTIVE TAB CONTACT, 1/4" GROUND PLANE SPACING</p>  <table border="1"> <tr><td>1-24</td><td>25-49</td></tr> <tr><td>\$36.50</td><td>\$33.95</td></tr> <tr><td>50-99</td><td>100 +</td></tr> <tr><td>\$31.39</td><td>\$29.20</td></tr> </table>	1-24	25-49	\$36.50	\$33.95	50-99	100 +	\$31.39	\$29.20	<p>Model No. PE4536 SMA FEMALE BULKHEAD, FRONT MOUNT, .380" MOUNTING HOLE SOLDER CUP CONTACT MOUNTING HOLE B04</p>  <table border="1"> <tr><td>1-24</td><td>25-49</td></tr> <tr><td>\$36.50</td><td>\$33.95</td></tr> <tr><td>50-99</td><td>100 +</td></tr> <tr><td>\$31.39</td><td>\$29.20</td></tr> </table>	1-24	25-49	\$36.50	\$33.95	50-99	100 +	\$31.39	\$29.20	<p>Model No. PE4537 SMA FEMALE, .500" X .375" 4 HOLE PANEL MOUNT SOLDER CUP CONTACT MOUNTING HOLE E01</p>  <table border="1"> <tr><td>1-24</td><td>25-49</td></tr> <tr><td>\$19.80</td><td>\$18.41</td></tr> <tr><td>50-99</td><td>100 +</td></tr> <tr><td>\$17.03</td><td>\$15.84</td></tr> </table>	1-24	25-49	\$19.80	\$18.41	50-99	100 +	\$17.03	\$15.84	<p>Model No. PE4538 SMA FEMALE, .500" X .375" 4 HOLE PANEL MOUNT, STUB CONTACT, .590" EXTENDED DIELECTRIC MOUNTING HOLE E01</p>  <table border="1"> <tr><td>1-24</td><td>25-49</td></tr> <tr><td>\$25.85</td><td>\$24.04</td></tr> <tr><td>50-99</td><td>100 +</td></tr> <tr><td>\$22.23</td><td>\$20.68</td></tr> </table>	1-24	25-49	\$25.85	\$24.04	50-99	100 +	\$22.23	\$20.68	<p>Model No. PE4539 SMA FEMALE, .500" X .375" 4 HOLE PANEL MOUNT FLUSH DIELECTRIC REMOVABLE TAB CONTACT MOUNTING HOLE E01</p>  <table border="1"> <tr><td>1-24</td><td>25-49</td></tr> <tr><td>\$19.80</td><td>\$18.41</td></tr> <tr><td>50-99</td><td>100 +</td></tr> <tr><td>\$17.03</td><td>\$15.84</td></tr> </table>	1-24	25-49	\$19.80	\$18.41	50-99	100 +	\$17.03	\$15.84
1-24	25-49																																											
\$36.50	\$33.95																																											
50-99	100 +																																											
\$31.39	\$29.20																																											
1-24	25-49																																											
\$36.50	\$33.95																																											
50-99	100 +																																											
\$31.39	\$29.20																																											
1-24	25-49																																											
\$19.80	\$18.41																																											
50-99	100 +																																											
\$17.03	\$15.84																																											
1-24	25-49																																											
\$25.85	\$24.04																																											
50-99	100 +																																											
\$22.23	\$20.68																																											
1-24	25-49																																											
\$19.80	\$18.41																																											
50-99	100 +																																											
\$17.03	\$15.84																																											
<p>Model No. PE4540 SMA FEMALE, 4 HOLE PANEL MOUNT, .020" DIA STUB CONTACT, HERMETICALLY SEALED WITH O-RING MOUNTING HOLE A01</p>  <table border="1"> <tr><td>1-24</td><td>25-49</td></tr> <tr><td>\$30.00</td><td>\$27.90</td></tr> <tr><td>50-99</td><td>100 +</td></tr> <tr><td>\$25.80</td><td>\$24.00</td></tr> </table>	1-24	25-49	\$30.00	\$27.90	50-99	100 +	\$25.80	\$24.00	<p>Model No. PE4541 SMA MALE, 4 HOLE PANEL MOUNT, .020" DIA. STUB CONTACT, HERMETICALLY SEALED WITH O-RING MOUNTING HOLE A01</p>  <table border="1"> <tr><td>1-24</td><td>25-49</td></tr> <tr><td>\$31.30</td><td>\$29.11</td></tr> <tr><td>50-99</td><td>100 +</td></tr> <tr><td>\$26.92</td><td>\$25.04</td></tr> </table>	1-24	25-49	\$31.30	\$29.11	50-99	100 +	\$26.92	\$25.04	<p>Model No. PE4544 SMA MALE BULKHEAD, FRONT MOUNT, .380" MOUNTING HOLE WITH SOLDER CUP CONTACT MOUNTING HOLE B04</p>  <table border="1"> <tr><td>1-24</td><td>25-49</td></tr> <tr><td>\$17.40</td><td>\$16.18</td></tr> <tr><td>50-99</td><td>100 +</td></tr> <tr><td>\$14.96</td><td>\$13.92</td></tr> </table>	1-24	25-49	\$17.40	\$16.18	50-99	100 +	\$14.96	\$13.92	<p>Model No. PE4545 SMA FEMALE BULKHEAD RIGHT ANGLE, P.C. MOUNT MOUNTING HOLE D01 MOUNTING HOLE B02</p>  <table border="1"> <tr><td>1-24</td><td>25-49</td></tr> <tr><td>\$20.30</td><td>\$18.88</td></tr> <tr><td>50-99</td><td>100 +</td></tr> <tr><td>\$17.46</td><td>\$16.24</td></tr> </table>	1-24	25-49	\$20.30	\$18.88	50-99	100 +	\$17.46	\$16.24	<p>Model No. PE4546 SMA FEMALE, 4 HOLE PANEL MOUNT, 1" FLANGE FLUSH DIELECTRIC REMOVABLE TAB CONTACT MOUNTING HOLE A05</p>  <table border="1"> <tr><td>1-24</td><td>25-49</td></tr> <tr><td>\$26.85</td><td>\$24.97</td></tr> <tr><td>50-99</td><td>100 +</td></tr> <tr><td>\$23.09</td><td>\$21.48</td></tr> </table>	1-24	25-49	\$26.85	\$24.97	50-99	100 +	\$23.09	\$21.48
1-24	25-49																																											
\$30.00	\$27.90																																											
50-99	100 +																																											
\$25.80	\$24.00																																											
1-24	25-49																																											
\$31.30	\$29.11																																											
50-99	100 +																																											
\$26.92	\$25.04																																											
1-24	25-49																																											
\$17.40	\$16.18																																											
50-99	100 +																																											
\$14.96	\$13.92																																											
1-24	25-49																																											
\$20.30	\$18.88																																											
50-99	100 +																																											
\$17.46	\$16.24																																											
1-24	25-49																																											
\$26.85	\$24.97																																											
50-99	100 +																																											
\$23.09	\$21.48																																											
<p>Model No. PE4549 SMA FEMALE BULKHEAD SOLDER CUP CONTACT MOUNTING HOLE F01</p>  <table border="1"> <tr><td>1-24</td><td>25-49</td></tr> <tr><td>\$13.05</td><td>\$12.14</td></tr> <tr><td>50-99</td><td>100 +</td></tr> <tr><td>\$11.22</td><td>\$10.44</td></tr> </table>	1-24	25-49	\$13.05	\$12.14	50-99	100 +	\$11.22	\$10.44	<p>Model No. PE4910 SMA FEMALE, SURFACE MOUNT</p>  <table border="1"> <tr><td>1-24</td><td>25-49</td></tr> <tr><td>\$11.45</td><td>\$10.65</td></tr> <tr><td>50-99</td><td>100 +</td></tr> <tr><td>\$9.85</td><td>\$9.16</td></tr> </table>	1-24	25-49	\$11.45	\$10.65	50-99	100 +	\$9.85	\$9.16	<p>Model No. PE4911 SMA FEMALE, RIGHT ANGLE SURFACE MOUNT</p>  <table border="1"> <tr><td>1-24</td><td>25-49</td></tr> <tr><td>\$16.30</td><td>\$15.16</td></tr> <tr><td>50-99</td><td>100 +</td></tr> <tr><td>\$14.02</td><td>\$13.04</td></tr> </table>	1-24	25-49	\$16.30	\$15.16	50-99	100 +	\$14.02	\$13.04	<p>Model No. PE44235 SMA FEMALE, SURFACE MOUNT END LAUNCH</p>  <table border="1"> <tr><td>1-24</td><td>25-49</td></tr> <tr><td>\$13.55</td><td>\$12.60</td></tr> <tr><td>50-99</td><td>100 +</td></tr> <tr><td>\$11.65</td><td>\$10.84</td></tr> </table>	1-24	25-49	\$13.55	\$12.60	50-99	100 +	\$11.65	\$10.84	<p>Model No. PE44236 SMA FEMALE, RIGHT ANGLE 4 HOLE PANEL MOUNT .590" EXTENDED DIELECTRIC MOUNTING HOLE A01</p>  <table border="1"> <tr><td>1-24</td><td>25-49</td></tr> <tr><td>\$29.20</td><td>\$27.16</td></tr> <tr><td>50-99</td><td>100 +</td></tr> <tr><td>\$25.11</td><td>\$23.36</td></tr> </table>	1-24	25-49	\$29.20	\$27.16	50-99	100 +	\$25.11	\$23.36
1-24	25-49																																											
\$13.05	\$12.14																																											
50-99	100 +																																											
\$11.22	\$10.44																																											
1-24	25-49																																											
\$11.45	\$10.65																																											
50-99	100 +																																											
\$9.85	\$9.16																																											
1-24	25-49																																											
\$16.30	\$15.16																																											
50-99	100 +																																											
\$14.02	\$13.04																																											
1-24	25-49																																											
\$13.55	\$12.60																																											
50-99	100 +																																											
\$11.65	\$10.84																																											
1-24	25-49																																											
\$29.20	\$27.16																																											
50-99	100 +																																											
\$25.11	\$23.36																																											
<p>Model No. PE44237 SMA FEMALE, RIGHT ANGLE 2 HOLE PANEL MOUNT 90° DIRECTION .590 EXTENDED DIELECTRIC MOUNTING HOLE C01</p>  <table border="1"> <tr><td>1-24</td><td>25-49</td></tr> <tr><td>\$29.20</td><td>\$27.16</td></tr> <tr><td>50-99</td><td>100 +</td></tr> <tr><td>\$25.11</td><td>\$23.36</td></tr> </table>	1-24	25-49	\$29.20	\$27.16	50-99	100 +	\$25.11	\$23.36	<p>Model No. PE44238 Model No. PE44239 SMA FEMALE, RIGHT ANGLE 2 HOLE PANEL MOUNT +45° DIRECTION. -45° DIRECTION, ORDER PE44239 MOUNTING HOLE C01</p>  <table border="1"> <tr><td>1-24</td><td>25-49</td></tr> <tr><td>\$29.20</td><td>\$27.16</td></tr> <tr><td>50-99</td><td>100 +</td></tr> <tr><td>\$25.11</td><td>\$23.36</td></tr> </table>	1-24	25-49	\$29.20	\$27.16	50-99	100 +	\$25.11	\$23.36	<p>Model No. PE44593 SMA FEMALE, RIGHT ANGLE 2 HOLE PANEL MOUNT 90° DIRECTION .250 EXTENDED DIELECTRIC MOUNTING HOLE C01</p>  <p><b>NEW</b></p> <table border="1"> <tr><td>1-24</td><td>25-49</td></tr> <tr><td>\$29.20</td><td>\$27.16</td></tr> <tr><td>50-99</td><td>100 +</td></tr> <tr><td>\$25.11</td><td>\$23.36</td></tr> </table>	1-24	25-49	\$29.20	\$27.16	50-99	100 +	\$25.11	\$23.36	<p>Model No. PE44240 SMA FEMALE, PRESS MOUNT .010" X .020" TAB CONTACT MOUNTING HOLE F07</p>  <table border="1"> <tr><td>1-24</td><td>25-49</td></tr> <tr><td>\$17.70</td><td>\$16.46</td></tr> <tr><td>50-99</td><td>100 +</td></tr> <tr><td>\$15.22</td><td>\$14.16</td></tr> </table>	1-24	25-49	\$17.70	\$16.46	50-99	100 +	\$15.22	\$14.16	<p>Model No. PE44241 SMA FEMALE, PRESS MOUNT .030" ROUND CONTACT MOUNTING HOLE F07</p>  <table border="1"> <tr><td>1-24</td><td>25-49</td></tr> <tr><td>\$17.70</td><td>\$16.46</td></tr> <tr><td>50-99</td><td>100 +</td></tr> <tr><td>\$15.22</td><td>\$14.16</td></tr> </table>	1-24	25-49	\$17.70	\$16.46	50-99	100 +	\$15.22	\$14.16
1-24	25-49																																											
\$29.20	\$27.16																																											
50-99	100 +																																											
\$25.11	\$23.36																																											
1-24	25-49																																											
\$29.20	\$27.16																																											
50-99	100 +																																											
\$25.11	\$23.36																																											
1-24	25-49																																											
\$29.20	\$27.16																																											
50-99	100 +																																											
\$25.11	\$23.36																																											
1-24	25-49																																											
\$17.70	\$16.46																																											
50-99	100 +																																											
\$15.22	\$14.16																																											
1-24	25-49																																											
\$17.70	\$16.46																																											
50-99	100 +																																											
\$15.22	\$14.16																																											
<p>Model No. PE44340 27 GHz SMA FEMALE, 2 HOLE PANEL MOUNT, STUB CONTACT EXTENDED DIELECTRIC MOUNTING HOLE C01 MAX VSWR 1.20:1 PRECISION CONNECTOR</p>  <table border="1"> <tr><td>1-24</td><td>25-49</td></tr> <tr><td>\$39.65</td><td>\$36.87</td></tr> <tr><td>50-99</td><td>100 +</td></tr> <tr><td>\$34.10</td><td>\$31.72</td></tr> </table>	1-24	25-49	\$39.65	\$36.87	50-99	100 +	\$34.10	\$31.72	<p>Model No. PE44341 27 GHz SMA FEMALE, 2 HOLE PANEL MOUNT, SOLDER CUP CONTACT, MOUNTING HOLE C01 MAX VSWR 1.20:1 PRECISION CONNECTOR</p>  <table border="1"> <tr><td>1-24</td><td>25-49</td></tr> <tr><td>\$31.30</td><td>\$29.11</td></tr> <tr><td>50-99</td><td>100 +</td></tr> <tr><td>\$26.92</td><td>\$25.04</td></tr> </table>	1-24	25-49	\$31.30	\$29.11	50-99	100 +	\$26.92	\$25.04	<p>Model No. PE44342 27 GHz SMA FEMALE, P.C. MOUNT MOUNTING HOLE D01 MAX VSWR 1.20:1 PRECISION CONNECTOR</p>  <table border="1"> <tr><td>1-24</td><td>25-49</td></tr> <tr><td>\$31.30</td><td>\$29.11</td></tr> <tr><td>50-99</td><td>100 +</td></tr> <tr><td>\$26.92</td><td>\$25.04</td></tr> </table>	1-24	25-49	\$31.30	\$29.11	50-99	100 +	\$26.92	\$25.04	<p>Model No. PE44343 27 GHz SMA FEMALE, 2 HOLE PANEL MOUNT, STUB CONTACT .590" EXTENDED DIELECTRIC MOUNTING HOLE C01 MAX VSWR 1.20:1 PRECISION CONNECTOR</p>  <table border="1"> <tr><td>1-24</td><td>25-49</td></tr> <tr><td>\$31.30</td><td>\$29.11</td></tr> <tr><td>50-99</td><td>100 +</td></tr> <tr><td>\$26.92</td><td>\$25.04</td></tr> </table>	1-24	25-49	\$31.30	\$29.11	50-99	100 +	\$26.92	\$25.04	<p>Model No. PE44344 27 GHz SMA FEMALE BULKHEAD .050" DIA STUB CONTACT MOUNTING HOLE F01 MAX VSWR 1.20:1 PRECISION CONNECTOR</p>  <table border="1"> <tr><td>1-24</td><td>25-49</td></tr> <tr><td>\$31.30</td><td>\$29.11</td></tr> <tr><td>50-99</td><td>100 +</td></tr> <tr><td>\$26.92</td><td>\$25.04</td></tr> </table>	1-24	25-49	\$31.30	\$29.11	50-99	100 +	\$26.92	\$25.04
1-24	25-49																																											
\$39.65	\$36.87																																											
50-99	100 +																																											
\$34.10	\$31.72																																											
1-24	25-49																																											
\$31.30	\$29.11																																											
50-99	100 +																																											
\$26.92	\$25.04																																											
1-24	25-49																																											
\$31.30	\$29.11																																											
50-99	100 +																																											
\$26.92	\$25.04																																											
1-24	25-49																																											
\$31.30	\$29.11																																											
50-99	100 +																																											
\$26.92	\$25.04																																											
1-24	25-49																																											
\$31.30	\$29.11																																											
50-99	100 +																																											
\$26.92	\$25.04																																											

Connectors

# SMA FIELD REPLACEABLE CONNECTORS

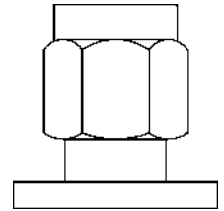
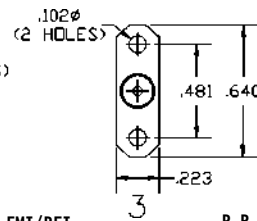
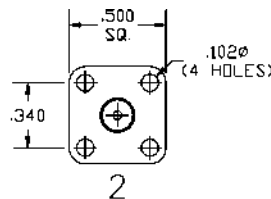
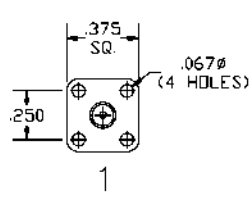
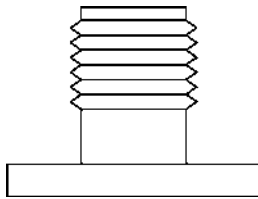

Model No.	CONNECTOR	FLANGE STYLE	ACCEPTS PIN SIZE	EMI/RFI GASKET	P R I C E			
					1-24	25-49	50-99	100 +
PE44000	FEMALE	1	.012	YES	\$20.85	\$19.39	\$17.93	\$16.68
PE44001	FEMALE	1	.015	YES	20.85	19.39	17.93	16.68
PE44002	FEMALE	1	.018	YES	20.85	19.39	17.93	16.68
PE44003	FEMALE	1	.020	NO	20.85	19.39	17.93	16.68
PE44004	FEMALE	1	.036	NO	20.85	19.39	17.93	16.68
PE44005	MALE	1	.012	YES	26.05	24.23	22.40	20.84
PE44006	MALE	1	.015	YES	26.05	24.23	22.40	20.84
PE44007	MALE	1	.018	YES	26.05	24.23	22.40	20.84
PE44008	MALE	1	.020	NO	26.05	24.23	22.40	20.84
PE44009	MALE	1	.036	NO	26.05	24.23	22.40	20.84
PE44010	FEMALE	2	.012	YES	20.85	19.39	17.93	16.68
PE44011	FEMALE	2	.015	YES	20.85	19.39	17.93	16.68
PE44012	FEMALE	2	.018	YES	20.85	19.39	17.93	16.68
PE44013	FEMALE	2	.020	NO	20.85	19.39	17.93	16.68
PE44014	FEMALE	2	.036	NO	20.85	19.39	17.93	16.68
PE44015	FEMALE RIGHT ANGLE	2	.012	YES	31.95	29.71	27.48	25.56
PE44016	FEMALE RIGHT ANGLE	2	.015	YES	31.30	29.11	26.92	25.04
PE44017	FEMALE RIGHT ANGLE	2	.018	YES	31.30	29.11	26.92	25.04
PE44018	MALE	2	.012	YES	26.05	24.23	22.40	20.84
PE44019	MALE	2	.015	YES	26.05	24.23	22.40	20.84
PE44020	MALE	2	.018	YES	26.05	24.23	22.40	20.84
PE44021	MALE	2	.020	NO	26.05	24.23	22.40	20.84
PE44022	MALE	2	.036	NO	26.05	24.23	22.40	20.84
PE44023	FEMALE	3	.012	YES	26.05	24.23	22.40	20.84
PE44024	FEMALE	3	.015	YES	20.85	19.39	17.93	16.68
PE44025	FEMALE	3	.018	YES	23.95	22.27	20.60	19.16
PE44026	FEMALE	3	.020	NO	20.85	19.39	17.93	16.68
PE44027	FEMALE	3	.036	NO	20.85	19.39	17.93	16.68
PE44028	MALE	3	.012	YES	26.05	24.23	22.40	20.84
PE44029	MALE	3	.015	YES	26.05	24.23	22.40	20.84
PE44030	MALE	3	.018	YES	26.05	24.23	22.40	20.84
PE44031	MALE	3	.020	NO	26.05	24.23	22.40	20.84
PE44032	MALE	3	.036	NO	26.05	24.23	22.40	20.84

Connectors

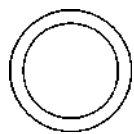

MODEL NO.  
PE1003-1

## EMI / RFI GASKET

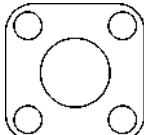

MOUNTING HOLE A01

**NEW**

MODEL NO.  
PE1003-2

PRICE PER PACKAGE OF 5	
1-24 PACKS*	25-49 PACKS*
\$13.05	\$12.14
50-99 PACKS*	100+ PACKS*
\$11.22	\$10.44

\*SOLD IN PACKS OF 5 PCS.

1-24	25-49
\$9.95	\$9.25
50-99	100 +
\$8.56	\$7.96

SOLD INDIVIDUALLY

## FIELD REPLACABLE CONTACTS FOR USE WITH CONNECTORS WITHOUT SEALS

Model No.	DIM A
PE1002-1	.020
PE1002-2	.036

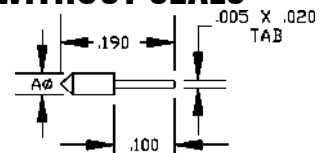

PRICE PER PACKAGE OF 5			
1-24 PACKS*	25-49 PACKS*	50-99 PACKS*	100+ PACKS*
\$13.05	\$12.14	\$11.22	\$10.44

\*SOLD IN PACKS OF 5 PCS.

## SOLDER IN HERMETIC SEALS

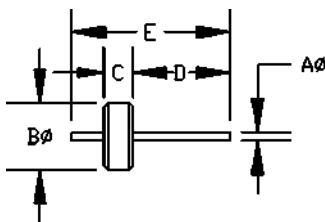

Model No.	DIMENSIONS					PRICE PER PACKAGE OF 5 *SOLD IN PACKS OF 5 PCS.			
	A	B	C	D	E				
PE1001-1	.012	.100	.063	.180	.315	\$14.15	\$13.16	\$12.17	\$11.32
PE1001-2	.015	.100	.063	.180	.315	15.25	14.18	13.12	12.20
PE1001-3	.018	.112	.063	.180	.315	14.15	13.16	12.17	11.32
PE1001-4	.020	.158	.069	.070	.220	15.25	14.18	13.12	12.20
PE1001-5	.020	.158	.069	.229	.375	15.25	14.18	13.12	12.20
PE1001-6	.012	.076	.055	.041	.125	17.40	16.18	14.96	13.92
PE1001-7	.009	.068	.055	.031	.112	80.80	75.14	69.49	64.64

# 3.5mm CONNECTORS

SEE PAGE 266 FOR MOUNTING HOLES

	Model No.	FITS MIL SPEC AND EQUIVALENT CABLES	ATTACHMENT METHOD	P R I C E			
				1-24	25-49	50-99	100 +
3.5mm MALE FOR CABLE ATTACHMENT	PE4981	RG402, PE-SR402AL, PE-SR402FL (.141")	SOLDER/CLAMP	\$57.85	\$53.80	\$49.75	\$46.28
	PE4982	RG405, PE-SR405AL, PE-SR405FL (.085")	SOLDER/CLAMP	57.85	53.80	49.75	46.28
3.5mm FEMALE FOR CABLE ATTACHMENT	PE4983	RG402, PE-SR402AL, PE-SR402FL (.141")	SOLDER/CLAMP	57.85	53.80	49.75	46.28
	PE4984	RG405, PE-SR405AL, PE-SR405FL (.085")	SOLDER/CLAMP	94.00	87.42	80.84	75.20
3.5mm FEMALE BULKHEAD FOR CABLE ATTACHMENT	PE4985	RG402, PE-SR402AL, PE-SR402FL (.141")	SOLDER/CLAMP	177.60	165.17	152.74	142.08
	PE4986	RG405, PE-SR405AL, PE-SR405FL (.085")	SOLDER/CLAMP	73.10	67.98	62.87	58.48

# 2.92mm CONNECTORS

SEE PAGE 266 FOR MOUNTING HOLES

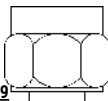
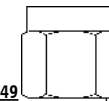
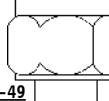
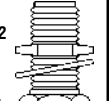
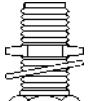
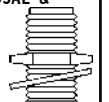
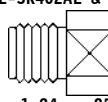
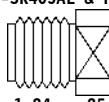
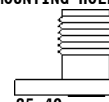
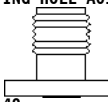
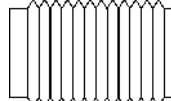
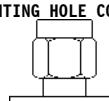
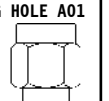
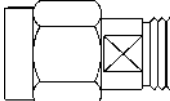
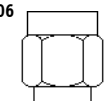
<p>Model No. PE4987 2.92mm MALE, SOLDER ATTACHMENT FOR RG402, PE-SR402AL &amp; PE-SR402FL</p>  <table> <tr><td>1-24</td><td>25-49</td></tr> <tr><td>\$31.30</td><td>\$29.11</td></tr> <tr><td>50-99</td><td>100 +</td></tr> <tr><td>\$26.92</td><td>\$25.04</td></tr> </table>	1-24	25-49	\$31.30	\$29.11	50-99	100 +	\$26.92	\$25.04	<p>Model No. PE4988 2.92mm MALE, SOLDER ATTACHMENT FOR RG405, PE-SR405AL &amp; PE-SR405FL</p>  <table> <tr><td>1-24</td><td>25-49</td></tr> <tr><td>\$31.30</td><td>\$29.11</td></tr> <tr><td>50-99</td><td>100 +</td></tr> <tr><td>\$26.92</td><td>\$25.04</td></tr> </table>	1-24	25-49	\$31.30	\$29.11	50-99	100 +	\$26.92	\$25.04	<p>Model No. PE4989 2.92mm MALE, SOLDER ATTACHMENT FOR .118" SEMI-RIGID</p>  <table> <tr><td>1-24</td><td>25-49</td></tr> <tr><td>\$41.75</td><td>\$38.83</td></tr> <tr><td>50-99</td><td>100 +</td></tr> <tr><td>\$35.91</td><td>\$33.40</td></tr> </table>	1-24	25-49	\$41.75	\$38.83	50-99	100 +	\$35.91	\$33.40	<p>Model No. PE4990 2.92mm FEMALE BULKHEAD SOLDER/CLAMP ATTACHMENT FOR RG402, PE-SR402AL &amp; PE-SR402FL MOUNTING HOLE B02</p>  <table> <tr><td>1-24</td><td>25-49</td></tr> <tr><td>\$83.55</td><td>\$77.70</td></tr> <tr><td>50-99</td><td>100 +</td></tr> <tr><td>\$71.85</td><td>\$66.84</td></tr> </table>	1-24	25-49	\$83.55	\$77.70	50-99	100 +	\$71.85	\$66.84	<p>Model No. PE4991 2.92mm FEMALE BULKHEAD SOLDER/CLAMP ATTACHMENT FOR .118" SEMI-RIGID MOUNTING HOLE B02</p>  <table> <tr><td>1-24</td><td>25-49</td></tr> <tr><td>\$99.20</td><td>\$92.26</td></tr> <tr><td>50-99</td><td>100 +</td></tr> <tr><td>\$85.31</td><td>\$79.36</td></tr> </table>	1-24	25-49	\$99.20	\$92.26	50-99	100 +	\$85.31	\$79.36
1-24	25-49																																											
\$31.30	\$29.11																																											
50-99	100 +																																											
\$26.92	\$25.04																																											
1-24	25-49																																											
\$31.30	\$29.11																																											
50-99	100 +																																											
\$26.92	\$25.04																																											
1-24	25-49																																											
\$41.75	\$38.83																																											
50-99	100 +																																											
\$35.91	\$33.40																																											
1-24	25-49																																											
\$83.55	\$77.70																																											
50-99	100 +																																											
\$71.85	\$66.84																																											
1-24	25-49																																											
\$99.20	\$92.26																																											
50-99	100 +																																											
\$85.31	\$79.36																																											
<p>Model No. PE4992 2.92mm FEMALE BULKHEAD SOLDER/CLAMP ATTACHMENT FOR RG405, PE-SR405AL &amp; PE-SR405FL MOUNTING HOLE B02</p>  <table> <tr><td>1-24</td><td>25-49</td></tr> <tr><td>\$94.00</td><td>\$87.42</td></tr> <tr><td>50-99</td><td>100 +</td></tr> <tr><td>\$80.84</td><td>\$75.20</td></tr> </table>	1-24	25-49	\$94.00	\$87.42	50-99	100 +	\$80.84	\$75.20	<p>Model No. PE44227 2.92mm FEMALE, SOLDER/CLAMP ATTACHMENT FOR RG402, PE-SR402AL &amp; PE-SR402FL</p>  <table> <tr><td>1-24</td><td>25-49</td></tr> <tr><td>\$62.65</td><td>\$58.26</td></tr> <tr><td>50-99</td><td>100 +</td></tr> <tr><td>\$53.88</td><td>\$50.12</td></tr> </table>	1-24	25-49	\$62.65	\$58.26	50-99	100 +	\$53.88	\$50.12	<p>Model No. PE44228 2.92mm FEMALE, SOLDER/CLAMP ATTACHMENT FOR RG405, PE-SR405AL &amp; PE-SR405FL</p>  <table> <tr><td>1-24</td><td>25-49</td></tr> <tr><td>\$62.65</td><td>\$58.26</td></tr> <tr><td>50-99</td><td>100 +</td></tr> <tr><td>\$53.88</td><td>\$50.12</td></tr> </table>	1-24	25-49	\$62.65	\$58.26	50-99	100 +	\$53.88	\$50.12	<p>Model No. PE44229 2.92mm FEMALE, 2 HOLE PANEL MOUNT, ACCEPTS .012" DIA. CONTACT, MOUNTING HOLE C01</p>  <table> <tr><td>1-24</td><td>25-49</td></tr> <tr><td>\$78.30</td><td>\$72.82</td></tr> <tr><td>50-99</td><td>100 +</td></tr> <tr><td>\$67.34</td><td>\$62.64</td></tr> </table>	1-24	25-49	\$78.30	\$72.82	50-99	100 +	\$67.34	\$62.64	<p>Model No. PE44230 2.92mm FEMALE, 4 HOLE PANEL MOUNT, ACCEPTS .012" DIA. CONTACT, MOUNTING HOLE A01</p>  <table> <tr><td>1-24</td><td>25-49</td></tr> <tr><td>\$73.10</td><td>\$67.98</td></tr> <tr><td>50-99</td><td>100 +</td></tr> <tr><td>\$62.87</td><td>\$58.48</td></tr> </table>	1-24	25-49	\$73.10	\$67.98	50-99	100 +	\$62.87	\$58.48
1-24	25-49																																											
\$94.00	\$87.42																																											
50-99	100 +																																											
\$80.84	\$75.20																																											
1-24	25-49																																											
\$62.65	\$58.26																																											
50-99	100 +																																											
\$53.88	\$50.12																																											
1-24	25-49																																											
\$62.65	\$58.26																																											
50-99	100 +																																											
\$53.88	\$50.12																																											
1-24	25-49																																											
\$78.30	\$72.82																																											
50-99	100 +																																											
\$67.34	\$62.64																																											
1-24	25-49																																											
\$73.10	\$67.98																																											
50-99	100 +																																											
\$62.87	\$58.48																																											
<p>Model No. PE44231 2.92mm FEMALE, SPARKPLUG ACCEPTS .012" DIA. CONTACT</p>  <table> <tr><td>1-24</td><td>25-49</td></tr> <tr><td>\$62.65</td><td>\$58.26</td></tr> <tr><td>50-99</td><td>100 +</td></tr> <tr><td>\$53.88</td><td>\$50.12</td></tr> </table>	1-24	25-49	\$62.65	\$58.26	50-99	100 +	\$53.88	\$50.12	<p>Model No. PE44232 2.92mm MALE, 2 HOLE PANEL MOUNT, ACCEPTS .012" DIA. CONTACT, MOUNTING HOLE C02</p>  <table> <tr><td>1-24</td><td>25-49</td></tr> <tr><td>\$44.90</td><td>\$41.76</td></tr> <tr><td>50-99</td><td>100 +</td></tr> <tr><td>\$38.61</td><td>\$35.92</td></tr> </table>	1-24	25-49	\$44.90	\$41.76	50-99	100 +	\$38.61	\$35.92	<p>Model No. PE44233 2.92mm MALE, 4 HOLE PANEL MOUNT, ACCEPTS .012" DIA. CONTACT, MOUNTING HOLE A01</p>  <table> <tr><td>1-24</td><td>25-49</td></tr> <tr><td>\$62.65</td><td>\$58.26</td></tr> <tr><td>50-99</td><td>100 +</td></tr> <tr><td>\$53.88</td><td>\$50.12</td></tr> </table>	1-24	25-49	\$62.65	\$58.26	50-99	100 +	\$53.88	\$50.12	<p>Model No. PE44234 2.92mm MALE, SPARKPLUG ACCEPTS .012" DIA. CONTACT</p>  <table> <tr><td>1-24</td><td>25-49</td></tr> <tr><td>\$62.65</td><td>\$58.26</td></tr> <tr><td>50-99</td><td>100 +</td></tr> <tr><td>\$53.88</td><td>\$50.12</td></tr> </table>	1-24	25-49	\$62.65	\$58.26	50-99	100 +	\$53.88	\$50.12	<p>Model No. PE44347 2.92mm MALE, 2 HOLE PANEL MOUNT, .025" DIA. CONTACT MOUNTING HOLE C06</p>  <table> <tr><td>1-24</td><td>25-49</td></tr> <tr><td>\$88.75</td><td>\$82.54</td></tr> <tr><td>50-99</td><td>100 +</td></tr> <tr><td>\$76.33</td><td>\$71.00</td></tr> </table>	1-24	25-49	\$88.75	\$82.54	50-99	100 +	\$76.33	\$71.00
1-24	25-49																																											
\$62.65	\$58.26																																											
50-99	100 +																																											
\$53.88	\$50.12																																											
1-24	25-49																																											
\$44.90	\$41.76																																											
50-99	100 +																																											
\$38.61	\$35.92																																											
1-24	25-49																																											
\$62.65	\$58.26																																											
50-99	100 +																																											
\$53.88	\$50.12																																											
1-24	25-49																																											
\$62.65	\$58.26																																											
50-99	100 +																																											
\$53.88	\$50.12																																											
1-24	25-49																																											
\$88.75	\$82.54																																											
50-99	100 +																																											
\$76.33	\$71.00																																											

# 2.4mm CONNECTORS

SEE PAGE 266 FOR MOUNTING HOLES

Model No. PE44215  
2.4mm MALE, SOLDER  
ATTACHMENT FOR RG405,  
PE-SR405AL & PE-SR405FL

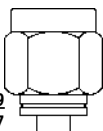

1-24	25-49
\$39.65	\$36.87
50-99	100 +
\$34.10	\$31.72

Model No. PE44216  
2.4mm FEMALE, SOLDER/CLAMP  
ATTACHMENT FOR RG405,  
PE-SR405AL & PE-SR405FL



1-24	25-49
\$106.50	\$99.05
50-99	100 +
\$91.59	\$85.20

Model No. PE44217  
2.4mm FEMALE, 2 HOLE PANEL  
MOUNT, .250" EXTENDED  
DIELECTRIC  
MOUNTING HOLE C05

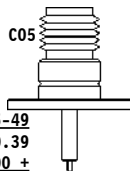

1-24	25-49
\$107.95	\$100.39
50-99	100 +
\$92.84	\$86.36

Model No. PE44218  
2.4mm FEMALE, 4 HOLE PANEL  
MOUNT, .250" EXTENDED  
DIELECTRIC  
MOUNTING HOLE A01



1-24	25-49
\$81.45	\$75.75
50-99	100 +
\$70.05	\$65.16

Model No. PE44219  
2.4mm FEMALE, SPARKPLUG  
ACCEPTS .012" DIA. CONTACT

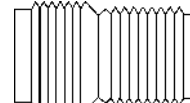

1-24	25-49
\$81.45	\$75.75
50-99	100 +
\$70.05	\$65.16

Model No. PE44220  
2.4mm MALE, 2 HOLE PANEL  
MOUNT, .250" EXTENDED  
DIELECTRIC  
MOUNTING HOLE C05

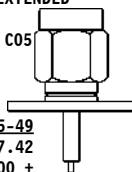

1-24	25-49
\$94.00	\$87.42
50-99	100 +
\$80.84	\$75.20

Model No. PE44221  
2.4mm MALE, 4 HOLE PANEL  
MOUNT, .250" EXTENDED  
DIELECTRIC  
MOUNTING HOLE A01

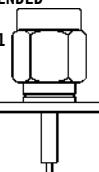

1-24	25-49
\$81.45	\$75.75
50-99	100 +
\$70.05	\$65.16

Model No. PE44222  
2.4mm MALE, SPARKPLUG  
ACCEPTS .012" DIA. CONTACT

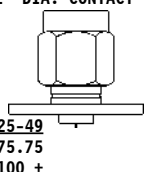

1-24	25-49
\$81.45	\$75.75
50-99	100 +
\$70.05	\$65.16

Model No. PE44223  
2.4mm MALE, 2 HOLE PANEL  
MOUNT, STRIPLINE CIRCUITS  
.003" X .011" TAB CONTACT  
MOUNTING HOLE C05

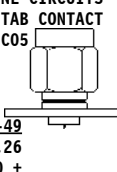

1-24	25-49
\$99.20	\$92.26
50-99	100 +
\$85.31	\$79.36

Model No. PE44224  
2.4mm MALE, 4 HOLE PANEL  
MOUNT, STRIPLINE CIRCUITS  
.003" X .011" TAB CONTACT  
MOUNTING HOLE A01

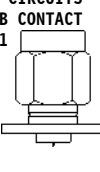

1-24	25-49
\$156.70	\$145.73
50-99	100 +
\$134.76	\$125.36

Model No. PE44225  
2.4mm FEMALE, 2 HOLE PANEL  
MOUNT, STRIPLINE CIRCUITS  
.003" X .011" TAB CONTACT  
MOUNTING HOLE C05

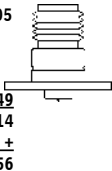

1-24	25-49
\$104.45	\$97.14
50-99	100 +
\$89.83	\$83.56

Model No. PE44226  
2.4mm FEMALE, 4 HOLE PANEL  
MOUNT, STRIPLINE CIRCUITS  
.003" X .011" TAB CONTACT  
MOUNTING HOLE A01



1-24	25-49
\$81.45	\$75.75
50-99	100 +
\$70.05	\$65.16

Model No. PE44345  
2.4mm MALE, SOLDER/CLAMP  
ATTACHMENT FOR RG405,  
PE-SR405AL & PE-SR405FL

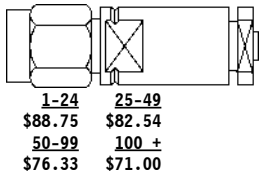

1-24	25-49
\$88.75	\$82.54
50-99	100 +
\$76.33	\$71.00

Model No. PE44346  
2.4mm FEMALE BULKHEAD  
SOLDER/CLAMP ATTACHMENT  
FOR RG405, PE-SR405AL &  
PE-SR405FL  
MOUNTING HOLE B14



1-24	25-49
\$94.00	\$87.42
50-99	100 +
\$80.84	\$75.20

**PLEASE CONTACT  
OUR ENGINEERING  
DEPARTMENT FOR  
ALL YOUR SPECIAL  
REQUIREMENTS AT  
(866) 727-8376 EXT. 3**

# 1.85mm CONNECTORS

SEE PAGE 266 FOR MOUNTING HOLES

Model No. PE44335  
1.85mm MALE, SOLDER/CLAMP  
ATTACHMENT FOR PE-047SR,  
PE-SR047AL & PE-SR047FL

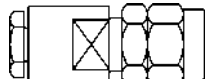

1-24	25-49
\$104.45	\$97.14
50-99	100 +
\$89.83	\$83.56

Model No. PE44336  
1.85mm MALE, SOLDER  
ATTACHMENT FOR RG405,  
PE-SR405AL & PE-SR405FL

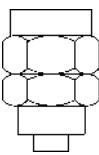

1-24	25-49
\$94.00	\$87.42
50-99	100 +
\$80.84	\$75.20

Model No. PE44337  
1.85mm FEMALE, 2 HOLE  
PLANEL MOUNT,  
ACCEPTS .009" DIA. CONTACT  
MOUNTING HOLE C01

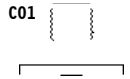

1-24	25-49
\$104.45	\$97.14
50-99	100 +
\$89.83	\$83.56

Model No. PE44338  
1.85mm MALE, SPARKPLUG  
ACCEPTS .009" DIA. CONTACT

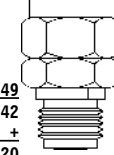

1-24	25-49
\$94.00	\$87.42
50-99	100 +
\$80.84	\$75.20

Model No. PE44339  
1.85mm FEMALE, SPARKPLUG  
ACCEPTS .009" DIA. CONTACT

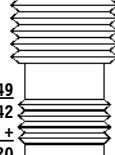

1-24	25-49
\$94.00	\$87.42
50-99	100 +
\$80.84	\$75.20

# MHV CONNECTORS

SEE PAGE 266 FOR MOUNTING HOLES

MHV MALE  
FOR CABLE  
ATTACHMENT

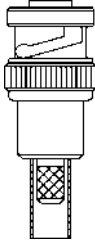

Model No.	FITS MIL SPEC AND EQUIVALENT CABLES	ATTACHMENT METHOD	P R I C E			
			1-24	25-49	50-99	100 +
PE4299	RG8, RG9, RG11, RG213, RG214, RG225, RG393	CLAMP	\$20.85	\$19.39	\$17.93	\$16.68
PE4493	RG8, RG213	CRIMP	22.00	20.46	18.92	17.60
PE4350	RG9, RG214	CRIMP	21.80	20.27	18.75	17.44
PE4076	RG55, RG58, RG141, RG142, RG223, RG400	CLAMP	9.75	9.07	8.39	7.80
PE4657	RG55, RG141, RG142, RG223, RG400	CRIMP	13.55	12.60	11.65	10.84
PE4093	RG58	CRIMP	11.85	11.02	10.19	9.48
PE4098	RG59B/U, RG62	CLAMP	10.00	9.30	8.60	8.00
PE4075	RG59B/U, RG62	CRIMP	10.45	9.72	8.99	8.36
PE4494	RG174, RG188, RG316	CLAMP	12.05	11.21	10.36	9.64
PE4933	RG174, RG188, RG316	CRIMP	26.05	24.23	22.40	20.84

MHV MALE  
RIGHT ANGLE  
FOR CABLE  
ATTACHMENT

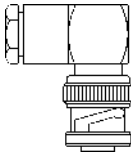

PE4709	RG8, RG9, RG11, RG213, RG214, RG225, RG393	CLAMP	38.00	35.34	32.68	30.40
PE4226	RG55, RG58, RG141, RG142, RG223, RG400	CLAMP	22.30	20.74	19.18	17.84
PE4227	RG59B/U, RG62	CLAMP	21.80	20.27	18.75	17.44
PE4710	RG174, RG188, RG316	CLAMP	23.10	21.48	19.87	18.48

MHV FEMALE  
FOR CABLE  
ATTACHMENT

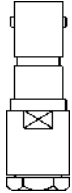

PE4373	RG8, RG9, RG11, RG213, RG214, RG225, RG393	CLAMP	28.15	26.18	24.21	22.52
PE4225	RG55, RG58, RG141, RG142, RG223, RG400	CLAMP	15.25	14.18	13.12	12.20
PE44100	RG55, RG141, RG142, RG223, RG400	CRIMP	20.85	19.39	17.93	16.68
PE44102	RG58	CRIMP	18.75	17.44	16.13	15.00
PE4181	RG59B/U, RG62	CLAMP	15.25	14.18	13.12	12.20
PE44103	RG59B/U, RG62	CRIMP	20.85	19.39	17.93	16.68
PE44104	RG174, RG188, RG316	CLAMP	19.80	18.41	17.03	15.84

MHV FEMALE  
BULKHEAD  
FOR CABLE  
ATTACHMENT



PE44105	RG8, RG9, RG11, RG213, RG214, RG225, RG393	CLAMP	40.30	37.48	34.66	32.24
PE44106	RG55, RG58, RG141, RG142, RG223, RG400	CLAMP	26.05	24.23	22.40	20.84
PE44107	RG55, RG141, RG142, RG223, RG400	CRIMP	24.00	22.32	20.64	19.20
PE44108	RG58	CRIMP	22.90	21.30	19.69	18.32
PE44109	RG59B/U, RG62	CLAMP	26.05	24.23	22.40	20.84
PE44110	RG59B/U, RG62	CRIMP	27.10	25.20	23.31	21.68
PE44111	RG174, RG188, RG316	CLAMP	31.30	29.11	26.92	25.04

USE MOUNTING HOLE B06

MHV FEMALE  
PANEL MOUNT  
FOR CABLE  
ATTACHMENT



PE44112	RG8, RG9, RG11, RG213, RG214, RG225, RG393	CLAMP	31.30	29.11	26.92	25.04
PE4313	RG55, RG58, RG141, RG142, RG223, RG400	CLAMP	29.20	27.16	25.11	23.36
PE4314	RG59B/U, RG62	CLAMP	29.20	27.16	25.11	23.36
PE44113	RG174, RG188, RG316	CLAMP	29.20	27.16	25.11	23.36

USE MOUNTING HOLE A03 EXCEPT PE44112 USES MOUNTING HOLE A05

Model No. PE4193  
MHV FEMALE BULKHEAD, FRONT  
MOUNT WITH O-RING SEAL  
SOLDER CUP CONTACT  
MOUNTING HOLE G02

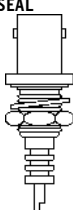

1-24	25-49
\$13.80	\$12.83
50-99	100 +
\$11.87	\$11.04

Model No. PE4228  
MHV FEMALE, PANEL MOUNT  
SOLDER CUP CONTACT  
MOUNTING HOLE A03

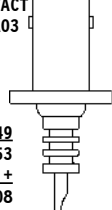

1-24	25-49
\$18.85	\$17.53
50-99	100 +
\$16.21	\$15.08

Model No. PE4311  
MHV FEMALE BULKHEAD, FRONT  
MOUNT, HERMETICALLY SEALED  
MOUNTING HOLE G02

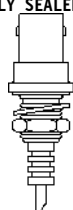

1-24	25-49
\$31.30	\$29.11
50-99	100 +
\$26.92	\$25.04

Model No. PE4312  
MHV FEMALE BULKHEAD, REAR  
MOUNT, TURRET TERMINAL  
MOUNTING HOLE B08

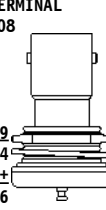

1-24	25-49
\$22.95	\$21.34
50-99	100 +
\$19.74	\$18.36

Model No. PE4495  
MHV FEMALE BULKHEAD, REAR  
MOUNT, HERMETICALLY SEALED  
SOLDER CUP CONTACT  
MOUNTING HOLE B06

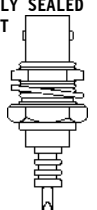

1-24	25-49
\$30.15	\$28.04
50-99	100 +
\$25.93	\$24.12

# SHV CONNECTORS

SEE PAGE 266 FOR MOUNTING HOLES

SHV PLUG  
FOR CABLE  
ATTACHMENT



Model No.	FITS MIL SPEC AND EQUIVALENT CABLES
PE4333	RG8, RG9, RG213, RG214, RG225, RG393
PE4496	RG8, RG213
PE4349	RG9, RG214, RG225, RG393
PE4316	RG55, RG58, RG141, RG142, RG223, RG400
PE4497	RG55, RG141, RG142, RG223, RG400
PE4194	RG58
PE4100	RG59B/U, RG62
PE4343	RG59B/U, RG62
PE4498	RG174, RG188, RG316

ATTACHMENT METHOD

P R I C E				
	1-24	25-49	50-99	100 +
CLAMP	\$24.00	\$22.32	\$20.64	\$19.20
CRIMP	24.25	22.55	20.86	19.40
CRIMP	24.45	22.74	21.03	19.56
CLAMP	16.60	15.44	14.28	13.28
CRIMP	24.25	22.55	20.86	19.40
CRIMP	24.45	22.74	21.03	19.56
CLAMP	16.65	15.48	14.32	13.32
CRIMP	24.45	22.74	21.03	19.56
CLAMP	24.25	22.55	20.86	19.40

SHV JACK BULKHEAD  
FOR CABLE  
ATTACHMENT



PE44049	RG8, RG9, RG213, RG214, RG225, RG393
PE44080	RG55, RG58, RG141, RG142, RG223, RG400
PE4315	RG59B/U, RG62
PE44093	RG174, RG188, RG316

CLAMP	37.35	34.74	32.12	29.88
CLAMP	30.50	28.37	26.23	24.40
CLAMP	30.50	28.37	26.23	24.40
CLAMP	31.90	29.67	27.43	25.52

MOUNTING HOLE B06

Connectors

Model No. PE4239  
SHV JACK BULKHEAD, FRONT  
MOUNT, SOLDER CUP CONTACT  
MOUNTING HOLE B04



1-24	25-49
\$13.30	\$12.37
50-99	100 +
\$11.44	\$10.64

Model No. PE4499  
SHV JACK BULKHEAD, REAR  
MOUNT, SOLDER CUP CONTACT  
MOUNTING HOLE B06



1-24	25-49
\$16.30	\$15.16
50-99	100 +
\$14.02	\$13.04

Model No. PE4500  
SHV JACK BULKHEAD, FRONT  
MOUNT, HERMETICALLY SEALED  
SOLDER CUP CONTACT  
MOUNTING HOLE B04



1-24	25-49
\$41.75	\$38.83
50-99	100 +
\$35.91	\$33.40

Model No. PE4501  
SHV JACK, PANEL MOUNT  
SOLDER CUP CONTACT  
MOUNTING HOLE A15



1-24	25-49
\$19.60	\$18.23
50-99	100 +
\$16.86	\$15.68

Model No. PE44118  
SHV PLUG BULKHEAD, FRONT  
MOUNT, SOLDER CUP CONTACT  
MOUNTING HOLE B04



1-24	25-49
\$31.30	\$29.11
50-99	100 +
\$26.92	\$25.04

## NOTES

# C CONNECTORS

SEE PAGE 266 FOR MOUNTING HOLES

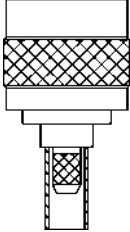
	Model No.	FITS MIL SPEC AND EQUIVALENT CABLES	ATTACHMENT METHOD	P R I C E			
				1-24	25-49	50-99	100 +
C MALE FOR CABLE ATTACHMENT 	PE4243	RG8, RG9, RG11, RG213, RG214, RG225, RG393	CLAMP	\$26.05	\$24.23	\$22.40	\$20.84
	PE4950	RG8, RG9, RG11, RG213, RG214, RG225, RG393	CLAMP/HIGH VOLTAGE	31.30	29.11	26.92	25.04
	PE4518	RG8, RG213	CRIMP	24.00	22.32	20.64	19.20
	PE4375	RG9, RG214, RG225, RG393	CRIMP	19.10	17.76	16.43	15.28
	PE4951	RG14, RG217	CLAMP	36.50	33.95	31.39	29.20
	PE4242	RG55, RG58, RG141, RG142, RG223, RG400	CLAMP	26.05	24.23	22.40	20.84
	PE4445	RG55, RG141, RG142, RG223, RG400	CRIMP	18.10	16.83	15.57	14.48
	PE4517	RG58	CRIMP	23.95	22.27	20.60	19.16
	PE4952	RG59B/U, RG62	CLAMP	26.05	24.23	22.40	20.84
	PE4953	RG174, RG188, RG316	CLAMP	22.90	21.30	19.69	18.32
	PE4954	RG218	CLAMP	62.65	58.26	53.88	50.12

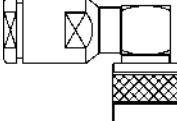
C MALE RIGHT ANGLE FOR CABLE ATTACHMENT 	PE4244	RG8, RG9, RG11, RG213, RG214, RG225, RG393	CLAMP	46.75	43.48	40.21	37.40
	PE4955	RG8, RG213	CRIMP	46.95	43.66	40.38	37.56
	PE4949	RG9, RG214, RG225, RG393	CRIMP	52.20	48.55	44.89	41.76
	PE4957	RG55, RG58, RG141, RG142, RG223, RG400	CLAMP	51.15	47.57	43.99	40.92
	PE4958	RG55, RG141, RG142, RG223, RG400	CRIMP	46.95	43.66	40.38	37.56
	PE4959	RG58	CRIMP	51.15	47.57	43.99	40.92

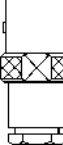
C FEMALE FOR CABLE ATTACHMENT 	PE4960	RG8, RG9, RG11, RG213, RG214, RG225, RG393	CLAMP	36.50	33.95	31.39	29.20
	PE4961	RG55, RG58, RG141, RG142, RG223, RG400	CLAMP	46.95	43.66	40.38	37.56
	PE4962	RG59B/U, RG62	CLAMP	32.70	30.41	28.12	26.16
	PE4963	RG14, RG217	CLAMP	46.95	43.66	40.38	37.56

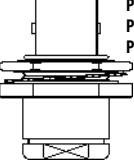
C FEMALE BULKHEAD REAR MOUNT FOR CABLE ATTACHMENT 	PE4964	RG8, RG9, RG11, RG213, RG214, RG225, RG393	CLAMP	39.65	36.87	34.10	31.72
	PE4965	RG55, RG58, RG141, RG142, RG223, RG400	CLAMP	46.95	43.66	40.38	37.56
	PE4966	RG59B/U, RG62	CLAMP	46.95	43.66	40.38	37.56

USE MOUNTING HOLE B07

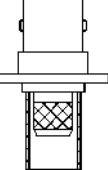
C FEMALE PANEL MOUNT FOR CABLE ATTACHMENT 	PE4967	RG8, RG9, RG11, RG213, RG214, RG225, RG393	CLAMP	46.95	43.66	40.38	37.56
	PE4968	RG8, RG213	CRIMP	36.50	33.95	31.39	29.20
	PE4374	RG9, RG214, RG225, RG393	CRIMP	41.75	38.83	35.91	33.40
	PE4969	RG55, RG58, RG141, RG142, RG223, RG400	CLAMP	36.50	33.95	31.39	29.20
	PE4970	RG59B/U, RG62	CLAMP	46.95	43.66	40.38	37.56

USE MOUNTING HOLE A19 EXCEPT PE4374 & PE4968 USE MOUNTING HOLE A05

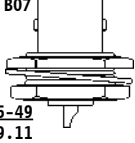
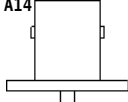
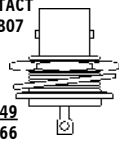
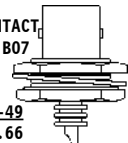
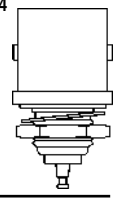
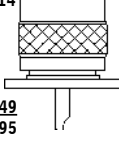
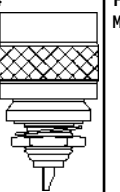
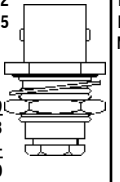
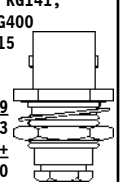
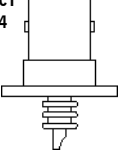
<b>Model No. PE4240</b> C FEMALE BULKHEAD, REAR MOUNT, SOLDER CUP CONTACT MOUNTING HOLE B07  <table border="1"> <tr><td>1-24</td><td>25-49</td></tr> <tr><td>\$31.30</td><td>\$29.11</td></tr> <tr><td>50-99</td><td>100 +</td></tr> <tr><td>\$26.92</td><td>\$25.04</td></tr> </table>	1-24	25-49	\$31.30	\$29.11	50-99	100 +	\$26.92	\$25.04	<b>Model No. PE4241</b> C FEMALE, PANEL MOUNT SOLDER CUP CONTACT MOUNTING HOLE A14  <table border="1"> <tr><td>1-24</td><td>25-49</td></tr> <tr><td>\$14.15</td><td>\$13.16</td></tr> <tr><td>50-99</td><td>100 +</td></tr> <tr><td>\$12.17</td><td>\$11.32</td></tr> </table>	1-24	25-49	\$14.15	\$13.16	50-99	100 +	\$12.17	\$11.32	<b>Model No. PE4971</b> C FEMALE BULKHEAD, REAR MOUNT, HERMETICALLY SEALED SOLDER CUP CONTACT MOUNTING HOLE B07  <table border="1"> <tr><td>1-24</td><td>25-49</td></tr> <tr><td>\$46.95</td><td>\$43.66</td></tr> <tr><td>50-99</td><td>100 +</td></tr> <tr><td>\$40.38</td><td>\$37.56</td></tr> </table>	1-24	25-49	\$46.95	\$43.66	50-99	100 +	\$40.38	\$37.56	<b>Model No. PE4972</b> C FEMALE BULKHEAD REAR MOUNT, HIGH VOLTAGE 3000 VOLTS SOLDER CUP CONTACT MOUNTING HOLE B07  <table border="1"> <tr><td>1-24</td><td>25-49</td></tr> <tr><td>\$46.95</td><td>\$43.66</td></tr> <tr><td>50-99</td><td>100 +</td></tr> <tr><td>\$40.38</td><td>\$37.56</td></tr> </table>	1-24	25-49	\$46.95	\$43.66	50-99	100 +	\$40.38	\$37.56	<b>Model No. PE4973</b> C FEMALE BULKHEAD, FRONT MOUNT, TURRET TERMINAL MOUNTING HOLE B04  <table border="1"> <tr><td>1-24</td><td>25-49</td></tr> <tr><td>\$46.95</td><td>\$43.66</td></tr> <tr><td>50-99</td><td>100 +</td></tr> <tr><td>\$40.38</td><td>\$37.56</td></tr> </table>	1-24	25-49	\$46.95	\$43.66	50-99	100 +	\$40.38	\$37.56
1-24	25-49																																											
\$31.30	\$29.11																																											
50-99	100 +																																											
\$26.92	\$25.04																																											
1-24	25-49																																											
\$14.15	\$13.16																																											
50-99	100 +																																											
\$12.17	\$11.32																																											
1-24	25-49																																											
\$46.95	\$43.66																																											
50-99	100 +																																											
\$40.38	\$37.56																																											
1-24	25-49																																											
\$46.95	\$43.66																																											
50-99	100 +																																											
\$40.38	\$37.56																																											
1-24	25-49																																											
\$46.95	\$43.66																																											
50-99	100 +																																											
\$40.38	\$37.56																																											
<b>Model No. PE44096</b> C MALE, 4 HOLE PANEL MOUNT SOLDER CUP CONTACT MOUNTING HOLE A14  <table border="1"> <tr><td>1-24</td><td>25-49</td></tr> <tr><td>\$36.50</td><td>\$33.95</td></tr> <tr><td>50-99</td><td>100 +</td></tr> <tr><td>\$31.39</td><td>\$29.20</td></tr> </table>	1-24	25-49	\$36.50	\$33.95	50-99	100 +	\$31.39	\$29.20	<b>Model No. PE44097</b> C MALE BULKHEAD, FRONT MOUNT, SOLDER CUP CONTACT MOUNTING HOLE B04  <table border="1"> <tr><td>1-24</td><td>25-49</td></tr> <tr><td>\$46.95</td><td>\$43.66</td></tr> <tr><td>50-99</td><td>100 +</td></tr> <tr><td>\$40.38</td><td>\$37.56</td></tr> </table>	1-24	25-49	\$46.95	\$43.66	50-99	100 +	\$40.38	\$37.56	<b>Model No. PE44098</b> C FEMALE BULKHEAD, FRONT MOUNT, CLAMP ATTACHMENT FOR RG59B/U, RG62 MOUNTING HOLE B15  <table border="1"> <tr><td>1-24</td><td>25-49</td></tr> <tr><td>\$41.75</td><td>\$38.83</td></tr> <tr><td>50-99</td><td>100 +</td></tr> <tr><td>\$35.91</td><td>\$33.40</td></tr> </table>	1-24	25-49	\$41.75	\$38.83	50-99	100 +	\$35.91	\$33.40	<b>Model No. PE44099</b> C FEMALE BULKHEAD, FRONT MOUNT, CLAMP ATTACHMENT FOR RG55, RG58, RG141, RG142, RG223, RG400 MOUNTING HOLE B15  <table border="1"> <tr><td>1-24</td><td>25-49</td></tr> <tr><td>\$41.75</td><td>\$38.83</td></tr> <tr><td>50-99</td><td>100 +</td></tr> <tr><td>\$35.91</td><td>\$33.40</td></tr> </table>	1-24	25-49	\$41.75	\$38.83	50-99	100 +	\$35.91	\$33.40	<b>Model No. PE44117</b> C FEMALE, 4 HOLE PANEL MOUNT HIGH VOLTAGE 3000 VOLTS SOLDER CUP CONTACT MOUNTING HOLE A14  <table border="1"> <tr><td>1-24</td><td>25-49</td></tr> <tr><td>\$22.90</td><td>\$21.30</td></tr> <tr><td>50-99</td><td>100 +</td></tr> <tr><td>\$19.69</td><td>\$18.32</td></tr> </table>	1-24	25-49	\$22.90	\$21.30	50-99	100 +	\$19.69	\$18.32
1-24	25-49																																											
\$36.50	\$33.95																																											
50-99	100 +																																											
\$31.39	\$29.20																																											
1-24	25-49																																											
\$46.95	\$43.66																																											
50-99	100 +																																											
\$40.38	\$37.56																																											
1-24	25-49																																											
\$41.75	\$38.83																																											
50-99	100 +																																											
\$35.91	\$33.40																																											
1-24	25-49																																											
\$41.75	\$38.83																																											
50-99	100 +																																											
\$35.91	\$33.40																																											
1-24	25-49																																											
\$22.90	\$21.30																																											
50-99	100 +																																											
\$19.69	\$18.32																																											



# 50 OHM BNC CONNECTORS

SEE PAGE 266 FOR MOUNTING HOLES

### PRICE

BNC MALE  
FOR CABLE  
ATTACHMENT

Model No.

FITS MIL SPEC AND EQUIVALENT CABLES

ATTACHMENT METHOD

1-24	25-49	50-99	100 +
CLAMP	\$9.75	\$9.07	\$8.39
CLAMP	10.00	9.30	8.60
CRIMP	16.65	15.48	14.32
CLAMP	10.85	10.09	9.33
CRIMP	14.40	13.39	12.38
CLAMP	4.45	4.14	3.83
CRIMP	4.50	4.19	3.87
CRIMP	4.70	4.37	4.04
CRIMP	10.40	9.67	8.94
CLAMP	5.50	5.12	4.73
CRIMP	4.45	4.14	3.83
CRIMP	10.40	9.67	8.94
CLAMP	7.60	7.07	6.54
CRIMP	6.90	6.42	5.93
CRIMP	15.25	14.18	13.12
CLAMP	12.05	11.21	10.36
CLAMP	21.95	20.41	18.88
CRIMP	8.65	8.04	7.44
CRIMP	9.90	9.21	8.51
SOLDER/CLAMP	17.55	16.32	15.09
DIRECT SOLDER	30.40	28.27	26.14
SOLDER/CLAMP	14.30	13.30	12.30
DIRECT SOLDER	16.30	15.16	14.02
SOLDER/CLAMP	16.45	15.30	14.15
DIRECT SOLDER	16.30	15.16	14.02
DIRECT SOLDER	19.80	18.41	17.03
CRIMP	8.65	8.04	7.44
CLAMP	17.70	16.46	15.22
CRIMP	19.95	18.55	17.16
CLAMP	10.95	10.18	9.42
CRIMP	10.95	10.18	9.42
CLAMP	10.95	10.18	9.42

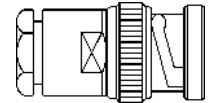
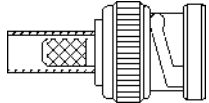

PE4377	RG6A/U
PE4109	RG8, RG9, RG11, RG213, RG214, RG225, RG393
PE4378	RG8, RG213
PE4379	RG8X, PE-T042RML
PE4351	RG9, RG214, RG225, RG393
PE4023	RG55, RG58, RG141, RG142, RG223, RG400
PE4044	RG55, RG141, RG142, RG223, RG400
PE4016	RG58
PE4381	RG58 PLENUM
PE4024	RG59B/U, RG62
PE4018	RG59B/U, RG62
PE4382	RG59B/U PLENUM
PE4084	RG174, RG188, RG316
PE4043	RG174, RG188, RG316
PE4643	RG178, RG196
PE4384	RG178, RG196
PE4383	RG180, RG195, BELDEN 8218, PE-B8128
PE4247	RG180, RG195, BELDEN 8218, PE-B8128
PE4385	RG188-DS, RG316-DS
PE4380	RG401, PE-SR401AL, PE-SR401FL (.250" SEMI-RIGID)
PE4908	RG401, PE-SR401AL, PE-SR401FL (.250" SEMI-RIGID)
PE4206	RG402, PE-SR402AL, PE-SR402FL (.141" SEMI-RIGID)
PE4650	RG402, PE-SR402AL, PE-SR402FL (.141" SEMI-RIGID)
PE4207	RG405, PE-SR405AL, PE-SR405FL (.085" SEMI-RIGID)
PE4651	RG405, PE-SR405AL, PE-SR405FL (.085" SEMI-RIGID)
PE4974	PE-0475R, PE-SR047AL, PE-SR047FL (.047" SEMI-RIGID)
PE4210	BELDEN 8281, PE-B1828
PE4386	BELDEN 9913 & 9914, PE-B3199, PE-B4199, PE-T004RML
PE44294	BELDEN 9913 & 9914, PE-B3199, PE-B4199, PE-T004RML
PE44040	PE-T002RML
PE44041	PE-T002RML
PE44042	PE-T003RML

BNC MALE  
RIGHT ANGLE  
FOR CABLE  
ATTACHMENT

PE4387	RG8, RG9, RG11, RG213, RG214, RG225, RG393
PE4053	RG55, RG58, RG141, RG142, RG223, RG400
PE4345	RG55, RG141, RG142, RG223, RG400
PE4298	RG58
PE4320	RG59B/U, RG62
PE4195	RG59B/U, RG62
PE4307	RG174, RG188, RG316
PE4393	RG174, RG188, RG316
PE4388	RG178, RG196
PE4396	RG188-DS, RG316-DS
PE4092	RG402, PE-SR402AL, PE-SR402FL (.141" SEMI-RIGID)
PE4102	RG405, PE-SR405AL, PE-SR405FL (.085" SEMI-RIGID)

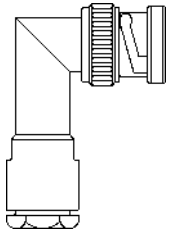

CLAMP	22.90	21.30	19.69	18.32
CLAMP	11.95	11.11	10.28	9.56
CRIMP	14.30	13.30	12.30	11.44
CRIMP	14.40	13.39	12.38	11.52
CLAMP	16.65	15.48	14.32	13.32
CRIMP	15.60	14.51	13.42	12.48
CLAMP	17.10	15.90	14.71	13.68
CRIMP	17.00	15.81	14.62	13.60
CLAMP	16.45	15.30	14.15	13.16
CRIMP	19.80	18.41	17.03	15.84
DIRECT SOLDER	22.90	21.30	19.69	18.32
DIRECT SOLDER	26.05	24.23	22.40	20.84

BNC FEMALE  
FOR CABLE  
ATTACHMENT

PE4212	RG8, RG9, RG11, RG213, RG214, RG225, RG393
PE4058	RG55, RG58, RG141, RG142, RG223, RG400
PE4397	RG55, RG141, RG142, RG223, RG400
PE4070	RG58
PE4057	RG59B/U, RG62
PE4308	RG59B/U, RG62
PE4321	RG174, RG188, RG316
PE4079	RG174, RG188, RG316
PE4389	RG178, RG196
PE4390	RG188-DS, RG316-DS
PE4204	RG402, PE-SR402AL, PE-SR402FL (.141" SEMI-RIGID)
PE4205	RG405, PE-SR405AL, PE-SR405FL (.085" SEMI-RIGID)

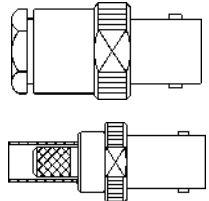

CLAMP	28.30	26.32	24.34	22.64
CLAMP	6.00	5.58	5.16	4.80
CRIMP	7.25	6.74	6.24	5.80
CRIMP	5.85	5.44	5.03	4.68
CLAMP	5.40	5.02	4.64	4.32
CRIMP	8.65	8.04	7.44	6.92
CLAMP	9.90	9.21	8.51	7.92
CRIMP	10.00	9.30	8.60	8.00
CLAMP	13.20	12.28	11.35	10.56
CRIMP	10.95	10.18	9.42	8.76
SOLDER/CLAMP	19.80	18.41	17.03	15.84
SOLDER/CLAMP	19.80	18.41	17.03	15.84

BNC FEMALE  
BULKHEAD  
FOR CABLE  
ATTACHMENT

PE4632	RG8, RG9, RG11, RG213, RG214, RG225, RG393
PE4078	RG55, RG58, RG141, RG142, RG223, RG400
PE4209	RG55, RG141, RG142, RG223, RG400
PE4208	RG58
PE4310	RG59B/U, RG62
PE4309	RG59B/U, RG62
PE4319	RG174, RG188, RG316
PE4106	RG174, RG188, RG316
PE4391	RG178, RG196
PE4392	RG188-DS, RG316-DS
PE4915	RG402, PE-SR402AL, PE-SR402FL (.141" SEMI-RIGID)
PE4916	RG405, PE-SR405AL, PE-SR405FL (.085" SEMI-RIGID)

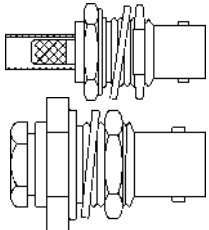

CLAMP	29.40	27.34	25.28	23.52
CLAMP	10.85	10.09	9.33	8.68
CRIMP	12.75	11.86	10.97	10.20
CRIMP	9.35	8.70	8.04	7.48
CLAMP	19.80	18.41	17.03	15.84
CRIMP	11.95	11.11	10.28	9.56
CLAMP	12.05	11.21	10.36	9.64
CRIMP	10.60	9.86	9.12	8.48
CLAMP	14.30	13.30	12.30	11.44
CRIMP	13.20	12.28	11.35	10.56
SOLDER/CLAMP	23.10	21.48	19.87	18.48
SOLDER/CLAMP	23.10	21.48	19.87	18.48

USE MOUNTING HOLE B06

# 50 OHM BNC CONNECTORS

SEE PAGE 266 FOR MOUNTING HOLES

**Model No. PE4010**  
BNC FEMALE, PANEL MOUNT  
SOLDER CUP CONTACT  
#3-56 TAPPED HOLES  
MOUNTING HOLE A03

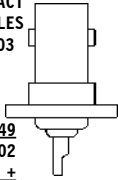

1-24	25-49
\$5.40	\$5.02
50-99	100 +
\$4.64	\$4.32

**Model No. PE4011**  
BNC FEMALE, PANEL MOUNT  
TURRET TERMINAL  
MOUNTING HOLE A16

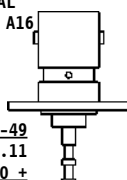

1-24	25-49
\$11.95	\$11.11
50-99	100 +
\$10.28	\$9.56

**Model No. PE4014**  
BNC FEMALE BULKHEAD FOR UP  
TO 1/8" PANEL THICKNESS  
SOLDER CUP CONTACT  
MOUNTING HOLE B05

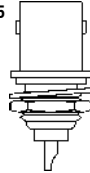

1-24	25-49
\$4.45	\$4.14
50-99	100 +
\$3.83	\$3.56

**Model No. PE4015**  
BNC FEMALE BULKHEAD FOR UP  
TO 1/4" PANEL THICKNESS  
SOLDER CUP CONTACT  
MOUNTING HOLE B04



1-24	25-49
\$4.45	\$4.14
50-99	100 +
\$3.83	\$3.56

**Model No. PE4049**  
BNC FEMALE BULKHEAD, REAR  
MOUNT, HERMETICALLY SEALED  
MOUNTING HOLE B06

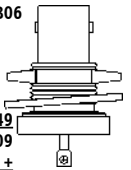

1-24	25-49
\$10.85	\$10.09
50-99	100 +
\$9.33	\$8.68

**Model No. PE4055**  
BNC FEMALE, RIGHT ANGLE  
BULKHEAD, SOLDER CUP  
CONTACT, MOUNTING HOLE B13

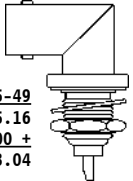

1-24	25-49
\$16.30	\$15.16
50-99	100 +
\$14.02	\$13.04

**Model No. PE4056**  
BNC FEMALE, PANEL MOUNT  
CLAMP ATTACHMENT FOR RG55,  
RG58, RG141, RG142, RG223  
& RG400, #3-56 TAPPED  
HOLES, MOUNTING HOLE A03

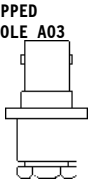

1-24	25-49
\$10.85	\$10.09
50-99	100 +
\$9.33	\$8.68

**Model No. PE4077**  
BNC FEMALE BULKHEAD, FRONT  
MOUNT, HERMETICALLY SEALED  
MOUNTING HOLE B04



1-24	25-49
\$10.85	\$10.09
50-99	100 +
\$9.33	\$8.68

**Model No. PE4082**  
BNC MALE, PANEL MOUNT  
SOLDER CUP CONTACT  
MOUNTING HOLE A07

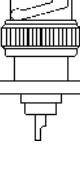

1-24	25-49
\$10.85	\$10.09
50-99	100 +
\$9.33	\$8.68

**Model No. PE4091**  
BNC FEMALE BULKHEAD  
ISOLATED GROUND  
SOLDER CUP CONTACT  
MOUNTING HOLE B04

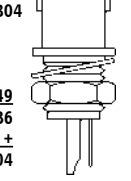

1-24	25-49
\$6.30	\$5.86
50-99	100 +
\$5.42	\$5.04

**Model No. PE4211**  
BNC MALE BULKHEAD MOUNT  
SOLDER CUP CONTACT  
MOUNTING HOLE B04



1-24	25-49
\$10.00	\$9.30
50-99	100 +
\$8.60	\$8.00

**Model No. PE4317**  
BNC FEMALE, RIGHT ANGLE  
PANEL MOUNT, SOLDER CUP  
CONTACT, MOUNTING HOLE A16

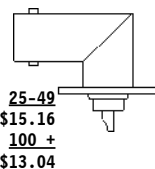

1-24	25-49
\$16.30	\$15.16
50-99	100 +
\$14.02	\$13.04

**Model No. PE4318**  
BNC FEMALE BULKHEAD  
ISOLATED GROUND  
SOLDER CUP CONTACT  
MOUNTING HOLE B06



1-24	25-49
\$11.10	\$10.32
50-99	100 +
\$9.55	\$8.88

**Model No. PE4394**  
BNC FEMALE, PANEL MOUNT  
SOLDER CUP CONTACT  
MOUNTING HOLE A04

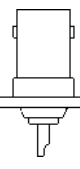

1-24	25-49
\$8.00	\$7.44
50-99	100 +
\$6.88	\$6.40

**Model No. PE4395**  
BNC FEMALE, PANEL MOUNT  
1" SQ. FLANGE, SOLDER CUP  
CONTACT, MOUNTING HOLE A05

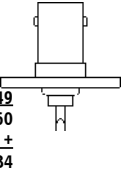

1-24	25-49
\$13.55	\$12.60
50-99	100 +
\$11.65	\$10.84

**Model No. PE44616** **NEW**  
BNC FEMALE, PCB-GRIP  
EDGE LAUNCH

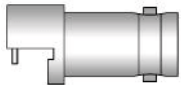

1-24	25-49
\$8.95	\$8.32
50-99	100 +
\$7.70	\$7.16

**Model No. PE44618** **NEW**  
BNC FEMALE BULKHEAD  
PCB-GRIP, EDGE LAUNCH  
MOUNTING HOLE F02



1-24	25-49
\$10.95	\$10.18
50-99	100 +
\$9.42	\$8.76

**PLEASE CONTACT OUR ENGINEERING DEPARTMENT FOR ALL  
YOUR SPECIAL REQUIREMENTS AT (866) 727-8376 EXT. 3**

Connectors

## NOTES

# 1.0/2.3 SNAP ON CONNECTORS

SEE PAGE 266 FOR MOUNTING HOLES

1.0/2.3 SNAP ON PLUG FOR CABLE ATTACHMENT	Model No. PE44242 PE44243 PE44244	FITS MIL SPEC AND EQUIVALENT CABLES RG55, RG142, RG223, RG400 RG58 RG174, RG188, RG316	ATTACHMENT METHOD CRIMP CRIMP CRIMP	P R I C E			
				1-24	25-49	50-99	100 +
				\$8.30	\$7.72	\$7.14	\$6.64
				8.30	7.72	7.14	6.64
				8.30	7.72	7.14	6.64

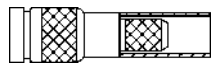

1.0/2.3 SNAP ON PLUG RIGHT ANGLE FOR CABLE ATTACHMENT	Model No. PE44247 PE44248 PE44249	RG55, RG142, RG223, RG400 RG58 RG174, RG188, RG316	CRIMP CRIMP CRIMP	P R I C E			
				1-24	25-49	50-99	100 +
				10.50	9.77	9.03	8.40
				10.40	9.67	8.94	8.32
				10.40	9.67	8.94	8.32

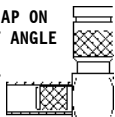

1.0/2.3 SNAP ON JACK BULKHEAD FOR CABLE ATTACHMENT	Model No. PE44252 PE44253 PE44254 PE44255 PE44256	RG55, RG142, RG223, RG400* RG58* RG174, RG188, RG316* RG402, PE-SR402AL, PE-SR402FL (.141")** RG405, PE-SR405AL, PE-SR405FL (.085")**	CRIMP CRIMP CRIMP SOLDER SOLDER	P R I C E			
				1-24	25-49	50-99	100 +
				9.45	8.79	8.13	7.56
				9.35	8.70	8.04	7.48
				9.35	8.70	8.04	7.48
				10.40	9.67	8.94	8.32
				10.40	9.67	8.94	8.32



\*MOUNTING HOLE G06  
\*\*MOUNTING HOLE B02

Model No. PE44257 1.0/2.3 SNAP ON JACK, P.C. MOUNT MOUNTING HOLE D07	Model No. PE44258 1.0/2.3 SNAP ON JACK RIGHT ANGLE, P.C. MOUNT MOUNTING HOLE D07	Model No. PE44259 1.0/2.3 SNAP ON JACK BULKHEAD, P.C. MOUNT MOUNTING HOLE D07	Model No. PE44260 1.0/2.3 SNAP ON JACK BULKHEAD, RIGHT ANGLE CRIMP ATTACHMENT FOR RG58 MOUNTING HOLE G05	Model No. PE44261 1.0/2.3 SNAP ON JACK BULKHEAD RIGHT ANGLE, CRIMP ATTACHMENT FOR RG174, RG188 & RG316 MOUNTING HOLE G05																																								
<table border="1"> <tr><td>1-24</td><td>25-49</td></tr> <tr><td>\$5.40</td><td>\$5.02</td></tr> <tr><td>50-99</td><td>100 +</td></tr> <tr><td>\$4.64</td><td>\$4.32</td></tr> </table>	1-24	25-49	\$5.40	\$5.02	50-99	100 +	\$4.64	\$4.32	<table border="1"> <tr><td>1-24</td><td>25-49</td></tr> <tr><td>\$7.60</td><td>\$7.07</td></tr> <tr><td>50-99</td><td>100 +</td></tr> <tr><td>\$6.54</td><td>\$6.08</td></tr> </table>	1-24	25-49	\$7.60	\$7.07	50-99	100 +	\$6.54	\$6.08	<table border="1"> <tr><td>1-24</td><td>25-49</td></tr> <tr><td>\$7.60</td><td>\$7.07</td></tr> <tr><td>50-99</td><td>100 +</td></tr> <tr><td>\$6.54</td><td>\$6.08</td></tr> </table>	1-24	25-49	\$7.60	\$7.07	50-99	100 +	\$6.54	\$6.08	<table border="1"> <tr><td>1-24</td><td>25-49</td></tr> <tr><td>\$10.85</td><td>\$10.09</td></tr> <tr><td>50-99</td><td>100 +</td></tr> <tr><td>\$9.33</td><td>\$8.68</td></tr> </table>	1-24	25-49	\$10.85	\$10.09	50-99	100 +	\$9.33	\$8.68	<table border="1"> <tr><td>1-24</td><td>25-49</td></tr> <tr><td>\$10.85</td><td>\$10.09</td></tr> <tr><td>50-99</td><td>100 +</td></tr> <tr><td>\$9.33</td><td>\$8.68</td></tr> </table>	1-24	25-49	\$10.85	\$10.09	50-99	100 +	\$9.33	\$8.68
1-24	25-49																																											
\$5.40	\$5.02																																											
50-99	100 +																																											
\$4.64	\$4.32																																											
1-24	25-49																																											
\$7.60	\$7.07																																											
50-99	100 +																																											
\$6.54	\$6.08																																											
1-24	25-49																																											
\$7.60	\$7.07																																											
50-99	100 +																																											
\$6.54	\$6.08																																											
1-24	25-49																																											
\$10.85	\$10.09																																											
50-99	100 +																																											
\$9.33	\$8.68																																											
1-24	25-49																																											
\$10.85	\$10.09																																											
50-99	100 +																																											
\$9.33	\$8.68																																											

Connectors

## SSMB CONNECTORS

SEE PAGE 266 FOR MOUNTING HOLES







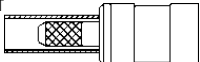
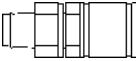

<b>Model No. PE4017</b> SSMB PLUG, CRIMP ATTACHMENT FOR RG174, RG179, RG188 & RG316  <table border="1"> <tr><td>1-24</td><td>25-49</td></tr> <tr><td>\$17.70</td><td>\$16.46</td></tr> <tr><td>50-99</td><td>100 +</td></tr> <tr><td>\$15.22</td><td>\$14.16</td></tr> </table>	1-24	25-49	\$17.70	\$16.46	50-99	100 +	\$15.22	\$14.16	<b>Model No. PE4019</b> SSMB PLUG, CRIMP ATTACHMENT FOR RG178 & RG196  <table border="1"> <tr><td>1-24</td><td>25-49</td></tr> <tr><td>\$17.95</td><td>\$16.69</td></tr> <tr><td>50-99</td><td>100 +</td></tr> <tr><td>\$15.44</td><td>\$14.36</td></tr> </table>	1-24	25-49	\$17.95	\$16.69	50-99	100 +	\$15.44	\$14.36	<b>Model No. PE4334</b> SSMB PLUG, RIGHT ANGLE CRIMP ATTACHMENT FOR RG174, RG179, RG188 & RG316  <table border="1"> <tr><td>1-24</td><td>25-49</td></tr> <tr><td>\$17.70</td><td>\$16.46</td></tr> <tr><td>50-99</td><td>100 +</td></tr> <tr><td>\$15.22</td><td>\$14.16</td></tr> </table>	1-24	25-49	\$17.70	\$16.46	50-99	100 +	\$15.22	\$14.16	<b>Model No. PE4335</b> SSMB PLUG, RIGHT ANGLE CRIMP ATTACHMENT FOR RG178 & RG196  <table border="1"> <tr><td>1-24</td><td>25-49</td></tr> <tr><td>\$11.95</td><td>\$11.11</td></tr> <tr><td>50-99</td><td>100 +</td></tr> <tr><td>\$10.28</td><td>\$9.56</td></tr> </table>	1-24	25-49	\$11.95	\$11.11	50-99	100 +	\$10.28	\$9.56	<b>Model No. PE4336</b> SSMB JACK, BULKHEAD CRIMP ATTACHMENT FOR RG174, RG179, RG188 & RG316, MOUNTING HOLE B10  <table border="1"> <tr><td>1-24</td><td>25-49</td></tr> <tr><td>\$20.85</td><td>\$19.39</td></tr> <tr><td>50-99</td><td>100 +</td></tr> <tr><td>\$17.93</td><td>\$16.68</td></tr> </table>	1-24	25-49	\$20.85	\$19.39	50-99	100 +	\$17.93	\$16.68
1-24	25-49																																											
\$17.70	\$16.46																																											
50-99	100 +																																											
\$15.22	\$14.16																																											
1-24	25-49																																											
\$17.95	\$16.69																																											
50-99	100 +																																											
\$15.44	\$14.36																																											
1-24	25-49																																											
\$17.70	\$16.46																																											
50-99	100 +																																											
\$15.22	\$14.16																																											
1-24	25-49																																											
\$11.95	\$11.11																																											
50-99	100 +																																											
\$10.28	\$9.56																																											
1-24	25-49																																											
\$20.85	\$19.39																																											
50-99	100 +																																											
\$17.93	\$16.68																																											
<b>Model No. PE4337</b> SSMB JACK BULKHEAD, CRIMP ATTACHMENT FOR RG178 & RG196, MOUNTING HOLE B10  <table border="1"> <tr><td>1-24</td><td>25-49</td></tr> <tr><td>\$20.85</td><td>\$19.39</td></tr> <tr><td>50-99</td><td>100 +</td></tr> <tr><td>\$17.93</td><td>\$16.68</td></tr> </table>	1-24	25-49	\$20.85	\$19.39	50-99	100 +	\$17.93	\$16.68	<b>Model No. PE4338</b> SSMB JACK BULKHEAD, REAR MOUNT, MOUNTING HOLE B10  <table border="1"> <tr><td>1-24</td><td>25-49</td></tr> <tr><td>\$15.60</td><td>\$14.51</td></tr> <tr><td>50-99</td><td>100 +</td></tr> <tr><td>\$13.42</td><td>\$12.48</td></tr> </table>	1-24	25-49	\$15.60	\$14.51	50-99	100 +	\$13.42	\$12.48	<b>Model No. PE4339</b> SSMB JACK BULKHEAD, FRONT MOUNT, MOUNTING HOLE B10  <table border="1"> <tr><td>1-24</td><td>25-49</td></tr> <tr><td>\$15.60</td><td>\$14.51</td></tr> <tr><td>50-99</td><td>100 +</td></tr> <tr><td>\$13.42</td><td>\$12.48</td></tr> </table>	1-24	25-49	\$15.60	\$14.51	50-99	100 +	\$13.42	\$12.48	<b>Model No. PE4340</b> SSMB JACK, PRINTED CIRCUIT MOUNT, MOUNTING HOLE D03  <table border="1"> <tr><td>1-24</td><td>25-49</td></tr> <tr><td>\$8.65</td><td>\$8.04</td></tr> <tr><td>50-99</td><td>100 +</td></tr> <tr><td>\$7.44</td><td>\$6.92</td></tr> </table>	1-24	25-49	\$8.65	\$8.04	50-99	100 +	\$7.44	\$6.92	<b>Model No. PE4341</b> SSMB JACK, RIGHT ANGLE PRINTED CIRCUIT MOUNT MOUNTING HOLE D03  <table border="1"> <tr><td>1-24</td><td>25-49</td></tr> <tr><td>\$13.55</td><td>\$12.60</td></tr> <tr><td>50-99</td><td>100 +</td></tr> <tr><td>\$11.65</td><td>\$10.84</td></tr> </table>	1-24	25-49	\$13.55	\$12.60	50-99	100 +	\$11.65	\$10.84
1-24	25-49																																											
\$20.85	\$19.39																																											
50-99	100 +																																											
\$17.93	\$16.68																																											
1-24	25-49																																											
\$15.60	\$14.51																																											
50-99	100 +																																											
\$13.42	\$12.48																																											
1-24	25-49																																											
\$15.60	\$14.51																																											
50-99	100 +																																											
\$13.42	\$12.48																																											
1-24	25-49																																											
\$8.65	\$8.04																																											
50-99	100 +																																											
\$7.44	\$6.92																																											
1-24	25-49																																											
\$13.55	\$12.60																																											
50-99	100 +																																											
\$11.65	\$10.84																																											
<b>Model No. PE44455</b> SSMB JACK, 4 HOLE PANEL MOUNT, TAB CONTACT MOUNTING HOLE D15  <table border="1"> <tr><td>1-24</td><td>25-49</td></tr> <tr><td>\$16.65</td><td>\$15.48</td></tr> <tr><td>50-99</td><td>100 +</td></tr> <tr><td>\$14.32</td><td>\$13.32</td></tr> </table>	1-24	25-49	\$16.65	\$15.48	50-99	100 +	\$14.32	\$13.32	<p><b>PLEASE CONTACT OUR ENGINEERING DEPARTMENT FOR ALL YOUR SPECIAL REQUIREMENTS AT (866) 727-8376 EXT. 3</b></p>																																			
1-24	25-49																																											
\$16.65	\$15.48																																											
50-99	100 +																																											
\$14.32	\$13.32																																											

# SMB CONNECTORS

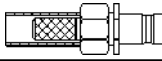
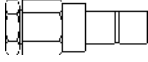
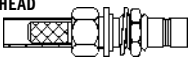
## STANDARD 50 OHM M39012 INTERFACE

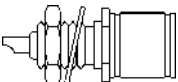
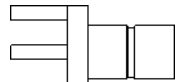
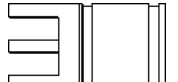
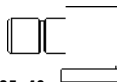
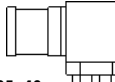
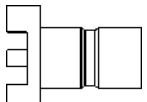
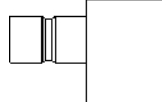
SEE PAGE 266 FOR MOUNTING HOLES

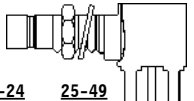
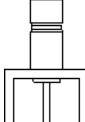
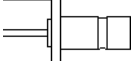
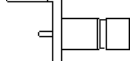
These 50 Ohm SMB connectors will interface with all M39012 50 Ohm SMB connectors. These will NOT mate with any 75 Ohm SMB connectors. JACK=MALE contact, PLUG=FEMALE contact

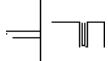
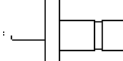
		P R I C E							
		1-24	25-49	50-99	100 +				
<b>PLUG, CRIMP ATTACHMENT</b> 	<b>Model No.</b>	<b>FITS MIL SPEC AND EQUIVALENT CABLES</b>							
	PE4523	RG58	\$12.25	\$11.39	\$10.54	\$9.80			
	PE4593	RG55, RG142, RG223, RG400	12.05	11.21	10.36	9.64			
	PE4046	RG174, RG188, RG316	8.30	7.72	7.14	6.64			
	PE4080	RG178, RG196	11.10	10.32	9.55	8.88			
<b>PLUG, CLAMP ATTACHMENT</b> 	PE4200	RG174, RG188, RG316	10.60	9.86	9.12	8.48			
	PE4250	RG178, RG196	13.55	12.60	11.65	10.84			
	PE4356	RG405, PE-SR405AL, PE-SR405FL (SEMI-RIGID)	9.90	9.21	8.51	7.92			
<b>PLUG, RIGHT ANGLE, CRIMP ATTACHMENT</b> 	PE4522	RG58	14.15	13.16	12.17	11.32			
	PE4595	RG55, RG142, RG223, RG400	14.30	13.30	12.30	11.44			
	PE4052	RG174, RG188, RG316	11.20	10.42	9.63	8.96			
	PE4159	RG178, RG196	10.85	10.09	9.33	8.68			
<b>PLUG, RIGHT ANGLE, CLAMP ATTACHMENT</b> 	PE4260	RG174, RG188, RG316	27.10	25.20	23.31	21.68			
	PE4261	RG178, RG196	27.10	25.20	23.31	21.68			
	PE4358	RG405, PE-SR405AL, PE-SR405FL (SEMI-RIGID)	10.40	9.67	8.94	8.32			
<b>JACK, CRIMP ATTACHMENT</b> 	PE4096	RG174, RG188, RG316	8.85	8.23	7.61	7.08			
	PE4926	RG178, RG196	16.65	15.48	14.32	13.32			
<b>JACK, CLAMP ATTACHMENT</b> 	PE4268	RG174, RG188, RG316	9.95	9.25	8.56	7.96			
	PE4269	RG178, RG196	15.60	14.51	13.42	12.48			
	PE4360	RG405, PE-SR405AL, PE-SR405FL (SEMI-RIGID)	12.50	11.63	10.75	10.00			
<b>JACK, BULKHEAD CRIMP ATTACHMENT</b> 	PE44048	RG55, RG142, RG223, RG400	20.85	19.39	17.93	16.68			
	PE44094	RG58	19.50	18.14	16.77	15.60			
	PE4097	RG174, RG188, RG316	10.00	9.30	8.60	8.00			
	PE4364	RG178, RG196	10.00	9.30	8.60	8.00			
<b>JACK, BULKHEAD CLAMP ATTACHMENT</b> 	PE4276	RG174, RG188, RG316	10.40	9.67	8.94	8.32			
	PE4277	RG178, RG196	10.40	9.67	8.94	8.32			
	PE4362	RG405, PE-SR405AL, PE-SR405FL (SEMI-RIGID)	11.95	11.11	10.28	9.56			
MOUNTING HOLES B01									
<b>Model No. PE4288</b> SMB PLUG BULKHEAD RECEPTACLE SOLDER CUP CONTACT MOUNTING HOLE B01 		<b>Model No. PE4174</b> SMB JACK, PRINTED CIRCUIT MOUNT, MOUNTING HOLE D02 		<b>Model No. PE4366</b> SMB PLUG, PRINTED CIRCUIT MOUNT, MOUNTING HOLE D02 		<b>Model No. PE4177</b> SMB JACK, RIGHT ANGLE PRINTED CIRCUIT MOUNT MOUNTING HOLE D02 		<b>Model No. PE4245</b> SMB PLUG, RIGHT ANGLE PRINTED CIRCUIT MOUNT MOUNTING HOLE D02 	
1-24 \$10.40 25-49 \$9.67 50-99 \$8.94 100+ \$8.32		1-24 \$4.45 25-49 \$4.14 50-99 \$3.83 100+ \$3.56		1-24 \$12.75 25-49 \$11.86 50-99 \$10.97 100+ \$10.20		1-24 \$7.75 25-49 \$7.21 50-99 \$6.67 100+ \$6.20		1-24 \$12.75 25-49 \$11.86 50-99 \$10.97 100+ \$10.20	
<b>Model No. PE44119</b> SMB JACK, SURFACE MOUNT 		<b>Model No. PE44121</b> SMB JACK, RIGHT ANGLE SURFACE MOUNT 		<b>Model No. PE44123</b> SMB JACK BULKHEAD P.C. MOUNT MOUNTING HOLE B01 & D02 		<b>Model No. PE44126</b> SMB JACK BULKHEAD RIGHT ANGLE, P.C. MOUNT MOUNTING HOLE B01 & D02 		<b>Model No. PE44129</b> SMB JACK, END LAUNCH FOR .062" THICK BOARD ROUND CONTACT 	
1-24 \$5.40 25-49 \$5.02 50-99 \$4.64 100+ \$4.32		1-24 \$12.95 25-49 \$12.04 50-99 \$11.14 100+ \$10.36		1-24 \$12.25 25-49 \$11.39 50-99 \$10.54 100+ \$9.80		1-24 \$14.40 25-49 \$13.39 50-99 \$12.38 100+ \$11.52		1-24 \$13.55 25-49 \$12.60 50-99 \$11.65 100+ \$10.84	
<b>Model No. PE44132</b> SMB JACK, END LAUNCH FOR .042" THICK BOARD ROUND CONTACT 		<b>Model No. PE44135</b> SMB JACK, END LAUNCH FOR .062" THICK BOARD TAB CONTACT 		<b>Model No. PE44137</b> SMB JACK, END LAUNCH FOR .042" THICK BOARD TAB CONTACT 		<b>Model No. PE44139</b> SMB JACK, 2 HOLE FLANGE SOLDER CUP CONTACT MOUNTING HOLE C07 		<b>Model No. PE44142</b> SMB JACK, 4 HOLE FLANGE SOLDER CUP CONTACT MOUNTING HOLE A22 	
1-24 \$15.60 25-49 \$14.51 50-99 \$13.42 100+ \$12.48		1-24 \$12.95 25-49 \$12.04 50-99 \$11.14 100+ \$10.36		1-24 \$13.55 25-49 \$12.60 50-99 \$11.65 100+ \$10.84		1-24 \$15.60 25-49 \$14.51 50-99 \$13.42 100+ \$12.48		1-24 \$15.60 25-49 \$14.51 50-99 \$13.42 100+ \$12.48	

Connectors

# MC-CARD CONNECTORS

**Model No. PE44308**  
MC-CARD PLUG, RIGHT ANGLE  
CRIMP ATTACHMENT FOR RG174,  
RG188 & RG316

1-24	25-49
\$8.65	\$8.04
50-99	100 +
\$7.44	\$6.92

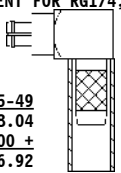

**Model No. PE44309**  
MC-CARD PLUG, CRIMP  
ATTACHMENT FOR RG174,  
RG188 & RG316

1-24	25-49
\$7.60	\$7.07
50-99	100 +
\$6.54	\$6.08

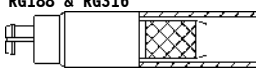

**Model No. PE44310**  
MC-CARD PLUG CRIMP  
ATTACHMENT FOR RG178  
& RG196

1-24	25-49
\$7.60	\$7.07
50-99	100 +
\$6.54	\$6.08



**Model No. PE44311**  
MC-CARD PLUG, RIGHT ANGLE  
CRIMP ATTACHMENT FOR  
RG178 & RG196

1-24	25-49
\$8.65	\$8.04
50-99	100 +
\$7.44	\$6.92

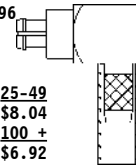

**PLEASE CONTACT OUR  
ENGINEERING  
DEPARTMENT FOR ALL  
YOUR SPECIAL  
REQUIREMENTS AT  
(866) 727-8376 EXT. 3**

## NEW LFU CONNECTORS

Compatible with Hirose U.FL™ Connectors



**Model No.**  
PE44594

**DESCRIPTION**  
LFU SURFACE MOUNT JACK, 6 GHz

P R I C E			
1-24	25-49	50-99	100 +
\$0.99	\$0.92	\$0.85	\$0.79

Note: U.FL™ is Registered Trademark of Hirose Electric Group

## MMCX CONNECTORS

SEE PAGE 266 FOR MOUNTING HOLES

**Model No. PE4896**  
MMCX PLUG, CRIMP  
ATTACHMENT FOR RG174,  
RG188 & RG316

1-24	25-49
\$11.10	\$10.32
50-99	100 +
\$9.55	\$8.88



**Model No. PE4897**  
MMCX PLUG, CRIMP  
ATTACHMENT FOR RG178  
& RG196

1-24	25-49
\$10.85	\$10.09
50-99	100 +
\$9.33	\$8.68

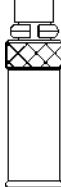

**Model No. PE4898**  
MMCX PLUG, RIGHT ANGLE  
CRIMP ATTACHMENT FOR  
RG174, RG188 & RG316

1-24	25-49
\$13.80	\$12.83
50-99	100 +
\$11.87	\$11.04



**Model No. PE4899**  
MMCX PLUG, RIGHT ANGLE  
CRIMP ATTACHMENT FOR  
RG178 & RG196

1-24	25-49
\$11.95	\$11.11
50-99	100 +
\$10.28	\$9.56

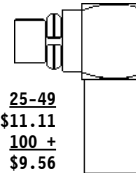

**Model No. PE4900**  
MMCX PLUG, RIGHT ANGLE  
SOLDER ATTACHMENT FOR  
RG405, PE-SR405AL &  
PE-SR405FL

1-24	25-49
\$11.95	\$11.11
50-99	100 +
\$10.28	\$9.56

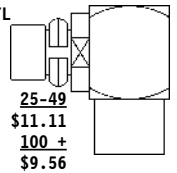

**Model No. PE4901**  
MMCX JACK, CRIMP  
ATTACHMENT FOR RG174,  
RG188 & RG316

1-24	25-49
\$10.85	\$10.09
50-99	100 +
\$9.33	\$8.68



**Model No. PE4902**  
MMCX JACK, CRIMP  
ATTACHMENT FOR RG178  
& RG196

1-24	25-49
\$10.85	\$10.09
50-99	100 +
\$9.33	\$8.68

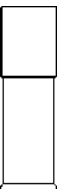

**Model No. PE4903**  
MMCX JACK, RIGHT ANGLE  
P.C. MOUNT, .115" LEGS  
MOUNTING HOLE D03

1-24	25-49
\$16.65	\$15.48
50-99	100 +
\$14.32	\$13.32

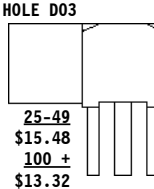

**Model No. PE4904**  
MMCX JACK, P.C. MOUNT  
.115" LEGS  
MOUNTING HOLE D03

1-24	25-49
\$8.65	\$8.04
50-99	100 +
\$7.44	\$6.92

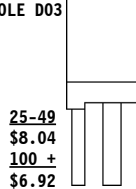

**Model No. PE4905**  
MMCX PLUG, P.C. MOUNT  
.115" LEGS  
MOUNTING HOLE D03

1-24	25-49
\$17.70	\$16.46
50-99	100 +
\$15.22	\$14.16

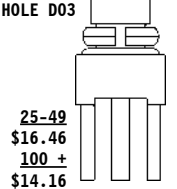

**Model No. PE44453**  
MMCX PLUG, SOLDER  
ATTACHMENT FOR RG405,  
PE-SR405AL & PE-SR405FL

1-24	25-49
\$10.85	\$10.09
50-99	100 +
\$9.33	\$8.68

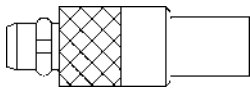

**Model No. PE44456**  
MMCX PLUG, SOLDER  
ATTACHMENT FOR PE-047SR,  
PE-SR047AL & PE-SR047FL

1-24	25-49
\$13.55	\$12.60
50-99	100 +
\$11.65	\$10.84

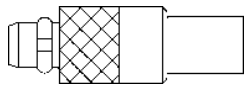

**Model No. PE44457**  
MMCX PLUG, RIGHT ANGLE  
SOLDER ATTACHMENT FOR  
PE-047SR, PE-SR047AL &  
PE-SR047FL

1-24	25-49
\$15.25	\$14.18
50-99	100 +
\$13.12	\$12.20

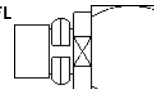

**Model No. PE44458**  
MMCX JACK, SOLDER  
ATTACHMENT FOR RG405,  
PE-SR405AL & PE-SR405FL

1-24	25-49
\$13.55	\$12.60
50-99	100 +
\$11.65	\$10.84

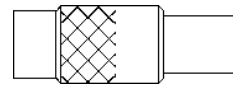

**Model No. PE44459**  
MMCX JACK, SOLDER  
ATTACHMENT FOR PE-047SR,  
PE-SR047AL & PE-SR047FL

1-24	25-49
\$18.75	\$17.44
50-99	100 +
\$16.13	\$15.00

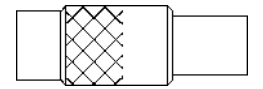

# MCX CONNECTORS

SEE PAGE 266 FOR MOUNTING HOLES

Connectors

Model No. PE4551  
MCX PLUG, CRIMP ATTACHMENT  
FOR RG174, RG188 & RG316

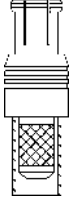

1-24	25-49
\$8.85	\$8.23
50-99	100 +
\$7.61	\$7.08

Model No. PE4552  
MCX PLUG, CRIMP ATTACHMENT  
FOR RG178 & RG196

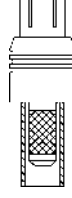

1-24	25-49
\$11.45	\$10.65
50-99	100 +
\$9.85	\$9.16

Model No. PE4553  
MCX PLUG, RIGHT ANGLE  
CRIMP ATTACHMENT FOR  
RG174, RG188 & RG316

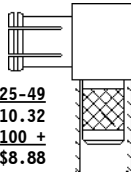

1-24	25-49
\$11.10	\$10.32
50-99	100 +
\$9.55	\$8.88

Model No. PE4554  
MCX PLUG, RIGHT ANGLE  
CRIMP ATTACHMENT FOR  
RG178 & RG196

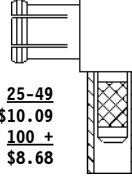

1-24	25-49
\$10.85	\$10.09
50-99	100 +
\$9.33	\$8.68

Model No. PE4555  
MCX JACK, P.C. MOUNT  
MOUNTING HOLE D04

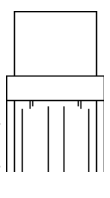

1-24	25-49
\$7.75	\$7.21
50-99	100 +
\$6.67	\$6.20

Model No. PE4556  
MCX JACK, RIGHT ANGLE  
P.C. MOUNT  
MOUNTING HOLE D04



1-24	25-49
\$10.00	\$9.30
50-99	100 +
\$8.60	\$8.00

Model No. PE4559  
MCX PLUG, P.C. MOUNT  
MOUNTING HOLE D04



1-24	25-49
\$12.65	\$11.76
50-99	100 +
\$10.88	\$10.12

Model No. PE4560  
MCX JACK, RIGHT ANGLE  
BULKHEAD MOUNT  
MOUNTING HOLE B01

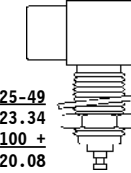

1-24	25-49
\$25.10	\$23.34
50-99	100 +
\$21.59	\$20.08

Model No. PE4561  
MCX JACK BULKHEAD MOUNT  
MOUNTING HOLE B01

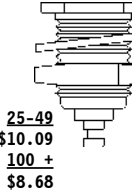

1-24	25-49
\$10.85	\$10.09
50-99	100 +
\$9.33	\$8.68

Model No. PE4562  
MCX JACK, CRIMP ATTACHMENT  
FOR RG174, RG188 & RG316

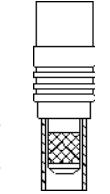

1-24	25-49
\$13.55	\$12.60
50-99	100 +
\$11.65	\$10.84

Model No. PE4876  
MCX PLUG, SOLDER  
ATTACHMENT FOR RG405,  
PE-SR405AL & PE-SR405FL



1-24	25-49
\$13.55	\$12.60
50-99	100 +
\$11.65	\$10.84

Model No. PE4877  
MCX PLUG, RIGHT ANGLE  
SOLDER ATTACHMENT FOR  
RG405, PE-SR405AL &  
PE-SR405FL



1-24	25-49
\$15.60	\$14.51
50-99	100 +
\$13.42	\$12.48

Model No. PE4878  
MCX PLUG, CRIMP ATTACHMENT  
FOR RG188-DS & RG316-DS

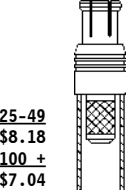

1-24	25-49
\$8.80	\$8.18
50-99	100 +
\$7.57	\$7.04

Model No. PE4879  
MCX PLUG, RIGHT ANGLE  
CRIMP ATTACHMENT FOR  
RG188-DS & RG316-DS

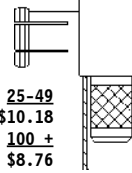

1-24	25-49
\$10.95	\$10.18
50-99	100 +
\$9.42	\$8.76

Model No. PE4880  
MCX PLUG, CRIMP  
ATTACHMENT FOR RG58

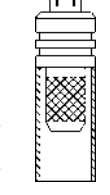

1-24	25-49
\$13.55	\$12.60
50-99	100 +
\$11.65	\$10.84

Model No. PE4881  
MCX PLUG, CRIMP ATTACHMENT  
FOR RG55, RG142, RG223  
& RG400

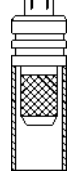

1-24	25-49
\$17.95	\$16.69
50-99	100 +
\$15.44	\$14.36

Model No. PE4882  
MCX PLUG, RIGHT ANGLE  
CRIMP ATTACHMENT FOR RG58

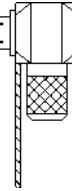

1-24	25-49
\$11.95	\$11.11
50-99	100 +
\$10.28	\$9.56

Model No. PE4883  
MCX PLUG, RIGHT ANGLE  
CRIMP ATTACHMENT FOR RG55,  
RG142, RG223 & RG400

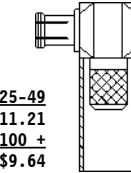

1-24	25-49
\$12.05	\$11.21
50-99	100 +
\$10.36	\$9.64

Model No. PE4884  
MCX JACK, CRIMP ATTACHMENT  
FOR RG178 & RG196

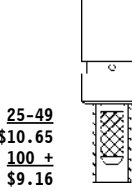

1-24	25-49
\$11.45	\$10.65
50-99	100 +
\$9.85	\$9.16

Model No. PE4885  
MCX JACK, CRIMP ATTACHMENT  
FOR RG188-DS & RG316-DS

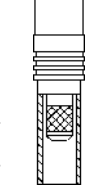

1-24	25-49
\$11.45	\$10.65
50-99	100 +
\$9.85	\$9.16

Model No. PE4886  
MCX JACK BULKHEAD, CRIMP  
ATTACHMENT FOR RG178  
& RG196  
MOUNTING HOLE B01

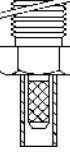

1-24	25-49
\$19.80	\$18.41
50-99	100 +
\$17.03	\$15.84

Model No. PE4887  
MCX JACK BULKHEAD, CRIMP  
ATTACHMENT FOR RG174,  
RG188 & RG316  
MOUNTING HOLE B01



1-24	25-49
\$11.95	\$11.11
50-99	100 +
\$10.28	\$9.56

Model No. PE4888  
MCX JACK BULKHEAD, CRIMP  
ATTACHMENT FOR RG188-DS  
& RG316-DS  
MOUNTING HOLE B01

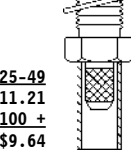

1-24	25-49
\$12.05	\$11.21
50-99	100 +
\$10.36	\$9.64

Model No. PE4889  
MCX JACK, SURFACE MOUNT

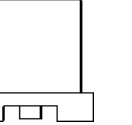

1-24	25-49
\$8.65	\$8.04
50-99	100 +
\$7.44	\$6.92

Model No. PE4890  
MCX JACK, RIGHT ANGLE  
SURFACE MOUNT



1-24	25-49
\$15.60	\$14.51
50-99	100 +
\$13.42	\$12.48

CONTINUED ON NEXT PAGE

# MCX CONNECTORS (CONT'D)

SEE PAGE 266 FOR MOUNTING HOLES

Model No. PE4891  
MCX JACK, 2 HOLE PANEL  
MOUNT, SOLDER CUP CONTACT  
MOUNTING HOLE C03



1-24	25-49
\$11.45	\$10.65
50-99	100 +
\$9.85	\$9.16

Model No. PE4892  
MCX JACK, END LAUNCH FOR  
.062" THICK BOARD  
.019" ROUND CONTACT

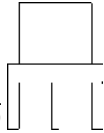

1-24	25-49
\$13.55	\$12.60
50-99	100 +
\$11.65	\$10.84

Model No. PE4893  
MCX JACK, END LAUNCH FOR  
.042" THICK BOARD  
.019" ROUND CONTACT



1-24	25-49
\$11.45	\$10.65
50-99	100 +
\$9.85	\$9.16

Model No. PE4894  
MCX JACK, 2 HOLE PANEL  
MOUNT, .200" EXTENDED  
DIELECTRIC  
MOUNTING HOLE C03

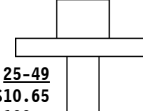

1-24	25-49
\$11.45	\$10.65
50-99	100 +
\$9.85	\$9.16

Model No. PE4895  
MCX JACK, 4 HOLE PANEL  
MOUNT, SOLDER CUP CONTACT  
MOUNTING HOLE A17

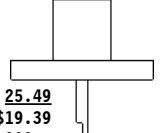

1-24	25-49
\$20.85	\$19.39
50-99	100 +
\$17.93	\$16.68

Model No. PE44613  
MCX PLUG, SURFACE MOUNT

**NEW**

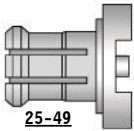

1-24	25-49
\$8.95	\$8.32
50-99	100 +
\$7.70	\$7.16

PLEASE CONTACT OUR ENGINEERING DEPARTMENT FOR ALL  
YOUR SPECIAL REQUIREMENTS AT (866) 727-8376 EXT. 3

**NEW**

## QN CONNECTORS

MANUFACTURED AND TESTED TO QLF® SPECIFICATIONS

QUICK LOCK FORMULA®, THE QLF QUICK LOCK FORMULA® LOGO AND THE QLF® LOGO ARE REGISTERED TRADEMARKS OF HUBER+SUHNER AG AND RADIALL SA.

SEE PAGE 266 FOR MOUNTING HOLES

QN MALE 11 GHz	Model No.	FITS MIL SPEC AND EQUIVALENT CABLES	ATTACHMENT METHOD	P R I C E			
				1-24	25-49	50-99	100 +
	PE44595	RG55, RG142, RG223, RG400	SOLDER-CRIMP	\$19.95	\$18.55	\$17.16	\$15.96
	PE44596	RG58, RG141, RG303	SOLDER-CRIMP	19.95	18.55	17.16	15.96
	PE44597	RG213, RG215	SOLDER-CRIMP	27.95	25.99	24.04	22.36
	PE44598	RG214, RG225	SOLDER-CRIMP	27.95	25.99	24.04	22.36
	PE44599	RG402, PE-SR402AL, PE-SR402FL (.141")	SOLDER	24.95	23.20	21.46	19.96

QN MALE RIGHT ANGLE 11 GHz 	PE44600	RG55, RG142, RG223, RG400	SOLDER-CRIMP	24.95	23.20	21.46	19.96
	PE44601	RG58, RG141, RG303	SOLDER-CRIMP	24.95	23.20	21.46	19.96
	PE44602	RG213, RG215	SOLDER-CRIMP	32.95	30.64	28.34	26.36
	PE44603	RG214, RG225	SOLDER-CRIMP	32.95	30.64	28.34	26.36
	PE44604	RG402, PE-SR402AL, PE-SR402FL (.141")	SOLDER	32.95	30.64	28.34	26.36

QN FEMALE BULKHEAD 11 GHz 	PE44605	RG55, RG142, RG223, RG400	SOLDER-CRIMP	22.95	21.34	19.74	18.36
	PE44606	RG58, RG141, RG303	SOLDER-CRIMP	22.95	21.34	19.74	18.36
	PE44607	RG213, RG215	SOLDER-CRIMP	30.95	28.78	26.62	24.76
	PE44608	RG214, RG225	SOLDER-CRIMP	30.95	28.78	26.62	24.76
	PE44609	RG402, PE-SR402AL, PE-SR402FL (.141")	SOLDER	30.95	28.78	26.62	24.76

MOUNTING HOLE F02

QN FEMALE PANEL MOUNT 11 GHz 	PE44610	1" SQ FLANGE, SOLDER CUP CONTACT	MOUNTING HOLE D16	45.95	42.73	39.52	36.76
--	---------	----------------------------------	-------------------	-------	-------	-------	-------

PLEASE SEE PAGE 84 & 85 FOR QN CABLE ASSEMBLIES

**NEW**

# QMA CONNECTORS

**MANUFACTURED AND TESTED TO QLF® SPECIFICATIONS**

QUICK LOCK FORMULA®, THE QLF QUICK LOCK FORMULA® LOGO AND THE QLF® LOGO ARE REGISTERED TRADEMARKS OF HUBER+SUHNER AG AND RADIALL SA.

**SEE PAGE 266 FOR MOUNTING HOLES**

QMA MALE 18 GHz	Model No.	FITS MIL SPEC AND EQUIVALENT CABLES	ATTACHMENT METHOD	P R I C E			
				1-24	25-49	50-99	100 +
	PE44503	RG58, RG141	SOLDER-CRIMP	\$12.50	\$11.63	\$10.75	\$10.00
	PE44501	RG174, RG188, RG316	SOLDER-CRIMP	12.50	11.63	10.75	10.00
	PE44502	RG316-DS	SOLDER-CRIMP	12.50	11.63	10.75	10.00
	PE44496	RG402, PE-SR402AL, PE-SR402FL (.141")	SOLDER	12.50	11.63	10.75	10.00
	PE44495	RG405, PE-SR405AL, PE-SR405FL (.085")	SOLDER	12.50	11.63	10.75	10.00

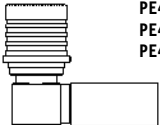
QMA MALE RIGHT ANGLE 18 GHz 	PE44506	RG58, RG141	SOLDER-CRIMP	15.60	14.51	13.42	12.48
	PE44504	RG174, RG188, RG316	SOLDER-CRIMP	14.60	13.58	12.56	11.68
	PE44505	RG316-DS	SOLDER-CRIMP	14.60	13.58	12.56	11.68
	PE44498	RG402, PE-SR402AL, PE-SR402FL (.141")	SOLDER	15.60	14.51	13.42	12.48
	PE44497	RG405, PE-SR405AL, PE-SR405FL (.085")	SOLDER	15.60	14.51	13.42	12.48

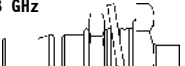
QMA FEMALE BULKHEAD 18 GHz 	PE44509	RG58, RG141	SOLDER-CRIMP	12.50	11.63	10.75	10.00
	PE44507	RG174, RG188, RG316	SOLDER-CRIMP	12.50	11.63	10.75	10.00
	PE44508	RG316-DS	SOLDER-CRIMP	12.50	11.63	10.75	10.00
	PE44500	RG402, PE-SR402AL, PE-SR402FL (.141")	SOLDER	14.60	13.58	12.56	11.68
	PE44499	RG405, PE-SR405AL, PE-SR405FL (.085")	SOLDER	14.60	13.58	12.56	11.68

**MOUNTING HOLES B17**

QMA FEMALE 18 GHz 	PE44510	PCB SURFACE MOUNT	34.45	32.04	29.63	27.56
	PE44512	PCB THRU HOLE	8.30	7.72	7.14	6.64

QMA FEMALE RIGHT ANGLE 18 GHz 	PE44511	PCB SURFACE MOUNT	20.85	19.39	17.93	16.68
	PE44513	PCB THRU HOLE	15.60	14.51	13.42	12.48



PLEASE SEE PAGE 55 FOR QMA CABLE ASSEMBLIES

## NOTES

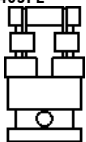
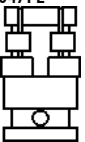

# SMP CONNECTORS

SEE PAGE 266 FOR MOUNTING HOLES

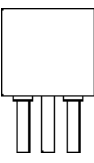
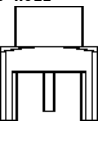
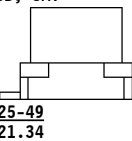
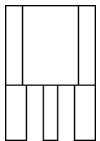
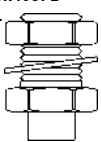
<p><b>Model No. PE44272</b> SMP FEMALE, SOLDER ATTACHMENT FOR RG405, PE-SR405AL &amp; PE-SR405FL</p>  <table border="1"> <tr><td>1-24</td><td>25-49</td></tr> <tr><td>\$25.05</td><td>\$23.30</td></tr> <tr><td>50-99</td><td>100 +</td></tr> <tr><td>\$21.54</td><td>\$20.04</td></tr> </table>	1-24	25-49	\$25.05	\$23.30	50-99	100 +	\$21.54	\$20.04	<p><b>Model No. PE44273</b> SMP FEMALE, SOLDER ATTACHMENT FOR PE-0475R, PE-SR047AL &amp; PE-SR047FL</p>  <table border="1"> <tr><td>1-24</td><td>25-49</td></tr> <tr><td>\$25.05</td><td>\$23.30</td></tr> <tr><td>50-99</td><td>100 +</td></tr> <tr><td>\$21.54</td><td>\$20.04</td></tr> </table>	1-24	25-49	\$25.05	\$23.30	50-99	100 +	\$21.54	\$20.04	<p><b>Model No. PE44274</b> SMP FEMALE, RIGHT ANGLE SOLDER ATTACHMENT FOR PE-0475R, PE-SR047AL &amp; PE-SR405FL</p>  <table border="1"> <tr><td>1-24</td><td>25-49</td></tr> <tr><td>\$24.40</td><td>\$22.69</td></tr> <tr><td>50-99</td><td>100 +</td></tr> <tr><td>\$20.98</td><td>\$19.52</td></tr> </table>	1-24	25-49	\$24.40	\$22.69	50-99	100 +	\$20.98	\$19.52	<p><b>Model No. PE44275</b> SMP FEMALE, RIGHT ANGLE SOLDER ATTACHMENT FOR RG405, PE-SR405AL &amp; PE-SR405FL</p>  <table border="1"> <tr><td>1-24</td><td>25-49</td></tr> <tr><td>\$20.85</td><td>\$19.39</td></tr> <tr><td>50-99</td><td>100 +</td></tr> <tr><td>\$17.93</td><td>\$16.68</td></tr> </table>	1-24	25-49	\$20.85	\$19.39	50-99	100 +	\$17.93	\$16.68	<p><b>Model No. PE44348</b> SMP MALE, P.C. MOUNT MOUNTING HOLE D03</p>  <table border="1"> <tr><td>1-24</td><td>25-49</td></tr> <tr><td>\$20.85</td><td>\$19.39</td></tr> <tr><td>50-99</td><td>100 +</td></tr> <tr><td>\$17.93</td><td>\$16.68</td></tr> </table>	1-24	25-49	\$20.85	\$19.39	50-99	100 +	\$17.93	\$16.68
1-24	25-49																																											
\$25.05	\$23.30																																											
50-99	100 +																																											
\$21.54	\$20.04																																											
1-24	25-49																																											
\$25.05	\$23.30																																											
50-99	100 +																																											
\$21.54	\$20.04																																											
1-24	25-49																																											
\$24.40	\$22.69																																											
50-99	100 +																																											
\$20.98	\$19.52																																											
1-24	25-49																																											
\$20.85	\$19.39																																											
50-99	100 +																																											
\$17.93	\$16.68																																											
1-24	25-49																																											
\$20.85	\$19.39																																											
50-99	100 +																																											
\$17.93	\$16.68																																											
<p><b>Model No. PE44480</b> SMP MALE, PCB THRU HOLE</p>  <table border="1"> <tr><td>1-24</td><td>25-49</td></tr> <tr><td>\$21.90</td><td>\$20.37</td></tr> <tr><td>50-99</td><td>100 +</td></tr> <tr><td>\$18.83</td><td>\$17.52</td></tr> </table>	1-24	25-49	\$21.90	\$20.37	50-99	100 +	\$18.83	\$17.52	<p><b>Model No. PE44481</b> SMP MALE, PCB, SMT</p>  <table border="1"> <tr><td>1-24</td><td>25-49</td></tr> <tr><td>\$22.95</td><td>\$21.34</td></tr> <tr><td>50-99</td><td>100 +</td></tr> <tr><td>\$19.74</td><td>\$18.36</td></tr> </table>	1-24	25-49	\$22.95	\$21.34	50-99	100 +	\$19.74	\$18.36	<p><b>Model No. PE44482</b> SMP MALE, PCB, EDGE MOUNT</p>  <table border="1"> <tr><td>1-24</td><td>25-49</td></tr> <tr><td>\$16.65</td><td>\$15.48</td></tr> <tr><td>50-99</td><td>100 +</td></tr> <tr><td>\$14.32</td><td>\$13.32</td></tr> </table>	1-24	25-49	\$16.65	\$15.48	50-99	100 +	\$14.32	\$13.32	<p><b>Model No. PE44483</b> SMP MALE BULKHEAD REAR MOUNT FOR RG405, PE-SR405AL &amp; PE-SR405FL MOUNTING HOLE F11</p>  <table border="1"> <tr><td>1-24</td><td>25-49</td></tr> <tr><td>\$25.05</td><td>\$23.30</td></tr> <tr><td>50-99</td><td>100 +</td></tr> <tr><td>\$21.54</td><td>\$20.04</td></tr> </table>	1-24	25-49	\$25.05	\$23.30	50-99	100 +	\$21.54	\$20.04									
1-24	25-49																																											
\$21.90	\$20.37																																											
50-99	100 +																																											
\$18.83	\$17.52																																											
1-24	25-49																																											
\$22.95	\$21.34																																											
50-99	100 +																																											
\$19.74	\$18.36																																											
1-24	25-49																																											
\$16.65	\$15.48																																											
50-99	100 +																																											
\$14.32	\$13.32																																											
1-24	25-49																																											
\$25.05	\$23.30																																											
50-99	100 +																																											
\$21.54	\$20.04																																											

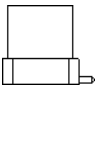
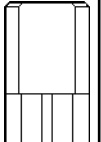
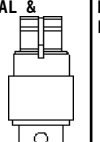
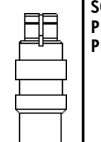
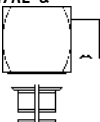
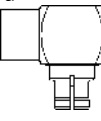

## MINI SMP CONNECTORS

SEE PAGE 266 FOR MOUNTING HOLES

<p><b>Model No. PE44489</b> MINI SMP MALE, PCB, SURFACE MOUNT, 65 GHz</p>  <table border="1"> <tr><td>1-24</td><td>25-49</td></tr> <tr><td>\$22.95</td><td>\$21.34</td></tr> <tr><td>50-99</td><td>100 +</td></tr> <tr><td>\$19.74</td><td>\$18.36</td></tr> </table>	1-24	25-49	\$22.95	\$21.34	50-99	100 +	\$19.74	\$18.36	<p><b>Model No. PE44490</b> MINI SMP MALE, PCB EDGE MOUNT, 65 GHz</p>  <table border="1"> <tr><td>1-24</td><td>25-49</td></tr> <tr><td>\$16.65</td><td>\$15.48</td></tr> <tr><td>50-99</td><td>100 +</td></tr> <tr><td>\$14.32</td><td>\$13.32</td></tr> </table>	1-24	25-49	\$16.65	\$15.48	50-99	100 +	\$14.32	\$13.32	<p><b>Model No. PE44491</b> MINI SMP FEMALE, 65 GHz SOLDER ATTACHMENT FOR PE-0475R, PE-SR047AL &amp; PE-SR047FL</p>  <table border="1"> <tr><td>1-24</td><td>25-49</td></tr> <tr><td>\$22.95</td><td>\$21.34</td></tr> <tr><td>50-99</td><td>100 +</td></tr> <tr><td>\$19.74</td><td>\$18.36</td></tr> </table>	1-24	25-49	\$22.95	\$21.34	50-99	100 +	\$19.74	\$18.36	<p><b>Model No. PE44492</b> MINI SMP FEMALE, 65 GHz SOLDER ATTACHMENT FOR RG405, PE-SR405AL &amp; PE-SR405FL</p>  <table border="1"> <tr><td>1-24</td><td>25-49</td></tr> <tr><td>\$20.85</td><td>\$19.39</td></tr> <tr><td>50-99</td><td>100 +</td></tr> <tr><td>\$17.93</td><td>\$16.68</td></tr> </table>	1-24	25-49	\$20.85	\$19.39	50-99	100 +	\$17.93	\$16.68	<p><b>Model No. PE44493</b> MINI SMP FEMALE RIGHT ANGLE, 65 GHz SOLDER ATTACHMENT FOR PE-0475R, PE-SR047AL &amp; PE-SR047FL</p>  <table border="1"> <tr><td>1-24</td><td>25-49</td></tr> <tr><td>\$26.05</td><td>\$24.23</td></tr> <tr><td>50-99</td><td>100 +</td></tr> <tr><td>\$22.40</td><td>\$20.84</td></tr> </table>	1-24	25-49	\$26.05	\$24.23	50-99	100 +	\$22.40	\$20.84
1-24	25-49																																											
\$22.95	\$21.34																																											
50-99	100 +																																											
\$19.74	\$18.36																																											
1-24	25-49																																											
\$16.65	\$15.48																																											
50-99	100 +																																											
\$14.32	\$13.32																																											
1-24	25-49																																											
\$22.95	\$21.34																																											
50-99	100 +																																											
\$19.74	\$18.36																																											
1-24	25-49																																											
\$20.85	\$19.39																																											
50-99	100 +																																											
\$17.93	\$16.68																																											
1-24	25-49																																											
\$26.05	\$24.23																																											
50-99	100 +																																											
\$22.40	\$20.84																																											
<p><b>Model No. PE44494</b> MINI SMP FEMALE RIGHT ANGLE, 65 GHz SOLDER ATTACHMENT FOR RG405, PE-SR405AL &amp; PE-SR405FL</p>  <table border="1"> <tr><td>1-24</td><td>25-49</td></tr> <tr><td>\$25.05</td><td>\$23.30</td></tr> <tr><td>50-99</td><td>100 +</td></tr> <tr><td>\$21.54</td><td>\$20.04</td></tr> </table>	1-24	25-49	\$25.05	\$23.30	50-99	100 +	\$21.54	\$20.04	<p><b>PLEASE CONTACT OUR ENGINEERING DEPARTMENT FOR ALL YOUR SPECIAL REQUIREMENTS AT (866) 727-8376 EXT. 3</b></p>																																			
1-24	25-49																																											
\$25.05	\$23.30																																											
50-99	100 +																																											
\$21.54	\$20.04																																											

## 75 OHM 1.6/5.6 CONNECTORS

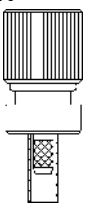
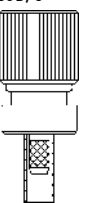
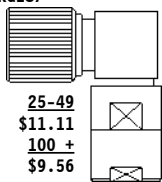
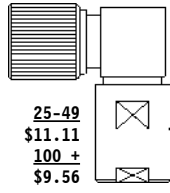
SEE PAGE 266 FOR MOUNTING HOLES

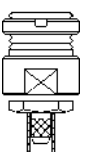
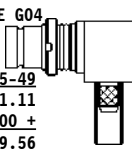
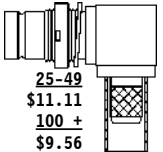
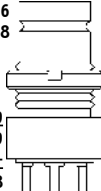
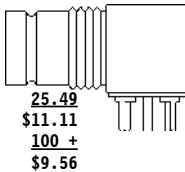
<p><b>Model No. PE44262</b> 1.6/5.6 PLUG, CRIMP ATTACHMENT FOR RG179 &amp; RG187</p>  <table border="1"> <tr><td>1-24</td><td>25-49</td></tr> <tr><td>\$9.75</td><td>\$9.07</td></tr> <tr><td>50-99</td><td>100 +</td></tr> <tr><td>\$8.39</td><td>\$7.80</td></tr> </table>	1-24	25-49	\$9.75	\$9.07	50-99	100 +	\$8.39	\$7.80	<p><b>Model No. PE44263</b> 1.6/5.6 PLUG, CRIMP ATTACHMENT FOR RG59B/U</p>  <table border="1"> <tr><td>1-24</td><td>25-49</td></tr> <tr><td>\$9.75</td><td>\$9.07</td></tr> <tr><td>50-99</td><td>100 +</td></tr> <tr><td>\$8.39</td><td>\$7.80</td></tr> </table>	1-24	25-49	\$9.75	\$9.07	50-99	100 +	\$8.39	\$7.80	<p><b>Model No. PE44264</b> 1.6/5.6 PLUG RIGHT ANGLE CLAMP ATTACHMENT FOR RG179 &amp; RG187</p>  <table border="1"> <tr><td>1-24</td><td>25-49</td></tr> <tr><td>\$11.95</td><td>\$11.11</td></tr> <tr><td>50-99</td><td>100 +</td></tr> <tr><td>\$10.28</td><td>\$9.56</td></tr> </table>	1-24	25-49	\$11.95	\$11.11	50-99	100 +	\$10.28	\$9.56	<p><b>Model No. PE44265</b> 1.6/5.6 PLUG RIGHT ANGLE CLAMP ATTACHMENT FOR RG59B/U</p>  <table border="1"> <tr><td>1-24</td><td>25-49</td></tr> <tr><td>\$11.95</td><td>\$11.11</td></tr> <tr><td>50-99</td><td>100 +</td></tr> <tr><td>\$10.28</td><td>\$9.56</td></tr> </table>	1-24	25-49	\$11.95	\$11.11	50-99	100 +	\$10.28	\$9.56	<p><b>Model No. PE44266</b> 1.6/5.6 JACK BULKHEAD CRIMP ATTACHMENT FOR RG179 &amp; RG187 MOUNTING HOLE G04</p>  <table border="1"> <tr><td>1-24</td><td>25-49</td></tr> <tr><td>\$10.85</td><td>\$10.09</td></tr> <tr><td>50-99</td><td>100 +</td></tr> <tr><td>\$9.33</td><td>\$8.68</td></tr> </table>	1-24	25-49	\$10.85	\$10.09	50-99	100 +	\$9.33	\$8.68
1-24	25-49																																											
\$9.75	\$9.07																																											
50-99	100 +																																											
\$8.39	\$7.80																																											
1-24	25-49																																											
\$9.75	\$9.07																																											
50-99	100 +																																											
\$8.39	\$7.80																																											
1-24	25-49																																											
\$11.95	\$11.11																																											
50-99	100 +																																											
\$10.28	\$9.56																																											
1-24	25-49																																											
\$11.95	\$11.11																																											
50-99	100 +																																											
\$10.28	\$9.56																																											
1-24	25-49																																											
\$10.85	\$10.09																																											
50-99	100 +																																											
\$9.33	\$8.68																																											
<p><b>Model No. PE44267</b> 1.6/5.6 JACK BULKHEAD CRIMP ATTACHMENT FOR RG59B/U MOUNTING HOLE G04</p>  <table border="1"> <tr><td>1-24</td><td>25-49</td></tr> <tr><td>\$10.85</td><td>\$10.09</td></tr> <tr><td>50-99</td><td>100 +</td></tr> <tr><td>\$9.33</td><td>\$8.68</td></tr> </table>	1-24	25-49	\$10.85	\$10.09	50-99	100 +	\$9.33	\$8.68	<p><b>Model No. PE44268</b> 1.6/5.6 JACK BULKHEAD RIGHT ANGLE, CRIMP ATTACHMENT FOR RG179 &amp; RG187 MOUNTING HOLE G04</p>  <table border="1"> <tr><td>1-24</td><td>25-49</td></tr> <tr><td>\$11.95</td><td>\$11.11</td></tr> <tr><td>50-99</td><td>100 +</td></tr> <tr><td>\$10.28</td><td>\$9.56</td></tr> </table>	1-24	25-49	\$11.95	\$11.11	50-99	100 +	\$10.28	\$9.56	<p><b>Model No. PE44269</b> 1.6/5.6 JACK BULKHEAD RIGHT ANGLE, CRIMP ATTACHMENT FOR RG59B/U MOUNTING HOLE G04</p>  <table border="1"> <tr><td>1-24</td><td>25-49</td></tr> <tr><td>\$11.95</td><td>\$11.11</td></tr> <tr><td>50-99</td><td>100 +</td></tr> <tr><td>\$10.28</td><td>\$9.56</td></tr> </table>	1-24	25-49	\$11.95	\$11.11	50-99	100 +	\$10.28	\$9.56	<p><b>Model No. PE44270</b> 1.6/5.6 JACK BULKHEAD P.C. MOUNT MOUNTING HOLE D06 MOUNTING HOLE F08</p>  <table border="1"> <tr><td>1-24</td><td>25-49</td></tr> <tr><td>\$10.85</td><td>\$10.09</td></tr> <tr><td>50-99</td><td>100 +</td></tr> <tr><td>\$9.33</td><td>\$8.68</td></tr> </table>	1-24	25-49	\$10.85	\$10.09	50-99	100 +	\$9.33	\$8.68	<p><b>Model No. PE44271</b> 1.6/5.6 JACK RIGHT ANGLE P.C. MOUNT MOUNTING HOLE D06</p>  <table border="1"> <tr><td>1-24</td><td>25-49</td></tr> <tr><td>\$11.95</td><td>\$11.11</td></tr> <tr><td>50-99</td><td>100 +</td></tr> <tr><td>\$10.28</td><td>\$9.56</td></tr> </table>	1-24	25-49	\$11.95	\$11.11	50-99	100 +	\$10.28	\$9.56
1-24	25-49																																											
\$10.85	\$10.09																																											
50-99	100 +																																											
\$9.33	\$8.68																																											
1-24	25-49																																											
\$11.95	\$11.11																																											
50-99	100 +																																											
\$10.28	\$9.56																																											
1-24	25-49																																											
\$11.95	\$11.11																																											
50-99	100 +																																											
\$10.28	\$9.56																																											
1-24	25-49																																											
\$10.85	\$10.09																																											
50-99	100 +																																											
\$9.33	\$8.68																																											
1-24	25-49																																											
\$11.95	\$11.11																																											
50-99	100 +																																											
\$10.28	\$9.56																																											

# 75 OHM BNC CONNECTORS

SEE PAGE 266 FOR MOUNTING HOLES

	Model No.	FITS MIL SPEC AND EQUIVALENT CABLES	ATTACHMENT METHOD	P R I C E			
				1-24	25-49	50-99	100 +
75 OHM BNC MALE FOR CABLE ATTACHMENT	PE4597	RG6A/U	CLAMP	\$14.15	\$13.16	\$12.17	\$11.32
	PE4598	RG6A/U	CRIMP	14.40	13.39	12.38	11.52
	PE4599	RG11, RG216	CLAMP	17.70	16.46	15.22	14.16
	PE4600	RG11	CRIMP	13.05	12.14	11.22	10.44
	PE4601	RG59B/U	CLAMP	10.60	9.86	9.12	8.48
	PE4602	RG59B/U	CRIMP	10.00	9.30	8.60	8.00
	PE4603	RG179, RG187	CLAMP	9.75	9.07	8.39	7.80
	PE4604	RG179, RG187	CRIMP	10.15	9.44	8.73	8.12
	PE44626	PE-B1505, 1505A, VMP2000	CRIMP (3 PIECE)	5.95	5.53	5.12	4.76
	PE44627	PE-B1694	CRIMP (3 PIECE)	5.95	5.53	5.12	4.76
	PE44628	PE-B7731, 7731A, VHD1100	CRIMP (3 PIECE)	6.95	6.46	5.98	5.56
	PE4633	BELDEN 8218, PE-B8128	CRIMP	9.75	9.07	8.39	7.80
	PE4634	BELDEN 8281, PE-B1828	CRIMP	9.75	9.07	8.39	7.80
	PE44625	MINI 59, 1855A, VDM230, PE-BYR940	CRIMP (3 PIECE)	5.95	5.53	5.12	4.76

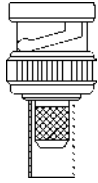

**NEW**  
**NEW**  
**NEW**

75 OHM BNC MALE RIGHT ANGLE FOR CABLE ATTACHMENT	PE4605	RG6A/U	CLAMP	18.75	17.44	16.13	15.00
	PE4606	RG11, RG216	CLAMP	22.95	21.34	19.74	18.36
	PE4607	RG59B/U	CLAMP	18.75	17.44	16.13	15.00
	PE4608	RG59B/U	CRIMP	22.95	21.34	19.74	18.36
	PE4609	RG179, RG187	CLAMP	22.95	21.34	19.74	18.36
	PE4610	RG179, RG187	CRIMP	18.10	16.83	15.57	14.48

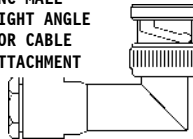

75 OHM BNC FEMALE FOR CABLE ATTACHMENT	PE4611	RG6A/U	CLAMP	25.10	23.34	21.59	20.08
	PE4612	RG11, RG216	CLAMP	17.40	16.18	14.96	13.92
	PE4613	RG59B/U	CLAMP	12.50	11.63	10.75	10.00
	PE4614	RG59B/U	CRIMP	11.95	11.11	10.28	9.56
	PE4615	RG179, RG187	CLAMP	15.60	14.51	13.42	12.48
	PE4616	RG179, RG187	CRIMP	11.95	11.11	10.28	9.56

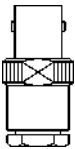

75 OHM BNC FEMALE BULKHEAD FOR CABLE ATTACHMENT	PE4635	RG6A/U	CLAMP	31.30	29.11	26.92	25.04
	PE4636	RG11, RG216	CLAMP	31.30	29.11	26.92	25.04
	PE4637	RG59B/U	CLAMP	15.60	14.51	13.42	12.48
	PE4638	RG59B/U	CRIMP	18.80	17.48	16.17	15.04
	PE4639	RG179, RG187	CLAMP	20.85	19.39	17.93	16.68
	PE4640	RG179, RG187	CRIMP	14.40	13.39	12.38	11.52
	PE4641	BELDEN 8218, PE-B8128	CRIMP	16.30	15.16	14.02	13.04
	PE4642	BELDEN 8281, PE-B1828	CRIMP	16.30	15.16	14.02	13.04



## MOUNTING HOLE B06

<p>Model No. PE4617 75 OHM BNC FEMALE, PANEL MOUNT, SOLDER CUP CONTACT #3-56 TAPPED HOLES MOUNTING HOLE A03</p> <table border="1"> <tr><td>1-24</td><td>25-49</td></tr> <tr><td>\$8.65</td><td>\$8.04</td></tr> <tr><td>50-99</td><td>100 +</td></tr> <tr><td>\$7.44</td><td>\$6.92</td></tr> </table>	1-24	25-49	\$8.65	\$8.04	50-99	100 +	\$7.44	\$6.92	<p>Model No. PE4618 75 OHM BNC FEMALE, PANEL MOUNT, TURRET TERMINAL MOUNTING HOLE A07</p> <table border="1"> <tr><td>1-24</td><td>25-49</td></tr> <tr><td>\$24.95</td><td>\$23.20</td></tr> <tr><td>50-99</td><td>100 +</td></tr> <tr><td>\$21.46</td><td>\$19.96</td></tr> </table>	1-24	25-49	\$24.95	\$23.20	50-99	100 +	\$21.46	\$19.96	<p>Model No. PE4619 75 OHM BNC FEMALE BULKHEAD MOUNT FOR UP TO 1/8" PANEL THICKNESS SOLDER CUP CONTACT MOUNTING HOLE B05</p> <table border="1"> <tr><td>1-24</td><td>25-49</td></tr> <tr><td>\$5.40</td><td>\$5.02</td></tr> <tr><td>50-99</td><td>100 +</td></tr> <tr><td>\$4.64</td><td>\$4.32</td></tr> </table>	1-24	25-49	\$5.40	\$5.02	50-99	100 +	\$4.64	\$4.32	<p>Model No. PE4620 75 OHM BNC FEMALE BULKHEAD MOUNT FOR UP TO 1/4" PANEL THICKNESS SOLDER CUP CONTACT MOUNTING HOLE B04</p> <table border="1"> <tr><td>1-24</td><td>25-49</td></tr> <tr><td>\$8.75</td><td>\$8.14</td></tr> <tr><td>50-99</td><td>100 +</td></tr> <tr><td>\$7.53</td><td>\$7.00</td></tr> </table>	1-24	25-49	\$8.75	\$8.14	50-99	100 +	\$7.53	\$7.00	<p>Model No. PE4621 75 OHM BNC FEMALE BULKHEAD, REAR MOUNT HERMETICALLY SEALED MOUNTING HOLE B06</p> <table border="1"> <tr><td>1-24</td><td>25-49</td></tr> <tr><td>\$20.85</td><td>\$19.39</td></tr> <tr><td>50-99</td><td>100 +</td></tr> <tr><td>\$17.93</td><td>\$16.68</td></tr> </table>	1-24	25-49	\$20.85	\$19.39	50-99	100 +	\$17.93	\$16.68
1-24	25-49																																											
\$8.65	\$8.04																																											
50-99	100 +																																											
\$7.44	\$6.92																																											
1-24	25-49																																											
\$24.95	\$23.20																																											
50-99	100 +																																											
\$21.46	\$19.96																																											
1-24	25-49																																											
\$5.40	\$5.02																																											
50-99	100 +																																											
\$4.64	\$4.32																																											
1-24	25-49																																											
\$8.75	\$8.14																																											
50-99	100 +																																											
\$7.53	\$7.00																																											
1-24	25-49																																											
\$20.85	\$19.39																																											
50-99	100 +																																											
\$17.93	\$16.68																																											
<p>Model No. PE4622 75 OHM BNC FEMALE RIGHT ANGLE BULKHEAD SOLDER CUP CONTACT MOUNTING HOLE B13</p> <table border="1"> <tr><td>1-24</td><td>25-49</td></tr> <tr><td>\$31.30</td><td>\$29.11</td></tr> <tr><td>50-99</td><td>100 +</td></tr> <tr><td>\$26.92</td><td>\$25.04</td></tr> </table>	1-24	25-49	\$31.30	\$29.11	50-99	100 +	\$26.92	\$25.04	<p>Model No. PE4623 75 OHM BNC FEMALE, PANEL MOUNT, CLAMP ATTACHMENT FOR RG59B/U MOUNTING HOLE A03</p> <table border="1"> <tr><td>1-24</td><td>25-49</td></tr> <tr><td>\$20.85</td><td>\$19.39</td></tr> <tr><td>50-99</td><td>100 +</td></tr> <tr><td>\$17.93</td><td>\$16.68</td></tr> </table>	1-24	25-49	\$20.85	\$19.39	50-99	100 +	\$17.93	\$16.68	<p>Model No. PE4624 75 OHM BNC FEMALE BULKHEAD, FRONT MOUNT HERMETICALLY SEALED MOUNTING HOLE B04</p> <table border="1"> <tr><td>1-24</td><td>25-49</td></tr> <tr><td>\$20.85</td><td>\$19.39</td></tr> <tr><td>50-99</td><td>100 +</td></tr> <tr><td>\$17.93</td><td>\$16.68</td></tr> </table>	1-24	25-49	\$20.85	\$19.39	50-99	100 +	\$17.93	\$16.68	<p>Model No. PE4625 75 OHM BNC MALE, PANEL MOUNT, SOLDER CUP CONTACT MOUNTING HOLE A07</p> <table border="1"> <tr><td>1-24</td><td>25-49</td></tr> <tr><td>\$14.15</td><td>\$13.16</td></tr> <tr><td>50-99</td><td>100 +</td></tr> <tr><td>\$12.17</td><td>\$11.32</td></tr> </table>	1-24	25-49	\$14.15	\$13.16	50-99	100 +	\$12.17	\$11.32	<p>Model No. PE4626 75 OHM BNC FEMALE BULKHEAD, ISOLATED GROUND SOLDER CUP CONTACT MOUNTING HOLE B04</p> <table border="1"> <tr><td>1-24</td><td>25-49</td></tr> <tr><td>\$7.60</td><td>\$7.07</td></tr> <tr><td>50-99</td><td>100 +</td></tr> <tr><td>\$6.54</td><td>\$6.08</td></tr> </table>	1-24	25-49	\$7.60	\$7.07	50-99	100 +	\$6.54	\$6.08
1-24	25-49																																											
\$31.30	\$29.11																																											
50-99	100 +																																											
\$26.92	\$25.04																																											
1-24	25-49																																											
\$20.85	\$19.39																																											
50-99	100 +																																											
\$17.93	\$16.68																																											
1-24	25-49																																											
\$20.85	\$19.39																																											
50-99	100 +																																											
\$17.93	\$16.68																																											
1-24	25-49																																											
\$14.15	\$13.16																																											
50-99	100 +																																											
\$12.17	\$11.32																																											
1-24	25-49																																											
\$7.60	\$7.07																																											
50-99	100 +																																											
\$6.54	\$6.08																																											

# 75 OHM BNC CONNECTORS (CONT'D)

SEE PAGE 266 FOR MOUNTING HOLES

**Model No. PE4627**  
75 OHM BNC MALE BULKHEAD  
MOUNT, SOLDER CUP CONTACT  
MOUNTING HOLE B04



<u>1-24</u>	<u>25-49</u>
\$13.05	\$12.14
<u>50-99</u>	<u>100 +</u>
\$11.22	\$10.44

**Model No. PE4628**  
75 OHM BNC FEMALE  
RIGHT ANGLE, PANEL MOUNT  
SOLDER CUP CONTACT  
MOUNTING HOLE A16

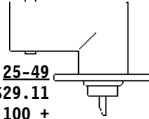

<u>1-24</u>	<u>25-49</u>
\$31.30	\$29.11
<u>50-99</u>	<u>100 +</u>
\$26.92	\$25.04

**Model No. PE4629**  
75 OHM BNC FEMALE  
BULKHEAD, ISOLATED GROUND  
SOLDER CUP CONTACT  
MOUNTING HOLE B06



<u>1-24</u>	<u>25-49</u>
\$13.05	\$12.14
<u>50-99</u>	<u>100 +</u>
\$11.22	\$10.44

**Model No. PE4630**  
75 OHM BNC FEMALE, PANEL  
MOUNT, SOLDER CUP CONTACT  
MOUNTING HOLE A04

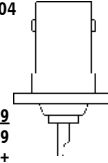

<u>1-24</u>	<u>25-49</u>
\$10.85	\$10.09
<u>50-99</u>	<u>100 +</u>
\$9.33	\$8.68

**Model No. PE4631**  
75 OHM BNC FEMALE  
PANEL MOUNT, 1" SQ. FLANGE  
SOLDER CUP CONTACT  
MOUNTING HOLE A05

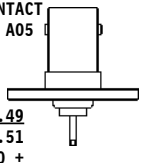

<u>1-24</u>	<u>25-49</u>
\$15.60	\$14.51
<u>50-99</u>	<u>100 +</u>
\$13.42	\$12.48

**Model No. PE44619**  
75 OHM BNC FEMALE, PCB GRIP  
EDGE LAUNCH



<u>1-24</u>	<u>25-49</u>
\$9.95	\$9.25
<u>50-99</u>	<u>100 +</u>
\$8.56	\$7.96

**NEW**

**Model No. PE44620**  
75 OHM BNC FEMALE BULKHEAD  
PCB GRIP. EDGE LAUNCH  
MOUNTING HOLE F02

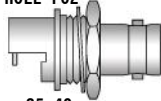

<u>1-24</u>	<u>25-49</u>
\$11.95	\$11.11
<u>50-99</u>	<u>100 +</u>
\$10.28	\$9.56

**NEW**

**PLEASE CONTACT OUR ENGINEERING DEPARTMENT FOR ALL  
YOUR SPECIAL REQUIREMENTS AT (866) 727-8376 EXT. 3**

## NOTES

# HIGH DEFINITION (HD) CONNECTORS

SEE PAGE 266 FOR MOUNTING HOLES

The new HD series is a professional-grade, 75 Ohm connector line designed for applications that include HDTV, satellite communications, and digital broadcast. The HD series connectors are designed around the popular Mini-59 type coaxial cables, such as Pasternack's new PE-BYR940. The HD Precision connectors are designed specifically for Pasternack's PE-BYR940 and Belden's 1855A cables, while the HD Universal connectors are designed for generic 75 Ohm cables with a 23, 24 or 25 AWG center conductor.

## **NEW** HD 75 OHM BNC CONNECTORS

Highly suited for HD Broadcast Audio and Video applications

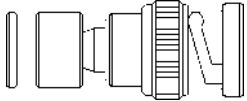
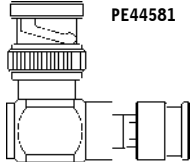
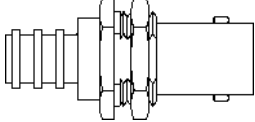
	Model No.	FITS MIL SPEC AND EQUIVALENT CABLES	ATTACHMENT METHOD	P R I C E			
				1-24	25-49	50-99	100 +
HD 75 OHM BNC PLUG FOR CABLE ATTACHMENT 	PE44584	PRECISION PE-BYR940, 1855A	CRIMP	\$9.45	\$8.79	\$8.13	\$7.56
	PE44577	PRECISION PE-BYR940, 1855A	COMPRESSION	9.95	9.25	8.56	7.96
	PE44629	RG179-DS, 179DT	CRIMP	9.45	8.79	8.13	7.56
	PE44630	MINI59, 1855A, VDM230, PE-BYR940	CRIMP	9.45	8.79	8.13	7.56
	PE44631	PE-B1505, 1505A, VPM2000	CRIMP	9.45	8.79	8.13	7.56
	PE44632	PE-B1694, 1694A, VSD2001	CRIMP	9.45	8.79	8.13	7.56
HD 75 OHM BNC PLUG FOR CABLE ATTACHMENT 	PE44578	UNIVERSAL MINI 59 COAX	COMPRESSION	9.95	9.25	8.56	7.96
	PE44581	UNIVERSAL MINI 59 COAX	COMPRESSION	12.95	12.04	11.14	10.36
HD 75 OHM BNC PLUG RIGHT ANGLE FOR CABLE ATTACHMENT 	PE44581	UNIVERSAL MINI 59 COAX	COMPRESSION	12.95	12.04	11.14	10.36
	PE44587	PRECISION PE-BYR940, 1855A	CRIMP	12.95	12.04	11.14	10.36
HD 75 OHM BNC JACK BULKHEAD FOR CABLE ATTACHMENT 	PE44587	PRECISION PE-BYR940, 1855A	CRIMP	12.95	12.04	11.14	10.36
		MOUNTING HOLE B06					

## **NEW** HD RCA CONNECTORS

Highly suited for HD Broadcast Audio and Video applications

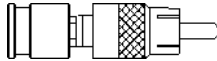
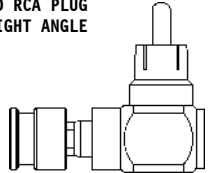
	Model No.	FITS MIL SPEC AND EQUIVALENT CABLES	ATTACHMENT METHOD	P R I C E			
				1-24	25-49	50-99	100 +
HD RCA PLUG FOR CABLE ATTACHMENT 	PE44575 (ALL GOLD)	PRECISION PE-BYR940, 1855A	COMPRESSION	\$9.95	\$9.25	\$8.56	\$7.96
	PE44574	PRECISION PE-BYR940, 1855A	COMPRESSION	6.95	6.46	5.98	5.56
	PE44583	PRECISION PE-BYR940, 1855A	CRIMP	5.95	5.53	5.12	4.76
	PE44576	UNIVERSAL MINI 59 COAX	COMPRESSION	6.95	6.46	5.98	5.56
	PE44622	MINI 59, 1855A, VDM230, PE-BYR940	CRIMP (3 PIECE)	8.95	8.32	7.70	7.16
	PE44623	PE-B1694, 1694A, VSD2001	CRIMP (3 PIECE)	8.95	8.32	7.70	7.16
	PE44624	PE-B1505, 1505A, VPM2000	CRIMP (3 PIECE)	8.95	8.32	7.70	7.16
	PE44580	UNIVERSAL MINI 59 COAX	COMPRESSION	11.95	11.11	10.28	9.56
HD RCA JACK BULKHEAD FOR CABLE ATTACHMENT 	PE44586	PRECISION PE-BYR940, 1855A	CRIMP	9.95	9.25	8.56	7.96
		MOUNTING HOLE B06					

SEE NEXT PAGE FOR MORE PRODUCTS

# HIGH DEFINITION (HD) CONNECTORS (cont'd)

SEE PAGE 266 FOR MOUNTING HOLES

The new HD series is a professional-grade, 75 Ohm connector line designed for applications that include HDTV, satellite communications, and digital broadcast. The HD series connectors are designed around the popular Mini-59 type coaxial cables, such as Pasternack's new PE-BYR940. The HD Precision connectors are designed specifically for Pasternack's PE-BYR940 and Belden's 1855A cables, while the HD Universal connectors are designed for generic 75 Ohm cables with a 23, 24 or 25 AWG center conductor.

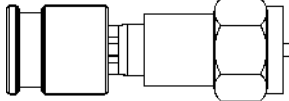
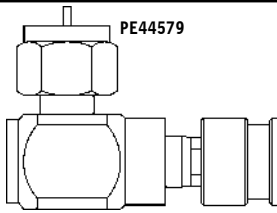
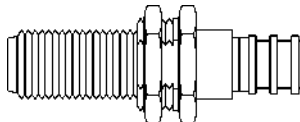

## **NEW** HD F CONNECTORS

Highly suited for HD Broadcast Audio and Video applications

HD F PLUG FOR CABLE ATTACHMENT	Model No.	FITS MIL SPEC AND EQUIVALENT CABLES	ATTACHMENT METHOD	P R I C E			
				1-24	25-49	50-99	100 +
	PE44582 PE44572 PE44573	PRECISION PE-BYR940, 1855A PRECISION PE-BYR940, 1855A UNIVERSAL MINI 59 COAX	CRIMP COMPRESSION COMPRESSION	\$2.95 3.95 3.95	\$2.74 3.67 3.67	\$2.54 3.40 3.40	\$2.36 3.16 3.16
							
HD F PLUG RIGHT ANGLE	PE44579	UNIVERSAL MINI 59 COAX	COMPRESSION	7.95	7.39	6.84	6.36
							
HD F JACK BULKHEAD FOR CABLE ATTACHMENT	PE44585	PRECISION PE-BYR940, 1855A	CRIMP	3.95	3.67	3.40	3.16
		MOUNTING HOLE Ø06					

## **NEW** HD 75 OHM MINI SMB CONNECTORS

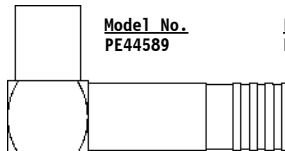
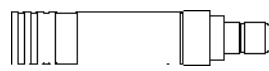
Highly suited for HD Broadcast Audio and Video applications

HD 75 OHM MINI SMB JACK RIGHT ANGLE FOR CABLE ATTACHMENT	Model No.	FITS MIL SPEC AND EQUIVALENT CABLES	ATTACHMENT METHOD	P R I C E			
				1-24	25-49	50-99	100 +
	PE44589	PRECISION PE-BYR940, 1855A	CRIMP	\$21.95	\$20.41	\$18.88	\$17.56
							
HD 75 OHM MINI SMB JACK FOR CABLE ATTACHMENT	PE44590	PRECISION PE-BYR940, 1855A	CRIMP	16.95	15.76	14.58	13.56
							
HD 75 OHM MINI SMB PLUG FOR CABLE ATTACHMENT	PE44588	PRECISION PE-BYR940, 1855A	CRIMP	19.10	17.76	16.43	15.28
							

FOR HD PRECISION CABLE ASSEMBLIES USING THE ABOVE CONNECTORS,  
TURN TO PAGE 140 & 141

OR  
CALL TECHNICAL SUPPORT AT (866) 727-8376 EXT. 3  
OR







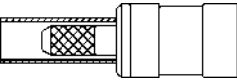

EMAIL: [TechSupport@Pasternack.com](mailto:TechSupport@Pasternack.com)

# 75 OHM SMB CONNECTORS

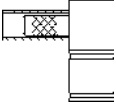
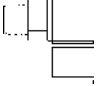
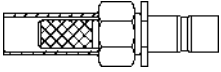
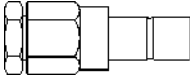
## 75 OHM M39012 INTERFACE

SEE PAGE 266 FOR MOUNTING HOLES

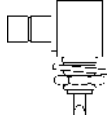
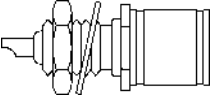
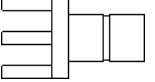
These 75 Ohm SMB connectors will interface with all M39012 75 Ohm SMB connectors. These will NOT mate with any 50 Ohm SMB connectors. JACK=MALE contact, PLUG=FEMALE contact

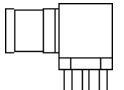
PLUG, CRIMP ATTACHMENT		Model No. PE4472 PE4248 PE4157	FITS MIL SPEC AND EQUIVALENT CABLES RG59B/U, RG62 RG179, RG187 RG180, RG195	P R I C E			
				1-24	25-49	50-99	100 +
PLUG, CLAMP ATTACHMENT		PE4203 PE4257	RG59B/U, RG62 RG179, RG187	13.05 15.60	12.14 14.51	11.22 13.42	10.44 12.48
PLUG, RIGHT ANGLE, CRIMP ATTACHMENT		PE4251 PE4161	RG179, RG187 RG180, RG195	15.60 20.85	14.51 19.39	13.42 17.93	12.48 16.68
PLUG, RIGHT ANGLE, CLAMP ATTACHMENT		PE4264 PE4265	RG59B/U, RG62 RG180, RG195	27.10 20.85	25.20 19.39	23.31 17.93	21.68 16.68
JACK, CRIMP ATTACHMENT		PE4253 PE4163	RG179, RG187 RG180, RG195	27.10 14.15	25.20 13.16	23.31 12.17	21.68 11.32
JACK, CLAMP ATTACHMENT		PE4272 PE4928 PE4273	RG59B/U, RG62 RG179, RG187 RG180, RG195	20.85 27.10 20.85	19.39 25.20 19.39	17.93 23.31 17.93	16.68 21.68 16.68
JACK, BULKHEAD CRIMP ATTACHMENT	 MOUNTING HOLES B01	PE4255 PE4165	RG179, RG187 RG180, RG195	27.10 24.95	25.20 23.20	23.31 21.46	21.68 19.96
JACK, BULKHEAD CLAMP ATTACHMENT	 MOUNTING HOLES B01	PE4280 PE4925 PE4281	RG59B/U, RG62 RG179, RG187 RG180, RG195	18.50 18.50 18.50	17.21 17.21 17.21	15.91 15.91 15.91	14.80 14.80 14.80
JACK, BULKHEAD RECEPTACLE, SOLDER CUP CONTACT		Model No. PE4168 PE4172	MOUNTING HOLE REAR MOUNT, F10 FRONT MOUNT, B03	10.85 10.85	10.09 10.09	9.33 9.33	8.68 8.68
JACK, RIGHT ANGLE BULKHEAD RECEPTACLE, SOLDER CUP CONTACT		PE4286	FRONT MOUNT, B03	41.75	38.83	35.91	33.40
PLUG, BULKHEAD RECEPTACLE, SOLDER CUP CONTACT		PE4290	FRONT MOUNT, B03	36.50	33.95	31.39	29.20
JACK, PRINTED CIRCUIT MOUNT		PE4110	D02	11.45	10.65	9.85	9.16
PLUG, PRINTED CIRCUIT MOUNT		PE4368	D02	17.70	16.46	15.22	14.16
JACK, RIGHT ANGLE PRINTED CIRCUIT MOUNT		PE4179	D02	15.60	14.51	13.42	12.48
PLUG, RIGHT ANGLE PRINTED CIRCUIT MOUNT		PE4292	D02	38.60	35.90	33.20	30.88

# 75 OHM SMB "POSITIVE SNAP" CONNECTORS

WILL MATE TO ALL STANDARD "75 OHM SMB" JACK CONNECTORS

Model No. PE44442  
SMB POSITIVE SNAP, CRIMP ATTACHMENT FOR RG59B/U & RG62

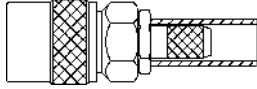

1-24	25-49
\$20.85	\$19.39
50-99	100 +
\$17.93	\$16.68

Model No. PE44443  
SMB POSITIVE SNAP, CRIMP ATTACHMENT FOR RG179 & RG187

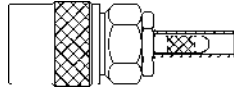

1-24	25-49
\$20.85	\$19.39
50-99	100 +
\$17.93	\$16.68

Model No. PE44444  
SMB POSITIVE SNAP, CRIMP ATTACHMENT FOR RG180 & RG195

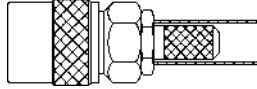

1-24	25-49
\$20.85	\$19.39
50-99	100 +
\$17.93	\$16.68

Model No. PE44445  
SMB POSITIVE SNAP RIGHT ANGLE, CRIMP ATTACHMENT FOR RG179 & RG187

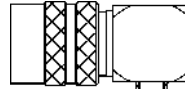

1-24	25-49
\$22.95	\$21.34
50-99	100 +
\$19.74	\$18.36

Model No. PE44446  
SMB POSITIVE SNAP RIGHT ANGLE, CRIMP ATTACHMENT FOR RG180 & RG195

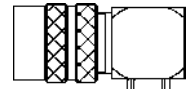

1-24	25-49
\$22.95	\$21.34
50-99	100 +
\$19.74	\$18.36

## MINI 75 OHM SMB CONNECTORS

75 OHM M39012 INTERFACE

SEE PAGE 266 FOR MOUNTING HOLES

These Mini 75 Ohm SMB connectors will interface with all M39012 Mini 75 Ohm SMB connectors. These will NOT mate with any 50 Ohm SMC connectors. JACK=MALE contact, PLUG=FEMALE contact

Connectors

PLUG, CRIMP ATTACHMENT	Model No.	FITS MIL SPEC AND EQUIVALENT CABLES	P R I C E			
			1-24	25-49	50-99	100 +
	PE4993	RG179, RG187	\$10.75	\$10.00	\$9.25	\$8.60
	PE4994	RG59B/U, RG62	13.05	12.14	11.22	10.44
PLUG, RIGHT ANGLE, CRIMP ATTACHMENT	PE4995	RG179, RG187	13.05	12.14	11.22	10.44
	PE4996	RG59B/U, RG62	17.70	16.46	15.22	14.16
JACK, PRINTED CIRCUIT MOUNT	Model No. PE4997	MOUNTING HOLE D09	9.75	9.07	8.39	7.80
JACK, RIGHT ANGLE PRINTED CIRCUIT MOUNT	PE4998	D09	14.15	13.16	12.17	11.32
JACK, BULKHEAD P.C. MOUNT	PE44125	B01 & D09	26.05	24.23	22.40	20.84
JACK, BULKHEAD RIGHT ANGLE P.C. MOUNT	PE44128	B01 & D09	17.70	16.46	15.22	14.16
JACK, 2 HOLE PANEL MOUNT, SOLDER CUP CONTACT	PE44141	C07	15.60	14.51	13.42	12.48

Model No. PE44131  
MINI 75 OHM SMB JACK END LAUNCH FOR .062" THICK BOARD, ROUND CONTACT

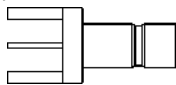

1-24	25-49
\$14.95	\$13.90
50-99	100 +
\$12.86	\$11.96

Model No. PE44134  
MINI 75 OHM SMB JACK END LAUNCH FOR .042" THICK BOARD, ROUND CONTACT

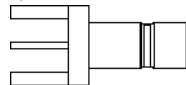

1-24	25-49
\$13.55	\$12.60
50-99	100 +
\$11.65	\$10.84

Model No. PE44588  
HD PRECISION MINI 75 OHM SMB PLUG, CRIMP ATTACHMENT FOR PE-BYR940 & 1855A

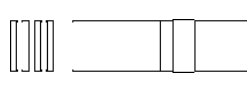

1-24	25-49
\$19.10	\$17.76
50-99	100 +
\$16.43	\$15.28

Model No. PE44589  
HD PRECISION MINI 75 OHM SMB PLUG, RIGHT ANGLE CRIMP ATTACHMENT FOR PE-BYR940 & 1855A **NEW**

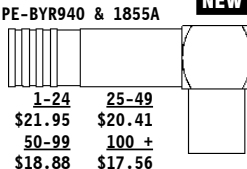

1-24	25-49
\$21.95	\$20.41
50-99	100 +
\$18.88	\$17.56



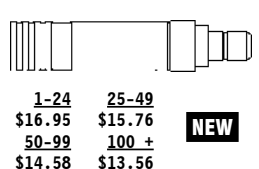

Model No. PE44590  
HD PRECISION MINI 75 OHM SMB JACK, CRIMP ATTACHMENT FOR PE-BYR940 & 1855A **NEW**



1-24	25-49
\$16.95	\$15.76
50-99	100 +
\$14.58	\$13.56

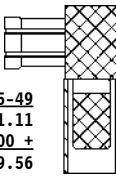

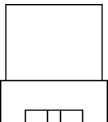
# 75 OHM MCX CONNECTORS

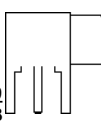
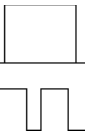
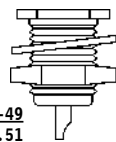
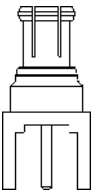
SEE PAGE 266 FOR MOUNTING HOLES

<p><b>Model No. PE44298</b> 75 OHM MCX PLUG, CRIMP ATTACHMENT FOR RG179 &amp; RG187</p>  <table border="1"> <tr><td>1-24</td><td>25-49</td></tr> <tr><td>\$10.00</td><td>\$9.30</td></tr> <tr><td>50-99</td><td>100 +</td></tr> <tr><td>\$8.60</td><td>\$8.00</td></tr> </table>	1-24	25-49	\$10.00	\$9.30	50-99	100 +	\$8.60	\$8.00	<p><b>Model No. PE44299</b> 75 OHM MCX PLUG, RIGHT ANGLE, CRIMP ATTACHMENT FOR RG179 &amp; RG187</p>  <table border="1"> <tr><td>1-24</td><td>25-49</td></tr> <tr><td>\$11.95</td><td>\$11.11</td></tr> <tr><td>50-99</td><td>100 +</td></tr> <tr><td>\$10.28</td><td>\$9.56</td></tr> </table>	1-24	25-49	\$11.95	\$11.11	50-99	100 +	\$10.28	\$9.56	<p><b>Model No. PE44300</b> 75 OHM MCX JACK, CRIMP ATTACHMENT FOR RG179 &amp; RG187</p>  <table border="1"> <tr><td>1-24</td><td>25-49</td></tr> <tr><td>\$15.60</td><td>\$14.51</td></tr> <tr><td>50-99</td><td>100 +</td></tr> <tr><td>\$13.42</td><td>\$12.48</td></tr> </table>	1-24	25-49	\$15.60	\$14.51	50-99	100 +	\$13.42	\$12.48	<p><b>Model No. PE44301</b> 75 OHM MCX JACK BULKHEAD CRIMP ATTACHMENT FOR RG179 &amp; RG187 MOUNTING HOLE B01</p>  <table border="1"> <tr><td>1-24</td><td>25-49</td></tr> <tr><td>\$26.05</td><td>\$24.23</td></tr> <tr><td>50-99</td><td>100 +</td></tr> <tr><td>\$22.40</td><td>\$20.84</td></tr> </table>	1-24	25-49	\$26.05	\$24.23	50-99	100 +	\$22.40	\$20.84	<p><b>Model No. PE44302</b> 75 OHM MCX JACK, SURFACE MOUNT</p>  <table border="1"> <tr><td>1-24</td><td>25-49</td></tr> <tr><td>\$13.55</td><td>\$12.60</td></tr> <tr><td>50-99</td><td>100 +</td></tr> <tr><td>\$11.65</td><td>\$10.84</td></tr> </table>	1-24	25-49	\$13.55	\$12.60	50-99	100 +	\$11.65	\$10.84
1-24	25-49																																											
\$10.00	\$9.30																																											
50-99	100 +																																											
\$8.60	\$8.00																																											
1-24	25-49																																											
\$11.95	\$11.11																																											
50-99	100 +																																											
\$10.28	\$9.56																																											
1-24	25-49																																											
\$15.60	\$14.51																																											
50-99	100 +																																											
\$13.42	\$12.48																																											
1-24	25-49																																											
\$26.05	\$24.23																																											
50-99	100 +																																											
\$22.40	\$20.84																																											
1-24	25-49																																											
\$13.55	\$12.60																																											
50-99	100 +																																											
\$11.65	\$10.84																																											
<p><b>Model No. PE44303</b> 75 OHM MCX JACK P.C. MOUNT MOUNTING HOLE D08</p>  <table border="1"> <tr><td>1-24</td><td>25-49</td></tr> <tr><td>\$10.00</td><td>\$9.30</td></tr> <tr><td>50-99</td><td>100 +</td></tr> <tr><td>\$8.60</td><td>\$8.00</td></tr> </table>	1-24	25-49	\$10.00	\$9.30	50-99	100 +	\$8.60	\$8.00	<p><b>Model No. PE44304</b> 75 OHM MCX JACK, RIGHT ANGLE, P.C. MOUNT MOUNTING HOLE D09</p>  <table border="1"> <tr><td>1-24</td><td>25-49</td></tr> <tr><td>\$14.60</td><td>\$13.58</td></tr> <tr><td>50-99</td><td>100 +</td></tr> <tr><td>\$12.56</td><td>\$11.68</td></tr> </table>	1-24	25-49	\$14.60	\$13.58	50-99	100 +	\$12.56	\$11.68	<p><b>Model No. PE44305</b> 75 OHM MCX JACK, END LAUNCH FOR .068" THICK BOARD, .028" ROUND CONTACT</p>  <table border="1"> <tr><td>1-24</td><td>25-49</td></tr> <tr><td>\$9.75</td><td>\$9.07</td></tr> <tr><td>50-99</td><td>100 +</td></tr> <tr><td>\$8.39</td><td>\$7.80</td></tr> </table>	1-24	25-49	\$9.75	\$9.07	50-99	100 +	\$8.39	\$7.80	<p><b>Model No. PE44306</b> 75 OHM MCX JACK BULKHEAD MOUNTING HOLE B02</p>  <table border="1"> <tr><td>1-24</td><td>25-49</td></tr> <tr><td>\$15.60</td><td>\$14.51</td></tr> <tr><td>50-99</td><td>100 +</td></tr> <tr><td>\$13.42</td><td>\$12.48</td></tr> </table>	1-24	25-49	\$15.60	\$14.51	50-99	100 +	\$13.42	\$12.48	<p><b>Model No. PE44307</b> 75 OHM MCX PLUG, P.C. MOUNT MOUNTING HOLE D10</p>  <table border="1"> <tr><td>1-24</td><td>25-49</td></tr> <tr><td>\$13.55</td><td>\$12.60</td></tr> <tr><td>50-99</td><td>100 +</td></tr> <tr><td>\$11.65</td><td>\$10.84</td></tr> </table>	1-24	25-49	\$13.55	\$12.60	50-99	100 +	\$11.65	\$10.84
1-24	25-49																																											
\$10.00	\$9.30																																											
50-99	100 +																																											
\$8.60	\$8.00																																											
1-24	25-49																																											
\$14.60	\$13.58																																											
50-99	100 +																																											
\$12.56	\$11.68																																											
1-24	25-49																																											
\$9.75	\$9.07																																											
50-99	100 +																																											
\$8.39	\$7.80																																											
1-24	25-49																																											
\$15.60	\$14.51																																											
50-99	100 +																																											
\$13.42	\$12.48																																											
1-24	25-49																																											
\$13.55	\$12.60																																											
50-99	100 +																																											
\$11.65	\$10.84																																											

# 75 OHM TNC CONNECTORS

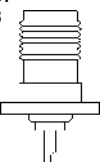
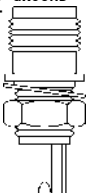
SEE PAGE 266 FOR MOUNTING HOLES

		FITS MIL SPEC AND EQUIVALENT CABLES		ATTACHMENT METHOD	P R I C E																																											
					1-24	25-49	50-99	100 +																																								
75 OHM TNC MALE FOR CABLE ATTACHMENT	Model No. PE44161	RG6A/U	CLAMP	\$16.65	\$15.48	\$14.32	\$13.32																																									
	PE44162	RG6A/U	CRIMP	12.50	11.63	10.75	10.00																																									
	PE44163	RG11, RG216	CLAMP	31.30	29.11	26.92	25.04																																									
	PE44164	RG11	CRIMP	20.85	19.39	17.93	16.68																																									
	PE44165	RG59B/U	CLAMP	12.50	11.63	10.75	10.00																																									
	PE44166	RG59B/U	CRIMP	12.50	11.63	10.75	10.00																																									
	PE44167	RG179, RG187	CLAMP	12.50	11.63	10.75	10.00																																									
	PE44168	RG179, RG187	CRIMP	12.50	11.63	10.75	10.00																																									
	75 OHM TNC MALE RIGHT ANGLE FOR CABLE ATTACHMENT	PE44169	RG6A/U	CLAMP	31.30	29.11	26.92	25.04																																								
		PE44170	RG11, RG216	CLAMP	31.30	29.11	26.92	25.04																																								
	PE44171	RG59B/U	CLAMP	31.30	29.11	26.92	25.04																																									
	PE44172	RG179, RG187	CLAMP	31.30	29.11	26.92	25.04																																									
75 OHM TNC FEMALE BULKHEAD FOR CABLE ATTACHMENT	PE44173	RG6A/U	CLAMP	26.05	24.23	22.40	20.84																																									
	PE44174	RG11, RG216	CLAMP	28.30	26.32	24.34	22.64																																									
	PE44175	RG59B/U	CLAMP	26.05	24.23	22.40	20.84																																									
	PE44176	RG179, RG187	CLAMP	26.05	24.23	22.40	20.84																																									
	MOUNTING HOLE B06																																															
Model No. PE44177	Model No. PE44178	Model No. PE44179	Model No. PE44180	Model No. PE44181																																												
75 OHM TNC FEMALE BULKHEAD, SOLDER CUP CONTACT MOUNTING HOLE B05	75 OHM TNC FEMALE, PANEL MOUNT, #3-56 TAPPED HOLES SOLDER CUP CONTACT MOUNTING HOLE A03	75 OHM TNC FEMALE BULKHEAD, ISOLATED GROUND SOLDER CUP CONTACT MOUNTING HOLE B04	75 OHM TNC FEMALE BULKHEAD, SOLDER CUP CONTACT MOUNTING HOLE B04	75 OHM TNC FEMALE BULKHEAD, ISOLATED GROUND SOLDER CUP CONTACT MOUNTING HOLE B06																																												
																																																
<table border="1"> <tr><td>1-24</td><td>25-49</td></tr> <tr><td>\$10.85</td><td>\$10.09</td></tr> <tr><td>50-99</td><td>100 +</td></tr> <tr><td>\$9.33</td><td>\$8.68</td></tr> </table>	1-24	25-49	\$10.85	\$10.09	50-99	100 +	\$9.33	\$8.68	<table border="1"> <tr><td>1-24</td><td>25-49</td></tr> <tr><td>\$10.85</td><td>\$10.09</td></tr> <tr><td>50-99</td><td>100 +</td></tr> <tr><td>\$9.33</td><td>\$8.68</td></tr> </table>	1-24	25-49	\$10.85	\$10.09	50-99	100 +	\$9.33	\$8.68	<table border="1"> <tr><td>1-24</td><td>25-49</td></tr> <tr><td>\$11.45</td><td>\$10.65</td></tr> <tr><td>50-99</td><td>100 +</td></tr> <tr><td>\$9.85</td><td>\$9.16</td></tr> </table>	1-24	25-49	\$11.45	\$10.65	50-99	100 +	\$9.85	\$9.16	<table border="1"> <tr><td>1-24</td><td>25-49</td></tr> <tr><td>\$13.55</td><td>\$12.60</td></tr> <tr><td>50-99</td><td>100 +</td></tr> <tr><td>\$11.65</td><td>\$10.84</td></tr> </table>	1-24	25-49	\$13.55	\$12.60	50-99	100 +	\$11.65	\$10.84	<table border="1"> <tr><td>1-24</td><td>25-49</td></tr> <tr><td>\$15.60</td><td>\$14.51</td></tr> <tr><td>50-99</td><td>100 +</td></tr> <tr><td>\$13.42</td><td>\$12.48</td></tr> </table>	1-24	25-49	\$15.60	\$14.51	50-99	100 +	\$13.42	\$12.48				
1-24	25-49																																															
\$10.85	\$10.09																																															
50-99	100 +																																															
\$9.33	\$8.68																																															
1-24	25-49																																															
\$10.85	\$10.09																																															
50-99	100 +																																															
\$9.33	\$8.68																																															
1-24	25-49																																															
\$11.45	\$10.65																																															
50-99	100 +																																															
\$9.85	\$9.16																																															
1-24	25-49																																															
\$13.55	\$12.60																																															
50-99	100 +																																															
\$11.65	\$10.84																																															
1-24	25-49																																															
\$15.60	\$14.51																																															
50-99	100 +																																															
\$13.42	\$12.48																																															



Connectors



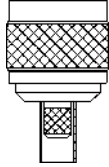

# 75 OHM N CONNECTORS

THESE CONNECTORS **WILL NOT** MATE WITH STANDARD 50 OHM N CONNECTORS

SEE PAGE 266 FOR MOUNTING HOLES

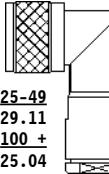
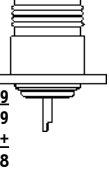
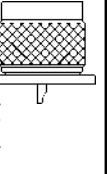
	Model No.	FITS MIL SPEC AND EQUIVALENT CABLES	ATTACHMENT METHOD	PRICE			
				1-24	25-49	50-99	100 +
75 OHM N MALE FOR CABLE ATTACHMENT 	PE4507	RG6A/U	CLAMP	\$14.15	\$13.16	\$12.17	\$11.32
	PE4508	RG6A/U	CRIMP	15.25	14.18	13.12	12.20
	PE4509	RG11, RG144, RG216	CLAMP	18.75	17.44	16.13	15.00
	PE4510	RG11, RG144, RG216	CRIMP	15.25	14.18	13.12	12.20
	PE4511	RG59B/U, RG62	CLAMP	14.15	13.16	12.17	11.32
	PE4512	RG59B/U, RG62	CRIMP	15.25	14.18	13.12	12.20
	PE4513	RG179, RG187	CLAMP	14.30	13.30	12.30	11.44
PE4656	RG179, RG187	CRIMP	16.30	15.16	14.02	13.04	
75 OHM N FEMALE FOR CABLE ATTACHMENT 	PE4514	RG6A/U	CLAMP	17.70	16.46	15.22	14.16
	PE4515	RG11, RG144, RG216	CLAMP	19.55	18.18	16.81	15.64
	PE4516	RG59B/U, RG62	CLAMP	20.85	19.39	17.93	16.68

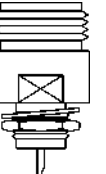
Model No.	Description	Model No.	Description	Model No.	Description	Model No.	Description	Model No.	Description
PE4502	75 OHM N MALE, RIGHT ANGLE, CLAMP ATTACHMENT FOR RG11, RG144 & RG216 	PE4503	75 OHM N FEMALE, PANEL MOUNT, SOLDER CUP CONTACT MOUNTING HOLE A05 	PE4504	75 OHM N MALE, PANEL MOUNT, SOLDER CUP CONTACT MOUNTING HOLE A05 	PE4505	75 OHM N FEMALE BULKHEAD FRONT MOUNT, SOLDER CUP CONTACT, MOUNTING HOLE G01 	PE4506	75 OHM N FEMALE BULKHEAD FRONT MOUNT, SOLDER CUP CONTACT, MOUNTING HOLE F05 
1-24 \$31.30	25-49 \$29.11	1-24 \$10.85	25-49 \$10.09	1-24 \$15.25	25-49 \$14.18	1-24 \$16.10	25-49 \$14.97	1-24 \$10.85	25-49 \$10.09
50-99 \$26.92	100 + \$25.04	50-99 \$9.33	100 + \$8.68	50-99 \$13.12	100 + \$12.20	50-99 \$13.85	100 + \$12.88	50-99 \$9.33	100 + \$8.68

# F CONNECTORS

SEE PAGE 266 FOR MOUNTING HOLES

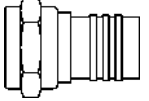
F MALE FOR CABLE ATTACHMENT 	Model No.	FITS MIL SPEC AND EQUIVALENT CABLES	ATTACHMENT METHOD	PRICE PER PACKAGE			
				1-24	25-49	50-99	100 +
	PE44312	RG6A/U	CRIMP	**\$7.60	\$7.07	\$6.54	\$6.08
	PE44313	RG6-CATV	CRIMP (3 PIECE)	*\$13.60	12.65	11.70	10.88
	PE44314	RG6A/U	TWIST	**\$7.60	7.07	6.54	6.08
	PE44452	RG6-CATV	CRIMP	**\$7.60	7.07	6.54	6.08
	PE44315	RG11	CRIMP (3 PIECE)	*\$17.75	16.51	15.27	14.20
	PE44316	RG59B/U, RG62	CRIMP	**\$7.85	7.30	6.75	6.28
	PE44317	RG59B/U, RG62	CRIMP (3 PIECE)	**\$17.40	16.18	14.96	13.92
	PE44318	RG59B/U, RG62	TWIST	**\$7.60	7.07	6.54	6.08
	PE44319	RG179, RG187	CRIMP (3 PIECE)	**\$17.75	16.51	15.27	14.20



F MALE RIGHT ANGLE FOR CABLE ATTACHMENT 	PE44320	RG6-CATV	CRIMP	*\$14.15	13.16	12.17	11.32
	PE44321	RG6-CATV	TWIST	*\$14.15	13.16	12.17	11.32
	PE44322	RG59B/U, RG62	CRIMP	*\$14.15	13.16	12.17	11.32
	PE44323	RG59B/U, RG62	TWIST	*\$14.15	13.16	12.17	11.32

\*SOLD IN PACKS OF 5 PC.

F FEMALE BULKHEAD FOR CABLE ATTACHMENT 	PE44324	RG6-CATV, MOUNTING HOLE B04	CRIMP	*\$13.05	12.14	11.22	10.44
	PE44325	RG59B/U, RG62, MOUNTING HOLE B04	CRIMP	*\$13.05	12.14	11.22	10.44
	PE44326	RG179, RG187, MOUNTING HOLE G07	CRIMP	*\$13.60	12.65	11.70	10.88

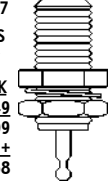
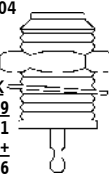
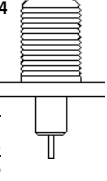
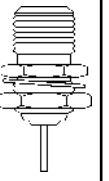
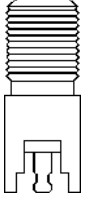
\*SOLD IN PACKS OF 5 PC.

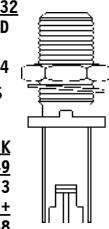
Model No. PE44327 F FEMALE BULKHEAD FRONT MOUNT, TAB CONTACT MOUNTING HOLE G07 *SOLD IN PACKS OF 10 PIECES* PRICE PER PACK 1-24 \$10.85 25-49 \$10.09 50-99 \$9.33 100 + \$8.68 	Model No. PE44328 F FEMALE BULKHEAD REAR MOUNT, TAB CONTACT MOUNTING HOLE B04 *SOLD IN PACKS OF 10 PIECES* PRICE PER PACK 1-24 \$4.20 25-49 \$3.91 50-99 \$3.61 100 + \$3.36 	Model No. PE44329 F FEMALE, 4 HOLE PANEL MOUNT, ROUND CONTACT MOUNTING HOLE A04 *SOLD IN PACKS OF 5 PIECES* PRICE PER PACK 1-24 \$19.60 25-49 \$18.23 50-99 \$16.86 100 + \$15.68 	Model No. PE44330 F FEMALE BULKHEAD, FRONT MOUNT, ROUND CONTACT MOUNTING HOLE F05 *SOLD IN PACKS OF 10 PIECES* PRICE PER PACK 1-24 \$12.35 25-49 \$11.49 50-99 \$10.62 100 + \$9.88 	Model No. PE44331 F FEMALE, P.C. MOUNT MOUNTING HOLE D13 *SOLD IN PACKS OF 10 PIECES* PRICE PER PACK 1-24 \$10.85 25-49 \$10.09 50-99 \$9.33 100 + \$8.68 
--	---	--	--	--







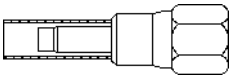
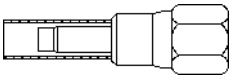
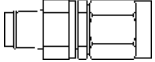
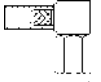

Model No. PE44332 F FEMALE BULKHEAD P.C. MOUNT MOUNTING HOLE D14 *SOLD IN PACKS OF 5 PIECES* PRICE PER PACK 1-24 \$19.60 25-49 \$18.23 50-99 \$16.86 100 + \$15.68 	Model No. PE44333 F FEMALE, RIGHT ANGLE P.C. MOUNT MOUNTING HOLE D11 *SOLD IN PACKS OF 5 PIECES* PRICE PER PACK 1-24 \$20.10 25-49 \$18.69 50-99 \$17.29 100 + \$16.08 	Model No. PE44334 F FEMALE BULKHEAD RIGHT ANGLE, P.C. MOUNT MOUNTING HOLES D11, B04 *SOLD IN PACKS OF 5 PIECES* PRICE PER PACK 1-24 \$20.70 25-49 \$19.25 50-99 \$17.80 100 + \$16.56 	<p><b>Please see Page 182 for High Definition F Connectors, or visit our website at <a href="http://www.Pasternack.com">www.Pasternack.com</a> or call (866) 727-8376 EXT 3 for Technical Support.</b></p>
---	---	--	--

# 75 OHM SMC CONNECTORS

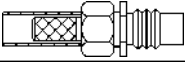
## 75 OHM M39012 INTERFACE

SEE PAGE 266 FOR MOUNTING HOLES

These 75 Ohm SMC connectors will interface with all M39012 75 Ohm SMC connectors. These will NOT mate with any 50 Ohm SMC connectors. JACK=MALE contact, PLUG=FEMALE contact

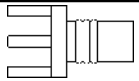
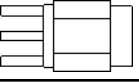
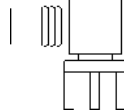
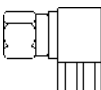
		Model No.	FITS MIL SPEC AND EQUIVALENT CABLES	P R I C E			
				1-24	25-49	50-99	100 +
PLUG, CRIMP ATTACHMENT		PE4658	RG59B/U, RG62	\$13.55	\$12.60	\$11.65	\$10.84
		PE4249	RG179, RG187	13.55	12.60	11.65	10.84
		PE4158	RG180, RG195	13.55	12.60	11.65	10.84
PLUG, CLAMP ATTACHMENT		PE4258	RG59B/U, RG62	27.10	25.20	23.31	21.68
		PE4259	RG179, RG187	27.10	25.20	23.31	21.68
PLUG, RIGHT ANGLE, CRIMP ATTACHMENT		PE4252	RG179, RG187	20.85	19.39	17.93	16.68
		PE4162	RG180, RG195	20.85	19.39	17.93	16.68
PLUG, RIGHT ANGLE, CLAMP ATTACHMENT		PE4266	RG59B/U, RG62	20.85	19.39	17.93	16.68
		PE4267	RG180, RG195	20.85	19.39	17.93	16.68
JACK, CRIMP ATTACHMENT		PE4254	RG179, RG187	19.80	18.41	17.03	15.84
		PE4164	RG180, RG195	19.80	18.41	17.03	15.84
JACK, CLAMP ATTACHMENT		PE4274	RG59B/U, RG62	19.80	18.41	17.03	15.84
		PE4929	RG179, RG187	19.80	18.41	17.03	15.84
		PE4275	RG180, RG195	19.80	18.41	17.03	15.84
JACK, BULKHEAD CRIMP ATTACHMENT		PE4256	RG179, RG187	19.80	18.41	17.03	15.84
		PE4166	RG180, RG195	19.80	18.41	17.03	15.84
	MOUNTING HOLES B01						
JACK, BULKHEAD CLAMP ATTACHMENT		PE4282	RG59B/U, RG62	19.80	18.41	17.03	15.84
		PE4906	RG179, RG187	19.80	18.41	17.03	15.84
		PE4283	RG180, RG195	19.80	18.41	17.03	15.84
	MOUNTING HOLES B01						
JACK, BULKHEAD RECEPTACLE, SOLDER CUP CONTACT		Model No.	MOUNTING HOLE				
		PE4169	REAR MOUNT, B03	19.80	18.41	17.03	15.84
		PE4173	FRONT MOUNT, B03	10.85	10.09	9.33	8.68
JACK, RIGHT ANGLE BULKHEAD RECEPTACLE, SOLDER CUP CONTACT		PE4287	FRONT MOUNT, B03	36.50	33.95	31.39	29.20
PLUG, BULKHEAD RECEPTACLE, SOLDER CUP CONTACT		PE4291	FRONT MOUNT, B03	27.10	25.20	23.31	21.68
JACK, PRINTED CIRCUIT MOUNT		PE4176	D02	10.40	9.67	8.94	8.32
PLUG, PRINTED CIRCUIT MOUNT		PE4369	D02	22.95	21.34	19.74	18.36
JACK, RIGHT ANGLE PRINTED CIRCUIT MOUNT		PE4180	D02	16.65	15.48	14.32	13.32
PLUG, RIGHT ANGLE PRINTED CIRCUIT MOUNT		PE4293	D02	28.15	26.18	24.21	22.52

# 50 OHM REVERSE POLARITY BNC CONNECTORS

## MEETS FCC PART 15.203 REQUIREMENTS

SEE PAGE 266 FOR MOUNTING HOLES

REVERSE POLARITY BNC MALE FOR CABLE ATTACHMENT	Model No.	FITS MIL SPEC AND EQUIVALENT CABLES	ATTACHMENT METHOD	P R I C E			
				1-24	25-49	50-99	100 +
	PE4711	RG8, RG9, RG213, RG214, RG225, RG393	CLAMP	\$20.85	\$19.39	\$17.93	\$16.68
	PE4712	RG8, RG213	CRIMP	20.85	19.39	17.93	16.68
	PE4713	RG9, RG214	CRIMP	20.85	19.39	17.93	16.68
	PE4714	RG55, RG58, RG141, RG142, RG223, RG400	CLAMP	20.85	19.39	17.93	16.68
	PE4715	RG55, RG141, RG142, RG223, RG400	CRIMP	10.40	9.67	8.94	8.32
	PE4716	RG58	CRIMP	10.40	9.67	8.94	8.32
	PE4717	RG59B/U, RG62	CLAMP	20.85	19.39	17.93	16.68
	PE4718	RG59B/U, RG62	CRIMP	10.40	9.67	8.94	8.32
	PE4719	RG174, RG188, RG316	CLAMP	20.85	19.39	17.93	16.68
	PE4720	RG174, RG188, RG316	CRIMP	15.60	14.51	13.42	12.48
	PE4721	RG178, RG196	CLAMP	20.85	19.39	17.93	16.68
	PE4722	RG402, PE-SR402AL, PE-SR402FL (.141" SEMI-RIGID)	SOLDER/CLAMP	17.70	16.46	15.22	14.16
	PE4723	RG402, PE-SR402AL, PE-SR402FL (.141" SEMI-RIGID)	SOLDER	20.85	19.39	17.93	16.68
	PE4724	RG405, PE-SR405AL, PE-SR405FL (.085" SEMI-RIGID)	SOLDER/CLAMP	17.70	16.46	15.22	14.16
	PE4725	RG405, PE-SR405AL, PE-SR405FL (.085" SEMI-RIGID)	SOLDER	20.85	19.39	17.93	16.68
	PE4726	BELDEN 9913, BELDEN 9914, PE-B3199, PE-B4199	CLAMP	20.85	19.39	17.93	16.68

REVERSE POLARITY BNC MALE, RIGHT ANGLE FOR CABLE ATTACHMENT 	PE4727	RG8, RG9, RG213, RG214, RG225, RG393	CLAMP	26.05	24.23	22.40	20.84
	PE4728	RG55, RG58, RG141, RG142, RG223, RG400	CLAMP	20.85	19.39	17.93	16.68
	PE4729	RG55, RG141, RG142, RG223, RG400	CRIMP	17.70	16.46	15.22	14.16
	PE4730	RG58	CRIMP	17.70	16.46	15.22	14.16
	PE4731	RG59B/U, RG62	CLAMP	20.85	19.39	17.93	16.68
	PE4732	RG174, RG188, RG316	CLAMP	20.85	19.39	17.93	16.68
	PE4733	RG174, RG188, RG316	CRIMP	15.60	14.51	13.42	12.48
	PE4734	RG178, RG196	CLAMP	20.85	19.39	17.93	16.68

REVERSE POLARITY BNC FEMALE FOR CABLE ATTACHMENT 	PE4735	RG8, RG9, RG213, RG214, RG225, RG393	CLAMP	25.10	23.34	21.59	20.08
	PE4736	RG55, RG58, RG141, RG142, RG223, RG400	CLAMP	20.85	19.39	17.93	16.68
	PE4737	RG55, RG141, RG142, RG223, RG400	CRIMP	15.60	14.51	13.42	12.48
	PE4738	RG58	CRIMP	15.60	14.51	13.42	12.48
	PE4739	RG59B/U, RG62	CRIMP	15.60	14.51	13.42	12.48
	PE4740	RG59B/U, RG62	CLAMP	20.85	19.39	17.93	16.68
	PE4741	RG174, RG188, RG316	CLAMP	20.85	19.39	17.93	16.68
	PE4742	RG174, RG188, RG316	CRIMP	15.60	14.51	13.42	12.48
	PE4743	RG178, RG196	CLAMP	20.85	19.39	17.93	16.68
	PE4744	RG402, PE-SR402AL, PE-SR402FL (.141" SEMI-RIGID)	SOLDER/CLAMP	17.70	16.46	15.22	14.16
PE4745	RG405, PE-SR405AL, PE-SR405FL (.085" SEMI-RIGID)	SOLDER/CLAMP	17.70	16.46	15.22	14.16	

REVERSE POLARITY BNC FEMALE BULKHEAD FOR CABLE ATTACHMENT 	PE4746	RG55, RG58, RG141, RG142, RG223, RG400	CLAMP	15.25	14.18	13.12	12.20
	PE4747	RG55, RG141, RG142, RG223, RG400	CRIMP	17.70	16.46	15.22	14.16
	PE4748	RG58	CRIMP	17.70	16.46	15.22	14.16
	PE4749	RG59B/U, RG62	CLAMP	17.70	16.46	15.22	14.16
	PE4750	RG59B/U, RG62	CRIMP	17.70	16.46	15.22	14.16
	PE4751	RG174, RG188, RG316	CLAMP	17.40	16.18	14.96	13.92
	PE4752	RG174, RG188, RG316	CRIMP	17.70	16.46	15.22	14.16
	PE4753	RG178, RG196	CLAMP	17.40	16.18	14.96	13.92
	PE4754	RG402, PE-SR402AL, PE-SR402FL (.141" SEMI-RIGID)	SOLDER/CLAMP	20.85	19.39	17.93	16.68
	PE4755	RG405, PE-SR405AL, PE-SR405FL (.085" SEMI-RIGID)	SOLDER/CLAMP	20.85	19.39	17.93	16.68







### USE MOUNTING HOLE B06

<p>Model No. PE4756 REVERSE POLARITY BNC FEMALE, PANEL MOUNT SOLDER CUP CONTACT #3-56 TAPPED HOLES MOUNTING HOLE A03</p> <table> <tr><td>1-24</td><td>25-49</td></tr> <tr><td>\$15.60</td><td>\$14.51</td></tr> <tr><td>50-99</td><td>100 +</td></tr> <tr><td>\$13.42</td><td>\$12.48</td></tr> </table>	1-24	25-49	\$15.60	\$14.51	50-99	100 +	\$13.42	\$12.48	<p>Model No. PE4757 REVERSE POLARITY BNC FEMALE BULKHEAD FOR UP TO 1/8" PANEL THICKNESS SOLDER CUP CONTACT MOUNTING HOLE B05</p> <table> <tr><td>1-24</td><td>25-49</td></tr> <tr><td>\$9.75</td><td>\$9.07</td></tr> <tr><td>50-99</td><td>100 +</td></tr> <tr><td>\$8.39</td><td>\$7.80</td></tr> </table>	1-24	25-49	\$9.75	\$9.07	50-99	100 +	\$8.39	\$7.80	<p>Model No. PE4758 REVERSE POLARITY BNC FEMALE BULKHEAD FOR UP TO 1/4" PANEL THICKNESS SOLDER CUP CONTACT MOUNTING HOLE B04</p> <table> <tr><td>1-24</td><td>25-49</td></tr> <tr><td>\$9.75</td><td>\$9.07</td></tr> <tr><td>50-99</td><td>100 +</td></tr> <tr><td>\$8.39</td><td>\$7.80</td></tr> </table>	1-24	25-49	\$9.75	\$9.07	50-99	100 +	\$8.39	\$7.80	<p>Model No. PE4759 REVERSE POLARITY BNC FEMALE, RIGHT ANGLE BULKHEAD, SOLDER CUP CONTACT, MOUNTING HOLE B13</p> <table> <tr><td>1-24</td><td>25-49</td></tr> <tr><td>\$31.30</td><td>\$29.11</td></tr> <tr><td>50-99</td><td>100 +</td></tr> <tr><td>\$26.92</td><td>\$25.04</td></tr> </table>	1-24	25-49	\$31.30	\$29.11	50-99	100 +	\$26.92	\$25.04	<p>Model No. PE4760 REVERSE POLARITY BNC FEMALE, RIGHT ANGLE, PANEL MOUNT, SOLDER CUP CONTACT MOUNTING HOLE A16</p> <table> <tr><td>1-24</td><td>25-49</td></tr> <tr><td>\$31.30</td><td>\$29.11</td></tr> <tr><td>50-99</td><td>100 +</td></tr> <tr><td>\$26.92</td><td>\$25.04</td></tr> </table>	1-24	25-49	\$31.30	\$29.11	50-99	100 +	\$26.92	\$25.04
1-24	25-49																																											
\$15.60	\$14.51																																											
50-99	100 +																																											
\$13.42	\$12.48																																											
1-24	25-49																																											
\$9.75	\$9.07																																											
50-99	100 +																																											
\$8.39	\$7.80																																											
1-24	25-49																																											
\$9.75	\$9.07																																											
50-99	100 +																																											
\$8.39	\$7.80																																											
1-24	25-49																																											
\$31.30	\$29.11																																											
50-99	100 +																																											
\$26.92	\$25.04																																											
1-24	25-49																																											
\$31.30	\$29.11																																											
50-99	100 +																																											
\$26.92	\$25.04																																											

<p>Model No. PE4761 REVERSE POLARITY BNC MALE BULKHEAD MOUNT, SOLDER CUP CONTACT, MOUNTING HOLE B04</p> <table> <tr><td>1-24</td><td>25-49</td></tr> <tr><td>\$15.60</td><td>\$14.51</td></tr> <tr><td>50-99</td><td>100 +</td></tr> <tr><td>\$13.42</td><td>\$12.48</td></tr> </table>	1-24	25-49	\$15.60	\$14.51	50-99	100 +	\$13.42	\$12.48	<p>Model No. PE4762 REVERSE POLARITY BNC MALE PANEL MOUNT, SOLDER CUP CONTACT, MOUNTING HOLE A07</p> <table> <tr><td>1-24</td><td>25-49</td></tr> <tr><td>\$15.60</td><td>\$14.51</td></tr> <tr><td>50-99</td><td>100 +</td></tr> <tr><td>\$13.42</td><td>\$12.48</td></tr> </table>	1-24	25-49	\$15.60	\$14.51	50-99	100 +	\$13.42	\$12.48	<p>Model No. PE4763 REVERSE POLARITY BNC FEMALE, PANEL MOUNT .125" MOUNTING HOLES SOLDER CUP CONTACT MOUNTING HOLE A04</p> <table> <tr><td>1-24</td><td>25-49</td></tr> <tr><td>\$15.60</td><td>\$14.51</td></tr> <tr><td>50-99</td><td>100 +</td></tr> <tr><td>\$13.42</td><td>\$12.48</td></tr> </table>	1-24	25-49	\$15.60	\$14.51	50-99	100 +	\$13.42	\$12.48	<p>Model No. PE4764 REVERSE POLARITY BNC FEMALE BULKHEAD ISOLATED GROUND SOLDER CUP CONTACT MOUNTING HOLE B06</p> <table> <tr><td>1-24</td><td>25-49</td></tr> <tr><td>\$13.05</td><td>\$12.14</td></tr> <tr><td>50-99</td><td>100 +</td></tr> <tr><td>\$11.22</td><td>\$10.44</td></tr> </table>	1-24	25-49	\$13.05	\$12.14	50-99	100 +	\$11.22	\$10.44	<p>Model No. PE4765 REVERSE POLARITY BNC FEMALE, PANEL MOUNT, CLAMP ATTACHMENT FOR RG55, RG58, RG141, RG142, RG223 &amp; RG400 #3-56 TAPPED HOLES MOUNTING HOLE A03</p> <table> <tr><td>1-24</td><td>25-49</td></tr> <tr><td>\$20.85</td><td>\$19.39</td></tr> <tr><td>50-99</td><td>100 +</td></tr> <tr><td>\$17.93</td><td>\$16.68</td></tr> </table>	1-24	25-49	\$20.85	\$19.39	50-99	100 +	\$17.93	\$16.68
1-24	25-49																																											
\$15.60	\$14.51																																											
50-99	100 +																																											
\$13.42	\$12.48																																											
1-24	25-49																																											
\$15.60	\$14.51																																											
50-99	100 +																																											
\$13.42	\$12.48																																											
1-24	25-49																																											
\$15.60	\$14.51																																											
50-99	100 +																																											
\$13.42	\$12.48																																											
1-24	25-49																																											
\$13.05	\$12.14																																											
50-99	100 +																																											
\$11.22	\$10.44																																											
1-24	25-49																																											
\$20.85	\$19.39																																											
50-99	100 +																																											
\$17.93	\$16.68																																											

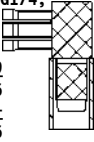
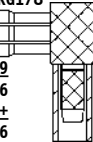
# REVERSE POLARITY MCX CONNECTORS

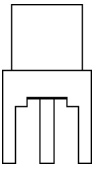
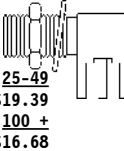
SEE PAGE 266 FOR MOUNTING HOLES

<b>Model No. PE44369</b> REVERSE POLARITY MCX PLUG CRIMP ATTACHMENT FOR RG174, RG188 & RG316 	<b>Model No. PE44370</b> REVERSE POLARITY MCX PLUG CRIMP ATTACHMENT FOR RG178 & RG196 	<b>Model No. PE44371</b> REVERSE POLARITY MCX PLUG RIGHT ANGLE, CRIMP ATTACHMENT FOR RG174, RG188 & RG316 	<b>Model No. PE44372</b> REVERSE POLARITY MCX PLUG RIGHT ANGLE, CRIMP ATTACHMENT FOR RG178 & RG196 	<b>Model No. PE44373</b> REVERSE POLARITY MCX JACK BULKHEAD, CRIMP ATTACHMENT FOR RG174, RG188 & RG316 MOUNTING HOLE B01 
1-24 25-49 \$15.60 \$14.51 50-99 100 + \$13.42 \$12.48	1-24 25-49 \$15.60 \$14.51 50-99 100 + \$13.42 \$12.48	1-24 25-49 \$17.70 \$16.46 50-99 100 + \$15.22 \$14.16	1-24 25-49 \$17.70 \$16.46 50-99 100 + \$15.22 \$14.16	1-24 25-49 \$19.80 \$18.41 50-99 100 + \$17.03 \$15.84
<b>Model No. PE44374</b> REVERSE POLARITY MCX JACK BULKHEAD, CRIMP ATTACHMENT FOR RG178 & RG196 MOUNTING HOLE B01 	<b>Model No. PE44375</b> REVERSE POLARITY MCX JACK P.C. MOUNT MOUNTING HOLE D02 	<b>Model No. PE44376</b> REVERSE POLARITY MCX JACK BULKHEAD, RIGHT ANGLE P.C. MOUNT MOUNTING HOLE D02 & B01 	<b>Model No. PE44377</b> REVERSE POLARITY MCX JACK BULKHEAD, END LAUNCH MOUNTING HOLE B01 	<b>PLEASE CONTACT OUR                  ENGINEERING                  DEPARTMENT FOR ALL                  YOUR SPECIAL                  REQUIREMENTS AT                  (866) 727-8376 EXT. 3</b>
1-24 25-49 \$19.80 \$18.41 50-99 100 + \$17.03 \$15.84	1-24 25-49 \$9.35 \$8.70 50-99 100 + \$8.04 \$7.48	1-24 25-49 \$20.85 \$19.39 50-99 100 + \$17.93 \$16.68	1-24 25-49 \$15.60 \$14.51 50-99 100 + \$13.42 \$12.48	

# REVERSE POLARITY N CONNECTORS

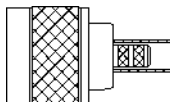
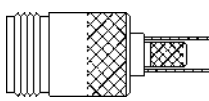
	Model No.	FITS MIL SPEC AND EQUIVALENT CABLES	ATTACHMENT METHOD	PRICE			
				1-24	25-49	50-99	100 +
REVERSE POLARITY N MALE FOR CABLE ATTACHMENT 	PE44472	R68, RG213	CRIMP	\$19.80	\$18.41	\$17.03	\$15.84
	PE44471	RG55, RG141, RG142, RG223, RG400	CRIMP	18.75	17.44	16.13	15.00
	PE44473	RG58	CRIMP	18.75	17.44	16.13	15.00
	PE44474	RG214 & RG393	CRIMP	19.80	18.41	17.03	15.84
	PE44470	BELDEN 9913 & 9914, PE-B3199, PE-B4199, PE-T004RML	CRIMP	19.80	18.41	17.03	15.84
REVERSE POLARITY N FEMALE FOR CABLE ATTACHMENT 	PE44478	R68, RG213	CRIMP	18.75	17.44	16.13	15.00
	PE44477	RG9, RG214, RG225, RG393	CRIMP	18.75	17.44	16.13	15.00
	PE44475	RG55, RG141, RG142, RG223, RG400	CRIMP	18.75	17.44	16.13	15.00
	PE44476	RG58	CRIMP	18.75	17.44	16.13	15.00

# 50 OHM REVERSE POLARITY TNC CONNECTORS

MEETS FCC PART 15.203 REQUIREMENTS

SEE PAGE 266 FOR MOUNTING HOLES

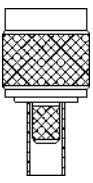
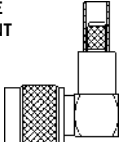
	Model No.	FITS MIL SPEC AND EQUIVALENT CABLES	ATTACHMENT METHOD	PRICE				
				1-24	25-49	50-99	100 +	
REVERSE POLARITY TNC MALE FOR CABLE ATTACHMENT 	PE4659	R68, RG9, RG213, RG214, RG225, RG393	CLAMP	\$15.25	\$14.18	\$13.12	\$12.20	
	PE4660	R68, RG213	CRIMP	16.45	15.30	14.15	13.16	
	PE4661	RG9, RG214	CRIMP	16.30	15.16	14.02	13.04	
	PE4662	RG55, RG58, RG141, RG142, RG223, RG400	CLAMP	8.65	8.04	7.44	6.92	
	PE4663	RG55, RG141, RG142, RG223, RG400	CRIMP	8.85	8.23	7.61	7.08	
	PE4664	RG58	CRIMP	8.80	8.18	7.57	7.04	
	PE4665	RG59B/U, RG62	CLAMP	9.75	9.07	8.39	7.80	
	PE4666	RG59B/U, RG62	CRIMP	8.65	8.04	7.44	6.92	
	PE4667	RG174, RG188, RG316	CLAMP	16.65	15.48	14.32	13.32	
	PE4668	RG174, RG188, RG316	CRIMP	15.25	14.18	13.12	12.20	
	PE4669	RG178, RG196	CLAMP	15.40	14.32	13.24	12.32	
	PE4670	RG402, PE-SR402AL, PE-SR402FL(.141" SEMI-RIGID)	SOLDER/CLAMP	17.55	16.32	15.09	14.04	
	PE4671	RG402, PE-SR402AL, PE-SR402FL(.141" SEMI-RIGID)	SOLDER	20.70	19.25	17.80	16.56	
	PE4672	RG405, PE-SR405AL, PE-SR405FL(.085" SEMI-RIGID)	SOLDER/CLAMP	17.55	16.32	15.09	14.04	
	PE4673	RG405, PE-SR405AL, PE-SR405FL(.085" SEMI-RIGID)	SOLDER	20.70	19.25	17.80	16.56	
	PE4674	BELDEN 9913, BELDEN 9914, PE-B3199, PE-B4199	CLAMP	16.30	15.16	14.02	13.04	
	REVERSE POLARITY TNC MALE, RIGHT ANGLE FOR CABLE ATTACHMENT 	PE4675	R68, RG9, RG213, RG214, RG225, RG393	CLAMP	28.15	26.18	24.21	22.52
		PE4676	RG55, RG58, RG141, RG142, RG223, RG400	CLAMP	19.60	18.23	16.86	15.68
		PE4677	RG55, RG141, RG142, RG223, RG400	CRIMP	17.55	16.32	15.09	14.04
		PE4678	RG58	CRIMP	17.40	16.18	14.96	13.92
PE4679		RG59B/U, RG62	CLAMP	20.70	19.25	17.80	16.56	
PE4680		RG174, RG188, RG316	CLAMP	17.55	16.32	15.09	14.04	
PE4681		RG174, RG188, RG316	CRIMP	18.50	17.21	15.91	14.80	
PE4682	RG178, RG196	CLAMP	20.85	19.39	17.93	16.68		

SEE NEXT PAGE FOR MORE PRODUCTS

# 50 OHM REVERSE POLARITY TNC CONNECTORS (cont'd)

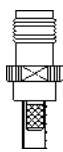

MEETS FCC PART 15.203 REQUIREMENTS

SEE PAGE 266 FOR MOUNTING HOLES

	Model No.	FITS MIL SPEC AND EQUIVALENT CABLES	ATTACHMENT METHOD	P R I C E			
				1-24	25-49	50-99	100 +
REVERSE POLARITY TNC FEMALE FOR CABLE ATTACHMENT 	PE4683	RG8, RG9, RG213, RG214, RG225, RG393	CLAMP	\$25.10	\$23.34	\$21.59	\$20.08
	PE4684	RG55, RG58, RG141, RG142, RG223, RG400	CLAMP	10.85	10.09	9.33	8.68
	PE4685	RG55, RG141, RG142, RG223, RG400	CRIMP	10.95	10.18	9.42	8.76
	PE4686	RG58	CRIMP	10.85	10.09	9.33	8.68
	PE4687	RG59B/U, RG62	CRIMP	11.95	11.11	10.28	9.56
	PE4688	RG59B/U, RG62	CLAMP	15.65	14.55	13.46	12.52
	PE4689	RG174, RG188, RG316	CLAMP	13.20	12.28	11.35	10.56
	PE4690	RG174, RG188, RG316	CRIMP	13.05	12.14	11.22	10.44
	PE4691	RG178, RG196	CLAMP	14.30	13.30	12.30	11.44
	PE4692	RG402, PE-SR402AL, PE-SR402FL (.141" SEMI-RIGID)	SOLDER/CLAMP	17.55	16.32	15.09	14.04
	PE4693	RG405, PE-SR405AL, PE-SR405FL (.085" SEMI-RIGID)	SOLDER/CLAMP	17.55	16.32	15.09	14.04

REVERSE POLARITY TNC FEMALE BULKHEAD FOR CABLE ATTACHMENT 	PE4694	RG55, RG58, RG141, RG142, RG223, RG400	CLAMP	15.25	14.18	13.12	12.20
	PE4695	RG55, RG141, RG142, RG223, RG400	CRIMP	14.30	13.30	12.30	11.44
	PE4696	RG58	CRIMP	18.25	16.97	15.70	14.60
	PE4697	RG59B/U, RG62	CLAMP	17.40	16.18	14.96	13.92
	PE4698	RG59B/U, RG62	CRIMP	17.40	16.18	14.96	13.92
	PE4699	RG174, RG188, RG316	CLAMP	17.55	16.32	15.09	14.04
	PE4700	RG174, RG188, RG316	CRIMP	17.40	16.18	14.96	13.92
	PE4701	RG178, RG196	CLAMP	17.55	16.32	15.09	14.04
	PE4702	RG402, PE-SR402AL, PE-SR402FL (.141" SEMI-RIGID)	SOLDER/CLAMP	20.85	19.39	17.93	16.68
	PE4703	RG405, PE-SR405AL, PE-SR405FL (.085" SEMI-RIGID)	SOLDER/CLAMP	20.85	19.39	17.93	16.68

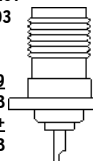
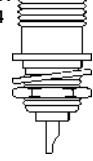
## USE MOUNTING HOLE B06

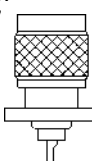
Model No.	PE4704	Model No.	PE4705	Model No.	PE4706	Model No.	PE4707	Model No.	PE4708
REVERSE POLARITY TNC FEMALE BULKHEAD SOLDER CUP CONTACT MOUNTING HOLE B05		REVERSE POLARITY TNC FEMALE, PANEL MOUNT SOLDER CUP CONTACT MOUNTING HOLE A03		REVERSE POLARITY TNC FEMALE BULKHEAD SOLDER CUP CONTACT MOUNTING HOLE B04		REVERSE POLARITY TNC FEMALE BULKHEAD ISOLATED GROUND SOLDER CUP CONTACT MOUNTING HOLE B06		REVERSE POLARITY TNC MALE, PANEL MOUNT SOLDER CUP CONTACT MOUNTING HOLE A07	
1-24 \$10.85 50-99 \$9.33	25-49 \$10.09 100 + \$8.68	1-24 \$14.60 50-99 \$12.56	25-49 \$13.58 100 + \$11.68	1-24 \$10.85 50-99 \$9.33	25-49 \$10.09 100 + \$8.68	1-24 \$14.60 50-99 \$12.56	25-49 \$13.58 100 + \$11.68	1-24 \$15.25 50-99 \$13.12	25-49 \$14.18 100 + \$12.20

# REVERSE THREAD SMA CONNECTORS

MEETS FCC PART 15.203 REQUIREMENTS

SEE PAGE 266 FOR MOUNTING HOLES

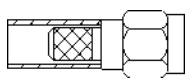
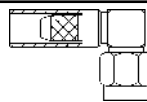
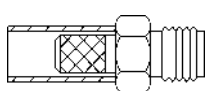
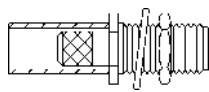

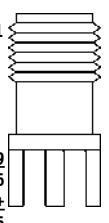
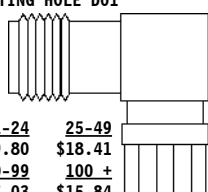
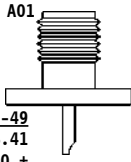
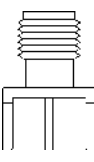
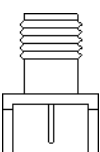
	Model No.	FITS MIL SPEC AND EQUIVALENT CABLES	ATTACHMENT METHOD	P R I C E			
				1-24	25-49	50-99	100 +
REVERSE THREAD SMA MALE FOR CABLE ATTACHMENT 	PE44182	RG55, RG141, RG142, RG223, RG400	CRIMP	\$15.60	\$14.51	\$13.42	\$12.48
	PE44183	RG58	CRIMP	15.60	14.51	13.42	12.48
	PE44184	RG174, RG188, RG316	CRIMP	15.60	14.51	13.42	12.48
	PE44185	RG178, RG196	CRIMP	15.60	14.51	13.42	12.48
REVERSE THREAD SMA MALE RIGHT ANGLE FOR CABLE ATTACHMENT 	PE44186	RG55, RG141, RG142, RG223, RG400	CRIMP	27.10	25.20	23.31	21.68
	PE44187	RG58	CRIMP	27.10	25.20	23.31	21.68
	PE44188	RG174, RG188, RG316	CRIMP	27.10	25.20	23.31	21.68
	PE44189	RG178, RG196	CRIMP	27.10	25.20	23.31	21.68
REVERSE THREAD SMA FEMALE FOR CABLE ATTACHMENT 	PE44190	RG55, RG141, RG142, RG223, RG400	CRIMP	17.70	16.46	15.22	14.16
	PE44191	RG58	CRIMP	18.75	17.44	16.13	15.00
	PE44192	RG174, RG188, RG316	CRIMP	17.70	16.46	15.22	14.16
	PE44193	RG178, RG196	CRIMP	17.70	16.46	15.22	14.16
REVERSE THREAD SMA FEMALE BULKHEAD FOR CABLE ATTACHMENT 	PE44194	RG55, RG141, RG142, RG223, RG400	CRIMP	20.85	19.39	17.93	16.68
	PE44195	RG58	CRIMP	20.85	19.39	17.93	16.68
	PE44196	RG174, RG188, RG316	CRIMP	20.85	19.39	17.93	16.68
	PE44197	RG178, RG196	CRIMP	20.85	19.39	17.93	16.68

Model No.	PE44198	Model No.	PE44199	Model No.	PE44200	Model No.	PE44201	Model No.	PE44202
REVERSE THREAD SMA FEMALE P.C. MOUNT MOUNTING HOLE D01		REVERSE THREAD SMA FEMALE RIGHT ANGLE, P.C. MOUNT MOUNTING HOLE D01		REVERSE THREAD SMA FEMALE 4 HOLE PANEL MOUNT SOLDER CUP CONTACT MOUNTING HOLE A01		REVERSE THREAD SMA FEMALE END LAUNCH FOR .062" THICK BOARD, .030" ROUND CONTACT		REVERSE THREAD SMA FEMALE END LAUNCH FOR .062" THICK BOARD, TAB CONTACT .020" X .010"	
1-24 \$17.70 50-99 \$15.22	25-49 \$16.46 100 + \$14.16	1-24 \$19.80 50-99 \$17.03	25-49 \$18.41 100 + \$15.84	1-24 \$19.80 50-99 \$17.03	25-49 \$18.41 100 + \$15.84	1-24 \$17.70 50-99 \$15.22	25-49 \$16.46 100 + \$14.16	1-24 \$17.70 50-99 \$15.22	25-49 \$16.46 100 + \$14.16



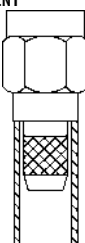
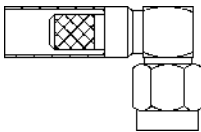

# REVERSE POLARITY SMA CONNECTORS

MEETS FCC PART 15.203 REQUIREMENTS

SEE PAGE 266 FOR MOUNTING HOLES

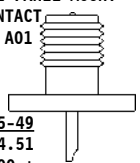
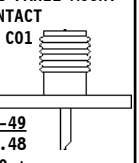
		P R I C E					
		1-24	25-49	50-99	100 +		
<b>REVERSE POLARITY SMA MALE FOR CABLE ATTACHMENT</b> 	Model No. PE4766	FITS MIL SPEC AND EQUIVALENT CABLES RG55, RG58, RG141, RG142, RG223, RG400	ATTACHMENT METHOD CLAMP	\$18.75	\$17.44	\$16.13	\$15.00
	PE4767	RG55, RG141, RG142, RG223, RG400	CRIMP	13.20	12.28	11.35	10.56
	PE4768	RG55, RG58, RG141, RG142, RG223, RG400	SOLDER	15.60	14.51	13.42	12.48
	PE4769	RG58	CRIMP	15.60	14.51	13.42	12.48
	PE4770	RG174, RG188, RG316	CLAMP	20.85	19.39	17.93	16.68
	PE4771	RG174, RG188, RG316	CRIMP	12.25	11.39	10.54	9.80
	PE4772	RG174, RG188, RG316	SOLDER	15.60	14.51	13.42	12.48
	PE4773	RG178, RG196	CLAMP	18.75	17.44	16.13	15.00
	PE4774	RG178, RG196	CRIMP	18.75	17.44	16.13	15.00
	PE4775	RG178, RG196	SOLDER	15.30	14.23	13.16	12.24
	PE4776	RG180, RG195	CLAMP	18.75	17.44	16.13	15.00
	PE4777	RG180, RG195	CRIMP	19.80	18.41	17.03	15.84
	PE4778	RG402, PE-SR402AL, PE-SR402FL (.141" SEMI-RIGID)	SOLDER	15.60	14.51	13.42	12.48
	PE4779	RG405, PE-SR405AL, PE-SR405FL (.085" SEMI-RIGID)	SOLDER	15.60	14.51	13.42	12.48
<b>REVERSE POLARITY SMA MALE, RIGHT ANGLE FOR CABLE ATTACHMENT</b> 	PE4780	RG55, RG58, RG141, RG142, RG223, RG400	CLAMP	26.05	24.23	22.40	20.84
	PE4781	RG55, RG141, RG142, RG223, RG400	CRIMP	26.05	24.23	22.40	20.84
	PE4782	RG55, RG58, RG141, RG142, RG223, RG400	SOLDER	26.05	24.23	22.40	20.84
	PE4783	RG58	CRIMP	24.00	22.32	20.64	19.20
	PE4784	RG174, RG188, RG316	CLAMP	31.30	29.11	26.92	25.04
	PE4785	RG174, RG188, RG316	CRIMP	26.05	24.23	22.40	20.84
	PE4786	RG174, RG188, RG316	SOLDER	26.05	24.23	22.40	20.84
	PE4787	RG178, RG196	CLAMP	63.95	59.47	55.00	51.16
	PE4788	RG178, RG196	CRIMP	26.05	24.23	22.40	20.84
	PE4789	RG178, RG196	SOLDER	26.05	24.23	22.40	20.84
	PE4790	RG402, PE-SR402AL, PE-SR402FL (.141" SEMI-RIGID)	SOLDER	26.05	24.23	22.40	20.84
PE4791	RG405, PE-SR405AL, PE-SR405FL (.085" SEMI-RIGID)	SOLDER	26.05	24.23	22.40	20.84	
<b>REVERSE POLARITY SMA FEMALE FOR CABLE ATTACHMENT</b> 	PE4792	RG55, RG58, RG141, RG142, RG223, RG400	CLAMP	20.85	19.39	17.93	16.68
	PE4793	RG55, RG141, RG142, RG223, RG400	CRIMP	19.80	18.41	17.03	15.84
	PE4794	RG55, RG58, RG141, RG142, RG223, RG400	SOLDER	18.75	17.44	16.13	15.00
	PE4795	RG58	CRIMP	18.75	17.44	16.13	15.00
	PE4796	RG174, RG188, RG316	CLAMP	20.85	19.39	17.93	16.68
	PE4797	RG174, RG188, RG316	CRIMP	18.75	17.44	16.13	15.00
	PE4798	RG174, RG188, RG316	SOLDER	18.75	17.44	16.13	15.00
	PE4799	RG178, RG196	CRIMP	18.75	17.44	16.13	15.00
	PE4850	RG178, RG196	CLAMP	20.85	19.39	17.93	16.68
	PE4851	RG178, RG196	SOLDER	18.75	17.44	16.13	15.00
	PE4852	RG402, PE-SR402AL, PE-SR402FL (.141" SEMI-RIGID)	SOLDER	19.80	18.41	17.03	15.84
PE4853	RG405, PE-SR405AL, PE-SR405FL (.085" SEMI-RIGID)	SOLDER	19.80	18.41	17.03	15.84	
<b>REVERSE POLARITY SMA FEMALE BULKHEAD FOR CABLE ATTACHMENT</b> 	PE4854	RG55, RG58, RG141, RG142, RG223, RG400	CLAMP	26.05	24.23	22.40	20.84
	PE4855	RG55, RG141, RG142, RG223, RG400	CRIMP	17.70	16.46	15.22	14.16
	PE4856	RG55, RG58, RG141, RG142, RG223, RG400	SOLDER	18.75	17.44	16.13	15.00
	PE4857	RG58	CRIMP	17.70	16.46	15.22	14.16
	PE4858	RG174, RG188, RG316	CLAMP	26.05	24.23	22.40	20.84
	PE4859	RG174, RG188, RG316	CRIMP	17.70	16.46	15.22	14.16
	PE4860	RG174, RG188, RG316	SOLDER	18.75	17.44	16.13	15.00
	PE4861	RG178, RG196	CLAMP	26.05	24.23	22.40	20.84
	PE4862	RG178, RG196	CRIMP	17.70	16.46	15.22	14.16
	PE4863	RG178, RG196	SOLDER	19.80	18.41	17.03	15.84
	PE4864	RG402, PE-SR402AL, PE-SR402FL (.141" SEMI-RIGID)	SOLDER	21.90	20.37	18.83	17.52
	PE4865	RG405, PE-SR405AL, PE-SR405FL (.085" SEMI-RIGID)	SOLDER	22.95	21.34	19.74	18.36

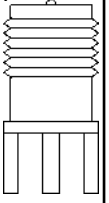
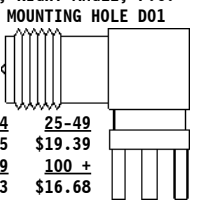
## USE MOUNTING HOLE B02

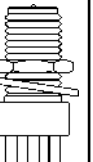
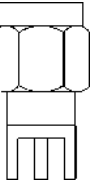
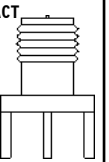
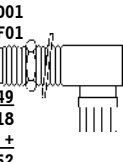
<b>Model No. PE4866</b> REVERSE POLARITY SMA FEMALE, 4 HOLE PANEL MOUNT SOLDER CUP CONTACT MOUNTING HOLE A01  <table border="0"> <tr><td>1-24</td><td>25-49</td></tr> <tr><td>\$15.60</td><td>\$14.51</td></tr> <tr><td>50-99</td><td>100 +</td></tr> <tr><td>\$13.42</td><td>\$12.48</td></tr> </table>	1-24	25-49	\$15.60	\$14.51	50-99	100 +	\$13.42	\$12.48	<b>Model No. PE4867</b> REVERSE POLARITY SMA FEMALE, 2 HOLE PANEL MOUNT SOLDER CUP CONTACT MOUNTING HOLE C01  <table border="0"> <tr><td>1-24</td><td>25-49</td></tr> <tr><td>\$16.65</td><td>\$15.48</td></tr> <tr><td>50-99</td><td>100 +</td></tr> <tr><td>\$14.32</td><td>\$13.32</td></tr> </table>	1-24	25-49	\$16.65	\$15.48	50-99	100 +	\$14.32	\$13.32	<b>Model No. PE4868</b> REVERSE POLARITY SMA FEMALE BULKHEAD, REAR MOUNT, SOLDER CUP CONTACT MOUNTING HOLE B02  <table border="0"> <tr><td>1-24</td><td>25-49</td></tr> <tr><td>\$13.55</td><td>\$12.60</td></tr> <tr><td>50-99</td><td>100 +</td></tr> <tr><td>\$11.65</td><td>\$10.84</td></tr> </table>	1-24	25-49	\$13.55	\$12.60	50-99	100 +	\$11.65	\$10.84	<b>Model No. PE4869</b> REVERSE POLARITY SMA FEMALE, P.C. MOUNT MOUNTING HOLE D01  <table border="0"> <tr><td>1-24</td><td>25-49</td></tr> <tr><td>\$14.60</td><td>\$13.58</td></tr> <tr><td>50-99</td><td>100 +</td></tr> <tr><td>\$12.56</td><td>\$11.68</td></tr> </table>	1-24	25-49	\$14.60	\$13.58	50-99	100 +	\$12.56	\$11.68	<b>Model No. PE4870</b> REVERSE POLARITY SMA FEMALE, RIGHT ANGLE, P.C. MOUNT, MOUNTING HOLE D01  <table border="0"> <tr><td>1-24</td><td>25-49</td></tr> <tr><td>\$20.85</td><td>\$19.39</td></tr> <tr><td>50-99</td><td>100 +</td></tr> <tr><td>\$17.93</td><td>\$16.68</td></tr> </table>	1-24	25-49	\$20.85	\$19.39	50-99	100 +	\$17.93	\$16.68
1-24	25-49																																											
\$15.60	\$14.51																																											
50-99	100 +																																											
\$13.42	\$12.48																																											
1-24	25-49																																											
\$16.65	\$15.48																																											
50-99	100 +																																											
\$14.32	\$13.32																																											
1-24	25-49																																											
\$13.55	\$12.60																																											
50-99	100 +																																											
\$11.65	\$10.84																																											
1-24	25-49																																											
\$14.60	\$13.58																																											
50-99	100 +																																											
\$12.56	\$11.68																																											
1-24	25-49																																											
\$20.85	\$19.39																																											
50-99	100 +																																											
\$17.93	\$16.68																																											
<b>Model No. PE4871</b> REVERSE POLARITY SMA FEMALE BULKHEAD, FRONT MOUNT, SOLDER CUP CONTACT MOUNTING HOLE B02  <table border="0"> <tr><td>1-24</td><td>25-49</td></tr> <tr><td>\$15.60</td><td>\$14.51</td></tr> <tr><td>50-99</td><td>100 +</td></tr> <tr><td>\$13.42</td><td>\$12.48</td></tr> </table>	1-24	25-49	\$15.60	\$14.51	50-99	100 +	\$13.42	\$12.48	<b>Model No. PE4872</b> REVERSE POLARITY SMA FEMALE BULKHEAD, P.C. MOUNT, MOUNTING HOLE D01 MOUNTING HOLE F01  <table border="0"> <tr><td>1-24</td><td>25-49</td></tr> <tr><td>\$15.25</td><td>\$14.18</td></tr> <tr><td>50-99</td><td>100 +</td></tr> <tr><td>\$13.12</td><td>\$12.20</td></tr> </table>	1-24	25-49	\$15.25	\$14.18	50-99	100 +	\$13.12	\$12.20	<b>Model No. PE4873</b> REVERSE POLARITY SMA MALE P.C. MOUNT MOUNTING HOLE D01  <table border="0"> <tr><td>1-24</td><td>25-49</td></tr> <tr><td>\$15.60</td><td>\$14.51</td></tr> <tr><td>50-99</td><td>100 +</td></tr> <tr><td>\$13.42</td><td>\$12.48</td></tr> </table>	1-24	25-49	\$15.60	\$14.51	50-99	100 +	\$13.42	\$12.48	<b>Model No. PE4874</b> REVERSE POLARITY SMA FEMALE, END LAUNCH FOR .062" THICK BOARD .030" ROUND CONTACT  <table border="0"> <tr><td>1-24</td><td>25-49</td></tr> <tr><td>\$15.60</td><td>\$14.51</td></tr> <tr><td>50-99</td><td>100 +</td></tr> <tr><td>\$13.42</td><td>\$12.48</td></tr> </table>	1-24	25-49	\$15.60	\$14.51	50-99	100 +	\$13.42	\$12.48	<b>Model No. PE4875</b> REVERSE POLARITY SMA FEMALE BULKHEAD, RIGHT ANGLE, P.C. MOUNT MOUNTING HOLE D01 MOUNTING HOLE F01  <table border="0"> <tr><td>1-24</td><td>25-49</td></tr> <tr><td>\$28.15</td><td>\$26.18</td></tr> <tr><td>50-99</td><td>100 +</td></tr> <tr><td>\$24.21</td><td>\$22.52</td></tr> </table>	1-24	25-49	\$28.15	\$26.18	50-99	100 +	\$24.21	\$22.52
1-24	25-49																																											
\$15.60	\$14.51																																											
50-99	100 +																																											
\$13.42	\$12.48																																											
1-24	25-49																																											
\$15.25	\$14.18																																											
50-99	100 +																																											
\$13.12	\$12.20																																											
1-24	25-49																																											
\$15.60	\$14.51																																											
50-99	100 +																																											
\$13.42	\$12.48																																											
1-24	25-49																																											
\$15.60	\$14.51																																											
50-99	100 +																																											
\$13.42	\$12.48																																											
1-24	25-49																																											
\$28.15	\$26.18																																											
50-99	100 +																																											
\$24.21	\$22.52																																											

# BANANA PLUGS

Model No. PE4050  
BANANA PLUG WITH SOLDER  
TURRET TERMINALS

1-24	25-49	
\$4.35	\$4.05	
50-99	100 +	
\$3.74	\$3.48	

Model No. PE4089  
BANANA PLUG, CRIMP  
ATTACHMENT FOR RG55,  
RG142, RG223 & RG400

1-24	25-49	
\$7.25	\$6.74	
50-99	100 +	
\$6.24	\$5.80	

Model No. PE4301  
BANANA PLUG, CRIMP  
ATTACHMENT FOR RG58

1-24	25-49	
\$5.50	\$5.12	
50-99	100 +	
\$4.73	\$4.40	

Model No. PE44145  
BANANA PLUG, CRIMP  
ATTACHMENT FOR RG174,  
RG188 & RG316

1-24	25-49	
\$9.35	\$8.70	
50-99	100 +	
\$8.04	\$7.48	

## D SUBMINIATURE COAXIAL CONTACTS

This series of coaxial contacts fits D Subminiature rectangular shells and are interchangeable with contacts manufactured by other companies.

STRAIGHT RECEPTACLE	CRIMP ATTACHMENT Model No.	SOLDER ATTACHMENT Model No.	FITS MIL SPEC AND EQUIVALENT CABLES	P R I C E			
				1-24	25-49	50-99	100 +
	PE4837	PE4838	RG55, RG142, RG223, RG400	\$8.80	\$8.18	\$7.57	\$7.04
	PE4800	PE4804	RG58, RG141, RG303	7.60	7.07	6.54	6.08
	PE4801	PE4805	RG174, RG187, RG188, RG316	7.60	7.07	6.54	6.08
	PE4802	PE4806	RG178, RG196	7.60	7.07	6.54	6.08
	PE4803	PE4807	RG180, RG195	7.60	7.07	6.54	6.08
		PE4839	RG402, PE-SR402AL, PE-SR402FL	13.55	12.60	11.65	10.84
		PE4840	RG405, PE-SR405AL, PE-SR405FL	9.75	9.07	8.39	7.80
		PE4841	PE-047SR, PE-SR047AL, PE-SR047FL	10.85	10.09	9.33	8.68



STRAIGHT PLUG	Model No.	Model No.	FITS MIL SPEC AND EQUIVALENT CABLES	P R I C E			
				1-24	25-49	50-99	100 +
	PE4842	PE4843	RG55, RG142, RG223, RG400	10.95	10.18	9.42	8.76
	PE4808	PE4812	RG58, RG141, RG303	9.90	9.21	8.51	7.92
	PE4809	PE4813	RG174, RG187, RG188, RG316	10.55	9.81	9.07	8.44
	PE4810	PE4814	RG178, RG196	9.90	9.21	8.51	7.92
	PE4811	PE4815	RG180, RG195	9.75	9.07	8.39	7.80
		PE4844	RG402, PE-SR402AL, PE-SR402FL	13.55	12.60	11.65	10.84
		PE4845	RG405, PE-SR405AL, PE-SR405FL	11.95	11.11	10.28	9.56
		PE4846	PE-047SR, PE-SR047AL, PE-SR047FL	13.05	12.14	11.22	10.44

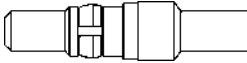

RIGHT ANGLE RECEPTACLE	Model No.	Model No.	FITS MIL SPEC AND EQUIVALENT CABLES	P R I C E			
				1-24	25-49	50-99	100 +
	PE4847	PE4848	RG55, RG142, RG223, RG400	10.95	10.18	9.42	8.76
	PE4816	PE4820	RG58, RG141, RG303	9.90	9.21	8.51	7.92
	PE4817	PE4821	RG174, RG187, RG188, RG316	9.75	9.07	8.39	7.80
	PE4818	PE4822	RG178, RG196	9.75	9.07	8.39	7.80
	PE4819	PE4823	RG180, RG195	9.75	9.07	8.39	7.80
		PE4849	RG402, PE-SR402AL, PE-SR402FL	14.15	13.16	12.17	11.32
		PE44033	RG405, PE-SR405AL, PE-SR405FL	14.15	13.16	12.17	11.32
		PE44034	PE-047SR, PE-SR047AL, PE-SR047FL	15.25	14.18	13.12	12.20

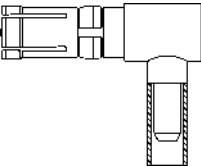

RIGHT ANGLE PLUG	Model No.	Model No.	FITS MIL SPEC AND EQUIVALENT CABLES	P R I C E			
				1-24	25-49	50-99	100 +
	PE44035	PE44036	RG55, RG142, RG223, RG400	10.95	10.18	9.42	8.76
	PE4824	PE4828	RG58, RG141, RG303	9.75	9.07	8.39	7.80
	PE4825	PE4829	RG174, RG187, RG188, RG316	9.75	9.07	8.39	7.80
	PE4826	PE4830	RG178, RG196	9.75	9.07	8.39	7.80
	PE4827	PE4831	RG180, RG195	9.75	9.07	8.39	7.80
		PE44037	RG402, PE-SR402AL, PE-SR402FL	17.40	16.18	14.96	13.92
		PE44038	RG405, PE-SR405AL, PE-SR405FL	17.40	16.18	14.96	13.92
		PE44039	PE-047SR, PE-SR047AL, PE-SR047FL	18.50	17.21	15.91	14.80

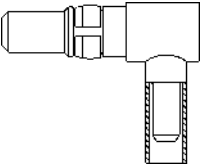

Model No. PE4832  
D SUBMINIATURE STRAIGHT  
RECEPTACLE, PRINTED CIRCUIT MOUNT  
MOUNTING HOLE J01

1-24	25-49
\$9.75	\$9.07
50-99	100 +
\$8.39	\$7.80

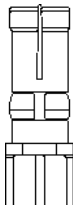

Model No. PE4833  
D SUBMINIATURE STRAIGHT PLUG  
PRINTED CIRCUIT MOUNT  
MOUNTING HOLE J01

1-24	25-49
\$9.75	\$9.07
50-99	100 +
\$8.39	\$7.80

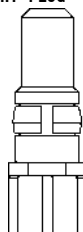

Model No. PE4834  
D SUBMINIATURE RECEPTACLE, RIGHT  
ANGLE, PRINTED CIRCUIT MOUNT  
MOUNTING HOLE J01

1-24	25-49
\$13.55	\$12.60
50-99	100 +
\$11.65	\$10.84

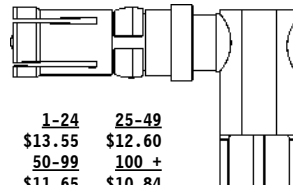

Model No. PE4835  
D SUBMINIATURE PLUG, RIGHT  
ANGLE, PRINTED CIRCUIT MOUNT  
MOUNTING HOLE J01

1-24	25-49
\$13.55	\$12.60
50-99	100 +
\$11.65	\$10.84

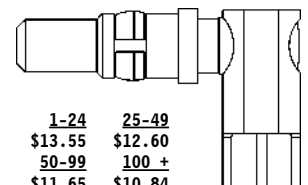

# GR874 CONNECTORS

Model No. PE4233  
GR874, CRIMP ATTACHMENT  
FOR RG55, RG58, RG141,  
RG142, RG223 & RG400



1-24	25-49
\$57.85	\$53.80
50-99	100 +
\$49.75	\$46.28

Model No. PE4348  
GR874 REBUILD KIT, BODY,  
CONTACT, INSULATOR &  
RETAINING NUT ONLY

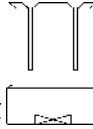

1-24	25-49
\$29.40	\$27.34
50-99	100 +
\$25.28	\$23.52

Model No. PE4352  
GR874, CRIMP ATTACHMENT  
FOR RG9, RG214, RG225  
& RG393



1-24	25-49
\$57.85	\$53.80
50-99	100 +
\$49.75	\$46.28

## BNC TWINAX

SEE PAGE 266 FOR MOUNTING HOLES

Model No. PE4234  
BNC TWINAX PLUG, CRIMP  
ATTACHMENT FOR RG108A/U,  
78 OHM BALANCED  
CABLE OR EQUAL



1-24	25-49
\$12.25	\$11.39
50-99	100 +
\$10.54	\$9.80

Model No. PE4235  
BNC TWINAX JACK, CRIMP  
ATTACHMENT FOR RG108A/U,  
78 OHM BALANCED  
CABLE OR EQUAL

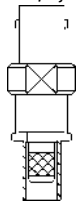

1-24	25-49
\$20.85	\$19.39
50-99	100 +
\$17.93	\$16.68

Model No. PE4236  
BNC TWINAX PLUG, CLAMP  
ATTACHMENT FOR RG108A/U,  
78 OHM BALANCED  
CABLE OR EQUAL

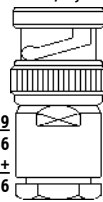

1-24	25-49
\$17.70	\$16.46
50-99	100 +
\$15.22	\$14.16

Model No. PE4237  
BNC TWINAX JACK, CLAMP  
ATTACHMENT FOR RG108A/U,  
78 OHM BALANCED  
CABLE OR EQUAL

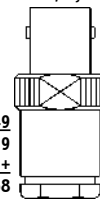

1-24	25-49
\$20.85	\$19.39
50-99	100 +
\$17.93	\$16.68

Model No. PE4238  
BNC TWINAX JACK, BULKHEAD  
SOLDER CUP CONTACT  
MOUNTING HOLE B04

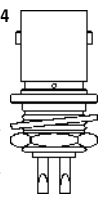

1-24	25-49
\$11.95	\$11.11
50-99	100 +
\$10.28	\$9.56

Model No. PE4324  
BNC TWINAX JACK, PANEL  
MOUNT, SOLDER CUP CONTACT  
MOUNTING HOLE A03

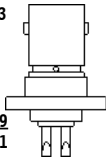

1-24	25-49
\$15.60	\$14.51
50-99	100 +
\$13.42	\$12.48

Model No. PE44114  
BNC TWINAX JACK, BULKHEAD  
CLAMP ATTACHMENT FOR  
RG108A/U, 78 OHM BALANCED  
CABLE OR EQUAL  
MOUNTING HOLE B06



1-24	25-49
\$28.15	\$26.18
50-99	100 +
\$24.21	\$22.52

Model No. PE44115  
BNC TWINAX JACK, P.C  
MOUNT, MOUNTING HOLE H01

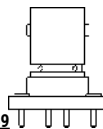

1-24	25-49
\$17.40	\$16.18
50-99	100 +
\$14.96	\$13.92

Model No. PE44116  
BNC TWINAX JACK, RIGHT  
ANGLE, P.C. MOUNT  
MOUNTING HOLE H01

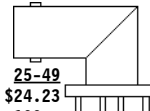

1-24	25-49
\$26.05	\$24.23
50-99	100 +
\$22.40	\$20.84

## 3/4"-20 THREADED TWINAX

SEE PAGE 266 FOR MOUNTING HOLES

Model No. PE4104  
TWINAX MALE FOR BELDEN 9207  
OR EQUAL CABLE

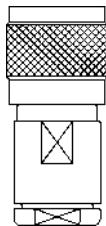

1-24	25-49
\$14.90	\$13.86
50-99	100 +
\$12.81	\$11.92

Model No. PE4105  
TWINAX FEMALE BULKHEAD  
SOLDER CUP CONTACT  
MOUNTING HOLE B07

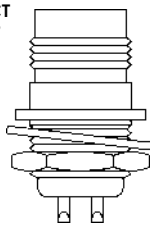

1-24	25-49
\$15.25	\$14.18
50-99	100 +
\$13.12	\$12.20

Model No. PE4346  
TWINAX FEMALE FOR BELDEN 9207  
OR EQUAL CABLE

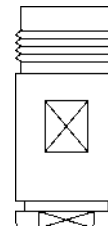

1-24	25-49
\$15.25	\$14.18
50-99	100 +
\$13.12	\$12.20

Model No. PE4347  
TWINAX FEMALE, PANEL MOUNT  
SOLDER CUP CONTACT  
MOUNTING HOLE A05

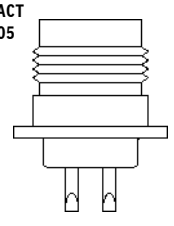

1-24	25-49
\$18.50	\$17.21
50-99	100 +
\$15.91	\$14.80



# CONNECTOR FREQUENCY RANGE CHART

Point to Point Cable Routers LAN	Broadcast TV LAN	Cable TV Mobile Radio Body Scanners	Telecommunications Airport Search Radar Test & Measurement Datacom	Satcom (uplink)	Airborne Radar Navigation Radar Antenna Base Stations	Satcom (downlink) Test & Measurement Police Radar Microwave Radio Links	Instrumentation	Test Measurement High Frequency Communication	Military Aerospace Electronic Warfare
									1.85mm
									MINI SMP
									2.4mm
									SSMA
									SMP
									2.92mm
									3.5mm
							SMA, QMA		
									SSMB
									TNC <sup>6</sup>
									N <sup>5</sup>
									C, SC
									SMC <sup>4</sup>
									1.0/2.3
									GR874
									7/16
									MMCX
									MCX <sup>3</sup>
									LFU
									SMB <sup>2</sup>
									HN
									BNC <sup>1</sup>
									F
									MINI UHF
									10-32
									LC
									1.6/5.6
									UHF
									FME
									TWINAX
									BNC TWINAX
<b>VHF</b> 100-300 MHz	<b>UHF</b> 300 MHz 1 GHz	<b>L</b> 1-2 GHz	<b>S</b> 2-4 GHz	<b>C</b> 4-8 GHz	<b>X</b> 8-12.4 GHz	<b>Ku</b> 12.4-18 GHz	<b>K</b> 18-26 GHz	<b>Ka</b> 26-40 GHz	<b>mm</b> 40-100 GHz

## Notes:

- 1: BNC-75 Ohm connectors operate up to 1 GHz
- 2: SMB-75 Ohm & Mini SMB-75 Ohm connectors operate up to 4 GHz
- 3: MCX-75 Ohm connectors operate up to 6 GHz
- 4: SMC-75 Ohm connectors operate up to 10 GHz
- 5: N-75 Ohm connectors operate up to 1.5 GHz
- 6: TNC-75 Ohm connectors operate up to 1 GHz







# ADAPTER SELECTION LIST

## SMA MALE TO: (cont'd)

N MALE PRECISION	PE9431
REVERSE POLARITY MCX PLUG	PE9581
REVERSE POLARITY SMA FEMALE	PE9534
REVERSE POLARITY TNC FEMALE	PE9600
REVERSE POLARITY TNC MALE	PE9601
REVERSE THREAD SMA FEMALE	PE9682
SMB JACK	PE9145
SMB PLUG	PE9144
SMC JACK	PE9149
SMC PLUG	PE9148
SMP FEMALE PRECISION	PE9513
SMP MALE PRECISION	PE9511
SSMA FEMALE	PE9063
SSMA MALE	PE9187
SSMB JACK	PE9401
TNC FEMALE	PE9078
TNC FEMALE (P)	PE9384
TNC FEMALE PRECISION	PE9441
TNC MALE	PE9076
TNC MALE PRECISION	PE9439
UHF FEMALE	PE9400

## SMB IN SERIES:

JACK TO JACK	PE9116
JACK TO JACK (B)	PE9122
PLUG TO JACK	PE9120
PLUG TO PLUG	PE9118
T, JACK-JACK-JACK	PE9302
T, JACK-PLUG-JACK	PE9243
T, PLUG-JACK-JACK	PE9309
T, PLUG-PLUG-PLUG	PE9310

## SMB JACK TO:

BNC FEMALE	PE9136
BNC FEMALE (B)	PE9240
BNC MALE	PE9132
N FEMALE	PE9315
N MALE	PE9313
SMA FEMALE	PE9143
SMA MALE	PE9145
SMC JACK	PE9283
SMC PLUG	PE9284

## SMB PLUG TO:

BNC FEMALE	PE9137
BNC FEMALE (B)	PE9241
BNC MALE	PE9135
N FEMALE	PE9316
N MALE	PE9314
SMA FEMALE	PE9142
SMA MALE	PE9144
SMC JACK	PE9282
SMC PLUG	PE9281

## 75 OHM SMB IN SERIES:

JACK TO JACK	PE9248
PLUG TO PLUG	PE9271
T, JACK-PLUG-JACK	PE9245

## 75 OHM SMB JACK TO:

75 OHM N FEMALE	PE9583
75 OHM N MALE	PE9582
BNC FEMALE	PE9231
BNC MALE	PE9229
MINI 75 OHM SMB PLUG	PE9735

## 75 OHM SMB PLUG TO:

75 OHM N FEMALE	PE9585
75 OHM N MALE	PE9584
BNC FEMALE	PE9232
BNC MALE	PE9230
MINI 75 OHM SMB JACK	PE9736

## SMC IN SERIES:

JACK TO JACK	PE9115
JACK TO JACK (B)	PE9121
JACK TO PLUG 90°	PE9303
PLUG TO JACK	PE9119
PLUG TO PLUG	PE9117
T, JACK-JACK-JACK	PE9304
T, JACK-PLUG-JACK	PE9242
T, PLUG-PLUG-PLUG	PE9305

## SMC JACK TO:

BNC FEMALE	PE9140
BNC FEMALE (B)	PE9108
BNC MALE	PE9138
N FEMALE	PE9319
N MALE	PE9317
SMA FEMALE	PE9147
SMA MALE	PE9149
SMB JACK	PE9283
SMB PLUG	PE9282
TNC MALE	PE9226

## SMC PLUG TO:

BNC FEMALE	PE9141
BNC MALE	PE9139
N FEMALE	PE9320
N MALE	PE9318
SMA FEMALE	PE9146
SMA MALE	PE9148
SMB JACK	PE9284
SMB PLUG	PE9281

## 75 OHM SMC IN SERIES:

JACK TO JACK	PE9227
JACK TO JACK (B)	PE9228
PLUG TO PLUG	PE9272
T, JACK-PLUG-JACK	PE9244

## 75 OHM SMC JACK TO:

75 OHM N FEMALE	PE9587
75 OHM N MALE	PE9586
BNC FEMALE	PE9235
BNC MALE	PE9233

## 75 OHM SMC PLUG TO:

75 OHM N FEMALE	PE9589
75 OHM N MALE	PE9588
BNC FEMALE	PE9236
BNC MALE	PE9234

## SMP IN SERIES:

FEMALE TO FEMALE	PE9686
FEMALE TO FEMALE BULLET	PE9775
FEMALE TO FEMALE BULLET	PE9776
FEMALE TO FEMALE BULLET	PE9777

## SMP FEMALE TO:

SMA FEMALE PRECISION	PE9514
SMA FEMALE PRECISION	PE9779
SMA MALE PRECISION	PE9513

## SMP MALE TO:

SMA FEMALE PRECISION	PE9512
SMA FEMALE PRECISION	PE9778
SMA MALE PRECISION	PE9511

## SSMA IN SERIES:

FEMALE TO FEMALE	PE9192
FEMALE TO FEMALE (B)	PE9189
FEMALE TO MALE 90°	PE9334
MALE TO FEMALE	PE9358
MALE TO MALE	PE9357

## SSMA FEMALE TO:

1.85mm FEMALE PRECISION	PE9765
1.85mm MALE PRECISION	PE9762
2.92mm FEMALE PRECISION	PE9769
2.92mm MALE PRECISION	PE9766
7mm PRECISION	PE9356
BNC MALE	PE9191
N FEMALE	PE9354
N MALE	PE9352
SMA FEMALE	PE9399
SMA MALE	PE9063
SSMA MALE (QD)	PE9685

## SSMA MALE TO:

1.85mm FEMALE PRECISION	PE9764
1.85mm MALE PRECISION	PE9763
2.92mm FEMALE PRECISION	PE9768
2.92mm MALE PRECISION	PE9767
7mm PRECISION	PE9355
BNC FEMALE	PE9250
BNC MALE	PE9213
N FEMALE	PE9353
N MALE	PE9351
SMA FEMALE	PE9188
SMA MALE	PE9187
SSMA FEMALE (QD)	PE9685

## SSMB JACK TO:

BNC FEMALE	PE9394
BNC MALE	PE9392
SMA MALE	PE9401

## SSMB PLUG TO:

BNC FEMALE	PE9395
BNC MALE	PE9393
SMA FEMALE	PE9402

## TNC IN SERIES:

FEMALE TO FEMALE	PE9099
FEMALE TO FEMALE (B) (H)	PE9154
FEMALE TO FEMALE (B) (I)	PE9287
FEMALE TO FEMALE (P)	PE9288
FEMALE TO FEMALE PRECISION	PE9444
FEMALE TO MALE	PE9270
FEMALE TO MALE (QD)	PE9561
FEMALE TO MALE PRECISION	PE9443
MALE TO FEMALE 90°	PE9100
MALE TO MALE	PE9091
MALE TO MALE 90°	PE9560
MALE TO MALE PRECISION	PE9445
T, FEMALE-FEMALE-FEMALE	PE9289
T, FEMALE-MALE-FEMALE	PE9195
T, MALE-FEMALE-FEMALE	PE9290

## TNC FEMALE TO:

7/16 FEMALE	PE9639
7/16 MALE	PE9636
7mm PRECISION	PE9218
BNC FEMALE	PE9097
BNC FEMALE (B) (H)	PE9483
BNC MALE	PE9098
C MALE	PE9564
FME JACK	PE9714
MCX JACK	PE9544
MCX JACK (B)	PE9521
MCX PLUG	PE9545
MINI UHF MALE	PE9346
N FEMALE (P) PRECISION	PE9450
N FEMALE PRECISION	PE9449
N MALE	PE9090
N MALE 90°	PE9550
N MALE PRECISION	PE9448
REVERSE POLARITY SMA FEMALE	PE9599
REVERSE POLARITY SMA MALE	PE9596
REVERSE POLARITY TNC MALE	PE9531
SMA FEMALE	PE9079
SMA FEMALE (B)	PE9251
SMA FEMALE (P)	PE9276
SMA FEMALE PRECISION	PE9442
SMA MALE	PE9078
SMA MALE (P)	PE9384
SMA MALE PRECISION	PE9441
UHF MALE	PE9372

## TNC MALE TO:

7/16 FEMALE	PE9638
7/16 MALE	PE9637
7mm PRECISION	PE9219
BNC FEMALE	PE9088
BNC FEMALE 90°	PE9783
BNC MALE	PE9110
C FEMALE	PE9562
FME JACK	PE9713
FME PLUG	PE9699
FME PLUG 90°	PE9700
HN MALE	PE9563
MCX JACK	PE9542
MCX PLUG	PE9543
MINI UHF FEMALE	PE9345
N FEMALE	PE9089
N FEMALE 90°	PE9263
N FEMALE PRECISION	PE9447
N MALE	PE9130
N MALE PRECISION	PE9446
REVERSE POLARITY SMA FEMALE	PE9598
REVERSE POLARITY SMA MALE	PE9597
REVERSE POLARITY TNC FEMALE	PE9532
SMA FEMALE	PE9077
SMA FEMALE PRECISION	PE9440
SMA MALE	PE9076
SMA MALE PRECISION	PE9439
SMC JACK	PE9226
UHF FEMALE	PE9291

## 75 OHM TNC IN SERIES:

FEMALE TO FEMALE	PE9622
FEMALE TO FEMALE (B) (H)	PE9624
FEMALE TO FEMALE (B) (I)	PE9625
FEMALE TO MALE 90°	PE9623

## 75 OHM TNC FEMALE TO:

75 OHM BNC MALE	PE9630
75 OHM N FEMALE	PE9629
75 OHM N MALE	PE9627

## 75 OHM TNC MALE TO:

75 OHM BNC FEMALE	PE9631
75 OHM N FEMALE	PE9628
75 OHM N MALE	PE9626

## UHF IN SERIES:

FEMALE TO FEMALE	PE9094
FEMALE TO FEMALE (B)	PE9114
FEMALE TO MALE 90°	PE9209
MALE TO MALE	PE9096
T, FEMALE-MALE-FEMALE	PE9095

## UHF FEMALE TO:

BNC FEMALE	PE9421
BNC MALE	PE9107
F FEMALE	PE9167
MINI UHF MALE	PE9344
N FEMALE	PE9385
N MALE	PE9111
SMA MALE	PE9400
TNC MALE	PE9291



## UHF MALE TO:

BNC FEMALE	PE9004
BNC MALE	PE9201
FME PLUG	PE9701
F FEMALE	PE9165
MINI UHF FEMALE	PE9348
N FEMALE	PE9112
N MALE	PE9113
SMA FEMALE	PE9415
TNC FEMALE	PE9372

# ADAPTERS

SEE ADAPTER SELECTION CHART ON PAGES 195 THRU 198

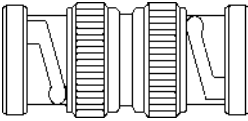
SEE PAGE 266 FOR MOUNTING HOLES

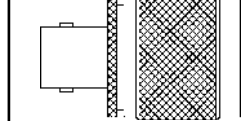
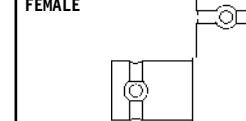
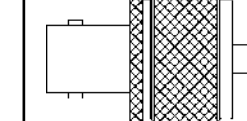
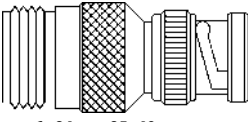
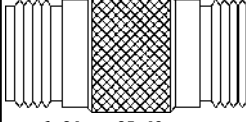
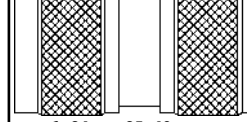
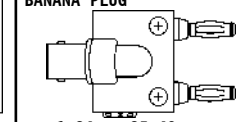
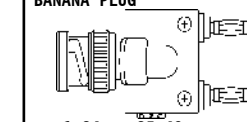
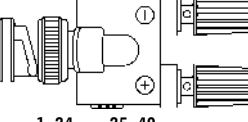
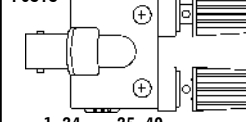
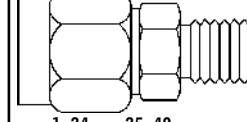
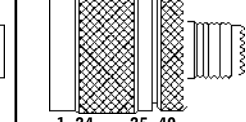
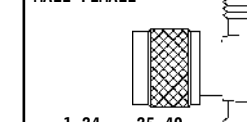
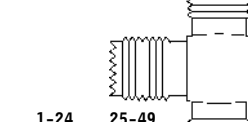
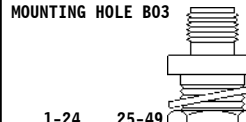
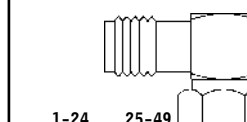
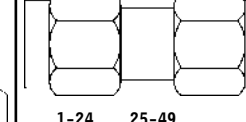
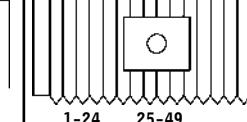
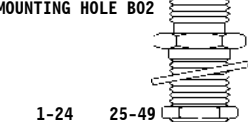
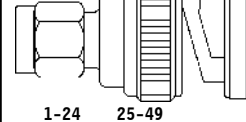
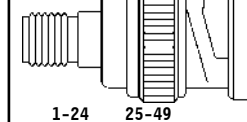
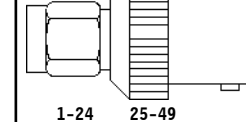
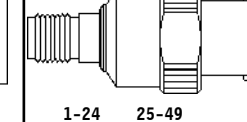
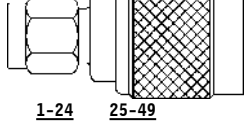
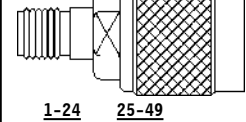
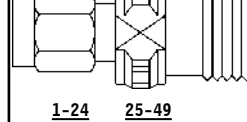
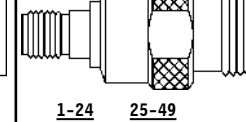
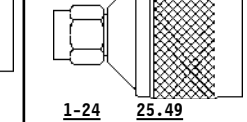
<p>Model No. PE9000 BNC MALE TO BNC MALE</p>  <table border="1"> <tr><td>1-24</td><td>25-49</td></tr> <tr><td>\$10.60</td><td>\$9.86</td></tr> <tr><td>50-99</td><td>100 +</td></tr> <tr><td>\$9.12</td><td>\$8.48</td></tr> </table>	1-24	25-49	\$10.60	\$9.86	50-99	100 +	\$9.12	\$8.48	<p>Model No. PE9001 BNC "T" FEMALE-MALE-FEMALE</p>  <table border="1"> <tr><td>1-24</td><td>25-49</td></tr> <tr><td>\$12.15</td><td>\$11.30</td></tr> <tr><td>50-99</td><td>100 +</td></tr> <tr><td>\$10.45</td><td>\$9.72</td></tr> </table>	1-24	25-49	\$12.15	\$11.30	50-99	100 +	\$10.45	\$9.72	<p>Model No. PE9002 BNC FEMALE TO N MALE</p>  <table border="1"> <tr><td>1-24</td><td>25-49</td></tr> <tr><td>\$12.15</td><td>\$11.30</td></tr> <tr><td>50-99</td><td>100 +</td></tr> <tr><td>\$10.45</td><td>\$9.72</td></tr> </table>	1-24	25-49	\$12.15	\$11.30	50-99	100 +	\$10.45	\$9.72	<p>Model No. PE9003 BNC "T" FEMALE-FEMALE-FEMALE</p>  <table border="1"> <tr><td>1-24</td><td>25-49</td></tr> <tr><td>\$15.55</td><td>\$14.46</td></tr> <tr><td>50-99</td><td>100 +</td></tr> <tr><td>\$13.37</td><td>\$12.44</td></tr> </table>	1-24	25-49	\$15.55	\$14.46	50-99	100 +	\$13.37	\$12.44	<p>Model No. PE9004 BNC FEMALE TO UHF MALE</p>  <table border="1"> <tr><td>1-24</td><td>25-49</td></tr> <tr><td>\$9.75</td><td>\$9.07</td></tr> <tr><td>50-99</td><td>100 +</td></tr> <tr><td>\$8.39</td><td>\$7.80</td></tr> </table>	1-24	25-49	\$9.75	\$9.07	50-99	100 +	\$8.39	\$7.80
1-24	25-49																																											
\$10.60	\$9.86																																											
50-99	100 +																																											
\$9.12	\$8.48																																											
1-24	25-49																																											
\$12.15	\$11.30																																											
50-99	100 +																																											
\$10.45	\$9.72																																											
1-24	25-49																																											
\$12.15	\$11.30																																											
50-99	100 +																																											
\$10.45	\$9.72																																											
1-24	25-49																																											
\$15.55	\$14.46																																											
50-99	100 +																																											
\$13.37	\$12.44																																											
1-24	25-49																																											
\$9.75	\$9.07																																											
50-99	100 +																																											
\$8.39	\$7.80																																											
<p>Model No. PE9005 N FEMALE TO BNC MALE</p>  <table border="1"> <tr><td>1-24</td><td>25-49</td></tr> <tr><td>\$11.10</td><td>\$10.32</td></tr> <tr><td>50-99</td><td>100 +</td></tr> <tr><td>\$9.55</td><td>\$8.88</td></tr> </table>	1-24	25-49	\$11.10	\$10.32	50-99	100 +	\$9.55	\$8.88	<p>Model No. PE9006 N FEMALE TO N FEMALE</p>  <table border="1"> <tr><td>1-24</td><td>25-49</td></tr> <tr><td>\$10.00</td><td>\$9.30</td></tr> <tr><td>50-99</td><td>100 +</td></tr> <tr><td>\$8.60</td><td>\$8.00</td></tr> </table>	1-24	25-49	\$10.00	\$9.30	50-99	100 +	\$8.60	\$8.00	<p>Model No. PE9007 N MALE TO N MALE</p>  <table border="1"> <tr><td>1-24</td><td>25-49</td></tr> <tr><td>\$10.00</td><td>\$9.30</td></tr> <tr><td>50-99</td><td>100 +</td></tr> <tr><td>\$8.60</td><td>\$8.00</td></tr> </table>	1-24	25-49	\$10.00	\$9.30	50-99	100 +	\$8.60	\$8.00	<p>Model No. PE9008 BNC FEMALE TO DOUBLE BANANA PLUG</p>  <table border="1"> <tr><td>1-24</td><td>25-49</td></tr> <tr><td>\$13.30</td><td>\$12.37</td></tr> <tr><td>50-99</td><td>100 +</td></tr> <tr><td>\$11.44</td><td>\$10.64</td></tr> </table>	1-24	25-49	\$13.30	\$12.37	50-99	100 +	\$11.44	\$10.64	<p>Model No. PE9009 BNC MALE TO DOUBLE BANANA PLUG</p>  <table border="1"> <tr><td>1-24</td><td>25-49</td></tr> <tr><td>\$16.30</td><td>\$15.16</td></tr> <tr><td>50-99</td><td>100 +</td></tr> <tr><td>\$14.02</td><td>\$13.04</td></tr> </table>	1-24	25-49	\$16.30	\$15.16	50-99	100 +	\$14.02	\$13.04
1-24	25-49																																											
\$11.10	\$10.32																																											
50-99	100 +																																											
\$9.55	\$8.88																																											
1-24	25-49																																											
\$10.00	\$9.30																																											
50-99	100 +																																											
\$8.60	\$8.00																																											
1-24	25-49																																											
\$10.00	\$9.30																																											
50-99	100 +																																											
\$8.60	\$8.00																																											
1-24	25-49																																											
\$13.30	\$12.37																																											
50-99	100 +																																											
\$11.44	\$10.64																																											
1-24	25-49																																											
\$16.30	\$15.16																																											
50-99	100 +																																											
\$14.02	\$13.04																																											
<p>Model No. PE9011 BNC MALE TO BINDING POSTS</p>  <table border="1"> <tr><td>1-24</td><td>25-49</td></tr> <tr><td>\$16.30</td><td>\$15.16</td></tr> <tr><td>50-99</td><td>100 +</td></tr> <tr><td>\$14.02</td><td>\$13.04</td></tr> </table>	1-24	25-49	\$16.30	\$15.16	50-99	100 +	\$14.02	\$13.04	<p>Model No. PE9013 BNC FEMALE TO BINDING POSTS</p>  <table border="1"> <tr><td>1-24</td><td>25-49</td></tr> <tr><td>\$16.30</td><td>\$15.16</td></tr> <tr><td>50-99</td><td>100 +</td></tr> <tr><td>\$14.02</td><td>\$13.04</td></tr> </table>	1-24	25-49	\$16.30	\$15.16	50-99	100 +	\$14.02	\$13.04	<p>Model No. PE9063 SMA MALE TO SSMA FEMALE</p>  <table border="1"> <tr><td>1-24</td><td>25-49</td></tr> <tr><td>\$37.10</td><td>\$34.50</td></tr> <tr><td>50-99</td><td>100 +</td></tr> <tr><td>\$31.91</td><td>\$29.68</td></tr> </table>	1-24	25-49	\$37.10	\$34.50	50-99	100 +	\$31.91	\$29.68	<p>Model No. PE9064 N MALE TO MINI UHF FEMALE</p>  <table border="1"> <tr><td>1-24</td><td>25-49</td></tr> <tr><td>\$11.95</td><td>\$11.11</td></tr> <tr><td>50-99</td><td>100 +</td></tr> <tr><td>\$10.28</td><td>\$9.56</td></tr> </table>	1-24	25-49	\$11.95	\$11.11	50-99	100 +	\$10.28	\$9.56	<p>Model No. PE9065 MINI UHF "T" FEMALE-MALE-FEMALE</p>  <table border="1"> <tr><td>1-24</td><td>25-49</td></tr> <tr><td>\$8.65</td><td>\$8.04</td></tr> <tr><td>50-99</td><td>100 +</td></tr> <tr><td>\$7.44</td><td>\$6.92</td></tr> </table>	1-24	25-49	\$8.65	\$8.04	50-99	100 +	\$7.44	\$6.92
1-24	25-49																																											
\$16.30	\$15.16																																											
50-99	100 +																																											
\$14.02	\$13.04																																											
1-24	25-49																																											
\$16.30	\$15.16																																											
50-99	100 +																																											
\$14.02	\$13.04																																											
1-24	25-49																																											
\$37.10	\$34.50																																											
50-99	100 +																																											
\$31.91	\$29.68																																											
1-24	25-49																																											
\$11.95	\$11.11																																											
50-99	100 +																																											
\$10.28	\$9.56																																											
1-24	25-49																																											
\$8.65	\$8.04																																											
50-99	100 +																																											
\$7.44	\$6.92																																											
<p>Model No. PE9066 MINI UHF "T" FEMALE-FEMALE-FEMALE</p>  <table border="1"> <tr><td>1-24</td><td>25-49</td></tr> <tr><td>\$9.75</td><td>\$9.07</td></tr> <tr><td>50-99</td><td>100 +</td></tr> <tr><td>\$8.39</td><td>\$7.80</td></tr> </table>	1-24	25-49	\$9.75	\$9.07	50-99	100 +	\$8.39	\$7.80	<p>Model No. PE9067 SMA FEMALE TO SMA FEMALE BULKHEAD, ISOLATED GROUND MOUNTING HOLE B03</p>  <table border="1"> <tr><td>1-24</td><td>25-49</td></tr> <tr><td>\$25.60</td><td>\$23.81</td></tr> <tr><td>50-99</td><td>100 +</td></tr> <tr><td>\$22.02</td><td>\$20.48</td></tr> </table>	1-24	25-49	\$25.60	\$23.81	50-99	100 +	\$22.02	\$20.48	<p>Model No. PE9068 SMA FEMALE TO SMA MALE RIGHT ANGLE</p>  <table border="1"> <tr><td>1-24</td><td>25-49</td></tr> <tr><td>\$18.85</td><td>\$17.53</td></tr> <tr><td>50-99</td><td>100 +</td></tr> <tr><td>\$16.21</td><td>\$15.08</td></tr> </table>	1-24	25-49	\$18.85	\$17.53	50-99	100 +	\$16.21	\$15.08	<p>Model No. PE9069 SMA MALE TO SMA MALE</p>  <table border="1"> <tr><td>1-24</td><td>25-49</td></tr> <tr><td>\$15.55</td><td>\$14.46</td></tr> <tr><td>50-99</td><td>100 +</td></tr> <tr><td>\$13.37</td><td>\$12.44</td></tr> </table>	1-24	25-49	\$15.55	\$14.46	50-99	100 +	\$13.37	\$12.44	<p>Model No. PE9070 SMA FEMALE TO SMA FEMALE</p>  <table border="1"> <tr><td>1-24</td><td>25-49</td></tr> <tr><td>\$15.55</td><td>\$14.46</td></tr> <tr><td>50-99</td><td>100 +</td></tr> <tr><td>\$13.37</td><td>\$12.44</td></tr> </table>	1-24	25-49	\$15.55	\$14.46	50-99	100 +	\$13.37	\$12.44
1-24	25-49																																											
\$9.75	\$9.07																																											
50-99	100 +																																											
\$8.39	\$7.80																																											
1-24	25-49																																											
\$25.60	\$23.81																																											
50-99	100 +																																											
\$22.02	\$20.48																																											
1-24	25-49																																											
\$18.85	\$17.53																																											
50-99	100 +																																											
\$16.21	\$15.08																																											
1-24	25-49																																											
\$15.55	\$14.46																																											
50-99	100 +																																											
\$13.37	\$12.44																																											
1-24	25-49																																											
\$15.55	\$14.46																																											
50-99	100 +																																											
\$13.37	\$12.44																																											
<p>Model No. PE9071 SMA FEMALE TO SMA FEMALE BULKHEAD MOUNTING HOLE B02</p>  <table border="1"> <tr><td>1-24</td><td>25-49</td></tr> <tr><td>\$21.10</td><td>\$19.62</td></tr> <tr><td>50-99</td><td>100 +</td></tr> <tr><td>\$18.15</td><td>\$16.88</td></tr> </table>	1-24	25-49	\$21.10	\$19.62	50-99	100 +	\$18.15	\$16.88	<p>Model No. PE9072 SMA MALE TO BNC MALE</p>  <table border="1"> <tr><td>1-24</td><td>25-49</td></tr> <tr><td>\$26.60</td><td>\$24.74</td></tr> <tr><td>50-99</td><td>100 +</td></tr> <tr><td>\$22.88</td><td>\$21.28</td></tr> </table>	1-24	25-49	\$26.60	\$24.74	50-99	100 +	\$22.88	\$21.28	<p>Model No. PE9073 SMA FEMALE TO BNC MALE</p>  <table border="1"> <tr><td>1-24</td><td>25-49</td></tr> <tr><td>\$25.60</td><td>\$23.81</td></tr> <tr><td>50-99</td><td>100 +</td></tr> <tr><td>\$22.02</td><td>\$20.48</td></tr> </table>	1-24	25-49	\$25.60	\$23.81	50-99	100 +	\$22.02	\$20.48	<p>Model No. PE9074 SMA MALE TO BNC FEMALE</p>  <table border="1"> <tr><td>1-24</td><td>25-49</td></tr> <tr><td>\$25.60</td><td>\$23.81</td></tr> <tr><td>50-99</td><td>100 +</td></tr> <tr><td>\$22.02</td><td>\$20.48</td></tr> </table>	1-24	25-49	\$25.60	\$23.81	50-99	100 +	\$22.02	\$20.48	<p>Model No. PE9075 SMA FEMALE TO BNC FEMALE</p>  <table border="1"> <tr><td>1-24</td><td>25-49</td></tr> <tr><td>\$26.15</td><td>\$24.32</td></tr> <tr><td>50-99</td><td>100 +</td></tr> <tr><td>\$22.49</td><td>\$20.92</td></tr> </table>	1-24	25-49	\$26.15	\$24.32	50-99	100 +	\$22.49	\$20.92
1-24	25-49																																											
\$21.10	\$19.62																																											
50-99	100 +																																											
\$18.15	\$16.88																																											
1-24	25-49																																											
\$26.60	\$24.74																																											
50-99	100 +																																											
\$22.88	\$21.28																																											
1-24	25-49																																											
\$25.60	\$23.81																																											
50-99	100 +																																											
\$22.02	\$20.48																																											
1-24	25-49																																											
\$25.60	\$23.81																																											
50-99	100 +																																											
\$22.02	\$20.48																																											
1-24	25-49																																											
\$26.15	\$24.32																																											
50-99	100 +																																											
\$22.49	\$20.92																																											
<p>Model No. PE9076 SMA MALE TO TNC MALE</p>  <table border="1"> <tr><td>1-24</td><td>25-49</td></tr> <tr><td>\$30.50</td><td>\$28.37</td></tr> <tr><td>50-99</td><td>100 +</td></tr> <tr><td>\$26.23</td><td>\$24.40</td></tr> </table>	1-24	25-49	\$30.50	\$28.37	50-99	100 +	\$26.23	\$24.40	<p>Model No. PE9077 SMA FEMALE TO TNC MALE</p>  <table border="1"> <tr><td>1-24</td><td>25-49</td></tr> <tr><td>\$31.15</td><td>\$28.97</td></tr> <tr><td>50-99</td><td>100 +</td></tr> <tr><td>\$26.79</td><td>\$24.92</td></tr> </table>	1-24	25-49	\$31.15	\$28.97	50-99	100 +	\$26.79	\$24.92	<p>Model No. PE9078 SMA MALE TO TNC FEMALE</p>  <table border="1"> <tr><td>1-24</td><td>25-49</td></tr> <tr><td>\$31.55</td><td>\$29.34</td></tr> <tr><td>50-99</td><td>100 +</td></tr> <tr><td>\$27.13</td><td>\$25.24</td></tr> </table>	1-24	25-49	\$31.55	\$29.34	50-99	100 +	\$27.13	\$25.24	<p>Model No. PE9079 SMA FEMALE TO TNC FEMALE</p>  <table border="1"> <tr><td>1-24</td><td>25-49</td></tr> <tr><td>\$31.90</td><td>\$29.67</td></tr> <tr><td>50-99</td><td>100 +</td></tr> <tr><td>\$27.43</td><td>\$25.52</td></tr> </table>	1-24	25-49	\$31.90	\$29.67	50-99	100 +	\$27.43	\$25.52	<p>Model No. PE9080 SMA MALE TO N MALE</p>  <table border="1"> <tr><td>1-24</td><td>25-49</td></tr> <tr><td>\$35.60</td><td>\$33.11</td></tr> <tr><td>50-99</td><td>100 +</td></tr> <tr><td>\$30.62</td><td>\$28.48</td></tr> </table>	1-24	25-49	\$35.60	\$33.11	50-99	100 +	\$30.62	\$28.48
1-24	25-49																																											
\$30.50	\$28.37																																											
50-99	100 +																																											
\$26.23	\$24.40																																											
1-24	25-49																																											
\$31.15	\$28.97																																											
50-99	100 +																																											
\$26.79	\$24.92																																											
1-24	25-49																																											
\$31.55	\$29.34																																											
50-99	100 +																																											
\$27.13	\$25.24																																											
1-24	25-49																																											
\$31.90	\$29.67																																											
50-99	100 +																																											
\$27.43	\$25.52																																											
1-24	25-49																																											
\$35.60	\$33.11																																											
50-99	100 +																																											
\$30.62	\$28.48																																											

# ADAPTERS

SEE ADAPTER SELECTION CHART ON PAGES 195 THRU 198

SEE PAGE 266 FOR MOUNTING HOLES

Model No. PE9081  
SMA FEMALE TO N MALE

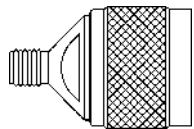

1-24	25-49
\$37.25	\$34.64
50-99	100 +
\$32.04	\$29.80

Model No. PE9082  
SMA MALE TO N FEMALE

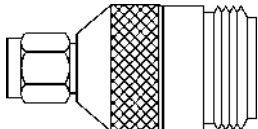

1-24	25-49
\$38.85	\$36.13
50-99	100 +
\$33.41	\$31.08

Model No. PE9083  
SMA FEMALE TO N FEMALE

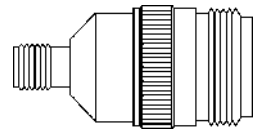

1-24	25-49
\$36.75	\$34.18
50-99	100 +
\$31.61	\$29.40

Model No. PE9084  
BNC FEMALE TO BNC FEMALE

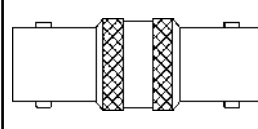

1-24	25-49
\$5.80	\$5.39
50-99	100 +
\$4.99	\$4.64

Model No. PE9085  
BNC FEMALE RIGHT ANGLE  
TO BNC MALE

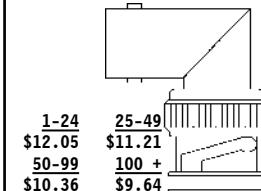

1-24	25-49
\$12.05	\$11.21
50-99	100 +
\$10.36	\$9.64

Model No. PE9086  
N FEMALE RIGHT ANGLE  
TO N MALE

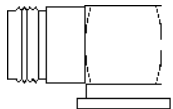

1-24	25-49
\$14.70	\$13.67
50-99	100 +
\$12.64	\$11.76

Model No. PE9087  
BNC FEMALE TO C MALE

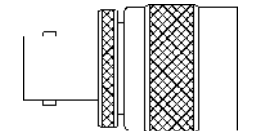

1-24	25-49
\$25.10	\$23.34
50-99	100 +
\$21.59	\$20.08

Model No. PE9088  
TNC MALE TO BNC FEMALE

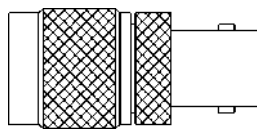

1-24	25-49
\$17.75	\$16.51
50-99	100 +
\$15.27	\$14.20

Model No. PE9089  
TNC MALE TO N FEMALE

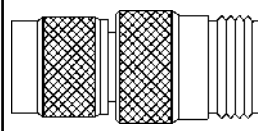

1-24	25-49
\$17.00	\$15.81
50-99	100 +
\$14.62	\$13.60

Model No. PE9090  
TNC FEMALE TO N MALE

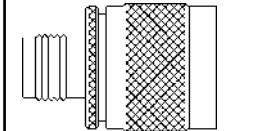

1-24	25-49
\$17.90	\$16.65
50-99	100 +
\$15.39	\$14.32

Model No. PE9091  
TNC MALE TO TNC MALE

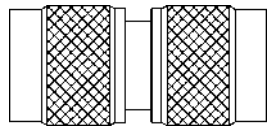

1-24	25-49
\$16.60	\$15.44
50-99	100 +
\$14.28	\$13.28

Model No. PE9093  
BNC FEMALE TO BNC FEMALE  
BULKHEAD, HERMETICALLY  
SEALED, MOUNTING  
HOLE B06

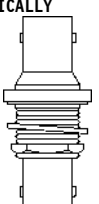

1-24	25-49
\$10.00	\$9.30
50-99	100 +
\$8.60	\$8.00

Model No. PE9094  
UHF FEMALE TO UHF FEMALE

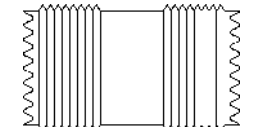

1-24	25-49
\$7.60	\$7.07
50-99	100 +
\$6.54	\$6.08

Model No. PE9095  
UHF "T" FEMALE-MALE-FEMALE

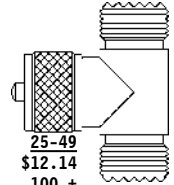

1-24	25-49
\$13.05	\$12.14
50-99	100 +
\$11.22	\$10.44

Model No. PE9096  
UHF MALE TO UHF MALE

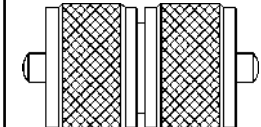

1-24	25-49
\$8.65	\$8.04
50-99	100 +
\$7.44	\$6.92

Model No. PE9097  
TNC FEMALE TO BNC FEMALE

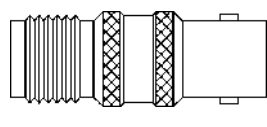

1-24	25-49
\$15.55	\$14.46
50-99	100 +
\$13.37	\$12.44

Model No. PE9098  
BNC MALE TO TNC FEMALE

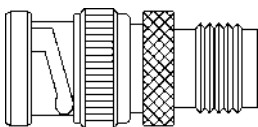

1-24	25-49
\$18.85	\$17.53
50-99	100 +
\$16.21	\$15.08

Model No. PE9099  
TNC FEMALE TO TNC FEMALE

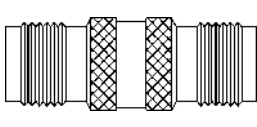

1-24	25-49
\$16.60	\$15.44
50-99	100 +
\$14.28	\$13.28

Model No. PE9100  
TNC MALE TO TNC FEMALE  
RIGHT ANGLE

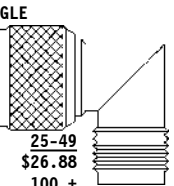

1-24	25-49
\$28.90	\$26.88
50-99	100 +
\$24.85	\$23.12

Model No. PE9101  
N "T" FEMALE-FEMALE-  
FEMALE

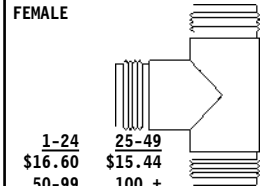

1-24	25-49
\$16.60	\$15.44
50-99	100 +
\$14.28	\$13.28

Model No. PE9102  
N "T" FEMALE-MALE-FEMALE

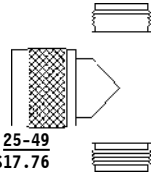

1-24	25-49
\$19.10	\$17.76
50-99	100 +
\$16.43	\$15.28

Model No. PE9103  
SMA MALE TO SMA FEMALE

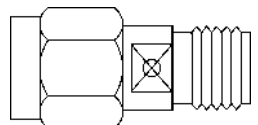

1-24	25-49
\$15.55	\$14.46
50-99	100 +
\$13.37	\$12.44

Model No. PE9104  
N FEMALE TO SMA FEMALE  
PANEL MOUNT  
MOUNTING HOLE A05

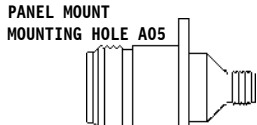

1-24	25-49
\$42.60	\$39.62
50-99	100 +
\$36.64	\$34.08

Model No. PE9105  
N FEMALE TO SMA MALE  
PANEL MOUNT  
MOUNTING HOLE A05

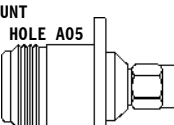

1-24	25-49
\$62.20	\$57.85
50-99	100 +
\$53.49	\$49.76

Model No. PE9106  
BNC FEMALE TO BNC FEMALE  
PANEL MOUNT  
MOUNTING HOLE A03

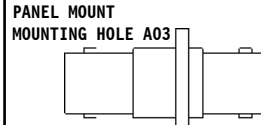

1-24	25-49
\$9.75	\$9.07
50-99	100 +
\$8.39	\$7.80

Model No. PE9107  
BNC MALE TO UHF FEMALE

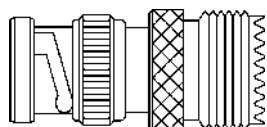

1-24	25-49
\$9.75	\$9.07
50-99	100 +
\$8.39	\$7.80

Model No. PE9108  
BNC FEMALE TO SMC JACK  
BULKHEAD  
MOUNTING HOLE B04

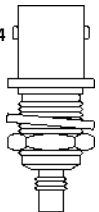

1-24	25-49
\$45.45	\$42.27
50-99	100 +
\$39.09	\$36.36

Model No. PE9109  
BNC MALE TO C FEMALE

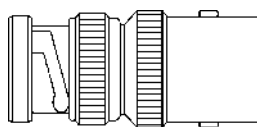

1-24	25-49
\$33.80	\$31.43
50-99	100 +
\$29.07	\$27.04

Model No. PE9110  
BNC MALE TO TNC MALE

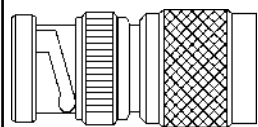

1-24	25-49
\$19.60	\$18.23
50-99	100 +
\$16.86	\$15.68

Model No. PE9111  
UHF FEMALE TO N MALE

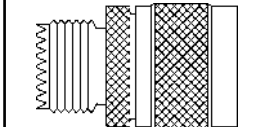

1-24	25-49
\$15.55	\$14.46
50-99	100 +
\$13.37	\$12.44

# ADAPTERS

SEE ADAPTER SELECTION CHART ON PAGES 195 THRU 198

SEE PAGE 266 FOR MOUNTING HOLES

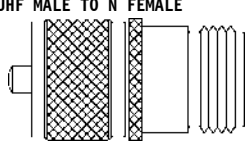
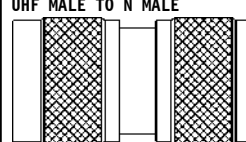
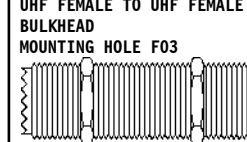
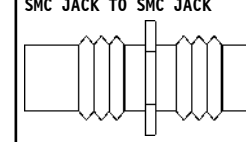
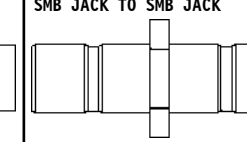
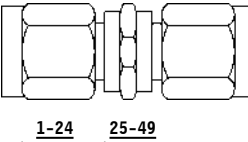
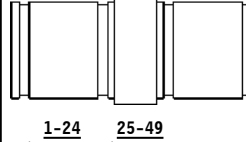
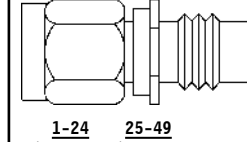
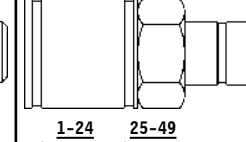
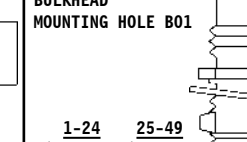
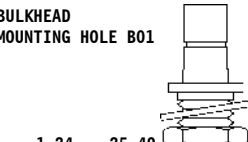
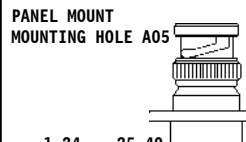
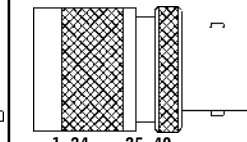
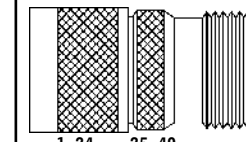
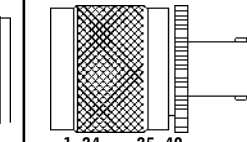
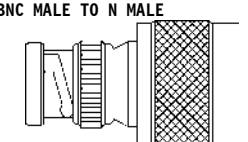
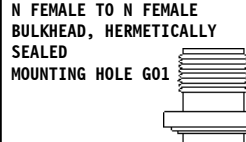
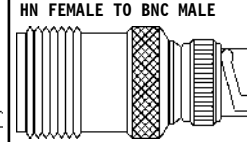
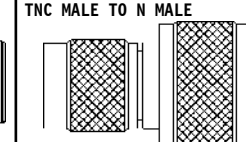
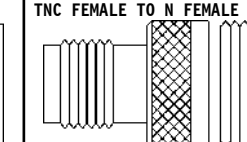
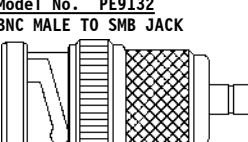
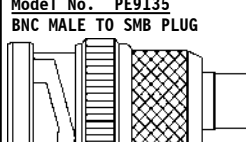
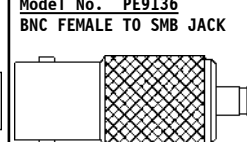
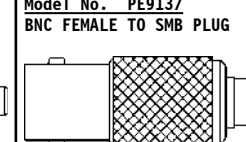
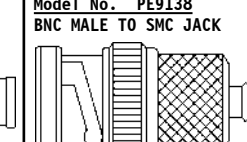
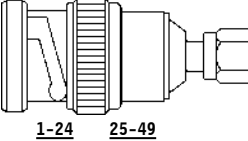
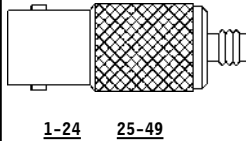
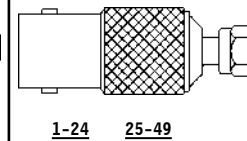
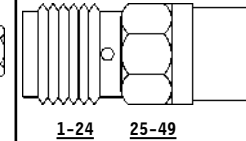
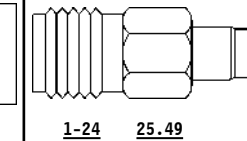
<p>Model No. PE9112 UHF MALE TO N FEMALE</p>  <table border="0"> <tr> <td>1-24</td> <td>25-49</td> </tr> <tr> <td>\$15.95</td> <td>\$14.83</td> </tr> <tr> <td>50-99</td> <td>100 +</td> </tr> <tr> <td>\$13.72</td> <td>\$12.76</td> </tr> </table>	1-24	25-49	\$15.95	\$14.83	50-99	100 +	\$13.72	\$12.76	<p>Model No. PE9113 UHF MALE TO N MALE</p>  <table border="0"> <tr> <td>1-24</td> <td>25-49</td> </tr> <tr> <td>\$20.70</td> <td>\$19.25</td> </tr> <tr> <td>50-99</td> <td>100 +</td> </tr> <tr> <td>\$17.80</td> <td>\$16.56</td> </tr> </table>	1-24	25-49	\$20.70	\$19.25	50-99	100 +	\$17.80	\$16.56	<p>Model No. PE9114 UHF FEMALE TO UHF FEMALE BULKHEAD MOUNTING HOLE F03</p>  <table border="0"> <tr> <td>1-24</td> <td>25-49</td> </tr> <tr> <td>\$29.35</td> <td>\$27.30</td> </tr> <tr> <td>50-99</td> <td>100 +</td> </tr> <tr> <td>\$25.24</td> <td>\$23.48</td> </tr> </table>	1-24	25-49	\$29.35	\$27.30	50-99	100 +	\$25.24	\$23.48	<p>Model No. PE9115 SMC JACK TO SMC JACK</p>  <table border="0"> <tr> <td>1-24</td> <td>25-49</td> </tr> <tr> <td>\$18.50</td> <td>\$17.21</td> </tr> <tr> <td>50-99</td> <td>100 +</td> </tr> <tr> <td>\$15.91</td> <td>\$14.80</td> </tr> </table>	1-24	25-49	\$18.50	\$17.21	50-99	100 +	\$15.91	\$14.80	<p>Model No. PE9116 SMB JACK TO SMB JACK</p>  <table border="0"> <tr> <td>1-24</td> <td>25-49</td> </tr> <tr> <td>\$18.50</td> <td>\$17.21</td> </tr> <tr> <td>50-99</td> <td>100 +</td> </tr> <tr> <td>\$15.91</td> <td>\$14.80</td> </tr> </table>	1-24	25-49	\$18.50	\$17.21	50-99	100 +	\$15.91	\$14.80
1-24	25-49																																											
\$15.95	\$14.83																																											
50-99	100 +																																											
\$13.72	\$12.76																																											
1-24	25-49																																											
\$20.70	\$19.25																																											
50-99	100 +																																											
\$17.80	\$16.56																																											
1-24	25-49																																											
\$29.35	\$27.30																																											
50-99	100 +																																											
\$25.24	\$23.48																																											
1-24	25-49																																											
\$18.50	\$17.21																																											
50-99	100 +																																											
\$15.91	\$14.80																																											
1-24	25-49																																											
\$18.50	\$17.21																																											
50-99	100 +																																											
\$15.91	\$14.80																																											
<p>Model No. PE9117 SMC PLUG TO SMC PLUG</p>  <table border="0"> <tr> <td>1-24</td> <td>25-49</td> </tr> <tr> <td>\$18.50</td> <td>\$17.21</td> </tr> <tr> <td>50-99</td> <td>100 +</td> </tr> <tr> <td>\$15.91</td> <td>\$14.80</td> </tr> </table>	1-24	25-49	\$18.50	\$17.21	50-99	100 +	\$15.91	\$14.80	<p>Model No. PE9118 SMB PLUG TO SMB PLUG</p>  <table border="0"> <tr> <td>1-24</td> <td>25-49</td> </tr> <tr> <td>\$20.85</td> <td>\$19.39</td> </tr> <tr> <td>50-99</td> <td>100 +</td> </tr> <tr> <td>\$17.93</td> <td>\$16.68</td> </tr> </table>	1-24	25-49	\$20.85	\$19.39	50-99	100 +	\$17.93	\$16.68	<p>Model No. PE9119 SMC PLUG TO SMC JACK</p>  <table border="0"> <tr> <td>1-24</td> <td>25-49</td> </tr> <tr> <td>\$34.15</td> <td>\$31.76</td> </tr> <tr> <td>50-99</td> <td>100 +</td> </tr> <tr> <td>\$29.37</td> <td>\$27.32</td> </tr> </table>	1-24	25-49	\$34.15	\$31.76	50-99	100 +	\$29.37	\$27.32	<p>Model No. PE9120 SMB PLUG TO SMB JACK</p>  <table border="0"> <tr> <td>1-24</td> <td>25-49</td> </tr> <tr> <td>\$20.85</td> <td>\$19.39</td> </tr> <tr> <td>50-99</td> <td>100 +</td> </tr> <tr> <td>\$17.93</td> <td>\$16.68</td> </tr> </table>	1-24	25-49	\$20.85	\$19.39	50-99	100 +	\$17.93	\$16.68	<p>Model No. PE9121 SMC JACK TO SMC JACK BULKHEAD MOUNTING HOLE B01</p>  <table border="0"> <tr> <td>1-24</td> <td>25-49</td> </tr> <tr> <td>\$21.80</td> <td>\$20.27</td> </tr> <tr> <td>50-99</td> <td>100 +</td> </tr> <tr> <td>\$18.75</td> <td>\$17.44</td> </tr> </table>	1-24	25-49	\$21.80	\$20.27	50-99	100 +	\$18.75	\$17.44
1-24	25-49																																											
\$18.50	\$17.21																																											
50-99	100 +																																											
\$15.91	\$14.80																																											
1-24	25-49																																											
\$20.85	\$19.39																																											
50-99	100 +																																											
\$17.93	\$16.68																																											
1-24	25-49																																											
\$34.15	\$31.76																																											
50-99	100 +																																											
\$29.37	\$27.32																																											
1-24	25-49																																											
\$20.85	\$19.39																																											
50-99	100 +																																											
\$17.93	\$16.68																																											
1-24	25-49																																											
\$21.80	\$20.27																																											
50-99	100 +																																											
\$18.75	\$17.44																																											
<p>Model No. PE9122 SMB JACK TO SMB JACK BULKHEAD MOUNTING HOLE B01</p>  <table border="0"> <tr> <td>1-24</td> <td>25-49</td> </tr> <tr> <td>\$21.80</td> <td>\$20.27</td> </tr> <tr> <td>50-99</td> <td>100 +</td> </tr> <tr> <td>\$18.75</td> <td>\$17.44</td> </tr> </table>	1-24	25-49	\$21.80	\$20.27	50-99	100 +	\$18.75	\$17.44	<p>Model No. PE9123 BNC MALE TO N FEMALE PANEL MOUNT MOUNTING HOLE A05</p>  <table border="0"> <tr> <td>1-24</td> <td>25-49</td> </tr> <tr> <td>\$52.20</td> <td>\$48.55</td> </tr> <tr> <td>50-99</td> <td>100 +</td> </tr> <tr> <td>\$44.89</td> <td>\$41.76</td> </tr> </table>	1-24	25-49	\$52.20	\$48.55	50-99	100 +	\$44.89	\$41.76	<p>Model No. PE9124 N MALE TO C FEMALE</p>  <table border="0"> <tr> <td>1-24</td> <td>25-49</td> </tr> <tr> <td>\$43.65</td> <td>\$40.59</td> </tr> <tr> <td>50-99</td> <td>100 +</td> </tr> <tr> <td>\$37.54</td> <td>\$34.92</td> </tr> </table>	1-24	25-49	\$43.65	\$40.59	50-99	100 +	\$37.54	\$34.92	<p>Model No. PE9125 N MALE TO HN FEMALE</p>  <table border="0"> <tr> <td>1-24</td> <td>25-49</td> </tr> <tr> <td>\$33.40</td> <td>\$31.06</td> </tr> <tr> <td>50-99</td> <td>100 +</td> </tr> <tr> <td>\$28.72</td> <td>\$26.72</td> </tr> </table>	1-24	25-49	\$33.40	\$31.06	50-99	100 +	\$28.72	\$26.72	<p>Model No. PE9126 HN MALE TO BNC FEMALE</p>  <table border="0"> <tr> <td>1-24</td> <td>25-49</td> </tr> <tr> <td>\$40.90</td> <td>\$38.04</td> </tr> <tr> <td>50-99</td> <td>100 +</td> </tr> <tr> <td>\$35.17</td> <td>\$32.72</td> </tr> </table>	1-24	25-49	\$40.90	\$38.04	50-99	100 +	\$35.17	\$32.72
1-24	25-49																																											
\$21.80	\$20.27																																											
50-99	100 +																																											
\$18.75	\$17.44																																											
1-24	25-49																																											
\$52.20	\$48.55																																											
50-99	100 +																																											
\$44.89	\$41.76																																											
1-24	25-49																																											
\$43.65	\$40.59																																											
50-99	100 +																																											
\$37.54	\$34.92																																											
1-24	25-49																																											
\$33.40	\$31.06																																											
50-99	100 +																																											
\$28.72	\$26.72																																											
1-24	25-49																																											
\$40.90	\$38.04																																											
50-99	100 +																																											
\$35.17	\$32.72																																											
<p>Model No. PE9127 BNC MALE TO N MALE</p>  <table border="0"> <tr> <td>1-24</td> <td>25-49</td> </tr> <tr> <td>\$28.90</td> <td>\$26.88</td> </tr> <tr> <td>50-99</td> <td>100 +</td> </tr> <tr> <td>\$24.85</td> <td>\$23.12</td> </tr> </table>	1-24	25-49	\$28.90	\$26.88	50-99	100 +	\$24.85	\$23.12	<p>Model No. PE9128 N FEMALE TO N FEMALE BULKHEAD, HERMETICALLY SEALED MOUNTING HOLE G01</p>  <table border="0"> <tr> <td>1-24</td> <td>25-49</td> </tr> <tr> <td>\$15.55</td> <td>\$14.46</td> </tr> <tr> <td>50-99</td> <td>100 +</td> </tr> <tr> <td>\$13.37</td> <td>\$12.44</td> </tr> </table>	1-24	25-49	\$15.55	\$14.46	50-99	100 +	\$13.37	\$12.44	<p>Model No. PE9129 HN FEMALE TO BNC MALE</p>  <table border="0"> <tr> <td>1-24</td> <td>25-49</td> </tr> <tr> <td>\$41.75</td> <td>\$38.83</td> </tr> <tr> <td>50-99</td> <td>100 +</td> </tr> <tr> <td>\$35.91</td> <td>\$33.40</td> </tr> </table>	1-24	25-49	\$41.75	\$38.83	50-99	100 +	\$35.91	\$33.40	<p>Model No. PE9130 TNC MALE TO N MALE</p>  <table border="0"> <tr> <td>1-24</td> <td>25-49</td> </tr> <tr> <td>\$28.30</td> <td>\$26.32</td> </tr> <tr> <td>50-99</td> <td>100 +</td> </tr> <tr> <td>\$24.34</td> <td>\$22.64</td> </tr> </table>	1-24	25-49	\$28.30	\$26.32	50-99	100 +	\$24.34	\$22.64	<p>Model No. PE9131 TNC FEMALE TO N FEMALE</p>  <table border="0"> <tr> <td>1-24</td> <td>25-49</td> </tr> <tr> <td>\$29.05</td> <td>\$27.02</td> </tr> <tr> <td>50-99</td> <td>100 +</td> </tr> <tr> <td>\$24.98</td> <td>\$23.24</td> </tr> </table>	1-24	25-49	\$29.05	\$27.02	50-99	100 +	\$24.98	\$23.24
1-24	25-49																																											
\$28.90	\$26.88																																											
50-99	100 +																																											
\$24.85	\$23.12																																											
1-24	25-49																																											
\$15.55	\$14.46																																											
50-99	100 +																																											
\$13.37	\$12.44																																											
1-24	25-49																																											
\$41.75	\$38.83																																											
50-99	100 +																																											
\$35.91	\$33.40																																											
1-24	25-49																																											
\$28.30	\$26.32																																											
50-99	100 +																																											
\$24.34	\$22.64																																											
1-24	25-49																																											
\$29.05	\$27.02																																											
50-99	100 +																																											
\$24.98	\$23.24																																											
<p>Model No. PE9132 BNC MALE TO SMB JACK</p>  <table border="0"> <tr> <td>1-24</td> <td>25-49</td> </tr> <tr> <td>\$35.60</td> <td>\$33.11</td> </tr> <tr> <td>50-99</td> <td>100 +</td> </tr> <tr> <td>\$30.62</td> <td>\$28.48</td> </tr> </table>	1-24	25-49	\$35.60	\$33.11	50-99	100 +	\$30.62	\$28.48	<p>Model No. PE9135 BNC MALE TO SMB PLUG</p>  <table border="0"> <tr> <td>1-24</td> <td>25-49</td> </tr> <tr> <td>\$34.90</td> <td>\$32.46</td> </tr> <tr> <td>50-99</td> <td>100 +</td> </tr> <tr> <td>\$30.01</td> <td>\$27.92</td> </tr> </table>	1-24	25-49	\$34.90	\$32.46	50-99	100 +	\$30.01	\$27.92	<p>Model No. PE9136 BNC FEMALE TO SMB JACK</p>  <table border="0"> <tr> <td>1-24</td> <td>25-49</td> </tr> <tr> <td>\$35.60</td> <td>\$33.11</td> </tr> <tr> <td>50-99</td> <td>100 +</td> </tr> <tr> <td>\$30.62</td> <td>\$28.48</td> </tr> </table>	1-24	25-49	\$35.60	\$33.11	50-99	100 +	\$30.62	\$28.48	<p>Model No. PE9137 BNC FEMALE TO SMB PLUG</p>  <table border="0"> <tr> <td>1-24</td> <td>25-49</td> </tr> <tr> <td>\$35.60</td> <td>\$33.11</td> </tr> <tr> <td>50-99</td> <td>100 +</td> </tr> <tr> <td>\$30.62</td> <td>\$28.48</td> </tr> </table>	1-24	25-49	\$35.60	\$33.11	50-99	100 +	\$30.62	\$28.48	<p>Model No. PE9138 BNC MALE TO SMC JACK</p>  <table border="0"> <tr> <td>1-24</td> <td>25-49</td> </tr> <tr> <td>\$34.90</td> <td>\$32.46</td> </tr> <tr> <td>50-99</td> <td>100 +</td> </tr> <tr> <td>\$30.01</td> <td>\$27.92</td> </tr> </table>	1-24	25-49	\$34.90	\$32.46	50-99	100 +	\$30.01	\$27.92
1-24	25-49																																											
\$35.60	\$33.11																																											
50-99	100 +																																											
\$30.62	\$28.48																																											
1-24	25-49																																											
\$34.90	\$32.46																																											
50-99	100 +																																											
\$30.01	\$27.92																																											
1-24	25-49																																											
\$35.60	\$33.11																																											
50-99	100 +																																											
\$30.62	\$28.48																																											
1-24	25-49																																											
\$35.60	\$33.11																																											
50-99	100 +																																											
\$30.62	\$28.48																																											
1-24	25-49																																											
\$34.90	\$32.46																																											
50-99	100 +																																											
\$30.01	\$27.92																																											
<p>Model No. PE9139 BNC MALE TO SMC PLUG</p>  <table border="0"> <tr> <td>1-24</td> <td>25-49</td> </tr> <tr> <td>\$34.90</td> <td>\$32.46</td> </tr> <tr> <td>50-99</td> <td>100 +</td> </tr> <tr> <td>\$30.01</td> <td>\$27.92</td> </tr> </table>	1-24	25-49	\$34.90	\$32.46	50-99	100 +	\$30.01	\$27.92	<p>Model No. PE9140 BNC FEMALE TO SMC JACK</p>  <table border="0"> <tr> <td>1-24</td> <td>25-49</td> </tr> <tr> <td>\$67.15</td> <td>\$62.45</td> </tr> <tr> <td>50-99</td> <td>100 +</td> </tr> <tr> <td>\$57.75</td> <td>\$53.72</td> </tr> </table>	1-24	25-49	\$67.15	\$62.45	50-99	100 +	\$57.75	\$53.72	<p>Model No. PE9141 BNC FEMALE TO SMC PLUG</p>  <table border="0"> <tr> <td>1-24</td> <td>25-49</td> </tr> <tr> <td>\$34.90</td> <td>\$32.46</td> </tr> <tr> <td>50-99</td> <td>100 +</td> </tr> <tr> <td>\$30.01</td> <td>\$27.92</td> </tr> </table>	1-24	25-49	\$34.90	\$32.46	50-99	100 +	\$30.01	\$27.92	<p>Model No. PE9142 SMA FEMALE TO SMB PLUG</p>  <table border="0"> <tr> <td>1-24</td> <td>25-49</td> </tr> <tr> <td>\$35.60</td> <td>\$33.11</td> </tr> <tr> <td>50-99</td> <td>100 +</td> </tr> <tr> <td>\$30.62</td> <td>\$28.48</td> </tr> </table>	1-24	25-49	\$35.60	\$33.11	50-99	100 +	\$30.62	\$28.48	<p>Model No. PE9143 SMA FEMALE TO SMB JACK</p>  <table border="0"> <tr> <td>1-24</td> <td>25-49</td> </tr> <tr> <td>\$35.60</td> <td>\$33.11</td> </tr> <tr> <td>50-99</td> <td>100 +</td> </tr> <tr> <td>\$30.62</td> <td>\$28.48</td> </tr> </table>	1-24	25-49	\$35.60	\$33.11	50-99	100 +	\$30.62	\$28.48
1-24	25-49																																											
\$34.90	\$32.46																																											
50-99	100 +																																											
\$30.01	\$27.92																																											
1-24	25-49																																											
\$67.15	\$62.45																																											
50-99	100 +																																											
\$57.75	\$53.72																																											
1-24	25-49																																											
\$34.90	\$32.46																																											
50-99	100 +																																											
\$30.01	\$27.92																																											
1-24	25-49																																											
\$35.60	\$33.11																																											
50-99	100 +																																											
\$30.62	\$28.48																																											
1-24	25-49																																											
\$35.60	\$33.11																																											
50-99	100 +																																											
\$30.62	\$28.48																																											



# ADAPTERS

SEE ADAPTER SELECTION CHART ON PAGES 195 THRU 198

SEE PAGE 266 FOR MOUNTING HOLES

Model No. PE9144  
SMA MALE TO SMB PLUG

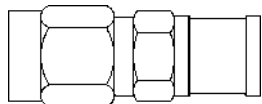

1-24	25-49
\$66.80	\$62.12
50-99	100 +
\$57.45	\$53.44

Model No. PE9145  
SMA MALE TO SMB JACK

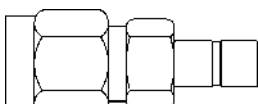

1-24	25-49
\$35.60	\$33.11
50-99	100 +
\$30.62	\$28.48

Model No. PE9146  
SMA FEMALE TO SMC PLUG

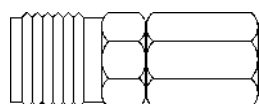

1-24	25-49
\$38.70	\$35.99
50-99	100 +
\$33.28	\$30.96

Model No. PE9147  
SMA FEMALE TO SMC JACK

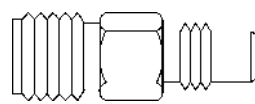

1-24	25-49
\$34.90	\$32.46
50-99	100 +
\$30.01	\$27.92

Model No. PE9148  
SMA MALE TO SMC PLUG

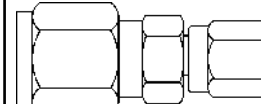

1-24	25-49
\$34.90	\$32.46
50-99	100 +
\$30.01	\$27.92

Model No. PE9149  
SMA MALE TO SMC JACK

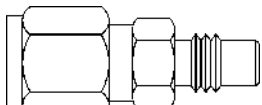

1-24	25-49
\$34.90	\$32.46
50-99	100 +
\$30.01	\$27.92

Model No. PE9150  
BNC MALE TO F FEMALE

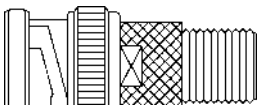

1-24	25-49
\$10.30	\$9.58
50-99	100 +
\$8.86	\$8.24

Model No. PE9151  
BNC FEMALE TO F MALE

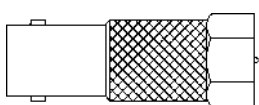

1-24	25-49
\$10.00	\$9.30
50-99	100 +
\$8.60	\$8.00

Model No. PE9152  
BNC MALE TO F MALE

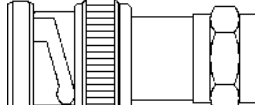

1-24	25-49
\$9.75	\$9.07
50-99	100 +
\$8.39	\$7.80

Model No. PE9153  
BNC FEMALE TO F FEMALE

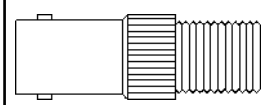

1-24	25-49
\$9.75	\$9.07
50-99	100 +
\$8.39	\$7.80

Model No. PE9154  
TNC FEMALE TO TNC FEMALE  
BULKHEAD, HERMETICALLY  
SEALED  
MOUNTING HOLE B06

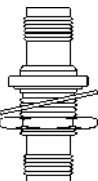

1-24	25-49
\$16.60	\$15.44
50-99	100 +
\$14.28	\$13.28

Model No. PE9155  
N MALE TO F FEMALE

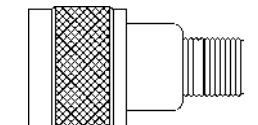

1-24	25-49
\$16.60	\$15.44
50-99	100 +
\$14.28	\$13.28

Model No. PE9158  
BNC FEMALE TO RCA PLUG

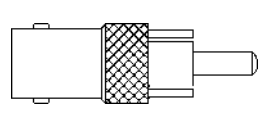

1-24	25-49
\$10.00	\$9.30
50-99	100 +
\$8.60	\$8.00

Model No. PE9159  
F MALE TO F MALE

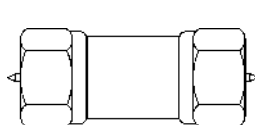

1-24	25-49
\$9.75	\$9.07
50-99	100 +
\$8.39	\$7.80

Model No. PE9160  
F MALE PUSH ON TO  
F FEMALE

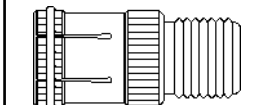

1-24	25-49
\$9.75	\$9.07
50-99	100 +
\$8.39	\$7.80

Model No. PE9163  
F FEMALE TO RCA PLUG

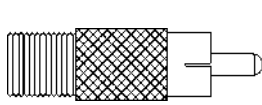

1-24	25-49
\$10.50	\$9.77
50-99	100 +
\$9.03	\$8.40

Model No. PE9164  
F FEMALE TO F FEMALE

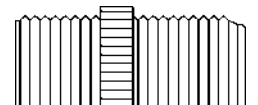

1-24	25-49
\$4.35	\$4.05
50-99	100 +
\$3.74	\$3.48

Model No. PE9165  
F FEMALE TO UHF MALE

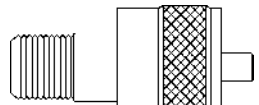

1-24	25-49
\$20.70	\$19.25
50-99	100 +
\$17.80	\$16.56

Model No. PE9166  
F FEMALE TO F MALE  
RIGHT ANGLE

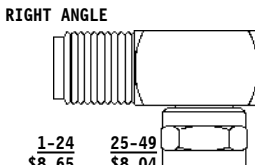

1-24	25-49
\$8.65	\$8.04
50-99	100 +
\$7.44	\$6.92

Model No. PE9167  
F FEMALE TO UHF FEMALE

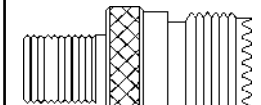

1-24	25-49
\$20.70	\$19.25
50-99	100 +
\$17.80	\$16.56

Model No. PE9168  
F FEMALE TO RCA JACK

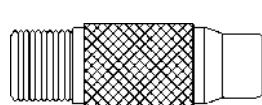

1-24	25-49
\$9.75	\$9.07
50-99	100 +
\$8.39	\$7.80

Model No. PE9169  
BNC MALE TO SINGLE BINDING  
POST



1-24	25-49
\$9.75	\$9.07
50-99	100 +
\$8.39	\$7.80

Model No. PE9171  
BNC MALE TO RCA JACK



1-24	25-49
\$9.75	\$9.07
50-99	100 +
\$8.39	\$7.80

Model No. PE9172  
BNC FEMALE TO BNC FEMALE  
BULKHEAD, ISOLATED GROUND  
MOUNTING HOLE B06

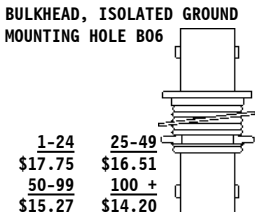

1-24	25-49
\$17.75	\$16.51
50-99	100 +
\$15.27	\$14.20

Model No. PE9173  
N FEMALE TO N FEMALE  
PANEL MOUNT  
MOUNTING HOLE A05

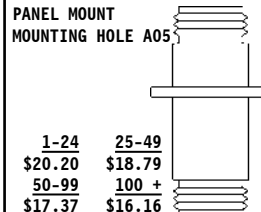

1-24	25-49
\$20.20	\$18.79
50-99	100 +
\$17.37	\$16.16

Model No. PE9174  
BNC "T" MALE-FEMALE-FEMALE

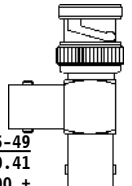

1-24	25-49
\$32.70	\$30.41
50-99	100 +
\$28.12	\$26.16

Model No. PE9175  
BNC FEMALE TO SINGLE  
BANANA PLUG

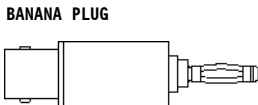

1-24	25-49
\$17.70	\$16.46
50-99	100 +
\$15.22	\$14.16

Model No. PE9178  
7/16 FEMALE TO N MALE

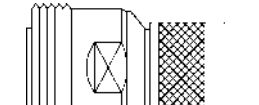

1-24	25-49
\$75.65	\$70.35
50-99	100 +
\$65.06	\$60.52

Model No. PE9179  
7/16 MALE TO N FEMALE

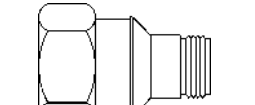

1-24	25-49
\$86.10	\$80.07
50-99	100 +
\$74.05	\$68.88

Model No. PE9180  
7/16 FEMALE TO N FEMALE

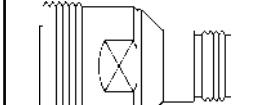





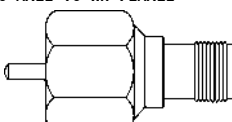
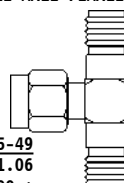
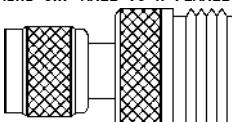
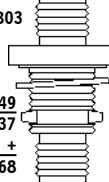

1-24	25-49
\$88.75	\$82.54
50-99	100 +
\$76.33	\$71.00

# ADAPTERS

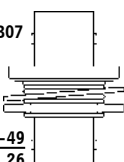
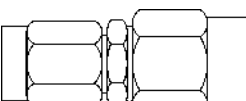
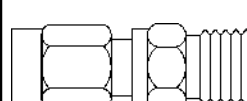
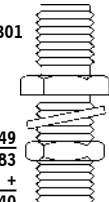
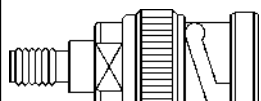
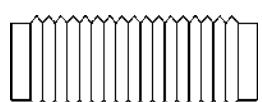
SEE ADAPTER SELECTION CHART ON PAGES 195 THRU 198

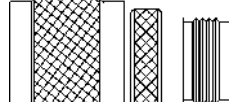
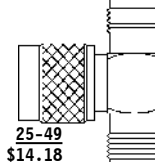
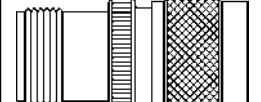
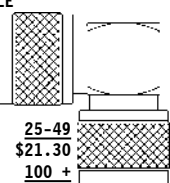
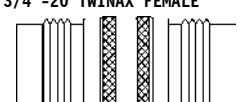
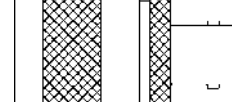
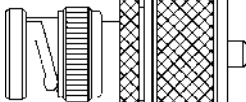
SEE PAGE 266 FOR MOUNTING HOLES

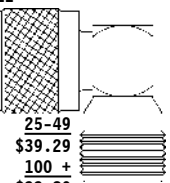
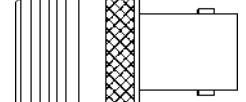
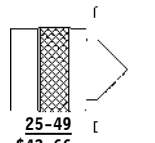
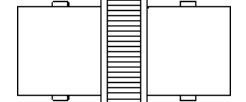
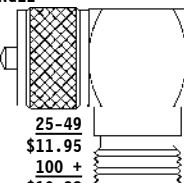
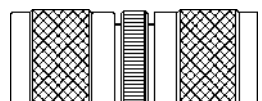
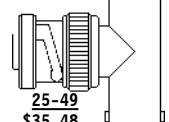
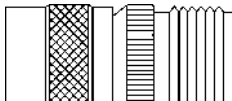
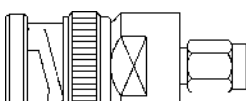
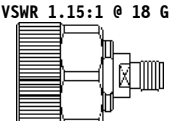
<p>Model No. PE9181 LC MALE TO HN FEMALE</p>  <table border="0"> <tr> <td>1-24</td> <td>25-49</td> </tr> <tr> <td>\$212.25</td> <td>\$197.39</td> </tr> <tr> <td>50-99</td> <td>100 +</td> </tr> <tr> <td>\$182.54</td> <td>\$169.80</td> </tr> </table>	1-24	25-49	\$212.25	\$197.39	50-99	100 +	\$182.54	\$169.80	<p>Model No. PE9182 SMA "T" FEMALE-MALE-FEMALE</p>  <table border="0"> <tr> <td>1-24</td> <td>25-49</td> </tr> <tr> <td>\$33.40</td> <td>\$31.06</td> </tr> <tr> <td>50-99</td> <td>100 +</td> </tr> <tr> <td>\$28.72</td> <td>\$26.72</td> </tr> </table>	1-24	25-49	\$33.40	\$31.06	50-99	100 +	\$28.72	\$26.72	<p>Model No. PE9183 MINI UHF MALE TO N FEMALE</p>  <table border="0"> <tr> <td>1-24</td> <td>25-49</td> </tr> <tr> <td>\$14.15</td> <td>\$13.16</td> </tr> <tr> <td>50-99</td> <td>100 +</td> </tr> <tr> <td>\$12.17</td> <td>\$11.32</td> </tr> </table>	1-24	25-49	\$14.15	\$13.16	50-99	100 +	\$12.17	\$11.32	<p>Model No. PE9184 SMA FEMALE TO SMA FEMALE BULKHEAD, HERMETICALLY SEALED MOUNTING HOLE B03</p>  <table border="0"> <tr> <td>1-24</td> <td>25-49</td> </tr> <tr> <td>\$28.35</td> <td>\$26.37</td> </tr> <tr> <td>50-99</td> <td>100 +</td> </tr> <tr> <td>\$24.38</td> <td>\$22.68</td> </tr> </table>	1-24	25-49	\$28.35	\$26.37	50-99	100 +	\$24.38	\$22.68	<p>Model No. PE9185 SMA FEMALE TO BNC FEMALE BULKHEAD MOUNTING HOLE B06</p>  <table border="0"> <tr> <td>1-24</td> <td>25-49</td> </tr> <tr> <td>\$35.60</td> <td>\$33.11</td> </tr> <tr> <td>50-99</td> <td>100 +</td> </tr> <tr> <td>\$30.62</td> <td>\$28.48</td> </tr> </table>	1-24	25-49	\$35.60	\$33.11	50-99	100 +	\$30.62	\$28.48	
1-24	25-49																																												
\$212.25	\$197.39																																												
50-99	100 +																																												
\$182.54	\$169.80																																												
1-24	25-49																																												
\$33.40	\$31.06																																												
50-99	100 +																																												
\$28.72	\$26.72																																												
1-24	25-49																																												
\$14.15	\$13.16																																												
50-99	100 +																																												
\$12.17	\$11.32																																												
1-24	25-49																																												
\$28.35	\$26.37																																												
50-99	100 +																																												
\$24.38	\$22.68																																												
1-24	25-49																																												
\$35.60	\$33.11																																												
50-99	100 +																																												
\$30.62	\$28.48																																												
<p>Model No. PE9186 C FEMALE TO C FEMALE BULKHEAD MOUNTING HOLE B07</p>  <table border="0"> <tr> <td>1-24</td> <td>25-49</td> </tr> <tr> <td>\$62.65</td> <td>\$58.26</td> </tr> <tr> <td>50-99</td> <td>100 +</td> </tr> <tr> <td>\$53.88</td> <td>\$50.12</td> </tr> </table>	1-24	25-49	\$62.65	\$58.26	50-99	100 +	\$53.88	\$50.12	<p>Model No. PE9187 SSMA MALE TO SMA MALE</p>  <table border="0"> <tr> <td>1-24</td> <td>25-49</td> </tr> <tr> <td>\$41.75</td> <td>\$38.83</td> </tr> <tr> <td>50-99</td> <td>100 +</td> </tr> <tr> <td>\$35.91</td> <td>\$33.40</td> </tr> </table>	1-24	25-49	\$41.75	\$38.83	50-99	100 +	\$35.91	\$33.40	<p>Model No. PE9188 SSMA MALE TO SMA FEMALE</p>  <table border="0"> <tr> <td>1-24</td> <td>25-49</td> </tr> <tr> <td>\$32.70</td> <td>\$30.41</td> </tr> <tr> <td>50-99</td> <td>100 +</td> </tr> <tr> <td>\$28.12</td> <td>\$26.16</td> </tr> </table>	1-24	25-49	\$32.70	\$30.41	50-99	100 +	\$28.12	\$26.16	<p>Model No. PE9189 SSMA FEMALE TO SSMA FEMALE BULKHEAD MOUNTING HOLE B01</p>  <table border="0"> <tr> <td>1-24</td> <td>25-49</td> </tr> <tr> <td>\$41.75</td> <td>\$38.83</td> </tr> <tr> <td>50-99</td> <td>100 +</td> </tr> <tr> <td>\$35.91</td> <td>\$33.40</td> </tr> </table>	1-24	25-49	\$41.75	\$38.83	50-99	100 +	\$35.91	\$33.40	<p>Model No. PE9191 SSMA FEMALE TO BNC MALE</p>  <table border="0"> <tr> <td>1-24</td> <td>25-49</td> </tr> <tr> <td>\$41.75</td> <td>\$38.83</td> </tr> <tr> <td>50-99</td> <td>100 +</td> </tr> <tr> <td>\$35.91</td> <td>\$33.40</td> </tr> </table>	1-24	25-49	\$41.75	\$38.83	50-99	100 +	\$35.91	\$33.40	
1-24	25-49																																												
\$62.65	\$58.26																																												
50-99	100 +																																												
\$53.88	\$50.12																																												
1-24	25-49																																												
\$41.75	\$38.83																																												
50-99	100 +																																												
\$35.91	\$33.40																																												
1-24	25-49																																												
\$32.70	\$30.41																																												
50-99	100 +																																												
\$28.12	\$26.16																																												
1-24	25-49																																												
\$41.75	\$38.83																																												
50-99	100 +																																												
\$35.91	\$33.40																																												
1-24	25-49																																												
\$41.75	\$38.83																																												
50-99	100 +																																												
\$35.91	\$33.40																																												
<p>Model No. PE9192 SSMA FEMALE TO SSMA FEMALE</p>  <table border="0"> <tr> <td>1-24</td> <td>25-49</td> </tr> <tr> <td>\$41.75</td> <td>\$38.83</td> </tr> <tr> <td>50-99</td> <td>100 +</td> </tr> <tr> <td>\$35.91</td> <td>\$33.40</td> </tr> </table>	1-24	25-49	\$41.75	\$38.83	50-99	100 +	\$35.91	\$33.40	<p>Model No. PE9193 HN FEMALE TO HN FEMALE BULKHEAD MOUNTING HOLE G03</p>  <table border="0"> <tr> <td>1-24</td> <td>25-49</td> </tr> <tr> <td>\$41.75</td> <td>\$38.83</td> </tr> <tr> <td>50-99</td> <td>100 +</td> </tr> <tr> <td>\$35.91</td> <td>\$33.40</td> </tr> </table>	1-24	25-49	\$41.75	\$38.83	50-99	100 +	\$35.91	\$33.40	<p>Model No. PE9194 HN MALE TO N FEMALE</p>  <table border="0"> <tr> <td>1-24</td> <td>25-49</td> </tr> <tr> <td>\$25.85</td> <td>\$24.04</td> </tr> <tr> <td>50-99</td> <td>100 +</td> </tr> <tr> <td>\$22.23</td> <td>\$20.68</td> </tr> </table>	1-24	25-49	\$25.85	\$24.04	50-99	100 +	\$22.23	\$20.68	<p>Model No. PE9195 TNC "T" FEMALE-MALE-FEMALE</p>  <table border="0"> <tr> <td>1-24</td> <td>25-49</td> </tr> <tr> <td>\$15.25</td> <td>\$14.18</td> </tr> <tr> <td>50-99</td> <td>100 +</td> </tr> <tr> <td>\$13.12</td> <td>\$12.20</td> </tr> </table>	1-24	25-49	\$15.25	\$14.18	50-99	100 +	\$13.12	\$12.20	<p>Model No. PE9196 SC FEMALE TO N MALE</p>  <table border="0"> <tr> <td>1-24</td> <td>25-49</td> </tr> <tr> <td>\$73.10</td> <td>\$67.98</td> </tr> <tr> <td>50-99</td> <td>100 +</td> </tr> <tr> <td>\$62.87</td> <td>\$58.48</td> </tr> </table>	1-24	25-49	\$73.10	\$67.98	50-99	100 +	\$62.87	\$58.48	
1-24	25-49																																												
\$41.75	\$38.83																																												
50-99	100 +																																												
\$35.91	\$33.40																																												
1-24	25-49																																												
\$41.75	\$38.83																																												
50-99	100 +																																												
\$35.91	\$33.40																																												
1-24	25-49																																												
\$25.85	\$24.04																																												
50-99	100 +																																												
\$22.23	\$20.68																																												
1-24	25-49																																												
\$15.25	\$14.18																																												
50-99	100 +																																												
\$13.12	\$12.20																																												
1-24	25-49																																												
\$73.10	\$67.98																																												
50-99	100 +																																												
\$62.87	\$58.48																																												
<p>Model No. PE9198 N MALE TO N MALE RIGHT ANGLE</p>  <table border="0"> <tr> <td>1-24</td> <td>25-49</td> </tr> <tr> <td>\$22.90</td> <td>\$21.30</td> </tr> <tr> <td>50-99</td> <td>100 +</td> </tr> <tr> <td>\$19.69</td> <td>\$18.32</td> </tr> </table>	1-24	25-49	\$22.90	\$21.30	50-99	100 +	\$19.69	\$18.32	<p>Model No. PE9199 3/4"-20 TWINAX FEMALE TO 3/4"-20 TWINAX FEMALE</p>  <table border="0"> <tr> <td>1-24</td> <td>25-49</td> </tr> <tr> <td>\$15.25</td> <td>\$14.18</td> </tr> <tr> <td>50-99</td> <td>100 +</td> </tr> <tr> <td>\$13.12</td> <td>\$12.20</td> </tr> </table>	1-24	25-49	\$15.25	\$14.18	50-99	100 +	\$13.12	\$12.20	<p>Model No. PE9200 SC MALE TO BNC FEMALE</p>  <table border="0"> <tr> <td>1-24</td> <td>25-49</td> </tr> <tr> <td>\$73.10</td> <td>\$67.98</td> </tr> <tr> <td>50-99</td> <td>100 +</td> </tr> <tr> <td>\$62.87</td> <td>\$58.48</td> </tr> </table>	1-24	25-49	\$73.10	\$67.98	50-99	100 +	\$62.87	\$58.48	<p>Model No. PE9201 BNC MALE TO UHF MALE</p>  <table border="0"> <tr> <td>1-24</td> <td>25-49</td> </tr> <tr> <td>\$16.30</td> <td>\$15.16</td> </tr> <tr> <td>50-99</td> <td>100 +</td> </tr> <tr> <td>\$14.02</td> <td>\$13.04</td> </tr> </table>	1-24	25-49	\$16.30	\$15.16	50-99	100 +	\$14.02	\$13.04	<p>Model No. PE9204 BNC FEMALE TO C FEMALE BULKHEAD MOUNTING HOLE G01</p>  <table border="0"> <tr> <td>1-24</td> <td>25-49</td> </tr> <tr> <td>\$62.65</td> <td>\$58.26</td> </tr> <tr> <td>50-99</td> <td>100 +</td> </tr> <tr> <td>\$53.88</td> <td>\$50.12</td> </tr> </table>	1-24	25-49	\$62.65	\$58.26	50-99	100 +	\$53.88	\$50.12	
1-24	25-49																																												
\$22.90	\$21.30																																												
50-99	100 +																																												
\$19.69	\$18.32																																												
1-24	25-49																																												
\$15.25	\$14.18																																												
50-99	100 +																																												
\$13.12	\$12.20																																												
1-24	25-49																																												
\$73.10	\$67.98																																												
50-99	100 +																																												
\$62.87	\$58.48																																												
1-24	25-49																																												
\$16.30	\$15.16																																												
50-99	100 +																																												
\$14.02	\$13.04																																												
1-24	25-49																																												
\$62.65	\$58.26																																												
50-99	100 +																																												
\$53.88	\$50.12																																												
<p>Model No. PE9205 HN MALE TO HN FEMALE RIGHT ANGLE</p>  <table border="0"> <tr> <td>1-24</td> <td>25-49</td> </tr> <tr> <td>\$42.25</td> <td>\$39.29</td> </tr> <tr> <td>50-99</td> <td>100 +</td> </tr> <tr> <td>\$36.34</td> <td>\$33.80</td> </tr> </table>	1-24	25-49	\$42.25	\$39.29	50-99	100 +	\$36.34	\$33.80	<p>Model No. PE9206 N FEMALE TO BNC FEMALE</p>  <table border="0"> <tr> <td>1-24</td> <td>25-49</td> </tr> <tr> <td>\$18.50</td> <td>\$17.21</td> </tr> <tr> <td>50-99</td> <td>100 +</td> </tr> <tr> <td>\$15.91</td> <td>\$14.80</td> </tr> </table>	1-24	25-49	\$18.50	\$17.21	50-99	100 +	\$15.91	\$14.80	<p>Model No. PE9207 C "T" FEMALE-MALE-FEMALE</p>  <table border="0"> <tr> <td>1-24</td> <td>25-49</td> </tr> <tr> <td>\$46.95</td> <td>\$43.66</td> </tr> <tr> <td>50-99</td> <td>100 +</td> </tr> <tr> <td>\$40.38</td> <td>\$37.56</td> </tr> </table>	1-24	25-49	\$46.95	\$43.66	50-99	100 +	\$40.38	\$37.56	<p>Model No. PE9208 C FEMALE TO C FEMALE</p>  <table border="0"> <tr> <td>1-24</td> <td>25-49</td> </tr> <tr> <td>\$30.50</td> <td>\$28.37</td> </tr> <tr> <td>50-99</td> <td>100 +</td> </tr> <tr> <td>\$26.23</td> <td>\$24.40</td> </tr> </table>	1-24	25-49	\$30.50	\$28.37	50-99	100 +	\$26.23	\$24.40	<p>Model No. PE9209 UHF MALE TO UHF FEMALE RIGHT ANGLE</p>  <table border="0"> <tr> <td>1-24</td> <td>25-49</td> </tr> <tr> <td>\$12.85</td> <td>\$11.95</td> </tr> <tr> <td>50-99</td> <td>100 +</td> </tr> <tr> <td>\$11.05</td> <td>\$10.28</td> </tr> </table>	1-24	25-49	\$12.85	\$11.95	50-99	100 +	\$11.05	\$10.28	
1-24	25-49																																												
\$42.25	\$39.29																																												
50-99	100 +																																												
\$36.34	\$33.80																																												
1-24	25-49																																												
\$18.50	\$17.21																																												
50-99	100 +																																												
\$15.91	\$14.80																																												
1-24	25-49																																												
\$46.95	\$43.66																																												
50-99	100 +																																												
\$40.38	\$37.56																																												
1-24	25-49																																												
\$30.50	\$28.37																																												
50-99	100 +																																												
\$26.23	\$24.40																																												
1-24	25-49																																												
\$12.85	\$11.95																																												
50-99	100 +																																												
\$11.05	\$10.28																																												
<p>Model No. PE9210 HN MALE TO HN MALE</p>  <table border="0"> <tr> <td>1-24</td> <td>25-49</td> </tr> <tr> <td>\$38.15</td> <td>\$35.48</td> </tr> <tr> <td>50-99</td> <td>100 +</td> </tr> <tr> <td>\$32.81</td> <td>\$30.52</td> </tr> </table>	1-24	25-49	\$38.15	\$35.48	50-99	100 +	\$32.81	\$30.52	<p>Model No. PE9211 MHV "T" FEMALE-MALE-FEMALE</p>  <table border="0"> <tr> <td>1-24</td> <td>25-49</td> </tr> <tr> <td>\$38.15</td> <td>\$35.48</td> </tr> <tr> <td>50-99</td> <td>100 +</td> </tr> <tr> <td>\$32.81</td> <td>\$30.52</td> </tr> </table>	1-24	25-49	\$38.15	\$35.48	50-99	100 +	\$32.81	\$30.52	<p>Model No. PE9212 C MALE TO HN FEMALE</p>  <table border="0"> <tr> <td>1-24</td> <td>25-49</td> </tr> <tr> <td>\$62.65</td> <td>\$58.26</td> </tr> <tr> <td>50-99</td> <td>100 +</td> </tr> <tr> <td>\$53.88</td> <td>\$50.12</td> </tr> </table>	1-24	25-49	\$62.65	\$58.26	50-99	100 +	\$53.88	\$50.12	<p>Model No. PE9213 BNC MALE TO SSMA MALE</p>  <table border="0"> <tr> <td>1-24</td> <td>25-49</td> </tr> <tr> <td>\$75.30</td> <td>\$70.03</td> </tr> <tr> <td>50-99</td> <td>100 +</td> </tr> <tr> <td>\$64.76</td> <td>\$60.24</td> </tr> </table>	1-24	25-49	\$75.30	\$70.03	50-99	100 +	\$64.76	\$60.24	<p>Model No. PE9214 7mm TO SMA FEMALE MAX VSWR 1.15:1 @ 18 GHz</p>  <table border="0"> <tr> <td>1-24</td> <td>25-49</td> <td rowspan="4">PRECISION ADAPTER</td> </tr> <tr> <td>\$146.25</td> <td>\$136.01</td> </tr> <tr> <td>50-99</td> <td>100 +</td> </tr> <tr> <td>\$125.78</td> <td>\$117.00</td> </tr> </table>	1-24	25-49	PRECISION ADAPTER	\$146.25	\$136.01	50-99	100 +	\$125.78	\$117.00
1-24	25-49																																												
\$38.15	\$35.48																																												
50-99	100 +																																												
\$32.81	\$30.52																																												
1-24	25-49																																												
\$38.15	\$35.48																																												
50-99	100 +																																												
\$32.81	\$30.52																																												
1-24	25-49																																												
\$62.65	\$58.26																																												
50-99	100 +																																												
\$53.88	\$50.12																																												
1-24	25-49																																												
\$75.30	\$70.03																																												
50-99	100 +																																												
\$64.76	\$60.24																																												
1-24	25-49	PRECISION ADAPTER																																											
\$146.25	\$136.01																																												
50-99	100 +																																												
\$125.78	\$117.00																																												

# ADAPTERS

SEE ADAPTER SELECTION CHART ON PAGES 195 THRU 198

SEE PAGE 266 FOR MOUNTING HOLES

Model No. PE9215  
7mm TO SMA MALE  
MAX VSWR 1.15:1 @ 18 GHz

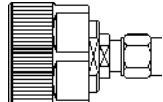

1-24	25-49	
\$165.40	\$153.82	PRECISION
50-99	100 +	ADAPTER
\$142.24	\$132.32	

Model No. PE9216  
7mm TO N FEMALE  
MAX VSWR 1.15:1 @ 18 GHz

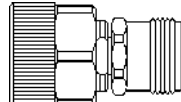

1-24	25-49	
\$152.50	\$141.83	PRECISION
50-99	100 +	ADAPTER
\$131.15	\$122.00	

Model No. PE9217  
7mm TO N MALE  
MAX VSWR 1.15:1 @ 18 GHz

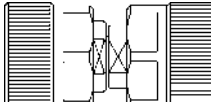

1-24	25-49	
\$156.70	\$145.73	PRECISION
50-99	100 +	ADAPTER
\$134.76	\$125.36	

Model No. PE9218  
7mm TO TNC FEMALE  
MAX VSWR 1.15:1 @ 18 GHz

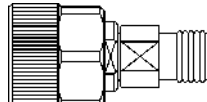

1-24	25-49	
\$208.95	\$194.32	PRECISION
50-99	100 +	ADAPTER
\$179.70	\$167.16	

Model No. PE9219  
7mm TO TNC MALE  
MAX VSWR 1.15:1 @ 18 GHz

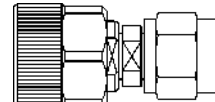

1-24	25-49	
\$208.95	\$194.32	PRECISION
50-99	100 +	ADAPTER
\$179.70	\$167.16	

Model No. PE9220  
7mm TO BNC FEMALE  
MAX VSWR 1.15:1 @ 8 GHz

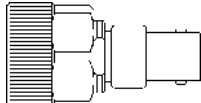

1-24	25-49	
\$156.70	\$145.73	PRECISION
50-99	100 +	ADAPTER
\$134.76	\$125.36	

Model No. PE9221  
7mm TO BNC MALE  
MAX VSWR 1.15:1 @ 8 GHz

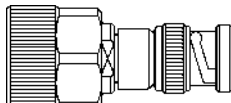

1-24	25-49	
\$208.95	\$194.32	PRECISION
50-99	100 +	ADAPTER
\$179.70	\$167.16	

Model No. PE9222  
GR874 TO BNC FEMALE

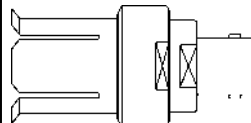

1-24	25-49	
\$103.65	\$96.39	
50-99	100 +	
\$89.14	\$82.92	

Model No. PE9223  
GR874 TO BNC MALE

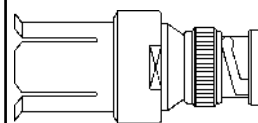

1-24	25-49	
\$103.65	\$96.39	
50-99	100 +	
\$89.14	\$82.92	

Model No. PE9224  
3/4"-20 TWINAX "T" FEMALE-FEMALE

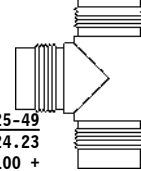

1-24	25-49	
\$26.05	\$24.23	
50-99	100 +	
\$22.40	\$20.84	

Model No. PE9225  
SC "T" FEMALE-MALE-FEMALE

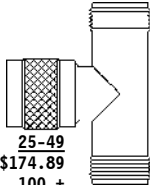

1-24	25-49	
\$188.05	\$174.89	
50-99	100 +	
\$161.72	\$150.44	

Model No. PE9226  
TNC MALE TO SMC JACK

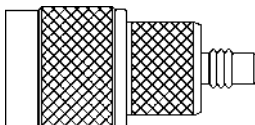

1-24	25-49	
\$38.15	\$35.48	
50-99	100 +	
\$32.81	\$30.52	

Model No. PE9227  
75 Ohm SMC JACK TO  
75 Ohm SMC JACK

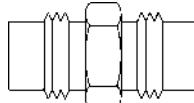

1-24	25-49	
\$25.05	\$23.30	
50-99	100 +	
\$21.54	\$20.04	

Model No. PE9228  
75 Ohm SMC JACK TO  
75 Ohm SMC JACK BULKHEAD  
MOUNTING HOLE B03



1-24	25-49	
\$31.30	\$29.11	
50-99	100 +	
\$26.92	\$25.04	

Model No. PE9229  
BNC MALE TO 75 Ohm SMB  
JACK

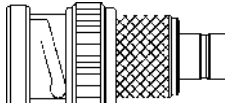

1-24	25-49	
\$40.35	\$37.53	
50-99	100 +	
\$34.70	\$32.28	

Model No. PE9230  
BNC MALE TO 75 Ohm SMB  
PLUG

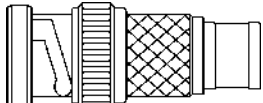

1-24	25-49	
\$40.35	\$37.53	
50-99	100 +	
\$34.70	\$32.28	

Model No. PE9231  
BNC FEMALE TO 75 Ohm SMB  
JACK



1-24	25-49	
\$40.35	\$37.53	
50-99	100 +	
\$34.70	\$32.28	

Model No. PE9232  
BNC FEMALE TO 75 Ohm SMB  
PLUG

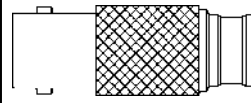

1-24	25-49	
\$40.35	\$37.53	
50-99	100 +	
\$34.70	\$32.28	

Model No. PE9233  
BNC MALE TO 75 Ohm SMC  
JACK

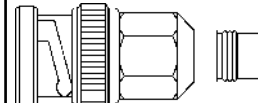

1-24	25-49	
\$40.35	\$37.53	
50-99	100 +	
\$34.70	\$32.28	

Model No. PE9234  
BNC MALE TO 75 Ohm SMC  
PLUG

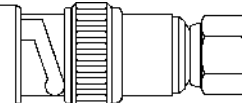

1-24	25-49	
\$46.95	\$43.66	
50-99	100 +	
\$40.38	\$37.56	

Model No. PE9235  
BNC FEMALE TO 75 Ohm SMC  
JACK

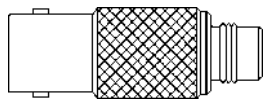

1-24	25-49	
\$46.95	\$43.66	
50-99	100 +	
\$40.38	\$37.56	

Model No. PE9236  
BNC FEMALE TO 75 Ohm SMC  
PLUG

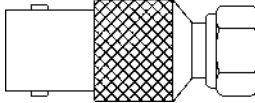

1-24	25-49	
\$46.95	\$43.66	
50-99	100 +	
\$40.38	\$37.56	

Model No. PE9237  
LC MALE TO N FEMALE

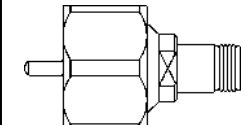

1-24	25-49	
\$161.90	\$150.57	
50-99	100 +	
\$139.23	\$129.52	

Model No. PE9238  
BNC FEMALE TO N FEMALE  
PANEL MOUNT  
MOUNTING HOLE A05

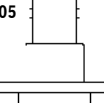

1-24	25-49	
\$29.00	\$26.97	
50-99	100 +	
\$24.94	\$23.20	

Model No. PE9239  
N MALE TO C FEMALE  
RIGHT ANGLE

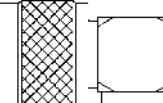

1-24	25-49	
\$62.65	\$58.26	
50-99	100 +	
\$53.88	\$50.12	

Model No. PE9240  
BNC FEMALE TO SMB JACK  
BULKHEAD  
MOUNTING HOLE B05

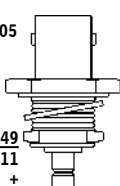

1-24	25-49	
\$33.45	\$31.11	
50-99	100 +	
\$28.77	\$26.76	

Model No. PE9241  
BNC FEMALE TO SMB PLUG  
BULKHEAD  
MOUNTING HOLE B05

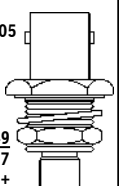

1-24	25-49	
\$30.50	\$28.37	
50-99	100 +	
\$26.23	\$24.40	

Model No. PE9242  
SMC "T" JACK-PLUG-JACK

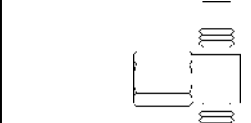

1-24	25-49	
\$25.10	\$23.34	
50-99	100 +	
\$21.59	\$20.08	

Model No. PE9243  
SMB "T" JACK-PLUG-JACK

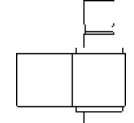

1-24	25-49	
\$25.10	\$23.34	
50-99	100 +	
\$21.59	\$20.08	

Model No. PE9244  
75 Ohm SMC "T"  
JACK-PLUG-JACK

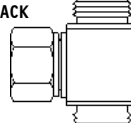





1-24	25-49	
\$46.95	\$43.66	
50-99	100 +	
\$40.38	\$37.56	

# ADAPTERS

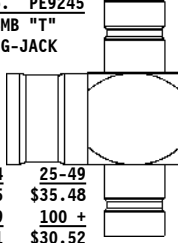
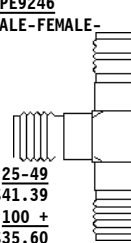
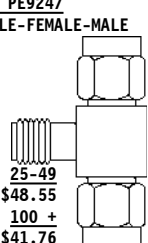
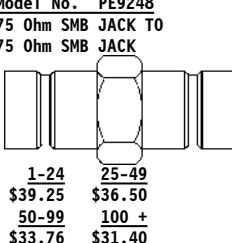
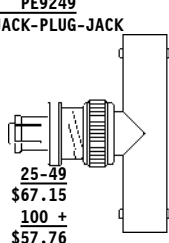
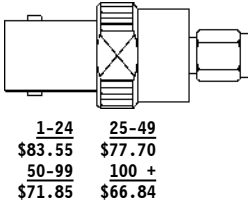
SEE ADAPTER SELECTION CHART ON PAGES 195 THRU 198

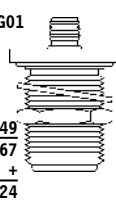
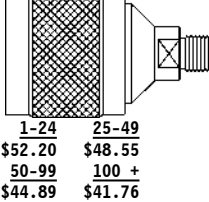
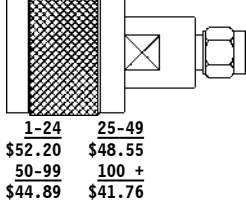
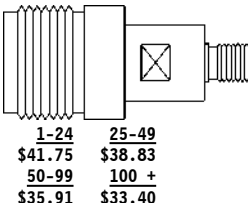
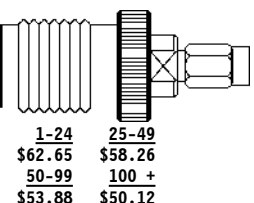
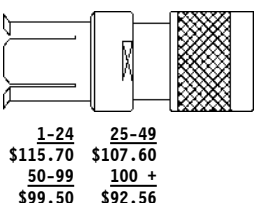
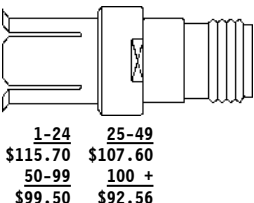
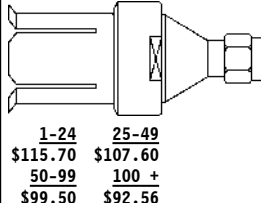
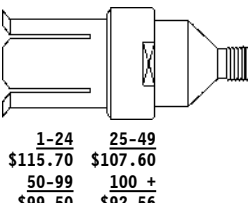

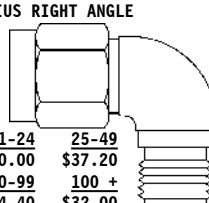
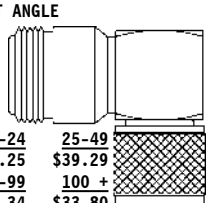
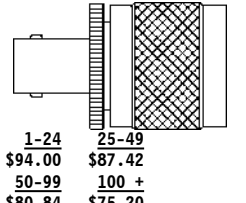
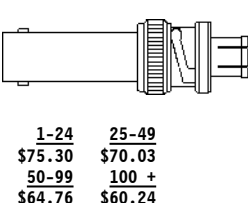
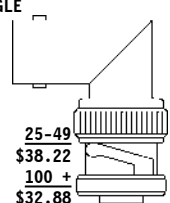
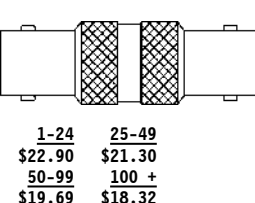
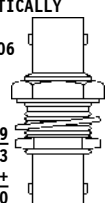
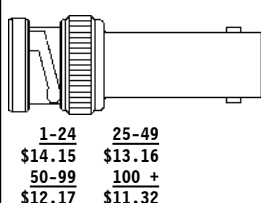
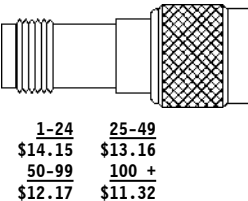
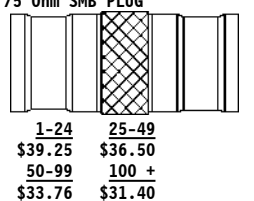
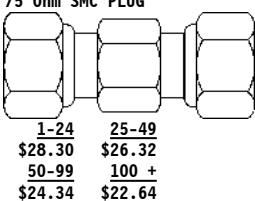
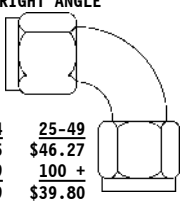
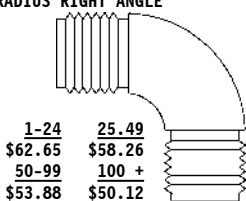



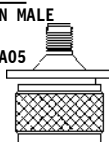
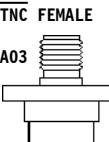
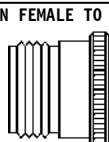
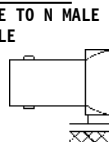
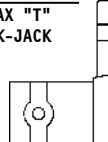
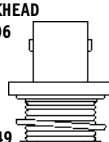
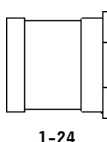
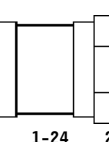
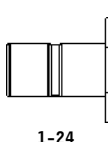
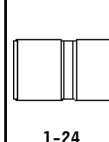
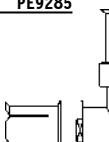
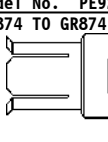

SEE PAGE 266 FOR MOUNTING HOLES

<p>Model No. PE9245 75 Ohm SMB "T" JACK-PLUG-JACK</p>  <table border="1"> <tr><td>1-24</td><td>25-49</td></tr> <tr><td>\$38.15</td><td>\$35.48</td></tr> <tr><td>50-99</td><td>100 +</td></tr> <tr><td>\$32.81</td><td>\$30.52</td></tr> </table>	1-24	25-49	\$38.15	\$35.48	50-99	100 +	\$32.81	\$30.52	<p>Model No. PE9246 SMA "T" FEMALE-FEMALE- FEMALE</p>  <table border="1"> <tr><td>1-24</td><td>25-49</td></tr> <tr><td>\$44.50</td><td>\$41.39</td></tr> <tr><td>50-99</td><td>100 +</td></tr> <tr><td>\$38.27</td><td>\$35.60</td></tr> </table>	1-24	25-49	\$44.50	\$41.39	50-99	100 +	\$38.27	\$35.60	<p>Model No. PE9247 SMA "T" MALE-FEMALE-MALE</p>  <table border="1"> <tr><td>1-24</td><td>25-49</td></tr> <tr><td>\$52.20</td><td>\$48.55</td></tr> <tr><td>50-99</td><td>100 +</td></tr> <tr><td>\$44.89</td><td>\$41.76</td></tr> </table>	1-24	25-49	\$52.20	\$48.55	50-99	100 +	\$44.89	\$41.76	<p>Model No. PE9248 75 Ohm SMB JACK TO 75 Ohm SMB JACK</p>  <table border="1"> <tr><td>1-24</td><td>25-49</td></tr> <tr><td>\$39.25</td><td>\$36.50</td></tr> <tr><td>50-99</td><td>100 +</td></tr> <tr><td>\$33.76</td><td>\$31.40</td></tr> </table>	1-24	25-49	\$39.25	\$36.50	50-99	100 +	\$33.76	\$31.40	<p>Model No. PE9249 SHV "T" JACK-PLUG-JACK</p>  <table border="1"> <tr><td>1-24</td><td>25-49</td></tr> <tr><td>\$72.20</td><td>\$67.15</td></tr> <tr><td>50-99</td><td>100 +</td></tr> <tr><td>\$62.09</td><td>\$57.76</td></tr> </table>	1-24	25-49	\$72.20	\$67.15	50-99	100 +	\$62.09	\$57.76
1-24	25-49																																											
\$38.15	\$35.48																																											
50-99	100 +																																											
\$32.81	\$30.52																																											
1-24	25-49																																											
\$44.50	\$41.39																																											
50-99	100 +																																											
\$38.27	\$35.60																																											
1-24	25-49																																											
\$52.20	\$48.55																																											
50-99	100 +																																											
\$44.89	\$41.76																																											
1-24	25-49																																											
\$39.25	\$36.50																																											
50-99	100 +																																											
\$33.76	\$31.40																																											
1-24	25-49																																											
\$72.20	\$67.15																																											
50-99	100 +																																											
\$62.09	\$57.76																																											
<p>Model No. PE9250 BNC FEMALE TO SSMA MALE</p>  <table border="1"> <tr><td>1-24</td><td>25-49</td></tr> <tr><td>\$83.55</td><td>\$77.70</td></tr> <tr><td>50-99</td><td>100 +</td></tr> <tr><td>\$71.85</td><td>\$66.84</td></tr> </table>	1-24	25-49	\$83.55	\$77.70	50-99	100 +	\$71.85	\$66.84	<p>Model No. PE9251 SMA FEMALE TO TNC FEMALE BULKHEAD MOUNTING HOLE B05</p>  <table border="1"> <tr><td>1-24</td><td>25-49</td></tr> <tr><td>\$35.10</td><td>\$32.64</td></tr> <tr><td>50-99</td><td>100 +</td></tr> <tr><td>\$30.19</td><td>\$28.08</td></tr> </table>	1-24	25-49	\$35.10	\$32.64	50-99	100 +	\$30.19	\$28.08	<p>Model No. PE9252 SMA FEMALE TO N FEMALE BULKHEAD MOUNTING HOLE G01</p>  <table border="1"> <tr><td>1-24</td><td>25-49</td></tr> <tr><td>\$34.05</td><td>\$31.67</td></tr> <tr><td>50-99</td><td>100 +</td></tr> <tr><td>\$29.28</td><td>\$27.24</td></tr> </table>	1-24	25-49	\$34.05	\$31.67	50-99	100 +	\$29.28	\$27.24	<p>Model No. PE9253 HN MALE TO SMA FEMALE</p>  <table border="1"> <tr><td>1-24</td><td>25-49</td></tr> <tr><td>\$52.20</td><td>\$48.55</td></tr> <tr><td>50-99</td><td>100 +</td></tr> <tr><td>\$44.89</td><td>\$41.76</td></tr> </table>	1-24	25-49	\$52.20	\$48.55	50-99	100 +	\$44.89	\$41.76	<p>Model No. PE9254 HN MALE TO SMA MALE</p>  <table border="1"> <tr><td>1-24</td><td>25-49</td></tr> <tr><td>\$52.20</td><td>\$48.55</td></tr> <tr><td>50-99</td><td>100 +</td></tr> <tr><td>\$44.89</td><td>\$41.76</td></tr> </table>	1-24	25-49	\$52.20	\$48.55	50-99	100 +	\$44.89	\$41.76
1-24	25-49																																											
\$83.55	\$77.70																																											
50-99	100 +																																											
\$71.85	\$66.84																																											
1-24	25-49																																											
\$35.10	\$32.64																																											
50-99	100 +																																											
\$30.19	\$28.08																																											
1-24	25-49																																											
\$34.05	\$31.67																																											
50-99	100 +																																											
\$29.28	\$27.24																																											
1-24	25-49																																											
\$52.20	\$48.55																																											
50-99	100 +																																											
\$44.89	\$41.76																																											
1-24	25-49																																											
\$52.20	\$48.55																																											
50-99	100 +																																											
\$44.89	\$41.76																																											
<p>Model No. PE9255 HN FEMALE TO SMA FEMALE</p>  <table border="1"> <tr><td>1-24</td><td>25-49</td></tr> <tr><td>\$41.75</td><td>\$38.83</td></tr> <tr><td>50-99</td><td>100 +</td></tr> <tr><td>\$35.91</td><td>\$33.40</td></tr> </table>	1-24	25-49	\$41.75	\$38.83	50-99	100 +	\$35.91	\$33.40	<p>Model No. PE9256 HN FEMALE TO SMA MALE</p>  <table border="1"> <tr><td>1-24</td><td>25-49</td></tr> <tr><td>\$62.65</td><td>\$58.26</td></tr> <tr><td>50-99</td><td>100 +</td></tr> <tr><td>\$53.88</td><td>\$50.12</td></tr> </table>	1-24	25-49	\$62.65	\$58.26	50-99	100 +	\$53.88	\$50.12	<p>Model No. PE9257 GR874 TO N MALE</p>  <table border="1"> <tr><td>1-24</td><td>25-49</td></tr> <tr><td>\$115.70</td><td>\$107.60</td></tr> <tr><td>50-99</td><td>100 +</td></tr> <tr><td>\$99.50</td><td>\$92.56</td></tr> </table>	1-24	25-49	\$115.70	\$107.60	50-99	100 +	\$99.50	\$92.56	<p>Model No. PE9258 GR874 TO N FEMALE</p>  <table border="1"> <tr><td>1-24</td><td>25-49</td></tr> <tr><td>\$115.70</td><td>\$107.60</td></tr> <tr><td>50-99</td><td>100 +</td></tr> <tr><td>\$99.50</td><td>\$92.56</td></tr> </table>	1-24	25-49	\$115.70	\$107.60	50-99	100 +	\$99.50	\$92.56	<p>Model No. PE9259 GR874 TO SMA MALE</p>  <table border="1"> <tr><td>1-24</td><td>25-49</td></tr> <tr><td>\$115.70</td><td>\$107.60</td></tr> <tr><td>50-99</td><td>100 +</td></tr> <tr><td>\$99.50</td><td>\$92.56</td></tr> </table>	1-24	25-49	\$115.70	\$107.60	50-99	100 +	\$99.50	\$92.56
1-24	25-49																																											
\$41.75	\$38.83																																											
50-99	100 +																																											
\$35.91	\$33.40																																											
1-24	25-49																																											
\$62.65	\$58.26																																											
50-99	100 +																																											
\$53.88	\$50.12																																											
1-24	25-49																																											
\$115.70	\$107.60																																											
50-99	100 +																																											
\$99.50	\$92.56																																											
1-24	25-49																																											
\$115.70	\$107.60																																											
50-99	100 +																																											
\$99.50	\$92.56																																											
1-24	25-49																																											
\$115.70	\$107.60																																											
50-99	100 +																																											
\$99.50	\$92.56																																											
<p>Model No. PE9260 GR874 TO SMA FEMALE</p>  <table border="1"> <tr><td>1-24</td><td>25-49</td></tr> <tr><td>\$115.70</td><td>\$107.60</td></tr> <tr><td>50-99</td><td>100 +</td></tr> <tr><td>\$99.50</td><td>\$92.56</td></tr> </table>	1-24	25-49	\$115.70	\$107.60	50-99	100 +	\$99.50	\$92.56	<p>Model No. PE9261 N FEMALE TO BNC FEMALE BULKHEAD MOUNTING HOLE G01</p>  <table border="1"> <tr><td>1-24</td><td>25-49</td></tr> <tr><td>\$40.35</td><td>\$37.53</td></tr> <tr><td>50-99</td><td>100 +</td></tr> <tr><td>\$34.70</td><td>\$32.28</td></tr> </table>	1-24	25-49	\$40.35	\$37.53	50-99	100 +	\$34.70	\$32.28	<p>Model No. PE9262 SMA MALE TO SMA FEMALE RADIUS RIGHT ANGLE</p>  <table border="1"> <tr><td>1-24</td><td>25-49</td></tr> <tr><td>\$40.00</td><td>\$37.20</td></tr> <tr><td>50-99</td><td>100 +</td></tr> <tr><td>\$34.40</td><td>\$32.00</td></tr> </table>	1-24	25-49	\$40.00	\$37.20	50-99	100 +	\$34.40	\$32.00	<p>Model No. PE9263 N FEMALE TO TNC MALE RIGHT ANGLE</p>  <table border="1"> <tr><td>1-24</td><td>25-49</td></tr> <tr><td>\$42.25</td><td>\$39.29</td></tr> <tr><td>50-99</td><td>100 +</td></tr> <tr><td>\$36.34</td><td>\$33.80</td></tr> </table>	1-24	25-49	\$42.25	\$39.29	50-99	100 +	\$36.34	\$33.80	<p>Model No. PE9264 MHV FEMALE TO HN MALE</p>  <table border="1"> <tr><td>1-24</td><td>25-49</td></tr> <tr><td>\$94.00</td><td>\$87.42</td></tr> <tr><td>50-99</td><td>100 +</td></tr> <tr><td>\$80.84</td><td>\$75.20</td></tr> </table>	1-24	25-49	\$94.00	\$87.42	50-99	100 +	\$80.84	\$75.20
1-24	25-49																																											
\$115.70	\$107.60																																											
50-99	100 +																																											
\$99.50	\$92.56																																											
1-24	25-49																																											
\$40.35	\$37.53																																											
50-99	100 +																																											
\$34.70	\$32.28																																											
1-24	25-49																																											
\$40.00	\$37.20																																											
50-99	100 +																																											
\$34.40	\$32.00																																											
1-24	25-49																																											
\$42.25	\$39.29																																											
50-99	100 +																																											
\$36.34	\$33.80																																											
1-24	25-49																																											
\$94.00	\$87.42																																											
50-99	100 +																																											
\$80.84	\$75.20																																											
<p>Model No. PE9265 MHV FEMALE TO SHV PLUG</p>  <table border="1"> <tr><td>1-24</td><td>25-49</td></tr> <tr><td>\$75.30</td><td>\$70.03</td></tr> <tr><td>50-99</td><td>100 +</td></tr> <tr><td>\$64.76</td><td>\$60.24</td></tr> </table>	1-24	25-49	\$75.30	\$70.03	50-99	100 +	\$64.76	\$60.24	<p>Model No. PE9266 MHV FEMALE TO MHV MALE RIGHT ANGLE</p>  <table border="1"> <tr><td>1-24</td><td>25-49</td></tr> <tr><td>\$41.10</td><td>\$38.22</td></tr> <tr><td>50-99</td><td>100 +</td></tr> <tr><td>\$35.35</td><td>\$32.88</td></tr> </table>	1-24	25-49	\$41.10	\$38.22	50-99	100 +	\$35.35	\$32.88	<p>Model No. PE9267 MHV FEMALE TO MHV FEMALE</p>  <table border="1"> <tr><td>1-24</td><td>25-49</td></tr> <tr><td>\$22.90</td><td>\$21.30</td></tr> <tr><td>50-99</td><td>100 +</td></tr> <tr><td>\$19.69</td><td>\$18.32</td></tr> </table>	1-24	25-49	\$22.90	\$21.30	50-99	100 +	\$19.69	\$18.32	<p>Model No. PE9268 MHV FEMALE TO MHV FEMALE BULKHEAD, HERMETICALLY SEALED MOUNTING HOLE B06</p>  <table border="1"> <tr><td>1-24</td><td>25-49</td></tr> <tr><td>\$41.75</td><td>\$38.83</td></tr> <tr><td>50-99</td><td>100 +</td></tr> <tr><td>\$35.91</td><td>\$33.40</td></tr> </table>	1-24	25-49	\$41.75	\$38.83	50-99	100 +	\$35.91	\$33.40	<p>Model No. PE9269 BNC MALE TO BNC FEMALE</p>  <table border="1"> <tr><td>1-24</td><td>25-49</td></tr> <tr><td>\$14.15</td><td>\$13.16</td></tr> <tr><td>50-99</td><td>100 +</td></tr> <tr><td>\$12.17</td><td>\$11.32</td></tr> </table>	1-24	25-49	\$14.15	\$13.16	50-99	100 +	\$12.17	\$11.32
1-24	25-49																																											
\$75.30	\$70.03																																											
50-99	100 +																																											
\$64.76	\$60.24																																											
1-24	25-49																																											
\$41.10	\$38.22																																											
50-99	100 +																																											
\$35.35	\$32.88																																											
1-24	25-49																																											
\$22.90	\$21.30																																											
50-99	100 +																																											
\$19.69	\$18.32																																											
1-24	25-49																																											
\$41.75	\$38.83																																											
50-99	100 +																																											
\$35.91	\$33.40																																											
1-24	25-49																																											
\$14.15	\$13.16																																											
50-99	100 +																																											
\$12.17	\$11.32																																											
<p>Model No. PE9270 TNC FEMALE TO TNC MALE</p>  <table border="1"> <tr><td>1-24</td><td>25-49</td></tr> <tr><td>\$14.15</td><td>\$13.16</td></tr> <tr><td>50-99</td><td>100 +</td></tr> <tr><td>\$12.17</td><td>\$11.32</td></tr> </table>	1-24	25-49	\$14.15	\$13.16	50-99	100 +	\$12.17	\$11.32	<p>Model No. PE9271 75 Ohm SMB PLUG TO 75 Ohm SMB PLUG</p>  <table border="1"> <tr><td>1-24</td><td>25-49</td></tr> <tr><td>\$39.25</td><td>\$36.50</td></tr> <tr><td>50-99</td><td>100 +</td></tr> <tr><td>\$33.76</td><td>\$31.40</td></tr> </table>	1-24	25-49	\$39.25	\$36.50	50-99	100 +	\$33.76	\$31.40	<p>Model No. PE9272 75 Ohm SMC PLUG TO 75 Ohm SMC PLUG</p>  <table border="1"> <tr><td>1-24</td><td>25-49</td></tr> <tr><td>\$28.30</td><td>\$26.32</td></tr> <tr><td>50-99</td><td>100 +</td></tr> <tr><td>\$24.34</td><td>\$22.64</td></tr> </table>	1-24	25-49	\$28.30	\$26.32	50-99	100 +	\$24.34	\$22.64	<p>Model No. PE9273 SMA MALE TO SMA MALE RADIUS RIGHT ANGLE</p>  <table border="1"> <tr><td>1-24</td><td>25-49</td></tr> <tr><td>\$49.75</td><td>\$46.27</td></tr> <tr><td>50-99</td><td>100 +</td></tr> <tr><td>\$42.79</td><td>\$39.80</td></tr> </table>	1-24	25-49	\$49.75	\$46.27	50-99	100 +	\$42.79	\$39.80	<p>Model No. PE9274 SMA FEMALE TO SMA FEMALE RADIUS RIGHT ANGLE</p>  <table border="1"> <tr><td>1-24</td><td>25-49</td></tr> <tr><td>\$62.65</td><td>\$58.26</td></tr> <tr><td>50-99</td><td>100 +</td></tr> <tr><td>\$53.88</td><td>\$50.12</td></tr> </table>	1-24	25-49	\$62.65	\$58.26	50-99	100 +	\$53.88	\$50.12
1-24	25-49																																											
\$14.15	\$13.16																																											
50-99	100 +																																											
\$12.17	\$11.32																																											
1-24	25-49																																											
\$39.25	\$36.50																																											
50-99	100 +																																											
\$33.76	\$31.40																																											
1-24	25-49																																											
\$28.30	\$26.32																																											
50-99	100 +																																											
\$24.34	\$22.64																																											
1-24	25-49																																											
\$49.75	\$46.27																																											
50-99	100 +																																											
\$42.79	\$39.80																																											
1-24	25-49																																											
\$62.65	\$58.26																																											
50-99	100 +																																											
\$53.88	\$50.12																																											

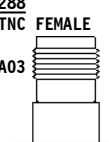
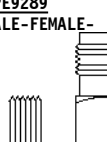
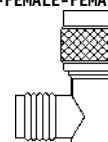
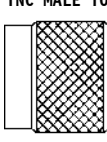
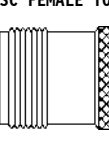
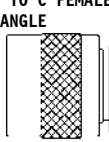
# ADAPTERS

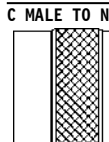
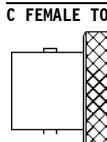
SEE ADAPTER SELECTION CHART ON PAGES 195 THRU 198

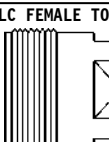
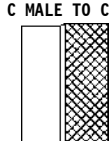
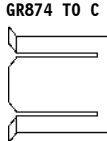
SEE PAGE 266 FOR MOUNTING HOLES

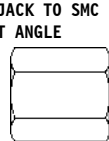
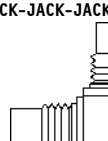
<p>Model No. PE9275 SMA FEMALE TO N MALE PANEL MOUNT MOUNTING HOLE A05</p>  <table border="1"> <tr><td>1-24</td><td>25-49</td></tr> <tr><td>\$63.25</td><td>\$58.82</td></tr> <tr><td>50-99</td><td>100 +</td></tr> <tr><td>\$54.40</td><td>\$50.60</td></tr> </table>	1-24	25-49	\$63.25	\$58.82	50-99	100 +	\$54.40	\$50.60	<p>Model No. PE9276 SMA FEMALE TO TNC FEMALE PANEL MOUNT MOUNTING HOLE A03</p>  <table border="1"> <tr><td>1-24</td><td>25-49</td></tr> <tr><td>\$36.20</td><td>\$33.67</td></tr> <tr><td>50-99</td><td>100 +</td></tr> <tr><td>\$31.13</td><td>\$28.96</td></tr> </table>	1-24	25-49	\$36.20	\$33.67	50-99	100 +	\$31.13	\$28.96	<p>Model No. PE9277 N FEMALE TO SC MALE</p>  <table border="1"> <tr><td>1-24</td><td>25-49</td></tr> <tr><td>\$73.10</td><td>\$67.98</td></tr> <tr><td>50-99</td><td>100 +</td></tr> <tr><td>\$62.87</td><td>\$58.48</td></tr> </table>	1-24	25-49	\$73.10	\$67.98	50-99	100 +	\$62.87	\$58.48	<p>Model No. PE9278 BNC FEMALE TO N MALE RIGHT ANGLE</p>  <table border="1"> <tr><td>1-24</td><td>25-49</td></tr> <tr><td>\$40.35</td><td>\$37.53</td></tr> <tr><td>50-99</td><td>100 +</td></tr> <tr><td>\$34.70</td><td>\$32.28</td></tr> </table>	1-24	25-49	\$40.35	\$37.53	50-99	100 +	\$34.70	\$32.28	<p>Model No. PE9279 BNC TWINAX "T" JACK-JACK-JACK</p>  <table border="1"> <tr><td>1-24</td><td>25-49</td></tr> <tr><td>\$36.50</td><td>\$33.95</td></tr> <tr><td>50-99</td><td>100 +</td></tr> <tr><td>\$31.39</td><td>\$29.20</td></tr> </table>	1-24	25-49	\$36.50	\$33.95	50-99	100 +	\$31.39	\$29.20
1-24	25-49																																											
\$63.25	\$58.82																																											
50-99	100 +																																											
\$54.40	\$50.60																																											
1-24	25-49																																											
\$36.20	\$33.67																																											
50-99	100 +																																											
\$31.13	\$28.96																																											
1-24	25-49																																											
\$73.10	\$67.98																																											
50-99	100 +																																											
\$62.87	\$58.48																																											
1-24	25-49																																											
\$40.35	\$37.53																																											
50-99	100 +																																											
\$34.70	\$32.28																																											
1-24	25-49																																											
\$36.50	\$33.95																																											
50-99	100 +																																											
\$31.39	\$29.20																																											
<p>Model No. PE9280 BNC TWINAX JACK TO BNC TWINAX JACK BULKHEAD MOUNTING HOLE B06</p>  <table border="1"> <tr><td>1-24</td><td>25-49</td></tr> <tr><td>\$22.90</td><td>\$21.30</td></tr> <tr><td>50-99</td><td>100 +</td></tr> <tr><td>\$19.69</td><td>\$18.32</td></tr> </table>	1-24	25-49	\$22.90	\$21.30	50-99	100 +	\$19.69	\$18.32	<p>Model No. PE9281 SMB PLUG TO SMC PLUG</p>  <table border="1"> <tr><td>1-24</td><td>25-49</td></tr> <tr><td>\$26.05</td><td>\$24.23</td></tr> <tr><td>50-99</td><td>100 +</td></tr> <tr><td>\$22.40</td><td>\$20.84</td></tr> </table>	1-24	25-49	\$26.05	\$24.23	50-99	100 +	\$22.40	\$20.84	<p>Model No. PE9282 SMB PLUG TO SMC JACK</p>  <table border="1"> <tr><td>1-24</td><td>25-49</td></tr> <tr><td>\$26.05</td><td>\$24.23</td></tr> <tr><td>50-99</td><td>100 +</td></tr> <tr><td>\$22.40</td><td>\$20.84</td></tr> </table>	1-24	25-49	\$26.05	\$24.23	50-99	100 +	\$22.40	\$20.84	<p>Model No. PE9283 SMB JACK TO SMC JACK</p>  <table border="1"> <tr><td>1-24</td><td>25-49</td></tr> <tr><td>\$26.05</td><td>\$24.23</td></tr> <tr><td>50-99</td><td>100 +</td></tr> <tr><td>\$22.40</td><td>\$20.84</td></tr> </table>	1-24	25-49	\$26.05	\$24.23	50-99	100 +	\$22.40	\$20.84	<p>Model No. PE9284 SMB JACK TO SMC PLUG</p>  <table border="1"> <tr><td>1-24</td><td>25-49</td></tr> <tr><td>\$26.05</td><td>\$24.23</td></tr> <tr><td>50-99</td><td>100 +</td></tr> <tr><td>\$22.40</td><td>\$20.84</td></tr> </table>	1-24	25-49	\$26.05	\$24.23	50-99	100 +	\$22.40	\$20.84
1-24	25-49																																											
\$22.90	\$21.30																																											
50-99	100 +																																											
\$19.69	\$18.32																																											
1-24	25-49																																											
\$26.05	\$24.23																																											
50-99	100 +																																											
\$22.40	\$20.84																																											
1-24	25-49																																											
\$26.05	\$24.23																																											
50-99	100 +																																											
\$22.40	\$20.84																																											
1-24	25-49																																											
\$26.05	\$24.23																																											
50-99	100 +																																											
\$22.40	\$20.84																																											
1-24	25-49																																											
\$26.05	\$24.23																																											
50-99	100 +																																											
\$22.40	\$20.84																																											
<p>Model No. PE9285 GR874 "T"</p>  <table border="1"> <tr><td>1-24</td><td>25-49</td></tr> <tr><td>\$253.30</td><td>\$235.57</td></tr> <tr><td>50-99</td><td>100 +</td></tr> <tr><td>\$217.84</td><td>\$202.64</td></tr> </table>	1-24	25-49	\$253.30	\$235.57	50-99	100 +	\$217.84	\$202.64	<p>Model No. PE9286 GR874 TO GR874 RIGHT ANGLE</p>  <table border="1"> <tr><td>1-24</td><td>25-49</td></tr> <tr><td>\$253.30</td><td>\$235.57</td></tr> <tr><td>50-99</td><td>100 +</td></tr> <tr><td>\$217.84</td><td>\$202.64</td></tr> </table>	1-24	25-49	\$253.30	\$235.57	50-99	100 +	\$217.84	\$202.64	<p>Model No. PE9287 TNC FEMALE TO TNC FEMALE BULKHEAD, ISOLATED GROUND MOUNTING HOLE B06</p>  <table border="1"> <tr><td>1-24</td><td>25-49</td></tr> <tr><td>\$18.50</td><td>\$17.21</td></tr> <tr><td>50-99</td><td>100 +</td></tr> <tr><td>\$15.91</td><td>\$14.80</td></tr> </table>	1-24	25-49	\$18.50	\$17.21	50-99	100 +	\$15.91	\$14.80	<p>Model No. PE9288 TNC FEMALE TO TNC FEMALE PANEL MOUNT MOUNTING HOLE A03</p>  <table border="1"> <tr><td>1-24</td><td>25-49</td></tr> <tr><td>\$10.85</td><td>\$10.09</td></tr> <tr><td>50-99</td><td>100 +</td></tr> <tr><td>\$9.33</td><td>\$8.68</td></tr> </table>	1-24	25-49	\$10.85	\$10.09	50-99	100 +	\$9.33	\$8.68	<p>Model No. PE9289 TNC "T" FEMALE-FEMALE-FEMALE</p>  <table border="1"> <tr><td>1-24</td><td>25-49</td></tr> <tr><td>\$20.70</td><td>\$19.25</td></tr> <tr><td>50-99</td><td>100 +</td></tr> <tr><td>\$17.80</td><td>\$16.56</td></tr> </table>	1-24	25-49	\$20.70	\$19.25	50-99	100 +	\$17.80	\$16.56
1-24	25-49																																											
\$253.30	\$235.57																																											
50-99	100 +																																											
\$217.84	\$202.64																																											
1-24	25-49																																											
\$253.30	\$235.57																																											
50-99	100 +																																											
\$217.84	\$202.64																																											
1-24	25-49																																											
\$18.50	\$17.21																																											
50-99	100 +																																											
\$15.91	\$14.80																																											
1-24	25-49																																											
\$10.85	\$10.09																																											
50-99	100 +																																											
\$9.33	\$8.68																																											
1-24	25-49																																											
\$20.70	\$19.25																																											
50-99	100 +																																											
\$17.80	\$16.56																																											
<p>Model No. PE9290 TNC "T" MALE-FEMALE-FEMALE</p>  <table border="1"> <tr><td>1-24</td><td>25-49</td></tr> <tr><td>\$36.50</td><td>\$33.95</td></tr> <tr><td>50-99</td><td>100 +</td></tr> <tr><td>\$31.39</td><td>\$29.20</td></tr> </table>	1-24	25-49	\$36.50	\$33.95	50-99	100 +	\$31.39	\$29.20	<p>Model No. PE9291 TNC MALE TO UHF FEMALE</p>  <table border="1"> <tr><td>1-24</td><td>25-49</td></tr> <tr><td>\$13.05</td><td>\$12.14</td></tr> <tr><td>50-99</td><td>100 +</td></tr> <tr><td>\$11.22</td><td>\$10.44</td></tr> </table>	1-24	25-49	\$13.05	\$12.14	50-99	100 +	\$11.22	\$10.44	<p>Model No. PE9292 SC FEMALE TO N FEMALE</p>  <table border="1"> <tr><td>1-24</td><td>25-49</td></tr> <tr><td>\$73.10</td><td>\$67.98</td></tr> <tr><td>50-99</td><td>100 +</td></tr> <tr><td>\$62.87</td><td>\$58.48</td></tr> </table>	1-24	25-49	\$73.10	\$67.98	50-99	100 +	\$62.87	\$58.48	<p>Model No. PE9293 C MALE TO C FEMALE RIGHT ANGLE</p>  <table border="1"> <tr><td>1-24</td><td>25-49</td></tr> <tr><td>\$41.75</td><td>\$38.83</td></tr> <tr><td>50-99</td><td>100 +</td></tr> <tr><td>\$35.91</td><td>\$33.40</td></tr> </table>	1-24	25-49	\$41.75	\$38.83	50-99	100 +	\$35.91	\$33.40	<p>Model No. PE9294 C "T" FEMALE-FEMALE-FEMALE</p>  <table border="1"> <tr><td>1-24</td><td>25-49</td></tr> <tr><td>\$62.65</td><td>\$58.26</td></tr> <tr><td>50-99</td><td>100 +</td></tr> <tr><td>\$53.88</td><td>\$50.12</td></tr> </table>	1-24	25-49	\$62.65	\$58.26	50-99	100 +	\$53.88	\$50.12
1-24	25-49																																											
\$36.50	\$33.95																																											
50-99	100 +																																											
\$31.39	\$29.20																																											
1-24	25-49																																											
\$13.05	\$12.14																																											
50-99	100 +																																											
\$11.22	\$10.44																																											
1-24	25-49																																											
\$73.10	\$67.98																																											
50-99	100 +																																											
\$62.87	\$58.48																																											
1-24	25-49																																											
\$41.75	\$38.83																																											
50-99	100 +																																											
\$35.91	\$33.40																																											
1-24	25-49																																											
\$62.65	\$58.26																																											
50-99	100 +																																											
\$53.88	\$50.12																																											
<p>Model No. PE9295 C MALE TO N FEMALE</p>  <table border="1"> <tr><td>1-24</td><td>25-49</td></tr> <tr><td>\$39.40</td><td>\$36.64</td></tr> <tr><td>50-99</td><td>100 +</td></tr> <tr><td>\$33.88</td><td>\$31.52</td></tr> </table>	1-24	25-49	\$39.40	\$36.64	50-99	100 +	\$33.88	\$31.52	<p>Model No. PE9296 C FEMALE TO HN MALE</p>  <table border="1"> <tr><td>1-24</td><td>25-49</td></tr> <tr><td>\$41.75</td><td>\$38.83</td></tr> <tr><td>50-99</td><td>100 +</td></tr> <tr><td>\$35.91</td><td>\$33.40</td></tr> </table>	1-24	25-49	\$41.75	\$38.83	50-99	100 +	\$35.91	\$33.40	<p>Model No. PE9297 MHV MALE TO BNC FEMALE</p>  <table border="1"> <tr><td>1-24</td><td>25-49</td></tr> <tr><td>\$28.30</td><td>\$26.32</td></tr> <tr><td>50-99</td><td>100 +</td></tr> <tr><td>\$24.34</td><td>\$22.64</td></tr> </table>	1-24	25-49	\$28.30	\$26.32	50-99	100 +	\$24.34	\$22.64	<p>Model No. PE9298 LC FEMALE TO N FEMALE</p>  <table border="1"> <tr><td>1-24</td><td>25-49</td></tr> <tr><td>\$156.70</td><td>\$145.73</td></tr> <tr><td>50-99</td><td>100 +</td></tr> <tr><td>\$134.76</td><td>\$125.36</td></tr> </table>	1-24	25-49	\$156.70	\$145.73	50-99	100 +	\$134.76	\$125.36	<p>Model No. PE9299 LC FEMALE TO N MALE</p>  <table border="1"> <tr><td>1-24</td><td>25-49</td></tr> <tr><td>\$198.50</td><td>\$184.61</td></tr> <tr><td>50-99</td><td>100 +</td></tr> <tr><td>\$170.71</td><td>\$158.80</td></tr> </table>	1-24	25-49	\$198.50	\$184.61	50-99	100 +	\$170.71	\$158.80
1-24	25-49																																											
\$39.40	\$36.64																																											
50-99	100 +																																											
\$33.88	\$31.52																																											
1-24	25-49																																											
\$41.75	\$38.83																																											
50-99	100 +																																											
\$35.91	\$33.40																																											
1-24	25-49																																											
\$28.30	\$26.32																																											
50-99	100 +																																											
\$24.34	\$22.64																																											
1-24	25-49																																											
\$156.70	\$145.73																																											
50-99	100 +																																											
\$134.76	\$125.36																																											
1-24	25-49																																											
\$198.50	\$184.61																																											
50-99	100 +																																											
\$170.71	\$158.80																																											
<p>Model No. PE9300 C MALE TO C MALE</p>  <table border="1"> <tr><td>1-24</td><td>25-49</td></tr> <tr><td>\$41.75</td><td>\$38.83</td></tr> <tr><td>50-99</td><td>100 +</td></tr> <tr><td>\$35.91</td><td>\$33.40</td></tr> </table>	1-24	25-49	\$41.75	\$38.83	50-99	100 +	\$35.91	\$33.40	<p>Model No. PE9301 GR874 TO C FEMALE</p>  <table border="1"> <tr><td>1-24</td><td>25-49</td></tr> <tr><td>\$126.60</td><td>\$117.74</td></tr> <tr><td>50-99</td><td>100 +</td></tr> <tr><td>\$108.88</td><td>\$101.28</td></tr> </table>	1-24	25-49	\$126.60	\$117.74	50-99	100 +	\$108.88	\$101.28	<p>Model No. PE9302 SMB "T" JACK-JACK-JACK</p>  <table border="1"> <tr><td>1-24</td><td>25-49</td></tr> <tr><td>\$30.50</td><td>\$28.37</td></tr> <tr><td>50-99</td><td>100 +</td></tr> <tr><td>\$26.23</td><td>\$24.40</td></tr> </table>	1-24	25-49	\$30.50	\$28.37	50-99	100 +	\$26.23	\$24.40	<p>Model No. PE9303 SMC JACK TO SMC PLUG RIGHT ANGLE</p>  <table border="1"> <tr><td>1-24</td><td>25-49</td></tr> <tr><td>\$36.50</td><td>\$33.95</td></tr> <tr><td>50-99</td><td>100 +</td></tr> <tr><td>\$31.39</td><td>\$29.20</td></tr> </table>	1-24	25-49	\$36.50	\$33.95	50-99	100 +	\$31.39	\$29.20	<p>Model No. PE9304 SMC "T" JACK-JACK-JACK</p>  <table border="1"> <tr><td>1-24</td><td>25-49</td></tr> <tr><td>\$41.75</td><td>\$38.83</td></tr> <tr><td>50-99</td><td>100 +</td></tr> <tr><td>\$35.91</td><td>\$33.40</td></tr> </table>	1-24	25-49	\$41.75	\$38.83	50-99	100 +	\$35.91	\$33.40
1-24	25-49																																											
\$41.75	\$38.83																																											
50-99	100 +																																											
\$35.91	\$33.40																																											
1-24	25-49																																											
\$126.60	\$117.74																																											
50-99	100 +																																											
\$108.88	\$101.28																																											
1-24	25-49																																											
\$30.50	\$28.37																																											
50-99	100 +																																											
\$26.23	\$24.40																																											
1-24	25-49																																											
\$36.50	\$33.95																																											
50-99	100 +																																											
\$31.39	\$29.20																																											
1-24	25-49																																											
\$41.75	\$38.83																																											
50-99	100 +																																											
\$35.91	\$33.40																																											

# ADAPTERS

SEE ADAPTER SELECTION CHART ON PAGES 195 THRU 198

SEE PAGE 266 FOR MOUNTING HOLES

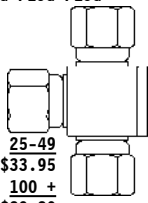
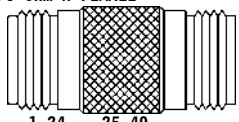
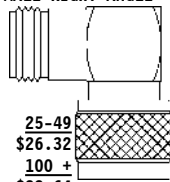
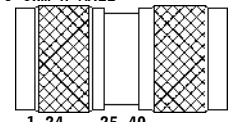
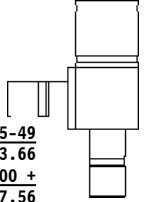
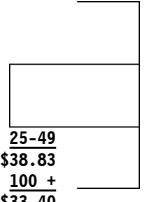
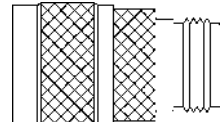
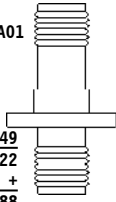
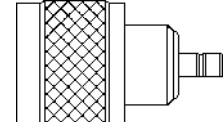
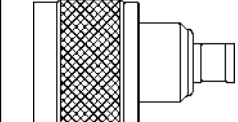
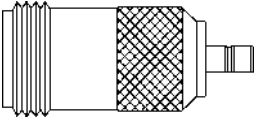
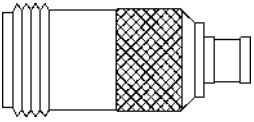
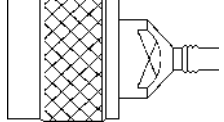
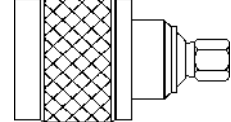
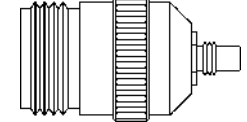
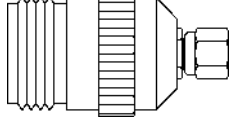
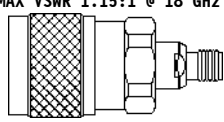
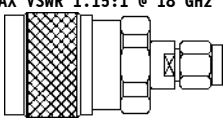
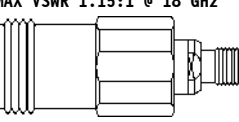
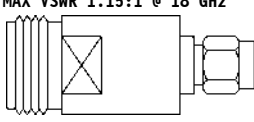
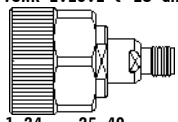
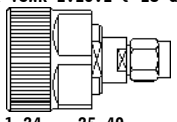
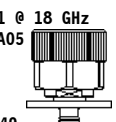
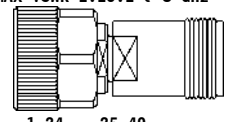
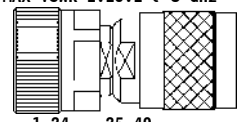
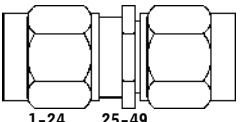
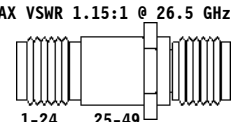
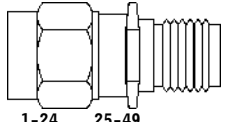
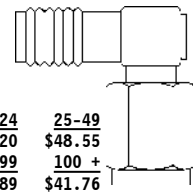
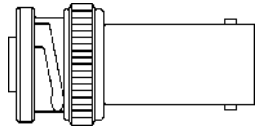
<p>Model No. PE9305 SMC "T" PLUG-PLUG-PLUG</p>  <table border="0"> <tr> <td>1-24</td> <td>25-49</td> </tr> <tr> <td>\$36.50</td> <td>\$33.95</td> </tr> <tr> <td>50-99</td> <td>100 +</td> </tr> <tr> <td>\$31.39</td> <td>\$29.20</td> </tr> </table>	1-24	25-49	\$36.50	\$33.95	50-99	100 +	\$31.39	\$29.20	<p>Model No. PE9306 75 Ohm N FEMALE TO 75 Ohm N FEMALE</p>  <table border="0"> <tr> <td>1-24</td> <td>25-49</td> </tr> <tr> <td>\$20.70</td> <td>\$19.25</td> </tr> <tr> <td>50-99</td> <td>100 +</td> </tr> <tr> <td>\$17.80</td> <td>\$16.56</td> </tr> </table>	1-24	25-49	\$20.70	\$19.25	50-99	100 +	\$17.80	\$16.56	<p>Model No. PE9307 75 Ohm N FEMALE TO 75 Ohm N MALE RIGHT ANGLE</p>  <table border="0"> <tr> <td>1-24</td> <td>25-49</td> </tr> <tr> <td>\$28.30</td> <td>\$26.32</td> </tr> <tr> <td>50-99</td> <td>100 +</td> </tr> <tr> <td>\$24.34</td> <td>\$22.64</td> </tr> </table>	1-24	25-49	\$28.30	\$26.32	50-99	100 +	\$24.34	\$22.64	<p>Model No. PE9308 75 Ohm N MALE TO 75 Ohm N MALE</p>  <table border="0"> <tr> <td>1-24</td> <td>25-49</td> </tr> <tr> <td>\$20.70</td> <td>\$19.25</td> </tr> <tr> <td>50-99</td> <td>100 +</td> </tr> <tr> <td>\$17.80</td> <td>\$16.56</td> </tr> </table>	1-24	25-49	\$20.70	\$19.25	50-99	100 +	\$17.80	\$16.56	<p>Model No. PE9309 SMB "T" PLUG-JACK-JACK</p>  <table border="0"> <tr> <td>1-24</td> <td>25-49</td> </tr> <tr> <td>\$46.95</td> <td>\$43.66</td> </tr> <tr> <td>50-99</td> <td>100 +</td> </tr> <tr> <td>\$40.38</td> <td>\$37.56</td> </tr> </table>	1-24	25-49	\$46.95	\$43.66	50-99	100 +	\$40.38	\$37.56
1-24	25-49																																											
\$36.50	\$33.95																																											
50-99	100 +																																											
\$31.39	\$29.20																																											
1-24	25-49																																											
\$20.70	\$19.25																																											
50-99	100 +																																											
\$17.80	\$16.56																																											
1-24	25-49																																											
\$28.30	\$26.32																																											
50-99	100 +																																											
\$24.34	\$22.64																																											
1-24	25-49																																											
\$20.70	\$19.25																																											
50-99	100 +																																											
\$17.80	\$16.56																																											
1-24	25-49																																											
\$46.95	\$43.66																																											
50-99	100 +																																											
\$40.38	\$37.56																																											
<p>Model No. PE9310 SMB "T" PLUG-PLUG-PLUG</p>  <table border="0"> <tr> <td>1-24</td> <td>25-49</td> </tr> <tr> <td>\$41.75</td> <td>\$38.83</td> </tr> <tr> <td>50-99</td> <td>100 +</td> </tr> <tr> <td>\$35.91</td> <td>\$33.40</td> </tr> </table>	1-24	25-49	\$41.75	\$38.83	50-99	100 +	\$35.91	\$33.40	<p>Model No. PE9311 N MALE TO N FEMALE</p>  <table border="0"> <tr> <td>1-24</td> <td>25-49</td> </tr> <tr> <td>\$17.75</td> <td>\$16.51</td> </tr> <tr> <td>50-99</td> <td>100 +</td> </tr> <tr> <td>\$15.27</td> <td>\$14.20</td> </tr> </table>	1-24	25-49	\$17.75	\$16.51	50-99	100 +	\$15.27	\$14.20	<p>Model No. PE9312 SMA FEMALE TO SMA FEMALE PANEL MOUNT MOUNTING HOLE A01</p>  <table border="0"> <tr> <td>1-24</td> <td>25-49</td> </tr> <tr> <td>\$41.10</td> <td>\$38.22</td> </tr> <tr> <td>50-99</td> <td>100 +</td> </tr> <tr> <td>\$35.35</td> <td>\$32.88</td> </tr> </table>	1-24	25-49	\$41.10	\$38.22	50-99	100 +	\$35.35	\$32.88	<p>Model No. PE9313 N MALE TO SMB JACK</p>  <table border="0"> <tr> <td>1-24</td> <td>25-49</td> </tr> <tr> <td>\$41.75</td> <td>\$38.83</td> </tr> <tr> <td>50-99</td> <td>100 +</td> </tr> <tr> <td>\$35.91</td> <td>\$33.40</td> </tr> </table>	1-24	25-49	\$41.75	\$38.83	50-99	100 +	\$35.91	\$33.40	<p>Model No. PE9314 N MALE TO SMB PLUG</p>  <table border="0"> <tr> <td>1-24</td> <td>25-49</td> </tr> <tr> <td>\$41.75</td> <td>\$38.83</td> </tr> <tr> <td>50-99</td> <td>100 +</td> </tr> <tr> <td>\$35.91</td> <td>\$33.40</td> </tr> </table>	1-24	25-49	\$41.75	\$38.83	50-99	100 +	\$35.91	\$33.40
1-24	25-49																																											
\$41.75	\$38.83																																											
50-99	100 +																																											
\$35.91	\$33.40																																											
1-24	25-49																																											
\$17.75	\$16.51																																											
50-99	100 +																																											
\$15.27	\$14.20																																											
1-24	25-49																																											
\$41.10	\$38.22																																											
50-99	100 +																																											
\$35.35	\$32.88																																											
1-24	25-49																																											
\$41.75	\$38.83																																											
50-99	100 +																																											
\$35.91	\$33.40																																											
1-24	25-49																																											
\$41.75	\$38.83																																											
50-99	100 +																																											
\$35.91	\$33.40																																											
<p>Model No. PE9315 N FEMALE TO SMB JACK</p>  <table border="0"> <tr> <td>1-24</td> <td>25-49</td> </tr> <tr> <td>\$41.75</td> <td>\$38.83</td> </tr> <tr> <td>50-99</td> <td>100 +</td> </tr> <tr> <td>\$35.91</td> <td>\$33.40</td> </tr> </table>	1-24	25-49	\$41.75	\$38.83	50-99	100 +	\$35.91	\$33.40	<p>Model No. PE9316 N FEMALE TO SMB PLUG</p>  <table border="0"> <tr> <td>1-24</td> <td>25-49</td> </tr> <tr> <td>\$41.75</td> <td>\$38.83</td> </tr> <tr> <td>50-99</td> <td>100 +</td> </tr> <tr> <td>\$35.91</td> <td>\$33.40</td> </tr> </table>	1-24	25-49	\$41.75	\$38.83	50-99	100 +	\$35.91	\$33.40	<p>Model No. PE9317 N MALE TO SMC JACK</p>  <table border="0"> <tr> <td>1-24</td> <td>25-49</td> </tr> <tr> <td>\$52.20</td> <td>\$48.55</td> </tr> <tr> <td>50-99</td> <td>100 +</td> </tr> <tr> <td>\$44.89</td> <td>\$41.76</td> </tr> </table>	1-24	25-49	\$52.20	\$48.55	50-99	100 +	\$44.89	\$41.76	<p>Model No. PE9318 N MALE TO SMC PLUG</p>  <table border="0"> <tr> <td>1-24</td> <td>25-49</td> </tr> <tr> <td>\$56.00</td> <td>\$52.08</td> </tr> <tr> <td>50-99</td> <td>100 +</td> </tr> <tr> <td>\$48.16</td> <td>\$44.80</td> </tr> </table>	1-24	25-49	\$56.00	\$52.08	50-99	100 +	\$48.16	\$44.80	<p>Model No. PE9319 N FEMALE TO SMC JACK</p>  <table border="0"> <tr> <td>1-24</td> <td>25-49</td> </tr> <tr> <td>\$52.20</td> <td>\$48.55</td> </tr> <tr> <td>50-99</td> <td>100 +</td> </tr> <tr> <td>\$44.89</td> <td>\$41.76</td> </tr> </table>	1-24	25-49	\$52.20	\$48.55	50-99	100 +	\$44.89	\$41.76
1-24	25-49																																											
\$41.75	\$38.83																																											
50-99	100 +																																											
\$35.91	\$33.40																																											
1-24	25-49																																											
\$41.75	\$38.83																																											
50-99	100 +																																											
\$35.91	\$33.40																																											
1-24	25-49																																											
\$52.20	\$48.55																																											
50-99	100 +																																											
\$44.89	\$41.76																																											
1-24	25-49																																											
\$56.00	\$52.08																																											
50-99	100 +																																											
\$48.16	\$44.80																																											
1-24	25-49																																											
\$52.20	\$48.55																																											
50-99	100 +																																											
\$44.89	\$41.76																																											
<p>Model No. PE9320 N FEMALE TO SMC PLUG</p>  <table border="0"> <tr> <td>1-24</td> <td>25-49</td> </tr> <tr> <td>\$52.20</td> <td>\$48.55</td> </tr> <tr> <td>50-99</td> <td>100 +</td> </tr> <tr> <td>\$44.89</td> <td>\$41.76</td> </tr> </table>	1-24	25-49	\$52.20	\$48.55	50-99	100 +	\$44.89	\$41.76	<p>Model No. PE9321 N MALE TO 3.5mm FEMALE MAX VSWR 1.15:1 @ 18 GHz</p>  <table border="0"> <tr> <td>1-24</td> <td>25-49</td> </tr> <tr> <td>\$115.70</td> <td>\$107.60</td> </tr> <tr> <td>50-99</td> <td>100 +</td> </tr> <tr> <td>\$99.50</td> <td>\$92.56</td> </tr> </table> <p>PRECISION ADAPTER</p>	1-24	25-49	\$115.70	\$107.60	50-99	100 +	\$99.50	\$92.56	<p>Model No. PE9322 N MALE TO 3.5mm MALE MAX VSWR 1.15:1 @ 18 GHz</p>  <table border="0"> <tr> <td>1-24</td> <td>25-49</td> </tr> <tr> <td>\$130.55</td> <td>\$121.41</td> </tr> <tr> <td>50-99</td> <td>100 +</td> </tr> <tr> <td>\$112.27</td> <td>\$104.44</td> </tr> </table> <p>PRECISION ADAPTER</p>	1-24	25-49	\$130.55	\$121.41	50-99	100 +	\$112.27	\$104.44	<p>Model No. PE9323 N FEMALE TO 3.5mm FEMALE MAX VSWR 1.15:1 @ 18 GHz</p>  <table border="0"> <tr> <td>1-24</td> <td>25-49</td> </tr> <tr> <td>\$117.15</td> <td>\$108.95</td> </tr> <tr> <td>50-99</td> <td>100 +</td> </tr> <tr> <td>\$100.75</td> <td>\$93.72</td> </tr> </table> <p>PRECISION ADAPTER</p>	1-24	25-49	\$117.15	\$108.95	50-99	100 +	\$100.75	\$93.72	<p>Model No. PE9324 N FEMALE TO 3.5mm MALE MAX VSWR 1.15:1 @ 18 GHz</p>  <table border="0"> <tr> <td>1-24</td> <td>25-49</td> </tr> <tr> <td>\$120.05</td> <td>\$111.65</td> </tr> <tr> <td>50-99</td> <td>100 +</td> </tr> <tr> <td>\$103.24</td> <td>\$96.04</td> </tr> </table> <p>PRECISION ADAPTER</p>	1-24	25-49	\$120.05	\$111.65	50-99	100 +	\$103.24	\$96.04
1-24	25-49																																											
\$52.20	\$48.55																																											
50-99	100 +																																											
\$44.89	\$41.76																																											
1-24	25-49																																											
\$115.70	\$107.60																																											
50-99	100 +																																											
\$99.50	\$92.56																																											
1-24	25-49																																											
\$130.55	\$121.41																																											
50-99	100 +																																											
\$112.27	\$104.44																																											
1-24	25-49																																											
\$117.15	\$108.95																																											
50-99	100 +																																											
\$100.75	\$93.72																																											
1-24	25-49																																											
\$120.05	\$111.65																																											
50-99	100 +																																											
\$103.24	\$96.04																																											
<p>Model No. PE9325 7mm TO 3.5mm FEMALE MAX VSWR 1.15:1 @ 18 GHz</p>  <table border="0"> <tr> <td>1-24</td> <td>25-49</td> </tr> <tr> <td>\$208.95</td> <td>\$194.32</td> </tr> <tr> <td>50-99</td> <td>100 +</td> </tr> <tr> <td>\$179.70</td> <td>\$167.16</td> </tr> </table> <p>PRECISION ADAPTER</p>	1-24	25-49	\$208.95	\$194.32	50-99	100 +	\$179.70	\$167.16	<p>Model No. PE9326 7mm TO 3.5mm MALE MAX VSWR 1.15:1 @ 18 GHz</p>  <table border="0"> <tr> <td>1-24</td> <td>25-49</td> </tr> <tr> <td>\$208.95</td> <td>\$194.32</td> </tr> <tr> <td>50-99</td> <td>100 +</td> </tr> <tr> <td>\$179.70</td> <td>\$167.16</td> </tr> </table> <p>PRECISION ADAPTER</p>	1-24	25-49	\$208.95	\$194.32	50-99	100 +	\$179.70	\$167.16	<p>Model No. PE9327 7mm TO SMA FEMALE PANEL MOUNT MAX VSWR 1.15:1 @ 18 GHz MOUNTING HOLE A05</p>  <table border="0"> <tr> <td>1-24</td> <td>25-49</td> </tr> <tr> <td>\$365.70</td> <td>\$340.10</td> </tr> <tr> <td>50-99</td> <td>100 +</td> </tr> <tr> <td>\$314.50</td> <td>\$292.56</td> </tr> </table> <p>PRECISION ADAPTER</p>	1-24	25-49	\$365.70	\$340.10	50-99	100 +	\$314.50	\$292.56	<p>Model No. PE9328 7mm TO SC FEMALE MAX VSWR 1.15:1 @ 8 GHz</p>  <table border="0"> <tr> <td>1-24</td> <td>25-49</td> </tr> <tr> <td>\$253.30</td> <td>\$235.57</td> </tr> <tr> <td>50-99</td> <td>100 +</td> </tr> <tr> <td>\$217.84</td> <td>\$202.64</td> </tr> </table> <p>PRECISION ADAPTER</p>	1-24	25-49	\$253.30	\$235.57	50-99	100 +	\$217.84	\$202.64	<p>Model No. PE9329 7mm TO SC MALE MAX VSWR 1.15:1 @ 8 GHz</p>  <table border="0"> <tr> <td>1-24</td> <td>25-49</td> </tr> <tr> <td>\$253.30</td> <td>\$235.57</td> </tr> <tr> <td>50-99</td> <td>100 +</td> </tr> <tr> <td>\$217.84</td> <td>\$202.64</td> </tr> </table> <p>PRECISION ADAPTER</p>	1-24	25-49	\$253.30	\$235.57	50-99	100 +	\$217.84	\$202.64
1-24	25-49																																											
\$208.95	\$194.32																																											
50-99	100 +																																											
\$179.70	\$167.16																																											
1-24	25-49																																											
\$208.95	\$194.32																																											
50-99	100 +																																											
\$179.70	\$167.16																																											
1-24	25-49																																											
\$365.70	\$340.10																																											
50-99	100 +																																											
\$314.50	\$292.56																																											
1-24	25-49																																											
\$253.30	\$235.57																																											
50-99	100 +																																											
\$217.84	\$202.64																																											
1-24	25-49																																											
\$253.30	\$235.57																																											
50-99	100 +																																											
\$217.84	\$202.64																																											
<p>Model No. PE9330 3.5mm MALE TO 3.5mm MALE MAX VSWR 1.15:1 @ 26.5 GHz</p>  <table border="0"> <tr> <td>1-24</td> <td>25-49</td> </tr> <tr> <td>\$135.80</td> <td>\$126.29</td> </tr> <tr> <td>50-99</td> <td>100 +</td> </tr> <tr> <td>\$116.79</td> <td>\$108.64</td> </tr> </table> <p>PRECISION ADAPTER</p>	1-24	25-49	\$135.80	\$126.29	50-99	100 +	\$116.79	\$108.64	<p>Model No. PE9331 3.5mm FEMALE TO 3.5mm FEMALE MAX VSWR 1.15:1 @ 26.5 GHz</p>  <table border="0"> <tr> <td>1-24</td> <td>25-49</td> </tr> <tr> <td>\$105.75</td> <td>\$98.35</td> </tr> <tr> <td>50-99</td> <td>100 +</td> </tr> <tr> <td>\$90.95</td> <td>\$84.60</td> </tr> </table> <p>PRECISION ADAPTER</p>	1-24	25-49	\$105.75	\$98.35	50-99	100 +	\$90.95	\$84.60	<p>Model No. PE9332 3.5mm MALE TO 3.5mm FEMALE MAX VSWR 1.15:1 @ 26.5 GHz</p>  <table border="0"> <tr> <td>1-24</td> <td>25-49</td> </tr> <tr> <td>\$135.80</td> <td>\$126.29</td> </tr> <tr> <td>50-99</td> <td>100 +</td> </tr> <tr> <td>\$116.79</td> <td>\$108.64</td> </tr> </table> <p>PRECISION ADAPTER</p>	1-24	25-49	\$135.80	\$126.29	50-99	100 +	\$116.79	\$108.64	<p>Model No. PE9334 SSMA FEMALE TO SSMA MALE RIGHT ANGLE</p>  <table border="0"> <tr> <td>1-24</td> <td>25-49</td> </tr> <tr> <td>\$52.20</td> <td>\$48.55</td> </tr> <tr> <td>50-99</td> <td>100 +</td> </tr> <tr> <td>\$44.89</td> <td>\$41.76</td> </tr> </table>	1-24	25-49	\$52.20	\$48.55	50-99	100 +	\$44.89	\$41.76	<p>Model No. PE9335 MHV MALE TO SHV JACK</p>  <table border="0"> <tr> <td>1-24</td> <td>25-49</td> </tr> <tr> <td>\$80.80</td> <td>\$75.14</td> </tr> <tr> <td>50-99</td> <td>100 +</td> </tr> <tr> <td>\$69.49</td> <td>\$64.64</td> </tr> </table>	1-24	25-49	\$80.80	\$75.14	50-99	100 +	\$69.49	\$64.64
1-24	25-49																																											
\$135.80	\$126.29																																											
50-99	100 +																																											
\$116.79	\$108.64																																											
1-24	25-49																																											
\$105.75	\$98.35																																											
50-99	100 +																																											
\$90.95	\$84.60																																											
1-24	25-49																																											
\$135.80	\$126.29																																											
50-99	100 +																																											
\$116.79	\$108.64																																											
1-24	25-49																																											
\$52.20	\$48.55																																											
50-99	100 +																																											
\$44.89	\$41.76																																											
1-24	25-49																																											
\$80.80	\$75.14																																											
50-99	100 +																																											
\$69.49	\$64.64																																											

# ADAPTERS

SEE ADAPTER SELECTION CHART ON PAGES 195 THRU 198

SEE PAGE 266 FOR MOUNTING HOLES

Adapters

**Model No. PE9336**  
SHV JACK TO SHV JACK  
BULKHEAD, HERMETICALLY  
SEALED  
MOUNTING HOLE B06



1-24	25-49
\$53.40	\$49.66
50-99	100 +
\$45.92	\$42.72

**Model No. PE9337**  
SHV JACK TO SHV JACK

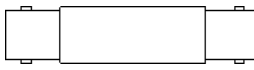

1-24	25-49
\$28.30	\$26.32
50-99	100 +
\$24.34	\$22.64

**Model No. PE9338**  
SHV JACK TO SHV PLUG  
RIGHT ANGLE

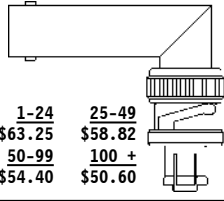

1-24	25-49
\$63.25	\$58.82
50-99	100 +
\$54.40	\$50.60

**Model No. PE9339**  
SHV JACK TO MHV FEMALE

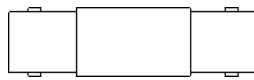

1-24	25-49
\$40.35	\$37.53
50-99	100 +
\$34.70	\$32.28

**Model No. PE9340**  
SHV PLUG TO MHV MALE

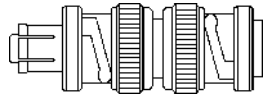

1-24	25-49
\$63.25	\$58.82
50-99	100 +
\$54.40	\$50.60

**Model No. PE9341**  
MINI-UHF FEMALE TO  
BNC MALE

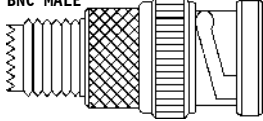

1-24	25-49
\$9.75	\$9.07
50-99	100 +
\$8.39	\$7.80

**Model No. PE9342**  
MINI-UHF MALE TO  
BNC FEMALE

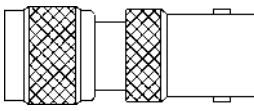

1-24	25-49
\$9.75	\$9.07
50-99	100 +
\$8.39	\$7.80

**Model No. PE9343**  
MINI-UHF FEMALE TO  
MINI-UHF FEMALE

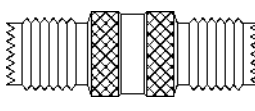

1-24	25-49
\$9.75	\$9.07
50-99	100 +
\$8.39	\$7.80

**Model No. PE9344**  
MINI-UHF MALE TO  
UHF FEMALE

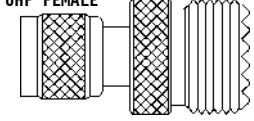

1-24	25-49
\$10.45	\$9.72
50-99	100 +
\$8.99	\$8.36

**Model No. PE9345**  
MINI-UHF FEMALE TO  
TNC MALE

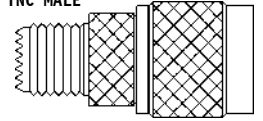

1-24	25-49
\$9.75	\$9.07
50-99	100 +
\$8.39	\$7.80

**Model No. PE9346**  
MINI-UHF MALE TO  
TNC FEMALE

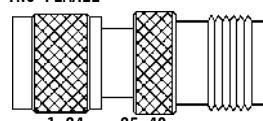

1-24	25-49
\$9.75	\$9.07
50-99	100 +
\$8.39	\$7.80

**Model No. PE9347**  
MINI-UHF MALE TO  
MINI-UHF FEMALE  
RIGHT ANGLE

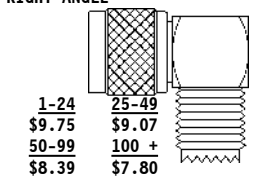

1-24	25-49
\$9.75	\$9.07
50-99	100 +
\$8.39	\$7.80

**Model No. PE9348**  
MINI-UHF FEMALE TO  
UHF MALE

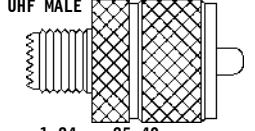

1-24	25-49
\$9.75	\$9.07
50-99	100 +
\$8.39	\$7.80

**Model No. PE9349**  
75 OHM N FEMALE TO  
50 Ohm N MALE

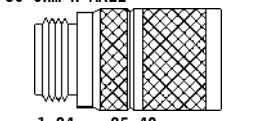

1-24	25-49
\$33.00	\$30.69
50-99	100 +
\$28.38	\$26.40

**Model No. PE9350**  
75 OHM N MALE TO  
50 Ohm N FEMALE

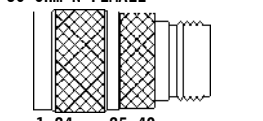

1-24	25-49
\$28.30	\$26.32
50-99	100 +
\$24.34	\$22.64

**Model No. PE9351**  
N MALE TO SSMA MALE

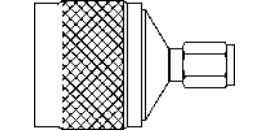

1-24	25-49
\$51.25	\$47.66
50-99	100 +
\$44.08	\$41.00

**Model No. PE9352**  
N MALE TO SSMA FEMALE

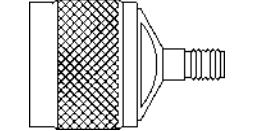

1-24	25-49
\$51.25	\$47.66
50-99	100 +
\$44.08	\$41.00

**Model No. PE9353**  
N FEMALE TO SSMA MALE

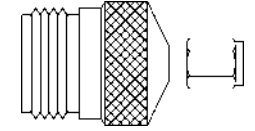

1-24	25-49
\$52.20	\$48.55
50-99	100 +
\$44.89	\$41.76

**Model No. PE9354**  
N FEMALE TO SSMA FEMALE

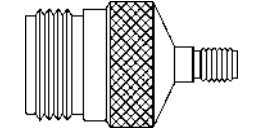

1-24	25-49
\$52.20	\$48.55
50-99	100 +
\$44.89	\$41.76

**Model No. PE9355**  
SSMA MALE TO 7mm  
MAX VSWR 1.15:1 @ 18 GHz

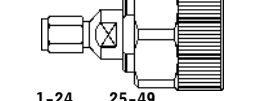

1-24	25-49
\$219.45	\$204.09
50-99	100 +
\$188.73	\$175.56

PRECISION ADAPTER

**Model No. PE9356**  
SSMA FEMALE TO 7mm  
MAX VSWR 1.15:1 @ 18 GHz

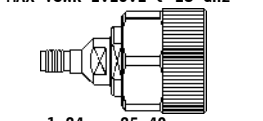

1-24	25-49
\$219.45	\$204.09
50-99	100 +
\$188.73	\$175.56

PRECISION ADAPTER

**Model No. PE9357**  
SSMA MALE TO SSMA MALE

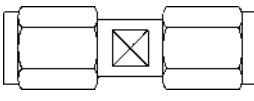

1-24	25-49
\$74.15	\$68.96
50-99	100 +
\$63.77	\$59.32

**Model No. PE9358**  
SSMA MALE TO SSMA FEMALE

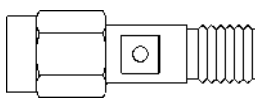

1-24	25-49
\$41.75	\$38.83
50-99	100 +
\$35.91	\$33.40

**Model No. PE9359**  
N FEMALE TO N FEMALE  
RIGHT ANGLE

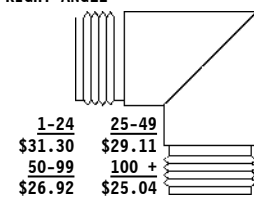

1-24	25-49
\$31.30	\$29.11
50-99	100 +
\$26.92	\$25.04

**Model No. PE9360**  
N FEMALE TO HN FEMALE

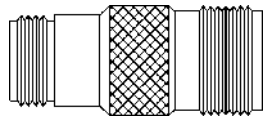

1-24	25-49
\$50.15	\$46.64
50-99	100 +
\$43.13	\$40.12

**Model No. PE9361**  
75 Ohm BNC MALE TO  
75 Ohm BNC FEMALE  
RIGHT ANGLE  
MATES WITH 50 Ohm BNC'S

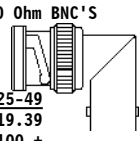

1-24	25-49
\$20.85	\$19.39
50-99	100 +
\$17.93	\$16.68

**Model No. PE9362**  
75 Ohm BNC FEMALE TO  
75 Ohm BNC FEMALE  
MATES WITH 50 Ohm BNC'S

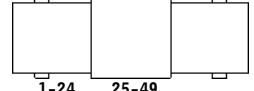

1-24	25-49
\$14.15	\$13.16
50-99	100 +
\$12.17	\$11.32

**Model No. PE9363**  
75 Ohm BNC FEMALE TO  
75 Ohm BNC FEMALE  
BULKHEAD, MATES WITH  
50 Ohm BNC'S  
MOUNTING HOLE B06

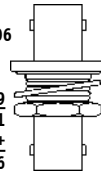

1-24	25-49
\$23.45	\$21.81
50-99	100 +
\$20.17	\$18.76

**Model No. PE9364**  
75 Ohm BNC MALE TO  
75 Ohm BNC MALE  
MATES WITH 50 Ohm BNC'S

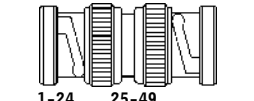

1-24	25-49
\$14.15	\$13.16
50-99	100 +
\$12.17	\$11.32

**Model No. PE9365**  
75 Ohm BNC "T"  
FEMALE-MALE-FEMALE  
MATES WITH 50 Ohm  
BNC'S

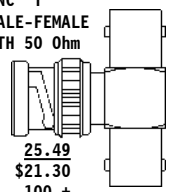

1-24	25-49
\$22.90	\$21.30
50-99	100 +
\$19.69	\$18.32

# ADAPTERS

SEE ADAPTER SELECTION CHART ON PAGES 195 THRU 198

SEE PAGE 266 FOR MOUNTING HOLES

Model No. PE9366  
75 Ohm BNC FEMALE TO  
75 Ohm BNC FEMALE  
BULKHEAD, ISOLATED GROUND  
MATES WITH 50 Ohm BNC'S  
MOUNTING HOLE B06

1-24	25-49
\$24.00	\$22.32
50-99	100 +
\$20.64	\$19.20

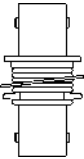

Model No. PE9367  
75 Ohm BNC FEMALE TO  
75 Ohm BNC FEMALE  
PANEL MOUNT, MATES WITH  
50 Ohm BNC'S  
MOUNTING HOLE A03

1-24	25-49
\$24.00	\$22.32
50-99	100 +
\$20.64	\$19.20

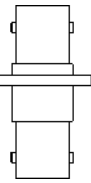

Model No. PE9368  
75 Ohm BNC MALE TO  
75 Ohm N FEMALE  
MATES WITH 50 Ohm BNC'S

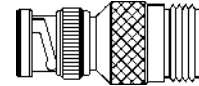

1-24	25-49
\$20.70	\$19.25
50-99	100 +
\$17.80	\$16.56

Model No. PE9369  
75 Ohm BNC FEMALE TO  
75 Ohm N MALE  
MATES WITH 50 Ohm BNC'S

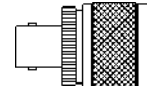

1-24	25-49
\$20.70	\$19.25
50-99	100 +
\$17.80	\$16.56

Model No. PE9370  
75 Ohm BNC MALE TO  
75 Ohm N MALE  
MATES WITH 50 Ohm BNC'S

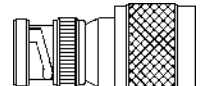

1-24	25-49
\$41.45	\$38.55
50-99	100 +
\$35.65	\$33.16

Model No. PE9371  
75 Ohm BNC FEMALE TO  
75 Ohm N FEMALE  
MATES WITH 50 Ohm BNC'S

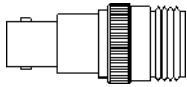

1-24	25-49
\$60.50	\$56.27
50-99	100 +
\$52.03	\$48.40

Model No. PE9372  
UHF MALE TO TNC FEMALE

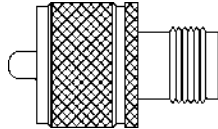

1-24	25-49
\$14.15	\$13.16
50-99	100 +
\$12.17	\$11.32

Model No. PE9373  
3/4"-20 TWINAX FEMALE TO  
3/4"-20 TWINAX FEMALE  
BULKHEAD, MOUNTING HOLE  
B07



1-24	25-49
\$31.30	\$29.11
50-99	100 +
\$26.92	\$25.04

Model No. PE9374  
3/4"-20 TWINAX "T"  
FEMALE-MALE-FEMALE

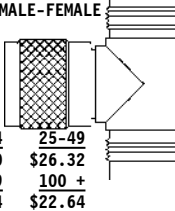

1-24	25-49
\$28.30	\$26.32
50-99	100 +
\$24.34	\$22.64

Model No. PE9375  
BNC TWINAX "T"  
JACK-PLUG-JACK

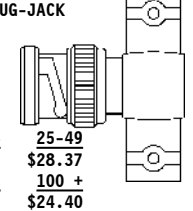

1-24	25-49
\$30.50	\$28.37
50-99	100 +
\$26.23	\$24.40

Model No. PE9376  
BNC TWINAX PLUG TO  
BNC TWINAX PLUG

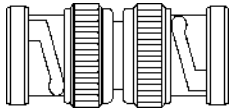

1-24	25-49
\$32.70	\$30.41
50-99	100 +
\$28.12	\$26.16

Model No. PE9377  
BNC TWINAX PLUG TO  
BNC TWINAX JACK  
RIGHT ANGLE

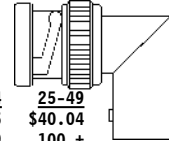

1-24	25-49
\$43.05	\$40.04
50-99	100 +
\$37.02	\$34.44

Model No. PE9378  
BNC TWINAX JACK TO  
BNC TWINAX JACK



1-24	25-49
\$20.70	\$19.25
50-99	100 +
\$17.80	\$16.56

Model No. PE9379  
SMA "T" MALE-MALE-MALE

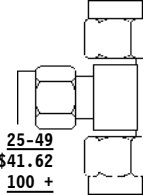

1-24	25-49
\$44.75	\$41.62
50-99	100 +
\$38.49	\$35.80

Model No. PE9380  
SMA FEMALE TO SMA FEMALE  
WITH KNURL

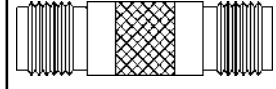

1-24	25-49
\$20.00	\$18.60
50-99	100 +
\$17.20	\$16.00

Model No. PE9381  
SMA MALE TO SMA FEMALE  
45 DEGREE ANGLE

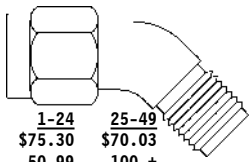

1-24	25-49
\$75.30	\$70.03
50-99	100 +
\$64.76	\$60.24

Model No. PE9382  
N FEMALE TO N FEMALE  
BULKHEAD, ISOLATED GROUND  
MOUNTING HOLE G01



1-24	25-49
\$28.30	\$26.32
50-99	100 +
\$24.34	\$22.64

Model No. PE9383  
N FEMALE TO N FEMALE  
BULKHEAD, HERMETICALLY  
SEALED FOR A 1"  
MAX PANEL  
MOUNTING HOLE G01



1-24	25-49
\$51.25	\$47.66
50-99	100 +
\$44.08	\$41.00

Model No. PE9384  
SMA MALE TO TNC FEMALE  
PANEL MOUNT  
MOUNTING HOLE A09

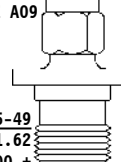

1-24	25-49
\$44.75	\$41.62
50-99	100 +
\$38.49	\$35.80

Model No. PE9385  
N FEMALE TO UHF FEMALE

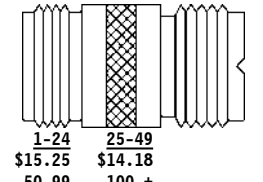

1-24	25-49
\$15.25	\$14.18
50-99	100 +
\$13.12	\$12.20

Model No. PE9386  
GR874 TO HN MALE

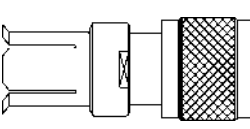

1-24	25-49
\$149.55	\$139.08
50-99	100 +
\$128.61	\$119.64

Model No. PE9387  
GR874 TO HN FEMALE

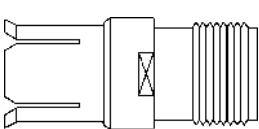

1-24	25-49
\$149.55	\$139.08
50-99	100 +
\$128.61	\$119.64

Model No. PE9388  
N MALE TO BNC FEMALE  
PANEL MOUNT  
MOUNTING HOLE A05

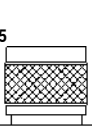

1-24	25-49
\$36.50	\$33.95
50-99	100 +
\$31.99	\$29.20

Model No. PE9389  
F MALE TO N FEMALE

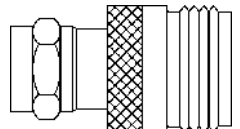

1-24	25-49
\$24.60	\$22.88
50-99	100 +
\$21.16	\$19.68

Model No. PE9390  
N "T" MALE-MALE-MALE

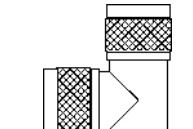

1-24	25-49
\$41.75	\$38.83
50-99	100 +
\$35.91	\$33.40

Model No. PE9391  
75 Ohm N MALE TO  
75 Ohm N FEMALE

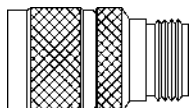

1-24	25-49
\$21.80	\$20.27
50-99	100 +
\$18.75	\$17.44

Model No. PE9392  
BNC MALE TO SSMB JACK

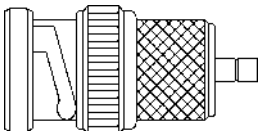

1-24	25-49
\$52.20	\$48.55
50-99	100 +
\$44.89	\$41.76

Model No. PE9393  
BNC MALE TO SSMB PLUG

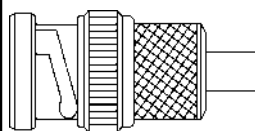

1-24	25-49
\$52.20	\$48.55
50-99	100 +
\$44.89	\$41.76

Model No. PE9394  
BNC FEMALE TO SSMB JACK

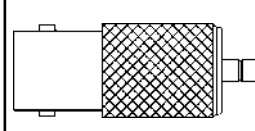

1-24	25-49
\$54.95	\$51.10
50-99	100 +
\$47.26	\$43.96

Model No. PE9395  
BNC FEMALE TO SSMB PLUG

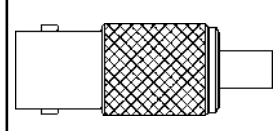

1-24	25-49
\$52.20	\$48.55
50-99	100 +
\$44.89	\$41.76









Adapters

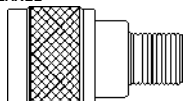
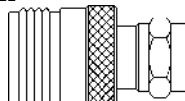

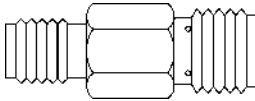
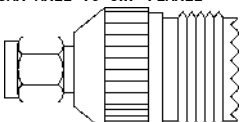
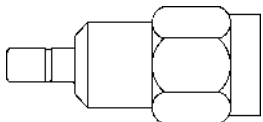
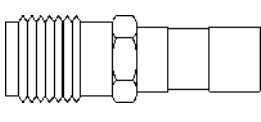
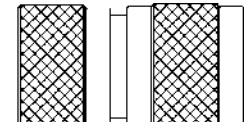
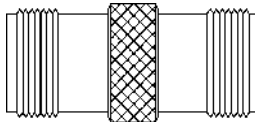
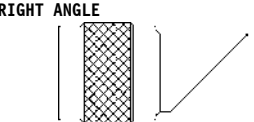
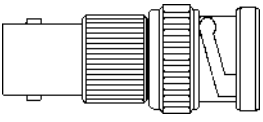
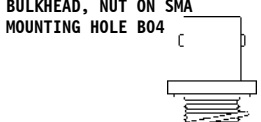
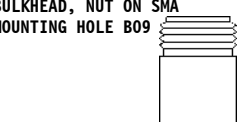
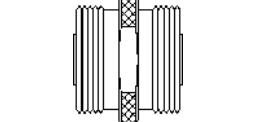
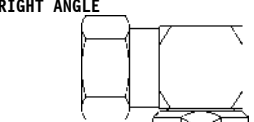
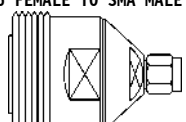
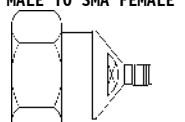
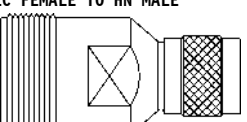
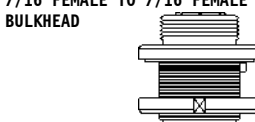
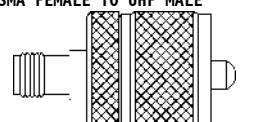
# ADAPTERS

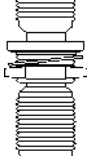
SEE ADAPTER SELECTION CHART ON PAGES 195 THRU 198

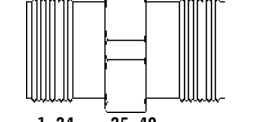
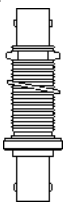
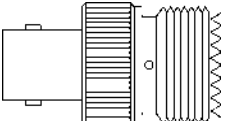

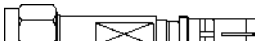
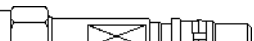

SEE PAGE 266 FOR MOUNTING HOLES

<p>Model No. PE9396 75 Ohm N MALE TO F FEMALE</p>  <p>1-24 25-49 \$26.70 \$24.83 50-99 100 + \$22.96 \$21.36</p>	<p>Model No. PE9397 75 Ohm N FEMALE TO F MALE</p>  <p>1-24 25-49 \$32.20 \$29.95 50-99 100 + \$27.69 \$25.76</p>	<p>Model No. PE9398 LC MALE TO LC FEMALE RIGHT ANGLE</p>  <p>1-24 25-49 \$271.65 \$252.63 50-99 100 + \$233.62 \$217.32</p>	<p>Model No. PE9399 SSMA FEMALE TO SMA FEMALE</p>  <p>1-24 25-49 \$41.75 \$38.83 50-99 100 + \$35.91 \$33.40</p>	<p>Model No. PE9400 SMA MALE TO UHF FEMALE</p>  <p>1-24 25-49 \$28.30 \$26.32 50-99 100 + \$24.34 \$22.64</p>
<p>Model No. PE9401 SSMB JACK TO SMA MALE</p>  <p>1-24 25-49 \$38.15 \$35.48 50-99 100 + \$32.81 \$30.52</p>	<p>Model No. PE9402 SMA FEMALE TO SSMB PLUG</p>  <p>1-24 25-49 \$41.75 \$38.83 50-99 100 + \$35.91 \$33.40</p>	<p>Model No. PE9403 SC MALE TO SC MALE</p>  <p>1-24 25-49 \$73.10 \$67.98 50-99 100 + \$62.87 \$58.48</p>	<p>Model No. PE9404 SC FEMALE TO SC FEMALE</p>  <p>1-24 25-49 \$73.10 \$67.98 50-99 100 + \$62.87 \$58.48</p>	<p>Model No. PE9405 SC MALE TO SC FEMALE RIGHT ANGLE</p>  <p>1-24 25-49 \$104.45 \$97.14 50-99 100 + \$89.83 \$83.56</p>
<p>Model No. PE9406 MHV FEMALE TO BNC MALE</p>  <p>1-24 25-49 \$70.35 \$65.43 50-99 100 + \$60.50 \$56.28</p>	<p>Model No. PE9407 BNC FEMALE TO SMA FEMALE BULKHEAD, NUT ON SMA MOUNTING HOLE B04</p>  <p>1-24 25-49 \$43.65 \$40.59 50-99 100 + \$37.54 \$34.92</p>	<p>Model No. PE9408 N FEMALE TO SMA FEMALE BULKHEAD, NUT ON SMA MOUNTING HOLE B09</p>  <p>1-24 25-49 \$45.80 \$42.59 50-99 100 + \$39.39 \$36.64</p>	<p>Model No. PE9409 7/16 FEMALE TO 7/16 FEMALE</p>  <p>1-24 25-49 \$75.30 \$70.03 50-99 100 + \$64.76 \$60.24</p>	<p>Model No. PE9410 7/16 MALE TO 7/16 FEMALE RIGHT ANGLE</p>  <p>1-24 25-49 \$126.60 \$117.74 50-99 100 + \$108.88 \$101.28</p>
<p>Model No. PE9411 7/16 FEMALE TO SMA MALE</p>  <p>1-24 25-49 \$83.55 \$77.70 50-99 100 + \$71.85 \$66.84</p>	<p>Model No. PE9412 7/16 MALE TO SMA FEMALE</p>  <p>1-24 25-49 \$83.55 \$77.70 50-99 100 + \$71.85 \$66.84</p>	<p>Model No. PE9413 LC FEMALE TO HN MALE</p>  <p>1-24 25-49 \$161.55 \$150.24 50-99 100 + \$138.93 \$129.24</p>	<p>Model No. PE9414 7/16 FEMALE TO 7/16 FEMALE BULKHEAD</p>  <p>1-24 25-49 \$172.35 \$160.29 50-99 100 + \$148.22 \$137.88</p>	<p>Model No. PE9415 SMA FEMALE TO UHF MALE</p>  <p>1-24 25-49 \$34.90 \$32.46 50-99 100 + \$30.01 \$27.92</p>
<p>Model No. PE9416 75 Ohm N FEMALE TO 75 Ohm N FEMALE BULKHEAD, HERMETICALLY SEALED, MOUNTING HOLE G01</p>  <p>1-24 25-49 \$34.05 \$31.67 50-99 100 + \$29.28 \$27.24</p>	<p>Model No. PE9417 75 Ohm N FEMALE TO 75 Ohm N FEMALE BULKHEAD, ISOLATED GROUND MOUNTING HOLE G01</p>  <p>1-24 25-49 \$52.20 \$48.55 50-99 100 + \$44.89 \$41.76</p>	<p>Model No. PE9418 SMA MALE TO SMA MALE RIGHT ANGLE</p>  <p>1-24 25-49 \$32.25 \$29.99 50-99 100 + \$27.74 \$25.80</p>	<p>Model No. PE9419 LC FEMALE TO LC FEMALE</p>  <p>1-24 25-49 \$135.80 \$126.29 50-99 100 + \$116.79 \$108.64</p>	<p>Model No. PE9420 BNC FEMALE TO BNC FEMALE BULKHEAD, HERMETICALLY SEALED, 1" MAX PANEL MOUNTING HOLE B06</p>  <p>1-24 25-49 \$34.90 \$32.46 50-99 100 + \$30.01 \$27.92</p>
<p>Model No. PE9421 BNC FEMALE TO UHF FEMALE</p>  <p>1-24 25-49 \$14.15 \$13.16 50-99 100 + \$12.17 \$11.32</p>	<p>Model No. PE9422 SMA FEMALE TO D SUBMINIATURE PLUG</p>  <p>1-24 25-49 \$20.85 \$19.39 50-99 100 + \$17.93 \$16.68</p>	<p>Model No. PE9423 SMA FEMALE TO D SUBMINIATURE RECEPTACLE</p>  <p>1-24 25-49 \$20.85 \$19.39 50-99 100 + \$17.93 \$16.68</p>	<p>Model No. PE9424 SMA MALE TO D SUBMINIATURE RECEPTACLE</p>  <p>1-24 25-49 \$20.85 \$19.39 50-99 100 + \$17.93 \$16.68</p>	<p>Model No. PE9425 SMA MALE TO D SUBMINIATURE PLUG</p>  <p>1-24 25-49 \$20.85 \$19.39 50-99 100 + \$17.93 \$16.68</p>

# ADAPTERS

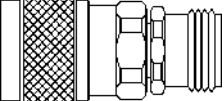
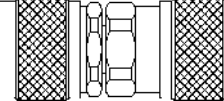
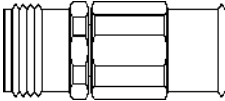
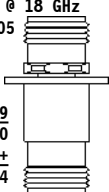
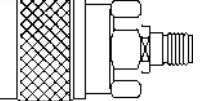
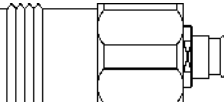
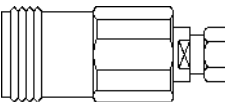
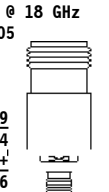
SEE ADAPTER SELECTION CHART ON PAGES 195 THRU 198

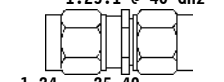
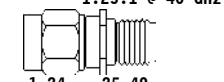
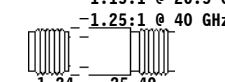
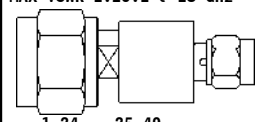
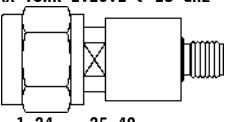
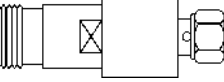
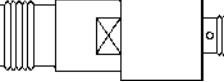
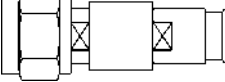
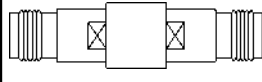
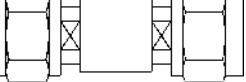
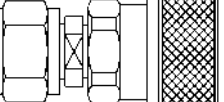
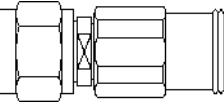
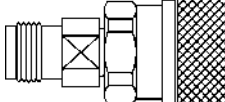
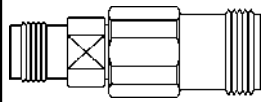
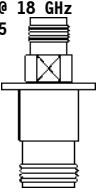
SEE PAGE 266 FOR MOUNTING HOLES

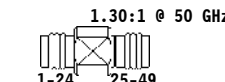
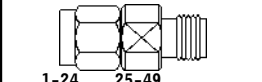
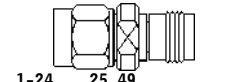





<p><b>Model No. PE9426</b> N MALE TO N FEMALE MAX VSWR 1.15:1 @ 18 GHz</p>  <table border="0"> <tr> <td>1-24</td> <td>25-49</td> <td></td> </tr> <tr> <td>\$83.55</td> <td>\$77.70</td> <td>PRECISION</td> </tr> <tr> <td>50-99</td> <td>100 +</td> <td>ADAPTER</td> </tr> <tr> <td>\$71.85</td> <td>\$66.84</td> <td></td> </tr> </table>	1-24	25-49		\$83.55	\$77.70	PRECISION	50-99	100 +	ADAPTER	\$71.85	\$66.84		<p><b>Model No. PE9427</b> N MALE TO N MALE MAX VSWR 1.15:1 @ 18 GHz</p>  <table border="0"> <tr> <td>1-24</td> <td>25-49</td> <td></td> </tr> <tr> <td>\$64.55</td> <td>\$60.03</td> <td>PRECISION</td> </tr> <tr> <td>50-99</td> <td>100 +</td> <td>ADAPTER</td> </tr> <tr> <td>\$55.51</td> <td>\$51.64</td> <td></td> </tr> </table>	1-24	25-49		\$64.55	\$60.03	PRECISION	50-99	100 +	ADAPTER	\$55.51	\$51.64		<p><b>Model No. PE9428</b> N FEMALE TO N FEMALE MAX VSWR 1.15:1 @ 18 GHz</p>  <table border="0"> <tr> <td>1-24</td> <td>25-49</td> <td></td> </tr> <tr> <td>\$71.30</td> <td>\$66.31</td> <td>PRECISION</td> </tr> <tr> <td>50-99</td> <td>100 +</td> <td>ADAPTER</td> </tr> <tr> <td>\$61.32</td> <td>\$57.04</td> <td></td> </tr> </table>	1-24	25-49		\$71.30	\$66.31	PRECISION	50-99	100 +	ADAPTER	\$61.32	\$57.04		<p><b>Model No. PE9429</b> N FEMALE TO N FEMALE PANEL MOUNT MAX VSWR 1.15:1 @ 18 GHz MOUNTING HOLE A05</p>  <p>PRECISION ADAPTER</p> <table border="0"> <tr> <td>1-24</td> <td>25-49</td> <td></td> </tr> <tr> <td>\$83.55</td> <td>\$77.70</td> <td></td> </tr> <tr> <td>50-99</td> <td>100 +</td> <td></td> </tr> <tr> <td>\$71.85</td> <td>\$66.84</td> <td></td> </tr> </table>	1-24	25-49		\$83.55	\$77.70		50-99	100 +		\$71.85	\$66.84		<p><b>Model No. PE9430</b> N MALE TO SMA FEMALE MAX VSWR 1.15:1 @ 18 GHz</p>  <table border="0"> <tr> <td>1-24</td> <td>25-49</td> <td></td> </tr> <tr> <td>\$64.55</td> <td>\$60.03</td> <td>PRECISION</td> </tr> <tr> <td>50-99</td> <td>100 +</td> <td>ADAPTER</td> </tr> <tr> <td>\$55.51</td> <td>\$51.64</td> <td></td> </tr> </table>	1-24	25-49		\$64.55	\$60.03	PRECISION	50-99	100 +	ADAPTER	\$55.51	\$51.64	
1-24	25-49																																																															
\$83.55	\$77.70	PRECISION																																																														
50-99	100 +	ADAPTER																																																														
\$71.85	\$66.84																																																															
1-24	25-49																																																															
\$64.55	\$60.03	PRECISION																																																														
50-99	100 +	ADAPTER																																																														
\$55.51	\$51.64																																																															
1-24	25-49																																																															
\$71.30	\$66.31	PRECISION																																																														
50-99	100 +	ADAPTER																																																														
\$61.32	\$57.04																																																															
1-24	25-49																																																															
\$83.55	\$77.70																																																															
50-99	100 +																																																															
\$71.85	\$66.84																																																															
1-24	25-49																																																															
\$64.55	\$60.03	PRECISION																																																														
50-99	100 +	ADAPTER																																																														
\$55.51	\$51.64																																																															
<p><b>Model No. PE9431</b> N MALE TO SMA MALE MAX VSWR 1.15:1 @ 18 GHz</p>  <table border="0"> <tr> <td>1-24</td> <td>25-49</td> <td></td> </tr> <tr> <td>\$83.55</td> <td>\$77.70</td> <td>PRECISION</td> </tr> <tr> <td>50-99</td> <td>100 +</td> <td>ADAPTER</td> </tr> <tr> <td>\$71.85</td> <td>\$66.84</td> <td></td> </tr> </table>	1-24	25-49		\$83.55	\$77.70	PRECISION	50-99	100 +	ADAPTER	\$71.85	\$66.84		<p><b>Model No. PE9432</b> N FEMALE TO SMA FEMALE MAX VSWR 1.15:1 @ 18 GHz</p>  <table border="0"> <tr> <td>1-24</td> <td>25-49</td> <td></td> </tr> <tr> <td>\$64.55</td> <td>\$60.03</td> <td>PRECISION</td> </tr> <tr> <td>50-99</td> <td>100 +</td> <td>ADAPTER</td> </tr> <tr> <td>\$55.51</td> <td>\$51.64</td> <td></td> </tr> </table>	1-24	25-49		\$64.55	\$60.03	PRECISION	50-99	100 +	ADAPTER	\$55.51	\$51.64		<p><b>Model No. PE9433</b> N FEMALE TO SMA MALE MAX VSWR 1.15:1 @ 18 GHz</p>  <table border="0"> <tr> <td>1-24</td> <td>25-49</td> <td></td> </tr> <tr> <td>\$64.55</td> <td>\$60.03</td> <td>PRECISION</td> </tr> <tr> <td>50-99</td> <td>100 +</td> <td>ADAPTER</td> </tr> <tr> <td>\$55.51</td> <td>\$51.64</td> <td></td> </tr> </table>	1-24	25-49		\$64.55	\$60.03	PRECISION	50-99	100 +	ADAPTER	\$55.51	\$51.64		<p><b>Model No. PE9434</b> N FEMALE TO SMA FEMALE PANEL MOUNT MAX VSWR 1.15:1 @ 18 GHz MOUNTING HOLE A05</p>  <p>PRECISION ADAPTER</p> <table border="0"> <tr> <td>1-24</td> <td>25-49</td> <td></td> </tr> <tr> <td>\$104.45</td> <td>\$97.14</td> <td></td> </tr> <tr> <td>50-99</td> <td>100 +</td> <td></td> </tr> <tr> <td>\$89.83</td> <td>\$83.56</td> <td></td> </tr> </table>	1-24	25-49		\$104.45	\$97.14		50-99	100 +		\$89.83	\$83.56		<p><b>Model No. PE9435</b> N FEMALE TO SMA FEMALE BULKHEAD, NUT ON SMA MAX VSWR 1.15:1 @ 18 GHz MOUNTING HOLE G01</p>  <p>PRECISION ADAPTER</p> <table border="0"> <tr> <td>1-24</td> <td>25-49</td> <td></td> </tr> <tr> <td>\$94.60</td> <td>\$87.98</td> <td></td> </tr> <tr> <td>50-99</td> <td>100 +</td> <td></td> </tr> <tr> <td>\$81.36</td> <td>\$75.68</td> <td></td> </tr> </table>	1-24	25-49		\$94.60	\$87.98		50-99	100 +		\$81.36	\$75.68	
1-24	25-49																																																															
\$83.55	\$77.70	PRECISION																																																														
50-99	100 +	ADAPTER																																																														
\$71.85	\$66.84																																																															
1-24	25-49																																																															
\$64.55	\$60.03	PRECISION																																																														
50-99	100 +	ADAPTER																																																														
\$55.51	\$51.64																																																															
1-24	25-49																																																															
\$64.55	\$60.03	PRECISION																																																														
50-99	100 +	ADAPTER																																																														
\$55.51	\$51.64																																																															
1-24	25-49																																																															
\$104.45	\$97.14																																																															
50-99	100 +																																																															
\$89.83	\$83.56																																																															
1-24	25-49																																																															
\$94.60	\$87.98																																																															
50-99	100 +																																																															
\$81.36	\$75.68																																																															
<p><b>Model No. PE9436</b> 2.92mm MALE TO 2.92mm MALE MAX VSWR 1.10:1 @ 18 GHz 1.15:1 @ 26.5 GHz 1.25:1 @ 40 GHz</p>  <table border="0"> <tr> <td>1-24</td> <td>25-49</td> <td></td> </tr> <tr> <td>\$135.80</td> <td>\$126.29</td> <td>PRECISION</td> </tr> <tr> <td>50-99</td> <td>100 +</td> <td>ADAPTER</td> </tr> <tr> <td>\$116.79</td> <td>\$108.64</td> <td></td> </tr> </table>	1-24	25-49		\$135.80	\$126.29	PRECISION	50-99	100 +	ADAPTER	\$116.79	\$108.64		<p><b>Model No. PE9437</b> 2.92mm MALE TO 2.92mm FEMALE MAX VSWR 1.10:1 @ 18 GHz 1.15:1 @ 26.5 GHz 1.25:1 @ 40 GHz</p>  <table border="0"> <tr> <td>1-24</td> <td>25-49</td> <td></td> </tr> <tr> <td>\$135.80</td> <td>\$126.29</td> <td>PRECISION</td> </tr> <tr> <td>50-99</td> <td>100 +</td> <td>ADAPTER</td> </tr> <tr> <td>\$116.79</td> <td>\$108.64</td> <td></td> </tr> </table>	1-24	25-49		\$135.80	\$126.29	PRECISION	50-99	100 +	ADAPTER	\$116.79	\$108.64		<p><b>Model No. PE9438</b> 2.92mm FEMALE TO 2.92mm FEMALE MAX VSWR 1.10:1 @ 18 GHz 1.15:1 @ 26.5 GHz 1.25:1 @ 40 GHz</p>  <table border="0"> <tr> <td>1-24</td> <td>25-49</td> <td></td> </tr> <tr> <td>\$135.80</td> <td>\$126.29</td> <td>PRECISION</td> </tr> <tr> <td>50-99</td> <td>100 +</td> <td>ADAPTER</td> </tr> <tr> <td>\$116.79</td> <td>\$108.64</td> <td></td> </tr> </table>	1-24	25-49		\$135.80	\$126.29	PRECISION	50-99	100 +	ADAPTER	\$116.79	\$108.64		<p><b>Model No. PE9439</b> TNC MALE TO SMA MALE MAX VSWR 1.25:1 @ 18 GHz</p>  <table border="0"> <tr> <td>1-24</td> <td>25-49</td> <td></td> </tr> <tr> <td>\$78.30</td> <td>\$72.82</td> <td>PRECISION</td> </tr> <tr> <td>50-99</td> <td>100 +</td> <td>ADAPTER</td> </tr> <tr> <td>\$67.34</td> <td>\$62.64</td> <td></td> </tr> </table>	1-24	25-49		\$78.30	\$72.82	PRECISION	50-99	100 +	ADAPTER	\$67.34	\$62.64		<p><b>Model No. PE9440</b> TNC MALE TO SMA FEMALE MAX VSWR 1.25:1 @ 18 GHz</p>  <table border="0"> <tr> <td>1-24</td> <td>25-49</td> <td></td> </tr> <tr> <td>\$78.30</td> <td>\$72.82</td> <td>PRECISION</td> </tr> <tr> <td>50-99</td> <td>100 +</td> <td>ADAPTER</td> </tr> <tr> <td>\$67.34</td> <td>\$62.64</td> <td></td> </tr> </table>	1-24	25-49		\$78.30	\$72.82	PRECISION	50-99	100 +	ADAPTER	\$67.34	\$62.64	
1-24	25-49																																																															
\$135.80	\$126.29	PRECISION																																																														
50-99	100 +	ADAPTER																																																														
\$116.79	\$108.64																																																															
1-24	25-49																																																															
\$135.80	\$126.29	PRECISION																																																														
50-99	100 +	ADAPTER																																																														
\$116.79	\$108.64																																																															
1-24	25-49																																																															
\$135.80	\$126.29	PRECISION																																																														
50-99	100 +	ADAPTER																																																														
\$116.79	\$108.64																																																															
1-24	25-49																																																															
\$78.30	\$72.82	PRECISION																																																														
50-99	100 +	ADAPTER																																																														
\$67.34	\$62.64																																																															
1-24	25-49																																																															
\$78.30	\$72.82	PRECISION																																																														
50-99	100 +	ADAPTER																																																														
\$67.34	\$62.64																																																															
<p><b>Model No. PE9441</b> TNC FEMALE TO SMA MALE MAX VSWR 1.25:1 @ 18 GHz</p>  <table border="0"> <tr> <td>1-24</td> <td>25-49</td> <td></td> </tr> <tr> <td>\$78.30</td> <td>\$72.82</td> <td>PRECISION</td> </tr> <tr> <td>50-99</td> <td>100 +</td> <td>ADAPTER</td> </tr> <tr> <td>\$67.34</td> <td>\$62.64</td> <td></td> </tr> </table>	1-24	25-49		\$78.30	\$72.82	PRECISION	50-99	100 +	ADAPTER	\$67.34	\$62.64		<p><b>Model No. PE9442</b> TNC FEMALE TO SMA FEMALE MAX VSWR 1.25:1 @ 18 GHz</p>  <table border="0"> <tr> <td>1-24</td> <td>25-49</td> <td></td> </tr> <tr> <td>\$83.55</td> <td>\$77.70</td> <td>PRECISION</td> </tr> <tr> <td>50-99</td> <td>100 +</td> <td>ADAPTER</td> </tr> <tr> <td>\$71.85</td> <td>\$66.84</td> <td></td> </tr> </table>	1-24	25-49		\$83.55	\$77.70	PRECISION	50-99	100 +	ADAPTER	\$71.85	\$66.84		<p><b>Model No. PE9443</b> TNC MALE TO TNC FEMALE MAX VSWR 1.25:1 @ 18 GHz</p>  <table border="0"> <tr> <td>1-24</td> <td>25-49</td> <td></td> </tr> <tr> <td>\$83.55</td> <td>\$77.70</td> <td>PRECISION</td> </tr> <tr> <td>50-99</td> <td>100 +</td> <td>ADAPTER</td> </tr> <tr> <td>\$71.85</td> <td>\$66.84</td> <td></td> </tr> </table>	1-24	25-49		\$83.55	\$77.70	PRECISION	50-99	100 +	ADAPTER	\$71.85	\$66.84		<p><b>Model No. PE9444</b> TNC FEMALE TO TNC FEMALE MAX VSWR 1.25:1 @ 18 GHz</p>  <table border="0"> <tr> <td>1-24</td> <td>25-49</td> <td></td> </tr> <tr> <td>\$83.55</td> <td>\$77.70</td> <td>PRECISION</td> </tr> <tr> <td>50-99</td> <td>100 +</td> <td>ADAPTER</td> </tr> <tr> <td>\$71.85</td> <td>\$66.84</td> <td></td> </tr> </table>	1-24	25-49		\$83.55	\$77.70	PRECISION	50-99	100 +	ADAPTER	\$71.85	\$66.84		<p><b>Model No. PE9445</b> TNC MALE TO TNC MALE MAX VSWR 1.25:1 @ 18 GHz</p>  <table border="0"> <tr> <td>1-24</td> <td>25-49</td> <td></td> </tr> <tr> <td>\$83.55</td> <td>\$77.70</td> <td>PRECISION</td> </tr> <tr> <td>50-99</td> <td>100 +</td> <td>ADAPTER</td> </tr> <tr> <td>\$71.85</td> <td>\$66.84</td> <td></td> </tr> </table>	1-24	25-49		\$83.55	\$77.70	PRECISION	50-99	100 +	ADAPTER	\$71.85	\$66.84	
1-24	25-49																																																															
\$78.30	\$72.82	PRECISION																																																														
50-99	100 +	ADAPTER																																																														
\$67.34	\$62.64																																																															
1-24	25-49																																																															
\$83.55	\$77.70	PRECISION																																																														
50-99	100 +	ADAPTER																																																														
\$71.85	\$66.84																																																															
1-24	25-49																																																															
\$83.55	\$77.70	PRECISION																																																														
50-99	100 +	ADAPTER																																																														
\$71.85	\$66.84																																																															
1-24	25-49																																																															
\$83.55	\$77.70	PRECISION																																																														
50-99	100 +	ADAPTER																																																														
\$71.85	\$66.84																																																															
1-24	25-49																																																															
\$83.55	\$77.70	PRECISION																																																														
50-99	100 +	ADAPTER																																																														
\$71.85	\$66.84																																																															
<p><b>Model No. PE9446</b> TNC MALE TO N MALE MAX VSWR 1.15:1 @ 18 GHz</p>  <table border="0"> <tr> <td>1-24</td> <td>25-49</td> <td></td> </tr> <tr> <td>\$94.00</td> <td>\$87.42</td> <td>PRECISION</td> </tr> <tr> <td>50-99</td> <td>100 +</td> <td>ADAPTER</td> </tr> <tr> <td>\$80.84</td> <td>\$75.20</td> <td></td> </tr> </table>	1-24	25-49		\$94.00	\$87.42	PRECISION	50-99	100 +	ADAPTER	\$80.84	\$75.20		<p><b>Model No. PE9447</b> TNC MALE TO N FEMALE MAX VSWR 1.15:1 @ 18 GHz</p>  <table border="0"> <tr> <td>1-24</td> <td>25-49</td> <td></td> </tr> <tr> <td>\$94.00</td> <td>\$87.42</td> <td>PRECISION</td> </tr> <tr> <td>50-99</td> <td>100 +</td> <td>ADAPTER</td> </tr> <tr> <td>\$80.84</td> <td>\$75.20</td> <td></td> </tr> </table>	1-24	25-49		\$94.00	\$87.42	PRECISION	50-99	100 +	ADAPTER	\$80.84	\$75.20		<p><b>Model No. PE9448</b> TNC FEMALE TO N MALE MAX VSWR 1.15:1 @ 18 GHz</p>  <table border="0"> <tr> <td>1-24</td> <td>25-49</td> <td></td> </tr> <tr> <td>\$94.00</td> <td>\$87.42</td> <td>PRECISION</td> </tr> <tr> <td>50-99</td> <td>100 +</td> <td>ADAPTER</td> </tr> <tr> <td>\$80.84</td> <td>\$75.20</td> <td></td> </tr> </table>	1-24	25-49		\$94.00	\$87.42	PRECISION	50-99	100 +	ADAPTER	\$80.84	\$75.20		<p><b>Model No. PE9449</b> TNC FEMALE TO N FEMALE MAX VSWR 1.15:1 @ 18 GHz</p>  <table border="0"> <tr> <td>1-24</td> <td>25-49</td> <td></td> </tr> <tr> <td>\$99.30</td> <td>\$92.35</td> <td>PRECISION</td> </tr> <tr> <td>50-99</td> <td>100 +</td> <td>ADAPTER</td> </tr> <tr> <td>\$85.40</td> <td>\$79.44</td> <td></td> </tr> </table>	1-24	25-49		\$99.30	\$92.35	PRECISION	50-99	100 +	ADAPTER	\$85.40	\$79.44		<p><b>Model No. PE9450</b> TNC FEMALE TO N FEMALE PANEL MOUNT MAX VSWR 1.15:1 @ 18 GHz MOUNTING HOLE A05</p>  <p>PRECISION ADAPTER</p> <table border="0"> <tr> <td>1-24</td> <td>25-49</td> <td></td> </tr> <tr> <td>\$94.00</td> <td>\$87.42</td> <td></td> </tr> <tr> <td>50-99</td> <td>100 +</td> <td></td> </tr> <tr> <td>\$80.84</td> <td>\$75.20</td> <td></td> </tr> </table>	1-24	25-49		\$94.00	\$87.42		50-99	100 +		\$80.84	\$75.20	
1-24	25-49																																																															
\$94.00	\$87.42	PRECISION																																																														
50-99	100 +	ADAPTER																																																														
\$80.84	\$75.20																																																															
1-24	25-49																																																															
\$94.00	\$87.42	PRECISION																																																														
50-99	100 +	ADAPTER																																																														
\$80.84	\$75.20																																																															
1-24	25-49																																																															
\$94.00	\$87.42	PRECISION																																																														
50-99	100 +	ADAPTER																																																														
\$80.84	\$75.20																																																															
1-24	25-49																																																															
\$99.30	\$92.35	PRECISION																																																														
50-99	100 +	ADAPTER																																																														
\$85.40	\$79.44																																																															
1-24	25-49																																																															
\$94.00	\$87.42																																																															
50-99	100 +																																																															
\$80.84	\$75.20																																																															
<p><b>Model No. PE9451</b> 2.4mm MALE TO 2.4mm MALE MAX VSWR 1.10:1 @ 18 GHz 1.20:1 @ 26.5 GHz 1.30:1 @ 50 GHz</p>  <table border="0"> <tr> <td>1-24</td> <td>25-49</td> <td></td> </tr> <tr> <td>\$369.05</td> <td>\$343.22</td> <td>PRECISION</td> </tr> <tr> <td>50-99</td> <td>100 +</td> <td>ADAPTER</td> </tr> <tr> <td>\$317.38</td> <td>\$295.24</td> <td></td> </tr> </table>	1-24	25-49		\$369.05	\$343.22	PRECISION	50-99	100 +	ADAPTER	\$317.38	\$295.24		<p><b>Model No. PE9452</b> 2.4mm MALE TO 2.4mm FEMALE MAX VSWR 1.10:1 @ 18 GHz 1.20:1 @ 26.5 GHz 1.30:1 @ 50 GHz</p>  <table border="0"> <tr> <td>1-24</td> <td>25-49</td> <td></td> </tr> <tr> <td>\$369.05</td> <td>\$343.22</td> <td>PRECISION</td> </tr> <tr> <td>50-99</td> <td>100 +</td> <td>ADAPTER</td> </tr> <tr> <td>\$317.38</td> <td>\$295.24</td> <td></td> </tr> </table>	1-24	25-49		\$369.05	\$343.22	PRECISION	50-99	100 +	ADAPTER	\$317.38	\$295.24		<p><b>Model No. PE9453</b> 2.4mm FEMALE TO 2.4mm FEMALE MAX VSWR 1.10:1 @ 18 GHz 1.20:1 @ 26.5 GHz 1.30:1 @ 50 GHz</p>  <table border="0"> <tr> <td>1-24</td> <td>25-49</td> <td></td> </tr> <tr> <td>\$390.95</td> <td>\$363.58</td> <td>PRECISION</td> </tr> <tr> <td>50-99</td> <td>100 +</td> <td>ADAPTER</td> </tr> <tr> <td>\$336.22</td> <td>\$312.76</td> <td></td> </tr> </table>	1-24	25-49		\$390.95	\$363.58	PRECISION	50-99	100 +	ADAPTER	\$336.22	\$312.76		<p><b>Model No. PE9454</b> 2.4mm MALE TO 2.92mm FEMALE MAX VSWR 1.10:1 @ 18 GHz 1.20:1 @ 26.5 GHz 1.30:1 @ 40 GHz</p>  <table border="0"> <tr> <td>1-24</td> <td>25-49</td> <td></td> </tr> <tr> <td>\$369.05</td> <td>\$343.22</td> <td>PRECISION</td> </tr> <tr> <td>50-99</td> <td>100 +</td> <td>ADAPTER</td> </tr> <tr> <td>\$317.38</td> <td>\$295.24</td> <td></td> </tr> </table>	1-24	25-49		\$369.05	\$343.22	PRECISION	50-99	100 +	ADAPTER	\$317.38	\$295.24		<p><b>Model No. PE9455</b> 2.92mm MALE TO 2.4mm FEMALE MAX VSWR 1.10:1 @ 18 GHz 1.20:1 @ 26.5 GHz 1.30:1 @ 40 GHz</p>  <table border="0"> <tr> <td>1-24</td> <td>25-49</td> <td></td> </tr> <tr> <td>\$369.05</td> <td>\$343.22</td> <td>PRECISION</td> </tr> <tr> <td>50-99</td> <td>100 +</td> <td>ADAPTER</td> </tr> <tr> <td>\$317.38</td> <td>\$295.24</td> <td></td> </tr> </table>	1-24	25-49		\$369.05	\$343.22	PRECISION	50-99	100 +	ADAPTER	\$317.38	\$295.24	
1-24	25-49																																																															
\$369.05	\$343.22	PRECISION																																																														
50-99	100 +	ADAPTER																																																														
\$317.38	\$295.24																																																															
1-24	25-49																																																															
\$369.05	\$343.22	PRECISION																																																														
50-99	100 +	ADAPTER																																																														
\$317.38	\$295.24																																																															
1-24	25-49																																																															
\$390.95	\$363.58	PRECISION																																																														
50-99	100 +	ADAPTER																																																														
\$336.22	\$312.76																																																															
1-24	25-49																																																															
\$369.05	\$343.22	PRECISION																																																														
50-99	100 +	ADAPTER																																																														
\$317.38	\$295.24																																																															
1-24	25-49																																																															
\$369.05	\$343.22	PRECISION																																																														
50-99	100 +	ADAPTER																																																														
\$317.38	\$295.24																																																															

Adapters

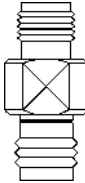
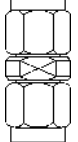
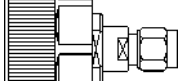
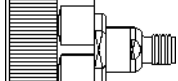
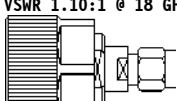
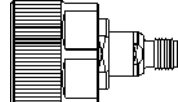
# ADAPTERS

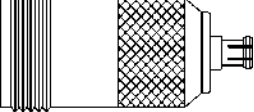
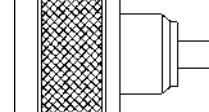
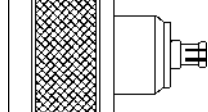
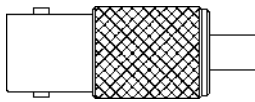
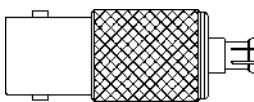
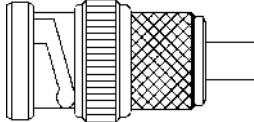
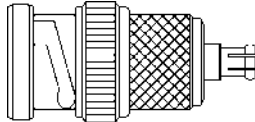
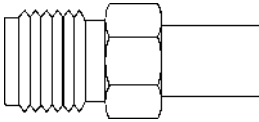
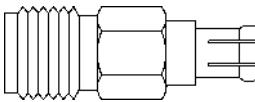
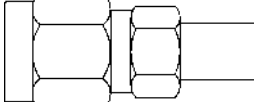
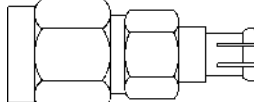
SEE ADAPTER SELECTION CHART ON PAGES 195 THRU 198

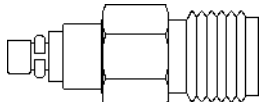
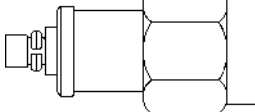
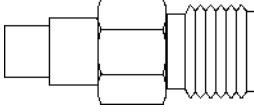
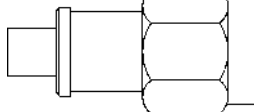
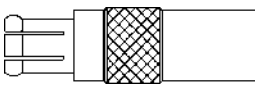
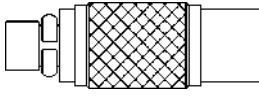
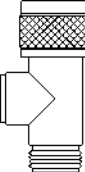

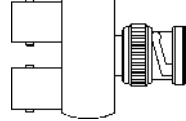
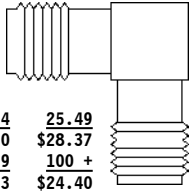

SEE PAGE 266 FOR MOUNTING HOLES

<p><b>Model No. PE9456</b> 2.4mm FEMALE TO 2.92mm FEMALE MAX VSWR 1.10:1 @ 18 GHz 1.20:1 @ 26.5 GHz 1.30:1 @ 40 GHz</p>  <p>1-24 25-49 \$376.40 \$350.05 PRECISION 50-99 100 + ADAPTER \$323.70 \$301.12</p>	<p><b>Model No. PE9457</b> 2.4mm MALE TO 2.92mm MALE MAX VSWR 1.10:1 @ 18 GHz 1.20:1 @ 26.5 GHz 1.30:1 @ 40 GHz</p>  <p>1-24 25-49 \$369.05 \$343.22 PRECISION 50-99 100 + ADAPTER \$317.38 \$295.24</p>	<p><b>Model No. PE9458</b> 7mm TO 2.4mm MALE MAX VSWR 1.10:1 @ 18 GHz</p>  <p>1-24 25-49 \$495.75 \$461.05 PRECISION 50-99 100 + ADAPTER \$426.35 \$396.60</p>	<p><b>Model No. PE9459</b> 7mm TO 2.4mm FEMALE MAX VSWR 1.10:1 @ 18 GHz</p>  <p>1-24 25-49 \$522.45 \$485.88 PRECISION 50-99 100 + ADAPTER \$449.31 \$417.96</p>	<p><b>Model No. PE9460</b> 7mm TO 2.92mm MALE MAX VSWR 1.10:1 @ 18 GHz</p>  <p>1-24 25-49 \$313.45 \$291.51 PRECISION 50-99 100 + ADAPTER \$269.57 \$250.76</p>
<p><b>Model No. PE9461</b> 7mm TO 2.92mm FEMALE MAX VSWR 1.10:1 @ 18 GHz</p>  <p>1-24 25-49 \$313.45 \$291.51 PRECISION 50-99 100 + ADAPTER \$269.57 \$250.76</p>	<p><b>Model No. PE9462</b> N FEMALE TO MCX JACK</p>  <p>1-24 25-49 \$62.65 \$58.26 50-99 100 + \$53.88 \$50.12</p>	<p><b>Model No. PE9463</b> N FEMALE TO MCX PLUG</p>  <p>1-24 25-49 \$62.65 \$58.26 50-99 100 + \$53.88 \$50.12</p>	<p><b>Model No. PE9464</b> N MALE TO MCX JACK</p>  <p>1-24 25-49 \$62.65 \$58.26 50-99 100 + \$53.88 \$50.12</p>	<p><b>Model No. PE9465</b> N MALE TO MCX PLUG</p>  <p>1-24 25-49 \$62.65 \$58.26 50-99 100 + \$53.88 \$50.12</p>
<p><b>Model No. PE9466</b> BNC FEMALE TO MCX JACK</p>  <p>1-24 25-49 \$52.20 \$48.55 50-99 100 + \$44.89 \$41.76</p>	<p><b>Model No. PE9467</b> BNC FEMALE TO MCX PLUG</p>  <p>1-24 25-49 \$52.20 \$48.55 50-99 100 + \$44.89 \$41.76</p>	<p><b>Model No. PE9468</b> BNC MALE TO MCX JACK</p>  <p>1-24 25-49 \$46.95 \$43.66 50-99 100 + \$40.38 \$37.56</p>	<p><b>Model No. PE9469</b> BNC MALE TO MCX PLUG</p>  <p>1-24 25-49 \$41.45 \$38.55 50-99 100 + \$35.65 \$33.16</p>	<p><b>Model No. PE9470</b> SMA FEMALE TO MCX JACK</p>  <p>1-24 25-49 \$44.75 \$41.62 50-99 100 + \$38.49 \$35.80</p>
<p><b>Model No. PE9471</b> SMA FEMALE TO MCX PLUG</p>  <p>1-24 25-49 \$45.60 \$42.41 50-99 100 + \$39.22 \$36.48</p>	<p><b>Model No. PE9472</b> SMA MALE TO MCX JACK</p>  <p>1-24 25-49 \$64.85 \$60.31 50-99 100 + \$55.77 \$51.88</p>	<p><b>Model No. PE9473</b> SMA MALE TO MCX PLUG</p>  <p>1-24 25-49 \$52.20 \$48.55 50-99 100 + \$44.89 \$41.76</p>	<p><b>Model No. PE9474</b> MCX JACK TO MCX JACK BULKHEAD MOUNTING HOLE B01</p>  <p>1-24 25-49 \$13.55 \$12.60 50-99 100 + \$11.65 \$10.84</p>	<p><b>Model No. PE9475</b> MMCX PLUG TO SMA FEMALE</p>  <p>1-24 25-49 \$56.75 \$52.78 50-99 100 + \$48.81 \$45.40</p>
<p><b>Model No. PE9476</b> MMCX PLUG TO SMA MALE</p>  <p>1-24 25-49 \$62.65 \$58.26 50-99 100 + \$53.88 \$50.12</p>	<p><b>Model No. PE9477</b> MMCX JACK TO SMA FEMALE</p>  <p>1-24 25-49 \$55.65 \$51.75 50-99 100 + \$47.86 \$44.52</p>	<p><b>Model No. PE9478</b> MMCX JACK TO SMA MALE</p>  <p>1-24 25-49 \$55.65 \$51.75 50-99 100 + \$47.86 \$44.52</p>	<p><b>Model No. PE9479</b> MCX PLUG TO MCX JACK</p>  <p>1-24 25-49 \$41.75 \$38.83 50-99 100 + \$35.91 \$33.40</p>	<p><b>Model No. PE9480</b> MMCX PLUG TO MMCX JACK</p>  <p>1-24 25-49 \$41.75 \$38.83 50-99 100 + \$35.91 \$33.40</p>
<p><b>Model No. PE9481</b> N "T" MALE-FEMALE-FEMALE</p>  <p>1-24 25-49 \$52.20 \$48.55 50-99 100 + \$44.89 \$41.76</p>	<p><b>Model No. PE9482</b> N FEMALE TO TNC FEMALE BULKHEAD MOUNTING HOLE G01</p>  <p>1-24 25-49 \$30.50 \$28.37 50-99 100 + \$26.23 \$24.40</p>	<p><b>Model No. PE9483</b> BNC FEMALE BULKHEAD TO TNC FEMALE HERMETICALLY SEALED MOUNTING HOLE B06</p>  <p>1-24 25-49 \$30.50 \$28.37 50-99 100 + \$26.23 \$24.40</p>	<p><b>Model No. PE9484</b> BNC "Y" FEMALE-MALE-FEMALE</p>  <p>1-24 25-49 \$30.50 \$28.37 50-99 100 + \$26.23 \$24.40</p>	<p><b>Model No. PE9485</b> SMA FEMALE TO SMA FEMALE RIGHT ANGLE</p>  <p>1-24 25-49 \$30.50 \$28.37 50-99 100 + \$26.23 \$24.40</p>

# ADAPTERS

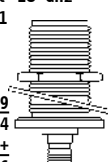
SEE ADAPTER SELECTION CHART ON PAGES 195 THRU 198

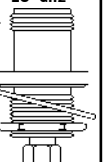
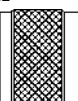
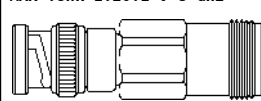
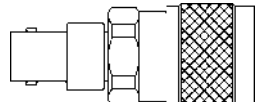
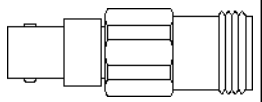
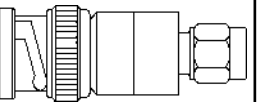
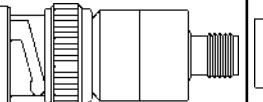
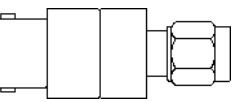
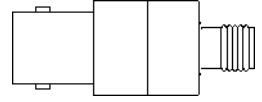
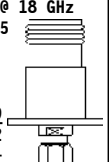
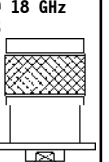
SEE PAGE 266 FOR MOUNTING HOLES

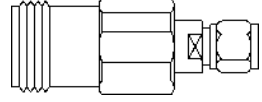
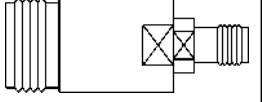
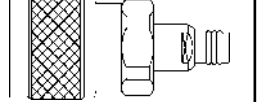
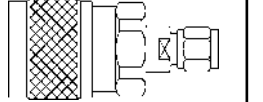
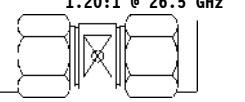
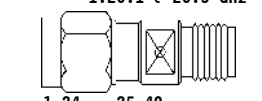
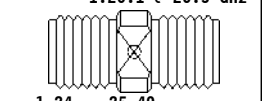
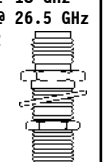
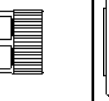
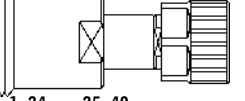
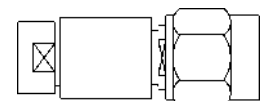
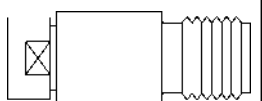
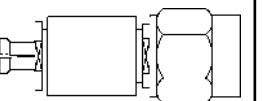
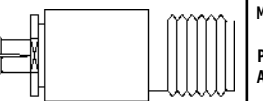
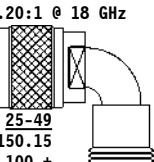
<p>Model No. PE9486 N FEMALE TO SMA FEMALE BULKHEAD MAX VSWR 1.15:1 @ 18 GHz MOUNTING HOLE G01</p>  <p>PRECISION ADAPTER</p> <table border="1"> <tr><td>1-24</td><td>25-49</td></tr> <tr><td>\$104.45</td><td>\$97.14</td></tr> <tr><td>50-99</td><td>100 +</td></tr> <tr><td>\$89.83</td><td>\$83.56</td></tr> </table>	1-24	25-49	\$104.45	\$97.14	50-99	100 +	\$89.83	\$83.56	<p>Model No. PE9487 N FEMALE TO SMA MALE BULKHEAD MAX VSWR 1.15:1 @ 18 GHz MOUNTING HOLE G01</p>  <p>PRECISION ADAPTER</p> <table border="1"> <tr><td>1-24</td><td>25-49</td></tr> <tr><td>\$94.00</td><td>\$87.42</td></tr> <tr><td>50-99</td><td>100 +</td></tr> <tr><td>\$80.84</td><td>\$75.20</td></tr> </table>	1-24	25-49	\$94.00	\$87.42	50-99	100 +	\$80.84	\$75.20	<p>Model No. PE9488 N FEMALE TO SMA MALE BULKHEAD, NUT ON SMA MAX VSWR 1.15:1 @ 18 GHz MOUNTING HOLE G01</p>  <p>PRECISION ADAPTER</p> <table border="1"> <tr><td>1-24</td><td>25-49</td></tr> <tr><td>\$94.00</td><td>\$87.42</td></tr> <tr><td>50-99</td><td>100 +</td></tr> <tr><td>\$80.84</td><td>\$75.20</td></tr> </table>	1-24	25-49	\$94.00	\$87.42	50-99	100 +	\$80.84	\$75.20	<p>Model No. PE9489 BNC MALE TO N MALE VSWR 1.20:1 @ 8 GHz</p>  <p>PRECISION ADAPTER</p> <table border="1"> <tr><td>1-24</td><td>25-49</td></tr> <tr><td>\$94.00</td><td>\$87.42</td></tr> <tr><td>50-99</td><td>100 +</td></tr> <tr><td>\$80.84</td><td>\$75.20</td></tr> </table>	1-24	25-49	\$94.00	\$87.42	50-99	100 +	\$80.84	\$75.20	<p>Model No. PE9490 BNC MALE TO N FEMALE MAX VSWR 1.20:1 @ 8 GHz</p>  <p>PRECISION ADAPTER</p> <table border="1"> <tr><td>1-24</td><td>25-49</td></tr> <tr><td>\$94.00</td><td>\$87.42</td></tr> <tr><td>50-99</td><td>100 +</td></tr> <tr><td>\$80.84</td><td>\$75.20</td></tr> </table>	1-24	25-49	\$94.00	\$87.42	50-99	100 +	\$80.84	\$75.20
1-24	25-49																																											
\$104.45	\$97.14																																											
50-99	100 +																																											
\$89.83	\$83.56																																											
1-24	25-49																																											
\$94.00	\$87.42																																											
50-99	100 +																																											
\$80.84	\$75.20																																											
1-24	25-49																																											
\$94.00	\$87.42																																											
50-99	100 +																																											
\$80.84	\$75.20																																											
1-24	25-49																																											
\$94.00	\$87.42																																											
50-99	100 +																																											
\$80.84	\$75.20																																											
1-24	25-49																																											
\$94.00	\$87.42																																											
50-99	100 +																																											
\$80.84	\$75.20																																											
<p>Model No. PE9491 BNC FEMALE TO N MALE MAX VSWR 1.20:1 @ 8 GHz</p>  <p>PRECISION ADAPTER</p> <table border="1"> <tr><td>1-24</td><td>25-49</td></tr> <tr><td>\$94.00</td><td>\$87.42</td></tr> <tr><td>50-99</td><td>100 +</td></tr> <tr><td>\$80.84</td><td>\$75.20</td></tr> </table>	1-24	25-49	\$94.00	\$87.42	50-99	100 +	\$80.84	\$75.20	<p>Model No. PE9492 BNC FEMALE TO N FEMALE MAX VSWR 1.20:1 @ 8 GHz</p>  <p>PRECISION ADAPTER</p> <table border="1"> <tr><td>1-24</td><td>25-49</td></tr> <tr><td>\$94.00</td><td>\$87.42</td></tr> <tr><td>50-99</td><td>100 +</td></tr> <tr><td>\$80.84</td><td>\$75.20</td></tr> </table>	1-24	25-49	\$94.00	\$87.42	50-99	100 +	\$80.84	\$75.20	<p>Model No. PE9493 BNC MALE TO SMA MALE MAX VSWR 1.25:1 @ 8 GHz</p>  <p>PRECISION ADAPTER</p> <table border="1"> <tr><td>1-24</td><td>25-49</td></tr> <tr><td>\$52.20</td><td>\$48.55</td></tr> <tr><td>50-99</td><td>100 +</td></tr> <tr><td>\$44.89</td><td>\$41.76</td></tr> </table>	1-24	25-49	\$52.20	\$48.55	50-99	100 +	\$44.89	\$41.76	<p>Model No. PE9494 BNC MALE TO SMA FEMALE MAX VSWR 1.25:1 @ 8 GHz</p>  <p>PRECISION ADAPTER</p> <table border="1"> <tr><td>1-24</td><td>25-49</td></tr> <tr><td>\$46.75</td><td>\$43.48</td></tr> <tr><td>50-99</td><td>100 +</td></tr> <tr><td>\$40.21</td><td>\$37.40</td></tr> </table>	1-24	25-49	\$46.75	\$43.48	50-99	100 +	\$40.21	\$37.40	<p>Model No. PE9495 BNC FEMALE TO SMA MALE MAX VSWR 1.25:1 @ 8 GHz</p>  <p>PRECISION ADAPTER</p> <table border="1"> <tr><td>1-24</td><td>25-49</td></tr> <tr><td>\$94.00</td><td>\$87.42</td></tr> <tr><td>50-99</td><td>100 +</td></tr> <tr><td>\$80.84</td><td>\$75.20</td></tr> </table>	1-24	25-49	\$94.00	\$87.42	50-99	100 +	\$80.84	\$75.20
1-24	25-49																																											
\$94.00	\$87.42																																											
50-99	100 +																																											
\$80.84	\$75.20																																											
1-24	25-49																																											
\$94.00	\$87.42																																											
50-99	100 +																																											
\$80.84	\$75.20																																											
1-24	25-49																																											
\$52.20	\$48.55																																											
50-99	100 +																																											
\$44.89	\$41.76																																											
1-24	25-49																																											
\$46.75	\$43.48																																											
50-99	100 +																																											
\$40.21	\$37.40																																											
1-24	25-49																																											
\$94.00	\$87.42																																											
50-99	100 +																																											
\$80.84	\$75.20																																											
<p>Model No. PE9496 BNC FEMALE TO SMA FEMALE MAX VSWR 1.25:1 @ 8 GHz</p>  <p>PRECISION ADAPTER</p> <table border="1"> <tr><td>1-24</td><td>25-49</td></tr> <tr><td>\$52.20</td><td>\$48.55</td></tr> <tr><td>50-99</td><td>100 +</td></tr> <tr><td>\$44.89</td><td>\$41.76</td></tr> </table>	1-24	25-49	\$52.20	\$48.55	50-99	100 +	\$44.89	\$41.76	<p>Model No. PE9497 N FEMALE TO SMA MALE PANEL MOUNT MAX VSWR 1.15:1 @ 18 GHz MOUNTING HOLE A05</p>  <p>PRECISION ADAPTER</p> <table border="1"> <tr><td>1-24</td><td>25-49</td></tr> <tr><td>\$94.00</td><td>\$87.42</td></tr> <tr><td>50-99</td><td>100 +</td></tr> <tr><td>\$80.84</td><td>\$75.20</td></tr> </table>	1-24	25-49	\$94.00	\$87.42	50-99	100 +	\$80.84	\$75.20	<p>Model No. PE9498 N MALE TO SMA FEMALE PANEL MOUNT MAX VSWR 1.15:1 @ 18 GHz MOUNTING HOLE A05</p>  <p>PRECISION ADAPTER</p> <table border="1"> <tr><td>1-24</td><td>25-49</td></tr> <tr><td>\$94.00</td><td>\$87.42</td></tr> <tr><td>50-99</td><td>100 +</td></tr> <tr><td>\$80.84</td><td>\$75.20</td></tr> </table>	1-24	25-49	\$94.00	\$87.42	50-99	100 +	\$80.84	\$75.20	<p>Model No. PE9499 N MALE TO SMA MALE PANEL MOUNT MAX VSWR 1.15:1 @ 18 GHz MOUNTING HOLE A05</p>  <p>PRECISION ADAPTER</p> <table border="1"> <tr><td>1-24</td><td>25-49</td></tr> <tr><td>\$94.00</td><td>\$87.42</td></tr> <tr><td>50-99</td><td>100 +</td></tr> <tr><td>\$80.84</td><td>\$75.20</td></tr> </table>	1-24	25-49	\$94.00	\$87.42	50-99	100 +	\$80.84	\$75.20	<p>Model No. PE9500 N FEMALE TO N FEMALE BULKHEAD MAX VSWR 1.15:1 @ 18 GHz MOUNTING HOLE G01</p>  <p>PRECISION ADAPTER</p> <table border="1"> <tr><td>1-24</td><td>25-49</td></tr> <tr><td>\$130.55</td><td>\$121.41</td></tr> <tr><td>50-99</td><td>100 +</td></tr> <tr><td>\$112.27</td><td>\$104.44</td></tr> </table>	1-24	25-49	\$130.55	\$121.41	50-99	100 +	\$112.27	\$104.44
1-24	25-49																																											
\$52.20	\$48.55																																											
50-99	100 +																																											
\$44.89	\$41.76																																											
1-24	25-49																																											
\$94.00	\$87.42																																											
50-99	100 +																																											
\$80.84	\$75.20																																											
1-24	25-49																																											
\$94.00	\$87.42																																											
50-99	100 +																																											
\$80.84	\$75.20																																											
1-24	25-49																																											
\$94.00	\$87.42																																											
50-99	100 +																																											
\$80.84	\$75.20																																											
1-24	25-49																																											
\$130.55	\$121.41																																											
50-99	100 +																																											
\$112.27	\$104.44																																											
<p>Model No. PE9501 N FEMALE TO 2.4mm MALE MAX VSWR 1.15:1 @ 18 GHz</p>  <p>PRECISION ADAPTER</p> <table border="1"> <tr><td>1-24</td><td>25-49</td></tr> <tr><td>\$156.70</td><td>\$145.73</td></tr> <tr><td>50-99</td><td>100 +</td></tr> <tr><td>\$134.76</td><td>\$125.36</td></tr> </table>	1-24	25-49	\$156.70	\$145.73	50-99	100 +	\$134.76	\$125.36	<p>Model No. PE9502 N FEMALE TO 2.4mm FEMALE MAX VSWR 1.15:1 @ 18 GHz</p>  <p>PRECISION ADAPTER</p> <table border="1"> <tr><td>1-24</td><td>25-49</td></tr> <tr><td>\$156.70</td><td>\$145.73</td></tr> <tr><td>50-99</td><td>100 +</td></tr> <tr><td>\$134.76</td><td>\$125.36</td></tr> </table>	1-24	25-49	\$156.70	\$145.73	50-99	100 +	\$134.76	\$125.36	<p>Model No. PE9503 N MALE TO 2.4mm FEMALE MAX VSWR 1.15:1 @ 18 GHz</p>  <p>PRECISION ADAPTER</p> <table border="1"> <tr><td>1-24</td><td>25-49</td></tr> <tr><td>\$156.70</td><td>\$145.73</td></tr> <tr><td>50-99</td><td>100 +</td></tr> <tr><td>\$134.76</td><td>\$125.36</td></tr> </table>	1-24	25-49	\$156.70	\$145.73	50-99	100 +	\$134.76	\$125.36	<p>Model No. PE9504 N MALE TO 2.4mm MALE MAX VSWR 1.15:1 @ 18 GHz</p>  <p>PRECISION ADAPTER</p> <table border="1"> <tr><td>1-24</td><td>25-49</td></tr> <tr><td>\$125.35</td><td>\$116.58</td></tr> <tr><td>50-99</td><td>100 +</td></tr> <tr><td>\$107.80</td><td>\$100.28</td></tr> </table>	1-24	25-49	\$125.35	\$116.58	50-99	100 +	\$107.80	\$100.28	<p>Model No. PE9505 SMA MALE TO SMA MALE MAX VSWR 1.15:1 @ 18 GHz 1.20:1 @ 26.5 GHz</p>  <p>PRECISION ADAPTER</p> <table border="1"> <tr><td>1-24</td><td>25-49</td></tr> <tr><td>\$47.90</td><td>\$44.55</td></tr> <tr><td>50-99</td><td>100 +</td></tr> <tr><td>\$41.19</td><td>\$38.32</td></tr> </table>	1-24	25-49	\$47.90	\$44.55	50-99	100 +	\$41.19	\$38.32
1-24	25-49																																											
\$156.70	\$145.73																																											
50-99	100 +																																											
\$134.76	\$125.36																																											
1-24	25-49																																											
\$156.70	\$145.73																																											
50-99	100 +																																											
\$134.76	\$125.36																																											
1-24	25-49																																											
\$156.70	\$145.73																																											
50-99	100 +																																											
\$134.76	\$125.36																																											
1-24	25-49																																											
\$125.35	\$116.58																																											
50-99	100 +																																											
\$107.80	\$100.28																																											
1-24	25-49																																											
\$47.90	\$44.55																																											
50-99	100 +																																											
\$41.19	\$38.32																																											
<p>Model No. PE9506 SMA MALE TO SMA FEMALE MAX VSWR 1.15:1 @ 18 GHz 1.20:1 @ 26.5 GHz</p>  <p>PRECISION ADAPTER</p> <table border="1"> <tr><td>1-24</td><td>25-49</td></tr> <tr><td>\$38.95</td><td>\$36.22</td></tr> <tr><td>50-99</td><td>100 +</td></tr> <tr><td>\$33.50</td><td>\$31.16</td></tr> </table>	1-24	25-49	\$38.95	\$36.22	50-99	100 +	\$33.50	\$31.16	<p>Model No. PE9507 SMA FEMALE TO SMA FEMALE MAX VSWR 1.15:1 @ 18 GHz 1.20:1 @ 26.5 GHz</p>  <p>PRECISION ADAPTER</p> <table border="1"> <tr><td>1-24</td><td>25-49</td></tr> <tr><td>\$41.10</td><td>\$38.22</td></tr> <tr><td>50-99</td><td>100 +</td></tr> <tr><td>\$35.35</td><td>\$32.88</td></tr> </table>	1-24	25-49	\$41.10	\$38.22	50-99	100 +	\$35.35	\$32.88	<p>Model No. PE9508 SMA FEMALE TO SMA FEMALE BULKHEAD MAX VSWR 1.15:1 @ 18 GHz 1.30:1 @ 26.5 GHz MOUNTING HOLE B02</p>  <p>PRECISION ADAPTER</p> <table border="1"> <tr><td>1-24</td><td>25-49</td></tr> <tr><td>\$83.55</td><td>\$77.70</td></tr> <tr><td>50-99</td><td>100 +</td></tr> <tr><td>\$71.85</td><td>\$66.84</td></tr> </table>	1-24	25-49	\$83.55	\$77.70	50-99	100 +	\$71.85	\$66.84	<p>Model No. PE9509 7/16 MALE TO 7mm MAX VSWR 1.35:1 @ 7 GHz</p>  <p>PRECISION ADAPTER</p> <table border="1"> <tr><td>1-24</td><td>25-49</td></tr> <tr><td>\$271.65</td><td>\$252.63</td></tr> <tr><td>50-99</td><td>100 +</td></tr> <tr><td>\$233.62</td><td>\$217.32</td></tr> </table>	1-24	25-49	\$271.65	\$252.63	50-99	100 +	\$233.62	\$217.32	<p>Model No. PE9510 7/16 FEMALE TO 7mm MAX VSWR 1.35:1 @ 7 GHz</p>  <p>PRECISION ADAPTER</p> <table border="1"> <tr><td>1-24</td><td>25-49</td></tr> <tr><td>\$313.45</td><td>\$291.51</td></tr> <tr><td>50-99</td><td>100 +</td></tr> <tr><td>\$269.57</td><td>\$250.76</td></tr> </table>	1-24	25-49	\$313.45	\$291.51	50-99	100 +	\$269.57	\$250.76
1-24	25-49																																											
\$38.95	\$36.22																																											
50-99	100 +																																											
\$33.50	\$31.16																																											
1-24	25-49																																											
\$41.10	\$38.22																																											
50-99	100 +																																											
\$35.35	\$32.88																																											
1-24	25-49																																											
\$83.55	\$77.70																																											
50-99	100 +																																											
\$71.85	\$66.84																																											
1-24	25-49																																											
\$271.65	\$252.63																																											
50-99	100 +																																											
\$233.62	\$217.32																																											
1-24	25-49																																											
\$313.45	\$291.51																																											
50-99	100 +																																											
\$269.57	\$250.76																																											
<p>Model No. PE9511 SMP MALE TO SMA MALE MAX VSWR 1.20:1 @ 18 GHz</p>  <p>PRECISION ADAPTER</p> <table border="1"> <tr><td>1-24</td><td>25-49</td></tr> <tr><td>\$83.55</td><td>\$77.70</td></tr> <tr><td>50-99</td><td>100 +</td></tr> <tr><td>\$71.85</td><td>\$66.84</td></tr> </table>	1-24	25-49	\$83.55	\$77.70	50-99	100 +	\$71.85	\$66.84	<p>Model No. PE9512 SMP MALE TO SMA FEMALE MAX VSWR 1.20:1 @ 18 GHz</p>  <p>PRECISION ADAPTER</p> <table border="1"> <tr><td>1-24</td><td>25-49</td></tr> <tr><td>\$97.00</td><td>\$90.21</td></tr> <tr><td>50-99</td><td>100 +</td></tr> <tr><td>\$83.42</td><td>\$77.60</td></tr> </table>	1-24	25-49	\$97.00	\$90.21	50-99	100 +	\$83.42	\$77.60	<p>Model No. PE9513 SMP FEMALE TO SMA MALE MAX VSWR 1.20:1 @ 18 GHz</p>  <p>PRECISION ADAPTER</p> <table border="1"> <tr><td>1-24</td><td>25-49</td></tr> <tr><td>\$94.00</td><td>\$87.42</td></tr> <tr><td>50-99</td><td>100 +</td></tr> <tr><td>\$80.84</td><td>\$75.20</td></tr> </table>	1-24	25-49	\$94.00	\$87.42	50-99	100 +	\$80.84	\$75.20	<p>Model No. PE9514 SMP FEMALE TO SMA FEMALE MAX VSWR 1.20:1 @ 18 GHz</p>  <p>PRECISION ADAPTER</p> <table border="1"> <tr><td>1-24</td><td>25-49</td></tr> <tr><td>\$104.45</td><td>\$97.14</td></tr> <tr><td>50-99</td><td>100 +</td></tr> <tr><td>\$89.83</td><td>\$83.56</td></tr> </table>	1-24	25-49	\$104.45	\$97.14	50-99	100 +	\$89.83	\$83.56	<p>Model No. PE9515 N MALE TO N FEMALE RADIUS RIGHT ANGLE MAX VSWR 1.20:1 @ 18 GHz</p>  <p>PRECISION ADAPTER</p> <table border="1"> <tr><td>1-24</td><td>25-49</td></tr> <tr><td>\$161.45</td><td>\$150.15</td></tr> <tr><td>50-99</td><td>100 +</td></tr> <tr><td>\$138.85</td><td>\$129.16</td></tr> </table>	1-24	25-49	\$161.45	\$150.15	50-99	100 +	\$138.85	\$129.16
1-24	25-49																																											
\$83.55	\$77.70																																											
50-99	100 +																																											
\$71.85	\$66.84																																											
1-24	25-49																																											
\$97.00	\$90.21																																											
50-99	100 +																																											
\$83.42	\$77.60																																											
1-24	25-49																																											
\$94.00	\$87.42																																											
50-99	100 +																																											
\$80.84	\$75.20																																											
1-24	25-49																																											
\$104.45	\$97.14																																											
50-99	100 +																																											
\$89.83	\$83.56																																											
1-24	25-49																																											
\$161.45	\$150.15																																											
50-99	100 +																																											
\$138.85	\$129.16																																											

# ADAPTERS

SEE ADAPTER SELECTION CHART ON PAGES 195 THRU 198

SEE PAGE 266 FOR MOUNTING HOLES

Model No. PE9516  
BNC FEMALE TO MMCX JACK

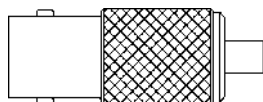

1-24	25-49
\$57.40	\$53.38
50-99	100 +
\$49.36	\$45.92

Model No. PE9517  
BNC MALE TO MMCX PLUG

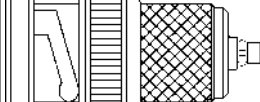

1-24	25-49
\$57.40	\$53.38
50-99	100 +
\$49.36	\$45.92

Model No. PE9518  
BNC MALE TO MMCX JACK

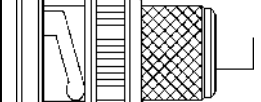

1-24	25-49
\$57.40	\$53.38
50-99	100 +
\$49.36	\$45.92

Model No. PE9519  
BNC FEMALE TO MMCX PLUG

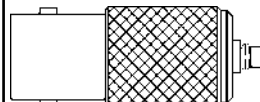

1-24	25-49
\$63.85	\$59.38
50-99	100 +
\$54.91	\$51.08

Model No. PE9520  
BNC FEMALE TO  
MCX JACK BULKHEAD  
MOUNTING HOLE B04



1-24	25-49
\$57.40	\$53.38
50-99	100 +
\$49.36	\$45.92

Model No. PE9521  
MCX JACK BULKHEAD TO  
TNC FEMALE  
MOUNTING HOLE B04

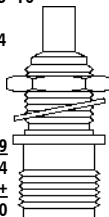

1-24	25-49
\$59.50	\$55.34
50-99	100 +
\$51.17	\$47.60

Model No. PE9522  
MMCX JACK TO MMCX JACK  
BULKHEAD  
MOUNTING HOLE B01



1-24	25-49
\$46.95	\$43.66
50-99	100 +
\$40.38	\$37.56

Model No. PE9523  
MMCX JACK TO MMCX JACK

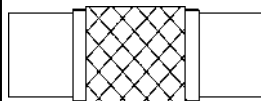

1-24	25-49
\$41.75	\$38.83
50-99	100 +
\$35.91	\$33.40

Model No. PE9524  
MCX JACK TO MCX JACK

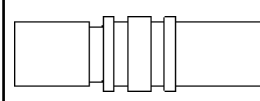

1-24	25-49
\$10.40	\$9.67
50-99	100 +
\$8.94	\$8.32

Model No. PE9525  
MCX JACK TO MMCX PLUG

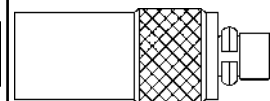

1-24	25-49
\$52.20	\$48.55
50-99	100 +
\$44.89	\$41.76

Model No. PE9526  
MCX JACK TO MMCX JACK

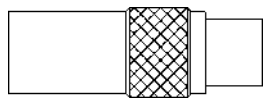

1-24	25-49
\$52.20	\$48.55
50-99	100 +
\$44.89	\$41.76

Model No. PE9527  
MCX PLUG TO MMCX PLUG

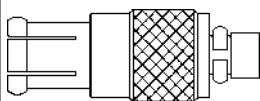

1-24	25-49
\$52.20	\$48.55
50-99	100 +
\$44.89	\$41.76

Model No. PE9528  
MCX PLUG TO MMCX JACK

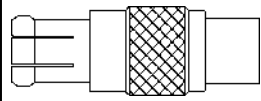

1-24	25-49
\$52.20	\$48.55
50-99	100 +
\$44.89	\$41.76

Model No. PE9529  
REVERSE POLARITY BNC MALE  
TO STANDARD BNC FEMALE

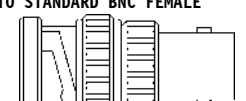

1-24	25-49
\$26.05	\$24.23
50-99	100 +
\$22.40	\$20.84

Model No. PE9530  
REVERSE POLARITY BNC FEMALE  
TO STANDARD BNC MALE

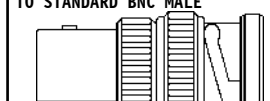

1-24	25-49
\$26.05	\$24.23
50-99	100 +
\$22.40	\$20.84

Model No. PE9531  
REVERSE POLARITY TNC MALE  
TO STANDARD TNC FEMALE

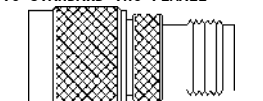

1-24	25-49
\$26.05	\$24.23
50-99	100 +
\$22.40	\$20.84

Model No. PE9532  
REVERSE POLARITY TNC  
FEMALE TO STANDARD TNC  
MALE

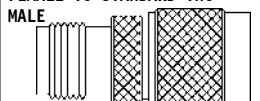

1-24	25-49
\$26.05	\$24.23
50-99	100 +
\$22.40	\$20.84

Model No. PE9533  
REVERSE POLARITY SMA MALE  
TO STANDARD SMA FEMALE

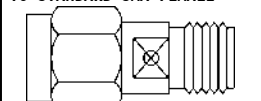

1-24	25-49
\$21.25	\$19.76
50-99	100 +
\$18.28	\$17.00

Model No. PE9534  
REVERSE POLARITY SMA  
FEMALE TO STANDARD SMA  
MALE

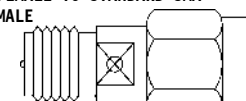

1-24	25-49
\$30.00	\$27.90
50-99	100 +
\$25.80	\$24.00

Model No. PE9535  
N MALE TO 7/16 MALE

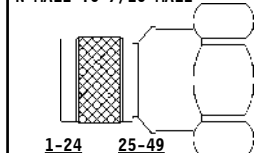

1-24	25-49
\$126.60	\$117.74
50-99	100 +
\$108.88	\$101.28

Model No. PE9536  
BNC MALE TO C MALE

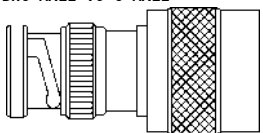

1-24	25-49
\$41.75	\$38.83
50-99	100 +
\$35.91	\$33.40

Model No. PE9537  
BNC FEMALE TO C FEMALE

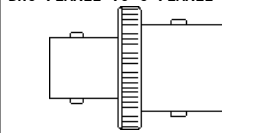

1-24	25-49
\$41.75	\$38.83
50-99	100 +
\$35.91	\$33.40

Model No. PE9538  
N MALE TO C MALE

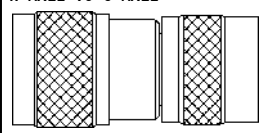

1-24	25-49
\$41.75	\$38.83
50-99	100 +
\$35.91	\$33.40

Model No. PE9539  
C FEMALE TO N FEMALE

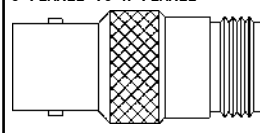

1-24	25-49
\$41.75	\$38.83
50-99	100 +
\$35.91	\$33.40

Model No. PE9540  
BNC FEMALE TO N FEMALE  
BULKHEAD, MOUNTS FROM N  
FEMALE SIDE  
MOUNTING HOLE G01

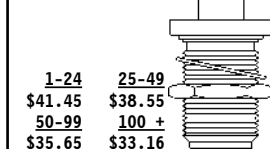

1-24	25-49
\$41.45	\$38.55
50-99	100 +
\$35.65	\$33.16

Model No. PE9541  
N FEMALE TO N FEMALE  
BULKHEAD, RIGHT ANGLE  
MOUNTING HOLE G01

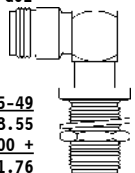

1-24	25-49
\$52.20	\$48.55
50-99	100 +
\$44.89	\$41.76

Model No. PE9542  
TNC MALE TO MCX JACK

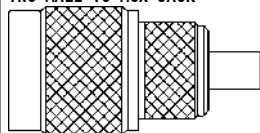

1-24	25-49
\$45.60	\$42.41
50-99	100 +
\$39.22	\$36.48

Model No. PE9543  
TNC MALE TO MCX PLUG

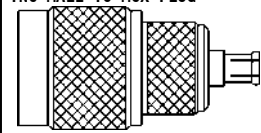

1-24	25-49
\$52.20	\$48.55
50-99	100 +
\$44.89	\$41.76

Model No. PE9544  
TNC FEMALE TO MCX JACK

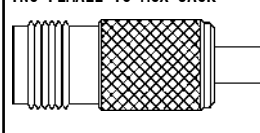

1-24	25-49
\$52.20	\$48.55
50-99	100 +
\$44.89	\$41.76

Model No. PE9545  
TNC FEMALE TO MCX PLUG

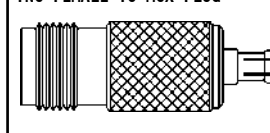

1-24	25-49
\$52.20	\$48.55
50-99	100 +
\$44.89	\$41.76

# ADAPTERS

SEE ADAPTER SELECTION CHART ON PAGES 195 THRU 198

SEE PAGE 266 FOR MOUNTING HOLES

**Model No. PE9546**  
SMA MALE QUICK DISCONNECT  
TO SMA FEMALE

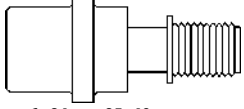

1-24	25-49
\$99.35	\$92.40
50-99	100 +
\$85.44	\$79.48

**Model No. PE9547**  
N MALE QUICK DISCONNECT  
TO N FEMALE



1-24	25-49
\$114.90	\$106.86
50-99	100 +
\$98.81	\$91.92

**Model No. PE9548**  
N CROSS FEMALE-FEMALE-  
FEMALE-FEMALE

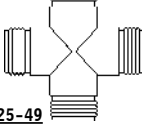

1-24	25-49
\$52.20	\$48.55
50-99	100 +
\$44.89	\$41.76

**Model No. PE9549**  
N CROSS FEMALE-FEMALE-  
FEMALE-MALE

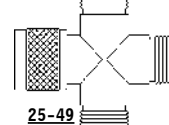

1-24	25-49
\$52.20	\$48.55
50-99	100 +
\$44.89	\$41.76

**Model No. PE9550**  
N MALE RIGHT ANGLE TO  
TNC FEMALE

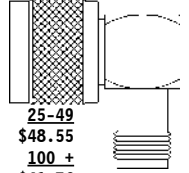

1-24	25-49
\$52.20	\$48.55
50-99	100 +
\$44.89	\$41.76

**Model No. PE9551**  
N MALE TO SMA FEMALE  
BULKHEAD  
MOUNTING HOLE B09



1-24	25-49
\$41.75	\$38.83
50-99	100 +
\$35.91	\$33.40

**Model No. PE9552**  
N FEMALE TO TNC FEMALE  
PANEL MOUNT  
MOUNTING HOLE A05

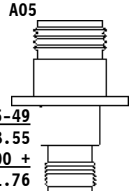

1-24	25-49
\$52.20	\$48.55
50-99	100 +
\$44.89	\$41.76

**Model No. PE9553**  
N FEMALE TO HN FEMALE  
PANEL MOUNT  
MOUNTING HOLE A08

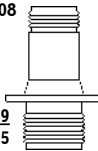

1-24	25-49
\$52.20	\$48.55
50-99	100 +
\$44.89	\$41.76

**Model No. PE9554**  
N MALE TO HN MALE

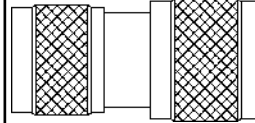

1-24	25-49
\$52.20	\$48.55
50-99	100 +
\$44.89	\$41.76

**Model No. PE9555**  
7/16 MALE TO 7/16 MALE

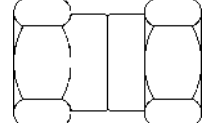

1-24	25-49
\$83.55	\$77.70
50-99	100 +
\$71.85	\$66.84

**Model No. PE9556**  
7/16 "T" FEMALE-FEMALE-  
FEMALE

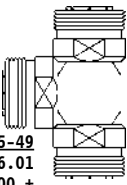

1-24	25-49
\$146.25	\$136.01
50-99	100 +
\$125.78	\$117.00

**Model No. PE9557**  
7/16 "T" FEMALE-MALE-  
FEMALE

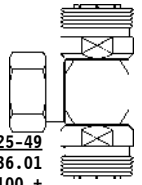

1-24	25-49
\$146.25	\$136.01
50-99	100 +
\$125.78	\$117.00

**Model No. PE9558**  
7/16 MALE TO HN FEMALE

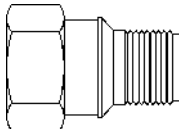

1-24	25-49
\$104.45	\$97.14
50-99	100 +
\$89.83	\$83.56

**Model No. PE9559**  
7/16 FEMALE TO HN MALE

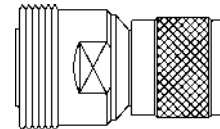

1-24	25-49
\$104.45	\$97.14
50-99	100 +
\$89.83	\$83.56

**Model No. PE9560**  
TNC MALE TO TNC MALE  
RIGHT ANGLE

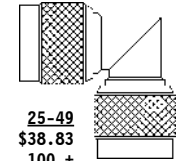

1-24	25-49
41.75	\$38.83
50-99	100 +
\$35.91	\$33.40

**Model No. PE9561**  
TNC MALE QUICK DISCONNECT  
TO TNC FEMALE

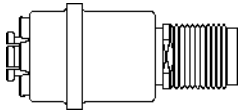

1-24	25-49
\$94.00	\$87.42
50-99	100 +
\$80.84	\$75.20

**Model No. PE9562**  
TNC MALE TO C FEMALE

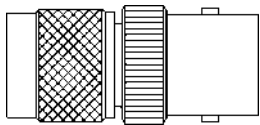

1-24	25-49
\$52.35	\$48.69
50-99	100 +
\$45.02	\$41.88

**Model No. PE9563**  
TNC MALE TO HN MALE

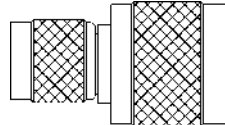

1-24	25-49
\$52.35	\$48.69
50-99	100 +
\$45.02	\$41.88

**Model No. PE9564**  
TNC FEMALE TO C MALE

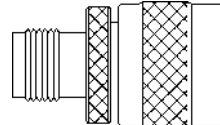

1-24	25-49
\$67.65	\$62.91
50-99	100 +
\$58.18	\$54.12

**Model No. PE9565**  
BNC MALE TO N MALE  
RIGHT ANGLE

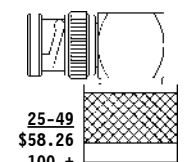

1-24	25-49
\$62.65	\$58.26
50-99	100 +
\$53.88	50.12

**Model No. PE9566**  
BNC MALE TO N FEMALE  
RIGHT ANGLE

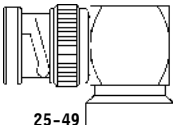

1-24	25-49
\$42.60	\$39.62
50-99	100 +
\$36.64	\$34.08

**Model No. PE9567**  
BNC MALE TO HN MALE

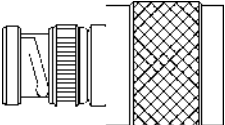

1-24	25-49
\$52.35	\$48.69
50-99	100 +
\$45.02	\$41.88

**Model No. PE9568**  
BNC MALE TO SC MALE

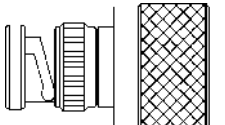

1-24	25-49
\$73.10	\$67.98
50-99	100 +
\$62.87	\$58.48

**Model No. PE9569**  
LC MALE TO LC MALE

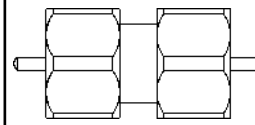

1-24	25-49
\$177.60	\$165.17
50-99	100 +
\$152.74	\$142.08

**Model No. PE9570**  
SC MALE TO N MALE

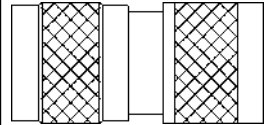

1-24	25-49
\$73.10	\$67.98
50-99	100 +
\$62.87	\$58.48

**Model No. PE9571**  
SC FEMALE TO BNC FEMALE

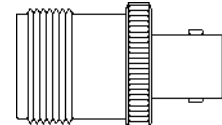

1-24	25-49
\$73.10	\$67.98
50-99	100 +
\$62.87	\$58.48

**Model No. PE9572**  
SC MALE TO SC FEMALE

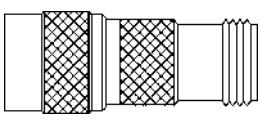

1-24	25-49
\$73.10	\$67.98
50-99	100 +
\$62.87	\$58.48

**Model No. PE9573**  
SC FEMALE TO SC FEMALE  
BULKHEAD  
MOUNTING HOLE B11

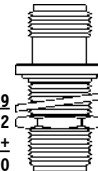

1-24	25-49
\$94.00	\$87.42
50-99	100 +
\$80.84	\$75.20

**Model No. PE9574**  
HN "T" FEMALE-FEMALE-  
FEMALE

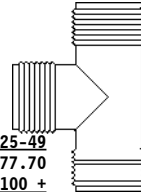

1-24	25-49
\$83.55	\$77.70
50-99	100 +
\$71.85	\$66.84

**Model No. PE9575**  
HN "T" FEMALE-MALE-  
FEMALE

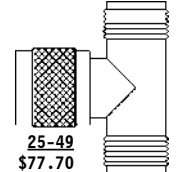



1-24	25-49
\$83.55	\$77.70
50-99	100 +
\$71.85	\$66.84

Adapters

# ADAPTERS

SEE ADAPTER SELECTION CHART ON PAGES 195 THRU 198

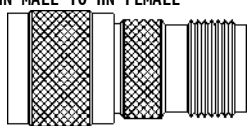
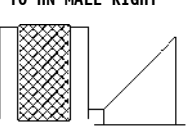
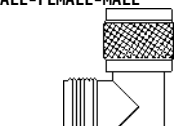
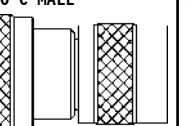
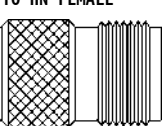
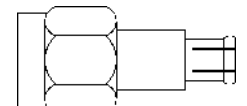
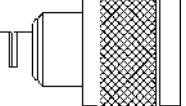
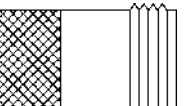
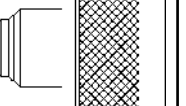
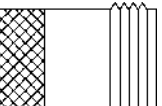
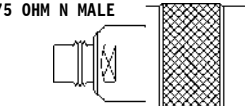
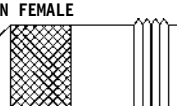
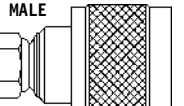
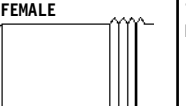
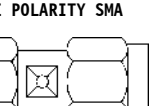
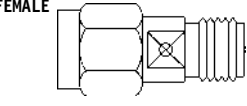
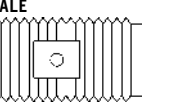

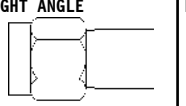
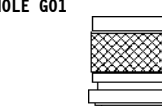
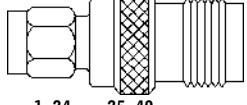
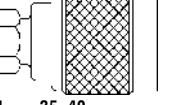
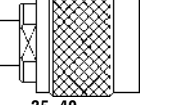
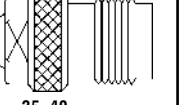
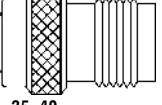
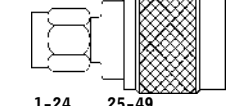
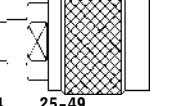
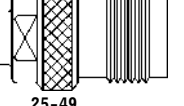
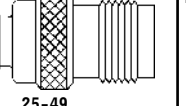
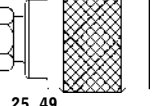



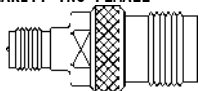
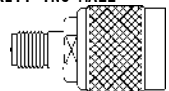
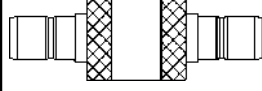
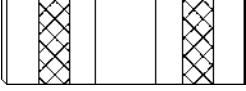

SEE PAGE 266 FOR MOUNTING HOLES

<p><b>Model No. PE9576</b> HN MALE TO HN FEMALE</p>  <table border="0"> <tr> <td>1-24</td> <td>25-49</td> </tr> <tr> <td>\$62.65</td> <td>\$58.26</td> </tr> <tr> <td>50-99</td> <td>100 +</td> </tr> <tr> <td>\$53.88</td> <td>\$50.12</td> </tr> </table>	1-24	25-49	\$62.65	\$58.26	50-99	100 +	\$53.88	\$50.12	<p><b>Model No. PE9577</b> HN MALE TO HN MALE RIGHT ANGLE</p>  <table border="0"> <tr> <td>1-24</td> <td>25-49</td> </tr> <tr> <td>\$73.10</td> <td>\$67.98</td> </tr> <tr> <td>50-99</td> <td>100 +</td> </tr> <tr> <td>\$62.87</td> <td>\$58.48</td> </tr> </table>	1-24	25-49	\$73.10	\$67.98	50-99	100 +	\$62.87	\$58.48	<p><b>Model No. PE9578</b> HN "T" MALE-FEMALE-MALE</p>  <table border="0"> <tr> <td>1-24</td> <td>25-49</td> </tr> <tr> <td>\$83.55</td> <td>\$77.70</td> </tr> <tr> <td>50-99</td> <td>100 +</td> </tr> <tr> <td>\$71.85</td> <td>\$66.84</td> </tr> </table>	1-24	25-49	\$83.55	\$77.70	50-99	100 +	\$71.85	\$66.84	<p><b>Model No. PE9579</b> HN MALE TO C MALE</p>  <table border="0"> <tr> <td>1-24</td> <td>25-49</td> </tr> <tr> <td>\$62.65</td> <td>\$58.26</td> </tr> <tr> <td>50-99</td> <td>100 +</td> </tr> <tr> <td>\$53.88</td> <td>\$50.12</td> </tr> </table>	1-24	25-49	\$62.65	\$58.26	50-99	100 +	\$53.88	\$50.12	<p><b>Model No. PE9580</b> HN FEMALE TO HN FEMALE</p>  <table border="0"> <tr> <td>1-24</td> <td>25-49</td> </tr> <tr> <td>\$36.50</td> <td>\$33.95</td> </tr> <tr> <td>50-99</td> <td>100 +</td> </tr> <tr> <td>\$31.39</td> <td>\$29.20</td> </tr> </table>	1-24	25-49	\$36.50	\$33.95	50-99	100 +	\$31.39	\$29.20
1-24	25-49																																											
\$62.65	\$58.26																																											
50-99	100 +																																											
\$53.88	\$50.12																																											
1-24	25-49																																											
\$73.10	\$67.98																																											
50-99	100 +																																											
\$62.87	\$58.48																																											
1-24	25-49																																											
\$83.55	\$77.70																																											
50-99	100 +																																											
\$71.85	\$66.84																																											
1-24	25-49																																											
\$62.65	\$58.26																																											
50-99	100 +																																											
\$53.88	\$50.12																																											
1-24	25-49																																											
\$36.50	\$33.95																																											
50-99	100 +																																											
\$31.39	\$29.20																																											
<p><b>Model No. PE9581</b> SMA MALE TO REVERSE POLARITY MCX PLUG</p>  <table border="0"> <tr> <td>1-24</td> <td>25-49</td> </tr> <tr> <td>\$57.85</td> <td>\$53.80</td> </tr> <tr> <td>50-99</td> <td>100 +</td> </tr> <tr> <td>\$49.75</td> <td>\$46.28</td> </tr> </table>	1-24	25-49	\$57.85	\$53.80	50-99	100 +	\$49.75	\$46.28	<p><b>Model No. PE9582</b> 75 OHM SMB JACK TO 75 OHM N MALE</p>  <table border="0"> <tr> <td>1-24</td> <td>25-49</td> </tr> <tr> <td>\$55.35</td> <td>\$51.48</td> </tr> <tr> <td>50-99</td> <td>100 +</td> </tr> <tr> <td>\$47.60</td> <td>\$44.28</td> </tr> </table>	1-24	25-49	\$55.35	\$51.48	50-99	100 +	\$47.60	\$44.28	<p><b>Model No. PE9583</b> 75 OHM SMB JACK TO 75 OHM N FEMALE</p>  <table border="0"> <tr> <td>1-24</td> <td>25-49</td> </tr> <tr> <td>\$62.65</td> <td>\$58.26</td> </tr> <tr> <td>50-99</td> <td>100 +</td> </tr> <tr> <td>\$53.88</td> <td>\$50.12</td> </tr> </table>	1-24	25-49	\$62.65	\$58.26	50-99	100 +	\$53.88	\$50.12	<p><b>Model No. PE9584</b> 75 OHM SMB PLUG TO 75 OHM N MALE</p>  <table border="0"> <tr> <td>1-24</td> <td>25-49</td> </tr> <tr> <td>\$62.65</td> <td>\$58.26</td> </tr> <tr> <td>50-99</td> <td>100 +</td> </tr> <tr> <td>\$53.88</td> <td>\$50.12</td> </tr> </table>	1-24	25-49	\$62.65	\$58.26	50-99	100 +	\$53.88	\$50.12	<p><b>Model No. PE9585</b> 75 OHM SMB PLUG TO 75 OHM N FEMALE</p>  <table border="0"> <tr> <td>1-24</td> <td>25-49</td> </tr> <tr> <td>\$62.65</td> <td>\$58.26</td> </tr> <tr> <td>50-99</td> <td>100 +</td> </tr> <tr> <td>\$53.88</td> <td>\$50.12</td> </tr> </table>	1-24	25-49	\$62.65	\$58.26	50-99	100 +	\$53.88	\$50.12
1-24	25-49																																											
\$57.85	\$53.80																																											
50-99	100 +																																											
\$49.75	\$46.28																																											
1-24	25-49																																											
\$55.35	\$51.48																																											
50-99	100 +																																											
\$47.60	\$44.28																																											
1-24	25-49																																											
\$62.65	\$58.26																																											
50-99	100 +																																											
\$53.88	\$50.12																																											
1-24	25-49																																											
\$62.65	\$58.26																																											
50-99	100 +																																											
\$53.88	\$50.12																																											
1-24	25-49																																											
\$62.65	\$58.26																																											
50-99	100 +																																											
\$53.88	\$50.12																																											
<p><b>Model No. PE9586</b> 75 OHM SMC JACK TO 75 OHM N MALE</p>  <table border="0"> <tr> <td>1-24</td> <td>25-49</td> </tr> <tr> <td>\$57.85</td> <td>\$53.80</td> </tr> <tr> <td>50-99</td> <td>100 +</td> </tr> <tr> <td>\$49.75</td> <td>\$46.28</td> </tr> </table>	1-24	25-49	\$57.85	\$53.80	50-99	100 +	\$49.75	\$46.28	<p><b>Model No. PE9587</b> 75 OHM SMC JACK TO 75 OHM N FEMALE</p>  <table border="0"> <tr> <td>1-24</td> <td>25-49</td> </tr> <tr> <td>\$57.85</td> <td>\$53.80</td> </tr> <tr> <td>50-99</td> <td>100 +</td> </tr> <tr> <td>\$49.75</td> <td>\$46.28</td> </tr> </table>	1-24	25-49	\$57.85	\$53.80	50-99	100 +	\$49.75	\$46.28	<p><b>Model No. PE9588</b> 75 OHM SMC PLUG TO 75 OHM N MALE</p>  <table border="0"> <tr> <td>1-24</td> <td>25-49</td> </tr> <tr> <td>\$62.65</td> <td>\$58.26</td> </tr> <tr> <td>50-99</td> <td>100 +</td> </tr> <tr> <td>\$53.88</td> <td>\$50.12</td> </tr> </table>	1-24	25-49	\$62.65	\$58.26	50-99	100 +	\$53.88	\$50.12	<p><b>Model No. PE9589</b> 75 OHM SMC PLUG TO 75 OHM N FEMALE</p>  <table border="0"> <tr> <td>1-24</td> <td>25-49</td> </tr> <tr> <td>\$62.65</td> <td>\$58.26</td> </tr> <tr> <td>50-99</td> <td>100 +</td> </tr> <tr> <td>\$53.88</td> <td>\$50.12</td> </tr> </table>	1-24	25-49	\$62.65	\$58.26	50-99	100 +	\$53.88	\$50.12	<p><b>Model No. PE9590</b> REVERSE POLARITY SMA MALE TO REVERSE POLARITY SMA MALE</p>  <table border="0"> <tr> <td>1-24</td> <td>25-49</td> </tr> <tr> <td>\$31.30</td> <td>\$29.11</td> </tr> <tr> <td>50-99</td> <td>100 +</td> </tr> <tr> <td>\$26.92</td> <td>\$25.04</td> </tr> </table>	1-24	25-49	\$31.30	\$29.11	50-99	100 +	\$26.92	\$25.04
1-24	25-49																																											
\$57.85	\$53.80																																											
50-99	100 +																																											
\$49.75	\$46.28																																											
1-24	25-49																																											
\$57.85	\$53.80																																											
50-99	100 +																																											
\$49.75	\$46.28																																											
1-24	25-49																																											
\$62.65	\$58.26																																											
50-99	100 +																																											
\$53.88	\$50.12																																											
1-24	25-49																																											
\$62.65	\$58.26																																											
50-99	100 +																																											
\$53.88	\$50.12																																											
1-24	25-49																																											
\$31.30	\$29.11																																											
50-99	100 +																																											
\$26.92	\$25.04																																											
<p><b>Model No. PE9591</b> REVERSE POLARITY SMA MALE TO REVERSE POLARITY SMA FEMALE</p>  <table border="0"> <tr> <td>1-24</td> <td>25-49</td> </tr> <tr> <td>\$31.30</td> <td>\$29.11</td> </tr> <tr> <td>50-99</td> <td>100 +</td> </tr> <tr> <td>\$26.92</td> <td>\$25.04</td> </tr> </table>	1-24	25-49	\$31.30	\$29.11	50-99	100 +	\$26.92	\$25.04	<p><b>Model No. PE9592</b> REVERSE POLARITY SMA FEMALE TO REVERSE POLARITY SMA FEMALE</p>  <table border="0"> <tr> <td>1-24</td> <td>25-49</td> </tr> <tr> <td>\$18.50</td> <td>\$17.21</td> </tr> <tr> <td>50-99</td> <td>100 +</td> </tr> <tr> <td>\$15.91</td> <td>\$14.80</td> </tr> </table>	1-24	25-49	\$18.50	\$17.21	50-99	100 +	\$15.91	\$14.80	<p><b>Model No. PE9593</b> REVERSE POLARITY SMA FEMALE TO REVERSE POLARITY SMA FEMALE BULKHEAD MOUNTING HOLE B02</p>  <table border="0"> <tr> <td>1-24</td> <td>25-49</td> </tr> <tr> <td>\$31.30</td> <td>\$29.11</td> </tr> <tr> <td>50-99</td> <td>100 +</td> </tr> <tr> <td>\$26.92</td> <td>\$25.04</td> </tr> </table>	1-24	25-49	\$31.30	\$29.11	50-99	100 +	\$26.92	\$25.04	<p><b>Model No. PE9594</b> REVERSE POLARITY SMA MALE TO REVERSE POLARITY SMA FEMALE RIGHT ANGLE</p>  <table border="0"> <tr> <td>1-24</td> <td>25-49</td> </tr> <tr> <td>\$23.35</td> <td>\$21.72</td> </tr> <tr> <td>50-99</td> <td>100 +</td> </tr> <tr> <td>\$20.08</td> <td>\$18.68</td> </tr> </table>	1-24	25-49	\$23.35	\$21.72	50-99	100 +	\$20.08	\$18.68	<p><b>Model No. PE9595</b> N MALE TO N FEMALE BULKHEAD MOUNTING HOLE G01</p>  <table border="0"> <tr> <td>1-24</td> <td>25-49</td> </tr> <tr> <td>\$29.80</td> <td>\$27.71</td> </tr> <tr> <td>50-99</td> <td>100 +</td> </tr> <tr> <td>\$25.63</td> <td>\$23.84</td> </tr> </table>	1-24	25-49	\$29.80	\$27.71	50-99	100 +	\$25.63	\$23.84
1-24	25-49																																											
\$31.30	\$29.11																																											
50-99	100 +																																											
\$26.92	\$25.04																																											
1-24	25-49																																											
\$18.50	\$17.21																																											
50-99	100 +																																											
\$15.91	\$14.80																																											
1-24	25-49																																											
\$31.30	\$29.11																																											
50-99	100 +																																											
\$26.92	\$25.04																																											
1-24	25-49																																											
\$23.35	\$21.72																																											
50-99	100 +																																											
\$20.08	\$18.68																																											
1-24	25-49																																											
\$29.80	\$27.71																																											
50-99	100 +																																											
\$25.63	\$23.84																																											
<p><b>Model No. PE9596</b> REVERSE POLARITY SMA MALE TO TNC FEMALE</p>  <table border="0"> <tr> <td>1-24</td> <td>25-49</td> </tr> <tr> <td>\$41.75</td> <td>\$38.83</td> </tr> <tr> <td>50-99</td> <td>100 +</td> </tr> <tr> <td>\$35.91</td> <td>\$33.40</td> </tr> </table>	1-24	25-49	\$41.75	\$38.83	50-99	100 +	\$35.91	\$33.40	<p><b>Model No. PE9597</b> REVERSE POLARITY SMA MALE TO TNC MALE</p>  <table border="0"> <tr> <td>1-24</td> <td>25-49</td> </tr> <tr> <td>\$41.75</td> <td>\$38.83</td> </tr> <tr> <td>50-99</td> <td>100 +</td> </tr> <tr> <td>\$35.91</td> <td>\$33.40</td> </tr> </table>	1-24	25-49	\$41.75	\$38.83	50-99	100 +	\$35.91	\$33.40	<p><b>Model No. PE9598</b> REVERSE POLARITY SMA FEMALE TO TNC MALE</p>  <table border="0"> <tr> <td>1-24</td> <td>25-49</td> </tr> <tr> <td>\$41.75</td> <td>\$38.83</td> </tr> <tr> <td>50-99</td> <td>100 +</td> </tr> <tr> <td>\$35.91</td> <td>\$33.40</td> </tr> </table>	1-24	25-49	\$41.75	\$38.83	50-99	100 +	\$35.91	\$33.40	<p><b>Model No. PE9599</b> REVERSE POLARITY SMA FEMALE TO TNC FEMALE</p>  <table border="0"> <tr> <td>1-24</td> <td>25-49</td> </tr> <tr> <td>\$41.75</td> <td>\$38.83</td> </tr> <tr> <td>50-99</td> <td>100 +</td> </tr> <tr> <td>\$35.91</td> <td>\$33.40</td> </tr> </table>	1-24	25-49	\$41.75	\$38.83	50-99	100 +	\$35.91	\$33.40	<p><b>Model No. PE9600</b> SMA MALE TO REVERSE POLARITY TNC FEMALE</p>  <table border="0"> <tr> <td>1-24</td> <td>25-49</td> </tr> <tr> <td>\$36.10</td> <td>\$33.57</td> </tr> <tr> <td>50-99</td> <td>100 +</td> </tr> <tr> <td>\$31.05</td> <td>\$28.88</td> </tr> </table>	1-24	25-49	\$36.10	\$33.57	50-99	100 +	\$31.05	\$28.88
1-24	25-49																																											
\$41.75	\$38.83																																											
50-99	100 +																																											
\$35.91	\$33.40																																											
1-24	25-49																																											
\$41.75	\$38.83																																											
50-99	100 +																																											
\$35.91	\$33.40																																											
1-24	25-49																																											
\$41.75	\$38.83																																											
50-99	100 +																																											
\$35.91	\$33.40																																											
1-24	25-49																																											
\$41.75	\$38.83																																											
50-99	100 +																																											
\$35.91	\$33.40																																											
1-24	25-49																																											
\$36.10	\$33.57																																											
50-99	100 +																																											
\$31.05	\$28.88																																											
<p><b>Model No. PE9601</b> SMA MALE TO REVERSE POLARITY TNC MALE</p>  <table border="0"> <tr> <td>1-24</td> <td>25-49</td> </tr> <tr> <td>\$35.25</td> <td>\$32.78</td> </tr> <tr> <td>50-99</td> <td>100 +</td> </tr> <tr> <td>\$30.32</td> <td>\$28.20</td> </tr> </table>	1-24	25-49	\$35.25	\$32.78	50-99	100 +	\$30.32	\$28.20	<p><b>Model No. PE9602</b> SMA FEMALE TO REVERSE POLARITY TNC MALE</p>  <table border="0"> <tr> <td>1-24</td> <td>25-49</td> </tr> <tr> <td>\$35.60</td> <td>\$33.11</td> </tr> <tr> <td>50-99</td> <td>100 +</td> </tr> <tr> <td>\$30.62</td> <td>\$28.48</td> </tr> </table>	1-24	25-49	\$35.60	\$33.11	50-99	100 +	\$30.62	\$28.48	<p><b>Model No. PE9603</b> SMA FEMALE TO REVERSE POLARITY TNC FEMALE</p>  <table border="0"> <tr> <td>1-24</td> <td>25-49</td> </tr> <tr> <td>\$44.20</td> <td>\$41.11</td> </tr> <tr> <td>50-99</td> <td>100 +</td> </tr> <tr> <td>\$38.01</td> <td>\$35.36</td> </tr> </table>	1-24	25-49	\$44.20	\$41.11	50-99	100 +	\$38.01	\$35.36	<p><b>Model No. PE9604</b> REVERSE POLARITY SMA MALE TO REVERSE POLARITY TNC FEMALE</p>  <table border="0"> <tr> <td>1-24</td> <td>25-49</td> </tr> <tr> <td>\$49.05</td> <td>\$45.62</td> </tr> <tr> <td>50-99</td> <td>100 +</td> </tr> <tr> <td>\$42.18</td> <td>\$39.24</td> </tr> </table>	1-24	25-49	\$49.05	\$45.62	50-99	100 +	\$42.18	\$39.24	<p><b>Model No. PE9605</b> REVERSE POLARITY SMA MALE TO REVERSE POLARITY TNC MALE</p>  <table border="0"> <tr> <td>1-24</td> <td>25-49</td> </tr> <tr> <td>\$41.75</td> <td>\$38.83</td> </tr> <tr> <td>50-99</td> <td>100 +</td> </tr> <tr> <td>\$35.91</td> <td>\$33.40</td> </tr> </table>	1-24	25-49	\$41.75	\$38.83	50-99	100 +	\$35.91	\$33.40
1-24	25-49																																											
\$35.25	\$32.78																																											
50-99	100 +																																											
\$30.32	\$28.20																																											
1-24	25-49																																											
\$35.60	\$33.11																																											
50-99	100 +																																											
\$30.62	\$28.48																																											
1-24	25-49																																											
\$44.20	\$41.11																																											
50-99	100 +																																											
\$38.01	\$35.36																																											
1-24	25-49																																											
\$49.05	\$45.62																																											
50-99	100 +																																											
\$42.18	\$39.24																																											
1-24	25-49																																											
\$41.75	\$38.83																																											
50-99	100 +																																											
\$35.91	\$33.40																																											

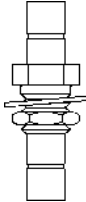
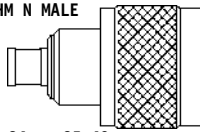
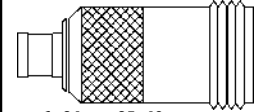
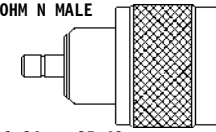
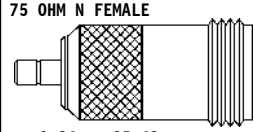
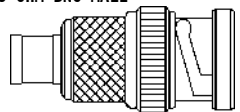
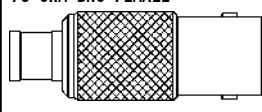
# ADAPTERS

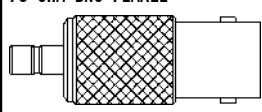
SEE ADAPTER SELECTION CHART ON PAGES 195 THRU 198

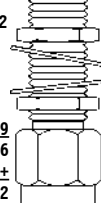
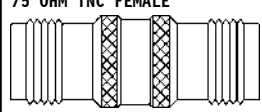
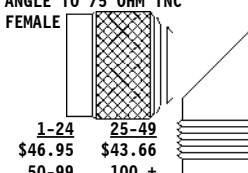
SEE PAGE 266 FOR MOUNTING HOLES

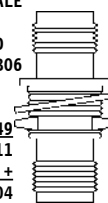
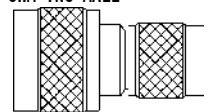
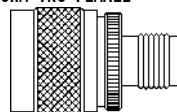
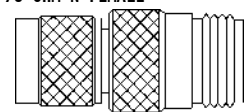
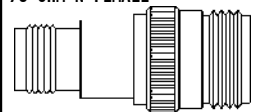
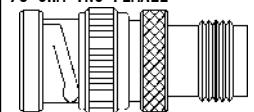
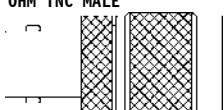
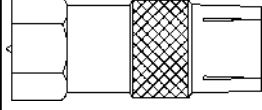
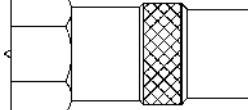
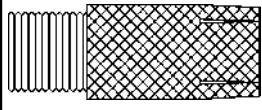
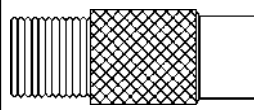

<p><b>Model No. PE9606</b> REVERSE POLARITY SMA FEMALE TO REVERSE POLARITY TNC FEMALE</p>  <table border="0"> <tr> <td>1-24</td> <td>25-49</td> </tr> <tr> <td>\$41.75</td> <td>\$38.83</td> </tr> <tr> <td>50-99</td> <td>100 +</td> </tr> <tr> <td>\$35.91</td> <td>\$33.40</td> </tr> </table>	1-24	25-49	\$41.75	\$38.83	50-99	100 +	\$35.91	\$33.40	<p><b>Model No. PE9607</b> REVERSE POLARITY SMA FEMALE TO REVERSE POLARITY TNC MALE</p>  <table border="0"> <tr> <td>1-24</td> <td>25-49</td> </tr> <tr> <td>\$41.75</td> <td>\$38.83</td> </tr> <tr> <td>50-99</td> <td>100 +</td> </tr> <tr> <td>\$35.91</td> <td>\$33.40</td> </tr> </table>	1-24	25-49	\$41.75	\$38.83	50-99	100 +	\$35.91	\$33.40	<p><b>Model No. PE9608</b> MINI 75 OHM SMB JACK TO MINI 75 OHM SMB JACK</p>  <table border="0"> <tr> <td>1-24</td> <td>25-49</td> </tr> <tr> <td>\$19.60</td> <td>\$18.23</td> </tr> <tr> <td>50-99</td> <td>100 +</td> </tr> <tr> <td>\$16.86</td> <td>\$15.68</td> </tr> </table>	1-24	25-49	\$19.60	\$18.23	50-99	100 +	\$16.86	\$15.68	<p><b>Model No. PE9609</b> MINI 75 OHM SMB PLUG TO MINI 75 OHM SMB PLUG</p>  <table border="0"> <tr> <td>1-24</td> <td>25-49</td> </tr> <tr> <td>\$19.60</td> <td>\$18.23</td> </tr> <tr> <td>50-99</td> <td>100 +</td> </tr> <tr> <td>\$16.86</td> <td>\$15.68</td> </tr> </table>	1-24	25-49	\$19.60	\$18.23	50-99	100 +	\$16.86	\$15.68	<p><b>Model No. PE9610</b> MINI 75 OHM SMB PLUG TO MINI 75 OHM SMB JACK</p>  <table border="0"> <tr> <td>1-24</td> <td>25-49</td> </tr> <tr> <td>\$31.30</td> <td>\$29.11</td> </tr> <tr> <td>50-99</td> <td>100 +</td> </tr> <tr> <td>\$26.92</td> <td>\$25.04</td> </tr> </table>	1-24	25-49	\$31.30	\$29.11	50-99	100 +	\$26.92	\$25.04
1-24	25-49																																											
\$41.75	\$38.83																																											
50-99	100 +																																											
\$35.91	\$33.40																																											
1-24	25-49																																											
\$41.75	\$38.83																																											
50-99	100 +																																											
\$35.91	\$33.40																																											
1-24	25-49																																											
\$19.60	\$18.23																																											
50-99	100 +																																											
\$16.86	\$15.68																																											
1-24	25-49																																											
\$19.60	\$18.23																																											
50-99	100 +																																											
\$16.86	\$15.68																																											
1-24	25-49																																											
\$31.30	\$29.11																																											
50-99	100 +																																											
\$26.92	\$25.04																																											
<p><b>Model No. PE9611</b> MINI 75 OHM SMB JACK TO MINI 75 OHM SMB JACK BULKHEAD MOUNTING HOLE B01</p>  <table border="0"> <tr> <td>1-24</td> <td>25-49</td> </tr> <tr> <td>\$31.30</td> <td>\$29.11</td> </tr> <tr> <td>50-99</td> <td>100 +</td> </tr> <tr> <td>\$26.92</td> <td>\$25.04</td> </tr> </table>	1-24	25-49	\$31.30	\$29.11	50-99	100 +	\$26.92	\$25.04	<p><b>Model No. PE9612</b> MINI 75 OHM SMB PLUG TO 75 OHM N MALE</p>  <table border="0"> <tr> <td>1-24</td> <td>25-49</td> </tr> <tr> <td>\$52.20</td> <td>\$48.55</td> </tr> <tr> <td>50-99</td> <td>100 +</td> </tr> <tr> <td>\$44.89</td> <td>\$41.76</td> </tr> </table>	1-24	25-49	\$52.20	\$48.55	50-99	100 +	\$44.89	\$41.76	<p><b>Model No. PE9613</b> MINI 75 OHM SMB PLUG TO 75 OHM N FEMALE</p>  <table border="0"> <tr> <td>1-24</td> <td>25-49</td> </tr> <tr> <td>\$73.10</td> <td>\$67.98</td> </tr> <tr> <td>50-99</td> <td>100 +</td> </tr> <tr> <td>\$62.87</td> <td>\$58.48</td> </tr> </table>	1-24	25-49	\$73.10	\$67.98	50-99	100 +	\$62.87	\$58.48	<p><b>Model No. PE9614</b> MINI 75 OHM SMB JACK TO 75 OHM N MALE</p>  <table border="0"> <tr> <td>1-24</td> <td>25-49</td> </tr> <tr> <td>\$52.20</td> <td>\$48.55</td> </tr> <tr> <td>50-99</td> <td>100 +</td> </tr> <tr> <td>\$44.89</td> <td>\$41.76</td> </tr> </table>	1-24	25-49	\$52.20	\$48.55	50-99	100 +	\$44.89	\$41.76	<p><b>Model No. PE9615</b> MINI 75 OHM SMB JACK TO 75 OHM N FEMALE</p>  <table border="0"> <tr> <td>1-24</td> <td>25-49</td> </tr> <tr> <td>\$52.20</td> <td>\$48.55</td> </tr> <tr> <td>50-99</td> <td>100 +</td> </tr> <tr> <td>\$44.89</td> <td>\$41.76</td> </tr> </table>	1-24	25-49	\$52.20	\$48.55	50-99	100 +	\$44.89	\$41.76
1-24	25-49																																											
\$31.30	\$29.11																																											
50-99	100 +																																											
\$26.92	\$25.04																																											
1-24	25-49																																											
\$52.20	\$48.55																																											
50-99	100 +																																											
\$44.89	\$41.76																																											
1-24	25-49																																											
\$73.10	\$67.98																																											
50-99	100 +																																											
\$62.87	\$58.48																																											
1-24	25-49																																											
\$52.20	\$48.55																																											
50-99	100 +																																											
\$44.89	\$41.76																																											
1-24	25-49																																											
\$52.20	\$48.55																																											
50-99	100 +																																											
\$44.89	\$41.76																																											
<p><b>Model No. PE9616</b> MINI 75 OHM SMB PLUG TO 75 OHM BNC MALE</p>  <table border="0"> <tr> <td>1-24</td> <td>25-49</td> </tr> <tr> <td>\$52.20</td> <td>\$48.55</td> </tr> <tr> <td>50-99</td> <td>100 +</td> </tr> <tr> <td>\$44.89</td> <td>\$41.76</td> </tr> </table>	1-24	25-49	\$52.20	\$48.55	50-99	100 +	\$44.89	\$41.76	<p><b>Model No. PE9617</b> MINI 75 OHM SMB PLUG TO 75 OHM BNC FEMALE</p>  <table border="0"> <tr> <td>1-24</td> <td>25-49</td> </tr> <tr> <td>\$41.45</td> <td>\$38.55</td> </tr> <tr> <td>50-99</td> <td>100 +</td> </tr> <tr> <td>\$35.65</td> <td>\$33.16</td> </tr> </table>	1-24	25-49	\$41.45	\$38.55	50-99	100 +	\$35.65	\$33.16	<p><b>Model No. PE9618</b> MINI 75 OHM SMB JACK TO 75 OHM BNC MALE</p>  <table border="0"> <tr> <td>1-24</td> <td>25-49</td> </tr> <tr> <td>\$52.20</td> <td>\$48.55</td> </tr> <tr> <td>50-99</td> <td>100 +</td> </tr> <tr> <td>\$44.89</td> <td>\$41.76</td> </tr> </table>	1-24	25-49	\$52.20	\$48.55	50-99	100 +	\$44.89	\$41.76	<p><b>Model No. PE9619</b> MINI 75 OHM SMB JACK TO 75 OHM BNC FEMALE</p>  <table border="0"> <tr> <td>1-24</td> <td>25-49</td> </tr> <tr> <td>\$52.20</td> <td>\$48.55</td> </tr> <tr> <td>50-99</td> <td>100 +</td> </tr> <tr> <td>\$44.89</td> <td>\$41.76</td> </tr> </table>	1-24	25-49	\$52.20	\$48.55	50-99	100 +	\$44.89	\$41.76	<p><b>Model No. PE9620</b> SMA FEMALE TO SMA FEMALE BULKHEAD WITH O-RING MOUNTING HOLE B02</p>  <table border="0"> <tr> <td>1-24</td> <td>25-49</td> </tr> <tr> <td>\$22.90</td> <td>\$21.30</td> </tr> <tr> <td>50-99</td> <td>100 +</td> </tr> <tr> <td>\$19.69</td> <td>\$18.32</td> </tr> </table>	1-24	25-49	\$22.90	\$21.30	50-99	100 +	\$19.69	\$18.32
1-24	25-49																																											
\$52.20	\$48.55																																											
50-99	100 +																																											
\$44.89	\$41.76																																											
1-24	25-49																																											
\$41.45	\$38.55																																											
50-99	100 +																																											
\$35.65	\$33.16																																											
1-24	25-49																																											
\$52.20	\$48.55																																											
50-99	100 +																																											
\$44.89	\$41.76																																											
1-24	25-49																																											
\$52.20	\$48.55																																											
50-99	100 +																																											
\$44.89	\$41.76																																											
1-24	25-49																																											
\$22.90	\$21.30																																											
50-99	100 +																																											
\$19.69	\$18.32																																											
<p><b>Model No. PE9621</b> SMA FEMALE BULKHEAD TO SMA MALE MOUNTING HOLE B02</p>  <table border="0"> <tr> <td>1-24</td> <td>25-49</td> </tr> <tr> <td>\$34.90</td> <td>\$32.46</td> </tr> <tr> <td>50-99</td> <td>100 +</td> </tr> <tr> <td>\$30.01</td> <td>\$27.92</td> </tr> </table>	1-24	25-49	\$34.90	\$32.46	50-99	100 +	\$30.01	\$27.92	<p><b>Model No. PE9622</b> 75 OHM TNC FEMALE TO 75 OHM TNC FEMALE</p>  <table border="0"> <tr> <td>1-24</td> <td>25-49</td> </tr> <tr> <td>\$20.85</td> <td>\$19.39</td> </tr> <tr> <td>50-99</td> <td>100 +</td> </tr> <tr> <td>\$17.93</td> <td>\$16.68</td> </tr> </table>	1-24	25-49	\$20.85	\$19.39	50-99	100 +	\$17.93	\$16.68	<p><b>Model No. PE9623</b> 75 OHM TNC MALE RIGHT ANGLE TO 75 OHM TNC FEMALE</p>  <table border="0"> <tr> <td>1-24</td> <td>25-49</td> </tr> <tr> <td>\$46.95</td> <td>\$43.66</td> </tr> <tr> <td>50-99</td> <td>100 +</td> </tr> <tr> <td>\$40.38</td> <td>\$37.56</td> </tr> </table>	1-24	25-49	\$46.95	\$43.66	50-99	100 +	\$40.38	\$37.56	<p><b>Model No. PE9624</b> 75 OHM TNC FEMALE TO 75 OHM TNC FEMALE BULKHEAD, HERMETICALLY SEALED MOUNTING HOLE B06</p>  <table border="0"> <tr> <td>1-24</td> <td>25-49</td> </tr> <tr> <td>\$52.20</td> <td>\$48.55</td> </tr> <tr> <td>50-99</td> <td>100 +</td> </tr> <tr> <td>\$44.89</td> <td>\$41.76</td> </tr> </table>	1-24	25-49	\$52.20	\$48.55	50-99	100 +	\$44.89	\$41.76	<p><b>Model No. PE9625</b> 75 OHM TNC FEMALE TO 75 OHM TNC FEMALE BULKHEAD ISOLATED GROUND MOUNTING HOLE B06</p>  <table border="0"> <tr> <td>1-24</td> <td>25-49</td> </tr> <tr> <td>\$31.30</td> <td>\$29.11</td> </tr> <tr> <td>50-99</td> <td>100 +</td> </tr> <tr> <td>\$26.92</td> <td>\$25.04</td> </tr> </table>	1-24	25-49	\$31.30	\$29.11	50-99	100 +	\$26.92	\$25.04
1-24	25-49																																											
\$34.90	\$32.46																																											
50-99	100 +																																											
\$30.01	\$27.92																																											
1-24	25-49																																											
\$20.85	\$19.39																																											
50-99	100 +																																											
\$17.93	\$16.68																																											
1-24	25-49																																											
\$46.95	\$43.66																																											
50-99	100 +																																											
\$40.38	\$37.56																																											
1-24	25-49																																											
\$52.20	\$48.55																																											
50-99	100 +																																											
\$44.89	\$41.76																																											
1-24	25-49																																											
\$31.30	\$29.11																																											
50-99	100 +																																											
\$26.92	\$25.04																																											
<p><b>Model No. PE9626</b> 75 OHM N MALE TO 75 OHM TNC MALE</p>  <table border="0"> <tr> <td>1-24</td> <td>25-49</td> </tr> <tr> <td>\$50.10</td> <td>\$46.59</td> </tr> <tr> <td>50-99</td> <td>100 +</td> </tr> <tr> <td>\$43.09</td> <td>\$40.08</td> </tr> </table>	1-24	25-49	\$50.10	\$46.59	50-99	100 +	\$43.09	\$40.08	<p><b>Model No. PE9627</b> 75 OHM N MALE TO 75 OHM TNC FEMALE</p>  <table border="0"> <tr> <td>1-24</td> <td>25-49</td> </tr> <tr> <td>\$31.30</td> <td>\$29.11</td> </tr> <tr> <td>50-99</td> <td>100 +</td> </tr> <tr> <td>\$26.92</td> <td>\$25.04</td> </tr> </table>	1-24	25-49	\$31.30	\$29.11	50-99	100 +	\$26.92	\$25.04	<p><b>Model No. PE9628</b> 75 OHM TNC MALE TO 75 OHM N FEMALE</p>  <table border="0"> <tr> <td>1-24</td> <td>25-49</td> </tr> <tr> <td>\$31.30</td> <td>\$29.11</td> </tr> <tr> <td>50-99</td> <td>100 +</td> </tr> <tr> <td>\$26.92</td> <td>\$25.04</td> </tr> </table>	1-24	25-49	\$31.30	\$29.11	50-99	100 +	\$26.92	\$25.04	<p><b>Model No. PE9629</b> 75 OHM TNC FEMALE TO 75 OHM N FEMALE</p>  <table border="0"> <tr> <td>1-24</td> <td>25-49</td> </tr> <tr> <td>\$31.30</td> <td>\$29.11</td> </tr> <tr> <td>50-99</td> <td>100 +</td> </tr> <tr> <td>\$26.92</td> <td>\$25.04</td> </tr> </table>	1-24	25-49	\$31.30	\$29.11	50-99	100 +	\$26.92	\$25.04	<p><b>Model No. PE9630</b> 75 OHM BNC MALE TO 75 OHM TNC FEMALE</p>  <table border="0"> <tr> <td>1-24</td> <td>25-49</td> </tr> <tr> <td>\$31.30</td> <td>\$29.11</td> </tr> <tr> <td>50-99</td> <td>100 +</td> </tr> <tr> <td>\$26.92</td> <td>\$25.04</td> </tr> </table>	1-24	25-49	\$31.30	\$29.11	50-99	100 +	\$26.92	\$25.04
1-24	25-49																																											
\$50.10	\$46.59																																											
50-99	100 +																																											
\$43.09	\$40.08																																											
1-24	25-49																																											
\$31.30	\$29.11																																											
50-99	100 +																																											
\$26.92	\$25.04																																											
1-24	25-49																																											
\$31.30	\$29.11																																											
50-99	100 +																																											
\$26.92	\$25.04																																											
1-24	25-49																																											
\$31.30	\$29.11																																											
50-99	100 +																																											
\$26.92	\$25.04																																											
1-24	25-49																																											
\$31.30	\$29.11																																											
50-99	100 +																																											
\$26.92	\$25.04																																											
<p><b>Model No. PE9631</b> 75 OHM BNC FEMALE TO 75 OHM TNC MALE</p>  <table border="0"> <tr> <td>1-24</td> <td>25-49</td> </tr> <tr> <td>\$15.25</td> <td>\$14.18</td> </tr> <tr> <td>50-99</td> <td>100 +</td> </tr> <tr> <td>\$13.12</td> <td>\$12.20</td> </tr> </table>	1-24	25-49	\$15.25	\$14.18	50-99	100 +	\$13.12	\$12.20	<p><b>Model No. PE9632</b> F MALE TO PAL JACK</p>  <table border="0"> <tr> <td>1-24</td> <td>25-49</td> </tr> <tr> <td>\$9.35</td> <td>\$8.70</td> </tr> <tr> <td>50-99</td> <td>100 +</td> </tr> <tr> <td>\$8.04</td> <td>\$7.48</td> </tr> </table>	1-24	25-49	\$9.35	\$8.70	50-99	100 +	\$8.04	\$7.48	<p><b>Model No. PE9633</b> F MALE TO PAL PLUG</p>  <table border="0"> <tr> <td>1-24</td> <td>25-49</td> </tr> <tr> <td>\$9.35</td> <td>\$8.70</td> </tr> <tr> <td>50-99</td> <td>100 +</td> </tr> <tr> <td>\$8.04</td> <td>\$7.48</td> </tr> </table>	1-24	25-49	\$9.35	\$8.70	50-99	100 +	\$8.04	\$7.48	<p><b>Model No. PE9634</b> F FEMALE TO PAL JACK</p>  <table border="0"> <tr> <td>1-24</td> <td>25-49</td> </tr> <tr> <td>\$9.35</td> <td>\$8.70</td> </tr> <tr> <td>50-99</td> <td>100 +</td> </tr> <tr> <td>\$8.04</td> <td>\$7.48</td> </tr> </table>	1-24	25-49	\$9.35	\$8.70	50-99	100 +	\$8.04	\$7.48	<p><b>Model No. PE9635</b> F FEMALE TO PAL PLUG</p>  <table border="0"> <tr> <td>1-24</td> <td>25-49</td> </tr> <tr> <td>\$8.65</td> <td>\$8.04</td> </tr> <tr> <td>50-99</td> <td>100 +</td> </tr> <tr> <td>\$7.44</td> <td>\$6.92</td> </tr> </table>	1-24	25-49	\$8.65	\$8.04	50-99	100 +	\$7.44	\$6.92
1-24	25-49																																											
\$15.25	\$14.18																																											
50-99	100 +																																											
\$13.12	\$12.20																																											
1-24	25-49																																											
\$9.35	\$8.70																																											
50-99	100 +																																											
\$8.04	\$7.48																																											
1-24	25-49																																											
\$9.35	\$8.70																																											
50-99	100 +																																											
\$8.04	\$7.48																																											
1-24	25-49																																											
\$9.35	\$8.70																																											
50-99	100 +																																											
\$8.04	\$7.48																																											
1-24	25-49																																											
\$8.65	\$8.04																																											
50-99	100 +																																											
\$7.44	\$6.92																																											



# ADAPTERS

SEE ADAPTER SELECTION CHART ON PAGES 195 THRU 198

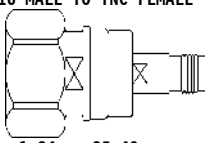
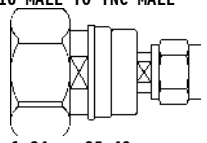
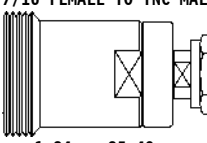
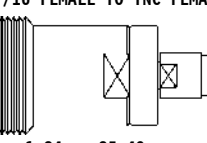

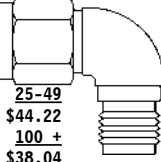
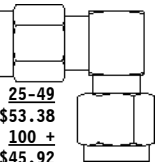
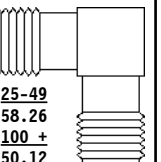
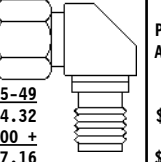
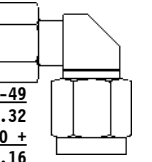
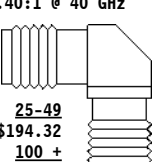
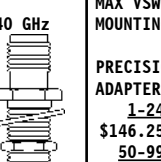
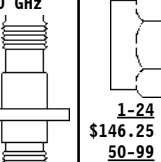
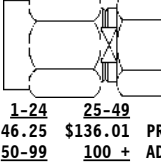
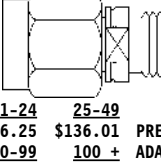
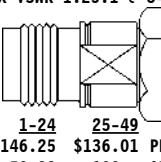
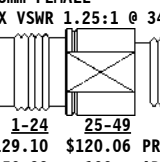
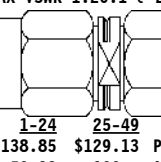
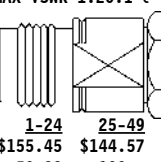
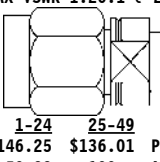
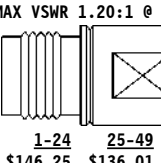
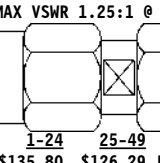
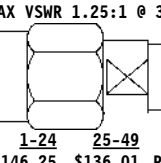
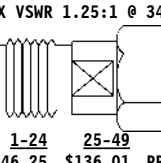
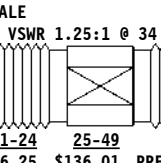
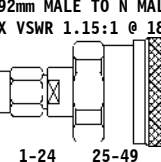
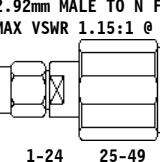
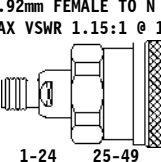
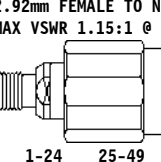
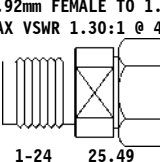





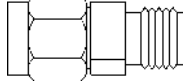

SEE PAGE 266 FOR MOUNTING HOLES

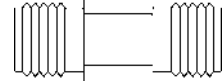
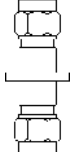
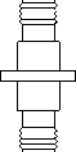
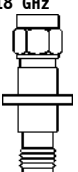
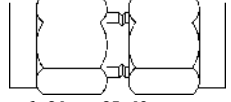
<p><b>Model No. PE9636</b> 7/16 MALE TO TNC FEMALE</p>  <p>1-24 25-49 \$177.60 \$165.17 50-99 100 + \$152.74 \$142.08</p>	<p><b>Model No. PE9637</b> 7/16 MALE TO TNC MALE</p>  <p>1-24 25-49 \$177.60 \$165.17 50-99 100 + \$152.74 \$142.08</p>	<p><b>Model No. PE9638</b> 7/16 FEMALE TO TNC MALE</p>  <p>1-24 25-49 \$167.15 \$155.45 50-99 100 + \$143.75 \$133.72</p>	<p><b>Model No. PE9639</b> 7/16 FEMALE TO TNC FEMALE</p>  <p>1-24 25-49 \$177.60 \$165.17 50-99 100 + \$152.74 \$142.08</p>	<p><b>Model No. PE9640</b> 2.4mm FEMALE TO 2.4mm FEMALE BULKHEAD MAX VSWR 1.40:1 @ 50 GHz MOUNTING HOLE B14</p>  <p>PRECISION ADAPTER 1-24 25-49 \$230.35 \$214.23 50-99 100 + \$198.10 \$184.28</p>
<p><b>Model No. PE9641</b> SMA MALE TO SMA FEMALE RIGHT ANGLE MAX VSWR 1.35:1 @ 27 GHz</p>  <p>PRECISION ADAPTER 1-24 25-49 \$47.55 \$44.22 50-99 100 + \$40.89 \$38.04</p>	<p><b>Model No. PE9642</b> SMA MALE TO SMA MALE RIGHT ANGLE MAX VSWR 1.35:1 @ 27 GHz</p>  <p>PRECISION ADAPTER 1-24 25-49 \$57.40 \$53.38 50-99 100 + \$49.36 \$45.92</p>	<p><b>Model No. PE9643</b> SMA FEMALE TO SMA FEMALE RIGHT ANGLE MAX VSWR 1.35:1 @ 27 GHz</p>  <p>PRECISION ADAPTER 1-24 25-49 \$62.65 \$58.26 50-99 100 + \$53.88 \$50.12</p>	<p><b>Model No. PE9644</b> 2.92mm MALE TO 2.92mm FEMALE RIGHT ANGLE MAX VSWR 1.40:1 @ 40 GHz</p>  <p>PRECISION ADAPTER 1-24 25-49 \$208.95 \$194.32 50-99 100 + \$179.70 \$167.16</p>	<p><b>Model No. PE9645</b> 2.92mm MALE TO 2.92mm MALE RIGHT ANGLE MAX VSWR 1.40:1 @ 40 GHz</p>  <p>PRECISION ADAPTER 1-24 25-49 \$208.95 \$194.32 50-99 100 + \$179.70 \$167.16</p>
<p><b>Model No. PE9646</b> 2.92mm FEMALE TO 2.92mm FEMALE, RIGHT ANGLE MAX VSWR 1.40:1 @ 40 GHz</p>  <p>PRECISION ADAPTER 1-24 25-49 \$208.95 \$194.32 50-99 100 + \$179.70 \$167.16</p>	<p><b>Model No. PE9647</b> 2.92mm FEMALE TO 2.92mm FEMALE BULKHEAD MOUNTING HOLE B02 MAX VSWR 1.25:1 @ 40 GHz</p>  <p>PRECISION ADAPTER 1-24 25-49 \$146.25 \$136.01 50-99 100 + \$125.78 \$117.00</p>	<p><b>Model No. PE9648</b> 2.92mm FEMALE TO 2.92mm FEMALE, 4 HOLE PANEL MOUNT MAX VSWR 1.25:1 @ 40 GHz MOUNTING HOLE A01</p>  <p>PRECISION ADAPTER 1-24 25-49 \$146.25 \$136.01 50-99 100 + \$125.78 \$117.00</p>	<p><b>Model No. PE9649</b> 2.4mm MALE TO 3.5mm MALE MAX VSWR 1.25:1 @ 34 GHz</p>  <p>PRECISION ADAPTER 1-24 25-49 \$146.25 \$136.01 50-99 100 + \$125.78 \$117.00</p>	<p><b>Model No. PE9650</b> 2.4mm MALE TO 3.5mm FEMALE MAX VSWR 1.25:1 @ 34 GHz</p>  <p>PRECISION ADAPTER 1-24 25-49 \$146.25 \$136.01 50-99 100 + \$125.78 \$117.00</p>
<p><b>Model No. PE9651</b> 2.4mm FEMALE TO 3.5mm MALE MAX VSWR 1.25:1 @ 34 GHz</p>  <p>PRECISION ADAPTER 1-24 25-49 \$146.25 \$136.01 50-99 100 + \$125.78 \$117.00</p>	<p><b>Model No. PE9652</b> 2.4mm FEMALE TO 3.5mm FEMALE MAX VSWR 1.25:1 @ 34 GHz</p>  <p>PRECISION ADAPTER 1-24 25-49 \$129.10 \$120.06 50-99 100 + \$111.03 \$103.28</p>	<p><b>Model No. PE9653</b> 2.4mm MALE TO SMA MALE MAX VSWR 1.20:1 @ 26.5 GHz</p>  <p>PRECISION ADAPTER 1-24 25-49 \$138.85 \$129.13 50-99 100 + \$119.41 \$111.08</p>	<p><b>Model No. PE9654</b> 2.4mm FEMALE TO SMA MALE MAX VSWR 1.20:1 @ 26.5 GHz</p>  <p>PRECISION ADAPTER 1-24 25-49 \$155.45 \$144.57 50-99 100 + \$133.69 \$124.36</p>	<p><b>Model No. PE9655</b> 2.4mm MALE TO SMA FEMALE MAX VSWR 1.20:1 @ 26.5 GHz</p>  <p>PRECISION ADAPTER 1-24 25-49 \$146.25 \$136.01 50-99 100 + \$125.78 \$117.00</p>
<p><b>Model No. PE9656</b> 2.4mm FEMALE TO SMA FEMALE MAX VSWR 1.20:1 @ 26.5 GHz</p>  <p>PRECISION ADAPTER 1-24 25-49 \$146.25 \$136.01 50-99 100 + \$125.78 \$117.00</p>	<p><b>Model No. PE9657</b> 3.5mm MALE TO 2.92mm MALE MAX VSWR 1.25:1 @ 34 GHz</p>  <p>PRECISION ADAPTER 1-24 25-49 \$135.80 \$126.29 50-99 100 + \$116.79 \$108.64</p>	<p><b>Model No. PE9658</b> 3.5mm MALE TO 2.92mm FEMALE MAX VSWR 1.25:1 @ 34 GHz</p>  <p>PRECISION ADAPTER 1-24 25-49 \$146.25 \$136.01 50-99 100 + \$125.78 \$117.00</p>	<p><b>Model No. PE9659</b> 3.5mm FEMALE TO 2.92mm MALE MAX VSWR 1.25:1 @ 34 GHz</p>  <p>PRECISION ADAPTER 1-24 25-49 \$146.25 \$136.01 50-99 100 + \$125.78 \$117.00</p>	<p><b>Model No. PE9660</b> 3.5mm FEMALE TO 2.92mm FEMALE MAX VSWR 1.25:1 @ 34 GHz</p>  <p>PRECISION ADAPTER 1-24 25-49 \$146.25 \$136.01 50-99 100 + \$125.78 \$117.00</p>
<p><b>Model No. PE9661</b> 2.92mm MALE TO N MALE MAX VSWR 1.15:1 @ 18 GHz</p>  <p>PRECISION ADAPTER 1-24 25-49 \$135.80 \$126.29 50-99 100 + \$116.79 \$108.64</p>	<p><b>Model No. PE9662</b> 2.92mm MALE TO N FEMALE MAX VSWR 1.15:1 @ 18 GHz</p>  <p>PRECISION ADAPTER 1-24 25-49 \$219.40 \$204.04 50-99 100 + \$188.68 \$175.52</p>	<p><b>Model No. PE9663</b> 2.92mm FEMALE TO N MALE MAX VSWR 1.15:1 @ 18 GHz</p>  <p>PRECISION ADAPTER 1-24 25-49 \$146.25 \$136.01 50-99 100 + \$125.78 \$117.00</p>	<p><b>Model No. PE9664</b> 2.92mm FEMALE TO N FEMALE MAX VSWR 1.15:1 @ 18 GHz</p>  <p>PRECISION ADAPTER 1-24 25-49 \$135.80 \$126.29 50-99 100 + \$116.79 \$108.64</p>	<p><b>Model No. PE9665</b> 2.92mm FEMALE TO 1.85mm MALE MAX VSWR 1.30:1 @ 40 GHz</p>  <p>PRECISION ADAPTER 1-24 25-49 \$355.25 \$330.38 50-99 100 + \$305.52 \$284.20</p>

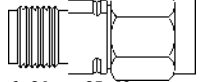
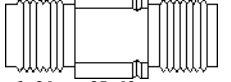
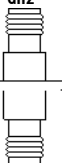
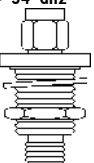
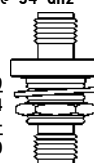
# ADAPTERS

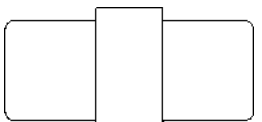
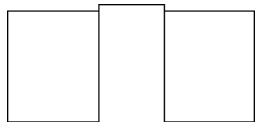
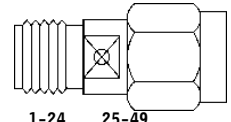
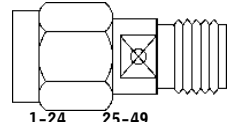
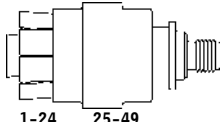
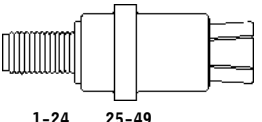
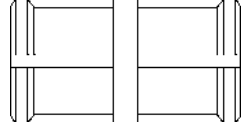
SEE ADAPTER SELECTION CHART ON PAGES 195 THRU 198

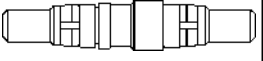

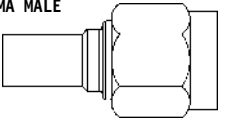
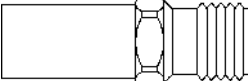
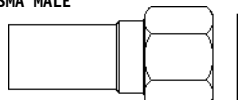
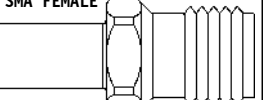
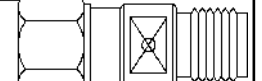
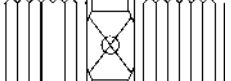

SEE PAGE 266 FOR MOUNTING HOLES

<p><b>Model No. PE9666</b> 2.92mm MALE TO 1.85mm FEMALE MAX VSWR 1.25:1 @ 40 GHz</p>  <p>1-24 25-49 \$355.25 \$330.38 PRECISION 50-99 100 + ADAPTER \$305.52 \$284.20</p>	<p><b>Model No. PE9667</b> 2.92mm MALE TO 1.85mm MALE MAX VSWR 1.25:1 @ 40 GHz</p>  <p>1-24 25-49 \$355.25 \$330.38 PRECISION 50-99 100 + ADAPTER \$305.52 \$284.20</p>	<p><b>Model No. PE9668</b> 2.92mm FEMALE TO 1.85mm FEMALE MAX VSWR 1.25:1 @ 40 GHz</p>  <p>1-24 25-49 \$355.25 \$330.38 PRECISION 50-99 100 + ADAPTER \$305.52 \$284.20</p>	<p><b>Model No. PE9669</b> SMA MALE TO SMA MALE 4 HOLE PANEL MOUNT MOUNTING HOLE A01 MAX VSWR 1.25:1 @ 18 GHz</p>  <p>PRECISION ADAPTER 1-24 25-49 \$95.65 \$88.95 50-99 100 + \$82.26 \$76.52</p>	<p><b>Model No. PE9670</b> SMA FEMALE TO SMA FEMALE 4 HOLE PANEL MOUNT MOUNTING HOLE A01 MAX VSWR 1.25:1 @ 18 GHz</p>  <p>PRECISION ADAPTER 1-24 25-49 \$62.65 \$58.26 50-99 100 + \$53.88 \$50.12</p>
<p><b>Model No. PE9671</b> SMA MALE TO SMA FEMALE 4 HOLE PANEL MOUNT MOUNTING HOLE A01 MAX VSWR 1.25:1 @ 18 GHz</p>  <p>PRECISION ADAPTER 1-24 25-49 \$62.65 \$58.26 50-99 100 + \$53.88 \$50.12</p>	<p><b>Model No. PE9672</b> 1.85mm MALE TO 2.4mm MALE MAX VSWR 1.30:1 @ 50 GHz</p>  <p>1-24 25-49 \$397.05 \$369.26 PRECISION 50-99 100 + ADAPTER \$341.46 \$317.64</p>	<p><b>Model No. PE9673</b> 1.85mm MALE TO 2.4mm FEMALE MAX VSWR 1.30:1 @ 50 GHz</p>  <p>1-24 25-49 \$386.60 \$359.54 PRECISION 50-99 100 + ADAPTER \$332.48 \$309.28</p>	<p><b>Model No. PE9674</b> 1.85mm FEMALE TO 2.4mm MALE MAX VSWR 1.30:1 @ 50 GHz</p>  <p>1-24 25-49 \$386.60 \$359.54 PRECISION 50-99 100 + ADAPTER \$332.48 \$309.28</p>	<p><b>Model No. PE9675</b> 1.85mm FEMALE TO 2.4mm FEMALE MAX VSWR 1.30:1 @ 50 GHz</p>  <p>1-24 25-49 \$386.60 \$359.54 PRECISION 50-99 100 + ADAPTER \$332.48 \$309.28</p>
<p><b>Model No. PE9676</b> 3.5mm FEMALE TO 3.5mm FEMALE, 4 HOLE PANEL MOUNT MOUNTING HOLE A01 MAX VSWR 1.25:1 @ 34 GHz</p>  <p>PRECISION ADAPTER 1-24 25-49 \$156.70 \$145.73 50-99 100 + \$134.76 \$125.36</p>	<p><b>Model No. PE9677</b> 3.5mm MALE TO 3.5mm FEMALE BULKHEAD MOUNTING HOLE B09 MAX VSWR 1.25:1 @ 34 GHz</p>  <p>PRECISION ADAPTER 1-24 25-49 \$125.35 \$116.58 50-99 100 + \$107.80 \$100.28</p>	<p><b>Model No. PE9678</b> 3.5mm FEMALE TO 3.5mm FEMALE BULKHEAD MOUNTING HOLE B09 MAX VSWR 1.25:1 @ 34 GHz</p>  <p>PRECISION ADAPTER 1-24 25-49 \$118.00 \$109.74 50-99 100 + \$101.48 \$94.40</p>	<p><b>Model No. PE9679</b> 3.5mm MALE TO 3.5mm MALE BULKHEAD MOUNTING HOLE B05 MAX VSWR 1.25:1 @ 34 GHz</p>  <p>PRECISION ADAPTER 1-24 25-49 \$198.50 \$184.61 50-99 100 + \$170.71 \$158.80</p>	<p><b>Model No. PE9680</b> PAL PLUG TO PAL PLUG</p>  <p>1-24 25-49 \$8.65 \$8.04 50-99 100 + \$7.44 \$6.92</p>
<p><b>Model No. PE9681</b> PAL JACK TO PAL JACK</p>  <p>1-24 25-49 \$8.65 \$8.04 50-99 100 + \$7.44 \$6.92</p>	<p><b>Model No. PE9682</b> REVERSE THREAD SMA FEMALE TO SMA MALE</p>  <p>1-24 25-49 \$31.30 \$29.11 50-99 100 + \$26.92 \$25.04</p>	<p><b>Model No. PE9683</b> REVERSE THREAD SMA MALE TO SMA FEMALE</p>  <p>1-24 25-49 \$22.90 \$21.30 50-99 100 + \$19.69 \$18.32</p>	<p><b>Model No. PE9684</b> N MALE QUICK DISCONNECT TO SMA FEMALE</p>  <p>1-24 25-49 \$104.45 \$97.14 50-99 100 + \$89.83 \$83.56</p>	<p><b>Model No. PE9685</b> SSMA MALE QUICK DISCONNECT TO SSMA FEMALE</p>  <p>1-24 25-49 \$103.65 \$96.39 50-99 100 + \$89.14 \$82.92</p>
<p><b>Model No. PE9686</b> SMP FEMALE TO SMP FEMALE</p>  <p>1-24 25-49 \$26.05 \$24.23 50-99 100 + \$22.40 \$20.84</p>	<p><b>Model No. PE9687</b> D SUBMINIATURE PLUG TO D SUBMINIATURE RECEPTACLE</p>  <p>1-24 25-49 \$36.50 \$33.95 50-99 100 + \$31.39 \$29.20</p>	<p><b>Model No. PE9688</b> D SUBMINIATURE PLUG TO D SUBMINIATURE PLUG</p>  <p>1-24 25-49 \$36.50 \$33.95 50-99 100 + \$31.39 \$29.20</p>	<p><b>Model No. PE9689</b> D SUBMINIATURE RECEPTACLE TO D SUBMINIATURE RECEPTACLE</p>  <p>1-24 25-49 \$36.50 \$33.95 50-99 100 + \$31.39 \$29.20</p>	<p><b>Model No. PE9690</b> 1.0/2.3 SLIDE ON JACK TO SMA MALE</p>  <p>1-24 25-49 \$59.55 \$55.38 50-99 100 + \$51.21 \$47.64</p>
<p><b>Model No. PE9691</b> 1.0/2.3 SLIDE ON PLUG TO SMA FEMALE</p>  <p>1-24 25-49 \$57.40 \$53.38 50-99 100 + \$49.36 \$45.92</p>	<p><b>Model No. PE9692</b> 1.0/2.3 SLIDE ON PLUG TO SMA MALE</p>  <p>1-24 25-49 \$57.40 \$53.38 50-99 100 + \$49.36 \$45.92</p>	<p><b>Model No. PE9693</b> 1.0/2.3 SLIDE ON JACK TO SMA FEMALE</p>  <p>1-24 25-49 \$57.40 \$53.38 50-99 100 + \$49.36 \$45.92</p>	<p><b>Model No. PE9694</b> SMA MALE TO SMA FEMALE MAX VSWR 1.15:1 @ 18 GHz</p>  <p>1-24 25-49 \$31.30 \$29.11 PRECISION 50-99 100 + ADAPTER \$26.92 \$25.04</p>	<p><b>Model No. PE9695</b> SMA FEMALE TO SMA FEMALE MAX VSWR 1.15:1 @ 18 GHz</p>  <p>1-24 25-49 \$31.30 \$29.11 PRECISION 50-99 100 + ADAPTER \$26.92 \$25.04</p>

# ADAPTERS

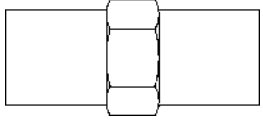
SEE ADAPTER SELECTION CHART ON PAGES 195 THRU 198

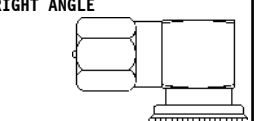
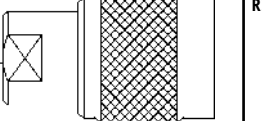
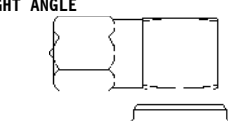
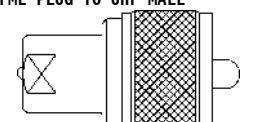
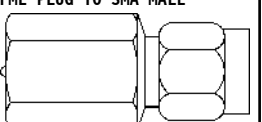
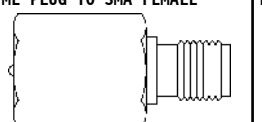
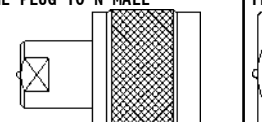
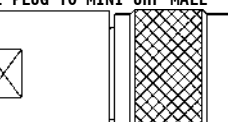
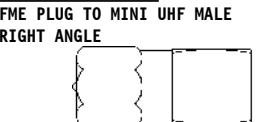
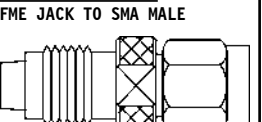
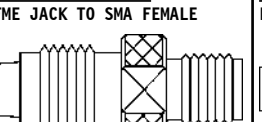
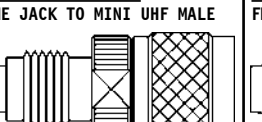

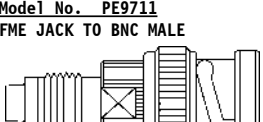
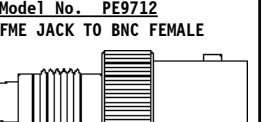
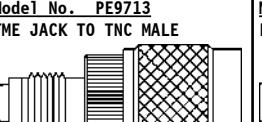
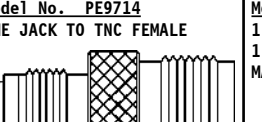
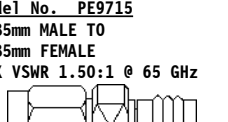
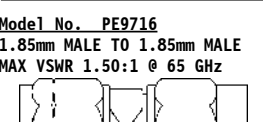
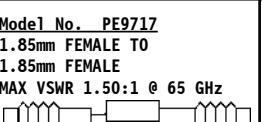
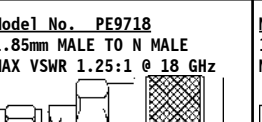
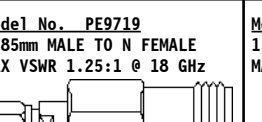
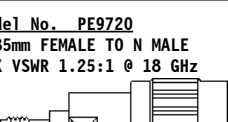
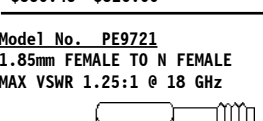
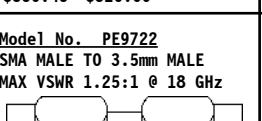
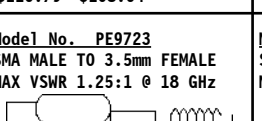
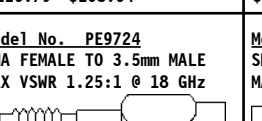
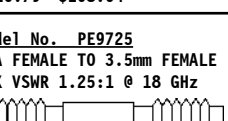

SEE PAGE 266 FOR MOUNTING HOLES

<p><b>Model No. PE9696</b> FME PLUG TO FME PLUG</p>  <table border="0"> <tr> <td>1-24</td> <td>25-49</td> </tr> <tr> <td>\$10.40</td> <td>\$9.67</td> </tr> <tr> <td>50-99</td> <td>100 +</td> </tr> <tr> <td>\$8.94</td> <td>\$8.32</td> </tr> </table>	1-24	25-49	\$10.40	\$9.67	50-99	100 +	\$8.94	\$8.32	<p><b>Model No. PE9697</b> FME PLUG TO BNC MALE</p>  <table border="0"> <tr> <td>1-24</td> <td>25-49</td> </tr> <tr> <td>\$10.40</td> <td>\$9.67</td> </tr> <tr> <td>50-99</td> <td>100 +</td> </tr> <tr> <td>\$8.94</td> <td>\$8.32</td> </tr> </table>	1-24	25-49	\$10.40	\$9.67	50-99	100 +	\$8.94	\$8.32	<p><b>Model No. PE9698</b> FME PLUG TO BNC MALE RIGHT ANGLE</p>  <table border="0"> <tr> <td>1-24</td> <td>25-49</td> </tr> <tr> <td>\$10.40</td> <td>\$9.67</td> </tr> <tr> <td>50-99</td> <td>100 +</td> </tr> <tr> <td>\$8.94</td> <td>\$8.32</td> </tr> </table>	1-24	25-49	\$10.40	\$9.67	50-99	100 +	\$8.94	\$8.32	<p><b>Model No. PE9699</b> FME PLUG TO TNC MALE</p>  <table border="0"> <tr> <td>1-24</td> <td>25-49</td> </tr> <tr> <td>\$10.40</td> <td>\$9.67</td> </tr> <tr> <td>50-99</td> <td>100 +</td> </tr> <tr> <td>\$8.94</td> <td>\$8.32</td> </tr> </table>	1-24	25-49	\$10.40	\$9.67	50-99	100 +	\$8.94	\$8.32	<p><b>Model No. PE9700</b> FME PLUG TO TNC MALE RIGHT ANGLE</p>  <table border="0"> <tr> <td>1-24</td> <td>25-49</td> </tr> <tr> <td>\$10.40</td> <td>\$9.67</td> </tr> <tr> <td>50-99</td> <td>100 +</td> </tr> <tr> <td>\$8.94</td> <td>\$8.32</td> </tr> </table>	1-24	25-49	\$10.40	\$9.67	50-99	100 +	\$8.94	\$8.32
1-24	25-49																																											
\$10.40	\$9.67																																											
50-99	100 +																																											
\$8.94	\$8.32																																											
1-24	25-49																																											
\$10.40	\$9.67																																											
50-99	100 +																																											
\$8.94	\$8.32																																											
1-24	25-49																																											
\$10.40	\$9.67																																											
50-99	100 +																																											
\$8.94	\$8.32																																											
1-24	25-49																																											
\$10.40	\$9.67																																											
50-99	100 +																																											
\$8.94	\$8.32																																											
1-24	25-49																																											
\$10.40	\$9.67																																											
50-99	100 +																																											
\$8.94	\$8.32																																											
<p><b>Model No. PE9701</b> FME PLUG TO UHF MALE</p>  <table border="0"> <tr> <td>1-24</td> <td>25-49</td> </tr> <tr> <td>\$10.40</td> <td>\$9.67</td> </tr> <tr> <td>50-99</td> <td>100 +</td> </tr> <tr> <td>\$8.94</td> <td>\$8.32</td> </tr> </table>	1-24	25-49	\$10.40	\$9.67	50-99	100 +	\$8.94	\$8.32	<p><b>Model No. PE9702</b> FME PLUG TO SMA MALE</p>  <table border="0"> <tr> <td>1-24</td> <td>25-49</td> </tr> <tr> <td>\$10.40</td> <td>\$9.67</td> </tr> <tr> <td>50-99</td> <td>100 +</td> </tr> <tr> <td>\$8.94</td> <td>\$8.32</td> </tr> </table>	1-24	25-49	\$10.40	\$9.67	50-99	100 +	\$8.94	\$8.32	<p><b>Model No. PE9703</b> FME PLUG TO SMA FEMALE</p>  <table border="0"> <tr> <td>1-24</td> <td>25-49</td> </tr> <tr> <td>\$10.40</td> <td>\$9.67</td> </tr> <tr> <td>50-99</td> <td>100 +</td> </tr> <tr> <td>\$8.94</td> <td>\$8.32</td> </tr> </table>	1-24	25-49	\$10.40	\$9.67	50-99	100 +	\$8.94	\$8.32	<p><b>Model No. PE9704</b> FME PLUG TO N MALE</p>  <table border="0"> <tr> <td>1-24</td> <td>25-49</td> </tr> <tr> <td>\$10.40</td> <td>\$9.67</td> </tr> <tr> <td>50-99</td> <td>100 +</td> </tr> <tr> <td>\$8.94</td> <td>\$8.32</td> </tr> </table>	1-24	25-49	\$10.40	\$9.67	50-99	100 +	\$8.94	\$8.32	<p><b>Model No. PE9705</b> FME PLUG TO MINI UHF MALE</p>  <table border="0"> <tr> <td>1-24</td> <td>25-49</td> </tr> <tr> <td>\$10.40</td> <td>\$9.67</td> </tr> <tr> <td>50-99</td> <td>100 +</td> </tr> <tr> <td>\$8.94</td> <td>\$8.32</td> </tr> </table>	1-24	25-49	\$10.40	\$9.67	50-99	100 +	\$8.94	\$8.32
1-24	25-49																																											
\$10.40	\$9.67																																											
50-99	100 +																																											
\$8.94	\$8.32																																											
1-24	25-49																																											
\$10.40	\$9.67																																											
50-99	100 +																																											
\$8.94	\$8.32																																											
1-24	25-49																																											
\$10.40	\$9.67																																											
50-99	100 +																																											
\$8.94	\$8.32																																											
1-24	25-49																																											
\$10.40	\$9.67																																											
50-99	100 +																																											
\$8.94	\$8.32																																											
1-24	25-49																																											
\$10.40	\$9.67																																											
50-99	100 +																																											
\$8.94	\$8.32																																											
<p><b>Model No. PE9706</b> FME PLUG TO MINI UHF MALE RIGHT ANGLE</p>  <table border="0"> <tr> <td>1-24</td> <td>25-49</td> </tr> <tr> <td>\$10.40</td> <td>\$9.67</td> </tr> <tr> <td>50-99</td> <td>100 +</td> </tr> <tr> <td>\$8.94</td> <td>\$8.32</td> </tr> </table>	1-24	25-49	\$10.40	\$9.67	50-99	100 +	\$8.94	\$8.32	<p><b>Model No. PE9707</b> FME JACK TO SMA MALE</p>  <table border="0"> <tr> <td>1-24</td> <td>25-49</td> </tr> <tr> <td>\$11.45</td> <td>\$10.65</td> </tr> <tr> <td>50-99</td> <td>100 +</td> </tr> <tr> <td>\$9.85</td> <td>\$9.16</td> </tr> </table>	1-24	25-49	\$11.45	\$10.65	50-99	100 +	\$9.85	\$9.16	<p><b>Model No. PE9708</b> FME JACK TO SMA FEMALE</p>  <table border="0"> <tr> <td>1-24</td> <td>25-49</td> </tr> <tr> <td>\$12.50</td> <td>\$11.63</td> </tr> <tr> <td>50-99</td> <td>100 +</td> </tr> <tr> <td>\$10.75</td> <td>\$10.00</td> </tr> </table>	1-24	25-49	\$12.50	\$11.63	50-99	100 +	\$10.75	\$10.00	<p><b>Model No. PE9709</b> FME JACK TO MINI UHF MALE</p>  <table border="0"> <tr> <td>1-24</td> <td>25-49</td> </tr> <tr> <td>\$10.40</td> <td>\$9.67</td> </tr> <tr> <td>50-99</td> <td>100 +</td> </tr> <tr> <td>\$8.94</td> <td>\$8.32</td> </tr> </table>	1-24	25-49	\$10.40	\$9.67	50-99	100 +	\$8.94	\$8.32	<p><b>Model No. PE9710</b> FME JACK TO MINI UHF FEMALE</p>  <table border="0"> <tr> <td>1-24</td> <td>25-49</td> </tr> <tr> <td>\$10.40</td> <td>\$9.67</td> </tr> <tr> <td>50-99</td> <td>100 +</td> </tr> <tr> <td>\$8.94</td> <td>\$8.32</td> </tr> </table>	1-24	25-49	\$10.40	\$9.67	50-99	100 +	\$8.94	\$8.32
1-24	25-49																																											
\$10.40	\$9.67																																											
50-99	100 +																																											
\$8.94	\$8.32																																											
1-24	25-49																																											
\$11.45	\$10.65																																											
50-99	100 +																																											
\$9.85	\$9.16																																											
1-24	25-49																																											
\$12.50	\$11.63																																											
50-99	100 +																																											
\$10.75	\$10.00																																											
1-24	25-49																																											
\$10.40	\$9.67																																											
50-99	100 +																																											
\$8.94	\$8.32																																											
1-24	25-49																																											
\$10.40	\$9.67																																											
50-99	100 +																																											
\$8.94	\$8.32																																											
<p><b>Model No. PE9711</b> FME JACK TO BNC MALE</p>  <table border="0"> <tr> <td>1-24</td> <td>25-49</td> </tr> <tr> <td>\$10.40</td> <td>\$9.67</td> </tr> <tr> <td>50-99</td> <td>100 +</td> </tr> <tr> <td>\$8.94</td> <td>\$8.32</td> </tr> </table>	1-24	25-49	\$10.40	\$9.67	50-99	100 +	\$8.94	\$8.32	<p><b>Model No. PE9712</b> FME JACK TO BNC FEMALE</p>  <table border="0"> <tr> <td>1-24</td> <td>25-49</td> </tr> <tr> <td>\$11.45</td> <td>\$10.65</td> </tr> <tr> <td>50-99</td> <td>100 +</td> </tr> <tr> <td>\$9.85</td> <td>\$9.16</td> </tr> </table>	1-24	25-49	\$11.45	\$10.65	50-99	100 +	\$9.85	\$9.16	<p><b>Model No. PE9713</b> FME JACK TO TNC MALE</p>  <table border="0"> <tr> <td>1-24</td> <td>25-49</td> </tr> <tr> <td>\$10.40</td> <td>\$9.67</td> </tr> <tr> <td>50-99</td> <td>100 +</td> </tr> <tr> <td>\$8.94</td> <td>\$8.32</td> </tr> </table>	1-24	25-49	\$10.40	\$9.67	50-99	100 +	\$8.94	\$8.32	<p><b>Model No. PE9714</b> FME JACK TO TNC FEMALE</p>  <table border="0"> <tr> <td>1-24</td> <td>25-49</td> </tr> <tr> <td>\$10.40</td> <td>\$9.67</td> </tr> <tr> <td>50-99</td> <td>100 +</td> </tr> <tr> <td>\$8.94</td> <td>\$8.32</td> </tr> </table>	1-24	25-49	\$10.40	\$9.67	50-99	100 +	\$8.94	\$8.32	<p><b>Model No. PE9715</b> 1.85mm MALE TO 1.85mm FEMALE MAX VSWR 1.50:1 @ 65 GHz</p>  <table border="0"> <tr> <td>1-24</td> <td>25-49</td> </tr> <tr> <td>\$407.50</td> <td>\$378.98</td> </tr> <tr> <td>50-99</td> <td>100 +</td> </tr> <tr> <td>\$350.45</td> <td>\$326.00</td> </tr> </table> <p>PRECISION ADAPTER</p>	1-24	25-49	\$407.50	\$378.98	50-99	100 +	\$350.45	\$326.00
1-24	25-49																																											
\$10.40	\$9.67																																											
50-99	100 +																																											
\$8.94	\$8.32																																											
1-24	25-49																																											
\$11.45	\$10.65																																											
50-99	100 +																																											
\$9.85	\$9.16																																											
1-24	25-49																																											
\$10.40	\$9.67																																											
50-99	100 +																																											
\$8.94	\$8.32																																											
1-24	25-49																																											
\$10.40	\$9.67																																											
50-99	100 +																																											
\$8.94	\$8.32																																											
1-24	25-49																																											
\$407.50	\$378.98																																											
50-99	100 +																																											
\$350.45	\$326.00																																											
<p><b>Model No. PE9716</b> 1.85mm MALE TO 1.85mm MALE MAX VSWR 1.50:1 @ 65 GHz</p>  <table border="0"> <tr> <td>1-24</td> <td>25-49</td> </tr> <tr> <td>\$407.50</td> <td>\$378.98</td> </tr> <tr> <td>50-99</td> <td>100 +</td> </tr> <tr> <td>\$350.45</td> <td>\$326.00</td> </tr> </table> <p>PRECISION ADAPTER</p>	1-24	25-49	\$407.50	\$378.98	50-99	100 +	\$350.45	\$326.00	<p><b>Model No. PE9717</b> 1.85mm FEMALE TO 1.85mm FEMALE MAX VSWR 1.50:1 @ 65 GHz</p>  <table border="0"> <tr> <td>1-24</td> <td>25-49</td> </tr> <tr> <td>\$407.50</td> <td>\$378.98</td> </tr> <tr> <td>50-99</td> <td>100 +</td> </tr> <tr> <td>\$350.45</td> <td>\$326.00</td> </tr> </table> <p>PRECISION ADAPTER</p>	1-24	25-49	\$407.50	\$378.98	50-99	100 +	\$350.45	\$326.00	<p><b>Model No. PE9718</b> 1.85mm MALE TO N MALE MAX VSWR 1.25:1 @ 18 GHz</p>  <table border="0"> <tr> <td>1-24</td> <td>25-49</td> </tr> <tr> <td>\$135.80</td> <td>\$126.29</td> </tr> <tr> <td>50-99</td> <td>100 +</td> </tr> <tr> <td>\$116.79</td> <td>\$108.64</td> </tr> </table> <p>PRECISION ADAPTER</p>	1-24	25-49	\$135.80	\$126.29	50-99	100 +	\$116.79	\$108.64	<p><b>Model No. PE9719</b> 1.85mm MALE TO N FEMALE MAX VSWR 1.25:1 @ 18 GHz</p>  <table border="0"> <tr> <td>1-24</td> <td>25-49</td> </tr> <tr> <td>\$135.80</td> <td>\$126.29</td> </tr> <tr> <td>50-99</td> <td>100 +</td> </tr> <tr> <td>\$116.79</td> <td>\$108.64</td> </tr> </table> <p>PRECISION ADAPTER</p>	1-24	25-49	\$135.80	\$126.29	50-99	100 +	\$116.79	\$108.64	<p><b>Model No. PE9720</b> 1.85mm FEMALE TO N MALE MAX VSWR 1.25:1 @ 18 GHz</p>  <table border="0"> <tr> <td>1-24</td> <td>25-49</td> </tr> <tr> <td>\$135.80</td> <td>\$126.29</td> </tr> <tr> <td>50-99</td> <td>100 +</td> </tr> <tr> <td>\$116.79</td> <td>\$108.64</td> </tr> </table> <p>PRECISION ADAPTER</p>	1-24	25-49	\$135.80	\$126.29	50-99	100 +	\$116.79	\$108.64
1-24	25-49																																											
\$407.50	\$378.98																																											
50-99	100 +																																											
\$350.45	\$326.00																																											
1-24	25-49																																											
\$407.50	\$378.98																																											
50-99	100 +																																											
\$350.45	\$326.00																																											
1-24	25-49																																											
\$135.80	\$126.29																																											
50-99	100 +																																											
\$116.79	\$108.64																																											
1-24	25-49																																											
\$135.80	\$126.29																																											
50-99	100 +																																											
\$116.79	\$108.64																																											
1-24	25-49																																											
\$135.80	\$126.29																																											
50-99	100 +																																											
\$116.79	\$108.64																																											
<p><b>Model No. PE9721</b> 1.85mm FEMALE TO N FEMALE MAX VSWR 1.25:1 @ 18 GHz</p>  <table border="0"> <tr> <td>1-24</td> <td>25-49</td> </tr> <tr> <td>\$135.80</td> <td>\$126.29</td> </tr> <tr> <td>50-99</td> <td>100 +</td> </tr> <tr> <td>\$116.79</td> <td>\$108.64</td> </tr> </table> <p>PRECISION ADAPTER</p>	1-24	25-49	\$135.80	\$126.29	50-99	100 +	\$116.79	\$108.64	<p><b>Model No. PE9722</b> SMA MALE TO 3.5mm MALE MAX VSWR 1.25:1 @ 18 GHz</p>  <table border="0"> <tr> <td>1-24</td> <td>25-49</td> </tr> <tr> <td>\$135.80</td> <td>\$126.29</td> </tr> <tr> <td>50-99</td> <td>100 +</td> </tr> <tr> <td>\$116.79</td> <td>\$108.64</td> </tr> </table> <p>PRECISION ADAPTER</p>	1-24	25-49	\$135.80	\$126.29	50-99	100 +	\$116.79	\$108.64	<p><b>Model No. PE9723</b> SMA MALE TO 3.5mm FEMALE MAX VSWR 1.25:1 @ 18 GHz</p>  <table border="0"> <tr> <td>1-24</td> <td>25-49</td> </tr> <tr> <td>\$130.55</td> <td>\$121.41</td> </tr> <tr> <td>50-99</td> <td>100 +</td> </tr> <tr> <td>\$112.27</td> <td>\$104.44</td> </tr> </table> <p>PRECISION ADAPTER</p>	1-24	25-49	\$130.55	\$121.41	50-99	100 +	\$112.27	\$104.44	<p><b>Model No. PE9724</b> SMA FEMALE TO 3.5mm MALE MAX VSWR 1.25:1 @ 18 GHz</p>  <table border="0"> <tr> <td>1-24</td> <td>25-49</td> </tr> <tr> <td>\$130.55</td> <td>\$121.41</td> </tr> <tr> <td>50-99</td> <td>100 +</td> </tr> <tr> <td>\$112.27</td> <td>\$104.44</td> </tr> </table> <p>PRECISION ADAPTER</p>	1-24	25-49	\$130.55	\$121.41	50-99	100 +	\$112.27	\$104.44	<p><b>Model No. PE9725</b> SMA FEMALE TO 3.5mm FEMALE MAX VSWR 1.25:1 @ 18 GHz</p>  <table border="0"> <tr> <td>1-24</td> <td>25-49</td> </tr> <tr> <td>\$130.55</td> <td>\$121.41</td> </tr> <tr> <td>50-99</td> <td>100 +</td> </tr> <tr> <td>\$112.27</td> <td>\$104.44</td> </tr> </table> <p>PRECISION ADAPTER</p>	1-24	25-49	\$130.55	\$121.41	50-99	100 +	\$112.27	\$104.44
1-24	25-49																																											
\$135.80	\$126.29																																											
50-99	100 +																																											
\$116.79	\$108.64																																											
1-24	25-49																																											
\$135.80	\$126.29																																											
50-99	100 +																																											
\$116.79	\$108.64																																											
1-24	25-49																																											
\$130.55	\$121.41																																											
50-99	100 +																																											
\$112.27	\$104.44																																											
1-24	25-49																																											
\$130.55	\$121.41																																											
50-99	100 +																																											
\$112.27	\$104.44																																											
1-24	25-49																																											
\$130.55	\$121.41																																											
50-99	100 +																																											
\$112.27	\$104.44																																											

# ADAPTERS

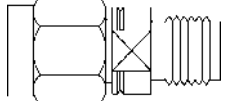
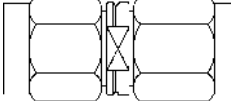
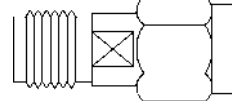
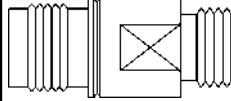
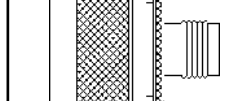
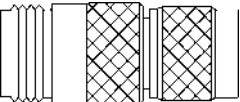
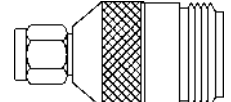
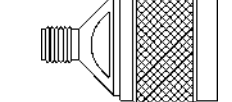
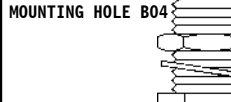
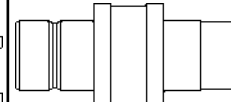
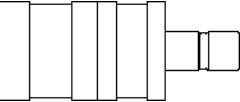
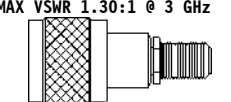
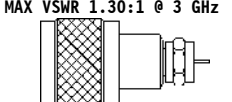
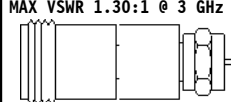
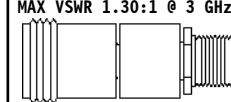
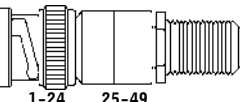
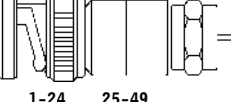
SEE ADAPTER SELECTION CHART ON PAGES 195 THRU 198

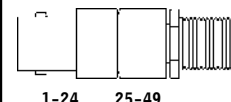
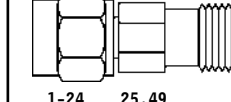
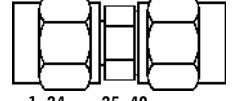
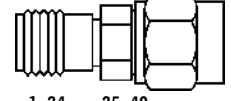
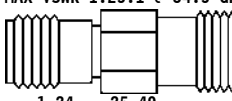
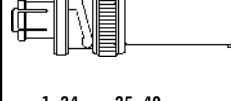
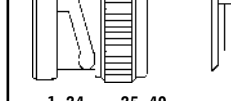
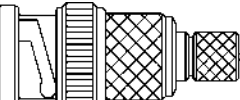
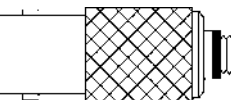
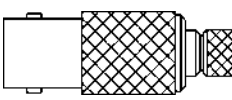
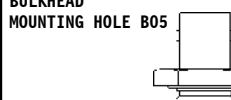
SEE PAGE 266 FOR MOUNTING HOLES





<p>Model No. PE9726 1.85mm MALE TO SMA FEMALE MAX VSWR 1.30:1 @ 18 GHz</p>  <p>1-24 25-49 \$135.80 \$126.29 PRECISION 50-99 100 + ADAPTER \$116.79 \$108.64</p>	<p>Model No. PE9727 1.85mm MALE TO SMA MALE MAX VSWR 1.30:1 @ 18 GHz</p>  <p>1-24 25-49 \$135.80 \$126.29 PRECISION 50-99 100 + ADAPTER \$116.79 \$108.64</p>	<p>Model No. PE9728 1.85mm FEMALE TO SMA MALE MAX VSWR 1.30:1 @ 18 GHz</p>  <p>1-24 25-49 \$135.80 \$126.29 PRECISION 50-99 100 + ADAPTER \$116.79 \$108.64</p>	<p>Model No. PE9729 1.85mm FEMALE TO SMA FEMALE MAX VSWR 1.30:1 @ 18 GHz</p>  <p>1-24 25-49 \$135.80 \$126.29 PRECISION 50-99 100 + ADAPTER \$116.79 \$108.64</p>	<p>Model No. PE9730 N MALE TO REVERSE POLARITY TNC FEMALE</p>  <p>1-24 25-49 \$30.50 \$28.37 50-99 100 + \$26.23 \$24.40</p>
<p>Model No. PE9731 N FEMALE TO REVERSE POLARITY TNC MALE</p>  <p>1-24 25-49 \$28.30 \$26.32 50-99 100 + \$24.34 \$22.64</p>	<p>Model No. PE9732 REVERSE POLARITY SMA MALE TO N FEMALE</p>  <p>1-24 25-49 \$51.25 \$47.66 50-99 100 + \$44.08 \$41.00</p>	<p>Model No. PE9733 REVERSE POLARITY SMA FEMALE TO N MALE</p>  <p>1-24 25-49 \$51.25 \$47.66 50-99 100 + \$44.08 \$41.00</p>	<p>Model No. PE9734 F FEMALE TO F FEMALE BULKHEAD MOUNTING HOLE B04</p>  <p>1-24 25-49 \$10.85 \$10.09 50-99 100 + \$9.33 \$8.68</p>	<p>Model No. PE9735 75 OHM SMB JACK TO MINI 75 OHM SMB PLUG</p>  <p>1-24 25-49 \$41.75 \$38.83 50-99 100 + \$35.91 \$33.40</p>
<p>Model No. PE9736 75 OHM SMB PLUG TO MINI 75 OHM SMB JACK</p>  <p>1-24 25-49 \$41.75 \$38.83 50-99 100 + \$35.91 \$33.40</p>	<p>Model No. PE9737 75 OHM N MALE TO F FEMALE MAX VSWR 1.30:1 @ 3 GHz</p>  <p>1-24 25-49 \$79.05 \$73.52 PRECISION 50-99 100 + ADAPTER \$67.98 \$63.24</p>	<p>Model No. PE9738 75 OHM N MALE TO F MALE MAX VSWR 1.30:1 @ 3 GHz</p>  <p>1-24 25-49 \$62.65 \$58.26 PRECISION 50-99 100 + ADAPTER \$53.88 \$50.12</p>	<p>Model No. PE9739 75 OHM N FEMALE TO F MALE MAX VSWR 1.30:1 @ 3 GHz</p>  <p>1-24 25-49 \$62.65 \$58.26 PRECISION 50-99 100 + ADAPTER \$53.88 \$50.12</p>	<p>Model No. PE9740 75 OHM N FEMALE TO F FEMALE MAX VSWR 1.30:1 @ 3 GHz</p>  <p>1-24 25-49 \$73.10 \$67.98 PRECISION 50-99 100 + ADAPTER \$62.87 \$58.48</p>
<p>Model No. PE9741 75 OHM BNC MALE TO F FEMALE MAX VSWR 1.30:1 @ 3 GHz</p>  <p>1-24 25-49 \$73.10 \$67.98 PRECISION 50-99 100 + ADAPTER \$62.87 \$58.48</p>	<p>Model No. PE9742 75 OHM BNC MALE TO F MALE MAX VSWR 1.30:1 @ 3 GHz</p>  <p>1-24 25-49 \$62.65 \$58.26 PRECISION 50-99 100 + ADAPTER \$53.88 \$50.12</p>	<p>Model No. PE9743 75 OHM BNC FEMALE TO F MALE MAX VSWR 1.30:1 @ 3 GHz</p>  <p>1-24 25-49 \$73.10 \$67.98 PRECISION 50-99 100 + ADAPTER \$62.87 \$58.48</p>	<p>Model No. PE9744 75 OHM BNC FEMALE TO F FEMALE MAX VSWR 1.30:1 @ 3 GHz</p>  <p>1-24 25-49 \$73.90 \$68.73 PRECISION 50-99 100 + ADAPTER \$63.55 \$59.12</p>	<p>Model No. PE9745 3.5mm MALE TO 1.85mm FEMALE MAX VSWR 1.25:1 @ 34.5 GHz</p>  <p>1-24 25-49 \$125.35 \$116.58 PRECISION 50-99 100 + ADAPTER \$107.80 \$100.28</p>
<p>Model No. PE9746 3.5mm MALE TO 1.85mm MALE MAX VSWR 1.25:1 @ 34.5 GHz</p>  <p>1-24 25-49 \$125.35 \$116.58 PRECISION 50-99 100 + ADAPTER \$107.80 \$100.28</p>	<p>Model No. PE9747 3.5mm FEMALE TO 1.85mm MALE MAX VSWR 1.25:1 @ 34.5 GHz</p>  <p>1-24 25-49 \$125.35 \$116.58 PRECISION 50-99 100 + ADAPTER \$107.80 \$100.28</p>	<p>Model No. PE9748 3.5mm FEMALE TO 1.85mm FEMALE MAX VSWR 1.25:1 @ 34.5 GHz</p>  <p>1-24 25-49 \$125.35 \$116.58 PRECISION 50-99 100 + ADAPTER \$107.80 \$100.28</p>	<p>Model No. PE9749 SHV PLUG TO SHV JACK</p>  <p>1-24 25-49 \$80.80 \$75.14 50-99 100 + \$69.49 \$64.64</p>	<p>Model No. PE9750 BNC MALE TO 10-32 FEMALE</p>  <p>1-24 25-49 \$41.75 \$38.83 50-99 100 + \$35.91 \$33.40</p>
<p>Model No. PE9751 BNC MALE TO 10-32 MALE</p>  <p>1-24 25-49 \$41.75 \$38.83 50-99 100 + \$35.91 \$33.40</p>	<p>Model No. PE9752 BNC FEMALE TO 10-32 FEMALE</p>  <p>1-24 25-49 \$41.75 \$38.83 50-99 100 + \$35.91 \$33.40</p>	<p>Model No. PE9753 BNC FEMALE TO 10-32 MALE</p>  <p>1-24 25-49 \$41.75 \$38.83 50-99 100 + \$35.91 \$33.40</p>	<p>Model No. PE9754 BNC FEMALE TO 10-32 FEMALE BULKHEAD MOUNTING HOLE B05</p>  <p>1-24 25-49 \$41.75 \$38.83 50-99 100 + \$35.91 \$33.40</p>	<p>Model No. PE9755 BNC FEMALE TO 10-32 MALE BULKHEAD MOUNTING HOLE B05</p>  <p>1-24 25-49 \$52.20 \$48.55 50-99 100 + \$44.89 \$41.76</p>

# ADAPTERS

SEE ADAPTER SELECTION CHART ON PAGES 195 THRU 198

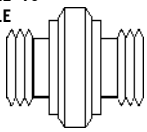
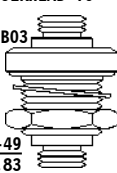
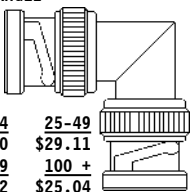
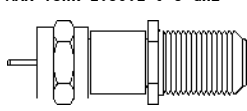
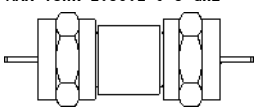
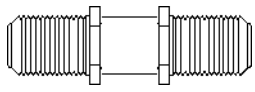
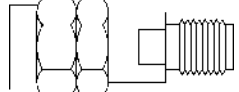
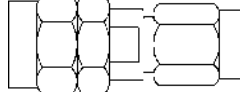
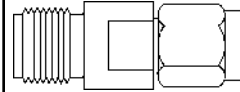
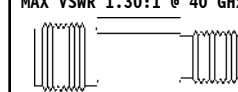
SEE PAGE 266 FOR MOUNTING HOLES

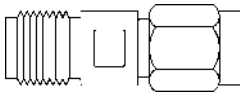
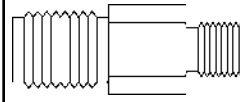
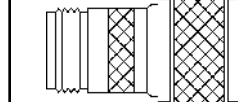
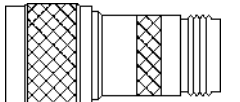
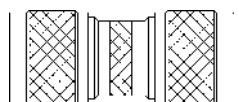
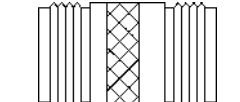
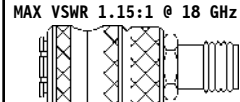
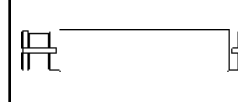
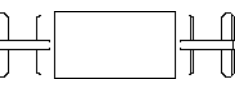
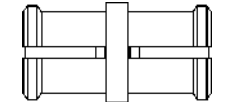
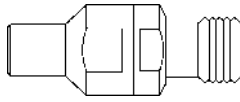
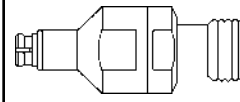
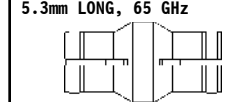
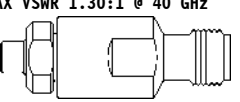
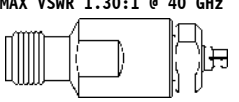
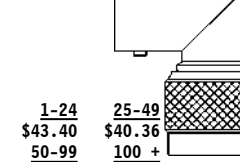
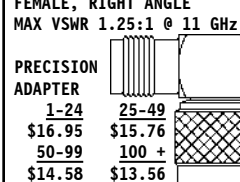
Adapters

<p>Model No. PE9756 10-32 FEMALE TO 10-32 FEMALE</p>  <table border="0"> <tr> <td>1-24</td> <td>25-49</td> <td></td> </tr> <tr> <td>\$31.30</td> <td>\$29.11</td> <td></td> </tr> <tr> <td>50-99</td> <td>100 +</td> <td></td> </tr> <tr> <td>\$26.92</td> <td>\$25.04</td> <td></td> </tr> </table>	1-24	25-49		\$31.30	\$29.11		50-99	100 +		\$26.92	\$25.04		<p>Model No. PE9757 10-32 FEMALE BULKHEAD TO 10-32 FEMALE MOUNTING HOLE B03</p>  <table border="0"> <tr> <td>1-24</td> <td>25-49</td> <td></td> </tr> <tr> <td>\$41.75</td> <td>\$38.83</td> <td></td> </tr> <tr> <td>50-99</td> <td>100 +</td> <td></td> </tr> <tr> <td>\$35.91</td> <td>\$33.40</td> <td></td> </tr> </table>	1-24	25-49		\$41.75	\$38.83		50-99	100 +		\$35.91	\$33.40		<p>Model No. PE9758 BNC MALE TO BNC MALE RIGHT ANGLE</p>  <table border="0"> <tr> <td>1-24</td> <td>25-49</td> <td></td> </tr> <tr> <td>\$31.30</td> <td>\$29.11</td> <td></td> </tr> <tr> <td>50-99</td> <td>100 +</td> <td></td> </tr> <tr> <td>\$26.92</td> <td>\$25.04</td> <td></td> </tr> </table>	1-24	25-49		\$31.30	\$29.11		50-99	100 +		\$26.92	\$25.04		<p>Model No. PE9759 F MALE TO F FEMALE MAX VSWR 1.30:1 @ 3 GHz</p>  <table border="0"> <tr> <td>1-24</td> <td>25-49</td> <td></td> </tr> <tr> <td>\$46.95</td> <td>\$43.66</td> <td>PRECISION</td> </tr> <tr> <td>50-99</td> <td>100 +</td> <td>ADAPTER</td> </tr> <tr> <td>\$40.38</td> <td>\$37.56</td> <td></td> </tr> </table>	1-24	25-49		\$46.95	\$43.66	PRECISION	50-99	100 +	ADAPTER	\$40.38	\$37.56		<p>Model No. PE9760 F MALE TO F MALE MAX VSWR 1.30:1 @ 3 GHz</p>  <table border="0"> <tr> <td>1-24</td> <td>25-49</td> <td></td> </tr> <tr> <td>\$46.95</td> <td>\$43.66</td> <td>PRECISION</td> </tr> <tr> <td>50-99</td> <td>100 +</td> <td>ADAPTER</td> </tr> <tr> <td>\$40.38</td> <td>\$37.56</td> <td></td> </tr> </table>	1-24	25-49		\$46.95	\$43.66	PRECISION	50-99	100 +	ADAPTER	\$40.38	\$37.56	
1-24	25-49																																																															
\$31.30	\$29.11																																																															
50-99	100 +																																																															
\$26.92	\$25.04																																																															
1-24	25-49																																																															
\$41.75	\$38.83																																																															
50-99	100 +																																																															
\$35.91	\$33.40																																																															
1-24	25-49																																																															
\$31.30	\$29.11																																																															
50-99	100 +																																																															
\$26.92	\$25.04																																																															
1-24	25-49																																																															
\$46.95	\$43.66	PRECISION																																																														
50-99	100 +	ADAPTER																																																														
\$40.38	\$37.56																																																															
1-24	25-49																																																															
\$46.95	\$43.66	PRECISION																																																														
50-99	100 +	ADAPTER																																																														
\$40.38	\$37.56																																																															
<p>Model No. PE9761 F FEMALE TO F FEMALE MAX VSWR 1.30:1 @ 3 GHz</p>  <table border="0"> <tr> <td>1-24</td> <td>25-49</td> <td></td> </tr> <tr> <td>\$46.95</td> <td>\$43.66</td> <td>PRECISION</td> </tr> <tr> <td>50-99</td> <td>100 +</td> <td>ADAPTER</td> </tr> <tr> <td>\$40.38</td> <td>\$37.56</td> <td></td> </tr> </table>	1-24	25-49		\$46.95	\$43.66	PRECISION	50-99	100 +	ADAPTER	\$40.38	\$37.56		<p>Model No. PE9762 1.85mm MALE TO SSMA FEMALE MAX VSWR 1.30:1 @ 40 GHz</p>  <table border="0"> <tr> <td>1-24</td> <td>25-49</td> <td></td> </tr> <tr> <td>\$203.70</td> <td>\$189.44</td> <td>PRECISION</td> </tr> <tr> <td>50-99</td> <td>100 +</td> <td>ADAPTER</td> </tr> <tr> <td>\$175.18</td> <td>\$162.96</td> <td></td> </tr> </table>	1-24	25-49		\$203.70	\$189.44	PRECISION	50-99	100 +	ADAPTER	\$175.18	\$162.96		<p>Model No. PE9763 1.85mm MALE TO SSMA MALE MAX VSWR 1.30:1 @ 40 GHz</p>  <table border="0"> <tr> <td>1-24</td> <td>25-49</td> <td></td> </tr> <tr> <td>\$203.70</td> <td>\$189.44</td> <td>PRECISION</td> </tr> <tr> <td>50-99</td> <td>100 +</td> <td>ADAPTER</td> </tr> <tr> <td>\$175.18</td> <td>\$162.96</td> <td></td> </tr> </table>	1-24	25-49		\$203.70	\$189.44	PRECISION	50-99	100 +	ADAPTER	\$175.18	\$162.96		<p>Model No. PE9764 1.85mm FEMALE TO SSMA MALE MAX VSWR 1.30:1 @ 40 GHz</p>  <table border="0"> <tr> <td>1-24</td> <td>25-49</td> <td></td> </tr> <tr> <td>\$203.70</td> <td>\$189.44</td> <td>PRECISION</td> </tr> <tr> <td>50-99</td> <td>100 +</td> <td>ADAPTER</td> </tr> <tr> <td>\$175.18</td> <td>\$162.96</td> <td></td> </tr> </table>	1-24	25-49		\$203.70	\$189.44	PRECISION	50-99	100 +	ADAPTER	\$175.18	\$162.96		<p>Model No. PE9765 1.85mm FEMALE TO SSMA FEMALE MAX VSWR 1.30:1 @ 40 GHz</p>  <table border="0"> <tr> <td>1-24</td> <td>25-49</td> <td></td> </tr> <tr> <td>\$203.70</td> <td>\$189.44</td> <td>PRECISION</td> </tr> <tr> <td>50-99</td> <td>100 +</td> <td>ADAPTER</td> </tr> <tr> <td>\$175.18</td> <td>\$162.96</td> <td></td> </tr> </table>	1-24	25-49		\$203.70	\$189.44	PRECISION	50-99	100 +	ADAPTER	\$175.18	\$162.96	
1-24	25-49																																																															
\$46.95	\$43.66	PRECISION																																																														
50-99	100 +	ADAPTER																																																														
\$40.38	\$37.56																																																															
1-24	25-49																																																															
\$203.70	\$189.44	PRECISION																																																														
50-99	100 +	ADAPTER																																																														
\$175.18	\$162.96																																																															
1-24	25-49																																																															
\$203.70	\$189.44	PRECISION																																																														
50-99	100 +	ADAPTER																																																														
\$175.18	\$162.96																																																															
1-24	25-49																																																															
\$203.70	\$189.44	PRECISION																																																														
50-99	100 +	ADAPTER																																																														
\$175.18	\$162.96																																																															
1-24	25-49																																																															
\$203.70	\$189.44	PRECISION																																																														
50-99	100 +	ADAPTER																																																														
\$175.18	\$162.96																																																															
<p>Model No. PE9766 2.92mm MALE TO SSMA FEMALE MAX VSWR 1.30:1 @ 40 GHz</p>  <table border="0"> <tr> <td>1-24</td> <td>25-49</td> <td></td> </tr> <tr> <td>\$146.25</td> <td>\$136.01</td> <td>PRECISION</td> </tr> <tr> <td>50-99</td> <td>100 +</td> <td>ADAPTER</td> </tr> <tr> <td>\$125.78</td> <td>\$117.00</td> <td></td> </tr> </table>	1-24	25-49		\$146.25	\$136.01	PRECISION	50-99	100 +	ADAPTER	\$125.78	\$117.00		<p>Model No. PE9767 2.92mm MALE TO SSMA MALE MAX VSWR 1.30:1 @ 40 GHz</p>  <table border="0"> <tr> <td>1-24</td> <td>25-49</td> <td></td> </tr> <tr> <td>\$203.70</td> <td>\$189.44</td> <td>PRECISION</td> </tr> <tr> <td>50-99</td> <td>100 +</td> <td>ADAPTER</td> </tr> <tr> <td>\$175.18</td> <td>\$162.96</td> <td></td> </tr> </table>	1-24	25-49		\$203.70	\$189.44	PRECISION	50-99	100 +	ADAPTER	\$175.18	\$162.96		<p>Model No. PE9768 2.92mm FEMALE TO SSMA MALE MAX VSWR 1.30:1 @ 40 GHz</p>  <table border="0"> <tr> <td>1-24</td> <td>25-49</td> <td></td> </tr> <tr> <td>\$146.25</td> <td>\$136.01</td> <td>PRECISION</td> </tr> <tr> <td>50-99</td> <td>100 +</td> <td>ADAPTER</td> </tr> <tr> <td>\$125.78</td> <td>\$117.00</td> <td></td> </tr> </table>	1-24	25-49		\$146.25	\$136.01	PRECISION	50-99	100 +	ADAPTER	\$125.78	\$117.00		<p>Model No. PE9769 2.92mm FEMALE TO SSMA FEMALE MAX VSWR 1.30:1 @ 40 GHz</p>  <table border="0"> <tr> <td>1-24</td> <td>25-49</td> <td></td> </tr> <tr> <td>\$203.70</td> <td>\$189.44</td> <td>PRECISION</td> </tr> <tr> <td>50-99</td> <td>100 +</td> <td>ADAPTER</td> </tr> <tr> <td>\$175.18</td> <td>\$162.96</td> <td></td> </tr> </table>	1-24	25-49		\$203.70	\$189.44	PRECISION	50-99	100 +	ADAPTER	\$175.18	\$162.96		<p>Model No. PE9770 N FEMALE TO REVERSE POLARITY N MALE</p>  <table border="0"> <tr> <td>1-24</td> <td>25-49</td> <td></td> </tr> <tr> <td>\$20.85</td> <td>\$19.39</td> <td></td> </tr> <tr> <td>50-99</td> <td>100 +</td> <td></td> </tr> <tr> <td>\$17.93</td> <td>\$16.68</td> <td></td> </tr> </table>	1-24	25-49		\$20.85	\$19.39		50-99	100 +		\$17.93	\$16.68	
1-24	25-49																																																															
\$146.25	\$136.01	PRECISION																																																														
50-99	100 +	ADAPTER																																																														
\$125.78	\$117.00																																																															
1-24	25-49																																																															
\$203.70	\$189.44	PRECISION																																																														
50-99	100 +	ADAPTER																																																														
\$175.18	\$162.96																																																															
1-24	25-49																																																															
\$146.25	\$136.01	PRECISION																																																														
50-99	100 +	ADAPTER																																																														
\$125.78	\$117.00																																																															
1-24	25-49																																																															
\$203.70	\$189.44	PRECISION																																																														
50-99	100 +	ADAPTER																																																														
\$175.18	\$162.96																																																															
1-24	25-49																																																															
\$20.85	\$19.39																																																															
50-99	100 +																																																															
\$17.93	\$16.68																																																															
<p>Model No. PE9771 N MALE TO REVERSE POLARITY N FEMALE</p>  <table border="0"> <tr> <td>1-24</td> <td>25-49</td> <td></td> </tr> <tr> <td>\$20.85</td> <td>\$19.39</td> <td></td> </tr> <tr> <td>50-99</td> <td>100 +</td> <td></td> </tr> <tr> <td>\$17.93</td> <td>\$16.68</td> <td></td> </tr> </table>	1-24	25-49		\$20.85	\$19.39		50-99	100 +		\$17.93	\$16.68		<p>Model No. PE9772 REVERSE POLARITY N MALE TO REVERSE POLARITY N MALE</p>  <table border="0"> <tr> <td>1-24</td> <td>25-49</td> <td></td> </tr> <tr> <td>\$24.00</td> <td>\$22.32</td> <td></td> </tr> <tr> <td>50-99</td> <td>100 +</td> <td></td> </tr> <tr> <td>\$20.64</td> <td>\$19.20</td> <td></td> </tr> </table>	1-24	25-49		\$24.00	\$22.32		50-99	100 +		\$20.64	\$19.20		<p>Model No. PE9773 REVERSE POLARITY N FEMALE TO REVERSE POLARITY N FEMALE</p>  <table border="0"> <tr> <td>1-24</td> <td>25-49</td> <td></td> </tr> <tr> <td>\$20.85</td> <td>\$19.39</td> <td></td> </tr> <tr> <td>50-99</td> <td>100 +</td> <td></td> </tr> <tr> <td>\$17.93</td> <td>\$16.68</td> <td></td> </tr> </table>	1-24	25-49		\$20.85	\$19.39		50-99	100 +		\$17.93	\$16.68		<p>Model No. PE9774 SMA MALE QUICK-DISCONNECT TO SMA FEMALE MAX VSWR 1.15:1 @ 18 GHz</p>  <table border="0"> <tr> <td>1-24</td> <td>25-49</td> <td></td> </tr> <tr> <td>\$83.55</td> <td>\$77.70</td> <td>PRECISION</td> </tr> <tr> <td>50-99</td> <td>100 +</td> <td>ADAPTER</td> </tr> <tr> <td>\$71.85</td> <td>\$66.84</td> <td></td> </tr> </table>	1-24	25-49		\$83.55	\$77.70	PRECISION	50-99	100 +	ADAPTER	\$71.85	\$66.84		<p>Model No. PE9775 BULLET, SMP FEMALE TO SMP FEMALE, 22.4mm LONG</p>  <table border="0"> <tr> <td>1-24</td> <td>25-49</td> <td></td> </tr> <tr> <td>\$40.70</td> <td>\$37.85</td> <td></td> </tr> <tr> <td>50-99</td> <td>100 +</td> <td></td> </tr> <tr> <td>\$35.00</td> <td>\$32.56</td> <td></td> </tr> </table>	1-24	25-49		\$40.70	\$37.85		50-99	100 +		\$35.00	\$32.56	
1-24	25-49																																																															
\$20.85	\$19.39																																																															
50-99	100 +																																																															
\$17.93	\$16.68																																																															
1-24	25-49																																																															
\$24.00	\$22.32																																																															
50-99	100 +																																																															
\$20.64	\$19.20																																																															
1-24	25-49																																																															
\$20.85	\$19.39																																																															
50-99	100 +																																																															
\$17.93	\$16.68																																																															
1-24	25-49																																																															
\$83.55	\$77.70	PRECISION																																																														
50-99	100 +	ADAPTER																																																														
\$71.85	\$66.84																																																															
1-24	25-49																																																															
\$40.70	\$37.85																																																															
50-99	100 +																																																															
\$35.00	\$32.56																																																															
<p>Model No. PE9776 BULLET, SMP FEMALE TO SMP FEMALE, 12.6mm LONG</p>  <table border="0"> <tr> <td>1-24</td> <td>25-49</td> <td></td> </tr> <tr> <td>\$40.70</td> <td>\$37.85</td> <td></td> </tr> <tr> <td>50-99</td> <td>100 +</td> <td></td> </tr> <tr> <td>\$35.00</td> <td>\$32.56</td> <td></td> </tr> </table>	1-24	25-49		\$40.70	\$37.85		50-99	100 +		\$35.00	\$32.56		<p>Model No. PE9777 BULLET, SMP FEMALE TO SMP FEMALE, 6.45mm LONG</p>  <table border="0"> <tr> <td>1-24</td> <td>25-49</td> <td></td> </tr> <tr> <td>\$31.30</td> <td>\$29.11</td> <td></td> </tr> <tr> <td>50-99</td> <td>100 +</td> <td></td> </tr> <tr> <td>\$26.92</td> <td>\$25.04</td> <td></td> </tr> </table>	1-24	25-49		\$31.30	\$29.11		50-99	100 +		\$26.92	\$25.04		<p>Model No. PE9778 SMP MALE TO SMA FEMALE MAX VSWR 1.45:1 @ 26.5 GHz</p>  <table border="0"> <tr> <td>1-24</td> <td>25-49</td> <td></td> </tr> <tr> <td>\$261.20</td> <td>\$242.92</td> <td>PRECISION</td> </tr> <tr> <td>50-99</td> <td>100 +</td> <td>ADAPTER</td> </tr> <tr> <td>\$224.63</td> <td>\$208.96</td> <td></td> </tr> </table>	1-24	25-49		\$261.20	\$242.92	PRECISION	50-99	100 +	ADAPTER	\$224.63	\$208.96		<p>Model No. PE9779 SMP FEMALE TO SMA FEMALE MAX VSWR 1.30:1 @ 18 GHz</p>  <table border="0"> <tr> <td>1-24</td> <td>25-49</td> <td></td> </tr> <tr> <td>\$261.20</td> <td>\$242.92</td> <td>PRECISION</td> </tr> <tr> <td>50-99</td> <td>100 +</td> <td>ADAPTER</td> </tr> <tr> <td>\$224.63</td> <td>\$208.96</td> <td></td> </tr> </table>	1-24	25-49		\$261.20	\$242.92	PRECISION	50-99	100 +	ADAPTER	\$224.63	\$208.96		<p>Model No. PE9780 BULLET, MINI SMP FEMALE TO MINI SMP FEMALE 5.3mm LONG, 65 GHz</p>  <table border="0"> <tr> <td>1-24</td> <td>25-49</td> <td></td> </tr> <tr> <td>\$31.30</td> <td>\$29.11</td> <td></td> </tr> <tr> <td>50-99</td> <td>100 +</td> <td></td> </tr> <tr> <td>\$26.92</td> <td>\$25.04</td> <td></td> </tr> </table>	1-24	25-49		\$31.30	\$29.11		50-99	100 +		\$26.92	\$25.04	
1-24	25-49																																																															
\$40.70	\$37.85																																																															
50-99	100 +																																																															
\$35.00	\$32.56																																																															
1-24	25-49																																																															
\$31.30	\$29.11																																																															
50-99	100 +																																																															
\$26.92	\$25.04																																																															
1-24	25-49																																																															
\$261.20	\$242.92	PRECISION																																																														
50-99	100 +	ADAPTER																																																														
\$224.63	\$208.96																																																															
1-24	25-49																																																															
\$261.20	\$242.92	PRECISION																																																														
50-99	100 +	ADAPTER																																																														
\$224.63	\$208.96																																																															
1-24	25-49																																																															
\$31.30	\$29.11																																																															
50-99	100 +																																																															
\$26.92	\$25.04																																																															
<p>Model No. PE9781 MINI SMP MALE TO 2.92mm FEMALE MAX VSWR 1.30:1 @ 40 GHz</p>  <table border="0"> <tr> <td>1-24</td> <td>25-49</td> <td></td> </tr> <tr> <td>\$470.20</td> <td>\$437.29</td> <td>PRECISION</td> </tr> <tr> <td>50-99</td> <td>100 +</td> <td>ADAPTER</td> </tr> <tr> <td>\$404.37</td> <td>\$376.16</td> <td></td> </tr> </table>	1-24	25-49		\$470.20	\$437.29	PRECISION	50-99	100 +	ADAPTER	\$404.37	\$376.16		<p>Model No. PE9782 2.92mm FEMALE TO MINI SMP FEMALE MAX VSWR 1.30:1 @ 40 GHz</p>  <table border="0"> <tr> <td>1-24</td> <td>25-49</td> <td></td> </tr> <tr> <td>\$470.20</td> <td>\$437.29</td> <td>PRECISION</td> </tr> <tr> <td>50-99</td> <td>100 +</td> <td>ADAPTER</td> </tr> <tr> <td>\$404.37</td> <td>\$376.16</td> <td></td> </tr> </table>	1-24	25-49		\$470.20	\$437.29	PRECISION	50-99	100 +	ADAPTER	\$404.37	\$376.16		<p>Model No. PE9783 <b>NEW</b> TNC MALE TO BNC FEMALE RIGHT ANGLE</p>  <table border="0"> <tr> <td>1-24</td> <td>25-49</td> <td></td> </tr> <tr> <td>\$43.40</td> <td>\$40.36</td> <td></td> </tr> <tr> <td>50-99</td> <td>100 +</td> <td></td> </tr> <tr> <td>\$37.32</td> <td>\$34.72</td> <td></td> </tr> </table>	1-24	25-49		\$43.40	\$40.36		50-99	100 +		\$37.32	\$34.72		<p>Model No. PE9918 <b>NEW</b> REVERSE POLARITY TNC MALE TO REVERSE POLARITY TNC FEMALE, RIGHT ANGLE MAX VSWR 1.25:1 @ 11 GHz</p>  <table border="0"> <tr> <td>1-24</td> <td>25-49</td> <td></td> </tr> <tr> <td>\$16.95</td> <td>\$15.76</td> <td></td> </tr> <tr> <td>50-99</td> <td>100 +</td> <td></td> </tr> <tr> <td>\$14.58</td> <td>\$13.56</td> <td></td> </tr> </table>	1-24	25-49		\$16.95	\$15.76		50-99	100 +		\$14.58	\$13.56		<p>Model No. PE9786 <b>NEW</b> QMA MALE TO SMA FEMALE</p>  <table border="0"> <tr> <td>1-24</td> <td>25-49</td> <td></td> </tr> <tr> <td>\$39.95</td> <td>\$37.15</td> <td></td> </tr> <tr> <td>50-99</td> <td>100 +</td> <td></td> </tr> <tr> <td>\$34.36</td> <td>\$31.96</td> <td></td> </tr> </table>	1-24	25-49		\$39.95	\$37.15		50-99	100 +		\$34.36	\$31.96	
1-24	25-49																																																															
\$470.20	\$437.29	PRECISION																																																														
50-99	100 +	ADAPTER																																																														
\$404.37	\$376.16																																																															
1-24	25-49																																																															
\$470.20	\$437.29	PRECISION																																																														
50-99	100 +	ADAPTER																																																														
\$404.37	\$376.16																																																															
1-24	25-49																																																															
\$43.40	\$40.36																																																															
50-99	100 +																																																															
\$37.32	\$34.72																																																															
1-24	25-49																																																															
\$16.95	\$15.76																																																															
50-99	100 +																																																															
\$14.58	\$13.56																																																															
1-24	25-49																																																															
\$39.95	\$37.15																																																															
50-99	100 +																																																															
\$34.36	\$31.96																																																															

# ADAPTERS

SEE ADAPTER SELECTION CHART ON PAGES 195 THRU 198

SEE PAGE 266 FOR MOUNTING HOLES

Model No. PE9787  
QMA FEMALE TO N MALE **NEW**

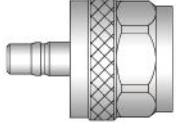

<u>1-24</u>	<u>25-49</u>
\$89.95	\$83.65
<u>50-99</u>	<u>100 +</u>
\$77.36	\$71.96

Model No. PE9788  
QN MALE TO N FEMALE **NEW**

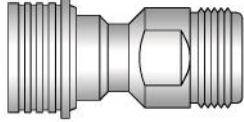

<u>1-24</u>	<u>25-49</u>
\$89.95	\$83.65
<u>50-99</u>	<u>100 +</u>
\$77.36	\$71.96

Model No. PE9789  
QN FEMALE TO N MALE **NEW**

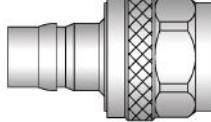

<u>1-24</u>	<u>25-49</u>
\$89.95	\$83.65
<u>50-99</u>	<u>100 +</u>
\$77.36	\$71.96

## NOTES

# INDEX GUIDE TO ATTENUATORS & OTHER PRODUCTS

**GUIDE: TO FIND THE FIXED ATTENUATOR YOU NEED, PLEASE TURN THE PAGE AND REFER TO THE FIXED ATTENUATOR SELECTOR GUIDE. FOR FURTHER ASSISTANCE, CALL OUR TECH SUPPORT DEPARTMENT TOLL-FREE 866-727-8376.**

**NEW PRODUCTS AND CATEGORIES ARE IDENTIFIED WITH THE NEW SYMBOL.**

<b>FIXED ATTENUATORS</b>	
2.92mm .....	226
7mm .....	226
<span style="border: 1px solid black; padding: 0 2px;">NEW</span> SMA.....	226 & 227
N .....	227 & 228
TNC .....	228 & 229
7/16.....	229
BNC .....	230
75 OHM F .....	230
75 OHM BNC.....	230
75 OHM N .....	230
<b>OTHER ATTENUATORS</b>	
DC BIAS PASSING.....	231
CONT. VARIABLE .....	231
SINGLE-STAGE ROTARY .....	232
2 & 3 STAGE ROTARY .....	232
PUSHBUTTON .....	233
TOGGLE.....	233
PROGRAMMABLE .....	233
IMPEDANCE MATCHING PADS .....	234
<b>TERMINATIONS</b>	
<span style="border: 1px solid black; padding: 0 2px;">NEW</span> HIGH POWER .....	234
FEED-THRU PRECISION .....	235
50 & 75 OHM PRECISION.....	235
RESISTOR .....	236
<b>DIRECTIONAL COUPLERS</b>	
90° HYBRIDS.....	236
BROADBAND .....	237
OCTAVE .....	238
DUAL .....	239
HIGHPOWER .....	239
<b>POWER DIVIDERS</b>	
50 OHM RESISTIVE .....	240
POWER DIVIDERS .....	240

ISOLATORS / CIRCULATORS.....	241
PHASE SHIFTERS .....	241
PHASE TRIMMERS .....	241
D.C. BLOCKS .....	241
BIAS "TEES" .....	242
CAPS / SHORTS.....	242
SURGE PROTECTORS.....	243
N FUSE HOLDER.....	243
<b>SWITCHES</b>	
COAXIAL .....	243 & 244
RELAY .....	244
TRANSFER .....	244
<b>ACTIVE DEVICES</b>	
NOISE GENERATORS.....	245 & 246
<span style="border: 1px solid black; padding: 0 2px;">NEW</span> GENERAL PURPOSE AMPLIFIERS.....	245
LOW-NOISE AMPLIFIERS .....	245
<b>DETECTORS / LIMITERS</b>	
SCHOTTKY DIODE DETECTORS	246 & 247
BNC DETECTORS.....	246
LOG DETECTOR .....	246
SCHOTTKY DIODE LIMITERS.....	247
PIN-PIN DIODE LIMITERS.....	247
DOUBLE BALANCED MIXERS .....	248
FREQUENCY DOUBLERS .....	248
<b>WAVEGUIDE PRODUCTS</b>	
WAVEGUIDE TERMINATIONS... ..	248 & 250
STANDARD GAIN HORNS.....	249
END-LAUNCH ADAPTERS.....	250 & 251
<b>ANTENNAS</b>	
<span style="border: 1px solid black; padding: 0 2px;">NEW</span> MOBILE & STATIONARY .....	252 & 253
<span style="border: 1px solid black; padding: 0 2px;">NEW</span> MOBILE MOUNTS .....	254
<span style="border: 1px solid black; padding: 0 2px;">NEW</span> CABLE ASSEMBLIES.....	254 & 255

# PASTERNAK FIXED ATTENUATOR SELECTOR GUIDE

P/N	Conn.	Page No.	Imp. (Ohms)	Max Freq (GHz)	Max Power (W)	Attenuator Extension (dB value)															
						1	2	3	4	5	6	7	8	9	10	12	15	20	30	40	
PE7024	2.92mm	226	50	26.5	0.5	X	X	X			X			X			X	X			
PE7046	2.92mm	226	50	40	0.5			X			X			X			X	X			
PE7039	7/16	229	50	7.5	5	X	X	X			X			X			X	X	X		
PE7040	7/16	229	50	7.5	10	X	X	X			X			X			X	X	X		
PE7041	7/16	229	50	7.5	25	X	X	X			X			X			X	X	X		
PE7042	7/16	229	50	7.5	50						X			X			X	X	X		
PE7043	7/16	229	50	1.5	100						X			X			X	X	X		
PE7023	7mm	226	50	18	2	X	X	X			X			X			X	X			
PE7000	BNC	230	50	2	1	X	X	X			X			X			X	X			
PE7049	BNC	230	50	4	2	X	X	X			X			X			X	X			
PE7025	BNC	230	50	2	10		X	X			X			X			X	X	X		
PE7026	BNC	230	50	1	100			X			X			X			X	X	X		
PE7002	N	227	50	2	1	X	X	X			X			X			X	X	X		
PE7047	N	227	50	12.4	2	X	X	X	X	X	X	X	X	X	X	X	X	X	X		
PE7004	N	227	50	18	2	X	X	X	X	X	X	X	X	X	X	X	X	X	X		
PE7014	N	227	50	18	5	X	X	X			X			X			X	X	X		
PE7048	N	228	50	12.4	10	X	X	X			X			X			X	X	X		
PE7010	N	227	50	2	10		X	X			X			X			X	X	X		
PE7015	N	228	50	18	10	X	X	X			X			X			X	X	X		
PE7017	N	228	50	18	25	X	X	X			X			X			X	X	X		
PE7019	N	228	50	18	50						X			X			X	X	X		
PE7021	N	228	50	1.5	100						X			X			X	X	X		
PE7031	N	228	50	1	300	X	X	X			X			X			X	X			
PE7032	N	228	50	0.5	500	X	X	X			X			X			X	X			
PE7161	SMA	226	50	2	1	X	X	X	X	X	X	X	X	X	X	X	X	X	X		
PE7001	SMA	226	50	3	2	X	X	X	X	X	X	X	X	X	X	X	X	X	X		
PE7162	SMA	226	50	6	2	X	X	X	X	X	X	X	X	X	X	X	X	X	X		
PE7045	SMA	226	50	12.4	2	X	X	X	X	X	X	X	X	X	X	X	X	X	X		
PE7005	SMA	226	50	18	2	X	X	X	X	X	X	X	X	X	X	X	X	X	X		
PE7013	SMA	227	50	18	5	X	X	X			X			X			X	X	X		
PE7016	SMA	227	50	18	10	X	X	X			X			X			X	X	X		
PE7018	SMA	227	50	18	25	X	X	X			X			X			X	X	X		
PE7020	SMA	227	50	18	50						X			X			X	X	X		
PE7022	SMA	227	50	1.5	100						X			X			X	X	X		
PE7003	TNC	228	50	2	1	X	X	X			X			X			X	X	X		
PE7051	TNC	228	50	12.4	2	X	X	X			X			X			X	X	X		
PE7030	TNC	228	50	18	2	X	X	X			X			X			X	X			
PE7052	TNC	229	50	18	5	X	X	X			X			X			X	X	X		
PE7053	TNC	229	50	18	10	X	X	X			X			X			X	X	X		
PE7054	TNC	229	50	18	25	X	X	X			X			X			X	X	X		
PE7055	TNC	229	50	18	50						X			X			X	X	X		
PE7056	TNC	229	50	1.5	100						X			X			X	X	X		
PE7009	BNC	230	75	1	1	X	X	X			X			X			X	X			
PE7050	BNC	230	75	4	2	X	X	X			X			X			X	X			
PE7057	F	230	75	1	2	X	X	X			X			X							
PE7029	N	230	75	1	1	X	X	X			X			X			X	X			
PE7044	N	230	75	4	2	X	X	X			X			X			X	X			

Attenuators /  
RF Components



## DC TO 26.5 GHZ 2.92mm\* ATTENUATORS

IMPEDANCE: 50 Ohms  
 ACCURACY: 1 THRU 6 dB, ± .5 dB  
 10 AND 20 dB, ± .6 dB  
 30 dB, ± .8 dB

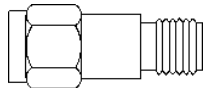

VSWR: 1.40:1 MAXIMUM  
 AVERAGE POWER HANDLING CAPABILITY: 2 WATTS

Model No.	ATTENUATION	1-24	25-49	50-99	100 +
PE7024-1	1 dB	\$177.60	\$165.17	\$152.74	\$142.08
PE7024-2	2 dB	177.60	165.17	152.74	142.08
PE7024-3	3 dB	177.60	165.17	152.74	142.08
PE7024-6	6 dB	177.60	165.17	152.74	142.08
PE7024-10	10 dB	177.60	165.17	152.74	142.08
PE7024-20	20 dB	177.60	165.17	152.74	142.08
PE7024-30	30 dB	177.60	165.17	152.74	142.08

\*2.92mm CONNECTORS WILL MATE BOTH ELECTRICALLY AND MECHANICALLY WITH ALL SMA, 3.5mm & K CONNECTORS. THE K CONNECTOR IS A REGISTERED TRADEMARK OF THE ANRITSU COMPANY.

## DC TO 40 GHZ 2.92mm\* ATTENUATORS

IMPEDANCE: 50 Ohms  
 ACCURACY: 3 AND 6 dB, ± .8 dB  
 10 THRU 30 dB, ± 1.0 dB

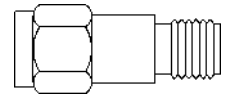

VSWR: 1.40:1 MAXIMUM  
 AVERAGE POWER HANDLING CAPABILITY: .5 WATT

Model No.	ATTENUATION	1-24	25-49	50-99	100 +
PE7046-3	3 dB	\$313.45	\$291.51	\$269.57	\$250.76
PE7046-6	6 dB	313.45	291.51	269.57	250.76
PE7046-10	10 dB	313.45	291.51	269.57	250.76
PE7046-20	20 dB	313.45	291.51	269.57	250.76
PE7046-30	30 dB	313.45	291.51	269.57	250.76

\*2.92mm CONNECTORS WILL MATE BOTH ELECTRICALLY AND MECHANICALLY WITH ALL SMA, 3.5mm & K CONNECTORS. THE K CONNECTOR IS A REGISTERED TRADEMARK OF THE ANRITSU COMPANY.

## DC TO 18 GHZ 7mm ATTENUATORS

IMPEDANCE: 50 Ohms  
 ACCURACY: 1 THRU 6 dB, ± .3 dB  
 10 AND 20 dB, ± .5 dB  
 30 dB, ± .75 dB

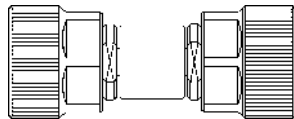

VSWR: 1.20:1 MAXIMUM

AVERAGE POWER HANDLING CAPABILITY: 2 WATTS

Model No.	ATTENUATION	1-24	25-49	50-99	100 +
PE7023-1	1 dB	\$365.70	\$340.10	\$314.50	\$292.56
PE7023-2	2 dB	365.70	340.10	314.50	292.56
PE7023-3	3 dB	365.70	340.10	314.50	292.56
PE7023-6	6 dB	365.70	340.10	314.50	292.56
PE7023-10	10 dB	365.70	340.10	314.50	292.56
PE7023-20	20 dB	365.70	340.10	314.50	292.56
PE7023-30	30 dB	365.70	340.10	314.50	292.56

## 1 WATT, DC TO 2 GHZ SMA ATTENUATORS

ACCURACY: 1 THRU 10 dB, ± .6 dB  
 12, 15, & 20 dB, ± .75 dB  
 30 dB ± .90 dB, 40 dB ± 1.50 dB

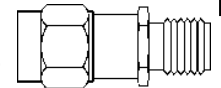

VSWR: 1.2:1 MAXIMUM

Model No.	ATTENUATION	1-24	25-49	50-99	100 +
PE7161-1	1 dB	\$39.95	\$37.15	\$34.36	\$31.96
PE7161-2	2 dB	39.95	37.15	34.36	31.96
PE7161-3	3 dB	39.95	37.15	34.36	31.96
PE7161-4	4 dB	39.95	37.15	34.36	31.96
PE7161-5	5 dB	39.95	37.15	34.36	31.96
PE7161-6	6 dB	39.95	37.15	34.36	31.96
PE7161-7	7 dB	39.95	37.15	34.36	31.96
PE7161-8	8 dB	39.95	37.15	34.36	31.96
PE7161-9	9 dB	39.95	37.15	34.36	31.96
PE7161-10	10 dB	39.95	37.15	34.36	31.96
PE7161-12	12 dB	39.95	37.15	34.36	31.96
PE7161-15	15 dB	39.95	37.15	34.36	31.96
PE7161-20	20 dB	39.95	37.15	34.36	31.96
PE7161-30	30 dB	39.95	37.15	34.36	31.96
PE7161-40	40 dB	39.95	37.15	34.36	31.96

NEW

## 2 WATT, DC TO 3 GHZ SMA ATTENUATORS

ACCURACY: 1 THRU 10 dB, ± .5 dB  
 12, 15 & 20 dB, ± .75 dB  
 30 & 40 dB, ± 1.50 dB

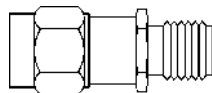

VSWR: 1.15:1 MAXIMUM

Model No.	ATTENUATION	1-24	25-49	50-99	100 +
PE7001-1	1 dB	\$52.20	\$48.55	\$44.89	\$41.76
PE7001-2	2 dB	52.20	48.55	44.89	41.76
PE7001-3	3 dB	52.20	48.55	44.89	41.76
PE7001-4	4 dB	52.20	48.55	44.89	41.76
PE7001-5	5 dB	52.20	48.55	44.89	41.76
PE7001-6	6 dB	52.20	48.55	44.89	41.76
PE7001-7	7 dB	52.20	48.55	44.89	41.76
PE7001-8	8 dB	52.20	48.55	44.89	41.76
PE7001-9	9 dB	52.20	48.55	44.89	41.76
PE7001-10	10 dB	52.20	48.55	44.89	41.76
PE7001-12	12 dB	52.20	48.55	44.89	41.76
PE7001-15	15 dB	52.20	48.55	44.89	41.76
PE7001-20	20 dB	52.20	48.55	44.89	41.76
PE7001-30	30 dB	52.20	48.55	44.89	41.76
PE7001-40	40 dB	67.85	63.10	58.35	54.28

## 2 WATTS, DC TO 6 GHZ SMA ATTENUATORS

ACCURACY: 1 THRU 10 dB, ± .6 dB  
 12, 15, & 20 dB, ± .75 dB  
 30 dB ± .90 dB, 40 dB ± 1.50 dB

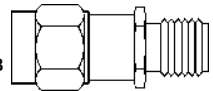

VSWR: 1.2:1 MAXIMUM

Model No.	ATTENUATION	1-24	25-49	50-99	100 +
PE7162-1	1 dB	\$59.95	\$55.75	\$51.56	\$47.96
PE7162-2	2 dB	59.95	55.75	51.56	47.96
PE7162-3	3 dB	59.95	55.75	51.56	47.96
PE7162-4	4 dB	59.95	55.75	51.56	47.96
PE7162-5	5 dB	59.95	55.75	51.56	47.96
PE7162-6	6 dB	59.95	55.75	51.56	47.96
PE7162-7	7 dB	59.95	55.75	51.56	47.96
PE7162-8	8 dB	59.95	55.75	51.56	47.96
PE7162-9	9 dB	59.95	55.75	51.56	47.96
PE7162-10	10 dB	59.95	55.75	51.56	47.96
PE7162-12	12 dB	59.95	55.75	51.56	47.96
PE7162-15	15 dB	59.95	55.75	51.56	47.96
PE7162-20	20 dB	59.95	55.75	51.56	47.96
PE7162-30	30 dB	59.95	55.75	51.56	47.96
PE7162-40	40 dB	59.95	55.75	51.56	47.96

NEW

## 2 WATTS, DC TO 12.4 GHZ SMA ATTENUATORS

ACCURACY: 1 THRU 10 dB, ± .5 dB  
 12, 15 & 20 dB, ± .75 dB  
 30 & 40 dB, ± 1.50 dB

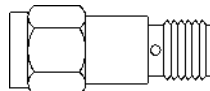

VSWR: 1.25:1 MAXIMUM

Model No.	ATTENUATION	1-24	25-49	50-99	100 +
PE7045-1	1 dB	\$73.10	\$67.98	\$62.87	\$58.48
PE7045-2	2 dB	73.10	67.98	62.87	58.48
PE7045-3	3 dB	73.10	67.98	62.87	58.48
PE7045-4	4 dB	73.10	67.98	62.87	58.48
PE7045-5	5 dB	73.10	67.98	62.87	58.48
PE7045-6	6 dB	73.10	67.98	62.87	58.48
PE7045-7	7 dB	73.10	67.98	62.87	58.48
PE7045-8	8 dB	73.10	67.98	62.87	58.48
PE7045-9	9 dB	73.10	67.98	62.87	58.48
PE7045-10	10 dB	73.10	67.98	62.87	58.48
PE7045-12	12 dB	73.10	67.98	62.87	58.48
PE7045-15	15 dB	73.10	67.98	62.87	58.48
PE7045-20	20 dB	73.10	67.98	62.87	58.48
PE7045-30	30 dB	73.10	67.98	62.87	58.48
PE7045-40	40 dB	94.00	87.42	80.84	75.20

## 2 WATTS, DC TO 18 GHZ SMA ATTENUATORS

ACCURACY: 1 THRU 10 dB, ± .5 dB  
 12, 15 & 20 dB, ± .75 dB  
 30 & 40 dB, ± 1.50 dB

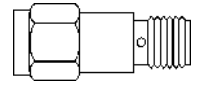

VSWR: 1.35:1 MAX

Model No.	ATTENUATION	1-24	25-49	50-99	100 +
PE7005-1	1 dB	\$85.20	\$79.24	\$73.27	\$68.16
PE7005-2	2 dB	83.55	77.70	71.85	66.84
PE7005-3	3 dB	85.20	79.24	73.27	68.16
PE7005-4	4 dB	83.55	77.70	71.85	66.84
PE7005-5	5 dB	83.55	77.70	71.85	66.84
PE7005-6	6 dB	85.20	79.24	73.27	68.16
PE7005-7	7 dB	83.55	77.70	71.85	66.84
PE7005-8	8 dB	83.55	77.70	71.85	66.84
PE7005-9	9 dB	83.55	77.70	71.85	66.84
PE7005-10	10 dB	85.20	79.24	73.27	68.16
PE7005-12	12 dB	83.55	77.70	71.85	66.84
PE7005-15	15 dB	83.55	77.70	71.85	66.84
PE7005-20	20 dB	85.20	79.24	73.27	68.16
PE7005-30	30 dB	85.20	79.24	73.27	68.16
PE7005-40	40 dB	106.55	99.09	91.63	85.24

### 5 WATT, DC TO 18 GHZ SMA ATTENUATORS

IMPEDANCE: 50 Ohms  
 ACCURACY: 1 THRU 6 dB, ± .3 dB  
 10 AND 20 dB, ± .5 dB  
 30 AND 40 dB, ± 1.5 dB

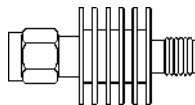

VSWR: 1.35:1 MAXIMUM

Model No.	ATTENUATION	1-24	25-49	50-99	100 +
PE7013-1	1 dB	\$114.90	\$106.86	\$98.81	\$91.92
PE7013-2	2 dB	114.90	106.86	98.81	91.92
PE7013-3	3 dB	114.90	106.86	98.81	91.92
PE7013-6	6 dB	114.90	106.86	98.81	91.92
PE7013-10	10 dB	114.90	106.86	98.81	91.92
PE7013-20	20 dB	114.90	106.86	98.81	91.92
PE7013-30	30 dB	114.90	106.86	98.81	91.92
PE7013-40	40 dB	135.80	126.29	116.79	108.64

### 10 WATT, DC TO 18 GHZ SMA ATTENUATORS

IMPEDANCE: 50 Ohms  
 ACCURACY: 1 THRU 6 dB, ± .5 dB  
 10 AND 20 dB, ± .7 dB  
 30 AND 40 dB, ± 1.5 dB

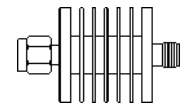

VSWR: 1.40:1 MAXIMUM

Model No.	ATTENUATION	1-24	25-49	50-99	100 +
PE7016-1	1 dB	\$240.30	\$223.48	\$206.66	\$192.24
PE7016-2	2 dB	240.30	223.48	206.66	192.24
PE7016-3	3 dB	240.30	223.48	206.66	192.24
PE7016-6	6 dB	240.30	223.48	206.66	192.24
PE7016-10	10 dB	240.30	223.48	206.66	192.24
PE7016-20	20 dB	240.30	223.48	206.66	192.24
PE7016-30	30 dB	240.30	223.48	206.66	192.24
PE7016-40	40 dB	261.20	242.92	224.63	208.96

### 25 WATT, DC TO 18 GHZ SMA ATTENUATORS

IMPEDANCE: 50 Ohms  
 ACCURACY: 1 THRU 6 dB, ± .8 dB  
 10 AND 20 dB, ± 1.0 dB  
 30 AND 40 dB, ± 2.0 dB

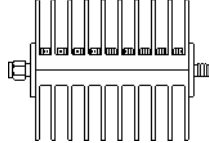

VSWR: 1.40:1 MAXIMUM

Model No.	ATTENUATION	1-24	25-49	50-99	100 +
PE7018-1	1 dB	\$365.70	\$340.10	\$314.50	\$292.56
PE7018-2	2 dB	365.70	340.10	314.50	292.56
PE7018-3	3 dB	365.70	340.10	314.50	292.56
PE7018-6	6 dB	365.70	340.10	314.50	292.56
PE7018-10	10 dB	365.70	340.10	314.50	292.56
PE7018-20	20 dB	365.70	340.10	314.50	292.56
PE7018-30	30 dB	365.70	340.10	314.50	292.56
PE7018-40	40 dB	386.60	359.54	332.48	309.28

### 50 WATT, DC TO 18 GHZ SMA ATTENUATORS

IMPEDANCE: 50 Ohms  
 ACCURACY: 6 AND 10 dB, ± .85 dB  
 20 AND 30 dB, ± 1.5 dB  
 40 dB, ± 2.0 dB

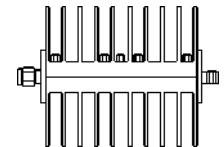

VSWR: 1.45:1 MAXIMUM

Model No.	ATTENUATION	1-24	25-49	50-99	100 +
PE7020-6	6 dB	\$428.40	\$398.41	\$368.42	\$342.72
PE7020-10	10 dB	428.40	398.41	368.42	342.72
PE7020-20	20 dB	428.40	398.41	368.42	342.72
PE7020-30	30 dB	428.40	398.41	368.42	342.72
PE7020-40	40 dB	449.30	417.85	386.40	359.44

### 100 WATT, DC TO 1.5 GHZ SMA ATTENUATORS

IMPEDANCE: 50 Ohms  
 ACCURACY: 6 dB, ± .5 dB  
 10, 20 & 30 dB, ± .75 dB  
 40 dB, ± 1.0 dB

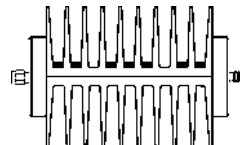

VSWR: 1.25:1 MAXIMUM

Model No.	ATTENUATION	1-24	25-49	50-99	100 +
PE7022-6	6 dB	\$574.70	\$534.47	\$494.24	\$459.76
PE7022-10	10 dB	574.70	534.47	494.24	459.76
PE7022-20	20 dB	574.70	534.47	494.24	459.76
PE7022-30	30 dB	574.70	534.47	494.24	459.76
PE7022-40	40 dB	595.60	553.91	512.22	476.48

### 1 WATT, DC TO 2 GHZ N ATTENUATORS

ACCURACY: 1,2,3 & 6 ± .3 dB  
 10 & 20 ± .5 dB  
 30 ± .75 dB  
 40 ± 1.5 dB

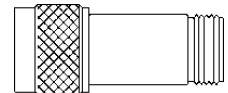

VSWR: 1.25:1 MAXIMUM

Model No.	ATTENUATION	1-24	25-49	50-99	100 +
PE7002-1	1 dB	\$52.20	\$48.55	\$44.89	\$41.76
PE7002-2	2 dB	52.20	48.55	44.89	41.76
PE7002-3	3 dB	52.20	48.55	44.89	41.76
PE7002-6	6 dB	52.20	48.55	44.89	41.76
PE7002-10	10 dB	52.20	48.55	44.89	41.76
PE7002-20	20 dB	52.20	48.55	44.89	41.76
PE7002-30	30 dB	49.95	46.45	42.96	39.96
PE7002-40	40 dB	67.85	63.10	58.35	54.28

### 2 WATTS, DC TO 12.4 GHZ N ATTENUATORS

ACCURACY: 1 THRU 10,12,15 & 20 dB, ± .5 dB  
 30 & 40 dB, ± 1.50 dB



VSWR: 1.25:1 MAXIMUM

Model No.	ATTENUATION	1-24	25-49	50-99	100 +
PE7047-1	1 dB	\$103.45	\$96.21	\$88.97	\$82.76
PE7047-2	2 dB	103.45	96.21	88.97	82.76
PE7047-3	3 dB	103.45	96.21	88.97	82.76
PE7047-4	4 dB	103.45	96.21	88.97	82.76
PE7047-5	5 dB	103.45	96.21	88.97	82.76
PE7047-6	6 dB	103.45	96.21	88.97	82.76
PE7047-7	7 dB	103.45	96.21	88.97	82.76
PE7047-8	8 dB	103.45	96.21	88.97	82.76
PE7047-9	9 dB	103.45	96.21	88.97	82.76
PE7047-10	10 dB	103.45	96.21	88.97	82.76
PE7047-12	12 dB	103.45	96.21	88.97	82.76
PE7047-15	15 dB	103.45	96.21	88.97	82.76
PE7047-20	20 dB	103.45	96.21	88.97	82.76
PE7047-30	30 dB	103.45	96.21	88.97	82.76
PE7047-40	40 dB	135.80	126.29	116.79	108.64

### 2 WATTS, DC TO 18 GHZ N ATTENUATORS

ACCURACY: 1 THRU 10,12,15 & 20 dB, ± .5 dB  
 30 & 40 dB, ± 1.5 dB

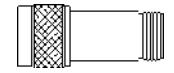

VSWR: 1.35:1 MAXIMUM

Model No.	ATTENUATION	1-24	25-49	50-99	100 +
PE7004-1	1 dB	\$130.55	\$121.41	\$112.27	\$104.44
PE7004-2	2 dB	130.55	123.88	114.55	106.56
PE7004-3	3 dB	130.55	121.41	112.27	104.44
PE7004-4	4 dB	130.55	121.41	112.27	104.44
PE7004-5	5 dB	130.55	121.41	112.27	104.44
PE7004-6	6 dB	130.55	121.41	112.27	104.44
PE7004-7	7 dB	130.55	121.41	112.27	104.44
PE7004-8	8 dB	130.55	121.41	112.27	104.44
PE7004-9	9 dB	130.55	121.41	112.27	104.44
PE7004-10	10 dB	133.20	123.88	114.55	106.56
PE7004-12	12 dB	133.20	123.88	114.55	106.56
PE7004-15	15 dB	133.20	123.88	114.55	106.56
PE7004-20	20 dB	133.20	123.88	114.55	106.56
PE7004-30	30 dB	133.20	123.88	114.55	106.56
PE7004-40	40 dB	151.45	140.85	130.25	121.16

### 5 WATT, DC TO 18 GHZ N ATTENUATORS

IMPEDANCE: 50 Ohms  
 ACCURACY: 1 THRU 6 dB, ± .3 dB  
 10 AND 20 dB, ± .5 dB  
 30 AND 40 dB, ± 1.50 dB

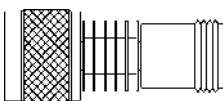

VSWR: 1.40:1 MAXIMUM

Model No.	ATTENUATION	1-24	25-49	50-99	100 +
PE7014-1	1 dB	\$188.05	\$174.89	\$161.72	\$150.44
PE7014-2	2 dB	188.05	174.89	161.72	150.44
PE7014-3	3 dB	188.05	174.89	161.72	150.44
PE7014-6	6 dB	188.05	174.89	161.72	150.44
PE7014-10	10 dB	188.05	174.89	161.72	150.44
PE7014-20	20 dB	188.05	174.89	161.72	150.44
PE7014-30	30 dB	188.05	174.89	161.72	150.44
PE7014-40	40 dB	208.95	194.32	179.70	167.16

### 10 WATT, DC TO 2 GHZ N ATTENUATORS

IMPEDANCE: 50 Ohms  
 ACCURACY: 1,000 MHz, ± .7 dB  
 2,000 MHz, ± 1.0 dB

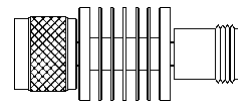

VSWR: 1,000 MHz, 1.30:1 MAXIMUM  
 2,000 MHz, 1.60:1 MAXIMUM

Model No.	ATTENUATION	1-24	25-49	50-99	100 +
PE7010-2	2 dB	\$156.70	\$145.73	\$134.76	\$125.36
PE7010-3	3 dB	156.70	145.73	134.76	125.36
PE7010-6	6 dB	156.70	145.73	134.76	125.36
PE7010-10	10 dB	156.70	145.73	134.76	125.36
PE7010-20	20 dB	156.70	145.73	134.76	125.36
PE7010-30	30 dB	156.70	145.73	134.76	125.36
PE7010-40	40 dB	177.60	165.17	152.74	142.08

Attenuators / RF Components

## 10 WATT, DC TO 12.4 GHZ N ATTENUATORS

IMPEDANCE: 50 Ohms  
 ACCURACY: 1 THRU 6 dB, ± .3 dB  
 10 AND 20 dB, ± .5 dB  
 30 AND 40 dB, ± 1.5 dB  
 VSWR: 1:30:1 MAX

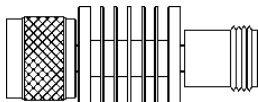

Model No.	ATTENUATION	1-24	25-49	50-99	100 +
PE7048-1	1 dB	\$240.30	\$223.48	\$206.66	\$192.24
PE7048-2	2 dB	240.30	223.48	206.66	192.24
PE7048-3	3 dB	240.30	223.48	206.66	192.24
PE7048-6	6 dB	240.30	223.48	206.66	192.24
PE7048-10	10 dB	240.30	223.48	206.66	192.24
PE7048-20	20 dB	240.30	223.48	206.66	192.24
PE7048-30	30 dB	240.30	223.48	206.66	192.24
PE7048-40	40 dB	261.20	242.92	224.63	208.96

## 10 WATT, DC TO 18 GHZ N ATTENUATORS

IMPEDANCE: 50 Ohms  
 ACCURACY: 1 THRU 6 dB, ± .5 dB  
 10 AND 20 dB, ± .7 dB  
 30 AND 40 dB, ± 1.5 dB  
 VSWR: 1.40:1 MAXIMUM

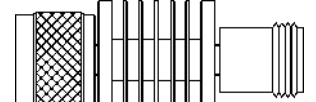

Model No.	ATTENUATION	1-24	25-49	50-99	100 +
PE7015-1	1 dB	\$261.20	\$242.92	\$224.63	\$208.96
PE7015-2	2 dB	261.20	242.92	224.63	208.96
PE7015-3	3 dB	261.20	242.92	224.63	208.96
PE7015-6	6 dB	261.20	242.92	224.63	208.96
PE7015-10	10 dB	266.40	247.75	229.10	213.12
PE7015-20	20 dB	266.40	247.75	229.10	213.12
PE7015-30	30 dB	266.40	247.75	229.10	213.12
PE7015-40	40 dB	282.10	262.35	242.61	225.68

## 25 WATT, DC TO 18 GHZ N ATTENUATORS

IMPEDANCE: 50 Ohms  
 ACCURACY: 1 THRU 6 dB, ± .8 dB  
 10 AND 20 dB, ± 1.0 dB  
 30 AND 40 dB, ± 2.0 dB  
 VSWR: 1.40:1 MAXIMUM

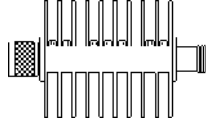

Model No.	ATTENUATION	1-24	25-49	50-99	100 +
PE7017-1	1 dB	\$365.70	\$340.10	\$314.50	\$292.56
PE7017-2	2 dB	365.70	340.10	314.50	292.56
PE7017-3	3 dB	365.70	340.10	314.50	292.56
PE7017-6	6 dB	365.70	340.10	314.50	292.56
PE7017-10	10 dB	365.70	340.10	314.50	292.56
PE7017-20	20 dB	365.70	340.10	314.50	292.56
PE7017-30	30 dB	365.70	340.10	314.50	292.56
PE7017-40	40 dB	417.95	388.69	359.44	334.36

## 50 WATT, DC TO 18 GHZ N ATTENUATORS

IMPEDANCE: 50 Ohms  
 ACCURACY: 6 AND 10 dB, ± 1.0 dB  
 20 AND 30 dB, ± 1.5 dB  
 40 dB, ± 2.0 dB  
 VSWR: 1.45:1 MAXIMUM



Model No.	ATTENUATION	1-24	25-49	50-99	100 +
PE7019-6	6 dB	\$417.95	\$388.69	\$359.44	\$334.36
PE7019-10	10 dB	417.95	388.69	359.44	334.36
PE7019-20	20 dB	417.95	388.69	359.44	334.36
PE7019-30	30 dB	426.30	396.46	366.62	341.04
PE7019-40	40 dB	470.20	437.29	404.37	376.16

## 100 WATT, DC TO 1.5 GHZ N ATTENUATORS

IMPEDANCE: 50 Ohms  
 ACCURACY: 6 dB, ± .5 dB  
 10, 20 & 30 dB, ± .75 dB  
 40 dB, ± 1.0 dB  
 VSWR: 1.25:1 MAXIMUM



Model No.	ATTENUATION	1-24	25-49	50-99	100 +
PE7021-6	6 dB	\$522.45	\$485.88	\$449.31	\$417.96
PE7021-10	10 dB	522.45	485.88	449.31	417.96
PE7021-20	20 dB	522.45	485.88	449.31	417.96
PE7021-30	30 dB	522.45	485.88	449.31	417.96
PE7021-40	40 dB	574.70	534.47	494.24	459.76

## 300 WATT, N ATTENUATORS

IMPEDANCE: 50 Ohms  
 FREQUENCY RANGE: DC TO 1 GHz  
 ACCURACY: ± .75 dB  
 VSWR: 1.40:1 MAXIMUM  
 RF INPUT POWER: 300 WATT AVERAGE AT 25°C  
 DERATED TO 75 WATTS AT 85°C

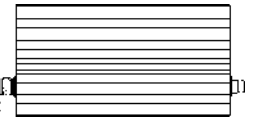

Model No.	ATTENUATION	1-24	25-49	50-99	100 +
PE7031-1	1 dB	\$1353.25	\$1258.52	\$1163.80	\$1082.60
PE7031-2	2 dB	1353.25	1258.52	1163.80	1082.60
PE7031-3	3 dB	1353.25	1258.52	1163.80	1082.60
PE7031-6	6 dB	1353.25	1258.52	1163.80	1082.60
PE7031-10	10 dB	1353.25	1258.52	1163.80	1082.60
PE7031-20	20 dB	1353.25	1258.52	1163.80	1082.60
PE7031-30	30 dB	1353.25	1258.52	1163.80	1082.60

## 500 WATT, N ATTENUATORS

IMPEDANCE: 50 Ohms  
 FREQUENCY RANGE: DC TO 500 MHz  
 ACCURACY: ± .5 dB  
 VSWR: 1.15:1 MAXIMUM  
 RF INPUT POWER: 500 WATT AVERAGE AT 25°C  
 DERATED TO 250 WATTS AT 100°C

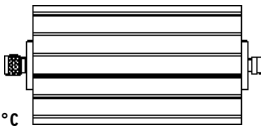

Model No.	ATTENUATION	1-24	25-49	50-99	100 +
PE7032-1	1 dB	\$1567.45	\$1457.73	\$1348.01	\$1253.96
PE7032-2	2 dB	1567.45	1457.73	1348.01	1253.96
PE7032-3	3 dB	1567.45	1457.73	1348.01	1253.96
PE7032-6	6 dB	1567.45	1457.73	1348.01	1253.96
PE7032-10	10 dB	1567.45	1457.73	1348.01	1253.96
PE7032-20	20 dB	1567.45	1457.73	1348.01	1253.96
PE7032-30	30 dB	1567.45	1457.73	1348.01	1253.96

## DC TO 2 GHZ TNC ATTENUATORS

IMPEDANCE: 50 OHMS  
 ACCURACY: 1 GHz, ± .5 dB  
 2 GHz, ± .8 dB  
 VSWR: 1 GHz, 1.20:1 MAXIMUM  
 2 GHz, 1.40:1 MAXIMUM

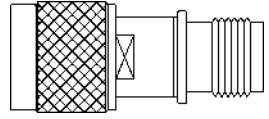

AVERAGE POWER HANDLING CAPABILITY: 1 WATT

Model No.	ATTENUATION	1-24	25-49	50-99	100 +
PE7003-1	1 dB	\$46.95	\$43.66	\$40.38	\$37.56
PE7003-2	2 dB	46.95	43.66	40.38	37.56
PE7003-3	3 dB	46.95	43.66	40.38	37.56
PE7003-6	6 dB	46.95	43.66	40.38	37.56
PE7003-10	10 dB	46.95	43.66	40.38	37.56
PE7003-20	20 dB	46.95	43.66	40.38	37.56
PE7003-30	30 dB	46.95	43.66	40.38	37.56
PE7003-40	40 dB	67.85	63.10	58.35	54.28

## DC TO 12.4 GHZ TNC ATTENUATORS

IMPEDANCE: 50 OHMS  
 ACCURACY: 1 THRU 6 dB, ± .3 dB  
 10 AND 20 dB, ± .5 dB  
 30 AND 40 dB, ± 1.5 dB  
 VSWR: 1.25:1 MAXIMUM  
 AVERAGE POWER HANDLING CAPABILITY: 2 WATTS

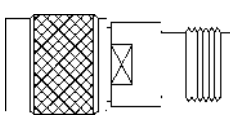

Model No.	ATTENUATION	1-24	25-49	50-99	100 +
PE7051-1	1 dB	\$94.00	\$87.42	\$80.84	\$75.20
PE7051-2	2 dB	94.00	87.42	80.84	75.20
PE7051-3	3 dB	94.00	87.42	80.84	75.20
PE7051-6	6 dB	94.00	87.42	80.84	75.20
PE7051-10	10 dB	94.00	87.42	80.84	75.20
PE7051-20	20 dB	94.00	87.42	80.84	75.20
PE7051-30	30 dB	94.00	87.42	80.84	75.20
PE7051-40	40 dB	114.90	106.86	98.81	91.92

## DC TO 18 GHZ TNC ATTENUATORS

IMPEDANCE: 50 Ohms  
 ACCURACY: 1 THRU 6 dB, ± .3 dB  
 10 AND 20 dB, ± .5 dB  
 30 dB, ± 1.5 dB  
 VSWR: 1.35:1 MAXIMUM  
 AVERAGE POWER HANDLING CAPABILITY: 2 WATTS

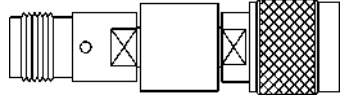

Model No.	ATTENUATION	1-24	25-49	50-99	100 +
PE7030-1	1 dB	\$188.05	\$174.89	\$161.72	\$150.44
PE7030-2	2 dB	188.05	174.89	161.72	150.44
PE7030-3	3 dB	188.05	174.89	161.72	150.44
PE7030-6	6 dB	188.05	174.89	161.72	150.44
PE7030-10	10 dB	188.05	174.89	161.72	150.44
PE7030-20	20 dB	188.05	174.89	161.72	150.44
PE7030-30	30 dB	188.05	174.89	161.72	150.44

## 5 WATT, DC TO 18 GHZ TNC ATTENUATORS

IMPEDANCE: 50 Ohms  
 ACCURACY: 1 THRU 6 dB, ± .3 dB  
 10 AND 20 dB, ± .5 dB  
 30 dB, ± 1.5 dB  
 VSWR: 1.35:1 MAXIMUM

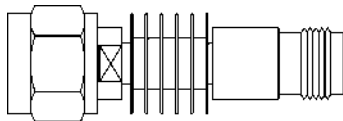

Model No.	ATTENUATION	1-24	25-49	50-99	100 +
PE7052-1	1 dB	\$208.95	\$194.32	\$179.70	\$167.16
PE7052-2	2 dB	208.95	194.32	179.70	167.16
PE7052-3	3 dB	208.95	194.32	179.70	167.16
PE7052-6	6 dB	208.95	194.32	179.70	167.16
PE7052-10	10 dB	208.95	194.32	179.70	167.16
PE7052-20	20 dB	208.95	194.32	179.70	167.16
PE7052-30	30 dB	208.95	194.32	179.70	167.16

## 10 WATT, DC TO 18 GHZ TNC ATTENUATORS

IMPEDANCE: 50 Ohms  
 ACCURACY: 1 THRU 6 dB, ± .5 dB  
 10 AND 20 dB, ± .7 dB  
 30 AND 40 dB, ± 1.5 dB  
 VSWR: 1.40:1 MAXIMUM

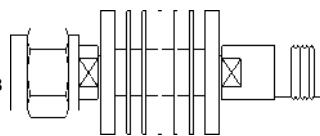

Model No.	ATTENUATION	1-24	25-49	50-99	100 +
PE7053-1	1 dB	\$313.45	\$291.51	\$269.57	\$250.76
PE7053-2	2 dB	313.45	291.51	269.57	250.76
PE7053-3	3 dB	313.45	291.51	269.57	250.76
PE7053-6	6 dB	313.45	291.51	269.57	250.76
PE7053-10	10 dB	313.45	291.51	269.57	250.76
PE7053-20	20 dB	313.45	291.51	269.57	250.76
PE7053-30	30 dB	313.45	291.51	269.57	250.76
PE7053-40	40 dB	344.80	320.66	296.53	275.84

## 25 WATT, DC TO 18 GHZ TNC ATTENUATORS

IMPEDANCE: 50 Ohms  
 ACCURACY: 1 THRU 6 dB, ± .8 dB  
 10 AND 20 dB, ± 1.0 dB  
 30 AND 40 dB, ± 2.0 dB  
 VSWR: 1.40:1 MAXIMUM

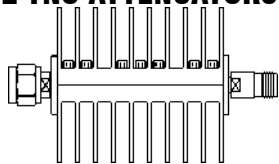

Model No.	ATTENUATION	1-24	25-49	50-99	100 +
PE7054-1	1 dB	\$449.30	\$417.85	\$386.40	\$359.44
PE7054-2	2 dB	449.30	417.85	386.40	359.44
PE7054-3	3 dB	449.30	417.85	386.40	359.44
PE7054-6	6 dB	449.30	417.85	386.40	359.44
PE7054-10	10 dB	449.30	417.85	386.40	359.44
PE7054-20	20 dB	449.30	417.85	386.40	359.44
PE7054-30	30 dB	449.30	417.85	386.40	359.44
PE7054-40	40 dB	470.20	437.29	404.37	376.16

## 50 WATT, DC TO 18 GHZ TNC ATTENUATORS

IMPEDANCE: 50 Ohms  
 ACCURACY: 6 AND 10 dB, ± 1.0 dB  
 20 AND 30 dB, ± 1.5 dB  
 40 dB, ± 2.0 dB  
 VSWR: 1.45:1 MAXIMUM

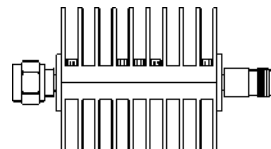

Model No.	ATTENUATION	1-24	25-49	50-99	100 +
PE7055-6	6 dB	\$522.45	\$485.88	\$449.31	\$417.96
PE7055-10	10 dB	522.45	485.88	449.31	417.96
PE7055-20	20 dB	522.45	485.88	449.31	417.96
PE7055-30	30 dB	522.45	485.88	449.31	417.96
PE7055-40	40 dB	543.35	505.32	467.28	434.68

## 100 WATT, DC TO 1.5 GHZ TNC ATTENUATORS

IMPEDANCE: 50 Ohms  
 ACCURACY: 6 dB, ± .8 dB  
 10 AND 20 dB, ± 1.0 dB  
 30 AND 40 dB, ± 2.0 dB  
 VSWR: 1.40:1 MAXIMUM

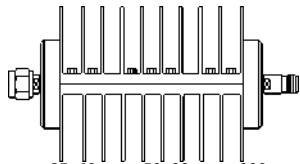

Model No.	ATTENUATION	1-24	25-49	50-99	100 +
PE7056-6	6 dB	\$626.95	\$583.06	\$539.18	\$501.56
PE7056-10	10 dB	626.95	583.06	539.18	501.56
PE7056-20	20 dB	626.95	583.06	539.18	501.56
PE7056-30	30 dB	626.95	583.06	539.18	501.56
PE7056-40	40 dB	647.85	602.50	557.15	518.28

## 5 WATT, DC TO 7.5 GHZ 7/16 ATTENUATORS

IMPEDANCE: 50 Ohms  
 ACCURACY: 1 THRU 6 dB, ± .4 dB  
 10 AND 20 dB, ± .6 dB  
 30 AND 40 dB, ± 1.5 dB  
 VSWR: 1.25:1 MAXIMUM

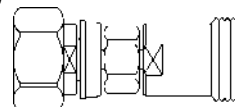

Model No.	ATTENUATION	1-24	25-49	50-99	100 +
PE7039-1	1 dB	\$156.70	\$145.73	\$134.76	\$125.36
PE7039-2	2 dB	156.70	145.73	134.76	125.36
PE7039-3	3 dB	156.70	145.73	134.76	125.36
PE7039-6	6 dB	156.70	145.73	134.76	125.36
PE7039-10	10 dB	156.70	145.73	134.76	125.36
PE7039-20	20 dB	156.70	145.73	134.76	125.36
PE7039-30	30 dB	156.70	145.73	134.76	125.36
PE7039-40	40 dB	177.60	165.17	152.74	142.08

## 10 WATT, DC TO 7.5 GHZ 7/16 ATTENUATORS

IMPEDANCE: 50 Ohms  
 ACCURACY: 1 THRU 6 dB, ± .6 dB  
 10 AND 20 dB, ± .8 dB  
 30 AND 40 dB, ± 1.5 dB  
 VSWR: 1.30:1 MAXIMUM

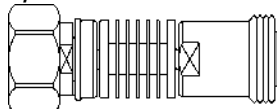

Model No.	ATTENUATION	1-24	25-49	50-99	100 +
PE7040-1	1 dB	\$229.85	\$213.76	\$197.67	\$183.88
PE7040-2	2 dB	229.85	213.76	197.67	183.88
PE7040-3	3 dB	229.85	213.76	197.67	183.88
PE7040-6	6 dB	229.85	213.76	197.67	183.88
PE7040-10	10 dB	229.85	213.76	197.67	183.88
PE7040-20	20 dB	229.85	213.76	197.67	183.88
PE7040-30	30 dB	229.85	213.76	197.67	183.88
PE7040-40	40 dB	250.75	233.20	215.65	200.60

## 25 WATT, DC TO 7.5 GHZ 7/16 ATTENUATORS

IMPEDANCE: 50 Ohms  
 ACCURACY: 1 THRU 6 dB, ± .4 dB  
 10 AND 20 dB, ± .6 dB  
 30 AND 40 dB, ± 1.5 dB  
 VSWR: DC-4GHz 1.25 MAX  
 4-7.5 GHz 1.45 MAX

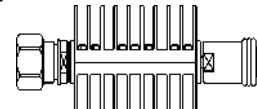

Model No.	ATTENUATION	1-24	25-49	50-99	100 +
PE7041-1	1 dB	\$365.70	\$340.10	\$314.50	\$292.56
PE7041-2	2 dB	365.70	340.10	314.50	292.56
PE7041-3	3 dB	365.70	340.10	314.50	292.56
PE7041-6	6 dB	365.70	340.10	314.50	292.56
PE7041-10	10 dB	365.70	340.10	314.50	292.56
PE7041-20	20 dB	365.70	340.10	314.50	292.56
PE7041-30	30 dB	365.70	340.10	314.50	292.56
PE7041-40	40 dB	386.60	359.54	332.48	309.28

## 50 WATT, DC TO 7.5 GHZ 7/16 ATTENUATORS

IMPEDANCE: 50 Ohms  
 ACCURACY: 6 AND 10 dB, ± 1.0 dB  
 20 AND 30 dB, ± 1.5 dB  
 40 dB, ± 2.0 dB  
 VSWR: 1.40:1 MAXIMUM

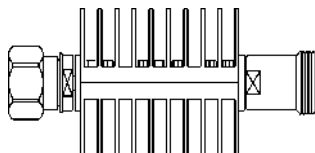

Model No.	ATTENUATION	1-24	25-49	50-99	100 +
PE7042-6	6 dB	\$417.95	\$388.69	\$359.44	\$334.36
PE7042-10	10 dB	417.95	388.69	359.44	334.36
PE7042-20	20 dB	417.95	388.69	359.44	334.36
PE7042-30	30 dB	417.95	388.69	359.44	334.36
PE7042-40	40 dB	417.95	388.69	359.44	334.36

## 100 WATT, DC TO 1.5 GHZ 7/16 ATTENUATORS

IMPEDANCE: 50 Ohms  
 ACCURACY: 6 dB, ± .5 dB  
 10, 20 & 30 dB, ± .75 dB  
 40 dB, ± 1.0 dB  
 VSWR: 1.25:1 MAXIMUM

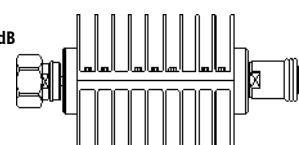

Model No.	ATTENUATION	1-24	25-49	50-99	100 +
PE7043-6	6 dB	\$470.20	\$437.29	\$404.37	\$376.16
PE7043-10	10 dB	470.20	437.29	404.37	376.16
PE7043-20	20 dB	470.20	437.29	404.37	376.16
PE7043-30	30 dB	470.20	437.29	404.37	376.16
PE7043-40	40 dB	470.20	437.29	404.37	376.16

Attenuators /  
RF Components

## DC TO 2 GHz BNC ATTENUATORS

IMPEDANCE: 50 Ohms  
 ACCURACY: 1 GHz,  $\pm .5$  dB  
 2 GHz,  $\pm .8$  dB  
 VSWR: 1 GHz, 1.20:1 MAXIMUM  
 2 GHz, 1.40:1 MAXIMUM

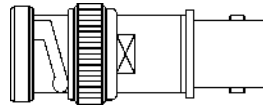

AVERAGE POWER HANDLING CAPABILITY: 1 WATT

Model No.	ATTENUATION	1-24	25-49	50-99	100 +
PE7000-1	1 dB	\$31.30	\$29.11	\$26.92	\$25.04
PE7000-2	2 dB	31.30	29.11	26.92	25.04
PE7000-3	3 dB	31.30	29.11	26.92	25.04
PE7000-6	6 dB	31.30	29.11	26.92	25.04
PE7000-10	10 dB	29.95	27.85	25.76	23.96
PE7000-20	20 dB	29.95	27.85	25.76	23.96
PE7000-30	30 dB	41.75	38.83	35.91	33.40

## DC TO 4 GHz BNC ATTENUATORS

IMPEDANCE: 50 Ohms  
 ACCURACY: 1 THRU 6 dB,  $\pm .4$  dB  
 10 AND 20 dB,  $\pm .6$  dB  
 30 dB,  $\pm .8$  dB  
 VSWR: 1.25:1 MAXIMUM

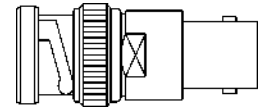

AVERAGE POWER HANDLING CAPABILITY: 2 WATTS

Model No.	ATTENUATION	1-24	25-49	50-99	100 +
PE7049-1	1 dB	\$73.10	\$67.98	\$62.87	\$58.48
PE7049-2	2 dB	73.10	67.98	62.87	58.48
PE7049-3	3 dB	73.10	67.98	62.87	58.48
PE7049-6	6 dB	73.10	67.98	62.87	58.48
PE7049-10	10 dB	73.10	67.98	62.87	58.48
PE7049-20	20 dB	73.10	67.98	62.87	58.48
PE7049-30	30 dB	73.10	67.98	62.87	58.48

## 10 WATT, BNC ATTENUATORS

IMPEDANCE: 50 Ohms  
 FREQUENCY RANGE: DC TO 2,000 MHz  
 ACCURACY: 1,000 MHz,  $\pm .6$  dB  
 2,000 MHz,  $\pm 1.0$  dB  
 VSWR: 1,000 MHz, 1.30:1 MAXIMUM  
 2,000 MHz, 1.60:1 MAXIMUM

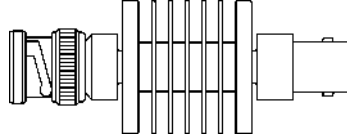

Model No.	ATTENUATION	1-24	25-49	50-99	100 +
PE7025-2	2 dB	\$198.50	\$184.61	\$170.71	\$158.80
PE7025-3	3 dB	198.50	184.61	170.71	158.80
PE7025-6	6 dB	198.50	184.61	170.71	158.80
PE7025-10	10 dB	198.50	184.61	170.71	158.80
PE7025-20	20 dB	198.50	184.61	170.71	158.80
PE7025-30	30 dB	198.50	184.61	170.71	158.80
PE7025-40	40 dB	229.85	213.76	197.67	183.88

## 100 WATT, BNC ATTENUATORS

IMPEDANCE: 50 Ohms  
 FREQUENCY RANGE: DC TO 1 GHz  
 ACCURACY: 3 & 6  $\pm .5$  dB  
 10, 20 & 30  $\pm .75$  dB  
 40  $\pm 1.0$  dB  
 VSWR: 1.40:1 MAXIMUM

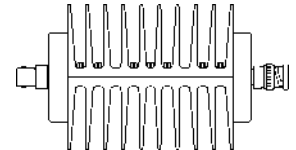

Model No.	ATTENUATION	1-24	25-49	50-99	100 +
PE7026-3	3 dB	\$574.70	\$534.47	\$494.24	\$459.76
PE7026-6	6 dB	574.70	534.47	494.24	459.76
PE7026-10	10 dB	574.70	534.47	494.24	459.76
PE7026-20	20 dB	574.70	534.47	494.24	459.76
PE7026-30	30 dB	574.70	534.47	494.24	459.76
PE7026-40	40 dB	622.75	579.16	535.57	498.20

## 75 OHM F ATTENUATORS

FREQUENCY RANGE: DC TO 1,000 MHz  
 ACCURACY:  $\pm .5$  dB  
 VSWR: 1.30:1 MAXIMUM  
 AVERAGE POWER HANDLING CAPABILITY: 2 WATTS

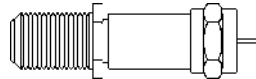

Model No.	ATTENUATION	1-24	25-49	50-99	100 +
PE7057-1	1 dB	\$67.85	\$63.10	\$58.35	\$54.28
PE7057-2	2 dB	67.85	63.10	58.35	54.28
PE7057-3	3 dB	67.85	63.10	58.35	54.28
PE7057-6	6 dB	67.85	63.10	58.35	54.28
PE7057-10	10 dB	67.85	63.10	58.35	54.28

## DC TO 1 GHz 75 OHM BNC ATTENUATORS

ACCURACY:  $\pm .6$  dB  
 VSWR: 1.30:1 MAXIMUM

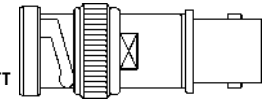

AVERAGE POWER HANDLING CAPABILITY: 1 WATT

Model No.	ATTENUATION	1-24	25-49	50-99	100 +
PE7009-1	1 dB	\$36.50	\$33.95	\$31.39	\$29.20
PE7009-2	2 dB	36.50	33.95	31.39	29.20
PE7009-3	3 dB	36.50	33.95	31.39	29.20
PE7009-6	6 dB	36.50	33.95	31.39	29.20
PE7009-10	10 dB	36.50	33.95	31.39	29.20
PE7009-20	20 dB	36.50	33.95	31.39	29.20
PE7009-30	30 dB	36.50	33.95	31.39	29.20

## DC TO 4 GHz 75 OHM BNC ATTENUATORS

ACCURACY: 1 THRU 6 dB,  $\pm .4$  dB  
 10 AND 20 dB,  $\pm .6$  dB  
 30 dB,  $\pm .8$  dB  
 VSWR: 1.35:1 MAXIMUM

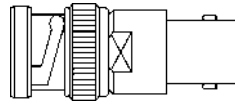

AVERAGE POWER HANDLING CAPABILITY: 2 WATTS

Model No.	ATTENUATION	1-24	25-49	50-99	100 +
PE7050-1	1 dB	\$94.00	\$87.42	\$80.84	\$75.20
PE7050-2	2 dB	94.00	87.42	80.84	75.20
PE7050-3	3 dB	94.00	87.42	80.84	75.20
PE7050-6	6 dB	94.00	87.42	80.84	75.20
PE7050-10	10 dB	94.00	87.42	80.84	75.20
PE7050-20	20 dB	94.00	87.42	80.84	75.20
PE7050-30	30 dB	94.00	87.42	80.84	75.20

**PLEASE CONTACT OUR ENGINEERING DEPARTMENT FOR ALL YOUR SPECIAL REQUIREMENTS AT (949) 261-1920.**

## DC TO 1 GHz 75 OHM N ATTENUATORS

ACCURACY:  $\pm .6$  dB  
 VSWR: 1.30:1 MAXIMUM  
 AVERAGE POWER HANDLING CAPABILITY: 1 WATT

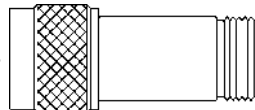

Model No.	ATTENUATION	1-24	25-49	50-99	100 +
PE7029-1	1 dB	\$52.20	\$48.55	\$44.89	\$41.76
PE7029-2	2 dB	52.20	48.55	44.89	41.76
PE7029-3	3 dB	52.20	48.55	44.89	41.76
PE7029-6	6 dB	52.20	48.55	44.89	41.76
PE7029-10	10 dB	52.20	48.55	44.89	41.76
PE7029-20	20 dB	52.20	48.55	44.89	41.76
PE7029-30	30 dB	52.20	48.55	44.89	41.76

\*WARNING: WILL NOT MATE TO 50 OHM N CONNECTORS

## DC TO 4 GHz 75 OHM N ATTENUATORS

ACCURACY: 1 THRU 6 dB,  $\pm .4$  dB  
 10 AND 20 dB,  $\pm .6$  dB  
 30 dB,  $\pm .8$  dB

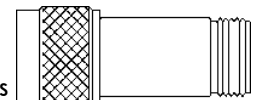

VSWR: 1.30:1 MAXIMUM  
 AVERAGE POWER HANDLING CAPABILITY: 2 WATTS

Model No.	ATTENUATION	1-24	25-49	50-99	100 +
PE7044-1	1 dB	\$104.45	\$97.14	\$89.83	\$83.56
PE7044-2	2 dB	104.45	97.14	89.83	83.56
PE7044-3	3 dB	104.45	97.14	89.83	83.56
PE7044-6	6 dB	104.45	97.14	89.83	83.56
PE7044-10	10 dB	104.45	97.14	89.83	83.56
PE7044-20	20 dB	104.45	97.14	89.83	83.56
PE7044-30	30 dB	104.45	97.14	89.83	83.56

\*WARNING: WILL NOT MATE TO 50 OHM N CONNECTORS

# DC BIAS PASSING ATTENUATORS

## ELECTRICAL SPECIFICATIONS (@25°C AMBIENT)

FREQUENCY RANGE.....	500 MHz-2 GHz
ATTENUATION ACCURACY	
6 dB.....	±1.0 dB MAX.
10 dB.....	±1.5 dB MAX.
20 dB.....	±2.0 dB MAX.
IMPEDANCE.....	50 OHMS EXCEPT "F" IS 75 OHMS
VSWR.....	1.35:1 MAX. EXCEPT "F" IS 1.45:1 MAX.
VOLTAGE RATING.....	100 VOLTS MAX.
DC CURRENT.....	2 AMPS MAX.
RF POWER (AVG).....	2 WATTS MAX.
OPERATING TEMP. RANGE.....	-55°C TO +125°C

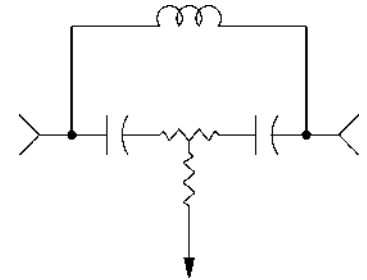

### SMA

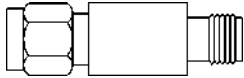

Model No.	ATTENUATION	PRICE			
		1-24	25-49	50-99	100 +
PE7061-6	6 dB	\$69.85	\$64.96	\$60.07	\$55.88
PE7061-10	10 dB	69.85	64.96	60.07	55.88
PE7061-20	20 dB	69.85	64.96	60.07	55.88

### N

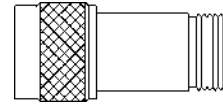

Model No.	ATTENUATION	PRICE			
		1-24	25-49	50-99	100 +
PE7062-6	6 dB	\$80.80	\$75.14	\$69.49	\$64.64
PE7062-10	10 dB	80.80	75.14	69.49	64.64
PE7062-20	20 dB	84.85	78.91	72.97	67.88

### TNC

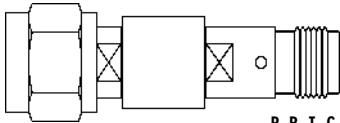

Model No.	ATTENUATION	PRICE			
		1-24	25-49	50-99	100 +
PE7063-6	6 dB	\$92.75	\$86.26	\$79.77	\$74.20
PE7063-10	10 dB	92.75	86.26	79.77	74.20
PE7063-20	20 dB	95.70	89.00	82.30	76.56

### F

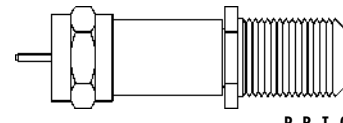

Model No.	ATTENUATION	PRICE			
		1-24	25-49	50-99	100 +
PE7064-6	6 dB	\$99.35	\$92.40	\$85.44	\$79.48
PE7064-10	10 dB	99.35	92.40	85.44	79.48
PE7064-20	20 dB	99.35	92.40	85.44	79.48

# CONTINUOUSLY VARIABLE BENCH MOUNT ATTENUATORS

Turns Counting Dial With Locking Lever  
 SMA Female Connectors  
 50 Ohm Nominal Impedance  
 Average Power 5 Watts  
 Peak Power 3KW

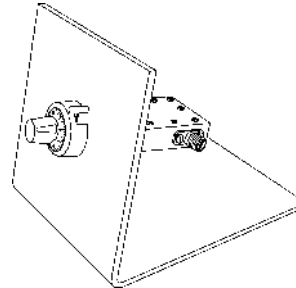

Attenuators /  
RF Components

MODEL NO.	FREQUENCY RANGE	ATTENUATION RANGE	VSWR MAX.	INSERTION LOSS (MAX.)	PRICE			
					1-24	25-49	50-99	100 +
PE7065-1	1-2 GHz	7 dB	2.0:1	.5 dB	\$426.95	\$397.06	\$367.18	\$341.56
PE7065-2	2-4 GHz	10 dB	1.8:1	.5 dB	426.95	397.06	367.18	341.56
PE7065-3	2-4 GHz	20 dB	1.5:1	.5 dB	449.85	418.36	386.87	359.88
PE7065-4	4-8 GHz	10 dB	1.5:1	.75 dB	430.50	400.37	370.23	344.40
PE7065-5	4-8 GHz	20 dB	1.5:1	.75 dB	449.85	418.36	386.87	359.88
PE7065-6	4-8 GHz	30 dB	1.5:1	.75 dB	508.30	472.72	437.14	406.64
PE7065-7	8-12.4 GHz	10 dB	1.7:1	.75 dB	472.80	439.70	406.61	378.24
PE7065-8	8-12.4 GHz	20 dB	1.7:1	.75 dB	522.45	485.88	449.31	417.96
PE7065-9	8-12.4 GHz	30 dB	1.7:1	.75 dB	522.45	485.88	449.31	417.96
PE7065-10	8-12.4 GHz	40 dB	1.7:1	.75 dB	522.45	485.88	449.31	417.96
PE7065-11	12.4-18 GHz	10 dB	1.5:1	.75 dB	522.45	485.88	449.31	417.96
PE7065-12	12.4-18 GHz	20 dB	1.5:1	.75 dB	522.45	485.88	449.31	417.96
PE7065-13	12.4-18 GHz	30 dB	1.5:1	.75 dB	522.45	485.88	449.31	417.96
PE7065-14	12.4-18 GHz	40 dB	1.5:1	.75 dB	522.45	485.88	449.31	417.96

# SINGLE STAGE BENCH MOUNT ROTARY ATTENUATORS

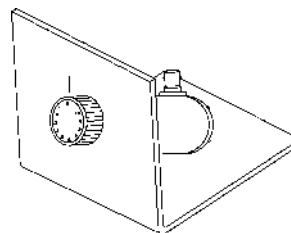

**ALL UNITS HAVE 1 WATT AVERAGE POWER,  
1000 WATTS PEAK, AND -20° C to 85° C  
OPERATING TEMPERATURE.**

MODEL NO.	FREQUENCY RANGE	IMPEDANCE	CONNECTORS	ATTENUATION RANGE	ATTENUATION ACCURACY OVERALL	VSWR (MAX)	P R I C E			
							1-24	25-49	50-99	100 +
PE7034-1	DC-1 GHz	50 OHMS	BNC FEMALE	0-1 dB in .1 dB steps	±.05 dB	1.20:1	\$292.55	\$272.07	\$251.59	\$234.04
PE7034-2	DC-1 GHz	50 OHMS	BNC FEMALE	0-100 dB in 10 dB steps	±.5 dB or 2%	1.20:1	365.70	340.10	314.50	292.56
PE7034-3	DC-2 GHz	50 OHMS	BNC FEMALE	0-10 dB in 1 dB steps	±.4 dB	DC-1 GHz @ 1.20:1 1-2 GHz @ 1.40:1	289.95	269.65	249.36	231.96
PE7034-4	DC-2 GHz	50 OHMS	BNC FEMALE	0-70 dB in 10 dB steps	±.5 dB or 3%	DC-1 GHz @ 1.20:1 1-2 GHz @ 1.40:1	344.80	320.66	296.53	275.84
PE7034-5	DC-2 GHz	50 OHMS	BNC FEMALE	0-100 dB in 10 dB steps	±.5 dB or 3%	DC-1 GHz @ 1.30:1 1-2 GHz @ 1.50:1	490.35	456.03	421.70	392.28
PE7034-6	DC-2 GHz	50 OHMS	BNC FEMALE	0-1 dB in .1 dB steps	±.05 dB	1.30:1	344.80	320.66	296.53	275.84
PE7035-1	DC-500 MHz	75 OHMS	BNC FEMALE	0-1 dB in .1 dB steps	±.05 dB	1.30:1	313.45	291.51	269.57	250.76
PE7035-2	DC-500 MHz	75 OHMS	BNC FEMALE	0-10 dB in 1 dB steps	±.25 dB	1.30:1	313.45	291.51	269.57	250.76
PE7035-3	DC-500 MHz	75 OHMS	BNC FEMALE	0-70 dB in 10 dB steps	±1.0 dB	1.30:1	313.45	291.51	269.57	250.76
PE7035-4	DC-1 GHz	75 OHMS	BNC FEMALE	0-10 dB in 1 dB steps	±.4 dB	DC-500 MHz @ 1.30:1 500 MHz - 1 GHz @ 1.40:1	323.15	300.53	277.91	258.52
PE7035-5	DC-1 GHz	75 OHMS	BNC FEMALE	0-1 dB in .1 dB steps	±.07 dB	DC-500 MHz @ 1.30:1 500 MHz - 1 GHz @ 1.40:1	323.15	300.53	277.91	258.52
PE7059-1	DC-26.5 GHz	50 OHMS	3.5mm FEMALE	0-9 dB in 1 dB steps	±.5 dB	DC-18 GHz @ 1.45:1 18-26.5 GHz @ 1.70:1	1771.25	1647.26	1523.28	1417.00

## TWO & THREE STAGE BENCH MOUNT ROTARY ATTENUATORS

Attenuators /  
RF Components

**ALL UNITS HAVE 50 OHMS BNC FEMALE CONNECTORS,  
1 WATT AVERAGE POWER, 1000 WATTS PEAK,  
AND -20° C TO 85° C OPERATING TEMPERATURE.**

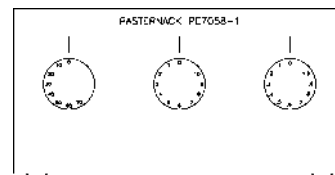
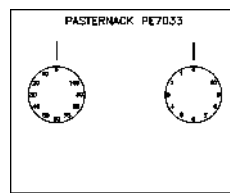

MODEL NO.	FREQUENCY RANGE	NO. OF STAGES	ATTENUATION RANGE	ATTENUATION ACCURACY OVERALL	VSWR (MAX)	P R I C E			
						1-24	25-49	50-99	100 +
PE7033	DC-2 GHz	2	0-110 dB in 1 dB steps	±.5 dB or 3%	DC-1000 MHz @ 1.30:1 1000-1500 MHz @ 1.50:1 1500-2000 MHz @ 1.70:1	\$691.20	\$642.82	\$594.43	\$552.96
PE7033-2	DC-2 GHz	2	0-80 dB in 1 dB steps	±.5 dB or 3%	DC-1000 MHz @ 1.30:1 1000-1500 MHz @ 1.50:1 1500-2000 MHz @ 1.70:1	634.40	589.99	545.58	507.52
PE7058-1	DC-1 GHz	3	0-81 dB in .1 dB steps	DC-30 MHz 0-1 dB, ±.02 dB 1-10 dB, ±.1 dB 10-81 dB, ±.2 dB 30-500 MHz 0-1 dB, ±.04 dB 1-10 dB, ±.2 dB 10-81 dB, ±.5 dB 500-1000 MHz 0-1 dB, ±.06 dB 1-10 dB, ±.3 dB 10-81 dB, ±.8 dB	DC-30 MHz @ 1.10:1 30-500 MHz @ 1.30:1 500-1000 MHz @ 1.50:1	1267.80	1179.05	1090.31	1014.24

# PUSHBUTTON ATTENUATORS

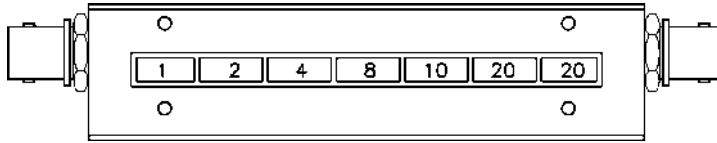

All units have 1 watt average power with 1000 watts peak.  
All units have BNC female connectors.

Model No.	FREQUENCY RANGE	IMPEDANCE	ATTENUATION RANGE	ATTENUATION STEPS	ATTENUATION ACCURACY OVERALL	VSWR	P R I C E			
							1-24	25-49	25-49	100 +
PE7008-1	DC-750 MHz	50 OHMS	0-65 dB in 1.0 dB steps	1, 2, 4, 8, 10, 20 & 20 dB	DC-100 MHz, $\pm .3$ dB 100-300 MHz, $\pm .5$ dB 300-500 MHz, $\pm .8$ dB 500-750 MHz, $\pm 1.3$ dB	DC-100 MHz, 1.10:1 MAX 100-500 MHz, 1.25:1 MAX 500-750 MHz, 1.40:1 MAX	\$460.80	\$428.54	\$396.29	\$368.64
PE7008-2	DC-750 MHz	50 OHMS	0-45.5 dB in 0.5 dB steps	0.5, 1, 2, 4, 8, 10 & 20 dB	DC-100 MHz, $\pm .2$ dB 100-300 MHz, $\pm .3$ dB 300-500 MHz, $\pm .5$ dB 500-750 MHz, $\pm .75$ dB	DC-100 MHz, 1.10:1 MAX 100-500 MHz, 1.25:1 MAX 500-750 MHz, 1.40:1 MAX	460.80	428.54	396.29	368.64
PE7008-3	DC-500 MHz	75 OHMS	0-65 dB in 1.0 dB steps	1, 2, 4, 8, 10, 20 & 20 dB	DC-100 MHz, $\pm .3$ dB 100-300 MHz, $\pm .5$ dB 300-500 MHz, $\pm .8$ dB	DC-100 MHz, 1.10:1 MAX 100-300 MHz, 1.20:1 MAX 300-500 MHz, 1.30:1 MAX	460.80	428.54	396.29	368.64
PE7008-4	DC-500 MHz	75 OHMS	0-45.5 dB in 0.5 dB steps	0.5, 1, 2, 4, 8, 10 & 20 dB	DC-100 MHz, $\pm .2$ dB 100-300 MHz, $\pm .3$ dB 300-500 MHz, $\pm .5$ dB	DC-100 MHz, 1.10:1 MAX 100-300 MHz, 1.20:1 MAX 300-500 MHz, 1.30:1 MAX	460.80	428.54	396.29	368.64
PE7008-5	DC-750 MHz	50 OHMS	0-102 dB in 1.0 dB steps	1, 2, 3, 6, 10, 20, 20, 20 & 20 dB	$\pm .3$ dB or 1%	1.40:1 MAX	799.35	743.40	687.44	639.48
PE7008-6	DC-750 MHz	50 OHMS	0-82.5 dB in 0.5 dB steps	0.5, 1, 2, 3, 6, 10, 20,	$\pm .3$ dB or 1%	1.40:1 MAX	799.35	743.40	687.44	639.48

# TOGGLE SWITCH ATTENUATORS

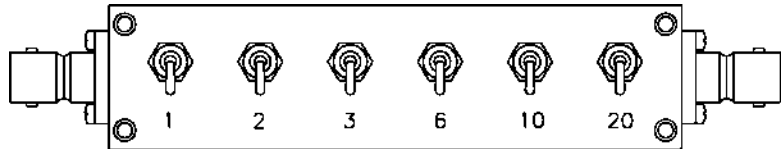

All units have BNC female connectors.  
PE7036 & PE7038 series have 1 watt average power.  
PE7037 series has 10 watts average power with 5000 watts peak.

Model No.	FREQUENCY RANGE	IMPEDANCE	ATTENUATION RANGE	ATTENUATION ACCURACY OVERALL	VSWR MAX.	P R I C E			
						1-24	25-49	50-99	100 +
PE7036-1	DC-1 GHz	50 OHMS	0-42 dB in 1 dB steps	$\pm 1.0$ dB	1.40:1	\$584.15	\$543.26	\$502.37	\$467.32
PE7036-2	DC-1 GHz	50 OHMS	0-82.5 dB in .5 dB steps	$\pm 1.5$ dB	1.40:1	584.15	543.26	502.37	467.32
PE7036-3	DC-1 GHz	50 OHMS	0-102 dB in 1 dB steps	$\pm 1.5$ dB	1.40:1	633.30	588.97	544.64	506.64
PE7037-1	DC-500 MHz	50 OHMS	0-42 dB in 1 dB steps	$\pm 1.5$ dB	1.50:1	1567.45	1457.73	1348.01	1253.96
PE7037-2	DC-500 MHz	50 OHMS	0-82.5 dB in .5 dB steps	$\pm 1.5$ dB	1.50:1	1880.95	1749.28	1617.62	1504.76
PE7038-1	DC-1 GHz	75 OHMS	0-42 dB in 1 dB steps	$\pm 1.0$ dB	1.40:1	574.70	534.47	494.24	459.76
PE7038-2	DC-1 GHz	75 OHMS	0-82.5 dB in .5 dB steps	$\pm 1.5$ dB	1.40:1	563.50	524.06	484.61	450.80
PE7038-3	DC-1 GHz	75 OHMS	0-102 dB in 1 dB steps	$\pm 1.5$ dB	1.40:1	599.45	557.49	515.53	479.56

Attenuators / RF Components

# PROGRAMMABLE ATTENUATOR

IMPEDANCE..... 50 Ohms NOMINAL  
FRQUENCY RANGE..... DC TO 1,000 MHz  
ATTENUATION ACCURACY PER STEP.....  $\pm .3$  dB  
VSWR..... 1.4:1 MAXIMUM  
POWER HANDLING CAPABILITY..... ½ WATT AVERAGE; 50 WATTS PEAK  
SWITCHING TIME..... 15 MILLISECONDS  
OPERATING TEMPERATURE RANGE..... -20°C TO +60°C  
OPERATING VOLTAGE..... +12 VDC AT 45 mA PER STEP MAXIMUM  
CONNECTORS..... SMA FEMALE

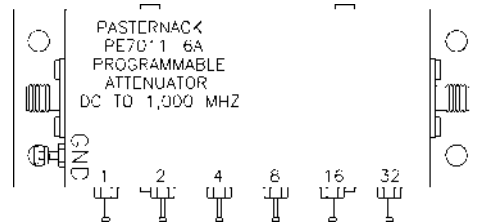

Model No.	ATTENUATION RANGE	ATTENUATION STEPS	INSERTION LOSS	P R I C E			
				1-24	25-49	50-99	100 +
PE7011-6A	63 dB IN 1 dB STEPS	1, 2, 4, 8, 16, 32 dB	2 dB	\$679.20	\$631.66	\$584.11	\$543.36

Vikasपुरi, New Delhi-110018, .  
Email-pradeep@rfconnectorhouse.com  
Skype Accout - pradeepag

Mobile 91-98101 38894, Fax -91 11 2853 1435  
Website-http://www.rfconnectorhouse.com/  
My trademanager ID -synergytelecom;



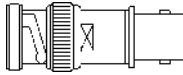

# IMPEDANCE MATCHING PADS

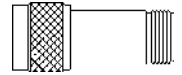

MODEL NO.	CONNECTOR A 50 OHM	CONNECTOR B 75 OHM	FREQUENCY DC TO GHz	VSWR MAXIMUM	ATTENUATION LOSS	ACCURACY	P R I C E			
							1-24	25-49	50-99	100 +
PE7006	BNC MALE	BNC FEMALE	1	1.20:1	5.7 dB	± .5 dB	\$37.55	\$34.92	\$32.29	\$30.04
PE7007	BNC FEMALE	BNC MALE	1	1.20:1	5.7 dB	± .5 dB	37.55	34.92	32.29	30.04
PE7066	BNC MALE	F FEMALE	3	1.25:1	5.7 dB	± .5 dB	73.10	67.98	62.87	58.48
PE7067	BNC MALE	F MALE	3	1.25:1	5.7 dB	± .5 dB	73.10	67.98	62.87	58.48
PE7068	BNC FEMALE	F MALE	3	1.25:1	5.7 dB	± .5 dB	76.35	71.01	65.66	61.08
PE7069	BNC FEMALE	F FEMALE	3	1.25:1	5.7 dB	± .5 dB	69.95	65.05	60.16	55.96
PE7027	N MALE	N FEMALE*	1	1.20:1	5.7 dB	± .5 dB	73.10	67.98	62.87	58.48
PE7028	N FEMALE	N MALE*	1	1.20:1	5.7 dB	± .5 dB	73.10	67.98	62.87	58.48
PE7070	N MALE	N FEMALE*	3	1.35:1	5.7 dB	± .5 dB	73.10	67.98	62.87	58.48
PE7083	N FEMALE	N MALE*	3	1.35:1	5.7 dB	± .5 dB	73.10	67.98	62.87	58.48
PE7071	N MALE	F FEMALE	3	1.25:1	5.7 dB	± .5 dB	73.10	67.98	62.87	58.48
PE7072	N MALE	F MALE	3	1.25:1	5.7 dB	± .5 dB	73.10	67.98	62.87	58.48
PE7073	N FEMALE	F MALE	3	1.25:1	5.7 dB	± .5 dB	73.10	67.98	62.87	58.48
PE7074	N FEMALE	F FEMALE	3	1.25:1	5.7 dB	± .5 dB	73.10	67.98	62.87	58.48
PE7075	SMA MALE	F MALE	3	1.25:1	5.7 dB	± .5 dB	73.10	67.98	62.87	58.48
PE7076	SMA MALE	F FEMALE	3	1.25:1	5.7 dB	± .5 dB	73.10	67.98	62.87	58.48
PE7077	SMA FEMALE	F MALE	3	1.25:1	5.7 dB	± .5 dB	73.10	67.98	62.87	58.48
PE7078	SMA FEMALE	F FEMALE	3	1.25:1	5.7 dB	± .5 dB	73.10	67.98	62.87	58.48
PE7079	TNC MALE	F FEMALE	3	1.25:1	5.7 dB	± .5 dB	78.30	72.82	67.34	62.64
PE7080	TNC MALE	F MALE	3	1.25:1	5.7 dB	± .5 dB	78.30	72.82	67.34	62.64
PE7081	TNC FEMALE	F MALE	3	1.25:1	5.7 dB	± .5 dB	78.30	72.82	67.34	62.64
PE7082	TNC FEMALE	F FEMALE	3	1.25:1	5.7 dB	± .5 dB	78.30	72.82	67.34	62.64

\*WARNING: 75 OHM N CONNECTORS WILL NOT MATE TO STANDARD 50 OHM N CONNECTORS.

# HIGH POWER TERMINATIONS

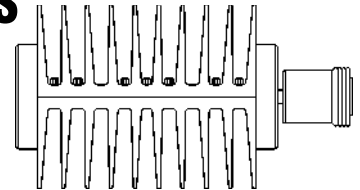
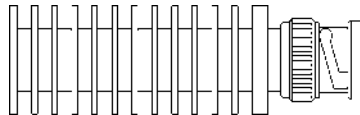
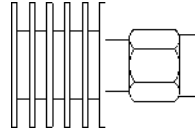
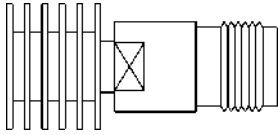

MODEL NO.	CONNECTOR SERIES	POWER HANDLING CAP. WATTS	FREQUENCY RANGE DC TO GHz	MAXIMUM VSWR	P R I C E			
					1-24	25-49	50-99	100 +
PE6095	SMA MALE	5	18	1.25	\$84.60	\$78.68	\$72.76	\$67.68
PE6096	SMA FEMALE	5	18	1.25	109.65	101.97	94.30	87.72
PE6097	N MALE	5	18	1.25	80.80	75.14	69.49	64.64
PE6098	N FEMALE	5	18	1.25	80.80	75.14	69.49	64.64
PE6099	TNC MALE	5	18	1.25	92.75	86.26	79.77	74.20
PE6138	TNC FEMALE	5	18	1.25	104.45	97.14	89.83	83.56
PE6100	7/16 MALE	5	7	1.25	104.45	97.14	89.83	83.56
PE6139	7/16 FEMALE	5	7	1.25	104.45	97.14	89.83	83.56
PE6034	BNC MALE	10	4	1.25	115.70	107.60	99.50	92.56
PE6101	BNC FEMALE	10	4	1.25	135.80	126.29	116.79	108.64
PE6035	N MALE	10	18	1.25	179.05	166.52	153.98	143.24
PE6102	N FEMALE	10	18	1.25	179.05	166.52	153.98	143.24
PE6036	SMA MALE	10	18	1.25	149.55	139.08	128.61	119.64
PE6103	SMA FEMALE	10	18	1.40	149.55	139.08	128.61	119.64
PE6104	TNC MALE	10	18	1.25	191.05	177.68	164.30	152.84
PE6140	TNC FEMALE	10	18	1.25	191.05	177.68	164.30	152.84
PE6105	7/16 MALE	10	7	1.25	207.45	192.93	178.41	165.96
PE6141	7/16 FEMALE	10	7	1.25	207.45	192.93	178.41	165.96
PE6106	N MALE	25	18	1.40	282.10	262.35	242.61	225.68
PE6037	N FEMALE	25	18	1.25	365.70	340.10	314.50	292.56
PE6038	SMA FEMALE	25	18	1.40	313.45	291.51	269.57	250.76
PE6107	7/16 MALE	25	7	1.25	313.45	291.51	269.57	250.76
PE6039	N FEMALE	50	18	1.45	387.55	360.42	333.29	310.04
PE6040	SMA FEMALE	50	18	1.45	387.30	360.19	333.08	309.84
PE6112	7/16 FEMALE	50	7	1.35	392.00	364.56	337.12	313.60
PE6041	BNC FEMALE	100	2	1.25	576.55	536.19	495.83	461.24
PE6042	N FEMALE	100	2	1.25	609.95	567.25	524.56	487.96
PE6043	SMA FEMALE	100	2	1.25	616.50	573.35	530.19	493.20
PE6137	7/16 FEMALE	100	2	1.25	634.40	589.99	545.58	507.52

Attenuators /  
RF Components

# FEEDTHRU TERMINATIONS

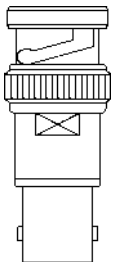
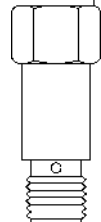
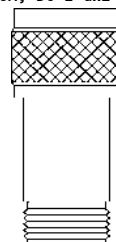
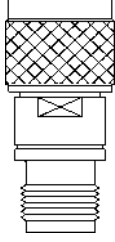
<b>BNC</b>		<b>SMA</b>		<b>N</b>		<b>TNC</b>	
VSWR: 1.20:1 MAXIMUM, DC-1 GHz POWER: 1 WATT AVERAGE		50 Ohms, 2 WATTS VSWR: 1.25:1 MAXIMUM, DC-1 GHz		50 Ohms, 2 WATTS VSWR: 1.65:1 MAXIMUM, DC-1 GHz		VSWR: 1.20:1 MAXIMUM, DC-1 GHz POWER: 1 WATT AVERAGE	
							
<b>Model No.</b>	<b>Impedance</b>	<b>Model No.</b>		<b>Model No.</b>		<b>Model No.</b>	<b>Impedance</b>
PE6008-50	50 Ohms	PE6026		PE6033		PE6142-50	50 Ohms
PE6008-75	75 Ohms					PE6142-75	75 Ohms
PE6008-XX	Any					PE6142-XX	Any
Price Upon Request						Price Upon Request	
1-24	25-49	1-24	25-49	1-24	25-49	1-24	25-49
\$28.60	\$26.60	\$59.00	\$54.87	\$67.85	\$63.10	\$38.50	\$35.81
50-99	100 +	50-99	100 +	50-99	100 +	50-99	100 +
\$24.60	\$22.88	\$50.74	\$47.20	\$58.35	\$54.28	\$33.11	\$30.80

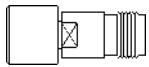

## 50 & 75 OHM PRECISION TERMINATIONS

\*2.92mm connectors will mate with SMA, 3.5mm and K connectors.  
The K connector is a registered trademark of the Anritsu Company.

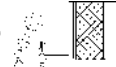

Female - No Chain

Male - With Chain

MODEL NO.	CONNECTOR SERIES	CHAIN	FREQUENCY RANGE DC TO GHz	POWER HANDLING CAP. WATTS	MAX. VSWR	PRICE			
						1-24	25-49	50-99	100 +
PE6088	2.92mm FEMALE*	YES	40	1/2	1.20	\$292.55	\$272.07	\$251.59	\$234.04
PE6087	2.92mm FEMALE*	NO	40	1/2	1.20	271.65	252.63	233.62	217.32
PE6086	2.92mm MALE*	YES	40	1/2	1.20	282.10	262.35	242.61	225.68
PE6085	2.92mm MALE*	NO	40	1/2	1.20	277.95	258.49	239.04	222.36
PE6155	BNC MALE	NO	1	2	1.10	17.40	16.18	14.96	13.92
PE6156	BNC MALE	NO	4	2	1.35	18.50	17.21	15.91	14.80
PE6162	MINI SMP FEMALE	NO	40	1/2	1.35	156.70	145.73	134.76	125.36
PE6163	MINI SMP MALE	NO	40	1/2	1.35	156.70	145.73	134.76	125.36
PE6076	N FEMALE	YES	18	2	1.30	67.85	63.10	58.35	54.28
PE6032	N FEMALE	NO	18	2	1.30	51.25	47.66	44.08	41.00
PE6152	N MALE	NO	1	2	1.05	18.70	17.39	16.08	14.96
PE6153	N MALE	NO	2	2	1.10	20.85	19.39	17.93	16.68
PE6154	N MALE	NO	4	2	1.10	22.90	21.30	19.69	18.32
PE6075	N MALE	YES	18	2	1.30	44.75	41.62	38.49	35.80
PE6009	N MALE	NO	18	2	1.30	39.40	36.64	33.88	31.52
<b>NEW</b> PE6164	QMA MALE	NO	12.4	1	1.30	16.65	15.48	14.32	13.32
PE6070	SMA FEMALE	YES	12.4	1/2	1.17	38.15	35.48	32.81	30.52
PE6003	SMA FEMALE	NO	12.4	1/2	1.17	32.70	30.41	28.12	26.16
PE6074	SMA FEMALE	YES	18	1	1.20	54.35	50.55	46.74	43.48
PE6084	SMA FEMALE	YES	18	2	1.20	52.20	48.55	44.89	41.76
PE6073	SMA FEMALE	NO	18	1	1.20	46.10	42.87	39.65	36.88
PE6083	SMA FEMALE	NO	18	2	1.20	43.65	40.59	37.54	34.92
PE6080	SMA FEMALE	YES	26.5	1	1.35	76.40	71.05	65.70	61.12
PE6079	SMA FEMALE	NO	26.5	1	1.35	69.85	64.96	60.07	55.88
PE6148	SMA MALE	NO	1	1	1.05	16.30	15.16	14.02	13.04
PE6149	SMA MALE	NO	2.5	1	1.10	18.85	17.53	16.21	15.08
PE6150	SMA MALE	NO	4	1	1.10	21.10	19.62	18.15	16.88
PE6151	SMA MALE	NO	8	1	1.15	23.35	21.72	20.08	18.68
PE6069	SMA MALE	YES	12.4	1/2	1.17	38.15	35.48	32.81	30.52
PE6002	SMA MALE	NO	12.4	1/2	1.17	33.40	31.06	28.72	26.72
PE6072	SMA MALE	YES	18	1	1.20	47.00	43.71	40.42	37.60
PE6082	SMA MALE	YES	18	2	1.20	49.05	45.62	42.18	39.24
PE6071	SMA MALE	NO	18	1	1.20	39.40	36.64	33.88	31.52
PE6081	SMA MALE	NO	18	2	1.20	43.35	40.32	37.28	34.68
PE6078	SMA MALE	YES	26.5	1	1.25	69.85	64.96	60.07	55.88
PE6077	SMA MALE	NO	26.5	1	1.25	64.55	60.03	55.51	51.64
PE6160	SMP FEMALE	NO	10	1	1.25	133.70	124.34	114.98	106.96
PE6161	SMP MALE	NO	10	1	1.25	130.55	121.41	112.27	104.44
PE6092	TNC FEMALE	YES	18	2	1.25	86.20	80.17	74.13	68.96
PE6091	TNC FEMALE	NO	18	2	1.25	80.80	75.14	69.49	64.64
PE6157	TNC MALE	NO	2	2	1.15	18.50	17.21	15.91	14.80
PE6158	TNC MALE	NO	4	2	1.15	20.70	19.25	17.80	16.56
PE6090	TNC MALE	YES	18	2	1.25	93.00	86.49	79.98	74.40
PE6089	TNC MALE	NO	18	2	1.25	87.30	81.19	75.08	69.84
<b>75 OHM</b>									
<b>NEW</b> PE6165	75 OHM HD BNC	NO	3 GHz	1/4		16.50	15.35	14.19	13.20

Attenuators / RF Components

## RESISTOR TERMINATIONS

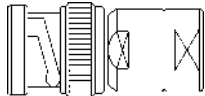

Male

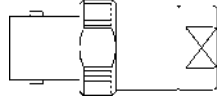

FEMALE

1% TOLERANCE, 1/2 WATT MAXIMUM DISSIPATION

Model No.	Connector	Impedance		P R I C E			
		OHMS	1-24	25-49	50-99	100 +	
PE6000-50	BNC MALE	50	\$15.40	\$14.32	\$13.24	\$12.32	
PE6000-75	BNC MALE (1)	75	15.40	14.32	13.24	12.32	
PE6000-93	BNC MALE (1)	93	15.40	14.32	13.24	12.32	
PE6001-50	N MALE	50	16.65	15.48	14.32	13.32	
PE6001-75	N MALE (1)	75	16.65	15.48	14.32	13.32	
PE6001-93	N MALE (1)	93	16.65	15.48	14.32	13.32	
PE6011-50	TNC MALE	50	16.45	15.30	14.15	13.16	
PE6011-75	TNC MALE (1)	75	16.45	15.30	14.15	13.16	
PE6011-93	TNC MALE (1)	93	16.45	15.30	14.15	13.16	
PE6027-50	BNC FEMALE	50	16.45	15.30	14.15	13.16	
PE6027-75	BNC FEMALE (1)	75	16.45	15.30	14.15	13.16	
PE6028-50	N FEMALE	50	17.55	16.32	15.09	14.04	
PE6028-75	N FEMALE (1)	75	17.55	16.32	15.09	14.04	
PE6029-50	TNC FEMALE	50	19.10	17.76	16.43	15.28	
PE6029-75	TNC FEMALE (1)	75	19.10	17.76	16.43	15.28	
PE6044	SMB PLUG	50	19.80	18.41	17.03	15.84	
PE6045	SMB JACK	50	25.35	23.58	21.80	20.28	
PE6047	75 OHM N MALE	75	19.80	18.41	17.03	15.84	
PE6048	75 OHM N FEMALE	75	25.85	24.04	22.23	20.68	
PE6049	SMC PLUG	50	19.80	18.41	17.03	15.84	
PE6050	SMC JACK	50	19.80	18.41	17.03	15.84	
PE6051	75 OHM BNC MALE	75	21.30	19.81	18.32	17.04	
PE6052	75 OHM BNC FEMALE	75	19.80	18.41	17.03	15.84	
PE6053	75 OHM SMB PLUG	75	25.35	23.58	21.80	20.28	
PE6054	75 OHM SMB JACK	75	31.90	29.67	27.43	25.52	
PE6055	75 OHM SMC PLUG	75	25.35	23.58	21.80	20.28	
PE6056	75 OHM SMC JACK	75	31.90	29.67	27.43	25.52	
PE6145	C MALE	50	35.25	32.78	30.32	28.20	
PE6146	7/16" MALE	50	60.00	55.80	51.60	48.00	
PE6159	MINI 75 OHM SMB PLUG	75	23.10	21.48	19.87	18.48	

NOTES: (1) THIS TERMINATION UTILIZES A STANDARD 50 OHM CONNECTOR INTERFACE. FOR SPECIAL VALUES, CHANGE SUFFIX TO DESIRED VALUE - PRICE UPON REQUEST.

## RESISTOR TERMINATIONS WITH CHAINS

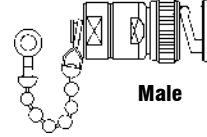

Male

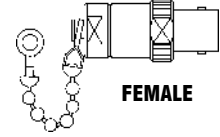

FEMALE

1% TOLERANCE, 1/2 WATT MAXIMUM DISSIPATION

Model No.	Connector	Impedance		P R I C E			
		OHMS	1-24	25-49	50-99	100 +	
PE6061-50	BNC MALE	50	\$18.70	\$17.39	\$16.08	\$14.96	
PE6061-75	BNC MALE (1)	75	18.70	17.39	16.08	14.96	
PE6061-93	BNC MALE (1)	93	18.70	17.39	16.08	14.96	
PE6062-50	N MALE	50	19.80	18.41	17.03	15.84	
PE6062-75	N MALE (1)	75	19.80	18.41	17.03	15.84	
PE6062-93	N MALE (1)	93	19.80	18.41	17.03	15.84	
PE6063-50	TNC MALE	50	22.00	20.46	18.92	17.60	
PE6063-75	TNC MALE (1)	75	22.00	20.46	18.92	17.60	
PE6063-93	TNC MALE (1)	93	22.00	20.46	18.92	17.60	
PE6064-50	BNC FEMALE	50	22.00	20.46	18.92	17.60	
PE6064-75	BNC FEMALE (1)	75	22.00	20.46	18.92	17.60	
PE6065-50	N FEMALE	50	23.10	21.48	19.87	18.48	
PE6065-75	N FEMALE (1)	75	23.10	21.48	19.87	18.48	
PE6066-50	TNC FEMALE	50	23.10	21.48	19.87	18.48	
PE6066-75	TNC FEMALE (1)	75	23.10	21.48	19.87	18.48	
PE6067	75 OHM N MALE	75	25.35	23.58	21.80	20.28	
PE6068	75 OHM N FEMALE	75	28.60	26.60	24.60	22.88	
PE6093	75 OHM BNC MALE	75	28.40	26.41	24.42	22.72	
PE6094	75 OHM BNC FEMALE	75	25.35	23.58	21.80	20.28	
PE6147	C MALE	50	38.50	35.81	33.11	30.80	

NOTES: (1) THIS TERMINATION UTILIZES A STANDARD 50 OHM CONNECTOR INTERFACE. FOR SPECIAL VALUES, CHANGE SUFFIX TO DESIRED VALUE - PRICE UPON REQUEST.

## 90° HYBRIDS

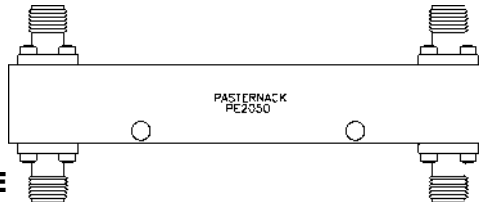

ALL CONNECTORS ARE SMA FEMALE

MODEL NO.	FREQUENCY RANGE (GHz)	COUPLING OR THRU LOSS (dB) INCLUDES FREQ. SENSITIVITY	FREQUENCY SENSITIVITY (dB)	ISOLATION (dB Min.)	VSWR (MAX)	POWER AVERAGE (WATTS)	PEAK (KW)	P R I C E			
								1-24	25-49	50-99	100 +
PE2050	0.5 - 1.0	3.1 ± 0.6	± 0.5	28	1.10	50	3	303.00	281.79	260.58	242.40
PE2051	1.0 - 2.0	3.1 ± 0.6	± 0.5	28	1.10	50	3	303.00	281.79	260.58	242.40
PE2052	2.0 - 4.0	3.1 ± 0.6	± 0.5	22	1.20	50	3	334.35	310.95	287.54	267.48
PE2053	2.6 - 5.2	3.1 ± 0.6	± 0.5	20	1.25	50	3	334.35	310.95	287.54	267.48
PE2054	4.0 - 8.0	3.2 ± 0.7	± 0.5	18	1.25	50	3	365.70	340.10	314.50	292.56
PE2055	6.0 - 12.4	3.2 ± 0.7	± 0.5	18	1.35	50	3	397.05	369.26	341.46	317.64
PE2056	7.5 - 16.0	3.4 ± 0.9	± 0.6	15	1.45	40	2	397.05	369.26	341.46	317.64
PE2057	12.0 - 18.0	3.4 ± 1.0	± 0.7	15	1.50	40	1	344.80	320.66	296.53	275.84
PE2058	2.0 - 8.0	3.3 ± 0.8	± 0.4	17	1.30	30	3	379.95	353.35	326.76	303.96
PE2059	4.0 - 12.4	3.3 ± 0.8	± 0.4	17	1.40	20	2	434.95	404.50	374.06	347.96
PE2060	7.0 - 18.0	3.5 ± 1.25	± 0.75	13	1.50	20	1	470.20	437.29	404.37	376.16

# DIRECTIONAL COUPLERS BROADBAND

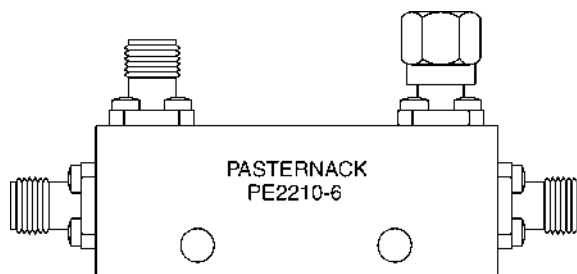

**ALL CONNECTORS ARE SMA FEMALE**  
**OPERATING TEMPERATURE: - 55° C TO +105° C**  
**POWER PEAK: 3 kW**

MODEL NO.	FREQUENCY RANGE (GHz)	COUPLING (dB) INCLUDES FREQUENCY SENSITIVITY	FREQUENCY SENSITIVITY (dB)	INSERTION LOSS (dB)		DIRECTIVITY (dB MINIMUM)		VSWR MAXIMUM		POWER AVG. INC. WATTS	POWER AVG. RFLCTD. WATTS	PRICE			
				EXCLUDING COUPLED POWER	TRUE	1-18 GHz		PRIMARY LINE	SECONDARY LINE			1-24	25-49	50-99	100 +
						1-12.4 GHz	12.4-18 GHz								
PE2208-6	0.5 - 2.0	6 ± 1.00	± 0.75	0.35	2.00	23		1.20	1.20	50	2	\$344.80	\$320.66	\$296.53	\$275.84
PE2208-10	0.5 - 2.0	10 ± 1.00	± 0.75	0.35	0.90	23		1.20	1.20	50	5	344.80	320.66	296.53	275.84
PE2208-20	0.5 - 2.0	20 ± 1.00	± 0.75	0.35	0.40	23		1.20	1.20	50	50	344.80	320.66	296.53	275.84
PE2209-6	1.0 - 4.0	6 ± 1.00	± 0.50	0.35	2.00	23		1.20	1.20	50	2	344.80	320.66	296.53	275.84
PE2209-10	1.0 - 4.0	10 ± 1.00	± 0.50	0.35	0.90	23		1.20	1.20	50	5	344.80	320.66	296.53	275.84
PE2209-20	1.0 - 4.0	20 ± 1.00	± 0.50	0.40	0.45	23		1.20	1.20	50	50	344.80	320.66	296.53	275.84
PE2210-6	2.0 - 8.0	6 ± 1.00	± 0.50	0.50	2.20	20		1.25	1.25	50	2	344.80	320.66	296.53	275.84
PE2210-10	2.0 - 8.0	10 ± 1.00	± 0.50	0.35	1.00	20		1.25	1.25	50	5	344.80	320.66	296.53	275.84
PE2210-20	2.0 - 8.0	20 ± 1.00	± 0.60	0.40	0.45	20		1.25	1.25	50	50	344.80	320.66	296.53	275.84
PE2211-6	4.0 - 12.4	6 ± 1.00	± 0.50	0.50	2.20	17		1.30	1.30	50	2	344.80	320.66	296.53	275.84
PE2211-10	4.0 - 12.4	10 ± 1.00	± 0.50	0.50	1.20	17		1.30	1.30	50	5	344.80	320.66	296.53	275.84
PE2211-20	4.0 - 12.4	20 ± 1.00	± 0.60	0.50	0.45	17		1.30	1.30	50	50	344.80	320.66	296.53	275.84
PE2212-10	7.0 - 18.0	10 ± 1.25	± 0.75	0.60	1.10	15		1.35	1.40	50	5	344.80	320.66	296.53	275.84
PE2213-10	0.6 - 4.0	10 ± 1.25	± 0.75	0.40	0.90	18		1.25	1.30	50	5	522.45	485.88	449.31	417.96
PE2214-10	1.0 - 18.0	10 ± 1.00	± 0.50	0.90	1.50	15	12	1.40	1.50	25	5	1253.95	1166.17	1078.40	1003.16
PE2214-16	1.0 - 18.0	16 ± 1.00	± 0.50	0.80	0.90	15	12	1.40	1.50	25	20	1253.95	1166.17	1078.40	1003.16
PE2214-20	1.0 - 18.0	20 ± 1.00	± 0.50	0.80	0.90	15	12	1.40	1.50	25	25	1253.95	1166.17	1078.40	1003.16
PE2215-6	2.0 - 18.0	6 ± 1.00	± 0.50	0.90	2.00	15	12	1.35	1.50	25	2	1253.95	1166.17	1078.40	1003.16
PE2215-10	2.0 - 18.0	10 ± 1.00	± 0.50	0.80	1.30	15	12	1.35	1.50	25	5	1253.95	1166.17	1078.40	1003.16
PE2215-16	2.0 - 18.0	16 ± 1.00	± 0.50	0.80	0.90	15	12	1.35	1.40	25	20	1253.95	1166.17	1078.40	1003.16
PE2215-20	2.0 - 18.0	20 ± 1.00	± 0.50	0.80	0.90	15	12	1.35	1.40	25	25	1253.95	1166.17	1078.40	1003.16
PE2216-6	4.0 - 18.0	6 ± 1.00	± 0.50	0.90	2.00	15	12	1.35	1.40	25	2	522.45	485.88	449.31	417.96
PE2216-10	4.0 - 18.0	10 ± 1.00	± 0.50	0.80	1.00	15	12	1.35	1.40	25	5	522.45	485.88	449.31	417.96
PE2216-20	4.0 - 18.0	20 ± 1.00	± 0.50	0.60	0.70	15	12	1.40	1.40	25	25	522.45	485.88	449.31	417.96

Attenuators /  
RF Components

# DIRECTIONAL COUPLERS OCTAVE

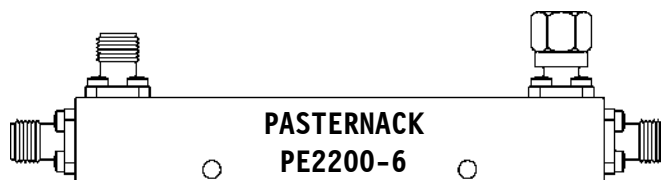

**ALL CONNECTORS ARE SMA FEMALE**  
**OPERATING TEMPERATURE: - 55° C TO +105° C**

MODEL NO.	FREQUENCY RANGE (GHz)	COUPLING (dB) INCLUDES FREQUENCY SENSITIVITY	FREQUENCY SENSITIVITY (dB)	INSERTION LOSS (dB)		DIRECTIVITY (dB MINIMUM)	VSWR MAXIMUM		POWER AVG. INC. WATTS	POWER AVG. RFLCTD. WATTS	POWER PEAK (kW)	P R I C E			
				EXCLUDING COUPLED POWER	TRUE		PRIMARY LINE	SECONDARY LINE				1-24	25-49	50-99	100 +
PE2200-6	0.5 - 1.0	6 ± 1.00	± 0.60	0.20	1.80	25	1.15	1.15	50	2	3	\$261.20	\$242.92	\$224.63	\$208.96
PE2200-10	0.5 - 1.0	10 ± 1.25	± 0.75	0.20	0.80	25	1.10	1.10	50	5	3	261.20	242.92	224.63	208.96
PE2200-20	0.5 - 1.0	20 ± 1.25	± 0.75	0.15	0.20	25	1.10	1.10	50	50	3	261.20	242.92	224.63	208.96
PE2200-30	0.5 - 1.0	30 ± 1.25	± 0.75	0.15	0.20	25	1.10	1.10	50	50	3	261.20	242.92	224.63	208.96
PE2201-6	1.0 - 2.0	6 ± 1.00	± 0.60	0.20	1.80	25	1.15	1.15	50	2	3	261.20	242.92	224.63	208.96
PE2201-10	1.0 - 2.0	10 ± 1.25	± 0.75	0.20	0.80	25	1.10	1.10	50	5	3	261.20	242.92	224.63	208.96
PE2201-20	1.0 - 2.0	20 ± 1.25	± 0.75	0.15	0.20	25	1.10	1.10	50	50	3	261.20	242.92	224.63	208.96
PE2201-30	1.0 - 2.0	30 ± 1.25	± 0.75	0.15	0.20	25	1.10	1.10	50	50	3	261.20	242.92	224.63	208.96
PE2202-6	2.0 - 4.0	6 ± 1.00	± 0.60	0.20	1.80	22	1.15	1.15	50	2	3	261.20	242.92	224.63	208.96
PE2202-10	2.0 - 4.0	10 ± 1.25	± 0.75	0.20	0.80	22	1.15	1.15	50	5	3	261.20	242.92	224.63	208.96
PE2202-20	2.0 - 4.0	20 ± 1.25	± 0.75	0.15	0.20	22	1.15	1.15	50	50	3	261.20	242.92	224.63	208.96
PE2202-30	2.0 - 4.0	30 ± 1.25	± 0.75	0.15	0.20	22	1.15	1.15	50	50	3	261.20	242.92	224.63	208.96
PE2203-6	2.6 - 5.2	6 ± 1.00	± 0.60	0.20	1.80	20	1.25	1.25	50	2	3	261.20	242.92	224.63	208.96
PE2203-10	2.6 - 5.2	10 ± 1.25	± 0.75	0.20	0.80	20	1.25	1.25	50	5	3	261.20	242.92	224.63	208.96
PE2203-20	2.6 - 5.2	20 ± 1.25	± 0.75	0.20	0.25	20	1.25	1.25	50	50	3	261.20	242.92	224.63	208.96
PE2203-30	2.6 - 5.2	30 ± 1.25	± 0.75	0.20	0.20	20	1.25	1.25	50	50	3	261.20	242.92	224.63	208.96
PE2204-6	4.0 - 8.0	6 ± 1.00	± 0.60	0.25	1.90	20	1.25	1.25	50	2	3	261.20	242.92	224.63	208.96
PE2204-10	4.0 - 8.0	10 ± 1.25	± 0.75	0.25	0.90	20	1.25	1.25	50	5	3	261.20	242.92	224.63	208.96
PE2204-20	4.0 - 8.0	20 ± 1.25	± 0.75	0.25	0.30	20	1.25	1.25	50	50	3	261.20	242.92	224.63	208.96
PE2204-30	4.0 - 8.0	30 ± 1.25	± 0.75	0.25	0.25	20	1.25	1.25	50	50	3	261.20	242.92	224.63	208.96
PE2205-6	7.0 - 12.4	6 ± 1.00	± 0.50	0.30	2.00	17	1.30	1.30	50	2	3	261.20	242.92	224.63	208.96
PE2205-10	7.0 - 12.4	10 ± 1.00	± 0.50	0.30	1.00	17	1.30	1.30	50	5	3	261.20	242.92	224.63	208.96
PE2205-20	7.0 - 12.4	20 ± 1.00	± 0.50	0.30	0.35	17	1.30	1.30	50	50	3	261.20	242.92	224.63	208.96
PE2205-30	7.0 - 12.4	30 ± 1.00	± 0.50	0.30	0.30	17	1.30	1.30	50	50	3	261.20	242.92	224.63	208.96
PE2206-6	7.5 - 16.0	6 ± 1.10	± 0.60	0.60	2.00	12	1.35	1.40	50	2	2	261.20	242.92	224.63	208.96
PE2206-10	7.5 - 16.0	10 ± 1.25	± 0.75	0.60	1.00	12	1.35	1.40	50	5	2	261.20	242.92	224.63	208.96
PE2206-20	7.5 - 16.0	20 ± 1.25	± 0.75	0.50	0.55	15	1.35	1.40	50	50	2	261.20	242.92	224.63	208.96
PE2206-30	7.5 - 16.0	30 ± 1.25	± 0.75	0.50	0.50	15	1.35	1.40	50	50	2	261.20	242.92	224.63	208.96
PE2207-6	12.4 - 18.0	6 ± 1.00	± 0.50	0.60	2.20	15	1.30	1.40	50	2	1	261.20	242.92	224.63	208.96
PE2207-10	12.4 - 18.0	10 ± 1.00	± 0.50	0.60	1.20	15	1.30	1.40	50	5	1	261.20	242.92	224.63	208.96
PE2207-20	12.4 - 18.0	20 ± 1.00	± 0.50	0.50	0.55	15	1.30	1.40	50	50	1	261.20	242.92	224.63	208.96
PE2207-30	12.4 - 18.0	30 ± 1.00	± 0.50	0.50	0.50	15	1.30	1.40	50	50	1	261.20	242.92	224.63	208.96

**Attenuators /  
RF Components**

# DUAL DIRECTIONAL COUPLERS

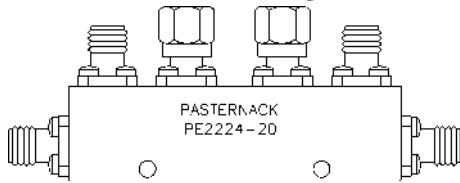

**ALL CONNECTORS ARE SMA FEMALE**  
**OPERATING TEMPERATURE: - 55° C TO + 105° C**

**P R I C E**

1-24	25-49	50-99	100 +
\$522.45	\$485.88	\$449.31	\$417.96

MODEL NO.	FREQUENCY RANGE (GHz)	COUPLING (dB) INCLUDES FREQUENCY SENSITIVITY	FREQUENCY SENSITIVITY (dB)	TRUE INSERTION LOSS (dB MAX)	DIRECTIVITY (dB MINIMUM)	VSWR MAXIMUM		POWER AVERAGE INCIDENT WATTS	POWER PEAK (kW)
						PRIMARY LINE	SECONDARY LINE		
PE2217-10	0.5 - 1.0	10 ± 1.25	± 0.80	1.50	22	1.15	1.10	10	3
PE2217-20	0.5 - 1.0	20 ± 1.25	± 0.80	0.50	22	1.15	1.10	50	3
PE2217-30	0.5 - 1.0	30 ± 1.25	± 0.80	0.40	22	1.15	1.10	50	3
PE2218-10	1.0 - 2.0	10 ± 1.25	± 0.80	1.50	22	1.15	1.10	10	3
PE2218-20	1.0 - 2.0	20 ± 1.25	± 0.80	0.50	22	1.15	1.10	50	3
PE2218-30	1.0 - 2.0	30 ± 1.25	± 0.80	0.40	22	1.15	1.10	50	3
PE2219-10	2.0 - 4.0	10 ± 1.25	± 0.80	1.50	20	1.20	1.15	10	3
PE2219-20	2.0 - 4.0	20 ± 1.25	± 0.80	0.50	20	1.20	1.15	50	3
PE2219-30	2.0 - 4.0	30 ± 1.25	± 0.80	0.40	20	1.20	1.15	50	3
PE2220-10	2.6 - 5.2	10 ± 1.25	± 0.80	1.50	18	1.30	1.25	10	3
PE2220-20	2.6 - 5.2	20 ± 1.25	± 0.80	0.50	18	1.30	1.25	50	3
PE2220-30	2.6 - 5.2	30 ± 1.25	± 0.80	0.40	18	1.30	1.25	50	3
PE2221-10	4.0 - 8.0	10 ± 1.25	± 0.80	1.70	18	1.35	1.25	10	3
PE2221-20	4.0 - 8.0	20 ± 1.25	± 0.80	0.50	18	1.35	1.25	50	3
PE2221-30	4.0 - 8.0	30 ± 1.25	± 0.80	0.40	18	1.35	1.25	50	3
PE2222-10	7.0 - 12.4	10 ± 1.25	± 0.60	1.90	16	1.35	1.30	10	3
PE2222-20	7.0 - 12.4	20 ± 1.25	± 0.60	0.70	16	1.35	1.30	50	3
PE2222-30	7.0 - 12.4	30 ± 1.25	± 0.60	0.60	16	1.35	1.30	50	3
PE2223-10	8.0 - 16.0	10 ± 1.25	± 0.80	2.20	15	1.40	1.40	10	2
PE2223-20	8.0 - 16.0	20 ± 1.25	± 0.80	1.00	15	1.40	1.40	50	2
PE2223-30	8.0 - 16.0	30 ± 1.25	± 0.80	1.00	15	1.40	1.40	50	2
PE2224-20	12.4 - 18.0	20 ± 1.25	± 0.60	1.00	15	1.40	1.40	50	1
PE2224-30	12.4 - 18.0	30 ± 1.25	± 0.60	1.00	15	1.40	1.40	50	1

## HIGH POWER DIRECTIONAL COUPLERS

**600 WATTS CW**  
**10K PEAK**

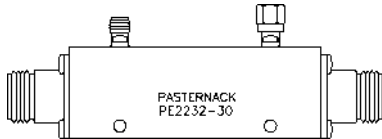

**INPUT & OUTPUT CONNECTORS ARE N FEMALE**  
**COUPLED PORT IS SMA FEMALE**

MODEL NO.	FREQUENCY RANGE (GHz)	COUPLING (dB) INCLUDES FREQ. SENSITIVITY	FREQUENCY SENSITIVITY (dB)	INSERTION LOSS (dB MAX)	DIRECTIVITY (dB Min.)	VSWR (MAX) PRIMARY LINE	P R I C E			
							1-24	25-49	50-99	100 +
PE2225-30	0.5 - 2.0	30 ± 1.0	± 0.75	0.2	18	1.15	\$1044.95	\$971.80	\$898.66	\$835.96
PE2226-30	1.0 - 2.0	30 ± 1.0	± 0.75	0.2	18	1.15	929.50	864.44	799.37	743.60
PE2227-30	2.0 - 4.0	30 ± 1.0	± 0.75	0.2	18	1.15	1035.00	962.55	890.10	828.00
PE2228-30	1.0 - 4.0	30 ± 1.0	± 0.70	0.2	15	1.15	1182.50	1099.73	1016.95	946.00
PE2229-30	2.6 - 5.2	30 ± 1.0	± 0.75	0.2	18	1.20	880.00	818.40	756.80	704.00
PE2230-30	4.0 - 8.0	30 ± 1.0	± 0.75	0.2	18	1.30	926.75	861.88	797.01	741.40
PE2231-30	1.5 - 4.5	30 ± 1.0	± 0.60	0.2	18	1.20	1182.50	1099.73	1016.95	946.00
PE2232-30	2.0 - 8.0	30 ± 1.0	± 0.60	0.2	16	1.30	1393.95	1296.37	1198.80	1115.16
PE2233-30	7.0 - 11.0	30 ± 1.0	± 0.50	0.2	16	1.30	880.00	818.40	756.80	704.00
PE2234-30	5.0 - 11.0	30 ± 1.0	± 0.50	0.2	15	1.30	731.50	680.30	629.09	585.20
PE2235-30	4.0 - 12.0	30 ± 1.0	± 0.60	0.2	15	1.30	1182.50	1099.73	1016.95	946.00
PE2236-35	1.0 - 11.0	35 ± 1.5	± 1.50	0.2	15	1.30	1776.45	1652.10	1527.75	1421.16

**Attenuators / RF Components**

# 50 OHM RESISTIVE POWER DIVIDERS

INPUT POWER..... 1 WATT AVERAGE  
 TEMPERATURE RANGE..... -65°C TO +125°C  
 OUTPUT PORTS ARE SYMMETRICAL TO MALE INPUT.

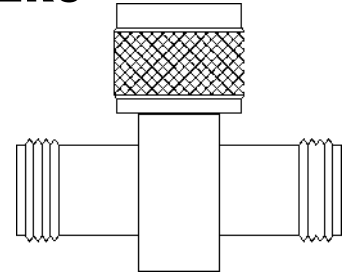
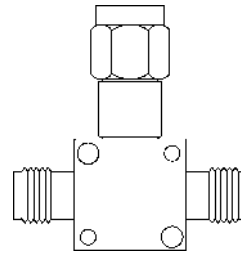

MODEL NO.	CONNECTORS	FREQUENCY	INSERTION	PHASE	VSWR	P R I C E			
		RANGE				LOSS	TRACKING	MAXIMUM	1-24
PE2063	2.92mm*	12.4	6 dB	±2°	1.20:1	\$282.10	\$262.35	\$242.61	\$225.68
PE2064	2.92mm*	18	7.5 dB	±3°	1.30:1	365.70	340.10	314.50	292.56
PE2065	2.92mm*	26.5	8.5 dB	±4°	1.40:1	522.45	485.88	449.31	417.96
PE2066	N	18	6 dB	±3°	1.35:1	365.70	340.10	314.50	292.56
PE2069	SMA	6	6 dB	±2°	1.20:1	208.95	194.32	179.70	167.16
PE2067	SMA	12.4	6 dB	±2°	1.20:1	313.45	291.51	269.57	250.76
PE2068	SMA	18	7.5 dB	±3°	1.30:1	334.35	310.95	287.54	267.48

\*2.92mm connectors will mate with SMA, 3.5mm and K connectors. The K connector is a registered trademark of the Anritsu Company.

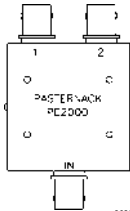

## POWER DIVIDERS

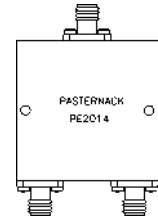

Model No.	FREQUENCY RANGE	NUMBER OF OUTPUT PORTS	CONNECTORS	MINIMUM ISOLATION dB	MAXIMUM VSWR	MAXIMUM INSERTION LOSS (dB)	P R I C E			
							1-24	25-49	50-99	100 +
PE2000	2-500 MHz	2	BNC FEMALE	25	1.35	1.00	\$129.10	\$120.06	\$111.03	\$103.28
PE2001	2-500 MHz	4	BNC FEMALE	22	1.35	1.50	261.20	242.92	224.63	208.96
PE2002	2-500 MHz	8	BNC FEMALE	20	1.50	2.00	417.95	388.69	359.44	334.36
PE2003	10-1000 MHz	2	BNC FEMALE	20	1.50	1.50	156.70	145.73	134.76	125.36
PE2004	10-1000 MHz	4	BNC FEMALE	20	1.70	2.00	344.80	320.66	296.53	275.84
PE2005	2-500 MHz	12	BNC FEMALE	20	1.50	3.00	574.70	534.47	494.24	459.76
PE2006	1-175 MHz	6	BNC FEMALE	20	1.50	1.50	397.05	369.26	341.46	317.64
PE2007	2-200 MHz	3	BNC FEMALE	25	1.35	1.00	261.20	242.92	224.63	208.96
PE2008	.5-1 GHz	2	SMA FEMALE	22	1.20	0.20	261.20	242.92	224.63	208.96
PE2009	.5-1 GHz	4	SMA FEMALE	20	1.30	0.40	344.80	320.66	296.53	275.84
PE2011	1-2 GHz	2	SMA FEMALE	22	1.25	0.25	227.20	211.30	195.39	181.76
PE2012	1-2 GHz	4	SMA FEMALE	20	1.60	0.60	386.60	359.54	332.48	309.28
PE2014	2-4 GHz	2	SMA FEMALE	20	1.30	0.30	209.35	194.70	180.04	167.48
PE2015	2-4 GHz	4	SMA FEMALE	18	1.50	0.60	417.95	388.69	359.44	334.36
PE2026	2-8 GHz	2	SMA FEMALE	20	1.35	0.40	322.95	300.34	277.74	258.36
PE2031	2-8 GHz	4	SMA FEMALE	18	1.50	1.00	434.35	403.95	373.54	347.48
PE2028	2-18 GHz	2	SMA FEMALE	20	1.50	1.00	417.95	388.69	359.44	334.36
PE2029	2-18 GHz	4	SMA FEMALE	15	1.60	2.00	705.05	655.70	606.34	564.04
PE2017	4-8 GHz	2	SMA FEMALE	20	1.30	0.35	261.20	242.92	224.63	208.96
PE2018	4-8 GHz	4	SMA FEMALE	20	1.40	0.40	344.80	320.66	296.53	275.84
PE2020	7-12.4 GHz	2	SMA FEMALE	20	1.35	0.40	261.20	242.92	224.63	208.96
PE2021	7-12.4 GHz	4	SMA FEMALE	16	1.50	1.00	344.80	320.66	296.53	275.84
PE2027	8-18 GHz	2	SMA FEMALE	20	1.40	0.60	365.70	340.10	314.50	292.56
PE2030	8-18 GHz	4	SMA FEMALE	18	1.50	1.50	470.20	437.29	404.37	376.16
PE2023	12-18 GHz	2	SMA FEMALE	20	1.35	0.60	285.80	265.79	245.79	228.64
PE2024	12-18 GHz	4	SMA FEMALE	18	1.50	1.50	365.70	340.10	314.50	292.56
PE2044	2-500 MHz	2	N FEMALE	25	1.35	1.00	261.20	242.92	224.63	208.96
PE2045	2-500 MHz	4	N FEMALE	22	1.35	1.50	417.95	388.69	359.44	334.36
PE2046	2-500 MHz	8	N FEMALE	20	1.50	2.00	555.45	516.57	477.69	444.36
PE2047	10-1000 MHz	2	N FEMALE	20	1.50	1.50	229.85	213.76	197.67	183.88
PE2032	.5-1 GHz	2	N FEMALE	25	1.20	0.25	417.95	388.69	359.44	334.36
PE2038	.5-1 GHz	4	N FEMALE	20	1.50	2.25	626.95	583.06	539.18	501.56
PE2033	1-2 GHz	2	N FEMALE	25	1.20	0.25	417.95	388.69	359.44	334.36
PE2039	1-2 GHz	4	N FEMALE	20	2.00	2.25	679.20	631.66	584.11	543.36
PE2034	2-4 GHz	2	N FEMALE	23	1.20	0.40	470.20	437.29	404.37	376.16
PE2040	2-4 GHz	4	N FEMALE	20	2.00	2.25	626.95	583.06	539.18	501.56
PE2035	4-8 GHz	2	N FEMALE	20	1.30	0.70	470.20	437.29	404.37	376.16
PE2041	4-8 GHz	4	N FEMALE	20	1.60	2.25	626.95	583.06	539.18	501.56
PE2036	8-12.4 GHz	2	N FEMALE	16	1.60	1.00	470.20	437.29	404.37	376.16
PE2042	8-12.4 GHz	4	N FEMALE	20	1.60	1.50	574.70	534.47	494.24	459.76
PE2037	12-18 GHz	2	N FEMALE	20	1.60	1.00	470.20	437.29	404.37	376.16
PE2043	12-18 GHz	4	N FEMALE	15	1.70	1.50	626.95	583.06	539.18	501.56
PE2048	2-500 MHz*	2	75 OHM BNC FEMALE	25	1.35	1.00	261.20	242.92	224.63	208.96
PE2049	2-500 MHz*	4	75 OHM BNC FEMALE	22	1.35	1.50	303.00	281.79	260.58	242.40
PE2061	2-500 MHz*	8	75 OHM BNC FEMALE	20	1.50	2.00	522.45	485.88	449.31	417.96
PE2062	10-1000 MHz*	2	75 OHM BNC FEMALE	20	1.50	1.50	282.10	262.35	242.61	225.68

\*DENOTES 75 OHM POWER DIVIDER

Attenuators / RF Components

# FERRITE ISOLATORS & CIRCULATORS

ALL CONNECTORS ARE SMA FEMALE  
INSERTION LOSS: .6 dB MAXIMUM

ISOLATOR MODEL NO.	CIRCULATOR MODEL NO.	FREQUENCY RANGE (GHz)	ISOLATION dB MINIMUM	VSWR MAXIMUM
PE8300	PE8400	1-2	18	1.35
PE8301	PE8401	2-4	18	1.30
PE8302	PE8402	4-8	18	1.30
PE8303	PE8403	7-12.4	20	1.25
PE8304	PE8404	8-18	16	1.45
PE8305	PE8405	11-18	20	1.25
PE8306	PE8406	18-26.5	17	1.40

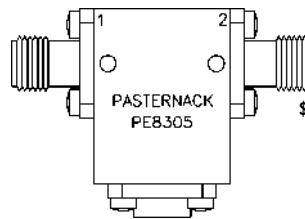

P R I C E			
1-24	25-49	50-99	100 +
\$551.70	\$513.08	\$474.46	\$441.36
367.45	341.73	316.01	293.96
218.55	203.25	187.95	174.84
189.70	176.42	163.14	151.76
218.55	203.25	187.95	174.84
189.70	176.42	163.14	151.76
209.00	194.37	179.74	167.20

CONNECTORS: SMA FEMALE  
RF POWER: 100 WATTS AVERAGE  
3000 WATTS PEAK

## PHASE SHIFTERS



MODEL NO.	FREQUENCY RANGE	PHASE ADJUSTMENT	INSERTION LOSS (dB MAX)	VSWR (MAX)
PE8243	DC - 2	60° PER GHz	.5	1.5:1
PE8244	DC - 4	60° PER GHz	.5	1.5:1
PE8245	DC - 8	60° PER GHz	.6	1.5:1
PE8246	DC - 12	60° PER GHz	.7	1.5:1
PE8247	DC - 18	60° PER GHz	1.0	1.6:1
PE8248	18.0 - 26.5	0 - 360° PER GHz	1.5	1.8:1
PE8249	26.5 - 40.0	0 - 360° PER GHz	2.5	2.0:1

P R I C E			
1-24	25-49	50-99	100 +
\$626.95	\$583.06	\$539.18	\$501.56
679.20	631.66	584.11	543.36
731.45	680.25	629.05	585.16
783.70	728.84	673.98	626.96
835.95	777.43	718.92	668.76
862.05	801.71	741.36	689.64
1563.25	1453.82	1344.40	1250.60

## 18 GHZ SMA ADJUSTABLE PHASE TRIMMERS

IMPEDANCE..... 50 Ohms  
VSWR..... 1.30:1 UP TO 18 GHz  
INSERTION LOSS..... .5 dB MAXIMUM AT 18 GHz  
PHASE ADJUSTMENT RANGE..... 10° x F (GHz)  
FOR EXAMPLE..... 40° AT 4 GHz

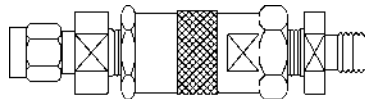

Model No.	Description
PE8200	SMA MALE TO SMA FEMALE
PE8202	SMA MALE TO (.085" SEMI-RIGID, SOLDER ATTACHMENT)

P R I C E			
1-24	25-49	50-99	100 +
\$167.15	\$155.45	\$143.75	\$133.72
161.55	150.24	138.93	129.24

## D.C. BLOCKS

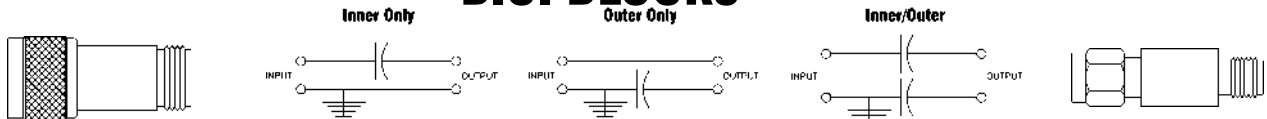

MODEL NO.	CONFIGURATION	FREQ. RANGE		TYPE OF D.C. BLOCK	VSWR MAX	INSERTION LOSS MAX	WORKING VOLTAGE	P R I C E			
		10 MHz TO						1-24	25-49	50-99	100 +
PE8210	SMA MALE TO SMA FEMALE	18 GHz		INNER	1.35	.5 dB	200	\$80.15	\$74.54	\$68.93	\$64.12
PE8250	SMA MALE TO SMA FEMALE	18 GHz		INNER	1.45	1.5 dB	950	86.20	80.17	74.13	68.96
PE8211	SMA MALE TO SMA FEMALE	18 GHz		OUTER	1.35	.5 dB	200	146.25	136.01	125.78	117.00
PE8212	SMA MALE TO SMA FEMALE	18 GHz		INNER & OUTER	1.35	.5 dB	200	170.40	158.47	146.54	136.32
PE8213	N MALE TO N FEMALE	18 GHz		INNER	1.35	.6 dB	200	105.75	98.35	90.95	84.60
PE8251	N MALE TO N FEMALE	18 GHz		INNER	1.45	1.5 dB	950	115.70	107.60	99.50	92.56
PE8214	N MALE TO N FEMALE	18 GHz		OUTER	1.35	.6 dB	200	138.60	128.90	119.20	110.88
PE8215	N MALE TO N FEMALE	18 GHz		INNER & OUTER	1.35	.6 dB	200	190.00	176.70	163.40	152.00
PE8216	BNC MALE TO BNC FEMALE	4 GHz		INNER	1.35	.5 dB	200	135.80	126.29	116.79	108.64
PE8217	BNC MALE TO BNC FEMALE	4 GHz		OUTER	1.35	.5 dB	200	161.55	150.24	138.93	129.24
PE8218	BNC MALE TO BNC FEMALE	4 GHz		INNER & OUTER	1.35	.5 dB	200	219.45	204.09	188.73	175.56
PE8219	TNC MALE TO TNC FEMALE	18 GHz		INNER	1.35	.75 dB	200	161.55	150.24	138.93	129.24
PE8252	TNC MALE TO TNC FEMALE	18 GHz		INNER	1.45	1.5 dB	950	179.05	166.52	153.98	143.24
PE8220	TNC MALE TO TNC FEMALE	18 GHz		OUTER	1.35	.75 dB	200	190.00	176.70	163.40	152.00
PE8221	TNC MALE TO TNC FEMALE	18 GHz		INNER & OUTER	1.35	.75 dB	200	244.80	227.66	210.53	195.84
PE8222	2.92mm MALE TO 2.92mm FEMALE**	26.5 GHz		INNER	1.35	.75 dB	200	192.50	179.03	165.55	154.00
PE8223	2.92mm MALE TO 2.92mm FEMALE**	26.5 GHz		OUTER	1.35	.5 dB	200	205.25	190.88	176.52	164.20
PE8224	2.92mm MALE TO 2.92mm FEMALE**	26.5 GHz		INNER & OUTER	1.35	.5 dB	200	284.60	264.68	244.76	227.68
PE8225	2.92mm MALE TO 2.92mm FEMALE**	40 GHz		INNER	1.45	.5 dB	200	522.45	485.88	449.31	417.96
PE8226	2.92mm MALE TO 2.92mm FEMALE**	40 GHz		OUTER	1.45	.5 dB	200	772.75	718.66	664.57	618.20
PE8227	2.92mm MALE TO 2.92mm FEMALE**	40 GHz		INNER & OUTER	1.45	.5 dB	200	846.50	787.25	727.99	677.20
PE8228	7mm TO 7mm	18 GHz		INNER	1.35	1.0 dB	200	686.85	638.77	590.69	549.48
PE8229	7mm TO 7mm	18 GHz		OUTER	1.35	1.0 dB	200	714.15	664.16	614.17	571.32
PE8230	7mm TO 7mm	18 GHz		INNER & OUTER	1.35	1.0 dB	200	749.05	696.62	644.18	599.24
PE8231	75 OHM BNC MALE TO 75 OHM BNC FEMALE	4 GHz*		INNER	1.35	.5 dB	200	188.05	174.89	161.72	150.44
PE8232	75 OHM BNC MALE TO 75 OHM BNC FEMALE	4 GHz*		OUTER	1.35	.5 dB	200	151.25	140.66	130.08	121.00
PE8233	75 OHM BNC MALE TO 75 OHM BNC FEMALE	4 GHz*		INNER & OUTER	1.35	.5 dB	200	242.40	225.43	208.46	193.92
PE8234	75 OHM N MALE TO 75 OHM N FEMALE	4 GHz*		INNER	1.35	.5 dB	200	179.05	166.52	153.98	143.24
PE8235	75 OHM N MALE TO 75 OHM N FEMALE	4 GHz*		OUTER	1.35	.5 dB	200	192.50	179.03	165.55	154.00
PE8236	75 OHM N MALE TO 75 OHM N FEMALE	4 GHz*		INNER & OUTER	1.35	.5 dB	200	253.30	235.57	217.84	202.64
PE8237	2.4mm MALE TO 2.4mm FEMALE	50 GHz*		INNER	1.75	1.5 dB	75	1044.95	971.80	898.66	835.96
PE8238	2.4mm MALE TO 2.4mm FEMALE	50 GHz*		OUTER	1.75	1.5 dB	75	1358.45	1263.36	1168.27	1086.76
PE8239	2.4mm MALE TO 2.4mm FEMALE	50 GHz*		INNER & OUTER	1.75	1.5 dB	75	1358.45	1263.36	1168.27	1086.76
PE8240	F MALE TO F FEMALE	2 GHz		INNER	1.35	.5 dB	200	72.00	66.96	61.92	57.60
PE8241	F MALE TO F FEMALE	2 GHz		OUTER	1.35	.5 dB	200	108.65	101.04	93.44	86.92
PE8242	F MALE TO F FEMALE	2 GHz		INNER & OUTER	1.35	.5 dB	200	148.50	138.11	127.71	118.80

\*FROM 100 MHz TO SPECIFIED FREQUENCY

\*\*2.92mm CONNECTORS WILL MATE WITH SMA, 3.5mm & K CONNECTORS. THE K CONNECTOR IS A REGISTERED TRADEMARK OF THE ANRITSU COMPANY.

Attenuators / RF Components



# BIAS "TEE"

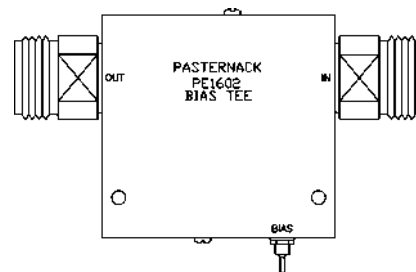
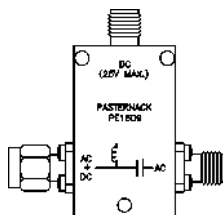
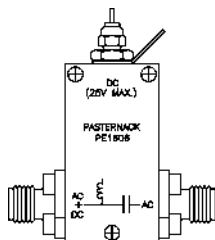

MODEL NO.	CONNECTORS		BIAS CONNECTORS	FREQUENCY RANGE	VSWR MAXIMUM	ISOLATION (RF TO BIAS PORT)		DC VOLT MAX.	DC CURRENT MAXIMUM	P R I C E			
	RF OUT & RF IN					TYPICAL	MAX.			1-24	25-49	50-99	100 +
PE1606	SMA FEMALE		SOLDER LUG & PIN	100 KHz-12.4 GHz	1.60:1	30 dB	24	.75 AMPS	\$344.80	\$320.66	\$296.53	\$275.84	
PE1607	SMA FEMALE		SOLDER LUG & PIN	100 KHz-18 GHz	1.80:1	30 dB	24	.75 AMPS	417.95	388.69	359.44	334.36	
PE1608	SMA FEMALE		SOLDER LUG & PIN	100 KHz-26.5 GHz	1.80:1	30 dB	24	.75 AMPS	806.95	750.46	693.98	645.56	
PE1609	2.92mm MALE/FEMALE*		SMA FEMALE	100 KHz-40 GHz	1.80:1	30 dB	25	250 mA	1353.25	1258.52	1163.80	1082.60	
PE1610	2.4mm MALE/FEMALE**		SMA FEMALE	100 KHz-50 GHz	1.80:1	30 dB	25	250 mA	1666.75	1550.08	1433.41	1333.40	
PE1611	SMA FEMALE		SOLDER LUG & PIN	10 MHz-2.5 GHz	1.60:1	30 dB	100	2.5 AMPS	208.95	194.32	179.70	167.16	
PE1613	SMA FEMALE		SOLDER LUG & PIN	10 MHz-4 GHz	1.60:1	30 dB	100	2.5 AMPS	240.30	223.48	206.66	192.24	
PE1615	SMA FEMALE		SOLDER LUG & PIN	10 MHz-6 GHz	1.60:1	30 dB	100	2.5 AMPS	240.30	223.48	206.66	192.24	
PE1604	SMA FEMALE		SOLDER PINS	100 MHz-6 GHz	1.50:1	25 dB	50	500 mA	198.50	184.61	170.71	158.80	
PE1617	SMA FEMALE		SOLDER LUG & PIN	250 MHz -2.5 GHz	1.50:1	20 dB	100	7 AMPS	470.20	437.29	404.37	376.16	
PE1605	SMA FEMALE		SOLDER PINS	500 MHz-10 GHz	1.50:1	25 dB	50	200 mA	313.45	291.51	269.57	250.76	
PE1603	SMA FEMALE		SOLDER PINS	1 GHz-5 GHz	1.50:1	25 dB	50	1000 mA	188.05	174.89	161.72	150.44	
PE1612	N FEMALE		SOLDER LUG & PIN	10 MHz-2.5 GHz	1.60:1	30 dB	100	2.5 AMPS	208.95	194.32	179.70	167.16	
PE1614	N FEMALE		SOLDER LUG & PIN	10 MHz-4 GHz	1.60:1	30 dB	100	2.5 AMPS	261.20	242.92	224.63	208.96	
PE1616	N FEMALE		SOLDER LUG & PIN	10 MHz-6 GHz	1.60:1	30 dB	100	2.5 AMPS	261.20	242.92	224.63	208.96	
PE1618	N FEMALE		SOLDER LUG & PIN	250 MHz-2.5 GHz	1.50:1	20 dB	100	7 AMPS	517.25	481.04	444.84	413.80	

\*2.92mm connectors will mate with SMA, 3.5mm and K connectors. The K connector is a registered trademark of the Anritsu Company.  
 \*\*1.85mm, 2.4mm & V connectors will mate mechanically & electrically to each other. The V connector is a trademark of the Anritsu Company.

## CAPS

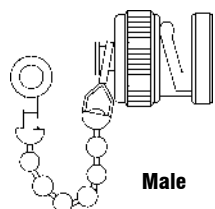

Male

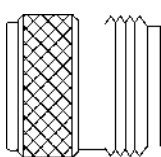

Female

## SHORTS

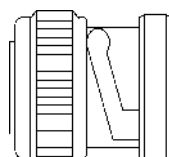

Male

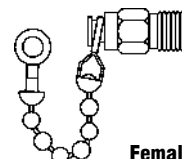

Female

Model No.	Series	Gender	Chain	1-24	25-49	50-99	100 +	Model No.	Series	Gender	Chain	1-24	25-49	50-99	100 +
PE6058	7/16	FEMALE	YES	\$29.20	\$27.16	\$25.11	\$23.36	PE6012	BNC	MALE	NO	\$6.60	\$6.14	\$5.68	\$5.28
PE6057	7/16	MALE	YES	29.20	27.16	25.11	23.36	PE6127	BNC	MALE	YES	9.35	8.70	8.04	7.48
PE6013	BNC	MALE	YES	5.30	4.93	4.56	4.24	PE6030	BNC	FEMALE	NO	9.35	8.70	8.04	7.48
PE6014	BNC	MALE	NO	3.20	2.98	2.75	2.56	PE6128	BNC	FEMALE	YES	12.50	11.63	10.75	10.00
PE6015	BNC	FEMALE	YES	4.45	4.14	3.83	3.56	PE6022	N	MALE	NO	13.55	12.60	11.65	10.84
PE6108	BNC	FEMALE	NO	5.15	4.79	4.43	4.12	PE6129	N	MALE	YES	16.10	14.97	13.85	12.88
PE6046	C	MALE	YES	13.70	12.74	11.78	10.96	PE6031	N	FEMALE	NO	14.60	13.58	12.56	11.68
PE6109	C	MALE	NO	13.05	12.14	11.22	10.44	PE6130	N	FEMALE	YES	17.70	16.46	15.22	14.16
PE6110	C	FEMALE	YES	17.40	16.18	14.96	13.92	PE6006	SMA	MALE	NO	14.40	13.39	12.38	11.52
PE6111	C	FEMALE	NO	16.65	15.48	14.32	13.32	PE6131	SMA	MALE	YES	12.50	11.63	10.75	10.00
PE6059	HN	MALE	YES	18.05	16.79	15.52	14.44	PE6007	SMA	FEMALE	NO	15.55	14.46	13.37	12.44
PE6113	HN	MALE	NO	13.05	12.14	11.22	10.44	PE6132	SMA	FEMALE	YES	16.65	15.48	14.32	13.32
PE6114	HN	FEMALE	YES	18.75	17.44	16.13	15.00	PE6133	TNC	MALE	NO	13.55	12.60	11.65	10.84
PE6115	HN	FEMALE	NO	17.70	16.46	15.22	14.16	PE6134	TNC	MALE	YES	16.65	15.48	14.32	13.32
PE6016	N/UHF	MALE	YES	4.60	4.28	3.96	3.68	PE6135	TNC	FEMALE	NO	13.55	12.60	11.65	10.84
PE6017	N/UHF	MALE	NO	4.85	4.51	4.17	3.88	PE6136	TNC	FEMALE	YES	16.65	15.48	14.32	13.32
PE6018	N	FEMALE	YES	6.90	6.42	5.93	5.52								
PE6116	N	FEMALE	NO	5.60	5.21	4.82	4.48								
PE6117	SC	MALE	YES	73.10	67.98	62.87	58.48								
PE6118	SC	FEMALE	YES	62.65	58.26	53.88	50.12								
PE6019	SMA	MALE	YES	7.40	6.88	6.36	5.92								
PE6024	SMA	MALE	NO	6.50	6.05	5.59	5.20								
PE6119	SMA	FEMALE	YES	14.80	13.76	12.73	11.84								
PE6120	SMA	FEMALE	NO	14.55	13.53	12.51	11.64								
PE6121	SMB	PLUG	YES	15.60	14.51	13.42	12.48								
PE6122	SMB	JACK	YES	7.60	7.07	6.54	6.08								
PE6123	SMC	PLUG	YES	10.40	9.67	8.94	8.32								
PE6124	SMC	JACK	YES	10.40	9.67	8.94	8.32								
PE6020	SSMA	MALE	NO	7.25	6.74	6.24	5.80								
PE6125	75 OHM SMB	PLUG	YES	22.95	21.34	19.74	18.36								
PE6126	75 OHM SMC	PLUG	YES	22.95	21.34	19.74	18.36								
PE6021	TNC	FEMALE	YES	7.75	7.21	6.67	6.20								
PE6143	TNC	FEMALE	NO	7.60	7.07	6.54	6.08								
PE6023	TNC	MALE	YES	5.55	5.16	4.77	4.44								
PE6144	TNC	MALE	NO	5.90	5.49	5.07	4.72								

Attenuators / RF Components

# COAX SURGE PROTECTOR

## SPECIFICATIONS

FREQUENCY RANGE: DC - 3 GHz  
 INSERTION LOSS: .5 dB  
 IMPEDANCE: 50 OHMS  
 DC BLOCKING: NONE. WILL PASS DC FOR POWER AND CONTROL PURPOSES.  
 MAX DC OR PEAK AC IS 150 V  
 FIRING POINT: 350 V  $\pm 15\%$  @  $100V/S > 1000 @ 5kv/\mu s$  RISE  
 BREAKDOWN VOLTAGE: 20 TO 30V  
 SURGE CURRENT: 5000 A (8/20  $\mu s$  PULSE)  
 PLUG LIFE: >600 TIMES @ 500A PULSE (FIELD REPLACEABLE)

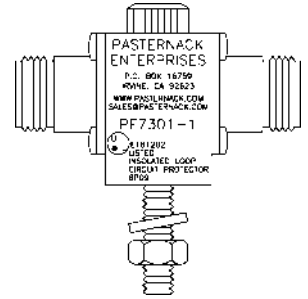
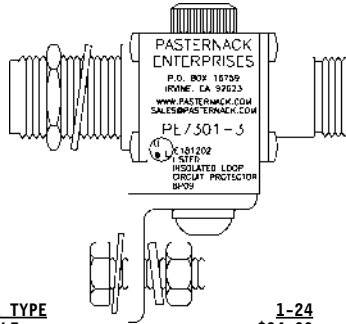

Model No.	POWER HANDLING		CONNECTOR TYPE	PRICE			
	WATTS			1-24	25-49	50-99	100 +
PE7301-1	200		N FEMALE	\$94.00	\$87.42	\$80.84	\$75.20
PE7301-2	2000		N FEMALE	104.45	97.14	89.83	83.56
PE7301-3	200		N FEMALE BULKHEAD	110.75	103.00	95.25	88.60
PE7301-4	2000		N FEMALE BULKHEAD	110.75	103.00	95.25	88.60
<b>REPLACEMENT CARTRIDGE</b>				<b>CARTRIDGE FOR</b>			
PE7301-200CART	200		PE7301-1/PE7301-3	14.60	13.58	12.56	11.68
PE7301-2000CART	2000		PE7301-2/PE7301-4	14.60	13.58	12.56	11.68

# MANUAL COAX SWITCH WITH SURGE PROTECTOR

## SPECIFICATIONS

FREQUENCY RANGE: DC - 1.3 GHz  
 VSWR: 1.6:1 MAX  
 INSERTION LOSS: .75 dB  
 ISOLATION: 50 dB  
 POWER HANDLING: 1500 WATTS RF  
 IMPEDANCE: 50 OHMS  
 CONNECTOR TYPE: N FEMALE  
 REPLACEABLE CARTRIDGE  
 SWITCHING FUNCTIONS: WHEN THE KNOB POINTS TO THE CENTER (GROUND) SWITCH POSITION ALL ANTENNA CIRCUITS ARE INTERNALLY DISCONNECTED AND GROUNDED. WHEN THE KNOB IS IN AN ACTIVE POSITION THE UNUSED ANTENNA PORTS ARE GROUNDED. THE ACTIVE POSITION CIRCUIT IS CONTINUOUSLY PROTECTED BY THE REPLACEABLE CARTRIDGE.

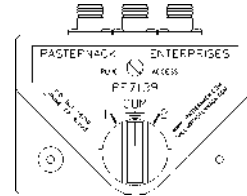

MODEL NO.	NUMBER OF OUTPUT PORTS	PRICE			
		1-24	25-49	50-99	100 +
PE7139	2	\$146.25	\$136.01	\$125.78	\$117.00
PE7140	4	167.15	155.45	143.75	133.72
<b>REPLACEMENT CARTRIDGE</b>		<b>CARTRIDGE FOR</b>			
PE7139-CART	PE7139/PE7140	15.25	14.18	13.12	12.20

# N FUSE HOLDERS

IMPEDANCE: 50 OHMS  
 FREQUENCY RANGE: DC TO 1,000 MHZ  
 VSWR: 1.50:1 MAXIMUM  
 FUSE LEVEL: 1/16 AMP = +23 dBM  
 1/8 AMP = +29 dBM  
 1/4 AMP = +35 dBM

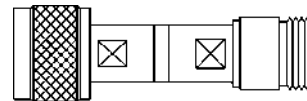

Model No.	FUSE ELEMENT	PRICE			
		1-24	25-49	50-99	100 +
PE7300-1	1/16 AMP	\$75.30	\$70.03	\$64.76	\$60.24
PE7300-2	1/8 AMP	75.30	70.03	64.76	60.24
PE7300-3	1/4 AMP	75.30	70.03	64.76	60.24

# A / B COAXIAL SWITCHES

FREQUENCY RANGE..... DC TO 1,000 MHZ  
 VSWR..... 1.60:1 MAXIMUM  
 INSERTION LOSS..... .70 dB MAXIMUM  
 ISOLATION..... 50 dB MINIMUM  
 POWER HANDLING CAPACITY..... 5 WATTS CW, COMMON TO SWITCHED PORTS (SWITCHED PORTS TERMINATED),  
 1/2 WATT SWITCHED PORTS TO COMMON  
 SWITCHING TIME..... 15 MILLISECONDS  
 OPERATING VOLTAGE (ACTUATED TO "B" POSITION)..... +12 VDC AT 45mA MAXIMUM  
 OPERATING TEMPERATURE RANGE..... -20°C TO +60°C

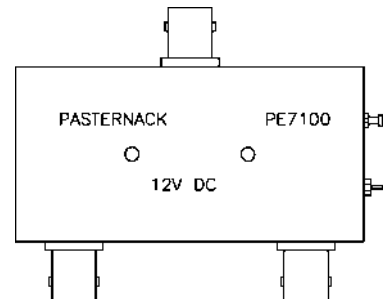

MODEL NO.	CONNECTOR TYPE	NOMINAL IMPEDANCE	PRICE			
			1-24	25-49	50-99	100 +
PE7100	BNC FEMALE	50 OHMS	\$239.95	\$223.15	\$206.36	\$191.96
PE7101	75 OHM BNC FEMALE	75 OHMS	412.15	383.30	354.45	329.72
PE7102	N FEMALE	50 OHMS	261.20	242.92	224.63	208.96
PE7103	75 OHM N FEMALE	75 OHMS	219.45	204.09	188.73	175.56

Attenuators / RF Components

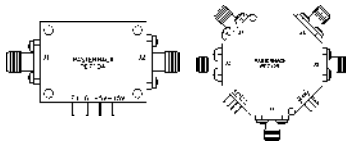

# COAXIAL SWITCHES

CONTROLS:

SPST  
TTL LOGIC 0: LOW LOSS  
TTL LOGIC 1: ISOLATION

SP3T  
TTL LOGIC 0: LOW LOSS  
TTL LOGIC 1: ISOLATION  
E1 CONTROLS: J2-J1  
E2 CONTROLS: J3-J1  
E3 CONTROLS: J4-J1

SP4T  
TTL LOGIC 0: LOW LOSS  
TTL LOGIC 1: ISOLATION  
E1 CONTROLS: J2-J1  
E2 CONTROLS: J3-J1  
E3 CONTROLS: J4-J1  
E4 CONTROLS: J5-J1

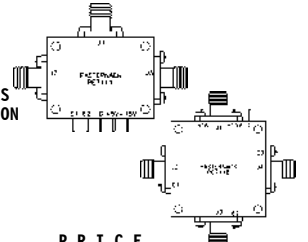

ALL CONNECTORS ARE SMA FEMALE  
DC BIAS: +5.0 ± 0.5V @ 40mA MAX.  
-15.0 ± 3.0V @ 40mA MAX.

MODEL NO.	FREQUENCY RANGE	SWITCH TYPE	INSERTION		ISOLATION (dB MIN)	POWER WATTS (MAX)	P R I C E			
			LOSS (dB MAX)	VSWR (MIN)			1-24	25-49	50-99	100 +
PE7104	10 MHz - 1 GHz	SPST	1.2	1.5	80	2.0	\$1724.25	\$1603.55	\$1482.86	\$1379.40
PE7105	1 GHz - 2 GHz	SPST	0.9	1.5	85	2.0	1263.40	1174.96	1086.52	1010.72
PE7106	1 GHz - 18 GHz	SPST	2.9	2.0	65	0.5	1670.00	1553.10	1436.20	1336.00
PE7107	2 GHz - 4 GHz	SPST	1.1	1.6	75	1.0	1263.40	1174.96	1086.52	1010.72
PE7108	4 GHz - 8 GHz	SPST	1.7	1.6	75	1.0	1335.00	1241.55	1148.10	1068.00
PE7109	8 GHz - 12 GHz	SPST	1.9	1.8	70	1.0	1263.40	1174.96	1086.52	1010.72
PE7110	12 GHz - 18 GHz	SPST	2.8	2.0	65	0.5	1263.40	1174.96	1086.52	1010.72
PE7111	10 MHz - 1 GHz	SPDT	1.3	1.5	80	2.0	1493.85	1389.28	1284.71	1195.08
PE7112	1 GHz - 2 GHz	SPDT	1.0	1.5	85	2.0	1493.85	1389.28	1284.71	1195.08
PE7113	1 GHz - 18 GHz	SPDT	3.1	2.0	65	0.5	1755.00	1632.15	1509.30	1404.00
PE7114	2 GHz - 4 GHz	SPDT	1.2	1.6	75	1.0	1608.50	1495.91	1383.31	1286.80
PE7115	4 GHz - 8 GHz	SPDT	1.8	1.6	75	1.0	1608.50	1495.91	1383.31	1286.80
PE7116	8 GHz - 12 GHz	SPDT	2.0	1.8	70	1.0	2089.95	1943.65	1797.36	1671.96
PE7117	12 GHz - 18 GHz	SPDT	3.0	2.0	65	0.5	1493.85	1389.28	1284.71	1195.08
PE7118	10 MHz - 1 GHz	SP3T	1.4	1.5	80	2.0	1493.85	1389.28	1284.71	1195.08
PE7119	1 GHz - 2 GHz	SP3T	1.1	1.5	85	2.0	1493.85	1389.28	1284.71	1195.08
PE7120	1 GHz - 18 GHz	SP3T	3.3	2.0	65	0.5	1954.65	1817.82	1681.00	1563.72
PE7121	2 GHz - 4 GHz	SP3T	1.3	1.6	75	1.0	1263.40	1174.96	1086.52	1010.72
PE7122	4 GHz - 8 GHz	SP3T	1.9	1.6	75	1.0	1608.50	1495.91	1383.31	1286.80
PE7123	8 GHz - 12 GHz	SP3T	2.2	1.8	70	1.0	1608.50	1495.91	1383.31	1286.80
PE7124	12 GHz - 18 GHz	SP3T	3.2	2.0	65	0.5	1608.50	1495.91	1383.31	1286.80
PE7125	10 MHz - 1 GHz	SP4T	1.5	1.5	80	2.0	1954.65	1817.82	1681.00	1563.72
PE7126	1 GHz - 2 GHz	SP4T	1.2	1.5	85	2.0	1838.95	1710.22	1581.50	1471.16
PE7127	1 GHz - 18 GHz	SP4T	3.5	2.0	65	0.5	2070.40	1925.47	1780.54	1656.32
PE7128	2 GHz - 4 GHz	SP4T	1.4	1.6	75	1.0	1838.95	1710.22	1581.50	1471.16
PE7129	4 GHz - 8 GHz	SP4T	2.0	1.6	75	1.0	2070.40	1925.47	1780.54	1656.32
PE7130	8 GHz - 12 GHz	SP4T	2.4	1.8	70	1.0	1954.65	1817.82	1681.00	1563.72
PE7131	12 GHz - 18 GHz	SP4T	3.4	2.0	65	0.5	1838.95	1710.22	1581.50	1471.16

## FEATURES

- F = FAILSAFE
- H = HOT SWITCHES
- I = INDICATORS
- L = LATCHING
- N = NORMALLY OPEN
- P = PULSE LATCHING
- S = SELF CUT OFF
- T = TERMINATED



# RELAY SWITCHES

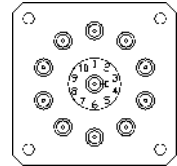

MODEL NO.	FREQUENCY RANGE	SWITCH TYPE	FEATURES	CONNECTOR TYPE	ACTUATING VOLTAGE	VSWR (MAX)	P R I C E			
							1-24	25-49	50-99	100 +
PE7141	DC - 18 GHz	SPDT	F	SMA	28	1.50	\$278.75	\$259.24	\$239.73	\$223.00
PE7142	DC - 18 GHz	SPDT	F	SMA	12	1.50	278.75	259.24	239.73	223.00
PE7143	DC - 18 GHz	SPDT	I, L, S	SMA	28	1.50	705.30	655.93	606.56	564.24
PE7144	DC - 18 GHz	SPDT	I, L, S	SMA	12	1.50	376.40	350.05	323.70	301.12
PE7145	DC - 18 GHz	SPDT	I, P	SMA	28	1.50	313.45	291.51	269.57	250.76
PE7146	DC - 18 GHz	SPDT	I, P	SMA	12	1.50	345.25	321.08	296.92	276.20
PE7147	DC - 4 GHz	SPDT	F	N	28	1.20	398.05	370.19	342.32	318.44
PE7148	DC - 4 GHz	SPDT	F	N	12	1.20	398.05	370.19	342.32	318.44
PE7149	DC - 8 GHz	SPDT	H, I, P	N	28	1.45	2089.95	1943.65	1797.36	1671.96
PE7150	DC - 18 GHz	SPST	F	SMA	28	1.50	407.50	378.98	350.45	326.00
PE7151	DC - 18 GHz	TRANSFER	I, L, S	SMA	28	1.50	627.85	583.90	539.95	502.28
PE7152	DC - 18 GHz	TRANSFER	I, P	SMA	28	1.50	517.40	481.18	444.96	413.92
PE7153	DC - 4 GHz	TRANSFER	F	N	28	1.20	501.55	466.44	431.33	401.24
PE7154	DC - 18 GHz	DPDT	F, T	SMA	28	1.50	739.90	739.26	683.61	635.92
PE7155	DC - 18 GHz	DPDT	I, P	SMA	28	1.50	731.45	680.25	629.05	585.16
PE7156	DC - 18 GHz	DPDT	I, P, T	SMA	28	1.50	835.95	777.43	718.92	668.76
PE7157	DC - 18 GHz	DPDT	I, P, T, TTL	SMA	28	1.50	888.20	826.03	763.85	710.56
PE7158	DC - 18 GHz	SP4T	N	SMA	28	1.50	590.00	548.70	507.40	472.00
PE7159	DC - 18 GHz	SP6T	N	SMA	28	1.50	857.70	797.66	737.62	686.16
PE7160	DC - 8 GHz	SP10T	N	SMA	28	1.30	2200.00	2046.00	1892.00	1760.00

ALL CONNECTORS ARE SMA FEMALE  
DC BIAS: +5.0 ± 0.5V @ 80mA MAX.  
-15.0 ± 3.0V @ 80mA MAX.

# TRANSFER SWITCHES

CONTROLS: TTL LOGIC 0: J1-J2, J3-J4 LOW LOSS  
J1-J4, J2-J3 ISOLATION  
TTL LOGIC 1: J1-J4, J2-J3 LOW LOSS  
J1-J2, J3-J4 ISOLATION

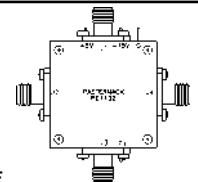

MODEL NO.	FREQUENCY RANGE	LOSS (dB MAX)	VSWR (MAX)	ISOLATION (dB MIN)	POWER WATTS (MAX)	P R I C E			
						1-24	25-49	50-99	100 +
PE7132	10 MHz - 1 GHz	1.3	1.5	80	2.0	\$2070.40	\$1925.47	\$1780.54	\$1656.32
PE7133	1 GHz - 2 GHz	1.0	1.5	85	2.0	1838.95	1710.22	1581.50	1471.16
PE7134	1 GHz - 18 GHz	3.1	2.0	65	0.5	2531.25	2354.06	2176.88	2025.00
PE7135	2 GHz - 4 GHz	1.2	1.6	75	1.0	2185.10	2032.14	1879.19	1748.08
PE7136	4 GHz - 8 GHz	1.8	1.6	75	1.0	2300.85	2139.79	1978.73	1840.68
PE7137	8 GHz - 12 GHz	2.0	1.8	70	1.0	2070.40	1925.47	1780.54	1656.32
PE7138	12 GHz - 18 GHz	3.0	2.0	65	0.5	1954.65	1817.82	1681.00	1563.72

# HIGH OUTPUT NOISE GENERATORS

## SPECIFICATION:

INPUT POWER +28VDC AT 20 mA MAX.



MODEL NO.	FREQUENCY RANGE (GHZ)	BIAS CONNECTORS	CONNECTORS	NOISE OUTPUT	FLATNESS dB	PRICE			
						1-24	25-49	50-99	100 +
PE8505	1 - 2	SMA FEMALE	SMA MALE	30-35	± 1	\$855.00	\$795.15	\$735.30	\$684.00
PE8506	2 - 4	SMA FEMALE	SMA MALE	30-35	± 1	997.50	927.68	857.85	798.00
PE8507	4 - 8	SMA FEMALE	SMA MALE	30-35	± 1	1070.35	995.43	920.50	856.28
PE8508	8 - 12	SMA FEMALE	SMA MALE	28-33	± 1	1140.00	1060.20	980.40	912.00
PE8509	12 - 18	SMA FEMALE	SMA MALE	28-33	± 1	1254.00	1166.22	1078.44	1003.20

# IN-LINE AMPLIFIERS

## SPECIFICATIONS

**ELECTRICAL:**  
 FREQUENCY RANGE..... 500 - 2 GHz  
 SMALL SIGNAL GAIN..... 18 dB TYP.  
 16 dB MIN.  
 OUTPUT POWER AT 1 dB COMPRESSION (@2 GHz)..... 10 dBm TYP.  
 NF NOISE FIGURE (@2 GHz)..... 4 dB TYP.  
 THIRD ORDER INTERCEPT POINT (@2 GHz)..... 23 dBm TYP.  
 VSWR INPUT & OUTPUT..... 2.0:1 MAX.  
 OPERATING VOLTAGE..... +15V  
**MAX RATING:**  
 DEVICE CURRENT..... 50 mA  
 RF INPUT POWER..... 100 mW  
 OPERATING TEMP. RANGE..... -45°C TO +85°C  
 STORAGE TEMP. RANGE..... -65°C TO +125°C

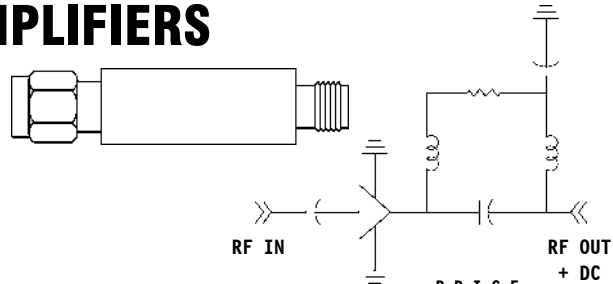

MODEL NO.	CONNECTOR	PRICE			
		1-24	25-49	50-99	100 +
PE1510	SMA	\$146.25	\$136.01	\$125.78	\$117.00
PE1511	N	156.70	145.73	134.76	125.36
PE1512	TNC	156.70	145.73	134.76	125.36

# GENERAL PURPOSE AMPLIFIERS

## SPECIFICATIONS

OPERATING VOLTAGE ..... 9-15 VDC  
 OPERATING TEMPERATURE ..... -10° C to +65° C  
 STORAGE TEMPERATURE RANGE ... -65° C to +125° C



MODEL NO.	OPERATING CURRENT	FREQUENCY	GAIN (dB MIN)	OUTPUT P1dB (dBm MIN)	NOISE FIGURE (dB MAX)	INPUT RL (dB TYP)	OUTPUT RL (dB TYP)	PRICE			
								1-24	25-49	50-99	100 +
PE1513	50 mA	10-1000 MHz	20	13	2.7	-18	-12	\$313.45	\$291.51	\$269.57	\$250.76
		1-2 GHz	17	11	3.5	-18	-14				
		2-3 GHz	14	9	5	-15	-10				
PE1514	40 mA	10-2000 MHz	12	10	5.5	-15	-15	313.45	291.51	269.57	250.76
		2-3 GHz	10	9	7	-11	-10				
PE1515	80 mA	10-1000 MHz	13	16	7	-12	-14	313.45	291.51	269.57	250.76
		1-2 GHz	12	15	7	-12	-14				
		2-3 GHz	10	14	8.5	-11	-10				
PE1516	120 mA	100-1000 MHz	18	16	6	-18	-10	313.45	291.51	269.57	250.76
		1-2 GHz	21	15	6	-20	-15				
		2-3 GHz	18	14	7	-18	-10				
<b>NEW</b> PE1525	120 mA	20-2500 MHz	18	15	6	-17	-14	299.95	278.95	257.96	239.96

Attenuators / RF Components

# LOW NOISE AMPLIFIERS

## SPECIFICATIONS

OPERATING VOLTAGE ..... 12 VDC  
 OPERATING TEMPERATURE ..... -30° C to +70° C  
 STORAGE TEMPERATURE RANGE ... -40° C to +90° C

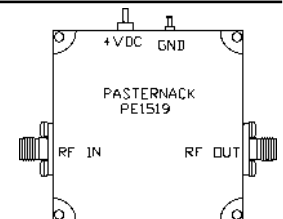

MODEL NO.	FREQUENCY	GAIN	GAIN FLATNESS	P1dB (dBm TYP.)	INPUT VSWR	OUTPUT VSWR	NOISE FIGURE	CURRENT AT +12VDC	PRICE			
									1-24	25-49	50-99	100 +
PE1517	.05-1 GHz	21	1	12	2:1	2:1	3.5	100mA	\$365.70	\$340.10	\$314.50	\$292.56
PE1518	.05-2 GHz	21	1.5	12	2:1	2:1	3.5	100mA	365.70	340.10	314.50	292.56
PE1519	1-4 GHz	25	1	15	2:1	2:1	2.5	100mA	522.45	485.88	449.31	417.96
PE1520	2-4 GHz	25	1	15	2:1	2:1	2.5	100mA	470.20	437.29	404.37	376.16
PE1521	2-6 GHz	25	1	15	2:1	2:1	3.0	100mA	470.20	437.29	404.37	376.16
PE1522	4-8 GHz	25	1	15	2:1	2:1	3.0	100mA	470.20	437.29	404.37	376.16
PE1523	6-18 GHz	21	1.5	13	2:1	2:1	3.5	120mA	679.20	631.66	584.11	543.36
PE1524	2-18 GHz	21	1.5	13	2:1	2:1	3.5	120mA	726.25	675.41	624.58	581.00

# NOISE GENERATORS

**SPECIFICATION:**

INPUT POWER +28VDC AT 20 mA MAX.



MODEL NO.	FREQUENCY RANGE (GHZ)	BIAS CONNECTORS	RF CONNECTORS	NOISE OUTPUT (ENR - dB)	VSWR (MAX) ON/OFF	P R I C E			
						1-24	25-49	50-99	100 +
PE8500	1 - 2	BNC FEMALE	SMA MALE	15.5 ± 0.5	1.20:1	\$997.50	\$927.68	\$857.85	\$798.00
PE8501	2 - 4	BNC FEMALE	SMA MALE	15.5 ± 0.5	1.20:1	1140.00	1060.20	980.40	912.00
PE8502	4 - 8	BNC FEMALE	SMA MALE	15.5 ± 0.5	1.20:1	1212.85	1127.95	1043.05	970.28
PE8503	8 - 12	BNC FEMALE	SMA MALE	15.5 ± 0.5	1.35:1	1282.50	1192.73	1102.95	1026.00
PE8504	12 - 18	BNC FEMALE	SMA MALE	15.5 ± 0.5	1.35:1	1396.50	1298.75	1200.99	1117.20

# BIASED SCHOTTKY DIODE DETECTORS

**BROADBAND BIASED DETECTORS**

Negative Output Polarity is standard.

Maximum Input Power: 200 mW CW

Operating Temperature Range: -55° C to +125° C

Storage Temperature Range: -65° C to +150° C

Specification @ +25° C, 100 µA Bias typical, Input Power at -20 dBm

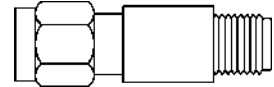

**SMA MALE INPUT / SMA FEMALE OUTPUT**

MODEL NO.	FREQUENCY RANGE (GHZ)	VOLTAGE SENSITIVITY <sup>1</sup> (MIN. mV/mW)	TANGENTIAL SENSITIVITY (MIN. dBm)	FLATNESS MAX. dB	VIDEO CAPACITANCE (MAX. pF)	P R I C E			
						1-24	25-49	50-99	100 +
PE8001	0.5 - 1.0	1800	-52	0.50	100	\$313.45	\$291.51	\$269.57	\$250.76
PE8002	1.0 - 2.0	2000	-52	0.50	20	323.90	301.23	278.55	259.12
PE8003	2.0 - 4.0	2000	-52	0.50	10	365.70	340.10	314.50	292.56
PE8004	4.0 - 8.0	2000	-52	0.50	10	365.70	340.10	314.50	292.56
PE8005	6.0 - 18.0	1600	-52	0.80	10	397.05	369.26	341.46	317.64
PE8006	8.0 - 12.0	1800	-52	0.50	10	365.70	340.10	314.50	292.56
PE8007	8.0 - 16.0	1800	-52	0.60	10	386.60	359.54	332.48	309.28
PE8008	8.0 - 18.0	1600	-52	0.70	10	386.60	359.54	332.48	309.28
PE8009	18.0 - 26.0	1500	-52	1.00	10	417.95	388.69	359.44	334.36

<sup>1</sup> Tss is measured with a 2 MHz video bandwidth and 2 dB NF amplifier.

# BNC DETECTORS

FREQUENCY RANGE: 100 kHz-1,000 MHz

VSWR: 1.20:1 MAXIMUM

FLATNESS: ± .2 dB TO 500 MHz  
± .4 dB TO 1,000 MHz

DC OUTPUT POLARITY: POSITIVE

MAXIMUM RF INPUT POWER: 100 mW

OUTPUT CAPACITANCE: 1,000 pF

RF INPUT: BNC MALE

DC OUTPUT: BNC FEMALE

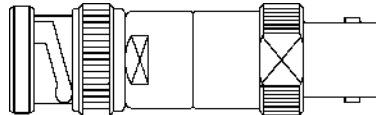

Model No.	NOMINAL IMPEDANCE	P R I C E			
		1-24	25-49	50-99	100 +
PE8000-50	50 OHMS	\$167.15	\$155.45	\$143.75	\$133.72
PE8000-75	75 OHMS	149.95	139.45	128.96	119.96

# LOG DETECTOR

**SPECIFICATIONS**

OPERATING VOLTAGE ..... 9-15 VDC

OPERATING TEMPERATURE RANGE ..... -10° C to +65° C

STORAGE TEMPERATURE RANGE ..... -65° C to +125° C

LINEAR-IN-dB RESPONSE CHARACTERISTICS

P R I C E			
1-24	25-49	50-99	100 +
\$331.20	\$308.02	\$284.83	\$264.96

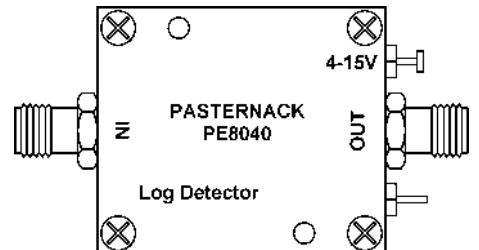

MODEL NO.	FUNCTION	OPERATING CURRENT	FREQUENCY	SLOPE (mV/dB)	INTERCEPT POINT (dBm)	DYNAMIC RANGE (dB MIN)	INPUT IMPEDANCE (OHMS)	INPUT RL (dB)	OUTPUT CURRENT (mA MAX)	OUTPUT VOLTAGE (V MAX)	OUTPUT SLEW RATE (V/mSEC)
PE8040	LOG DETECTOR	50 mA	10-1000 MHz	41	-54	50	50	-15	0.5	2.1	20
			1-2 GHz	40	-55	50	50	-10	0.5	2.1	20
			2-3 GHz	37	-50	45	50	-8	0.5	2.0	20

Attenuators / RF Components

# ZERO BIAS SCHOTTKY DIODE DETECTORS

No Bias Required.  
 Negative Output Polarity is standard.  
 Maximum Input Power: 200 mW CW  
 Operating Temperature Range: -55° C to +125° C  
 Storage Temperature Range: -65° C to +150° C  
 Specification @ +25° C, Input Power at -20 dBm

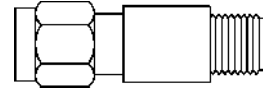

## SMA MALE INPUT / SMA FEMALE OUTPUT

MODEL NO.	FREQUENCY RANGE (GHz)	VOLTAGE SENSITIVITY <sup>1</sup> (MIN. mV/mW)	FLATNESS (MAX. dB)	VSWR (TYPICAL)	P R I C E			
					1-24	25-49	50-99	100 +
PE8010	0.01 - 2.0	500	0.20	1.20:1	\$344.80	\$320.66	\$296.53	\$275.84
PE8011	0.01 - 4.0	500	0.30	1.30:1	355.25	330.38	305.52	284.20
PE8012	0.01 - 12.4	500	0.30	1.40:1	340.75	316.90	293.05	272.60
PE8013	0.01 - 18.5	400	0.50	1.50:1	417.95	388.69	359.44	334.36
PE8014	0.01 - 26.5	100	.050 (to 18 GHz) 1.00 (18 to 26.5 GHz)	1.50:1 (to 18 GHz) 2.0:1 (18 to 26.5 GHz)	449.30	417.85	386.40	359.44
PE8015	2.0 - 4.0	500	0.20	1.20:1	323.90	301.23	278.55	259.12
PE8016	2.0 - 8.0	500	0.20	1.20:1	386.60	359.54	332.48	309.28

<sup>1</sup> Tss is measured with a 2 MHz video bandwidth and 2 dB NF amplifier.

# PIN-PIN DIODE LIMITERS

PASSIVE PIN DIODE LIMITERS  
 1 Watt CW and 100 Watt Peak (1μsec) power handling  
 0.1% duty cycle, derated to 20% at +125° C  
 Internal DC Return  
 Limiting Threshold above +9 dBm typical  
 Operating Temperature Range: -55° C to +125° C

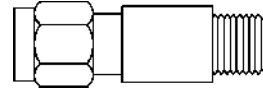

## SMA MALE INPUT / SMA FEMALE OUTPUT

MODEL NO.	FREQUENCY RANGE (GHz)	INSERTION LOSS <sup>1</sup> (MAX dB)	VSWR <sup>1</sup> (MAX)	LEAKAGE @ 1W CW INPUT (MAX. dBm)	P R I C E			
					1-24	25-49	50-99	100 +
PE8017	0.5 - 1.0	0.4	1.40:1	+19.0	\$323.90	\$301.23	\$278.55	\$259.12
PE8018	0.5 - 2.0	0.5	1.40:1	+19.0	334.35	310.95	287.54	267.48
PE8019	1.0 - 2.0	0.4	1.40:1	+19.0	323.90	301.23	278.55	259.12
PE8020	2.0 - 4.0	0.8	1.50:1	+18.5	306.25	284.81	263.38	245.00
PE8021	2.0 - 8.0	1.2	1.60:1	+16.0	386.60	359.54	332.48	309.28
PE8022	2.0 - 18.0	2.5	2.20:1	+18.0	397.05	369.26	341.46	317.64
PE8023	4.0 - 8.0	1.2	1.50:1	+16.0	344.80	320.66	296.53	275.84
PE8024	6.0 - 18.0	2.2	2.00:1	+16.0	386.60	359.54	332.48	309.28
PE8025	7.0 - 12.0	1.5	1.80:1	+16.0	365.70	340.10	314.50	292.56
PE8026	8.0 - 16.0	2.0	2.00:1	+16.0	376.15	349.82	323.49	300.92
PE8027	11.0 - 18.0	2.2	2.20:1	+16.0	417.95	388.69	359.44	334.36

<sup>1</sup> Insertion loss and VSWR are measured at -10 dBm.

# PIN-SCHOTTKY DIODE LIMITERS

DETECTOR ACTIVATED LIMITERS  
 1 Watt CW and 200 Watt Peak (1μsec) power handling  
 0.1% duty cycle, derated to 20% at +125° C  
 Internal DC Blocks  
 Limiting Threshold below +9 dBm typical  
 Operating Temperature Range: -55° C to +125° C

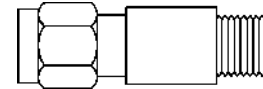

## SMA MALE INPUT / SMA FEMALE OUTPUT

MODEL NO.	FREQUENCY RANGE (GHz)	INSERTION LOSS <sup>1</sup> (MAX dB)	VSWR <sup>1</sup> (MAX)	LEAKAGE @ 1W CW INPUT (MAX. dBm)	P R I C E			
					1-24	25-49	50-99	100 +
PE8028	0.5 - 1.0	0.5	1.40:1	+14.0	\$313.45	\$291.51	\$269.57	\$250.76
PE8029	0.5 - 2.0	0.6	1.40:1	+14.0	334.35	310.95	287.54	267.48
PE8030	1.0 - 2.0	0.6	1.40:1	+14.0	323.90	301.23	278.55	259.12
PE8031	2.0 - 4.0	0.8	1.50:1	+14.0	344.80	320.66	296.53	275.84
PE8032	2.0 - 8.0	1.4	1.60:1	+14.0	323.90	301.23	278.55	259.12
PE8033	2.0 - 18.0	2.5	2.50:1	+14.0	397.05	369.26	341.46	317.64
PE8034	4.0 - 8.0	1.4	1.50:1	+13.0	334.35	310.95	287.54	267.48
PE8035	6.0 - 18.0	2.5	2.20:1	+13.0	397.05	369.26	341.46	317.64
PE8036	7.0 - 12.0	2.0	1.80:1	+12.0	386.60	359.54	332.48	309.28
PE8037	8.0 - 16.0	2.2	1.80:1	+12.0	386.60	359.54	332.48	309.28
PE8038	11.0 - 18.0	2.5	2.20:1	+12.0	417.95	388.69	359.44	334.36

<sup>1</sup> Insertion loss & VSWR are measured at -10 dBm.

Attenuators / RF Components

# DOUBLE BALANCED MIXERS

ALL UNITS HAVE SMA FEMALE CONNECTORS.  
INPUT DRIVER LEVEL +10 dBm TO +13 dBm

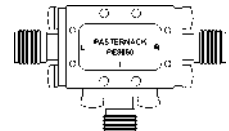

MODEL NO.	RF GHz	LO GHz	IF GHz	LO POWER (dBm)	CONVRSN. LOSS dB (TYP.)	L-R ISO dB (TYP.)	L-I ISO dB (TYP.)	1 dB COMP (dBm)	INPUT TOIP (dBm)	P R I C E			
										1-24	25-49	50-99	100 +
PE8650	2.0 - 8.0	2.0 - 8.0	DC - 1.5	+10	6.0	30	33	+4	+14	\$469.60	\$436.73	\$403.86	\$375.68
PE8651	2.0 - 8.0	2.0 - 8.0	0.1 - 4.0	+10	6.2	26	28	+4	+14	558.50	519.41	480.31	446.80
PE8652	2.0 - 18.0	2.0 - 18.0	DC - 0.6	+10	7.3	27	22	+4	+13	608.95	566.32	523.70	487.16
PE8653	5.0 - 18.0	5.0 - 18.0	DC - 4.0	+10	6.2	35	30	+4	+14	658.30	612.22	566.14	526.64
PE8654	6.0 - 18.0	6.0 - 18.0	1.5 - 8.0	+10	7.0	28	26	+4	+14	658.30	612.22	566.14	526.64

# FREQUENCY DOUBLERS

ALL UNITS HAVE SMA FEMALE CONNECTORS.

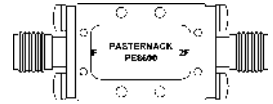

MODEL NO.	INPUT FREQUENCY GHz	OUTPUT FREQUENCY GHz	CONVERSION LOSS dB (TYP.)	FUNDAMENTAL ISO dB (TYP.)	P R I C E			
					1-24	25-49	50-99	100 +
PE8600	1.5-5.0	3.0-10.0	8.5	25	\$449.95	\$418.45	\$386.96	\$359.96
PE8601	2.0-6.0	4.0-12.0	11.0	25	469.95	437.05	404.16	375.96
PE8602	4.0-9.0	8.0-18.0	10.0	25	479.95	446.35	412.76	383.96
PE8603	9.0-13.0	18.0-26.0	10.0	25	509.95	474.25	438.56	407.96

# HIGH POWER WAVEGUIDE TERMINATIONS

WAVEGUIDE	FREQUENCY RANGE (GHz)	MODEL NO.	VSWR (MAX.)	AVERAGE POWER (WATTS MAX.)	P R I C E			
					1-24	25-49	50-99	100 +
WR-28	26.50-40.00	PE6827	1.10:1	75	\$835.95	\$777.43	\$718.92	\$668.76
WR-34	22.00-33.00	PE6828	1.10:1	75	835.95	777.43	718.92	668.76
WR-42	18.00-26.50	PE6829	1.10:1	100	835.95	777.43	718.92	668.76
WR-51	15.00-22.00	PE6830	1.10:1	100	835.95	777.43	718.92	668.76
WR-62	12.40-18.00	PE6831	1.10:1	175	835.95	777.43	718.92	668.76
WR-75	10.00-15.00	PE6832	1.10:1	175	909.10	845.46	781.83	727.28
WR-90	8.20-12.40	PE6833	1.10:1	200	909.10	845.46	781.83	727.28
WR-102	7.00-11.00	PE6834	1.10:1	300	909.10	845.46	781.83	727.28
WR-112	7.05-10.00	PE6835	1.10:1	300	909.10	845.46	781.83	727.28

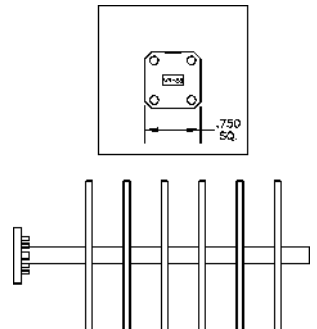

# MEDIUM POWER WAVEGUIDE TERMINATIONS

WAVEGUIDE	FREQUENCY RANGE (GHz)	MODEL NO.	VSWR (MAX.)	AVERAGE POWER (WATTS MAX.)	P R I C E			
					1-24	25-49	50-99	100 +
WR-28	26.50-40.00	PE6818	1.07:1	40	\$626.95	\$583.06	\$539.18	\$501.56
WR-34	22.00-33.00	PE6819	1.07:1	40	626.95	583.06	539.18	501.56
WR-42	18.00-26.50	PE6820	1.07:1	50	626.95	583.06	539.18	501.56
WR-51	15.00-22.00	PE6821	1.07:1	55	626.95	583.06	539.18	501.56
WR-62	12.40-18.00	PE6822	1.07:1	60	626.95	583.06	539.18	501.56
WR-75	10.00-15.00	PE6823	1.07:1	75	731.45	680.25	629.05	585.16
WR-90	8.20-12.40	PE6824	1.07:1	90	731.45	680.25	629.05	585.16
WR-102	7.00-11.00	PE6825	1.07:1	100	731.45	680.25	629.05	585.16
WR-112	7.05-10.00	PE6826	1.07:1	100	731.45	680.25	629.05	585.16

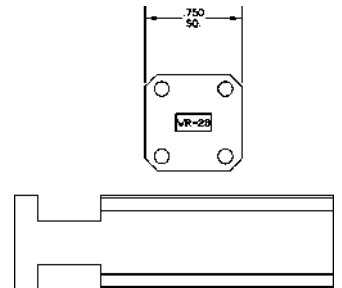

# PRECISION WAVEGUIDE TERMINATIONS

WAVEGUIDE	FREQUENCY RANGE (GHz)	MODEL NO.	VSWR (MAX.)	AVERAGE POWER (WATTS MAX.)	P R I C E			
					1-24	25-49	49-50	100 +
WR-28	26.50-40.00	PE6809	1.03:1	.50	\$417.95	\$388.69	\$359.44	\$334.36
WR-34	22.00-33.00	PE6810	1.03:1	.50	417.95	388.69	359.44	334.36
WR-42	18.00-26.50	PE6811	1.03:1	.50	417.95	388.69	359.44	334.36
WR-51	15.00-22.00	PE6812	1.03:1	1.0	417.95	388.69	359.44	334.36
WR-62	12.40-18.00	PE6813	1.03:1	1.5	417.95	388.69	359.44	334.36
WR-75	10.00-15.00	PE6814	1.03:1	2.0	522.45	485.88	449.31	417.96
WR-90	8.20-12.40	PE6815	1.03:1	2.0	522.45	485.88	449.31	417.96
WR-102	7.00-11.00	PE6816	1.03:1	2.0	522.45	485.88	449.31	417.96
WR-112	7.05-10.00	PE6817	1.03:1	2.0	522.45	485.88	449.31	417.96

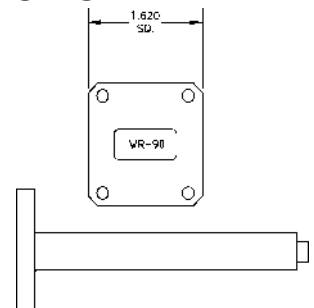

# STANDARD GAIN HORNS

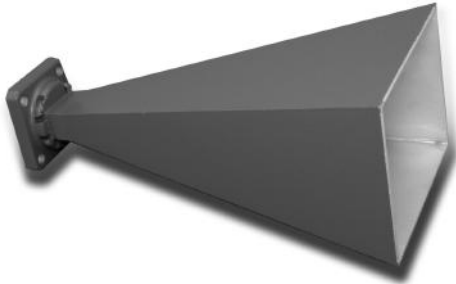

MODEL NO.	WAVEGUIDE SIZE	FREQUENCY RANGE DC TO GHz	GAIN	P R I C E			
				1-4	5-9	10-24	25-49
PE9850-10	WR28	26.50-40.00	10 dB	\$553.80	\$515.03	\$476.27	\$443.04
PE9850-15	WR28	26.50-40.00	15 dB	595.60	553.91	512.22	476.48
PE9850-20	WR28	26.50-40.00	20 dB	626.95	583.06	539.18	501.56
PE9851-10	WR34	22.00-33.00	10 dB	553.80	515.03	476.27	443.04
PE9851-15	WR34	22.00-33.00	15 dB	595.60	553.91	512.22	476.48
PE9851-20	WR34	22.00-33.00	20 dB	626.95	583.06	539.18	501.56
PE9852-10	WR42	18.00-26.50	10 dB	553.80	515.03	476.27	443.04
PE9852-15	WR42	18.00-26.50	15 dB	595.60	553.91	512.22	476.48
PE9852-20	WR42	18.00-26.50	20 dB	626.95	583.06	539.18	501.56
PE9853-10	WR51	15.00-22.00	10 dB	553.80	515.03	476.27	443.04
PE9853-15	WR51	15.00-22.00	15 dB	595.60	553.91	512.22	476.48
PE9853-20	WR51	15.00-22.00	20 dB	626.95	583.06	539.18	501.56
PE9854-10	WR62	12.40-18.00	10 dB	522.45	485.88	449.31	417.96
PE9854-15	WR62	12.40-18.00	15 dB	553.80	515.03	476.27	443.04
PE9854-20	WR62	12.40-18.00	20 dB	585.15	544.19	503.23	468.12
PE9855-10	WR75	10.00-15.00	10 dB	522.45	485.88	449.31	417.96
PE9855-15	WR75	10.00-15.00	15 dB	553.80	515.03	476.27	443.04
PE9855-20	WR75	10.00-15.00	20 dB	585.15	544.19	503.23	468.12
PE9856-10	WR90	8.20-12.40	10 dB	522.45	485.88	449.31	417.96
PE9856-15	WR90	8.20-12.40	15 dB	553.80	515.03	476.27	443.04
PE9856-20	WR90	8.20-12.40	20 dB	585.15	544.19	503.23	468.12
PE9857-10	WR102	7.0-11.00	10 dB	553.80	515.03	476.27	443.04
PE9857-15	WR102	7.0-11.00	15 dB	595.60	553.91	512.22	476.48
PE9857-20	WR102	7.0-11.00	20 dB	626.95	583.06	539.18	501.56
PE9858-10	WR112	7.05-10.00	10 dB	553.80	515.03	476.27	443.04
PE9858-15	WR112	7.05-10.00	15 dB	595.60	553.91	512.22	476.48
PE9858-20	WR112	7.05-10.00	20 dB	626.95	583.06	539.18	501.56
PE9859-10	WR137	5.85-8.20	10 dB	553.80	515.03	476.27	443.04
PE9859-15	WR137	5.85-8.20	15 dB	589.95	548.65	507.36	471.96
PE9859-20	WR137	5.85-8.20	20 dB	626.95	583.06	539.18	501.56
PE9860-10	WR159	4.90-7.05	10 dB	595.60	553.91	512.22	476.48
PE9860-15	WR159	4.90-7.05	15 dB	647.85	602.50	557.15	518.28
PE9860-20	WR159	4.90-7.05	20 dB	700.10	651.09	602.09	560.08
PE9861-10	WR187	3.95-5.85	10 dB	626.95	583.06	539.18	501.56
PE9861-15	WR187	3.95-5.85	15 dB	705.30	655.93	606.56	564.24
PE9861-20	WR187	3.95-5.85	20 dB	775.25	720.98	666.72	620.20
PE9862-10	WR229	3.30-4.90	10 dB	679.20	631.66	584.11	543.36
PE9862-15	WR229	3.30-4.90	15 dB	757.55	704.52	651.49	606.04
PE9862-20	WR229	3.30-4.90	20 dB	1044.95	971.80	898.66	835.96
PE9863-10	WR284	2.60-3.95	10 dB	783.70	728.84	673.98	626.96
PE9863-15	WR284	2.60-3.95	15 dB	940.45	874.62	808.79	752.36
PE9863-20	WR284	2.60-3.95	20 dB	1358.45	1263.36	1168.27	1086.76
PE9864-10	WR430	1.70-2.60	10 dB	999.95	929.95	859.96	799.96
PE9864-15	WR430	1.70-2.60	15 dB	1462.95	1360.54	1258.14	1170.36
PE9864-20	WR430	1.70-2.60	20 dB	2639.00	2454.27	2269.54	2111.20



# WAVEGUIDE END LAUNCH TO COAX ADAPTER

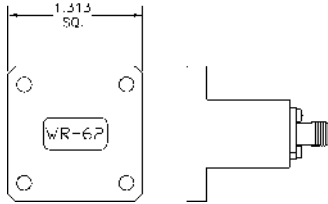

## WAVEGUIDE END LAUNCH TO SMA TYPE FEMALE

WAVEGUIDE	FREQUENCY RANGE (GHz)	MODEL NO.	P R I C E			
			1-24	25-49	50-99	100 +
WR-42	18.0-26.50	PE9844	\$616.50	\$573.35	\$530.19	\$493.20
WR-51	15.00-22.00	PE9845	538.10	500.43	462.77	430.48
WR-62	12.40-18.00	PE9846	437.75	407.11	376.47	350.20
WR-75	10.00-15.00	PE9847	424.20	394.51	364.81	339.36
WR-90	8.20-12.40	PE9848	381.35	354.66	327.96	305.08
WR-102	7.00-11.00	PE9849	407.50	378.98	350.45	326.00
WR-112	7.05-10.00	PE9865	407.50	378.98	350.45	326.00

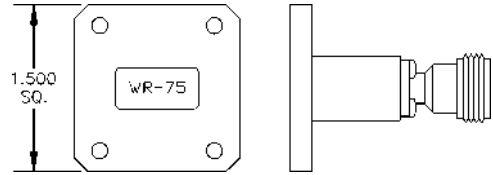

## WAVEGUIDE END LAUNCH TO N FEMALE

WAVEGUIDE	FREQUENCY RANGE (GHz)	MODEL NO.	P R I C E			
			1-24	25-49	50-99	100 +
WR-62	12.40-18.00	PE9866	\$480.90	\$447.24	\$413.57	\$384.72
WR-75	10.00-15.00	PE9867	459.75	427.57	395.39	367.80
WR-90	8.20-12.40	PE9868	459.75	427.57	395.39	367.80
WR-102	7.00-11.00	PE9869	459.75	427.57	395.39	367.80
WR-112	7.05-10.00	PE9870	491.10	456.72	422.35	392.88

# WAVEGUIDE TERMINATIONS

WAVEGUIDE	FREQUENCY RANGE (GHz)	MODEL NO.	VSWR (MAX.)	AVERAGE POWER (WATTS MAX.)	P R I C E			
					1-24	25-49	49-50	100 +
WR-28	26.50-40.00	PE6800	1.30:1	0.5	\$161.55	\$150.24	\$138.93	\$129.24
WR-34	22.00-33.00	PE6801	1.25:1	0.5	161.55	150.24	138.93	129.24
WR-42	18.00-26.50	PE6802	1.25:1	0.5	261.20	242.92	224.63	208.96
WR-51	15.00-22.00	PE6803	1.20:1	1.0	261.20	242.92	224.63	208.96
WR-62	12.40-18.00	PE6804	1.20:1	1.5	261.20	242.92	224.63	208.96
WR-75	10.00-15.00	PE6805	1.20:1	2.0	313.45	291.51	269.57	250.76
WR-90	8.20-12.40	PE6806	1.20:1	2.0	313.45	291.51	269.57	250.76
WR-102	7.00-11.00	PE6807	1.20:1	2.0	313.45	291.51	269.57	250.76
WR-112	7.05-10.00	PE6808	1.20:1	2.0	313.45	291.51	269.57	250.76

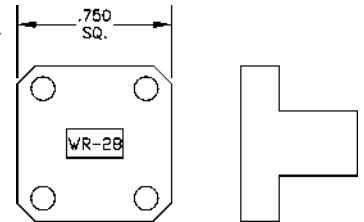

## NOTES

# WAVEGUIDE TO COAX ADAPTERS

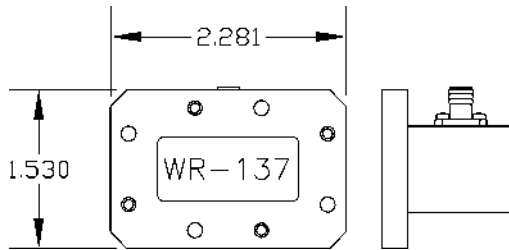

**WAVEGUIDE TO N FEMALE**

WAVEGUIDE	FREQUENCY		P R I C E			
	RANGE (GHz)	MODEL NO.	1-24	25-49	50-99	100 +
WR-62	12.40-18.00	PE9800	\$275.00	\$255.75	\$236.50	\$220.00
WR-75	10.00-15.00	PE9817	329.75	306.67	283.59	263.80
WR-90	8.20-12.40	PE9801	261.20	242.92	224.63	208.96
WR-102	7.00-11.00	PE9802	313.45	291.51	269.57	250.76
WR-112	7.05-10.00	PE9820	253.30	235.57	217.84	202.64
WR-137	5.85-8.20	PE9818	288.25	268.07	247.90	230.60
WR-159	4.90-7.05	PE9821	505.15	469.79	434.43	404.12
WR-187	3.95-5.85	PE9822	417.95	388.69	359.44	334.36
WR-229	3.30-4.90	PE9823	417.95	388.69	359.44	334.36
WR-284	2.60-3.95	PE9824	574.70	534.47	494.24	459.76
WR-430	1.70-2.60	PE9825	887.80	825.65	763.51	710.24

**WAVEGUIDE TO SMA TYPE MALE**

WAVEGUIDE	FREQUENCY		P R I C E			
	RANGE (GHz)	MODEL NO.	1-24	25-49	50-99	100 +
WR-42	18.00-26.50	PE9813	\$417.95	\$388.69	\$359.44	\$334.36
WR-62	12.40-18.00	PE9809	261.20	242.92	224.63	208.96
WR-90	8.20-12.40	PE9810	292.55	272.07	251.59	234.04
WR-102	7.00-11.00	PE9811	344.80	320.66	296.53	275.84

**WAVEGUIDE TO 7mm**

WAVEGUIDE	FREQUENCY		P R I C E			
	RANGE (GHz)	MODEL NO.	1-24	25-49	50-99	100 +
WR-62	12.40-18.00	PE9814	\$522.45	\$485.88	\$449.31	\$417.96
WR-90	8.20-12.40	PE9815	480.65	447.00	413.36	384.52
WR-102	7.00-11.00	PE9816	491.10	456.72	422.35	392.88

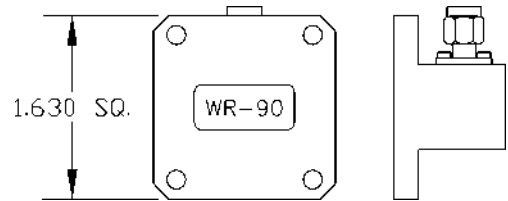

**WAVEGUIDE TO SMA TYPE FEMALE**

WAVEGUIDE	FREQUENCY		P R I C E			
	RANGE (GHz)	MODEL NO.	1-24	25-49	50-99	100 +
WR-28	26.50-40.00	PE9826	\$599.15	\$557.21	\$515.27	\$479.32
WR-34	22.00-33.00	PE9827	576.55	536.19	495.83	461.24
WR-42	18.00-26.50	PE9812	416.95	387.76	358.58	333.56
WR-51	15.00-22.00	PE9828	449.85	418.36	386.87	359.88
WR-62	12.40-18.00	PE9803	261.20	242.92	224.63	208.96
WR-75	10.00-15.00	PE9819	258.40	240.31	222.22	206.72
WR-90	8.20-12.40	PE9804	261.20	242.92	224.63	208.96
WR-102	7.00-11.00	PE9805	313.45	291.51	269.57	250.76
WR-112	7.05-10.00	PE9829	261.25	242.96	224.68	209.00
WR-137	5.85-8.20	PE9830	365.70	340.10	314.50	292.56
WR-159	4.90-7.05	PE9831	414.90	385.86	356.81	331.92
WR-187	3.95-5.85	PE9832	574.70	534.47	494.24	459.76
WR-229	3.30-4.90	PE9833	444.05	412.97	381.88	355.24
WR-284	2.60-3.95	PE9834	679.20	631.66	584.11	543.36
WR-430	1.70-2.60	PE9835	966.55	898.89	831.23	773.24

**FOR ADDITIONAL TECHNICAL INFORMATION ON WAVEGUIDES, PLEASE CONTACT OUR ENGINEERING DEPARTMENT AT (949) 261-1920.**

**WAVEGUIDE TO N MALE**

WAVEGUIDE	FREQUENCY		P R I C E			
	RANGE (GHz)	MODEL NO.	1-24	25-49	50-99	100 +
WR-62	12.40-18.00	PE9806	\$315.00	\$292.95	\$270.90	\$252.00
WR-90	8.20-12.40	PE9807	313.45	291.51	269.57	250.76
WR-102	7.00-11.00	PE9808	365.70	340.10	314.50	292.56

# WAVEGUIDE WITH O-RING GROOVE TO COAX ADAPTERS

**WAVEGUIDE TO N FEMALE**

WAVEGUIDE	FREQUENCY		P R I C E			
	RANGE (GHz)	MODEL NO.	1-24	25-49	50-99	100 +
CPR-90G	8.20-12.40	PE9836	\$344.80	\$320.66	\$296.53	\$275.84
CPR-112G	7.05-10.00	PE9837	407.50	378.98	350.45	326.00
CPR-137G	5.85-8.20	PE9838	417.95	388.69	359.44	334.36
CPR-159G	4.90-7.05	PE9839	522.45	485.88	449.31	417.96
CPR-187G	3.95-5.85	PE9840	599.95	557.95	515.96	479.96
CPR-229G	3.30-4.90	PE9841	626.95	583.06	539.18	501.56
CPR-284G	2.60-3.95	PE9842	679.20	631.66	584.11	543.36
CPR-430G	1.70-2.60	PE9843	1044.95	971.80	898.66	835.96

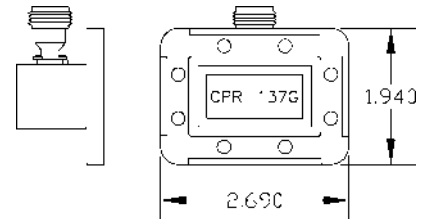

Attenuators / RF Components

**NEW**

# MOBILE ANTENNAS

## FOR LAND MOBILE RADIO APPLICATIONS

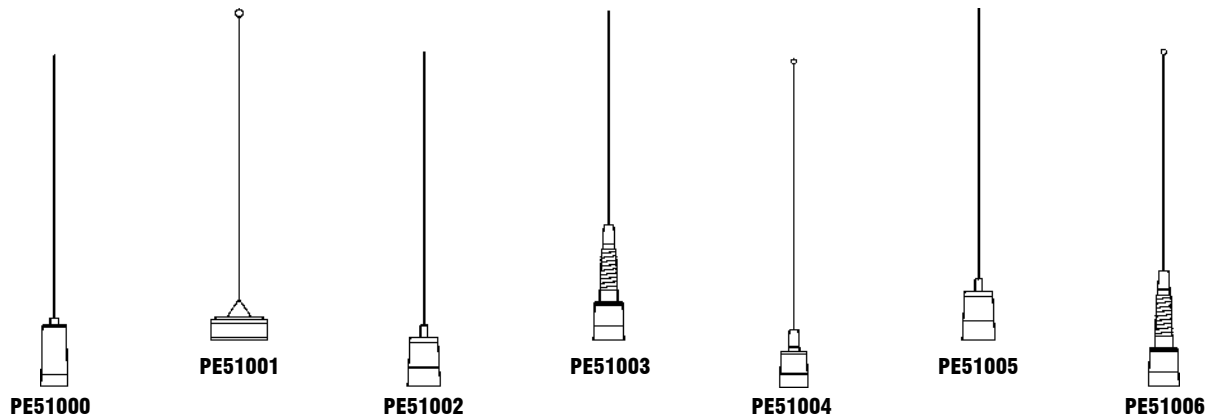

Model No.	Description	Frequency (MHz)	Gain	Max Power	1-24	25-49	50-99	100 +
PE51000	Mobile Antenna, Heavy Duty Base Loaded $\frac{1}{2}$ wave	40 - 47	Unity	200W	\$40.95	\$38.08	\$35.22	\$32.76
PE51001	Mobile Antenna, Field Tunable $\frac{1}{2}$ wave	118 - 940	Unity	150W	10.95	10.18	9.42	8.76
PE51002	Wideband Mobile Antenna, 20MHz BW @ 2:1 VSWR	132 - 174	2.4dB	150W	50.95	47.38	43.82	40.76
PE51003	Wideband Mobile Antenna, Field Tunable $\frac{1}{2}$ wave	132 - 512	Unity	200W	36.95	34.36	31.78	29.56
PE51004	Mobile Base Loaded $\frac{1}{2}$ wave, Field Tunable, No GP	132 - 174	2.4dB*	200W	36.95	34.36	31.78	29.56
PE51005	Wideband Mobile Antenna, 80MHz BW @ 2:1 VSWR, No GP	380 - 460	2.0dB*	150W	48.95	45.52	42.10	39.16
PE51006	Wideband Mobile Antenna, 106MHz BW @ 2:1 VSWR, No GP	406 - 512	2.0dB*	150W	60.95	56.68	52.42	48.76

\*Note: Gain shown with a ground plane GP; without ground plane gain is Unity

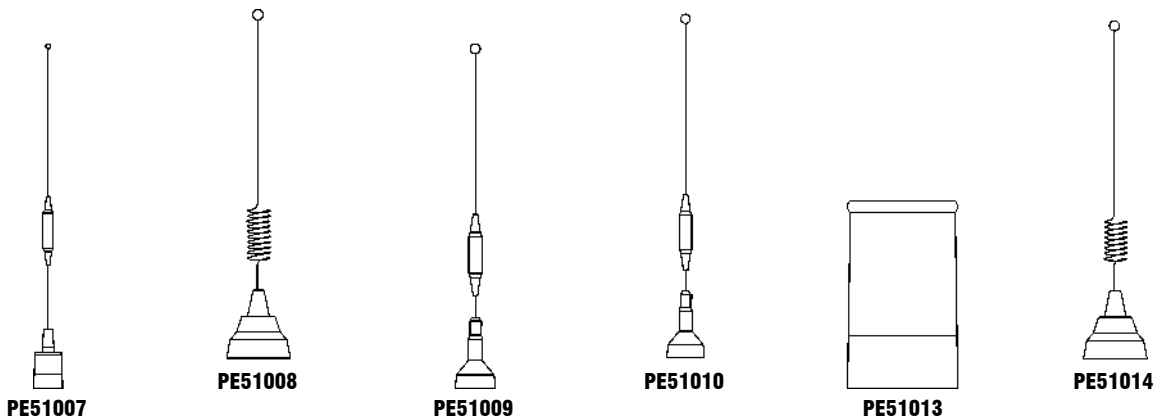

Model No.	Description	Frequency (MHz)	Gain	Max Power	1-24	25-49	50-99	100 +
PE51007	Wideband Mobile Antenna, 40MHz BW @ 2:1 VSWR, No GP	440 - 480	4.5dB	150W	\$53.95	\$50.17	\$46.40	\$43.16
PE51008	Mobile Antenna, 5/8 wave over $\frac{1}{2}$ wave, tuned to 835 MHz	806 - 896	3dB	150W	23.95	22.27	20.60	19.16
PE51009	Mobile Antenna, Dual $\frac{1}{2}$ wave over $\frac{1}{2}$ wave, tuned to 835 MHz	825 - 896	5dB	150W	35.95	33.43	30.92	28.76
PE51010	Mobile Antenna, Dual $\frac{1}{2}$ wave over $\frac{1}{2}$ wave, tuned to 898 MHz	870 - 950	5dB	150W	35.95	33.43	30.92	28.76
PE51013	PCS/iDEN/Cellular Low Profile Antenna	806 - 960 & 1710 -1990	3dBi	150W	58.95	54.82	50.70	47.16
PE51014	PCS/Cellular Mobile Antenna, Dual Band Collinear	824 - 960 & 1850 - 1990	2.2 dBi / 4 dBi	150W	36.95	34.36	31.78	29.56

**NEW**

# ANTENNAS

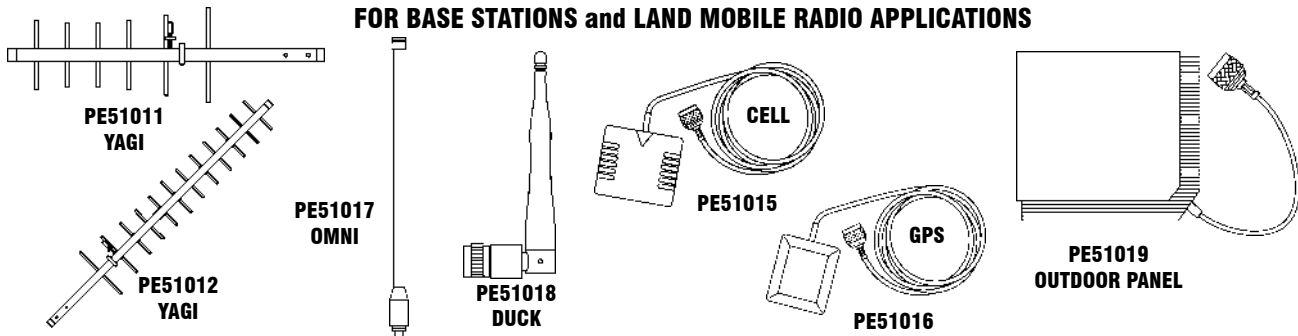
**FOR BASE STATIONS and LAND MOBILE RADIO APPLICATIONS**

Model No.	Description	Frequency (MHz)	Gain	Max Power	1-24	25-49	50-99	100 +
PE51011	YAGI Antenna, 9 dB, Tuned to 930 MHz	890 - 960	9 dB	150W	\$101.95	\$94.81	\$87.68	\$81.56
PE51012	YAGI Antenna, 11 dB, Tuned to 930 MHz	890 - 960	11 dB	150W	160.95	149.68	138.42	128.76
PE51017	2.4 GHz Omnidirectional Extreme Weather Antenna*	2400 - 2483.5	8 dBi	25W	158.95	147.82	136.70	127.16
PE51018	2.4 GHz Portable Duck Antenna, SMA Male	2400 - 2483.5	2.0 dBi	50W	23.95	22.27	20.60	19.16

\*Note: Mounting Bracket Included

Model No.	Description	Frequency (MHz)	Gain	Max Power	1-24	25-49	50-99	100 +
PE51019	2.4 GHz Directional Panel Outdoor Antenna, with 12 foot RG58 Coaxial Cable attached, VSWR < 1.6:1	2300-2500	9 dBi	20W	\$49.95	\$46.45	\$42.96	\$39.96
PE51019-1	Cable terminated with SMA Male connector	Same	Same	Same	58.55	54.45	50.35	46.84
PE51019-2	Cable terminated with SMA Female connector	Same	Same	Same	58.55	54.45	50.35	46.84
PE51019-3	Cable terminated with N Male connector	Same	Same	Same	58.55	54.45	50.35	46.84
PE51019-4	Cable terminated with N Female connector	Same	Same	Same	58.55	54.45	50.35	46.84
Need a different connector? Call for same-day shipping!					Same-day Shipping / Call for Pricing			

Model No.	Description	Frequency (MHz)	Gain	Max Power	1-24	25-49	50-99	100 +
PE51015	PCS/Cellular Concealed Glass Mount Dual Band Antenna, with 10 foot RG58 Coaxial Cable attached	824-896 / 1850-1990	Unity	10W	\$42.95	\$39.94	\$36.94	\$34.36
PE51015-1	Cable terminated with SMA Male connector	Same	Same	Same	49.95	46.45	42.96	39.96
PE51015-2	Cable terminated with TNC Male connector	Same	Same	Same	49.95	46.45	42.96	39.96
PE51015-3	Cable terminated with Mini-UHF Male connector	Same	Same	Same	49.95	46.45	42.96	39.96
PE51015-4	Cable terminated with FME Male connector	Same	Same	Same	49.95	46.45	42.96	39.96
PE51015-5	Cable terminated with N Male connector	Same	Same	Same	49.95	46.45	42.96	39.96
Need a different connector? Call for same-day shipping!					Same-day Shipping / Call for Pricing			

Model No.	Description	Frequency (MHz)	Gain	Noise Figure	1-24	25-49	50-99	100 +
PE51016	GPS Antenna, Magnetic Mount, with 15 foot RG174/U Coaxial Cable attached	L1: 1575.4	31 dB	2.2 dB max	\$111.95	\$104.11	\$96.28	\$89.56
PE51016-1	Cable terminated with SMA Male connector	Same	Same	Same	118.95	110.62	102.30	95.16
PE51016-2	Cable terminated with SMA Female connector	Same	Same	Same	118.95	110.62	102.30	95.16
PE51016-3	Cable terminated with FME Female connector	Same	Same	Same	118.95	110.62	102.30	95.16
PE51016-4	Cable terminated with FME Male connector	Same	Same	Same	118.95	110.62	102.30	95.16
PE51016-5	Cable terminated with MMCX Male connector	Same	Same	Same	118.95	110.62	102.30	95.16
PE51016-6	Cable terminated with MCX Male connector	Same	Same	Same	118.95	110.62	102.30	95.16
Need a different connector? Call for same-day shipping!					Same-day Shipping / Call for Pricing			

**Attenuators /  
RF Components**

**NEW**

# ANTENNA MOUNTS AND CABLE ASSEMBLIES

FOR BASE STATIONS and LAND MOBILE RADIO APPLICATIONS

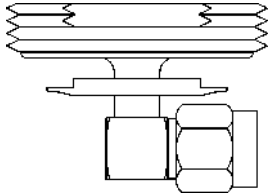
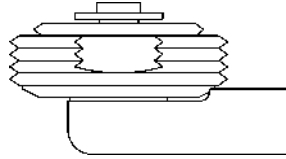
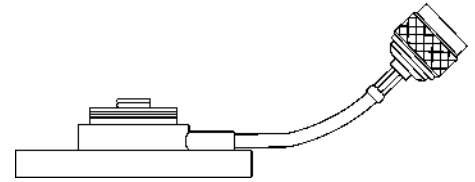
**PE51020****PE51021****PE51022**

Model No.	Description	Frequency (MHz)	1-24	25-49	50-99	100+
PE51020	NMO Crimp Mount, for Antennas over 1 GHz, SMA Connector	DC - 5800	\$28.95	\$26.92	\$24.90	\$23.16
PE51021	NMO Mount, no cable or connector (See cable assemblies below)	DC - 1000	7.95	7.39	6.84	6.36
PE51022	NMO Magnetic Mount, with 12 foot RG58 Coaxial Cable	DC - 2400	33.95	31.57	29.20	27.16
PE51022-1	Cable terminated with SMA Male connector	Same	40.95	38.08	35.22	32.76
PE51022-2	Cable terminated with SMA Female connector	Same	40.95	38.08	35.22	32.76
PE51022-3	Cable terminated with N Male connector	Same	40.95	38.08	35.22	32.76
PE51022-4	Cable terminated with N Female connector	Same	40.95	38.08	35.22	32.76
PE51022-5	Cable terminated with FME Female connector	Same	40.95	38.08	35.22	32.76
PE51022-6	Cable terminated with BNC Male connector	Same	40.95	38.08	35.22	32.76
PE51022-7	Cable terminated with BNC Female connector	Same	40.95	38.08	35.22	32.76
PE51022-8	Cable terminated with TNC Male connector	Same	40.95	38.08	35.22	32.76
PE51022-9	Cable terminated with TNC Female connector	Same	40.95	38.08	35.22	32.76
PE51022-10	Cable terminated with Mini-UHF Male connector	Same	40.95	38.08	35.22	32.76
PE51022-11	Cable terminated with Mini-UHF Female connector	Same	40.95	38.08	35.22	32.76
PE51022-12	Cable terminated with Reverse Polarity SMA Male connector	Same	41.35	38.46	35.56	33.08
PE51022-13	Cable terminated with PL-259 UHF connector	DC - 300	41.35	38.46	35.56	33.08
Need a different connector? Call for same-day shipping!			Same-day Shipping / Call for Pricing			

**NEW**

## ANTENNA MOUNT (NMO) CABLE ASSEMBLIES

NMO MOUNT REQUIRES 3/4" HOLE; 1-1/8"-18 THREAD, AND INSTALLS FROM ABOVE.

ALL CABLE ASSEMBLIES SHOWN ARE RATED UP TO 1 GHz AT 50 OHM.

### NMO MOUNT TO SMA MALE, 1 GHZ, RG58C/U



Model No.	Length	1-24	25-49	50-99	100 +
PE37840-60	60in (5ft)	\$22.60	\$21.02	\$19.44	\$18.08
PE37840-120	120in (10ft)	26.75	24.88	23.01	21.40
PE37840-180	180in (15ft)	30.85	28.69	26.53	24.68
PE37840-XX	Any	Same-Day Shipment / Call for Pricing			

### NMO MOUNT TO SMA FEMALE, 1 GHZ, RG58C/U



Model No.	Length	1-24	25-49	50-99	100 +
PE37841-60	60in (5ft)	\$22.60	\$21.02	\$19.44	\$18.08
PE37841-120	120in (10ft)	26.75	24.88	23.01	21.40
PE37841-180	180in (15ft)	30.85	28.69	26.53	24.68
PE37841-XX	Any	Same-Day Shipment / Call for Pricing			

**\*\*CONTINUED ON NEXT PAGE\*\***Attenuators /  
RF Components

**NEW**

# ANTENNA MOUNT (NMO) CABLE ASSEMBLIES

NMO MOUNT REQUIRES 3/4" HOLE; 1-1/8"-18 THREAD, AND INSTALLS FROM ABOVE.

ALL CABLE ASSEMBLIES SHOWN ARE RATED UP TO 1 GHZ AT 50 OHM.

## NMO MOUNT TO FME PLUG, 1 GHZ, RG58C/U



Model No.	Length	1-24	25-49	50-99	100 +
PE37842-60	60in (5ft)	\$22.60	\$21.02	\$19.44	\$18.08
PE37842-120	120in (10ft)	26.75	24.88	23.01	21.40
PE37842-180	180in (15ft)	30.85	28.69	26.53	24.68
PE37842-XX	Any	Same-Day Shipment / Call for Pricing			

## NMO MOUNT TO FME JACK, 1 GHZ, RG58C/U



Model No.	Length	1-24	25-49	50-99	100 +
PE37843-60	60in (5ft)	\$22.60	\$21.02	\$19.44	\$18.08
PE37843-120	120in (10ft)	26.75	24.88	23.01	21.40
PE37843-180	180in (15ft)	30.85	28.69	26.53	24.68
PE37843-XX	Any	Same-Day Shipment / Call for Pricing			

## NMO MOUNT TO BNC MALE, 1 GHZ, RG58C/U



Model No.	Length	1-24	25-49	50-99	100 +
PE37844-60	60in (5ft)	\$22.60	\$21.02	\$19.44	\$18.08
PE37844-120	120in (10ft)	26.75	24.88	23.01	21.40
PE37844-180	180in (15ft)	30.85	28.69	26.53	24.68
PE37844-XX	Any	Same-Day Shipment / Call for Pricing			

## NMO MOUNT TO BNC FEMALE, 1 GHZ, RG58C/U



Model No.	Length	1-24	25-49	50-99	100 +
PE37845-60	60in (5ft)	\$22.60	\$21.02	\$19.44	\$18.08
PE37845-120	120in (10ft)	26.75	24.88	23.01	21.40
PE37845-180	180in (15ft)	30.85	28.69	26.53	24.68
PE37845-XX	Any	Same-Day Shipment / Call for Pricing			

## NMO MOUNT TO MINI UHF MALE, 1 GHZ, RG58C/U



Model No.	Length	1-24	25-49	50-99	100 +
PE37846-60	60in (5ft)	\$22.60	\$21.02	\$19.44	\$18.08
PE37846-120	120in (10ft)	26.75	24.88	23.01	21.40
PE37846-180	180in (15ft)	30.85	28.69	26.53	24.68
PE37846-XX	Any	Same-Day Shipment / Call for Pricing			

## NMO MOUNT TO MINI UHF FEMALE, 1 GHZ, RG58C/U



Model No.	Length	1-24	25-49	50-99	100 +
PE37847-60	60in (5ft)	\$22.60	\$21.02	\$19.44	\$18.08
PE37847-120	120in (10ft)	26.75	24.88	23.01	21.40
PE37847-180	180in (15ft)	30.85	28.69	26.53	24.68
PE37847-XX	Any	Same-Day Shipment / Call for Pricing			

## NMO MOUNT TO TNC MALE, 1 GHZ, RG58C/U



Model No.	Length	1-24	25-49	50-99	100 +
PE37848-60	60in (5ft)	\$22.60	\$21.02	\$19.44	\$18.08
PE37848-120	120in (10ft)	26.75	24.88	23.01	21.40
PE37848-180	180in (15ft)	30.85	28.69	26.53	24.68
PE37848-XX	Any	Same-Day Shipment / Call for Pricing			

## NMO MOUNT TO TNC FEMALE, 1 GHZ, RG58C/U



Model No.	Length	1-24	25-49	50-99	100 +
PE37849-60	60in (5ft)	\$22.60	\$21.02	\$19.44	\$18.08
PE37849-120	120in (10ft)	26.75	24.88	23.01	21.40
PE37849-180	180in (15ft)	30.85	28.69	26.53	24.68
PE37849-XX	Any	Same-Day Shipment / Call for Pricing			

Attenuators /  
RF Components

## NMO MOUNT TO N MALE, 1 GHZ, RG58C/U



Model No.	Length	1-24	25-49	50-99	100 +
PE37850-60	60in (5ft)	\$22.60	\$21.02	\$19.44	\$18.08
PE37850-120	120in (10ft)	26.75	24.88	23.01	21.40
PE37850-180	180in (15ft)	30.85	28.69	26.53	24.68
PE37850-XX	Any	Same-Day Shipment / Call for Pricing			

## NMO MOUNT TO N FEMALE, 1 GHZ, RG58C/U



Model No.	Length	1-24	25-49	50-99	100 +
PE37851-60	60in (5ft)	\$22.60	\$21.02	\$19.44	\$18.08
PE37851-120	120in (10ft)	26.75	24.88	23.01	21.40
PE37851-180	180in (15ft)	30.85	28.69	26.53	24.68
PE37851-XX	Any	Same-Day Shipment / Call for Pricing			

# FIBER OPTIC CABLE ASSEMBLIES

## ST TO ST SIMPLEX



### SINGLE MODE

Model No.	Length	1-24	25-49	50-99	100 +
PE300000-1	1m	\$15.60	\$14.51	\$13.42	\$12.48
PE300000-2	2m	16.50	15.35	14.19	13.20
PE300000-3	3m	17.40	16.18	14.96	13.92
PE300000-5	5m	19.25	17.90	16.56	15.40

### MULTI MODE

Model No.	Length	1-24	25-49	50-99	100 +
PE300001-1	1m	\$10.40	\$9.67	\$8.94	\$8.32
PE300001-2	2m	11.30	10.51	9.72	9.04
PE300001-3	3m	12.20	11.35	10.49	9.76
PE300001-5	5m	14.05	13.07	12.08	11.24

## ST TO ST DUPLEX



### SINGLE MODE

Model No.	Length	1-24	25-49	50-99	100 +
PE300006-1	1m	\$23.40	\$21.76	\$20.12	\$18.72
PE300006-2	2m	25.20	23.44	21.67	20.16
PE300006-3	3m	27.05	25.16	23.26	21.64
PE300006-5	5m	30.70	28.55	26.40	24.56

### MULTI MODE

Model No.	Length	1-24	25-49	50-99	100 +
PE300007-1	1m	\$18.20	\$16.93	\$15.65	\$14.56
PE300007-2	2m	20.00	18.60	17.20	16.00
PE300007-3	3m	21.85	20.32	18.79	17.48
PE300007-5	5m	25.50	23.72	21.93	20.40

## SC TO SC SIMPLEX



### SINGLE MODE

Model No.	Length	1-24	25-49	50-99	100 +
PE300002-1	1m	\$15.60	\$14.51	\$13.42	\$12.48
PE300002-2	2m	16.50	15.35	14.19	13.20
PE300002-3	3m	17.40	16.18	14.96	13.92
PE300002-5	5m	19.25	17.90	16.56	15.40

### MULTI MODE

Model No.	Length	1-24	25-49	50-99	100 +
PE300003-1	1m	\$10.40	\$9.67	\$8.94	\$8.32
PE300003-2	2m	11.30	10.51	9.72	9.04
PE300003-3	3m	12.20	11.35	10.49	9.76
PE300003-5	5m	14.05	13.07	12.08	11.24

## SC TO SC DUPLEX



### SINGLE MODE

Model No.	Length	1-24	25-49	50-99	100 +
PE300008-1	1m	\$23.40	\$21.76	\$20.12	\$18.72
PE300008-2	2m	25.20	23.44	21.67	20.16
PE300008-3	3m	27.05	25.16	23.26	21.64
PE300008-5	5m	30.70	28.55	26.40	24.56

### MULTI MODE

Model No.	Length	1-24	25-49	50-99	100 +
PE300009-1	1m	\$18.20	\$16.93	\$15.65	\$14.56
PE300009-2	2m	20.00	18.60	17.20	16.00
PE300009-3	3m	21.85	20.32	18.79	17.48
PE300009-5	5m	25.50	23.72	21.93	20.40

## ST TO SC SIMPLEX



### SINGLE MODE

Model No.	Length	1-24	25-49	50-99	100 +
PE300004-1	1m	\$15.60	\$14.51	\$13.42	\$12.48
PE300004-2	2m	16.50	15.35	14.19	13.20
PE300004-3	3m	17.40	16.18	14.96	13.92
PE300004-5	5m	19.25	17.90	16.56	15.40

### MULTI MODE

Model No.	Length	1-24	25-49	50-99	100 +
PE300005-1	1m	\$10.40	\$9.67	\$8.94	\$8.32
PE300005-2	2m	11.30	10.51	9.72	9.04
PE300005-3	3m	12.20	11.35	10.49	9.76
PE300005-5	5m	14.05	13.07	12.08	11.24

## ST TO SC DUPLEX



### SINGLE MODE

Model No.	Length	1-24	25-49	50-99	100 +
PE300010-1	1m	\$23.40	\$21.76	\$20.12	\$18.72
PE300010-2	2m	25.20	23.44	21.67	20.16
PE300010-3	3m	27.05	25.16	23.26	21.64
PE300010-5	5m	30.70	28.55	26.40	24.56

### MULTI MODE

Model No.	Length	1-24	25-49	50-99	100 +
PE300011-1	1m	\$18.20	\$16.93	\$15.65	\$14.56
PE300011-2	2m	20.00	18.60	17.20	16.00
PE300011-3	3m	21.85	20.32	18.79	17.48
PE300011-5	5m	25.50	23.72	21.93	20.40

# FIBER OPTIC CABLE ASSEMBLIES

## FC TO FC SIMPLEX



### SINGLE MODE

Model No.	Length	1-24	25-49	50-99	100 +
PE300012-1	1m	\$14.30	\$13.30	\$12.30	\$11.44
PE300012-2	2m	15.20	14.14	13.07	12.16
PE300012-3	3m	16.10	14.97	13.85	12.88
PE300012-5	5m	17.95	16.69	15.44	14.36

### MULTI MODE

Model No.	Length	1-24	25-49	50-99	100 +
PE300013-1	1m	\$14.30	\$13.30	\$12.30	\$11.44
PE300013-2	2m	15.20	14.14	13.07	12.16
PE300013-3	3m	16.10	14.97	13.85	12.88
PE300013-5	5m	17.95	16.69	15.44	14.36

## FC TO FC DUPLEX



### SINGLE MODE

Model No.	Length	1-24	25-49	50-99	100 +
PE300018-1	1m	\$31.20	\$29.02	\$26.83	\$24.96
PE300018-2	2m	33.00	30.69	28.38	26.40
PE300018-3	3m	34.85	32.41	29.97	27.88
PE300018-5	5m	38.50	35.81	33.11	30.80

### MULTI MODE

Model No.	Length	1-24	25-49	50-99	100 +
PE300019-1	1m	\$26.00	\$24.18	\$22.36	\$20.80
PE300019-2	2m	27.80	25.85	23.91	22.24
PE300019-3	3m	29.65	27.57	25.50	23.72
PE300019-5	5m	33.30	30.97	28.64	26.64

## LC TO LC SIMPLEX



### SINGLE MODE

Model No.	Length	1-24	25-49	50-99	100 +
PE300014-1	1m	\$20.80	\$19.34	\$17.89	\$16.64
PE300014-2	2m	21.70	20.18	18.66	17.36
PE300014-3	3m	22.60	21.02	19.44	18.08
PE300014-5	5m	24.45	22.74	21.03	19.56

### MULTI MODE

Model No.	Length	1-24	25-49	50-99	100 +
PE300015-1	1m	\$15.60	\$14.51	\$13.42	\$12.48
PE300015-2	2m	16.50	15.35	14.19	13.20
PE300015-3	3m	17.40	16.18	14.96	13.92
PE300015-5	5m	19.25	17.90	16.56	15.40

## LC TO LC DUPLEX



### SINGLE MODE

Model No.	Length	1-24	25-49	50-99	100 +
PE300020-1	1m	\$33.80	\$31.43	\$29.07	\$27.04
PE300020-2	2m	35.60	33.11	30.62	28.48
PE300020-3	3m	37.45	34.83	32.21	29.96
PE300020-5	5m	41.10	38.22	35.35	32.88

### MULTI MODE

Model No.	Length	1-24	25-49	50-99	100 +
PE300021-1	1m	\$28.60	\$26.60	\$24.60	\$22.88
PE300021-2	2m	30.40	28.27	26.14	24.32
PE300021-3	3m	32.25	29.99	27.74	25.80
PE300021-5	5m	35.90	33.39	30.87	28.72

## ST TO FC SIMPLEX



### SINGLE MODE

Model No.	Length	1-24	25-49	50-99	100 +
PE300016-1	1m	\$14.30	\$13.30	\$12.30	\$11.44
PE300016-2	2m	15.20	14.14	13.07	12.16
PE300016-3	3m	16.10	14.97	13.85	12.88
PE300016-5	5m	17.95	16.69	15.44	14.36

### MULTI MODE

Model No.	Length	1-24	25-49	50-99	100 +
PE300017-1	1m	\$14.30	\$13.30	\$12.30	\$11.44
PE300017-2	2m	15.20	14.14	13.07	12.16
PE300017-3	3m	16.10	14.97	13.85	12.88
PE300017-5	5m	17.95	16.69	15.44	14.36

## ST TO FC DUPLEX



### SINGLE MODE

Model No.	Length	1-24	25-49	50-99	100 +
PE300022-1	1m	\$31.20	\$29.02	\$26.83	\$24.96
PE300022-2	2m	33.00	30.69	28.38	26.40
PE300022-3	3m	34.85	32.41	29.97	27.88
PE300022-5	5m	38.50	35.81	33.11	30.80

### MULTI MODE

Model No.	Length	1-24	25-49	50-99	100 +
PE300023-1	1m	\$26.00	\$24.18	\$22.36	\$20.80
PE300023-2	2m	27.80	25.85	23.91	22.24
PE300023-3	3m	29.65	27.57	25.50	23.72
PE300023-5	5m	33.30	30.97	28.64	26.64



# FIBER OPTIC CABLE ASSEMBLIES

## ST TO LC SIMPLEX



		SINGLE MODE			
Model No.	Length	1-24	25-49	50-99	100 +
PE300024-1	1m	\$19.50	\$18.14	\$16.77	\$15.60
PE300024-2	2m	20.40	18.97	17.54	16.32
PE300024-3	3m	21.30	19.81	18.32	17.04
PE300024-5	5m	23.15	21.53	19.91	18.52

		MULTI MODE			
Model No.	Length	1-24	25-49	50-99	100 +
PE300025-1	1m	\$14.30	\$13.30	\$12.30	\$11.44
PE300025-2	2m	15.20	14.14	13.07	12.16
PE300025-3	3m	16.10	14.97	13.85	12.88
PE300025-5	5m	17.95	16.69	15.44	14.36

## ST TO LC DUPLEX



		SINGLE MODE			
Model No.	Length	1-24	25-49	50-99	100 +
PE300030-1	1m	\$31.20	\$29.02	\$26.83	\$24.96
PE300030-2	2m	33.00	30.69	28.38	26.40
PE300030-3	3m	34.85	32.41	29.97	27.88
PE300030-5	5m	38.50	35.81	33.11	30.80

		MULTI MODE			
Model No.	Length	1-24	25-49	50-99	100 +
PE300031-1	1m	\$26.00	\$24.18	\$22.36	\$20.80
PE300031-2	2m	27.80	25.85	23.91	22.24
PE300031-3	3m	29.65	27.57	25.50	23.72
PE300031-5	5m	33.30	30.97	28.64	26.64

## SC TO LC SIMPLEX



		SINGLE MODE			
Model No.	Length	1-24	25-49	50-99	100 +
PE300026-1	1m	\$19.50	\$18.14	\$16.77	\$15.60
PE300026-2	2m	20.40	18.97	17.54	16.32
PE300026-3	3m	21.30	19.81	18.32	17.04
PE300026-5	5m	23.15	21.53	19.91	18.52

		MULTI MODE			
Model No.	Length	1-24	25-49	50-99	100 +
PE300027-1	1m	\$14.30	\$13.30	\$12.30	\$11.44
PE300027-2	2m	15.20	14.14	13.07	12.16
PE300027-3	3m	16.10	14.97	13.85	12.88
PE300027-5	5m	17.95	16.69	15.44	14.36

## SC TO LC DUPLEX



		SINGLE MODE			
Model No.	Length	1-24	25-49	50-99	100 +
PE300032-1	1m	\$31.20	\$29.02	\$26.83	\$24.96
PE300032-2	2m	33.00	30.69	28.38	26.40
PE300032-3	3m	34.85	32.41	29.97	27.88
PE300032-5	5m	38.50	35.81	33.11	30.80

		MULTI MODE			
Model No.	Length	1-24	25-49	50-99	100 +
PE300033-1	1m	\$26.00	\$24.18	\$22.36	\$20.80
PE300033-2	2m	27.80	25.85	23.91	22.24
PE300033-3	3m	29.65	27.57	25.50	23.72
PE300033-5	5m	33.30	30.97	28.64	26.64

## MTRJ TO MTRJ DUPLEX



		MULTI MODE			
Model No.	Length	1-24	25-49	50-99	100 +
PE300028-1	1m	\$20.80	\$19.34	\$17.89	\$16.64
PE300028-2	2m	22.60	21.02	19.44	18.08
PE300028-3	3m	24.45	22.74	21.03	19.56
PE300028-5	5m	28.10	26.13	24.17	22.48

## ST TO MTRJ DUPLEX



		MULTI MODE			
Model No.	Length	1-24	25-49	50-99	100 +
PE300034-1	1m	\$26.00	\$24.18	\$22.36	\$20.80
PE300034-2	2m	27.80	25.85	23.91	22.24
PE300034-3	3m	29.65	27.57	25.50	23.72
PE300034-5	5m	33.30	30.97	28.64	26.64

## VF45 TO VF45 DUPLEX



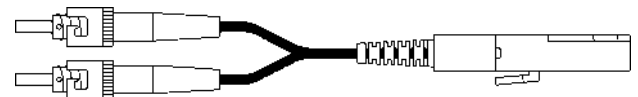

		MULTI MODE			
Model No.	Length	1-24	25-49	50-99	100 +
PE300029-1	1m	\$13.00	\$12.09	\$11.18	\$10.40
PE300029-2	2m	13.65	12.69	11.74	10.92
PE300029-3	3m	14.30	13.30	12.30	11.44
PE300029-5	5m	14.95	13.90	12.86	11.96

## ST TO VF45 DUPLEX



		MULTI MODE			
Model No.	Length	1-24	25-49	50-99	100 +
PE300035-1	1m	\$13.00	\$12.09	\$11.18	\$10.40
PE300035-2	2m	13.65	12.69	11.74	10.92
PE300035-3	3m	14.30	13.30	12.30	11.44
PE300035-5	5m	14.95	13.90	12.86	11.96

# FIBER OPTIC ADAPTERS

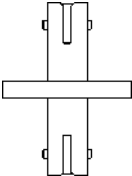
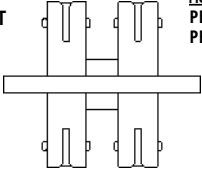
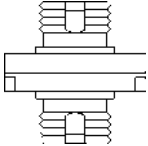
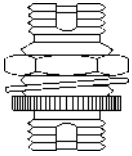
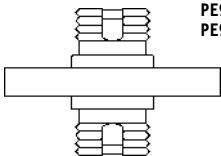
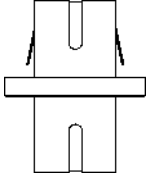
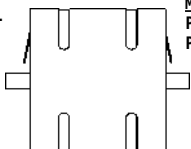
		Model No.	MODE	SLEEVE MATERIAL	P R I C E			
					1-24	25-49	50-99	100 +
ST BULKHEAD		PE900001 PE900002	SINGLE MULTI	ZIRCONIA PHOSPHOR BRONZE	\$7.25 7.25	\$6.74 6.74	\$6.24 6.24	\$5.80 5.80
ST PANEL MOUNT		PE900004 PE900005	SINGLE MULTI	ZIRCONIA PHOSPHOR BRONZE	\$10.40 10.40	\$9.67 9.67	\$8.94 8.94	\$8.32 8.32
ST DUPLEX PANEL MOUNT		PE900007 PE900008	SINGLE MULTI	ZIRCONIA PHOSPHOR BRONZE	\$13.55 10.40	\$12.60 9.67	\$11.65 8.94	\$10.84 8.32
FC SQUARE PANEL MOUNT		PE900010 PE900011	SINGLE MULTI	ZIRCONIA PHOSPHOR BRONZE	\$11.45 10.40	\$10.65 9.67	\$9.85 8.94	\$9.16 8.32
FC BULKHEAD		PE900013 PE900014	SINGLE MULTI	ZIRCONIA PHOSPHOR BRONZE	\$13.55 13.55	\$12.60 12.60	\$11.65 11.65	\$10.84 10.84
FC PANEL MOUNT		PE900016 PE900017	SINGLE MULTI	ZIRCONIA PHOSPHOR BRONZE	\$13.55 10.40	\$12.60 9.67	\$11.65 8.94	\$10.84 8.32
SC SIMPLEX PANEL MOUNT		PE900019 PE900020	SINGLE MULTI	ZIRCONIA PHOSPHOR BRONZE	\$10.40 10.40	\$9.67 9.67	\$8.94 8.94	\$8.32 8.32
SC DUPLEX PANEL MOUNT		PE900022 PE900023	SINGLE MULTI	ZIRCONIA PHOSPHOR BRONZE	\$13.55 13.55	\$12.60 12.60	\$11.65 11.65	\$10.84 10.84

# FIBER OPTIC ADAPTERS

## PRICE

ST TO FC  
PANEL MOUNT

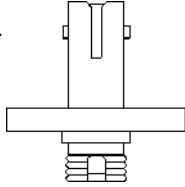

Model No.  
PE900025  
PE900026

MODE  
SINGLE  
MULTI

SLEEVE MATERIAL  
ZIRCONIA  
PHOSPHOR BRONZE

1-24	25-49	50-99	100 +
\$11.45	\$10.65	\$9.85	\$9.16
11.45	10.65	9.85	9.16

ST TO SC  
PANEL MOUNT

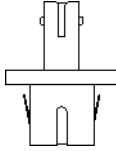

Model No.  
PE900028  
PE900029

MODE  
SINGLE  
MULTI

SLEEVE MATERIAL  
ZIRCONIA  
PHOSPHOR BRONZE

1-24	25-49	50-99	100 +
\$12.50	\$11.63	\$10.75	\$10.00
12.50	11.63	10.75	10.00

SC TO FC  
PANEL MOUNT

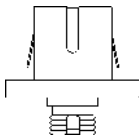

Model No.  
PE900031  
PE900032

MODE  
SINGLE  
MULTI

SLEEVE MATERIAL  
ZIRCONIA  
PHOSPHOR BRONZE

1-24	25-49	50-99	100 +
\$12.50	\$11.63	\$10.75	\$10.00
12.50	11.63	10.75	10.00

ST TO SC DUPLEX  
PANEL MOUNT

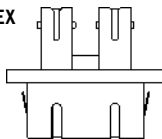

Model No.  
PE900034  
PE900035

MODE  
SINGLE  
MULTI

SLEEVE MATERIAL  
ZIRCONIA  
PHOSPHOR BRONZE

1-24	25-49	50-99	100 +
\$17.70	\$16.46	\$15.22	\$14.16
17.70	16.46	15.22	14.16

LC DUPLEX  
PANEL MOUNT

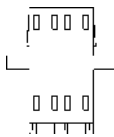

Model No.  
PE900038  
PE900039

MODE  
SINGLE  
MULTI

SLEEVE MATERIAL  
ZIRCONIA  
PHOSPHOR BRONZE

1-24	25-49	50-99	100 +
\$24.95	\$23.20	\$21.46	\$19.96
15.95	14.83	13.72	12.76

NEW

# FIBER OPTIC ATTENUATORS

## FC ATTENUATOR

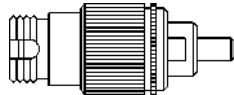

Model No.	ATTENUATION	PRICE			
		1-24	25-49	50-99	100 +
PE700000-5	5 dB	\$67.85	\$63.10	\$58.35	\$54.28
PE700000-10	10 dB	67.85	63.10	58.35	54.28
PE700000-15	15 dB	67.85	63.10	58.35	54.28
PE700000-20	20 dB	67.85	63.10	58.35	54.28
PE700000-25	25 dB	67.85	63.10	58.35	54.28

## ST ATTENUATOR

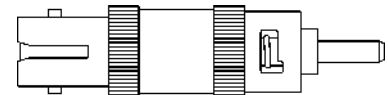

Model No.	ATTENUATION	PRICE			
		1-24	25-49	50-99	100 +
PE700001-5	5 dB	\$67.85	\$63.10	\$58.35	\$54.28
PE700001-10	10 dB	67.85	63.10	58.35	54.28
PE700001-15	15 dB	67.85	63.10	58.35	54.28
PE700001-20	20 dB	67.85	63.10	58.35	54.28
PE700001-25	25 dB	67.85	63.10	58.35	54.28

## SC ATTENUATOR

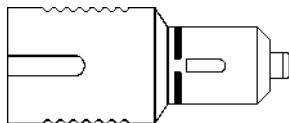

Model No.	ATTENUATION	PRICE			
		1-24	25-49	50-99	100 +
PE700002-5	5 dB	\$67.85	\$63.10	\$58.35	\$54.28
PE700002-10	10 dB	67.85	63.10	58.35	54.28
PE700002-15	15 dB	67.85	63.10	58.35	54.28
PE700002-20	20 dB	67.85	63.10	58.35	54.28
PE700002-25	25 dB	67.85	63.10	58.35	54.28

## ST BULKHEAD ATTENUATOR

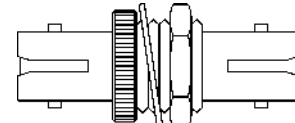

Model No.	ATTENUATION	PRICE			
		1-24	25-49	50-99	100 +
PE700003-5	5 dB	\$78.30	\$72.82	\$67.34	\$62.64
PE700003-10	10 dB	78.30	72.82	67.34	62.64
PE700003-15	15 dB	78.30	72.82	67.34	62.64
PE700003-20	20 dB	78.30	72.82	67.34	62.64
PE700003-25	25 dB	78.30	72.82	67.34	62.64

# COAXIAL CABLE

MEETS OR EXCEEDS MIL-C-17 SPECIFICATIONS WHERE APPLICABLE

MODEL NO.	NOMINAL IMP.	MAX. VOLTAGE (V RMS)	CAPACITANCE pF / FT.	VELOCITY FACTOR	ATTENUATION AT		AVER. POWER HANDLING		PRICE PER FOOT	
					1 GHz dB/100FT	5 GHz dB/100FT	AT 1 GHZ (WATTS)	AT 5 GHZ (WATTS)	50-99FT	100-249FT
	NO. OF SHIELDS	CONDUCTOR DIAM. (in) [strands]	NOMINAL DIELECTRIC DIAM. (in)	DIELECTRIC MATERIAL	NOMINAL JACKET DIAM. (in)	JACKET MATERIAL	WEIGHT LBS/FT	OPERATING TEMP. RANGE, °C	PRICE PER FOOT 250-499FT 500+ FT	
RG6A/U	75Ω 2	2700 0.029	20.6 0.185	65.9% PE (S)	11.0 0.332	30.0 PVC	125 W 0.078	40 W -40 TO +80	\$1.18 \$1.01	\$1.10 \$0.94
RG6-CATV	75Ω 3	350 0.040	16.2 0.18	83.0% PE (F)	6.5 0.275	N/A PVC	6.5 W 0.03	N/A -40 TO +80	\$0.60 \$0.55	\$0.60 \$0.51
RG8A/U	52Ω 1	5000 0.072 [7]	29.5 0.285	65.9% PE (S)	9.0 0.405	28.0 PVC	190 W 0.105	65 W -40 TO +80	\$1.78 \$1.53	\$1.66 \$1.42
RG8X	50Ω 1	2500 .056 [19]	26.0 0.155	80.0% PE (F)	13.5 0.242	35.0 PVC	60 W 0.038	19 W -40 TO +80	\$2.01 \$1.73	\$1.87 \$1.61
RG11A/U	75Ω 1	5000 .0477 [7]	20.6 0.285	65.9% PE (S)	9.0 0.405	28.0 PVC	150 W 0.093	50 W -40 TO +80	\$1.03 \$0.89	\$0.96 \$0.82
RG55B/U	53.5Ω 2	1900 0.032	28.5 0.116	65.9% PE (S)	16.5 0.206	51.0 PE	53 W 0.033	20 W -55 TO +80	\$1.06 \$0.91	\$0.99 \$0.85
RG58C/U	50Ω 1	1900 .0355 [19]	30.8 0.116	65.9% PE (S)	20.0 0.195	60.0 PVC	44 W 0.025	15 W -40 TO +80	\$0.43 \$0.37	\$0.40 \$0.34
RG58-P (1)	50Ω 1	1900 0.032	29.0 0.112	68.0% PTFE (S)	14.0 0.163	39.0 FEP	632 W 0.028	280 W -40 TO +80	\$2.43 \$2.09	\$2.26 \$1.94
RG59B/U	75Ω 1	2300 0.023	20.6 0.146	65.9% PE (S)	11.5 0.242	41.0 PVC	77 W 0.033	27 W -40 TO +80	\$0.57 \$0.49	\$0.53 \$0.46
RG59-P (1)	75Ω 1	2300 0.0253 [7]	16.5 0.138	82.0% PTFE (S)	11.0 0.194	32.0 FEP	880 W 0.028	390 W -40 TO +80	\$1.22 \$1.05	\$1.13 \$0.98
RG62A/U	93Ω 1	750 0.025	13.5 0.146	84.0% PE (A)	8.5 0.242	29.5 PVC	77 W 0.033	27 W -40 TO +80	\$0.72 \$0.62	\$0.67 \$0.58
RG71B/U	93Ω 2	750 0.025	13.5 0.146	84.0% PE (A)	8.5 0.250	29.5 PE	77 W 0.04	27 W -55 TO +80	\$2.26 \$1.94	\$2.10 \$1.81
RG108A/U (TWINAX)	78Ω 1	1000 2X 0.0378 [7]	19.7 0.079	65.9% PE (S)	26.2 0.235	80.0 PVC	30 W 0.035	10 W -40 TO +80	\$0.92 \$0.79	\$0.86 \$0.74
RG122/U	50Ω 1	1900 0.03 [27]	30.8 0.096	65.9% PE (S)	29.2 0.160	89.0 PVC	35 W 0.018	12 W -40 TO +80	\$1.45 \$1.25	\$1.35 \$1.16
RG141A/U	50Ω 1	1900 0.039	29.4 0.116	69.5% PE (S)	13.0 0.190	36.0 PTFE (FR)	650 W 0.033	245 W -55 TO +250	\$3.23 \$2.78	\$3.00 \$2.58
RG142B/U	50Ω 2	1900 0.039	29.4 0.116	69.2% PE (S)	13.0 0.195	36.0 FEP	650 W 0.043	245 W -55 TO +200	\$3.25 \$2.80	\$3.02 \$2.60
RG174A/U	50Ω 1	1500 0.0189 [7]	30.8 0.06	69.5% PTFE (S)	31.0 0.100	97.0 PVC	16 W 0.008	5 W -40 TO +80	\$0.29 \$0.25	\$0.27 \$0.23
RG178B/U	50Ω 1	1000 0.012 [7]	29.4 0.034	69.5% PE (S)	45.0 0.075	115.0 FEP	78 W 0.005	28 W -55 TO +200	\$0.58 \$0.50	\$0.54 \$0.46
RG179B/U	75Ω 1	1200 0.012 [7]	23.0 0.063	69.5% PTFE (S)	25.0 0.100	62.5 FEP	200 W 0.011	76 W -55 TO +200	\$1.29 \$1.11	\$1.20 \$1.03
RG180B/U	95Ω 1	1500 0.0120	15.4 0.102	69.5% PTFE (S)	16.5 0.145	49.5 FEP	250 W 0.018	93 W -55 TO +200	\$2.03 \$1.75	\$1.89 \$1.62
RG187A/U	75Ω 1	1200 0.012 [7]	19.5 0.06	69.5% PTFE (S)	25.0 0.110	62.5 PTFE	200 W 0.01	76 W -55 TO +250	\$2.00 \$1.72	\$1.86 \$1.60
RG188A/U	50Ω 1	1200 0.0201 [7]	29.4 0.06	69.5% PTFE (S)	30.0 0.110	79.0 PTFE	160 W 0.01	57 W -55 TO +250	\$1.16 \$1.00	\$1.08 \$0.93
RG188-DS	50Ω 2	1200 0.0201 [7]	29.4 0.06	69.5% PTFE (S)	30.0 0.122	79.0 PTFE	160 W 0.015	57 W -55 TO +250	\$2.11 \$1.81	\$1.96 \$1.69
RG196A/U	50Ω 1	1000 0.012 [7]	29.4 0.034	69.5% PTFE (S)	45.0 0.080	115.0 PTFE	78 W 0.005	28 W -55 TO +250	\$0.84 \$0.72	\$0.78 \$0.67
RG210/U	93Ω 1	750 0.0253	13.5 0.146	84.0% PTFE (A)	3.1 0.242	9.0 PTFE (FR)	620 W 0.043	220 W -55 TO +250	\$12.67 \$10.90	\$11.78 \$10.14
RG213/U	50Ω 1	5000 0.0888 [7]	30.8 0.285	65.9% PTFE (S)	9.0 0.405	28.0 PVC	190 W 0.105	65 W -40 TO +80	\$1.00 \$0.86	\$0.93 \$0.80
RG214/U	50Ω 2	5000 0.0888 [7]	30.8 0.285	65.9% PTFE (S)	9.0 0.425	28.0 PVC	190 W 0.123	65 W -40 TO +80	\$3.96 \$3.41	\$3.68 \$3.17
RG216/U	75Ω 2	5000 0.0477 [7]	20.6 0.285	65.9% PE (S)	9.0 0.425	28.0 PVC	150 W 0.123	50 W -40 TO +80	\$1.35 \$1.16	\$1.26 \$1.08
RG217/U	50Ω 2	7000 0.106	30.8 0.37	65.9% PE (S)	5.8 0.545	19.0 PVC	260 W 0.225	85 W -40 TO +80	\$2.80 \$2.41	\$2.60 \$2.24
RG218/U	50Ω 1	11000 0.195	30.8 0.68	65.9% PE (S)	3.8 0.870	13.5 PVC	560 W 0.478	160 W -40 TO +80	\$7.19 \$6.18	\$6.69 \$5.75
RG219/U	50Ω 1	11000 0.195	30.8 0.68	65.9% PE (S)	3.8 0.945	13.5 PVC	560 W 0.515	160 W -40 TO +80	\$26.45 \$22.75	\$24.60 \$21.16
RG223/U	50Ω 2	1900 0.035	30.8 0.116	65.9% PE (S)	16.5 0.216	51.0 PVC	53 W 0.035	20 W -40 TO +80	\$1.75 \$1.51	\$1.63 \$1.40

Tools & Bulk Cable

# COAXIAL CABLE

MEETS OR EXCEEDS MIL-C-17 SPECIFICATIONS WHERE APPLICABLE

MODEL NO.	NOMINAL IMP.	MAX. VOLTAGE (V RMS)	CAPACITANCE pF / FT.	VELOCITY FACTOR	ATTENUATION AT		AVER. POWER HANDLING		PRICE PER FOOT	
					1 GHz	5 GHz	AT 1 GHz	AT 5 GHz	50-99FT	100-249FT
	NO. OF SHIELDS	CONDUCTOR DIAM. (in) [strands]	NOMINAL DIELECTRIC DIAM. (in)	DIELECTRIC MATERIAL	NOMINAL JACKET DIAM. (in)	JACKET MATERIAL	WEIGHT LBS/FT	OPERATING TEMP. RANGE, °C	250-499FT	500+ FT
RG225/U	50Ω 2	5000 0.094 [7]	29.4 0.285	69.0% PTFE (S)	7.5 0.430	21.0 PTFE (FR)	1700 W 0.173	620 W -55 TO +250	\$21.08 \$18.13	\$19.60 \$16.86
RG302/U	75Ω 1	2300 0.025	19.5 0.146	69.5% PTFE (S)	13.0 0.206	36.0 FEP	650 W 0.038	245 W -55 TO +200	\$3.13 \$2.69	\$2.91 \$2.50
RG303/U	50Ω 1	1900 0.039	29.4 0.116	69.5% PTFE (S)	13.0 0.170	36.0 FEP	650 W 0.03	245 W -55 TO +200	\$2.95 \$2.54	\$2.74 \$2.36
RG316/U	50Ω 1	1200 0.0201 [7]	29.4 0.06	69.5% PTFE (S)	30.0 0.102	79.0 FEP	160 W 0.01	57 W -55 TO +200	\$1.89 \$1.63	\$1.76 \$1.51
RG316-DS	50Ω 2	900 0.0201 [7]	29.4 0.06	69.5% PTFE (S)	30.0 0.114	79.0 FEP	160 W 0.015	57 W -55 TO +200	\$1.82 \$1.57	\$1.69 \$1.46
RG393/U	50Ω 2	5000 0.0936 [7]	29.4 0.285	69.5% PTFE (S)	7.5 0.390	21.0 FEP	1700 W 0.158	620 W -55 TO +200	\$10.05 \$8.64	\$9.35 \$8.04
RG400/U	50Ω 2	1900 0.0385 [18]	29.4 0.116	69.5% PTFE (S)	13.0 0.195	36.0 FEP	650 W 0.043	245 W -55 TO +200	\$4.29 \$3.69	\$3.99 \$3.43
RG401/U (3,13)	50Ω 1	3000 0.065	29.4 0.215	69.5% PTFE (S)	9.7 0.250	26.1 Cu	870 W 0.1	330 W -55 TO +125	\$12.81 \$11.02	\$11.91 \$10.25
RG402/U (4,13)	50Ω 1	2500 0.036	29.4 0.119	69.5% PTFE (S)	13.0 0.141	36.0 Cu	650 W 0.032	245 W -55 TO +125	\$4.23 \$3.64	\$3.93 \$3.38
RG405/U (4,13)	50Ω 1	2000 0.020	32.0 0.066	66.0% PTFE (S)	22.0 0.085	50.0 Cu	130 W 0.014	54 W -55 TO +125	\$3.78 \$3.25	\$3.52 \$3.02
PE-020SR (3,13)	50Ω 1	750 0.004	29.0 0.015	69.5% PTFE (S)	85.0 0.020	175.0 Cu	2.9 W 0.001	1.1 W -55 TO +85	\$10.55 \$9.07	\$9.81 \$8.44
PE-034SR (3,13)	50Ω 1	2000 0.008	32.0 0.026	66.0% PTFE (S)	60.0 0.034	120.0 Cu	10 W 0.002	4.5 W -55 TO +100	\$7.37 \$6.34	\$6.85 \$5.90
PE-047SR (4,13)	50Ω 1	1000 0.011	32.0 0.037	66.0% PTFE (S)	40.0 0.047	105.0 Cu	32 W 0.005	13 W -55 TO +100	\$6.31 \$5.43	\$5.87 \$5.05
PE-118SR (3)	50Ω 1	1000 0.0320	27.0 0.095	77.0% PTFE (LD)	12.2 0.118	28.2 Cu	500 W 0.023	210 W -40 TO +150	\$20.95 \$18.02	\$19.48 \$16.76
PE-142LL	50Ω 3	1400 0.037	29.0 0.116	70.0% PTFE (S)	12.5 0.195	31.0 FEP	650 W 0.04	330 W -55 TO +200	\$5.46 \$4.70	\$5.08 \$4.37
PE-B1828 (5)	75Ω 2	2900 0.031	21.0 0.198	66.0% PE (S)	9.2 0.305	23.0 PVC	52 W 0.068	17 W -40 TO +80	\$1.11 \$0.95	\$1.03 \$0.89
PE-B3199 (6)	50Ω 2	600 0.108	24.0 0.285	84.0% PE (AS)	4.5 0.405	12.0 PVC	344 W 0.105	113 W -40 TO +80	\$1.36 \$1.17	\$1.26 \$1.09
PE-B4199 (7)	50Ω 2	600 0.013	26.0 0.285	78.0% PE (F)	6.0 0.403	15.0 PVC	190 W 0.103	60 W -40 TO +80	\$0.95 \$0.82	\$0.88 \$0.76
PE-B7029 (TWINAX) (2)	100Ω 2	300 2X 0.037 [7]	15.5 0.236	66.0% PE (S)	N/A 0.330	N/A PVC	N/A 0.065	N/A -30 TO +75	\$1.42 \$1.22	\$1.32 \$1.14
PE-B8128 (8)	75Ω 1	600 0.017 [7]	20.5 0.1	66.0% PE (S)	20.0 0.150	50.0 PVC	25 W 0.018	8 W -40 TO +80	\$0.48 \$0.41	\$0.45 \$0.38
<b>NEW</b> PE-BYR940-BL (26)	75Ω 2	300 0.023	16.3 0.102	82% PE (F)	12.5 0.159	31.0 PVC	N/A 0.017	N/A -30 TO +75	\$0.95 \$0.82	\$0.88 \$0.76
<b>NEW</b> PE-BYR940-BK (26)	75Ω 2	300 0.023	16.3 0.102	82% PE (F)	12.5 0.159	31.0 PVC	N/A 0.017	N/A -30 TO +75	\$0.95 \$0.82	\$0.88 \$0.76
<b>NEW</b> PE-BYR940-WH (26)	75Ω 2	300 0.023	16.3 0.102	82% PE (F)	12.5 0.159	31.0 PVC	N/A 0.017	N/A -30 TO +75	\$0.95 \$0.82	\$0.88 \$0.76
<b>NEW</b> PE-BYR940-RD (26)	75Ω 2	300 0.023	16.3 0.102	82% PE (F)	12.5 0.159	31.0 PVC	N/A 0.017	N/A -30 TO +75	\$0.95 \$0.82	\$0.88 \$0.76
<b>NEW</b> PE-BYR940-GR (26)	75Ω 2	300 0.023	16.3 0.102	82% PE (F)	12.5 0.159	31.0 PVC	N/A 0.017	N/A -30 TO +75	\$0.95 \$0.82	\$0.88 \$0.76
<b>NEW</b> PE-BYR940-YW (26)	75Ω 2	300 0.023	16.3 0.102	82% PE (F)	12.5 0.159	31.0 PVC	N/A 0.017	N/A -30 TO +75	\$0.95 \$0.82	\$0.88 \$0.76
PE-SR047AL (4,11)	50Ω 1	1000 0.011	32.0 0.037	69.5% PTFE (S)	41.0 0.047	93.0 Al (Tn)	32 W 0.002	13 W -55 TO +100	\$5.25 \$4.52	\$4.88 \$4.20
PE-SR047FL (17)	50Ω 1	1000 0.011	27.0 0.037	69.5% PTFE (S)	40.0 0.047	98.0 Cu (Tn)	32 W 0.003	13 W -40 TO +100	\$4.51 \$3.88	\$4.19 \$3.61
PE-SR401AL (3,12)	50Ω 1	3000 0.064	29.6 0.209	70.0% PTFE (S)	8.0 0.250	21.0 Al (Tn)	1400 W 0.06	680 W -55 TO +125	\$10.55 \$9.07	\$9.81 \$8.44
PE-SR401FL (16)	50Ω 1	5000 0.065	29.6 0.21	70.0% PTFE (S)	7.0 0.250	18.0 Cu (Tn)	1400 W 0.08	680 W -55 TO +200	\$9.49 \$8.16	\$8.83 \$7.59
PE-SR402-75 (4,13)	75Ω 1	1500 0.020	19.3 0.118	69.5% PTFE (S)	12.5 0.141	30.5 Cu	280 W 0.031	114 W -55 TO +125	\$5.04 \$4.33	\$4.69 \$4.03

CONTINUED ON NEXT PAGE WITH REFERENCE NOTES

# COAXIAL CABLE

MEETS OR EXCEEDS MIL-C-17 SPECIFICATIONS WHERE APPLICABLE  
(CONTINUED)

MODEL NO.	NOMINAL IMP.	MAX. VOLTAGE (V RMS)	CAPACITANCE pF / FT.	VELOCITY FACTOR	ATTENUATION AT		AVER. POWER HANDLING		PRICE PER FOOT	
	NO. OF SHIELDS	CONDUCTOR DIAM. (in) [strands]	NOMINAL DIELECTRIC DIAM. (in)	DIELECTRIC MATERIAL	1 GHz dB/100FT	5 GHz dB/100FT	AT 1 GHZ (WATTS)	AT 5 GHZ (WATTS)	50-99FT	100-249FT
					NOMINAL JACKET DIAM. (in)	JACKET MATERIAL	WEIGHT LBS/FT	OPERATING TEMP. RANGE, °C	PRICE PER FOOT 250-499FT	500+ FT
PE-SR402AL (4,15)	50Ω	2500	29.9	69.5%	13.0	31.0	450 W	180 W	\$5.14	\$4.78
	1	0.036	0.118	PTFE (S)	0.141	Al (Tn)	0.019	-55 TO +125	\$4.42	\$4.11
PE-SR402FL (9)	50Ω	1900	29.0	69.5%	12.0	29.0	450 W	180 W	\$4.71	\$4.38
	1	0.036	0.118	PTFE (S)	0.141	Cu (Tn)	0.025	-40 TO +125	\$4.05	\$3.77
PE-SR405AL (4,14)	50Ω	2000	32.0	69.5%	23.0	51.0	130 W	54 W	\$4.76	\$4.43
	1	0.020	0.066	PTFE (S)	0.085	Al (Tn)	0.007	-55 TO +125	\$4.09	\$3.81
PE-SR405FL (10)	50Ω	1500	29.0	69.5%	22.0	50.0	130 W	54 W	\$6.65	\$6.18
	1	0.020	0.063	PTFE (S)	0.085	Cu (Tn)	0.013	-40 TO +125	\$5.72	\$5.32
PE-T100A (25)	50Ω	500	30.8	66.0%	23.5	60.0	45 W	12 W	\$1.15	\$1.07
	2	0.018	0.06	PE (S)	0.110	PVC	0.009	-40 TO +85	\$0.99	\$0.92
PE-T195 (24)	50Ω	1000	24.3	80.0%	11.5	26.5	150 W	65 W	\$0.95	\$0.88
	2	0.037	0.11	PE (F)	0.195	PE	0.022	-40 TO +85	\$0.82	\$0.76
PE-T200 (18)	50Ω	1000	24.5	83.0%	11.0	19.0	170 W	75 W	\$2.72	\$2.53
	2	0.044	0.116	PE (F)	0.195	PE	0.022	-40 TO +85	\$2.34	\$2.18
PE-T240 (23)	50Ω	1500	24.2	84.0%	8.0	19.0	250 W	120 W	\$1.92	\$1.79
	2	0.056	0.15	PE (F)	0.240	PE	0.034	-40 TO +85	\$1.65	\$1.54
PE-T300 (19)	50Ω	2000	24.1	85.0%	6.5	15.5	350 W	150 W	\$1.68	\$1.56
	2	0.070	0.19	PE (F)	0.300	PE	0.055	-40 TO +85	\$1.44	\$1.34
PE-T400 (20)	50Ω	2500	23.9	85.0%	4.5	10.0	550 W	240 W	\$3.35	\$3.12
	2	0.109	0.285	PE (F)	0.405	PE	0.07	-40 TO +85	\$2.88	\$2.68
PE-T500 (21)	50Ω	3000	23.6	86.0%	3.5	8.5	720 W	280 W	\$2.55	\$2.37
	2	0.142	0.37	PE (F)	0.500	PE	0.1	-40 TO +85	\$2.19	\$2.04
PE-T600 (22)	50Ω	4000	23.4	87.0%	3.0	7.0	900 W	350 W	\$3.79	\$3.52
	2	0.176	0.455	PE (F)	0.590	PE	0.135	-40 TO +85	\$3.26	\$3.03
PE-T002RML (18)	50Ω	1000	24.5	83.0%	11.0	19.0	170 W	75 W	\$2.72	\$2.53
	2	0.044	0.116	PE (F)	0.195	PE	0.022	-40 TO +85	\$2.34	\$2.18
PE-T003RML (19)	50Ω	2000	24.1	85.0%	6.5	15.5	350 W	150 W	\$1.68	\$1.56
	2	0.070	0.19	PE (F)	0.300	PE	0.055	-40 TO +85	\$1.44	\$1.34
PE-T004RML (20)	50Ω	2500	23.9	85.0%	4.5	10.0	550 W	240 W	\$3.35	\$3.12
	2	0.109	0.285	PE (F)	0.405	PE	0.07	-40 TO +85	\$2.88	\$2.68
PE-T005RML (21)	50Ω	3000	23.6	86.0%	3.5	8.5	720 W	280 W	\$2.55	\$2.37
	2	0.142	0.37	PE (F)	0.500	PE	0.1	-40 TO +85	\$2.19	\$2.04
PE-T006RML (22)	50Ω	4000	23.4	87.0%	3.0	7.0	900 W	350 W	\$3.79	\$3.52
	2	0.176	0.455	PE (F)	0.590	PE	0.135	-40 TO +85	\$3.26	\$3.03
PE-T042RML (23)	50Ω	1500	24.2	84.0%	8.0	19.0	250 W	120 W	\$1.92	\$1.79
	2	0.056	0.15	PE (F)	0.240	PE	0.034	-40 TO +85	\$1.65	\$1.54
PE-T591RML (24)	50Ω	1000	24.3	80.0%	11.5	26.5	150 W	65 W	\$0.95	\$0.88
	2	0.037	0.11	PE (F)	0.195	PE	0.022	-40 TO +85	\$0.82	\$0.76

## NOTES:

- (1) P = PLENUM CABLE, NEC 725-2(b) CLASS 2 - REQUIRES SPECIAL CONNECTORS
- (2) TWINAXIAL CABLE SIMILAR TO BELDEN 9207\*\*
- (3) SEMI-RIGID CABLE, SOLD IN 5 FEET STRAIGHT PIECES ONLY
- (4) SEMI-RIGID CABLE, SOLD IN EITHER 5 FEET STRAIGHT PIECES OR COILS OF 50 FEET
- (5) SIMILAR TO BELDEN 8281\*\*
- (6) SIMILAR TO BELDEN 9913\*\*
- (7) SIMILAR TO BELDEN 9914\*\*
- (8) SIMILAR TO BELDEN 8218\*\*
- (9) RE-SHAPEABLE VERSION OF RG402/U
- (10) RE-SHAPEABLE VERSION OF RG405/U
- (11) TINNED ALUMINUM VERSION OF PE-047SR
- (12) TINNED ALUMINUM VERSION OF RG401/U
- (13) BARE COPPER JACKET
- (14) TINNED ALUMINUM VERSION OF RG405/U
- (15) TINNED ALUMINUM VERSION OF RG402/U
- (16) RE-SHAPEABLE VERSION OF RG401/U
- (17) RE-SHAPEABLE VERSION OF PE-047SR
- (18) SIMILAR TO LMR200\*
- (19) SIMILAR TO LMR300\*
- (20) SIMILAR TO LMR400\*
- (21) SIMILAR TO LMR500\*
- (22) SIMILAR TO LMR600\*

## NOTES: (CONT'D)

- (23) SIMILAR TO LMR240\*
- (24) SIMILAR TO LMR195\*
- (25) SIMILAR TO LMR100A\*
- (26) SIMILAR TO BELDEN 1855A\*\*

## MATERIALS:

Al (Tn)	TIN PLATED ALUMINUM
Cu	BARE COPPER
Cu (Tn)	TIN PLATED COPPER
FEP	FLUORINATED ETHYLENE PROPYLENE
PE	POLYETHYLENE
PE (A)	AIR-SPACE SOLID PE
PE (AS)	AIR-SPACE SEMI-SOLID PE
PE (F)	FOAM PE
PE (S)	SOLID PE
PTFE	POLYTETRAFLUOROETHYLENE
PTFE (A)	AIR-SPACE SOLID PTFE
PTFE (LD)	LOW-DENSITY PTFE
PTFE (S)	SOLID PTFE
PTFE (FR)	FIBERGLASS REINFORCED PTFE
PVC	POLYVINYLCHLORIDE

\* LMR® IS A REGISTERED TRADEMARK OF TIMES MICROWAVE SYSTEMS

\*\* BELDEN® IS A REGISTERED TRADEMARK OF BELDEN CDT INC.

# COAXIAL CABLE CUTTING TOOL

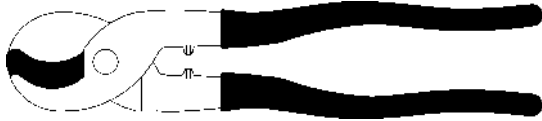

MODEL NO.	P R I C E			
	1-24	25-49	50-99	100 +
PE5200	\$62.65	\$58.26	\$53.88	\$50.12

**HEAVY DUTY TOOL SPECIFICALLY DESIGNED FOR CUTTING COAXIAL CABLE**

# PRESET TORQUE WRENCHES

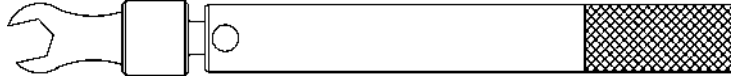

Model No.	DESCRIPTION	PRESET TORQUE	HEX SIZE	P R I C E			
				1-24	25-49	50-99	100 +
PE5011-1	SMA/2.92mm/3.5mm	8 IN. LBS	5/16	\$151.40	\$140.80	\$130.20	\$121.12
PE5011-2	SMC	3 IN. LBS	1/4	208.95	194.32	179.70	167.16
PE5011-3	7mm	14 IN. LBS	3/4	208.95	194.32	179.70	167.16
PE5011-4	TNC (HEX NUT)	14 IN. LBS	5/8	208.95	194.32	179.70	167.16
PE5011-5	SSMA	8 IN. LBS	1/4	208.95	194.32	179.70	167.16
PE5011-6	N/SC (HEX NUT)	14 IN. LBS	13/16	208.95	194.32	179.70	167.16

# **NEW** COAXIAL COMPRESSION TOOL

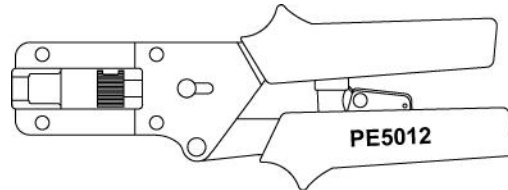

Model No.	DESCRIPTION	P R I C E			
		1-24	25-49	50-99	100 +
PE5012	RG6, RG11 & RG59 COMPRESSION CONNECTORS	\$99.95	\$92.95	\$85.96	\$79.96

# SCREWS

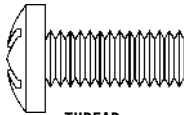

Model No.	THREAD SIZE	HEAD TYPE	LENGTH INCHES	MATERIAL	100 PIECES PER PACKAGE PRICE PER PACKAGE	
					1-24	25-49
PE1004-1	3-56	PHILLIPS	1/4"	STAINLESS STEEL	\$20.85	\$19.39
PE1004-2	3-56	PHILLIPS	3/8"	STAINLESS STEEL	20.85	19.39
PE1004-3	3-56	PHILLIPS	1/2"	STAINLESS STEEL	20.85	19.39
PE1005-1	4-40	PHILLIPS	1/4"	STAINLESS STEEL	20.85	19.39
PE1005-2	4-40	PHILLIPS	3/8"	STAINLESS STEEL	20.85	19.39
PE1005-3	4-40	PHILLIPS	1/2"	STAINLESS STEEL	20.85	19.39
PE1006-1	4-40	PHILLIPS	1/4"	ZINC PLATED	20.85	19.39
PE1006-2	4-40	PHILLIPS	3/8"	ZINC PLATED	20.85	19.39
PE1006-3	4-40	PHILLIPS	1/2"	ZINC PLATED	20.85	19.39

# NUTS

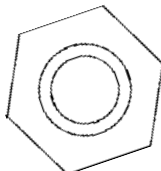

Model No.	THREAD SIZE	MATERIAL	100 PIECES PER PACKAGE PRICE PER PACKAGE	
			1-24	25-49
PE1007	3-56	STAINLESS STEEL	\$13.05	\$12.14
PE1008	4-40	STAINLESS STEEL	13.05	12.14
PE1009	4-40	ZINC PLATED	11.95	11.11

# COAXIAL CRIMPING TOOLS

THESE RATCHET CONTROLLED CRIMP TOOLS ARE DESIGNED TO PROVIDE CONSISTENT, RELIABLE HEX CRIMP TERMINATIONS TO INDUSTRY SPECIFICATIONS ON A WIDE RANGE OF COAX CONNECTORS. A UNIQUE RATCHET RELEASE MECHANISM IS PROVIDED TO ALLOW REMOVAL OF AN INCORRECTLY PLACED CONNECTOR OR CRIMP RING PRIOR TO COMPLETING THE CRIMP CYCLE.

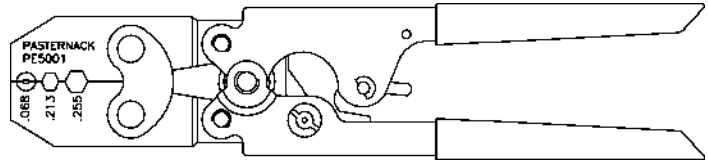

P R I C E			
1-24	25-49	50-99	100 +
\$94.60	\$87.98	\$81.36	\$75.68

Model No.	FOR CABLE SERIES	HEX CAVITY SIZES			
PE5001	RG55, RG58, RG59, RG62, RG142, RG223 & RG400	.068	.213	.255	
PE5006	RG174, RG179, RG180, RG187, RG188, RG195 & RG316	.068	.100	.128	.178
PE5007	RG9, RG11, RG87A, RG149, RG165, RG213, RG214, RG216, RG225 & RG393	.100	.429		

## Model No. PE5004-KIT

FULL CYCLE INTERCHANGEABLE DIE CRIMPING TOOL. COMPLETE KIT IN STORAGE CASE.

P R I C E			
1-24	25-49	50-99	100 +
\$258.40	\$240.31	\$222.22	\$206.72

THIS KIT CONTAINS DIES HAVING THE FOLLOWING HEX SIZES: .042, .068, .080, .100, .128, .151, .178, .213, .255, .324 & .429

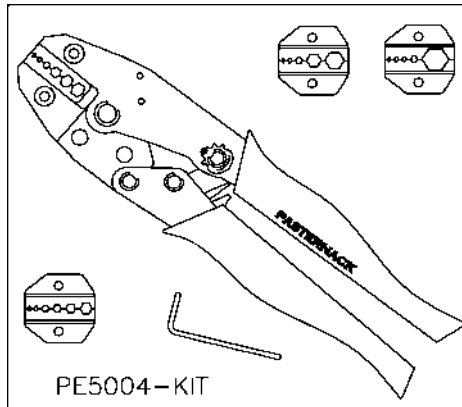

THIS CRIMPING TOOL KIT CONSISTS OF A FULL CYCLE, RATCHET CONTROLLED CRIMP TOOL FRAME, 4 INTERCHANGEABLE SETS OF DIES AND A STORAGE CASE.

CRIMPS COAXIAL CONNECTORS ON THE FOLLOWING SERIES OF COAXIAL CABLE: RG5, RG6, RG8, RG9, RG11, RG21, RG55, RG58, RG59, RG62, RG87A, RG140, RG141, RG142, RG143, RG165, RG174, RG179, RG180, RG187, RG188, RG195, RG210, RG212, RG213, RG214, RG216, RG222, RG223, RG225, RG303, RG304, RG316, RG393 & RG400

## PRODUCTION GRADE CRIMPING TOOLS

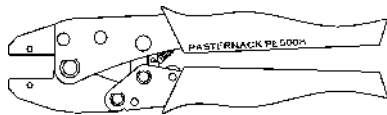

SCISSOR  
PE5008  
PRICE  
\$104.50



STRAIGHT  
PE5009  
PRICE  
\$130.65

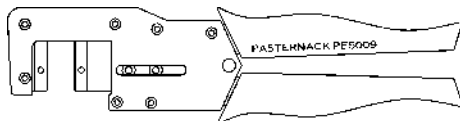

### SPECIFICATIONS

THESE RATCHET CONTROLLED TOOLS ARE DESIGNED TO PROVIDE CONSISTENT, RELIABLE HEX CRIMP TERMINATIONS TO INDUSTRY SPECIFICATIONS. THESE TOOLS ARE MADE OF FORGED STEEL TO HANDLE YEARS OF PRODUCTION. DIES MUST BE PURCHASED SEPARATELY. \*(SEE RIGHT)\*

## \*INTERCHANGEABLE DIES\*

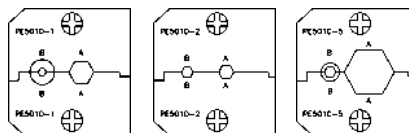

PRICE: \$82.55				
MODEL NO.	HEX A	LENGTH A	HEX B	LENGTH B
PE5010-1	.213	.400	.068	.093
PE5010-2	.128	.325	.100	.325
PE5010-3	.255	.400	.068	.093
PE5010-4	.178	.400	.068	.093
PE5010-5	.429	.400	.100	.120
PE5010-6	.314	.400	.151	.400

THESE DIES ARE HEAT-TREATED, NICKEL-PLATED STEEL. NO ADJUSTMENT IS REQUIRED WHEN CHANGING DIES. SETUP IS QUICK.



# MOUNTING HOLES

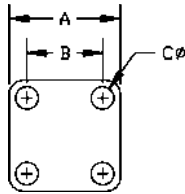

CODE	A	B	C
A01	.500	.340	.102
A02	.687	.500	.109
A03	.687	.500	#3-56 TAP
A04	.687	.500	.125
A05	1.000	.718	.125
A06	.750	.531	.140
A07	.750	.531	.125
A08	1.190	.906	.125
A09	.687	.500	#4-40 TAP
A10	.687	.500	.136
A11	1.250	.975	.147
A12	2.000	1.440	.257
A13	1.000	.718	.141
A14	1.000	.718	.144
A15	.687	.500	.104
A16	.750	.531	.136
A17	.375	.232	.067
A18	.625	.437	.094
A19	1.000	.718	#6-32 TAP
A20	.500	.340	#2-56 TAP
A21	1.250	.975	.142
A22	.375	.232	.093

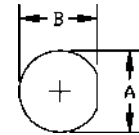

CODE	A	B
B01	.195	.177
B02	.250	.235
B03	.330	.295
B04	.380	.350
B05	.440	.410
B06	.500	.475
B07	.760	.720
B08	.565	.537
B09	.312	.295
B10	.140	.126
B11	.695	.655
B12	.625	.575
B13	.405	.361
B14	.277	.252
B15	.630	.596
B16	.317	.285
B17	.284	.268

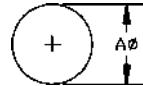

CODE	A
F01	.250
F02	.500
F03	.630
F04	1.200
F05	.380
F06	.450
F07	.200
F08	.362
F09	.220
F10	.317
F11	4.83mm

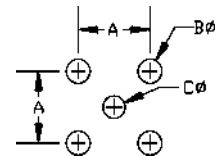

CODE	A	B	C
D01	.200	.067	.062
D02	.200	.067	.046
D03	.100	.031	.031
D04	.200	.052	.052
D05	.260	.067	.043
D06	.200	.052	.047
D07	.200	.055	.043
D08	.200	.067	.035
D09	.200	.055	.028
D10	.200	.055	.035
D11	.320	.091	.031
D12	.400	.062	.062
D13	.320	.091	.091
D14	.340	.091	.043
D15	.164	.067	.091
D16	.500	.126	.440

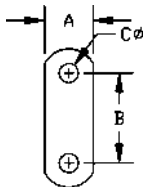

CODE	A	B	C
C01	.223	.481	.102
C02	.260	.481	.102
C03	.192	.328	.067
C04	.640	1.000	.125
C05	.275	.481	.102
C06	.230	.354	.067
C07	.188	.328	.093

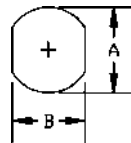

CODE	A	B
G01	.640	.546
G02	.380	.340
G03	.765	.712
G04	.362	.323
G05	.236	.197
G06	.217	.177
G07	.380	.310
G08	1.161	1.000

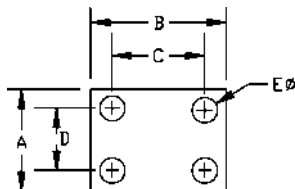

CODE	A	B	C	D	E
E01	.375	.500	.340	.222	.093

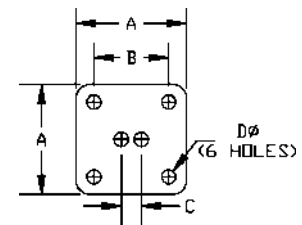

CODE	A	B	C	D
H01	.687	.500	.125	.045

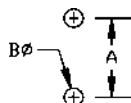

CODE	A	B
J01	.200	.046

# Customer Satisfaction Survey

Please evaluate the level of service you have experienced at our company, as we want to ensure that you receive an Excellent Customer Experience at Pasternack. Please fax your response to +91 9810138894 or Email- pradeep @rfconnectorhouse.com, and thank you for your time and consideration in helping us to improve!

Customer Service	Excellent	Good	Average	Poor	Very Poor
1. Please rate your overall satisfaction with the customer service at our company.					
2. Please rate the courtesy of our staff.					
3. Please rate the knowledge of our technical support staff.					
4. Please rate our staff on their enthusiasm for helping customers.					
5. Please rate our staff on their overall ability to make customers feel valued.					
6. Please rate our staff on expressing gratitude for your business.					
7. Based only on our customer service, would you recommend our company to friends & colleagues?	YES		NO		
<b>Operations and Product Delivery</b>					
8. Please rate our Product Quality.					
9. Please rate your satisfaction with our Order Delivery.					
10. Please rate your satisfaction with our Pricing.					
11. Please rate our Product Availability.					
12. Please rate your satisfaction with our Catalog.					
13. Please rate your satisfaction with our Website.					
<b>How Do We Compare to the Market</b>	Best	Better	Same	Worse	Worst
14. Overall, how does our company's customer service compare to that of our competitors? Are we...					
15. Overall, how does our customer service compare to what it was 12 months ago? Is it...					
16. Please tell us about any instances of dissatisfaction you have experienced with the staff at our company.					
17. Please provide one way that our staff can improve the service that our company provides to customers.					
18. What other Products or Product Categories would you like us to provide?					