

ALPINE



ALPINE FUTURE TOUR

ENSTONE FIELD TRIP

26.06.2023

LUCA DE MEO

CEO, Renault Group

RENAISSANCE

RESURRECTION
Achieved in advance



RENOVATION
Already secured



REVOLUTION
Time to accelerate



2020

2021

2022

2023

2024

2025

NEXT-GENERATION ORGANIZATION

5 SPORTS AND NEW RULES OF THE GAME



ICE &
HYBRID



Scale



EV &
SOFTWARE



Technology



FINANCING,
ENERGY & MOBILITY



Client
lifecycle



CIRCULAR
ECONOMY



Access
to materials
& Process
Technology



HIGH-END



Brand
Move
upmarket

STRATEGIC
ISSUES

HERITAGE, SPORTY, GLOBAL, ELECTRIC RINGS A BELL?



AIMING FOR THE PODIUM

Sales development

 **#1**
Sports car in France

 **Sales x2**
(2022 vs. 2020)

 **3,500**
units sold in 2022

Partnerships attractivity

 **Capital investment**
in **Alpine Racing Ltd**

 **Miami partnership**
with **AutoNation**

Brand awareness

 **Brand Value¹**
>€550M

Breaking into the
most valued brands
in France

ALPINE AMBITION IS STRAIGHTFORWARD

Internationally growing high-end anchor

Revenue

- △ 40% CAGR (revenue) 2023-2030
- △ €2bn revenue in 2026
- △ >€8bn revenue in 2030

Operating margin

- △ Breakeven in 2026
- △ >10% in 2030

Main ESG targets

- △ 100% electric line-up by end 2026
- △ Net zero carbon production in 2030

LAURENT ROSSI

CEO, Alpine

ALPINE



01

MADE BY RACERS, FROM DAY 1

RACING AT THE CORE



BORN FROM
RACING

An equity built on motorsport excellence since 1955, currently undergoing a new hype



MADE BY
RACERS

A team of passionate professionals, designing tech innovations from track to road



FOR
RACERS@HEART

An undeniable brand legitimacy to tap into a huge pool of audience

MOTORSPORT AS FUNDAMENTAL DNA



BORN FROM RACING

1955

Founded in 1955
by French racing driver
Jean Rédélé

10

Victories at the 24h
of Le Mans, first one
in 1964, latest one in 2019

1973

First constructor
to win the World Rally
Championship, in 1973

I had the most fun when I was zipping around the Alps in my Renault 4 CV. I therefore decided to call my future cars "Alpine". My customers had to find this same pleasure at the wheel of the car that I wanted to build

Jean Rédélé, founder of Alpine

LIVING UP TO THE LEGACY



MADE BY
RACERS



Racing
Engineering



Sportscar
Engineering



Specialty
Manufacturing

50% engineers in total workforce

UNDENIABLE BRAND LEGITIMACY



FOR

RACERS@HEART

For whom **Life is a Race...**
... seeking **self-realization, exhilaration and performance**

UNIQUE BRAND POSITIONING

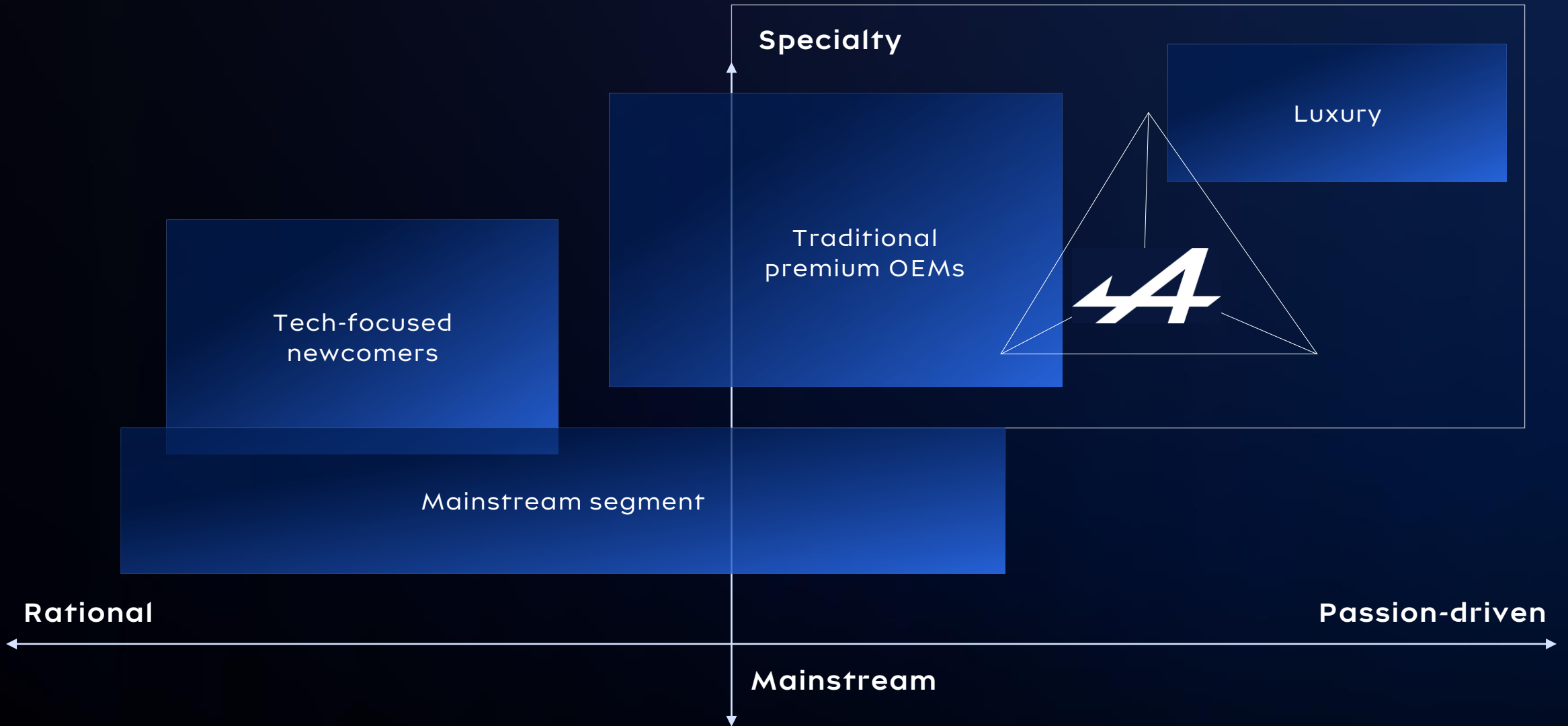

CAPITALIZING ON OUR ICONIC A110



Best-in-class specs & agility

~300kg lighter
than Porsche Cayman

0-100 km/h in < 4s¹



Unique know-how & technology

Aluminum rivet bonding
know-how

30% less CO₂ emissions⁴



The reference of the market

1st most sold 2-seater coupé
in Europe²

8 prestigious awards in 2022³

We are in awe of its **poise and balance**, admire its precision and delicacy, and appreciate its **design and engineering**. A triumph of fun over speed, of engineering over brute force

Top Gear, "Alpine A110: TG mag's Sports Car of the Year"

¹ Specs for Alpine A110 R

² 1st most sold 2-seater in Europe in 2022 according to IHS March 2023, ahead of Porsche Cayman

³ Including "Sports Car of the Year" for A110 S (MororSport, France), "Best Cars 2022 Award" for A110S (Auto Motor und Sport, Germany), "Most iconic model" for A110 (Grand Prix Auto Moto, France)

⁴ vs competitors

ALWAYS AIMING UP

>7-MONTH ORDER BANK

Sales, in units



SUCCESS FUELING BRAND VALUE

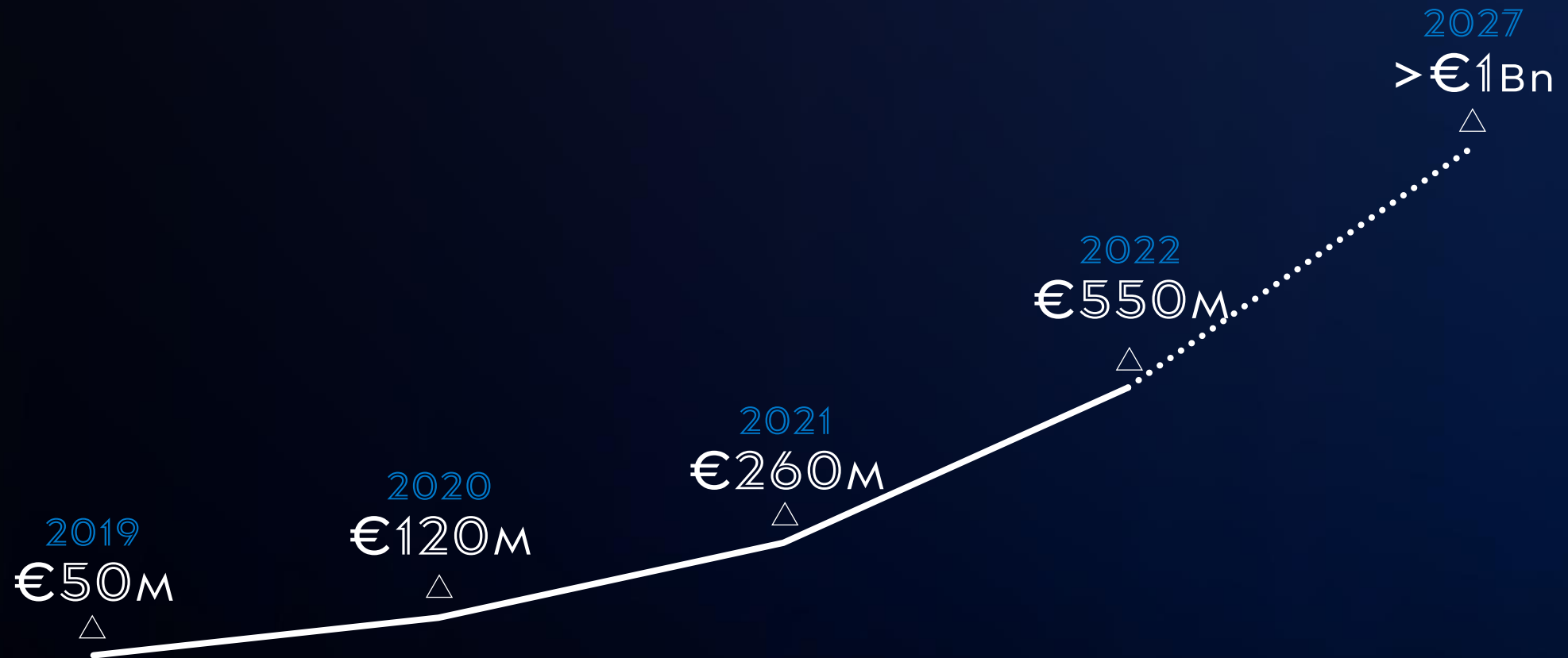

ALPINE



02

BUILDING A GLOBAL BRAND

MOTORSPORT PIVOTAL IN BUSINESS MODEL

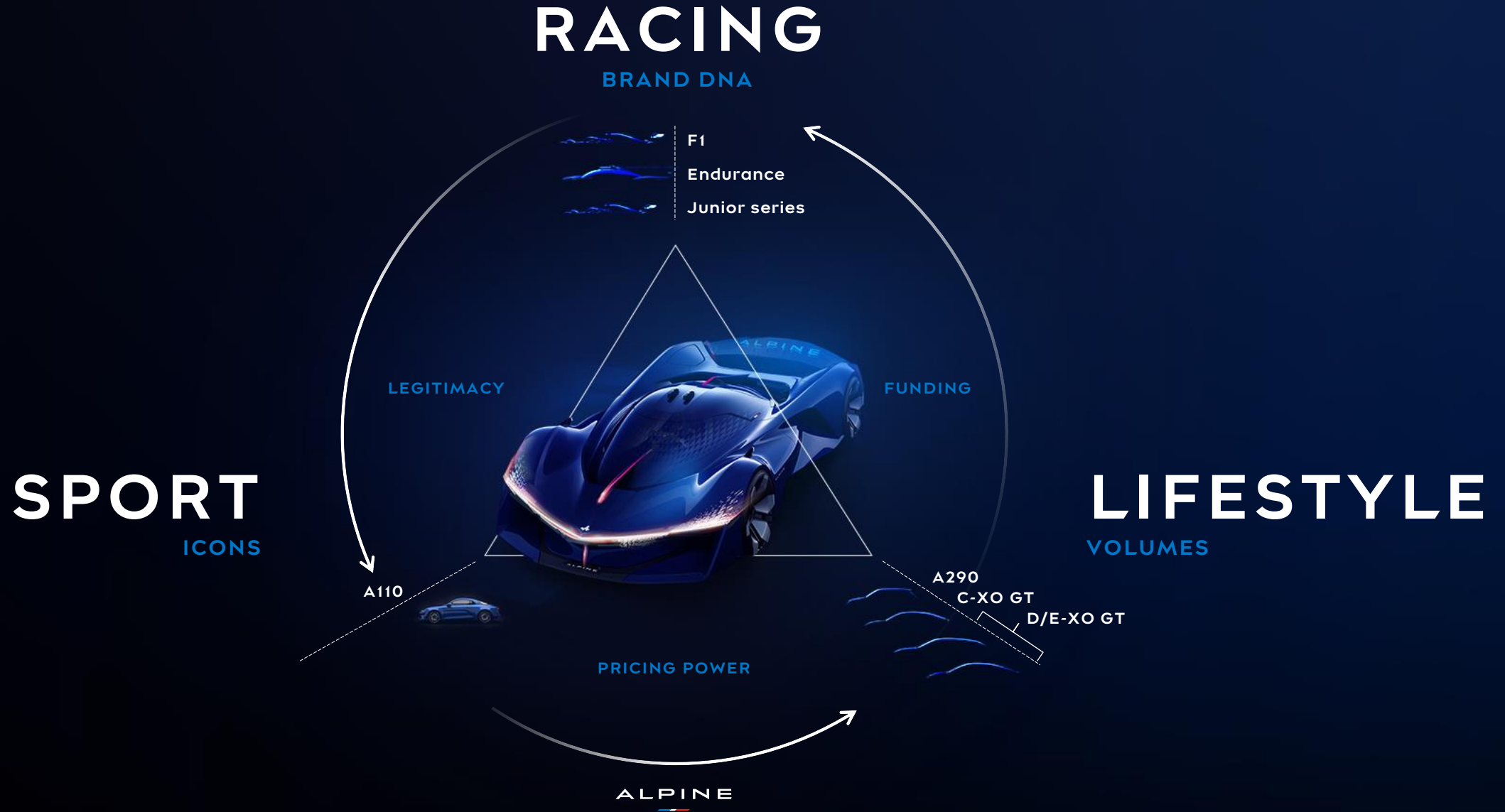

A110: PERPETUATING EXCELLENCE



OUR CHASSIS, OUR SAVOIR-FAIRE



**"I WANT TO ELECTRIFY ALPINE TO ENSHRINE IT INTO
E-TERNITE"**



ANNOUNCING APP, ALPINE PERFORMANCE PLATFORM



APP TO KEEP AGILITY AT HEART OF A110...



... AND ITS SISTER, THE ROADSTER



EXPANDING THE PLAYGROUND WITH A310



APP TO ALLOW FOR FURTHER LINE-UP EXPANSION

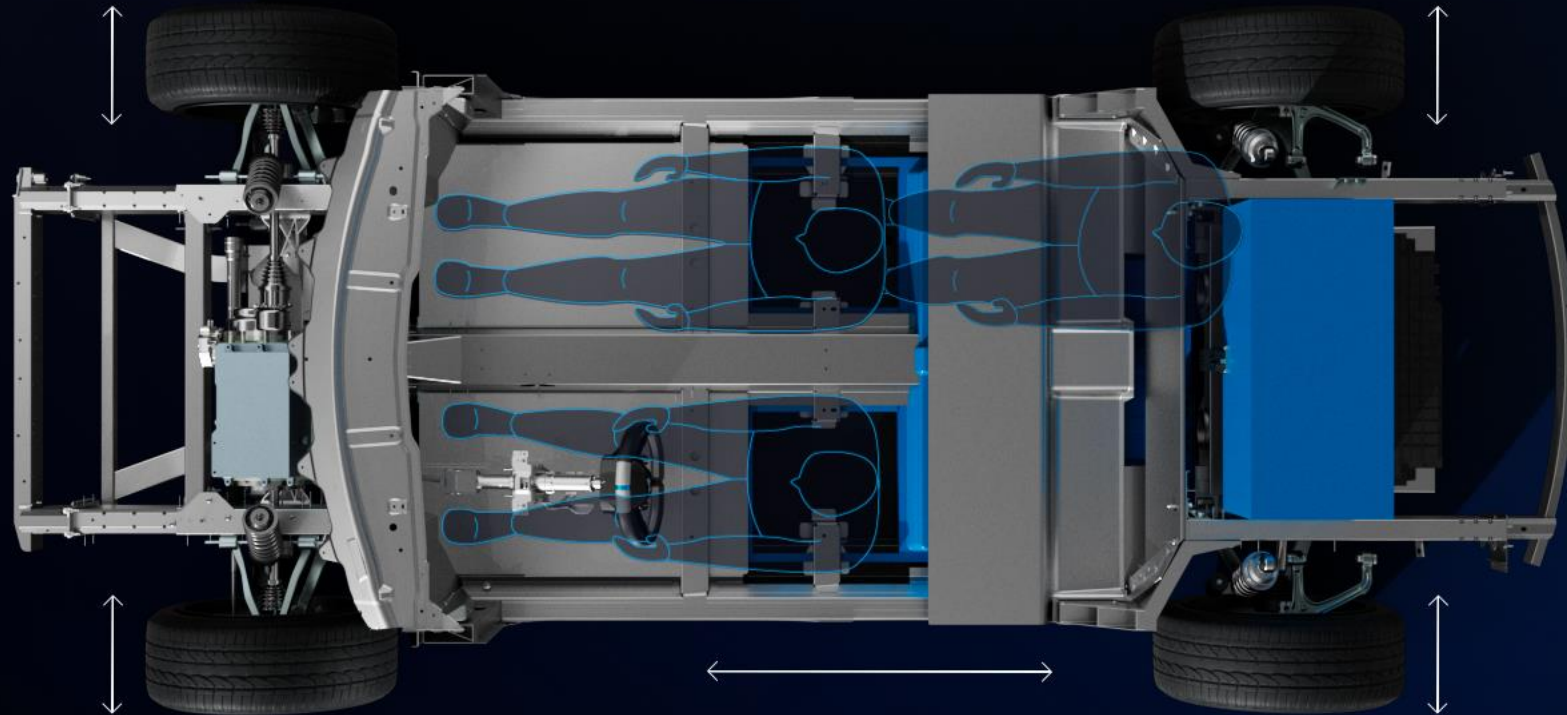

A COMPREHENSIVE LINE-UP TO SUPPORT OUR AMBITIONS

RACING

BRAND DNA

SPORT

ICONS

At the core of Alpine DNA
Control of core-technology

LIFESTYLE

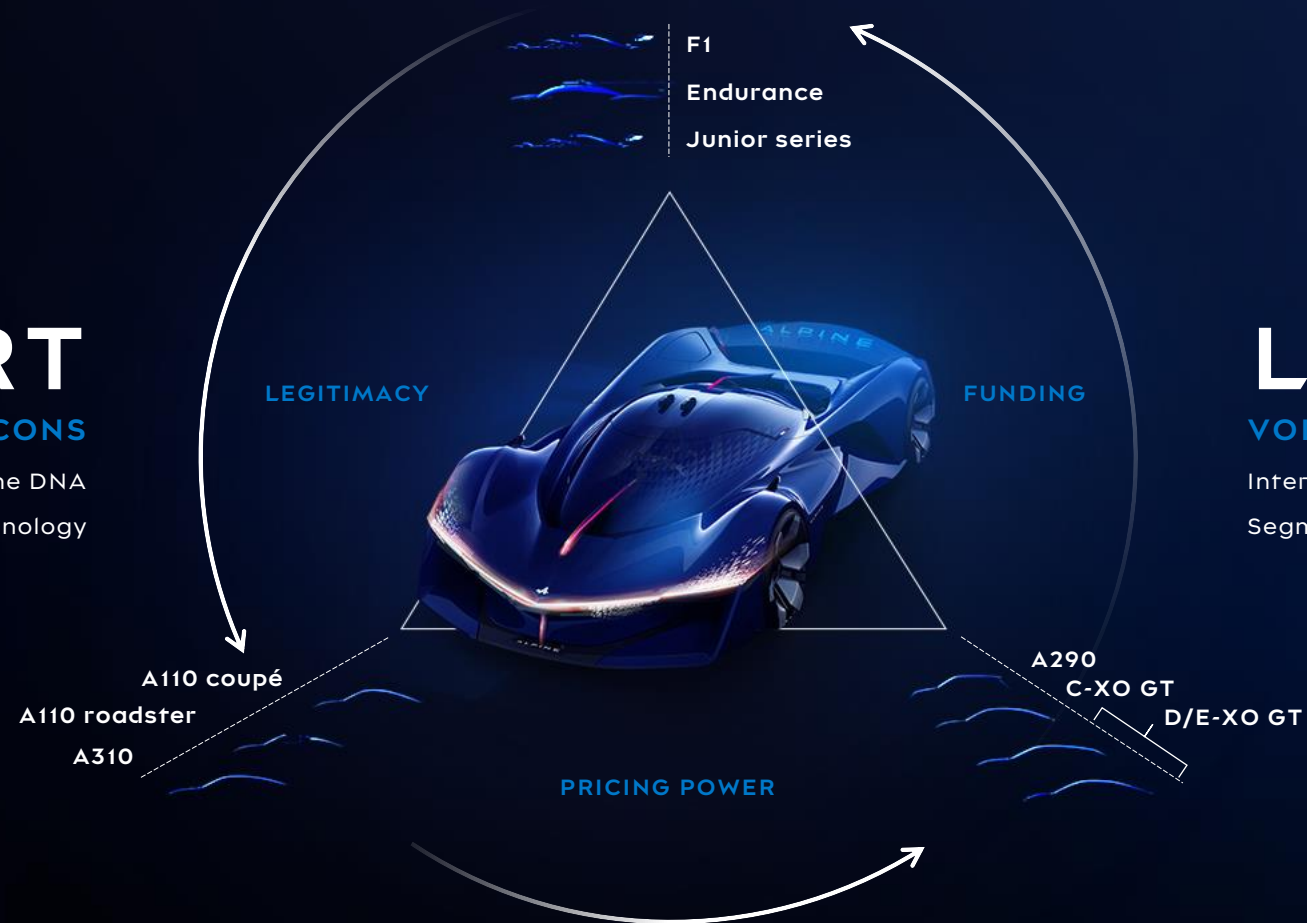

VOLUMES

International expansion
Segment coverage









A PRODUCT PORTFOLIO TO EXPAND GLOBALLY...

SPORT LINE-UP

| Model | 2023 | 2024 | 2025 | 2026 | 2027 | 2028 | 2029 | 2030 | |
|---------------------|---|---|------|---|---|---|---|------|--|
| A110 |  |  | → | | | | | | |
| A110 Coupe/Roadster |  | | |  |  | → | | | |
| A310 |  | | | | |  |  | → | |

LIFESTYLE LINE-UP

| | | | | | | | | |
|-----------|---|---|--|---|---|---|---|--|
| A290 |  |  | → | | | | | |
| C-XO GT |  | |  | → | | | | |
| D/E-XO GT |  | | | |  |  | → | |

... AND INCREASE OUR MARKET COVERAGE

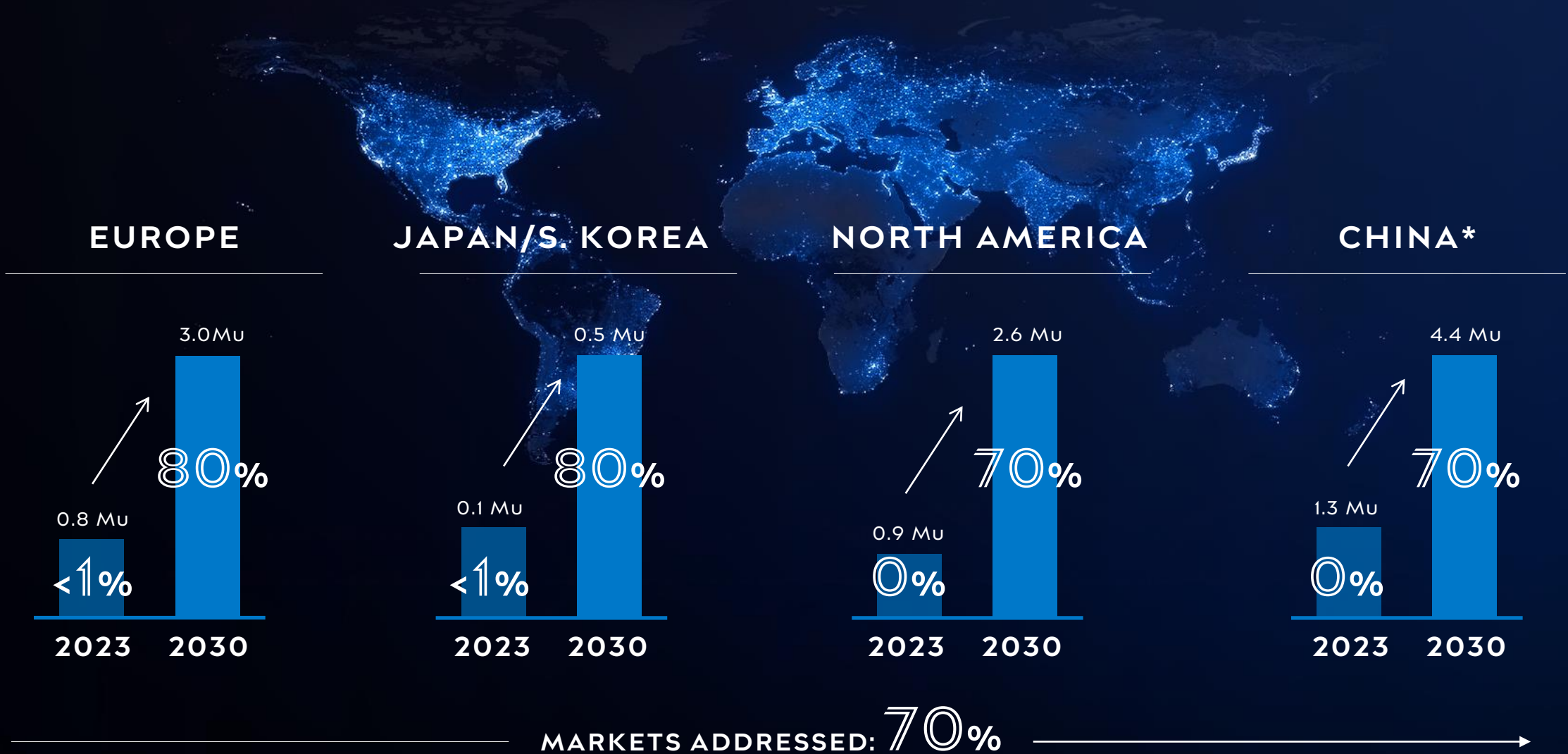

SOURCE: Market Research

Note: Premium EV volumes in Mu & Alpine market coverage in %

* China as an opportunity

A 2-FOLD EXPANSION TO GROW PROFITS



Note: Addressed Profit Pool in €Bn (A110-specific in 2023, EV Premium in 2030)

ALPINE



03

BUILT FOR SUCCESS

AN ASSET-LIGHT MODEL



TAPPING INTO PARENT GROUP'S STRONG ECOSYSTEM



AMPERE

TECH & FACTORIES

Scale effect on CMF-platforms, access to state-of-the-art EV plants & software technologies

ElectriCity



FINANCIAL SERVICES

THROUGH OUR OWN CAPTIVE

Expertise from Møbilize
Financial Services globally

MØBILIZE

ALPINE



INDUSTRIAL NETWORK

GLOBALLY

Access to engineering centers
and industrial assets

Renault
Group

COMPLEMENTED BY BEST-IN-CLASS PARTNERS

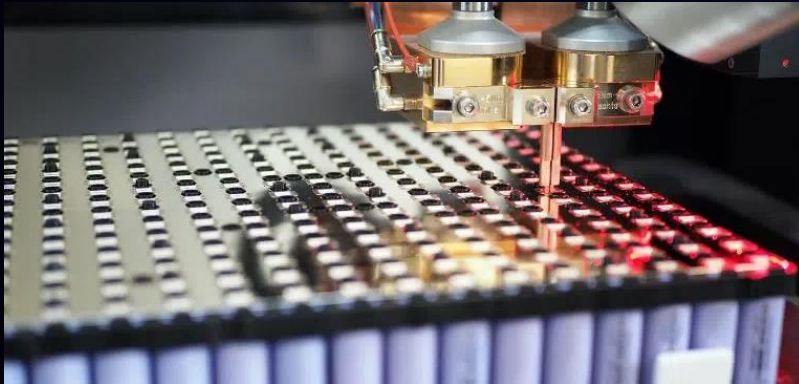

HIGH-PERFORMANCE

CHEMISTRY

Long-term commercial partnership for high-performance, low-carbon batteries



BENCHMARK

CONNECTIVITY

Extensive partnership to shift towards software-defined vehicle



SPORT

FRANCHISE

Strategic partner to boost sport franchise business potential



BUILDING A MOTORSPORT FRANCHISE

ALPINE BRAND

PARTNERSHIP

COMMUNICATION

MARKETING

ALPINE CARS



MOTORSPORT FRANCHISE



eSport

GT4

Formula 1

WEC / Le Mans

Rallye

INCREDIBLE F1 MOMENTUM



A FAVORABLE FRANCHISE CONTEXT

\$1.2Bn

Increasing F1 revenues⁽¹⁾

<\$300M

Cost cap on chassis & power unit

+20%

Increasing sponsoring revenues

>€0.5Bn

3rd party financial investments in F1⁽²⁾

Note: ⁽¹⁾ amount paid to the teams
⁽²⁾ over the past 5 years

ALPINE F1 BUILT ON SOLID FOUNDATIONS



A WORLD-CLASS TEAM

4x driver championships

3x constructor championships

63x GP victories

1 out of 4
Works teams

46 years
Long-term
commitment

THE RIGHT PARTNERS FOR ALPINE RACING FRANCHISE



OTRO / CAPITAL

REDBIRD
CAPITAL PARTNERS

MAXIMUM EFFORT



ONETEAM

 ON LOCATION
EXPERIENCES
Official Hospitality of the NFL

FENWAY | SPORTS | GROUP



ZELUS

ALPINE

UNIQUE EXPERTISE

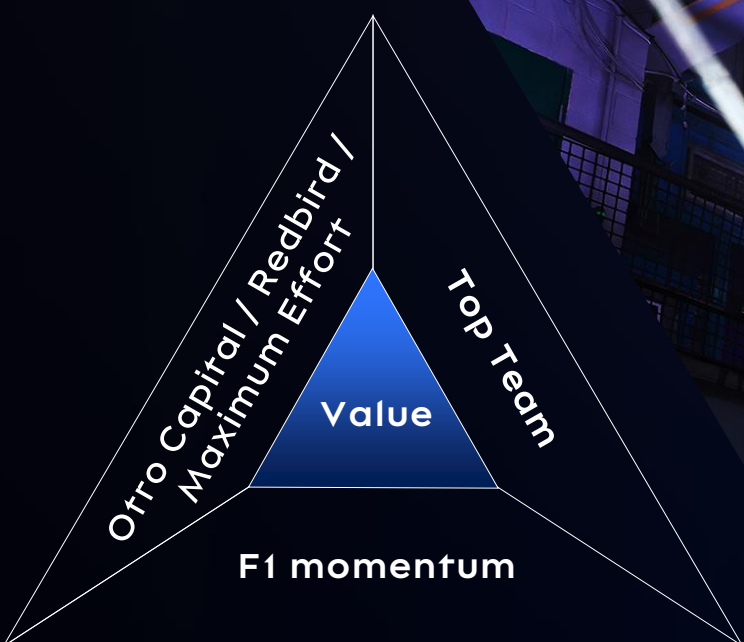

TO INCREASE MONETIZATION

Sponsoring
revenues

Licensing
& merchandising

Hospitality
& experience

FROM ASSET-LIGHT TO ASSET-RIGHT



FROM ASSET-LIGHT TO ASSET-RIGHT



ALPINE PERFORMANCE PLATFORM

Leverage distinctive aluminum know-how to develop state-of-the-art lightweight EV platform

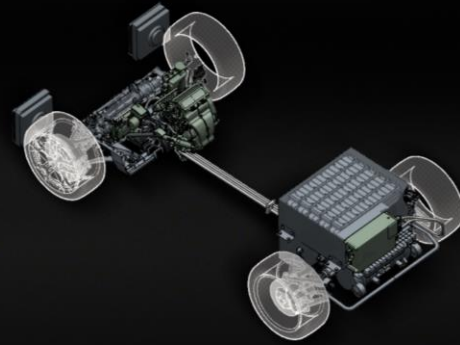

DYNAMIC MODULES

Central intelligence to drive & synchronize all chassis, powertrain, aerodynamics, thermal management systems



BREAKTHROUGH H2 POWERTRAIN

Combining engineering excellence for racing and road cars

ONLY CENTERS OF EXCELLENCE



Enstone



Viry



Les Ulis



ElectriCity



RG



Dieppe



ALPINE



04

BUSINESS OUTLOOK

ADDRESSING ALL 3 PILLARS OF SUSTAINABLE PERFORMANCE

EQUAL OPPORTUNITIES

Inclusion by chasing the best talents where they are

Ex: Rac(h)er program training 10 young female drivers + parity in top-management

Education by promoting STEAM careers

Ex: connections with local education ecosystems (10+ institutions)

Transmission of human and technical excellence

Ex: National mechanics contest open to >1k students

ALPINE

BUSINESS

PERENNITY

Heritage promotion with specific experiences

Forward-looking vision for business perennity

Tech for good through Alpine R&D Lab

ENVIRONMENTAL SUSTAINABILITY

Decarbonation of our motorsport & road car activities

Ex: Developing breakthrough Hydrogen engine technology

Regeneration of resources with circular value chains

Ex: line-up 100% upgradable over-the-air by end 2026

Preservation of ecosystems & biodiversity

Ex: Zero-deforestation sourcing by end 2030

ALPINE

EQUAL OPPORTUNITIES AS BASE PRINCIPLE



RAC(H)ER



CEMA



DRIVER ACADEMY

ENVIRONMENTAL SUSTAINABILITY ALONG THE VALUE CHAIN



**NET ZERO
PRODUCTION**



**100% ELECTRIC
LINE-UP**



**SUSTAINABLE
MATERIALS**

TECH FOR GOOD WITH ALPINE R&D LAB



SKI MOJO EXOSKELETON FOR

**SAFETY &
PERFORMANCE**



AQUALINES FOR

**ULTRA-FAST LOW CARBON
MARINE TRANSPORTATION**



IQ ENDOSCOPES FOR

**SMART HEALTH
SYSTEMS**

AQUALINES FOR ULTRA-FAST LOW CARBON MARINE TRANSPORTATION



Aqualines presentation

- ✓ French start-up developing a new generation of low carbon ultra-fast flying ships (electric/H₂ powered craft)
- ✓ Revolutionizing transportation over water through a complementary solution to planes & boats



Alpine undertaking

- ✓ Wind tunnel model production & aerodynamic testing
- ✓ Key expertise: design, manufacturing, electronics, wind tunnel testing
- ✓ Project duration: 3 months, from September to November 2022

IQ ENDOSCOPES FOR SMART HEALTH SYSTEMS



IQ Endoscopes presentation

- ✓ UK Medtech company developing a range of single use flexible endoscope system
- ✓ Solution helping accelerate the early detection of disease in a more sustainable & affordable manner than traditional technologies



Alpine undertaking

- ✓ Engineering design
- ✓ Key expertise: design, analysis
- ✓ **Project duration:** 2 months, from January to March 2023

SKI MOJO EXOSKELETON FOR SAFETY & PERFORMANCE

ski~mojo

ALPINE

Ski~mojo presentation

- ✓ French company producing a winter sports **exoskeleton**, improving safety, performance and reducing pain
- ✓ Product commercialized for several years in Europe, with ~20K users



Alpine undertaking

- ✓ Engineering design
- ✓ **Key expertise:** design, manufacturing, material science, stress analysis
- ✓ **Project duration:** +10 months, from September 2022 to July 2023

GROWING FROM NICHE TO GLOBAL BRAND



A PLAN CARRIED OUT BY A ROBUST & EXPERIENCED MANAGEMENT TEAM



>150-YEAR COMBINED
OF COMPREHENSIVE & GLOBAL
EXPERIENCE IN AUTOMOTIVE

STRATEGY
& VALUE-ORIENTED

KEY STRATEGIC RECRUITMENTS
FROM REFERENCE BRANDS
& INSTITUTIONS