

IBM Storage FlashSystem 5200 Product Guide for IBM Storage Virtualize 8.6

Hartmut Lonzer

Corne Lottering

Vasfi Gucer



Storage



IBM Storage FlashSystem 5200 product guide

This IBM® Redpaper product guide publication describes the IBM Storage FlashSystem (IBM FlashSystem®) 5200 solution, which is a next-generation IBM FlashSystem control enclosure. It is an NVMe end-to-end platform that is targeted at the entry and midrange market and delivers the full capabilities of IBM FlashCore® technology.

The IBM FlashSystem 5200 also provides a rich set of software-defined storage (SDS) features that are delivered by IBM Storage Virtualize, including the following features:

- ▶ Data reduction and deduplication
- ▶ Dynamic tiering
- ▶ Thin provisioning
- ▶ Snapshots
- ▶ Cloning
- ▶ Replication
- ▶ Data copy services
- ▶ Transparent Cloud Tiering
- ▶ IBM HyperSwap® including 3-site replication for high availability (HA)
- ▶ Inline Data Corruption Detection

Scale-out and scale-up configurations further enhance capacity and throughput for better availability.

The IBM FlashSystem 5200 is a high-performance storage solution that is based on a revolutionary 1U form factor. It consists of 12 NVMe Flash Devices in a 1U storage enclosure drawer with full redundant canister components and no single point of failure.

It is designed for businesses of all sizes, including small, remote, branch offices and regional clients. It is a self-optimizing solution that requires less management, which can help organizations to overcome their storage challenges.

Flash price point reductions mean that some parts of the storage market are seeing the value of moving over to flash and NVMe-based solutions. The IBM FlashSystem 5200 advances this transition by providing incredibly dense tiers of flash in a more affordable package. With the benefit of IBM FlashCore Module compression and QLC flash-based technology, a compelling argument exists to move away from Nearline SAS storage and on to NVMe.

With the release of IBM FlashSystem 5200 Software V8.6, extra functions and features are available, including support for Non-Volatile Memory express (NVMe) over TCP host connectivity features, support for iSCSI performance improvement, and enhancement to IBM Storage Insights for threat detection.

Flash for less than the cost of disk

Integral to the IBM FlashSystem 5200 solution is the IBM FlashCore technology. The FlashCore Module (FCM) design uses the NVMe protocol. The recent evolution of this technology saw the introduction of inline hardware compression and decompression.

The IBM FlashSystem 5200 system with IBM FCMs features built-in hardware data compression as standard, and the compression is always active. This compression is implemented in hardware by using field-programmable gate arrays (FPGAs) within each module and a modified dynamic compression algorithm. With this approach, the solution can deliver as much performance as systems without compression, with the added benefit of better use of the physical storage.

Compression and decompression do not affect the performance. It also scales linearly with the number of instances; that is, performance depends on the number of instances, not whether compression is used.

In addition, the IBM FlashSystem 5200 control enclosure supports DRP compression and deduplication that can increase the effective capacity of your flash storage up to 5x, which decreases the cost for effective capacity up to 80%.

DRPs support active data, unlike some other data reduction solutions. The IBM FlashSystem 5200 control enclosure offers several features that benefit DRP compression workloads. These features include eight Intel core processors with up to 256 GB of memory per node, and a built-in compression accelerator for hardware-assisted compression. In addition, the IBM FlashSystem 5200 system with IBM FCMs applies compression to any data that is not compressed.

The IBM FlashSystem 5200 system also supports Storage Class Memory (SCM) drives. SCM is a new storage media technology that offers high endurance, high IOPS, and low latencies.

For more information, see “Storage Class Memory” on page 15.

Agile integration

The IBM FlashSystem 5200 system features the following agile characteristics:

- ▶ Fully integrated system management
- ▶ Application-aware data services
- ▶ Advanced Encryption Standard (AES), data at rest encryption with all NVMe type drives, SAS drives, and IBM FlashCore Modules drives with FIPS 140-2
- ▶ Inline hardware compression with IBM FCMs.
- ▶ External storage virtualization
- ▶ Tiering or mirroring to existing cloud storage
- ▶ Mixed workload consolidation
- ▶ Nondisruptive data migrations
- ▶ Concurrent code load

By accelerating physical and virtual applications, the IBM FlashSystem 5200 system can help organizations reduce costs, increase revenue, and improve customer satisfaction for all types of applications, including the following categories:

- ▶ Transactional
- ▶ Enterprise resource planning (ERP) and supply chain management
- ▶ Big data and analytics
- ▶ Server and desktop virtualization
- ▶ Edge computing
- ▶ Cloud Native
- ▶ Hybrid and Multi-Cloud

AI-empowered

The IBM FlashSystem 5200 system includes the following AI-empowered characteristics:

- ▶ AI-based data placement for optimal data center performance and zero-downtime data migration
- ▶ IBM Storage Insights, which includes AI-empowered predictive analytics, storage resource management, and a support platform that is delivered over the cloud.

Multicloud enabled

With IBM Storage Virtualize on-premises, IBM Storage Virtualize for Public Cloud can enable clients to migrate data to and from supported public cloud providers, including IBM Cloud, Microsoft Azure, OpenStack Swift, and Amazon Web Services (AWS). Clients can create hybrid multicloud solutions for their traditional block data and workloads by using built-in IP replication capabilities. For example, clients can implement Disaster Recovery strategies between on-premises and cloud data centers or between cloud data centers.

IBM Storage Virtualize for Public Cloud is deployed on a cloud infrastructure as a service (IaaS) from IBM Cloud, Microsoft Azure, OpenStack Swift or AWS on bare metal servers in IBM Cloud, or Microsoft Azure virtual machine (VM) instances, or on Amazon Elastic Compute Cloud (Amazon EC2) instances on AWS, and virtualized AWS Amazon Elastic Block Store (EBS) storage. This setup enables clients to create clustered configurations, such as on-premises, and provides the optimization and virtualization capabilities of IBM Storage Virtualize to public cloud infrastructures. These capabilities include most of the key features of IBM Storage Virtualize, such as the following features:

- ▶ IBM FlashCopy®
- ▶ Transparent Cloud Tiering
- ▶ Thin provisioning
- ▶ Global Mirror
- ▶ Metro Mirror
- ▶ Global Mirror with change volumes
- ▶ IBM Easy Tier® to public cloud IaaS
- ▶ Safeguarded Copy

IBM Storage Virtualize on-premises and IBM Storage Virtualize for Public Cloud together enable a hybrid multicloud deployment with a single data management layer between on-premises systems and the cloud across heterogeneous storage pools that might exist in the data center. IBM Storage Virtualize provides the following functions:

- ▶ Storage pooling and automated allocation with thin provisioning
- ▶ Easy Tier automated tiering
- ▶ Deduplication and compression to reduce cloud storage costs
- ▶ FlashCopy® and remote mirror for local snapshots and remote replication
- ▶ Support for the following virtualized and containerized server environments:
 - VMware
 - MicrosoftHyper-V
 - IBM PowerVM®
 - Red Hat OpenShift
 - CRI-O
 - Kubernetes

For more information about IBM FlashSystem systems and Hybrid Multicloud, see [Embracing Hybrid Cloud](#).

IBM FlashSystem 5200 Advanced Data Services

The IBM FlashSystem 5200 system provides the following advanced data services:

- ▶ Business continuity with replication services
- ▶ Data Protection with IBM FlashCopy services
- ▶ Higher storage efficiency with thin provisioning
- ▶ DRPs that provide compression with deduplication
- ▶ IBM Easy Tier
- ▶ External virtualization
- ▶ IP quorum support
- ▶ N_Port ID Virtualization (NPIV) support
- ▶ VMware vSphere Virtual Volume (VVOL) support and space-efficient copies
- ▶ Transparent Cloud Tiering
- ▶ IBM HyperSwap with remote replication (3-site replication)
- ▶ Clustering up to 4 IBM FlashSystem 5200 systems
- ▶ Distributed RAID (DRAID) 6 and DRAID 1 support
- ▶ Redirect on write snapshot in Data reduction pools
- ▶ Child pool support in DRP pools
- ▶ More SCM drives support
- ▶ Security enhancements
- ▶ Safeguarded Copy

IBM FlashSystem 5200 enclosure overview

The IBM FlashSystem 5200 system features the following types of enclosures:

- ▶ A *control enclosure* manages your storage systems, communicates with the host, and manages interfaces. In addition, it can house up to 12 NVMe-capable flash drives. These drives can be industry standard NVMe types or the exclusive IBM FlashCore Module (FCM) NVMe type and up to 12 optional Storage Class Memory (SCM) drives.

- ▶ An *expansion enclosure* increases the available capacity of an IBM FlashSystem 5200 cluster. It communicates with the control enclosure through a dual pair of 12 Gbps serial-attached SCSI (SAS) connections. This enclosure can house many of the flash (solid-state drive (SSD)) and HDD type SAS type drives, depending on which model of enclosure is ordered.

Figure 1 shows the IBM FlashSystem 5200 control enclosure front and 3/4 ISO view. In the front view, you can see the 12 NVMe drives in two rows of six drives.

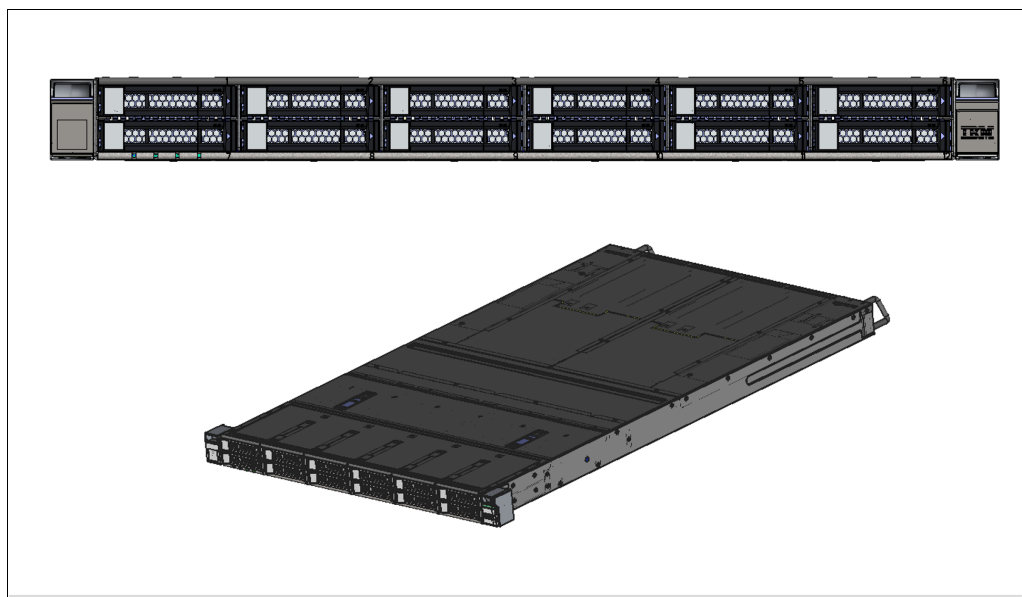

Figure 1 IBM FlashSystem 5200 control enclosure showing the front and 3/4 ISO view

Control enclosures

Each control enclosure can have multiple, attached expansion enclosures, which expand the available capacity of the entire system. The IBM FlashSystem 5200 solution supports up to four control enclosures and up to two chains of SAS expansion enclosures per control enclosure.

The IBM FlashSystem 5200 control enclosure supports up to 12 NVMe-capable flash drives in a 1U high form factor and consists of the following machine types and models:

- ▶ 4662-6H2 IBM FlashSystem 5200 control enclosure
- ▶ 4662-UH6 IBM FlashSystem 5200 control enclosure utility model

Note: The 4662 UH6 model is an IBM FlashSystem 5200 solution with a 1-year warranty, and is a 4662 offered in the Storage Utility Offering space. This model is physically and functionally identical to the IBM FlashSystem 4662 6H2 model, except for target configurations and variable capacity billing.

The variable capacity billing uses IBM Storage Control or IBM Storage Insights to monitor the system usage, which allows allocated storage usage to exceed a base subscription rate to be billed per terabyte per quarter. Allocated storage is identified as storage that is allocated to a specific host (and unusable to other hosts), whether data is written. For thin-provisioning, the data that is written is considered used. For thick-provisioning, the total allocated volume space is considered used.

Expansion enclosures

The IBM FlashSystem 5200 expansion enclosures consist of the following machine types and models: 4662 models 12G, 24G, and 92G.

The new SAS-based small form factor (SFF) and large form factor (LFF) expansion enclosures support flash and HDD MDisks in a storage pool, which can be used for IBM Easy Tier. Consider the following points:

- ▶ IBM FlashSystem 5200 LFF expansion enclosure model 12G offers drive options with up to 12 3.5-inch HDD or SSD flash drives. Up to 240 drives in 20 12G SAS expansion enclosures are supported per IBM FlashSystem 5200 control enclosure. The 12G expansion enclosure is 2U high.
- ▶ IBM FlashSystem 5200 SFF expansion enclosure model 24G offers drive options with up to 24 2.5-inch HDD or SSD flash drives. Up to 480 drives in 20 24G SAS expansion enclosures are supported per IBM FlashSystem 5200 control enclosure. The 24G expansion enclosure is 2U high.
- ▶ IBM FlashSystem 5200 LFF expansion enclosure model 92G offers drive options with up to 92 3.5-inch (and 2.5-inch drives in carriers) HDD and SSD flash drives. Up to 784 drives in eight 92G SAS expansion enclosures are supported per IBM FlashSystem 5200 control enclosure. The 92G expansion enclosure is 5U high.

Note: The maximum limit of storage that can be managed by the IBM FlashSystem 5200 is 32 PB. With higher density drives, this limit might be reached sooner; therefore, measurements must be considered to observe storage consumption.

The IBM FlashSystem 5200 control enclosure can be recognized by the nomenclature on the left and side snap catch cover, which covers the rack-mounting screws. This label contains the machine type, and model and serial numbers of the IBM FlashSystem 5200 control enclosure.

Figure 2 shows the IBM FlashSystem 5200 bezel and NVMe drive description.



Figure 2 IBM FlashSystem 5200 bezel and IBM FlashCore Module description

Labeling on the NVMe drive provides the drive type, capacity, and FRU number. The example that is shown in Figure 2 on page 6 is the IBM FlashCore Module NVMe 19.2 TB type.

The IBM FlashSystem 5200 expansion enclosures that are shown next show the size of the respective units and the number of drives in each (12G and 24G only).

Figure 3 shows the IBM FlashSystem 5200 expansion enclosure model 12G and the twelve installed 3.5-inch drives.



Figure 3 IBM FlashSystem 5200 expansion enclosure model 12G front view

Figure 4 shows the IBM FlashSystem 5200 expansion enclosure model 24G and the 24 2.5-inch drives installed.



Figure 4 IBM FlashSystem 5200 expansion enclosure model 24G front view

Figure 5 shows the IBM FlashSystem 5200 expansion enclosure model 92G. This enclosure can contain up to 92 drives of 3.5-inch or 2.5-inch, in-drive carriers.

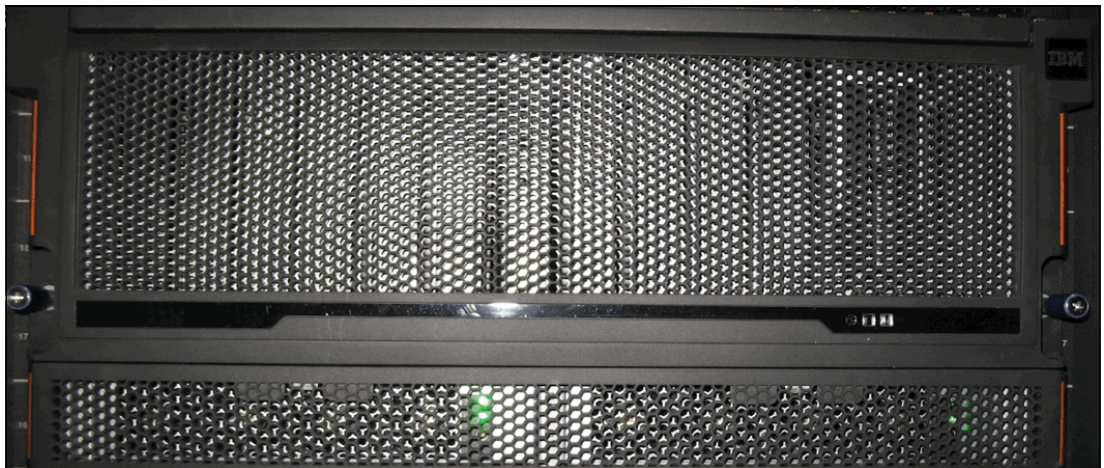

Figure 5 IBM FlashSystem 5200 expansion enclosure model 92G front view

Placing your IBM Storage FlashSystem family storage system in your infrastructure

This section describes the possible use cases and where to place the IBM FlashSystem 5200 (or another system belonging to the IBM FlashSystem family) in the client infrastructure. This kind of solution system can address many possible requirements and can be used to optimize and simplify an IT storage infrastructure.

The IBM FlashSystem 5200 can be used as a production data repository and a component of a DR solution because a primary system can send data in an efficient way into the hybrid multicloud infrastructure.

In particular, the IBM FlashSystem 5200 can meet the following customer requirements:

- ▶ First tier repository for production data.
- ▶ Primary or target system for data replication or disaster recovery.
- ▶ Provide HA services enables the HyperSwap solution with 2 IBM FlashSystem 5200 enclosures in sync replication.
- ▶ Use Storage Virtualize capabilities to manage and virtualize older IBM or non-IBM storage and extend advanced Storage Virtualize functions (for example, data reduction) to the external capacity presented by the old storage.

Old storage systems can be decommissioned or their usage can be extended as an added pool of resources to the IBM FlashSystem 5200.

- ▶ Storage Virtualize in the IBM FlashSystem 5200 can provide the intelligent data migration tool from an outer storage to replace it or distribute application workload on more systems.
- ▶ The IBM FlashSystem 5200 can use Transparent Cloud Tiering to move data into the cloud:
 - Use IBM Storage Virtualize for Public Cloud on Amazon AWS or other providers.
 - Use the Container Storage Interface (CSI) driver for Red Hat OpenShift Container Platform, which enables Cloud Pak foundation.
- ▶ IBM software-defined storage (SDS) capabilities:
 - Storage Scale support because the IBM FlashSystem 5200 can be used as a repository for several tiers in initial microprogram load (IML) processing
 - IBM Storage Protect as cache or data repository
 - Copy Data Management

Figure 6 shows an IBM FlashSystem 5200 as the main provider of advanced data services for on-premises and in a hybrid multicloud system.

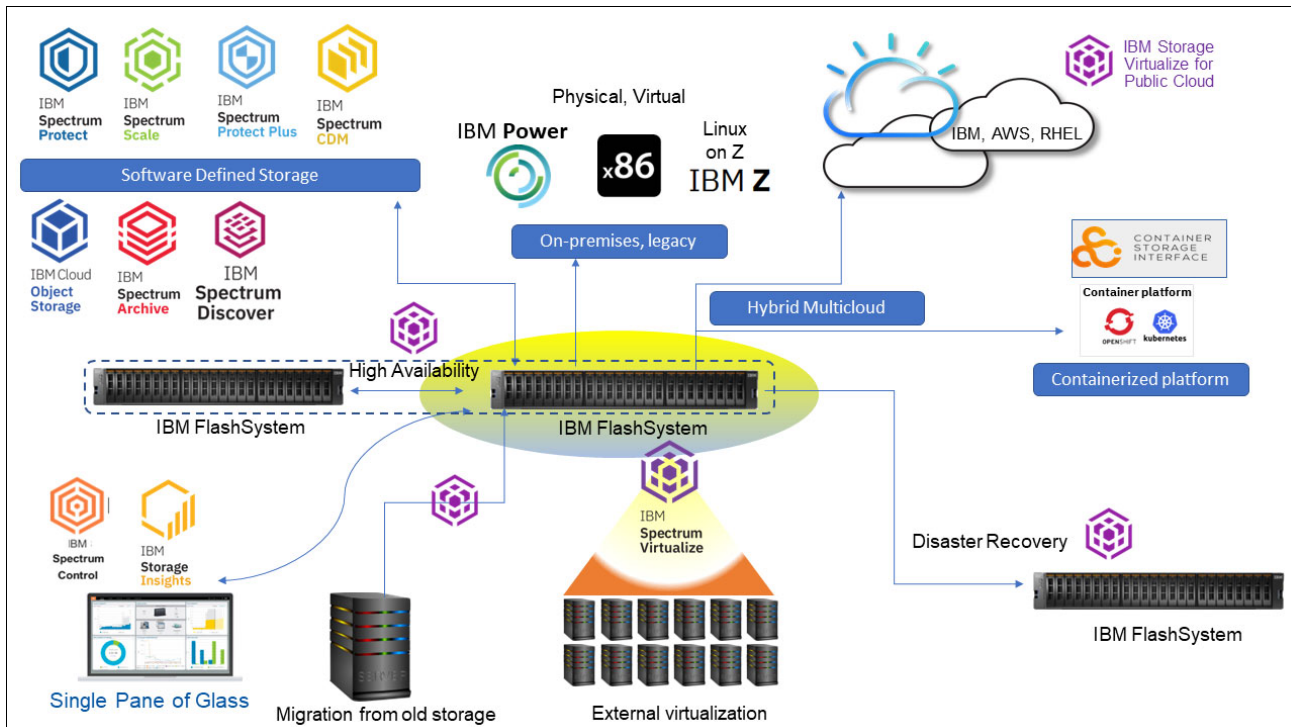

Figure 6 IBM FlashSystem 5200 as the main provider of advanced data services

The client can expect the modern and advanced data services that are provided by a storage system to cover several scopes concurrently. The IBM FlashSystem products, which include the IBM FlashSystem 5200, all share this main characteristic.

Because all IBM FlashSystem products share the functions and software layer, it can be easier to select the suitable system that can match performance, capacity, and functional requirements.

For example, Figure 6, describes the on-premises, legacy case and the modern use case. In the on-premises case, an on-premises shared storage system is connected to an older environment in the primary IT location. In the modern case, the storage system is connected to a containerized environment.

This configuration enables the remote connection to feed the remote IBM Storage Virtualize for Public Cloud that is equipped with the same software platform. This Hybrid Multicloud scenario enables the requested extended services, such as archiving and testing.

All of these capabilities are provided by the common SDS solution that is called IBM Storage Virtualize.

The described example is shown in Figure 7.

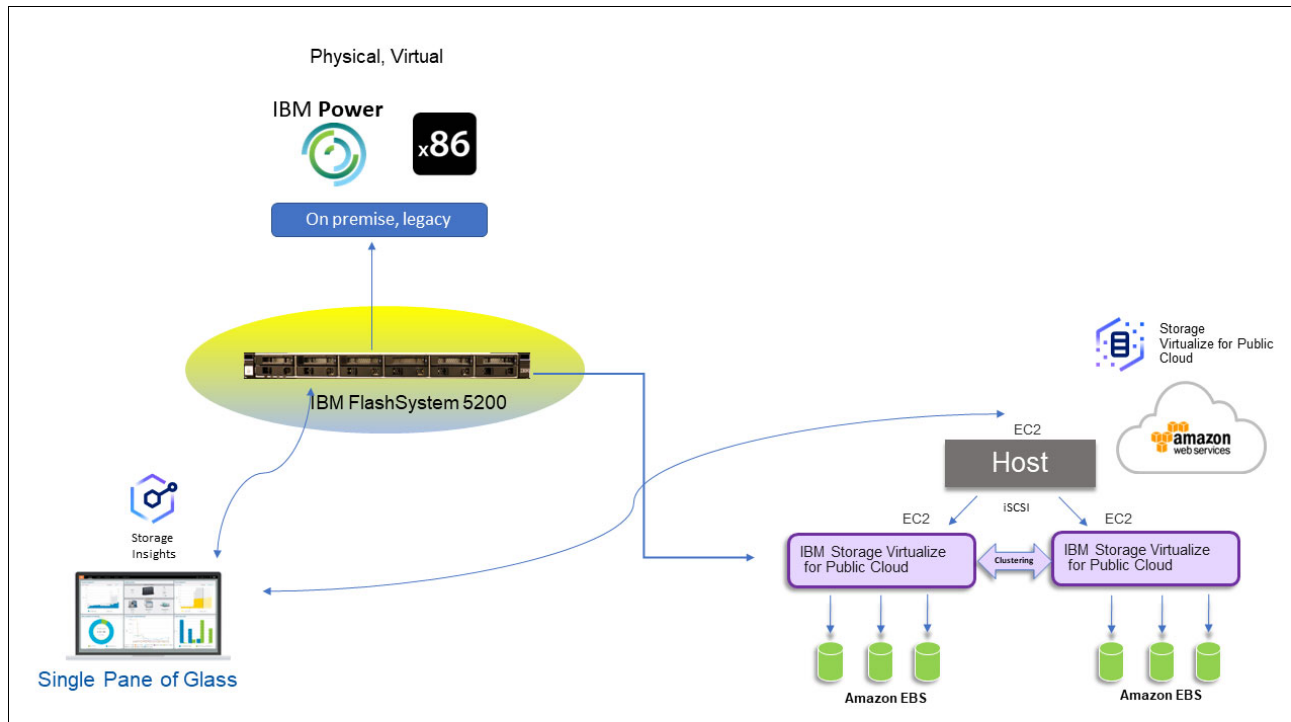

Figure 7 Sample scenario

IBM Storage Virtualize is included in all the IBM FlashSystem storage products including the IBM FlashSystem 5200 and can be deployed in the AWS or RHEL cloud platforms.

Functions provided by the IBM FlashSystem 5200

The IBM FlashSystem 5200 control enclosure runs IBM Storage Virtualize V8.6.0 or later, which provides the following functions:

- ▶ Supports the IBM FCMs, which contain IBM enhanced flash technology.
- ▶ A maximum of 12 ultra-low latency 2.5-inch (SFF) IBM FCMs in capacities of 4.8 TB, 9.6 TB, 19.2 TB, and 38.4 TB.
- ▶ A maximum of 12 NVMe industry-standard drive of capacities of 1.92 TB, 3.84 TB, 7.68 TB, 15.36 TB, and 30.72 TB.
- ▶ A mixture of both FCMs and industry-standard drives.
- ▶ Supports a maximum of 12 NVMe SCM Drives in capacities of 375 GB, 750 GB, 800 GB, or 1.6 TB. At the time of writing, only the 1.6 TB drive is available with new orders.
- ▶ IBM FCMs provide automatic data compression and encryption without affecting the system performance.
- ▶ The use of IBM Security Guardium® Key Lifecycle Manager or USB key encryption. Up to four IBM Security Guardium Key Lifecycle Manager key servers are supported.
- ▶ Offers hardware-based AES 256 data-at-rest encryption by using USB key and IBM Security Key Lifecycle Manager key server-based encryption, with no performance impact.

- ▶ Remote Support Assistance (RSA) that enables IBM support personnel to access the system to complete troubleshooting tasks.
- ▶ Consistency protection for Global Mirror and Metro Mirror replication, and High Availability.
- ▶ Management GUI support for host clusters, including private and shared volume mappings.
- ▶ Throttling, which allows customers to control resources that are used when the system is processing I/Os on hosts, host clusters, volumes, copy offload operations, and storage pools.
- ▶ Transparent Cloud Tiering is a function of IBM Storage Virtualize that uses IBM FlashCopy mechanisms to produce a point-in-time snapshot of the data.
- ▶ Flexible interface types, including FC and Ethernet (iWARP, RDMA over Converged Ethernet [RoCE], and NVMe over TCP protocols) to easily integrate into SAN and iSCSI network environments.
- ▶ IBM Storage Insights, which monitors the performance, capacity, and health of each device. In addition, Storage Insights monitoring includes the detection of potential ransomware attacks.
- ▶ Supports DRAID 1 and DRAID 6 to provide the suitable level of reliability and performance.
- ▶ The 5200 can support up to 340 TB usable capacity or, assuming that the compression ratio is 3:1, 1020 TB effective capacity in 1U.
- ▶ Support for an intermix of 2U and 5U SAS expansion enclosures with a total chain weight of 10 in each of two SAS chains, per control enclosure with a SAS expansion card that is installed in the second adapter slot:
 - Support for up to 12 LFF drives in a 2U SAS expansion enclosures 4662-12G and 4662-F12, each enclosure with a chain weight of 1.
 - Support for a maximum of 24 SFF drives in a 2U SAS expansion enclosures 4662-24G or 4662-F24 with a chain weight of 1.
 - Support for up to 92 SFF drives in a 5U SAS expansion enclosures 4662-92G or 4662-F92, with a chain weight of 2.5.

Note: Connecting enclosures from Storwize V5000E or IBM FlashSystem 5000 to IBM FlashSystem 5200 is not supported.

New in IBM FlashSystem 5200 Software V8.6.0

The following functions are included in IBM FlashSystem 5200 Software V8.6.0:

- ▶ Non-Volatile Memory express (NVMe) over TCP host connectivity:
 - The Non-Volatile Memory express (NVMe) transport protocol provides enhanced performance on high-demand IBM Storage FlashSystem drives.
 - NVMe is a logical device interface specification for accessing non-volatile storage media. Host hardware and software use NVMe to fully use the levels of parallelism possible in modern solid-state drives (SSDs).
 - Supported protocols (HBA dependent):
 - NVMe over Fibre Channel,
 - NVMe over RDMA

- NVMe over TCP protocol.
 - For more information, see [IBM System Storage Interoperation Center \(SSIC\)](#)
- ▶ CLI command **chfcportfeature** to enable or disable the Fibre Channel port features such as fabric device management interface (FDMI) registration, discovery, and port state.
- ▶ Support for iSCSI performance improvement includes a procedure that can help to resolve host performance problems while connected to a system and its connectivity to the network switch. For more information, see [iSCSI performance analysis and tuning](#).
- ▶ Support for migrating remote copy to policy-based replication:
 - Policy-based replication uses volume groups and replication policies to automatically deploy and manage replication. Policy-based replication can simplify configuring, managing, and monitoring replication between two systems.
 - With policy-based replication, you can replicate data between systems with minimal management, higher throughput, and reduced latency compared to the remote-copy function.
 - A replication policy has the following properties:
 - Replication policies cannot be changed after they are created. If changes are required, a new policy can be created and assigned to the associated volume group.
 - Each system supports up to a maximum of 32 replication policies.
- ▶ Support for SMTP authentication includes the ability to configure Call Home with email notifications on any of the following email servers:
 - Local email server where you can send, receive, and archive emails on physical servers in an on-premises location
 - Cloud-based email server where you can send, receive, and archive emails on cloud-based server providers such as Google Mail and Microsoft Office 365.

- ▶ Support for TLS 1.3:
 - Security of all key server communications is governed by TLS 1.2 and TLS 1.3 protocols.
 - Encryption keys are distributed between nodes in the system by using TLS 1.2 and TLS1.3.
 - The system uses AES-256 encryption that uses OpenSSL library interfaces. To establish a connection between the key server and the system, the key server or services must support the configured TLS version.
- ▶ Support for DNS check to be turned off includes the **1sdnserver** command, which lists information for any Domain Name System (DNS) servers in the system.
- ▶ FDMI information in Call Home. FDMI discovery runs every 6 hours, enables any storage endpoint to register itself the FC, and collects fabric information that includes HBA and port details.
- ▶ Version 2 metadata volume for VMware Virtual Volumes (vVols):
 - The system provides native support for VMware vSphere APIs for Storage Awareness (VASA) through a VASA Provider (also known as Storage Provider) which sends and receives information about storage that is used by VMware vSphere to the vCenter Server.
 - Through VASA, the system also supports VMware Virtual Volumes (also known as vVols), which allows VMware vCenter to automate the creation, deletion and mapping of volumes.
- ▶ Enhancement to IBM Storage Insights for threat detection:
 - A key part of monitoring your system includes the detection of potential ransomware attacks. To ensure that you have the latest storage metadata for detecting those types of attacks, compression and cyber resiliency statistics for volumes are collected every 5 minutes.
 - With the collected storage metadata, IBM Storage Insights builds a historical model of a storage system and uses its built-in intelligence and formulas to identify when and where ransomware attacks might be occurring.
 - For more information on statistics, see [IBM Storage Insights](#).
- ▶ Support for a nonsuperuser to manage the system:
 - Each user of the management GUI has an associated role. Roles are assigned at the system level. For example, a user can be the administrator for one system, but the security administrator for another system.
 - Security administrators can create role-based user groups where any users that are added to the group are assigned to the role defined for that user group. With this feature, users other than superuser can monitor and manage certain functions on the system.
- ▶ Downloading a software fix through Call Home by using Restful API:
 - This option enables Call Home with cloud services to connect to support and to directly transfer the latest update available to the storage system.
 - To download a software fix through the Call Home by using the Restful API, the user enters the **satask downloadsoftware** command plus the specific fix they require.

For more information about these features, see [What's new in v8.6.0](#).

IBM FlashCore technology

When IBM FCMs are installed, a predominant aspect of the IBM FlashSystem 5200 system is IBM FlashCore technology, which consists of the following key elements:

- ▶ Hardware-accelerated architecture that is engineered for flash, with a hardware-only data path.
- ▶ The IBM FlashSystem data compression and decompression algorithm is a dynamic algorithm. It is implemented completely in hardware, and no processor intervention is required.
- ▶ IBM FCMs, which are designed for low latency, density, and reliability.
- ▶ IBM Advanced Flash Management, which improves flash endurance over standard implementations without sacrificing latency.

Figure 8 shows IBM FlashCore technology.

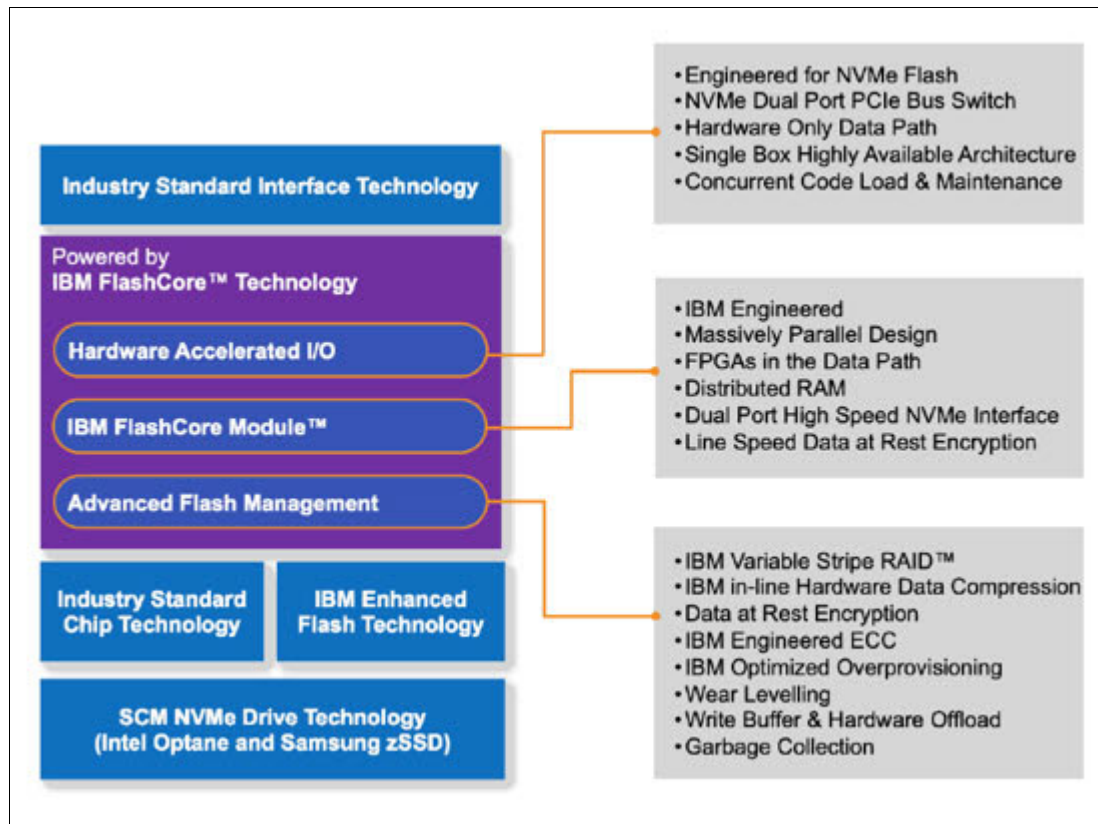

Figure 8 IBM FlashCore technology

IBM released the second generation of FCMs that can deliver improved performance, capacity, and reliability.

Clients can experience latency as low as 70 microseconds, which helps remove bottlenecks in their workloads. The outstanding performance of FCMs includes data reduction that is obtained from embedded hardware. Data reduction occurs while data is written to the modules.

At the time of writing, a new 38.4 TB FCM was released. Because each FCM delivers wire-speed compression and because IBM provides a 3:1 compression guarantee, clients obtain 115.2 TB in each 2.5-inch small form factor device. Therefore, with 12 FCMs installed,

clients have 1.38 PB of effective raw capacity in only 1U of space without affecting performance.

A less obvious benefit of the FCMs is greatly enhanced flash endurance. Many factors help deliver up to 7x greater flash endurance than an industry-standard, commodity solid-state-drive (SSD), which means fewer issues for clients. It also means that time does not have to be spent dealing with failing SSDs and drive rebuilds.

For more information about IBM FlashCore technology, see [What is flash storage?](#)

Storage Class Memory

SCM is an industry-wide standard definition for non-volatile memory devices that perform faster (~10 μ s latency) than traditional NAND SSDs (100 μ s latency), but slower than dynamic random access memory (DRAM); 100 ns.

The technology pricing sits between DRAM and traditional NAND. Price is significantly more expensive than traditional NAND drives.

The IBM FlashSystem 5200 system supports low-latency, high-speed SCM drives in any of the slots of the control enclosure. The drives are inserted into the control enclosure from right to left, bottom row to top row. The control enclosure can contain up to twelve 1.6 TB 2.5-inch NVMe Storage Class Memory Drives, which fills the slots in the control enclosure.

Figure 9 shows the SCM drive locations in the IBM FlashSystem 5200 control enclosure. The SCM Drives are populated in reverse slot order starting with slot 12. Start with slots 12–7 and continue with slots 6–1.

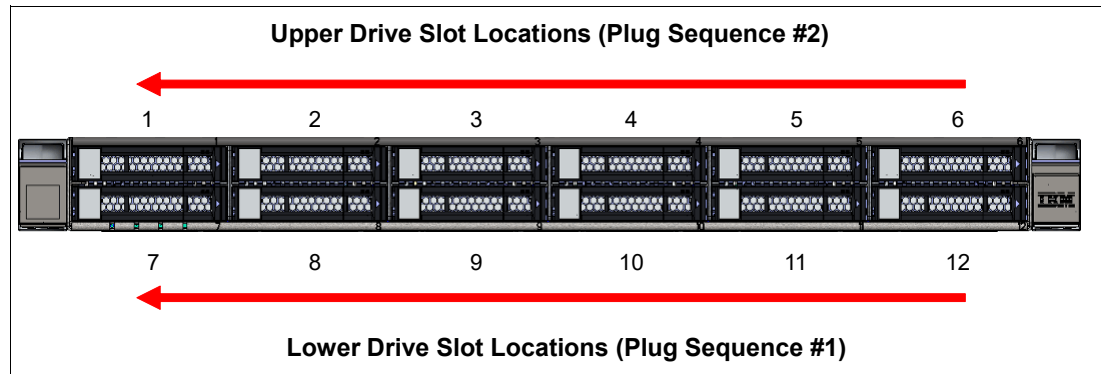

Figure 9 SCM Drive locations slots

SCM and Easy Tier

Because of their faster speed, SCM drives are placed in *tier_scm* of Easy Tier. This new tier is ranked higher than the *tier0_flash* that is used for NVMe NAND drives. Easy tier features the following levels:

Storage Class Memory

Storage Class Memory tier exists when the pool contains drives that use persistent memory technologies that improve the endurance and speed of current flash storage device technologies. The tier name in CLI commands is **tier_scm**.

Tier 0 flash

Tier 0 flash tier exists when the pool contains high-performance flash drives. The tier name in CLI commands is **tier0_flash**.

Tier 1 flash

Tier 1 flash tier exists when the pool contains tier 1 flash drives. Tier 1 flash drives typically offer larger capacities, but slightly slower performance and write endurance characteristics. The tier name in CLI commands is **tier1_flash**.

Enterprise tier

Enterprise tier exists when the pool contains enterprise-class MDisks, which are disk drives that are optimized for performance. The tier name in CLI commands is **tier_enterprise**.

Nearline tier

Nearline tier exists when the pool contains nearline-class MDisks, which are disk drives that are optimized for capacity. The tier name in CLI commands is **tier_nearline**.

Hot data is placed in the SCM tier when Easy Tier is enabled. DRP and VG extent allocation was tuned to use SCM drives, especially for metadata (directory volume lookups). This example is one of the main reasons to use SCM drives in an IBM FlashSystem 5200 system.

SCM and RAID configurations

SCM drives feature the following rules regarding RAID supported configurations:

- ▶ DRAID 1 with two drives (including distributed spare capacity) or more and is a best practice and configuration.
- ▶ DRAID 5 with four drives (including distributed spare capacity) or more is supported.
- ▶ DRAID 6 with six drives (including distributed spare capacity) or more is supported.
- ▶ Traditional RAID (TRAID) 1 and TRAID 10 with two drives is supported. However, no spare is available, and performance might be limited, and the use of DRAID arrays is a best practice.
- ▶ SCM drives have their own SCM technology type and drive class.
- ▶ SCM and Standard NVMe (or SAS) cannot intermix in the same array.
- ▶ Easy Tier tier_scm arrays can take lower tech types as spare drives when no *tier_scm* drives are available.
- ▶ Lower-tier arrays can accept tier_scm drives as superior drives.

SCM drive formatting and UNMAPS

Because of its media technology, SCM drive formats take much longer to format than a typical NVMe drive. Formatting a drive can take as much as 15 minutes.

SCM drive formats occur when one of the following conditions exists:

- ▶ A drive is replaced.
- ▶ An enclosure is managed.
- ▶ An array or MDisk is removed.

Note: Intel Optane drives do not support **UNMAPS**. Instead, the system writes zeros to deallocate drive sectors.

IBM Storage Expert Care Service and Support options

A new set of IBM Storage Expert Care Service and Support options are available for IBM FlashSystem 5200. The options provide new levels of service cover with the options of a duration of 1–5 years.

Base warranty

The IBM FlashSystem 5200 models 6H2 and UH6 control enclosures are sold with a one-year, parts-only warranty at the point of ordering. The customer must then choose between the Silver or Gold services offering and also the duration of the contract, which can be 1–5 years.

This level of one-year, parts-only base warranty also applies to the IBM FlashSystem 5200 models 12G, 24G, and 92G expansion enclosures. These enclosures must also have the same service level offering applied to them as the IBM FlashSystem 5200 control enclosure to which they are going to be attached at the point of the initial order.

Note: The duration of the contract for these expansion enclosures does not have to be the same as the control enclosure. This flexibility gives the customer the ability to choose the duration of the coverage that they require.

Service and support levels

The following warranty and service levels are available for the IBM FlashSystem 5200 with IBM Storage Expert Care service and support:

Note: The following abbreviations are used in this list:

- ▶ CRU: Customer Replaceable Unit
- ▶ NBD: Next Business Day
- ▶ SBD: Same Business Day
- ▶ LMC: Licensed Machine Code
- ▶ 24x7x4: 24 hours per day, 7 days a week, and a 4-hour response time
- ▶ 9x5: 9 hours per day, Monday - Friday only (no weekends or public holidays).

- ▶ Base warranty:
 - Parts Only
 - HW CRU (9x5 available as exception)
 - Remote Technical Support included (HW only)
- ▶ Basic:
 - 9x5, NBD
 - HW CRU (9x5 available as an exception)
 - SW/LMC Subscription and Support
 - Storage Insights basic (ticket opening)
 - Remote Technical Support (HW and InfoSphere MDM Server Workbench)
 - Client or Business Partner installation
- ▶ Advanced:
 - 24x7x4, SBD
 - IBM onsite repair (includes hardware, CRU)
 - SW/LMC subscription and support
 - Storage Insights with Predictive Support
 - Remote Technical Support (hardware and software)

Service contract duration

This section details the contract duration and renewal terms:

- ▶ Annual: 1, 2, 3, 4 or 5 years
- ▶ Renewable: On an annual auto-renewal basis

Figure 10 shows an overview of the various service levels that are available with the IBM FlashSystem 5200. The basic and advanced offerings are designated by a new machine type and model, plus a numerical value to denote the number of years for which the contract runs.

For example, consider the following service offering 4663-B03:

- ▶ 4663: Service offering machine type for IBM FlashSystem 5200
- ▶ B: Denotes basic level of service offering
- ▶ 03: Denotes an offering of three years duration

Figure 10 shows IBM Storage Expert Care Service and Support options.

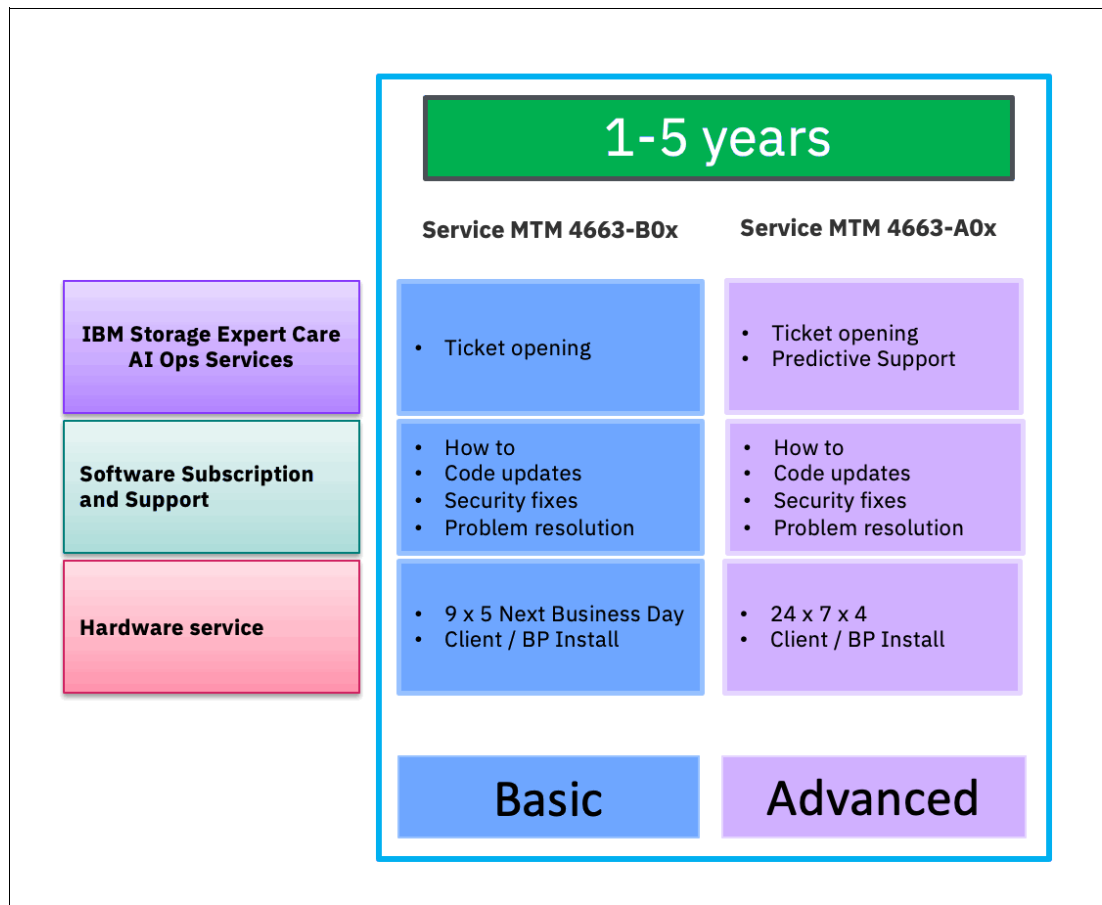

Figure 10 IBM Storage Expert Care Service and Support options

For more information about these offerings, contact your local IBM Sales representative or IBM reseller.

IBM FlashWatch overview

IBM FlashWatch is a new offering from IBM to complement the purchase of the IBM FlashSystem 5200 system. It provides the following features that are included in the purchase of the product:

- ▶ Acquisition:
 - HA Guarantee:
 - Proven 99.9999% availability
 - Optional 100% commitment when HyperSwap is used
 - Data Reduction Guarantee:
 - 3:1 self-certified
 - Up to 5:1 with workload profiling
 - All-inclusive Licensing
All storage function included in the licensing cost for internal storage.
- ▶ Operation:
 - IBM® Storage Expert Care
1–5 years of 9x5 or 24x7 support (selectable at product purchase time)
 - Cloud Analytics
Storage Insights included at no extra cost to proactively manage your environment.
 - Flash Endurance Guarantee
Flash media is covered for all workloads while under warranty or maintenance.
- ▶ Migration:
 - IBM Flash Momentum - Storage Upgrade Program
Replace your controller and storage every 3 years with full flexibility.
 - Cloud-like Pricing
Storage Utility pricing has monthly payments for only the storage that you use.
 - No Cost Migration
90 day, no-cost data migration from over 500 storage controllers (IBM and non-IBM).

For more information about the IBM FlashWatch offering, see [IBM FlashWatch FAQ](#).

The IBM FlashWatch offering is applicable across the IBM Storage Virtualize family. The Product Matrix in the FAQ describes which elements are applicable against which product.

IBM Storage Insights

IBM Storage Insights is a part of the monitoring to help provide continued availability of the IBM FlashSystem 5200.

Available at no charge, cloud-based IBM Storage Insights provides a single dashboard that provides a clear view of all of your IBM block storage. You can make better decisions by seeing trends in performance and capacity.

Because of Storage Insights provides storage health information, you can focus on areas that need attention. In addition, when IBM support is needed, Storage Insights simplifies uploading logs, speeds resolution with online configuration data, and provides an overview of open tickets all in one place.

IBM Storage Insights includes the following features:

- ▶ A unified view of IBM systems:
 - Provides a single window to see all of your system's characteristics
 - See all of your IBM storage inventory
- ▶ Provides a live event feed so that you know, up to the second, what is occurring with your storage so that you can respond quickly.
- ▶ IBM Storage Insight® collects telemetry data and Call Home data, and provides up-to-the-second system reporting of capacity and performance.
- ▶ Overall storage monitoring:
 - The overall health of the system
 - Monitor the configuration to see whether it meets the best practices
 - System resource management to determine whether the system is being overly taxed and provide proactive recommendations to fix it
- ▶ Detection of potential ransomware attacks.

Storage Insights builds a historical model of a storage system and uses its built-in intelligence and formulas to identify when and where ransomware attacks might be occurring.
- ▶ Storage Insights provides advanced customer service with an event filter that enables the following functions:
 - The ability for you and support to view, open, and close support tickets, and track trends.
 - Auto log collection capability so you can collect the logs and send them to IBM before support starts investigating the problem. This feature can save as much as 50% of the time to resolve the case.

In addition to the free Storage Insights, the Storage Insights Pro option is available. Storage Insights Pro is a paid subscription service that provides longer historical views of data, which offers more reporting and optimization options. It also supports IBM file and block storage, Pure Storage, Dell, NetApp, and Lenovo storage arrays.

Figure 11 shows the comparison of Storage Insights and Storage Insights Pro.

Resource Management	Capabilities	Storage Insights (included)	Storage Insights Pro
Monitoring	Resource management	IBM Block Storage	IBM and non-IBM block, file, and object storage
	Telemetry Data Collection	5 mins	5 mins
	Health	Call home events	Call home events
	Capacity data	4 metrics	25+ metrics
	Performance data	3 metrics	100+ metrics
	Retention data	24 hours	Up to 2 years
	Monitor Brocade and Cisco data fabric	✓	✓
	Monitor numerous competitor's systems		✓
Services	Filter events to quickly isolate trouble spots	✓	✓
	Hassle-free log collection	✓	✓
	Show active PMRs and ticket history	✓	✓
	Best practice violations	✓	✓
	Enhanced reporting		✓
Analytics and Optimization	Full customizable alerting		✓
	Business impact analysis		✓
	Optimize capacity with reclamation		✓

Figure 11 Storage Insights and Storage Insights Pro Chart

Architecture, security, and data collection

Figure 12 shows the architecture of the Storage Insights application, the supported products, and the three main teams of people who can benefit from the use of the tool.

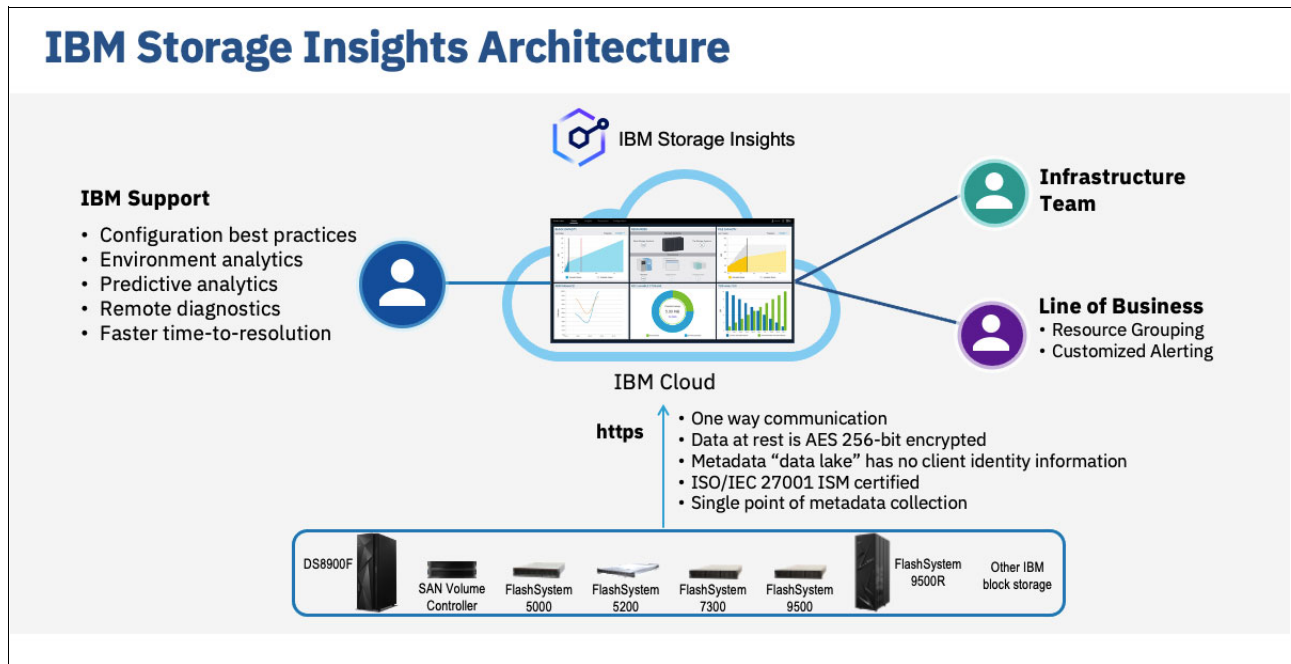

Figure 12 Storage Insights Architecture

Storage Insights provides a lightweight data collector that is deployed on a customer-supplied server. This server can be a Linux, Windows, or IBM AIX® server, or a guest in a virtual machine (for example, a VMware guest).

The data collector streams performance, capacity, asset, and configuration metadata to your IBM Cloud® instance.

The metadata flows in one direction: from your data center to IBM Cloud over HTTPS. In the IBM Cloud, your metadata is protected by physical, organizational, access, and security controls. IBM Storage Insights is ISO/IEC 27001 Information Security Management certified.

Figure 13 shows the data flow from systems to the IBM Storage Insights cloud.

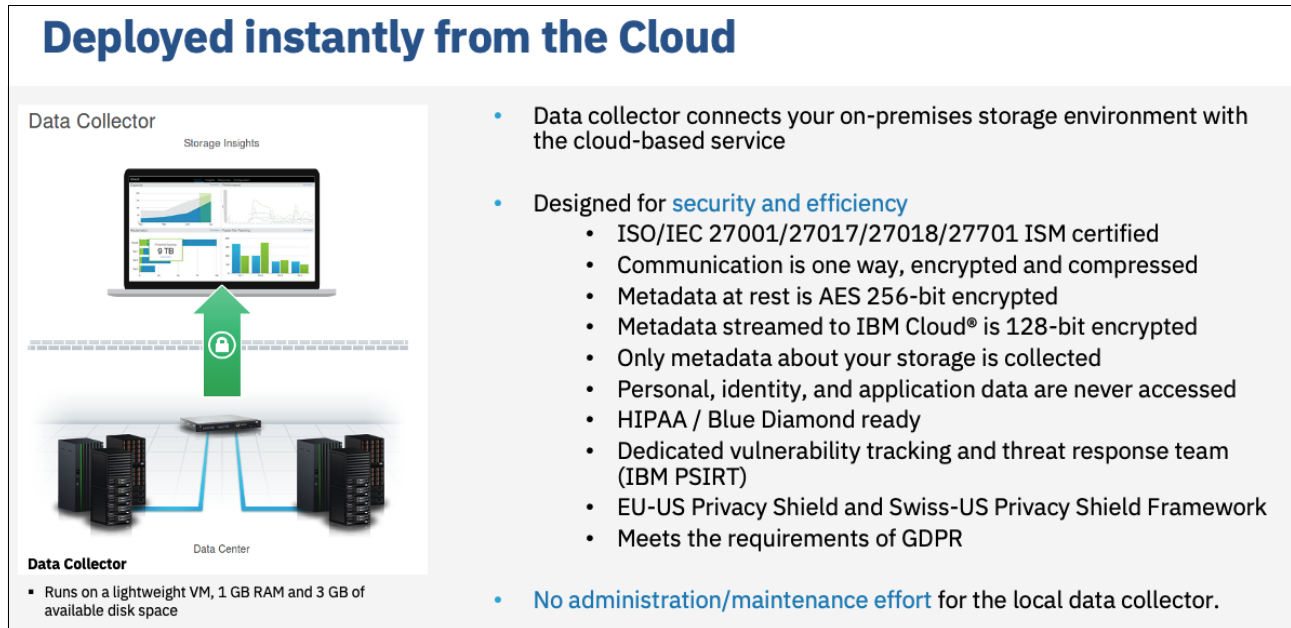

Figure 13 Data flow from the storage systems to the IBM Storage Insights cloud.

In addition, you can now use IBM Call Home with cloud services to create a direct connection between your IBM FlashSystem 5200 and IBM Storage Insights with no data collector required.

When you enable Call Home with cloud services on an IBM FlashSystem 5200, you have the option to integrate that storage system with IBM Storage Insights. With this integration, you can collect the same metadata as a data collector and send it securely to IBM Cloud for analysis and reporting in IBM Storage Insights.

If the IBM FlashSystem 5200 was not integrated with IBM Storage Insights during the initial system setup, an inline notification to add the storage system to IBM Storage Insights is displayed on the Call Home page and the Dashboard. On the Dashboard, an inline notification is displayed whenever the system is upgraded to a later version from the current version. If you close the notification, the system reminds you after 30 days.

The ability to use Call Home with cloud services for monitoring is available for IBM FlashSystem products that meet the following requirements:

- ▶ IBM Storage Virtualize 8.5.3 and later
- ▶ At least 128 GB of system memory

Note: The ability to integrate IBM FlashSystem 5200 with IBM Storage Insights by using Call Home with cloud services is available for storage systems that are not being monitored. Storage systems that are currently monitored by IBM Storage Insights with data collectors are not yet eligible.

Collected metadata

The following metadata about the configuration and operations of storage resources is collected:

- ▶ Name, model, firmware, and type of storage system.
- ▶ Inventory and configuration metadata, such as volumes, pools, disks, and ports.
- ▶ Capacity values, such as capacity, unassigned space, used space, and the compression ratio.
- ▶ Performance metrics, such as read and write data rates, I/O rates, and response times.

Note: The data collector cannot access the application data that is stored on the storage systems.

Accessing the metadata

Access to the metadata that is collected is restricted to the following users:

- ▶ The customer who owns the dashboard
- ▶ The administrators who are authorized to access the dashboard, such as the customer's operations team
- ▶ The IBM Cloud team that is responsible for the day-to-day operation and maintenance of IBM Cloud instances
- ▶ IBM Support for investigating and closing service tickets

Customer dashboard

Figure 14 shows a view of the Storage Insights main dashboard and the systems that it is monitoring.

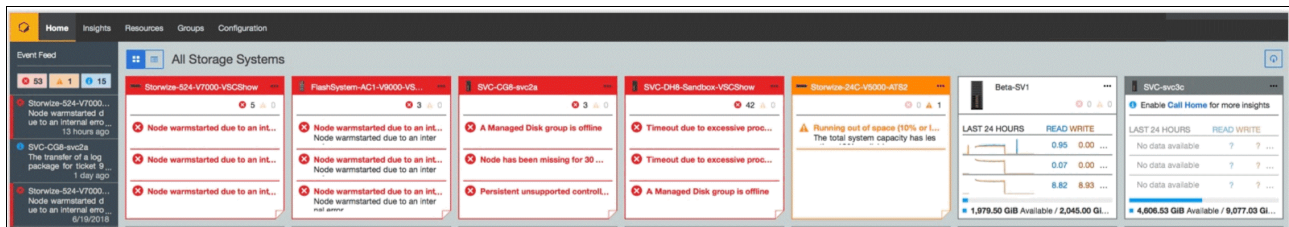

Figure 14 Storage Insights Dashboard

More views and images of dashboard displays can be found in the supporting documentation that is listed in the following sections.

For more information about Storage Insights and to register for the free service, see the following resources:

- ▶ [Fact Sheet](#)
- ▶ [Demonstration](#)
- ▶ [Security Guide](#)
- ▶ [IBM Documentation](#)
- ▶ [Registration link](#)

IBM Storage Connect

When you use IBM Storage Connect (formerly known as IBM Spectrum® Connect and IBM Storage Control Base), then the IBM FlashSystem 5200 supports the following features:

- ▶ IBM Storage Provider for VMware VASA
- ▶ IBM Storage Enhancements for VMware vSphere Web Client
- ▶ IBM Storage Plug-in for VMware vRealize Orchestrator
- ▶ IBM Storage Management Pack for VMware vRealize Operations Manager
- ▶ IBM Storage Automation Plug-in for PowerShell

This centralized server system consolidates a range of IBM storage provisioning, virtualization, cloud, automation, and monitoring solutions through a unified server platform. For more information about this feature, see [Lifecycle and support matrix](#).

IBM Storage Connect provides insight and awareness about the configuration capabilities, storage health, and events of a storage system regarding VMware and vSphere. With this capability, VMware administrators can independently and centrally manage their storage resources on IBM storage systems.

With Storage Virtualize v8.5.1 and later, native system support for VMware vSphere APIs for Storage Awareness (VASA) is provided through a VASA Provider (also known as Storage Provider) which sends and receives information about storage that is used by VMware vSphere to the vCenter Server. Through VASA, the system also supports VMware Virtual Volumes (also known as vVols), which allows VMware vCenter to automate the creation, deletion and mapping of volumes.

IBM FlashSystem 5200 GUI

The IBM FlashSystem 5000 family systems include an easy-to-use management GUI that runs on one of the node canisters in the control enclosure to help you monitor, manage, and configure your system. You can access the GUI by opening any supported web browser and entering the management IP addresses.

The IBM FlashSystem 5200 uses a GUI with the same type of interface as other IBM FlashSystem family solutions for a consistent management experience across all platforms. The GUI features an improved overview dashboard that provides all information in a format that is easier to understand. The GUI also provides a view of effective capacity. The new GUI can help you deploy storage more quickly and manage it efficiently.

Figure 15 shows the GUI Dashboard.

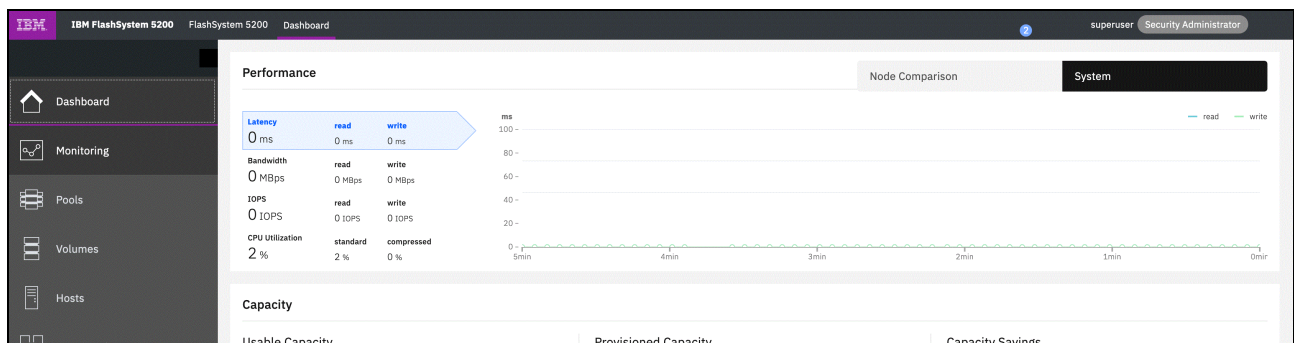

Figure 15 GUI dashboard

Figure 16 shows the control enclosure window. You can open this window by selecting **Monitoring** → **System Hardware** from the left menu.

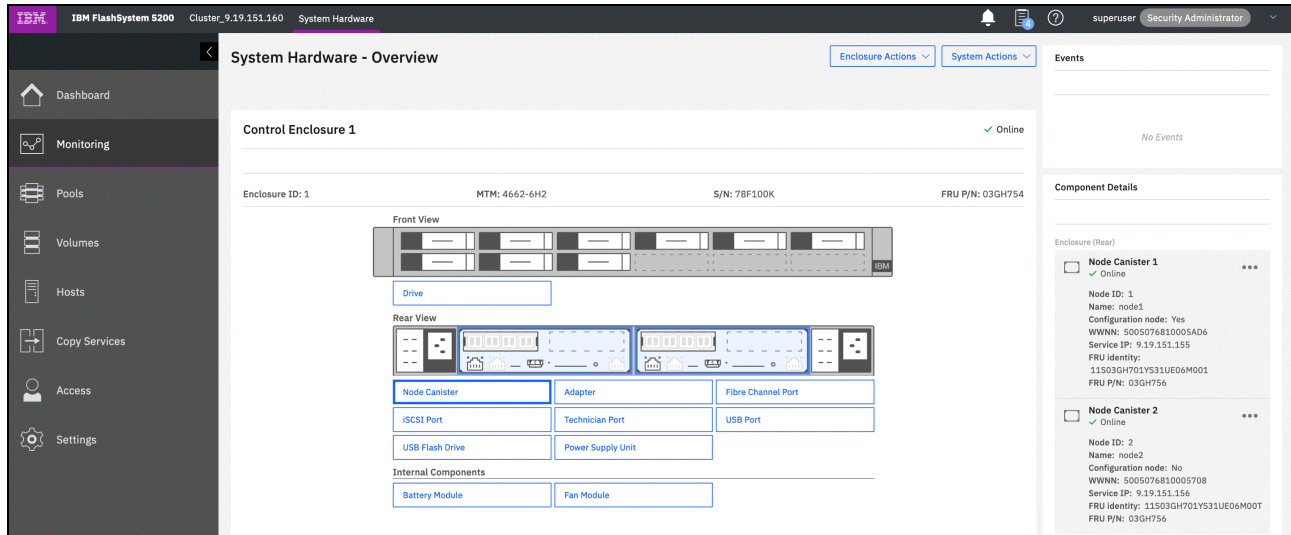

Figure 16 IBM FlashSystem 5200 system overview of the control enclosure

The IBM FlashSystem 5200 system includes a command-line interface (CLI), which is useful for scripting, and an intuitive GUI for simple and familiar management of the product. The IBM FlashSystem 5200 system supports SNMP email forwarding that uses Simple Mail Transfer Protocol (SMTP), and syslog redirection for complete enterprise management access.

By using the GUI, you can quickly deploy storage and manage it efficiently. The GUI runs on the IBM FlashSystem 5200 control enclosure, so a separate console is not needed. Enter the system IP address in a supported web browser, and you can manage all of the control and expansion enclosures from one place.

The IBM FlashSystem 5200 control enclosure node canisters are configured for active-active redundancy. The node canisters run a highly customized Linux-based operating system that coordinates and monitors all significant functions in the system.

The node canisters provide a web interface, Secure Shell (SSH) access, and SNMP connectivity through external Ethernet interfaces. By using the web and SSH interfaces, administrators can monitor system performance and health metrics, configure storage, and collect support data, among other features.

The storage configuration includes defining logical units with capacities, access policies, and other parameters. No software is needed on host computers to administer the IBM FlashSystem 5200 system beyond a web browser or a standard SSH client.

Supported platforms

The IBM FlashSystem 5200 system has extensive interoperability with support for a wide range of operating systems that includes Microsoft Windows Server 2008 and Microsoft Windows Server 2012, Linux, IBM AIX, and IBM i; a range of hardware platforms that include IBM System x, IBM Power Systems, and x86 servers that are not from IBM; plus host bus adapters (HBAs), and SAN fabrics.

For more information, see [IBM System Storage Interoperation Center \(SSIC\)](#).

IBM FlashSystem 5200 hardware component overview

The IBM FlashSystem 5200 control enclosure is a 1U rack-mounted NVMe flash memory enclosure that is based on IBM flash technology. It provides the primary management interface (GUI) and the host interface configuration. The IBM FlashSystem 5200 control enclosures support FC Protocol (FCP and FC-NVMe), iSCSI, NVMe over RDMA, and NVMe over TCP protocol interfaces. For iSCSI, the RoCE and iWARP protocols are supported.

Figure 17 shows the front view of the IBM FlashSystem 5200 control enclosure. Also shown are six NVMe drives that are installed in upper slots 1–6 and six fillers in lower slots 7–12.

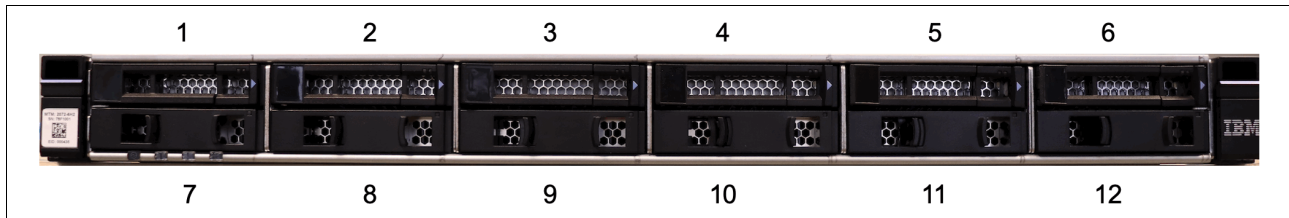

Figure 17 IBM FlashSystem 5200 control enclosure front view with drive slot locations

The IBM FlashSystem provides the following NVMe technologies:

- ▶ Supports unique world class IBM FCMs with inline compression
- ▶ Supports industry-standard NVMe drives
- ▶ Option for SCM type drives
- ▶ NVMe-oF on FC
- ▶ NVMe over RDMA or NVMe over TCP protocol
- ▶ IBM FlashSystem® 5200 system is offered as two models:
 - 4662 model 6H2: IBM FlashSystem 5200 NVMe control enclosure
 - 4662 model UH6: IBM FlashSystem 5200 NVMe control enclosure utility model

Note: The 4662-UH6 utility-based model features fixed configurations because they are Capacity on Demand (CoD) based offerings.

- ▶ Macroefficiency with up to 460 TB of raw maximum protected capacity with inline hardware data compression if you use IBM FCMs.
- ▶ Support for industry-standard NVMe drives with up to 184 TB of maximum raw capacity.
- ▶ Extreme performance with IBM MicroLatency FlashCore Modules.
- ▶ Optional expansion enclosures that provide tiering options with SSD flash and HDD drives.

The IBM FlashSystem 5200 configuration consists of the following components:

- ▶ A total of 1–4 IBM FlashSystem 5200 control enclosures
- ▶ A total of 1–20 IBM FlashSystem 5200 SFF/LFF expansion enclosures
- ▶ A total of 1–8 IBM FlashSystem 5200 LFF High Density (HD) expansion enclosures

The following machine warranties are offered for the IBM FlashSystem 5200 system:

- ▶ Machine type 4662-6H2 with a 12-month, parts-only warranty
- ▶ Machine type 4662-UH6 with a 12-month, parts-only warranty

The IBM FlashSystem 5200 control enclosure includes integrated AC power supplies (PSU) and battery units inside each of the canisters. These batteries supply power to the control enclosure during a sudden power loss or failure, so the system can correctly commit all transactions to the storage medium.

The IBM FlashSystem 5200 control enclosure includes the following features:

- ▶ Full internal redundancy:
 - Redundant and hot-swappable canisters
 - Redundant and hot-swappable batteries within each canister
 - Hot-swappable PCI Express (PCIe) adapters
 - Redundant and hot-swappable power supplies, DIMMs, and fans

Figure 18 shows a top view of the IBM FlashSystem 5200 enclosure. Highlighted are the various components of the control enclosure and the two canisters.

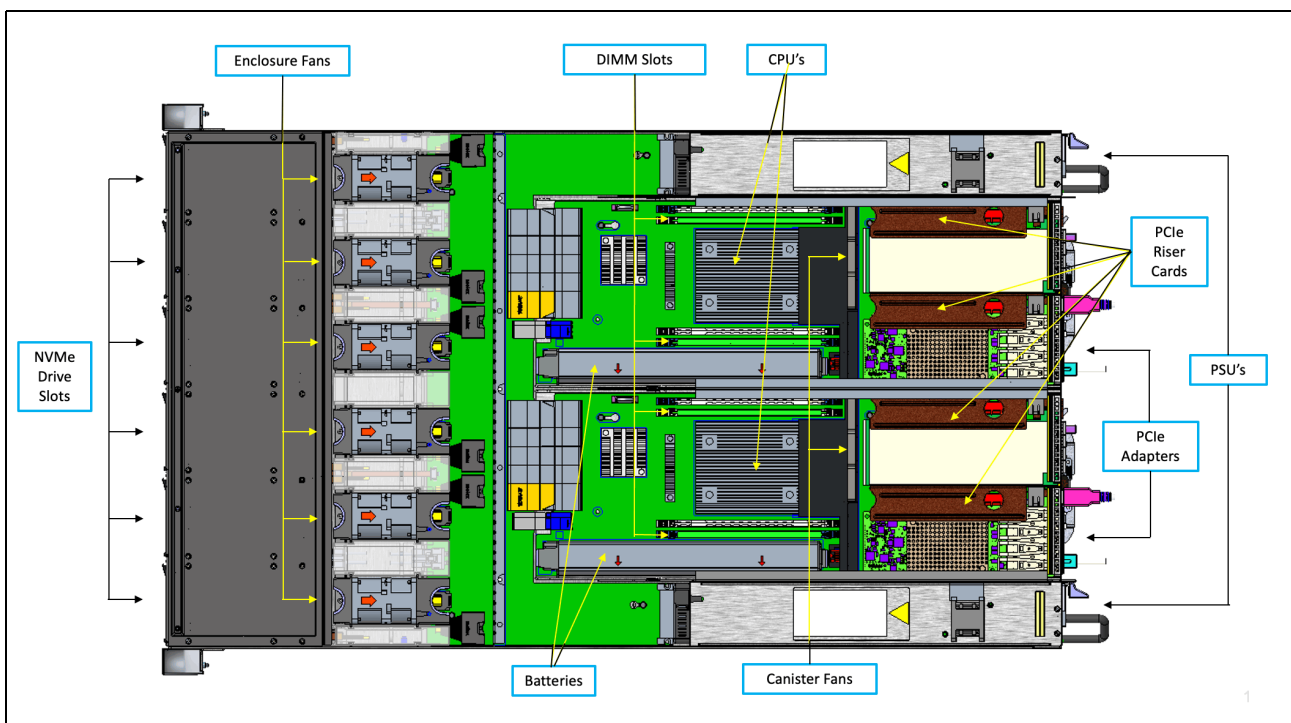

Figure 18 Top view of the IBM FlashSystem 5200 enclosure

- ▶ Control enclosure:
 - Two canisters that are placed side by side
 - 12 NVMe drive slots
 - Six enclosure fan assemblies
- ▶ Each canister contains the following components and quantities:
 - CPU (1)
 - DIMM Slots (4)
 - Battery (1)
 - Canister Fans (3)
 - Power Supply PSU (1)
 - PCIe adapters (0–2)
 - PCIe riser cards (2)
 - PCIe adapter blanking plates (0-2)

Note: The number of PCIe adapters is configurable at product ordering time and can be added or removed by a sales MES.

Figure 19 shows the rear view of the IBM FlashSystem 5200 control enclosure. You can see the two canisters side by side, the interface cards, power supply units, and the various USB and Ethernet ports. All components are concurrently maintainable, except for the passive midplanes. All external connections are from the rear of the system.

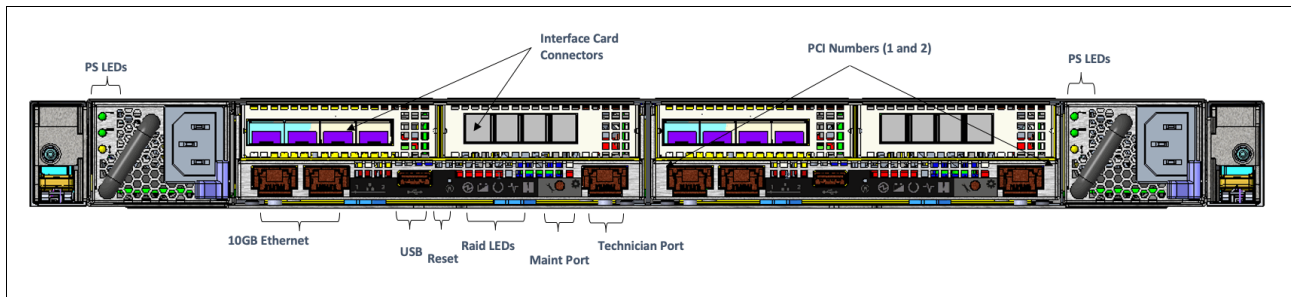

Figure 19 Rear view of IBM FlashSystem 5200 control enclosure

Figure 20 shows a more detailed view of the rear of a canister.

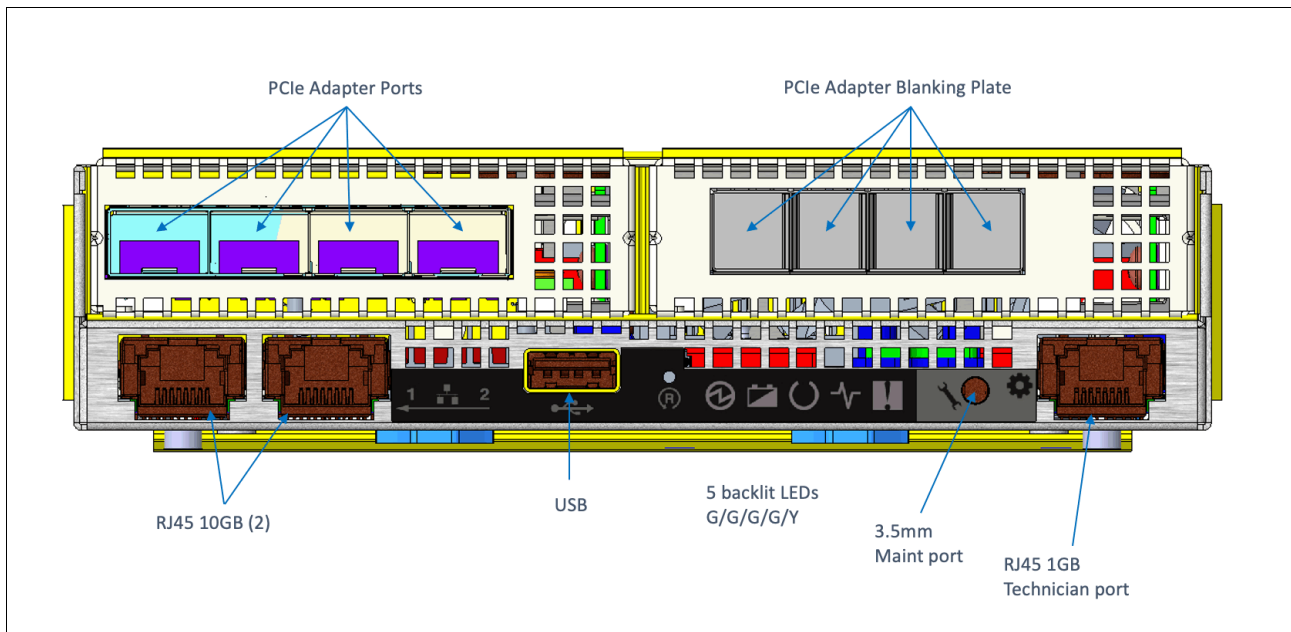

Figure 20 IBM FlashSystem 5200 canister rear view

In Figure 20, you can see the RJ45 and USB ports and the PCIe adapters. The PCIe adapter that is shown on the left is populated with a four-port card. The adapter that is on the right side is not present and a blanking plate assembly is in place to ensure and maintain the correct air flow for cooling through the canister.

IBM FlashSystem 5200 NVMe drive options

The IBM FlashSystem 5200 control enclosure supports up to 12 NVMe 2.5-inch drives, which can be the IBM FlashCore Module NVMe type drives or the industry-standard NVMe drives.

When FCMs are installed, a DRAID 6 array is considered a best practice. DRAID 5 arrays are also supported. The following 2.5-inch (SFF) IBM FCMs are supported in IBM FlashSystem 5200 control enclosures:

- ▶ 4.8 TB 2.5-inch NVMe FCM
- ▶ 9.6 TB 2.5-inch NVMe FCM
- ▶ 19.2 TB 2.5-inch NVMe FCM
- ▶ 38.4 TB 2.5-inch NVMe FCM

When NVMe industry-standard flash drives are installed, it is considered a best practice to configure a TRAIT 10 or DRAID 6 array. DRAID 5 arrays are also supported. The following 2.5-inch (SFF) NVMe industry-standard flash drives are supported in IBM FlashSystem 5200 control enclosures:

- ▶ 800 GB 2.5-inch
- ▶ 1.92 TB 2.5-inch
- ▶ 3.84 TB 2.5-inch
- ▶ 7.68 TB 2.5-inch
- ▶ 15.36 TB 2.5-inch

The drive modules in the IBM FlashSystem 5200 control enclosure are required to be plugged in a specific order (see Figure 21). The top row of drives is labeled slot 1–6; the bottom row of drives is labeled as slot 7–12.

The plug rules for populating drives follow the numbering of the slots, as shown in Figure 21.

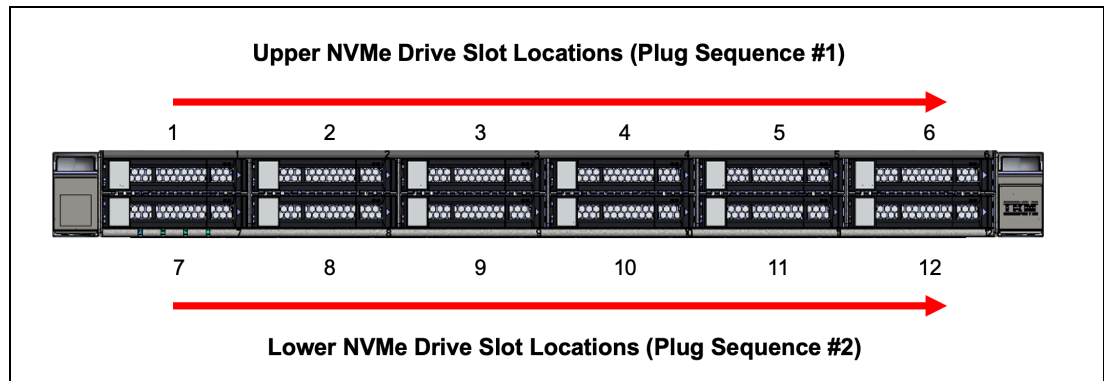

Figure 21 NVMe drive slot locations and plugging rules

All slots must be filled regardless of the number of drive modules. If a slot does not have a drive module installed, a filler must be used to ensure correct air flow through the enclosure.

Figure 22 shows the first four NVMe drives and eight fillers installed.

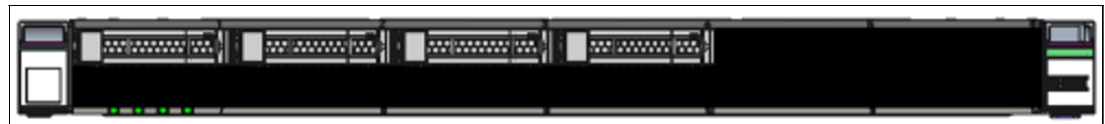

Figure 22 IBM FlashSystem 5200 NVMe drive slots with four drives populated and eight fillers

Figure 23 shows the first eight NVMe drives plugged and four fillers installed.



Figure 23 IBM FlashSystem 5200 NVMe drive slots supported by eight drives that are populated and four fillers

It also supports up to 12 1.6 TB NVMe SCM Drives.

Note: The 375 GB NVMe, 750 GB NVMe, 800 GB NVMe SCMs are no longer available, but they are still supported in the IBM FlashSystem 5200.

Important: SCM drives feature a special plugging sequence. They are plugged in *reverse* sequence in drive slots 12–1. For more information, see “Storage Class Memory” on page 15.

With fewer than 4 drives, a DRAID 1 array is considered a best practice. DRAID 5 requires a minimum of 4 drives. DRAID 6 requires a minimum of 6 drives. TRAIID 1 or 10 arrays are supported with fewer than four drives but are not recommended because they can cause performance issues. Consider the following points:

- ▶ All drives are dual-port and hot-swappable. Drives of the same form factor and connector type can be intermixed within an enclosure.
- ▶ All flash modules must be the same type and capacity within the same DRAID 6 array.
- ▶ Each IBM FCM contains IBM enhanced flash chips, FPGA chips, an IBM PowerPC® processor, and DRAM devices that are connected to the flash controllers and processor.
- ▶ Cache options from 32 GB per canister to 256 GB per canister.
- ▶ Four 10 Gbps Ethernet ports standard for iSCSI connectivity.
- ▶ 32 Gbps and 16 Gbps FC, 25 Gbps Ethernet, and 10 Gbps Ethernet ports are available for FC and iSCSI connectivity.
- ▶ 12 Gbps SAS ports for Host Attachment and also expansion enclosure attachments are available.

The IBM FlashSystem 5200 control enclosure supports FCP with point-to-point (FC-P2P), arbitrated loop (FC-AL), and switched fabric (FC-SW) topologies. FC interfaces can be configured as N_port or NL_port types.

The FC ports come configured in NPIV mode, so the user must check that this configuration is preferred for their installation. If not, this configuration must be changed from the default when you set up the SAN infrastructure. Full active-active multipathing across all interfaces also is supported, although host software support for this function can vary.

The IBM FlashSystem 5200 support a maximum of 4 control enclosures and supports the addition of expansion enclosures. For supported expansion enclosure configurations, see “IBM FlashSystem 5200 expansion enclosures” on page 33.

IBM FlashSystem 5200 utility model UH6

IBM FlashSystem 5200 utility models UH6 provide a variable capacity storage offering. These models also offer a fixed capacity, with a base subscription of approximately 35% of the total capacity.

IBM Storage Insights is used to monitor system usage and capacity that is used. This usage is billed on the capacity-used basis. With this billing structure, you can grow or shrink usage, and pay for the configured capacity only.

IBM FlashSystem utility models are provided for customers who can benefit from a variable capacity system, where billing is based on provisioned space only. The hardware is leased through IBM Global Finance on a three-year lease, which entitles the customer to use approximately 30 - 40% of the total system capacity at no extra cost (customer individual contract-dependent). If storage must increase beyond that initial capacity, usage is billed based on the average daily provisioned capacity per terabyte per month on a quarterly basis.

Example: A total system capacity of 115 TB

A customer has an IBM FlashSystem 5200 utility model with 12 9.6 TB NVMe drives for a total system capacity of 115 TB. The base subscription for such a system is 40.25 TB. No extra billing occurs during the months where the average daily usage is less than 40.25 TB.

The system monitors daily provisioned capacity and averages those daily usage rates over the month. The result is the average daily usage for the month.

If a customer uses 45 TB, 42.5 TB, and 50 TB in three consecutive months, IBM Storage Insights calculates the overage (see Table 1), rounding to the nearest terabyte.

Table 1 Billing calculations based on customer usage

Average daily	Base	Overage	To be billed
45 TB	40.25 TB	4.75 TB	5 TB
42.5 TB	40.25 TB	2.25 TB	2 TB
50 TB	40.25 TB	9.75 TB	10 TB

The total capacity that is billed at the end of the quarter is 17 TB per month in this example.

Flash drive expansions can be ordered with the system in all supported configurations. Table 2 lists the feature codes that are associated with the UH6 utility model billing.

Table 2 5200 UH6 utility model billing feature codes

Feature code	Description
#AE00	Variable Usage 1 TB/month
#AE01	Variable Usage 10 TB/month
#AE02	Variable Usage 100 TB/month

These features are used to purchase the variable capacity that is used in the utility models. The features #AE00, #AE01, and #AE02 provide terabytes of capacity beyond the base subscription on the system. Usage is based on the average capacity that is used per month. The total of the prior three months' usage is totaled, and the corresponding number of #AE00, #AE01, and #AE02 features ordered quarterly.

Billing

The local project office compiles the usage information from IBM Storage Insights on a quarterly basis. This data is compared to the base system capacity subscription. Any provisioned capacity beyond that base subscription is billed per terabyte, per month on a quarterly basis.

The calculated usage is based on the average use over a month. In a highly variable environment, such as managed or cloud service providers, this subscription enables the system to be used only as much as is necessary during any month. Usage can increase or decrease, and is billed.

Provisioned capacity is considered capacity that is reserved by the system. In thick-provisioned environments, this capacity is the capacity that is allocated to a host, whether it has data that is written. For thin-provisioned environments, the data that is written is used because of the different ways in which thick- and thin-provisioning use flash drive space.

Figure 24 shows a summary of the IBM FlashSystem 5200 machine types and models.

Machine Type Model	4662-6H2	4662-UH6
Mktg Name	FlashSystem 5200	
Warranty	HW parts only, 1 Year; 9x5 Next Business Day (NBD)	
Install	Customer Set Up (CSU): SSR Install available through priced service offerings	
Software Support & Services	Optional priced service offerings	
Expansion Enclosures	12G, 24G and 92G	
Misc	NVMe FCM , SCM and Industry Standard drives in control enclosures Flash SSD and HDD drives in expansion enclosures	

Figure 24 IBM FlashSystem 5200 machine type and models

IBM FlashSystem 5200 expansion enclosures

The IBM FlashSystem 5200 system supports the addition of storage expansion enclosures. IBM FlashSystem 5200 expansion enclosures are 2U or 5U rack-mounted units.

Note: To support SAS-attached expansion enclosures, a 2-port 12 Gbps SAS adapter (slot 2 only) is required to be installed in each canister of an IBM FlashSystem 5200 system control enclosure.

Model 92G

IBM FlashSystem 5200 HD expansion enclosure model 92G supports up to 92 SAS drives in 3.5-inch carriers. A maximum of eight Model 92G expansion enclosures is supported per control enclosure with a maximum capacity of 2826 TB each. The drives can be formatted as DRAID 5 or DRAID 6. For feature codes to order drives, see “IBM FlashSystem 5200 expansion enclosure drive options for model 92G” on page 56.

The following 3.5-inch SAS drives are supported in the model 92G expansion enclosures:

- ▶ 1.92 TB, 3.84 TB, 7.68 TB, 15.36 TB, and 30.72 TB flash drives
- ▶ 1.2 TB, 1.8 TB, and 2.4 TB 10,000 rpm drives
- ▶ 6 TB, 8 TB, 10 TB, 12 TB, 14 TB, 16 TB, 18 TB, and 20 TB 7,200 rpm drives

IBM FlashSystem 5200 LFF expansion enclosure model 92G delivers the following features:

- ▶ Up to 92 drives that are top-loaded into drive slots of the expansion enclosure.
- ▶ 5U 19-inch rack-mount enclosure with slide rail and cable management assembly.
- ▶ High-performance flash drive support
- ▶ Redundant 200 - 240 V AC power supplies (new PDU power cord required).

Figure 25 shows the front view of IBM FlashSystem 5200 LFF model 92G expansion enclosure.

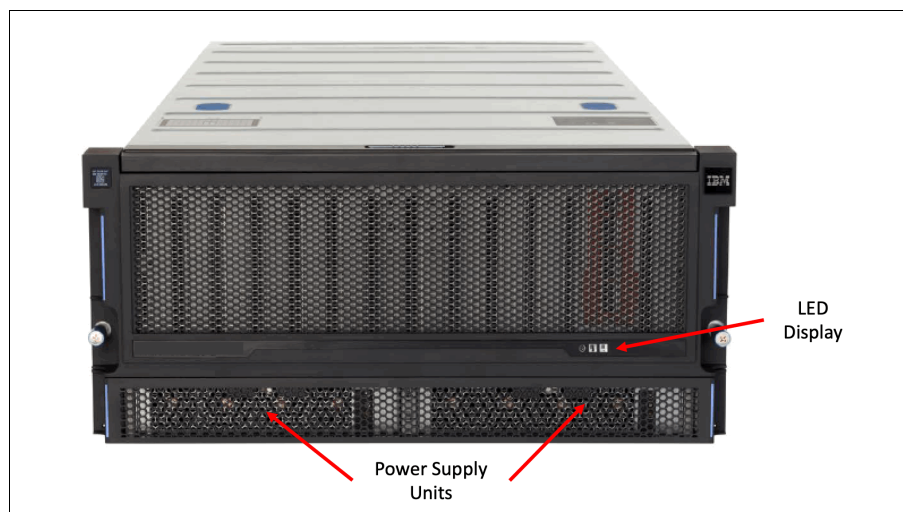

Figure 25 Front view of IBM FlashSystem 5200 LFF model 92G expansion enclosure

Figure 26 shows the rear view of IBM FlashSystem 5200 LFF model 92G expansion enclosure.

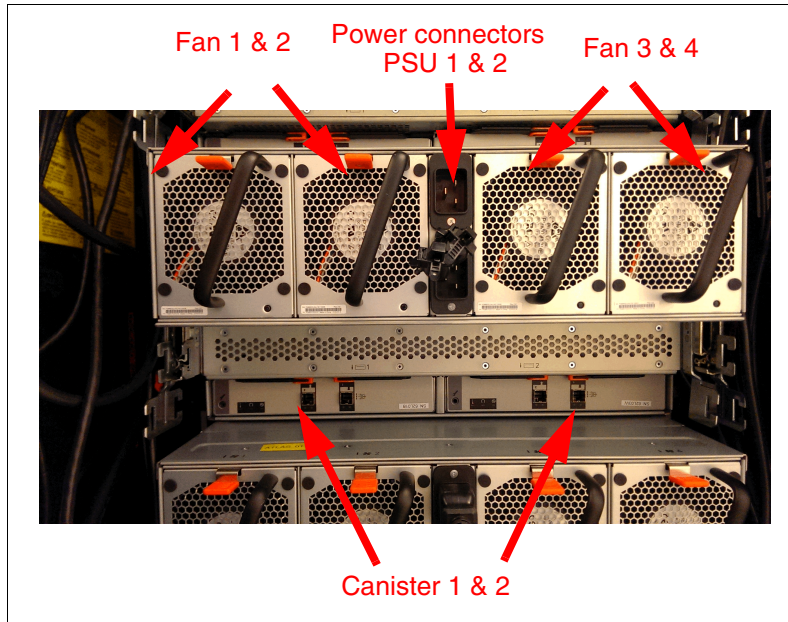

Figure 26 Rear view of IBM FlashSystem 5200 LFF model 92G expansion enclosure

Model 24G

The IBM FlashSystem 5200 SFF expansion enclosure model 24G also offers tiering options. Each SFF expansion enclosure supports up to 24 2.5-inch SAS drives. The drives can be formatted as DRAID 5 or DRAID 6.

The following 2.5-inch SAS drives are supported in the 24G expansion enclosures:

- ▶ 800 GB, 1.92 TB, 3.84 TB, 7.68 TB, 15.36 TB, and 30.72 TB flash drives
- ▶ 900 GB, 1.2 TB, 1.8 TB, and 2.4 TB 10,000 rpm drives
- ▶ 2 TB 7,200 rpm drives

A maximum of 20 model 24G expansion enclosures is supported per IBM FlashSystem 5200 control enclosure, which provides up to 480 drives with up to 14.7 PB of SAS SSD capacity. For feature codes to order drives, see “IBM FlashSystem 5200 expansion enclosure drive options for model 24G” on page 55.

Figure 27 shows the front view of the expansion enclosure model 24G.

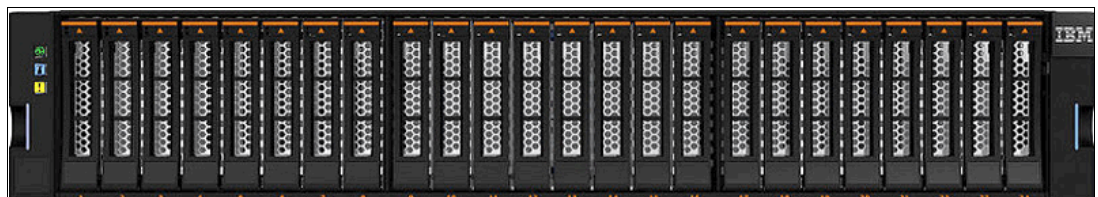

Figure 27 Front view of the IBM FlashSystem 5200 SFF expansion enclosure model 24G

The IBM FlashSystem 5200 SFF expansion enclosure model 24G includes the following features:

- ▶ Up to 24 2.5-inch flash SSDs or HDDs
- ▶ Two expansion canisters
- ▶ 12 Gbps SAS ports for attachment to the IBM FlashSystem 5200 control enclosures
- ▶ 2U 19-inch rack-mount enclosure with AC power supplies

Figure 28 shows the rear view of IBM FlashSystem 5200 LFF expansion enclosure model 12G and IBM FlashSystem 5200 SFF expansion enclosure model 24G.



Figure 28 Rear view of IBM FlashSystem 5200 expansion enclosure models 12G and 24G

Model 12G

IBM FlashSystem 5200 SFF expansion enclosure model 12G supports up to 12 3.5-inch SAS drives. The drives can be formatted as DRAID 5 or DRAID 6. A maximum of 20 model 12G expansion enclosures are supported per IBM FlashSystem 5200 control enclosure, which provides a maximum of 240 drives with up to 4.3 PB of SAS capacity. For feature codes to order drives, see “IBM FlashSystem 5200 expansion enclosure drive options for model 12G” on page 55.

The following 3.5-inch SAS drives are supported in the 12G expansion enclosures:

- ▶ 900 GB, 1.2 TB, 1.8 TB, and 2.4 TB 10,000 rpm drives
- ▶ 4 TB, 6 TB, 8 TB, 10 TB, 12 TB, 14 TB, 16 TB, 18 TB, and 20 TB 7,200 rpm drives

Figure 29 shows the front view of the expansion enclosure model 12G.



Figure 29 Front view of the IBM FlashSystem 5200 SFF expansion enclosure model 12G

The IBM FlashSystem 5200 LFF expansion enclosure model 12G includes the following features:

- ▶ A maximum of twelve 3.5-inch flash SSDs or HDDs
- ▶ Two expansion canisters
- ▶ 12 Gbps SAS ports for attachment to the IBM FlashSystem 5200 control enclosures
- ▶ 2U 19-inch rack-mount enclosure with AC power supplies

Mixing types of enclosures

Expansion enclosures can be intermixed within an IBM FlashSystem 5200 system. IBM FlashSystem 5200 systems scale a maximum of 748 drives with the attachment of IBM FlashSystem 5200 expansion enclosures. An IBM FlashSystem 5200 clustered system can contain a maximum of four IBM FlashSystem 5200 enclosures and a maximum of 2,992 drives.

When attaching expansion enclosures to the control enclosure, you are not limited by the type of the enclosure. The only limitation for each of the two SAS chains is its chain weight. Each type of enclosure has its own chain weight:

- ▶ Enclosures 12G and 24G have a chain weight of 1.
- ▶ Enclosure 92G has a chain weight of 2.5.

The maximum SAS chain weight is 10.

For example, you can combine seven 24G and one 92G expansions ($7 \times 1 + 1 \times 2.5 = 9.5$ chain weight), or two 92G enclosures, one 12G, and four 24G ($2 \times 2.5 + 1 \times 1 + 4 \times 1 = 10$ chain weight).

Note: The IBM Storage Virtualize maximum storage limit is 32 PB.

For more information about mixing expansion enclosures and the maximum configurations that are allowed, see [V8.6.0.x Configuration Limits and Restrictions for IBM FlashSystem 5x00](#) and see [Enclosures](#).

Scalability and performance

The IBM FlashSystem 5200 system includes the following scalability and performance features:

- ▶ A maximum of 340 TB is usable and 1020 TB effective flash capacity in only 1U with 3:1 compression.
- ▶ A maximum of 1.36 PB usable and 6.8 PB maximum flash capacity in only 4U (4 IBM FlashSystem 5200 control enclosures) with 5:1 compression.
- ▶ Extra scalability through expansion enclosures models 12G, 24G, and 92G and increased raw capacity to a maximum of 32 PB.
- ▶ The IBM FlashSystem 5200 system can deliver up to 1.5 million IOPS, with latency down to 50 μ s and a maximum bandwidth of 21 Gbps from a single system.
- ▶ A clustered IBM FlashSystem 5200 system can scale linearly and delivers 6 million IOPS and 84 Gbps on a fully configured IBM FlashSystem 5200 cluster with 4 control enclosures.

Advanced functions

The IBM FlashSystem 5200 system provides the following advanced functions, which are described in this section:

- ▶ HyperSwap
- ▶ NVMe over Fabrics (NVMe-oF)
- ▶ NVMe over RDMA and NVMe over TCP
- ▶ IP quorum base support
- ▶ Data reduction tools
- ▶ N_Port ID Virtualization support
- ▶ VMware integration
- ▶ RAID types
- ▶ External Virtualization
- ▶ Manageability and security

HyperSwap

The IBM HyperSwap function is a high availability feature that provides dual-site access to a volume and is available with IBM FlashSystem 5200. The configuration tolerates combinations of I/O groups and site failures, and uses change volumes to provide consistency protection during automatic resynchronization.

The HyperSwap function uses a HyperSwap topology to spread the I/O groups of the clustered system across two sites. It also requires a third site to host a quorum device or IP quorum application that provides an automatic tie-break if a link fails between the two main sites.

HyperSwap includes the following characteristics:

- ▶ Data is stored on two sites in parallel.
- ▶ The maximum distance between sites is 300 km (186.4 miles).
- ▶ Two independent copies of data are maintained (four if you use another volume mirroring to two pools in each site).
- ▶ HyperSwap uses a standard host multipathing driver.
- ▶ Cache data is retained if only one site is online.
- ▶ Automatically synchronizes and resynchronizes copies.
- ▶ Based on the host site, automatic host-to-storage-system path optimization, which requires Asymmetric Logical Unit Access (ALUA) and Target Port Groups Support (TPGS) support from the multipathing driver.
- ▶ Consistent state data is retained during resynchronization for DR.
- ▶ The maximum number of highly available volumes is 2000.
- ▶ A HyperSwap topology system can be configured through site allocation and topology change CLI commands. The management GUI configures a HyperSwap topology with the Modify System Topology wizard, which guides you through the configuration.

Figure 30 shows how the HyperSwap function works between two FlashSystem 5200 systems.

Each primary volume (P) has a secondary volume (S) on the opposite I/O group. The secondary volumes are not mapped to the hosts. The dual-write to the secondary volumes is handled by the IBM FlashSystem 5200 HyperSwap function, and is transparent to the hosts.

Consider the following points:

- ▶ The HyperSwap topology uses extra system resources to support a fully independent cache at each site. This configuration provides full performance, even if one site is lost.
- ▶ Hosts, IBM FlashSystem 5200 control enclosures and their expansion enclosures are in one of two failure domains or sites.
- ▶ Volumes are visible as a single object across both sites (I/O groups).

A 2-site HyperSwap configuration can be extended to a third site for Disaster Recovery that uses the IBM Storage Virtualize 3-Site Orchestrator. IBM Storage Virtualize 3-Site Orchestrator is a CLI-based application that runs on a separate Linux host that configures and manages supported replication configurations on IBM Storage Virtualize products. IBM Storage Virtualize 3-Site Orchestrator coordinates replication of data for disaster recovery and high availability scenarios between systems that are on three geographically dispersed sites.

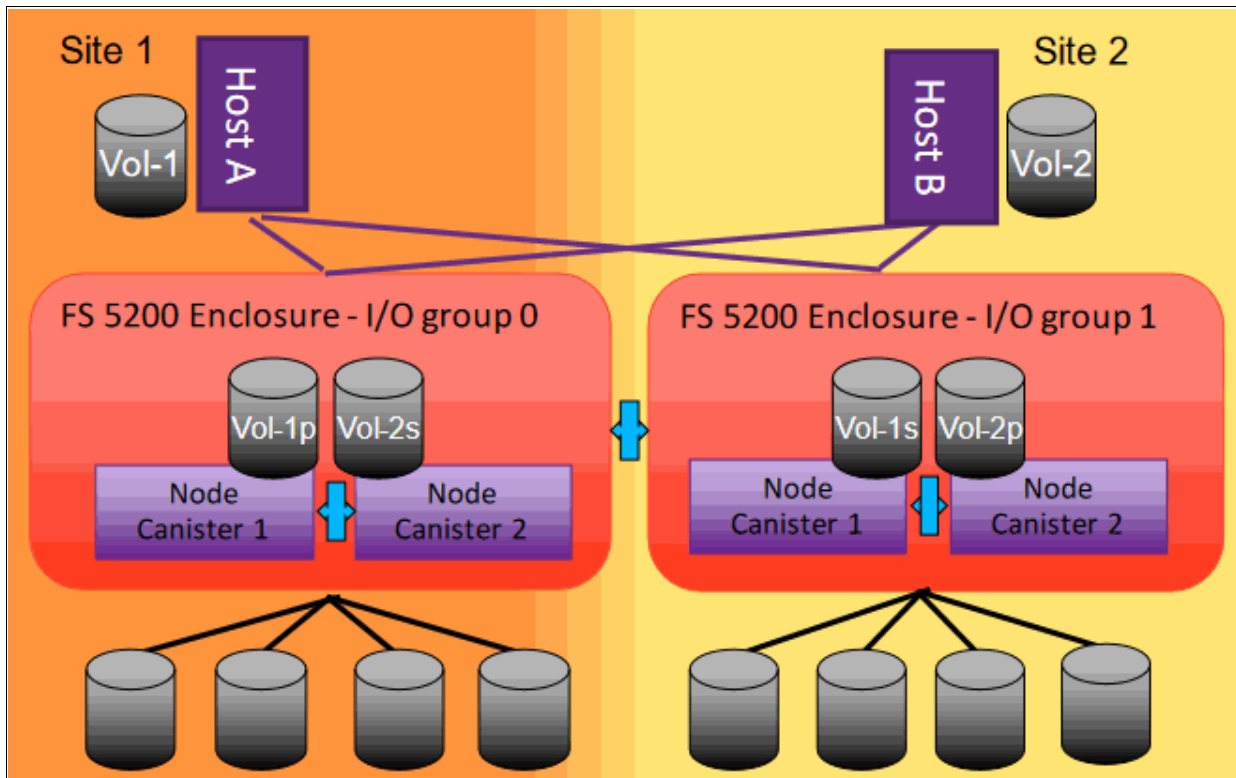

Figure 30 HyperSwap function

Non-volatile Memory Express over Fabrics

The Non-volatile Memory Express (NVMe) protocol is an open collection of standards and interfaces that uses the benefits of non-volatile memory in all types of computing environments, from mobile to data center. NVMe is designed to deliver high bandwidth and low latency storage access. This section describes the NVMe protocol and interface as it relates specifically to flash-based architectures.

The NVMe protocol is an interface specification for communicating with storage devices, and it is functionally the same as other protocols, such as Serial ATA (SATA) and SAS. However, the NVMe interface was designed for extremely fast storage media, such as flash-based, low-latency non-volatile storage technologies.

NVMe storage devices are typically directly attached to a host system over a PCIe bus and the NVMe controller is contained in the storage device. This configuration alleviates the need for another I/O controller between the CPU and the storage device. It also results in lower latency, throughput scalability, and simpler system designs.

This design is implemented in the IBM FlashSystem 5200 system, with its dual-ported PCIe based NVMe drives.

However, the PCIe bus limits the number of NVMe drives that can be attached to a host over the bus to a few tens of devices. Because the maximum length of PCIe cabling is also only a few meters, the flexibility of deploying PCIe NVMe drives outside the host server is severely limited and data center level scalability is not feasible.

NVMe over Fabrics (NVMe-oF) overcomes the limitations of the SCSI protocol and the limited number of concurrent queues by extending the benefits of low latency and high efficiency of the NVMe technology across network fabrics to support sharing of NVMe storage at a large scale of 100s or 1000s of devices and over distance.

Figure 31 shows that the NVMe architecture supports many different network fabric technologies.

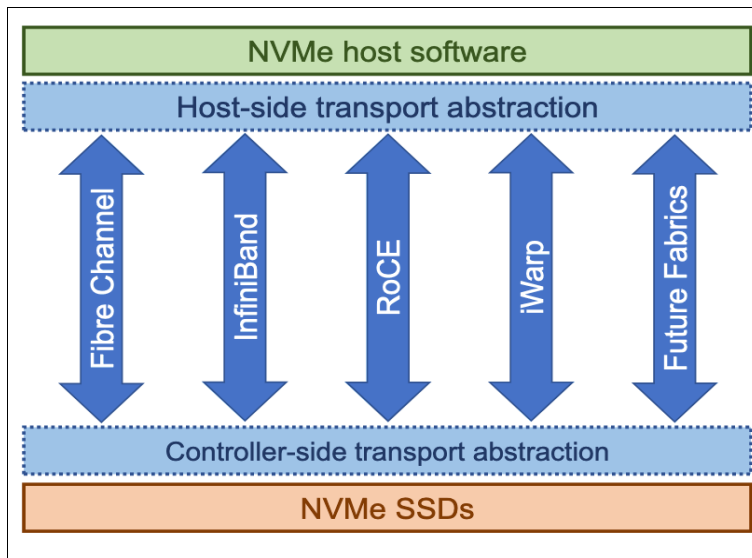

Figure 31 NVMe technology support options

The NVMe transport layer can be mapped to different network fabric technologies.

NVMe over Fabrics that use FC (FC-NVMe) uses the Fibre Channel Protocol (FCP) as its transport mechanism, which puts the data transfer in control of the target and transfers data direct from host memory, similar to RDMA. In addition, FC-NVMe allows for a host to send commands and data together (first burst), which eliminates the first data “read” by the target and provides better performance at distances.

The NVMe over Fabrics interface uses the same model of submission and completion queues as PCIe NVMe. As such, it maintains the same asynchronous submission and completion model and achieves similar benefits in terms of latency, efficiency, and scalability as the NVMe technology because of the shortened code paths and lockless concurrency in multi-core environments.

The IBM FlashSystem 5200 system supports NVMe protocols by way of the various PCIe cards that can be ordered and installed in the control enclosure. For more information about these options, see “Host I/O connectivity and expansion enclosure adapters” on page 51.

For more information about NVMeoF protocols and architecture, see *IBM Storage and the NVM Express Revolution*, [IBM Storage and the NVM Express Revolution](#), REDP-5437.

NVMe over RDMA and NVMe over TCP

RDMA data transfer uses specialized network switches and requires less resources than FC-NVMe. RDMA allows higher throughput and better performance with lower latency. In addition, RDMA requires less expertise at the storage networking level than the Fibre Channel implementation, potentially reducing overall costs.

The advantage of using TCP data transfer is that unlike RDMA data transfer, TCP uses the existing Ethernet adapters on the host and network infrastructure.

On the FlashSystem 5200, every physical Ethernet port supports four virtual ports: one for SCSI host connectivity, one for RDMA or TCP host connectivity, one for SCSI host failover, and one for RDMA or TCP host failover. Every NVMe virtual port supports the functions of NVMe discovery controllers and NVMe I/O controllers. Hosts create associations (NVMe logins) to the discovery controllers to discover volumes or to I/O controllers to complete I/O operations on NVMe volumes. Up to 128 discovery associations are allowed per port, not including N_Port ID virtualization (NPIV) failover. The number of ports per node depend on your storage system configuration.

IP quorum base support

For a lower implementation operation cost HA solution, you can use an IP network-attached host as a quorum disk.

In a HyperSwap setup, a quorum disk at the third site is needed by way of FC-storage or IP quorum to cope with tie-breaker situations. The quorum disk on the third site must be the active quorum disk. Only the active quorum disk acts as a tie-breaker.

A quorum device is also used to store a backup copy of important system configuration data. Just over 256 MB is reserved for this purpose on each quorum device.

A system can have only one active quorum device. However, a maximum of three quorum devices are used to record a backup of system configuration data if a disaster occurs. The system automatically selects one quorum device to be the active quorum device.

For more information about configuring quorum disks within two or three sites, see [Configuring quorum](#).

Note: Fibre Channel over IP (FCIP) connectivity is not supported between nodes when a HyperSwap system is configured without the use of inter-switch links (ISLs).

Data reduction tools

Compression and deduplication are a key part of the IBM FlashSystem 5200 system. The IBM Comprestimator and the Data Reduction Estimator Tool (DRET) are the key sizing tools to estimate how much capacity savings that a client can expect.

IBM FlashSystem models are supported by the IBM Comprestimator (available as a stand-alone tool and also found in the IBM FlashSystem 5200 GUI) and the stand-alone DRET.

This DRET tool is a host-based application that the user runs to estimate the amount of compression and deduplication on the IBM FlashSystem 5200 system for specific workloads or data set.

Figure 32 shows how to start the Estimate Compression Saving option from the GUI:

1. From the main menu, click **Volumes** → **Volumes** and select one volume.
2. Right-click to see the menu. From this menu, select **Capacity Savings** → **Estimate Compression Saving**.

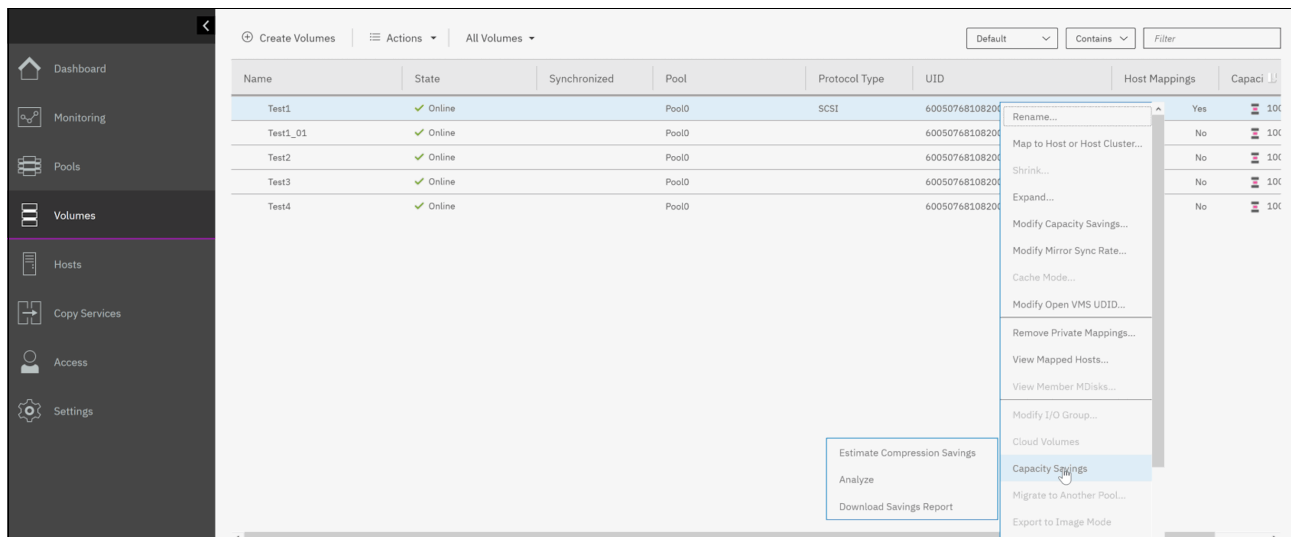

Figure 32 Estimate Compression Saving from the GUI

Note: A DRP has Comprestimator always on.

Choose your data reduction approach and use the tools to estimate the amount of usable storage that is required by reviewing the following tools:

- ▶ IBM FCM - IBM FCM Compression:
 - Use the FCM option.
 - Do not use the Estimate Compression Saving option in the GUI to calculate the IBM FlashCore Module savings.

- ▶ **DRP compression:**
 - Use the DRP option.
 - Workloads that are on any IBM Storage Virtualize platforms can use the Estimate Compression Saving option in the GUI.
- ▶ **DRP compression and deduplication:**
 - IBM Comprestimator and DRET show the savings for thin-provisioning, compression, and deduplication.
 - IBM Comprestimator and DRET read entire volumes to identify deduplicated data, so it takes longer to run.

For more information about DRP compression and setup, see [Introduction and Implementation of Data Reduction Pools and Deduplication, SG24-8430](#).

N_Port ID Virtualization support

N_Port ID Virtualization (NPIV) is a method for virtualizing a physical Fibre Channel port that is used for host I/O. The use of NPIV increases resilience during firmware updates, scheduled maintenance, or controller issues where the virtual worldwide port names (WWPNs) are automatically moved to the controller that is not being affected. As a result, FC-attached hosts experience a momentary path loss, but the persistence of the WWPNs lessens the multipathing effort on the host considerably during path recovery.

Important: On the IBM FlashSystem 5200 system, NPIV is enabled by default. Therefore, if the customer does not want to use it, they must turn it off before they configure FC ports for host communications.

VMware integration

IBM FlashSystem 5200 includes support for the following features, which enable tight integration with VMware:

- ▶ **vCenter plug-in**
 - Enables monitoring and self-service provisioning of the system from within VMware vCenter
- ▶ **VAAI (vStorage API for Array Integration) support**
 - This function supports hardware-accelerated virtual machine (VM) copy and migration and hardware-accelerated VM initiation, and accelerates VMware Virtual Machine File System (VMFS).
- ▶ **Microsoft Windows System Resource Manager (SRM) for VMware Site Recovery Manager**
 - Supports automated storage and host failover, failover testing, and failback
- ▶ **vVol (Virtual Volumes) integration for better usability**
 - The migration of space-efficient volumes between storage containers maintains the space efficiency of volumes. Cloning a VM achieves a full independent set of vVols, and resiliency is improved for VMs if volumes start running out of space.

Before the availability of vVols, a VM in a VMware environment was presented as a VMware Virtual Machine Disk (VMDK) file. This file represented a physical disk to the VM, which was accessed by the operating system that is installed on the VM in the same way that a physical volume on a regular server was presented.

The VMDK file was placed in a file system that is called VMFS, which is hosted by a standard volume (LUN). For example, it might be implemented on an external storage system, such as the IBM FlashSystem 5200 system. With the availability of the vVol technology, each VM disk can now be mapped to an external storage volume (for example, an IBM FlashSystem 5200 volume).

With vVol, the IBM FlashSystem 5200 solution is “aware” of individual VMDK files. Therefore, data operations, such as snapshot and replication, can be performed directly by the IBM FlashSystem 5200 system at the VMDK level rather than the entire VMFS data store.

Note: The integration of vVol with the IBM FlashSystem 5200 system is based on the VASA. IBM support for VASA is delivered through native system support, or as part of IBM Storage Connect.

Scaling up and scaling out

The IBM FlashSystem 5200 system’s scalable architecture enables flash capacity to be added, or scaled up, to support multiple applications by adding expansion enclosures. Scale out expands NVMe capacity, with the processing power to use that capacity to linearly scale IOPS and bandwidth. As a result, your organization can gain a competitive advantage through a more flexible, responsive, and efficient storage environment.

The IBM FlashSystem 5200 system features the following flexible scalability configuration options:

- ▶ Base configuration
- ▶ Scale up: Add capacity
- ▶ Scale out: Add control enclosures and capacity

Each IBM FlashSystem 5200 system has two canisters (sometimes also known as *nodes* or *controllers*). Each canister contains the CPUs, cache memory, PCIe cards, and other hardware to communicate to the NVMe drives and connected hosts. These two canisters are housed in a chassis that is known as a *control enclosure*.

A maximum of four control enclosures can be connected to form a cluster.

Table 3 lists the values of the CPUs, cache memory, raw NVMe drive size, and PCIe adapters cards for each number of control enclosures.

Table 3 Maximum values for each canister and control enclosure

Element Description	Number of CPUs	Maximum cache memory (GB)	Max NVMe 12 drive capacity (TB)	Inclusive onboard Ethernet ports	Max PCIe ports (FC / Ethernet)
One Canister	1	256	N/A	2	4 / 2
One Enclosure	2	512	460	4	8 / 4
Two Enclosures	4	1024	920	8	16 / 8

Element Description	Number of CPUs	Maximum cache memory (GB)	Max NVMe 12 drive capacity (TB)	Inclusive onboard Ethernet ports	Max PCIe ports (FC / Ethernet)
Three Enclosures	6	1536	1380	12	24 / 12
Four Enclosures	8	2048	1840	16	32 / 16

A basic configuration of an IBM FlashSystem 5200 storage platform consists of one IBM FlashSystem 5200 control enclosure. For a balanced increase of performance and scale, a maximum of four IBM FlashSystem 5200 control enclosures can be clustered into a single storage system, which multiplies performance and capacity with each addition.

The clustered IBM FlashSystem 5200 system can include dedicated internal FC switches for internal communications. However, other methods are available to configure the switches and ports to provide performance improvements.

For more information about how to restrict the FC ports for control enclosure inter-node connections and host connections, see [Fibre Channel port masking](#).

In total, an IBM FlashSystem 5200 system can contain a maximum of four IBM FlashSystem 5200 control enclosures. This configuration offers a potential storage capacity of 1.84 PB usable and up to 5.52 PB effective capacity, assuming 3:1 hardware compression, when the IBM FCMs are used.

With software-based data reduction, you can scale to 9.2 PB effective, assuming 5:1 data reduction that uses compression and deduplication.

The IBM FlashSystem 5200 system is expandable up to 32 PB by using SAS drives in expansion enclosures.

Maximum capacity configurations

Table 4 lists the maximum raw capacity, usable capacity, and maximum effective capacity for scalable configurations that are built on the IBM FlashSystem 5200 control enclosures.

Table 4 IBM FlashSystem 5200 maximum usable and effective capacity within the controller.

Number of control enclosures	Maximum usable capacity by using 12 drives (terabytes)	Maximum effective capacity (terabytes) with inline IBM FlashCore Modules Drive compression @ 3:1 ratio	Maximum effective capacity (terabytes) with software data reduction @ 5:1 ratio
One control enclosure	460	1380	2300
Two control enclosures	920	2760	4600
Three control enclosures	1380	4140	6900
Four control enclosures	1840	5520	9200

Consider the following points:

- ▶ IBM FCMs
 - Six drive minimum.
 - DRAID 6 (recommended) and DRAID 5 (supported).
 - IBM FlashCore Modules in the same DRAID array must have the same capacity.
- ▶ Industry-standard NVMe drives:
 - Two drive minimum (varies by RAID type).
 - Traditional RAID 10 and DRAID 6 (recommended) and DRAID 5 (supported).
 - Industry-standard NVMe drives in the same RAID array must have the same capacity.
- ▶ SCM:
 - Two drive minimum with up to 12 drives of the same type and capacity
 - Distributed RAID 6, 5 or 1, or TRAIID 1 or 10 with fewer than four drives

Note: IBM FCM inline compression is hardware-based and operates at line speed, which does not affect performance.

RAID types

The IBM FlashSystem 5200 system supports the following main DRAID types:

- ▶ IBM FlashCore Modules:
 - Six drive minimum with DRAID 6 is recommended.
 - Smaller member drive array configurations are supported by DRAID 1 with restrictions.
 - IBM FlashCore Modules in the same RAID array must be of the same capacity.
- ▶ Industry standard NVMe drives:
 - Two drive minimum supported.
 - DRAID 1 recommended with 2 - 6 member drives, with restrictions.
 - DRAID 6 recommended with six and more member drives.
 - DRAID 5 supported by four- or five-member drive arrays only.
 - Industry-standard NVMe drives in the same RAID array must be of the same capacity.
- ▶ SCM NVMe drives:
 - Two drive minimum with up to 12 drives.
 - DRAID 1 is recommended with restrictions.
 - DRAID 5 supported by four- or five-member drive arrays only.
 - Start in slot 12–1 in the control enclosure.
 - SCM NVMe drives in the same RAID array must be of the same capacity.
- ▶ SAS HDD or SAS SSD flash drives in an IBM FlashSystem 5200 expansion enclosure:
 - DRAID 1 recommended with 2 - 6 member drives, with restrictions.
 - DRAID 6 recommended with six and more member drives.
 - DRAID 5 supported by four- or five-member drive arrays only.

The extra SAS attached expansion enclosures can be configured with various RAID options. DRAID 6 is preferred for expansion enclosures because of the drive sizes that are used.

Supported array types and RAID levels summary

IBM FlashSystem 5200 systems support IBM FlashCore Module NVMe drives, industry-standard NVMe drives, and SAS drives that are within expansion enclosures. The type and level of arrays varies, depending on the type of drives in the IBM FlashSystem.

The IBM FlashSystem 5200 system does *not* support mixing SAS drives in an array with NVMe drives or mixing IBM FlashCore Modules in an array with industry-standard NVMe drives.

Note: DRAID 6 is recommended for all types of drives where applicable, except for SCM drives. Some of the RAID arrays can be created by using only the CLI, not the GUI.

For more information about the types of supported RAID configurations and restrictions, see [Array configurations](#).

External Virtualization

The IBM FlashSystem 5200 system offers external virtualization technology that helps you manage other IBM or third-party storage arrays with thin-provisioning, space-efficient copies, and DR tools, such as data replication. External virtualization can also make it easier to migrate data from one storage device to another.

You can use the IBM FlashSystem 5200 system to manage the capacity of other disk systems with external storage virtualization. When the IBM FlashSystem 5200 system virtualizes a storage system, its capacity becomes part of the IBM FlashSystem 5200 system and is managed in the same manner as the internal flash modules within the IBM FlashSystem 5200. Capacity in external storage systems inherits all the functions and ease of use of the IBM FlashSystem 5200 system.

You can use the IBM FlashSystem 5200 system to preserve your investments in storage, to centralize management, and to make storage migrations easier with storage virtualization and Easy Tier. The IBM FlashSystem 5200 system provides nondisruptive operations because of storage virtualization.

Virtualization also helps insulate applications from changes that are made to the physical storage infrastructure. When you add storage capacity or a new tier of storage, for example, the changes are transparent to applications. Therefore, downtime is minimal.

Any externally virtualized storage needs extra licenses to be purchased and are charged on a capacity basis of the storage that is added.

Manageability and security

The IBM FlashSystem 5200 system offers the following manageability and security features:

- ▶ Advanced security for data at rest with hardware-accelerated AES-XTS 256 encryption.
- ▶ A GUI to manage the IBM FlashSystem 5200 system and its expansion enclosures. The GUI is available in any supported browser. Included with the GUI is the CLI, which supports a collection of commands that you can use to manage the IBM FlashSystem 5200 system.
- ▶ Support for Representational State Transfer (REST) application programming interface (API). The REST-API consists of command targets that are used to retrieve system information and to create, modify, and delete system resources.

- ▶ RSA provides a secure connection for IBM Remote Support that can remotely troubleshoot, install software, and obtain diagnostic logs.
- ▶ Email alerts.
- ▶ SNMP alerts.
- ▶ Syslog redirect to send system log messages to another host.
- ▶ Inline Data Corruption Detection.
- ▶ Immutable Snapshots and logical air gap protection of data.

Note: At the time of this writing, the IBM FlashCore Modules in the IBM FlashSystem 5200 system are undergoing a FIPS validation process.

Reliability, availability, and serviceability

The IBM FlashSystem 5200 system delivers the following enterprise-class reliability features:

- ▶ Concurrent code load enables customer applications to remain online during firmware upgrades to all components, including the flash drives. Onsite and remote code upgrades are supported.

- ▶ Redundant hot-swappable components

The IBM FlashSystem 5200 control enclosure has two clustered, hot-swappable node canisters that contain hot-swappable fan modules and batteries and redundant Trusted Platform Modules (TPMs), DIMMs, and PCIe adapters. The enclosure also houses two AC power supplies that are N+1 redundant and hot-swappable.

If an IBM FlashCore Module failure occurs, critical customer applications can remain online while the defective module is replaced because a spare module is available. IBM Distributed RAID (DRAID) is a patented IBM technology that provides an intra-module RAID stripe within each flash module. Variable Stripe RAID technology helps reduce downtime, and maintains performance and capacity during partial or full flash chip failures.

IBM FlashSystem 5200 data encryption is based on the AES algorithm, which uses a 256-bit symmetric encryption key in XTS mode, as defined in the IEEE 1619-2007 standard and NIST Special Publication 800-38E as XTS-AES-256. The data encryption key is protected by a 256-bit AES key wrap of a key that is derived from the access key that is stored on the USB flash drive. The wrapped key is stored in the system in non-volatile form.

Encryption on the IBM FlashSystem 5200 system requires the following feature codes:

- ▶ Encryption Enablement (#ALE0)

This feature enables the encryption function. A single instance of this feature enables the function on the entire IBM FlashSystem 5200 system (IBM FlashSystem 5200 control enclosure and all attached IBM FlashSystem 5200 expansion enclosures) and on externally virtualized storage subsystems.

USB flash drives (#ALEC) or IBM Security® Key Lifecycle Manager are required for encryption key management.

- ▶ Encryption USB flash drives (four pack) Optional (#ALEC)

This feature provides four USB flash drives for storing the encryption master access key.

Unless IBM Security Guardium Key Lifecycle Manager is used for encryption keys management, a total of three USB flash drives are required per IBM FlashSystem 5200 cluster when encryption is enabled in the cluster, regardless of the number of systems in the cluster. If encryption is used in a cluster, this feature should be ordered on one IBM FlashSystem 5200 system, which results in a shipment of four USB flash drives.

Encryption can be applied to virtualized storage arrays, even if the virtualized array does not have encryption capabilities. In this scenario, the encryption is done by using IBM Storage Virtualize software. Encrypted volumes are transparent to applications, which eases implementation and operation. In addition, the IBM FlashSystem 5200 system has the following functions:

- ▶ Encryption Activation: Adding an encryption license to a system is not concurrent and must be done at array initialization time.
- ▶ Encryption Deactivation: Removing encryption is also nonconcurrent and destroys any data on the array.
- ▶ Encryption Rekey: Changing the encryption key on a previously initialized system is concurrent and can be done while the array is in use.

These operations require that you purchase an Encryption Enablement Pack (#ALE0).

Self-encrypting drives

The IBM FlashCore Modules and NVMe Flash SSD type drives, including the SCMs, in the IBM FlashSystem 5200 control enclosure are self-encrypting drives (SEDs). With SEDs, you can encrypt the data on the drive within the hardware.

These types of flash drives include the following features:

- ▶ Encryption of data is done in the electrical circuit of the drive; therefore, it is not affected by performance issues from software encryption.
- ▶ Data Encryption Keys never leave the confines of the SED and are never loaded into CPU or memory.
- ▶ You can perform a fast cryptographic erasure of a SED by using a single CLI command to replace the DEK or revert the entire device to factory settings.
- ▶ Supports a security feature that is called *auto-lock*, which protects against someone plugging your drive into another system and accessing your data.
- ▶ Drives automatically lock themselves on power loss and require an access key at start time to unlock and allow I/O operations.
- ▶ If an SED drive is taken from a system with encryption and placed in another system, the drive data is not readable. The system posts an error message saying it is locked. The only way to use the drive is to format it. This formatting also performs a cryptographic erase by removing any encryption keys; therefore, all of the data on the drive is destroyed.

Combining system encryption with self-encrypting drives

For control enclosures that support NVMe architecture, NVMe-attached drives are self-encrypting and self-compressing. With SEDs that use NVMe architecture, data encryption is completed in the drive. Data encryption keys remain on the drive without being stored in system memory.

In addition, the system supports automatic locks of encrypted drives when the system or drive is powered down. When the drive or system restarts, a master key is required to unlock the drive and continue I/O operations.

Because the encryption of data is done in the electrical circuit of the drive, it is not affected by any potential performance issues from software encryption.

Consider the following points:

- ▶ SEDs are always encrypting, and you cannot stop them from being encrypted.
- ▶ You can use SEDs without enabling encryption on the system, but SEDs are unlocked by default unless they are configured with extra protection.
- ▶ With system encryption in IBM Storage Virtualize, you can use USB flash drives or IBM Security Guardium Key Lifecycle Manager to manage access to encrypted objects on the system. This feature ensures that when a system is powered on, this extra encryption key is required to read the data on the drives.
- ▶ Software in the operating system is required to manage an access key that can be used to lock and unlock the SEDs and bring them online for I/O.

Therefore, the best solution is to use the SEDs with the Encryption Enablement Pack and USB or IBM Security Key Lifecycle Manager type encryption, or a mixture of both. This configuration ensures the maximum level of encrypting for your data that is on the system.

Transparent Cloud Tiering and encryption

Transparent Cloud Tiering is a licensed function that enables volume data to be copied and transferred to cloud storage. The system supports creating connections to cloud service providers to store copies of volume data in private or public cloud storage.

With Transparent Cloud Tiering, administrators can move older data to cloud storage to clear some used capacity on the system. Point-in-time snapshots of data can be created on the system and then copied and stored on cloud storage.

An external cloud service provider manages the cloud storage, which reduces storage costs for the system. At the time of this writing, IBM supports the IBM Cloud, OpenStack Swift, Amazon S3, and Microsoft Azure cloud service providers.

The following considerations apply to Transparent Cloud Tiering and encryption:

- ▶ When a cloud account is created, it must continue to use the same encryption type throughout the life of the data in that cloud account. Even if the cloud account object is removed and remade on the system, the encryption type for that cloud account might not be changed if back up data for that system exists in the cloud provider.
- ▶ When performing rekeying operations on a system that has an encryption-enabled cloud account, run the commit operation immediately after the prepare operation. Retain the previous system master key (on a USB or in the key server) because this key might be needed to retrieve your cloud backup data when performing a T4 recovery or an import.
- ▶ The `restore_uid` option should not be used when the backup is imported to a new cluster.
- ▶ Importing Transparent Cloud Tiering data is supported only from systems whose backup data was created at V7.8.0.1 or later.
- ▶ Transparent Cloud Tiering uses Sig V2 when connecting to Amazon regions, and does not currently support regions that require Sig V4.

For more information, see [Transparent Cloud Tiering](#).

Secure drive erasure process

The IBM FlashSystem 5200 system provides methods to securely erase data from a drive or boot drive when a control enclosure is decommissioned or before a drive is removed from the system during a repair activity.

Secure data deletion effectively erases or overwrites all traces of data from a data storage device. The original data on that device becomes inaccessible and cannot be reconstructed. You can securely delete data on individual drives and on a boot drive of a control enclosure. The methods and commands that are used to securely delete data enable the system to be used in compliance with European Regulation EU2019/424.

The following types of drives can be used for this process:

- ▶ Expansion enclosure SAS SSDs and HDDs
- ▶ NVMe drives (IBM FlashCore Modules and industry standard)
- ▶ Control enclosure node canister SSD boot drives

The methods that the system uses to securely delete data from the drives varies according to the CLI commands that each type of drive can support. The completion time for the erase procedure also varies, depending on the amount of data and the method that is used to delete the data. In each case, when the operation completes, the result is that the data on the drive can no longer be accessed.

Table 5 lists the types of erasure, the methods used, and the time taken.

Table 5 Comparison of methods to securely delete data from drives

Priority	Deletion type	Method	Completion time
1	Cryptographic erase	Changes the encryption key and makes the data inaccessible.	Instant
2	Block erase	Quickly increases and decreases the voltage level of the storage element. Physical blocks are altered with a vendor-specific value.	Fast
3	Data Overwrite	Replaces the existing data with random data.	Slow

The methods that are used to securely delete data vary according to manufacture, drive type, and drive firmware. For more information, see the documentation that is provided by the drive manufacturer.

If a drive supports more than one data deletion method, the system uses the highest priority method.

For more information about the CLI commands that are used to run this secure erase function, see [Secure data deletion](#).

Options and feature codes

This section describes the major options and feature codes that are available for the IBM FlashSystem 5200 control and expansion enclosures.

Memory options

Table 6 lists the memory options by feature code.

Table 6 IBM FlashSystem 5200 memory options

Feature code	Existing memory size per canister (GB)	Memory upgrade (GB)	Total memory per enclosure (GB)	Comments
ALG0	32 GB	N/A	64 GB	Provides two 32 GB DIMMs (DDR4) that are installed with the base system
ALG1	256 GB	N/A	512 GB	Provides eight 64 GB memory DIMMS (DDR4) that are installed with the base system
ALGC	32 GB	192 GB Cache Upgrade	256 GB	Provides six 32 GB memory DIMMS to add to the system
ALGD	32 GB	512 GB Cache Upgrade	512 GB	Provides eight 64 GB memory DIMMS to replace all existing 32 GB DIMMS

The following cache upgrade feature codes are available:

- ▶ (#ALGC): 192 GB Cache upgrade
This feature requires that the base machine is configured with 64 GB (32 GB for each canister) and is upgraded to 256 GB by adding six 32 GB (three per canister) DIMMS to the enclosure.
- ▶ (#ALCD): 512 GB Cache upgrade
This feature provides 512 GB of cache (256 GB for each node canister) to replace the existing 32 GB DIMMS with eight (four per canister) 64 GB ones.

Note: Feature Codes ALG0 or ALG1 must be selected in the initial order. ALG1 and ALGD are incompatible.

Host I/O connectivity and expansion enclosure adapters

Four PCIe slots are available for port expansions in the IBM FlashSystem 5200 control enclosure. Each canister has two PCIe adapter slots and both canisters must have the same configuration. The PCIe adapter feature codes offer a pair of adapters to ensure that they are supplied symmetrically in each canister.

The control enclosure can be configured with two I/O adapter features to provide up to sixteen 16 Gbps FC ports or eight 32 Gbps FC, up to sixteen 10 Gbps Ethernet ports, up to eight 25 Gbps Ethernet (iSCSI or iSCSI Extensions for RDMA (iSER) capable) ports. The control

enclosure also includes four 10 Gbps Ethernet ports as standard for iSCSI connectivity and management GUI use, plus two 1 Gbps Ethernet maintenance ports for engineering use. A feature code is also available to include the SAS expansion card if the user wants to use optional expansion enclosures of for host-based connections.

Table 7 lists the maximum host port count per building block configuration (1, 2, 3, or 4 control enclosures).

Table 7 Maximum host port count per control enclosure

Number of control enclosures	16 Gbps FC	32 Gbps FC	10 Gbps onboard iSCSI ports	10 Gbps Ethernet	25 Gbps iSCSI (RoCE)	25 Gbps iSCSI (iWARP)	25 Gbps NVMe over RDMA and NVMe over TCP
One	16	8	4	16	8	8	8
Two	32	16	8	32	16	16	16
Three	48	24	12	48	24	24	24
Four	64	32	16	64	32	32	32

Note: All connectivity ports are FC-NVMe hardware-ready.

Table 8 lists the current features for host and connectivity for the IBM FlashSystem 5200 control enclosure 4662-6H2 and 4662-UH6 machine types.

Table 8 Supported expansion enclosure and interface components MTMs 4662-6H2 and 4662-UH6

Item	Feature code	Description	Ports
16 Gbps FC 4 Port Adapter Pair	#ALBJ	This feature provides two I/O adapters. It is used to add 16 Gbps FC connectivity.	Each adapter has four 16 Gbps FC ports and shortwave SFP transceivers.
32 Gbps FC 2 Port Adapter Pair	#ALBK	This feature provides two I/O adapters. It is used to add 32 Gbps FC connectivity.	Each adapter has two 32 Gbps FC ports and shortwave SFP transceivers.
10 Gbps Ethernet Adapter Pair	#ALBL	This feature provides two I/O adapters. It is used to add 10 Gbps Ethernet connectivity.	Each adapter has four 10 Gbps Ethernet ports and SFP+ transceivers.
25 Gbps Ethernet (RoCE) Adapter Pair	#ALBM	This feature provides two I/O adapters. It is used to add 25 Gbps Ethernet connectivity. Supports RoCE V2.	Each adapter has two 25 Gbps Ethernet ports and SFP28 transceivers.
25 Gbps Ethernet (iWARP) Adapter Pair	#ALBN	This feature provides two I/O adapters. It is used to add 25 Gbps Ethernet connectivity. Supports RDMA with iWARP.	Each adapter has two 25 Gbps Ethernet ports and SFP28 transceivers.
12 Gbps SAS expansion enclosure Attach Card (Pair)	#ALBQ	This feature provides two 4-port 12 Gbps SAS expansion enclosure attachment adapters. This feature is used to attach up to 20 expansion enclosures.	Each adapter only has two active SAS ports per card.

Item	Feature code	Description	Ports
12 Gbps SAS Host Adapter Cards (Pair)	#ALBP	This feature provides two 4-port 12 Gbps SAS Host attachment adapters.	Two cards with 4 ports and mini-SAS HD connectors for host attachment
16 Gbps FC LW SFP Transceivers (Pair)	#ACHU	This feature provides two 16 Gbps longwave SFP transceivers for use with 16 Gbps FC I/O ports.	#ALBJ is a prerequisite. The maximum allowed is four for each instance of #ALBJ.

Note: For more information, see [Adapter slot guidelines](#).

Cables

Table 9 lists the cable feature codes that are available.

Table 9 Cable feature codes and options

Feature code	Description	Comments
ACSQ	1 m OM3 Fibre Channel cable (LC)	
ACSR	5 m OM3 Fibre Channel cable (LC)	
ACSS	10 m OM3 Fibre Channel cable (LC)	
ACST	25 m OM3 Fibre Channel cable (LC)	
ACUA	0.6 m 12 Gbps SAS cable (mSAS HD)	SAS cable for expansion
ACUB	1.5 m 12 Gbps SAS cable (mSAS HD)	SAS cable for expansion
ACUC	3 m 12 Gbps SAS cable (mSAS HD)	SAS cable for expansion
ACUD	6 m 12 Gbps SAS cable (mSAS HD)	SAS cable for expansion

IBM FlashSystem 5200 control enclosure drive options for models 6H2/UH6

The IBM FlashSystem 5200 control enclosure supports IBM FCMs, SCMs, industry-standard flash drives, and an intermix of all three.

IBM FlashCore Modules combine IBM MicroLatency technology, advanced flash management, and reliability into a 2.5-inch SFF NVMe with built-in, performance-neutral hardware compression and encryption.

For improved flexibility, IBM FlashSystem 5200 systems also support various industry-standard, self-encrypting NVMe flash drives.

Table 10 lists the available NVMe flash drive feature codes.

Table 10 IBM FlashSystem 5200 control enclosure drive options

Feature code	Description	Comments
AGS5	4.8 TB NVMe FlashCore Module	FCM drive
AGS6	9.6 TB NVMe FlashCore Module	FCM drive
AGS7	19.2 TB NVMe FlashCore Module	FCM drive

Feature code	Description	Comments
AGS8	38.4 TB NVMe FlashCore Module	FCM drive
AGT1	800 GB NVMe Flash Drive	Industry Standard drive
AGT2	1.92 TB NVMe Flash Drive	Industry Standard drive
AGT3	3.84 TB NVMe Flash Drive	Industry Standard drive
AGT4	7.68 TB NVMe Flash Drive	Industry Standard drive
AGT5	15.36 TB NVMe Flash Drive	Industry Standard drive
AGT6	30.72 TB NVMe Flash Drive	Industry Standard drive
AGTA	375 GB NVMe SCM Drive	SCM drive
AGTB	750 GB NVMe SCM Drive	SCM drive
AGTE	800 GB NVMe SCM Drive	SCM drive
AGTF	1.6 TB NVMe SCM Drive	SCM drive

Consider the following points regarding limitations and drives:

- ▶ IBM FlashCore Modules:
 - Six drive minimum.
 - DRAID 6 (recommended) or DRAID5 (supported).
 - IBM FlashCore Modules in the same RAID array must be of the same capacity.
- ▶ Industry-standard NVMe drives:
 - Two drive minimum (varies by RAID type).
 - RAID 10 and DRAID 6 (recommended) and DRAID 5 (supported).
 - Industry-standard NVMe drives in the same RAID array must be of the same capacity.
- ▶ SCM NVMe drives:
 - Two drive minimum (varies by RAID type); 12 drives maximum.
 - Can occupy slots 1–12 in the control enclosure (installed in reverse order slots 12–1).
 - DRAID 1 preferred, DRAID, 5 and 6 supported.
 - TRAIT 1 and 10 supported but not best practice.
 - SCM NVMe drives in the same RAID array must be of the same capacity.

For additional information about supported drive types and supported RAID types, see “RAID types” on page 45

IBM FlashSystem 5200 expansion enclosure drive options for model 12G

The IBM FlashSystem 5200 expansion enclosure model 12G supports the drives that are listed in Table 11. The model 12G supports a maximum of 12 installed drives.

Table 11 Expansion enclosure model 12G drives type and capacities

Feature code	Description	Comments
AL27	900 GB 10K 3.5-Inch HDD	10K RPM 2.5-inch drive in 3.5-inch carrier
AL28	1.2 TB 10K 3.5-Inch HDD	10K RPM 2.5-inch drive in 3.5-inch carrier
AL29	1.8 TB 10K 3.5-Inch HDD	10K RPM 2.5-inch drive in 3.5-inch carrier
AL2A	2.4 TB 10K 3.5-Inch HDD	10K RPM 2.5-inch drive in 3.5-inch carrier
AL39	4 TB 7.2K 3.5-Inch NL HDD	7200 RPM drive
AL3A	6 TB 7.2K 3.5-Inch NL HDD	7200 RPM drive
AL3B	8 TB 7.2K 3.5-Inch NL HDD	7200 RPM drive
AL3C	10 TB 7.2K 3.5-Inch NL HDD	7200 RPM drive
AL3D	12 TB 7.2K 3.5-Inch NL HDD	7200 RPM drive
AL3E	14 TB 7.2K 3.5-Inch NL HDD	7200 RPM drive
AL3F	16 TB 7.2K 3.5-Inch NL HDD	7200 RPM drive
AL3G	18 TB 7.2K 3.5-Inch NL HDD	7200 RPM drive
AL3H	20 TB 7.2K 3.5-Inch NL HDD	7200 RPM drive

IBM FlashSystem 5200 expansion enclosure drive options for model 24G

The IBM FlashSystem 5200 expansion enclosure model 24G supports the drives listed in Table 12. The model 24G supports a maximum of 24 installed drives.

Table 12 Expansion enclosure model 24G drive types and capacities (continued on the next page)

Feature code	Description	Comments
AL68	900 GB 10K 2.5-inch HDD	10K RPM drive
AL69	1.2 TB 10K 2.5-inch HDD	10K RPM drive
AL6A	1.8 TB 10K 2.5-inch HDD	10K RPM drive
AL6B	2.4 TB 10K 2.5-inch HDD	10K RPM drive
AL76	2 TB 7.2K 2.5-inch NL HDD	7200 RPM drive
AL8A	800 GB 3DWPD 2.5-inch Flash Drive	
AL80	1.92 TB 2.5-inch Flash Drive	
AL81	3.84 TB 2.5-inch Flash Drive	
AL82	7.68 TB 2.5-inch Flash Drive	
AL83	15.36 TB 2.5-inch Flash Drive	
AL84	30.72 TB 2.5-inch Flash Drive	

IBM FlashSystem 5200 expansion enclosure drive options for model 92G

The IBM FlashSystem 5200 expansion enclosure model 92G supports the following drives and capacities. The model 92G can have a maximum of 92 drives installed.

Table 13 lists the drive matrix for the model 92G.

Table 13 Expansion enclosure model 92G drive types and capacities

Feature code	Description	Comments
AL43	1.2 TB 10K 3.5-inch HDD	10K RPM 2.5-inch drive in 3.5-inch carrier
AL44	1.8 TB 10K 3.5-inch HDD	10K RPM 2.5-inch drive in 3.5-inch carrier
AL45	2.4 TB 10K 3.5-inch HDD	10K RPM 2.5-inch drive in 3.5-inch carrier
AL47	6 TB 7.2K 3.5-inch NL HDD	7200 RPM drive
AL48	8 TB 7.2K 3.5-inch NL HDD	7200 RPM drive
AL49	10 TB 7.2K 3.5-inch NL HDD	7200 RPM drive
AL4A	12 TB 7.2K 3.5-inch NL HDD	7200 RPM drive
AL4B	14 TB 7.2K 3.5-inch NL HDD	7200 RPM drive
AL4C	16 TB 7.2K 3.5-inch NL HDD	7200 RPM drive
AL4D	18 TB 7.2K 3.5-inch NL HDD	7200 RPM drive
AL4E	20 TB 7.2K 3.5-inch NL HDD	7200 RPM drive
AL4J	1.92 TB 3.5-inch Flash Drive	2.5-inch drive in 3.5-inch carrier
AL4K	3.84 TB 3.5-inch Flash Drive	2.5-inch drive in 3.5-inch carrier
AL4L	7.68 TB 3.5-inch Flash Drive	2.5-inch drive in 3.5-inch carrier
AL4M	15.36 TB 3.5-inch Flash Drive	2.5-inch drive in 3.5-inch carrier
AL4N	30.72 TB 3.5-inch Flash Drive	2.5-inch drive in 3.5-inch carrier

Physical and electrical specifications

Specifications for the control and expansion enclosures are listed in the following sections.

IBM FlashSystem 5200 control enclosure (4662 models 6H2 and UH6)

The control enclosure features the following specifications:

- ▶ Physical specifications:
 - ▶ Height: 43.5 mm (1.71 in.); 1U Rack Standard
 - ▶ Width: 446 mm (17.56 in.); 19-inch Rack Standard
 - ▶ Depth: 816 mm (30.31 in.); from rack mounting flange to power supply handle
 - Approximate weight:
 - Empty: 15.9 kg (30.0 lb)
 - Fully configured: approx. 19.5 kg (43 lb) including 4 PCIe cards and 12 drives
 - ▶ Air temperature:
 - Operating: ASHRAE A2: 10°C–35°C (41°F–95°F); 0 - 3050 m (0–10,000 ft.). Above 900 m, decrease maximum air temperature 1°C per 300 m.
 - Continual operating range 10°C–35°C (50°F–95°F).
 - Nonoperating: -40°C–50°C (-40°F–122°F).
 - ▶ Relative humidity:
 - ▶ Operating: 8%–80%, non-condensing (ASHRAE class A2 environment)
 - ▶ Non-operating: 8%–80% noncondensing
 - ▶ Deliquescent relative humidity (RH): 60%
 - ▶ Electrical power:
 - Voltage range: 200–240 V AC
 - Frequency: 50–60 Hz
 - Power:
 - A new auto-ranging PSU. This PSU supports both HI, 220 volt, and LOW, 110 volt, power. This makes it easier for the user when doing their planning for install. They will not have to change the available power to accommodate our system.
 - Requires IEC C13 power sockets in PD
 - 525 W, typical operation
- The maximum power that is required depends on the configuration of the enclosure.
- ▶ Heat output:
 - Typical: approximately 1791BTU per hour (525 W)
 - Maximum configuration: 3071BTU per hour (900W)
 - Acoustical noise emission: 6.7 bels (idling), 6.7 bels (operating)

IBM FlashSystem 5200 LFF expansion enclosure (4662 model 12G)

The expansion enclosure model 12G has the following specifications:

- ▶ Physical specifications:
 - Height: 8.7 cm (3.4 in.); 2U Rack Standard
 - Width: 44.6 cm (17.56 in.); 19-inch Rack Standard
 - Depth: 55.6 cm (21.9 in.)
 - Approximate weight:
 - Empty: 16.4 kg (36.2 lb)
 - Fully configured: 26.7 kg (58.9 lb)
- ▶ Air temperature:
 - Operating: 5°C–40°C (41°F–104°F); 0–3048 m (0–10,000 ft). Above 900 m, decrease maximum air temperature 1°C per 300 m.
 - Nonoperating: 1°C–50°C (34°F–122°F).
 - Storage: 1°C–60°C (34°F–140°F).
 - Shipping: -40°C–60°C (-40°F–140°F).
- ▶ Relative humidity:
 - Operating: 8%–80% noncondensing
 - Nonoperating: 8%–80% noncondensing
 - Storage: 5%–80% noncondensing
 - Shipping: 5%–100% condensing, but not precipitating
- ▶ Electrical power:
 - Voltage range: 100–240 V AC
 - Frequency: 50–60 Hz
 - Power: 764 W
 - Requires IEC C13 power sockets in PDU
 - Typical: approximately 1791 BTU per hour (525 W)
 - Maximum configuration: 2883 BTU per hour (845 W)
 - Acoustical noise emission: 6.1 bels (idling), 6.1 bels (operating)

IBM FlashSystem 5200 SFF expansion enclosure (4662 model 24G)

The expansion enclosure model 24G has the following specifications:

- ▶ Physical specifications:
 - Height: 8.75 cm (3.44 in.); 2U Rack Standard
 - Width: 44.6 cm (17.56 in.); 19-inch Rack Standard
 - Depth: 55.6 cm (21.9 in.)
 - Approximate weight:
 - Empty: 16.7 kg (36.8 lb)
 - Fully configured: 25.0 kg (55.1 lb)
- ▶ Air temperature:
 - Operating: 5°C–40°C (41°F–104°F); 0–3048 m (0–10,000 ft). Above 900 m, decrease maximum air temperature 1°C per 300 m.
 - Nonoperating: 1°C–50°C (34°F–122°F).
 - Storage: 1°C–60°C (34°F–140°F).
 - Shipping: -40°C–60°C (-40°F–140°F).

- ▶ Relative humidity:
 - Operating: 8%–80% noncondensing
 - Nonoperating: 8%–80% noncondensing
 - Storage: 5%–80% noncondensing
 - Shipping: 5%–100% condensing, but not precipitating
- ▶ Electrical power:
 - Voltage range: 100–240 V AC
 - Frequency: 50–60 Hz
 - Power: 764 W
 - Requires IEC C13 power sockets in PDU
 - Heat dissipation (BTU per hour): 2,607
 - Acoustical noise emission: 6.2 bels (idling), 6.2 bels (operating)

IBM FlashSystem 5200 LFF expansion enclosure (4662 model 92G)

The expansion enclosure model 92G has the following specifications:

- Physical specifications:
 - Height: 22.2 cm (8.75 in.); 2U Rack Standard
 - Width: 44.6 cm (17.56 in.); 19-inch Rack Standard
 - Depth: 96.8 cm (38.1 in.)
 - Approximate weight:
 - Empty: 67.0 kg (147.7 lb)
 - Fully configured: 135.0 kg (297.0 lb)
- ▶ Air temperature:
 - Operating: 5°C–35°C (41°F–95°F) 0–3048 m (0–10,000 ft). Above 900 m, decrease maximum air temperature 1°C per 300 m.
 - Nonoperating: 1°C–50°C (34°F–122°F).
 - Storage: 1°C–60°C (34°F–140°F).
 - Shipping: -40°C–60°C (-40°F–140°F).
- ▶ Relative humidity:
 - Operating: 8%–80% noncondensing
 - Nonoperating: 8%–80% noncondensing
 - Storage: 5%–80% noncondensing
 - Shipping: 5%–100% condensing, but not precipitating
- ▶ Electrical power:
 - Voltage range: 200–240 V AC
 - Frequency: 47–63 Hz
 - Power: 2400 W
 - Requires IEC C19 power sockets in PDU
 - Heat dissipation (BTU per hour): 8,189
 - Acoustical noise emission: 7.8 bels (idling), 7.8 bels (operating)

Note: All noise emission levels that are stated are the declared (upper limit) sound power level (in bels) for a random sample of machines. All measurements are made in accordance with ISO 7779 and reported in conformance with ISO 9296.

Software and licensing

All IBM FlashSystem 5200 functions are provided through IBM Storage Virtualize License Machine Code. IBM FlashSystem 5200 requires IBM Storage Virtualize software V8.4 or later to operate and it comes preinstalled.

All features are inclusive except for external virtualization and encryption, which is a feature code that is enabled for those countries that allow it. An External Virtualization license is required for any connected storage that is attached to the control enclosure that is not an IBM FlashSystem 5200 control enclosure or an IBM FlashSystem 5200 expansion enclosure. Charges for the External Virtualization license are based upon per storage capacity unit (SCU) that is based on the tier of storage that is available on the external storage system. In addition, if you use FlashCopy and Remote Mirroring on an external storage system, you must purchase a per terabyte (TiB) license to use these functions.

Consider the following points:

- ▶ The IBM FlashSystem 5200 supports external storage virtualization. Use of the external virtualization capability is enabled through the acquisition of IBM Storage Virtualize Software for SAN Volume Controller (SW PID 5641-VC8 in AAS and SW PID 5725-M19 in IBM Passport Advantage®).
- ▶ With the IBM FlashSystem 5200 system, a license exists for the hardware-assisted encryption if it is purchased (Encryption Enablement [#ALE0]). This feature code is needed if you want to use USB-Key encryption, IBM Security Key Lifecycle Manager-based encryption, or both on the control enclosure.
- ▶ The 5641-VC8 (External Virtualization, FlashCopy, and Remote Mirroring Features) licenses are licensed per enterprise within one country. These licenses are the same licenses as for IBM SAN Volume Controller. Therefore, existing SAN Volume Controller licenses can be used for the IBM FlashSystem 5200 system for these features.
- ▶ A storage system that is used only as a quorum device does not need a software license.

To set these licenses, use the Licensed Function page in the System Setup wizard. If you are adding these licenses to a system, select **Settings** → **System** → **Licensed Function** in the management GUI. You can also use the `chlicense` CLI command to update current settings on the system.

For more information about IBM Storage Virtualize licensing, see [Licensed functions](#).

IBM Storage Virtualize External Virtualization Licensing

The IBM FlashSystem 5200 system supports differential, capacity, and key-based licensing. For example, with external virtualization, differential licensing charges different rates for different types of storage. This difference provides cost-effective management of capacity across many storage tiers. Licensing for these functions is based on the number of storage capacity units (SCUs) that are purchased.

With other functions, such as remote mirroring and FlashCopy, the license grants a specific number of terabytes of capacity for that function.

Key-based licenses, such as encryption, require an authorization code and key to be downloaded to the system before the function can be used.

Note: SCUs are needed for only external virtualized storage that does not include the base license.

The SCU is defined in terms of the category of the storage capacity, as listed in Table 14.

Table 14 SCU category definitions

License	Drive class	SCU ratio
SCM	SCM devices	SCU equates to 1.00 TiB usable of Category 1 storage
Flash	All flash devices, other than SCM drives	SCU equates to 1.18 TiB usable of Category 2 storage
Enterprise	10K or 15K RPM drives	SCU equates to 2 TiB usable of Category 3 storage
Nearline	Nearline SATA drives	SCU equates to 4.00 TiB usable of Category 4 storage

Any storage use case that is not listed in Table 14 is classified as Category 1.

Table 15 shows an example of calculating SCUs. The example is a customer who virtualizes external disk arrays with 30 TB SCM capacity, 200 TB SSD flash capacity, and 2400 TB Nearline capacity.

Table 15 Example of calculating SCUs

Category	Type	Capacity	Rule	Number of SCUs
Category 1	SCM	30	/ 1	30
Category 2	SSD	200	/ 1.18	170
Category 4	Nearline	2400	/ 4	600
Total				800

A total of 800 SCUs are required for the example that is shown in Table 15. When you calculate the number of SCUs per category, fractions must be rounded up to the next higher integer number.

For more information about IBM Storage Virtualize Differential Licensing, see [Licensed functions](#).

IBM Financing

IBM Financing offers competitive financing to credit-qualified customers and IBM Business Partners to assist them in acquiring IT solutions. The offerings include financing for IT acquisition, including hardware, software, and services from IBM and other manufacturers or vendors. Also offered is commercial financing (revolving lines of credit, term loans, acquisition facilities, and inventory financing credit lines) for IBM Business Partners.

Offerings (for small, medium, and large enterprise customer segments), rates, terms, and availability can vary by country. For more information, contact your local IBM Financing organization or see the [IBM Financing website](#).

Ordering information

For more information about ordering IBM FlashSystem 5200 expansions, see “Scaling up and scaling out” on page 43.

For more information about ordering hardware features, see “Options and feature codes” on page 51.

For more information about ordering software licenses, see “Software and licensing” on page 60.

Related publications

IBM Redbooks

For more information, see the following resources:

- ▶ *Introduction and Implementation of Data Reduction Pools and Deduplication*, SG24-8430
- ▶ *Storage and the NVM Express Revolution*, REDP-5437

You can search for, view, download, or order these documents and other IBM Redbooks® publications, Redpapers, web docs, drafts, and additional materials, at the following website:

<https://www.redbooks.ibm.com/>

Online Resources

- ▶ IBM Documentation - IBM Storage FlashSystem 5200:
<https://www.ibm.com/docs/en/flashsystem-5x00/8.6.x?topic=5200-storage-flashsystem>
- ▶ IBM FlashSystem 5200 product web page:
<https://www.ibm.com/products/flashsystem-5200>
- ▶ IBM FlashSystem Family FAQ. Overview of the IBM FlashSystem family with guidance on how to select the product that is right for you:
<https://www.ibm.com/downloads/cas/9OGKVW2R>
- ▶ IBM FlashWatch FAQ. Guidance for the IBM FlashWatch programs:
<https://www.ibm.com/downloads/cas/YVMYPEDE>
- ▶ IBM FlashSystems and SAN Volume Controller FAQ. Information about the IBM FlashSystem family and IBM SAN Volume Controller:
<https://www.ibm.com/downloads/cas/2DWAMWRB>

Authors

Corne Lottering is a Storage Client Technical Specialist in the US, focusing on technical sales in Texas and Louisiana within the Public Sector industry. He has been with IBM for more than 20 years, and has experience in various storage technologies, including the IBM System Storage DS5000, IBM DS8000®, IBM Storwize, XIV®, IBM Storage FlashSystem, IBM SAN switches, IBM Tape Systems, and Software Defined Storage software. Since joining IBM, he has fulfilled roles in support, implementation, and pre-sales support across various African and Middle Eastern countries. Corne is the author of several IBM Redbooks publications that are related to the midrange IBM System Storage DS Storage Manager range of products, and IBM FlashSystem products.

Hartmut Lonzer is the IBM Storwize® Territory Account Manager for DACH. In addition, he covers the SAN portfolio as Offering Manager DACH. Before this position, he was OEM Alliance Manager for Lenovo in IBM Germany. His working location is at the IBM German headquarters in Ehningen. His main focus is on the IBM Storage FlashSystem family and the IBM SAN Volume Controller. His experience with the IBM SAN Volume Controller and IBM FlashSystem products goes back to the beginning of these products. Hartmut has been with IBM in various technical and sales roles for 44 years.

Vasfi Gucer works as the Storage Team Leader on the IBM Redbooks Team. He has more than 30 years of experience in the areas of systems management, networking hardware, and software. He writes extensively and teaches IBM classes worldwide about IBM products. His focus has been primarily on storage, cloud computing, and cloud storage technologies for the last 8 years. Vasfi is also an IBM Certified Senior IT Specialist, Project Management Professional (PMP), IT Infrastructure Library (ITIL) V2 Manager, and ITIL V3 Expert.

Thanks to the following people for their contributions to this project:

Evelyn Perez, Greg Shepherd, Liam P Moyna, Matthew Smith
IBM Hursley, UK

Gerard Kimbuende, Jeffrey Franke, Lourdes Gee, Meagan M Miller, John Blase
IBM US

Jorge Escalante
IBM Mexico

Marcin Soltysiak
IBM Poland

The team also would like to thank the authors of the previous edition of this publication:
Aldo Araujo Fonseca, Jon Herd, Leandro Torolho and Sandro De Santi.

Now you can become a published author, too!

Here's an opportunity to spotlight your skills, grow your career, and become a published author—all at the same time! Join an ITSO residency project and help write a book in your area of expertise, while honing your experience using leading-edge technologies. Your efforts will help to increase product acceptance and customer satisfaction, as you expand your network of technical contacts and relationships. Residencies run from two to six weeks in length, and you can participate either in person or as a remote resident working from your home base.

Find out more about the residency program, browse the residency index, and apply online at:

ibm.com/redbooks/residencies.html

Stay connected to IBM Redbooks

- ▶ Look for us on LinkedIn:
<http://www.linkedin.com/groups?home=&gid=2130806>
- ▶ Explore new IBM Redbooks publications, residencies, and workshops with the IBM Redbooks weekly newsletter:
<https://www.redbooks.ibm.com/Redbooks.nsf/subscribe?OpenForm>
- ▶ Stay current on recent Redbooks publications with RSS Feeds:
<http://www.redbooks.ibm.com/rss.html>

Notices

This information was developed for products and services offered in the US. This material might be available from IBM in other languages. However, you may be required to own a copy of the product or product version in that language in order to access it.

IBM may not offer the products, services, or features discussed in this document in other countries. Consult your local IBM representative for information on the products and services currently available in your area. Any reference to an IBM product, program, or service is not intended to state or imply that only that IBM product, program, or service may be used. Any functionally equivalent product, program, or service that does not infringe any IBM intellectual property right may be used instead. However, it is the user's responsibility to evaluate and verify the operation of any non-IBM product, program, or service.

IBM may have patents or pending patent applications covering subject matter described in this document. The furnishing of this document does not grant you any license to these patents. You can send license inquiries, in writing, to:

IBM Director of Licensing, IBM Corporation, North Castle Drive, MD-NC119, Armonk, NY 10504-1785, US

INTERNATIONAL BUSINESS MACHINES CORPORATION PROVIDES THIS PUBLICATION "AS IS" WITHOUT WARRANTY OF ANY KIND, EITHER EXPRESS OR IMPLIED, INCLUDING, BUT NOT LIMITED TO, THE IMPLIED WARRANTIES OF NON-INFRINGEMENT, MERCHANTABILITY OR FITNESS FOR A PARTICULAR PURPOSE. Some jurisdictions do not allow disclaimer of express or implied warranties in certain transactions, therefore, this statement may not apply to you.

This information could include technical inaccuracies or typographical errors. Changes are periodically made to the information herein; these changes will be incorporated in new editions of the publication. IBM may make improvements and/or changes in the product(s) and/or the program(s) described in this publication at any time without notice.

Any references in this information to non-IBM websites are provided for convenience only and do not in any manner serve as an endorsement of those websites. The materials at those websites are not part of the materials for this IBM product and use of those websites is at your own risk.

IBM may use or distribute any of the information you provide in any way it believes appropriate without incurring any obligation to you.

The performance data and client examples cited are presented for illustrative purposes only. Actual performance results may vary depending on specific configurations and operating conditions.

Information concerning non-IBM products was obtained from the suppliers of those products, their published announcements or other publicly available sources. IBM has not tested those products and cannot confirm the accuracy of performance, compatibility or any other claims related to non-IBM products. Questions on the capabilities of non-IBM products should be addressed to the suppliers of those products.

Statements regarding IBM's future direction or intent are subject to change or withdrawal without notice, and represent goals and objectives only.

This information contains examples of data and reports used in daily business operations. To illustrate them as completely as possible, the examples include the names of individuals, companies, brands, and products. All of these names are fictitious and any similarity to actual people or business enterprises is entirely coincidental.

COPYRIGHT LICENSE:

This information contains sample application programs in source language, which illustrate programming techniques on various operating platforms. You may copy, modify, and distribute these sample programs in any form without payment to IBM, for the purposes of developing, using, marketing or distributing application programs conforming to the application programming interface for the operating platform for which the sample programs are written. These examples have not been thoroughly tested under all conditions. IBM, therefore, cannot guarantee or imply reliability, serviceability, or function of these programs. The sample programs are provided "AS IS", without warranty of any kind. IBM shall not be liable for any damages arising out of your use of the sample programs.

Trademarks

IBM, the IBM logo, and ibm.com are trademarks or registered trademarks of International Business Machines Corporation, registered in many jurisdictions worldwide. Other product and service names might be trademarks of IBM or other companies. A current list of IBM trademarks is available on the web at “Copyright and trademark information” at <http://www.ibm.com/legal/copytrade.shtml>

The following terms are trademarks or registered trademarks of International Business Machines Corporation, and might also be trademarks or registered trademarks in other countries.

AIX®	IBM Cloud®	PowerPC®
DS8000®	IBM FlashCore®	PowerVM®
Easy Tier®	IBM FlashSystem®	Rational®
FlashCopy®	IBM Security®	Redbooks®
Guardium®	IBM Spectrum®	Redbooks (logo)  ®
HyperSwap®	Insight®	Storwize®
IBM®	Passport Advantage®	XIV®

Intel, Intel logo, Intel Inside logo, and Intel Centrino logo are trademarks or registered trademarks of Intel Corporation or its subsidiaries in the United States and other countries.

ITIL is a Registered Trade Mark of AXELOS Limited.

The registered trademark Linux® is used pursuant to a sublicense from the Linux Foundation, the exclusive licensee of Linus Torvalds, owner of the mark on a worldwide basis.

Microsoft, Windows, and the Windows logo are trademarks of Microsoft Corporation in the United States, other countries, or both.

Red Hat, OpenShift, are trademarks or registered trademarks of Red Hat, Inc. or its subsidiaries in the United States and other countries.

VMware, VMware vSphere, and the VMware logo are registered trademarks or trademarks of VMware, Inc. or its subsidiaries in the United States and/or other jurisdictions.

Other company, product, or service names may be trademarks or service marks of others.



REDP-5617-01

ISBN 0738461342

Printed in U.S.A.

Get connected

