

# IBM Tape Library Guide for Open Systems

Ole Asmussen

Robert Beiderbeck

Albrecht Friess

Hans-Günther Hörhammer

Khanh Ngo

Jesus Eduardo Cervantes Rolon

Fabian Corona Villarreal

Larry Coyne



**Storage**





International Technical Support Organization

**IBM Tape Library Guide for Open Systems**

March 2022

**Note:** Before using this information and the product it supports, read the information in “Notices” on page xiii.



**Eighteenth Edition (March 2022)**



# Contents

<b>Notices</b> .....	xiii
Trademarks .....	xiv
<b>Preface</b> .....	xv
Authors .....	xvi
Now you can become a published author, too .....	xix
Comments welcome .....	xix
Stay connected to IBM Redbooks .....	xix
<b>Summary of changes</b> .....	xxi
November 2022, Eighteenth Edition (minor update) .....	xxi
October 2022, Eighteenth Edition (minor update) .....	xxi
March 2022, Eighteenth Edition .....	xxi
July 2021, Seventeenth Edition (minor update) .....	xxii
March 2020, Seventeenth Edition .....	xxii
November 2018, Sixteenth Edition .....	xxii
March 2018, Fifteenth Edition .....	xxii
August 2017, Fourteenth Edition .....	xxiii
August 2016, Thirteenth Edition .....	xxiii
January 2016, Twelfth Edition .....	xxiii
February 2015, Eleventh Edition .....	xxiv
June 2013, Tenth Edition .....	xxiv
June 2012, Ninth Edition .....	xxv
June 2011, Eighth Edition .....	xxv
September 2008, Seventh Edition .....	xxvi
October 2007, Sixth Edition .....	xxvi
April 2007, Fifth Edition .....	xxvii
September 2005, Fourth Edition .....	xxvii
June 2004, Third Edition .....	xxvii
June 2003, Second Edition .....	xxviii
November 2000, First Edition .....	xxviii
<b>Part 1. Tape basics of open systems</b> .....	1
<b>Chapter 1. Tape technology introduction</b> .....	3
1.1 Introduction .....	4
1.2 Tape products and technologies .....	5
1.2.1 Recording technology .....	6
1.2.2 Tape reels .....	7
1.2.3 Quarter-inch cartridge .....	8
1.2.4 Digital Data Standard .....	9
1.2.5 The 8 mm format .....	10
1.2.6 SuperDLT .....	14
1.2.7 IBM 3850 .....	14
1.2.8 IBM 3480 .....	15
1.2.9 IBM 3490 .....	15
1.2.10 IBM 3590 .....	16
1.2.11 LTO Ultrium tape .....	18

1.2.12	IBM TS1100 tape drive family . . . . .	20
1.2.13	Rack-mount option for TS1160, TS1155, TS1150, and TS1140 models . . . . .	23
1.2.14	Libraries . . . . .	23
1.3	Tape solutions in a SAN environment . . . . .	26
1.3.1	Sharing tape devices in a SAN environment . . . . .	26
1.4	IBM Spectrum Scale . . . . .	27
1.4.1	Key capabilities . . . . .	28
1.4.2	Benefits . . . . .	28
1.5	IBM Spectrum Archive . . . . .	29
1.5.1	Key capabilities . . . . .	29
1.5.2	Benefits . . . . .	30
1.5.3	IBM Linear Tape File System . . . . .	30
1.5.4	IBM Spectrum Archive editions . . . . .	31
1.6	IBM Tape System Library Manager . . . . .	34
<b>Chapter 2. Overview of IBM Linear Tape-Open Ultrium tape drives.</b> . . . . .		<b>37</b>
2.1	The LTO organization . . . . .	39
2.1.1	Overview . . . . .	39
2.1.2	LTO standards . . . . .	41
2.1.3	Data compression . . . . .	45
2.1.4	Tape cartridge . . . . .	46
2.1.5	IBM LTO Ultrium common subassembly drive . . . . .	52
2.2	Tape encryption overview . . . . .	61
2.2.1	IBM Security Guardium Key Lifecycle Manager . . . . .	63
2.2.2	Encryption methods . . . . .	64
2.2.3	LTO Ultrium tape encryption . . . . .	66
2.3	IBM LTO Ultrium highlights . . . . .	67
2.3.1	IBM LTO Ultrium compatibility . . . . .	67
2.3.2	LTO performance . . . . .	69
2.3.3	Reliability . . . . .	72
2.4	IBM LTO Ultrium 9 tape drives . . . . .	74
2.4.1	IBM LTO Ultrium 9 tape drive range . . . . .	78
2.5	IBM LTO Ultrium 8 tape drives . . . . .	80
2.5.1	The IBM LTO Ultrium 8 tape drive range . . . . .	83
2.6	IBM LTO Ultrium 7 tape drives . . . . .	85
2.6.1	The IBM LTO Ultrium 7 tape drive range . . . . .	88
2.7	IBM LTO Ultrium 6 tape drives . . . . .	90
2.7.1	The IBM LTO Ultrium 6 tape drive range . . . . .	93
2.8	IBM LTO Ultrium family of tape drives and libraries . . . . .	98
2.8.1	Multipath architecture . . . . .	101
2.8.2	Next-generation multipath architecture . . . . .	104
<b>Chapter 3. IBM TS1100 tape drives</b> . . . . .		<b>105</b>
3.1	IBM TS1100 tape drive family . . . . .	106
3.1.1	1 TB and beyond . . . . .	106
3.1.2	Nomenclature . . . . .	107
3.2	Common characteristics of the 3592 tape drive family . . . . .	108
3.2.1	Technology enhancements . . . . .	108
3.2.2	Recording format . . . . .	108
3.2.3	Reliability and availability . . . . .	109
3.2.4	Features that are designed for capacity and performance . . . . .	112
3.2.5	Performance or capacity scaling . . . . .	114
3.3	Physical attachment . . . . .	116

3.3.1	Multiple Fibre Channel ports . . . . .	117
3.3.2	Supported topologies . . . . .	117
3.3.3	Ethernet drives . . . . .	118
3.4	Media . . . . .	119
3.4.1	3592 media cartridge . . . . .	120
3.4.2	WORM functionality . . . . .	124
3.4.3	Tape encryption for TS1100 . . . . .	126
3.4.4	Rack-mount option for TS1160, TS1155, TS1150, and TS1140 models . . . . .	127
3.5	IBM TS1160 tape drive . . . . .	128
3.5.1	Physical attachment . . . . .	131
3.5.2	TS1160 physical characteristics . . . . .	132
3.5.3	Media . . . . .	133
3.5.4	Capacity and performance . . . . .	134
3.5.5	Access performance specifications and drive characteristics . . . . .	140
3.5.6	Emulation . . . . .	141
3.5.7	IBM Spectrum Archive and LTFS support . . . . .	142
3.5.8	Data safe mode . . . . .	143
3.5.9	Upgrade considerations . . . . .	143
3.5.10	Firmware updates . . . . .	143
3.5.11	RAS . . . . .	144
3.5.12	Improved media Statistical Analysis and Reporting System . . . . .	144
3.5.13	Encryption . . . . .	145
3.6	IBM TS1155 and TS1150 tape drive . . . . .	145
3.6.1	Physical attachment . . . . .	147
3.6.2	Media . . . . .	148
3.6.3	Capacity and performance . . . . .	149
3.6.4	Access performance specifications and drive characteristics . . . . .	156
3.6.5	Emulation . . . . .	157
3.6.6	IBM Spectrum Archive and LTFS support . . . . .	157
3.6.7	Data safe mode . . . . .	159
3.6.8	Enhanced Ethernet support . . . . .	160
3.6.9	TS1155 and TS1150 physical characteristics . . . . .	160
3.6.10	Upgrade considerations . . . . .	163
3.6.11	Firmware updates . . . . .	164
3.6.12	RAS . . . . .	164
3.6.13	Improved media SARS . . . . .	165
3.6.14	Encryption . . . . .	165
3.7	IBM TS1140 tape drive . . . . .	166
3.7.1	Physical attachment . . . . .	167
3.7.2	Media . . . . .	167
3.7.3	Capacity and performance . . . . .	168
3.7.4	Access performance specifications and drive characteristics . . . . .	171
3.7.5	Emulation . . . . .	172
3.7.6	IBM Spectrum Archive and LTFS support . . . . .	173
3.7.7	Data safe mode . . . . .	173
3.7.8	Enhanced Ethernet support . . . . .	173
3.7.9	TS1140 physical characteristics . . . . .	174
3.7.10	Upgrade considerations . . . . .	175
3.7.11	Firmware updates . . . . .	176
3.7.12	RAS features . . . . .	176
3.7.13	Improved media SARS . . . . .	176
3.7.14	Encryption . . . . .	176
3.7.15	Tracking data that is written . . . . .	177

<b>Chapter 4. IBM TS2290 tape drive</b> . . . . .	179
4.1 Product description . . . . .	180
4.2 Half-High Ultrium 9 tape drive . . . . .	181
4.2.1 Platform support . . . . .	182
4.2.2 Performance highlights . . . . .	182
4.3 Media . . . . .	183
4.3.1 Data cartridges . . . . .	183
4.3.2 Write Once Read Many cartridges . . . . .	183
4.3.3 Cleaning cartridges . . . . .	183
4.3.4 Cartridge memory . . . . .	184
4.4 Encryption . . . . .	184
4.5 IBM Spectrum Archive and Linear Tape File System . . . . .	185
4.6 Physical attachment . . . . .	185
4.6.1 Serial-attached SCSI . . . . .	185
4.7 Specifications . . . . .	186
4.7.1 Physical specifications . . . . .	186
4.7.2 Power specifications . . . . .	187
4.8 Feature codes . . . . .	187
<b>Chapter 5. IBM TS2280 tape drive</b> . . . . .	189
5.1 Product description . . . . .	190
5.2 Half-High Ultrium 8 tape drive . . . . .	191
5.2.1 Platform support . . . . .	192
5.2.2 Performance highlights . . . . .	192
5.3 Media . . . . .	193
5.3.1 Data cartridges . . . . .	193
5.3.2 Write Once Read Many cartridges . . . . .	193
5.3.3 Cleaning cartridges . . . . .	194
5.3.4 Cartridge memory . . . . .	194
5.4 Encryption . . . . .	194
5.5 IBM Spectrum Archive and Linear Tape File System . . . . .	195
5.6 Physical attachment . . . . .	196
5.6.1 Serial-attached SCSI . . . . .	196
5.7 Specifications . . . . .	196
5.7.1 Physical specifications . . . . .	196
5.7.2 Power specifications . . . . .	197
5.8 Feature codes . . . . .	197
<b>Chapter 6. IBM TS2270 tape drive</b> . . . . .	199
6.1 Product description . . . . .	200
6.2 Half-High Ultrium 7 tape drive . . . . .	201
6.2.1 Platform support . . . . .	202
6.2.2 Performance highlights . . . . .	202
6.3 Media . . . . .	202
6.3.1 Data cartridges . . . . .	203
6.3.2 Write Once Read Many cartridges . . . . .	203
6.3.3 Cleaning cartridges . . . . .	203
6.3.4 Cartridge memory . . . . .	204
6.4 Encryption . . . . .	204
6.5 IBM Spectrum Archive and Linear Tape File System . . . . .	205
6.6 Physical attachment . . . . .	205
6.6.1 Serial-attached SCSI . . . . .	205
6.7 Specifications . . . . .	206
6.7.1 Physical specifications . . . . .	206

6.7.2 Power specifications . . . . .	207
6.8 Feature codes . . . . .	207
<b>Chapter 7. IBM TS2260 tape drive . . . . .</b>	<b>209</b>
7.1 Product description . . . . .	210
7.2 Half-High Ultrium 6 tape drive . . . . .	211
7.2.1 Platform support . . . . .	212
7.2.2 Performance highlights . . . . .	212
7.3 Media . . . . .	212
7.3.1 Data cartridges . . . . .	212
7.3.2 Write Once Read Many cartridges . . . . .	213
7.3.3 Cleaning cartridges . . . . .	213
7.3.4 Cartridge memory . . . . .	213
7.4 Encryption . . . . .	214
7.5 IBM Spectrum Archive and LTFS . . . . .	214
7.6 Physical attachment . . . . .	215
7.6.1 Serial-attached SCSI . . . . .	215
7.7 Specifications . . . . .	216
7.7.1 Physical specifications . . . . .	216
7.7.2 Power specifications . . . . .	216
7.8 Feature codes . . . . .	216
<b>Chapter 8. IBM TS2360 tape drive . . . . .</b>	<b>219</b>
8.1 Product description . . . . .	220
8.2 Full-High Ultrium 6 tape drive . . . . .	221
8.2.1 Platform support . . . . .	222
8.2.2 Performance highlights . . . . .	222
8.3 Media . . . . .	223
8.3.1 Data cartridges . . . . .	223
8.3.2 Write Once Read Many cartridges . . . . .	223
8.3.3 Cleaning cartridges . . . . .	224
8.3.4 Cartridge memory (LTO-CM) . . . . .	224
8.4 Encryption . . . . .	224
8.5 IBM Spectrum Archive and Linear Tape File System . . . . .	225
8.6 Physical attachment . . . . .	225
8.6.1 Serial-attached SCSI . . . . .	225
8.7 Specifications . . . . .	226
8.7.1 Physical specifications . . . . .	226
8.7.2 Power specifications . . . . .	227
8.8 Feature codes . . . . .	227
<b>Part 2. IBM tape libraries for open systems . . . . .</b>	<b>229</b>
<b>Chapter 9. IBM TS2900 tape autoloader . . . . .</b>	<b>231</b>
9.1 Overview . . . . .	233
9.2 TS2900 tape autoloader components . . . . .	235
9.2.1 Operator Control Panel . . . . .	237
9.2.2 Robotics . . . . .	238
9.2.3 Bar code reader . . . . .	238
9.2.4 Cartridge storage . . . . .	238
9.3 IBM LTO Ultrium Half-High tape drives . . . . .	239
9.3.1 LTO-9 Half-High tape drive . . . . .	239
9.3.2 Encryption . . . . .	240
9.3.3 IBM Spectrum Archive and LTFS . . . . .	240

9.3.4	Notifications	241
9.4	Physical attachments	241
9.4.1	SAS interface	241
9.5	Media	241
9.5.1	Data cartridges	242
9.5.2	Write Once Read Many cartridges	242
9.5.3	Cleaning cartridges	242
9.5.4	Cartridge Memory chip	243
9.6	Specifications	243
9.6.1	Physical specifications	243
9.6.2	Power specifications	243
9.7	Feature codes	244
<b>Chapter 10.</b>	<b>IBM TS4300 tape library</b>	<b>245</b>
10.1	Product description	246
10.1.1	TS4300 tape library Model L3A (Machine Type 3555)	247
10.1.2	TS4300 tape library Model E3A (Machine Type 3555)	248
10.2	Library expansion	248
10.3	Front panel components	250
10.3.1	I/O station and magazine	251
10.3.2	Access door	252
10.3.3	Operator control panel	252
10.3.4	Power button	252
10.3.5	Front panel LEDs	252
10.4	Rear panel components	253
10.4.1	Library Controller	254
10.4.2	Tape drives	254
10.4.3	Power supply	256
10.5	Interior components	257
10.5.1	Storage columns	257
10.5.2	Robotic system	258
10.6	Optional features	258
10.6.1	IBM Ultrium tape drives	258
10.6.2	Redundant power supply	259
10.6.3	Rack mounting kit	260
10.6.4	Feature code previews	260
10.7	Library management	260
10.7.1	Operator Control Panel	261
10.7.2	Web user interface	262
10.7.3	Encryption	268
10.7.4	Notifications	270
10.8	Multipath architecture	271
10.8.1	Using multiple control paths	271
10.8.2	Using multiple control paths for Control Path Failover	271
10.8.3	Using multiple data paths for Data Path Failover	272
10.9	Working with logical libraries	272
10.10	Media	276
10.10.1	Data cartridges	276
10.10.2	Cleaning cartridges	277
10.10.3	Cartridge memory chip	278
10.11	Supported environments	278
10.11.1	Supported storage software	278
10.12	Specifications	278



10.12.1	Timings	278
10.12.2	Physical specifications	279
10.12.3	Operating environment	279
10.13	Feature codes	280
10.13.1	Power cords	281
10.13.2	Fibre Channel cables	282
10.13.3	SAS cables	282
10.13.4	Publications	282
<b>Chapter 11.</b>	<b>IBM TS4500 tape library</b>	<b>283</b>
11.1	Overview of the IBM TS4500 tape library	286
11.2	TS4500 product description	288
11.2.1	TS4500 tape library frames for IBM LTO Ultrium Fibre Channel and Serial Attached SCSI drives	291
11.2.2	TS4500 tape library frames for IBM 3592 Fibre Channel, Ethernet over optical fiber and Serial Attached SCSI drives	296
11.2.3	TS4500 tape library storage-only HD frames	299
11.2.4	TS4500 High Availability (HA) option	302
11.2.5	External TSSC	305
11.2.6	TS4500 tape library top rack frame TR1	306
<b>Part 3.</b>	<b>Appendixes</b>	<b>309</b>
<b>Appendix A.</b>	<b>Data storage values</b>	<b>311</b>
<b>Appendix B.</b>	<b>IBM LTO Ultrium and 3592 media</b>	<b>313</b>
Features available with the initial IBM hardware order		314
IBM stand-alone tape drives		314
IBM TS2900 tape autoloader		314
IBM TS3100 tape library		315
IBM TS3200 tape library		315
IBM TS3310 tape library		315
IBM TS4300 tape library		315
IBM TS3500 tape library		315
IBM TS4500 tape library		315
IBM 3589 LTO Ultrium tape cartridges		316
Cartridge compatibility		317
Model description and ordering media supplies		318
Bar code labels		323
IBM 3599 tape cartridges		324
Model description		324
Labeling service		330
Ordering bar code labels		332
<b>Appendix C.</b>	<b>IBM tape product names</b>	<b>333</b>
TS series family names		334
TS1000 tape drives (LTO)		334
TS1100 tape drives (Enterprise)		335
TS2000 tape enclosures (LTO)		336
TS2900 tape autoloader		337
TS4300 tape library		337
TS4500 tape library		338

<b>Related publications</b> .....	339
IBM Redbooks publications .....	339
Other publications .....	339
Online resources .....	340
Help from IBM .....	341

# Notices

This information was developed for products and services offered in the US. This material might be available from IBM in other languages. However, you may be required to own a copy of the product or product version in that language in order to access it.

IBM may not offer the products, services, or features discussed in this document in other countries. Consult your local IBM representative for information on the products and services currently available in your area. Any reference to an IBM product, program, or service is not intended to state or imply that only that IBM product, program, or service may be used. Any functionally equivalent product, program, or service that does not infringe any IBM intellectual property right may be used instead. However, it is the user's responsibility to evaluate and verify the operation of any non-IBM product, program, or service.

IBM may have patents or pending patent applications covering subject matter described in this document. The furnishing of this document does not grant you any license to these patents. You can send license inquiries, in writing, to:

*IBM Director of Licensing, IBM Corporation, North Castle Drive, MD-NC119, Armonk, NY 10504-1785, US*

INTERNATIONAL BUSINESS MACHINES CORPORATION PROVIDES THIS PUBLICATION "AS IS" WITHOUT WARRANTY OF ANY KIND, EITHER EXPRESS OR IMPLIED, INCLUDING, BUT NOT LIMITED TO, THE IMPLIED WARRANTIES OF NON-INFRINGEMENT, MERCHANTABILITY OR FITNESS FOR A PARTICULAR PURPOSE. Some jurisdictions do not allow disclaimer of express or implied warranties in certain transactions, therefore, this statement may not apply to you.

This information could include technical inaccuracies or typographical errors. Changes are periodically made to the information herein; these changes will be incorporated in new editions of the publication. IBM may make improvements and/or changes in the product(s) and/or the program(s) described in this publication at any time without notice.

Any references in this information to non-IBM websites are provided for convenience only and do not in any manner serve as an endorsement of those websites. The materials at those websites are not part of the materials for this IBM product and use of those websites is at your own risk.

IBM may use or distribute any of the information you provide in any way it believes appropriate without incurring any obligation to you.

The performance data and client examples cited are presented for illustrative purposes only. Actual performance results may vary depending on specific configurations and operating conditions.

Information concerning non-IBM products was obtained from the suppliers of those products, their published announcements or other publicly available sources. IBM has not tested those products and cannot confirm the accuracy of performance, compatibility or any other claims related to non-IBM products. Questions on the capabilities of non-IBM products should be addressed to the suppliers of those products.

Statements regarding IBM's future direction or intent are subject to change or withdrawal without notice, and represent goals and objectives only.

This information contains examples of data and reports used in daily business operations. To illustrate them as completely as possible, the examples include the names of individuals, companies, brands, and products. All of these names are fictitious and any similarity to actual people or business enterprises is entirely coincidental.

## COPYRIGHT LICENSE:

This information contains sample application programs in source language, which illustrate programming techniques on various operating platforms. You may copy, modify, and distribute these sample programs in any form without payment to IBM, for the purposes of developing, using, marketing or distributing application programs conforming to the application programming interface for the operating platform for which the sample programs are written. These examples have not been thoroughly tested under all conditions. IBM, therefore, cannot guarantee or imply reliability, serviceability, or function of these programs. The sample programs are provided "AS IS", without warranty of any kind. IBM shall not be liable for any damages arising out of your use of the sample programs.

# Trademarks

IBM, the IBM logo, and [ibm.com](http://www.ibm.com) are trademarks or registered trademarks of International Business Machines Corporation, registered in many jurisdictions worldwide. Other product and service names might be trademarks of IBM or other companies. A current list of IBM trademarks is available on the web at “Copyright and trademark information” at <http://www.ibm.com/legal/copytrade.shtml>

The following terms are trademarks or registered trademarks of International Business Machines Corporation, and might also be trademarks or registered trademarks in other countries.

AIX®	IBM Security™	Redbooks®
DB2®	IBM Spectrum®	Redbooks (logo)  ®
FICON®	IBM Z®	Tivoli®
Guardium®	Interconnect®	XIV®
IBM®	NPS®	z/OS®
IBM Elastic Storage®	OS/400®	zEnterprise®
IBM Research®	ProtecTIER®	

The following terms are trademarks of other companies:

SoftLayer, are trademarks or registered trademarks of SoftLayer, Inc., an IBM Company.

Intel, Intel logo, Intel Inside logo, and Intel Centrino logo are trademarks or registered trademarks of Intel Corporation or its subsidiaries in the United States and other countries.

The registered trademark Linux® is used pursuant to a sublicense from the Linux Foundation, the exclusive licensee of Linus Torvalds, owner of the mark on a worldwide basis.

Linear Tape-Open, LTO, Ultrium, the LTO Logo and the Ultrium logo are trademarks of HP, IBM Corp. and Quantum in the U.S. and other countries.

Microsoft, Windows, and the Windows logo are trademarks of Microsoft Corporation in the United States, other countries, or both.

Java, and all Java-based trademarks and logos are trademarks or registered trademarks of Oracle and/or its affiliates.

UNIX is a registered trademark of The Open Group in the United States and other countries.

Other company, product, or service names may be trademarks or service marks of others.

# Preface

This IBM® Redbooks® publication presents a general introduction to the latest (current) IBM® tape and tape library technologies. Featured tape technologies include the IBM LTO Ultrium and Enterprise 3592 tape drives, and their implementation in IBM tape libraries.

This 18th edition includes information about the latest IBM Linear Tape-Open (LTO) Ultrium 9 tape drive, IBM TS4500 tape library, IBM TS4300 tape library, TS2900 tape autoloader, along with technical information about each IBM tape product for open systems. It also includes generalized sections about Small Computer System Interface (SCSI) and Fibre Channel connections, and multipath architecture configurations.

This book also covers tools and techniques for library management. It is intended for anyone who wants to understand more about IBM tape products and their implementation. It is suitable for IBM clients, IBM Business Partners, IBM specialist sales representatives, and technical specialists. If you do not have a background in computer tape storage products, you might need to read other sources of information. In the interest of being concise, topics that are generally understood are not covered in detail.

## Authors

This book was produced by an international team working with the IBM Tucson Redbooks center.



**Ole Asmussen** is a Product Field Engineer for IBM Storage based in Hamburg, Germany. He has supported IBM Tape for over 20 years, working in various support level and supporting all IBM Tape products (3494, 3584, TS7700, and ProtecTier). He joined IBM as a Customer Service Representative in 1999 and was responsible for different accounts in Germany. In 2001, he joined the Support Center in Mainz, Germany.



**Robert Beiderbeck** is an IBM Senior Accredited Specialist for Product Service profession and works as a Team Leader for the EMEA RMSS Product Field Engineering (PFE) group in Germany. He joined IBM in 1989 as a Customer Service Representative for Mainframe (IBM Z® Systems) and worked later in the Z Systems Hardware Support Center, responsible for Server, ESCON, and IBM FICON® Switches and Infrastructure. Robert then became a Storage Specialist for Tape Libraries, VTS, and Drives in the field before he joined second-level support in 2002. His areas of expertise include Enterprise Tape Systems, such as TS7700, TS3500, 3494, VTS (P2P), and 3590/3592 Drives and Control Units.



**Albrecht Friess** is an IBM® Remote Technical Support (RTS) Specialist and works as a Subject Matter Expert (SME) for IBM EMEA Tape Storage, leveraging the close collaboration with product development, support centers, and other business units to provide seamless problem resolution and drive continuous quality improvements. After completing his studies with a degree in engineering, he joined IBM in 1996. After serving in different roles, he joined the second level EMEA Tape Storage Hardware Support in 2012. His area of expertise includes Enterprise Tape Systems, such as TS3500 and TS4500, and attached LTO and Jaguar tape drive devices. In addition to his work in the remote support center, he supports customers across Europe on-site with complex installations or problems. Albrecht also is frequently asked to conduct training courses for customers and customer service representatives. He also acts as a focal point for specific premium storage customers.



**Hans-Günther Hörhammer** is a pre-sales support and services specialist. He joined IBM in 1999. Hans supported and delivered services for various products and solutions, such as DS8K, NAS Gatwéway, and IBM XIV®. He developed HA/DR solutions for Oracle and SAP. His latest area of expertise is pre-sales support for Tape libraries in Open System environment.



**Khanh Ngo** is an IBM Senior Technical Staff Member and Master Inventor in Tucson, Arizona. Khanh is in the Storage CTO Office specializing in data integration with IBM Storage products. He joined IBM in 2000 with a Bachelor of Science degree in Electrical Engineering and a Bachelor of Science in Computer Science. Later, he received a Master of Science degree in Engineering Management. Because of his design and implementation work with many IBM Spectrum® Archive Enterprise Edition (EE) customers across multiple industries worldwide, Khanh is often sought out for his expertise to lead, execute, and successfully complete proof of concepts and custom engineering solutions integrating IBM Spectrum Archive EE into customers' production environments.

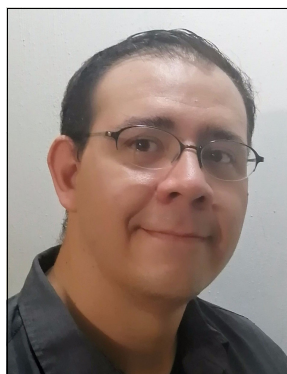

**Jesus Eduardo Cervantes Rolon** is an IBM Software Test Engineer in Guadalajara, Mexico. He holds a bachelor's degree in Electronics and Computers Engineering from CETI (Mexico) and he is a certified ISTQB FL Tester. He has been with IBM since 2012. During the last 7 years, he has been collaborating with the IBM next generation of storage management systems, the IBM TS4500 tape library in the Product Test area (focused in Functional Verification Test) where he has served as the team leader for the last 3 years.



**Fabian Corona Villarreal** is a Test Engineer for the IBM Mexico Software Lab, he joined IBM in 2004 and he's been involved in multiple test projects since then. He started working on Storage products in 2010 when he joined the IBM ProtecTIER® team, there, he served as a test engineer, project leader, and team leader during the different releases of the product. In 2014 he moved to the physical tapes area as the RAS team lead for the 3584, 3576, 3573, 3572, and 3555 tape libraries. Fabian holds a bachelor's degree in Computer Science from the Universidad de Guadalajara. He also is a certified ISTQB Advanced Level Test Manager.



**Larry Coyne** is a Project Leader at the IBM International Technical Support Organization, Tucson, Arizona, center. He has over 35 years of IBM experience, with 23 years in IBM storage software management. He holds degrees in Software Engineering from the University of Texas at El Paso and Project Management from George Washington University. His areas of expertise include client relationship management, quality assurance, development management, and support management for IBM storage management software.

Thanks to the following people for their contributions to this project:

Carlos Sandoval Castro  
Larry Hogan  
Lee Jesionowski  
Javier Justo  
Jeremy Tudgay  
Rick West  
Roberta Winston  
**IBM Systems**

Special thanks to Michael Engelbrecht and Simon Browne.



## Now you can become a published author, too

Here's an opportunity to spotlight your skills, grow your career, and become a published author—all at the same time. Join an ITSO residency project and help write a book in your area of expertise, while honing your experience using leading-edge technologies. Your efforts will help to increase product acceptance and customer satisfaction, as you expand your network of technical contacts and relationships. Residencies run from two to six weeks in length, and you can participate either in person or as a remote resident working from your home base.

Find out more about the residency program, browse the residency index, and apply online:

<http://www.ibm.com/redbooks/residencies.html>

## Comments welcome

Your comments are important to us.

We want our books to be as helpful as possible. Send us your comments about this book or other IBM Redbooks® publications in one of the following ways:

- ▶ Use the online **Contact us** review Redbooks form on this website:

<http://www.ibm.com/redbooks>

- ▶ Send your comments by email:

[redbooks@us.ibm.com](mailto:redbooks@us.ibm.com)

- ▶ Mail your comments:

IBM Corporation, International Technical Support Organization  
Dept. HYTD Mail Station P099  
2455 South Road  
Poughkeepsie, NY 12601-5400

## Stay connected to IBM Redbooks

- ▶ Look for us on LinkedIn:

<http://www.linkedin.com/groups?home=&gid=2130806>

- ▶ Explore new Redbooks publications, residencies, and workshops with the IBM Redbooks weekly newsletter:

<https://www.redbooks.ibm.com/Redbooks.nsf/subscribe?OpenForm>

- ▶ Stay current on recent Redbooks publications with RSS Feeds:

<http://www.redbooks.ibm.com/rss.html>



# Summary of changes

This section describes the technical changes that were made in this edition of the book. This edition might also include minor corrections and editorial changes that are not identified below.

Summary of Changes for SG24-5946-17  
for IBM Tape Library Guide for Open Systems  
as created or updated on December 7, 2022.

## December 2022, Eighteenth Edition (minor update)

This revision includes the following updates:

Updated performance numbers with corrected values.

Corrected table information for Table 2-10 on page 76 and *Table 2-12 on page 82*

## November 2022, Eighteenth Edition (minor update)

This revision includes the following updates:

Updated performance numbers with corrected values.

Corrected table information for 2.4, “IBM LTO Ultrium 9 tape drives” on page 74 and 4.2.2, “Performance highlights” on page 182

## October 2022, Eighteenth Edition (minor update)

This revision includes the following updates:

Updated the TS2290 figure in 4.6, “Physical attachment” on page 185 to show the correct back panel information.

## March 2022, Eighteenth Edition

This update reflects the addition of new and changed information.

### **New information**

The following functions were added for this edition:

- ▶ Added new chapter for support of the IBM Linear Tape-Open (LTO) Ultrium 9 tape drive. See Chapter 4., “IBM TS2290 tape drive” on page 179.
- ▶ Added Open Recommended Access Order (oRAO) for LTO-9.
- ▶ Updated book with IBM Security Guardium® Key Lifecycle Manager (formerly IBM Security™ Key Lifecycle Manager).
- ▶ Updated technology and introduction chapters with LTO-09 tape drive and media information.
- ▶ Updated TS2900, TS4300, and TS4500 tape library chapters about new function and LTO-9 tape drive support.

### **Changed information**

Updated links to new product levels and other resources.

## **July 2021, Seventeenth Edition (minor update)**

This revision reflects the addition, deletion, or modification of new and changed information.

### **Changed information**

This book includes the following changed information:

- ▶ Updated IBM Spectrum Scale icon in 1.4, “IBM Spectrum Scale” on page 27.
- ▶ Updated IBM Spectrum Archive icon in 1.5, “IBM Spectrum Archive” on page 29.
- ▶ Updated 3.5, “IBM TS1160 tape drive” on page 128 with Streaming Lossless Data Compression (SLDC).

## **March 2020, Seventeenth Edition**

This revision reflects the addition, deletion, or modification of new and changed information.

### **Changed information**

This book includes the following changed information:

- ▶ TS4500 R6
- ▶ TS4300
- ▶ Removed chapters with withdrawn from marketing tape libraries

## **November 2018, Sixteenth Edition**

This revision reflects the addition, deletion, or modification of new and changed information.

### **New information**

The book includes the following new information:

- ▶ TS1160 60G

### **Changed information**

This book includes the following changed information:

- ▶ TS4300 R2

## **March 2018, Fifteenth Edition**

This revision reflects the addition, deletion, or modification of new and changed information.

### **New information**

The book includes the following new information:

- ▶ “M8 format” on page 68 for the new LTO 8 Type M cartridge (M8)
- ▶ Chapter 2.5, “IBM LTO Ultrium 8 tape drives” on page 80 for the new LTO 8 tape drive
- ▶ Chapter 3.6, “IBM TS1155 and TS1150 tape drive” on page 145 for the new TS1155 55G model tape drive
- ▶ Chapter 5, “IBM TS2280 tape drive” on page 189
- ▶ Chapter 10, “IBM TS4300 tape library” on page 245 for enhancements to the TS4300

## **August 2017, Fourteenth Edition**

### **New information**

The book includes the following new information:

- ▶ “IBM TS4300 tape library” on page 245 for the new TS4300 tape library
- ▶ “IBM TS1100 tape drives” on page 105 for the new TS1155 tape drive

## **August 2016, Thirteenth Edition**

This revision reflects the addition, deletion, or modification of new and changed information.

### **New information**

The book includes the following new information:

- ▶ IBM TS4500 tape library enhancements
- ▶ IBM TS7650G ProtecTIER model 3958-DD6

### **Changed information**

This book includes the following changed information:

- ▶ IBM TS7600 ProtecTIER Systems

## **January 2016, Twelfth Edition**

This revision reflects the addition, deletion, or modification of new and changed information.

### **New information**

The book includes the following new information:

- ▶ IBM TS2270 Ultrium 7 tape drive
- ▶ IBM TS4500 tape library enhancements
- ▶ Ultrium 7 tape drive updates for IBM tape libraries
- ▶ IBM Spectrum Scale and IBM Spectrum Archive

### **Changed information**

This book includes the following changed information:

- ▶ IBM TS2900 tape autoloader
- ▶ IBM TS3100 tape library
- ▶ IBM TS3200 tape library
- ▶ IBM TS3310 tape library
- ▶ IBM TS3500 tape library
- ▶ IBM TS7600 ProtecTIER Systems

## **February 2015, Eleventh Edition**

This revision reflects the addition, deletion, or modification of new and changed information.

### **New information**

The book includes the following new information:

- ▶ IBM TS4500 tape library
- ▶ IBM TS1150 tape drive (3592 Model E08)
- ▶ IBM TS2260 tape drive update for optional USB 3.0 port
- ▶ TS1150 tape drive updates for IBM tape libraries
- ▶ IBM Linear Tape File System Enterprise Edition (LTFS EE)

### **Changed information**

This book includes the following changed information:

- ▶ IBM TS1150 tape drive (Model 3592 EH8)
- ▶ IBM TS3500 tape library

## **June 2013, Tenth Edition**

This revision reflects the addition, deletion, or modification of new and changed information.

### **New information**

The book includes the following new information:

- ▶ IBM TS2260 LTO-6 tape drive
- ▶ IBM TS2360 LTO-6 tape drive
- ▶ LTO-6 tape drive updates for IBM tape libraries
- ▶ Tape Systems Library Manager (TSLM)
- ▶ IBM Linear Tape File System expanded installation and support information updated in a Redbooks publication: *Linear Tape File System: Installation and Configuration*, SG24-8090

## **Changed information**

This book includes the following changed information:

- ▶ IBM TS2260 tape drive
- ▶ IBM TS2360 tape drive
- ▶ IBM TS2900 tape autoloader
- ▶ IBM TS3100 tape library
- ▶ IBM TS3200 tape library
- ▶ IBM TS3310 tape library
- ▶ Removed IBM TS3400 tape library
- ▶ IBM TS3500 tape library
- ▶ IBM TS7600 ProtecTIER Systems
- ▶ IBM Library Management

## **June 2012, Ninth Edition**

This revision reflects the addition, deletion, or modification of new and changed information.

### **New information**

The book includes the following new information:

- ▶ IBM TS1140 tape drive (3592 Model E07)
- ▶ IBM TS3500 tape library shuttle complex (Model SC1)
- ▶ High Performance Storage System (HPSS)
- ▶ IBM Linear Tape File System Single Drive Edition (LTFS SDE) expanded installation information
- ▶ IBM Linear Tape File System Library Edition (LTFS LE)
- ▶ LTO-5 tape drive updates for tape libraries

### **Changed information**

This book includes the following changed information:

- ▶ IBM TS2250 tape drive
- ▶ IBM TS2350 tape drive
- ▶ IBM TS2900 tape autoloader
- ▶ IBM TS3100 tape library
- ▶ IBM TS3200 tape library
- ▶ IBM TS3310 tape library
- ▶ IBM TS3400 tape library
- ▶ IBM TS3500 tape library
- ▶ IBM TS7600 ProtecTIER Systems

## June 2011, Eighth Edition

This revision reflects the addition, deletion, or modification of new and changed information.

### **New information**

The book includes the following new information:

- ▶ ALMS required to support LTO-5 tape drives
- ▶ FC 1700 and FC 1701 required for LTO-5 support in Models L32/D32, L52/D52
- ▶ HA/HD mixed media configuration
- ▶ Linear Tape File System (LTFS)
- ▶ LTO-5 tape drives
- ▶ LTO-5 Bridge Boxes
- ▶ LTO-5 tape drives dual ported 8 Gbps Fibre Channel interface
- ▶ TS1050 (3588 F5A)

### **Changed information**

This book includes the following changed information:

- ▶ TS2250
- ▶ TS2900
- ▶ TS3100
- ▶ TS3200
- ▶ TS3310
- ▶ TS3500

## September 2008, Seventh Edition

This revision reflects the addition, deletion, or modification of new and changed information.

### **New information**

The book includes the following new information:

- ▶ TS1130 tape drive
- ▶ TS2240 tape drive
- ▶ TS2900 tape autoloader
- ▶ TS3310 Advanced Reporting
- ▶ IPV6 Protocol
- ▶ ITDT Graphical Edition
- ▶ TS3500 High Density

### **Changed information**

This book includes the following changed information:

- ▶ TS3100
- ▶ TS3200
- ▶ TS3310
- ▶ TS3400
- ▶ TS3500
- ▶ IBM Tivoli® Productivity Center Version 3.3
- ▶ Library management



## October 2007, Sixth Edition

This revision reflects the addition, deletion, or modification of the following new and changed information.

### **New information**

The book includes the following new information:

- ▶ TS2230 tape drive
- ▶ TS2340 tape drive
- ▶ IBM Linear Tape-Open Ultrium 4 tape drive
- ▶ IBM TS3400 tape library
- ▶ Tape encryption

### **Changed information**

The book includes the following changed information:

- ▶ IBM TS3310 tape library
- ▶ IBM TS3500 tape library

## April 2007, Fifth Edition

This revision reflects the addition, deletion, or modification of the following new and changed information.

### **New information**

The book includes the following new information:

- ▶ IBM TS3100 tape library
- ▶ IBM TS3200 tape library
- ▶ IBM TS3310 tape library
- ▶ Library management

### **Changed information**

The book includes the following changed information:

- ▶ IBM TS1020 tape drive
- ▶ IBM TS1120 tape drive
- ▶ IBM TS3500 tape library

## September 2005, Fourth Edition

This revision reflects the addition, deletion, or modification of the following new and changed information.

### **New information**

The book includes the following new information:

- ▶ Write Once Read Many (WORM) media for Ultrium 3 drives
- ▶ Ultrium 3 drives and libraries
- ▶ Virtual I/O for IBM 3584 Tape Library

## June 2004, Third Edition

This revision reflects the addition, deletion, or modification of the following new and changed information.

### **New information**

The book includes the following new information:

- ▶ Description of WORM technology
- ▶ New models IBM TotalStorage 3581 2U Tape Autoloader L28 and F28
- ▶ New frames and features for the IBM 3584 Tape Library, including support for IBM 3592 Tape Drive with WORM media
- ▶ Advanced Library Management System (ALMS) for the IBM TotalStorage 3584 Tape Library

## June 2003, Second Edition

This revision reflects the addition, deletion, or modification of new and changed information described below.

### **New information**

- ▶ Ultrium 2 drives in existing LTO libraries
- ▶ New model, IBM Ultrium tape library 3582
- ▶ New functions (multi-path architecture, Control Path Failover) for LTO libraries

## November 2000, First Edition

This revision reflects the addition of new and information described below.

### **New information**

- ▶ Introduction to Linear Tape-Open technology
- ▶ Introduction to the family of IBM LTO Ultrium products
- ▶ Configuration information for stand-alone environments and backup and recovery software
- ▶ General information for SCSI connections, multipath configurations, and tape technology comparisons



# Part 1

# Tape basics of open systems

Part 1 includes information about tape technologies for open systems. It also includes information about the IBM tape drives that can be installed inside IBM tape libraries for open systems hosts.

The following chapters are included in Part 1:

- ▶ Chapter 1, “Tape technology introduction” on page 3
- ▶ Chapter 2, “Overview of IBM Linear Tape-Open Ultrium tape drives” on page 37
- ▶ Chapter 3, “IBM TS1100 tape drives” on page 105
- ▶ Chapter 4, “IBM TS2290 tape drive” on page 179
- ▶ Chapter 5, “IBM TS2280 tape drive” on page 189
- ▶ Chapter 6, “IBM TS2270 tape drive” on page 199
- ▶ Chapter 7, “IBM TS2260 tape drive” on page 209
- ▶ Chapter 8, “IBM TS2360 tape drive” on page 219





# Tape technology introduction

Tape systems traditionally were associated with the mainframe computer market. They represented an essential element in mainframe systems architectures since the early 1950s as a cost-effective way to store large amounts of data. By contrast, the midrange and client/server computer market made limited use of tape technology until recently.

Over the past few years, growth in the demand for data storage and reliable backup and archiving solutions greatly increased the need to provide manageable and cost-effective tape library products. The value of using tape for backup purposes has only gradually become obvious and important in these environments.

This chapter reviews the history of tape technology, including the technologies, formats, and standards that you see for tape products in today's market. This chapter also includes information about several products from non-IBM vendors. For more information about these non-IBM vendors' products, see their respective websites.

This chapter includes the following sections:

- ▶ 1.1, "Introduction" on page 4
- ▶ 1.2, "Tape products and technologies" on page 5
- ▶ 1.3, "Tape solutions in a SAN environment" on page 26
- ▶ 1.4, "IBM Spectrum Scale" on page 27
- ▶ 1.4, "IBM Spectrum Scale" on page 27
- ▶ 1.5, "IBM Spectrum Archive" on page 29
- ▶ 1.6, "IBM Tape System Library Manager" on page 34

## 1.1 Introduction

Magnetic tape was first used in 1930 for sound recording and later for video recording in 1951. In the following year, IBM invented the concept of using magnetic tape for computer data storage with the introduction of the IBM Model 726: The world's first reel tape system. It had a storage density of 100 characters per inch and speeds up to 70 inches per second.

Since these early days, tape continues to figure significantly in IT infrastructures for high-capacity storage backup. Its unique attributes can help users manage their storage requirements and contribute to the ever-present value of tape in the storage hierarchy.

Tape includes the following features:

- ▶ **Removable:**  
Store it securely to protect it from viruses, sabotage, and other corruption
- ▶ **Scalable:**  
Simply add more low-cost cartridges, not drives
- ▶ **Portable:**  
Easily move it to another site to avoid destruction if the first site suffers threat or damage
- ▶ **Fast:**  
Provides up to 900 MBps (with 2.5:1 compression ratio) for the IBM Linear Tape-Open (LTO) generation 9 systems
- ▶ **Reliable:**  
IBM servo technology, read after write verification, and advanced error correction systems to help to make tape more reliable than disk
- ▶ **Green:**  
Has low power consumption

As new storage formats and devices are developed and refined, industry experts periodically forecast the demise of tape, pronouncing it slow and outmoded. However, tape continues to be the most cost-effective, flexible, and scalable medium for high-capacity storage backup.

Over the last 70 years, IBM delivered many innovations in tape storage, and that innovation continues today. This chapter provides a brief overview of the major changes that occurred in tape technology over this time.

## 1.2 Tape products and technologies

Table 1-1 shows a summary of important milestones in the evolution of tapes over the last 60 years. Each milestone is described in more detail in this chapter.

Table 1-1 Tape timeline

Year	Manufacturer	Model number	Density or capacity	Advancements
1952	IBM	726	100 characters/inch	First use of plastic tape on a reel
1958	IBM	729	200 characters/inch	First readback drive
1964	IBM	2400	800 bpi	9-track tape, EBCDIC, and ASCII
1970	IBM	3400	6250 bpi	
1972	3M	QIC-11	20 MB	Quarter-inch cartridge with two reels
1974	IBM	3850		Tape cartridge with a single reel. First robotic tape library.
1984	IBM	3480	200 MB	Thin-film magnetoresistive (MR) head
1984	DEC	TK50	94 MB	Digital Linear Tape (DLT)
1986	IBM	3480	400 MB	Hardware data compression IRDC
1987	Exabyte	EXB-8200	2.4 GB	First helical scan tape drive
1989	HP	DDS1	2 GB	4 mm tape
1991	IBM	3490E	800 MB	
1992	IBM	3490E	2.4 GB	IRDC compression
1995	IBM	3590	10 GB	
1997	IBM	VTS		Virtual tape
1999	Exabyte	Mammoth-2	60 GB	
1999	HP	DDS4	20 GB	
2000	Quantum	Super DLT	110 GB	More precise head positioning
2000	IBM	LTO-1	100 GB	First LTO drive
2003	IBM	3592		Virtual backhitch
2003	IBM	LTO-2	200 GB	
2005	IBM	LTO-3	400 GB	
2006	IBM	3592		Encryption Integrated into drive
2007	IBM	LTO-4	800 GB	
2008	IBM	TS1130	1 TB	GMR heads

Year	Manufacturer	Model number	Density or capacity	Advancements
2010	IBM	LTO-5	1.5 TB	2 tape partitions. IBM Linear Tape File System (LTFS)
2011	IBM	TS1140	4 TB	
2012	IBM	LTO-6	2.5 TB	4 tape partitions
2014	IBM	TS1150	10 TB	
2015	IBM	LTO-7	6 TB	32 Tracks
2017	IBM	TS1155	15 TB	FC or Ethernet host attachment
2017	IBM	LTO-8	12 TB	TMR head Technology
2018	IBM	TS1160	20 TB	JE media
2021	IBM	LTO-9	18 TB	oRAO

### 1.2.1 Recording technology

The first computer tape systems used linear recording technology. This technology provides excellent data integrity, rapid access to data records, and reasonable storage density. Until the mid-1980s, all computer tape systems employed this linear recording technology, which uses a stationary head that writes data in a longitudinal way. Figure 1-4 on page 8 shows an example of longitudinal technology.

However, in the mid-1980s, helical tape technology (developed for video applications) became available for computer data storage. This technology uses heads that rotate on a drum and write data at an angle. Helical tape systems found natural applications in backing up magnetic disk systems where their cost advantages substantially outweighed their operational disadvantages. Figure 1-5 on page 9 shows an example of helical scan technology.

The first implementation of linear recording technology used magnetic tapes on open reels. Later, the tape was protected inside cartridges by using one or two reels. Linear technology drives write each data track on the entire length of the tape. Data is first written onto a track along the entire length of the tape. When the end is reached, the heads are repositioned to record a new track again along the entire length of the tape, which is now moving in the opposite direction. This method continues back and forth until the tape is full. On linear drives, the tape is guided around a static head.

By contrast, on helical scan systems, the tape is wrapped around a rotating drum that contains read/write heads. Because of the more complicated path, mechanical stress is placed on the tape. Compared with linear tape systems, helical tape systems have higher density (and lower media cost). However, they have lower data transfer rates (because of the smaller number of active read/write heads), less effective access to random data records, increased maintenance requirements, and reduced data integrity.

Linear and helical tape systems advanced substantially over the past decade. Linear systems improved significantly in storage density (and cost). They also improved in operational convenience, with various removable cartridge systems, such as 3590, quarter-inch cartridge (QIC), digital linear tape (DLT), and now Linear Tape-Open (LTO), replacing reel-to-reel systems. Helical systems improved in the areas of transfer rate and data integrity with the implementation of both channel and error correction coding technologies.



Over the past few decades, one of the most significant advances in tape technology for computer applications was the maturation of serpentine linear recording systems. For the first time, linear recording systems can provide recording density that is comparable with that of helical systems. The first commercially successful serpentine linear tape system for professional applications was DLT. Another important improvement is the use of servo tracks, which was first introduced by IBM on the IBM Magstar 3590 tape. Servo tracks are recorded at the time of manufacture. These tracks enable the tape drive to position the read/write head accurately regarding the media while the tape is in motion.

## 1.2.2 Tape reels

The first data backup device (and the ancestor of magnetic tape devices with a 1/2-inch-wide tape format) used magnetic tape reels, as shown in Figure 1-1. They were manufactured and sold in many different lengths and brands. The most common densities used were 1600 and 6250 bpi. The IBM 2400 was a 9-track 800 bpi tape drive. This was the first 9-track model from IBM that recorded EBCDIC (8-bit) or ASCII (7-bit) data. In the 1970s, the IBM 3400 was introduced and it supported up to 6250 bpi.



Figure 1-1 Tape reels, 1/2-inch

In the 1970s, the IBM 3420 that is shown in Figure 1-2 was introduced and supported up to 6250 bpi.



Figure 1-2 IBM 3420

### 1.2.3 Quarter-inch cartridge

The QIC tape device was first introduced in 1972 by the 3M company as a means to store data from telecommunications and data acquisition applications. As time passed, the comparatively inexpensive QIC tape device became an accepted data storage system, especially for stand-alone PCs.

A QIC tape device (shown in Figure 1-3) looks similar to an audio tape cassette with two reels inside, one with tape and the other for take-up.

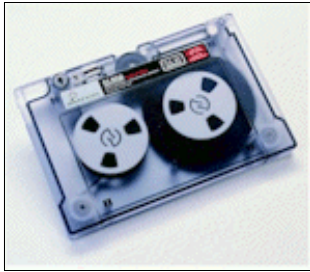

Figure 1-3 QIC tape

The QIC format employs a linear (or longitudinal) recording technique in which data is written to parallel tracks that run along the length of the tape. The number of tracks is the principle determinant of capacity.

The QIC uses a linear read/write head similar to the heads found in cassette recorders, as shown in Figure 1-4. The head contains a single write head that is flanked on either side by a read head so that the tape drive can verify data that is just written when the tape is running in either direction.

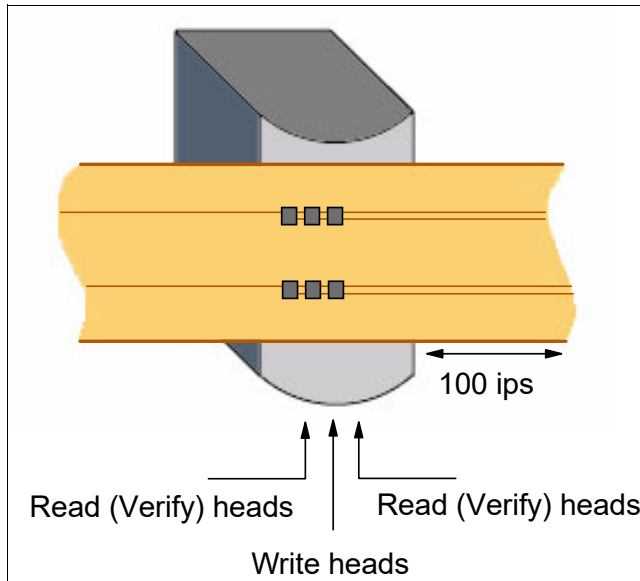

Figure 1-4 QIC head diagram

Tandberg Data manufactures QIC drives with its Scalable Linear Recording (SLR) technology. Their most recent drive, the SLR140, provides 70 GB (native) and 140 GB (with a 2:1 compression ratio) capacity on a single data cartridge. The maximum data transfer rates are 6 MBps uncompressed and 12 MBps (with a 2:1 compression ratio).

## 1.2.4 Digital Data Standard

The Digital Audio Tape (DAT) standard was created in 1987. As its name implies, it was originally conceived as a CD-quality audio format that offered 3 hours of digital sound on a single tape. The Digital Data Standard (DDS) is based on DAT and uses a similar technology. The cartridge design is common to both, but different tape formulations were developed. In 1988, Sony and Hewlett-Packard (HP) defined the DDS standard, which transformed the format into one that can be used for digital data storage.

DAT technology is a 4 mm tape that uses helical scan recording technology (as shown in Figure 1-5). Over the years, the DAT capacity has grown from DDS-1 at 1.3 GB to DAT-320 at 160 GB (native) and 320 GB (with a 2:1 compression ratio). This technology is the same type of recording that is used in videocassette recorders (VCRs) and is inherently slower than the linear type.

The tape in a helical scan system is pulled from a two-reel cartridge and wrapped around a cylindrical drum that contains two read heads and two write heads, arranged alternately. The read heads verify the data that is written by the write heads. The cylinder head is tilted slightly in relation to the tape and spins at 2000 revolutions per minute (RPM). The tape moves in the opposite direction to the cylindrical spin, at less than 1 inch per second. However, because it is recording more than one line at a time, it has an effective speed of 150 inches per second.

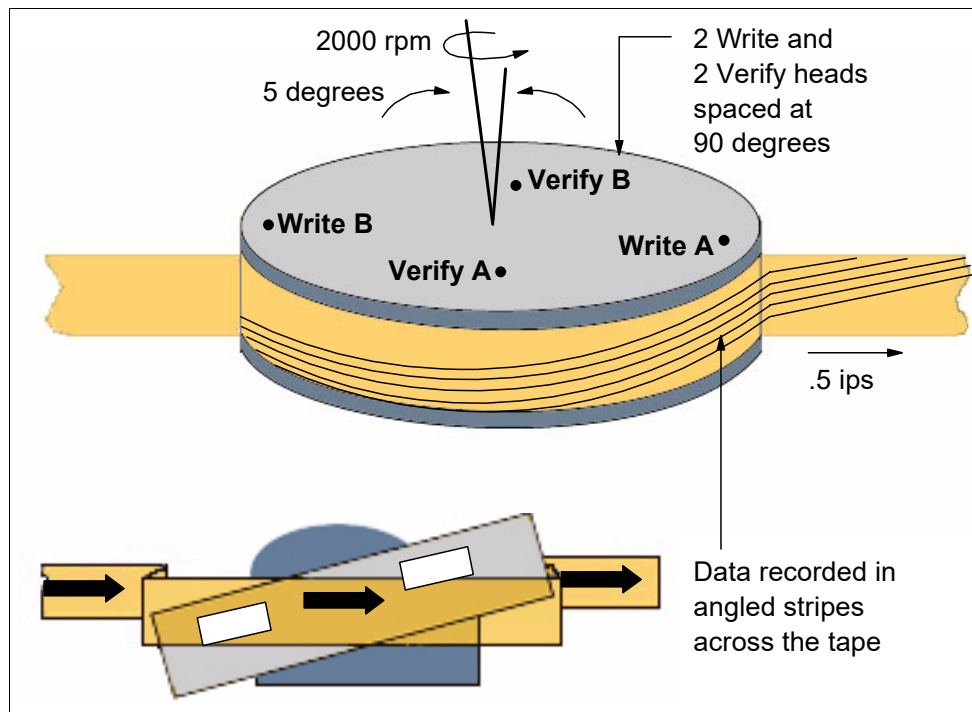

Figure 1-5 Helical-scan recording diagram

A directory of files is stored in a partition at the front of the tape. Similar to linear recording, the performance can be greatly improved if more read/write heads are added. However, this change is difficult with helical scan devices because of the design of the rotating head. The fact that the heads can be added only in pairs makes it challenging to fit the wiring inside a single cylinder, which limits the potential performance of helical scan devices. Because of the wide-wrap angle of the tape and the consequent degree of physical contact, the head and the media are prone to wear and tear.

## 1.2.5 The 8 mm format

Designed for the video industry, 8 mm tape technology was created to transfer high-quality color images to tape for storage and retrieval and was adopted by the computer industry. Similar to DAT, but with greater capacities, 8 mm drives also are based on the helical scan technology. One of the earliest was the Exabyte EXB-8200. A drawback to the helical scan system is the complicated tape path. Because the tape must be pulled from a cartridge and wrapped tightly around the spinning read/write cylinder (as shown in Figure 1-6), a great deal of stress is placed on the tape.

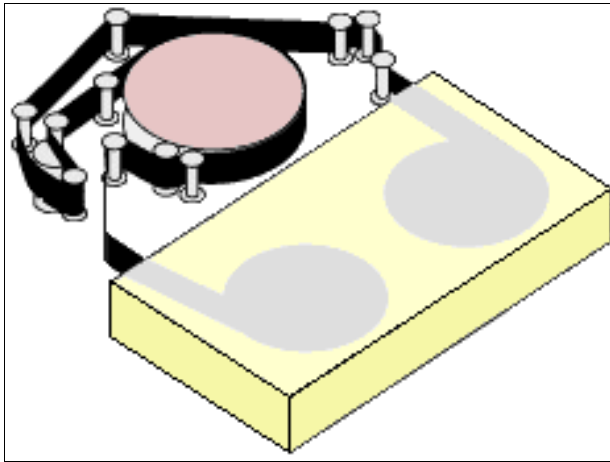

Figure 1-6 An 8 mm tape path

Two major protocols use different compression algorithms and drive technologies, but the basic function is the same. Exabyte Corporation sponsors standard 8 mm and VXA formats, and Seagate and Sony represent the 8 mm technology that is known as Advanced Intelligent Tape (AIT).

### Mammoth tape format

The Mammoth tape format is a Small Computer System Interface (SCSI)-based 8 mm tape technology that is designed for open systems applications. It is a proprietary implementation of the 8 mm original format that has been available since 1987 and uses Advanced Metal Evaporative (AME) media. This media has a coating over the recording surface that seals and protects the recording surface.

The Exabyte Mammoth drives have a 5¼-inch form factor. The first generation provided 20 GB (native) and 40 GB (with a 2:1 compression ratio) capacity on a single 8 mm data cartridge. The maximum data transfer rates were 3 MBps uncompressed and 6 MBps (with a 2:1 compression ratio).

With the Mammoth-2 technology, the capacity and data rate increased to 60 GB (150 GB with a 2.5:1 compression ratio) and 12 MBps decompressed 30 MBps with a 2.5:1 compression ratio). Mammoth-2 drives are read compatible with the previous models.

## **VXA tape format**

The VXA tape format is 8 mm tape technology that is designed for open systems applications. It is a proprietary implementation of an 8 mm packet format that is available since 2001 and uses AME media.

The Exabyte VXA drives have a 5¼-inch form factor. The first generation provided 32 GB (native) and 64 GB (with a 2:1 compression ratio) capacity on a single 8 mm data cartridge. The maximum data transfer rates were 3 MBps decompressed and 6 MBps (with a 2:1 compression ratio).

With the VXA-2 technology, the capacity and data rate increased to 80 GB (160 GB with a 2:1 compression ratio) and 6 MBps decompressed (12 MBps with a 2:1 compression ratio). VXA-2 drives are read compatible with the previous model.

With the VXA-3 technology, the capacity and data rate increased to 160 GB (320 GB with a 2:1 compression ratio) and 12 MBps decompressed (24 MBps with a 2:1 compression ratio). VXA-3 drives are read compatible with the previous model.

## **Advanced Intelligent Tape format**

The Advanced Intelligent Tape (AIT) format was developed by Sony. Available in a 3½-inch form factor, Sony AIT-1 drives and media provide 25 GB (native) and 50 GB (with a 2:1 compression ratio) capacity on a single 8 mm data cartridge. The maximum data transfer rate is 3 MBps native.

The AIT-5 format from Sony has the capacity and performance of 400 GB (1040 GB with a 2.5:1 compression ratio) and 24 MBps data transfer rate.

AIT drives feature an Auto Tracking Following (ATF) system, which provides a closed-loop, self-adjusting path for tape tracking. This servo tracking system adjusts for tape flutter so that data tracks can be written much closer together for high-density recording. AIT uses the Adaptive Lossless Data Compression (ALDC) technology compression algorithm.

## **Digital Linear Tape**

Digital Linear Tape (DLT) drives became available in 1985 when Digital Equipment Corporation needed a backup system for their MicroVAX systems. This system uses a square cartridge that contains tape media but no take-up reel. The take-up reel was built into the drive itself. This design eliminated the space that was typically associated with cassette and cartridge drives, such as QIC or 8 mm.

The drive had to be made larger than most drives to accommodate the internal take-up reel. The drive fit into a Full-High, 5¼-inch drive bay. Called the TK50, the tape drive could store 94 MB per cartridge.

By using a ferrite read/write head, the TK50 recorded data in linear blocks along 22 tracks. Its read/write head contained two sets of read/write elements. One set was used when reading and writing forward, and the other set was used when reading and writing backward.

In 1987, Digital Equipment Corporation released the TK70. This tape drive offered 294 MB of storage on the same square tape cartridge, a threefold improvement over the TK50. Digital accomplished this capacity by increasing the number of tracks to 48 and by increasing density on the same ½-inch tape.

In 1989, Digital Equipment Corporation introduced the first true DLT system. The TF85 (later called the DLT 260) incorporated a new feature that enabled the system to pack 2.6 GB onto a 1200-foot tape (CompacTape III, later known as DLTtape III).

The DLT Tape Head Guide Assembly was incorporated for the first time in the TF85 drive. Six precision rollers improved tape life. The six-roller head guide assembly gave the TF85 a much shorter tape path than helical scan systems, as shown in Figure 1-7.

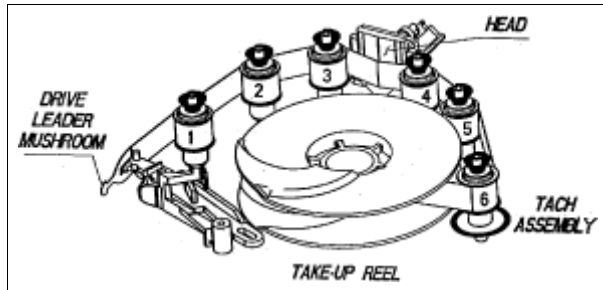

Figure 1-7 DLT tape path mechanism

The read/write head was equipped with another write element so that the elements were arranged in a write/read/write pattern. With this pattern, the TF85 reads after writing on two channels and in forward and reverse directions, as shown in Figure 1-8.

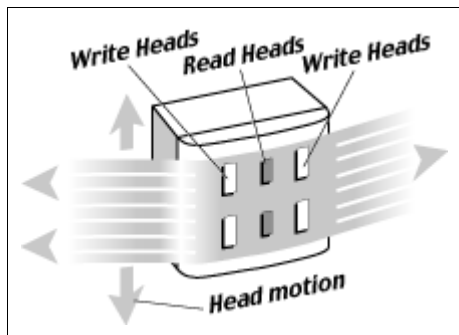

Figure 1-8 DLT 2000 recording head design

Two years later, Digital Equipment Corporation introduced the TZ87, later known as the *DLT 2000 tape drive*. This system offered 10 GB of native capacity on a single CompacTape III cartridge (Figure 1-9), later known as DLTtape III. It supported 2 MB of read/write data cache memory and offered a data transfer rate of 1.25 MBps. This cartridge was the first generation of DLT.

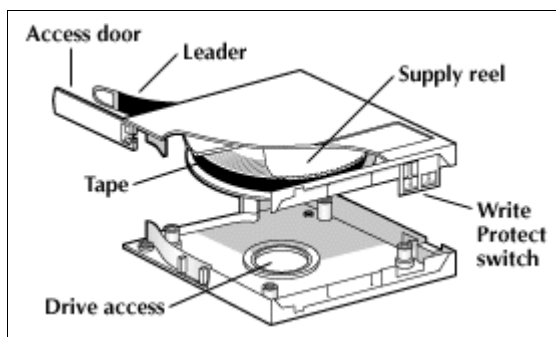

Figure 1-9 DLT cartridge

In 1994, Quantum acquired the Storage division of Digital Equipment Corporation. In late 1994, Quantum released the DLT 4000. By increasing real density (bits per inch) from 62,500 to 82,000 and tape length by 600 feet (DLTtape IV), the capacity of the DLT 4000 grew up to 20 GB (40 GB compressed) on a single ½-inch DLTtape IV cartridge. The new DLT tape system provided a data transfer of 1.5 MBps (3 MBps compressed) and was fully read/write compatible with previous generations of DLT tape drives.

DLT 2000 and DLT 4000 drives write data on two channels simultaneously in linear tracks that run the length of the tape, as shown in Figure 1-10.

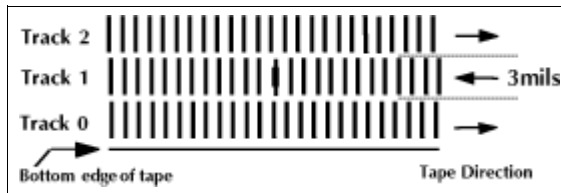

Figure 1-10 DLT 2000/4000 linear recording format

The DLT 7000 became available in 1996. This drive offered a total storage capacity of 35 GB native and 70 GB compressed on the 1800-foot DLTtape IV cartridge. The DLT 7000 incorporated a four-channel head that gives the drive a transfer rate of 5 MBps of data in native mode, as shown in Figure 1-11.

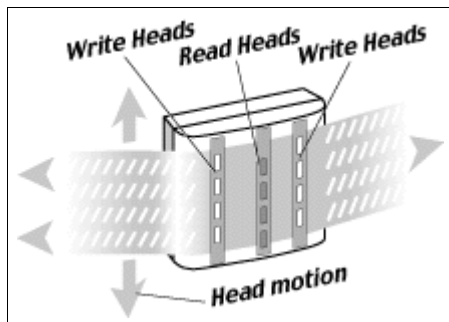

Figure 1-11 DLT 7000/8000 tape head

The latest DLT product from Quantum is the DLT 8000 drive. This tape drive features a native transfer rate of up to 6 MBps, with a native capacity of 40 GB. The DLT 7000/8000 drives incorporate the Symmetric Phase Recording technology that writes data in an angled pattern, as shown in Figure 1-12.

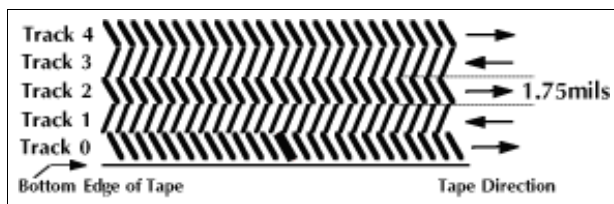

Figure 1-12 Symmetric Phase Recording technology

## 1.2.6 SuperDLT

SuperDLT (SDLT) is a format specification that was developed by Quantum Corporation as an evolution of the DLT standard. It uses Laser Guided Magnetic Recording (LGMR) technology. This technology includes the Pivoting Optical Servo (POS). This optically assisted servo system is implemented on the unused reverse side of the media and uses a laser to read the servo guide. SDLT uses 100% of the media for data recording. SDLT uses Advanced Metal Powder (AMP) media, which contains embedded information for the Pivoting Optical Servo system.

The recording mechanism is made of Magneto-Resistive Cluster (MRC) heads, which are a cluster of small magneto-resistive tape heads.

The first SDLT drive (the SDLT 220) was introduced in late 2000. It provides a capacity of 110 GB (native) and 220 GB (with a 2:1 compression ratio). The native data transfer rate is 11 MBps. This first drive was not backward-read compatible with earlier models. In 2001, Quantum released a version of the SDLT 220 drive that was backward-read compatible with the DLTtape IV cartridge.

The second SDLT 320 drive from Quantum became available in 2002. It increased the native capacity to 160 GB (320 GB with a 2:1 compression ratio) and the native transfer rate to 16 MBps (32 MBps with a 2:1 compression ratio). The SDLT 320 is backward read compatible with DLTtape IV cartridges and uses Super DLTtape I media.

The SDLT 600 is the third generation of the SDLT product range from Quantum. It provides a capacity of 300 GB (native) and 600 GB (with a 2:1 compression ratio) and the native transfer rate increased to 36 MBps (72 MBps with a 2:1 compression ratio). The SDLT600 comes with an LVD 160 Small Computer System Interface (SCSI) or with a 2 GB Fibre Channel (FC) interface. The SDLT 600 is compatible with earlier versions with the SDLT 320 and the DLT VS 160.

The DLT-S4 is the fourth generation of the SDLT product range from Quantum. It provides a capacity of 800 GB (native) and 1.6 TB (with a 2:1 compression ratio) and the native transfer rate increased to 324 MBps (400 MBps with a 2:1 compression ratio). The DLT-S4 comes with an LVD 320 Small Computer System Interface (SCSI) or with a 4 GB Fibre Channel (FC) interface. The DLT-S4 can read all Super DLTtape two cartridges that are written by SDLT 600 drives, and Super DLTtape 1 cartridges written by SDLT 320 drives.

The media format has the following capacity:

- ▶ DLT-4 (read/write) 800 GB native capacity
- ▶ Super DLTtape II (read only) 300 GB native capacity
- ▶ Super DLTtape I (read only) 160 GB native capacity

## 1.2.7 IBM 3850

Beginning in the late-1960s, IBM engineers in Boulder, Colorado, began development of a low-cost mass storage system that was based on magnetic tape in cartridges. By 1970, the proposed device was code named “Comanche” and was described as an online tape library to provide computer-controlled access to stored information. Numerous marketing studies and design changes were made during the early 1970s, and Comanche was announced as the IBM 3850 Mass Storage System (MSS) in October 1974.



The components of the 3850 were new data cartridges. The data cartridges were circular cylinders, 2 inches in diameter and 4 inches long, each holding a spool holding 770 inches of tape. Cartridges were stored in a two-dimensional array of bins, which were hexagonal, rather than square, to save space and, for the first time, were automatically accessed through a robot (accessor), shown in Figure 1-13.



Figure 1-13 IBM 3850

### 1.2.8 IBM 3480

The second generation of IBM magnetic media and the first one to use an enclosed cartridge containing  $\frac{1}{2}$ -inch tape, the IBM 3480 Magnetic Tape Subsystem was announced on 22 March 1984, shown in Figure 1-14. The tape was stored in a now-familiar cartridge, which was smaller, more robust, and easier to handle than tape reels. The cartridge capacity was 200 MB, and the channel data rate was 3 MBps, writing 18 tracks in one direction.



Figure 1-14 IBM 3480

### 1.2.9 IBM 3490

The IBM 3490 replaced the IBM 3480 tape technology and used the same tape cartridge media. With a tape capacity of 800 MB uncompactd (2.4 GB compressed assuming 3:1 compression ratio) and a channel data rate of 3 MBps, the IBM 3490E increased the capacity of the 3480 four-fold. It used a double-length tape and wrote data in both directions: 18 tracks to the end of tape and 18 tracks back to the start of the tape.

During this second generation, automatic cartridge loaders and automated tape libraries, such as the IBM 3495 and 3494 libraries, were introduced to reduce or eliminate the need for tape operators. Software management applications, such as CA-1, TLMS, and the DFSMS Removable Media Manager (DFSMSrmm), were implemented to manage the tape volumes automatically.

The IBM 3490 and compatible drives were probably the first family of tape products that was mostly used with automatic tape libraries rather than being installed as stand-alone drives operated manually.

The Improved Data Recording Capability (IDRC), which compacts the data, reduced the number of tape volumes that were used.

Magnetic disks were widely used for online data. Therefore, these second-generation tape systems became primarily a medium for backup and were introduced as an archive medium. The process of archiving was also automated with products, such as Hierarchical Storage Manager (HSM) and DFSMSHsm (a component of DFSMS), by using tape as the lowest level in a storage hierarchy. Tape was still used as an interchange medium, but networks were also used for that purpose.

### 1.2.10 IBM 3590

The IBM 3590 drive was originally called the IBM Magstar 3590. The IBM Magstar tape technology was first introduced in July 1995. The original cartridge maintained the external form factor of the IBM 3490 (as shown in Figure 1-15), had a capacity of 10 GB uncompact (30 GB compressed), and a data rate of 9 MBps. Later drive models and newer media increased these figures. The data format was incompatible with the IBM 3490.

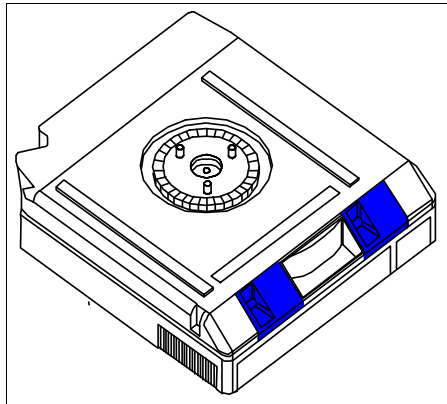

Figure 1-15 IBM 3590 tape cartridge

The IBM 3590 drive (as shown in Figure 1-16) incorporated longitudinal technology, Serpentine Interleaved Longitudinal Recording.

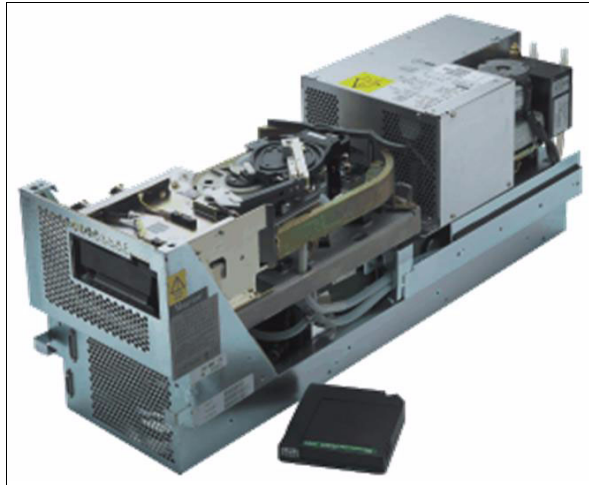

Figure 1-16 IBM 3590 tape drive

Data was written in each direction in turn. To increase capacity further, the concept of *head indexing* was introduced, which wrote multiple sets of tracks in parallel. The entire set of heads was slightly shifted after one pass, and all subsequent passes (for a total of eight) were used to write data tracks next to the existing ones. This method meant a significant improvement in the tape capacity and transfer rates without changing the tape speed (2 mps) and media length (600 m).

The IBM 3590 drive used a buffer and compressed the data before it wrote the data to tape. In addition, the drive completed a stop-start cycle in approximately 100 ms. The performance was improved for both start-stop and streaming applications.

With the IBM 3590 Model H, the capacity and data rate increased to 60 GB (180 GB assuming 3:1 compression ratio). With the Extended Length Cartridges, the capacity and data rate increased to 14 MBps native. Both drives were made available in 2002 and maintain compatibility with earlier version for reading with the base models.

This design incorporated innovations such as servo tracks on the tape to guide the read/write heads along the data tracks and the implementation of an improved error-correcting code (ECC). A portion of the tape within each cartridge was reserved for statistical information. This portion was continually updated after each read or write. It provided statistics that you can use to obtain drive and media information and identify problems with a particular tape or drive as early as possible.

## Technology

The IBM 3590 provided high capacity, performance, reliability, and a wide range of host connectivity. This technology used a fourth-generation magneto resistive (MR) head, a 16 MB buffer, predictive failure analysis, and state-of-the-art electronic packaging.

While reading or writing 16 tracks at a time, the IBM 3590 models used serpentine, interleaved, longitudinal recording technology for a total of four, eight, or twelve round trips from the physical beginning to the physical end of the tape and back again. The tape read/write head indexes, or moved vertically, when it completed each round trip so that the recorded tracks are interleaved across the width of the tape.

Figure 1-17 shows the recording element of the IBM Enterprise 3590 tape drives. It also shows how the read/write heads moved over the width of the tape medium.

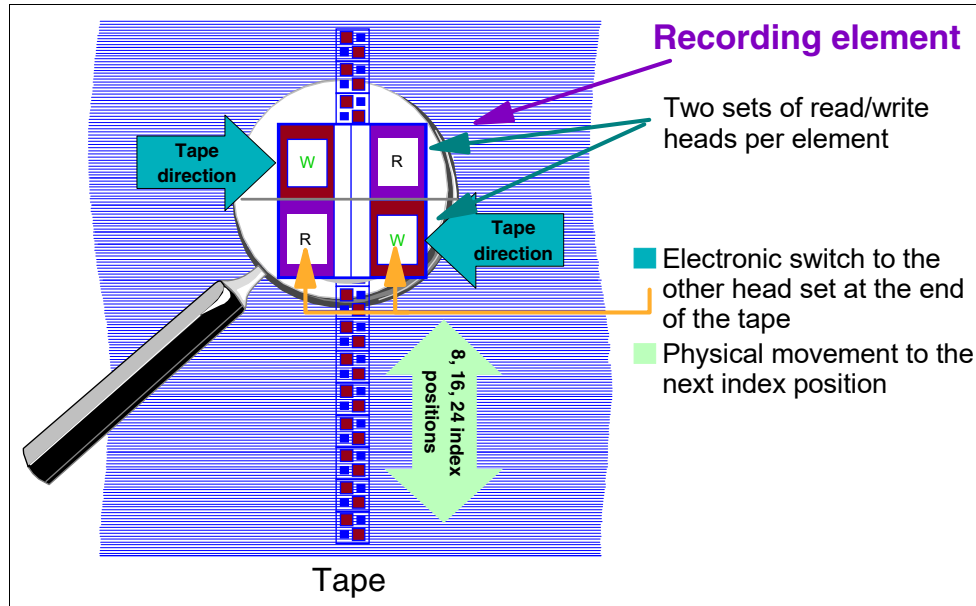

Figure 1-17 IBM 3590 recording

The 3590 tape drives used a metal particle medium in the tape cartridge that stores 10, 20, 30, 40, or 60 GB of uncompact data, depending on the cartridge type and the drive model. The integrated control unit used a compaction algorithm that increases the storage capacity of these cartridges. Assuming a compression ratio of three to one (3:1), the cartridge capacity increased to 60 GB on E models and to 90 GB on H models.

The 3590E and 3590H models have a 14 MBps device data rate, and the 3590B models have a 9 MBps device data rate. With data compression, the 3590 tape drive can more effectively use the full capability of the Ultra-SCSI data rate, the IBM Enterprise Systems Connection (ESCON) data rate, or the IBM Fibre Connection (FICON) data rate. The Ultra Wide SCSI data rate is up to 40 MB per second and the Fibre Channel data rate is up to 100 MB per second.

### Metal particle media

A chromium dioxide medium was used in the IBM 3480 and 3490 cartridges. The IBM 3590 High Performance Tape Cartridge used a metal particle medium, which has a significantly increased coercivity. Therefore, it permits a much higher data recording density in comparison with chromium dioxide media as the linear density is proportional to the coercivity of the medium. The linear density of the IBM 3590 tape is approximately three times that of the IBM 3480 and 3490. The track density is also improved approximately four-fold.

Advances in the metal particle coatings and media binders afford reliability and magnetic stability equal or superior to chrome media.

## 1.2.11 LTO Ultrium tape

The LTO standard was released as a joint initiative of IBM, Hewlett-Packard, and Seagate Technology. As a result of this initiative, two LTO formats (Ultrium and Accelis) were defined. However, for performance reasons, there was no demand for the Accelis format of the LTO tape, and drive nor media were commercially produced.

The consortium now consists of IBM, Hewlett-Packard, and Quantum, which are known as the *technology provider companies*. For more information about technology specifications, see the [Ultrium LTO website](#).

The LTO Ultrium 9 technology is the current generation of LTO Ultrium tape. It provides 18 TB of native physical capacity (45 TB compressed) per cartridge and native data transfer rate of up to 400 MBps.

Table 1-2 lists the native capacities and transfer rates of the previous format LTO Ultrium generations.

*Table 1-2 Previous LTO Ultrium generation capacity and transfer rates*

LTO Ultrium generation	Native capacity	Native data transfer rate of up to
8	12 TB	360 MBps
7	6 TB	300 MBps
6	2.5 TB	160 MBps
5	1.5 TB	140 MBps
4	800 GB	120 MBps
3	400 GB	80 MBps
2	200 GB	40 MBps
1	100 GB	20 MBps

Up to LTO8, each LTO Ultrium generation doubled the compressed media storage capacity and increased the data transfer rate. Further, each LTO Ultrium drive generation is compatible with earlier versions for read and write capability with the prior media generation.

Up to LTO7 each LTO Ultrium drive generation is also compatible with earlier versions for read capability with the two prior media generations.

From LTO 8 in an effort to push the innovation boundaries of tape technology going forward, the current LTO format required a recording technology transition that supports capacity growth for future LTO generations. To address this technological shift and maintain affordability in times of extreme data growth, the latest LTO generation 9 specifications are intended to be backwards compatible only with LTO generation 8 cartridges.

For more information about the LTO Ultrium tape format specification, see 2.1.2, “LTO standards” on page 41.

For more information about the IBM LTO Ultrium tape drive, see 2.1.5, “IBM LTO Ultrium common subassembly drive” on page 52.

**LTO WORM cartridges**

The IBM Ultrium Write Once Read Many (WORM) cartridges (Machine Type 3589) were designed for applications such as archiving and data retention, and for applications that require an audit trail. The IBM Ultrium WORM cartridges work with the IBM LTO Ultrium tape drive to prevent the alteration or deletion of user data. In addition, IBM has taken the following steps to reduce the possibility of tampering with the information:

- ▶ The bottom of the cartridge is molded in a different color than rewritable cartridges.
- ▶ The special cartridge memory helps protect the WORM nature of the media.
- ▶ A unique format is factory-written on each WORM cartridge.

Based on LTO specifications, the IBM LTO Ultrium 9 WORM format provides a tape cartridge capacity of up to 18 TB native physical capacity (45 TB with a 2.5:1 compression ratio). The 18 TB WORM cartridge can be used only in the IBM Ultrium 9 tape drive. Also, the IBM LTO Ultrium 9 tape drive can process the previous LTO Ultrium 8, 12 TB WORM format for read and write data.

### 1.2.12 IBM TS1100 tape drive family

The IBM TS1100 tape drive family offers a design that is focused on high capacity, performance, and high reliability for storing mission-critical data. Introduced in October 2003, the 3592-J1A tape drive had 300 GB of native capacity in a ½-inch format tape cartridge. It was also a foundation for future generations of this new tape drive family based on the concept of media reuse. This design helps protect the client's investment in tape cartridges.

In October 2005, the second generation of the 3592 drive, the IBM TS1120 tape drive Model E05, was introduced. The IBM 3592-E05 has the same physical measurements as the 3592-J1A tape drive, but the capacity increased 1.6 times from 300 GB to 500 GB native capacity on one cartridge. It has a dual 4 GB Fibre Channel attachment and a native data rate of up to 100 MBps.

The capacity characteristics of the third generation of 3592 tape drives increased again. The IBM TS1130 Model E06 tape drive was the third generation of the 3592 family that achieved the unprecedented capacity of 1 TB of uncompressed data on the JB cartridge type.

The fourth generation of 3592, the IBM TS1140 model E07, again took tape capacity to a new level. The TS1140 can store 1.6 TB of uncompressed data on the JB cartridge type and 4 TB of uncompressed data on the advanced JC cartridge type.

With the fifth generation of 3592, the IBM TS1150 model E08, IBM took tape capacity to a new level. The TS1150 can store 7 TB of uncompressed data on the existing JC cartridge types, and 10 TB of uncompressed data on the advanced JD cartridge types, with improved levels of performance.

The IBM TS1155 (models 55F, 55E and 55G), is an enhanced version of the TS1150 drive, which provides higher levels of cartridge capacity, and is designed to provide an increased capacity of 50% to 15TB on JD, and 3TB on JL media types, compared with its predecessor.

The primary differences of the TS1155 models (55F, 55E and 55G) from the base TS1150 (E08, EH8) is the increase of the native capacity on Advanced media types, 15TB (JD) and 3TB (JL). This is achieved by using advanced tunneling magneto resistive (TMR) head technology. In addition the TS1155 model 55E provides dual 10 Gb Ethernet host attachment interface optimized for cloud-based and hyperscale environments.

The IBM TS1160 (models 60F, 60E and 60G) provides higher levels of cartridge capacity. It also can provide an increased capacity of 50% to 20 TB on JE media, and 4TB on JM media types, compared with its predecessor.

Figure 1-18 shows the IBM TS1160 tape drive 3592 Model E08.



Figure 1-18 IBM TS1160 tape drive 3592 Model 60G.

The TS1160 tape drives maintains the same features and technology enhancements that were introduced with the TS1120 and extended by the TS1130, TS1140, TS1150, and TS1155. The TS1160 also offers several enhancements over the predecessor models. These enhancements are explained next.

For more information about the TS1130, TS1140, TS1150, and TS1155 tape drives, see Chapter 3, “IBM TS1100 tape drives” on page 105.

### **TS1100 family key features**

The TS1160 has the following key features, which were introduced with the 3590 J1A, TS1120, TS1130, TS1140, TS1150, and TS1155:

- ▶ Digital speed matching
- ▶ Channel calibration
- ▶ High-resolution tape directory
- ▶ Recursive accumulating backhitchless flush or non-volatile caching
- ▶ Backhitchless backspace
- ▶ Streaming Lossless Data Compression (SLDC) algorithm
- ▶ Capacity scaling
- ▶ Single field replaceable unit (FRU)
- ▶ Error detection and reporting
- ▶ Statistical Analysis Recording System (SARS) algorithm with extended mount count
- ▶ Revised encryption support
- ▶ Dual-stage 32-head actuator
- ▶ Offboard data string searching
- ▶ Enhanced logic to report logical end of tape
- ▶ Added partitioning support
- ▶ End-to-end logical block protection support
- ▶ Data safe mode
- ▶ Enhanced Ethernet support
- ▶ Enhanced Barium Ferrite (BaFe) particle media types
- ▶ 16 Gbps Fibre Channel (FC) dual port interface
- ▶ Enhanced read-ahead buffer management
- ▶ High access performance for locate/search



- ▶ SkipSync and FastSync write performance accelerators
- ▶ 32-channel enhanced ECC recording format

### Performance improvement

Performance was improved on the TS1160, TS1155, and TS1150 by the following changes:

- ▶ Improved data rate and capacity
- ▶ Improved latency by reducing access time to data
- ▶ Improved data compression
- ▶ Beginning of Partition (BOP) caching
- ▶ Humidity sensor support
- ▶ Increased Cartridge Memory size and related functions
- ▶ Improved High Resolution Tape Directory (HRTD)
- ▶ Larger main data buffer
- ▶ Extended copy support

### Higher data rates and capacity

The following format data rates are available for the TS1160, TS1155, and TS1150:

- ▶ By using J6 (TS1160) format, maximum data rates increase to 400 MBps native and up to 900 MBps compressed.
- ▶ By using the J5A (TS1155) and J5 (TS1150) format, maximum data rates increase to 360 MBps native and up to 700 MBps compressed (650 MBps compressed on TS1155 55E).
- ▶ By using the J4 (TS1140) format, maximum data rates increase to 250 MBps native and up to 650 MBps compressed.

Table 1-3 lists the capacity and performance characteristics for decompressed data.

Table 1-3 Native capacity and performance summary

Media Type	TS1160 format capacity data rate (minimum - maximum)	TS1155 format capacity data rate (minimum - maximum)	TS1150 format capacity data rate (minimum - maximum)
JC or JY	7 TB (6.37 TiB) 99 MBps - 303 MBps	7 TB 99 MBps - 303 MBps	7 TB 99 MBps - 303 MBps
JD or JZ	15 TB (13.64 TiB) 112 MBps - 365 MBps	15 TB 112 MBps - 365 MBps	10 TB 112 MBps - 365 MBps
JE or JV	20 TB (18.12 TiB) 122 MBps - 407 MBps	N/A	N/A
JK	900 GB (.82 TiB) 99 MBps - 303 MBps	900 GB 99 MBps - 303 MBps	900 GB 99 MBps - 303 MBps
JL	3 TB (2.73 TiB) 112 MBps - 365 MBps	3 TB 112 MBps - 365 MBps	2 TB 112 MBps - 365 MBps
JM	5 TB (4.55 TiB) 122 MBps - 407 MBps	N/A	N/A



### 1.2.13 Rack-mount option for TS1160, TS1155, TS1150, and TS1140 models

Rack-mount options are available for the 3592 drives to be used as a stand-alone drive option. The rack-mount kits are ordered by using the following feature codes:

- ▶ FC 4804 for 60F, 55F, EH8, or EH7 drives
- ▶ FC 4802 (Left Hand) or FC 4812 (Right Hand) for E60F, 55F, EH8, or EH7 drives

For more information, see 3.4.4, “Rack-mount option for TS1160, TS1155, TS1150, and TS1140 models” on page 127.

### 1.2.14 Libraries

System administrators are clamoring for technologies that help them to efficiently and economically manage the explosive growth in stored data. As the amount of data increases, the backup process takes longer and longer. The solution to this problem is to use a device that integrates the tape drive with a level of automation. The challenge is to choose the correct solution in terms of size and automation level.

System administrators industry-wide recognized the need to automate the backup-and-restore process to the extent that it requires little or no human intervention. This method is known as *lights-out backup*. This process can be done off-shift or concurrently with other applications during normal operations. Multi-drive tape libraries are the only available technology to offer reliability and low cost to make lights-out backup practical.

The hardware options for automation are autoloaders and a range of multi-drive automated tape libraries.

#### Autoloaders

*Autoloaders* have one tape drive. Clients typically use autoloaders to access a few tapes once a day. Most autoloaders are designed for purely sequential operations. These units place little emphasis on performance.

#### Automated tape libraries

*Automated tape libraries* have one or more tape drives, but clients typically use them with at least two tape drives. All tape cartridges are accessible to all drives, making concurrent reading and writing operations possible.

You can increase throughput by adding more drives and HBAs. With automation eliminating the manual intervention to load tapes, file-restore response times are substantially improved. Tape libraries are mandatory for lights-out operations and other higher performance tape storage applications. Tape libraries also offer the security of knowing that other drives are available if one fails.

Multi-drive automated tape libraries and ultra-scalable tape libraries, combined with storage management software, including concurrent backup, archive, and hierarchical storage management (HSM), offer the most robust solution for managing and protecting huge amounts of corporate data.

Automated tape libraries allow random access to large numbers of tape cartridges and the concurrent use of two or more drives, rather than manually loading one tape after another or by using a single-drive sequential autoloader.

## Enterprise tape libraries

*Enterprise tape libraries* are automated tape libraries that provide enhanced levels of automation, scalability, reliability, availability, and serviceability. They typically have the capacity to house dozens of drives and hundreds of tapes. Equipped with high-performance robotic mechanisms, bar code scanners, and support for cartridge I/O ports, these libraries often offer redundant components and a high degree of flexibility through a modular design.

Certain models add support for multiple SCSI, Fibre Channel-Arbitrated Loop (FC-AL), Fibre Channel Protocol (FCP), and ESCON or FICON connections to allow connection to more than one host platform.

The top-of-the-line of the enterprise tape library is the IBM TS4500 tape library and can be shared between two or more heterogeneous host systems. All of the hosts have access to the control functions of the tape library robotics. The library is shared in a physical way, with each system operating as though it really owns the entire library.

### The IBM TS4500 tape library

The IBM TS4500 is a highly scalable, stand-alone tape library that provides high-density tape storage and high-performance, automated tape handling for open systems environments.

Figure 1-19 shows a three-frame version of the TS4500 tape library. An individual library consists of one base frame and up to 17 expansion frames and can include up to 128 tape drives and more than 23,000 tape cartridges.



Figure 1-19 IBM TS4500 introduction

The IBM TS4500 tape library provides the following capabilities, which are described in more detail in the following chapters:

- ▶ High availability dual active accessors with integrated service bays to reduce inactive service space by 40%. You can use the Elastic Capacity option to eliminate inactive service space.
- ▶ All of the frames include high-density (HD) slot technology.
- ▶ You can place additional HD2 frame models in any active position so that the library can grow from both the right side and the left side of the first L frame.
- ▶ HD generation 1 frames from the existing IBM TS3500 library can be redeployed into a TS4500. These frames must be installed to the right of the Lx5 frame, and FC 1742 must be installed on each frame before they can exist in an IBM TS4500 library string.

- ▶ New Single Deep Cell technology.
- ▶ Integrated management console (IMC) with support for external TSSC/IMC.
- ▶ New user interface for improved usability.
- ▶ Updated control system.
- ▶ Input/output (I/O) magazine to allow individual cartridge handling to be performed independently of the library.
- ▶ Top-rack space to house extra tape solution components within the library footprint.
- ▶ Support for HD2-compatible models of the TS1160 (3592 60E and 60F), TS1155 (3592 55E and 55F), TS1150 (3592 EH8), TS1140 (3592 EH7), LTO Ultrium 8 (3588 F8C), LTO Ultrium 7 (3588 F7C), LTO Ultrium 6 (3588 F6C), and LTO Ultrium 5 (3588 F5C) tape drives.
- ▶ Up to 4 Library-Managed Encryption (LME) key paths per logical library.

The TS4500 tape library is available with several tape drives, frame models, and feature options, to meet your specific needs. Additional features of the TS4500 tape library are highlighted in the following list:

- ▶ Advanced Library Management System (ALMS)
- ▶ Ability to attach multiple simultaneous heterogeneous servers
- ▶ Remote management with the TS4500 management GUI or the TS4500 command-line interface (CLI)
- ▶ Remote monitoring by using SNMP, email, or syslog
- ▶ SNMP query configuration
- ▶ Media health verification
- ▶ Multipath architecture
- ▶ Drive and media exception reporting
- ▶ Host-based path failover
- ▶ Up to 288 I/O slots (36 I/O slots standard for LTO libraries and 32 I/O slots standard for 3592 libraries with extra I/O slots that are available as a feature add-on for all D25 and D55 frames)
- ▶ Up to four Encryption Key Manager (EKM) servers can be configured on each logical library

For more information about the TS4500 Library see, *IBM TS4500 R8 Tape Library Guide*, [SG24-8235](#).

## 1.3 Tape solutions in a SAN environment

Connectivity to tape is essential for most backup processes. However, manual tape operations and tape handling are expensive. Studies show that automation of tape processing saves money and increases reliability. Enterprises had to use staff to remove these tapes, transport them to a storage site, and then return them to the tape drive for mounting when necessary. Client tape planning initiatives are directed at more efficient use of drives and libraries and at minimization of manual labor that is associated with tape processing.

The biggest challenges with SCSI tape implementations are the limited cable length and the limited possibilities to share drives between several systems. For LVD SCSI, the total cable length is limited to 25 m (82 ft.) that uses point-to-point interconnection (such as one host that is connected to only one tape drive).

With multidrop interconnection (one host that is connected to more than one tape drive on the same SCSI bus), the total cable length is 12 m (39.4 ft.) for LVD SCSI and 25 m (82 ft.) for High Voltage Differential (HVD) SCSI. Most SCSI tape drives have only one SCSI port and can be attached only on one SCSI bus. This method severely limits the number of hosts that can physically use the drive without recabling.

SANs enable greater connectivity of the tape libraries and tape drives and enable tape sharing. Fibre Channel enables multiple host scenarios without recabling.

If software to manage tape-drive sharing is unavailable, you must isolate (or *zone*) the drives to unique hosts by using functions that are commonly available on SAN gateways or switches. With the correct management software, each drive can communicate with each host, and connections can be dynamic without recabling.

Backup solutions can use SAN technology several ways to reduce the costs of their implementation and increase their performance.

### 1.3.1 Sharing tape devices in a SAN environment

The tape world has the following distinct means of sharing:

- ▶ Library sharing
- ▶ Drive sharing
- ▶ Media sharing

#### Library sharing

Library sharing occurs when multiple servers that are attached to a tape library share the library and the robotics. Tape drives within the library might or might not be shared (*pooled*) among the attached servers. Tape library sharing is a prerequisite for tape-drive sharing.

#### Drive sharing

The sharing of one or more tape drives among multiple servers is called *drive sharing*. To share drives between heterogeneous applications within a tape library, the tape library must provide multiple paths to the robotics and be able to define the drives and slots of a library as multiple logical libraries. The server that is attached to each logical library has no knowledge of any drives or slots outside the logical library.

## Media sharing

Media sharing today is possible only in a homogeneous environment between servers that use the same backup server and the same library to back up their data. For systems that are not backed up by the same backup server, it is possible to share only a tape scratch pool.

## SAN best practices for tape

The following are best practices for tape in a SAN environment:

- ▶ Use dedicated HBAs for tape devices due to inherent differences in data streams (short blocks versus sequential).
- ▶ Use separate zoning for tape devices. Zones should not mix disk and tape devices.
- ▶ Use single initiator zoning. Each SAN zone should contain only one HBA, but it can contain a number of targets (tape devices).
- ▶ Limit zoning of tape devices to only systems which will actively use them. Limiting the size of each zone reduces chances of external interferences and allows for quicker diagnostics in case of any issues.
- ▶ When planning new environments or expanding existing ones, take into account all parts of the data path to avoid bottlenecks. For example, zoning multiple high-speed devices to a single HBA which cannot sustain such data transfer is not recommended.

Also, having multiple high-speed HBAs in a single system and connected on the same bus will result in a bottleneck inside the system bus itself.

- ▶ When performing SAN zoning changes, avoid changes for zones in which the devices are active (performing backup or restore). Changing zones while data transfer is active can interrupt the data transfer, thus causing the backup or restore operation to fail.
- ▶ Avoid using multivendor switches in a single SAN cloud. Combining switching equipment from different vendors can cause equipment to run in compatibility mode that might not include FCP-2 tape safe extensions.
- ▶ Take into account the bandwidth available to port groups. Depending on switch or blade types, ports can share bandwidth across a group of ports, and using all ports to high-speed tape device might exceed the bandwidth available to the group. For tape, try to use dedicated ports where possible.
- ▶ Avoid over-subscription of inter-switch links (ISL) and inter-chassis links (ICL) by using the highest performance FC switches available.

## 1.4 IBM Spectrum Scale



IBM Spectrum Scale is a proven, scalable, high-performance file management solution. IBM Spectrum Scale provides world-class storage management with extreme scalability, flash accelerated performance, and automatic policy-based storage tiering from flash, to disk to tape. IBM Spectrum Scale reduces storage costs up to 90% and improves security and management efficiency in cloud, big data, and analytics environments.

First introduced in 1998, this mature technology enables a maximum volume size of 8 YB, a maximum file size of 8 EB, and up to 18.4 quintillion (two by the 64th power) files per file system. IBM Spectrum Scale provides simplified data management and integrated information lifecycle tools as software defined storage for cloud, big data, and analytics. It introduces enhanced security, flash accelerated performance, and improved usability. Also, capacity quotas, ACLs, and a powerful snapshot functionality are implemented.

## 1.4.1 Key capabilities

IBM Spectrum Scale adds elasticity with the following capabilities:

- ▶ Global namespace with high-performance access scales from departmental to global
- ▶ Automated tiering, data lifecycle management from flash (6x acceleration) to tape (10x savings)
- ▶ Enterprise ready: data security (encryption), availability, reliability, large scale proven
- ▶ Open: POSIX compliant, integrated with OpenStack components and Hadoop

## 1.4.2 Benefits

IBM Spectrum Scale provides the following benefits:

- ▶ Improves performance by removing data-related bottlenecks
- ▶ Automated tiering, data lifecycle management from flash (acceleration) to tape (savings)
- ▶ Lowers cost by eliminating duplicate data
- ▶ Enables sharing of data across multiple applications
- ▶ Reduces cost per performance by placing data on most applicable storage (flash to tape)

IBM Spectrum Scale is part of the IBM market-leading software-defined storage family:

- ▶ As a software-only solution: Runs on virtually any hardware platform and supports almost any block storage device. IBM Spectrum Scale runs on Linux (including Linux on z Systems), IBM AIX®, and Microsoft Windows-based systems.
- ▶ As an integrated IBM Elastic Storage® Server solution: A bundled hardware, software, and services offering that includes installation and ease of management with a graphical user interface. Elastic Storage Server (ESS) provides unsurpassed end-to-end data availability, reliability, and integrity with unique technologies, including IBM Spectrum Scale Redundant Array of Independent Disks (RAID).
- ▶ As a Cloud service: IBM Spectrum Scale delivered as a service, brings high performance, scalable storage, and integrated data governance for managing large amounts of data and files in the IBM SoftLayer® cloud.

IBM Spectrum Scale features enhanced security with native encryption and secure erase. It can increase performance by using server-side flash cache to increase I/O performance up to six times. IBM Spectrum Scale provides improved usability through data replication capabilities, data migration capabilities, Active File Management (AFM), File Placement Optimizer (FPO), and IBM Spectrum Scale Native RAID.

Figure 1-20 shows an example of the IBM Spectrum Scale architecture.

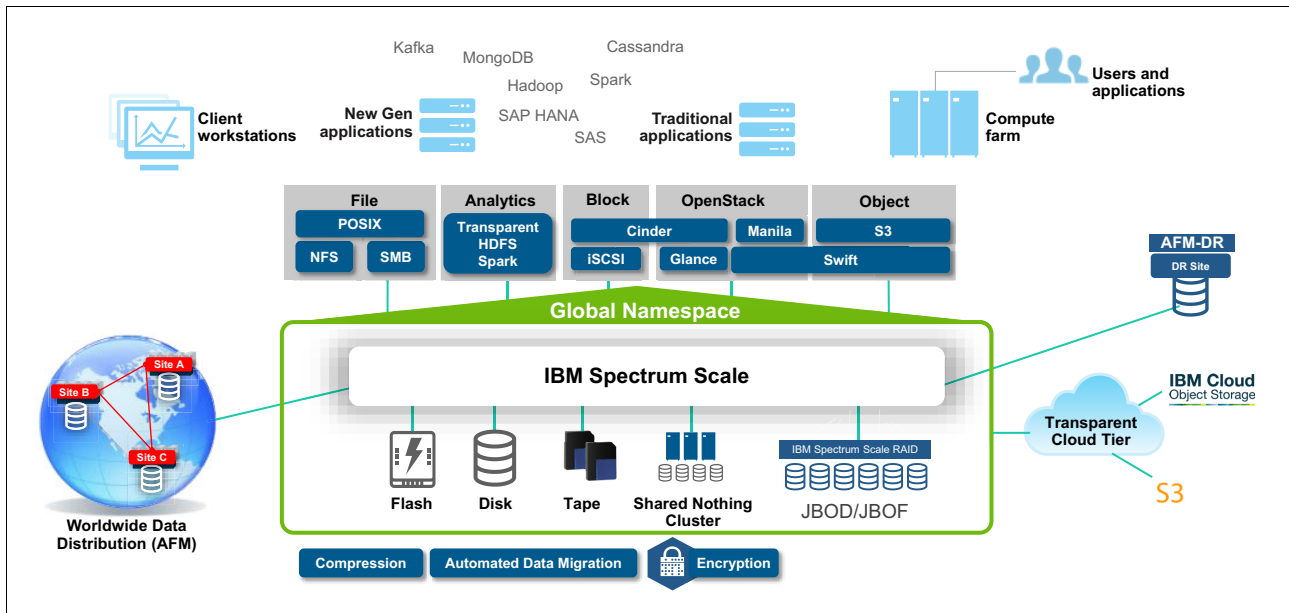

Figure 1-20 IBM Spectrum Scale Architecture

For more information about IBM Spectrum Scale, see the Systems Hardware Data Sheet [IBM Spectrum Scale: Performance and simplicity for the hybrid cloud](#).

## 1.5 IBM Spectrum Archive



IBM Spectrum Archive, a member of the IBM Spectrum Storage family, enables direct, intuitive, and graphical access to data stored in IBM tape drives and libraries by incorporating the Linear Tape File System (LTFS) format standard for reading, writing and exchanging descriptive metadata on formatted tape cartridges. IBM Spectrum Archive eliminates the need for additional tape management and software to access data.

IBM Spectrum Archive offers three software solutions for managing your digital files with the LTFS format: Single Drive Edition (SDE), Library Edition (LE), and Enterprise Edition (EE). With IBM Spectrum Archive Enterprise Edition and IBM Spectrum Scale tape can now add savings as a low-cost storage tape tier.

Network-attached unstructured data storage with native tape support that uses Linear Tape File System delivers the best mix of performance and lowest cost storage.

### 1.5.1 Key capabilities

IBM Spectrum Archive options can support small, medium, and enterprise businesses with these features:

- ▶ Seamless virtualization of storage tiers
- ▶ Policy-based placement of data
- ▶ Single universal namespace for all file data
- ▶ Security and protection of assets
- ▶ Open, non-proprietary, cross platform interchange
- ▶ Integrated functions with IBM Spectrum Scale and IBM Elastic Storage System (ESS)

## 1.5.2 Benefits

IBM Spectrum Archive enables direct, intuitive, and graphical access to data stored in IBM tape drives and libraries by incorporating the LTF5 format standard for reading, writing, and exchanging descriptive metadata on formatted tape cartridges. IBM Spectrum Archive eliminates the need for additional tape management and software to access data.

IBM Spectrum Archive takes advantage of the low cost of tape storage and making it as easy to use as drag. Here are several of the IBM Spectrum Archive benefits:

- ▶ Access and manage all data in stand-alone tape environments as simply as though it were on disk
- ▶ Enable easy-as-disk access to single or multiple cartridges in a tape library
- ▶ Improve efficiency and reduce costs for long-term, tiered storage
- ▶ Optimize data placement for cost and performance
- ▶ Enable data file sharing without proprietary software
- ▶ Scalable, low cost

## 1.5.3 IBM Linear Tape File System

LTF5 is the first file system that works with LTO generation 9, 8, 7, 6, and 5 tape technology (or the IBM TS1160, TS1155, TS1150, and TS1140 tape drives) to set a new standard for ease of use and portability for open systems tape storage. With this application, accessing data that is stored on an IBM tape cartridge is as easy and intuitive as using a USB flash drive. Tapes are self-describing, and you can quickly recall any file from a tape without having to read the whole tape from beginning to end.

Furthermore, any LTF5-capable system can read a tape that is created by any other LTF5-capable system (regardless of the operating system platform). Any LTF5-capable system can identify and retrieve the files that are stored on it.

LTF5-capable systems have the following characteristics:

- ▶ Files and directories are displayed to you as a directory tree listing.
- ▶ More intuitive searches of cartridge and library content are now possible due to the addition of file tagging.
- ▶ Files can be moved to and from LTF5 tape by using the familiar drag-and-drop metaphor common to many operating systems.
- ▶ Many applications that were written to use files on disk can now use files on tape without any modification.
- ▶ All standard File Open, Write, Read, Append, Delete, and Close functions are supported.



## 1.5.4 IBM Spectrum Archive editions

As shown in Figure 1-21, IBM Spectrum Archive is available in different editions that support small, medium, and enterprise businesses.

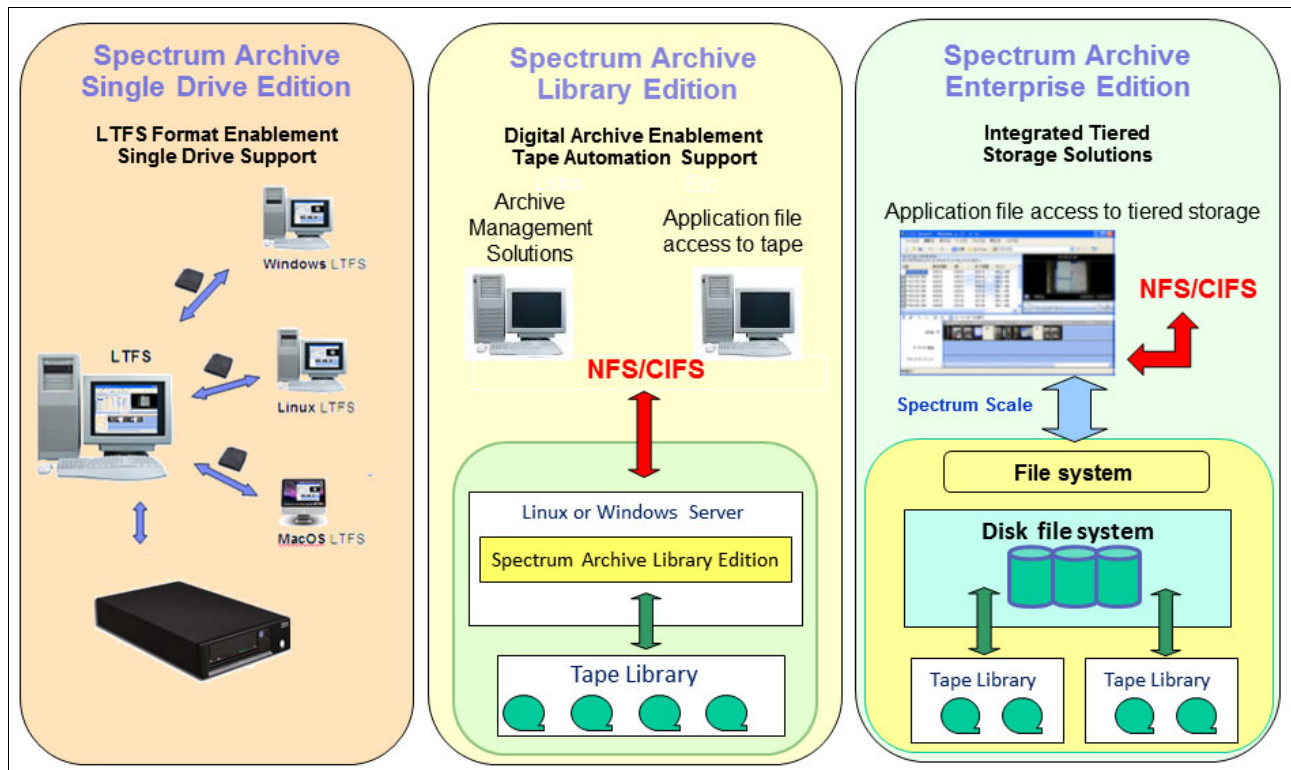

Figure 1-21 IBM Spectrum Archive Single Drive Edition, Library Edition, and Enterprise Edition implementations

### **IBM Spectrum Archive Enterprise Edition**

IBM Spectrum Archive EE gives organizations an easy way to use cost-effective IBM tape drives and libraries within a tiered storage infrastructure. By using tape libraries instead of disks for Tier 2 and Tier 3 data storage, data that is stored for long-term retention, organizations can improve efficiency and reduce costs.

In addition, IBM Spectrum Archive EE seamlessly integrates with the scalability, manageability, and performance of IBM Spectrum Scale, an IBM enterprise file management platform that enables organizations to move beyond simply adding storage to optimizing data management.

Here are some of the IBM Spectrum Archive EE highlights:

- ▶ Simplify tape storage with LTFs format, which is combined with the scalability, manageability, and performance of IBM Spectrum Scale
- ▶ Help reduce IT expenses by replacing tiered disk storage (Tier 2 and Tier 3) with IBM tape libraries
- ▶ Expand archive capacity simply by adding and provisioning media, without impacting the availability of data already in the pool
- ▶ Add extensive capacity to IBM Spectrum Scale installations with lower media, floor space, and power costs

IBM Spectrum Archive EE for the IBM TS4500, IBM TS4300, IBM TS3500, and IBM TS3310 tape libraries provides seamless integration of IBM Spectrum Archive with IBM Spectrum Scale by creating an LTFS tape tier. You can run any application that is designed for disk files on tape by using IBM Spectrum Archive EE. IBM Spectrum Archive EE can play a major role in reducing the cost of storage for data that does not need the access performance of primary disk. Improve efficiency and reduce costs for long-term, tiered storage.

With IBM Spectrum Archive EE, you can enable the use of LTFS for the policy management of tape as a storage tier in a IBM Spectrum Scale environment and use tape as a critical tier in the storage environment.

IBM Spectrum Archive EE supports:

- ▶ IBM Linear Tape-Open (LTO) Ultrium 9, 8, 7, 6, and 5 tape drives
- ▶ IBM TS1160, TS1155, TS1150, and TS1140 tape drives that are installed in TS4500 and TS3500 tape libraries
- ▶ LTO Ultrium 8, 7, 6, and 5 tape drives that are installed in the TS3310 tape libraries

The use of IBM Spectrum Archive EE to replace disks with tape in Tier 2 and Tier 3 storage can improve data access over other storage solutions because it improves efficiency and streamlines management for files on tape. IBM Spectrum Archive EE simplifies the use of tape by making it not apparent to the user and manageable by the administrator under a single infrastructure.

Figure 1-22 shows the integration of IBM Spectrum Archive EE archive solution with IBM Spectrum Scale.

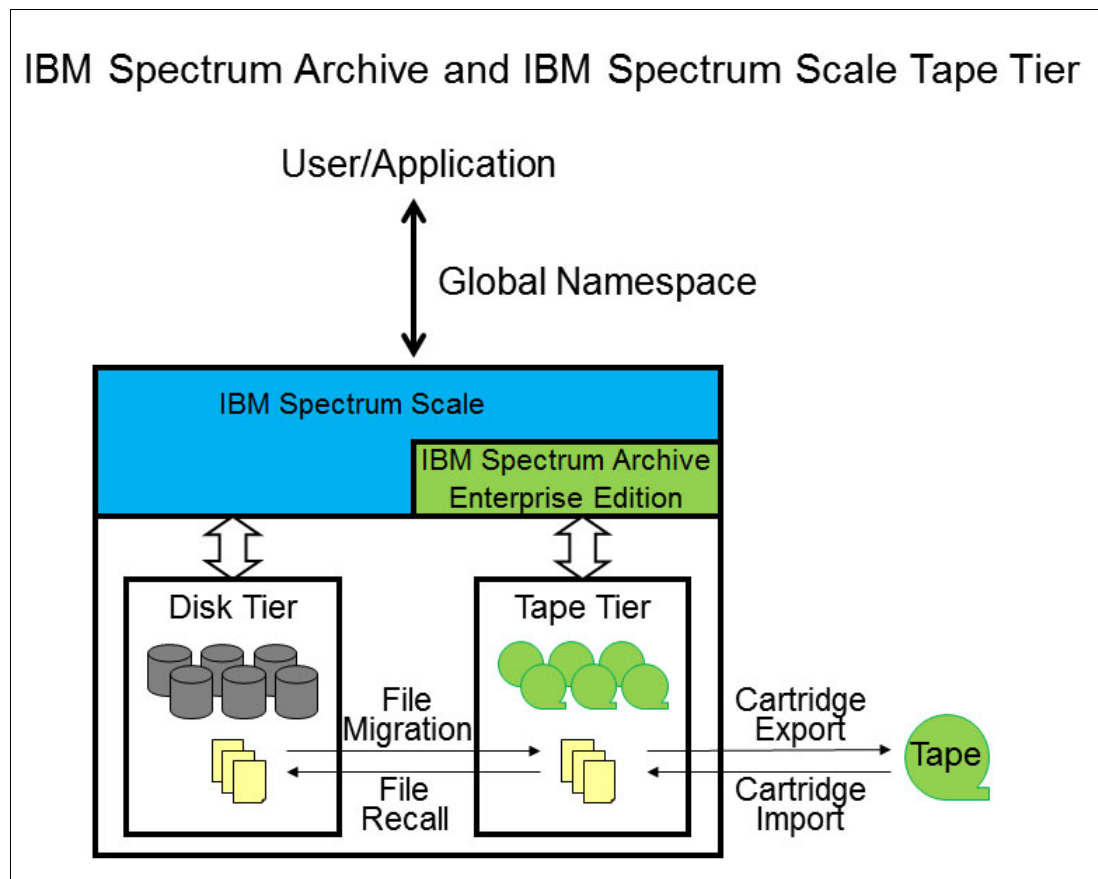

Figure 1-22 Integration of IBM Spectrum Scale and IBM Spectrum Archive Enterprise Edition

The seamless integration offers transparent file access in a continuous namespace. It provides the following features:

- ▶ File-level write and read caching with disk staging area
- ▶ Policy-based movement from disk to tape
- ▶ Creation of multiple data copies on different tapes
- ▶ Load balancing and high availability in multi-node clusters
- ▶ Data exchange on LTFS tape by using import and export function
- ▶ Fast import of file name space from LTFS tapes without reading data
- ▶ Built-in tape reclamation and reconciliation
- ▶ Simple administration and management

For more information about IBM Spectrum Archive, see [this web page](#).

### ***IBM Spectrum Archive Library Edition***

IBM Spectrum Archive LE extends the file manager capability of the IBM Spectrum Archive SDE. IBM Spectrum Archive LE was introduced with Version 2.0 of LTFS. Enable easy-as-disk access to single or multiple cartridges in a tape library.

LTFS is the first file system that works with IBM tape technology to optimize ease of use and portability for open-systems tape storage. It manages the automation and provides operating system-level access to the contents of the library.

IBM Spectrum Archive LE is based on the LTFS format specification, enabling tape library cartridges to be interchangeable with cartridges that are written with the open source SDE version of IBM Spectrum Archive. IBM Spectrum Archive LE supports most IBM tape libraries:

- ▶ TS2900 tape autoloader
- ▶ TS3100 tape library
- ▶ TS3200 tape library
- ▶ TS3310 tape library
- ▶ TS4300 tape library
- ▶ TS3500 tape library
- ▶ TS4500 tape library

IBM TS1160, TS1155, TS1150, and IBM TS1140 tape drives are supported on IBM TS4500 and IBM TS3500 tape libraries only.

IBM Spectrum Archive LE enables the reading, writing, searching, and indexing of user data on tape and access to user metadata. *Metadata* is the descriptive information about user data that is stored on a cartridge. Metadata enables searching and accessing of files through the graphical user interface (GUI) of the operating system. IBM Spectrum Archive LE supports both Linux and Microsoft Windows.

IBM Spectrum Archive LE provides the following product features:

- ▶ Direct access and management of data on tape libraries with LTO Ultrium 9 (LTO-9), LTO Ultrium 8 (LTO-8), LTO Ultrium 7 (LTO-7), LTO Ultrium 6 (LTO-6), and LTO Ultrium 5 (LTO-5) tape drives, and the TS1160, TS1155, TS1150, and TS1140 tape drives
- ▶ Tagging of files with any text, allowing more intuitive searches of cartridge and library content
- ▶ Exploitation of the partitioning of the media in LTO tape format standard
- ▶ One-to-one mapping of tape cartridges in tape libraries to file folders
- ▶ Capability to create a single file system mount point for a logical library that is managed by a single instance of LTFS and runs on a single computer system

- ▶ Capability to cache tape indexes and to search, query, and display tape content within an IBM tape library without having to mount tape cartridges

The IBM Spectrum Archive LE offers the same basic capabilities as the SDE with additional support of tape libraries. Each LTFS tape cartridge in the library appears as an individual folder within the file space. The user or application can navigate into each of these folders to access the files that are stored on each tape. The IBM Spectrum Archive LE software automatically controls the tape library robotics to load and unload the necessary LTFS Volumes to provide access to the stored files.

### ***IBM Spectrum Archive Single Drive Edition***

The IBM Spectrum Archive Single Drive Edition implements the LTFS Format and allows tapes to be formatted as an LTFS Volume. These LTFS Volumes can then be mounted by using LTFS to allow users and applications direct access to files and directories that are stored on the tape. No integration with tape libraries exists in this edition. All data can be accessed and managed in stand-alone tape environments as simply as though it were on disk.

## **1.6 IBM Tape System Library Manager**

IBM Tape System Library Manager Version 1.4 (TSLM) expands and simplifies the use of IBM TS4500 and IBM TS3500 tape libraries by providing a consolidated view of multiple libraries. The tape pathing maintenance and definitions can be reduced by up to 75%.

TSLM provides a resource management layer between applications, such as IBM Spectrum Protect and the tape library hardware. Essentially, TSLM decouples tape resources from applications, which simplifies the aggregation and sharing of tape resources.

TSLM provides the following benefits:

- ▶ Consolidated, mainframe-class media management services
- ▶ Centralized repository, access control, and administration
- ▶ Management beyond physical library boundaries:
  - Access multiple TS4500 or TS3500 tape libraries as a single library image
  - TS3500 tape libraries can be separate (at SAN distances) or connected in a shuttle complex
- ▶ Dynamic sharing of resources across heterogeneous application boundaries
- ▶ Security features to permit or prevent application access to tapes:
  - Helps to enable common scratch pool and private pools for every application
  - Ensures secure use and visibility
- ▶ Policy-based drive and cartridge allocation
- ▶ Policy-based media-lifecycle management
- ▶ IBM Spectrum Protect:
  - Simplified path management
  - Simplified device sharing
- ▶ Emulation of an IBM 3494 library on top of an attached TS4500 library

Figure 1-23 shows the architecture.

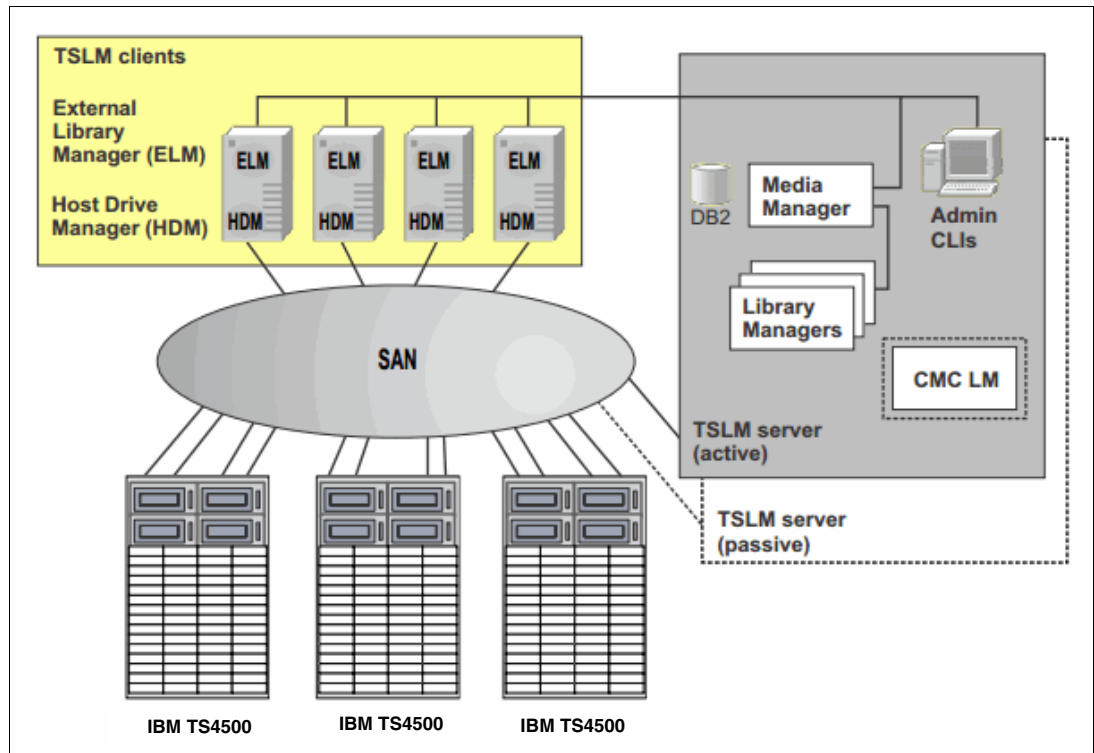

Figure 1-23 IBM Tape System Library Manager architecture

TSLM is composed of the following modules with specific functions:

► **Media Manager**

The Media Manager (MM) is the central server component which, among other tasks, coordinates access to drives and cartridges, handles volume allocation and deallocation requests, and stores a log of all activities. The MM uses a TSLM bundled (and constrained) version of IBM DB2® for persistent storage.

► **Library Manager**

The Library Manager (LM) provides the MM access to library media changers. The LM reports all slots, tape drives, and cartridges to the MM, controls libraries on behalf of the MM, and encapsulates (that is, virtualizes) the library hardware. Because of this virtualization, new library hardware can be integrated into TSLM without any changes to an installed MM.

► **Library Manager for CMC**

Library management and sharing for the Connected Media Changer (CMC) is only for the IBM TS4500 tape library, or the TS3500 tape library shuttle complex, and includes the following functions:

- The ability to discover shuttle connections in the shuttle configuration
- The ability to identify connected libraries that have a shuttle connection to a specific library
- The ability to use direct flight to shuttle cartridges from one library to another library

► **Host Drive Manager**

The Host Drive Manager (HDM) reports all local device handles to MM, runs mount and unmount commands, checks the path before a cartridge is loaded, and reports statistical data to MM when a cartridge is unloaded.

► External Library Manager

The External Library Manager (ELM) serves as a management layer between IBM Spectrum Protect and the TSLM Media Management software. It translates the IBM Spectrum Protect External Media Management Interface (EMMI) API into commands of the IEEE 1244 Media Management Protocol that is understood by TSLM. The ELM executable file must be on the same server that runs the IBM Spectrum Protect server for TSLM because the IBM Spectrum Protect server directly runs the ELM executable file. The ELM executable file communicates with TSLM over a TCP/IP connection.

For more information about this product, see this [IBM Documentation web page](#).



# Overview of IBM Linear Tape-Open Ultrium tape drives

The Linear Tape-Open (LTO) program was conceived as a joint initiative of IBM, Hewlett-Packard, and Seagate Technology. In 1997, the three technology provider companies set out to enable the development of best-in-class tape storage products by consolidating state-of-the-art technologies from numerous sources. In November 1997, they produced a joint press release about LTO technology. The three technology provider companies for LTO technology are now IBM Corporation, Hewlett-Packard (HP), and Quantum.

In the tape storage industry, the member companies saw a common set of problems affecting clients in the midrange and network server areas. Multiple tape options were available, each offering certain strengths in terms of capacity, performance, data integrity, reliability, and cost, but no single option seemed to meet all of these client needs effectively. The objective of LTO technology was to establish new open-format specifications for high-capacity, high-performance tape storage products for use in the midrange and network server computing environments and to enable superior tape product options.

This chapter provides information about the LTO format specifications in general terms, including the first, second, third, fourth, fifth, sixth, and seventh generation Ultrium technologies. The documented LTO specification includes information referring to the data cartridge, the format in which data is written, elements of the drive specification relating to that format, and the compression algorithm description. This information applies to all product offerings of LTO manufacturers to ensure cartridge interchangeability.

The information in this chapter that relates to the LTO Ultrium drive also relates to the IBM LTO Ultrium drive. It might differ from information from other manufacturers in regard to features, such as data rate and reliability.

This chapter includes the following sections:

- ▶ 2.1, “The LTO organization” on page 39
- ▶ 2.2, “Tape encryption overview” on page 61
- ▶ 2.3, “IBM LTO Ultrium highlights” on page 67
- ▶ 2.4, “IBM LTO Ultrium 9 tape drives” on page 74
- ▶ 2.5, “IBM LTO Ultrium 8 tape drives” on page 80
- ▶ 2.6, “IBM LTO Ultrium 7 tape drives” on page 85
- ▶ 2.7, “IBM LTO Ultrium 6 tape drives” on page 90
- ▶ 2.8, “IBM LTO Ultrium family of tape drives and libraries” on page 98



## 2.1 The LTO organization

For more information about marketing, technical, and licensing for the Linear Tape-Open program, see the [Ultrium LTO website](#).

### 2.1.1 Overview

Two LTO formats (Ultrium and Accelis) were introduced in 1997, and licenses for the technology were made available. Since then, the Accelis format has not been actively pursued by manufacturers because it is apparent that the Ultrium format meets market needs.

The three LTO sponsoring companies took steps to protect client investment by providing a Generation 12 roadmap that illustrates native capacity (see Figure 2-1). They also established an infrastructure to enable compatibility between products.

**Important:** IBM, Hewlett-Packard, and Quantum reserve the right to change the information in this migration path without notice.

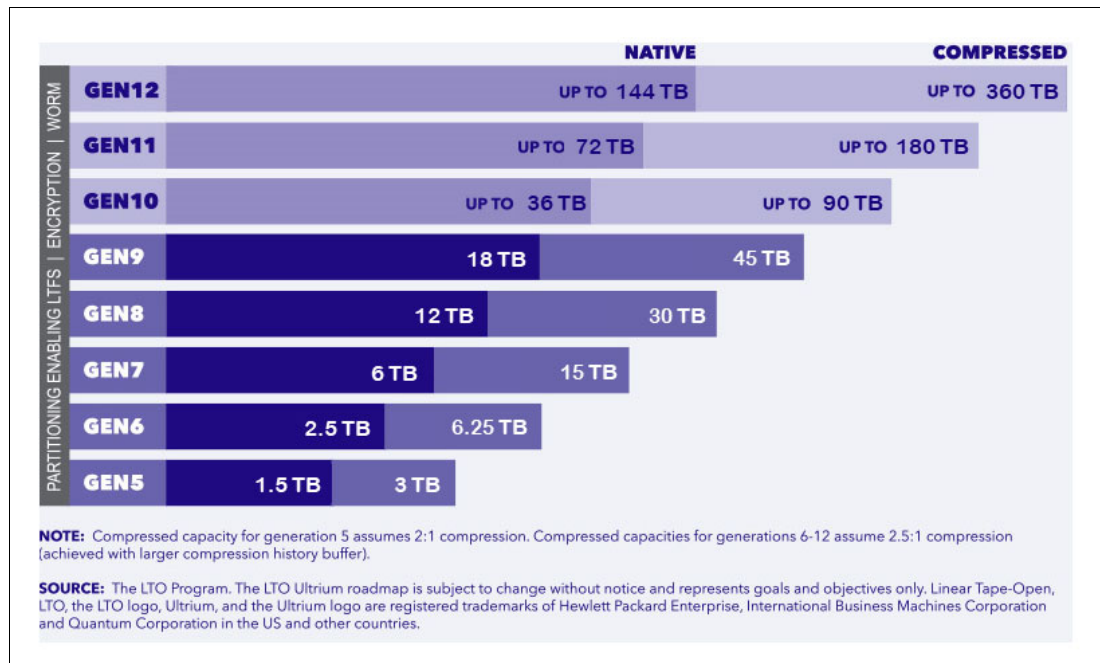

Figure 2-1 LTO Ultrium Roadmap<sup>1</sup>

The LTO Ultrium compatibility investment protection is provided based on the following principles:

- ▶ An Ultrium drive is expected to write data to a cartridge in its own generation and to a cartridge from the immediate previous generation in the format of that generation.
- ▶ LTO 1 to 7 drives are expected to read data from a cartridge in its own generation and at least the two previous generations.
- ▶ From LTO 9, the Ultrium drive is expected to read from a cartridge in its own generation and one previous generation.

<sup>1</sup> For more information, see LTO Technology: <http://www.lto.org/technology/what-is-lto-technology>

For more information about compatibility among the available Ultrium media, see 2.3.1, “IBM LTO Ultrium compatibility” on page 67.

The three technology provider companies (IBM, HP, and Quantum) all made significant contributions of time and expertise to the definition of the LTO format specifications. All three companies have deep knowledge of client needs. They provided expert knowledge and engineering skill in the critical areas of magnetic recording technology, mechanism design, media materials, and cartridge design. This cooperative process created stronger LTO format definitions than any of the individual companies might have developed working alone.

## Open licensing and manufacturing

To answer industry calls for open-tape format specifications, LTO format specifications were made available to all who want to participate through standard licensing provisions. More than 30 companies, including IBM, HP, and Quantum, became LTO technology licensees. The licensees include an impressive array of worldwide storage industry leaders, including the following companies who currently passed the compliance verification requirements to sell LTO Ultrium branded tape drives and cartridges:

- ▶ IBM Corporation
- ▶ FujiFilm Corporation
- ▶ Hewlett-Packard Company
- ▶ Quantum Corporation
- ▶ Sony Corporation

For more information about Linear Tape-Open Technology (LTO) licensed companies, see the [Ultrium LTO website](#).

In attracting these other industry-leading companies, LTO program technology and LTO specified products (tape drives and tape storage cartridges) can reach the market from multiple manufacturers, not just the technology provider companies. This availability is critical to meeting an open market objective and is accomplished through open licensing of the technology.

## License packages

The following combinations of packages are available for potential licensees:

- ▶ Ultrium Specification Document provides the opportunity to review the Ultrium format specification with minimal investment and is suitable for companies that are interested in a feasibility investigation.
- ▶ Ultrium Tape Cartridge License Package is for companies that are only interested in designing Ultrium tape cartridges.
- ▶ Ultrium Tape Mechanism License Package enables licensees to design Ultrium tape drive mechanisms.

Each license package contains one or all of the following types of documents:

- ▶ Format specification documentation provides technical information about the format that is necessary to develop mechanisms and cartridges that interchange between products of the same format.
- ▶ License documentation provides more technical information about tolerance interdependencies and interchange verification testing. It also provides a conceptual overview of the design.

- ▶ The trademark style guide describes the use of the Ultrium trademarks and logos. Figure 2-2 shows an example of an LTO Ultrium logo.



Figure 2-2 Ultrium logo example

**More information:** For more information about packages, documentation, and licensing, see this see this [Ultrium LTO web page](#).

### Compliance verification

The technical strategy for accomplishing format compliance verification among the licensees was defined and an independent Compliance Verification Entity (CVE) was selected. To promote interchangeability of tape cartridges, a third-party verification test company was enlisted to perform specification compliance verification testing. These tests are required annually for all companies that use the logo.

The objective of the compliance testing is to test only the ability to produce, read, or write Ultrium cartridges that meet the format specifications. The objective of this format compliance testing is not to evaluate Ultrium drive quality, mean time before failures (MTBF), physical form factor, or other parameters that are not directly related to the LTO program formats and interchangeability. LTO program licensees have wide latitude to establish their own mechanical, electrical, and logical designs to meet the format specifications. These factors are not tested as part of the compliance verification process.

### 2.1.2 LTO standards

LTO technology was originally developed for two open-tape format specifications: Accelis and Ultrium. The Accelis format (fast-access) is not being developed because the Ultrium format provides adequate fast-access performance.

#### LTO core technology

Multichannel linear serpentine recording is at the core of the LTO formats. It enables an optimum balance of reliability and data integrity, performance, and high capacity. In the LTO recording format, data is written in tracks that run down the length of the tape.

The LTO Ultrium 9 format records data on 8960 tracks across the half-inch tape width. This linear recording format has a *serpentine characteristic*. The drive mechanism makes multiple passes from the beginning of the tape to the end of the tape and back to read or write the full capacity of the cartridge.

In the LTO Ultrium 9 format, the 8960 tracks are split into four data bands of 2240 tracks each, and 32 read/write channels. Table 2-1 lists the values for the Ultrium 9 and previous LTO generations.

Table 2-1 Data tracks, density, and channels

LTO generation	Data tracks	Tracks/band	Linear density	Read/write channels
Ultrium 1	384	96	124 kbp	8
Ultrium 2	512	128	188 kbp	8
Ultrium 3	704	176	250 kbp	16
Ultrium 4	896	224	328 kbp	16
Ultrium 5	1280	320	368 kbp	16
Ultrium 6	2176	544	385 kbp	16
Ultrium 7	3584	896	485 kbp	32
Ultrium 8	6656	1664	524 kbp	32
Ultrium 9	8960	2240	545 kbp	32

Data is written to the innermost bands first to provide protection to the data that was recorded earliest in the process by writing it in the center, which is the most physically stable area on the tape. Data also is verified as it is written.

During the first pass down the length of the tape up to 32 tracks (see the “Read/write channels” column in Table 2-1) are concurrently read or written. At the end of the tape, the second pass of the starts. The read/write heads are indexed and positioned over 32 new tracks, and the tape reverses direction back toward the beginning of the tape to complete the round trip. For the next round trip, the heads again are indexed to a new position over a new group of 32 tracks.

Because track densities (as shown in Table 2-1) are high, and because the tape is subject to lateral movement as it is moved, the read/write heads must always be positioned precisely over the correct tracks for performance and data integrity. This positioning is accomplished by using the *timing-based servo* technique. This technique makes it possible to use high track densities (now and in the future) without changing the format of the media. This technique also provides the ability to read data, even with media imperfections.

In the LTO system, electronic signals are generated through the real-time reading of servo data bands that are pre-recorded on the LTO tape. These signals enable the servo system to dynamically control the positioning of the read/write heads across the width of the tape. Similar magnetically based, track-following servo systems are used successfully in tens of thousands of tape drives that are in use today, such as the IBM 3590 tape drive (IBM 3590) and IBM 3592 tape drive (IBM 3592).

The LTO formats also use advanced error correction codes for data integrity. These systems automatically correct most cross-track errors and provide data correction even if a full track is lost. Data is further protected by the demarcation of bad areas of the tape (for example, where servo signals are unreliable) and through dynamically rewriting bad blocks.

Cartridge memory is embedded in the LTO cartridges to record use and error information. A noncontacting radio frequency (RFI) module provides for storage and retrieval with the following nonvolatile memory capacities:

- ▶ Ultrium 9: 32,640 bytes
- ▶ Ultrium 8, Ultrium 7, and Ultrium 6: 16,320 bytes
- ▶ Ultrium 5 and Ultrium 4: 8192 bytes
- ▶ LTO Ultrium 3: 4096 bytes

### Ultrium tape formats

Figure 2-3 shows the IBM Ultrium 9 cartridge, which is distinguished by the color green. The Ultrium 8 cartridge colored is burgundy, the Ultrium 7 cartridge colored purple, and the Ultrium 6 cartridge is colored black.

The IBM Write Once Read Many (WORM) cartridges are two-tone cartridges with a platinum bottom. The top is like the normal LTO Ultrium cartridges.

The Ultrium 9 cartridge is green (see Figure 2-3), the Ultrium 9 WORM (see Figure 2-4 on page 44) is green with platinum bottom, the Ultrium 8 WORM is Burgundy with platinum bottom, and the Ultrium 7 WORM is green with platinum bottom.



Figure 2-3 IBM LTO Ultrium 9 tape cartridge



Figure 2-4 IBM LTO Ultrium 9 WORM tape cartridge

The Ultrium tape format specification is optimized for high capacity and performance with outstanding reliability, in a stand-alone or automated environment. The Ultrium cartridge uses a larger single-reel design (see Figure ) and ½-inch tape to provide ultra-high storage capacity. The tape is extracted from the cartridge by the tape drive through a leader pin and is wound onto a take-up reel that is contained within the drive.

This design is focused on client requirements for high capacity and performance and is ideally suited for backup, restore, and archive applications.

Ultrium drive technology is intended to meet the needs of the enterprise on a roadmap, or migration path, that extends well into the future. The Ultrium tape format established a new benchmark for large volume backup and archive options.

### ***WORM tape format***

Beginning with LTO Ultrium format generation 3, WORM functionality provides for non-erasable, nonrewritable operation with tape media and is for long-term, tamper-resistant record retention. LTO Ultrium 9, 8, 7, 6, 5, and 4 drives provide the same WORM capability with higher data capacity.

The format specification for WORM for LTO Ultrium generations includes low-level encoding in the cartridge memory and is mastered into the servo pattern as part of the manufacturing process. This encoding prevents tampering.

Data can be appended at the end of a WORM cartridge to which data was previously written, which allows the full use of the high-capacity tape media.

### **Interleaved recording**

The LTO drive uses an interleaved, serpentine, longitudinal recording format. The first set of data tracks is written from near the physical beginning of the tape to near the physical end of the tape. The head then repositions to the next set of tracks for the return. This process continues until all tracks are written and the tape is full.

The format of the recording of the data and servo tracks is defined as part of the LTO specification to meet the requirement for interchange among implementations of different manufacturers.

### Servo tracks

Servo tracks or bands enable accurate positioning of the tape drive head over the data track, which ensures that the head does not stray onto an adjacent track. They are necessary to support high-data densities on the tape where the tracks are extremely close together. The servo bands are written when the cartridge is manufactured before the cartridge is usable for data storage and retrieval. If the servo bands are erased, the tape becomes unusable.

## 2.1.3 Data compression

The LTO Consortium created a superior data compression technique that is known as LTO Data Compression (LTO-DC). Although an excellent data compression algorithm, adaptive lossless data compression (ALDC) is not optimized for incompressible data, such as encrypted or previously compressed data. For incompressible data, it is best not to apply any data compression algorithm, but rather to pass the input data directly to the compressed data stream (pass-through).

Given the variations in data, there are times when ALDC is desirable and times when a simple pass-through is better. For example, if ALDC-based data compression is used, it is best if all segments of incompressible data are recorded without expansion by using a pass-through technique. Figure 2-5 shows the LTO-DC data compression technique that uses the two schemes.

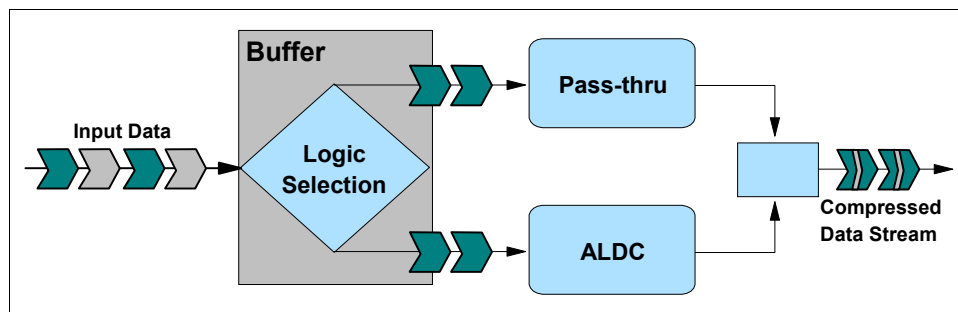

Figure 2-5 LTO-DC block diagram

The ability to swap schemes between ALDC and a pass-through mode gives a tape drive the power to automatically adapt to the incoming data stream.

No standardization of when to swap modes (scheme swap) when compressing data was specified by LTO-DC. LTO-DC was approved by Ecma International as the Streaming Lossless Data Compression (SLDC) standard. For more information, see [this web page](#).

**Compression technique:** LTO uses the SLDC technique for compression. The IBM 3592 tape drive also uses the SLDC compression technique.

Because no standardization is specified, all vendor implementations might perform scheme swapping differently. What is specified and tested is that the resultant compressed data stream is decompressible by the defined set of LTO-DC rules. This capability enables interchange between drives from multiple vendors. Each vendor's Ultrium drive can read and decompress the LTO-DC streams of the other vendors' Ultrium drives.



## 2.1.4 Tape cartridge

The Ultrium tape cartridge is a single-reel cartridge, meaning that the whole tape is wrapped around a single reel when the cartridge is not loaded in a drive. During the loading process, the threader of the drive catches the leader pin of the tape and threads it through the drive and the machine reel. During the read/write process, the tape is stored on the machine reel and the cartridge.

Figure 2-6 and Figure 2-7 show two views of the tape cartridge.

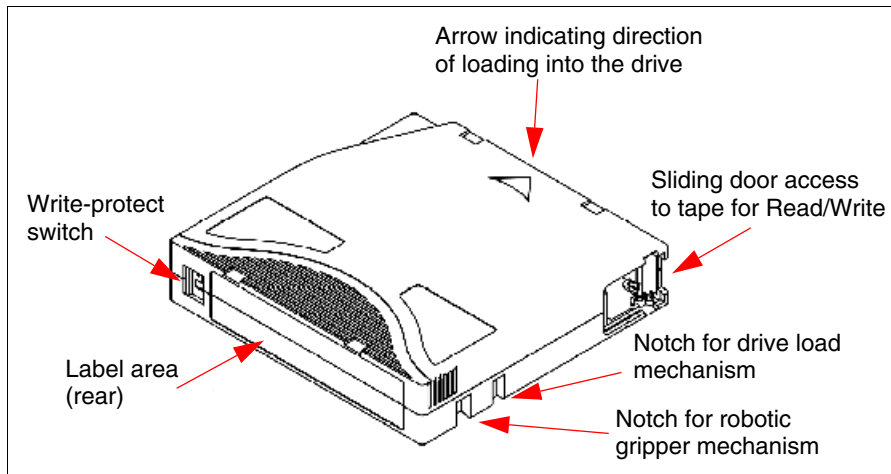

Figure 2-6 View of the Ultrium tape cartridge from the top and rear

The cartridge is approximately 10.2 cm long, 10.5 cm wide, and 2.2 cm high (which is approximately 4 x 4.16 x 0.87 inches). The cartridge contains 12.6 mm (½-inch) metal-particle tape with a high-density recording area.

Figure 2-7 shows several components of the cartridge.

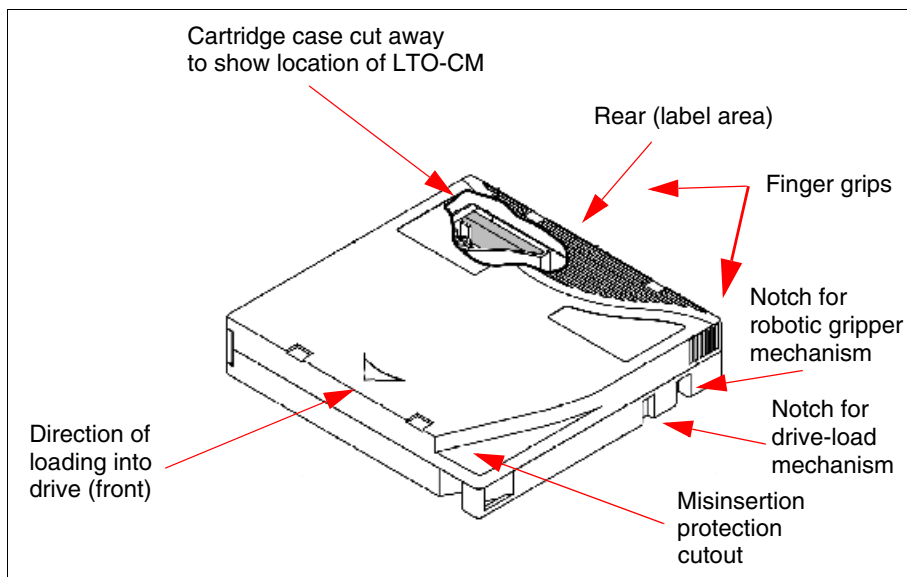

Figure 2-7 Ultrium cartridge view from top and front



The cartridge includes the following components:

- ▶ Grips

Molded areas on the cartridge casing that are finger grips for manual loading.

- ▶ Label area

At the designated area at the rear of the cartridge where the adhesive bar code label is applied.

- ▶ Sliding door

The cartridge door (see Figure 2-6 on page 46) that protects the tape from contamination whenever the cartridge is out of the drive. Behind the door, the tape is threaded onto a leader pin (as shown in Figure 2-8), which is used to pull the tape from the cartridge for use. A locking mechanism prevents the media from unwinding when the cartridge is not in the drive.

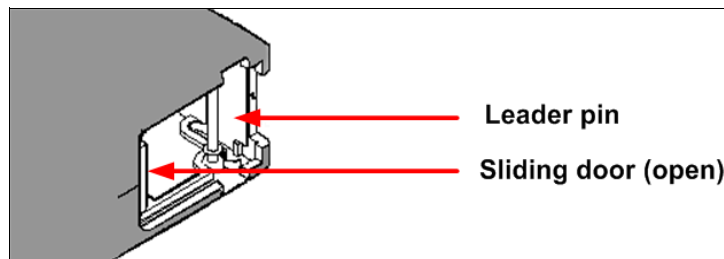

Figure 2-8 Leader pin attached to the tape medium

- ▶ Notches

Two sets of molded notches in the cartridge casing are on the sides near the rear. The first pair enables the robotic gripper to pull the cartridge out of the drive mouth after the cartridge is unloaded. The second pair enables the drive to grip the cartridge and pull it into the loading position inside the drive.

- ▶ Misinsertion protection

A cutout in the front side of the cartridge casing that prevents the cartridge from being inserted into the drive in the wrong orientation. This feature prevents the use of unsuitable cartridges of similar, but not identical, construction.

The various cartridges are color-coded for easy visual distinction, as shown in Table 2-2. (For more information, see “Ultrium tape formats” on page 43).

*Table 2-2 Data cartridge identification by case color*

<b>Data cartridge</b>	<b>Case color</b>
Ultrium 9 WORM	Green, platinum (silver gray) bottom
Ultrium 8 WORM	Burgundy, platinum (silver gray) bottom
Ultrium 7 WORM	Purple, platinum (silver gray) bottom
Ultrium 6 WORM	Black top, platinum (silver gray) bottom
Ultrium 5 WORM	Slate burgundy top, platinum (silver gray) bottom
Ultrium 4 WORM	Slate green top, platinum (silver gray) bottom
Ultrium 3 WORM	Slate blue top, platinum (silver gray) bottom
Ultrium 9	Green
Ultrium 8	Burgundy
Ultrium 7	Purple
Ultrium 6	Black
Ultrium 5	Burgundy
Ultrium 4	Green
Ultrium 3	Slate blue

Although the servo tracks are similar on Ultrium 9 and Ultrium 8 cartridges, Ultrium 8 cartridges are required to be used with an Ultrium 9 drive and achieve Ultrium 8 capacity. Similarly, Ultrium 9, Ultrium 8, Ultrium 7 and Ultrium 6 cartridges are required to achieve their respective drive capacities and performance. For more information about media compatibility among the generation, see 2.3.1, “IBM LTO Ultrium compatibility” on page 67.

### **LTO data cartridge capacity**

When the Ultrium tape cartridge is processed, the Ultrium tape drive uses a linear, serpentine recording format. The Ultrium 5 drive writes data on 1280 tracks, also 16 tracks at a time. The Ultrium 6 drive reads and writes data on 2176 tracks, 16 tracks at a time. The Ultrium 7 drive reads and writes data on 3584 tracks, 32 tracks at a time. The Ultrium 8 drive reads and writes data on 6656 tracks, 32 tracks at a time. The Ultrium 9 drive reads and writes data on 8960 tracks, 32 tracks at a time.

The first set of tracks is written from near the beginning of the tape to near the end of the tape. The head then repositions to the next set of tracks for the return pass. This process continues until all tracks are written and the cartridge is full or until all data is written.

To ensure that the IBM Ultrium tape drive conforms to the IBM specifications for reliability, IBM suggests the use of only IBM LTO Ultrium tape cartridges. The IBM LTO Ultrium data cartridges cannot be interchanged with the media that are used in other IBM non-LTO Ultrium tape products.

Table 2-3 lists the native data capacity of Ultrium data cartridges.

Table 2-3 Native capacity

Data cartridge	Native data capacity
Ultrium 9 and WORM	18 TB (45 TB at a 2.5:1 compression ratio)
Ultrium 8 and WORM	12 TB (30 TB at a 2.5:1 compression ratio)
Ultrium 7 M8 Format (for LTO8 drives only)	9 TB (22.5 TB at a 2.5:1 compression ratio)
Ultrium 7 and WORM	6 TB (15 TB at a 2.5:1 compression ratio)
Ultrium 6 and WORM	2.5 TB (6.250 TB at a 2.5:1 compression ratio)
Ultrium 5 and WORM	1.50 TB (3 TB at a 2:1 compression ratio)
Ultrium 4 and WORM	800 GB (1.6 TB at a 2:1 compression ratio)
Ultrium 3 and WORM	400 GB (800 GB at a 2:1 compression ratio)
Ultrium 2	200 GB (400 GB at a 2:1 compression ratio)
Ultrium 1	100 GB (200 GB at a 2:1 compression ratio)

### Metal particle tape medium

The metal particle tape medium consists of a transparent polyethylene base material with two coatings. On one side, the base has two fine coats of a strong yet flexible ferromagnetic material, which is dispersed in a suitable binder. This side is the surface on which the data is written. The back surface is coated with a non-ferromagnetic conductive coating.

Metal particle media have high *coercivity*, which is a measure of their ability to retain their magnetic properties after the data is written to the tape. Coercivity is one of the factors in enabling a potentially longer shelf life than other media.

### Cartridge memory

Within the cartridge is the LTO Cartridge Memory (LTO-CM), which is a passive, contactless silicon storage device that is physically a part of the cartridge. The memory chip also is known as medium auxiliary memory (MAM). For more information, see the *IBM System Storage LTO Tape Drive SCSI Reference (LTO-5 through LTO-9)*, GA32-0928.

Information about the cartridge and tape is written to the LTO-CM. The LTO-CM is only accessible and used by the drive itself and contains no customer data. The LTO-CM is serial Electronically Erasable Programmable Read-Only Memory (EEPROM) with read-only and rewritable areas. It is housed inside the cartridge casing at the left rear (label side) corner as shown in Figure 2-7 on page 46.

The LTO-CM is used to hold usage and error information about the cartridge, the media inside that cartridge, and the data on the media. The storage capacity of the Generation 9 LTO-CM is 32640 bytes, double capacity of Generation 6, 7 and 8 LTO-CM which is 16320 bytes and double the 8160-byte capacity of the Generation 5 and 4 LTO-CM. The Generations 3, 2, and 1 cartridges use a 4096-byte LTO-CM. The LTO-CM is in the left rear corner of the cartridge. A copy of this information also is kept in the first data set within the user data area and is given the data set number zero.

Communication between the drive and the LTO-CM is performed by a low-level radio frequency (RF) field generated (in the IBM implementation) by the drive. The LTO-CM is nonvolatile storage that is updated by using the RF field. It requires no other power source. This type of technology has an expected shelf life of more than 30 years.

Although transparent to the user, keeping this type of information enhances the efficiency of the drive and the cartridge. Data and block locations are stored in memory. For example, the end-of-data location is stored so that when the tape is next loaded, the drive can use the fast locate function to move directly to the recording area and begin recording.

Storing data about the age of the cartridge, the number of times it was loaded, and the number of errors it has accumulated aids in determining the reliability of the cartridge. This data is of particular value if it is stored with the cartridge itself, so that whenever the cartridge is mounted on any host system, the history is accessible.

This product is not the first tape product where information was kept on the cartridge. However, previously it was written on the tape medium itself in a portion of the tape not accessible to users, before the beginning-of-tape marker, such as in the IBM 3590 tape drive.

### Bar code label

Each data and cleaning cartridge that is processed by an Ultrium tape library must have a bar code label. This bar code label is mandatory for libraries that have an installed bar code reader. The label, as shown in Figure 2-9, contains a human-readable volume serial number or volume label and the corresponding machine-readable bar code.



Figure 2-9 Bar code label example

The bar code has the following format:

- ▶ Quiet zones at each end of the bar code.
- ▶ A start character indicating the beginning of the label.
- ▶ A six-character volume label.
- ▶ A two-character cartridge media-type identifier (L1, L2, L3, L4, L5, L6, L7, M8, L8, or L9), which identifies the cartridge as an LTO cartridge (“L”) and indicates the LTO generation.

**Note:** The M8 identifier designates a LTO7 media formatted for use in LTO8.

- ▶ Other identifiers also are specified by the LTO standard. Therefore, the LTO-5 WORM cartridge is identified by LV, the LTO-6 WORM cartridge is identified by LW, the LTO-7 WORM cartridge is identified by LX, the LTO-8 WORM cartridge is identified by LY and the LTO-9 WORM cartridge is identified by LZ.
- ▶ A stop character indicating the end of the label.

When read by the bar code reader of the library, the bar code identifies the volume label of the cartridge to the tape library. The bar code volume label also indicates to the library whether the cartridge is a data, cleaning, or diagnostic cartridge.

Tape cartridges are often supplied with the labels already attached, or labels can be attached after purchase. The Ultrium cartridge features a recessed area for the label (see Figure 2-6 on page 46). The label must be applied only in the recessed label area. If the label extends outside of the recessed label area, it can cause loading problems in the drive.

### Volume label format

The LTO cartridge label uses the Uniform Symbol Specification-39 bar code symbols.

The volume label of a cartridge consists of six characters, starting from the left. Except for cleaning and diagnostic cartridges, these six characters are limited to the following ASCII characters:

- ▶ Uppercase A - Z (ASCII character code: 41h - 5Ah)
- ▶ 0 - 9 (ASCII character code: 30h - 39h)

The volume label must consist of six, all uppercase alphabetic, all numeric, or alphanumeric characters, such as ABCGVE, 123621, or F8H5N9. The volume label cannot consist of fewer than six characters.

A volume label format of CLN*U**nn* represents a universal cleaning cartridge. A volume label of the form CLN*v**nn* is used for a unique cleaning cartridge, where *v* is an alphanumeric identifier that represents the vendor of a drive-unique cleaning cartridge. An IBM-unique cleaner cartridge uses the label format CLN*I**nn*. This identifier is logged in the vendor information pages in the Ultrium tape drive.

A volume label of the form DG(space)*v**nn* is used for diagnostic and service cartridges. The drive uses the *v* to determine whether the drive-unique diagnostic cartridge is loaded. The *nn* represents a specific cartridge and is logged in the vendor information pages in the Ultrium tape drive.

The internal and external labels on a cartridge do not need to match. Therefore, the volume label on the bar code label does not need to match the volume label that is recorded on the tape in the tape label area when it is initialized. However, it is preferable for them to match to avoid confusion.

### Ordering bar code labels

For more information about ordering bar code labels, see Appendix B, “IBM LTO Ultrium and 3592 media” on page 313.

### Write-protect switch

The write-protect switch is at the front of the cartridge to the left of the bar code label (see Figure 2-6 on page 46). The position of the write-protect switch on the tape cartridge determines whether the tape can be written to. The tape cannot be written to when the switch is pushed to the right. When the write-protect switch is set to inhibit writing, a visual lock mark (such as a padlock) is visible.

In most cases, back up and recovery host application software is used to achieve the most benefit from the use of an LTO system. It is better to rely on the host application software to write-protect the cartridges rather than to manually set the write-protect switch. This way, the host software can identify a cartridge that no longer contains current data and is eligible to become a scratch cartridge. If the switch is set and the host application sets the cartridge to scratch status, the tape drive is unable to write new data to the tape.

### **Cartridge life**

The magnetic tape inside the cartridge is made of highly durable materials. However, the tape wears after repeated cycles. Eventually, such wear can cause an increase in tape errors, records of which are stored in the LTO-CM. Cartridge performance can be tracked and monitored, which enables predictive failure analysis and enhances data integrity. This tracking is done automatically, and the drive issues a message when errors on the tape exceed a threshold.

The IBM Ultrium 9, 8, 7, 6, and 5 data cartridges have a usable life of 100,000 load and unload cycles in a typical computer environment. The data that is recorded on the cartridge has an archive storage life of a minimum of 30 years with less than 5% loss in demagnetization. The cartridge must be stored at 16° C (60° F) to 25° C (77° F), with 20 - 50% non-condensing humidity, and a wet bulb temperature of 26° C (79° F) maximum.

### **Specifications for cleaning cartridges**

In the past, to support client and application requirements and expectations for cleaning, each LTO drive vendor provided its own cleaning cartridge specifically for its Ultrium drives. To avoid potential interoperability problems, the LTO consortium decided to introduce a universal cleaning cartridge. IBM offers only the universal cleaning cartridge type that can be used on any LTO drive type.

The IBM Ultrium LTO tape drive is self-monitoring and self-cleaning. Therefore, use the automatic cleaning function that is provided with the library or by the application as recommended by IBM. Each drive determines when it must be cleaned and alerts the library or the application to initiate a cleaning cycle.

To prevent recontamination of drive surfaces, each specific cleaner cartridge is limited up to 50 cleaning cycles. Cleaner tape use is determined by the length of the tape that is already used, and so the average number of cleaning cycles for a cleaning cartridge is 50, but it can be marked used before, or after, 50 mounts.

## **2.1.5 IBM LTO Ultrium common subassembly drive**

Certain elements of the Ultrium drive design are covered by the LTO format specification, such as anything related to writing the specified data format that enables tape interchange. However, there is no strict LTO definition in terms of how the drive module is constructed. Therefore, in this area, manufacturer drives might differ from each other in performance and specification, such as the data rate or quality design points.

This section relates specifically to the IBM LTO implementation. However, it emphasizes again that the IBM LTO Ultrium cartridges are compatible with those of all other licensed manufacturers.

The IBM LTO Ultrium common subassembly drive (as shown in Figure 2-10) is a high-performance, high-capacity tape drive. The drive records data by using the specified linear serpentine recording format on ½-inch tape that is housed within the LTO Ultrium cartridge. The data tracks are located by using preformatted servo tracks, as described in “Servo tracks” on page 45.



*Figure 2-10 IBM LTO Ultrium common subassembly*

The original basic unit was the first-generation IBM LTO series of products. Subsequent generations of IBM LTO promote extensive reuse, making the IBM Ultrium drives extremely reliable. Especially starting in LTO-3, several reliability improvements were made to tape path and internal tape handling. These units are a common subassembly and do not have an IBM machine type.

The subassembly is not available for clients to purchase directly, but only as a part number that is used in the assembly of other IBM machine types. The subassembly does not have its own power supply, but is powered by the library, frame, or casing into which it is integrated.

The IBM machine types that integrate the subassembly are addressed in 2.8, “IBM LTO Ultrium family of tape drives and libraries” on page 98, and in later chapters. The subassembly is sold on the original equipment manufacturer (OEM) market to other LTO library manufacturers. The common subassembly is a single field-replaceable unit (FRU). That is, if it fails, the whole unit is replaced, and no parts or subassemblies within the unit are replaced when the drive is maintained by an IBM service support representative (SSR).

### **Drive head**

When the cartridge is inserted into the drive, a threading mechanism pulls the leader pin and attached tape (see Figure 2-8 on page 47) out of the cartridge, across the drive read/write head, and onto a nonremovable take-up reel. The drive head can then read or write data from or to the tape.

In generations 4, 5, and 6 the drive has a 2 x 16; in generations 7, 8, and 9, the drive has 2 x 32 element head, reading or writing data on 16 or 32 tracks at a time, as shown in Figure 2-11. Unlike the IBM 3590, for example, it does not cover the entire width of the tape.

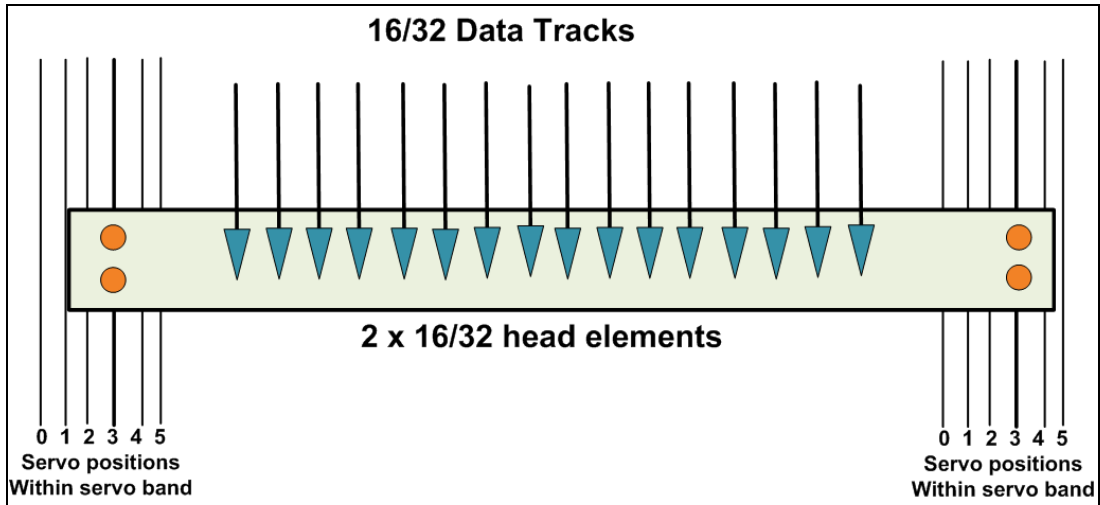

Figure 2-11 One of 16/32 element heads shown with servo elements

The write elements are immediately followed by read/verify elements. Therefore, two sets of eight head elements (eight write elements and eight read elements) allow the tape to write in the forward and reverse directions down the length of the tape. Two sets of heads (read/write and write/read) are required because the tape is written and read in both directions.

The LTO Generation 6, LTO Generation 5, LTO Generation 4, and Generation 3 drives have a 2 x 16 element head, reading or writing data at 16 tracks at a time. The LTO Generation 9, 8, and 7 drives have a 2 x 32 element head, reading or writing 32 tracks at a time. Conceptually, they are similar except that higher number has elements of a smaller size.

Figure 2-12 shows the allocation of read and write heads for forward and reverse wraps.

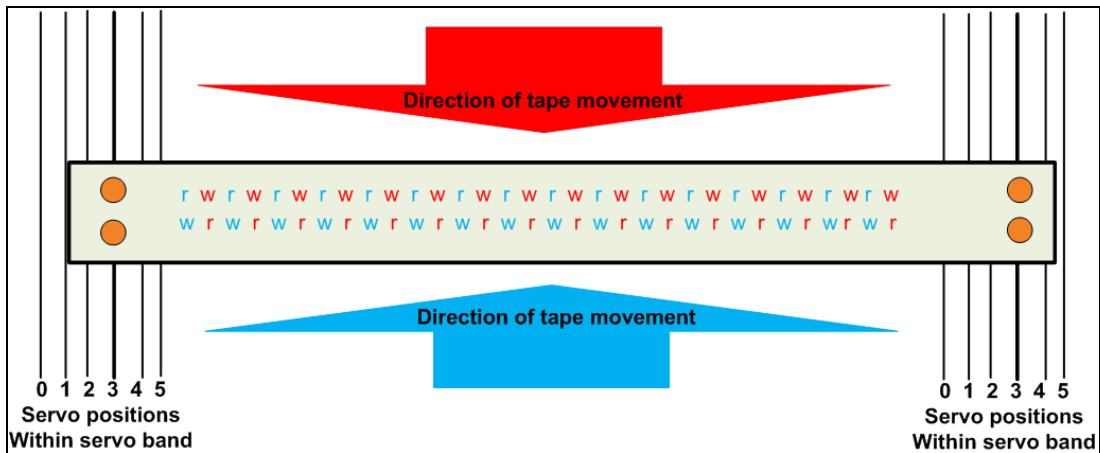

Figure 2-12 Conceptual allocation of read and write heads for forward and reverse wrap

Four servo elements are used: Two for each set of read/write elements. The head uses both servo tracks at each edge of the data band it writes.



For more information, an animated conceptual explanation can be found in the LTO Ultrium technology primers at this [Ultrium LTO web page](#).

The animation on the website provides a basic understanding of LTO technology.

### Data compression

As described in 2.1.3, “Data compression” on page 45, data compression implementation can differ from vendor to vendor. However, all vendors conform to the basic rules, and the data that is written by one vendor’s drive can be read by the drives of any other vendor.

The LTO consortium decided (as many other vendors also do in the open environment) to indicate characteristics of LTO products for both native data. When assuming a data compression ratio of 2:1. LTO-9, LTO-8, LTO-7, and LTO-6, a compression ratio of 2.5:1 was assumed.

For enterprise-related (mainframe) tape products, IBM and other manufacturers assume a compression ratio of 3:1, even though the IBM LTO and IBM 3592 use the same compression algorithm (SLDC). In any case, the real compression that is reached by the drive depends on the nature of the data. Any capacity sizing estimates should be based on the native value.

### Interfaces

The IBM LTO Ultrium drive is available with a choice of the following interfaces:

- ▶ Serial-Attached SCSI (SAS)
- ▶ Fibre Channel (FC)

When an IBM tape drive product is ordered, a drive interface is chosen. The interface cannot be changed after it is ordered. If a different interface is required, the complete drive assembly must be replaced.

Fibre Channel connections that use SANs have become standard technology. SAS connections are now the SCSI standard.

Historically, SCSI connections were used for attachment of tape drives and libraries to open systems. These previous SCSI interfaces were:

- ▶ SCSI single-ended
- ▶ SCSI differential (HVD)
- ▶ SCSI differential (LVD)

Table 2-4 shows the SCSI terms that are used to describe different host and device adapters and what they imply about bus width and speed.

*Table 2-4 SCSI terms and descriptions*

SCSI term	Bus width (bits)	Speed (MBps)	Maximum length	Maximum number of devices
SCSI	8	5	6 m	7
Fast SCSI	8	10	3 m	7
Fast Wide SCSI	16	20	3 m	15
Ultra (Wide) SCSI HVD	16	40	25 m	15
Ultra (Wide) SCSI 2 LVD	16	80	25 m/12 m	15
Ultra 160 SCSI LVD	16	160	12 m	15

### Serial-attached SCSI history

Serial-attached SCSI (SAS) was introduced because parallel SCSI has a maximum bandwidth of 320 MBps. There was a need for a faster interface to attach tapes and disks on a host bus adapter (HBA). In 1981, Adaptec designed a standardized bus that became ANSI approved. From that time forward, it was called Small Computer System Interface (SCSI).

SCSI attaches hard disks on an I/O bus. However, over the years, all types of devices were able to connect to the SCSI bus, such as tape drives, scanners, plotters, printers, and optical devices. As the types of devices changed, the bandwidth increased from 5 MBps up to 320 MBps, better known as Ultra320 SCSI.

In 2003, the SCSI bus speed was increased up to 640 MBps, but it never became a standard for the SCSI speed. One problem when the SCSI speed increases is a phenomenon that is called *clock skew*. Clock skew occurs in synchronous circuits in which the clock signal that is sent from the clock circuit arrives at different components at different times.

This action is typically the result of two causes. The first cause is material variability, in which a signal travels faster or slower than expected. The second cause is distance. The further a signal must travel, the longer it takes to arrive. Therefore, signals arrive at different points at different times. As the clock rate of a circuit increases, timing becomes more critical, and less variation can be tolerated while still functioning properly.

The industry was looking for a new, faster interface. A serial version of SCSI was designed and approved in 2002 by the SCSI Trade Association and by the International Committee for Information Technology Standards. In 2005, the first devices came on the market with a SAS interface. The first generation of SAS has a native speed of 3 Gbps, next generation of SAS has a speed of 6 Gbps, followed by a speed of 12 Gbps, and the current speed is 24 Gbps.

Figure 2-13 shows future generations on the SAS roadmap.

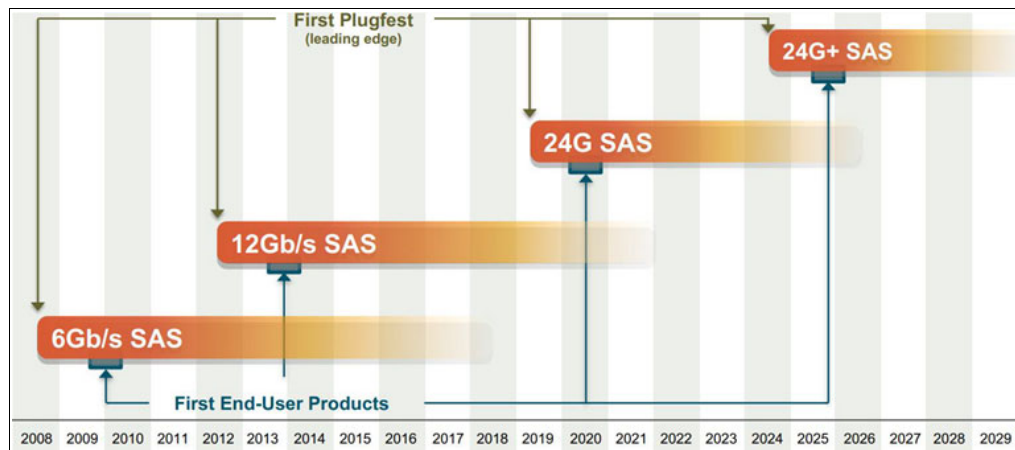

Figure 2-13 SAS roadmap<sup>2</sup>

<sup>2</sup> The roadmap is published by SCSI Trade Association, which is available at this web page: [https://www.scsita.org/library/serial\\_attached\\_scsi\\_technology\\_roadmap/](https://www.scsita.org/library/serial_attached_scsi_technology_roadmap/)

A benefit of SAS is that it can communicate with Advanced Technology Attachment (ATA) devices. SAS has a point-to-point architecture and a bandwidth of up to 2400 MBps (24 Gbps SAS interface). Because of its point-to-point architecture, more devices can be handled at the same time on the bus with a maximum of 128 targets. Another advantage of SAS is that the connection cables between the HBA and the devices are much thinner and more scalable.

SAS devices do not need external terminators. The I/O bus is electronically terminated. The total cable length from the device to the HBA is limited to 5.5 m (18.04 ft.).

Figure 2-14 shows an IBM 12 Gbps SAS adapter, part number 00AE912.

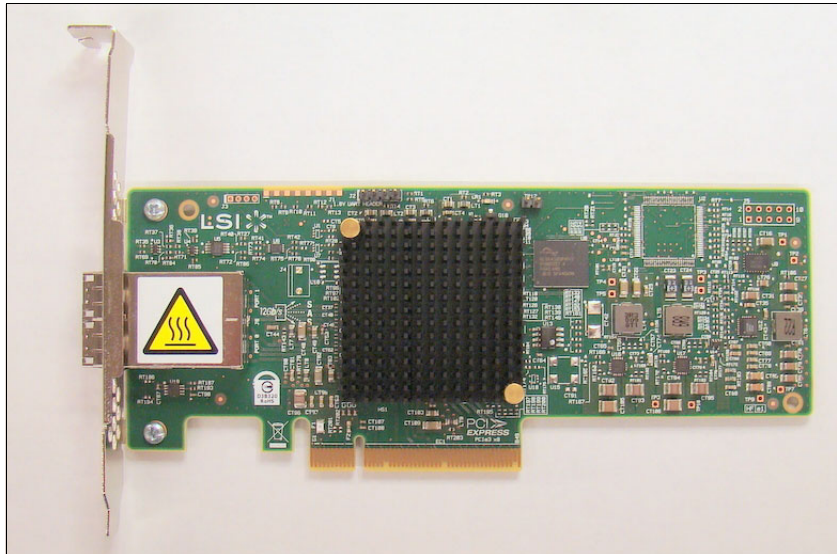

Figure 2-14 12 Gbps SAS HBA with IBM part number 00AE912

The Peripheral Component Interconnect® Express (PCIe), small form-factor IBM 6 Gb SAS HBA, is based on LSI's SAS2008 controller and can handle medium-capacity to large-capacity server storage applications by connecting an eight-lane PCIe adapter with one external x4 SFF-8088 connector and four internal SATA connectors.

The following connecting interfaces are used for connecting the external devices:

- ▶ Mini-SAS (SFF-8088), as shown in Figure 2-15

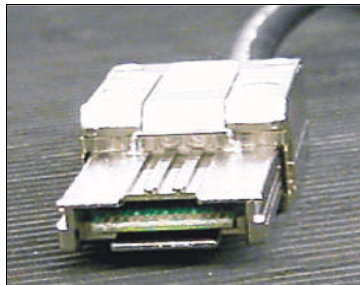

Figure 2-15 Mini-SAS (SFF-8088) connector

- ▶ SFF-8470, as shown in Figure 2-16



Figure 2-16 SAS (SFF-8470) connector

All IBM SAS tape drives have a *Mini-SAS* (SFF-8088) interface. SAS cables are available in several lengths with a maximum length of 5.5 m (18.04 ft.) and in any combination of the SFF-8470 and SFF-8088 connectors.

The requirements for SAS bus connections are different for the SCSI bus. Each tape drive is required to have a dedicated bus to the initiator, referred to as point-to-point connection. SAS architecture does not support multiple tape drives that are connected to a single host adapter port.

The following IBM LTO tape drives are available with the SAS interface:

- ▶ IBM LTO Ultrium 9 Full-High and Half-High tape drive
- ▶ IBM LTO Ultrium 8 Full-High and Half-High tape drive
- ▶ IBM LTO Ultrium 7 Full-High and Half-High tape drive
- ▶ IBM LTO Ultrium 6 Full-High and Half-High tape drive
- ▶ IBM LTO Ultrium 5 Full-High and Half-High tape drive

### ***Fibre Channel***

One of the biggest challenges with SCSI tape technologies is the limited ability to share storage devices between systems. Fibre Channel (FC) storage area networks (SANs) enable greater connectivity of servers to storage devices, including tape drives. It becomes possible to share devices easily between systems by Fibre Channel attaching them to SAN switches, which allows any servers that are attached to that SAN fabric and have the correct SAN zoning to access to the devices.

The latest FC devices are 8 Gbps capable, where older devices attach at 4 Gbps, 2 Gbps, or 1 Gbps. FC devices auto-negotiate speeds with switches to find the highest compatible speed.

The following IBM LTO tape drives are available with the FC interface:

- ▶ IBM LTO Ultrium 9 Full-High and Half-High tape drive
- ▶ IBM LTO Ultrium 8 Full-High and Half-High tape drive
- ▶ IBM LTO Ultrium 7 Full-High and Half-High tape drive
- ▶ IBM LTO Ultrium 6 Full-High and Half-High tape drive
- ▶ IBM LTO Ultrium 5 Full-High and Half-High tape drive

The maximum distances that a drive or library supports on a Fibre Channel link are determined by the link speed and the device to which the drive or library is attached.

If the library attaches to a server HBA, the distances that are supported by that HBA should be referred to. If the library attaches to a switch, the distances that are listed in Table 2-5 are supported.

Table 2-5 50-micron cabling distances

Data rate/Link speed	M5 (OM2) cable	M5E (OM3) cable	M5F (OM4) cable
8 Gbps	50 m (164 ft.)	150 m (492 ft.)	190 m (623 ft.)
4 Gbps	150 m (492 ft.)	380 m (1247 ft.)	400 m (1312 ft.)
2 Gbps	300 m (984 ft.)	Not specified	Not specified
1 Gbps	500 m (1640 ft.)	Not specified	Not specified

### FC connector types

This section describes the following FC connector types:

- ▶ FC SC
- ▶ FC LC

#### FC SC

The duplex Subscriber Connector (SC) connector (as shown in Figure 2-17) is a low-loss, push/pull fitting connector. Each of the two fibers has its own part of the connector. The connector is keyed to ensure correct polarization (transmit to receive and receive to transmit) when connected. Most 1 Gbps SAN devices, including IBM Ultrium 1 FC drives, use SC connectors.

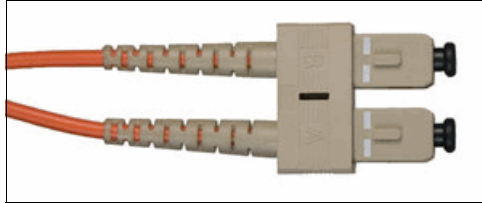

Figure 2-17 SC connector

#### FC LC

Connectors that plug into SFF or small form-factor pluggable (SFP) devices are called *LC connectors*, as shown in Figure 2-18 on page 60. Also, a duplex version is used so that the transmit and receive are connected in one step. The primary advantage of these LC connectors compared to SC connectors is that the LC connectors use a smaller form factor. Therefore, manufacturers of Fibre Channel components can provide more connections in the same amount of space.

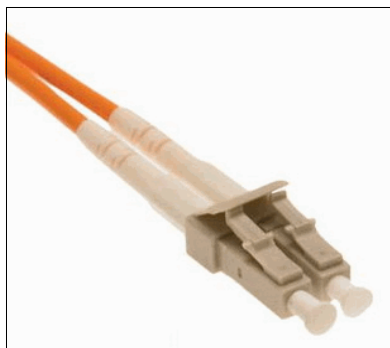

Figure 2-18 LC connector

Most 2 Gbps or higher SAN devices, including the IBM Ultrium 9, 8, 7, 6, 5, 4, 3, and 2 FC drives, use LC connectors.

### Available interfaces for IBM Ultrium 5 and 6 tape drives

IBM Ultrium 5 and 6 drives offer the following connection types on Full-High and Half-High models:

- ▶ 6 Gbps dual port SAS
- ▶ 8 Gbps native FC
- ▶ USB 3.0

With the USB option, the drive has a single SAS port and a single USB port host interface. The USB host interface supports USB 3.0 connectivity and can negotiate a transfer rate. It also supports USB 2.0 connectivity at the slower transfer rates. The USB interface auto-negotiates speed.

There are no configurable topologies, thus no feature switches associated with USB. The tape drive with SAS/USB ports requires a device driver for USB 3.0 operation.

The SAS speed is auto-negotiated to the highest available speed and cannot be changed. IBM tape libraries TS2900, TS3100, and TS3200 support IBM Ultrium 5 and 6 tape drive, 6 Gbps SAS attachment.

The FC drive can work in fabric or FC-AL mode. According to the SNIA standard, the drive first attempts to connect as FC\_AL. If this approach fails, the drive tries to log in as a fabric device. It automatically senses the speed and connects with 1 Gbps, 2 Gbps, 4 Gbps, or 8 Gbps.

With the IBM tape libraries TS3100, TS3200, TS3310, TS3500, TS4300 (IBM Ultrium 6 and higher), and TS4500, the FC port speed and the FC protocol mode can be set.

### Available interfaces for IBM Ultrium 7 and 8 tape drives

IBM Ultrium 7 and 8 drives offer the following connection types on Full-High and Half-High models:

- ▶ 6 Gbps dual port SAS
- ▶ 8 Gbps native FC

The SAS speed is auto-negotiated to the highest available speed and cannot be changed. IBM tape libraries TS2900, TS3100, TS3200, and TS4300 support IBM Ultrium 7 and 8 tape drive, 6 Gbps SAS attachment.

The FC drive can work in fabric or FC-AL mode. According to the SNIA standard, the drive first attempts to connect as FC\_AL. If this approach fails, the drive tries to log in as a fabric device. It automatically senses the speed and connects with 1 Gbps, 2 Gbps, 4 Gbps, or 8 Gbps.

With the IBM tape libraries TS3100, TS3200, TS3310, TS3500, TS4300, and TS4500, the FC port speed and the FC protocol mode can be set.

### **Available interfaces for IBM Ultrium 9 tape drive**

IBM Ultrium 9 drives offer the following connection types on Full-High and Half-High models:

- ▶ 12 Gbps dual port SAS
- ▶ 8 Gbps native FC

The SAS speed is auto-negotiated to the highest available speed and cannot be changed. IBM tape libraries TS2900, TS3100, TS3200, TS4300, and TS4500 support IBM Ultrium 9 tape drive, 12 Gbps SAS attachment.

The FC drive can work in fabric or FC-AL mode. According to the SNIA standard, the drive first attempts to connect as FC\_AL. If this approach fails, the drive attempts to log in as a fabric device. It automatically senses the speed and connects with 1 Gbps, 2 Gbps, 4 Gbps, or 8 Gbps.

With the IBM tape libraries TS4300 and TS4500 support Fibre Channel attachment. The FC port speed and the FC protocol mode can be set.

IBM Ultrium drives can be connected to many different types of servers. For more information about the server interface cards or host bus adapters (HBAs) that are supported by the IBM Ultrium drives, see this [IBM Support web page](#).

**Important:** When Fibre tape drives are connected to a Fibre HBA on the host server, ensure that the Fibre Channel Tape Support option is enabled on the Fibre HBA so that proper class 3 error recovery is performed on the Fibre Channel. For more information about how to set this option, see the HBA manufacturer.

## **2.2 Tape encryption overview**

Data is one of the most highly valued resources in a competitive business environment. Protecting this data, controlling access to it, and verifying its authenticity while maintaining its availability are priorities in this security-conscious world. Tape encryption is a process that answers many of these needs.

Beginning with Ultrium 4 and TS1120 cartridge drives, the encryption of data on tape became possible.

The IBM TS1160, TS1155, TS1150, TS1140, TS1130, and TS1120 Ultrium drives (including the IBM Ultrium 9, 8, 7, 6, and 5 tape drives) can encrypt data as it is written to tape.

The TS1160, TS1155, TS1150, TS1140, TS1130, and TS1120 support multiple types of IBM Enterprise 3592 tape cartridge, including WORM cartridges.

The Ultrium 5 drives support Ultrium 5 media for encryption, and the Ultrium 6 drives support Ultrium 5 or Ultrium 6 data cartridges for data encryption, including WORM cartridges. The Ultrium 7 drives support Ultrium 7 or Ultrium 6 data cartridges for data encryption, including WORM cartridges.

The Ultrium 8 drives support Ultrium 8 or Ultrium 7 data cartridges for data encryption, including WORM cartridges. The Ultrium 9 drives support Ultrium 9 or Ultrium 8 data cartridges for data encryption, including WORM cartridges. Encryption is performed at full line speed in the tape drive after compression.

**Note:** Compression before encryption is more efficient, as compressing encrypted data can affect the compression ratio. It is recommended not to mix software encryption with hardware compression or hardware encryption with software compression.

**Important:** The encryption process is less than 1% of the performance impact on the read/write throughput.

Encryption for the TS1160, TS1155, TS1150, and TS1140 tape drives is available at no charge.

The TS1160, TS1150, and TS1140 tape drives can be installed in the TS3500 tape libraries. The TS1160, TS1155, TS1150, and TS1140 drives can be installed in the TS4500 library.

For the Ultrium 9, Ultrium 8, Ultrium 7, Ultrium 6, and Ultrium 5 tape drives, the application-managed encryption method is available at no charge. The stand-alone tape drives include the application-managed encryption offering.

However, for those drives that are installed in libraries, system-managed and library-managed encryption requires a billable feature code (FC5901 for TS2900, FC1604 for TS3500 and TS4500, and FC5900 for all other libraries) to be installed to support transparent LTO encryption.

IBM Security Guardium Key Lifecycle Manager, formerly known as *IBM Security Key Lifecycle Manager*, also is required in this case.

**Note:** The releases before Version 4.1.0 were IBM Security Key Lifecycle Manager; since Version 4.1.0, the name that is used is IBM Security Guardium Key Lifecycle Manager.



Supported tape libraries for different drives are shown in Table 2-6.

Table 2-6 Drive encryption support

Drive	TS2900	TS3100	TS3200	TS3310	TS4300	TS3500	TS4500
LTO5	Yes	Yes	Yes	Yes	N/A	Yes	Yes
LTO6	Yes	Yes	Yes	Yes	Yes	Yes	Yes
LTO7	Yes	Yes	Yes	Yes	Yes	Yes	Yes
LTO8	Yes	Yes	Yes	Yes	Yes	Yes	Yes
LTO9	Yes	N/A	N/A	N/A	Yes	N/A	Yes
TS1140	N/A	N/A	N/A	N/A	N/A	Yes	Yes
TS1150	N/A	N/A	N/A	N/A	N/A	Yes	Yes
TS1155	N/A	N/A	N/A	N/A	N/A	Yes	Yes
TS1160	N/A	N/A	N/A	N/A	N/A	Yes	Yes

Encryption adds significant strength to the security of the stored data without the processing overhead and performance degradation that is associated with encryption that is performed on the server or the expense of a dedicated appliance.

Encryption keys are used to encrypt data when it is written and to decrypt the data when it is read from a data cartridge. IBM Security Guardium Key Lifecycle Manager assists the encryption-capable tape drives in generating, protecting, storing, and maintaining encryption keys.

For more information about and examples of tape encryption, see *IBM System Storage Tape Encryption Solutions*, SG24-7320.

## 2.2.1 IBM Security Guardium Key Lifecycle Manager

IBM Security Guardium Key Lifecycle Manager is the IBM strategic platform for storage and delivery of encryption keys to encrypting storage end-point devices.

Security Guardium Key Lifecycle Manager provides a simple solution to the complex problem of key management. Traditionally, the more encryption you deploy, the more keys you must manage. These keys have their own lifecycles, which are separate from the data that they are protecting. These lifecycles must be managed, from initialization and activation through expiration and destruction.

Security Guardium Key Lifecycle Manager can help you better manage the encryption key lifecycle by allowing you to simplify, centralize, and automate your organization's key-management processes and reduce operational costs.

Security Guardium Key Lifecycle Manager serves keys at the time of use to allow for centralized storage of key material in a secure location. This unique approach supports multiple protocols for serving symmetric and asymmetric keys. Users also can centrally create, import, distribute, back up, archive, and manage the lifecycle of those keys by using a customizable graphical user interface (GUI).

Security Guardium Key Lifecycle Manager provides an easy-to-use, web-based GUI that helps simplify key configuration and management tasks. By using this GUI, administrators can easily create keystores, assign keys, and manage the lifecycle of both from a centralized console.

For more information about the Security Guardium Key Lifecycle Manager, see this [IBM Documentation web page](#).

For more information about this offering, see the [IBM Security Guardium Key Lifecycle Manager website](#).

**Important:** Because of the critical nature of keys in the keystore, ensure that the keystore is backed up regularly. This way, it can be recovered as needed and can read the data cartridges that were encrypted by using the certificate with that drive or library. Backups should not be encrypted.

## 2.2.2 Encryption methods

The encryption methods for the TS1160, TS1155, TS1150, TS1140, TS1130, and TS1120, and the Ultrium 9, 8, 7, 6, and 5 tape drives differ slightly. These differences are described next.

The following sections also contain a brief description of encryption methods. In these sections, we use the term *Key Manager (KM)* to refer to Security Guardium Key Lifecycle Manager and any other key managers.

### Symmetric key encryption

Encryption of data by using a symmetric key and algorithm is sometimes called *private key encryption* or *secret key*, which is not to be confused with the private key in an asymmetric key system. In a symmetric key system, the cipher key that is used for encrypting data is the same as the cipher key that is used for decryption.

The encryption and decryption ciphers can be related by a simple transformation on the key, or the encryption key and the decryption key can be identical. In the IBM Tape Encryption solution Security Guardium Key Lifecycle Manager, the same encryption key is used for encryption and decryption of the data. This key is protected by an asymmetric key algorithm and is never available in clear text.

Symmetric key encryption is several orders of magnitude faster than asymmetric key encryption. Secret key algorithms can support encryption 1 bit at a time or by specified blocks of bits. The AES standard supports 128-bit block sizes and key sizes of 128, 192, and 256. The IBM Tape Encryption solution uses the AES standard with a 256-bit key. Other well-known symmetric key examples include Twofish, Blowfish, Serpent, Cast5, DES, TDES, and IDEA.

### Asymmetric key encryption

Another important method of encryption that is widely used today is referred to as *public/private key encryption* or *asymmetric encryption*. When this encryption methodology is used, ciphers are generated in pairs. The first key is used to encrypt the data, and the second key is used to decrypt the data.

This technique was pioneered in the 1970s and represented a significant breakthrough in cryptography. The RSA algorithm is the most widely used public key technique. The power of this approach is a public key, which is used to encrypt the data. This public key can be widely shared, and anyone who wants to send secure data to an organization can use its public key. The receiving organization then uses its private key to decrypt the data, which makes public/private key encryption useful for sharing information between organizations.

This methodology is widely used on the Internet today to secure transactions, including Secure Sockets Layer (SSL).

Asymmetric key encryption is much slower and more computationally intensive than symmetric key encryption. The advantage of asymmetric key encryption is the ability to share secret data without sharing the encryption key.

## **Managing encryption**

There are three different methods of encryption management available. These methods differ in where the key manager application is located. The operating environment determines which is best, with the result that key management and the encryption policy engine can be in any one of the environmental layers that are described next.

### ***Application-managed tape encryption***

The application-managed tape encryption method is best in operating environments that run an application that already can generate and manage encryption policies and keys, such as the IBM Security Guardium Key Lifecycle Manager Policies that specify when encryption is to be used are defined through the application interface. The policies and keys pass through the data path between the application layer and the encryption-capable tape drives.

Encryption is the result of interaction between the application and the encryption-enabled tape drive and is transparent to the system and library layers. Because the application manages the encryption keys, volumes that are written and encrypted with the application method can be read only by using the application-managed tape encryption method.

Application-managed encryption is provided at no cost for those IBM tape drives that support encryption.

### ***System-managed tape encryption***

The system-managed tape encryption method can be used for open systems operating environments where there is no application that is capable of key management. Encryption policies that specify when to use encryption are set up through each instance of the IBM device driver.

Key generation and management are performed by the key manager, a Java application that is running on the host or externally on another host. Policy controls and keys pass through the data path between the system layer and the TS1160, TS1155, TS1150, TS1140, TS1130, and TS1120, and Ultrium 9, 8, 7, 6, and 5 tape drives that are installed in the libraries.

Encryption is transparent to the applications. System-managed tape encryption and library-managed tape encryption are transparent to one another. A tape that is encrypted by using system-managed encryption can be decrypted by using library-managed encryption. The reverse is true, if they both have access to the same key manager keystore.

IBM Security Guardium Key Lifecycle Manager is required for enabling system-managed tape encryption for Ultrium 9, 8, 7, 6, and 5.

### ***Library-managed tape encryption***

The library-managed tape encryption method is supported on the following IBM tape libraries:

- ▶ TS2900 tape autoloader with Ultrium 9, 8, 7, 6, and 5 Half-High tape drives
- ▶ TS3100 tape library with the following drives:
  - Ultrium 8 Full-High and Half-High tape drives
  - Ultrium 7 Full-High and Half-High tape drives
  - Ultrium 6 Full-High and Half-High tape drives
  - Ultrium 5 Full-High and Half-High tape drives
- ▶ TS3200 tape library with Ultrium 7 Full-High and Half-High tape drives
- Ultrium 6 Full-High and Half-High tape drives
- Ultrium 5 Full-High and Half-High tape drives
- ▶ TS3310 tape library with Ultrium 8, 7, 6, and 5 Full-High tape drives
- ▶ TS4300 tape library with Ultrium 9, 8, 7, and 6 Full-High and Half-High tape drives.
- ▶ TS3500 tape library with the TS1160, TS1150, TS1140, TS1130, and TS1120, and Ultrium 8, 7, 6, and 5 tape drives
- ▶ TS4500 tape library with TS1160, TS1155, TS1150, and TS1140, and Ultrium 9, 8, 7, 6, and 5 tape drives

Key generation and management are performed by the key manager, a Java application that is running on a library-attached host. The keys pass through the library-to-drive interface. Therefore, encryption is transparent to the applications. When it is used with specific applications, such as IBM Security Guardium Key Lifecycle Manager, library-managed encryption includes support for an internal label option.

When the internal label option is configured, the TS1160, TS1155, TS1150, TS1140, TS1130, and TS1120, and Ultrium 9, 8, 7, 6, and 5 tape drives automatically derive the encryption policy and key information from the metadata that is written on the tape volume by the application.

IBM Security Guardium Key Lifecycle Manager is required for enabling library-managed tape encryption for Ultrium 9, 8, 7, 6, and 5 tape drives.

System-managed tape encryption and library-managed tape encryption are transparent to one another. A tape that is encrypted by using system-managed encryption can be decrypted by using library-managed encryption. The reverse is true, if they both have access to the same key manager keystore and both use IBM AIX and the IBM device driver. Otherwise, this capability might not be available.

**Important:** IBM Security Guardium Key Lifecycle Manager is required for enabling system-managed and library-managed tape encryption for Ultrium 9, 8, 7, 6, and 5 tape drives.

### **2.2.3 LTO Ultrium tape encryption**

The LTO Ultrium tape encryption differs from the 3592 drive encryption. Unlike the TS1160, TS1155, TS1150, TS1140, TS1130, and TS1120 tape drives, the Ultrium 9, 8, 7, 6, and 5 tape drives cannot store a wrapped form of the symmetric encryption key on the tape cartridge. The symmetric encryption key is stored in the keystore that is attached to the key manager.

An associated *key identifier* or *alias* maps to the data key in the keystore. This alias is stored with each block of data on the tape. AES 256-bit encryption is used, as with the TS1160, TS1155, TS1150, TS1140, TS1130, and TS1120 tape drives, to encrypt and decrypt the data on the data cartridge. The IBM key manager for tape products is Security Guardium Key Lifecycle Manager.

## 2.3 IBM LTO Ultrium highlights

This section provides an overview of the features of IBM Ultrium 9, 8, 7, 6, 5, 4, and 3 tape drives. It also includes information about drive and cartridge compatibility, cartridge capacity, and drive performance. An overview of IBM libraries and the multipath architecture also is provided.

### 2.3.1 IBM LTO Ultrium compatibility

The following rules describe the compatibility among the various LTO cartridge generations:

- ▶ Data cartridges one generation and earlier are read/write compatible
- ▶ From Ultrium 9, Data cartridges two generations and earlier are not supported
- ▶ Up to Ultrium 7, Data cartridges two generations and earlier are read only supported
- ▶ Data cartridges three generations and earlier are never supported

Ultrium 9 drives can read and write only on Ultrium 9 and Ultrium 8 cartridges, it cannot read Ultrium 7 cartridges. Ultrium 8 drives also can read and write on Ultrium 7 cartridges at 9 TB capacity. If this media was formatted as a M8 format cartridge, see “M8 format” on page 68.

Ultrium 7 drives can read and write Ultrium 6 cartridges, and read Ultrium 5 cartridges, and thus can interchange data with Ultrium 6 and Ultrium 5 tape drives. However, the Ultrium 7 drive allows only an Ultrium 6 cartridge to be written at the LTO Generation 6 operating point (2.5 TB). More specifically, the Ultrium 7 drive does not allow an Ultrium 6 cartridge (2.500 TB) to be reformatted to the Ultrium 7 format (6 TB). This concept is generally true when a data cartridge is used in a higher generation LTO Ultrium tape drive.

Table 2-7 shows the read/write compatibility among the last 5 generations of data cartridges.

Table 2-7 Ultrium data cartridge compatibility

IBM Ultrium tape drive	IBM LTO Ultrium data cartridge generation						
	18 TB (Ultrium 9)	12 TB (Ultrium 8)	9 TB M8 Format (Ultrium 7)	6 TB L7 Format (Ultrium 7)	2.5 TB (Ultrium 6)	1.5 TB (Ultrium 5)	800 GB (Ultrium 4)
Ultrium 9	Read/write	Read/write	N/A	N/A	N/A	N/A	N/A
Ultrium 8	N/A	Read/write	Read/write	Read/write	N/A	N/A	N/A
Ultrium 7	N/A	N/A	N/A	Read/write	Read/write	Read only	N/A
Ultrium 6	N/A	N/A	N/A	N/A	Read/write	Read/write	Read only
Ultrium 5	N/A	N/A	N/A	N/A	N/A	Read/write	Read/write
Ultrium 4	N/A	N/A	N/A	N/A	N/A	N/A	Read/write

### ***M8 format***

The LTO Program introduced a new capability with Ultrium 8 drives. The Ultrium 8 drive can write 9 TB on a brand new Ultrium 7 cartridge instead of 6 TB as specified by the Ultrium 7 format. Such a cartridge is called an Ultrium 7 initialized Ultrium 8 Type M cartridge. The TPC's have agreed to designate these Ultrium 8 Type M cartridges by using an automation barcode label ending with the last two characters *M8*.

A normal Ultrium 8 cartridges is referred to as Ultrium 8 Type A. It has a capacity of 12 TB, and is indicated with an automation barcode label ending in *L8*. A normal 6 TB Ultrium 7 cartridge is indicated with an automation barcode label ending in *L7*.

Only new, unused Ultrium 7 cartridges can be initialized as Ultrium 8 Type M. After a cartridge is initialized as Type M, it cannot be changed back to a 6TB Ultrium 7 cartridge. Also, an Ultrium 7 initialized Ultrium 8 Type M cartridge can only be written and read in an Ultrium 8 drive. Ultrium 7 drives are not capable of reading Ultrium 8 Type M cartridges. Ultrium 7 Worm cartridges cannot be formatted as media type M8.

Media can be purchased as pre-initialized Ultrium Type M media or as un-initialized Ultrium 7 media. Un-initialized Ultrium 7 media can be initialized as LTO Type M media by applying an M8 barcode label and writing data to the media in a tape library that supports un-initialized LTO Type M.

Previously used Ultrium 7 media cannot be converted to Ultrium 8 Type M media. This used Ultrium 7 media will remain as such for the life of the media. Similarly, previously used Ultrium 8 Type M media will remain as such for the life of the media.

Only compatible Ultrium 8 tape libraries will initialize Ultrium 7 brand new cartridges as Ultrium 8 Type M media, if the barcode label M8 has been applied to the cartridge. Ultimately, it is the user's responsibility to ensure tape library compatibility and label cartridges correctly.

If an Ultrium 8 Type M media is loaded into an LTO-7 tape drive, the drive will post an error message indicating that the cartridge format is incompatible and will not thread the media.

**Restriction:** The TS3500 only supports the use of pre-initialized M8 media.

### ***IBM Media identification***

The various generations of data cartridges can be recognized quickly by the case color or media identifier at the right side of the bar code label. Table 2-8 shows the different case colors and media identifiers for the different LTO Ultrium generations.

*Table 2-8 Cartridge color and media identifier*

<b>LTO Ultrium data cartridge</b>	<b>Case color</b>	<b>Media identifier</b>
LTO Ultrium 3	Slate blue	L3
LTO Ultrium 4	Green	L4
LTO Ultrium 5	Burgundy	L5
LTO Ultrium 6	Black	L6
LTO Ultrium 7	Purple	L7
LTO Ultrium 8	Burgundy	L8
LTO Ultrium 9	Green	L9
LTO Ultrium 3 WORM	Slate blue and silvery gray	LT

LTO Ultrium data cartridge	Case color	Media identifier
LTO Ultrium 4 WORM	Green and silvery gray	LU
LTO Ultrium 5 WORM	Burgundy and silvery gray	LV
LTO Ultrium 6 WORM	Black and silvery gray	LW
LTO Ultrium 7 WORM	Purple and silvery gray	LX
LTO Ultrium 8 WORM	Burgundy and silvery gray	LY
LTO Ultrium 9 WORM	Green and silvery gray	LZ

### 2.3.2 LTO performance

IBM LTO drives provide high performance and continue to improve with each new generation of products. Applications that are highly dependent on tape-processing speed can benefit from the significant performance that is provided by the LTO Ultrium tape drives.

IBM LTO Ultrium drives provide high-speed tape operations and relief to users who have difficulty completing tape activities in the time available. For those applications with limited system backup windows or have large amounts of disk data to back up, LTO Ultrium tape drives are ideal.

By using the built-in data-compression capability of the LTO Ultrium drive, far greater data rates than the decompressed data rate can potentially be achieved. However, the actual throughput is a function of many components, such as the host system processor, disk data rate, block size, data compression ratio, SCSI bus capabilities, and system or application software. Installing multiple tape drives in general (or more than two in the case of IBM LTO) on a single SCSI bus can adversely affect data transfer rates.

#### IBM LTO Ultrium 5 tape drive

The IBM LTO Ultrium 5 tape drive includes the following performance characteristics:

- ▶ 140 MBps native sustained data transfer rate
- ▶ Sustained data transfer rate at a 2:1 compression ratio:
  - For SAS, 280 MBps
  - For USB, 280 MBps
  - For FC, 280 MBps
- ▶ 12 s nominal load-to-ready time
- ▶ 17 s nominal unload time
- ▶ Average search time to first byte of data:
  - 49 s for a Full-High drive
  - 72 s for a Half-High drive
- ▶ Average rewind time:
  - 60 s for a Full-High drive
  - 75 s for a Half-High drive
- ▶ Rewind speed:
  - 10 mps for a Full-High drive
  - 6.4 mps for a Half-High drive

- ▶ Data buffer size:
  - 512 MB for a Full-High drive
  - 256 MB for a Half-High drive

### **IBM LTO Ultrium 6 tape drive**

The IBM LTO Ultrium 6 tape drive has the following performance characteristics:

- ▶ 160 MBps native sustained data transfer rate
- ▶ Sustained data transfer rate at a 2.5:1 compression ratio:
  - For SAS, 400 MBps
  - For USB, 400 MBps
  - For FC, 400 MBps
- ▶ 12 s nominal load-to-ready time
- ▶ 17 s nominal unload time
- ▶ Average search time to first byte of data:
  - 49 s for a Full-High drive
  - 60 s for a Half-High drive
- ▶ Average rewind time:
  - 42 s for a Full-High drive
  - 62 s for a Half-High drive
- ▶ Rewind speed:
  - 10 mps for a Full-High drive
  - 9 mps for a Half-High drive
- ▶ Data buffer size:
  - 1024 MB for a Full-High drive
  - 512 MB for a Half-High drive

### **IBM LTO Ultrium 7 tape drive**

The IBM LTO Ultrium 7 tape drive has the following performance characteristics:

- ▶ 300 MBps native sustained data transfer rate
- ▶ Sustained data transfer rate at a 2.5:1 compression ratio:
  - For SAS, 500 MBps
  - For FC, 700 MBps
- ▶ 15 s nominal load-to-ready time
- ▶ 20 s nominal unload time
- ▶ Average search time to first byte of data:
  - 56 s for a Full-High drive
  - 60 s for a Half-High drive
- ▶ Average rewind time:
  - 59 s for a Full-High drive
  - 62 s for a Half-High drive
- ▶ Rewind speed:



- 10 mps for a Full-High drive
- 9 mps for a Half-High drive
- ▶ Data buffer size:
  - 1024 MB for both Full-High and Half-High drives

### **IBM LTO Ultrium 8 tape drive**

The IBM LTO Ultrium 8 tape drive has the following performance characteristics:

- ▶ For a Full-High drive 360 MBps native sustained data transfer rate
- ▶ For a Half-High drive 300 MBps native sustained data transfer rate
- ▶ Sustained data transfer rate at a 2.5:1 compression ratio:
  - For SAS, 500 MBps
  - For FC, 700 MBps
- ▶ 15 s nominal load-to-ready time
- ▶ 24 s nominal unload time
- ▶ Average search time to first byte of data:
  - 59 s for a Full-High drive
  - 60 s for a Half-High drive
- ▶ Average rewind time:
  - 59 s for a Full-High drive
  - 62 s for a Half-High drive
- ▶ Rewind speed:
  - 10 mps for a Full-High drive
  - 9 mps for a Half-High drive
- ▶ Data buffer size:
  - 1024 MB for both Full-High and Half-High drives

### **IBM LTO Ultrium 9 tape drive**

The IBM LTO Ultrium 9 tape drive has the following performance characteristics:

- ▶ For a Full-High drive 400 MBps native sustained data transfer rate
- ▶ For a Half-High drive 300 MBps native sustained data transfer rate
- ▶ Sustained data transfer rate at a 2.5:1 compression ratio:
  - For SAS, 900 MBps
  - For FC, 700 MBps
- ▶ 17 s nominal load-to-ready time
- ▶ 24 s nominal unload time
- ▶ Average search time to first byte of data:
  - 45 s for a Full-High drive
  - 60 s for a Half-High drive
- ▶ Average rewind time:
  - 52 s for a Full-High drive
  - 62 s for a Half-High drive

- ▶ Rewind speed:
  - 10 mps for a Full-High drive
  - 9 mps for a Half-High drive
- ▶ Data buffer size:
  - 1024 MB for both Full-High and Half-High drives

### 2.3.3 Reliability

The IBM LTO Ultrium tape format differs from earlier non-Ultrium IBM products. The reliability and availability features of the Ultrium technology are described in this section.

#### Data integrity

The drive performs a read after write for verification. Incorrectly written data, such as the result of a tape defect, is automatically rewritten by the drive in a new location. Data that is rewritten as the result of media defects is not counted against the drive error performance.

The drive never records incorrect data to the tape media without posting an error condition.

#### Power loss

No recorded data is lost as a result of normal or abnormal power loss while the drive is reading or writing data. If power is lost while writing data, only the data block that is being written might be in error. Any previously written data is not destroyed.

#### Error correction

Data integrity features include two levels of error correction that can provide recovery from longitudinal media scratches.

#### Integrated head cleaner

The head of the drive must be kept clean to prevent errors that are caused by contamination. During the load process, a brush that is integrated into the drive mechanism cleans the head before it is used with the tape. This brush keeps the head and media free of debris on a continuing basis and requires fewer drive-cleaning operations.

#### Surface Control Guiding Mechanism

The Surface Control Guiding Mechanism, which is patented by IBM, guides the tape along the tape path by using the surface of the tape rather than the edges to control tape motion. By using grooved rollers (as shown in Figure 2-19), an air cushion builds between the tape and the rollers that keep the tape in the correct position.

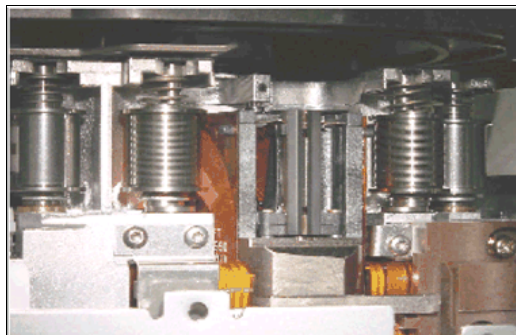

Figure 2-19 Surface Control Guiding Mechanism

On LTO Ultrium 6 and Ultrium 5, flangeless rollers are installed on all four rollers for Full-High tape drives to allow the tape to float naturally. Ultrium 6 Half-High drive rollers are semi-flangeless; only two of the rollers are flanged. On the Ultrium 7 drives and later generations, all four rollers are flangeless, on both Half-High and Full-High drives.

This flangeless roller feature helps to prevent tape damage (especially to the edges of the tape) and debris build-up on the roller that can accumulate in the head area, which minimizes the chance of physical damage to the tape media.

### **Flat lap head**

The flat lap head (as shown in Figure 2-20) improves contact between the read and write recording elements and the tape, which increases the quality of the recording and readback of data.

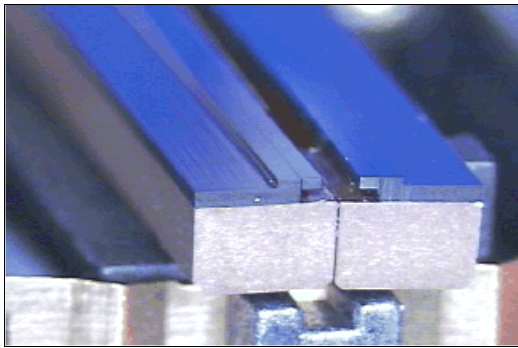

*Figure 2-20 Flat lap head*

The Surface Control Guiding Mechanism and the flat lap head help minimize debris that is generated as the tape moves through its path, which resulting in increased reliability of reading and writing data. This feature also potentially increases the life expectancy of the media by not using the edges of the tape to guide it over the read/write head, which historically was a major source of debris on the tape path.

### **Statistical Analysis and Reporting System**

Statistical Analysis and Reporting System (SARS) is another IBM exclusive feature. Only IBM LTO drives provide this level of preventive diagnostic reporting. The Ultrium drive uses this reporting system to help isolate failures between media and hardware.

SARS uses the cartridge performance history that is saved in the cartridge memory module and the drive performance history that is kept in the drive flash EEPROM to determine the most likely cause of failure. It can then cause the drive to request a cleaner tape, to mark the media as degraded, and to indicate that the hardware has degraded. SARS reports the results of its analysis in the form of a Tape Alert, if necessary.

## 2.4 IBM LTO Ultrium 9 tape drives

Ultrium 9 is the latest LTO generation, which was released in September 2021. The IBM Ultrium 9 offerings represent significant improvements in capacity, performance, and reliability over the previous generation (IBM Ultrium 8) while still protecting investment in the previous technology.

The Ultrium 9 tape drive is a high-performance, high-capacity tape drive. The drive records data by using a linear serpentine recording format on half-inch tape that is housed within a cartridge. The data tracks are located by using preformatted servo tracks.

The Ultrium 9 tape drive provides the following improvements over the older Ultrium 8 models:

- ▶ Increases the native transfer speed to 400 MBps compared with 360 MBps for the Ultrium 8 tape drive
- ▶ Compressed speed of 700 MBps for Fibre Channel (900 MBps for SAS interface)
- ▶ More than doubles the potential capacity of a cartridge in Ultrium 8 format

### Ultrium 9 tape drive features at a glance

The LTO Generation 9 tape drive range includes the following characteristics:

- ▶ Native data transfer rate of up to 400 MBps (FH) and 300 MBps (HH)
- ▶ Compressed data transfer rate of up to 700 MBps FC / 900 MBps SAS
- ▶ LTO Ultrium 9 data and WORM tape cartridge native physical capacity of up to 18 TB
- ▶ 8 Gbps Fibre Channel attachment option
- ▶ 12 Gbps SAS dual port attachment option
- ▶ 1024 MB internal data buffer
- ▶ Application-managed encryption support
- ▶ System-managed and library-managed encryption support for non stand-alone drives
- ▶ 32 KB cartridge memory with Ultrium 9 media
- ▶ Introducing Open Recommended Access Order (oRAO)
- ▶ Enhancement to IBM Spectrum Archive Single Drive Edition, Library Edition, and Enterprise Edition support
- ▶ The LTO Ultrium 9 tape media provides partitioning support, which with IBM Spectrum Archive, provides users with file-level access to tape data
- ▶ Management solutions, such as IBM Spectrum Protect or third-party storage management software can extend the power of IBM LTO 9 tape drive

### Compatibility

In addition to reading and writing to LTO Ultrium 9 tape cartridges, the Ultrium 9 tape drives can read and write to LTO Ultrium 8 cartridges. They cannot read Ultrium 1, 2, 3, 4, 5, 6 and 7 cartridges.

The drive also writes to tapes that can be read by other licensed LTO Ultrium 8 drives. In addition to the use of the IBM LTO Ultrium data cartridge with up to 12 TB capacity, the drive offers read/write capability for certified LTO Ultrium 8 tape cartridges.

Table 2-11 shows the native data transfer rate when a data cartridge of another generation is processed.

Table 2-9 Native data transfer rate with various media

Item	Generation 9 media	Generation 8 media
Supported methods of operating	Read/write	Read/write
Native data rate Full Height (MBps)	400	360
Native data rate Half High (MBps)	300	300

### Connectivity

The LTO Ultrium 9 tape drive family offers high capacity, performance technology for the midrange open systems environment. These drives offer the following connection types:

- ▶ 12 Gbps SAS for point-to-point attachment (not in TS3310, TS1090/TS3500 configuration)
- ▶ 8 Gbps Fibre Channel interface for point-to-point or FC-AL attachment (not on TS2980 and TS2900)

IBM Ultrium drives can be connected to many different types of servers. For more information about server interface cards or host bus adapters (HBAs) that are supported by the Ultrium drives, see this [IBM Support web page](#).

### Performance

The LTO Ultrium 9 tape drive uses 8960 data tracks to read and write to Ultrium 9 tape. These tracks are grouped in four data bands. The high-bandwidth servo system features a low-mass servo to help more effectively track servo bands and improve data throughput with damaged media in less-than-optimal shock and vibration environments.

The native data transfer rate for Ultrium 9 tape drives is 400 MBps. Compressed data rates can reach up to 700 MBps on the FC interface and 900 MBps on the SAS interface. The maximum interface burst transfer rate is 1200 MBps for SAS and 800 MBps for FC. IBM suggests the use of the IBM LTO Ultrium 9, 18 TB data cartridge, which provides up to 45 TB of storage with a 2.5:1 compression ratio.

### Dynamic speed matching

The LTO Ultrium 9 tape drive performs *dynamic speed matching* at one of 12 speeds to adjust the native data rate of the drive as closely as possible to the net host data rate (after factoring out data compressibility). This approach helps to reduce the number of backhitch repositions and improves throughput performance.

*Backhitching* is the condition that occurs when a data cartridge stops, reverses, and restarts motion. A backhitch is the result of a mismatch between the data rates of the connected server and the tape drive.

Table 2-12 lists the data rates for the LTO Ultrium 9 FH drives.

Table 2-10 LTO-9 FH drive speed matching data rates

Performance parameters	Generation 9 media	Generation 8 media
Speed matching data rates in MBps	406	365
	385	344
	366	319
	347	297
	325	273
	305	250
	284	227
	263	204
	244	181
	223	158
	203	135
	177	112
	152	89
	117	66

## Encryption

The LTO Ultrium 9 tape drive family is encryption-capable and supports application-managed tape encryption at no charge on the SAS and Fibre Channel tape drives. For library use, system-managed tape encryption and library-managed tape encryption are supported by the Transparent LTO Encryption features (FC5901 for TS2900, FC1604 for TS4500, and FC5900 for all other libraries).

IBM Security Guardium Key Lifecycle Manager is required for encryption key management with LTO Ultrium 9 drives.

## Statistical analysis and reporting system

The Ultrium 9 tape drives use SARS to help isolate failures between media and hardware. SARS uses the data cartridge performance history that is saved in the cartridge memory module and the drive performance history that is kept in the drive flash Electrically Erasable Programmable Read-Only Memory (EEPROM) to help determine the likely cause of the failure. SARS can cause the drive to request a cleaning tape, mark the media as degraded, and indicate that the hardware degraded.

## Open Recommended Access Order

A new technology introduced to the IBM LTO 9 tape drive, Open Recommended Access Order (oRAO) reduces tape data access times in LTO Ultrium Gen 9 tape technology by up to 73%.

RAO enables tape control applications to accelerate the retrieval of a specific number of “files” from a single tape, which reduces the seek time between those “files” (see Figure 2-21 on page 77). Developed from IBM file access acceleration technology, it can add cyber resilience by optimizing the access times to recovery data.

RAO is a native drive function that supports compressed and uncompressed data. It is available for LTO 9 generation technologies only.

Achieve up to 73% faster data access retrieval by using the IBM LTO 9 tape drive oRAO technology when working with larger volumes of data.

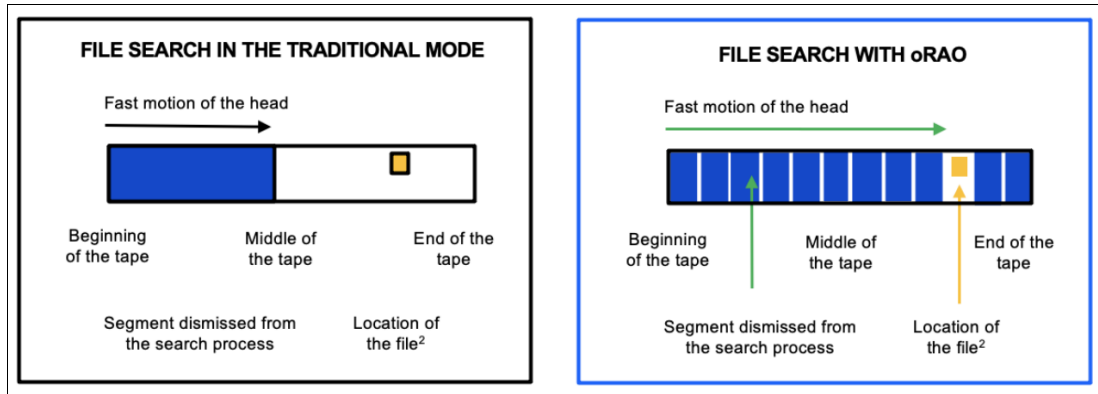

Figure 2-21 IBM LTO 9 Open Recommended Access Order

**Note:** IBM LTO 9 oRAO is available oRAO on LTO-9 Full High tape drives.

## IBM Spectrum Archive software application

IBM Ultrium 9 tape drives are compatible with the IBM Spectrum Archive software application and the underlying LTFS. LTFS uses the LTO media partitioning functions that are present on Ultrium 9, 8, 7, 6, and 5 cartridges.

LTFS provides a standard tape cartridge format at low cost that can be used without other database applications. LTFS presents tape media as though it were a disk file system. IBM Spectrum Archive supports IBM LTO Ultrium 9, 8, 7, 6, and 5, and IBM TS1160, TS1155, TS1150, and TS1140 tape drives.

Tape as a storage medium features the following benefits

- ▶ Reliable
- ▶ Portable
- ▶ Low-cost
- ▶ Low-power
- ▶ High-capacity

However, tape is not easy to use, has no standard format, and data often cannot be used without first copying it to disk.

IBM Spectrum Archive enables direct, intuitive, and graphical access to data that is stored in IBM tape drives and libraries by incorporating the LTFS format standard for reading, writing, and exchanging descriptive metadata on formatted tape cartridges.

IBM Spectrum Archive eliminates the need for extra tape management and software to access data. IBM Spectrum Archive offers three software solutions for managing your digital files with the LTFS format: Single Drive Edition, Library Edition, and Enterprise Edition.

For more information about IBM Spectrum Archive and LTFS, see *IBM Linear Tape File System Installation and Configuration*, SG24-8090.

## 2.4.1 IBM LTO Ultrium 9 tape drive range

The IBM LTO Ultrium 9 drive range is a mix of Half-High and Full-High stand-alone and library-installable drives. This mix offers high-performance, high-capacity data storage devices to back up and restore open systems applications. The drive can be integrated into an enclosure, such as a desktop unit, tape autoloader, or tape library.

The IBM LTO Ultrium 9 drive range consists of the following components:

- ▶ TS2290 (3580 Model H9S) dual port SAS Half-High stand-alone drive
- ▶ Ultrium 9 SAS Half-High tape drive sled inside a TS2900 tape autoloader
- ▶ Ultrium 9 SAS Half-High tape drive sled inside a TS4300 tape library
- ▶ Ultrium 9 FC Half-High or Full-High tape drive sled inside a TS4300 tape library
- ▶ TS1090 (3588 F9C) FC tape drive sled within a TS4500 tape library

**Note:** The IBM Ultrium 9 range does not include a Full-High stand-alone drive.

### IBM TS2290 (3580 H9S) tape drive H9S

IBM TS2290 tape drive model H9S (3580 H9S) is an external Half-High (2 EIA units high) stand-alone or rack-mountable unit that offers high capacity and performance for the midrange systems environment.

The TS2290 Model H9S tape drive uses a dual-port 12 Gbps SAS (serial-attached SCSI) host interface. (An optional USB feature is *not* available for this model.) The new TS2290 attaches to selected IBM Power Systems models and to IBM System x and PC servers. The TS2290 also supports Microsoft Windows, HP-UX, Oracle Solaris, and UNIX.

The two ports per drive are available to improve availability and ease of attachment. The Ultrium 9 SAS drive attempts to connect at 12 Gbps, but automatically negotiates down to 6 Gbps (or even 3 Gbps) if the system that it is connected to cannot support 12 Gbps or encounters problems on the physical connection. Expander use is *not* supported.

The TS2290 can read and write to Ultrium 8 cartridges. The TS2290 cannot read Ultrium 7, 6, 5, 4, 3, 2, or 1 cartridges. The Ultrium 7 tape drive is encryption-capable and supports application-managed encryption.

IBM Spectrum Archive Single Drive Edition (SDE) software is included with each TS2290 tape drive. IBM Spectrum Archive and its associated LTFS use LTO-9 tape drive partitioning. It enables a self-describing tape file format and delivers an easy tape storage and distribution solution without the use of more database applications. Customers of IBM Spectrum Archive SDE software are those who require a standard tape cartridge format at a low cost and use stand-alone IBM LTO-9, LTO-8, LTO-7, LTO-6, or LTO-5 tape drives.

The enclosure width allows two TS2290 storage units to be mounted side-by-side in a 19-inch IBM server rack mount shelf kit that requires two EIA units (2U) of rack space.

Consider the following points:

- ▶ The TS2280 tape drive provides an excellent migration path from digital linear tape (DLT or SDLT), 1/4 inch (QIC), 4 mm (DAT), 8 mm, or older LTO generation tape drives.
- ▶ Unique power supplies are *not* required. The TS2290 tape drive can attach to 100 V - 125 V power supplies at 60 Hz or 200 V - 240 V supplies at 50 Hz AC.
- ▶ IBM LTO Ultrium 9 Half-High tape drives have an internal buffer of 1024 MB.

For a more information about the TS2290 Ultrium tape drive, see Chapter 6, “IBM TS2270 tape drive” on page 199.



Figure 2-23 shows a TS2290 Half-High LTO Ultrium 9 tape drive.



Figure 2-22 TS2290 LTO Ultrium 9 tape drive

### IBM LTO Ultrium 9 library drives

The library-installable Ultrium 9 tape drives can read and write to Ultrium 9 and Ultrium 8 cartridges and are not read-compatible with Ultrium 7 data cartridges.

The LTO Ultrium 9 tape drives support data encryption on the base drive with Ultrium 9 or Ultrium 8 media. System Managed and Library Managed Encryption and associated IBM Security Guardium Key Lifecycle Manager access are available as a chargeable licensed key, Transparent LTO Encryption (feature code 5901 for TS2900, feature code 5900 for TS3100 or 3200, feature code 5900 for TS4300, and feature code 1604 for TS4500 libraries). IBM Security Guardium Key Lifecycle Manager is required with this feature.

The Ultrium 9 and Ultrium 8 drives support media partitioning and the use of the IBM Spectrum Archive Library Edition (LE) and IBM Spectrum Archive Enterprise Edition (EE) if installed in a supported library.

For more information about IBM Spectrum Archive and LTFS, see *IBM Linear Tape File System Installation and Configuration*, SG24-8090.

For more information about IBM Spectrum Archive EE, see *IBM Spectrum Archive Enterprise Edition V1.3.2.2 Installation and Configuration Guide*, [SG24-8333](#).

### IBM LTO Ultrium 9 Full-High library drives

IBM LTO Ultrium 9 Full-High (4 EIA units high) drives are available for use in the TS4300 and TS4500 libraries. The following drives can be specified and ordered with the library:

- ▶ The TS4300 base L3A unit can accommodate one Ultrium 9 Full-High FC tape drive
- ▶ The TS4300 optional E3A expansion unit can accommodate one Ultrium 9 Full-High FC tape drive
- ▶ The TS4500 libraries can accommodate up to 128 TS1090 drives, depending on their base and expansion frame configurations

IBM LTO Ultrium 9 Full-High tape drives have an internal buffer of 1024 MB.

### IBM LTO Ultrium 9 Half-High library drives

IBM LTO Ultrium 9 Half-High (2 EIA units high) drives are available for use in the TS2900 and TS4300 libraries. The following drives are specified and ordered with the library:

- ▶ The TS2900 autoloader can accommodate one Ultrium 9 SAS Half-High tape drive.
- ▶ The TS4300 library can accommodate three Ultrium 9 SAS or FC Half-High tape drives.

IBM LTO Ultrium 9 Half-High tape drives have an internal buffer of 1024 MB.

## 2.5 IBM LTO Ultrium 8 tape drives

Ultrium 8 is the latest LTO generation, which was released in November 2017. The IBM Ultrium 8 offerings represent significant improvements in capacity, performance, and reliability over the previous generation, IBM Ultrium 7, while still protecting investment in the previous technology.

The Ultrium 8 tape drive is a high-performance, high-capacity tape drive. The drive records data by using a linear serpentine recording format on half-inch tape that is housed within a cartridge. The data tracks are located by using preformatted servo tracks.

The Ultrium 8 tape drive provides the following improvements over the older Ultrium 7 models:

- ▶ Increases the native transfer speed to 360 MBps compared with 300 MBps for the Ultrium 7 tape drive
- ▶ Compressed speed of 700 MBps for Fibre Channel (500 MBps for SAS interface)
- ▶ More than doubles the potential capacity of a cartridge in Ultrium 7 format

### Ultrium 8 tape drive features at a glance

The LTO Generation 8 tape drive range has the following characteristics:

- ▶ Native data transfer rate of up to 360 MBps
- ▶ Compressed data transfer rate of up to 700 MBps
- ▶ LTO Ultrium 8 data and WORM tape cartridge native physical capacity of up to 12 TB
- ▶ LTO Ultrium 7 data tape cartridge using M8 format have a physical capacity of up to 9 TB
- ▶ 8 Gbps Fibre Channel attachment option
- ▶ 6 Gbps SAS dual port attachment option
- ▶ 1024 MB internal data buffer
- ▶ Application-managed encryption support
- ▶ System-managed and library-managed encryption support for non-stand-alone drives
- ▶ 16 KB cartridge memory with Ultrium 8 media
- ▶ IBM Spectrum Archive Single Drive Edition, Library Edition, and Enterprise Edition support
- ▶ IBM Linear Tape File System (LTFS) partitioning support

### Compatibility

In addition to reading and writing to LTO Ultrium 8 tape cartridges, the Ultrium 8 tape drives can read and write to LTO Ultrium 7 cartridges. They cannot read Ultrium 1, 2, 3, 4, 5, and 6 cartridges.

The drive also writes to tapes that can be read by other licensed LTO Ultrium 7 drives. In addition to using the IBM LTO Ultrium data cartridge with up to 6 TB capacity, the drive offers read/write capability for certified LTO Ultrium 7 tape cartridges.

Table 2-11 lists the native data transfer rate when a data cartridge of another generation is processed.

Table 2-11 Native data transfer rate with various media

Item	Generation 8 media	Generation 7 media format M8	Generation 7 media Format L7
Supported methods of operating	Read/write	Read/write	Read/write
Native data rate Full Height (MBps)	360	360	300
Native data rate Half High (MBps)	300	300	300

## Connectivity

The LTO Ultrium 8 tape drive family offers high capacity, performance technology for the midrange open systems environment. These drives offer the following connection types:

- ▶ 6 Gbps SAS for point-to-point attachment (not in TS3310, TS1080/TS3500, or TS1080/TS4500 configuration)
- ▶ 8 Gbps Fibre Channel interface for point-to-point or FC-AL attachment (not on TS2280)

IBM Ultrium drives can be connected to many different types of servers. For a list of server interface cards or host bus adapters (HBAs) that are supported by the Ultrium drives, see this [IBM Support web page](#).

## Performance

The LTO Ultrium 8 tape drive uses 6656 data tracks to read and write to Ultrium 8 tape. These tracks are grouped in four data bands. The high-bandwidth servo system features a low-mass servo to help more effectively track servo bands and improve data throughput with damaged media in less-than-optimal shock and vibration environments.

The native data transfer rate for Ultrium 8 tape drives is 360 MBps. Compressed data rates can reach up to 700 MBps on the FC interface and 500 MBps on the SAS interface. The maximum interface burst transfer rate is 600 MBps for SAS and 800 MBps for FC. IBM suggests the use of the IBM LTO Ultrium 8, 12 TB data cartridge, which provides up to 30 TB of storage with a 2.5:1 compression ratio.

## Dynamic speed matching

The LTO Ultrium 8 tape drive performs *dynamic speed matching* at one of 12 speeds to adjust the native data rate of the drive as closely as possible to the net host data rate (after factoring out data compressibility). This approach helps to reduce the number of backhitch repositions and improves throughput performance.

*Backhitching* is the condition that occurs when a data cartridge stops, reverses, and restarts motion. A backhitch is the result of a mismatch between the data rates of the connected server and the tape drive.

Table 2-12 lists the data rates for the LTO Ultrium 8 drives.

Table 2-12 LTO-8 drive speed matching data rates

Performance parameter	Generation 8 media	Generation 7 media
Speed matching data rates in MBps	365	306
	344	288
	319	269
	297	251
	273	232
	250	213
	227	194
	204	176
	181	158
	158	139
	135	120
	112	102

## Encryption

The LTO Ultrium 8 tape drive family is encryption-capable and supports application-managed tape encryption at no charge on the SAS and Fibre Channel tape drives. For library use, system-managed tape encryption and library-managed tape encryption are supported by the Transparent LTO Encryption features (FC5901 for TS2900, FC1604 for TS3500, FC5900 for all other libraries). IBM Security Guardium Key Lifecycle Manager is required for encryption key management with LTO Ultrium 8 drives.

## Statistical Analysis and Reporting System

The Ultrium 8 tape drives use SARS to help isolate failures between media and hardware. SARS uses the data cartridge performance history that is saved in the cartridge memory module and the drive performance history that is kept in the drive flash Electrically Erasable Programmable Read-Only Memory (EEPROM) to help determine the likely cause of the failure. SARS can cause the drive to request a cleaning tape, mark the media as degraded, and indicate that the hardware degraded.

## IBM Spectrum Archive software application

IBM Ultrium 8 tape drives are compatible with the IBM Spectrum Archive software application, and the underlying LTFS. LTFS uses the LTO media partitioning functionality, present on Ultrium 8, 7, 6, and 5 cartridges.

LTFS provides a standard tape cartridge format at low cost that can be used without other database applications. LTFS presents tape media as though it were a disk file system. IBM Spectrum Archive supports IBM LTO Ultrium 8, 7, 6, and 5, and IBM 3592-E08 and 3592-E07 tape drives.

Tape as a storage medium has many benefits: It is reliable, portable, low-cost, low-power, and high-capacity. However, tape is not particularly easy to use, has no standard format, and data often cannot be used without first copying it to disk.

IBM Spectrum Archive enables direct, intuitive, and graphical access to data stored in IBM tape drives and libraries by incorporating the LTFS format standard for reading, writing, and exchanging descriptive metadata on formatted tape cartridges. IBM Spectrum Archive eliminates the need for additional tape management and software to access data. IBM Spectrum Archive offers three software solutions for managing your digital files with the LTFS format: Single Drive Edition, Library Edition, and Enterprise Edition.

For more information about IBM Spectrum Archive and LTFS, see *IBM Linear Tape File System Installation and Configuration*, SG24-8090.

## 2.5.1 The IBM LTO Ultrium 8 tape drive range

The IBM LTO Ultrium 8 drive range is a mix of Half-High and Full-High stand-alone and library-installable drives. This mix offers high-performance, high-capacity data storage devices to back up and restore open systems applications. The drive can be integrated into an enclosure, such as a desktop unit, tape autoloader, or tape library.

The IBM LTO Ultrium 8 drive range consists of the following components:

- ▶ TS2280 (3580 Model H8S) dual port SAS Half-High stand-alone drive
- ▶ Ultrium 8 SAS Half-High tape drive sled inside a TS2900 tape autoloader
- ▶ Ultrium 8 SAS Half-High tape drive sled inside a TS3100 tape library
- ▶ Ultrium 8 FC Half-High or Full-High tape drive sled inside a TS3100 tape library
- ▶ Ultrium 8 SAS Half-High tape drive sled inside a TS3200 tape library
- ▶ Ultrium 8 FC Half-High or Full-High tape drive sled inside a TS3200 tape library
- ▶ Ultrium 8 SAS Half-High tape drive sled inside a TS4300 tape library
- ▶ Ultrium 8 FC Half-High or Full-High tape drive sled inside a TS4300 tape library
- ▶ Ultrium 8 FC Full-High tape drive sled inside a TS3310 tape library
- ▶ TS1080 (3588 F8A) FC tape drive sled within a TS3500 tape library
- ▶ TS1080 (3588 F8C) FC tape drive sled within a TS4500 tape library

**Note:** The IBM Ultrium 8 range does not include a Full-High stand-alone drive.

### IBM TS2280 (3580 H8S) tape drive H8S

IBM TS2280 tape drive model H8S (3580 H8S) is an external Half-High (2 EIA units high) stand-alone or rack-mountable unit that offers high capacity and performance for the midrange systems environment.

The TS2280 Model H8S tape drive uses a dual-port 6 Gbps SAS (serial-attached SCSI) host interface. An optional USB feature is *not* available for this model. The TS2280 attaches to selected IBM Power Systems models and to IBM System x and PC servers. The TS2280 also supports Microsoft Windows, HP-UX, Oracle Solaris, and UNIX.

The two ports per drive are available to improve availability and ease of attachment. The Ultrium 8 SAS drive attempts to connect at 6 Gbps, but automatically negotiates down to 3 Gbps or even 1.5 Gbps, if the system that it is connected to cannot support 6 Gbps or has problems on the physical connection. Expander use is not supported.

The TS2280 can read and write to Ultrium 8 and Ultrium 7 cartridges. The TS2280 cannot read Ultrium 6, 5, 4, 3, 2, or 1 cartridges. The Ultrium 8 tape drive is encryption-capable and supports application-managed encryption.

IBM Spectrum Archive Single Drive Edition (SDE) software is included with each TS2280 tape drive. IBM Spectrum Archive and its associated LTFS use LTO-8 tape drive partitioning. It enables a self-describing tape file format and delivers an easy tape storage and distribution solution without the use of more database applications. Customers of IBM Spectrum Archive SDE software are those who require a standard tape cartridge format at a low cost and use stand-alone IBM LTO-8, LTO-7, LTO-6, or LTO-5 tape drives.

The enclosure width allows two TS2280 storage units to be mounted side by side in a 19-inch IBM server rack mount shelf kit that requires two EIA units (2U) of rack space.

The TS2280 tape drive provides an excellent migration path from digital linear tape (DLT or SDLT), 1/4 inch (QIC), 4 mm (DAT), 8 mm, or older LTO generation tape drives.

There are no unique power supply requirements. The TS2280 tape drive can attach to 100 V to 125 V power supplies at 60 Hz or 200 V to 240 V supplies at 50 Hz AC.

IBM LTO Ultrium 8 Half-High tape drives have an internal buffer of 1024 MB.

For a more information about the TS2280 Ultrium tape drive, see Chapter 6, “IBM TS2270 tape drive” on page 199.

Figure 2-23 shows a TS2280 Half-High LTO Ultrium 8 tape drive.



Figure 2-23 TS2280 LTO Ultrium 8 tape drive

### **IBM LTO Ultrium 8 library drives**

The library-installable Ultrium 8 tape drives can read and write to Ultrium 8 and Ultrium 7 cartridges and are not read-compatible with Ultrium 6 data cartridges.

The LTO Ultrium 8 tape drives support data encryption on the base drive with Ultrium 8 or Ultrium 7 media. System Managed and Library Managed Encryption and associated IBM Security Guardium Key Lifecycle Manager access are available as a chargeable licensed key, Transparent LTO Encryption (feature code 5901 for TS2900, feature code 5900 for TS3100 or 3200, feature code 5900 for TS4300, and feature code 1604 for TS3500 and TS4500 libraries). IBM Security Guardium Key Lifecycle Manager is required with this feature.

The Ultrium 8 and Ultrium 7 drives support media partitioning and the use of the IBM Spectrum Archive Library Edition (LE) and IBM Spectrum Archive Enterprise Edition (EE) if installed in a supported library.

For more information about IBM Spectrum Archive and LTFS, see *IBM Linear Tape File System Installation and Configuration*, SG24-8090.

For more information about IBM Spectrum Archive EE, see *IBM Spectrum Archive Enterprise Edition V1.2.5.1 Installation and Configuration Guide*, SG24-8333.

### **IBM LTO Ultrium 8 Full-High library drives**

IBM LTO Ultrium 8 Full-High (4 EIA units high) drives are available for use in the TS3310, TS4300, TS3500, and TS4500 libraries. The following drives can be specified and ordered with the library:

- ▶ The TS4300 base L3A unit can accommodate one Ultrium 8 Full-High FC tape drive
- ▶ The TS4300 optional E3A expansion unit can accommodate one Ultrium 8 Full-High FC tape drive
- ▶ The TS3310 base L5B unit can accommodate two Ultrium 8 FC Full-High tape drives

- ▶ The TS3310 optional E9U expansion unit can accommodate four Ultrium 8 FC Full-High tape drives
- ▶ The TS3500 libraries can accommodate up to 192 TS1080 drives, depending on their base and expansion frame configurations
- ▶ The TS4500 libraries can accommodate up to 128 TS1080 drives, depending on their base and expansion frame configurations

IBM LTO Ultrium 8 Full-High tape drives have an internal buffer of 1024 MB.

### **IBM LTO Ultrium 8 Half-High library drives**

IBM LTO Ultrium 8 Half-High (2 EIA units high) drives are available for use in the TS2900, TS3100, TS3200, and TS4300 libraries. The following drives are specified and ordered with the library:

- ▶ The TS2900 autoloader can accommodate one Ultrium 8 SAS Half-High tape drive.
- ▶ The TS3100 library can accommodate two Ultrium 8 SAS or FC Half-High tape drives.
- ▶ The TS3200 library can accommodate four Ultrium 8 SAS or FC Half-High tape drives.
- ▶ The TS4300 library can accommodate three Ultrium 8 SAS or FC Half-High tape drives.

IBM LTO Ultrium 8 Half-High tape drives have an internal buffer of 1024 MB.

## **2.6 IBM LTO Ultrium 7 tape drives**

Ultrium 7 is the latest LTO Generation. Released in October 2015, IBM Ultrium 7 offerings represent significant improvements in capacity, performance, and reliability over the previous generation, Ultrium 6, while still protecting investment in the previous technology.

The Ultrium 7 tape drive is a high-performance, high-capacity tape drive. The drive records data by using a linear serpentine recording format on half-inch tape that is housed within a cartridge. The data tracks are located by using preformatted servo tracks.

The Ultrium 7 tape drive provides the following improvements over the older Ultrium 6 models:

- ▶ Increases the native transfer speed to 300 MBps compared with 160 MBps for the Ultrium 6 tape drive
- ▶ Increases the compressed speed to 700 MBps for Fibre Channel (500 MBps for SAS interface)
- ▶ More than doubles the potential capacity of a cartridge in Ultrium 6 format

### **Ultrium 7 tape drive features at a glance**

The LTO Generation 7 tape drive range has the following characteristics:

- ▶ Native data transfer rate of up to 300 MBps
- ▶ Compressed data transfer rate of up to 700 MBps
- ▶ LTO Ultrium 7 data and WORM tape cartridge native physical capacity of up to 6 TB
- ▶ 8 Gbps Fibre Channel attachment option
- ▶ 6 Gbps SAS dual port attachment option
- ▶ 1024 MB internal data buffer
- ▶ Application-managed encryption support
- ▶ System-managed and library-managed encryption support for non stand-alone drives

- ▶ 16 KB cartridge memory with Ultrium 7 media
- ▶ IBM Spectrum Archive Single Drive Edition, Library Edition, and Enterprise Edition support
- ▶ IBM Linear Tape File System partitioning support

### Compatibility

In addition to reading and writing to LTO Ultrium 7 tape cartridges, the Ultrium 7 tape drives can read and write to LTO Ultrium 6 cartridges and read LTO Ultrium 5 cartridges. They cannot read Ultrium 1, Ultrium 2, Ultrium 3, or Ultrium 4 cartridges.

The drive also writes to tapes that can be read by other licensed LTO Ultrium 7 drives. In addition to using the IBM LTO Ultrium data cartridge with up to 6 TB capacity, the drive offers read/write capability for certified LTO Ultrium 7 tape cartridges.

Table 2-13 shows the native data transfer rate when a data cartridge of another generation is processed.

Table 2-13 Native data transfer rate with various media

Item	Generation 7 media	Generation 6 media	Generation 5 media
Supported methods of operating	Read/write	Read/write	Read only
Native data rate SAS and USB (MBps)	300	160	140
Native data rate Fibre Channel (MBps)	300	160	140

### Connectivity

The LTO Ultrium 7 tape drive family offers high capacity, performance technology for the midrange open systems environment. These drives offer the following connection types:

- ▶ 6 Gbps SAS for point-to-point attachment (not in TS3310, TS1070/TS3500, or TS1070/TS4500 configuration)
- ▶ 8 Gbps Fibre Channel interface for point-to-point or FC-AL attachment (not on TS2270)

**Note:** USB connectivity is not available on the LTO-7 TS2270 stand-alone model. The TS2270 has dual port SAS interfaces only. USB connectivity is available on the LTO-6 based TS2260 with a feature code.

IBM Ultrium drives can be connected to many different types of servers. For a list of server interface cards or host bus adapters (HBAs) that are supported by the Ultrium drives, see this [IBM Support web page](#).

### Performance

The LTO Ultrium 7 tape drive uses 3584 data tracks to read and write to Ultrium 7 tape. These tracks are grouped in four data bands. The high-bandwidth servo system features a low-mass servo to help more effectively track servo bands and improve data throughput with damaged media in less-than-optimal shock and vibration environments.

The native data transfer rate for Ultrium 7 tape drives is 300 MBps. Compressed data rates can reach up to 700 MBps on the FC interface and 500 MBps on the SAS interface. IBM suggests the use of the IBM LTO Ultrium 7 6 TB data cartridge, which provides up to 15 TB of storage with a 2.5:1 compression ratio.



## Dynamic speed matching

The LTO Ultrium 7 tape drive performs *dynamic speed matching* at one of 12 speeds to adjust the native data rate of the drive as closely as possible to the net host data rate (after factoring out data compressibility). This approach helps to reduce the number of backhitch repositions and improves throughput performance. *Backhitching* is the condition that occurs when a data cartridge stops, reverses, and restarts motion. A backhitch is the result of a mismatch between the data rates of the connected server and the tape drive.

Table 2-14 lists the data rates for the LTO Ultrium 7 drives.

Table 2-14 LTO-7 drive speed matching data rates

Performance parameter	Generation 7 media	Generation 6 media	Generation 5 media
Speed matching data rates MBps	306.00	160.00	140.0
	287.52	150.77	130.0
	268.56	141.54	120.0
	250.66	132.31	112.7
	231.86	123.08	105.5
	213.06	113.85	98.2
	194.26	104.62	90.9
	175.46	95.38	83.6
	157.67	86.15	76.4
	138.52	76.92	69.1
	120.11	67.69	61.8
	101.46	58.46	53.5
	49.23	46.3	
	40.00	40.0	

## Encryption

The LTO Ultrium 7 tape drive family is encryption-capable and supports application-managed tape encryption at no charge on the SAS and Fibre Channel tape drives. In case of library use, system-managed tape encryption and library-managed tape encryption are supported by the Transparent LTO Encryption features (FC5901 for TS2900, FC1604 for TS3500, FC5900 for all other libraries). IBM Security Guardium Key Lifecycle Manager is required for encryption key management with LTO Ultrium 7 drives.

## Statistical Analysis and Reporting System

The Ultrium 7 tape drives use SARS to help isolate failures between media and hardware. The SARS uses the data cartridge performance history that is saved in the cartridge memory module and the drive performance history that is kept in the drive flash Electronically Erasable Programmable Read-Only Memory (EEPROM) to help determine the likely cause of the failure. SARS can cause the drive to request a cleaning tape, to mark the media as degraded, and to indicate that the hardware degraded.

## IBM Spectrum Archive software application

IBM Ultrium 7 tape drives are compatible with the IBM Spectrum Archive software application, and the underlying Linear Tape File System (LTFS). LTFS uses the LTO media partitioning functionality, present on Ultrium 7, 6, and 5 cartridges.

LTFS provides a standard tape cartridge format at low cost that can be used without other database applications. LTFS presents tape media as though it were a disk file system. IBM Spectrum Archive supports IBM LTO Ultrium 7, 6, and 5, and IBM 3592-E08 and 3592-E07 tape drives.

Tape as a storage medium has many benefits: It is reliable, portable, low-cost, low-power, and high-capacity. However, tape is not particularly easy to use, has no standard format, and data often cannot be used without first copying it to disk.

IBM Spectrum Archive enables direct, intuitive, and graphical access to data stored in IBM tape drives and libraries by incorporating the LTFS format standard for reading, writing and exchanging descriptive metadata on formatted tape cartridges. IBM Spectrum Archive eliminates the need for additional tape management and software to access data. IBM Spectrum Archive offers three software solutions for managing your digital files with the LTFS format: Single Drive Edition, Library Edition, and Enterprise Edition.

For more information about IBM Spectrum Archive and LTFS, see *IBM Linear Tape File System Installation and Configuration*, SG24-8090.

## 2.6.1 The IBM LTO Ultrium 7 tape drive range

The IBM LTO Ultrium 7 drive range is a mix of Half-High and Full-High stand-alone and library-installable drives. This mix offers high-performance, high-capacity data storage devices to back up and restore open systems applications. The drive can be integrated into an enclosure, such as a desktop unit, tape autoloader, or tape library.

The IBM LTO Ultrium 7 drive range consists of the following components:

- ▶ TS2270 (3580 Model H7S) dual port SAS Half-High stand-alone drive
- ▶ Ultrium 7 SAS Half-High tape drive sled inside a TS2900 tape autoloader
- ▶ Ultrium 7 SAS Half-High tape drive sled inside a TS3100 tape library
- ▶ Ultrium 7 FC Half-High or Full-High tape drive sled inside a TS3100 tape library
- ▶ Ultrium 7 SAS Half-High tape drive sled inside a TS3200 tape library
- ▶ Ultrium 7 FC Half-High or Full-High tape drive sled inside a TS3200 tape library
- ▶ Ultrium 7 SAS Half-High tape drive sled inside a TS4300 tape library
- ▶ Ultrium 7 FC Half-High or Full-High tape drive sled inside a TS4300 tape library
- ▶ Ultrium 7 FC Full-High tape drive sled inside a TS3310 tape library
- ▶ TS1070 (3588 F7A) FC tape drive sled within a TS3500 tape library
- ▶ TS1070 (3988 F7C) FC tape drive sled within a TS4500 tape library

**Note:** The IBM Ultrium 7 range does not include a Full-High stand-alone drive.

### IBM TS2270 (3580 H7S) tape drive H7S

IBM TS2270 tape drive model H7S (3580 H7S) is an external Half-High (2 EIA units high) stand-alone or rack-mountable unit that offers high capacity and performance for the midrange systems environment.

The TS2270 Model H7S tape drive uses a dual-port 6 Gbps SAS (serial-attached SCSI) host interface. There is not an optional USB feature for this model. The new TS2270 attaches to selected IBM Power Systems models and to IBM System x and PC servers. The TS2260 also supports Microsoft Windows, HP-UX, Oracle Solaris, and UNIX.

The two ports per drive are available to improve availability and ease of attachment. The Ultrium 7 SAS drive attempts to connect at 6 Gbps, but automatically negotiates down to 3 Gbps or even 1.5 Gbps, if the system that it is connected to cannot support 6 Gbps or has problems on the physical connection. Expander use is not supported.

The TS2270 can read and write to Ultrium 7 and Ultrium 6 cartridges, and is read-compatible with Ultrium 5 data cartridges. The Ultrium 7 tape drive is encryption-capable and supports application-managed encryption.

IBM Spectrum Archive Standalone Drive Edition (SDE) software is included with each TS2270 tape drive. IBM Spectrum Archive and its associated LTFS use LTO-7 tape drive partitioning. It enables a self-describing tape file format and to deliver an easy tape storage and distribution solution without the use of more database applications. Customers of IBM Spectrum Archive SDE software are those who require a standard tape cartridge format at a low cost and use stand-alone IBM LTO-7, LTO-6, or LTO-5 tape drives.

The enclosure width allows two TS2270 storage units to be mounted side by side in a 19-inch IBM server rack mount shelf kit that requires two EIA units (2U) of rack space.

The TS2270 tape drive provides an excellent migration path from digital linear tape (DLT or SDLT), 1/4 inch (QIC), 4 mm (DAT), 8 mm, or older LTO generation tape drives.

There are no unique power supply requirements. The TS2270 tape drive can attach to 100 V to 125 V power supplies at 60 Hz or 200 V to 240 V supplies at 50 Hz AC.

IBM LTO Ultrium 7 Half-High tape drives have an internal buffer of 1024 MB.

For a more information about the TS2270 Ultrium tape drive, see Chapter 6, “IBM TS2270 tape drive” on page 199.

Figure 2-24 shows a TS2270 Half-High LTO Ultrium 7 tape drive.



Figure 2-24 TS2270 LTO Ultrium 7 tape drive

### IBM LTO Ultrium 7 library drives

The library-installable Ultrium 7 tape drives can read and write to Ultrium 7 and Ultrium 6 cartridges and are read-compatible with Ultrium 5 data cartridges.

The LTO Ultrium 7 tape drives support data encryption on the base drive with Ultrium 7 or Ultrium 6 media. System Managed and Library Managed Encryption and associated IBM Security Guardium Key Lifecycle Manager access are available as a chargeable licensed key, Transparent LTO Encryption (feature code 5901 for TS2900, feature code 5900 for TS3100 or 3200, and feature code 1604 for TS3500 and TS4500 libraries). IBM Security Guardium Key Lifecycle Manager is required with this feature.

The Ultrium 7 and Ultrium 6 drives support media partitioning and the use of the IBM Spectrum Archive Library Edition (LE) and IBM Spectrum Archive Enterprise Edition (EE) if installed in a supported library.

For more information about IBM Spectrum Archive and LTFS, see *IBM Linear Tape File System Installation and Configuration*, SG24-8090. For more information about IBM Spectrum Archive EE, see *IBM Spectrum Archive Enterprise Edition V1.2.5.1 Installation and Configuration Guide*, SG24-8333.

## **IBM LTO Ultrium 7 Full-High library drives**

IBM LTO Ultrium 7 Full-High (4 EIA units high) drives are available for use in the TS3100, TS3200, TS3310, TS3500, and TS4500 libraries. The following drives can be specified and ordered with the library:

- ▶ The TS3100 tape library can accommodate one Ultrium 7 Full-High SAS or FC tape drive
- ▶ The TS3200 tape library can accommodate two Ultrium 7 Full-High, SAS, or FC tape drives
- ▶ The TS4300 base L3A unit can accommodate one Ultrium 7 Full-High FC tape drive
- ▶ The TS4300 optional E3A expansion unit can accommodate one Ultrium 7 Full-High
- ▶ The TS3310 base L5B unit can accommodate two Ultrium 7 FC Full-High tape drives
- ▶ The TS3310 optional E9U expansion unit can accommodate four Ultrium 7 FC Full-High tape drives
- ▶ The TS3500 libraries can accommodate up to 192 TS1070 drives, depending on their base and expansion frame configurations
- ▶ The TS4500 libraries can accommodate up to 128 TS1070 drives, depending on their base and expansion frame configurations

IBM LTO Ultrium 7 Full-High tape drives have an internal buffer of 1024 MB.

## **IBM LTO Ultrium 7 Half-High library drives**

IBM LTO Ultrium 7 Half-High (2 EIA units high) drives are available for use in the TS2900, TS3100, and TS3200 libraries. The following drives are specified and ordered with the library:

- ▶ The TS2900 autoloader can accommodate one Ultrium 7 SAS Half-High tape drive
- ▶ The TS3100 library can accommodate two Ultrium 7 SAS or FC Half-High tape drives
- ▶ The TS3200 library can accommodate four Ultrium 7 SAS or FC Half-High tape drives
- ▶ The TS4300 library can accommodate three Ultrium 7 SAS or FC Half-High tape drives

IBM LTO Ultrium 7 Half-High tape drives have an internal buffer of 1024 MB.

## **2.7 IBM LTO Ultrium 6 tape drives**

Ultrium 6, was released in 2012. The Ultrium 6 tape drive is a high-performance, high-capacity tape drive. The drive records data by using a linear serpentine recording format on half-inch tape that is housed within a cartridge. The data tracks are located by using preformatted servo tracks.

Ultrium 6 tape drive provides the following improvements over the older Ultrium 5 models:

- ▶ Increases the native transfer speed to 160 MBps compared with 140 MBps for Ultrium 5 tape drive
- ▶ Increases the compressed speed to 400 MBps compared with 280 MBps for Ultrium 5
- ▶ More than doubles the potential capacity of a cartridge in Ultrium 5 format

### **Ultrium 6 tape drive features at a glance**

The LTO Generation 6 tape drive range has the following characteristics:

- ▶ Native data transfer rate of up to 160 MBps
- ▶ Compressed data transfer rate of up to 400 MBps
- ▶ LTO Ultrium 6 data and WORM tape cartridge native physical capacity of up to 2.5 TB

- ▶ 8 Gbps Fibre Channel attachment option
- ▶ 6 Gbps SAS dual port attachment option
- ▶ USB 3.0 single port and 6 Gbps SAS single port attachment option
- ▶ 1024 MB internal data buffer for Full-High drives
- ▶ 512 MB internal buffer for Half-High drives
- ▶ Application-managed encryption support
- ▶ System-managed and library-managed encryption support for non stand-alone drives
- ▶ 16 KB cartridge memory with Ultrium 6 media
- ▶ IBM Spectrum Archive Single Drive Edition, Library Edition, and Enterprise Edition support
- ▶ IBM Linear Tape File System partitioning support

### Compatibility

In addition to reading and writing to LTO Ultrium 6 tape cartridges, the Ultrium 6 tape drives can read and write to LTO Ultrium 5 cartridges and read LTO Ultrium 4 cartridges. Ultrium 6 drives cannot read Ultrium 3, Ultrium 2, or Ultrium 1 cartridges.

The drive also writes to tapes that can be read by other licensed LTO Ultrium 6 drives. In addition to using the IBM LTO Ultrium data cartridge with up to 2.5 TB capacity, the drive offers read/write capability for certified LTO Ultrium 6 tape cartridges.

Table 2-15 lists the native data transfer rate when a data cartridge of another generation is processed.

*Table 2-15 Native data transfer rate with various media*

Item	Generation 6 media	Generation 5 media	Generation 4 media
Supported methods of operating	Read/write	Read/write	Read/write
Native data rate SAS and USB (MBps)	160	140	120
Native data rate Fibre Channel (MBps)	160	140	120

### Connectivity

The LTO Ultrium 6 tape drive family offers high capacity, performance, and technology for the midrange open systems environment. These drives offer the following connection types:

- ▶ 6 Gbps SAS for point-to-point attachment (not in TS3310 or TS1060/TS3500 configuration)
- ▶ 8 Gbps Fibre Channel interface for point-to-point or FC-AL attachment (not on TS2260 or TS2360)
- ▶ USB 3.0 Type B connector attachment for TS2260 only

IBM Ultrium drives can be connected to many different types of servers. For a list of server interface cards or HBAs that are supported by the Ultrium drives, see this [IBM Support web page](#).

## Performance

The LTO Ultrium 6 tape drive uses 2176 data tracks to read and write to Ultrium 6 tape. These tracks are grouped in five servo bands. Like the Ultrium 5 drives, the high-bandwidth servo system features a low-mass servo to help more effectively track servo bands and improve data throughput with damaged media in less-than-optimal shock and vibration environments.

The native data transfer rate for Ultrium 6 tape drives is 160 MBps. Compressed data rates can reach 400 MBps. IBM suggests the use of the IBM LTO Ultrium 6 2.5 TB data cartridge, which provides up to 6.250 TB of storage with a 2.5:1 compression ratio.

## Dynamic speed matching

The LTO Ultrium 6 tape drive performs *dynamic speed matching* at one of 14 speeds to adjust the native data rate of the drive as closely as possible to the net host data rate (after factoring out data compressibility). This approach helps to reduce the number of backhitch repositions and improves throughput performance.

*Backhitching* is the condition that occurs when a data cartridge stops, reverses, and restarts motion. A backhitch is the result of a mismatch between the data rates of the connected server and the tape drive.

Table 2-16 lists the data rates for the LTO Ultrium 6 drives.

Table 2-16 LTO-6 drive speed matching data rates

Performance parameter	Generation 6 media	Generation 5 media	Generation 4 media
Speed matching data rates MBps	160.00	140.0	120.0
	150.77	130.0	113.1
	141.54	120.0	106.1
	132.31	112.7	99.2
	123.08	105.5	92.3
	113.85	98.2	85.3
	104.62	90.9	78.6
	95.38	83.6	71.4
	86.15	76.4	64.6
	76.92	69.1	57.6
	67.69	61.8	50.8
	58.46	53.5	43.8
	49.23	46.3	36.9
	40.00	40.0	30.5

## Encryption

The LTO Ultrium 6 tape drive family is encryption-capable and supports application-managed tape encryption at no charge on the SAS and Fibre Channel tape drives. In case of library use, system-managed tape encryption and library-managed tape encryption are supported by the Transparent LTO Encryption features (FC5901 for TS2900, FC1604 for TS3500, FC5900 for all other libraries). IBM Security Guardium Key Lifecycle Manager is required for encryption key management with LTO Ultrium 6 drives.

## Statistical Analysis and Reporting System

The Ultrium 6 tape drives use the Statistical Analysis and Reporting System (SARS) to help isolate failures between media and hardware. The SARS uses the data cartridge performance history that is saved in the cartridge memory module and the drive performance history that is kept in the drive flash Electronically Erasable Programmable Read-Only Memory (EEPROM) to help determine the likely cause of the failure. SARS can cause the drive to request a cleaning tape to mark the media as degraded, and to indicate that the hardware degraded.

## IBM Spectrum Archive software application

IBM Ultrium 6 tape drives are compatible with the IBM Spectrum Archive software application. IBM Spectrum Archive and the underlying Linear Tape File System (LTFS) use the LTO Ultrium 6 and Ultrium 5 media partitioning functionality. The LTFS provides a standard tape cartridge format at low cost and can be used without other database applications. LTFS presents tape media as though it were a file system on a disk drive. LTFS supports only IBM LTO Ultrium 7, Ultrium 6, and Ultrium 5, IBM 3593-E08, and 3592-E07 tape drives.

Tape as a storage medium has many benefits: It is reliable, portable, low-cost, low-power, and high-capacity. However, tape is not easy to use, has no standard format, and data often cannot be used without first copying it to disk.

IBM Spectrum Archive enables direct, intuitive, and graphical access to data stored in IBM tape drives and libraries by incorporating the LTFS format standard for reading, writing, and exchanging descriptive metadata on formatted tape cartridges. IBM Spectrum Archive eliminates the need for additional tape management and software to access data. IBM Spectrum Archive offers three software solutions for managing your digital files with the LTFS format: Single Drive Edition, Library Edition, and Enterprise Edition.

For more information about IBM Spectrum Archive and LTFS, see *IBM Linear Tape File System Installation and Configuration*, SG24-8090.

### 2.7.1 The IBM LTO Ultrium 6 tape drive range

The IBM LTO Ultrium 6 drive range is a mix of Half-High and Full-High stand-alone and library-installable drives. This mix offers high-performance, high-capacity data storage devices to back up and restore open systems applications. The drive can be integrated into an enclosure, such as a desktop unit, tape autoloader, or tape library.

The IBM LTO Ultrium 6 drive range consists of the following components:

- ▶ TS2360 (3580 Model S63) SAS Full-High stand-alone drive
- ▶ TS2260 (3580 Model H6S) two port SAS Half-High stand-alone drive
- ▶ TS2260 (3580 Model H6S FC 5760) single SAS and USB 3.0 port, Half-High stand-alone drive
- ▶ Ultrium 6 SAS Half-High tape drive sled inside a TS2900 tape autoloader
- ▶ Ultrium 6 SAS Half-High tape drive sled inside a TS3100 tape library
- ▶ Ultrium 6 FC Half-High or Full-High tape drive sled inside a TS3100 tape library
- ▶ Ultrium 6 SAS Half-High tape drive sled inside a TS3200 tape library
- ▶ Ultrium 6 FC Half-High or Full-High tape drive sled inside a TS3200 tape library
- ▶ Ultrium 6 SAS Half-High tape drive sled inside a TS4300 tape library
- ▶ Ultrium 6 FC Half-High or Full-High tape drive sled inside a TS4300 tape library

- ▶ Ultrium 6 FC Full-High tape drive sled inside a TS3310 tape library
- ▶ TS1060 (3588 F6A) FC tape drive sled within a TS3500 tape library
- ▶ TS1060 (3988 F6C) FC tape drive sled within a TS4500 tape library

### **IBM TS2360 (3580 S63) tape drive S63**

IBM TS2360 tape drive model S63 (3580 S63) is an external Full-High (4 EIA units high) stand-alone or rack mountable unit that offers high capacity and performance for the midrange systems environment.

The TS2360 model S63 tape drive uses a 6 Gbps dual port SAS interface for connection to a wide spectrum of system servers. The new TS2360 attaches to selected IBM Power Systems models and to IBM System x and PC servers. The TS2360 also supports Microsoft Windows, HP-UX, Oracle Solaris, and UNIX.

The two ports per drive are available to improve availability and ease of attachment. The Ultrium 6 SAS drive attempts to connect at 6 Gbps, but auto-negotiates down to 3 Gbps or even 1.5 Gbps if the system it is connected to cannot support 6 Gbps or has problems on the physical connection. Expander use is not supported.

The TS2360 can read and write to Ultrium 6 and Ultrium 5 cartridges and is read compatible with Ultrium 4 data cartridges. The Ultrium 6 tape drive is encryption-capable and supports application-managed encryption.

IBM Spectrum Archive Standalone Drive Edition (SDE) software is included with each TS2360 tape drive. IBM Spectrum Archive and the underlying LTFS use LTO-6 tape drive partitioning. It enables a self-describing tape file format and to deliver an easy tape storage and distribution solution without the use of more database applications. Customers of IBM Spectrum Archive software are those who require a standard tape cartridge format at a low cost and use stand-alone IBM LTO-6 or LTO-5 tape drives.

The enclosure width allows two TS2360 storage units to be mounted side by side in a 19-inch IBM server rack mount shelf kit that requires three EIA units (3U) of rack space.

The TS2360 tape drive provides an excellent migration path from digital linear tape (DLT or SDLT), 1/4 inch (QIC), 4 mm (DAT), 8 mm, or older LTO generation tape drives.

There are no unique power supply requirements. The TS2360 tape drive can attach to 100 V - 125 V power supplies at 60 Hz, or 200 V - 240 V supplies at 50 Hz AC.

IBM LTO Ultrium 6 Full-High tape drives have an internal buffer of 1024 MB.

For more information about the TS2360 Ultrium tape drive, see Chapter 8, “IBM TS2360 tape drive” on page 219.



Figure 2-25 shows a TS2360 Full-High LTO Ultrium 6 tape drive.



Figure 2-25 TS2360 LTO Ultrium 6 tape drive

### **IBM TS2260 (3580 H6S) tape drive H6S**

IBM TS2260 tape drive model H6S (3580 H6S) is an external Half-High (2 EIA units high) stand-alone or rack-mountable unit that offers high capacity and performance for the midrange systems environment.

The TS2260 Model H6S tape drive uses a dual-port 6 Gbps SAS (serial-attached SCSI) host interface or an optional single 6 Gbps SAS and single USB 3.0 port. The TS2260 attaches to selected IBM Power Systems models and to IBM System x and PC servers. The TS2260 also supports Microsoft Windows, HP-UX, Oracle Solaris, and UNIX.

The following options are available for host connectivity:

- ▶ SAS connectivity only

The two ports per drive are available to improve availability and ease of attachment. The Ultrium 6 SAS drive attempts to connect at 6 Gbps, but automatically negotiates down to 3 Gbps (or even 1.5 Gbps if the system that it is connected to cannot support 6 Gbps or encounters problems on the physical connection). Expander use is *not* supported.

- ▶ SAS or USB connectivity

A single SAS port and a single USB port host interface are provided. The single-port SAS connector provides the same 6 Gbps connectivity as the dual port. The USB host interface supports USB 3.0 connectivity and can negotiate a Super Speed transfer rate. It also supports USB 2.0 connectivity at the slower transfer rates.

The USB interface automatically negotiates speed. Because no topologies are configurable, no feature switches are associated with USB. The tape drive with SAS or USB ports requires a device driver for USB 3.0 operation.

The TS2260 can read and write to Ultrium 6 and Ultrium 5 cartridges, and is read-compatible with Ultrium 4 data cartridges. The Ultrium 6 tape drive is encryption-capable and supports application-managed encryption.

IBM Spectrum Archive Standalone Drive Edition (SDE) software is included with each TS2260 tape drive. IBM Spectrum Archive and the underlying LTFS use LTO-6 tape drive partitioning. It enables a self-describing tape file format and to deliver an easy tape storage and distribution solution without the use of more database applications. Customers of IBM Spectrum Archive software are those who require a standard tape cartridge format at a low cost and use stand-alone IBM LTO-6 or LTO-5 tape drives.

The enclosure width allows two TS2260 storage units to be mounted side by side in a 19-inch IBM server rack mount shelf kit that requires two EIA units (2U) of rack space.

The TS2260 tape drive provides an excellent migration path from digital linear tape (DLT or SDLT), 1/4 inch (QIC), 4 mm (DAT), 8 mm, or older LTO generation tape drives.

There are no unique power supply requirements. The TS2260 tape drive can attach to 100 V - 125 V power supplies at 60 Hz, or 200 V - 240 V supplies at 50 Hz AC.

IBM LTO Ultrium 6 Half-High tape drives have an internal buffer of 512 MB.

For a more information about the TS2260 Ultrium tape drive, see Chapter 7, “IBM TS2260 tape drive” on page 209.

Figure 2-26 shows a TS2260 Half-High LTO Ultrium 6 tape drive.



Figure 2-26 TS2260 LTO Ultrium 6 tape drive

### **IBM LTO Ultrium 6 library drives**

The library-installable Ultrium 6 tape drives can read and write to Ultrium 6 and Ultrium 5 cartridges, and are read-compatible with Ultrium 4 data cartridges.

The LTO Ultrium 6 tape drives support data encryption on the base drive with Ultrium 6 or Ultrium 5 media. System Managed and Library Managed Encryption and associated IBM Security Guardium Key Lifecycle Manager access are available as a chargeable licensed key, Transparent LTO Encryption (feature code 5901 for TS2900, feature code 5900 for TS3100 or 3200, and feature code 1604 for TS3500 libraries). IBM Security Guardium Key Lifecycle Manager is required with this feature.

The Ultrium 6 and Ultrium 5 drives support media partitioning and the use of the IBM Spectrum Archive Library Edition (LE) and Enterprise Edition (EE) if installed in a supported library.

For more information about IBM Spectrum Archive and LTFS, see *IBM Linear Tape File System Installation and Configuration*, SG24-8090.

For more information about IBM Spectrum Archive EE, see *IBM Spectrum Archive Enterprise Edition V1.2.5.1 Installation and Configuration Guide*, SG24-8333.

### **IBM LTO Ultrium 6 Full-High library drives**

IBM LTO Ultrium 6 Full-High (4 EIA units high) drives are available for use in the TS3100, TS3200, TS3310, TS3500, and TS4500 libraries. The following drives are specified and ordered with the library:

- ▶ TS3100 library can accommodate one Ultrium 6 SAS or FC Full-High tape drive.
- ▶ TS3200 library can accommodate two Ultrium 6 SAS or FC Full-High tape drives.
- ▶ TS4300 base L3A unit can accommodate one Ultrium 6 FC Full-High tape drive.
- ▶ TS4300 optional E3A expansion unit can accommodate one Ultrium 6 FC Full-High tape drive.
- ▶ TS3310 base L5B unit can accommodate two Ultrium 6 FC Full-High tape drives.
- ▶ TS3310 optional E9U expansion unit can accommodate four Ultrium 6 FC Full-High tape drives.
- ▶ TS3500 libraries can accommodate up to 192 TS1060 drives, depending on their base and expansion frame configurations.
- ▶ TS4500 libraries can accommodate up to 60 TS1060 drives, depending on their base and expansion frame configurations.

IBM LTO Ultrium 6 Full-High tape drives have an internal buffer of 1024 MB.

### **IBM LTO Ultrium 6 Half-High library drives**

IBM LTO Ultrium 6 Half-High (2 EIA units high) drives are available for use in the TS2900, TS3100, and TS3200 libraries. The following drives are specified and ordered with the library:

- ▶ TS2900 autoloader can accommodate one Ultrium 6 SAS Half-High tape drive.
- ▶ TS3100 library can accommodate two Ultrium 6 SAS or FC Half-High tape drives.
- ▶ TS3200 library can accommodate four Ultrium 6 SAS or FC Half-High tape drives.
- ▶ TS4300 library can accommodate three Ultrium 6 SAS or FC Half-High tape drives.

IBM LTO Ultrium 6 Half-High tape drives have an internal buffer of 512 MB.

## 2.8 IBM LTO Ultrium family of tape drives and libraries

The IBM LTO Ultrium family of tape drives and libraries (as shown in Figure 2-27) consists of the product offerings that range from a stand-alone unit to a highly scalable, automated library.



Figure 2-27 IBM tape libraries, tape autoloader, and tape drives

The TS4500 tape library base frame is shown in Figure 2-28.



Figure 2-28 TS4500 tape library base frame

TS4500 expansion frames can be wrapped with custom images, as shown in Figure 2-29.

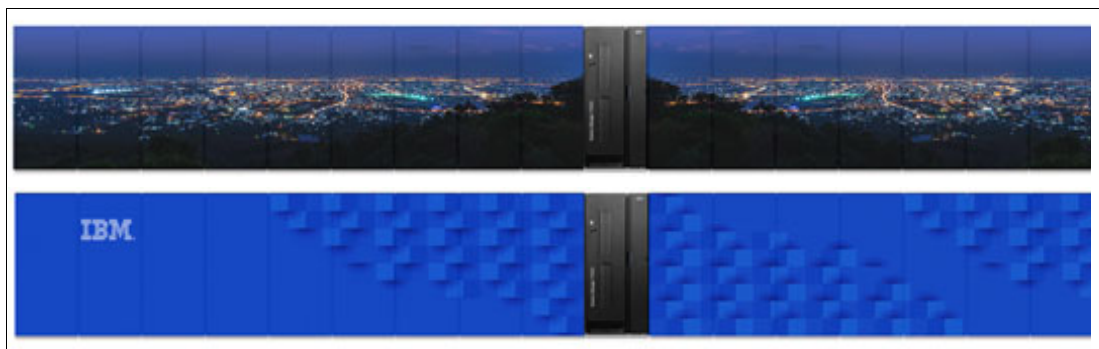

Figure 2-29 TS4500s with image wrapped expansion frames



The product offerings are all based on a common tape drive subassembly that is packaged in various robotic and stand-alone environments. As shown on the right side of Figure 2-27 on page 98, the following tape drives and libraries are available:

- ▶ The IBM TS2290 tape drive is an external stand-alone or rack-mountable (optional) unit for the family of IBM LTO Ultrium Tape products. It features the LTO Ultrium 9 Half-High tape drive.
- ▶ The IBM TS2900 tape autoloader is an external stand-alone or rack-mountable unit in the family of IBM LTO Ultrium Tape products. When it is mounted in a rack, it occupies one unit of the rack. It features one LTO Ultrium Half-High tape drive.
- ▶ The IBM TS3100 tape library is a desktop or rack-mountable single drive unit that can hold up to 24 cartridges. A robotic system moves the cartridges to and from the drive. When it is mounted in a rack, it occupies two units of the rack. It features up to two LTO Ultrium Half-High tape drives or one LTO Ultrium Full-High tape drive.
- ▶ The IBM TS3200 tape library is a desktop or rack-mountable single or dual drive unit that can hold up to 48 cartridges. It has a three slot I/O station that must be shared when logical libraries are configured. When it is mounted in a rack, it occupies four units of the rack. It features up to four LTO Ultrium Half-High tape drives or up to two LTO Ultrium Full-High tape drives.
- ▶ The IBM TS4300 tape library is a modular Ultrium LTO library. The smallest configuration includes a 3U base module with one to three LTO Ultrium Half-High or one Full-High and one Half-High tape drives, up to 384TB of native tape storage (32 slots), and 4 I/O slots.

This tape library can be upgraded using expansion modules to a fully configured rack-mounted library 21U high. The largest configuration has up to 21 LTO Ultrium Half-High tape drives and up to 5 PB with a full configuration of one 3U base module plus six rack-mountable expansion modules. The TS4300 hosts Ultrium LTO-9, LTO-8, LTO-7, or LTO-6 tape drives.

- ▶ The IBM TS3310 tape library is highly modular and vertically expandable. The smallest configuration includes a base module with one to two LTO Ultrium Full-High tape drives, 210 TB of native tape storage (35 slots), and 6 I/O slots. This tape library can be upgraded to a fully configured rack-mounted library 41U high. It has up to 18 LTO Ultrium Full-High tape drives, over 4908 TB of native tape storage (409 slots), and up to 54 I/O slots.
- ▶ The IBM TS3500 tape library is shown on the left side of Figure 2-27 on page 98. This tape library is a larger modular enterprise class library with the potential to house a maximum of 192 IBM LTO or IBM 3592 tape drives in as many as 16 frames. The library also can be ordered with a dual accessor model option to help increase mount performance and overall system reliability and availability.

A TS3500 tape library with High Density (HD) frames can store over 241 PB of decompressed data or 602 PB at a 2.5:1 compression ratio. With the release of the TS3500 tape library shuttle complex configuration that supports over 300,000 LTO cartridges, an astounding capacity value of over 3,600 PB can be reached.

- ▶ The IBM TS4500 is a highly scalable, stand-alone tape library that provides high-density tape storage and high-performance, automated tape handling for open systems environments. An individual library consists of one base frame and up to 17 expansion frames and can include up to 128 tape drives and more than 23,000 tape cartridges, as shown in Figure 2-28 on page 99.

The TS4500 tape library provides the following capabilities:

- All of the frames include high-density (HD) slot technology
- Additional frame models can be placed in any active position so that the library can grow from both the right side and the left side of the first L frame

- Integrated management console (IMC)
- User interface for improved usability
- Updated control system
- Input/output (I/O) magazine to allow individual cartridge handling to be performed independently of the library
- Top-rack space to house extra tape solution components within the library footprint
- Support for HD2-compatible models of the TS1160(3592 60F and 60E), TS1155 (3592 55F and 55E), TS1150 (3592 EH8), TS1140 (3592 EH7), LTO-9 (3588 F9C), LTO-8 (3588 F8C), LTO-7 (3588 F7C), LTO-6 (3588 F6C), and LTO-5 (3588 F5C) tape drives
- Legacy Frame Support for S54 and S24 frames from the TS3500 library

The TS4500 tape library is available with several tape drives, frame models, and feature options, to meet your specific needs. Additional features of the TS4500 tape library are highlighted in the following list:

- Advanced Library Management System (ALMS)
- Ability to attach multiple simultaneous heterogeneous servers
- Supports SCSI in band method for sending REST API commands and receiving HTTP responses that use SCSI Write Buffer and Read Buffer commands. The method is called REST over SCSI or RoS, for short. ITDT handles the RoS calls.
- Remote management with the TS4500 management GUI or the TS4500 command line
- Command-line interface (CLI)
- Remote monitoring by using Simple Network Management Protocol (SNMP), email, or syslog
- Multipath architecture
- Drive and media exception reporting
- Host-based path failover
- Up to 288 I/O slots (36 I/O slots standard for LTO libraries and 32 I/O slots standard for 3592 libraries)

For more information about the TS4500 tape library, see *IBM TS4500 R8 Tape Library Guide*, SG24-8235.

## 2.8.1 Multipath architecture

The patented multipath architecture is an IBM unique feature. The TS3100, TS3200, TS3310, TS3500, TS4300 and TS4500 tape libraries implemented the second generation of the architecture. It uses the SCSI-3 Move Media command set that is featured in midrange and open libraries. The multipath architecture removes the need for a dedicated server plus middleware to control the use of a library by multiple hosts that are using various operating systems because each drive has its own path to the control unit.

Conventional tape libraries use a dedicated host port to communicate with the library; for example, for sending mount request commands. IBM LTO tape libraries use the same path to communicate with the drives and the library controller, as shown in Figure 2-30. This path is not one dedicated path; it might be any path to any tape drive.

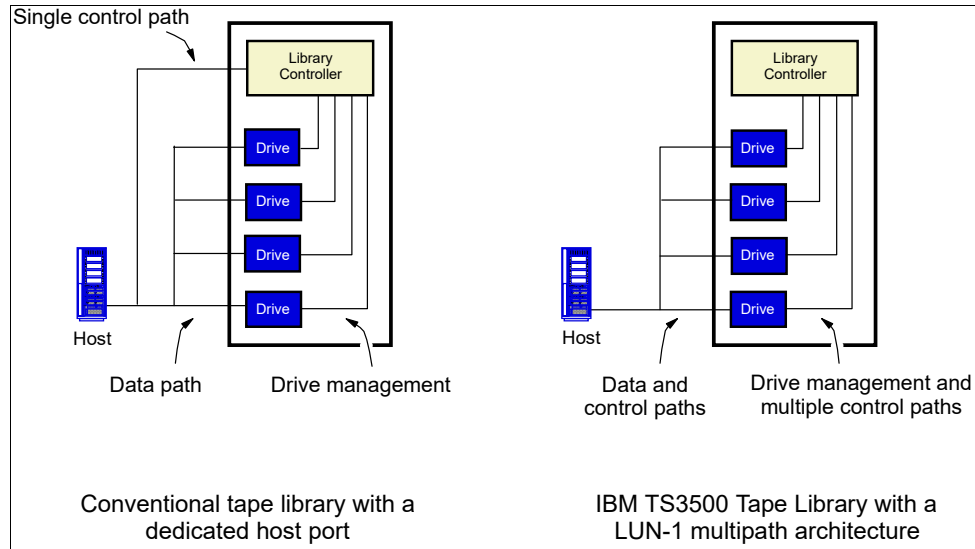

Figure 2-30 Conventional tape library compared to multipath architecture

For conventional tape libraries, the control path is a single point of failure. By contrast, the IBM LTO tape libraries offer as many control paths as there are drives that are installed in the library. Therefore, if an individual control path failure occurs, the library communication can be over different, redundant control paths.



As shown in Figure 2-31, if one path to a drive is broken because of a defective switch port, cable, or HBA, communication to the library controller can occur by using one of the other available paths. With automatic Control Path Failover, this design constitutes a unique high-availability option.

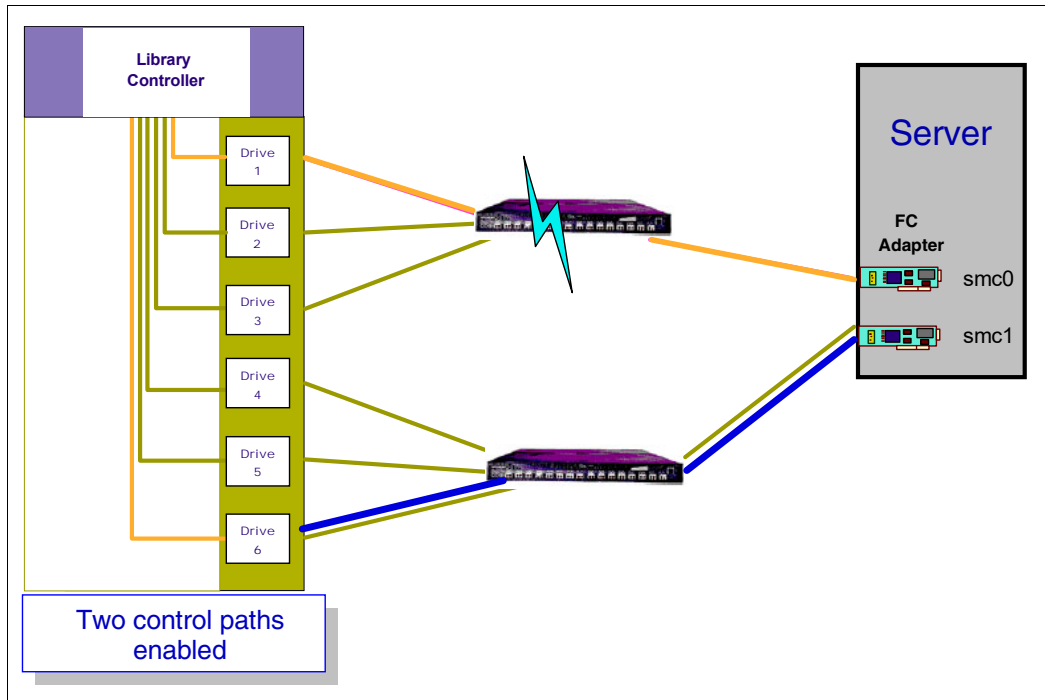

Figure 2-31 Redundant control paths to the library controller

In addition to the redundant control path, multipath architecture offers the benefit of built-in partitioning. With the partitioning feature of the IBM LTO libraries, the physical library can be divided into several smaller logical libraries, which are independent of each other. The maximum number of logical libraries varies by model type. A logical library must contain at least one tape drive and cartridge cell, and can consist of more than one tape drive that shares cartridge cells.

Multiple heterogeneous hosts can share the library with this partitioning option. Each logical library has its own drives, cartridges, and control paths. Because of barriers between the logical libraries, cartridges cannot be moved from one logical library to another.

Figure 2-32 shows three logical libraries, with two drives each and several cartridge storage slots that are dedicated to each of the heterogeneous servers.

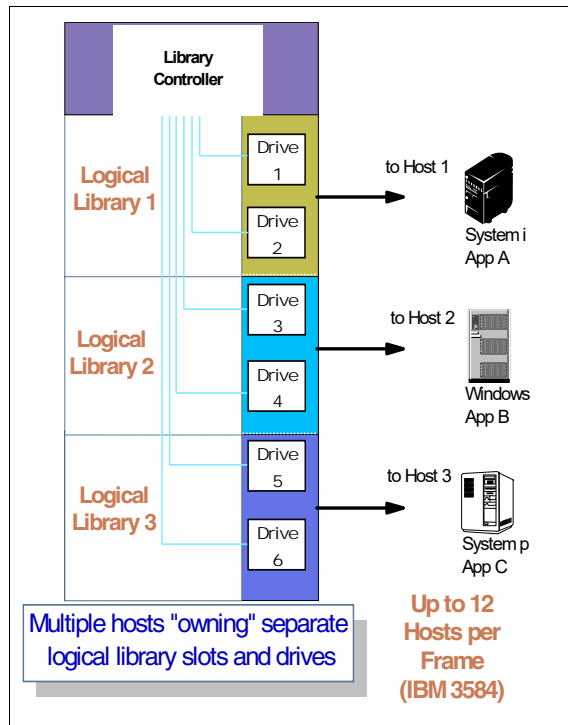

Figure 2-32 IBM LTO tape library partitioned into three logical libraries

## 2.8.2 Next-generation multipath architecture

The Advanced Library Management System is an optional extension to the IBM patented multipath architecture. The multipath architecture virtualized the library accessor. This architecture enabled a library to be partitioned into multiple logical libraries and allowed a single library accessor to be used by multiple host computers in a transparent manner. The ALMS virtualizes the SCSI element address for storage slots, I/O slots, and drives.

ALMS provides enhanced automation functionality, such as dynamic partitioning, including storage slot pooling and flexible drive assignment. Tape drives can be assigned to any logical library and to multiple logical libraries by using a web browser-based user interface. Logical libraries can be added, deleted, or easily changed non-disruptively. Storage capacity can be changed without any impact to host applications.

**Note:** Advanced Library Management System (ALMS), which comes standard on the TS4500, always shows as installed. For more information, see *IBM TS4500 R8 Tape Library Guide*, [SG24-8235](#).



## IBM TS1100 tape drives

This chapter describes the TS1100 tape drive family, its common characteristics, the differences between the six generations, and the IBM 3592 media characteristics. This chapter focuses on the following models:

- ▶ IBM TS1160 tape drive (3592 Model 60E and Model 60F and Model 60G)
- ▶ IBM TS1155 tape drive (3592 Model 55E and Model 55F and Model 55G)
- ▶ IBM TS1150 tape drive (3592 Model E08 and Model EH8)
- ▶ IBM TS1140 tape drive (3592 Model E07 and Model EH7)
- ▶ IBM TS1130 tape drive (3592 Model E06 and Model EU6)
- ▶ IBM TS1120 tape drive (3592 Model E05)
- ▶ IBM Enterprise 3592 Model J1A tape drive

**Note:** Consider the following points:

- ▶ The 3592 model E09 and EH9 are referred to as 3592 model 60E, 60F, and 60G in this document.
- ▶ The 3592 Model J1A, TS1120 (3592 Model E05), and TS1130 (3592 Model E06) are withdrawn from marketing and can no longer be purchased. Therefore, they are not described here.
- ▶ TS1160 model 60F, TS1155 model 55F, TS1150 model EH8, and TS1140 model EH7 are functionally the same as TS1160 model 60G, TS1155 model 55G, TS1150 Model E08, and TS1140 model E07. However, they are packaged for integration into a TS4500. For more information, see *IBM TS4500 R4 Tape Library Guide*, SG24-8235.
- ▶ Only models 60G, 55G, E08, and E07 are described in this chapter.

This chapter includes the following topics:

- ▶ 3.1, “IBM TS1100 tape drive family” on page 106
- ▶ 3.2, “Common characteristics of the 3592 tape drive family” on page 108
- ▶ 3.3, “Physical attachment” on page 116
- ▶ 3.4, “Media” on page 119
- ▶ 3.5, “IBM TS1160 tape drive” on page 128
- ▶ 3.6, “IBM TS1155 and TS1150 tape drive” on page 145
- ▶ 3.7, “IBM TS1140 tape drive” on page 166

## 3.1 IBM TS1100 tape drive family

The IBM TS1160 (Machine type 3592-60G), TS1155 (Machine Type 3592-55G), TS1150 (Machine Type 3592-E08), TS1140 (Machine Type 3592-E07) offer a design that is focused on high capacity, performance, and high reliability for storing mission-critical data. With the introduction of the first generation of the new family of tape drives, IBM advanced its high-end, half-inch cartridge tape technology to a new level.

The 3592 family was enlarged and improved with the addition of the IBM TS1160, 3592 Model 60G tape drives. The TS1160 is the sixth generation of the 3592 tape drive family. It provides the unprecedented capacity of 20 TB of uncompressed data on a single tape and new physical connection options.

### 3.1.1 1 TB and beyond.

On 5 April 2002, IBM achieved an unprecedented feat when 1 TB of data was recorded, without compression, to a half-inch format tape. This record was a technological accomplishment that set the foundation for the 3592 tape drive family.

In 2006, IBM further demonstrated their technology leadership by the recording of 8 TB to a half-inch format tape, and in 2010 demonstrated recording 35 TB of uncompressed data to a half-inch format tape.

In 2014, the capacity of tape was demonstrated by IBM and FujiFilm announcing that their researchers broke the world record in the amount of data that can be stored per square inch on Linear Tape-Open (LTO) cartridge. IBM showed that FujiFilm's "double-coated" tape can store 85.9 billion bits per square inch on areal data density on linear magnetic particulate tape. With this density, a standard tape cartridge can store 154 TB of uncompressed data.

In 2017, IBM achieved a new record of 201 Gb/in<sup>2</sup> (gigabits per square inch) in a real density, which was achieved on a prototype sputtered magnetic tape that was developed by Sony Storage Media Solutions.

This record was increased to 330 terabytes (TB) of uncompressed data on a single tape cartridge that fit in the palm of your hand. For more information, see this [IBM Newsroom web page](#).

The evolutionary progression of technology building blocks that were set in place over the preceding years to make these advances possible. An enterprise tape drive roadmap was laid out to ultimately reach and far exceed the 1 TB in native cartridge capacity within 3592 tape drive generations.

The 3592 Model J1A became the first tape drive generation of the Enterprise Tape family. It enabled the storage of 300 GB of data to a cartridge (900 GB with 3:1 compressible data).

The same cartridges can be reused by the second generation of 3592 tape drives. The TS1120 Model E05 is able to store even more data than before. By using the JA media, it is possible to store without compression 500 GB of data, and with the high capacity JB cartridge 700 GB of data.

With the third generation of IBM 3592 tape drive, it was possible to store 640 GB on JA media and 1 TB on the JB media.

With the fourth generation of 3592, the IBM TS1140 model E07, IBM again takes advanced tape capacity to a new level. The TS1140 can store over 1.6 TB of data on the JB cartridge type and 4 TB of data on the JC cartridge type.

The fifth generation of 3592, the IBM TS1150 model E08, IBM took tape technology to the next level. The TS1150 can store 7 TB of data on the JC cartridge type and 10 TB of data on the new advanced JD cartridge type.

With the enhanced fifth generation 3592, the IBM TS1155 model 55E, 55F, and 55G, IBM again demonstrated its commitment to tape technology by taking tape capacity to a new level. The TS1155 can store 7 TB of data on the JC cartridge type and 15 TB of data on the new advanced JD cartridge type. IBM kept its documented promise in the roadmap for 3592 tape drives and provided a 15 TB tape drive.

With the new sixth generation 3592, the IBM TS1160 model 60E, 60F, and 60G, IBM again demonstrated its commitment to tape technology by taking tape capacity to a new level. The TS1160 can store 15 TB of data on the JD cartridge type and 20 TB of data on the new advanced JE cartridge type. IBM kept its documented promise in the roadmap for 3592 tape drives and provided a 20 TB tape drive.

### 3.1.2 Nomenclature

Because of many common considerations for the TS1120, TS1130, TS1140, TS1150, TS1155, and TS1160 tape drives, and to make reading more convenient, the following names are used in this publication:

- ▶ 3592 is used, referring to all models
- ▶ TS1160 is used for the 3592 60E, 60F, and 60G tape drive
- ▶ TS1155 is used for the 3592 55E, 55F, and 55G tape drive
- ▶ TS1150 is used for the 3592 E08 tape drive
- ▶ TS1140 is used for the 3592 E07 tape drive
- ▶ TS1130 is used for the 3592 E06 tape drive
- ▶ TS1120 is used for the 3592 E05 tape drive
- ▶ 3592-J1A is used for the first 3592 generation
- ▶ Media format 3592 is used, referring to all 3592 media formats
- ▶ 60E, 60G and 60F are used for the 3592 60E, 60G, and 60F media format J6
- ▶ 55E, 55G and 55F are used for the 3592 55E, 55G, and 55F media format J5A
- ▶ E08 is used for the 3592 E08 media format J5
- ▶ E07 is used for the 3592 E07 media format J4
- ▶ E06 is used for the 3592 E06 media format J3
- ▶ E05 is used for the 3592 E05 media format J2
- ▶ J1A is used for the first 3592 J1A media format J1

**Note:** TS1160 denotes the product name, and 3592 55F denotes the machine type and model. For TS1160 model 60E is TS4500 Ethernet attach, 60F is TS4500 Fiber attach and 60G is TS3500 Fiber attach.

## 3.2 Common characteristics of the 3592 tape drive family

The 3592 tape drive family has the following common characteristics, which are described in this section:

- ▶ Technology enhancements
- ▶ Reliability and availability improvements
- ▶ Features for performance and capacity
- ▶ Media that can be reused by the next generations of drives

### 3.2.1 Technology enhancements

The 3592 tape drive family includes the following key features:

- ▶ Virtual backhitch, which is the optimum adaptive format and algorithm for improved start-and-stop write performance. For more information, see “Virtual backhitch (nonvolatile caching)” on page 113.
- ▶ High performance and robust dual microprocessor architecture. One microprocessor operates the host attachment interface (which is running proven 3590 host-attach Licensed Internal Code). The other microprocessor focuses strictly on writing data and reading data from tape. Each microprocessor resets the other microprocessor to act as a fail-safe.
- ▶ Statistical Analysis Recording System (SARS) algorithm with extended mount count.
- ▶ Fast random access performance when operating on any of the Short Length Cartridge (SLC) types.
- ▶ Support of an enhanced capacity scaling and segmentation format when operating on the full-length, read/write cartridge type JA, JB, JC, JD, and JE, which enables fast locate and read times.
- ▶ Streaming Lossless Data Compression (SLDC) algorithm, which is an enhancement of the Lempel-Ziv class 1 (LZ-1) data compression algorithm.
- ▶ The JE, JD, JZ, and JL media types contain 16 KB cartridge memory, increased from the 8 KB cartridge memory that is contained in JC and JB media types and 4 KB cartridge memory that is contained in JA, JW, JR, and JJ media types.

### 3.2.2 Recording format

The IBM 3592 tape drive uses an advanced interleaved bidirectional serpentine recording technique that writes 8, 16, or 32 (depending on the drive) data tracks at a time on a 3592 cartridge. The 3592 cartridge is a half-inch, advanced metal particle, dual layer tape. The tape layout consists of five servo bands (pre-recorded on the tape) and four data bands where the data is written, as shown in Figure 3-1 on page 109.

The servo bands provide location information to control the positioning of the head as it writes and reads data within the data band. For more information about this design, see “Servo tracks” on page 109.

As shown in Figure 3-1, the area between adjacent servo bands is a *data band*. The 3592 media has four data bands, each with a number of data tracks (128 - 288, which is different for each model).

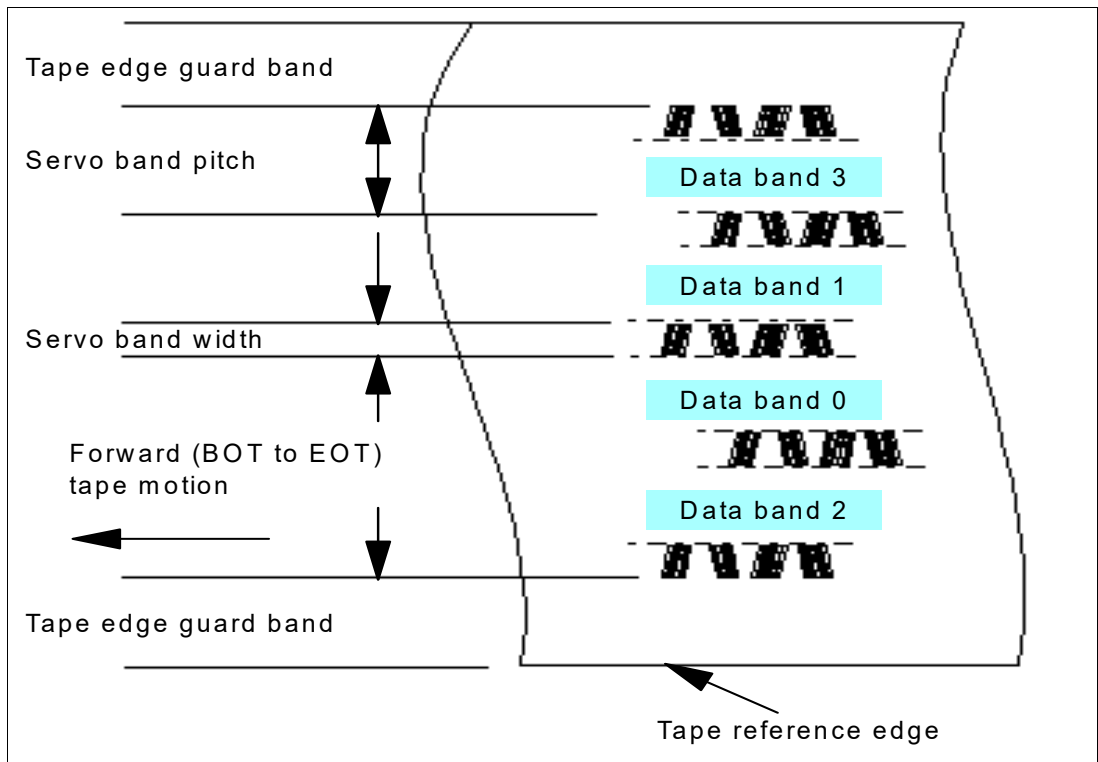

Figure 3-1 Layout of the servo and data bands on the 3592 media

### Servo tracks

*Servo tracks* or bands help to ensure accurate positioning of the tape drive head over the data track so that the head does not stray onto an adjacent track. Servo tracks are necessary to support high-data densities on the tape where the tracks are extremely close together.

The servo tracks are written at the time of cartridge manufacture before the cartridge is usable for data storage and retrieval. Each tape write head has two *servo heads*, one servo head for each of the two *servo bands* that it spans.

Two servo bands are used simultaneously to provide two sources of servo information for increased accuracy. Control positions within the servo band are used to reposition the head to write forward and reverse wraps, within each of the four data bands. This timing-based servo technology can be finely tuned. It supports extremely high-track densities for future 3592 generations because more than eight positions can be defined within the same servo band, thus expanding the potential track densities.

In addition, there are significant advances in the tape coating process, which uses high-quality metal particle media.

### 3.2.3 Reliability and availability

The 3592 tape drive incorporates and expands on the high reliability and function of previous IBM drives that were developed over many years of experience. It builds on proven technologies to enhance and apply new techniques to ensure high reliability and availability.

## Improved availability

Improved availability includes the following characteristics:

- ▶ Single field-replaceable unit (FRU)

When a service call is placed, the IBM Service Support Representative (SSR) does not replace any parts or subassemblies inside the canister. The smaller drive unit means that for any failure within the drive, the IBM SSR exchanges the entire unit rather than performing lengthy diagnostics or component replacement in the field.
- ▶ Redundant, hot-pluggable power supplies

In all configurations, the drives are seated in *cradles* that contain two power supplies. Each pair of power supplies can be used by one or two drives. One of these power supplies is sufficient to run both drives, and the second power supply is provided for redundancy.
- ▶ Retention of the Fibre Channel (FC) worldwide name ID or Ethernet port settings during service action.

When a failed drive is exchanged, the attached hosts or storage area network (SAN) do not need to be reconfigured to recognize a replacement drive. This function also eliminates any issues with SAN or Ethernet host finding incorrect addresses during a system reboot.

## Advanced technology

Advanced technology includes the following characteristics:

- ▶ Robust loader mechanism

The loader mechanism is suitable for the heavy-duty cycle use in mainframe systems. The leader block on the tape cartridge is replaced by a metal pin, which is enhanced over previous drive implementations for increased robustness.
- ▶ Elimination of drive pneumatics and mechanical adjustments

The aerodynamic movement of the tape over the flat-lap head pulls the tape close to the head while the tape is moving and provides maximum efficiency in reading and writing. Because of the shape of the head, particles do not accumulate on the tape, which eliminates the possibility of debris contaminating the tape surface.

Air-bearing heads effectively cushion the tape moving across the head. However, whenever the tape stops, it relaxes toward the head surface. The head has a two-stage actuator: One mechanism for moving to the required tape wrap and another finer actuator for adjustments to the track-following servo.
- ▶ Straighter and shorter tape path for better tape tracking

Tape tracking is improved by using grooved rollers to provide surface-controlled guiding. This enhancement decreases potential wear or damage on the edges of the tape and, with the shorter tape path, decreases lateral movement.
- ▶ Speed matching to reduce backhitching (see 3.2.4, “Features that are designed for capacity and performance” on page 112).

Buffering, speed matching, and virtual backhitch algorithms all serve to eliminate physical backhitching. They improve performance and reduce the wear on the drive mechanics that are caused by continually braking and reversing direction.
- ▶ Channel calibration to optimize performance and data integrity

The drive uses individual read/write data channel calibration, which uses sophisticated techniques that were originally implemented in disk technology.



## Enhanced service functions

The following service functions were enhanced:

- ▶ Enhanced SARS recording

The tape drive uses the Statistical Analysis Recording System (SARS) to help isolate failures between media and hardware. The SARS uses the cartridge performance history that is saved in the cartridge memory module and the drive performance history that is kept in the drive flash.

The cartridge memory is a serial Electrically Erasable Programmable Read-Only Memory (EEPROM), with read-only and rewritable areas, to determine the more likely cause of failure. The SARS can cause the drive to request a cleaner cartridge (based on use) to mark the media as degraded and to indicate that the hardware is degraded. SARS information is reported through the TapeAlert flags and through media information messages (MIMs) and service information messages (SIMs).

- ▶ Diagnostic information

The drive maintains logs to assist engineering or service personnel. The logs are included in drive memory dumps and are accessible to service personnel in several ways, including through the hot-pluggable service window. Memory dumps are maintained over Power On Reset (POR).

- ▶ More temperature and voltage sensors to improve error isolation

The drive contains sensors and circuits to detect errors. A temperature sensor monitors the temperature of the drive electronics. Voltage sensors detect when the power supply is out of tolerance.

Other error checks, such as tape velocity checks, read/write data integrity checks, and servo checks are performed by using circuitry and sensors. The drive Licensed Internal Code checks for logic errors to handle hardware-detected errors and to detect and report Licensed Internal Code-related errors.

- ▶ Drive status indicators and reliability, availability, and serviceability (RAS) functions on the library drive interface

The drive provides indicators for FC status, whether the power is good, and faults. However, the drive hot-pluggable service panel is the key service tool to perform test procedures and interpret results. Many functions and information can now be accessed that were previously available only from this panel in the 3494 Library Manager interface, which is more convenient and accessible to clients and service personnel.

- ▶ Concurrent Licensed Internal Code update, with options to switch the new or old copy of drive code

- ▶ Backup drive vital product data (VPD card) stored from the drive

When a drive is replaced, the VPD can be quickly downloaded to the drive by using the backup, which reduces the time that is taken for repair or configuration.

- ▶ Functional Licensed Internal Code updates through the library manager

The firmware (Licensed Internal Code) can be updated in the 3592 tape drive in several ways, and the update no longer requires a Field Microcode Replacement (FMR) tape. The firmware can be updated by using the following components:

- FMR cartridge that contains the updated code
- Host attachment (FC bus) by using the write buffer command or by using ITDT
- RS-422 port to the drive if supported by the library automation
- Management Ethernet port (on TS1160, TS1155, TS1150, and TS1140 only)

- ▶ Preventive maintenance

The 3592 tape drive requires no preventive maintenance beyond the use of the cleaning cartridge. The 3592 media cartridges require proper care and appropriate handling and shipping procedures.

### 3.2.4 Features that are designed for capacity and performance

The unique features and specifications of the 3592 make it a true enterprise tape drive in terms of performance and reliability. The following sections describe these industry-leading features in greater detail.

**Important:** These features are generic for all 3592 drives. The TS1160 have other advanced features that are described in 3.5, “IBM TS1160 tape drive” on page 128.

#### Data buffer

The drive has a large data buffer with read-ahead buffer management that addresses the lowest band of data rates. It effectively collects more blocks of data in the buffer before writing to the drive at a higher speed. As a result of this data buffer, the drive stops and starts less often, which generally improves the overall performance and reliability of the drive and tape.

#### Speed matching

For medium data rates when they are operating from a host that cannot sustain the maximum 3592 data rate, the drive performs dynamic *speed matching*. The drive adjusts the native data rate of the drive as closely as possible to the net host data rate (after factoring out data compressibility). The 3592 drive operates at various speeds (6 - 13 speeds, depending on the drive that is used) when the 3592 format is read or written to in an attempt to match the effective host data rates.

If the net host data rate is between two of the speed matching native data rates, the drive calculates at which of the two data rates to operate. Speed matching reduces the number of required backhitches. In some environments, the backhitch of the drive is masked by the data buffer of the drive. Therefore, the system throughput is not improved or reduced by speed matching.

#### Cartridge memory

Contained within the cartridge is the Cartridge Memory (CM), which is a passive, contactless silicon storage device that is physically a part of the cartridge. The CM is used to hold information about that specific cartridge, the media in the cartridge, and the data on the media.

The 3592 uses the same CM module as LTO media, with a capacity of 4 KiB, extended to 8 KiB on JB/JX media and JC/JY/JK media, enhanced to 16 KiB for JE, JV, JD, JL, JM, or JZ media. The CM is designed for 3592 to support the high-resolution tape directory feature and differs from the LTO specification. It supports the high-resolution tape directory feature (see “High-resolution tape directory” on page 113).

Communication between the drive and the cartridge memory occurs through a noncontact, passive radio frequency interface (RFI), which eliminates the need for physical connections to the cartridge for power or signals.

## High-resolution tape directory

The 3592 drive maintains a tape directory structure with a higher granularity of information about the physical position of data blocks and file marks on the media. This feature gives the 3592 drive improved nominal and average access times for locate operations.

Locate times are uniform. They are based on the position of the block or file mark on the tape independent of the uniformity of the block size or file mark distribution along the length of the tape. Therefore, the 3592 locate and space performance is targeted to be completely and individually dependent on the longitudinal position on tape of the target block or file mark.

## Virtual backhitch (nonvolatile caching)

The 3592 stages write-data through an intermediate dynamic random access memory (DRAM) buffer on its way to tape. This buffer is volatile because it does not retain what is stored if power is lost. For streamed writes (or reads), this buffer yields considerably improved performance.

When streaming writes cease, a typical pre-3592 tape drive halts the tape and repositions it directly upstream of where the writing ended. From this action, later received data can be written immediately following the previously written data. This method eliminates the waste of the considerable length of tape. Substantial lengths of unwritten tape can significantly reduce capacity. Here, a backhitch (reverse) by typical tape drives is used to eliminate this capacity loss following a write to tape.

Nonvolatile caching (NVC) is a 3592 feature that can help greatly improve write performance through backhitch reduction. This system temporarily reserves portions of physical tape for cache areas. Data that is received from the host is written to the volatile buffer as usual and to nonvolatile tape cache areas with the exception that no backhitch is necessary when temporary copies are written to cache areas of tape. This temporary capacity loss is easily recouped.

The data is written to temporary cache areas and is not released in the volatile buffer, but instead it accumulates. This accumulation continues until the buffer is nearly full. Now, the accumulated data in the buffer is rewritten through a streamed write to the standard area of tape. When the rewrite is complete, the temporary cache areas of tape are released so that they can be overwritten.

To significantly improve the average write throughput to tape, temporary copies can be written to the cache areas of tape without backhitching until the buffer is nearly full. Then, a rewrite of the data can be streamed to the standard area of tape.

Aside from the improved write throughput performance, the second effect of NVC writing is to recover the capacity that is lost by the standard writing technique. Data that is received between synchronization events fills containers of data to be written to tape called *device blocks* or *data sets*. The standard writing technique calls for padding the last partially filled data set. This padding on average amounts to half the size of the last data set. Given the large data set sizes of modern tape drives, this loss can be substantial.

The streaming rewrite of the data that is accumulated in a buffer causes nearly all data sets written to a standard area of tape to be written in full, which is known as *data set packing*.

Writing in NVC mode is automatically started by the drive when host writing behaviors are detected that get better performance when in NVC writing mode. Similarly, NVC writing is discontinued when host commands are received that do not benefit from NVC writing, or when commands, such as rewind, are received.

When NVC writing is exited, the drive writes any packed data sets that are accumulated in its buffer before running the command that caused NVC mode to be stopped. Because it is automatically started and stopped, NVC writing is not apparent to host applications. The only indication that NVC writing occurs is the improved capacity and performance that can result from this mode of writing.

The two components of nonvolatile caching, backhitch reduction and data set packing, provide major performance and capacity improvements over standard tape drives, such as the 3590, or Linear Tape-Open (LTO) writing of synchronized data. Data set packing improves overall tape capacity. Backhitch reduction decreases the frequency of mechanical repositions. NVC provides an innovative approach to increasing capacity and write performance in a way that is not apparent to host applications.

### 3.2.5 Performance or capacity scaling

The 3592 drives support scaling and segmentation modes on the read/write (JA, JB, JC, JD, or JE) cartridges so that users can trade off capacity for improved access times.

**Important:** Capacity scaling is not supported for economy (JJ, JK, JL, and JM) or Write Once Read Many (WORM) tapes (JW, JX, JY, JR, and JZ).

Although 256 settings of capacity are supported on the 3592 drive, the following settings are often used:

- ▶ Full capacity default mode
- ▶ A 20% scaled fast access mode (capacity scaled, front of tape through an x'35' setting)
- ▶ Performance scaling for 86.6% capacity (segmented format, capacity scaling setting x'E0')

Performance scaling, also known as *capacity scaling*, is a function through which data can be contained in a specified fraction of the tape, which yields faster locate and read times. This function is made possible through the action of modifying internal formatting indicators in the medium and in the cartridge memory chip.

The normal serpentine track format is altered in such a way as to limit the recorded portion of the tape to a specified fraction of the length of the tape (as shown for 3592-60F in Figure 3-2). In the 3592, an application can issue a **Mode Select** command to scale an individual cartridge. It pertains only to the cartridge that is loaded and is not persistent.

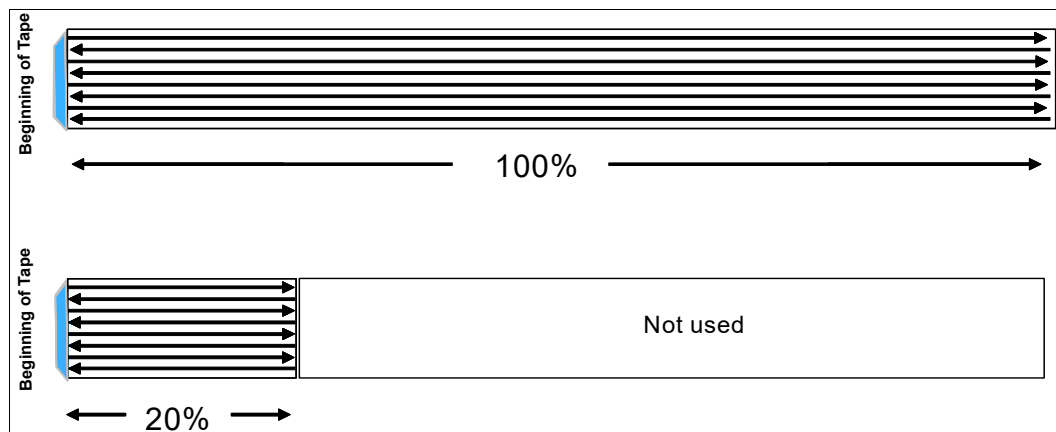

Figure 3-2 Examples for a 100% tape and scaled tape by 20%

The result of performance scaling a tape to a percentage value (for example, 20%) is that the maximum number of recordable gigabytes is reduced to 20% of the normal value. Also, the average time to locate a random record on a full tape starting from load point is (roughly) 20% of the time to locate a random record from load point for a full, unscaled tape.

The cartridge can be rescaled from any current value to any supported new value. Tape is logically erased by this rescaling (the end of data mark is written at the beginning of the tape), but not physically erased as with the long erase command. Scaling or rescaling one cartridge does not cause rescaling of the next cartridge. An explicit command must be issued for each cartridge to be scaled or rescaled.

### Capacity scaling and segmentation

Capacity segmentation provides fast access and capacity by allowing the tape to be divided into two segments. One segment is a fast access segment to be filled first, and the other segment is more capacity to be filled after the first segment. Therefore, it is high performance in two ways. It has segmentation and has high-performance random access in the first segment, as though it was a scaled cartridge, and providing other larger capacity, as shown in Figure 3-3.

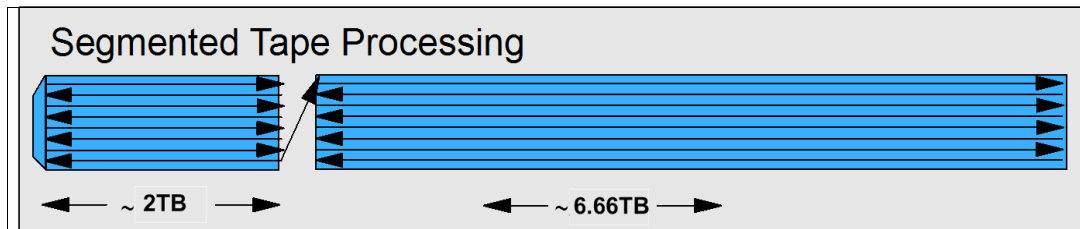

Figure 3-3 Segmented tape on 3592-E08 JD media

Performance capacity scaling and segmentation have the following implications:

- ▶ If host systems provide a means to limit the amount of data that a client places on the media (for example, with a percent utilization construct), the user achieves a much faster average access time to the first data. Also, more locates on the same volume improve significantly.
- ▶ When the performance segmentation option is used, the overall capacity of the cartridge is limited to 86.6% of the total capacity. The fast access segment occupies the first 20% of the cartridge, followed by the slower access segment.

### 3.3 Physical attachment

The 3592 tape drives are supported in various environments, including selected IBM mainframes (IBM Z and zEnterprise® systems), IBM System i, IBM iSeries, AS/400, IBM Power Systems (p6 and newer), IBM System p (p5 and older), IBM RS/6000, IBM pSeries, IBM System x, IBM xSeries, Oracle, and Hewlett-Packard servers. They also are supported on Intel technology-compatible servers that are running Microsoft Windows and Linux.

For more information about the systems that were tested and are approved for use, see the [IBM System Storage Interoperability Center \(SSIC\)](#).

Most 3592 tape drives also can attach to IBM Z servers with the IBM Fibre Connection (FICON) channels by using the IBM TS7760T, IBM 3592 Model C06, and C07 FICON Tape Controllers. The TS1155 and TS1160 are *not* supported on IBM Z systems.

The 3592 Fibre Channel (FC) attach tape drives feature dual-ported, switched FC attachments 8 Gbps (TS1155, TS1150, and TS1140), and 16 Gbps (TS1160). This function provides capability for the attachment to multiple servers or a single server with redundancy. This function also offers attachment flexibility in an open systems environment. The drive can be directly attached to open systems servers with use of a Fibre Channel host bus adapters (HBAs).

The TS1160 and TS1155 Ethernet attach tape drive includes two 10 GB optical Ethernet ports, or the option for two 25 Gbps Ethernet ports on the TS1160.

The TS1160 tape drives attempt to connect at 16 Gbps. However, they autonegotiate down to 8 Gbps, or 4 Gbps if the system or port that they are connected to cannot support higher bandwidth.

The TS1155, TS1150, and TS1140 tape drives attempt to connect at 8 Gbps. However, they can autonegotiate down to 4 Gbps, 2 Gbps, or 1 Gbps if the system or port that they are connected to cannot support higher bandwidth.

The 3592 8Gb Fibre Channel (FC) attach tape drives can operate as a node loop port (NL\_port) (Fibre Channel Arbitrated Loop [FC-AL] support) or as a node (N\_port), which supports direct connection to a SAN switch (also known as *point-to-point* or fabric mode). The 3592 tape drives autonegotiate to the N\_port or NL\_port, depending on whether a loop or a point-to-point connection is detected when the drive boots.

The drives do not autonegotiate if the drive was set to use a specific setting of these configurations. Regardless of whether the 3592 tape drives connect as an NL\_port or an N\_port, they autonegotiate to be a public device (attached to a switch) or a private device (attached to another N\_port; that is, directly to a host).

The 3592 16 Gb Fibre Channel (FC) connected tape drives only operate in node or fabric mode (N\_port), supporting direct connection to a SAN switch or supported HBA. (This mode is also known as *point-to-point* or fabric mode). The 16 Gb port does not support Fibre Channel Arbitrated Loop (FC-AL) mode.

If a library drive is replaced, an IBM SSR might select the replacement unit to automatically inherit the configuration attributes of the failed unit. This way, a user can avoid reconfiguring the zoning in the switches. Alternatively, the panels can be used to change these fields directly at any time.

For more information about FC attachment planning, see *IBM System Storage 3592 Tape Drive and Controller Introduction and Planning Guide 3592 Models E06, EU6, E07/EH7, E08/EH8, GA32-0555*.

For more information about applications and their levels that support 3592 tape drives, see [Independent Software Vendor \(ISV\) matrix for IBM TotalStorage 3592 tape drives and LTO](#).

### 3.3.1 Multiple Fibre Channel ports

All 3592 FC models have two independent FC interfaces or ports. Both ports run the SCSI protocol with FC tape support. By using these two ports, concurrent attachment of two independent FC configurations can be made to each drive. One or both ports can be attached to various open systems servers, SAN switches, and directors.

The 3592 tape drives support industry-standard shortwave LC-Duplex fiber optic cables, with cable lengths of up to 500 m (1640 ft.) and 50 microns of core fiber, depending on the attachment speed required.

The following maximum distances are supported by the shortwave adapters with the 50/125 LC-Duplex fibre optic cables:

- ▶ 1 Gbps shortwave adapters have a maximum distance of 500 meters (1,640 ft.)
- ▶ 2 Gbps shortwave adapters have a maximum distance of 300 meters (984 ft.)
- ▶ 4 Gbps shortwave adapters have a maximum distance of 150 meters (492 ft.)
- ▶ 8 Gbps shortwave adapters have a maximum distance of 50 meters (164 ft.)
- ▶ 16 Gbps shortwave adapters have a maximum distance of 35 meters (115 ft.)

The following maximum distances are supported by the shortwave adapters with the OM3 LC-Duplex Fibre optic cables:

- ▶ 8 Gbps shortwave adapters have a maximum distance of 150 meters (492 ft.)
- ▶ 16 Gbps shortwave adapters have a maximum distance of 100 meters (328 ft.)

### 3.3.2 Supported topologies

The 3592 tape drives support switched fabric and point-to-point loop topologies.

#### Switched fabric

Two or more FC endpoints interconnect through a switch. The FC architecture supports up to 256 ports through each switch. Switches include a function that is called *zoning*. By using this function, the user can partition the switch ports into port groups and then assign group access to other groups. This function prevents group interference. With switched fabrics, all of their ports have simultaneous use of the full FC architecture bandwidth.

#### Point-to-point loop

A point-to-point loop is similar to a point-to-point topology. Both have two connected FC endpoints. The difference is in the protocol. Therefore, when only two FC endpoints are connected, either protocol is usable. However, both endpoints must use the same protocol. The 3592 model supports a point-to-point loop. Most FC adapters default to the loop protocol when not directly connected to a fabric.

**Important:** SAN switches normally default the switch port to loop mode. If port is set to automatic mode, loop mode is the first mode that is attempted during the port login process. The 3592 accepts loop mode and logs in to the port. To get the 3592 to log in to the SAN switch port in fabric mode, the port on the switch should be set to fixed fabric mode by the switch administrator or at the drive by using the management interface.

The TS1160 (model 60F and 60G) 16 Gb FC ports do not support FC-AL.

## Address assignments

The 3592 tape drives must have an FC address to communicate over the FC interface. The tape drives support hard and soft addressing. Most FC hosts (initiators) support hard addressing and do not support soft addressing. For more information, see the device driver documentation.

## Fibre Channel worldwide name ID

Each Fibre Channel card on the 3592 tape drive has four names (Node 0, Node 1, Port 0, and Port 1) that are hardcoded into the electronics of the card by IBM manufacturing. These names are similar to a serial number and are unique throughout the world. For more information, see the device driver documentation. If the drive is inside a library, the WWN is configured by the library based on the library serial number and physical location inside the library.

**Note:** The WWN of a drive changes if drives are moved to a different location that is inside a library or to a different library. Such a move can require zoning changes.

## 3.3.3 Ethernet drives

IBM TS1160 Tape Drive, Model 60E, delivers 10 Gb or 25Gb, and the IBM TS1155 Tape Drive, Model 50E delivers 10 Gb Ethernet host attachment interface, which is optimized for cloud-based and hyperscale environments.

This configuration provides dual 10 Gb or 25Gb optical Ethernet host attachment ports, using Remote Direct Memory Access (RDMA) over Converged Ethernet for cloud-based and open-compute environments.

The dual 10 Gb or dual 25 Gb ports use short wave multi-mode optical SFP transceivers and the allowable cable lengths are listed in Table 3-1.

Table 3-1 Ethernet optical cable limits

Fiber cable type	Connector Type	Minimum modal bandwidth at 850 nm (MHz x km)	Operating range in meters
62.5 µm MMF	LC	160	2-26
62.5 µm MMF	LC	200	2-33
50 µm MMF	LC	400	2-66
50 µm MMF	LC	500	2-82
50 µm MMF	LC	2000	2-300
16 Gb 50 µm MMF	LC	2000	2-300
16 Gb 50 µm MMF	LC	4700	2-400

The TS1100 Ethernet drives support iSCSI Extension for RDMA (iSER) on Converged Ethernet (RoCEv2). This specific protocol uses a UDP transport layer and required Data Center Bridging (DCB) switches and lossless networks.



Extensions for RDMA (iSER) is a standard that enables iSCSI hosts and targets to take advantage of RDMA capabilities. iSER runs on top of a RDMA capable Network Interface Card (rNIC) regardless of the protocol.

The TS1160 60E and TS1155 55E is supported through Microsoft Windows device driver and requires approval of i-RPQ 8B3685.

Figure 3-4 shows current and future interface support.

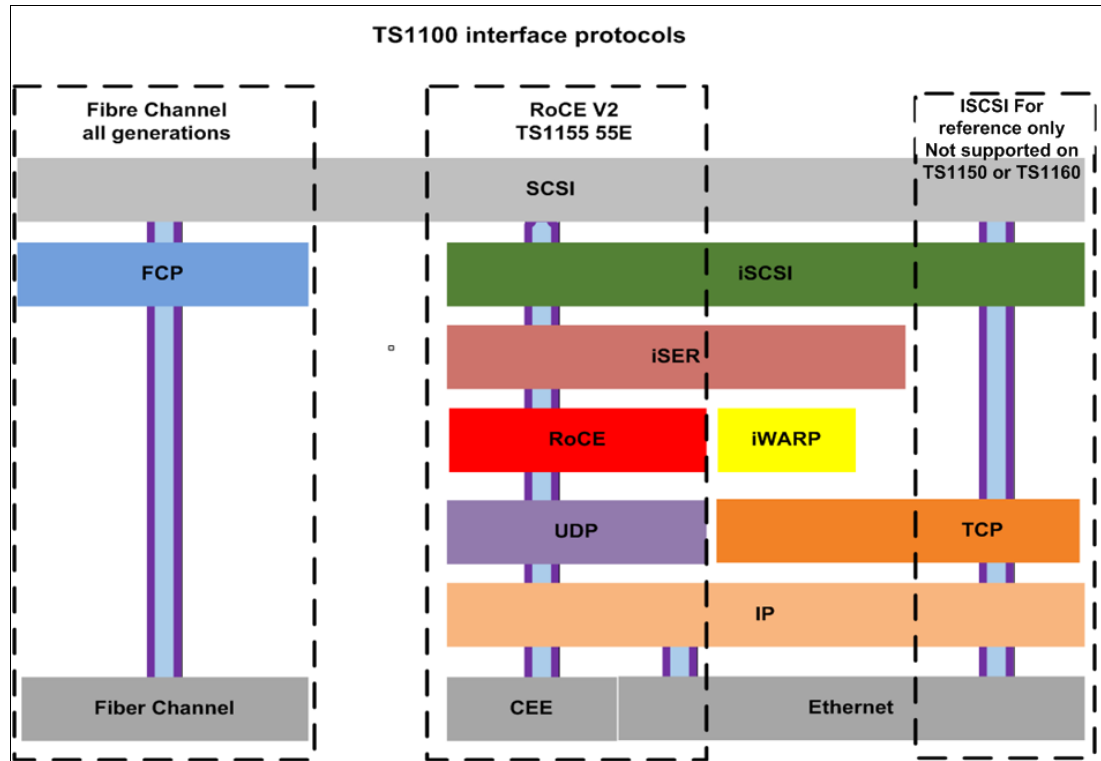

Figure 3-4 Interfaces available on TS 1100

### 3.4 Media

Users must cost-effectively store more digital information than ever before, often to meet growing regulatory and legal requirements. The 3592 tape drives help to meet these needs with the IBM Tape Cartridge 3592. The TS1160, TS1155, TS1150, TS1140, TS1130, TS1120, and 3592-J1A all use the 3592 tape cartridge. This tape cartridge offers various capacity options, depending on the drive and recording format that are used or the cartridge model that was ordered (Data, WORM, or Economy).

These capabilities expand the range of client data workloads that can be addressed with the 3592 tape drives. The economy cartridge can help lower the cartridge cost for users with smaller capacity needs and provide faster access to data. The WORM cartridges provide nonerasable, nonrewritable storage media. Users with regulatory or legal requirements to store electronic records for long periods might be able to use the 3592 tape drives to provide cost-effective storage.

The 3592 cartridges have a form factor similar to the 3590 tape cartridge. They are supported in the following IBM cartridge library environments:

- ▶ IBM TS3500 tape library
- ▶ IBM TS4500 tape library

The IBM 3592 ½-inch tape cartridge contains an advanced fourth-generation metal particle formulation in a dual-layer coating on a half-inch-wide tape. The IBM tape uses an advanced magnetic coating and process that provides a high output and signal quality to support the current 3592 tape drives.

The tape features an ultra-smooth and uniform magnetic layer less than 0.2 microns thick and a specially refined coating formulation that is designed to help improve media reliability and performance and minimize wear of the tape heads and components. A precision timing-based servo with enhanced features helps enable high track densities, high data rates, data access performance and high reliability, and stop-start performance.

The following are the media types used for the different media types:

- ▶ Dual coat, MP nanocubic particle, PEN substrate 8.9 µm nominal thickness (JA types)
- ▶ Dual coat, MP nanocubic particle, PEN substrate 6.6 µm nominal thickness (JB types)
- ▶ Dual coat, Barium Ferrite (BaFe) particle, PEN substrate, 6.1 µm nominal thickness (JC types)
- ▶ Dual coat, BaFe particle, Aramid substrate, 5.0 µm nominal thickness (JD types)
- ▶ Hc perpendicularly oriented BaFe particle (JE types)

Modifications to the cartridge design and construction help improve pin retention, hub and clutch engagement, spool alignment and tape stacking within the cartridge. These enhancements help improve reliability and durability of the media and the tape drive. Enhanced assembly strengthens the cartridge at critical locations and helps make the 3592 cartridge less susceptible to damage, such as from being dropped.

The tape is pulled from the cartridge with a leader pin rather than a leader block as in the 3590 cartridge. A sliding door covers the area that was formerly occupied by the leader block in a 3590 cartridge. A locking mechanism prevents the media from unwinding when the cartridge is not in a drive. A special mechanical design provision prevents the 3592 cartridge types from being loaded into 3590 or 3490 drives. If a 3592 cartridge is inadvertently loaded into a 3590, the cartridge present sensor does not change state and the drive does not attempt to load.

### 3.4.1 3592 media cartridge

This section provides more detail about the 3592 tape cartridge media.

#### Media types and compatibility

There are multiple different media types in the 3592 range. The capacity of the 3592 tape cartridge depends on the format that is used when writing from the beginning-of-tape (BOT). Two basic formats are used: Enterprise Format (EFMT) and Enterprise Encrypted Format (EEFMT). The TS11160 and TS11155 are not supported for IBM z/OS® attachment.

Each tape drive model has different formatting capabilities, as listed in Table 3-2.

Table 3-2 Read and write SMS z/OS media types that are supported

Drive type	EFMT1	EFMT2 EEFMT2	EFMT3 EEFMT3	EFMT4 EEFMT4	EFMT5 EEFMT5
3592 J1A	Read/write	No	No	No	No
TS1120	Read/write	Read/write	No	No	No
TS1130	Read only	Read/write	Read/write	No	No
TS1140	Read only	Read only	Read/write	Read/write	No
TS1150	No	No	No	Read/write	Read/write

All 3592 tape drives support cartridge reuse. The 3592 tape cartridges can be reformatted to any tape format that is supported by the tape drive when writing from BOT. When reformatting, all existing data on the cartridge is erased.

**Note:** Cartridge reuse depends on compatibility of the media on the drive being used.

Using the supported densities on the different 3592 drives, they can use different media. Table 3-3 lists the capability of each drive to use different media.

Table 3-3 Drive and cartridge compatibility

Tape unit	JE, JM, and JV cartridge	JD, JL, and JZ cartridges	JC, JK, and JY cartridges	JB and JX cartridges	JA, JJ, JW, and JR cartridges
3592 J1A	No	No	No	No	Read/write
TS1120	No	No	No	Read/write	Read/write
TS1130	No	No	No	Read/write	Read/write
TS1140	No	No	Read/write	Read/write	Read only
TS1150 and TS1155	No	Read/write	Read/write	No	No
TS1160	Read/write	Read/write	Read/write	No	No

Table 3-4 lists the media types, native capacity options, and compatibility options that are available with 3592 tape drives.

Table 3-4 IBM 3592 media type capability

Media type	Media type	3592 60F format J6 native capacity	3592 55E, 55F, Format J5A	3592 E08, EH8 Format J5	3592 E07, EH7 Format J4	3592 E06 Format J3
Data	JA	Not supported	Not supported	Not supported	640 GB <sup>a</sup>	640 GB
					500 GB <sup>a</sup> E05 format	500 GB E05 format
					300 GB <sup>a</sup> J1A format	300 GB <sup>a</sup> J1A format

Media type	Media type	3592 60F format J6 native capacity	3592 55E, 55F, Format J5A	3592 E08, EH8 Format J5	3592 E07, EH7 Format J4	3592 E06 Format J3
Extended Data	JB	Not supported	Not supported	Not supported	1.6 TB (1.46 TiB)	1 000 GB
					1 TB (.9 TiB) E06 format	
Advanced Data	JC	7 TB (6.37 TiB)	7 TB (6.37 TiB)	7 TB (6.37 TiB)	4 TB (3.6 TiB)	Not supported
Advanced Data	JD	15 TB (13.64 TiB)	15 TB (13.64 TiB)	10 TB (9.1 TiB)	Not supported	Not supported
Advanced Data	JE	20TB (18.19 TiB)	Not supported	Not supported	Not supported	Not supported
Economy	JJ	Not supported	Not supported	Not supported	128 GB <sup>a</sup>	128 GB
					100 GB <sup>a</sup> E05 format	100 GB E05 format
					60 GB <sup>a</sup> J1A format	60 GB <sup>a</sup> J1A format
Advanced Economy	JK	900 GB (0.82 TiB)	900 GB (0.82 TiB)	900 GB (0.82 TiB)	500 GB	Not supported
Advanced Economy	JL	3 TB (2.73 TiB)	3 TB (2.73 TiB)	2 TB (1.82 TiB)	Not supported	Not supported
Advanced Economy	JM	5TB (4.55 TiB)	Not supported	Not supported	Not supported	Not supported
Economy WORM	JR	Not supported	Not supported	Not supported	128 GB <sup>a</sup>	128 GB
					100 GB <sup>a</sup> E05 format	100 GB E05 format
					60 GB <sup>a</sup> J1A format	60 GB <sup>a</sup> J1A format
WORM	JW	Not supported	Not supported	Not supported	640 GB <sup>a</sup>	640 GB
					500 GB <sup>a</sup> E05 format	500 GB E05 format
					300 GB <sup>a</sup> J1A format	300 GB <sup>a</sup> J1A format
Extended WORM	JX	Not supported	Not supported	Not supported	1.6 TB (1.46 TiB)	1.6 TB (1.46 TiB)
					1 TB (.9 TiB) E06 format	
Advanced WORM	JV	20 TB (18.19 TiB)	Not supported	Not supported	Not supported	Not supported

Media type	Media type	3592 60F format J6 native capacity	3592 55E, 55F, Format J5A	3592 E08, EH8 Format J5	3592 E07, EH7 Format J4	3592 E06 Format J3
Advanced WORM	JY	7 TB (6.37 TiB)	7 TB (6.37 TiB)	7 TB (6.37 TiB)	4 TB (3.6 TiB)	Not supported
Advanced WORM	JZ	15 TB (13.64 TiB)	15 TB (13.64 TiB)	10 TB (9.1 TiB)	Not supported	Not supported

a. Read Only (RO)

**Important:** The TS1160, TS1155, and TS1150 cannot read or write to a JA, JW, JJ, JR, JB, or JX media.

The TS1140 can read but not write to a JA, JJ, JW, or JR media that is written in a supported format.

Figure 3-5 shows an example of the media types: A full length read/write tape on the left, WORM cartridges in the middle, and economy read/write cartridges on the right. The WORM cartridges have a platinum-colored shell, and the read/write cartridges have a black shell.



Figure 3-5 IBM 3592 WORM and read/write cartridges

### Labels

The 3592 cartridges use a media label to describe the cartridge type. Figure 3-6 shows a 3592 JE cartridge label. In tape libraries, the library vision system identifies the types of cartridges during an inventory operation. The vision system reads a volume serial number (VOLSER), which is on the label on the edge of the cartridge. The VOLSER contains 1 - 6 characters, which are left-aligned on the label. If fewer than 6 characters are used, spaces are added. The media type is indicated by the seventh and eighth characters.



Figure 3-6 View of the 3592 cartridge label

## Cleaning cartridges

One cleaning cartridge is designed specifically for the 3592 drives. As with the data cartridges, the 3592 cleaning cartridges are not interchangeable with any other model cleaning cartridges (for example, LTO cleaning cartridges). Therefore, both types of cleaning cartridges must be inserted into the library if there are both types of drives in the environment.

The cleaning cartridge also contains a cartridge memory device, which automatically tracks the number of times that it was used. Cleaning cartridges must be replaced after 50 cleaning cycles.

The physical characteristics of the 3592 cleaning cartridge can be used to distinguish it from the 3592 data cartridges. The product label on the top of the cartridge is white with the word “cleaning” printed on it. Instead of the write-protect switch, there is a non-movable light gray block, which is shown as 1 in Figure 3-7. The cartridge door is also light gray. If cleaning cartridges with pre-attached labels are ordered, the first 3 characters of the VOLSER are CLN, as identified by the number 2 label in Figure 3-7.

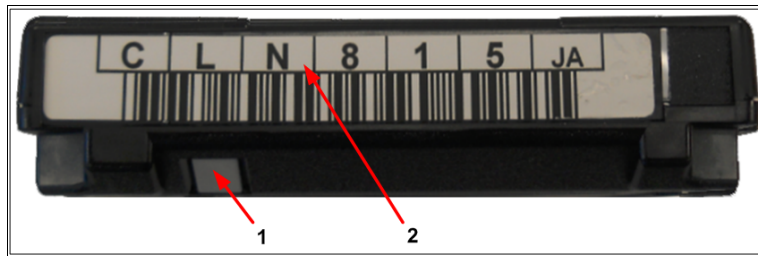

Figure 3-7 Cleaning cartridge

### 3.4.2 WORM functionality

All 3592 tape drives with the appropriate Licensed Internal Code version installed can read and write WORM cartridges. The WORM data cartridges for the IBM 3592 tape drive provide nonalterable, nonrewritable tape media for long-term records retention. WORM includes the following characteristics:

- ▶ WORM cartridges are available in the following formats:
  - JV (advanced), which is supported by the 3592 60E, 60G, and 60F, at 20 TB.
  - JW (full length), which is supported by 3592 J1A, E05, E06, and E07 (read only) tape drives, 640 GB in E06 format, 500 GB in E05 format, and 300 GB in J1A format.
  - JX (extended), which is supported by 3592 E05, E06, and E07, with 1.6 TB in E07 format, 1TB in E06 format, and 700 GB in E05 format.
  - JY (advanced), which is supported by the 3592 E07 and E08 tape drives only, 5 TB in E07 format, and 7 TB in E08, 55G, 55F, 55F, 60G, 60F, and 60E format.
  - JZ (advanced), which is supported by the 3592 E08 tape drive only, 10 TB in E08 format and 15 TB in the 60G, 55G, 55E, 55F, 60G, 60F, and 60E format.
- ▶ Nonreversible screws are used to secure the media housing.
- ▶ WORM and read/write cartridges can be intermixed within the same IBM TS3500 or TS4500 tape library.
- ▶ When the drive senses that a cartridge is a WORM cartridge, the Licensed Internal Code prohibits changing or altering user data that is already written on the tape. The Licensed Internal Code tracks the last appendable point on the tape with an overwrite-protection pointer that is stored in the cartridge memory.

- ▶ Each WORM cartridge is identified by using a worldwide cartridge identifier (WWCID), which is permanent and locked and provides another level of security for data that must be maintained.
- ▶ A WORM cartridge never can be made non-WORM and a non-WORM cartridge cannot be made WORM.
- ▶ Written user data never can be modified or erased.

### **WORM basics**

The 3592 tape drives support 3592 read/write cartridges and 3592 WORM cartridges. The WORM cartridge is geometrically identical to a read/write cartridge and uses the same rewritable media formulation. However, the servo format, which is mastered onto the tape at manufacturing, is different for WORM cartridge types.

The WORM function does not come from any inherent non-reversible media characteristic (such as permanent WORM on optical CD-R media or optical WORM). Instead, the WORM function is enabled by the method the Licensed Internal Code of the 3592 drive handles a WORM cartridge.

The Licensed Internal Code of the drive does not support overwrite or erasure of previously written user data, such as records or file marks. However, the Licensed Internal Code of the drive supports appending new data following existing data.

### **Unique cartridge identifier**

Each IBM 3592 Tape WORM cartridge is identifiable through a unique cartridge identifier (UCID). The intent of the UCID is that it is constructed to ensure that it is unique worldwide. This identifier is derived from the 4-byte unique cartridge memory serial number of the cartridge memory chip in the 3592 WORM cartridge.

This serial number is concatenated with the 8-byte unique tape serial number that was created from information that is mastered into the timing-based servo at the time that the cartridge is manufactured.

The parts of UCID that come from this combined serial number are written to a locked part of the cartridge memory. This other level of security supports legal audit requirements. Furthermore, the UCID supports unique cartridge tracking and can be the differentiator to using other WORM tape providers.

### **Drive operation to prevent overwriting**

A WORM drive handles a WORM cartridge differently than a read/write cartridge. In general, a WORM drive responds to a subset of the SCSI commands that work on a read/write cartridge. For example, an **Erase** command is rejected with the appropriate error posted.

Additionally, a WORM drive rejects certain command sequences of otherwise valid commands. For example, if a cartridge is not empty, a **Rewind** command followed by a **Write** command is rejected with the appropriate error posted.

The Licensed Internal Code tracks the last appendable point on the tape by using an overwrite-protection pointer that is stored in the cartridge memory (CM). Statistical Analysis and Reporting System (SARS) data can be written and updated on WORM tapes because the SARS data is not in the user area of the tape.

The 3592 tape drives allow append operations to data already on WORM cartridges, and allow overwrite of file marks and other non-data attributes to provide application transparency. However, they do not allow data overwrite under any circumstances. After they are full of data, WORM cartridges cannot be reused or erased by the drive and must be physically destroyed or bulk degaussed to delete data. For full tape application use, certain trailer and label record overwrites are allowed.

**Important:** WORM cartridges cannot be reused after they are written to. Therefore, WORM cartridges must be physically destroyed when they are no longer of use. Before it is discarded, if the WORM cartridge has sensitive data, it must be bulk-erased, which erases everything on the tape including the mastered servo pattern and renders it useless.

### 3.4.3 Tape encryption for TS1100

The TS1160, TS1155, TS1150, and TS1140 tape drives use an AES encryption key, which is a random string of bits that are generated specifically to scramble and unscramble data. Encryption keys are created by using algorithms that ensure that each key is unique and unpredictable. The longer the key string is, the harder it is to break the encryption code. These drives use 256-bit AES algorithm keys to encrypt data.

The following types of encryption algorithms are used by for encryption:

- ▶ Symmetric algorithms

Symmetric (or secret key) encryption uses a single key for encryption and decryption. Symmetric key encryption generally is used for encrypting large amounts of data efficiently.

- ▶ Asymmetric algorithms

Asymmetric encryption uses a pair of keys. Data that is encrypted by using one key can be decrypted only by using the other key in the asymmetric key pair.

When an asymmetric or public or private key pair is generated, the public key is used for encryption, and the private key is used for decryption.

TS1100 tape drives use both types of encryption algorithms. Symmetric encryption is used for high-speed encryption of user or host data. Asymmetric encryption (which is slower) is used for protecting the symmetric key that is used to encrypt the data (key wrapping).

The TS1100 tape drives support three encryption management techniques: System, Application, and Library Managed. For more information about encryption, see 2.2.2, “Encryption methods” on page 64.

#### **IBM Security Guardium Key Lifecycle Manager**

IBM Security Guardium Key Lifecycle Manager (GKLM) is the IBM strategic platform for storage and delivery of encryption keys to encrypting storage end-point devices. IBM GKLM can be used with the TS1160, TS1155, TS1150, and TS1140 encrypting tape drives.

IBM GKLM serves data keys to the tape drive. It focuses on ease of use and provides a graphical user interface (GUI) to help with the installation and configuration of the key manager. It also allows for the creation and management of the key encrypting keys (certificates).



**Important:** EKM should no longer be downloaded for new tape encryption installations. EKM still can be downloaded by EKM customers that implemented EKM, or by IBM i5/OS clients who want to run their key manager on i5/OS. If you use the EKM, you can migrate to the new IBM GKLM.

For more information about IBM GKLM (formerly IBM Security Key Lifecycle Manager), see the IBM Security Guardium Key Lifecycle Manager documentation at this [IBM Documentation web page](#).

### 3.4.4 Rack-mount option for TS1160, TS1155, TS1150, and TS1140 models

Rack-mount options are available for the 3592 drives when they are stand-alone drives. The rack-mount kits are ordered by a feature code, which is FC 4804 for EH7, EH8, 55F, and 60F drives, and FC 9806 (Left Hand) or FC 9807 (Right Hand) for EH7, EH8, 55F, and 60F drives.

The 3592 rack mount for 3592 EH7 or EH8 drives is shown in Figure 3-8. It is a 3-rack unit (RU) feature that mounts up to two EH7 or EH8 drives.

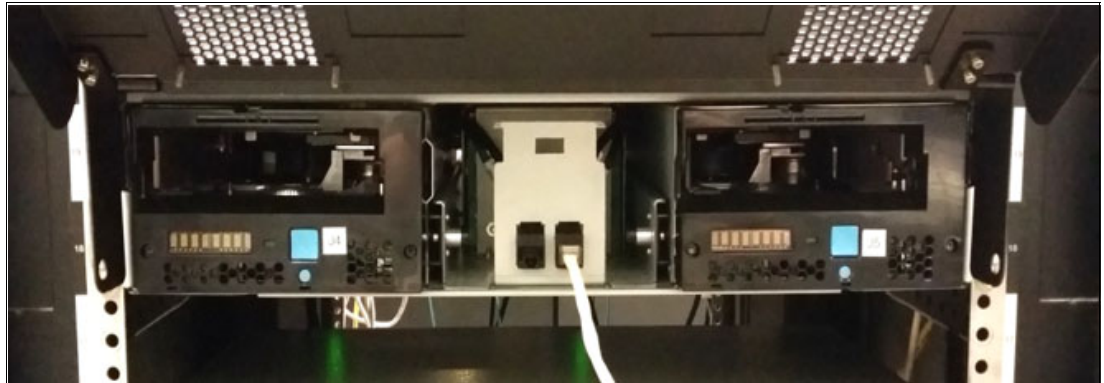

Figure 3-8 3592 Rack Mount Kit for EH7, EH8, 55E, or 55F drives

FC 4808 has dual power for redundancy and the Remote Management Communication (RMC) card reuses design circuitry from the BPC and DSC in the TS4500. The power cords are C13-C14 for PDU attachment, and the feature does not support country-specific power cords.

The user interface is a GUI that is connected through Ethernet to the drives by a panel in the center of the rack enclosure. It also supports temporary connection to a notebook for the IBM Engineer to load code or to download logs. An air baffle (FC 4806) is available if only one drive is installed.

The old style 3592 rack mount for 3592 J1A, E05, E06, E07, or E08 drives is shown in Figure 3-9. It is a 10 rack unit kit that is compatible only with E0x drive canisters. The User Interface is through a CE panel on the rear of the machine.

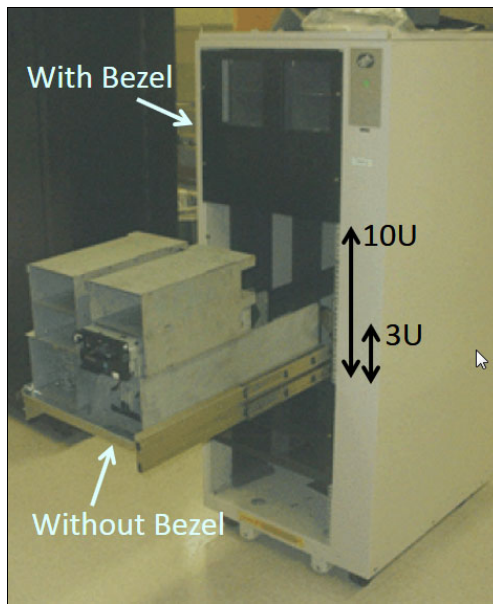

Figure 3-9 3592 Rack Mount Kit for J1A or E0x drives

## 3.5 IBM TS1160 tape drive

The IBM TS1160 tape drive (which is also referred to as the *3592 Model 60G, 60E, or 60F*) is an enhanced sixth-generation tape drive of the IBM 3592 tape family. The TS1160 tape drive provides higher levels of cartridge capacity than the TS1150 Model E08 (EH8). It is designed to provide an increased capacity on JE media types compared with its predecessors.

**Note:** The TS1160 model 60G drive is designed for installation in the TS3500.

Depending on interface type ordered, the TS1160 model 60E will be available with dual 10 GB, or dual 25 GB fiber Ethernet (RoCE v2) ports for host attachment. These ports are optimized for cloud-based and large, open-compute environments.

The TS1160 model 60F and 60G tape drives have a dual-port, 16-Gbps Fibre Channel interface for Fibre Channel attachment to host systems, or a switched fabric environment.

The TS1160 Tape drive is capable of reading and writing up to 20 TB capacity on JE media types (JE/JV/JM), compared to 15 TB for TS1155 on JD media.

The TS1160 tape drive can read (read only), TS1140 formatted tapes on JC, JY, and JK media.

The TS1160 can read and write to any media written in TS1150 and TS155 format.

Although media that is written in TS1160 format is not readable by TS1155 or TS1150, the media is back-portable for reformatting to TS1155 or TS1150 format.

The IBM TS1160 tape drive (which is also referred to as the *3592 Model 60F*, *3592 Model 60G*, or *3592 Model 60E*) is the sixth tape drive generation of the IBM 3592 tape family. The TS1160 tape drive provides higher levels of performance, reliability, and cartridge capacity than the TS1155 tape drive.

The TS1160 uses Tunnel Magneto Resistive TMR head technology, which is a high-technology, 3-module, 32-channel head technology that is designed for higher native data rate performance and reliability.

The TS1160 provide a native data rate performance of up to 400 MBps versus the 360 MBps data rate of the TS1155 tape drive Model 55E.

The TS1160 records in two native recording formats, supporting encryption and nonencryption:

- ▶ J6 logical format is used to represent the non-encrypted recording format for TS1160
- ▶ J6-E is used to denote the encrypted recording format for TS1160

The TS1160 TS1160 is downward read/write compatible to the TS1150 and TS1155 formats and is read-only compatible to TS1140 format (J4 and J4-E) on supported cartridges.

**Note:** The TS1160 cannot read or write any format from J3, J3-E (TS1130), or earlier.

The host interfaces to open systems platforms are maintained as with previous 3592 models.

The TS1160 support integration with the TS3500 or TS4500 tape library. Figure 3-10 shows the IBM TS1160 (3592 60G) tape drive for TS3500 library.



Figure 3-10 3592 60G tape drive

The TS1160 maintains the same features and technology enhancements that were introduced with the TS1120 and extended by the TS1130, TS1140, TS1150, and then the TS1155. The TS1160 offers several enhancements over the predecessor models.

The TS1160 has the following key features, including those features that were introduced with the TS1155 and previous models:

- ▶ Digital speed matching
- ▶ Channel calibration
- ▶ High-resolution tape directory
- ▶ Recursive accumulating backhitch-less flush or nonvolatile caching (NVC)
- ▶ Backhitch-less backspace
- ▶ Virtual backhitch
- ▶ Read ahead
- ▶ Streaming Lossless Data Compression (SLDC)
- ▶ Capacity scaling
- ▶ Single FRU
- ▶ Error detection and reporting
- ▶ SARS
- ▶ Revised encryption support
- ▶ Dual-stage 32-head actuator
- ▶ Offboard data string searching
- ▶ Enhanced logic to report logical end of tape
- ▶ Added partitioning support
- ▶ Data Safe mode
- ▶ Enhanced Ethernet support
- ▶ New enhanced Barium Ferrite (BaFe) particle media types
- ▶ Dual-port, 16 Gb FC attachment with failover support for FC drives
- ▶ Dual port, 10 or 25 Gb Ethernet ports for TS1155 model 3592 60E
- ▶ Max Capacity mode logical end-of-tape (LEOT) support for up to 4% more capacity
- ▶ Partitioning that is supported by Spectrum Archive and IBM Linear Tape File System (LTFS)

### 3.5.1 Physical attachment

The TS1160 is supported for attachment in the TS3500 or TS4500 tape libraries or as rack mounted. Table 3-5 lists the attachment configurations that are available for TS1160.

Table 3-5 Maximum 3592 tape drive attachments in environments without a tape controller

Environment	Number of TS1160 tape drives
2.0-meter rack (IBM Model 7014-T42)	Up to 16
1.6-meter rack (IBM Model 7014-S00)	Up to 12
1.8-meter rack (IBM Model 7014-T00)	Up to 12
TS3500	Up to 12 <sup>a</sup> per frame
TS4500	Up to 16 per frame

a. Prerequisites must be met for installing TS1160 into a TS3500. The TS3500 must include enhanced node cards installed. The TS3500 must have the latest version of Firmware level which supports the TS1160 installed. Consult with IBM support to ensure compatible code is installed for the drive type to be installed.

The TS1160 is supported for attachment in the IBM TS3500, and communicates with the TS3500 tape library through an internal library connection. It uses Statistical Analysis and Reporting System (SARS) to isolate failures between the media and the hardware.

The TS1160 Model 60F, or 60G, offers a dual-port 16 Gbps Fibre Channel host attachment interface. This feature provides flexibility in open systems environments because the drives can attach to open systems servers directly with Fibre Channel attachments.

The TS1160 have the same front bezel with a chevron fiducial as the TS1140. The buttons and display are the same buttons and display on all of the previous models of 3592 drives.

Figure 3-11 shows the front of the 3592 60E tape drive.

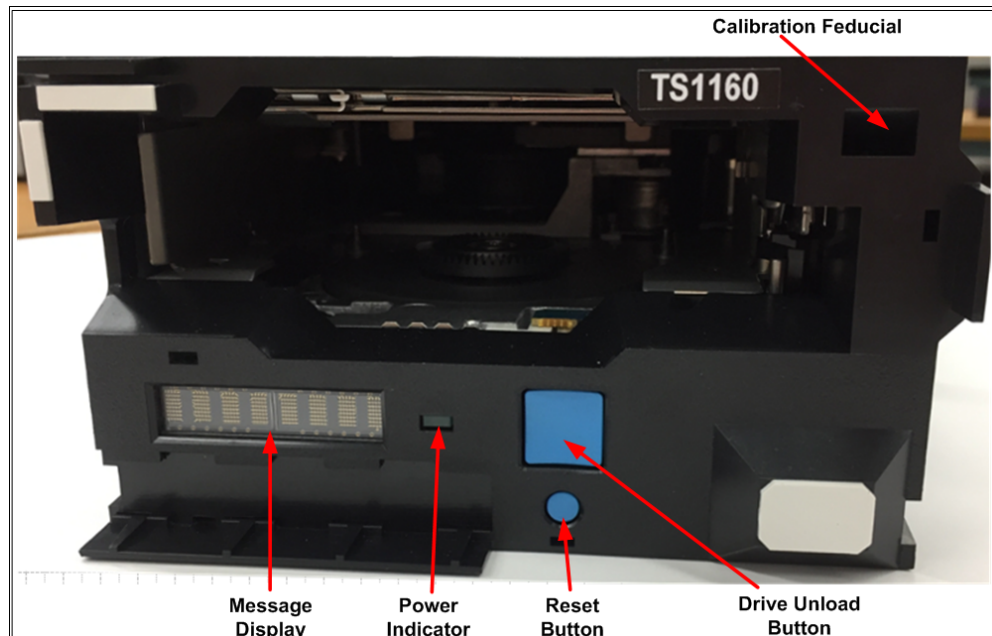

Figure 3-11 3592 model 60G front panel

### 3.5.2 TS1160 physical characteristics

The TS1160 drives have an identical form factor, and it is plug-compatible with existing 3592 models. It maintains low power and improves power management. The drive power usage is 53 - 60 watts maximum operating power. Standby power is fewer than 35 watts.

The drives have a standby cooling management feature, which reduces the fan speed when the drive is idle to further reduce power and reduce airborne debris contaminants. The fan operating mode is controlled by a single input signal that is called *full-speed mode* or *variable-speed mode*. In full-speed mode, the fan or blower runs at full speed. In variable-speed mode, the blower adjusts its speed based on the ambient temperature down to a minimum of about 50% of its full speed.

The speed of the fan is based on the following conditions:

- ▶ The drive code enables variable-speed mode under the following conditions:
  - The drive is unloaded and idle for 5 minutes.
  - The internal temperature is at least 3 degrees below the full speed required temperature limit.
- ▶ The drive code reverts to full-speed mode as soon as the following conditions are met:
  - A cartridge is placed in the loader or loaded.
  - The internal temperature of the drive rises above the full speed required temperature limit.

The internal temperature sensor is sampled at 5-minute intervals.

#### Internal hardware enhancements

These drives feature the following hardware enhancements over the previous models:

- ▶ New dataflow ASIC chip (Bara) in CU-32 technology
- ▶ Enables higher data rate of 400 MBps
- ▶ Enables longer C2 ECC code and iterative decoding (effective SNRa uplift)
- ▶ Increases HIB transfer rate to 1600 MBps for FC-16/Ethernet attachment
- ▶ SPA write driver
- ▶ TMR read sensor technology of approximately 1um reader width
- ▶ High Bs writer to support writing of higher capacity JE tape
- ▶ TMR Shorting mitigators TBALL Readers
- ▶ New FC-16 Lancer G6 host target chip and PCIE bridge FPGA
- ▶ New Arrowhead Qlogic Ethernet chip with support for iSCSI/RoCE 10Gb, 25Gb
- ▶ Spring load rollers with new lubricant
- ▶ New JE media support
- ▶ Magnetic layer features new higher Hc perpendicularly oriented BaFe particle
- ▶ Thinner underlayer supporting longer tape

The data-dependent, noise-predictive, maximum-likelihood (DD-NPML) detection scheme was developed at IBM Research®, Zurich to enable the accurate detection of data errors.

### 3.5.3 Media

The TS1160 drives use the following enhanced Barium Ferrite (BaFe) second-generation particle media types. This new media uses oriented perpendicular BaFe mag layer that is approximately a 1.8 dB bbSNR improvement from JC/JD. The new media can be read/written up to 400 MBps native sustained data rate (up to 900 MBps at 3:1 compression ratio) in the new 32-channel Jag6, 6E, 5, 5E, 5A, and 5AE logical format, as listed in Table 3-6.

Table 3-6 Media type and read/write format compatibility

Media type	TS1160					
	Logical Format read/write					
JE	J6	J6-E				
JM	J6	J6-E				
JV	J6	J6-E				
JD	J6	J6-E	J5A	J5A-E	J5	J5-E
JZ	J6	J6-E	J5A	J5A-E	J5	J5-E
JL	J6	J6-E	J5A	J5A-E	J5	J5-E
JC	J6	J6A-E	J5A	J5A-E	J5	J5-E
JY	J6	J6A-E	J5A	J5A-E	J5	J5-E
JK	J6	J6A-E	J5A	J5A-E	J5	J5-E

**Important:** TS1160 is not compatible with several older 3592 cartridge media types: JA, JB, JW, JJ, JR, and JX media types J3, J2, and J1 (MEDIA5, MEDIA6, MEDIA7, MEDIA8, MEDIA9, and MEDIA10).

- ▶ These drives improve capacity and performance by writing and reading J6 logical format by using a new longer 32-channel C2 ECC code and iterative decoding format with a higher linear density on the same media types.
- ▶ The appropriate microcode levels that are available for TS1160, TS1155, TS1150, and TS1140 and must be installed that enable the recognition of the J6 format and allow reuse of the media in the older formats. Therefore, a model J6A drive can reformat media that was written in the older format, and write on it in the appropriate format.

**Important:** This design supports a common scratch pool by media type, regardless of the last written format or allocation target drive.

### 3.5.4 Capacity and performance

Capacity and performance were improved from the TS1160 tape drive for all media types, and for all formats that the drives reads or writes. This improvement requires the TS1160 to format the tape or write from BOT.

#### Capacity improvement

The use of the 3592-60E and 60F logical format offers the following capacity improvements on existing and new cartridges:

- ▶ IBM Enterprise Advanced Data media (JV and JE), which is a capacity of 20 TB
- ▶ IBM Enterprise Advanced Data media (JZ and JD), which is a capacity of 15 TB
- ▶ IBM Enterprise Advanced Data media (JC and JY), which is a capacity of 7TB
- ▶ IBM Enterprise Economy Data media (JM), which is a capacity of 5 TB
- ▶ IBM Enterprise Economy Data media (JZ), which is a capacity of 3 TB
- ▶ IBM Enterprise Economy Data media (JK), which is a capacity of 900 GB

#### Performance

The overall performance is improved over the previous model by various improvements:

- ▶ Improved data rate and capacity
- ▶ Improved latency by reducing access time to data
- ▶ Increases HIB transfer rate to 1200 MBps
- ▶ Beginning of partition (BOP) caching
- ▶ Humidity sensor support
- ▶ Increased cartridge memory size and related functions
- ▶ Improved high-resolution tape directory (HRTD)
- ▶ New dataflow ASIC chip in CU-32 technology
- ▶ Extended copy support

#### Higher data rates and capacity

The following format data rates are available (at 256K and greater block size):

- ▶ The 60E and 60F format data rates go up to 400 MBps maximum native, and to 900 MBps maximum compressed.

Table 3-7 lists the capacity and performance characteristics for uncompressed data.

Table 3-7 Capacity and performance summary

Media	60E or 60F format capacity native data rate (min. - max.)	55E or 55F format capacity native data rate (min. - max.)	EH8 format capacity data native rate (min. - max.)
JE or JV	20 TB (18.12 TiB) 122 MBps - 407 MBps	N/A	N/A
JC or JY	7 TB (6.37 TiB) 99 MBps - 303 MBps	7 TB (6.37 TiB) 99 MBps - 303 MBps	7 TB (6.37 TiB) 99 MBps - 303 MBps
JD or JZ	15 TB (13.64 TiB) 112 MBps - 365 MBps	15 TB (13.64 TiB) 112 MBps - 365 MBps	10 TB (9.1 TiB) 112 MBps - 365 MBps
JM	5 TB (4.55 TiB) 122 MBps - 407 MBps	N/A	N/A
JL	3 TB (2.73 TiB) 112 MBps - 365 MBps	3 TB (2.73 TiB) 112 MBps - 365 MBps	2 TB (1.82 TiB) 112 MBps - 365 MBps
JK	900 GB (.82 TiB) 99 MBps - 303 MBps	900 GB (.82 TiB) 99 MBps - 303 MBps	900 GB (.82 TiB) 99 MBps - 303 MBps



## Improved latency

These tape drives add features to improve latency by reducing access time to data:

- ▶ Improved locate and rewind speed profile for the new media types by using 12.4 meters (13.5 yards) per second (mps) end-to-end versus 12.4 mps profiled (JE, JD, JV, JZ, JM, and JL media only):
  - JE, JD, JZ, JM, and JL media feature a redesigned brake button for higher reliability, longer life, and higher locate speeds.
  - The improved profile represents a 9% speed improvement for a rewind/locate operation from EOT to BOT versus the previous profile, which partially compensates for the longer tape length of the new media types.
- ▶ Load and thread times are reduced by approximately 33% from 15 seconds load/ready to 10 seconds load/ready. This reduction applies to JC, JD, and JE media types.

This improvement is possible by operating the motors at a higher operating speed for repeatable read (RR), loader and threader motors.

## Compression

The TS1160 drives feature the same history buffer usage in the compression core as the TS1155. The history buffer is 16 KiB, which enables more efficient compression by increasing the history over which string matches can be applied. The new method can increase the nominal compression ratio for the Calgary Corpus data standard from approximately 2.0 to 3.1.

As in previous models, the 3592 tape drive uses the data compression that is known as *Streaming Lossless Data Compression Algorithm* (SLDC). This compression method is identical to the method that was used in previous models, except for the larger history buffer.

SLDC is an implementation of a Lempel-Ziv class 1 (LZ-1) data compression algorithm. SLDC is an extension to the Adaptive Lossless Data Compression (ALDC) algorithm, which is used in leading industry tape products. Users of SLDC can expect to achieve the same, or better, data compression as users of ALDC.

A key difference between SLDC and previous lossless compression algorithms is that record boundaries and file marks are encoded as control symbols. The encoding of record boundaries and file marks as control symbols allows the compressed data stream to be separated into a serial stream of records and file marks by the decompression logic without requiring more information, such as information from an attached header.

## Beginning of partition caching

These drives implement beginning of partition (BOP) caching. In this implementation, after the initial set of tape blocks in a partition is read by the read-ahead function or a specific command, the initial set of tape blocks remains in a special place in the cache data buffer (until an unmount or a partition change). Subsequent locate operations to BOP or read operations of these blocks complete quickly, without requiring completion of physical motion. BOP caching is supported in all partition modes.

This feature is automatic, cannot be disabled, and uses approximately 6 MB space (one data set) in the main data buffer.

## Humidity sensor

The drive contains a humidity sensor and a temperature sensor. The humidity sensor provides the following functions:

- ▶ Humidity tracing in drive logs  
The drive logs humidity data in the tape map during read and write.
- ▶ Maximum humidity logging in cartridge memory  
The maximum humidity that is sensed during a cartridge mount is loaded in the cartridge memory.
- ▶ Humidity data is externalized in log pages and, like temperature data, humidity data can now be read through standardized SCSI Log pages by an initiator. However, environmental thresholds cannot be set.

## Improved high-resolution tape directory

The TS1160 drive provides a higher-granularity directory to improve the accuracy of tape locate operations for the new JE, JV, and JM media types. The granularity of wrap entries is unchanged from JD media. High-resolution tape directory (HRTD) resolution for JC media types also is unchanged. HRTD directories are maintained separately for partitions.

They maintain a tape directory structure with a high granularity of information about the physical position of data blocks and file marks on the media. The longitudinal position (LPOS) longitudinal location information that is contained in the servo pattern is associated with and recorded with the host block information in the HRTD. This feature allows the 3592 to have fast and consistent nominal and average access times for locate operations.

Therefore, locate times are uniform and based on the position of the block or file mark on the tape independently of the uniformity of the block size or file mark distribution along the length of the tape.

The HRTD feature maintains an overall granularity of 64 directory entries per logical wrap:

- ▶ JA media 570 meters (623.36 yards) logical wrap results in a granularity of 8.9 meters (29.1 feet).
- ▶ JB media 775 meters (847.55 yards) logical wrap results in a granularity of 12.1 meters (39.6 feet).
- ▶ JC media 842 meters (920.8 yards) logical wrap results in a granularity of 13.2 meters (43.3 feet).
- ▶ JD media 1032 meters (1128.6 yards) logical wrap results in a granularity of 8.06 meters (26.4 feet). Granularity is improved for the segmented or scaled formats with shorter logical wraps.
- ▶ JE media 1088 meters (1190 yards) logical wrap results in a granularity of 8.06 meters (26.4 feet). Granularity is improved For the segmented or scaled formats with shorter logical wraps.

The 3592 drive has many redundancy and recovery features that prevent the possibility of data loss in the loss of a directory and allow a rebuild of the directory under all circumstances:

- ▶ The HRTD table consists of information for each logical wrap. Each wrap area contains up to 64 entries. Each entry contains the LPOS, logical block, and file mark count information with access point and other internal information of interest.
- ▶ The entire HRTD table is stored in the housekeeping data set on tape. The entire HRTD structure is also written in the end-of-data (EOD) data set for the tape if the tape has a valid EOD.

The HRTD entries are also distributed in accumulating sequential fashion into the Data Set Information Table of all user data sets as they are written on tape. Control structures, which define the validity of the HRTD and EOD information on the tape, are in the cartridge memory.

- ▶ If a valid HRTD cannot be recovered from the housekeeping data set, the HRTD might be rebuilt by using the EOD or distributed copies of HRTD information. The HRTD can also be rebuilt by reading the tape. Depending on the mechanism that must be used to rebuild the HRTD, this rebuild can occur quickly (seconds if the EOD copy can be used) or take longer (minutes if a full rebuild is required).
- ▶ The drive can read all data from a cartridge without any HRTD information, although locate times might be affected. However, the drive does not allow a write operation without a valid HRTD to guarantee the integrity and validity of the information on tape.

### **Main data buffer**

These drives feature the same 2 GB main data buffer as TS1155, which is twice the size of the 1 GB main buffer in the TS1140 drive. The extra buffer is used to improve overall performance, reduce backhitches, improve speed matching performance, and support BOP caching and other improvements.

### **External copy support**

These drives support the *external copy* function, which offers the following advantages:

- ▶ The capability is similar to serverless copy in that it allows data to be copied from one drive to another drive with no transfer through the host at high data rates.
- ▶ Data can be an entire volume or a group of logical blocks.
- ▶ The hosting drive (TS1160 or any drive that supports the feature) can pull or push data to a second drive of any type (vendor-neutral and does not require feature support).
- ▶ The function works in a SAN environment, and it is supported on true switches (non-hubs).

### **SkipSync or Same Wrap Backhitchless Flush mode feature**

As with previous models, these drives implement a feature that is known as same wrap backhitchless flush mode (SWBF mode), which is also called the *SkipSync* feature. This feature is similar to previous models, plus the following enhancements:

- ▶ In default mode, SkipSync is enabled to use up to 1.5% capacity loss and uses spare capacity, so client capacity is not affected in the nominal Constant Capacity LEOT mode.
- ▶ SkipSync can be programmed through Mode page 0x30 to allow up to 33% capacity loss, which essentially enables SkipSync for all transactions.
- ▶ The performance (throughput) improves for operations or transaction sizes that use SkipSync because of the increased nominal data rates of the TS1160.

### **How SkipSync operates**

When a sync command (**WFM 0**) or a Write File Mark (WFM) non-immediate command is received after a block or series of data blocks (referred to here as a *transaction*), the TS1160 drive does not perform a backhitch immediately after the synchronization or WFM completes. Instead, it continues to stream on the same wrap and write a Data Set Separator (DSS) pattern until enough data is received to record additional data sets. SkipSync results in a significant performance improvement due to backhitch avoidance but a reduction in the overall available capacity on the volume.

In default mode, SWBF mode (SkipSync) is entered after a flush is received under the following conditions:

- ▶ The received transaction size is greater than 204 MB compressed.
- ▶ The drive is not already in Recursive Accumulating Backhitchless Flush (RABF) mode.
- ▶ Enough excess capacity remains based on the current LPOS so that the drive predicts that it will still achieve the minimum capacity threshold that is selected. The minimum capacity threshold is 1.5% for the TS1160 default mode.

### **Dynamic speed matching support**

The TS1155 and TS1150 drives continue to perform dynamic speed matching to minimize backhitches when it operates from a host that cannot sustain the maximum data rate. The drive performs dynamic speed matching automatically to adjust the native data rate of the drive as closely as possible to the net host data rate (after data compressibility is factored out).

The following data rate ranges depend on the logical format and the media type that are used:

- ▶ Twelve speeds from 122 MBps to 407 MBps for 3592 JE, JV, and JM cartridges that are initialized in J6 format
- ▶ Twelve speeds from 112 MBps to 365 MBps for 3592 JD, JZ, and JL cartridges that are initialized in J5 and J5A format
- ▶ Twelve speeds from 99 MBps to 303 MBps for 3592 JC, JY, or JK cartridges that are initialized in J5 format
- ▶ Twelve speeds from 62 MBps to 252 MBps for 3592 JC or JY cartridges that are initialized in J4 format

Throughput is increased through speed matching as the drive performs the following functions:

- ▶ Adjusts tape speed based on host data rate
- ▶ Calculates effective host data rate (EHDR)
- ▶ Optimizes data rate by selecting optimal EHDR
- ▶ Forces speed changes mid-wrap if it is advantageous
- ▶ Minimizes time to record data

### **Virtual backhitch**

These drives include the following key feature improvements:

- ▶ Virtual backhitch (transaction write with sync)
- ▶ Single wrap backhitchless flush (large transaction writes with sync)
- ▶ Backhitchless backspacing (American National Standards Institute [ANSI] file writes)

The TS1160 function utilizes Recursive Accumulating Backhitchless Flush (RABF) and the addition of a new same wrap backhitchless flush (SWBF) function that extends virtual backhitch effectiveness for large files.

Fast sync and skip performance for these tape drive are enhanced because of the better data rate performance over the TS1140.

For more information about these features, see “Virtual backhitch (nonvolatile caching)” on page 113.

## Read ahead feature

On sequential reads, the tape drive automatically runs *read ahead* and fills the buffer with data sequentially beyond the target block.

These drives support advanced automatic read-ahead and read-space virtualization at improved access performance and 2x data buffer size. When the drive processes a command to locate or read a block, the drive automatically continues to stream down the tape and to read ahead until the data buffer is full. This feature allows subsequent **Locate** or **Read** commands to be fulfilled from the data buffer at faster speeds, rather than requiring access to the tape.

With this unique function, the drive outperforms competitive drives, which stop and wait for the next command.

## Performance scaling and segmentation

This section summarizes the TS1160 tape drive models capacity scaling support. The drives also support capacity scaling only on full-length read/write media type.

### **Format support**

The TS1160 drive models support capacity scaling only on the JC, JE, and JD full length read/write media type as follows:

- ▶ For J6/J6E scaled format on JE type media
- ▶ Segmented formats are not supported on JE media
- ▶ For J5/J5E and J5A/J5AE scaled format on JD type media and for J5/J5E

Segmented formats are supported:

- ▶ Full cartridge ABF capability is supported on any scaled cartridge.
- ▶ JD and JC media is up-formatted at the same time the scaling operation is performed, unless the format is controlled through explicit means.
- ▶ For JD and JC media, the scaling value is retained and the scaled capacity is uplifted to the capacity ratio of the new format when a scaled cartridge is up-formatted.

### **Partitioning support**

The following partitioning is supported:

- ▶ Scaling is supported on single partition cartridges only.
- ▶ Issuing a **Format Medium** command to attempt to partition a scaled cartridge results in the rejection of the command.
- ▶ Scaling a partitioned cartridge results in resetting the cartridge to a scaled, single partition format.

The effect of *capacity scaling* is to contain data in a specified fraction of the tape, which yields faster locate and read times. Alternatively, economy tapes can be purchased.

*Performance scaling* limits the data that is written to the first 20% of the cartridge. When the performance segmentation option is used, the overall capacity of the cartridge is limited to 86.6% of the total capacity.

The fast access segment occupies the first 20% of the cartridge, followed by the slower access segment. Medium capacity is calculated as a fraction of nominal maximum capacity. Scaled medium capacity is approximately equal to the nominal unscaled medium capacity times this value divided by 256.

Segmentation is available only within a specified range of capacity scaling settings that achieve this faster performance.

**Note:** On a TS1160 when a scaling operation is requested on a JD type cartridge, the media is up-formatted to the J6 logical format at the same time the scaling operation is performed (unless the format is controlled through specific means).

On a TS1160 when a scaling operation is requested on a JC type cartridge, the media is reformatted to the J6 logical format at the same time that the scaling operation is performed (unless the format is controlled through specific means).

Cartridges that are performance-scaled or performance-segmented can be reused (reformatted) to their full capacity, to the performance-scaled capacity, or to the performance segmentation format as indicated through the assigned data class.

**Important:** Capacity scaling is not supported for economy or WORM tapes.

For more information about the capacity scaling limitations and set up instructions, see *IBM Tape Device Drivers Installation and User's Guide*, [GC27-2130](#).

### 3.5.5 Access performance specifications and drive characteristics

Table 3-8 lists the access performance and drive characteristics of the 3592-55E, 3592-55F, 3592-EH8, and 3592-EH7. For better performance, the block size of the data should be at least 256 K.

Table 3-8 Access performance specifications and drive characteristics

Parameter	3592-60E and 60F	3592-EH8, 55E and 55F
Tape speed, locate/rewind	12.4 mps	12.4 mps
Drive load/ready time	12 seconds (s)	12 seconds (s)
Block locate time from load point average	45 s for JE and JV 13 s 20% scaled JE 40 s for JC and JY 45 s for JD and JZ 11 s for JK 13 s for JL 12 s 20% scaled JC 13 s 20% scaled JD	40 s for JC and JY 45 s for JD and JZ 11 s for JK 13 s for JL 12 s 20% scaled JC 13 s 20% scaled JD
Time to first data average (load/ready + locate)	55 s for JE and JV 23 s 20% scaled JE 50 s for JC and JY 55 s for JD and JZ 22 s for JK 23 s for JL 23 s 20% scaled JC 23 s 20% scaled JD	50 s for JC and JY 55 s for JD and JZ 22 s for JK 23 s for JL 23 s 20% scaled JC 23 s 20% scaled JD
Unload time	36 s for JD, JZ, JL, JC, JY, and JK	36 s for JD, JZ, JL, JC, JY, and JK

Parameter	3592-60E and 60F	3592-EH8, 55E and 55F
Maximum rewind time	94 s 100% scales JE, and JV 34 s 20% scaled JE, and JV 76 s 100% scaled JC and JY 26 s 20% scaled JC 18 s JK 94 s 100% scaled JD and JZ 34 s 20% scaled JD and JZ 34 s JL-	76 s 100% scaled JC and JY 26 s 20% scaled JC 18 s JK 94 s 100% scaled JD and JZ 34 s 20% scaled JD and JZ 34 s JL
Native data rate	400 MBps	360 MBps
Device data rate: Maximum that is sustained with maximally compressible data	900 MBps	700 MBps 600 Mbps for 3592-55E
Interface burst transfer rate: Maximum	1600 MBps (FC-16)	800 MBps (FC-8)
Number of tracks	J6 format, 8704 JE, JV, and JM J6A format, 7680 JD J6 format, 5120 JD, JZ, and JL J6 format, 4608 JC, JK, and JY	J5A format, 7680 JD J5 format, 5120 JD, JZ, and JL J5 format, 4608 JC, JK, and JY
Number of passes (from BOT to EOT)	J6 format, 272 JE, JV, and JM J6A format 240 JD J6 format 160 JD, JZ, and JL J6 format 144 JC, JK, and JY	J5A format 249 JD J5 format 160 JD, JZ, and JL J5 format 144 JC, JK, and JY
Linear density	555 kilo bits per inch (Kbpi)	510 kilo bits per inch (Kbpi)
Servo regions	5	5
Data tracks recorded simultaneously	32	32
Buffer size	2 GB	2 GB

### 3.5.6 Emulation

The TS1160, TS1155, and TS1150 support drive emulation, but not emulation mode.

#### Emulation mode

Because the drive cannot write the TS1130, TS1120, or J1A logical format, it cannot fully emulate all format behaviors of a previous model 3592 drive.

#### Drive emulation

The TS1160 can read and write in J5A and J5 format with compatible IBM 3592 tape cartridges.

The TS1160 tape drive can reformat any compatible J5 tape when it is writing from BOT and the TS1160 can reformat any J5 format tape. Table 3-9 lists the available modes for TS1150 and TS155.

Table 3-9 Drive emulation for TS1160

Drive mode setting	Formats read	Format that is used when the writing cartridge is at BOT	Format that is used when the writing cartridge is not at BOT	Model type that is reported to host in response to the Inquiry command
EH8 J5 format	J4 J5	J5	J5 if format at J5 J4 if format at J4	E08
55E and 55F J5A format	J5 J5A	J5A	J5A if format at J5A J5 if format at J5	55E or 55F
60E and 60F J6 format	J5A J5 J6	J6	J6 if format at J6 J5A if format at J5A J5 if format at J5	60E or 60F

The TS1150 and TS1155 can reformat a compatible tape written in J6 format, but cannot read in this format.

### 3.5.7 IBM Spectrum Archive and LTFS support

TS1160 tape drives is compatible with the IBM Spectrum Archive software application and the underlying IBM LTFS. LTFS uses media partitioning functionality. LTFS provides a standard tape cartridge format at low cost, which can be used without other database applications.

LTFS presents tape media as though it were a disk file system. IBM Spectrum Archive supports the IBM LTO Ultrium 8, 7, 6, and 5, and IBM TS1160, TS1155, TS1150, and TS1140 tape drives.

Tape as a storage medium offers many benefits. Tape is reliable, portable, low-cost, low-power, and high-capacity. However, tape is not particularly easy to use. It has no standard format, and data often cannot be used unless the data is copied to disk first.

With IBM Spectrum Archive and LTFS, accessing data that is stored on an IBM tape cartridge became as intuitive as the use of a USB flash drive. With IBM Spectrum Archive, reading data on a tape cartridge is as easy as dropping a file. Users can run any application that is designed for disk files against tape data without concern that the data is physically stored on tape.

LTFS implements a true file system for tape. IBM Spectrum Archive also supports library automation, including the ability to find data on a tape in a library without mounting and searching tape volumes.

IBM Spectrum Archive Library Edition (LE) supports IBM tape automation and the single drive edition IBM Linear Tape File System. With IBM Spectrum Archive LE, you can create a single file system mount point for a logical library that is managed by a single instance of the software, which is running on a single server. In addition, it provides for caching of tape indexes, and for searching, querying, and displaying tapes' contents within an IBM tape library without the requirement to mount tape cartridges.



The TS1160 provides the same LTFS support as the TS1150, but with increased capacity and performance. LTFS is provided with the following features:

- ▶ Ability to configure up to four partitions
- ▶ Wrap-wise partitioning only
- ▶ Support on all non-WORM media formats
- ▶ **Format** command support

For more information about IBM Spectrum Archive and LTFS, see 1.5, “IBM Spectrum Archive” on page 29.

### 3.5.8 Data safe mode

The TS1160 supports *data safe mode*. This mode is controlled by the application and prevents inadvertent overwrite. Data safe mode treats the tape volume that is mounted as a WORM drive and prevents inadvertent overwrite. This mode is set by the application or host system.

### 3.5.9 Upgrade considerations

A drive-field *Miscellaneous Equipment Specification* (MES) conversion feature is available for a 3592-EH7 model to 3592-EH8 model conversion to a TS1150.

**Important:** If you choose this MES to replace the TS1140 drive, only the drive changes. The canister remains the same. The serial number of the original drive is written by the library to the vital product data (VPD) of the replacement drive. The MES is valid for the TS4500 tape library and a rack-mounted drive.

#### TS1160 Field MES support

The following drive MES conversions are supported:

- ▶ 3592 EH8 drive > 3592 60F model upgrade
- ▶ 3592 55F drive > 3592 60F model upgrade
- ▶ 3592 60G drive > 3592 60F model upgrade
- ▶ 3592 55G drive > 3592 60G model upgrade
- ▶ 3592 E08 drive > 3592 60G model conversion

### 3.5.10 Firmware updates

No changes were made to the firmware update mechanisms for the TS1160 as compared to previous TS1100 tape drives. Consider the following points:

- ▶ The TS1160 continues to support concurrent Licensed Internal Code (LIC) load with deferred activation.
- ▶ The TS1160 has a single LIC image that is unique from previous models.

Unique LIC is required for the model 60E drives because the LOAD ID differs from the LOAD ID that is required for previous versions of 3592. The firmware for the 3592 60E drive can be updated by using one of the following methods, depending on where the drive is installed:

- ▶ Through the library management GUI.
- ▶ Through the host attachment by using the write buffer command or IBM TotalStorage Tape Diagnostic Tool (ITDT), which is the preferred method.

### 3.5.11 RAS

The RAS features are improved or maintained relative to the TS1155. They are similar to their predecessor models, the TS1160 is a single FRU, which are hot-pluggable without a maintenance window and support nondisruptive code loading. As with the TS1140, fan speed management and unique device microcode file management are available through a LOAD ID.

The end of life usage alert for media activates on full-file pass usage. The Nearing Media Life alert occurs at 19,900 mounts or 295 full-file passes. The Media Life alert for JD or JL media use within a TS1150 drive is now rated for 20 M motion meters as opposed to 300 Full-File Passes (FFPs).

### 3.5.12 Improved media Statistical Analysis and Reporting System

The TS1160 supports Statistical Analysis and Reporting System (SARS) in a similar manner to previous drive models.

The tape drive uses SARS to help isolate failures between media and hardware. SARS uses the cartridge performance history, which is saved in the cartridge memory (CM) module. It also uses the drive performance history, which is kept in the drive flash electrically erasable programmable read only memory (EEPROM) to determine the likely cause of failure. SARS can cause the drive to request a cleaning tape to mark the media as degraded, and indicate that the hardware is degraded.

SARS information is reported through the TapeAlert flags and through media information messages (MIMs) or service information messages (SIMs).

The 3592 drive maintains a history of the last 100 mounts for Volume Statistical Analysis and Reporting System (VSARS) and Hardware Statistical Analysis and Reporting System (HSARS).

**Note:** Media SARS information is preserved when media is reformatted.

The TS1150 implements an enhanced SARS function that is known as client-centric SARS (ccSARS). This function improves the overall amount of information that is maintained, and the presentation means to the client with the automation system.

The media SARS function for the drives includes the following actions:

- ▶ Tape alerts are generated when media passes usage life, as determined by full-file passes, meters of tape that were processed, or the write pass count, and the total number of mounts (which was supported).
- ▶ A media SARS summary is maintained in the cartridge memory in a manner where it can be rebuilt on tape if the SARS records on tape cannot be read and must be reinitialized. This cartridge memory copy is also readable on an earlier level TS1140 drive to preserve SARS information between logical format conversions.

### 3.5.13 Encryption

The TS1160 tape drive is encryption-capable. Like the previous models, you do not need to enable the drive specifically.

Encryption support includes the following enhancements:

- ▶ LME, AME, and SME (for TS7700).
- ▶ T10 default method support.
- ▶ Continued encrypted data key (EEDK) wrapped key support in LME and SME.
- ▶ Enhanced protocol support for Internet Printing Protocol (IPP), which can be configured for security, and Java Platform, Enterprise Edition 2 historical mode (as used by IBM Spectrum Protect), T10 default method, Security Protocol IN (SPIN), and Security Protocol OUT (SPOUT).
- ▶ Enhanced drive cryptographic upgrades to change the default authentication means from Secure Hash Algorithm-1 (SHA-1) to SHA-2 when you use IBM Security Guardium Key Lifecycle Manager.

T10 standards-based encryption control on a logical block basis (not tied to format identifier) and writes encrypted data and clear data to the same tape cartridge.

## 3.6 IBM TS1155 and TS1150 tape drive

The IBM TS1155 tape drive (which is also referred to as the *3592 Model 55E, 55F, or 55G*) is an enhanced fifth generation tape drive of the IBM 3592 tape family. The TS1155 tape drive provides higher levels of cartridge capacity than the TS1150 Model E08 (EH8). It is designed to provide an increased capacity of 50% on JD media types compared with its predecessors.

The primary difference of the TS1155 (55E, 55F, and 55G) from the base TS1150 drive (E08, EH8) is that the capacity is increased 50% on JD media types. In addition, for the TS1155, model 55E Ethernet host attachment (RoCE v2) ports have been added.

The TS1155 model 55F and 55G tape drive has a dual-port 8-Gbps Fibre Channel interface for Fibre Channel attachment to host systems, or a switched fabric environment.

The TS1155 model 55E tape drive has a dual ported 10 Gb Ethernet port for host attachment that is optimized for cloud-based and large, open-compute environments.

The TS1155 Tape drive is capable of reading and writing 15 TB capacity on existing JD media types (JD/JZ/JL), compared to 10 TB for TS1150. The TS1155 tape drive supports JC 4 TB format (read only) and JC 7 TB format (R/W). Media written in TS1155 format is not readable by TS1150, but is back-portable for reformatting to TS1150 format of 10 TB.

The TS1155 Tape drive is not compatible with IBM TS7700 or Enterprise Tape Control Unit environments.

The IBM TS1150 tape drive (which is also referred to as the *3592 Model EH8*) is the fifth tape drive generation of the IBM 3592 tape family. The TS1150 tape drive provides higher levels of performance, reliability, and cartridge capacity than the TS1140 Model EH7 tape drive.

**Note:** The TS1150 model EH8 is functionally the same as the TS1150 model E08, but packaged for integration into a TS4500. For more information about these models, see *IBM TS4500 R4 Tape Library Guide*, SG24-8235. This section describes 3592 E08 models only.

The TS1155 and TS1150 use the new Tunnel Magnetoresistive (TMR) head technology. The initial generation of the TS1150 used a Giant Magnetoresistive (GMR) head design. Both use high-technology, 3-module, 32-channel head technology for higher native data rate performance. The TS1155 and TS1150 provide a native data rate performance of up to 360 MBps versus the 250 MBps data rate of the TS1140 tape drive Model EH7.

The TS1155 55F and 55G, and TS1150 E08 tape drives have dual-port 8-Gbps Fibre Channel interface for Fibre Channel attachment to host systems, or to a switched fabric environment.

The TS1155 and TS 1150 record in two native recording formats that support encryption and nonencryption:

- ▶ J5A logical format is used to represent the non-encrypted recording format, and J5A-E is used to denote the encrypted recording format for TS1155.
- ▶ J5 logical format is used to represent the non-encrypted recording format, and J5-E is used to denote the encrypted recording format for TS1150.

The TS1155 is downward read only compatible to TS1140 format (J4 and J4-E) on supported cartridges, and the TS1150 is downward read/write compatible to the TS1140 formats.

**Note:** The TS1155 and TS1150 cannot read or write any format from J3, J3-E, or earlier.

Host interfaces to open systems platforms are maintained as with previous 3592 models.

The TS1150 support integration into the TS3500 or TS4500 tape libraries, and as stand-alone rack mounted. Figure 3-12 shows the IBM TS1155 tape drive. The TS1155 is supported on the TS4500 and TS3500, and as rack mounted.



Figure 3-12 TS1155 tape drive

This tape drive maintains the same features and technology enhancements that were introduced with the TS1120 and extended by the TS1130 and the TS1140. In addition, the TS1155 and TS 1150 offer several enhancements over the predecessor models, which are described next.

The TS1155 and TS1150 has the following key features, including those that were introduced with the 3592-J1A, TS1120, TS1130, and TS1140:

- ▶ Digital speed matching
- ▶ Channel calibration
- ▶ High-resolution tape directory
- ▶ Recursive accumulating backhitch-less flush or non-volatile caching (NVC)
- ▶ Backhitch-less backspace
- ▶ Virtual backhitch
- ▶ Read Ahead
- ▶ SLDC compression
- ▶ Capacity scaling
- ▶ Single FRU
- ▶ Error detection and reporting
- ▶ SARS
- ▶ Revised Encryption Support
- ▶ Dual-stage 32-head actuator
- ▶ Offboard data string searching
- ▶ Enhanced logic to report logical end of tape
- ▶ Added Partitioning Support
- ▶ Data Safe mode
- ▶ Enhanced Ethernet support
- ▶ Enhanced Barium Ferrite (BaFe) particle media types
- ▶ Dual, 8 Gb FC attachment with failover support
- ▶ Dual port, 10 Gb Ethernet ports for TS1155 55E
- ▶ Partitioning that is supported by LTFS
- ▶ Max Capacity mode logical end-of-tape (LEOT) support allowing up to 4% more capacity

### 3.6.1 Physical attachment

The TS1150 and TS1155 is supported for attachment in the TS3500 or TS4500 tape libraries or as rack mounted. Table 3-10 lists the attachment configurations that are allowed for TS1150.

*Table 3-10 Maximum 3592 tape drive attachments in environments without a tape controller*

Environment	Number of TS1150 tape drives
2.0-meter rack (IBM Model 7014-T42)	Up to 16
1.6-meter rack (IBM Model 7014-S00)	Up to 12
1.8-meter rack (IBM Model 7014-T00)	Up to 12
TS3500	Up to 12 <sup>a</sup> per frame
TS4500	Up to 16 per frame

a. There are prerequisites for installing TS1150 and TS1155 into a TS3500. The TS3500 must have enhanced node cards installed. The TS3500 must have the latest version of Firmware level installed, TS4500 supports both TS1155 and TS1150. Consult with IBM support to ensure compatible code is installed for the drive type to be installed.

### 3.6.2 Media

The TS1155 and TS1150 use the following enhanced Barium Ferrite (BaFe) second-generation particle media types. The new media can be read/written at up to a 360 MBps native sustained data rate (up to 700 MBps at 3:1 compression ratio) in the new 32-channel Jag-5A, J5A-E, J5, and J5-E logical format. The media for 3592 can have these formats:

- ▶ 3592 model J1A read/write format J1 and for encrypted format is J1-E. (EFMT1)
- ▶ 3592 model E05 read/write format J2 and for encrypted format is J2-E (EFMT2 or EEFMT2)
- ▶ 3592 model E06 read/write format J3 and for encrypted format is J3-E (EFMT3 or EEFMT3)
- ▶ 3592 model E07 and EH7 read/write format J4 and for encrypted format is J4-E (EFMT4 or EEFMT4)
- ▶ 3592 model E08 and EH8 read/write format J5 and for encrypted format is J5-E (EFMT5 or EEFMT5)
- ▶ 3592 model 55E, 55F, and 55G read/write format J5A and for encrypted format is J5A-E

Table 3-11 lists the compatibility table for TS1155 and TS1150 drives.

Table 3-11 Media type and read/write format compatibility

Media type	TS1155				TS1150				
	Logical Format read/write				Logical Format read/write			z/OS Media Type	
JD	J5A	J5A-E	J5	J5-E	J5	J5-E			Media 14
JZ	J5A	J5A-E	J5	J5-E	J5	J5-E			Media 15
JL	J5A	J5A-E	J5	J5-E	J5	J5-E			Media 16
JC	J5A	J5A -E	J5	J5-E	J5	J5-E	J4	J4-E	Media 11
JY	J5A	J5A -E	J5	J5-E	J5	J5-E	J4	J4-E	Media 12
JK	J5A	J5A-E	J5	J5-E	J5	J5-E	J4	J4-E	Media 13

Consider the following points regarding these drives:

**Important:** The TS1155 and TS1150 are not compatible with several older 3592 cartridge media types: JA, JB, JW, JJ, JR, and JX media types J3, J2, and J1 (MEDIA5, MEDIA6, MEDIA7, MEDIA8, MEDIA9, and MEDIA10).

- ▶ These drives improve capacity and performance by writing and reading J5 and J5A logical format, by using a new 32-channel enhanced ECC recording format with a higher track density and higher linear density on the same media types.
- ▶ The suitable microcode levels that are available for TS1150 and TS1140. They must be installed to enable the recognition of the J5A and J5 format and allow reuse of the media in the older formats. Therefore, a model J5A drive can reformat media that was written in the older format and write on it in the appropriate format.

**Important:** This design supports a common scratch pool by media type regardless of the last written format or allocation target drive.

### 3.6.3 Capacity and performance

Capacity and performance were improved from the IBM TS1155 and TS1150 tape drive for all media types and for all formats that the TS1155 and TS1150 reads or writes.

#### Capacity improvement

The use of the TS1155 logical format offers the following capacity improvements on existing and new cartridges:

- ▶ IBM Enterprise Advanced Data media (JZ and JD), which is a capacity of 15 TB
- ▶ IBM Enterprise Advanced Data media (JC and JY), which is a capacity of 7 TB
- ▶ IBM Enterprise Economy Data media (JZ), which is a capacity of 3 TB
- ▶ IBM Enterprise Economy Data media (JK), which is a capacity of 900 GB

The use of the 3592-EH8 logical format offers the following capacity on existing and new cartridges:

- ▶ IBM Enterprise Advanced Data media (JZ and JD), which is a capacity of 10 TB
- ▶ IBM Enterprise Advanced Data media (JC and JY), which is a capacity of 7 TB
- ▶ IBM Enterprise Economy Data media (JZ), which is a capacity of 2 TB
- ▶ IBM Enterprise Economy Data media (JK), which is a capacity of 900 GB

Using the IBM Enterprise Advanced WORM with data media (JY or JC), a 75% capacity uplift 4 - 7 TB is achieved.

#### Performance improvement

The overall performance is increased over previous model by various improvements, as shown in the following examples:

- ▶ Improved data rate and capacity
- ▶ Improved latency by reducing access time to data
- ▶ Improved Data Compression
- ▶ Beginning of Partition (BOP) Caching
- ▶ Humidity Sensor support
- ▶ Increased Cartridge Memory size and related functions
- ▶ Improved high resolution tape directory (HRTD)
- ▶ Larger Main Data Buffer
- ▶ Extended Copy support

#### Higher data rates and capacity

The following format data rates are available (at 256 K and greater block size):

- ▶ The 55E format data rates go up to 360 MBps maximum native and to 600 MBps maximum compressed.
- ▶ The EH8 55G and 55F format data rates go up to 360 MBps maximum native and to 700 MBps maximum compressed.
- ▶ The EH7 format data rates go up to 250 MBps maximum native and to 700 MBps maximum compressed.

Table 3-12 lists the capacity and performance characteristics for uncompressed data.

Table 3-12 Capacity and performance summary

Media	E08 format capacity data rate (minimum-maximum)	E07 format capacity data rate (minimum-maximum)
JC or JY	7 TB 99 MBps - 303 MBps	7 TB 99 MBps - 303 MBps
JD or JZ	15 TB 112 MBps - 365 MBps	10 TB 112 MBps - 365 MBps
JK	900 GB 99 MBps - 303 MBps	900 GB 99 MBps - 303 MBps
JL	3 TB 112 MBps - 365 MBps	2 TB 112 MBps - 365 MBps

### Improved latency

These tape drives add features to improve latency by reducing access time to data. These features can be summarized as follows:

- ▶ Improved locate and rewind speed profile for the new media types by using 12.4 m/s end-end versus 12.4 m/s profiled (JD, JZ, and JL media only):
  - JD, JZ, and JL media feature a redesigned brake button for higher reliability, longer life, and higher locate speeds.
  - The improved profile represents a 9% speed improvement for a rewind/locate operation from EOT to BOT versus the previous profile, which partially compensates for the longer tape length of the new media types.
- ▶ Load and thread times are reduced by approximately 33% from 15 seconds load/ready to 10 seconds load/ready. This reduction is applicable to both JC and JD media types.

This improvement is possible by operating the motors at higher operating speed for RR, loader, and threader motors.

### Improved data compression

The TS1155 and TS1150 features a larger history buffer use in the compression core. This change increases the history buffer 1 - 16 K, which enables more efficient compression by increasing the history over which string matches can be applied. The new method can increase the nominal compression ratio for Calgary Corpus data standard from approximately 2.0 to 3.1.

**Note:** The improved compression method is available only when processing the EH8 logical formats on the new JD, JZ, and JL media, or on unformatted JC, JY, or JK media. When processing the EH7 format, the established compression method is used for compatibility. TS1155 cannot write in EH7 format.

As in previous models, the 3592 tape drive uses the data compression that is known as streaming lossless data compression (SLDC) algorithm. This compression method is identical to the method used in previous models except for the larger history buffer. SLDC is an implementation of a Lempel-Ziv class 1 (LZ-1) data compression algorithms. SLDC is an extension to the adaptive lossless data compression (ALDC) algorithm, which is used in leading industry tape products. Users of SLDC can expect to achieve the same, or better, data compression as users of ALDC.



A key difference between SLDC and previous lossless compression algorithms is that record boundaries and file marks are encoded as control symbols. The encoding of record boundaries and file marks as control symbols allows the compressed data stream to be separated into a serial stream of records and file marks by the decompression logic without requiring additional information such as from an attached header.

### **Beginning of Partition Caching**

The drives implement BOP Caching. In this implementation, after the initial set of tape blocks in a partition are read, either by read-ahead function or explicit command, they remain in a special place in the cache data buffer (until unmount or partition change). Subsequent locate operations to BOP or read operations of these blocks complete quickly, without requiring completion of physical motion. BOP Caching is supported in all partition modes.

This feature is automatic, cannot be disabled, and uses approximately 6 MB space (one data set) in the main data buffer.

### **Humidity sensor**

The drives contain a humidity sensor and a temperature sensor. The humidity sensor provides the following functions:

- ▶ Humidity tracing in drive logs  
The drive logs humidity data in the tape map during read and write.
- ▶ Max humidity logging in cartridge memory  
The max humidity sensed during a cartridge mount is loaded in cartridge memory.
- ▶ Humidity data that is externalized in log pages  
As with temperature data, humidity data can now be read through SCSI log pages by an initiator. For more information, see *IBM System Storage LTO Tape Drive SCSI Reference (LTO-5 through LTO-9)*, [GA32-0928](#).

### **Increased cartridge memory size and related functions**

The new JD, JZ, and JL media types contain 16 KB cartridge memory (CM), increased from the 8 KB contained in JC and JB media types. The CM contains a larger medium auxiliary memory (MAM) area, which is available to the application.

### **Improved high-resolution tape directory**

The TS1155 and TS1150 tape drive provides a higher-granularity directory to improve the accuracy of tape locate operations for the new JD, JZ, and JL media types. The granularity of wrap entries is increased from 64/wrap to 128/wrap for the new media types. HRTD resolution for JC media types is unchanged. HRTD directories are maintained separately for partitions.

These drives maintain a tape directory structure with a high granularity of information about the physical position of data blocks and file marks on the media. The LPOS longitudinal location information that is contained in the servo pattern is associated and recorded with the host block information in the HRTD. This feature allows the 3592 to have fast and consistent nominal and average access times for locate operations. Therefore, locate times are uniform and based on the position of the block or file mark on the tape. They are independent of the uniformity of the block size or file mark distribution along the length of the tape.

The HRTD feature maintains an overall granularity of 64 directory entries per logical wrap. For a JA media 570 m logical wrap, this feature results in a granularity of 8.9 meters. For a JB media 775 m logical wrap, this feature results in a granularity of 12.1 meters. For a JC media 842 m logical wrap, this feature results in a granularity of 13.2 meters. For JD media, the nominal granularity with 128 entries is 8.06 meters. For the segmented or scaled formats where there are shorter logical wraps, granularity is improved.

The 3592 drive has many redundancy and recovery features, which prevent the possibility of data loss if there is a directory loss and allow rebuild of the directory under all circumstances:

- ▶ The HRTD table consists of information for each logical wrap with each wrap area containing up to 64 entries. Each entry contains LPOS, logical block, and file mark count information along with access point and other internal information of interest.
- ▶ The entire HRTD table is stored in the housekeeping data set on tape. The entire HRTD structure is also written in the end-of-data (EOD) data set for the tape if the tape has a valid EOD. The HRTD entries are also distributed in accumulating sequential fashion into the Data Set Information Table of all user data sets as they are written on tape. Control structures are in the cartridge memory that defines the validity of the HRTD and EOD information about the tape.
- ▶ If a valid HRTD cannot be recovered from the housekeeping data set, the HRTD can be rebuilt by using the EOD or distributed copies of HRTD information. The HRTD can also be rebuilt by reading the tape. Depending on the mechanism that must be used to rebuild the HRTD, this process can occur relatively quickly (in seconds if the EOD copy can be used) or take longer (minutes if a full rebuild is required).
- ▶ The drive can read all data from a cartridge without any HRTD information, although locate times can be affected. However, the drive does not allow a write operation without a valid HRTD to help ensure integrity and validity of the information on tape.

### **Larger main data buffer**

The TS1155 and TS1150 drives feature a 2 GB main data buffer, twice the size of the 1 GB main buffer in the TS1140 drive. The larger buffer improves overall performance, reduces back hitches, improves speed matching performance, supports BOP caching, and other improvements.

### **Extended copy support**

These drives support a new function that is called External Copy, which offers these advantages:

- ▶ The capability is similar to serverless copy in that it allows data to be copied from one drive to another drive with no transfer through the host at high data rates.
- ▶ Data can be an entire volume or a group of logical blocks.
- ▶ The hosting drive (TS1155 or any drive that supports the feature) can pull or push data to a second drive of any type (vendor-neutral and does not require feature support).
- ▶ It works in a SAN environment, supported on true switches (non-hubs).

## SkipSync (the Same Wrap Backhitchless Flush feature)

The TS1155 and TS1150, like previous models, implement a feature that is known as Same Wrap Backhitchless Flush mode (SWBF mode), also called the *SkipSync* feature. This feature on the TS1155 and TS1150 is similar to previous models plus the following enhancements:

- ▶ In default mode, SkipSync is enabled to use up to 1.5% capacity loss and uses spare capacity. Therefore, there is no impact to customer capacity in the nominal Constant Capacity LEOT mode.
- ▶ SkipSync can be programmed through Mode page 0x30 to allow up to 33% capacity loss, which essentially enables SkipSync for all transactions.
- ▶ The performance (throughput) improves for operations or transaction sizes by using SkipSync because of the increased nominal data rates of the TS1155 and TS1150.

### How SkipSync operates

When a sync command (**WFM 0**) or a Write File Mark non-immediate command is received after a block or series of data blocks (called a *transaction*), the TS1155 or TS1150 drive does not perform a backhitch immediately after the synchronization or WFM is completed. Instead, it continues to stream on the same wrap and write DSS pattern until enough data is received to begin recording additional data sets. This process results in a significant performance improvement due to backhitch avoidance, but a reduction in the overall available capacity on the volume.

In default mode, SWBF mode (SkipSync) is entered after a flush is received under these conditions:

- ▶ The received transaction size is greater than 204 MB compressed.
- ▶ The drive is not already in Recursive Accumulating Backhitchless Flush (RABF) mode.
- ▶ There is enough remaining excess capacity based on the current logical position that the drive predicts that it still achieves the Minimum Capacity threshold currently selected. This threshold is 1.5% for TS1155 and TS1150 default mode.

### Dynamic speed matching support

These drives continue to perform dynamic speed matching to minimize backhitches when operating from a host that cannot sustain the maximum data rate. The drive performs dynamic speed matching automatically to adjust the native data rate of the drive as closely as possible to the net host data rate (after data compressibility is factored out).

The data rate ranges depend on the logical format and the media type used:

- ▶ Twelve speeds of 112 - 365 MBps for 3592 JD, JZ, and JL cartridges that are initialized in J5 and J5A format
- ▶ Twelve speeds of 99 - 303 MBps for 3592 JC, JY, or JK cartridges that are initialized in J5 format
- ▶ Twelve speeds of 62 - 252 MBps for 3592 JC or JY cartridges that are initialized in J4 format

Throughput is increased through speed matching as the drive performs the following functions:

- ▶ Adjusts tape speed based on host data rate
- ▶ Calculates effective host data rate (EHDR)
- ▶ Optimizes data rate by selecting optimal EHDR
- ▶ Forces speed changes mid-wrap if advantageous
- ▶ Minimizes time to record data

## Virtual backhitch

These drives include the following key feature improvements:

- ▶ Virtual backhitch (transaction write with sync)
- ▶ Single wrap backhitchless flush (large transaction writes with sync)
- ▶ Backhitchless backspacing (American National Standard file writes)

The TS1155 and TS1150 have improved functions, such as RABF, and the addition of a new SWBF function that extends virtual backhitch effectiveness for large files.

Fast sync and skip performance for the TS1155 and TS1150 tape drive is enhanced because of the better data rate performance over the TS1140.

For more information about these features, see “Virtual backhitch (nonvolatile caching)” on page 113.

## Read Ahead feature

On sequential reads, the tape drive automatically runs Read Ahead and fills the buffer with data sequentially beyond the target block.

These drives support advanced automatic read-ahead and read-space virtualization at improved access performance and 2X data buffer size. When the drive processes a command to locate or read a block, the drive automatically continues to stream down the tape and reads ahead until the data buffer is full. This process allows subsequent Locate or Read commands to be fulfilled from the data buffer at faster speeds, rather than requiring access to the tape.

With this unique function, the drive outperforms competitive drives, which stop and wait for the next command.

## Performance scaling and segmentation

The support on these drivers for capacity scaling is summarized in this section. They support capacity scaling only on full-length R/W media type (JD or JC).

**Note:** When a scaling operation is requested on a JC type cartridge, the media is reformatted to the J5 logical format at the same time that the scaling operation is performed unless the format is controlled through explicit means.

### ***Format support***

The TS1155 drive models support capacity scaling only on the JD full length R/W media type.

The TS1150 drive writes the EH7 scaled format (JC media only) and the scaled EH8 format (on JC and JD media). Segmented formats are supported.

EH7 scaled format behavior on JC media is unchanged from the TS1140, and full cartridge accumulating backhitchless flush (ABF) capability is supported on any scaled cartridge.

When a scaled cartridge is up-formatted (applicable to JC media only), the scaling value is retained, and the scaled capacity is uplifted to the capacity ratio of the new format.

### **Partitioning support**

Consider the following items for partition support:

- ▶ Scaling is supported only on single-partition cartridges.
- ▶ Issuing a **Format Medium** command to attempt to partition a scaled cartridge results in the command being rejected.
- ▶ Scaling a partitioned cartridge results in the cartridge being reset to a scaled, single-partition format.

The effect of capacity scaling is to contain data in a specified fraction of the tape, which yields faster locate and read times. Alternatively, economy tapes (the JK or JL media type) can be purchased.

Performance scaling limits the data that is written to the first 20% of the cartridge. When the performance segmentation option is used, the overall capacity of the cartridge is limited to 86.6% of the total capacity.

The fast access segment occupies the first 20% of the cartridge, followed by the slower access segment. Medium Capacity is calculated as a fraction of nominal maximum capacity. Scaled medium capacity is approximately equal to the nominal unscaled medium capacity multiplied by this value and divided by 256.

Segmentation is available only within a specified range of capacity scaling settings that achieve this faster performance.

Cartridges that are performance-scaled or performance-segmented can be reused (reformatted) to their full capacity, to the performance-scaled capacity, or to the performance segmentation format as indicated through the assigned data class.

On a TS1155, when a scaling operation is requested on a JD type cartridge, the media are up-formatted to the J5A logical format at the same time the scaling operation is performed unless the format is controlled through explicit means.

On a TS1150, when a scaling operation is requested on a JC type cartridge, the media is reformatted to the J5 logical format at the same time that the scaling operation is performed unless the format is controlled through explicit means.

**Important:** Consider the following points:

- ▶ Capacity scaling is not supported for economy (JK, JL) or WORM tapes (JY and JZ).
- ▶ Check the *IBM Tape Device Drivers Installation and User's Guide*, [GC27-2130](#), for the capacity scaling limitations and instructions for setup.

### 3.6.4 Access performance specifications and drive characteristics

Table 3-13 lists the access performance and drive characteristics of the 3592-E08, 3592-E07, and 3592-E06.

Table 3-13 Access performance specifications and drive characteristics

Parameter	3592-E08, 55E, 55F, and 55G Format J5 or J5A	3592-E07 Format J4	3592-E06 Format J3
Tape speed, locate/rewind	12.4 mps	12.4 mps	12.4 mps
Drive load/ready time	12 s	15 s	13 s
Block locate time from load point average	40 s for JC, JY 45 s for JD, JZ 11 s for JK 13 s for JL 12 sec 20% scaled JC 13 sec 20% scaled JD	37 s for JB, JX 40 s for JC, JY 11 s for JK 15 sec 20% scaled JB 12 sec 20% scaled JC	28 s for JA, JW 11 s for JJ, JR 37 s for JB, JX 11 sec 20% scaled JA 15 s for 20% scaled JB
Time to first data average (load/ready + locate)	50 s for JC, JY 55 s for JD, JZ 22 s for JK 23 s for JL 23 sec 20% scaled JC 23 sec 20% scaled JD	42 s for JB, JX 55 s for JC, JY 26 s for JK 30 s for 20% scaled JB 27 s for 20% scaled JC	41 s for JA, JW 24 s for JJ, JR 50 s for JB, JX 24 s for 20% scaled JA 28 s for 20% scaled JB
Unload time	36 s for JD, JZ, JL, JC, JY, JK	24 s for JB, JX 36 s for JC, JY, JK	21 s for JA, JW, JR, JJ, JB, JX
Maximum rewind time	76 sec 100% scaled JC, JY 26 sec 20% scaled JC 18 sec JK 94 sec 100% scaled JD, JZ 34 sec 20% scaled JD, JZ 34 sec JL	72 sec 100% scaled JB, JX 24 sec 20% scaled JB 76 sec 100% scaled JC, JY 26 sec 20% scaled JC 18 sec JK	55 sec 100% scaled JA, JW 18 sec 20% scaled JA 18 sec JJ, JR 72 sec 100% scaled JB, JX 24 sec 20% scaled JB
Native Data Rate	360 Mbps	250 Mbps	163 Mbps
Device data rate, maximum sustained with maximally compressible data	700 MBps 600 MBps for 3592-55E	650 MBps	350 MBps
Interface burst transfer rate, maximum	800 MBps (FC-8)	800 MBps (FC-8)	400 MBps (FC-4)
Number of tracks	J5A format, 7680 JD J5 format, 5120 JD, JZ, JL J5 format, 4608 JC, JK, JY	1792 JB, JX 2560 JC, JK, JY	1152
Number of passes (from BOT to EOT)	J5A format 249 JD J5 format 160 JD, JZ, JL J5 format 144 JC, JK, JY	56 JB, JX 80 JC, JK, JY	72
Linear density	510 kbp	500 kbp	321 kbp
Servo regions	5	5	5
Data tracks recorded simultaneously	32	32	16
Buffer size	2 GB	1 GB	1 GB

### 3.6.5 Emulation

This topic describes emulation mode and drive emulation regarding the TS1155 and TS1150 tape drive.

#### Emulation mode

The TS1155 and TS1150 does not support any emulation modes. Because the drive cannot write the TS1120 or J1A logical format, it cannot fully emulate all format behaviors of a previous model 3592 drive.

#### Drive emulation

The TS1155 and the TS1150 tape drive do not support emulation. The TS1155 can read and write in J5A and J5 format with compatible IBM 3592 tape cartridges. The TS1150 can read and write in J5 and J4 format with compatible IBM 3592 tape cartridges.

The TS1155 tape drive can reformat any compatible J5 tape when it is writing from BOT and the TS1150 can reformat any J4 format tape. Table 3-14 lists the available modes for TS1150 and TS155.

Table 3-14 Drive emulation for TS1150

Drive mode setting	Formats read	Format used when writing cartridge is at BOT	Format used when writing cartridge is not at BOT	Model type reported to host in response to an Inquiry command
EH8 J5 and J5-E format	J4 / J4-E J5 / J5-E	J5 / J5-E	J5 if format at J5 J4 if format at J4	E08
55E, 55F, and 55G J5A and J5A-E format	J5A / J5A-E J5 / J5-E	J5A / J5A-E	J5A if format at J5A J5 if format at J5	55E, 55F, or 55G

### 3.6.6 IBM Spectrum Archive and LTFS support

Tape as a storage medium has many benefits: It is reliable, portable, low-cost, low-power, and high-capacity. However, tape is not easy to use because it has no standard format and data often cannot be used without first copying it to a disk.

IBM Spectrum Archive enables direct, intuitive, and graphical access to data stored in IBM tape drives and libraries by incorporating the LTFS format standard for reading, writing, and exchanging descriptive metadata on formatted tape cartridges. IBM Spectrum Archive eliminates the need for additional tape management and software to access data. IBM Spectrum Archive offers three software solutions for managing your digital files with the LTFS format: Single Drive Edition, Library Edition, and Enterprise Edition.

For more information about IBM Spectrum Archive and LTFS, see *IBM Linear Tape File System Installation and Configuration*, SG24-8090.

The TS1155 and TS1150 provides LTFS support with the following features:

- ▶ Ability to configure up to four partitions
- ▶ Wrap-wise and longitudinal-wise partitioning
- ▶ Supported on all non-WORM TS1150 formats (JC, JK, and JB formats)
- ▶ Format command support
- ▶ Each partition can use a separate encryption method, or none

The TS1155 and TS1150 drive supports partitioning in an identical manner to the previous E07 model, except the capacity of a given partition scales up with the newly supported J5 format:

- ▶ The TS1155 and TS1150 drive supports both the wrap-wise and longitudinal partitioning models and the same number of partitions.
- ▶ The TS1155 and TS1150 drive supports the partitioning of WORM media types (JD and JY media types) to enable LTFs support on WORM media.
- ▶ As introduced on TS1140, the TS1150 and TS1155 supports a default wrap-wise partitioning model with minimal capacity loss at the expense of ABF capability within all partitions at all times.

Partitioning allows a volume to be split into multiple logical partitions, each of which can be read, navigated, written, erased, appended, updated, and managed as separate logical entities, with unique logical block sequences.

The primary user of this partitioning capability is the LTFs, which partitions a volume into two logical partitions: An index partition and a data partition. The TS1155 and TS1150 drive supports both TS1140 style partitions.

The TS1155 and TS1150 supports additional partitioning enhancements, specifically, both wrap-wise partitioning and longitudinal partitioning methods.

The following items apply in general to partitioning support on the E08:

- ▶ Partitioning is supported on media in the TS1155, TS1150, and TS1140 logical formats.  
In the case of JC media reuse, issuing of a Format Medium command performs an implicit reformat to the TS1150 format if the media is in the TS1140 format.
- ▶ Partitioning is only supported on unscaled, R/W Data, and WORM media types, which support writing in the TS1150 or TS1140 format.

In the case of scaled media, the **Format Medium** command is rejected.

Attempts to scale a partitioned media are accepted. As part of scaling, the volume is set to a single data partition cartridge.

For more information about partitioning behavior, see *IBM System Storage Tape Drive 3592 SCSI Reference*, [GA32-0968](#).

## Wrap-wise partitioning

Figure 3-13 shows wrap-wise partitioning.

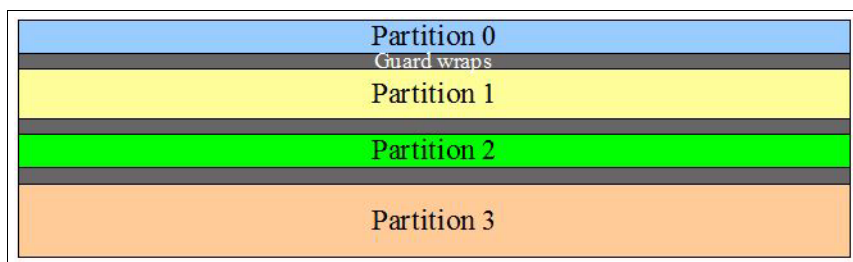

Figure 3-13 Wrap-wise partitioning



Consider the following points about wrap-wise partitioning in the TS1155 and TS1150:

- ▶ A maximum of four partitions are supported. Two or three partitions can be assigned if wanted.
- ▶ A minimum of two wraps are allocated to a partition, regardless of the minimum selected capacity.
- ▶ The full length of tape (LP3 to LP5) is always assigned to each partition.
- ▶ In general, two physical wraps between partitions are reserved as guard wraps. Therefore, some percent of usable capacity can be lost, up to 3% per partition boundary.

RABF operations are performed in any partition if spare usable ABF wraps exist within a partition. In general, the last four wraps of a partition, or any partition smaller than four wraps, does not support RABF operation.

### Longitudinal partitioning

Figure 3-14 on page 159 shows longitudinal partitioning. The following apply to longitudinal partitioning in the TS1155 and TS1150:

- ▶ A maximum of four partitions is supported.
- ▶ A minimum of 50 meters is allocated to a longitudinal partition.
- ▶ The physical data wraps on the portion of tape that is assigned to the partition belong exclusively to each logical partition that is configured. Each partition starts from wrap 0 and ends on the last wrap.
- ▶ A guard gap between partitions is reserved to protect user data against systematic debris accumulation. The guardband is approximately 7 meters and results in a capacity loss of less than 1%.
- ▶ RABF is performed within the boundaries of each partition, with the same wrap sequence as base J5 RABF operation.
- ▶ Performance is slightly poorer due to less total ABF wrap length.
- ▶ Just as in non-partitioned media, the last four wraps' RABF cannot be used.
- ▶ Better performance is provided for random access because of shortened tape length for the partition.

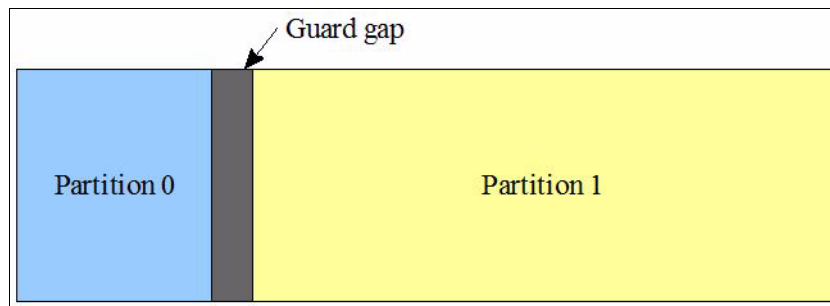

Figure 3-14 Longitudinal partitioning

### 3.6.7 Data safe mode

TS1155 and TS1150 supports *data safe mode*. This mode is controlled by the application and prevents inadvertent overwrite. Data safe mode treats the tape volume that is mounted as WORM drive and prevents inadvertent overwrite. This mode is set by the application or host system.

### 3.6.8 Enhanced Ethernet support

The 3592 Model 55E, 55F, 55G, and E08 tape drive include an Ethernet port for use by an IBM Service Support Representative (SSR) for procedures such as updating Licensed Internal Code, uploading a drive memory dump, or viewing drive status. The Ethernet port on the TS1155 and TS1150 also can be used by the user for providing the capability to access a drive's virtual operator panel and advanced status pages remotely by attaching an Ethernet cable from the drive to the users' network.

**Important:** The Ethernet function is not supported on TS1150 and TS1155 drives in a TS3500 tape library.

#### Expanded Ethernet port functionality

The Ethernet port is used in the TS1155 and TS1150 Rack mount configuration, when in a TS3500 tape library configuration the TS3500 tape library management interface (MI) can be used to manage the TS1155 and TS1150 instead. Figure 3-17 on page 163 shows the location of the Ethernet port.

### 3.6.9 TS1155 and TS1150 physical characteristics

The TS1155 and TS1150 tape drive includes an identical form factor and is plug-compatible with existing 3592 models. It maintains low power and improves power management. The maximum continuous operating power decreased by 5 watts from the TS1140. The drive power use is 46 watts maximum operating power, as compared to 51 watts for the TS1140. Standby power is fewer than 23 watts.

The TS1155 and TS1150 has a standby cooling management feature, which reduces the fan speed when idle to further reduce power and reduce airborne debris contaminants. The fan operating mode is controlled by a single input signal that is called *full-speed mode* or *variable-speed mode*. In full-speed mode, the fan or blower runs at full speed. In variable-speed mode, the blower adjusts its speed based on the ambient temperature down to a minimum of about 50% of its full speed.

The speed of the fan is based on the following conditions:

- ▶ 3592-EH8 drive code enables variable-speed mode under the following conditions:
  - The drive is unloaded and idle for 5 minutes.
  - The internal temperature is at least 3 degrees below the full speed required temperature limit.
- ▶ The drive code reverts to full-speed mode as soon as the following conditions are met:
  - A cartridge is placed in the loader or loaded.
  - The internal temperature of the drive rises above the full speed required temperature limit.

The internal temperature sensor is sampled at 5-minute intervals.

### 3592 packaging

As in previous models, the TS1155 and TS1150 tape drive is a drive that is packaged inside the canister. The canisters are the same and only differ by the unique markings on the front and rear of the canister that allow the identification of an E08, 55G, or 55F from a previous version of the drive. The canister enclosure provides mounting, connections, fiducial labels for calibration, and status LEDs for the use in automation frames.

Figure 3-15 shows the standard TS1150 drive canister for TS3500 and the TS1150 drive canister for TS4500.



Figure 3-15 TS1150 canister

The front panel of the TS1150, as shown in Figure 3-16, contains all of the operator controls and display.

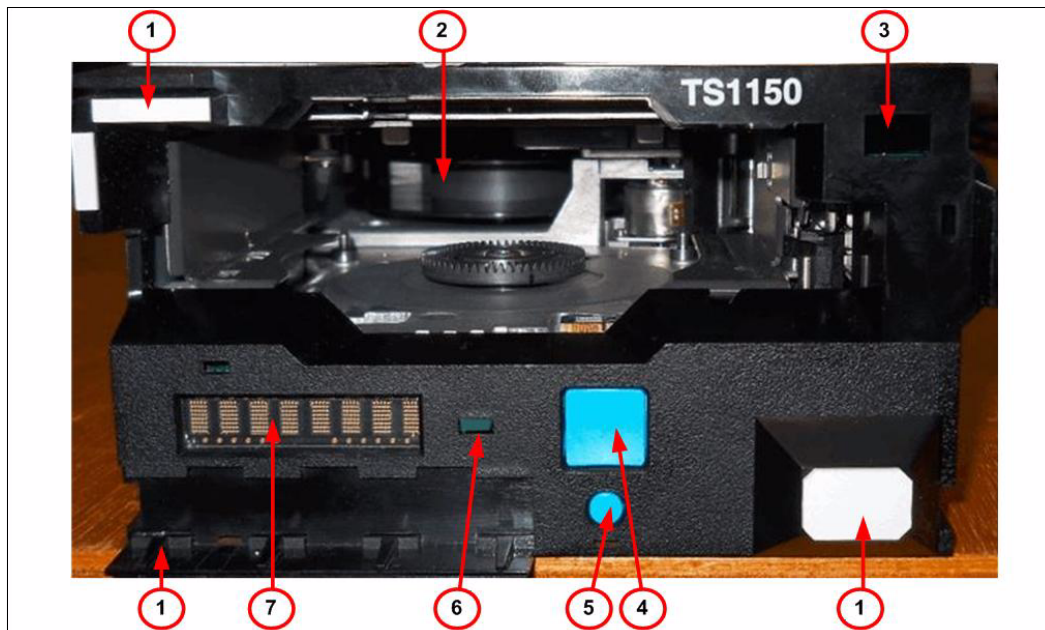

Figure 3-16 TS1150 front panel

Table 3-15 lists the front panel of the TS1150 for a TS3500.

*Table 3-15 TS 1150 front panel*

<b>Reference number</b>	<b>Item</b>	<b>More information</b>
1	Reflective fiducial	Used by library accessor. Upper left, C20 Silo. Lower-left, Quantum Scalar library. Lower right, 3494.
2	Tape cartridge slot	Area where tape cartridge is loaded.
3	Non-reflective fiducial	Used by TS3500.
4	Unload button	Press to manually unload a tape cartridge.
5	Reset button	Press to generate a drive reset.
6	LED power indicator	Green LED indicates that power is applied. Yellow during activities like a Licensed Internal Code load and reset.
7	Eight-character (message) display	Information area for operator. This display provides FID messages, attention drive messages, clean messages, and drive status.

The canister is mounted in various forms of mounting hardware for use in different automation systems. The drive unit is inside the canister. The TS1150 drive has the same physical form factor as the TS1140, TS1130, TS1120, and 3592-J1A drive. Thus, only the complete canister can be changed or replaced and not the drive alone.

The 3592-E08, 55E and 55F canisters no longer have an RS-232 serial port. An Ethernet service port was added to the drive, which is for service, and use by the user. It provides the capability for users to access advanced drive status pages, and for service personnel to access a drive virtual operator panel and perform firmware uploads and download drive memory dumps. It is a single, standard RJ45 connector at the rear of the canister, as shown in Figure 3-17.

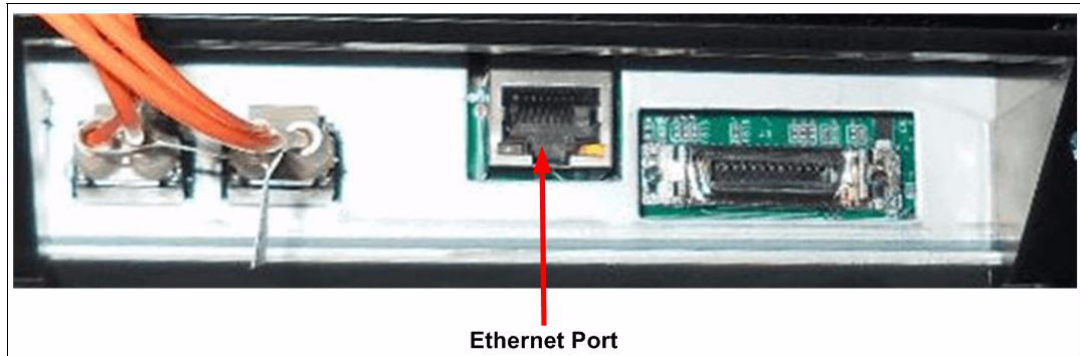

Figure 3-17 TS1150 Ethernet port

**Important:** This product might not be certified in the country of installation for connection by any means whatsoever to interfaces of public telecommunications networks. Further certification might be required by law before making any such connection. Contact IBM for more information.

### Internal hardware enhancements

The TS1155 and TS1150 features the following significant hardware enhancements over the previous models:

- ▶ 32-channel enhanced ECC recording format.
- ▶ Enhanced JD-type media servo pattern.
- ▶ Flangeless rollers, which are designed to minimize tape edge damage and debris buildup by elimination of the roller flanges.
- ▶ Tunnel magnetoresistive (TMR) head is used on the TS1155 and on new version of the TS1150, whereas the older generation of TS1150 uses Giant Magneto Resistive (GMR) Heads. These advanced heads are designed to reduce friction with advanced head coating to prevent corrosion and to extend head and tape cartridge life.
- ▶ Skew Actuator, which allows dynamic skew adjustment of the head to keep head perpendicular to tape.
- ▶ Data-dependent, noise-predictive, maximum-likelihood (DD-NPML) detection scheme was developed at IBM Research, Zurich to enable the accurate detection of data errors.

### 3.6.10 Upgrade considerations

A drive-field miscellaneous equipment specification (MES) conversion feature is available for a TS1149 model to TS1150 model conversion and TS1150 to TS1155. If this method is chosen to replace the TS1140 or TS1150 drive, only the drive changes, the canister remains the same.

The serial number of the original drive is written by the library to the vital product data (VPD) of the replacement drive. The MES is valid for both the TS3500 tape library and a rack-mounted drive.

## TS1100 field MES support

The following drive MES conversions are supported:

- ▶ 3592 EH8 drive → 3592 55F model conversion
- ▶ 3592 E07 drive → 3592 E08 model conversion
- ▶ 3592 E07 drive → 3592 EH7 model conversion
- ▶ 3592 EH7 drive → 3592 EH8 model conversion
- ▶ 3592 E08 drive → 3592 EH8 model conversion
- ▶ 3592 E08 drive → 3592 55G model conversion
- ▶ 3592 55G drive → 3592 55F model conversion

**Note:** It is important for a TS1140 drive to have IBM Assembly and Deploy Tools (IADT)-capable Licensed Internal Code loaded before conversion to the EH8 model. Without it, communication to the library is not possible. It can be obtained from IBM Fix Central. Only one MES model upgrade is supported during the life of the drive.

### 3.6.11 Firmware updates

No changes were made to the firmware update mechanisms for the TS1155 and TS1150 compared to TS1140 tape drives:

- ▶ All four mechanisms that are currently supported for Licensed Internal Code updates on the 3592-E07 also provide support on the E08 and 55E, 55F, and 55G.
- ▶ The TS1155 and TS1150 continues to support concurrent Licensed Internal Code load with deferred activation.
- ▶ The TS1155 and TS1150 has a single Licensed Internal Code image unique from previous models. A unique LOAD ID and incremented RU name field is assigned for the drive.

Unique Licensed Internal Code is required for the model E07 drives because the LOAD ID differs from the LOAD ID that is required for previous versions of 3592. The firmware for the 3592-55E, 55F, 55G, and E08 drive can be updated by using one of the following methods, depending on where the drive is installed:

- ▶ Through the host attachment by using the **write buffer** command
- ▶ Through the Ethernet port on the drive
- ▶ Through the library RS-422 port to the drive canister (not supported on rack mount)
- ▶ By using an FMR cartridge (might not be supported on automation systems)

### 3.6.12 RAS

The RAS features are improved or maintained relative to the TS1140. Similar to its predecessor models, the TS1160 is a single FRU, which is hot pluggable without a maintenance window and supports nondisruptive code loading. As with TS1155, fan speed management and unique device Licensed Internal Code file management are available through a LOAD ID. Support also is available for a larger service display.

The end-of-life (EOL) use alert for media becomes activated on full file pass use. The Media Life alert for JD or JL media use within a TS1160, TS1155 and TS1150 drive is now rated for 150 FFP (Full File Pass) and nearing EOL is set at 130 FFP.

### 3.6.13 Improved media SARS

The TS1160 supports SARS in a similar manner to previous drive models.

The tape drive uses the Statistical Analysis and Reporting System (SARS) to help isolating failures between media and hardware. The SARS uses the cartridge performance history that is saved in the CM module and the drive performance history that is kept in the drive flash EEPROM to determine the more likely cause of failure. SARS can cause the drive to request a cleaner tape through use to mark the media as degraded, and to indicate that the hardware has degraded.

SARS information is reported through the TapeAlert flags, and through MIM or SIM messages.

The 3592 drive maintains a history of the last 100 mounts for both Volume (VSARS) and Hardware (HSARS).

**Note:** Media SARS information is preserved when media is reformatted.

The TS1155 and TS1150 implements an enhanced SARS function that is known as ccSARS or customer-centric SARS. This function improves the overall amount of information that is maintained and the presentation means to the customer in concert with the automation system.

The media SARS function for the drives includes the following items:

- ▶ Tape alerts are generated when media passes use life, as determined by full-file passes, meters of tape that are processed, or write pass count, and the total number of mounts (already supported).
- ▶ A media SARS summary is maintained in the cartridge memory in a manner where it can be rebuilt on tape if the SARS records on tape cannot be read and must be reinitialized. This cartridge memory copy is also readable on an earlier level TS1140 drive to preserve SARS information between logical format conversions.

### 3.6.14 Encryption

The TS1155 and TS1150 tape drive is encryption-capable. Like the TS1140, there is no need to enable the drive explicitly.

Encryption includes the following enhancements:

- ▶ LME, SME, AME, T10 default method support
- ▶ Continued EEDK wrapped key support in LME, SME
- ▶ Enhanced protocol support for IPP and Java Platform, Enterprise Edition legacy mode (as used by IBM Spectrum Protect), T10 default method, SPIN, and SPOUT
- ▶ Enhanced drive cryptographic upgrades to change the default authentication means from SHA-1 to SHA-2 when using IBM Security Guardium Key Lifecycle Manager
- ▶ T10 standards-based encryption control on a logical block basis (not tied to format identifier), and writes encrypted data and clear data to the same tape cartridge

## 3.7 IBM TS1140 tape drive

The IBM TS1140 tape drive (which is also referred to as the *3592 Model E07*) is the fourth tape drive generation of the IBM 3592 tape family. The TS1140 tape drive is designed to provide higher levels of performance, reliability, and cartridge capacity than the TS1130 Model E06 tape drive.

The TS1140 has a high-technology 32-channel Giant Magneto Resistive (GMR) head design, and provides a native data rate performance of up to 250 MBps versus the 160 MBps data rate of the TS1130 tape drive Model E06.

The TS1140 E07 tape drive has a dual-port 8-Gbps Fibre Channel interface for Fibre Channel attachment to host systems, or a switched fabric environment.

The TS1140 records in two recording formats, supporting encryption and nonencryption. Enterprise Format 4 (EFMT4) is used to represent the non-encrypted recording format, and Enterprise Encrypted Format 4 (EEFMT4) is used to denote the encrypted recording format. With these recording formats, the non-compressed capacity of the extended length MEDIA11 and MEDIA12 cartridges is increased from 1 TB to 4 TB.

The 3592 Model E07 is downward read compatible to the 3592 Model E05 and J1A format (EFMT1/EFMT2) and is downward read/write compatible to the 3592 Model E06 formats (EFMT3/EEFMT3).

Host interfaces to IBM Z and open systems platforms are maintained. The TS1140 tape drive is supported for IBM Z by the use of IBM 3592 Model C06 and C07 FICON Tape Controllers, and the TS7700 Virtualization Engine that uses 8 Gbps dual port fiber cards.

The TS1140 supports integration into the TS3500 tape library, and as stand-alone rack mounted. Figure 3-18 shows the IBM TS1140 tape drive.



Figure 3-18 TS1140 tape drive

The TS1140 tape drive maintains the same features and technology enhancements that were introduced with the TS1120 and extended by the TS1130. In addition, the TS1140 offers several enhancements over the predecessor models, which are described next.



The TS1140 has the following key features, including those that were introduced with the 3592-J1A, 3592-E05, and 3592-E06:

- ▶ Digital speed matching
- ▶ Channel calibration
- ▶ High-resolution tape directory
- ▶ Recursive accumulating backhitch-less flush or NVC
- ▶ Backhitch-less backspace
- ▶ SLDC compression
- ▶ Capacity scaling
- ▶ Single FRU
- ▶ Error detection and reporting
- ▶ SARS
- ▶ Revised Encryption Support
- ▶ Dual-stage 32-head actuator
- ▶ Offboard data string searching
- ▶ Enhanced logic to report logical end of tape
- ▶ Added Partitioning Support
- ▶ Data Safe mode
- ▶ Enhanced Ethernet support
- ▶ Enhanced Barium Ferrite (BaFe) particle media types
- ▶ 8 Gbps Fibre Channel (FC) dual port interface

### 3.7.1 Physical attachment

The TS1140 is supported for attachment in the TS3500 tape library or as rack mounted. Table 3-16 lists the attachment configuration that is allowed for TS1140.

*Table 3-16 Maximum 3592 tape drive attachments in environments without a tape controller*

Environment	Number of TS1140 3592 drives
2.0-meter rack (IBM Model 7014-T42)	Up to 16
1.6-meter rack (IBM Model 7014-S00)	Up to 12
1.8-meter rack (IBM Model 7014-T00)	Up to 12
3584 L22 and L23	Up to 12 <sup>a</sup>
3584 D22 and D23	Up to 12 per frame <sup>a</sup>

a. There are prerequisites for installing TS1140 into a 3584. 3584 must have enhanced node cards that are installed. 3584 must have the latest version B Firmware installed.

### 3.7.2 Media

The TS1140 introduces the following enhanced Barium Ferrite (BaFe) particle media types that can be used only by the TS1140. The new media can be read/written up to 250 MBps native sustained data rate (up to 650 MBps at 3:1 compression ratio) in the new 32-channel Jag-4 logical format:

- ▶ IBM Enterprise Advanced Tape Cartridge (JC): MEDIA11
- ▶ IBM Enterprise Advanced WORM Tape Cartridge (JY): MEDIA12
- ▶ IBM Enterprise Advanced Economy Tape Cartridge (JK): MEDIA13

The following TS1140 tape drive capacity and performance improvements are provided on the existing 3592 media:

- ▶ The TS1140 tape drive reuses the following TS1130 and TS1120 supported media types:
  - IBM 3592 Extended Tape Cartridge (JB) - MEDIA9
  - IBM 3592 Extended WORM Tape Cartridge (JX) - MEDIA10

**Important:** The 3592 Model E07 is read-only compatible with the older 3592 media types (MEDIA5, MEDIA6, MEDIA7, MEDIA8), cartridge types JA, JW, JJ, and JR.

- ▶ The TS1140 improves capacity and performance by writing and reading the E07 logical format by using a new 32-channel enhanced ECC recording format with a higher track density and higher linear density on the same media types.
- ▶ The TS1140 supports downward reading of 3592 J1A and TS1120 native formats and writing and reading the TS1130 format.
- ▶ The appropriate Licensed Internal Code levels that are available for TS1130 and TS1120 must be applied that enable the recognition of the E06 format and allow reuse of the media in the older formats. Thus, a model E06 or E05 drive can reformat media that was previously written in the older format and write on it in the appropriate format.

**Important:** This design supports a common scratch pool by media type regardless of the last written format or allocation target drive.

### 3.7.3 Capacity and performance

Capacity and performance were improved from the IBM TS1130 tape drive for all media types and for all formats that the TS1140 reads or writes.

#### Capacity improvement

The use of the 3592-E07 logical format offers the following capacity improvements on existing and the cartridges:

- ▶ IBM Enterprise Extended WORM with data media (JB or JX) has a 60% capacity uplift from 1 TB to 1.6 TB.
- ▶ IBM Enterprise Advanced WORM with data media (JC or JY) has a capacity of 4.0 TB.
- ▶ IBM Enterprise Economy Data media (JK) has a capacity of 500 GB.

#### Performance improvement

The overall performance is increased by various improvements, as shown in the following examples:

- ▶ Improved data rate
- ▶ Larger 1 GB main data buffer
- ▶ Better backhitching
- ▶ Improved speed with digital speed matching
- ▶ Enhanced read-ahead buffer management
- ▶ High access performance for locate/search
- ▶ Improved communication links, with dual 8 Gbps fiber ports
- ▶ SkipSync and FastSync write performance accelerators
- ▶ New 32-channel enhanced ECC recording format

## Higher data rates

Performance is improved from the TS1130 up to 64% in TS1140 mode, 50% in TS1130 mode for read and writes, and 50% in TS1120 mode for reads only. The following format data rates are available:

- ▶ The E07 format data rates go up to 250 MBps maximum native and to 650 MBps maximum compressed.
- ▶ The E06 format data rates go up to 200 MBps maximum native and to 650 MBps maximum compressed.
- ▶ The E05 format data rates go up to 104 MBps maximum native and to 650 MBps maximum compressed.

Table 3-17 lists the capacity and performance characteristics for uncompressed data.

*Table 3-17 Capacity and performance summary*

Media	E07 format capacity data rate (minimum - maximum)	E06 format capacity data rate (minimum - maximum)	E05 format capacity data rate (minimum - maximum)
JB/JX	1.6 TB 80 MBps - 200 MBps	1 TB 50 MBps - 160 MBps	700 GB 40 MBps - 150 MBps
JC/JY	4 TB 90 MBps - 250 MBps	N/A	N/A
JK	500 GB 60 MBps - 250 MBps	N/A	N/A

## Buffer

The TS1140 E07 tape drive has a 1 GB internal data buffer. Along with enabling higher performance characteristics, the data buffer uses support read ahead of compressed data from tape and provides high performance random skip forward sequential (short hop) locates that are common in database search and tape software recycle operations.

This improves the drive agility, file access, and small file handling, which might still be a requirement on IBM z/OS platforms. Furthermore, the buffer reduces backhitches for all workloads and improves overall read/write performance.

## Offboard data string searching

The TS1140 E07 tape drive can search the data content of host records for string matches offboard from the host server. The tape drive can perform this search at maximum data rate (250 MBps native). It takes much longer for a host server to read the data, buffer the data to disk, and then parse the actual data stream with host software routines.

## Enhanced logic to report logical end of tape

LEOT is now reported, based on a combination of capacity-based and position-based LEOT indicators. The TS1140 E07 monitors the total accumulated number of physical tape data sets that are written to the volume and reports LEOT based on this capacity-based LEOT value. This configuration allows tape copies to complete without overflow at a much higher percentage of the time.

## High-resolution tape directory

The TS1140 E07 tape drive maintains a tape directory structure with a high granularity of information about the physical position of data blocks on the media. This feature and the increased search speed allow the TS1140 E07 to have improved nominal and average access times for locate operations versus previous IBM tape drives.

## Speed matching

The speed matching function is improved on the TS1140 drive because the number of speeds and the range of supported data rates is improved. The following data rate ranges depend on the logical format and the media type used:

- ▶ Thirteen speeds, 76 - 251 MBps for 3592 JC/JK/JY cartridges initialized in Gen 4 format
- ▶ Thirteen speeds, 74 - 203 MBps for 3592 JB/JX cartridges initialized in Gen 4 format
- ▶ Thirteen speeds, 41 - 163 MBps for 3592 JB/JX cartridges initialized in Gen 3 format
- ▶ Thirteen speeds, 39 - 151 MBps for 3592 JB/JX cartridges initialized in Gen 2 format
- ▶ Thirteen speeds, 18 - 72 MBps for 3592 JA/JJ/JR/JW cartridges initialized in Gen 1 format
- ▶ Thirteen speeds, 36 - 144 MBps for 3592 JA/JJ/JR/JW cartridges initialized in Gen 2 or Gen 3 format

Throughput is increased through speed matching as the drive performs the following functions:

- ▶ Adjusts tape speed based on host data rate
- ▶ Calculates effective host data rate (EHDR)
- ▶ Optimizes data rate by selecting optimal EHDR
- ▶ Forces speed changes mid-wrap if advantageous
- ▶ Minimizes time to record data

## Virtual backhitch

The TS1140 includes the following key feature improvements:

- ▶ Virtual backhitch (transaction write with sync)
- ▶ Single wrap backhitchless flush (large transaction writes with sync)
- ▶ Backhitchless backspacing (ANSI file writes)

The TS1140 has improved functions, such as recursive accumulating backhitchless flush (RABF), and the addition of a new same wrap backhitchless flush (SWBF) function that extends virtual backhitch effectiveness for large files.

For more information about these features, see “Virtual backhitch (nonvolatile caching)” on page 113.

## Read Ahead

On sequential reads, the tape drive automatically runs Read Ahead, and fills the buffer with data sequentially beyond the target block.

The 3592-E07 supports Read Ahead of approximately 1000 MB of compressed data from tape. When the drive processes a command to locate or read a block, the drive automatically continues to stream down the tape and reads ahead until the data buffer is full. This allows subsequent Locate or Read commands to be fulfilled from the data buffer at faster speeds, rather than requiring access to the tape.

The drive outperforms competitive drives, which stop and wait for the next command, with this unique functionality.

## Performance scaling and segmentation

The TS1140 tape drives support capacity scaling for tape cartridges of media types JB and JC over a broad range of capacities. The effect of capacity scaling is to contain data in a specified fraction of the tape, which yields faster locate and read times. Alternatively, economy tapes (the JJ or JK media type) can be purchased.

Performance scaling limits the data that is written to the first 20% of the cartridge. When the performance segmentation option is used, the overall capacity of the cartridge is limited to 86.6% of the total capacity.

The fast access segment occupies the first 20% of the cartridge, followed by the slower access segment. For example, with the Model E07 tape drive operating in EFMT4 format, the 3592 Advanced Data Tape Cartridge (type JC) can be scaled to 800 GB. By using performance segmentation, the 4000 GB Extended Data cartridge can be segmented into an 800 GB fast access segment and a 3200 GB slower access segment.

Segmentation is available only within a specified range of capacity scaling settings that achieve this faster performance.

Cartridges that are performance-scaled or performance-segmented can be reused (reformatted) to their full capacity, to the performance-scaled capacity, or to the performance segmentation format as indicated through the assigned data class.

**Important:** Capacity scaling is supported for economy (JJ, JK) or WORM tapes (JW, JX, JY, and JR) in read-only mode.

**Tip:** Check with the device driver user guide for capacity scaling limitations and instructions for setup.

### 3.7.4 Access performance specifications and drive characteristics

Table 3-18 lists the access performance and drive characteristics of the 3592-E07, 3592-E06, and 3592-E05.

Table 3-18 Access performance specifications and drive characteristics

Parameter	3592-E07 EFMT4 or EEFMT4 (J4 or J4-E)	3592-E06 EFMT3 or EEFMT3 (J3 or J3-E)	3592-E05 EFMT2 or EEFMT2 (J2 or J2-E)
Tape speed, locate/rewind	12.4 mps	12.4 mps	10 mps
Drive load/ready time	15 s	13 s	13 s
Block locate time from load point average	37 s for JB, JX 40 s for JC, JY 11 s for JK 15 sec 20% scaled JB 12 sec 20% scaled JC	28 s for JA, JW 11 s for JJ, JR 37 s for JB, JX 11 sec 20% scaled JA 15 s for 20% scaled JB	33 s for JA, JW 11 s for JJ, JR 45 s for JB, JX 15 s for 20% scaled JB
Time to first data average (load/ready + locate)	42 s for JB, JX 55 s for JC, JY 26 s for JK 30 s for 20% scaled JB 27 s for 20% scaled JC	41 s for JA, JW 24 s for JJ, JR 50 s for JB, JX 24 s for 20% scaled JA 28 s for 20% scaled JB	46 s for JA, JW 24 s for JJ, JR 58 s for JB, JX 28 s for 20% scaled JB
Unload time	24 s for JB, JX 36 s for JC, JY, JK	21 s for JA, JW, JR, JJ, JB, JX	23 s for JA, JW, JR, JJ, JB, JX

Parameter	3592-E07 EFMT4 or EEFMT4 (J4 or J4-E)	3592-E06 EFMT3 or EEFMT3 (J3 or J3-E)	3592-E05 EFMT2 or EEFMT2 (J2 or J2-E)
Maximum rewind time	72 sec 100% scaled JB, JX 24 sec 20% scaled JB 76 sec 100% scaled JC, JY 26 sec 20% scaled JC 18 sec JK	55 sec 100% scaled JA, JW 18 sec 20% scaled JA 18 sec JJ, JR 72 sec 100% scaled JB, JX 24 sec 20% scaled JB	66 sec 100% scaled JA, JW 18 sec 20% scaled JA 18 sec JJ, JR 90 sec 100% scaled JB, JX 24 sec 20% scaled JB
Native Data Rate	250 MBps	163 MBps	104 MBps
Number of tracks	1792 JB, JX 2560 JC, JK, JY	1152	896
Number of passes (from BOT to EOT)	56 JB, JX 80 JC, JK, JY	72	56
Linear density	500 kbp	321 kbp	282 kbp
Servo regions	5	5	5
Data tracks recorded simultaneously	32	16	16
Buffer size	1 GB	1 GB	512 MB

### 3.7.5 Emulation

This topic describes emulation mode and drive emulation regarding the TS1140 tape drive.

#### Emulation mode

The TS1140 tape drive does not support any emulation modes. Because the drive cannot write the TS1120 or J1A logical format, it cannot fully emulate all format behaviors of a previous model 3592 drive.

#### Drive emulation

Although the TS1140 tape drive does not support emulation, it can read in EFMT2, EFMT3, and EFMT4 format. It also can write in EFMT3 and EFMT4 format with compatible IBM 3592 tape cartridges. The TS1140 tape drive can reformat any compatible EFMT2, EFMT3, or EFMT4 tape to EFMT3 or EFMT4 format when it is writing from BOT. Table 3-19 lists the modes available for TS1140.

Table 3-19 Drive emulation for TS1140

Drive Mode Setting	Formats read	Format used when writing cartridge is at BOT	Format used when writing cartridge is not at BOT	Model type reported to host in response to an Inquiry command
E07	EFMT1 EFMT2 EFMT3 EFMT4	EFMT3 EFMT4	EFMT3 EFMT4	E07

The following are the media formats for 3592:

- ▶ 3592 model J1A read/write format J1 and for encrypted format is J1-E (EFMT1).
- ▶ 3592 model E05 read/write format J2 and for encrypted format is J2-E (EFMT2 and EEFMT2).

- ▶ 3592 model E06 read/write format J3 and for encrypted format is J3-E (EFMT3 and EEFMT3).
- ▶ 3592 model E07 and EH7 read/write format J4 and for encrypted format is J4-E (EFMT4 and EEFMT4).

### 3.7.6 IBM Spectrum Archive and LTFS support

The TS1140 provided LTFS support with the following features:

- ▶ Ability to configure up to four partitions
- ▶ Wrap-wise and longitudinal-wise partitioning
- ▶ Supported on all non-WORM TS1140 formats (JC, JK, and JB formats)
- ▶ Format command support
- ▶ Each partition can use a separate encryption method, or none

Tape as a storage medium has many benefits: it is reliable, portable, low-cost, low-power, and high-capacity. However, tape is not easy to use. It has no standard format, and data often cannot be used without first copying it to disk.

IBM Spectrum Archive enables direct, intuitive, and graphical access to data stored in IBM tape drives and libraries by incorporating the LTFS format standard for reading, writing, and exchanging descriptive metadata on formatted tape cartridges. IBM Spectrum Archive eliminates the need for additional tape management and software to access data. IBM Spectrum Archive offers three software solutions for managing your digital files with the LTFS format: Single Drive Edition, Library Edition, and Enterprise Edition.

For more information, see the following IBM Documentation web pages:

- ▶ [IBM Spectrum Archive Enterprise Edition \(EE\)](#)
- ▶ [IBM Spectrum Archive Library Edition \(LE\)](#)
- ▶ [IBM Spectrum Archive Single Drive Edition \(SDE\)](#)

### 3.7.7 Data safe mode

TS1140 supports *data safe mode*. This mode is controlled by the application and prevents inadvertent overwrite. Data safe mode treats the tape volume that is mounted as WORM drive and prevents inadvertent overwrite. This mode is set by the application or host system.

### 3.7.8 Enhanced Ethernet support

The 3592 Model E07 tape drive includes an Ethernet port for use by an IBM Service Support Representative (SSR) for procedures such as updating Licensed Internal Code, uploading a drive memory dump, or viewing drive status. The Ethernet port on the TS1140 also can be used by the user for providing the capability to access a drive's virtual operator panel and advanced status pages remotely by attaching an Ethernet cable from the drive to the users' network.

**Important:** The Ethernet function is not supported on TS1140 drives in a TS3500 tape library.

#### Expanded Ethernet port functionality

The Ethernet port is used in the TS1140 Rack mount configuration when in a TS3500 tape library configuration the TS3500 tape library management interface (MI) can be used to manage the TS1140 instead. Figure 3-19 on page 175 shows the location of the Ethernet port.

### 3.7.9 TS1140 physical characteristics

The TS1140 tape drive includes an identical form factor and is plug-compatible with existing 3592 models. It maintains low power and improves power management. The maximum continuous operating power increased by 2 watts from the TS1120 because of faster motor speeds and enhanced electronics. The drive power use is 51 watts maximum operating power, as compared to 39 watts for the TS1130. Standby power is fewer than 24 watts.

The TS1140 has a standby cooling management feature, which reduces the fan speed when idle to further reduce power and reduce airborne debris contaminants. The fan operating mode is controlled by a single input signal that is called *full-speed mode* or *variable-speed mode*. In full-speed mode, the fan or blower runs at full speed. In variable-speed mode, the blower adjusts its speed based on the ambient temperature down to a minimum of about 50% of its full speed.

The speed of the fan is based on the following conditions:

- ▶ 3592-E07 drive code enables variable-speed mode under the following conditions:
  - The drive is unloaded and idle for 5 minutes.
  - The internal temperature is at least 3 degrees below the full speed required temperature limit.
- ▶ The drive code reverts to full-speed mode as soon as the following conditions are met:
  - A cartridge is placed in the loader or loaded.
  - The internal temperature of the drive rises above the full speed required temperature limit.

The internal temperature sensor is sampled at 5-minute intervals.

#### 3592 packaging

As in previous models, the TS1140 tape drive is a canister with a drive that is packaged inside the canister. Unique markings on the front and rear of the canister allow the identification of an E07 from a previous version of the drive. The canister enclosure provides mounting, connections, fiducial labels for calibration, and status LEDs for the use in automation frames.

The canister is mounted in various forms of mounting hardware for use in different automation systems. The drive unit is inside the canister. The 3592-E07 drive has the same physical form factor as the TS1130, TS1120, and 3592-J1A drive. Thus, only the complete canister can be changed or replaced and not the drive alone.



The 3592-E07 canister no longer has an RS-232 serial port. An Ethernet service port was added to the drive, which is for service, and use by the user. It provides the capability for users to access advanced drive status pages and for service personnel to access a drive virtual operator panel and perform firmware uploads and download drive memory dumps. It is a single, standard RJ45 connector at the rear of the canister, as shown in Figure 3-19.

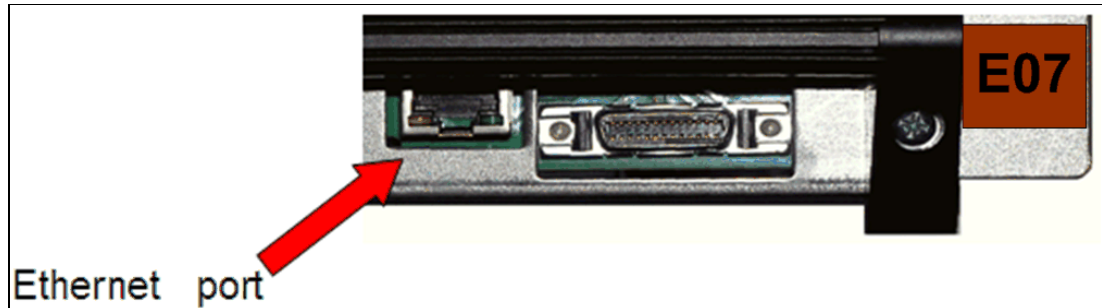

Figure 3-19 TS1140 Ethernet port

**Important:** This product might not be certified in the country of installation for connection by any means whatsoever to interfaces of public telecommunications networks. Further certification might be required by law before making any such connection. Contact IBM for more information.

### Internal hardware enhancements

The TS1140 features the following significant hardware enhancements over the previous models:

- ▶ New 32-channel enhanced ECC recording format.
- ▶ Enhanced JC-type media servo pattern.
- ▶ Flangeless rollers, which are designed to minimize tape edge damage and debris buildup by elimination of the roller flanges.
- ▶ Giant Magneto Resistive head (GMR head). This advanced high gain head is designed to reduce friction. It has an advanced head coating to prevent corrosion and to extend head and tape cartridge life.
- ▶ Skew Actuator, which allows dynamic skew adjustment of the head to keep head perpendicular to tape.
- ▶ Data-dependent, noise-predictive, maximum-likelihood (DD-NPML) detection scheme was developed at IBM Research, Zurich to enable the accurate detection of data errors.

### 3.7.10 Upgrade considerations

A drive-field MES conversion feature is available for a 3592-E06 model to 3592-E07 model conversion to a TS1140. If this method is chosen to replace the TS1130 drive, only the drive changes; the canister remains the same. The model EU6, which was previously upgraded from a model E05, cannot be upgraded to a model E07.

The serial number of the original drive is written by the library to the vital product data (VPD) of the replacement drive. The MES is valid for both the TS3500 tape library and a rack-mounted drive.

### 3.7.11 Firmware updates

No changes were made to the firmware update mechanisms for the TS1140 compared to TS1130 tape drives:

- ▶ All four mechanisms that are currently supported for Licensed Internal Code updates on the 3592-E06 also provide support on the E07.
- ▶ The TS1140 continues to support concurrent Licensed Internal Code load with deferred activation.
- ▶ The TS1140 has a single Licensed Internal Code image unique from previous models. A unique LOAD ID and incremented RU name field is assigned for the 3592-E04 drive.

Unique Licensed Internal Code is required for the model E07 drives because the LOAD ID differs from the LOAD ID that is required for previous versions of 3592. The firmware for the 3592-E07 drive can be updated by using one of the following methods, depending on where the drive is installed:

- ▶ Through the host attachment by using the write buffer command
- ▶ Through the Ethernet port on the drive
- ▶ Through the library RS-422 port to the drive canister (not supported on rack mount)
- ▶ Through the use of an FMR cartridge (might not be supported on automation systems)

### 3.7.12 RAS features

The RAS features are improved or maintained relative to the TS1130. Similar to its predecessor models, the TS1140 is a single FRU, which is hot pluggable without a maintenance window and supports nondisruptive code loading. As with TS1130, there is fan speed management and unique device Licensed Internal Code file management through a LOAD ID. Support is available for a larger service display.

The end-of-life use alert for media becomes activated on full file pass use and is depended on the media being used. The Nearing Media Life alert is given at 19,900 mounts or 295 full-file passes, and the Media Life alert is given at 20,000 mounts or 300 full-file passes.

### 3.7.13 Improved media SARS

The media SARS function for the TS1140 includes the following improvements:

- ▶ Tape alerts are now generated when media passes use life, as determined by full-file passes, meters of tape that are processed, or write pass count, and the total number of mounts (already supported).
- ▶ A media SARS summary is maintained in the cartridge memory in a manner where it can be rebuilt on tape if the SARS records on tape cannot be read and must be reinitialized. This cartridge memory copy also is readable on an earlier level TS1120 drive to preserve SARS information between logical format conversions.

### 3.7.14 Encryption

The TS1140 tape drive is encryption-capable. Like the TS1130, there is no need to enable the drive explicitly, which was the case with the TS1120 tape drive.

When the drive is installed behind a 3592 C07 or 3592 C06 Tape Controller, it is encryption-enabled as part of the installation, which is a controller requirement.

Encryption on TS1140 includes the following enhancements:

- ▶ LME, SME, AME, and T10 method support
- ▶ Continued EEDK wrapped key support in LME and SME
- ▶ Enhanced Protocol support: IPP, T10 SPIN and SPOUT, and IKEv2 (PGA)
- ▶ Enhanced drive cryptographic upgrades to change the default authentication means from SHA-1 to SHA-2 when using IBM Security Guardium Key Lifecycle Manager
- ▶ T10 standards-based encryption control on logical block basis (not tied to format identifier), and even write encrypted data and clear data to the same tape cartridge

### **3.7.15 Tracking data that is written**

An application can track the following data in KBs:

- ▶ The number of logical bytes written
- ▶ The number of physical bytes written
- ▶ The amount of free space remaining on a volume
- ▶ The capacity of the volume
- ▶ The number of logical bytes deleted

Now with the 4000 GB tape (non-compressed), the possibility exists with the TS1140 to overflow some of the 4-byte fields that contain these values. Of particular concern are the logical data-related fields that (with compression) deal with an amount of data that might be larger than the physical capacity of the tape. Applications that use, store, and display this type of information might need to account for and determine how best to handle an overflow situation.





## IBM TS2290 tape drive

The IBM TS2290 tape drive (3580 model H9S) is an external stand-alone or rack-mountable unit that offers high capacity and performance for the midrange system environment. The TS2290 tape drive incorporates the IBM Linear Tape-Open (LTO) Ultrium 9 Half-High tape drive and uses a dual-port 12 Gbps serial-attached SCSI (SAS) host interface. The tape drive supports a native sustained data rate performance of up to 400 MBps, which increases to 900 MBps under compression.

The IBM LTO Ultrium 9 tape drive uses the IBM LTO Ultrium 9, 18 TB data cartridge and IBM LTO Ultrium 8, 12 TB data cartridge. It provides tape data capacity of up to 45 TB on a L9 format cartridge, and 30 TB on a L8 format cartridge, with a 2.5:1 compression ratio. IBM Ultrium 9 tape drives can read and write LTO Ultrium 8 data cartridges. LTO 9 cannot read LTO 7 data cartridges. The TS2290 tape drive supports Write Once Read Many (WORM) on WORM cartridge types.

The Ultrium 9 tape drive is encryption capable and supports application-managed encryption.

The TS2290 tape drive Model H9S uses a 12 Gbps dual port SAS interface for connection to open system servers.

The TS2290 tape drive is a client-replaceable unit (CRU). If a TS2290 tape drive failure occurs, IBM provides a replacement drive.

This chapter includes the following topics:

- ▶ 4.1, “Product description” on page 180
- ▶ 4.2, “Half-High Ultrium 9 tape drive” on page 181
- ▶ 4.3, “Media” on page 183
- ▶ 4.4, “Encryption” on page 184
- ▶ 4.5, “IBM Spectrum Archive and Linear Tape File System” on page 185
- ▶ 4.6, “Physical attachment” on page 185
- ▶ 4.7, “Specifications” on page 186
- ▶ 4.8, “Feature codes” on page 187

**Note:** The TS2290 is the only stand-alone cartridge drive in the IBM LTO-9 family.

## 4.1 Product description

The IBM TS2290 tape drive is an external stand-alone or rack-mountable unit, and part of the family of IBM Ultrium Tape products. It incorporates the latest generation of the Ultrium 9 Half-High tape drives, which features write cartridges with a native physical capacity of up to 18 TB. The IBM Ultrium 9 technology supports tape partitioning and the IBM Spectrum Archive with Linear Tape File System (LTFS) technology. It also supports encryption of data and WORM cartridges. For the remainder of this chapter, the terms *TS2290* is used as an abbreviation for the IBM TS2290 tape drive.

Only one model (number 3580-H9S) is available for the TS2290 tape drive, as shown in Figure 4-1.



Figure 4-1 The TS2290 tape drive

The TS2290 tape drive comes with a dual-port 12 Gbps Serial SAS interface.

The TS2290 tape drive is encryption-capable and uses Application Managed Encryption (AME). Encryption is supported on Ultrium 9, 8, 7, 6, and 5 data cartridges. On the tape drive, an encryption LED shows you when the drive uses encryption.

The TS2290 tape drive is a CRU. When a TS2290 tape drive encounters a failure, IBM provides a replacement drive.

A single-character display (SCD) at the front of the TS2290 tape drive displays error codes and messages.

The TS2290 tape drive attaches to selected IBM Power Systems models, IBM System x, and PC servers. The TS2290 tape drive also supports attachment to other servers that are running Microsoft Windows, AIX, and Linux. For more information about the latest supported servers and operating system versions, see the [IBM System Storage Interoperation Center \(SSIC\) website](#).

In summary, the drive offers the following features:

- ▶ Dual-port 12 Gbps SAS Computer Systems Interface
- ▶ Half-High form factor
- ▶ Native storage capacity of 18 TB per cartridge (45 TB at 2.5:1 compression ratio) on LTO 9 cartridge
- ▶ Native storage capacity of 12 TB per cartridge (30 TB at 2.5:1 compression ratio) on LTO 8 cartridge
- ▶ Maximum native data transfer rate of up to 400 MBps
- ▶ Maximum Interface Transfer Rate 900 MBps

- ▶ Burst data transfer rate of 1200 MBps
- ▶ 1024 MB read-and-write cache
- ▶ Support for encryption on Ultrium 9, and Ultrium 8 tape cartridges
- ▶ SCD operator panel
- ▶ Ready, Fault, and Encryption status lights
- ▶ Maintenance Mode functions
- ▶ Ethernet Port (drive service use only)
- ▶ Uses Tunneling Magnetoresistive (TMR) head technology

## 4.2 Half-High Ultrium 9 tape drive

The TS2290 houses the Half-High Ultrium 9 tape drive, as shown in Figure 4-2.

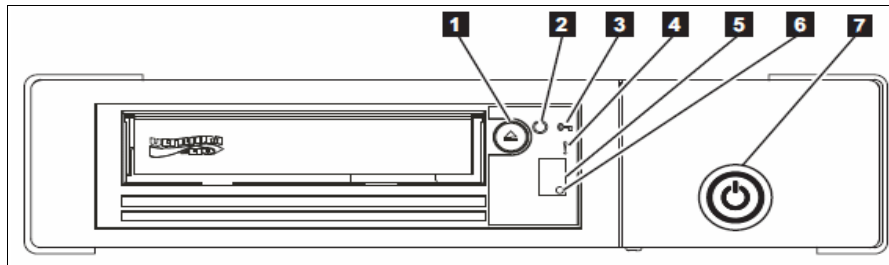

Figure 4-2 Front view of the TS2290 tape drive

The TS2290 is an ideal tape drive for clients with small installations who want a reliable tape drive that uses LTO Ultrium 9 technology. For more information, see 2.4.1, “IBM LTO Ultrium 9 tape drive range” on page 78.

The TS2290 tape drive features a 12 Gbps SAS interface for connection to a wide spectrum of open system servers. The LTO Ultrium 9 Tape Media provides partitioning support, which, with IBM Spectrum Archive (LTFS) technology, provides the ability to have file-level access to tape data. This support helps quickly locate and update data that is on the tape media.

The IBM Ultrium 9 technology also is designed to support encryption of data. The hardware encryption and decryption core and control core are in the IBM Ultrium 9 tape drive.

In addition to reading and writing to Ultrium 9 tape cartridges, the TS2290 tape drive can read and write to Ultrium 8 cartridges.

The numbers in Figure 4-2 highlight the following components:

- 1.** Cartridge unload button
- 2.** Ready light (green)
- 3.** Encryption light (white)
- 4.** Fault light (amber)
- 5.** Single Character Display (SCD)
- 6.** SCD dot
- 7.** Power button

## 4.2.1 Platform support

For more information about the supported platforms and operating systems, see the [IBM System Storage Interoperation Center \(SSIC\) website](#).

## 4.2.2 Performance highlights

If you run applications that are highly dependent on tape processing speed, take advantage of the significant performance improvements that are provided by this tape drive. Table 4-1 lists the performance characteristics of the TS2290 tape drive.

Table 4-1 TS2290 tape drive performance characteristics

Performance characteristics	TS2290 tape drive
Native data rate	400 Mbps (with Ultrium 9 media)
Maximum Interface Transfer Rate (maximum sustained with maximally compressible data)	1000 Mbps (with Ultrium 9 media) 900 Mbps (with Ultrium 8 media)
Interface Burst transfer rate	800 Mbps FC 1200 Mbps SAS
Nominal load-to-ready time	17 seconds
Nominal unload time	30 seconds
Average rewind time	55 seconds

By using the built-in data compression capability of the tape drive, greater data rates than the native data transfer rate can be achieved.

To improve system performance, the drive uses a technique that is called *speed matching* to dynamically adjust its native (uncompressed) data rate to the slower data rate of a server. With speed matching, the drive operates at different speeds when it is reading or writing the Ultrium 9 or 8 cartridge format.

**Important:** Although the TS2290 tape drive provides the capability for excellent tape performance, other components of the system might limit the actual performance that is achieved. The compression technology that is used in the tape drive can more than double the amount of data that can be stored on the media. However, the actual degree of compression that is achieved is highly sensitive to the characteristics of the data that is compressed.



## 4.3 Media

To ensure that the IBM Ultrium tape drive conforms to the IBM specifications for reliability, only IBM LTO Ultrium tape cartridges should be used. Other LTO-certified data cartridges can be used, but they might not meet the standards of reliability that are established by IBM.

### 4.3.1 Data cartridges

The TS2290 tape drive uses the Ultrium 9 data cartridge, which features a native capacity of 18 TB. It has a compressed capacity of 45 TB with a 2.5:1 compression ratio, and uses a linear, serpentine recording format. The TS2290 tape drive reads and writes data on 8960 tracks, 32 tracks at a time.

TS2290 tape drive can read and write Ultrium 8 data cartridges.

**Note:** TS2290 tape drive cannot read or write M8 media cartridges.

The outside of the Ultrium 9 cartridges is green with a silk-screened label on the top that specifies “Ultrium 9 – 18000 GB”, and the WORM cartridge color is green and silvery gray. The cartridge has a nominal life of 20,000 load and unload cycles.

In Table , the compatibility of the Ultrium data cartridges and tape drives is listed. Ultrium 7, 6, 5, 4, 3, 2, and 1 data cartridges are *not* supported when Ultrium 9 tape drives are used.

Table 4-2 *TS2290 tape drive support for Ultrium 9 and Ultrium 8 data cartridges*

IBM LTO Ultrium data cartridge	TS2290 support	Cartridge capacity
Ultrium 9	Read/write	18 TB
Ultrium 8	Read/write	12 TB

### 4.3.2 Write Once Read Many cartridges

Certain records retention and data security applications require a WORM method for storing data on tape. To meet this data storage requirement, a WORM feature is available on IBM LTO Ultrium generation 9, 8, 7, 6, and 5 drives. You can enable the WORM feature by upgrading to WORM-capable drive firmware and by using a special WORM tape cartridge.

A specially formatted WORM tape cartridge is required because standard read/write media are incompatible with the WORM feature. Each WORM cartridge has a unique worldwide cartridge identifier (WWCID), which comprises the unique Cartridge Memory (CM) chip serial number and the unique tape media serial number. For more information about WORM media, see “WORM tape format” on page 44.

### 4.3.3 Cleaning cartridges

A specially labeled IBM LTO Ultrium Cleaning Cartridge cleans the drive. One cleaning cartridge is included with the shipping package of the TS2290 tape drive.

**Important:** The drive automatically ejects an expired cleaning cartridge.

For more information, see “Specifications for cleaning cartridges” on page 52.

### 4.3.4 Cartridge memory

All generations of the IBM LTO Ultrium data cartridges include a Linear Tape-Open Cartridge Memory (LTO-CM) chip, which is a passive contact-less silicon storage device that is physically a part of the cartridge. It holds information about the specific cartridge, the media in the tape drive, and the data on the media.

The LTO-CM enhances the efficiency of the cartridge and aids in determining the reliability of the cartridge by storing data about its age, how many times it was loaded, and how many errors it accumulated. Whenever a tape cartridge is unloaded, the tape drive writes any pertinent information to the cartridge memory. A cleaning cartridge’s LTO-CM chip tracks the number of times that the cartridge is used to prevent it from being used more than 50 times.

The storage capacity of the Ultrium 9 Tape Cartridge Memory Chip is 32640 bytes. Communication between the TS2290 tape drive and the LTO-CM is through a low-level radio frequency field that is transmitted by the drive to the cartridge.

## 4.4 Encryption

The TS2290 tape drive supports host AME, which uses T10 protocols. In this drive, data encryption is supported by LTO Ultrium 9 and 8 data cartridges.

The TS2290 tape drive features a white key symbol on the front of the tape drive that indicates the encryption status, as shown in Figure 4-3. It illuminates only when an Ultrium 9 or 8 data cartridge is loaded and all data on the cartridge is encrypted.

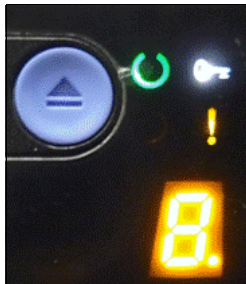

Figure 4-3 Front view of TS2290 showing illuminated encryption symbol

The encryption-enabled drive contains the necessary hardware and firmware to encrypt and decrypt host tape application data. The encryption policy and encryption keys are provided by the host application, and no encryption setup is required (or available) for this drive.

Encryption requires the latest tape device drivers. For more information and to download the drivers, see IBM Support’s [Fix Central web page](#).

For more information about tape encryption, see *IBM System Storage Open Systems Tape Encryption Solutions*, SG24-7907.

## 4.5 IBM Spectrum Archive and Linear Tape File System

IBM Spectrum Archive uses LTFS, which is the first file system that works with the multiple partitioning that is available on LTO Ultrium 9, 8, 7, 6, and 5 tapes. LTFS brings a new level of use and portability to open systems tape storage.

IBM Spectrum Archive storage software helps you reduce complexity in data management and access time through the enablement of a self-describing tape that includes a simple file index. It helps to decrease tape, file management, and archive costs while improving response time for new business needs.

LTFS enables files and directories to be shown on the desktop and directory listing, and files to be dragged-and-dropped to and from tape. It also supports data exchange and has a simple, one-time installation.

The IBM Spectrum Archive Single Drive Edition (SDE) software is included with each TS2290 and uses LTO 9 tape partitioning. It enables a self-describing tape file format and delivers an easy tape storage and distribution solution without the use of more database applications.

IBM Spectrum Archive is the perfect solution for those in the media and entertainment industry and other fields that need massive data storage on tape for long retention periods, such as banking, scientific research, and government sectors.

For more information and a list of supported operating systems, see the following IBM Documentation web pages:

For more information, see the following IBM Documentation web pages:

- ▶ [IBM Spectrum Archive Enterprise Edition \(EE\)](#)
- ▶ [IBM Spectrum Archive Library Edition \(LE\)](#)
- ▶ [IBM Spectrum Archive Single Drive Edition \(SDE\)](#)

## 4.6 Physical attachment

The specifications for the SAS 12 Gbps physical attachment interface are described next.

### 4.6.1 Serial-attached SCSI

The TS2290 tape drive includes a 12 Gbps dual-port SAS interface on the back of the drive. For more information about SAS, see “Serial-attached SCSI history” on page 56.

For the latest list of supported adapters, see the [IBM System Storage Interoperation Center \(SSIC\) website](#).

Figure 4-4 shows the rear view of the TS2290 tape drive with a dual-ports SFF-8644 mini SAS HD interface.

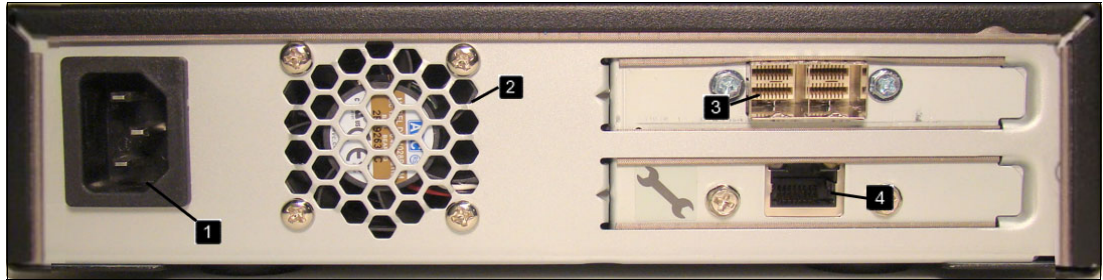

Figure 4-4 Rear view of the TS2290 tape drive

The numbers in Figure 4-4 highlight the following components:

- 1.** Power connector
- 2.** Air vents for fan
- 3.** Dual-ports SFF-8644 mini SAS HD interface
- 4.** Ethernet connector (for service only)

## 4.7 Specifications

This section describes the physical, power, and environmental specifications for the drive.

### 4.7.1 Physical specifications

Table 4-3 lists the physical specifications for the tape drive.

Table 4-3 Physical specifications

Specification	Measurement
Width	213 mm (8.4 in.)
Length	332 mm (13.1 in.)
Height	58 mm (2.3 in.)
Weight (without a cartridge)	4.3 kg (9.4 lbs.)

## 4.7.2 Power specifications

Table 4-4 lists the power specifications for the tape drive.

Table 4-4 Power specifications

Power measurements	Drive
AC line current	100 - 240 V
Line frequency	50 - 60 Hz, auto-ranging
Line current at 100 Vac	1.0 A
Line current at 240 Vac	0.5 A

## 4.8 Feature codes

Table 4-5 shows the available feature codes for the TS2290 tape drive.

Table 4-5 Feature codes

Feature code	Description
AGKD	1.5 M Mini-SASHD/Mini-SAS HD Cable
AGKB	3.0 M Mini-SAS/Mini-SAS HD Cable
5507	4.0 M SAS/Mini-SAS Cable
7003	Rack Mount Shelf Kit w/PDU Line Cord
8002	Ultrium Cleaning Cartridge
8804	Ultrium 8 Data Cartridge (Single)
8806	Ultrium 8 Data Cartridges (5-pack)
8901	Ultrium 9 Data Cartridge (Single)
8905	Ultrium 9 Data Cartridge (5-pack)
9212	Attached to Windows System
9215	Attached to Linux System
9600	Attached to IBM AIX System
9800-9847	Power cord (different feature code for each country)
9848	Rack Device to PDU Line Cord





## IBM TS2280 tape drive

The IBM TS2280 tape drive (3580 model H8S) is an external stand-alone or rack-mountable unit that is designed to offer high capacity and performance for the midrange system environment. The TS2280 tape drive incorporates the IBM Linear Tape-Open (LTO) Ultrium 8 Half-High tape drive and uses a dual-port 6 Gbps serial-attached SCSI (SAS) host interface. The tape drive supports a native sustained data rate performance of up to 300 MBps, which increases to 600 MBps under compression.

The IBM LTO Ultrium 8 tape drive uses the IBM LTO Ultrium 8, 12 TB data cartridge, and 9 TB M8 format Ultrium 7 data cartridge. It provides tape data capacity of up to 30 TB on a L8 format cartridge, and 22.5 TB on a M8 format cartridge, with a 2.5:1 compression ratio. IBM Ultrium 8 tape drives can read and write LTO Ultrium 7 data cartridges. LTO 8 cannot read LTO 6 data cartridges. The TS2280 tape drive supports Write Once Read Many (WORM) on WORM cartridge types.

The Ultrium 8 tape drive is encryption capable and supports application-managed encryption.

The TS2280 tape drive Model H8S uses a 6 Gbps dual port SAS interface for connection to open system servers.

The TS220 tape drive is a client-replaceable unit (CRU). If there is a TS2280 tape drive failure, IBM provides a replacement drive.

This chapter includes the following topics:

- ▶ 5.1, “Product description” on page 190
- ▶ 5.2, “Half-High Ultrium 8 tape drive” on page 191
- ▶ 5.3, “Media” on page 193
- ▶ 5.4, “Encryption” on page 194
- ▶ 5.5, “IBM Spectrum Archive and Linear Tape File System” on page 195
- ▶ 5.6, “Physical attachment” on page 196
- ▶ 5.7, “Specifications” on page 196
- ▶ 5.8, “Feature codes” on page 197

**Note:** The TS2280 is the only stand-alone cartridge drive in the IBM LTO-8 family.

## 5.1 Product description

The IBM TS2280 tape drive is an external stand-alone or rack-mountable unit, and part of the family of IBM Ultrium Tape products. It incorporates the latest generation of the Ultrium 8 Half-High tape drives, which features write cartridges with a native physical capacity of up to 12 TB. The IBM Ultrium 8 technology supports tape partitioning and the IBM Spectrum Archive with Linear Tape File System (LTFS) technology. It also supports encryption of data and WORM cartridges. For the remainder of this chapter, the terms *TS2280* is used as an abbreviation for the IBM TS2280 tape drive.

Only one model (number 3580-H8S) is available for the TS2280 tape drive, as shown in Figure 5-1.



Figure 5-1 The TS2280 tape drive

The TS2280 tape drive uses 6 Gbps Serial SAS SFF-8088 interfaces.

The TS2280 tape drive is encryption-capable and uses Application Managed Encryption (AME). Encryption is supported on Ultrium 8, 7, 6, and 5 data cartridges. On the tape drive, an encryption LED shows you when the drive is using encryption.

The TS2280 tape drive is a CRU. When a TS2280 tape drive has a failure, IBM provides a replacement drive.

A Single-character Display (SCD) at the front of the TS2280 tape drive displays error codes and messages.

The TS2280 tape drive attaches to selected IBM Power Systems models, IBM System x, and PC servers. The TS2280 tape drive also supports attachment to other servers that are running Microsoft Windows, AIX, and Linux. For more information about the latest supported servers and operating system versions, see the [IBM System Storage Interoperation Center \(SSIC\) website](#).

In summary, the drive offers the following features:

- ▶ Dual-port 6 Gbps SAS Computer Systems Interface
- ▶ Half-High form factor
- ▶ Native storage capacity of 12 TB per cartridge (15 TB at 2.5:1 compression ratio) on LTO 8 cartridge



- ▶ Native storage capacity of 9 TB per cartridge (22.5 TB at 2.5:1 compression ratio) on LTO 7 cartridge using M8 format.
- ▶ Maximum native data transfer rate of up to 300 MB per second
- ▶ Maximum Interface Transfer Rate MB per second
- ▶ Burst data transfer rate of 600 MB per second
- ▶ 1024 MB read-and-write cache
- ▶ Support for encryption on Ultrium 8, and Ultrium 7 tape cartridges
- ▶ SCD operator panel
- ▶ Ready, Fault, and Encryption status lights
- ▶ Maintenance Mode functions
- ▶ Ethernet Port (drive service use only)
- ▶ Uses Tunneling Magnetoresistive (TMR) head technology

## 5.2 Half-High Ultrium 8 tape drive

The TS2280 houses the Half-High Ultrium 8 tape drive, as shown in Figure 5-2. The TS2280 is an ideal tape drive for clients with small installations who want a reliable tape drive that uses LTO Ultrium 8 technology. For more information, see 2.5.1, “The IBM LTO Ultrium 8 tape drive range” on page 83.

The TS2280 tape drive features a 6 Gbps SAS interface for connection to a wide spectrum of open system servers. The LTO Ultrium 8 Tape Media provides partitioning support, which, with IBM LTFS technology, provides the ability to have file-level access to tape data. This support helps quickly locate and update information on the tape media. The IBM Ultrium 8 technology is also designed to support encryption of data. The hardware encryption and decryption core and control core are in the IBM Ultrium 8 tape drive.

In addition to reading and writing to Ultrium 8 tape cartridges, the TS2280 tape drive can read and write to Ultrium 7 cartridges.

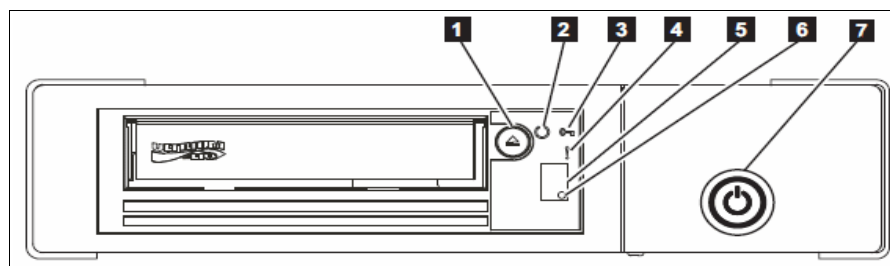

Figure 5-2 Front view of the TS2270 tape drive

The numbers in Figure 5-2 on page 191 highlight the following components:

- 1.** Cartridge unload button
- 2.** Ready light (green)
- 3.** Encryption light (white)
- 4.** Fault light (amber)
- 5.** Single Character Display (SCD)

- 6. SCD dot
- 7. Power button

## 5.2.1 Platform support

For the latest list of supported platforms and operating systems, see the [IBM System Storage Interoperation Center \(SSIC\) website](#).

## 5.2.2 Performance highlights

If you run applications that are highly dependent on tape processing speed, take advantage of the significant performance improvements that are provided by this tape drive. Table 5-1 shows the performance characteristics of the TS2270 tape drive.

Table 5-1 TS2270 tape drive performance characteristics

Performance characteristics	TS2270 tape drive
Native data rate	300 MBps (with Ultrium 7 media)
Maximum Interface Transfer Rate (maximum sustained with maximally compressible data)	500 MBps (SAS)
Interface Burst transfer rate	600 MBps (SAS)
Nominal load-to-ready time	15 seconds
Nominal unload time	24 seconds
Average rewind time	62 seconds

By using the built-in data compression capability of the tape drive, greater data rates than the native data transfer rate can be achieved.

To improve system performance, the drive uses a technique that is called *speed matching* to dynamically adjust its native (uncompressed) data rate to the slower data rate of a server. With speed matching, the drive operates at different speeds when it is reading or writing the Ultrium 8 or 7 cartridge format.

**Important:** Although the TS2280 tape drive provides the capability for excellent tape performance, other components of the system might limit the actual performance that is achieved. The compression technology that is used in the tape drive can more than double the amount of data that can be stored on the media. However, the actual degree of compression that is achieved is highly sensitive to the characteristics of the data that is compressed.

## 5.3 Media

To ensure that the IBM Ultrium tape drive conforms to the IBM specifications for reliability, only IBM LTO Ultrium tape cartridges should be used. Other LTO-certified data cartridges can be used, but they might not meet the standards of reliability that are established by IBM.

### 5.3.1 Data cartridges

The TS2280 tape drive uses the Ultrium 8 data cartridge, which has a native capacity of 12 TB. It has a compressed capacity of 30 TB with a 2.5:1 compression ratio, and uses a linear, serpentine recording format. The TS2270 tape drive reads and writes data on 6656 tracks, 32 tracks at a time.

Ultrium 7 data cartridges specially formatted to Ultrium 8 use can be used on this drive. In this case, these tapes will be pre-formatted as media format M8 and labeled as M8 media. This format allows the LTO8 drive to use Ultrium 7 media with the same performance as Ultrium 8 media and a higher capacity than Ultrium 7. M8 format media provide native capacity of 9 TB. It has a compressed capacity of 22.5 TB with a 2.5:1 compression ratio.

**Note:** LTO7 media with the M8 format can only be used on LTO 8 drives, and cannot be reformatted for read in an LTO7 drive. Using M8 media requires the latest version of drive FW to be installed.

See “M8 format” on page 68 for more details about M8 format.

The outside of the Ultrium 8 cartridges is burgundy, and the WORM cartridge color is burgundy and silvery gray. The cartridge has a nominal life of 20,000 load and unload cycles.

In Table 5-2, the compatibility of the Ultrium data cartridges and tape drives is shown. Ultrium 6, 5, 4, 3, 2, and 1 data cartridges are not supported when Ultrium 8 tape drives are used.

Table 5-2 *Ultrium compatibility among the generations*

IBM Ultrium	IBM LTO Ultrium data cartridge						
	12 TB (Ultrium 8)	9 TB (Ultrium 7 M8 format)	6 TB (Ultrium 7)	2.5 TB (Ultrium 6)	1.5 TB (Ultrium 5)	800 GB (Ultrium 4)	400 GB (Ultrium 3)
Ultrium 8	Read/write	Read/write	Read/write				
Ultrium 7			Read/write	Read/write	Read only		
Ultrium 6				Read/write	Read/write	Read only	
Ultrium 5					Read/write	Read/write	Read only
Ultrium 4						Read/write	Read/write
Ultrium 3							Read/write

### 5.3.2 Write Once Read Many cartridges

Certain records retention and data security applications require a WORM method for storing data on tape. To meet this data storage requirement, a WORM feature is available on IBM LTO Ultrium generation 8, 7, 6, and 5 drives. You can enable the WORM feature by upgrading to WORM-capable drive firmware and by using a special WORM tape cartridge.

A specially formatted WORM tape cartridge is required because standard read/write media are incompatible with the WORM feature. Each WORM cartridge has a unique worldwide cartridge identifier (WWCID), which comprises the unique Cartridge Memory (CM) chip serial number and the unique tape media serial number. For more information about WORM media, see “WORM tape format” on page 44.

### 5.3.3 Cleaning cartridges

A specially labeled IBM LTO Ultrium Cleaning Cartridge cleans the drive. One cleaning cartridge is included with the shipping package of the TS2280 tape drive.

**Important:** The drive automatically ejects an expired cleaning cartridge.

For more information, see “Specifications for cleaning cartridges” on page 52.

### 5.3.4 Cartridge memory

All generations of the IBM LTO Ultrium data cartridges include a Linear Tape-Open Cartridge Memory (LTO-CM) chip, which is a passive contact-less silicon storage device that is physically a part of the cartridge. It holds information about the specific cartridge, the media in the tape drive, and the data on the media.

The LTO-CM enhances the efficiency of the cartridge and aids in determining the reliability of the cartridge by storing data about its age, how many times it was loaded, and how many errors it accumulated. Whenever a tape cartridge is unloaded, the tape drive writes any pertinent information to the cartridge memory. A cleaning cartridge’s LTO-CM chip tracks the number of times that the cartridge is used to prevent it from being used more than 50 times.

The storage capacity of the Ultrium 8 Tape Cartridge Memory Chip is 16320 bytes. Communication between the TS2280 tape drive and the LTO-CM is through a low-level radio frequency field that is transmitted by the drive to the cartridge.

## 5.4 Encryption

The TS2280 tape drive supports host AME, which uses T10 protocols. In this drive, data encryption is supported by LTO Ultrium 8, and 7 data cartridges.

The TS2280 tape drive has a white key symbol on the front of the tape drive that indicates the encryption status, as shown in Figure 5-3. It illuminates only when an Ultrium 8 or 7 data cartridge is loaded and all data on the cartridge is encrypted.

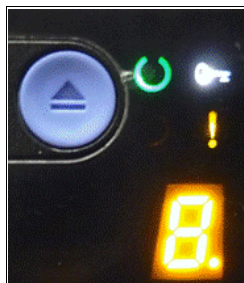

Figure 5-3 Front view of TS2270 showing illuminated encryption symbol

The encryption-enabled drive contains the necessary hardware and firmware to encrypt and decrypt host tape application data. The encryption policy and encryption keys are provided by the host application, and no encryption setup is required (or available) for this drive.

Encryption requires the latest tape device drivers, which are available at IBM Support's [Fix Central web page](#).

For more information about tape encryption, see *IBM System Storage Open Systems Tape Encryption Solutions*, SG24-7907.

## 5.5 IBM Spectrum Archive and Linear Tape File System

IBM Spectrum Archive uses LTFS, which is the first file system that works with the multiple partitioning that is available on LTO Ultrium 7, 6, and 5 tapes. LTFS brings a new level of use and portability to open systems tape storage. IBM Spectrum Archive storage software helps you reduce complexity in data management and access time through the enablement of a self-describing tape that includes a simple file index. It helps to decrease tape, file management, and archive costs while improving response time for new business needs.

LTFS enables files and directories to be shown on the desktop and directory listing, and files to be dragged-and-dropped to and from tape. It also supports data exchange and has a simple, one-time installation.

The IBM Spectrum Archive SDE software is included with each TS2270 and uses LTO 7 tape partitioning. It enables a self-describing tape file format and delivers an easy tape storage and distribution solution without the use of more database applications.

IBM Spectrum Archive is the perfect solution for those in the media and entertainment industry and other fields that need massive data storage on tape for long retention periods, such as banking, scientific research, and government sectors. For more information and a list of supported operating systems, see these websites:

For more information, see the following IBM Documentation web pages:

- ▶ [IBM Spectrum Archive Enterprise Edition \(EE\)](#)
- ▶ [IBM Spectrum Archive Library Edition \(LE\)](#)
- ▶ [IBM Spectrum Archive Single Drive Edition \(SDE\)](#)

## 5.6 Physical attachment

The specifications for the SAS 6 Gbps physical attachment interface are described next.

### 5.6.1 Serial-attached SCSI

The TS2280 tape drive comes with a dual-port SFF-8088 interface on the back of the drive. For more information about SAS, see “Serial-attached SCSI history” on page 56.

For the latest list of supported adapters, see the [IBM System Storage Interoperation Center \(SSIC\) website](#).

Figure 5-4 shows the rear view of the TS2280 tape drive with a dual-port SFF-8088 interface.



Figure 5-4 Rear view of the TS2280 tape drive

The numbers in Figure 5-4 highlight the following components:

- 1.** Power connector
- 2.** Air vents for fan
- 3.** SAS connector, dual port
- 4.** Ethernet connector (for service only)

## 5.7 Specifications

This section describes the physical, power, and environmental specifications for the drive.

### 5.7.1 Physical specifications

Table 5-3 lists the physical specifications for the tape drive.

Table 5-3 Physical specifications

Specification	Measurement
Width	213 mm (8.4 in.)
Length	332 mm (13.1 in.)
Height	58 mm (2.3 in.)
Weight (without a cartridge)	4.3 kg (9.4 lbs.)

## 5.7.2 Power specifications

Table 5-4 lists the power specifications for the tape drive.

Table 5-4 Power specifications

Power measurements	Drive
AC line current	100 - 240 V
Line frequency	50 - 60 Hz, auto-ranging
Line current at 100 Vac	1.0 A
Line current at 240 Vac	0.5 A

## 5.8 Feature codes

Table 5-5 lists the available feature codes for the TS2280 tape drive.

Table 5-5 Feature code

Feature code	Description
5402	2.0 M SAS/Mini-SAS Cable
5501	1.0 M Hi-Perf SAS External Cable
5502	2.0 M Mini-SAS/Mini-SAS Cable
5507	HD SAS to Mini SAS Cable
5509	Y SAS HD to Mini SAS Cable
7003	Rack Mount Shelf Kit w/PDU Line Cord
8002	Ultrium Cleaning Cartridge
8704	Ultrium 7 Data Cartridge (Single)
8706	Ultrium 7 Data Cartridges (5-pack)
9210	Attached to HP-UX System
9212	Attached to Windows System
9215	Attached to Linux System
9600	Attached to IBM AIX System
9800 - 9847	Power cord (different feature code for each country)
9848	Rack Device to PDU Line Cord







## IBM TS2270 tape drive

The IBM TS2270 tape drive (3580 model H7S) is an external stand-alone or rack-mountable unit, which is designed to offer high capacity and performance for the midrange system environment. The TS2270 tape drive incorporates the IBM Linear Tape-Open (LTO) Ultrium 7 Half-High tape drive and uses a dual-port 6 Gbps serial-attached SCSI (SAS) host interface. The tape drive supports a native sustained data rate performance of up to 300 MBps, which increases to 600 MBps under compression.

The IBM LTO Ultrium 7 tape drive uses the IBM LTO Ultrium 7 6-TB data cartridge and provides tape data capacity with up to 15 TB with a 2.5:1 compression ratio. IBM Ultrium 7 tape drives can read and write LTO Ultrium 6 data cartridges, and can read LTO Ultrium 5 data cartridges. The TS2270 tape drive supports Write Once Read Many (WORM) on WORM cartridge types.

The Ultrium 7 tape drive is encryption capable and supports application-managed encryption.

The TS2270 tape drive Model H7S uses a 6 Gbps dual port SAS interface for connection to open system servers.

The TS2270 tape drive is a client-replaceable unit (CRU). If there is a TS2270 tape drive failure, IBM provides a replacement drive.

This chapter includes the following topics:

- ▶ 6.1, “Product description” on page 200
- ▶ 6.2, “Half-High Ultrium 7 tape drive” on page 201
- ▶ 6.3, “Media” on page 202
- ▶ 6.4, “Encryption” on page 204
- ▶ 6.5, “IBM Spectrum Archive and Linear Tape File System” on page 205
- ▶ 6.6, “Physical attachment” on page 205
- ▶ 6.7, “Specifications” on page 206
- ▶ 6.8, “Feature codes” on page 207

**Note:** The TS2270 is the only stand-alone cartridge drive in the IBM LTO-7 family.

## 6.1 Product description

The IBM TS2270 tape drive is an external stand-alone or rack-mountable unit, and part of the family of IBM Ultrium Tape products. It incorporates the latest generation of the Ultrium 7 Half-High tape drives, which features write cartridges with a native physical capacity of 6 TB. The IBM Ultrium 7 technology supports tape partitioning and the IBM Spectrum Archive with Linear Tape File System (LTFS) technology. It also supports encryption of data and WORM cartridges. For the remainder of this chapter, the terms *TS2270* are used as abbreviations for the IBM TS2270 tape drive.

Only one model (number 3580-H7S) is available for the TS2270 tape drive, as shown in Figure 6-1.



Figure 6-1 Side view of the TS2270 tape drive

The TS2270 tape drive uses 6 Gbps Serial SAS SFF-8088 interfaces.

The TS2270 tape drive is encryption-capable and uses Application Managed Encryption (AME). Encryption is supported on Ultrium 7, 6, and 5 data cartridges. On the tape drive, an encryption LED shows you when the drive is using encryption.

The TS2270 tape drive is a client-replaceable unit (CRU). When a TS2270 tape drive has a failure, IBM provides a replacement drive.

For error codes and messages, there is a Single Character Display (SCD) at the front of the TS2270 tape drive.

The TS2270 tape drive attaches to selected IBM Power Systems models, IBM System x, and PC servers. The TS2270 tape drive also supports attachment to other servers that are running Microsoft Windows, HP-UX, Oracle Solaris, and UNIX.

For more information about the latest supported servers, see the [IBM System Storage Interoperation Center \(SSIC\) website](#).

In summary, the drive offers the following features:

- ▶ Dual-port 6 Gbps Serial Attached Small (SAS) Computer Systems Interface
- ▶ Half-High form factor
- ▶ Native storage capacity of 6 TB per cartridge (15 TB at 2.5:1 compression ratio)
- ▶ Maximum native data transfer rate of up to 300 MB per second
- ▶ Burst data transfer rate of 600 MB per second
- ▶ 1024 MB read-and-write cache
- ▶ Support for encryption on Ultrium 7, Ultrium 6, and Ultrium 5 tape cartridges
- ▶ Single Character Display (SCD) operator panel
- ▶ Ready, Fault, and Encryption status lights
- ▶ Maintenance Mode functions
- ▶ Ethernet Port (drive service use only)
- ▶ Giant Magneto Resistive (GMR) head with beveled contouring for reducing stiction/friction

## 6.2 Half-High Ultrium 7 tape drive

The TS2270 houses the Half-High Ultrium 7 tape drive (as shown in Figure 6-2). The TS2270 is an ideal tape drive for clients with small installations who want a reliable tape drive that uses LTO Ultrium 7 technology. For more information, see 2.6.1, “The IBM LTO Ultrium 7 tape drive range” on page 88.

The TS2270 tape drive features a 6 Gbps SAS interface for connection to a wide spectrum of open system servers. The LTO Ultrium 7 Tape Media provides partitioning support, which, with IBM Linear Tape File System technology, provides the ability to have file-level access to tape data. This support helps quickly locate and update information on the tape media. The IBM Ultrium 7 technology also is designed to support encryption of data. The hardware encryption and decryption core and control core are in the IBM Ultrium 7 tape drive.

In addition to reading and writing to Ultrium 7 tape cartridges, the TS2270 tape drive can read and write to Ultrium 6 cartridges and read Ultrium 5 cartridges.

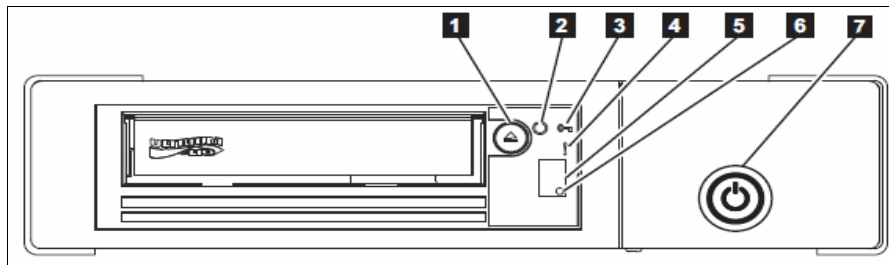

Figure 6-2 Front view of the TS2270 tape drive

The numbers in Figure 6-2 highlight the following components:

- 1.** Cartridge unload button
- 2.** Ready light (green)
- 3.** Encryption light (white)
- 4.** Fault light (amber)
- 5.** Single Character Display (SCD)
- 6.** SCD dot
- 7.** Power button

## 6.2.1 Platform support

For the latest list of supported platforms and operating systems, see the [IBM System Storage Interoperation Center \(SSIC\) website](#).

## 6.2.2 Performance highlights

If you run applications that are highly dependent on tape processing speed, take advantage of the significant performance improvements that are provided by this tape drive. Table 6-1 shows the performance characteristics of the TS2270 tape drive.

Table 6-1 TS2270 tape drive performance characteristics

Performance characteristics	TS2270 tape drive
Native data rate	300 MBps (with Ultrium 7 media)
Maximum Interface Transfer Rate (maximum sustained with maximally compressible data)	500 MBps (SAS)
Interface Burst transfer rate	600 MBps (SAS)
Nominal load-to-ready time	15 seconds
Nominal unload time	20 seconds
Average rewind time	62 seconds

By using the built-in data compression capability of the tape drive, greater data rates than the native data transfer rate can be achieved.

To improve system performance, the drive uses a technique that is called *speed matching* to dynamically adjust its native (uncompressed) data rate to the slower data rate of a server. With speed matching, the drive operates at different speeds when it is reading or writing the Ultrium 7 or 6 cartridge format.

**Important:** Although the TS2270 tape drive provides the capability for excellent tape performance, other components of the system might limit the actual performance that is achieved. The compression technology that is used in the tape drive can more than double the amount of data that can be stored on the media. However, the actual degree of compression that is achieved is highly sensitive to the characteristics of the data that is compressed.

## 6.3 Media

To ensure that the IBM Ultrium tape drive conforms to the IBM specifications for reliability, only IBM LTO Ultrium tape cartridges should be used. Other LTO-certified data cartridges can be used, but they might not meet the standards of reliability that are established by IBM.

### 6.3.1 Data cartridges

The TS2270 tape drive uses the Ultrium 7 data cartridge, which has a native capacity of 6 TB. It has a compressed capacity of 15 TB with a 2.5:1 compression ratio, and uses a linear, serpentine recording format. The TS2270 tape drive reads and writes data on 3584 tracks, 32 tracks at a time.

The outside of the Ultrium 7 cartridges is purple, and the WORM cartridge color is purple and silvery gray. The cartridge has a nominal life of 20,000 load and unload cycles.

In Table 6-2, the compatibility of the Ultrium data cartridges and tape drives is shown. Ultrium 4, Ultrium 3, Ultrium 2, and Ultrium 1 data cartridges are not supported when Ultrium 7 tape drives are used.

Table 6-2 *Ultrium compatibility among the generations*

IBM Ultrium	IBM LTO Ultrium data cartridge						
	6 TB (Ultrium 7)	2.5 TB (Ultrium 6)	1.5 TB (Ultrium 5)	800 GB (Ultrium 4)	400 GB (Ultrium 3)	200 GB (Ultrium 2)	100 GB (Ultrium 1)
Ultrium 7	Read/write	Read/write	Read only				
Ultrium 6		Read/write	Read/write	Read only			
Ultrium 5			Read/write	Read/write	Read only		
Ultrium 4				Read/write	Read/write	Read only	
Ultrium 3					Read/write	Read/write	Read only
Ultrium 2						Read/write	Read/write
Ultrium 1							Read/write

### 6.3.2 Write Once Read Many cartridges

Certain records retention and data security applications require a WORM method for storing data on tape. To meet this data storage requirement, a WORM feature is available on IBM LTO Ultrium generation 7, 6, and 5 drives. You can enable the WORM feature by upgrading to WORM-capable drive firmware and by using a special WORM tape cartridge.

A specially formatted WORM tape cartridge is required because standard read/write media are incompatible with the WORM feature. Each WORM cartridge has a unique worldwide cartridge identifier (WWCID), which comprises the unique Cartridge Memory (CM) chip serial number and the unique tape media serial number. For more information about WORM media, see “WORM tape format” on page 44.

### 6.3.3 Cleaning cartridges

A specially labeled IBM LTO Ultrium Cleaning Cartridge cleans the drive. One cleaning cartridge is included with the shipping package of the TS2270 tape drive.

**Important:** The drive automatically ejects an expired cleaning cartridge.

For more information, see “Specifications for cleaning cartridges” on page 52.

### 6.3.4 Cartridge memory

All generations of the IBM LTO Ultrium data cartridges include a Linear Tape-Open Cartridge Memory (LTO-CM) chip, which is a passive contact-less silicon storage device that is physically a part of the cartridge. It holds information about the specific cartridge, the media in the tape drive, and the data on the media.

The LTO-CM enhances the efficiency of the cartridge and aids in determining the reliability of the cartridge by storing data about its age, how many times it was loaded, and how many errors it accumulated. Whenever a tape cartridge is unloaded, the tape drive writes any pertinent information to the cartridge memory. A cleaning cartridge's LTO-CM chip tracks the number of times that the cartridge is used to prevent it from being used more than 50 times.

The storage capacity of the Ultrium 7 Tape Cartridge Memory Chip is 16320 bytes. Communication between the TS2270 tape drive and the LTO-CM is through a low-level radio frequency field that is transmitted by the drive to the cartridge.

## 6.4 Encryption

The TS2270 tape drive supports host Application Managed Encryption (AME), which uses T10 protocols. Data encryption is supported by LTO Ultrium 7, 6, and 5 data cartridges.

The TS2270 tape drive has a white key symbol on the front of the tape drive that indicates the encryption status, as shown in Figure 6-3. It illuminates only when an Ultrium 7 cartridge is loaded and all data on the cartridge is encrypted.

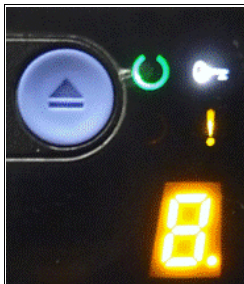

Figure 6-3 Front view of TS2270 showing illuminated encryption symbol

The encryption-enabled drive contains the necessary hardware and firmware to encrypt and decrypt host tape application data. The encryption policy and encryption keys are provided by the host application, and there is no encryption setup required (or available) for this drive.

Encryption requires the latest tape device drivers, which are available at IBM Support's [Fix Central web page](#).

For more information about tape encryption, see *IBM System Storage Open Systems Tape Encryption Solutions*, SG24-7907.

## 6.5 IBM Spectrum Archive and Linear Tape File System

IBM Spectrum Archive uses the Linear Tape File System (LTFS), which is the first file system that works with the multiple partitioning that is available on LTO Ultrium 7, 6, and 5 tapes. LTFS brings a new level of use and portability to open systems tape storage. IBM Spectrum Archive storage software helps you reduce complexity in data management and access time through the enablement of a self-describing tape that includes a simple file index. It helps to decrease tape, file management, and archive costs while improving response time for new business needs.

LTFS allows files and directories to be shown on the desktop and directory listing and files can be dragged-and-dropped to and from tape. It also supports data exchange and has a simple, one-time installation.

The IBM Spectrum Archive Single Drive Edition (SDE) software is included with each TS2270 and uses LTO 7 tape partitioning. It enables a self-describing tape file format and delivers an easy tape storage and distribution solution without the use of more database applications.

IBM Spectrum Archive is the perfect solution for those in the Media and Entertainment industry and other fields that need massive data storage on tape for long retention periods, such as banking, scientific research, and government sectors.

For more information, see the following IBM Documentation web pages:

- ▶ [IBM Spectrum Archive Enterprise Edition \(EE\)](#)
- ▶ [IBM Spectrum Archive Library Edition \(LE\)](#)
- ▶ [IBM Spectrum Archive Single Drive Edition \(SDE\)](#)

## 6.6 Physical attachment

The specifications for the SAS 6 Gbps physical attachment interface are described next.

### 6.6.1 Serial-attached SCSI

The TS2270 tape drive comes with a dual-port SFF-8088 interface on the back of the drive. For more information about SAS, see “Serial-attached SCSI history” on page 56.

For the latest list of supported adapters, see the [IBM System Storage Interoperation Center \(SSIC\) website](#).

Figure 6-4 shows the rear view of the TS2270 tape drive with a dual-port SFF-8088 interface.

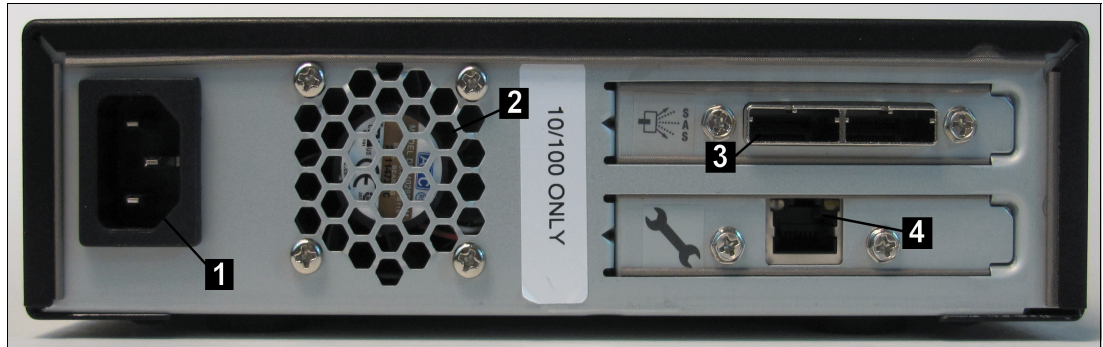

Figure 6-4 Rear view of the TS2270 tape drive

The numbers in Figure 6-4 highlight the following components:

- 1.** Power connector
- 2.** Air vents for fan
- 3.** SAS connector, dual port
- 4.** Ethernet connector (for service only)

## 6.7 Specifications

This section describes the physical, power, and environmental specifications for the drive.

### 6.7.1 Physical specifications

Table 6-3 lists the physical specifications for the tape drive.

Table 6-3 Physical specifications

Specification	Measurement
Width	213 mm (8.4 in.)
Length	332 mm (13.1 in.)
Height	58 mm (2.3 in.)
Weight (without a cartridge)	4.3 kg (9.4 lbs.)



## 6.7.2 Power specifications

Table 6-4 lists the power specifications for the tape drive.

Table 6-4 Power specifications

Power measurements	Drive
AC line current	100 - 240 V
Line frequency	50 - 60 Hz, auto-ranging
Line current at 100 Vac	1.0 A
Line current at 240 Vac	0.5 A

## 6.8 Feature codes

Table 6-5 lists the available feature codes for the TS2270 tape drive.

Table 6-5 Feature code

Feature code	Description
5401	1.0 M SAS/Mini-SAS Cable
5402	2.0 M SAS/Mini-SAS Cable
5502	2.0 M Mini-SAS/Mini-SAS Cable
7003	Rack Mount Shelf Kit w/PDU Line Cord
8002	Ultrium Cleaning Cartridge
8605	Ultrium 6 Data Cartridges (5-pack)
8706	Ultrium 7 Data Cartridges (5-pack)
9210	Attached to HP-UX System
9211	Attached to Oracle Solaris System
9212	Attached to Windows System
9215	Attached to Linux System
9400	Attached to IBM i (i5/OS & OS/400®) System
9600	Attached to IBM AIX System
9800-9847	Power cord (different feature code for each country)
9848	Rack Device to PDU Line Cord





## IBM TS2260 tape drive

The IBM TS2260 tape drive (3580 model H6S) is an external stand-alone or rack mountable unit, which is designed to offer high capacity and performance for the midrange system environment. The TS2260 tape drive incorporates the IBM Linear Tape-Open (LTO) Ultrium 6 Half-High tape drive and uses a dual-port 6 Gbps SAS (serial-attached SCSI) host interface. The tape drive supports a native data rate performance of up to 160 MBps.

The IBM LTO Ultrium 6 tape drive uses the IBM LTO Ultrium 6 2.5 TB data cartridge and provides tape data capacity with up to 6.25 TB with a 2.5:1 compression ratio. IBM Ultrium 6 tape drives can read and write LTO Ultrium 5 data cartridges, and can read LTO Ultrium 4 data cartridges. The TS2260 tape drive also supports WORM on WORM cartridge types.

The Ultrium 6 tape drive is encryption capable and supports application-managed encryption.

The TS2260 tape drive Model H6S uses a 6 Gbps dual port SAS interface for connection to open system servers, or with feature code 5760.

The TS2260 tape drive is a client-replaceable unit (CRU). In the case of TS2260 tape drive failure, IBM provides a replacement drive.

This chapter includes the following topics:

- ▶ 7.1, “Product description” on page 210
- ▶ 7.2, “Half-High Ultrium 6 tape drive” on page 211
- ▶ 7.3, “Media” on page 212
- ▶ 7.4, “Encryption” on page 214
- ▶ 7.5, “IBM Spectrum Archive and LTFS” on page 214
- ▶ 7.6, “Physical attachment” on page 215
- ▶ 7.7, “Specifications” on page 216
- ▶ 7.8, “Feature codes” on page 216

## 7.1 Product description

The IBM TS2260 tape drive is an external stand-alone or rack mountable unit, and part of the family of IBM Ultrium Tape products. It incorporates the latest generation of the Ultrium 6 Half-High tape drives, which features write cartridges with a native physical capacity of 2.5 TB. The IBM Ultrium 6 technology supports tape partitioning and the IBM Linear Tape File System (LTFS) technology. It also supports encryption of data and WORM cartridges. For the remainder of this chapter, the terms *TS2260* and *TS2260 tape drive* are used as abbreviations for IBM TS2260 tape drive.

Only one model (number 3580-H6S) is available for the TS2260 tape drive, as shown in Figure 7-1.



Figure 7-1 Side view of the TS2260 tape drive

The TS2260 tape drive uses 6 Gbps Serial SAS interfaces for connecting to servers.

The SAS interfaces are SFF-8088.

The TS2260 tape drive is encryption-capable and uses Application Managed Encryption (AME). Encryption is supported on Ultrium 6, Ultrium 5, and Ultrium 4 data cartridges. On the tape drive, an encryption LED shows you when the drive is using encryption.

The TS2260 tape drive is a client-replaceable unit (CRU). In the case of TS2260 tape drive failure, IBM provides a replacement drive.

For error codes and messages, there is a Single Character Display (SCD) at the front of the TS2260 tape drive.

The TS2260 tape drive attaches to selected IBM Power Systems models and also supports attachment to other servers that are running Microsoft Windows, Linux, HP-UX, Oracle Solaris, and UNIX.

For more information about the latest supported platforms, see the [IBM System Storage Interoperation Center \(SSIC\) website](#).

In summary, the drive offers the following features:

- ▶ Dual port 6 Gbps Serial Attached Small (SAS) Computer Systems Interface
- ▶ Half-High form factor
- ▶ Native storage capacity of 2.5 TB per cartridge (6.25 TB at 2.5:1 compression ratio)
- ▶ Maximum native data transfer rate of up to 160 MB per second

- ▶ Burst data transfer rate of 600 MB per second
- ▶ 512 MB read-and-write cache
- ▶ Support for encryption on Ultrium 6, Ultrium 5, and Ultrium 4 tape cartridges
- ▶ Single Character Display (SCD) operator panel
- ▶ Ready, Fault, and Encryption status lights
- ▶ Maintenance Mode functions
- ▶ Ethernet Port (drive service use only)
- ▶ Giant Magneto Resistive (GMR) head with beveled contouring for reducing stiction/friction

## 7.2 Half-High Ultrium 6 tape drive

The TS2260 houses the Half-High Ultrium 6 tape drive (as shown in Figure 7-2). The TS2260 is an ideal tape drive for clients with small installations who want a reliable tape drive that uses LTO Ultrium 6 technology. For more information, see 2.7.1, “The IBM LTO Ultrium 6 tape drive range” on page 93.

The TS2260 tape drive features a 6 Gbps SAS for connection to a wide spectrum of open system servers. The LTO Ultrium 6 Tape Media provides partitioning support, which, with IBM Spectrum Archive and Linear Tape File System technologies, provides the ability to have file-level access to tape data. This support helps quickly locate and update information on the tape media.

The IBM Ultrium 6 technology is also designed to support encryption of data. The hardware encryption and decryption core and control core are in the IBM Ultrium 6 tape drive. In addition to reading and writing to Ultrium 6 tape cartridges, the TS2260 tape drive can read and write to Ultrium 5 cartridges and read Ultrium 4 cartridges.

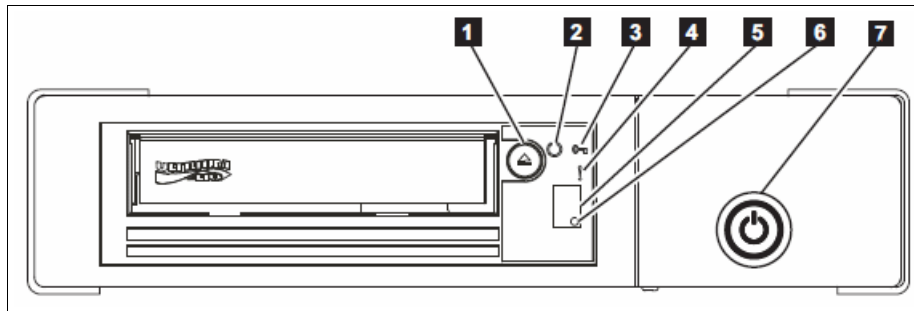

Figure 7-2 Front view of the TS2260 tape drive

The numbers in Figure 7-2 highlight the following components:

- 1.** Cartridge unload button
- 2.** Ready light (green)
- 3.** Encryption light (white)
- 4.** Fault light (amber)
- 5.** Single Character Display (SCD)
- 6.** SCD dot
- 7.** Power button

## 7.2.1 Platform support

For the latest list of supported platforms and operating systems, see the [IBM System Storage Interoperation Center \(SSIC\) website](#).

## 7.2.2 Performance highlights

If you run applications that are highly dependent on tape processing speed, take advantage of the significant performance improvements that are provided by this tape drive. Table 7-1 shows the performance characteristics of the TS2260 tape drive.

Table 7-1 TS2260 tape drive performance characteristics

Performance characteristics	TS2260 tape drive
Native data rate	160 MBps (with Ultrium 6 media)
Maximum interface transfer rate (maximum sustained with maximally compressible data)	500 MBps (SAS)
Interface Burst transfer rate	600 MBps (SAS)
Nominal load-to-ready time	12 seconds
Nominal unload time	22 seconds
Average rewind time	62 seconds

By using the built-in data compression capability of the tape drive, greater data rates than the native data transfer rate can be achieved.

To improve system performance, the drive uses a technique that is called *speed matching* to dynamically adjust its native (uncompressed) data rate to the slower data rate of a server. With speed matching, the drive operates at different speeds when it is reading or writing the Ultrium 6 or Ultrium 5 cartridge format.

**Important:** Although the TS2260 tape drive provides the capability for excellent tape performance, other components of the system might limit the actual performance that is achieved. The compression technology that is used in the tape drive often can double the amount of data that can be stored on the media. However, the actual degree of compression that is achieved is highly sensitive to the characteristics of the data that is compressed.

## 7.3 Media

To ensure that the IBM Ultrium tape drive conforms to the IBM specifications for reliability, only IBM LTO Ultrium tape cartridges should be used. Other LTO-certified data cartridges can be used, but they might not meet the standards of reliability that are established by IBM.

### 7.3.1 Data cartridges

The TS2260 tape drive uses the Ultrium 6 data cartridge, which has a native capacity of 2.5 TB. It has a compressed capacity of 6.25 TB with a 2.5:1 compression ratio, and uses a linear, serpentine recording format. The TS2260 tape drive reads and writes data on 2176 tracks, 16 tracks at a time.

The outside of the Ultrium 6 cartridges is black, and the WORM cartridge color is black and silvery gray. The cartridge has a nominal life of 20,000 load and unload cycles.

In Table 7-2, the compatibility of the Ultrium data cartridges and tape drives are shown. Ultrium 3, Ultrium 2, and Ultrium 1 data cartridges are not supported when Ultrium 6 tape drives are used.

Table 7-2 Ultrium compatibility among the generations

IBM Ultrium tape drive	IBM LTO Ultrium data cartridge					
	2.5 TB (Ultrium 6)	1.5 TB (Ultrium 5)	800 GB (Ultrium 4)	400 GB (Ultrium 3)	200 GB (Ultrium 2)	100 GB (Ultrium 1)
Ultrium 6	Read/write	Read/write	Read only			
Ultrium 5		Read/write	Read/write	Read only		
Ultrium 4			Read/write	Read/write	Read only	
Ultrium 3				Read/write	Read/write	Read only
Ultrium 2					Read/write	Read/write
Ultrium 1						Read/write

### 7.3.2 Write Once Read Many cartridges

Certain records retention and data security applications require a WORM method for storing data on tape. To meet this data storage requirement, a WORM feature is available on IBM LTO Ultrium generation 6, 5, 4, and 3 drives. You can enable the WORM feature by upgrading to WORM-capable drive firmware and by using a special WORM tape cartridge.

A specially formatted WORM tape cartridge is required because standard read/write media are incompatible with the WORM feature. Each WORM cartridge has a unique, worldwide cartridge identifier (WWCID), which comprises the unique CM chip serial number and the unique tape media serial number. For more information about WORM media, see “WORM tape format” on page 44.

### 7.3.3 Cleaning cartridges

A specially labeled IBM LTO Ultrium Cleaning Cartridge cleans the drive. One cleaning cartridge is included with the shipping package of the TS2260 tape drive.

**Important:** The drive automatically ejects an expired cleaning cartridge.

For more information, see “Specifications for cleaning cartridges” on page 52.

### 7.3.4 Cartridge memory

All generations of the IBM LTO Ultrium data cartridges include a Linear Tape-Open Cartridge Memory (LTO-CM) chip, which is a passive contact-less silicon storage device that is physically a part of the cartridge. It holds information about the specific cartridge, the media in the tape drive, and the data on the media.

The LTO-CM enhances the efficiency of the cartridge and aids in determining the reliability of the cartridge by storing data about its age, how many times it was loaded, and how many errors it accumulated. Whenever a tape cartridge is unloaded, the tape drive writes any pertinent information to the cartridge memory. A cleaning cartridge's LTO-CM chip tracks the number of times that the cartridge is used to prevent it from being used more than 50 times.

The storage capacity of the Ultrium 6 Tape Cartridge Memory Chip is 16320 bytes. Communication between the TS2260 tape drive and the LTO-CM is through a low-level radio frequency field that is transmitted by the drive to the cartridge.

## 7.4 Encryption

The TS2260 tape drive supports host Application Managed Encryption (AME), which uses T10 protocols. Data encryption is supported by LTO Ultrium 6, Ultrium 5, and Ultrium 4 data cartridges only.

The TS2260 tape drive has a white key symbol on the front of the tape drive that indicates the encryption status, as shown in Figure 7-3. It illuminates only when an Ultrium 6 cartridge is loaded and all data on the cartridge is encrypted.

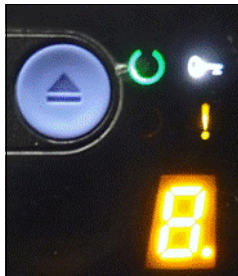

Figure 7-3 Front view of TS2260 showing illuminated encryption symbol

The encryption-enabled drive contains the necessary hardware and firmware to encrypt and decrypt host tape application data. The encryption policy and encryption keys are provided by the host application, and there is no encryption setup required (or available) for this drive.

Encryption requires the latest tape device drivers, which are available at IBM Support's [Fix Central web page](#).

For more information about tape encryption, see *IBM System Storage Open Systems Tape Encryption Solutions*, SG24-7907.

## 7.5 IBM Spectrum Archive and LTFS

IBM Spectrum Archive uses Linear Tape File System (LTFS), which is the first file system that works with the multiple partitioning that is available on LTO Ultrium 6 and LTO Ultrium 5 tape. This system brings a new level of use and portability to open systems tape storage.

IBM Spectrum Archive storage software helps you reduce complexity in data management and access time through the enablement of a self-describing tape that includes a simple file index. It helps to decrease tape, file management, and archive costs while improving response time for new business needs.



LTFS allows files and directories to be shown on the desktop and directory listing and files can be dragged-and-dropped to and from tape. It also supports data exchange and has a simple, one-time installation.

The IBM Spectrum Archive Single Drive Edition (SDE) software is included with each TS2260 and uses the LTO 6 tape partitioning. It enables a self-describing tape file format and delivers an easy tape storage and distribution solution without the use of more database applications. IBM Spectrum Archive and Linear Tape File System provide the perfect solution for those in the Media and Entertainment industry and other fields that need massive data storage on tape for long retention periods, such as banking, scientific research, and government sectors.

For more information, see the following IBM Documentation web pages:

- ▶ [IBM Spectrum Archive Enterprise Edition \(EE\)](#)
- ▶ [IBM Spectrum Archive Library Edition \(LE\)](#)
- ▶ [IBM Spectrum Archive Single Drive Edition \(SDE\)](#)

## 7.6 Physical attachment

The specifications for the physical attachment interface, SAS 6 Gbps, is described next.

### 7.6.1 Serial-attached SCSI

The TS2260 tape drive comes with a dual-port SFF-8088 interface on the back of the drive. For more information about SAS, see “Serial-attached SCSI history” on page 56.

For the latest list of supported adapters, see the [IBM System Storage Interoperation Center \(SSIC\) website](#).

Figure 7-4 shows the rear view of the TS2260 tape drive with a dual-port SFF-8088 interface.

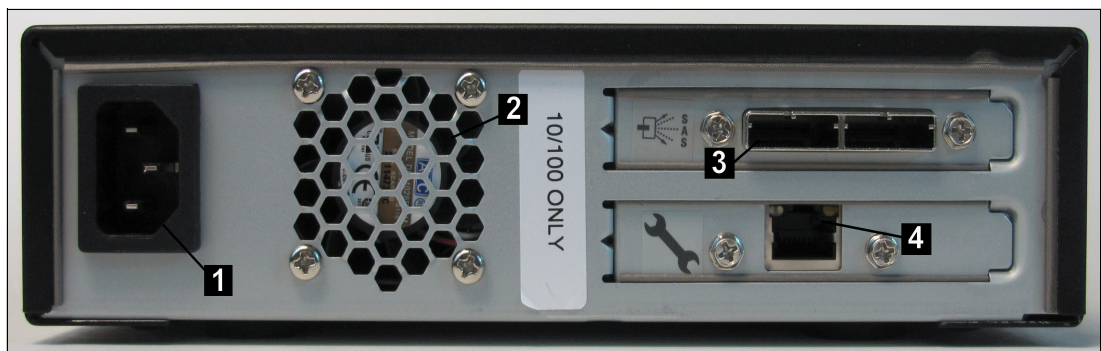

Figure 7-4 Rear view of the TS2260 tape drive

The numbers in Figure 7-4 highlight the following components:

- 1.** Power connector
- 2.** Air vents for fan
- 3.** SAS connector, dual port
- 4.** Ethernet connector (for service only)

## 7.7 Specifications

This section describes the physical, power, and environmental specifications for the drive.

### 7.7.1 Physical specifications

Table 7-3 lists the physical specifications for the tape drive.

Table 7-3 Physical specifications

Specification	Measurement
Width	213 mm (8.4 in.)
Length	332 mm (13.1 in.)
Height	58 mm (2.3 in.)
Weight (without a cartridge)	4.3 kg (9.4 lbs.)

### 7.7.2 Power specifications

Table 7-4 lists the power specifications for the tape drive.

Table 7-4 Power specifications

Power measurements	Drive
AC line current	100 - 240 V
Line frequency	50 - 60 Hz, auto-ranging
Line current at 100 Vac	1.0 A
Line current at 240 Vac	0.5 A

## 7.8 Feature codes

Table 7-5 shows the available feature codes for the TS2260 tape drive.

Table 7-5 Feature code

Feature code	Description
5402	2.0 M SAS/Mini-SAS Cable
5501	1.0 M SAS/Mini-SAS Cable
5507	4 M Mini-SAS HD/Mini-SAS Cable
5509	3M Mini-SAS HD/Mini-SAS 2X Cable
7003	Rack Mount Shelf Kit w/PDU Line Cord
8002	Ultrium Cleaning Cartridge
8505	Ultrium 5 Data Cartridges (5-pack)
8605	Ultrium 6 Data Cartridges (5-pack)
9210	Attached to HP-UX System
9211	Attached to Oracle Solaris System

<b>Feature code</b>	<b>Description</b>
9212	Attached to Windows System
9215	Attached to Linux System
9400	Attached to IBM i (i5/OS & OS/400) System
9600	Attached to IBM AIX System
9800-9847	Power cord (different feature code for each country)
9848	Rack Device to PDU Line Cord





## IBM TS2360 tape drive

The IBM TS2360 tape drive (3580 model S63) is an external stand-alone or rack mountable unit, which offers high capacity and performance for the midrange systems environment. The IBM TS2360 tape drive incorporates the Linear Tape-Open (LTO) IBM Ultrium 6 full Full-High serial-attached SCSI (SAS) tape drive, which provides maximum tape drive throughput and a native data rate performance of up to 160 MBps.

In addition, with the use of the IBM LTO Ultrium 6 2.5 TB data cartridge, the TS2360 tape drive provides tape cartridge capacity up to 6.25 TB with a 2.5:1 compression ratio compared to the previous Ultrium 5 1.5 TB (3 TB with a 2:1 compression ratio) tape cartridges. IBM Ultrium 6 tape drives can read and write LTO Ultrium 5 data cartridges, and can read LTO Ultrium 4 data cartridges. The TS2360 tape drive supports Write Once Read Many (WORM) on WORM cartridge types.

The TS2360 tape drive Model S63 uses 6 Gbps serial-attached SCSI (SAS) interfaces and has dual-port Mini-SAS (SFF-8088) interfaces for connecting to open systems servers.

The TS2360 tape drive is encryption-capable and supports Application Managed Encryption (AME).

The TS2360 tape drive is a client-replaceable unit (CRU). In the case of tape drive failure, IBM provides a replacement drive.

This chapter includes the following topics:

- ▶ 8.1, “Product description” on page 220
- ▶ 8.2, “Full-High Ultrium 6 tape drive” on page 221
- ▶ 8.3, “Media” on page 223
- ▶ 8.4, “Encryption” on page 224
- ▶ 8.5, “IBM Spectrum Archive and Linear Tape File System” on page 225
- ▶ 8.6, “Physical attachment” on page 225
- ▶ 8.7, “Specifications” on page 226
- ▶ 8.8, “Feature codes” on page 227

## 8.1 Product description

The IBM S2360 tape drive is an external stand-alone or rack mountable unit and part of the family of IBM Ultrium Tape products. It incorporates the latest generation of the Ultrium 6 Full-High SAS tape drives, which write cartridges with a native physical capacity of 2.5 TB. The IBM Ultrium 6 technology supports media partitioning and the IBM Linear Tape File System (LTFS) technology. It also continues to support encryption of data and WORM cartridges. For the remainder of this chapter, the terms *TS2360* and *TS2360 tape drive* are used as abbreviations for IBM S2360 tape drive.

The only model that is available for the TS2360 tape drive is the TS2360 model tape drive S63, which has a SAS interface that has a native data transfer rate of up to 6 Gbps.

Figure 8-1 shows the side view of the TS2360 tape drive.



Figure 8-1 Side view of the TS2360 tape drive

The TS2360 tape drive uses 6 Gbps SAS interfaces for connecting to open systems servers. These interfaces are dual-port Mini-SAS (SFF-8088).

The TS2360 tape drive is encryption-capable and uses Application Managed Encryption (AME).

The TS2360 tape drive is a CRU. In the case of TS2360 tape drive failure, IBM provides a replacement drive.

For error codes and messages, there is a Single Character Display (SCD) at the front of the TS2360 tape drive.

The TS2360 tape drive attaches to selected IBM Power System models and also supports attachment to other servers that are running Microsoft Windows, Linux, HP-UX, Oracle Solaris, and UNIX.

For more information about the latest supported servers, see the [IBM System Storage Interoperation Center \(SSIC\) website](#).

In summary, the Ultrium 6 tape drive offers the following features:

- ▶ Dual-port 6 Gbps Serial Attached Small Computer Systems Interface (SAS)
- ▶ Support for WORM on WORM cartridge types
- ▶ Native storage capacity of 2.5 TB per cartridge (6.25 TB at 2.5:1 compression ratio) when Ultrium 6 cartridges are used
- ▶ Native data transfer rate of up to 160 MB per second
- ▶ Burst data transfer rate of 600 MB per second
- ▶ 1024 MB read-and-write cache
- ▶ Support for encryption of data on Ultrium 6, Ultrium 5, and Ultrium 4 cartridges
- ▶ Full-High form factor
- ▶ SCD operator panel
- ▶ Ready and Fault status lights
- ▶ Maintenance Mode functions

## 8.2 Full-High Ultrium 6 tape drive

The TS2360 tape drive houses the Full-High Ultrium 6 tape drive, as shown in Figure 8-2. The TS2360 is an ideal tape drive for clients who want a robust and reliable tape drive with LTO Ultrium 6 technology. For more information, see 2.7.1, “The IBM LTO Ultrium 6 tape drive range” on page 93.

The TS2360 tape drive features a 6 Gbps SAS interface for connection to a wide spectrum of open systems servers. The LTO Ultrium 6 Tape Media provides partitioning support, which, with IBM Linear Tape File System technology, provides the ability to have file-level access to tape data. This support helps to quickly locate and update information on the tape media.

The IBM Ultrium 6 technology also supports encryption of data. The hardware encryption and decryption core and control core are in the IBM Ultrium 6 tape drive. In addition to reading and writing to Ultrium 6 tape cartridges, the TS2360 tape drive can read and write to Ultrium 5 cartridges and read Ultrium 4 cartridges.

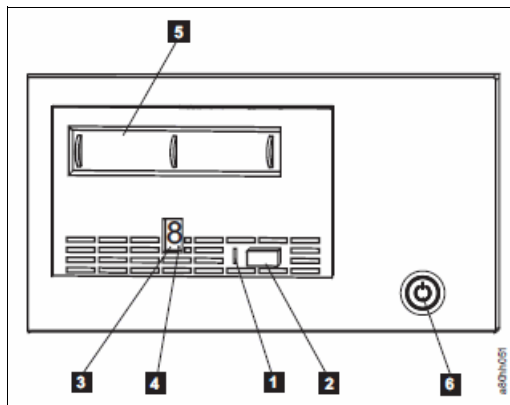

Figure 8-2 Front view of TS2360 tape drive

The numbers in Figure 8-2 on page 221 highlight the following components:

1. Status light
2. Unload button
3. Single Character Display (SCD)
4. SCD dot
5. Cartridge slot
6. Power button

## 8.2.1 Platform support

For the latest list of supported platforms and operating systems, see the [IBM System Storage Interoperation Center \(SSIC\) website](#).

## 8.2.2 Performance highlights

In general terms, Half-High drives are designed for small to medium workload requirements whereas Full-High drives are designed for medium to large workloads. Although the data rates between Half-High and Full-High are the same at 160 MBps, Full-High drives have significantly better times for rewind/locate operations and file access than that of the Half-High equivalent.

Full-High drives also provide three times the load/unload life. Therefore, if you run applications that are highly dependent on tape processing speed, take advantage of the significant performance improvements that are provided by this tape drive. Table 8-1 shows the performance characteristics of the TS2360 tape drive.

Table 8-1 TS2360 tape drive Performance characteristics

Performance characteristics	TS2360 tape drive
Native data rate	160 MBps (with Ultrium 6 media)
Maximum interface transfer rate (maximum sustained with maximally compressible data)	500 MBps (SAS)
Interface Burst transfer rate	600 MBps (SAS)
Nominal load-to-ready time	12 seconds
Nominal unload time	17 seconds
Average rewind time	42 seconds

By using the built-in data compression capability of the tape drive, greater data rates than the native data transfer rate can be achieved.

**Important:** Although the TS2360 tape drive provides the capability for excellent tape performance, other components of the system might limit the actual performance that is achieved. Also, although the compression technology that is used in the tape drive can typically double the amount of data that can be stored on the media, the actual degree of compression that is achieved is highly sensitive to the characteristics of the data that is being compressed.



## 8.3 Media

To ensure that the IBM Ultrium tape drive conforms to the IBM specifications for reliability, use IBM LTO Ultrium tape cartridges. Other LTO-certified data cartridges can be used, but they might not meet the standards of reliability that are established by IBM.

### 8.3.1 Data cartridges

The TS2360 tape drive uses the Ultrium 6 data cartridge. It has a native capacity of 2.5 TB, and compressed capacity of 6.25 TB with a 2.5:1 compression ratio. It uses a linear, serpentine recording format. The TS2360 tape drive reads and writes data on 2176 tracks, 16 tracks at a time.

The outside of the Ultrium 6 cartridges is black, whereas WORM cartridges are black and silvery gray. The cartridge has a nominal life of 20,000 load and unload cycles.

In Table 8-2, the compatibilities of the Ultrium data cartridges and tape drives are shown. Ultrium 3, Ultrium 2, and Ultrium 1 data cartridges are not supported when Ultrium 6 tape drives are used.

Table 8-2 Ultrium compatibility among the generations

IBM Ultrium tape drive	IBM LTO Ultrium data cartridge					
	2.5 TB (Ultrium 6)	1.5 TB (Ultrium 5)	800 GB (Ultrium 4)	400 GB (Ultrium 3)	200 GB (Ultrium 2)	100 GB (Ultrium 1)
Ultrium 6	Read/write	Read/write	Read only			
Ultrium 5		Read/write	Read/write	Read only		
Ultrium 4			Read/write	Read/write	Read only	
Ultrium 3				Read/write	Read/write	Read only
Ultrium 2					Read/write	Read/write
Ultrium 1						Read/write

### 8.3.2 Write Once Read Many cartridges

Certain records retention and data security applications require a WORM method for storing data on tape. To meet this data storage requirement, a WORM feature is available on IBM LTO Ultrium generation 6, 5, 4, and 3 drives. You can enable the WORM feature by upgrading to WORM-capable drive firmware and by using a special WORM tape cartridge.

A specially formatted WORM tape cartridge is required because standard read/write media are incompatible with the WORM feature. Each WORM cartridge has a unique, worldwide cartridge identifier (WWCID), which comprises the unique CM chip serial number and the unique tape media serial number.

For more information about WORM media, see “Ordering bar code labels” on page 51.

### 8.3.3 Cleaning cartridges

A specially labeled IBM LTO Ultrium Cleaning Cartridge cleans the drive. One cleaning cartridge is included in the shipping package of the TS2360 tape drive.

**Important:** The drive automatically ejects an expired cleaning cartridge.

For more information about the cleaning cartridge, see “Specifications for cleaning cartridges” on page 52.

### 8.3.4 Cartridge memory (LTO-CM)

All generations of the IBM LTO Ultrium data cartridges include a Linear Tape-Open Cartridge Memory (LTO-CM) chip, which is a passive contact-less silicon storage device that is physically a part of the cartridge. It is designed to hold information about specific cartridge, the media in the tape drive and the data on the media.

The LTO-CM enhances the efficiency of the cartridge and aids in determining the reliability of the cartridge by storing data about its age, how many times it was loaded, and how many errors it accumulated. Whenever a tape cartridge is unloaded, the tape drive writes any pertinent information to the cartridge memory. A cleaning cartridge’s LTO-CM chip tracks the number of times that the cartridge is used to prevent it being used more than 50 times.

The storage capacity of the Ultrium 6 Tape Cartridge Memory Chip is 16320 bytes. Communication between the TS2360 tape drive and the LTO-CM is through a low-level radio frequency field that is transmitted by the drive to the cartridge.

## 8.4 Encryption

The IBM Storage System TS2360 tape drive supports host Application Managed Encryption (AME), which uses T10 encryption protocols. Data encryption is supported by LTO Ultrium 6, Ultrium 5, and Ultrium 4 data cartridges only.

The encryption-enabled drive contains the necessary hardware and firmware to encrypt and decrypt host tape application data. The Encryption policy and encryption keys are provided by the host application, and there is no encryption setup required (or available) for this drive.

Encryption requires the latest tape device drivers that are available at IBM Support’s [Fix Central web page](#).

For more information about tape encryption, see *IBM System Storage Open Systems Tape Encryption Solutions*, SG24-7907.

## 8.5 IBM Spectrum Archive and Linear Tape File System

IBM Spectrum Archive uses Linear Tape File System (LTFS), which is the first file system that works with the multiple partitioning that is available on LTO Ultrium 6 and LTO Ultrium 5 tape. This system brings a new level of use and portability to open systems tape storage.

IBM Spectrum Archive storage software helps you reduce complexity in data management and access time through the enablement of a self-describing tape that includes a simple file index. It helps to decrease tape, file management, and archive costs while improving response time for new business needs.

LTFS allows files and directories to be shown on desktop and the directory listing and you can drag-and-drop files to and from tape. LTFS also supports data exchange and has a simple one-time installation.

The IBM Spectrum Archive Single Drive Edition (SDE) software is included with each TS2360 and uses LTO 6 tape partitioning. It enables a self-describing tape file format and delivers an easy tape storage and distribution solution without the use of more database applications.

IBM Spectrum Archive is the perfect solution for those in the Media and Entertainment industry and other fields that need massive data storage on tape for long retention periods, such as banking, scientific research, and government sectors.

For more information, see the following IBM Documentation web pages:

- ▶ [IBM Spectrum Archive Enterprise Edition \(EE\)](#)
- ▶ [IBM Spectrum Archive Library Edition \(LE\)](#)
- ▶ [IBM Spectrum Archive Single Drive Edition \(SDE\)](#)

## 8.6 Physical attachment

The specifications for the physical attachment interface, SAS 6 Gbps, are described next.

### 8.6.1 Serial-attached SCSI

The TS2360 tape drive comes with a dual-port SFF-8088 interface on the back of the drive. For more information about serial-attached SCSI (SAS), see “Serial-attached SCSI history” on page 56.

For the latest list of supported adapters, see the [IBM System Storage Interoperation Center \(SSIC\) website](#).

Figure 8-3 shows the rear view of the TS2360 tape drive with a dual-port SFF-8088 interface.

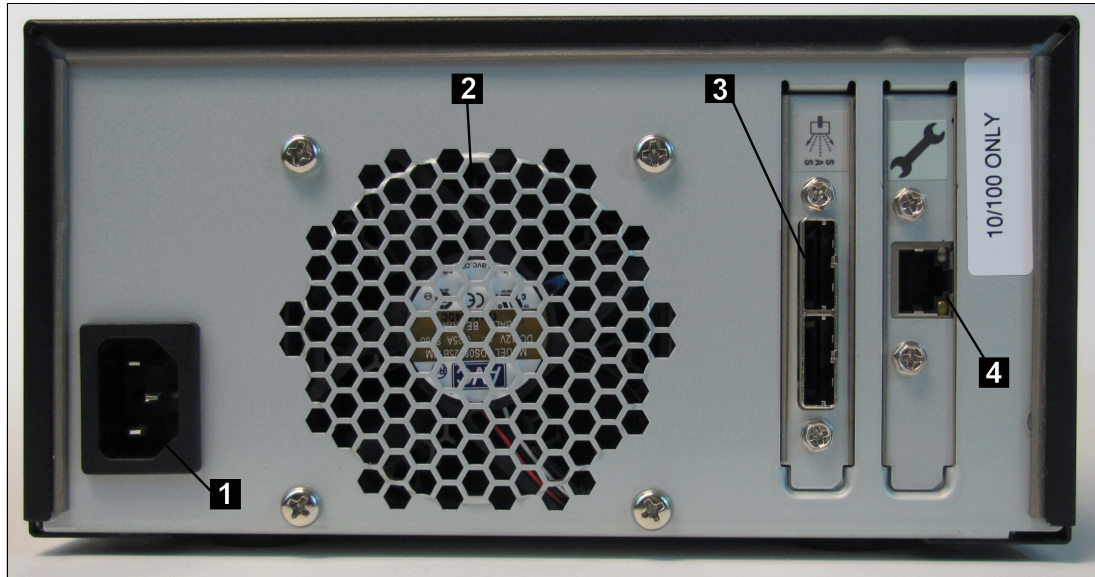

Figure 8-3 Rear view of the TS2360 tape drive

The numbers in Figure 8-3 highlight the following components:

- 1.** Power connector
- 2.** Fan
- 3.** Serial-attached SCSI connectors
- 4.** Ethernet connector

## 8.7 Specifications

The following sections describe the physical, power, and environmental specifications for the drive.

### 8.7.1 Physical specifications

Table 8-3 lists the physical specifications for the tape drive.

Table 8-3 Physical specifications

Specification	Measurement
Width	213 mm (8.4 in.)
Length	332 mm (13.1 in.)
Height	109 mm (4.3 in.)
Weight (without a cartridge)	6.3 kg (13.84 lbs.)

## 8.7.2 Power specifications

Table 8-4 lists the power specifications for the tape drive.

Table 8-4 *Power specifications*

Power measurements	Drive
AC line current	100 - 240 V
Line frequency	50 - 60 Hz, auto-ranging
Line current at 100 Vac	1.0 A
Line current at 240 Vac	0.5 A

## 8.8 Feature codes

Table 8-5 lists the available feature codes for the TS2360 tape drive.

Table 8-5 *TS2360 feature codes*

Feature code	Description
5402	2.0 M SAS/Mini-SAS 1x Cable
5502	2.0 M Mini-SAS/Mini-SAS 1x Cable
7003	Rack Mount Shelf Kit w/PDU Line Cord
8002	Ultrium Cleaning Cartridge
8505	Ultrium 5 Data Cartridge (5-Pack)
8605	Ultrium 6 Data Cartridge (5-Pack)
9210	Attached to HP-UX System
9211	Attached to Oracle Solaris System
9212	Attached to Windows System
9215	Attached to Linux System
9400	Attached to i5/OS or OS/400 Systems
9600	Attached to IBM AIX System
9800-9847	Power cord (different feature code for each country)
9848	Rack Device to PDU Line Cord





## Part 2

# IBM tape libraries for open systems

This part introduces the current IBM tape library models for Linear Tape-Open tape drives, virtual tape libraries, and library management tools and technology.

The following chapters are included in Part 2:

- ▶ Chapter 9, “IBM TS2900 tape autoloader” on page 231
- ▶ Chapter 10, “IBM TS4300 tape library” on page 245
- ▶ Chapter 11, “IBM TS4500 tape library” on page 283







## IBM TS2900 tape autoloader

The IBM TS2900 tape autoloader (Machine Type 3572) provides an efficient, high capacity, low-cost solution for unattended data backup. The library has a compact 1U form factor with easy access to tape cartridges through a removable magazine.

The IBM TS2900 tape autoloader is an external stand-alone or rack-mountable unit that incorporates a single Ultrium 9, 8, 7, 6, or 5, Half-High tape drive. It is equipped with a serial-attached SCSI (SAS) host adapter attachment that has a data transfer rate of up to 12 Gbps (12 Gbps for LTO-9; 6 Gbps for LTO-8, 7, 6, and 5).

The IBM TS2900 tape autoloader has a removable cartridge magazine that provides nine data cartridge slots, including a configurable single slot I/O station. IBM TS2900 tape autoloader is an entry point for IBM Linear Tape-Open (LTO) tape automation. This autoloader uses the IBM patented high density (HD) slot technology.

The following features are standard:

- ▶ Application-Managed Encryption (AME)
- ▶ Bar code reader
- ▶ LCD display for local management
- ▶ Web User Interface (GUI) for remote management
- ▶ Configurable I/O station
- ▶ Removable magazine with IBM patented HD Slot technology

The following features are optional:

- ▶ Transparent System-Managed Encryption (SME) and Library-Managed Encryption (LME)
- ▶ Choice of rack-mount or desktop packaging

For the remainder of this chapter, the terms *TS2900* and *TS2900 tape autoloader* are used as abbreviations for the IBM TS2900 tape autoloader.

This chapter includes the following topics:

- ▶ 9.1, “Overview” on page 233
- ▶ 9.2, “TS2900 tape autoloader components” on page 235
- ▶ 9.3, “IBM LTO Ultrium Half-High tape drives” on page 239
- ▶ 9.4, “Physical attachments” on page 241
- ▶ 9.5, “Media” on page 241
- ▶ 9.6, “Specifications” on page 243
- ▶ 9.7, “Feature codes” on page 244

## 9.1 Overview

The IBM TS2900 tape autoloader (Machine Type 3572 1U Autoloader) supports one LTO-9, LTO-8, LTO-7, LTO-6, or LTO-5 Half-High tape drive.

The following models are available for the TS2900 tape autoloader:

- ▶ The 3572-S9H includes an Ultrium 9 Half-High tape drive that has a SAS interface with a data transfer rate of 12 Gbps. The SAS Ultrium 9 tape drive includes an Mini SAS HD SFF-8644 interface. The Ultrium 9 tape drive provides a sustained native data transfer rate of 300 MBps.
- ▶ The 3572-S8H includes an Ultrium 8 Half-High tape drive that has a SAS interface with a data transfer rate of 6 Gbps. The SAS Ultrium 8 tape drive includes an SFF-8088 interface. The Ultrium 8 tape drive provides a sustained native data transfer rate of 300 MBps.
- ▶ The 3572-S7H includes an Ultrium 7 Half-High tape drive that has a SAS interface with a data transfer rate of 6 Gbps. The SAS Ultrium 7 tape drive includes an SFF-8088 interface. The Ultrium 7 tape drive provides a sustained native data transfer rate of 300 MBps.
- ▶ The 3572-S6H includes an Ultrium 6 Half-High tape drive that has a SAS interface with a data transfer rate of 6 Gbps. The SAS Ultrium 6 tape drive includes an SFF-8088 interface. The Ultrium 6 tape drive provides a sustained native data transfer rate of 160 MBps.
- ▶ The 3572-S5H includes an Ultrium 5 Half-High tape drive that has a SAS interface with a data transfer rate of 6 Gbps. The SAS Ultrium 5 tape drive includes an SFF-8088 interface. The Ultrium 5 tape drive provides a sustained native data transfer rate of 140 MBps.

**Important:** The IBM TS2900 tape autoloader comes ready to be mounted in a standard 19-inch rack. Feature code 7006 must be ordered, which provides the rack mounting hardware. If you want to install the TS2900 tape autoloader as a desk side model, feature code 7010 must be ordered to provide covers.

Figure 9-1 shows the front view of the TS2900 tape autoloader. The cartridge magazine can be seen in the center. The Operator Control Panel is visible on the right side.



Figure 9-1 IBM TS2900 tape autoloader

The following cartridges are supported in the TS2900 tape autoloader:

- ▶ IBM LTO Tape Cartridge Ultrium 9 (18 TB native physical capacity)
- ▶ IBM LTO Tape Cartridge Ultrium 8 (12 TB native physical capacity)
- ▶ IBM LTO Tape Cartridge Ultrium 7 M8 format (9 TB native physical capacity)
- ▶ IBM LTO Tape Cartridge Ultrium 7 (6 TB native physical capacity)
- ▶ IBM LTO Tape Cartridge Ultrium 6 (2.5 TB native physical capacity)
- ▶ IBM LTO Tape Cartridge Ultrium 5 (1.5 TB native physical capacity)

- ▶ Write Once Read Many (WORM) cartridges

Cartridge support depends on the tape drive that is installed in the TS2900 tape autoloader.

The library media capacity can be increased by using hardware compression (2:1 compression ratio for Ultrium 5 and below tape drives, and 2.5:1 for Ultrium 9, 8, 7, and 6 tape drives).

The TS2900 tape autoloader has a 12 Gbps SFF-8644 SAS connector for LTO9 and 6 Gbps SFF-8088 SAS connector for all of the other models. The tape drive is integrated into the library. There are no tape drive field-replaceable units (FRUs) or customer-replaceable units (CRUs) because the entire library is a CRU. Designed for tape automation, the TS2900 tape autoloader can be attached to many different systems.

For more information and a list of supported operating systems, see the [IBM System Storage Interoperation Center \(SSIC\) website](#).

Depending on which generation of IBM Ultrium tape drive is installed in the TS2900 tape autoloader, the following data cartridges can be used:

- ▶ IBM LTO Ultrium 18 TB data cartridge or 18 TB WORM cartridge when the IBM Ultrium 9 tape drive is installed. The Ultrium 9 tape drive can write up to 18 TB native capacity and up to 45 TB with a 2.5:1 compression ratio. IBM Ultrium 9 tape drives can read and write LTO Ultrium 8 data cartridges, it does not support earlier LTO Ultrium data cartridges.
- ▶ IBM LTO Ultrium 12 TB data cartridge or 12 TB WORM cartridge when the IBM Ultrium 8 tape drive is installed. The Ultrium 8 tape drive can write up to 12 TB native capacity and up to 30 TB with a 2.5:1 compression ratio. IBM Ultrium 8 tape drives can read and write LTO Ultrium 7 data cartridges, it does not support earlier LTO Ultrium data cartridges.
- ▶ IBM LTO Ultrium 9 TB data cartridges are specially formatted LTO Ultrium 7 data cartridges which can be used in the LTO 8 drive. In this case these tapes will be formatted as media format M8 and labeled as M8 media. This allows the LTO8 drive to use Ultrium 7 media with the same performance as Ultrium 8 media and a higher capacity than Ultrium 7. M8 format media will provide native capacity of 9 TB. It has a compressed capacity of 22.5TB with a 2.5:1 compression ratio.

**Note:** LTO7 media with the M8 format can only be used on LTO 8 drives, and cannot be reformatted for read in a LTO7 drive.

The use of M8 media requires the latest version of drive and library FW to be installed.

See “M8 format” on page 68 for more details about M8 format.

- ▶ IBM LTO Ultrium 6 TB data cartridge or 6 TB WORM cartridge when the IBM Ultrium 7 tape drive is installed. The Ultrium 7 tape drive can write up to 6 TB native capacity and up to 15 TB with a 2.5:1 compression ratio. IBM Ultrium 7 tape drives can read and write LTO Ultrium 6 data cartridges, read LTO Ultrium 5 data cartridges, and do not support earlier LTO Ultrium data cartridges.
- ▶ IBM LTO Ultrium 2.5 TB data cartridge or 2.5 TB WORM cartridge when the IBM Ultrium 6 tape drive is installed. The Ultrium 6 tape drive can write up to 2.5 TB native capacity and up to 6.25 TB with a 2.5:1 compression ratio. IBM Ultrium 6 tape drives can read and write LTO Ultrium 5 data cartridges, read LTO Ultrium 4 data cartridges, and do not support earlier LTO Ultrium data cartridges.

- ▶ IBM LTO Ultrium 1.5 TB data cartridge or 1.5 TB WORM cartridge when the IBM Ultrium 5 tape drive is installed. The Ultrium 5 tape drive can write up to 1.5 TB native capacity and up to 3.0 TB with a 2:1 compression ratio. IBM Ultrium 5 tape drives can read and write LTO Ultrium 4 data cartridges, read LTO Ultrium 3 data cartridges, and do not support earlier LTO Ultrium data cartridges.

The library has a capacity of a maximum of nine tape cartridges, which provides a maximum media capacity of up to 108 TB (270 TB with a 2.5:1 compression ratio) of data storage using LTO 8 media.

## 9.2 TS2900 tape autoloader components

The TS2900 tape autoloader has an improved robotic system that moves along an axis from front to back next to the cartridge magazine. This limited movement provides robust robotics. The standard bar code reader is installed on the picker.

TS2900 tape autoloader houses a cartridge magazine, Operator Control Panel, accessor, library controller card, power supply, and a Half-High tape drive.

Figure 9-2 shows the top view of the TS2900 tape autoloader. The right side of the image is the rear of the library and the left side is the front. The TS2900 tape autoloader is not a modular system and does not allow you to change parts.

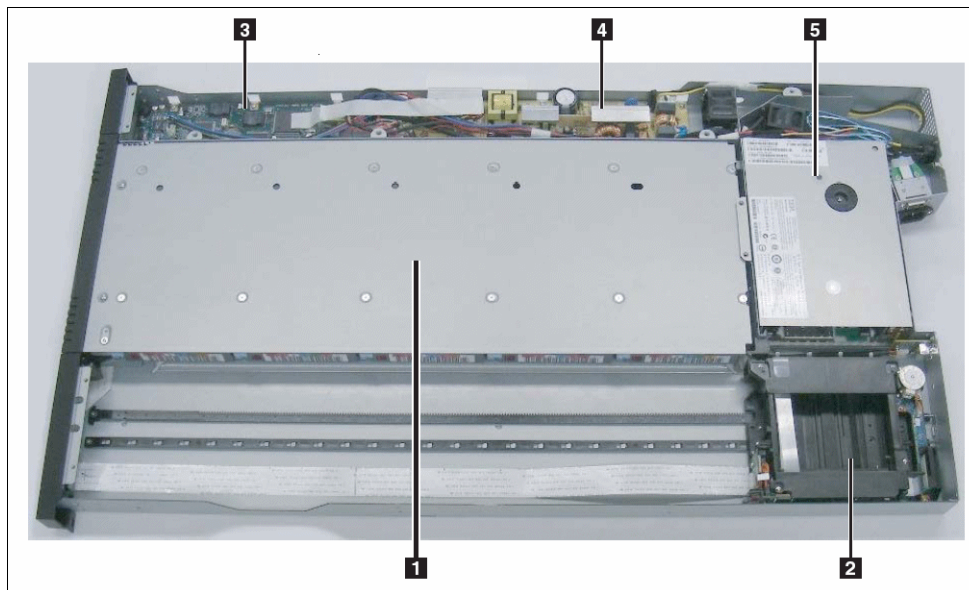

Figure 9-2 Internal top view of the TS2900 tape autoloader

The following components are shown in Figure 9-2:

- 1.** Cartridge magazine: The front slot of the first column (far left) in the cartridge magazine can be configured as an I/O station or cleaning slot. The back slot of the first column of the cartridge magazine is used as the exchange slot. The I/O station is used to import and export cartridges without interrupting normal library operation. Cleaning cartridges are used to clean the tape drive heads.
- 2.** Accessor: This component contains the library robot and the bar code reader. The accessor moves cartridges to and from the cartridge magazine.

3. Library control board: The library control board manages the entire library, including the Operator Control Panel and Accessor, and is responsible for monitoring the library to ensure that the library functions properly. It stores vital product data (VPD), such as library settings, the serial number, library logs, and Accessor calibration backup data.
4. Power supply: The power supply is the sole source of power for the library.
5. Tape drive: This library supports the Ultrium 9,8,7,6, and 5 tape drives. The tape drive in the library is packaged in a container that is called a *drive sled*. The drive sled is not a CRU.

**Important:** There is no need to open the top cover of the TS2900 tape autoloader because there are no client serviceable components inside the library. The whole library is a CRU. IBM provides a replacement of the TS2900 tape autoloader if there is a failure.

Figure 9-3 shows the components from the rear of the TS2900 tape autoloader.

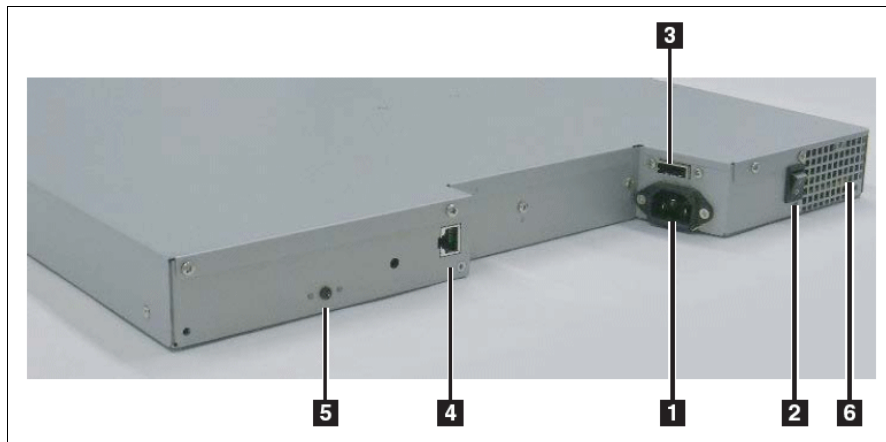

Figure 9-3 Rear panel components of the TS2900 tape autoloader

The following components are shown in Figure 9-3:

1. Power connector: The library uses this power connector to connect to a 110/240 Volt AC power supply.
2. Power switch: The library is powered ON when the power supply switch on the rear panel is ON. The library has no independent power switch on the front panel.
3. SAS port: The serial-attached SCSI host interface cable connection. The Ultrium 9 SAS drive use the SFF-8644 connection at the drive end and the SFF-8088 or SFF-8644 connection at the host adapter end. The Ultrium 8, 7, 6, and 5 SAS drives use the SFF-8088 connection at the drive end and the SFF-8088 or SFF-8470 connection at the host adapter end.
4. Ethernet port: Connects the library to the network by using this port.
5. Shipping lock screw: Used to restrain the accessor robot assembly during transportation. Store the shipping lock screw in the storage slot on the rear panel of the library and cover it with the label for future use.
6. Air vent: These vents allow air to escape from the power supply and tape drive sled.

## 9.2.1 Operator Control Panel

The library is equipped with an Operator Control Panel (OCP) with which you can perform simple actions with the medium changer. By using the OCP interface, you can monitor the medium changer operation, make configuration changes, and perform media access commands.

**Important:** When a user runs a medium access command through the OCP interface, the medium changer reports Not Ready to Ready status on the SCSI bus.

For more information about the medium changer SCSI command, see *IBM System Storage TS2900 SCSI Reference*, GC27-2211.

### The Operator Control Panel interface

The Operator Control Panel (OCP) is on the front of the library and allows users to work locally on the library. The OCP features a monochrome 16-character LCD graphic display. Library operations and service functions are performed from this display. As shown in Figure 9-4.



Figure 9-4 TS2900 front panel

Figure 9-5 shows the top-level menu tree structure of the OCP on the front of the TS2900 tape autoloader. For more information about all of the OCP functions, see the specification in *IBM System Storage TS2900 Tape Autoloader Setup, Operator, and Service Guide*, GC27-2212.

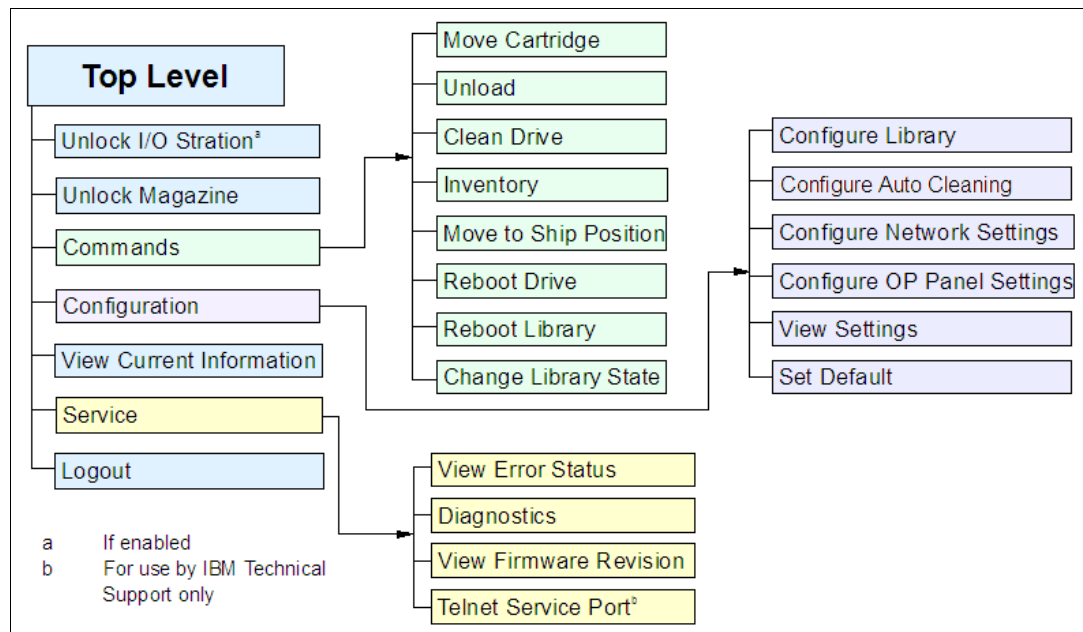

Figure 9-5 Operator control panel menu tree

## 9.2.2 Robotics

The IBM TS2900 tape autoloader uses an independent tape loader, threader motors, and a positive pin retention. These features help improve the reliability of loading and unloading a cartridge and to retain the pin, even if tension is dropped. An independent loader motor, which is coupled with the positive pin retention, threads the tape with a higher level of reliability.

## 9.2.3 Bar code reader

The bar code reader is a part of the library Accessor. It reads each cartridge bar code label and the fiducial labels, which identify the types of cartridge magazines and tape drive that are installed in the library, and provides inventory feedback to the host application, OCP, and web User Interface. The library stores the customized inventory data in memory. Library firmware supports a six-character or eight-character volume serial number (VOLSER) on the bar code label on the tape cartridge.

## 9.2.4 Cartridge storage

The TS2900 tape autoloader has one removable magazine with 10 cartridge slots. The slots are organized as five High Density (HD) slots ( $2 \times 5 = 10$ ), but one of the 10 slots is reserved for library swap space, so the magazine has a total user capacity of nine cartridges. If a dedicated I/O slot is defined, the magazine has a capacity of eight cartridges.

When the magazines are filled with cartridges, the web User Interface (UI) can be used to log in to the TS2900 tape autoloader to look at which cartridges are stored and in which storage slot location, as shown in Figure 9-6.



Figure 9-6 Inventory of the magazine

The left part of the magazine is the I/O station and it can be opened by using the Operator Control Panel.



## 9.3 IBM LTO Ultrium Half-High tape drives

TS2900 tape autoloader houses the LTO-9, 8, 7, 6, or 5 HH tape drive. This section describes several of the highlights of the Half-High Ultrium 9 tape drive. The TS2900 tape autoloader is an ideal tape autoloader for clients who want to have a reliable tape library with LTO technology.

**Important:** For more information about the LTO9, LTO-8, LTO-7, and LTO 6 Half-High tape drives, see:

- ▶ 2.4, “IBM LTO Ultrium 9 tape drives” on page 74
- ▶ 2.5, “IBM LTO Ultrium 8 tape drives” on page 80
- ▶ 2.6, “IBM LTO Ultrium 7 tape drives” on page 85
- ▶ 2.7, “IBM LTO Ultrium 6 tape drives” on page 90.

### 9.3.1 LTO-9 Half-High tape drive

This section describes the characteristics of the LTO-9 Half-High tape drive. For more information, see 2.4.1, “IBM LTO Ultrium 9 tape drive range” on page 78.

#### Platform support

For the latest list of supported platforms and operating systems, see the [IBM System Storage Interoperation Center \(SSIC\) website](#).

#### Performance highlights

The TS2900 tape autoloader incorporates the ninth-generation of IBM Half-High Ultrium tape drive technology. The maximum tape drive throughput data rate is up to 300 MBps of native data. Data tracks are written 32 at a time and there are 8960 data tracks.

**Important:** Although the TS2900 tape autoloader provides the capability for excellent tape performance, other components of the system might limit the actual performance that is achieved. Also, although the compression technology that is used in the tape drive can typically double the amount of data that can be stored on the media, the actual degree of compression that is achieved is highly sensitive to the characteristics of the data that is being compressed.

The drive uses a technique called *dynamic speed matching* to adjust the tape drive native data rate as closely as possible to the net host data rate (after data compressibility is factored out). With speed matching, the drive operates at different speeds when it is reading or writing the Ultrium 9 or Ultrium 8 cartridge format.

For more information about LTO-9 Half-High tape drives, see 2.4, “IBM LTO Ultrium 9 tape drives” on page 74.

## 9.3.2 Encryption

The IBM TS2900 tape library supports data encryption with LTO-9 Half-High SAS tape drives. The following modes of encryption are supported:

- ▶ System Managed (available for AIX, Linux, Solaris, and Microsoft Windows)
- ▶ Library Managed (available for OS/400, i5/OS, AIX, Linux, HP-UX, Solaris, and Windows)
- ▶ Application Managed (IBM Spectrum Protect)

For LTO Ultrium 9, the Transparent LTO encryption feature is required for enabling encryption. The IBM Security Guardium Key Lifecycle Manager is required for enabling System Managed and Library Managed encryption.

For more information about GKLM, see this [IBM Documentation web page](#).

The installation of an Ultrium 9 tape drive with encryption might require code updates for IBM Power Systems supported open systems devices drivers or storage management software.

An update of the open systems device drivers can be obtained from IBM Support's [Fix Central download portal](#).

For more information about Encryption, see 2.2.3, "LTO Ultrium tape encryption" on page 66.

## 9.3.3 IBM Spectrum Archive and LTFS

The TS2900 Models S9H, S8H, S7H, S6H, and S5H support IBM Spectrum Archive Library Edition (LE) software.

IBM Spectrum Archive provides software to manage, monitor, archive, and restore files. Linear Tape File System (LTFS) is the file system that works with the multiple partitioning that is available on LTO Ultrium 9, 8, 7, 6, and 5 tape drives and brings a new level of use and portability to open systems tape storage.

This storage software helps to reduce complexity in data management and access time through the enablement of a self-describing tape that includes a simple file index. IBM Spectrum Archive and LTFS allow files and directories to be shown on the desktop, directory listings, and drag-and-drop of files to and from tape. It also supports data exchange and has a simple, one-time installation.

IBM Spectrum Archive LE allows cartridges in the TS2900 Autoloader to be mounted and viewed as a single file system with the individual tape cartridge viewed as subdirectories within the file system. It is the perfect solution for those in the Media and Entertainment industry and other fields that need massive data storage on tape for long retention periods, such as banking, scientific research, and government sectors.

For more information about IBM Spectrum Archive LE and LTFS, see this [IBM Documentation web page](#).

## 9.3.4 Notifications

The TS3200 has the following options available for sending notifications to the host:

- ▶ Simple Mail Transfer Protocol

Simple Mail Transfer Protocol (SMTP) automatically sends an email that contains event information to the email addresses that are specified whenever an event of a certain level occurs.

- ▶ Simple Network Management Protocol

Simple Network Management Protocol (SNMP) is a set of protocols for managing complex networks. SNMP works by sending messages that are called protocol data units (PDUs) to various parts of a network. Agents, which are SNMP-compliant devices, store data about themselves in Management Information Bases (MIBs) and return this data to the SNMP requesters, such as the host's monitoring application.

## 9.4 Physical attachments

The TS2900 tape autoloader is available with a serial-attached SCSI (SAS) interface that has a data rate of 6 Gbps or 12 Gbps.

### 9.4.1 SAS interface

The SAS Half-High tape drives that are installed into the TS2900 tape autoloader come with either one SFF-8644 interface for model S9H or one SFF-8088 interface for all other models. This interface is on the rear of the TS2900, above the power connection. on the back of the TS2900tape drive as shown in Figure 9-3 on page 236. For more information about SAS, see “Serial-attached SCSI history” on page 56.

Verify that the HBA of your server is supported. Check the IBM interoperability matrix at the [IBM System Storage Interoperation Center \(SSIC\) website](#).

## 9.5 Media

To ensure that the IBM Ultrium tape drive conforms to the IBM specifications for reliability, use only IBM LTO Ultrium tape cartridges. Other LTO-certified data cartridges can be used, but they might not meet the standards of reliability that are established by IBM.

## 9.5.1 Data cartridges

The TS2900 tape autoloader with LTO-9 Half-High tape drives uses the Ultrium 9 data cartridge. It has a native capacity of 18 TB, and compressed capacity of 45 TB with a 2.5:1 compression ratio. It uses a linear, serpentine recording format.

Table 9-1 shows the compatibility matrix among the seven types of Ultrium cartridges.

Table 9-1 Ultrium compatibility among the generations

IBM Ultrium	IBM LTO Ultrium data cartridge					
	18 TB (Ultrium 9)	12 TB (Ultrium 8)	9 TB (Ultrium 7 format M8)	6 TB (Ultrium 7)	2.5 TB (Ultrium 6)	1.5 TB (Ultrium 5)
Ultrium 9	Read/write	Read/write				
Ultrium 8		Read/write	Read/write	Read/write		
Ultrium 7				Read/write	Read/write	Read only
Ultrium 6					Read/write	Read/write
Ultrium 5						Read/write

## 9.5.2 Write Once Read Many cartridges

Certain records retention and data security applications require a WORM method for storing data on tape. To meet this data storage requirement, a WORM feature is available on IBM LTO Ultrium generation 9, 8, 7, 6, and 5 drives. You can enable the WORM feature by upgrading to WORM-capable drive firmware and by using a special WORM tape cartridge.

A specially formatted WORM tape cartridge is required because standard read/write media are incompatible with the WORM feature. Each WORM cartridge has a unique, worldwide cartridge identifier (WWCID), which comprises the unique Cartridge Memory (CM) chip serial number and the unique tape media serial number.

For more information about WORM media, see “WORM tape format” on page 44.

## 9.5.3 Cleaning cartridges

A specially labeled IBM LTO Universal Ultrium Cleaning Cartridge cleans the drive in your library. The drive determines when it needs to be cleaned and notifies the library. When notified, the library indicates that the drive needs cleaning by turning on the Clean Drive LED on the front panel of the library and posting a message on the library display.

The TS2900 tape autoloader supports automatic cleaning and manual cleaning. The library also can be configured for dedicated cleaning cartridge slots, which is achieved by reducing the number of active slots. A reserved slot is not accessible to any host application. In fact, the host has no knowledge that the slot even exists.

A reserved slot that contains a cleaning cartridge is referred to as a *dedicated cleaning slot*. These slots can be used for automatic cleaning or for manual cleaning. To remove a cleaning cartridge, move it to the I/O slot.

IBM Cleaning Cartridges are valid for 50 uses. The cartridge's LTO-CM chip tracks the number of times that the cartridge is used.

For more information about cleaning cartridges, see "Specifications for cleaning cartridges" on page 52.

### 9.5.4 Cartridge Memory chip

All generations of the IBM LTO Ultrium data cartridges include a Linear Tape-Open Cartridge Memory (LTO-CM) chip that contains information about the cartridge and the tape (such as the name of the manufacturer that created the tape), and statistical information about the cartridge's use.

The LTO-CM also helps determine the reliability of the cartridge by storing data about its age, how many times it was loaded, and how many errors it accumulated. Whenever a tape cartridge is unloaded, the tape drive writes any pertinent information to the cartridge memory. The storage capacity of the Ultrium 9 Tape Cartridge Memory Chip is 32640 bytes.

For more information about the LTO-CM, see "Cartridge memory" on page 49.

## 9.6 Specifications

The technical specifications of the TS2900 are described next.

### 9.6.1 Physical specifications

Table 9-2 lists the physical specifications for the TS2900 tape autoloader.

*Table 9-2 Physical specifications for the TS2900 tape autoloader*

Parameter	Measurement
Front panel width (chassis/bezel)	445 mm (17.52 in.)/483 mm (19.02 in.)
Depth	850 mm (33.3 in.)
Height	43.6 mm (1.7 in.)
Weight (library only)	13 kg (28.66 lbs)

### 9.6.2 Power specifications

Table 9-3 lists the power specifications for the tape autoloader.

*Table 9-3 Power specifications for the TS2900 tape autoloader*

Parameter	Measurement
Voltage	100 - 240 Vac.
Frequency	50 - 60 Hz
Power consumption	110 W

## 9.7 Feature codes

Table 9-4 lists the available feature codes for the TS2900 tape autoloader.

Table 9-4 Feature codes for the TS2900 tape autoloader

Feature code	Description
AGKB	3 m Mini-SAS HD/Mini-SAS HD 1x Cable (from HBA with SFF-8644 to tape drive (LTO-9) with SFF-8644).
AGKD	1.5 m Mini-SAS HD/Mini-SAS HD 1x Cable (from HBA with SFF-8644 to tape drive (LTO-9) with SFF-8644).
5402	2.0 m SAS/Mini-SAS 1x Cable (from HBA with SFF-8470 to tape drive (LTO-4 - LTO-8) with SFF-8088).
5502	2.0 m Mini-SAS/Mini-SAS 1x Cable (from HBA with SFF-8088 to tape drive (LTO-4 - LTO-8) with SFF-8088).
5507	4m Mini-SAS HD/Mini-SAS 1X Cable (from HBA with SFF-8644 to tape drive (LTO-4 - LTO-8) with SFF-8088). (from tape drive (LTO-9) with SFF-8644 to HBA with SFF-8088).
5901	Transparent LTO Encryption
7006	3572 Rack Mount Kit with Device to PDU line cord
7010	3572 Deskside Covers
7703	OEM - No IBM Logo
8002	Ultrium Cleaning Cartridge L1 UCC
0983	TAA Compliant
8111	3572 Additional Magazine
8505	Ultrium 5 Data Cartridge (5-Pack)
8605	Ultrium 6 Data Cartridge (5-Pack)
8706	Ultrium 7 Data Cartridge (5-Pack)
8806	Ultrium 8 Data Cartridge (5-Pack)
8905	Ultrium 9 Data Cartridge (5-Pack)
9210	Attached to HP-UX System
9211	Attached to Oracle Solaris System
9212	Attached to Windows System
9215	Attached to Linux System
9400	Attached to i5/OS or IBM OS/400 System
9600	Attached to AIX System
9800-9847	Power cord (different feature code for each country)

For more information, see [this web page](#).



## IBM TS4300 tape library

The latest library from IBM, the IBM TS4300 tape library (Model 3555), is a highly expandable IBM Ultrium library that supports LTO 9, 8, 7, and 6 drives. Starting with one 3U base module (Model L3A), you can add up to six expansion modules (Model E3A) in the same rack, which results in a maximum capacity of 280 LTO cartridges, and up to 5 PB of data storage. The TS4300 base module also can be used as a table top library if no further capacity expansion is required.

The base unit of the TS4300 tape library can accommodate up to three Ultrium half-high tape drives, one Ultrium full-high, or a combination of one Ultrium full-high plus one Ultrium half high tape drive. SAS and Fibre Channel drives can both be installed. It can also hold up to 40 data cartridge slots in two removable magazines, including a standard five-cartridge I/O station. Other standard features include a 240 x 128 Monochrome control panel with a front USB port, a 10/100/1000 Ethernet Port, and a high-speed bar code reader.

On its maximum configuration of one base unit and six expansions, the TS4300 tape library can accommodate up to 21 Ultrium half-high tape drives, seven Ultrium full-high tape drives, or a combination of both based on the drive form factor. The space needed for one full-height drive equals two half-height drives.

This chapter includes the following topics:

### Product description

- ▶ 10.1, “Product description” on page 246
- ▶ 10.2, “Library expansion” on page 248
- ▶ 10.3, “Front panel components” on page 250
- ▶ 10.4, “Rear panel components” on page 253
- ▶ 10.5, “Interior components” on page 257
- ▶ 10.6, “Optional features” on page 258
- ▶ 10.7, “Library management” on page 260
- ▶ 10.8, “Multipath architecture” on page 271
- ▶ 10.9, “Working with logical libraries” on page 272
- ▶ 10.10, “Media” on page 276
- ▶ 10.11, “Supported environments” on page 278
- ▶ 10.12, “Specifications” on page 278
- ▶ 10.13, “Feature codes” on page 280

## 10.1 Product description

The IBM TS4300 tape library is a modular, vertically scalable library design offering with the following features and support:

- ▶ A 3-U rack-mounted L3A base module that provides up to three Half-High IBM Ultrium LTO-9, 8, 7, or 6, or one Full-High and one Half-High Ultrium LTO-9, 8, 7, or 6 tape drives, up to 40 storage slots, and up to five I/O slots.
- ▶ Installation of up to six 3-U E3A expansion modules in each library, each of which provides three Half-High IBM Ultrium LTO-9, 8, 7, or 6, or one Full-High and one Half-High Ultrium LTO-9, 8, 7, or 6 tape drives, up to 40 storage slots, up to five of which you can optionally configure as I/O slots.
- ▶ IBM Ultrium 9 tape drive support for 8 Gbps Fibre Channel or 12 Gbps SAS tape drives, which can be mixed in the physical library.
- ▶ IBM Ultrium 8 tape drive support for 8 Gbps Fibre Channel or 6 Gbps SAS tape drives, which can be mixed in the physical library.
- ▶ IBM Ultrium 7 tape drive support for 8 Gbps Fibre Channel or 6 Gbps SAS tape drives, which can be mixed in the physical library.
- ▶ IBM Ultrium 6 tape drive support for 8 Gbps Fibre Channel or 6 Gbps SAS tape drives, which can be mixed in the physical library.
- ▶ Support for remote management through a web interface. Local management is done through a black and white Operator Control Panel and buttons.
- ▶ Data security and regulatory compliance through support for library-managed encryption (LME) and WORM media on LTO Ultrium 9, 8, 7, and 6 tape drives.
- ▶ IBM patented multi-path architecture with logical library support to share the library between multiple homogeneous or heterogeneous systems or applications.
- ▶ Supports media partitioning and self-describing tape with IBM Spectrum Archive Library Edition (LE) and Enterprise Edition (EE) enabling Linear Tape File System (LTFS) software.
- ▶ Supports the use of Key Management Interoperability Protocol (KMIP) on key management servers, including sKLM for z/OS Encryption (IBM IPP).
- ▶ Support for a wide range of systems including IBM Power Systems (p6 and newer), IBM System p (p5 and earlier), pSeries, System x, xSeries, System i, iSeries, Intel, and Oracle.
- ▶ A bar code reader.
- ▶ Support of Sequential mode logical library configuration.

**Note:** Ultrium 5 and earlier drives are not supported in the TS4300 library.

Optionally, you can install the following features:

- ▶ Path failover for control paths and data paths
- ▶ LTO Lib Managed Encryption
- ▶ Redundant power supplies for each module
- ▶ Rack mounting kit



A fully expanded TS4300 tape library today occupies 21U of rack space and a potential maximum of 280 storage slots with the following storage:

- ▶ 5 PB of storage on Ultrium 9 media at native capacity (12.5 PB at a 2.5:1 compression ratio)
- ▶ 3.3 PB of storage on Ultrium 8 media at native capacity (8.4 PB at a 2.5:1 compression ratio)
- ▶ 1680 TB of storage on Ultrium 7 media at native capacity (4.2 PB at a 2.5:1 compression ratio)
- ▶ 700 TB of storage on Ultrium 6 media at native capacity (1.75 PB at a 2.5:1 compression ratio)

All configurations require one TS4300 tape library Model L3A base module. Expansion is provided through the addition of the TS4300 tape library Model E3A expansion modules.

The TS4300 tape library supports all the following encryption methods:

- ▶ Application-managed encryption is available at no charge
- ▶ Library-managed encryption by using FC 9500

### 10.1.1 TS4300 tape library Model L3A (Machine Type 3555)

The base module (as shown in Figure 10-1) offers the following standard features:

- ▶ A library control module with a remote management interface.
- ▶ 40 storage slots per module.
- ▶ Up to five I/O slots, configurable as storage slots if the library is expanded or if an I/O station is not required.
- ▶ A black and white Operator Control Panel for local management.
- ▶ Cartridge handling robotics and bar code reader.
- ▶ Support for logical libraries.
- ▶ Up to three Ultrium 9, 8, 7, or 6 Half-High tape drives, or one Full-High and one Half-High Ultrium 9, 8, 7, or 6 tape drive.
- ▶ A power supply unit (PSU). A second PSU is optionally available for redundancy.
- ▶ Enablement of path failover for control paths and data paths through a chargeable license.

The TS4300 L3A base module front view is shown in Figure 10-1.



Figure 10-1 Front view of TS4300 L3A base module

## 10.1.2 TS4300 tape library Model E3A (Machine Type 3555)

The expansion module (as shown in Figure 11-2) offers the following features:

- ▶ 40 storage slots per module.
- ▶ Up to five I/O slots, configurable as storage slots if the library is expanded or if an I/O station is not required.
- ▶ Up to three Ultrium 9, 8, 7, or 6 Half-High tape drives, or one Full-High and one Half-High Ultrium 9, 8, 7, or 6 tape drive.
- ▶ A PSU. A second optional PSU is available for redundancy.

The TS4300 E3A expansion module front view is shown in Figure 10-2.



Figure 10-2 Front view of TS4300 E3A expansion module

## 10.2 Library expansion

As described earlier in this chapter, the base library can be easily scaled up with the addition of expansion modules. The TS4300 tape library uses a single robust flow-through design robotic system to access all drives and media. The design does not use complex pass-through ports or elevator systems, which removes the need for expensive duplication of robotics and control electronics with each library expansion. It also results in more reliable library operations.

Expansion modules can be installed above or below the base module. This process takes approximately an hour to complete. When multiple expansion modules are used, they can be installed around the base module, if preferred. However, keep the base module at a convenient access height for access to the control panel. A full TS4300 library consists of three expansion modules on the top, then a base module, and three expansion modules on the bottom. I/O station slots can be configured in both base and expansion modules, depending on your preference.

**Note:** I/O station slots and drives are dedicated to logical libraries and are not shared. It is important to consider this factor when planning logical libraries for the TS4300.

For more information about the preferred library configuration setup, see *IBM TS4300 Tape Library Machine Type 3555 Users Guide*, SC27-4629.

**Tip:** Consider leaving a minimum clearance of 6 inches above the library for service clearance.

Figure 10-3 shows the TS4300 expansion path. The addition of each expansion module provides another 40 storage slots.

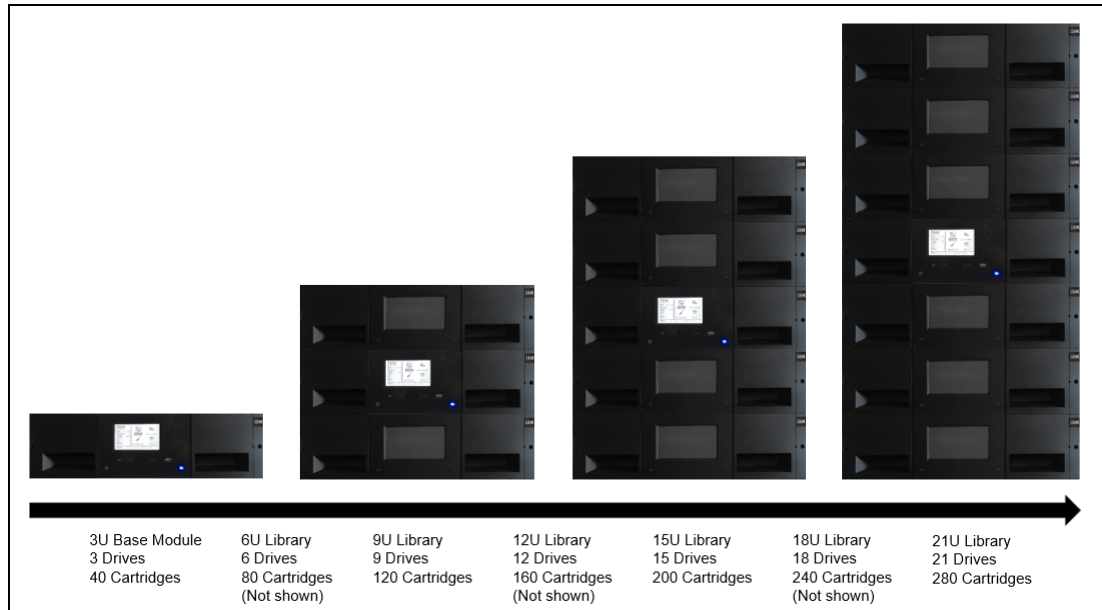

Figure 10-3 TS4300 tape library expansion path

You can configure the I/O slots in each module to operate as I/O slots or storage slots. This method provides a high degree of flexibility. For example, in a library configuration of one L3A base unit and one E3A expansion unit, the following combinations are possible:

- ▶ No I/O slots (slots will become available for storage slots)
- ▶ A total of 5 I/O slots (all in the base module)
- ▶ A total of 10 I/O slots (that use the slots in the base module and the expansion module)

Expansion of the TS4300 tape library is granular and highly configurable. Table 10-1 lists the configuration options that are available as the base module expands. The cartridge accessor mechanism cannot access the bottom row of cartridge slots in the library.

Table 10-1 TS4300 tape library configuration

Library configuration	Number of available I/O station slots	Number of accessible storage slots	Total slots
3U library (base module only)	0, 5	40, 35	40
6U library (base module and expansion)	0, 5, 10	80, 75, 70	80
9U library (base library and two expansions)	0, 5, 10, 15	120, 115, 110, 105	120
12U library (base library and three expansions)	0, 5, 10, 15, 20	160, 155, 150, 145, 140	160
15U library (base library and four expansions)	0, 5, 10, 15, 20, 25	200, 195, 190, 185, 180, 175	200

Library configuration	Number of available I/O station slots	Number of accessible storage slots	Total slots
18U library (base library and five expansions)	0, 5, 10, 15, 20, 25, 30	240, 235, 230, 225, 220, 215, 210	240
21U library (base library and six expansions)	0, 5, 10, 15, 20, 25, 30, 35	280, 275, 270, 265, 260, 255, 250, 245	280

**Note:** It is possible to disable all I/O stations in the TS4300, and use all the I/O slots as storage slots. In this case, a bulk cartridge load of the library is required, and any subsequent imports/exports of cartridges cause the library to be taken offline during the process.

## 10.3 Front panel components

Figure 10-4 shows the front view of a TS4300 tape library with a base module and expansion module on top. The access door (top cover) is on the top of the library to allow access to the interior of the library. The expansion module is shown with its I/O station open, ready for the import of cartridges. The front panel of the base module contains the Operator Control Panel and associated buttons to the right, power button, and magazine buttons.

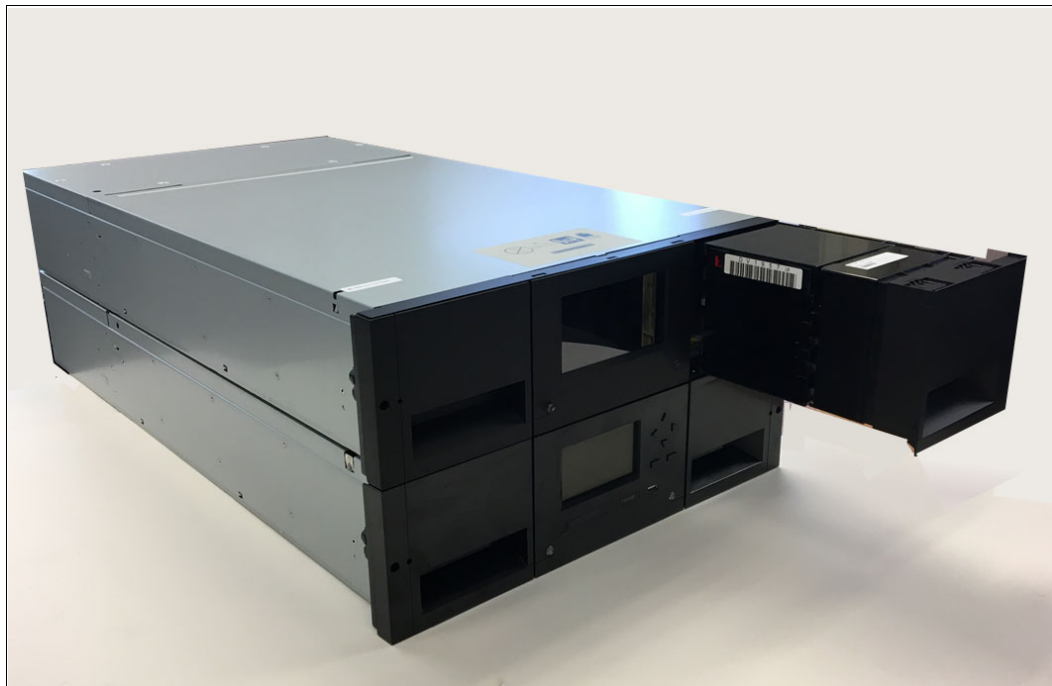

Figure 10-4 Front view of a TS4300 6U library configuration

### 10.3.1 I/O station and magazine

Figure 10-5 shows the right side I/O station and magazine door.

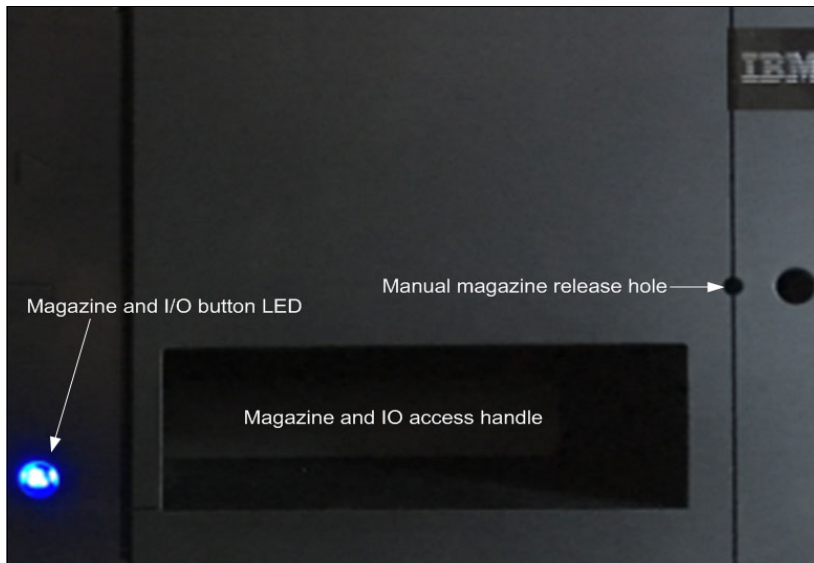

Figure 10-5 I/O door and Magazine

I/O stations are on the right side of the front panel of the library to enable the inserting and removing of cartridges without interrupting normal library operations. An expansion module's I/O station has a capacity of up to five cartridges.

Individual I/O station elements cannot be shared between logical libraries. Importing or exporting cartridges in a logical library without an assigned I/O station requires magazine access, which takes the whole library offline.

When an operator places cartridges in the I/O station and closes it, the library scans the slots to update the library inventory. Cartridges should then be moved to storage slot locations by using the Web User Interface (Web UI) or your backup application. Using the Web UI, cartridges can be moved from one logical library's I/O station slot to a storage slot in another logical library. However, a warning alert box is shown and the action must be confirmed.

To unlock the I/O station, click **Library** → **Modules and Magazines** → **Actions** → **Unlock I/O Station** from the management interface. The station can then be opened by pulling on the magazine access handle. The magazine I/O button LED will indicate status of the I/O and magazine, as shown in Table 10-2.

Table 10-2 Magazine state

Magazine state	LED state	Description
Closed	Steady ON	I/O station is enabled
Closed	Slow Flash	Magazine open is in process
Closed	Fast Flash	Magazine is opened
Closed	OFF	I/O station is not enabled
Opened	OFF	Magazine is opened

**Note:** Using the management interface to open the I/O station times out after 30 seconds. To manually open the I/O station after timeout, press the magazine button for less than 3 seconds and then open using the handle. To open the entire magazine, press the magazine button for more than 3 seconds.

Careful planning for logical libraries, including I/O station elements and cartridge drives, should be performed before configuration of the library occurs. Consideration should be given to media import and export operations during this planning phase.

### 10.3.2 Access door

Each TS4300 base module and expansion module has a top cover that allows access to the internal components of the library. This top cover is released by using two screwdrivers to depress small button clips near the front of the cover.

When the top cover is removed, all in-progress motion commands stop and the library is taken offline. When the top cover is replaced, the library returns any media in the accessor to its original storage slot.

**Attention:** Do not override the top cover switch because this action might result in accessor mechanism damage.

### 10.3.3 Operator control panel

The Operator Control Panel (OCP) consists of a black and white display and buttons on the front of the base module. Library operations, configuration, and service functions are performed from this display and its associated buttons.

The OCP has a power button, an LCD display, six navigation buttons, and five LEDs. With the OCP, you can monitor, configure, and operate most library functions from the library front panel. To use the OCP, use the six navigation buttons (up/down, left/right, Enter, Back).

The Web UI offers part of the same functionality as the operator window from a web browser, which enables remote access to the library.

### 10.3.4 Power button

Pressing the power button on the front panel of a control module turns the library on or off. However, with the power button in the off position, power is still applied to the power supplies. The power button is used during library shutdown and to manually restart the library.

### 10.3.5 Front panel LEDs

Figure 10-6 on page 253 shows the row of LEDs on the front of the library to the right of the power button:

- ▶ Green: Ready LED. Steady when power is on, flashing with tape Ready drive or library robotic activity.
- ▶ Blue: Unit ID LED. The unit identification (UID) LEDs are controlled by the user through the OCP Maintenance → UID LED control panel.

The UIDs on the OCP and base module back panel are activated and deactivated together. In addition, UIDs on drives and expansion module back panels can be activated separately. The UIDs are helpful for locating components of the library in a Data Center.

- ▶ Amber: Clean LED. On when a tape drive clean operation is recommended.
- ▶ Amber: Attention LED. Flashing if the library has detected a condition for which user attention is necessary, but the library can still complete most operations.
- ▶ Amber: Error LED. On, if an unrecoverable tape drive or library error occurs. A corresponding error message is displayed on the LCD panel. User intervention is required because the library is not capable of completing some operations.



Figure 10-6 Front panel LEDs

## 10.4 Rear panel components

Figure 10-7 shows the rear view of a 6U (one base module and one expansion module) TS4300 library and its major components. On the right side of the library, you can see the expansion cable which connects the base module library controller to the expansion module. Subsequent expansion modules are also “daisy-chained” together in this way.



Figure 10-7 Rear panel view of 6U library



## 10.4.1 Library Controller

The Library Controller manages the entire library, including the operator panel and accessor. It is responsible for running system tests to ensure that the library functions properly. The Library Controller stores vital product data (VPD), such as library settings and the library serial number.

The Library Controller indicates status with three vertically positioned LEDs. The color of the LED identifies the area of the component that is reported. They are, from top to bottom, as follows:

- ▶ Green: Ready LED. Library in Ready Status and operating properly
- ▶ Amber: Error LED. Library in Error Status and the controller has a hardware issue
- ▶ Blue: Unit ID LED. The UID LEDs are controlled by the user through the maintenance panel. The UIDs are helpful for locating components of the library in a Data Center

## 10.4.2 Tape drives

The TS4300 library supports Half-High SAS and Fibre Channel, and Full-High SAS and Fibre Channel for Ultrium 9 drives; and Half-High SAS and Fibre Channel, and Full-High Fibre Channel for Ultrium 8, 7, and 6 drives. Ultrium 5 and earlier drives are not supported in the TS4300.

Tape drives are hot-addable; that is, the library power remains on and operations of the tape drives are still active. Drives can be removed and installed without tools. The drive sleds are customer-replaceable units (CRU).

Drives are mounted in sleds that are installed into tape drive slots in the rear of the library. If a tape drive slot is empty, a metal plate covers the empty drive slots to prevent any debris from entering the library.

**Important:** If you install Full-High drives in the TS4300, they must be in the lowest drive position of each 3U module. In this case, another Half-High drive can be installed above it, if needed.

### TS4300 tape library Ultrium 9 models

The following models are available for the TS3200 tape library:

- ▶ The 3555-L3A feature AGLA specifies an IBM Ultrium 9 Half-High Fibre Channel tape drive. The Ultrium 9 HH Fibre Channel drive has a single 8 Gbps Fibre Channel interface. The Ultrium 9 HH Fibre Channel drive has a native data rate of 300 MBps.
- ▶ The 3555-L3A feature AGLB specifies an IBM Ultrium 9 Half-High SAS tape drive. The Ultrium 9 HH SAS drive has a dual port 12 Gbps Mini-SAS HD (SFF-8644) interface. The Ultrium 9 HH SAS drive provides a native data rate of 300 MBps.
- ▶ The 3555-L3A feature AGLC specifies an IBM Ultrium 9 Full-High Fibre Channel tape drive. The Ultrium 9 FH Fibre Channel drive has dual 8 Gbps Fibre Channel interface. The Ultrium 9 FH Fibre Channel drive has a native data rate of 400 MBps.
- ▶ The 3555-L3A feature AGLD specifies an IBM Ultrium 9 Full-High SAS tape drive. The Ultrium 9 FH SAS drive has a dual port 12 Gbps Mini-SAS HD (SFF-8644) interface. The Ultrium 9 FH SAS drive provides a native data rate of 400 MBps.



### **TS4300 tape library Ultrium 8 models**

The following models are available for the TS3200 tape library:

- ▶ The 3555-L3A feature AGKP specifies an IBM Ultrium 8 Full-High Fibre Channel tape drive. The Ultrium 8 Fibre Channel drive has a dual-port 8 Gbps Fibre Channel interface that can be connected to Fibre Channel host adapters. The Ultrium 8 tape drive has a native data transfer rate of 360 MBps.
- ▶ The 3555-L3A feature AGKN specifies an IBM Ultrium 8 Half-High tape drive that has an SAS interface and a native data transfer rate of up to 6 Gbps. The SAS Ultrium 8 tape drive comes with dual-port Mini-SAS (SFF-8088) interfaces. The Ultrium 8 tape drive provides a sustained native data transfer rate of 300 MBps.
- ▶ The 3555-L3A feature AGKM specifies an IBM Ultrium 8 Half-High Fibre Channel tape drive. The Ultrium 8 Fibre Channel drive has a single port 8 Gbps Fibre Channel interface that can be connected to Fibre Channel host adapters. The Ultrium 8 tape drive has a native data transfer rate of 300 MBps.

### **TS4300 tape library Ultrium 7 models**

The following models are available for the TS3200 tape library:

- ▶ The 3555-L3A feature AGKL specifies an IBM Ultrium 7 Full-High Fibre Channel tape drive. The Ultrium 7 Fibre Channel drive has a dual-port 8 Gbps Fibre Channel interface that can be connected to Fibre Channel host adapters. The Ultrium 7 tape drive has a native data transfer rate of 300 MBps.
- ▶ The 3555-L3A feature AGKK specifies an IBM Ultrium 7 Half-High tape drive that has an SAS interface and a native data transfer rate of up to 6 Gbps. The SAS Ultrium 7 tape drive comes with dual-port Mini-SAS (SFF-8088) interfaces. The Ultrium 7 tape drive provides a sustained native data transfer rate of 300 MBps.
- ▶ The 3555-L3A feature AGKJ specifies an IBM Ultrium 7 Half-High Fibre Channel tape drive. The Ultrium 7 Fibre Channel drive has a single port 8 Gbps Fibre Channel interface that can be connected to Fibre Channel host adapters. The Ultrium 7 tape drive has a native data transfer rate of 300 MBps.

### **TS4300 tape library Ultrium 6 models**

The following models are available for the TS3200 tape library:

- ▶ The 3555-L3A feature AGKH specifies an IBM Ultrium 6 Full-High Fibre Channel tape drive. The Ultrium 6 Fibre Channel drive has a dual-port 8 Gbps Fibre Channel interface that can be connected to Fibre Channel host adapters. The Ultrium 6 tape drive has a native data transfer rate of 160 MBps.
- ▶ The 3555-L3A feature AGKG specifies an IBM Ultrium 7 Half-High tape drive that has an SAS interface and a native data transfer rate of up to 6 Gbps. The SAS Ultrium 6 tape drive comes with dual-port Mini-SAS (SFF-8088) interfaces. The Ultrium 6 tape drive provides a sustained native data transfer rate of 160 MBps.
- ▶ The 3573-L4U feature AGKF specifies an IBM Ultrium 6 Half-High Fibre Channel tape drive. The Ultrium 6 Fibre Channel drive has a single port 8 Gbps Fibre Channel interface that can be connected to Fibre Channel host adapters. The Ultrium 6 tape drive has a native data transfer rate of 160 MBps.

Figure 10-8 shows the back of an LTO-8 Full-High FC tape drive, LTO-8 HH FC tape drive, and LTO-8 HH SAS drive.

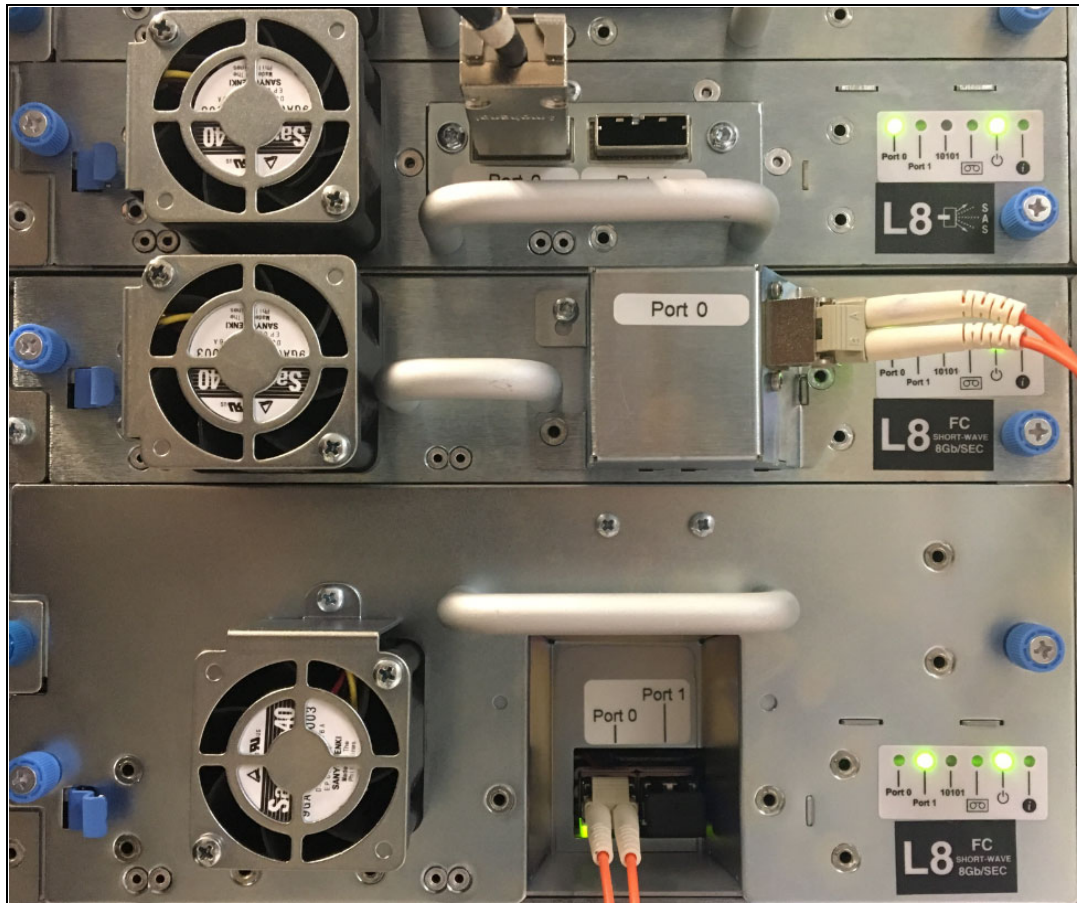

Figure 10-8 Back side of the LTO-8 Full-High FC tape drive

**Tip:** When connecting, Fibre Channel tape drives are connected to a Fibre Channel host bus adapter (HBA) on the host server. Ensure that the Fibre Channel Tape Support option is enabled on the Fibre Channel HBA so that proper class 3 error recovery is performed on the Fibre Channel. For more information about how to set this option, see the HBA manufacturer instructions.

### 10.4.3 Power supply

The library supports single and redundant power configurations. Each TS4300 base or expansion module has an upper and lower power supply. A single power configuration has a power supply that is installed in the upper slot of each library module. A redundant power configuration has power supplies that are installed in both upper and lower slots of each library module.

When two power supplies are used in a single module, the power load is spread evenly over both power supplies. If one of the power supplies fails, the power load is drawn entirely from the functioning power supply.

The single configuration has a single AC line input and a single DC power supply. The optional redundant configuration has dual AC line input and dual DC power supplies. A power supply can be hot-swapped if the library has a redundant power supply, and a redundant power supply can be hot added.

**Note:** There are no power switches on the power supplies on the back of the modules. The library should be powered down by using the power button on the base module and following the prompts. Except in emergency situations, use the shutdown procedure before removing power to the modules.

The power system of the library contains the following components:

- ▶ Power Supply Unit
- ▶ An AC power cord

The power supply has two LEDs that provide status information. The LEDs, which are to the right of the power cord, are green and white and indicate the following conditions:

- ▶ White Upper LED: AC power is connected
- ▶ Green Lower LED: Module powered ON

## 10.5 Interior components

Storage columns and the robotic system are in the body of the library.

### 10.5.1 Storage columns

Storage columns within the library store the tape cartridges while they are not loaded in a drive.

Figure 10-9 shows an example of the TS4300 tape library storage columns in the base model. The library contains four storage columns and the I/O Station, when configured, is in the upper right corner of the photo. Drives are visible in the center left side of Figure 10-9.



Figure 10-9 TS4300 tape library storage columns

## 10.5.2 Robotic system

The TS4300 robotic system includes the Y-axis assembly that houses the Y motor, which is attached to the carrier, and the bar code scanner. The climber moves the robotic system within the library. The accessor (robotic arm) has finger-like mechanisms that it uses to grab tape cartridges and move them to and from the I/O station, storage slots, and drives.

The bar code scanner reads each cartridge bar code label and the fiducial labels that identify the types of cartridge magazines and tape drives that are installed in the library.

Figure 10-10 shows the robot accessor in the center of the photo, and the robotic lock lever for transportation at the right side. Also visible above and below the accessor are the magazines that contain storage slots, and on the upper right side are the I/O slots if configured.



Figure 10-10 TS4300 robotic accessor

## 10.6 Optional features

The TS4300 tape library is highly configurable and enhanced functionality is available through the provision of optional features.

### 10.6.1 IBM Ultrium tape drives

The TS4300 tape library allows the following tape drive options:

- ▶ Ultrium LTO-9 12 Gbps SAS Half and Full High drives
- ▶ Ultrium LTO-8 6 Gbps SAS Half-High drive
- ▶ Ultrium LTO-7 6 Gbps SAS Half-High drive
- ▶ Ultrium LTO-6 6 Gbps SAS Half-High drive
- ▶ Ultrium LTO-9 8 Gbps Fibre Channel Half and Full High drives
- ▶ Ultrium LTO-8 8 Gbps Fibre Channel Half and Full High drives
- ▶ Ultrium LTO-7 8 Gbps Fibre Channel Half and Full High drives
- ▶ Ultrium LTO-6 8 Gbps Fibre Channel Half and Full High drives

Ultrium LTO-5 technology and earlier drives are not supported in the TS4300 library.

For more information, see Chapter 2, “Overview of IBM Linear Tape-Open Ultrium tape drives” on page 37.

The IBM Ultrium tape drive contains the electronics and logic for reading and writing data, controlling the tape drive, managing the data buffer, and handling error recovery procedures. It is a CRU and can easily be replaced if necessary.

Table 10-3 shows a comparison of some features and characteristics of the Ultrium LTO 9, 8, 7, and 6 tape drives.

Table 10-3 Characteristics and features

Characteristics and features	Ultrium 9 tape drive	Ultrium 8 tape drive	Ultrium 7 tape drive	Ultrium 6 tape drive
Native data rate	400 MBps (FH FC) 400 MBps (FH SAS) 300 MBps (HH FC) 300 MBps (HH SAS) (with Ultrium 9 media)	360 MBps (FH FC) 300 MBps (HH FC) 300 MBps (SAS) (with Ultrium 8 media)	300 MBps (FH FC) 300 MBps (HH FC) 300 MBps (SAS) (with Ultrium 7 media)	160 MBps (FH FC) 160 MBps (HH FC) 160 MBps (SAS) (with Ultrium 6 media)
Cartridge compatibility Ultrium and Ultrium WORM	LTO-9 read/write LTO-8 read/write	LTO-8 read/write LTO-7 read/write M8 format media LTO-7 read/write	LTO-7 read/write LTO-6 read/write LTO-5 read only	LTO-6 read/write LTO-5 read/write LTO-4 read only
Cartridge capacity native/compressed	18 TB/45 TB using LTO-9 media	12 TB/30 TB using LTO-8 media 9 TB/22.5 TB using M8 format media	6 TB/15 TB using LTO-7 media	2.5 TB/6.25 TB using LTO-6 media
Speed matching support	Yes	Yes	Yes	Yes
Channel calibration	Yes	Yes	Yes	Yes
Giant magneto-resistive head	No	No	Yes	Yes
Tunneling Magnetoresistive (TMR) head technology	Yes	Yes	No	No

## 10.6.2 Redundant power supply

The service representative can hot swap the optional redundant configuration power supplies (FC1900) without interrupting library operation. Each supply in a control module and expansion module includes its own input AC power cord. During redundant operation, each supply carries half the power load. If a power cord or power supply fails, the second supply provides the complete power load. Optionally, you can install a single power supply and power cord if redundant power is not required.

The second power supply slot is physically covered in this configuration. The library can be upgraded to redundant power later. If the configuration consists of the base model and expansion units, if a second power supply is added to one model, it should also be added to the other model.

### 10.6.3 Rack mounting kit

This feature (FC7002) provides the necessary rack mount hardware to mount the TS4300 Tape Library in a standard 19-inch equipment rack. Three EIA units are required. The feature (FC9848) Rack to PDU Line Cord must be ordered with the rack mount kit.

### 10.6.4 Feature code previews

For more information about available feature codes, see this [IBM Documentation web page](#).

#### **LTO Lib Managed Encryption (FC5900)**

TS4300 tape libraries support data encryption on the base drive with LTO-9, 8, 7, 6, 5, and 4 media meeting LTO Generation 9, 8 and 7 media specifications and AME. LME is supported by the LTO LME feature number 5900. IBM Security Key Lifecycle Manager (SKLM) V1 or later is required with this feature. IBM Security Key Lifecycle Manager is now IBM Security Guardium Key Lifecycle Manager ([GKLM](#)).

#### **Path failover (FC1682)**

The path failover feature ensures the use of a redundant communication path when the primary path fails. Two types of path failover capabilities exist: Control Path Failover (CPF) and Data Path Failover (DPF).

##### ***Control Path Failover***

A *control path* is a logical path into the library through which a server sends standard SCSI medium changer commands to control the logical library. Other control paths reduce the possibility that failure in one control path causes the entire library to be unavailable. Use of the Control Path Failover feature further reduces that possibility.

Control path failover is configured on the host device driver. The device driver is controlling failover for the host. For more information and about how to configure this function, see *IBM Tape Device Drivers Installation and User's Guide*, GC27-2130.

##### ***Data Path Failover***

Data Path Failover provides a failover mechanism in the IBM device driver with which you can configure multiple redundant paths in a SAN environment. If a path or component failure occurs, the failover mechanism automatically provides error recovery to try the current operation again by using an alternative, preconfigured path without stopping the current job in progress. This feature provides flexibility in SAN configuration, availability, and management.

Data path failover is configured on the host device driver. The device driver is controlling failover for the host. For more information and about how to configure this function, see *IBM Tape Device Drivers Installation and User's Guide*, GC27-2130.

## 10.7 Library management

The library includes the following interfaces for management:

- ▶ Operator Control Panel (OCP) for local management
- ▶ Web UI for remote management through the network

The operator panel is on the front of the base library module. With the Operator Control Panel, operators can work locally on the library by using the touch panel. With the web UI, you can view and perform several library functions from remote sites.



## 10.7.1 Operator Control Panel

The Operator Control Panel is on the front panel of the base module with its associated buttons to the right side. To access the menus, you must first log in by using the panel and buttons. The first display that is shown is the main panel, as shown in Figure 10-11 on page 261.

The main panel provides four menu options:

- ▶ Operation menu: Consists of commands Move Cartridge from Drive to Home Slot and Move Cartridge
- ▶ Configuration menu: Consists of configuration commands that you can use to initially configure the library, set date and time, set network configuration, work with user accounts and reset the library
- ▶ Maintenance menu: Provides submenus for Library Tests, Viewing Problem Tickets, Drive and Library Firmware Upgrades, and LCD adjustments.
- ▶ Status Menu: Provides submenus for viewing status of Network Settings, Library, and Drives
- ▶ Logout: Provides a logout option from the operator panel

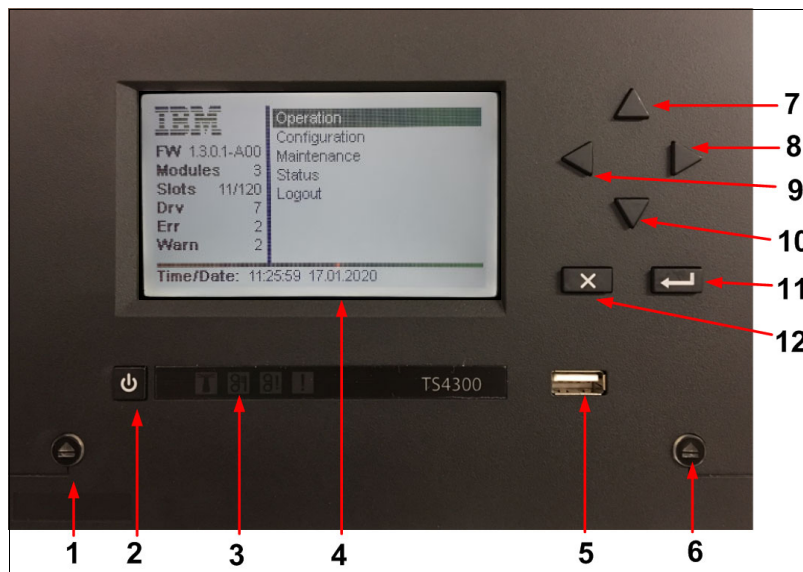

Figure 10-11 Main panel on the Operator Control Panel

These functions are described in Table 10-4.

Table 10-4 Operator control panel index

Index	Description
1	Left magazine button, used to unlock left magazine.
2	Power button, used to power off and on the library.
3	Front panel LEDs (see 10.3.5, “Front panel LEDs” on page 252).
4	Operator Panel display, this is not a touchscreen. Use buttons to control menu.
5	USB port Base Module only.

Index	Description
6	Right magazine button, used to open I/O and right storage magazine. To open the I/O station, press the magazine button for less than 3 seconds. To open the entire magazine, press the magazine button for more than 3 seconds.
7	Navigation Up button, to move option on panel up.
8	Navigation Right button, to move option on panel right.
9	Navigation Left button, to move option on panel left.
10	Navigation Sown button, to move option on panel down.
11	Enter button, used to select option on panel.
12	Back/Return button.

**Note:** The panel is used for basic initial setup and limited operational functions. Use the Web user interface to perform complex functions, such as media moves.

## 10.7.2 Web user interface

The Web UI is accessible from a web browser. The log in window is shown in Figure 10-12. To manage the library by using the Web UI, you must set up the initial network configuration of the library from the Operator Control Panel.

To log in, you need the following initial login information:

- ▶ User: administrator
- ▶ Password: adm001



Figure 10-12 TS4300 Web UI log in window



## Web UI dashboard window

When you log on to the TS4300 Web UI, you are first taken to the Dashboard window, as shown in Figure 10-13.

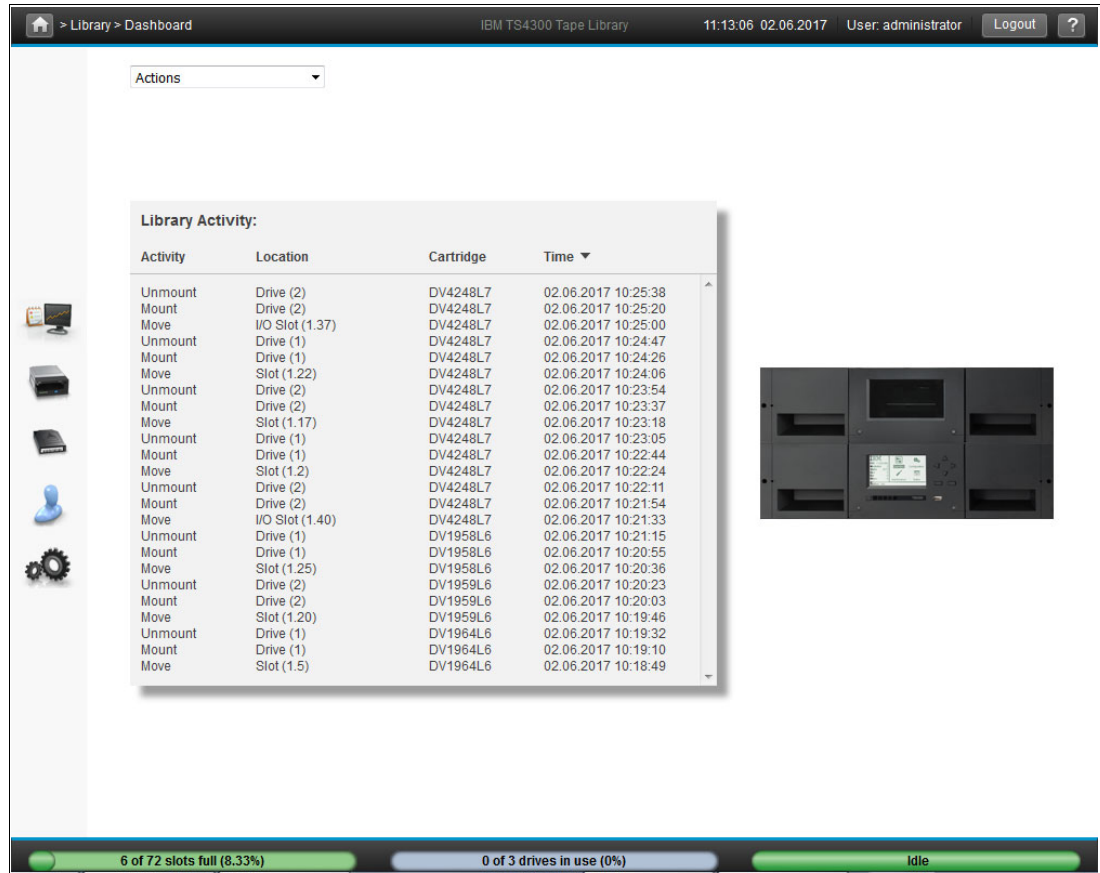

Figure 10-13 Web UI dashboard window

Recent library activity is shown in the center of the window, and on the right side is a graphical representation of the configuration of your TS4300 library.

Down the left side, the following Web UI icons are shown:

- ▶ Dashboard: The following options are available under this icon:
  - Dashboard: Shows the dashboard window.
  - Modules and Magazines: Shows the configuration and status of the library modules and the magazines and allows them to be managed.
  - Logical Libraries: Shows the configuration and status of the logical libraries and allows them to be managed.
  - Events: Shows active events such as errors, and allows them to be managed.
- ▶ Drives and Ports: Shows drive and port status and configuration, and allows them to be managed.
- ▶ Cartridges and Slots: Shows the cartridges in the storage and I/O station slots and allows them to be managed.
- ▶ Users: Allows users of the library to be managed.

- ▶ Settings: The following options are available under this icon:
  - Library: Allows features such as date / time and licensed features to be set up.
  - Network: Allows configuration of the Ethernet ports and DHCP settings.
  - Notifications: Allows configuration of the SMTP and SNMP settings.
  - Security: Allows configuration of encryption and LDAP remote authentication.

These icons are shown on each window of the Web UI to allow you to quickly navigate and administer the functions of the library and drives.

Figure 10-14 shows the Web UI Modules and Magazines window.

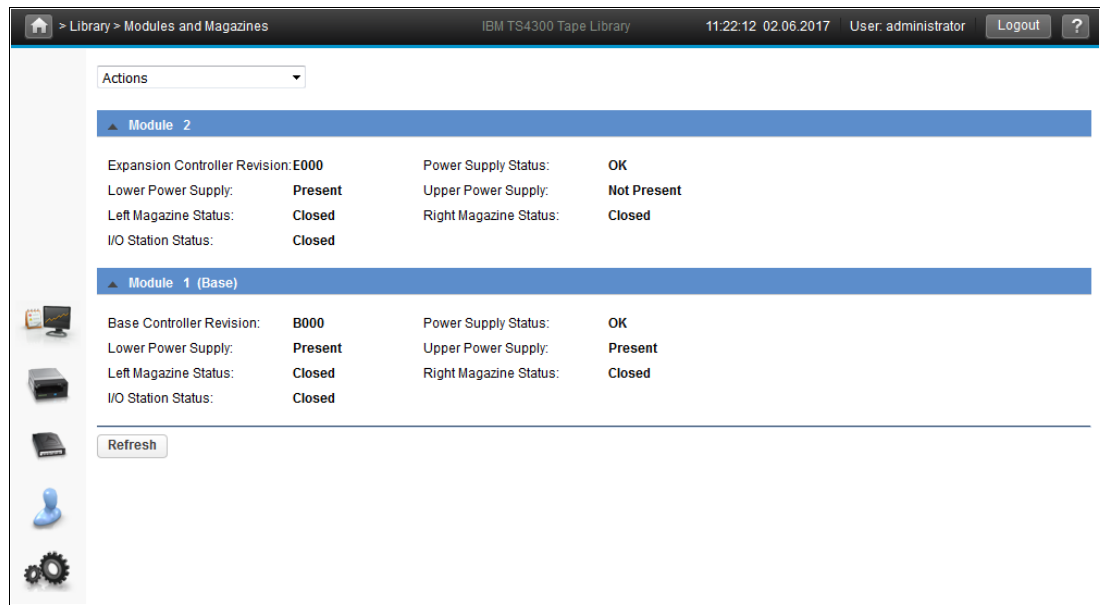

Figure 10-14 Web UI Modules and Magazines window

The Web UI Logical Libraries window is shown in Figure 10-15.

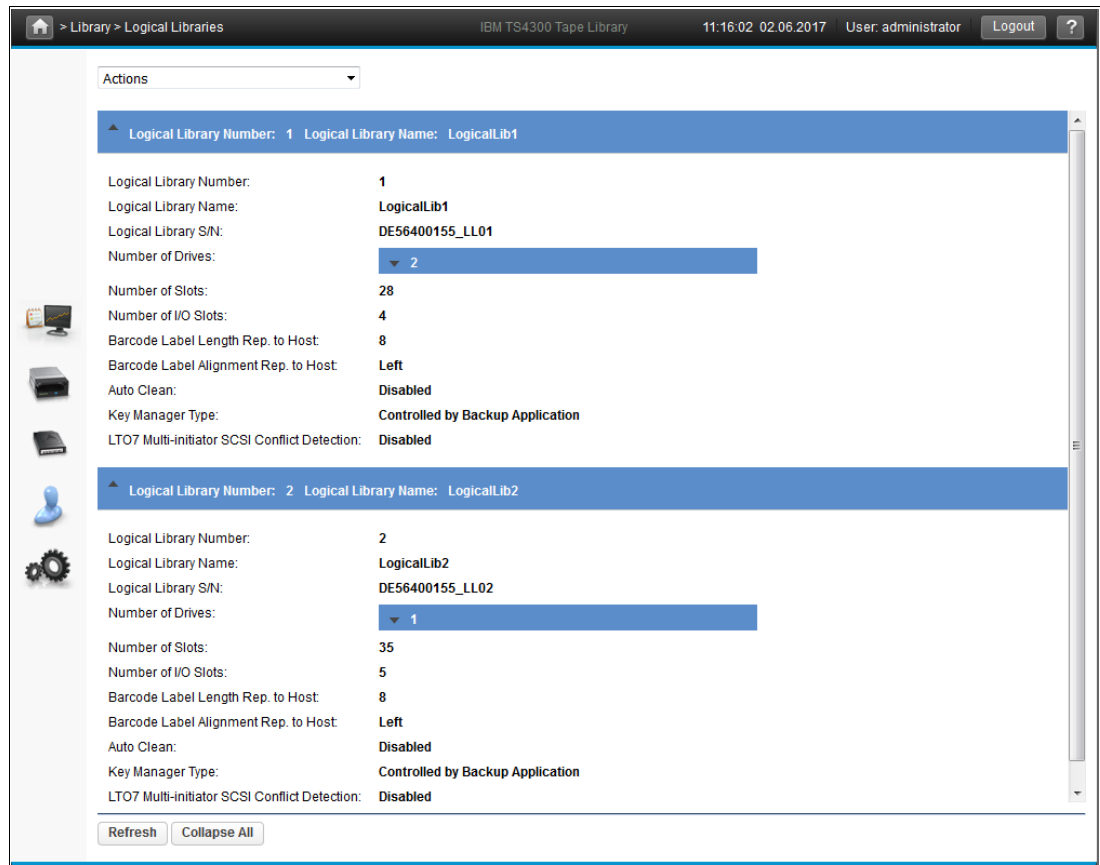

Figure 10-15 Web UI Logical Libraries window

The Web UI Events window is shown in Figure 10-16.

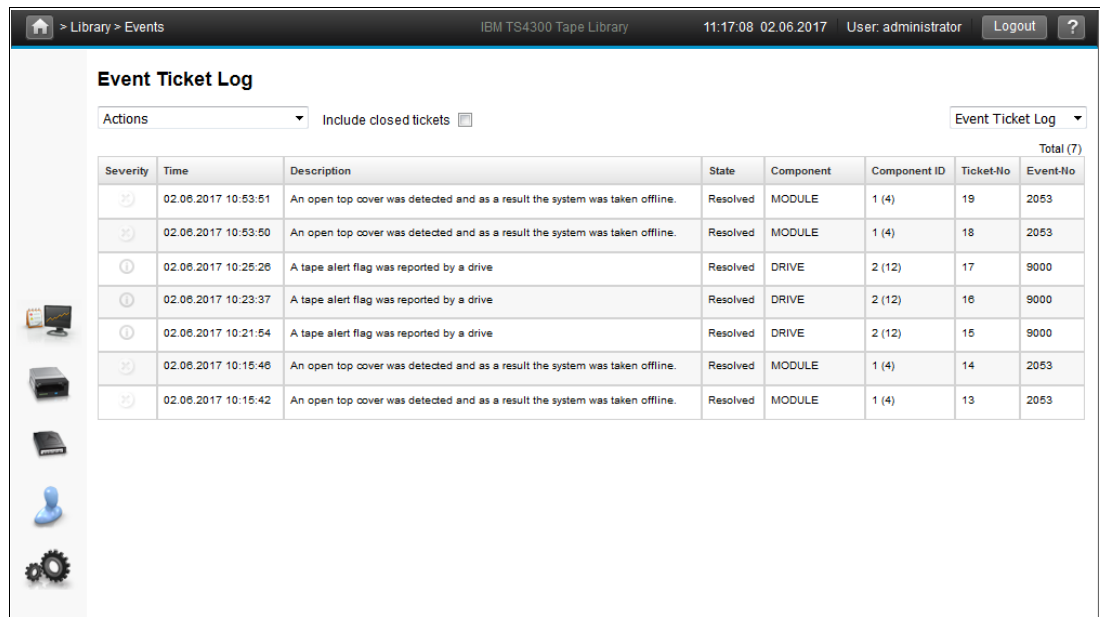

Figure 10-16 Web UI Events window

The Web UI Drives and Ports window is shown in Figure 10-17. This window shows the installed drives, and their serial numbers, interface information, and status.

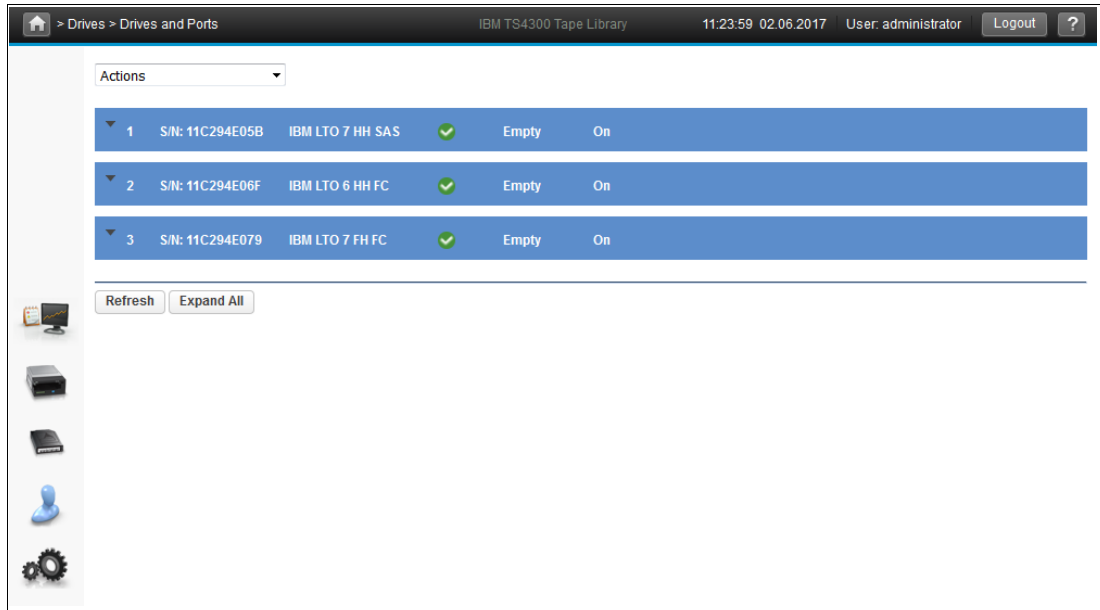

Figure 10-17 Web UI Drives and Ports window

The Web UI Cartridges and Slots window is shown in Figure 10-18. This window shows the cartridges inside the library, and their slot locations, Ultrium LTO generation, and which logical library they belong to.

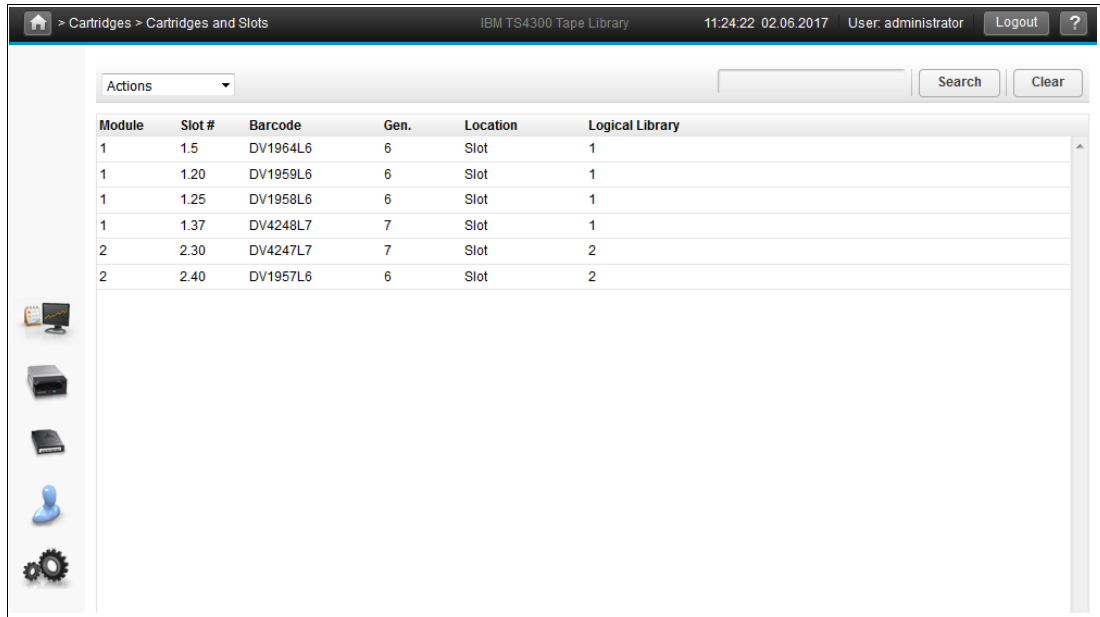

Figure 10-18 Web UI Cartridges and Slots window

Figure 10-19 shows the Web UI Users window, where you can add, delete, and modify User privileges.

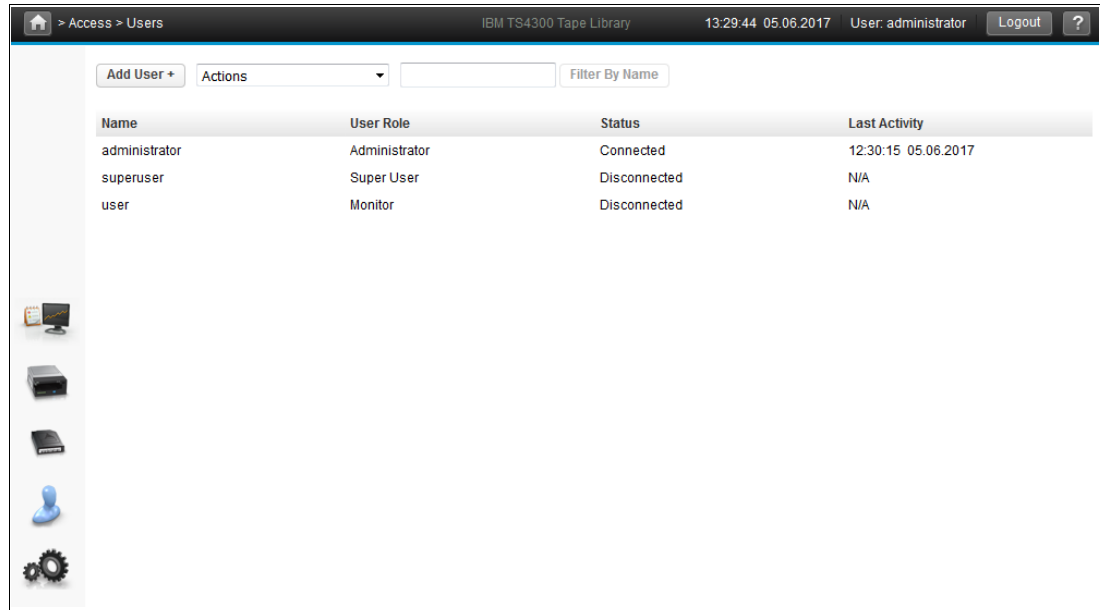

Figure 10-19 Web UI Users window

## User privileges

User privilege levels are manually assigned to user accounts that are created within the library. Controlling access to windows and operations within the library preserves the integrity of the library and the data that is stored in the library.

The following types of user roles are available in the library:

- ▶ **Administrator:** Users are allowed access to the entire physical library and all of its logical libraries.
- ▶ **Superuser:** Users have same access rights as the Administrator role, except the ability to access the User and most of the Security pages.
- ▶ **Monitor:** Users can access library status information, but they cannot access configuration, maintenance, or operation features.
- ▶ **Service:** This role provides access to the service functions on the Management GUI.

## Lightweight Directory Access Protocol support

Local authentication control is managed on the library. An administrator sets up accounts and privileges on the library. To use local authentication, a user must enter a local user name and password.

Remote authentication is managed by a Lightweight Directory Access Protocol (LDAP) server. Enabling LDAP allows existing user accounts that are on an LDAP server to be integrated into the library's current user account management subsystem. User account information is centralized and shared by different applications, which simplifies user account management tasks.

Administrative users can configure and enable LDAP. After LDAP is enabled, users can access the library with LDAP or local authentication. To use LDAP authentication, a user must enter a directory service user name and password and specify an LDAP domain. To use local authentication, a user must enter only a local user name and password.

Administrative users can add, delete, and modify only local user account information. The library web client and operator panel do not allow you to create, modify, or delete user account information about an LDAP server. This procedure must be done by the directory service provider. For more information about LDAP user accounts, see your server documentation.

Figure 10-20 shows the TS4300 LDAP configuration window.

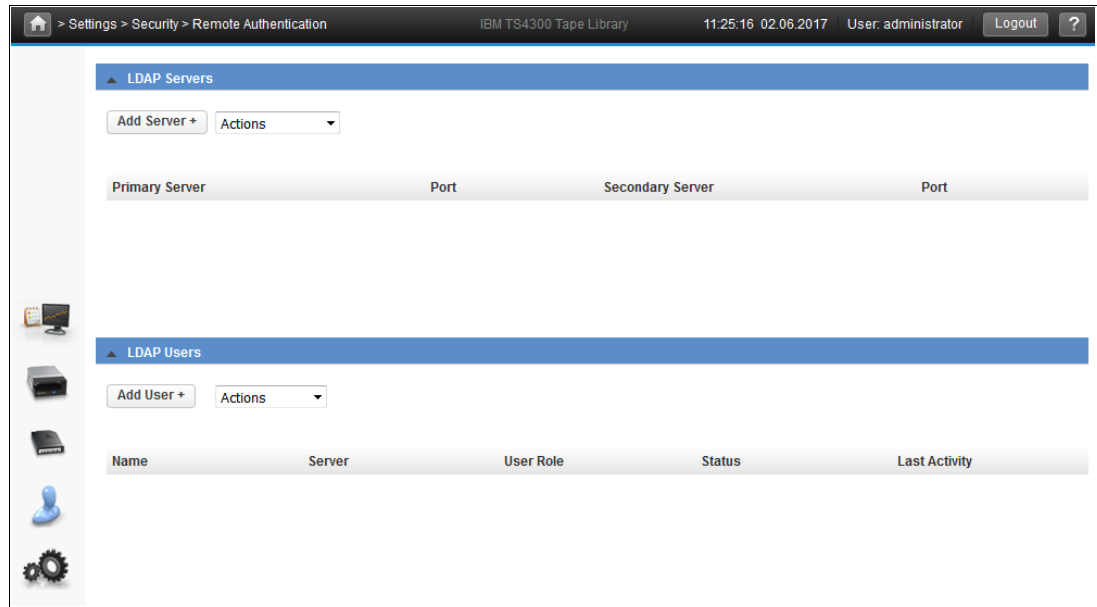

Figure 10-20 TS4300 LDAP configuration window

### 10.7.3 Encryption

With the TS4300 tape library, encryption is managed at the logical library level. All drives that are assigned to a logical library use the same method of encryption. The rules for setting up encryption differ whether you use LME or application-managed encryption (AME).

The encryption enabled drive contains the necessary hardware and firmware to encrypt and decrypt host tape application data. Encryption policy and encryption keys are provided by the host application or host server. A drive digital certificate is installed at manufacturing time. Each drive receives a unique serial number and certificate. The application might validate each drive instance by checking the drive's digital certificate.

For more information about how to set up encryption on the TS4300 tape library, see *IBM TS4300 Tape Library Machine Type 3555 User's Guide*, SC27-4629.

Encryption requires the latest device drivers, which are available at IBM Support's [Fix Central web page](#).

For more information, see 2.2, "Tape encryption overview" on page 61.

#### Application-managed encryption

The application-managed tape encryption method is best in operating environments that run an application that can already generate and manage encryption policies and keys, such as IBM Spectrum Protect. Policies that specify when encryption is to be used are defined through the application interface. The policies and keys pass through the data path between the application layer and the encryption-capable tape drives.

AME requires no license key to implement.

## Library-managed encryption

Key generation and management are performed by the key manager, which is a Java application that is running on a library-attached host. The keys pass through the library-to-drive interface. IBM GKLM V3.0 and later (SKLM V1.0, V2.0, or V3.0) is required for enabling LME.

For more information about SGLKM, see this [IBM Documentation web page](#).

Feature code 5900, LTO Library Managed Encryption, is required if LME and the latest FW version are used.

## Key Management Interoperability Protocol

The IBM Security Key Lifecycle Manager server v2.6 and later supports KMIP communication with clients for key management operations on cryptographic material.

For more information, see this [IBM Documentation web page](#).

The Key Management Interoperability Protocol is part of an Organization for the Advancement of Structured Information Standards (OASIS) standardization project for encryption of stored data and cryptographic key management.

For more information, see Key Management Interoperability Protocol documentation, which is available at [this web page](#).

You can configure the use of KMIP key management servers with the TS4300 library. This process requires FC5900, LTO Library Managed Encryption. For more set up information, see this [IBM Documentation web page](#).

**Note:** Consider the following points:

- ▶ If self-signed certificates are failing in SKLM 2.7.0, but working in 2.6.0.3 then make the following change in the properties file on the sKLM server and then restart the sKLM server to pick up the configuration change:

```
TransportListener.ssl.protocols from SSL_TLS to SSL_TLSv2
```

For more information, see this [IBM Support web page](#).

- ▶ If sKLM 2.7 is used, ensure that Library Code 1.1.1.2-A00 or higher is installed. After you install this Library Code from an older version of Library Code, you must select **Clear all Wizard Settings** and start the configuration process again.

## sKLM for z/OS Encryption (IBM IPP)

This option provides a second way of setting up encryption on this Library, besides only KMIP. This option will use the IBM IPP encryption code.

You can have a mixed combination of Logical Libraries in this library using either KMIP or sKLM for z/OS Encryption.

**Note:** At the time of this writing, a KPD test option is not available.

Encrypted tapes can be interchanged between the two Encryption Options; that is, written on KMIP and be read on IBM IPP and vice-versa.

To configure go to the Library menu and complete the following steps:

1. Go to Logical Libraries. Select **Actions**; then, select **Manage SKLM for z/OS encryption**.
2. Enter the IP address and the port of the SKLM z/OS server. Then, click **Modify**.
3. Return to Actions and select **Manage Logical Library (Expert Mode)**.
4. In the Expert Logical Library Wizard window, click **General Settings**.
5. Next to Encryption Mode, choose **Library Managed Encryption (SKLM for z/OS) (Licensed)**.
6. Click **Next**. Then, click **Finish Configuration**.

A message appears when the Logical Library was successfully enabled for SKLM for z/OS.

7. Click **Settings** → **Security** → **Encryption**. The Security Encryption Status and the Logical Library Encryption Status shows Library Managed Encryption (SKLM for z/OS) as Enabled.

Figure 10-21 shows a configuration example of z/OS encryption configuration.

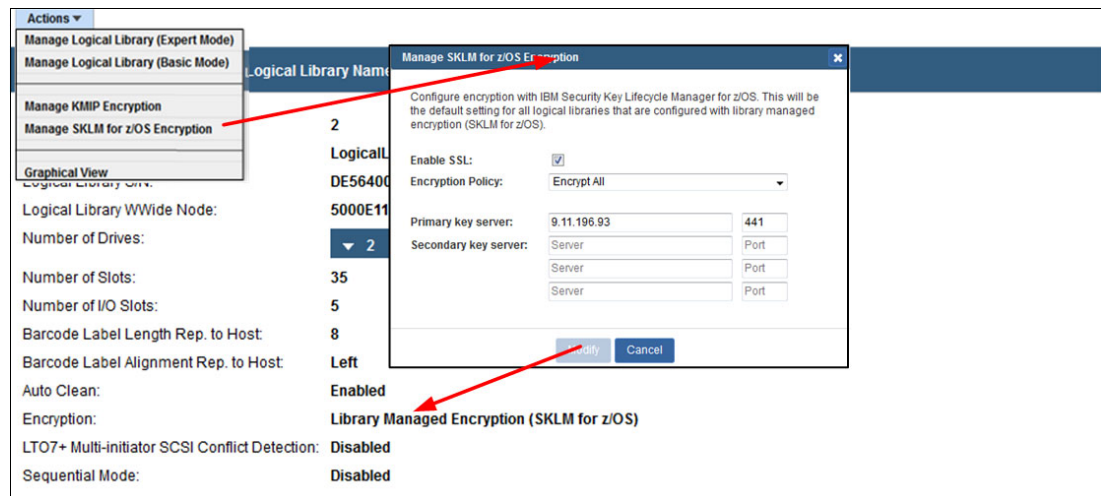

Figure 10-21 Configuring z/OS Encryption

**Note:** sKLM for z/OS Encryption currently has no test connection option.

## 10.7.4 Notifications

The TS4300 has the following options that are available for sending notifications to the host:

- ▶ Simple Mail Transfer Protocol

Simple Mail Transfer Protocol (SMTP) automatically sends an email that contains event information to the email addresses that is specified whenever an event of a certain level occurs.

- ▶ Simple Network Management Protocol

Simple Network Management Protocol (SNMP) is a set of protocols for managing complex networks. SNMP works by sending messages that are called protocol data units (PDUs) to various parts of a network. Agents are SNMP-compliant devices that store data about themselves in Management Information Bases (MIBs). They return this data to the SNMP requesters, such as the host's monitoring application.



The TS4300 mib file is part of the installed FW file and can be downloaded by clicking **Settings** → **Notifications** → **SNMP** → **Download MIB file**.

▶ Remote Logging (rsyslog)

Rsyslog allows sending library events to a remote syslog server.

## 10.8 Multipath architecture

With a multipath architecture, multiple systems can share the robotics of a library without middleware or a dedicated server (host) acting as a library manager. The library is controlled through the same physical connection as the connection that is used for the tape drives. By using multipath architecture, more control paths and data paths can be configured for any one logical library.

Multipath architecture has the following benefits:

- ▶ Eliminates the need for a separate dedicated control path to the library, which removes a single point of failure.
- ▶ Allows for Control Path Failover. If one control path is lost, for example because of a tape drive hardware failure, the library can still operate through a different path without the need for manual intervention.
- ▶ Allows for Data Path Failover. For example, if access to a drive by using one HBA is lost, a separate path can be used without the need for manual intervention.
- ▶ Allows the library to be partitioned into multiple logical libraries. Each system that is connected to the library (through the tape drives) considers that it has access to an entire library (rather than merely part of a physical library) and is unaware that the robotics are shared.

Multipath architecture is compliant with SCSI and Fibre Channel interfaces. The library is certified for SAN solutions, such as LAN-free backup.

### 10.8.1 Using multiple control paths

In addition to creating multiple logical libraries, any logical library can be configured to have more than one control path. When more control paths are configured, more library sharing configurations and availability options are made possible. Access to the logical library is on a first-come, first-served basis. Each control path for a logical library can accept commands while the library is in use by another control path.

To add or remove control paths, use the Web UI. For a particular logical library, you can enable as many control paths as there are drives in that logical library.

### 10.8.2 Using multiple control paths for Control Path Failover

Command failures and time outs are costly. You want your library to run smoothly and efficiently. To ensure continued processing, the library offers an optional Control Path Failover feature. By using this feature, the host device driver can resend the command to an alternative control path for the same logical library.

With Control Path Failover installed, the alternative control path can include another HBA, SAN, or library control path drive. The device driver initiates error recovery and continues the operation on the alternative control path without interrupting the application. AIX, Linux, Solaris, HP-UX, and Windows hosts are supported for this feature, which can be installed by the client.

For more information about how to configure and use the Control Path Failover feature, see *IBM Tape Device Driver Installation and Users Guide*, GC27-2130, which is available at [IBM Fix Central](#).

### 10.8.3 Using multiple data paths for Data Path Failover

Data Path Failover and load balancing support native Fibre Channel Ultrium 8, 7, and 6 tape drives in the library by using the IBM device driver for AIX, Linux, Solaris, HP-UX, and Windows. Data Path Failover provides a failover mechanism in the IBM device driver so that multiple redundant paths can be configured in a SAN environment.

If a path or component failure occurs, the failover mechanism can automatically provide error recovery to try the current operation again by using an alternative, preconfigured path without stopping the current job in progress. The failover mechanism provides flexibility in SAN configuration, availability, and management.

When a tape drive device is accessed that was configured with alternative paths across multiple host ports, the IBM device driver automatically selects a path through the HBA that has the fewest open tape devices. It then assigns that path to the application. This autonomic self-optimizing capability is called *load balancing*.

The dynamic load balancing support optimizes resources for devices that have physical connections to multiple HBAs in the same machine. The device driver dynamically tracks the use on each HBA as applications open and close devices. It also balances the number of applications that use each HBA in the machine. The dynamic load balancing support can help optimize resources and improve overall performance.

Furthermore, Data Path Failover provides autonomic self-healing capabilities similar to Control Path Failover, with transparent failover to an alternative data path if a failure occurs in the primary host-side path.

For more information about how to configure and use the Data Path Failover feature, see *IBM Tape Device Driver Installation and Users Guide*, GC27-2130, which is available at the [IBM Fix Central web page](#).

## 10.9 Working with logical libraries

Logical libraries are virtual sections within a library that present the appearance of multiple, separate libraries for the purposes of file management, access by multiple users, or dedication to one or more host applications. You must have at least one logical library in the TS4300, even if this logical library has all storage slot, I/O station slot, and drive resources assigned to it.

**Note:** I/O station slots and drives are dedicated to logical libraries and are not shared. It is important to consider this factor when planning logical libraries for the TS4300.

You can create logical libraries by using one of the following methods:

- ▶ **Basic Mode:** The Basic Logical Library Wizard allows for simplified logical library creation by auto-assigning all library elements into logical libraries based on the number of logical libraries that the user elects to create.
- ▶ **Expert Mode:** The Expert Logical Library Wizard allows an administrative user to assign the storage slots, drives, and I/O station slots per logical library on a granular level.

Every logical library must have at least one drive and five storage slots that are assigned to it. For example, if the library has two tape drives and 12 slots available, the maximum number of logical libraries that you can create is two.

If the library has only one logical library with all resources that are assigned to it, that logical library can be deleted to free resources so you can reallocate them to a new logical library. Or, it can be modified to free resources so that they can be reallocated to the new logical library.

Multiple logical libraries require the careful planning of library resources. If, for example, you are planning three logical libraries and have only two library modules, then careful consideration must be given to I/O station resources. Otherwise, you can choose to have a logical library with no I/O slots. In this case, import and export of cartridges causes the library to go offline while the cartridges are being loaded into the magazines.

Figure 10-22 shows the Logical Libraries window.

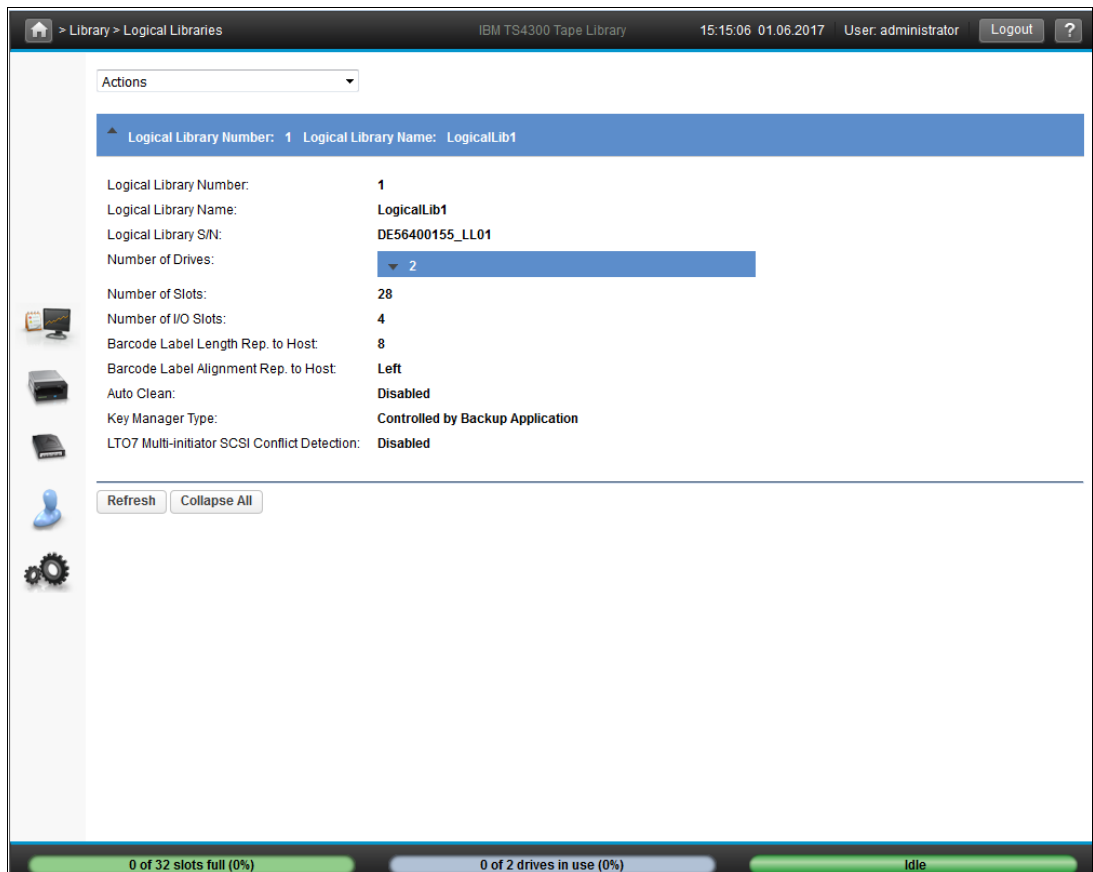

Figure 10-22 TS4300 Logical Libraries window

You can configure a logical library using different library settings.

## Library mode

Library mode is the default setting and is used to set up separate library partitions. This mode allows you to configure Drives, Slots, and I/O for a logical library partition. The application has full control of all library operations like media move and import/export.

## Sequential mode

Sequential Mode is intended to be used by host applications that are not supporting SCSI media changer devices but need to get another media loaded if the current media is full or application unloads drive.

Select **Enable Sequential Mode** on the logical library setup wizard to enable it.

Consider the following points regarding when this mode is used:

- ▶ The library predefines the sequential order the cartridges are moved to the drive.
- ▶ I/O slots are hidden because they are not assignable to a logical library with sequential mode enabled.
- ▶ Only one drive can be assigned to a logical library with sequential mode enabled.
- ▶ No control path drive is available and no media changer device is configured to the host server.

The options to consider when Sequential Mode is chosen are described next.

### ***Basic Sequential Mode function***

To start the use of cartridges, the user issues a **Move Cartridge** command to the drive through the Management GUI. After the load, the host application can begin data I/O activity. When the host application unloads the drive, the library then moves the next cartridge into the drive.

This behavior is implicit, unless it is defined by selecting one of the that are described here. The media that is used first is the lowest slot number and ends when the last tape is used.

### ***Loop Option***

If a move sequence ends because no other cartridges are available in the current logical library, the sequence starts again by loading the first cartridge of the logical library. This option can be chosen with or without the Autoload function.

### ***Autoload Option***

If enabled, the library loads the first cartridge of the logical library, the slot with the lowest number with media installed to the Sequential Mode tape drive during library startup after inventory scan is finished. This option changes the implicit behavior of the Basic function. This option can be chosen with or without the Loop option.

**Note:** If storage slots are configured to I/O slots after assignment to a Sequential Mode logical library, they are still considered valid available slots and are used for movements. This option remains until you run the expert wizard again; then, these I/O slots no longer appear in the list of available slots.

If a cartridge is loaded to the tape drive when powering up, this cartridge stays in the drive and no other cartridges can be loaded to the drive.

Figure 10-23 shows the options that are available on the Logical Library wizard setup page.

**Note:** Before V2.0 library firmware, a logical library in Sequential Mode shows Idle (Offline) in red instead Idle in green.

### Create Logical Library Scheme

---

**Free Resources That Will Be Used by the Logical Library Scheme**

---

Slots :	105
I/O Slots :	15
Drives :	6
Max. Logical Libraries :	6

---

**Logical Library Settings**

---

Logical Library Count (max. 21)	1
Barcode Label Length Reported To Host	8
Barcode Label Alignment Reported To Host	Left
Auto Clean	<input checked="" type="checkbox"/>
Encryption Mode	Application Managed Encryption

---

Enable Sequential Mode	<input type="checkbox"/>
Loop Mode	<input type="checkbox"/>
• Restarting sequence when finished	
Autoload Mode	<input type="checkbox"/>
• Load first cartridge automatically in sequential mode	

Figure 10-23 Logical Library settings

Figure 10-24 shows the Logical Libraries Graphical View.



Figure 10-24 TS4300 Logical Libraries Graphical View

## 10.10 Media

To ensure that your IBM Ultrium tape drive conforms to the IBM specifications for reliability, use IBM LTO Ultrium tape cartridges. You can use other LTO-certified data cartridges, but they might not meet the standards of reliability that have been established by IBM.

### 10.10.1 Data cartridges

All sixth generations contain ½-inch, dual-coated, metal-particle tape. Table 10-5 lists the native data capacity of Ultrium data cartridges.

Table 10-5 Ultrium native capacity

Data cartridge	Native data capacity
Ultrium 9 and WORM	18 TB (45 TB at a 2.5:1 compression ratio)
Ultrium 8 and WORM	12 TB (30 TB at a 2.5:1 compression ratio)
Ultrium 7 using format M8 for LTO 8	9 TB (22.5 TB at a 2.5:1 compression ratio)
Ultrium 7 and WORM	6 TB (15 TB at a 2.5:1 compression ratio)
Ultrium 6 and WORM	2.5 TB (6.25 TB at a 2.5:1 compression ratio)
Ultrium 5 and WORM	1.5 TB (3.0 TB at a 2:1 compression ratio)
Ultrium 4 and WORM	800 GB (1.6 TB at a 2:1 compression ratio)

Table 10-6 shows the compatibility among the six types of Ultrium cartridges.

Table 10-6 Ultrium compatibility among the generations

IBM Ultrium	IBM LTO Ultrium data cartridge						
	18 TB (Ultrium 9)	12 TB (Ultrium 8)	9 TB (Ultrium 7 M8 format)	6 TB (Ultrium 7)	2.5 TB (Ultrium 6)	1.5 TB (Ultrium 5)	800 GB (Ultrium 4)
Ultrium 9	Read/write	Read/write					
Ultrium 8		Read/write	Read/write	Read/write			
Ultrium 7				Read/write	Read/write	Read only	
Ultrium 6					Read/write	Read/write	Read only

For more information about tape cartridges, see 2.1.4, “Tape cartridge” on page 46.

**Note:** LTO7 media with the M8 format can only be used on LTO 8 drives, and cannot be reformatted for read in an LTO7 drive.

Using M8 media requires that the latest version of drive and library FW to be installed. For more information, see “M8 format” on page 68.

### Write Once Read Many media

Certain records retention and data security applications require a WORM method for storing data on tape. To meet this data storage requirement, a WORM feature is available on IBM LTO Ultrium generation 9, 8, 7, and 6 drives. You can enable the WORM feature by upgrading to WORM-capable drive firmware and using a special WORM tape cartridge.

A specially formatted WORM tape cartridge is required because standard read/write media are incompatible with the WORM feature. Each WORM cartridge has a unique, worldwide cartridge identifier (WWCID), which comprises the unique Cartridge Memory (CM) chip serial number and the unique tape media serial number.

For more information about WORM media, see “WORM tape format” on page 44.

## 10.10.2 Cleaning cartridges

A specially labeled IBM LTO Universal Ultrium Cleaning Cartridge cleans the drive in your library.

The drive determines when a head needs cleaning and communicates this information to the library. When the cleaning is finished, the drive ejects the cartridge, and the picker takes the cartridge and places it back in any storage slot. To remove a cleaning cartridge, export it from the library.

The IBM Cleaning Cartridge is valid for 50 uses. The Linear Tape-Open Cartridge Memory (LTO-CM) chip of the cartridge tracks the number of times that the cartridge is used.

For more information about cleaning cartridges, see “Specifications for cleaning cartridges” on page 52.

### 10.10.3 Cartridge memory chip

All generations of the IBM LTO Ultrium data cartridges include an LTO-CM chip. This chip contains information about the cartridge and the tape (such as the name of the manufacturer that created the tape), and statistical information about the use of the cartridge.

The LTO-CM also helps to determine the reliability of the cartridge by storing data about its age, the number of times it was loaded, and the number of errors it accumulated. Whenever a tape cartridge is unloaded, the tape drive writes any pertinent information to the cartridge memory. The storage capacity of the Ultrium 6 Tape Cartridge Memory Chip is 16320 bytes.

For more information about the LTO-CM, see “Cartridge memory” on page 49.

## 10.11 Supported environments

For a current list of supported server platforms, operating systems, host bus adapters, SCSI adapters, and SAN switches, see the [IBM System Storage Interoperation Center \(SSIC\) website](#).

On the page, under Storage Family, select **IBM System Storage LTO Ultrium Tape**. Then, select the product model for the TS4300 tape library and the version.

### 10.11.1 Supported storage software

For a current list of host software versions and release levels that support the TS4300 tape library, see the [IBM System Storage Interoperation Center \(SSIC\) website](#).

For more information about LTO and backup applications, see this [IBM Support web page](#) and select **Independent Software Vendor (ISV)**.

## 10.12 Specifications

This section describes the physical specifications and the operating environment for the TS4300 tape library.

### 10.12.1 Timings

The following timings are approximate and are provided as indicative values:

- ▶ To perform an inventory of a 3U library: 50 seconds
- ▶ To perform an inventory of a 21U library: 362 seconds
- ▶ To mount a cartridge in a 3U library: 14 seconds
- ▶ To mount a cartridge in a 21U library: 40 seconds



## 10.12.2 Physical specifications

Physical specifications are provided for the L3A base module and the E3A expansion module.

### Model L3A

A 3-U L3A base module has the following physical specifications:

- ▶ Width: 480 mm (18.9 in)
- ▶ Depth: 885 mm (34.84 in)
- ▶ Height: 133.35 mm (5.25 in)
- ▶ Weight: 20 kg (44 lbs)
- ▶ Maximum configuration: Three Half-High drives and two power supplies

### Model E3A

A 3-U E3A expansion module has the following physical specifications:

- ▶ Width: 480 mm (18.9 in)
- ▶ Depth: 885 mm (34.84 in)
- ▶ Height: 133.35 mm (5.25 in)
- ▶ Weight: 13 kg (28.66 lbs)
- ▶ Maximum configuration: Three Half-High drives and two power supplies

## 10.12.3 Operating environment

The following operating environments are supported for all library configurations:

- ▶ Allowable temperature: 15°C to 32°C (60°F to 90°F). Recommended: 16°C to 25°C (60.8°F to 77°F).
- ▶ Maximum Wet bulb temperature: 26°C (78.8°F)
- ▶ Allowable Relative humidity: 20% - 80% noncondensing. Recommended: 20% - 50% noncondensing.
- ▶ Electrical power: max 9.5 amps, 100-240 V 50/60 Hz, 230 W

TS4300 tape libraries are classified as Category 1 products as defined in C-S 1-1710-006.

## 10.13 Feature codes

The TS4300 can be ordered with the optional features that are listed in Table 10-7. For more information, see this [IBM Documentation web page](#).

Table 10-7 Optional features

Feature code	Description
1411	Fibre wrap tool
1412	SAS wrap tool
1682	Path Failover
1899	First Power Supply
1900	Extra Power Supply
7002	Rack Mount Kit
8106	Right Side Magazine
8109	Left Side Magazine
5500	Mini-SAS/Mini-SAS 4x Interposer
5502	2 m Mini-SAS/Mini-SAS 1x Cable
5507	4 m Mini-SAS HD/Mini-SAS 1x Cable Enables attachment of a single tape drive to a host with HD applications (from HD HBA with SFF-8644 to Drive with SFF-8088 connector).
5509	3 m Mini-SAS HD/Mini-SAS 2x Cable Enables attachment of one or two tape drives to a host with HD applications, from HD HBA with SFF-8644 to Drives with SFF-8088 connectors. This cable fans out to enable connection of two devices to one HBA port.
5900	Encryption Configuration
AGK1	10-meter OM3 fiber Cable (LC)
AGK2	25-meter OM3 fiber Cable (LC)
AGKB	3 m Mini-SAS HD/Mini-SAS HD 1X Cable
AGKC	3 m Mini-SAS HD/Mini-SAS HD 2X Cable
AGKD	1.5 m Mini-SAS HD/Mini-SAS HD 1X Cable
AGKF	LTO 6 HH Fibre Channel Drive
AGKG	LTO 6 HH SAS Drive
AGKH	LTO 6 FH Fibre Channel Drive
AGKJ	LTO 7 HH Fibre Channel Drive
AGKK	LTO 7 HH SAS Drive
AGKL	LTO 7 FH Fibre Channel Drive
AGKM	LTO 8 HH Fibre Channel Drive
AGKN	LTO 8 HH SAS Drive
AGKP	LTO 8 FH Fibre Channel Drive

Feature code	Description
AGLA	LTO 9 HH Fibre Channel Drive
AGLB	LTO 9 HH SAS Drive
AGLC	LTO 9 FH Fibre Channel Drive
AGLD	LTO 9 FH SAS Drive
8002	Cleaning Cartridge L1 UCC
8905	Ultrium 9 Data Cartridges (5-pack)
8806	LTO 8 Data Cartridges (5-pack)
5521	LTO M8 Data Cartridges (20-pack)
8706	LTO 7 Data Cartridges (5-pack)
8605	LTO 6 Data Cartridges (5-pack)
9800 - 9847	Power cords
9848	Rack Power Distribution Unit (PDU) power cord

### 10.13.1 Power cords

The following power cord features are available:

- |        |   |                    |
|--------|---|--------------------|
| ▶ 9800 | 9-foot (2.8 m) Power Cord, 125 V, 15 A        | US and Canada      |
| ▶ 9820 | 9-foot (2.8 m) Power Cord, 250 V, 16 A (AC)   | France and Germany |
| ▶ 9821 | 9-foot (2.8 m) Power Cord, 250 V, 11 A        | Denmark            |
| ▶ 9825 | 9-foot (2.8 m) Power Cord, 250 V, 13 A        | UK and China       |
| ▶ 9827 | 9-foot (2.8 m) Power Cord, 250 V, 6-16 A      | Israel             |
| ▶ 9828 | 9-foot (2.8 m) Power Cord, 255 V, 10 A        | Switzerland        |
| ▶ 9829 | 9-foot (2.8 m) Power Cord, 250 V, 16 A        | South Africa       |
| ▶ 9830 | 9-foot (2.8 m) Power Cord, 250 V, 10 and 16 A | Italy              |
| ▶ 9831 | 9-foot (2.8 m) Power Cord, 250 V, 10 A        | Australia/NZ       |
| ▶ 9833 | 9-foot (2.8 m) Power Cord, 250 V, 15 A        | US and Canada      |
| ▶ 9834 | 9-foot (2.8 m) Power Cord, 250 V, 10 A        | Uruguay            |
| ▶ 9835 | 9-foot (2.8 m) Power Cord, 125 V, 15 A        | Taiwan             |
| ▶ 9840 | 9-foot (2.8 m) Power Cord, 250 V, 10 A        | China (PRC)        |
| ▶ 9841 | 9-foot (2.8 m) Power Cord, 250 V, 10 A        | Taiwan             |
| ▶ 9842 | 9-foot (2.8 m) Power Cord, 125 V, 12 A        | Japan              |
| ▶ 9843 | 9-foot (2.8 m) Power Cord, 250 V, 12 A        | Japan              |
| ▶ 9844 | 9-foot (2.8 m) Power Cord, 250 V, 12 A        | Korea              |
| ▶ 9845 | 9-foot (2.8 m) Power Cord, 250 V, 10 A        | India              |
| ▶ 9847 | 9-foot (2.8 m) Power Cord, 250 V, 10 A        | Brazil             |

### 10.13.2 Fibre Channel cables

The Fibre Channel tape drive has an LC connector. A cable is required to connect this connector directly to a system HBA or a SAN switch. The following feature codes are available:

- ▶ AGK1 10-meter OM3 fiber Cable (LC)
- ▶ AGK2 25-meter OM3 fiber Cable (LC)

### 10.13.3 SAS cables

The SAS tape drive has a mini-SAS connector. A cable is required to connect this connector directly to a SAS HBA. The following feature codes are available:

- ▶ 5500: Mini-SAS/Mini-SAS 4x Interposer
- ▶ 5502: 2 m Mini-SAS/Mini-SAS 1x Cable
- ▶ 5507: 4 m Mini-SAS HD/Mini-SAS 1x Cable
- ▶ 5509: 3 m Mini-SAS HD/Mini-SAS 2x Cable

### 10.13.4 Publications

The following publications are included with the Model L3A hardware:

- ▶ *IBM TS4300 Tape Library Getting Started Guide, SC27-4630*
- ▶ *IBM TS4300 Tape Library Machine Type 3555 Users Guide, SC27-4629*
- ▶ *IBM Tape Device Drivers Installation and User's Guide, GC27-2130*



## IBM TS4500 tape library

The IBM TS4500 tape library is a next-generation storage solution that is designed to help mid-size and large enterprises respond to storage challenges. Some of these challenges include high data volume, growth in data centers, increasing cost of data center storage footprints, difficulty migrating data across vendor platforms, and increased complexity of IT training and management as staff resources shrink.

The TS4500 tape library combines reliable, automated tape handling and storage with reliable, high performance in an open systems environment. Incorporating IBM Linear Tape-Open (LTO) Ultrium tape and 3592 drives, the TS4500 tape library offers outstanding retrieval performance with typical cartridge move times of less than 3 seconds.

The TS4500, installed with the High Availability (HA) option, provides dual active accessors for redundancy, and can double the robot performance during tape move operations. The HA option on TS4500 has no dedicated service bays and provides the Elastic Capacity option for the use of the storage slots in these integrated service bays.

The TS4500 can be deployed as a single frame library and upgraded to a maximum of 18 frames, with a combination of either LTO and 3592 frames. This single frame library can be partitioned into multiple logical libraries. This feature makes the TS4500 tape library an excellent choice for consolidating tape workloads from multiple heterogeneous open systems servers.

The TS4500 protects investment by providing for redeployment of S24 and S54 frames from the TS3500 onto the TS4500.

The library provides outstanding reliability and redundancy through provision of redundant power supplies in each drive frame, control and data path failover, dual grippers within the cartridge accessor, and dual active accessors. Both library and drive firmware can be upgraded nondisruptively, without interrupting normal operations. Encryption is supported on the following tape drives:

- ▶ LTO Ultrium 9 tape drive (Model 3588 F9C)
- ▶ LTO Ultrium 9 tape drive (Model 3588 F9S)
- ▶ LTO Ultrium 9 tape drive (Model 3588 S9C)
- ▶ LTO Ultrium 8 tape drive (Model 3588 F8C)
- ▶ LTO Ultrium 9 tape drive (Model 3588 F8S)

- ▶ LTO Ultrium 7 tape drive (Model 3588 F7C)
- ▶ LTO Ultrium 6 tape drive (Model 3588 F6C)
- ▶ LTO Ultrium 5 tape drive (Model 3588 F5C)
- ▶ TS1160 tape drive (Model 3592 60E, 60F, and 60S)
- ▶ TS1155 tape drive (Model 3592 55E and 55F)
- ▶ TS1150 tape drive (Model 3592 EH8)
- ▶ TS1140 tape drive (Model 3592 EH7)

Three encryption methods are supported:

- ▶ Application-managed encryption (AME)
- ▶ Library-managed encryption (LME)
- ▶ System-managed encryption (SME) for IBM z/OS TS7700 support

From TS4500 Release 2, the following functions were supported, over and above the first release of the TS4500:

- ▶ Automatic media verification
- ▶ Flexible remote authentication
- ▶ Primary control system failover
- ▶ Mixed media types within the same TS4500 library
- ▶ Scalability to 18 frames
- ▶ Up to 128 tape drives
- ▶ Simple Network Management Protocol (SNMP) query configuration
- ▶ Redeployment of S24 and S54 frames from TS3500 to TS4500

With TS4500 Release 3, the following new functions are now supported:

- ▶ High availability with dual active accessors
- ▶ Support for external TSSC/IMC
- ▶ Flexible growth options with new flex track design

TS4500 Release 4 added new functions, which include:

- ▶ TS1155 model 55E
- ▶ TS1155 model 55F

TS4500 Release 4.1 added new functions, which include:

- ▶ LTO Ultrium 8 tape drive (Model 3588 F8C)

TS4500 Release 5.0 added new functions, which include:

- ▶ TS1160 model 60F
- ▶ LTO Ultrium 8 tape drive (Model 3588 F8S)

TS4500 Release 6.0 added new functions, which include:

- ▶ TS1160 model 60E
- ▶ TS4500 REST API - REST over SCSI (RoS) commands
- ▶ New CLI commands for Service actions

TS4500 Release 7.0 added new functions, which include:

- ▶ Activity log on GUI System Summary
- ▶ Support for rear door open detection and reporting (feature code 4892)

TS4500 Release 7.1 added new functions, including 3592-60S (Jag6 SAS) Drive Support.

TS4500 Release 7.5 added new functions, which include:

- ▶ 3588-F9C (LTO9 FC Multi Mode) Drive Support
- ▶ 3588-F9S (LTO9 FC Single Mode) Drive Support
- ▶ 3588-S9C (LTO9 SAS) Drive Support

**Note:** All R7 release levels contain additional REST support for different attributes, options and tasks.

TS4500 Release 8.0 added new functions, which include:

- ▶ TLS support for GKLM (IBM Security Guardium Key Lifecycle Manager)
- ▶ IBM NPS® (Net Promoter Score)
- ▶ Hyper-scale requirements, REST API Improvements

This chapter includes the following sections:

- ▶ 11.1, “Overview of the IBM TS4500 tape library” on page 286
- ▶ 11.2, “TS4500 product description” on page 288

## 11.1 Overview of the IBM TS4500 tape library

The IBM TS4500 is a highly scalable, stand-alone tape library that provides high-density tape storage and high-performance, automated tape handling for open systems environments.

Figure 11-1 shows a seven-frame version of the TS4500 tape library. An individual library can consist of one L frame and up to 17 expansion frames, and can include up to 128 tape drives and more than 23,000 tape cartridges, as shown in Figure 11-3 on page 289.



Figure 11-1 TS4500 base frame with six expansion frames

The TS4500 tape library provides the following capabilities, which are described in more detail in the following sections:

- ▶ High availability dual active accessors with integrated service bays to reduce inactive service space by 40%. The Elastic Capacity option can be used to eliminate inactive service space.
- ▶ All of the frames include high-density (HD) slot technology.
- ▶ Additional HD2 frame models can be placed in any active position so that the library can grow from both the right side and the left side of the first L frame.
- ▶ HD generation 1 frames from the existing TS3500 library can be redeployed into a TS4500. These frames must be installed to the right of the Lx5 frame, and Feature Code (FC) 1742 must be installed on each frame before they can exist in a TS4500 library string.
- ▶ New Single Deep Cell technology.
- ▶ Integrated management console (IMC) with support for an external TSSC/IMC.
- ▶ New user interface for improved usability.
- ▶ Updated control system.
- ▶ Input/output (I/O) magazine to allow individual cartridge handling to be performed independently of the library.
- ▶ Top-rack space to house extra tape solution components within the library footprint.
- ▶ Support for HD2-compatible models of the TS1160 (3592 60E, 60F, and 60S), TS1155 (3592 55E and 55F), TS1150 (3592 EH8), TS1140 (3592 EH7), LTO Ultrium 9 (3588 F9C, F9S, S9C), LTO Ultrium 8 (3588 F8C, F8S), LTO Ultrium 7 (3588 F7C), LTO Ultrium 6 (3588 F6C), and LTO Ultrium 5 (3588 F5C) tape drives.



- ▶ Up to four Library-Managed Encryption (LME) key paths per logical library.

The TS4500 tape library is available with several tape drives, frame models, and feature options to meet your specific needs. Additional features of the TS4500 tape library are highlighted in the following list:

- ▶ Advanced Library Management System (ALMS)
- ▶ Ability to attach multiple simultaneous heterogeneous servers
- ▶ Remote management with the TS4500 management GUI or the TS4500 command-line interface (CLI)
- ▶ TS4500 REST API - REST over SCSI (RoS) commands
- ▶ Remote monitoring by using SNMP, email, or syslog
- ▶ SNMP query configuration
- ▶ Media health verification
- ▶ Multipath architecture
- ▶ Drive and media exception reporting
- ▶ Host-based path failover
- ▶ Up to 288 I/O slots (36 I/O slots standard for LTO libraries and 32 I/O slots standard for 3592 libraries with extra I/O slots that are available as a feature add-on for all D25 and D55 frames)
- ▶ Up to four Encryption Key Manager (EKM) servers can be configured on each logical library
- ▶ Library activity log display (see Figure 11-2)

Activity	Location	Cartridge	Time
Close	Frame 2		2021-10-01T10:12:07+0200
Open	Frame 2		2021-10-01T10:10:53+0200
Demount	Drive F1, C4, R2	VEC003JD	2021-09-29T16:30:47+0200
Mount	Drive F1, C4, R2	VEC003JD	2021-09-29T16:19:19+0200
Move	Slot F3, C1, R1, T1	DG I01L7	2021-09-28T12:02:10+0200
Move	Slot F3, C2, R1, T0	DG I01L7	2021-09-28T12:02:06+0200
Move	Slot F3, C1, R1, T1	DG I01L7	2021-09-28T12:02:02+0200
Move	Slot F3, C2, R1, T0	DG I01L7	2021-09-28T12:01:57+0200
Demount	Drive F3, C2, R3	LTO801L8	2021-09-17T16:18:17+0200
Mount	Drive F3, C2, R3	LTO801L8	2021-09-17T16:09:20+0200
Demount	Drive F1, C4, R3	CLN002JA	2021-09-16T15:03:11+0200
Mount	Drive F1, C4, R3	CLN002JA	2021-09-16T14:53:57+0200
Demount	Drive F1, C4, R3	CLN002JA	2021-09-16T14:18:49+0200
Mount	Drive F1, C4, R3	CLN002JA	2021-09-16T14:18:40+0200
Move	Slot F3, C1, R1, T1	DG I01L7	2021-09-16T13:43:29+0200
Move	Slot F3, C2, R1, T0	DG I01L7	2021-09-16T13:43:24+0200
Move	Slot F3, C1, R1, T1	DG I01L7	2021-09-16T13:43:19+0200
Move	Slot F3, C2, R1, T0	DG I01L7	2021-09-16T13:43:13+0200
Move	Slot F3, C1, R1, T1	DG I01L7	2021-09-16T13:20:10+0200
Move	Slot F3, C2, R1, T0	DG I01L7	2021-09-16T13:19:57+0200
Move	Slot F3, C1, R1, T1	DG I01L7	2021-09-16T13:19:53+0200
Move	Slot F3, C2, R1, T0	DG I01L7	2021-09-16T13:19:49+0200
Failed mount	Drive F1, C4, R2	VEC009JD	2021-09-16T12:52:52+0200
Move	Slot F3, C1, R1, T1	DG I01L7	2021-09-16T12:52:44+0200
Move	Slot F3, C2, R1, T0	DG I01L7	2021-09-16T12:52:33+0200
Move	Slot F3, C1, R1, T1	DG I01L7	2021-09-16T12:52:24+0200
Move	Slot F3, C2, R1, T0	DG I01L7	2021-09-16T12:52:20+0200
Move	Slot F3, C1, R1, T1	DG I01L7	2021-09-16T11:33:42+0200
Move	Slot F3, C2, R1, T0	DG I01L7	2021-09-16T11:33:38+0200

Figure 11-2 Library activity log display

## 11.2 TS4500 product description

The IBM TS4500 tape library (Machine Type 3584) is a modular tape library that consists of a high-density base frame and up to 17 high-density expansion frames. The frames join side by side and can grow to the left or to the right of the base frame. All frames are supported by a single cartridge accessor. You can install a single-frame base library (Figure 11-1) and grow it to 18 frames, tailoring the library to match your system capacity requirements.

Table 11-1 lists the supported combinations of frames, tape drives, and their capabilities.

*Table 11-1 TS4500 tape library capabilities*

<b>Models</b>	<b>Drives in frames</b>	<b>Maximum cartridges</b>	<b>Maximum native capacity</b>
L25, D25, S25, and S24	3592 tape drives	17,550	351 PB
L55, D55, S55, and S54	LTO tape drives	23,170	417 PB
The maximum native capacity figures are based on library configurations with one base frame with all Ultrium 9 or TS1160 tape drives, and 17 storage-only HD frames.			

The TS4500 tape library base frame is shown in Figure 11-3.



Figure 11-3 TS4500 tape library base frame

There are eight types of frames that are supported in the current TS4500 tape library range. Each frame is identified by a three-character model number (L25, D25, L55, D55, S25, S55, S24, and S54), which describes the nature of the frame.

The TS4500 tape library is built from a single frame model that is called the *base frame*. The scalability of the library allows an increase in capacity by adding up to 17 additional frames, called *expansion frames*. The frames join side by side and can grow to the left or to the right of the base frame. All frames can be supported by either a single cartridge accessor, or by dual active accessors with the high availability feature. The TS4500 tape library can contain a mix of 3592 and LTO frames.

The TS4500 tape library supports first generation (S54, S24) frames (HD1), and second-generation high-density (HD2) frames. HD2 frames like the first-generation HD1 frames, offer increased capacity without increasing frame size or required floor space by using high-density storage slots for tape cartridges. In addition, HD2 frames provide the following enhancements:

- ▶ HD2 frames can be installed in the left-most position of the library (frame number 1).
- ▶ Drive-capable HD2 frames support up to 16 HD2-compatible tape drives (3588 F9C, 3588 F9S, 3588 S9C, 3588 F8C, 3588 F8S, 3588 F7C, 3588 F6C, 3588 F5C, 3592 60E, 3592 60F, 3592 60S, 3592 55E, 3592 55F, 3592 EH8, and 3592 EH7) when positioned as frame number 2 or higher.

Generation 1 HD frames from TS3500 (Model S24 and S54) can be redeployed into a TS4500. These HD1 frames must be installed to the right of the Lx5 frame. These S24 or S54 (SX4) frames must have FC 1742 applied to them before they can exist in a TS4500 library string.

**Note:** The HD1 models S24 and S54 cannot be installed to the left of the Lx5 frame and cannot be installed as the right-most frame in a dual accessor tape library.

The L25 and L55 (Lx5) frames and D25 and D55 (Dx5) frames are HD2, drive-capable frames, which means that they contain high-density cartridge storage slots, and slots to house up to 16 tape drives. The S25, S55 (Sx5) HD2 frames, and S54, S24 (SX4) HD1 frames, are storage-only frames, which means that they contain high-density cartridge storage slots, but no tape drives. All HD frames provide internal light-emitting diode (LED) lighting.

The TS4500 also supports the addition of a top rack frame. The top rack, 3584 Model TR1, provides an extra 10U of rack space on any frame in a library without requiring more floor space.

Table 11-2 lists the frames that are supported by the library and their specific media type and capacity.

Table 11-2 TS4500 tape library frame models

Frame model	Type	Media type	Capacity		Other
			Frame position 1	Frame position 2+	
L25	Base frame	3592	Up to 12 tape drives and 550 storage slots	Up to 16 tape drives and 660 storage slots	<ul style="list-style-type: none"> <li>▶ Equipped with two I/O stations and two 16-slot magazines</li> <li>▶ Optionally equipped with top rack (Model TR1)</li> </ul>
L55	Base frame	LTO	Up to 12 tape drives and 730 storage slots	Up to 16 tape drives and 882 storage slots	<ul style="list-style-type: none"> <li>▶ Equipped with two I/O stations and two 18-slot magazines</li> <li>▶ Optionally equipped with top rack (Model TR1)</li> </ul>
D25	Expansion frame	3592	Up to 12 tape drives and 590 storage slots	Up to 16 tape drives and 740 storage slots	<ul style="list-style-type: none"> <li>▶ Equipped with two I/O stations and two 16-slot magazines</li> <li>▶ Optionally equipped with top rack (Model TR1)</li> </ul>

Frame model	Type	Media type	Capacity		Other
			Frame position 1	Frame position 2+	
L25	Base frame	3592	Up to 12 tape drives and 550 storage slots	Up to 16 tape drives and 660 storage slots	<ul style="list-style-type: none"> <li>▶ Equipped with two I/O stations and two 16-slot magazines</li> <li>▶ Optionally equipped with top rack (Model TR1)</li> </ul>
D55	Expansion frame	LTO	Up to 12 tape drives and 774 storage slots	Up to 16 tape drives and 970 storage slots	<ul style="list-style-type: none"> <li>▶ Equipped with two I/O stations and two 18-slot magazines</li> <li>▶ Optionally equipped with top rack (Model TR1)</li> </ul>
S25	Storage-only expansion frame	3592	798 storage slots	1000 storage slots	<ul style="list-style-type: none"> <li>▶ Optionally equipped with top rack (Model TR1)</li> </ul>
S55	Storage-only expansion frame	LTO	1054 storage slots	1320 storage slots	<ul style="list-style-type: none"> <li>▶ Optionally equipped with top rack (Model TR1)</li> </ul>
S24	Storage-only expansion frame	3592	Not supported	1000 storage slots	<ul style="list-style-type: none"> <li>▶ Optionally equipped with top rack (Model TR1)</li> </ul>
S54	Storage-only expansion frame	LTO	Not supported	1320 storage slots	<ul style="list-style-type: none"> <li>▶ Optionally equipped with top rack (Model TR1)</li> </ul>

### 11.2.1 TS4500 tape library frames for IBM LTO Ultrium Fibre Channel and Serial Attached SCSI drives

The TS4500 tape library models L55 and D55 integrate the HD2 versions of the LTO-9, LTO-8, LTO-7, LTO-6, and LTO-5 (8 Gbps dual-port Fibre Channel/12 Gbps dual-port SAS (LTO9 model S9C)) tape drives. The TS4500 Model S55 is a high capacity storage-only frame for LTO cartridge slots.

The Model L55 frame includes the frame control assembly with two power supplies (for redundancy), an optimized dual-gripper cartridge accessor, on-demand storage slot capacity, and with two I/O stations with two 18-slot magazines.

#### TS4500 tape library Model L55

The L55 frame can be installed on its own as a complete library enclosure, as shown in Figure 11-4 on page 292, or it can have up to 17 expansion frames that are attached to it. This frame provides the major library components for the whole library, whether it has a single frame or multiple frames.

It also provides cartridge storage capacity for LTO media and can be equipped with the HD2 versions of the LTO-9, LTO-8, LTO-7, LTO-6, and LTO-5 dual-port Fibre Channel tape drives that facilitate 8 Gbps Fibre Channel connectivity and dual-port 12 Gbps SAS (LTO9 model S9C only) connectivity.

HD2 expansion frames can be added to either the left or right of the L55 frame. HD1 frames can be added only to the right side of L55 frame. See Figure 11-4.

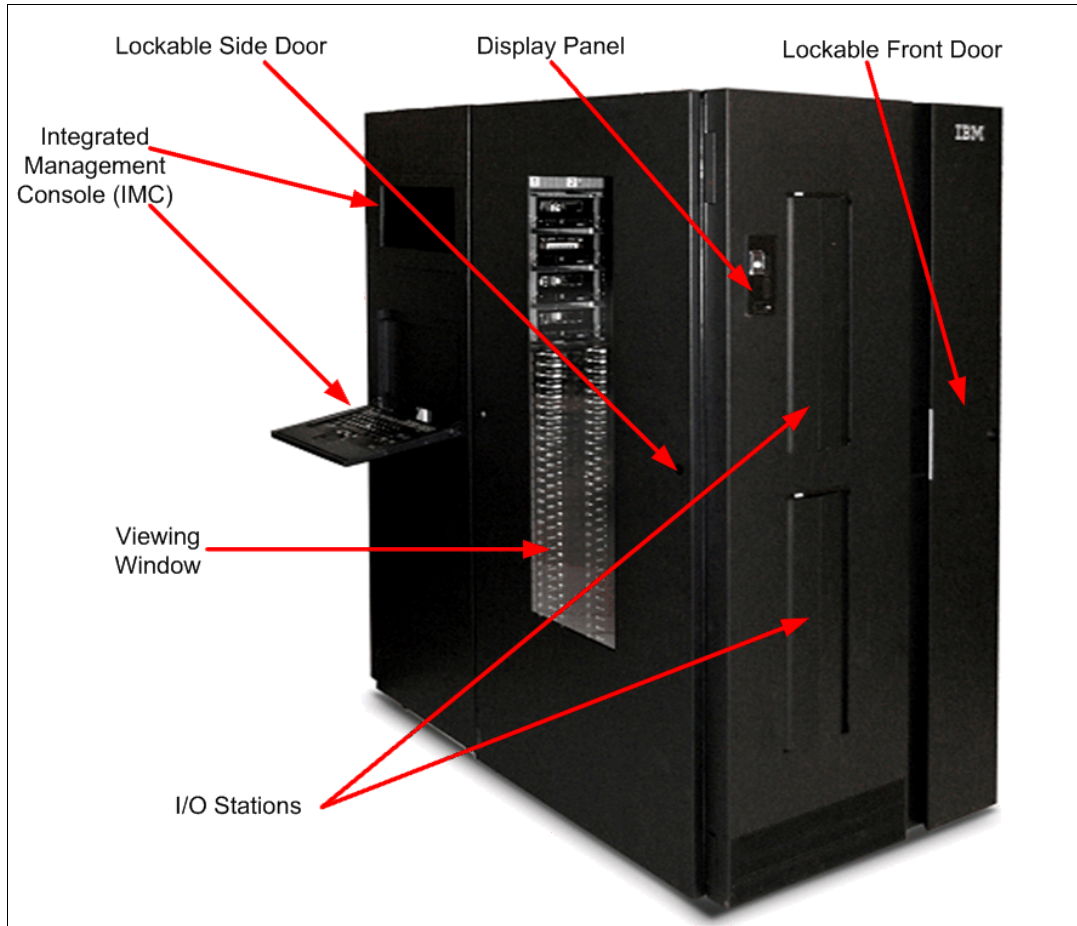

Figure 11-4 TS4500 tape library L55/L25 base frame

The number of LTO cartridge storage slots ranges 100 - 882. With the minimum configuration, 100 slots are available for use. The maximum of 882 slots is already physically installed.

More slots can be added by enabling them through a capacity on demand (CoD) license key.

There are a number of CoD feature codes for the L55 frame and the number of slots available depends on the frame position.

The Intermediate Capacity feature (Feature Code (FC) 1643) gives a maximum number of usable cartridge slots of 200. This feature is a prerequisite for the Base Capacity on Demand (FC 1644), which gives the maximum capacity of 400 cartridge slots. FC 1644 is required to attach an optional expansion frame. Both FC 1643 and 1644 are prerequisites to install the HD CoD for L55 (FC 1648). This configuration gives the maximum capacity of 730 - 882 slots.

Depending on the frame position, the maximum number of LTO drives that can be installed is 16. Five generations of HD2-compatible LTO drives exist: The LTO Ultrium 9 tape drive (Model 3588 F9C, F9S, S9C), LTO Ultrium 8 tape drive (Model 3588 F8C, F8S), LTO Ultrium 7 tape drive (Model 3588 F7C), LTO Ultrium 6 tape drive (Model 3588 F6C), and the LTO Ultrium 5 tape drive (Model 3588 F5C), which can be installed in the L55 frame. Drive slots are fixed.

Adding drives to the L55 frame does not affect the number of available storage slots.

Drive slots and HD slots are shown in Figure 11-5.

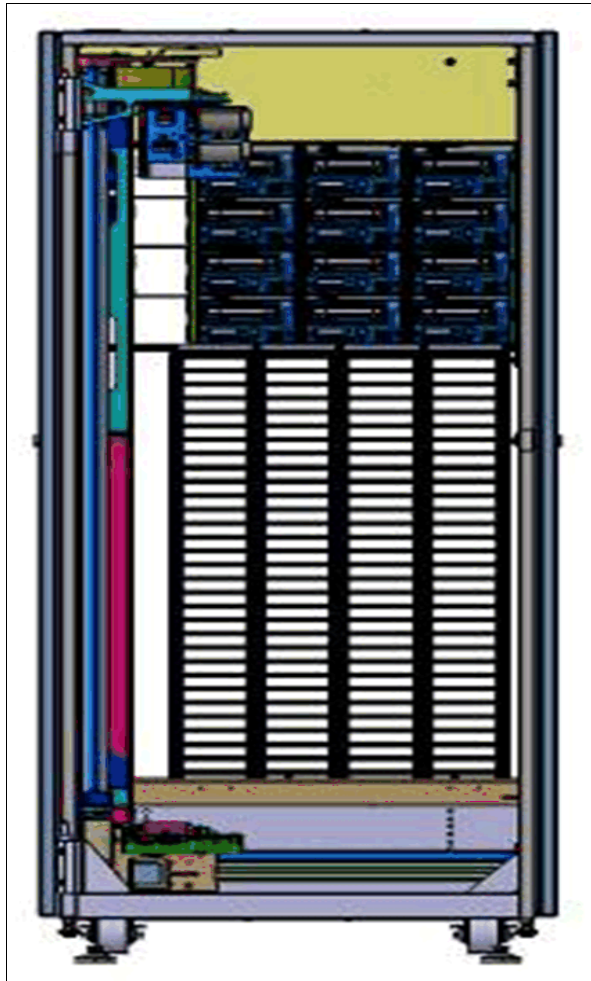

Figure 11-5 L55/L25 frame internal

When CoD features are installed, the position and configuration of the frame affect the total available capacity of the L55. Table 11-3 shows the available storage capacity based on possible frame positions and configurations.

Table 11-3 Quantity of storage slots in an L55 frame

Licensed features	Frame position	Quantity of drives	Quantity of I/O slots	Quantity of storage slots
Entry	1	1 - 12	36	100
Intermediate	1	1 - 12	36	200
Base	1	0 - 12	36	400
Base	2+	0 - 16	36	400
HD CoD	1	0 - 12	36	730
HD CoD	2+	0 - 16	36	882

The L55 frame comes standard with two I/O stations. Each I/O station houses a cartridge magazine that allows individual cartridge handling to be done independently of the tape library. The cartridge magazine for each I/O station on LTO frames can hold up to 18 cartridges, providing a total of 36 I/O slots. The TS4500 tape library Model L55 imports or exports cartridges from the library, without requiring reinventory, or interruption of library operations.

The lockable library door can be opened for bulk-loading LTO tape cartridges. Reinventory of the cartridges in Tier 0 and Tier 1 is done in fewer than 60 seconds per frame, each time that the library door is closed. A bar code reader that is mounted on the autochanger is used to scan the cartridge bar code labels during inventory.

On an HD frame, the inventory checks only Tier 1 bar code labels, and checks the other tier labels only if Tier 1 changed.

A door lock is included to restrict physical access to cartridges in the library and a door open sensor is equipped to prevent accessor movement while the door is open. With plant feature code 4892, we support for rear door open detection and reporting.

**Note:** The left and right side doors also contain the door lock and open sensor.

Included in the L55 frame is the integrated management console (IMC), which is a built-in platform for tools that are used to manage the TS4500 tape library. The IMC, which includes an LCD panel and a keyboard with touchpad, can be mounted on either end of your TS4500 tape library.

A library controller card (LCC) and power source are required within that end frame or within the adjacent frame. Alternatively, feature code 2737, IMC Separate Power Source, can source the IMC power independently and to an LCC anywhere in the library.

### **TS4500 tape library Model D55**

The D55 frame, as shown in Figure 11-6 on page 295, has the same footprint as the model L55.

The D55 frame cannot be installed on its own. It must be connected to a library with a base frame. A maximum of 18 frames, including the L55 frame, can be connected, as shown in Figure 11-3 on page 289.

**Note:** The combined number of D55 or D25 drive frames that are allowed in a TS4500 library is limited to seven.

The number of additional LTO cartridge storage slots per D55 frame is 500 - 970. With the minimum configuration, only 500 slots are available for use. More slots can be enabled by installing a CoD license key.

The base capacity on a D55 frame gives the maximum capacity of 500 cartridge slots. FC 1644 must be installed on the L55 frame, along with either FC 9002, or FC 9003, and the corresponding prerequisite FC, to attach a D55 expansion frame. The HD CoD for D55 (FC 1650) gives the maximum capacity of 730 - 970 slots, depending on the frame position.



Depending on the frame position, the maximum number of LTO drives that can be installed is 16. As with the L55 frame, five generations of HD2-compatible LTO drives, which are the LTO Ultrium 9 tape drive (Model 3588 F9C, F9S and S9C), LTO Ultrium 8 tape drive (Model 3588 F8C), LTO Ultrium 7 tape drive (Model 3588 F7C), LTO Ultrium 6 tape drive (Model 3588 F6C), and the LTO Ultrium 5 tape drive (Model 3588 F5C), can be installed in the D55 frame.

Drive slots are fixed. Adding drives to the D55 frame does not affect the number of storage slots that are available.

Two extra I/O stations can be installed in any Dx5 expansion frame by ordering FC 1652. This feature installs two I/O stations in one expansion frame. Each additional pair of I/O stations increases the maximum insert/eject throughput for the library. The maximum cartridge capacity for expansion frames with two I/O stations is reduced by 44 cartridges for the model D55.

Drive slots and HD slots are shown in Figure 11-6.



Figure 11-6 TS4500 model D55/L55

The position and configuration of the frame, number of I/O slots, and the installation of CoD features all affect the total available storage capacity of the D55.

Table 11-4 lists the available storage capacity based on possible frame positions and configurations.

Table 11-4 Quantity of storage slots in the D55 frame

Licensed features	Frame position	Quantity of drives	Quantity of I/O slots	Quantity of storage slots
Base	1	0 - 12	0 - 36	500
Base	2+	0 - 16	0 - 36	500
HD CoD	1	0 - 12	36	730
HD CoD	1	0 - 16	0	774
HD CoD	2+	0 - 16	36	882
HD CoD	2+	0 - 16	0	970

## 11.2.2 TS4500 tape library frames for IBM 3592 Fibre Channel, Ethernet over optical fiber and Serial Attached SCSI drives

The TS4500 tape library models L25 and D25 integrate the TS1160, TS1155, TS1150, and TS1140 tape drives. The TS4500 Model S25 is a high-capacity storage-only frame for 3592 slots.

The Model L25 frame includes the Frame Control Assembly with two power supplies (for redundancy), an optimized dual-gripper cartridge accessor, on-demand storage slot capacity, and with two I/O stations with two 16-slot magazines.

### TS4500 tape library Model L25

The L25 can be installed on its own as a complete library enclosure, as shown in Figure 11-4 on page 292, or it can have up to 17 expansion frames that are attached to it. This frame provides the major library components for the whole library, whether it has a single or multiple frames. It also provides cartridge storage capacity for 3592 media and can be equipped with TS1160, TS1155, TS1150, and TS1140 (3592 model 60F, 55F, EH8, and EH7) dual-ported drives provide 8 Gbps Fibre Channel connectivity.

The TS1160 (3592-60E) Ethernet over optical fiber dual-ported drives provide 10 Gbps or 25Gbps Ethernet connectivity. The TS1155 (3592-55E) Ethernet over optical fiber dual-ported drives provide 10 Gbps Ethernet connectivity. The TS1160 (3592-60S) dual-ported drives provide 12 Gbps SAS connectivity.

HD2 expansion frames can be added to either the left or right of the L25 frame. HD1 frames can be added only to the right side of the L25 frame.

The Intermediate Capacity feature (FC 1643) gives a maximum total number of usable cartridge slots of 200. This feature is a prerequisite for the Base Capacity on Demand (FC 1644), which gives the maximum capacity of 400 cartridge slots. FC 1644 is required to attach an optional expansion frame. FC 1644 is a prerequisite to install the HD CoD for L25 (FC 1647), which offers the maximum capacity of 550 - 660 slots.

Depending on the frame position, the maximum number of 3592 drives that can be installed is 16. Three generations of HD2-compatible 3592 drives, the TS1160 (3592 60E, 60F and 60S), TS1155 (3592 55E and 55F), TS1150 (3592 EH8), and TS1140 (3592 EH7) tape drives, are supported in the L25 frame. Drive slots are fixed. Adding drives to the L25 frame does not affect on the number of storage slots available.

Drive slots and HD slots are shown in Figure 11-7.



Figure 11-7 TS4500 model D25/L25

The position and configuration of the frame and the installation of CoD features affect the total available capacity of the L25. Table 11-5 shows available storage capacity based on possible frame positions and configurations.

Table 11-5 Quantity of storage slots in L25 frame

Licensed features	Frame position	Quantity of drives	Quantity of I/O slots	Quantity of storage slots
Entry	1	1 - 12	32	100
Intermediate	1	1 - 12	32	200
Base	1	0 - 12	32	400
Base	2+	0 - 16	32	400
HD CoD	1	0 - 12	32	550
HD CoD	2+	0 - 16	32	660

The L25 frame comes standard with two I/O stations. Each I/O station houses a cartridge magazine that allows importing or exporting cartridges from the library without requiring reinventory or interruption of library operations. The cartridge magazine for each I/O station on 3592 frames can hold up to 16 cartridges, providing a total of 32 I/O slots.

The lockable library door can be opened for bulk-loading IBM LTO Ultrium tape cartridges. Reinvention of the cartridges in Tier 0 and Tier 1 is done in fewer than 60 seconds per frame, each time that the library door is closed. A bar code reader that is mounted on the autochanger is used to scan the cartridge bar code labels during inventory.

**Note:** If a bulk load is performed, the top two rows on tier 1 must remain empty to allow for the initial inventory.

On an HD frame, the inventory checks only Tier 1 bar code labels, and checks the other Tier labels only if Tier 1 changed.

A door lock is included to restrict physical access to cartridges in the library. A door open sensor also is equipped to prevent accessor movement while the door is open. With plant feature code 4892, rear door open detection and reporting is supported.

Included in the L25 frame is the IMC, which is a built-in platform for tools that are used to manage the TS4500 tape library. The IMC, which includes an LCD panel and a keyboard with touch pad, can be mounted on either end of your TS4500 tape library.

An LCC and power source are required within that end frame or within the adjacent frame. Alternatively, feature code 2737, IMC Separate Power Source, can source the IMC power independently and to an LCC anywhere in the library.

### **TS4500 tape library Model D25**

The D25 frame, as shown in Figure 11-6 on page 295, has the same footprint as the Model L25. The D25 frame cannot be installed on its own. It must be connected to a library with a base frame and optional expansion frames. A maximum of 18 frames, including the L25 frame, can be connected, as shown in Figure 11-3 on page 289.

**Note:** The combined number of D55 or D25 frames that are allowed in a TS4500 library is limited to seven.

The number of additional 3592 cartridge storage slots per D25 frame ranges from 500 - 740. With the minimum configuration, only 500 slots are available for use.

More slots can be enabled by installing a CoD license key.

The base capacity on a D25 frame gives the maximum capacity of 500 cartridge slots. FC 1644 must be installed on the L55 frame with either FC 9002 or 9003 and the corresponding prerequisite FC to attach a D25 expansion frame.

The HD CoD for D25 (FC 1649) gives the maximum capacity of 660 - 740 slots, depending on frame position.

Depending on the frame position, the maximum number of 3592 drives that can be installed is 16. Three generations of HD2-compatible 3592 drives, the TS1160 (3592 60E, 60F and 60S), TS1155 (3592 55E and 55F), TS1150 (3592 EH8), and TS1140 (3592 EH7) tape drives are supported in the D25 frame. Drive slots are fixed. Adding drives to the D25 frame does not affect on the number of storage slots available.

Drive slots and HD slots are shown in Figure 11-7 on page 297. Two extra I/O stations can be installed in any Dx5 expansion frame by ordering FC 1652. This feature installs two I/O stations in one expansion frame. Each additional pair of I/O stations increases the maximum insert/eject throughput for the library. The maximum cartridge capacity for expansion frames with two I/O stations is reduced by 80 cartridges for the Model D25 frame.

The position and configuration of the frame, number of I/O slots, and the installation of CoD features all affect the total available storage capacity of the D55. Table 11-6 shows available storage capacity based on possible frame positions and configurations.

Table 11-6 Quantity of storage slots in D25 frame

Licensed features	Frame position	Quantity of drives	Quantity of I/O slots	Quantity of storage slots
Base	1	0 - 12	0 or 32	500
Base	2+	0 - 16	0 or 32	500
HD CoD	1	0 - 12	32	550
HD CoD	1	0 - 12	0	590
HD CoD	2+	0 - 16	32	660
HD CoD	2+	0 - 16	0	740

### 11.2.3 TS4500 tape library storage-only HD frames

This section describes TS4500 tape library storage-only HD frame models.

#### Model S55 and S25

IBM TS4500 includes the Model S25 frame and the Model S55 frame, which are high density (HD) version 2 storage-only expansion frames, which are shown in Figure 11-8.

These frames are designed to greatly increase storage capacity without increasing frame size or required floor space.



Figure 11-8 SX5/SX4 frame

HD slots contain tape cartridges in a tiered architecture. The cartridge immediately accessible in the HD slot is a Tier 1 cartridge. Behind that is Tier 2, and so on. The maximum tier in an LTO HD slot is Tier 5. The maximum tier in a 3592 HD slot is Tier 4 because the 3592 tape cartridge is slightly longer than the LTO cartridge. The single-deep slots on the door side of HD frames are referred to as *Tier 0 slots*.

On the left, Figure 11-9 shows the inside of an HD frame from the side. On the right, Figure 11-9 shows a top-down view of one row of an HD frame with cartridges in tiers 0 (door side), 1, 2, and 3.

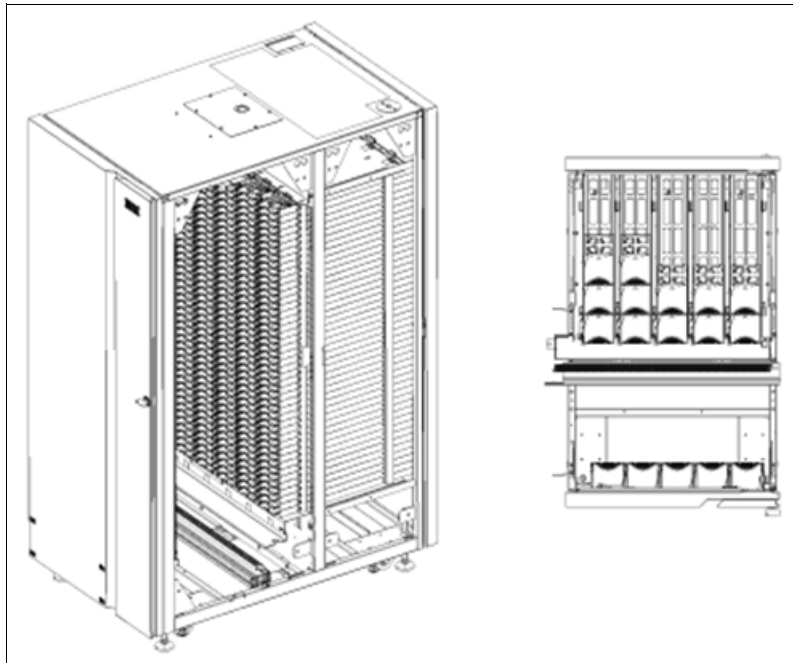

Figure 11-9 The HD frame (left) and top-down view of a row in an HD frame (right)

### Model S24 and S54

The IBM TS3500 storage-only frame HD1 Model, S24 and S54, can be attached to the TS4500.

These generation 1 HD frames can be redeployed into a TS4500 if they are installed to the right of the Lx5 frame. They must have FC 1742 installed before they can be added to a TS4500 library string. This feature code replaced the TS3500 cards to be supported on TS4500, shown in Figure 11-10.

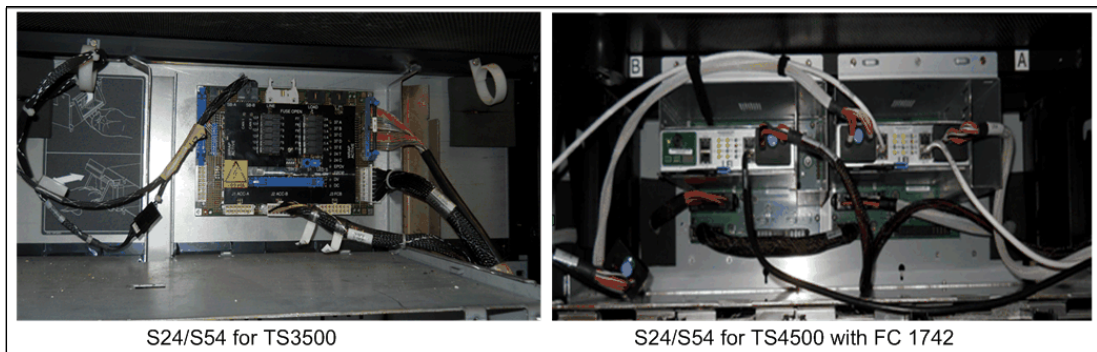

Figure 11-10 Changes to S24/S54 for TS4500 attach



The TS3500 tape library Model S24 and S54 frames are HD version 1 storage only expansion frames, which were attached to existing TS3500 tape libraries and frames.

The model S24 expansion frame is for 3592 data cartridges. Up to 17 Model S24 expansion frames can be added to the right of the Lx5 frame, the TS4500 Model L25 base frame to increase 3592 cartridge storage. Each Model S24 frame supports up to 1000 IBM 3592 cartridge slots.

The model S54 expansion frame is for LTO data cartridges. Up to 17 Model S54 expansion frames can be added to the right of the Lx5 frame, the TS4500 tape library Model L55 base frame, to increase LTO cartridge storage. Each Model S54 Frame supports up to 1320 LTO cartridge slots.

The HD1 model S24 and S54 can be added to any TS4500 expansion frame, if it is right of the LX5 frame and to a total of 18 expansion frames, including the LX5 frame.

### HD1 and HD2 frames

All HD slots are black; however, the location of the cartridge retention latch differentiates LTO HD slots from 3592 HD slots. The cartridge retention latch is on the left side of LTO HD slots and on the right side of 3592 HD slots, as shown in Figure 11-11.

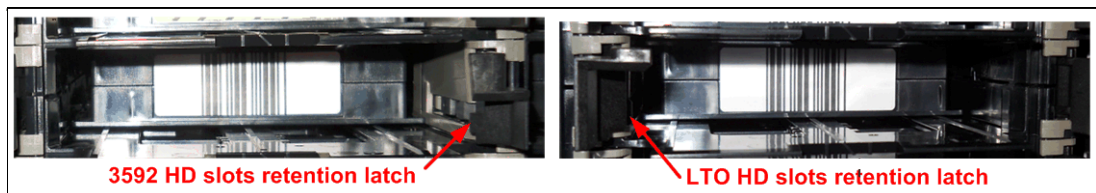

Figure 11-11 HD slot

**Attention:** The HD slots have a constant force spring for maintaining forward pressure on the tape cartridges. Use caution when inserting or removing cartridges from HD slots.

In an HD library, a standard inventory is a scan of Tier 0 and Tier 1; however, at times, it is necessary to inventory all tiers. This operation takes more time because it requires moving the cartridges within an HD slot to scan each bar code. For all inventory operations, Tier 2 and higher tiers in an HD slot are only scanned when one of the following changes occurs:

- ▶ A Tier 1 cartridge bar code label changed
- ▶ Enough Tier 1 bar code labels changed in a column to warrant an inventory of the entire column of HD slots
- ▶ Inventory of all tiers is selected when initiating a manual inventory from the TS4500 management GUI

In HD frames, the cartridge accessor performs a shuffle operation to access the cartridges that are stored in Tier 2 and beyond. A *shuffle* is the process of moving cartridges in lower tiers into the gripper, or other available slots, to access cartridges in higher tiers (Tier 2 or greater). To reduce shuffle operations and take advantage of repeated accesses of certain cartridges, the role of cartridge cache is assigned to all single-deep (Tier 0) slots in an HD library.

To maintain efficient shuffle operations, the library uses load balancing to store cartridges across all HD slots in the library string. Therefore, all HD slots are filled to a minimum tier level until that tier is full across the library.

For the initial bulk load on a newly installed frame, insert cartridges into the deep slots, but leave the top two rows empty. The slots in the top two rows must be empty for the initial audit of the frame to start. The initial audit fills these slots and then they are used like any other HD slot in subsequent library operations.

First-generation HD (HD1) can be installed only to the right of an LX5 frame.

Second-generation HD (HD2) frames provide the following enhancements:

- ▶ Can be installed in the left-most library position (frame position 1)
- ▶ Offer drive-capable models that support up to 16 HD2-compatible tape drives when in frame position 2 or higher

The position and configuration of the frame, and the installation of CoD features, all affect the total available storage capacity of the S25 and S55 frames. Table 11-7 shows available storage capacity based on possible frame positions and configurations.

*Table 11-7 Quantity of storage slots in S25/S55 frames*

Model	Licensed features	Frame position	Quantity of storage slots
S25	S25 Base	Any	600
S55	S55 Base	Any	660
S25	S25 HD CoD	1	798
S55	S55 HD CoD	1	1,054
S25	S25 HD CoD	2+	1,000
S55	S55 HD CoD	2+	1,320
S24	S24 HD CoD	2+	1,000
S54	S54 HD CoD	2+	1,320

## 11.2.4 TS4500 High Availability (HA) option

The TS4500 High Availability (HA) option provides a second accessor for redundancy and performance. This feature allows for dual accessors in a dual-active mode and has an integrated service bay to reduce service space.

The TS4500 HA option and Integrated Service Bays replace the HA1 frame and Service Bay B frames that are used on the TS3500. The Integrated Service Bay allows a section of a frame to be used for servicing an accessor while the remaining portion of the frame is still available for active storage and drives. Accessor service must be performed through the side opening doors of Integrated Service Bays. Any HD2 frame can be an Integrated Service Bay.

The second accessor, accessor B, is provided when you order a new DX5 or SX5 frame with FC 1442. The new DX5 or SX5 frame can be installed in any position and is shipped with the new B accessor. The accessor can be removed from the new frame and installed on the right side of the TS4500 if the new frame is installed on the left side.



Figure 11-12 shows the HA feature that is shipped in a new D25 frame.



*Figure 11-12 D25 frame that is ordered with FC 1442*

The left or A side Integrated Service Bay allows cartridges to be populated in storage columns 9 and 10, and drives can be populated in drive column 4.

The right or B side Integrated Service Bay allows cartridges to be populated in storage columns, 1, 2, 3, and 4, and drives can be populated in drive columns 1 and 2. The I/O stations are accessible in the right Integrated Service Bay. Integrated Service Bays allow for a minimum dual accessor system to be only two frames.

The available storage for HA is shown in Figure 11-13.

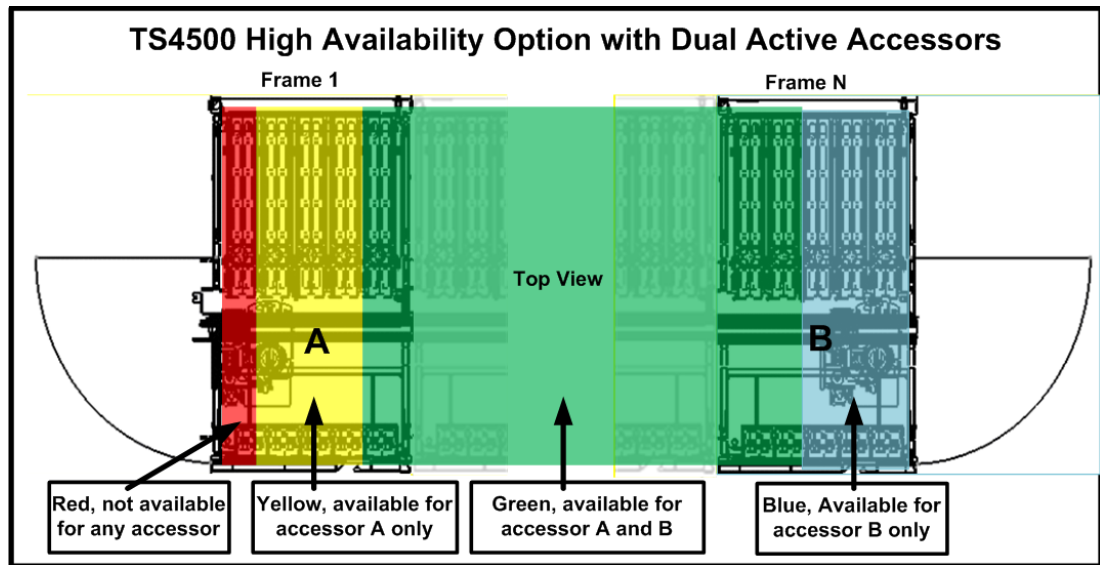

Figure 11-13 Available storage with the HA option

**Note:** I/O stations are not accessible in the left Integrated Service Bay, so a L25 or L55 frame cannot be used as a left integrated Service Bay. The frame that is shipped with the HA option can be installed on the left side if required, as there are no dedicated service bays and the new accessor can be installed in the right side frame.

### Elastic capacity

The TS4500 provides the Elastic Capacity option to eliminate inactive service space and can provide temporary relief for temporary overflow conditions. These slots are referred to as Tier 10 - 15 slots, and standard storage slots are Tier 0 - 5.

With dual active accessors, some storage slots are available only to a single accessor and are unavailable during accessor service. The ability to use these slots is optional and can be enabled or disabled on the management interface.

Here are the Elastic Capacity options:

- ▶ Do not use
- ▶ Use for temporary overflow
- ▶ Use for maximum capacity

#### ***Do not use***

In this mode, the TS4500 does not use the Elastic Capacity slots for media storage, so all media is usable when only one accessor is available. Tier T10 - 15 slots are not used.

#### ***Use for temporary overflow***

In this mode, the only time cartridges are moved to elastic storage is when the library is 100% full and new inserts have no other destination choice. In this case, T10 - T15 is used as temporary storage to handle the library overflow. Cartridges are returned to HA space after space becomes available either manually by a user or when the application mounts and unmounts the cartridges in the Elastic Capacity slots (T10 - T15).

### ***Use for maximum capacity***

Use this setting to store media cartridges in the limited access (Elastic Capacity) columns as normal storage. The use of these slots can be managed by using different methods:

- ▶ **Manually:** A user can select a cartridge to destage to elastic storage through the CLI. If the cartridge is already in elastic storage, no action is taken.
- ▶ **SCSI:** An application can use the HD Control field of the SCSI Move Medium command to specify that the move is an elastic storage destage.
- ▶ **Periodic:** When the dual-access area (the cartridge slots that both A and B accessors can reach) exceeds the usage threshold, the least recently used cartridges are moved into the Elastic Capacity area. The default usage threshold is 98%.

### **TS4500 Slot and Capacity Calculator Tool**

The IBM Tape Library Slot and Capacity Calculator Tool helps calculate capacity and slot numbers for all IBM Tape Libraries, including TS3100, TS3200, TS3310, TS3500, and the TS4500, including TS4500 capacity with the different Elastic Capacity options.

This tool is available at this [IBM Support web page](#).

## **11.2.5 External TSSC**

Since R3, TS4500 supports an external TSSC, which can be configured so that a single TSSC provides call home capability for several TS7700, TS4500, or TS3500 devices on the same site, as shown in Figure 11-14.

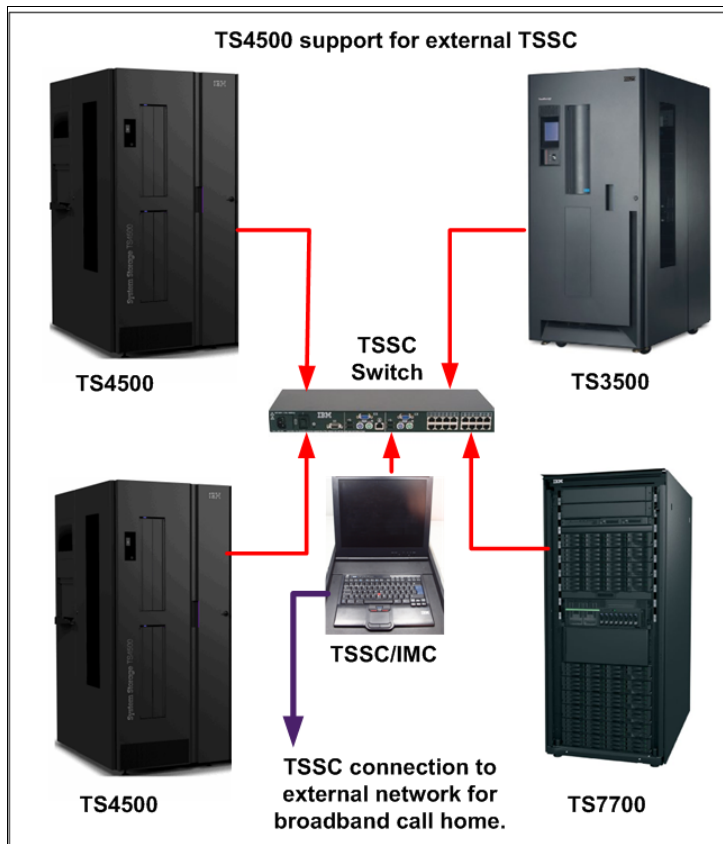

Figure 11-14 External TSSC server

## 11.2.6 TS4500 tape library top rack frame TR1

The top rack, 3584 Model TR1, provides an extra 10U of rack space on any frame in a library without requiring more floor space.

The optional top rack, shown in Figure 11-15, reduces the storage footprint and simplifies cabling by providing extra rack space above the library for power distribution units, Fibre Channel switches, tape data movers, or IBM Spectrum Archive nodes.



*Figure 11-15 Tape library with top rack installed*

A top rack is installed in the field by an IBM service representative on one or more frames of a TS4500 tape library. The top rack, and any components that are housed in the rack, are supported and serviced independently of the TS4500 tape library.

Feature code 1750, top rack end covers, is required for the left and right ends of one or more adjacent top racks. This feature is only required for the first top rack that is ordered when multiple top racks are ordered for adjacent frames.

Feature code 1751, power distribution unit (PDU), can optionally be ordered for any top rack. Up to two of FC 1751 can be ordered for any top rack. The first PDU does not use any of the 10U rack space. A second PDU, for redundancy, uses 1U of rack space. One power cord feature, FC 9954 through FC 9959 or FC 9966, is required for each PDU that is ordered.

Figure 11-16 shows the top rack without covers and devices installed.

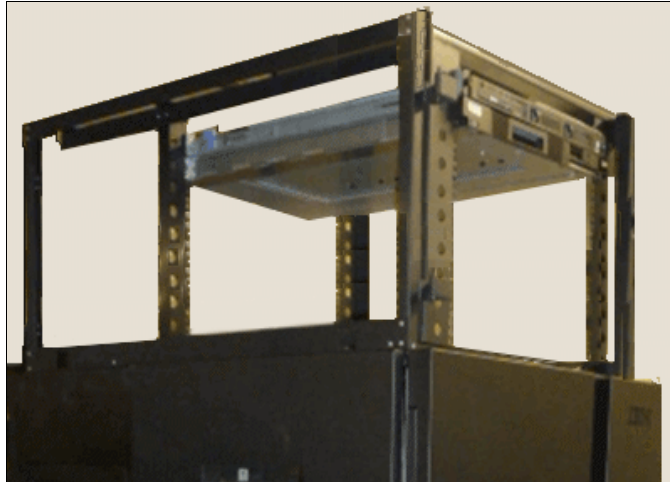

*Figure 11-16 Top rack without covers*

**Note:** The top rack is treated as an independent rack space and it is not tied to the service or support of the tape library.

For more information about the TS4500, see the following resources:

- ▶ This [IBM Documentation web page](#)
- ▶ *IBM TS4500 R4 Tape Library Guide*, SG24-8235





## Part 3

# Appendixes

This part contains additional material that is related to the topics in this book.

The following appendixes are included in Part 3:

- ▶ Appendix A, “Data storage values” on page 311
- ▶ Appendix B, “IBM LTO Ultrium and 3592 media” on page 313
- ▶ Appendix C, “IBM tape product names” on page 333







# A

## Data storage values

This appendix describes the units of measure that are used to express data storage values in the IBM Tape Storage products. For example, in the IBM TS4500 tape library displays data storage values by using decimal (base-10) prefixes and binary (base-2) units of measurement.

Decimal units such as KB, MB, GB, and TB are commonly used to express data storage values, although these values are more accurately expressed by using binary units, such as KiB, MiB, GiB, and TiB. At the kilobyte level, the difference between decimal and binary units of measurement is relatively small (2.4%). This difference grows as data storage values increase, and when values reach terabyte levels, the difference between decimal and binary units approaches 10%.

To reduce the possibility of confusion, this appendix represents data storage by using decimal and binary units. Data storage values are displayed by using the following format:

#### decimal unit (binary unit)

By this example, the value 512 terabytes is displayed as shown in the following example:

512 TB (465.6 TiB)

Table A-1 compares the names, symbols, and values of the binary and decimal units.

*Table A-1 Comparison of binary and decimal units and values*

Decimal			Binary		
Name	Symbol	Value (BASE10)	Name	Symbol	Value (BASE2)
kilo	K	10 <sup>3</sup>	kibi	Ki	2 <sup>10</sup>
mega	M	10 <sup>6</sup>	mebi	Mi	2 <sup>20</sup>
giga	G	10 <sup>9</sup>	gibi	Gi	2 <sup>30</sup>
tera	T	10 <sup>12</sup>	tebi	Ti	2 <sup>40</sup>
peta	P	10 <sup>15</sup>	pebi	Pi	2 <sup>50</sup>
exa	E	10 <sup>18</sup>	exbi	Ei	2 <sup>60</sup>

Table A-2 lists the increasing percentage difference between binary and decimal units.

*Table A-2 Percentage difference between binary and decimal units*

Decimal value	Binary value	Percentage difference
100 kilobytes (KB)	97.65 kibibytes (KiB)	2.35%
100 megabytes (MB)	95.36 mebibytes (MiB)	4.64%
100 gigabytes (GB)	93.13 gibibytes (GiB)	6.87%
100 terabytes (TB)	90.94 tebibytes (TiB)	9.06%
100 petabytes (PB)	88.81 pebibytes (PiB)	11.19%
100 exabytes (EB)	86.73 exbibytes (EiB)	13.27%



# B

## IBM LTO Ultrium and 3592 media

When an IBM tape library is ordered, it is supplied with one Ultrium data cartridge or one 3592 data cartridge and one cleaning cartridge at no charge. Each member of the IBM 35xx, TS3xxx and TS4500 tape library family has different media features and rules that apply when the order is placed. The information in this appendix assists you when you are ordering more media.

To order media for your Ultrium or 3592 tape drives, see this IBM IT Infrastructure [web page](#).

On this page, a list of authorized distributors is presented by location.

For a list of other features for IBM Linear Tape-Open (LTO) Ultrium and 3592 supply data cartridges with bar code labels that are separately delivered to the data cartridges, see “Features available with the initial IBM hardware order” on page 314. The value of bar code labels cannot be predetermined. For cartridges with predefined bar code labels and predetermined bar code values, order cartridges from an IBM reseller (see Table B-9 on page 332).

Media suppliers can supply tape cartridges from various manufacturers or offer a choice of brands. The tape cartridges that you use must be manufactured by a qualified LTO media company to meet LTO standards.

This appendix includes the following topics:

- ▶ “Features available with the initial IBM hardware order” on page 314
- ▶ “IBM 3589 LTO Ultrium tape cartridges” on page 316
- ▶ “Bar code labels” on page 323
- ▶ “IBM 3599 tape cartridges” on page 324
- ▶ “Labeling service” on page 330

## Features available with the initial IBM hardware order

The following media features are available for inclusion with the initial hardware order. All media and cleaning cartridges are warranted separately from the IBM Ultrium hardware.

### IBM stand-alone tape drives

The following IBM stand-alone tape drives are available:

- ▶ IBM TS2250 tape drive  
Part number 46C2084 or feature code 8505 provides a pack of five Ultrium 5 data cartridges.
- ▶ IBM TS2350 tape drive  
Part number 46C2084 or feature code 8505 provides a pack of five Ultrium 5 data cartridges.
- ▶ IBM TS2260 tape drive  
Part number 39P1901 or feature code 8605 provides a pack of five Ultrium 6 data cartridges.
- ▶ IBM TS2360 tape drive  
Part number 39P1901 or feature code 8605 provides a pack of five Ultrium 6 data cartridges.
- ▶ IBM TS2270 tape drive  
Feature code 8706 provides a pack of five Ultrium 7 data cartridges.
- ▶ IBM TS2280 tape drive  
Feature code 8806 provides a pack of five Ultrium 8 data cartridges.
- ▶ IBM TS2290 tape drive  
Feature code 6507 provides a pack of five Ultrium 9 data cartridges.

### IBM TS2900 tape autoloader

The following chargeable features provide media with the TS2900 tape autoloader and are available with the initial order:

- ▶ Part number 46C2084 or feature code 8505 provides a pack of five Ultrium 5 data cartridges.
- ▶ Part number 39P1901 or feature code 8605 provides a pack of five Ultrium 6 data cartridges.
- ▶ Feature code 8706 provides a pack of five Ultrium 7 data cartridges.
- ▶ Feature code 8806 provides a pack of five Ultrium 8 data cartridges.
- ▶ Feature code 8905 provides a pack of five Ultrium 9 data cartridges.
- ▶ Feature code 8807 provides a single Ultrium cleaning cartridge. For the high volume sellers, the cleaning cartridge must be ordered by using part number 23R7008.

## **IBM TS3100 tape library**

The following chargeable features provide media with the TS3100 tape library and are available with the initial order:

- ▶ Feature code 8505 provides a pack of five Ultrium 5 data cartridges.
- ▶ Feature code 8605 provides a pack of five Ultrium 6 data cartridges.
- ▶ Feature code 8706 provides a pack of five Ultrium 7 data cartridges.
- ▶ Feature code 8806 provides a pack of five Ultrium 8 data cartridges.
- ▶ Feature code 8905 provides a pack of five Ultrium 9 data cartridges.

## **IBM TS3200 tape library**

The following chargeable features provide media with the TS3200 tape library and are available with the initial order:

- ▶ Feature code 8505 provides a pack of five Ultrium 5 data cartridges.
- ▶ Feature code 8605 provides a pack of five Ultrium 6 data cartridges.
- ▶ Feature code 8706 provides a pack of five Ultrium 7 data cartridges.
- ▶ Feature code 8806 provides a pack of five Ultrium 8 data cartridges.
- ▶ Feature code 8905 provides a pack of five Ultrium 9 data cartridges.

## **IBM TS3310 tape library**

For more information about ordering media supplies for the TS3310 tape library, see “IBM 3589 LTO Ultrium tape cartridges” on page 316.

## **IBM TS4300 tape library**

- ▶ Feature code 8605 provides a pack of five Ultrium 6 data cartridges.
- ▶ Feature code 8706 provides a pack of five Ultrium 7 data cartridges.
- ▶ Feature code 8806 provides a pack of five Ultrium 8 data cartridges.
- ▶ Feature code 8905 provides a pack of five Ultrium 9 data cartridges.

## **IBM TS3500 tape library**

For more information about ordering media supplies for the TS3500 tape library, see “IBM 3589 LTO Ultrium tape cartridges” on page 316, and “IBM 3599 tape cartridges” on page 324.

## **IBM TS4500 tape library**

For more information about ordering media supplies for the TS4500 tape library, see “IBM 3589 LTO Ultrium tape cartridges” on page 316, and “IBM 3599 tape cartridges” on page 324.

## IBM 3589 LTO Ultrium tape cartridges

To ensure that the IBM Ultrium tape drive conforms to the IBM specification for reliability, use only IBM LTO Ultrium tape cartridges. IBM LTO Ultrium data cartridges cannot be interchanged with the media that is used in other IBM non-LTO Ultrium tape products.

Table B-1 lists the generations of IBM Ultrium data cartridges, which are identified by color.

*Table B-1 LTO Ultrium data cartridges identified by color*

<b>Data cartridge</b>	<b>Case color</b>
Ultrium 9 WORM	Teal and Silvery gray
Ultrium 9	Teal
Ultrium 8 WORM <sup>a</sup>	Burgundy and silvery gray
Ultrium 8	Burgundy
Ultrium 7 WORM	Purple and silvery gray
Ultrium 7	Purple
Ultrium 6 WORM	Black and silvery gray
Ultrium 6	Black
Ultrium 5 WORM	Burgundy and silvery gray
Ultrium 5	Burgundy
Ultrium 4 WORM	Green top, platinum (silvery gray bottom)
Ultrium 4	Green
Ultrium 3 WORM	Blue top, platinum (silvery gray bottom)
Ultrium 3	Blue
Ultrium 2	Purple
Ultrium 1	Black

a. Ultrium 8 WORM tape cartridges are available from media resellers.

All six generations contain ½-inch, dual-coat, metal-particle tape. Table B-2 lists the native capacity of Ultrium data cartridges.

Table B-2 Native capacity of the Ultrium data cartridges

Data cartridge	Native data capacity
Ultrium 9 WORM	18 TB (45 TB at 2.5:1 compression)
Ultrium 9	18 TB (45 TB at 2.5:1 compression)
Ultrium 8 WORM <sup>a</sup>	12 TB (30 TB at a 2.5:1 compression ratio)
Ultrium 8	12 TB (30TB at a 2.5:1 compression ratio)
Ultrium 7 M8 Format <sup>b</sup>	9 TB (22.5 TB at a 2.5:1 compression ratio)
Ultrium 7 WORM	6 TB (15 TB at a 2.5:1 compression ratio)
Ultrium 7	6 TB (15 TB at a 2.5:1 compression ratio)
Ultrium 6 WORM	2.5 TB (6.25 TB at a 2.5:1 compression ratio)
Ultrium 6	2.5 TB (6.25 TB at a 2.5:1 compression ratio)
Ultrium 5 WORM	1.5 TB (3.0 TB at a 2:1 compression ratio)
Ultrium 5	1.5 TB (3.0 TB at a 2:1 compression ratio)
Ultrium 4 WORM	800 GB (1600 GB at a 2:1 compression ratio)
Ultrium 4	800 GB (1600 GB at a 2:1 compression ratio)
Ultrium 3 WORM	400 GB (800 GB at a 2:1 compression ratio)
Ultrium 3	400 GB (800 GB at a 2:1 compression ratio)
Ultrium 2	200 GB (400 GB at a 2:1 compression ratio)
Ultrium 1	100 GB (200 GB at a 2:1 compression ratio)

a. Ultrium 8 WORM tape cartridges are available from media resellers.

b. M8 media will not be supported on WORM cartridges.

## Cartridge compatibility

Table B-3 lists the compatibility of all Ultrium cartridges in Ultrium 9-4 tape drives.

Table B-3 Ultrium data cartridge compatibility.

IBM Ultrium tape drive	IBM LTO Ultrium data cartridge generation							
	18 TB (Ultrium 9)	12 TB (Ultrium 8)	9 TB M8 Format (Ultrium 7)	6 TB L7 Format (Ultrium 7)	2.5 TB (Ultrium 6)	1.5 TB (Ultrium 5)	800 GB (Ultrium 4)	400 GB (Ultrium 3)
Ultrium 9	Read/write	Read/write	N/A	N/A	N/A	N/A	N/A	N/A
Ultrium 8	N/A	Read/write	Read/write	Read/write	N/A	N/A	N/A	N/A
Ultrium 7	N/A	N/A	N/A	Read/write	Read/write	Read only	N/A	N/A
Ultrium 6	N/A	N/A	N/A	N/A	Read/write	Read/write	Read only	N/A
Ultrium 5	N/A	N/A	N/A	N/A	N/A	Read/write	Read/write	Read only
Ultrium 4	N/A	N/A	N/A	N/A	N/A	N/A	Read/write	Read/write

## Model description and ordering media supplies

This section includes two tables to help you easily find the media description and several methods that can be used to order the media.

Table B-4 lists the models of the IBM Storage Tape Media 3589 for use with IBM Ultrium tape drives. IBM 3589 now supports volume serial (VOLSER) labels with embedded radio-frequency identification (RFID)-enabled bar code labels, which store and allow remote retrieval of VOLSER information. RFID labels contain a 216-bit unique pre-programmed field and a 256-bit user-defined field. These RFID labels work with most standard asset tracking and management software. RFID labels for LTO-8 tape cartridges are available from media resellers.

Table B-4 3589 media (20-pack)

Model	Description	Media identifier	Feature code
3589-02	IBM Ultrium 1 cartridge (100 GB) with labels	L1	FC2020
3589-03	IBM Ultrium 1 cartridge (100 GB) without labels		FC3020
3589-06	IBM Ultrium 2 cartridge (200 GB) with labels	L2	FC6020
3589-07	IBM Ultrium 2 cartridge (200 GB) without labels		FC7020
3589-08	IBM Ultrium 3 cartridge (400 GB) with labels	L3	FC0820
3589-09	IBM Ultrium 3 cartridge (400 GB) without labels		FC0920
3589-10	IBM Ultrium 4 cartridge (800 GB) with labels	L4	FC1020
3589-11	IBM Ultrium 4 cartridge (800 GB) without labels		FC1120
3589-14	IBM Ultrium 5 cartridge (1.5 TB) with labels	L5	FC1420
3589-15	IBM Ultrium 5 cartridge (1.5 TB) without labels		FC1520
3589-550	IBM Ultrium 6 cartridge (2.5 TB) with labels	L6	FC5500
3589-650	IBM Ultrium 6 cartridges (2.5 TB) without labels		FC6500
3589-551	IBM Ultrium 7 cartridge (6 TB) with labels	L7	FC5501
3589-651	IBM Ultrium 7 cartridge (6 TB) without labels		FC6501
3589-452	IBM Ultrium 7 M8 cartridge (9 TB) with labels	M8	FC5521
3589-552	IBM Ultrium 8 cartridge (12 TB) with labels	L8	FC5502
3589 652	IBM Ultrium 8 cartridge (12 TB) without labels		FC6502
3589 553	IBM Ultrium 9 cartridge (18 TB) with labels	L9	FC 5503
3589 653	IBM Ultrium 9 cartridge (18 TB) without labels		FC 6503
3589-28	IBM Ultrium 3 WORM cartridge (400 GB) with labels	LT	FC2820
3589-29	IBM Ultrium 3 WORM cartridge (400 GB) without labels		FC2920
3589-32	IBM Ultrium 4 WORM cartridge (800 GB) with labels	LU	FC3220
3589-33	IBM Ultrium 4 WORM cartridge (800 GB) without labels		FC3320
3589-34	IBM Ultrium 5 WORM cartridge (1.5 TB) with labels	LV	FC3420
3589-35	IBM Ultrium 5 WORM cartridge (1.5 TB) without labels		FC3520



Model	Description	Media identifier	Feature code
3589-570	IBM Ultrium 6 WORM cartridge (2.5 TB) with labels	LW	FC5700
3589-670	IBM Ultrium 6 WORM cartridge (2.5 TB) without labels		FC6700
3589-571	IBM Ultrium 7 WORM cartridge (6 TB) with labels	LX	FC5701
3589-671	IBM Ultrium 7 WORM cartridge (6 TB) without labels		FC6701
3589-572	IBM Ultrium 8 WORM cartridge (12 TB) with labels	LY	Available from media resellers.
3589-672	IBM Ultrium 8 WORM cartridge (12 TB) without labels		Available from media resellers.
3589-573	IBM Ultrium 9 WORM cartridge (18 TB) with labels	LZ	Available from media resellers.
3589-673	IBM Ultrium 9 WORM cartridge (18 TB) without labels		Available from media resellers.

With the media identifier, the following type of cartridge is identified:

- ▶ Media identifier L1 is an Ultrium 1 cartridge
- ▶ Media identifier L2 is an Ultrium 2 cartridge
- ▶ Media identifier L3 is an Ultrium 3 cartridge
- ▶ Media identifier L4 is an Ultrium 4 cartridge
- ▶ Media identifier L5 is an Ultrium 5 cartridge
- ▶ Media identifier L6 is an Ultrium 6 cartridge
- ▶ Media identifier L7 is an Ultrium 7 cartridge
- ▶ Media identifier M8 is an Ultrium 7 cartridge formatted for LTO8 use
- ▶ Media identifier L8 is an Ultrium 8 cartridge
- ▶ Media Identifier L9 is an Ultrium 9 cartridge
- ▶ Media identifier LT is an Ultrium 3 WORM cartridge
- ▶ Media identifier LU is an Ultrium 4 WORM cartridge
- ▶ Media identifier LV is an Ultrium 5 WORM cartridge
- ▶ Media identifier LW is an Ultrium 6 WORM cartridge
- ▶ Media identifier LX is an Ultrium 7 WORM cartridge
- ▶ Media identifier LY is an Ultrium 8 WORM cartridge
- ▶ Media Identifier LZ is an Ultrium 9 WORM cartridge

Table B-5 lists the media supplies. To find the closest IBM-authorized distributor, call 1-888-IBM-MEDIA or see this [IBM Storage media web page](#).

Table B-5 Media supplies

Item type	Description	Quantity	Order by machine type or model from an IBM sales representative or authorized IBM Business Partner	Order by part number from an IBM authorized distributor
Data cartridges (with labels)  (Specify the VOLSER characters that you want.)	Ultrium 9	20-pack	Machine Type: 3589 Model: 553	N/A
	Ultrium 8	20-pack	Machine Type: 3589 Model: 552	01PL041L
	Ultrium 7 M8	20-pack	Machine Type: 3589 Model: 452	N/A
	Ultrium 7	20-pack	Machine Type: 3589 Model: 551	N/A
	Ultrium 6	20-pack	Machine Type: 3589 Model: 550	00V7590L
	Ultrium 5	20-pack	Machine Type: 3589 Model: 014	46X1953 (color label) 46X1951 (black and white label)
	Ultrium 4	20-pack	Machine Type: 3589 Model: 010	95P4443 (color label) 95P4445 (black and white label)
	Ultrium 3	20-pack	Machine Type: 3589 Model: 008	96P1470 (color label) 96P1471 (black and white label)

Item type	Description	Quantity	Order by machine type or model from an IBM sales representative or authorized IBM Business Partner	Order by part number from an IBM authorized distributor
Data cartridges (without labels)  Order VOLSER labels separately (for more information, see "Bar code labels" on page 323).	Ultrium 9	20-pack	Machine Type: 3589 Model: 653	
	Ultrium 9	5-pack		
	Ultrium 8	20-pack	Machine Type: 3589 Model: 652	01PL041
	Ultrium 8	5-pack		
	Ultrium 7 M8	20-pack	Machine Type: 3589 Model: 651	28L7302
	Ultrium 7 M8	5-pack		
	Ultrium 7	20-pack	Machine Type: 3589 Model: 651	N/A
	Ultrium 7	5-pack		
	Ultrium 6	20-pack	Machine Type: 3589 Model: 650	00V7590
	Ultrium 6	5-pack		35P1902
	Ultrium 5	20-pack	Machine Type: 3589 Model: 015	46X1960
	Ultrium 5	5-pack		46C2084
	Ultrium 4	20-pack	Machine Type: 3589 Model: 011	95P4447
	Ultrium 3	1	Machine Type: 3589 Model: 009	24R1922

Item type	Description	Quantity	Order by machine type or model from an IBM sales representative or authorized IBM Business Partner	Order by part number from an IBM authorized distributor
WORM cartridges (with labels)  (Specify the VOLSER characters that you want.)	Ultrium 9	20-pack	Machine Type: 3589 Model: 573	02XW569L
	Ultrium 8	20-pack	Machine Type: 3589 Model: 572	
	Ultrium 7	20-pack	Machine Type: 3589 Model: 571	N/A
	Ultrium 6	20-pack	Machine Type: 3589 Model: 570	00V7591L
	Ultrium 5	20-pack	Machine Type: 3589 Model: 034	46X1965 (color label) 46X1963 (black and white label)
	Ultrium 4	20-pack	Machine Type: 3589 Model: 032  WORM cartridges that are labeled with starting volume serial information and, optionally, packed in individual jewel cases.	95P4457 (color label) 95P4459 (black and white label)
	Ultrium 3	20-pack	Machine Type: 3589 Model: 028  WORM cartridges that are labeled with starting volume serial information and, optionally, packed in individual jewel cases.	

Item type	Description	Quantity	Order by machine type or model from an IBM sales representative or authorized IBM Business Partner	Order by part number from an IBM authorized distributor
WORM cartridges (without labels)  Order VOLSER labels separately (for more information, see "Bar code labels" on page 323").	Ultrium 9	20-pack	Machine Type: 3589 Model: 673	02XW569
	Ultrium 8	20-pack	Machine Type: 3589 Model: 672	
	Ultrium 7	20-pack	Machine Type: 3589 Model: 671	38L7303
	Ultrium 6	20-pack	Machine Type: 3589 Model: 670	00V7591
	Ultrium 5	20-pack	Machine Type: 3589 Model: 035	46X1972
	Ultrium 4	20-pack	Machine Type: 3589 Model: 033	95P4461
	Ultrium 3	20-pack	Machine Type: 3589 Model: 029 Feature Core 2920  WORM cartridges that are packed in individual jewel cases with unattached blank labels.	
Cleaning Cartridge (with label)	Universal Cleaning Cartridge	5-pack	Machine Type: 3589 Model: 004 Feature Core 4005	35L2086
Repair Tools	Leader Pin Reattachment Kit	1	Not available in the sales channel	08L9129
	Manual Rewind Tool	1	Not available in the sales channel	08L9130

## Bar code labels

The LTO Ultrium 6 tape drives do not require cartridge bar code labels. However, if you use your data cartridges or cleaning cartridges in an IBM tape library product, you might need cartridge bar code labels if your tape library product requires them. You can order these labels separately from the IBM data cartridges and cleaning cartridges.

You can order bar code labels directly from the authorized label suppliers that are listed in Table B-9 on page 332.

## IBM 3599 tape cartridges

This section provides information about how to order media supplies, including feature codes and part numbers for ordering media supplies for 3592 tape drives. Selected media supplies can be ordered by using feature codes when a 3592 drive is purchased. This method is the pack-in method of ordering, and the media is included with the hardware order. Not all media types are available with this method.

The 3599 tape media method is available for ordering all types of data and cleaning cartridges. This method is typically used for ordering larger quantities and for ordering initialized and pre-labeled cartridges. Media supplies also can be ordered by using part numbers through distributors that are authorized by IBM.

### Model description

For clients who order media by using the 3599 tape media method, with IBM Enterprise Tape Media 3599, you can order unlabeled, prelabeled, initialized, and bulk-packaged tape data cartridges. You can order them in various combinations. You also can order cleaning cartridges for the TS1160, TS1155, TS1150, TS1140, TS1130, TS1120, and 3592 J1A tape drives.

Each 3592 data cartridge contains a passive, contactless, silicon storage device called cartridge memory (CM). The CM module holds information about that specific cartridge, the media in the cartridge, and the data on the media. The cartridge and media information is stored in a protected, read-only area of the CM. When the cartridge is loaded into the drive, a CM reader in the drive uses a contactless, radio-frequency interface to read the information. Each cleaning cartridge also contains a CM module, which tracks the number of cleaning uses and the location of the used cleaning media.

Cartridge capacity depends on the following recording formats of the tape drive that is writing the cartridges:

- ▶ TS1160 can write in format J6, J5A, and J5. TS1160 models 60G, 60F, and 60E can also write in encrypted formats J6-E, J5A-E, and J5-E, which do not change the capacity of the cartridge compared to the non-encrypted format.
- ▶ TS1155 can write in format J5A and J5. TS1155 models 55G, 55F, and 55E can also write in encrypted formats J5A-E and J5-E, which do not change the capacity of the cartridge compared to the non-encrypted format.
- ▶ TS1150 can write in format J5 and J4. TS1150 models E08 and EH8 can also write in encrypted formats J4-E and J5-E, which do not change the capacity of the cartridge compared to the non-encrypted format.
- ▶ TS1140 can write in format J4 and J3. TS1140 models E07 and EH7 can also write in encrypted formats J3-E and J4-E, which do not change the capacity of the cartridge compared to the non-encrypted format.
- ▶ TS1130 can write in the J3 and J2 formats. The TS1140 model E06 can also write in encrypted formats J3-E and J2-E, which do not change the capacity of the cartridge compared to the non-encrypted format.
- ▶ TS1120 writes in J1 or J2 format, and the E05 also can write in encrypted format J2-E, which does not change the capacity of the cartridge compared to the non-encrypted format.
- ▶ 3592-J1A writes in Format J1 only.

### 3592 media types

The TS1160 tape drive uses the Advanced Data (type JE) and Advanced WORM (type JV) cartridges. The type JE and JV cartridges have a maximum capacity of 20000 GB when the TS1160 is used.

The TS1155 tape drive uses the Advanced Data (type JD) and Advanced WORM (type JZ) cartridges. The type JD and JZ cartridges have a maximum capacity of 15000 GB when the TS1155 is used.

The TS1150 tape drive uses the Advanced Data (type JD) and Advanced WORM (type JZ) cartridges. The type JD and JZ cartridges have a maximum capacity of 10000 GB.

TS1150 and TS1140 tape drives use the Advanced Data (type JC) and Advanced WORM (type JY) cartridges. The type JC and JY cartridges have a maximum capacity of 4000 GB in J4 format and 7000 GB in J5 format.

Tape drives TS1140, TS1130, and TS1120 all can use 3592 Extended Data (type JB) and Extended WORM (type JX) with a maximum capacity of 1600 GB that uses the J4 format, 1000 GB that uses the J3 format, and 700 GB that uses the J2 format. The 3592 E07 tape drive can read format J2 only.

Tape drives TS1130, TS1120, and 3592 JIA use 3592 Standard Data (type JA) and Standard WORM (type JW) cartridges with a maximum capacity of 640 GB that uses J3 format, 500 GB that uses J2 format, and 300 GB that uses J1 format. The TS1140 tape drive does support cartridge types JA and JW in read-only on any format.

Tape drives TS1130, TS1140, and 3592 JIA use 3592 Economy Data (type JJ) and Economy WORM (type JR) cartridges with a maximum capacity of 128 GB that uses J3 format, 100 GB that uses J2 format, and 60 GB that uses J1 format. The 3592 E07 tape drive supports cartridge types JJ and JR in read-only on any format.

The TS1140 tape drive uses the 3592 Advanced Economy (type JK) cartridge with a maximum capacity of 500 GB that uses J4 format and 900 GB in J5 format.

The TS1150 and TS1155 tape drive uses the 3592 Advanced Economy (type JL) cartridge with a maximum capacity of 2000 GB in J5 format and 3000 GB in J5A format.

The TS1160 tape drive uses the 3592 Advanced Economy (type JM) cartridge with a maximum capacity of 4000 GB in J6 format.

### Ordering 3592 media supplies by using the 3599 tape media method

If you order media by using the 3599 tape media method, IBM Enterprise Tape Media 3599, you can order unlabeled, pre-labeled, initialized, and bulk-packaged data cartridges in various combinations. You also can order cleaning cartridges. Table B-6 lists the data cartridges that can be ordered by using the 3599 tape media method.

Table B-6 3599 media feature description

3599 model	Media ID/ Feature Code	Feature Code for labeling, initialization, and quantity		Format	Individual cartridge capacity	Description
		Regular	RFID			
011	JA/9030	1020	1021	9082	640 GB	3592 Enterprise Tape Cartridge labeled and initialized
				9081	500 GB	
				9080	300 GB	

3599 model	Media ID/ Feature Code	Feature Code for labeling, initialization, and quantity		Format	Individual cartridge capacity	Description
		Regular	RFID			
012	JA/9030	2020	2021	N/A	500 GB	3592 Enterprise Tape Cartridge labeled and not initialized
					300 GB	
013	JA/9030	3020	N/A	N/A	500 GB	3592 Enterprise Tape Cartridge not labeled and not initialized
					300 GB	
014	JB/9032	4020	4021	9084	1600 GB	3592 Extended Tape Cartridge labeled and initialized
				9082	1000 GB	
				9081	700 GB	
015	JB/9032	5020	5021	N/A	700 GB	3592 Extended Tape Cartridge labeled and not initialized
016	JB/9032	6020	N/A	N/A	700 GB	3592 Extended Tape Cartridge not labeled and not initialized
420	JC/9035	4211	4221	9084	4 TB	3592 Advanced Tape Cartridge labeled and initialized
520	JC/9035	5221	5231	N/A	4 TB	3592 Advanced Tape Cartridge labeled and not initialized
620	JC/9035	6200	N/A	N/A	4 TB	3592 Advanced Tape Cartridge not labeled and not initialized
	JC/9035	N/A	N/A	N/A	7 TB	3592 Advanced Tape Cartridge labeled and initialized
	JC/9035	N/A	N/A	N/A	7 TB	3592 Advanced Tape Cartridge labeled and not initialized
	JC/9035	N/A	N/A	N/A	7 TB	3592 Advanced Tape Cartridge not labeled and not initialized
425	JD/9036	4251	4261	9085	15 TB	3592 Advanced Tape Cartridge labeled and initialized
525	JD/9036	5251	5261	N/A	15 TB	3592 Advanced Tape Cartridge labeled and not initialized
625	JD/9036	6250	N/A	N/A	15 TB	3592 Advanced Tape Cartridge not labeled and not initialized
	JE				20 TB	3592 Advanced Tape Cartridge labeled and initialized
	JE			N/A	20 TB	3592 Advanced Tape Cartridge labeled and not initialized
	JE			N/A	20 TB	3592 Advanced Tape Cartridge not labeled and not initialized
E11	JJ/9050	1120	1121	9082	128 GB	3592 Economy Tape Cartridge labeled and initialized
				9081	100 GB	
				9080	60 GB	



3599 model	Media ID/ Feature Code	Feature Code for labeling, initialization, and quantity		Format	Individual cartridge capacity	Description
		Regular	RFID			
E12	JJ/9050	1220	1221	N/A	60 GB	3592 Economy Tape Cartridge labeled and not initialized
E13	JJ/9050	1320	N/A	N/A	60 GB	3592 Economy Tape Cartridge not labeled and not initialized
430	JK/9052	4300	4310	9084	500 GB	3592 Advanced Economy Tape Cartridge labeled and initialized
530	JK/9052	5300	5310	N/A	500 GB	3592 Advanced Economy Tape Cartridge labeled and not initialized
630	JK/9052	6300	N/A	N/A	500 GB	3592 Advanced Economy Tape Cartridge not labeled and not initialized
	JK/9052	N/A	N/A	N/A	900 GB	3592 Advanced Economy Tape Cartridge labeled and initialized
	JK/9052	N/A	N/A	N/A	900 GB	3592 Advanced Economy Tape Cartridge labeled and not initialized
	JK/9052	N/A	N/A	N/A	900 GB	3592 Advanced Economy Tape Cartridge not labeled and not initialized
435	JL/9054	4351	4361	9085	2 TB	3592 Advanced Economy Tape Cartridge labeled and initialized
535	JL/9054	5351	5361	N/A	2 TB	3592 Advanced Economy Tape Cartridge labeled and not initialized
635	JL/9054	6351	N/A	N/A	2 TB	3592 Advanced Economy Tape Cartridge not labeled and not initialized
	JM				5 TB	3592 Advanced Economy Tape Cartridge labeled and initialized
	JM			N/A	5 TB	3592 Advanced Economy Tape Cartridge labeled and not initialized
	JM		N/A	N/A	5TB	3592 Advanced Economy Tape Cartridge not labeled and not initialized
021	JR/9042	3120	3121	9082	128 GB	3592 WORM Tape Cartridge labeled and initialized
				9081	100 GB	
				9080	60 GB	
022	JR/9042	3220	3221	N/A	100 GB	3592 WORM Tape Cartridge labeled and not initialized
					60 GB	

3599 model	Media ID/ Feature Code	Feature Code for labeling, initialization, and quantity		Format	Individual cartridge capacity	Description
		Regular	RFID			
023	JR/9042	3320	N/A	N/A	100 GB	3592 WORM Tape Cartridge not labeled and not initialized
					60 GB	
021	JW/9040	2120	2121	9082	640 GB	3592 WORM Tape Cartridge labeled and initialized
				9081	500 GB	
				9080	300 GB	
022	JW/9040	2220	2221	N/A	500 GB	3592 WORM Tape Cartridge labeled and not initialized
					300 GB	
023	JW/9040	2320	N/A	N/A	500 GB	3592 WORM Tape Cartridge not labeled and not initialized
					300 GB	
024	JX/9044	2420	2421	9082	1000 GB	3592 Extended WORM Tape Cartridge labeled and initialized
				9081	700 GB	
025	JX/9044	2520	2521	N/A	700 GB	3592 Extended WORM Tape Cartridge labeled and not initialized
026	JX/9044	2620	N/A	N/A	700 GB	3592 Extended WORM Tape Cartridge not labeled and not initialized
440	JY/9046	4400	4410	9084	5 TB	3592 Advanced WORM Tape Cartridge labeled and initialized
540	JY/9046	5400	5410	N/A	5 TB	3592 Advanced WORM Tape Cartridge labeled and not initialized
640	JY/9046	6400	N/A	N/A	5 TB	3592 Advanced WORM Tape Cartridge not labeled and not initialized
	JY/9046	N/A	N/A	N/A	7 TB	3592 Advanced WORM Tape Cartridge labeled and initialized
	JY/9046	N/A	N/A	N/A	7 TB	3592 Advanced WORM Tape Cartridge labeled and not initialized
	JY/9046	N/A	N/A	N/A	7 TB	3592 Advanced WORM Tape Cartridge not labeled and not initialized
445	JZ/9046	4455	4465	9085	15 TB	3592 Advanced WORM Tape Cartridge labeled and initialized
545	JZ/9046	5451	5461	N/A	15 TB	3592 Advanced WORM Tape Cartridge labeled and not initialized

3599 model	Media ID/ Feature Code	Feature Code for labeling, initialization, and quantity		Format	Individual cartridge capacity	Description
		Regular	RFID			
645	JZ/9046	645	N/A	N/A	15 TB	3592 Advanced WORM Tape Cartridge not labeled and not initialized
	JV				20 TB	3592 Advanced WORM Tape Cartridge labeled and initialized
	JV			N/A	20 TB	3592 Advanced WORM Tape Cartridge labeled and not initialized
	JV		N/A	N/A	20 TB	3592 Advanced WORM Tape Cartridge not labeled and not initialized
017	JA	FC 7005	NA	No	N/A	5-pack 3592 Cleaning Cartridges, with media identification labels
017	JA	FC 7006	NA	No	N/A	5-pack 3592 Cleaning Cartridges, without media identification labels

With the 3599 tape media method of ordering, model numbers are used to identify the cartridge types. Feature code combinations are used to specify the quantities, labeling, and initialization options.

IBM 3599 supports volume serial number (VOLSER) labels with embedded radio frequency identification (RFID)-enabled bar code labels, which store and allow remote retrieval of VOLSER information. RFID labels contain a 216-bit unique pre-programmed field and a 256-bit user-defined field. These RFID labels work with most standard asset tracking and management software.

**Important:** For cartridges that are not initialized, the actual cartridge capacity depends on the format that is used to write the cartridge.

Table B-7 lists the data cartridges and media supplies that you can order for the 3592 tape drives.

*Table B-7 Media supplies for the 3592 drive*

Supply item	Media ID	Part number
IBM 3592 Advanced Enterprise Tape Cartridge	JE	02CE960
IBM 3592 Advanced Enterprise Tape Cartridge	JD	2727263
IBM 3592 Advanced Enterprise Tape Cartridge	JC	46X7452
IBM 3592 Extended Enterprise Tape Cartridge	JB	25R9830
IBM 3592 Enterprise Tape Cartridge	JA	18P7534
IBM 3592 Economy Tape Cartridge	JJ	24R0316
IBM 3592 Advanced Economy Tape Cartridge	JK	46X7453
IBM 3592 Advanced Economy Tape Cartridge	JL	2727264
IBM 3592 Advanced Economy Tape Cartridge	JM	
IBM 3592 Economy Tape Cartridge WORM	JR	24R0317
IBM 3592 Enterprise Cartridge WORM	JW	18P7538
IBM 3592 Extended Enterprise Cartridge WORM	JX	23R9831
IBM 3592 Advanced Enterprise Cartridge WORM	JY	46X7454
IBM 3592 Advanced Enterprise Cartridge WORM	JZ	2727265
IBM 3592 Advanced Enterprise Cartridge WORM	JV	
IBM Enterprise Data Cartridge 3592 cleaning, 50 uses	JA	18P7535

You can use one of the following methods to order the cartridges:

- ▶ Order by part number through an IBM authorized distributor. For more information about the nearest distributor, see this [IBM Storage media web page](#).
- ▶ If you do not have internet access, you can order the cartridges from any authorized IBM Business Partner or your IBM marketing representative.
- ▶ Call 1-888-IBM-MEDIA.

**Note:** All WORM cartridges must be ordered by using their part number, as shown in Table B-7 on page 330.

## Labeling service

The labeling service applies to IBM 3589 and IBM 3599 media types that have labels, as described in the previous sections.

Six characters are in the VOLSER. IBM provides specific codes to give you the flexibility to choose where to begin the volume range that you require. The sixth character is always a 0 character because your volume serial range always must begin at a 0 boundary for labeling.

Also, the labels that are supplied are sequential. For example, if you order 20 cartridges, the first cartridge is labeled with a sixth digit of 0, and the 20th cartridge is labeled with a sixth digit of 9.

The character identifier features are four-digit feature numbers in the form 9nnn, where:

- ▶ The first digit (9) indicates that the feature carries no charge.
- ▶ A second digit of 1, 2, 3, 4, or 5 indicates which character in the VOLSER this feature is specifying (1st, 2nd, 3rd, 4th, or 5th).
- ▶ The third and fourth digits range 00 - 35, where 00 - 09 represent the characters 1 - 9, and 10 - 35 represent the characters A - Z.

Choose the first 1, 2, 3, 4, or 5 digits by using the following feature numbers:

- ▶ For the first alphanumeric digit (0 - 9 or A - Z), use FC9100 (0) to FC9135 (Z).
- ▶ For the second alphanumeric digit (0 - 9 or A - Z), use FC9200 (0) to FC9235 (Z).
- ▶ For the third alphanumeric digit (0 - 9 or A - Z), use FC9300 (0) to FC9335 (Z).
- ▶ For the fourth numeric digit (0 - 9), use FC9400 (0) to FC9409 (9).
- ▶ For the fifth numeric digit (0 - 9), use FC9500 (0) to FC9509 (9).
- ▶ The sixth numeric digit is set to 0 as standard.
- ▶ The seventh and eighth characters of the VOLSER are set based on media type. For more information, see the “Media identifier” column in Table B-4 on page 318 and “Labeling service” on page 330.

If you do not specify a feature code, the supplied starting character is a 0. Therefore, if you specify features for the first three characters as ABC but no more, the sequence of labels begins ABC000.

The following specific features indicate requirements for colored labels:

- ▶ FC9077 specifies a white background.
- ▶ FC9022 specifies a colored background for alphabetic characters.

If you specify FC9022, you can choose from 10 available colors, as listed in Table B-8.

*Table B-8 Color-specific feature codes for the IBM 3599*

<b>Feature code</b>	<b>Alpha prefix background</b>
9003	Red
9004	Yellow
9005	Light green
9006	Light blue
9007	Gray
9008	Orange
9009	Pink
9010	Dark green
9011	Light orange
9012	Purple

## Ordering bar code labels

You can order bar code labels from one of the authorized suppliers that are listed in Table B-9.

Table B-9 Authorized suppliers of custom bar code labels

In the Americas	In Europe and Asia
EDP/Tri-Optic 6800 West 117th Avenue Broomfield, CO 80020 US Telephone: 888-438-8362 <a href="http://www.tri-optic.com">http://www.tri-optic.com</a>	EDP Europe, Ltd. 43 Redhills Road South Woodham Ferrers Chelmsford, Essex CM3 5UL UK Telephone: 44 (0) 1245-322380 <a href="http://www.edpeurope.com/en/products/media-labels-and-storage">http://www.edpeurope.com/en/products/media-labels-and-storage</a>
NetC, L.L.C. <sup>a</sup> 100 Corporate Drive Trumbull, CT 06611 US Telephone: 203-372-6382 <a href="http://www.netc11c.com">http://www.netc11c.com</a>	Netc Europe <sup>a</sup>  Telephone.: +49-2151-970-900 Fax: +49-2151-970-908 Email: Vertrieb@netclabels.de <a href="http://www.netclabels.de">http://www.netclabels.de</a>
	NetC Asia Pacific Pty Ltd <sup>a</sup> Postal Address: PO Box 872 Cooroy QLD 4563 Australia Telephone: 61 (0)7 5442 6263 <a href="http://www.netclabels.com.au">http://www.netclabels.com.au</a>

a. Netc is the only authorized supplier of radio frequency identification (RFID) labels. Orders for RFID labels must be placed through the U.S. office. Orders are shipped worldwide.



## IBM tape product names

All tape products are preceded by the IBM TS brand name. The short names that are defined in the related product tables that are included in this appendix must appear in parentheses and must be used exclusively in the rest of the document. The use of the short name (for example, *machine type* or *model*) is acceptable only in diagrams or presentation material. Exceptions are tape virtualization products with names that are preceded with Virtualization Engine, library frames, and media.

This appendix includes the following topics:

- ▶ “TS series family names” on page 334
- ▶ “TS1000 tape drives (LTO)” on page 334
- ▶ “” on page 334
- ▶ “TS2000 tape enclosures (LTO)” on page 336
- ▶ “TS2900 tape autoloader” on page 337
- ▶ “TS4300 tape library” on page 337
- ▶ “TS4500 tape library” on page 338

## TS series family names

The TS series family names that are include the following breakdown:

- ▶ The 1000 series is reserved for tape drives,; for example, the TS1160 (3592) and TS1080 (LTO Ultrium) tape drives.
- ▶ The 2000 series is reserved for storage enclosures, for example, the TS2200 and TS2300 LTO Ultrium tape drives.
- ▶ The 3000/4000 series is reserved for automation, for example, the TS4500 tape library.
- ▶ The 7000 series is reserved for virtualization, for example, the TS7700 Virtual tape library.

The tables in the following sections identify the IBM tape products with the machine type and model, the new name, and a short name.

## TS1000 tape drives (LTO)

Table C-1 lists the TS1000 tape drive naming conventions, including machine type, model, new name, and short name.

*Table C-1 TS1000 tape drive naming*

M/T	Model	New name	Short name
	3580	IBM TS1000 LTO tape drive Series	
3588	F5A, F5C	IBM TS1050 tape drive Models F5A, F5C	TS1050 LTO tape drive
	F6A, F6C	IBM TS1060 tape drive Models F6A, F6C	TS1060 LTO tape drive
	F7A, F7C	IBM TS1070 tape drive Models F7A, F7C	TS1070 LTO tape drive
	F8A, F8C, F8S	IBM TS1080 tape drive Models F8A, F8C, F8S	TS1080 LTO tape drive
	F9C/F9S/S9C	IBM TS1090 tape drive Models F9C, F9S, S9C	TS1090 LTO tape drive



## TS1100 tape drives (Enterprise)

Table C-2 lists the TS1100 tape drive naming conventions, including machine type, model, new name, and short name.

Table C-2 TS1100 tape drive naming

M/T	Model	New name	Short name
	3592		
3592	E06	IBM TS1130 tape drive Model E06	TS1130 tape drive
	EU6	IBM TS1130 tape drive Model EU6	TS1130 tape drive
	E07	IBM TS1140 tape drive Model E07	TS1140 tape drive
	EH7	IBM TS1140 tape drive Model EH7	TS1140 tape drive
	E08	IBM TS1150 tape drive Model E08	TS1150 tape drive
	EH8	IBM TS1150 tape drive Model EH8	TS1150 tape drive
	55E/55F/55G	IBMTS1155 tape drive Model 55E/55F/55G	TS1155 tape drive
	60E/60F/60G	IBMTS1160 tape drive Model 60E/60F/60G	TS1160 tape drive
	C06	IBM 3592 Tape Controller Model C06	3952 C06 Tape Controller
	C07	IBM 3592 Tape Controller Model C07	3592 C07 Tape Controller
	C20	IBM 3592 Tape Frame Model C20	3592 C20 Frame

## TS2000 tape enclosures (LTO)

Table C-3 lists the TS2000 tape enclosure naming conventions, including machine type, model, new name, and short name.

Table C-3 TS2000 Tape enclosure naming

M/T	Model	New names	Short name
3580		IBM TS2000 Storage Enclosures Series	
3580	L43	IBM TS2340 tape drive Model L43 (LVD – AAS)	TS2340 tape drive
	S43	IBM TS2340 tape drive Model S43 (SAS – AAS)	
	L4X	IBM TS2340 tape drive Model L4X (LVD – HVEC)	
	S4X	IBM TS2340 tape drive Model S4X (SAS – HVEC)	
	S4V	IBM TS2340 tape drive Model H4V (SAS – HVEC)	
3580	H4S	IBM TS2240 tape drive Model H4S (SAS – AAS)	TS2240 tape drive
	S4E	IBM TS2240 tape drive Model S4E (SAS – HVEC)	
	E4S	IBM TS2240 tape drive Model E4E (SAS – HVEC)	
	S53	IBM TS2350 tape drive Model S53 (SAS – AAS)	TS2350 tape drive
	S5X	IBM TS2350 tape drive Model S5X (SAS – HVEC)	
	H5S	IBM TS2250 tape drive Model H5S (SAS – AAS)	TS2250 tape drive
	S5E	IBM TS2250 tape drive Model S5E (SAS – HVEC)	
	H6S	IBM TS2260 tape drive Model H6S (SAS – AAS)	TS2260 tape drive
	S6E	IBM TS2260 tape drive Model S6E (SAS – HVEC)	
	S63	IBM TS2360 tape drive Model S63 (SAS – AAS)	TS2360 tape drive
	S6X	IBM TS2360 tape drive Model S6X (SAS – HVEC)	
	H7S	IBM TS2270 tape drive Model H7S (SAS – AAS)	TS2270 tape drive
	S7E	IBM TS2270 tape drive Model S7E (SAS – HVEC)	
	H8S	IBM TS2280 tape drive Model H8S (SAS)	TS2280 tape drive
	H9S	IBM TS2290 tape drive Model H9S (SAS)	TS2290 tape drive

## TS2900 tape autoloader

Table C-4 lists the TS2900 tape autoloader naming conventions, including machine type, model, new name, and short name.

Table C-4 TS2900 tape autoloader naming

M/T	Model	New name	Short name
3572		IBM TS2900 tape autoloader	TS2900 tape autoloader
3572	S5H	IBM TS2900 tape autoloader Model S5H (AAS)	
	S5R	IBM TS2900 tape autoloader Model S5R (HVEC)	
	S6H	IBM TS2900 tape autoloader Model S6H (AAS)	
	S6R	IBM TS2900 tape autoloader Model S6R (HVEC)	
	S7H	IBM TS2900 tape autoloader Model S7H (AAS)	
	S7R	IBM TS2900 tape autoloader Model S7R (HVEC)	
	S8H	IBM TS2900 tape autoloader Model S8H	
	S9H	IBM TS2900 tape autoloader Model S9H	

## TS4300 tape library

Table C-5 lists the TS4300 tape library naming conventions, including machine type, model, new name, and short name.

Table C-5 TS4300 tape library naming

M/T	Model	New name	Short name
3555		IBM TS4300 tape library	TS4300 tape library
355	L3A	IBM TS4300 tape library Model L3A	L3A Module
	E3A	IBM TS4300 tape library Model E3A	E3A Module

## TS4500 tape library

Table C-6 lists the TS4500 tape library naming conventions, including machine type, model, new name, and short name.

Table C-6 TS4500 tape library naming

M/T	Model	New name	Short name
3584		IBM TS4500 tape library	TS4500 tape library
3584	L25	IBM TS4500 Model L25	TS4500 L25 Frame
	L55	IBM TS4500 Model L55	TS4500 L55 Frame
	D25	IBM TS4500 Model D25	TS4500 D25 Frame
	D55	IBM TS4500 Model D55	TS4500 D55 Frame
	S25	IBM TS4500 Model S25	TS4500 S25 Frame
	S55	IBM TS4500 Model S55	TS4500 S55 Frame

# Related publications

The publications that are listed in this section are considered suitable for a more detailed discussion of the topics that are covered in this book.

## IBM Redbooks publications

The following IBM Redbooks publications provide more information about the topics in this book. Some publications that are referenced in this list might be available in softcopy only:

- ▶ *IBM Spectrum Archive Enterprise Edition V1.2.5.1 Installation and Configuration Guide*, SG24-8333
- ▶ *IBM SAN Survival Guide*, SG24-6143
- ▶ *IBM System Storage Tape Encryption Solutions*, SG24-7320
- ▶ *IBM Tivoli Storage Manager as a Data Protection Solution*, SG24-8134
- ▶ *IBM TS4500 R4 Tape Library Guide*, SG24-8235
- ▶ *Implementing IBM Tape in Linux and Windows*, SG24-6268
- ▶ *Implementing IBM Tape in UNIX Systems*, SG24-6502

You can search for, view, download, or order these publications and other Redbooks, IBM Redpapers, web docs, draft, and other materials at the following website:

<http://www.ibm.com/redbooks>

## Other publications

The following publications also are relevant as further information sources:

- ▶ *IBM TS4300 Tape Library Machine Type 3555 Users Guide*, SC27-4629:  
<https://www.ibm.com/support/pages/ibm-ts4300-tape-library-machine-type-3555-users-guide>
- ▶ *IBM System Storage 3592 Tape Drives and TS1120 Controller Operator Guide for 3592 Models J1A, E05, E06, EU6, E07, J70 and C06*, GA32-0556:  
<https://www.ibm.com/support/pages/ibm-3592-tape-drives-and-ts1120-controller-operator-guide-3592-models-j1a-e05-e06-eu6-e07-e08-eh7-eh8-55f-60f-j70-and-c06>
- ▶ *IBM System Storage TS2250 Tape Drive Setup, Operator and Service Guide*, GC27-2275:  
<https://www.ibm.com/support/pages/ibm-system-storage-ts2250-tape-drive-setup-operator-and-service-guide-1>
- ▶ *IBM System Storage TS2350 Tape Drive Setup, Operator and Service Guide*, GC27-2277:  
<https://www.ibm.com/support/pages/ibm-system-storage-ts2350-tape-drive-setup-operator-and-service-guide-machine-type-3580-model-s53>
- ▶ *IBM System Storage TS2360 Tape Drive Setup, Operator and Service Guide*, GA32-2228:  
<https://www.ibm.com/support/pages/ibm-system-storage-ts2360-tape-drive-setup-operator-and-service-guide>

- ▶ *IBM System Storage TS2900 Tape Autoloader Setup, Operator and Service Guide, GC27-2212:*  
<https://www.ibm.com/support/pages/ibm-ts2900-tape-autoloader-setup-operator-and-service-guide-machine-type-3572>
- ▶ *IBM TS2280, Setup, Operator, and Service Guide, Machine Type 3580 Model H8S, SC27-4649:*  
<https://www.ibm.com/support/pages/ibm-ts2280-setup-operator-and-service-guide-machine-type-3580-model-h8s>
- ▶ *IBM TS2270, Setup, Operator, and Service Guide, Machine Type 3580 Model H7S, SC27-8519:*  
<https://www.ibm.com/support/pages/node/656069>
- ▶ *IBM Tape Device Drivers Installation and User's Guide, GC27-2130:*  
<https://www.ibm.com/support/pages/ibm-tape-device-drivers-installation-and-users-guide>
- ▶ *IBM Tape Device Drivers Programming Reference, GA32-0566:*  
<https://www.ibm.com/support/pages/ibm-tape-device-drivers-programming-reference-0>
- ▶ *IBM TotalStorage LTO Ultrium Tape Drive SCSI Reference, GA32-0450:*  
<https://www.ibm.com/support/pages/ibm-totalstorage-lto-ultrium-tape-drive-scsi-reference-0>

## Online resources

The following websites and web pages also are relevant as further information sources:

- ▶ *IBM 3580 Ultrium Tape Drive Firmware:*  
<http://www.ibm.com/support/fixcentral>
- ▶ *IBM 3584 drive and library firmware:*  
<http://www.ibm.com/support/fixcentral>
- ▶ *IBM Offering Information:*  
<http://www.ibm.com/common/ssi/index.wss>
- ▶ *IBM Security Guardium Key Lifecycle Manager:*  
<https://www.ibm.com/products/ibm-security-key-lifecycle-manager>
- ▶ *IBM Spectrum Archive EE IBM Documentation:*  
<https://www.ibm.com/docs/en/spectrum-archive-ee>
- ▶ *IBM Spectrum Archive LE IBM Documentation:*  
<https://www.ibm.com/docs/en/spectrum-archive-le>
- ▶ *IBM Spectrum Archive SDE IBM Documentation:*  
<https://www.ibm.com/docs/en/spectrum-archive-sde>
- ▶ *IBM Storage media:*  
<https://www.ibm.com/it-infrastructure/storage/tape/media>
- ▶ *IBM System Storage Interoperation Center (SSIC):*  
<http://www.ibm.com/systems/support/storage/ssic>

- ▶ IBM System Storage and TotalStorage products:  
<https://www.ibm.com/storage>
- ▶ IBM Tape Storage Systems:  
<https://www.ibm.com/it-infrastructure/tape-library>
- ▶ LTO Technology Organization website for information about the technology, formats, and licensing:  
<http://www.lto-technology.com>
- ▶ The SCSI Trade Association website, which provides information about SCSI standards and terms:  
<http://www.scsita.org>
- ▶ Streaming Lossless Compression Algorithm standard from Ecma International:  
<http://www.ecma-international.org/publications/standards/ECMA-321.HTM>
- ▶ Tape device driver downloads:  
<http://www.ibm.com/support/fixcentral>

## Help from IBM

Help is available from IBM through the following resources:

- ▶ IBM Support and downloads:  
<http://www.ibm.com/support>
- ▶ IBM Global Services:  
<http://www.ibm.com/services>





**Redbooks**

**IBM Tape Library Guide for Open Systems**

SG24-5946-17

ISBN 0738460443



(0.5" spine)

0.475" x 0.873"

250 <-> 459 pages







SG24-5946-17

ISBN 0738460443

Printed in U.S.A.

Get connected

