



Quad-core NAS Series

TS-231P3 TS-431P3

2.5GbE connectivity for home



TS-431X3

supports 10GbE SFP+/2.5GbE RJ45
for SOHO



Quad-core TS-231P3, TS-431P3, TS-431X3 with new 2.5GbE support



- Needs for a larger storage space and efficient file backup and sharing
- All models with 2.5GbE support, additional 10GbE SFP+ on TS-431X3
- Ready-to-use applications for worry-free file backup and sharing

Storage need for shooting many 4K 60P VLOGs?



4K 60FPS video
400MB per minute
= 2.4GB per hour



How to quickly share files or collaborate with multiple users?

- Spend \$\$\$ to buy a 10GbE switch?
- Spend \$\$\$ to buy a 10GbE NAS?
- Spend \$\$\$ to upgrade the LAN cable wiring infrastructure?



Quad-core 1.7GHz with 2.5GbE/10GbE

TS-431X3

1 x 10G SFP+
1 x 2.5G RJ45
1 x 1G RJ45



TS-431X3-4G

4 GB RAM (1 x 4 GB)

TS-431P3

1 x 2.5G RJ45
1 x 1G RJ45



TS-431P3-2G

2 GB RAM (1 x 2 GB)

TS-431P3-4G

4 GB RAM (1 x 4 GB)

TS-231P3

1 x 2.5G RJ45
1 x 1G RJ45



TS-231P3-2G

2 GB RAM (1 x 2 GB)

TS-231P3-4G

4 GB RAM (1 x 4 GB)

Performance you can count on



4-core 1.7GHz

Alpine AL-314 ARM v7 processor

- Native 4 x SATA 6 Gb/s ports for the optimal throughput
- Built-in AES 256-bit encryption engine for security and performance
- ARM NEON v2 floating point acceleration engine
- 2MB L2 cache, twice more than the competition!

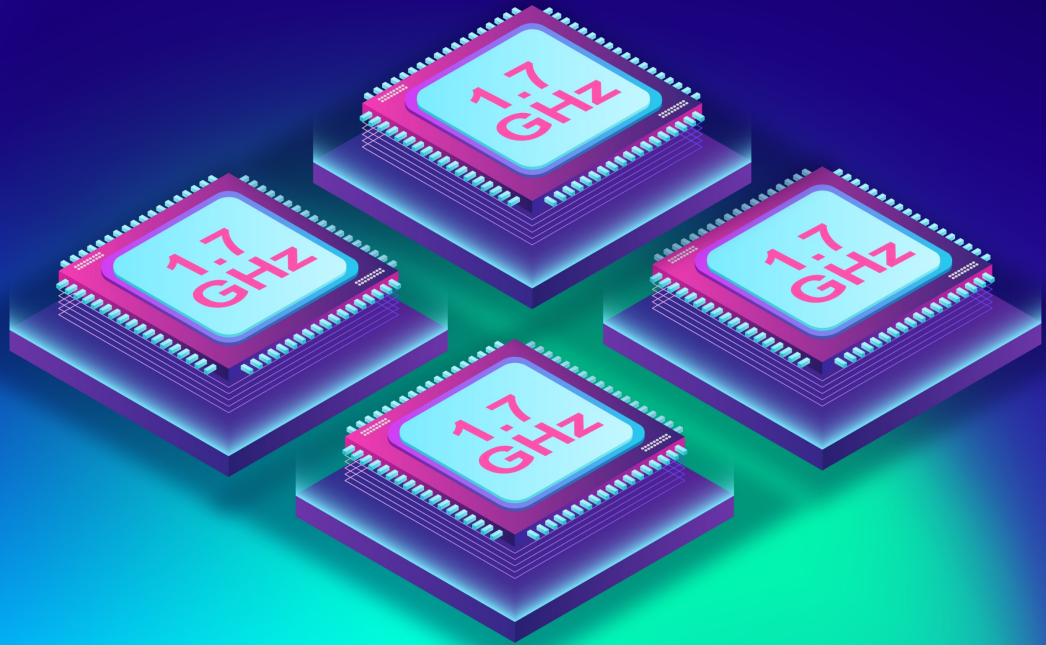



TS-231P3, TS-431P3 front view

LEDs:
Status, LAN, USB

Drive LEDs:
HDD 1, HDD 2,
HDD 3, HDD 4

Power

Copy

USB 3.2 Gen 1
port

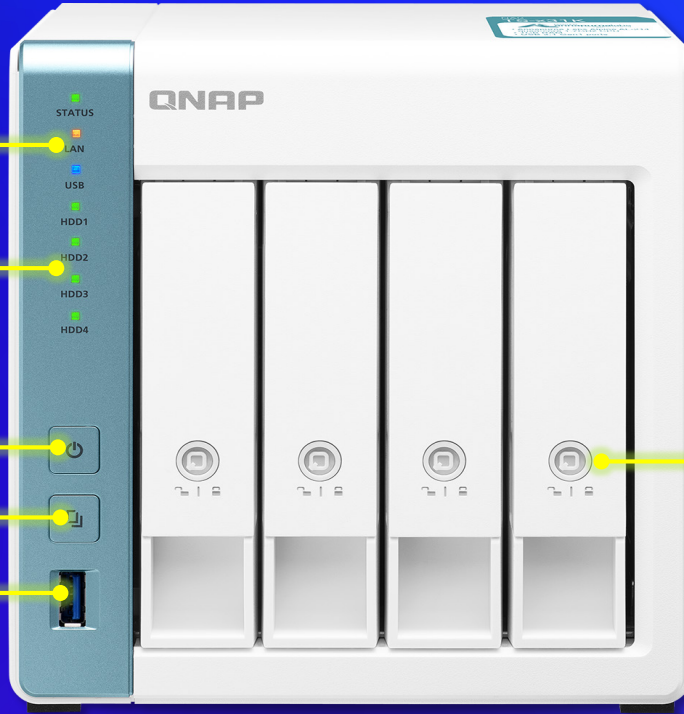

4x 3.5-inch /
2.5-inch
SATA 6Gb/s
HDD bays



Lockable drive trays with 2
keys provided





TS-231P3, TS-431P3 rear view



Smart fan
TS-431P3: 1 x 120mm
TS-231P3: 1 x 70mm

Kensington security slot

Reset

1 x 2.5 GbE RJ45 port

1 x 1 GbE RJ45 port

2 x USB 3.2 Gen 1 (5Gbps) port

DC 12V power input

TS-431X3 front view

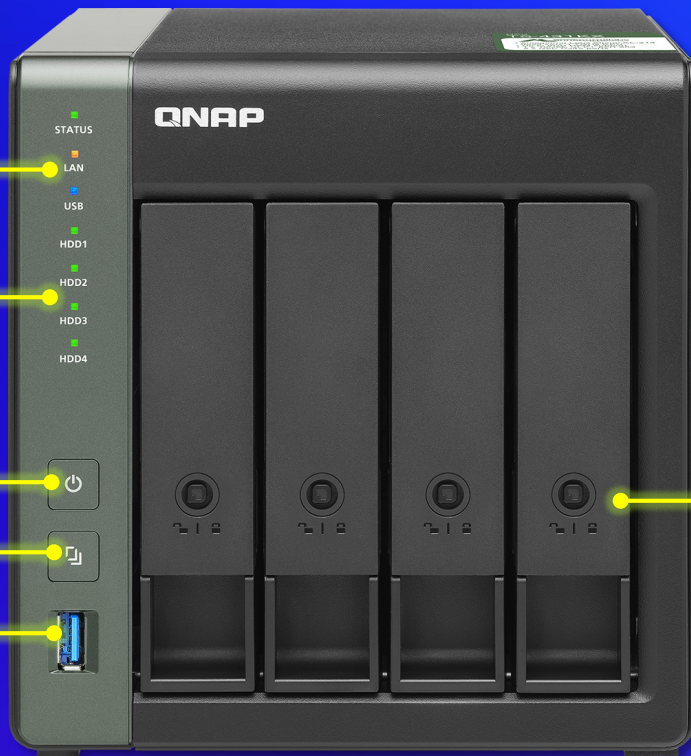

LEDs:
Status, LAN, USB

Drive LEDs:
HDD 1, HDD 2,
HDD 3, HDD 4

Power

Copy

USB 3.2 Gen 1
port

4x 3.5-inch /
2.5-inch
SATA 6Gb/s
HDD bays



Lockable drive trays with
2 keys provided



TS-431X3 rear view



1 x 120mm smart fan

Kensington security slot

Reset

1 x 10 GbE SFP+ port

1 x 2.5 GbE RJ45 port

1 x 1 GbE RJ45 port

2 x USB 3.2 Gen 1 port
(5Gbps)

DC 12V power input

All models support up to 8GB RAM



1 x DDR3L SO-DIMM RAM slot
Up to **8 GB** memory support

Ordering information: 2GB: RAM-2GDR3T0-SO-1600
4GB: RAM-4GDR3-SO-1600
8GB: RAM-8GDR3-SO-1600

1. Remove side cover

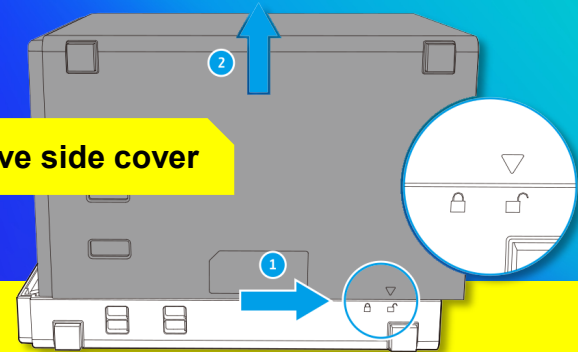

2. Remove HDD bracket

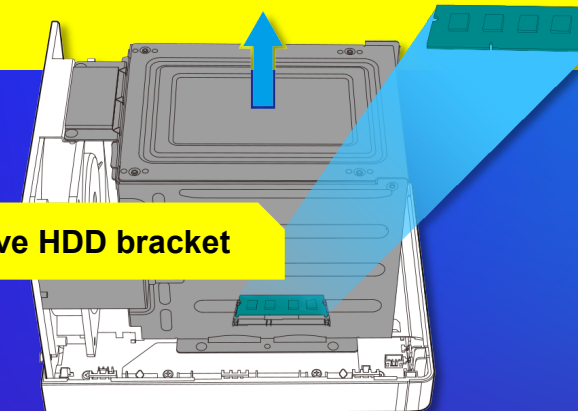

Easy HDD and SSD installations

3.5-inch HDD: tool-less

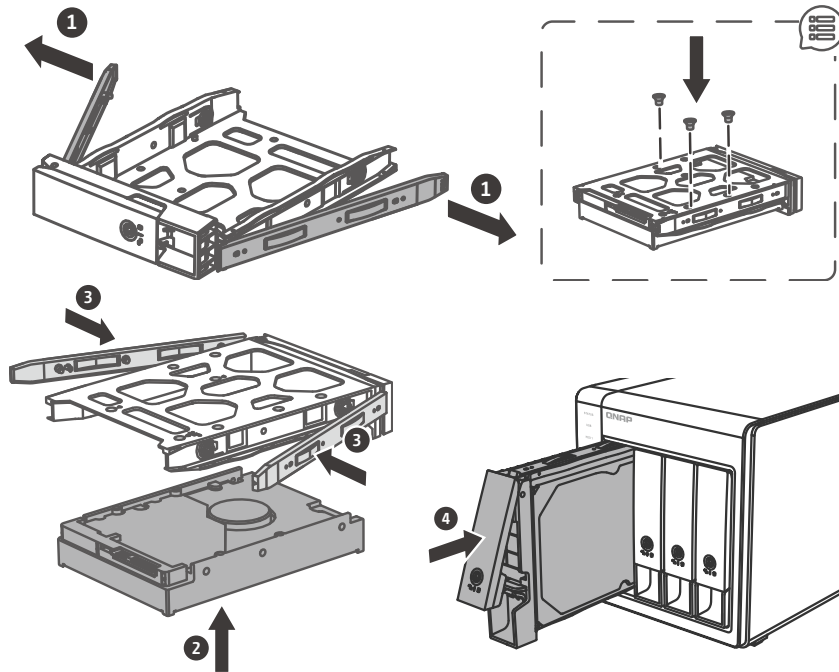

2.5-inch HDD/SSD: screws

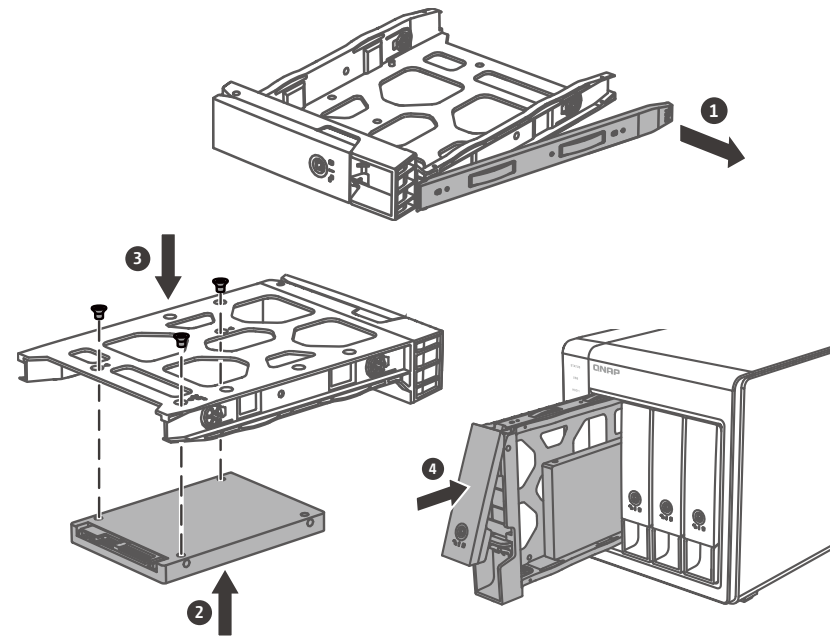

Upgrade to 2.5GbE with existing cable wiring

Multiple QNAP 10G switch supporting 2.5GbE



QSW-M408-4C (Managed)
4 x 10G/5G/2.5G
RJ45 Multi-Gig



QSW-M408-2C (Managed)
2 x 10G/5G/2.5G
RJ45 Multi-Gig



QSW-1208-8C
8 x 10G/5G/2.5G
RJ45 Multi-Gig



QSW-308-1C
1 x 10G/5G/2.5G
RJ45 Multi-Gig



	CAT 5e	CAT 6	CAT 6A
100M	✓	✓	✓
1G	✓	✓	✓
2.5G	✓	✓	✓
5G	✓	✓	✓
10G	X	✓ (55m)	✓

Faster TS-431X3 with 10GbE SFP+



High-speed throughput for large data backup and recovery, multi-user environment, or containerized applications.

QSW-308-1C



Short distance SFP+ DAC cables

1.5M SFP+ 10GbE
DAC cable



Part number:
CAB-DAC15M-SFPP

3.0M SFP+ 10GbE
DAC cable



Part number:
CAB-DAC30M-SFPP

5.0M SFP+ 10GbE
DAC cable



Part number:
CAB-DAC50M-SFPP

TS-431P3 2.5GbE performance

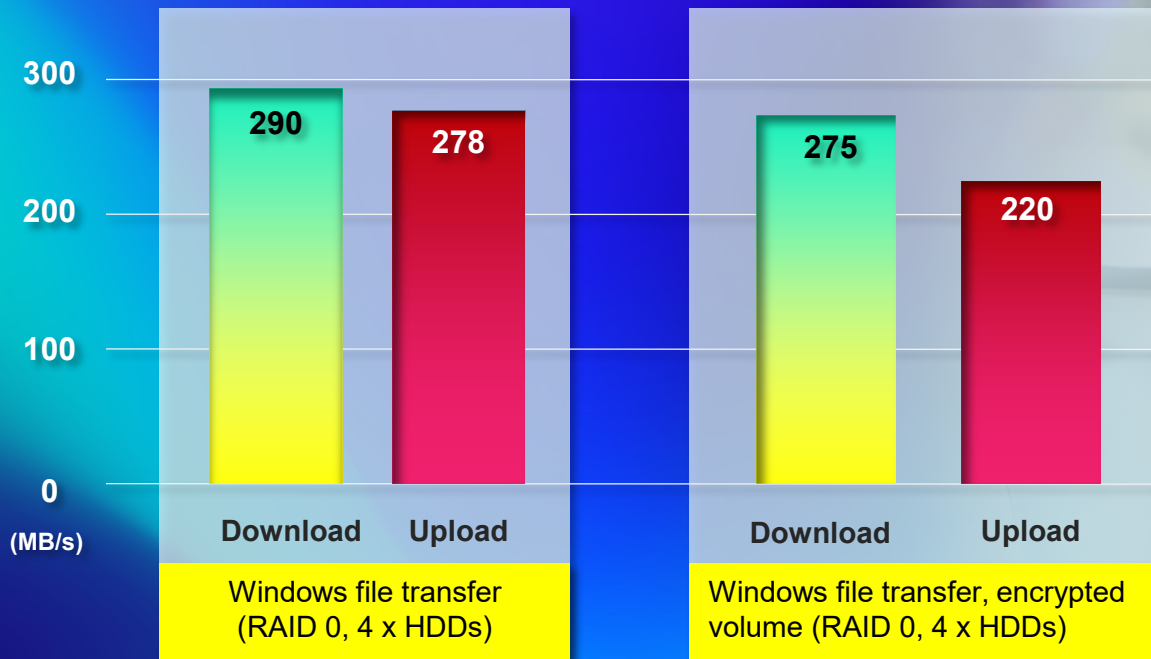

Tested in QNAP lab. Results vary depending on the environment.
Test Configuration: TS-431P3-2G, QTS 4.4.2, RAID 0, 4 x Seagate ST1000NM0033 HDDs

Client PC :
Intel Core i7-6700 3.4 GHz; 64GB RAM; QNAP LAN-10G2T-X550; MTU 9000,
Microsoft Windows 10 64bit, 10GB file



TS-431X3 10GbE SFP+ performance

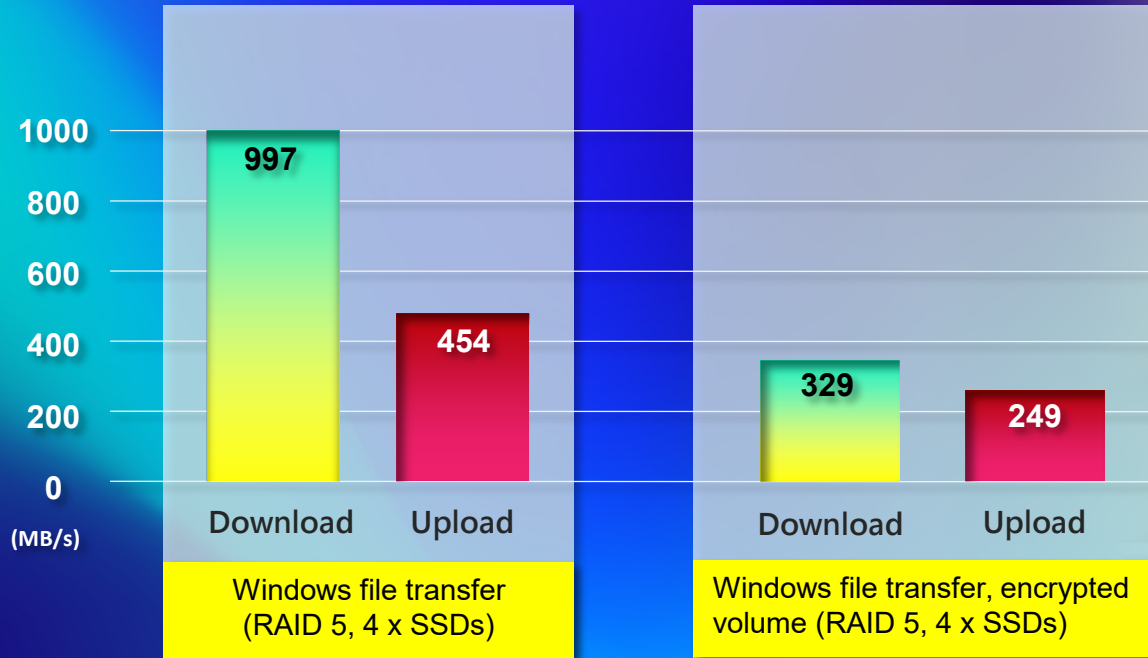

Tested in QNAP lab. Results vary depending on the environment.
Test Configuration: TS-431X3 -4G, QTS 4.4.2, RAID 5, 4 x Samsung 850 Pro 1TB SSDs

Client PC :
Intel Core i7-6700 3.4 GHz; 64GB RAM; QNAP LAN-10G2T-X550; MTU 9000,
Microsoft Windows 10 64bit, 10GB file, 10G switch

Use USB to 5GbE/2.5GbE to enhance the performance of PC/ other NAS

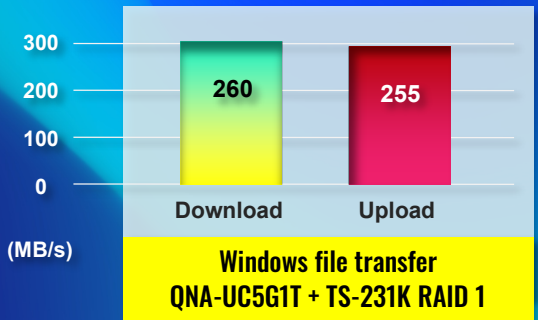

QNAP

Live Demo

- 1 x memory slot for RAM upgrade
- 2.5GbE & 10GbE performance tests



“

**Various NAS applications
for your work-from-home
needs**

”



Fight against virus and ransomware

Mac O.S.

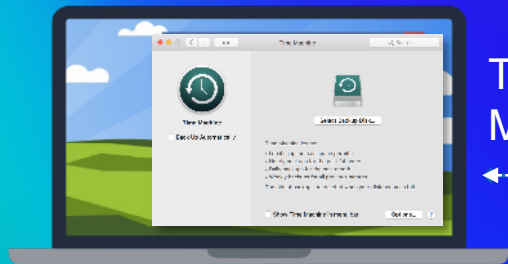

Time Machine



Windows



NetBak Replicator



TS-431P3

**Real-time or
scheduled data
backup**

Free Mac Time Machine backup

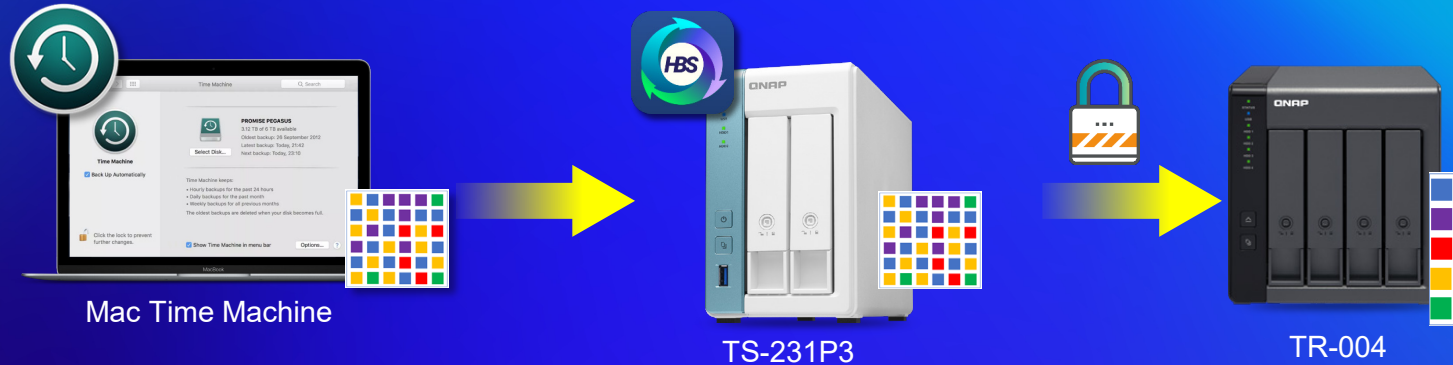

Create the backup job

- 1** Select Time Machine Backup as Source
- 2** Select TR-004 as Destination
- 3** Setup the backup schedule in HBS 3

HBS 3 for backup and recovery

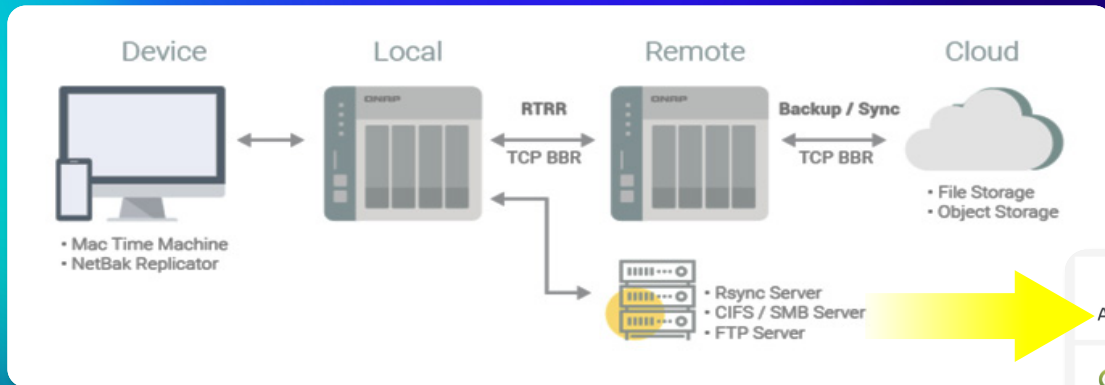

Use HBS 3 (Hybrid Backup Sync 3) to easily transfer your data to local, remote and cloud storage spaces as a comprehensive data storage and disaster recovery plan.

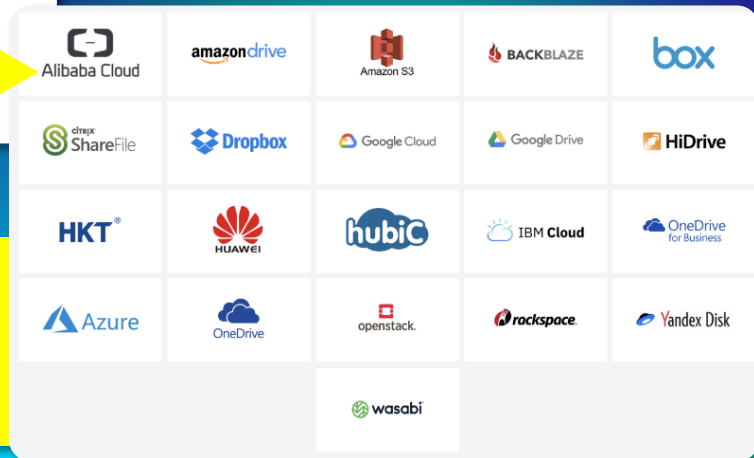

QNAP snapshot for file recovery

1. Fully supports all storage configurations at the storage pool level.
2. Easily take, manage and restore snapshots.
3. Using the mature Ext4 file system for "out of volume" snapshots

RAM size	NAS models	Maximum total snapshot numbers	Maximum snapshot number per Volume/LUN
2GB	TS-431P3-2G, TS-231P3-2G	64	32
4GB and above	TS-431X3-4G, TS-431P3-4G, TS-231P3-4G	256	64

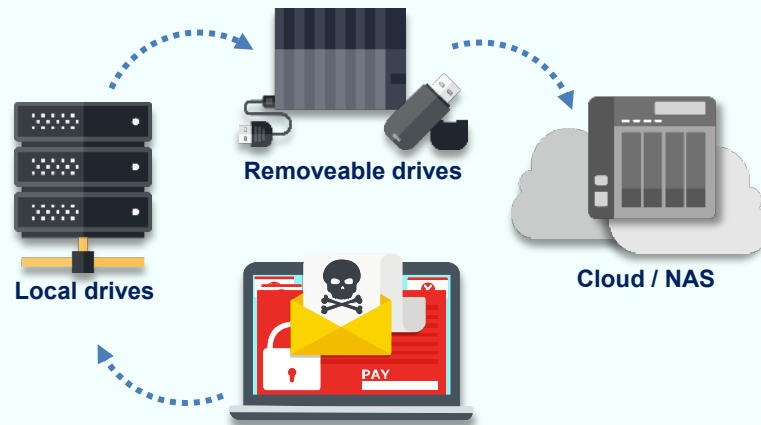
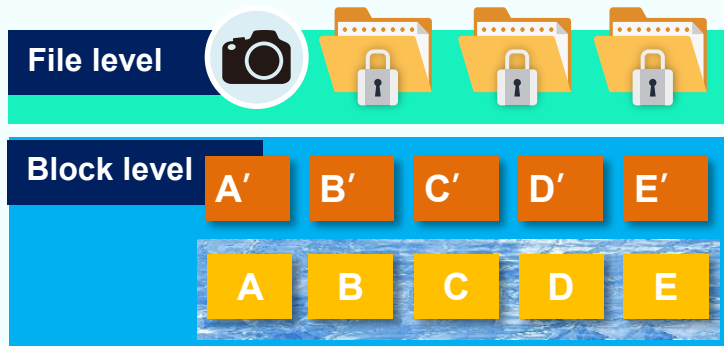

Connect to home or office NAS with myQNAPcloud and QNAP ID (QID)

Anytime / Anywhere



Register and login with
Email or phone number

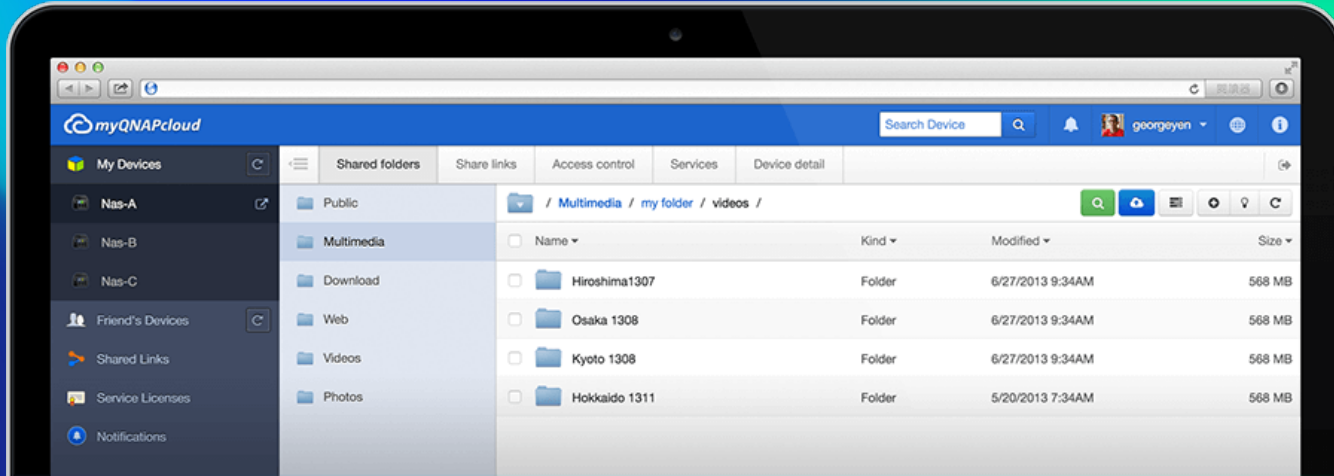

Connect to Dropbox, One Drive, Google Drive and more

Qfile

Mobile

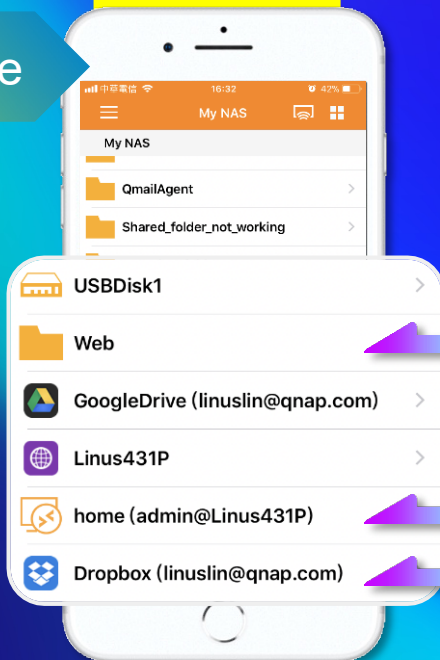

Local
NAS

Remote
NAS
Cloud
storage

Computer

File Station

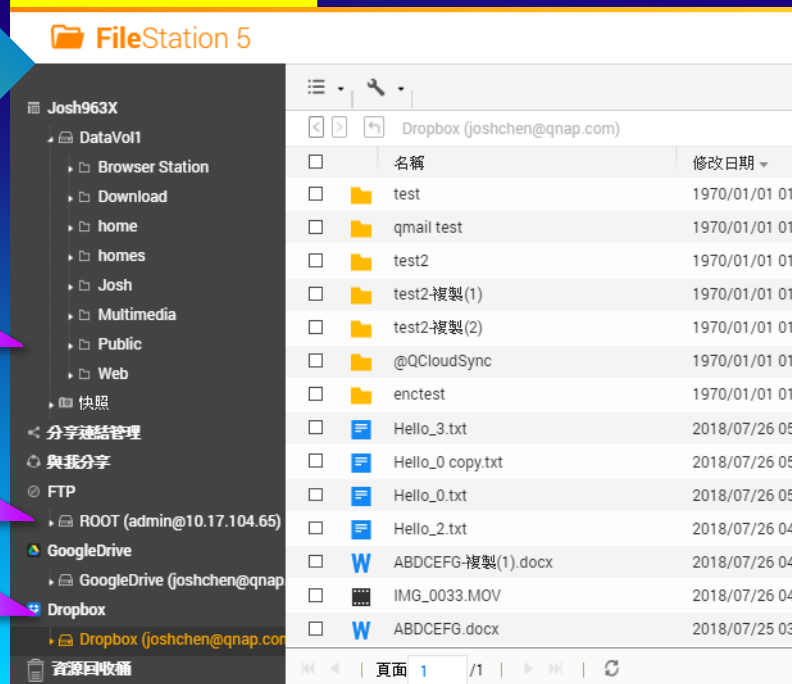

QNAP QVPN and QBelt protocol for anywhere access



Secure Encrypted Connection:

DTLS + SSL + AES-256 encryption



New QBelt protocol:

Decreases the chance of being detected



Works on desktop and mobile devices

Windows, macOS, Android, iOS

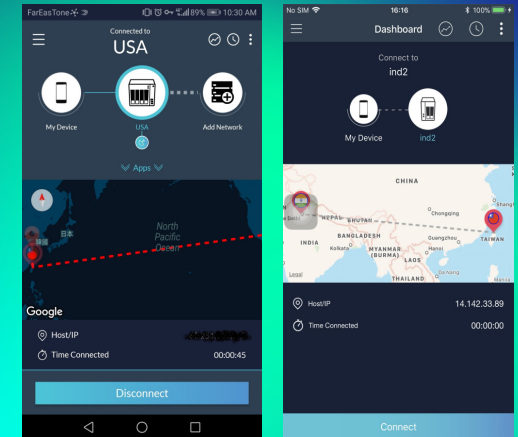
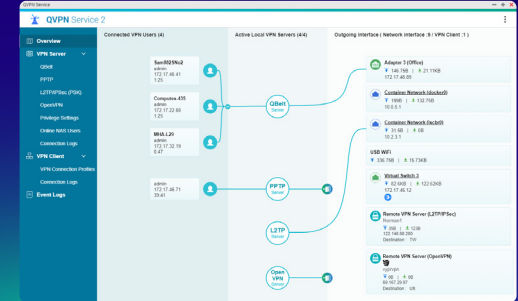

Build your site with the free WordPress

1. Enable SQL server
2. Install phpMyAdmin and create a database
3. Install WordPress from NAS App Center

QNAP file management utilities improve content publishing efficiency



Free personal domain for quickly enabling SSL certificates

From setup to backup, QNAP NAS has it all

Host multiple websites on QNAP NAS with Virtual Hosting



QuMagie photo management

Album view

Folder view

Albums and Smart Albums

The screenshot displays the QuMagie photo management interface. At the top left is the QuMagie logo. The main area shows a grid of photos under the heading "All Photo 6,356 photos, 163 videos". A "View" dropdown menu is visible. The photos are organized by date, with a vertical timeline on the right side showing years from 2015 to 2018. The current view shows photos from 2018/06/16 (12 photos, 2 videos) and 2018/06/02 (2 photos, 1 video). The photos include a family portrait, people riding bicycles, a couple, a group of people at a picnic, and a camera lens. A date selector "2016/08" is visible on the right side of the interface.



Use Cinema28 for whole-home streaming

Integrate multiple streaming devices and streaming protocols into a single interface for centralized management, allowing users to easily stream digital multimedia files to audio/video devices in every corner of the house.

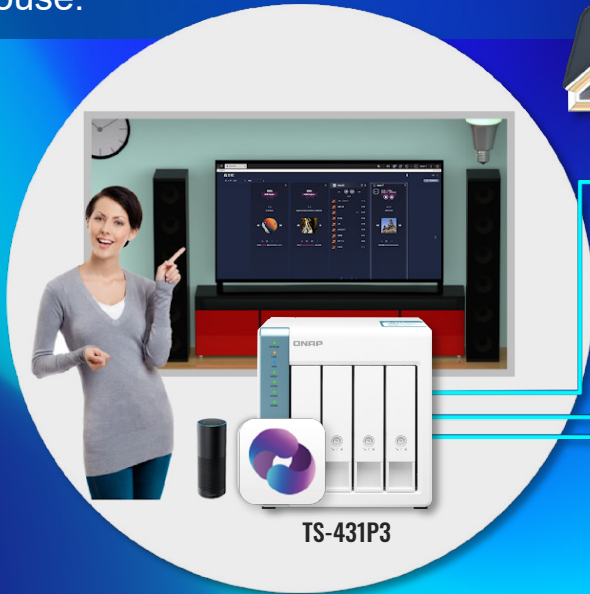

PLEX Server for media streaming



Internet



Streaming Devices



ROKU



Chromecast



amazon fireTV



Apple tv



Smart TV



Computer



Phone



Tablet

TS-431P3

24x7 surveillance for security

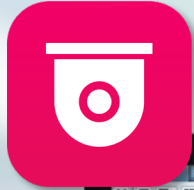

Surveillance Station 5.1



Vmobile



Recording channels
Free: 2 Max: 16



TS-231P3

Quad-core w/ max 8GB RAM, best for Container Station to show your creativity

AI, IoT, Commonly-used Container Recommendation

- One-click installation wizard helps you quickly setup
- Supports Docker Compose YAML format to create applications

Easily import/export containers

- Imports images or containers from PC or NAS
- Exports images or containers to NAS as backup

The screenshot displays the Container Station web interface. On the left is a navigation sidebar with sections for Management (Overview, Create, Import, Export, Logs, Preferences) and Resource (Images, Volume, Containers). The main area shows a container named 'jenkins-1' in a 'DOCKED' state. It is currently 'Running'. The interface includes buttons for Terminal, Settings, Stop, and Remove. Below the container details is a console log showing connection information and timestamps.

Field	Value
URL:	http://172.17.28.13:32771/ → 50000
Image:	jenkins:2.19.1
ID:	d5f9d1b4c8b4
Application:	--
Entrypoint:	/bin/tini - /usr/local/bin/jenkins.sh
Command:	--
CPU:	0%
RAM:	5%

```
INFO: Accepted connection #5 from /10.0.2.1:47066
Feb 21, 2018 3:23:41 AM Hudson.TopSlaveAgentListener$ConnectionHandler run
INFO: Accepted connection #6 from /10.0.2.1:47184
Feb 21, 2018 3:24:01 AM Hudson.TopSlaveAgentListener$ConnectionHandler run
INFO: Accepted connection #7 from /10.0.2.1:47302
Feb 21, 2018 3:24:21 AM Hudson.TopSlaveAgentListener$ConnectionHandler run
INFO: Accepted connection #8 from /10.0.2.1:47416
Feb 21, 2018 3:24:41 AM Hudson.TopSlaveAgentListener$ConnectionHandler run
INFO: Accepted connection #9 from /10.0.2.1:47538
Feb 21, 2018 3:25:01 AM Hudson.TopSlaveAgentListener$ConnectionHandler run
INFO: Accepted connection #10 from /10.0.2.1:47650
Feb 21, 2018 3:25:21 AM Hudson.TopSlaveAgentListener$ConnectionHandler run
INFO: Accepted connection #11 from /10.0.2.1:47758
Feb 21, 2018 3:25:27 AM Hudson.TopSlaveAgentListener$ConnectionHandler run
INFO: Accepted connection #12 from /10.0.2.1:47822
```

Built-in Docker Hub Marketplace
Easily downloadable tools



QNAP mobiles apps for data on the go

File & System



Qfile
File management



Qsync
File backup



Qmanager
NAS management

Multimedia



Qphoto
Photo library



QuMagie
Photo library



Qvideo
Video library



Qmusic
Music library



DJ2 Client
Live streaming



Photo Tagger
Classification tool



Qget (Android only)
Download management

Productivity



QmailClient
E-mail backup



Qcontactz
Contacts backup



Qnotes3
Notes taker



Vmobile
Mobile surveillance

QNAP TR USB RAID & TL USB JBOD

support 2 modes on NAS

- NAS supports maximum two QNAP TR-002/TR-004 RAID enclosures or one TL-D800C USB JBOD enclosure ([Compatibility list](#)).
- Internal mode with storage pool support or external mode with cross-platform compatibility with Windows/Mac computers.

Mode 1: Expanding the NAS with new volume



Mode 2: Work as backup destination for snapshot replica



Cost-effective 2.5GbE & 10GbE NAS



NAS model	TS-431X3	TS-431X2	TS-431P3/231P3	TS-431P2/231P2
Processor	AnnapurnaLabs AL-314 Quad-core 1.7 GHz CPU			
SKUs	<ul style="list-style-type: none"> • TS-431X3-4G 	<ul style="list-style-type: none"> • TS-431X2-8G • TS-431X2-2G 	<ul style="list-style-type: none"> • TS-431P3-4G • TS-431P3-2G • TS-231P3-4G • TS-231P3-2G 	<ul style="list-style-type: none"> • TS-431P2-4G • TS-431P2-1G • TS-231P2-4G • TS-231P2-1G
10GbE port	1 x 10GbE SFP+	1 x 10GbE SFP+	---	---
2.5GbE port	1	---	1	---
GbE port	1	2	1	2
Lockable drive trays	Yes	---	Yes	---

Optional 3-year extended warranty purchase for a total of 5 years

Ordering information:
LIC-NAS-EXTW-GREEN-3Y



QNAP

TS-x31P3 & TS-431X3

The affordable choice for quad-core
1.7GHz NAS with 2.5GbE and 10GbE.

Copyright © 2020 QNAP Systems, Inc. All rights reserved. QNAP® and other names of QNAP Products are proprietary marks or registered trademarks of QNAP Systems, Inc. Other products and company names mentioned herein are trademarks of their respective holders.

