

CATV ■

SATELLITE ■

FIBER OPTICS ■

TELECOMMUNICATIONS ■

RESIDENTIAL RF COMMUNICATIONS ■

For over 20 years, Holland Electronics LLC has earned a reputation as an innovator in the CATV, SMATV, Satellite, Wireless and Fiber Optic markets specializing in connectivity, broadband distribution, head-end and installation accessories. Having facilities and staff in both the USA and Asia, we have been successful in providing the quality and reliability demanded by today's evolving and emerging telecommunications industries.

This unique structure enables us to provide custom tailored solutions to our customers in a short period of time. Beginning with the idea, our own experienced technical staff can design and develop a solution that will meet your needs. Our in house abilities include CNC machining, screw machines, diecasting, injection molding, stamping and many second operation machines. Our years of experience with these processes ensures our customers efficient solutions to the demands of today's telecommunications needs.

We are committed to providing our customers with the personalized service and cost effective solutions that has earned us your trust in the past and will continue to strengthen our relationship into the future.

**Michael Holland**  
CEO



# TABLE OF CONTENTS

## AMPLIFIERS

Amplifier Selection Chart.....	2
Antenna/Home.....	3, 4
Broadband Distribution.....	5, 6
CATV/MDU Distribution.....	7-12
Drop/Subscriber.....	13, 14
In-Line.....	15, 16
Satellite.....	17, 18

## COAXIAL CABLE & JUMPER ASSEMBLIES

Coaxial Drop Cable.....	19
Mini Precision Video Coaxial Cables.....	20
Molded Patchcords & Interconnects.....	21
Jumpers & Cable Assemblies.....	22

## CONNECTORS & ADAPTERS

SLCU Series Compression Connectors.....	23-26
Attached Ring Crimp Connectors.....	27, 28
Mini Coax Series Connectors.....	29, 30
Adapters & Terminators.....	31
Attenuators / CATV Security Products.....	32
Splices.....	33, 34
Grounding Hardware.....	35, 36
OEM Capabilities.....	37, 38

## FIBER OPTIC

CATV Optical Transmitters.....	39, 40
CATV Optical Receivers.....	41, 42
CATV Optical Amplifiers.....	43, 44
Fiber Optic Distribution System.....	45-47

## FILTER / DIPLEXERS

Single Channel Filters.....	49
High Pass/Custom Filters.....	50
Filters / Diplexers.....	51
Cable Drop Protection.....	52

## HEAD-END PRODUCTS

Mini Modular Head-End System.....	53, 56
Fixed Channel Modulators.....	57, 58
Agile Modulators.....	59, 60
Saw Filtered Modulators.....	61, 62
Agile Processors.....	63, 64
Demodulators.....	65, 66
Single Channel Amplifier.....	67, 68
Rack Mounted Amplifiers.....	69, 70
Head-End Combiners.....	71, 72
Rack Mounted Multiswitches.....	73, 74
Sub-Band to High-Band Converters.....	75, 76
Head-End Accessories.....	77, 78
Pre-Built Head-End Systems.....	78

## HOME CONSUMER PRODUCTS

Multimedia Modulators.....	79, 80
Signal Combiners / AB Switches.....	81
Video Cameras.....	82

## INSTALLATION MATERIALS

Wall Plates.....	83
Bushings, Cable Clips / Ties, Weather Boots.....	84
Enclosures, Tape, Sealants.....	85
Hardware.....	86

## PASSIVES

Broadband Splitters.....	87, 88
Digital CATV Splitters.....	89,90
Premium Digital CATV Splitters.....	91, 92
Satellite Broadband Splitters.....	93, 94
Directional Couplers.....	95-98
High Performance Satellite Splitters.....	99, 100
Specialty Splitters / Power Inserters.....	101, 102
Hard-Line Multi Taps.....	103, 104
Hard-Line Passives.....	105, 106

## SATELLITE

Diplexers.....	107
Passives.....	108
Multiswitches.....	109, 110
Stackers & Destackers.....	111
Satellite Distribution Systems.....	112

## TELEPHONE/DATA ACCESSORIES

Station Wire/Surface Jacks/Cord Sets.....	113
Adapters/Couplers/Modular Plugs.....	113

## TEST EQUIPMENT

Satellite Finder/Cable Ringer/Cable Ringer Kit.....	114
MDU Cable ID System.....	114
Test Meters/Receivers.....	115-118

## TOOLS

Hex Crimp & Compression Tools.....	119
Coax Cable Strippers.....	119
Cable Conductor Guide/Installation Tools.....	120
Locking Terminators/Drill Bits.....	120

INDEX.....	121-122
------------	---------

# AMPLIFIER SELECTION CHART

MODELS	FREQUENCY (MHz)	RETURN BANDWIDTH (MHz)	CHANNEL CAPACITY	GAIN (dB)	MAXIMUM OUTPUT (dBmV)	RETURN PATH (Gain,dB)	ADJ.'S	NOTES
--------	-----------------	------------------------	------------------	-----------	-----------------------	-----------------------	--------	-------

## BROADBAND

HA-201T	50 - 500	–	–	20	43 (7 Ch.)	–	Slope	Small CATV
HA-30	54 - 108 174 - 216	–	–	31	52 (7 Ch.)	–	Gain	Antenna
HDA-10	50 - 900	–	–	10	35 (7 Ch.)	–	–	Home, Economy
HDA-15	54 - 216 470 - 890	–	–	15	50 (7 Ch.)	–	–	Home, CATV
HDA-25	54 - 1000	–	–	25	48 (7 Ch.)	–	–	Home, CATV
HDA-25E	54 - 800	–	–	25	40 (7 Ch.)	–	Gain	Home, Economy
HDA-30	54 - 1000	–	–	30	50 (7 Ch.)	–	Gain	Home Distribution
HDA-36	54 - 108 174 - 216 470 - 800	–	–	36	54 (7 Ch.)	–	Gain	Antenna / MDU
HDA-1000	54 - 1000	–	157	34	57 (7 Ch.)	P	Gain	High Channel Capacity

## CATV

HCA-3051	54 - 550	–	77	30	45	–	Gain/Slope	CATV Hybrid Amplifier
HCA-5051	54 - 550	–	77	50	45	–	Gain/Slope	CATV Hybrid Amplifier
HCA-3086RP	54 - 860	5 - 42	134	30	41	P (-2 dB)	Gain/Slope	CATV Hybrid Amplifier
HCA-3051RK	54 - 550	–	77	30	45	–	Gain/Slope	CATV Hybrid Amplifier
HCA-3086RK	54 - 860	5 - 42	134	30	41	P (-2 dB)	Gain/Slope	CATV Hybrid Amplifier
HCA-36ERA	54 - 750	5 - 40	116	36	42	A (18 dB)	Gain/Slope	Bi-Directional, Hybrid
HCDA-1	54 - 1000	5 - 42	157	15	25	P (-2 dB)	–	Cable Drop
HCDA-2	54 - 1000	5 - 42	157	11	21.5	P (-2dB)	–	Cable Drop
HCDA-4	54 - 1000	5 - 42	157	7	18	P (-2 dB)	–	Cable Drop
HCDA-1FRA	54 - 1000	5 - 42	157	15	25	A (10 dB)	–	Cable Drop
HCDA-1RA	54 - 1000	5 - 42	3	-2 dB	–	A (10 dB)	–	Cable Drop

## SATELLITE

LA-141A LA-142A LA-143A	250 - 2150	–	32 Trns. + Ka	14	-14 dBm -14 dBm -14 dBm	–	–	Auto Leveling DBS Drop Amps
NA2530A-T	250 - 2150	–	32 Trns. + Ka	30	-1 dBm	–	–	Dual Node Amp
PA2530A-T	250 - 2150	–	32 Trns. + Ka	30	–	–	–	Power LNB
PAL1-T PAL5-T PAL10-T	950 - 2150	–	32 Trns. + Ka	40 40 40	-1 dBm -5 dBm -10 dBm	–	–	Auto Leveling Gain Control
TA2330D-T	950 - 2150	–	32 Trns. + Ka	30	-1 dBm	–	–	Generates 13/18v

P= Passive A= Active. Maximum output specified at full channel loading unless otherwise indicated.

# HA SERIES

■ MODELS HA-201T : HA-30



MODEL HA-201T



MODEL HA-30

## ■ FEATURES

- Low Noise Figure
- Adjustable Slope Control (HA-201T)
- High Input Capability
- FM Trap (HA-30)
- Output Test Port (HA-30)

## ▼ CUSTOMER NOTES:

### HA-201T : 20 DB LOW NOISE AMPLIFIER

The **HA-201T** is a low noise, high output amplifier well suited for small channel capacity CATV amplification where slope adjustment is needed.

### HA-30 : 30 DB VHF/FM AMPLIFIER

The **HA-30** has been specially designed for MDU, off-air VHF antenna systems requiring separate Hi/Lo band level controls, FM traps, high gain and high output.

## HA SERIES

## ■ SPECIFICATIONS

FORWARD PATH	HA-201T	HA-30
Frequency	50 - 500 MHz	54 - 108, 174 - 216 MHz
Gain	20 dB	31 dB
Gain Adjustment Range	–	15 dB
FM Trap	–	(2) -20 dB (Switchable)
Maximum Input (7 Ch.)	23 dBmV	21 dBmV
Maximum Output (7 Ch.)	43 dBmV	52 dBmV
Slope	8 dB (Adj.)	–
GENERAL		
Power Requirements	117VAC, 60 Hz, 3 W	117VAC, 60 Hz, 3 W
Operating Temperature	-20° to 60° Celsius	-20° to 60° Celsius
Dimensions	3.5" x 2" x 1.25"	8.375" x 3.75" x 2"
Weight	.7 lbs.	2.25 lbs.

NOTE: All specifications typical unless otherwise noted

# HDA SERIES

■ MODELS HDA-10 : HDA-15 : HDA-25 : HDA-25E : HDA-30 : HDA-36



MODEL  
HDA-10



MODEL  
HDA-15



MODEL  
HDA-25/HDA-25E



MODEL  
HDA-30



MODEL  
HDA-36

## ■ FEATURES

- High Input / Output Capability
- Switchable FM Trap (HDA-25,30)
- Low Distortion
- Adjustable Gain (HDA-30, HDA-36)

## ▼ CUSTOMER NOTES:

### HDA-10/HDA-15 : 10/15 DB VHF/UHF AMPLIFIERS

The **HDA-10 / HDA-15** are all purpose amplifiers for home or small system applications requiring performance at an economical price.

### HDA-25 : 25 DB HIGH OUTPUT AMPLIFIER

The **HDA-25** is a full spectrum, high output, general purpose amplifier. The high output capability provides lower distortion than economy models while maintaining quality and reliability for the most sophisticated applications.

\* **ALSO AVAILABLE IN ECONOMY MODEL HDA-25E.**

### HDA-30 : 30 DB OFF-AIR, MDU AMPLIFIER

The **HDA-30** has been specifically designed for the high end home distribution market where a flat, full bandwidth amplifier is required. The low noise and high output capability make this amplifier ideal for systems with either the weakest or strongest input signals.

### HDA-36 : OFF-AIR, MDU AMPLIFIER

The **HDA-36** is the most versatile of our off-air amplifiers providing high gain and output for all off-air signals as well as independent band gain adjustments and FM traps.

# HDA SERIES

## SPECIFICATIONS

FORWARD PATH	HDA-10	HDA-15	HDA-25	HDA-25E
Frequency	50 - 900 MHz	54 - 216 MHz, 470 - 890 MHz	54 - 1000 MHz	54 - 800 MHz
Gain	10 dB	15 dB (54-216 MHz) 12dB (470-890 MHz)	25 dB	25 dB (54-450 MHz) 22 dB (450-800 MHz)
Gain Adjustment Range	-	-	-	-
FM Trap	-	-	20 dB (Switchable)	20 dB (Switchable)
Maximum Input (7 Ch.)	25 dBmV	35 dBmV VHF, 37 dBmV UHF	23 dBmV	15 dBmV
Maximum Output (7 Ch.)	35 dBmV	50 dBmV	48 dBmV	40 dBmV
Noise Figure	5 dB	5 dB VHF, 6 dB UHF	5 dB VHF, 7 dB UHF	-
GENERAL				
Power Requirements	117VAC, 60 Hz, 3 W	117VAC, 60 Hz, 3 W	117VAC, 60 Hz, 2 W	117VAC, 60 Hz, 2 W
Operating Temperature	-20° to 60° Celsius	0° to 50° Celsius	-20° to 60° Celsius	-20° to 60° Celsius
Dimensions	2.5" x 3.75" x 1.375"	4.5" x 3.25" x 1.25"	5.5" x 3" x 1.625"	5" x 3.25" x 1.5"
Weight	.9 lbs.	1 lb.	1.25 lbs.	.9 lbs.

FORWARD PATH	HDA-30	HDA-36
Frequency	54 - 1000 MHz	54 - 108 MHz, 174 - 216 MHz, 470 - 800 MHz
Gain	30 dB	31 dB VHF, 36 dB UHF
Gain Adjustment Range	8 dB	15 dB
FM Trap	25 dB (Switchable)	20 dB (Switchable)
Maximum Input (7 Ch.)	28 dBmV	37 dBmV
Maximum Output (7 Ch.)	50 dBmV	52 dBmV VHF, 54 dBmV UHF
GENERAL		
Power Requirements	117VAC, 60 Hz, 3 W	117VAC, 60 Hz, 5 W
Operating Temperature	0° to 50° Celsius	-20° to 60° Celsius
Dimensions	4.5" x 3.25" x 1.25"	8" x 4.5" x 2"
Weight	1 lb.	2.5 lbs.

NOTE: All specifications typical unless otherwise noted



# 1 GHZ AMPLIFIER

■ MODEL HDA-1000

GREAT FOR DIGITAL APPLICATIONS



MODEL HDA-1000



## ■ FEATURES

- Low Distortion, High Channel Capacity
- Bi-Directional (Passive Return)
- 34 dB Gain
- Wide Frequency Range (54-1000 MHz)
- Push-Pull, SMD Circuitry
- High Output

## ▼ CUSTOMER NOTES:

### HDA-1000 : 1 GHz BI-DIRECTIONAL AMPLIFIER

The **HDA-1000** is a unique amplifier combining the features of our push-pull, high output designs with an extended 1,000 MHz range; making this amplifier applicable to CATV, off-air, wireless and RF data distribution. The "SMD" surface mount design insures reliability and performance at the highest frequencies.

Separate gain and slope controls and a passive return path make this amp ideal for large homes and MDU's.

# 1 GHz AMPLIFIER

## SPECIFICATIONS

FORWARD PATH		HDA-1000
Frequency		54 - 1000 MHz
Gain		34 dB
Gain Adjust Range		15 dB
Maximum Input (135 Ch.)		5 dBmV
Maximum Output (135 Ch.)		39 dBmV
Flatness		54 - 750 MHz $\pm 1$ dB 750 - 1000 MHz $\pm 1.5$ dB
Noise Figure		6 dB
Cross Modulation (XMOD)		-65 dB (77 Ch.)
Composite Second Order (CSO)		-65 dB (77 Ch.)
Composite Triple Beat (CTB)		-70 dB (77 Ch.)
RETURN PATH		
Frequency		5 - 42 MHz
Gain		Passive (-2.5 dB)
GENERAL		
Power Requirements		117VAC, 60 Hz, 6 W
Operating Temperature		-10° to 55° Celsius
Dimensions		8" x 3.375" x 2"
Weight		3 lbs.

NOTE: All specifications typical unless otherwise noted

# HCA SERIES

■ MODELS HCA-3051 : HCA-5051 : HCA-3086RP : HCA-3051RK : HCA-3086RK



MODEL HCA-3086RP



MODEL HCA-3086RK

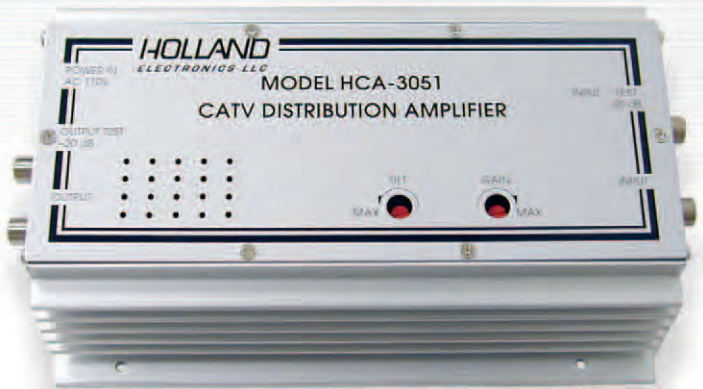

MODEL HCA-3051

## ■ FEATURES

- Low Distortion CATV Hybrid Amplifiers
- High Output
- Large Heatsink Case
- 550 and 860 MHz Models
- Adjustable Gain & Slope
- High Gain (30 or 50 dB)
- Return Path (Selected Models)

## ▼ CUSTOMER NOTES:

### HCA SERIES

The **HCA series** amplifiers incorporate high quality push-pull, hybrid modules to provide the highest output and lowest distortion levels possible. A regulated power supply, along with an extra large heatsink case, provide the reliability required for operation in even the most extreme environments. The **HCA series** is available in 30 or 50 dB gain, 550 or 860MHz bandwidth, and a 120 or 220VAC power supply (220VAC optional). Rack mounted models available.

## SPECIFICATIONS

FORWARD PATH	HCA-3051*	HCA-5051	HCA-3086RP	HCA-3086RK
Frequency	54 - 550 MHz	54 - 550 MHz	54 - 860 MHz	54 - 860 MHz
Gain	30 dB	50 dB	30 dB	30 dB
Gain Adjust Range	18 dB	18 dB	18 dB	18 dB
Maximum Input	15 dBmV (77 Ch.)	-5 dBmV **	11 dBmV (134 Ch.)	11 dBmV (134 Ch.)
Maximum Output	45 dBmV (77 Ch.)	45 dBmV (77 Ch.)	41 dBmV (134 Ch.)	41 dBmV (134 Ch.)
Slope	15 dB (Adj.)	12 dB (Adj.)	15 dB (Adj.)	15 dB (Adj.)
Flatness	±1 dB	±1 dB	±1 dB	±1 dB
Noise Figure	6.5 dB	6.5 dB	6.5 dB	6.5 dB
Input Return Loss (Min.)	12 dB	12 dB	12 dB	12 dB
Output Return Loss (Min.)	12 dB	12 dB	12 dB	12 dB
Cross Modulation (XMOD)	-58 dB	-58 dB	-58 dB	-58 dB
Composite Second Order (CSO)	-75 dB	-75 dB	-75 dB	-75 dB
Composite Triple Beat (CTB)	-60 dB	-60 dB	-60 dB	-60 dB
RETURN PATH				
Frequency	–	–	5 - 42 MHz	–
Gain	–	–	Passive (-2.5 dB)	–
GENERAL				
Power Requirements	117VAC, 60Hz, 8 W	117VAC, 60Hz, 8 W	117VAC, 60Hz, 8 W	117VAC, 60Hz, 8 W
Operating Temperature	-20° to 60° Celsius	-10° to 50° Celsius	-20° to 60° Celsius	-20° to 60° Celsius
Dimensions	8" x 5.375" x 2"	7.75" x 3" x 1.75"	8" x 3" x 1.75"	17" x 3" x 1.75"
Weight	3.5 lbs.	2.55 lbs.	2.55 lbs.	4.35 lbs.

\* Rack mount model available. (Model **HCA-3051RK**)

\*\* Maximum input specified at full channel capacity. Full gain at maximum channel capacity is not recommended.

Maximum input increases as channel load decreases.

Please see our support section at [www.hollandelectronics.com](http://www.hollandelectronics.com) for channel loading application sheet.

NOTE: All specifications typical unless otherwise noted

# BI-DIRECTIONAL CATV AMPLIFIER

■ MODEL HCA-36ERA

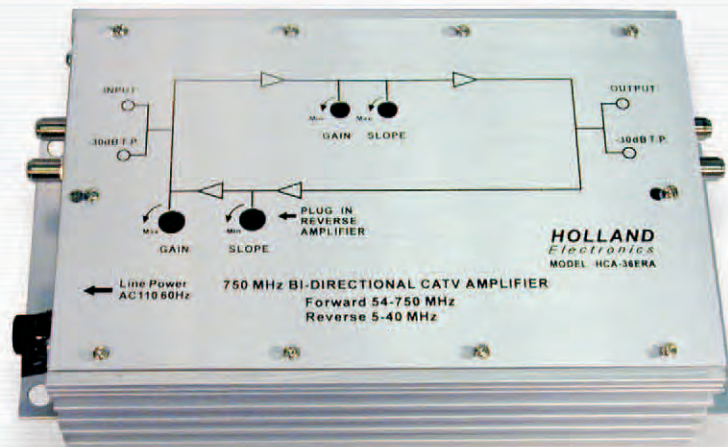

MODEL HCA-36ERA



## ■ FEATURES

- 54-750 MHz Forward Operation
- Variable EQ & Gain Control
- Input & Output Test Ports (Forward & Reverse)
- Bi-Directional (Amplified Return)
- High Output with Low Distortion
- High Return Input Level Capability

## ▼ CUSTOMER NOTES:

### 750 MHz BI-DIRECTIONAL CATV AMPLIFIER

Our highest performance **CATV Amplifier** provides a two-way amplified capability with very low distortion from the use of two hybrid amplifier stages with inter-stage slope and gain controls. The variable controls in both directions make this amplifier ideal for use in larger MDU installations.

# BI-DIRECTIONAL CATV AMPLIFIER

## SPECIFICATIONS

FORWARD PATH	HCA-36ERA
Frequency	54 - 750 MHz
Gain	36 dB
Gain Adjustment Range	15 dB (Adj.)
Maximum Input (116 Ch.)	6 dBmV
Maximum Output (116 Ch.)	42 dBmV
Slope	12 dB
Flatness	±1 dB
Noise Figure	7 dB
Cross Modulation (XMOD)	-60 dB
Composite Second Order (CSO)	-65 dB
Composite Triple Beat (CTB)	-62 dB
RETURN PATH	
Frequency	5 - 40 MHz
Gain	18 dB
Adjustment Range	10 dB
Flatness	±1 dB
EQ Adjustment Range	10 dB
Maximum Input (3 Ch.)	42 dBmV
Maximum Output (3 Ch.)	60 dBmV
GENERAL	
Power Requirements	117VAC, 60Hz, 18 W
Operating Temperature	-10° to 60° Celsius
Dimensions	9.5" x 6.5" x 2.5"
Weight	5.5 lbs.

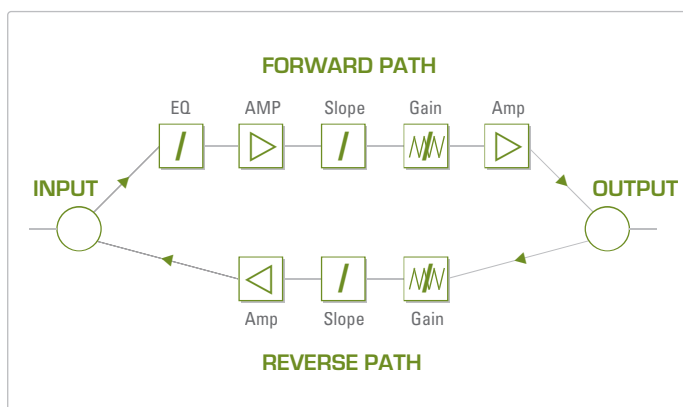

NOTE: All specifications typical unless otherwise noted

# HCDA SERIES

■ MODELS HCDA-1/FRA/RA, 2, 4



MODEL HCDA-2



MODEL HCDA-4



MODEL HCDA-1/FRA/RA

## ■ FEATURES

- 1 GHz Bandwidth
- Hermetically Sealed Case & Ports
- Low Noise Figure: 3 dB
- High Return Input Capability
- Direct or Line Powering Capability
- High Return Loss
- Surge Protected (IEE C62.41-1991, All Ports)
- 130 dB RFI Shielding
- LED Power Indicator

## ▼ CUSTOMER NOTES:

### HCDA-1/FRA/RA, 2, 4 BI-DIRECTIONAL CABLE DROP AMPLIFIER

The **HCDA Series** is the top of the line CATV drop/subscriber amplifier. The **HCDA** amplifiers are unsurpassed in environmental ruggedness with sealed "F" ports, powder coated paint, and a RFI hermetically sealed back plate. This amplifier comes in one, two and four output port models, with active or passive return.

The **HCDA-1FRA** is the same quality drop amplifier as the rest of the **HCDA Series**, with the addition of reverse amplification to overcome return path loss.

The **HCDA-1RA** provides amplification to the return path only, forward path passive.

### HCDA POWERING OPTIONS



MODEL HCDA-PI

The **HCDA-PI** power inserter allows amplifier powering through an existing output cable.

# HCDA SERIES

## SPECIFICATIONS

FORWARD PATH	HCDA-1	HCDA-2	HCDA-4	HCDA-1FRA	HCDA-1RA
Frequency	54 - 1000 MHz	54 - 1000 MHz	54 - 1000 MHz	54 - 1000 MHz	54 - 1000 MHz
Gain	15 dB	11 dB	7 dB	15 dB	-1.5 dB
Maximum Input (157 Ch.)	7 dB	7 dB	7 dB	7 dB	-
Maximum Output (79 Analog Chs. & 33 Digital Chs.)	25 dBmV	21.5 dBmV	18 dBmV	25 dBmV	-
Slope	-	-	-	-	-
Flatness	±1 dB	±1 dB	±1 dB	±1 dB	± 1 dB
Group Delay	See Table Below	See Table Below	See Table Below	-	-
Noise Figure	3 dB	3 dB	3 dB	3 dB	-
Input Return Loss	20 dB	20 dB	20 dB	20 dB	18 dB
Output Return Loss	20 dB	20 dB	20 dB	20 dB	18 dB
Cross Modulation (XMOD)	-75 dB	-75 dB	-75 dB	-75 dB	-
Composite Second Order (CSO)	-62 dB	-62 dB	-62 dB	-62 dB	-
Composite Triple Beat (CTB)	-75 dB	-75 dB	-75 dB	-75 dB	-
RETURN PATH					
Frequency	5 - 42 MHz	5 - 42 MHz	5 - 42 MHz	5 - 42 MHz	5 - 42 MHz
Gain	Passive (-1 dB)	Passive (-4.5 dB)	Passive (-8 dB)	10 dB	10 dB
Flatness	± .5 dB	± .5 dB	± .5 dB	±1 dB	± 1 dB
Group Delay	See Table Below	See Table Below	See Table Below	-	-
Maximum Input (1 Ch.)	-	-	-	45 dBmV	45 dBmV
Maximum Output (1 Ch.)	-	-	-	55 dBmV	55 dBmV
GENERAL					
Power Requirements	12VDC, 2.4W	12VDC, 2.4W	12VDC, 2.4W	12VDC, 3.6W	12VDC, 1.2W
Operating Temperature	-40° to 60° Celsius	-40° to 60° Celsius	-40° to 60° Celsius	-40° to 60° Celsius	-40° to 60° Celsius
Dimensions	2.5" x 4.5"	2.5" x 4.5"	2.5" x 4.5"	2.5" x 4.5"	2.5" x 4.5"
Weight	1 lb. (w/adaptor)	1 lb. (w/adaptor)	1 lb. (w/adaptor)	1 lb. (w/adaptor)	1 lb. (w/adaptor)

GROUP DELAY : FORWARD PATH (HCDA 1, 2 & 4 : 54 - 1000 MHz)	
20 ns Max.	For Ch. 2, 3.58 MHz Span
10 ns Max.	For Ch. 3, 3.58 MHz Span
5 ns Max.	For All Other Channels, 3.58 MHz Span
GROUP DELAY : RETURN PATH (HCDA 1, 2 & 4 : 5 - 42 MHz)	
20 ns Max.	5 - 42 MHz, 2 MHz Span
5 ns Max.	10 - 36 MHz, 1 MHz Span

NOTE: All specifications typical unless otherwise noted



# LA SERIES

■ MODELS LA-10 : LA-520 : LA-2150H



MODEL LA-10



MODEL LA-520



MODEL LA-2150H

## ■ FEATURES

- Line Powered
- Low Noise Figure
- Optional Power Inserter (PS-10)
- Wideband & High Output Models
- Hermetically Sealed / Outdoor Rated

## ▼ CUSTOMER NOTES:

### LINE POWERED AMPLIFIERS

When extra amplification is needed, **Holland Electronic's LA Series** small in-line amplifiers are the choice of industry professionals world-wide. The **LA Series** can be powered with existing line voltage, or used with the optional **PS-10** power inserter.

### LA-10

The **LA-10** is a full band (5-900 MHz) 10 dB gain, CATV, UHF/VHF line amplifier with medium output capability.

### LA-520

Our most versatile line amplifier with wideband capabilities from 50 to 2050 MHz and 20 dB gain.

### LA-2150H

This high-output line amplifier has been specifically designed for satellite systems with a frequency range of 950 to 2150 MHz and 20 dB gain.

**SPECIFICATIONS**

FORWARD PATH	LA-10	LA-520	LA-2150H
Frequency	5 - 900 MHz	50 - 2050 MHz	950 - 2150 MHz
Gain	10 dB	20 dB	20 dB
Maximum Input	20 dBmV (7 Ch.)	-38 dBm (16 Trns.)	-35 dBm (16 Trns.)
Maximum Output	30 dBmV	-18 dBm (16 Trns.)	-15 dBm (16 Trns.)
Noise Figure	4 dB	5 dB	5 dB
GENERAL			
Power Requirements	12 - 18VDC @ 40 mA	12 - 18VDC @ 50 mA	12 - 18VDC @ 50 mA
Dimensions	2.3" x .75"	2.25" x 1" x .75"	3.5" x 1" x .75"
Weight	.05 lbs.	.15 lbs.	.15 lbs.

**LA SERIES POWERING OPTIONS**

The **PS-10** is an optional UL listed power supply and inserter for the **LA Series** line amplifiers or other DC line powered amplifiers.



**MODEL PS-10**

PS-10	
Frequency	5 - 2150 MHz
AC In	117VAC
DC Out	15VDC @ 100 mA

NOTE: All specifications typical unless otherwise noted

# SATELLITE AMPLIFIERS

■ MODELS PAL \*-T : LA- \* : NA2530A-T : PA2530A-T : TA2330D-T

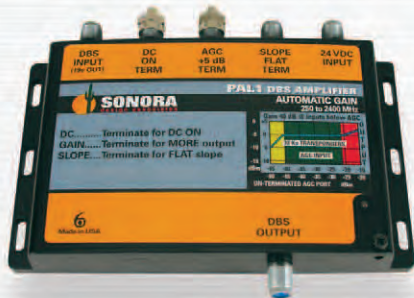

PAL SERIES

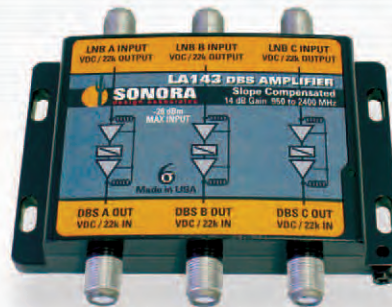

LA SERIES

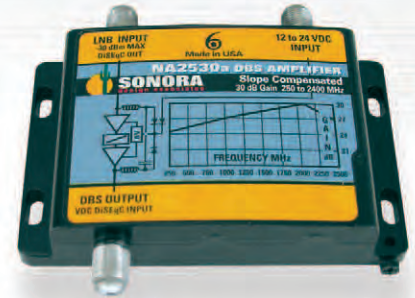

NA/PA/TA SERIES

## ■ FEATURES

- High Return Loss
- Flat Signal Response
- Slope Compensation
- Multiple Powering Options
- Automatic Gain Control (PAL Series)
- Ka Models Available

## ▼ CUSTOMER NOTES:

### PAL1-T, 5-T, 10-T, 20-T, 30-T AUTO GAIN CONTROL DISTRIBUTION AMPLIFIERS

The **PAL Series** amplifiers provide unmatched auto leveling/auto gain performance. Within fractions of a second, they respond to signal strength variations due to rain fade and atmospheric variables to provide a constant and stable fixed output; making them ideal for MDU Distribution. The **PAL** amplifiers come in -1, -5, -10, -20 and -30 dBm power outputs.

### LA-141A, 142A, 143A LINE AMPLIFIERS

The **LA Series** drop amplifiers compensate for approximately 200 feet of coaxial cable loss between the LNB & DBS receiver. They offer 14 dB of gain and 4 dB of slope compensation. These amplifiers are receiver powered, outdoor capable and pass 22 kHz/DiSEqC control signals.

### NA2530A-T : TA2330D-T FIXED GAIN DISTRIBUTION AMPLIFIERS

The **NA2530A-T** & **TA2330D-T** fixed gain amplifiers, with their slope compensation and high return loss, make them ideal for driving DBS distribution systems.

The **TA2330D-T** model powers dual LNB's. The **NA2530A-T** also comes in a dual input/dual output model.



# SATELLITE AMPLIFIERS

## SPECIFICATIONS

FORWARD PATH	PAL1-T,5-T,10-T,20-T,30-T	LA-141A,142A,143A	NA2530A-T	TA2330D-T
Frequency	950 - 2150 MHz	250 - 2400 MHz	250 - 2150 MHz	950 - 2150 MHz
Gain	20 dB (PAL-1,5,10) 30 dB (PAL-20,30)	14 dB	30 dB	30 dB
Gain Adjust Range	Auto-Leveling	Fixed	Fixed	Fixed
Maximum Input (32 Trns.)	-21, -25, -29, -31, -35 dBm	-28 dBm	-31 dBm	-27 dBm
Maximum Output (32 Trns.)	-1, -5, -10, -20, -30 dBm	-14 dBm	-1 dBm	+3 dBm
Slope	7 dB	4 dB	3 dB	5 dB
Flatness	± 0.2 dB	± 0.2 dB	± 0.2 dB	± 0.2 dB
Noise Figure	7 dB	7 dB	7 dB	7 dB
Input Return Loss	12 dB	15 dB	10 dB	12 dB
Output Return Loss	13 dB	13 dB	12 dB	14 dB
GENERAL				
Power Requirements	14 - 20VDC	12 - 22VDC	15 - 24VDC	24VDC
Operating Temperature	0° to 50° Celsius	-30° to 70° Celsius	0° to 50° Celsius	0° to 50° Celsius
Dimensions	5.5" x 4.5" x 1.5"	4" x 3" x .75"	5.5" x 4.5" x 1.5"	8.5" x 4.5" x 1.5"
Weight	1.8 lbs.	.5 lbs.	1.9 lbs.	1.7 lbs.

\* Please see the satellite section (page 111) for dishes, stackers & satellite accessories.

NOTE: All specifications typical unless otherwise noted

# COAXIAL DROP CABLE

■ MODELS RG6-60-\*\* : RG11-\*\*



MODEL RG6-60-PR\*



MODEL RG6-60-\*R



MODEL RG6-60-\*B

Holland's premium drop cable is made using the highest grade components such as copper-clad steel center conductor (18 AWG), aluminum braid (min. 60%), gas injected foam dielectric and a UV inhibited PVC jacket. All drop cable is swept tested to 2250 MHz. \* Optional UL Listed Models Available Upon Request

1st Asterisk = Color

2nd Asterisk = Packaging

MODEL	*	*
RG6-60-**	B or W	R, B or PR
RG6-60-*M	B or W	Messenger (Only Available on Reels)
RG6-Q-**	B or W	Reel Only
RG11-60-*	B or W	Reel Only
RG11-60-*M	B or W	Messenger (Only Available on Reels)

**COLORS:** B = Black / W = White    **PACKAGING:** R = Reel / B = Box / PR = Pull Reel-in-Box

■ **MAXIMUM CABLE ATTENUATION (dB/100 FT @ 68°F)**

FREQUENCY	RG-59	RG-6	RG-11	HVS-1
55	1.88	1.50	.95	2.4
550	5.9	4.76	3.01	8.5
870	7.54	6.09	3.9	10.62
1450	9.82	7.89	5.29	13.82
2150	12.1	9.69	6.6	16.74



**U.S. MANUFACTURED CABLE AVAILABLE UPON REQUEST.**

# MINI PRECISION VIDEO COAXIAL CABLES

MODELS 1855940 : 1855941 : 1855942 : 1855943 : HVS-1\* : HVS-3 : HVS-5 ■

## YR940 SERIES FROM BELDEN

Holland Electronics is proud to offer **YR940** micro-coaxial cable. The **YR940** micro cable is a precision 75 Ohm video cable with a 23 AWG solid copper center conductor, bonded foil, and a 95% tinned copper braid (enabling its SDI rating) and comes in a variety of colors. It is stocked individually as well as 2, 3, 5, 8, 10, 12 and 16-pack bundles. Custom bundle cables are also available. The **YR940** Series, when matched with our 1855 connectors provide the perfect solution for your A/V applications.



MODEL 1855940\*



MODEL 1855941



MODEL 1855942



MODEL 1855943

YR940 SERIES FROM BELDEN	REEL SIZE	BUNDLE **	COLORS
1855940-*	250' & 1000' Reels Available	Single Conductor	BL, BK, BR, G, GR, O, R, V, W, Y
1855941	250' & 1000' Reels Available	3 Conductor	R, G, BL
1855942	250' & 1000' Reels Available	5 Conductor	R, GR, BL, Y, W
1855943	250' & 1000' Reels Available	10 Conductor	All 10 Colors

\* = Available in 10 different colors.

\*\* = Other bundles available. Please call for part number and pricing.



MAXIMUM TRANSMISSION DISTANCE (FT)						
Distance in Feet (Max.)	1000	910	750	650	530	210
Application	Composite NTSC	Composite PAL	Component Video	Component Widescreen	Component Widescreen	HDTV

## HOLLAND PRECISION VIDEO CABLE

**Holland's** precision mini-coaxial cable is the cost-effective micro cable solution. The **HVS Series** also uses a 23 AWG solid copper center conductor, bonded foil and 95% tinned copper braid. Overseas manufacturing allows us to provide an excellent quality cable at an affordable price.



MODEL HVS-1\*



MODEL HVS-3



MODEL HVS-5

HOLLAND VIDEO SELECT	REEL SIZE	BUNDLE	COLORS
HVS-1*	250' & 1000' Reels Available	Single Conductor	R, G, BL, Y, W, BK
HVS-3-250	250' Reels	3 Conductor	R, G, BL
HVS-5-250	250' Reels	5 Conductor	R, G, BL, Y, W
HVS-6-250	250' Reels	6 Conductor	R, G, BL, Y, W, BK

\* = Available in 6 different colors.

\*\* = Other custom bundles available. Please call for details.

**NOTE:** See page 29 for mini connectors.

# MOLDED PATCHCORDS & INTERCONNECTS

■ MODELS JRR-3 : JRR-3D : JRR-3T : JRR-6 : JRR-6D : JRR-6T : JRR-12D : JRR-12T : J72-S : J72-RGB : J144-S

All **Holland** pre-molded jumper cables use the highest quality RCA, F, and S-Video connectors covered with a flexible rubber strain relief boot.



**MODEL JRR-3**  
3' Single RCA Cable



**MODEL JRR-3D**  
3' Dual RCA Cable



**MODEL JRR-3T**  
3' Triple RCA Cable



**MODEL JRR-6**  
6' Single RCA Cable



**MODEL JRR-6D**  
6' Dual RCA Cable



**MODEL JRR-6T**  
6' Triple RCA Cable

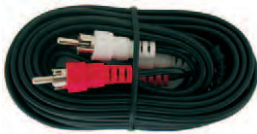

**MODEL JRR-12D**  
12' Dual RCA Cable



**MODEL JRR-12T**  
12' Triple RCA Cable



**MODEL J72-S**  
6' Single S-Video Cable



**MODEL J72-RGB**  
6' Component RGB Video Cable



**MODEL J144-S**  
12' Single S-Video Cable

Standard patchcords are nickel plated, premium are available with gold plating. Triple Patchcords have two audio and one RG-59 video cable.

MODEL	LENGTH	NO. OF CABLES
JRR-3	3 Ft.	Single
JRR-3D	3 Ft.	Dual
JRR-3T*	3 Ft.	Triple
JRR-6	6 Ft.	Single
JRR-6D	6 Ft.	Dual
JRR-6T*	6 Ft.	Triple

MODEL	LENGTH	NO. OF CABLES
JRR-12D	12 Ft.	Dual
JRR-12T*	12 Ft.	Triple
J72-S (S-VIDEO)*	6 Ft.	Single
J72-RGB*	6 Ft.	Triple
J144-S (S-VIDEO)*	12 Ft.	Single

\* = Gold plated

# JUMPERS & ADAPTERS

MODELS J36-BFF : J72-BFF : J36-6BFF : J72-6BFF : SV-RCA : RCA-Y : RCA-YF ■

## COAXIAL JUMPERS

All **Holland** jumper cables are made to the highest CATV standards using Belden, Commscope, or Lunatron cable. All are crimped with precision automatic equipment assuring the highest pull force available.



**MODEL J36-BFF : J72-BFF**  
Premium RG-59 jumper cables.  
(36" & 72" Standard)



**MODEL J36-6BFF : J72-6BFF**  
Premium RG-6 jumper cables.  
(36" & 72" Standard)

## CUSTOM JUMPER ASSEMBLIES

**Holland** offers a variety of precision custom jumpers in all cable types. Many connector types and brands of cable are available (ie. Male/ Female, F, RCA, BNC, SMB, etc.).

MODEL	LENGTH	COLOR	CABLE	CONNECTOR
J*-*-*	In Inches	Multiple Colors Available	RG-59, RG-6, RG-11, 1855	F, RCA, BNC, SMB

**EXAMPLE:** J12-BK-59-F (12" Black RG-59 Jumper with F Connector)

## RCA & S-VIDEO ADAPTERS



**MODEL SV-RCA : S-VIDEO BREAKOUT ADAPTER**  
Save time, money, and extend S-Video transmission distance to 200' while maintaining picture quality with our S-Video adapters. This adapter converts the S-Video components to two coaxial cables allowing you to run S-Video much further.



**MODEL RCA-Y**  
Two female, one male



**MODEL RCA-YF**  
Two male, one female



# SLCU SERIES COMPRESSION CONNECTORS

■ MODELS SLCU-\* : SLCU-\* RCA : SLCU-\* BNC



**SLCU-\***  
F TYPE



**SLCU-\* RCA**  
RCA TYPE



**SLCU-\* BNC**  
BNC TYPE

## ■ FEATURES

- All Metal Construction
- Dual O-Ring Moisture Sealing (F Type)
- Dual Compression Points
- Patented Viewing Window (#6,929,508)
- Accommodates Color-Coded Application Bands (SRR)
- Interchangeable Internal Grip Ring
- 1 Piece Fixed Pin For BNC & RCA

## ▼ CUSTOMER NOTES:

### SUPERLOK COMPRESSION CONNECTORS

The **Superlok™** series compression connector utilizes two independent compression points to seal and hold the coaxial cable to the connector. **Holland Electronic's** patented viewing window allows users to determine when complete cable insertion has been achieved prior to compression.

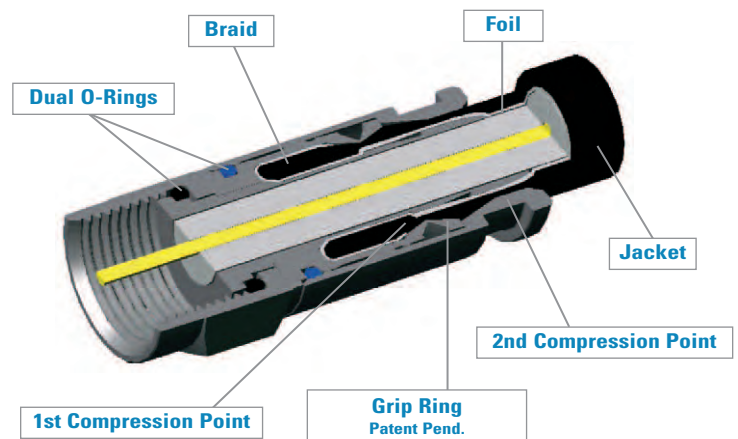

Patent #6,217,383 / #7,008,263 / #6,929,508

# SLCU SERIES COMPRESSION CONNECTORS

## SLCU IDENTIFICATION



1. Marking grooves used to indicate cable braid configuration.
2. Colored front O-Rings for visual verification of cable type. (Also provides improved moisture sealing)
3. Rear groove for **SRR** marking bands to indicate application.

CABLE TYPE	MARKING (1)	ID (2)
Standard 6	No Grooves	Blue O-Ring
Tri-Shield 6	1 Groove	Black O-Ring
Quad-Shield 6	2 Grooves	Green O-Ring
Triple O-Ring 6	3 Grooves	Blue O-Ring
Triple O-Ring Quad-Shield 6	3 Grooves	Green O-Ring

CABLE TYPE	MARKING (1)	ID (2)
Standard 59	No Grooves	Red O-Ring
Tri-Shield 59	1 Groove	Yellow O-Ring
Quad-Shield 59, HEC2	2 Grooves	Yellow O-Ring
Standard 11	No Grooves	Black O-Ring
Quad-Shield 11	2 Grooves	Green O-Ring
SLCU-HEC2	2 Grooves	Yellow O-Ring

## SPECIFICATIONS

ELECTRICAL	
Frequency	DC - 3 GHz
Insertion Loss	.1 dB
Return Loss	30 dB
MECHANICAL	
Material	Brass
Cable Strip Length	1/4" x 1/4"

## HOLLANDS SUPERLOK CONNECTORS PASS THE FOLLOWING SCTE SPECIFICATIONS

SCTE IPS-TP-401	Cable Retention Force	> 40 lbs.
SCTE IPS-TP-004	Insertion Force	< 20 lbs.
SCTE IPS-TP-013	Moisture Migration	Pass
SCTE IPS-TP-110	Return Loss	> 30 dB to 1 GHz
SCTE IPS-TP-403	Shielding	> 90 dB to 1 GHz
SCTE IPS-TP-406	Salt Spray	Pass
SCTE IPS-TP-400	Tightening Torque	Pass

## SRR-\* REPLACEABLE BANDS

Easily identify application source with **SRR Marking Bands**. \* = COLOR



BL = BLUE	W = WHITE	B = BLACK	Y = YELLOW	G = GREEN	P = PURPLE	R = RED
-----------	-----------	-----------	------------	-----------	------------	---------

**EXAMPLE:** Yellow=Video, Red=Audio, etc.

\* SEE SUPPORT SECTION OF OUR SITE ([WWW.HOLLANDELECTRONICS.COM/SUPPORT](http://WWW.HOLLANDELECTRONICS.COM/SUPPORT)) FOR CONNECTOR INSTALLATION INSTRUCTIONS.

NOTE: All specifications typical unless otherwise noted

# SLC-11 SERIES COMPRESSION CONNECTOR

■ MODELS SLC-11 : SLC-11Q

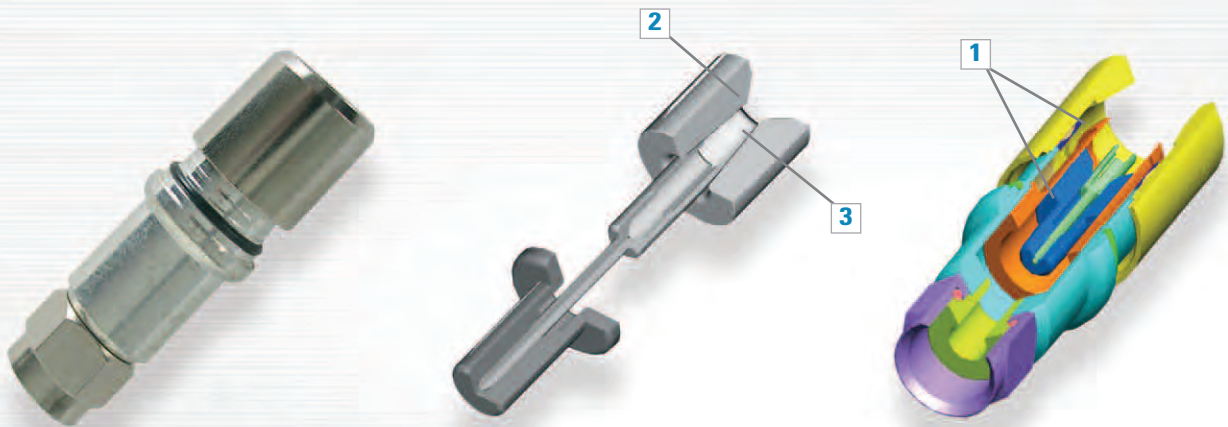

SLC-11/SLC-11Q

\* SEE NOTES BELOW

## ■ FEATURES

- Dual Compression Points
- Internal Center Conductor Guide
- High Center Conductor Holding Force
- Long Term Sealing
- Low Cable Insertion Force
- All Metal Construction

## ▼ CUSTOMER NOTES:

### SLC-11 SERIES FOR RG-11 CABLE

Holland Electronic's **SLC11's** advanced pin capture mechanism makes it an ideal choice for professional RG-11 terminations. The **SLC 11** features a sliding pin design that avoids blind mating and ensures positive center conductor insertion to provide the most reliable termination available. Patent pending dual compression point technology guarantees long term sealing and reduces the amount of insertion force required. The improved sealing and all metal construction ensure connector reliability even in the most adverse environments.

#### SLC-11 FEATURES:

- 1 Dual compression points
- 2 Internal center conductor guide
- 3 Higher cable center conductor holding force

MODEL #	DESCRIPTION	PLATING	TOOL CLOSURE SIZE
SLC-11	Standard	Nickel	36.1 mm
SLC-11Q	Quad Shield	Nickel	36.1 mm

# CONNECTOR SELECTION CHART

## SERIES 59 CABLE



MODEL #	DESCRIPTION	PLATING	CLOSURE SIZE
SLCU-59	F Male	Nickel	21 mm
SLC59-HEC	F Male / Tri-Shield	Nickel	21 mm
SLCUHEC2	F Male / Head-End	Nickel	21 mm
SLC59-RCA	RCA Male / Fixed Pin / 1 Piece	Nickel	29.8 mm
SLC59-RCAG	RCA Male / Fixed Pin / 1 Piece	Gold	29.8 mm
SLC59-BNC	BNC Male / Fixed Pin / 1 Piece	Nickel	29.8 mm
SLC59-BNCG	BNC Male / Fixed Pin / 1 Piece	Gold	29.8 mm

## SERIES 6 CABLE



MODEL #	DESCRIPTION	PLATING	CLOSURE SIZE
SLCU-6	F Male	Nickel	21 mm
SLCU-6T	F Male / Tri-Shield	Nickel	21 mm
SLCU-6Q	F Male / Quad-Shield	Nickel	21 mm
SLCU-6-0	F Male w/Triple O-Ring	Nickel	21 mm
SLC-6M	F Male / Short	Nickel	20.1 mm
SLCU-6Q0	F Male / Quad-Shield w/Triple O-Ring	Nickel	21 mm
SLC6-RCA	RCA Male / Fixed Pin / 1 Piece	Nickel	29.8 mm
SLC6-RCAG	RCA Male / Fixed Pin / 1 Piece	Gold	29.8 mm
SLC6Q-RCA	RCA Male / Fixed Pin / Quad-Shield / 1 Piece	Nickel	29.8 mm
SLC6Q-RCAG	RCA Male / Fixed Pin / Quad-Shield / 1 Piece	Gold	29.8 mm
SLC6-BNC	BNC Male / Fixed Pin / 1 Piece	Nickel	29.8 mm
SLC6-BNCG	BNC Male / Fixed Pin / 1 Piece	Gold	29.8 mm
SLC6Q-BNC	BNC Male / Fixed Pin / Quad-Shield / 1 Piece	Nickel	29.8 mm
SLC6Q-BNCG	BNC Male / Fixed Pin / Quad-Shield / 1 Piece	Gold	29.8 mm

\* Series 6 photos shown with optional **SRR** bands.

\* SEE SUPPORT SECTION OF OUR SITE ([WWW.HOLLANDELECTRONICS.COM/SUPPORT](http://WWW.HOLLANDELECTRONICS.COM/SUPPORT)) FOR CONNECTOR INSTALLATION INSTRUCTIONS.

# ATTACHED RING CRIMP CONNECTORS

■ FOR SERIES RG-59 CABLE : SERIES RG6 CABLE : SERIES 11 CABLE : SERIES 7 CABLE

All **Holland** brand premium F connectors have been made to precise specifications and standards for over 20 years in our **ISO 9001:2000** factory. We continue to use high grade brass for our connectors and have made significant improvements in our annealing process that guarantees quality and performance.

## SERIES 59 CABLE



MODEL #	DESCRIPTION	PLATING	CRIMP TOOL HEX SIZE
F59-290G	F Male / Brass	Gold Iridite	.324
F59-290T	F Male / Brass	Tin	.324
F59-290D	F Male / Zinc Nut	Nickel	.324
F9-290	F Male / Economy	Nickel	.324
F59-290CC	F Male / Brass / Conical Crimp	Tin	.324
RCA59-290	RCA Male / Fixed Pin / 1 Piece	Nickel	.324
RCA59-290G	RCA Male / Fixed Pin / 1 Piece	Gold	.324
BNC-C290	BNC Male / Fixed Pin / 1 Piece	Nickel	.324
F59-UNIV	F Male / Brass / Universal	Gold Iridite	.360

## SERIES 6 CABLE



MODEL #	DESCRIPTION	PLATING	CRIMP TOOL HEX SIZE
F56-324G	F Male / Brass	Gold Iridite	.324
F56-324T	F Male / Brass	Tin	.324
F56-324D	F Male / Zinc Nut	Nickel	.324
F56-324	F Male / Zinc Nut	Gold Iridite	.324
F6-324	F Male / Economy	Nickel	.324
F56-324CC	F Male / Brass / Conical Crimp	Tin	Uses RTC-360 or Similar
F56-324CCWP	F Male / Brass / Conical Crimp with O-Ring	Tin	Uses RTC-360 or Similar
F56-324K	F Male / Brass / Knurled	Tin	.324
F56-342G	F Male / Brass / Tri Shield	Gold Iridite	.324
F56-342T	F Male / Brass / Tri Shield	Tin	.324
F56-357G	F Male / Brass / Quad Shield	Gold Iridite	.360
F56-357T	F Male / Brass / Quad Shield	Tin	.360
F56-UNIV	F Male / Brass / Universal	Gold Iridite	.360
F-5681G	F Female / 1 Piece / High Return Loss	Gold Iridite	.324
BNC-C324	BNC Male / Fixed Pin / 1 Piece	Nickel	.324

# ATTACHED RING CRIMP CONNECTORS

## SERIES 11 CABLE



MODEL #	DESCRIPTION	PLATING	CRIMP TOOL HEX SIZE
F11-460	F Male / Fixed Pin	Tin	.472
F11-480	F Male / Fixed Pin / Quad Shield	Tin	.472
F11-460WOL	F Male / Fixed Pin with O-Ring and Gel	Tin	.472

## SERIES 7 CABLE



MODEL #	DESCRIPTION	PLATING	CRIMP TOOL HEX SIZE
F7-413T	F Male / Brass	Tin	.410

## SERIES 59 & 6 WEATHERPROOF



MODEL #	DESCRIPTION	PLATING	CRIMP TOOL HEX SIZE
F59-290WOL	F Male / Brass / O-Ring and Gel	Gold Iridite	.324
F6-324WL	F Male / Economy / Large Nut / O-Ring and Gel	Gold Iridite	.324
F56-324W	F Male / Brass/ Zinc Nut / O-Ring and Gel	Gold Iridite	.324
F56-324WOL	F Male / Brass/ 4 Turn Nut / O-Ring and Gel	Gold Iridite	.324
F56-324WL	F Male / Brass/ Large Nut / O-Ring and Gel	Gold Iridite	.324
F56-324GWP	F Male / Brass/ 4 Turn Nut / O-Ring	Gold Iridite	.324
F56-UNIV-WL	F Male / Brass / Universal / Large Nut O-Ring and Gel	Gold Iridite	.360

# MINI COAX SERIES CONNECTORS

■ FOR SERIES 23AWG CABLE : SERIES 25AWG CABLE : SERIES 30AWG CABLE

**Holland** offers the most complete line of connectors for mini coax available in the industry. Take advantage of our one piece designs that enable you to terminate your cables in 15 seconds. Our connectors are available for the most popular mini cable sizes ranging from 23-30AWG center conductors. Designed for all applications in CATV, satellite, home theater, broadcast and satellite radio. **Holland's** patented **U** (Universal) **Models** (#7,112,093) can be used on a wider range of cable sizes.

## COMPRESSION - 23 AWG 25 AWG 30 AWG



SLC1855-FP2  
SLC1855-FPU  
SLC-MINI25U  
SLC-179DT-FP (2 PIECE)



SLC1855-BNCFP  
SLC1855-BNCFPU  
SLC-BNC-MINI25U  
SLC-BNC-179DT (2 PIECE)



SLC1855-RCAFP  
SLC1855-RCAFPU  
SLC-RCA-MINI25U  
SLC-RCA-179DT (2 PIECE)

## CRIMP - 23 AWG



F1855-FP



BNC1855-FP



RCA-1855

## RIGHT ANGLE COMPRESSION



SLC1855-90-F



SLC1855-90-BNC



SLC1855-90-RCA

## FEMALE BULKHEADS



GF-1855-A



BNCFPFBH



RCAFPFBH

## SATELLITE RADIO



SMBFP



SMBFP90



SMBFPF

## INSTALLERS KIT

Our installer kits are designed to keep your installation materials organized. Features six internal pockets to keep connector styles separate, external tool pockets, a retractable handle, wheels, and a 250' internal cable spooler.

MODEL #	DESCRIPTION
1855940-STARTER	Kit with Tools, 250' Cable, and Crimp Connectors
1855940STARTERC	Kit with Tools, 250' Cable, and Compression Connectors
INSTALLER PACK	Installation Bag Only. No Tools, Cable, or Connectors



# MINI COAX SERIES CONNECTORS

## SERIES 23AWG CABLE

(Nominal Cable OD .159")

### COMPRESSION CONNECTORS

For **Holland HVS Series** : **Belden** YR46940, 1855A : **Commscope** 7538 or Similar

MODEL #	DESCRIPTION	PLATING	CLOSURE SIZE
SLC1855-FP2	F Male / Fixed Pin / 1 Piece	Nickel	29.8 mm
SLC1855-FPU	F Male / Fixed Pin / 1 Piece / Universal	Nickel	29.8 mm
SLC1855-RCAFP	RCA Male / Fixed Pin / 1 Piece	Nickel	29.8 mm
SLC1855-RCAFPG	RCA Male / Fixed Pin / 1 Piece	Gold	29.8 mm
SLC1855-RCAFPU	RCA Male / Fixed Pin / 1 Piece / Universal	Nickel	29.8 mm
SLC1855-BNCFP	BNC Male / Fixed Pin / 1 Piece	Nickel	29.8 mm
SLC1855-BNCFPU	BNC Male / Fixed Pin / 1 Piece / Universal	Nickel	29.8 mm
SLC1855-90-F	90° F Male / Fixed Pin / 1 Piece	Nickel	29.8 mm
SLC1855-90-RCA	90° RCA Male / Fixed Pin / 1 Piece	Nickel	29.8 mm
SLC1855-90-BNC	90° BNC Male / Fixed Pin / 1 Piece	Nickel	29.8 mm

## SERIES 23AWG CABLE

(Nominal Cable OD .159")

### CRIMP CONNECTORS

For **Holland HVS Series** : **Belden** YR46940, 1855A : **Commscope** 7538 or Similar

MODEL #	DESCRIPTION	PLATING	HEX SIZE
F1855-FP	F Male / Fixed Pin / 1 Piece	Nickel	.270 mm
RCA-1855	RCA Male / Fixed Pin / 1 Piece	Nickel	.270 mm
BNC1855-FP	BNC Male / Fixed Pin / 1 Piece	Nickel	.270 mm
GF-1855-A	F Female / Fixed Pin / 1 Piece	Nickel	.270 mm
RCAFPFBH	RCA Female / Fixed Pin / 1 Piece	Nickel	.270 mm
BNCFPFBH	BNC Female / Fixed Pin / 1 Piece	Nickel	.270 mm
SMBFP	SMB Plug / 1 Piece	Nickel	.213 mm
SMBFP90	90° SMB Plug / 1 Piece	Nickel	.213 mm
SMBFPF	SMB Jack / 1 Piece	Nickel	.213 mm

## SERIES 25AWG CABLE

(Nominal Cable OD .141")

### COMPRESSION CONNECTORS

For **Belden** 1279R, 1279P, HC2950 or Similar

MODEL #	DESCRIPTION	PLATING	CLOSURE SIZE
SLC-MINI25-U	F Male / Fixed Pin / 1 Piece	Nickel	29.8 mm
SLC-RCA-MINI25U	RCA Male / Fixed Pin / 1 Piece	Nickel	29.8 mm
SLC-BNC-MINI25U	BNC Male / Fixed Pin / 1 Piece	Nickel	29.8 mm

## SERIES 30 AWG CABLE

(Nominal Cable OD .110")

### COMPRESSION CONNECTORS

For **Belden** 179DT or Similar

MODEL #	DESCRIPTION	PLATING	CLOSURE SIZE
SLC-179DT-FP	F Male / Fixed Pin / 2 Piece	Nickel	29.8 mm
SLC-RCA-179DT	RCA Male / Fixed Pin / 2 Piece	Nickel	29.8 mm
SLC-BNC-179DT	BNC Male / Fixed Pin / 2 Piece	Nickel	29.8 mm

**NOTE:** Ask your sales representative for the right connectors if your cable is not listed here.



# ADAPTERS & TERMINATORS

## HIGH PERFORMANCE ADAPTERS



**F-71**  
F MALE - F MALE



**FF-R**  
F FEMALE - RCA MALE



**RCA-F**  
RCA FEMALE - F MALE



**BFA**  
BNC MALE - F FEMALE



**PF-59**  
F FEMALE - F MALE PUSH ON



**SV-RCA**  
S VIDEO - RCA FEMALES



**F-90**  
RIGHT ANGLE F



**F-90HR**  
RIGHT ANGLE F, HRL



**VBC**  
VOLTAGE BLOCK



**VBC-HR**  
VOLTAGE BLOCK, HRL

The **Holland** series of adapters have been developed to meet high performance requirements. We have added the **HR Series** to our standard line of selected adapters to meet higher standards and improve performance of CATV and satellite systems operating to 2 and 3 GHz. The **HR Series** use our patented (#5,667,409) round seizing mechanism.

MODEL #	INSERTION LOSS			RETURN LOSS		
	1GHz	2GHz	3GHz	1GHz	2GHz	3GHz
F-90	.3 dB	.5 dB	1 dB	18 dB	13 dB	8 dB
F-90HR	.3 dB	.4 dB	.5 dB	35 dB	26 dB	18 dB
VBC*	.3 dB	.5 dB	1.2 dB	20 dB	13 dB	9 dB
VBC-HR*	.2 dB	.3 dB	.5 dB	40 dB	27 dB	15 dB

\* Max. Voltage 35VDC

## F SERIES TERMINATORS

Our **F Series** Terminators are used to provide a 75 Ohm termination on F type connections. Our **F-59TH** uses precise machining and component matching to achieve high return loss.

MODEL #	RETURN LOSS			BODY MATERIAL
	1GHz	2GHz	3GHz	
F-59T	15 dB	10 dB	8 dB	Brass
F-59TH	40 dB	30 dB	22 dB	Zinc



**F-59T**



**F-59TH**

## PRECISION PUSH-ON F CONNECTOR

**Holland's** patented high return loss push-on F connector is ideal for industrial high-use environments where reliability over repeated insertions is critical.



**G-PF-59**

- Self-Aligning Body
- High Return Loss
- Conical F Female Seizing Pin (Patent 5,667,409)
- High Insertion Life: Over 3,000

NOTE: All specifications typical unless otherwise noted

# ATTENUATORS/CATV SECURITY PRODUCTS

## ATTENUATORS



**FAM-\***  
F TYPE ATTENUATOR



**FAM-\*HR**  
F TYPE ATTENUATOR  
HIGH PERFORMANCE (HRL)



**FAMP-\***  
F TYPE ATTENUATOR  
DC POWER PASSING



**FAMP-\*HR**  
F TYPE ATTENUATOR  
DC POWER PASSING (HRL)

SPECIFICATIONS	FAM-*	FAM-*HR	FAMP-*	FAMP-*HR
Frequency Range	5 MHz - 3 GHz	5 MHz - 3 GHz	DC - 3 GHz	DC - 3 GHz
Attenuator Values	3, 6, 8, 10, 12, 16, 20 (dB)	3, 6, 8, 10, 12, 16, 20 (dB)	3, 6, 10, 12, 20 (dB)	3, 6, 10 (dB)
Accuracy	± .5	± .5	± 1	± .5
Flatness	.8	.5	1.5	.8
Return Loss (1 GHz / 2 GHz / 3 GHz)	22 / 18 / 15 (dB)	27 / 23 / 20 (dB)	18 / 14 / 8 (dB)	26 / 25 / 20 (dB)
Max. Voltage / Max. Current	-	-	35VDC / 750mA	35VDC / 750mA

NOTE: All specifications typical unless otherwise noted

## PPLT SERIES LOCKING TERMINATORS

This locking terminator has been specially designed to overcome problems of theft and tool breakage.



**PPLT-75**



**PPLT-LR**  
( Less Resistor )



**PPLT-T**

- Heavy Duty Zinc Body
- High Theft Resistance
- Patented Locking Mechanism (# 5,106,312)
- Unique Tool Design

## GLT SERIES LOCKING TERMINATORS

- Aluminum Body
- Compatible with GTP-59 type tools
- Widely Used for Over 25 Years



**GLT**



**GLT-LR**  
( Less Resistor )



**GLT-T**

## SECURITY SLEEVES

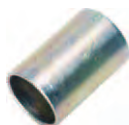

**SS**  
HEAVY DUTY ZINC BODY



**SSS**  
THREADED FRONT



**SS-NS**  
NYLON BODY



**ST-1**  
TOOL FOR SS SLEEVES

# F SPLICES

■ MODELS F-811 : F-81 : G-F811 : G-F81F : G-F81F\* : G-F81XL



G-F811

G-F81F

G-F81F\*

G-F81XL

F-811

F-81

G SERIES HIGH PERFORMANCE

STANDARD

## ■ G SERIES FEATURES

- 3 GHz Operation
- Lower Insertion Loss
- High Return Loss (> 35 dB)
- Flat Port Ends (IPS SP 400)
- High Holding Force: > 200 grams
- Beryllium Copper Seizing Pin
- Greater Contact Area

## ■ STANDARD SERIES FEATURES

- Heavy Duty Zinc Body (F-811)
- Machine Thread (F-81)

## ▼ CUSTOMER NOTES:

## HIGH PERFORMANCE F SPLICE PRODUCTS

**Holland Electronics** has advanced the traditional F splice technology with a patented design offering a higher level of electrical and mechanical features. The advanced features provide increased return loss beyond 3 GHz, twice the pin contact area and increased holding force for higher current handling and greater reliability.

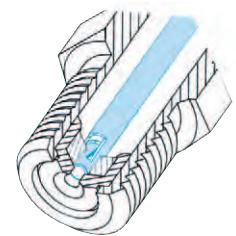

\* PASSES ALL SCTE REQUIREMENTS. PLEASE SEE BACK FOR ADDITIONAL TEST SPECIFICATIONS.

Patents #5,863,226 / #5,498,175 / #5,667,409 / #6,113,431 / #6,276,970

## F SPLICE SPECIFICATIONS

MODEL	F-811	F-81	G-F811	G-F81F	G-F81F*	G-F81XL
Frequency Range	DC - 3 GHz	DC - 3 GHz	DC - 3 GHz	DC - 3 GHz	DC - 3 GHz	DC - 3 GHz
Insertion Loss	.3 dB (1 GHz) .6 dB (2 GHz) 2.0 dB (3 GHz)	.3 dB (1 GHz) .6 dB (2 GHz) 2.0 dB (3 GHz)	< .1 dB (1 GHz) < .2 dB (2 GHz) < .3 dB (3 GHz)	< .1 dB (1 GHz) < .2 dB (2 GHz) < .3 dB (3 GHz)	< .1 dB (1 GHz) < .2 dB (2 GHz) < .3 dB (3 GHz)	< .1 dB (1 GHz) < .2 dB (2 GHz) < .3 dB (3 GHz)
Return Loss	> 12 dB (1 GHz) > 9 dB (2 GHz) > 6 dB (3 GHz)	> 12 dB (1 GHz) > 9 dB (2 GHz) > 6 dB (3 GHz)	> 35 dB (1 GHz) > 28 dB (2 GHz) > 26 dB (3 GHz)	> 35 dB (1 GHz) > 28 dB (2 GHz) > 26 dB (3 GHz)	> 35 dB (1 GHz) > 28 dB (2 GHz) > 26 dB (3 GHz)	> 35 dB (1 GHz) > 28 dB (2 GHz) > 26 dB (3 GHz)
Pin Holding Force	> 50g (Initial)	> 50g (Initial)	> 200g (Initial) > 120g (After 50 Inserts)	> 200g (Initial) > 120g (After 50 Inserts)	> 200g (Initial) > 120g (After 50 Inserts)	> 200g (Initial) > 120g (After 50 Inserts)

## MECHANICAL

Total Length (mm)	21.2	21.2	26.3	27	27	34.05
Long End/Short End (mm)	11.6 / 8.1	11.2 / 8	11.6 / 10.3	12.6 / 10.1	15.4 / 8.6	15 / 15
Nut Size (mm)	11 Hex (7/16")	11 Hex (7/16")	11 Hex (7/16")	11 Hex (7/16")	11 Hex (7/16")	11 Hex (7/16")
Body Material	Zinc	Zinc	Zinc	Brass	Brass	Brass
Threads	Die Cast	Machined	Machined	Machined	Machined	Machined
Contact Pin	Phos. Bronze	Phos. Bronze	BeCu	BeCu	BeCu	BeCu
Insulator	PE	PE	HDPE	HDPE	HDPE	HDPE

MEETS APPLICABLE SCTE SPECIFICATIONS ( G-SERIES ).

## GROUND BLOCK SPECIFICATIONS ( PLEASE SEE GROUND BLOCKS ON PAGE 35 )

MODEL	GRB-1	GRB-2	G-G2B2	GL-G2B2	GRB-2DHR	GRB-2THRUL	GRB-S	GRB-SL
Frequency Range	DC -1 GHz	DC -1 GHz	DC - 3 GHz	DC - 3 GHz	DC - 3 GHz	DC - 3 GHz	DC - 3 GHz	DC - 3 GHz
Insertion Loss	.3	.3	< .1 dB (1 GHz) < .2 dB (2 GHz) < .3 dB (3 GHz)	< .1 dB (1 GHz) < .2 dB (2 GHz) < .3 dB (3 GHz)	< .1 dB (1 GHz) < .2 dB (2 GHz) < .3 dB (3 GHz)	< .1 dB (1 GHz) < .2 dB (2 GHz) < .3 dB (3 GHz)	< .1 dB (1 GHz) < .2 dB (2 GHz) < .3 dB (3 GHz)	< .1 dB (1 GHz) < .2 dB (2 GHz) < .3 dB (3 GHz)
Return Loss (1 GHz/2 GHz/3 GHz)	10	10	35 / 30 / 26	35 / 30 / 26	35 / 25 / 20	35 / 25 / 20	35 / 30 / 26	35 / 30 / 26
Pin Holding Force (Initial)	50g	50g	200g	200g	200g	200g	200g	200g
MECHANICAL								
Splice Length (mm)	25.4	25.4	25.7	34.6	25.8	25.6	27	34.6
Body Material	Zinc	Zinc	Zinc / Brass	Zinc / Brass	Zinc	Zinc	SS / Brass	SS / Brass
Groundscrews / Material	1 / Steel	1 / Steel	1 / Steel	1 / Steel	2 / Stainless	3 / Stainless	1 / Stainless	1 / Stainless
Groundwire Range (AWG)	12 - 16	12 - 16	10 - 14	10 - 14	10 - 14	8 - 14	10 - 14	10 - 14
Contact Pin	Phos. Bronze	Phos. Bronze	BeCu	BeCu	BeCu	BeCu	BeCu	BeCu
Insulator	PVC	PVC	HDPE	HDPE	HDPE	HDPE	HDPE	HDPE

MEETS APPLICABLE SCTE SPECIFICATIONS ( EXCLUDING GRB-1, GRB-2 ).

NOTE: All specifications typical unless otherwise noted

# GROUNDING HARDWARE

## ■ GROUND BLOCKS



GRB-S



GRB-SL



G-G2B2



GL-G2B2



GRB-2DHR



GRB-2THR-UL

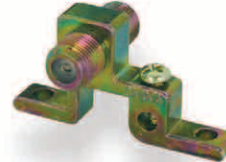

GRB-1



GRB-2

## ■ FEATURES

- High Electrical Performance for Satellite Frequency
- Single, Dual & Extended Lengths
- Patented Splice Design
- UL Listed Models Available
- Machined Threads
- High Return Loss (>35 dB)
- Lower Insertion Loss
- Flat Port Ends

## ▼ CUSTOMER NOTES:

### HIGH PERFORMANCE SINGLE GROUND BLOCKS G-G2B2 : GL-G2B2

Holland's high performance ground blocks utilize a zinc base and brass splice to achieve 3/8-2A-UNEF thread quality. Standard and extended length models available.

### HIGH PERFORMANCE DUAL GROUND BLOCKS GRB-2DHR : GRB-2THRUL

Holland's high performance ground blocks feature a zinc body with machined threads and multiple ground screw configurations. These grounding blocks are nickel plated and utilize stainless steel ground screws for maximum outdoor survivability.

### STAINLESS STEEL GROUND BLOCKS GRB-S : GRB-SL

Holland's stainless steel series ground blocks offer the advantage of a stainless body for strength and anti-corrosive characteristics and a brass splice to achieve 3/8-2A-UNEF. These ground blocks accept a wide range of ground wire sizes.

### STANDARD GROUND BLOCKS GRB-1 : GRB-2

Holland's standard series zinc ground blocks are available in single or dual splice models.

\* SEE PAGE 34 FOR PRODUCT SPECIFICATIONS.

Patents #5,863,226/#5,498,175/#5,667,409/#6,113,431/#6,276,970

# GROUNDING HARDWARE

HARDWARE : GROUNDSTRAPS : GROUNDING RODS ■



SB-4, 6, 8



CWPC-1B



MBC



A-5/8

MODEL	DESCRIPTION	INTENDED USE	MATERIAL
SB-4,6,8	Split Bolt	Copper to Copper Bonding	Copper Plated Brass
CWPC-1B	Water Pipe Clamp	Bonds Ground Wire to Water Pipes or Steel Conduit	Steel / Zinc Plated
MBC	Meter Box Clamp	Bonding Protection for Meter Pan and Ground Wire	Stainless Steel
A-5/8	Brass Ground Clamp	Secures Ground Wire To Ground	Copper Plated Brass

## GROUND STRAPS

Comes in 6", 9", 12" and 24" lengths, copper or galvanized steel available.



MODEL A-24-6, 9, 12



MODEL A-24-6G, 9G, 12G

MODEL	LENGTH	PIPE SIZE	WIRE SIZE	MATERIAL
A-24-6	6"	5/8"-1 3/4"	10-18 AWG	Copper
A-24-9	9"	-	10-18 AWG	Copper
A-24-12	12"	-	10-18 AWG	Copper
A-24-6G	6"	-	10-18 AWG	Galvanized Steel
A-24-9G	9"	-	10-18 AWG	Galvanized Steel
A-24-12G	12"	-	10-18 AWG	Galvanized Steel

## GROUNDING ROD

Universal 4' ground rod, clamp included.



MODEL A-21-4

# OEM RF CONNECTORS

**Holland Electronics** is a major manufacturer of OEM connectors for all RF applications including Wireless, Microwave, Satellite, HDTV and CATV.



## WE OFFER:

- Custom USA Design Services

---

- Fast, Low-Cost Prototyping

---

- Low-Cost Asian Volume Pricing

---

- Precision Mechanical Parts: Brass and Stainless, Zinc Die-Cast, Stampings

---

- Wide Frequency Range designs from DC to 6 GHz

---

- Precision Electrical Designs for 50 and 75 ohm

---

- Wide Variety of Shape Formats: PCB, Bulkhead, Chassis Mount, Cable (SMB, SMA, F, MCX, MMCX, G, N, ETC)

---

- RoHs Compliance / ISO-9001:2000

---

- Specializing in Moisture-Proof High Performance Designs

### MATERIALS

Brass  
Stainless  
Beryllium  
Copper  
Zinc  
Teflon  
Silicone  
Rubber

### PLATINGS

Gold  
Silver  
Tin  
Nickel  
Ni-Tin  
Chromate

### PROCESSES

CNC/Screw  
Diecast  
Extrusion  
Injection  
Stamping  
Powder  
Compression  
Annealing

### TESTING

Electrical (20 GHz)  
Temperature  
Moisture  
Hi-Pot  
Plating X-ray  
Hardness  
Shock/Vibration

### APPROVAL CAPABILITIES

MIL-STD  
SCTE  
ANSII

## HIGH-FREQUENCY F SPECIALIZATION

Our OEM connectors may be supplied with our patented high performance conical female seizing pin and/or moisture proof designs.

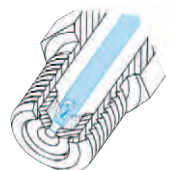

## OEM RF CONNECTORS

## HIGH-FREQUENCY SPECIALIZED PRODUCTS

Available in PCB, Chassis, Bulkhead, Cable Mount and other formats. Below items are for reference purposes only. All types, sizes and models made to the OEM's specifications.

F



G-F61-PCB90XTL



G-F610H



GF61H



G-F61-PCBV

G



GF-GSM



G-PCBV-BH



G-PCBV



G-PCB90

BNC



BNC-PCBV-FL



BNCFPFBH



BNC-PCBE-CL



BNC-PCBE-BH

SMA/SMB



SMB-75FPF



SMB90-179



SMA-SS



FAKRA STYLE

MICROWAVE



MCC-PCB90-F2



MC-PCBV



TNC-PCB90



TNC-L600R

MCX



MCX1855-FP



MCX-PCBE



MCX-1672-RA



MMCX-RA-174

SPECIALTY



N-PCB90



BLINDMATE SMB'S



GSK-F



G-F81GF

MISC.



IEC-F-90-PCB



7807-CT



1.0/2.3 PLUG



1.0/2.3 JACK



# CATV OPTICAL TRANSMITTERS

■ MODELS NE1000LN-\* : NE5000L : NE7000



MODEL NE1000LN-\*



## ■ FEATURES

- 45 - 870 MHz Operation
- Power Ranges from 4-20mW
- Automatic Gain Control Using Pilot Carriers
- Highly Stable Output
- Network Management Capability
- RS485 Control Interface
- LCD Display
- Patented Pre-distortion Circuitry, Low-Distortion Performance, High CNR

## ▼ CUSTOMER NOTES:

## CATV OPTICAL TRANSMITTERS

Holland's optical transmitters offer great flexibility to meet the demands of today's CATV requirements. The **NE1000 Series** transmitters are ideal for offering a combination of analog and digital content. These transmitters utilize a directly-modulated 1310nm DFB laser diode and superior circuit design supporting automatic temperature and power control.

Features include gain control (both AGC or MGC) for RF input level, and excellent linearity due to patented pre-distortion technology.

The **NE1000 Series** transmitters are an ideal solution for today's medium sized CATV system offering a wide array of services.

# CATV OPTICAL TRANSMITTERS



## SPECIFICATIONS

OPTICAL	NE1000LN-*	NE5000L
Wavelength	1310 ± 20 nm	1550 ± 10 nm
Output Power (mW) Output Power (dBm)	4, 6, 8, 10, 13, 16, 20 mW 4, 8, 9, 10, 11, 12, 13 dBm	≥5 mW ≥7 dBm
Laser RIN Noise Density	–	≤-160 dB/Hz
SBS Suspension Threshold	–	13, 16 & 18 dBm
Return Loss	>60 dB	>60 dB
Output Ports	1	2
Connectors	FC/APC, SC/APC, E2000/APC	FC/APC, SC/APC, E2000/APC
LINK PERFORMANCE		
Composite Second Order (CSO)	<-64 dBc	≤-65 dBc @ Port 1 ≤-63 dBc @ Port 2
Composite Triple Beat (CTB)	<-68 dBc	<-65 dBc
Cross Modulation	< -65 dBc	NA
RF PARAMETERS		
Frequency Range	45 - 870 MHz	45 - 870 MHz
Input Range	15 - 25 dBmV	15 - 25 dBmV
Input Level Narrow Port	–	45 dBmV
Gain Control Range	10 dB	10 dB
Flatness	± .75 dB	± .75 dB
Return Loss	>16 dB	>16 dB
GENERAL		
Power Supply	90 to 260VAC., 50/60 Hz, 15 W (Max.)	90 to 260VAC., 50/60 Hz, 15 W (Max.)
Operating Temperature	0° to 50° Celsius	0° to 50° Celsius
Dimensions	350D x 485W x 45H (mm)	350D x 485W x 45H (mm)
Weight	4.6 kg	4.6 kg

NOTE: All specifications typical unless otherwise noted



## SATELLITE OPTICAL TRANSMITTER

	NE7000
Frequency Range	54 - 2050 MHz
Flatness	±1.5 dB
Return Loss	>12 dB
Frequency (Optical)	1310 nm ± 20 nm
Fiber Type	Single Mode
Connectors	FC/APC, SC/APC
Link Loss (950-2050)	13 dB (45 dB C/N)
RF Input	-40 dBm (Min. for Full Output)
Power Supply	9 - 36 VDC@250 mA

\* = The **NE7000** can also be used for up to 4 channel CATV applications. Please call for details.

# CATV OPTICAL RECEIVERS

■ MODELS NE1100L : NE1101 : NE7100



MODEL NE1100L



MODEL NE1101L



## ■ FEATURES

- 870 MHz Bandwidth
- Optional Return Path Transmitters (NE1100L)
- Rack or Strand Mount
- Automatic Gain Control Using Pilot Carriers

## ▼ CUSTOMER NOTES:

### NE1100L CATV OPTICAL NODE

The **NE1100L** optical node is the perfect solution for operators implementing fiber in their system. By using AGC/MGC, the **NE1100L** provides a stable RF output with a varying optical input. Features an optional return path transmitter and remote monitor module, along with hermetically-sealed housing and ports for excellent reliability in any environment.

### NE1101L RACK MOUNT CATV OPTICAL RECEIVER

The **NE1101L** utilizes the same tried and true technology as the NE1100L in an indoor rack-mount design with many additional features. Features include LCD display, status monitoring, and front panel controls making it simple to operate.

# CATV OPTICAL RECEIVERS



## SPECIFICATIONS

OPTICAL	NE1100L	NE1101L	NE7100
Wavelength	1260 - 1600 nm	1260 - 1600 nm	1200 - 1600 nm
Input Power	-6 to 3 dBm	-6 to 3 dBm	> -13 dBm
Detector	InGaAs PIN	InGaAs PIN	InGaAs PIN
Connectors	FC/APC or SC/APC	FC/APC or SC/APC	FC/APC or SC/APC
Return Loss	>60 dB	>60 dB	> 55 dB
RF PARAMETERS			
Frequency Range	45 - 870 MHz	45 - 870 MHz	200 - 2050 MHz
Output Level	36 dBmV (-3 dBm Input)	36 dBmV (-3 dBm Input)	37 dBmV
Flatness	± 1 dB	± 1 dB	-
Gain Control	AGC Module / Plug-In Pads	AGC / MGC	-
Return Loss	>16 dB	>16 dB	12 dB
NETWORK MANAGEMENT			
NMS Data Rate	19.2 Kbps	19.2 Kbps	-
Pilot Carrier	10.7 MHz	10.7 MHz	-
Monitor Connector	15 pin D sub	15 pin D sub	-

## OPTIONS

NE1100L	
01	Plug In Attenuators (0-13 dB)
02	AGC Module
03	Plug In Equalizer
04	Diplex Filter
05	Directional Coupler / Splitter
06	Return Path Transmitter

NE1101L	
01	Diplex Filter
02	Network Management

NOTE: All specifications typical unless otherwise noted

# CATV OPTICAL AMPLIFIERS

■ MODEL NE6000L



MODEL NE6000L-\*



## ■ FEATURES

- Output Power Range from 14-24 dBm
- High Reliability 980/1480 nm Pump Laser Diode
- Wide Operating Range with High Gain and Low Noise Figure
- Network Management Capability  
RS485 Control Interface

## ▼ CUSTOMER NOTES:

### CATV OPTICAL AMPLIFIER

The **NE6000L-\*** is a high performance optical amplifier designed for 1550 nm based network applications. This 19" rack mount module is ideal for long haul applications, fiber dense systems, and transport architectures such as broadcast layer transmission and redundant rings. Features high power output ranging from 14 to 24 dBm.

# CATV OPTICAL AMPLIFIERS



## SPECIFICATIONS

OPTICAL	NE6000L-*
Wavelength	1540 - 1560 nm
Noise Figure	≤5.0 dB for output power <20 dBm ≤5.5 dB for output power ≥20 dBm
Optical Input Power Range	-5 to 10 dBm
Output Power (*)	14 - 24 dBm (must specify power, 1 dB increments)
Polarization Sensitivity	≤.5 dB
Output Power Variation	± .5 dB
Optical Connector	SC/APC
Minimum Optical Input Power for Rated Output Power	0 dBm (when output ≤20 dBm) 4 dBm (when output ≤24 dBm)
PHYSICAL	
Control Interface	RS 485
Power Supply	90 - 260VAC, 50/60 Hz, 50 W (Max.)
Operating Temperature	0° to 50° Celsius
Relative Humidity	85% Max.

NOTE: All specifications typical unless otherwise noted

# FIBER OPTIC DISTRIBUTION SYSTEM

■ MODELS FOD-PF : FOD-AC : FOD-1310TX-\* : FOD-FRX : FOD-RPR : FOD-RPT

## FOD MODULAR FIBER OPTIC DISTRIBUTION SYSTEM

The **FOD Modular Fiber Optic Distribution System** consists of a 10-slot mounting rack for holding our modular fiber-optic power supplies, transmitters, amplifiers and receivers. The 8 3/4" rack height covers 5 EIA rack spacings, making the 10 module system space efficient. The **FOD System** has an LCD display for status monitoring, and modules can be changed in/out without power shutdown to the distribution system.

## UNIVERSAL CHASSIS PLATFORM

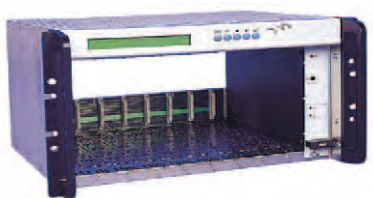

MODEL FOD-PF

- 10 Plug-in Slot Capacity
- RS-232/RS-485 Interface
- LCD Display for On-Site Status Monitoring
- Only Requires 5-RU

## AC POWER SUPPLY



MODEL FOD-AC

## DOWNSTREAM TRANSMITTER



MODEL FOD-1310TX-\*

PARAMETERS	MODEL FOD-AC
Input Voltage Range	90 - 260VAC
Output Voltage Range	24 - 26VDC
Output Current	.1 - 8 A
Power Consumption	< 240 W

PHYSICAL	
Operating Temperature	0° to 50° Celsius
Operating Humidity	85% Max.

OPTICAL	MODEL FOD-1310TX-*
Wavelength	1310 ± 20 nm
Output Power*	4, 6, 8, 10, 13, 16, 20 mW
Laser Type	Cooled DFB LD w/ isolator
Connector	SC/APC
Laser RIN Noise Density	≤ -155 dB/Hz
Composite Second Order (CSO)	≤ -64 dBc
Composite Triple Beat (CTB)	≤ -68 dBc
Cross Modulation (XMOD)	≤ -65 dBc

RF PARAMETERS	
Operating Bandwidth	45 - 870 MHz
Analog Channel Loading	45 - 550 MHz
Digital Channel Loading	550 - 870 MHz
RF Input Return Loss	≤ -16 dB
RF Input Level (Analog)	15 - 25 dBmV (w/ AGC)

PHYSICAL	
Operating Temperature	0° to 50° Celsius
Operating Humidity	85% Max.

NOTE: All specifications typical unless otherwise noted

# FIBER OPTIC DISTRIBUTION SYSTEM

MODELS FOD-FRX : FOD-RPR : FOD-RPT ■

## FORWARD PATH OPTICAL RECEIVER



MODEL FOD-FRX

OPTICAL	FOD-FRX
Photodiode Type	InGaAs PIN
Wavelength	1310 ± 20 nm; 1550 ± 20 nm
Connector	SC/APC
Power Input Range	-10 to 3 dBm
RF PARAMETERS	
Operating Bandwidth	45 - 870 MHz
RF Output Level (Analog)	36 dBmV/Ch. @ -3 dBm Optical Input
Gain Control Range	10 dB
Slope Adjustment	-1 to 2 dB
RF Output Return Loss	≤ -16 dB
Flatness	± 1 dB
Pilot Tone for AGC	10.7 MHz ± 50 kHz
PHYSICAL	
Operating Temperature	0° to 50° Celsius
Operating Humidity	85% Max.

## DUAL RETURN PATH RECEIVER



MODEL FOD-RPR

OPTICAL	FOD-RPR
Photodiode Type	InGaAs PIN
Wavelength	1310 ± 20 nm; 1550 ± 20 nm
Connector	SC/APC
Power Input Range	-10 to 3 dBm
RF PARAMETERS	
Operating Bandwidth	5 - 300 MHz
RF Output Level (Analog)	≥ 46 dBmV/Ch. @ -10 dBm Optical Input
Gain Control Range	25 dB
RF Output Return Loss	≤ -16 dB
Flatness	± .75 dB
PHYSICAL	
Operating Temperature	0° to 50° Celsius
Operating Humidity	85% Max.

## CATV RETURN PATH TRANSMITTER



MODEL FOD-RPT  
(For Use in NE-1100L)

OPTICAL	FOD-RPT
Laser Type	Isolated, Uncooled, FP Laser (FP-B) Nonisolated, Uncooled FP or DFB Laser (FP-A/DFB-A)
Wavelength	1310 ± 20 nm
Connector	SC/APC
Output Power	> 0 dBm (FP-A, DFB-A); > -3 dBm (FP-B)
RF PARAMETERS	
Operating Bandwidth	5 - 100 MHz
RF Output Return Loss	≤ -16 dB
RF Input Level (1 Video)	≤ 15 dBmV
Data Input Level (When NPR ≥ 40 dB)	8 - 18 dBmV
PHYSICAL	
Operating Temperature	-40° to 60° Celsius
Operating Humidity	90% Max.

NOTE: All specifications typical unless otherwise noted



# FIBER OPTIC DISTRIBUTION SYSTEM

■ MODELS ATD-\* : PATCHCORDS : OCP-\*

## ATTENUATORS

Available in single or dual window with 1-20 dB values. SC, FC, UPC & APC performance designs available.



MODEL ATD-FCU-\*

SPECIFICATIONS	ATTENUATORS
Wavelength	1310, 1550 nm (±2 nm)
Accuracy	±.75 dB (1-3 dB values), ±1.5 dB (4-20 dB values)
Housings	Brass, Zinc
Return Loss	>50 dB Standard, >65 dB APC
Operating Temperature	-40° to +75° Celsius

ORDERING	WINDOW	CONNECTOR	PERFORMANCE	ATTENUATION
AT	S = Single D = Dual	SC FC	U = UPC A = APC	1 - 20 dB (1 dB Increments)
Example = AT	D	FC	A	3

## PATCHCORDS & PIGTAILS



Holland Electronics high quality patchcords are available in standard or custom lengths, in UPC, or APC and in simplex or duplex configurations. All patchcords come with a performance certification report and are guaranteed to meet all specifications.

ORDERING	LENGTH	FIBER	CONNECTOR	PERFORMANCE	CONNECTOR	PERFORMANCE
J	Meters	S = Single M = Multi	FC SC	U = UPC A = APC	FC SC	U = UPC A = APC
Example = J	1	S	FC	U	FC	A

## COUPLERS

Coupler's configured in bare fiber, connectorized, open or enclosed with feed-thru's or connectors.



MODEL OCP-\*

SPECIFICATIONS	PATCHCORDS
Wavelength	1310, 1550 nm (±40 nm)
Directivity	> 50 dB
Polarization Dependence	< .1 dB
Coupling Ratio	50/50, 45/55, 35/65, 25/75, 15/85
Operating Temperature	-40° to +75° Celsius

ORDERING	# SPLITS	MODE	RATIO	PERFORMANCE
OCP	12 = 1x2 13 = 1x3	S = Single M = Multi	50 = 50/50 XX = XX/100-XX	H = High (3.7dB, 50/50) S = Super (3.6dB, 50/50)
Example = OCP-	12	S	50	S

NOTE: All specifications typical unless otherwise noted

Page Intentionally Left Blank

# FILTERS

■ MODELS BPF-\* : CEF750-\*

## SINGLE CHANNEL BANDPASS FILTER

The **BPF-\*** is a 19" rack mount, single channel band pass filter for use when additional channel isolation is required in applications such as UHF to VHF converters, broadband amplifiers or when an unusually high off-air signal creates unwanted beats or distortion.

- Available for Channels 2-13, A-I
- High Adjacent Channel Rejection
- 19" Rack Mount



MODEL BPF-\*

SINGLE CHANNEL BANDPASS FILTER : MODEL BPF-*	
Bandwidth	6 MHz
Insertion Loss	5 dB (Low & Mid Band), 7 dB (High)
ADJACENT CHANNEL REJECTION	
Lower Video	-60 dB
Lower Audio	-40 dB
Upper Video	-40 dB
Upper Audio	-60 dB

## SINGLE CHANNEL ELIMINATION FILTER

The **CEF750-\*** is a 19" rack mounted filter intended to eliminate one CATV channel from an adjacent channel system. Applications include replacing one channel or eliminating interfering signals.

- Available for Channels 2-78
- Low Insertion Loss on Adjacent Channel
- High Rejection of Assigned Channel



MODEL CEF750-\*

SINGLE CHANNEL ELIMINATION FILTER : MODEL CEF750-*	
Channel Rejection (Min.)	-50 dB
ADJACENT CHANNEL INSERTION LOSS	
Low Band Models	-4 dB
Mid/Hi/Super Band Models	-6 dB
Hyper Band Models	-7.5 dB
PASSBAND INSERTION LOSS	
Passband Frequency	54 - 750 MHz
Super Band	3.5 dB (54 - 600 MHz), 5dB (601 - 750 MHz)
Hyper Band (Ch. AA - Ch. RR)	1.5 dB (54 - 500 MHz), 3.5 dB (501 - 750 MHz)
Hyper Band (Ch. SS - Ch. ZZ)	1.5 dB (54 - 500 MHz), 4 dB (501 - 750 MHz)
Low / Mid / Hi Band	2 dB (54 - 600 MHz) 3.5 dB (601 - 750 MHz)

NOTE: All specifications typical unless otherwise noted

# FILTERS

MODELS HPF-54HR : LPF-\* : HPF-\* : NF-\* : WF-\* : BRF-\*

## HIGH PASS FILTERS

Holland's HPF-54HR high pass filter attenuates inpressive noise in the sub-band section of the cable spectrum to optimize return path services. This filter can also be used to eliminate or restrict user access to the sub-band return frequencies.

- Small Size
- Moisture Resistant
- High Performance Seizing Pin for Increased Reliability
- High Return Loss
- High Sub Band Rejection



MODEL HPF-54HR

HIGH PASS FILTER : MODEL HPF-54HR	
Frequency Range	5 - 1000 MHz
Insertion Loss (54-1000 MHz)	1 dB Max.
Sub Band Rejection (5-40 MHz)	-45 dB Min.
Return Loss (54-1000 MHz)	20 dB Min.

NOTE: All specifications typical unless otherwise noted

## CUSTOM FILTERS: LOW PASS, HIGH PASS, NOTCH & TIER TRAPS

Holland Electronics has vast experience in manufacturing custom filters for virtually any application. Our filters and traps have been used by major MSO's for over 17 years. We have the ability to produce filters in a variety of case styles and configurations.

- Positive and Negative Traps
- Low and High Pass, Band Rejection, Window, Data
- Wide Operating Temperature

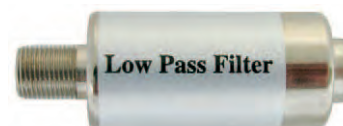

PRODUCT NUMBER	
LPF-*	Low Pass Filter, Channel / Frequency Assignment
HPF-*	High Pass Filter, Channel Assignment / Frequency Assignment
NF-*	Negative Filter, Channel Assignment / Frequency Assignment
TT-*	Tier Trap, Channel Assignment / Frequency Assignment
WF-*	Window Filter, Channel Assignment / Frequency Assignment
BRF-*	Band Rejection Filter, Channel Assignment / Frequency Assignment

# FILTERS / DIPLEXERS

■ MODELS DPD2 : STVC : SBD : UVSJ : HLSJ

## SATELLITE / OFF-AIR & CATV DIPLEXER (HIGH PERFORMANCE)

Allows the combining (or separating if used in the reverse ) of Off-Air / CATV signals with satellite signals to a common cable. Separates TV and satellite signals prior to satellite receiver input and filters harmonics in the off-air spectrum from satellite conversion devices. The **DPD2** diplexer is specifically designed for Dish Network's™ DP44 installations, requiring continuous 2 amp power passing.



MODEL DPD2

PORT	Insertion Loss			Rejection		
	FREQUENCY (MHz)	QC	TYP	FREQUENCY	QC	TYP
VHF/UHF, CATV	40 - 806	1.5 dB	1 dB	950 - 2150	40 dB	40 - 50 dB
SATELLITE	950 - 2150	1.5 dB	1 dB	40 - 806	40 dB	40 - 50 dB

## SATELLITE / OFF-AIR & CATV DIPLEXER

The **STVC** allows the combining or separating of off-air and CATV signals with satellite signals to a common cable.



MODEL STVC

PORT	Insertion Loss		Rejection	
	FREQUENCY (MHz)	TYP	FREQUENCY	TYP
VHF/UHF,CATV	5 - 806	1 dB	950 - 2150	22 dB
SATELLITE	950 - 2150	1 dB	5 - 806	25 dB

## SUB-BAND/CATV SEPARATOR/JOINER

Allows the combining or separating of return signals sub-bands (1-40 Mhz) and forward signals (54-1000 Mhz). Also provides low loss sub-band signal insertion in the distribution system or at the head-end. Can be used to enable 1-way amplifiers to become bi-directional.



MODEL SBD

PORT	Insertion Loss		Rejection	
	FREQUENCY (MHz)	TYP	FREQUENCY	TYP
SUB	1 - 40	.5 dB	54 - 1000	25 dB
CATV	54 - 1000	.7 dB	1 - 40	25 dB

## UHF/VHF SEPARATOR/JOINER

The **UVSJ** combines or separates UHF and VHF signals. Allows balancing of bands prior to amplification and the use of separate amplifiers in a system.



MODEL UVSJ

PORT	Insertion Loss		Rejection	
	FREQUENCY (MHz)	TYP	FREQUENCY	TYP
VHF	DC - 216	.5 dB	400 - 890	25 dB
UHF	470 - 890	.7 dB	DC - 216	25 dB

## HIGHBAND/LOWBAND SEPARATOR/JOINER

Combines or separates high and low band VHF signals. Provides low insertion loss prior to channel processing and allows the balancing of bands prior to amplification.



MODEL HLSJ

PORT	Insertion Loss		Rejection	
	FREQUENCY (MHz)	TYP	FREQUENCY	TYP
LOW	DC - 130	.5 dB	170 - 600	25 dB
HIGH	170 - 600	.7 dB	DC - 130	25 dB

NOTE: All specifications typical unless otherwise noted

# CABLE DROP PROTECTION

MODELS CCI-1 : CISP : SA-1F : GRB-AR ■

## CABLE ISOLATORS



**MODEL CCI-1**  
ISOLATOR

- Blocks 60 Hz Power up to 5,000 Volts
- Reduces the Energy Level of Spikes
- Eliminates Ground Loop Hum



**MODEL CISP**  
ISOLATOR W/ SPIKE PROTECTION

- Blocks 60 Hz Power up to 5,000 Volts
- Reduces the Energy Level of Spikes
- Eliminates Ground Loop Hum
- Does Not Degrade with Repetitive Spikes
- Electronic Clamping IC Technology (SIDACTor)

CABLE ISOLATORS	CCI-1	CISP
Frequency Range	5 - 1500 MHz	5 - 1500 MHz
Insertion Loss	1 dB	1 dB
Return Loss ( 1 GHz / 1.5 GHz )	23 dB / 12 dB	23 dB / 12 dB
RF Shielding	> 60 dB	> 60 dB
Voltage Breakdown	3 kVA 5 hits, 7 kVA Max	3 kVA 5 hits, 7 kVA Max
Spike Protection (CISP)	-	See SA-1F Spec Below
Connectors	2 F Female	1 F Male-1 F Female

## SPIKE PROTECTION

Prevents dangerous transient spikes from damaging digital set top boxes, cable modems, satellite receivers and any other equipment on the coax line.



**MODEL SA-1F**

- Electronic Clamping Using IC Technology (SIDACTor)
- Faster Response Time
- Does Not Degrade with Repetitive Spikes



**MODEL GRB-AR**

- Uses Traditional Clamping (Gas Tube Arrestor)

	SA-1F	GRB-AR
Frequency Range	DC - 1500 MHz	DC - 2150 MHz
Insertion Loss	1 dB	1 dB
Return Loss ( 1 GHz / 1.5 GHz )	25 dB / 12 dB	16 dB
Current Suppression	500 amps (2x10 μs)	750 amps (2x10 μs)
Response Time	1 ns	5 ns
Firing Voltage	65 Volts	90 Volts
RFI Shielding	120 dB	120 dB

NOTE: All specifications typical unless otherwise noted

# MODULAR HEAD-END SYSTEM

■ MODELS HMMS : HMMA : HMDS : HMMB : HMPS : HMR

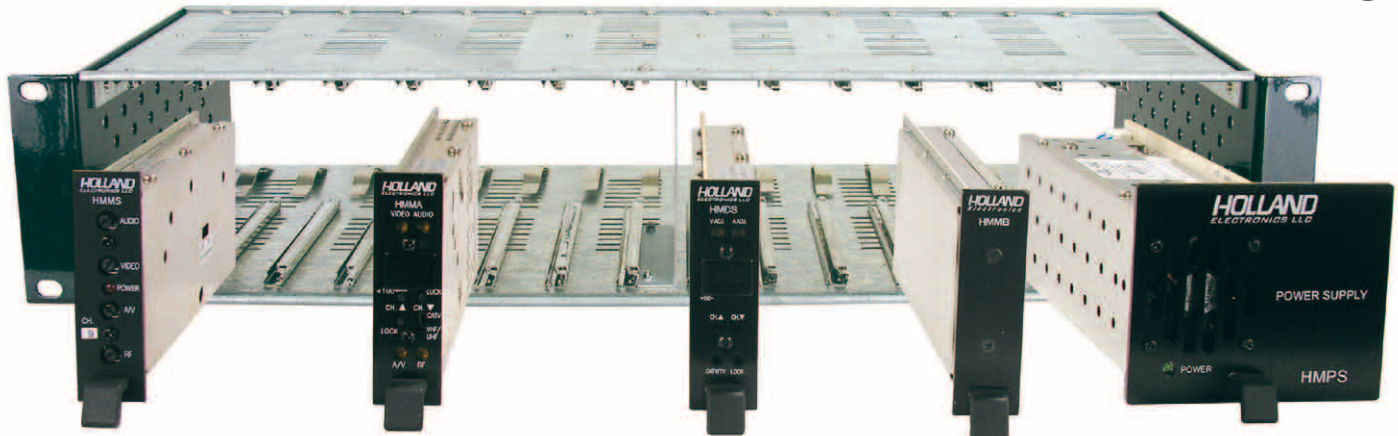

**HMMS-\***  
SAW MODULATOR

**HMMA**  
AGILE MODULATOR

**HMDS**  
AGILE DEMODULATOR

**HMMB**  
BLANK INSERT

**HMPS**  
POWER SUPPLY

## ■ FEATURES

- SAW Filtered
- PLL Oscillator Controlled Modulators
- Stereo Encoder Available (ST-MOD)
- Microprocessor Controlled (HMMA/HMDS)
- Fan Cooled Power Supply for Extra Reliability
- International Power Supply (95-240VAC)
- Front Panel Controls
- Five Year Warranty

## ▼ CUSTOMER NOTES:

## MODULAR HEAD-END SYSTEM

**Holland Electronic's Modular Head-End System** consists of a 12-slot mounting chassis and power supply capable of holding any combination of 12 high-quality SAW filtered modulators and/or demodulators. The **HMR** slide-in mounting system uses only 3.5" of rack height, making for easy installation and efficient use of space (as simple as sliding in the modules and plugging in the **HMPS** power supply). All components come with a five year warranty.

## AVAILABLE OPTIONS

- Inverted Channel Format (HMMS)
- Stereo Encoder (ST-MOD)
- HMMB: Blank Insert for Unused Slots

# MODULAR HEAD-END SYSTEM

## REQUIRED COMPONENTS

### HMR RACK

12-Slot Modular Chassis.



#### MOUNTING RACK : MODEL HMR

Width	19"
Height	3.5"
Depth	9"
Capacity	12 Individual Slots (Not Including HMPS)

### HMPS POWER SUPPLY

Power Supply for 12-Slot System.



#### POWER SUPPLY : MODEL HMPS

AC Input	95 - 240VAC (50 - 60 Hz)
DC Output	5VDC, 12VDC
Output Current (Max.)	5.5A @ 5V, 4A @ 12V
Protection	Short Circuit & Overload
Regulation	5%
Ripple	25 mV
Operating Temperature	0 to 50° Celsius

## AVAILABLE OPTIONS



### ST-MOD

Converts right and left audio inputs to stereo output. Small size and lightweight allows for easy integration with the **HMM\* Head-End System**.

### HMMB

Blank insert for unused slots.

#### STEREO ENCODER : MODEL ST-MOD

Audio Input	10K ohms
Input Level	.5 - 1.5 V
Output	BTSC
Separation	20 dB (50 Hz - 13 kHz)

#### BLANKS : MODEL HMMB

Single Slot Blank Insert	Model HMMB
--------------------------	------------

NOTE: All specifications typical unless otherwise noted



# MODULAR HEAD-END SYSTEM

■ MODELS HMMS-\* : HMMA : HMDS



MODEL HMMS-\*



MODEL HMMA



MODEL HMDS



## ■ FEATURES

- SAW Filtered
- PLL Controlled Oscillator
- Front Panel Controls
- Low Out-of-Band Noise
- LED Channel Display (HMMA/HMDS)
- Microprocessor Controlled (HMMA/HMDS)
- Stereo Encoder Available (ST-MOD)
- Five Year Warranty

## ▼ CUSTOMER NOTES:

### HMMS : FIXED SAW MODULATOR

The **HMMS-\*** mini-modulator is a commercial grade fixed channel modulator that integrates with Holland's **Modular Head-End System**. The **HMMS-\*** accepts any A/V base-band input and modulates to CATV channels 2-135.

### HMMA : AGILE SAW MODULATOR

The **HMMA** is a high quality SAW filtered frequency agile modulator covering 860 MHz and has been designed to meet high CATV performance standards. Low out-of-band noise makes it ideal in adjacent channel head-ends.

### HMDS : AGILE DEMODULATOR

The **HMDS** is a commercial grade frequency agile mini demodulator for use with **Holland's Modular Head-End System**. With SAW filtering and PLL controlled oscillators for enhanced adjacent channel performance.

### AVAILABLE OPTIONS

- Inverted Channel Format (For HMMS)
- Stereo Encoder (ST-MOD)
- HRC & IRC Offsets Available (For HMMS)

# MODULAR HEAD-END SYSTEM

## SPECIFICATIONS

RF	HMMS-*	HMMA
Output Channels:	2 - 117 CATV (54-750 MHz) 14 - 59 UHF (470-750 MHz)	2 - 135 CATV (54 - 860 MHz) 14 - 69 UHF (470 - 806 MHz)
FCC Offsets (Where Applicable)	±12.5 kHz, ±25 kHz	±12.5 kHz, ±25 kHz
Output Level	30 - 45 dBmV (Adj.)	30 - 45 dBmV (Adj.)
A/V Ratio	-11 to -18 dB (Adj.)	-11 to -18 dB (Adj.)
Frequency Stability	±5 kHz (Meets FCC Docket 21006)	±5 kHz (Meets FCC Docket 21006)
Aural Carrier Frequency	4.5 MHz ± 5 kHz	4.5 MHz ± 5 kHz
Spurious Outputs	-60 dBc	-60 dBc
C/N (In-Band)	60 dB	60 dB
Out-of-Band Noise	-95 dBc	-78 dBc
Output RL	12 dB	12 dB
<b>VIDEO</b>		
Input Level (Min.)	.5V p-p (for 87.5% Modulation)	.8V p-p (for 87.5% Modulation)
Frequency Response	±1.5 dB (50 Hz - 4.2 MHz)	±1.5 dB (50 Hz - 4.2 MHz)
Video C/N	60 dB	60 dB
Hum/Noise	-60 dB	-60 dB
Modulation Range	0 - 90%	0 - 90%
Input Impedance	75 Ohms	75 Ohms
Differential Phase	±5°	±3°
Differential Gain	±5%	±5%
Group Delay	75 ns	75 ns
<b>AUDIO</b>		
Input Level	.5V p-p (25 kHz Dev)	.5V p-p (25 kHz Dev)
Input Impedance	5k Ohms	10k Ohms
Distortion (THD)	1%	1%
Flatness	±1 dB (50 Hz - 15 kHz)	±1 dB (50 Hz - 15 kHz)
Pre-Emphasis	75 µs (Switchable)	75 µs (Switchable)
BTSC Stereo Encoder	Optional	Optional
<b>CONNECTORS</b>		
Video Input, RF Output	F	F
Audio Input	RCA	RCA
<b>GENERAL</b>		
Power Requirements	5VDC@ 190mA, 12VDC@ 100mA	5VDC @ 280mA, 12VDC @ 400mA
Operating Temperature	0° to 50° Celsius	0° to 50° Celsius
Dimensions	1" x 3.1" x 7.5"	1" x 3.1" x 7.5"
Weight	.75 lbs.	.75 lbs.

RF	HMDS
Input Channels	2-125 CATV/HRC/IRC 14 - 69 UHF (470 - 806 MHz)
Input Power Range	0 - 25 dBmV
Noise Figure	6 dB: VHF / 8 dB: UHF
<b>VIDEO</b>	
Output Level	.5 - 1.2V p-p (Adj.)
Impedance	75 Ohms
Frequency Response	± 2 dB
Differential Phase	± 5°
Differential Gain	± 5%
<b>AUDIO</b>	
Output Level	.8 - 1.5V p-p (Adj.)
Output Impedance	600 Ohms
Distortion (THD)	2%
<b>CONNECTORS</b>	
RF Input, Video Output	F
Audio Output	RCA
<b>GENERAL</b>	
Power Requirements	12VDC, 5VDC @ 150 mA
Operating Temperature	0 to 50° Celsius
Dimensions	1" x 3.1" x 8.5"
Weight	.75 lbs.

NOTE: All specifications typical unless otherwise noted

# FIXED CHANNEL MODULATORS

■ MODELS HPM55-\* : HSM55-\*

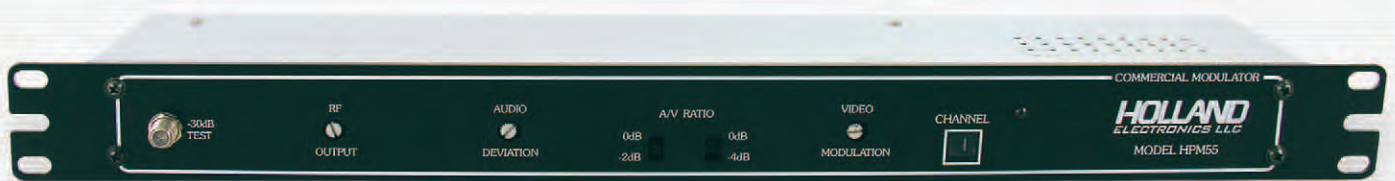

MODEL HPM55-\*



MODEL HSM55-\*



## ■ FEATURES

- 18 Years of Proven Reliability
- Adjacent Channel Performance (Except Sub-band)
- PLL Controlled Oscillator
- Low Out-of-Band Noise
- Complies with FCC Offsets & Accuracy Requirements
- Includes New Video Low Pass Filter
- T8 - T14 Available (HPM)

## ▼ CUSTOMER NOTES:

### HPM55-\* : FIXED CHANNEL MODULATOR

The **HPM55-\*** is an adjacent channel audio/video modulator specifically designed for head-ends requiring proven performance. The **HPM55's** internal filters provide sharp VSB rejection for adjacent channel operation while maintaining similar C/N and video response found in more expensive SAW modulators.

### HSM55-\* : FIXED CHANNEL MODULATOR

The **HSM55-\*** is the same proven modulator as the **HPM55-\*** with additional SAW filtering providing unparalleled adjacent channel performance.

### AVAILABLE OPTIONS

- Stereo Encoder (ST-M0D)

# FIXED CHANNEL MODULATORS

## SPECIFICATIONS

RF	HPM55-*	HSM55-*
Output Channels:	2 - 13 CATV (54 - 216 MHz) A - W CATV (121 - 300 MHz) T8 - T14 CATV (13 - 54 MHz)	2 - 125 CATV (54 - 750 MHz) 14 - 69 UHF (Optional)
FCC Offsets (Where Applicable)	±12.5 kHz, ±25 kHz	±12.5 kHz, ±25 kHz
Output Level	40 - 55 dBmV (Adj.)	40 - 55 dBmV (Adj.)
A/V Ratio	-11 to -18 dB (Adj.)	-11 to -18 dB (Adj.)
Frequency Stability	±5 kHz (Meets FCC Docket 21006)	±5 kHz (Meets FCC Docket 21006)
Aural Carrier Frequency	4.5 MHz ± 1.5 kHz	4.5 MHz ± 1.5 kHz
Spurious Outputs	-60 dBc	-60 dBc
C/N (In-Band)	60 dB	60 dB
Out-of-Band Noise	-95 dBc	-95 dBc
Output RL	10 dB	10 dB
<b>VIDEO</b>		
Input Level (Min.)	.5V p-p min. (for 87.5% Modulation)	.5V p-p min. (for 87.5% Modulation)
Frequency Response	±2 dB (50 Hz - 4.2 MHz)	±1.5 dB (50 Hz - 4.2 MHz)
Video C/N	60 dB	60 dB
Hum/Noise	-60 dB	-60 dB
Modulation Range	0 - 90%	0 - 90%
Input Impedance	75 Ohms	75 Ohms
Differential Phase	±2°	±2°
Differential Gain	±3%	±3%
Group Delay	75 ns	75 ns
<b>AUDIO</b>		
Input Level	.4V p-p (25 kHz Dev)	.5V p-p (25 kHz Dev)
Input Impedance	600 Ohms (Unbalanced)	600 Ohms (Unbalanced)
Distortion (THD)	1.5%	1.5%
Flatness	±1 dB (50 Hz - 15 kHz)	±1 dB (50 Hz - 15 kHz)
Pre-Emphasis	75 µs	75 µs
BTSC Stereo Encoder	Optional	Optional
<b>CONNECTORS</b>		
Video Input, RF Output	F	F
Audio Input	F	F
<b>GENERAL</b>		
Power Requirements	117VAC, 60 Hz, 7 W	117VAC, 60 Hz, 7 W
Operating Temperature	0° to 50° Celsius	0° to 50° Celsius
Dimensions	19" x 1.75" x 3"	19" x 1.75" x 3"
Weight	5 lbs.	5 lbs.
Auxiliary Outlet	117VAC, 600 W	117VAC, 600 W
Test Port	-20 dB	-20 dB

NOTE: All specifications typical unless otherwise noted

# HMA SERIES AGILE MODULATORS

■ MODELS HMA-550H : HMA-860H



MODEL HMA-550H



MODEL HMA-860H



## ■ FEATURES

- 60 dBmV Output
- Triple I.F. Loop
- SAW Filtered
- Low Out-of-Band Noise
- Crystal Referencing PLL Tuning
- International Power Supply (90-260VAC)
- BTSC Stereo Compatible (ST-MOD)
- Easy-to-Read LED Channel Display
- Overmodulation Indicators

## ▼ CUSTOMER NOTES:

## FREQUENCY AGILE MODULATORS

The **HMA-550H** and the **HMA-860H** are commercial grade, SAW filtered, frequency agile modulators specifically designed to meet the highest CATV performance standards. All channels are easily selected using front panel buttons and verified with an easy-to-read LED channel display. The modulators feature extremely low out-of-band noise allowing their use in large channel capacity head-ends. The **HMA-550H** and the **HMA-860H** modulators are the ideal choice for any system where performance, flexibility, and reliability are required.

## AVAILABLE OPTIONS

- Stereo Encoder (ST-MOD)

# HMA SERIES AGILE MODULATORS

## SPECIFICATIONS

RF	HMA-550H	HMA-860H
Output Channels:	2 - 78 CATV (54 - 550 MHz)	2 - 135 CATV (54 - 860 MHz) 14 - 69 UHF (471 - 801 MHz)
FCC Offsets (Where Applicable)	±12.5 kHz, ±25 kHz (Selectable)	±12.5 kHz, ±25 kHz (Selectable)
Output Level	45 - 60 dBmV (Adj.)	45 - 60 dBmV (Adj.)
A/V Ratio	-9 to -20 dB (Adj.)	-9 to -20 dB (Adj.)
Frequency Stability	±5 kHz (Meets FCC Docket 21006)	±5 kHz (Meets FCC Docket 21006)
Aural Carrier Frequency	4.5 MHz ± 1 kHz	4.5 MHz ± 1 kHz
Spurious Outputs	-60 dBc	-60 dBc
C/N (In-Band)	65 dB	65 dB
Out-of-Band Noise	-75 dBc	-75 dBc
Output RL	15 dB	15 dB
<b>VIDEO</b>		
Input Level (Min.)	.7V p-p (for 87.5% Modulation)	.7V p-p (for 87.5% Modulation)
Frequency Response	±1 dB (50 Hz - 4.2 MHz)	±1 dB (50 Hz - 4.2 MHz)
Video C/N	60 dB	60 dB
Hum/Noise	-60 dB	-60 dB
Modulation Range	0 - 90%	0 - 90%
Input Impedance	75 Ohms	75 Ohms
Differential Phase	±5°	±5°
Differential Gain	± 5%	± 5%
Group Delay	75 ns	75 ns
<b>AUDIO</b>		
Input Level	.5V p-p (25 kHz Dev)	.5V p-p (25 kHz Dev)
Input Impedance	600 Ohms (Unbalanced)	600 Ohms (Unbalanced)
Distortion (THD)	1%	1%
Flatness	±1 dB (50 Hz - 15 kHz)	±1 dB (50 Hz - 15 kHz)
Pre-Emphasis	75 µs	75 µs
BTSC Stereo Encoder	Optional	Optional
<b>CONNECTORS</b>		
Video Input, RF Output, IF	F	F
Audio Input	RCA	RCA
<b>GENERAL</b>		
Power Requirements	90 - 260VAC (50 - 60 Hz), 25 W	90 - 260VAC (50 - 60 Hz), 25 W
Operating Temperature	0° to 50° Celsius	0° to 50° Celsius
Dimensions	19" x 1.75" x 12"	19" x 1.75" x 12"
Weight	7 lbs.	7 lbs.
Auxiliary Outlet	Yes	Yes
Test Port	-30 dB	-30 dB

NOTE: All specifications typical unless otherwise noted

# SAW FILTERED MODULATOR

■ MODEL SAWM60-\*



MODEL SAWM60-\*



## ■ FEATURES

- 60 dBmV Output
- PLL Controlled Oscillator
- SAW Filtered
- Low Out-of-Band Noise
- I.F. Loop (Triple I.F. Loop Available)
- Overmodulation Indicators
- BTSC Stereo Compatible (ST-MOD)

## ▼ CUSTOMER NOTES:

### FIXED CHANNEL SAW FILTERED MODULATOR

The **SAWM60-\*** is a commercial grade fixed channel modulator specifically designed for crowded head-end systems requiring high performance and reliability. The **SAWM60-\*** incorporates SAW filtering, heterodyne processing, and output band pass filtering to provide excellent rejection. The simplicity of the fixed channel design provides high reliability and stability over agile units.

### AVAILABLE OPTIONS

- Stereo Encoder (ST-MOD)

# SAW FILTERED MODULATOR

## SPECIFICATIONS

RF	SAWM60-*
Output Channels	2 - 117 CATV (54 - 750 MHz) 14 - 59 UHF (Optional)
FCC Offsets (Where Applicable)	±12.5 kHz, ±25 kHz (Selectable)
Output Level	45 - 60 dBmV (Adj.)
A/V Ratio	-9 to -20 dB (Adj.)
Frequency Stability	±5 kHz (Meets FCC Docket 21006)
Aural Carrier Frequency	4.5 MHz ± 1 kHz
Spurious Outputs	-60 dBc
C/N (In-Band)	60 dB
Out-of-Band Noise	-90 dBc
Output RL	15 dB
VIDEO	
Input Level (Min.)	.5V p-p (for 87.5% Modulation)
Frequency Response	±1.2 dB (50 Hz - 4.2 MHz)
Video C/N	62 dB
Hum/Noise	-62 dB
Modulation Range	0 - 90%
Input Impedance	75 Ohms
Differential Phase	±5°
Differential Gain	±5%
Group Delay	75 ns
AUDIO	
Input Level	.5V p-p (25 kHz Dev)
Input Impedance	600 Ohms (Unbalanced)
Distortion (THD)	1%
Flatness	±1 dB (50 Hz - 15 kHz)
Pre-Emphasis	75 µs
BTSC Stereo Encoder	Optional
CONNECTORS	
Video Input, RF Output, IF	F
Audio Input	RCA
GENERAL	
Power Requirements	117VAC, 60 Hz, 10 W
Operating Temperature	0° to 50° Celsius
Dimensions	19" x 1.75" x 12"
Weight	8.5 lbs.
Auxiliary Outlet	117VAC, 600 W
Test Port	-30 dB

NOTE: All specifications typical unless otherwise noted



# HPH SERIES AGILE PROCESSORS

■ MODELS HPH-860 : HPH-860AD



MODEL HPH-860



MODEL HPH-860AD



## ■ FEATURES

- 60 dBmV Output
- Dual Saw Filtering
- Double Heterodyne Conversion
- Maintains Broadcast Stereo Format
- Precise Signal Regulation
- Front Panel LED Channel Display
- International Power Supply (90 - 260VAC)
- Adjacent Channel Performance

## ▼ CUSTOMER NOTES:

### FREQUENCY AGILE PROCESSORS

The **HPH Series** frequency agile processors have been designed to convert any off-air or cable channel to any unused cable channel. All channel conversions are performed using simple front panel buttons and a large LED display indicating input and output channels. Frequency control is accomplished by a microprocessor controlled, PLL synthesized tuning circuit to assure accurate, stable operation. The **HPH Series** uses dual SAW filtering to assure high out-of-band rejection, as well as high reliability. A CATV hybrid amplifier is used for low distortion and high output performance.

The **HPH-860AD** digital processor utilizes sophisticated SAW filters and circuitry specifically designed to process digital signals in addition to analog, retaining the digital integrity of broadcast channels.

# HPH SERIES AGILE PROCESSORS

## SPECIFICATIONS

INPUT SECTION	HPH-860	HPH-860AD
Input Channels	2 - 125 CATV/HRC (54 - 806 MHz) 14 - 69 UHF (470 - 806 Mhz)	2 - 125 CATV/HRC (54 - 806 MHz) 14 - 69 UHF (470 - 806 Mhz)
Selectivity	-60 dB (Adj. Ch.)	-60 dB (Adj. Ch.)
Noise Figure	8 dB: CATV / 10 dB: UHF	8 dB: CATV / 10 dB: UHF
Input Range	0 - 30 dB	0 - 30 dB Analog / -32 to +4 dB Digital
Tuning	PLL	PLL
OUTPUT SECTION		
Output Channels	2 - 135 CATV/HRC (54 - 860 MHz) 14 - 69 UHF (470 - 806 Mhz)	2 - 135 CATV/HRC (54 - 860 MHz) 14 - 69 UHF (470 - 806 Mhz)
FCC Offsets (Where Applicable)	±12.5 kHz, ±25 kHz (Selectable)	±12.5 kHz, ±25 kHz (Selectable)
Output Level	45 - 60 dBmV (Adj.)	45 - 60 dBmV (Adj.)
Frequency Stability	±5 kHz (Meets FCC Docket 21006)	±5 kHz (Meets FCC Docket 21006)
Aural Carrier	0 - 10 dB (Adj.)	0 - 10 dB (Adj.)
I.F. Output	35 dBmV @ 45.75 MHz	35 dBmV @ 45.75 MHz
Frequency Response	± 2 dB	± 2 dB
Spurious Outputs	-60 dBc	-60 dBc
C/N (In-Band)	60 dB	60 dB
Out-of-Band Noise	-60 dBc	-60 dBc
Return Loss	12 dB	12 dB
CONNECTORS		
RF Input, RF Output, IF	F	F
GENERAL		
Power Requirements	90 - 260VAC (50 - 60 Hz), 20 W	90 - 260VAC (50 - 60 Hz), 20 W
Operating Temperature	0° to 50° Celsius	0° to 50° Celsius
Dimensions	19" x 1.75" x 12"	19" x 1.75" x 12"
Weight	9 lbs.	9 lbs.
Auxiliary Outlet	Yes	Yes
Test Port	-30 dB	-30 dB

NOTE: All specifications typical unless otherwise noted

# HD SERIES DEMODULATORS

■ MODELS HDTV-ST2 : HDM-1



MODEL HDTV-ST2



MODEL HDM-1



## ■ FEATURES

- 8 VSB Digital Off-Air Tuner (HDTV-ST2)
- Low Distortion
- Agile Input
- SAW Filtered (HDM-1)
- Non-Volatile Memory (On-Channel Power Up)
- Front Panel LED Channel Display (HDM-1)
- Adjustable A/V Outputs (HDM-1)
- BTSC Stereo Output (HDM-1)

## ▼ CUSTOMER NOTES:

### HDTV-ST2 FREQUENCY AGILE DEMODULATOR (DIGITAL)

The **HDTV-ST2** digital 8VSB tuner can be used as a stand alone digital receiver delivering high resolution signals for an unsurpassed viewing experience. The **HDTV-ST2** can also be used in head-end environments to deliver perfect digital quality reception in your Head-End system.

### HDM-1 : FREQUENCY AGILE DEMODULATOR

The **HDM-1** frequency agile demodulator (analog) is designed to receive and demodulate any VHF, UHF, and CATV channel to baseband audio, and video. The **HDM-1** uses a microprocessor driven PLL synthesized tuning circuit to assure accuracy. The microprocessor controls all functions and provides for easy channel selection using front panel channel up/down buttons.

# HD SERIES DEMODULATORS

## SPECIFICATIONS

RF	HDM-1
Input Channels	2 - 125 CATV (54 - 806 MHz) 14 - 61 UHF (470 - 806 MHz)
Input Power Range	-5 to 30 dBmV
Noise Figure	8 dB: CATV / 8 dB: UHF
<b>VIDEO</b>	
Output Level	.5 - 1.5V p-p (Adj.)
Impedance	75 Ohms
Frequency Response	±2 dB
Differential Phase	< 5°
Differential Gain	< 5%
<b>AUDIO</b>	
Output Level	.8 - 1.5V p-p (Adj.)
Impedance	600 Ohms
Harmonic Distortion (THD)	2%
Outputs	Baseband / MPX / 4.5 MHz
<b>CONNECTORS</b>	
RF In, Video Out, Audio Out, 4.5 MHz, MPX Out	F
<b>GENERAL</b>	
Power Requirements	117VAC, 60 Hz, 20 W
Operating Temperature	0° to 50° Celsius
Dimensions	19" x 1.75" x 3.5"
Weight	5 lbs.

RF	HDTV-ST2
Frequency	54 - 860 MHz
Input Power Range	-23 to 25 dBmV
Formats	ATSC, 8VSB
<b>VIDEO</b>	
Formats	Baseband, Component, S-Video
Aspect Ratio	4:3 / 16:9
Resolution	1080i, 720p, 480p, 480i
<b>AUDIO</b>	
Formats	Dolby Digital / PCM Stereo
Sample Rate	32 kHz / 44.1 kHz / 48 kHz
<b>DATA I/O</b>	
Connector	RS-232
<b>FRONT PANEL</b>	
7 Key Function Controls	
Status LED (Power & Channel Lock)	
<b>REMOTE CONTROL</b>	
30 Key	
<b>POWER SUPPLY</b>	
Input Voltage	117VAC, 60 Hz
Output Voltage	12VDC, 1.2A (Center +)
<b>CONNECTORS</b>	
RF In	F
Outputs	Composite Video, Component Video, A/V = RCA S-Video, SPDIF Optical Audio
<b>GENERAL</b>	
Operating Temperature	0° to 50° Celsius
Dimensions	9" x 6" x 3"
Weight	1.6 lbs.

NOTE: All specifications typical unless otherwise noted

# SINGLE CHANNEL AMPLIFIER

■ MODEL HSA-\*

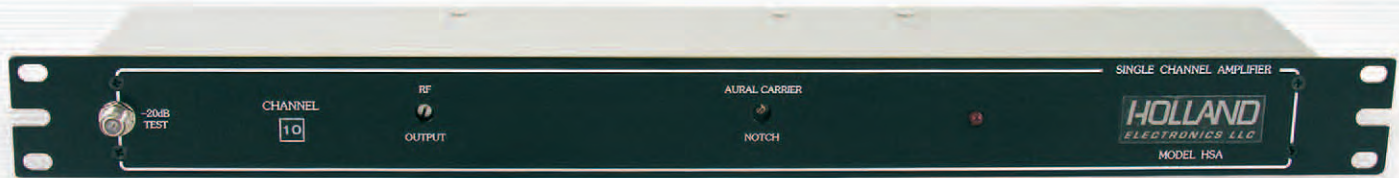

MODEL HSA-\*



## ■ FEATURES

- High Adjacent Channel Rejection
- Low Noise Circuitry
- Low AGC Threshold (-2dBmV)
- Adjustable Aural Carrier Levels
- AGC Controlled Constant Output
- Auxiliary AC Outlet

## ▼ CUSTOMER NOTES:

### SINGLE CHANNEL AMPLIFIER

The **HSA** is a single channel amplifier designed for use in head-end's with adjacent channels. The AGC accepts a wide input level range while maintaining a consistent output. A low noise input amplifier provides the cleanest picture at low input levels.

# SINGLE CHANNEL AMPLIFIER

## SPECIFICATIONS

RF	HSA-*
Input Channels	2 - 13 VHF
Gain	50 dB
AGC Range	-2 to 30 dBmV
Maximum Input	30 dBmV
Maximum Output	43 - 55 dBmV (Adj.)
Output Range	12 dBmV
Frequency Response	±1.5 dB
Aural Carrier Trap Range	0 to -12 dB
Adjacent Channel Rejection (±4 MHz from center)	-35 dB
Non-Adjacent Channel Rejection	-60 dB
Impedance	75 Ohms
AGC Stiffness	±1 dB
Noise Figure	4 dB
Return Loss	14 dB
CONNECTORS	
RF Input, RF Output	F
GENERAL	
Power Requirements	117VAC, 60 Hz, 10 W
Operating Temperature	0° to 50° Celsius
Dimensions	19" x 1.75" x 3"
Weight	4 lbs.
Auxiliary Outlet	117VAC, 60 Hz
Test Port	-20 dB

NOTE: All specifications typical unless otherwise noted

# RACK MOUNTED AMPLIFIERS

■ MODELS HCA-3051RK : HCA-3086RK

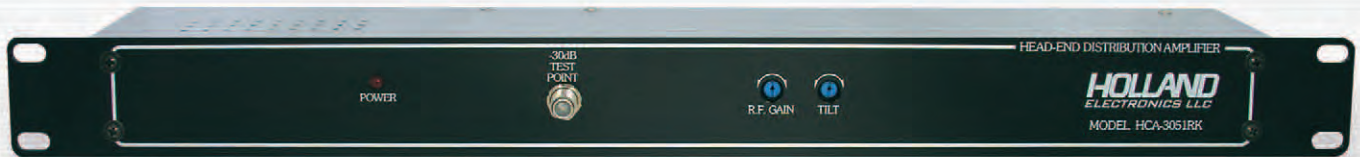

MODEL HCA-3051RK

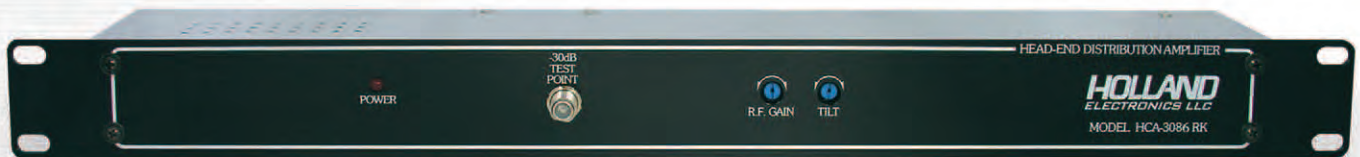

MODEL HCA-3086RK



## ■ FEATURES

- Push-Pull CATV Hybrid Amplifier
- High Output/High Channel Capacity
- Adjustable Gain & Slope
- -30 dB Output Test Port
- Auxiliary AC Outlet

## ▼ CUSTOMER NOTES:

### RACK MOUNTED LAUNCH AMPLIFIERS

Holland's HCA-3051RK and HCA-3086RK are rack-mountable high-output hybrid amplifiers perfect for any head-end application.

These amplifiers utilize push-pull CATV hybrid circuitry assuring extremely low noise and distortion.

Front panel adjustable slope and gain allow easy system balancing.

# RACK MOUNTED AMPLIFIERS

## SPECIFICATIONS

RF	HCA-3051RK	HCA-3086RK
Frequency	54 - 550 MHz (2 - 78)	54 - 860 MHz (2 - 135)
Gain	30 dB	30 dB
Gain Adjustment Range	10 dB	20 dB
Maximum Input	15 dBmV (77 Ch.)	12 dBmV (134 Ch.)
Maximum Output	45 dBmV (77 Ch.)	42 dBmV (134 Ch.)
Slope	0 - 10 dB (Adj.)	0 - 15 dB (Adj.)
Flatness	±1 dB	±1 dB
Noise Figure	7.5 dB	7.5 dB
Input Return Loss	16 dB	16 dB
Output Return Loss	16 dB	16 dB
Cross Modulation (XMOD)	-58 dB	-58 dB
Composite Triple Beat (CTB)	-60 dB	-60 dB
Hum Modulation	-60 dB	-60 dB
CONNECTORS		
RF In, RF Out	F	F
GENERAL		
Power Requirements	117VAC, 60 Hz, 8 W	117VAC, 60 Hz, 14 W
Operating Temperature	0° to 50° Celsius	0° to 50° Celsius
Dimensions	19" x 1.75" x 3.5"	19" x 1.75" x 3.5"
Weight	4 lbs.	4 lbs.
Test Port	-30 dB	-30 dB

**NOTE:** Two-way compatible using optional SBD Diplexer. See page 51 for SBD specifications.

NOTE: All specifications typical unless otherwise noted



# HEAD-END COMBINERS

■ MODELS HCG-12 : HCG-24 : AHC-16-860

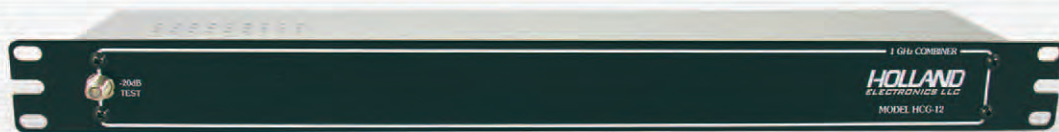

MODEL HCG-12



MODEL HCG-24



MODEL AHC-16-860



## ■ FEATURES

- High Isolation Design
- Consistent Port to Port Performance
- Front Panel Test Port
- Low Distortion Hybrid Amplifier (AHC-16-860)

## ▼ CUSTOMER NOTES:

### HCG-12 : HCG-24 : PASSIVE COMBINERS

The **HCG Series** (12 port / 24 port) passive head-end combiners are designed to combine multiple RF inputs into a single RF output while maintaining high isolation between ports. The **HCG Series** combiners operate at a full 1 GHz passband.

### AHC-16-860 : ACTIVE COMBINER

The **AHC-16-860** is a high isolation 16 channel active head-end combiner utilizing an integrated CATV hybrid push-pull amplifier. The **AHC-16-860** provides gain to overcome insertion loss and drive the distribution system. This combiner features a front panel gain control and a -20 dB test port.

# HEAD-END COMBINERS

## SPECIFICATIONS

RF	HCG-12	HCG-24
Frequency	5 - 1000 MHz	5 - 1000 MHz
Insertion Loss	16 dB	20 dB
Port-to-Port Isolation	30 dB	35 dB
Input Return Loss	18 dB	22 dB
Output Return Loss	12 dB	12 dB
GENERAL		
Operating Temperature	0° to 50° Celsius	0° to 50° Celsius
Dimensions	19" x 1.75" x 3.5"	19" x 1.75" x 3.5"
Weight	4 lbs.	4 lbs.
Test Port	-20 dB	-20 dB

RF	AHC-16-860
Frequency	54 - 860 MHz
Gain	6 - 12 dB (Adj.)
Port-to-Port Isolation	40 dB
Input Return Loss	16 dB
Output Return Loss	14 dB
Maximum Input Level	58 dBmV (16 Ch.)
GENERAL	
Power Requirements	117VAC, 60 Hz, 12 W
Operating Temperature	0° to 50° Celsius
Dimensions	19" x 1.75" x 3"
Weight	4.5 lbs.
Test Port	-20 dB
Auxiliary Outlet	Yes

NOTE: All specifications typical unless otherwise noted

# RACK MOUNTED MULTI-SWITCHES

■ MODEL HMS-16APR : HMS-412 ARK



MODEL HMS-16APR



MODEL HMS-412ARK



## ■ FEATURES

- Single Satellite Input (HMS-16APR)
- Multi-Satellite Input (HMS-412ARK)
- Low Distortion Amplification
- Provides LNB Powering
- Generates 22 kHz Tone (HMS-412ARK)
- High Isolation
- High Reliability

## ▼ CUSTOMER NOTES:

### SINGLE SATELLITE SWITCH

The **HMS-16APR** is a rack mounted multiswitch specifically designed for SMATV applications. The switch generates the voltage required for powering a dual LNB (13 & 18 volts). Also provides amplification to help overcome the insertion loss of the 16 outputs.

### MULTI-SATELLITE SWITCH

The **HMS-412ARK** is a 4 LNB input, 12 output multiswitch designed to provide solid state multi-sat switching for head-end systems. This unit provides 13 and 18 volts as well as 22 kHz tone to lock the LNB's on the required satellites.

# RACK MOUNTED MULTI-SWITCHES

## SPECIFICATIONS

RF	HMS-16APR	HMS-412ARK
Input Frequency	950 - 2150 MHz	950 - 2150 MHz
LNB Power	13V, 18V	13V + 0 kHz, 18V + 0 kHz 13V + 22 kHz, 18V + 22 kHz
Insertion Loss	-4 dB 950-2150 MHz	3 dB Gain 950 - 2150 MHz
Isolation	25 dB	30 dB
Switching Voltage (Rx to Switch)	13/18VDC	13/18VDC, 0/22 kHz
CONNECTORS		
All Ports	F	F
GENERAL		
Power Requirements	24VDC, 600 mA Center + (AC to DC Transformer Included)	117VAC, 60 Hz, 26 W
Weight	6 lbs.	5 lbs.
Dimensions	19" x 1.75" x 3.5"	19" x 1.75" x 5.5"

NOTE: All specifications typical unless otherwise noted

# SUB-BAND TO HIGH-BAND CONVERTER

■ MODEL SHC



MODEL SHC



## ■ FEATURES

- Converts Sub-Band to High-Band
- LED Power Indicator
- Can be Used with Optional SBD Sub-Band Diplexer

## ▼ CUSTOMER NOTES:

### SUB-BAND TO HIGH-BAND CONVERTER

The **SHC** converter is ideal for use in head-end and local origination applications. In head-end applications, the **SHC** is used to convert the incoming sub-band (T7 - T13) to VHF (7 - 13).

For local origination applications, the **SHC** can be used in offices, hospitals, or any situation where sub-band can be utilized to allow a TV within the system to view channels not available to others. These converted sub-band channels can then be redistributed using standard processors and demodulators.

# SUB-BAND TO HIGH-BAND CONVERTER

## SPECIFICATIONS

RF	SHC
Input Channels	T7 - T13 (7 - 47 MHz)
Output Channels	7 - 13 (174 - 216 MHz) (T7 converts to Ch. 7, etc.)
Insertion Loss	-7 dB
Frequency Stability	±5 kHz
Input Level Range	5 - 30 dBmV
POWER SUPPLY	
Input Voltage	120VAC, 60 Hz
Output Voltage	18VDC @ 100 mA
GENERAL	
Weight	1.5 lbs.
Dimensions	6" x 3" x 1.5"

## HEAD-END APPLICATIONS

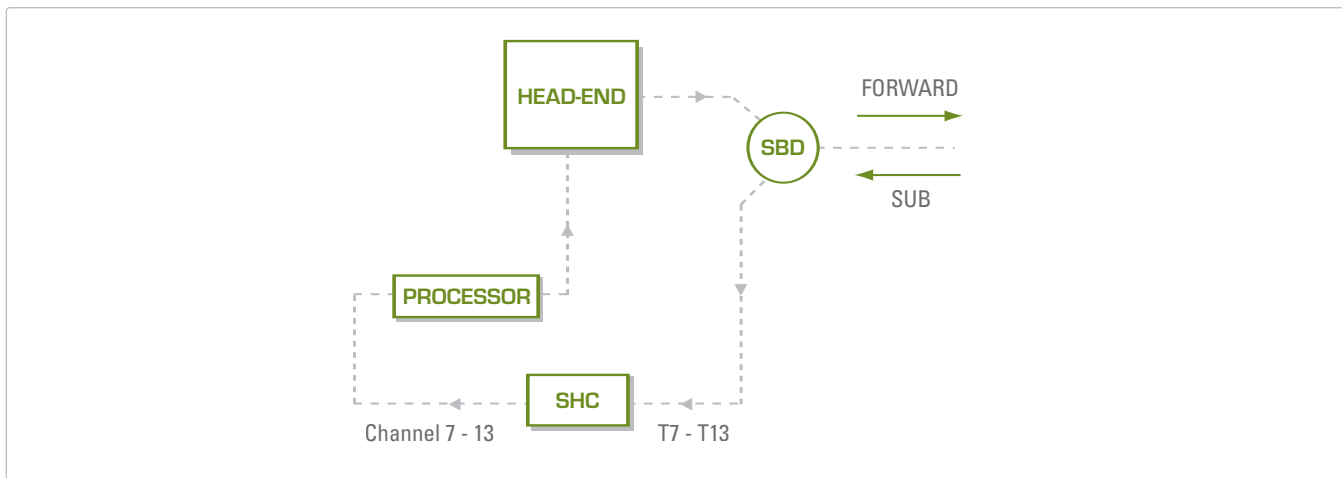

## LOCAL ORIENTATION APPLICATIONS

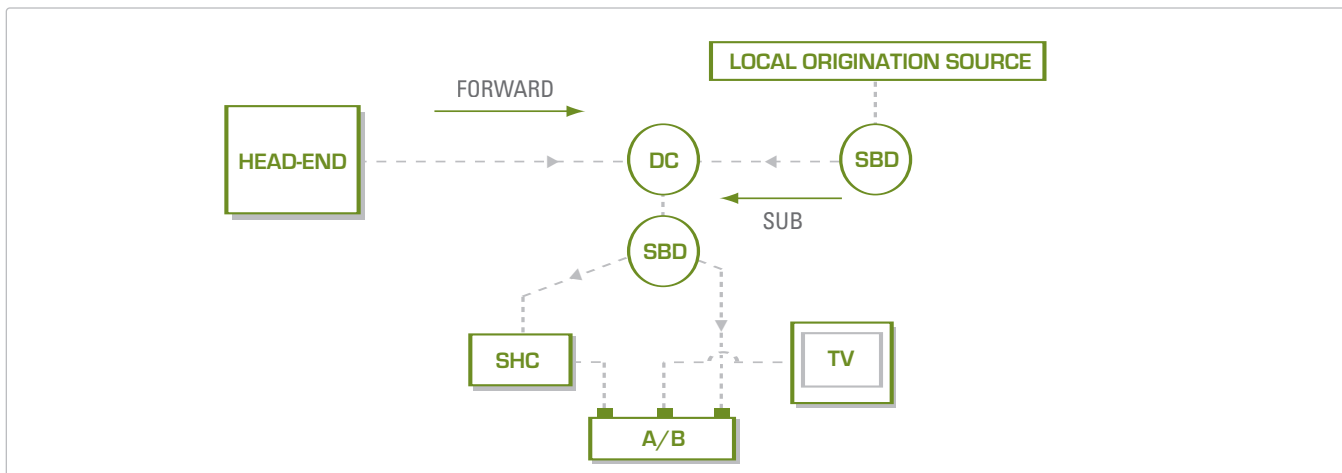

NOTE: All specifications typical unless otherwise noted

# HEAD-END ACCESSORIES

■ MODELS MOR-71 : ORS : RK-6S : RK6-2800 : HAC-10RK : RSW : PRE-BUILT



MODEL MOR-71

## EQUIPMENT RACK

The **MOR-71** is a standard 71" equipment rack and is solidly constructed from 12-gauge steel with fine-thread panel mounting screw holes and a scratch resistant black hammer-tone finish. The rack has multiple shelving options and a mounting capacity of up to 40 1 3/4" rack devices. The **MOR-71** is suitable for all industry standard 19" panel widths and utilizes a rack footprint of 2' x 2' for added stability. Meets EIA standard RS310C 19" rack spacing. Assembly required.

## 19" RACK SHELF

The **ORS** rack shelf is ideal for DBS receivers, DVD players, monitors, or other non-rack mounted equipment. Black finish, 19" x 2 3/4" x 12 1/2". Rated to 15 lbs.



MODEL ORS

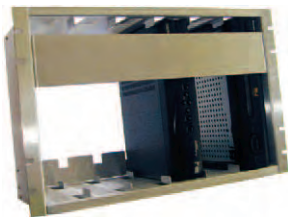

MODEL RK-6S

## VERTICAL RECEIVER RACKS

Holland offers vertical receiver racks to fit most receivers available today. These racks hold 6 to 9 receivers (depending on receiver model used) securely in a head-end rack. Some models include infra-red block plugs to prevent unwanted channel changes. Other models (not shown) available.



MODEL RK6-2800

# HEAD-END ACCESSORIES

## 10-OUTLET POWER STRIP

Standard rack mounted power strip containing 10 surge protected AC outlets and a relay switch for over-current protection and a power rating of 15 amps.



MODEL HAC-10RK



MODEL RSW

## RACK SCREWS

**RSW** rack screws are black anodized and precision threaded. Available in bags of 100 with non-scratch washers included.

## PRE-BUILT HEAD-END SYSTEMS

**Holland Electronics** is proud to offer pre-racked head-ends to simplify your next commercial installation. We offer both mini-mods and full-sized modulators or a combination of both if desired. All of our head-ends are balanced, burned in, and then re-tested to ensure signal stability before arrival to the job site.

Pre-racked head-ends include all adapters, cables, interconnects and components necessary for plug and play operations and carry a 5-year warranty on all parts.

- All Systems Burned In & Balanced
- Mini-Mods & Full-Size Available
- Color Coded Interconnects
- 5-Year Warranty





# HMM SERIES MULTIMEDIA MODULATORS

■ MODELS HMM-10H : HMM-3



MODEL HMM-10H



MODEL HMM-3

## ■ FEATURES

- High Output (25 dB)
- Push Button Programming
- Non-Volatile Memory
- LED Front Panel Display
- Built-In Combiner (HMM-3)
- Switchable Video Impedance (For Loop Thru)

## ▼ CUSTOMER NOTES:

### MULTIMEDIA MODULATORS

The **HMM-10H** and **HMM-3** are microprocessor controlled agile modulators (CATV ultraband and UHF) developed for use in adding satellite, VCR, DVD, or security video channels to an existing home distribution system.

### HMM-10H : SINGLE MODULATOR

The **HMM-10H** accepts one audio/video input source and modulates to a single RF output.

### HMM-3 : TRIPLE MODULATOR

The **HMM-3** accepts three audio/video input sources and modulates to three different non-adjacent channels that are combined into a single output.

# HMM SERIES MULTIMEDIA MODULATORS

## SPECIFICATIONS

RF	HMM-10H	HMM-3
Frequency Range	470 - 860 MHz	470 - 860 MHz
Output Channels:	CATV: 65 - 135, UHF: 14 - 78	CATV: 65 - 135, UHF: 14 - 78
Output Level	25 dBmV	25 dBmV (15 dB Adj.)
Frequency Stability	PLL Crystal Stabilized $\pm 5$ kHz	PLL Crystal Stabilized $\pm 5$ kHz
<b>VIDEO</b>		
Input Level (Min.)	1V p-p (for 87.5% Modulation)	1V p-p (for 87.5% Modulation)
<b>AUDIO</b>		
	1	3
Input Level	1V RMS, 10K Ohms	1V RMS, 10K Ohms
<b>CONNECTORS</b>		
Video In, Audio In	RCA	RCA
RF Output	F	F
<b>GENERAL</b>		
Power Requirements	117VAC, 60 Hz, 12 W	117VAC, 60 Hz, 12 W
Operating Temperature	0° to 50° Celsius	0° to 50° Celsius
Dimensions	3.5" x 3.75" x 1.15"	5.5" x 3.25" x 1.15"
Weight	.45 lbs.	.6 lbs.

## SINGLE MODULATOR INSTALLATION

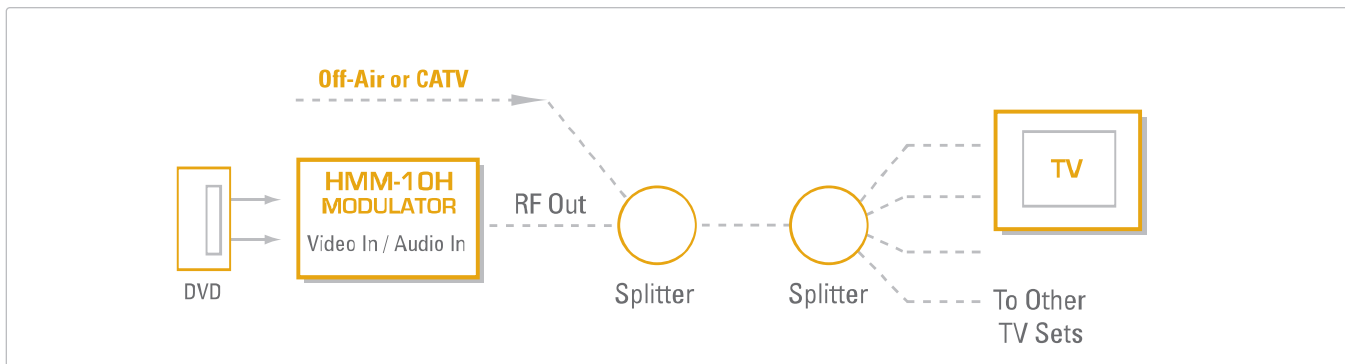

## TRIPLE MODULATOR INSTALLATION

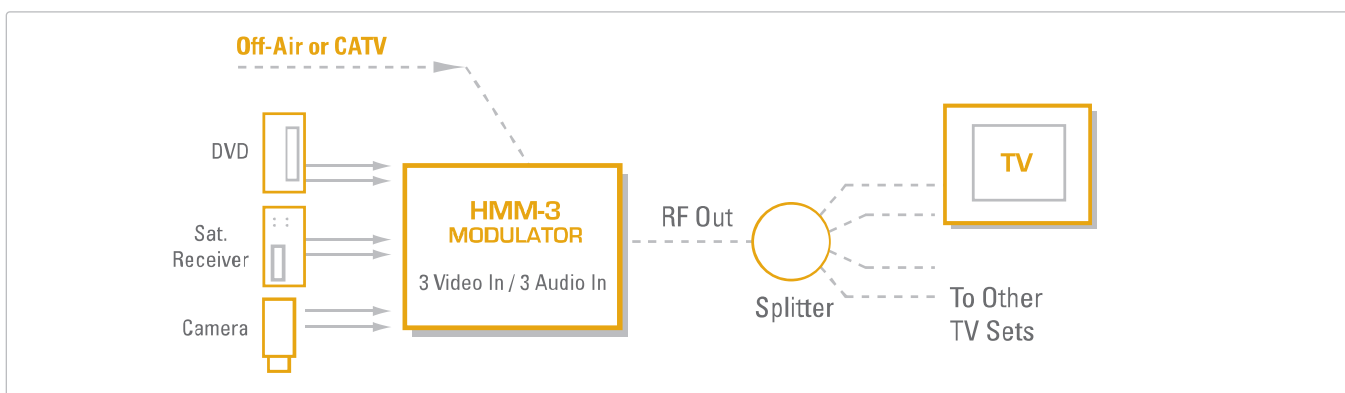

NOTE: All specifications typical unless otherwise noted

# SIGNAL COMBINERS/AB SWITCHES

■ MODELS SC-3 : SC-4 : AB-90 : AB-4 : AB-75



MODEL SC-3



MODEL SC-4



MODEL AB-90



MODEL AB-4

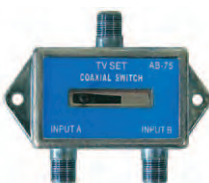

MODEL AB-75

## SIGNAL COMBINERS

The **SC-3** and **SC-4** are multi-filter channel combiners enabling locally originated channels (3 or 4) to be combined and balanced with off-air signals resulting in a clean insertion of channel 3 or 4 into a distribution system.

### INSERTION LOSS : ANTENNA TO TV

Ch. 2 & 4 (SC-3), Ch. 3 & 5 (SC-4)	-1 dB
Ch. 3 (SC-3), Ch. 4 (SC-4)	-25 dB

### INSERTION LOSS : CH.3 (SC-3) CH.4 (SC-4) TO TV

Ch. 2 Video (SC-3), Ch. 3 Video (SC-4)	-35 dB
Ch. 4 Video (SC-3), Ch. 5 Video (SC-4)	-15 dB
Ch. 3 (SC-3), Ch. 4 (SC-4) To TV	-4 dB
Balance Adjustment Range	10 dB

## PUSH BUTTON AB SWITCHES

The **AB-90** is the latest design of high isolation RF switches having the advantage of top mounted push buttons. The **AB-90** is designed to have higher isolation and increased reliability over other push button switches. The **AB-4** features the same performance as the **AB-90** with forward facing push buttons.

### MODEL AB-90, AB-4

Frequency Range	DC - 2 GHz
Isolation	90 dB, 54 - 216 MHz 70 dB, 216 - 750 MHz 60 dB, 750 - 1 GHz
Return Loss	20 dB
Insertion Loss	<1 dB (DC - 1 GHz)

## SLIDE SWITCH

The **AB-75** is an economy RF AB switch for applications where standard performance is acceptable.

NOTE: All specifications typical unless otherwise noted

# VIDEO CAMERAS

MODELS CBW-1P : CCOL-1 : CBW-1LED ■

## SECURITY VIDEO CAMERAS

All **Holland** camera's use Sony® CCD's and come in water-resistant cases. They provide unmatched clarity, even in low light environments. All cameras include mounting hardware.



**MODEL CBW-1P**  
BLACK & WHITE



**MODEL CCOL-1**  
COLOR

- Water Resistant Cases
- Mini-Bullet Design
- 1/3" CCD (B&W), 1/4" CCD (Color)
- Power Supply Included
- 480 Line Resolution
- LED Infra-Red Illumination (CBW-1LED)
- Mounting Bracket Included



**MODEL CBW-1LED**  
BLACK & WHITE  
WITH NIGHT VISION

	CBW-1WP	CCOL-1	CBW-1LED
Image Device	1/3" CCD	1/4" CCD	1/3" CCD
Resolution	480	480	480
Min. Illumination	.1 lux (f=1.2)	1 lux	.1 lux (LED off)
Power Requirements	12VDC, 1.3 W	12VDC, 1.5 W	12VDC, 1.3 W
Dimensions	.9"Diameter 2.2" Length	.8"Diameter 2.2" Length	1.4"Diameter 2" Length
Lens	3.6 mm	3.6 mm	3.6 mm
Angle of View	45°	45°	45°

# INSTALLATION MATERIALS

■ BP SERIES : WP SERIES : WPG SERIES

## BP SERIES: BLANK WALL PLATES

Holland's blank wall plates are made from high-impact plastic, available with one or two 3/8" holes (inset hex). Available in ivory or white.



BP-1\*



BP-4\*



BP-2\*

## WP SERIES: WALL PLATES WITH STANDARD SPLICE

The WP Series wall plates use the same high-impact plastic as our BP Series. Available in combinations utilizing our standard F splice and telephone jacks. Available in ivory or white.



WP-81\*



WP-81D\*



WP-T81\*



WP-T81D\*

## WPG SERIES : 3 GHz WALL PLATES WITH PATENTED HIGH PERFORMANCE 3 GHz SPLICE

WPG Series wall plates use Holland Electronics patented high-return loss 3 GHz splice and trademarked blue insulator. Ideal for CATV and satellite applications. Available in combinations utilizing our 3 GHz splice and telephone jacks. All modular receptacles are 4 conductor type. Available in ivory and white.



WP-81G\*



WP-81GD\*



WP-T81G\*



WP-T81GD\*

\* = COLOR: IV=ivory / WH=white

All telephone jacks are 6P4C. Splice patents #5,863,226 / #5,498,175 / #5,667,409 / #6,113,431 / #6,276,970

# INSTALLATION MATERIALS

MODELS CC-\* : CT-\* : FTB-\* : WB-1UV : WS-\* ■

## CABLE CLIPS

High impact plastic clips with pre-installed steel nails. Suitable for wood or masonry applications. Available in black or white.



MODEL CC-6\*, CC-7\*, CC-155\*

CABLE CLIPS	CABLE TYPE	NAIL LENGTH
CC-3.5B, CC-3.5I	Ground Wire	.59"
CC-6B, CC-6I	Series-59 Cable	1.1"
CC-7B, CC-7I	Series-6 Cable	1.1"
CC-135B, CC-135I	Series-59 Dual	1.1"
CC-155B, CC-155I	Series-6 Dual	1.1"

## CABLE TIES

High tensile strength nylon cable ties. Available in black or white.



MODEL CT-\*

CABLE TIES	NOMINAL LENGTH	MIN. TENSILE STRENGTH	MAX. BUNDLE DIAMETER
CT-20*	4"	20 lbs.	1"
CT-30*	6"	30 lbs.	1 1/4"
CT-50*	8"	50 lbs.	2 3/4"
CT-11*	11"	75 lbs.	3 1/4"
CT-14*	14"	120 lbs.	4"

\* = COLOR: B=black / W=white



MODEL FTB-56 / FTB-59

## FEED THROUGH BUSHINGS

Holland's feed through bushings are made from UV stabilized ABS plastic. Available in black or white, single or dual cable bushings available.



MODEL WB-1UV

## WEATHER BOOT

Inhibits moisture in F connections by maintaining a tight seal around the connector and cable. UV resistant and ribbed for easy installation.



MODEL WS-250, WS-375, WS-500

## WEATHER SEALS

Weather seals are used on standard "F" female ports for weather-proofing the F connector and F port connection. Recommended for all outdoor installations. Available in 1/4" (WS-250), 3/8" (WS-375) and 1/2" (WS-500) thicknesses.

# INSTALLATION MATERIALS

■ MODELS TE-\* : SFT-\* : RTV-3 : VC-6-5

## TELECOMMUNICATION ENCLOSURES

Mount passives, amplifiers and connections in a secure box. Available in four sizes.



MODEL  
TE-128, TE-130,  
TE-136, TE-140

- For Indoor or Outdoor Use
- Durable Polypropylene Material
- Secures with a Lock, Clasp, or CATV Locking Terminator
- Weather Resistant Cable Entry

MODEL	DIMENSIONS
TE-128	2.75" X 4.8" X 9"
TE-130	2.9" X 5.55" X 7.1"
TE-136	3" X 7.8" X 10.5"
TE-140	4.1" X 9.2" X 13"

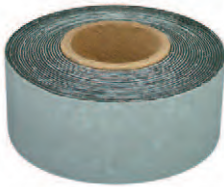

MODEL  
SFT-130 & SFT-150

## SELF-AMALGAMATING TAPE

Holland's SFT-\* is an ethylene propylene rubber based tape which provides excellent moisture and corrosion protection. SFT-\* tape is self-amalgamating, which when properly installed melds together to create a tight fitting permanent protective seal. SFT-\* is an all purpose tape providing superior UV and ozone protection plus low temperature (-55°) flexibility.

**SFT-130:** 1" x 30'

**SFT-150:** 1.5" x 15'



MODEL RTV-3

## SILICONE SEALANT

Silicone sealants are ideal for use with feed thru bushings and connectors where a flexible weather seal is important. UV and heat resistant, this sealant provides years of worry free weather sealing.



MODEL VC-6-5

## SILICONE GREASE

Silicone dielectric compound is ideal for use with CATV connectors as a high voltage insulator, corrosion preventative, moisture barrier and for flashover protection for electrical insulators.

# HARDWARE

MODELS A-6 : A-10 : A-2 : A-3 : A-22 ■

## HARDWARE

Holland offers a variety of hardware for CATV and Satellite installations.



A-6



A-10



A-2



A-3



A-22

MODEL	DESCRIPTION	MATERIAL
A-6	J Hook	Galvanized Steel
A-10	P Hook	Plated Steel
A-2	Q-Span Clamp	Aluminum Clamp, Galvanized Steel Bolt
A-3	C-Span Clamp	Aluminum Clamp, Galvanized Steel Bolt
A-22, A-22-12	4" Tap Bracket, 12" Tap Bracket	Aluminum Bracket, Galvanized Bolt



# HSU SERIES SPLITTERS

■ MODELS HSU-2 : HSU-3 : HSU-4 : HSU-8

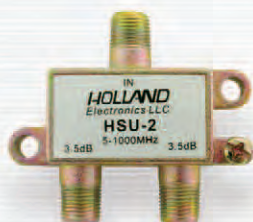

MODEL HSU-2



MODEL HSU-3



MODEL HSU-4



MODEL HSU-8

## ■ FEATURES

- Wide Frequency Range
- Heavy Duty Zinc Diecast Case
- Anti-Corrosive Chromate Finish
- Precision Machined Threads
- DC Power Passing Through All Ports
- Mounting Screws Included

## ▼ CUSTOMER NOTES:

### ECONOMY BROADBAND SPLITTERS

The **HSU** splitter series has been manufactured to the highest performance standards in its class, using the same quality control standards and materials used in our premium performance lines. Though intended for use with home or MDU off-air systems in the 5-1000MHz range, the **HSU Series** offer many features such as, machined threads, and an epoxy sealed case.

# HSU SERIES SPLITTERS

## ■ SPECIFICATIONS

PARAMETER	FREQUENCY RANGE (MHz)	HSU-2	HSU-3	HSU-4	HSU-8
Insertion Loss (dB)	5 - 15	4.5	4.0 / 8.5	8.0	10
	16 - 40	4.0	3.5 / 7.5	7.2	10
	41 - 450	3.6	3.7 / 7.3	7.2	11
	451 - 750	3.7	3.8 / 7.8	7.9	12.2
	751 - 1000	4.2	4.0 / 8.2	8.5	13
Isolation (dB)	5 - 15	15	25	16	20
	16 - 40	17	25	17	20
	41 - 450	23	23	20	22
	451 - 750	25	21	17	22
	751 - 1000	23	20	18	20
Return Loss (dB)	5 - 15	15	10	10	18
	16 - 40	15	12	12	18
	41 - 450	21	22	16	20
	451 - 750	21	25	21	20
	751 - 1000	20	20	15	18

POWER PASSING SPECIFICATIONS	HSU-*
Voltage (Max)	30V
Current Rating (Max)	750mA

NOTE: All specifications typical unless otherwise noted

# GHS/GSV SERIES DIGITAL CATV SPLITTERS

■ MODELS GHS-2 : GHS-3 : GHS-4 : GHS-8 : GSV-2 : GSV-3 : GSV-4 : GSV-6 : GSV-8



MODEL GHS-2



MODEL GHS-3



MODEL GHS-4



MODEL GHS-8



MODEL GSV-2



MODEL GSV-3



MODEL GSV-4



MODEL GSV-6



MODEL GSV-8

## ■ FEATURES

- Flat-End F-Ports
- Enhanced Sub-Band Performance
- Low Intermodulation Distortion
- Capacitor Decoupled
- 6kV Survivability
- Double-Thick Plating
- 130 dB RFI Shielding
- 3-Way Ground Screw: Hex/Phillips/Slot

## ▼ CUSTOMER NOTES:

### CATV DIGITAL SPLITTERS

The **GHS** and **GSV Series** 1 GHz Splitters are state-of-the-art product lines designed and tested using the most current procedures. New performance features have been incorporated to make both series compatible with the latest digital and return path requirements.

\* POWER PASSING MODELS AVAILABLE. PLEASE SEE PAGE 101.

# GHS/GSV SERIES DIGITAL CATV SPLITTERS

## SPECIFICATIONS

PARAMETER	FREQUENCY RANGE (MHz)	GHS-2		GHS-3		GHS-3B		GHS-4		GHS-8	
		TYP.	QC.	TYP.	QC.	TYP.	QC.	TYP.	QC.	TYP.	QC.
Insertion Loss (dB)	5 - 15	3.5	3.6	3.7 / 6.9	3.8 / 7.0	5.6	5.8	7.0	7.1	10.7	11.2
	16 - 40	3.6	3.7	3.7 / 6.9	3.8 / 7.0	5.6	5.8	6.8	6.9	10.5	11
	41 - 450	3.7	3.8	3.7 / 7.0	3.8 / 7.0	6.2	6.5	7.0	7.1	11	11.5
	451 - 750	3.8	3.9	3.9 / 7.5	4.0 / 7.6	6.3	6.5	7.5	7.6	12	12.5
	751 - 1000	3.9	4.0	4.0 / 8.0	4.2 / 8.2	6.9	7	8.1	8.2	12	12.5
Isolation (dB)	5 - 15	26	25	30	22	25	20	30	22	24	20
	16 - 40	45	40	38	35	38	35	40	32	28	25
	41 - 450	31	30	30	25	28	25	30	25	28	25
	451 - 750	31	30	28	25	25	23	28	25	23	20
	751 - 1000	30	25	25	23	22	20	25	23	22	20
Input Return Loss (dB)	5 - 15	25	24	25	20	22	20	25	20	24	20
	16 - 40	26	25	28	24	25	22	28	24	26	22
	41 - 450	26	25	28	23	25	22	28	23	24	20
	451 - 750	26	25	28	20	23	20	25	20	23	20
	751 - 1000	25	22	24	20	22	20	21	20	22	20
Output Return Loss (dB)	5 - 15	26	24	25	22	24	20	25	20	24	20
	16 - 40	35	30	35	30	32	28	30	28	27	24
	41 - 450	26	25	30	23	25	22	28	23	25	21
	451 - 750	26	25	25	20	22	20	25	20	24	20
	751 - 1000	25	22	24	20	22	20	21	20	23	20

PARAMETER	FREQUENCY RANGE (MHz)	GSV-2		GSV-3		GSV-4		GSV-6		GSV-8	
		TYP.	QC.	TYP.	QC.	TYP.	QC.	TYP.	QC.	TYP.	QC.
Insertion Loss (dB)	5 - 15	3.3	3.5	3.5 / 6.8	3.6 / 6.9	6.8	6.9	9.1	9.2	10	10.5
	16 - 40	3.3	3.5	3.5 / 6.9	3.6 / 7.0	6.9	7.0	9.1	9.2	10.3	10.8
	41 - 450	3.6	3.8	3.8 / 7.4	3.9 / 7.5	7.4	7.5	9.9	10	11	11.5
	451 - 750	3.9	4.2	4 / 8	4.1 / 8.1	8	8	10.5	11	11.7	12.2
	751 - 1000	4	4.4	4 / 8	4.2 / 8.2	8.1	8.2	11.3	11.5	12.2	12.5
Isolation (dB)	5 - 15	26	20	35	23	29	24	24	23	30	25
	16 - 40	33	25	38	25	29	25	25	24	30	24
	41 - 450	35	22	36	22	30	25	23	22	25	22
	451 - 750	32	20	30	22	28	24	22	20	23	21
	751 - 1000	28	20	25	20	27	24	21	20	22	20
Input Return Loss (dB)	5 - 15	24	20	21	19	22	18	19	18	22	18
	16 - 40	27	22	23	21	24	20	21	20	25	22
	41 - 450	23	20	23	20	25	21	21	20	24	20
	451 - 750	24	18	22	20	22	18	20	18	23	19
	751 - 1000	24	18	21	18	21	18	19	18	22	18
Output Return Loss (dB)	5 - 15	22	20	20	18	21	18	17	16	22	18
	16 - 40	28	22	32	20	25	22	21	20	28	22
	41 - 450	31	20	26	20	28	25	21	20	24	20
	451 - 750	30	20	22	18	23	18	20	18	23	19
	751 - 1000	25	20	20	18	21	18	19	18	22	18

# GHS-\*FC LI SERIES DIGITAL CATV SPLITTERS

■ MODELS GHS-2FC LI : GHS-3FC LI : GHS-4FC LI : GHS-8FC LI



MODEL GHS-2FC LI



MODEL GHS-3FC LI

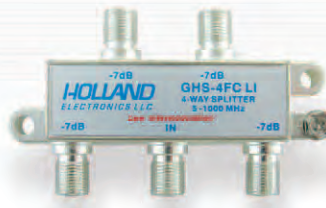

MODEL GHS-4FC LI



MODEL GHS-8FC LI

## ■ FEATURES

- Low Intermodulation Distortion (Patent Pending)
- Non-Magnetizing Ferrite Design (Patent Pending)
- Pressure Sealed F-Ports to 30 PSI
- Flat-end, Small Aperture F-Ports with 1" Spacing
- U.L. Listed: Ground Block (Optional Model)
- Capacitor Decoupling on All Ports
- 6kV Survivability
- Enhanced Return Loss & Isolation
- Heavy Duty Zinc Rear Cover

## ▼ CUSTOMER NOTES:

## PREMIUM DIGITAL SPLITTERS

The **GHS-FCLI Series** splitters are premium digital splitters featuring low intermod distortion and non-magnetizing circuit design (patents pending). The low intermod distortion allows high level return path signals (cable modems, STB's, etc.) while maintaining product integrity and eliminating the possibility of harmonics due to magnetization. Also features sealed F-ports which protect splitter circuitry from varying environmental conditions. Zinc back cover ensures maximum outdoor survivability.

# GHS-FC LI SERIES CATV SPLITTERS

## SPECIFICATIONS

PARAMETER	FREQUENCY RANGE (MHz)	GHS-2FC LI		GHS-3FC LI		GHS-3BFC LI		GHS-4FC LI		GHS-8FC LI	
		TYP.	QC.	TYP.	QC.	TYP.	QC.	TYP.	QC.	TYP.	QC.
Insertion Loss (dB)	5 - 15	3.3	3.4	3.4 / 7.0	3.5 / 7.1	5.6	6.0	7.4	7.7	10.7	11.0
	16 - 40	3.4	3.5	3.5 / 7.2	3.6 / 7.3	5.5	6.0	7.1	7.3	10.5	10.8
	41 - 450	3.8	3.9	3.6 / 7.4	3.8 / 7.5	5.7	6.5	7.2	7.3	10.7	11.0
	451 - 750	3.8	3.9	3.7 / 7.4	4.0 / 8.0	5.9	6.8	7.3	8.0	10.9	11.5
	751 - 1000	3.8	3.9	3.9 / 7.9	4.0 / 8.0	6.5	7.1	7.5	8.0	11.4	12.2
Isolation (dB)	5 - 15	23	22	23	22	28	22	30	22	32	25
	16 - 40	41	40	36	35	36	30	40	35	38	32
	41 - 450	35	30	36	30	30	25	30	25	30	25
	451 - 750	28	25	31	25	28	22	29	25	28	24
	751 - 1000	26	25	26	25	25	20	28	25	25	20
Input Return Loss (dB)	5 - 15	23	22	23	22	24	20	25	20	26	20
	16 - 40	26	25	25	24	28	24	28	24	30	25
	41 - 450	28	25	24	23	26	22	28	23	28	23
	451 - 750	25	22	23	22	25	22	27	20	25	20
	751 - 1000	23	22	23	22	23	20	25	20	25	20
Output Return Loss (dB)	5 - 15	23	22	23	22	24	22	25	20	28	20
	16 - 40	31	30	31	30	32	28	35	30	32	25
	41 - 450	28	25	29	23	28	23	28	23	28	23
	451 - 750	25	22	24	22	25	22	26	22	25	20
	751 - 1000	23	22	23	22	24	20	22	20	23	20

## GENERAL

Temperature Range	-40° to 60° Celsius	-40° to 60° Celsius	-40° to 60° Celsius	-40° to 60° Celsius	-40° to 60° Celsius	-40° to 60° Celsius
Port Spacing	1"	1"	1"	1"	1"	1"
RFI	≥130 dB	≥130 dB	≥130 dB	≥130 dB	≥130 dB	≥130 dB
Impedance (Ohm)	75	75	75	75	75	75
Blocking Capacitors	Yes	Yes	Yes	Yes	Yes	Yes

NOTE: All specifications typical unless otherwise noted

# SATELLITE / BROADBAND SPLITTERS

■ MODELS HFS-2 : HFS-2P : HFS-4 : HFS-4P



MODEL HFS-2



MODEL HFS-2P

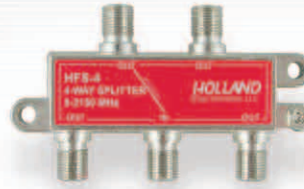

MODEL HFS-4

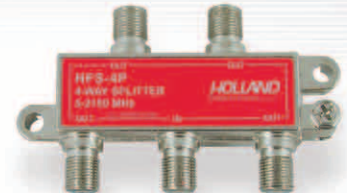

MODEL HFS-4P

## ■ FEATURES

- 5 - 2150 MHz Performance
- Power Passing to One or All Ports
- High Port-to-Port Isolation

The **HFS Series** broadband splitters are an advanced design providing the lowest insertion loss from 5-2150 MHz while maintaining high isolation. The **HFS-2/HFS-4** are power passing to one port, and the **HFS-2P/HFS-4P** pass power to all ports.

# SATELLITE/BROADBAND SPLITTERS (DIODE STEERED)

■ MODELS HFS-2D : HFS-3D : HFS-4D



MODEL HFS-2D



MODEL HFS-3D



MODEL HFS-4D

## ■ FEATURES

- 15 - 2150 MHz Wideband Operation
- High Return Loss
- Flat Frequency Response
- Flat End F Ports with 1" Spacing
- Solder Back Case (-130 dB RFI Shielding)

**Hollands HFS-\*D** series high frequency splitters have been designed for residential and commercial applications. The diode protected circuitry allows the DC power to pass from any output port to the input port and prevents DC backfeeding.

# SATELLITE/BROADBAND SPLITTERS

## SPECIFICATIONS

PARAMETER	FREQUENCY RANGE (MHz)	HFS-2/2P		HFS-4/4P		HFS-2D		HFS-3D		HFS-4D	
		TYP.	QC.	TYP.	QC.	TYP.	QC.	TYP.	QC.	TYP.	QC.
Insertion Loss (dB)	15 - 40	4.4	4.5	7.8	8.0	4.3	4.5	4.2 / 8.3	4.5 / 8.5	8.2	8.5
	41 - 550	4.3	4.5	7.8	8.0	4.2	4.5	4.5 / 9.2	4.8 / 9.3	9.0	9.3
	551 - 950	4.4	4.7	8.0	8.2	4.3	4.7	4.7 / 9.4	5.0 / 9.5	9.2	9.5
	951 - 1450	4.8	5.0	9.0	9.5	5.2	5.3	5.3/10.5	5.5/10.8	10.5	10.8
	1451 - 2150	5.0	5.3	10	10.5	5.3	5.5	5.5/10.9	5.9/11.5	10.9	11.2
Isolation (dB)	15 - 40	20	18	24	23	25	22	24	23	27	25
	41 - 550	23	19	22	21	27	25	23	22	22	21
	551 - 950	23	19	21	20	26	24	23	22	22	21
	951 - 1450	24	20	21	20	22	21	22	21	22	21
	1451 - 2150	24	20	21	20	22	21	22	21	22	20
Input Return Loss (dB)	15 - 40	11	8	11	8	16	15	16	15	16	15
	41 - 550	11	8	11	8	16	15	16	15	16	15
	551 - 950	11	8	11	8	16	15	16	15	16	15
	951 - 1450	11	8	11	8	16	15	16	15	16	15
	1451 - 2150	11	8	11	8	16	15	16	15	16	15
Output Return Loss (dB)	15 - 40	11	8	11	8	20	15	16	15	16	15
	41 - 550	11	8	11	8	20	15	16	15	16	15
	551 - 950	11	8	11	8	19	15	16	15	16	15
	951 - 1450	11	8	11	8	18	15	16	15	16	15
	1451 - 2150	11	8	11	8	17	15	16	15	16	15
<b>GENERAL</b>											
Temperature Range	-40° to 60° Celsius	-40° to 60° Celsius		-40° to 60° Celsius		-40° to 60° Celsius		-40° to 60° Celsius		-40° to 60° Celsius	
Port Spacing	1"	1"		1"		1"		1"		1"	
RFI	≥130 dB	≥130 dB		≥130 dB		≥130 dB		≥130 dB		≥130 dB	
Impedance (Ohm)	75	75		75		75		75		75	

POWER PASSING SPECIFICATIONS	HFS-*/*P	HFS-*D
Voltage (Max.)	35V	35V
Current Rating (Max.)	750 mA	1.0 A

NOTE: All specifications typical unless otherwise noted



# DCG SERIES 1 GHz DIRECTIONAL COUPLERS

■ MODELS DCG-\* : DCWG-\* : DCG2-\* : DCG4-\*

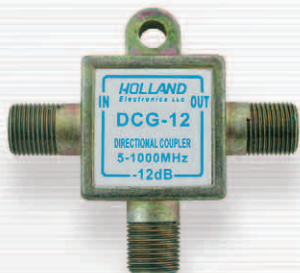

MODEL DCG-\*



MODEL DCWG-\*



MODEL DCG2-\*



MODEL DCG4-\*

## ■ FEATURES

- 1 GHz Bandwidth
- 90 dB RFI Shielding
- Heavy Duty Diecast Case
- High Downstream Isolation (Tap-Out)
- Low Insertion Loss
- Precision Machined Threads

## ▼ CUSTOMER NOTES:

### DCG SERIES DIRECTIONAL COUPLERS

The **DCG** line of high quality directional couplers have been developed for indoor or outdoor applications requiring high isolation. Numerous values and port configurations available to facilitate proper distribution system design.

# DCG SERIES 1 GHz DIRECTIONAL COUPLERS

## 1 PORT MODELS (DCG-\*)

* TAP VALUE	6	9	12	16	20	24	27	30
<b>Insertion Loss (dB) (In - Out)</b>								
5 - 47	2	1.5	1	.8	.8	.7	.7	.7
48 - 450	2	1.5	1	.8	.8	.6	.6	.6
451 - 750	2.3	1.6	1.3	1	1	.8	.8	.8
751 - 1000	2.5	2	1.5	1.2	1.2	1	1	1
<b>Isolation (dB) (Out - Tap)</b>								
5 - 47	25	30	30	35	40	40	40	41
48 - 450	25	25	28	30	35	40	40	40
451 - 750	22	24	25	28	30	35	35	40
751 - 1000	22	22	22	23	25	30	35	36

## 2 PORT MODELS (DCG2-\*)

* TAP VALUE	9	12	16	20	24	27	30
<b>Insertion Loss (dB) (In - Out)</b>							
5 - 47	3.5	1.9	1.5	.7	.7	.7	.7
48 - 450	3.4	1.5	1.3	.6	.6	.6	.6
451 - 750	3.6	2	1.5	.8	.8	.8	.8
751 - 1000	4	2.2	1.7	1	1	1	1
<b>Isolation (dB) (Out - Tap)</b>							
5 - 47	25	35	35	40	45	45	45
48 - 450	25	25	30	35	40	40	40
451 - 750	22	24	28	30	35	35	35
751 - 1000	22	22	23	27	30	30	30

## 4 PORT MODELS (DCG4-\*)

* TAP VALUE	8	12	16	20	24	30
<b>Insertion Loss (dB) (In - Out)</b>						
5 - 47	Self Term.	3.7	1.4	.9	.9	.9
48 - 450	Self Term.	3.9	1.3	.8	.8	.8
451 - 750	Self Term.	4	1.7	.9	.9	.9
751 - 1000	Self Term.	4.1	1.9	1.1	1.1	1.1
<b>Isolation (dB) (Out - Tap)</b>						
5 - 47	Self Term.	27	30	32	40	45
48 - 450	Self Term.	27	28	30	35	40
451 - 750	Self Term.	22	26	28	30	37
751 - 1000	Self Term.	21	23	25	29	34

GENERAL	5 - 47 (MHZ)	48 - 450 (MHZ)	451 - 750 (MHZ)	751 - 1000 (MHZ)
Input Return Loss (dB)	18	20	20	18
Output Return Loss (dB)	18	20	20	18
Tap Return Loss (dB)	20	20	20	20

NOTE: All specifications typical unless otherwise noted

# DCG-\*SB SERIES DIRECTIONAL COUPLERS

■ MODELS DCG-\*SB : DCWG-\*SB : DCG2-\*SB : DCG4-\*SB



MODEL DCG-\*SB



MODEL DCWG-\*SB



MODEL DCG2-\*SB



MODEL DCG4-\*SB

## ■ FEATURES

- 1 GHz Bandwidth
- 130 dB RFI Shielding (Solderback)
- PCB Design
- High Downstream Isolation (Tap-Out)
- High Return Loss
- Precision Machined Threads

## ▼ CUSTOMER NOTES:

### DCG-\*SB SERIES HIGH PERFORMANCE DIRECTIONAL COUPLERS

The **DCG-SB Series** of high quality directional couplers have been developed to support the latest advancements in distribution requirements. High return loss and low insertion loss make the **DCG-SB Series** ideal for any application. Advanced PCB design assures consistent performance.

# DCG-\* SB SPECIFICATIONS

## 1 PORT MODELS (DCG-\* SB)

* TAP VALUE	6	9	12	16	20	24	27	30
<b>Insertion Loss (dB) (In - Out)</b>								
5 - 47	2	1.5	1	.8	.8	.7	.7	.7
48 - 450	2	1.5	1	.8	.8	.6	.6	.6
451 - 750	2.3	1.6	1.3	1	1	.8	.8	.8
751 - 1000	2.5	2	1.5	1.2	1.2	1	1	1
<b>Isolation (dB) (Out - Tap)</b>								
5 - 47	25	30	30	35	40	40	40	41
48 - 450	25	25	28	30	35	40	40	40
451 - 750	22	24	25	28	30	35	35	40
751 - 1000	22	22	22	23	25	30	35	36

## 2 PORT MODELS (DCG2-\* SB)

* TAP VALUE	9	12	16	20	24	27	30
<b>Insertion Loss (dB) (In - Out)</b>							
5 - 47	3.5	1.9	1.5	.7	.7	.7	.7
48 - 450	3.4	1.5	1.3	.6	.6	.6	.6
451 - 750	3.6	2	1.5	.8	.8	.8	.8
751 - 1000	4	2.2	1.7	1	1	1	1
<b>Isolation (dB) (Out - Tap)</b>							
5 - 47	25	35	35	40	45	45	45
48 - 450	25	25	30	35	40	40	40
451 - 750	22	24	28	30	35	35	35
751 - 1000	22	22	23	27	30	30	30

## 4 PORT MODELS (DCG4-\* SB)

* TAP VALUE	8	12	16	20	24	30
<b>Insertion Loss (dB) (In - Out)</b>						
5 - 47	Self Term.	3.7	1.4	.9	.9	.9
48 - 450	Self Term.	3.9	1.3	.8	.8	.8
451 - 750	Self Term.	4	1.7	.9	.9	.9
751 - 1000	Self Term.	4.1	1.9	1.1	1.1	1.1
<b>Isolation (dB) (Out - Tap)</b>						
5 - 47	Self Term.	27	30	32	40	45
48 - 450	Self Term.	27	28	30	35	40
451 - 750	Self Term.	22	26	28	30	37
751 - 1000	Self Term.	21	23	25	29	34

GENERAL	5 - 47 MHZ	48 - 450 MHZ	451 - 750 MHZ	751 - 1000 MHZ
Input Return Loss (dB)	18	20	20	18
Output Return Loss (dB)	18	20	20	18
Tap Return Loss (dB)	20	20	20	20

NOTE: All specifications typical unless otherwise noted

# HIGH PERFORMANCE SATELLITE PASSIVES

■ HR S SERIES : HRV S SERIES : HR T\*\* SERIES : HRV T1\*\* SERIES : HR TW\* SERIES

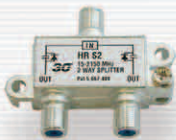

HR S2

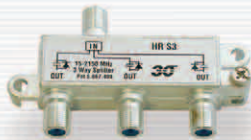

HR S3

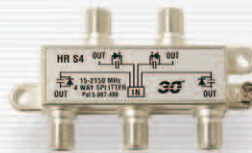

HR S4



HR S8



HRV S2

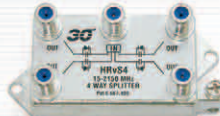

HRV S4

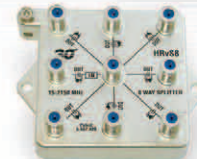

HRV S8



HR T1\*\*



HRV T1\*\*



HR TW\*

## ■ FEATURES

- Wideband Operation (15 MHz to 2150 MHz)
- High Return Loss (15 dB @ 2 GHz Typical)
- Frequency-Flat Response  
(±0.1 dB in any 24 MHz)
- Flat "F" Ports with 1" Spacing
- Solder Back Case (130 dB RFI Shielding)

## ▼ CUSTOMER NOTES:

### "3 SIGMA PERFORMANCE"

Hollands high performance passives are designed for distribution of digital satellite signals in applications where signal integrity is critical. The **HRS** and **HR VS Series** splitters utilize diode protected circuitry to prevent DC back-feeding.

# HIGH PERFORMANCE SATELLITE PASSIVES

## SPECIFICATIONS - HR S\* SPLITTERS

PARAMETER	INSERTION LOSS (DB) (15 - 950 MHz)	INSERTION LOSS (DB) (950 - 2150 MHz)	RETURN LOSS (DB) (15 - 950 MHz)	RETURN LOSS (DB) (950 - 2150 MHz)
HR S2	4.2	5.4	18	16
HR S2P	4.2	5.4	18	16
HRV S2	4.2	5.4	17	15
HR S3 (unbalanced)	4.6 / 8.4	10.8	17	15
HRV S3 (unbalanced)	4.6 / 8.4	10.8	17	15
HR S4	7.8	9.5	17	15
HRV S4	8.4	10.2	17	15
HRV S6 (unbalanced)	7.8 / 11.5	12.5	17	15
HR S8	13.2	17	17	15
HRV S8	13.2	17	17	15

### GENERAL

Port Spacing	1"
Voltage (Max.)	35 V
Current Rating (Max.)	1A

## SPECIFICATIONS - HR T\* DIRECTIONAL COUPLERS

PARAMETER	INSERTION LOSS (15 - 950 MHz)	INSERTION LOSS (950 - 2150 MHz)	RETURN LOSS (15 - 950 MHz)	RETURN LOSS (950 - 2150 MHz)
HR T106	2.5 dB	3.3 dB	16 dB	17 dB
HR TW6	2.5 dB	3.3 dB	22 dB	22 dB
HRV T106	2.5 dB	3 dB	16 dB	17 dB
HR T108	1.9 dB	2.7 dB	17 dB	18 dB
HR TW9	1.9 dB	2.1 dB	18 dB	19 dB
HRV T109	1.8 dB	2 dB	18 dB	19 dB
HR T112	1.6 dB	1.9 dB	16 dB	17 dB
HR TW12	1.6 dB	1.9 dB	19 dB	20 dB
HRV T112	1.6 dB	1.9 dB	19 dB	20 dB
HR T116	1.5 dB	1.9 dB	17 dB	18 dB
HR TW16	1.5 dB	1.9 dB	18 dB	20 dB
HRV T116	1.5 dB	1.7 dB	18 dB	20 dB

### POWER PASSING SPECIFICATIONS

Voltage (Max.)	35V
Current Rating (Max.)	1A
DC Passing	DC Passing In/Out, DC Blocking Tap/In

NOTE: All specifications typical unless otherwise noted

# SPECIALTY SPLITTERS

■ MODELS GHS-2P : GHS-3P : GHS-4P



MODEL GHS-2P



MODEL GHS-3P



MODEL GHS-4P

## ■ FEATURES

- 1 GHz Operation
- Low Intermodulation Distortion
- High Voltage / Current Capability

## ▼ CUSTOMER NOTES:

### SPECIALTY DC/AC POWER PASSING TO ONE PORT SPLITTERS

The **GHS-\*P Series** power passing to one port splitters have been specifically designed to meet the highest electrical specifications. Careful isolation of the RF and DC path is required to prevent saturation or burn-out of the high permeability ferrite core. This has been accomplished using a separate DC bypass core material which can withstand higher impulse spikes before saturating.

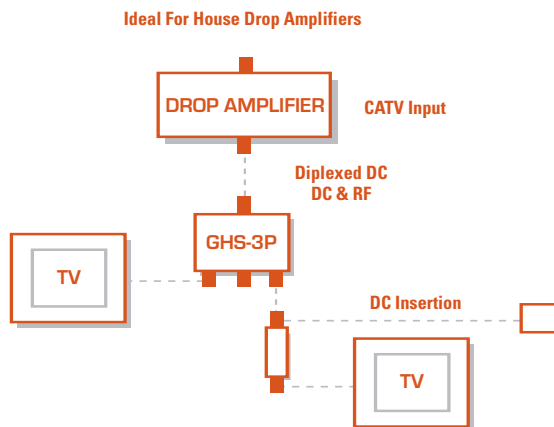

# SPECIALTY SPLITTERS

## ■ SPECIFICATIONS

PARAMETER	FREQUENCY RANGE (MHz)	GHS-2P		GHS-3P		GHS-4P	
		TYP.	QC.	TYP.	QC.	TYP.	QC.
Insertion Loss (dB)	5 - 47	3.7	3.8	3.8 / 7	3.9 / 7.1	7.1	7.2
	48 - 450	3.7	3.8	3.8 / 7	3.9 / 7.1	6.9	7
	451 - 750	3.9	4	3.8 / 7.1	3.9 / 7.1	7.1	7.2
	751 - 1000	4	4.1	4 / 7.6	4.1 / 7.7	7.6	7.7
Isolation (dB)	5 - 47	21	20	22	20	22	20
	48 - 450	23	22	26	24	26	24
	451 - 750	23	22	25	22	25	23
	751 - 1000	21	20	22	20	22	20
Input Return Loss (dB)	5 - 47	22	20	22	20	20	21
	48 - 450	24	22	25	23	26	23
	451 - 750	24	22	24	22	24	22
	751 - 1000	21	20	22	20	22	20
Output Return Loss (dB)	5 - 47	22	21	23	21	23	21
	48 - 450	28	25	28	25	28	26
	451 - 750	25	23	25	23	25	23
	751 - 1000	21	20	23	21	23	21

POWER PASSING SPECIFICATIONS	GHS-*P
Voltage (Max.)	30V
Current Rating (Max.)	750mA

## POWER INSERTERS



**MODEL HCDA-PI**  
F TYPE PI, 1 GHz



**MODEL HRF PI**  
F TYPE PI, 2300 MHz,  
SINGLE LEG DC



**MODEL HRF PIB**  
F TYPE PI, 2300 MHz,  
BOTH LEGS DC



**MODEL HR PI**  
F TYPE PI, 2150 MHz,  
SINGLE LEG DC

The **HR PI** is designed to power satellite applications.

## SPECIAL CASE 2-WAY SPLITTERS



**MODEL GHS-2TL**  
SIDE PORT INPUT, MINI CASE



**MODEL MS-2D**  
WALL PLATE MOUNT



**MODEL GDS-2V**  
T-TYPE

NOTE: All specifications typical unless otherwise noted



# GHT SERIES HARD-LINE MULTI TAPS

■ MODEL GHT2-\* : GHT4-\* : GHT8-\*

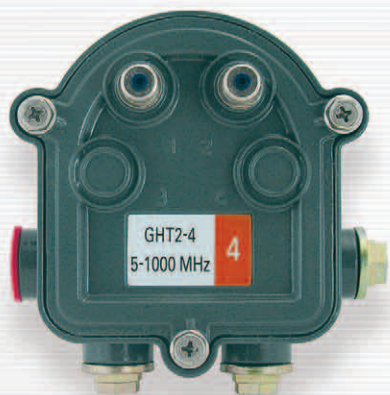

MODEL GHT2-\*



MODEL GHT4-\*



MODEL GHT8-\*

## ■ FEATURES

- Interchangeable Covers & Circuitry (2&4 Port)
- Corrosion Resistant 360 Aluminum Case
- Neoprene Weather Sealed Cover
- Plastic Component Covers for Additional Protection of Circuitry During Handling
- Weather Resistant Baked-On Epoxy Finish
- Captive Stainless Steel Hardware
- Maximum RFI Integrity
- Brass, Neoprene Sealed F-Ports

## ▼ CUSTOMER NOTES:

### HARD LINE MULTI TAPS

**Hollands** hard-line multi taps provide excellent bi-directional compatibility, low insertion loss, and high port-to-port isolation. Designed for compatibility with 30, 60, and 90 VAC systems, with current capacity up to 15A. The 15 psi weatherproof seal, epoxy finish, and neoprene sealed covers provide outstanding environmental protection. Available in a variety of configurations to suit your application needs.

NOTE: Power Passing Models Available (P Series)

# GHT SERIES HARD-LINE MULTI TAPS

## SPECIFICATIONS

FREQUENCY (MHz)	INSERTION LOSS (dB) (Max.)				OUT-TAP ISOLATION (dB) (Min.)			
	5 - 47	48 - 450	451 - 750	751 - 1000	5 - 47	48 - 450	451 - 750	751 - 1000
<b>2-PORT TAPS (GHT2-*)</b>								
GHT2-8	4	4.4	5	5.6	18	22	20	18
GHT2-11	2.3	2.3	2.8	4	18	25	23	18
GHT2-14	1.4	1.4	1.9	2.7	20	23	20	18
GHT2-17	1.5	1.6	1.9	2.4	27	30	30	25
GHT2-20	1.1	1.1	1.5	1.8	30	30	27	23
GHT2-23	1	1	1.5	1.8	30	33	28	27
GHT2-26	1	1	1.5	1.8	34	34	26	25
GHT2-29	1	1	1.5	1.8	36	42	30	27
GHT2-32	1	1	1.5	1.8	38	42	32	31
<b>4-PORT TAPS (GHT4-*)</b>								
GHT4-8 (Self Terminating)	-	-	-	-	-	-	-	-
GHT4-11	4	4.4	5.1	5.6	18	24	22	18
GHT4-14	2	2	2.9	4	20	25	20	20
GHT4-17	1.5	1.4	2.5	3.1	22	20	19	18
GHT4-20	1.3	1.2	2	2.2	27	33	31	28
GHT4-23	1	1	1.6	2	30	36	32	25
GHT4-26	.9	.9	1.6	2	34	34	30	25
GHT4-29	.9	.9	1.6	2	36	40	30	27
GHT4-32	.9	.9	1.6	2	38	40	30	27
<b>8-PORT TAPS (GHT8-*)</b>								
GHT8-11 (Self Terminating)	-	-	-	-	-	-	-	-
GHT8-14	4	4.4	5.1	5.6	20	22	20	18
GHT8-17	2.2	2.4	3.1	3.5	20	20	19	18
GHT8-20	1.7	1.9	2.2	3.1	25	20	19	18
GHT8-23	1.5	1.5	1.7	2.2	34	32	30	28
GHT8-26	1.2	1.3	1.6	1.8	34	32	30	27
GHT8-29	1	1.3	1.6	1.8	37	32	28	26
GHT8-32	1	1.2	1.8	1.8	39	34	33	27

GENERAL	5 - 47 MHz	48 - 450 MHz	451 - 750 MHz	751 - 1000 MHz
Input Return Loss (dB)	15	15	15	15
Output Return Loss (dB)	15	15	15	15
Tap Return Loss (dB)	12	16	16	15

NOTE: Power Passing Models Available (P Series)

NOTE: All specifications typical unless otherwise noted

# GH SERIES HARD-LINE PASSIVES

■ MODELS GHDC-\* : GHLS-\* : GHP-1



MODEL GHDC-\*



MODEL GHLS-2



MODEL GHLS-3



MODEL GHP-1

## ■ FEATURES

- 1 GHz Performance
- Fused Outputs for Power Direction
- Epoxy Coated Aluminum Housing
- Neoprene Weather Sealing
- Tongue & Groove Faceplate
- Stainless Steel Mounting Hardware
- Directional Coupler Available in 8,12 and 16 dB
- Captive Hardware

## ▼ CUSTOMER NOTES:

### HARD-LINE PASSIVES

The **Holland** hard-line passives are high performance products manufactured for over eighteen years to the highest quality standards. Power compatibility with 30, 60, and 90 VAC systems with a current capacity up to 15A make them ideal for most CATV applications. Our hard-line passives feature high return loss and low insertion loss providing excellent bi-directional compatibility. Neoprene sealing, epoxy coating, and pressure sealed F-ports provide excellent durability in any environment.

# GH SERIES HARD-LINE PASSIVES

## SPECIFICATIONS

PARAMETER	FREQUENCY RANGE (MHz)	GHDC-8	GHDC-12	GHDC-16	GHLS-2	GHLS-3B	GHLS-3	GHP-1
Tap Loss (dB)	5 - 40	8 ± 1.5	11 ± 1.5	15 ± 1.5	-	-	-	-
	41 - 750	8 ± 1.5	12 ± 1.5	16 ± 1.5	-	-	-	-
	751 - 1000	8 ± 1.5	12 ± 1.5	16 ± 1.5	-	-	-	-
Insertion Loss (dB) (In/Out)	5 - 15	2.1	1.2	1	4	6.5	4.4 / 7.4	.8
	16 - 40	2.1	1.2	1	4.4	6.3	4.3 / 7.4	.8
	41 - 250	2.1	1.2	1.2	4.6	6.3	4.3 / 7.5	.8
	251 - 550	2.1	1.4	1.2	5	6.5	4.3 / 7.5	.8
	551 - 750	2.1	1.4	1.2	5.2	6.8	4.3 / 7.8	.8
	751 - 1000	3	2	1.6	5.5	7.8	5.2 / 8.8	1.2
Isolation (dB) (Out/Tap)	5 - 15	18	20	20	-	-	-	-
	16 - 40	25	28	28	-	-	-	-
	41 - 250	25	28	28	-	-	-	-
	251 - 450	25	28	28	-	-	-	-
	451 - 550	25	28	28	-	-	-	-
	551 - 750	22	22	22	-	-	-	-
	751 - 860	20	20	20	-	-	-	-
	861 - 1000	20	20	20	-	-	-	-
Isolation (dB) (Out/Out)	5 - 15	-	-	-	18	20	20	65
	16 - 40	-	-	-	28	24	28	70
	41 - 250	-	-	-	28	24	28	70
	251 - 550	-	-	-	28	24	28	65
	551 - 750	-	-	-	25	24	25	65
	751 - 1000	-	-	-	22	22	22	60
Return Loss (dB) (All Ports)	5 - 15	16	16	16	16	16	16	16
	16 - 40	17	17	17	17	17	17	17
	41 - 250	17	17	17	17	17	17	17
	251 - 550	17	17	17	17	17	17	17
	551 - 750	17	17	17	17	17	17	17
751 - 1000	16	16	16	16	16	16	16	

## GENERAL

Impedance (Ohm)	75
Connector (In/Out/Tap)	5/8" - 24 UNEF Female
Waterproof Condition	15 PSI
Power Passing	15A 30/60/90 VAC
Dimensions	120mm L x 100mm W x 70mm H

NOTE: All specifications typical unless otherwise noted

# DIPLEXERS

■ MODELS STVC : DPD2 : HR D2 : HR D3 : DP54



MODEL STVC

## SATELLITE/TV DIPLEXER

The **STVC** allows the combining or separating of off-air and CATV signals with satellite signals to a common cable.

\* Please see page 51 for additional details.



MODEL DPD2

## SATELLITE/TV DIPLEXER

Allows the combining (or separating if used in the reverse ) of Off-Air / CATV signals with satellite signals to a common cable. Separates TV and satellite signals prior to satellite receiver input and filters harmonics in the off-air spectrum from satellite conversion devices. The **DPD2** diplexer is specifically designed for Dish Network's™ DP44 installations, requiring continuous 2 amp power passing.

\* Please see page 51 for additional details.

## "3 SIGMA" HIGH PERFORMANCE DIPLEXERS

Hollands "3 Sigma" diplexers are specifically designed to work in MDU applications where high return loss and high isolation are critical for proper system function. The **HR D2** is intended for subscriber satellite drops. The **HR D3's** additional isolation make it an ideal choice as a trunk-grade diplexer. Solderback sealed.



MODEL HR D2



MODEL HR D3

- Wideband Operation (15 MHz - 2150 MHz)
- Higher Return Loss (15 dB @ 2 GHz Typical)
- Ultra-Flat Response ( $\pm 0.1$  in any 24 MHz)
- Flat "F" Ports



MODEL DP 54

## SATELLITE/TV DIPLEXER

The **DP 54** diplexer combines terrestrial signals, or basic cable and data modem signals, to each of the four **DP34** outputs. Allows data modem subscribers to connect their computer using the same coax providing DBS service.

MODELS HFS-\* : HFS-\*P : HFS-\*D : HR S\* : HR T\* : HRV T\* : HR TW\* ■

**HFS SERIES HIGH FREQUENCY BROADBAND SPLITTERS**

The **HFS Series** broadband splitters are an advanced design providing the lowest insertion loss from 5-2150 MHz while maintaining high isolation. The **HFS-2/HFS-4** are power passing to one port, and the **HFS-2P/HFS-4P** pass power to all ports.



MODEL HFS-2

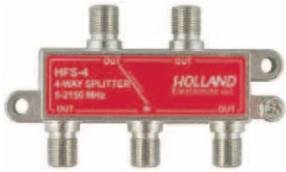

MODEL HFS-4



MODEL HFS-2P



MODEL HFS-4P

\* Please see page 93 for additional details.

**HFS-\*D SERIES: HIGH FREQUENCY BROADBAND SPLITTERS**

Hollands **HFS-\*D** series high frequency splitters have been designed for residential and commercial applications. The diode protected circuitry allows the DC power to pass from any output port to the input port and prevents DC back-feeding.



MODEL HFS-2D



MODEL HFS-3D

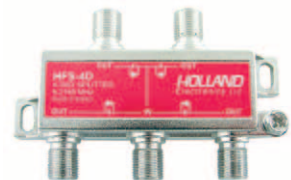

MODEL HFS-4D

\* Please see page 93 for additional details.

**HR S SERIES**

Our **HR S\* Series** diode steered splitters offer 130 RFI shielding. Features include solder back housing and our patented round-pin design for improved connectivity.



MODEL HR S2



MODEL HR S3

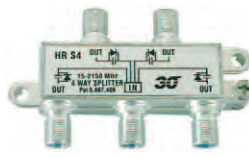

MODEL HR S4



MODEL HR S8

\* Please see page 99 for additional details.

**HIGH PERFORMANCE TAPS**

Holland's "3 Sigma" taps are designed for MDU applications where high return loss and high isolation are required.



MODEL HR T\*



MODEL HRV T\*



MODEL HR TW\*

\* Please see page 99 for additional details.

# SATELLITE MULTISWITCHES

■ MODELS HMS-4A : HMS-8A : SAM-3402 : HMS-54\* : HMS-58\*

Holland Electronic's multiswitches are designed for the independent operation of four to eight satellite receivers. In addition they provide terrestrial VHF/UHF signal diplexing when required. Compact size of the **SAM-3402** allows placement where larger switches won't fit.

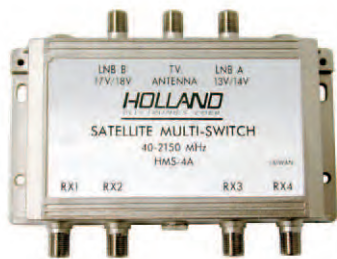

MODEL HMS-4A

- High Isolation
- Non-Amplified Terrestrial Input
- Receiver Line Powered



MODEL SAM-3402

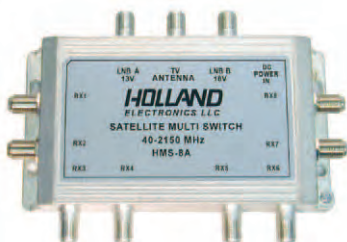

MODEL HMS-8A

- Amplified Terrestrial and Satellite Inputs

\* Please see reverse side for specifications.

## MULTI SATELLITE MULTISWITCHES (HDTV)

The professional series multi satellite multiswitches have been specifically designed for both high-end home installations and MDU's requiring high performance and reliability. These switches are ideal for use in multi satellite dish installs. CATV/Off-Air input ports are standard on all **HMS** series multiswitches. The **HMS-58C** provides 22 kHz tone switching allowing switches to be cascaded.



MODEL HMS-54B



MODEL HMS-58B, C

\* The **HMS-58C** model includes transformer to power switch and LNB.

**NOTE:** Please See Page 73 for our rackmounted multiswitches (MODELS HMS-16APR & HMS-412ARK)

# SATELLITE MULTISWITCHES

## SPECIFICATIONS

MODEL	INPUTS		OUTPUTS	GAIN/LOSS		22 kHz TONE	POWER
	SATELLITE	TERRESTRIAL		SATELLITE	TERRESTRIAL		
HMS-4A	2	1	4	-2	-10	NO	SAT. LINE ONLY
HMS-8A	2	1	8	-4	-3	NO	SAT. LINE OR PS**
SAM-3402	2	1	4	-	-	NO	SAT. LINE ONLY
HMS-54B	4	1	4	0	-3	PASSES	SAT. LINE ONLY
HMS-58B	4	1	8	0	-3	PASSES	SAT. LINE ONLY
HMS-58C	4	1	8	0	-3	YES	PS INCLUDED

\*\* The HMS-8A may use optional HMS-PS.

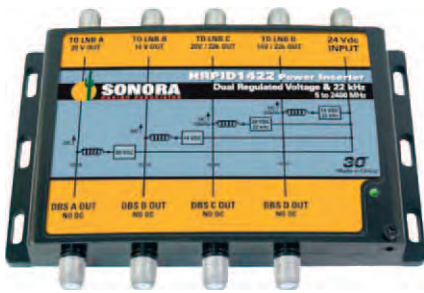

MODEL HR PID1422

### POLARITY LOCKER

Designed to power a DirecTV™ AT9 dish. Locks the four LNB outputs for splitting to multiswitches. Also increases DC line voltage for longer cable runs. Ideal for use on MDU trunk lines.

POLARITY LOCKER	TYP.	MIN.
Insertion Loss	.5 dB	1 dB
Return Loss	12 dB	10 dB
Input Transformer	24 VDC, 1 A	
Inputs / Outputs	950 - 2400 MHz	

### TYPICAL APPLICATION

#### COLOR CODE

- Ka ●Ka** 13v.....101° ODD RHCP, 99° Ka Lo, 99° Ka Hi
- Ka ●Ka** 18v.....101° Even LHCP, 99° Ka Lo, 99° Ka Hi
- Ka ●Ka ●** 13v 22kHz..119° Odd RHCP, 103° Ka Lo, 103° Ka Hi
- Ka ●●Ka** 18v 22kHz..110°/119° Odd LHCP, 103° Ka Lo, 103° Ka Hi

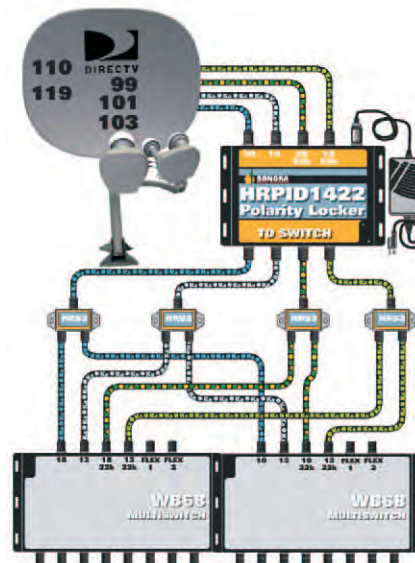

To DirecTV™ Receivers

NOTE: All specifications typical unless otherwise noted



# SATELLITE STACKERS & DESTACKERS

■ MODELS US575-T : D575 : D575D : DMUX35

## SATELLITE STACKER

The **US575-T** is a frequency up-converter that places both transponder polarities onto a single coax output. This reduces the number of coax cables required from the dish to the distribution point.



MODEL US575-T

	US575-T
RF Input Frequency	(2) 950 - 1450 MHz
RF Output	950 - 2150 MHz
DBS Input Window	-32 to -42 dBm
Insertion Loss	6 dB (odd, 950 - 1450 MHz) 3 dB (even, 1550 - 2050 MHz)
High Return Loss	12 dB input, 12 dB output
LNB Power	18VDC @ 300 mA

## SATELLITE DESTACKERS

Destackers are frequency down converters that take stacked DBS signals and separates them to 13/18 V switch format when needed. Contact us for help in selecting an appropriate model for your application.

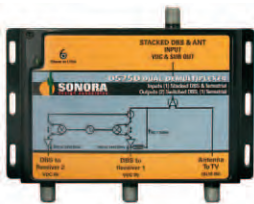

MODEL D575



MODEL D575D

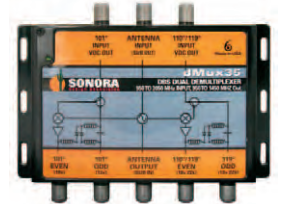

MODEL DMUX35

\* Power passing model available.

NOTE: All specifications typical unless otherwise noted

INSERTION LOSS (dB)	D575		D575D		DMUX35	
	TYP.	MIN.	TYP.	MIN.	TYP.	MIN.
5 - 550 MHz	-1	-2	-1	-2	-	-
5 - 806 MHz	-	-	-	-	.5	1.5
806 MHz	-6	-9	-6	-9	-	-
950 - 1450 MHz	2	±2	2	±2	6	±1
1525 - 2025 MHz	8	±2	8	±2	5	±2
<b>INPUT RETURN LOSS (dB)</b>						
5 - 550 MHz	13	12	13	12	-	-
5 - 750 MHz	-	-	-	-	15	12
750 - 806 MHz	8	6	8	6	-	-
950 - 2025 MHz	12	10	12	10	12	10
<b>OUTPUT RETURN LOSS (dB)</b>						
5 - 750 MHz	-	-	-	-	12	10
5 - 806 MHz	13	11	13	11	-	-
950 - 1450 MHz	10	9	10	9	12	10
<b>GENERAL</b>						
Operating Voltage	11 to 18VDC		11 to 18VDC		11 to 18VDC	
DBS Input Window	-35 to -58 dBm		-35 to -58 dBm		-37 to -57 dBm	

# SATELLITE DISTRIBUTION SYSTEMS

## SATELLITE DISTRIBUTION SYSTEMS

**Holland Electronics** offers a variety of satellite distribution systems specifically designed for MDU and large home applications. With multiple input/output configurations, auto gain control amplifiers, HDTV capabilities, and integrated sub-band returns for data applications, **Holland Electronics** has a system to meet your specific needs. All distribution hubs and routers are 100% bench tested ensuring worry-free plug and play installation.

- DirecTV™ and Dish Network™ Compatible
- HDTV Ready
- Supports kA Bands
- High Output Capabilities for Long Cable Runs



\* Please Contact a **Holland** sales representative for help in selecting a system for your specific needs.

### DISH NETWORK™ EXAMPLE

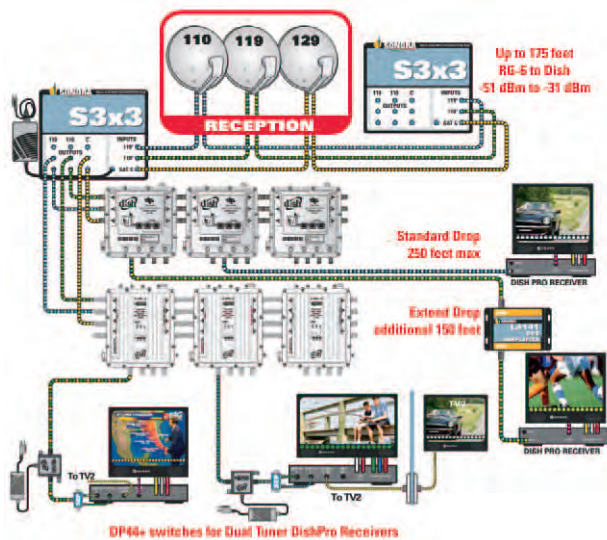

### DIRECTV™ EXAMPLE

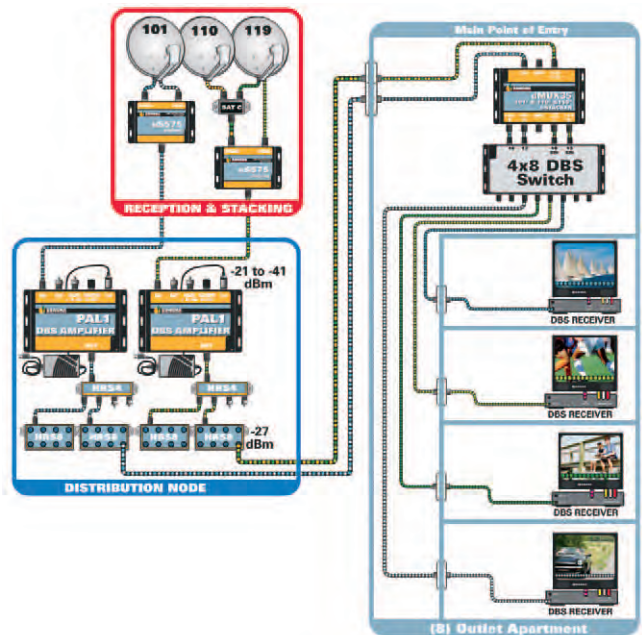

# TELEPHONE/DATA ACCESSORIES

■ MODELS TFW-\* : DAM-\* : DAF-\* : TMS-\* : TMP-\* : TMC-\* : TSM-4

## STATION WIRE

The **Holland** telephone station wire is a durable high grade round (twisted pair), or flat silver satin communications wire.



MODEL	GAUGE	CONDUCTORS	WIRE TYPE
TFW-428	28	4	FLAT
TFW-424	24	4	ROUND
TFW-624	24	6	ROUND

## DUPLIX ADAPTERS



**MODEL DAM-\***  
1 Male - 2 Female

MODEL	CONDUCTORS
DAM-4	4
DAM-8	8



**MODEL DAF-\***  
All Female

MODEL	CONDUCTORS
DAF-4	4
DAF-8	8

## MODULAR COUPLERS/MODULAR PLUGS



**MODEL TMS-\***

MODEL	CONDUCTORS
TMS-4	4
TMS-8	8



**MODEL TMP-\***

MODEL	CONDUCTORS	CABLE
TMP-4	4	FLAT
TMP-8	8	ROUND

## SURFACE JACK

Made of ABS plastic with 6 micron gold-plated contacts. Available in ivory.



**MODEL TSM-4**

## MODULAR CORD SETS

Flat silver satin wire #26 AWG.



**MODEL TMC-\***

MODEL	CONDUCTORS	LENGTH
TMC-47	4	7'
TMC-415	4	15'
TMC-425	4	25'
TMC-450	4	50'

# TEST EQUIPMENT

MODELS SF-95-22 : TSTL-1 : TSTL-3A : TSTL-3AKIT : PFT : PFT-A : PFTK ■

## SATELLITE FINDER

Holland's satellite finder installs in-line between the receiver and dish for precise satellite alignment. Features audio tone and a 50 dB input range.



MODEL SF-95-22

## STANDARD CABLE RINGER

The **TSTL-1** cable ringer has been designed to "tone" cables allowing quick identification. The **TSTL-1** detects DC continuity with an audible tone or indicates DC shorts by lighting the LED. Uses 12V replaceable battery.



MODEL TSTL-1

## PREMIUM CABLE RINGER

The **TSTL-3A** is modeled after our popular **TSTL-1**. The **TSTL-3A** incorporates a standard "AAA" battery in addition to a newly designed head unit for more rugged use. The **TSTL-3A** is the must have tool for quick and easy cable identification.



MODEL TSTL-3A

## CABLE RINGER TEST KIT

The **TSTL-3AKIT** comes complete with all the test adapters an installer needs to verify different connector/cable configurations. Can be used with **TSTL-1** or **TSTL-3A** to identify continuity or shorts in cables. Kit includes TSTL-3A and adapters for F, BNC, RCA and SMB.



MODEL TSTL-3AKIT

## MDU CABLE ID SYSTEM

The **PFT System** allows the MDU installer to identify up to 20 locations or cables by installing coded push-on terminators in an apartment or routing box location and then electronically identify the correct cable at the other end using a Volt/Ohm (VOM) meter. The **PFT-A** adapter plugs into your VOM, and when set on 50k or greater the correct terminator code is displayed as the first 2 digits on your meter.



MODEL PFT-A



MODEL PFT



MODEL PFTK

# DARK METER SYSTEM

■ MODELS DST-5000 : DSTR-5000



MODEL DST-5000



MODEL DSTR-5000



## ■ FEATURES

- Generates Five Carriers: 20, 55, 950, 1450, and 2150 MHz.
- Verifies Cable Attenuation
- Cable ID Function (Using PFT Terminators)
- TDR to Detect Cable Length and Distance to Shorts
- Stores Up to 50 Locations
- Data Downloadable Via RS-232
- Rechargeable Li-Ion Battery
- Durable Neoprene Case

## ▼ CUSTOMER NOTES:

### HAND HELD TEST METER/ RECEIVER

The **Holland Dark Meter** and companion transmitter make it possible to sweep RF distribution systems before CATV / satellite signals are present. This pre-signal testing verifies if connections are correct, if all passives and cables are passing signals, and if not, where an open or short circuit exists. The measured signal attenuation levels for up to 50 separate stations can be stored in memory. A built-in RS-232 port allows the user to download this data from the meter to a remote device at the push of a single button. The **Holland Dark Meter** is also capable of measuring cable length using the TDR function. The cable ID function can be used to identify up to 20 locations by using **PFT** terminators.

# DARK METER SYSTEM

## SPECIFICATIONS

RECEIVER : MODEL DST-5000	
Frequencies (MHz)	20, 55, 950, 1450, 2150
Input Range	- 16 dBmV to +23 dBmV
Memory Stations	50
TDR	
TDR Range	300' (Max.) / 15' (Min.)
CABLE ID	
Reads 20 locating terminators and cable shorts.	
PFT terminator kit...20 push-on terminators included	
DISPLAY	
Display Type	64 x 128, B/W Dot Matrix
Display Range	40 dB Total in 2 dB Steps
GENERAL	
Dimensions	104 x 47 x 234 mm
Weight	500 g
Battery	Li-ION (Rechargeable)
Operating Time Between Charges	8 hours
Battery Charge Indicator	Low, Charged

TRANSMITTER : MODEL DSTR-5000	
Frequencies (MHz)	20, 55, 950, 1450, 2150
Output Level	23 dBmV (Adj.)
Operating Time Between Charges	10 Hours
DC Power Supply	Included
Battery Charge Indicator LED	Low = Red / Charging = Amber / Charged = Green
Cable Types (50 & 75 Ohms)	RG6, RG59, RG11, RG58, Custom Cables
GENERAL	
Dimensions	87 x 40 x 130 mm
Weight	335 g
Battery	Li-ION (re-chargeable)
Charging Time	5 hours

\* Includes chargers, neoprene case, and 20 cable ID terminators.

NOTE: All specifications typical unless otherwise noted

# SIGNAL LEVEL METERS

■ MODEL ST-5128S : ST-4000D

## HAND HELD SIGNAL LEVEL METER

The **ST-5128S** is a full-featured hand-held signal measurement device. The **ST-5128S** performs signal level, channel flatness, video/audio ratio and full spectrum scans, making it the perfect tool for any installer.



MODEL **ST-5128S**

- Signal Level Measurements (Aural and Visual Carriers)
- Single Channel Spectrum (Views Channel Flatness, In-band and LSB Levels)
- All Channel Sweep / Frequency Spectrum (870 MHz)
- Full Bandwidth Operation (CATV: Ch. 2-135, Off-Air: 2-79)
- Wide Dynamic Range (-40 dBmV to 60 dBmV)
- Direct Channel or Frequency Entry  
(Programmed Channels or 10 kHz Frequency Selection)

## HAND HELD SIGNAL LEVEL METER

The **ST-4000D** is our new hand-held signal level meter that has been fine tuned to handle the basic needs of maintaining RF distribution systems. Its rugged design and protective carrying case make it a perfect choice for everyday use.



MODEL **ST-4000D**

- Full Bandwidth Operation (CATV: Ch. 2-136, Off-Air: 2-69)
- Analog, Digital ATSC, 8VSB Measurement
- Wide Dynamic Range (-28 to 55 dBmV)
- Signal Level Measurements (Aural and Visual Carriers)
- Direct Channel or Frequency Entry
- Group Channel Selection  
(For quick system tests just push a button and read only the favorite channels)
- Leather Case

# SIGNAL LEVEL METERS

## SPECIFICATIONS

MODEL ST-5128S	
Input Frequency	46-870 MHz
Accuracy	±1.5 dB
Minimum Tuning Increment	10 kHz
I.F. Bandwidth	300 kHz
Input Range	-40 to 60 dBmV
SPECTRUM ANALYZER MODE	
Resolution	100 kHz
Dynamic Range	40 dB
GENERAL	
Dimensions	4.3" x 10" x 2.6"
Weight	2 lbs.
Battery	Ni-MH (Rechargeable)
Operating Time Between Charges	8 hours
Charger	Included
Case	Included

MODEL ST-4000D	
Input Frequency	46 - 870 MHz
Accuracy	±2.5 dB
Minimum Tuning Increment	10 kHz
I.F. Bandwidth	280 kHz
Input Range	-28 to 55 dBmV
GENERAL	
Dimensions	8.4" x 3.7" x 1.8"
Weight	3 lbs. (w/ Charger)
Battery	Ni-MH (Rechargeable)
Charging Time	5 hours
Charger	Included
Case	Included

NOTE: All specifications typical unless otherwise noted



# TOOLS

■ MODELS ACT-270 : ACT-483 : HX 596Q : HCT-116 : CT-21R : CT-FBR : CST-6 : CST-1855 : CPT-6590 : CPT-7538

## HEX CRIMP TOOLS

Holland Electronics offers a variety of hex crimp tools designed for use with different connector sizes and types.



**MODEL ACT-270**  
Mini Coax Connectors (Hex .270)



**MODEL ACT-483**  
Mini Coax Connectors (Hex .213 & .270)



**MODEL HX 596Q**  
RG-59, RG-6, and RG-6 Quad Connectors  
(Hex .324 & .360)



**MODEL HCT-116**  
RG-59, RG-6, and RG-11 Connectors  
(Hex .324 & .472)

## COMPRESSION TOOLS

For use with **Holland** compression connectors or similar (21mm closure). Each tool utilizes a ratchet mechanism that insures complete closure.

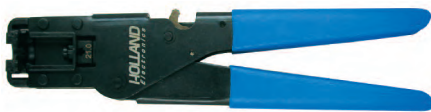

**MODEL CT-21R**  
(F Type Connectors)



**MODEL CT-FBR**  
(F, BNC & RCA Connectors)

## COAX CABLE STRIPPERS

Holland offers a variety of cable strippers which provide industry standard 1/4" x 1/4" strips.



**MODEL CST-6**  
**MODEL CST-1855**

**ADJUSTABLE**  
Works with RG-59, 6 and Mini-Coax. Features adjustable strip length and blade height.



**MODEL CPT-6590**

**FIXED BLADE**  
Works with RG-6 Coax. Replaceable blade cartridge.



**MODEL STMINI596**

**MULTI-CARTRIDGE**  
Works with RG-6, 59 and Mini-Coax utilizing replaceable cartridges for specific cable sizes.



**MODEL CPT-7538**

**FIXED BLADE**  
Works with Mini-Coax. Replaceable blade cartridge.

MODELS CFGT-1 : CIT-1 : GTT-4 : GTT-7 : ST-1 : PPLT-T : DRB 3/8M : DRB 3/8W

**CONNECTOR GUIDE & INSTALLATION TOOL**

This tool is a unique multi-function device. Provides a cable center/dielectric guide function which insures proper alignment of cable into the F connector. Excellent for use in cold weather when installers typically wear gloves. **CGT-FBR** model available for use with RCA and BNC connectors.



MODEL CFGT-1

**CONNECTOR INSTALLATION TOOL**

The **CIT-1** installs and removes F connectors in high density and hard to reach locations, and is the only tool that works with bent coax. Provides enough leverage to achieve a 30 in/lb tightening force by hand. Helps insure proper connections thereby reducing the potential of loose connector related service calls. Patent #6,817,272.



MODEL CIT-1

**LOCKING TERMINATOR TOOLS**



MODEL GTT-4

For use with GTP-59 style locking terminators. Works with **Holland GLT**. 4" length.



MODEL GTT-7

For use with GTP-59 style locking terminators. Works with **Holland GLT**. 7" length.



MODEL ST-1

For use with CATV security sleeves.



MODEL PPLT-T

For use with the **Holland PPLT Series** locking terminators.

**DRILL BITS**

**Holland** offers precision machined masonry and wood drill bits made of quality steel. All masonry bits are designed with high quality carbide tips, and all wood bits have precision machined flutes and tips for great performance.

**MASONRY**



DRB 3/8M (3/8" Diameter)

**WOOD**



DRB 3/8W (3/8" Diameter)

## INDEX

1855940 . . . . .	20	DRB 3/8M, 3/8W . . . . .	120	GHDC-*** . . . . .	105	HMS-54B, 58B, C . . . . .	109
1855940-STARTER . . . . .	29	DST-5000, DST-R-5000 . . . . .	115	GHLS-2, 3 . . . . .	105	HPF-* . . . . .	50
1855940STARTERC . . . . .	29	F-5681G . . . . .	27	GHP-1 . . . . .	105	HPF-54HR . . . . .	50
1855941 . . . . .	20	F-71 . . . . .	31	GHS-2, 3, 4, 8 . . . . .	89	HPH-860, 860AD . . . . .	63
1855942 . . . . .	20	F-81, F-811 . . . . .	33	GHS-2, 3, 4, 8 FC LI . . . . .	91	HPM55-* . . . . .	57
1855943 . . . . .	20	F-90, 90HR . . . . .	31	GHS-2P, 3P, 4P . . . . .	101	HR D2, D3 . . . . .	107
A-2, 3, 6, 10 . . . . .	86	F11-460, 460WOL . . . . .	28	GHS-2TL . . . . .	102	HR PI . . . . .	102
A-21-4 . . . . .	36	F11-480 . . . . .	28	GHT2-*, 4-*, 8-* . . . . .	103	HRF PI . . . . .	102
A-22-* . . . . .	86	F1855-FP . . . . .	29	GL-G2B2 . . . . .	35	HRF PIB . . . . .	102
A-24-6, 9, 12 . . . . .	36	F56-324 . . . . .	27	GLT, -LR . . . . .	32	HR PID1422 . . . . .	110
A-24-6G, 9G, 12G . . . . .	36	F56-324CC . . . . .	27	GLT -T . . . . .	32	HR S2, S3, S4, S8 . . . . .	99, 108
A-5/8 . . . . .	36	F56-324CCWP . . . . .	27	GRB-1, 2 . . . . .	35	HR T1** . . . . .	99, 108
AB-4, 75, 90 . . . . .	81	F56-324D . . . . .	27	GRB-2DHR . . . . .	35	HR TW* . . . . .	99, 108
ACT-270, 483 . . . . .	119	F56-324G . . . . .	27	GRB-2THR-UL . . . . .	35	HRV S2, 4, 8 . . . . .	99
AHC-16-860 . . . . .	71	F56-324GWP . . . . .	28	GRB-AR . . . . .	52	HRV T1** . . . . .	99, 108
ATD-FCU* . . . . .	47	F56-324K . . . . .	27	GRB-S, SL . . . . .	35	HSA-* . . . . .	67
BFA . . . . .	31	F56-324T . . . . .	27	GSV-2, 3, 4, 6, 8 . . . . .	89	HSM55-* . . . . .	57
BNC-C290 . . . . .	27	F56-324W . . . . .	28	GTT-4, 7 . . . . .	120	HSU-2, 3, 4, 8 . . . . .	87
BNC-C324 . . . . .	27	F56-324WL . . . . .	28	HA-201T . . . . .	3	HVS-1*, 3, 5, 6 . . . . .	20
BNC1855-FP . . . . .	29	F56-324WOL . . . . .	28	HA-30 . . . . .	3	HX 596Q . . . . .	119
BNCFPFBH . . . . .	29	F56-342G, T . . . . .	27	HAC-10RK . . . . .	78	INSTALLER PACK . . . . .	29
BP-1*, 2*, 4* . . . . .	83	F56-357G, T . . . . .	27	HCA-3051 . . . . .	9	J144-S . . . . .	21
BPF-* . . . . .	49	F56-UNIV . . . . .	27	HCA-3051RK . . . . .	69	J36-6BFF . . . . .	22
BRF . . . . .	50	F56-UNIV-WL . . . . .	28	HCA-3086RK . . . . .	9, 69	J36-BFF . . . . .	22
CBW-1LED . . . . .	82	F59-290CC . . . . .	27	HCA-3086RP . . . . .	9	J72-6BFF . . . . .	22
CBW-1P . . . . .	82	F59-290D . . . . .	27	HCA-36ERA . . . . .	11	J72-BFF . . . . .	22
CC-6*, 7*, 155* . . . . .	84	F59-290G . . . . .	27	HCDA-1, 2, 4, FRA, RA . . . . .	13	J72-RGB . . . . .	21
CCI-1 . . . . .	52	F59-290T . . . . .	27	HCDA-PI . . . . .	13, 102	J72-S . . . . .	21
CCOL-1 . . . . .	82	F59-290WOL . . . . .	28	HCG-12, 24 . . . . .	71	JRR-3, 6 . . . . .	21
CEF750-* . . . . .	49	F59-UNIV . . . . .	27	HCT-116 . . . . .	119	JRR-3D, 6D, 12D . . . . .	21
CFGT-1 . . . . .	120	F-59T, 59TH . . . . .	31	HDA-10 . . . . .	5	JRR-3T, 6T, 12T . . . . .	21
CISP . . . . .	52	F6-324 . . . . .	28	HDA-1000 . . . . .	7	LA-10, 520 . . . . .	15
CIT-1 . . . . .	120	F6-324WL . . . . .	28	HDA-15 . . . . .	5	LA-2150H . . . . .	15
CPT-6590, 7538 . . . . .	119	F7-413T . . . . .	28	HDA-25/25E . . . . .	5	LA Series . . . . .	17
CST-6, 1855 . . . . .	119	F9-290 . . . . .	27	HDA-30 . . . . .	5	LPF-* . . . . .	50
CT-* . . . . .	84	FAM-* , HR . . . . .	32	HDA-36 . . . . .	5	MBC . . . . .	36
CT-21R, FBR . . . . .	119	FAMP-* , HR . . . . .	32	HDM-1 . . . . .	65	Mini Head-End System . . . . .	53
CWPC-18 . . . . .	36	FF-R . . . . .	31	HDTV-ST2 . . . . .	65	MOR-71 . . . . .	77
D575, 575D . . . . .	111	FOD-1310TX . . . . .	45	HFS-2, 2P, 4, 4P . . . . .	93, 108	MS-2D . . . . .	102
DAF-* . . . . .	113	FOD-AC . . . . .	45	HFS-2D, 3D, 4D . . . . .	93, 108	NA Series . . . . .	17
DAM-* . . . . .	113	FOD-FRX . . . . .	46	HLSJ . . . . .	51	NE1000LN . . . . .	39
DCG-* . . . . .	95	FOD-PF . . . . .	45	HMA-550H, 860H . . . . .	59	NE1100L . . . . .	41
DCG-*SB . . . . .	97	FOD-RPR . . . . .	46	HMDS . . . . .	55	NE1101L . . . . .	41
DCG2-* . . . . .	95	FOD-RPT . . . . .	46	HMM-10H, 3 . . . . .	79	NE5000L . . . . .	40
DCG2-*SB . . . . .	97	FTB-56, FTB-59 . . . . .	84	HMMA . . . . .	55	NE6000L-* . . . . .	43
DCG4-* . . . . .	95	G-F811 . . . . .	33	HMMB . . . . .	54	NE7000 . . . . .	40
DCG4-*SB . . . . .	97	G-F81F, F* . . . . .	33	HMMS . . . . .	55	NE7100 . . . . .	42
DCWG-* . . . . .	95	G-F81FXL . . . . .	33	HMPS . . . . .	54	NF-* . . . . .	50
DCWG-*SB . . . . .	97	G-G2B2 . . . . .	35	HMR . . . . .	54	OCP-* . . . . .	47
DMUX35 . . . . .	111	G-PF-59 . . . . .	31	HMS-16APR . . . . .	73	OEM RF Connectors . . . . .	37
DP 54 . . . . .	107	GDS-2V . . . . .	102	HMS-412ARK . . . . .	73	ORS . . . . .	77
DPD2 . . . . .	51, 107	GF-1855-A . . . . .	29	HMS-4A, 8A . . . . .	109	PA Series . . . . .	17

PAL Series . . . . .	17	SLC59-HEC . . . . .	26	WP-81* . . . . .	83
PF-59 . . . . .	31	SLC59-RCA . . . . .	26	WP-81D* . . . . .	83
PFT, PFTA, PFTK . . . . .	114	SLC59-RCAG . . . . .	26	WP-81G* . . . . .	83
PPLT-T . . . . .	120	SLC6-BNC . . . . .	26	WP-81GD* . . . . .	83
PPLT-75, LR, T . . . . .	32	SLC6-BNCG . . . . .	26	WP-T81* . . . . .	83
Pre-Built Head-End . . . . .	78	SLC6-RCA . . . . .	26	WP-T81D* . . . . .	83
PS-10 . . . . .	16	SLC6-RCAG . . . . .	26	WP-T81G* . . . . .	83
RCA-1855 . . . . .	29	SLC6Q-BNC . . . . .	26	WP-T81GD* . . . . .	83
RCA59-290 . . . . .	27	SLC6Q-BNCG . . . . .	26	WS-250, 375, 500 . . . . .	84
RCA59-290G . . . . .	27	SLC6Q-RCA . . . . .	26		
RCA-F . . . . .	31	SLC6Q-RCAG . . . . .	26		
RCAFPFBH . . . . .	29	SLCU-* . . . . .	23		
RCA-Y . . . . .	22	SLCU-*BNC . . . . .	23		
RCA-YF . . . . .	22	SLCU-*RCA . . . . .	23		
RG11-60-* . . . . .	19	SLCU-59 . . . . .	26		
RG11-60-*M . . . . .	19	SLCU-6 . . . . .	26		
RG6-60-*B . . . . .	19	SLCU-6-0 . . . . .	26		
RG6-60-*R . . . . .	19	SLCU-6Q . . . . .	26		
RG6-60-PR* . . . . .	19	SLCU-6Q0 . . . . .	26		
RG6-Q-** . . . . .	19	SLCU-6T . . . . .	26		
RK6-2800 . . . . .	77	SLCUHEC2 . . . . .	26		
RK-6S . . . . .	77	SMBFP90 . . . . .	29		
RSW . . . . .	78	SMBFP . . . . .	29		
RTV-3 . . . . .	85	SMBFPF . . . . .	29		
SA-1F . . . . .	52	SRR-* . . . . .	24		
SAM-3402 . . . . .	109	SS . . . . .	32		
Satellite Dist. Systems . . . . .	112	SS-NS . . . . .	32		
SAWM60-* . . . . .	61	SSS . . . . .	32		
SB-4, 6, 8 . . . . .	36	ST-1 . . . . .	32, 120		
SBD . . . . .	51	ST-4000D . . . . .	117		
SC-3, 4 . . . . .	81	ST-5128S . . . . .	117		
SF-95-22 . . . . .	114	ST-MOD . . . . .	54		
SFT-130, 150 . . . . .	85	STMINI596 . . . . .	119		
SHC . . . . .	75	STVC . . . . .	51, 107		
SLC-179DT-FP . . . . .	29	SV-RCA . . . . .	22, 31		
SLC-6M . . . . .	26	TA Series . . . . .	17		
SLC-BNC-179DT . . . . .	29	TE-128, 130, 136, 140 . . . . .	85		
SLC-BNC-MINI25U . . . . .	29	TFW-* . . . . .	113		
SLC-MINI25U . . . . .	29	TMC-* . . . . .	113		
SLC-RCA-179DT . . . . .	29	TMP-* . . . . .	113		
SLC-RCA-MINI25U . . . . .	29	TMS-* . . . . .	113		
SLC11 . . . . .	25	TSM-4 . . . . .	113		
SLC11Q . . . . .	25	TSTL-1 . . . . .	114		
SLC1855-90-BNC . . . . .	29	TSTL-3A, 3AKIT . . . . .	114		
SLC1855-90-F . . . . .	29	TT-* . . . . .	50		
SLC1855-90-RCA . . . . .	29	US575-T . . . . .	111		
SLC1855-BNCFP, U . . . . .	29	UVSJ . . . . .	51		
SLC1855-FP2 . . . . .	29	VBC . . . . .	31		
SLC1855-FPU . . . . .	29	VBC-HR . . . . .	31		
SLC1855-RCAFP, U . . . . .	29	VC-6-5 . . . . .	85		
SLC59-BNC . . . . .	26	WB-1UV . . . . .	84		
SLC59-BNCG . . . . .	26	WF . . . . .	50		

# FREQUENCY ALLOCATION CHART

VHF & CATV CHANNELS		
BAND	ALPHA/NUMERIC	SCA VISUAL CARRIER FREQ.
SUB	T-7	7
SUB	T-8	13
SUB	T-9	19
SUB	T-10	25
SUB	T-11	31
SUB	T-12	37
SUB	T-13	43
SUB	T-14	49
LOW	2 / 2	55.25
LOW	3 / 3	61.25
LOW	4 / 4	67.25
LOW	5 / 5	77.25
LOW	6 / 6	83.25
MID	A-5 / 95	91.25
MID	A-4 / 96	97.25
MID	A-3 / 97	103.25
MID	A-2 / 98*	109.25
MID	A-1 / 99*	115.25
MID	A / 14*	121.25
MID	B / 15*	127.25
MID	C / 16*	133.25
MID	D / 17	139.25
MID	E / 18	145.25
MID	F / 19	151.25
MID	G / 20	157.25
MID	H / 21	163.25
MID	I / 22	169.25
HIGH	7 / 7	175.25
HIGH	8 / 8	181.25
HIGH	9 / 9	187.25
HIGH	10 / 10	193.25
HIGH	11 / 11	199.25
HIGH	12 / 12	205.25
HIGH	13 / 13	211.25
SUPER	J / 23	217.25
SUPER	K / 24*	223.25
SUPER	L / 25*	229.25
SUPER	M / 26*	235.25
SUPER	N / 27*	241.25
SUPER	O / 28*	247.25
SUPER	P / 29*	253.25
SUPER	Q / 30*	259.25
SUPER	R / 31*	265.25
SUPER	S / 32*	271.25
SUPER	T / 33*	277.25
SUPER	U / 34*	283.25
SUPER	V / 35*	289.25
SUPER	W / 36*	295.25
HYPER	AA / 37*	301.25
HYPER	BB / 38*	307.25
HYPER	CC / 39*	313.25
HYPER	DD / 40*	319.25
HYPER	EE / 41*	325.25
HYPER	FF / 42*	331.25
HYPER	GG / 43*	337.25
HYPER	HH / 44*	343.25
HYPER	II / 45*	349.25
HYPER	JJ / 46*	355.25
HYPER	KK / 47*	361.25
HYPER	LL / 48*	367.25
HYPER	MM / 49*	373.25
HYPER	NN / 50*	379.25
HYPER	OO / 51*	385.25
HYPER	PP / 52*	391.25

VHF & CATV CHANNELS		
BAND	ALPHA/NUMERIC	SCA VISUAL CARRIER FREQ.
HYPER	QQ / 53*	397.25
HYPER	RR / 54	403.25
HYPER	SS / 55	409.25
HYPER	TT / 56	415.25
HYPER	UU / 57	421.25
HYPER	VV / 58	427.25
HYPER	WW / 59	433.25
HYPER	XX / 60	439.25
HYPER	YY / 61	445.25
HYPER	ZZ / 62	451.25
ULTRA	AAA / 63	457.25
ULTRA	BBB / 64	463.25
ULTRA	CCC / 65	469.25
ULTRA	DDD / 66	475.25
ULTRA	EEE / 67	481.25
ULTRA	FFF / 68	487.25
ULTRA	GGG / 69	493.25
ULTRA	HHH / 70	499.25
ULTRA	III / 71	505.25
ULTRA	JJJ / 72	511.25
ULTRA	KKK / 73	517.25
ULTRA	LLL / 74	523.25
ULTRA	MMM / 75	529.25
ULTRA	NNN / 76	535.25
ULTRA	OOO / 77	541.25
ULTRA	PPP / 78	547.25
ULTRA	QQQ / 79	553.25
ULTRA	RRR / 80	559.25
ULTRA	SSS / 81	565.25
ULTRA	TTT / 82	571.25
ULTRA	UUU / 83	577.25
ULTRA	VVV / 84	583.25
ULTRA	WWW / 85	589.25
ULTRA	XXX / 86	595.25
ULTRA	87	601.25
ULTRA	88	607.25
ULTRA	89	613.25
ULTRA	90	619.25
ULTRA	91	625.25
ULTRA	92	631.25
ULTRA	93	637.25
ULTRA	94	643.25
ULTRA	100	649.25
ULTRA	101	655.25
ULTRA	102	661.25
ULTRA	103	667.25
ULTRA	104	673.25
ULTRA	105	679.25
ULTRA	106	685.25
ULTRA	107	691.25
ULTRA	108	697.25
ULTRA	109	703.25
ULTRA	110	709.25
ULTRA	111	715.25
ULTRA	112	721.25
ULTRA	113	727.25
ULTRA	114	733.25
ULTRA	115	739.25
ULTRA	116	745.25
ULTRA	117	751.25

UHF BROADCAST CHANNELS			
CHANNEL #	VISUAL CARRIER FREQ.	CHANNEL #	VISUAL CARRIER FREQ.
14	471.25	42	639.25
15	477.25	43	645.25
16	483.25	44	651.25
17	489.25	45	657.25
18	495.25	46	663.25
19	501.25	47	669.25
20	501.25	48	675.25
21	513.25	49	681.25
22	519.25	50	687.25
23	525.25	51	693.25
24	531.25	52	699.25
25	537.25	53	795.25
26	543.25	54	711.25
27	549.25	55	717.25
28	555.25	56	723.25
29	561.25	57	729.25
30	567.25	58	735.25
31	573.25	59	741.25
32	579.25	60	747.25
33	585.25	61	753.25
34	591.25	62	759.25
35	597.25	63	765.25
36	603.25	64	771.25
37	609.25	65	777.25
38	615.25	66	783.25
39	621.25	67	789.25
40	627.25	68	795.25
41	633.25	69	801.25

MAXIMUM ATTENUATION (dB/100 FT @ 68 DEG F)						
FREQUENCY	RG-59	RG-6	RG-11	.500	.625	.750
5	.77	.57	.36	.16	.13	.11
55	1.88	1.50	.95	.55	.45	.37
211	3.59	2.87	1.81	1.08	.89	.73
250	3.89	3.12	1.98	1.19	.98	.81
270	4.05	3.24	2.06	1.24	1.02	.84
300	4.27	3.43	2.17	1.31	1.08	.89
330	4.50	3.61	2.29	1.38	1.14	.94
350	4.64	3.72	2.36	1.43	1.18	.97
400	4.88	4.00	2.53	1.53	1.27	1.05
450	5.30	4.28	2.69	1.63	1.35	1.12
500	5.50	4.51	2.85	1.73	1.43	1.18
550	5.90	4.76	3.01	1.82	1.51	1.25
600	6.18	4.98	3.16	1.91	1.58	1.31
750	6.96	5.62	3.58	2.16	1.79	1.48
870	7.54	6.09	3.90	2.35	1.95	1.61
950	7.90	6.39	4.10	2.49	2.04	1.72
1000	8.09	6.54	4.23	2.53	2.11	1.74
1200	8.91	7.18	4.71	2.83	2.32	1.96
1450	9.82	7.89	5.29	3.12	2.61	2.16
1750	10.92	8.74	5.95	3.47	2.92	2.41
1850	11.23	8.99	6.12	3.60	2.97	2.52
2000	11.67	9.34	6.36	3.76	3.12	2.64
2150	12.10	9.69	6.60	3.92	3.24	2.75

## WARRANTY INFORMATION:

Holland Electronics offers a 90 day warranty on all products with the following exceptions; 1 year warranty on all meters and distribution amplifiers, 5 year warranty on all head-end products.



# **HOLLAND**

*Electronics LLC*

2935 GOLF COURSE DRIVE ▪ VENTURA, CA 93003 ▪ (805) 339-9060 ▪ (800) 628-4511

[WWW.HOLLANDELECTRONICS.COM](http://WWW.HOLLANDELECTRONICS.COM)