



PROMAX Tools

“Feel The Edge”

Specializing In High Performance Solid Carbide Cutting Tools



**Winning The World Over
One Amazing Tool
At A Time**



VAR-A-TECH



SERIES 101 ROUGHER



PRO-4



SPECIALS

Vol. 1108A

**High Performance Products
For Shops That Seek Productivity**

INDEX

General Information

Pg. 3 & 47

Technical Information

Pg. 48 - 49

Roughing End Mills

General Purpose Series 100	pg. 20
Space Age Exotics Series 101	pg. 21
Light Alloys Series 102	pg. 25
Hardened Materials Series 103	pg. 44

Finishing End Mills

5 Flute for Super Finishing Series 112	pg. 4
4 Flute Patented PRO-4 Series 190 - Square End	pg. 5
Series 191 - Corner Radius	pgs. 6 - 7
Series 192 - Ball End	pg. 8
4 Flute VAR-A-TECH Series 155 - Square End	pg. 9
Series 156 - Corner Radius	pgs. 10 - 11
Series 157 - Ball End	pg. 12
4 Flute for Steels & Alloys Series 111 - Square End	pg. 14 - 15
Series 129 - Corner Radius	pg. 16 - 17
Series 116 - Ball Nose	pg. 13
3 Flute for High Speed Machining of Aluminum Series 110 - Square End	pg. 22
3 Flute for Aluminum Series 109 - Square End	pg. 23
3 Flute for Stainless Steel & High Temp Alloys Series 106 - Square End	pg. 26
Series 113 - Ball End	pg. 27
2 Flute for Aluminum Series 108 - Square End	pg. 30
Series 115 - Ball End	pg. 31



Roughing-Finishing End Mills

5 Flute for Steels & High Strength Alloys Series 121 - Square End	pg. 19
4 Flute for Stainless Steel & Titanium Series 120 - Square End	pgs. 18 - 19
3 Flute for Stainless Steel & High Temp Alloys Series 117 - Square End	pg. 28
Series 122 - Ball End	pg. 29
3 Flute for Aluminum Series 119 - Square End	pg. 24

Die & Mold Tools

Decimal End Mills Series 330 - 2 Flute Square	pg. 32 - 33
Series 331 - 2 Flute Ball	pg. 32 - 33
Series 332 - 4 Flute Square	pg. 34 - 35
Series 333 - 4 Flute Ball	pg. 34 - 35
2 Flute Taper with Ball End Series 250 - 254	pgs. 36 - 37
4 Flute Rib Tools Series 260 - 265 - Corner Radius	pgs. 38 - 40
Series 270 - 275 - Ball End	pgs. 41 - 43
Multi Flute for Hardened Materials Series 154 - Square End	pg. 44

Additional Tools

Corner Rounding End Mills Series 137 - 2 Flute	pg. 45
Series 138 - 4 Flute	pg. 45
Chamfer Spotting Tools Series 132 & 133 - 60 Degree	pg. 46
Series 134 & 135 - 90 Degree	pg. 46
Series 130 & 131 - 120 Degree	pg. 46

IMPORTANT POINTS TO REMEMBER WHEN WORKING WITH PROMAX TOOLS.

PROMAX End Mills

- Climb milling is the recommended technique of milling.
- Work piece rigidity is necessary for optimum cutting results.
- Correct coolant placement and pressure is essential for lubrication through the cut and to assure efficient chip evacuation and a longer tool life.
- Horsepower to cubic inch removal ratio should be checked for optimal performance.



PROMAX Roughers

- The minimum radial width of cut should not be less than the corner radius of the end mill.
- When slotting, the axial depth of cut should not exceed the diameter of the end mill.
- Feeds and speeds are recommendations and should be considered as starting points with possible variations to achieve optimum results.
- Work piece rigidity should be checked to assure there is no vibration.
- Check the horsepower available to cubic inch of material removal.
- The proper coolant flow and placement will wash the chips out of the cut, thus eliminating the recutting of chips, and damage to the end mill.



PROMAX Rougher-Finishers

- PROMAX Rougher-Finishers bridge the gap between full roughing and finishing.
- The PROMAX Rougher-Finisher can be used with any radial depth of cut.
- Surface footage generally can be increased with the rougher-finisher when light radial depths of cuts are made.

“FEEL THE EDGE”

The NEW EDGE PREP is standard on our PROMAX End Mills. This allows you to forgo the tedious and long break periods needed on most tools in order to receive the most production out of your tool. Combining our edge prep with our superior coatings and the results are clear – longer running tools with fewer tool changes per run equaling significant cost effectiveness.

SUPERIOR TOOL DESIGN:

PROMAX end mills are manufactured from high strength, ultra fine and submicron grain carbide with a high cobalt content to produce an extra tough end mill which has a transverse rupture strength (TRS) as high as 650,000 psi. Our end mills are eccentric relieved giving them the strongest cutting edge while running cooler and smoother to produce better finishes. We offer TiCN, AlTiN & ZrN hard coatings which increase tool life while enhancing chip flow and lubricity through the cut. With the advanced PROMAX end mill design, you can expect your productivity to increase 2 to 5 times over conventional carbide end mills.

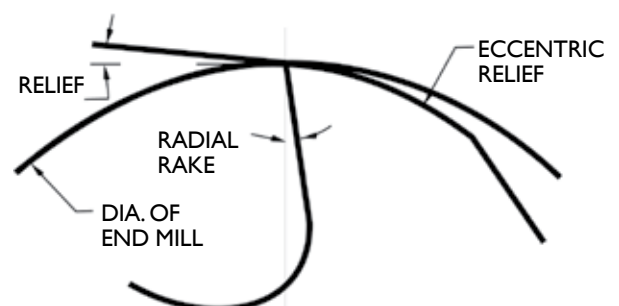

Series 112

5 Flute for Super Finishing

5 FLUTE



“Feel The Edge”

FOR CHALLENGING MATERIAL

This high performance end mill designed for maximum production capabilities is eccentric relieved for a smoother running end mill when profiling at maximum speeds. Engineered to accommodate high temperature, alloy & other more difficult materials while improving the surface finish while reducing harmonics with 5 flute geometry.

HELIX ANGLE:

- 1/8" thru 1" = 40 degrees

TOLERANCES:

- Shank: $-.0001/-0.0004$
- Cutting Diameter:
1/8" thru 1" = $+.000/-0.002$

UPON REQUEST:

- Coolant Slots, 3/8" thru 1"
- Set screw flats, 3/8" thru 1"



Coolant Slot

DIA	SHANK	LOC	OAL	FLUTES	TiCN	AlTiN
1/8	1/8	1/4	1-1/2	5	112-00822	112-00824
1/8	1/8	1/2	1-1/2	5	112-00812	112-00814
5/32	3/16	3/8	2	5	112-01022	112-01024
5/32	3/16	1/2	2	5	112-01012	112-01014
3/16	3/16	3/8	2	5	112-01222	112-01224
3/16	3/16	5/8	2	5	112-01212	112-01214
7/32	1/4	3/8	2	5	112-01422	112-01424
7/32	1/4	3/4	2-1/2	5	112-01412	112-01414
1/4	1/4	3/8	2	5	112-01622	112-01624
1/4	1/4	3/4	2-1/2	5	112-01612	112-01614
1/4	1/4	1-1/4	3	5	112-01632	112-01634
1/4	1/4	1-1/2	3-1/2	5	112-01642	112-01644
9/32	5/16	1/2	2-1/2	5	112-01822	112-01824
9/32	5/16	3/4	2-1/2	5	112-01812	112-01814
5/16	5/16	1/2	2-1/2	5	112-02022	112-02024
5/16	5/16	3/4	2-1/2	5	112-02012	112-02014
11/32	3/8	5/8	2	5	112-02222	112-02224
11/32	3/8	7/8	2-1/2	5	112-02212	112-02214
3/8	3/8	5/8	2	5	112-02422	112-02424
3/8	3/8	7/8	2-1/2	5	112-02412	112-02414
3/8	3/8	1-1/2	3-1/2	5	112-02432	112-02434
7/16	7/16	1	2-3/4	5	112-02812	112-02814
1/2	1/2	5/8	2-1/2	5	112-03222	112-03224
1/2	1/2	1-1/4	3	5	112-03212	112-03214
1/2	1/2	1-1/2	3-1/2	5	112-03232	112-03234
1/2	1/2	2	4	5	112-03242	112-03244
9/16	9/16	1-1/4	3-1/2	5	112-03612	112-03614
5/8	5/8	7/8	3	5	112-04022	112-04024
5/8	5/8	1-1/4	3-1/2	5	112-04012	112-04014
5/8	5/8	1-3/4	4	5	112-04032	112-04034
5/8	5/8	2-1/2	5	5	112-04042	112-04044
3/4	3/4	1	3	5	112-04822	112-04824
3/4	3/4	1-5/8	4	5	112-04812	112-04814
3/4	3/4	2-1/2	5	5	112-04832	112-04834
3/4	3/4	3-1/4	6	5	112-04842	112-04844
1	1	1-3/4	4	5	112-06412	112-06414
1	1	2-3/4	5	5	112-06432	112-06434
1	1	3-3/8	6	5	112-06442	112-06444

Series 190

PRO-4 Vibration Reducing - Square End



Patented

PRO-4

DIA	SHANK	LOC	LOR	NECK DIA	OAL	FLUTES	AlTiN
3/16	3/16	5/8			2	4	190-01214
1/4	1/4	3/8			2	4	190-01624
1/4	1/4	3/4			2-1/2	4	190-01614
1/4	1/4	3/4	2-1/8	.235	4	4	190-01664
5/16	5/16	3/4			2-1/2	4	190-02014
3/8	3/8	5/8			2	4	190-02424
3/8	3/8	7/8			2-1/2	4	190-02414
3/8	3/8	7/8	2-1/8	.355	4	4	190-02464
3/8	3/8	7/8	3-3/8	.355	6	4	190-02474
1/2	1/2	5/8			2-1/2	4	190-03224
1/2	1/2	1-1/4			3	4	190-03214
1/2	1/2	2			4	4	190-03234
1/2	1/2	1	2-3/8	.475	6	4	190-03264
1/2	1/2	1	3-3/8	.475	6	4	190-03274
1/2	1/2	1	4-1/8	.475	6	4	190-03284
5/8	5/8	7/8			3	4	190-04024
5/8	5/8	1-1/4			3-1/2	4	190-04014
5/8	5/8	1-1/4	2-3/8	.590	6	4	190-04064
5/8	5/8	1-1/4	3-3/8	.590	6	4	190-04074
5/8	5/8	1-1/4	4-1/8	.590	6	4	190-04084
3/4	3/4	1			3	4	190-04824
3/4	3/4	1-5/8			4	4	190-04814
3/4	3/4	1-5/8	2-1/2	.715	6	4	190-04864
3/4	3/4	1-5/8	3-3/8	.715	6	4	190-04874
3/4	3/4	1-5/8	4-1/8	.715	6	4	190-04884
1	1	1-3/4			4	4	190-06414
1	1	2-3/4			5	4	190-06434
1	1	1-3/4	2-1/2	.960	6	4	190-06464
1	1	1-3/4	3-3/8	.960	6	4	190-06474
1	1	1-3/4	4-1/8	.960	6	4	190-06484

The Patented PRO-4 solid carbide hybrid cutter combines the best elements of our Finishing End Mill and our Rougher-Finisher. With 8 geometries on 4 flutes, the PRO-4 presents an entirely unique approach to common problems in high-performance machining.

Unique Hybrid Geometry

Cutting edge chip-breakers & finishing geometry appear in an alternating pattern on either the lower or upper half of each flute. In the resulting cutting action, a chip-breaking edge on one half of the tool on one flute is followed by a finishing edge in the same region on the following flute. This geometry accomplishes what other geometries attempt through unequal indexing or multiple helixes.

TOLERANCES:

- Shank: -.0001/-.0004
- Cutting Diameter:
3/16" thru 1": +.000/-0.002

- Eliminates Chatter & Vibration
- Relieves Cutting Pressure Against The Tool With OD Chip-Breakers While Delivering An Excellent Finish
- Easy & Inexpensive To Regrind

Equally indexed flutes require standard face regrinding only. No OD or special Indexing.

- Ready For Shrink-Fit Holders
- Standard With The Most Advanced Aluminum-Titanium-Nitride (AlTiN) Coating

Series 191

PRO-4 Vibration Reducing - Corner Radius

PRO-4



Patented

TOLERANCES:

- Shank: $-.0001/-0.0004$
- Cutting Diameter:
3/16" thru 1": $+.000/-0.002$

With Special Edge Prep For Longer Tool Life

The Patented PRO-4 solid carbide hybrid cutter combines the best elements of our Finishing End Mill and our Rougher-Finisher. With 8 geometries on 4 flutes, the PRO-4 presents an entirely unique approach to common problems in high-performance machining.

Unique Hybrid Geometry

Cutting edge chip-breakers & finishing geometry appear in an alternating pattern on either the lower or upper half of each flute. In the resulting cutting action, a chip-breaking edge on one half of the tool on one flute is followed by a finishing edge in the same region on the following flute. This geometry accomplishes what other geometries attempt through unequal indexing or multiple helixes.

DIA	SHANK	LOC	LOR	NECK DIA	OAL	.010 RADIUS AITiN	
3/16	3/16	5/8			2	191-11214	
7/32	1/4	3/4			2-1/2	191-11414	
1/4	1/4	3/8			2	191-11624	
1/4	1/4	3/4			2-1/2	191-11614	
1/4	1/4	3/4	2-1/8	.235	4	191-11664	
5/16	5/16	3/4			2-1/2	191-12014	
3/8	3/8	5/8			2	191-12424	
3/8	3/8	7/8			2-1/2	191-12414	
3/8	3/8	7/8	2-1/8	.355	4	191-12464	
3/8	3/8	7/8	3-3/8	.355	6	191-12474	
1/2	1/2	5/8			2-1/2	191-13224	
1/2	1/2	1-1/4			3	191-13214	
1/2	1/2	2			4	191-13234	
1/2	1/2	1	2-3/8	.475	6	191-13264	
1/2	1/2	1	3-3/8	.475	6	191-13274	
1/2	1/2	1	4-1/8	.475	6	191-13284	
5/8	5/8	7/8			3	191-14024	
5/8	5/8	1-1/4			3-1/2	191-14014	
5/8	5/8	1-1/4	2-3/8	.590	6	191-14064	
5/8	5/8	1-1/4	3-3/8	.590	6	191-14074	
5/8	5/8	1-1/4	4-1/8	.590	6	191-14084	
3/4	3/4	1			3	191-14824	
3/4	3/4	1-5/8			4	191-14814	
3/4	3/4	1-5/8	2-1/2	.715	6	191-14864	
3/4	3/4	1-5/8	3-3/8	.715	6	191-14874	
3/4	3/4	1-5/8	4-1/8	.715	6	191-14884	
1	1	1-3/4			4		
1	1	2-3/4			5		
1	1	1-3/4	2-1/2	.960	6		
1	1	1-3/4	3-3/8	.960	6		
1	1	1-3/4	4-1/8	.960	6		

See Page 5 For PRO-4 Square End

See Page 8 For PRO-4 Ball End

Series 191

PRO-4 Vibration Reducing - Corner Radius



Extended Length

Patented

TOLERANCES:

- Shank: $-.0001/-0.0004$
- Cutting Diameter:
3/16" thru 1": $+0.000/-0.002$

PRO-4

	.015 RADIUS AITiN	.020 RADIUS AITiN	.030 RADIUS AITiN	.045 RADIUS AITiN	.060 RADIUS AITiN	.090 RADIUS AITiN	.125 RADIUS AITiN
	191-21214	191-31214	191-41214				
	191-21414	191-31414					
	191-21624	191-31624	191-41624				
	191-21614	191-31614	191-41614				
	191-21664	191-31664	191-41664				
	191-22014	191-32014	191-42014				
	191-22424	191-32424	191-42424				
	191-22414	191-32414	191-42414				
	191-22464	191-32464	191-42464				
	191-22474	191-32474	191-42474				
	191-23224	191-33224	191-43224	191-53224	191-63224		
	191-23214	191-33214	191-43214	191-53214	191-63214		
	191-23234	191-33234	191-43234	191-53234	191-63234		
	191-23264	191-33264	191-43264	191-53264	191-63264		
	191-23274	191-33274	191-43274	191-53274	191-63274		
	191-23284	191-33284	191-43284	191-53284	191-63284		
	191-24024	191-34024	191-44024		191-64024		
	191-24014	191-34014	191-44014		191-64014		
	191-24064	191-34064	191-44064		191-64064		
	191-24074	191-34074	191-44074		191-64074		
	191-24084	191-34084	191-44084		191-64084		
	191-24824	191-34824	191-44824		191-64824	191-74824	191-84824
	191-24814	191-34814	191-44814		191-64814	191-74814	191-84814
	191-24864	191-34864	191-44864		191-64864	191-74864	191-84864
	191-24874	191-34874	191-44874		191-64874	191-74874	191-84874
	191-24884	191-34884	191-44884		191-64884	191-74884	191-84884
			191-46414		191-66414	191-76414	191-86414
			191-46434		191-66434	191-76434	191-86434
			191-46464		191-66464	191-76464	191-86464
			191-46474		191-66474	191-76474	191-86474
			191-46484		191-66484	191-76484	191-86484

See Page 16 - 17 For Series 129 4 Flute Corner Radius End Mills

Series 192

PRO-4 Vibration Reducing - Ball End



Patented

PRO-4

- **Eliminates Chatter & Vibration**
- **Relieves Cutting Pressure Against The Tool With OD Chip-Breakers While Delivering An Excellent Finish**
- **Easy & Inexpensive To Regrind**
Equally indexed flutes require standard face regrinding only. No OD or special Indexing.
- **Ready For Shrink-Fit Holders**
- **Standard With The Most Advanced Aluminum-Titanium-Nitride (AlTiN) Coating**

TOLERANCES:

- Shank: -.0001/-.0004
- Cutting Diameter:
3/16" thru 1": +.000/-0.002
- Ball Radius: +.001/-0.001

DIA	SHANK	LOC	LOR	NECK DIA	OAL	FLUTES	AlTiN
3/16	3/16	5/8			2	4	192-01214
1/4	1/4	3/8			2	4	192-01624
1/4	1/4	3/4			2-1/2	4	192-01614
1/4	1/4	3/4	2-1/8	.235	4	4	192-01664
5/16	5/16	3/4			2-1/2	4	192-02014
3/8	3/8	5/8			2	4	192-02424
3/8	3/8	7/8			2-1/2	4	192-02414
3/8	3/8	7/8	2-1/8	.355	4	4	192-02464
3/8	3/8	7/8	3-3/8	.355	6	4	192-02474
1/2	1/2	5/8			2-1/2	4	192-03224
1/2	1/2	1-1/4			3	4	192-03214
1/2	1/2	2			4	4	192-03234
1/2	1/2	1	2-3/8	.475	6	4	192-03264
1/2	1/2	1	3-3/8	.475	6	4	192-03274
1/2	1/2	1	4-1/8	.475	6	4	192-03284
5/8	5/8	7/8			3	4	192-04024
5/8	5/8	1-1/4			3-1/2	4	192-04014
5/8	5/8	1-1/4	2-3/8	.590	6	4	192-04064
5/8	5/8	1-1/4	3-3/8	.590	6	4	192-04074
5/8	5/8	1-1/4	4-1/8	.590	6	4	192-04084
3/4	3/4	1			3	4	192-04824
3/4	3/4	1-5/8			4	4	192-04814
3/4	3/4	1-5/8	2-1/2	.715	6	4	192-04864
3/4	3/4	1-5/8	3-3/8	.715	6	4	192-04874
3/4	3/4	1-5/8	4-1/8	.715	6	4	192-04884
1	1	1-3/4			4	4	192-06414
1	1	2-3/4			5	4	192-06434
1	1	1-3/4	2-1/2	.960	6	4	192-06464
1	1	1-3/4	3-3/8	.960	6	4	192-06474
1	1	1-3/4	4-1/8	.960	6	4	192-06484

See Page 5 For PRO-4 Square End

See Pages 6-7 For PRO-4 Corner Radius

See Pages 18 - 19 For Series 120 4 Flute Rougher-Finishers

See Page 13 For Series 116 4 Flute Ball End Mills

Series 155

VAR-A-TECH Vibration Reducing - Square End

DIA	SHANK	LOC	LOR	NECK DIA	OAL	FLUTES	AITiN
1/8	1/8	1/4			1-1/2	4	155-00824
1/8	1/8	1/2			1-1/2	4	155-00814
5/32	3/16	3/8			2	4	155-01024
5/32	3/16	1/2			2	4	155-01014
3/16	3/16	3/8			2	4	155-01224
3/16	3/16	5/8			2	4	155-01214
7/32	1/4	3/8			2	4	155-01424
7/32	1/4	3/4			2-1/2	4	155-01414
1/4	1/4	3/8			2	4	155-01624
1/4	1/4	3/4			2-1/2	4	155-01614
1/4	1/4	3/4	2-1/8	.235	4	4	155-01664
9/32	5/16	3/4			2-1/2	4	155-01814
5/16	5/16	1/2			2-1/2	4	155-02024
5/16	5/16	3/4			2-1/2	4	155-02014
11/32	3/8	7/8			2-1/2	4	155-02214
3/8	3/8	5/8			2	4	155-02424
3/8	3/8	7/8			2-1/2	4	155-02414
3/8	3/8	7/8	2-3/8	.355	4	4	155-02464
3/8	3/8	7/8	3-3/8	.355	6	4	155-02474
7/16	7/16	5/8			2-3/4	4	155-02824
7/16	7/16	1			2-3/4	4	155-02814
1/2	1/2	5/8			2-1/2	4	155-03224
1/2	1/2	1			3	4	155-03214
1/2	1/2	1	2-3/8	.475	6	4	155-03264
1/2	1/2	1	3-3/8	.475	6	4	155-03274
1/2	1/2	1	4-1/8	.475	6	4	155-03284
9/16	9/16	1-1/4			3-1/2	4	155-03614
5/8	5/8	7/8			3	4	155-04024
5/8	5/8	1-1/4			3-1/2	4	155-04014
5/8	5/8	1-1/4	2-3/8	.590	6	4	155-04064
5/8	5/8	1-1/4	3-3/8	.590	6	4	155-04074
5/8	5/8	1-1/4	4-1/8	.590	6	4	155-04084
3/4	3/4	1			3	4	155-04824
3/4	3/4	1-5/8			4	4	155-04814
3/4	3/4	1-5/8	2-1/2	.715	6	4	155-04864
3/4	3/4	1-5/8	3-3/8	.715	6	4	155-04874
3/4	3/4	1-5/8	4-1/8	.715	6	4	155-04884
1	1	1-3/4			4	4	155-06414
1	1	2-3/4			5	4	155-06434
1	1	1-7/8	2-1/2	.960	6	4	155-06464
1	1	1-7/8	3-3/8	.960	6	4	155-06474
1	1	1-7/8	4-1/8	.960	6	4	155-06484



Extended Length

VAR-A-TECH

Reduced Vibration with Special Edge Prep

VAR-A-TECH by PROMAX

with Vibration Reducing Flute Geometry has a longer tool life resulting in greater productivity. Users will benefit from the reduction in chatter as it allows for more aggressive machining with greater depths-of-cut and heavier feeds. This New and exciting tool allows roughing and finishing at the same time while achieving improved surface finishes. Enjoy great results in Titanium, other High Temperature Alloys as well as Steels, Stainless Steels, High Strength Alloys and Cast Iron.

TOLERANCES:

- Shank: -.0001/-.0004
- Cutting Diameter:
1/8" thru 1": +.000/-.002

UPON REQUEST:

- Coolant Slots, 3/8" thru 1"
- Set screw flats, 3/8" thru 1"

Series 156

VAR-A-TECH Vibration Reducing - Corner Radius

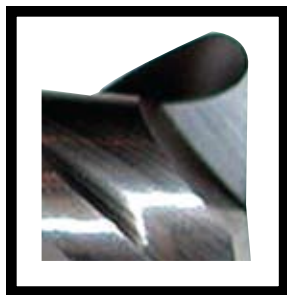

.060 Radius



VAR-A-TECH

**Reduced Vibration
with Special Edge Prep**

TOLERANCES:

- Shank: $-.0001/-0.0004$
- Cutting Diameter:
1/8" thru 1": $+.000/-0.002$
- Radius:
1/8" thru 1": $+.000/-0.001$

UPON REQUEST:

- Coolant Slots, 3/8" thru 1"
- Set screw flats, 3/8" thru 1"

DIA	SHANK	LOC	LOR	NECK DIA	OAL	Flutes	.010 RADIUS AITiN
1/8	1/8	1/4			1-1/2	4	156-10824
1/8	1/8	1/2			1-1/2	4	156-10814
5/32	3/16	3/8			2	4	156-11024
5/32	3/16	1/2			2	4	156-11014
3/16	3/16	3/8			2	4	156-11224
3/16	3/16	5/8			2	4	156-11214
7/32	1/4	3/8			2	4	156-11424
7/32	1/4	3/4			2-1/2	4	156-11414
1/4	1/4	3/8			2	4	156-11624
1/4	1/4	3/4			2-1/2	4	156-11614
1/4	1/4	3/4	2-1/8	.235	4	4	156-11664
9/32	5/16	3/4			2-1/2	4	
5/16	5/16	1/2			2-1/2	4	156-12024
5/16	5/16	3/4			2-1/2	4	156-12014
11/32	3/8	7/8			2-1/2	4	
3/8	3/8	5/8			2	4	156-12424
3/8	3/8	7/8			2-1/2	4	156-12414
3/8	3/8	7/8	2-3/8	.355	4	4	156-12464
3/8	3/8	7/8	3-3/8	.355	6	4	156-12474
7/16	7/16	5/8			2-3/4	4	
7/16	7/16	1			2-3/4	4	
1/2	1/2	5/8			2-1/2	4	156-13224
1/2	1/2	1			3	4	156-13214
1/2	1/2	1	2-3/8	.475	6	4	156-13264
1/2	1/2	1	3-3/8	.475	6	4	156-13274
1/2	1/2	1	4-1/8	.475	6	4	156-13284
9/16	9/16	1-1/4			3-1/2	4	
5/8	5/8	7/8			3	4	156-14024
5/8	5/8	1-1/4			3-1/2	4	156-14014
5/8	5/8	1-1/4	2-3/8	.590	6	4	156-14064
5/8	5/8	1-1/4	3-3/8	.590	6	4	156-14074
5/8	5/8	1-1/4	4-1/8	.590	6	4	156-14084
3/4	3/4	1			3	4	156-14824
3/4	3/4	1-5/8			4	4	156-14814
3/4	3/4	1-5/8	2-1/2	.715	6	4	156-14864
3/4	3/4	1-5/8	3-3/8	.715	6	4	156-14874
3/4	3/4	1-5/8	4-1/8	.715	6	4	156-14884
1	1	1-3/4			4	4	
1	1	2-3/4			5	4	
1	1	1-7/8	2-1/2	.960	6	4	
1	1	1-7/8	3-3/8	.960	6	4	
1	1	1-7/8	4-1/8	.960	6	4	

Series 156

VAR-A-TECH Vibration Reducing - Corner Radius

	.015 RADIUS AITiN	.020 RADIUS AITiN	.030 RADIUS AITiN	.045 RADIUS AITiN	.060 RADIUS AITiN	.090 RADIUS AITiN	.125 RADIUS AITiN
	156-20824	156-30824					
	156-20814	156-30814					
	156-21024	156-31024					
	156-21014	156-31014					
	156-21224	156-31224	156-41224				
	156-21214	156-31214	156-41214				
	156-21424	156-31424					
	156-21414	156-31414					
	156-21624	156-31624	156-41624				
	156-21614	156-31614	156-41614				
	156-21664	156-31664	156-41664				
		156-31814					
	156-22024	156-32024	156-42024				
	156-22014	156-32014	156-42014				
		156-32214					
	156-22424	156-32424	156-42424				
	156-22414	156-32414	156-42414				
	156-22464	156-32464	156-42464				
	156-22474	156-32474	156-42474				
		156-32824					
		156-32814					
	156-23224	156-33224	156-43224	156-53224	156-63224		
	156-23214	156-33214	156-43214	156-53214	156-63214		
	156-23264	156-33264	156-43264	156-53264	156-63264		
	156-23274	156-33274	156-43274	156-53274	156-63274		
	156-23284	156-33284	156-43284	156-53284	156-63284		
			156-43614				
	156-24024	156-34024	156-44024		156-64024		
	156-24014	156-34014	156-44014		156-64014		
	156-24064	156-34064	156-44064		156-64064		
	156-24074	156-34074	156-44074		156-64074		
	156-24084	156-34084	156-44084		156-64084		
	156-24824	156-34824	156-44824		156-64824	156-74824	156-84824
	156-24814	156-34814	156-44814		156-64814	156-74814	156-84814
	156-24864	156-34864	156-44864		156-64864	156-74864	156-84864
	156-24874	156-34874	156-44874		156-64874	156-74874	156-84874
	156-24884	156-34884	156-44884		156-64884	156-74884	156-84884
			156-46414		156-66414	156-76414	156-86414
			156-46434		156-66434	156-76434	156-86434
			156-46464		156-66464	156-76464	156-86464
			156-46474		156-66474	156-76474	156-86474
			156-46484		156-66484	156-76484	156-86484

VAR-A-TECH

Series 157

VAR-A-TECH Vibration Reducing - Ball End

"Feel The Edge"



Extended Length

VAR-A-TECH

VAR-A-TECH by PROMAX

with Vibration Reducing Flute Geometry has a longer tool life resulting in greater productivity. With this Ball End version of the VAR-A-TECH, users will benefit from the reduction in chatter as it allows for more aggressive machining with greater depths-of-cut and heavier feeds. This New and exciting tool allows roughing and finishing at the same time while achieving improved surface finishes. Enjoy fantastic results in Titanium, other High Temperature Alloys as well as Steels, Stainless Steels, High Strength Alloys and Cast Iron.

TOLERANCES:

- Shank: -.0001/- .0004
- Cutting Diameter:
1/8" thru 1": +.000/- .002
- Cutting Radius:
1/8" thru 1": +.001/- .001

UPON REQUEST:

- Coolant Slots, 3/8" thru 1"
- Set screw flats, 3/8" thru 1"

DIA	SHANK	LOC	LOR	NECK DIA	OAL	FLUTES	AITiN
1/8	1/8	1/4			1-1/2	4	157-00824
1/8	1/8	1/2			1-1/2	4	157-00814
5/32	3/16	3/8			2	4	157-01024
5/32	3/16	1/2			2	4	157-01014
3/16	3/16	3/8			2	4	157-01224
3/16	3/16	5/8			2	4	157-01214
7/32	1/4	3/8			2	4	157-01424
7/32	1/4	3/4			2-1/2	4	157-01414
1/4	1/4	3/8			2	4	157-01624
1/4	1/4	3/4			2-1/2	4	157-01614
1/4	1/4	3/4	2-1/8	.235	4	4	157-01664
9/32	5/16	3/4			2-1/2	4	157-01814
5/16	5/16	1/2			2-1/2	4	157-02024
5/16	5/16	3/4			2-1/2	4	157-02014
11/32	3/8	7/8			2-1/2	4	157-02214
3/8	3/8	5/8			2	4	157-02424
3/8	3/8	7/8			2-1/2	4	157-02414
3/8	3/8	7/8	2-3/8	.355	4	4	157-02464
3/8	3/8	7/8	3-3/8	.355	6	4	157-02474
7/16	7/16	5/8			2-3/4	4	157-02824
7/16	7/16	1			2-3/4	4	157-02814
1/2	1/2	5/8			2-1/2	4	157-03224
1/2	1/2	1			3	4	157-03214
1/2	1/2	1	2-3/8	.475	6	4	157-03264
1/2	1/2	1	3-3/8	.475	6	4	157-03274
1/2	1/2	1	4-1/8	.475	6	4	157-03284
9/16	9/16	1-1/4			3-1/2	4	157-03614
5/8	5/8	7/8			3	4	157-04024
5/8	5/8	1-1/4			3-1/2	4	157-04014
5/8	5/8	1-1/4	2-3/8	.590	6	4	157-04064
5/8	5/8	1-1/4	3-3/8	.590	6	4	157-04074
5/8	5/8	1-1/4	4-1/8	.590	6	4	157-04084
3/4	3/4	1			3	4	157-04824
3/4	3/4	1-5/8			4	4	157-04814
3/4	3/4	1-5/8	2-1/2	.715	6	4	157-04864
3/4	3/4	1-5/8	3-3/8	.715	6	4	157-04874
3/4	3/4	1-5/8	4-1/8	.715	6	4	157-04884
1	1	1-3/4			4	4	157-06414
1	1	2-3/4			5	4	157-06434
1	1	1-7/8	2-1/2	.960	6	4	157-06464
1	1	1-7/8	3-3/8	.960	6	4	157-06474
1	1	1-7/8	4-1/8	.960	6	4	157-06484

Series 116

4 Flute Ball End Mills For Mild Steels & Alloys



*With Special
Edge Prep
For Longer Tool Life*

DIA	SHANK	LOC	LOR	NECK DIA	OAL	FLUTES	TiCN	AlTiN
1/32	1/8	3/32			1-1/2	4	116-00212	116-00214
3/64	1/8	9/64			1-1/2	4	116-00312	116-00314
1/16	1/8	3/16			1-1/2	4	116-00412	116-00414
5/64	1/8	1/4			1-1/2	4	116-00512	116-00514
3/32	1/8	9/32			1-1/2	4	116-00612	116-00614
7/64	1/8	3/8			1-1/2	4	116-00712	116-00714
1/8	1/8	1/2			1-1/2	4	116-00812	116-00814
3/16	3/16	5/8			2	4	116-01212	116-01214
1/4	1/4	3/4			2-1/2	4	116-01612	116-01614
1/4	1/4	1-1/4			3	4	116-01632	116-01634
1/4	1/4	3/8	2-1/8	.235	4	4	116-01662	116-01664
5/16	5/16	3/4			2-1/2	4	116-02012	116-02014
5/16	5/16	7/16	2-1/8	.297	4	4	116-02062	116-02064
3/8	3/8	7/8			2-1/2	4	116-02412	116-02414
3/8	3/8	1-1/2			3-1/2	4	116-02432	116-02434
3/8	3/8	1/2	2-1/8	.355	6	4	116-02462	116-02464
3/8	3/8	1/2	3-3/8	.355	6	4	116-02472	116-02474
7/16	7/16	1			2-3/4	4	116-02812	116-02814
1/2	1/2	1-1/4			3	4	116-03212	116-03214
1/2	1/2	2			4	4	116-03242	116-03244
1/2	1/2	5/8	2-3/8	.475	6	4	116-03262	116-03264
1/2	1/2	5/8	3-3/8	.475	6	4	116-03272	116-03274
1/2	1/2	5/8	4-1/8	.475	6	4	116-03282	116-03284
9/16	9/16	1-1/4			3-1/2	4	116-03612	116-03614
5/8	5/8	1-1/4			3-1/2	4	116-04012	116-04014
5/8	5/8	2-1/2			5	4	116-04042	116-04044
5/8	5/8	3/4	2-3/8	.590	6	4	116-04062	116-04064
5/8	5/8	3/4	3-3/8	.590	6	4	116-04072	116-04074
5/8	5/8	3/4	4-1/8	.590	6	4	116-04082	116-04084
3/4	3/4	1-5/8			4	4	116-04812	116-04814
3/4	3/4	1	2-1/2	.715	6	4	116-04862	116-04864
3/4	3/4	1	3-3/8	.715	6	4	116-04872	116-04874
3/4	3/4	1	4-1/8	.715	6	4	116-04882	116-04884
3/4	3/4	3-1/4			6	4	116-04842	116-04844
1	1	1-3/4			4	4	116-06412	116-06414
1	1	1-1/4	2-1/2	.960	6	4	116-06462	116-06464
1	1	1-1/4	3-3/8	.960	6	4	116-06472	116-06474
1	1	1-1/4	4-1/8	.960	6	4	116-06482	116-06484
1	1	3-3/8			6	4	116-06442	116-06444

HELICAL BALL RADIUS

An eccentric relief cutting edge, & excellent chip flow reduces chatter in profiling, pocketing and shallow slotting applications. Designed for low and high carbon steels, stainless steel & high strength alloy materials.

HELIX ANGLE:

- 1/32" thru 7/64" = 30 degrees
- 1/8" thru 1" = 40 degrees

TOLERANCES:

- Shank: -.0001/-0.0004
- Cutting Diameter:
1/32" thru 7/64" = +.000/.0005
1/8" thru 1" = +.000/-.002
- Ball Radius: +.001/-0.001

UPON REQUEST:

- Coolant Slots, 1/4" thru 1"
- Set screw flats, 3/8" thru 1"

4 FLUTE

Series 111

4 Flute End Mills For Steels & Alloys



4 FLUTE

“Feel The Edge”

HIGHER CHIP LOADS

A 4 flute finishing tool for low & high carbon steels, stainless steel & high temperature alloys, it was designed with eccentric relief, creating a 25% stronger cutting edge while running smoother at maximum speeds. Improved surface finish at higher chip loads. Due to the balance of the geometry, substrate & coatings this high performance end mill will achieve levels never thought to be attainable.

HELIX ANGLE:

- 1/32" thru 7/64" = 30 degrees
- 1/8" thru 1" = 40 degrees

TOLERANCES:

- Shank: -.0001/- .0004
- Cutting Diameter:
1/32" thru 7/64" = +.000/- .0005
1/8" thru 1" = +.000/- .002

UPON REQUEST:

- Coolant, 3/8" thru 1"
- Set screw flats, 3/8" thru 1"

DIA	SHANK	LOC	LOR	NECK DIA	OAL	FLUTES	TiCN	AlTiN
1/32	1/8	3/32			1-1/2	4	111-00212	111-00214
3/64	1/8	9/64			1-1/2	4	111-00312	111-00314
1/16	1/8	1/8			1-1/2	4	111-00422	111-00424
1/16	1/8	3/16			1-1/2	4	111-00412	111-00414
5/64	1/8	1/4			1-1/2	4	111-00512	111-00514
3/32	1/8	3/16			1-1/2	4	111-00622	111-00624
3/32	1/8	9/32			1-1/2	4	111-00612	111-00614
7/64	1/8	3/16			1-1/2	4	111-00722	111-00724
7/64	1/8	3/8			1-1/2	4	111-00712	111-00714
1/8	1/8	1/4			1-1/2	4	111-00822	111-00824
1/8	1/8	1/2			1-1/2	4	111-00812	111-00814
5/32	3/16	3/8			2	4	111-01022	111-01024
5/32	3/16	1/2			2	4	111-01012	111-01014
3/16	3/16	3/8			2	4	111-01222	111-01224
3/16	3/16	5/8			2	4	111-01212	111-01214
7/32	1/4	3/8			2	4	111-01422	111-01424
7/32	1/4	3/4			2-1/2	4	111-01412	111-01414
1/4	1/4	3/8			2	4	111-01622	111-01624
1/4	1/4	3/4			2-1/2	4	111-01612	111-01614
1/4	1/4	1-1/4			3	4	111-01632	111-01634
1/4	1/4	1-1/2			3-1/2	4	111-01642	111-01644
1/4	1/4	3/8	2-1/8	.235	4	4	111-01662	111-01664
9/32	5/16	1/2			2-1/2	4	111-01822	111-01824
9/32	5/16	3/4			2-1/2	4	111-01812	111-01814
5/16	5/16	1/2			2-1/2	4	111-02022	111-02024
5/16	5/16	3/4			2-1/2	4	111-02012	111-02014
5/16	5/16	7/16	2-1/8	.297	4	4	111-02062	111-02064
11/32	3/8	5/8			2	4	111-02222	111-02224
11/32	3/8	7/8			2-1/2	4	111-02212	111-02214
3/8	3/8	5/8			2	4	111-02422	111-02424
3/8	3/8	7/8			2-1/2	4	111-02412	111-02414
3/8	3/8	1-1/2			3-1/2	4	111-02432	111-02434
3/8	3/8	2			4	4	111-02442	111-02444
3/8	3/8	1/2	2-1/8	.355	6	4	111-02462	111-02464
3/8	3/8	1/2	3-3/8	.355	6	4	111-02472	111-02474
7/16	7/16	1			2-3/4	4	111-02812	111-02814
1/2	1/2	5/8			2-1/2	4	111-03222	111-03224

Series 111

4 Flute End Mills For Steels & Alloys

DIA	SHANK	LOC	LOR	NECK DIA	OAL	FLUTES	TiCN	AlTiN
1/2	1/2	1-1/4			3	4	111-03212	111-03214
1/2	1/2	1-1/2			3-1/2	4	111-03232	111-03234
1/2	1/2	2			4	4	111-03242	111-03244
1/2	1/2	5/8	2-3/8	.475	6	4	111-03262	111-03264
1/2	1/2	5/8	3-3/8	.475	6	4	111-03272	111-03274
1/2	1/2	5/8	4-1/8	.475	6	4	111-03282	111-03284
9/16	9/16	1-1/4			3-1/2	4	111-03612	111-03614
5/8	5/8	7/8			3	4	111-04022	111-04024
5/8	5/8	1-1/4			3-1/2	4	111-04012	111-04014
5/8	5/8	1-3/4			4	4	111-04032	111-04034
5/8	5/8	2-1/2			5	4	111-04042	111-04044
5/8	5/8	3/4	2-3/8	.590	6	4	111-04062	111-04064
5/8	5/8	3/4	3-3/8	.590	6	4	111-04072	111-04074
5/8	5/8	3/4	4-1/8	.590	6	4	111-04082	111-04084
3/4	3/4	1			3	4	111-04822	111-04824
3/4	3/4	1-5/8			4	4	111-04812	111-04814
3/4	3/4	2-1/2			5	4	111-04832	111-04834
3/4	3/4	1	2-1/2	.715	6	4	111-04862	111-04864
3/4	3/4	1	3-3/8	.715	6	4	111-04872	111-04874
3/4	3/4	1	4-1/8	.715	6	4	111-04882	111-04884
3/4	3/4	3-1/4			6	4	111-04842	111-04844
1	1	1-3/4			4	4	111-06412	111-06414
1	1	2-3/4			5	4	111-06432	111-06434
1	1	1-1/4	2-1/2	.960	6	4	111-06462	111-06464
1	1	1-1/4	3-3/8	.960	6	4	111-06472	111-06474
1	1	1-1/4	4-1/8	.960	6	4	111-06482	111-06484



Extended Length

4 FLUTE

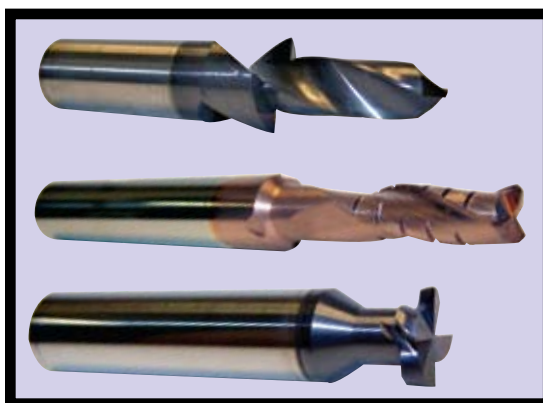

Our experienced and quality Specials Department, with state-of-the-art equipment, is ready to meet your specific requests.

See Page 16 - 17 For 4 Flute Corner Radius Tools

See Page 13 For 4 Flute Ball Nose Tools

Series 129

4 Flute Corner Radius End Mills

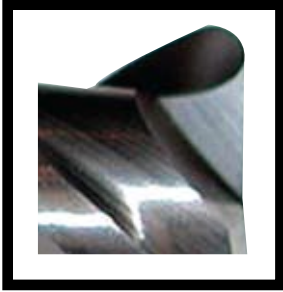

.060 Radius



Standard Length

**With Special Edge Prep
For Longer Tool Life**

4 FLUTE

DIA	SHANK	LOC	LOR	NECK DIA	OAL	.010 RADIUS TiCN	.010 RADIUS AlTiN	.015 RADIUS TiCN	.015 RADIUS AlTiN	.020 RADIUS TiCN	.020 RADIUS AlTiN	
1/8	1/8	1/2			1-1/2	129-10812	129-10814	129-20812	129-20814	129-30812	129-30814	
3/16	3/16	5/8			2	129-11212	129-11214	129-21212	129-21214	129-31212	129-31214	
1/4	1/4	3/4			2-1/2	129-11612	129-11614	129-21612	129-21614	129-31612	129-31614	
1/4	1/4	3/8	2-1/8	.235	4	129-11662	129-11664	129-21662	129-21664	129-31662	129-31664	
5/16	5/16	3/4			2-1/2	129-12012	129-12014	129-22012	129-22014	129-32012	129-32014	
5/16	5/16	7/16	2-1/8	.297	4	129-12062	129-12064	129-22062	129-22064	129-32062	129-32064	
3/8	3/8	7/8			2-1/2	129-12412	129-12414	129-22412	129-22414	129-32412	129-32414	
3/8	3/8	1/2	2-1/8	.355	6	129-12462	129-12464	129-22462	129-22464	129-32462	129-32464	
3/8	3/8	1/2	3-3/8	.355	6	129-12472	129-12474	129-22472	129-22474	129-32472	129-32474	
1/2	1/2	1-1/4			3	129-13212	129-13214	129-23212	129-23214	129-33212	129-33214	
1/2	1/2	5/8	2-3/8	.475	6	129-13262	129-13264	129-23262	129-23264	129-33262	129-33264	
1/2	1/2	5/8	3-3/8	.475	6	129-13272	129-13274	129-23272	129-23274	129-33272	129-33274	
1/2	1/2	5/8	4-1/8	.475	6	129-13282	129-13284	129-23282	129-23284	129-33282	129-33284	
5/8	5/8	1-1/4			3-1/2	129-14012	129-14014	129-24012	129-24014	129-34012	129-34014	
5/8	5/8	3/4	2-3/8	.590	6	129-14062	129-14064	129-24062	129-24064	129-34062	129-34064	
5/8	5/8	3/4	3-3/8	.590	6	129-14072	129-14074	129-24072	129-24074	129-34072	129-34074	
5/8	5/8	3/4	4-1/8	.590	6	129-14082	129-14084	129-24082	129-24084	129-34082	129-34084	
3/4	3/4	1-5/8			4	129-14812	129-14814	129-24812	129-24814	129-34812	129-34814	
3/4	3/4	1	2-1/2	.715	6	129-14862	129-14864	129-24862	129-24864	129-34862	129-34864	
3/4	3/4	1	3-3/8	.715	6	129-14872	129-14874	129-24872	129-24874	129-34872	129-34874	
3/4	3/4	1	4-1/8	.715	6	129-14882	129-14884	129-24882	129-24884	129-34882	129-34884	
1	1	1-3/4			4							
1	1	1-1/4	2-1/2	.960	6							
1	1	1-1/4	3-3/8	.960	6							
1	1	1-1/4	4-1/8	.960	6							

SMOOTH AT MAXIMUM SPEEDS

Designed for finish radius applications, the Series 129 is eccentric relieved and runs exceptionally smooth at maximum speeds. They also allow for improved surface finishes in profile & pocket applications.

TOLERANCES:

- Diameter:
1/8" thru 1" = +.000/-0.002
- Corner Radius: +/- .001

HELIX ANGLE:

- 1/8" thru 1" = 40 degrees

UPON REQUEST:

- Coolant Slots, 3/8" thru 1"
- Set screw flats, 3/8" thru 1"

Series 129

4 Flute Corner Radius End Mills



Extended Length

“Feel The Edge”

4 FLUTE

	.030 RADIUS TiCN	.030 RADIUS AlTiN	.045 RADIUS TiCN	.045 RADIUS AlTiN	.060 RADIUS TiCN	.060 RADIUS AlTiN	.090 RADIUS TiCN	.090 RADIUS AlTiN	.125 RADIUS TiCN	.125 RADIUS AlTiN
	129-41212	129-41214								
	129-41612	129-41614								
	129-41662	129-41664								
	129-42012	129-42014								
	129-42062	129-42064								
	129-42412	129-42414			129-62412	129-62414				
	129-42462	129-42464			129-62462	129-62464				
	129-42472	129-42474			129-62472	129-62474				
	129-43212	129-43214	129-53212	129-53214	129-63212	129-63214				
	129-43262	129-43264			129-63262	129-63264				
	129-43272	129-43274			129-63272	129-63274				
	129-43282	129-43284			129-63282	129-63284				
	129-44012	129-44014			129-64012	129-64014				
	129-44062	129-44064			129-64062	129-64064	129-74062	129-74064		
	129-44072	129-44074			129-64072	129-64074	129-74072	129-74074		
	129-44082	129-44084			129-64082	129-64084	129-74082	129-74084		
	129-44812	129-44814			129-64812	129-64814	129-74812	129-74814	129-84812	129-84814
	129-44862	129-44864			129-64862	129-64864	129-74862	129-74864	129-84862	129-84864
	129-44872	129-44874			129-64872	129-64874	129-74872	129-74874	129-84872	129-84874
	129-44882	129-44884			129-64882	129-64884	129-74882	129-74884	129-84882	129-84884
	129-46412	129-46414			129-66412	129-66414	129-76412	129-76414	129-86412	129-86414
	129-46462	129-46464			129-66462	129-66464	129-76462	129-76464	129-86462	129-86464
	129-46472	129-46474			129-66472	129-66474	129-76472	129-76474	129-86472	129-86474
	129-46482	129-46484			129-66482	129-66484	129-76482	129-76484	129-86482	129-86484

Special Needs ...
Special Tools ...
Modifications ...

Let PROMAX help you.
 Contact our Technical Service & Quotes Department
 at 800-878-0502
 and receive your Specials with
PROMAX Quality.

Series 120

4 Flute Rougher-Finisher for All Material Types

*With Special
Edge Prep
For Longer Tool Life*



4 FLUTE

DIA	SHANK	LOC	LOR	NECK DIA	RADIUS	OAL	FLUTES	TiCN	AITiN
1/8	1/8	1/4			.010	1-1/2	4	120-00822	120-00824
1/8	1/8	1/2			.010	1-1/2	4	120-00812	120-00814
5/32	3/16	3/8			.010	2	4	120-01022	120-01024
5/32	3/16	1/2			.010	2	4	120-01012	120-01014
3/16	3/16	3/8			.010	2	4	120-01222	120-01224
3/16	3/16	5/8			.010	2	4	120-01212	120-01214
7/32	1/4	3/8			.020	2	4	120-01422	120-01424
7/32	1/4	3/4			.020	2-1/2	4	120-01412	120-01414
1/4	1/4	3/8			.020	2	4	120-01622	120-01624
1/4	1/4	3/4			.020	2-1/2	4	120-01612	120-01614
1/4	1/4	1-1/4			.020	3	4	120-01632	120-01634
1/4	1/4	1-1/2			.020	3-1/2	4	120-01642	120-01644
1/4	1/4	3/4	2-1/8	.235	.020	4	4	120-01662	120-01664
9/32	5/16	1/2			.020	2-1/2	4	120-01822	120-01824
9/32	5/16	3/4			.020	2-1/2	4	120-01812	120-01814
5/16	5/16	1/2			.020	2-1/2	4	120-02022	120-02024
5/16	5/16	3/4			.020	2-1/2	4	120-02012	120-02014
11/32	3/8	5/8			.020	2	4	120-02222	120-02224
11/32	3/8	7/8			.020	2-1/2	4	120-02212	120-02214
3/8	3/8	5/8			.020	2	4	120-02422	120-02424
3/8	3/8	7/8			.020	2-1/2	4	120-02412	120-02414
3/8	3/8	1-1/2			.020	3-1/2	4	120-02432	120-02434
3/8	3/8	7/8	2-1/8	.355	.020	4	4	120-02462	120-02464
3/8	3/8	2			.020	4	4	120-02442	120-02444
3/8	3/8	7/8	3-3/8	.355	.020	6	4	120-02472	120-02474
7/16	7/16	1			.020	2-3/4	4	120-02812	120-02814
1/2	1/2	5/8			.020	2-1/2	4	120-03222	120-03224
1/2	1/2	1-1/4			.020	3	4	120-03212	120-03214
1/2	1/2	1-1/2			.020	3-1/2	4	120-03232	120-03234
1/2	1/2	2			.020	4	4	120-03242	120-03244
1/2	1/2	1	2-3/8	.475	.020	6	4	120-03262	120-03264
1/2	1/2	1	3-3/8	.475	.020	6	4	120-03272	120-03274
1/2	1/2	1	4-1/8	.475	.020	6	4	120-03282	120-03284
9/16	9/16	1-1/4			.030	3-1/2	4	120-03612	120-03614
5/8	5/8	7/8			.030	3	4	120-04022	120-04024
5/8	5/8	1-1/4			.030	3-1/2	4	120-04012	120-04014
5/8	5/8	1-3/4			.030	4	4	120-04032	120-04034

Series 120

4 Flute Rougher-Finisher for All Material Types

DIA	SHANK	LOC	LOR	NECK DIA	RADIUS	OAL	FLUTES	TiCN	AlTiN
5/8	5/8	2-1/2			.030	5	4	120-04042	120-04044
5/8	5/8	1-1/4	2-3/8	.590	.030	6	4	120-04062	120-04064
5/8	5/8	1-1/4	3-3/8	.590	.030	6	4	120-04072	120-04074
5/8	5/8	1-1/4	4-1/8	.590	.030	6	4	120-04082	120-04084
3/4	3/4	1			.030	3	4	120-04822	120-04824
3/4	3/4	1-5/8			.030	4	4	120-04812	120-04814
3/4	3/4	1-5/8	2-1/2	.715	.030	6	4	120-04862	120-04864
3/4	3/4	1-5/8	3-3/8	.715	.030	6	4	120-04872	120-04874
3/4	3/4	1-5/8	4-1/8	.715	.030	6	4	120-04882	120-04884
1	1	1-3/4			.030	4	4	120-06412	120-06414
1	1	1-3/4	2-1/2	.960	.030	6	4	120-06462	120-06464
1	1	1-3/4	3-3/8	.960	.030	6	4	120-06472	120-06474
1	1	1-3/4	4-1/8	.960	.030	6	4	120-06482	120-06484

4 FLUTE

GREAT SURFACE FINISH:

Bridging the gap between full roughing & finishing applications while maintaining an exceptional part surface finish, our Series 120 & 121 end mills relieve tool pressure during machining. A corner radius is standard for improved edge protection. These tools are perfect when machining Inconel, Titanium & Stainless Steel.

TOLERANCES:

- Shank: $-.0001/-0.0004$
- Cutting Diameter:
1/8" thru 1/4": $+.000/-0.002$
9/32" thru 1": $+.000/-0.003$

HELIX ANGLE:

- 1/8" thru 1" = 40 degrees

UPON REQUEST:

- Coolant Slots, 3/8" thru 1"

SET SCREW FLATS:

- Standard on 3/8" thru 1"
- Flats NOT included on tools with LOR

Series 121

5 Flute for Steels & High Strength Alloys



DIA	SHANK	LOC	RADIUS	OAL	FLUTES	TiCN	AlTiN
3/4	3/4	2-1/2	.030	5	5	121-04832	121-04834
3/4	3/4	3-1/4	.030	6	5	121-04842	121-04844
1	1	2-3/4	.030	5	5	121-06432	121-06434
1	1	3-3/8	.030	6	5	121-06442	121-06444

5 FLUTE

Series 100

4 Flute General Purpose Roughing End Mill



ROUGHING APPLICATIONS

Series 100 Roughing End Mills are recommended for general purpose applications in material up to 50 Rc, including normalized carbon & alloy steels, cast steels, stainless steels, cast irons, brass and bronze.

HELIX ANGLE:

- 1/4" thru 1" = 30 degrees

TOLERANCES:

- Shank: -.0001/-.0004
- Cutting Diameter: +.000/-.005

CORNER RADIUS:

(To strengthen end teeth)

- 3/16" = .025/.035
- 1/4" thru 5/16" = .040/.050
- 3/8" thru 1" = .055/.065

SET SCREW FLATS:

- Standard on 3/8" thru 1"

UPON REQUEST:

- Coolant Slots, 3/8" thru 1"

DIA	SHANK	LOC	OAL	FLUTES	TiCN	AlTiN
3/16	3/16	3/8	2	3	100-01222	100-01224
3/16	3/16	5/8	2	3	100-01212	100-01214
1/4	1/4	3/8	2	4	100-01622	100-01624
1/4	1/4	3/4	2-1/2	4	100-01612	100-01614
5/16	5/16	1/2	2-1/2	4	100-02022	100-02024
5/16	5/16	3/4	2-1/2	4	100-02012	100-02014
3/8	3/8	5/8	2	4	100-02422	100-02424
3/8	3/8	7/8	2-1/2	4	100-02412	100-02414
7/16	7/16	1	2-3/4	4	100-02812	100-02814
1/2	1/2	5/8	2-1/2	4	100-03222	100-03224
1/2	1/2	1-1/4	3	4	100-03212	100-03214
1/2	1/2	1-1/2	3-1/2	4	100-03232	100-03234
9/16	9/16	1-1/4	3-1/2	4	100-03612	100-03614
5/8	5/8	7/8	3	4	100-04022	100-04024
5/8	5/8	1-1/4	3-1/2	4	100-04012	100-04014
5/8	5/8	2	4	4	100-04032	100-04034
3/4	3/4	1	3	4	100-04822	100-04824
3/4	3/4	1-5/8	4	4	100-04812	100-04814
3/4	3/4	2-1/4	5	4	100-04832	100-04834
1	1	1-3/4	4	5	100-06412	100-06414
1	1	2-5/8	5	5	100-06432	100-06434



Each PROMAX Tool has Special Edge Prep to reduce or even eliminate the timely Break-In process.

"FEEL THE EDGE"

Series 101

4 Flute Roughing End Mills for Space Age Exotics



DIA	SHANK	LOC	OAL	FLUTES	TiCN	AlTiN
3/16	3/16	3/8	2	3	101-01222	101-01224
3/16	3/16	5/8	2	3	101-01212	101-01214
1/4	1/4	3/8	2	4	101-01622	101-01624
1/4	1/4	3/4	2-1/2	4	101-01612	101-01614
5/16	5/16	1/2	2-1/2	4	101-02022	101-02024
5/16	5/16	3/4	2-1/2	4	101-02012	101-02014
3/8	3/8	5/8	2	4	101-02422	101-02424
3/8	3/8	7/8	2-1/2	4	101-02412	101-02414
7/16	7/16	1	2-3/4	4	101-02812	101-02814
1/2	1/2	5/8	2-1/2	4	101-03222	101-03224
1/2	1/2	1-1/4	3	4	101-03212	101-03214
1/2	1/2	1-1/2	3-1/2	4	101-03232	101-03234
9/16	9/16	1-1/4	3-1/2	4	101-03612	101-03614
5/8	5/8	7/8	3	4	101-04022	101-04024
5/8	5/8	1-1/4	3-1/2	4	101-04012	101-04014
5/8	5/8	2	4	4	101-04032	101-04034
3/4	3/4	1	3	4	101-04822	101-04824
3/4	3/4	1-5/8	4	4	101-04812	101-04814
3/4	3/4	2-1/4	5	4	101-04832	101-04834
1	1	1-3/4	4	6	101-06412	101-06414
1	1	2-5/8	5	6	101-06432	101-06434

ROUGHING THE EXOTICS

Series 101 Roughing End Mills are designed for space age exotic materials, like titanium & nickel based/high temperature alloys (inconel, rene, wasp, etc). Its hi-helix & fine profile geometry reduces tool pressure & generates less heat while allowing heavier cuts at increased feed rates.

HELIX ANGLE:

- 3/16" thru 1" = 40 degrees

TOLERANCES:

- Shank: -.0001/-.0004
- Cutting Diameter: +.000/-0.005

CORNER RADIUS:

(To strengthen end teeth)

- 3/16" = .025/.035
- 1/4" thru 5/16" = .040/.050
- 3/8" thru 1" = .055/.065

SET SCREW FLATS:

- Standard on 3/8" thru 1"

UPON REQUEST:

- Coolant Slots, 3/8" thru 1"



With our own coating chamber, we are better able to meet our customer needs, including faster turn around times on specials as well as making sure the inventory is on hand.

4 FLUTE

Series 110

3 Flute for High Speed Machining of Aluminum



Standard Length



Extended Reach

3 FLUTE

VERY AGGRESSIVE

Series 110, with 3 Flute geometry, is designed for high speed machining of Aluminum & Light Alloys. Standard with corner radius.

HELIX:

- 1/4" thru 1": 35 Degree

TOLERANCES:

- Shank: -.0001/-.0004
- Cutting Diameter: 1/4" thru 1": +.000/-0.002

UPON REQUEST:

- Coolant Slots, 3/8" thru 1"
- Set screw flats, 3/8" thru 1"

DIA	SHANK	LOC	LOR	NECK DIA	RADIUS	OAL	FLUTES	ZrN
1/4	1/4	3/8			.015	2	3	110-01626
1/4	1/4	3/4			.015	2-1/2	3	110-01616
1/4	1/4	3/8	2-1/8	.235	.015	4	3	110-01666
3/8	3/8	5/8			.015	2	3	110-02426
3/8	3/8	7/8			.015	2-1/2	3	110-02416
3/8	3/8	5/8	2-3/8	.355	.015	4	3	110-02466
1/2	1/2	5/8			.025	2-1/2	3	110-03226
1/2	1/2	1			.025	3	3	110-03216
1/2	1/2	5/8	2-3/4	.475	.025	4	3	110-03266
5/8	5/8	1-1/4			.030	3-1/2	3	110-04016
5/8	5/8	3/4	3-1/2	.590	.030	6	3	110-04076
3/4	3/4	1-5/8			.030	4	3	110-04816
3/4	3/4	1	3-1/2	.715	.030	6	3	110-04876
1	1	1-3/4			.030	4	3	110-06416
1	1	1-1/4	3-1/2	.960	.030	6	3	110-06476



Our team works hard, so your jobs run smooth. The use of CNC grinding machines keep each tool we make consistent with the next. Our inspectors verify consistency and geometry so that our customers are sure to get the same tool every time they order.

Series 109

3 Flute for Aluminum

DIA	SHANK	LOC	OAL	FLUTES	AlTiN	ZrN
1/8	1/8	1/4	1-1/2	3	109-00824	109-00826
1/8	1/8	1/2	1-1/2	3	109-00814	109-00816
5/32	3/16	3/8	2	3	109-01024	109-01026
5/32	3/16	1/2	2	3	109-01014	109-01016
3/16	3/16	3/8	2	3	109-01224	109-01226
3/16	3/16	5/8	2	3	109-01214	109-01216
7/32	1/4	3/8	2	3	109-01424	109-01426
7/32	1/4	3/4	2-1/2	3	109-01414	109-01416
1/4	1/4	3/8	2	3	109-01624	109-01626
1/4	1/4	3/4	2-1/2	3	109-01614	109-01616
1/4	1/4	1-1/4	3	3	109-01634	109-01636
1/4	1/4	1-1/2	3-1/2	3	109-01644	109-01646
9/32	5/16	1/2	2-1/2	3	109-01824	109-01826
9/32	5/16	3/4	2-1/2	3	109-01814	109-01816
5/16	5/16	1/2	2-1/2	3	109-02024	109-02026
5/16	5/16	3/4	2-1/2	3	109-02014	109-02016
11/32	3/8	5/8	2	3	109-02224	109-02226
11/32	3/8	7/8	2-1/2	3	109-02214	109-02216
3/8	3/8	5/8	2	3	109-02424	109-02426
3/8	3/8	7/8	2-1/2	3	109-02414	109-02416
3/8	3/8	1-1/2	3-1/2	3	109-02434	109-02436
3/8	3/8	2	4	3	109-02444	109-02446
7/16	7/16	1	2-3/4	3	109-02814	109-02816
1/2	1/2	5/8	2-1/2	3	109-03224	109-03226
1/2	1/2	1-1/4	3	3	109-03214	109-03216
1/2	1/2	1-1/2	3-1/2	3	109-03234	109-03236
1/2	1/2	2	4	3	109-03244	109-03246
9/16	9/16	1-1/4	3-1/2	3	109-03614	109-03616
5/8	5/8	7/8	3	3	109-04024	109-04026
5/8	5/8	1-1/4	3-1/2	3	109-04014	109-04016
5/8	5/8	1-3/4	4	3	109-04034	109-04036
5/8	5/8	2-1/2	5	3	109-04044	109-04046
3/4	3/4	1	3	3	109-04824	109-04826
3/4	3/4	1-5/8	4	3	109-04814	109-04816
3/4	3/4	2-1/2	5	3	109-04834	109-04836
3/4	3/4	3-1/4	6	3	109-04844	109-04846
1	1	1-3/4	4	3	109-06414	109-06416
1	1	2-3/4	5	3	109-06434	109-06436
1	1	3-3/8	6	3	109-06444	109-06446



3 FLUTE

ALUMINUM & LIGHT ALLOY FINISHING

This high helix, 3 flute finisher is designed for aluminum and light alloy finishing applications.

HELIX ANGLE:

- 1/8" thru 1" = 40 degrees

TOLERANCES:

- Shank: -.0001/-.0004
- Cutting Diameter:
1/8" thru 1": +.000/-002

UPON REQUEST:

- Coolant Slots, 3/8" thru 1"
- Set screw flats, 3/8" thru 1"

See Page 27 For 3 Flute Ball Nose End Mills

Series 119

3 Flute Rougher-Finisher for Aluminum



3 FLUTE

PROFILE & POCKET ROUGHER-FINISHING

Series 119 is designed to improve performance in profiling and pocketing rougher-finishing applications in aluminum and light alloys. Eccentric relieved for a 25% stronger cutting edge that runs exceptionally smooth at maximum speeds.

HELIX ANGLE:

- 1/8" thru 1" = 40 degrees

TOLERANCES:

- Shank: $-.0001/-0.0004$
- Cutting Diameter:
1/8" thru 1": $+.000/-0.002$

SET SCREW FLATS:

- Standard on 3/8" thru 1"

UPON REQUEST:

- Coolant Slots, 3/8" thru 1"

DIA	SHANK	LOC	RADIUS	OAL	FLUTES	AlTiN	ZrN
1/8	1/8	1/4	.010	1-1/2	3	119-00824	119-00826
1/8	1/8	1/2	.010	1-1/2	3	119-00814	119-00816
5/32	3/16	3/8	.010	2	3	119-01024	119-01026
5/32	3/16	1/2	.010	2	3	119-01014	119-01016
3/16	3/16	3/8	.010	2	3	119-01224	119-01226
3/16	3/16	5/8	.010	2	3	119-01214	119-01216
7/32	1/4	3/8	.020	2	3	119-01424	119-01426
7/32	1/4	3/4	.020	2-1/2	3	119-01414	119-01416
1/4	1/4	3/8	.020	2	3	119-01624	119-01626
1/4	1/4	3/4	.020	2-1/2	3	119-01614	119-01616
1/4	1/4	1-1/4	.020	3	3	119-01634	119-01636
1/4	1/4	1-1/2	.020	3-1/2	3	119-01644	119-01646
9/32	5/16	1/2	.020	2-1/2	3	119-01824	119-01826
9/32	5/16	3/4	.020	2-1/2	3	119-01814	119-01816
5/16	5/16	1/2	.020	2-1/2	3	119-02024	119-02026
5/16	5/16	3/4	.020	2-1/2	3	119-02014	119-02016
11/32	3/8	5/8	.020	2	3	119-02224	119-02226
11/32	3/8	7/8	.020	2-1/2	3	119-02214	119-02216
3/8	3/8	5/8	.020	2	3	119-02424	119-02426
3/8	3/8	7/8	.020	2-1/2	3	119-02414	119-02416
3/8	3/8	1-1/2	.020	3-1/2	3	119-02434	119-02436
3/8	3/8	2	.020	4	3	119-02444	119-02446
7/16	7/16	1	.020	2-3/4	3	119-02814	119-02816
1/2	1/2	5/8	.020	2-1/2	3	119-03224	119-03226
1/2	1/2	1-1/4	.020	3	3	119-03214	119-03216
1/2	1/2	1-1/2	.020	3-1/2	3	119-03234	119-03236
1/2	1/2	2	.020	4	3	119-03244	119-03246
9/16	9/16	1-1/4	.030	3-1/2	3	119-03614	119-03616
5/8	5/8	7/8	.030	3	3	119-04024	119-04026
5/8	5/8	1-1/4	.030	3-1/2	3	119-04014	119-04016
5/8	5/8	1-3/4	.030	4	3	119-04034	119-04036
5/8	5/8	2-1/2	.030	5	3	119-04044	119-04046
3/4	3/4	1	.030	3	3	119-04824	119-04826
3/4	3/4	1-5/8	.030	4	3	119-04814	119-04816
3/4	3/4	2-1/2	.030	5	3	119-04834	119-04836
3/4	3/4	3-1/4	.030	6	3	119-04844	119-04846
1	1	1-3/4	.030	4	3	119-06414	119-06416
1	1	2-3/4	.030	5	3	119-06434	119-06436
1	1	3-3/8	.030	6	3	119-06444	119-06446

Series 102

3 Flute Rougher for Light Alloys



DIA	SHANK	LOC	OAL	FLUTES	AlTiN	ZrN
3/16	3/16	3/8	2	3	102-01224	102-01226
3/16	3/16	5/8	2	3	102-01214	102-01216
1/4	1/4	3/8	2	3	102-01624	102-01626
1/4	1/4	3/4	2-1/2	3	102-01614	102-01616
5/16	5/16	1/2	2-1/2	3	102-02024	102-02026
5/16	5/16	3/4	2-1/2	3	102-02014	102-02016
3/8	3/8	5/8	2	3	102-02424	102-02426
3/8	3/8	7/8	2-1/2	3	102-02414	102-02416
7/16	7/16	1	2-3/4	3	102-02814	102-02816
1/2	1/2	5/8	2-1/2	3	102-03224	102-03226
1/2	1/2	1-1/4	3	3	102-03214	102-03216
1/2	1/2	1-1/2	3-1/2	3	102-03234	102-03236
9/16	9/16	1-1/4	3-1/2	3	102-03614	102-03616
5/8	5/8	1-1/4	3-1/2	3	102-04014	102-04016
3/4	3/4	1-5/8	4	3	102-04814	102-04816
3/4	3/4	2-1/4	5	3	102-04834	102-04836
1	1	1-3/4	4	3	102-06414	102-06416
1	1	2-5/8	5	3	102-06434	102-06436

“Feel The Edge”

ROUGHING APPLICATIONS

Series 102 Roughing End Mills are designed for light materials like aluminum, brass, copper, etc. The 3 flute hi-helix roughing geometry produces a manageable chip that allows for maximum feed rates in profiling and slotting applications. Also used in general purpose applications for deep slots and pockets.

HELIX ANGLE:

- 3/16" thru 1" = 40 degrees

TOLERANCES:

- Shank: $-.0001/-0.0004$
- Cutting Diameter: $+.000/-0.005$

CORNER RADIUS:

(To strengthen end teeth)

- 3/16" = $.025/.035$
- 1/4" thru 5/16" = $.040/.050$
- 3/8" thru 1" = $.055/.065$

UPON REQUEST:

- Coolant Slots, 3/8" thru 1"

SET SCREW FLATS:

- Standard on 3/8" thru 1"

Automatic Shelving makes shipping our product a more efficient process.



3 FLUTE

Series 106

3 Flute for Stainless Steel

3 FLUTE



DIA	SHANK	LOC	LOR	NECK DIA	RADIUS	OAL	FLUTES	TiCN	AlTiN
1/8	1/8	1/4			.010	1-1/2	3	106-00822	106-00824
1/8	1/8	1/2			.010	1-1/2	3	106-00812	106-00814
5/32	3/16	3/8			.010	2	3	106-01022	106-01024
5/32	3/16	1/2			.010	2	3	106-01012	106-01014
3/16	3/16	3/8			.010	2	3	106-01222	106-01224
3/16	3/16	5/8			.010	2	3	106-01212	106-01214
7/32	1/4	3/8			.020	2	3	106-01422	106-01424
7/32	1/4	3/4			.020	2-1/2	3	106-01412	106-01414
1/4	1/4	3/8			.020	2	3	106-01622	106-01624
1/4	1/4	3/4			.020	2-1/2	3	106-01612	106-01614
1/4	1/4	3/8	2-1/8	.235	.020	4	3	106-01662	106-01664
9/32	5/16	1/2			.020	2-1/2	3	106-01822	106-01824
9/32	5/16	3/4			.020	2-1/2	3	106-01812	106-01814
5/16	5/16	1/2			.020	2-1/2	3	106-02022	106-02024
5/16	5/16	3/4			.020	2-1/2	3	106-02012	106-02014
5/16	5/16	7/16	2-1/8	.297	.020	4	3	106-02062	106-02064
11/32	3/8	5/8			.020	2	3	106-02222	106-02224
11/32	3/8	7/8			.020	2-1/2	3	106-02212	106-02214
3/8	3/8	5/8			.020	2	3	106-02422	106-02424
3/8	3/8	7/8			.020	2-1/2	3	106-02412	106-02414
3/8	3/8	1/2	2-1/8	.355	.020	6	3	106-02462	106-02464
3/8	3/8	1/2	3-3/8	.355	.020	6	3	106-02472	106-02474
7/16	7/16	5/8			.020	2-3/4	3	106-02822	106-02824
7/16	7/16	1			.020	2-3/4	3	106-02812	106-02814
1/2	1/2	5/8			.020	2-1/2	3	106-03222	106-03224
1/2	1/2	1-1/4			.020	3	3	106-03212	106-03214
1/2	1/2	5/8	2-3/8	.475	.020	6	3	106-03262	106-03264
1/2	1/2	5/8	3-3/8	.475	.020	6	3	106-03272	106-03274
1/2	1/2	5/8	4-1/8	.475	.020	6	3	106-03282	106-03284
5/8	5/8	7/8			.030	3	3	106-04022	106-04024
5/8	5/8	1-1/4			.030	3-1/2	3	106-04012	106-04014
5/8	5/8	3/4	2-3/8	.590	.030	6	3	106-04062	106-04064
5/8	5/8	3/4	3-3/8	.590	.030	6	3	106-04072	106-04074
5/8	5/8	3/4	4-1/8	.590	.030	6	3	106-04082	106-04084
3/4	3/4	1			.030	3	3	106-04822	106-04824
3/4	3/4	1-5/8			.030	4	3	106-04812	106-04814
3/4	3/4	1	2-1/2	.715	.030	6	3	106-04862	106-04864
3/4	3/4	1	3-3/8	.715	.030	6	3	106-04872	106-04874
3/4	3/4	1	4-1/8	.715	.030	6	3	106-04882	106-04884
1	1	1			.030	3	3	106-06422	106-06424
1	1	1-3/4			.030	4	3	106-06412	106-06414
1	1	1-1/4	2-1/2	.960	.030	6	3	106-06462	106-06464
1	1	1-1/4	3-3/8	.960	.030	6	3	106-06472	106-06474
1	1	1-1/4	4-1/8	.960	.030	6	3	106-06482	106-06484

HELIX ANGLE:

- 1/8" thru 1" = 35 degrees

TOLERANCES:

- Shank: -.0001/-.0004
- Cutting Diameter:
1/8" thru 1": +.000/-.002

UPON REQUEST:

- Coolant Slots, 3/8" thru 1"
- Set screw flats, 3/8" thru 1"

Series 113

3 Flute Ball for Stainless Steel

DIA	SHANK	LOC	LOR	NECK DIA	OAL	FLUTES	TiCN	AlTiN
1/8	1/8	1/4			1-1/2	3	113-00822	113-00824
1/8	1/8	1/2			1-1/2	3	113-00812	113-00814
5/32	3/16	3/8			2	3	113-01022	113-01024
5/32	3/16	1/2			2	3	113-01012	113-01014
3/16	3/16	3/8			2	3	113-01222	113-01224
3/16	3/16	5/8			2	3	113-01212	113-01214
7/32	1/4	3/8			2	3	113-01422	113-01424
7/32	1/4	3/4			2-1/2	3	113-01412	113-01414
1/4	1/4	3/8			2	3	113-01622	113-01624
1/4	1/4	3/4			2-1/2	3	113-01612	113-01614
1/4	1/4	3/8	2-1/8	.235	4	3	113-01662	113-01664
9/32	5/16	1/2			2-1/2	3	113-01822	113-01824
9/32	5/16	3/4			2-1/2	3	113-01812	113-01814
5/16	5/16	1/2			2-1/2	3	113-02022	113-02024
5/16	5/16	3/4			2-1/2	3	113-02012	113-02014
5/16	5/16	7/16	2-1/8	.297	4	3	113-02062	113-02064
11/32	3/8	5/8			2	3	113-02222	113-02224
11/32	3/8	7/8			2-1/2	3	113-02212	113-02214
3/8	3/8	5/8			2	3	113-02422	113-02424
3/8	3/8	7/8			2-1/2	3	113-02412	113-02414
3/8	3/8	1/2	2-1/8	.355	6	3	113-02462	113-02464
3/8	3/8	1/2	3-3/8	.355	6	3	113-02472	113-02474
7/16	7/16	5/8			2-3/4	3	113-02822	113-02824
7/16	7/16	1			2-3/4	3	113-02812	113-02814
1/2	1/2	5/8			2-1/2	3	113-03222	113-03224
1/2	1/2	1-1/4			3	3	113-03212	113-03214
1/2	1/2	5/8	2-3/8	.475	6	3	113-03262	113-03264
1/2	1/2	5/8	3-3/8	.475	6	3	113-03272	113-03274
1/2	1/2	5/8	4-1/8	.475	6	3	113-03282	113-03284
5/8	5/8	7/8			3	3	113-04022	113-04024
5/8	5/8	1-1/4			3-1/2	3	113-04012	113-04014
5/8	5/8	3/4	2-3/8	.590	6	3	113-04062	113-04064
5/8	5/8	3/4	3-3/8	.590	6	3	113-04072	113-04074
5/8	5/8	3/4	4-1/8	.590	6	3	113-04082	113-04084
3/4	3/4	1			3	3	113-04822	113-04824
3/4	3/4	1-5/8			4	3	113-04812	113-04814
3/4	3/4	1	2-1/2	.715	6	3	113-04862	113-04864
3/4	3/4	1	3-3/8	.715	6	3	113-04872	113-04874
3/4	3/4	1	4-1/8	.715	6	3	113-04882	113-04884
1	1	1			3	3	113-06422	113-06424
1	1	1-3/4			4	3	113-06412	113-06414
1	1	1-1/4	2-1/2	.960	6	3	113-06462	113-06464
1	1	1-1/4	3-3/8	.960	6	3	113-06472	113-06474
1	1	1-1/4	4-1/8	.960	6	3	113-06482	113-06484



3 FLUTE

SLOTTING & POCKETING APPLICATIONS

The 3 flute Series 106 & 113 with their 35 degree helix were engineered for slotting of stainless steel and alloy materials. Designed with an eccentric relief, these Series have a 25% stronger cutting edge that runs extremely smooth at maximum speeds. With the addition of AlTiN coating, for high heat applications, these tools combine chip clearance and strength for the most difficult slotting and pocketing applications.

HELIX ANGLE:

- 1/8" thru 1" = 35 degrees

TOLERANCES:

- Shank: -.0001/-.0004
- Cutting Diameter:
1/8" thru 1" = +.000/-0.002
- Ball Radius: +.001/-0.001

UPON REQUEST:

- Coolant Slots, 3/8" thru 1"
- Set screw flats, 3/8" thru 1"

Series 117

3 Flute Rougher-Finisher for Stainless Steel

**With Special
Edge Prep
For Longer Tool Life**



3 FLUTE

AGGRESSIVE SLOTING & POCKET MILLING

Same high performance geometry as the Series 106 end mill, only with advanced chip breakers designed for aggressive slotting and pocket milling in low and high carbon steels, stainless steels, titanium and high temperature alloys. K-land corner radius is standard for corner edge protection. An eccentric relief cutting edge for 25% more strength makes these tools run extremely smooth at maximum speeds.

HELIX ANGLE:

- 1/8" thru 1" = 35 degrees

TOLERANCES:

- Shank: -.0001/-.0004
- Cutting Diameter:
1/8" thru 1": +.000/-.002

SET SCREW FLATS:

- Standard on 3/8" thru 1"

UPON REQUEST:

- Coolant Slots, 3/8" thru 1"

DIA	SHANK	LOC	RADIUS	OAL	FLUTES	TiCN	AlTiN
1/8	1/8	1/4	.010	1-1/2	3	117-00822	117-00824
1/8	1/8	1/2	.010	1-1/2	3	117-00812	117-00814
5/32	3/16	3/8	.010	2	3	117-01022	117-01024
5/32	3/16	1/2	.010	2	3	117-01012	117-01014
3/16	3/16	3/8	.010	2	3	117-01222	117-01224
3/16	3/16	5/8	.010	2	3	117-01212	117-01214
7/32	1/4	3/8	.020	2	3	117-01422	117-01424
7/32	1/4	3/4	.020	2-1/2	3	117-01412	117-01414
1/4	1/4	3/8	.020	2	3	117-01622	117-01624
1/4	1/4	3/4	.020	2-1/2	3	117-01612	117-01614
9/32	5/16	1/2	.020	2-1/2	3	117-01822	117-01824
9/32	5/16	3/4	.020	2-1/2	3	117-01812	117-01814
5/16	5/16	1/2	.020	2-1/2	3	117-02022	117-02024
5/16	5/16	3/4	.020	2-1/2	3	117-02012	117-02014
11/32	3/8	5/8	.020	2	3	117-02222	117-02224
11/32	3/8	7/8	.020	2-1/2	3	117-02212	117-02214
3/8	3/8	5/8	.020	2	3	117-02422	117-02424
3/8	3/8	7/8	.020	2-1/2	3	117-02412	117-02414
7/16	7/16	5/8	.020	2-3/4	3	117-02822	117-02824
7/16	7/16	1	.020	2-3/4	3	117-02812	117-02814
1/2	1/2	5/8	.020	2-1/2	3	117-03222	117-03224
1/2	1/2	1-1/4	.020	3	3	117-03212	117-03214
5/8	5/8	7/8	.030	3	3	117-04022	117-04024
5/8	5/8	1-1/4	.030	3-1/2	3	117-04012	117-04014
3/4	3/4	1	.030	3	3	117-04822	117-04824
3/4	3/4	1-5/8	.030	4	3	117-04812	117-04814
1	1	1	.030	3	3	117-06422	117-06424
1	1	1-3/4	.030	4	3	117-06412	117-06414



Coolant
Slot

See Page 24 For 3 Flute Rougher-Finisher for Aluminum

Series 122

3 Flute Ball Rougher-Finisher for Stainless Steel



DIA	SHANK	LOC	OAL	FLUTES	TiCN	AlTiN
1/8	1/8	1/2	1-1/2	3	122-00812	122-00814
5/32	3/16	1/2	2	3	122-01012	122-01014
3/16	3/16	5/8	2	3	122-01212	122-01214
7/32	1/4	3/4	2-1/2	3	122-01412	122-01414
1/4	1/4	3/4	2-1/2	3	122-01612	122-01614
9/32	5/16	3/4	2-1/2	3	122-01812	122-01814
5/16	5/16	3/4	2-1/2	3	122-02012	122-02014
11/32	3/8	7/8	2-1/2	3	122-02212	122-02214
3/8	3/8	7/8	2-1/2	3	122-02412	122-02414
7/16	7/16	1	2-3/4	3	122-02812	122-02814
1/2	1/2	1-1/4	3	3	122-03212	122-03214
5/8	5/8	1-1/4	3-1/2	3	122-04012	122-04014
3/4	3/4	1-5/8	4	3	122-04812	122-04814
1	1	1-3/4	4	3	122-06412	122-06414

AGGRESSIVE SLOTING & BALL POCKET MILLING

Like the Series 117, the Series 122 has the same high performance geometry as the Series 113 end mill, only with advanced chip breakers designed for aggressive slotting and pocket milling in low and high carbon steels, stainless steels, titanium & high temperature alloys. An eccentric relief cutting edge for 25% more strength makes these tools run extremely smooth at maximum speeds.

HELIX ANGLE:

- 1/8" thru 1" = 35 degrees

TOLERANCES:

- Shank: -.0001/-.0004
- Cutting Diameter:
1/8" thru 1": +.000/-.002
- Ball Radius: +.001/-.001

SET SCREW FLATS:

- Standard on 3/8" thru 1"

UPON REQUEST:

- Coolant Slots, 3/8" thru 1"

3 FLUTE



PROMAX networks automatic grinding machines with an optical measuring system that accurately uses multiple light sensors to measure complex tool geometries without human contact. This process establishes a system that focuses on precision and consistency in our manufacturing environment.

Series 108

2 Flute End Mill for Aluminum



2 Flute

FOR ALUMINUM

The SERIES 108 end mill was designed to be a workhorse in milling ALUMINUM and other non-ferrous materials. This tool comes standard with Zirconium Nitrate (ZrN) coating.

HELIX ANGLE:

- 1/8" thru 1" = 40 degrees

TOLERANCES:

- Shank: -.0001/-.0004
- Cutting Diameter:
1/8" thru 1": +.000/-0.002

UPON REQUEST:

- Coolant Slots, 3/8" thru 1"
- Set screw flats, 3/8" thru 1"

DIA	SHANK	LOC	OAL	FLUTES	ZrN
1/8	1/8	1/4	1-1/2	2	108-00826
1/8	1/8	3/8	1-1/2	2	108-00816
5/32	3/16	5/16	2	2	108-01026
5/32	3/16	9/16	2	2	108-01016
3/16	3/16	5/16	2	2	108-01226
3/16	3/16	9/16	2	2	108-01216
7/32	1/4	3/8	2	2	108-01426
7/32	1/4	3/4	2-1/2	2	108-01416
1/4	1/4	3/8	2	2	108-01626
1/4	1/4	3/4	2-1/2	2	108-01616
1/4	1/4	1-1/4	3-1/2	2	108-01636
9/32	5/16	7/16	2-1/2	2	108-01826
9/32	5/16	13/16	2-1/2	2	108-01816
5/16	5/16	7/16	2-1/2	2	108-02026
5/16	5/16	13/16	2-1/2	2	108-02016
5/16	5/16	1-1/4	4	2	108-02036
5/16	5/16	2-1/8	4	2	108-02046
11/32	3/8	1/2	2-1/2	2	108-02226
11/32	3/8	1	2-1/2	2	108-02216
3/8	3/8	1/2	2-1/2	2	108-02426
3/8	3/8	1	2-1/2	2	108-02416
3/8	3/8	1-1/2	4	2	108-02436
3/8	3/8	2-1/2	6	2	108-02446
13/32	7/16	9/16	2-3/4	2	108-02626
13/32	7/16	1	2-3/4	2	108-02616
7/16	7/16	9/16	2-3/4	2	108-02826
7/16	7/16	1	2-3/4	2	108-02816
7/16	7/16	2	4	2	108-02836
15/32	1/2	5/8	2-1/2	2	108-03026
15/32	1/2	1-1/4	3	2	108-03016
1/2	1/2	5/8	2-1/2	2	108-03226
1/2	1/2	1-1/4	3	2	108-03216
1/2	1/2	2	4	2	108-03236
1/2	1/2	3	6	2	108-03246
5/8	5/8	3/4	3	2	108-04026
5/8	5/8	1-5/8	3-1/2	2	108-04016
5/8	5/8	2-1/2	5	2	108-04036
5/8	5/8	3-3/4	6	2	108-04046
3/4	3/4	1	4	2	108-04826
3/4	3/4	1-5/8	4	2	108-04816
3/4	3/4	3	6	2	108-04836
3/4	3/4	4	7	2	108-04846
1	1	1-1/4	4	2	108-06426
1	1	2	5	2	108-06416
1	1	3	6	2	108-06436
1	1	4-1/8	7	2	108-06446

Series 115

2 Flute Ball for Aluminum



DIA	SHANK	LOC	OAL	FLUTES	ZrN
1/4	1/4	3/8	2	2	115-01626
1/4	1/4	3/4	2-1/2	2	115-01616
1/4	1/4	1-1/4	3-1/2	2	115-01636
5/16	5/16	7/16	2-1/2	2	115-02026
5/16	5/16	13/16	2-1/2	2	115-02016
5/16	5/16	1-1/4	4	2	115-02036
3/8	3/8	1/2	2-1/2	2	115-02426
3/8	3/8	1	2-1/2	2	115-02416
3/8	3/8	1-1/2	4	2	115-02436
7/16	7/16	9/16	2-3/4	2	115-02826
7/16	7/16	1	2-3/4	2	115-02816
7/16	7/16	2	4	2	115-02836
1/2	1/2	5/8	2-1/2	2	115-03226
1/2	1/2	1-1/4	3	2	115-03216
1/2	1/2	2	4	2	115-03236
5/8	5/8	3/4	3	2	115-04026
5/8	5/8	1-5/8	3-1/2	2	115-04016
5/8	5/8	2-1/2	5	2	115-04036
3/4	3/4	1	4	2	115-04826
3/4	3/4	1-5/8	4	2	115-04816
3/4	3/4	3	6	2	115-04836
1	1	1-1/4	4	2	115-06426
1	1	2	5	2	115-06416
1	1	3	6	2	115-06436

"Feel The Edge"

FOR ALUMINUM

The all NEW SERIES 115 BALL NOSE end mill, like it's square end counter part, was designed to be a workhorse in milling ALUMINUM and other non-ferrous materials. This tool comes standard Zirconium Nitrate (ZrN) Coating.

HELIX ANGLE:

- 1/4" thru 1" = 40 degrees

TOLERANCES:

- Shank: -.0001/-.0004
- Cutting Diameter: 1/4" thru 1": +.000/-0.002
- Ball Radius: +/- .001

UPON REQUEST:

- Coolant Slots, 3/8" thru 1"
- Set screw flats, 3/8" thru 1"

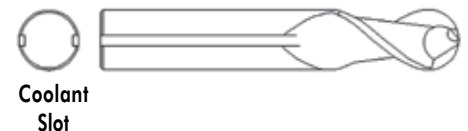

2 Flute



At PROMAX we know that Accuracy and Precision are key in producing a quality end product that customers can depend on. That is why we invest in the most current measuring equipment - so our customers can depend on us and their customers can depend on them.

Series 330 & 331

2 Flute Decimal End Mills



Series 330 - Square End



Series 331 - Ball End

TOLERANCES:

- Shank: +.0000/-.0003
- Cutting Diameter: +.000/-0.0005

2 FLUTES UNCOATED

DIA	SHANK	LOC	OAL	SQUARE END	BALL END
0.005	1/8	.008	1-1/2	330-00520	
0.005	1/8	.015	1-1/2	330-00510	
0.006	1/8	.009	1-1/2	330-00620	
0.006	1/8	.018	1-1/2	330-00610	
0.007	1/8	.011	1-1/2	330-00720	
0.007	1/8	.021	1-1/2	330-00710	
0.008	1/8	.012	1-1/2	330-00820	
0.008	1/8	.024	1-1/2	330-00810	
0.009	1/8	.014	1-1/2	330-00920	
0.009	1/8	.027	1-1/2	330-00910	
0.010	1/8	.015	1-1/2	330-01020	331-01020
0.010	1/8	.030	1-1/2	330-01010	331-01010
0.011	1/8	.017	1-1/2	330-01120	
0.011	1/8	.033	1-1/2	330-01110	331-01110
0.012	1/8	.018	1-1/2	330-01220	
0.012	1/8	.036	1-1/2	330-01210	331-01210
0.013	1/8	.020	1-1/2	330-01320	
0.013	1/8	.039	1-1/2	330-01310	331-01310
0.014	1/8	.021	1-1/2	330-01420	
0.014	1/8	.042	1-1/2	330-01410	331-01410
0.015	1/8	.023	1-1/2	330-01520	331-01520
0.015	1/8	.045	1-1/2	330-01510	331-01510
0.016	1/8	.024	1-1/2	330-01620	
0.016	1/8	.048	1-1/2	330-01610	331-01610
0.017	1/8	.026	1-1/2	330-01720	
0.017	1/8	.051	1-1/2	330-01710	331-01710
0.018	1/8	.027	1-1/2	330-01820	
0.018	1/8	.054	1-1/2	330-01810	331-01810
0.019	1/8	.029	1-1/2	330-01920	
0.019	1/8	.057	1-1/2	330-01910	331-01910
0.020	1/8	.030	1-1/2	330-02020	331-02020
0.020	1/8	.060	1-1/2	330-02010	331-02010

2 FLUTES UNCOATED

DIA	SHANK	LOC	OAL	SQUARE END	BALL END
0.021	1/8	.032	1-1/2	330-02120	
0.021	1/8	.063	1-1/2	330-02110	331-02110
0.022	1/8	.033	1-1/2	330-02220	
0.022	1/8	.066	1-1/2	330-02210	331-02210
0.023	1/8	.035	1-1/2	330-02320	
0.023	1/8	.069	1-1/2	330-02310	331-02310
0.024	1/8	.036	1-1/2	330-02420	
0.024	1/8	.072	1-1/2	330-02410	331-02410
0.025	1/8	.038	1-1/2	330-02520	331-02520
0.025	1/8	.075	1-1/2	330-02510	331-02510
0.026	1/8	.039	1-1/2	330-02620	
0.026	1/8	.078	1-1/2	330-02610	331-02610
0.027	1/8	.041	1-1/2	330-02720	
0.027	1/8	.081	1-1/2	330-02710	331-02710
0.028	1/8	.042	1-1/2	330-02820	
0.028	1/8	.084	1-1/2	330-02810	331-02810
0.029	1/8	.044	1-1/2	330-02920	
0.029	1/8	.087	1-1/2	330-02910	331-02910
0.030	1/8	.045	1-1/2	330-03020	331-03020
0.030	1/8	.090	1-1/2	330-03010	331-03010
0.031	1/8	.047	1-1/2	330-03120	
0.031	1/8	.093	1-1/2	330-03110	331-03110
0.032	1/8	.048	1-1/2	330-03220	
0.032	1/8	.096	1-1/2	330-03210	331-03210
0.033	1/8	.050	1-1/2	330-03320	
0.033	1/8	.099	1-1/2	330-03310	331-03310
0.034	1/8	.051	1-1/2	330-03420	
0.034	1/8	.102	1-1/2	330-03410	331-03410
0.035	1/8	.053	1-1/2	330-03520	331-03520
0.035	1/8	.105	1-1/2	330-03510	331-03510
0.036	1/8	.054	1-1/2	330-03620	
0.036	1/8	.108	1-1/2	330-03610	331-03610

DECIMAL

Series 330 & 331

2 Flute Decimal End Mills

2 FLUTES

UNCOATED

DIA	SHANK	LOC	OAL	SQUARE END	BALL END
0.037	1/8	.056	1-1/2	330-03720	
0.037	1/8	.111	1-1/2	330-03710	331-03710
0.038	1/8	.057	1-1/2	330-03820	
0.038	1/8	.114	1-1/2	330-03810	331-03810
0.039	1/8	.059	1-1/2	330-03920	
0.039	1/8	.117	1-1/2	330-03910	331-03910
0.040	1/8	.060	1-1/2	330-04020	331-04020
0.040	1/8	.120	1-1/2	330-04010	331-04010
0.041	1/8	.062	1-1/2	330-04120	
0.041	1/8	.123	1-1/2	330-04110	331-04110
0.042	1/8	.063	1-1/2	330-04220	
0.042	1/8	.126	1-1/2	330-04210	331-04210
0.043	1/8	.065	1-1/2	330-04320	
0.043	1/8	.129	1-1/2	330-04310	331-04310
0.044	1/8	.066	1-1/2	330-04420	
0.044	1/8	.132	1-1/2	330-04410	331-04410
0.045	1/8	.068	1-1/2	330-04520	331-04520
0.045	1/8	.135	1-1/2	330-04510	331-04510
0.046	1/8	.069	1-1/2	330-04620	
0.046	1/8	.138	1-1/2	330-04610	331-04610
0.047	1/8	.071	1-1/2	330-04720	
0.047	1/8	.141	1-1/2	330-04710	331-04710
0.048	1/8	.072	1-1/2	330-04820	
0.048	1/8	.144	1-1/2	330-04810	331-04810
0.049	1/8	.074	1-1/2	330-04920	
0.049	1/8	.147	1-1/2	330-04910	331-04910
0.050	1/8	.075	1-1/2	330-05020	331-05020
0.050	1/8	.150	1-1/2	330-05010	331-05010
0.051	1/8	.077	1-1/2	330-05120	
0.051	1/8	.153	1-1/2	330-05110	331-05110
0.052	1/8	.078	1-1/2	330-05220	
0.052	1/8	.156	1-1/2	330-05210	331-05210
0.053	1/8	.080	1-1/2	330-05320	
0.053	1/8	.159	1-1/2	330-05310	331-05310
0.054	1/8	.081	1-1/2	330-05420	
0.054	1/8	.162	1-1/2	330-05410	331-05410
0.055	1/8	.083	1-1/2	330-05520	331-05520
0.055	1/8	.165	1-1/2	330-05510	331-05510
0.056	1/8	.084	1-1/2	330-05620	
0.056	1/8	.168	1-1/2	330-05610	331-05610
0.057	1/8	.086	1-1/2	330-05720	
0.057	1/8	.171	1-1/2	330-05710	331-05710

2 FLUTES

UNCOATED

DIA	SHANK	LOC	OAL	SQUARE END	BALL END
0.058	1/8	.087	1-1/2	330-05820	
0.058	1/8	.174	1-1/2	330-05810	331-05810
0.059	1/8	.089	1-1/2	330-05920	
0.059	1/8	.177	1-1/2	330-05910	331-05910
0.060	1/8	.090	1-1/2	330-06020	331-06020
0.060	1/8	.180	1-1/2	330-06010	331-06010
0.061	1/8	.092	1-1/2	330-06120	
0.061	1/8	.183	1-1/2	330-06110	331-06110
0.062	1/8	.093	1-1/2	330-06220	
0.062	1/8	.186	1-1/2	330-06210	331-06210
0.063	1/8	.095	1-1/2	330-06320	
0.063	1/8	.189	1-1/2	330-06310	331-06310
0.064	1/8	.096	1-1/2	330-06420	
0.064	1/8	.192	1-1/2	330-06410	331-06410
0.065	1/8	.098	1-1/2	330-06520	331-06520
0.065	1/8	.195	1-1/2	330-06510	331-06510
0.070	1/8	.105	1-1/2	330-07020	331-07020
0.070	1/8	.210	1-1/2	330-07010	331-07010
0.075	1/8	.113	1-1/2	330-07520	331-07520
0.075	1/8	.225	1-1/2	330-07510	331-07510
0.080	1/8	.120	1-1/2	330-08020	331-08020
0.080	1/8	.240	1-1/2	330-08010	331-08010
0.085	1/8	.128	1-1/2	330-08520	331-08520
0.085	1/8	.255	1-1/2	330-08510	331-08510
0.090	1/8	.135	1-1/2	330-09020	331-09020
0.090	1/8	.270	1-1/2	330-09010	331-09010
0.095	1/8	.143	1-1/2	330-09520	331-09520
0.095	1/8	.285	1-1/2	330-09510	331-09510
0.100	1/8	.150	1-1/2	330-10020	331-10020
0.100	1/8	.300	1-1/2	330-10010	331-10010
0.105	1/8	.158	1-1/2	330-10520	331-10520
0.105	1/8	.315	1-1/2	330-10510	331-10510
0.110	1/8	.165	1-1/2	330-11020	331-11020
0.110	1/8	.330	1-1/2	330-11010	331-11010
0.115	1/8	.173	1-1/2	330-11520	331-11520
0.115	1/8	.345	1-1/2	330-11510	331-11510
0.120	1/8	.180	1-1/2	330-12020	331-12020
0.120	1/8	.360	1-1/2	330-12010	331-12010

DECIMAL

Series 332 & 333

4 Flute Decimal End Mills



Series 332 - Square End



Series 333 - Ball End

TOLERANCES:

- Shank: +.0000/-.0003
- Cutting Diameter: +.000/-.0005

4 FLUTE UNCOATED

DIA	SHANK	LOC	OAL	SQUARE END	BALL END
0.005	1/8	.008	1-1/2	332-00520	
0.005	1/8	.015	1-1/2	332-00510	
0.006	1/8	.009	1-1/2	332-00620	
0.006	1/8	.018	1-1/2	332-00610	
0.007	1/8	.011	1-1/2	332-00720	
0.007	1/8	.021	1-1/2	332-00710	
0.008	1/8	.012	1-1/2	332-00820	
0.008	1/8	.024	1-1/2	332-00810	
0.009	1/8	.014	1-1/2	332-00920	
0.009	1/8	.027	1-1/2	332-00910	
0.010	1/8	.015	1-1/2	332-01020	333-01020
0.010	1/8	.030	1-1/2	332-01010	333-01010
0.011	1/8	.017	1-1/2	332-01120	
0.011	1/8	.033	1-1/2	332-01110	333-01110
0.012	1/8	.018	1-1/2	332-01220	
0.012	1/8	.036	1-1/2	332-01210	333-01210
0.013	1/8	.020	1-1/2	332-01320	
0.013	1/8	.039	1-1/2	332-01310	333-01310
0.014	1/8	.021	1-1/2	332-01420	
0.014	1/8	.042	1-1/2	332-01410	333-01410
0.015	1/8	.023	1-1/2	332-01520	333-01520
0.015	1/8	.045	1-1/2	332-01510	333-01510
0.016	1/8	.024	1-1/2	332-01620	
0.016	1/8	.048	1-1/2	332-01610	333-01610
0.017	1/8	.026	1-1/2	332-01720	
0.017	1/8	.051	1-1/2	332-01710	333-01710
0.018	1/8	.027	1-1/2	332-01820	
0.018	1/8	.054	1-1/2	332-01810	333-01810
0.019	1/8	.029	1-1/2	332-01920	
0.019	1/8	.057	1-1/2	332-01910	333-01910
0.020	1/8	.030	1-1/2	332-02020	333-02020
0.020	1/8	.060	1-1/2	332-02010	333-02010
0.021	1/8	.032	1-1/2	332-02120	

4 FLUTE UNCOATED

DIA	SHANK	LOC	OAL	SQUARE END	BALL END
0.021	1/8	.063	1-1/2	332-02110	333-02110
0.022	1/8	.033	1-1/2	332-02220	
0.022	1/8	.066	1-1/2	332-02210	333-02210
0.023	1/8	.035	1-1/2	332-02320	
0.023	1/8	.069	1-1/2	332-02310	333-02310
0.024	1/8	.036	1-1/2	332-02420	
0.024	1/8	.072	1-1/2	332-02410	333-02410
0.025	1/8	.038	1-1/2	332-02520	333-02520
0.025	1/8	.075	1-1/2	332-02510	333-02510
0.026	1/8	.039	1-1/2	332-02620	
0.026	1/8	.078	1-1/2	332-02610	333-02610
0.027	1/8	.041	1-1/2	332-02720	
0.027	1/8	.081	1-1/2	332-02710	333-02710
0.028	1/8	.042	1-1/2	332-02820	
0.028	1/8	.084	1-1/2	332-02810	333-02810
0.029	1/8	.044	1-1/2	332-02920	
0.029	1/8	.087	1-1/2	332-02910	333-02910
0.030	1/8	.045	1-1/2	332-03020	333-03020
0.030	1/8	.090	1-1/2	332-03010	333-03010
0.031	1/8	.047	1-1/2	332-03120	
0.031	1/8	.093	1-1/2	332-03110	333-03110
0.032	1/8	.048	1-1/2	332-03220	
0.032	1/8	.096	1-1/2	332-03210	333-03210
0.033	1/8	.050	1-1/2	332-03320	
0.033	1/8	.099	1-1/2	332-03310	333-03310
0.034	1/8	.051	1-1/2	332-03420	
0.034	1/8	.102	1-1/2	332-03410	333-03410
0.035	1/8	.053	1-1/2	332-03520	333-03520
0.035	1/8	.105	1-1/2	332-03510	333-03510
0.036	1/8	.054	1-1/2	332-03620	
0.036	1/8	.108	1-1/2	332-03610	333-03610
0.037	1/8	.056	1-1/2	332-03720	

DECIMAL

Series 332 & 333

4 Flute Decimal End Mills

4 FLUTE UNCOATED

DIA	SHANK	LOC	OAL	SQUARE END	BALL END
0.037	1/8	.111	1-1/2	332-03710	333-03710
0.038	1/8	.057	1-1/2	332-03820	
0.038	1/8	.114	1-1/2	332-03810	333-03810
0.039	1/8	.059	1-1/2	332-03920	
0.039	1/8	.117	1-1/2	332-03910	333-03910
0.040	1/8	.060	1-1/2	332-04020	333-04020
0.040	1/8	.120	1-1/2	332-04010	333-04010
0.041	1/8	.062	1-1/2	332-04120	
0.041	1/8	.123	1-1/2	332-04110	333-04110
0.042	1/8	.063	1-1/2	332-04220	
0.042	1/8	.126	1-1/2	332-04210	333-04210
0.043	1/8	.065	1-1/2	332-04320	
0.043	1/8	.129	1-1/2	332-04310	333-04310
0.044	1/8	.066	1-1/2	332-04420	
0.044	1/8	.132	1-1/2	332-04410	333-04410
0.045	1/8	.068	1-1/2	332-04520	333-04520
0.045	1/8	.135	1-1/2	332-04510	333-04510
0.046	1/8	.069	1-1/2	332-04620	
0.046	1/8	.138	1-1/2	332-04610	333-04610
0.047	1/8	.071	1-1/2	332-04720	
0.047	1/8	.141	1-1/2	332-04710	333-04710
0.048	1/8	.072	1-1/2	332-04820	
0.048	1/8	.144	1-1/2	332-04810	333-04810
0.049	1/8	.074	1-1/2	332-04920	
0.049	1/8	.147	1-1/2	332-04910	333-04910
0.050	1/8	.075	1-1/2	332-05020	333-05020
0.050	1/8	.150	1-1/2	332-05010	333-05010
0.051	1/8	.077	1-1/2	332-05120	
0.051	1/8	.153	1-1/2	332-05110	333-05110
0.052	1/8	.078	1-1/2	332-05220	
0.052	1/8	.156	1-1/2	332-05210	333-05210
0.053	1/8	.080	1-1/2	332-05320	
0.053	1/8	.159	1-1/2	332-05310	333-05310
0.054	1/8	.081	1-1/2	332-05420	
0.054	1/8	.162	1-1/2	332-05410	333-05410
0.055	1/8	.083	1-1/2	332-05520	333-05520
0.055	1/8	.165	1-1/2	332-05510	333-05510
0.056	1/8	.084	1-1/2	332-05620	
0.056	1/8	.168	1-1/2	332-05610	333-05610
0.057	1/8	.086	1-1/2	332-05720	
0.057	1/8	.171	1-1/2	332-05710	333-05710

4 FLUTE UNCOATED

DIA	SHANK	LOC	OAL	SQUARE END	BALL END
0.058	1/8	.087	1-1/2	332-05820	
0.058	1/8	.174	1-1/2	332-05810	333-05810
0.059	1/8	.089	1-1/2	332-05920	
0.059	1/8	.177	1-1/2	332-05910	333-05910
0.060	1/8	.090	1-1/2	332-06020	333-06020
0.060	1/8	.180	1-1/2	332-06010	333-06010
0.061	1/8	.092	1-1/2	332-06120	
0.061	1/8	.183	1-1/2	332-06110	333-06110
0.062	1/8	.093	1-1/2	332-06220	
0.062	1/8	.186	1-1/2	332-06210	333-06210
0.063	1/8	.095	1-1/2	332-06320	
0.063	1/8	.189	1-1/2	332-06310	333-06310
0.064	1/8	.096	1-1/2	332-06420	
0.064	1/8	.192	1-1/2	332-06410	333-06410
0.065	1/8	.098	1-1/2	332-06520	333-06520
0.065	1/8	.195	1-1/2	332-06510	333-06510
0.070	1/8	.105	1-1/2	332-07020	333-07020
0.070	1/8	.210	1-1/2	332-07010	333-07010
0.075	1/8	.113	1-1/2	332-07520	333-07520
0.075	1/8	.225	1-1/2	332-07510	333-07510
0.080	1/8	.120	1-1/2	332-08020	333-08020
0.080	1/8	.240	1-1/2	332-08010	333-08010
0.085	1/8	.128	1-1/2	332-08520	333-08520
0.085	1/8	.255	1-1/2	332-08510	333-08510
0.090	1/8	.135	1-1/2	332-09020	333-09020
0.090	1/8	.270	1-1/2	332-09010	333-09010
0.095	1/8	.143	1-1/2	332-09520	333-09520
0.095	1/8	.285	1-1/2	332-09510	333-09510
0.100	1/8	.150	1-1/2	332-10020	333-10020
0.100	1/8	.300	1-1/2	332-10010	333-10010
0.105	1/8	.158	1-1/2	332-10520	333-10520
0.105	1/8	.315	1-1/2	332-10510	333-10510
0.110	1/8	.165	1-1/2	332-11020	333-11020
0.110	1/8	.330	1-1/2	332-11010	333-11010
0.115	1/8	.173	1-1/2	332-11520	333-11520
0.115	1/8	.345	1-1/2	332-11510	333-11510
0.120	1/8	.180	1-1/2	332-12020	333-12020
0.120	1/8	.360	1-1/2	332-12010	333-12010

DECIMAL

Series 250, 251 & 252

2 Flute Ball End Die and Mold Tools

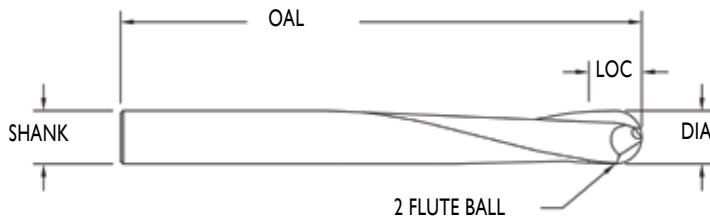

Series 250 0 Degree

DIA	SHANK	LOC	OAL	FLUTES	AITiN
1/8	1/8	1/8	3	2	250-00814
3/16	3/16	3/16	3	2	250-01214
1/4	1/4	1/4	4	2	250-01614
3/8	3/8	3/8	4	2	250-02414
3/8	3/8	3/8	6	2	250-02444
1/2	1/2	1/2	4	2	250-03214
1/2	1/2	1/2	6	2	250-03244

Series 251 1 Degree

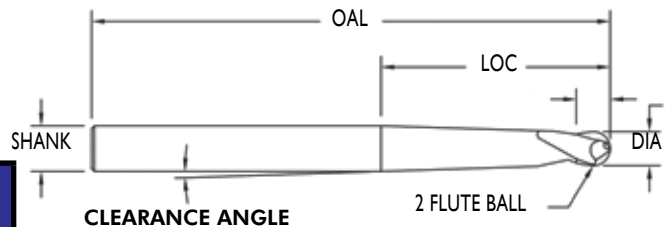

DIA	SHANK	LOC	LOR	OAL	FLUTES	AITiN
1/32	1/4	1/32	0.625	4	2	251-00214
.060	1/4	.060	1.250	4	2	251-00414
.080	1/4	.080	1.625	4	2	251-00514
3/32	1/4	3/32	1.875	4	2	251-00614
1/8	1/4	1/8	2.500	4	2	251-00814
3/16	1/4	3/16	2.265	4	2	251-01214

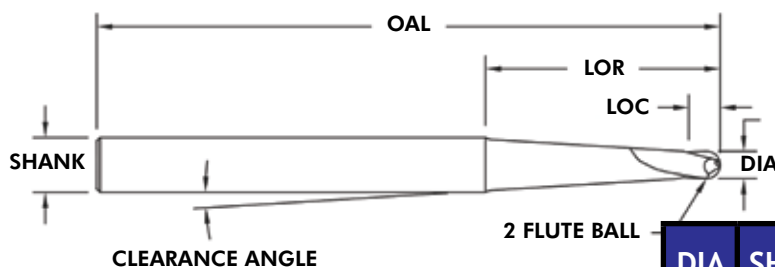

Series 252 3 Degree

DIA	SHANK	LOC	LOR	OAL	FLUTES	AITiN
1/32	1/4	1/32	2.112	4	2	252-00214
.060	1/4	.060	1.875	4	2	252-00414
.080	1/4	.080	1.704	4	2	252-00514
3/32	1/4	3/32	1.584	4	2	252-00614
1/8	1/4	1/8	1.324	4	2	252-00814
3/16	1/4	3/16	0.786	4	2	252-01214

Series 253 & 254

2 Flute Ball End Die and Mold Tools

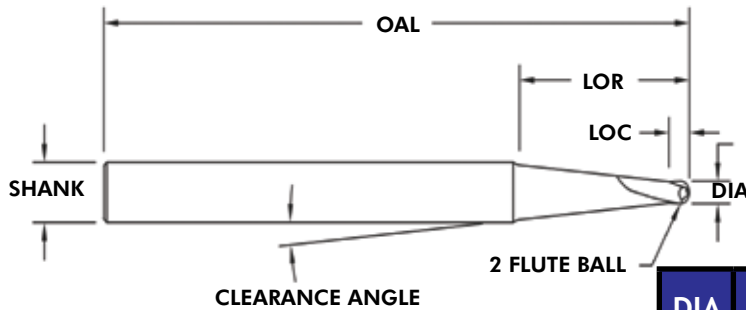

Series 253 5 Degree

DIA	SHANK	LOC	LOR	OAL	FLUTES	AlTiN
1/32	1/4	1/32	1.282	4	2	253-00214
.060	1/4	.060	1.175	4	2	253-00414
.080	1/4	.080	1.084	4	2	253-00514
3/32	1/4	3/32	1.018	4	2	253-00614
1/8	1/4	1/8	0.897	4	2	253-00814
3/16	1/4	3/16	0.680	4	2	253-01214

Series 254 8 Degree

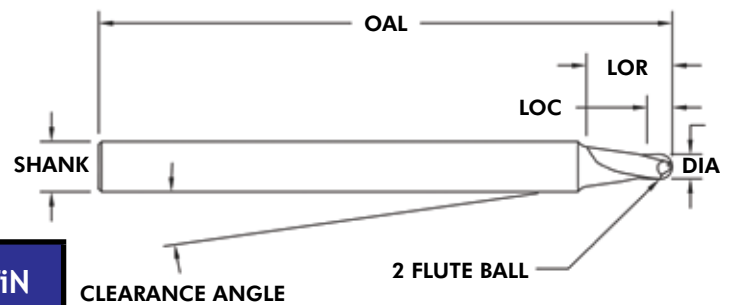

DIA	SHANK	LOC	LOR	OAL	FLUTES	AlTiN
1/32	1/4	1/32	0.851	4	2	254-00214
.060	1/4	.060	0.773	4	2	254-00414
.080	1/4	.080	0.726	4	2	254-00514
3/32	1/4	3/32	0.690	4	2	254-00614
1/8	1/4	1/8	0.636	4	2	254-00814
3/16	1/4	3/16	0.454	4	2	254-01214

TOLERANCES:

- Shank: $-.0001/-0.0004$
- Cutting Diameter: $1/32''$ thru $1/2''$: $+.000/-0.0008$
- Ball Radius: $+.000/-0.0004$

- Improve your production with Die & Mold End Mills designed to run at faster speeds and feeds resulting in reduced cycle times.
- Standard with the most advanced Aluminum-Titanium-Nitride (AlTiN) coating which allows for dry machining and extends the life of the tool.
- Ultrafine carbide grade for longer tool life.

Series 260 & 261

4 Flute Corner Radius Rib Tool

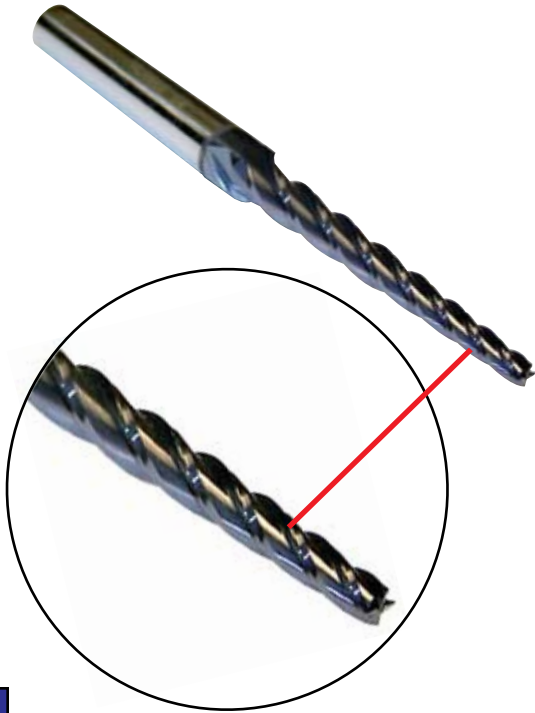

Series 260

0 Degree Taper

DIA	SHANK	LOC	RADIUS	OAL	FLUTES	AITiN
.030	3/16	.210	.010	3	4	260-03024
.030	3/16	.420	.010	3	4	260-03014
.040	3/16	.280	.010	3	4	260-04024
.040	3/16	.560	.010	3	4	260-04014
.050	3/16	.350	.010	3	4	260-05024
.050	3/16	.700	.010	3	4	260-05014
.060	3/16	.420	.010	3	4	260-06024
.060	3/16	.840	.010	3	4	260-06014
.070	3/16	.490	.010	3	4	260-07024
.070	3/16	.980	.010	3	4	260-07014
.080	3/16	.560	.010	3	4	260-08024
.080	3/16	1.120	.010	3	4	260-08014
.090	3/16	.630	.010	3	4	260-09024
.090	3/16	1.260	.010	3	4	260-09014
.100	3/16	.700	.010	3	4	260-10024
.100	3/16	1.400	.010	3	4	260-10014
.125	3/16	.875	.010	3	4	260-12524
.125	3/16	1.750	.010	3	4	260-12514

Series 261

1/2 Degree Taper

DIA	SHANK	LOC	RADIUS	OAL	FLUTES	AITiN
.030	3/16	.210	.010	3	4	261-03024
.030	3/16	.420	.010	3	4	261-03014
.040	3/16	.280	.010	3	4	261-04024
.040	3/16	.560	.010	3	4	261-04014
.050	3/16	.350	.010	3	4	261-05024
.050	3/16	.700	.010	3	4	261-05014
.060	3/16	.420	.010	3	4	261-06024
.060	3/16	.840	.010	3	4	261-06014
.070	3/16	.490	.010	3	4	261-07024
.070	3/16	.980	.010	3	4	261-07014
.080	3/16	.560	.010	3	4	261-08024
.080	3/16	1.120	.010	3	4	261-08014
.090	3/16	.630	.010	3	4	261-09024
.090	3/16	1.260	.010	3	4	261-09014
.100	3/16	.700	.010	3	4	261-10024
.100	3/16	1.400	.010	3	4	261-10014
.125	3/16	.875	.010	3	4	261-12524
.125	3/16	1.750	.010	3	4	261-12514

Series 262 & 263

4 Flute Corner Radius Rib Tool

Series 262

1 Degree Taper

DIA	SHANK	LOC	RADIUS	OAL	FLUTES	AlTiN
.030	3/16	.210	.010	3	4	262-03024
.030	3/16	.420	.010	3	4	262-03014
.040	3/16	.280	.010	3	4	262-04024
.040	3/16	.560	.010	3	4	262-04014
.050	3/16	.350	.010	3	4	262-05024
.050	3/16	.700	.010	3	4	262-05014
.060	3/16	.420	.010	3	4	262-06024
.060	3/16	.840	.010	3	4	262-06014
.070	3/16	.490	.010	3	4	262-07024
.070	3/16	.980	.010	3	4	262-07014
.080	3/16	.560	.010	3	4	262-08024
.080	3/16	1.120	.010	3	4	262-08014
.090	3/16	.630	.010	3	4	262-09024
.090	3/16	1.260	.010	3	4	262-09014
.100	3/16	.700	.010	3	4	262-10024
.100	3/16	1.400	.010	3	4	262-10014
.125	3/16	.875	.010	3	4	262-12524
.125	3/16	1.750	.010	3	4	262-12514

RIB TOOL

APPLICATIONS

PROMAX's series of Tapered Rib Tools are specifically designed to improve production in hi-speed machining of deep, tight grooves in plastic injection molds, eliminating time-consuming EDM burning operations resulting in a bench free rib. In addition, our tools reduce cycle times with faster speeds and feeds while our advanced Aluminum-Titanium-Nitride (AlTiN) coating allows for dry machining and extends the life of the tool.

DEGREE TAPER:

- Degree is Per Side

HELIX ANGLE:

- 30 degree

TOLERANCES:

- Tip Diameter Tolerance: +.000/- .001
- Taper: Series 260 = No Taper
Series 261- 265 = +/- .10'
- Radius: +.000/- .0005

Series 263 1-1/2 Degree Taper

DIA	SHANK	LOC	RADIUS	OAL	FLUTES	AlTiN
.030	3/16	.210	.010	3	4	263-03024
.030	3/16	.420	.010	3	4	263-03014
.040	3/16	.280	.010	3	4	263-04024
.040	3/16	.560	.010	3	4	263-04014
.050	3/16	.350	.010	3	4	263-05024
.050	3/16	.700	.010	3	4	263-05014
.060	3/16	.420	.010	3	4	263-06024
.060	3/16	.840	.010	3	4	263-06014
.070	3/16	.490	.010	3	4	263-07024
.070	3/16	.980	.010	3	4	263-07014
.080	3/16	.560	.010	3	4	263-08024
.080	3/16	1.120	.010	3	4	263-08014
.090	3/16	.630	.010	3	4	263-09024
.090	3/16	1.260	.010	3	4	263-09014
.100	3/16	.700	.010	3	4	263-10024
.100	3/16	1.400	.010	3	4	263-10014
.125	3/16	.875	.010	3	4	263-12524
.125	1/4	1.750	.010	3	4	263-12514

Series 264 & 265

4 Flute Corner Radius Rib Tool

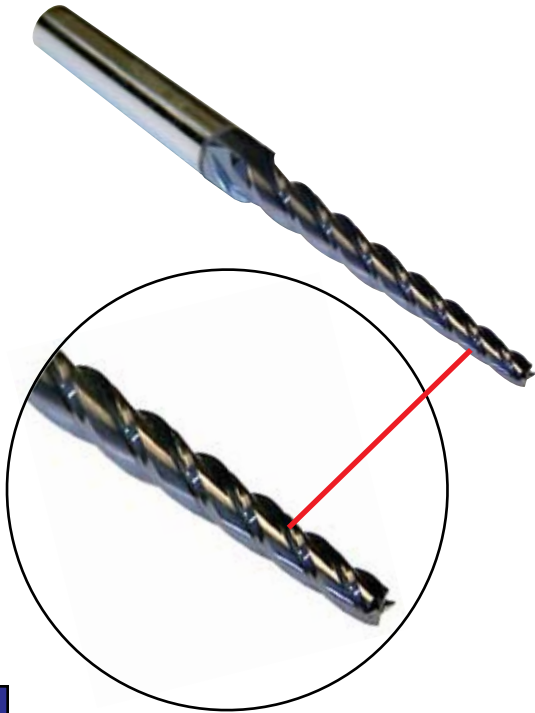

Series 264 2 Degree Taper

DIA	SHANK	LOC	RADIUS	OAL	FLUTES	AITiN
.030	3/16	.210	.010	3	4	264-03024
.030	3/16	.420	.010	3	4	264-03014
.040	3/16	.280	.010	3	4	264-04024
.040	3/16	.560	.010	3	4	264-04014
.050	3/16	.350	.010	3	4	264-05024
.050	3/16	.700	.010	3	4	264-05014
.060	3/16	.420	.010	3	4	264-06024
.060	3/16	.840	.010	3	4	264-06014
.070	3/16	.490	.010	3	4	264-07024
.070	3/16	.980	.010	3	4	264-07014
.080	3/16	.560	.010	3	4	264-08024
.080	3/16	1.120	.010	3	4	264-08014
.090	3/16	.630	.010	3	4	264-09024
.090	3/16	1.260	.010	3	4	264-09010
.100	3/16	.700	.010	3	4	264-10024
.100	1/4	1.400	.010	3	4	264-10014
.125	3/16	.875	.010	3	4	264-12524
.125	1/4	1.750	.010	3	4	264-12514

Series 265 3 Degree Taper

DIA	SHANK	LOC	RADIUS	OAL	FLUTES	AITiN
.030	3/16	.210	.010	3	4	265-03024
.030	3/16	.420	.010	3	4	265-03014
.040	3/16	.280	.010	3	4	265-04024
.040	3/16	.560	.010	3	4	265-04014
.050	3/16	.350	.010	3	4	265-05024
.050	3/16	.700	.010	3	4	265-05014
.060	3/16	.420	.010	3	4	265-06024
.060	3/16	.840	.010	3	4	265-06014
.070	3/16	.490	.010	3	4	265-07024
.070	3/16	.980	.010	3	4	265-07014
.080	3/16	.560	.010	3	4	265-08024
.080	1/4	1.120	.010	3	4	265-08014
.090	3/16	.630	.010	3	4	265-09024
.090	1/4	1.260	.010	3	4	265-09014
.100	3/16	.700	.010	3	4	265-10024
.100	1/4	1.400	.010	3	4	265-10014
.125	1/4	.875	.010	3	4	265-12524

Series 270 & 271

4 Flute Ball End Rib Tool

Series 270 0 Degree Taper

DIA	SHANK	LOC	OAL	FLUTES	AlTiN
.030	3/16	.210	3	4	270-03024
.030	3/16	.420	3	4	270-03014
.040	3/16	.280	3	4	270-04024
.040	3/16	.560	3	4	270-04014
.050	3/16	.350	3	4	270-05024
.050	3/16	.700	3	4	270-05014
.060	3/16	.420	3	4	270-06024
.060	3/16	.840	3	4	270-06014
.070	3/16	.490	3	4	270-07024
.070	3/16	.980	3	4	270-07014
.080	3/16	.560	3	4	270-08024
.080	3/16	1.120	3	4	270-08014
.090	3/16	.630	3	4	270-09024
.090	3/16	1.260	3	4	270-09014
.100	3/16	.700	3	4	270-10024
.100	3/16	1.400	3	4	270-10014
.125	3/16	.875	3	4	270-12524
.125	3/16	1.750	3	4	270-12514

RIB TOOL APPLICATIONS

PROMAX's series of Tapered Rib Tools are specifically designed to improve production in hi-speed machining of deep, tight grooves in plastic injection molds, eliminating time-consuming EDM burning operations resulting in a bench free rib. In addition, our tools reduce cycle times with faster speeds and feeds while our advanced Aluminum-Titanium-Nitride (AlTiN) coating allows for dry machining and extends the life of the tool.

DEGREE TAPER:

- Degree is Per Side

HELIX ANGLE:

- 30 degree

TOLERANCES:

- Tip Diameter Tolerance: +.000/-.001
- Taper: Series 270 = No Taper
Series 271- 275 = +/- .10'
- Ball Radius: +.000/-.0005

Series 271 1/2 Degree Taper

DIA	SHANK	LOC	OAL	FLUTES	AlTiN
.030	3/16	.210	3	4	271-03024
.030	3/16	.420	3	4	271-03014
.040	3/16	.280	3	4	271-04024
.040	3/16	.560	3	4	271-04014
.050	3/16	.350	3	4	271-05024
.050	3/16	.700	3	4	271-05014
.060	3/16	.420	3	4	271-06024
.060	3/16	.840	3	4	271-06014
.070	3/16	.490	3	4	271-07024
.070	3/16	.980	3	4	271-07014
.080	3/16	.560	3	4	271-08024
.080	3/16	1.120	3	4	271-08014
.090	3/16	.630	3	4	271-09024
.090	3/16	1.260	3	4	271-09014
.100	3/16	.700	3	4	271-10024
.100	3/16	1.400	3	4	271-10014
.125	3/16	.875	3	4	271-12524
.125	3/16	1.750	3	4	271-12514

Series 272 & 273

4 Flute Ball End Rib Tool

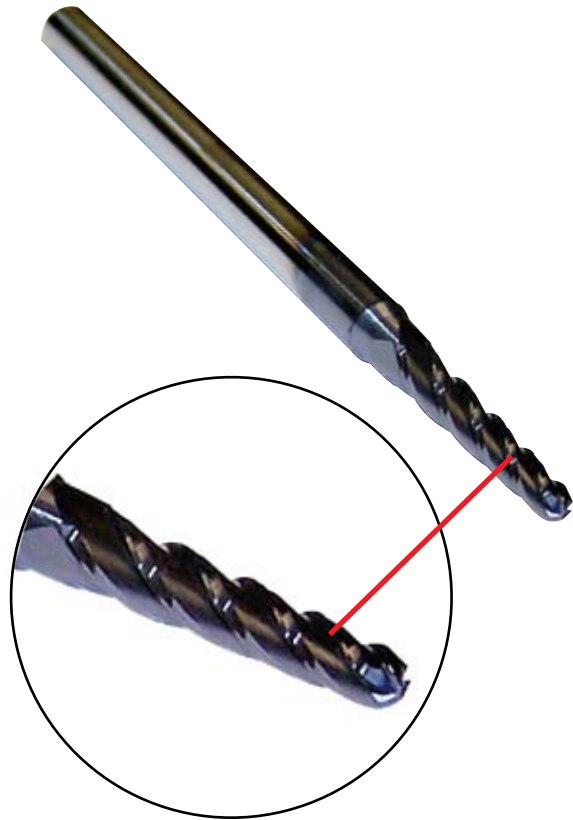

Series 272

1 Degree Taper

DIA	SHANK	LOC	OAL	FLUTES	AITiN
.030	3/16	.210	3	4	272-03024
.030	3/16	.420	3	4	272-03014
.040	3/16	.280	3	4	272-04024
.040	3/16	.560	3	4	272-04014
.050	3/16	.350	3	4	272-05024
.050	3/16	.700	3	4	272-05014
.060	3/16	.420	3	4	272-06024
.060	3/16	.840	3	4	272-06014
.070	3/16	.490	3	4	272-07024
.070	3/16	.980	3	4	272-07014
.080	3/16	.560	3	4	272-08024
.080	3/16	1.120	3	4	272-08014
.090	3/16	.630	3	4	272-09024
.090	3/16	1.260	3	4	272-09014
.100	3/16	.700	3	4	272-10024
.100	3/16	1.400	3	4	272-10014
.125	3/16	.875	3	4	272-12524
.125	3/16	1.750	3	4	272-12514

Series 273 1-1/2 Degree Taper

DIA	SHANK	LOC	OAL	FLUTES	AITiN
.030	3/16	.210	3	4	273-03024
.030	3/16	.420	3	4	273-03014
.040	3/16	.280	3	4	273-04024
.040	3/16	.560	3	4	273-04014
.050	3/16	.350	3	4	273-05024
.050	3/16	.700	3	4	273-05014
.060	3/16	.420	3	4	273-06024
.060	3/16	.840	3	4	273-06014
.070	3/16	.490	3	4	273-07024
.070	3/16	.980	3	4	273-07014
.080	3/16	.560	3	4	273-08024
.080	3/16	1.120	3	4	273-08014
.090	3/16	.630	3	4	273-09024
.090	3/16	1.260	3	4	273-09014
.100	3/16	.700	3	4	273-10024
.100	3/16	1.400	3	4	273-10014
.125	3/16	.875	3	4	273-12524
.125	1/4	1.750	3	4	273-12514

Series 274 & 275

4 Flute Ball End Rib Tool

Series 274 2 Degree Taper

DIA	SHANK	LOC	OAL	FLUTES	AlTiN
.030	3/16	.210	3	4	274-03024
.030	3/16	.420	3	4	274-03014
.040	3/16	.280	3	4	274-04024
.040	3/16	.560	3	4	274-04014
.050	3/16	.350	3	4	274-05024
.050	3/16	.700	3	4	274-05014
.060	3/16	.420	3	4	274-06024
.060	3/16	.840	3	4	274-06014
.070	3/16	.490	3	4	274-07024
.070	3/16	.980	3	4	274-07014
.080	3/16	.560	3	4	274-08024
.080	3/16	1.120	3	4	274-08014
.090	3/16	.630	3	4	274-09024
.090	3/16	1.260	3	4	274-09014
.100	3/16	.700	3	4	274-10024
.100	1/4	1.400	3	4	274-10014
.125	3/16	.875	3	4	274-12524
.125	1/4	1.750	3	4	274-12514

RIB TOOL

APPLICATIONS

PROMAX's series of Tapered Rib Tools are specifically designed to improve production in hi-speed machining of deep, tight grooves in plastic injection molds, eliminating time-consuming EDM burning operations resulting in a bench free rib. In addition, our tools reduce cycle times with faster speeds and feeds while our advanced Aluminum-Titanium-Nitride (AlTiN) coating allows for dry machining and extends the life of the tool.

DEGREE TAPER:

- Degree is Per Side

HELIX ANGLE:

- 30 degree

TOLERANCES:

- Tip Diameter Tolerance: +.000/- .001
- Taper: Series 270 = No Taper
Series 271-275 = +/- .10'
- Ball Radius: +.000/- .0005

Series 275 3 Degree Taper

DIA	SHANK	LOC	OAL	FLUTES	AlTiN
.030	3/16	.210	3	4	275-03024
.030	3/16	.420	3	4	275-03014
.040	3/16	.280	3	4	275-04024
.040	3/16	.560	3	4	275-04014
.050	3/16	.350	3	4	275-05024
.050	3/16	.700	3	4	275-05014
.060	3/16	.420	3	4	275-06024
.060	3/16	.840	3	4	275-06014
.070	3/16	.490	3	4	275-07024
.070	3/16	.980	3	4	275-07014
.080	3/16	.560	3	4	275-08024
.080	1/4	1.120	3	4	275-08014
.090	3/16	.630	3	4	275-09024
.090	1/4	1.260	3	4	275-09014
.100	3/16	.700	3	4	275-10024
.100	1/4	1.400	3	4	275-10014
.125	1/4	.875	3	4	275-12524

Series 103

Roughing End Mill for Hardened Materials



SERIES 103

This Rougher is designed for use on extremely tough to machine materials with a 60+ Rc hardness and high temperature alloys.

HELIX ANGLE:

- 1/4" thru 1" = 20 degrees

TOLERANCES:

- Shank: -.0001/-.0004
- Cutting Diameter: +.000/-.005

CORNER RADIUS:

(To strengthen end teeth)

- 3/16" = .025/.035
- 1/4" thru 5/16" = .040/.050
- 3/8" thru 1" = .055/.065

SET SCREW FLATS:

- Standard on 3/8" thru 1"

UPON REQUEST:

- Coolant Slots, 3/8" thru 1"

DIA	SHANK	LOC	OAL	FLUTES	TiCN	AlTiN
1/4	1/4	3/8	2	4	103-01622	103-01624
1/4	1/4	3/4	2-1/2	4	103-01612	103-01614
5/16	5/16	1/2	2-1/2	4	103-02022	103-02024
5/16	5/16	3/4	2-1/2	4	103-02012	103-02014
3/8	3/8	1/2	2	4	103-02422	103-02424
3/8	3/8	1	2-1/2	4	103-02412	103-02414
7/16	7/16	1	2-3/4	4	103-02812	103-02814
1/2	1/2	5/8	2-1/2	4	103-03222	103-03224
1/2	1/2	1-1/4	3	4	103-03212	103-03214
5/8	5/8	1-1/2	3-1/2	4	103-04012	103-04014
3/4	3/4	1-5/8	4	4	103-04812	103-04814
1	1	1-3/4	4	4	103-06412	103-06414

DIE & MOLD

Series 154

Multi Flute for Hardened Materials



SERIES 154

Designed for Superb Finishes on hardened materials up to 65 Rc.

HELIX ANGLE:

- 1/4" thru 3/4" = 40 degrees

TOLERANCES:

- Shank: -.0001/-.0004
- Cutting Diameter: +.000/-.002

DIA	SHANK	LOC	LOR	NECK DIA	RADIUS	OAL	FLUTES	AlTiN
1/4	1/4	1/4	1/2	.235	.010	2-1/2	5	154-01614
5/16	5/16	5/16		.297	.010	2-1/2	5	154-02014
3/8	3/8	3/8		.355	.015	3	5	154-02414
1/2	1/2	1/2	1	.475	.020	3-1/2	6	154-03214
5/8	5/8	5/8	1-1/4	.590	.020	3-1/2	8	154-04014
3/4	3/4	3/4	1.400	.715	.020	4	8	154-04814

Series 137 & 138

2 & 4 Flute Corner Rounders



Series 137

SHANK	RADIUS	MINOR DIA	OAL	FLUTES	UNCOATED	TiCN	AlTiN
1/8	.010	.105	1-1/2	2	137-00810	137-00812	137-00814
1/8	.015	.095	1-1/2	2	137-00820	137-00822	137-00824
1/8	.020	.085	1-1/2	2	137-00830	137-00832	137-00834
1/8	.025	.075	1-1/2	2	137-00840	137-00842	137-00844
1/8	.031	.063	1-1/2	2	137-00850	137-00852	137-00854
1/8	.035	.055	1-1/2	2	137-00860	137-00862	137-00864
1/8	.040	.045	1-1/2	2	137-00870	137-00872	137-00874
3/16	.046	.095	2	2	137-01210	137-01212	137-01214
3/16	.050	.087	2	2	137-01220	137-01222	137-01224
3/16	.055	.077	2	2	137-01230	137-01232	137-01234
3/16	.062	.062	2	2	137-01240	137-01242	137-01244
1/4	.072	.106	2-1/2	2	137-01610	137-01612	137-01614
1/4	.078	.094	2-1/2	2	137-01620	137-01622	137-01624
1/4	.085	.080	2-1/2	2	137-01630	137-01632	137-01634
1/4	.094	.062	2-1/2	2	137-01640	137-01642	137-01644
1/4	.100	.050	2-1/2	2	137-01650	137-01652	137-01654
5/16	.109	.094	2-1/2	2	137-02010	137-02012	137-02014
5/16	.118	.076	2-1/2	2	137-02020	137-02022	137-02024
5/16	.125	.063	2-1/2	2	137-02030	137-02032	137-02034
3/8	.140	.095	2-1/2	2	137-02410	137-02412	137-02414
3/8	.156	.063	2-1/2	2	137-02420	137-02422	137-02424

STRONGER CUTTING EDGE

With full form relief, resharpenings incur minimal change in geometry and provide a stronger cutting edge for extended tool life in both our 2 flute and 4 flute Corner Rounders. PROMAX's 2 flute Corner Rounders produce a convex form on materials ranging from aluminum to high temperature alloys, while 4 flute tools produce a convex form on low and high carbon steels, stainless steel and high temperature alloys. The 4 flute tools also maintain a minor diameter of .250 for ease of programming.

Series 138



SHANK	RADIUS	OAL	FLUTES	UNCOATED	TiCN	AlTiN
3/8	.010	2-1/2	4	138-02400	138-02402	138-02404
3/8	.015	2-1/2	4	138-02410	138-02412	138-02414
3/8	.020	2-1/2	4	138-02420	138-02422	138-02424
3/8	.025	2-1/2	4	138-02430	138-02432	138-02434
3/8	.031	2-1/2	4	138-02440	138-02442	138-02444
3/8	.035	2-1/2	4	138-02450	138-02452	138-02454
3/8	.040	2-1/2	4	138-02460	138-02462	138-02464
3/8	.046	2-1/2	4	138-02470	138-02472	138-02474
3/8	.050	2-1/2	4	138-02480	138-02482	138-02484
3/8	.055	2-1/2	4	138-02490	138-02492	138-02494
1/2	.062	3	4	138-03200	138-03202	138-03204
1/2	.072	3	4	138-03210	138-03212	138-03214
1/2	.078	3	4	138-03220	138-03222	138-03224
1/2	.085	3	4	138-03230	138-03232	138-03234
1/2	.093	3	4	138-03240	138-03242	138-03244
1/2	.100	3	4	138-03250	138-03252	138-03254
1/2	.109	3	4	138-03260	138-03262	138-03264
1/2	.120	3	4	138-03270	138-03272	138-03274

*.250 minor diameter on 4 Flute corner rounders.

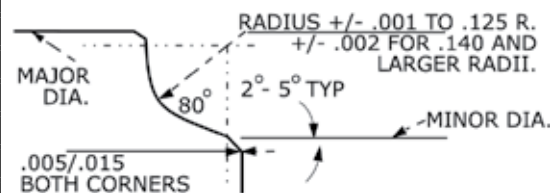

CORNER ROUNDERS

Chamfer Spotting Tools

2 & 4 Flute



Series 132 & 133

60 Degree Included Angle

DIA	OAL	CUT "A"	CUT "B"	FLUTES	UNCOATED	TiCN	AlTiN
*1/8	1-1/2	.098	.085	2	132-00820	132-00822	132-00824
*3/16	2	.147	.127	2	132-01220	132-01222	132-01224
1/4	2-1/2	.200	.173	4	133-01520	133-01522	133-01524
1/4	2-1/2	.200	.173	2	132-01520	132-01522	132-01524
3/8	2-1/2	.313	.271	2	132-02420	132-02422	132-02424
3/8	2-1/2	.313	.271	4	133-02420	133-02422	133-02424
1/2	3	.430	.372	4	133-03220	133-03222	133-03224
1/2	3	.430	.372	2	132-03220	132-03222	132-03224
3/4	4	.670	.580	4	133-04820	133-04822	133-04824

Series 134 & 135

90 Degree Included Angle

DIA	OAL	CUT "A"	CUT "B"	FLUTES	UNCOATED	TiCN	AlTiN
*1/8	1-1/2	.071	.050	2	134-00830	134-00832	134-00834
*3/16	2	.107	.076	2	134-01230	134-01232	134-01234
1/4	2-1/2	.141	.100	4	135-01530	135-01532	135-01534
1/4	2-1/2	.141	.100	2	134-01530	134-01532	134-01534
3/8	2-1/2	.221	.157	4	135-02430	135-02432	135-02434
3/8	2-1/2	.221	.157	2	134-02430	134-02432	134-02434
1/2	3	.304	.215	4	135-03230	135-03232	135-03234
1/2	3	.304	.215	2	134-03230	134-03232	134-03234
3/4	4	.474	.335	4	135-04830	135-04832	135-04834

*Series 130 & 131

120 Degree Included Angle

DIA	OAL	CUT "A"	CUT "B"	FLUTES	UNCOATED	TiCN	AlTiN
1/4	2-1/2	.124	.062	2	130-01510	130-01512	130-01514
1/4	2-1/2	.144	.072	4	131-01510	131-01512	131-01514
3/8	2-1/2	.217	.108	4	131-02410	131-02412	131-02414
3/8	2-1/2	.199	.100	2	130-02410	130-02412	130-02414
1/2	3	.289	.144	4	131-03210	131-03212	131-03214
1/2	3	.266	.133	2	130-03210	130-03212	130-03214

*No 118 Drill Point

MAXIMUM PRODUCTIVITY

Maximize your productivity with our combination chamfer and spotting drill. This dual-purpose tool, with a standard 118 degree drill point, reduces your cost by performing the job of two separate tools. Our chamfering angles have a constant form relief that allows for more resharpenings as well as a stronger, longer tool life.

TOLERANCES:

- Shank: -.0001/-.0004

*No 118° Drill Point

On 1/8" & 3/16"

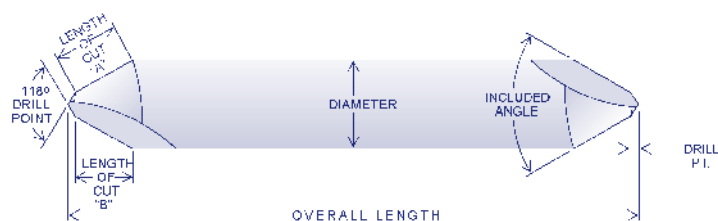
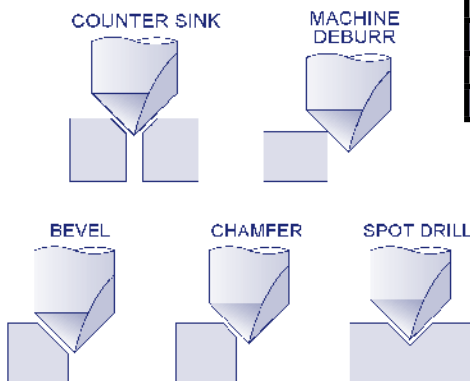

CHAMFER SPOTTING

PROMAX FOR PERFORMANCE:

All materials are not alike, that's why PROMAX Tools developed the performance series of carbide end mills. Using the latest in carbide tool technology and ultra fine and submicron grain carbide, PROMAX engineered the right geometries to produce maximum metal removal for all of your applications.

PROMAX Coatings

TiCN

(Titanium Carbonitride)



A performance coating is used for milling in general purpose applications in which excessive mechanically stressed cutting is encountered. It is also ideal where high feed and speed rates are desirable.

AlTiN

(Aluminum Titanium Nitride)



Designed specifically for use on carbide end mills, this single layer coating is used in machining hardened steel and high temperature alloy work pieces. Its excellent oxidation resistance allows high speed in semi-dry or dry machining operations where increased heat is generated.

ZrN

(Zirconium Nitride)



The next generation of coating developed specifically for machining aluminum yet excellent when machining all non-ferrous materials. Also, highly recommended for machining fiberglass, nylon and most polymer materials.

PROMAX CUSTOMER SERVICE

At PROMAX, we will provide the highest quality cutting tools to best suit your application. In addition, our customers receive both an excellent tool and the knowledge and assistance of our Technical Support and other departments. PROMAX Tools is built on the foundation that customer service is just as important as the product being sold. Our customers receive the answers they seek and the information they need in a more than timely manner. You can feel comfortable knowing that quality products and customer satisfaction are at the center of every decision PROMAX Tools makes.

Call the knowledgeable PROMAX Tech Line at 800-878-0502 for all of your cutting tool needs and questions.

LIMITED WARRANTY

PROMAX Tools warrants each new product manufactured and sold by PROMAX or one of our authorized dealers against defects in workmanship and/or materials. Our obligation is limited to the repair or replacement of defective products. At our discretion, we may refund the purchase price of a defective product. This warranty does not cover products that are damaged as a result of negligence or misuse including improper operating conditions and machine set up or any items that have been repaired or altered. This warranty excludes all other warranties, expressed or implied, including any implied warranties of merchant ability or fitness for a particular purpose. In no event will PROMAX be liable for any incidental, special or consequential damages of any nature.

RETURN POLICY

Returned products must be accompanied by a PROMAX Tools authorized Returned Goods Authorization number (RGA). Warranty claims should be made through the distributor from whom the product was purchased. Distributors may call PROMAX at 1-800-878-0502. to receive an RGA number. Returned goods may be subject to a restocking fee. Special, modified, non-catalog or altered tools are not acceptable for return.

TEST TOOL POLICY

Take the PROMAX Challenge: Throw it on the spindle and prove it to yourself. Higher production rates and longer tool life are your goals and ours. PROMAX Tools will authorize a test tool credit only when the proper procedures of the existing GUARANTEED TEST TOOL ORDER (GTO) are followed. For details on this program, please call our TECH LINE at 1-800-878-0502.

SAFETY PRECAUTIONS

Carbide cutting tools can break or shatter under improper or severe use. Always wear the proper personal protective equipment when performing metal cutting operations. Carbide cutting tools have sharp edges. Use caution while handling cutting tools to avoid injury.

Recommended Feeds & Speeds & Tool Selection Guidelines For ROUGHING Applications

MATERIAL	RECOMMENDED TOOL STYLE	RECOMMENDED COATING	BHN	SFM	FPT 1/4" - 3/8" DIA	FPT 1/2" - 5/8" DIA	FPT 3/4" - 1" DIA
ALUMINUM	SER 102 SER 119 SER 110	ZrN, TiCN	80	1200 To Max	.001 - .004	.004 - .008	.008 - .020
ALUMINUM - HIGH SILICONE CONTENT	SER 102 SER 119 SER 110	ZrN, TiCN, AlTiN	100	600	.001 - .003	.003 - .005	.005 - .008
CAST IRON	SER 100 SER 120 SER 117 SER 122	TiCN, AlTiN	160	500	.001 - .002	.002 - .004	.005 - .006
COPPER, BRASS	SER 102 SER 119 SER 110	TiCN, ZrN	100	750	.001	.002	.004 - .006
HIGH TEMP ALLOYS - NICKEL BASE (INCONEL, WASPALLOY, RENE, HASTALOY)	SER 101 SER 103 SER 120 SER 103	TiCN, AlTiN	200	60	.0008 - .0012	.0012 - .0018	.0018 - .0025
PLASTIC - HIGH GLASS CONTENT	SER 100 SER 102 SER 120	AlTiN, ZrN	--	550	.002 - .003	.004 - .005	.006 - .008
PLASTIC AND COMPOSITES	SER 100 SER 102 SER 120	TiCN, ZrN	--	1000+	.002 - .003	.004 - .007	.008 - .012
STEEL	SER 100 SER 120 SER 121	TiCN, AlTiN	200	275	.001 - .002	.002 - .003	.003 - .004
STEEL, STAINLESS	SER 100 SER 101 SER 103 SER 117 SER 120 SER 122	TiCN, AlTiN	200	200	.001 - .002	.002 - .003	.003 - .004
STEEL, TOOL	SER 101 SER 103 SER 120 SER 121	TiCN, AlTiN	200	200	.001	.002	.003 - .004
TITANIUM	SER 101 SER 103 SER 120	TiCN, AlTiN	275	160	.001	.002 - .003	.004 - .006

Roughing Application Formulas

Speeds and Feeds to be considered as a starting point. Values calculated at:

Axial Cut (depth) = Diameter x 1.0

Radial Cut (width) = Diameter x .5 to Diameter x 1.0 (Full Slot)

Formulas:

Spindle Speed (RPM) = $(3.82 \times \text{SFM}) / \text{Diameter}$

Feed (Inches Per Minute) = $\text{FPT (Feed per Tooth)} \times \text{RPM} \times \text{Number of Flutes}$

Example: For starting speed using a 1/2" 4 flute end mill cutting Titanium at a hardness of around 275 BHN, find SFM on above chart (SFM=160) and calculate RPM using formula as follows: $\text{RPM} = 3.82 \times 160 (\text{SFM}) / .5 (\text{DIA}) = 1222 \text{ RPM}$.

For starting feed: $.002 (\text{FPT}) \times 1222 (\text{RPM}) \times 4 (\text{Flutes}) = 9\text{-}3/4 \text{ IPM}$.

Recommended Feeds & Speeds & Tool Selection Guidelines For FINISHING Applications

Material	RECOMMENDED TOOL STYLE	RECOMMENDED COATING	BHN	SFM	FPT 1/4" - 3/8" DIA	FPT 1/2" - 5/8" DIA	FPT 3/4" - 1" DIA
ALUMINUM	SER 108 SER 115 SER 109 SER 110	TiCN, ZrN	80	1200 to MAX	.001 - .003	.003 - .006	.006 - .012
ALUMINUM - HIGH SILICONE CONTENT	SER 108 SER 115 SER 109 SER 110	TiCN, ZrN	100	800	.001 - .003	.003 - .005	.006 - .008
CAST IRON	PRO-4 VAR-A-TECH SER 106/113 SER 112 SER 111/116/129	TiCN, AlTiN	160	600	.001	.002 - .004	.005 - .006
COPPER, BRASS	SER 108 SER 115 SER 109 SER 110 SER 111 SER 116 SER 129	TiCN, ZrN	100	900	.001 - .002	.003 - .004	.005 - .007
GRAPHITE	SER 108 SER 115 SER 109 SER 111 SER 116 SER 129	AlTiN, ZrN	—	1000+	.002 - .004	.006 - .008	.010 - .012
HIGH TEMP ALLOYS - NICKEL BASE (INCOLOY, INCONEL, WASPALOY, RENE, HASTALOY)	PRO-4 VAR-A-TECH SER 111 SER 116 SER 112 SER 129	AlTiN, TiCN	200	80	.0008 - .0012	.0012 - .0018	.0018 - .0025
PLASTIC AND COMPOSITES	SER 108 SER 115 SER 109 SER 110 SER 111 SER 116 SER 129	TiCN, ZrN	—	1200+	.003 - .004	.005 - .008	.010 - .014
PLASTIC WITH HIGH GLASS CONTENT	SER 111 SER 116 SER 129 SER 110 SER 109 SER 112	AlTiN, ZrN	—	550	.003 - .004	.005 - .006	.007 - .010
STEEL	PRO-4 VAR-A-TECH SER 129 SER 111/116 SER 112	TiCN, AlTiN	200	400	.001 - .0015	.0015 - .003	.003 - .004
STEEL, STAINLESS	PRO-4 VAR-A-TECH SER 106/113 SER 111/116/129 SER 112	TiCN, AlTiN	200	350	.001 - .0015	.0015 - .003	.003 - .004
STEEL, TOOL	VAR-A-TECH SER 112 SER 111/116/129	TiCN, AlTiN	200	320	.001 - .0015	.0015 - .003	.003 - .004
STEEL/HARDENED	VAR-A-TECH SER 112 SER 111/116/129	TiCN, AlTiN	52 - 60 RC	30 - 60	.0008 - .001	.001 - .002	.002 - .003
TITANIUM	PRO-4 VAR-A-TECH SER 112 SER 111/116/129	TiCN, AlTiN	275	400	.001 - .015	.002 - .004	.004 - .006

Finishing Application Formulas

Speeds and Feeds to be considered as a starting point. Values calculated at:

Axial Cut (depth) = Diameter x 1.5 • Radial Cut (width) = .020 to .040

Formulas:

Spindle Speed (RPM) = (3.82 x SFM) / Diameter • Feed (Inches Per Minute) = FPT (Feed per Tooth) x RPM x Number of Flutes

Example: For starting speed using a 1/2" 4 flute end mill cutting Stainless at a hardness of around 200 BHN, find SFM on above chart (SFM=350) and calculate RPM using formula as follows: RPM = 3.82 x 350 (SFM) / .5 (DIA) = 2674 RPM. • For starting feed: .002 (FPT) x (RPM) x 4 (Flutes) = 21 IPM.



PROMAX

Tools

"Feel The Edge"

Phone: (916) 638-0501 / (800) 878-0502

Fax: (916) 638-0512

**11312 Sunrise Gold Circle
Rancho Cordova, CA 95742**

www.promaxtools.com



**Sold Through
Select Distributors**

With PROMAX You Get

QSD

Quality-Service-Dependability

Sponsored by



ISA

INDUSTRIAL SUPPLY ASSOCIATION

Linking Channel Partners