

# SUSPENSION TO TAME ANY TERRAIN



**OUR COIL  
SPRINGS  
ARE MADE IN  
AUSTRALIA**



**Shock  
Absorbers**



**Leaf  
Springs**



[www.Pro4wd.cz](http://www.Pro4wd.cz)

**Coil  
Springs**



*Terrain Tamer, built tough for Australian conditions,  
have been the trusted supplier of Suspension components  
to the trade for over 40 years.*

*That's why our Coil Springs are made in Australia using  
Australian steel. Talk to our expert support team, who have  
a lifetime of experience or visit [terraintamer.com](http://terraintamer.com)*



# Suspension Assessment Procedure

Please ask the following questions in order to supply the correct suspension kit

- Vehicle Make – Model – Manufacture date - VIN number
- Any additional items added to the vehicle

## Does the vehicle have constant Load Bearing Accessories (LBA)

- Front suspension:  
Bull Bar – Winch – Dual batteries - Roof rack - Others
- Rear suspension:  
Rear step bar – Tow bar – Wheel carriers – Draw compartments – LPG tank –  
Others – Extra fuel tank
- Is the vehicle a work truck with tools and other work equipment?

## Does the vehicle have Variable Load Conditions (VLC)

- Family wagon loaded with children and camping gear for weekend outing but unloaded at other times
- Tows a boat or heavy trailer only laden occasionally
- Does the customer want to raise the vehicle for extra ground clearance and only carry extra weight occasionally
- Does the customer require a softer more comfortable suspension
- What height does the customer desire

## Once you have determined the customer's needs:

- Constant Load Bearing Accessories (LBA)
- Variable Load Conditions (VLC)
- Extra ground clearance
- Comfort ride suspension
- Suspension height

Then refer to the accessories list in this catalogue for approximate weights and interpret the correct suspension for the customer's needs.

# Table of Contents

## Holden/Isuzu

Jackaroo UBS 1983 - April 1992	1
Jackaroo UBS after May 1992 inclusive	2
Rodeo TFS, R7, R9, 4WD June 1988 - February 2003	3
Rodeo&Colorado 4WD RA&D-Max after March 2003 inclusive	4

## Landrover

Defender 1992 - 2001	5
Discovery	6
Range Rover 1972 - April 1995	7

## Mitsubishi

Triton ME - MK	8
Triton ML	9
Pajero NA - NK January 1983 - September 1997	10
Pajero NF - NL August 1988 - June 2000	11
Pajero NM - NP May 2000 - December 2008	12

## Nissan

Patrol MQ	13
Patrol MK	15
Patrol GQ Cab/Chassis	17
Patrol GQ	19
Patrol GU	23
Navara D21 & D22	27
Navara D40	28
Pathfinder WD21	29
Pathfinder R50	30
Pathfinder R51	31
Terrano R20	32

## Suzuki

Sierra SJ LJ 7/81 - 3/96	33
Sierra SJ 80 7/81 - 3/96	35
Vitara	36
Grand Vitara	37

## Toyota

4WD Hilux & 4 Runner - leaf springs	38
4WD Hilux & 4 Runner - IFS & Rear leaf Springs	41
4WD Hilux & 4 Runner - IFS & Rear Coil Springs	43
4WD Hilux after March 2005 inclusive	44
LandCruiser 4# Series before July 1980 inclusive	46
LandCruiser 4# Series after August 1980 inclusive	49
LandCruiser FJ55 after January 1975 Inclusive	52
LandCruiser 60 Series August 1980 to January 1990	54
LandCruiser 7# Series	58
LandCruiser 80 Series	63
LandCruiser 105 Series	67
LandCruiser 100 Series	71
LandCruiser 200 Series	73
LandCruiser Prado 9# Series April 1996 - August 2002	74
LandCruiser Prado 120 Series after September 2002 inclusive	76
LandCruiser Prado 150 Series	78

# Suspension Application Form



Date: \_\_\_\_\_

Name: \_\_\_\_\_ Phone: \_\_\_\_\_

Address: \_\_\_\_\_

Fax: \_\_\_\_\_ Email: \_\_\_\_\_

## Vehicle Details

Make: \_\_\_\_\_ Model: \_\_\_\_\_ Year: \_\_\_\_\_

Vin No. \_\_\_\_\_

Roof Rack: Yes  No

Side Steps: Yes  No

Side Rails: Yes  No

Bull Bar .  
Yes  No

Alloy   
Steel

Winch  
Yes  No

Dual Batteries  
Yes  No

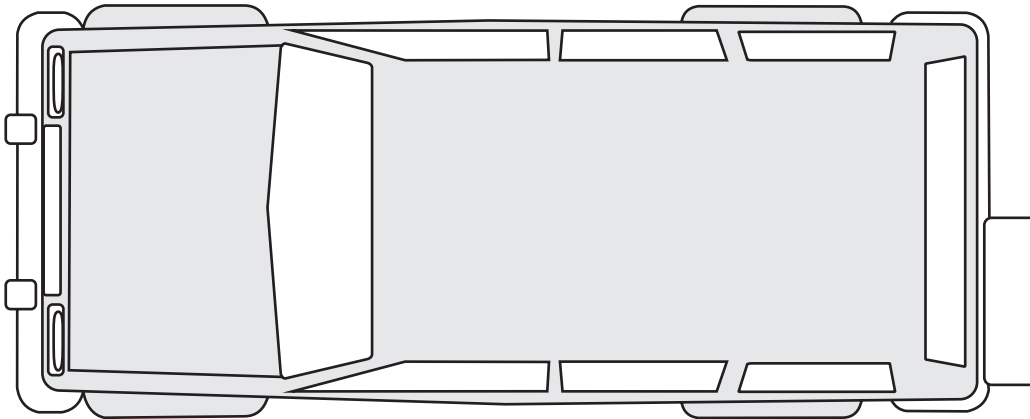

Rear Step Bar  
Yes  No

LPG Tank  
Yes  No

Towbar  
Yes  No

Rear Draw Set  
Yes  No

Tyre Carrier  
Yes  No

Place a "X" in the appropriate box to show if accessories are fitted.

### Front Suspension

Accessory	Weight	"X"
Bull Bar		
Winch		
Dual Battery		
Roof Rack		
Roof Rack		
Side Bars		
Other		
Total		
Total Weight		

### Rear Suspension

Accessory	Weight	"X"
Tow Bar		
Rear Step Bar		
Type Carrier		
Rear Draw Set		
Tray (Steel or Alloy)		
LPG Tank		
Roof Rack		
Side Bars		
Others		
Total Weight		

Front Spring Part No. \_\_\_\_\_

Rear Spring Part No. \_\_\_\_\_

Suggested Terrain Tamer Suspension Kit Part No. \_\_\_\_\_

# Our Coil Spring Manufacturing Process



Only the finest high stress material from One Steel is used, shipped to the plant in an annealed state, then bar peeled and polished to the exact size to remove all surface defects and then cut to length.

The material is heated in electric furnaces to 1000 degrees celsius, formed on computer controlled machines and hardened by quenching in oil to achieve a hardness of 62 HRC.

Spring end grinding is applied. Shot peening of the surface is completed to increase durability. Every spring is solid scragged, tested and a full and final inspection is carried out.

All coil springs are powder coated for the most durable finish and offering a professional presentation. The springs are finally labelled by inkjet, packed as pairs and ready for shipping.

Large stocks are held for immediate supply.

All springs are manufactured under a quality system certified as complying with ISO-9001:2000



[www.Pro4wd.cz](http://www.Pro4wd.cz)

# SUSPENSION RANGE

## Coil Springs

### Spring Application Guide

Comfort	10mm above original vehicle ride height Standard Height Comfort Ride
Standard	10mm above original vehicle ride height Standard Height Standard Ride
Raised	40 to 50mm above original vehicle ride height Raised Height Standard Ride
Raised Heavy Duty	50mm above original vehicle ride height Raised Height Load Bearing Accessories (LBA)
Raised Extra Heavy Duty	60-70mm above original vehicle ride height Raised Height Load Bearing Accessories (LBA)
Progressive Rate	10 to 40mm above original Ride Height Standard - Heavy Duty Rating

### Spring Characteristics

Comfort Ride	Suits original Ride Height with Softer Ride Characteristics
Standard	Suits original Load Capacity and Ride Characteristics approximately 10mm higher
Progressive Rate	Suits varying Load Conditions allows Comfortable Ride when empty and Heavy Duty Characteristics when Loaded
Heavy Duty or Raised	Suits constant Load Carrying Conditions eg Bull Bar, Winch, Dual Batteries, Tow Bar, Rear Draw Compartment LPG Tank, Additional Fuel Tank etc
LBA	Load Bearing Accessories
VLC	Variable Load Condition
H/Duty	Heavy Duty
E/H/Duty	Extra Heavy Duty

# SUSPENSION RANGE

## *Shock Absorbers*

### **TGS Series - Expanded Body Size**

Heavy duty construction and welding techniques

35mm Inside bore diameter for enhanced dampening effect

High quality 16mm chrome hardened shaft for maximum durability

Large expanded body 60mm outer tube for extra oil capacity and superior cooling

Twin tube design - Multi stage valving system - Extended length

Suitable for heavy to extreme usage leaf and coil application

3 Year/100,000km Warranty

### **G Series OEM - Standard Body Size**

Heavy duty construction and welding technique

35mm Inside bore diameter for enhanced dampening effect

High quality 16mm chrome hardened shaft for maximum durability

Twin tube design - Multi stage valving system - Extended length

Standard size heavy duty body 50mm outer tube heavy duty for normal or limited access fitment

Suitable for heavy duty use leaf spring and light duty coil application

3 Year/100,000km Warranty

## *Load Bearing Accessories (LBA)*

<b>LBA</b>	<b>Weight</b>
Alloy Bar	35kg
Steel Bar	75kg
Electric Winch	45kg
Dual Battery	25kg
Tow Bar	25kg
LPG Gas Tank (Full)	100kg
Roof Rack (Alloy)	20kg
Fuel Tank Other Than Original	100kg
Spare Wheel Carrier	25kg
Rear Draw Compartment	50kg

Please Note: The above specifications are approximate and should be used as a guide only

# SUSPENSION KITS

Make & Model

Page No. Kit No.

Make & Model	Page No.	Kit No.	
<b>Toyota</b>			
Landcruiser 40 Series SWB	FJ/BJ40 7/80~	49 SK013	
40 Series SWB	FJ/BJ40 ~7/80	46 SK015	
Ute/Troopie	FJ45/HJ47/BJ45 7/80~	49 SK012	
Ute Troopie	FJ45/HJ45 ~7/80	46 SK014	
Wagon	60 Series	54 SK010	
Wagon	BJ70/73/74 Series	58 SK008	
70 Series MWB	RJ/LJ70	58 SK011	
Ute/Troopie	75 Series	58 SK009	
Wagon	76 Series	58 SK036	
Ute/Troopie	78/79 Series	58 SK007	
Wagon	80 Series 8/91~	63 SK006	
Prado	90 Series	74 SK002	
Wagon	100 Series	71 SK003	
Wagon	105 Series	67 SK004	
Wagon	200 Series	73 SK022	
Prado	120 Series	76 SK001	
Prado	150 Series	78 SK025	
Hilux/4Runner	03/2005~	Frnt Coil / Rear Leaf 03/2005~	44 SK016
	03/2005~	Frnt Coil / Rear Leaf 03/2005~	44 SK017
		I.F.S. Frnt T/Bar Rear Coil	73 SK019
		I.F.S. Frnt T/Bar Rear Leaf	41 SK018
		Leaf Spring Frnt & Rear	38 SK020
		Single Cab	
		Extra/Dual Cab	
<b>Suzuki</b>			
Grand Vitara	SQ ~7/05 4 Cyl	37 SK021	
Grand Vitara	SQ ~7/05 V6	37 SK021	
Grand Vitara	SQ ~7/05 7 Seater	37 SK021	
Grand Vitara	JB 7/05~	37 SK023	
Vitara	1.6 Lt SWB	36 SK024	
Vitara	2.0 Lt LWB	36 SK024	
Vitara	V6 LWB	36 SK024	
Sierra	SJ 80	35 SK027	
Sierra	SJ LJ 81~	33 SK028	
<b>Nissan</b>			
Terrano	R20 3/97~	32 SK030	
Pathfinder	R51	31 SK031	
Pathfinder	R50	30 SK032	
Pathfinder	WD21	29 SK033	
Navara	D40	28 SK034	
Navara	D21	27 SK035	
Navara	D22	27 SK035	
Patrol	GU Leaf Rear	26 SK037	
Patrol	GU Coil All Round	23 SK038	
Patrol	GU Tray Back Coil All Round	23 SK029	
Patrol	GQ SWB Coil All Round	19 SK039	
Patrol	GQ LWB 3.0Lt Coil All Round	19 SK040	
Patrol	GQ LWB 4.2 Lt Coil All Round	19 SK042	
Patrol	GQ Tray Back Coil All Round	19 SK041	
Patrol	GQ Cab/Chassis Leaf Spring All Round	17 SK043	
Patrol	MK LWB	15 SK046	
Patrol	MK SWB	15 SK046	
Patrol	MQ LWB	13 SK044	
Patrol	MQ SWB	13 SK044	



# SUSPENSION KITS

Make & Model			Page No.	Kit No.
<b>Mitsubishi</b>	Pajero	NM-NP Petrol 05/00-12/06	12	SK045
	Pajero	NM-NP Diesel 05/00-12/06	12	SK045
	Pajero	NF-NG 8/88-6/00	11	SK050
	Pajero	NH-NL 8/88-6/00	11	SK051
	Pajero	NA-NG 01/83-09/97	10	SK052
	Pajero	NH-NK 01/83-09/97	10	SK053
	Triton	ML	9	SK054
	Triton	ME-MH	8	SK055
	Triton	MJ-MK	8	SK056
	<b>Land Rover</b>	Range Rover	72-4/95	7
Discovery		Series 1 Coil Frt & RR	6	SK058
Discovery		Series 2 Coil Frt & RR	6	SK059
Discovery		Series 3 Coil Frt & RR	6	SK060
Defender		1992-2001 Coil Frt & RR	5	SK061
<b>Holden/Isuzu</b>	Rodeo&Colorado	4WD RA&D-Max 3/03-	4	SK062
	Rodeo	TFS, R7, R9, 4wd	3	SK063
	Jackaroo	UBS 5/92- IFS & Coil RR	2	SK064
	Jackaroo	UBS 83-4/92 & Leaf RR	1	SK065

Our Suspension Kits includes all required components:

Coil Springs, Leaf Springs, Shock Absorbers, Bush Kit,  
Shackles, Pin Kit, U-bolts, Steering Damper

## Holden Range

*Jackaroo UBS ~ 1983 - April 1992* *P.1*

---

*Jackaroo UBS ~ after May 1992 inclusive* *P.2*

---

*Rodeo TFS, R7, R9, 4WD June 1988 - February 2003* *P.3*

---

*Roden RA 4WD After March 2009 inclusive* *P.4*

---



# JACKAROO UBS 1983 - April 1992

## IFS FRONT & LEAF SPRING REAR



Kit No.: SK065

HOLDEN

### FRONT SUSPENSION

MODEL / YEAR	HEIGHT	PART NO.	QTY	COMMENTS	
<b>FRONT SPRINGS</b>					
-7/88	Raised 40mm	ISU005HD	1 pr.	T/Bars, H/Duty 27mm OD, 928mm Long	
8/88-	Raised 40mm	ISU008HD	1 pr.	T/Bars, H/Duty 25.5mm OD, 998mm Long	
<b>FRONT SHOCK ABSORBERS</b>					
		349-228	TGS12543-2	2	Expanded Body Gas Shock
Long Travel		398-262	TGS12545	2	Expanded Body Gas Shock

### REAR SUSPENSION

<b>REAR SPRINGS</b>					
	Raised 40mm	ISU001C	2	Leaf Spring, Comfort ~ 150kg LBA	
	Raised 40mm	ISU001HD	2	Leaf Spring, H/Duty ~ 350kg LBA	
<b>REAR U-BOLTS</b>					
		TUB001	4	U-Bolt, Round Top 175X77X12	
<b>REAR SHOCK ABSORBERS</b>					
up to 10/86.		590-357	G12636	2	Gas Shock
		590-357	TGS2576B	2	Expanded Body Gas Shock
11/86 on.		595-363	TGS25564	2	Expanded Body Gas Shock
<b>REAR SHACLE &amp; PIN KITS</b>					
		TSK002	2	Shackle Kit, Greasable	
		TPK002	2	Pin Kit, Greasable	
<b>REAR SHACKLE BUSH</b>					
		BK41P	1	Shackle Bush Kit, Poly	

# JACKAROO UBS *After May 1992 inclusive*

## IFS FRONT & COIL SPRING REAR

Kit No.: SK064

HOLDEN

ISSUE

### FRONT SUSPENSION

MODEL / YEAR	HEIGHT	PART NO.	QTY	COMMENTS	
<b>FRONT SPRINGS</b>					
	Raised 40mm	ISU004HD	1 pr.	T/Bars, H/Duty 29mm OD, 1220mm Long	
<b>FRONT SHOCK ABSORBERS</b>					
		398-262	TGS12545	2	Expanded Body Gas Shock

### REAR SUSPENSION

<b>REAR SPRINGS</b>					
	Raised 40mm	TTCS-0997	2	Coil	Comfort Ride
	Raised 40mm	TTCS-0998	2	Coil	Heavy Duty
<b>REAR SHOCK ABSORBERS</b>					
		525-322	TGS2540B	2	Expanded Body Gas Shock

# RODEO TFS,R7,R9 4WD Jun 1988 - Feb 2003

## IFS FRONT & LEAF SPRING REAR

Kit No.: SK063



HOLDEN

ISSN

### FRONT SUSPENSION

MODEL / YEAR	HEIGHT	PART NO.	QTY	COMMENTS
<b>FRONT SPRINGS</b>				
	Raised 40mm	ISU007HD	1 pr.	T/Bars, H/Duty 26mm OD, 1000mm Long
<b>FRONT SHOCK ABSORBERS</b>				
		398-262 TGS12545	2	Expanded Body Gas Shock

### REAR SUSPENSION

<b>REAR SPRINGS</b>				
	Raised 40mm	ISU001HD	2	Leaf Spring, H/Duty ~ 300kg LBA
	Raised 40mm	ISU001EHD	2	Leaf Spring, E/H/Duty 300kg + LBA
<b>REAR U-BOLTS</b>				
		TUB004	4	U-Bolt, Round Top 195X83X14
<b>REAR SHOCK ABSORBERS</b>				
		590-357 G12636	2	Gas Shock
		590-357 TGS52576B	2	Expanded Body Gas Shock
<b>REAR SHACLE &amp; PIN KITS</b>				
		TSK009	2	Shackle Kit, Greasable
		TPK016	2	Pin Kit, Greasable
<b>REAR SHACKLE BUSH</b>				
		BK39P	1	Shackle Bush Kit, Poly

**RODEO RA** After March 2003 Inclusive

**COLORADO 4WD**

**D-Max**

**IFS FRONT & LEAF SPRING REAR**

Kit No.: SK062

H  
O  
L  
D  
E  
N

I  
S  
U  
N

## FRONT SUSPENSION

MODEL / YEAR	HEIGHT	PART NO.	QTY	COMMENTS
--------------	--------	----------	-----	----------

### FRONT SPRINGS

	Raised 40mm	ISU009HD	1 pr.	T/Bars, H/Duty 30mm OD, 1145mm Long
--	----------------	----------	-------	-------------------------------------

### FRONT SHOCK ABSORBERS

		398-262	TGS12545	2	Expanded Body Gas Shock
--	---	---------	----------	---	-------------------------

## REAR SUSPENSION



### REAR SPRINGS

	Raised 40mm	ISU006C	2	Leaf Spring, ~200kg LBA
	Raised 40mm	ISU006HD	2	Leaf Spring, H/Duty ~ 300kg LBA

### REAR U-BOLTS

		TUB016	4	U-Bolt, Round Top 200X88X14
--	--	--------	---	-----------------------------

### REAR SHOCK ABSORBERS

		590-357	G12636	2	Gas Shock
		590-357	TGS52576B	2	Expanded Body Gas Shock

### REAR SHACLE & PIN KITS

		TSK009	2	Shackle Kit, Greasable
		TPK016	2	Pin Kit, Greasable

		BK39P	1	Shackle Bush Kit, Poly
--	--	-------	---	------------------------

## Landrover Range

*Defender 1992 - 2001* *P.5*

---

*Discovery* *P.6*

---

*Range Rover 1972 - April 1995* *P.7*

---

# DEFENDER 1992 - 2001

## COIL SPRINGS ALLROUND

Kit No.: SK061

### FRONT SUSPENSION

MODEL / YEAR	HEIGHT	PART NO.	QTY	COMMENTS	
<b>FRONT SPRINGS</b>					
	Standard	TTCS-1261	1 pr.	Coil	Std Duty ~40kg LBA
	Raised 30mm	TTCS-1257	1 pr.	Coil	Std Duty ~40kg LBA
	Raised 40mm	TTCS-1258	1 pr.	Coil	H/Duty ~80kg LBA
<b>FRONT SHOCK ABSORBERS</b>					
	+	550-325	TGS12541	2	Expanded Body Gas Shock
<b>STEERING DAMPER</b>					
	+	512/308	T14032	1	35 mm Heavy Duty Replacement

### REAR SUSPENSION

<b>REAR SPRINGS</b>					
	Standard	TTCS-1108	1 pr.	Coil	Std Duty ~200kg LBA
	Raised 40mm	TTCS-1102	1 pr.	Coil	Std Duty ~200kg LBA
	Raised 40mm	TTCS-1103	1 pr.	Coil	H/Duty ~300kg LBA
<b>REAR SHOCK ABSORBERS</b>					
	♀	560-340	G12117	2	Gas Shock
	♀	550-330	TGS12542	2	Expanded Body Gas Shock



# DISCOVERY

## COIL SPRINGS ALLROUND

Kit No: Ser 1 SK058  
 Ser 11 SK059  
 Ser 111 SK060

### FRONT SUSPENSION

MODEL / YEAR	HEIGHT	PART NO.	QTY	COMMENTS	
<b>FRONT SPRINGS</b>					
Series 1, 91-1/99	Standard	TTCS-1260	1 pr.	Coil	Std Duty ~30kg LBA
	Raised 30mm	TTCS-1255	1 pr.	Coil	Std Duty ~30kg LBA
Series 11, 2/99-12/04	Standard	TTCS-1262	1 pr.	Coil	Std Duty ~30kg LBA
	Raised 30mm	TTCS-1259	1 pr.	Coil	Std Duty ~30kg LBA
Series 111, 1/05-	Raised 30mm	TTCS-2134	1 pr.	Coil	Std Duty ~30kg LBA
<b>FRONT SHOCK ABSORBERS</b>					
Series 1, 91-1/99 †	550-325	TGS12541	2	Expanded Body Gas Shock	
Series 11, 2/99-12/04 ♂	580-370	TGS12214	2	Expanded Body Gas Shock	

### REAR SUSPENSION

<b>REAR SPRINGS</b>					
Series 1 & 11, 91-12/04	Standard	TTCS-1272	1 pr.	Progressive Coil	Std Duty ~75kg LBA
	Raised 40mm	TTCS-1267	1 pr.	Progressive Coil	H/Duty ~100kg LBA
	Raised 40mm	TTCS-1268	1 pr.	Progressive Coil	E/H/Duty ~300kg LBA
Series 111, 1/05-	Raised 40mm	TTCS-2138	1 pr.	Progressive Coil	H/Duty ~100kg LBA
<b>REAR SHOCK ABSORBERS</b>					
Series 1, 91-1/99 ♀	560-340	G12117	2	Gas Shock	
	550-330	TGS12542	2	Expanded Body Gas Shock	
Series 11, 2/99-12/04 ♂	570-360	TGS12215	2	Expanded Body Gas Shock	

# RANGE ROVER 1972 - April 1995

## COIL SPRINGS ALLROUND

Kit No.: SK057

### FRONT SUSPENSION

MODEL / YEAR	HEIGHT	PART NO.	QTY	COMMENTS	
<b>FRONT SPRINGS</b>					
	Standard	TTCS-1260	1 pr.	Coil	Std Duty ~30kg LBA
	Raised 30mm	TTCS-1255	1 pr.	Coil	Std Duty ~30kg LBA
<b>FRONT SHOCK ABSORBERS</b>					
	⊥	550-325	TGS12541	2	Expanded Body Gas Shock
<b>STEERING DAMPER</b>					
	⊥	512/308	T14011	1	35 mm Heavy Duty Replacement
	⊕	655/395	T14012	1	35 mm Heavy Duty Replacement

### REAR SUSPENSION

<b>REAR SPRINGS</b>					
	Standard	TTCS-1272	1 pr.	Progressive Coil	Std Duty ~30kg LBA
	Raised 40mm	TTCS-1267	1 pr.	Progressive Coil	H/Duty ~100kg LBA
	Raised 40mm	TTCS-1268	1 pr.	Progressive Coil	E/H/Duty ~300kg LBA
<b>REAR SHOCK ABSORBERS</b>					
	♀	560-340	G12117	2	Gas Shock
	♀	550-330	TGS12542	2	Expanded Body Gas Shock

## Mitsubishi Range

*Triton ME - MK* *P.8*

---

*Triton ML* *P.9*

---

*Pajero NA - NK January 1983 - September 1997* *P.10*

---

*Pajero NF - NL August 1988 - June 2000* *P.11*

---



*Pajero NM - NP May 2000 - December 2008* *P.12*

---



# TRITON ME - MK

Kit No.: ME - MH SK055  
MJ - MK SK056

## FRONT SUSPENSION

MODEL / YEAR	HEIGHT	PART NO.	QTY	COMMENTS	
<b>FRONT SPRINGS</b>					
ME-MH	Raised 40mm	MIT002HD	1 pr.	Torsion Bars, H/Duty 1282mm Long	
MJ-MK	Raised 40mm	MIT003HD	1 pr.	Torsion Bars, H/Duty 1370mm Long	
<b>FRONT SHOCK ABSORBERS</b>					
ME-MJ		349-228	TGS12543-1	2	Expanded Body Gas Shock
MK		349-228	TGS12543-2	2	Expanded Body Gas Shock

## REAR SUSPENSION

<b>REAR SPRINGS</b>					
	Raised 40mm	MIT008C	2	Leaf Spring	H/Duty 150kg LBA
	Raised 40mm	MIT008HD	2	Leaf Spring	H/Duty 250kg LBA
<b>REAR U-BOLTS</b>					
		TUB001	4	U-Bolt, Round Top 175X77X12	
<b>REAR SHOCK ABSORBERS</b>					
		632-385	G12081B	2	Gas Shock
		632-385	TGS2525B	2	Expanded Body Gas Shock
<b>REAR SHACKLES &amp; PIN KITS</b>					
		TSK004	2	Shackle Kit, Greasable	
		TPK004	2	Pin Kit, Greasable	
<b>REAR SHACKLE BUSH</b>					
		BK30P	1	S/Bush Kit, Poly 35mm ID Front Spring Eye	

# TRITON ML

Kit No.: SK054

MITSUBISHI

## FRONT SUSPENSION

MODEL / YEAR	HEIGHT	PART NO.	QTY	COMMENTS	
<b>FRONT SPRINGS</b>					
	Raised 25mm	TTCS-2027	1 pr.	Coil	Standard Duty ~ 50kg
	Raised 40mm	TTCS-2028	1 pr.	Coil	Standard Duty ~ 50kg
<b>FRONT SHOCK ABSORBERS</b>					
Coil Over Strut 		G43800	2	Gas Shock	

## REAR SUSPENSION

<b>REAR SPRINGS</b>					
	Raised 40mm	MIT009C	2	Leaf Spring	Heavy Duty 150kg LBA
	Raised 40mm	MIT009HD	2	Leaf Spring	E/H/ Duty 300kg LBA
<b>REAR U-BOLTS</b>					
		TUB015	4	U-Bolt, Square Top 170X72X12	
<b>REAR SHOCK ABSORBERS</b>					
	590-357	TGS2576B	2	Expanded Body Gas Shock	
<b>REAR SHACKLES &amp; PIN KITS</b>					
		TSK004	2	Shackle Kit, Greasable	
		TPK004	2	Pin Kit, Greasable	
<b>REAR SHACKLE BUSH</b>					
		BK33P	1	Shackle Bush Kit, Poly	



# PAJERO NA - NK Jan 1983 - Sept 1997

## FRONT TORSION BAR & REAR LEAF



### SPRINGS

Kit No.: NA - NG SK052  
NH - NK SK053

#### FRONT SUSPENSION

MODEL / YEAR	HEIGHT	PART NO.	QTY	COMMENTS	
<b>FRONT SPRINGS</b>					
NA - NG	Raised 40mm	MIT002HD	1 pr.	Torsion Bars, H/Duty 1282mm Long	
NH - NK	Raised 40mm	MIT004HD	1 pr.	Torsion Bars, H/Duty 1307mm Long	
<b>FRONT SHOCK ABSORBERS</b>					
NA - NG		349-228	TGS12543-1	2	Expanded Body Gas Shock
NH - NK		349-228	TGS12543-2	2	Expanded Body Gas Shock

#### REAR SUSPENSION



<b>REAR SPRINGS</b>					
NA - NG	Raised 40mm	MIT003C	2	Leaf Spring	H/Duty 150kg LBA
NH - NK	Raised 40mm	MIT010C	2	Leaf Spring	H/Duty 150kg LBA
<b>REAR U-BOLTS</b>					
		TUB001	4	U-Bolt, Round Top 175X77X12	
<b>REAR SHOCK ABSORBERS</b>					
		590-357	G12636	2	Gas Shock
		590-357	TGS2576B	2	Expanded Body Gas Shock
<b>REAR SHACKLES &amp; PIN KITS</b>					
		TSK004	2	Shackle Kit, Greasable	
		TPK004	2	Pin Kit, Greasable	
<b>REAR SHACKLE BUSH</b>					
		BK30P	1	Shackle Bush Kit, Poly	

# PAJERO NF- NL August 1988 - June 2000



## FRONT TORSION BAR & REAR COIL SPRINGS

Kit No.: NF - NG SK050  
NH - NL SK051

### FRONT SUSPENSION

MODEL / YEAR	HEIGHT	PART NO.	QTY	COMMENTS	
<b>FRONT SPRINGS</b>					
NF - NG	Raised 40mm	MIT002HD	1 pr.	Torsion Bars, H/Duty 1282mm Long	
NH - NL	Raised 40mm	MIT004HD	1 pr.	Torsion Bars, H/Duty 1307mm Long	
<b>FRONT SHOCK ABSORBERS</b>					
NF - NG		349-228	TGS12543-1	2	Expanded Body Gas Shock
NH - NL		349-228	TGS12543-2	2	Expanded Body Gas Shock

### REAR SUSPENSION

<b>REAR SPRINGS</b>					
SWB	Standard	TTCS-0344	1 pr.	Progressive Coil	~150kg VLC - LBA
	Raised 40mm	TTCS-0327	1 pr.	Progressive Coil	H/Duty ~ 200kg VLC - LBA
LWB	Standard	TTCS-0341	1 pr.	Progressive Coil	Standard Duty
	Raised 40mm	TTCS-0324	1 pr.	Progressive Coil	H/Duty ~ 150kg VLC - LBA
	Raised 40mm	TTCS-0325	1 pr.	Progressive Coil	H/Duty ~200kg VLC - LBA
<b>REAR SHOCK ABSORBERS</b>					
NF - NG		487-305	G12635	2	Gas Shock
NH - NL		455-295	TGS12547	2	Expanded Body Gas Shock

# PAJERO NM - NP May 2000 - December 2006

## COIL SPRINGS ALLROUND

Kit No.: SK045

### FRONT SUSPENSION

MODEL / YEAR	HEIGHT	PART NO.	QTY	COMMENTS	
<b>FRONT SPRINGS</b>					
Petrol Eng.	Standard	TTCS-0283	1 pr.	Coil	Std Duty ~ 30kg LBA
	Raised 40mm	TTCS-0267	1 pr.	Coil	Std Duty ~30kg LBA
Diesel Eng.	Standard	TTCS-0267	1 pr.	Coil	Std Duty ~30kg LBA
	Raised 40mm	TTCS-0268	1 pr.	Coil	Std Duty ~30kg LBA
	Raised 40mm	TTCS-2026	1 pr.	Coil	E/H/Duty ~ 75kg LBA
<b>FRONT SHOCK ABSORBERS</b>					
Coil Over Strut 		TGS43783	2	Expanded Body Gas Shock	

### REAR SUSPENSION

<b>REAR SPRINGS</b>					
NM - SWB	Raised 40mm	TTCS-0346	1 pr.	Progressive Coil	H/Duty ~150kg LBA
NM - LWB	Standard	TTCS-0346	1 pr.	Progressive Coil	H/Duty ~150kg LBA
	Raised 40mm	TTCS-0328	1 pr.	Progressive Coil	H/Duty ~150kg LBA
NP - LWB	Raised 40mm	TTCS-0346	1 pr.	Progressive Coil	H/Duty ~150kg LBA
	Raised 40mm	TTCS-0329	1 pr.	Progressive Coil	H/Duty ~200kg LBA
<b>REAR SHOCK ABSORBERS</b>					
		G43784	2	Gas Shock	



## **Nissan Range**

*Patrol MQ* *P.13*

---

*Patrol MK* *P.15*

---

*Patrol GQ Cab/Chassis* *P.17*

---

*Patrol GQ* *P.19*

---

*Patrol GU* *P.23*

---

*Navara D21 & D22* *P.27*

---

*Navara D40* *P.28*

---

*Pathfinder WD21* *P.29*

---

*Pathfinder R50* *P.30*

---

*Pathfinder R51* *P.31*

---

*Terrano R20* *P.32*

---

# PATROL MQ

## ROUND HEADLIGHTS

Kit No.: SK044

NISSAN

### FRONT SUSPENSION

MODEL / YEAR	HEIGHT	PART NO.	QTY	COMMENTS	
<b>FRONT SPRINGS</b>					
LWB	Raised 50mm	NIS001HD	2	Leaf Spring H/Duty ~ 50kg LBA	
SWB	Raised 50mm	NIS002HD	2	Leaf Spring H/Duty ~ 50kg LBA	
<b>FRONT U-BOLTS</b>					
		C451	2	U-Bolt, P/S, Round Top 175X77X12	
		C452	2	U-Bolt, D/S, Square Top 95X62X12	
<b>FRONT SHOCK ABSORBERS</b>					
	†	510-310	G12114	2	Gas Shock
	†	510-310	TGS12491	2	Expanded Body Gas Shock
<b>STEERING DAMPER</b>					
		T14022	1	35 mm Heavy Duty Replacement	
<b>FRONT SHACKLE &amp; PIN KITS</b>					
-7/83	Type A	TSK018	2	Shackle Kit, Greasable	
		TPK013	2	Pin Kit, Greasable	
<b>FRONT SHACKLE BUSH</b>					
		55045-07200	2	Bush Metalastic Rear of Front	
		55046-00902	4	Bush Metal Front of Front	

# PATROL MQ

## ROUND HEADLIGHTS

### REAR SUSPENSION

MODEL / YEAR	HEIGHT	PART NO.	QTY	COMMENTS
<b>REAR SPRINGS</b>				
LWB	Raised 50mm	NIS003DSHD	1	Leaf H/Duty (Driver Side) ~200kg LBA
LWB	Raised 50mm	NIS003PSHD	1	Leaf H/Duty (Passenger Side) ~200kg LBA
SWB	Raised 50mm	NIS004DSHD	1	Leaf H/Duty (Driver Side) ~100kg LBA
SWB	Raised 50mm	NIS004PSHD	1	Leaf H/Duty (Passenger Side) ~100kg LBA
<b>REAR U-BOLTS</b>				
		C453	4	U-Bolt, Round Top 220X95X14
<b>REAR SHOCK ABSORBERS</b>				
	585-350	G12076	2	Gas Shock
<b>REAR SHACKLE &amp; PIN KITS</b>				
		TSK019	2	Shackle Kit, Greasable
		TPK013	2	Pin Kit, Greasable
<b>REAR SHACKLE BUSH</b>				
		55045-07200	2	Bush Metalastic Front of Rear
		55046-C6000	4	Bush Rubber, Long Rear of Rear
		55046-R8000	4	Bush Rubber, Short Rear of Rear

# PATROL MK

## SQUARE HEADLIGHTS

Kit No.: SK046

### FRONT SUSPENSION

MODEL / YEAR	HEIGHT	PART NO.	QTY	COMMENTS
<b>FRONT SPRINGS</b>				
LWB	Raised 50mm	NPT101	2	Leaf Spring H/Duty 7 Leaf ~ 50kg LBA
SWB	Raised 50mm	NPT103	2	Leaf Spring H/Duty 7 Leaf ~ 50kg LBA
<b>FRONT U-BOLTS</b>				
		C451	2	U-Bolt, P/S, Round Top 175X77X12
		C452	2	U-Bolt, D/S, Square Top 95X62X12
<b>FRONT SHOCK ABSORBERS</b>				
	† 510-310	G12114	2	Gas Shock
	† 510-310	TGS12491	2	Expanded Body Gas Shock
<b>STEERING DAMPER</b>				
		T14022	1	35 mm Heavy Duty Replacement
<b>FRONT SHACKLE &amp; PIN KITS</b>				
		TSK020	2	Shackle Kit, Greasable
		TPK013	2	Pin Kit, Greasable
<b>FRONT SHACKLE BUSH</b>				
		55045-07200	2	Bush Metalistic Rear of Front
		55046-00902	2	Bush Metal Front of Front in Chassis
8/83-		55045-10W00	4	Rubber Bush Front of Front

# PATROL MK

## SQUARE HEADLIGHTS

### REAR SUSPENSION

MODEL / YEAR	HEIGHT	PART NO.	QTY	COMMENTS
<b>REAR SPRINGS</b>				
LWB	Raised 50mm	NIS003DSHD	1	Leaf H/Duty (Drivers Side) ~ 200kg LBA
LWB	Raised 50mm	NIS003PSHD	1	Leaf H/Duty (Passenger Side) ~ 200kg LBA
SWB	Raised 50mm	NIS004DSHD	1	Leaf H/Duty (Drivers Side) ~ 100kg LBA
SWB	Raised 50mm	NIS004PSHD	2	Leaf H/Duty (Passenger Side) ~ 100kg LBA
<b>REAR U-BOLTS</b>				
		C453	4	U-Bolt, Round Top 220X95X14
<b>REAR SHOCK ABSORBERS</b>				
	585-350	G12076	2	Gas Shock
<b>REAR SHACKLE &amp; PIN KITS</b>				
		TSK019	2	Shackle Kit
		TPK013	2	Pin Kit, Greasable
<b>REAR SHACKLE BUSH</b>				
		55045-07200	2	Bush Metalastic Front of Rear
		55046-C6000	4	Bush Rubber, Long Rear of Rear
		55046-R8000	4	Bush Rubber, Short Rear of Rear

# PATROL GQ Cab/Chassis

## UTE WITH LEAF SPRINGS ALLROUND

Kit No.: SK043

NISSAN

### FRONT SUSPENSION

MODEL / YEAR	HEIGHT	PART NO.	QTY	COMMENTS	
<b>FRONT SPRINGS</b>					
	Raised 50mm	NPT104	2	7 Leaf, Heavy Duty ~ 100kg LBA	
<b>FRONT U-BOLTS</b>					
		C436	4	U-Bolt, Forged Square Top 220X72X14	
<b>FRONT SHOCK ABSORBERS</b>					
	⊕	491-301	TGS2526B	2	Expanded Body Gas Shock
<b>STEERING DAMPER</b>					
- 8/99	⊗		T14034	1	35 mm Heavy Duty Replacement
8/89-	⊕		T14036	1	35 mm Heavy Duty Replacement
<b>FRONT SHACKLE &amp; PIN KITS</b>					
		TSK024	2	Shackle Kit	
		667K	2	Pin Kit	
<b>FRONT SHACKLE BUSH</b>					
		90389-18002	8	Bush Rubber	
		90385-18009	4	Bush Rubber	
		90389-18002P	8	Polyurethane Bush	
		90385-18009P	4	Polyurethane Bush	

# PATROL GQ Cab/Chassis

## UTE WITH LEAF SPRINGS ALLROUND

### REAR SUSPENSION

MODEL / YEAR	HEIGHT	PART NO.	QTY	COMMENTS
<b>REAR SPRINGS</b>				
	Raised 50mm	NIS017DSDH	1	Leaf H/Duty (Driver Side) ~ 300kg LBA
	Raised 50mm	NIS017PSHD	1	Leaf H/Duty (Passenger Side) ~ 300kg LBA
	Raised 50mm	NIS018EHD	2	Leaf E/H/Duty ~ 500kg LBA, 7+2
<b>REAR U-BOLTS</b>				
		C453	4	U-Bolt, Round Top 220X95X14
<b>REAR SHOCK ABSORBERS</b>				
	♀ 654-397	TGS2525P	2	Expanded Body Gas Shock
<b>REAR SHACKLE &amp; PIN KITS</b>				
		666KR	2	Shackle Kit
		667K	2	Pin Kit
<b>REAR SHACKLE BUSH</b>				
		90389-18002	12	Bush Rubber
		BK5	1	Rubber Bush Kit
		90389-18002P	12	Polyurethane Bush
		BK5P	1	Polyurethane Bush Kit

# PATROL GQ

## COIL SPRINGS ALL ROUND

Kit No.: SWB SK039  
 LWB 3.0L SK040  
 TRAY BACK SK041  
 LWB 4.2L SK042

### FRONT SUSPENSION

MODEL / YEAR	HEIGHT	PART NO.	QTY	COMMENTS	
<b>FRONT SPRINGS</b>					
SWB	Standard	TTCS-0437	1 pr.	Coil	Std Duty ~35kg LBA
	Raised 40mm	TTCS-0406	1 pr.	Coil	Std Duty ~35kg LBA
LWB 3.0Lt	Standard	TTCS-0437	1 pr.	Coil	Std Duty ~35kg LBA
	Raised 40mm	TTCS-0406	1 pr.	Coil	Std Duty ~35kg LBA
LWB 4.2Lt	Standard	TTCS-0438	1 pr.	Coil	Std Duty ~35kg LBA
	Raised 40mm	TTCS-0407	1 pr.	Coil	Std Duty ~35kg LBA
Extra Raised	Raised 50mm	TTCS-0408	1 pr.	Coil	Std Duty ~35kg LBA
	Raised 40mm	TTCS-0453	1 pr.	Progressive Comfort - Std Duty ~35kg VLC	
	Raised 40mm	TTCS-0409	1 pr.	Coil	H/Duty ~50kg LBA
	Raised 50mm	TTCS-2009	1 pr.	Coil	E/H/Duty ~100kg LBA
Tray Back	Standard	TTCS-0438	1 pr.	Coil	Std Duty ~35kg LBA
	Raised 40mm	TTCS-0407	1 pr.	Coil	Std Duty ~35kg LBA
	Raised 3"	TTCS-1781	1pr	Coil	Competition Extreme Off Road
	Raised 4"	TTCS-0410	1pr	Coil	Competition Extreme Off Road

**Note** - Extreme off-road use coil springs ( 3" to 7" ) are available upon request.

### FRONT SHOCK ABSORBERS

	510-310	G12114	2	Gas Shock	
	510-310	TGS12491	2	Expanded Body Gas Shock	
Extra Raised	550-328	TGS12541	2	Expanded Body Gas Shock	





# PATROL GQ

## COIL SPRINGS ALL ROUND

### FRONT SUSPENSION

MODEL / YEAR	HEIGHT	PART NO.	QTY	COMMENTS
<b>STEERING DAMPER</b>				
-8/99	8	T14034	1	35 mm Heavy Duty Replacement
8/99-	+	T14036	1	35 mm Heavy Duty Replacement
<b>FRONT BUSH KITS</b>				
		48702-60050	4	Bush, Radius Arm to Diff Mount
		TSBK0001	1	Poly Bush Kit, Radius Arm to Diff Mount
		TSBK0002	1	Poly Bush Kit, Radius Arm to Chassis
For 1-2" Lift		TSBK0012	1	Poly Bush Kit, Castor Correction
For over 2" Lift		TSBK0013	1	Poly Bush Kit, Castor Correction
		TSBK0028	1	Bush Kit Panhard Rod
<b>FRONT ADJUSTABLE PANHARD ROD</b>				
		N83022	1	Adjustable Panhard Rod

# PATROL GQ



## COIL SPRINGS ALL ROUND

### REAR SUSPENSION

MODEL / YEAR	HEIGHT	PART NO.	QTY	COMMENTS
<b>REAR SPRINGS</b>				
SWB	Standard	TTCS-0539	1 pr.	Coil Standard Duty ~150kg LBA
	Raised 40 mm	TTCS-0506	1 pr.	Coil Standard Duty ~150kg LBA
LWB	Standard	TTCS-0540	1 pr.	Coil Standard Duty ~150kg LBA
	Raised 40 mm	TTCS-0455	1 pr.	Coil Standard Duty ~150kg LBA
Extra Raised	Raised 50 mm	TTCS-0509	1 pr.	Coil Standard Duty ~150kg LBA
	Raised 40 mm	TTCS-0510	1 pr.	Coil E/H/Duty ~300kg LBA
	Raised 40 mm	TTCS-0454	1 pr.	Coil Progressive Std Duty -150kg VLC
	Raised 40 mm	TTCS-0460	1 pr.	Coil Progressive H/Duty ~300kg VLC - LBA
	Raised 3"	TTCS-1783	1 pr	Coil Competition Extreme Off Road
	Raised 4"	TTCS-0511	1 pr	Coil Competition Extreme Off Road
Tray Back	Raised 50mm	TTCS-2047	1 pr.	Super H/Duty ~1 Tonne Constant LBA Rienforced Spring Seat Needed
	Raised 40mm	TTCS-0460	1 pr.	Progressive H/Duty ~300kg VLC - LBA
	Raised 40mm	TTCS-1735	1 pr.	Progressive E/H/Duty 300-500kg LBA
	Raised 40mm	TTCS-0508	1pr	E/H/Duty ~500kg LBA Rienforced Spring Seat Needed

**Note** - Extreme off-road use coil springs ( 3" to 7" ) are available upon request.

### REAR SHOCK ABSORBERS

SWB		632-385	G12081	2	Gas Shock
LWB & Ute		654-397	G12115	2	Gas Shock
LWB & Ute		654-397	TGS12492	2	Expanded Body Gas Shock

# PATROL GQ

## COIL SPRINGS ALL ROUND

### REAR SUSPENSION

MODEL / YEAR	HEIGHT	PART NO.	QTY	COMMENTS
--------------	--------	----------	-----	----------

#### REAR BUSH KITS

		TSBK0030	2	Bush Kit, Upper & Lower Trailing Arm
-89		TSBK0029	1	Bush Kit Panhard Rod
89-		TSBK0028	1	Bush Kit Panhard Rod

#### REAR ADJUSTABLE PANHARD ROD

		N82684	1	Adjustable Panhard Rod
--	--	--------	---	------------------------

**note...** Castor Adjusting Kit recommended for vehicles with raised suspension up to 50mm.

Castor Adjusting Kit compulsory for vehicles with raised suspension over 50mm.

# PATROL GU

## COIL SPRINGS ALL ROUND

Kit No.: TRAY BACK SK029  
LWB WAGON SK038

N  
I  
S  
S  
A  
N



### FRONT SUSPENSION

MODEL / YEAR	HEIGHT	PART NO.	QTY	COMMENTS	
<b>FRONT SPRINGS</b>					
LWB	Standard	TTCS-0438	1 pr.	Coil	Standard Duty ~35kg LBA
	Raised 40mm	TTCS-0407	1 pr.	Coil	Standard Duty ~35kg LBA
	Raised 40mm	TTCS-0453	1 pr.	Progressive	Comfort - Standard Duty ~35kg VLC - LBA
	Raised 40mm	TTCS-0409	1 pr.	Coil	H/Duty ~50kg LBA
	Raised 50mm	TTCS-2009	1 pr.	Coil	E/H/Duty ~100kg LBA
	Raised 3"	TTCS-1781	1pr	Coil	Competition Extreme Off Road
	Raised 4"	TTCS-0410	1pr	Coil	Competition Extreme Off Road
Tray Back	Standard	TTCS-0438	1 pr.	Coil	Standard Duty ~35kg LBA
	Raised 40mm	TTCS-0407	1 pr.	Coil	Standard Duty ~35kg LBA
	Raised 40mm	TTCS-0453	1 pr.	Progressive	Comfort - Standard Duty ~35kg VLC - LBA
	Raised 50mm	TTCS-2009	1 pr.	Coil	E/H/Duty ~100kg LBA
<b>FRONT SHOCK ABSORBERS</b>					
	†	510-310	G12114	2	Gas Shock
	†	510-310	TGS12491	2	Expanded Body Gas Shock
Extra Raised	†	550-328	TGS12541	2	Expanded Body Gas Shock
<b>STEERING DAMPER</b>					
12/97 - 4/00	†	512/308	T14011	1	35 mm Heavy Duty Replacement
4/00-	8	550/315	T14501	1	35 mm Heavy Duty Replacement

# PATROL GU

## COIL SPRINGS ALL ROUND

### FRONT SUSPENSION

MODEL / YEAR	HEIGHT	PART NO.	QTY	COMMENTS
<b>STEERING DAMPER</b>				
12/97 - 4/00 	512/308	T14011	1	35mm Heavy Duty Replacement
4/00- 	550/315	T14501	1	35mm Heavy Duty Replacement
<b>FRONT BUSH KITS</b>				
		48702-60050	4	Bush, Radius Arm to Diff Mount
		TSBK0001	1	Poly Bush Kit, Radius Arm to Diff Mount
		TSBK0002	1	Poly Bush Kit, Radius Arm to Chassis
For 1-2" Lift		TSBK0012	1	Poly Bush Kit, Castor Correction
For over 2" Lift		TSBK0013	1	Poly Bush Kit, Castor Correction
		TSBK0028	1	Bush Kit Panhard Rod
<b>FRONT ADJUSTABLE PANHARD ROD</b>				
		N83022	1	Adjustable Panhard Rod



# PATROL GU

## COIL SPRINGS ALL ROUND

### REAR SUSPENSION

MODEL / YEAR	HEIGHT	PART NO.	QTY	COMMENTS	
<b>REAR SPRINGS</b>					
LWB	Standard	TTCS-0541	1 pr.	Coil	Standard Duty
	Raised 40mm	TTCS-2048	1 pr.	Coil	Standard Duty
	Raised 40mm	TTCS-0456	1 pr.	Progressive	Comfort Ride VLC / LBA
	Raised 40mm	TTCS-0458	1 pr.	Progressive	E/H/Duty ~300kg VLC / LBA
	Raised 40mm	TTCS-1735	1 pr.	Progressive	E/H/Duty Plus 300-500kg VLC /LBA
	Raised 3"	TTCS-1783	1 pr	Coil	Competition Extreme Off Road
	Raised 4"	TTCS-0511	1 pr	Coil	Competition Extreme Off Road
Tray Back	Raised 40mm	TTCS-0454	1 pr.	Progressive	Std Duty ~150kg VLC / LBA
	Raised 40mm	TTCS-0460	1 pr.	Progressive	H/Duty ~300kg VLC - LBA
	Raised 40mm	TTCS-1735	1 pr.	Progressive	E/H/Duty Plus ~300-500kg
	Raised 40mm	TTCS-0508	1 pr	Progressive	E/H/Duty ~500kg LBA Rienforced Spring Seat Needed
	Raised 50mm	TTCS-2047	1 pr	Coil	Super H/Duty ~1 Tonne Rienforced Spring Seat Needed

### REAR SHOCK ABSORBERS

With Coil Spring		654-397	G12115	2	Gas Shock
		654-397	TGS12492	2	Expanded Body Gas Shock

### REAR BUSH KIT

		TSBK0030	2	Bush Kit, Upper & Lower Trailing Arm
		TSBK0028	1	Bush Kit Panhard Rod

### REAR ADJUSTABLE PABHARD ROD

		N82500	1	Adjustable Panhard Rod
--	--	--------	---	------------------------

**note...** Castor Adjusting Kit recommended for vehicles with raised suspension up to 50mm.

Castor Adjusting Kit compulsory for vehicles with raised suspension over 50mm.

# PATROL GU

## LEAF SPRING REAR

Kit No.: SK037

NISSAN

### FRONT SUSPENSION

MODEL / YEAR	HEIGHT	PART NO.	QTY	COMMENTS	
<b>FRONT SPRINGS</b>					
Tray Back	Standard	TTCS-0438	1 pr.	Coil	Standard Duty ~ 35kg LBA
	Raised 40 mm	TTCS-0407	1 pr.	Coil	Standard Duty ~ 35kg LBA
	Raised 40 mm	TTCS-0409	1 pr.	Coil	H/Duty ~ 50kg LBA
	Raised 50mm	TTCS-2009	1 pr.	Coil	E/H/Duty ~ 100kg LBA
	Raised 40mm	TTCS-0453	1 pr.	Progressive	Standard Duty ~ 35kg VLC
<b>FRONT SHOCK ABSORBERS</b>					
	†	510-310	G12114	2	Gas Shock
	†	510-310	TGS12491	2	Expanded Body Gas Shock
Extra Raised	†	550-328	TGS12541	2	Expanded Body Gas Shock
<b>FRONT BUSH KITS</b>					
		48702-60050	4	Bush, Radius Arm to Diff Mount	
		TSBK0001	1	Poly Bush Kit, Radius Arm to Diff Mount	
		TSBK0002	1	Poly Bush Kit, Radius Arm to Chassis	
For 1-2" Lift		TSBK0012	1	Poly Bush Kit, Castor Correction	
For over 2" Lift		TSBK0013	1	Poly Bush Kit, Castor Correction	
		TSBK0028	1	Bush Kit Panhard Rod	
<b>FRONT ADJUSTABLE PABHARD ROD</b>					
		N83022	1	Adjustable Panhard Rod	
<b>STEERING DAMPER</b>					
	†	512/308	T14011	1	35 mm Heavy Duty Replacement

# PATROL GU



## LEAF SPRING REAR

### REAR SUSPENSION



MODEL / YEAR	HEIGHT	PART NO.	QTY	COMMENTS
<b>REAR SPRINGS</b>				
Tray Back, Leaf Spring	Raised 50mm	NIS017DSHD	1	H/Duty (Drivers Side) ~300kg LBA
	Raised 50mm	NIS017PSHD	1	H/Duty (Passenger Side) ~300kg LBA
	Raised 50mm	NIS018EHD	2	E/H/Duty 500kg Constant LBA
<b>REAR U-BOLTS</b>				
		TUB008	4	U-Bolt, Round Top 220X95X14
<b>REAR SHOCK ABSORBERS</b>				
	♀ 654-397	TGS2525P	2	Expanded Body Gas Shock
<b>REAR SHACKLE &amp; PIN KITS</b>				
		666KR	2	Shackle Kit
		667K	2	Pin Kit
<b>REAR SHACKLE BUSH</b>				
		90389-18002	12	Bush Rubber
		BK5	1	Rubber Bush Kit
		90389-18002P	12	Polyurethane Bush
		BK5P	1	Polyurethane Bush Kit



## FRONT SUSPENSION

MODEL / YEAR	HEIGHT	PART NO.	QTY	COMMENTS
<b>FRONT SPRINGS</b>				
D21	Raised 40mm	NIS014HD	1 pr.	Torsion Bars, 27mm x 1205mm 50 kg LBA
D22	Raised 40mm	NIS020HD	1 pr.	Torsion Bars, 27 mm x 892mm 45kg LBA
<b>FRONT SHOCK ABSORBERS</b>				
D21		G12097	2	Gas Shock
D22		G12854	2	Gas Shock

## REAR SUSPENSION

<b>REAR SPRINGS</b>				
	Raised 45mm	NIS015C	2	Leaf H/Duty ~150kg LBA
	Raised 45mm	NIS015HD	2	Leaf H/Duty 300kg Constant LBA
<b>REAR SHOCK ABSORBERS</b>				
		G12636	2	Gas Shock
		TGS25760	2	Expanded Body Gas Shock
<b>REAR U-BOLTS</b>				
		TUB007	4	U-Bolt, Square Top 190X62X13
<b>REAR SHACKLE &amp; PIN KITS</b>				
		TSK005	2	Shackle Kit, Greasable
		TPK005	2	Pin Kit, Greasable
<b>REAR SHACKLE BUSH</b>				
		BK24P	1	Shackle Bush Kit, Poly

## FRONT SUSPENSION

MODEL / YEAR	HEIGHT	PART NO.	QTY	COMMENTS	
<b>FRONT SPRINGS</b>					
	Raised 40mm	TTCS-2042	1 pr.	Coil	Standard Duty ~ 50kg LBA
	Raised 40mm	TTCS-2174	1 pr.	Coil	H/Duty 50kg+ LBA
<b>FRONT SHOCK ABSORBERS</b>					
Coil Over Strut 		G12716	2	Gas Shock	

## REAR SUSPENSION

<b>REAR SPRINGS</b>					
	Raised 40mm	NIS025	2	Leaf	H/Duty ~ 150kg LBA
	Raised 40mm	NIS025HD	2	Leaf	E/H/Duty ~ 300kg LBA
<b>REAR U-BOLTS</b>					
		TUB003	4	U-Bolt, Square Top 190X62X13	
<b>REAR SHOCK ABSORBERS</b>					
		G12717	2	Gas Shock	
<b>REAR SHACKLE KITS</b>					
		TSK027	2	Shackle Kit, Greasable	
<b>REAR SHACKLE BUSH</b>					
		BK21P	1	Shackle Bush Kit, Poly	

## FRONT SUSPENSION

MODEL / YEAR	HEIGHT	PART NO.	QTY	COMMENTS
--------------	--------	----------	-----	----------

### FRONT SPRINGS

	Raised 40mm	NIS022HD	1 pr.	Leaf H/Duty, Increase rate, 27mm x 1230mm
--	----------------	----------	-------	---

### FRONT SHOCK ABSORBERS

		350-227	G12087	2	Gas Shock
--	---	---------	--------	---	-----------

## REAR SUSPENSION

### REAR SPRINGS

	Standard	TTCS-0538	1 pr.	Coil	H/Duty ~ 150kg LBA
	Raised 40mm	TTCS-0505	1 pr.	Coil	H/Duty 150kg+ LBA

### REAR SHOCK ABSORBERS

		590-357	G12636	2	Gas Shock
--	---	---------	--------	---	-----------

## FRONT SUSPENSION

MODEL / YEAR	HEIGHT	PART NO.	QTY	COMMENTS
--------------	--------	----------	-----	----------

### FRONT SPRINGS

	Raised 40mm	TTCS-0416	1 pr.	Coil	H/Duty ~ 40kg LBA
--	----------------	-----------	-------	------	-------------------

## REAR SUSPENSION

### REAR SPRINGS

	Raised 40mm	TTCS-0517	1 pr.	Coil	H/Duty ~100kg LBA
--	----------------	-----------	-------	------	-------------------

## FRONT SUSPENSION

MODEL / YEAR	HEIGHT	PART NO.	QTY	COMMENTS	
<b>FRONT SPRINGS</b>					
	Raised 40mm	TTCS-2042	1 pr.	Coil	H/Duty ~ 50kg LBA
	Raised 40mm	TTCS-2174	1 pr.	Coil	H/Duty ~ 50kg LBA
<b>FRONT SHOCK ABSORBERS</b>					
Coil Over Strut 	385-268	G45642	2	Gas Shock	

## REAR SUSPENSION

<b>REAR SPRINGS</b>					
	Raised 40mm	TTCS-2052	1 pr.	Coil	H/Duty ~ 150kg LBA
	Raised 40mm	TTCS-2053	1 pr.	Coil	E/H/Duty 150kg+ LBA
<b>REAR SHOCK ABSORBERS</b>					
	395-280	G45643	2	Gas Shock	

# TERRANO R20 *After March 1997 Inclusive*

Kit No.: SK030

NISSAN

## FRONT SUSPENSION

MODEL / YEAR	HEIGHT	PART NO.	QTY	COMMENTS
<b>FRONT SPRINGS</b>				
	Raised 40mm	NIS022HD	1 pr.	Leaf H/Duty, Increased rate, 27MM x 1230MM
<b>FRONT SHOCK ABSORBERS</b>				
		350-227	TGS12545	2 Gas Shock

## REAR SUSPENSION

<b>REAR SPRINGS</b>				
	Standard	TTCS-0538	1 pr.	Coil H/Duty ~150kg LBA
	Raised 40mm	TTCS-0505	1 pr.	Coil E/H/Duty 150kg+ LBA
<b>REAR SHOCK ABSORBERS</b>				
		590-357	TGS2576B	2 Gas Shock

## Suzuki Range

*Sierra SJ LJ Before 1981 inclusive* *P.33*

---

*Sierra SJ 80* *P.35*

---

*Vitara* *P.36*

---

*Grand Vitara* *P.37*

---



# SIERRA SJ LJ 7/81 to 3/96

## LEAF SPRINGS ALL ROUND

Kit No.: SK028

S  
U  
Z  
U  
K  
I

### FRONT SUSPENSION

MODEL / YEAR	HEIGHT	PART NO.	QTY	COMMENTS
<b>FRONT SPRINGS</b>				
	Raised 40mm	SUZ001C	2	Leaf H/Duty ~45kg LBA
<b>FRONT U-BOLTS</b>				
Drivers Side		TUB005	2	U-Bolt, Round Top 160X82X11
Passenger Side		TUB006	2	U-Bolt, Round Top 145X72X11
<b>FRONT SHOCK ABSORBERS</b>				
	491-301	G12639	2	Gas Shock
<b>STEERING DAMPER</b>				
		T14030	1	35 mm Heavy Duty Replacement
<b>FRONT SHACKLE KITS</b>				
		TSK028	2	Shackle Kit
		TPK017	2	Pin Kit
<b>FRONT SHACKLE BUSH</b>				
		BK22P	1	Shackle Bush Kit, Poly



# SIERRA SJ LJ 7/81 to 3/96

## LEAF SPRINGS ALL ROUND

### REAR SUSPENSION

MODEL / YEAR	HEIGHT	PART NO.	QTY	COMMENTS	
<b>REAR SPRINGS</b>					
	Raised 40mm	SUZ002C	2	Leaf	H/Duty ~120kg LBA
	Raised 40mm	SUZ002HD	2	Leaf	H/Duty ~80kg LBA
<b>REAR U-BOLTS</b>					
		TUB006	4	U-Bolt, Round Top 200X88X14	
<b>REAR SHOCK ABSORBERS</b>					
	 487-305	G12635	2	Gas Shock	
<b>REAR SHACKLE KITS</b>					
		TSK028	2	Shackle Kit	
		TPK017	2	Pin Kit	
<b>REAR SHACKLE BUSH</b>					
		BK22P	1	Shackle Bush Kit, Poly	

# SIERRA SJ 80 4/96 - 12/98

## COIL SPRINGS ALL ROUND

Kit No.: SK027

TTCS  
—  
K—

### FRONT SUSPENSION

MODEL / YEAR	HEIGHT	PART NO.	QTY		COMMENTS
--------------	--------	----------	-----	--	----------

#### FRONT SPRINGS

	Raised 40mm	TTCS-1295	1pr	Coil	H/Duty ~40kg LBA
--	----------------	-----------	-----	------	------------------

### REAR SUSPENSION

#### REAR SPRINGS

	Raised 40mm	TTCS-1335	1pr	Coil	H/Duty ~200kg LBA
--	----------------	-----------	-----	------	-------------------

# VITARA

## COIL SPRINGS ALL ROUND

Kit No.: SK024

S  
U  
Z  
U  
K  
I

### FRONT SUSPENSION

MODEL / YEAR	HEIGHT	PART NO.	QTY	COMMENTS	
<b>FRONT SPRINGS</b>					
1.6L Engine, SWB	Raised 40mm	TTCS-1289	1pr	Coil	H/Duty ~ 45kg LBA
2.0L 4 Cyl. SWB & LWB	Raised 40mm	TTCS-1290	1pr	Coil	H/Duty ~ 45kg LBA
V6 LWB 95-3/98	Raised 40mm	TTCS-1291	1pr	Coil	H/Duty ~ 45kg LBA
<b>FRONT SHOCK ABSORBERS</b>					
		G17043	2	Gas Strut	

### REAR SUSPENSION

<b>REAR SPRINGS</b>					
SWB	Raised 40mm	TTCS-1329	1pr	Coil	H/Duty ~ 45kg LBA
LWB	Raised 40mm	TTCS-1330	1pr	Coil	H/Duty ~ 195kg LBA
<b>REAR SHOCK ABSORBERS</b>					
		491-300	G17044	2	Gas Shock

# GRAND VITARA

## COIL SPRINGS ALL ROUND

Kit No.: SQ ~7/05 SK021  
JB 8/05~ SK023

### FRONT SUSPENSION

MODEL / YEAR	HEIGHT	PART NO.	QTY	COMMENTS	
<b>FRONT SPRINGS</b>					
SQ -7/05, 4 Cyl. SWB & LWB	Raised 40mm	TTCS-1307	1pr	Coil	H/Duty ~ 45kg
SQ -7/05, V6	Raised 40mm	TTCS-1298	1pr	Coil	H/Duty ~ 45kg
SQ -7/05, 7 Seater	Raised 40mm	TTCS-1299	1pr	Coil	H/Duty ~ 45kg
JB 8/05-, 4 Cyl.	Raised 40mm	TTCS-2185	1pr	Coil	H/Duty ~ 45kg
JB 8/05-, V6	Raised 40mm	TTCS-2142	1pr	Coil	H/Duty ~ 45kg
<b>FRONT SHOCK ABSORBERS</b>					
	⊥	G17043	2	Gas Strut	

### REAR SUSPENSION

<b>REAR SPRINGS</b>					
SQ -7/05 4Cyl SWB	Standard	TTCS-1357	1pr	Coil	H/Duty ~195kg
SQ -7/05 4&6 Cyl.	Raised 40mm	TTCS-1337	1pr	Coil	H/Duty ~195kg
SQ -7/05, 7 Seater	Raised 40mm	TTCS-1340	1pr	Coil	H/Duty ~195kg
JB 8/05- 4&6 CYL	Raised 40mm	TTCS-2152	1pr	Coil	H/Duty ~195kg
<b>REAR SHOCK ABSORBERS</b>					
	⊥	491-300	G17044	2	Gas Shock

## Toyota Range

<i>4WD Hilux &amp; 4 Runner - Leaf Springs</i>	<i>P.38</i>
<i>4WD Hilux &amp; 4 Runner - IFS &amp; Rear Leaf Springs</i>	<i>P.41</i>
<i>4WD Hilux &amp; 4 Runner - IFS &amp; Rear Coil Springs</i>	<i>P.43</i>
<i>4WD Hilux after March 2005 inclusive</i>	<i>P.44</i>
<i>4# Series before July 1980 inclusive</i>	<i>P.46</i>
<i>4# Series after August 1980 inclusive</i>	<i>P.49</i>
<i>FJ55 after January 1975 inclusive</i>	<i>P.52</i>
<i>60 Series August 1980 to January 1990</i>	<i>P.54</i>
<i>Landcruiser 7# Series</i>	<i>P.58</i>
<i>Landcruiser 80 Series</i>	<i>P.63</i>
<i>Landcruiser 100 Series</i>	<i>P.67</i>
<i>Landcruiser 105 Series</i>	<i>P.71</i>
<i>Landcruiser Prado 9# Series April 1996 - August 2002</i>	<i>P.73</i>
<i>Landcruiser Prado 120 Series after Sept 2002 inclusive</i>	<i>P.75</i>

**Toyota**

**4WD Hilux & 4 Runner - Leaf Springs**





# 4WD HILUX & 4 RUNNER

## LEAF SPRINGS ALL ROUND

Kit No.: SK020

TOYOTA

### FRONT SUSPENSION

MODEL / YEAR	HEIGHT	PART NO.	QTY	COMMENTS	
<b>FRONT SPRINGS</b>					
Petrol Engine	Raised 50mm	THL001DSC	1	Leaf H/Duty ~ 35kg LBA (Drivers Side)	
	Raised 50mm	THL001PSC	1	Leaf H/Duty ~ 35kg LBA (Passenger Side)	
Diesel Engine	Raised 50mm	THL001DSC	1	Leaf Comfort Ride ~ 35kg LBA (Drivers Side)	
	Raised 50mm	THL001PSC	1	Leaf Comfort Ride ~ 35kg LBA (Passenger Side)	
	Raised 50mm	THL001DSHD	1	Leaf H/Duty ~ 35kg LBA (Drivers Side)	
	Raised 50mm	THL001PSHD	1	Leaf H/Duty ~ 35kg LBA (Passenger Side)	
<b>FRONT U-BOLTS</b>					
Drivers Side		90117-14011S	1	Forged Top, Rr of Ft Spring	
		MUB1362	1	210X62X14 Square Top Frt of Ftr Spring	
Passenger Side		TUB003	2	180X62X14 Square Top	
<b>FRONT SHOCK ABSORBERS</b>					
		491-301	G12639	2	Gas Shock
		491-301	TGS12526	2	Expanded Body Gas Shock
<b>STEERING DAMPER</b>					
		535/340	T14021	1	35 mm H/Duty Replacement

# 4WD HILUX & 4 RUNNER

## LEAF SPRINGS ALL ROUND

### FRONT SUSPENSION





MODEL / YEAR	HEIGHT	PART NO.	QTY	COMMENTS
<b>FRONT SHACKLE &amp; PIN KITS</b>				
		TSK006	2	Shackle Kit, Greasable
		TPK009	2	Pin Kit, Greasable
<b>FRONT SHACKLE BUSH</b>				
		90385-18007	4	Rubber Bush
		90385-18046	8	Rubber Bush
		BK1	1	Rubber Bush Kit
		90385-18007P	4	Polyurethane Bush
		90385-18046P	8	Polyurethane Bush
		BK1P	1	Polyurethane Bush Kit



# 4WD HILUX & 4 RUNNER

## LEAF SPRINGS ALL ROUND

### REAR SUSPENSION

MODEL / YEAR	HEIGHT	PART NO.	QTY	COMMENTS	
<b>REAR SPRINGS</b>					
	Raised 50mm	THL002C	2	Leaf Comfort Ride 200kg LBA	
	Raised 50mm	THL002HD	2	Leaf E/H/Duty 300kg LBA	
<b>REAR U-BOLTS</b>					
		90118-14175	4	195X62X14 Square Top	
<b>REAR SHOCK ABSORBERS</b>					
All 79-7/83		590-357	G12636	2	Gas Shock
		632-385	G12081B	2	Gas Shock
		632-385	TGS2525B	2	Expanded Body Gas Shock
All 8/83-		632-385	G12081	2	Gas Shock
		632-385	TGS12525	2	Expanded Body Gas Shock
<b>REAR SHACKLE &amp; PIN KITS</b>					
	Type A	TSK009	2	Shackle Kit, Greasable	
		TPK009	2	Pin Kit, Greasable	
<b>REAR SHACKLE BUSH</b>					
		90385-18046	12	Rubber Bush	
		BK2	1	Rubber Bush Kit	
		90385-18046P	12	Polyurethane Bush	
		BK2P	1	Polyurethane Bush Kit	

**Toyota**

**4WD Hilux & 4 Runner - IFS & Rear Leaf Springs**





# 4WD HILUX & 4 RUNNER

## I.F.S & REAR LEAF SPRINGS

Kit No.: SK018

TOYOTA



### FRONT SUSPENSION

MODEL / YEAR	HEIGHT	PART NO.	QTY	COMMENTS	
<b>FRONT SPRINGS</b>					
	Raised 40mm	THL900	1 pr.	Torsion Bar, 26mm OD x 1063mm Long	
<b>FRONT SHOCK ABSORBERS</b>					
		378-245	G12088	2	Gas Shock
		378-245	TGS12544	2	Expanded Body Gas Shock
<b>STEERING DAMPER</b>					
		610/370	T14033	1	35 mm H/Duty Replacement
<b>FRONT SUSPENSION BUSHES &amp; BUSH KITS</b>					
		48632-26010	2	Bush, Upper Control Arm, Front	
		48635-26010	2	Bush, Upper Control Arm, Rear	
		TSBK0015	1	Poly Bush Kit, Upper Control Arm	
		48061-35011	4	Bush, Lower Control Arm	
		TSBK0016	1	Poly Bush Kit, Lower Control Arm	
<b>FRONT STABILIZER BAR PARTS</b>					
All ex. LN111, RN110		48815-14160	2	'D' Bush	
LN111, RN110		48815-24020	2	'D' Bush	
		90948-01002	8	Bush, Link rod.	

# 4WD HILUX & 4 RUNNER

## I.F.S & REAR LEAF SPRINGS

### REAR SUSPENSION

MODEL / YEAR	HEIGHT	PART NO.	QTY	COMMENTS	
<b>REAR SPRINGS</b>					
	Raised 50mm	THL004C	2	Leaf H/Duty ~150kg LBA	
	Raised 50mm	THL004HD	2	Leaf H/Duty ~250kg LBA	
<b>REAR U BOLTS</b>					
		90118-14175	4	195X60X14 Square Top	
<b>REAR SHOCK ABSORBERS</b>					
		632-385	G12081	2	Gas Shock
		632-385	TGS12525	2	Expanded Body Gas Shock
<b>REAR SHACKLE &amp; PIN KITS</b>					
3#, 4#, 5#, 6#, LN106, RN105		TSK009	2	Shackle Kit, Greasable	
LN107,111, RN105,110 and ALL		TSK010	2	Shackle Kit, Greasable	
3#, 4#, 5#, 6#, LN106, RN105		TPK009	2	Pin Kit, Greasable	
LN107,111, RN105,110 and ALL		TPK012	2	Bolt Kit, Greasable	
<b>REAR SHACKLE BUSH</b>					
LN147 & RZN14#		90389-14004	2	Metalistic Bush, Ft of Rr Spring	
All ex.LN147&RZN14#		90385-18046	4	Rubber Bush, Ft of Rr Spring	
All		90385-18012	4	Rubber Bush, Rr of Rr Spring Upper	
All ex. LN147 & RZN14#		90385-18046	8	Rubber Bush, Rear upper&lower	
All ex. LN147 & RZN14#		BK12P	1	Polyurethane Bush Kit	
<i>Note - I.F.S = Independent Front Suspension.</i>					

**Toyota**

**4WD Hilux & 4 Runner - IFS & Rear Coil Springs**





# 4WD HILUX & 4 RUNNER

## I.F.S & REAR COIL SPRINGS



Kit No.: SK019

TOYOTA

### FRONT SUSPENSION

MODEL / YEAR	HEIGHT	PART NO.	QTY	COMMENTS	
<b>FRONT SPRINGS</b>					
130 Series	Raised 40mm	THL900	1 pr.	Torsion Bar, 26mm OD X 1063mm Long	
<b>FRONT SHOCK ABSORBERS</b>					
130 Series		378-245	G12088	2	Gas Shock
		378-245	TGS12544	2	Expanded Body Gas Shock
<b>FRONT SUSPENSION BUSHES &amp; BUSH KITS</b>					
		48632-35050	2	Bush, Upper Control Arm, Front	
		48635-35010	2	Bush, Upper Control Arm, Rear	
		48061-35030	4	Bush, Lower Control Arm	
<b>FRONT STABILIZER BAR PARTS</b>					
		48815-14160	2	'D' Bush	
		90948-01002	4	Bush, Link rod.	

### REAR SUSPENSION

<b>REAR SPRINGS</b>					
130 Series	Standard	TTCS-1538	1 pr.	Coil	Standard Duty
	Raised 20mm	TTCS-1509	1 pr.	Coil	H/Duty ~ 100kg LBA
	Raised 50mm	TTCS-1458	1 pr.	Coil	Progressive Rate Comfort - H/Duty - 200kg VLC/LBA
	Raised 40mm	TTCS-1510	1 pr.	Coil	H/Duty - 200kg LBA
<b>REAR SHOCK ABSORBERS</b>					
130 Series		581-349	G12637	2	Gas Shock
		595-363	TGS12572	2	Expanded Body Gas Shock

**Toyota**

**4WD Hilux after March 2005 Inclusive**



# 4WD HILUX *After March 2005 Inclusive*

## FRONT COIL SPRINGS / REAR LEAF

### SPRINGS

Kit No.: *Single Cab SK016*  
*Xtr/Dual Cab SK017*

#### FRONT SUSPENSION

MODEL / YEAR	HEIGHT	PART NO.	QTY	COMMENTS
--------------	--------	----------	-----	----------

#### FRONT SPRINGS

	Standard	TTCS-1777	1 pr.	Coil	Std Duty ~35kg LBA
	Raised 40mm	TTCS-1695	1 pr.	Coil	H/Duty ~50kg LBA
	Raised 40mm	TTCS-1696	1 pr.	Coil	E/H/Duty 100kg+ LBA

#### FRONT SHOCK ABSORBERS

Coil Over Strut 		TGS80101	2	Expanded Body Gas Shock
---	--	----------	---	-------------------------

#### FRONT STABILIZER BAR PARTS

		48815-0K010	2	'D' Bush
		90948-T1002	4	Bush, Link rod.
		48820-0K030	1	Link rod, R/H
		48810-0K010	1	Link rod, L/H



# 4WD HILUX *After March 2005 Inclusive*

## FRONT COIL SPRINGS / REAR LEAF SPRINGS

### REAR SUSPENSION

MODEL / YEAR	HEIGHT	PART NO.	QTY	COMMENTS
<b>REAR SPRINGS</b>				
Single Cab	Raised 40mm	THL104	2	Leaf Comfort ~ 300kg LBA
	Raised 40mm	THL105	2	Leaf H/Duty ~ 300kg LBA
	Raised 40mm	THL106	2	Leaf E/H/Duty 300kg+ LBA
Xtra & Dual Cab	Raised 40mm	THL104	2	Leaf H/Duty ~200kg LBA
	Raised 40mm	THL106	2	Leaf H/Duty ~300kg LBA
	Raised 40mm	THL107	2	Leaf E/H/Duty ~500kg LBA
<b>REAR U-BOLTS</b>				
		TUB003	4	180X62X14 Square Top
<b>REAR SHOCK ABSORBERS</b>				
	632-385	G12081	2	Gas Shock
	632-385	TGS12525	2	Expanded Body Gas Shock
<b>REAR SHACKLE &amp; PIN KITS</b>				
-8/06		TSK025	2	Shackle Kit, Greasable
		TPK012	2	Pin Kit
<b>REAR SHACKLE BUSH</b>				
		90389-T0009	2	Rubber Bush, Ft of Rr Spring
		90385-T0001	4	Rubber Bush, Rr of Rr Spring Upper
		90385-T0002	4	Rubber Bush, Rr of Rr Spring Lower

**Toyota**

**LandCruiser 4# Series  
before July 1980 Inclusive**





# LANDCRUISER

## 4# SERIES *Before July 1980 Inclusive*

Kit No.: **SWB SK015**  
**LWB SK014**

TOYOTA

### FRONT SUSPENSION

MODEL / YEAR	HEIGHT	PART NO.	QTY	COMMENTS
<b>FRONT SPRINGS</b>				
	Raised 50mm	TLC001HD	2	Leaf H/Duty ~65kg LBA
<b>FRONT U-BOLTS</b>				
		MUB1369	4	85X230X14 ROUND TOP
<b>FRONT SHOCK ABSORBERS</b>				
	487-306	G12635	2	Gas Shock
	525-322	TGS12540	2	Expanded Body Gas Shock
<b>STEERING DAMPER</b>				
		T14023	1	35 mm H/Duty Replacement
<b>FRONT SHACKLE &amp; PIN KITS</b>				
		TSK007	2	Shackle Kit, Greasable
		TSK021AILH	1	Anti-Inversion Shackle, L/H Greasable
		TSK021AIRH	1	Anti-Inversion Shackle, R/H Greasable
		TPK006	2	Pin Kit, Greasable
<b>FRONT SHACKLE BUSH</b>				
		90385-15002	12	Rubber Bush
		BK3	1	Rubber Bush Kit
		90385-15002P	12	Polyurethane Bush
		BK3P	1	Polyurethane Bush Kit

# LANDCRUISER

## 4# SERIES *Before July 1980 Inclusive*

### REAR SUSPENSION

MODEL / YEAR	HEIGHT	PART NO.	QTY	COMMENTS	
<b>REAR SPRINGS</b>					
BJ/FJ40	Raised 50mm	TLC002E	2	Leaf Spring, Comfort Spring, 25mm Longer Main Leaf Leaf Spring, H/duty ~80kg LBA	
BJ/FJ40	Raised 50mm	TLC002HD	2		
FJ/HJ45	Raised 50mm	TLC003HD	2	Leaf H/Duty 300kg~ LBA (30mm eye)	
<b>REAR U-BOLTS</b>					
		MUB1369	4	85X230X14 ROUND TOP	
<b>REAR SHOCK ABSORBERS</b>					
All -1/75		487-306	G12635	2	Gas Shock
All 2/75-		590-357	G12636	2	Gas Shock
		590-357	TGS2576B	2	Expanded Body Gas Shock
<b>REAR SHACKLE &amp; PIN KITS</b>					
BJ/FJ40		TSK007	2	Shackle Kit, Greasable	
FJ/HJ45		TSK011	2	Shackle Kit, Greasable	
BJ/FJ40		TPK006	2	Pin Kit, Greasable	
FJ/HJ45		TPK008	2	Pin Kit, Greasable	

# LANDCRUISER

## 4# SERIES *Before July 1980 Inclusive*

### REAR SUSPENSION

MODEL / YEAR	HEIGHT	PART NO.	QTY	COMMENTS
<b>REAR SHACKLE BUSH</b>				
BJ/FJ40		90385-15002	12	Rubber Bush
		BK3	1	Rubber, Bush Kit
		90385-15002P	12	Polyurethane Bush
		BK3P	1	Polyurethane, Bush Kit
FJ/HJ45		90385-18025	12	Rubber Bush
		BK4	1	Rubber, Bush Kit
		90385-18025P	12	Polyurethane Bush
		BK4P	1	Polyurethane, Bush Kit
<b>REAR STABILIZER BAR PARTS</b>				
FJ/HJ45		48815-60010	2	'D' Bush
		90385-11021	4	Round Eye Bush
		48802-60010K	1	Link Rod Kit

**Toyota**

**LandCruiser 4# Series  
after August 1980 Inclusive**





# LANDCRUISER

## 4# SERIES *After August 1980 Inclusive*

Kit No.: **SWB SK013**  
**LWB SK012**

TOYOTA



### FRONT SUSPENSION

MODEL / YEAR	HEIGHT	PART NO.	QTY	COMMENTS
<b>FRONT SPRINGS</b>				
	Raised 50mm	TLC004E	2	Leaf Spring, Export, (35mm eye) Comfort, 25mm Longer Mainleaf
	Raised 50mm	TLC004HD	2	Leaf H/Duty ~65kg LBA
<b>FRONT U-BOLTS</b>				
FJ40/BJ42		MUB1369	4	85X230X14 ROUND TOP
FJ45/HJ47/BJ45		MUB1363	1	85X230X14 SQUARE TOP
		MUB1369	3	85X230X14 ROUND TOP
<b>FRONT SHOCK ABSORBERS</b>				
	 487-306	G12635	2	Gas Shock
	 525-322	TGS12540	2	Expanded Body Gas Shock
<b>STEERING DAMPER</b>				
		T14023	1	35 mm H/Duty Replacement
<b>FRONT SHACKLE &amp; PIN KITS</b>				
		TSK008	2	Shackle Kit, Greasable
		TPK007	2	Pin Kit, Greasable
<b>FRONT SHACKLE BUSH</b>				
		90389-18002	12	Rubber Bush
		BK5	1	Rubber Bush Kit
		90389-18002P	12	Polyurethane Bush
		BK5P	1	Polyurethane Bush Kit

# LANDCRUISER

## 4# SERIES *After August 1980 Inclusive*

### REAR SUSPENSION

MODEL / YEAR	HEIGHT	PART NO.	QTY	COMMENTS
<b>REAR SPRINGS</b>				
BJ42, FJ40	Raised 50mm	TLC005HD	2	Leaf H/Duty 85kg LBA (35mm eye)
BJ42, FJ40	Raised 50mm	TLC303		Leaf Spring, Comfort, 25mm longer Main leaf
FJ45, HJ47, BJ45	Raised	TLC006HD	2	Leaf H/Duty 300kg~ LBA (34mm eye)
<b>REAR U-BOLTS</b>				
		MUB1369	4	85X230X14 ROUND TOP
<b>REAR SHOCK ABSORBERS</b>				
	590-357	G12636	2	Gas Shock
	590-357	TGS2576B	2	Expanded Body Gas Shock
<b>REAR SHACKLE &amp; PIN KITS</b>				
BJ42, FJ40		TSK008	2	Shackle Kit, Greasable
FJ45, HJ47, BJ45		TSK013	1	Shackle Kit, RH Greasable
		TSK014	1	Shackle Kit, LH Greasable
		TPK007	2	Pin Kit, Greasable



# LANDCRUISER

## 4# SERIES *After August 1980 Inclusive*

### REAR SUSPENSION



MODEL / YEAR	HEIGHT	PART NO.	QTY	COMMENTS
<b>REAR SHACKLE BUSH KIT</b>				
		90389-18002	12	Rubber Bush
		BK5	1	Rubber Bush Kit
		90389-18002P	1	Polyurethane Bush
		BK5P	1	Polyurethane Bush Kit
<b>REAR STABILIZER BAR PARTS</b>				
FJ45, HJ47, BJ45		48815-60010	2	'D' Bush
		90385-11021	4	Round Eye Bush
		48802-60010K	1	Link Rod Kit

# LANDCRUISER

## 4# SERIES *After August 1980 Inclusive*

Kit No.: **SWB SK013**  
**LWB SK012**



### FRONT SUSPENSION

MODEL / YEAR	HEIGHT	PART NO.	QTY	COMMENTS
<b>FRONT SPRINGS</b>				
	Raised 50mm	TLC004E	2	Leaf Spring, Export, (35mm eye) Comfort, 25mm Longer Mainleaf
	Raised 50mm	TLC004HD	2	Leaf H/Duty ~65kg LBA
<b>FRONT U-BOLTS</b>				
FJ40/BJ42		MUB1369	4	85X230X14 ROUND TOP
FJ45/HJ47/BJ45		MUB1363	1	85X230X14 SQUARE TOP
		MUB1369	3	85X230X14 ROUND TOP
<b>FRONT SHOCK ABSORBERS</b>				
	 487-306	G12635	2	Gas Shock
	 525-322	TGS12540	2	Expanded Body Gas Shock
<b>STEERING DAMPER</b>				
		T14023	1	35 mm H/Duty Replacement
<b>FRONT SHACKLE &amp; PIN KITS</b>				
		TSK008	2	Shackle Kit, Greasable
		TPK007	2	Pin Kit, Greasable
<b>FRONT SHACKLE BUSH</b>				
		90389-18002	12	Rubber Bush
		BK5	1	Rubber Bush Kit
		90389-18002P	12	Polyurethane Bush
		BK5P	1	Polyurethane Bush Kit

# LANDCRUISER

## 4# SERIES *After August 1980 Inclusive*

### REAR SUSPENSION

MODEL / YEAR	HEIGHT	PART NO.	QTY	COMMENTS
<b>REAR SPRINGS</b>				
BJ42, FJ40	Raised 50mm	TLC005HD	2	Leaf H/Duty 85kg LBA (35mm eye)
BJ42, FJ40	Raised 50mm	TLC303		Leaf Spring, Comfort, 25mm longer Main leaf
FJ45, HJ47, BJ45	Raised	TLC006HD	2	Leaf H/Duty 300kg~ LBA (34mm eye)
<b>REAR U-BOLTS</b>				
		MUB1369	4	85X230X14 ROUND TOP
<b>REAR SHOCK ABSORBERS</b>				
	590-357	G12636	2	Gas Shock
	590-357	TGS2576B	2	Expanded Body Gas Shock
<b>REAR SHACKLE &amp; PIN KITS</b>				
BJ42, FJ40		TSK008	2	Shackle Kit, Greasable
FJ45, HJ47, BJ45		TSK013	1	Shackle Kit, RH Greasable
		TSK014	1	Shackle Kit, LH Greasable
		TPK007	2	Pin Kit, Greasable

# LANDCRUISER

## 4# SERIES *After August 1980 Inclusive*

### REAR SUSPENSION

MODEL / YEAR HEIGHT PART NO. QTY COMMENTS

#### REAR SHACKLE BUSH KIT

		90389-18002	12	Rubber Bush
		BK5	1	Rubber Bush Kit
		90389-18002P	1	Polyurethane Bush
		BK5P	1	Polyurethane Bush Kit

#### REAR STABILIZER BAR PARTS

FJ45, HJ47, BJ45		48815-60010	2	'D' Bush
		90385-11021	4	Round Eye Bush
		48802-60010K	1	Link Rod Kit

**Toyota**

**LandCruiser FJ 55  
after January 1975 Inclusive**



# LANDCRUISER

## FJ55 *After January 1975 Inclusive*

Kit No.: N/A

TOYOTA

### FRONT SUSPENSION

MODEL / YEAR	HEIGHT	PART NO.	QTY	COMMENTS	
<b>FRONT SPRINGS</b>					
	Raised	TLC027HD	2	Leaf Spring, Heavy Duty	
<b>FRONT U-BOLTS</b>					
		MUB1369	4	85X230X14 ROUND TOP	
<b>FRONT SHOCK ABSORBERS</b>					
		491-301	G12639S	2	Gas Shock
<b>FRONT SHACKLE &amp; PIN KITS</b>					
		04481-36020	2	Shackle Kit	
		TPK006	2	Pin Kit, Greasable	
<b>FRONT SHACKLE BUSH</b>					
		90385-18025	12	Rubber Bush	
		BK4	1	Rubber, Bush Kit	
		90385-18025P	12	Polyurethane Bush	
		BK4P	1	Polyurethane, Bush Kit	

# LANDCRUISER

## FJ55 *After January 1975 Inclusive*

### REAR SUSPENSION

MODEL / YEAR	HEIGHT	PART NO.	QTY	COMMENTS
<b>REAR SPRINGS</b>				
	Raised	TLC028HD	2	Leaf Spring, H/Duty
<b>REAR U-BOLTS</b>				
		MUB1369	4	85X230X14 ROUND TOP
<b>REAR SHOCK ABSORBERS</b>				
	 590-357	G12636	2	Gas Shock
<b>REAR SHACKLE &amp; PIN KITS</b>				
		TSK011	2	Shackle Kit, Greasable
		TPK011	2	Pin Kit, Greasable
<b>REAR SHACKLE BUSH</b>				
		90385-18025	12	Rubber Bush
		BK4	1	Rubber, Bush Kit
		90385-18025P	12	Polyurethane Bush
		BK4P	1	Polyurethane, Bush Kit

**Toyota**

**LandCruiser 60 Series  
August 1980 to January 1990**





# LANDCRUISER



## 60 SERIES

August 1980 to January 1990

Kit No.:SK010

TOYOTA

### FRONT SUSPENSION

MODEL / YEAR	HEIGHT	PART NO.	QTY	COMMENTS
<b>FRONT SPRINGS</b>				
	Raised 50mm	TLC106	2	Leaf Standard Duty ~ 50kg LBA
	Raised 50mm	TLC009HD	2	Leaf H/Duty ~ 85kg LBA
<b>FRONT U-BOLTS</b>				
		MUB1370	4	70X220X14 Square Top
<b>FRONT SHOCK ABSORBERS</b>				
	581-349	G12637	2	Gas Shock
	595-363	TGS12572	2	Expanded Body Gas Shock
<b>STEERING DAMPER</b>				
	675/420	T14024	1	35 mm H/Duty Replacement
<b>FRONT SHACKLE &amp; PIN KITS</b>				
		TSK008	2	Shackle Kit, Greasable
		TSK022AILH	1	Shackle Kit, Anti Inversion L/H
		TSK022AIRH	1	Shackle Kit, Anti Inversion R/H
		TPK007	2	Pin Kit, Greasable

# LANDCRUISER

## 60 SERIES *August 1980 to January 1990*

### FRONT SUSPENSION

MODEL / YEAR	HEIGHT	PART NO.	QTY	COMMENTS
--------------	--------	----------	-----	----------

#### FRONT SHACKLE BUSH

MODEL / YEAR	HEIGHT	PART NO.	QTY	COMMENTS
		90389-18002	12	Rubber Bush
		BK5	1	Rubber Bush Kit
		90389-18002P	12	Polyurethane Bush
		BK5P	1	Polyurethane Bush Kit







#### FRONT STABILIZER BAR PARTS

MODEL / YEAR	HEIGHT	PART NO.	QTY	COMMENTS
8/84-7/87		48815-20030	2	'D' Bush
7/87-		48815-30050	2	'D' Bush
		48817-30010	8	Round Eye Bush
		48817-30010k	1	Link Rod Kit

# LANDCRUISER

## 60 SERIES *August 1980 to January 1990*

### REAR SUSPENSION

MODEL / YEAR	HEIGHT	PART NO.	QTY	COMMENTS	
<b>REAR SPRINGS</b>					
	Raised 50mm	TLC010DSHD	1	Leaf Driver Side H/Duty ~ 275kg LBA	
	Raised 50mm	TLC010PSHD	1	Leaf Passenger Side H/Duty ~ 275kg LBA	
<b>REAR U-BOLTS</b>					
		MUB1369	4	85X230X14 ROUND TOP	
<b>REAR SHOCK ABSORBERS</b>					
All -10/85		590-357	G12636	2	Gas Shock, 16mm Eye
		632-385	G12081B	2	Gas Shock, 16mm Eye, Long Travel
		632-385	TGS2525B	2	Expanded Body Gas Shock, 16mm Eye
All 10/85-		595-363	G12650	2	Gas Shock, 19mm Eye
		632-385	G12081	2	Gas Shock, 19mm Eye, Long Travel
		632-385	TGS12525	2	Expanded Body Gas Shock, 19mm Eye
<b>REAR SHACKLE &amp; PIN KITS</b>					
		TSK015	2	Shackle Kit, Greasable	
		TSK023AILH	1	Anti-Inversion Shackle, L/H Greasable	
		TSK023AIRH	1	Anti-Inversion Shackle, R/H Greasable	
		TPK007	2	Pin Kit, Greasable	

# LANDCRUISER

## 60 SERIES *August 1980 to January 1990*

### REAR SUSPENSION

MODEL / YEAR	HEIGHT	PART NO.	QTY	COMMENTS
<b>REAR SHACKLE BUSH KIT</b>				
		90389-18002	12	Rubber Bush
		BK5	1	Rubber Bush Kit
		90389-18002P	12	Polyurethane Bush
		BK5P	1	Polyurethane Bush Kit
<b>REAR STABILIZER BAR PARTS</b>				
-7/87		48815-20060	2	'D' Bush
7/87-		48815-30050	2	'D' Bush
		90385-11021	4	Round Eye Bush
		90385-11021K	1	Bush kit , inc bushes, bolts, sleeves & nuts

**Toyota**

**LandCruiser 7# Series**



# LANDCRUISER

## 7# SERIES

Kit No.:	RJ/LJ70	SK011
	BJ70/73/74	SK008
	HZJ70/73	SK008
	75 Series	SK009
	78/79	SK007
	VDJ76	SK036
	HZJ76	SK036

TOYOTA

### FRONT SUSPENSION

MODEL / YEAR	HEIGHT	PART NO.	QTY	COMMENTS
--------------	--------	----------	-----	----------

#### FRONT SPRINGS

LJ/RJ70 -1/90	Standard	TTCS-1435	1 pr.	Coil	H/Duty ~50kg LBA
	Raised 40mm	TTCS-1403	1 pr.	Coil	H/Duty ~100kg LBA
75 Series BJ 70,73,74 HZJ 70,73	Raised 50mm	TLC013HD	2	Leaf	H/Duty ~100kg LBA
	Raised 50mm	TLC013M	2	Leaf	H/Duty Mine Spec.
78/79 Series	Standard	TTCS-1449	1pr.	Coil	H/Duty ~50kg LBA
	Raised 50mm	TTCS-1414	1pr.	Coil	H/Duty ~100kg LBA
	Raised 50mm	TTCS-1415	1pr.	Coil	H/Duty ~150kg LBA
VDJ76	Raised	TTCS-1414	1pr.	Coil	H/Duty ~100kg LBA
	Raised	TTCS-1415	1pr.	Coil	H/Duty ~150kg LBA

#### FRONT U-BOLTS

		MUB1370	4	70X220X14 Square Top
--	--	---------	---	----------------------

#### FRONT SHOCK ABSORBERS

ALL Models ex. 78/79 Series & LJ/RJ70	⊖	581-349	G12637	2	Gas Shock
	⊕	595-363	TGS12572	2	Expanded Body Gas Shock
76,78,79 Series & LJ/RJ70	⊖	510-310	G12114	2	Gas Shock
	⊕	510-310	TGS12491	2	Expanded Body Gas Shock

#### STEERING DAMPER

75 Series FZJ/HZJ78, 79 BJ 70,73,74	675/420	T14024	1	35 mm H/Duty Replacement
VDJ 76,78,79 HZJ 76		45700-69175	1	

#### FRONT SHACKLE & PIN KITS

		TSK008	2	Shackle Kit, Greasable
		TPK007	2	Pin Kit, Greasable

# LANDCRUISER

## 7# SERIES







### FRONT SUSPENSION

MODEL / YEAR	HEIGHT	PART NO.	QTY	COMMENTS
<b>FRONT SHACKLE BUSH</b>				
75 Series 11/84 on		90389-18002	12	Rubber Bush
		BK5	1	Rubber Bush Kit
		90389-18002P	12	Polyurethane Bush
		BK5P	1	Polyurethane Bush Kit
<b>FRONT SUSPENSION BUSHES &amp; BUSH KITS</b>				
78/79 Series		48702-60050	4	Bush, Radius Arm to Diff Mount
		TSBK0001	1	Poly Bush Kit, Radius Arm to Diff Mount
		48061-60010	2	Bush, Radius Arm to Chassis
		TSBK0004	1	Poly Bush Kit, Radius Arm to Chassis
For 1-2" Lift		TSBK0012	1	Poly Bush Kit, Castor Correction
For over 2" Lift		TSBK0013	1	Poly Bush Kit, Castor Correction
78/79 Series		48706-60030	2	Bush, Panhard Rod
		TSBK0007	1	Poly Bush Kit, Panhard Rod
<b>FRONT STABILIZER BAR PARTS</b>				
75# 10/85-4/91		48815-26040	2	'D' Bush
7# 4/91-8/99		48815-26020	2	'D' Bush
78/79 Series		48815-60170	2	'D' Bush
78/79 Series		90385-13009	2	Round Eye Bush
		90385-13009K	1	Bush kit , inc bushes, bolts, sleeves & nuts
7# 1/90-8/99		90948-01031	8	Bush, Link rod.
7# 10/84-1/90		48817-30010	8	Bush, Link rod.
7# 11/84-1/90		48817-30010k	1	Link Rod Kit
7# 1/90-8/99		48817-30011K	1	Link Rod Kit

# LANDCRUISER

## 7# SERIES

### REAR SUSPENSION

MODEL / YEAR	HEIGHT	PART NO.	QTY	COMMENTS	
<b>REAR SPRINGS</b>					
LJ/RJ70 -1/90	Standard	TTCS-1532	1 pr.	Coil H/Duty ~100kg LBA	
	Raised 40mm	TTCS-1504	1 pr.	Coil H/Duty ~100kg LBA	
70,73,74 Series HZJ70, 73	Raised 40mm	TLC010DSHD	1	Leaf H/Duty ~100kg LBA (Drivers Side)	
	Raised 40mm	TLC010PSHD	1	Leaf H/Duty ~100kg LBA (Passenger Side)	
75 Series	Raised	TLC015C	2	Leaf Standard Duty ~ 200kg LBA	
	Raised	TLC015HD	2	Leaf H/Duty ~ 300kg LBA	
	Raised	TLC015M	2	Leaf Leaf Spring, Mine Spec.	
78/79 Series	Raised	TLC016C	2	Leaf Standard Duty ~ 200kg LBA	
	Raised	TLC016HD	2	Leaf H/Duty ~ 300kg LBA	
	Raised	TLC016M	2	Leaf E/H/Duty Mine Spec.	
VDJ76 HZJ76	Raised	TLC034C	2	Leaf Comfort Ride	
	Raised 50mm	TLC034HD	2	Leaf H/Duty ~ 300kg LBA	
<b>REAR U-BOLTS</b>					
ALL		MUB1369	4	85X230X14 ROUND TOP	
<b>REAR SHOCK ABSORBERS</b>					
70,73,74 Series		595-363	G12650	2	Gas Shock
		632-385	TGS12525	2	Expanded Body Gas Shock
LJ/RJ70		581-349	G12637	1	Gas Shock LH
		595-363	G12650	1	Gas Shock RH
75,76,78.79 Series		654-397	G12115	2	Gas Shock
		654-397	TGS12492	2	Expanded Body Gas Shock



# LANDCRUISER 7# SERIES

## REAR SUSPENSION

MODEL / YEAR	HEIGHT	PART NO.	QTY	COMMENTS
<b>REAR SHACKLE &amp; PIN KITS</b>				
70/73/74 Series		TSK008	2	Shackle Kit, Greasable
		TPK007	2	Pin Kit, Greasable
75 Series		TSK015	2	Shackle Kit, Greasable
		TSK023AILH	1	Anti-Inversion Shackle, L/H Greasable
		TSK023AIRH	1	Anti-Inversion Shackle, R/H Greasable
		TPK010	2	Pin Kit, Greasable
78/79 Series		TSK026	2	Shackle Kit, Greasable H/Duty
78/79 Series		TPK011	2	Pin Kit, Greasable
<b>REAR STABILIZER BAR PARTS</b>				
78/79 Series		48815-26020	2	'D' Bush
		90385-11021	2	Round Eye Bush
		90385-11021K	1	Bush kit , inc bushes, bolts, sleeves & nuts
		48817-30010	4	Bush, Link rod.
		48802-60090K	1	Link Rod Kit

# LANDCRUISER 7# SERIES

## REAR SUSPENSION

MODEL / YEAR	HEIGHT	PART NO.	QTY	COMMENTS
<b>REAR SHACKLE BUSH</b>				
70/73/74 Series		90389-18002	12	Rubber Bush
		BK5	1	Rubber Bush Kit
		90389-18002P	12	Polyurethane Bush
		BK5P	1	Polyurethane Bush Kit
75 Series		90385-18009	1	Rubber Bush
		BK6	1	Rubber Bush Kit
		90385-18009P	1	Polyurethane Bush
		BK6P	1	Polyurethane Bush Kit
78 Series		90389-22003	2	Rubber Bush, Ft of Rr,
		90389-14056	2	Rubber Bush, Ft of Rr,
		90385-18022	4	Rubber Bush, Rr of Rr, Upper
		90385-18021	4	Rubber Bush, Rr of Rr, Lower
		BK10	1	Rubber Bush Kit, for genuine shackle
		BK10P	1	Polyurethane Bush Kit, for genuine shackle
		BK10/11PG	1	Polyurethane Bush Kit for H/Duty Shackle
79 Series		90389-22003	4	Rubber Bush, Ft of Rr & Rr of Rr Lower
		90389-14056	4	Rubber Bush, Ft of Rr & Rr of Rr Lower
		90385-18022	4	Rubber Bush, Rr of Rr, Upper
		BK11	1	Rubber Bush Kit, for genuine shackle
		BK11P	1	Polyurethane Bush Kit, for genuine shackle
		BK10/11PG	1	Polyurethane Bush Kit for H/Duty Shackle

**Toyota**

**LandCruiser 80 Series**



# LANDCRUISER 80 SERIES

Kit No.: SK006

TOYOTA

## FRONT SUSPENSION

MODEL / YEAR HEIGHT PART NO. QTY COMMENTS

### FRONT SPRINGS

#### Front Springs

	Standard	TTCS-1456	1 pr.	Coil Linear	Comfort Ride
	Standard	TTCS-1455	1 pr.	Coil Linear	H/Duty ~80kg Constant LBA
	Raised 20mm	TTCS-1447	1 pr.	Coil Linear	Comfort Ride
	Raised 20mm	TTCS-1446	1 pr.	Coil Linear	H/Duty ~80kg Constant LBA
	Raised 50mm	TTCS-1409	1 pr.	Coil Linear	H/Duty ~100kg Constant LBA
	Raised 50mm	TTCS-2164	1 pr.	Coil Linear	E/H/Duty ~150kg Constant LBA
	Raised 50mm	TTCS-1410	1 pr.	Coil Linear	S/H/Duty 150kg+ Constant LBA
	Raised 3"	TTCS-2163	1 pr.	Coil Linear	Competition Extreme Off Road
	Raised 4"	TTCS-1411	1 pr.	Coil Linear	Competition Extreme Off Road

Extra Length Shock Absorbers May be Required For 3" & 4" Extended Coils

### FRONT SHOCK ABSORBERS

	615-365	TGS12490	2	Expanded Body Gas Shock
---	---------	----------	---	-------------------------

### STEERING DAMPER

	675/420	T14024	1	35 mm Heavy Duty Replacement
---	---------	--------	---	------------------------------

# LANDCRUISER 80 SERIES

## FRONT SUSPENSION

MODEL / YEAR	HEIGHT	PART NO.	QTY	COMMENTS
<b>FRONT SUSPENSION BUSHES &amp; BUSH KITS</b>				
		48702-60050	4	Bush, Radius Arm to Diff Mount
		48061-60010	2	Bush, Radius Arm to Chassis
		TSBK0001	1	Poly Bush Kit, Radius Arm to Diff Mount
		TSBK0004	1	Poly Bush Kit, Radius Arm to Chassis
For 1-2" Lift		TSBK0012	1	Poly Bush Kit, Castor Correction
For over 2" Lift		TSBK0013	1	Poly Bush Kit, Castor Correction
		48706-60030	2	Bush, Panhard Rod
		TSBK0007	1	Poly Bush Kit, Panhard Rod
<b>FRONT STABILIZER BAR PARTS</b>				
1/90-1/92		48815-30100	2	'D' Bush - ID=25mm, OD=32mm
1/92-8/92		48815-26020	2	'D' Bush - ID=25mm, OD=38mm
8/92-		48815-60070	2	'D' Bush - ID=28mm, OD=38mm
		90385-11021	2	Round Eye Bush
		90385-11021K	1	Bush kit , inc bushes, bolts, sleeves & nuts
All -8/92		48817-30010	4	Bush, Link rod.
All -1/92		48822-60040K	1	Link Rod Kit
All 8/92-		48802-60050K	1	Link Rod Kit
<b>FRONT ADJUSTABLE PANHARD ROD</b>				
		N82681	1	Adjustable Panhard Rod ( Front )
		N83050	1	Adjustable Panhard Rod ( LHD )
Extra Length Shock Absorbers May be Required For 3" & 4" Extended Coils				

# LANDCRUISER 80 SERIES

## REAR SUSPENSION

MODEL / YEAR HEIGHT PART NO. QTY COMMENTS

### REAR SPRINGS

	Standard	TTCS-1553	1 pr.	Linear	H/Duty ~100kg Constant LBA
	Standard	TTCS-1554	1 pr.	Progressive	Comfort ~H/Duty -100kg VLC
	Raised 20mm	TTCS-1539	1 pr.	Linear	H/Duty ~100kg Constant LBA
	Raised 50mm	TTCS-1511	1 pr.	Linear	H/Duty ~100kg Constant LBA
	Raised 50mm	TTCS-1541	1 pr.	Linear	E/H/Duty ~300-500kg Constant LBA
	Raised 70mm	TTCS-1513	1 pr.	Linear	E/H/Duty ~300-500kg Constant LBA
	Raised 70mm	TTCS-1514	1 pr.	Linear	S/H/Duty ~500-750kg Constant LBA
	Raised 50mm	TTCS-1460	1 pr.	Progressive	Comfort Ride E/H/Duty ~200kg VLC
	Raised 3"	TTCS-2166	1 pr.	Linear	Competition Extreme Off Road
	Raised 4"	TTCS-1515	1 pr.	Linear	Competition Extreme Off Road

Extra Length Shock Absorbers May Be Required For 3" & 4" Extended Coils

### REAR SHOCK ABSORBERS

	613-372	TGS12489	2	Expanded Body Gas Shock	
---	---------	----------	---	-------------------------	--

# LANDCRUISER 80 SERIES

## REAR SUSPENSION

MODEL / YEAR	HEIGHT	PART NO.	QTY	COMMENTS
<b>REAR BUSHES &amp; BUSH KITS</b>				
		48702-60031	4	Bush, Upper Control Arm
		TSBK0006	2	Poly Bush Kit, Upper Control Arm
		48702-60040	4	Bush, Lower Control Arm
		TSBK0005	1	Poly Bush Kit, Lower Control Arm
		48706-60040	2	Bush, Panhard Rod
		TSBK0003	1	Poly Bush Kit, Panhard Rod
<b>REAR STABILIZER BAR PARTS</b>				
1/90-8/92		48815-30090	2	'D' Bush
8/92-		48815-26020	2	'D' Bush
		90385-11021	2	Round Eye Bush
		90385-11021K	1	Bush kit , inc bushes, bolts, sleeves & nuts
1/90-8/92 & 8/96-		48817-30010	4	Bush, Link rod.
1/90-8/92 & 8/96-		48802-60030K	1	Link Rod Kit
8/92-8/96		48802-60060	2	Link Rod
<b>REAR ADJUSTABLE PANHARD ROD</b>				
		N82685	1	Adjustable Panhard Rod ( Rear )
<p><b>Note...</b> Castor Adjusting Kit recommended for vehicles with raised suspension up to 50mm. Castor Adjusting Kit compulsory for vehicles with raised suspension over 50mm.</p>				

**Toyota**

**LandCruiser 105 Series**





# LANDCRUISER 105 Series

## Coil Springs Front & Rear

Kit No.: SK004

### FRONT SUSPENSION

MODEL / YEAR	HEIGHT	PART NO.	QTY	COMMENTS	
<b>FRONT SPRINGS</b>					
	Standard	TTCS-1456	1 pr.	Coil Linear Comfort Ride	
	Standard	TTCS-1455	1 pr.	Coil Linear H/Duty -80kg Constant LBA	
	Raised 20mm	TTCS-1447	1 pr.	Coil Linear Comfort Ride	
	Raised 20mm	TTCS-1446	1 pr.	Coil Linear H/Duty -80kg Constant LBA	
	Raised 50mm	TTCS-1409	1 pr.	Coil Linear E/H/Duty ~100kg Constant LBA	
	Raised 50mm	TTCS-2164	1 pr.	Coil Linear E/H/Duty ~150kg Constant LBA	
	Raised 50mm	TTCS-1410	1 pr.	Coil Linear S/H/Duty 150kg+ Constant LBA	
	Raised 3"	TTCS-2163	1 pr.	Coil Linear Competition Extreme Off Road	
	Raised 4"	TTCS-1411	1 pr.	Coil Linear Competition Extreme Off Road	
Extra Length Shock Absorbers May Be Required For 3' & 4" Extended Coils					
<b>FRONT SHOCK ABSORBERS</b>					
	†	615-365	TGS12490	2	Expanded Body Gas Shock
<b>STEERING DAMPER</b>					
	⌘	675/420	T14024	1	35 mm Heavy Duty Replacement

# LANDCRUISER 105 Series

## Coil Springs Front & Rear

### FRONT SUSPENSION

MODEL / YEAR	HEIGHT	PART NO.	QTY	COMMENTS
<b>FRONT SUSPENSION BUSHES &amp; BUSH KITS</b>				
		48702-60050	4	Bush, Radius Arm to Diff Mount
		TSBK0001	1	Poly Bush Kit, Radius Arm to Diff Mount
		48061-60010	2	Bush, Radius Arm to Chassis
		TSBK0004	1	Poly Bush Kit, Radius Arm to Chassis
For 1-2" Lift		TSBK0012	1	Poly Bush Kit, Castor Correction
For over 2" Lift		TSBK0013	1	Poly Bush Kit, Castor Correction
		48706-60030	2	Bush, Panhard Rod
		TSBK0007	1	Poly Bush Kit, Panhard Rod
<b>FRONT STABILIZER BAR PARTS</b>				
		48815-60160	2	'D' Bush
		90385-11021	2	Round Eye Bush
		90385-11021K	1	Bush kit , inc bushes, bolts, sleeves & nuts
		48802-60050K	1	Link Rod Kit
<b>FRONT ADJUSTABLE PANHARD ROD</b>				
		N82681	1	Adjustable Panhard Rod
		N83050	1	Adjustable Panhard Rod (LHD)

# LANDCRUISER 105 Series

## Coil Springs Front & Rear

### REAR SUSPENSION

MODEL / YEAR HEIGHT PART NO. QTY COMMENTS

#### REAR SPRINGS

	Standard	TTCS-1553	1 pr.	Linear	H/Duty ~100kg Constant LBA
	Standard	TTCS-1554	1 pr.	Progressive	Comfort Ride H/Duty ~100kg VLC
	Raised 50mm	TTCS-1539	1 pr.	Linear	H/Duty ~100kg Constant LBA
	Raised 50mm	TTCS-1540	1 pr.	Progressive	Comfort Ride H/Duty ~100kg VLC
	Raised 50mm	TTCS-1460	1 pr.	Progressive	Standard Ride H/Duty ~200kg VLC
	Raised 50mm	TTCS-1541	1 pr.	Linear	Extra H/Duty 300-500kg Constant LBA
	Raised 70mm	TTCS-1513	1 pr.	Linear	Extra H/Duty 300-500kg Constant LBA
	Raised 70mm	TTCS-1514	1 pr.	Linear	Super H/Duty 500-750kg Constant LBA
	Raised 3"	TTCS-2166	1pr.	Linear	Competition Extreme Off Road
	Raised 4"	TTCS-1515	1 pr.	Linear	Competition Extreme off Road

Extra Length Shock Absorbers May Be Required For 3" & 4" Extended Coils

**Note** - Extreme off-road use coil springs ( 3" to 7" ) are available upon request.

#### REAR SHOCK ABSORBERS

	613-372	TGS12489	2	Expanded Body Gas Shock
---	---------	----------	---	-------------------------

#### REAR BUSHES & BUSH KITS

		48702-60031	4	Bush, Upper Control Arm
		TSBK0006	2	Poly Bush Kit, Upper Control Arm
		48702-60040	4	Bush, Lower Control Arm
		TSBK0005	1	Poly Bush Kit, Lower Control Arm
		48706-60040	2	Bush, Panhard Rod
		TSBK0003	1	Poly Bush Kit, Panhard Rod

# LANDCRUISER 105 Series

## Coil Springs Front & Rear

### REAR SUSPENSION

MODEL / YEAR	HEIGHT	PART NO.	QTY	COMMENTS
<b>REAR STABILIZER BAR PARTS</b>				
		48815-26020	2	'D' Bush
		90385-11021	2	Round Eye Bush
		90385-11021K	1	Bush kit , inc bushes, bolts, sleeves & nuts
		48817-30010	4	Bush, Link rod.
		48802-60030K	1	Link Rod Kit
<b>REAR ADJUSTABLE PANHARD ROD</b>				
		N82685	1	Adjustable Panhard Rod
<p><b>Note...</b> Castor Adjusting Kit recommended for vehicles with raised suspension up to 50mm. Castor Adjusting Kit compulsory for vehicles with raised suspension over 50mm.</p>				

**Toyota**

**LandCruiser 100 Series**



# LANDCRUISER 100 Series

## I.F.S & Rear Coil Springs

Kit No.: SK003

TOYOTA

### FRONT SUSPENSION

MODEL / YEAR	HEIGHT	PART NO.	QTY	COMMENTS
<b>FRONT SPRINGS</b>				
All Petrol	Raised 40mm	TLC023HD	1 pr.	Torsion Bar- Length 1160mm
All Diesel	Raised 40mm	TLC024HD	1 pr.	Torsion Bar -Length 1210mm
		10-1054	1	Torsion Bar reinforcement bracket set
<b>FRONT SHOCK ABSORBERS</b>				
	442-290	TGS12231	2	Expanded Body Gas Shock
<b>FRONT SUSPENSION BUSHES &amp; BUSH KITS</b>				
		48654-60010	2	Bush, Lower Control Arm
		48655-60010	2	Bush, Lower Control Arm
		48632-60010	4	Bush, Upper Control Arm
<b>FRONT STABILIZER BAR PARTS</b>				
100 Series		48815-60111	2	'D' Bush
		90948-01031	4	Bush, Link rod.
		48849-60010	2	Bush, Link rod Eye

# LANDCRUISER 100 Series

## I.F.S & Rear Coil Springs

### REAR SUSPENSION

MODEL / YEAR	HEIGHT	PART NO.	QTY	COMMENTS
<b>REAR SPRINGS</b>				
100 Series	Standard	TTCS-1460	1pr.	Coil Progressive 150kg VLC/LBA
	Raised 50mm	TTCS-1459	1pr.	Coil Progressive 150kg VLC/LBA
	Standard	TTCS-2168	1pr.	Coil Linear With Active Ride Control
<b>REAR SHOCK ABSORBERS</b>				
All		613-372	TGS12230	2 Expanded Body Gas Shock
<b>REAR BUSHES &amp; BUSH KITS</b>				
		TSBK0018	2	Poly Bush Kit, Upper Control Arm
		TSBK0017	2	Poly Bush Kit, Lower Control Arm
		TSBK0019	1	Poly Bush Kit, Panhard Rod
<b>REAR STABILIZER BAR PARTS</b>				
With active ride control.		48815-60150	2	'D' Bush
		48815-26250	2	'D' Bush
		90385-11021	2	Round Eye Bush
		90385-11021K	1	Bush kit , inc bushes, bolts, sleeves & nuts
		48817-30010	4	Bush, Link rod.

**Toyota**

**LandCruiser 200 Series**





# LANDCRUISER 200 Series

## Coil Springs - Front & Rear

MODEL / YEAR	HEIGHT	PART NO.	QTY	COMMENTS		
<b>FRONT SPRINGS</b>						
	Standard	TTCS-2213	1pr.	Coil	Linear	H/Duty ~ 100kg
	Raised 40mm	TTCS-2214	1pr.	Coil	Linear	H/Duty ~ 100kg LBA
	Raised 40mm	TTCS-2215	1pr.	Coil	Linear	H/Duty ~ 150kg LBA
<b>FRONT SHOCK ABSORBERS</b>						
		G20688	2	Expanded Body Gas Shock		
<b>REAR SPRINGS</b>						
	Standard	TTCS-2218	1	Coil	Linear	H/Duty
	Raised 50mm	TTCS-2219	1	Coil	Linear	H/Duty ~ 300kg
	Raised 50mm	TTCS-2220	1	Coil	Linear	H/Duty 300-500kg (Constant) Load
	Raised 50mm	TTCS-2221	1	Coil	Linear	H/Duty 500-750kg (Constant) Load
<b>REAR SHOCK ABSORBERS</b>						
		TGS20682	2	Expanded Body Gas Shock		

**Toyota**

**LandCruiser Prado 9# Series  
April 1996 - August 2002**



# LANDCRUISER PRADO

9# Series April 1996 - August 2002

Kit No.: SK002

TOYOTA



## FRONT SUSPENSION

MODEL / YEAR	HEIGHT	PART NO.	QTY	COMMENTS
<b>FRONT SPRINGS</b>				
	Standard	TTCS-1443	1 pr.	Coil Linear H/Duty ~50kg Constant LBA
	Raised 40mm	TTCS-1405	1 pr.	Coil Linear H/Duty ~50kg Constant LBA
	Raised 50mm	TTCS-1789	1 pr.	Coil Linear H/Duty ~75kg Constant LBA
<b>FRONT SHOCK ABSORBERS</b>				
Coil Over Strut		TGS69188	2	Expanded Body Gas Shock
<b>FRONT SUSPENSION BUSHES &amp; BUSH KITS</b>				
		48061-35040	2	Bush, Lower Control Arm, Front
		TSBK0020	1	Poly Bush Kit, Lower Control Arm, Front
		48061-35050	2	Bush, Lower Control Arm, Rear
		TSBK0021		Poly Bush Kit, Lower Control Arm, Rear
		48632-35080	4	Bush, Upper Control Arm
		TSBK0022	1	Poly Bush Kit, Upper Control Arm
<b>FRONT STABILIZER BAR PARTS</b>				
1/98-		48815-35100	2	'D' Bush
4/96-1/98		48815-60100	2	'D' Bush
		90948-01031	4	Bush, Link rod.
		48820-35030	2	Link Rod

# LANDCRUISER PRADO

9# Series April 1996 - August 2002

## REAR SUSPENSION

MODEL / YEAR	HEIGHT	PART NO.	QTY	COMMENTS
<b>REAR SPRINGS</b>				
	Standard	TTCS-1534	1 pr.	Coil Progressive H/Duty ~100kg VLC
	Raised 40mm	TTCS-1507	1 pr.	Coil Progressive H/Duty ~100kg VLC
	Raised 50mm	TTCS-1508	1 pr.	Coil Progressive H/Duty ~250kg VLC
<b>REAR SHOCK ABSORBERS</b>				
	 581-349	G12637	2	Gas Shock
	 595-363	TGS12572	2	HD Expanded Body Gas Shock
<b>REAR BUSHES &amp; BUSH KITS</b>				
		TSBK0011	1	Poly Bush Kit, Upper Control Arm
		48702-35070	4	Bush , Lower Control Arm
		TSBK0010	1	Poly Bush Kit, Lower Control Arm
		TSBK0009	1	Poly Bush Kit, Panhard Rod
<b>REAR STABILIZER BAR PARTS</b>				
		48815-16170	2	'D' Bush
		48817-30020	4	Bush, Link rod.
		48830-35020	2	Link Rod

**Toyota**

**LandCruiser Prado 120 Series  
after September 2002 Inclusive**



# LANDCRUISER PRADO

**120 Series** After September 2002 Inclusive

Kit No.: SK001

TOYOTA

## FRONT SUSPENSION

MODEL / YEAR	HEIGHT	PART NO.	QTY	COMMENTS
<b>FRONT SPRINGS</b>				
	Standard	TTCS-1777	1 pr.	Coil Linear Standard Duty ~35kg LBA
	Raised 40mm	TTCS-1695	1pr.	Coil Linear H/Duty ~50kg LBA
	Raised 40mm	TTCS-1696	1 pr.	Coil Linear H/Duty ~100kg LBA
<b>FRONT SHOCK ABSORBERS</b>				
Coil Over Strut		TGS12800	2	Expanded Body Gas Shock
<b>FRONT SUSPENSION BUSHES &amp; BUSH KITS</b>				
		48654-60030	2	Bush, Lower Control Arm, Front
		TSBK0023	1	Poly Bush Kit, Lower Control Arm, Front
		48655-60030	2	Bush, Lower Control Arm, Rear
		TSBK0024	1	Poly Bush Kit, Lower Control Arm, Rear
		48632-60020	4	Bush, Upper Control Arm
		TSBK0025	1	Poly Bush Kit, Upper Control Arm
<b>FRONT STABILIZER BAR PARTS</b>				
		48815-60180	2	'D' Bush
		48820-60050	1	Link Rod, R/H
		48810-60040	1	Link Rod, L/H

# LANDCRUISER PRADO

**120 Series** After September 2002 Inclusive

## REAR SUSPENSION

MODEL / YEAR	HEIGHT	PART NO.	QTY	COMMENTS
<b>REAR SPRINGS</b>				
	Standard	TTCS-1697	1 pr.	Coil Linear Standard Duty ~35kg LBA
	Raised 40mm	TTCS-1698	1 pr.	Coil Linear H/Duty ~150kg LBA
	Raised 50mm	TTCS-1699	1 pr.	Coil Linear H/Duty ~250kg LBA
<b>REAR SHOCK ABSORBERS</b>				
		TGS59637	2	Expanded Body Gas Shock
<b>REAR BUSHES &amp; BUSH KITS</b>				
		TSBK0027	2	Poly Bush Kit, Upper Control Arm
		TSBK0018	2	Poly Bush Kit, Lower Control Arm
		48706-60060	2	Bush, Panhard Rod
		TSBK0026	1	Poly Bush Kit, Panhard Rod
<b>REAR STABILIZER BAR PARTS</b>				
9/02-2/06		48815-14140	2	'D' Bush
		48817-30010	4	Bush, Link rod.
		48830-60030	2	Link Rod

**Toyota**

**LandCruiser Prado 150 Series**





# LANDCRUISER PRADO

## 150 Series

Kit No.: SK025

TOYOTA

MODEL / YEAR	HEIGHT	PART NO.	QTY	COMMENTS
<b>FRONT SPRINGS</b>				
	Standard	TTCS-1777	1 pr.	Coil Linear Standard Duty ~35kg LBA
	Raised 40mm	TTCS-1695	1pr.	Coil Linear H/Duty ~50kg LBA
	Raised 40mm	TTCS-1696	1 pr.	Coil Linear H/Duty ~100kg LBA
<b>FRONT SHOCK ABSORBERS</b>				
Coil Over Strut		TGS59700 (Can use TGS12800)	2	Expanded Body Gas Shock
<b>REAR SPRINGS</b>				
	Standard	TTCS-1697	1 pr.	Coil Linear Standard Duty ~35kg LBA
	Raised 40mm	TTCS-1698	1pr.	Coil Linear H/Duty ~150kg LBA
	Raised 40mm	TTCS-1699	1 pr.	Coil Linear H/Duty ~250kg LBA
<b>REAR SHOCK ABSORBERS</b>				
		TGS59701 (Can use TGS59637)	2	Expanded Body Gas Shock

# Coil Springs Specification

Terrain Tamer	Application	Rate lbf/in	Material Dia	Free Height mm
TTCS-0267	PAJERO	670	18mm	325
TTCS-0268	PAJERO	760	19mm	320
TTCS-0324	PAJERO	170-225	17mm	390-400
TTCS-0325	PAJERO	205-290	18mm	390-400
TTCS-0327	PAJERO	135-230	16mm	390-400
TTCS-0328	PAJERO	1000	21mm	340-350
TTCS-0329	PAJERO	1250	22mm	320-330
TTCS-0346	PAJERO	1000	21mm	325-335
TTCS-0406	PATROL	205	15mm	400-415
TTCS-0407	PATROL	250	16mm	390-405
TTCS-0408	PATROL	250	16.5mm	415-430
TTCS-0409	PATROL	310	17mm	390-405
TTCS-0410	PATROL	290	17mm	470-485
TTCS-0438	PATROL	250	16mm	370-385
TTCS-0453	PATROL	190-250	16mm	430-435
TTCS-0454	PATROL	240-365	19mm	460-470
TTCS-0455	PATROL	220	17mm	460-470
TTCS-0456	PATROL	240-365	19mm	460-480
TTCS-0457	PATROL	275-445	20mm	430-445
TTCS-0458	PATROL	275-445	20mm	455-485
TTCS-0460	PATROL	275-445	20mm	450-465
TTCS-0505	PATHFINDER	180	14mm	430
TTCS-0506	PATROL	185	16mm	480-490
TTCS-0508	PATROL	470	21mm	460-470
TTCS-0509	PATROL	220	18mm	480-490
TTCS-0510	PATROL	330	19mm	460-470
TTCS-0511	PATROL	290	19mm	520-535
TTCS-0540	PATROL	220	17mm	430-440
TTCS-0541	PATROL	220	17mm	440-470
TTCS-0630	TERRITORY	355	16mm	450
TTCS-0723	TERRITORY	330	17mm	360
TTCS-1069	JEEP	195	15mm	445-465
TTCS-1101	L/ROVER	220	17mm	445
TTCS-1102	L/ROVER	470	20mm	410
TTCS-1103	L/ROVER	515	21mm	410
TTCS-1107	L/ROVER	220	17mm	425
TTCS-1255	R/ROVER	200	15mm	385-395
TTCS-1257	DEFENDER	225	15mm	375-385
TTCS-1258	DEFENDER	285	16.5mm	390-400
TTCS-1259	DISCOVERY	190	14.5mm	390-410
TTCS-1267	DISCOVERY	240-345	17mm	425-435
TTCS-1268	DISCOVERY	300-440	18mm	420-430
TTCS-1289	VITARA	435	15mm	290
TTCS-1290	VITARA	540	16mm	285
TTCS-1291	VITARA	540	16mm	295
TTCS-1295	SIERRA	160	10.5mm	300-310
TTCS-1298	VITARA	435	16mm	335
TTCS-1299	VITARA	435	16mm	340
TTCS-1307	VITARA	435	16mm	325
TTCS-1329	VITARA	145	11.5mm	345
TTCS-1330	VITARA	200	12.5mm	335
TTCS-1335	SIERRA	145	11mm	320
TTCS-1337	VITARA	175	12.5mm	360
TTCS-1340	VITARA	210	14mm	360
TTCS-1357	VITARA	175	12.5mm	340
TTCS-1403	BUNDERA	210	14mm	375-390

# Coil Springs Specification

Terrain Tamer	Application	Rate	Material Dia	Free Height
		lbf/in		mm
TTCS-1404	RAV4	165	15mm	350
TTCS-1405	PRADO	565	16mm	350
TTCS-1407	L/CRUISER	240	16.5mm	495-505
TTCS-1408	L/CRUISER	175	16.5mm	515-525
TTCS-1409	L/CRUISER	230	17mm	515-525
TTCS-1410	L/CRUISER	290	18mm	515-525
TTCS-1411	L/CRUISER	300	18mm	530-540
TTCS-1414	L/CRUISER	300	16mm	460
TTCS-1415	L/CRUISER	330	17mm	460
TTCS-1443	PRADO	565	16mm	335
TTCS-1446	L/CRUISER	240	16mm	475-485
TTCS-1447	L/CRUISER	175	15.5mm	495-505
TTCS-1449	L/CRUISER	275	16mm	440
TTCS-1455	L/CRUISER	240	16mm	460-470
TTCS-1456	L/CRUISER	175	15.5mm	475-485
TTCS-1458	4RUNNER	155-250	16mm	380-390
TTCS-1459	L/CRUISER	200-290	19mm	470-480
TTCS-1460	L/CRUISER	200-290	19mm	440-450
TTCS-1504	BUNDERA	215	16mm	400-410
TTCS-1506	RAV4	300	15mm	280
TTCS-1507	PRADO	210-300	17mm	370-380
TTCS-1508	PRADO	250-380	18mm	375-385
TTCS-1509	4RUNNER	165	15mm	380-390
TTCS-1510	4RUNNER	240	16mm	360-370
TTCS-1511	L/CRUISER	200	17mm	480-490
TTCS-1512	L/CRUISER	145-250	18mm	510-520
TTCS-1513	L/CRUISER	305	19mm	480-490
TTCS-1514	L/CRUISER	360	20mm	480-490
TTCS-1515	L/CRUISER	280	19mm	505-515
TTCS-1532	BUNDERA	215	16mm	380-390
TTCS-1538	4RUNNER	165	15mm	360-370
TTCS-1539	L/CRUISER	200	17mm	460-470
TTCS-1540	L/CRUISER	145-260	18mm	490-500
TTCS-1541	L/CRUISER	305	19mm	460-470
TTCS-1553	L/CRUISER	200	17mm	445-455
TTCS-1695	HILUX/PRADO	660	17mm	375
TTCS-1696	HILUX/PRADO	800	18mm	370
TTCS-1697	PRADO	260	17mm	365
TTCS-1698	PRADO	260	17mm	390
TTCS-1699	PRADO	320	18mm	390
TTCS-1735	PATROL	315-460	21mm	455-470
TTCS-1777	HILUX/PRADO	660	16.5mm	355
TTCS-1781	PATROL	290	17mm	445-460
TTCS-1783	PATROL	290	19mm	495-510
TTCS-1789	PRADO	580	17mm	365
TTCS-2009	PATROL	310	18mm	415-430
TTCS-2026	PAJERO	760	19mm	335
TTCS-2027	TRITON	750	18mm	315
TTCS-2028	TRITON	750	18mm	320
TTCS-2042	NAVARA/P/FINDER	500	17mm	375
TTCS-2047	PATROL	600	24mm	480-490
TTCS-2048	PATROL	220	18mm	460-490
TTCS-2052	PATHFINDER	390	19mm	440
TTCS-2053	PATHFINDER	460	20mm	430
TTCS-2142	VITARA	200	15mm	375
TTCS-2152	VITARA	540	17mm	345
TTCS-2163	L/CRUISER	300	18mm	505-515

# Coil Springs Specification

Terrain Tamer	Application	Rate	Material Dia	Free Height
		lbf/in		mm
TTCS-1404	RAV4	165	15mm	350
TTCS-1405	PRADO	565	16mm	350
TTCS-1407	L/CRUISER	240	16.5mm	495-505
TTCS-1408	L/CRUISER	175	16.5mm	515-525
TTCS-1409	L/CRUISER	230	17mm	515-525
TTCS-1410	L/CRUISER	290	18mm	515-525
TTCS-1411	L/CRUISER	300	18mm	530-540
TTCS-1414	L/CRUISER	300	16mm	460
TTCS-1415	L/CRUISER	330	17mm	460
TTCS-1443	PRADO	565	16mm	335
TTCS-1446	L/CRUISER	240	16mm	475-485
TTCS-1447	L/CRUISER	175	15.5mm	495-505
TTCS-1449	L/CRUISER	275	16mm	440
TTCS-1455	L/CRUISER	240	16mm	460-470
TTCS-1456	L/CRUISER	175	15.5mm	475-485
TTCS-1458	4RUNNER	155-250	16mm	380-390
TTCS-1459	L/CRUISER	200-290	19mm	470-480
TTCS-1460	L/CRUISER	200-290	19mm	440-450
TTCS-1504	BUNDERA	215	16mm	400-410
TTCS-1506	RAV4	300	15mm	280
TTCS-1507	PRADO	210-300	17mm	370-380
TTCS-1508	PRADO	250-380	18mm	375-385
TTCS-1509	4RUNNER	165	15mm	380-390
TTCS-1510	4RUNNER	240	16mm	360-370
TTCS-1511	L/CRUISER	200	17mm	480-490
TTCS-1512	L/CRUISER	145-250	18mm	510-520
TTCS-1513	L/CRUISER	305	19mm	480-490
TTCS-1514	L/CRUISER	360	20mm	480-490
TTCS-1515	L/CRUISER	280	19mm	505-515
TTCS-1532	BUNDERA	215	16mm	380-390
TTCS-1538	4RUNNER	165	15mm	360-370
TTCS-1539	L/CRUISER	200	17mm	460-470
TTCS-1540	L/CRUISER	145-260	18mm	490-500
TTCS-1541	L/CRUISER	305	19mm	460-470
TTCS-1553	L/CRUISER	200	17mm	445-455
TTCS-1695	HILUX/PRADO	660	17mm	375
TTCS-1696	HILUX/PRADO	800	18mm	370
TTCS-1697	PRADO	260	17mm	365
TTCS-1698	PRADO	260	17mm	390
TTCS-1699	PRADO	320	18mm	390
TTCS-1735	PATROL	315-460	21mm	455-470
TTCS-1777	HILUX/PRADO	660	16.5mm	355
TTCS-1781	PATROL	290	17mm	445-460
TTCS-1783	PATROL	290	19mm	495-510
TTCS-1789	PRADO	580	17mm	365
TTCS-2009	PATROL	310	18mm	415-430
TTCS-2026	PAJERO	760	19mm	335
TTCS-2027	TRITON	750	18mm	315
TTCS-2028	TRITON	750	18mm	320
TTCS-2042	NAVARA/P/FINDER	500	17mm	375
TTCS-2047	PATROL	600	24mm	480-490
TTCS-2048	PATROL	220	18mm	460-490
TTCS-2052	PATHFINDER	390	19mm	440
TTCS-2053	PATHFINDER	460	20mm	430
TTCS-2142	VITARA	200	15mm	375
TTCS-2152	VITARA	540	17mm	345
TTCS-2163	L/CRUISER	300	18mm	505-515

# Shock Absorber List

Part Number	TGS/G Number	Manufacturer	Open-Closed	Mounting
G12076		Nissan	585-350	Pin-Eye
G12081	TGS12525	Toyota	632-385	Eye-Eye
G12081B	TGS2525B	Mitsubishi, Toyota,	632-385	Eye-Eye
G12081N		Nissan	632-385	Eye-Eye
G12081P	TGS2525P	Nissan	615-365	Eye-Pin
G12087		Nissan	350-227	Pin-Eye
G12088	TGS12544	Toyota	378-245	Pin-Eye
G12097		Nissan	338-225	Pin -Eye
G12114	TGS12491	Nissan, Toyota	510-310	Pin-Pin
G12115	TGS12492	Nissan, Toyota	654-397	Eye-Eye
G12116	TGS12541	Landrover,	512-308	Pin-Pin
G12117	TGS12542	Landrover,	560-340	Eye-Pin
G12635	TGS12540	Mitsubishi,Toyota, Suzuki	487-305	Eye-Eye
G12636	TGS2258B	Holden, Mitsubishi, Nissan, Toyota	590-357	Eye-Eye
G12637	TGS12572	Toyota	581-349	Pin-Eye
G12639	TGS12526	Suzuki, Toyota,	491-301	Pin-Eye
G12639B	TGS2526B	Nissan	491-301	Pin-Eye
G12639S		Toyota	491-301	Pin-Eye
G12650	TGS12525	Toyota	595-363	Eye-Eye
G12716		Nissan (Coil Over Strut)		Pin-Eye
G12717		Nissan		Eye-Eye
G17043		Suzuki (Gas Strut)		Pin-Eye
G17044		Suzuki	491-300	Pin-Eye
G21463		Nissan	350-227	Pin-Eye
G43783		Mitsubishi ( Coil Over Strut)		Pin-Eye
G43784		Mitsubishi		Pin-Eye
G43800		Mitsubishi (Coil Over Strut)		Pin-Eye
G45642		Nissan	385-268	Pin-Eye
G45643		Nissan	395-280	Eye-Eye
G59220		Toyota (Coil Over Strut)		Pin-Eye
G61988A		Toyota (Coil Over Strut)	455-325	Pin-Eye
TGS12214		Landrover,	580-370	Eye-Eye
TGS12215		Landrover,	570-360	Eye-Eye
TGS12230		Toyota	613-372	Pin-Eye
TGS12231		Toyota	613-372	Pin-Eye
TGS12489		Toyota	613-372	Pin-Eye
TGS12490		Toyota	615-365	Pin-Pin
TGS12491	G12114	Nissan, Toyota	510-310	Pin-Pin
TGS12492	G12115	Nissan, Toyota	654-397	Eye-Eye
TGS12525	G12081	Toyota	632-385	Eye-Eye
TGS12526	G12639	Toyota	491-301	Pin-Eye
TGS12540	G12635	Toyota	525-322	Eye-Eye
TGS12541	G12116	Landrover,Nissan,	550-328	Pin-Pin
TGS12542	G12117	Landrover,	550-330	Eye-Pin
TGS12543-1		Mitsubishi	349-228	Pin-Eye
TGS12543-2		Holden, Mitsubishi	349-228	Pin-Eye
TGS12544	G12088	Toyota	378-245	Pin-Eye
TGS12545		Holden	398-262	Pin-Eye
TGS12547		Mitsubishi	455-295	Pin-Eye
TGS12572	G12637	Toyota	595-363	Pin-Eye
TGS12800	TGS59700	Toyota (Coil Over Strut)		Pin-Eye
TGS2258B		Holden, Nissan	590-357	Eye-Eye
TGS2525B	G12081B	Mitsubishi, Toyota	632-385	Eye-Eye
TGS2525P	G12081P	Nissan	654-397	Eye-Pin
TGS2526B	G12636B	Nissan, Toyota	491-301	Pin-Eye
TGS25564		Holden	595-363	Pin-Eye
TGS2576B	G12636	Holden, Mitsubishi, Toyota	590-357	Eye-Eye
TGS59637	TGS59701	Toyota		Pin-Eye
TGS2540B		Holden	525-322	Eye-Eye
TGS59700	TGS12800			
TGS59701	TGS59637			
TGS80101		Nissan	635-490	Pin-Eye

# SUBSCRIBE TO THE WILD SIDE



**Experience**   **Know How**   **Adventure**   **Adrenaline**   **Subscribe**   **Support**   **>>> 4WD PRODUCTS**

- 40 Years Experience
- Expert Support Team
- Connection to Australia's Repairers
- 4WD Tips
- Product Demonstration
- Large Range of Parts
- Trusted Recovery Gear
- Monthly Promotions
- Latest News
- Newsletter
- Forum
- Reviews
- 4WD Clubs

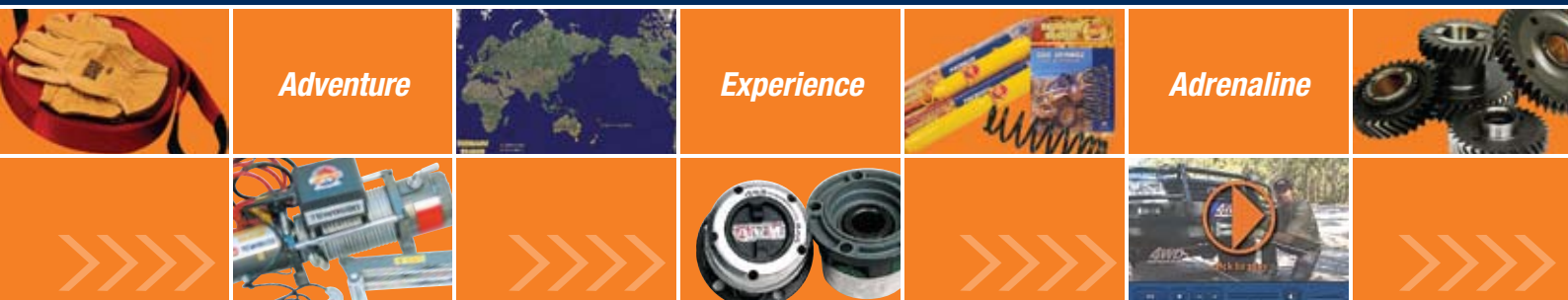





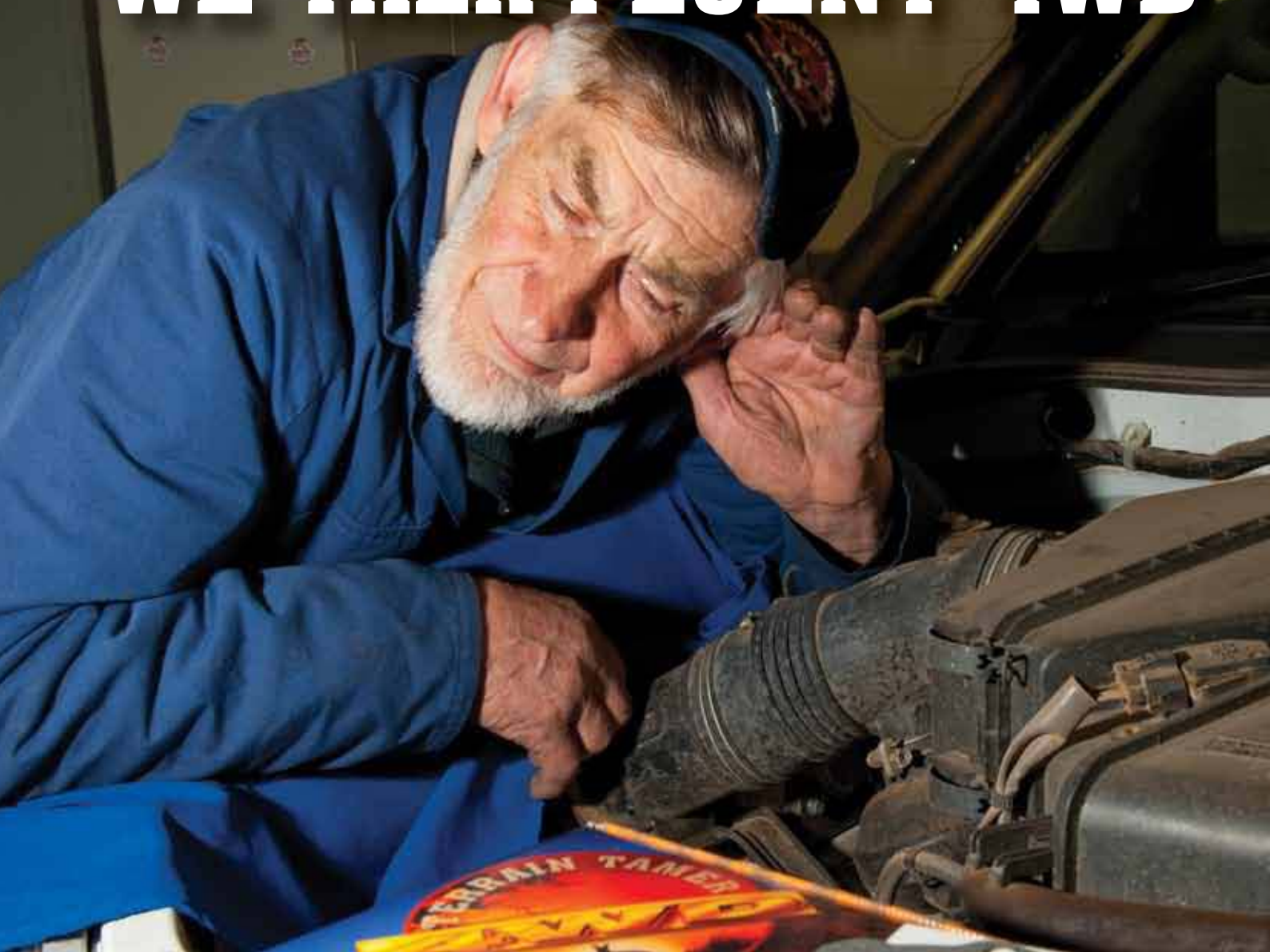

***terraintamer.com*** offers all the knowledge you need before setting off to tackle this great land. So for expert advice, new product releases, product demonstrations and more, ***Subscribe to the Wild Side.***



# WE TALK FLUENT 4WD



	<i>Transfer Case &amp; Gearbox</i>		<i>Engine &amp; Cooling</i>		<i>Steering &amp; Suspension</i>	
	<i>Differential &amp; Axle</i>		<i>Brake &amp; Clutch</i>			

Terrain Tamer products available from:

[www.Pro4wd.cz](http://www.Pro4wd.cz)

With over 40 year experience Terrain Tamer is the range of parts trusted by 4WDs all around the world. Over so many years our team of Parts Interpreters have learnt to talk fluent 4WD.

To next interpret your vehicle's needs visit [terraintamer.com](http://terraintamer.com)

