



Gesswein®

The Right Tools

Since 1914



***Providing precision tools, equipment and supplies for the
Metalworking Industries – Jewelry Making, Mold & Die Polishing,
Deburring, Micro-Welding, Inspecting, Polishing, Cleaning and more.***

How we came to be here, over 100 years after incorporating, is truly an American success story. The founder of our company, Paul H. Gesswein, came to America with his parents when he was in his early teens. His arrival in this country typified the struggle that many immigrants faced in becoming self-sufficient. As a teenager, Paul took a job working in a hardware store and soon found that he had many requests from nearby craftsmen for high quality small size precision tools. Recognizing a unique opportunity, in 1914 he decided to start his own business. He began by importing European tools and initially concentrated on local customers, who visited the store to make purchases. The original focus of the business was to supply tools and equipment to the thriving jewelry and silversmith industries in New York and Boston. After more people heard about his precision tools, requests from other parts of the country came in.

That's when Paul decided to produce a book of tools and supplies that he could mail to those who couldn't visit the store—and our first catalog was born. By the 1930s, the Paul H. Gesswein Company, Inc. occupied one room in a building on Maiden Lane in lower Manhattan. Paul made the sales calls while one employee manned the phones.

Some of the larger factories had a tool room and needed many other specialized products. Our 1943 Tool and Die Makers catalog illustrated mounted stones, India stones, files, saws, burs, brushes, etc. Items sold then were predecessors to the ones we offer in this very catalog.

The Paul H. Gesswein Company, Inc. began to grow, expanding as quickly as space became available in the Maiden Lane building. By 1950, the Paul H. Gesswein Company carried over 1,000 items.

In our General Catalog of 1952 we first see our Moldmakers Finishing Stones (Silicon Carbide), which were used by the fledgling Bakelite mold-making industry. During the 1950's plastic injection molding came about and grew very quickly. It became apparent that different types of finishing stones were needed – harder, softer, Aluminum Oxide, etc. In the next decade EDM required new solutions, which we were able to provide. Today Ceramic and our traditional stones are used with mechanical and Ultrasonic finishers. These measurably increase productivity and overall mold finish quality.



Paul H. Gesswein & Company Inc., Home Office, Bridgeport, Connecticut, USA

In 1963, the company finally outgrew its available space. We moved uptown a couple of miles to lower Park Avenue, beginning with 5,000 square feet of space. As the decade progressed, so did we. Within three years, another generation of Gesswein family members had entered the business. We were still on Park Avenue, but we were renting another floor and part of a third to store equipment. Even with the extra space, we had at least two employees sharing the same desk, alternating their workdays in the office. Another move was clearly in the offing. Ultimately, we decided on Connecticut, designing and constructing our own home office here, later acquiring first one adjacent building and then another.

Until roughly 50 years ago, we focused primarily on domestic sales. Paul's son, Roger H. Gesswein then visited Europe to call on suppliers and recognized a vast untapped market. He soon established numerous relationships which continue to this day with European customers who realized, like their American counterparts, the advantages of using our unique, high-quality products beginning a new era of international sales.

The Paul H. Gesswein Company, Inc. has come a long way from that one-room walk-in store on Maiden Lane. Today, we offer over 16,000 items to a large community of jewelry manufacturers and mold and die polishers around the globe. Even with this growth, however, we are still loyal to the vision Paul had a century ago. We are constantly adding new and innovative products to help the metal (precious as well as tool steel) and wood working industries, and these can instantly be seen on our interactive website 24/7.

As simply set forth in our guiding policy: "Our customers are the most important part of our business. Without them we would not be here. We are dedicated to giving them the ultimate in service and to making them think the best thing they ever did was to buy from Gesswein. Gesswein means quality and value. Our products include those of highest quality and precision as well as those of high value at lower costs. Service means giving the customers more than they expect, responding to their needs immediately and shipping orders the same day."









































In closing, it seems appropriate to us that we present this catalog with a passage from our very first: **"It is with justifiable pride that we contemplate its completion, and in presenting it to you we do so with the firm conviction that it will bring us into closer relations of mutual advantage"**.

Paul H. Gesswein & Company Inc., is a Proud Member of:



Table of Contents



ABRASIVES	2-125	
BRUSHES	126-135	
BUFFS	136-153	
BURS	154-179	
CAD/CAM	180-183	
CASTING	184-234	
CLEANING	235-247	
COMPRESSORS & PUMPS	248-250	
DRILLS & TAPS	251-256	
ELECTROPLATING	257-269	
ENAMEL	270-274	
ENGRAVING	275-293	
FILES	294-317	
HAMMERING & FORMING	318-329	
LATHES	330-331	
LIGHT BOXES & IMAGING	332-333	
LIGHTING	334-339	
MAGNIFIERS	340-349	
MEASURING	350-367	
PLIERS, CUTTERS & SHEARS	368-385	
POLISHING & RECOVERY	386-407	
RING TOOLS	408-411	
ROLLING & DRAWING	412-419	
ROTARY & ULTRASONIC	420-469	
SAFETY PRODUCTS	470-475	
SANDBLASTING	476-479	
SAWS	480-483	
SETTING	484-497	
SOLDERING	498-511	
TORCHES	512-521	
TUMBLERS	522-531	
TWEEZERS	532-541	
VICES	542-546	
WATCH TOOLS	547-554	
WELDING	555-566	
WORKBENCHES	567-574	
WORK PROCESSING & PACKAGING	575-583	
MANDRELS & REFERENCE CHARTS	584-591	
ORDERING & INFORMATION	592-596	
INDEX	597-613	

Gesswein® Finishing Stones For Mold & Die Polishing

For over 100 years, leading metalworkers have come to know and rely upon Gesswein for the best in abrasives.

We are proud Gesswein stones are the unquestionable choice of leading mold and die craftsmen worldwide. Their trust and confidence in us is due to:

- **Demanding Standards:** For each stone, careful grading eliminates oversized grains and special blending operations ensure absolute uniformity of finish, whatever your application.
- **Exceptional Quality Control:** Working closely with the best suppliers in the industry as well as making blocks and stones at our facility to ensure the highest standards are consistently met.
- **Quality Ingredients:** Our stones are composed of the purest ingredients.
 - Aluminum Oxide: An extremely tough abrasive; each grain holds its sharpness very well.
 - Levigated Alumina: A very fine form of aluminum oxide (stones made of this formulation are softer).
 - Silicon Carbide: Extremely sharp and brittle (these man-made particles are designed to shatter and expose new, sharp edges).



As an industry pioneer, we have long known an important key to continued success—provide a complete range of products that allows polishers to choose the perfect stone for each task. We continue to develop new products to meet the changing needs of our customers.



Add a STONE CHART to your order and receive it at no charge. (\$10.00 value)

Use the chart below to determine which finishing stone is right for you based upon the type of surface or call 800-544-2043 and speak with our technical staff to choose the best stone for your application.

Surface Type	Diemaker	EDM	EDM Blue	Oil Treated	Premium White	RA	General Purpose	Mold-maker	Mold-maker Plus	Super Fine	Ultra Soft	Rough Out	Ceramic Diamond Stones	Ceramic	Ruby
All Tool Steels	●	●	●	●	●	●	●	●	●			●	●	●	●
Heat Treated Tool Steel	●					◆							●	●	◆
EDM Surface		◆	●	●		●	●						●	●	
Machined Surface	●			◆	●		●						●	●	
Stainless Steel	●			●				◆	●				●	●	
Aluminum								●	●	●	◆	●	●	●	
Non-Ferrous								●	●	●	◆	●	●	●	
High Polishing										◆	●				
Rough Grinding												◆			
Carbide													●		◆





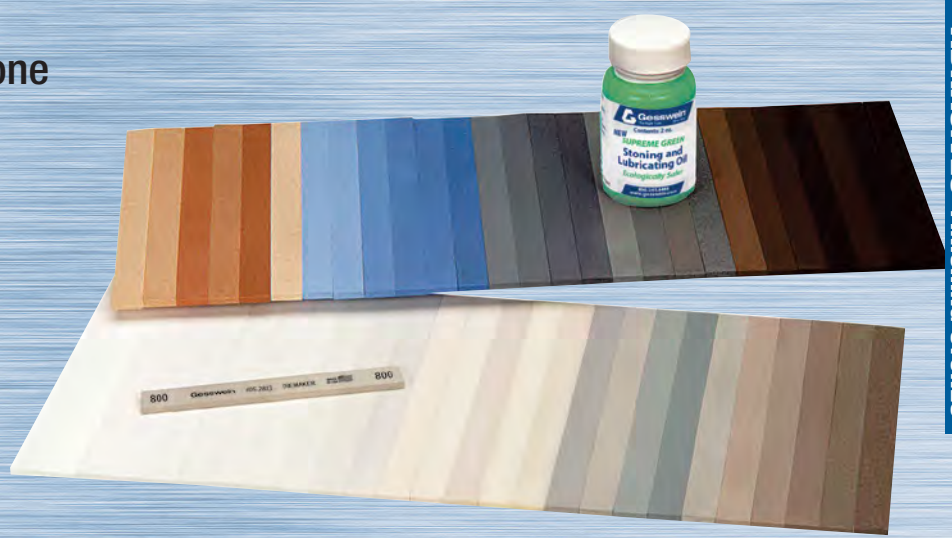







◆ Blue diamond indicates the most commonly used for each application.

Which Gesswein Stone is Right for Your Job?



ABRASIVES-FINISHING STONES

The chart below contains helpful information to guide you in selecting the appropriate finishing stone based on your application. Stones are listed from hardest to softest.

Type	Abrasive Material	Characteristics & Usage	Page (s)
RA 	Aluminum oxide	Special breakdown-resistant resin bond. Can be used aggressively and be ground to a sharp edge or for use on hard-to-reach areas such as slots and ribs.	12
EDM Blue 	Premium aluminum oxide	New harder formulation of our EDM stones especially designed to handle the high-speed back-and-forth motion of a profiler or ultrasonic machine. Superior for removing the hardest EDM scale. Designed for use on hard surfaces at high speed. Holds shape very well.	8
EDM 	Premium aluminum oxide	Our best stones for fast removal of EDM scale. They have sharp points and edges to cut and dig into material to better remove it. Use EDM for more aggressive polishing.	6-7
General Purpose 	White aluminum oxide	This soft stone acts harder due to a proprietary treatment. Experienced polishers will find this formula cuts fast, wears slowly and holds its shape well.	13
Premium White 	Premium aluminum oxide	Semi-hard, good for general purpose mold polishing. Special treatment provides load resistance and a lubricating effect.	14
Oil-Treated 	White aluminum oxide	Soaked in oil solution to prevent loading. Fast-cutting with moderate breakdown. Popular general purpose stones often used for EDM scale removal. Can be used without stoning oil.	9
Diemaker 	Aluminum oxide	Extremely popular. For general purpose stoning on all types of steel. Fast-cutting, wears at an average rate and gives a good surface finish.	4-5
Moldmaker Plus 	Premium silicon carbide	Green silicon carbide. Medium stone with slower breakdown characteristics than our standard Moldmaker stones.	11
Moldmaker 	Silicon carbide	Easy to shape stone for contour polishing. Medium-soft, nonloading and fast-cutting with rapid breakdown.	10
Rough Out 	Aluminum oxide	Coarse, fast-cutting with rapid breakdown. For deep machining marks. Also good for rust removal.	15
Super Fine 	Levigated alumina	Our softest and finest stones for steel surfaces. They don't scratch and are nonloading. For final finish before using diamond compound.	16
Ultra-Soft 	White aluminum oxide	Formulated for polishing aluminum, stainless steel, beryllium, kirksite and other soft metals. Very soft, fast-cutting and nonloading with very rapid breakdown.	16

IMPORTANT: Abrasive stones break down during mold and die polishing, grinding, tool sharpening, and dressing of cutting & grinding wheels. The resulting dust is classified by OSHA as inert or nuisance dust. Please consult the Material Safety Data Sheet for each stone; data provided therein pertains primarily to the dust produced during and after use. Please note that hazards may change when abrasive stones are used in conjunction with solvents, cutting fluids or other chemicals. For more complete information, consult the Material Safety Data Sheets of chemical products used with abrasive stone products.

Gesswein® Diemaker Stones

See Our Sampler Sets on pages 19-21

- Medium-hard aluminum oxide stones combine the characteristics of fast cutting and moderate breakdown.
- Ideal for general purpose stoning on hard and soft tool steels such as H-13, P-21, SS420 and pre-finishing.
- One of our most popular finishing stones.
- **New 100 grit stones in most sizes.**
- Sold in full box quantities of 6 or 12 each as indicated.



IMPORTANT: See dust warning on page 3.

5/32" x 5/32" x 4" 12pc EACH Prices

Style	Grit	Item#	12-60	72-132	144+
01	100	415-0001	\$1.61	\$1.45	\$1.29
1	150	415-0010	1.61	1.45	1.29
2	220	415-0020	1.61	1.45	1.29
3	320	415-0030	1.61	1.45	1.29
4	400	415-0040	1.61	1.45	1.29
6	600	415-0060	1.82	1.64	1.46
8	800	415-0080	1.82	1.64	1.46
9	900	415-0090	1.82	1.64	1.46
1200	1200	415-4080	2.00	1.80	1.61

1/4" x 1/16" x 4" 12pc EACH Prices

Style	Grit	Item#	12-60	72-132	144+
2210	220	405-2210	\$1.58	\$1.42	\$1.27
2310	320	405-2310	1.77	1.59	1.42
2410	400	405-2410	1.77	1.59	1.42
2610	600	405-2610	2.05	1.85	1.65
2910	900	405-2910	2.12	1.91	1.70
4010	1200	405-4010	2.33	2.10	1.87

1/4" x 1/8" x 6" 12pc EACH Prices

Style	Grit	Item#	12-60	72-132	144+
1801	100	405-1801	\$2.31	\$2.08	\$1.86
2101	150	405-2101	2.31	2.08	1.86
2201	220	405-2201	2.31	2.08	1.86
2301	320	405-2301	2.58	2.32	2.07
2401	400	405-2401	2.58	2.32	2.07
2601	600	405-2601	2.92	2.63	2.35
2801	800	405-2801	2.92	2.63	2.35
2901	900	405-2901	3.05	2.75	2.45
4001	1200	405-4001	3.35	3.02	2.69

1/4" x 1/4" x 6" 12pc EACH Prices

Style	Grit	Item#	12-60	72-132	144+
1802	100	405-1802	\$2.40	\$2.16	\$1.93
2102	150	405-2102	2.40	2.16	1.93
2202	220	405-2202	2.40	2.16	1.93
2302	320	405-2302	2.67	2.40	2.15
2402	400	405-2402	2.67	2.40	2.15
2602	600	405-2602	3.05	2.75	2.45
2802	800	405-2802	3.05	2.75	2.45
2902	900	405-2902	3.65	3.29	2.93
4002	1200	405-4002	4.00	3.60	3.21

3/8" x 3/8" x 6" 12pc EACH Prices

Style	Grit	Item#	12-60	72-132	144+
1808	100	405-1808	\$3.47	\$3.12	\$2.79
2108	150	405-2108	3.47	3.12	2.79
2208	220	405-2208	3.47	3.12	2.79
2308	320	405-2308	3.83	3.45	3.08
2408	400	405-2408	3.83	3.45	3.08
2608	600	405-2608	5.19	4.67	4.17
2808	800	405-2808	5.19	4.67	4.17
2908	900	405-2908	6.57	5.91	5.28
4008	1200	405-4008	7.22	6.50	5.80

1/2" x 1/16" x 6" 12pc EACH Prices

Style	Grit	Item#	12-60	72-132	144+
1800	100	405-1800	\$2.61	\$2.35	\$2.10
2100	150	405-2100	2.61	2.35	2.10
2200	220	405-2200	2.61	2.35	2.10
2300	320	405-2300	2.91	2.62	2.34
2400	400	405-2400	2.91	2.62	2.34
2600	600	405-2600	3.33	3.00	2.68
2900	900	405-2900	3.72	3.35	2.99
4000	1200	405-4000	4.08	3.67	3.28

1/2" x 1/8" x 6" 12pc EACH Prices

Style	Grit	Item#	12-60	72-132	144+
1803	100	405-1803	\$2.74	\$2.47	\$2.20
2103	150	405-2103	2.74	2.47	2.20
2203	220	405-2203	2.74	2.47	2.20
2303	320	405-2303	2.97	2.67	2.39
2403	400	405-2403	2.97	2.67	2.39
2603	600	405-2603	3.49	3.14	2.80
2803	800	405-2803	3.49	3.14	2.80
2903	900	405-2903	3.91	3.52	3.14
4003	1200	405-4003	4.30	3.87	3.46

1/2" x 1/4" x 6" 12pc EACH Prices

Style	Grit	Item#	12-60	72-132	144+
1804	100	405-1804	\$3.16	\$2.84	\$2.54
2104	150	405-2104	3.16	2.84	2.54
2204	220	405-2204	3.16	2.84	2.54
2304	320	405-2304	3.66	3.29	2.94
2404	400	405-2404	3.66	3.29	2.94
2604	600	405-2604	4.61	4.15	3.70
2804	800	405-2804	4.61	4.15	3.70
2904	900	405-2904	5.47	4.92	4.40
4004	1200	405-4004	6.02	5.42	4.84

Sold in full box quantities of 6 or 12 each as indicated by please order in these multiples.

1/2" x 1/2" x 6"  EACH Prices

Style	Grit	Item#	6-66	72-138	144+
1805	100	405-1805	\$4.20	\$3.78	\$3.37
2105	150	405-2105	4.20	3.78	3.37
2205	220	405-2205	4.20	3.78	3.37
2305	320	405-2305	6.08	5.47	4.89
2405	400	405-2405	6.08	5.47	4.89
2605	600	405-2605	7.89	7.10	6.34
2805	800	405-2805	7.89	7.10	6.34
2905	900	405-2905	8.21	7.39	6.60
4005	1200	405-4005	9.08	8.17	7.30

Hybrid, 1/4" x 1/4" x 6"  EACH Prices

Style	Grit	Item#	12-60	72-132	144+
1823H	100	405-1823	\$3.12	\$2.81	\$2.51
2123H	150	405-2123	3.12	2.81	2.51
2223H	220	405-2223	3.12	2.81	2.51
2323H	320	405-2323	3.47	3.12	2.79
2423H	400	405-2423	3.47	3.12	2.79
2623H	600	405-2623	3.97	3.57	3.19
2823H	800	405-2823	3.97	3.57	3.19
2923H	900	405-2923	4.75	4.28	3.82
4023H	1200	405-4023	5.23	4.71	4.20

1" x 1/8" x 6"  EACH Prices

Style	Grit	Item#	6-66	72-138	144+
1811	100	405-1811	\$4.50	\$4.05	\$3.62
2111	150	405-2111	4.50	4.05	3.62
2211	220	405-2211	4.50	4.05	3.62
2311	320	405-2311	5.07	4.56	4.07
2411	400	405-2411	5.07	4.56	4.07
2611	600	405-2611	6.79	6.11	5.46

Round, 1/4" x 6"  EACH Prices

Style	Grit	Item#	6-66	72-138	144+
3102	150	405-3102	\$4.60	\$4.14	\$3.70
3202	220	405-3202	4.60	4.14	3.70
3302	320	405-3302	5.00	4.50	4.02
3402	400	405-3402	5.00	4.50	4.02
3602	600	405-3602	5.21	4.69	4.19
3902	900	405-3902	6.42	5.78	5.16

1" x 1/4" x 6"  EACH Prices

Style	Grit	Item#	6-66	72-138	144+
1812	100	405-1812	\$4.72	\$4.25	\$3.79
2112	150	405-2112	4.72	4.25	3.79
2212	220	405-2212	4.72	4.25	3.79
2312	320	405-2312	6.04	5.44	4.85
2412	400	405-2412	6.04	5.44	4.85
2612	600	405-2612	8.07	7.26	6.48

Round, 3/8" x 6"  EACH Prices

Style	Grit	Item#	6-66	72-138	144+
3108	150	405-3108	\$5.66	\$5.09	\$4.55
3208	220	405-3208	5.66	5.09	4.55
3308	320	405-3308	7.56	6.80	6.07
3408	400	405-3408	7.56	6.80	6.07
3608	600	405-3608	8.94	8.05	7.18

1" x 1/2" x 6"  EACH Prices

Style	Grit	Item#	6-66	72-138	144+
1807	100	405-1807	\$5.82	\$5.24	\$4.68
2107	150	405-2107	5.82	5.24	4.68
2207	220	405-2207	5.82	5.24	4.68
2307	320	405-2307	9.17	8.25	7.37
2407	400	405-2407	9.17	8.25	7.37
2607	600	405-2607	12.07	10.86	9.70
2907	900	405-2907	14.00	12.60	11.25

Round, 1/2" x 6"  EACH Prices

Style	Grit	Item#	6-66	72-138	144+
3105	150	405-3105	\$6.47	\$5.82	\$5.20
3205	220	405-3205	6.47	5.82	5.20
3305	320	405-3305	6.47	5.82	5.20
3405	400	405-3405	8.55	7.70	6.87
3605	600	405-3605	9.17	8.25	7.37

1" x 1" x 6"  EACH Prices

Style	Grit	Item#	6-66	72-138	144+
1806	100	405-1806	\$9.98	\$8.98	\$8.02
2106	150	405-2106	9.98	8.98	8.02
2206	220	405-2206	9.98	8.98	8.02
2306	320	405-2306	13.65	12.29	10.97
2406	400	405-2406	13.65	12.29	10.97
2606	600	405-2606	20.20	18.18	16.23

Triangular, 1/4" x 6"  EACH Prices

Style	Grit	Item#	12-60	72-132	144+
21T2	150	405-2192	\$2.69	\$2.42	\$2.16
22T2	220	405-2292	2.69	2.42	2.16
23T2	320	405-2392	3.11	2.80	2.50
24T2	400	405-2492	3.11	2.80	2.50

Triangular, 3/8" x 6"  EACH Prices

Style	Grit	Item#	12-60	72-132	144+
21T8	150	405-2198	\$3.81	\$3.43	\$3.06
22T8	220	405-2298	3.81	3.43	3.06
23T8	320	405-2398	4.01	3.61	3.22
24T8	400	405-2498	4.01	3.61	3.22

Sold in full box quantities of 6 or 12 each as indicated by   please order in these multiples.

IMPORTANT: See dust warning on page 3.

Gesswein® EDM Stones

- Remove the tough, hard scale left by the EDM process much faster than any of our other finishing stones.
- Contains extra-sharp premium-grade aluminum oxide for fast cutting action.
- Special clay bond enables the EDM stones to hold their shape well for working small details and sharp corners.
- Breaks down slowly, cuts fast and resists loading.
- Sold in full box quantities of 6 or 12 each as indicated.



IMPORTANT: See dust warning on page 3.

See Our Sampler Sets
on pages 19-21

			12pc EACH Prices		
Style	Grit	Item#	12-60	72-132	144+
61	120	415-0610	\$1.69	\$1.52	\$1.36
62	180	415-0620	1.69	1.52	1.36
622	220	415-0622	1.69	1.52	1.36
63	320	415-0630	1.69	1.52	1.36
64	400	415-0640	1.69	1.52	1.36
66	600	415-0660	1.91	1.72	1.53

			12pc EACH Prices		
Style	Grit	Item#	12-60	72-132	144+
6128	120	425-6128	\$3.47	\$3.12	\$2.79
6188	180	425-6188	3.47	3.12	2.79
6208	220	425-6208	3.47	3.12	2.79
6308	320	425-6308	3.82	3.44	3.07

			12pc EACH Prices		
Style	Grit	Item#	12-60	72-132	144+
6110	180	425-6110	\$1.25	\$1.13	\$1.00
6210	220	425-6210	1.32	1.19	1.06
6310	320	425-6310	1.47	1.32	1.18
6410	400	425-6410	1.47	1.32	1.18
6610	600	425-6610	1.68	1.51	1.35

			12pc EACH Prices		
Style	Grit	Item#	12-60	72-132	144+
6120	120	425-6120	\$2.62	\$2.36	\$2.11
6180	180	425-6180	2.62	2.36	2.11
6200	220	425-6200	2.62	2.36	2.11
6300	320	425-6300	2.92	2.63	2.35
6400	400	425-6400	2.92	2.63	2.35
6600	600	425-6600	3.33	3.00	2.68

			12pc EACH Prices		
Style	Grit	Item#1	12-60	72-132	144+
6121	120	425-6121	\$2.42	\$2.18	\$1.94
6181	180	425-6181	2.42	2.18	1.94
6201	220	425-6201	2.42	2.18	1.94
6301	320	425-6301	2.58	2.32	2.07
6401	400	425-6401	2.58	2.32	2.07
6601	600	425-6601	2.99	2.69	2.40

			12pc EACH Prices		
Style	Grit	Item#	12-60	72-132	144+
6123	120	425-6123	\$2.74	\$2.47	\$2.20
6183	180	425-6183	2.74	2.47	2.20
6203	220	425-6203	2.74	2.47	2.20
6303	320	425-6303	2.92	2.63	2.35
6403	400	425-6403	2.92	2.63	2.35
6603	600	425-6603	4.03	3.63	3.24

			12pc EACH Prices		
Style	Grit	Item#	12-60	72-132	144+
6122	120	425-6122	\$2.55	\$2.30	\$2.05
6182	180	425-6182	2.55	2.30	2.05
6202	220	425-6202	2.55	2.30	2.05
6302	320	425-6302	2.72	2.45	2.19
6402	400	425-6402	2.72	2.45	2.19
6602	600	425-6602	3.28	2.95	2.64

			12pc EACH Prices		
Style	Grit	Item#	12-60	72-132	144+
6124	120	425-6124	\$3.32	\$2.99	\$2.67
6184	180	425-6184	3.32	2.99	2.67
6204	220	425-6204	3.32	2.99	2.67
6304	320	425-6304	3.68	3.31	2.96
6404	400	425-6404	3.68	3.31	2.96
6604	600	425-6604	5.32	4.79	4.27

Sold in full box quantities of 12 each as indicated by please order in these multiples.

1/2" x 1/2" x 6"			6pc EACH Prices		
Style	Grit	Item#	6-66	72-138	144+
6125	120	425-6125	\$4.20	\$3.78	\$3.37
6185	180	425-6185	4.20	3.78	3.37
6205	220	425-6205	4.20	3.78	3.37
6305	320	425-6305	6.08	5.47	4.89
6405	400	425-6405	6.08	5.47	4.89
6605	600	425-6605	7.89	7.10	6.34

Round, 1/4" x 6"			6pc EACH Prices		
Style	Grit	Item#	6-66	72-138	144+
E122	120	425-0122	\$4.73	\$4.26	\$3.80
E182	180	425-0182	4.73	4.26	3.80
E222	220	425-0222	4.73	4.26	3.80
E302	320	425-0302	5.08	4.57	4.08
E402	400	425-0402	5.08	4.57	4.08
E602	600	425-0602	5.79	5.21	4.65

1" x 1/2" x 6"			6pc EACH Prices		
Style	Grit	Item#	6-66	72-138	144+
6127	120	425-6127	\$5.82	\$5.24	\$4.68
6187	180	425-6187	5.82	5.24	4.68
6207	220	425-6207	5.82	5.24	4.68
6307	320	425-6307	9.17	8.25	7.37

Triangular, 1/4" x 6"			12pc EACH Prices		
Style	Grit	Item#	12-60	72-132	144+
61T2	120	425-6192	\$3.07	\$2.76	\$2.47
62T2	180	425-6292	3.07	2.76	2.47
63T2	320	425-6392	3.27	2.94	2.63

1" x 1" x 6"			6pc EACH Prices		
Style	Grit	Item#	6-66	72-138	144+
6126	120	425-6126	\$10.05	\$9.05	\$8.08
6186	180	425-6186	10.05	9.05	8.08
6206	220	425-6206	10.05	9.05	8.08
6306	320	425-6306	13.80	12.42	11.09

Triangular, 3/8" x 6"			12pc EACH Prices		
Style	Grit	Item#	12-60	72-132	144+
61T8	120	425-6198	\$4.10	\$3.69	\$3.29
62T8	180	425-6298	4.10	3.69	3.29
63T8	320	425-6398	4.59	4.13	3.69

Hybrid, 1/4" x 1/4" x 6"			12pc EACH Prices		
Style	Grit	Item#	12-60	72-132	144+
123H	120	425-0123	\$3.32	\$2.99	\$2.67
183H	180	425-0183	3.32	2.99	2.67
223H	220	425-0223	3.32	2.99	2.67
323H	320	425-0323	3.53	3.18	3.18
423H	400	425-0423	3.53	3.18	2.84
623H	600	425-0623	4.27	3.84	3.43



Sold in full box quantities of 6 or 12 each as indicated by please order in these multiples.

IMPORTANT: See dust warning on page 3.

Gesswein® EDM Blue Stones

- Harder than our regular EDM Stones and designed to remove the tough, hard scale left by the EDM process.
- Breaks down slowly and cuts fast.
- Maintains shape, saving you time.
- Contains extra-sharp premium-grade aluminum oxide for fast cutting action plus a small amount of cobalt blue for added hardness.
- Resists breakage and specifically designed for use in reciprocating profilers.
- Sold in full box quantities of 6 or 12 each as indicated.



See Our Sampler Sets on pages 19-21

IMPORTANT: See dust warning on page 3.

5/32" x 5/32" x 4" 12pc EACH Prices

Style	Grit	Item#	12-60	72-132	144+
61B	120	415-6010	\$1.69	\$1.52	\$1.36
62B	180	415-6020	1.69	1.52	1.36
622B	220	415-6022	1.69	1.52	1.36
63B	320	415-6030	1.69	1.52	1.36
64B	400	415-6040	1.69	1.52	1.36
66B	600	415-6060	1.91	1.72	1.53

1/2" x 1/8" x 6" 12pc EACH Prices

Style	Grit	Item#	12-60	72-132	144+
6123B	120	424-6123	\$2.74	\$2.47	\$2.20
6183B	180	424-6183	2.74	2.47	2.20
6203B	220	424-6203	2.74	2.47	2.20
6303B	320	424-6303	2.92	2.63	2.35
6403B	400	424-6403	2.92	2.63	2.35
6603B	600	424-6603	4.03	3.63	3.24

1/4" x 1/8" x 6" 12pc EACH Prices

Style	Grit	Item#	12-60	72-132	144+
6121B	120	424-6121	\$2.42	\$2.18	\$1.94
6181B	180	424-6181	2.42	2.18	1.94
6201B	220	424-6201	2.42	2.18	1.94
6301B	320	424-6301	2.58	2.32	2.07
6401B	400	424-6401	2.58	2.32	2.07
6601B	600	424-6601	2.99	2.69	2.40

1/2" x 1/4" x 6" 12pc EACH Prices

Style	Grit	Item#	12-60	72-132	144+
6124B	120	424-6124	\$3.32	\$2.99	\$2.67
6184B	180	424-6184	3.32	2.99	2.67
6204B	220	424-6204	3.32	2.99	2.67
6304B	320	424-6304	3.68	3.31	2.96
6404B	400	424-6404	3.68	3.31	2.96
6604B	600	424-6604	5.32	4.79	4.27

1/4" x 1/4" x 6" 12pc EACH Prices

Style	Grit	Item#	12-60	72-132	144+
6122B	120	424-6122	\$2.55	\$2.30	\$2.05
6182B	180	424-6182	2.55	2.30	2.05
6202B	220	424-6202	2.55	2.30	2.05
6302B	320	424-6302	2.72	2.45	2.19
6402B	400	424-6402	2.72	2.45	2.19
6602B	600	424-6602	3.28	2.95	2.64

1" x 1/2" x 6" 6pc EACH Prices

Style	Grit	Item#	6-66	72-138	144+
6127	120	424-6127	\$5.82	\$5.24	\$4.68
6187	180	424-6187	5.82	5.24	4.68
6207	220	424-6207	5.82	5.24	4.68
6307	320	424-6307	9.17	8.25	7.37

1/2" x 1/16" x 6" 12pc EACH Prices

Style	Grit	Item#	12-60	72-132	144+
6120B	120	424-6120	\$2.62	\$2.36	\$2.11
6180B	180	424-6180	2.62	2.36	2.11
6200B	220	424-6200	2.62	2.36	2.11
6300B	320	424-6300	2.92	2.63	2.35
6400B	400	424-6400	2.92	2.63	2.35
6600B	600	424-6600	3.33	3.00	2.68

Round, 1/4" x 6" 6pc EACH Prices

Style	Grit	Item#	6-66	72-138	144+
E122B	120	424-0122	\$4.73	\$4.26	\$3.80
E182B	180	424-0182	4.73	4.26	3.80
E302B	320	424-0302	5.08	4.57	4.08



Sold in full box quantities of 6 or 12 each as indicated by 6pc 12pc please order in these multiples.

Gesswein® Oil-Treated Stones

- Excellent for machined surfaces.
- Fine cutting ability.
- Medium-hard stone with white aluminum oxide soaked with oil. Can be used without additional lubrication.
- Holds shape well for finishing mold details.
- Moderate breakdown.
- Often used for EDM removal. Special oil treatment prevents loading.
- Sold in full box quantities of 6 or 12 each as indicated.

See Our Sampler Sets
on pages 19-21



IMPORTANT: See dust warning on page 3.

ABRASIVES-FINISHING STONES

5/32" x 5/32" x 4" 12pc EACH Prices

Style	Grit	Item#	12-60	72-132	144+
51	120	415-0510	\$1.69	\$1.52	\$1.36
50	180	415-0518	1.69	1.52	1.36
52	220	415-0520	1.69	1.52	1.36
53	320	415-0530	1.69	1.52	1.36
54	400	415-0540	1.69	1.52	1.36
56	600	415-0560	1.91	1.72	1.53
58	800	415-0580	1.91	1.72	1.53
59	1200	415-0590	2.17	1.95	1.74

1/2" x 1/4" x 6" 12pc EACH Prices

Style	Grit	Item#	12-60	72-132	144+
5104	120	435-5104	\$3.60	\$3.24	\$2.89
5004	180	435-5004	3.60	3.24	2.89
5204	220	435-5204	3.60	3.24	2.89
5304	320	435-5304	4.19	3.77	3.37
5404	400	435-5404	4.19	3.77	3.37
5604	600	435-5604	5.25	4.73	4.22
5804	800	435-5804	5.52	4.97	4.44
5904	1200	435-5904	5.52	4.97	4.44

1/4" x 1/8" x 6" 12pc EACH Prices

Style	Grit	Item#	12-60	72-132	144+
5101	120	435-5101	\$2.62	\$2.36	\$2.11
5001	180	435-5001	2.62	2.36	2.11
5201	220	435-5201	2.62	2.36	2.11
5301	320	435-5301	2.72	2.45	2.19
5401	400	435-5401	2.72	2.45	2.19
5601	600	435-5601	3.14	2.83	2.52
5801	800	435-5801	3.30	2.97	2.65
5901	1200	435-5901	3.62	3.26	2.91

Hybrid, 1/4" x 1/4" x 6" 12pc EACH Prices

Style	Grit	Item#	12-60	72-132	144+
5123H	120	435-5123	\$3.57	\$3.21	\$2.87
5023H	180	435-5023	3.57	3.21	2.87
5223H	220	435-5223	3.57	3.21	2.87
5323H	320	435-5323	3.72	3.35	2.99
5423H	400	435-5423	3.72	3.35	2.99
5623H	600	435-5623	4.63	4.17	3.72
5823H	800	435-5823	4.87	4.38	3.91
5923H	1200	435-5923	5.33	4.80	4.28

1/4" x 1/4" x 6" 12pc EACH Prices

Style	Grit	Item#	12-60	72-132	144+
5102	120	435-5102	\$2.74	\$2.47	\$2.20
5002	180	435-5002	2.74	2.47	2.20
5202	220	435-5202	2.74	2.47	2.20
5302	320	435-5302	2.86	2.57	2.30
5402	400	435-5402	2.86	2.57	2.30
5602	600	435-5602	3.57	3.21	2.87
5802	800	435-5802	3.75	3.38	3.01
5902	1200	435-5902	4.10	3.69	3.29

Round, 1/4" x 6" 6pc EACH Prices

Style	Grit	Item#	6-66	72-138	144+
E122B	120	435-0122	\$5.08	\$4.57	\$4.08
E182B	180	435-0182	5.08	4.57	4.08
E222B	220	435-0222	5.08	4.57	4.08
E302B	320	435-0302	5.28	4.75	4.24
E402B	400	435-0402	5.28	4.75	4.24
E602B	600	435-0602	6.60	5.94	5.30
E802B	800	435-0802	6.93	6.24	5.57
E902B	1200	435-0902	6.93	6.24	5.57

1/2" x 1/8" x 6" 12pc EACH Prices

Style	Grit	Item#	12-60	72-132	144+
5103	120	435-5103	\$2.86	\$2.57	\$2.30
5003	180	435-5003	2.86	2.57	2.30
5203	220	435-5203	2.86	2.57	2.30
5303	320	435-5303	3.04	2.74	2.44
5403	400	435-5403	3.04	2.74	2.44
5603	600	435-5603	3.77	3.39	3.03
5803	800	435-5803	3.97	3.57	3.19
5903	1200	435-5903	3.97	3.57	3.19



Sold in full box quantities of 12 each as indicated by 12pc please order in these multiples.

Gesswein® Moldmaker Stones

- Medium-soft stone with silicon carbide abrasive designed to break down rapidly and expose fresh edges.
- Suitable for working on all types of steels as well as roughing out nonferrous metals.
- Ideal for blending, detailing radii and following contours.
- Resists loading.
- Sold in full box quantities of 6 or 12 each as indicated.



IMPORTANT: See dust warning on page 3.

1/4" x 1/16" x 4" 12pc EACH Prices

Style	Grit	Item#	12-60	72-132	144+
100	100	410-0100	\$1.68	\$1.51	\$1.35
150	150	410-0150	1.68	1.51	1.35
200	220	410-0200	1.68	1.51	1.35
300	320	410-0300	1.97	1.77	1.58
400	400	410-0400	1.97	1.77	1.58
600	600	410-0600	2.46	2.21	1.98

1/2" x 1/4" x 6" 12pc EACH Prices

Style	Grit	Item#	12-60	72-132	144+
1104	100	410-1104	\$3.14	\$2.83	\$2.52
1154	150	410-1154	3.14	2.83	2.52
1204	220	410-1204	3.14	2.83	2.52
1304	320	410-1304	3.73	3.36	3.00
1404	400	410-1404	3.73	3.36	3.00
1604	600	410-1604	4.90	4.41	3.94

5/32" x 5/32" x 4" 12pc EACH Prices

Style	Grit	Item#	12-60	72-132	144+
10	100	415-1000	\$1.48	\$1.33	\$1.19
15	150	415-1001	1.48	1.33	1.19
20	220	415-1002	1.48	1.33	1.19
30	320	415-1003	1.48	1.33	1.19
40	400	415-1004	1.48	1.33	1.19
60	600	415-1006	1.65	1.49	1.33

1/2" x 1/2" x 6" 6pc EACH Prices

Style	Grit	Item#	6-66	72-138	144+
1105	120	410-1105	\$5.02	\$4.52	\$4.03
1155	150	410-1155	5.02	4.52	4.03
1205	220	410-1205	5.02	4.52	4.03
1305	320	410-1305	5.94	5.35	4.77
1405	400	410-1405	5.94	5.35	4.77
1605	600	410-1605	9.65	8.69	7.75

1/4" x 1/8" x 6" 12pc EACH Prices

Style	Grit	Item#	12-60	72-132	144+
1101	100	410-1101	\$2.30	\$2.07	\$1.85
1151	150	410-1151	2.30	2.07	1.85
1201	220	410-1201	2.30	2.07	1.85
1301	320	410-1301	2.69	2.42	2.16
1401	400	410-1401	2.69	2.42	2.16
1601	600	410-1601	3.32	2.99	2.67

1" x 1" x 6" 6pc EACH Prices

Style	Grit	Item#	6-66	72-138	144+
1106	100	410-1106	\$10.55	\$9.50	\$8.48
1156	150	410-1156	10.55	9.50	8.48
1206	220	410-1206	10.55	9.50	8.48
1306	320	410-1306	14.09	12.68	11.32
1406	400	410-1406	14.09	12.68	11.32
1606	600	410-1606	20.94	18.85	16.83

1/4" x 1/4" x 6" 12pc EACH Prices

Style	Grit	Item#	12-60	72-132	144+
1102	100	410-1102	\$2.33	\$2.10	\$1.87
1152	150	410-1152	2.33	2.10	1.87
1202	220	410-1202	2.33	2.10	1.87
1302	320	410-1302	2.76	2.48	2.22
1402	400	410-1402	2.76	2.48	2.22
1602	600	410-1602	3.40	3.06	2.73

Hybrid, 1/4" x 1/4" x 6" 12pc EACH Prices

Style	Grit	Item#	12-60	72-132	144+
023H	100	410-0023	\$3.03	\$2.73	\$2.43
123H	150	410-0123	3.03	2.73	2.43
223H	220	410-0223	3.03	2.73	2.43
323H	320	410-0323	3.58	3.22	2.88
423H	400	410-0423	3.58	3.22	2.88
623H	600	410-0623	4.42	3.98	3.55

1/2" x 1/8" x 6" 12pc EACH Prices

Style	Grit	Item#	12-60	72-132	144+
1103	100	410-1103	\$2.61	\$2.35	\$2.10
1153	150	410-1153	2.61	2.35	2.10
1203	220	410-1203	2.61	2.35	2.10
1303	320	410-1303	3.09	2.78	2.48
1403	400	410-1403	3.09	2.78	2.48
1603	600	410-1603	3.89	3.50	3.13

Round, 1/4" x 6" 6pc EACH Prices

Style	Grit	Item#	6-66	72-138	144+
102	100	410-0102	\$4.32	\$3.89	\$3.47
152	150	410-0152	4.32	3.89	3.47
222	220	410-0222	4.32	3.89	3.47
322	320	410-0322	5.10	4.59	4.10
422	400	410-0422	5.10	4.59	4.10
622	600	410-0622	6.30	5.67	5.06

Sold in full box quantities of 6 or 12 each as indicated by 6pc 12pc please order in these multiples.

Gesswein® Moldmaker PLUS Stones

- A premium complement to the Moldmaker Series.
- Produces a silky matte finish on all prehardened tool steels, from 28Rc SAE 4130 through 60Rc A2 and M2. Can also be used to rough out aluminum, beryllium copper and kirksite.
- Medium stone with slower breakdown characteristics than our standard Moldmaker stones.
- General purpose, premium-grade green silicon carbide stones.
- A good choice for stoning contours and radii.
- Sold in full box quantities of 6 or 12 each as indicated.

IMPORTANT: See dust warning on page 3.



See Our Sampler Sets
on pages 19-21

ABRASIVES-FINISHING STONES

5/32" x 5/32" x 4"

12pc EACH Prices

Style	Grit	Item#	12-60	72-132	144+
15P	150	415-1015	\$1.57	\$1.41	\$1.26
20P	220	415-1020	1.57	1.41	1.26
30P	320	415-1030	1.57	1.41	1.26
40P	400	415-1040	1.57	1.41	1.26
60P	600	415-1060	1.78	1.60	1.43
80P	800	415-1080	1.97	1.77	1.58
200P	1200	415-1200	2.26	2.03	1.82



1/4" x 1/8" x 6"

12pc EACH Prices

Style	Grit	Item#	12-60	72-132	144+
1101P	100	412-1101	\$2.52	\$2.27	\$2.02
1151P	150	412-1151	2.52	2.27	2.02
1201P	220	412-1201	2.52	2.27	2.02
1301P	320	412-1301	2.97	2.67	2.39
1401P	400	412-1401	2.97	2.67	2.39
1601P	600	412-1601	3.66	3.29	2.94
1801P	800	412-1801	4.05	3.65	3.25
2001P	1200	412-2001	4.84	4.36	3.89

1/2" x 1/4" x 6"

12pc EACH Prices

Style	Grit	Item#	12-60	72-132	144+
1104P	100	412-1104	\$3.46	\$3.11	\$2.78
1154P	150	412-1154	3.46	3.11	2.78
1204P	220	412-1204	3.46	3.11	2.78
1304P	320	412-1304	4.12	3.71	3.31
1404P	400	412-1404	4.12	3.71	3.31
1604P	600	412-1604	5.37	4.83	4.31
1804P	800	412-1804	5.91	5.32	4.75
2004P	1200	412-2004	7.11	6.40	5.71

1/4" x 1/4" x 6"

12pc EACH Prices

Style	Grit	Item#	12-60	72-132	144+
1102P	100	412-1102	\$2.57	\$2.31	\$2.06
1152P	150	412-1152	2.57	2.31	2.06
1202P	220	412-1202	2.57	2.31	2.06
1302P	320	412-1302	3.03	2.73	2.43
1402P	400	412-1402	3.03	2.73	2.43
1602P	600	412-1602	3.73	3.36	3.00
1802P	800	412-1802	4.12	3.71	3.31
2002P	1200	412-2002	4.94	4.45	3.97

1/2" x 1/2" x 6"

6pc EACH Prices

Style	Grit	Item#	6-66	72-138	144+
1105P	100	412-1105	\$5.52	\$4.97	\$4.44
1155P	150	412-1155	5.52	4.97	4.44
1205P	220	412-1205	5.52	4.97	4.44
1305P	320	412-1305	6.54	5.89	5.25
1405P	400	412-1405	6.54	5.89	5.25
1605P	600	412-1605	10.62	9.56	8.53
1805P	800	412-1805	11.68	10.51	9.38
2005P	1200	412-2005	13.99	12.59	11.24

1/2" x 1/8" x 6"

12pc EACH Prices

Style	Grit	Item#	12-60	72-132	144+
1103P	100	412-1103	\$2.87	\$2.58	\$2.31
1153P	150	412-1153	2.87	2.58	2.31
1203P	220	412-1203	2.87	2.58	2.31
1303P	320	412-1303	3.37	3.03	2.71
1403P	400	412-1403	3.37	3.03	2.71
1603P	600	412-1603	4.29	3.86	3.45
1803P	800	412-1803	4.73	4.26	3.80
2003P	1200	412-2003	5.67	5.10	4.56

1" x 1" x 6"

6pc EACH Prices

Style	Grit	Item#	6-66	72-138	144+
1106P	100	412-1106	\$11.57	\$10.41	\$9.30
1156P	150	412-1156	11.57	10.41	9.30
1206P	220	412-1206	11.57	10.41	9.30
1306P	320	412-1306	15.43	13.89	12.40

Sold in full box quantities of 6 or 12 each as indicated by 6pc 12pc please order in these multiples.

Gesswein® RA Stones

- Aluminum oxide abrasive bonded together with a unique organic resin bond gives these stones great resiliency.
- Retain their shape well, and are resistant to breakage even during heavy use.
- Leave a finer finish with less stock removal than other stones of the same grit.
- Can be used by hand, in a profiler or in an ultrasonic polisher on all mold and die steels.
- Ideal for finishing slots, deep ribs and other hard-to-reach mold areas and can also be used to remove EDM scale!
- Sold in full box quantities of twelve each.



See Our Sampler Sets
on pages 19-21

IMPORTANT: See dust warning on page 3.

5/32" x 5/32" x 4" EACH Prices

Style	Grit	Item#	12-60	72-132	144+
RA41	180	415-0410	\$2.03	\$1.83	\$1.63
RA42	220	415-0420	2.03	1.83	1.63
RA43	320	415-0430	2.14	1.93	1.72
RA44	400	415-0440	2.14	1.93	1.72
RA46	600	415-0460	2.43	2.19	1.95

1/4" x 1/8" x 6" EACH Prices

Style	Grit	Item#	12-60	72-132	144+
RA4091	90	420-4091	\$2.62	\$2.36	\$2.11
RA4121	120	420-4121	2.62	2.36	2.11
RA4181	180	420-4181	2.62	2.36	2.11
RA4201	220	420-4201	2.62	2.36	2.11
RA4301	320	420-4301	3.45	3.11	2.77
RA4401	400	420-4401	3.45	3.11	2.77
RA4601	600	420-4601	4.17	3.75	3.35

1/4" x 1/4" x 6" EACH Prices

Style	Grit	Item#	12-60	72-132	144+
RA4092	90	420-4092	\$2.72	\$2.45	\$2.19
RA4122	120	420-4122	2.72	2.45	2.19
RA4182	180	420-4182	2.72	2.45	2.19
RA4202	220	420-4202	2.72	2.45	2.19
RA4302	320	420-4302	3.91	3.52	3.14
RA4402	400	420-4402	3.91	3.52	3.14
RA4602	600	420-4602	4.45	4.01	3.58

1/2" x 1/16" x 6" EACH Prices

Style	Grit	Item#	12-60	72-132	144+
RA4120	120	420-4120	\$3.04	\$2.74	\$2.44
RA4180	180	420-4180	3.04	2.74	2.44
RA4200	220	420-4200	3.04	2.74	2.44
RA4300	320	420-4300	4.43	3.99	3.56
RA4400	400	420-4400	4.43	3.99	3.56
RA4600	600	420-4600	5.12	4.61	4.11

1/2" x 1/8" x 6" EACH Prices

Style	Grit	Item#	12-60	72-132	144+
RA4093	90	420-4093	\$3.04	\$2.74	\$2.44
RA4123	120	420-4123	3.04	2.74	2.44
RA4183	180	420-4183	3.04	2.74	2.44
RA4203	220	420-4203	3.04	2.74	2.44
RA4303	320	420-4303	4.43	3.99	3.56
RA4403	400	420-4403	4.43	3.99	3.56
RA4603	600	420-4603	5.12	4.61	4.11

1/2" x 1/4" x 6" EACH Prices

Style	Grit	Item#	12-60	72-132	144+
RA4094	90	420-4094	\$3.88	\$3.49	\$3.12
RA4124	120	420-4124	3.88	3.49	3.12
RA4184	180	420-4184	3.88	3.49	3.12
RA4204	220	420-4204	3.88	3.49	3.12
RA4304	320	420-4304	5.90	5.31	4.74
RA4404	400	420-4404	5.90	5.31	4.74
RA4604	600	420-4604	6.65	5.99	5.34

Round, 5/32" x 4" EACH Prices

Style	Grit	Item#	12-60	72-132	144+
RA33	320	420-0033	\$4.77	\$4.29	\$3.83



Sold in full box quantities 12 each as indicated by please order in these multiples.

Gesswein® General Purpose Stones

- Excellent for P-20 steel polishing!
- Used with stoning oil, the General Purpose stone cuts well and lasts long. Resists loading of steel particles.
- Made of extra-sharp pure white aluminum oxide grains in a specially formulated bond which provides a lubricating effect.
- Sold in full box quantities of 6 or 12 each as indicated.



See Our
Sampler Sets
on pages 19-21

ABRASIVES-FINISHING STONES

IMPORTANT: See dust warning on page 3.

5/32" x 5/32" x 4" Sizes are available in grits 150-1200 on page 17.

1/4" x 1/8" x 6"

Style	Grit	Item#	EACH Prices		
			12-60	72-132	144+
6151G	150	406-6151	\$2.36	\$2.12	\$1.90
6181G	180	406-6181	2.36	2.12	1.90
6201G	220	406-6201	2.36	2.12	1.90
6301G	320	406-6301	2.45	2.21	1.97
6401G	400	406-6401	2.45	2.21	1.97
6601G	600	406-6601	2.83	2.55	2.27
6801G	800	406-6801	3.73	3.36	3.00
6901G	1200	406-6901	4.28	3.85	3.44

1/4" x 1/4" x 6"

Style	Grit	Item#	EACH Prices		
			12-60	72-132	144+
6152G	150	406-6152	\$2.47	\$2.22	\$1.98
6182G	180	406-6182	2.47	2.22	1.98
6202G	220	406-6202	2.47	2.22	1.98
6302G	320	406-6302	2.57	2.31	2.06
6402G	400	406-6402	2.57	2.31	2.06
6602G	600	406-6602	3.21	2.89	2.58
6802G	800	406-6802	3.73	3.36	3.00
6902G	1200	406-6902	4.28	3.85	3.44

1/2" x 1/8" x 6"

Style	Grit	Item#	EACH Prices		
			12-60	72-132	144+
6153G	150	406-6153	\$2.57	\$2.31	\$2.06
6183G	180	406-6183	2.57	2.31	2.06
6203G	220	406-6203	2.57	2.31	2.06
6303G	320	406-6303	2.74	2.47	2.20
6403G	400	406-6403	2.74	2.47	2.20
6603G	600	406-6603	3.39	3.05	2.72
6803G	800	406-6803	4.19	3.77	3.37
6903G	1200	406-6903	4.61	4.15	3.70

1" x 1/8" x 6"

Style	Grit	Item#	EACH Prices		
			6-66	72-138	144+
6011G	150	406-6011	\$3.36	\$3.36	\$2.70
6111G	180	406-6111	3.36	3.02	2.70
6211G	220	406-6211	3.36	3.02	2.70
6311G	320	406-6311	4.06	3.65	3.26
6411G	400	406-6411	4.20	3.78	3.37
6611G	600	406-6611	4.99	4.49	4.01
6811G	800	406-6811	6.79	6.11	5.46
6911G	1200	406-6911	8.03	7.23	6.45

Hybrid, 1/4" x 1/4" x 6"

Style	Grit	Item#	EACH Prices		
			12-60	72-132	144+
1523H	150	406-1523	\$3.21	\$2.89	\$2.58
1823H	180	406-1823	3.21	2.89	2.58
1223H	220	406-1223	3.21	2.89	2.58
1323H	320	406-1323	3.35	3.02	2.69
1423H	400	406-1423	3.35	3.02	2.69
1623H	600	406-1623	4.17	3.75	3.35

1/2" x 1/4" x 6"

Style	Grit	Item#	EACH Prices		
			12-60	72-132	144+
6154G	150	406-6154	\$3.24	\$2.92	\$2.60
6184G	180	406-6184	3.24	2.92	2.60
6204G	220	406-6204	3.24	2.92	2.60
6304G	320	406-6304	3.77	3.39	3.03
6404G	400	406-6404	3.77	3.39	3.03
6604G	600	406-6604	4.73	4.26	3.80
6804G	800	406-6804	5.51	4.96	4.43
6904G	1200	406-6904	6.41	5.77	5.15

1" x 1/4" x 6"

Style	Grit	Item#	EACH Prices		
			6-66	72-138	144+
6012G	150	406-6012	\$4.77	\$4.29	\$3.83
6112G	180	406-6112	4.77	4.29	3.83
6212G	220	406-6212	4.77	4.29	3.83
6312G	320	406-6312	5.48	4.93	4.40
6412G	400	406-6412	5.65	5.09	4.54
6612G	600	406-6612	7.20	6.48	5.79
6812G	800	406-6812	9.90	8.91	7.95
6912G	1200	406-6912	11.16	10.04	8.97

1" x 1/2" x 6"

Style	Grit	Item#	EACH Prices		
			6-66	72-138	144+
6157G	150	406-6157	\$6.89	\$6.20	\$5.54
6187G	180	406-6187	6.89	6.20	5.54
6207G	220	406-6207	6.89	6.20	5.54
6307G	320	406-6307	8.15	7.34	7.34
6407G	400	406-6407	8.41	7.57	6.76
6607G	600	406-6607	9.83	8.85	7.90
6807G	800	406-6807	15.75	14.18	12.66
6907G	1200	406-6907	17.32	15.59	13.92

1" x 1" x 6"

Style	Grit	Item#	EACH Prices		
			6-66	72-138	144+
6011G	150	406-6156	\$10.34	\$9.31	\$8.31
6111G	180	406-6186	10.34	9.31	8.31
6211G	220	406-6206	10.34	9.31	8.31
6311G	320	406-6306	12.23	11.01	9.83
6411G	400	406-6406	12.23	11.01	9.83
6611G	600	406-6606	14.31	12.88	11.50

Round, 1/4" x 6"

Style	Grit	Item#	EACH Prices		
			6-66	72-138	144+
152	150	406-0152	\$4.47	\$4.02	\$3.59
182	180	406-0182	4.47	4.02	3.59
222	220	406-0222	4.47	4.02	3.59
322	320	406-0322	4.80	4.32	3.86
402	400	406-0402	4.80	4.32	3.86
602	600	406-0602	5.55	5.00	5.55
802	800	406-0802	6.35	5.72	6.35
902	1200	406-0902	6.98	6.28	6.98

Sold in full box quantities of 6 or 12 each as indicated by please order in these multiples.

Web Site Orders 24/7: gesswein.com

All prices subject to change without notice.

Gesswein® Premium White Stones

- Pure white premium-grade aluminum oxide stones.
- Specially formulated to be load-resistant.
- Can be used on all steels, from the hard A2, D2 and M2 to the softer P20, 420SS, M13 & S7.
- Moderate breakdown, retain their shape wells.
- Can be used in a profiler or ultrasonic polisher.
- Sold in full box quantities of twelve each.



IMPORTANT: See dust warning on page 3.

See Our Sampler Sets on pages 19-21

5/32" x 5/32" x 4"

12pc EACH Prices

Style	Grit	Item#	12-60	72-132	144+
2W	220	415-5002	\$1.87	\$1.68	\$1.50
3W	320	415-5003	1.87	1.68	1.50
4W	400	415-5004	1.87	1.68	1.50
6W	600	415-5006	2.10	1.89	1.69

1/4" x 1/16" x 4"

12pc EACH Prices

Style	Grit	Item#	12-60	72-132	144+
5210W	220	407-5210	\$1.84	\$1.66	\$1.48
5310W	320	407-5310	2.05	1.85	1.65
5410W	400	407-5410	2.05	1.85	1.65

1/4" x 1/8" x 6"

12pc EACH Prices

Style	Grit	Item#	12-60	72-132	144+
5101W	100	407-5101	\$2.54	\$2.29	\$2.04
5151W	150	407-5151	2.54	2.29	2.04
5201W	220	407-5201	2.54	2.29	2.04
5301W	320	407-5301	2.72	2.45	2.19
5401W	400	407-5401	2.72	2.45	2.19
5601W	600	407-5601	3.13	2.82	2.51

1/4" x 1/4" x 6"

12pc EACH Prices

Style	Grit	Item#	12-60	72-132	144+
5102W	100	407-5102	\$2.80	\$2.52	\$2.25
5152W	150	407-5152	2.80	2.52	2.25
5202W	220	407-5202	2.80	2.52	2.25
5302W	320	407-5302	2.99	2.69	2.40
5402W	400	407-5402	2.99	2.69	2.40
5602W	600	407-5602	3.60	3.24	2.89

1/2" x 1/8" x 6"

12pc EACH Prices

Style	Grit	Item#	12-60	72-132	144+
5103W	100	407-5103	\$2.87	\$2.58	\$2.31
5153W	150	407-5153	2.87	2.58	2.31
5203W	220	407-5203	2.87	2.58	2.31
5303W	320	407-5303	3.05	2.75	2.45
5403W	400	407-5403	3.05	2.75	2.45
5603W	600	407-5603	4.23	3.81	3.40

1/2" x 1/4" x 6"

12pc EACH Prices

Style	Grit	Item#	12-60	72-132	144+
5104W	100	407-5104	\$3.47	\$3.12	\$2.79
5154W	150	407-5154	3.47	3.12	2.79
5204W	220	407-5204	3.47	3.12	2.79
5304W	320	407-5304	3.85	3.47	3.09
5404W	400	407-5404	3.85	3.47	3.09
5604W	600	407-5604	5.57	5.01	4.48



A-C Double Enders

Will accommodate pencil stones as well as small round and square stones up to 1/4" x 1/4". Available in three colors (blue, black and red) that may be used to distinguish one grit or grade of stone from another. Set of three (#403-0120) contains one of each color. Measure 5 7/8" overall length.

Description	Item#	EACH Prices	
		1-2	3+
A. Blue	403-0101	\$5.75	\$5.18
B. Black	403-0102	5.75	5.18
C. Red	403-0103	5.75	5.18
Set of 3	403-0120	14.00	13.30

Sold in full box quantities 12 each as indicated by **12pc** please order in these multiples.

Gesswein® Rough Out Stones

- Large, coarse, relatively soft stones containing aluminum oxide.
- Cuts fast with rapid breakdown.
- Quickly remove rough scratches and machine tool marks.
- A good choice for roughing surfaces of larger molds and dies.
- Ideal for "hogging" out large amounts of material prior to finishing.
- Sold in full box quantities of 6 or 12 each as indicated.

IMPORTANT: See dust warning on page 3.



1/4" x 1/4" x 8"			12pc EACH Prices		
Style	Grit	Item#	12-60	72-132	144+
X8002	100	430-8002	\$1.96	\$1.76	\$1.57

1" x 1/2" x 8"			6pc EACH Prices		
Style	Grit	Item#	6-66	72-138	144+
X8081	80	430-8081	\$5.48	\$4.93	\$4.40
X8101	100	430-8101	5.48	4.93	4.40
X8151	150	430-8151	5.48	4.93	4.40
X8201	220	430-8201	5.48	4.93	4.40

1/2" x 1/4" x 6"			12pc EACH Prices		
Style	Grit	Item#	12-60	72-132	144+
X8004	100	430-8004	\$3.29	\$2.96	\$2.64

1 1/2" x 3/4" x 8"			6pc EACH Prices		
Style	Grit	Item#	6-66	72-138	144+
X8082	80	430-8082	\$8.82	\$7.94	\$7.09
X8102	100	430-8102	8.82	7.94	7.09
X8152	150	430-8152	8.82	7.94	7.09
X8202	220	430-8202	8.82	7.94	7.09

1" x 1/4" x 8"			12pc EACH Prices		
Style	Grit	Item#	12-60	72-132	144+
X8080	80	430-8080	\$4.44	\$4.00	\$3.57
X8100	100	430-8100	4.44	4.00	3.57
X8150	150	430-8150	4.44	4.00	3.57
X8200	220	430-8200	4.44	4.00	3.57



Gesswein® Supreme Green Stoning and Lubricating Oil

This stoning oil was developed for mold and die polishing. It is economical, practically odorless, and it's ecologically safer to use than alternative stoning oils. Use with finishing stones to prevent loading and keep the work surface clean. Lets stones cut better and more freely so they produce a bright, smooth surface. Eliminates the need for hazardous kerosene and other lubricating agents, which could be harmful to your health. Can also use with diamond tools where lubrication is suggested. Viscosity: 39.5/44.

Description	Item#	Each
A. 1 Pint (wide-mouth glass container)	800-0152	\$13.75
B. 1 Gallon	800-0151	44.95

Sold in full box quantities of 6 or 12 each as indicated by please order in these multiples.

Web Site Orders 24/7: gesswein.com

All prices subject to change without notice.

Gesswein® Ultra-Soft Stones

- Aluminum oxide abrasive with a special bonding agent designed for very rapid breakdown.
- Cuts fast without loading; easily shaped for contours.
- Formulated for soft metals, stainless steel, aluminum, brass, beryllium and kirksite.
- Sold in full box quantities of 6 or 12 each as indicated.

Gesswein® Super Fine Stones

- Contain levigated (finely powdered) alumina.
- One of our "softest" stones for finishing P20 and 420SS steel surfaces. Breaks down very rapidly and does not scratch.
- Good choice for finishing details.
- Not quite as soft as our Ultra-Soft stones.
- Sold in full box quantities of 12 each.

IMPORTANT: See dust warning on page 3.

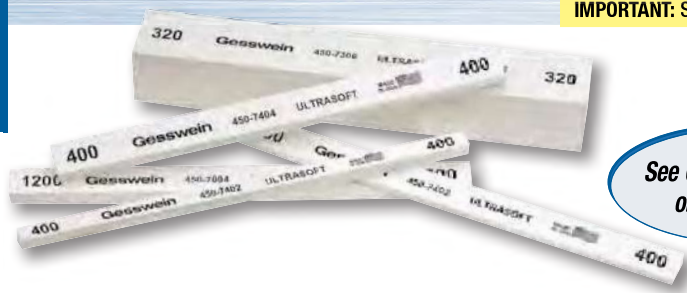

See Our Sampler Sets on pages 19-21

1/4" x 1/4" x 6" 12pc EACH Prices

Style	Grit	Item#	12-60	72-132	144+
7102	120	450-7102	\$2.52	\$2.27	\$2.02
7202	220	450-7202	2.52	2.27	2.02
7302	320	450-7302	2.86	2.57	2.30
7402	400	450-7402	2.86	2.57	2.30
7602	600	450-7602	3.47	3.12	2.79
7002	1200	450-7002	5.20	4.68	4.18

5/32" x 5/32" x 4" 12pc EACH Prices

Style	Grit	Item#	12-60	72-132	144+
12	1200	415-0120	\$1.91	\$1.72	\$1.53

1/2" x 1/8" x 6" 12pc EACH Prices

Style	Grit	Item#	12-60	72-132	144+
7103	120	450-7103	\$2.87	\$2.58	\$2.31
7203	220	450-7203	2.87	2.58	2.31
7303	320	450-7303	3.05	2.75	2.45
7403	400	450-7403	3.05	2.75	2.45
7603	600	450-7603	3.67	3.30	2.95
7003	1200	450-7003	5.50	4.95	4.42

1/4" x 1/8" x 6" 12pc EACH Prices

Style	Grit	Item#	12-60	72-132	144+
9001	1200	440-9001	\$3.01	\$2.71	\$2.42

1/2" x 1/4" x 6" 12pc EACH Prices

Style	Grit	Item#	12-60	72-132	144+
7104	120	450-7104	\$3.32	\$2.99	\$2.67
7204	220	450-7204	3.32	2.99	2.67
7304	320	450-7304	3.84	3.46	3.09
7404	400	450-7404	3.84	3.46	3.09
7604	600	450-7604	5.15	4.64	4.14
7004	1200	450-7004	7.73	6.96	6.21

1/4" x 1/4" x 6" 12pc EACH Prices

Style	Grit	Item#	12-60	72-132	144+
9002	1200	440-9002	\$3.47	\$3.12	\$2.79

1" x 1/2" x 6" 6pc EACH Prices

Style	Grit	Item#	6-66	72-138	144+
7107	120	450-7107	\$6.22	\$5.60	\$5.00
7307	320	450-7307	9.59	8.63	7.71
7607	600	450-7607	13.74	12.37	11.04
7007	1200	450-7007	20.62	18.56	16.57

1/2" x 1/8" x 6" 12pc EACH Prices

Style	Grit	Item#	12-60	72-132	144+
9003	1200	440-9003	\$3.97	\$3.57	\$3.19

1" x 1" x 6" 6pc EACH Prices

Style	Grit	Item#	6-66	72-138	144+
7106	120	450-7106	\$10.30	\$9.27	\$8.28
7306	320	450-7306	14.33	12.90	11.51
7606	600	450-7606	21.90	19.71	17.60
7006	1200	450-7006	32.00	28.80	25.71

1/2" x 1/4" x 6" 12pc EACH Prices

Style	Grit	Item#	12-60	72-132	144+
9004	1200	440-9004	\$4.78	\$4.30	\$3.84



Sold in full box quantities of 6 or 12 each as indicated by 6pc 12pc please order in these multiples.

Gesswein® Pencil Stones, 5/32" x 5/32" x 4"

A selection of our most popular finishing stones in a 4" long x 5/32" square, making them convenient for stoning small or intricate areas. Shorter length helps prevent wasteful breakage. Use with Pencil Stone Holder #403-0050, shown on page 22.

Sold in full box quantities of 12 or in a money-saving set (see below).



IMPORTANT: See dust warning on page 3.

Diemaker		EACH Prices			
Style	Grit	Item#	12-60	72-132	144+
01	100	415-0001	\$1.61	\$1.45	\$1.29
1	150	415-0010	1.61	1.45	1.29
2	220	415-0020	1.61	1.45	1.29
3	320	415-0030	1.61	1.45	1.29
4	400	415-0040	1.61	1.45	1.29
6	600	415-0060	1.82	1.64	1.46
8	800	415-0080	1.82	1.64	1.46
9	900	415-0090	1.82	1.64	1.46
1200	1200	415-4080	2.00	1.80	1.61

EDM		EACH Prices			
Style	Grit	Item#	12-60	72-132	144+
61	120	415-0610	\$1.69	\$1.52	\$1.36
62	180	415-0620	1.69	1.52	1.36
622	220	415-0622	1.69	1.52	1.36
63	320	415-0630	1.69	1.52	1.36
64	400	415-0640	1.69	1.52	1.36
66	600	415-0660	1.91	1.72	1.53

EDM Blue		EACH Prices			
Style	Grit	Item#	12-60	72-132	144+
61B	120	415-6010	\$1.69	\$1.52	\$1.36
62B	180	415-6020	1.69	1.52	1.36
622B	220	415-6022	1.69	1.52	1.36
63B	320	415-6030	1.69	1.52	1.36
64B	400	415-6040	1.69	1.52	1.36
66B	600	415-6060	1.91	1.72	1.53

Oil-Treated		EACH Prices			
Style	Grit	Item#	12-60	72-132	144+
51	120	415-0510	\$1.69	\$1.52	\$1.36
50	180	415-0518	1.69	1.52	1.36
52	220	415-0520	1.69	1.52	1.36
53	320	415-0530	1.69	1.52	1.36
54	400	415-0540	1.69	1.52	1.36
56	600	415-0560	1.91	1.72	1.53
58	800	415-0580	1.91	1.72	1.53
59	1200	415-0590	2.17	1.95	1.74

Super Fine		EACH Prices			
Style	Grit	Item#	12-60	72-132	144+
12	1200	415-0120	\$1.91	\$1.72	\$1.53

Premium White		EACH Prices			
Style	Grit	Item#	12-60	72-132	144+
2W	220	415-5002	\$1.87	\$1.68	\$1.50
3W	320	415-5003	1.87	1.68	1.50
4W	400	415-5004	1.87	1.68	1.50
6W	600	415-5006	2.10	1.89	1.69

Moldmaker		EACH Prices			
Style	Grit	Item#	12-60	72-132	144+
10	100	415-1000	\$1.48	\$1.33	\$1.19
15	150	415-1001	1.48	1.33	1.19
20	220	415-1002	1.48	1.33	1.19
30	320	415-1003	1.48	1.33	1.19
40	400	415-1004	1.48	1.33	1.19
60	600	415-1006	1.65	1.49	1.33

Moldmaker Plus		EACH Prices			
Style	Grit	Item#	12-60	72-132	144+
15P	150	415-1015	\$1.57	\$1.41	\$1.26
20P	220	415-1020	1.57	1.41	1.26
30P	320	415-1030	1.57	1.41	1.26
40P	400	415-1040	1.57	1.41	1.26
60P	600	415-1060	1.78	1.60	1.43
80P	800	415-1080	1.97	1.77	1.58
200P	1200	415-1200	2.26	2.03	1.82

RA		EACH Prices			
Style	Grit	Item#	12-60	72-132	144+
RA41	180	415-0410	\$2.03	\$1.83	\$1.63
RA42	220	415-0420	2.03	1.83	1.63
RA43	320	415-0430	2.14	1.93	1.72
RA44	400	415-0440	2.14	1.93	1.72
RA46	600	415-0460	2.43	2.19	1.95

General Purpose		EACH Prices			
Style	Grit	Item#	12-60	72-132	144+
15G	150	415-0315	\$1.69	\$1.52	\$1.36
18G	180	415-0318	1.69	1.52	1.36
22G	220	415-0320	1.69	1.52	1.36
32G	320	415-0330	1.69	1.52	1.36
42G	400	415-0340	1.69	1.52	1.36
60G	600	415-0360	1.91	1.72	1.53
80G	800	415-0380	2.42	2.18	1.94
120G	1200	415-0390	2.96	2.66	2.38

Medium India		EACH Prices			
Style	Grit	Item#	12-60	72-132	144+
10	240	415-0100	\$2.00	\$1.80	\$1.61

Gesswein® Pencil Stone Set V

Includes one each of every pencil stone we make, in every grit, for a total of 61 stones, including RA, EDM, EDM Blue, General Purpose, Premium White, Oil-Treated, Diemaker, Moldmaker Plus, Moldmaker, Super Fine and Medium India. Complete with Pencil Stone Holder and a free sample of Gesswein Stoning Oil.

Description	Item#	Each
Pencil Stone Set V	415-1031	\$89.95

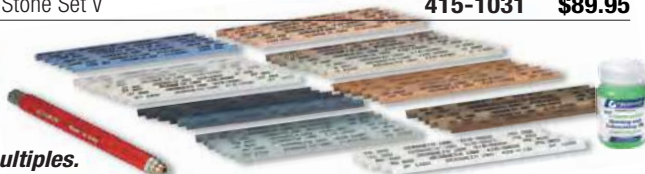

Sold in full box quantities of 12 each as indicated by please order in these multiples.

Gesswein® Hybrid Stones, 1/4" x 1/4" x 6"

Our Hybrid shape (half-round and half-square) combines all the advantages of round and flat stones without the higher costs normally associated with round stones. Use the round side on curved surfaces, the flat side on even surfaces and in 90° corners and slots.

Measures 1/4" x 1/4" x 6" long and are available in our most popular styles: Diemaker, EDM, General Purpose, Moldmaker and Oil-Treated. Sold in full box quantities of 12.



IMPORTANT: See dust warning on page 3.

Also available in a 20-piece set (see below)

Diemaker		12pc EACH Prices			
Style	Grit	Item#	12-60	72-132	144+
1823H	100	405-1823	\$3.12	\$2.81	\$2.51
2123H	150	405-2123	3.12	2.81	2.51
2223H	220	405-2223	3.12	2.81	2.51
2323H	320	405-2323	3.47	3.12	2.79
2423H	400	405-2423	3.47	3.12	2.79
2623H	600	405-2623	3.97	3.57	3.19
2823H	800	405-2823	3.97	3.57	3.19
2923H	900	405-2923	4.75	4.28	3.82
4023H	1200	405-4023	5.23	4.71	4.20

Oil-Treated		12pc EACH Prices			
Style	Grit	Item#	12-60	72-132	144+
5123H	120	435-5123	\$3.57	\$3.21	\$2.87
5023H	180	435-5023	3.57	3.21	2.87
5223H	220	435-5223	3.57	3.21	2.87
5323H	320	435-5323	3.72	3.35	2.99
5423H	400	435-5423	3.72	3.35	2.99
5623H	600	435-5623	4.63	4.17	3.72
5823H	800	435-5823	4.87	4.38	3.91
5923H	1200	435-5923	5.33	4.80	4.28

EDM		12pc EACH Prices			
Style	Grit	Item#	12-60	72-132	144+
123H	120	425-0123	\$3.32	\$2.99	\$2.67
183H	180	425-0183	3.32	2.99	2.67
223H	220	425-0223	3.32	2.99	2.67
323H	320	425-0323	3.53	3.18	2.84
423H	400	425-0423	3.53	3.18	2.84
623H	600	425-0623	4.27	3.84	3.43

Moldmaker		12pc EACH Prices			
Style	Grit	Item#	12-60	72-132	144+
023H	100	410-0023	\$3.03	\$2.73	\$2.43
123H	150	410-0123	3.03	2.73	2.43
223H	220	410-0223	3.03	2.73	2.43
323H	320	410-0323	3.58	3.22	2.88
423H	400	410-0423	3.58	3.22	2.88
623H	600	410-0623	4.42	3.98	3.55



New Hybrid
(half-round / half-square)

General Purpose		12pc EACH Prices			
Style	Grit	Item#	12-60	72-132	144+
1523H	150	406-1523	\$3.21	\$2.89	\$2.58
1823H	180	406-1823	3.21	2.89	2.58
1223H	220	406-1223	3.21	2.89	2.58
1323H	320	406-1323	3.35	3.02	2.69
1423H	400	406-1423	3.35	3.02	2.69
1623H	600	406-1623	4.17	3.75	3.35

Sold in full box quantities of 12 each as indicated by please order in these multiples.

Gesswein® 20-Piece Hybrid Stone Set

Our new Hybrid shape (half-round and half-square) combines all the advantages of round and flat stones without the higher costs normally associated with round stones.

Set contains 20 Hybrid stones.

Four each of the following in 220, 320, 400 and 600 grit:

- Diemaker
- EDM
- General Purpose
- Moldmaker
- Oil-Treated

Description	Item#	Each
Hybrid Stone Set	405-2086	\$51.00

Made in the USA



A-J Gesswein® Finishing Stone All-Grit Sets  1/2" x 1/8" x 6"

In order to try our most popular Gesswein stone types, we have created these sets ranging from 6 to 9 pieces covering all the grits available in the most popular 1/2" x 1/8" x 6" Size. Choose from Diemaker, EDM, EDM Blue, General Purpose, Moldmaker, Moldmaker Plus, Oil-Treated, Premium White Stone, Ultra-Soft and RA Sets. Or, select our 71-Piece Finishing Stone Sampler Set below.

IMPORTANT: See dust warning on page 3.

Sets	Grits	Item#	Set
Diemaker All-Grit Set - 9 pcs.	100, 150, 220, 320, 400, 600, 800, 900, 1200	405-2062	\$25.95
EDM All-Grit Set - 6 pcs.	120, 180, 220, 320, 400, 600	405-2031	16.25
EDM Blue All-Grit Set - 6 pcs.	120, 180, 220, 320, 400, 600	405-2041	13.25
Oil-Treated All-Grit Set - 8 pcs.	120, 180, 220, 320, 400, 600, 800, 1200	405-2091	23.95
Moldmaker All-Grit Set - 6 pcs.	100, 150, 220, 320, 400, 600	405-2066	15.95
Moldmaker Plus All-Grit Set - 8 pcs.	100, 150, 220, 320, 400, 600, 800, 1200	405-2021	26.95
RA All-Grit Set - 7 pcs.	90, 120, 180, 220, 320, 400, 600, 400, 600, 800, 1200	405-2001	23.50
General Purpose All-Grit Set - 8 pcs.	150, 180, 220, 320, 400, 600, 800, 1200	405-2097	24.50
Premium White All-Grit Set - 6 pcs.	100, 150, 220, 320, 400, 600	405-2011	16.95
Ultra-Soft All-Grit Set - 6 pcs.	120, 220, 320, 400, 600, 1200	405-2006	17.50



A



B



C

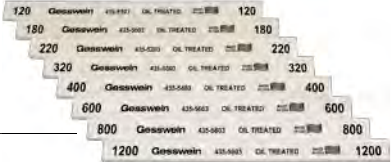

D



E



F



G



H



I

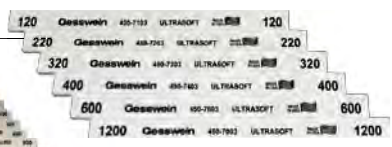

J

K. Gesswein® 71-Piece Finishing Stone Set

You never know when you need that special stone for an unexpected job. Keep this Finishing Stone Set handy to avoid such an occurrence. The set includes 11 Gesswein stone styles as shown above, as well as the Super Fine Stone, in the most popular size: 1/2" wide x 1/8" thick x 6" long. Also included are a 2 oz. bottle of Gesswein Stoning Oil and a double-ended LT Stone Holder.

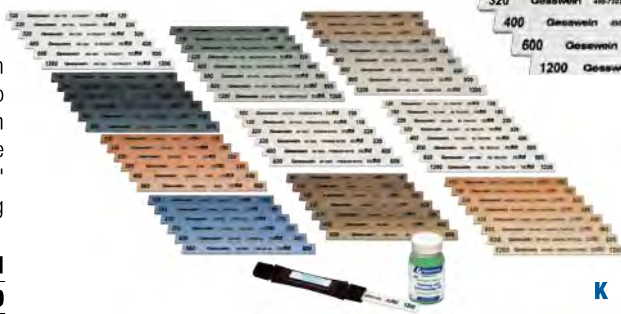

K

Description	Item#	EACH
71-piece Finishing Stone Set	405-2056	\$135.00

A-H Gesswein® 12-Piece Finishing Stone Sampler Sets   

We offer eight 12-piece stone sets of our most popular stones. Choose from Diemaker, EDM, EDM Blue, General Purpose, Moldmaker, Moldmaker Plus, Oil-Treated and Premium White Stone Sets. Or, select our Discovery Stone Set below, which includes all eight sets. Each Finishing Stone Set serves as a perfect introduction to our popular stone lines, and includes four different grits of the three most popular sizes: 1/4" x 1/8", 1/2" x 1/8", 1/2" x 1/4"; all 6" in length.

IMPORTANT: See dust warning on page 3.

	Sets	Grits	Item#	Set of 12
A 	Diemaker Stone Set	220, 320, 400, 600	405-2060	\$37.00
B 	EDM Stone Set	120, 180, 320, 400	405-2030	35.00
C 	EDM Blue Stone Set	120, 180, 320, 400	405-2040	35.00
D 	Oil-Treated Stone Set	220, 320, 400, 600	405-2090	41.00
E 	Moldmaker Stone Set	220, 320, 400, 600	405-2065	39.00
F 	Moldmaker Plus Stone Set	220, 400, 800, 1200	405-2020	49.00
G 	General Purpose Stone Set	220, 320, 400, 600	405-2095	33.00
H 	Premium White Stone Set	220, 320, 400, 600	405-2010	37.00

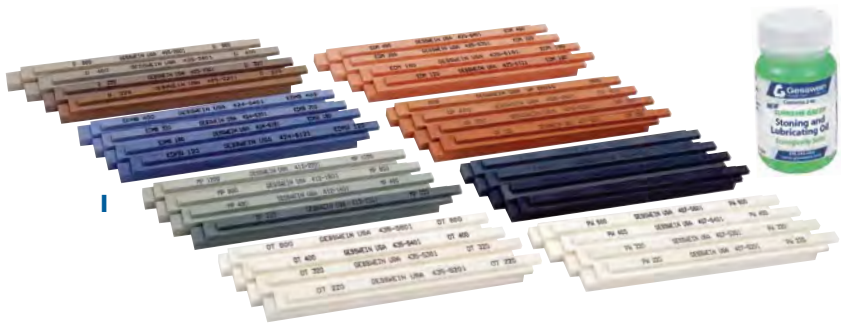

I. Gesswein® 96-Piece Discovery Stone Set

Includes all 8 of our 12-Piece Sets. This is our most comprehensive set with a total of 96 of our most popular stones. By purchasing all these sets at once, you save over the combined price of buying all the sets individually. Comes complete with a free sample of Gesswein Stoning Oil.

Description	Item#	EACH
96-piece Finishing Stone Set	405-2027	\$199.00

A. Gesswein® 20-Piece General Purpose Sets

Four 20-piece stone sets offered in our most popular stone sizes. Each set includes five different types of stones of the same size. All stones measure 6" long.

IMPORTANT: See dust warning on page 3.

Set contains one each of the following grits and types of stones. Simply select the size you require.						
	120 Grit	150 Grit	180 Grit	220 Grit	320 Grit	400 Grit
EDM			•	•	•	•
Oil-Treated	•			•	•	•
Diemaker		•		•	•	•
General Purpose	•			•	•	•
Moldmaker Plus		•		•	•	•

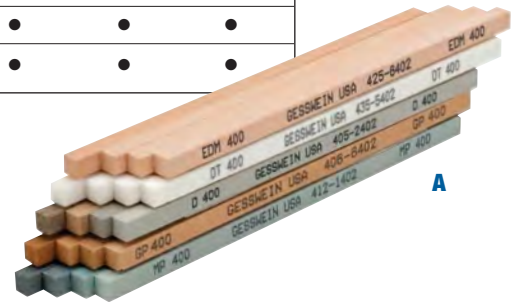

Size	Item#	Set of 20
1/4" x 1/8" x 6" Stone Set	405-2035	\$45.00
1/4" x 1/4" x 6" Stone Set	405-2045	47.00
1/2" x 1/8" x 6" Stone Set	405-2055	51.00
1/2" x 1/4" x 6" Stone Set	405-2075	64.00

B. Gesswein® 20-Piece Soft & Fine Set

Includes 4 different types of stones in various sizes ideal for final finishing and for preparation prior to diamond polishing. Use Diemaker (800 and 900 grit) and Super Fine (1200 grit) for polishing steel surfaces, Moldmaker Plus (800 grit) for radius-polishing stainless steel surfaces and Ultra-Soft (600 grit) for polishing aluminum and other soft metal surfaces. All stones measure 6" long except 5/32" x 5/32" Super Fine, which measures 4" long.

IMPORTANT: See dust warning on page 3.

Set contains one each of the following stones:						
	Grit	5/32" x 5/32"	1/4" x 1/8"	1/4" x 1/4"	1/2" x 1/8"	1/2" x 1/4"
Diemaker	800		•	•	•	•
Diemaker	900		•	•	•	•
Moldmaker Plus	800		•	•	•	•
Super Fine	1200	•	•	•	•	•
Ultra-Soft	600			•	•	•

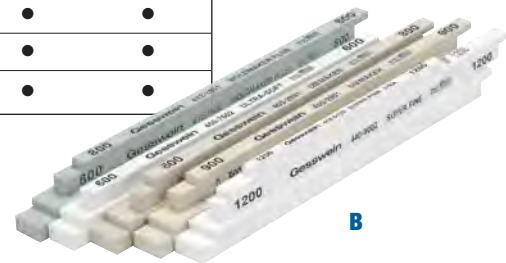

Description	Item#	Set of 20
Soft & Fine Set	405-2085	\$66.00

C. Rub-and-Rinse Stone Cleaner

Gesswein Rub-and-Rinse Stone Cleaner is a semiliquid material that sheds tiny metal particles from hard stones to keep them at their peak efficiency. Recommended for use on hard stones such as our Ruby, India and Hard Arkansas Stones. Contains 1/2 fl. oz.

Description	Item#	EACH
Rub-and-Rinse Stone Cleaner	813-1700	\$9.80



Gesswein® Supreme Green Stoning and Lubricating Oil

This stoning oil was developed for mold and die polishing. It is economical, practically odorless, and it's ecologically safer to use than alternative stoning oils. Use with finishing stones to prevent loading and keep the work surface clean. Lets stones cut better and more freely so they produce a bright, smooth surface. Eliminates the need for hazardous kerosene and other lubricating agents, which could be harmful to your health. Can also use with diamond tools where lubrication is suggested. Viscosity: 39.5/44.

Description	Item#	Each
D. 1 Pint (wide-mouth glass container)	800-0152	\$13.75
E. 1 Gallon	800-0151	44.95



F. Plastic Spray-Pump Bottle

Use to dispense stoning oil, cleaning solution and more. Spray gets into hard-to-reach areas. Capacity: 4 fl. oz.

Description	Item#	EACH Prices	
		1-2	3+
Plastic Spray-Pump Bottle	811-2460	\$2.15	\$1.94



Stone Holders & Accessories

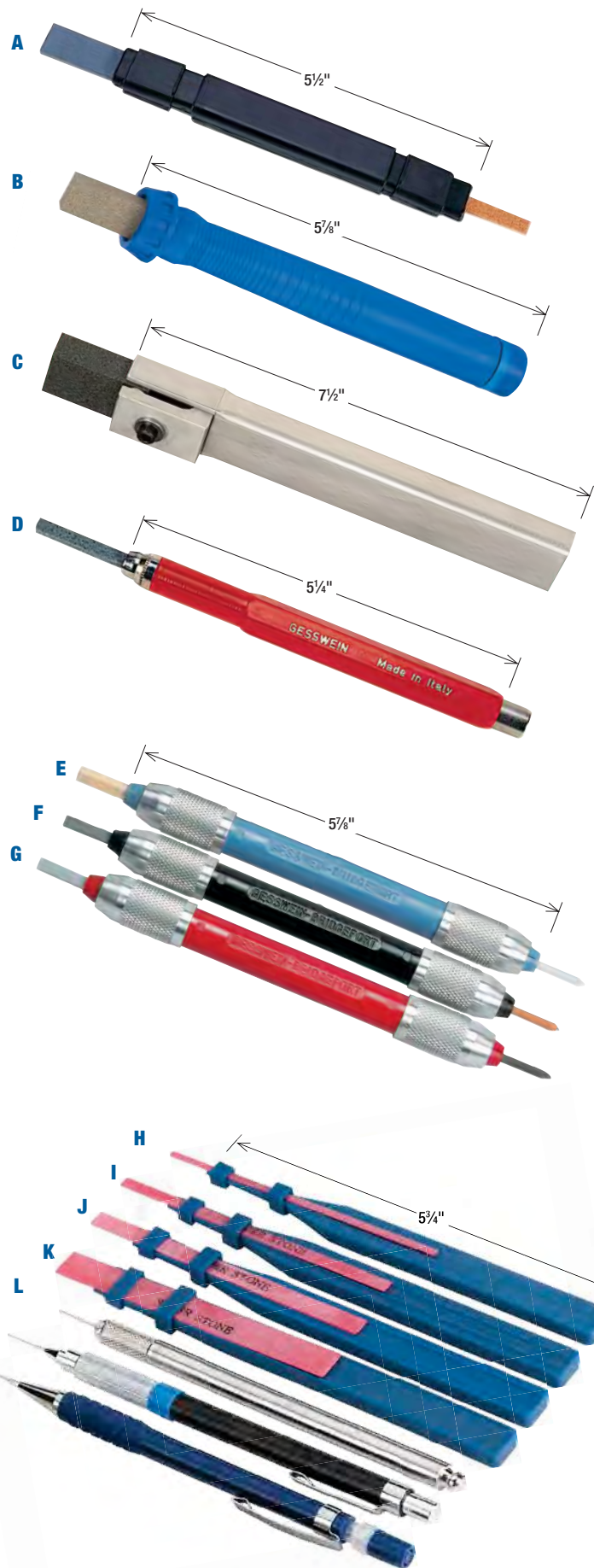

A. LT Stone Holder

An economically priced, lightweight, double-ended stone holder made of durable plastic with a black nonglare finish. One end holds 1/8" x 1/4" stones, and the other holds 1/8" x 1/2" and 1/4" x 1/4" stones. Measures 5 1/2" long.

Description	Item#	Each
LT Stone Holder	403-1020	\$4.80

B. Screw-Lock Stone Holder

Screw-type lock holds the stone securely. Designed for comfortable use. Holds 1/2" x 1/4" stones. Measures 5 7/8" long.

Description	Item#	EACH Prices		
		1-2	3-11	12+
Screw-Lock Stone Holder	403-0200	\$13.95	\$11.86	\$11.16

C. Handheld Stone Holder

Lightweight aluminum holder designed to hold stones firmly for roughing applications. Measures 7 1/2" long.

For Stone Sizes	Item#	Each
C. 1/2" x 1/2"	403-0350	24.75

D. Pencil Stone Holder

Push-button holder for easy loading. Holds 5/32" square stones. Measures 5 1/4" long. Made in Italy.

Description	Item#	EACH Prices		
		1-2	3-11	12+
D. Pencil Stone Holder	403-0050	\$9.95	\$9.35	\$8.46
Replacement Collet	403-0085	3.25	-	-

E-G Double Enders

Will accommodate pencil stones as well as small round and square stones up to 1/4" x 1/4". Available in three colors (blue, black and red) that may be used to distinguish one grit or grade of stone from another. Set of three (#403-0120) contains one of each color. Measure 5 7/8" overall length.

Description	Item#	EACH Prices	
		1-2	3+
E. Blue	403-0101	\$5.75	\$5.18
F. Black	403-0102	5.75	5.18
G. Red	403-0103	5.75	5.18
Set of 3, one each	403-0120	14.00	13.30

H-N Ceramic Stone Holders – For offhand work

For handheld work with ceramic stones. Available in 1, 2, 4, 6 and 10mm flat sizes, 3mm round or 0.5mm and 0.9mm square sizes. Measures approximately 5 3/4" long.

Description	Item#	Each
Flat Holder, 1mm	351-0291	\$7.90
H. Flat Holder, 2mm	351-0292	7.90
I. Flat Holder, 4mm	351-0270	7.90
J. Flat Holder, 6mm	351-0271	7.90
K. Flat Holder, 10mm	351-0272	7.90
L. Round Holder, 3mm	403-0011	12.75
M. Square Holder, 0.5mm	351-0345	12.75
N. Square Holder, 0.9mm	351-0350	12.75

A. Adjustable Stone Holder – 3mm Shank

Our finest quality. Made of nonmagnetic stainless steel with a 3mm shank. The surface has been tumble-polished to create a nonreflecting satin finish. Accommodates stones up to 1/4" in thickness.

Description	Item#	Each
Adjustable Stone Holder	403-1000	\$81.00



A

B. Economy Adjustable Stone Holder – 3mm Shank

The Economy Adjustable Stone Holder accommodates stones up to 9/16" thick. Plastic serrated jaw holds stones securely. Surface is black and nonreflecting. Made of steel (except serrated jaw and shank housing) with a 3mm shank.

Description	Item#	Each
Economy Adjustable Stone Holder	403-1015	\$39.95



B

C. ST-38 Stone Holder – 3mm Shank

Allows you to secure square, round, and rectangular stones in reciprocating handpieces, including our Power Hand 2X reciprocating handpieces, Di-Profilers and Super Hand Air Filers. Adjustable hinge lets you change the angle of the stone to fit your application. Made of durable plastic with serrated jaws and set screw for tightening stone into place. Accepts round stones up to 1/2" in diameter, rectangular stones up to 3/8"H x 1/2"W and square stones up to 3/8". 3mm steel shank. Complete with allen wrench. Color may vary.

Description	Item#	Each
ST-38 Stone Holder	403-1010	\$19.75



C

D. LT Recipro Stone Holder – 1/8" Shank

Economically priced holder for reciprocating handpieces. Made of durable plastic with black nonglare finish. Shank measures 1/8" dia. x 1/2"L (too short for use with FMH Di-Profiler; acceptable for use with FMC Di-Profiler).

Description	Item#	EACH Prices	
		1-2	3+
D. Small, for 1/8" x 1/4" stones	403-1025	\$6.25	\$5.63
Large, for 1/8" x 1/2" and 1/4" x 1/4" stones	403-1030	6.25	5.63



D

E. DiProfiling Stone Holder – 3mm Shank

Expands the use of your mini-filer or other profilers. Accommodates both flat and round stones or tools up to 1/4". Shank length 1 3/8", overall 2 5/8". Use for fine, more precise profiling jobs.

Description	Item#	Each
Universal Tool Holder	403-1050	\$57.50



E

F. Ceramic Stone Holder – 3mm Shank

Holds up to 1mm thick and up to 8mm wide stones. Shank length 3/4", overall length 1 1/4".

Description	Item#	Each
Ceramic Stone Holder	403-1045	\$34.95



F

Safety Recommendations – For Reciprocating Handpieces

Prolonged use of vibrating or reciprocating tools may result in vibration-induced circulation problems in the hands. Always follow safe operating procedures. Using hand protection (i.e., insulated gloves) and taking frequent breaks can help minimize but not guarantee against injury. Operating these types of tools in cold weather or with a tight grip will reduce the period of operation before risking potential injury. Individuals with a tendency to suffer from poor circulation, frequently cold fingers or itchy hands should closely monitor the condition of their hands. If symptoms appear, seek medical advice immediately.



Ceramic Stones *Strong yet incredibly flexible!*

New Super Stone (NSS) offers an improved cutting ability, increased heat resistance, and longer life. Made of long ceramic fibers that will not break even under the most strenuous conditions, the NSS can be used in ultrasonic polishers, reciprocating profilers, or by hand (see Ceramic Stone Holders on p. 26).

These strong yet flexible stones are ideal for polishing small intricate areas on all types of metals producing consistent and uniform surface finishes. NSS is non-loading and can be shaped with the Super Dresser #351-0300 (see p. 26). Available in 9 easy to identify color coded grits from 80 to 1200. Made in Japan.



IMPORTANT: See dust warning on page 3.

FLAT Stones

Dimensions (mm)	Violet 80 Grit	Emerald 120 Grit	Gold 180 Grit	Lt. Brown 300 Grit	Orange 400 Grit	Gray 600 Grit	Blue 800 Grit	White 1000 Grit	Red 1200 Grit	EACH Prices*	
	Item#	Item#	Item#	Item#	Item#	Item#	Item#	Item#	Item#	1-4	5+
0.5 x 1 x 100	355-0001	355-0101	355-0201	355-0401	355-0501	355-0601	355-0701	355-0801	355-0901	\$9.95	\$8.96
0.5 x 2 x 100	355-0002	355-0102	355-0202	355-0402	355-0502	355-0602	355-0702	355-0802	355-0902	13.50	12.15
0.5 x 4 x 100	355-0003	355-0103	355-0203	355-0403	355-0503	355-0603	355-0703	355-0803	355-0903	20.90	18.81
0.5 x 6 x 100	355-0004	355-0104	355-0204	355-0404	355-0504	355-0604	355-0704	355-0804	355-0904	31.45	28.31
0.5 x 10 x 100	355-0005	355-0105	355-0205	355-0405	355-0505	355-0605	355-0705	355-0805	355-0905	41.25	37.13
0.8 x 4 x 100	355-0008	355-0108	355-0208	355-0408	355-0508	355-0608	355-0708	355-0808	355-0908	20.90	18.81
0.8 x 6 x 100	355-0009	355-0109	355-0209	355-0409	355-0509	355-0609	355-0709	355-0809	355-0909	31.45	28.31
0.8 x 10 x 100	355-0010	355-0110	355-0210	355-0410	355-0510	355-0610	355-0710	355-0810	355-0910	41.25	37.13
1 x 1 x 100	355-0011	355-0111	355-0211	355-0411	355-0511	355-0611	355-0711	355-0811	355-0911	9.95	8.96
1 x 2 x 100	355-0012	355-0112	355-0212	355-0412	355-0512	355-0612	355-0712	355-0812	355-0912	12.00	10.80
1 x 4 x 100	355-0013	355-0113 ^a	355-0213 ^a	355-0413 ^a	355-0513	355-0613	355-0713 ^a	355-0813	355-0913 ^a	20.90	18.81
1 x 6 x 100	355-0014	355-0114	355-0214	355-0414 ^a	355-0514 ^a	355-0614 ^a	355-0714 ^a	355-0814 ^a	355-0914	31.45	28.31
1 x 10 x 100	355-0015	355-0115	355-0215	355-0415	355-0515	355-0615	355-0715	355-0815	355-0915	41.25	37.13
1.5 x 4 x 100	355-0018	355-0118	355-0218	355-0418	355-0518	355-0618	355-0718	355-0818	355-0918	31.25	28.13
1.5 x 6 x 100	355-0019	355-0119	355-0219	355-0419	355-0519	355-0619	355-0719	355-0819	355-0919	47.30	42.57
1.5 x 10 x 100	355-0020	355-0120	355-0220	355-0420	355-0520	355-0620	355-0720	355-0820	355-0920	62.45	56.21
2 x 4 x 100	355-0023	355-0123	355-0223	355-0423	355-0523	355-0623	355-0723	355-0823	355-0923	41.25	37.13
2 x 6 x 100	355-0024	355-0124	355-0224	355-0424	355-0524	355-0624	355-0724	355-0824	355-0924	62.90	56.61
2 x 10 x 100	355-0025	355-0125	355-0225	355-0425	355-0525	355-0625	355-0725	355-0825	355-0925	82.50	74.25

*Quantity discount for orders of one item number only; not assorted.

^aSee Stone & Holder Sets; next page

- Non-clogging—beautiful polishing results on all metals
- Available in any dimensions in flat/round profiles
- Incredible strength and flexibility
- Color coded—easy to identify
- Available in grits 80 to 1200
- Improved heat resistance
- Great cutting power
- Very long life



ROUND Stones

Dimensions (mm)	Violet 80 Grit	Emerald 120 Grit	Gold 180 Grit	Lt. Brown 300 Grit	Orange 400 Grit	Gray 600 Grit	Blue 800 Grit	White 1000 Grit	Red 1200 Grit	EACH Prices*	
	Item#	Item#	Item#	Item#	Item#	Item#	Item#	Item#	Item#	1-4	5+
2.35 x 50mm ○	355-0031	355-0131	355-0231	355-0431	355-0531	355-0631	355-0731	355-0831	355-0931	\$18.50	\$16.65
2.35 x 100mm ○	355-0032	355-0132	355-0232	355-0432	355-0532	355-0632	355-0732	355-0832	355-0932	39.00	35.10
3 x 50mm ○	355-0034	355-0134	355-0234 ^b	355-0434 ^b	355-0534	355-0634 ^b	355-0734 ^b	355-0834	355-0934 ^b	20.45	18.41
3 x 100mm ○	355-0035	355-0135	355-0235	355-0435	355-0535	355-0635	355-0735	355-0835	355-0935	39.50	35.55
3.175 x 50mm ○	355-0037	355-0137	355-0237	355-0437	355-0537	355-0637	355-0737	355-0837	355-0937	23.50	21.15
3.175 x 100mm ○	355-0038	355-0138	355-0238	355-0438	355-0538	355-0638	355-0738	355-0838	355-0938	40.00	36.00

SQUARE Stones

Dimensions (mm)	Violet 80 Grit	Emerald 120 Grit	Gold 180 Grit	Lt. Brown 300 Grit	Orange 400 Grit	Gray 600 Grit	Blue 800 Grit	White 1000 Grit	Red 1200 Grit	EACH Prices*	
	Item#	Item#	Item#	Item#	Item#	Item#	Item#	Item#	Item#	1-4	5+
0.5 x 0.5 x 50mm □	355-0041	355-0141	355-0241 ^c	355-0441	355-0541 ^c	355-0641	355-0741 ^c	355-0841	355-0941 ^c	\$7.00	\$6.30
0.9 x 0.9 x 50mm □	355-0043	355-0143	355-0243 ^d	355-0443	355-0543 ^d	355-0643	355-0743 ^d	355-0843	355-0943 ^d	7.00	6.30

PRECUT Stones – For Ultrasonic Handpieces

Dimensions (mm)	Violet 80 Grit	Emerald 120 Grit	Gold 180 Grit	Lt. Brown 300 Grit	Orange 400 Grit	Gray 600 Grit	Blue 800 Grit	White 1000 Grit	Red 1200 Grit	EACH Prices*	
	Item#	Item#	Item#	Item#	Item#	Item#	Item#	Item#	Item#	1-4	5+
0.8 x 4 x 40 ▬	355-0060	355-0160	355-0260	355-0460	355-0560	355-0660	355-0760	355-0860	355-0960	\$9.95	\$8.96
0.8 x 6 x 40 ▬	355-0061	355-0161	355-0261	355-0461	355-0561	355-0661	355-0761	355-0861	355-0961	16.65	14.99
1 x 4 x 40 ▬	355-0065	355-0165	355-0265	355-0465	355-0565	355-0665	355-0765	355-0865	355-0965	9.95	8.96
1 x 6 x 40 ▬	355-0066	355-0166	355-0266	355-0466	355-0566	355-0666	355-0766	355-0866	355-0966	16.10	14.49

*Quantity discount for orders of one item number only; not assorted. | ^{b-d}See Stone & Holder Sets below

STONE & HOLDER Sets

Set	Contents	Item #	Each
a. Flat set, 100mm	10 stones + 2 holders: 1 x 4 x 100 (120, 180, 300, 800, 1200 grit) 1 x 6 x 100 (300, 400, 600, 800, 1000 grit)	355-1100	\$199.00
b. Round set	5 stones + holder: 3 x 50mm (180, 300, 600, 800, 1200 grit)	355-1103	89.00
c. Square set, .5mm	4 stones + holder: 0.5 x 0.5 x 50mm (180, 400, 800, 1200 grit)	355-1105	37.00
d. Square set, .9mm	4 stones + holder: 0.9 x 0.9 x 50mm (180, 400, 800, 1200 grit)	355-1109	37.00
e. Square set, 40mm	9 stones: 1 x 4 x 40mm (all 9 grits) or (80, 120, 180, 300, 400, 600, 800, 1000, 1200 grit)	355-0099	79.95

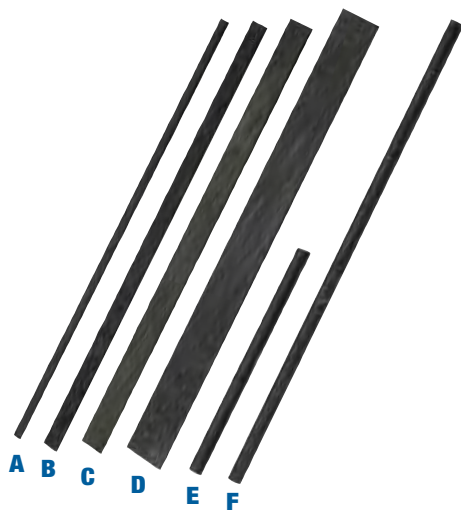

Black (200 Grit) shown

A-F SUPER Ceramic Diamond Stones

SUPER Ceramic Diamond (SCD) Stones combine ceramic fibers with multiple layers of evenly distributed diamond particles to ensure continuous cutting action. They're perfect for finishing hardened steel and carbide tools. SCD Stones don't load like plated diamond files, are more efficient than diamond compounds, and are easily shaped. SCD Stones will cut and polish flat to a surface, allowing fast and accurate polishing in open areas. SCD Stones are perfect for polishing ribs, hard-to-reach slots and sidewalls, and milled or EDM flat surfaces. Their strong, durable ceramic fiber construction makes them ideal for use in ultrasonic polishers and mechanical profilers or by hand. Available in flat and round shapes in four color-coded grits.

Shape	Size (mm)	Black	Gray	Green	Aqua	EACH Prices*	
		200 Grit Item#	400 Grit Item#	600 Grit Item#	800 Grit Item#	1-4	5+
A. Flat	1 x 2 x 100	351-0797	351-0798	351-0799	351-0815	\$16.50	\$14.85
B.	1 x 4 x 100	351-0800	351-0801	351-0802	351-0816	28.00	25.20
C.	1 x 6 x 100	351-0803	351-0804	351-0805	351-0817	42.00	37.80
D.	1 x 10 x 100	351-0806	351-0807	351-0808	351-0818	56.00	50.40
E. Round	3 x 50	351-0809	351-0810	351-0811	351-0819	40.00	36.00
F.	3 x 100	351-0812	351-0813	351-0814	351-0820	85.00	76.50

*Quantity discount for orders of one item number only; not assorted.



G-M Ceramic Stone Holders – For offhand work

For handheld work with ceramic stones. Available in 1, 2, 4, 6 and 10mm flat sizes, 3mm round or 0.5mm and 0.9mm square sizes. Measures approximately 5 3/4" long.

Description	Item#	Each
Flat Holder, 1mm	351-0291	\$7.90
G. Flat Holder, 2mm	351-0292	7.90
H. Flat Holder, 4mm	351-0270	7.90
I. Flat Holder, 6mm	351-0271	7.90
J. Flat Holder, 10mm	351-0272	7.90
K. Round Holder, 3mm	403-0011	12.75
L. Square Holder, 0.5mm	351-0345	12.75
M. Square Holder, 0.9mm	351-0350	12.75

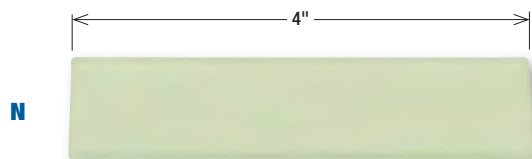

N. SUPER Dresser

Used to dress NSS and SUPER Ceramic Diamond Stones, as well as Cristone stones. Measures 1/8" x 1" x 4" (3 x 25 x 100mm).

Description	Item#	Each
SUPER Dresser	351-0300	\$17.75

CRISTONE Ceramic Stones

IMPORTANT: See dust warning on page 3.

Cristone ceramic stones are made with a unique crystal fiber and work best for fine polishing. The crystal fibers are round in shape and uniform in direction, thus allowing for an even and uniform surface finish free from deep scratches. Performs great on hardened and heat treated metals due to

its strong fiber and resin bond. Use by hand or with any Ultramax Ultrasonic Polisher for powered finishing. Has 180 Celsius heatproof temperature. Dress with Super Dresser (see p. 26).



Flat Shapes all 6 Grits



Round Shapes
150 Grit shown



Matrix Ceramic End Bristle Brush - 3mm
All Grit Shown

Shape	Size (mm)	Lt. Green 150 Grit Item#	Lt. Red 200 Grit Item#	Lt. Purple 400 Grit Item#	Lt. Orange 600 Grit Item#	Lt. Blue 800 Grit Item#	White 1000 Grit Item#	Each
Flat	1 x 2 x 100	355-1301	355-1302	355-1303	355-1304	355-1305	355-1306	\$11.00
	1 x 4 x 100	355-1311	355-1312	355-1313	355-1314	355-1315	355-1316	18.00
	1 x 6 x 100	355-1321	355-1322	355-1323	355-1324	355-1325	355-1326	28.00
	1 x 10 x 100	355-1331	355-1332	355-1333	355-1334	355-1335	355-1336	36.00
Round	2.35 x 50	355-1341	355-1342	355-1343	355-1344	355-1345	355-1346	18.50
	2.35 x 100	355-1351	355-1352	355-1353	355-1354	355-1355	355-1356	36.00
	3 x 50	355-1361	355-1362	355-1363	355-1364	355-1365	355-1366	18.50
	3 x 100	355-1371	355-1372	355-1373	355-1374	355-1375	355-1376	36.00

Cristone Matrix Ceramic End Bristle Brushes

These brushes are a versatile tool for many finishing applications including: surface polishing, deburring, removing tool marks and EDM scale. The ceramic fiber bristles produce a uniform finish and are color coded for easy grit identification from 150 up to 1000 grit. Easily dress shapes and angles into the brushes by using a diamond abrasive file. For example, you can dress a 45 degree angle to match the form of your working surface. Can be used wet or dry. Use in a micromotor handpiece or in a CNC machine. 18,000 Max RPM. 3mm shank. Length: 1¹⁵/₁₆" Width: 3/₁₆" (50mm x 5mm). Made in Japan.

Matrix Ceramic End Bristle Brush - 3mm	Size (mm)	Green 150 Grit Item#	Red 200 Grit Item#	Purple 400 Grit Item#	Orange 600 Grit Item#	Blue 800 Grit Item#	White 1000 Grit Item#	Each
	50 x 5	355-1510	355-1512	355-1514	355-1516	355-1518	355-1520	29.95

See the Multi-Function ULTRAMAX MF on page 463. Our most versatile polishing system!



DEGUSSIT® Ruby® Stones & Files For Use on Hardened Steel & Carbide

Gesswein Ruby Stones and Files are made from pure, sintered crystals of synthetic ruby. No bonding material is used, so these stones and files are extremely hard and resistant to changes in shape. This is particularly important for quality precision grinding and finishing. In addition, since Gesswein Ruby Stones and Files feature outstanding resistance to wear,

they are more economical to use than other comparable tools. Use dry or with Gesswein Stoning Oil to grind, touch up or debur steel and carbide parts. Also recommended for use on materials such as glass, quartz and porcelain. Made in Germany.

IMPORTANT: See dust warning on page 3.

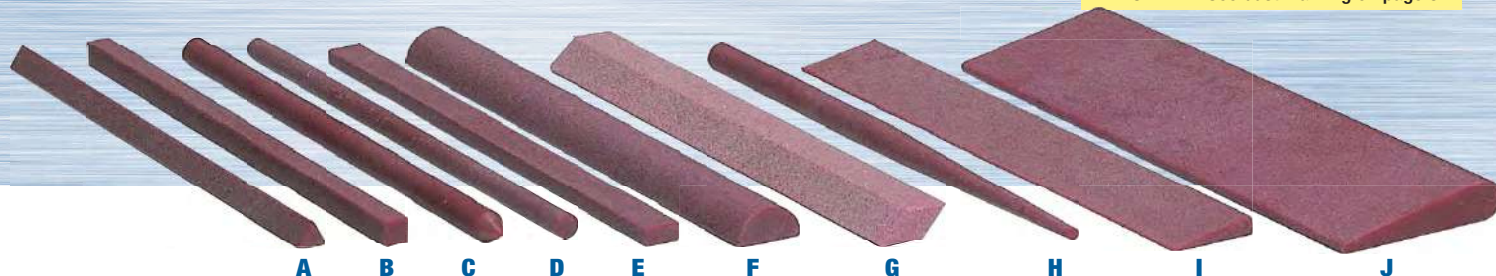

A-J DEGUSSIT® Ruby® Stones

For general purpose work. Available in coarse, medium and fine grits.

Shape	L x W x H* (mm)	Coarse		Medium		Fine	
		Item#	Each	Item#	Each	Item#	Each
A. Triangular	100 x 4	–	–	350-2002	\$61.65	350-2003	\$65.35
	100 x 6	350-2011	\$70.45	350-2012	70.45	350-2013	82.95
	100 x 8	350-2021	82.95	350-2022	93.45	350-2023	107.75
	100 x 10	–	–	350-2032	94.10	350-2033	122.60
B. Square	100 x 4	–	–	350-2102	76.65	350-2103	84.15
	100 x 6	350-2111	66.45	350-2112	72.80	350-2113	89.00
	100 x 8	350-2121	81.90	350-2122	93.70	350-2123	94.10
	100 x 10	350-2131	94.10	350-2132	105.55	350-2133	108.40
	120 x 13	–	–	350-2142	123.90	350-2143	135.55
C. Round, Pointed	100 x 5	–	–	–	–	350-2613	43.65
D. Round	100 x 4	–	–	350-2702	72.20	350-2703	72.20
	100 x 6	350-2711	73.45	350-2712	73.50	350-2713	79.80
	100 x 8	350-2721	86.10	350-2722	87.15	350-2723	89.15
	100 x 10	350-2731	88.20	350-2732	93.45	350-2733	99.00
E. Flat	100 x 6 x 3	–	–	350-2202	57.70	350-2203	58.80
	100 x 8 x 6	350-2211	72.90	350-2212	72.90	350-2213	83.10
	100 x 10	350-2311	75.60	350-2312	88.45	–	–
F. Half-Round	100 x 10	350-2311	75.60	350-2312	88.45	–	–
G. Rhomboid	100 x 13 x 5	350-2401	95.55	–	–	–	–
H. Round, One Tapered End	100 x 5 x 2	350-2551	65.10	–	–	350-2553	65.10
I. Knife Edge	100 x 15 x 3/0.5	–	–	350-2912	136.75	350-2913	139.65
J. Tapered, Rounded Edge	100 x 30 x 7/2	–	–	350-1052	183.75	–	–

*All dimensions have tolerance of ±0.1mm.

K. DEGUSSIT® Ruby® Stone Set #700

This handy set contains one each of the Ruby Stones indicated. Save over \$115.00 off the combined price of buying the stones individually.

Shape	L x W x H* (mm)	Grit
Round	100 x 6	Medium
Triangular	100 x 10	Medium
Flat	100 x 8 x 6	Fine
Half-Round	100 x 10	Coarse
Square	100 x 10	Medium
Description	Item#	Each
K. Ruby Stone Set #700	350-3000	\$305.55

*All dimensions have tolerance of ±0.1mm.



A-K DEGUSSIT® Ruby® Midget Files

Ruby Midget Files are invaluable for high detail and ultra-precision work. They may be broken off and cemented onto a holder or used with a pin vise. Available in fine grit. Made in Germany.

Shape	L x W x H* (mm)	Item#	EACH Prices	
			1-19	20+
A. Square	■ 50 x 1	350-4000	\$8.25	\$6.87
B. Round	● 50 x 1	350-4010	8.65	7.21
C. Triangular	▲ 50 x 2	350-4020	10.45	8.71
D. Flat	— 50 x 3 x 0.3	350-4060	10.35	8.62
EACH Prices				
			1-9	10+
E. Square	■ 100 x 2	350-4030	\$20.50	\$17.08
F. Round	● 100 x 2	350-4040	20.50	17.08
G. Round	● 100 x 3	350-4050	20.50	17.08
H. Half-Round	◐ 100 x 4 x 2	350-4070	31.00	25.83
I. Barrette	▲ 100 x 5 x 1.5	350-4090	33.55	27.96
J. Crossing	◊ 100 x 4 x 1.5	350-4110	31.00	25.83
K. Triangular	▲ 100 x 3	350-4130	31.00	25.83

*All dimensions have tolerance of ±0.1mm

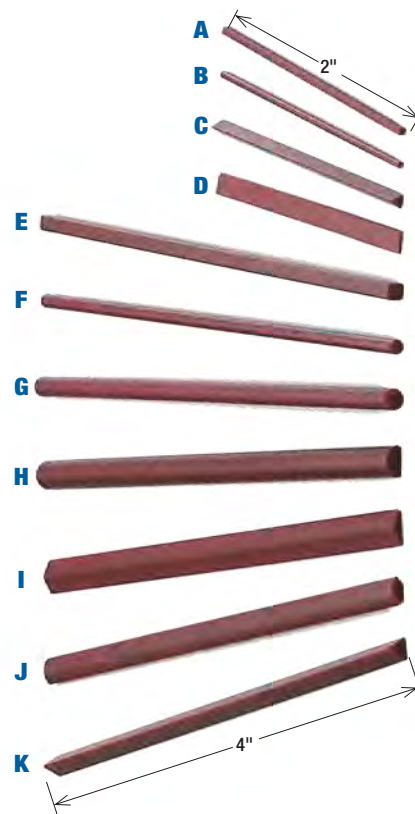

A-L DEGUSSIT® Ruby® Midget File Set #420

This money-saving kit contains all 11 of our Ruby Midget Files (see above) plus one double-ended holder with two collets. (Holder is available only with this kit and not separately.) Screw machine operators will find this set particularly helpful for dressing cutters without removing them from the machine. Made in Germany.

Description	Item#	Each
A-L Ruby Set #420	350-4200	\$183.75



M-P DEGUSSIT® Ruby® Bench Stones

Ideal for sharpening and for flattening steel and carbide parts as well as sharpening tools and gravers—even carbide. The pure sintered crystals of synthetic ruby have an outstanding resistance to wear, which makes them more economical than other stones. They will not groove, even after years of use. May be used dry or with Gesswein Stoning Oil (see p. 21). Two sizes of stones indicated with an asterisk are finished on both sides. The others are finished on one side only and come neatly mounted in wooden boxes.

Dimensions (inches)	Medium		Fine	
	Item#	Each	Item#	Each
M. 4 x 1 x 3/8*	350-1002	\$113.95	350-1003	\$132.30
N. 6 x 1 x 5/8*	350-1012	183.75	350-1013	183.75
O. 4 x 1 x 3/8**	350-1102	108.15	350-1103	130.20
P. 4 3/4 x 2 x 3/8**	350-1112	278.25	350-1113	278.25

*Finished on both sides

**Finished on one side & mounted in wooden box

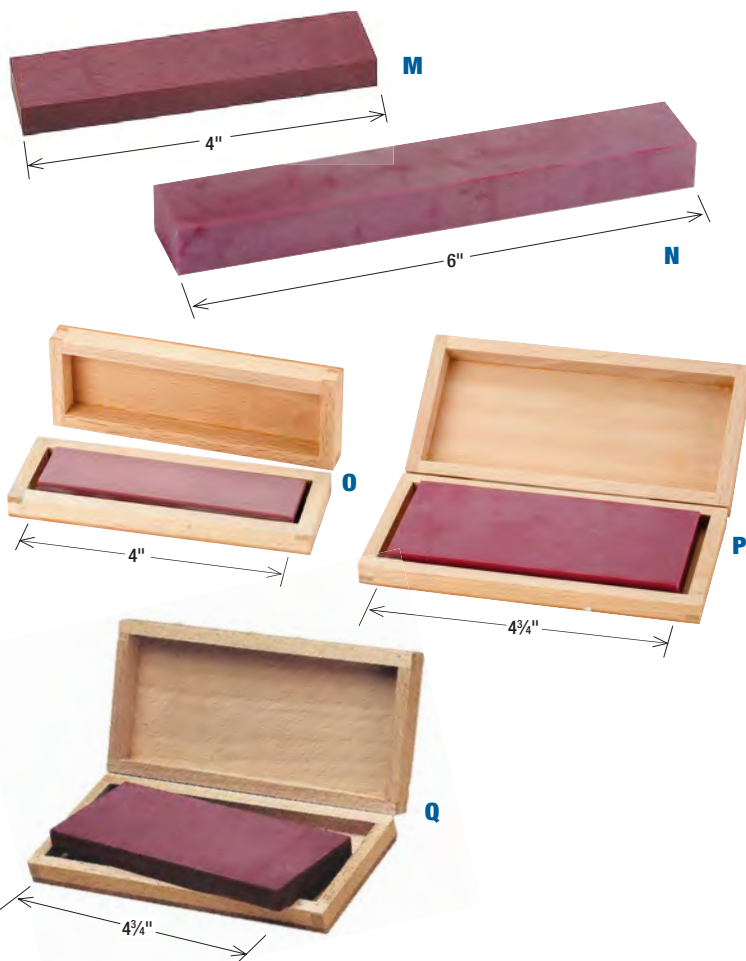

Q. DEGUSSIT® Ruby® Combination Bench Stone

Finished on two sides and neatly packaged in a wooden box. One side of the stone is medium to cut fast while shaping tools and the other is fine which will impart a brilliant finish. Ideal for sharpening knives and gravers made of high speed steel or carbide. Measures 4 3/4" L x 2" W x 3/8" H. Made in Germany.

Description	Item#	Each
Ruby Combination Bench Stone	350-1114	\$357.00

NORTON Arkansas Stones

Natural Arkansas Stones have gained a reputation over the years as the finest all-purpose stones for deburring and polishing operations as well as for sharpening precision tools. Hard Arkansas Stones are dense and fine-grained for final honing where the sharpest precision edges

possible are needed. Soft Arkansas, with its less dense and more open structure, is ideal for imparting a fine, smooth surface. Arkansas Stones are not oil-filled and should be used with Gesswein Stoning Oil (see p. 21). Made in USA.

IMPORTANT: See dust warning on page 3.

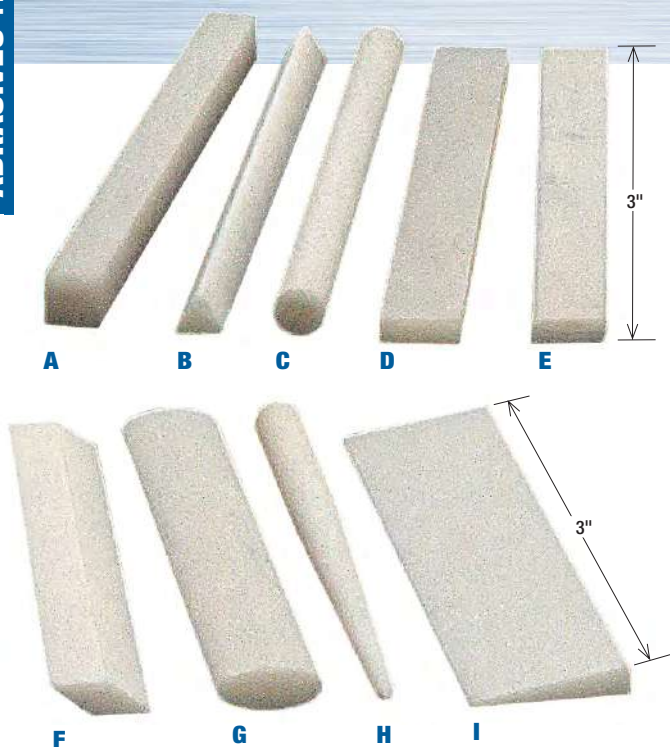

A-I Norton® Hard Arkansas Files – Ultra-Fine Grit

Dense, translucent stones in various shades of gray. All have precision edges.

Shape	Dimensions	Style	Item#	EACH Prices	
				1-9	10+
A. Square	3" x 1/4"	HF13	370-0130	\$24.50	\$16.42
	3" x 3/8"	HF33	370-0330	23.90	16.01
	3" x 1/2"	HF43	370-0430	32.90	22.04
B. Triangular	3" x 1/4"	HF113	370-1130	24.55	16.45
	3" x 3/8"	HF133	370-1330	24.90	16.68
	3" x 1/2"	HF143	370-1430	31.70	21.24
C. Round	3" x 1/4"	HF813	370-8130	33.95	22.75
D. Flat	3" x 3/8" x 1/8"	HF823	370-8230	36.10	24.19
E. Bevel	3" x 3/8" x 1/8"	HF833	370-8330	25.90	17.35
F. Diamond	3" x 1/2" x 3/16"	HF843	370-8430	46.90	31.42
G. Oval	3" x 1/2" x 3/16"	HF853	370-8530	36.65	24.56
H. Point	3" x 1/4" base	HF863	370-8630	45.15	30.25
I. Knife Blade	3" x 3/4" x 1/8"	HF873	370-8730	38.30	25.66

J. Norton® Soft Arkansas Engraver's Point AT11 Extra-Fine Grit

Small size for stoning and cleaning in recesses, corners and other tight areas. Used in Engraver's Chuck XT-1.

Shape	Dimensions	Style	Item#	EACH Prices	
				1-19	20+
Point	1" x 1/8" dia.	AT11	372-5110	\$9.85	\$6.60

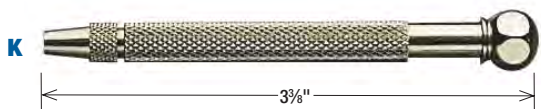
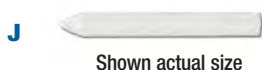

K. Engraver's Chuck XT-1

For holding either India or Arkansas Engraver's Points. Made of knurled, nickel-plated steel. Rounded end fits comfortably in palm of hand. Measures 3 3/8" overall length.

Dimensions	Style	Item#	EACH Prices	
			1-9	10+
3 3/8" x 1/4" dia.	XT-1	372-6000	\$32.95	\$22.08

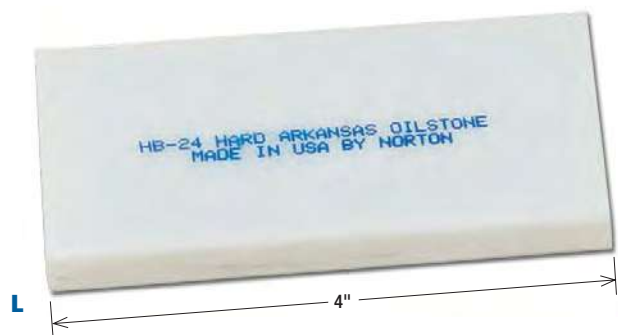

L. Norton® Hard Arkansas Bench Stones – Ultra-Fine Grit

Extremely hard and fine unmounted stones for the final finish on gravers and cutting tools. Can be used on both sides.

Dimensions	Style	Item#	EACH Prices	
			1-4	5+
4" x 2" x 3/8"	HB24	371-1045	\$101.60	\$68.07
4" x 2" x 3/4"	HB4	371-1040	180.00	120.60



M. Norton® Arkansas Penknife Stones

Can be used on both sides. Hard are ultra-fine grit, soft is extra-fine grit.

Type	Dimensions	Style	Item#	EACH Prices	
				1-9	10+
M. Hard	3" x 1" x 3/8"	HB13	371-1130	\$41.70	\$27.94
Hard	4" x 1" x 3/8"	HB14	371-1140	45.05	30.18
Soft	4" x 1" x 3/8"	SB14	371-4140	14.10	9.45

A. Quad-Hone Stone

Four different stones mounted on a rectangular block for a wide range of sharpening chores from rough shaping to producing a sharp final edge. Quad-Hone includes one each of coarse, medium, fine and ultra-fine Arkansas stones. Each stone measures approximately 6"L x 1"W x 1/4"H. Use with Gesswein Stoning Oil (see p. 21). Made in USA.

Description	Item#	Each
Quad-Hone Stone	380-1102	\$39.50

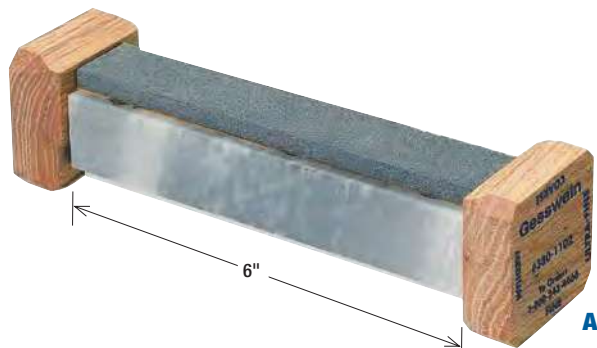

B-E Hard Black Arkansas Files – Fine Grit

For the machinist, woodworker or gunsmith who requires a smooth polished edge. These dense black stones are more aggressive than other Hard Arkansas Stones. The various shapes and sizes are ideal for deburring and polishing intricate tools and metal parts. All approximately 3" in length. Made in USA.

	Shape	Size	Item#	EACH Prices	
				1-9	10+
B. Square	■	1/4"	375-0131	\$13.50	\$12.15
		3/8"	375-0331	14.90	13.41
		1/2"	375-0431	19.00	17.10
C. Triangular	▲	1/4"	375-1131	14.20	12.78
		3/8"	375-1331	14.50	13.05
		1/2"	375-1431	19.20	17.28
D. Round	●	1/4"	375-8131	17.25	15.53
E. Knife Edge	▶	3/4" x 1/8" (tapers to a knife edge)	375-8731	21.85	19.67

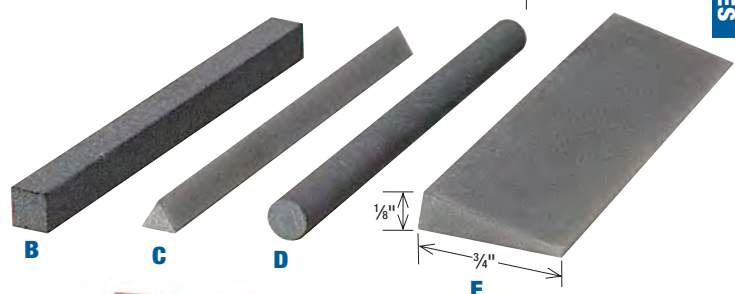

F. Hard Black Arkansas Bench Stone – Fine Grit

For precision sharpening or for finishing a very sharp edge. Measures 6"L x 2"W x 1/2"H. Packaged in an attractive cedar box. Made in USA.

Description	Item#	Each
Fine Grit	374-2000	\$65.00



G. Soft Arkansas Bench Stone – Medium Grit

A natural medium-grit bench stone. Recommended for relatively fast cutting. Excellent for shaping gravers, knives and precision tools prior to final finish with our Ruby or Hard Arkansas Stones. Use with Stoning Oil (see p. 21). Packaged in an attractive cedar box. Measures 6"L x 2"W x 1"H. Made in USA.

Description	Item#	Each
Medium Grit	374-1000	\$27.00



H, I Hard Arkansas Stones – Very Fine Grit

Genuine Hard Arkansas Stones, white to light gray. Each is glued into a hardwood storage box. Top surface of stone is finished and usable.

Dimensions	Item#	Each
H. 100 x 40mm (4" x 1 5/8")	374-0900	\$42.95
I. 150 x 50mm (6" x 2")	374-0910	109.00



NORTON India® Stones

These sharpening stones are made of synthetic aluminum oxide abrasive graded to a consistent particle size, blended with select bonding agents, molded to shape and finished to exacting surface configurations. Preferred for imparting durable, smooth cutting edges and finishing to close tolerances.

Orange-brown in color. Prefilled with oil to make cutting easier and more effective, retard loading

and eliminate the need for presoaking prior to first use. Note: Although prefilling minimizes the amount of oil needed, it does not eliminate the need for oil on the stone surface.

Apply Gesswein Stoning and Lubricating Oil (see p. 21) on the stone's sharpening surface prior to each use. This will prevent the pores of the stone from filling with material removed from the object being stoned.

India Stones are available in coarse, medium and fine grits. Use coarse grit for restoring badly worn cutting edges and for all sharpening not requiring a keen edge; use medium grit for producing an average edge on a broad range of tools, such as carving tools, milling cutters, lathe tools and die chasers; and use fine grit for producing sharper-than-average edges on gouges, reamers, taps and twist drills. Made in Mexico.

IMPORTANT: See dust warning on page 3.

A. India® Abrasive Files

Hold their shape while producing a fine, uniform finish. Use to debur, chamfer, radius and fit delicate parts. Choose from square, triangular, round and half-round to match different surface contours. Triangular files are excellent for reaching tight corners without disturbing other surfaces. All stones measure 4" (except style 76 which measures 6").



Shape	Style	Size	Coarse (100 grit) Item#	Medium (240 grit) Item#	Fine (320 grit) Item#	EACH Prices	
						1-19	20+
Square	14	1/4" x 4"	360-0141	360-0142	360-0143	\$5.14	\$3.44
	34	3/8" x 4"	360-0341	360-0342	360-0343	6.50	4.36
	44	1/2" x 4"	360-0441	360-0442	360-0443	6.50	4.36
	76	1" x 6"	360-0761	360-0762	360-0763	15.85	10.62
Triangular	114	1/4" x 4"	360-1141	360-1142	360-1143	7.15	4.79
	134	3/8" x 4"	360-1341	360-1342	360-1343	7.50	5.03
	144	1/2" x 4"	360-1441	360-1442	360-1443	7.50	5.03
Round	214	1/4" x 4"	360-2141	360-2142	360-2143	13.65	9.15
	234	3/8" x 4"	360-2341	360-2342	360-2343	14.35	9.61
	244	1/2" x 4"	360-2441	360-2442	360-2443	15.70	10.52
Half-Round	314	1/4" x 4"	-	360-3142	360-3143	11.65	7.81
	334	3/8" x 4"	-	360-3342	360-3343	13.30	8.91
	344	1/2" x 4"	360-3441	360-3442	360-3443	13.75	9.21

(Stones are made to an approximate ±1/8" length tolerance.)

B. Medium India® Pencil Stone

Style	Grit	Size	Item#	EACH Prices		
				12-60	72-132	144+
10	240	4" x 5/32" x 5/32"	415-0100	\$2.00	\$1.80	\$1.61

Twelve-piece minimum; please order in multiples of twelve.

C. Pencil Stone Holder

Push-button holder for easy loading. Holds 5/32" square stones. Measures 5 1/4" long. Made in Italy.

Description	Item#	EACH Prices		
		1-2	3-11	12+
C. Stone Holder	403-0050	\$9.95	\$9.35	\$8.46
Replacement Collet	403-0085	3.25	-	-

D. Norton® India® Engraver's Point

For stoning and cleaning tight corners and recesses of dies where close tolerances and accuracy are important. Measures 1" L x 1/8" dia. and tapers to a point. Fine (320 grit). Use in Engraver's Chuck XT-1 (below).

Dimensions	Style	Item#	EACH Prices	
			1-49	50+
1" x 1/8" dia.	FT-11	362-5113	\$8.90	\$6.23

E. Engraver's Chuck XT-1

For holding either India or Arkansas Engraver's Points. Made of knurled, nickel-plated steel. Rounded end fits comfortably in palm of hand. Measures 3 3/8" overall length.

Dimensions	Style	Item#	EACH Prices	
			1-9	10+
3 3/8" x 1/4" dia.	XT-1	372-6000	\$32.95	\$22.08

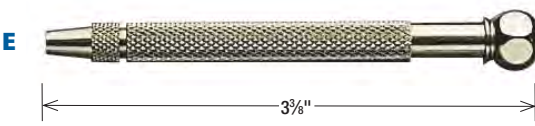

A-G Norton® India® Silversmith Stones

A variety of precision-shaped tapered stones used by silversmiths and mechanics for touching up instruments, lapping for close tolerances and cleaning tools and dies. Use round-edged stones to speed up the sharpening of curved tool steels and carbide tools. Use sharp-angled stones to get into hard-to-reach corners. Available only in aluminum oxide in coarse, medium and fine grits.

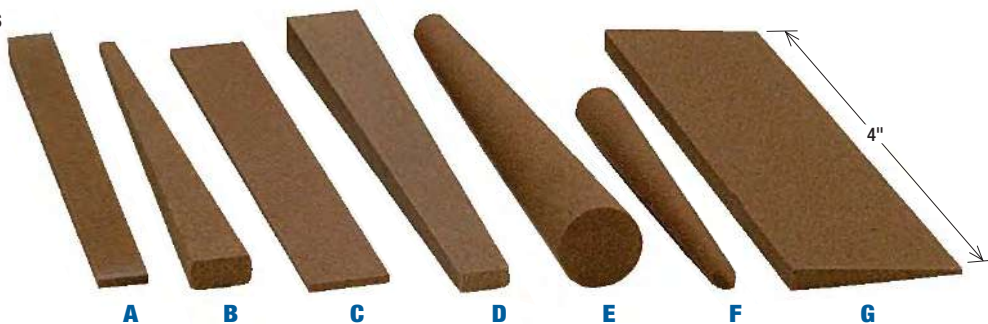

Style	L x W x H	Tapered to W x H	Coarse (100 grit)			Medium (240 grit)			Fine (320 grit)		
			Item#	EACH Prices		Item#	EACH Prices		Item#	EACH Prices	
				1-19	20+*		1-19	20+*		1-19	20+*
A. F-414	4" x 5/16" x 3/16"	5/16" x 1/16"	—			360-4142			360-4143	\$19.95	\$13.37
B. F-424	4" x 3/8" x 3/16"	1/8" x 1/16"	—			360-4242			—	18.95	12.70
C. F-444	4" x 1/2" x 1/16"	—	360-4441			360-4442			360-4443	18.95	12.70
D. F-474	4v x 1/2" x 1/4"	5/16" x 1/8"	—			360-4742			—	18.95	12.70
E. F-644	4" x 1/2" x 1/4"	—	—			360-6442			360-6443	18.95	12.70
F. F-723	3" x 5/16" base	—	360-7231			360-7232			360-7233	21.10	14.14
G. F-724	4" x 1" x 1/8" base	—	360-7241			360-7242			360-7243	15.25	10.22

*Quantity discount for orders of one item number only; not assorted.

H-J Norton® India® Reamer Stones

Durable fast-cutting stones designed for imparting a professional edge on reamers, taps and rough rounders on shoe machine tools. Available in aluminum oxide in medium and fine grits.

Style	L x W x H	Medium Grit		EACH Prices		Fine Grit		EACH Prices	
		Item#	1-19	20+	Item#	1-19	20+		
H. T124	4 1/2" x 1" x 5/16"	360-1242	\$14.45	\$9.68	—	—	—	—	
I. T125	5" x 1" x 3/16"	360-1252	14.35	9.61	360-1253	\$14.35	\$9.61	—	
J. T126	6" x 1" x 1/4"	360-1262	19.40	13.00	—	—	—	—	

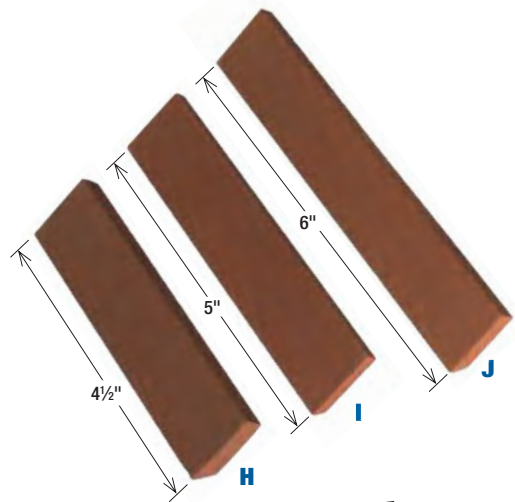

K. Norton® India® Bench Stones

Manufactured with the same aluminum oxide as our other India stones, Bench Stones are most popular for producing a strong, keen, long-lasting edge on high-quality tools. The frequent choice of artisans, craftsmen and mechanics. Use India Bench Stones to quickly restore the cutting edge on all straight edge tools, including chisels, plane blades, wood lathe cutters, draw knives, spoke shaves, precision tools and delicate instruments. Prefilled with oil to make cutting easier and more effective, eliminating the need to presoak prior to first use. Oil still should be supplied to the surface before each use.

Grit	L x W x H	Style	Item#	EACH Prices*	
				1-9	10+
Coarse	4" x 1" x 1/4"	14	361-0141	\$10.20	\$6.83
	4" x 1" x 1/2"	24	361-0241	14.35	9.61
	6" x 2" x 1"	6	361-0061	31.65	21.21
	8" x 2" x 1"	8	361-0081	37.85	25.36
Medium	4" x 1" x 1/4"	14	361-0142	9.60	6.43
	4" x 1" x 1/2"	24	361-0242	13.50	9.05
	6" x 2" x 1"	6	361-0062	31.65	21.21
	8" x 2" x 1"	8	361-0082	37.85	25.36
Fine	4" x 1" x 1/4"	14	361-0143	9.60	6.43
	4" x 1" x 1/2"	24	361-0243	13.50	9.05
	6" x 2" x 1"	6	361-0063	31.65	21.21
	8" x 2" x 1"	8	361-0083	37.85	25.36

*Please ask for quotes on larger quantities.

L. Norton® India® Combination Bench Stones

Fast cutting, man-made stones of tough aluminum oxide abrasive. Each Combination India Bench Stone has fine and coarse grit surfaces (one grit to each side), providing complete, economical sharpening.

Style	L x W x H	Item#	EACH Prices	
			1-9	10+
IB-134	4" x 1 3/4" x 5/8"	361-1344	\$21.10	\$14.14
IB-6	6" x 2" x 1"	361-0064	31.60	21.17
IB-8	8" x 2" x 1"	361-0084	39.90	26.73

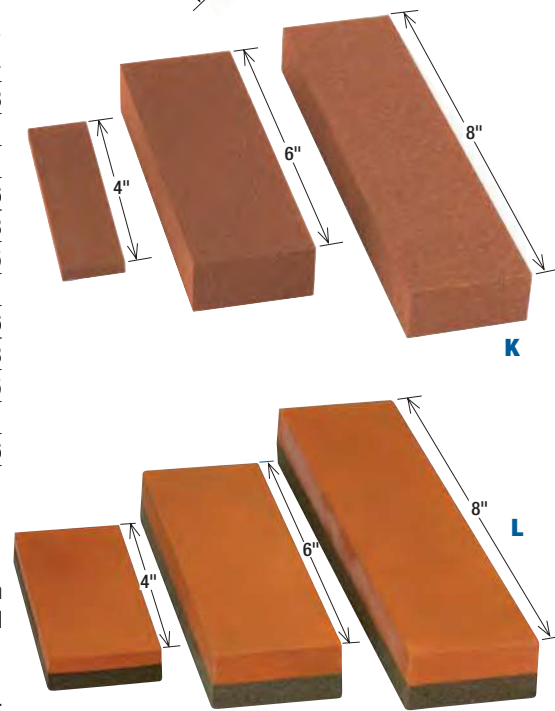



A

A. Mold Repair Kit

Can be carried directly to the mold for instant repair in the press. Helps you quickly put your molds back into production. Available in a money saving set with either the Dremel #3000 (850-8027 page 454) or the Marathon PH 2X (510-2946 page 433)

Includes:

- EDM & Diemaker All Grit Stone Set
- Moldmaker, RA, EDM & Ultra Soft Stones
- Supreme Green Stoning Oil
- End Brushes
- Blue and Red Mounted Stones
- Finishing Stone Holders
- Carbide burs
- G-Flex and GMX Abrasives
- Abrasive Belt Stick
- Lapping Sticks
- Felt Bobs, Sticks and Hand Buff
- 3 grades of Diamond Compounds
- Simichrome Polish

Description	Item#	Each
A. Mold Repair Kit only	382-1000	\$195.00
Mold Repair Kit w/Dremel #3000	382-1010	275.00
Mold Repair Kit w/Marathon PH 2X	382-1001	395.00



B

B. Aluminum Polishing Kit

This kit contains our best abrasives for getting the job done. Use the Moldmaker Plus and Ultra-soft stones for removing tooling marks. Champagne and 3M Wetordry paper for fine finishing. Also contains selection of GMX mounted points for aluminum deburring applications. If you need to diamond polish aluminum, try our Diamond Polishing Kit (# 216-0001).

Includes:

- GMX Mounted Points
- Ceramic stones
- Moldmaker Plus All Grit Set
- Ultrasoft All Grit Stone Set
- Supreme Green Stoning Oil
- 3M™ Wetordry Polishing Paper
- Norton Champagne A275 Paper
- Ceramic stone Holder
- LT Stone Holder
- Screw-Lock Stone Holder

Description	Item#	Each
B. Aluminum Polishing Kit	405-0001	\$199.00



C

C. Pocket-Size S.P.I.® Mold Finish Gauge

Take this handy guide anywhere. Flash chrome protectant ensures metal specimen surfaces will retain their exact finishes for years. Easy-to-read cross-reference table of S.P.I. and R.A. finishes makes for quick and accurate comparisons. Measures 5 7/8" L x 3 1/2" W.

Description	Item#	Each
Pocket-Size S.P.I. Mold Finish Gauge	811-0225	\$189.95



D

D. Diamond Polishing Kit – Everything you need for Diamond Polishing

Whether you carry it to the mold or have it under your workstation, our Diamond Polishing Kit has all the products you need, right at your fingertips! A convenient time saver and a money saver as well! Available alone or in a money saving kit with Marathon System (See 510-2946 on page 433).

Includes:

- Diamond Compounds
- Lube Thinner
- Felt Bobs & Felt Sticks
- Poli-Felts
- Wood Sticks
- End Brushes
- Cup Brushes
- Wheel Brushes

Description	Item#	Each
Diamond Polishing Kit	216-0001	\$249.00
Diamond Polishing Kit with Marathon	216-0002	449.00

IMPORTANT: See dust warning on page 3.

A. Rub-and-Rinse Stone Cleaner

Gesswein Rub-and-Rinse Stone Cleaner is a semiliquid material that sheds tiny metal particles from hard stones to keep them at their peak efficiency. Recommended for use on hard stones such as our Ruby, India and Hard Arkansas Stones. Contains 1/2" fl. oz.

Description	Item#	Each
Rub-and-Rinse Stone Cleaner	813-1700	\$9.80



B, C Gesswein® Supreme Green Stoning & Lubricating Oil

This stoning oil was developed for mold and die polishing. It is economical, practically odorless, and it's ecologically safer to use than alternative stoning oils. Use with finishing stones to prevent loading and keep the work surface clean. Lets stones cut better and more freely so they produce a bright, smooth surface. Eliminates the need for hazardous kerosene and other lubricating agents, which could be harmful to your health. Can also use with diamond tools where lubrication is suggested. Viscosity: 39.5/44.

Description	Item#	Each
B. 1 Pint (wide-mouth glass container)	800-0152	\$13.75
C. 1 Gallon	800-0151	44.95



D. Norton® India Stone Oil

Specifically formulated for use with sharpening stones. Will not load or gum up. Meets U.S. pharmaceutical standards for mineral oil purity and can be used around food preparation operations.

Description	Item#	Each
4.5 oz.	800-0121	\$7.00



E. Dispenser Bottle with Pump

Plastic bottle holds flux, solvents or other liquids. Special stainless steel lid allows pumping of solution into shallow well on top of bottle. One-way valve keeps solution in well, prevents contamination and eliminates odors. Ideal for dispensing solutions that would otherwise evaporate. 4 oz. capacity.

Description	Item#	Each
Dispenser Bottle with Pump	830-4525	\$26.45

F, G Syringe Dispensers

Plastic syringes with 18-gauge stainless steel needles for pinpoint delivery of stoning oil to the exact place you want. Plunger works smoothly and slides evenly to prevent accidental flooding and sputtering. Constructed of polyethylene and polypropylene. Available in two sizes: 5 and 10cc. Each includes tip sheath and cover. Sold in packages of six.

Description	Item#	PKG. of 6	
		1-3	4+
F. 5cc Syringe	811-2450	\$18.95	\$15.16
G. 10cc Syringe	811-2451	23.50	18.80



H. Pinpoint Dispenser

This handy plastic squeeze dispenser has a needle-point applicator for precise application of flux. No more mess—eliminates dried up flux brushes and dripping flux. An excellent applicator for applying flux to small areas where a flux brush will usually cause a mess; ideal for soldering earring posts, building up prongs, sizing rings and making many similar small repairs. 2 oz. capacity.

Description	Item#	Each
H. Pinpoint Dispenser	830-4520	\$4.79
Pinpoint Dispenser w/16 oz. Anti-Oxidizing Flux (see p. 501)	830-4515	20.00



I. Plastic Spray-Pump Bottle

Use to dispense stoning oil, cleaning solution and more. Spray gets into hard-to-reach areas. Capacity: 4 fl. oz.

Description	Item#	EACH Prices	
		1-2	3+
Plastic Spray-Pump Bottle	811-2460	\$2.15	\$1.94

Gesswein® Mounted Stones & Points

We have assembled an assortment of vitrified bonded mounted abrasives for most metal working applications. From general purpose grinding to specialty deburring, for fast cutting to smooth finishing—there is a stone for most every need. All are manufactured in the USA (except for the German Busch Pink Points, see p. 51) and only the finest materials and workmanship are employed. **See warnings on p. 50.**

Color	Page	Hardness	Grit	Bond	Abrasive	Recommended Metals	Benefit
Blue	44-47, 50	Hard	120	Porcelain	Semi-Friable Aluminum Oxide	Hardened Steels	Holds its shape extremely well
Purple	42-43	Hard-Sharp Cut	80/100/120	Vitrified	Sol-Gel Ceramic Grain + Pink Aluminum Oxide	High Nickel and Exotic Alloys	Fast cutting, cool running even on high nickel and other alloys
Light Blue	48	Medium-Sharp Cut	120	Vitrified	Sol-Gel Ceramic Grain + White Aluminum Oxide	High-Carbon, Stainless Steel, Non-Ferrous Alloys	Long lasting and cuts well
Red	36-39, 49	Medium	60/80/120	Clay	Friable Aluminum Oxide	Medium and Hardened Steels	Fast cutting and non-loading properties
Pink	40-41	Medium	80/100/120	Fused Vitrified	Pink Aluminum Oxide Alloyed with Chrome	Tool Steel and High Speed Steels	Sharp, cool cutting action for harder steels
White	52	Soft	400	Vitrified	Fine White Aluminum Oxide	Glass, Porcelain, Metal or Stone	Produces a fine finish

Note: Busch Pink omitted from chart as it is not a Gesswein stone (see p. 51).



A. Gesswein® Mounted Stone Sample Set – 1/8" Shank

Order our sample set of stones available on 1/8" shanks to see which type best fits your application. Set consists of B52 and W163 shapes in Red, Purple, Pink, Blue and Light Blue.

Description	Item#	Each
10-Piece Intro Mounted Stone Set	300-0010	\$20.25

Gesswein® Red Mounted Stones

Made in the USA



Superior quality stones made of aluminum oxide bonded with porcelain-type clays, which provide the greatest strength and rigidity required for fast stock removal and longer life. The ceramic bond controls the release of the aluminum oxide abrasive grains. As each particle begins to dull, the bond discharges it, allowing new abrasive grain to surface with fresh, sharp cutting edges. Stones are securely bonded to their shanks and are guaranteed to run true.

These fast-cutting, nonloading stones are easily identified by their reddish-brown color. The grit varies between 60, 80 (medium), and 120 (fine). For fast grinding of medium and hard materials. Ideal for internal grinding of tools, dies and gauges. All have 1 1/2" long plated steel shanks. Can be dressed with our Tru-Stone #380-1030 (see p. 51). For recommended speeds, consult the American National Standard Institute for full information on vitrified mounted wheels.

Available in plastic packages of 12 and boxes of 12, 36 or 72.

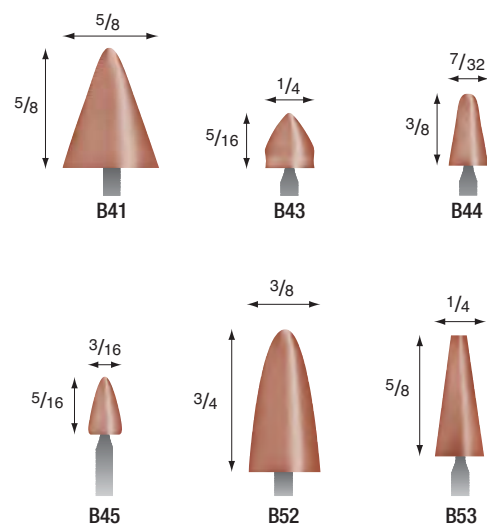

Shape dimensions shown in inches.

Style	Grit	Shank	Qty.	Item#	PKG./BOX Prices			
					1	2-3	4-9	10+
B41	80	1/8"	Pkg. of 12	309-0410	\$18.30	\$16.47	\$15.56	\$13.73
			Box of 36	301-0410	46.00	41.40	39.10	34.50
B43	80	1/8"	Pkg. of 12	309-0430	16.15	14.54	13.73	12.11
			Box of 72	301-0430	81.25	73.13	69.06	60.94
			3mm Box of 72	313-0430	81.25	73.13	69.06	60.94
B44	80	1/8"	Pkg. of 12	309-0440	15.20	13.68	12.92	11.40
			Box of 72	301-0440	81.25	73.13	69.06	60.94
			3mm Box of 72	313-0440	81.25	73.13	69.06	60.94
B45	80	1/8"	Pkg. of 12	309-0450	16.15	14.54	13.73	12.11
			Box of 72	301-0450	81.25	73.13	69.06	60.94
			3mm Box of 72	313-0450	81.25	73.13	69.06	60.94
B52	80	1/8"	Pkg. of 12	309-0520	17.35	15.62	14.75	13.01
			Box of 72	301-0520	88.75	79.88	75.44	66.56
			3mm Box of 72	313-0520	88.75	79.88	75.44	66.56
B53	80	1/8"	Pkg. of 12	309-0530	17.35	15.62	14.75	13.01
			Box of 72	301-0530	91.00	81.90	77.35	68.25

Gesswein® Red Mounted Stones (continued)

Style	Grit	Shank	Qty.	Item#	PKG./BOX Prices			
					1	2-3	4-9	10+
B55	120	1/8"	Pkg. of 12	309-0550	\$14.25	\$12.83	\$12.11	\$10.69
		1/8"	Box of 72	301-0550	69.75	62.78	59.29	52.31
		3mm	Box of 72	313-0550	69.75	62.78	59.29	52.31
B72	80	1/8"	Pkg. of 12	309-0720	15.20	13.68	12.92	11.40
		1/8"	Box of 36	301-0720	39.50	35.55	33.58	29.63
B73	80	1/8"	Pkg. of 12	309-0730	17.35	15.62	14.75	13.01
		1/8"	Box of 36	301-0730	42.00	37.80	35.70	31.50
		3mm	Box of 36	313-0730	45.00	40.50	38.25	33.75
B81	120	1/8"	Box of 12	301-0810	18.25	16.43	15.51	13.69
B82	80	1/8"	Pkg. of 12	309-0820	14.25	12.83	12.11	10.69
		1/8"	Box of 36	301-0820	35.25	31.73	29.96	26.44
B91	80	1/8"	Box of 12	301-0910	18.25	16.43	15.51	13.69
		3mm	Box of 12	313-0910	17.00	15.30	14.45	12.75
B96	120	1/8"	Pkg. of 12	309-0960	14.25	12.83	12.11	10.69
		1/8"	Box of 72	301-0960	69.50	62.55	59.08	52.13
B97	120	1/8"	Pkg. of 12	309-0970	16.15	14.54	13.73	12.11
		1/8"	Box of 72	301-0970	81.25	73.13	69.06	60.94
		3mm	Box of 72	313-0970	81.25	73.13	69.06	60.94
B98	120	1/8"	Pkg. of 12	309-0980	15.20	13.68	12.92	11.40
		1/8"	Box of 72	301-0980	69.50	62.55	59.08	52.13
B101	60	1/8"	Box of 12	301-1010	19.00	17.10	16.15	14.25
B104	80	1/8"	Pkg. of 12	309-1040	16.15	14.54	13.73	12.11
		1/8"	Box of 72	301-1040	81.25	73.13	69.06	60.94
B105	80	1/8"	Pkg. of 12	309-1050	14.25	12.83	12.11	10.69
		1/8"	Box of 72	301-1050	69.50	62.55	59.08	52.13
B121	80	1/8"	Pkg. of 12	309-1210	16.15	14.54	13.73	12.11
		1/8"	Box of 36	301-1210	40.75	36.68	34.64	30.56
B122	80	1/8"	Pkg. of 12	309-1220	16.15	14.54	13.73	12.11
		1/8"	Box of 72	301-1220	81.25	73.13	69.06	60.94
B123	120	1/8"	Pkg. of 12	309-1230	14.25	12.83	12.11	10.69
		1/8"	Box of 72	301-1230	69.50	62.55	59.08	52.13
		3mm	Box of 72	313-1230	69.50	62.55	59.08	52.13
B124	120	1/8"	Pkg. of 12	309-1240	16.15	14.54	13.73	12.11
		1/8"	Box of 72	301-1240	75.00	67.50	63.75	56.25
		3mm	Box of 72	313-1240	75.00	67.50	63.75	56.25
B125	80	1/8"	Pkg. of 12	309-1250	16.15	14.54	13.73	12.11
		1/8"	Box of 72	301-1250	83.50	75.15	70.98	62.63
		3mm	Box of 72	313-1250	83.50	75.15	70.98	62.63
B132	80	1/8"	Pkg. of 12	309-1320	13.30	11.97	11.31	9.98
		1/8"	Box of 72	301-1320	62.25	56.03	52.91	46.69
B133	80	1/8"	Pkg. of 12	309-1330	13.30	11.97	11.31	9.98
		1/8"	Box of 72	301-1330	60.00	54.00	51.00	45.00
B135	80	1/8"	Pkg. of 12	309-1350	13.30	11.97	11.31	9.98
		1/8"	Box of 72	301-1350	62.25	56.03	52.91	46.69
W140	120	1/8"	Pkg. of 12	309-1400	13.30	11.97	11.31	9.98
		1/8"	Box of 72	301-1400	64.25	57.83	54.61	48.19
		3mm	Box of 72	313-1400	64.25	57.83	54.61	48.19

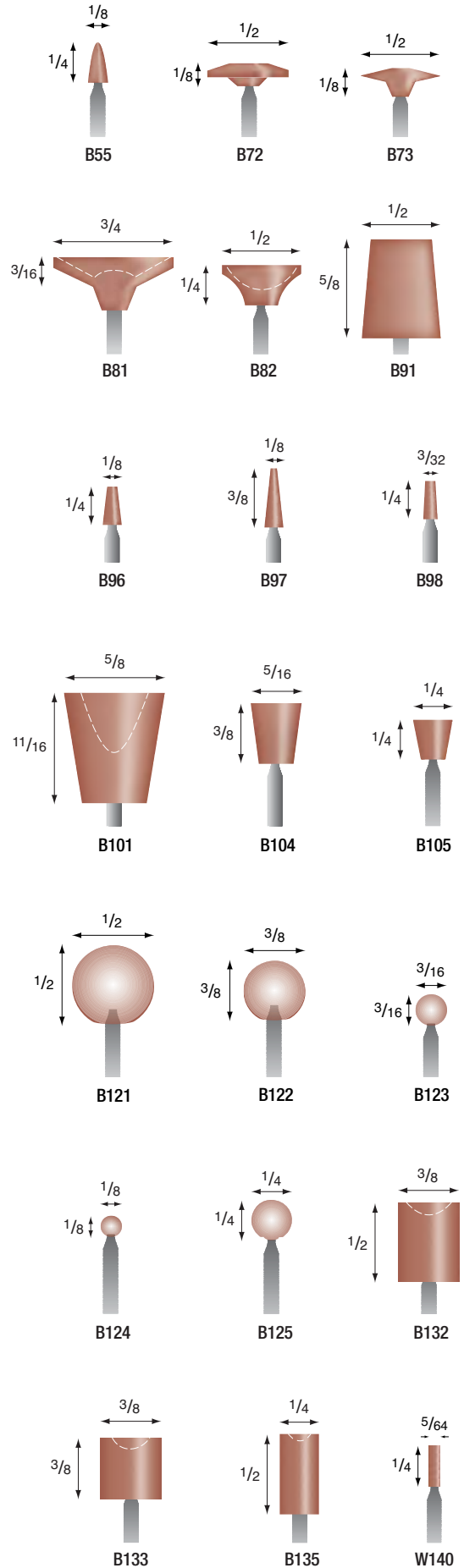

Shape dimensions shown in inches.

Gesswein® Red Mounted Stones (continued)

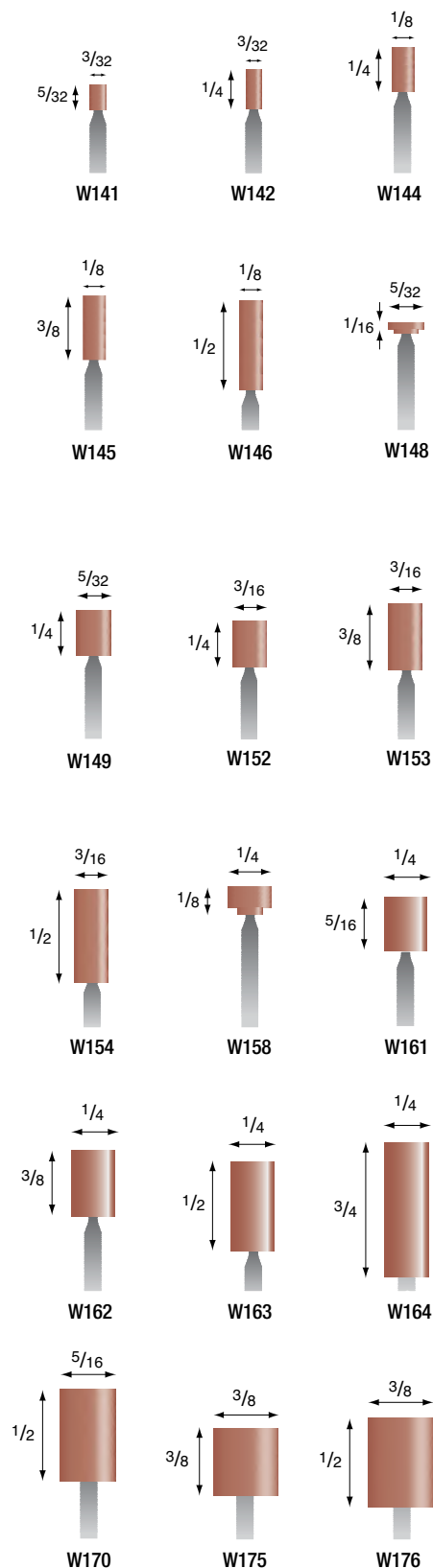

Style	Grit	Shank	Qty.	Item#	PKG./BOX Prices			
					1	2-3	4-9	10+
W141	120	1/8" 1/8"	Pkg. of 12	309-1410	13.30	11.97	11.31	9.98
			Box of 72	301-1410	60.00	54.00	51.00	45.00
W142	120	1/8"	Pkg. of 12	309-1420	13.30	11.97	11.31	9.98
		1/8"	Box of 72	301-1420	64.25	57.83	54.61	48.19
		3mm	Box of 72	313-1420	64.25	57.83	54.61	48.19
W144	120	1/8"	Pkg. of 12	309-1440	12.10	10.89	10.29	9.08
		1/8"	Box of 72	301-1440	58.75	52.88	49.94	44.06
		3mm	Box of 72	313-1440	58.75	52.88	49.94	44.06
W145	120	1/8"	Pkg. of 12	309-1450	13.80	12.42	11.73	10.35
		1/8"	Box of 72	301-1450	64.25	57.83	54.61	48.19
W146	120	1/8"	Pkg. of 12	309-1460	13.30	11.97	11.31	9.98
		1/8"	Box of 72	301-1460	64.25	57.83	54.61	48.19
W148	120	1/8"	Pkg. of 12	309-1480	14.25	12.83	12.11	10.69
		1/8"	Box of 72	301-1480	69.50	62.55	59.08	52.13
		3mm	Box of 72	313-1480	69.50	62.55	59.08	52.13
W149	120	1/8"	Pkg. of 12	309-1490	12.10	10.89	10.29	9.08
		1/8"	Box of 72	301-1490	58.75	52.88	49.94	44.06
		3mm	Box of 72	313-1490	58.75	52.88	49.94	44.06
W152	120	1/8"	Pkg. of 12	309-1520	12.10	10.89	10.29	9.08
		1/8"	Box of 72	301-1520	58.75	52.88	49.94	44.06
		3mm	Box of 72	313-1520	58.75	52.88	49.94	44.06
W153	120	1/8"	Pkg. of 12	309-1530	13.55	12.20	11.52	10.16
		1/8"	Box of 72	301-1530	64.25	57.83	54.61	48.19
		3mm	Box of 72	313-1530	64.25	57.83	54.61	48.19
W154	120	1/8"	Pkg. of 12	309-1540	13.30	11.97	11.31	9.98
		1/8"	Box of 72	301-1540	64.25	57.83	54.61	48.19
		3mm	Box of 72	313-1540	64.25	57.83	54.61	48.19
W158	120	1/8"	Pkg. of 12	309-1580	12.10	10.89	10.29	9.08
		1/8"	Box of 72	301-1580	58.75	52.88	49.94	44.06
W161	80	1/8"	Pkg. of 12	309-1610	13.30	11.97	11.31	9.98
		1/8"	Box of 72	301-1610	64.25	57.83	54.61	48.19
W162	80	1/8"	Pkg. of 12	309-1620	13.55	12.20	11.52	10.16
		1/8"	Box of 72	301-1620	64.25	57.83	54.61	48.19
		3mm	Box of 72	313-1620	64.25	57.83	54.61	48.19
W163	80	1/8"	Pkg. of 12	309-1630	13.30	11.97	11.31	9.98
		1/8"	Box of 72	301-1630	64.25	57.83	54.61	48.19
		3mm	Box of 72	313-1630	64.25	57.83	54.61	48.19
W164	80	1/8"	Pkg. of 12	309-1640	14.25	12.83	12.11	10.69
		1/8"	Box of 72	301-1640	68.50	61.65	58.23	51.38
W170	80	1/8"	Pkg. of 12	309-1700	12.10	10.89	10.29	9.08
		1/8"	Box of 72	301-1700	64.25	57.83	54.61	48.19
W175	80	1/8"	Pkg. of 12	309-1750	13.30	11.97	11.31	9.98
		1/8"	Box of 72	301-1750	64.25	57.83	54.61	48.19
		3mm	Box of 72	313-1750	64.25	-	-	-
		1/8"	Box of 72	301-1750	64.25	57.83	54.61	48.19
W176	80	1/8"	Pkg. of 12	309-1760	13.30	11.97	11.31	9.98
		1/8"	Box of 72	301-1760	64.25	57.83	54.61	48.19
		3mm	Box of 72	313-1760	64.25	57.83	54.61	48.19

Shape dimensions shown in inches.

Gesswein® Red Mounted Stones (continued)

Style	Grit	Shank	Qty.	Item#	PKG./BOX Prices			
					1	2-3	4-9	10+
W178	60	1/8"	Pkg. of 12	309-1780	\$15.20	\$13.68	\$12.92	\$11.40
		1/8"	Box of 72	301-1780	71.75	64.58	60.99	53.81
W182	80	1/8"	Pkg. of 12	309-1820	13.30	11.97	11.31	9.98
		1/8"	Box of 36	301-1820	30.00	27.00	25.50	22.50
		3mm	Box of 36	313-1820	30.00	27.00	25.50	22.50
W183	80	1/8"	Pkg. of 12	309-1830	13.30	11.97	11.31	9.98
		1/8"	Box of 36	301-1830	28.00	28.00	28.00	28.00
		3mm	Box of 36	313-1830	28.00	-	-	-
W185	80	1/8"	Pkg. of 12	309-1850	13.30	11.97	11.31	9.98
		1/8"	Box of 36	301-1850	32.00	28.80	27.20	24.00
		3mm	Box of 36	313-1850	32.00	28.80	27.20	24.00
W186	80	1/8"	Pkg. of 12	309-1860	14.25	12.83	12.11	10.69
		1/8"	Box of 36	301-1860	34.25	30.83	29.11	25.69
W187	80	1/8"	Pkg. of 12	309-1870	15.20	13.68	12.92	11.40
		1/8"	Box of 36	301-1870	36.50	32.85	31.03	27.38
W190	80	1/8"	Pkg. of 12	309-1900	13.30	11.97	11.31	9.98
		1/8"	Box of 36	301-1900	30.00	27.00	25.50	22.50
W200	80	1/8"	Box of 12	301-2000	11.75	10.58	9.99	8.81
W202	60	1/8"	Box of 12	301-2020	14.00	12.60	11.90	10.50
W204	60	1/8"	Box of 12	301-2040	16.00	14.40	13.60	12.00
W210	80	1/8"	Box of 12	301-2100	14.00	12.60	11.90	10.50
W211	80	1/8"	Box of 12	301-2110	14.00	12.60	11.90	10.50
W215	60	1/8"	Box of 12	301-2150	14.00	12.60	11.90	10.50
W216	60	1/8"	Box of 12	301-2160	14.00	12.60	11.90	10.50

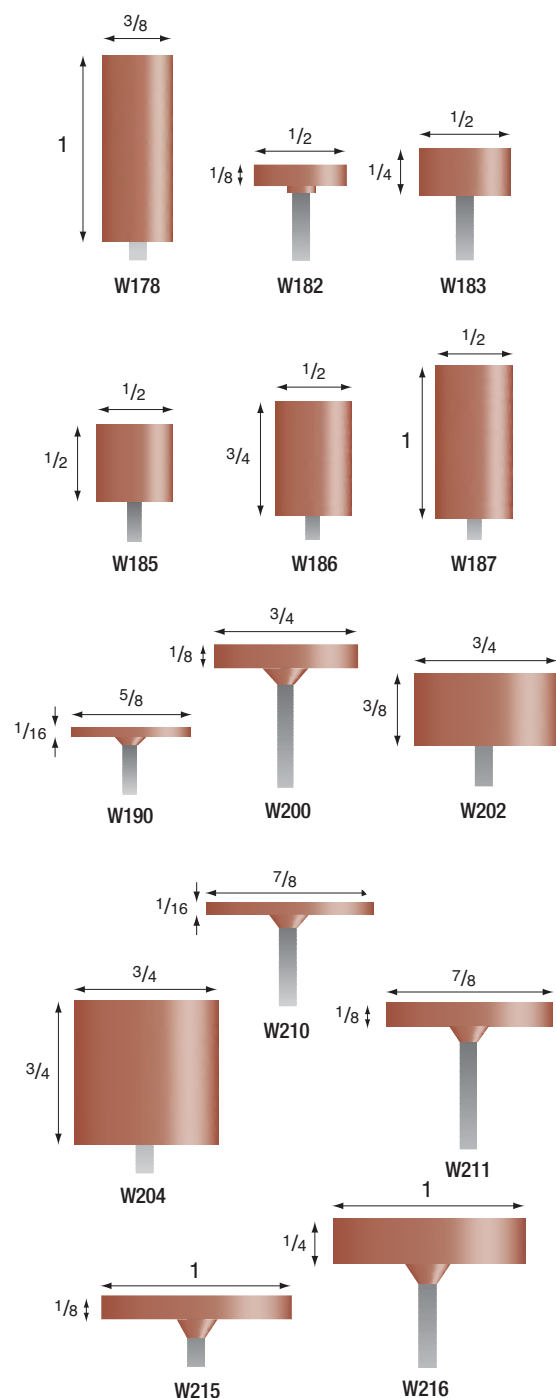

Shape dimensions shown in inches.

A, B Gesswein® Red Mounted Stone Sets – 1/8" Shank

Gesswein Red Mounted Stones are available in money-saving sets of 48 and 100 pieces. These assortments are made from our most popular shapes and offer a stone for almost every application. These sets offer big savings from the one-piece prices.

The 100-Piece Set includes ten each of our ten most popular shapes, conveniently packaged in a box to hold all 100 stones. Ten each of the following shapes: B44, B52, B96, B123, W144, W152, W162, W170, W175, W200.

The 48-Piece Set includes six each of eight popular shapes, conveniently packaged in a box to hold all 48 stones. Six each of the following shapes: B44, B52, B123, W144, W152, W162, W176, W200.

Description	Item#	Each
A. 100-Piece Red Mounted Stone Set	310-3000	\$108.50
B. 48-Piece Red Mounted Stone Set	310-3010	58.00

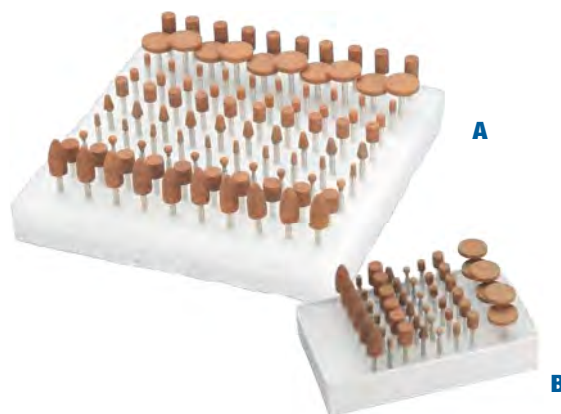

Gesswein® Pink Mounted Stones



These highly popular, high-quality mounted stones are made with a pure, fused aluminum oxide alloyed with chrome, with a medium vitrified bonding agent. This combination gives it a distinctive pink color. These stones have been popular in Europe for many years because of their versatility, on a variety of steels and alloys where a sharp cutting action is required. The attributes of using pink abrasive grain is that besides being friable and cool cutting, the stones exhibit markedly better form holding characteristics, making them exceptionally durable, while giving the sharp cut that is needed. All are mounted on 1 1/2" long plated steel shanks. Actual grit appears in the chart; varies from 80, 100 to 120.

Pink stones can be dressed with our Tru-Stone #380-1030 (see p.51). For recommended speeds, consult the American National Standards Institute for full information on vitrified mounted wheels. Other shapes also available. Please call to special order.

See warnings on p. 50.

Available in plastic packages of 12 and boxes of 12, 36 or 72.

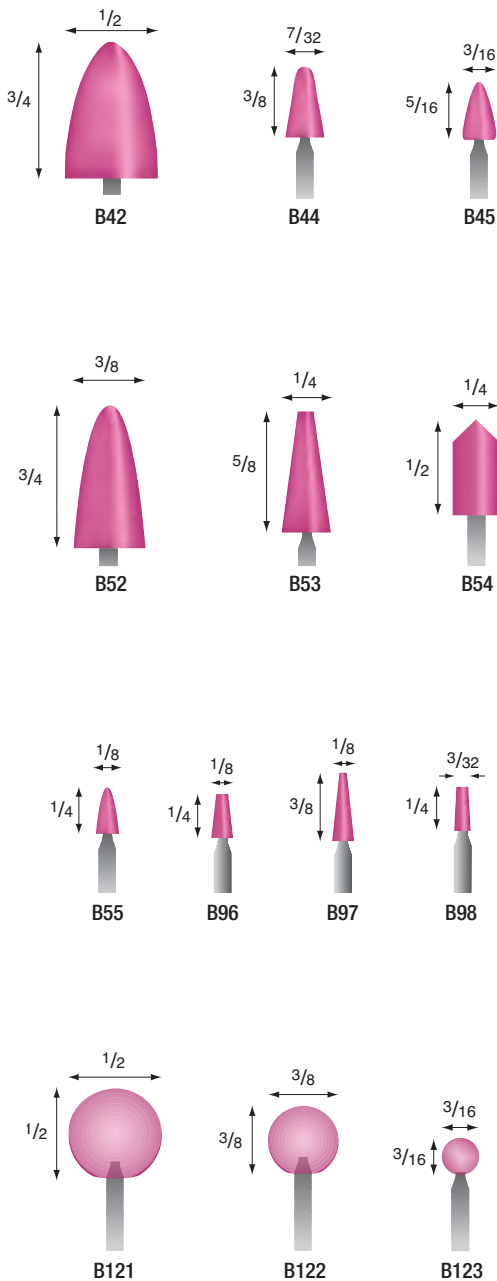

Shape dimensions shown in inches.

Style	Grit	Shank	Qty.	Item#	PKG./BOX Prices			
					1	2-3	4-9	10+
B42	80	1/8" 1/8" 3mm	Pkg. of 12	331-1042	\$20.65	\$18.59	\$17.55	\$15.49
			Box of 36	331-0042	51.00	45.90	43.35	38.25
			Box of 36	332-0042	49.50	44.55	42.08	37.13
B44	100	1/8" 1/8" 3mm	Pkg. of 12	331-1044	17.60	15.84	14.96	13.20
			Box of 72	331-0044	86.50	77.85	73.53	64.88
			Box of 72	332-0044	84.00	75.60	71.40	63.00
B45	120	1/8" 1/8" 3mm	Pkg. of 12	331-1045	17.60	15.84	14.96	13.20
			Box of 72	331-0045	86.50	77.85	73.53	64.88
			Box of 72	332-0045	84.00	75.60	71.40	63.00
B52	80	1/8" 1/8" 3mm	Pkg. of 12	331-1052	18.60	16.74	15.81	13.95
			Box of 72	331-0052	94.75	85.28	80.54	71.06
			Box of 72	332-0052	92.00	82.80	78.20	69.00
B53	80	1/8" 1/8" 3mm	Pkg. of 12	331-1053	18.60	16.74	15.81	13.95
			Box of 72	331-0053	94.75	85.28	80.54	71.06
			Box of 72	332-0053	92.00	82.80	78.20	69.00
B54	80	1/8" 1/8" 3mm	Pkg. of 12	331-1054	18.60	16.74	15.81	13.95
			Box of 72	331-0054	94.75	85.28	80.54	71.06
			Box of 72	332-0054	92.00	82.80	78.20	69.00
B55	80	1/8" 1/8" 3mm	Pkg. of 12	331-1055	15.70	14.13	13.35	11.78
			Box of 72	331-0055	74.25	66.83	63.11	55.69
			Box of 72	332-0055	72.00	64.80	61.20	54.00
B96	120	1/8" 1/8" 3mm	Pkg. of 12	331-1096	15.70	14.13	13.35	11.78
			Box of 72	331-0096	74.25	66.83	63.11	55.69
			Box of 72	332-0096	72.00	64.80	61.20	54.00
B97	120	1/8" 1/8" 3mm	Pkg. of 12	331-1097	17.60	15.84	14.96	13.20
			Box of 72	331-0097	86.50	77.85	73.53	64.88
			Box of 72	332-0097	84.00	75.60	71.40	63.00
B98	120	1/8" 1/8" 3mm	Pkg. of 12	331-1098	16.65	14.99	14.15	12.49
			Box of 72	331-0098	74.25	66.83	63.11	55.69
			Box of 72	332-0098	72.00	64.80	61.20	54.00
B121	80	1/8" 1/8" 3mm	Pkg. of 12	331-1121	17.60	15.84	14.96	13.20
			Box of 36	331-0121	43.25	38.93	36.76	32.44
			Box of 36	332-0121	42.00	37.80	35.70	31.50
B122	80	1/8" 1/8" 3mm	Pkg. of 12	331-1122	17.60	15.84	14.96	13.20
			Box of 72	331-0122	86.50	77.85	73.53	64.88
			Box of 72	332-0122	84.00	75.60	71.40	63.00
B123	120	1/8" 1/8" 3mm	Pkg. of 12	331-1123	15.70	14.13	13.35	11.78
			Box of 72	331-0123	74.25	66.83	63.11	55.69
			Box of 72	332-0123	72.00	64.80	61.20	54.00

Gesswein® Pink Mounted Stones (continued)

Style	Grit	Shank	Qty.	Item#	PKG./BOX Prices			
					1	2-3	4-9	10+
B131	80	1/8"	Pkg. of 12	331-1131	\$13.80	\$12.42	\$11.73	\$10.35
		1/8"	Box of 36	331-0131	35.00	31.50	29.75	26.25
		3mm	Box of 36	332-0131	34.00	30.60	28.90	25.50
B132	80	1/8"	Pkg. of 12	331-1132	13.80	12.42	11.73	10.35
		1/8"	Box of 72	331-0132	69.00	62.10	58.65	51.75
		3mm	Box of 72	332-0132	67.00	60.30	56.95	50.25
B135	80	1/8"	Pkg. of 12	331-1135	13.80	12.42	11.73	10.35
		1/8"	Box of 72	331-0135	69.00	62.10	58.65	51.75
		3mm	Box of 72	332-0135	67.00	60.30	56.95	50.25
W142	120	1/8"	Pkg. of 12	331-1142	14.80	13.32	12.58	11.10
		1/8"	Box of 72	331-0142	69.00	62.10	58.65	51.75
		3mm	Box of 72	332-0142	67.00	60.30	56.95	50.25
W144	120	1/8"	Pkg. of 12	331-1144	14.80	13.32	12.58	11.10
		1/8"	Box of 72	331-0144	62.75	56.48	53.34	47.06
		3mm	Box of 72	332-0144	61.00	54.90	51.85	45.75
W145	120	1/8"	Pkg. of 12	331-1145	13.80	12.42	11.73	10.35
		1/8"	Box of 72	331-0145	69.00	62.10	58.65	51.75
		3mm	Box of 72	332-0145	67.00	60.30	56.95	50.25
W146	120	1/8"	Pkg. of 12	331-1146	13.80	12.42	11.73	10.35
		1/8"	Box of 72	331-0146	69.00	62.10	58.65	51.75
		3mm	Box of 72	332-0146	67.00	60.30	56.95	50.25
W153	100	1/8"	Pkg. of 12	331-1153	13.80	12.42	11.73	10.35
		1/8"	Box of 72	331-0153	69.00	62.10	58.65	51.75
		3mm	Box of 72	332-0153	67.00	60.30	56.95	50.25
W154	100	1/8"	Pkg. of 12	331-1154	13.80	12.42	11.73	10.35
		1/8"	Box of 72	331-0154	69.00	62.10	58.65	51.75
		3mm	Box of 72	332-0154	67.00	60.30	56.95	50.25
W163	80	1/8"	Pkg. of 12	331-1163	13.80	12.42	11.73	10.35
		1/8"	Box of 72	331-0163	69.00	62.10	58.65	51.75
		3mm	Box of 72	332-0163	67.00	60.30	56.95	50.25
W164	80	1/8"	Pkg. of 12	331-1164	14.75	13.28	12.54	11.06
		1/8"	Box of 72	331-0164	73.25	65.93	62.26	54.94
		3mm	Box of 72	332-0164	71.00	63.90	60.35	53.25
W170	80	1/8"	Pkg. of 12	331-1170	12.85	11.57	10.92	9.64
		1/8"	Box of 72	331-0170	81.50	73.35	69.28	61.13
		3mm	Box of 72	332-0170	67.00	60.30	56.95	50.25
W171	80	1/8"	Pkg. of 12	331-1171	15.60	14.04	13.26	11.70
		1/8"	Box of 72	331-0171	73.25	65.93	62.26	54.94
		3mm	Box of 72	332-0171	71.00	63.90	60.35	53.25
W176	80	1/8"	Pkg. of 12	331-1176	13.80	12.42	11.73	10.35
		1/8"	Box of 72	331-0176	69.00	62.10	58.65	51.75
		3mm	Box of 72	332-0176	67.00	60.30	56.95	50.25
W182	80	1/8"	Pkg. of 12	331-1182	13.80	12.42	11.73	10.35
		1/8"	Box of 36	331-0182	32.00	28.80	27.20	24.00
		3mm	Box of 36	332-0182	31.00	27.90	26.35	23.25
W185	80	1/8"	Pkg. of 12	331-1185	13.80	12.42	11.73	10.35
		1/8"	Box of 36	331-0185	35.00	31.50	29.75	26.25
		3mm	Box of 36	332-0185	34.00	30.60	28.90	25.50

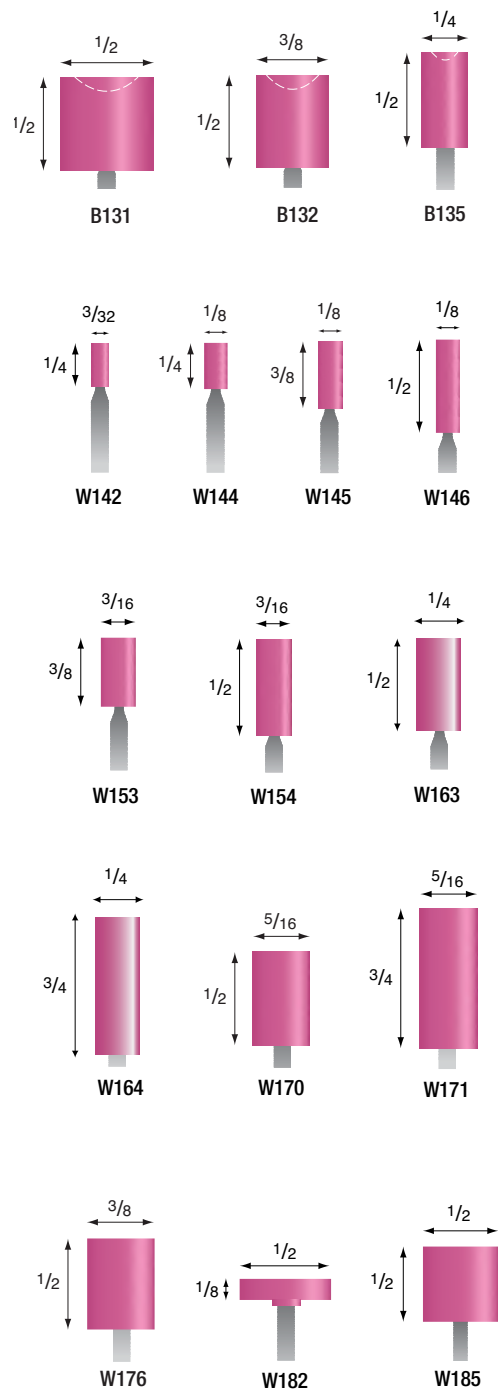

Shape dimensions shown in inches.



A. Gesswein® Pink Mounted Stone Set – 1/8" Shank

Gesswein Pink Mounted Stones are available in a money-saving set of 48 pieces. This assortment is made from our most popular shapes and offers a stone for almost every application. Includes six each of eight popular shapes, conveniently packaged in a box to hold all 48 stones. Six each of the following shapes: B44, B52, B53, B122, B123, W145, W163, W176.

Description	Item#	Each
48-Piece Pink Mounted Stone Set	331-0010	\$65.00

Gesswein® Purple Mounted Stones



These "top of the line" mounted stones are made with a unique combination of Sol Gel ceramic grain and our high quality Pink fused aluminum oxide to produce the sharpest cut, and most durable of the friable grain vitrified bond stones. This combination gives it a distinctive purple color. Ceramic grain is the most friable grain produced. Due to the sharp cutting action, this mixture is used on high nickel alloys for the aerospace industry, as well as many common varieties of steels and alloys. All are mounted on 1½" long plated steel shanks. Actual grit appears in the chart; varies from 80, 100 to 120.

Purple stones can be dressed with our Tru-Stone #380-1030 (see p. 51). For recommended speeds, consult the American National Standards Institute for full information on vitrified mounted wheels. Other shapes also available. Please call to special order. **See warnings on p. 50.**

Available in plastic packages of 12 and boxes of 12, 36 or 72.

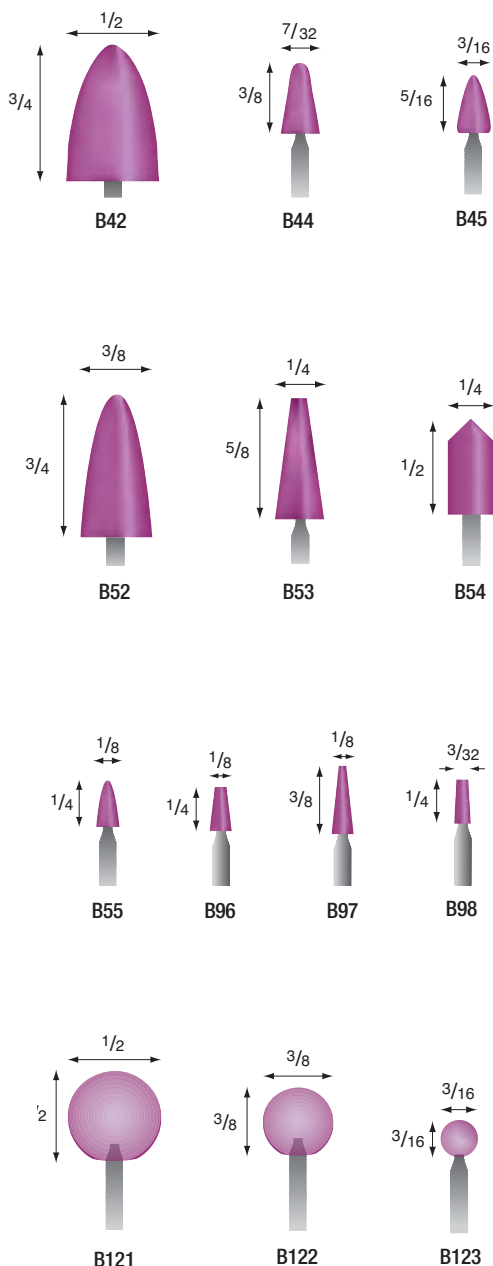

Shape dimensions shown in inches.

Style	Grit	Shank	Qty.	Item#	PKG./BOX Prices			
					1	2-3	4-9	10+
B42	80	1/8" 1/8" 3mm	Pkg. of 12	333-1042	\$21.85	\$19.67	\$18.57	\$16.39
			Box of 36	333-0042	54.00	48.60	45.90	40.50
			Box of 36	334-0042	54.00	48.60	45.90	40.50
B44	100	1/8" 1/8" 3mm	Pkg. of 12	333-1044	18.05	16.25	15.34	13.54
			Box of 72	333-0044	90.00	81.00	76.50	67.50
			Box of 72	334-0044	90.00	81.00	76.50	67.50
B45	100	1/8" 1/8" 3mm	Pkg. of 12	333-1045	18.05	16.25	15.34	13.54
			Box of 72	333-0045	90.00	81.00	76.50	67.50
			Box of 72	334-0045	90.00	81.00	76.50	67.50
B52	80	1/8" 1/8" 3mm	Pkg. of 12	333-1052	19.95	17.96	16.96	14.96
			Box of 72	333-0052	97.00	87.30	82.45	72.75
			Box of 72	334-0052	97.00	87.30	82.45	72.75
B53	120	1/8" 1/8" 3mm	Pkg. of 12	333-1053	19.95	17.96	16.96	14.96
			Box of 72	333-0053	97.00	87.30	82.45	72.75
			Box of 72	334-0053	97.00	87.30	82.45	72.75
B54	80	1/8" 1/8" 3mm	Pkg. of 12	333-1054	21.00	18.90	17.85	15.75
			Box of 72	333-0054	97.00	87.30	82.45	72.75
			Box of 72	334-0054	97.00	87.30	82.45	72.75
B55	120	1/8" 1/8" 3mm	Pkg. of 12	333-1055	16.15	14.54	13.73	12.11
			Box of 72	333-0055	78.00	70.20	66.30	58.50
			Box of 72	334-0055	78.00	70.20	66.30	58.50
B96	120	1/8" 1/8" 3mm	Pkg. of 12	333-1096	16.15	14.54	13.73	12.11
			Box of 72	333-0096	78.00	70.20	66.30	58.50
			Box of 72	334-0096	78.00	70.20	66.30	58.50
B97	120	1/8" 1/8" 3mm	Pkg. of 12	333-1097	16.15	14.54	13.73	12.11
			Box of 72	333-0097	91.00	81.90	77.35	68.25
			Box of 72	334-0097	91.00	81.90	77.35	68.25
B98	120	1/8" 1/8" 3mm	Pkg. of 12	333-1098	17.10	15.39	14.54	12.83
			Box of 72	333-0098	78.00	70.20	66.30	58.50
			Box of 72	334-0098	78.00	70.20	66.30	58.50
B121	80	1/8" 1/8" 3mm	Pkg. of 12	333-1121	18.05	16.25	15.34	13.54
			Box of 36	333-0121	46.00	41.40	39.10	34.50
			Box of 36	334-0121	46.00	41.40	39.10	34.50
B122	80	1/8" 1/8" 3mm	Pkg. of 12	333-1122	18.05	16.25	15.34	13.54
			Box of 72	333-0122	90.00	81.00	76.50	67.50
			Box of 72	334-0122	90.00	81.00	76.50	67.50
B123	120	1/8" 1/8" 3mm	Pkg. of 12	333-1123	18.05	16.25	15.34	13.54
			Box of 72	333-0123	78.00	70.20	66.30	58.50
			Box of 72	334-0123	78.00	70.20	66.30	58.50

Gesswein® Purple Mounted Stones (continued)

Style	Grit	Shank	Qty.	Item#	PKG./BOX Prices			
					1	2-3	4-9	10+
B131	80	1/8"	Pkg. of 12	333-1131	\$15.20	\$13.68	\$12.92	\$11.40
		1/8"	Box of 36	333-0131	36.00	32.40	30.60	27.00
		3mm	Box of 36	334-0131	36.00	32.40	30.60	27.00
B132	80	1/8"	Pkg. of 12	333-1132	15.20	13.68	12.92	11.40
		1/8"	Box of 72	333-0132	74.00	66.60	62.90	55.50
		3mm	Box of 72	334-0132	74.00	66.60	62.90	55.50
B135	80	1/8"	Pkg. of 12	333-1135	15.20	13.68	12.92	11.40
		1/8"	Box of 72	333-0135	74.00	66.60	62.90	55.50
		3mm	Box of 72	334-0135	74.00	66.60	62.90	55.50
W142	120	1/8"	Pkg. of 12	333-1142	15.20	13.68	12.92	11.40
		1/8"	Box of 72	333-0142	74.00	66.60	62.90	55.50
		3mm	Box of 72	334-0142	74.00	66.60	62.90	55.50
W144	120	1/8"	Pkg. of 12	333-1144	14.25	12.83	12.11	10.69
		1/8"	Box of 72	333-0144	65.00	58.50	55.25	48.75
		3mm	Box of 72	334-0144	65.00	58.50	55.25	48.75
W145	120	1/8"	Pkg. of 12	333-1145	15.20	13.68	12.92	11.40
		1/8"	Box of 72	333-0145	74.00	66.60	62.90	55.50
		3mm	Box of 72	334-0145	74.00	66.60	62.90	55.50
W146	120	1/8"	Pkg. of 12	333-1146	15.20	13.68	12.92	11.40
		1/8"	Box of 72	333-0146	74.00	66.60	62.90	55.50
		3mm	Box of 72	334-0146	74.00	66.60	62.90	55.50
W153	80	1/8"	Pkg. of 12	333-1153	15.20	13.68	12.92	11.40
		1/8"	Box of 72	333-0153	74.00	66.60	62.90	55.50
		3mm	Box of 72	334-0153	74.00	66.60	62.90	55.50
W154	80	1/8"	Pkg. of 12	333-1154	15.20	13.68	12.92	11.40
		1/8"	Box of 72	333-0154	74.00	66.60	62.90	55.50
		3mm	Box of 72	334-0154	74.00	66.60	62.90	55.50
W163	80	1/8"	Pkg. of 12	333-1163	15.20	13.68	12.92	11.40
		1/8"	Box of 72	333-0163	74.00	66.60	62.90	55.50
		3mm	Box of 72	334-0163	74.00	66.60	62.90	55.50
W164	100	1/8"	Pkg. of 12	333-1164	16.15	14.54	13.73	12.11
		1/8"	Box of 72	333-0164	78.00	70.20	66.30	58.50
		3mm	Box of 72	334-0164	78.00	70.20	66.30	58.50
W170	100	1/8"	Pkg. of 12	333-1170	14.25	12.83	12.11	10.69
		1/8"	Box of 72	333-0170	74.00	66.60	62.90	55.50
		3mm	Box of 72	334-0170	74.00	66.60	62.90	55.50
W171	100	1/8"	Pkg. of 12	333-1171	16.15	14.54	13.73	12.11
		1/8"	Box of 72	333-0171	78.00	70.20	66.30	58.50
		3mm	Box of 72	334-0171	78.00	70.20	66.30	58.50
W176	80	1/8"	Pkg. of 12	333-1176	15.20	13.68	12.92	11.40
		1/8"	Box of 72	333-0176	74.00	66.60	62.90	55.50
		3mm	Box of 72	334-0176	74.00	66.60	62.90	55.50
W182	100	1/8"	Pkg. of 12	333-1182	15.20	13.68	12.92	11.40
		1/8"	Box of 36	333-0182	34.00	30.60	28.90	25.50
		3mm	Box of 36	334-0182	34.00	30.60	28.90	25.50
W185	80	1/8"	Pkg. of 12	333-1185	15.20	13.68	12.92	11.40
		1/8"	Box of 36	333-0185	36.00	32.40	30.60	27.00
		3mm	Box of 36	334-0185	36.00	32.40	30.60	27.00

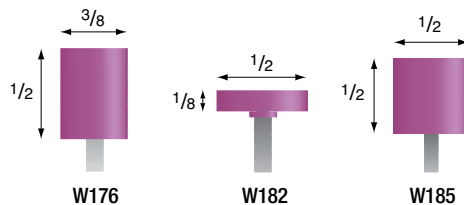
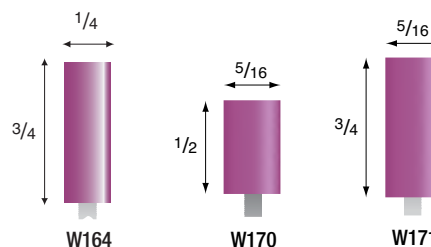
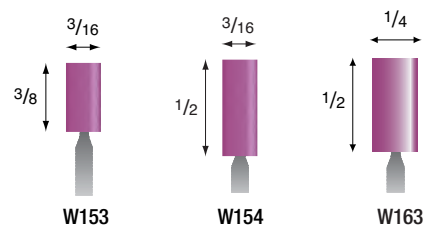
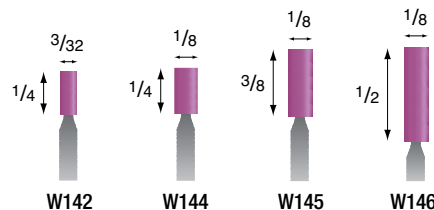
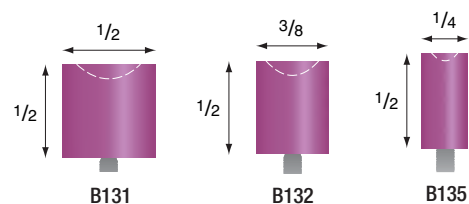

Shape dimensions shown in inches.



A. Gesswein® Purple Mounted Stone Set – 1/8" Shank

Gesswein Purple Mounted Stones are available in a money-saving set of 48 pieces. This assortment is made from our most popular shapes and offers a stone for almost every application. Includes six each of eight popular shapes, conveniently packaged in a box to hold all 48 stones. Six each of the following shapes: B44, B52, B53, B122, B123, W145, W163, W176.

Description	Item#	Each
48-Piece Purple Mounted Stone Set	333-0010	\$69.00

Gesswein® Blue Mounted Stones

Made in the USA



These superior quality stones are made of aluminum oxide bonded with porcelain-type bonds, which provide the greatest strength and rigidity required for fast stock removal and longer life. The ceramic bond controls the release of the aluminum oxide abrasive grains. As each particle begins to dull, the bond discharges it, allowing new abrasive grain to surface with fresh, sharp cutting edges. Stones are securely bonded to their shanks and are guaranteed to run true.

These hard stones hold their shapes exceptionally well. Recommended for use on hardened steel. All are 120 (fine) grit aluminum oxide. They cut well and leave a smooth surface. All have 1½" long plated steel shanks. Blue mounted stones can be dressed with our Tru-Stone #380-1030 (see p. 51). For recommended speeds, consult the American National Standard Institute for full information on vitrified mounted wheels.

See warnings on p. 50.

Available in plastic packages of 12 and boxes of 12, 36 or 72.

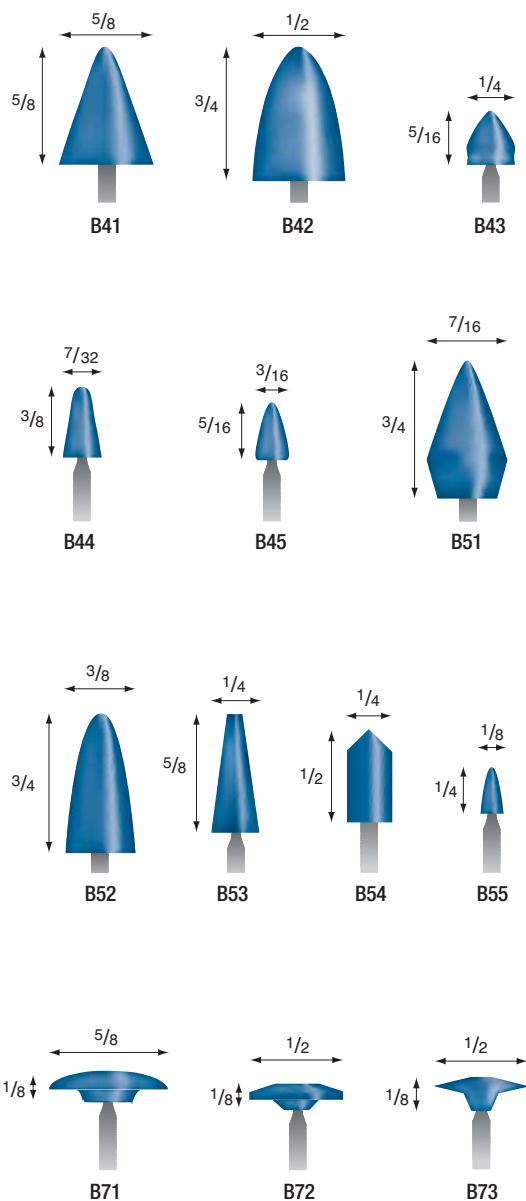

Shape dimensions shown in inches.

Style	Grit	Shank	Qty.	Item#	PKG./BOX Prices			
					1	2-3	4-9	10+
B41	120	1/8"	Pkg. of 12	304-0410	\$18.30	\$16.47	\$15.56	\$13.73
		1/8"	Box of 36	300-0410	46.00	41.40	39.10	34.50
		3mm	Box of 36	308-0410	46.00	41.40	39.10	34.50
B42	120	1/8"	Pkg. of 12	304-0420	19.25	17.33	16.36	14.44
		1/8"	Box of 36	300-0420	48.25	43.43	41.01	36.19
		3mm	Box of 36	308-0420	48.25	43.43	41.01	36.19
B43	120	1/8"	Pkg. of 12	304-0430	16.15	14.54	13.73	12.11
		1/8"	Box of 72	300-0430	81.25	73.13	69.06	60.94
		3mm	Box of 72	308-0430	81.25	73.13	69.06	60.94
B44	120	1/8"	Pkg. of 12	304-0440	16.15	14.54	13.73	12.11
		1/8"	Box of 72	300-0440	83.25	74.93	70.76	62.44
		3mm	Box of 72	308-0440	83.25	74.93	70.76	62.44
B45	120	1/8"	Pkg. of 12	304-0450	16.15	14.54	13.73	12.11
		1/8"	Box of 72	300-0450	81.25	73.13	69.06	60.94
		3mm	Box of 72	308-0450	81.25	73.13	69.06	60.94
B51	120	1/8"	Pkg. of 12	304-0510	19.25	17.33	16.36	14.44
		1/8"	Box of 72	300-0510	96.25	86.63	81.81	72.19
		3mm	Box of 72	308-0510	96.25	86.63	81.81	72.19
B52	120	1/8"	Pkg. of 12	304-0520	17.35	15.62	14.75	13.01
		1/8"	Box of 72	300-0520	91.00	81.90	77.35	68.25
		3mm	Box of 72	308-0520	88.75	79.88	75.44	66.56
B53	120	1/8"	Pkg. of 12	304-0530	17.80	17.80	16.02	13.35
		1/8"	Box of 72	300-0530	91.00	81.90	77.35	68.25
		3mm	Box of 72	308-0530	88.75	79.88	75.44	66.56
B54	120	1/8"	Pkg. of 12	304-0540	17.35	17.35	15.62	13.01
		1/8"	Box of 72	300-0540	88.75	79.88	75.44	66.56
		3mm	Box of 72	308-0540	83.00	74.70	70.55	62.25
B55	120	1/8"	Pkg. of 12	304-0550	14.25	12.83	12.11	10.69
		1/8"	Box of 72	300-0550	69.50	62.55	59.08	52.13
		3mm	Box of 72	308-0550	69.50	62.55	59.08	52.13
B71	120	1/8"	Pkg. of 12	304-0710	16.15	14.54	13.73	12.11
		1/8"	Box of 36	300-0710	45.00	40.50	38.25	33.75
		3mm	Box of 36	308-0710	45.00	40.50	38.25	33.75
B72	120	1/8"	Pkg. of 12	304-0720	15.20	12.92	11.40	11.40
		1/8"	Box of 36	300-0720	39.50	35.55	33.58	29.63
		3mm	Box of 36	308-0720	39.50	35.55	33.58	29.63
B73	120	1/8"	Pkg. of 12	304-0730	17.35	15.62	14.75	13.01
		1/8"	Box of 36	300-0730	42.00	37.80	35.70	31.50
		3mm	Box of 36	308-0730	45.00	40.50	38.25	33.75

Gesswein® Blue Mounted Stones (continued)

Style	Grit	Shank	Qty.	Item#	PKG./BOX Prices			
					1	2-3	4-9	10+
B84	120	1/8"	Pkg. of 12	304-0840	\$14.25	\$12.83	\$12.11	\$10.69
		1/8"	Box of 72	300-0840	69.50	62.55	59.08	52.13
		3mm	Box of 72	308-0840	69.50	62.55	59.08	52.13
B91	120	1/8"	Box of 12	300-0910	18.25	16.43	15.51	13.69
		3mm	Box of 12	308-0910	18.25	16.43	15.51	13.69
B92	120	1/8"	Pkg. of 12	304-0920	14.25	14.25	12.11	10.69
		1/8"	Box of 72	300-0920	71.75	64.58	60.99	53.81
		3mm	Box of 72	308-0920	71.75	64.58	60.99	53.81
B96	120	1/8"	Pkg. of 12	304-0960	14.25	12.83	12.11	10.69
		1/8"	Box of 72	300-0960	69.50	62.55	59.08	52.13
		3mm	Box of 72	308-0960	69.50	62.55	59.08	52.13
B97	120	1/8"	Pkg. of 12	304-0970	16.15	14.54	13.73	12.11
		1/8"	Box of 72	300-0970	83.25	74.93	70.76	62.44
		3mm	Box of 72	308-0970	83.25	74.93	70.76	62.44
B98	120	1/8"	Pkg. of 12	304-0980	15.20	13.68	12.92	11.40
		1/8"	Box of 72	300-0980	69.50	62.55	59.08	52.13
		3mm	Box of 72	308-0980	69.50	62.55	59.08	52.13
B103	120	1/8"	Box of 12	300-1030	18.25	16.43	15.51	13.69
		3mm	Box of 12	308-1030	18.25	16.43	15.51	13.69
B105	120	1/8"	Pkg. of 12	304-1050	14.25	12.83	12.11	10.69
		1/8"	Box of 72	300-1050	65.00	58.50	55.25	48.75
		3mm	Box of 72	308-1050	69.50	62.55	59.08	52.13
B121	120	1/8"	Pkg. of 12	304-1210	16.65	14.99	14.15	12.49
		1/8"	Box of 36	300-1210	40.75	36.68	34.64	30.56
		3mm	Box of 36	308-1210	40.75	36.68	34.64	30.56
B122	120	1/8"	Pkg. of 12	304-1220	16.65	14.99	14.15	12.49
		1/8"	Box of 72	300-1220	81.25	73.13	69.06	60.94
		3mm	Box of 72	308-1220	81.25	73.13	69.06	60.94
B123	120	1/8"	Pkg. of 12	304-1230	14.25	12.83	12.11	10.69
		1/8"	Box of 72	300-1230	71.25	64.13	60.56	53.44
		3mm	Box of 72	308-1230	71.25	64.13	60.56	53.44
B124	120	1/8"	Pkg. of 12	304-1240	16.65	14.99	14.15	12.49
		1/8"	Box of 72	300-1240	76.75	69.08	65.24	57.56
		3mm	Box of 72	308-1240	75.00	67.50	63.75	56.25
B125	120	1/8"	Pkg. of 12	304-1250	16.65	14.99	14.15	12.49
		1/8"	Box of 72	300-1250	83.50	75.15	70.98	62.63
		3mm	Box of 72	308-1250	85.50	76.95	72.68	64.13
B131	120	1/8"	Pkg. of 12	304-1310	13.30	11.97	11.31	9.98
		1/8"	Box of 36	300-1310	30.00	27.00	25.50	22.50
		3mm	Box of 36	308-1310	32.00	28.80	27.20	24.00
B135	120	1/8"	Pkg. of 12	304-1350	13.55	12.20	11.52	10.16
		1/8"	Box of 72	300-1350	64.25	57.83	54.61	48.19
		3mm	Box of 72	308-1350	64.25	57.83	54.61	48.19
W140	120	1/8"	Pkg. of 12	304-1400	13.55	12.20	11.52	10.16
		1/8"	Box of 72	300-1400	64.25	57.83	54.61	48.19
		3mm	Box of 72	308-1400	65.75	59.18	55.89	49.31
W142	120	1/8"	Pkg. of 12	304-1420	13.30	11.97	11.31	9.98
		1/8"	Box of 72	300-1420	64.25	57.83	54.61	48.19
		3mm	Box of 72	308-1420	64.25	57.83	54.61	48.19
W144	120	1/8"	Pkg. of 12	304-1440	12.10	10.89	10.29	9.08
		1/8"	Box of 72	300-1440	60.25	54.23	51.21	45.19
		3mm	Box of 72	308-1440	58.75	52.88	49.94	44.06
W145	120	1/8"	Pkg. of 12	304-1450	13.30	11.97	11.31	9.98
		1/8"	Box of 72	300-1450	65.75	59.18	55.89	49.31
		3mm	Box of 72	308-1450	65.75	59.18	55.89	49.31

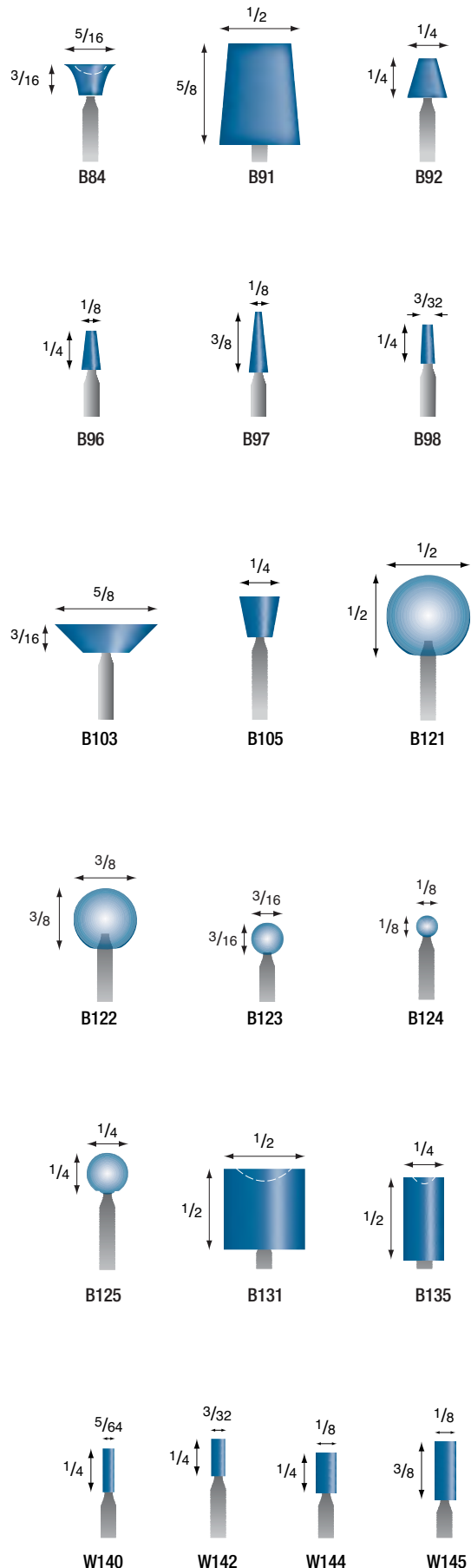

Shape dimensions shown in inches.

Gesswein® Blue Mounted Stones (continued)

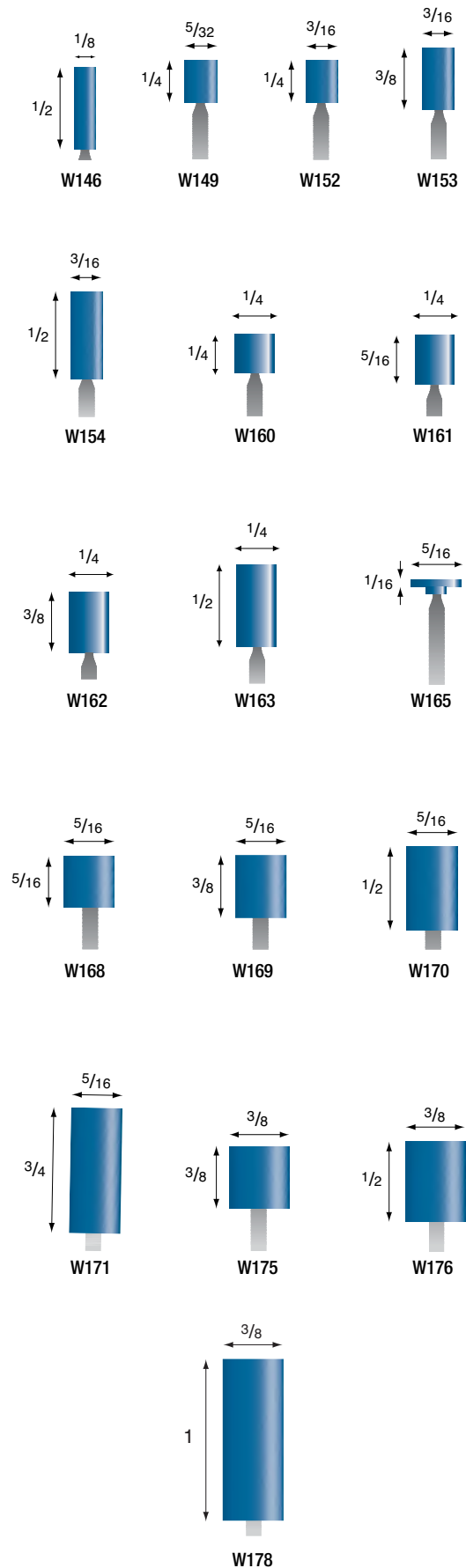

Style	Grit	Shank	Qty.	Item#	PKG./BOX Prices			
					1	2-3	4-9	10+
W146	120	1/8"	Pkg. of 12	304-1460	13.55	12.20	11.52	10.16
		1/8"	Box of 72	300-1460	65.75	59.18	55.89	49.31
		3mm	Box of 72	308-1460	64.25	57.83	54.61	48.19
W149	120	1/8"	Pkg. of 12	304-1490	12.10	10.89	10.29	9.08
		1/8"	Box of 72	300-1490	58.75	52.88	49.94	44.06
		3mm	Box of 72	308-1490	58.75	52.88	49.94	44.06
W152	120	1/8"	Pkg. of 12	304-1520	12.10	10.89	10.29	9.08
		1/8"	Box of 72	300-1520	58.75	52.88	49.94	44.06
		3mm	Box of 72	308-1520	58.75	52.88	49.94	44.06
W153	120	1/8"	Pkg. of 12	304-1530	13.55	12.20	11.52	10.16
		1/8"	Box of 72	300-1530	65.75	59.18	55.89	49.31
		3mm	Box of 72	308-1530	65.75	59.18	55.89	49.31
W154	120	1/8"	Pkg. of 12	304-1540	13.55	12.20	11.52	10.16
		1/8"	Box of 72	300-1540	64.25	57.83	54.61	48.19
		3mm	Box of 72	308-1540	64.25	57.83	54.61	48.19
W160	120	1/8"	Pkg. of 12	304-1600	12.10	10.89	10.29	9.08
		1/8"	Box of 72	300-1600	58.75	52.88	49.94	44.06
		3mm	Box of 72	308-1600	58.75	52.88	49.94	44.06
W161	120	1/8"	Pkg. of 12	304-1610	13.30	11.97	11.31	9.98
		1/8"	Box of 72	300-1610	64.25	57.83	54.61	48.19
		3mm	Box of 72	308-1610	64.25	57.83	54.61	48.19
W162	120	1/8"	Pkg. of 12	304-1620	13.55	12.20	11.52	10.16
		1/8"	Box of 72	300-1620	64.25	57.83	54.61	48.19
		3mm	Box of 72	308-1620	64.25	57.83	54.61	48.19
W163	120	1/8"	Pkg. of 12	304-1630	13.55	12.20	11.52	10.16
		1/8"	Box of 72	300-1630	64.25	57.83	54.61	48.19
		3mm	Box of 72	308-1630	65.75	59.18	55.89	49.31
W165	120	1/8"	Pkg. of 12	304-1650	12.10	10.89	10.29	9.08
		1/8"	Box of 72	300-1650	60.00	54.00	51.00	45.00
		3mm	Box of 72	308-1650	58.75	52.88	49.94	44.06
W168	120	1/8"	Pkg. of 12	304-1680	13.30	11.97	11.31	9.98
		1/8"	Box of 72	300-1680	62.00	55.80	52.70	46.50
		3mm	Box of 72	308-1680	66.25	59.63	56.31	49.69
W169	120	1/8"	Pkg. of 12	304-1690	13.30	11.97	11.31	9.98
		1/8"	Box of 72	300-1690	66.25	59.63	56.31	49.69
		3mm	Box of 72	308-1690	66.25	59.63	56.31	49.69
W170	120	1/8"	Pkg. of 12	304-1700	12.60	11.34	10.71	9.45
		1/8"	Box of 72	300-1700	64.25	57.83	54.61	48.19
		3mm	Box of 72	308-1700	64.25	57.83	54.61	48.19
W171	120	1/8"	Pkg. of 12	304-1710	14.25	12.83	12.11	10.69
		1/8"	Box of 72	300-1710	68.50	61.65	58.23	51.38
		3mm	Box of 72	308-1710	68.50	61.65	58.23	51.38
W175	120	1/8"	Pkg. of 12	304-1750	13.30	11.97	11.31	9.98
		1/8"	Box of 72	300-1750	64.25	57.83	54.61	48.19
		3mm	Box of 72	308-1750	64.25	57.83	54.61	48.19
W176	120	1/8"	Pkg. of 12	304-1760	13.30	11.97	11.31	9.98
		1/8"	Box of 72	300-1760	64.25	57.83	54.61	48.19
		3mm	Box of 72	308-1760	65.75	59.18	55.89	49.31
W178	120	1/8"	Pkg. of 12	304-1780	15.20	13.68	12.92	11.40
		1/8"	Box of 72	300-1780	71.75	64.58	60.99	53.81
		3mm	Box of 72	308-1780	68.75	61.88	58.44	51.56

Shape dimensions shown in inches.

Gesswein® Blue Mounted Stones (continued)

Style	Grit	Shank	Qty.	Item#	PKG./BOX Prices			
					1	2-3	4-9	10+
W181	120	1/8"	Pkg. of 12	304-1810	\$13.30	\$11.97	\$11.31	\$9.98
		1/8"	Box of 36	300-1810	30.00	27.00	25.50	22.50
		3mm	Box of 36	308-1810	30.00	27.00	25.50	22.50
W182	120	1/8"	Pkg. of 12	304-1820	13.30	11.97	11.31	9.98
		1/8"	Box of 36	300-1820	30.00	27.00	25.50	22.50
		3mm	Box of 36	308-1820	30.00	27.00	25.50	22.50
W183	120	1/8"	Pkg. of 12	304-1830	13.30	11.97	11.31	9.98
		1/8"	Box of 36	300-1830	30.00	27.00	25.50	22.50
		3mm	Box of 36	308-1830	30.00	27.00	25.50	22.50
W185	120	1/8"	Pkg. of 12	304-1850	13.30	11.97	11.31	9.98
		1/8"	Box of 36	300-1850	32.00	28.80	27.20	24.00
		3mm	Box of 36	308-1850	32.00	28.80	27.20	24.00
W186	120	1/8"	Pkg. of 12	304-1860	14.25	12.83	12.11	10.69
		1/8"	Box of 36	300-1860	34.25	30.83	29.11	25.69
		3mm	Box of 36	308-1860	34.25	30.83	29.11	25.69
W187	120	1/8"	Pkg. of 12	304-1870	15.20	13.68	12.92	11.40
		1/8"	Box of 36	300-1870	36.50	32.85	31.03	27.38
		3mm	Box of 36	308-1870	36.50	32.85	31.03	27.38
W190	120	1/8"	Pkg. of 12	304-1900	13.30	11.97	11.31	9.98
		1/8"	Box of 36	300-1900	32.00	28.80	27.20	24.00
		3mm	Box of 36	308-1900	32.00	28.80	27.20	24.00
W200	120	1/8"	Box of 12	300-2000	11.75	10.58	9.99	8.81
		3mm	Box of 12	308-2000	11.75	10.58	9.99	8.81
W201	120	1/8"	Box of 12	300-2010	11.75	10.58	9.99	8.81
		3mm	Box of 12	308-2010	11.75	10.58	9.99	8.81
W210	120	1/8"	Box of 12	300-2100	14.00	12.60	11.90	10.50
		3mm	Box of 12	308-2100	13.00	11.70	11.05	9.75
W211	120	1/8"	Box of 12	300-2110	14.00	12.60	11.90	10.50
		3mm	Box of 12	308-2110	14.00	12.60	11.90	10.50
W215	120	1/8"	Box of 12	300-2150	14.25	12.83	12.11	10.69
		3mm	Box of 12	308-2150	14.25	12.83	12.11	10.69

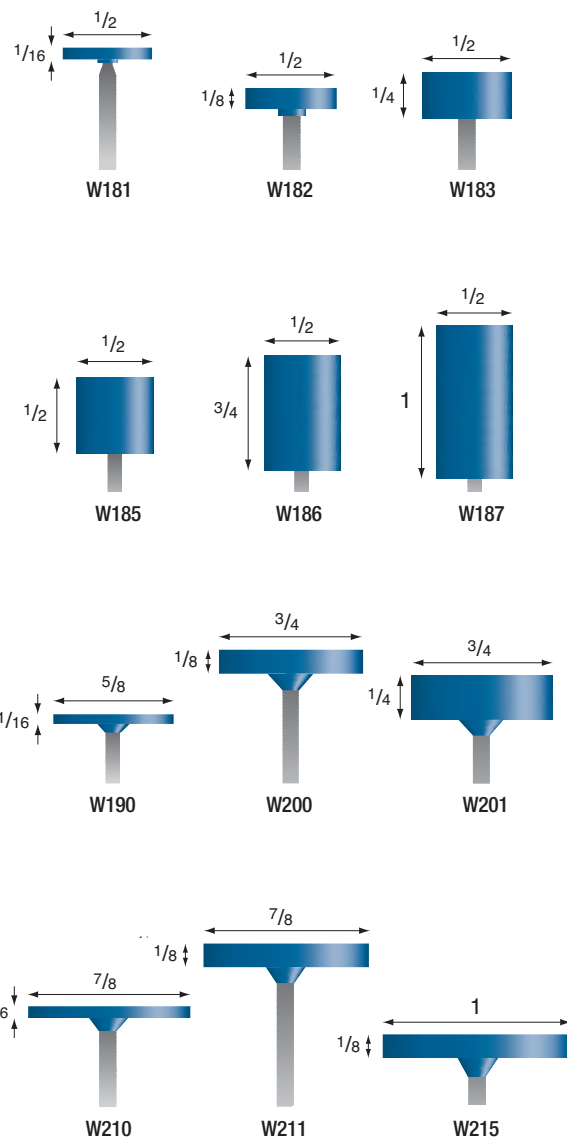

Shape dimensions shown in inches.

A, B Gesswein® Blue Mounted Stone Sets – 1/8" Shank

Gesswein Blue Mounted Stones are available in money-saving sets of 48 and 100 pieces. These assortments are made from our most popular shapes and offer a stone for almost every application. These sets offer big savings from the one-piece prices.

The 100-Piece Set includes ten each of our ten most popular shapes, conveniently packaged in a box to hold all 100 stones. Ten each of the following shapes: B44, B52, B96, B123, W144, W152, W162, W170, W175, W200.

The 48-Piece Set includes six each of eight popular shapes, conveniently packaged in a box to hold all 48 stones. Six each of the following shapes: B44, B52, B123, W144, W152, W162, W176, W200.

Description	Item#	Each
A. 100-Piece Blue Mounted Stone Set	305-3000	\$108.50
B. 48-Piece Blue Mounted Stone Set	305-3010	58.00

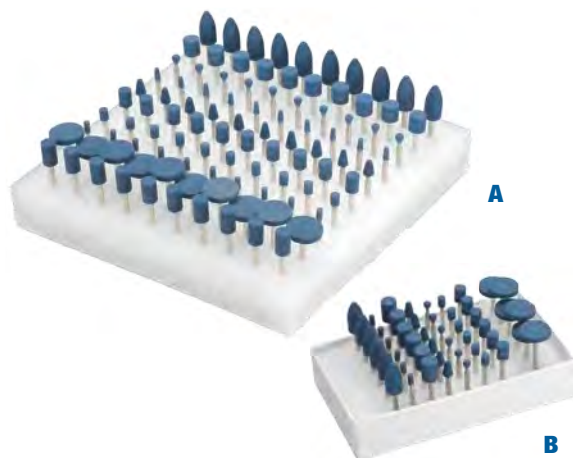

Made in the USA



Sold individually

Light Blue Mounted Stones

These ceramic mix mounted stones incorporate a unique Sol Gel ceramic abrasive. The Sol Gel abrasive, produced by Sol Gel processing, is both hard and tough. It provides exceptional durability and cut rates in grinding mild, high-carbon and stainless steel as well as many nonferrous alloys. Under normal use, cut rate and wheel life are two to three times that of Red and Blue Mounted Stones. Particularly suited for precision grinding. Form and radius holding are greatly increased due to Sol Gel's durability. Light Blue Mounted Stones are extremely tough in all grades, chemically pure and of uniform quality. All are 120 grit. Can be dressed with our Tru-Stone #380-1030 (see p. 51). All have 1 1/2" long plated steel shanks. For recommended speeds, consult the American National Standard Institute for full information.

See warnings on p. 50.

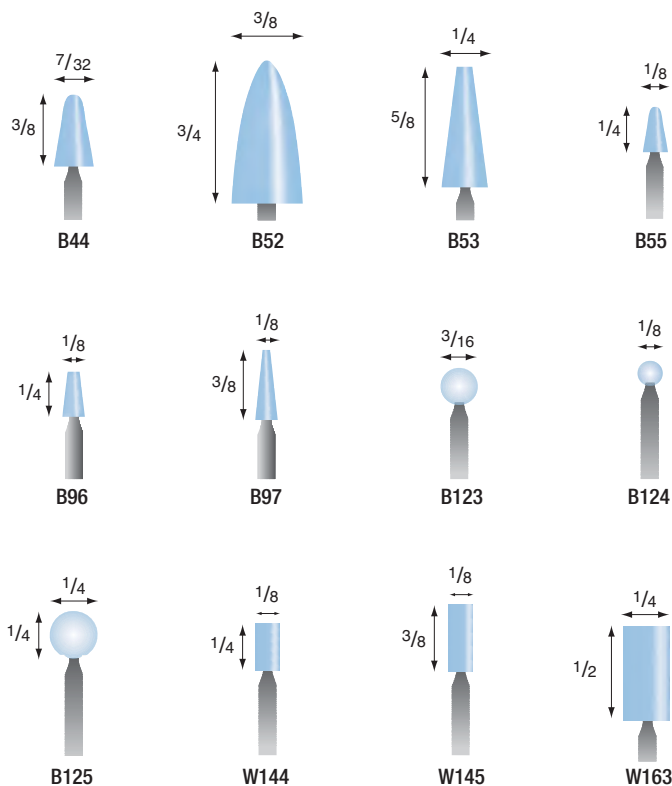

Style	Grit	Shank	Item#	EACH Prices	
				1-11	12+
B44	120	1/8" 3mm	312-0440	\$3.25	\$2.71
			312-3019	3.25	2.71
B52	120	1/8" 3mm	312-0520	3.25	2.71
			312-3020	3.25	2.71
B53	120	1/8" 3mm	312-0530	3.25	2.71
			312-3021	3.25	2.71
B55	120	1/8" 3mm	312-0550	2.25	1.87
			312-3022	2.25	1.87
B96	120	1/8" 3mm	312-0960	2.25	1.87
			312-3023	2.25	1.87
B97	120	1/8" 3mm	312-0970	3.25	2.71
			312-3024	3.25	2.71
B123	120	1/8" 3mm	312-1230	2.25	1.87
			312-3025	2.25	1.87
B124	120	1/8" 3mm	312-1240	2.25	1.87
			312-3026	2.25	1.87
B125	120	1/8" 3mm	312-1250	3.25	2.71
			312-3027	3.25	2.71
W144	120	1/8" 3mm	312-1440	2.25	1.87
			312-3028	2.25	1.87
W145	120	1/8" 3mm	312-1450	2.25	1.87
			312-3029	2.25	1.87
W163	120	1/8" 3mm	312-1630	2.25	1.87
			312-3030	2.25	1.87



A



B

A. Light Blue Mounted Stone Set

Buy the 12-piece assortment of these stones and have one for every application. Includes one each of above shapes. Conveniently packaged in a durable plastic box. Select between 1/8" or 3mm shanks.

Description	Item#	Each
Light Blue Mounted Stone Set, 1/8"	312-3000	\$26.75
Light Blue Mounted Stone Set, 3mm	312-3031	26.75

B. Handy Block - For 1/8" or 3/32" Shanks

An 88-hole block of cured hardwood for organizing burs, needle files, brushes and more. All holes are 1/8" in diameter to accommodate either 1/8" or 3/32" shanks. Block is slanted so user can see all tools at a glance. Stay-put rubber pads keep block from sliding. Weighs 1 lb., 2 oz. Measures 4 1/2" x 6".

Description	Item#	Each
Handy Block	814-1215	\$14.95

Red Mounted Points $\frac{3}{32}$ " Shank

Very fast-cutting, nonloading aluminum oxide stones, easily identified by their reddish-brown color. For fast grinding of medium and hard materials. Ideal for internal grinding of tools, dies and gauges. For recommended speeds, consult the American National Standard Institute for full information on vitrified mounted wheels. Mounted on $\frac{3}{32}$ " dia. x $1\frac{1}{2}$ " long plated steel shanks. All are 120 grit with the exception of shape #1 which is 80 Grit. Can be dressed with our Tru-Stone #380-1030 (see p. 51).

See warnings on p. 50.



Style	Grit	Shank	Qty.	Item#	Pkg./Box Price
1	80	$\frac{3}{32}$ " $\frac{3}{32}$ "	Pkg. of 12	321-0010	\$13.30
			Box of 72	319-0010	56.00
2	120	$\frac{3}{32}$ " $\frac{3}{32}$ "	Pkg. of 12	321-0020	13.30
			Box of 72	319-0020	56.00
6	120	$\frac{3}{32}$ " $\frac{3}{32}$ "	Pkg. of 12	321-0060	13.30
			Box of 72	319-0060	60.00
7	120	$\frac{3}{32}$ " $\frac{3}{32}$ "	Pkg. of 12	321-0070	13.30
			Box of 72	319-0070	60.00
9	120	$\frac{3}{32}$ "	Box of 72	319-0090	60.00
10	120	$\frac{3}{32}$ " $\frac{3}{32}$ "	Pkg. of 12	321-0100	13.30
			Box of 72	319-0100	60.00
12	120	$\frac{3}{32}$ " $\frac{3}{32}$ "	Pkg. of 12	321-0120	13.30
			Box of 72	319-0120	60.00
13	120	$\frac{3}{32}$ " $\frac{3}{32}$ "	Pkg. of 12	321-0130	13.30
			Box of 72	319-0130	60.00
14	120	$\frac{3}{32}$ " $\frac{3}{32}$ "	Pkg. of 12	321-0140	12.85
			Box of 72	319-0140	60.00
15	120	$\frac{3}{32}$ " $\frac{3}{32}$ "	Pkg. of 12	321-0150	13.30
			Box of 72	319-0150	60.00
16	120	$\frac{3}{32}$ " $\frac{3}{32}$ "	Pkg. of 12	321-0160	13.30
			Box of 72	319-0160	60.00
20	120	$\frac{3}{32}$ "	Pkg. of 12	321-0200	13.60
21	120	$\frac{3}{32}$ " $\frac{3}{32}$ "	Pkg. of 12	321-0210	13.30
			Box of 72	319-0210	60.00

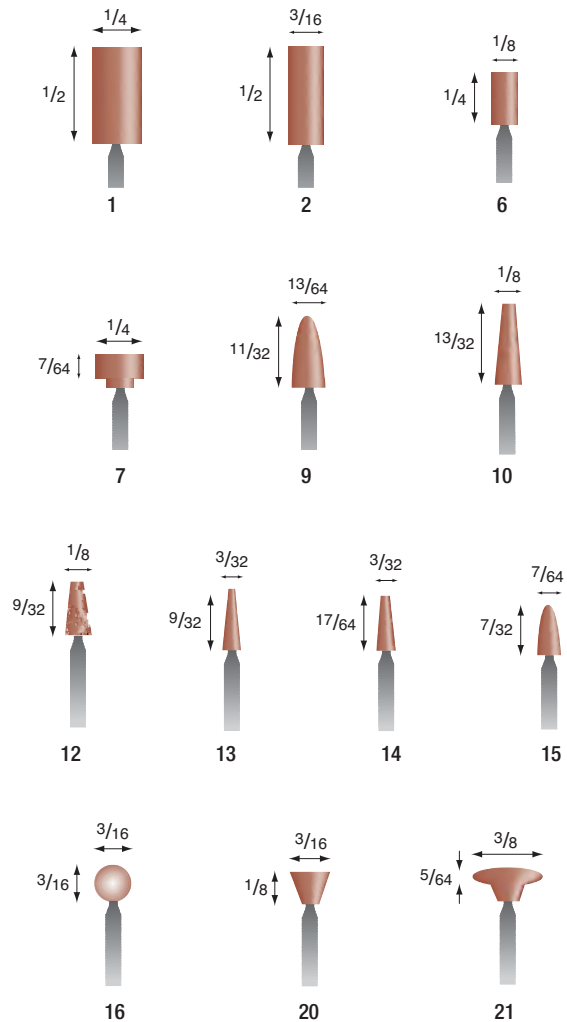

Shape dimensions shown in inches.

A, B Rotating Bur Holders – Choose between two styles

Rotating Bur and Tool Holder accepts up to 112 burs or tools. Features ball bearings for smooth action. Includes 92 holes for tools with $\frac{3}{32}$ " or $\frac{1}{8}$ " shanks, 13 holes for tools with $\frac{1}{4}$ " shanks, 7 holes for $\frac{1}{16}$ " to $\frac{5}{32}$ " drill bits and $2\frac{3}{4}$ " dia. x 3"H center cup for hand tools such as files, screwdrivers and more. Measures 7" dia. x 4"H.

Rotating Bur Holder Universal has 45 holes for tools with $\frac{1}{16}$ " shanks, 69 two-step holes for tools with $\frac{3}{32}$ " or $\frac{1}{8}$ " shanks and 12 holes for tools with $\frac{1}{4}$ " shanks. Measure 7" dia. x 4"H.

Description	Item#	Each
A. Rotating Bur and Tool Holder	850-0006	\$16.55
B. Rotating Bur Holder, Universal	850-0004	16.55

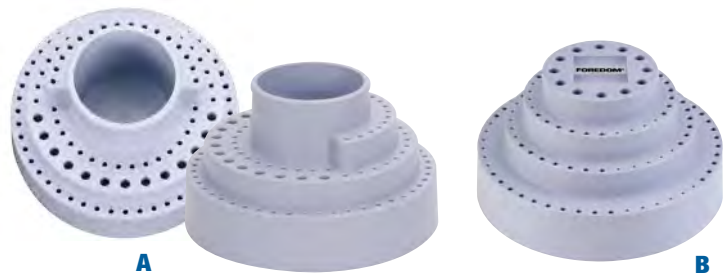

Gesswein® Blue Mounted Points $\frac{3}{32}$ " Shank

Made in the USA

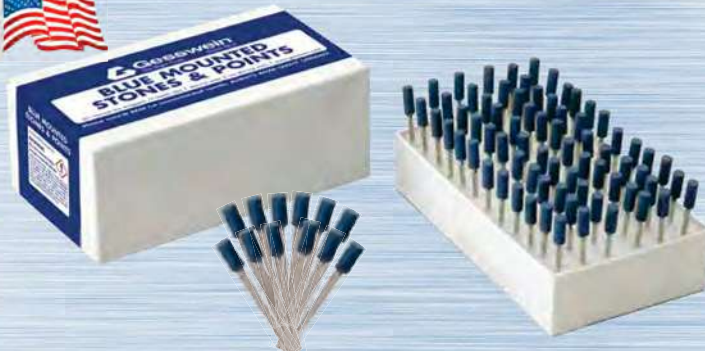

Hard blue aluminum oxide stones which hold their shapes, cut well and leave a smooth surface. Recommended for use on hardened steel. For recommended speeds, consult the American National Standard Institute for full information on vitrified mounted wheels. Mounted on $\frac{3}{32}$ " dia. x $1\frac{1}{2}$ " long plated steel shanks. All are 120 grit. Can be dressed with our Tru-Stone #380-1030 (see p. 51).

See warnings below.

Available in plastic packages of 12 and boxes of 72.

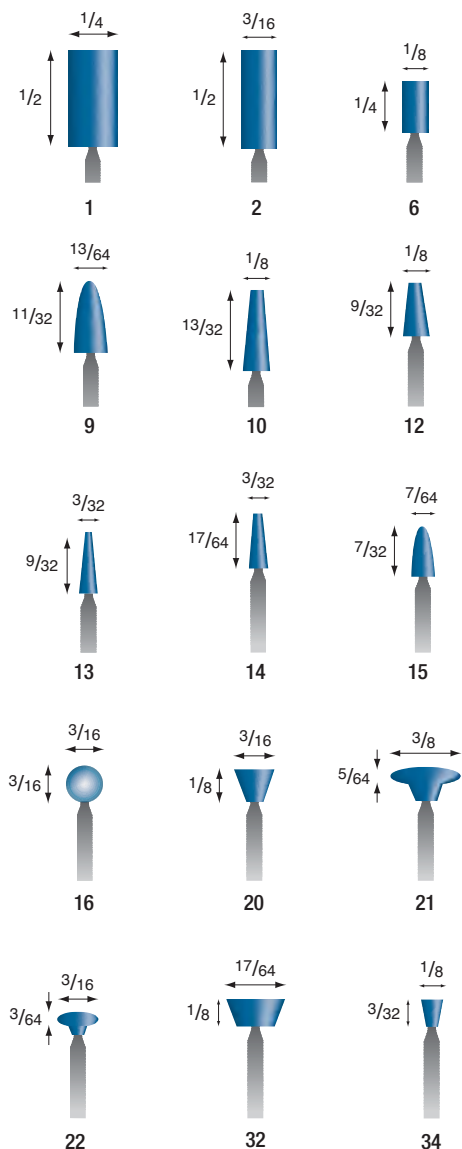

Shape dimensions shown in inches.

Style	Grit	Shank	Qty.	Item#	Pkg./Box Price
1	120	$\frac{3}{32}$ " $\frac{3}{32}$ "	Pkg. of 12	316-0010	\$14.25
			Box of 72	314-0010	65.25
2	120	$\frac{3}{32}$ " $\frac{3}{32}$ "	Pkg. of 12	316-0020	14.25
			Box of 72	314-0020	65.25
6	120	$\frac{3}{32}$ " $\frac{3}{32}$ "	Pkg. of 12	316-0060	14.25
			Box of 72	314-0060	65.25
9	120	$\frac{3}{32}$ " $\frac{3}{32}$ "	Pkg. of 12	316-0090	14.25
			Box of 72	314-0090	65.25
10	120	$\frac{3}{32}$ " $\frac{3}{32}$ "	Pkg. of 12	316-0100	14.25
			Box of 72	314-0100	65.25
12	120	$\frac{3}{32}$ " $\frac{3}{32}$ "	Pkg. of 12	316-0120	14.25
			Box of 72	314-0120	65.25
13	120	$\frac{3}{32}$ " $\frac{3}{32}$ "	Pkg. of 12	316-0130	14.25
			Box of 72	314-0130	65.25
14	120	$\frac{3}{32}$ " $\frac{3}{32}$ "	Pkg. of 12	316-0140	14.25
			Box of 72	314-0140	65.25
15	120	$\frac{3}{32}$ " $\frac{3}{32}$ "	Pkg. of 12	316-0150	14.25
			Box of 72	314-0150	65.25
16	120	$\frac{3}{32}$ " $\frac{3}{32}$ "	Pkg. of 12	316-0160	14.25
			Box of 72	314-0160	65.25
20	120	$\frac{3}{32}$ " $\frac{3}{32}$ "	Pkg. of 12	316-0200	14.25
			Box of 72	314-0200	65.25
21	120	$\frac{3}{32}$ " $\frac{3}{32}$ "	Pkg. of 12	316-0210	17.35
			Box of 72	314-0210	79.25
22	120	$\frac{3}{32}$ " $\frac{3}{32}$ "	Pkg. of 12	316-0220	17.35
			Box of 72	314-0220	74.00
32	120	$\frac{3}{32}$ " $\frac{3}{32}$ "	Pkg. of 12	316-0320	17.35
			Box of 72	314-0320	79.25
34	120	$\frac{3}{32}$ " $\frac{3}{32}$ "	Pkg. of 12	316-0340	17.35
			Box of 72	314-0340	79.25

Warning: For recommended speeds, consult the American National Standards Institute for full information on vitrified mounted wheels. Before using any abrasive product, follow all safe operating guidelines with respect to eye protection, hand protection, hearing protection and respiratory protection. Also read the Material Safety Data Sheet to be aware of any inherent hazards or cautions.

Important: Abrasive stones break down during mold and die polishing, grinding, tool sharpening, and dressing of cutting & grinding wheels. The resulting dust is classified by OSHA as inert or nuisance dust. Please consult the Material Safety Data Sheet for each stone; data provided therein pertains primarily to the dust produced during and after use. Please note that hazards may change when abrasive stones are used in conjunction with solvents, cutting fluids or other chemicals. For more complete information, consult the Material Safety Data Sheets of chemical products used with abrasive stone products.



Busch® Pink Polishing Points $\frac{3}{32}$ " Shank

Made of genuine corundum, these points are recommended for use on harder metals. For recommended speeds, consult the American National Standard Institute for full information on vitrified mounted wheels. Mounted on $\frac{3}{32}$ " dia. x $1\frac{1}{2}$ " L plated steel shanks. All are medium grit. Can be dressed with our Tru-Stone #380-1030 (see below). Made in Germany.

See warnings on p. 50.

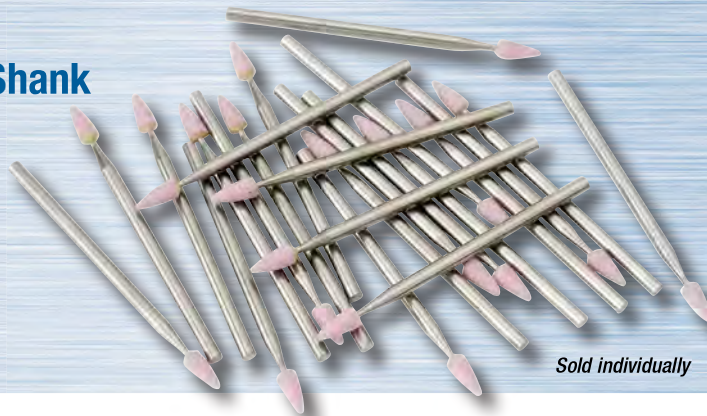

Sold individually

Style	Grit	Item#	EACH Prices		
			1-5	6-71	72+
601	Med.	330-1324	\$2.45	\$2.08	\$1.96
602	Med.	330-1325	2.85	2.42	2.28
603	Med.	330-1330	2.45	2.08	1.96
621	Med.	330-1340	2.45	2.08	1.96
624	Med.	330-1342	2.45	2.08	1.96
632	Med.	330-1345	2.45	2.08	1.96
633	Med.	330-1346	2.45	2.08	1.96
637	Med.	330-1350	2.45	2.08	1.96
639	Med.	330-1355	2.45	2.08	1.96
640	Med.	330-1360	2.45	2.08	1.96
648	Med.	330-1364	2.45	2.08	1.96
649	Med.	330-1365	2.45	2.08	1.96
652	Med.	330-1370	2.45	2.08	1.96
661	Med.	330-1375	2.45	2.08	1.96
662	Med.	330-1380	2.45	2.08	1.96
665	Med.	330-1382	2.45	2.08	1.96
716	Med.	330-1395	3.75	3.19	3.00

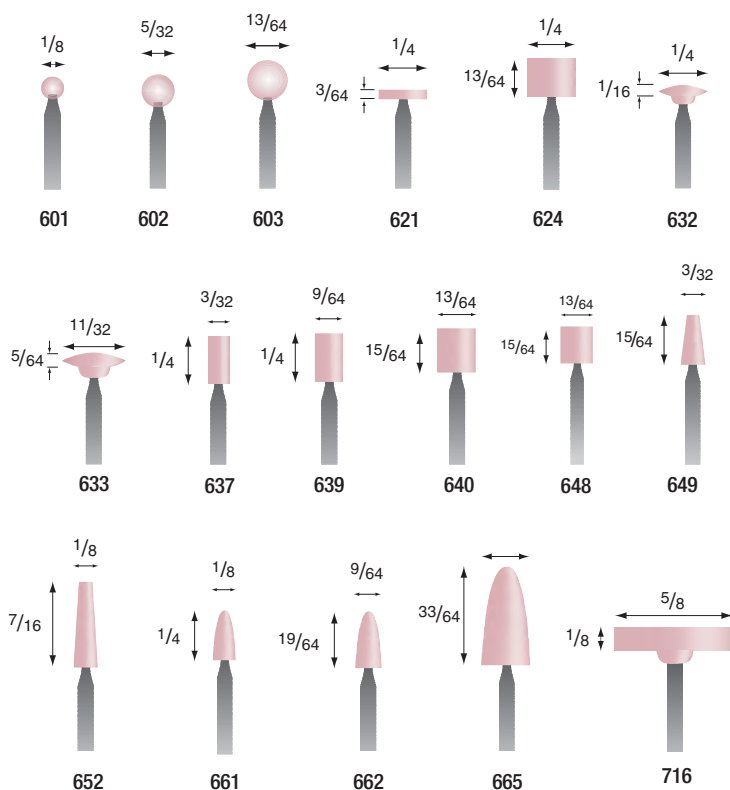

Shape dimensions shown in inches.

A. Rotating Bur Holder – $\frac{3}{32}$ " Shank

Handy tiered holder rotates to keep tools within easy reach. Holds 150 burs or tools. All holes are $\frac{3}{32}$ " in diameter to accommodate $\frac{3}{32}$ " shanks. Weighs 12 oz. Measures 4"H x 6" dia. at base.

Description	Item#	Each
Rotating Bur Holder	124-4720	\$12.75



A

B. Tru-Stone

For dressing and shaping mounted stones and abrasive wheels

A very hard and coarse grit silicon carbide stone with four different sized half-round grooves measuring $\frac{1}{16}$ ", $\frac{1}{8}$ ", $\frac{3}{16}$ " and $\frac{1}{4}$ " on one side. Quickly reshapes and resurfaces abrasive stones to like-new condition. Measures $3\frac{1}{2}$ " L x $1\frac{3}{8}$ " W x $\frac{9}{16}$ " H.

Description	Item#	EACH Prices	
		1-9	10+
Tru-Stone	380-1030	\$5.95	\$4.76



B

Gesswein® White Polishing Points $\frac{3}{32}$ " Shank

Formulated from 400 grit (extremely fine) white aluminum oxide in a soft vitrified bond, these points can be used on glass, porcelain, metal or stone. Produce a high finish. For recommended speeds, consult the American National Standard Institute for full information on vitrified mounted wheels. Mounted on $\frac{3}{32}$ " dia. x $1\frac{1}{2}$ "L plated steel shanks. Can be dressed with our Tru-Stone #380-1030 (see p. 51).

Before using any abrasive product, follow all safe operating guidelines with respect to eye protection, hand protection, hearing protection and respiratory protection. Also read the Material Safety Data Sheet (SDS) to be aware of any inherent hazards or cautions.



Available in plastic packages of 12 and boxes of 72.

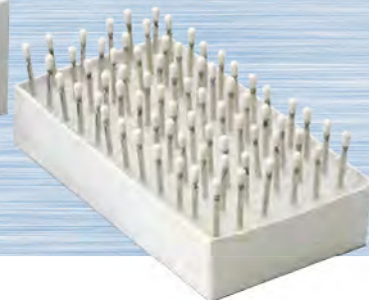

Made in the USA

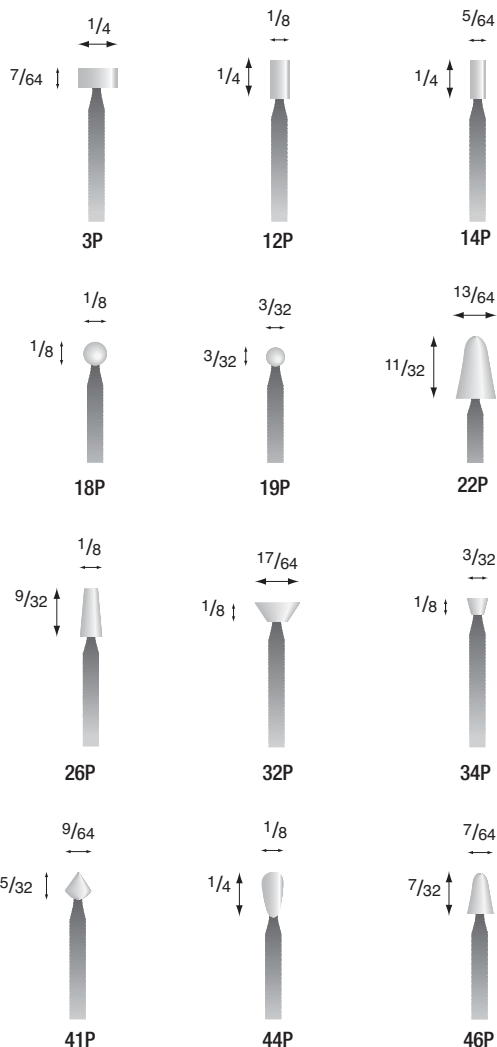

Shape dimensions shown in inches.

Style	Grit	Shank	Qty.	Item#	Pkg./Box Price
3P	400	$\frac{3}{32}$ " $\frac{3}{32}$ "	Pkg. of 12	326-0030	\$20.45
			Box of 72	324-0030	93.00
12P	400	$\frac{3}{32}$ " $\frac{3}{32}$ "	Pkg. of 12	326-0120	20.45
			Box of 72	324-0120	93.00
14P	400	$\frac{3}{32}$ " $\frac{3}{32}$ "	Pkg. of 12	326-0140	20.45
			Box of 72	324-0140	93.00
18P	400	$\frac{3}{32}$ " $\frac{3}{32}$ "	Pkg. of 12	326-0180	20.45
			Box of 72	324-0180	93.00
19P	400	$\frac{3}{32}$ " $\frac{3}{32}$ "	Pkg. of 12	326-0190	20.45
			Box of 72	324-0190	93.00
22P	400	$\frac{3}{32}$ " $\frac{3}{32}$ "	Pkg. of 12	326-0220	20.45
			Box of 72	324-0220	93.00
26P	400	$\frac{3}{32}$ " $\frac{3}{32}$ "	Pkg. of 12	326-0260	20.90
			Box of 72	324-0260	93.00
32P	400	$\frac{3}{32}$ " $\frac{3}{32}$ "	Pkg. of 12	326-0320	20.45
			Box of 72	324-0320	93.00
34P	400	$\frac{3}{32}$ " $\frac{3}{32}$ "	Pkg. of 12	326-0340	20.45
			Box of 72	324-0340	87.00
41P	400	$\frac{3}{32}$ " $\frac{3}{32}$ "	Pkg. of 12	326-0410	20.45
			Box of 72	324-0410	49.00
44P	400	$\frac{3}{32}$ " $\frac{3}{32}$ "	Pkg. of 12	326-0440	20.45
			Box of 72	324-0440	93.00
46P	400	$\frac{3}{32}$ " $\frac{3}{32}$ "	Pkg. of 12	326-0460	20.45
			Box of 72	324-0460	93.00



A

A. Plastic Bur Holder – For $\frac{3}{32}$ " Shanks

Accepts up to 100 burs or tools with $\frac{3}{32}$ " shanks. Supplied with tilt stand. Measures 5" x 3". Color may vary.

Description	Item#	EACH Prices	
		1-2	3+
Plastic Bur Holder	840-0007	\$4.95	\$3.96

A, B Type VS Dressing Stones for Diamond Wheels

Made of premium quality white aluminum oxide. Very soft stones used for cleaning diamond wheels. Stones are evenly bonded and have precise grits.

Grit	Dimensions	Item#	EACH Prices	
			6-18	24+
A. 80	6" x 1 1/2" x 1/2"	381-0005	\$2.85	\$2.57
120	6" x 1 1/2" x 1/2"	381-0105	2.85	2.57
150	6" x 1 1/2" x 1/2"	381-0115	2.85	2.57
220	6" x 1 1/2" x 1/2"	381-0205	2.85	2.57
320	6" x 1 1/2" x 1/2"	381-0305	3.90	3.51
B. 80	6" x 3/4" x 3/4"	381-1007	4.50	4.05
120	6" x 3/4" x 3/4"	381-1107	4.50	4.05
150	6" x 3/4" x 3/4"	381-1117	4.50	4.05
220	6" x 3/4" x 3/4"	381-1207	4.50	4.05
320	6" x 3/4" x 3/4"	381-1307	6.90	6.21

 Six-piece minimum; please order in multiples of six.

C. Dressing Stone – Coarse grit

A very hard, 20 grit stone that will quickly smooth out and take off irregular edges from almost any grinding wheel or MX Lap. Also excellent for shaping Bear-Tex Wheels. Measures 6" x 1" square.

Description	Grit	Item#	Each
Coarse Dressing Stone	20	380-1010	\$14.60

D. Dressing Stone – Medium grit

A very hard, 150 grit stone in a convenient shape for dressing grinding wheels, G-Flex and GMX wheels (see pp. 96-99). Measures 2 1/2"L x 1 1/2"W x 1/2"H.

Description	Grit	Item#	Each
Medium Dressing Stone	150	380-1020	\$4.05

E. Norton® Norbide® Dressing Stick

The Norbide Dressing Stick is used to economically dress, shape and true vitrified grinding wheels. It's also the choice for "roughing in" a shape prior to diamond truing precision grinding wheels. Measures 3"L x 1/2"W x 1/4"H.

Description	Item#	Each
Norbide Dressing Stick	380-1035	\$72.20

F. Wet Stick Diamond Dresser

Use this dressing stone with water for cleaning diamond points. Measures 2"L x 3/4"W x 1/2" thick.

Description	Item#	Each
Wet Stick	380-1022	\$2.30

G. Diamond Impregnated Dressing Stone

Has a concave center hole for forming a point on polishing rods. Measures 3/4" dia. x 1/8" thick.

Description	Item#	Each
Dressing Stone	145-1240	\$5.40

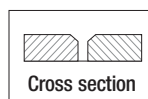

NORTON

A



A. Norton® 32A Aluminum Oxide Grinding Wheels

For medium to heavy stock removal

Sharp monocrystalline aluminum oxide grain. Outstanding form holding. For moderate to heavy grinding of tool steels, including tough alloys. Allow exceptionally fast, cool cutting. Requires minimum dressing. Cannot be used on a tapered spindle, must use on arbor (see p. 401).

Dia. x Thick x AH	Grit Hardness	Item#	EACH Prices	
			1-9	10-29
7" x 1/4" x 1 1/4"	80/I	245-3195	\$35.75	\$28.60
7" x 1/2" x 1 1/4"	46/K	245-3200	54.85	43.88

B



B. Norton® White Aluminum Oxide Grinding Wheels

For light grinding

For light grinding of all kinds. Particularly good on hard, heat-sensitive materials such as high-speed steel and cast-alloy tools. Available in two hardnesses, J (Softest) and K (Hardest). Cannot be used on a tapered spindle, must use on arbor (see p. 401).

Dia. x Thick x AH	Grit Hardness	Item#	EACH Prices	
			1-9	10+
4" x 1/2" x 1/2"	60/K	845-0054	\$25.90	\$15.54
	100/K	845-0100	24.75	14.85
7" x 1/4" x 1 1/4"	60/J	245-3080	30.60	24.48
	80/J	245-3085	30.60	24.48
	100/J	245-3090	30.60	24.48
	120/K	245-3095	30.60	24.48
	150/K	245-3100	53.35	42.68
7" x 1/2" x 1 1/4"	60/J	245-3120	46.30	37.04

C



D

C, D Norton® Bear-Tex® Wheels

For quick removal of marks, scratches and surface imperfections. Also great for producing a consistent satin finish. Made of a cushion-type nylon web impregnated with silicon carbide abrasive. Bear-Tex does not load or heat up. The 220 grit fine wheel is our most popular; the other grits are for faster finishing.

Dia. x Thick x AH	Grit	Max. RPM	Item#	EACH Prices	
				1-19	20+
A. 3" x 3/4" x 1/4"	150	8,000	845-0240	\$12.15	\$10.33
3" x 3/4" x 1/4"	220	8,000	845-0250	12.20	10.37

Dia. x Thick x AH	Grit	Max. RPM	Item#	EACH Prices	
				1-2	3+
B. 6" x 1" x 1" *	180	6,000	845-0259	93.25	83.93

*Comes with 1/2" bushing.

Before using any abrasive product, follow all safe operating guidelines with respect to eye protection, hand protection, hearing protection and respiratory protection. Also read the Material Safety Data Sheet (SDS) to be aware of any inherent hazards or cautions.

A. 3M™ Scrubber™ Light Deburring Wheel

Clean, safe and economical wheel for removing sprues, parting lines, firescale and oxidation. Produces a satin finish on gold, sterling silver, copper, brass and stainless steel. Silicon carbide. Use #145-1931 to mount on tapered spindles.

Description	Dia. x Thick x AH	Max. RPM	Item#	Each
Fine	6" x 1" x 1"	6,000	845-1089	\$77.25
Adapter for 1" AH		6,000	145-1931	5.80



B, C 3M™ Scotch-Brite™ EXL Wheel

Excellent choice for deburring and finishing. Medium grade aluminum oxide. Mount on an arbor (see p. 401) for use on polishing motor. Use #145-1921 to use with a tapered spindle.

Description	Dia. x Thick x AH	Max. RPM	Item#	EACH Prices	
				1-3	4+
D. Medium	6" x 1/2" x 1/2"	4,500	845-0305	\$39.95	\$35.96
E. Adapter for 1/2" AH			145-1921		2.30



D. GP Plus™ and LDW Convolute Wheels

Ideal for a variety of deburring, blending, finishing and polishing applications. Consist of fine silicon carbide embedded in nonwoven material wound around a core producing a cushion effect for controlled, fast cutting and consistent, uniform finishing. Easy to shape and dress. Can be used with water or water-soluble oil if desired. Choose GP Plus (high-density wheels, aggressive) for the toughest jobs and LDW (low-density wheels) for finer, more delicate work. Combine with flanges (see below) and appropriate arbor (see p. 401) to mount on your polishing motor.

Type	Grade*	6" x 1/2" x 1" AH	Each	6" x 1" x 1" AH	Each
GP Plus	9SF	845-0069	\$58.55	845-0070	\$79.75
GP Plus	8SF	845-0067	56.35	845-0068	79.75
LDW	7SF	845-0065	55.85	845-0066	81.65
Description		1" AH to 1/2" AH	1" AH to 3/8" AH		Pkg. of 2
Flanges for converting		277-0089	277-0091		\$5.50



E. Rub-Out Stick and Holder

For touch-ups and removal of light scratches on polished surfaces. Made of flexible rubber with silicon carbide abrasive. Holder gives support and gripping power. Stick can be exposed or withdrawn as desired and is easily dressed to the best shape for the job. Also removes rust, heat marks and stains while leaving a polished surface. Measures 6" L x 3/8" dia.

Description	Fine Grit	Extra-Fine Grit	SET Prices*	
			1-4	5+
Stick and Holder	145-1300	145-1302	\$20.50	\$18.45
Refill Stick	145-1306	145-1308	7.55	6.80

*Quantity discount for orders of one item number only; not assorted.

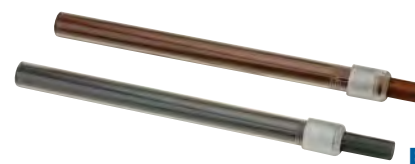

3M™ Roloc™ Discs

3M Roloc discs allow fast and efficient deburring, blending, polishing and finishing on all types of metal surfaces. They resist loading even under severe operating conditions. The Roloc design makes changing discs easy: the threaded male button on the back of each disc allows firm mounting to Roloc Disc Holder. Lock securely in place with a half-twist, or remove with half-twist in opposite direction. Discs are color-coded or have color-coded button for easy grit identification. Use with right-angle grinders.

Before using any abrasive product, follow all safe operating guidelines with respect to eye protection, hand protection, hearing protection and respiratory protection. Also read the Material Safety Data Sheet (MSDS) to be aware of any inherent hazards or cautions.

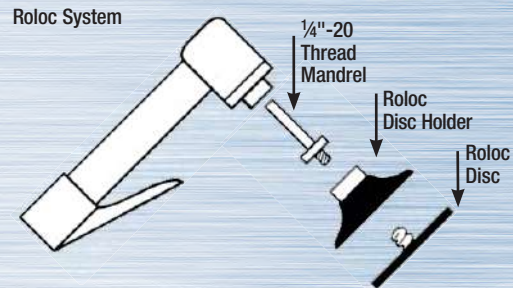

A. 3M™ Roloc™ Regalite™ Discs

Made of 3M Cubitron and premium aluminum oxide grains resin-bonded onto heavy cloth backing. Mount on Roloc Disc Holders (see below).

Dia.	Max. RPM	60 Grit	80 Grit	120 Grit	PKG of 50*	
		(Orange) Item#	(Yellow) Item#	(White) Item#	1-9	10+
2"	25,000**	105-3030	105-3035	105-3040	45.70	41.13

*Quantity discount for orders of one item number only; not assorted.
**Max. operating speed of 20,000rpm when used with the soft Roloc Disc Holder.



B. 3M™ Roloc™ Scotch-Brite™ Discs

These discs remove burs with ease, leaving metal surfaces ready for final finishing. Can also be used to remove light rust, oxides and coatings. Mount on Roloc Disc Holders (see below).

Dia.	Max. RPM	Coarse Grit	Medium Grit	Very Fine Grit	PKG of 10*		
		(Brown) Item#	(Maroon) Item#	(Blue) Item#	1-4	5-19	20+
1"	30,000	845-1152	845-1151	845-1150	\$8.90	\$8.46	\$8.01
1½"	30,000	845-1155	845-1154	845-1153	8.90	8.46	8.01
2"	25,000**	845-1158	845-1157	845-1156	12.95	12.30	11.66

*Quantity discount for orders of one item number only; not assorted.
**Max. operating speed of 20,000rpm when used with the soft Roloc Disc Holder.

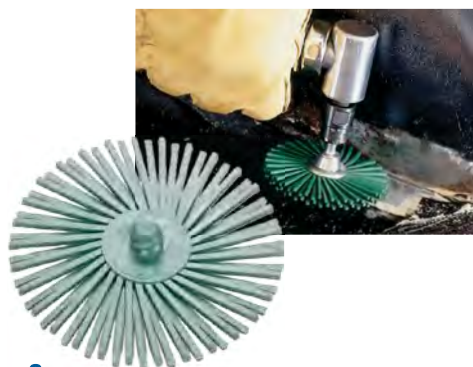

C. 3M™ Roloc™ Radial Bristle Discs

Use to remove surface contaminants, debur, blend and clean. Flexible bristles conform to surfaces and clean without damaging base material. Ideal for tight and awkward areas such as grooves and crevices. Use with 1" Roloc Disc Holder #105-3070 (see below).

Dia.	Trim Length	Max. RPM	50 Grit	80 Grit	120 Grit	EACH Prices*	
			(Green) Item#	(Yellow) Item#	(White) Item#	1-9	10+
3"	1"	25,000	145-1895	145-1900	145-1901	\$8.75	\$7.88

*Quantity discount for orders of one item number only; not assorted.



D-G 3M™ Roloc™ Disc Holders

Rubber holders available in corresponding diameters and varying degrees of hardness for a variety of grinding and surface finishing applications. Harder holders cause discs to act more aggressively. Use soft pads for contour work. Holders are female threaded to receive any standard ¼"-20 thread mandrel or our #105-3110. For use with Roloc discs (see above).

Dia.	Hardness	Max. RPM	Item#	EACH Prices*	
				1-4	5+
D. 1"	Medium	30,000	105-3070	\$12.90	\$12.26
E. 1½"	Hard	30,000	105-3085	15.40	14.63
	Medium	30,000	105-3080	15.40	14.63
	Soft	30,000	105-3075	16.55	15.72
F. 2"	X-Hard	25,000	105-3105	19.65	18.67
	Hard	25,000	105-3100	16.45	15.63
	Medium	25,000	105-3095	16.45	15.63
	Soft	20,000	105-3090	17.60	16.72
G. Disc Holder Mandrel, ¼" shank			105-3110	2.80	2.66

A-O 3M™ Scotch-Brite™ Small EXL Unitized Wheels

For deburring, blending parting lines, removing flash, cleaning and finishing on all metal alloys, as well as many plastics and composites. Great for cleanup prior to and after soldering and welding. Produce fine finishes on tooled pieces, aerospace, automotive and electronic components as well as medical instruments. Long-lasting to help reduce finishing operation costs. Synthetic fiber and resin construction makes a semi-resilient wheel that follows contours well and eliminates undercutting and gouging. All wheels are cool-running and resist heat buildup. Available in three color-coded grits: coarse (orange), medium (red) and fine (purple). See pp. 584- for mandrels.

Dia. x W x AH	Max. RPM	Item#	EACH Prices	
			1-9	10-49
Orange EXL – Coarse Grit (hard density AlO)				
A. 1/2" x 1/8" x 1/8"	40,100	845-1056	\$1.75	\$1.66
B. 3/4" x 1/8" x 1/8"	40,100	845-1057	2.05	1.95
C. 1" x 1/8" x 1/8"	35,100	845-1060	3.00	2.85
D. 1 1/2" x 1/8" x 3/16"	30,100	845-1069	4.25	4.04
E. 2" x 1/8" x 3/16"	22,100	845-1073	5.05	4.80
Red EXL – Medium Grit (medium density AlO)				
F. 1/2" x 1/8" x 1/8"	40,100	845-1055	\$1.65	\$1.57
G. 3/4" x 1/8" x 1/8"	40,100	845-1058	1.80	1.71
H. 1" x 1/8" x 1/8"	35,100	845-1059	2.80	2.66
I. 1 1/2" x 1/8" x 3/16"	30,100	845-1068	3.85	3.66
J. 2" x 1/8" x 3/16"	22,100	845-1072	4.45	4.23
Purple EXL – Fine (soft density SiC)				
K. 1/2" x 1/4" x 1/8"	35,100	845-1062	\$1.75	\$1.66
L. 3/4" x 1/4" x 1/8"	35,100	845-1063	2.15	2.04
M. 1" x 1/4" x 1/8"	30,100	845-1061*	2.60	2.47
N. 1 1/2" x 1/4" x 3/16"	20,100	845-1070	3.85	3.66
O. 2" x 1/4" x 3/16"	16,100	845-1074	4.60	4.37
Description		Item#	Each	
Mandrel for 3/16" AH wheels, 1/4" shank		840-3300	\$32.35	

*Most popular

P. 3M™ Scotch-Brite™ EXL Unitized Wheel Set

This 29-piece set includes 26 wheels from 1/2" to 2" in diameter (eight 1/2", six 1", six 1 1/2" and six 2" wheels) and two 1/8" shank mandrels.

Description	Item#	Each
29-Piece Set	845-1054	\$70.05

Q. 3M™ Scotch-Brite™ Fiber Discs

Made of 3M Scotch-Brite nonwoven fiber material. Feature reinforced Velcro-type webbed backing for quick attachment to the unique, convenient Fiber Disc Holders (see below), which also have Velcro-type backing. Excellent for right-angle handpieces and grinders.

Dia.	Abrasive	Alum.	Microfinish Range Generated			Color	Item#	PKG of 10
			Steel	Grit				
1 1/2"	Aluminum oxide	56-68	16-22	Coarse	Brown	108-8015	\$7.10	
	Aluminum oxide	28-37	10-16	Medium	Maroon	108-8010	6.30	
	Aluminum oxide	22-28	9-12	Very fine	Blue	108-8005	6.30	
	Silicon carbide	11-15	4-6	Super fine	Gray	108-8000	6.30	
2"	Aluminum oxide	56-68	16-22	Coarse	Brown	108-8035	10.10	
	Aluminum oxide	28-37	10-16	Medium	Maroon	108-8030	9.90	
	Aluminum oxide	22-28	9-12	Very fine	Blue	108-8025	9.00	
3"	Aluminum oxide	56-68	16-22	Coarse	Brown	108-8055	19.85	
	Aluminum oxide	28-37	10-16	Medium	Maroon	108-8050	17.45	
	Aluminum oxide	22-28	9-12	Very fine	Blue	108-8045	17.45	
	Silicon carbide	11-15	4-6	Super fine	Gray	108-8040	19.00	

R. 3M™ Scotch-Brite™ Fiber Disc Holders – 1/4" Shank

For use with 3M Scotch-Brite Fiber Discs only (see above). All have 1/4" shank.

Holder	Item#	Each
For 1 1/2" Fiber Disc	108-8060	\$4.80
For 2" Fiber Disc	108-8065	5.45
For 3" Fiber Disc	108-8070	6.35





A

A. Fiber Flap Wheel – 1/4" Shank

Made of resilient aluminum oxide material. These wheels replace hand pads and reduce the need for finishing operations. For light deburring, polishing and satin finishing steel, nonferrous metal and wood. Ideal for surface contaminant removal. Maximum speed: 20,000rpm. Mounted on 1/4" shanks. Made in USA.

Dia. x Thickness	Coarse	Medium	Fine	Very Fine	EACH Prices*	
					1-2	3+
2" x 1"	108-0040	108-0050	108-0060	108-0070	\$11.25	\$10.69
3" x 1"	108-0140	108-0150	108-0160	108-0170	13.60	12.92

*Quantity discount for orders of one item number only; not assorted.

B. Mounted Hard FR Fiber Wheel – 3/32" Shank

Ideal for stock removal, this wheel has only slight resilience and cuts fast. Made of silicon carbide. Measures 1" dia. x 1/4" thick. 3/32" stainless steel shank. Imported.

Description	Dia. x Thickness	Item#	EACH Prices	
			1-11	12+
FR Fiber Wheel	1" x 1/4"	288-2272	\$3.65	\$3.29

C. Mounted Flexible SLP Fiber Wheel – 3/32" Shank

A flexible yet firm unitized abrasive mounted wheel made of 180 grit pure alumina. Produces a fine, smooth finish. Measures 7/8" dia. x 1/8" thick. 3/32" stainless steel shank. Imported.

Description	Dia. x Thickness	Item#	EACH Prices	
			1-11	12+
SLP Fiber Wheel	7/8" x 1/8"	288-2276	\$1.70	\$1.53

D-F 3M™ Scotch-Brite™ Wheels – 2 Ply, 3/32" Shank

Soft double ply Scotch-Brite easily conforms to surface contours. Removes a small amount of metal while producing a satin finish. Measure approximately 7/8" dia. on 3/32" stainless steel shank. Maximum speed: 10,000rpm. Made in Germany.

Description	Abrasive	Color	Item#	EACH Prices	
				1-11	12+
D. Coarse	AIO	Brown	288-2280	\$1.55	\$1.40
E. Medium/Fine	AIO	Red	288-2282	1.55	1.40
F. Fine	AIO	Violet	288-2284	1.55	1.40

G-J Mounted Satin Finish Wheels – 3 Ply, 3/32" Shank

Use these extra-thick wheels to create the exact degree of satin finish you want, from the soft and subtle texture of Extra Cut to the lustrous glow of Ultra-Fine. Made of dense-weave fiber for a uniform, nondirectional finish. Last much longer than conventional satin finish buffs. Measure approx. 7/8" dia. x 3/8" thick with 3/32" shank. To try all four grits, purchase our money-saving eight-piece intro pack. Imported.

Description	Abrasive	Color	Item#	EACH Prices	
				1-11	12+
G. Extra Cut	AIO	Brown	288-2260	\$1.35	\$1.22
H. Medium	AIO	Red	288-2262	1.35	1.22
I. Very Fine	AIO	Dark Red	288-2264	1.35	1.22
J. Ultra-Fine	SiC	Gray	288-2266	1.35	1.22
8-Piece Pack (two of each grit)			288-2270	8.95	-

K Compressed Fiber Wheel – 3/32" Shank

Fibers are compressed and bonded with aluminum oxide to make a firm, dense long lasting wheel with some flexibility. Creates a beautiful distinct scratch finish that contrasts well with highly polished areas. Recommended working speed: 5,000rpm. Made in Germany.

Description	Dia. x Thickness	Item#	EACH Prices	
			1-11	12+
K. Coarse	7/8" x 3/8"	288-2250	\$4.95	\$4.46

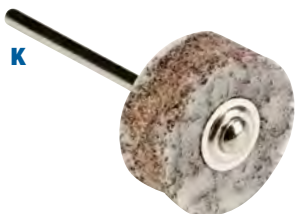

A, B Norton® Bear-Tex® Hand Pads

Made of loose nonwoven fiber with abrasive grain mixed throughout. Can be easily cut to desired size. For cleaning, scuffing, deburring or finishing surfaces by hand. Available in two grades. Measure approximately 6"L x 9"W x 3/8"H. Sold individually or in boxes of 20. Cut to fit pad holder 108-7462 below.

Color	Grit	Abrasive	Application	Item#	BOX of 20	
					1-2	3+
A. Maroon	Very Fine	AIO	General-purpose, deburring	108-7447	\$29.70	\$26.73
B. Gray	Ultra-Fine	SiC	Light cleaning and finishing	108-7448	35.60	32.04
Color	Grit	Abrasive	Application	Item#	Each	
A. Maroon	Very Fine	AIO	General-purpose, deburring	108-7445	\$1.70	
B. Gray	Ultra-Fine	SiC	Light cleaning and finishing	108-7446	1.70	

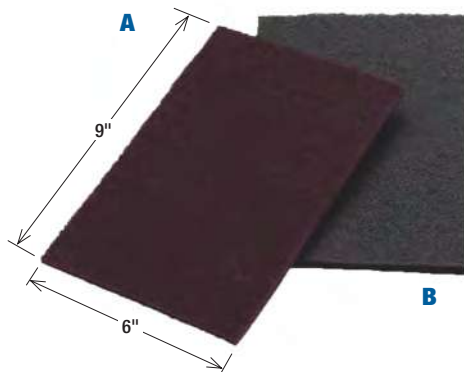

C-E 3M™ Scotch-Brite™ Hand Pads

On surfaces that require cleaning, scuffing, deburring or finishing by hand, Scotch-Brite hand pads outperform steel wool, wire brushes and other nonwoven hand pads. They cut faster and leave a more consistent finish. And Scotch-Brite pads will never rust, so they can be used with water or solvents. Available in three color-coded grades for a variety of cleaning and finishing jobs. Measure 6" x 9". Can be cut to fit Pad Holder or Mini Mandrel (see below).

Color	Grit	Abrasive	Application	Item#	BOX of 10	
					1-2	4+
C. Tan	Coarse	AIO	Heavy-duty cleaning	108-7461	\$40.25	\$36.23
Color	Grit	Abrasive	Application	Item#	BOX of 20	
D. Maroon	Fine	AIO	Cleaning and finishing	108-7457	\$32.40	\$29.16
E. Light Gray	Extra-Fine	SiC	Fine cleaning and finishing	108-7453	32.40	29.16

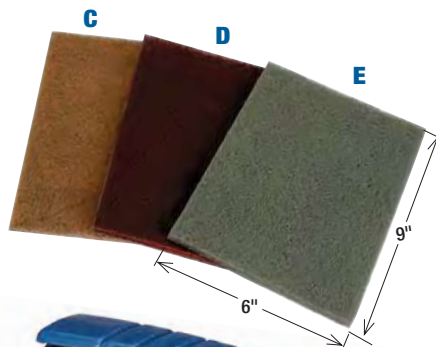

F. 3M™ Scotch-Brite™ Pad Holder

For use with Scotch-Brite hand pads (see above) cut to 4" x 6" size.

Description	Item#	Each
Pad Holder, 4" x 6"	108-7462	\$28.60



G. 3M™ Scotch-Brite™ Mini Mandrel – 1/4" Shank

For use with 1" x 1 1/2" pieces of Scotch-Brite hand pads (see above). Use on contours or to reach tight areas. Acts like a flap wheel. Measures 2 7/8" long. Has 1/4" shank.

Description	Max. RPM	Item#	Each
Mini Mandrel	14,000	108-7463	\$10.25

See our 3" Scotch-Brush on page 131



H. Satin Finish Buffs

Made of a stiff, nonwoven material, Satin Finish Buffs have abrasive embedded in a red synthetic fiber. They produce a beautiful satin finish and conform to a wide variety of surface contours. Available in either 2-ply or 3-ply with leather center. All measure 4" dia. x 3/16" AH. Made in USA.

Grit	2-PLY		EACH Prices		3-PLY		EACH Prices	
	Item#	1-11	12+	Item#	1-11	12+		
Coarse	142-3030	\$8.20	\$6.83	142-3050	\$11.00	\$9.17		
Medium	142-3020	6.80	5.67	142-3045	9.15	7.62		
Fine	142-3010	5.00	4.17	142-3040	7.15	5.96		
Extra-Fine	142-3005	4.60	3.83	142-3035	6.90	5.75		



I, J Satin Flap Wheels

Densest satin flap wheels on the market. Made of aluminum oxide. As each is used, fiber on the surface softens to create a beautiful finish with no cross-hatching or overlap marks. Medium produces a subtle line effect similar to a brush finish. Very Fine produces a glowing, bright satin finish. Measures 4" dia. x 1" thick x 3/8" AH. Imported.

Dia. x Thickness x AH	Grit	Item#	Each
I. 4" x 1" x 3/8"	Medium	142-3075	\$15.50
J. 4" x 1" x 3/8"	Very Fine	142-3070	12.85



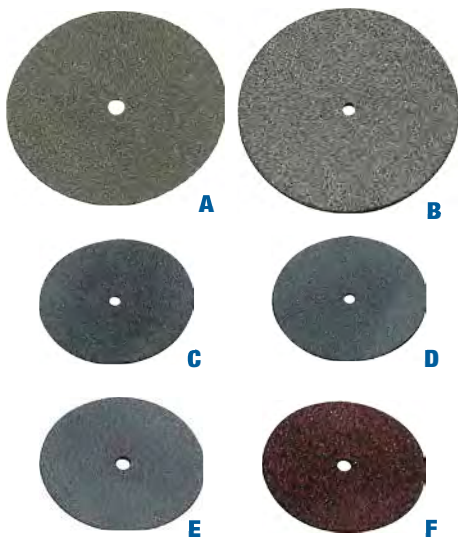

A-F Resin Bond Cut-Off Discs

Both sides and edges of these thin discs can be used for slitting and finishing gold, silver, brass, steel, porcelain and acrylics. Available in either silicon carbide (SiC) or aluminum oxide (AlO). Maximum operating speed: 25,000rpm for discs up to 1"; 21,000rpm for discs over 1". See pp. 584-585 for mandrel selection.

Dia. x Thick	Arbor Hole	Abrasive	Item#	50pc Each
A. 1 1/4" x .025"	1/16"	AIO	845-1024	\$0.40
B. 1 1/2" x .050"	1/16"	AIO	845-1025	0.40

50pc Fifty-piece minimum; please order in multiples of fifty.

Dia. x Thick	Arbor Hole	Abrasive	Item#	Box of 100
C. 7/8" x .023"	1/16"	SiC	845-1017*	\$9.50
D. 7/8" x .023"	1/16"	SiC	845-1020	9.50
E. 1" x .023"	1/16"	SiC	845-1021	9.50
F. 1" x .025"	1/16"	AIO	845-1022	9.50

*One side safe: abrasive on one side only.



G. Ultra-Thin Cut-Off Disc

This super thin silicon carbide disc will cut gates, sprues and rings in a second, leaving a very thin space. Recommended operating speed: 12,000 to 14,000rpm. See pp. 584-585 for mandrel selection.

Description	Dia. x Thick	Arbor Hole	Item#	Box of 25	
				1-4	5+
Ultra-Thin Disc	7/8" x .009"	1/16"	845-1050	\$10.50	\$9.98



H. Dedeco® Separating Disc

For fast, cool cutting. Use High-Speed disc on gold and all other metals. Cut on edges only. Maximum operating speed: 21,000rpm. See pp. 584-585 for mandrel selection.

Description	Dia. x Thick	Arbor Hole	Item#	Box of 100
High-Speed AIO Disc	7/8" x .025"	1/16"	845-1018	\$10.75

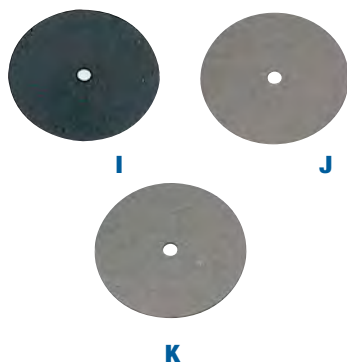

I-K Dedeco® Thin Separating Discs

Extremely thin discs coated with silicon carbide abrasive on both sides. Great for precision work on gold, silver and other jewelry metals. Allow fast, clean cutting. Available in three thicknesses: ultra-thin (UT), super-thin (ST) and very-thin (VT). Maximum operating speed: 21,000rpm. See pp. 584-585 for mandrel selection.

Description	Dia. x Thick	Arbor Hole	Item#	BOX Prices	
				1-4	5+
I. UT Discs, box of 25	7/8" x .005"	1/16"	845-1051	\$18.95	\$18.00
J. ST Discs, box of 25	7/8" x .009"	1/16"	845-1052	14.95	14.20
K. VT Discs, box of 50	7/8" x .015"	1/16"	845-1032	15.95	15.15

Before using any abrasive product, follow all safe operating guidelines with respect to eye protection, hand protection, hearing protection and respiratory protection. Also read the Material Safety Data Sheet (MSDS) to be aware of any inherent hazards or cautions.

A. Nylon Cut-Off Discs

These resin-bonded discs are reinforced with interwoven nylon fibers to provide extra strength and durability for cut off operations. Two types are offered: One with durable Semi-Friable Aluminum Oxide (AIO), and the other with a combination of Aluminum Oxide and Premium Ceramic Abrasive (Cera) which produces the sharpest cut. See pp. 584-585 for mandrel selection. All 80 grit. Made in USA.

Dia. x Thickness	Arbor Hole	Abrasive	Max. RPM	Item#	EACH Prices	
					1-9	10+
1" x .045"	1/16"	AIO	60,000	845-1011	\$2.00	\$1.80
1" x .045"	1/16"	AIO+CERA	60,000	845-1040	2.10	1.89
1 1/4" x .045"	1/16"	AIO	50,000	845-1012	2.10	1.89
1 1/4" x .045"	1/16"	AIO+CERA	50,000	845-1041	2.20	1.98
1 1/2" x .045"	1/16"	AIO	30,000	845-1028	2.15	1.94
1 1/2" x .045"	1/16"	AIO+CERA	30,000	845-1042	2.30	2.07
2" x .045"	1/8"	AIO	30,000	845-1013	2.35	2.12
2" x .045"	1/8"	AIO+CERA	30,000	845-1043	2.40	2.16
2" x .0625"	1/8"	AIO	30,000	845-1014	2.45	2.21
2" x .0625"	1/8"	AIO+CERA	30,000	845-1044	2.50	2.25

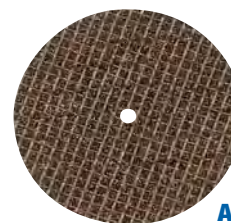

B. Fast Cut Discs

Truly unique and versatile discs made from cotton fiber, aluminum oxide grain and resin bonded. They are long lasting and very durable and produce a relatively smooth surface finish. The 1 1/2" disc is reinforced with Fiberglass for extra strength. Thickness dimension will vary due to nature of materials. Both have 1/8" arbor holes and cut on the edge. Made in the USA. See pp. 584-585 for mandrels.

Dia. x Thickness	Grit	Max. RPM	Item#	EACH Prices	
				1-11	12+
B. 1 1/2" x .0625"	80	36,000	845-3800	\$3.70	\$3.15
1" x .045"	180	45,000	845-3700	3.70	3.15

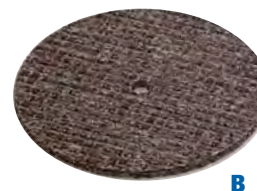

C-H Fiber Discs

Fast cutting cut-off discs reinforced for strength and durability. They are available in various sizes, thicknesses and abrasives. Aluminum Oxide for metals, Silicon Carbide for ceramics and Diamond for special applications. All have 1/16" arbor holes. See pp. 584-585 for mandrel selection. Made in Germany.

Dia. x Thickness	Abrasive	Max. RPM	Item#	PKG of 10
7/8" x .009" (22mm x 0.2mm)	AIO	15,000	845-1037	\$21.75
C. 7/8" x .009" (22mm x 0.2mm)	SiC	15,000	845-1053	21.75
D. 7/8" x .012" (22mm x 0.3mm)	AIO	15,000	845-1038	20.95
E. 1" x .012" (25mm x 0.3mm)	AIO	10,000	845-1016	23.30
F. 1" x .012" (25mm x 0.3mm)	SiC	10,000	845-1039	23.30
G. 1 7/8" x .039" (40mm x 1.0mm)	AIO	5,000	845-1049	32.00

Dia. x Thickness	Abrasive	Max. RPM	Item#	Each
H. 3/4" x .009" (20mm x 0.2mm)	Diamond	15,000	845-1082	\$7.85

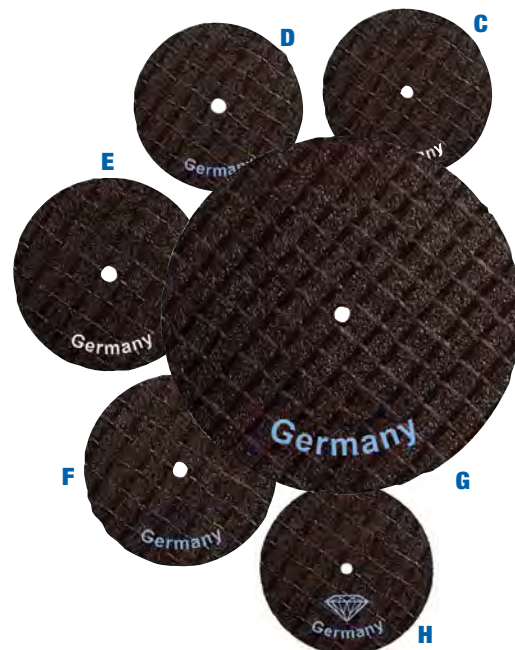

I, J Sintered Diamond Cut-Off Discs

These discs easily cut carbon fiber, carbide, steels, acrylics and other hard-to-cut materials. The 7/8" disc is sintered diamond throughout; the 1 1/4" disc is sintered diamond on outer edge only (approximately 1/8"). Each has 1/16" arbor hole. Max. operating speed: 20,000rpm. See pp. 584-585 for mandrel selection.

Dia. x Thickness*	Item#	Each
I. 7/8" x .007"	845-1080	\$35.95
J. 1 1/4" x .040"	845-1085	42.95

*Thickness of each disc may vary slightly.



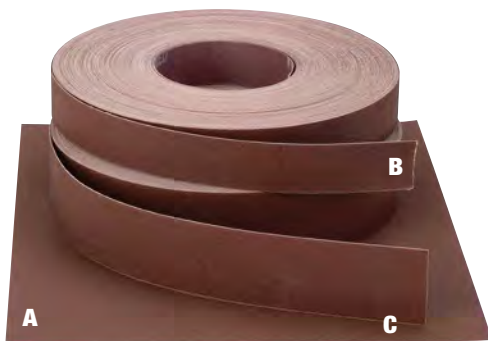

A-C Norton® Lightning Metalite Cloth

A long-lasting abrasive cloth used to clean or polish metal surfaces for a high-quality finish. Glue-bonded aluminum oxide on lightweight, flexible cloth backing. The 1" rolls can be used with our Polishing Stick 813-1950 or the Wolf Sanding Mandrel Set 840-2305, and 1½" rolls can be used with our Cone-Loc Drum.

Description	180 Grit	240 Grit	320 Grit	400 Grit	EACH Prices*	
					5pc 5-45	50+
A. 9" x 11" Sheet	109-3650	109-3750	109-3850	109-3950	\$2.00	\$1.60

Description	80 Grit	120 Grit	180 Grit	240 Grit	320 Grit	400 Grit	600 Grit	Each
B. 1" x 50-yd Roll	109-5149	109-5200	109-5300	109-5350	109-5400	109-5450	109-5510	\$33.50
C. 1½" x 50-yd Roll	109-5525	109-5545	109-5550	109-5600	109-5650	—	—	45.75

*Quantity discount for orders of one item number only; not assorted.

D. Cone-Loc Drum – 1½" Wide

Used with Lightning Metalite cloth ½" rolls (above), this is an excellent tool for deburring and sprue removal. By sanding or grinding with this wheel, hand filing can be practically eliminated. Made of heavy-gauge aluminum casting. Drum is covered by ½" thick rubber covering. Rubber covering allows surface to conform to work. Measures 6" dia. x 1½"W x ½"AH. Weighs 2 lbs. Maximum operating speed: 4,000rpm. Refer to p. 400 for arbors.

Description	Item#	Each
Cone-Loc Drum	840-1256	\$209.00

E. Foredom® Foam Wheel and Sanding Belts – 4" diameter, 1" width

Use Foam Wheel and sanding belts to quickly shape and smooth all metals, composites, and wood. Ideal for jewelers, knife makers, gunsmiths and woodworkers. Foam rubber wheel is 4" and has a ¼" continuous rubber rim over a foam core, so sanding belts fit snugly. Made in USA.

Description	Item#	Each
Foredom Foam Wheel	845-3010	\$27.25

Sanding Belts		EACH Prices			Sanding Belts		EACH Prices		
Grit	Item#	1-2	3-5	6+	Grit	Item#	1-2	3-5	6+
80	845-3011	\$11.75	\$11.16	\$10.58	320	845-3014	\$11.75	\$11.16	\$10.58
120	845-3012	11.75	11.16	10.58	600	845-3015	11.75	11.16	10.58
240	845-3013	11.75	11.16	10.58	1,000	845-3016	11.75	11.16	10.58

F-H Split Mandrels – ⅜" Shank

For holding strips of abrasive paper and cloth. All ⅜" shank and measure approximately 2¼" long.

Head	Diameter	Item#	EACH Prices	1-11	12+
F. Straight	11/64"	840-3405	\$2.45	\$2.04	
G. Straight	9/64"	840-3406	2.45	2.04	
H. Tapered	3/32" to 3/16"	840-3407	2.45	2.04	

I. Wolf™ Sanding Mandrel Set – ⅛" Shank

Large-diameter mandrels for sanding inside rings: ¼" dia. x 1¾"L with ⅛" shank (holds ¾" wide paper); 5/16" dia. x 1⅞"L with ⅛" shank (holds 1" wide paper); ½" dia. x 1⅞"L with 5/32" shank (holds 1" wide paper). Short, heavy shanks prevent wobble.

Description	Item#	Set of 3
Wolf Sanding Mandrel Set	840-2305	\$9.55

J. Parallel Split Ring Arbor – For Tapered Spindles

Wood arbors available with parallel or tapered shafts. Has slot to hold paper or cloth so it can be wound around to desired thickness. Both measure 4" long.

Description	Item#	EACH Prices	
		3pc 3-9	12+
J. Parallel Split Ring Arbor	840-4650	\$1.95	\$1.66
Tapered	840-4655	\$1.19	\$1.01

K. Polishing Stick

Use this tool as you would a file to smooth, debur and polish metal. Holds abrasive cloth and paper in 11" strips. Strips are easy to insert and remove and are held securely. Sanding surfaces measure 5" long, tapering from 3/8" thick to 1/16" at the tip. Made of high-impact, solvent-resistant plastic.

Style	Width x Length	Item#	Each
Polishing Stick	1" x 10"	813-1950	14.95

Three-piece minimum; please order in multiples of three. Five-piece minimum; please order in multiples of five.

A. PSA Strips

These pressure-sensitive strips are made of aluminum oxide, glue-bonded on a cloth backing. Just press them onto a flat surface such as a wood stick. Strips measure 1" x 11".

Grit	Item#	Box of 100	Grit	Item#	Box of 100
80	107-2550	\$43.15	240	107-2250	\$43.15
120	107-2050	43.15	320	107-2300	43.15
180	107-2150	43.15	400	107-2350	43.15



B-F PSA Discs

These flexible discs are made of aluminum oxide resin-bonded on a cloth backing for greater durability. Pressure-sensitive adhesive backing withstands the high frictional heat generated when a disc is in use. PSA Discs will stay on until removed from the holder by hand. Each disc has a peel-off backing to ensure adhesive freshness.

Dia.	Grit	Item#	Box of 100
B. 1/2"	80	105-0508	\$8.55
	120	105-0512	8.55
	180	105-0518	8.55
	240	105-0524	8.55
	320	105-0532	8.55
C. 3/4"	80	105-0708	10.15
	120	105-0712	10.15
	180	105-0718	10.15
	240	105-0724	10.15
	320	105-0732	10.15
D. 1"	60	105-1006	16.20
	80	105-1008	16.20
	120	105-1012	16.20
	180	105-1018	16.20
	240	105-1024	16.20
	320	105-1032	16.20
E. 1 1/2"	80	105-1508	19.40
	120	105-1512	19.40
	180	105-1518	19.40
	240	105-1524	19.40
	320	105-1532	19.40
F. 2"	60	105-2006	32.05
	80	105-2008	32.05
	120	105-2012	30.25
	180	105-2018	30.25
	240	105-2024	18.78
	320	105-2032	30.25
	400	105-2040	30.25



G-K PSA Disc Holders – 1/8" and 1/4" Shanks

Flexible rubber pads mounted on shanks to hold any PSA (Pressure Sensitive Adhesive) Discs. Rubber pads also provide cushioning for uniform finish. Actual pad diameters are slightly smaller than specified to ensure easy removal of discs and to prevent material from marring the work surface. Max. Operating speed: 22,000 rpm.

Head Dia.	1/8" Shank Item#	1/4" Shank Item#	EACH Prices*	
			1-2	3+
G. 1/2"	840-0010	840-0020	\$5.05	\$4.21
H. 3/4"	840-0030	840-0040	6.50	5.42
I. 1"	840-0050	840-0060	7.50	6.25
J. 1 1/2"	840-0070	840-0080	8.20	6.83
K. 2"	—	840-0090	10.75	8.96

*Quantity discount for orders of one item number only; not assorted.



L. Paper Discs, Aluminum Oxide

Paper discs are coated with Aluminum Oxide abrasive on one side. All have 1/16" arbor hole. See pp. 584-585 for mandrel selection.

Grit	Dia.	Item#	PKG of 100	
			1-9	10+
80	1 1/2"	845-1006	\$17.10	\$15.39
150	1 1/2"	845-1007	17.15	15.44
220	1 1/2"	845-1008	16.65	14.99

Shown actual size.



A-C Abrasive Bands - Aluminum Oxide

Long-lasting resin-bonded aluminum oxide bands with cloth backing. Provide chatter-free operation for grinding, blending, deburring, smoothing, finishing and polishing flat and contoured metal surfaces, including the insides of holes. Use on hard metals, class rings, etc. Use with Drum Arbors (see below). Max. operating speed: 30,000rpm. Made in USA.

Dia. x H	Grit	Item#	Box of 100
A. 1/4" x 1/2"	80	101-0208	\$8.50
	120	101-0212	8.50
	180	101-0218	8.50
	240	101-0224	8.50
B. 3/8" x 1/2"	60	101-0306	9.50
	80	101-0308	9.50
	120	101-0312	9.50
	240	101-0324	9.50
	320	101-0332	9.50
C. 1/2" x 1/2"	60	101-0406	11.95
	80	101-0408	11.95
	120	101-0412	11.95
	240	101-0424	11.95
	320	101-0432	11.95

Shown actual size.



D-F Abrasive Band Drum Arbors

Made of steel with a solid rubber drum which expands when screw or nut is tightened to hold Abrasive Bands snugly. The rubber drum provides a cushioned backing so that Abrasive Bands cut smoothly and leave a uniform finish. Balanced for maximum performance at high speeds.

Dia. x H	Shank	Item#	EACH Prices		
			1-2	3-11	12+
D. 1/4" x 1/2"	3/32"	840-1045	\$4.50	\$4.28	\$3.83
	1/8"	840-1050	4.50	4.28	3.83
E. 3/8" x 1/2"	3/32"	840-1035	4.50	4.28	3.83
	1/8"	840-1040	4.50	4.28	3.83
F. 1/2" x 1/2"	3/32"	840-1055	3.85	3.66	3.27
	1/8"	840-1060	3.85	3.66	3.27
	1/4"	840-1170	3.95	3.75	3.36

Shown actual size.



G. 3M™ Flex Diamond Bands

Incredibly durable, nonloading bands for cleaning, shaping and precision prefinishing. Ideal for dead end hole, tube and inside ring finishing. Coated with 220 grit micron-graded diamond abrasive in a honeycomb pattern for fast cutting. Can be used wet or dry on both soft and hard metals, including platinum, palladium and white gold, as well as soft stones. Produce optimal finishes with minimal metal removal. Won't gouge or catch. Use with drum arbor (see above). Max. operating speed: 20,000rpm.

Description	Grit	Item#	EACH Prices		
			1-4	5-9	10+
G. 1/4" x 1/2"	220	101-1315	4.10	3.69	3.28

Straight Abrasive Cartridge Rolls Aluminum Oxide Cloth

Resin-bonded aluminum oxide cloth rolls for both lapping surfaces and finishing inside diameters of dead end holes, tubes and rings. Self-renewing: wearing through one layer uncovers fresh layer of abrasive cloth making them an excellent tool for blending where uniform finishes required. Balanced to eliminate wobble. Use with cartridge roll mandrels (see pp. 584-585). Max. operating speed: 16,000–22,000rpm.



Dia. x L x AH	Use Mandrel	Grit	Item#	PKG of 100	
				1-2	3+
A. 1/8" x 3/4" x 5/64"	A1	80	103-1208	\$35.10	\$33.35
		120	103-1212	35.10	33.35
		180	103-1218	35.10	33.35
		240	103-1224	35.10	33.35
		320	103-1232	35.10	33.35
B. 1/8" x 1" x 5/64"	A1	80	103-1308	35.10	33.35
		120	103-1312	35.10	33.35
		180	103-1318	35.10	33.35
		240	103-1324	35.10	33.35
		320	103-1332	35.10	33.35
C. 3/16" x 3/4" x 3/32"	A2	120	103-2212	28.30	26.89
		180	103-2218	28.30	26.89
		240	103-2224	28.30	26.89
		320	103-2232	28.30	26.89
		D. 3/16" x 1" x 3/32"	A2	80	103-2308
120	103-2312			28.85	27.41
180	103-2318			28.85	27.41
240	103-2324			28.85	27.41
320	103-2332			28.85	27.41
E. 1/4" x 3/4" x 1/8"	A4 or A8	80	103-3208	28.85	27.41
		120	103-3212	28.85	27.41
		180	103-3218	28.85	27.41
		240	103-3224	28.85	27.41
		320	103-3232	28.85	27.41
F. 1/4" x 1" x 1/8"	A5 or A9	80	103-3308	28.85	27.41
		120	103-3312	28.85	27.41
		180	103-3318	28.85	27.41
		240	103-3324	28.85	27.41
		320	103-3332	28.85	27.41
G. 3/8" x 3/4" x 1/8"	A4 or A8	80	103-5208	28.85	27.41
		120	103-5212	28.85	27.41
		180	103-5218	28.85	27.41
		240	103-5224	28.85	27.41
		320	103-5232	28.85	27.41
H. 3/8" x 1" x 1/8"	A5 or A9	80	103-5308	31.40	29.83
		120	103-5312	31.40	29.83
		180	103-5318	31.40	29.83
		240	103-5324	31.40	29.83
		320	103-5332	31.40	29.83
I. 1/2" x 3/4" x 1/8"	A4 or A8	80	103-6208	31.40	29.83
		120	103-6212	31.40	29.83
		180	103-6218	31.40	29.83
		240	103-6224	31.40	29.83
		320	103-6232	31.40	29.83
J. 1/2" x 1" x 1/8"	A5 or A9	80	103-6308	36.05	34.25
		120	103-6312	36.05	34.25
		180	103-6318	36.05	34.25
		240	103-6324	36.05	34.25
		320	103-6332	36.05	34.25

Shown actual size



Color may vary slightly



Color may vary slightly

A, B Abrasive Tapered Cartridge Rolls – Aluminum Oxide Cloth

Made of resin-bonded aluminum oxide cloth. Particularly useful on jobs with channels, fillets and irregular concave contours. Hold at a 45° angle to workpiece for reaching into angles and corners, or hold at a lower angle to apply greater abrasive surface for faster cutting action. Self-renewing: wearing through one layer uncovers fresh layer. Balanced to eliminate wobble. Use with cartridge roll mandrels (see below). Max. operating speed: 16,000–22,000rpm.

Dia. x L x AH	Use Mandrel	Grit	Item#	BOX of 100	
				1-2	3+
A. 3/8" x 1 1/2" x 1/8"	A6 or A10	80	103-7001	\$64.85	\$61.61
		120	103-7002	64.85	61.61
		180	103-7003	67.45	64.08
		240	103-7004	67.45	64.08
B. 1/2" x 1 1/2" x 1/8"	A6 or A10	80	103-7007	68.30	64.89
		120	103-7008	68.30	64.89

C. Cartridge Roll Mandrels – 1/8" and 1/4" Shanks

Hardened steel mandrels firmly secure straight or tapered abrasive cartridge rolls. Match pilot size of mandrel to arbor hole on cartridge roll. More flexibility may be obtained if pilot length is slightly shorter than the cartridge rolls. If necessary, mandrels may be ground down to needed length. Available on 1/4" or 1/8" shanks.



Mandrel	Pilot Size	Shank	Item#	EACH Prices		
				1-2	3-11	12+
A1	5/64" x 1"	1/8"	840-2040	\$4.35	\$4.13	\$3.92
A2	3/32" x 1"	1/8"	840-2050	4.35	4.13	3.92
A3	1/8" x 1/2"	1/8"	840-2060	4.35	4.13	3.92
A4	1/8" x 3/4"	1/8"	840-2070	4.35	4.13	3.92
A5	1/8" x 1"	1/8"	840-2080	4.95	4.70	4.46
A6	1/8" x 1 1/2"	1/8"	840-2090	4.95	4.70	4.46
A7	1/8" x 1/2"	1/4"	840-2120	4.95	4.70	4.46
A8	1/8" x 3/4"	1/4"	840-2130	5.40	5.13	4.86
A9	1/8" x 1"	1/4"	840-2140	5.40	5.13	4.86
A10	1/8" x 1 1/2"	1/4"	840-2150	5.40	5.13	4.86
A11	1/8" x 2"	1/4"	840-2160	5.40	5.13	4.86

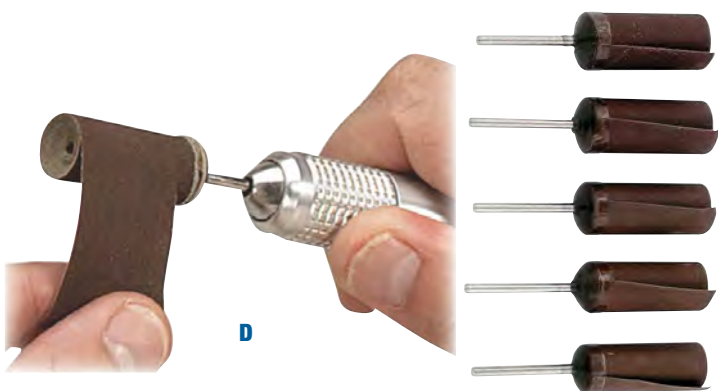

D. Premounted Abrasive Rolls – 3/32" Shank

Each roll consists of aluminum oxide abrasive paper wrapped around a 3/32" shank mandrel, creating many layers. Since paper is secured only at the bottom, user can easily tear off worn portion to expose fresh cutting surface. Unlike regular unmounted rolls, these long-lasting rolls require no truing. Recommended operating speed 16,000-22,000rpm.

Grit	Dia. x L	Item#	EACH Prices		
			1-9	10-99	100+
240	1/2" x 1 1/8"	103-7110	\$0.78	\$0.70	\$0.62
320	1/2" x 1 1/8"	103-7112	0.78	0.70	0.62
400	1/2" x 1 1/8"	103-7114	0.78	0.70	0.62
600	1/2" x 1 1/8"	103-7116	0.78	0.70	0.62
800	1/2" x 1 1/8"	103-7118	0.78	0.70	0.62

A-C Tapered Cone Points – Aluminum Oxide Cloth

Glue-bonded aluminum oxide points for finishing, deburring and polishing applications. All slightly longer than specified. Use with tapered cone point mandrels (below). Max. operating speed: 25,000rpm.

Style	Dia. x L	Grit	Item#	BOX of 100
A. K11 (2½° Taper)	¾" x 1"	60	107-1100	\$33.65
		80	107-1150	33.65
		100	107-1200	33.65
		120	107-1250	33.65
		180	107-1350	33.65
		240	107-1400	33.65
B. B2 (5° Taper)	⅝" x 1½"	60	107-0100	33.65
		80	107-0150	33.65
		100	107-0200	33.65
		120	107-0250	33.65
		180	107-0350	33.65
		240	107-0400	33.65
C. C3 (5° Taper)	¾" x 2"	80	107-0650	42.00
		120	107-0750	42.00
		320	107-0950	42.00



D-F Tapered Cone Point Mandrels – ⅛" and ¼" Shanks

For use with Tapered Cone Points (see above).

For Point Style	Shank	Item#	Each
D. K11	⅛"	840-2030	\$6.10
E. B2	¼"	840-2010	7.90
F. C3	¼"	840-2020	8.75

G-I Paper Bullets and Cones

Economical paper bullets and cones for sanding, blending and fine finishing in hard-to-reach areas. Cones expose new grit as they wear. Recommended for use at low speeds for better control and longer life. Designed for fast, easy changing. Use bullets and small cones with threaded mandrel (see below), large cones with split mandrel (see below).

Shape	Dia. x L	Color	Grit	Item#	PKG of 10
G. Bullet	¼" x ⅝"	Yellow	Coarse	107-1058	\$6.15
		Red	Medium	107-1057	6.15
		Green	Fine	107-1056	6.15
H. Small Cone	¼" x ⅞"	Yellow	Coarse	107-1055	6.15
		Red	Medium	107-1054	6.15
		Green	Fine	107-1053	6.15
I. Large Cone	⅝" x 1⅝"	Yellow	Coarse	107-1052	5.70
		Red	Medium	107-1051	5.70
		Green	Fine	107-1050	5.70



J. Paper Cone Set

Perfect for fine finishing in tight areas. Includes 10 yellow (coarse), 10 red (medium) and 10 green (fine) large cones; 10 yellow, 10 red and 10 green small cones; split mandrel for large cones, ⅜" shank; and threaded mandrel for small cones, ⅜" shank. Cones expose new grit as they wear. Recommended for use at low speeds for better control and longer life. Designed for fast, easy changing.

Description	Item#	Each
Paper Cone Set	107-1060	\$56.80



K, L Paper Bullet and Cone Mandrels – ⅜" Shanks

Use threaded with bullets and small cones (see above), split with large cones (see above).

Description	Shank	Item#	EACH Prices	
			1-11	12+
K. Threaded Mandrel	⅜"	840-3040	\$1.25	\$1.04
L. Split Mandrel	⅜"	840-3407	2.45	2.04





A. Grit Stick Sleeves

Sleeves made of aluminum oxide, glue-bonded on durable cloth. Slide over Grit Stick Sleeve Holder (see below) and work right up to corners. Measure 7 1/4" L x 7/8" W.

Grit	120	180	240	320	PKG of 10	
					1-9	10+*
Item#	107-3150	107-3350	107-3450	107-3550	\$9.90	\$8.42

*Quantity discount for orders of one item number only; not assorted.

B. Grit Stick Sleeve Holder

Wooden stick for holding Grit Stick Sleeves (see above). Measures approximately 8" L x 7/8" W x 1/4" thick.

Description	Item#	EACH Prices	
		3pc	12+*
Grit Stick Sleeve Holder	840-4400	\$4.55	\$4.10

C. Paper Ring Shells

Paper (Silicon Carbide with resin bond) ringshells for polishing inside of rings. Fit snugly on wooden Ring Shell Arbor (below). Measure 4" long. Packaged in boxes of 12 shells and supplied in different grits from 2 (coarsest) to 3/0 (finest).

Grit	Item#	Box of 12
2	107-8600	18.50
1	107-8550	18.50
0	107-8500	16.65
2/0	107-8450	18.50
3/0	107-8400	18.50



D. Assorted Paper Ring Shell Set

Contain six ring shells of different grits and one wooden ring shell arbor.

Description	Item#	Each
Paper Ring Shell Set	107-8300	13.98

E. Ring Shell Arbor - For Tapered Spindles

Solid wood, for holding Paper Ring Shells. Measures 4 1/4" long. Fits on tapered spindle.

Description	Item#	EACH Prices	
		3pc	12+*
Ring Shell Arbor	840-4600	\$2.40	\$2.04



F. Emery Hand Buffs

For removing scratches and file marks and for polishing. Fine-grade emery paper carefully mounted on seasoned wood. Corners are sharp and paper will not unravel. Measure 10" L x 3/4" W x 1/4" thick. Listed in order from coarsest (3 grit) to finest (4/0 grit).

Grit	3	2	1	0	EACH Prices	
					3pc	12+*
Item#	107-9850	107-9800	107-9750	107-9700	\$1.31	\$1.11

Grit	2/0	3/0	4/0	EACH Prices	
				3pc	12+*
Item#	107-9650	107-9600	107-9550	\$1.31	\$1.11

*Quantity discount for orders of one item number only; not assorted.

3pc Three-piece minimum; please order in multiples of three.



Flap Wheels 1/8" and 1/4" Shank

Flap Wheels are made of aluminum oxide resin-bonded to cloth and permanently attached to the hub. They are resilient and can be used on flat or contoured surfaces. Particularly useful in flexible shaft handpieces and other rotary tools. Excellent for blending on metal surfaces, deburring

and removing flash from machined parts and edge blending dies, molds and channels. Cutting action is slightly finer than normally expected from identical grit. Flap Wheels perform best when only slight pressure is applied.



A-E Small Wheels – 1/8" Shank

Dia. x Thickness	60 Grit Item#	80 Grit Item#	120 Grit Item#	180 Grit Item#	240 Grit Item#	320 Grit Item#	EACH Prices*	
							1-2	3+
A. 3/4" x 3/16"	107-5899	107-5900	107-5905	107-5908	107-5912	107-5915	\$3.95	\$3.75
B. 1 3/16" x 3/16"	107-5939	107-5940	107-5945	107-5948	107-5951	107-5955	3.95	3.75
C. 3/8" x 3/8"	107-6001	107-6002	107-6003	107-6004	107-6005	107-6006	3.75	3.56
D. 3/4" x 3/8"	107-5919	107-5920	107-5925	107-5928	107-5932	107-5935	3.95	3.75
E. 1" x 3/8"	107-5964	107-5965	107-5970	107-5976	107-5978	107-5980	4.60	4.37

*Quantity discount for orders of one item number only; not assorted.

F, G Medium Wheels – 1/8" Shank

Dia. x Thickness	60 Grit Item#	80 Grit Item#	120 Grit Item#	180 Grit Item#	240 Grit Item#	320 Grit Item#	EACH Prices*	
							1-2	3+
F. 5/8" x 5/8"	107-6011	107-6012	107-6013	107-6014	107-6015	107-6016	\$4.00	\$3.80
G. 3/4" x 3/4"	107-6020	107-6021	107-6022	107-6023	107-6024	107-6025	4.10	3.90

*Quantity discount for orders of one item number only; not assorted.



H, I Large Wheels – 1/4" Shank

Dia. x Thickness	Shank	Max. RPM	Grit	Item#	EACH Prices	
					1-2	3+
H. 1 1/2" x 1/2"	1/4"	30,000	40	107-7880	\$4.58	\$4.35
			60	107-7885	4.58	4.35
			80	107-7890	4.58	4.35
			120	107-7895	4.58	4.35
			180	107-7900	4.58	4.35
I. 2" x 3/4"	1/4"	25,000	60	107-6850	5.65	5.37
			80	107-6900	5.65	5.37
			120	107-6500	5.65	5.37
			240	107-6650	5.65	5.37



J. Cloth 4" Flap Wheels

Abrasive wheels with closely spaced cloth flaps for fast cutting action with a smooth uniform finish. The 80 grit is used for quick and aggressive metal removal. The 120 and 240 grits are ideal for quick metal removal such as sprue and gate removal. The 320 and 400 grits remove scratches and leave a much finer finish than expected. The 400 grit can also be used for blending after the previous grits are used. For use on tapered spindles. Made in Thailand.

Grit	Max. RPM	Item#	EACH Prices	
			1-2	3+
80	3,000	108-0173	\$23.55	\$22.37
120	3,000	108-0174	23.55	22.37
J. 240	3,000	108-0175	23.55	22.37
320	3,000	108-0176	23.55	22.37
400	3,000	108-0177	23.55	22.37





A



B



C



D

A-C Seamless Abrasive Caps and Holders – 1/8" and 1/4" Shanks

Use for deburring and finishing hard-to-reach, recessed areas. Designed for easy mounting and removal. Caps fit holders easily yet are held firmly by centrifugal force while working. Holders have 1/8" or 1/4" shanks (3mm and 6mm shanks available by special order).

Cap	Dia. x H	Max. RPM	Grit	Item#	PKG of 50	Holder	Item#	Each
A. Flat	3/16" x 3/8"	40,000	80	104-1000	\$38.00	1/8" shank	104-1200	\$3.50
			150	104-1005	39.25		104-1200	3.50
			280	104-1010	39.25		104-1200	3.50
	9/32" x 1/2"	30,000	60	104-1015	39.25	1/8" shank	104-1205	3.75
			150	104-1020	39.25		104-1205	3.75
			280	104-1025	39.25		104-1205	3.75
	3/8" x 5/8"	20,000	60	104-1030	45.00	1/8" shank	104-1210	3.75
			150	104-1035	45.00		104-1210	3.75
			280	104-1040	45.00		104-1210	3.75
	1/2" x 11/16"	16,000	60	104-1260	54.00	1/4" shank	104-1350	5.00
			150	104-1265	54.00		104-1350	5.00
			280	104-1270	54.00		104-1350	5.00
	5/8" x 1"	12,000	60	104-1275	54.00	1/4" shank	104-1355	5.00
			150	104-1280	54.00		104-1355	5.00
			280	104-1285	54.00		104-1355	5.00
B. Rd.	3/16" x 7/16"	40,000	80	104-1045	39.25	1/8" shank	104-1215	3.50
			150	104-1050	39.25		104-1215	3.50
			280	104-1055	39.25		104-1215	3.50
	9/32" x 1/2"	30,000	60	104-1060	39.25	1/8" shank	104-1220	3.75
			150	104-1065	39.25		104-1220	3.75
			280	104-1070	39.25		104-1220	3.75
	3/8" x 5/8"	20,000	60	104-1075	45.00	1/8" shank	104-1225	3.85
			150	104-1080	45.00		104-1225	3.85
			280	104-1085	45.00		104-1225	3.85
	1/2" x 11/16"	16,000	60	104-1290	54.00	1/4" shank	104-1360	5.00
			150	104-1295	54.00		104-1360	5.00
			280	104-1300	54.00		104-1360	5.00
	5/8" x 1"	12,000	60	104-1305	54.00	1/4" shank	104-1365	5.00
			150	104-1310	54.00		104-1365	5.00
			280	104-1315	54.00		104-1365	5.00
C. Cone	3/16" x 7/16"	40,000	80	104-1090	39.25	1/8" shank	104-1230	3.40
			150	104-1095	39.25		104-1230	3.40
			280	104-1100	39.25		104-1230	3.40
	9/32" x 1/2"	30,000	60	104-1105	39.25	1/8" shank	104-1235	3.75
			150	104-1110	39.25		104-1235	3.75
			280	104-1115	39.25		104-1235	3.75
	3/8" x 5/8"	20,000	60	104-1120	45.00	1/8" shank	104-1240	3.85
			150	104-1125	45.00		104-1240	3.85
			280	104-1130	45.00		104-1240	3.85
	1/2" x 11/16"	16,000	60	104-1320	54.00	1/4" shank	104-1370	5.00
			150	104-1325	54.00		104-1370	5.00
			280	104-1330	54.00		104-1370	5.00
	5/8" x 1"	12,000	60	104-1335	54.00	1/4" shank	104-1375	5.00
			150	104-1340	54.00		104-1375	5.00
			280	104-1345	54.00		104-1375	5.00

D. Seamless Abrasive Cap Set

This money-saving set includes 270 caps (six of each item# listed in chart above) and 15 corresponding holders (1/8" and 1/4" shanks). Supplied in a convenient 16-compartment plastic storage tray with lid.

Description	Item#	Each
Seamless Abrasive Cap Set	104-1245	\$345.00

A. Micro-Mesh® Abrasives - Silicon Carbide

Micro-Mesh features a unique cushion design that allows its abrasive crystals to recede into its resilient backing and “float” to an even cutting plane. Follows the contours of your work evenly—Perfect for refinishing steel tools and removing light scratches. Restores rolling mill rollers to brand-new condition.

Effective on gold, silver, platinum, even steel! Leaves a smoother, finer finish than expected: 400 grit Micro-Mesh cuts like a 400 grit but leaves an 800–1000 grit finish. Can be used dry or wet. Used dry, it lasts 5–7 times longer than common abrasives. Used with oil or water, it lasts 7–15 times longer.

Description	Grit	Item#	EACH Prices	
			1-11	12+
File (1/2" x 5 3/4", two-sided)	100/150	107-3114	\$2.20	\$1.98
	180/240	107-3115	2.10	1.89
	400/600	107-3116	2.10	1.89



B. Micro-Mesh® Ultra-Flex Pad Set

Micro-Mesh Soft Touch pads are handy for doing small jobs and for spot repair projects. The 2" x 2" foam core provides additional flexibility and conformity, while being easy to hold and operate.

Each pad has the same Micro-Mesh grade on both sides. This material is made to be used wet or dry and is made with a flexible cotton backing with polymer emulsion cushioning layer and large micron graded silicon carbide or aluminum oxide crystals suspended in a flexible resin bond. The MX bond is less flexible than other Micro-Mesh products so you can achieve a higher finish on metals. Stated grit size, due to this unique material, produces a finer than expected finish, i.e., 60MX = 240 grit. Each pad is printed with its corresponding grade. The complete set includes the following 13 grades:

SiC Abrasive: 60MX, 80MX, 100MX, 120MX, 150MX, 180MX, 240MX, 320MX, 360MX, 400MX, 600MX

AlO Abrasive: 800MX, 1200MX

Description	Item#	PKG of 13
Ultra-Flex Pad Set	107-3120	\$16.30

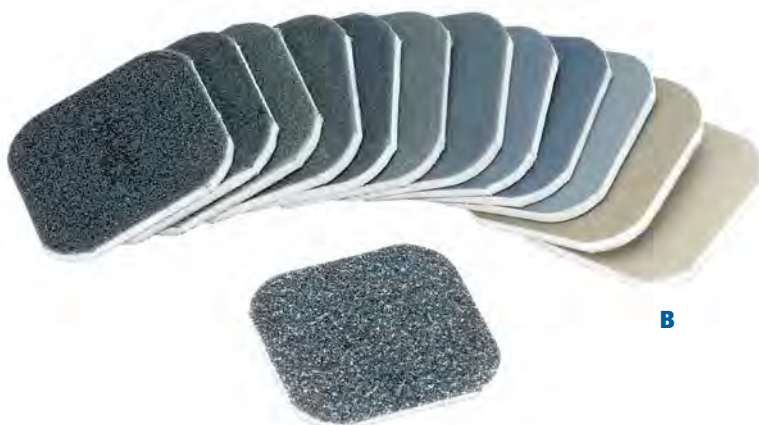

C. G-Tac 3-in-1 Hand Finisher

The handy shape and flexibility of the G-Tac also makes it ideal for polishing flat and curved surfaces. Each G-Tac Finisher keeps three grits, (800 = Blue, 1500 = White and 4000 = Gray) at your fingertips making it ideal for final touch-ups when polishing jewelry. Switching between grits takes mere seconds because it is a simple as turning or flipping the tool. Sold in packages of 5. Measure 7" long x 1 1/4" wide x 1/2" thick.

Description	Item#	PKG of 5
3-in-1 Hand Finisher	107-3125	\$9.95



Before using any abrasive product, follow all safe operating guidelines with respect to eye protection, hand protection, hearing protection and respiratory protection. Also read the Safety Data Sheet (SDS) to be aware of any inherent hazards or cautions.

A-E Mitchell's Abrasive Cords and Tapes – USA

Flexible cords and tapes fully covered in abrasives for grinding, polishing and finishing small holes, narrow slots, curved surfaces and other areas standard tools can't reach. Used by jewelers for polishing wire settings and small heads, inaccessible to points and wheels. Aluminum oxide and silicon carbide are for cutting, and crocus (ultra-fine iron oxide) is for especially fine polishing. Can be used by hand and in saw frames, drills and other tools on hard and soft metals, ceramic, plastic and wood. Won't tear or fray. Supplied in 50' spools.

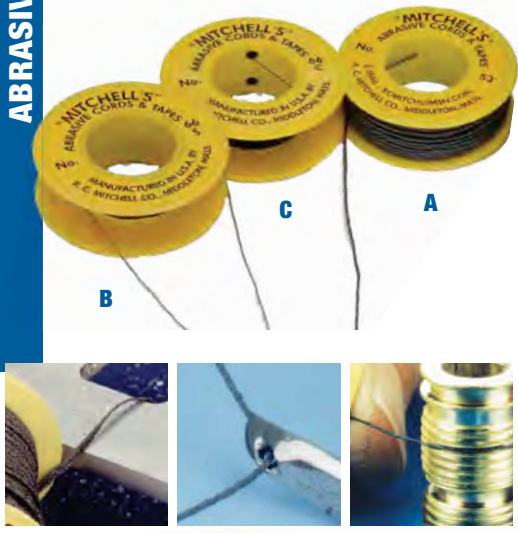

Cord	Shape	Style	Dia.	Grit	Item#	50' Spool	
A. AIO	●	48	.092"	150	102-0999	\$28.88	
		49	.082"	120	102-1000	18.70	
		50	.070"	180	102-1005	18.15	
		51	.055"	120	102-1010	10.75	
		53	.040"	180	102-1020	10.75	
B. SiC	●	54	.030"	180	102-1025	10.75	
		53-S	.040"	180	102-1021	16.80	
		54-H	.025"	200	102-1030	12.00	
		55	.018"	200	102-1035	12.00	
		60	.015"	200	102-1040	12.25	
C. Crocus	●	66	.012"	280	102-1045	29.60	
		52-C	.055"	Ultra-fine	102-1060	13.70	
		53-C	.040"	Ultra-fine	102-1065	12.80	
		54-C	.030"	Ultra-fine	102-1070	12.80	
		54-HC	.025"	Ultra-fine	102-1075	14.15	
		55-C	.018"	Ultra-fine	102-1080	14.15	
Tape	▬	60-C	.015"	Ultra-fine	102-1085	14.15	
		66-C	.012"	Ultra-fine	102-1090	29.75	
		AIO	56	.093" x .037"	180	102-1095	\$11.20
		D. AIO	57	.125" x .037"	180	102-1100	11.50
		E. Crocus	56-C	.093" x .030"	Ultra-fine	102-1115	13.00

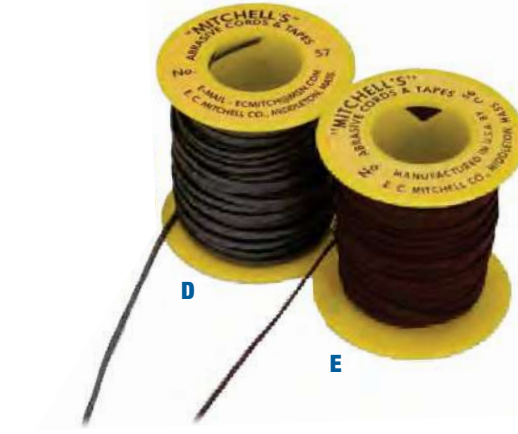

Available individually or in sets

Sanding Detailer™ – Multi-Functional Sanding Tool

The Sanding Detailer™ with Micro Finishing Film Belt, is an ergonomic shaped tool ideal for metal finishing, woodworking, welding cleanup, auto body finishing, mold finishing, jewelry making, gun repair and so much more. The tool features three unobstructed working areas, a tapered end, a flat bottom and a rounded end making it ideal when finishing any surface. An enclosed spring helps to maintain proper belt tension. Available with replaceable belts in 8 different grits. See chart below for grits and their corresponding colors.

- Specifications:**
- Dimensions: 6.25" (159mm) x .5" (12mm)
 - Work Surface: 6.25" (159mm) x .25" (6mm)
 - Micro Finishing Film, 8 Grits from 220 to 1200 (60 to 9 Microns)

Color	Grit/ Micron	Detailer Item#	Each	Belt Item#	PKG of 10
Black	220/60	107-3740	\$3.50	107-3770	\$12.95
Gray	270/50	107-3742	3.50	107-3772	12.95
Red	320/40	107-3744	3.50	107-3774	12.95
Green	400/30	107-3746	3.50	107-3776	12.95
Orange	600/15	107-3748	3.50	107-3778	12.95
Yellow	800/14	107-3750	3.50	107-3780	12.95
White	1000/12	107-3752	3.50	107-3782	12.95
Blue	1200/9	107-3754	3.50	107-3784	12.95



F-G Coarse and Fine Sets: Each set has 4 detailers (each with a belt installed) and 16 extra belts, 4 of each of the 4 grits. All Grit Set has all 8 detailers (each with one belt).

Sets	Grit	Item#	Each
F. Coarse Grit Set	220, 270, 320, 400	107-3795	\$34.00
G. Fine Grit Set	600, 800, 1000, 1200	107-3797	34.00
All Grit Set	All (one each)	107-3799	26.95

Belt Sticks & Sets Aluminum Oxide

Economical, versatile tools that accommodate 1/4", 1/2" or 3/4" wide abrasive belts, for sanding and smoothing hard-to-reach areas. Made of impact-resistant polypropylene. The tip can be easily reshaped to meet your exact needs. A spring-loaded tensioning device allows the abrasive belt to be rotated so that all areas of the belt can be used and permits quick belt changing. Belt Sticks may be used dry or with water, oil, or solvents. Sticks are supplied in 5 colors to help you quickly distinguish one grit from another. Abrasive belts are resin-bonded, cloth-backed aluminum oxide. Made in USA.

A. Belt Sticks

Size	Color	Grit	Belt Stick w/Belt		Extra Belts	PKG of 10	
			Item#	Each		Item#	1-9
1/4" x 6"	Red	120	107-3610	\$1.85	107-3621	\$6.75	\$6.08
	Blue	240	107-3612	1.85	107-3625	6.75	6.08
	Green	320	107-3614	1.85	107-3627	6.75	6.08
	Yellow	400	107-3616	1.85	107-3628	6.75	6.08
	Black	600	107-3618	1.85	107-3629	6.75	6.08
1/2" x 8"	Red	120	107-3640	3.25	107-3651	10.45	9.41
	Blue	240	107-3642	3.25	107-3655	10.45	9.41
	Green	320	107-3644	3.25	107-3657	10.45	9.41
	Yellow	400	107-3646	3.25	107-3658	10.45	9.41
	Black	600	107-3648	3.25	107-3659	10.45	9.41
3/4" x 10"	Red	120	107-3670	4.35	107-3681	13.85	12.47
	Blue	240	107-3672	4.35	107-3685	13.85	12.47
	Green	320	107-3674	4.35	107-3687	13.85	12.47
	Yellow	400	107-3676	4.35	107-3688	13.85	12.47
	Black	600	107-3678	4.35	107-3689	13.85	12.47



B. 10-Piece Belt Stick Set – 1/4"

Supplied with 5 Belt Sticks: red, blue, green, yellow and black (each with one abrasive belt of each grit: 120, 240, 320, 400 and 600).

Description	Size	Item#	Each
10-Piece Set	1/4"	107-3602	\$9.80



C. 36-Piece Belt Stick Set – 1/4"

Supplied with 3 Belt Sticks: red, blue and green (each with one abrasive belt). 30 additional abrasive belts included (10 of each grit: 120, 240 and 320).

Description	Size	Item#	Each
36-Piece Set	1/4"	107-3605	\$27.55



D-F 60-Piece Belt Stick Sets

Supplied with 5 Belt Sticks: red, blue, green, yellow and black (each with one abrasive belt). 50 additional abrasive belts included (10 of each grit: 120, 240, 320, 400 and 600).

Description	Size	Item#	Each
D. 60-Piece Set	1/4"	107-3606	\$44.85
E. 60-Piece Set	1/2"	107-3636	59.95
F. 60-Piece Set	3/4"	107-3666	71.95

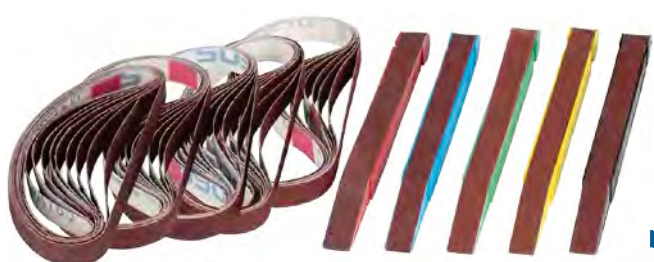
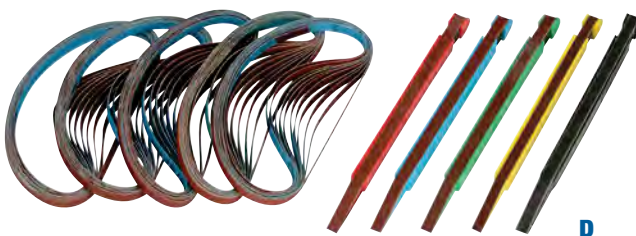



A

**A. 3M™ Imperial™ Micro-Finishing Film
Aluminum Oxide**

Precision micron-graded aluminum oxide resin-bonded to a polyester film backing. For close tolerance finishing on metals and plastic surfaces. Nonloading for longer life and greater efficiency. Measures 8½" x 11".

Color	Grit/Micron	Item#	EACH Prices	
			5pc	100+
Brown	180/80	109-8100	\$3.00	\$2.55
Black	220/60	109-8105	3.10	2.64
Blue	320/40	109-8110	3.10	2.64
Green	400/30	109-8115	3.10	2.64
Red	500/20	109-8125	3.10	2.79
Orange	600/15	109-8120	3.20	2.88
Light Blue	1200/9	109-8130	3.00	2.70
7-Piece Set (one each)		109-8135	SET Price	20.80



B

B. 3M™ Lapping Films – Aluminum Oxide

Popular prefinishing films for platinum. Feature precision micron-graded premium abrasive resin-bonded to film backing for reliable, repeatable performance. Impart fine, consistent finishes on both soft and hard metals. Resist water, oil and most solvents. Can be used wet or dry alone or cut and wrapped around a stick or file for fine work. Measure 8½" x 11". Use from 12 micron (coarse) to 3 micron (fine) before compounds.

Color	Grade/Grit	Item#	EACH Prices	
			5pc	50+
Yellow	12 micron/C	109-8353	\$2.05	\$1.85
Brown	5 micron/M	109-8352	2.05	1.85
Pink	3 micron/F	109-8351	2.05	1.85



C

C. Norton® Durite Abrasive Paper – Silicon Carbide

Fast-cutting silicon carbide. Excellent wear, nonloading. For intermediate and final dry sanding. Lightweight paper backing easily conforms to all shapes and angles. Sheets measure 9" x 11".

Grit	Item#	EACH Prices	
		5pc	100+
120	109-6051	\$0.98	\$0.69
180	109-6101	0.98	0.69
220	109-6151	0.98	0.69
320	109-6301	0.98	0.69



D

D. Norton® Lightning Metalite Cloth – Aluminum Oxide

A long-lasting abrasive cloth used to clean or polish metal surfaces for a high-quality finish. Glue-bonded aluminum oxide on lightweight, flexible cloth backing. Measure 9" x 11".

Grit	Type	Item#	EACH Prices	
			5pc	50+
180	Cloth	109-3650	\$2.00	\$1.60
240	Cloth	109-3750	2.00	1.60
320	Cloth	109-3850	2.00	1.60
400	Cloth	109-3950	2.00	1.60

5pc Five-piece minimum; Please order in multiples of five.

A. Norton, A275 Champagne Sandpaper – Great for Aluminum!

This load resistant paper is an excellent choice for aluminum polishing. The paper utilizes a No-Fil coating, which is a water-based stearate that provides maximum load resistance and extended life. Features a premium P-graded, heat-treated aluminum oxide abrasive yielding fast cut rates. Made with a fiber-reinforced latex-saturated backing, giving the paper exceptional flexibility and high tear strength. Sold in 9"x 11" sheets. Nine piece set includes one of each grit.

Grit	Item#	EACH Prices		Grit	Item#	EACH Prices	
		5pc	100+			5-95	100+
120	109-2001	\$0.90	\$0.81	800	109-2008	\$0.90	\$0.81
220	109-2002	0.90	0.81	1000	109-2010	1.10	0.99
320	109-2003	0.90	0.81	1200	109-2012	1.10	0.99
400	109-2004	0.90	0.81	1500	109-2015	1.10	0.99
600	109-2006	0.90	0.81	9-Piece Set	109-2000	7.75	6.98



A

B. 3M™ Wetordry™ Paper – Silicon Carbide

Provide finer finishes than traditional emery papers. Backing and coating offer enhanced cut rates, improved finishes and better durability. Coarser grits come on heavyweight paper (431Q), and finer grits come on lightweight and flexible papers (413Q and 401Q, respectively). All silicon carbide. Measure 9" x 11".

Grit	Paper Type	Item#	EACH Prices		Grit	Paper Type	Item#	EACH Prices	
			5pc	100+				5-95	100+
80	431Q	109-8185	\$1.95	\$1.76	400	431Q	109-8195	\$1.30	\$1.17
120	431Q	109-8187	1.45	1.31	600	431Q	109-8196	1.30	1.17
180	431Q	109-8189	1.30	1.17	1000	401Q	109-8200	2.30	2.07
220	413Q	109-8190	1.30	1.17	1500	401Q	109-8202	2.30	2.07
280	413Q	109-8197	1.30	1.17	2000	401Q	109-8203	2.30	2.07
320	413Q	109-8193	1.35	1.22	2500	401Q	109-8204	2.30	2.07

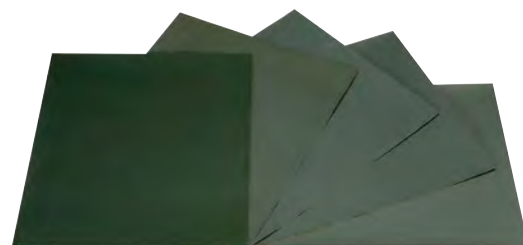

B

C. Norton® Waterproof Paper BLUE-BAK – Silicon Carbide

Silicon carbide abrasive with improved resin bond for exceptional finishes in both wet and dry applications and improved waterproof paper backing for better flexibility and wet-curl resistance. 120 grit comes on heavy weight paper (T461), 220 to 600 on light weight paper and 1200P on slightly lighter weight. Yield long life in rough, wet applications. Measure 9" x 11".

Grit	Paper Type	Item#	EACH Prices		Grit	Paper Type	Item#	EACH Prices	
			5pc	50+				5-45	50+
120	T461	109-7010	\$1.35	\$1.08	400	T414	109-7035	\$1.05	\$0.84
220	T414	109-7015	1.05	0.84	600	T414	109-7045	1.05	0.84
320	T414	109-7025	1.05	0.84	1200*	T401	109-7055	1.50	1.20

*slightly finer than 600

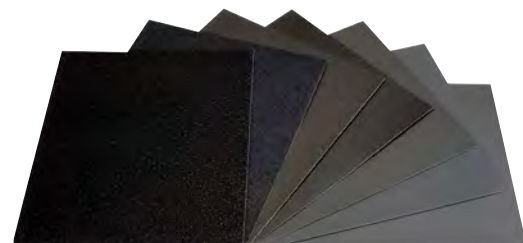

C

D. 3M™ Wetordry™ Polishing Paper Silicon Carbide + Aluminum Oxide

Super-flexible fibrous paper non-woven backing allows easy polishing of flat and contoured surfaces of softer materials. Precision micron-graded silicon carbide (481Q) and aluminum oxide (281Q) papers provide a uniform finish. Use wet or dry on precious metals, aluminum, plastic, polyurethane, solid surface composites, fiberglass and wood. Measure 8½" x 11".

Color	Grade/Grit	Paper Type	Item#	EACH Prices	
				5pc	100+
Green	30 micron/400	481Q	109-8001	\$1.60	\$1.44
Gray	15 micron/600	481Q	109-8005	1.60	1.44
Blue	9 micron/1200	281Q	109-8010	1.60	1.44
Pink	3 micron/4000	281Q	109-8015	1.60	1.44
Lt. Blue	2 micron/6000	281Q	109-8020	1.60	1.44
Mint	1 micron/8000	281Q	109-8025	1.60	1.44
6-Piece Set (one each)			109-8026	SET Price	8.25

5pc Five-piece minimum; Please order in multiples of five.

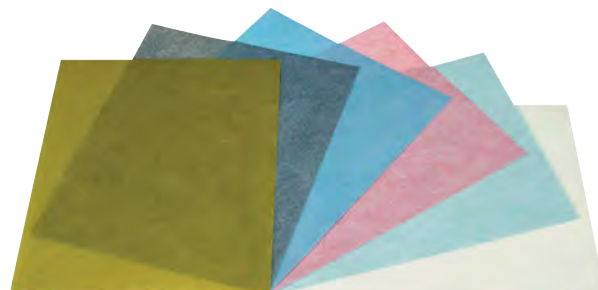

D



A-J Moore's Snap-On Discs

Snap-On Discs feature quick-change, sure-lock brass centers with one cutting face on paper or plastic backing.

Three types of paper-backed discs are available: **Emery** contain black silicon carbide, a fast cutting abrasive; **Adalox** contain aluminum oxide, less aggressive than Emery and **Garnet** which is a natural mineral and is slightly less aggressive than Adalox.

Five types of plastic-backed discs are available: **AIO** contains evenly dispersed micron-grade aluminum oxide, which provides smooth, fast cutting action; **Garnet** is a natural mineral which is slightly less aggressive than AIO; **Sand** contains long-lasting white aluminum oxide, slightly less aggressive than Garnet and **Water Proof Silicon Carbide** which is Silicon Carbide on a paper backing that has a water proof front and is less aggressive than Sand and **Felt** which contain no abrasive and can be charged with compound or paste for quick and easy finishing. Max. operating speed: 30,000rpm. Use with Snap-On Mandrel (see below). Made in USA

Type/ Backing	Dia.	Extra Coarse Item#	Coarse Grit Item#	Med. Grit Item#	Fine Grit Item#	Extra Fine Item#	BOX of 50*	
							1-11	12+
A. Emery/Paper	3/4"	-	845-2585	845-2590	845-2595	-	\$3.60	\$3.24
B. Emery/Paper	7/8"	-	845-2596	845-2597	845-2598	-	3.60	3.24
C. Adalox/Paper	3/4"	-	845-2600	845-2650	845-2700	-	4.40	3.96
D. Adalox/Paper	7/8"	-	845-2715	845-2710	845-2705	-	4.40	3.96
E. Sand/Plastic	3/4"	-	845-2858	845-2857	845-2856	845-2855	5.95	5.36
F. Sand/Plastic	7/8"	-	845-2865	845-2863	845-2860	845-2859	5.95	5.36
Garnet/Paper	3/4"	845-2821	845-2822	845-2823	-	-	5.95	5.36
Garnet/Paper	7/8"	845-2824	845-2825	845-2826	-	-	5.95	5.36
Garnet/Plastic	3/4"	-	-	-	845-2827	845-2828	5.95	5.36
G. Garnet/Plastic	7/8"	-	-	-	845-2829	845-2830	5.95	5.36
H. WP SiC/Plastic	7/8"	-	845-2893	845-2894	845-2895	-	4.45	4.01



Type/ Backing	Dia.	Coarse Grit Item#	Med. Grit Item#	Fine Grit Item#	No Grit Item#	BOX of 100*	
						1-11	12+
I. AIO/Plastic	7/8"	845-2900	845-2902	845-2899	-	\$14.50	\$12.33
Felt/Plastic	3/4"	-	-	-	845-0971	28.80	24.48
J. Felt/Plastic	7/8"	-	-	-	845-0970	28.80	24.48

*Quantity discount for orders of one item number only; not assorted.



K. Snap-On Mandrel - 3/32" Shank

One-piece construction from high quality steel. Fits Snap-On Discs. Made in Germany.

Description	Item#	EACH Prices*	
		1-11	12+
Snap-On Mandrel, 3/32" shank	840-3200	\$1.85	\$1.54

*Quantity discount for orders of one item number only; not assorted.



L. Snap-On 7/8" Disc Set

Includes 120 Snap-On Discs (10 of each Emery C/M/F, Adalox C/M/F, Sand C/M/F, AIO Plastic backed C/M and Felt 7/8" discs) plus two Snap-On Mandrels in a convenient storage box.

Description	Item#	Each
120-Piece Set, 7/8" dia.	845-2905	\$18.00

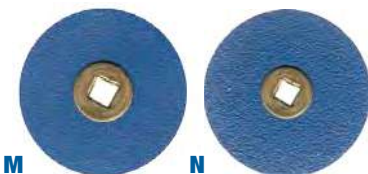

M, N Snap-on Blue Zirconia Discs

Blue Zirconia Alumina Sanding Discs are ideal for use with platinum, but will work well on gold and silver. These discs are resin-backed for superior durability and aggressively cut and grind metals with a uniform file-like finish. Last up to three times longer than conventional abrasives. Comes supplied in 3/4" and 7/8" diameters with snap-on centers. The brass-centered holes reduce vibration as they work. For snap-On Discs, use Gesswein's Snap-on Mandrel (Item#: 840-3200) Made in USA.

Description	Dia.	Coarse Grit Item#	Med. Grit Item#	Fine Grit Item#	BOX of 50			
					1-2	3-5	6-11	12+
M. Blue Zirconia Discs	7/8"	845-2725	845-2730	845-2735	\$8.70	\$8.27	\$7.83	\$7.40
N. Blue Zirconia Discs	3/4"	845-2740	845-2745	845-2750	8.70	8.27	7.83	7.40

A-D Pin Hole Adalox Discs

Pin hole discs with Adalox (aluminum oxide) abrasive on paper backing. Available in 4 sizes all with pin hole center. See pages 584-585 for screw mandrels. Sold in boxes of 100 discs.

Type/ Backing	Dia.	Coarse Grit Item#	Med. Grit Item#	Fine Grit Item#	BOX of 100
A. Adalox/Paper	1/2"	845-0981	845-0982	845-0983	\$5.40
B. Adalox/Paper	5/8"	845-0984	845-0985	845-0986	5.40
C. Adalox/Paper	3/4"	845-0987	845-0988	845-0989	5.40
D. Adalox/Paper	7/8"	845-0997	845-0998	845-0999	5.40

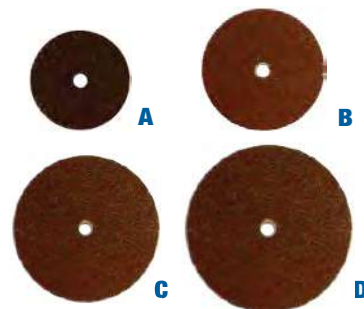

E, F Pin Hole Blue Zirconia Discs

Blue Zirconia Alumina Sanding Discs are ideal for use with platinum, but will work well on gold and silver. These discs are resin-backed for superior durability and aggressively cut and grind metals with a uniform file-like finish. Last up to three times longer than conventional abrasives. Comes supplied in 3/4" and 7/8" diameters with pin-hole centers. Made in USA.

Description	Dia.	Coarse Grit Item#	Med. Grit Item#	Fine Grit Item#	BOX of 100			
					1-2	3-5	6-1	12+
E. Blue Pin Hole Discs	7/8"	845-2755	845-2760	845-2765	\$8.70	\$8.27	\$7.83	\$7.40
F. Blue Pin Hole Discs	3/4"	845-2770	845-2775	845-2780	8.70	8.27	7.83	7.40

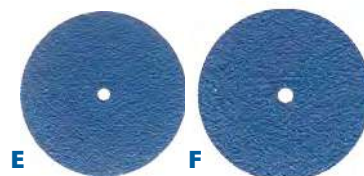

G. 3M™ Sponge Sanding Pads

Flexible, palm-sized Sponge Sanding Pads from 3M conform to almost any surface contour. Made of long-lasting, closed-cell rubber with micron-graded aluminum oxide abrasive grains, these pads will not gouge the work surface.

3M Sponge Sanding Pads can be used wet or dry for a variety of applications as well as folded or trimmed to fit into detailed areas.

Each pad measures 4 1/2" x 5 1/2". Available in Medium, Fine, Super-Fine, Ultra-Fine and Micro-Fine as well as a Set of all 5.

Description	Item#	EACH Prices		
		1-4	5-19	20+
Medium Pad	108-7020	\$1.95	\$1.79	\$1.71
Fine Pad	108-7015	1.95	1.79	1.71
Super-Fine Pad	108-7010	1.95	1.79	1.71
Ultra-Fine Pad	108-7005	3.35	3.07	2.93
Micro-Fine Pad	108-7000	3.35	3.07	2.93
			SET Price	
G. 5-Piece Set	108-7025			12.35

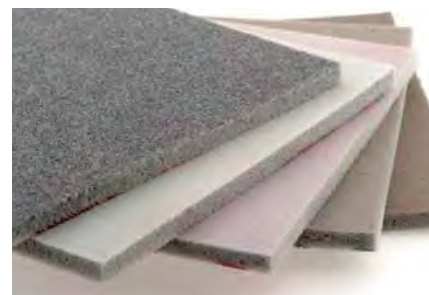

H, I Slurry Coated Strips and Cloths

Slurry coated polishing strips and cloths are strong and durable and a must for any bench jeweler. Made of Rayon and unique proprietary backing material that sets them apart from traditional polishing paper, and results in a consistent uniform finish. The blend of various types of micron particle minerals is applied to each strip in a slurry coating process along with the abrasive Silicone Carbide. The micron grading technique produces particles of the same size and shape to achieve a consistent finish every time. The Slurry Coated Strips are perfect for hard to reach places and provide consistent results. Use them by hand or in your favorite saw frame. The Slurry Coated Cloths are for larger items to be polished. Both are ideal for wet or dry applications. Available in 9 colors for easy identification of the grits (see below).

- The Strips come in a convenient assortment pack of all 9 colors/grits. Each pack includes 2 sheets per color/grit, overall size 1 7/8" W X 7" L and each sheet contains 12 pre-cut strips (5/32" W X 7" L).
- The Cloths come in a convenient assortment pack of 9 colors/grits. Each pack includes 18 cloths (4" W X 7 1/2" L). 2 cloths per color/grit.
- 360 Grey, 400 Orange, 600 Brown, 800 White, 1000 Red, 1200 Green, 1500 Purple, 2000 Yellow and 4000 Blue

Description	Item#	SET Prices	
		1-2	3+
H. Strips (216)	109-8510	\$17.50	\$15.75
I. Cloths (18)	109-8511	17.50	15.75

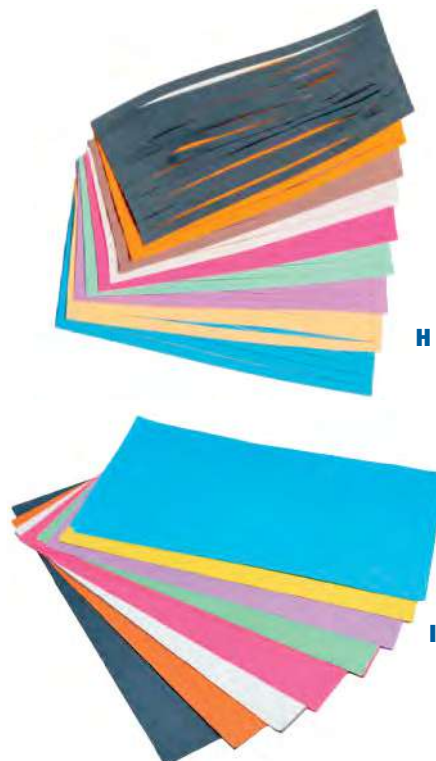

3M™ Scotch-Brite™ Radial Bristle Discs

For fast and easy cleaning and polishing without compound!

Use to clean, prepolish, blend and remove scratches and firescale. Excellent on gold, silver, platinum and most other metals. Require no compounds. Work fast and take the mess out of cleaning up small areas such as tiny findings, bracelet links, nugget rings and more. Long-lasting and nonloading. Color-coded for easy grit identification.

Use a single one for reaching tight areas, or stack several of them for covering large surface areas (for example, 2" and 3" discs can be stacked up to ten in a row). 6" discs consist of eight stacked discs mounted on a plastic hub. Includes adapters for 3/8", 1/2" and 5/8" and 3/4" arbors. Maximum operating speeds: 10,000rpm for 6" discs, 20,000rpm for 3" discs and 30,000rpm for all others (recommended operating speed for most applications: 15,000rpm). See pp. 584-585 for mandrels.



Color	Application
Brown	Removal of heaviest scratches
Green	Removal of heavy scratches
Yellow	Removal of scratches and firescale
White	Texturing, light cleaning
Red	Removal of light scratches and oxides
Blue	Blending, prepolishing
Pink	Very light cleaning, prepolishing
Peach	Polishing
Lt. Green	Final polishing

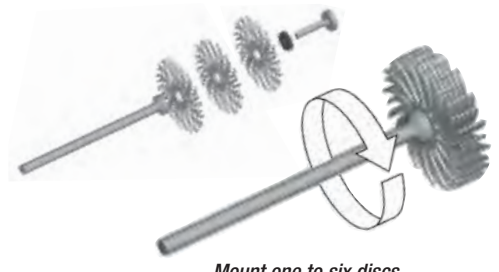

A-D Small Discs – For use with rotary handpieces

The 9/16" and 3/4" discs are sold in packages of 12 (see pp. 584-585 for mandrels) or in packages of 48 which includes one 3/32" mandrel. Maximum operating speed 30,000 rpm (although recommended for most applications will be 15,000 rpm).

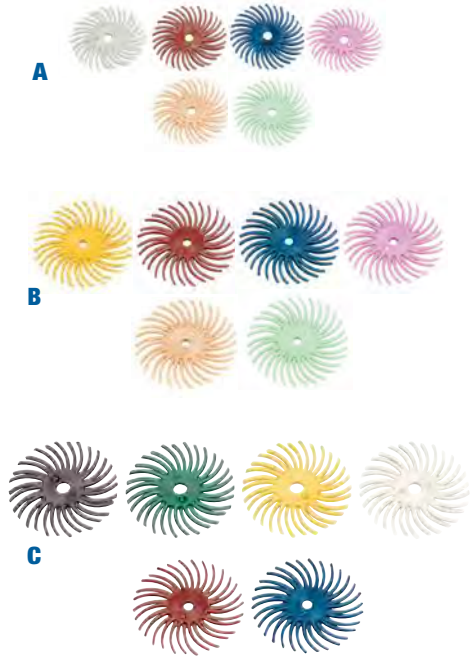

Dia. x AH	Color	Grit	Item#	PKG of 12	PKG of 48 with 3/32" Shank Mandrel	
					Item#	Each
A. 9/16" x 1/16"	White	120	145-1520	\$12.10	145-1620	\$44.55
	Red	220	145-1525	12.10	145-1625	44.55
	Blue	400	145-1530	12.10	145-1630	44.55
	Pink	Pumice	145-1535	12.10	145-1635	44.55
	Peach	6 Micron	145-1545	12.10	145-1645	44.55
B. 3/4" x 1/16"	Lt. Green	1 Micron	145-1540	12.10	145-1640	44.55
	Yellow	80	145-1500	12.60	145-1600	45.10
C. 1" x 1/8"	Red	220	145-1505	12.60	145-1605	45.10
	Blue	400	145-1510	12.60	145-1610	45.10
	Pink	Pumice	145-1515	12.60	145-1615	45.10
	Peach	6 Micron	145-1492	12.60	145-1590	45.10
	Lt. Green	1 Micron	145-1495	12.60	145-1595	45.10
	Brown	36	145-1550			
C. 1" x 1/8"	Green	50	145-1555			
	Yellow	80	145-1560			
	White	120	145-1565			
	Red	220	145-1570			
	Blue	400	145-1575			

Description	Item#	Each
D. 45-Piece Small Disc Set (includes three of each disc listed above (except for #145-1492, #145-1495, #145-1570 and 145-1575, one 3/32" shank mandrel and two 1/8" shank mandrels)	145-1670	\$51.40
73-Piece 9/16" Set (includes 12 of each 9/16" disc listed above and one 3/32" shank mandrel in a plastic case)	145-1672	73.35
73-Piece 3/4" Set (includes 12 of each 3/4" disc listed above and one 3/32" shank mandrel in a plastic case)	145-1673	93.45



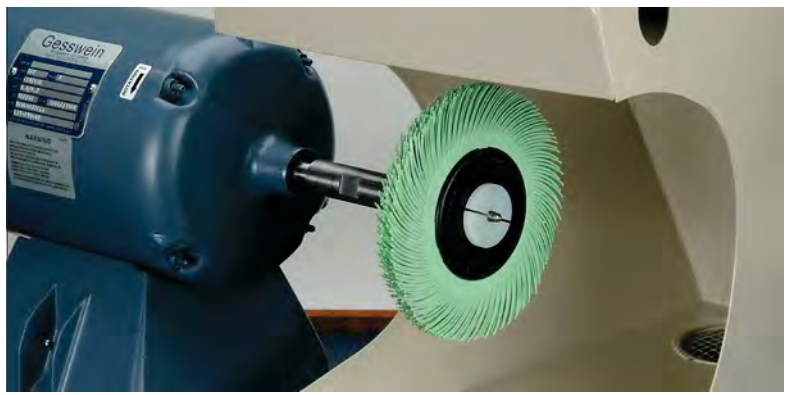

A-D 2-3" Discs – For use with polishing motors & Mini Max Combo

The 2" and 3" discs are sold with right hand (RH) tapered spindle adapters in packages of 10 or 40 discs and in sets of 4 of each disc and an adapter. Optional left hand (LH) adapter is also available. See below. Both have 1/4" arbor holes. Max. operating speed 30,000rpm for 2" and 20,000rpm for 3".

Dia. x AH	Color	Grit	Item#	Pkg. of 10	PKG of 40 w/hub Item#	Each
A. 2" x 3/8"	Yellow	80	145-1745	\$26.20	145-1675	\$99.70
	White	120	145-1750	26.20	145-1680	99.70
	Red	220	145-1755	26.20	145-1685	99.70
	Blue	400	145-1760	26.20	145-1690	99.70
	Pink	Pumice	145-1765	26.20	145-1695	99.70
	Peach	6 Micron	145-1770	26.20	145-1700	99.70
	Lt. Green	1 Micron	145-1775	26.20	145-1705	99.70
Description			Item#	Each		
29-Piece 2" Disc Set			145-1813	\$65.25		

Dia. x AH	Color	Grit	Item#	Pkg. of 10	PKG of 40 w/hub Item#	Each
B. 3" x 3/8"	Yellow	80	145-1780	\$34.15	145-1710	\$132.85
	White	120	145-1785	34.15	145-1715	132.85
	Red	220	145-1790	34.15	145-1720	132.85
	Blue	400	145-1795	34.15	145-1725	132.85
	Pink	Pumice	145-1800	34.15	145-1730	132.85
	Peach	6 Micron	145-1805	34.15	145-1735	132.85
	Lt. Green	1 Micron	145-1810	34.05	145-1740	132.85
Description			Item#	Each		
29-Piece 3" Disc Set			145-1816	\$85.25		

C. RH Tapered Spindle Adapter Hub for 2" and 3" discs	145-1921	2.30
D. LH Tapered Spindle Adapter for 2" and 3" discs	145-1922	2.30



E. 6" Discs – For use with polishing motors & Max 24

Each 6" disc consists of eight stacked discs mounted on a plastic hub. Includes adapters for 3/8", 1/2", 5/8" and 3/4" arbors. Approx. Thickness is 1/2" with a 1" Arbor Hole. Tapered spindle adapters sold separately. Max. operating speed 6,000rpm.

Dia. x Approx. Thickness x AH	Color	Grit	Item#	EACH Prices	
				1-2	3+
E. 6"dia. x 1/2"T x 1"AH*	Yellow	80	145-1925	\$63.00	\$59.85
	White	120	145-1926	63.00	59.85
	Red	220	145-1927	63.00	59.85
	Blue	400	145-1928	63.00	59.85
	Peach	6 Micron	145-1929	63.00	59.85
	Lt. Green	1 Micron	145-1930	63.00	59.85

*Complete with adapters for 3/8", 1/2", 5/8", and 3/4" arbors.

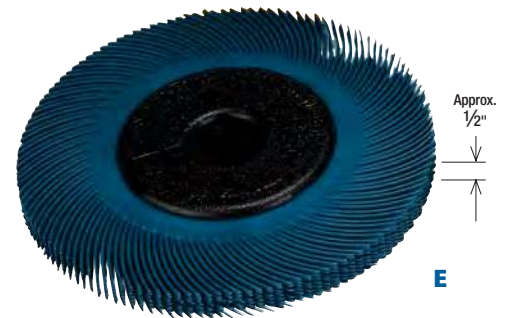

F. Tapered Spindle Adapter for 6" Discs

Description	Item#	Each
Tapered Spindle Adapter for 6" discs	145-1931	\$5.80



SUNBURST® Radial Disc Assortments & Midget Points

SUNBURST Products are designed with specially treated ceramic abrasive grain embedded throughout. This eliminates the need for polishing compound and produces minimal dust and heat. Ideal for finishing, smoothing and high-luster polishing of all precious, semi-precious and non-precious metals, acrylics and ceramics. See pages 404 and 405 for individual discs and larger sizes. Made in USA.



See website for additional SUNBURST products.

A. 1/2" Snap Radial Discs



Description (Pack of 30)	Item#	Pack of 30		
		1-5	6-9	10+
80 Grit (yellow)	145-5003	\$29.95	\$28.45	\$26.96
120 Grit (white)	145-5004	29.95	28.45	26.96
220 Grit (red)	145-5005	29.95	28.45	26.96
400 Grit (blue)	145-5006	29.95	28.45	26.96
600 Grit Pumice (pink)	145-5007	29.95	28.45	26.96
6 Micron (peach)	145-5008	29.95	28.45	26.96
1 Micron (light green)	145-5009	29.95	28.45	26.96
Assortment	Item#	SET Price		
A. (6 each of all 7 grits plus one mandrel)	145-5000	\$44.95		

B. All-In-One Assortment

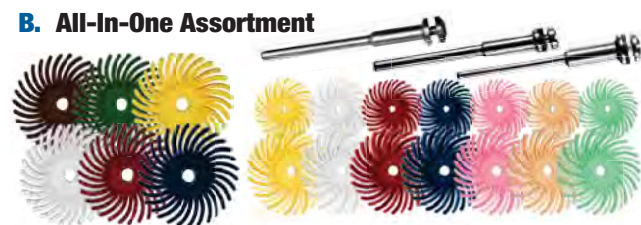

Description	Item#	SET Price
B. 83 piece All-In-One-Assortment 4 each of all grits in sizes 5/8", 7/8", and 1", plus 3 mandrels.	145-5270	\$66.95

C. 5/8" Radial Discs



Description	Item#	SET Price
C. 5/8" Radial Discs Assortment (12 each of all 7 grits plus 2 mandrels)	145-5020	\$62.95

D. 7/8" Radial Discs



Description	Item#	SET Price
D. 7/8" Radial Discs Assortment (12 each of all 7 grits plus 2 mandrels)	145-5060	\$62.95

E. 1" Radial Discs



Description	Item#	SET Price
E. 1" Radial Discs Assortment (8 each of all 6 grits plus 2 mandrels)	145-5120	\$54.95

G. Midgets Shape 12 - 3/32" Shank



Description	Item#	Pk of 12 Price	Item#	Pk of 72 Price
80 Grit (yellow)	145-0210	\$35.95	145-0211	\$172.95
120 Grit (white)	145-0212	35.95	145-0213	172.95
220 Grit (red)	145-0214	35.95	145-0215	172.95
400 Grit (blue)	145-0216	35.95	145-0217	172.95
6 Micron (peach)	145-0218	35.95	145-0219	172.95
1 Micron (lt green)	145-0220	35.95	145-0221	172.95

H. Midgets Shape 15 - 3/32" Shank



Description	Item#	Pk of 12 Price	Item#	Pk of 72 Price
80 Grit (yellow)	145-0234	\$35.95	145-0235	\$172.95
120 Grit (white)	145-0236	35.95	145-0237	172.95
220 Grit (red)	145-0238	35.95	145-0239	172.95
400 Grit (blue)	145-0240	35.95	145-0241	172.95
6 Micron (peach)	145-0242	35.95	145-0243	172.95
1 Micron (lt green)	145-0244	35.95	145-0245	172.95

I. Midgets Shape 14 - 3/32" Shank











Description	Item#	Pk of 12 Price	Item#	Pk of 72 Price
80 Grit (yellow)	145-0222	\$35.95	145-0223	\$172.95
120 Grit (white)	145-0224	35.95	145-0225	172.95
220 Grit (red)	145-0226	35.95	145-0227	172.95
400 Grit (blue)	145-0228	35.95	145-0229	172.95
6 Micron (peach)	145-0230	35.95	145-0231	172.95
1 Micron (lt green)	145-0232	35.95	145-0233	172.95

J. All-In-One Midget Assortment



Description	Item#	SET Price
J. 18 piece All-In-One-Assortment 3 each of all 6 grits in shapes 12, 14 & 15. 3/32" shanks.	145-0250	\$49.95

Abrasive Polishers & Wheels Brand Comparison

Brand >	Brightboy	GRX	PT	Dedeco	Airflex	Cratex	Poly	Edenta	Elite	SiC	Cera	SX	Diamond Abr.
Page	89	93	85	81, 94, 95	86, 95	90-92	84	82	86	83	88	85	115
Abrasive	AIO	AIO	AIO	SiC & AIO	SiC	SiC	SiC	SiC	SiC	SiC	Ceramic	SiC & AIO	Diamond
Bond	Rubber	Elastic	Rubber	Neoprene	Silicone Rubber	Rubber	Rubber	Rubber	Silicone Rubber	Silicone Rubber	Rubber	PVA	Rubber
Wheels 	●	●	●	●	●	●	●	●	●	●	●	●	●
Mtd. Wheels 			●				●	●					●
Cylinders 				●		●	●	●	●	●			
Mtd. Cylinders 							●				●	●	●
Points 						●							
Mtd. Points 			●				●	●					
Bullets 						●							
Mtd. Bullets 		●									●		
Rods		●	●			●		●					
Sticks	●	●				●							
Coarse	70	46, 80		100,120	C	C	C	Prepolish	180		80		
Medium		120, 150	M	180, 220	M	M	M	M	220	220, 240	120	220, 320	M
Fine			F	320	F	F	F	F			220, 320	400, 500, 600	F
Ultra-Fine				400		Extra-Fine	High Shine	High Shine	1000	280	500	800, 1000, 1500	Med, Fine, Ex-Fine

A. Gesswein® 50-Piece Polishing Set

A complete, compact set for every job from fast grinding to final finish. The set features a selection of our most popular rubberized abrasives in both straight- and knife-edged wheels, as well as rods which can be dressed to reach into the tiniest settings. Dressing stone included. The complete set includes:

- 5 Assorted Heatless Wheels: for fast grinding and brush finishing
- 10 Premium GK-10 Rubber Pumice Wheels: industry standard for scratch removal and shaping

- 10 Assorted Black Wheels: for light scratch and bur removal
- 10 Assorted Pink Silicone Polishing Wheels: for ultra-high polish
- 5 Brown Prepolisher Rods: for scratch removal in settings or recessed areas
- 5 Green High Shine Rods: for fine polishing of settings and recessed areas
- Dressing Stone for Rods: shapes rods to fine point
- 6 Mandrels: 3/32" + 1/8" for Wheels
- 1 Mandrel: 3/32" for Rods

Description	Item#	Each
Gesswein 50-Piece Polishing Set	145-0092	\$31.95

B-D Rubber Pumice Wheels

Soft, flexible rubber wheels compounded with pumice abrasive. The light action produces a smooth finish on gold, silver and soft metals. All with 1/16" arbor hole. See pp. 584-585 for mandrels. Maximum operating speed: 25,000rpm.

Style	Dia. x Thick	Item#	Pkg.(10)	Item#	Box(100)
B. 822	5/8" x 3/32"	-	-	845-2102	\$54.29
C. 888	7/8" x 1/8"	845-2151	\$8.85	845-2152	71.00
D. 999	5/8" tapered	845-2001	9.25	845-2002	73.08

E. Silipum Rubber Pumice Wheels

A combination of silicone and pumice make this an excellent product for removing scratches around bezel and prong set stones. Safe for most stones and are long lasting. Max. operating speed: 20,000rpm. See pp. 584-585 for mandrels.

Style	Dia.	Item#	Pkg.(10)	Item#	Box(100)
KE Wheel	5/8"	845-2059	\$4.50	845-2058	\$37.95

F, G Dedeco® White Universal – 100 Grit, Flexible

White (silicon carbide) with a neoprene bond.: Takes out scratches, parting lines and burs while leaving a very smooth finish with no flats or dusty residue. 1/16" arborhole. Max RPM 7,000. Made in USA.

Shape	Style	Dimensions	Item#	Box(100)
F. SE Wheel	7104	7/8" x 1/8"	145-0115	\$45.50
G. KE Wheel	7110	7/8"	145-0117	45.50

H-K Dedeco® White Flexies – 400 Grit, Flexible

White (aluminum oxide) with a neoprene bond.: For ultra-fine polishing of gold and other precious metals. 1/16" arborhole. Max RPM 21,000.

Shape	Style	Dimensions	Item#	Box(100)
H. SE Wheel	5029	5/8" x 1/16"	145-0064	\$32.50
I. KE Wheel	4981	5/8"	145-0083	39.50
J. SE Wheel	5009	7/8" x 1/8"	145-0065	32.50
K. KE Wheel	4980	7/8"	145-0084	39.50

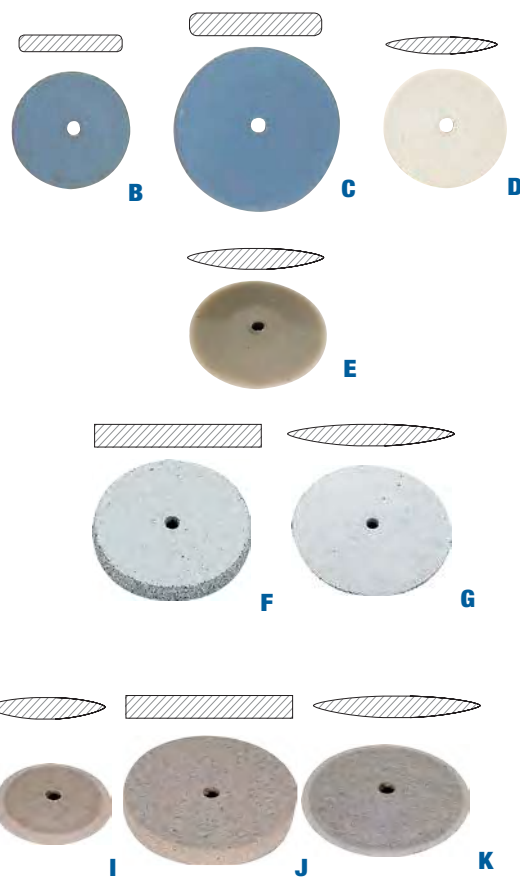

Edenta Polishers Natural Rubber – Silicon Carbide

This Swiss company is world famous for making the best quality and longest lasting Rubberized abrasive products, all manufactured under the stringent ISO 9001 guidelines. The abrasive is precision graded and then uniformly distributed throughout the rubber. This Natural Rubber bond is a far superior product as the wheels last over TWICE as long as Silicone and can operate at higher, more efficient speeds. Higher speeds create a brighter, shinier surface and require less pressure.

Brown TopStar Polishers remove light scratches and prepare surfaces for final polishing, max. operating speed: 20,000rpm. Pink Platinum Polishers work well as a prepolisher, max. operating speeds: 10,000rpm. The Gray Titanium Polisher is for removing scratches and flaws, max. operating speed: 20,000rpm, while Blue Titanium Polishers impart a final finish, max. operating speeds: 10,000rpm. Green TopStar Polishers impart a bright high shine, max. operating speed: 10,000rpm. **Mounted shapes have 3/32" shanks**, and unmounted shapes, except for rods have 1/16" arbor holes. See pp. 584-585 for mandrels. Made in Switzerland.

**Longer Lasting
Lowest Total Cost!**

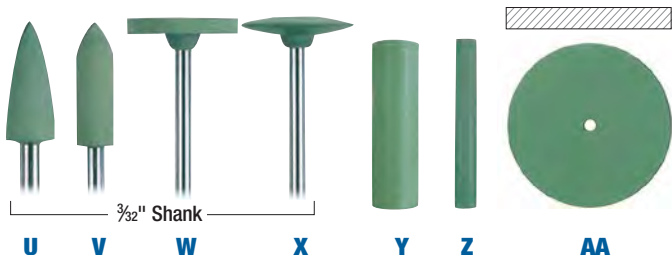
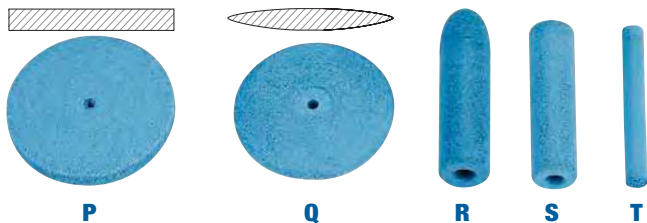
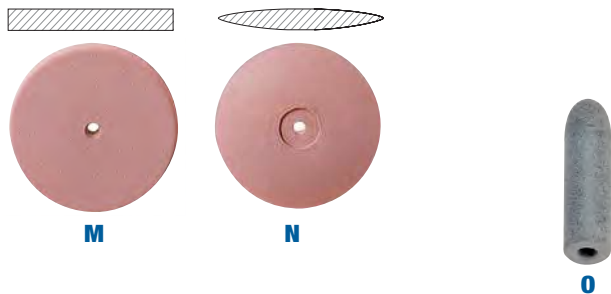
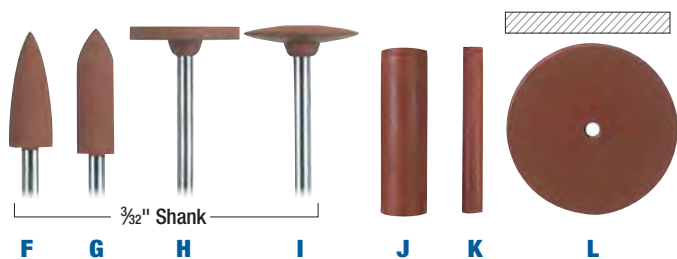
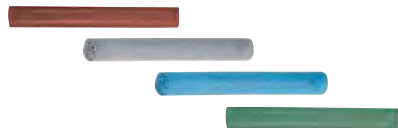

A-E Rubber Polishing Rods SiC – 3mm Dia. x 22mm L

Color	Grit	Item#	Pkg.(10)	Item#	Box(100)
A. Brown	Medium/Coarse	145-1425	\$7.90	145-1424	\$69.50
B. Grey	Medium	145-3201	7.90	145-3200	69.50
C. Blue	Fine	145-3211	7.90	145-3210	69.50
D. Green	Extra-Fine	145-1445	7.90	145-1444	69.50

Description	Item#	EACH Prices	
		1-2	3+
E. Mandrel for 3mm rod, 3/32" Shank	145-1419	\$9.95	\$8.96

F-L Brown TopStar Polishers – Prepolish, Flexible

Shape	Dia. x L (mm)	Item#	Pkg.(10)	Item#	Box(100)
F. Mtd. Point	5.5 x 15.5	145-1427	\$18.00	145-1426	\$165.00
G. Mtd. Bullet	5 x 16	145-1429	18.00	145-1428	165.00
H. SE Mtd. Wheel	14.5 x 2	145-1433	18.00	145-1432	165.00
I. KE Mtd. Wheel	15	145-1431	18.00	145-1430	165.00
J. Cylinder	6 x 22	145-1423	6.90	145-1422	63.00
K. Rod	3 x 22	145-1425	7.90	145-1424	69.50
L. SE Wheel	22 x 3	145-1421	6.90	145-1420	63.00

M, N Pink Platinum Polishers – Prepolish, Moderate Flex

Shape	Dia. x L (mm)	Item#	Pkg.(10)	Item#	Box(100)
M. SE Wheel	22 x 3	145-1487	\$6.90	145-1486	\$63.00
N. KE Wheel	22	145-1485	6.90	145-1484	63.00

O. Gray Titanium Polisher – Medium, Flexible

Shape	Dia. x L (mm)	Item#	Pkg.(10)	Item#	Box(100)
O. Bullet	6 x 23	145-3205	\$6.90	145-3204	\$63.00

P-T Blue Titanium Polishers – Fine, Flexible

Shape	Dia. x L (mm)	Item#	Pkg.(10)	Item#	Box(100)
P. SE Wheel	22 x 3	145-3219	\$7.90	145-3218	\$63.00
Q. KE Wheel	22 x 3	145-3217	7.90	145-3216	63.00
R. Bullet	6 x 23	145-3215	7.90	145-3214	63.00
S. Cylinder	6 x 22	145-3213	7.90	145-3212	63.00
T. Rod	3 x 22	145-3211	7.90	145-3210	69.50

U-AA Green TopStar Polishers – High Shine, Flexible

Shape	Dia. x L (mm)	Item#	Pkg.(10)	Item#	Box(100)
U. Mtd. Point	5.5 x 15.5	145-1447	\$18.00	145-1446	\$165.00
V. Mtd. Bullet	5 x 16	145-1449	18.00	145-1448	165.00
W. SE Mtd. Wheel	14.5 x 2	145-1453	18.00	145-1452	165.00
X. KE Mtd. Wheel	15	145-1451	18.00	145-1450	165.00
Y. Cylinder	6 x 22	145-1443	6.90	145-1442	63.00
Z. Rod	3 x 22	145-1445	7.90	145-1444	69.50
AA. SE Wheel	22 x 3	145-1441	6.90	145-1440	63.00

Silicone SiC Wheels and Points

Fast-cutting silicon carbide abrasive is uniformly dispersed throughout a silicone rubber bond for smooth finishing of precious metals. Ideal for intricate surfaces because of their high flexibility. Follow contours exceptionally well. Cut well and leave a smooth finish ready for polishing. Available in 3 grits: Green (220 grit) for cutting, Black (240 grit) for removal of light tool and file marks, and Blue (280 grit) for medium-fast cutting while leaving a smooth finish. All with 1/16" arbor hole. Maximum operating speed: 10,000rpm. See pp. 584-585 for mandrels. Made in Germany.



A, B Green Silicone SiC – 220 Grit, Extremely Flexible

Shape	Dia. x Thick	Item#	Pkg.(10)	Item#	Box(100)
A. SE Wheel	7/8" x 1/8"	145-1371	\$4.89	145-1370	\$39.15
B. KE Wheel	7/8"	145-1373	4.89	145-1372	39.15

C-E Black Silicone SiC – 240 Grit, Very Flexible

Shape	Dia. x Thick	Item#	Pkg.(10)	Item#	Box(100)
C. KE Wheel	5/8"	145-0972	\$3.87	145-0971	\$31.05
D. SE Wheel	7/8" x 1/8"	145-0974	3.87	145-0973	31.00
E. KE Wheel	7/8"	145-0976	3.87	145-0975	31.05

F, G Blue Silicone SiC – 280 Grit, Flexible

Shape	Dimensions	Item#	Pkg.(10)	Item#	Box(100)
F. SE Wheel	7/8" x 1/8"	145-0980	\$4.95	145-0999	\$40.35
G. KE Wheel	7/8"	145-0982	4.95	145-0998	40.35

H, I Rubber SiC– 240 Grit

All-purpose, hard rubberized bond, gray in color. Contains 240 grit silicon carbide and can be used for light grinding of parting lines and scratches on both hard and soft metals. Both with 1/16" arbor hole. See pp. 584-585 for mandrels. Maximum operating speed: 30,000rpm.

Type	Size	Item#	Box(100)
H. Wheel	7/8" x 1/8"	845-2200	\$17.85
I. Cylinder	1/4" x 7/8"	845-2400	17.85

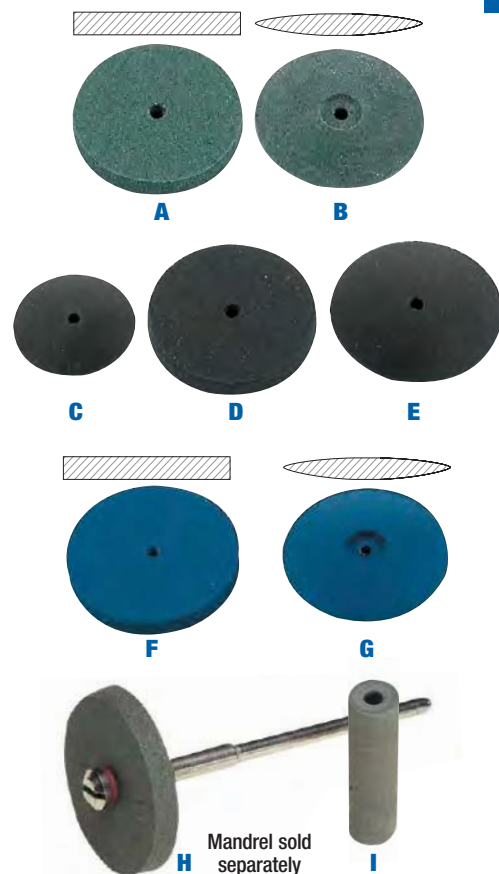

J-S Heatless Wheels – SiC in a Resinoid Bond

Especially useful in preparing contrast finishes and texturing—much coarser than a brushed satin finish. Also used for fast grinding and metal removal, these very hard wheels are made of silicon carbide in a resinoid bond. They break down quickly, constantly exposing new grit to produce a uniform, coarse, brushed-look finish with tiny highlights. Easily shaped with a file. 1/16" metal arbor hole. Maximum operating speed: 25,000rpm. (See mandrels, pp. 460-461)

Dia. x Thick	Item#	EACH Prices	
		10-40	50+
J. 1/2" x 3/32"	845-0015	\$0.45	\$0.41
K. 3/4" x 3/32"	845-0009	0.45	0.41
L. 1/2" x 1/8"	845-0014	0.45	0.41
M. 5/8" x 1/8"	845-0011	0.45	0.41
N. 7/8" x 1/8"	845-0005	0.45	0.41
O. 1" x 1/8"	845-0002	0.45	0.41
P. 1/2" x 3/16"	845-0013	0.45	0.41
Q. 3/4" x 3/16"	845-0007	0.45	0.41
R. 7/8" x 3/16"	845-0004	0.45	0.41
S. 1" x 3/16"	845-0001	0.45	0.41

Ten-piece minimum; please order in multiples of ten.

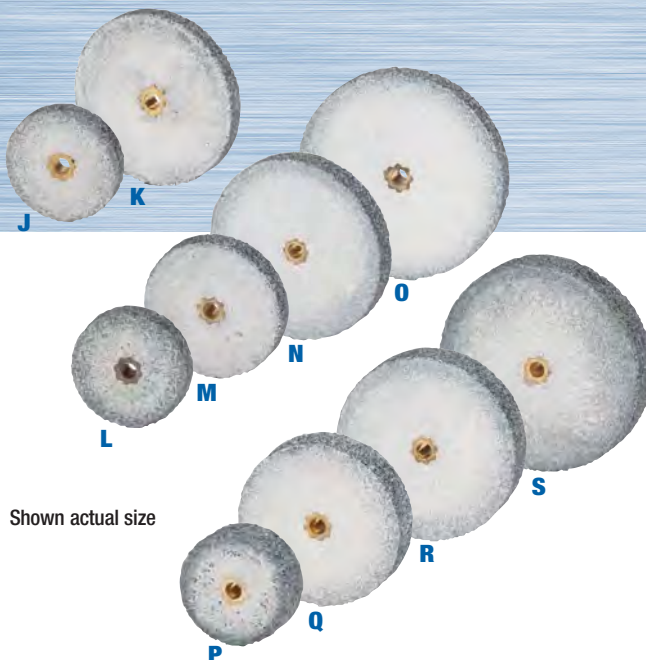

Poly Polishers Silicon Carbide

Superior results on all precious and nonprecious metals. Silicon carbide abrasive in a specially formulated polyurethane rubberized bond for long life—outlasts other types of rubber abrasives. Holds a crisp edge. Available in four color-coded grits (coarse blue, medium gray, fine prepolish brown, and high-shine green) to finish your castings and fabrications from rough to highly polished without getting up from the bench.

All our Polyurethane Polishers are available in a wide variety of shapes and sizes to finish any jewelry item from the largest ring shanks to the tiniest settings uniformly and without a lot of dressing to make them fit! Mounted abrasives are on $\frac{3}{32}$ " shanks. Unmounted wheels and cylinders have $\frac{1}{16}$ " holes and can be mounted on mandrels shown on pp. 460-461. Maximum operating speed: 12,000rpm. Made in Germany.

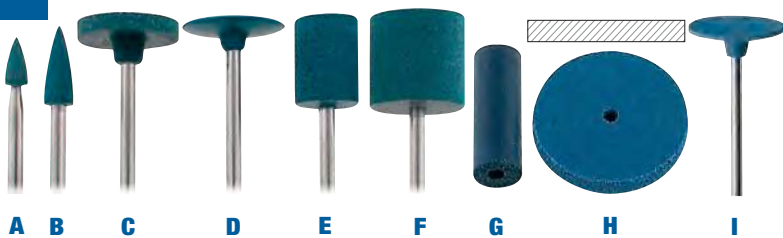

$\frac{3}{32}$ " Shank

A-H Blue Poly Polishers – Coarse, Slightly Flexible

Shape	Dia. x L	Item#	Pkg.(10)	Item#	Pkg.(100)
A. Mtd. Point	3 x 7mm	145-1401	\$12.50	145-1400	\$94.50
B. Mtd. Point	4 x 12mm	145-1115	12.50	145-1114	94.50
C. SE Mtd. Wheel	$\frac{5}{8}$ " x $\frac{3}{32}$ "	145-1409	13.50	145-1408	106.50
D. KE Mtd. Wheel	$\frac{5}{8}$ "	145-1119	13.50	145-1118	106.50
E. Mtd. Cylinder	10 x 12mm	145-1121	13.50	145-1120	106.50
F. Mtd. Cylinder	14 x 12mm	145-1123	18.50	145-1122	149.50
G. Cylinder	7 x 20mm	145-1113	5.50	145-1112	40.50
H. SE Wheel	$\frac{7}{8}$ " x $\frac{1}{8}$ "	145-1111	5.50	145-1110	40.50
I. Mtd. Floppy Disc	19" x 0.5mm	145-1383	12.50	145-1382	106.50

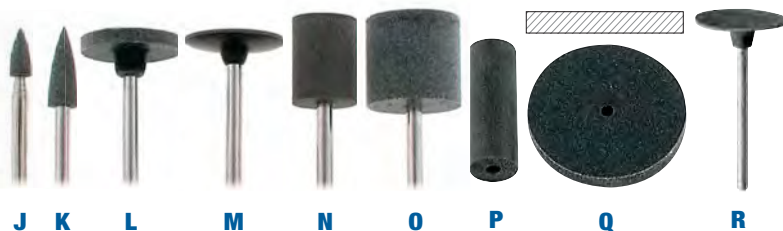

$\frac{3}{32}$ " Shank

J-R Gray Poly Polishers – Medium, Moderately Flexible

Shape	Dia. x L	Item#	Pkg.(10)	Item#	Pkg.(100)
J. Mtd. Point	3 x 7mm	145-1403	\$12.50	145-1402	\$94.50
K. Mtd. Point	4 x 12mm	145-1129	12.50	145-1128	94.50
L. SE Mtd. Wheel	$\frac{5}{8}$ " x $\frac{3}{32}$ "	145-1411	13.50	145-1410	106.50
M. KE Mtd. Wheel	$\frac{5}{8}$ "	145-1133	13.50	145-1132	106.50
N. Mtd. Cylinder	10 x 12mm	145-1135	13.50	145-1134	106.50
O. Mtd. Cylinder	14 x 12mm	145-1137	18.50	145-1136	149.50
P. Cylinder	7 x 20mm	145-1127	5.50	145-1126	40.50
Q. SE Wheel	$\frac{7}{8}$ " x $\frac{1}{8}$ "	145-1125	5.50	145-1124	40.50
R. Mtd. Floppy Disc	19" x 0.5mm	145-1385	12.50	145-1384	106.50

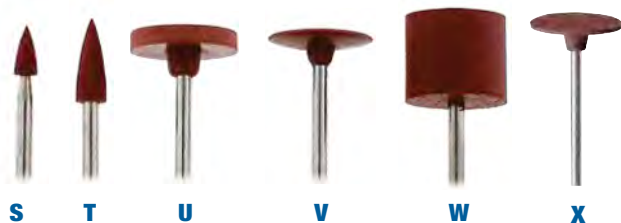

$\frac{3}{32}$ " Shank

S-X Brown Poly Polishers – Fine, Moderately Flexible

Shape	Dia. x L	Item#	Pkg.(10)	Item#	Pkg.(100)
S. Mtd. Point	3 x 7mm	145-1405	\$12.50	145-1404	\$94.50
T. Mtd. Point	4 x 12mm	145-1143	12.50	145-1142	94.50
U. SE Mtd. Wheel	$\frac{5}{8}$ " x $\frac{3}{32}$ "	145-1413	13.50	145-1412	106.50
V. KE Mtd. Wheel	$\frac{5}{8}$ "	145-1147	13.50	145-1146	106.50
W. Mtd. Cylinder	14 x 12mm	145-1151	18.50	145-1150	149.50
X. Mtd. Floppy Disc	19" x 0.5mm	145-1387	12.50	145-1386	106.50



$\frac{3}{32}$ " Shank

Y-CC Green Poly Polishers – High Shine, Moderately Flexible

Shape	Dia. x L	Item#	Pkg.(10)	Item#	Pkg.(100)
Y. Mtd. Point	3 x 7mm	145-1407	\$12.50	145-1406	\$94.50
Z. Mtd. Point	4 x 12mm	145-1157	12.50	145-1156	94.50
AA. SE Mtd. Wheel	$\frac{5}{8}$ " x $\frac{3}{32}$ "	145-1415	13.50	145-1414	106.50
BB. KE Mtd. Wheel	$\frac{5}{8}$ "	145-1161	13.50	145-1160	106.50
CC. Mtd. Floppy Disc	19" x 0.5mm	145-1389	12.50	145-1388	106.50

DD. Poly Polisher Point & Wheel Sets

These 24-piece sets contain three of each shape of mounted polishing points and wheels on $\frac{3}{32}$ " shanks.

Description	Item#	Each
Brown and Green Poly Polisher Set	145-1100	\$34.50
Blue and Gray Poly Polisher Set	145-1099	29.95

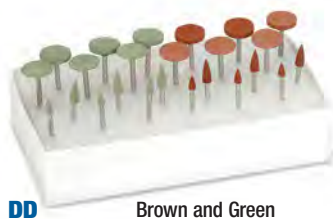

DD Brown and Green



Blue and Gray

SX Mounted Polishers $\frac{3}{32}$ " Shank

Features large foam cell size constructed of resilient PVA (polyvinyl acetate) foam, for cool operation and long life. Firm enough to lap flat surfaces yet flexible enough to allow polishing of curved surfaces without gouging. Ideal for hard and soft metals such as platinum, palladium, stainless steel, gold, aluminum and brass. Gray polishers contain silicon carbide while the white polishers have aluminum oxide abrasive. Measure 15mm ($\frac{5}{8}$ " dia. x 25mm (1" long with $\frac{3}{32}$ " shank. Max. operating speed: 15,000rpm. Made in Japan.

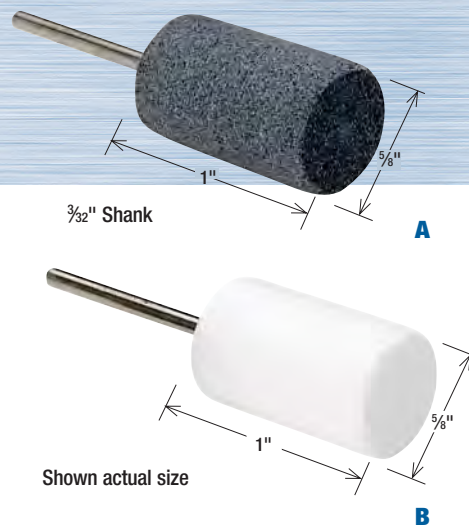

Description	Dimensions (mm)	Grit	Item#	EACH Prices	
				1-11	12+
A. Gray Polisher - SiC	15 x 25	220	145-3280	\$3.25	\$2.93
	15 x 25	320	145-3281	3.25	2.93
	15 x 25	400	145-3282	3.50	3.15
	15 x 25	500	145-3286	3.85	3.47
	15 x 25	600	145-3283	3.85	3.47
	15 x 25	800	145-3284	4.10	3.69
	15 x 25	1000	145-3285	4.10	3.69
B. White Polisher - AlO	15 x 25	1500	145-3288	4.90	4.41
8-Piece Set (one each of above)			145-3279	27.00	-

PT Platinum/Titanium Polishers

These polishers work especially well on titanium and platinum. Even abrasive distribution allows them to produce smooth, uniform surface finishes. Moderately hard silicone rubber impregnated with aluminum oxide conforms slightly to surfaces. All shapes hold their edges due to slow breakdown rate. Applications include removing tool marks, smoothing parting lines and removing casting scale. Choose from a variety of unmounted and mounted $\frac{3}{32}$ " shank shapes. Available in two color-coded grits: medium (gray) and fine (lilac). See pp. 584-585 for mandrels. Maximum operating speed: 10,000rpm. Made in Germany.



C-G Gray PT Polishers – Medium for breakdown

Shape	Dimensions	Item#	Pkg.(10)	Item#	Box(100)
C. Mtd. Point	$\frac{3}{16}$ " x $\frac{5}{8}$ "	145-1347	\$15.80	145-1346	\$135.00
D. KE Mtd. Wheel	$\frac{5}{8}$ "	145-1353	15.80	145-1352	135.00
E. SE Wheel	$\frac{7}{8}$ " x $\frac{1}{8}$ "	145-1341	6.50	145-1340	55.00
F. KE Wheel	$\frac{7}{8}$ "	145-1343	6.50	145-1342	55.00

Shape	Dimensions	Item#	Pkg.(25)	Item#	Box(100)
G. Rod	3mm x 1"	145-1345	\$15.65	145-1344	\$55.00

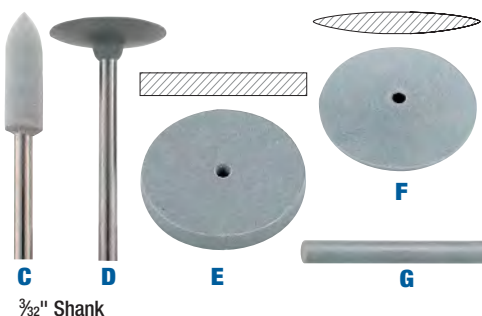

H, I Lilac PT Polisher – Fine for prepolish

Shape	Dimensions	Item#	Pkg.(10)	Item#	Box(100)
H. KE Wheel	$\frac{7}{8}$ "	145-1359	\$6.50	145-1358	\$55.00

Shape	Dimensions	Item#	Pkg.(25)	Item#	Box(100)
I. Rod	3mm x 1"	145-1361	\$15.65	145-1360	\$55.00

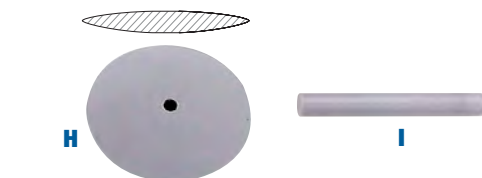

J. Diamond-Coated Dressing Block

Solid steel block with diamond coating for fast dressing and shaping of any of our rubberized abrasives. One side is grooved for shaping rods, points and knife-edged wheels. The other side is flat for dressing square-edged wheels. Measures $3\frac{1}{2}$ " overall length (including handle).

Description	Item#	Each
Diamond-Coated Dressing Block	145-1316	\$48.00



K, L Rod Mandrels – $\frac{3}{32}$ " Shank

Precision-machined mandrels for smooth-as-silk opening and closing. Holds 3mm rods securely with a twist-tightening grip. Nickel-plated tool steel.

Description	Item#	EACH Prices	
		1-2	3+
K. Edenta TopStar Mandrel for 3mm rod	145-1419	\$9.95	\$8.96
L. Polishing Mandrel for 3mm rod	145-1218	4.10	3.69





Gesswein® Elite Silicon Carbide

These popular wheels and cylinders contain silicon carbide grit for the most efficient cutting of nonferrous metals. Feature a more flexible silicone rubber bond that allows them to cut aggressively yet leave a smooth enough finish to go right to final polishing. Have 1/16" arbor holes see pp. 584-585 for wheel mandrels, and see below for cylinder mandrels.

A-E Gray Elite Silicone – 180 Grit, Very Flexible

Use Gray Silicone to remove deep scratches and burs quickly, max. operating speed: 10,000rpm.

Shape	Item#	Pkg.(10)	Item#	Box(100)
A. SE 5/8" x 1/8"	145-0016	\$4.90	145-0017	\$39.95
B. KE 5/8"	145-0018	4.90	145-0019	39.95
C. SE 7/8" x 1/8"	145-0020	4.90	145-0021	39.95
D. KE 7/8"	145-0022	4.90	145-0023	39.95
E. Cyl. 1/2" x 1"	145-0141	17.25	-	

F-J Green Elite Silicone – 220 Grit, Very Flexible

Use Green Silicone for removing light scratches, max. operating speed: 10,000rpm.

Shape	Item#	Pkg.(10)	Item#	Box(100)
F. SE 5/8" x 1/8"	145-0108	\$4.90	145-0109	\$39.95
G. KE 5/8"	145-0010	4.90	145-0011	39.95
H. SE 7/8" x 1/8"	145-0012	4.90	145-0013	39.95
I. KE 7/8"	145-0014	4.90	145-0015	39.95
J. Cyl. 1/2" x 1"	145-0142	17.25	-	

K-O Pink Elite Silicone – 1000 Grit, Very Flexible

Use Pink Silicone to produce a high shine, max. operating speed: 10,000rpm.

Shape	Item#	Pkg.(10)	Item#	Box(100)
K. SE 5/8" x 1/8"	145-0988	\$5.75	145-0989	\$46.95
L. KE 5/8"	145-0990	5.75	145-0991	46.95
M. SE 7/8" x 1/8"	145-0984	5.75	145-0985	46.95
N. KE 7/8"	145-0986	5.75	145-0987	46.95
O. Cyl. 1/2" x 1"	145-0143	20.50	-	

P. Elite Inside Ring Cylinder Set

Includes one each of all three Elite 1/2" x 1" Cylinders listed above and Mandrel #145-0146. Mandrel also sold separately.

Description	Item#	Each
P. Cylinder Set	145-0150	\$7.85
1/8" Shank Mandrel	145-0146	3.50

Q-S AirFlex Silicone Wheels – Silicone Carbide

Tiny pockets of air are uniformly interspersed throughout our AirFlex wheels, so they grind and polish quickly without overheating the workpiece. AirFlex Blue (coarse) quickly removes rough surfaces, burs and tool marks. AirFlex Gray (medium) removes medium-grit file marks and leaves a matte finish. AirFlex Brown (fine) removes light scratches and leaves a bright surface. AirFlex wheels work equally well on all precious alloys, including stainless steel and titanium. Flexible AirFlex follows contours and leaves a smooth, uniform finish. Made of silicon carbide abrasive in a silicone rubber bond. The 7/8" square edge wheels are 1/8" thick with 1/16" arbor hole. See pp. 584-585 for mandrels. Max. operating speed: 10,000rpm.

AirFlex	Dia. x Thick	Grit	Pkg. of 10		Box of 100	
			Item#	Each	Item#	Each
Q. Blue (coarse)	7/8" x 1/8"	80	145-1106	\$5.40	145-1107	\$48.00
R. Gray (medium)	7/8" x 1/8"	240	145-1108	5.40	145-1109	48.00
S. Brown (fine)	7/8" x 1/8"	800	145-1104	5.40	145-1105	48.00

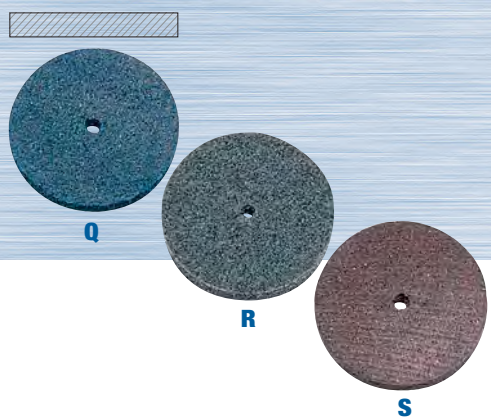
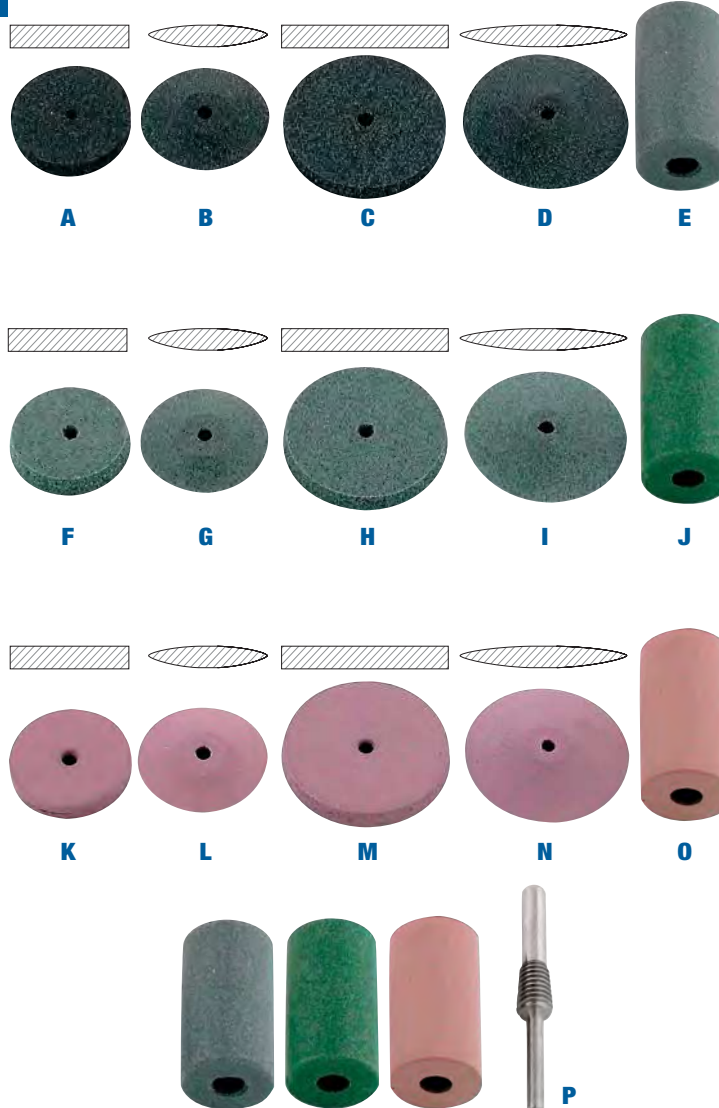

A-I Polyurethane Polishing Rods – SiC

Very popular, long lasting rods are designed for cleaning and polishing castings and metal parts. All are silicone carbide in a polyurethane carrier and can be shaped using our Dressing Stone #145-1240 shown below. Available in three sizes and various grits for all applications.

Each 83-piece set includes both 2 and 3mm sizes, two mandrels (3/32" shank) and a dressing stone to sharpen rods to a fine point. Packaged in a convenient reusable plastic storage box with cover. Choose between Brown and Green or Blue and Gray sets. Maximum operating speed: 21,000rpm. Made in Germany.

Color	Grit	Dia. x L	Item#	Pkg.(25)	Item#	Box(100)
A. Dk. Brown	Extra-coarse	2 x 20mm	145-1270	\$10.50	145-1241	\$36.60
	Extra-coarse	3 x 23mm	145-1271	10.50	145-1242	36.60
	Extra-coarse	4 x 25mm	145-1272	12.95	145-1243	45.40
B. Blue	Coarse	2 x 20mm	145-1273	10.50	145-1244	36.60
	Coarse	3 x 23mm	145-1274	10.50	145-1245	36.60
	Coarse	4 x 25mm	145-1275	12.95	145-1246	45.40
C. Dk. Gray	Medium	2 x 20mm	145-1276	10.50	145-1247	36.60
	Medium	3 x 23mm	145-1277	10.50	145-1248	36.60
	Medium	4 x 25mm	145-1278	12.95	145-1249	45.40
D. Gray	Medium	3mm x 1"	145-1345	15.65	145-1344	55.00
E. Lilac	Fine	3mm x 1"	145-1361	15.65	145-1360	55.00
F. Brown	Fine	2 x 20mm	145-1279	10.50	145-1250	36.60
	Fine	3 x 23mm	145-1280	10.50	145-1251	36.60
G. Green	Extra Fine	2 x 20mm	145-1282	10.50	145-1253	36.60
	Extra Fine	3 x 23mm	145-1283	10.50	145-1254	36.60
Description			Item#	Each		
H. 83-Piece Set (20 of each 2 and 3mm Brown and Green rods, two mandrels and a dressing stone)			145-1201	\$31.25		
I. 83-Piece Set (20 of each 2 and 3mm Blue and Dark Gray rods, two mandrels and a dressing stone)			145-1202	31.25		

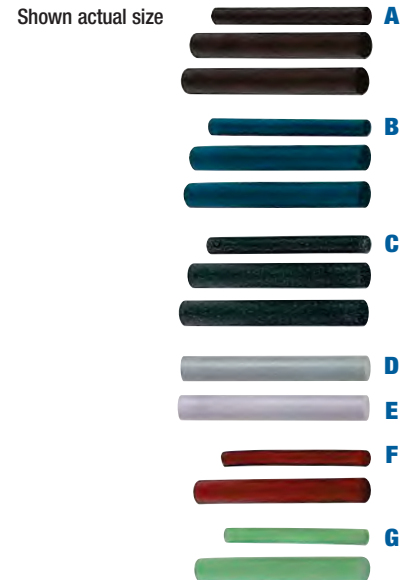

J, K Edenta TopStar Rod Mandrels – 3/32" Shank

Precision-machined for smooth-as-silk opening and closing. 2mm or 3mm rods. Swiss made.

Description	Item#	EACH Prices	
		1-2	3+
J. Mandrel for 2mm rod	145-1418	\$9.95	\$8.96
K. Mandrel for 3mm rod	145-1419	9.95	8.96



L, M Polishing Rod Mandrels – 3/32" Shank

For use with rods. Holds securely with a twist-tightening grip. Nickel-plated tool steel. Made in Germany.

Description	Item#	EACH Prices	
		1-2	3+
L. Mandrel for 2mm rod	145-1217	\$3.85	\$3.47
M. Mandrel for 3mm rod	145-1218	4.10	3.69
Mandrel for 4mm rod	145-1219	4.10	3.69



N. Diamond Impregnated Dressing Stone

Has a concave center hole for forming a point on polishing rods. Measures 3/4" dia. x 1/8" thick.

Description	Item#	Each
Dressing Stone	145-1240	\$5.40

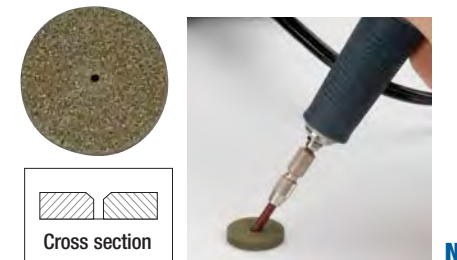

O, P Everlast Ceramic Polishing Rods – For hard and soft metals

Durable, long-lasting ceramic in an epoxy resin. Ideal for smoothing and polishing inside holes and hard-to-reach areas. Easily shaped to a fine point. Can be mounted directly into any flex shaft handpiece. For gold, silver, platinum, steel, titanium, brass, etc. Max. operating speed: 60,000rpm. Imported from Japan.

Grit	Color	Dia. x L	Item#	Each
O. 600	Brown	3/32" x 2"	145-0200	\$22.50
P. 1000	Green	3/32" x 2"	145-0205	22.50



Cera Wheels & Points Ceramic abrasive and synthetic rubber for a mirror-like shine

This revolutionary abrasive consists of ceramic particles mixed in a long-lasting synthetic rubber carrier. Its fast breakdown rate ensures ceramic particles are always exposed to the polishing surface. Resists clogging for high efficiency. Blends well and removes stoning scratches with ease, leaving a smooth finish with minimal wear. Cuts safely and smoothly. Great for cleaning, deburring, precision grinding, polishing and super finishing of molds, dies, small electrical components, sensitive equipment and more. Use dry or wet on steels, alloys and stainless steel. Work with light pressures. Choose from points, wheels and sticks. Refer to chart at right for grit designations. Made in Japan.

Color	Designation	Approx. Grit
Gray	Extra-Coarse	46
Red	Coarse	80
Blue	Medium	120
Green/Yellow	Fine	220
Purple	Extra-Fine	320
Orange	Ultra-Fine	500

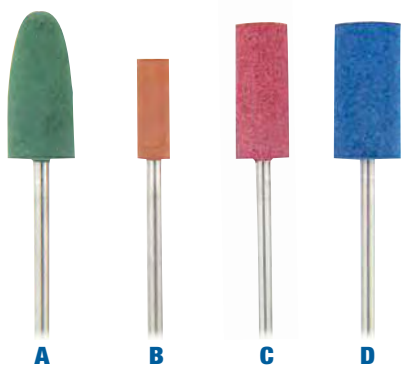

A-D Cera Points – 3/32" Shank

Points mounted on 3/32" stainless steel shanks. Max. operating speed: 24,000rpm on the 10mm diameter sizes; 30,000rpm on the smaller sizes.

Dimensions (mm)	Red 80 Item#	Blue 120 Item#	Green 220 Item#	Purple 320 Item#	Orange 500 Item#	EACH Prices	
						1-9	10+*
A. 10 x 22	351-0624	351-0625	351-0626	351-0627	351-0628	\$7.04	\$6.34
B. 5 x 15**	351-0600	351-0601	351-0603	351-0604	351-0605	5.89	5.30
C. 8 x 20**	351-0606	351-0607	351-0609	351-0610	351-0611	5.89	5.30
D. 10 x 20**	351-0612	351-0613	351-0615	351-0616	351-0617	5.89	5.30

*Quantity discount for orders of one item number only; not assorted. **3mm shanks also available.

Wondering which grit of CERA will work for your application? Try our money-saving set of the most popular 5 x 15 shape. One of each grit (Red 80, Blue 120, Green 220, Purple 320 and Orange 500).

Description	Item#	Each
Cera Point Starter Set	351-0629	\$24.95

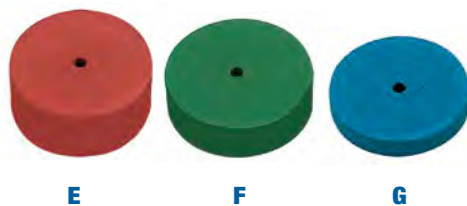

E-G Cera Wheels

Unmounted wheels with 1/16" arbor holes. Max. operating speed: 18,000rpm. See pp. 584-585 for mandrels.

Dimensions (mm)	Red 80 Item#	Blue 120 Item#	Green 220 Item#	Orange 500 Item#	PKG. of 10	
					1-4	5+*
E. 18 x 3	352-0101	352-0102	352-0103	352-0104	\$27.39	\$24.65
F. 18 x 2	–	352-0108	352-0109	352-0111	27.39	24.65
G. 18 x 1	–	352-0114	352-0115	352-0117	27.39	24.65

*Quantity discount for orders of one item number only; not assorted.



H. Cera Sticks

Each stick consists of a block of Cera abrasive mounted on a plastic holder. Material and holder are both flexible, so they conform well to irregular surfaces and hard-to-reach areas. Three slots on back of holder serve as convenient hacksaw guides for removing tip of Cera material once worn. Blocks measure 2 3/4"L x 3/8"W x 1/4"T. Sticks measure 7" overall length. Available individually or in a set of all five grits.

Color	Approx. Grit	Item#	EACH Prices	
			1-4	5+
Gray	46	352-0150	\$15.73	\$14.16
Red	80	352-0151	15.73	14.16
Blue	120	352-0152	15.73	14.16
Yellow	220	352-0153	15.73	14.16
Purple	320	352-0154	15.73	14.16
Description		Item#		Each
H. 5-Piece Set		352-0155		\$64.68



I. Diamond Dressing Block

Solid steel block with diamond coating for fast dressing and shaping of any of our rubberized abrasives. One side is grooved for shaping rods, points and knife edge wheels. Other side is flat for dressing square edge wheels. Measures 3 1/2" overall length.

Description	Item#	Each
Diamond Dressing Block	145-1316	\$48.00

Brightboy® Aluminum Oxide

Brightboy is made of aluminum oxide with a resilient rubber bond, making it long-lasting. Its uniform cutting action makes it ideal for deburring and scratch removal on nonferrous metals. Also for light grinding of carbon steel. Permits cushioned action on flat and contoured surfaces. The texture and cutting action are always uniform. Brightboy is approximately 70 grit and requires no additives such as cutting compounds. Not for use on tapered spindles. See pp. 584-585 for mandrels, p. 400 for arbors.



A. Brightboy® Wheels

Dia. x Thick x AH	Max. RPM	Style	Item#	EACH Prices	
				1-9	10+
1½" x ¾" x ¼"	10,125	5	275-0050	\$9.45	\$6.62
2" x ¼" x ¼"	7,625	17	275-0170	14.98	10.49
4" x ¼" x ½"	3,800	38	275-0380	23.87	16.71

B. Brightboy® Discs

Dia. x Thick x AH	Max. RPM	Shape	Item#	Pkg. of 10
B. ⅝" x ⅛" x ⅛"	25,000	KE	277-0031	\$31.00

C. Brightboy® Stick and Holder

Excellent for touch-ups and removal of light scratches. Used for cleaning otherwise unreachable deep cavities. Made of flexible rubber. Reusable clear plastic holder has screw-on collet that gives support and gripping power. Stick can be exposed or withdrawn as desired and is easily dressed to the best shape for the job. Also removes rust, heat marks and stains from soft and hard metals. Sticks measure 6"L x ⅝" diameter.

Description	Item#	Each
C. Brightboy Stick and Holder	277-0065	\$18.75
Brightboy Coarse Refill ⅝" dia.	277-0063	15.62

D. Brightboy® Tablet

Used for removing scratches or rust and for general surface cleaning and finishing.

Description	Dimensions	Item#	Each
Tablet	2¼"L x 1⅛"W x ⅜"H	277-0066	\$11.45

E. Gem Shine Polishing Wheels – Polishing just got easier!

The Gem Shine Polishing Wheels are unique polishing wheels designed for removing light surface scratches from soft stones such as onyx, cabochons and opals. Impregnated with a polishing paste to provide scratch removal and a final polish. Simply apply a little pressure to these wheels to allow the paste to flow out onto the stone and then return to a light polishing application with the same wheel. The results are amazing! Comes supplied in a box with (5) Gem Shine Polishing Wheels and a reinforced ⅜" mandrel.

Description	Item#	Set
Gem Shine Polishing Wheels	845-1105	\$22.95

F-H Elasto Wheels and Cylinders - ⅛" Shanks

Aluminum Oxide is combined with rubber to produce smooth running cushioned abrasive wheels and cylinders. They cut and polish very quickly, are load resistant and can easily be dressed. Use for polishing mold runners, deburring and descaling metal parts. Made in Germany.

Shape/Dimensions	80 Grit	180 Grit	240 Grit	400 Grit	EACH Prices	
					1-11	12+*
F. Wheel ¾" x ⅛"	845-1110	845-1111	845-1112	845-1113	\$3.40	\$2.89
G. Cylinder ¼" x ⅝"	845-1120	845-1121	845-1122	845-1123	4.25	3.61
H. Cylinder ⅝" x ⅝"	845-1130	845-1131	845-1132	845-1133	4.70	4.00

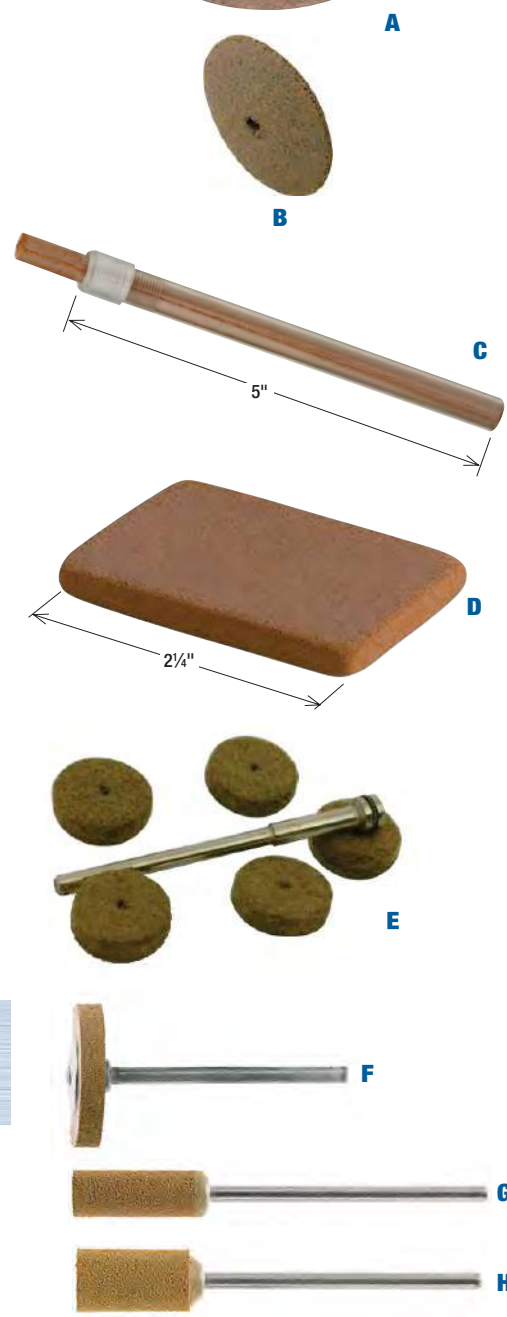

Abrasive Wheel Operating Recommendations: Certain precautions should be observed when running any abrasive wheel. Be sure to wear proper eye protection, and never exceed the recommended operating speed stamped on the box or wheel. An improperly used wheel is dangerous. Be sure to comply with American National Standards Institute Safety Code B-7.1 and Occupational Safety and Health Act covering speed, safety guards, flanges, mounting procedures, general operating rules, handling, storage, inspection and general machine conditions.

Cratex® Small Wheels **Tough, resilient, rubberized Silicon Carbide abrasive**

Utilizes silicon carbide as the abrasive grain in a standard bond of premium grade, oil-resistant chemical rubber. Its unique cushioned action allows the abrasive grains to cut freely, smoothly and softly without gouging or digging into the work surface.

Some typical applications:

- Cleaning and polishing to remove surface deposits.
- Polishing and smoothing to improve performance, appearance and cleanliness.
- Ideal for work on jewelry, plastic parts, small castings and models.

Color	Approx. Grit
Dark Green	Coarse 40
Brown	Medium 90
Red	Fine 120
Light Green	Extra-Fine 240

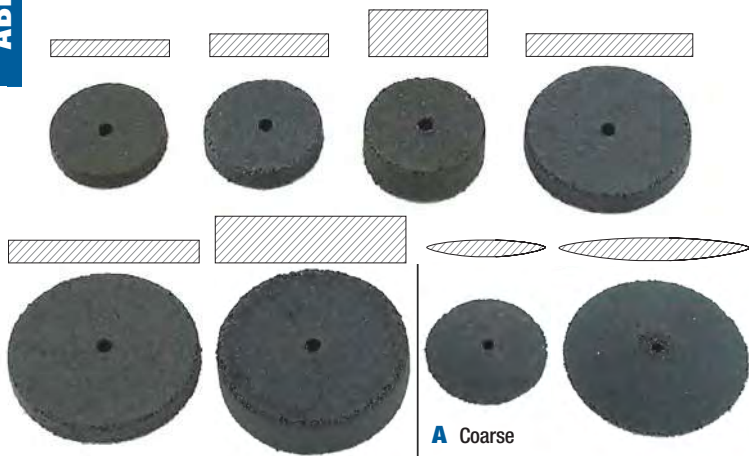

A Coarse



B Medium

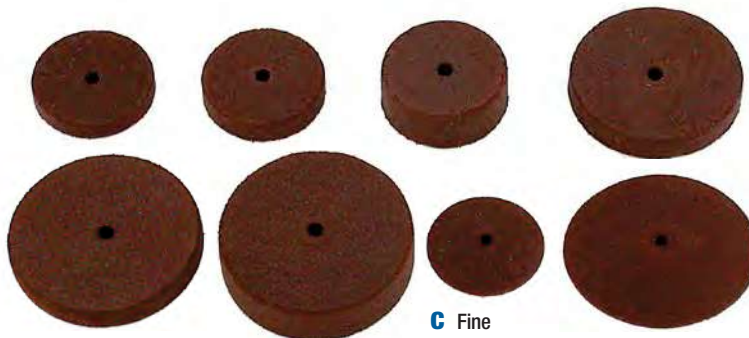

C Fine



D Extra-Fine

A-D Cratex® Small Wheels – Square and Knife Edge

All have 1/16" arbor hole. Maximum operating speed: 25,000rpm. See facing page for Cratex mandrels.

Grit	Shape	Dia. x Thick.	Style	Item#	Box(100)	
A. Coarse, 40	SE	5/8" x 3/32"	53C	149-0053	\$52.50	
	SE	5/8" x 1/8"	54C	149-0054	63.20	
	SE	5/8" x 1/4"	59C	149-0059	78.40	
	SE	7/8" x 1/8"	74C	149-0074	66.70	
	SE	1" x 1/8"	80C	149-0080	85.95	
	SE	1" x 1/4"	88C	149-0088	131.95	
	KE	5/8" x 3/32"	2C	149-0002	52.90	
	KE	1" x 1/8"	5C	149-0005	83.20	
	B. Medium, 90	SE	5/8" x 3/32"	53M	148-0053	52.50
		SE	5/8" x 1/8"	54M	148-0054	63.20
SE		5/8" x 1/4"	59M	148-0059	78.40	
SE		7/8" x 1/8"	74M	148-0074	66.70	
SE		1" x 1/8"	80M	148-0080	85.95	
SE		1" x 1/4"	88M	148-0088	85.95	
KE		5/8" x 3/32"	2M	148-0002	52.40	
KE		1" x 1/8"	5M	148-0005	83.20	
C. Fine, 120		SE	5/8" x 3/32"	53F	147-0053	40.00
		SE	5/8" x 1/8"	54F	147-0054	63.20
	SE	5/8" x 1/4"	59F	147-0059	78.40	
	SE	7/8" x 1/8"	74F	147-0074	66.70	
	SE	1" x 1/8"	80F	147-0080	85.95	
	SE	1" x 1/4"	88F	147-0088	131.95	
	KE	5/8" x 3/32"	2F	147-0002	47.80	
	KE	1" x 1/8"	5F	147-0005	83.20	
	D. Extra-Fine, 240	SE	5/8" x 3/32"	53XF	146-0053	52.50
		SE	5/8" x 1/8"	54XF	146-0054	63.20
SE		5/8" x 1/4"	59XF	146-0059	78.40	
SE		7/8" x 1/8"	74XF	146-0074	66.70	
SE		1" x 1/8"	80XF	146-0080	85.95	
SE		1" x 1/4"	88XF	146-0088	131.95	
KE		5/8" x 3/32"	2XF	146-0002	47.80	
KE		1" x 1/8"	5XF	146-0005	83.20	

E. Cratex® Set #777

Contains 80 small wheels and points in popular sizes including coarse, medium, fine and extra-fine grits. Four mandrels with 1/8" shanks are in the set. Packaged in a clear divided box for easy selection.

Description	Item#	Each
Cratex Set #777	146-7770	\$88.65



Cratex® Large Wheels Silicon Carbide

Feature the same tough, resilient, rubberized silicon carbide abrasive in a standard bond of oil-resistant chemical rubber as the small wheels. Unique cushioned action allows the abrasive grains to cut freely, smoothly and softly without gouging or digging into the work surface.

These square-edge wheels have either 1/4" or 1/2" arbor holes. See chart for maximum operating speeds. Frequently, speeds between 30% and 80% slower than the maximum will yield optimal results

Diameter	Max. Operating Speed
2" with 1/4" arbor hole	10,500rpm
2 1/2" with 1/4" arbor hole	8,300rpm
3" with 1/4" arbor hole	7,000rpm
4" with 1/2" arbor hole	5,250rpm
5" with 1/2" arbor hole	4,200rpm
6" with 1/2" arbor hole	3,500rpm

ABRASIVES - RUBBERIZED

A-D Cratex® Large Wheels – Square Edge

Grit	Shape	Dia. x Thick x AH	Style	Item#	Each
A. Coarse, 40	SE Wheel	2" x 1/4" x 1/4"	204C	149-0204	\$9.10
	SE Wheel	3" x 1/8" x 1/4"	302C	149-0302	13.00
	SE Wheel	3" x 1/2" x 1/4"	308C	149-0308	24.20
	SE Wheel	4" x 1/4" x 1/2"	404C	149-0404	22.85
	SE Wheel	4" x 1/2" x 1/2"	408C	149-0408	32.35
	SE Wheel	6" x 1/4" x 1/2"	604C	149-0604	49.15
	SE Wheel	6" x 1/2" x 1/2"	608C	149-0608	63.35
B. Medium, 90	SE Wheel	2" x 1/4" x 1/4"	204M	148-0204	9.10
	SE Wheel	3" x 1/8" x 1/4"	302M	148-0302	13.00
	SE Wheel	3" x 1/2" x 1/4"	308M	148-0308	24.20
	SE Wheel	4" x 1/4" x 1/2"	404M	148-0404	22.85
	SE Wheel	4" x 1/2" x 1/2"	408M	148-0408	32.35
	SE Wheel	6" x 1/4" x 1/2"	604M	148-0604	49.15
	SE Wheel	6" x 1/2" x 1/2"	608M	148-0608	63.35
C. Fine, 120	SE Wheel	2" x 1/4" x 1/4"	204F	147-0204	9.10
	SE Wheel	3" x 1/8" x 1/4"	302F	147-0302	13.00
	SE Wheel	3" x 1/2" x 1/4"	308F	147-0308	24.20
	SE Wheel	4" x 1/4" x 1/2"	404F	147-0404	22.85
	SE Wheel	4" x 1/2" x 1/2"	408F	147-0408	32.35
	SE Wheel	6" x 1/4" x 1/2"	604F	147-0604	49.15
	SE Wheel	6" x 1/2" x 1/2"	608F	147-0608	63.35
D. Extra Fine, 240	SE Wheel	2" x 1/4" x 1/4"	204XF	146-0204	9.10
	SE Wheel	3" x 1/8" x 1/4"	302XF	146-0302	13.00
	SE Wheel	3" x 1/2" x 1/4"	308XF	146-0308	24.20
	SE Wheel	4" x 1/4" x 1/2"	404XF	146-0404	22.85
	SE Wheel	4" x 3/8" x 1/2"	406XF	146-0406	30.05
	SE Wheel	4" x 1/2" x 1/2"	408XF	146-0408	28.65
	SE Wheel	6" x 1/4" x 1/2"	604XF	146-0604	49.10
SE Wheel	6" x 1/2" x 1/2"	608XF	146-0608	63.35	

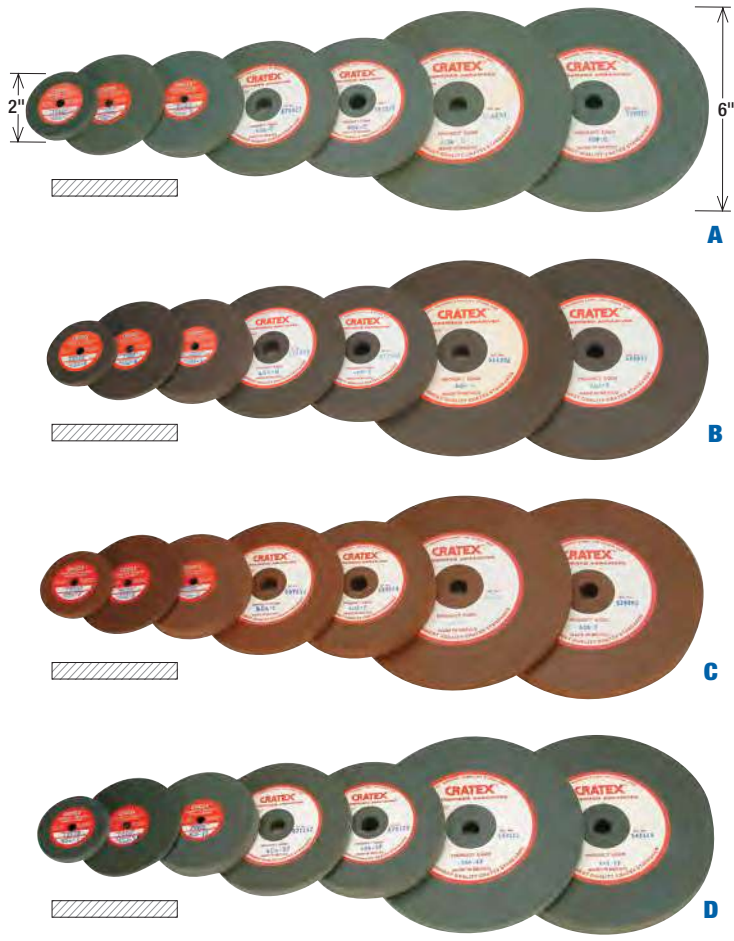

E-H Cratex® Blocks and Sticks

Grit	Shape	Dia. x Thick.	Style	Item#	Each
E. Coarse, 40	Round	1/4" x 6"	046C	149-0046	\$6.75
	Round	3/8" x 6"	066C	149-0066	7.75
	Round	1/2" x 6"	086C	149-0090	10.80
	Square	1/2" x 6"	6404C	149-6404	13.00
F. Medium, 90	Round	1/4" x 6"	046M	148-0046	6.75
	Round	3/8" x 6"	066M	148-0066	7.75
	Round	1/2" x 6"	086M	148-0090	10.80
	Square	1/2" x 6"	6404M	148-6404	13.00
G. Fine, 120	Round	1/4" x 6"	046F	147-0046	6.75
	Round	3/8" x 6"	066F	147-0066	7.75
	Round	1/2" x 6"	086F	147-0090	10.80
	Square	1/2" x 6"	6404F	147-6404	13.00
H. Extra Fine, 240	Round	1/4" x 6"	046XF	146-0046	6.80
	Round	3/8" x 6"	066XF	146-0066	7.75
	Round	1/2" x 6"	086XF	146-0090	10.80
	Square	1/2" x 6"	6404XF	146-6404	13.00

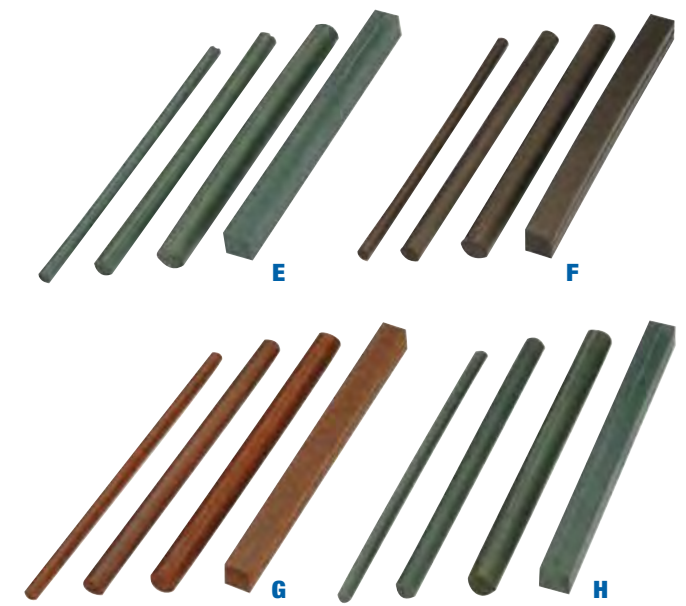

Cratex® Bullets, Cylinders & Points Silicon Carbide

Utilizes silicon carbide as the abrasive grain in a standard bond of premium grade, oil-resistant chemical rubber. Its unique cushioned action allows the abrasive grains to cut freely, smoothly and softly without gouging or digging into the work surface.

Some typical applications:

- Cleaning and polishing to remove surface deposits.
- Polishing and smoothing to improve performance, appearance and cleanliness.
- Ideal for work on jewelry, plastic parts, small castings and models.

Color	Approx. Grit
Dark Green	Coarse 40
Brown	Medium 90
Red	Fine 120
Light Green	Extra-Fine 240



A B C D

Shown actual size



Shown actual size



Shown actual size

A-D Cratex® Bullets

All have 1/4" arbor hole and threaded insert. See below for Cratex mandrels. Maximum operating speed: 20,000rpm.

Grit	Shape	Dia. x Length	Style	Item#	Each
A. Coarse, 40	Bullet	7/8" x 1 3/4"	4707C	149-4707	\$17.00
B. Medium, 90	Bullet	7/8" x 1 3/4"	4707M	148-4707	17.00
C. Fine, 120	Bullet	7/8" x 1 3/4"	4707F	147-4707	17.00
D. Extra Fine, 240	Bullet	7/8" x 1 3/4"	4707XF	146-4707	17.00

E-H Cratex® Cylinders and Points

All have 1/16" arbor hole. See below for Cratex mandrels. Maximum operating speed: 25,000rpm.

Grit	Shape	Dia. x Length	Style	Item#	Box(100)
E. Coarse, 40	Cylinder	1/4" x 1/2"	4C	149-0004	\$58.95
	Cylinder	1/4" x 7/8"	6C	149-0006	69.00
	Point	9/32" x 1"	8C	149-0008	69.00
F. Medium, 90	Point	3/8" x 5/8"	10C	149-0010	73.15
	Cylinder	1/4" x 1/2"	4M	148-0004	58.95
	Cylinder	1/4" x 7/8"	6M	148-0006	69.00
G. Fine, 120	Point	9/32" x 1"	8M	148-0008	69.00
	Point	3/8" x 5/8"	10M	148-0010	73.15
	Cylinder	1/4" x 1/2"	4F	147-0004	58.95
H. Extra Fine, 240	Cylinder	1/4" x 7/8"	6F	147-0006	69.00
	Point	9/32" x 1"	8F	147-0008	69.00
	Point	3/8" x 5/8"	10F	147-0010	73.15
	Cylinder	1/4" x 1/2"	4XF	146-0004	58.95
	Cylinder	1/4" x 7/8"	6XF	146-0006	65.85
	Point	9/32" x 1"	8XF	146-0008	69.00
	Point	3/8" x 5/8"	10XF	146-0010	73.15

I. Cratex® Set #778

Contains 64 points in 4 different grits plus 4 mandrels with 1/8" shanks. Packaged in a clear divided box for easy selection.

Description	Item#	Each
Cratex Set #778	146-7780	\$105.45

J-Q Cratex® Mandrels

Fit Cratex small wheels, cylinders points and bullets. Use light working pressure.

Style	Shank	For Hole	Item#	EACH Prices	
				1-11	12+
J. #2	3/32"	1/16"	840-3183	\$4.85	\$4.04
K. #3	1/8"	1/16"	840-3186	6.10	5.08
L. #5	1/8"	1/8"	840-3187	7.05	5.87
M. #1	3/32"	3/32"	840-3182	3.40	2.83
N. #4	1/8"	3/32"	840-3185	4.60	3.83
O. #6	1/8"	1/8"	840-3085	5.30	4.42
P. 1341	1/4"	1/4"	840-3180	7.90	6.58
Q. 1342	1/4"	1/4"	840-3184	12.35	10.29

GRX Innovative AIO abrasive material for fast grinding and superb surface finishing

GRX consists of aluminum oxide dispersed in a unique elastic bond. Cuts a bit slower than silicon carbide yet imparts a very smooth surface finish—each grit yields a much higher finish than expected. Grinds platinum, gold, silver, steel and aluminum without clogging. Prevents metal surfaces from becoming scorched during processing. Very long-lasting. Made in Japan.

A-C GRX Wheels

For grinding sprues or burs and removing surface roughness. Use on a polishing motor with arbor. Not for use on tapered spindles.

Dia. x Thick x AH	Grit	Max. RPM	Item#	EACH Prices	
				1-9	10+
A. 2" x 1/4" x 1/4"	80	9,600	277-0180	\$4.25	\$3.61
	120	9,600	277-0185	4.25	3.61
B. 3" x 1/8" x 1/4"	46	6,300	277-0190	6.00	5.10
	80	6,300	277-0195	6.00	5.10
C. 4" x 1/2" x 1/2"	80	4,800	277-0100	34.95	29.71
	150	4,800	277-0105	34.95	29.71

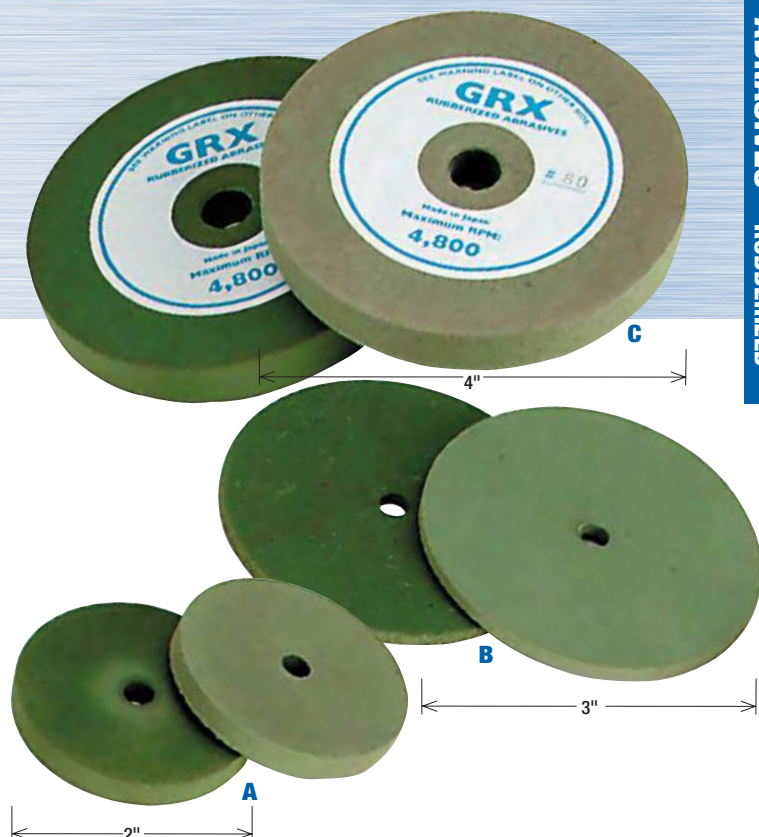

D. GRX Disc

See pp. 584-585 for mandrels.

Dia. x Thick x AH	Grit	Max. RPM	Item#	EACH Prices	
				1-9	10+
1" x 1/16" x 1/16"	150	12,000	277-0125	\$1.95	\$1.66

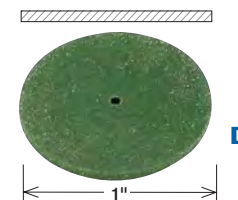

E. GRX Mounted Bullet

Dia. x L	Shank	Grit	Max. RPM	Item#	EACH Prices	
					1-9	10+
1/2" x 1"	3/32"	150	8,000	277-0116	\$3.95	\$3.36



F-H GRX Rods

Dimensions	Grit	Item#	EACH Prices	
			1-9	10+
F. 6"L x 1/4" dia.	80	277-0130	\$2.80	\$2.38
G. 6"L x 3/8" dia.	80	277-0140	4.75	4.04
	120	277-0145	4.75	4.04
H. 6"L x 1/2" dia.	80	277-0150	5.50	4.68
	120	277-0155	5.50	4.68

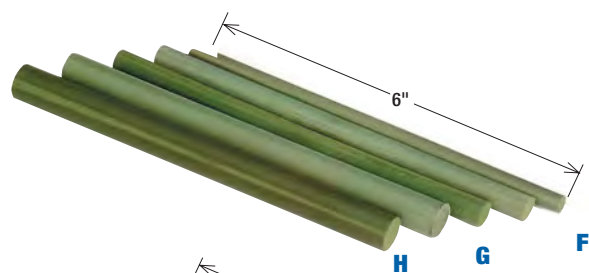

I. GRX Sticks

Dimensions	Grit	Item#	EACH Prices	
			1-9	10+
6"L x 1/2" square	80	277-0160	\$5.65	\$4.80
	120	277-0165	8.95	7.61

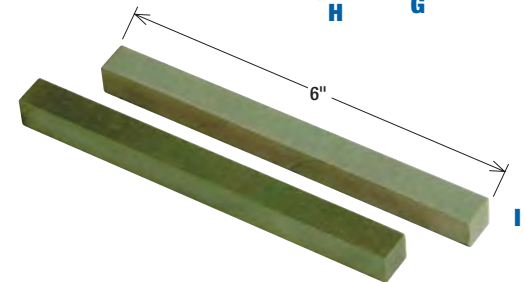



A-D Dedeco® Silicone Ring Buffs – Silicon Carbide

These silicone ring buffs are soft and flexible for use on precious metal alloys. Fits on a tapered spindle. Center hole is reinforced with a plastic tube.

White/Coarse: For removing deep scratches

Black/Medium: For smoothing and removing light scratches

Blue/Fine: For high-luster polishing

Pink/Extra-Fine: For super high-luster polishing and final finish

Color	Size	Grit	For Ring Size	Item#	Each	
A. White	3" x 5/8"–3/8"	120 (C)	Small	145-0160	\$26.50	
	White	3" x 3/4"–5/8"	120 (C)	Medium	145-0161	30.50
B. Black	3" x 3/4"–5/8"	180 (M)	Medium	145-0164	30.45	
	Black	4" x 15/16"–5/8"	180 (M)	Large	145-0165	34.25
C. Blue	3" x 5/8"–3/8"	220 (F)	Small	145-0166	26.45	
	Blue	3" x 3/4"–5/8"	220 (F)	Medium	145-0167	30.45
	Blue	4" x 15/16"–5/8"	220 (F)	Large	145-0168	34.25
D. Pink	3" x 5/8"–3/8"	400 (XF)	Small	145-0169	26.45	
	Pink	3" x 3/4"–5/8"	400 (XF)	Medium	145-0170	30.45



E-J MAX Inside Ring Polishers – Perfect for polishing insides of rings!

Created due to popular demand, these polishers excel at polishing finger holes of rings. Made of MX material, which features foam cell construction for good flexibility, cool operation and long life. Choose from straight and tapered styles in five grits; RA240 grit is a specially formulated 240 grit that removes metal much more quickly than standard 240 grit. Mount directly to the Mini Max Combo 854-0120 (see p. 387) or screw into unique steel adapters (sold separately) and mount on the right hand side of your 5/8" or 1/2" shaft polishing motor. Measure 3 1/8" long. Max. operating speed: 3,600rpm.

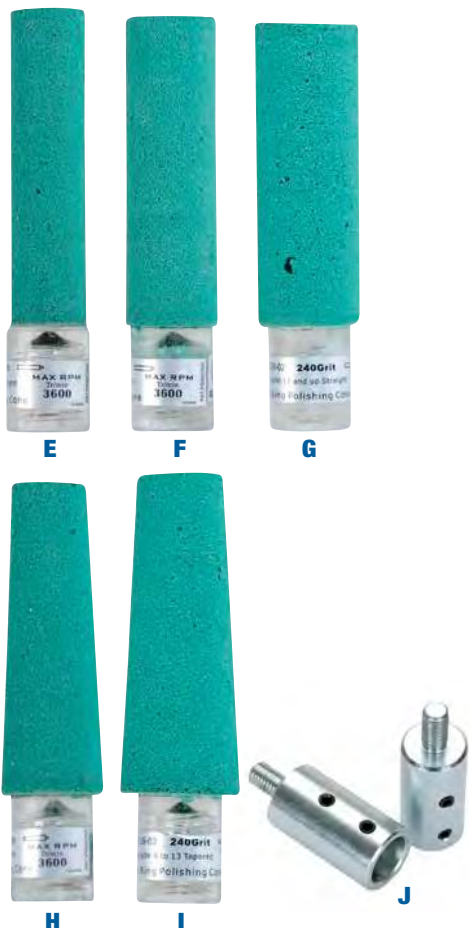

Description	Dia.	Ring Sizes	Grit	Item#	Each
E. Straight Polisher	14mm	4–6	RA240	845-3020	\$5.25
			240	845-3021	5.25
			600	845-3022	5.25
			1500	845-3023	5.25
			3000	845-3024	5.25
F. Straight Polisher	17mm	7–10	RA240	845-3025	5.25
			240	845-3026	5.25
			600	845-3027	5.25
			1500	845-3028	5.25
G. Straight Polisher	20mm	11+	3000	845-3029	5.25
			RA240	845-3030	5.25
			240	845-3031	5.25
H. Tapered Polisher	19–14mm	4–9	600	845-3032	5.25
			1500	845-3033	5.25
			3000	845-3034	5.25
			RA240	845-3035	5.25
I. Tapered Polisher	22–16mm	6–13	240	845-3036	5.25
			600	845-3037	5.25
			1500	845-3038	5.25
			3000	845-3039	5.25
			RA240	845-3040	5.25
J. Steel Adapter for 5/8" shaft			240	845-3041	5.25
			600	845-3042	5.25
			1500	845-3043	5.25
			3000	845-3044	5.25
J. Steel Adapter for 1/2" shaft				845-3045	7.30
Steel Adapter for 1/2" shaft				845-3046	7.30

A. Dedeco® Jeweler's Lathe Wheel – Silicon Carbide

This rubberized wheel is coarse enough to make quick work of grinding jobs yet flexible enough to follow contours and leave a smooth finish. Contains 220 grit silicon carbide abrasive. Max. operating speed: 3,800rpm. 1/2" Arbor Hole.

Shape	Grit	Dia. x Thick x AH	Item#	Each
SE Wheel	220	4" x 1/2" x 1/2"	145-0085	\$26.95



B, C AirFlex Poly Wheels – Silicon Carbide

Tiny pockets of air are uniformly interspersed throughout our AirFlex wheels, so they grind and polish quickly without overheating the workpiece. AirFlex Gray (medium) removes medium-grit file marks and leaves a matte finish. AirFlex Brown (fine) removes light scratches and leaves a bright surface. AirFlex wheels work equally well on all precious alloys, including stainless steel and titanium. Flexible AirFlex follows contours and leaves a smooth, uniform finish. Made of silicon carbide abrasive in a silicone rubber bond. Max. operating speed: 3,000rpm. 1/4" Arbor Hole.

AirFlex	Dia. x Thick x AH	Grit	Item#	Each
B. Gray (medium)	4" x 19/32" x 1/4"	240	145-1181	\$21.45
C. Brown (fine)	4" x 19/32" x 1/4"	800	145-1182	21.45

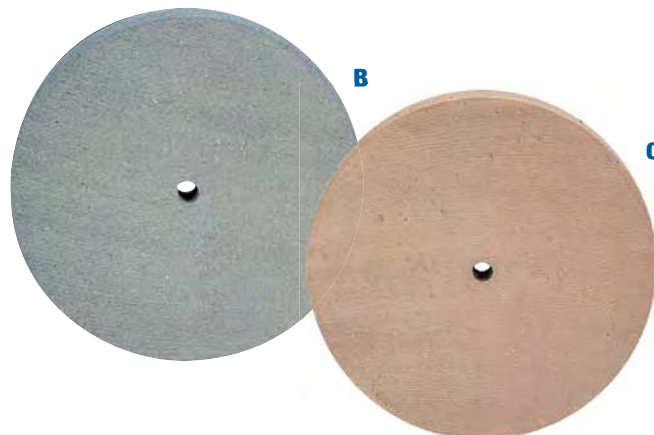

D. Unitized Mounted Points – 1/8" Shank

Ideal for a variety of deburring, blending, finishing and polishing applications. Consist of durable unitized material embedded with either silicon carbide for a fine finish or aluminum oxide for a medium or coarse finish. Mounted on 1/8" shanks. Conform to workpieces for consistent, uniform finishing without undercutting or gouging.

Style	Dia. x H	Max. RPM	Coarse	Medium	Fine	Each
B42	1/2" x 3/4"	33,750	845-0120	845-0110	845-0080	\$6.65
B52	3/8" x 3/4"	45,300	845-0121	845-0111	845-0081	5.60
B90	1/2" x 1/2"	34,500	845-0122	845-0112	845-0082	5.10
W160	1/4" x 1/4"	81,300	845-0123	845-0113	845-0083	3.60
W183	1/2" x 1/4"	51,700	845-0124	845-0114	845-0084	4.20
W185	1/2" x 1/2"	34,500	845-0125	845-0115	845-0085	4.90



Fine Silicon Carbide
Shown actual size.

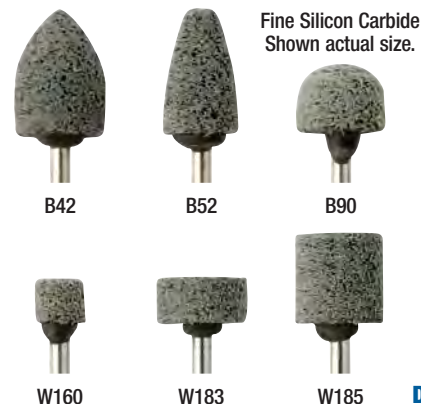

Polishing Safety Measures

- Many polishing compounds contain respirable silica or other hazardous ingredients. Be sure to use a dust collector to pull all polishing dust away from your breathing zone, and wear a properly fitted NIOSH respirator rated for the specific dust or chemicals with which you are working.
- Any grinding operation will remove small amounts of metal from the workpiece. To protect your eyes from flying debris, always wear safety goggles or similar eye protection.
- Tie back loose hair and clothing to prevent entanglement in the polishing motor or spindle.
- Firmly twist the buff onto the tapered spindle before turning on the motor, and keep the buff centered and straight to ensure true running. With the spindle correctly installed, turning force of the motor will keep the buff safely mounted during grinding and polishing.
- Always use the lower quarter of the buff to control the action and to prevent the workpiece from being pulled from your grip. Never entwine your fingers with the workpiece; instead hold it in a manner that will prevent your fingers from being harmed should it be pulled from your grip.

GMX/G-FLEX Cotton Fiber & Abrasive Mounted Points

GMX: Soft Latex Bond

GMX cotton fiber products utilize a unique flexible bond with laminates of non-woven, aluminum oxide abrasive impregnated fabric, with laminations that run parallel to the shank to prevent the ends from chipping. The construction continually exposes new abrasive grain for cooler running, and the flexible bond allows for reduced vibration and chattering. Unlike bonded or coated abrasives, these do not load up when working on softer metals or alloys, such as aluminum. Cylinders and other shapes can be dressed to conform to unique contours. Excellent for breaking edges, deburring, and blending on aluminum, stainless steel, and exotic alloys. GMX is also ideal for polishing mold runners and mold & die components. Available on 1/4", 3mm and 6mm shanks via special order.

G-Flex: Firm Resin Bond

G-Flex cotton fiber products are similar to the GMX, but use a firm resin bond. It is also non-loading and can grind and finish in one operation. A special formulation keeps it from being too aggressive, and works well on aluminum, stainless steel, and exotic alloys. Another favorite for cleaning and polishing mold runners, as well as deburring and edge breaking on all metals. Also work great for deflashing of die castings, as well as deburring and finishing of turbine blade roots. 3mm shanks are in stock on some cylinders, others are available by special order.



See Grinding Wheel Institute publications for operating speeds of mounted products.

Use 80 grit for deburring and sprue removal, 120 grit to remove parting lines and small burs, 180 and 320 grit for removing light scratches.

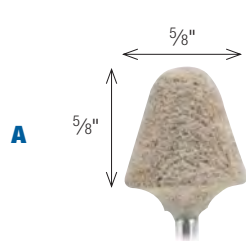

A. B41 Cone – 5/8" L x 5/8" dia.

Grit	Shank	SOFT GMX Item#	HARD G-FLEX Item#	EACH Prices			
				1-11	12-71	72-143	144+
80	1/8"	205-1812	135-1812	\$9.40	\$7.99	\$7.05	\$6.30
120	1/8"	205-1814	135-1814	9.40	7.99	7.05	6.30
180	1/8"	205-1816	135-1816	9.40	7.99	7.05	6.30
320	1/8"	205-1818	135-1818	10.25	8.71	7.69	6.87

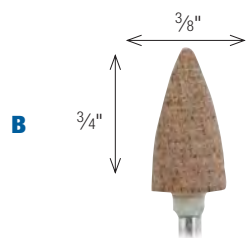

B. B52 Bullet – 3/4" L x 3/8" dia.

Grit	Shank	SOFT GMX Item#	HARD G-FLEX Item#	EACH Prices			
				1-11	12-71	72-143	144+
80	1/8"	205-1722	135-1722	\$7.45	\$6.33	\$5.59	\$4.99
120	1/8"	205-1724	135-1724	7.45	6.33	5.59	4.99
180	1/8"	205-1726	135-1726	7.45	6.33	5.59	4.99
320	1/8"	205-1728	135-1728	8.20	6.97	6.15	5.49

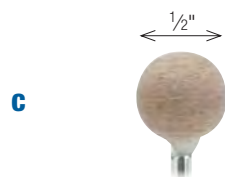

C. B121 Ball – 1/2" dia.

Grit	Shank	SOFT GMX Item#	HARD G-FLEX Item#	EACH Prices			
				1-11	12-71	72-143	144+
80	1/8"	205-1832	135-1832	\$6.15	\$5.23	\$4.61	\$4.12
120	1/8"	205-1834	135-1834	6.15	5.23	4.61	4.12
180	1/8"	205-1836	135-1836	6.15	5.23	4.61	4.12
320	1/8"	205-1838	135-1838	6.95	5.91	5.21	4.66

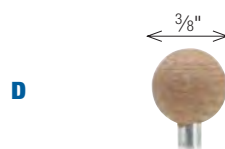

D. B122 Ball – 3/8" dia.

Grit	Shank	SOFT GMX Item#	HARD G-FLEX Item#	EACH Prices			
				1-11	12-71	72-143	144+
80	1/8"	205-1732	135-1732	\$6.15	\$5.23	\$4.61	\$4.12
120	1/8"	205-1734	135-1734	6.15	5.23	4.61	4.12
180	1/8"	205-1736	135-1736	6.15	5.23	4.61	4.12
320	1/8"	205-1738	135-1738	6.95	5.91	5.21	4.66

A. W154 Cylinder – 1/2"L x 3/16" dia.

Grit	Shank	SOFT GMX Item#	HARD G-FLEX Item#	EACH Prices			
				1-11	12-71	72-143	144+
80	1/8"	205-1542	135-1542	\$5.10	\$4.34	\$3.83	\$3.42
120	1/8"	205-1544	135-1544	5.10	4.34	3.83	3.42
120	3mm	–	136-1544	5.10	4.34	3.83	3.42
180	1/8"	205-1546	135-1546	5.10	4.34	3.83	3.42
320	1/8"	205-1548	135-1548	5.65	4.80	4.24	3.79

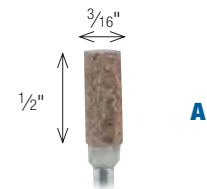

B. W163 Cylinder – 1/2"L x 1/4" dia.

Grit	Shank	SOFT GMX Item#	HARD G-FLEX Item#	EACH Prices			
				1-11	12-71	72-143	144+
80	1/8"	205-1632	135-1632	\$5.10	\$4.34	\$3.83	\$3.42
80	3mm	204-1632	136-1632	5.10	4.34	3.83	3.42
120	1/8"	205-1634	135-1634	5.10	4.34	3.83	3.42
120	3mm	204-1634	136-1634	5.10	4.34	3.83	3.42
180	1/8"	205-1636	135-1636	5.10	4.34	3.83	3.42
180	3mm	204-1636	136-1636	5.10	4.34	3.83	3.42
320	1/8"	205-1638	135-1638	5.95	5.06	4.46	3.99
320	3mm	204-1638	136-1638	5.95	5.06	4.46	3.99

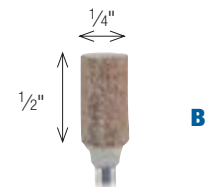

C. W176 Cylinder – 1/2"L x 3/8" dia.

Grit	Shank	SOFT GMX Item#	HARD G-FLEX Item#	EACH Prices			
				1-11	12-71	72-143	144+
80	1/8"	205-1762	135-1762	\$5.40	\$4.59	\$4.05	\$3.62
120	1/8"	205-1764	135-1764	5.40	4.59	4.05	3.62
120	3mm	–	136-1764	5.25	4.46	3.94	3.52
180	1/8"	205-1766	135-1766	5.40	4.59	4.05	3.62
320	1/8"	205-1768	135-1768	6.35	5.40	4.76	4.25

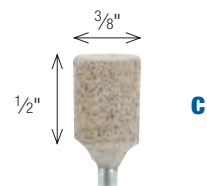

D. W177 Cylinder – 3/4"L x 3/8" dia.

Grit	Shank	SOFT GMX Item#	HARD G-FLEX Item#	EACH Prices			
				1-11	12-71	72-143	144+
80	1/8"	205-1772	135-1772	\$6.35	\$5.40	\$4.76	\$4.25
120	1/8"	205-1774	135-1774	6.35	5.40	4.76	4.25
180	1/8"	205-1776	135-1776	6.35	5.40	4.76	4.25
320	1/8"	205-1778	135-1778	7.15	6.08	5.36	4.79

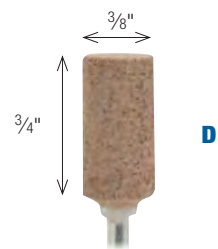

E. W185 Cylinder – 1/2"L x 1/2" dia.

Grit	Shank	SOFT GMX Item#	HARD G-FLEX Item#	EACH Prices			
				1-11	12-71	72-143	144+
80	1/8"	205-1852	135-1852	\$5.40	\$4.59	\$4.05	\$3.62
120	1/8"	205-1854	135-1854	5.40	4.59	4.05	3.62
180	1/8"	205-1856	135-1856	5.40	4.59	4.05	3.62
320	1/8"	205-1858	135-1858	5.75	4.89	4.31	3.85

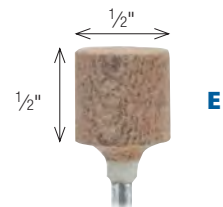

F. W186 Cylinder – 3/4"L x 1/2" dia.

Grit	Shank	SOFT GMX Item#	HARD G-FLEX Item#	EACH Prices			
				1-11	12-71	72-143	144+
80	1/8"	205-1862	–	\$6.35	\$5.40	\$4.76	\$4.25
120	1/8"	205-1864	–	6.35	5.40	4.76	4.25
180	1/8"	205-1866	–	6.35	5.40	4.76	4.25
320	1/8"	205-1868	–	7.30	6.21	5.48	4.89

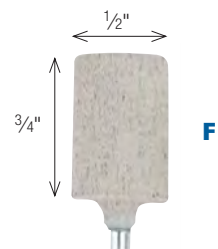



A-C GMX & G-Flex Application-Specific Sets – 1/8" Shank

All 3 Gesswein cotton fiber sets offer an assortment of 12 points: 6 GMX and 6 G-Flex points in various shapes and grits targeted to working in specific applications: General purpose deburring and edge finishing, aluminum and non-ferrous finishing and deburring, stainless and exotic alloy finishing and deburring. All are mounted on 1/8" shanks. Each set includes 12 pieces: 6 shapes in both GMX (gray, soft latex bond) and G-Flex (brown, firmer resin bond).

Description	Item#	Set of 12
A. General Purpose	135-1510	\$60.75
B. Aluminum/Non-Ferrous	135-1520	60.75
C. Stainless & Exotic Metals	135-1530	60.75

General Purpose	Shapes	Grit	Deburring and Edge Finishing — Item# 135-1510								
	B52 Bullet	80									
	B122 Ball	80									
	W154 Cyl.	320									
	W163 Cyl.	80									
	W177 Cyl.	180									
	W185 Cyl.	120									
			Aluminum/Non-Ferrous	Shapes	Grit	Finishing and Deburring — Item# 135-1520					
	B41 Cone	320									
	B52 Bullet	120									
	B122 Ball	80									
	W163 Cyl.	120									
	W176 Cyl.	180									
	W185 Cyl.	80									
			Stainless Steel & Exotic Metals	Shapes	Grit	Finishing and Deburring — Item# 135-1530					
	B52 Bullet	80									
	B122 Ball	80									
	W154 Cyl.	120									
	W163 Cyl.	80									
	W177 Cyl.	120									
	W185 Cyl.	80									



D-J GMX Discs

A long-lasting aluminum oxide abrasive in a unique composite of laminated cotton fiber in a rubber bond. The cotton base also creates a cushioned feel and helps reduce chatter and loading. GMX cuts and smooths in one operation, leaving a smooth, even finish. Discs can be dressed to conform to shape of workpiece. Use 80 grit for deburring, 120 grit to remove parting lines and small burs, 180 and 320 grit for removing light scratches. Made in USA.

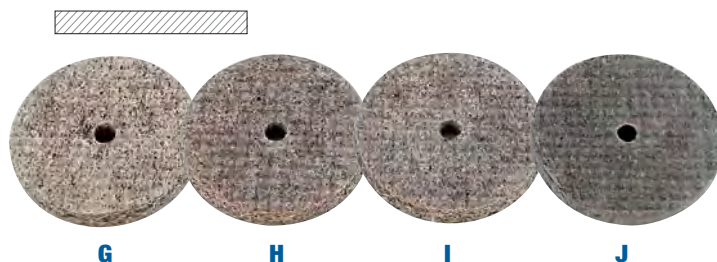

Dia. x Thick x AH	Grit	Max. RPM	Item#	EACH Prices	
				1-11	12+
D. 1" x 1/16" x 1/8"	120	36,290	205-5204	\$4.90	\$4.17
E.	180	36,290	205-5206	5.00	4.25
F.	320	36,290	205-5208	5.50	4.68
G. 1" x 1/8" x 1/8"	80	36,290	205-5252	5.00	4.25
H.	120	36,290	205-5254	5.00	4.25
I.	180	36,290	205-5256	5.00	4.25
J.	320	36,290	205-5258	5.50	4.68

GMX Long-lasting aluminum oxide abrasive

A unique composite of laminated cotton fiber in a rubber bond, GMX cuts and smooths in one operation, leaving a smooth, even finish. Can be dressed to conform to shape of workpiece. Use 80 grit for deburring and

sprue removal, 120 grit to remove parting lines and small burs, 180 and 320 grit for removing light scratches. See p. 401 for arbors. Additional GMX products are also available on pages 96-98. Made in USA.

A-E GMX Sticks and Rods

Used for polishing and touching up molds, dies and metal parts. Less aggressive than finishing stones, GMX sticks produce a surprisingly smooth surface.

Dimensions	Grit	Item#	EACH Prices	
			1-11	12+
A. 4"L x 1/4" square	80	206-9250	\$4.05	\$3.44
	120	206-9260	4.05	3.44
	180	206-9270	4.05	3.44
	320	206-9280	5.75	4.89
B. 4"L x 1/4" round	80	206-9320	7.45	6.33
	120	206-9325	7.55	6.42
	180	206-9330	7.55	6.42
	320	206-9335	8.60	7.31
C. 4"L x 1/2" round	80	206-9340	8.40	7.14
	120	206-9345	8.40	7.14
	180	206-9350	8.40	7.14
	320	206-9355	9.70	8.25
D. 6"L x 1/4" round	80	206-9360	10.45	8.88
	120	206-9365	10.45	8.88
	180	206-9370	10.45	8.88
	320	206-9375	12.20	10.37
E. 6"L x 1/2" round	80	206-9380	11.05	9.39
	120	206-9385	11.05	9.39
	180	206-9390	11.05	9.39
	320	206-9395	12.70	10.80



F, G GMX Wheels

Dia. x Thick x AH	Grit	Max. RPM	Item#	EACH Prices	
				1-24	25+
4" x 1/4" x 1/4"	80	9,075	206-1050	\$15.20	\$13.68
	120	9,075	206-1060	15.20	13.68
F.	180	9,075	206-1070	15.20	13.68
	320	9,075	206-1080	16.35	14.72

Dia. x Thick x AH	Grit	Max. RPM	Item#	EACH Prices	
				1-9	10+
6" x 1/8" x 1/2"	120	6,050	206-1360	\$18.05	\$16.25
G. 6" x 1/4" x 1/2"	120	6,050	206-1660	28.35	25.52
	180	6,050	206-1670	28.35	25.52
6" x 1/2" x 1/2"	80	6,050	206-1750	53.40	48.06



H. GMX Split Laps

Split and beveled for see-through lapping. The embedded abrasive allows fast cutting while the rubber bond assures a very smooth finish. Max. operating speed: 6,050rpm. Made to use with the Gesswein Split Lapping Machine (see p. 406).

Dia. x Thick x AH	Grit	Item#	EACH Prices	
			1-9	10+
H. 6" x 1/4" x 1/2"	80	206-3350	\$35.80	\$32.22
	120	206-3360	35.80	32.22
	180	206-3370	35.80	32.22



Polishing Compounds & Rouges

Gesswein offers the finest products for all aspects of polishing. From removing deep scratches to cutting, to final finishing to a very high luster finish, we have what you need to work on brass, stainless steel, gold (yellow and white), silver, platinum, rhodium, chrome, nickel steel, aluminum, copper, and zinc. Almost any metal you use we can help you polish as well as acrylics, epoxies and hard plastics.

We are proud to offer:

- Traditional polishing compounds—a careful blend of abrasives and binders in bars and tubes.
- Dialux premium polishing compounds are very popular in Europe due to their ability to adhere well to the buff, reducing the amount used.
- Water-soluble compounds contain a special emulsifier to make clean up easy with just soap and water.
- Veggie Compounds clean up easily and because they are completely free of animal products, are kosher.



A-N Polishing Compounds

Listed in approximate order from the most to least aggressive. All bar weights are approximate and may vary slightly from bar to bar.

Type	Description and Application	Approx. Weight	Item#	EACH Prices	
				1-9	10+
A. Gray Star*	Aggressive, dry compound for removing deep scratches, yet leaves a uniform finish. Excellent for brass, gold, silver and stainless steel.	1 lb. 2.2 lbs.	215-0915* 215-0910*	\$4.15 8.40	\$3.74 7.56
B. Chrome	Produces mirror finish on hard metals such as chrome, nickel steel and stainless steel. Medium cutting compound for soft metals.	1¾ lbs.	215-1550	11.50	9.20
C. Bobbing Compound	A fast cutting compound that leaves jewelry dull in appearance but scratch free. This is the first step to remove deep scratches in jewelry (gold, silver and platinum) and other hard metals like stainless steel and chrome.	14oz.	215-0428	4.50	3.83
D. Manhattan Bobbing*	Specially formulated for use on sterling silver, but also works on gold and brass to remove scratches & pits and to prepare for buffing with tripoli and rouge.	1¼ lbs.	215-0425*	6.95	5.91
E. NYC Tripoli*	Fast cutting on soft metals such as brass, aluminum, gold and silver. Sticks well to laps and brushes. Used in place of Tripoli.	1 lb.	215-0475*	2.60	2.21
F. Tripoli*	For cutting down and removing scratches from soft metals such as gold, silver, aluminum and brass. Leaves surface scratch-free for final polish.	1 lb.	215-1750*	2.30	1.84
G. Gray 800*	Light cutting compound for removing surface roughness and scratches from platinum.	7/8 lb.	215-0045*	19.50	16.58
H. ZAM®	For use on softer metals, epoxies and hard plastics. Cuts and polishes at the same time and leaves a high luster. Fast cleanup. Won't scratch softer stones like turquoise.	¼ lb. 1 lb.	215-1603 215-1602	4.35 6.25	3.92 5.63
I. White 1500*	Medium cutting compound for platinum. Removes light scratches and prepares surface for final polishing.	7/8 lb.	215-0049*	33.99	28.89
J. White 4000*	Fine cutting compound for platinum. Removes light haze and scratches.	½ lb.	215-0042*	32.50	27.63
K. White 6000*	Fine cut-and-color compound for platinum. Removes faint scratches and leaves a soft, bright finish.	½ lb.	215-0043*	35.70	30.35
L. 4X White Diamond*	A medium cut-and-color compound for soft metals such as gold, silver, and brass.	¾ lb.	215-1710*	2.10	1.68
M. White Rouge	High luster on platinum, white gold, chrome and stainless steel.	¼ lb.	215-0250	2.45	2.08
N. White 8000*	Polishing compound for ultra-white high shine on platinum.	½ lb.	215-0046*	37.99	32.29
O. Orange Luster	Formulated with low oil content to increase polishing power. Works fast and delivers the whitest, brightest shine on platinum	5 oz.	215-0037	18.50	15.73

***CAUTION:** This compound contains silica. See warning on facing page.

A-J Polishing Compounds, continued

Type	Description and Application	Approx. Weight	Item#	EACH Prices	
				1-9	10+
A. Red Rouge	Imparts extremely high luster on soft metals: gold, silver, brass and all nonferrous metals. The industry standard for producing the final finish.	1/4 lb.	215-1151	\$2.10	\$1.68
		1/2 lb.	215-1152	3.75	3.00
		1 lb.	215-1153	6.75	5.40
B. Blue Rouge	Clean working compound designed to produce high luster on gold, silver, brass, chrome and all nonferrous metals.	1 lb.	215-1702	3.50	2.80
C. Green Rouge	Produces an extremely high luster on chrome, stainless steel, silver, platinum, white gold and rhodium.	1/4 lb.	215-0805	4.40	3.52
D. Yellow Glow	For ultra-bright final finish on yellow gold and most metals except silver. Has a very light cutting action. Not greasy. Comes in peel-away tube.	14 oz.	215-0054	6.25	5.00
E. Lustre Bar	Produces very high luster finish on all metals as well as plastics. Will remove light scratches, yet leaves a bright mirror finish. Comes in peel-away tube.	1 lb.	215-1600	7.65	6.12
F. Platinum Blue	This specially formulated compound imparts the highest possible finish on platinum and other precious metals.	5 oz.	215-1784	16.95	14.41
G. Two-Step Platinum	Reduce the polishing steps associated with platinum. Adhere very well to buffs. Yellow bar (Step 1) removes scratches. Green bar (Step 2) imparts mirror finish.	13.4 oz.	215-0038	19.95	16.96
		13.4 oz.	215-0039	19.95	16.96
H. Platinum Pink	Imparts a highly reflective surface on platinum as well as white gold, titanium and other hard metals.	5 oz.	215-1786	19.25	16.36
I. C-Clear Watch Crystal	Restores plastic by removing scuffs and scratches. Used by jewelers to make old plastic watch crystals look new again.	1/4 lb.	215-0041	6.50	-
J. Platinum Sample Set*	Four different compounds for platinum: Gray 800, White 1500, White 8000 and Orange Luster.	3/4 lb.	215-0036*	25.00	-



Featured Compounds	 <p>Gray Star Aggressive, dry compound for removing deep scratches, yet leaves a uniform finish. Excellent for brass, gold, silver and stainless steel. 1 lb. bar. 215-0915* \$4.15</p>	 <p>Two-Step Yellow cuts and quickly removes scratches on stainless, titanium, aluminum, copper, zinc, brass, gold, silver and platinum. 215-0038 \$19.95 The green produces a mirror finish on precious and other metals. 215-0039 \$19.95</p>	 <p>Lustre Bar Produces very high luster finish on all metals as well as plastics. Will remove light scratches, yet leaves a bright mirror finish. Comes in peel-away tube. 215-1600 \$7.65</p>
	 <p>Platinum Blue This specially formulated compound imparts the highest possible finish on platinum and other precious metals. 215-1784 \$16.95</p>	 <p>Green Rouge Produces an extremely high luster on chrome, stainless steel, silver, platinum, white gold and rhodium. 215-0805 \$4.40</p>	 <p>White 8000 For an ultra-white high shine on platinum and titanium. 215-0046* \$37.99</p>

***CAUTION:** This compound contains silica. Normal use may generate fine dust, which can irritate eyes, skin and nasal passages. Use ventilation and safety protection, and wash after use. Long term exposure to silica-containing compounds may cause silicosis, lung damage or lung cancer which may be prevented by use of appropriately rated respirator and air exhaust.

Many polishing compounds contain hazardous ingredients. Be sure to use a dust collector to pull polishing dust away from your breathing zone and a properly fitted respirator rated for the specific dust or chemicals with which you are working. Normal use may generate fine dust which can irritate eyes, skin and nasal passages. Use ventilation and safety protection, and wash after use. Long term exposure to silica-containing compounds may cause silicosis, lung damage or lung cancer which may be prevented by use of appropriately rated respirator and air exhaust.

A-B Veggie Compounds – Vegetable oil-based!

These vegetable oil-based compounds offer several advantages over standard compounds, including faster loading time, easier cleanup and less dust. Completely free of animal by-products and also kosher. Use Tripoli for cutting and Red Rouge for final finishing. Available in 1/4 lb. tubes and 1 lb. bars.



Type	Description and Application	Approx. Weight	Item#	EACH Prices	
				1-9	10+
A. Premium Brown Tripoli	Fast cut and color compound. Removes scratches and leaves a matte surface ready for final polishing. Good on aluminum, brass, copper, nickel, silver gold and platinum.	1/4 lb. tube	215-1808	\$2.40	\$2.04
		1 lb.	215-1809	3.10	2.64
B. Premium Red Rouge	Imparts high color on soft metals. Ideal for final finishing of precious metals such as gold and silver, as well as brass and bronze.	1/4 lb. tube	215-1804	4.10	3.49
		1 lb.	215-1805	8.70	7.40

Please ask for quotes on larger quantities.

C. Pumice Powder

A natural abrasive used for cleaning surfaces and for removing imperfections and firescale. Mix with water or oil and apply with a muslin buff to create a fine matte finish. Sold by the pound.



Description	Item#	LB. Prices	
		1-9	10+
Pumice Powder	845-4000	\$4.25	\$3.61

Please ask for quotes on larger quantities.

D. SUPRA Pumice Paste

For smoothing rapid prototype models as it produces a mild cutting action on acrylic and soft metals. Use with the Scotch-Brush for best results. 80 gram bar.



Description	Item#	Each
SUPRA Pumice Paste	218-2045	\$7.20

E. SUPRA Polishing Crème (50g Tube)

For ultra high finishing of Rapid Prototype models as well as precious metals. Works best with a soft white muslin buff. 50 gram tube.



Description	Item#	Each
SUPRA Polishing Crème	218-2240	\$9.50

F. Rapid Prototype Finishing Kit

Gesswein has developed a kit to make it easy as 1, 2, 3 to put a high polish on your acrylic models. With technology gravitating towards rapid prototyping, models being produced on 3D printers may come off these printers with a smooth surface, but they are not highly polished!

Why should models be highly polished? Very simple! By giving them a mirror finish before the casting stage, or mold making stage, the end product will require much less finishing. This important extra step allows for manufacturing consistency and the surface quality will be greatly improved.

- Step 1:** Use the Scotch-Brush with Supra Pumice Paste to remove the fine build lines.
- Step 2:** The Duratex White Buff used with Supra Polishing Crème produces a very smooth surface.
- Step 3:** A soft loose Muslin Buff used with Platinum Pink Compound leaves a mirror bright finish.

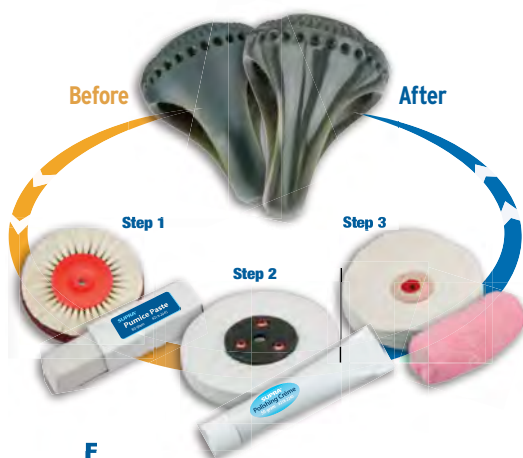

Description	Item#	Each
Rapid Prototype Finishing Kit	810-0035	\$59.00

A-H Dialux Polishing Compounds

Premium polishing compounds imported from Europe. Made from select abrasive grades, uniformly blended and manufactured under the strictest quality controls. Adhere exceptionally well to buffs, brushes and felts, so very little is needed, which helps reduce cleanup and save time. Individually packaged in cardboard boxes for cleaner handling. Each bar measures 3⁵/₈"L x 1¹/₈"W x 1"H and weighs approx. 4 oz.

Type	Description and Application	Approx. Weight	Item#	EACH Prices	
				1-9	10+
A. Dialux Bleu (Blue)	All-purpose compound for all types of metal	4 oz.	215-1771	\$4.95	\$4.46
B. Dialux Jaune (Yellow)*	For bright high polish of soft metals such as brass, bronze and copper.	4 oz.	215-1772*	4.95	4.46
C. Dialux Blanc (White)	For bright polishing of silver.	4 oz.	215-1773	4.95	4.46
D. Dialux Gris (Gray)	Recommended for fine polishing of stainless steel.	4 oz.	215-1774	4.95	4.46
E. Dialux Rouge (Red)	The brightest shine for yellow gold. Also produces a brilliant shine on silver.	4 oz.	215-1775	5.25	4.73
F. Dialux Vert (Green)	Recommended for bright polishing of hard alloys such as platinum, white gold, chrome, chrome cobalt and stainless steel.	4 oz.	215-1776	5.25	4.73
G. Dialux Noir (Black)	For final polishing of silver.	4 oz.	215-1777	5.25	4.73
H. Vornex (Orange)	Pre-polish cutting compound for all ferrous metals.	4 oz.	215-1778	4.95	4.46



I-Q Water-Soluble Polishing Compounds – Cooler buffing and faster clean up

Contains a special emulsifier so compounds rinse off easily with soap and water.

Type	Description and Application	Approx. Weight	Item#	EACH Prices	
				1-9	10+
I. Gray/Green*	For fast metal removal; more aggressive than Gray Star. For cutting white metals, gold, silver and brass.	2 lbs.	215-1752*	\$4.35	\$3.48
J. Gray Star	Aggressive dry compound for removing deep scratches, yet leaves a uniform finish. For brass, gold, silver and stainless steel.	1 lb.	215-1740	4.65	3.72
K. Tripoli*	Standard tripoli in a water soluble form. For cutting down and removing scratches from soft metals such as gold, silver, aluminum and brass. Leaves surface scratch-free and ready for final polish.	1 lb.	215-1750*	2.30	1.84
L. Yellow	Produces a very high, final finish on white metal, gold, silver and brass.	2 lbs.	215-1751	8.15	6.52
M. Green Rouge	Produces an extremely high luster on chrome, stainless steel, silver, platinum, white gold and rhodium.	1 lb.	215-1730	4.50	3.60
N. Premium Red Rouge	For the highest, brightest finish on yellow gold. Produces a premium grade finish on all precious metals, especially when teamed with our Chamois Buffs.	1/4 lb. 1 lb.	215-1715 215-1720	3.10 8.50	2.48 6.80
O. Black Rouge	Produces a deep, dark luster on gold, pewter and other precious metals and is especially effective on silver.	1 lb.	215-1701	5.15	4.12
P. Turquoise Rouge	For imparting the final finish on precious metals and soft, semiprecious stones. Ideal for buffing jewelry such as silver set with turquoise.	1 lb. 2 lb.	215-0152 215-0151	4.25 7.65	3.40 6.12
Q. Sample Set*	Four 1 lb. bars of our most popular compounds: Gray Star, Tripoli, Green Rouge and Red Rouge.	4 lbs.	215-1760*	18.50	-



***CAUTION:** This compound contains silica. See warning on page 101.

Gesswein® Diamond Compounds

Feature evenly distributed 100% virgin synthetic diamond, more consistent in shape than natural diamond, for fast, consistent cutting action. We stock in medium (M) 75% and heavy (H) 100% concentrations. Standard Oil-Soluble Compounds hold together very well, even under high-speed conditions. Specifically formulated for the mold and die industry. Can be thinned with Oil-Soluble Lubricant/Thinner. Water-Soluble compounds have the same

concentrations as Oil-Soluble Compounds. Allow fast and easy cleanup. Can be thinned with Water-Soluble Lubricant/Thinner. Consider Budget Oil-Soluble Compounds when affordability is a factor (lower prices are due to variations in particle size and friability). Packaged in 1-gram, 6-gram and 18-gram disposable syringes.



	Grit (Microns)	Application	Mesh	Color	Syringe Size (grams)	Standard Oil-Soluble Item#	Water-Soluble Item#	Each	Budget Oil-Soluble	Each
A.	½ M	Supreme finish	60000	White	1	216-0045	216-9051	\$3.40	–	–
					6	216-2045	216-9069	13.80	–	–
					18	216-7005	216-9055	33.75	–	–
B.	1 M	Super finish	14000	Ivory	1	216-0050	216-9053	2.60	–	–
					6	216-2050	216-9071	11.35	216-9100	\$9.10
					18	216-7055	216-9095	29.45	216-9112	23.60
C.	3 M	Very high finish	8000	Yellow	1	216-0100	216-9057	4.30	–	–
					6	216-2100	216-9075	22.45	216-9102	17.95
					18	216-7105	216-9083	62.20	216-9114	48.95
D.	6 M	Mirror finish	3000	Orange	1	216-0150	216-9059	5.60	–	–
					6	216-2150	216-9077	30.45	216-9104	23.95
					18	216-7155	216-9085	86.25	216-9115	67.95
E.	9 M	High finish	1800	Green	1	216-0200	216-9061	5.60	–	–
					6	216-2200	216-9079	30.45	216-9106	23.95
					18	216-7205	216-9087	86.25	216-9116	67.95
F.	15 M	Fine finish	1200	Blue	1	216-0250	216-9063	5.60	–	–
					6	216-2250	216-9073	30.45	216-9108	23.95
					18	216-7255	216-9089	86.25	216-9118	67.95
G.	30 H	Fast lapping	600	Red	1	216-0300	216-9067	8.25	–	–
					6	216-2300	216-9081	47.20	216-9110	38.15
					18	216-7305	216-9091	136.00	216-9120	108.00
H.	45 H	Medium cutting	325	Brown	1	216-0350	–	8.35	–	–
					6	216-2350	–	48.75	–	–
					18	216-7355	–	137.95	–	–
I.	60 H	Fast cutting	230	Purple	1	216-0400	–	8.35	–	–
					6	216-2400	–	48.75	–	–
					18	216-7405	–	137.95	–	–
J.	90 H	Coarse cutting	170	Gray	1	216-0450	–	8.35	–	–
					6	216-2450	–	48.75	–	–
					18	216-7455	–	135.95	–	–
K.	120 H	Fast grinding	120	Black	1	216-0500	–	8.35	–	–
					6	216-2500	–	48.75	–	–
					18	216-7505	–	135.95	–	–

A. SUPRA® Diamond Compounds

Oil-soluble compounds with very heavy concentration of 100% virgin synthetic diamond for sharp, even cutting action. Graded to closer tolerances than those dictated by nationally recognized standards. Provide much faster stock removal than traditional diamond compounds. Sold in 5-gram Precision Applicators, which afford finer control than ordinary syringes.

Grade	End Use	Approx. Micron	Mesh	Color	Item#	Each
1-S	Super finish for aluminum	0-2	14000	Ivory	217-0100	\$10.90
1-S	Super finish	0-2	14000	Ivory	217-0010	\$13.50
3-S	Very high finish	2-4	8000	Yellow	217-0015	22.30
6-S	Mirror finish	4-8	3000	Orange	217-0020	25.30
9-S	High finish	6-12	1800	Green	217-0025	26.50
15-S	Fine finish	10-20	1200	Blue	217-0030	26.50
30-S	Fast lapping	20-40	600	Red	217-0035	35.40



A

See the **NEW High Temp Diamond Compounds** on our website

B. Diamond Polishing Kit – Everything you need for Diamond Polishing

Whether you carry it to the mold or have it under your workstation, our Diamond Polishing Kit has all the products you need, right at your fingertips! A convenient time saver and a money saver as well! Available alone or in a money saving kit with Marathon System (See 510-2946 on page 433).

Includes:

- Diamond Compounds
- Lube Thinner
- Felt Bobs & Felt Sticks
- Poli-Felts
- Wood Sticks
- End Brushes
- Cup Brushes
- Wheel Brushes

Description	Item#	Each
Diamond Polishing Kit	216-0001	\$249.00
Diamond Polishing Kit with Marathon	216-0002	449.00



B

C-D Gesswein® Diamond Compound Sets

Convenient sets providing the compounds needed for lapping, polishing and gemstone shaping. All sets include ¾ ounce bottle of appropriate Lubricant/Thinner (see below for details).

Sets	60H	45H	30H	15M	9M	3M	1/2 M	Lub.	Item#	Each
C. Oil Soluble	•		•		•	•		•	216-9501	\$24.95
D. Water Soluble			•	•	•	•		•	216-9201	25.35
E. Gemstone		•	•	•			•	•	216-9511	23.65



E

D

C

F-J Lubricant/Thinner and Spray Bottle

To use all brands of compounds most efficiently, we recommend adding a lubricant to allow the compound to cut at its peak performance and to prevent the felt bob from gumming up or chattering. When added to diamond compound on the workpiece, lubricant thins out the mixture, creating a slurry and extending the compound. Available in two formulations: Oil-soluble and water-soluble, and in spray or squeeze bottle for moistening felts prior to diamond compound application.

Fill empty 4 oz. spray bottle with cleaning solution, lubricants and more for easy dispensing. Spray gets into hard-to-reach areas.

Size	F. ¾ oz	G. 4 oz	H. 8 oz	I. 32 oz
Oil Lubricant/Thinner	825-1295	825-1303	825-1300	825-1305
Water Lubricant/Thinner	825-1290	825-1310	825-1315	825-1320
Each	\$2.50	4.95	6.85	19.60

Description	Item#	EACH Prices
		1-2 3+
J. Empty 4 oz. Spray Bottle	811-2460	\$2.15 \$1.94



F

G

H

I

J



Rockwood Sticks

Very hard, laminated sticks that retain their shape well. Use by hand, with reciprocating or rotary tools for initial finishing with diamond and other compounds. Can be dressed with a knife or file. Measure 6" long with blunt ends (except #825-0005, which has one pointed end, and #825-0045, which has one beveled end). Dark brown in color.

Shape	Size	Item#	EACH Prices	
			1-11	12+
A. Round Pointed	1/8"	825-0005	\$3.33	\$2.77
Round	3/16"	825-0010*	4.85	4.04
	1/4"	825-0020*	5.95	4.96
	3/8"	825-0030	9.79	8.16
	1/2"	825-0040*	14.29	11.91
B. Square Beveled	1/8" x 1/8"	825-0045	2.98	2.48
Square	1/4" x 1/4"	825-0060	4.85	4.04
C. Rectangular	1/8" x 1/4"	825-0050*	3.95	3.29
	1/4" x 3/8"	825-0070*	5.89	4.91
	1/4" x 1/2"	825-0080*	6.55	5.46
	5/16" x 1"	825-0110	11.45	9.54
	*Set 1R, 18 pieces (three of each asterisked number)	825-0300	59.50	-
Set 2R, 27 pieces (three of each size except 1/8" square and round)	825-0400	99.00	-	

See The New Acrylic Laps (p. 146)

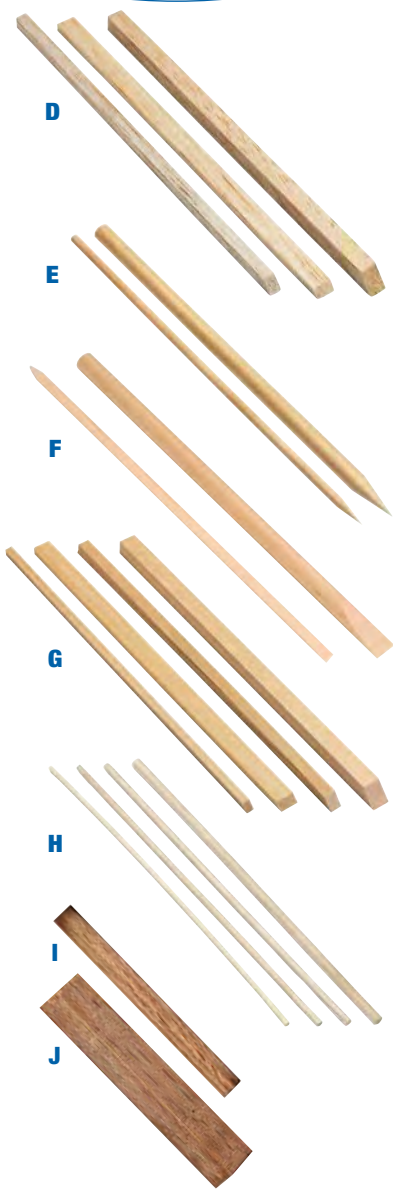

D. Very Soft Sticks – Select balsa wood with one shaped end

Use by hand, with reciprocating or rotary tools for final finishing with diamond and other compounds. Can be dressed with a knife or file. Measure 6" long.

Shape	Size	Item#	PKG. of 5	
			1-9	10+
Rectangular, beveled	3/16" x 3/16"	825-0532	\$9.95	\$7.96
	1/8" x 1/4"	825-0534	9.95	7.96
	1/4" x 1/4"	825-0536	9.95	7.96

E-G Soft Sticks – Select white birch or poplar with one shaped end

Use by hand, with reciprocating or rotary tools for intermediate to final finishing with diamond and other compounds. Measure 6" long.

Shape	Diameter	Item#	PKG. of 25	
			1-9	10+
E. Round, pointed	1/8"	825-0551	\$11.85	\$10.67
	1/4"	825-0557	11.85	10.67
F. Round, double-beveled	1/8"	825-0541	12.45	11.21
	1/4"	825-0547	11.85	10.67

Shape	Size	Item#	PKG. of 5	
			1-9	10+
G. Rectangular, beveled	1/8" x 1/8"	825-0501	\$6.95	\$5.56
	3/16" x 3/16"	825-0503	6.95	5.56
	1/8" x 1/4"	825-0505	6.95	5.56
	1/4" x 1/4"	825-0507	6.95	5.56

H. Pegwood Sticks

Flexible multipurpose sticks that maintain a fine point and resist breaking when pushed into a hole. Use by hand, with reciprocating or rotary tools for intermediate finishing with diamond and other compounds. Carefully chosen, round soft sticks can also be used when gluing or as a dop stick. Dress with a knife or file. Measure 6" long. Sold in bundles of 24.

Shape	Diameter	Item#	BUNDLE of 24	
			1-9	10+
Round	2mm	825-1201	\$10.00	\$8.50
	2.5mm	825-1202	10.25	8.71
	3mm	825-1203	10.50	8.93
	4mm	825-1204	10.75	9.14

I, J Wood Laps – For ULTRAMAX® units

For use with diamond compound. Can be shaped with a diamond file or stone. Excellent for polishing narrow slots.

Material	Size (mm)	Item#	Pkg. of 5
I. Extra-Hard Wood	3 x 30 round	508-3349	\$24.95
J. Extra-Hard Wood	3.2 x 6 x 30 flat	508-3351	20.00

Supplied with ULTRAMAX DF/SF.

Simichrome Polish®

One of the finest all-metal paste polishes in the world! Simply rub on with a soft cloth and rub off to obtain a brilliant luster. Will not harm uncoated metal surfaces. Unlike chemical polishes, it will not remove a layer of the metal surface being cleaned. Recommended for use after diamond compound. Removes tarnish, dirt and oils, and generally renews polished metal surfaces. Leaves a protective film, which retards oxidation but does not prevent tarnishing. Works well on virtually any ferrous or non-ferrous metal surface such as brass, copper, silver, gold, pewter, magnesium, bronze, chromium, stainless steel, platinum, aluminum and countless other similar uncoated metals. Do not use on painted or lacquered surfaces. Excellent for removing shallow scratches from most any plastic and is also used to charge dry polishing medias (such as Dri-Shine III, Walnut Shells, or crushed cob) for tumbling. Polishing grit is 8 to 10 microns. Made in Germany.



A-C Simichrome Polish®

Description	Item#	Each
A. 50g Tube	218-2050	\$13.70
50g Tube, Box of 24	218-2100	252.30
B. 250g Tin	218-2150	40.75
C. 1,000g Tin	218-2200	99.90

D. Clover® Lapping Compound

Grease-based silicon carbide compound. Great for refining surface finishes and cutting without heat buildup. Most economical for tight areas where compound loss is excessive. Best for use on 50HRC and softer steels. Packaged in 1 lb. cans.

Grit	Item#	Each	Grit	Item#	Each
180	218-3180	\$41.95	400	218-3400	\$46.00
220	218-3220	41.95	600	218-3600	67.00
320	218-3320	46.00	1200	218-3620	92.00



E. Tetrabor® Compound

Boron carbide compound. Great for refining surface finishes and cutting without heat buildup. Best for use on carbide and hardened steel. Packaged in 100 gram tubes.

Grit	Item#	Each	Grit	Item#	Each
60	218-1005	\$35.00	400	218-1090	\$39.00
100	218-1010	35.00	600	218-1100	47.00
220	218-1050	35.00	800	218-1110	47.00
320	218-1080	39.00	1200	218-1130	56.00



F. Brilliant Luster Cream – For a high polish without the harsh odor

Produces a lustrous mirror sheen on mold and die surfaces. Quickly removes stains and oxidation, as well as the haze created by diamond polishing. Can be used on all steels, aluminum, chrome, brass and bronze. Goes on and comes off easily with a felt bob, soft cloth or tissue paper. Emits no harsh odors, unlike other brands. Nonhazardous and noncorrosive.

Description	Item#	Each
F. 50g Jar	218-2220	\$7.25
50g Jars, box of 24	218-2225	145.00
250g Jar	218-2230	22.95
1,000g Jar	218-2235	61.95



G. Wood Bobs – 1/8" Shank

Natural wood bobs for intermediate finishing with rotary tools. Can be shaped for contours. Use dark-colored hard bobs with 15 micron or coarser diamond compounds, light-colored soft bobs with 15 micron or finer. Sold in packages of 10 or in a 12-piece set.

Description	Dia. x L (mm)	Hard Item#	Soft Item#	Pkg. of 10
Ball	10	825-0618	825-0638	\$33.00
Cylinder	6 x 15	825-0605	825-0625	31.95
	10 x 20	825-0607	825-0627	36.65
Flame	9 x 15	825-0610	825-0630	33.00
	10 x 30	825-0612	825-0632	36.65
	13 x 20	825-0614	825-0634	36.65

Description	Item#	Each
G. 12-Piece Set (one of each)	825-0640	\$37.55



Spectra Diamond Files

High-quality diamond files at economical prices. Feature a combination of natural and synthetic diamonds firmly plated onto durable steel blanks. Cushioned color-coded ends. Made in Germany.

Spectra Grit Chart

Medium	D126	120/140
Fine	D91	170/200
Very Fine	D64	230/270

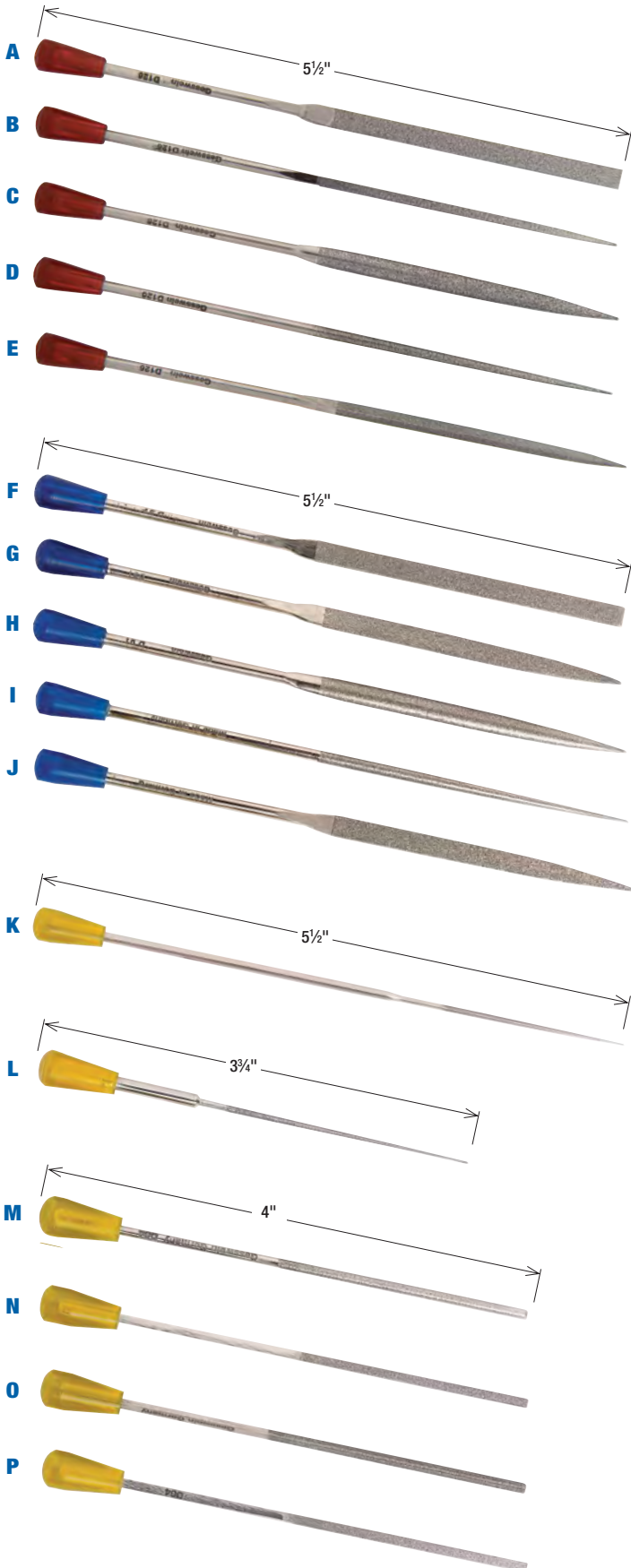

A-E Spectra Medium Diamond Needle Files

Diamond needle files with 3mm round handles. Measure 5 1/2" (14cm) long. Plated ends measure 2 3/4" long. Medium grit (D126, or U.S. standard 120/140).

Style	Shape	Item#	EACH Prices		
			1-4	5-9	10+
A. Equalling		241-0010	\$30.25	\$28.74	\$27.23
B. Flat-Pointed		241-0020	30.25	28.74	27.23
C. Half-Round		241-0030	30.25	28.74	27.23
D. Round		241-0040	30.25	28.74	27.23
E. Knife		241-0050	30.25	28.74	27.23
Set of all five		241-0250	141.00	-	-

F-J Spectra Fine Diamond Needle Files

Diamond needle files with 3mm round handles. Measure 5 1/2" (14cm) long. Plated ends measure 2 3/4" long. Fine grit (D91, or U.S. standard 170/200).

Style	Shape	Item#	EACH Prices		
			1-4	5-9	10+
F. Equalling		241-0012	\$30.25	\$28.74	\$27.23
G. Flat-Pointed		241-0022	30.25	28.74	27.23
H. Half-Round		241-0032	30.25	28.74	27.23
I. Round		241-0042	30.25	28.74	27.23
J. Knife		241-0052	30.25	28.74	27.23
Set of all five		241-0245	141.00	-	-

K. Spectra Very Fine Diamond Escapement File

Diamond escapement file with 3/32" square handle. Measures 5 1/2" (14cm) long. Plated end measures 1 3/4" long with 1/16"-1/32" taper. Very fine grit (D64, or U.S. standard 230/270).

Style	Shape	Item#	EACH Prices		
			1-4	5-9	10+
Round (tapered)		241-0150	\$33.00	\$31.35	\$29.70





L-P Spectra Very Fine Diamond Micro Files

Mini diamond files with 3/32" wide handles. Measure approx. 4" long except round, which measures approx. 3 3/4" long. Plated ends measure approx. 2" long with 1/16"-1/32" taper for round only. Very fine grit (D64, or U.S. standard 230/270).

Style	Shape	Item#	EACH Prices		
			1-4	5-9	10+
L. Round (tapered)		241-0500	\$26.00	\$24.70	\$23.40
M. Half-Round		241-0505	26.00	24.70	23.40
N. Square		241-0510	26.00	24.70	23.40
O. Three-Square		241-0515	26.00	24.70	23.40
P. Flat Hand		241-0520	26.00	24.70	23.40
Set of all five		241-0525	123.00	-	-

A-E Spectra Diamond Riffles – Medium and Fine

Curved, double-ended diamond files with square handles. Measure 6" long. Plated ends measure 1" long. Medium grit (D126, or U.S. standard 120/140) and fine grit (D91, or U.S. standard 170/200).

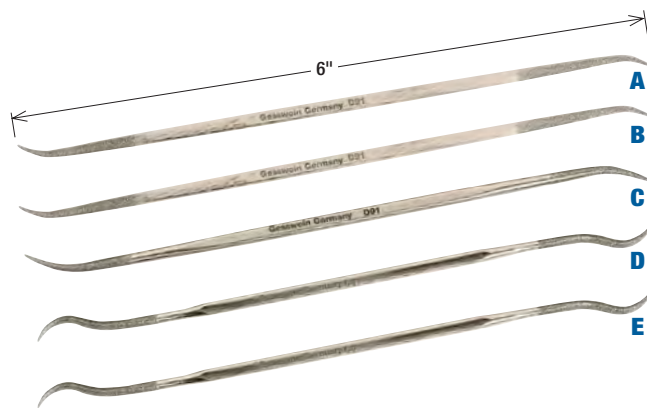

Style	Shape	Medium Item#	Fine Item#	EACH Prices		
				1-4	5-9*	10+*
A. Flat		241-0195	241-0170	\$42.00	\$39.90	\$37.80
B. Three-Square		241-0200	241-0175	42.00	39.90	37.80
C. Square		241-0205	241-0180	42.00	39.90	37.80
D. Round		241-0210	241-0185	42.00	39.90	37.80
E. Oval		241-0215	241-0190	42.00	39.90	37.80
Set of all five		241-0310	241-0305	195.00	-	-

*Quantity discount for orders of one item number only; not assorted.



F-N Spectra Diamond Poli Files – Medium – 3mm Shanks

Parallel diamond machine files for use in reciprocating handpieces. Plated ends measure 15mm long and files measure 2" in length, except where noted. Medium grit (D126, or U.S. standard 120/140). Made in Germany.

Style	Shape	Plated Size (mm)	Item#	EACH Prices		
				1-4	5-9	10+
F. Flat		2 x 1mm	241-0400	\$25.00	\$23.75	\$22.50
G.		3 x 1mm	241-0405	25.00	23.75	22.50
H.		4 x 1mm	241-0410	25.00	23.75	22.50
I.		5 x 2mm	241-0415	25.00	23.75	22.50
J.		5 x 2mm*	241-0420	25.00	23.75	22.50
K. Flat		2 x 1mm	241-0425	25.00	23.75	22.50
L.		3 x 1mm	241-0430	25.00	23.75	22.50
M.		5 x 2mm*	241-0435	25.00	23.75	22.50
N. Round		3mm*	241-0440	25.00	23.75	22.50
Set of all nine			241-0445	160.00	152.00	144.00

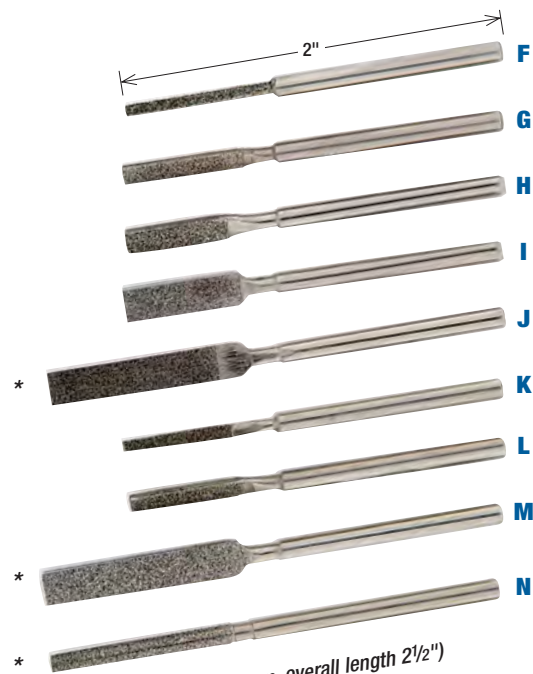

O-Q 3M® Diamond Hand Files

For filing hard-to-cut materials, finishing delicate surfaces, beveling edges, removing burrs and sharpening tools. Can be used wet or dry. Color-coded for easy grit identification. Overall length approximately 6 1/4".

Cutting Face (L x W)	Color	Grit/Micron	Item#	EACH Prices	
				1-9	10+
O. 1 1/2" x 3/4"	Black	120/M125	240-3010	\$9.65	\$8.69
	Red	200/M74	240-3011	9.20	8.28
	Yellow	400/M40	240-3012	8.15	7.34
	White	800/M20	240-3013	8.15	7.34
P. 1 3/4" x 1/2"	Black	120/M125	240-3014	9.25	8.33
	Red	200/M74	240-3015	8.60	7.74
	Yellow	400/M40	240-3016	8.50	7.65
Q. 1 3/4" x 1/2" half-round	Black	120/M125	240-3018	9.25	8.33
	Red	200/M74	240-3019	8.80	7.92

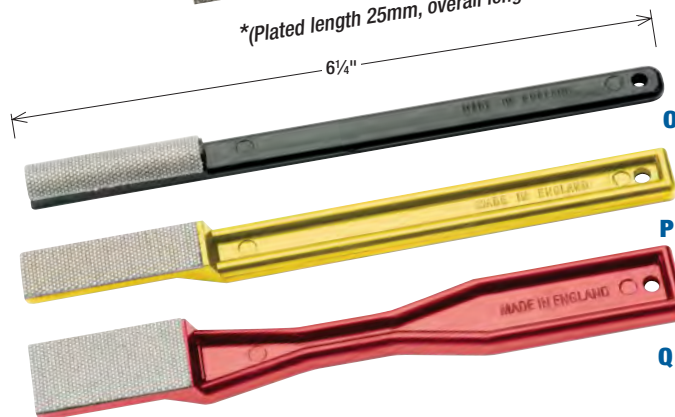

R, S Mini-Filer Diamond Tips – 2mm Shank

Mini-filing tips coated on one side with synthetic diamonds, precisely bonded to obtain the best physical properties for added strength and wear. These tips can be used in our Mini-Filers (see pp. 420-421, 426) and other light-duty profiling handpieces. All measure .5mm thick x approx. 23mm long. 40mm long mini-filer tip holder also available.

Shape/Grit	Coated Length	D181	D151	D107	D64	30 µm	15 µm
Rectangle	9.5mm	241-0604	241-0603	-	241-0602	241-0601	-
Spatula	9.5mm	241-0608	241-0607	-	241-0606	241-0605	-
Bent Spatula	9mm	-	-	-	241-0609	-	-
Knife	8mm	241-0620	241-0621	241-0622	241-0623	241-0624	241-0625
Package of 3		\$51.45	\$51.45	\$51.45	\$51.45	\$51.45	\$51.45

Description	Item#	Each
S. Mini-Filer Tip Holder - 40mm	241-0612	\$30.45

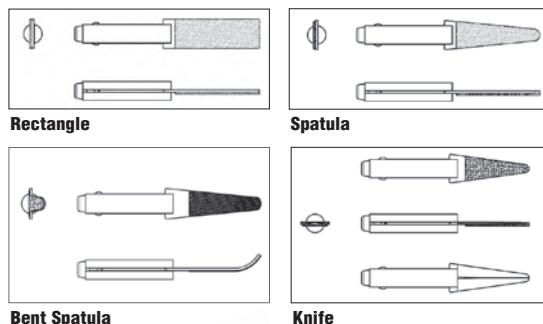

Gesswein® Diamond Files

Premium diamond files for use on steels, carbides, ceramics, plastics and more. Features 100% synthetic diamonds—more consistent in shape than natural diamonds—plated onto high-strength steel blanks for consistent cutting and long life. See p. 312 for file handles.



Side view of taper



Shown actual size



A-D Gesswein® Tapered Diamond Poli Files – 200, 400 or 600 Grits

Tapered diamond machine files for use in reciprocating handpieces. All have 3mm shanks. Plated ends measure 15mm (19/32") long with 1.4–0.3mm taper.

Style	Shape	W x L	200 Grit	400 Grit	600 Grit	Each
A. Flat		3 x 56mm	241-0814	241-0815	241-0816	\$12.50
B. Flat		6 x 56mm	241-0817	241-0818	241-0819	13.75
C. Flat		3 x 72mm	241-0820	241-0821	241-0822	12.50
D. Flat		6 x 72mm	241-0823	241-0824	241-0825	13.75
12-Piece Set (one of each)					241-0813	149.75

E-Q Gesswein® Diamond Poli Files – 150 Grit

Diamond parallel machine files for use in reciprocating handpieces. All have 3mm shanks. Measure approx. 2" long. Plated ends measure 5/8" long.

Style	Shape	W x Thick	Grit	Item#	EACH Prices		
					1-4	5-9	10+
E. Flat		2 x 1mm	150	240-1120*	\$12.50	\$11.88	\$11.25
F.		3 x 1mm	150	240-1130	12.50	11.88	11.25
G.		4 x 1mm	150	240-1140	12.50	11.88	11.25
H.		5 x 2mm	150	240-1150	12.50	11.88	11.25
I. 3-Square		2mm	150	240-1520*	12.50	11.88	11.25
J.		3mm	150	240-1535	12.50	11.88	11.25
K.		4.5mm	150	240-1545	12.50	11.88	11.25
L. Crossing		2 x 1mm	150	240-1410*	12.50	11.88	11.25
M. Round		1mm	150	240-1310	12.50	11.88	11.25
N.		2mm	150	240-1320*	12.50	11.88	11.25
O.		3mm	150	240-1330	12.50	11.88	11.25
P. Flat		4 x 1mm	150	240-1230*	12.50	11.88	11.25
Q. Knife		4 x 1mm	150	240-1610*	12.50	11.88	11.25
*6-Piece Set (one of each asterisked item)				240-1706	71.00		
12-Piece Set (one of each except #240-1150)				240-1712	142.00		







R-AA Gesswein® Diamond Riffler Poli Files – 150 Grit

Parallel diamond machine files for use in reciprocating handpieces. All have 3mm shanks. Measure approx. 2.5" long. Plated ends measure 5/8" long. Diamond coating measures approximately 7/8".

Style	Shape	W x Thick	Grit	Item#	Each
R. Equalling		5.8 x 1.2mm	150	240-1001	\$12.50
S. Equalling		3.2 x 1.4mm	150	240-1002	12.50
T. Half-Round Bent		5 x 2mm	150	240-1003	12.50
U. Equalling Bent		3.2 x 1.4mm	150	240-1004	12.50
V. Round Hook		3mm	150	240-1005	12.50
W. Round Curved		3mm	150	240-1006	12.50
X. Three-Square		2.5mm	150	240-1007	12.50
Y. Equalling Angle		3.2 x 1.4mm	150	240-1008	12.50
Z. Equalling Curved		3.2 x 1.4mm	150	240-1009	12.50
AA. Crossing Oval		3.5 x 2mm	150	240-1010	12.50
10-Piece Set (one of each)					240-1000 112.50

A-F Gesswein® Diamond Needle Files – 5½" 150 Grit



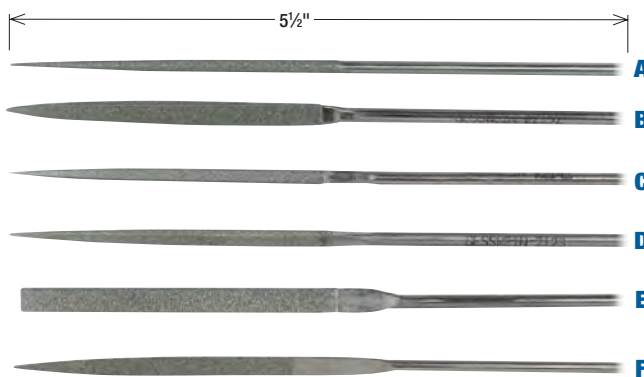

Diamond needle files with 3mm round handles. Plated ends measure 2¾" long (70mm). Can be used alone or with needle file handles (see p. 312).

Style	Shape	Grit	Length	Item#	EACH Prices		
					1-4	5-9	10+
A. Round		150	5½"	240-2162	\$22.00	\$20.90	\$19.80
B. Half-Round		150	5½"	240-2152	22.00	20.90	19.80
C. Square		150	5½"	240-2142	22.00	20.90	19.80
D. Three-Square		150	5½"	240-2132	22.00	20.90	19.80
E. Equalling		150	5½"	240-2112	22.00	20.90	19.80
F. Barrette		150	5½"	240-2102	22.00	20.90	19.80
6-Piece Set (one of each)				240-2200	SET Price	125.00	



G-K Gesswein® Diamond Needle Files – 7¾" 120 Grit





Diamond needle files with 3mm round handles. Plated ends measure 2¾" long (70mm). Can be used alone or with needle file handles (see p. 312).

Style	Shape	Grit	Length	Item#	EACH Prices		
					1-4	5-9	10+
G. Equalling		120	7¾"	240-2211	\$30.00	\$28.50	\$27.00
H. Half-Round		120	7¾"	240-2212	30.00	28.50	27.00
I. Round		120	7¾"	240-2213	30.00	28.50	27.00
J. Square		120	7¾"	240-2214	30.00	28.50	27.00
K. Three-Square		120	7¾"	240-2215	30.00	28.50	27.00
5-Piece Set (one of each)				240-2210	SET Price	135.00	



L-O Gesswein® Tapered Diamond Hand Files – 150, 200 or 400 Grits

Tapered diamond hand files with slim handles for sure grip. Measure 180mm (7") long. Plated ends measure 40mm long on 2mm wide files, 50mm long on all others.



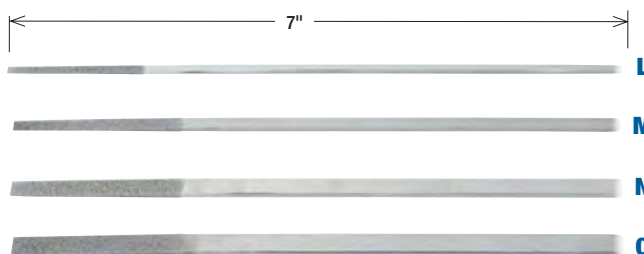

Style	Shape	W x Thick	150 Grit	200 Grit	400 Grit	
L. Flat		2 x 1.5–0.4mm	241-0801	241-0802	241-0803	
M. Flat		4 x 2.0–0.5mm	241-0804	241-0805	241-0806	
N. Flat		6 x 2.0–0.5mm	241-0807	241-0808	241-0809	
O. Flat		8 x 2.5–0.5mm	241-0810	241-0811	241-0812	
					EACH Price	\$22.00
12-Piece Set (one of each)			241-0800	SET Price	250.00	



 Side view of taper

P-T Gesswein® Diamond Hand Files – 100, 200 or 400 Grits

Heavy-duty diamond hand files with square shanks for use by hand or with handles. Measure 215mm (8½") long. Plated ends measure a generous 80mm (3½") long.

Style	Shape	W x Thick	100 Grit	200 Grit	400 Grit	
P. Equalling		11.0 x 3.5mm	241-0746	241-0747	241-0748	
Q. Square		6.3 x 6.3mm	241-0735	241-0736	241-0737	
R. Half-Round		10.5 x 4.4mm	241-0749	241-0730	241-0731	
S. Round		5.0mm	241-0732	241-0733	241-0734	
T. 3-Square		7.7mm	241-0738	241-0739	241-0740	
					EACH Price	\$39.95
5-Piece Sets (one of each style)			241-0741	241-0742	241-0743	
					SET Price	\$169.95

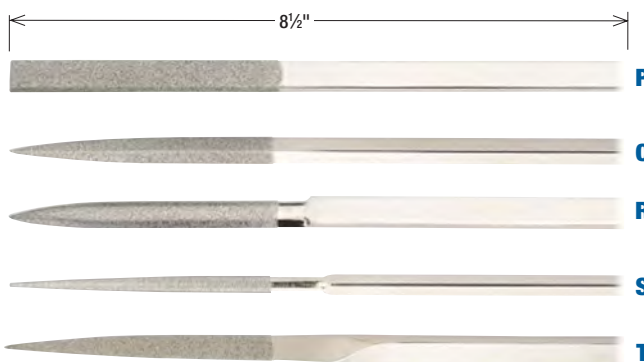



A-E Gesswein® Diamond Rifflers – Double Ended, 150 Grit

Curved, double-ended diamond files with square handles. Measure 6" long. Plated ends measure 1" long.

Style	Shape	Grit	Item#	EACH Prices		
				1-4	5-9	10+
A. 16R		150	240-3165	\$25.00	\$23.75	\$22.50
B. 18R		150	240-3180	25.00	23.75	22.50
C. 22R		150	240-3222	25.00	23.75	22.50
D. 24R		150	240-3225	25.00	23.75	22.50
E. 26R		150	240-3230	25.00	23.75	22.50
5-Piece Set (one of each)			240-3250	SET Price	115.00	



F-O Gesswein® Diamond Rifflers – 150 Grit

Gesswein Diamond Rifflers use 100% man-made diamonds. These synthetic diamonds are more consistent in shape than natural diamonds. This guarantees sharp and even cutting action, durability and long life. All blanks are precision-made of high-strength steel. High-density wear-resistant plating enables total usage of the full concentration of diamond.

Available individually or in a money saving set of all 10 shapes.

- Overall length: 5½" (140mm)
- Handle Diameter: 3.0mm
- Diamond Coated Length: ¾" (20mm)

Style	Grit	Item#	EACH Prices			
			1-4	5-9	10+	
F. Flat, 6 x 1.3mm	150	240-3301	\$18.00	\$17.10	\$16.20	
G. Tapered Square	150	240-3302	18.00	17.10	16.20	
H. Flat, 3.5 x 1.5mm	150	240-3303	18.00	17.10	16.20	
I. 3-Square	150	240-3304	18.00	17.10	16.20	
J. Half Round	150	240-3305	18.00	17.10	16.20	
K. Square	150	240-3306	18.00	17.10	16.20	
L. Oval	150	240-3307	18.00	17.10	16.20	
M. Round Hook	150	240-3308	18.00	17.10	16.20	
N. Knife Edge	150	240-3309	18.00	17.10	16.20	
O. Round	150	240-3310	18.00	17.10	16.20	
10-Piece Set (one of each)			240-3300	162.00	153.90	145.80

Other Rifflers are in the File Section see pp. 313-316.

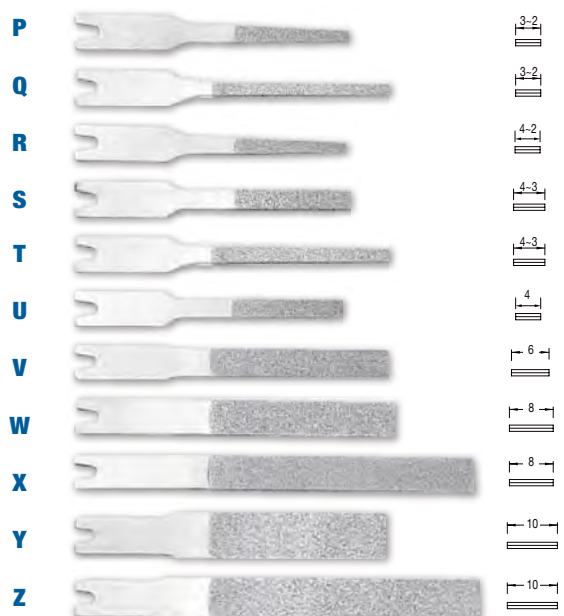

P-Z Turbo Lap Diamond Files









These diamond files are perfect for finishing in tight areas. The high quality diamond abrasive performs well in high speed and short stroke applications. Each diamond file has maximum thickness of 1mm and tapers down to 0.5mm thick. Each style is available in three grits.

Description	Item#	Each Prices			
		1-4	5-9*	10+*	
Turbo Lap Diamond Files	See chart below	\$7.25	\$6.89	\$6.53	
Style	Length x Abrasive (mm)	Size	120 Grit	200 Grit	400 Grit
P	60 x 25	3~2	241-0640	241-0641	241-0642
Q	70 x 40	4~2	241-0644	241-0645	241-0646
R	60 x 25	4~2	241-0648	241-0649	241-0650
S	60 x 25	4~3	241-0652	241-0653	241-0654
T	70 x 40	4~3	241-0656	241-0657	241-0658
U	60 x 25	4	241-0660	241-0661	241-0662
V	70 x 40	6	241-0664	241-0665	241-0666
W	70 x 40	8	241-0668	241-0669	241-0670
X	90 x 60	8	241-0672	241-0673	241-0674
Y	70 x 40	10	241-0676	241-0677	241-0678
Z	90 x 60	10	241-0680	241-0681	241-0682

*Quantity discount for orders of one item# only, not assorted.

A-C Resinoid Diamond Lappers

For touching up and sharpening cutting tools, carbide and high-speed steels. The diamond stone will remove scratches and other surface imperfections. Leaves a good finish due to its resin bonding. Diamond is embedded throughout the stone ensuring consistent cutting action as the stone wears.

Style	Shape	Stone Size:		Item#	Each
		Length x Width	Grit		
A. Flat stone		40 x 10mm	400	240-3031	\$35.95
		40 x 10mm	800	240-3033	35.95
		40 x 10mm	1200	240-3035	35.95
B. Half-Round stone		40 x 5mm	400	240-3041	40.95
		40 x 5mm	800	240-3043	40.95
		40 x 5mm	1200	240-3045	40.95
C. Flat stone		30 x 10mm	400	240-3051	38.40
		30 x 10mm	800	240-3053	38.40
		30 x 10mm	1200	240-3055	38.40

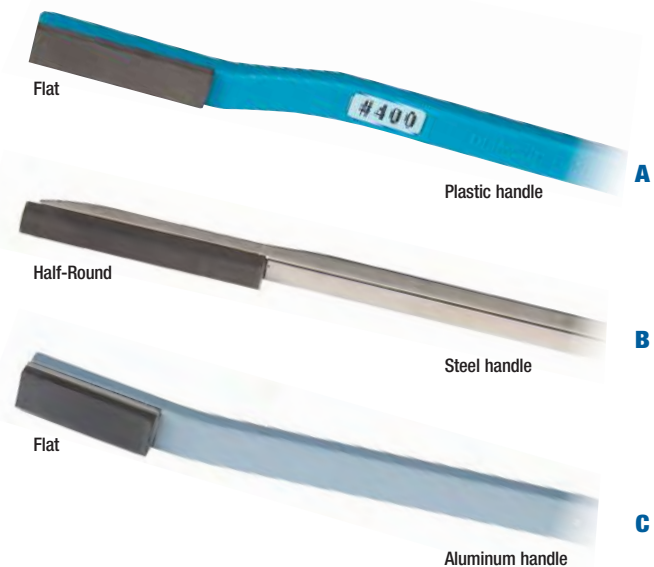

D-H EZE-LAP® Diamond Hand Lappers

These lappers are ideally suited for honing edges of carbide cutting tools. They offer excellent abrasion resistance for superior finishing. Available in assorted grits to match your finishing requirements. Comfort-fit handgrips are designed for accurate control and color-coded for easy grit identification. Measure 6"L x 3/4"W (diamond face measures 2"L x 3/4"W).

Hand Lappers	Color	Item#	Each
D. Extra-Coarse	Green	349-6009	\$11.95
E. Coarse (200)	Black	349-6010	9.30
F. Medium (325)	Purple	349-6012	7.75
G. Fine (600)	Red	349-6014	6.50
H. Super-Fine (1500)	Blue	349-6018	6.50

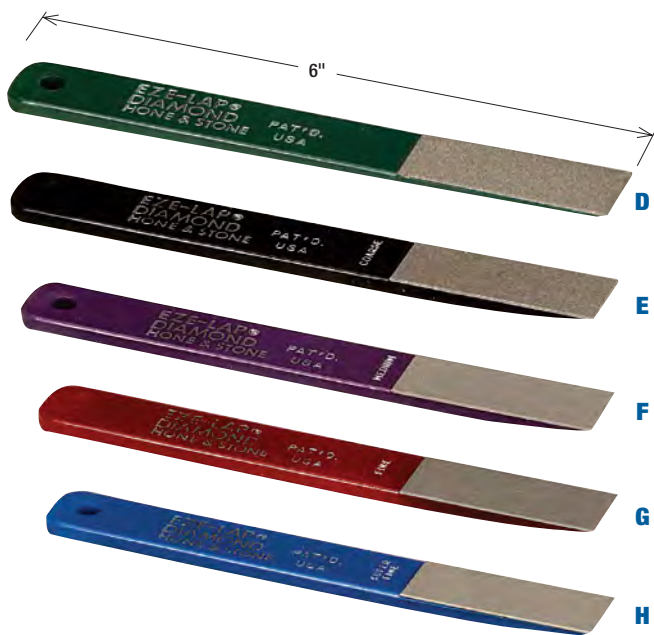

I, J EZE-LAP® Diamond Hand Sharpeners

These sharpeners are ideally suited for honing edges of carbide cutting tools. They offer excellent abrasion resistance for superior finishing. Folding sharpeners with butterfly knife-style handles are grit color-coded and measure 9"L x 1"W open, 5"L x 1"W closed (diamond face area measures 4"L x 3/4"W).

Folding Sharpeners	Color	Item#	Each
I. Fine/Medium	Silver	349-6020	\$35.10
J. Fine (tapered cone)	Red	349-6022	23.40

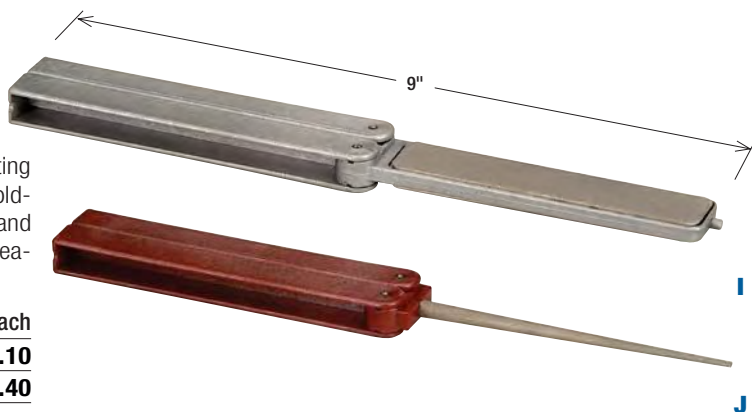

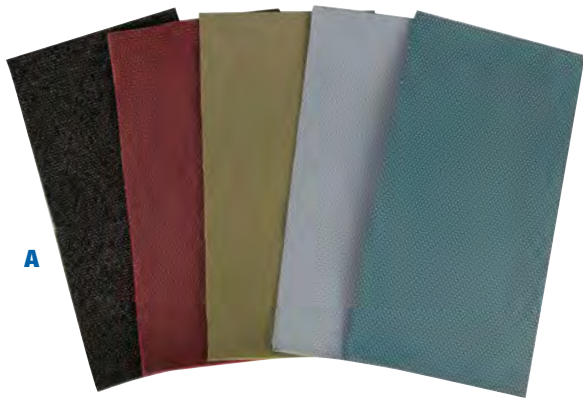

A

A. Diamond PSA Cloth

Features precisely graded diamond grit on a flexible cloth backed by pressure-sensitive adhesive. The diamond grit is positioned on raised "islands" covering the cloth, thus allowing greater flexibility and more aggressive cutting action. Can be easily cut with scissors, shaped, punched and bent to almost any configuration. Use wet or dry for applications on steel, carbide, ceramic, glass, etc. All diamond cloths are color coded for easy identification of grit. Measures 50 x 100mm (2" x 4").

Color	Grit	Size	Item#	Each
Brown	120	50 x 100mm	107-4951	\$51.00
Red	200	50 x 100mm	107-4952	39.00
Yellow	400	50 x 100mm	107-4953	35.00
White	600	50 x 100mm	107-4954	35.00
Blue	1000	50 x 100mm	107-4955	44.00



B

B. Diamond PSA Foil

Consists of diamond abrasive particles electroplated onto very thin and flexible metal foil. Backed by pressure-sensitive adhesive. Can cut to any size and shape with scissors. Simply remove the paper backing and stick foil on to your own tools, creating a new "self-made" tool. Wide range of grit selection for fast aggressive cutting or fine polishing on steels and carbides. Measures 50 x 100mm (2" x 4").

Grit	Size	Item#	Each
120	50 x 100mm	107-5790	\$40.50
200	50 x 100mm	107-5792	30.95
400	50 x 100mm	107-5794	27.00
600	50 x 100mm	107-5795	23.50
1200	50 x 100mm	107-5797	23.50

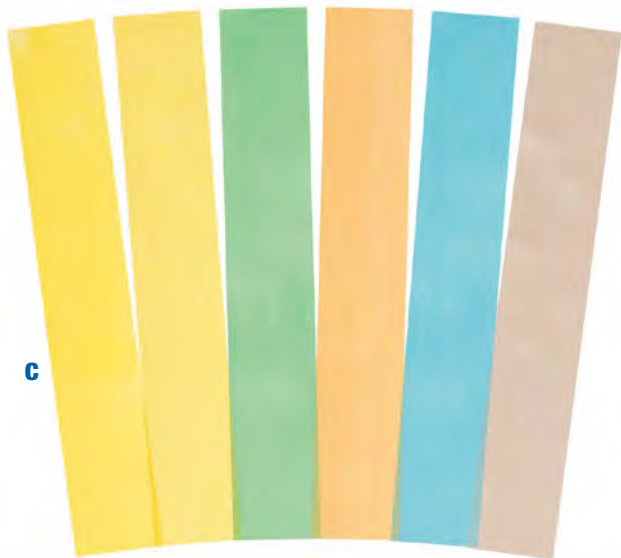

C

C. Diamond PSA Poly Film

These highly flexible films are made of precisely graded diamond particles bonded to high strength polyester backing and provide a uniform, consistent finish. The films are waterproof, have good heat resistance and have a PSA (Pressure Sensitive Adhesive) backing. Can be used on a variety of materials including hardened steels, tungsten carbide, ceramic, glass, precious stones and epoxy. Measures 25 x 150mm (1" x 6").

Micron	Size	Item#	Each
60	25 x 150mm	107-5786	\$20.00
45	25 x 150mm	107-5785	20.00
30	25 x 150mm	107-5784	20.00
15	25 x 150mm	107-5783	20.00
9	25 x 150mm	107-5782	20.00
6	25 x 150mm	107-5781	20.00

A-I Diamond-Impregnated Rubber Wheels and Points – 3/32" Shank

Diamond and rubber combined to give you fast finishes on platinum, precious alloys, titanium and stainless steel. Long-lasting, made in 3 versatile shapes to access the tightest areas. Color-coded for grit identification. Available in three color-coded grits: medium (green), fine (gray) and extra-fine (red). All 3/32" shanks. Max. operating speeds: 10,000rpm. Made in Germany.

Green Gem Polishers – Medium	Dimensions	Item#	Each
A. Mtd. Point	13 x 4mm	145-1322	\$8.85
B. SE Mtd. Wheel	11 x 2mm	145-1321	8.85
C. SE Mtd. Wheel	11 x 4mm	145-1323	15.60
Gray Gem Polishers – Fine	Dimensions	Item#	Each
D. Mtd. Point	13 x 4mm	145-1325	\$8.85
E. SE Mtd. Wheel	11 x 2mm	145-1324	8.85
F. SE Mtd. Wheel	11 x 4mm	145-1326	15.60
Red Gem Polishers – Extra-Fine	Dimensions	Item#	Each
G. Mtd. Point	13 x 4mm	145-1328	\$8.85
H. SE Mtd. Wheel	11 x 2mm	145-1327	8.85
I. SE Mtd. Wheel	11 x 4mm	145-1329	15.60

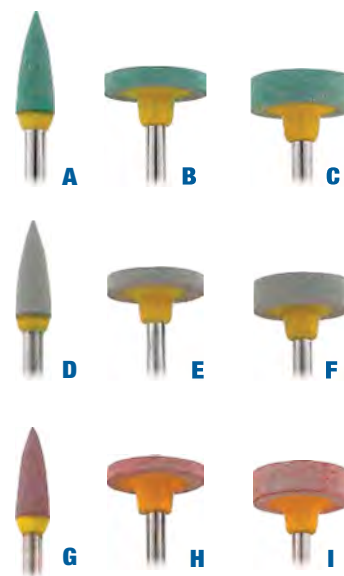

J. Diamond Embedded Polisher – 3/32" Shank

Developed to polish very hard metals (like Platinum, Palladium, Titanium, Stainless Steel). This square edge, 7/8" polisher has microfine ground diamonds evenly embedded in a synthetic rubber bond. Ideal for trimming, reduction, smoothing parting lines, pre-polishing, high-shine polishing. Also an excellent choice for polishing super hard carbide gravers. Max. operating speeds: 10,000rpm. Made in Germany.

Description	Item#	Set Price
Diamond Embedded Polisher	145-1380	\$23.50



K. 3M™ Diamond Hand Pads

Use for precision sharpening of all your blades and tools. Each pad has one cutting face that contains micron-graded diamonds. Open dot pattern provides aggressive cutting action and reduces loading. Flexible backing conforms to irregular surfaces. Pads are color-coded for easy grit identification. Cutting face measures 3 3/4"L x 2 1/4"W. Available individually or in a set of six.

Color	Grit	Micron	Item#	Each
Green	60	250	240-3060	\$37.45
Black	120	125	240-3061	28.90
Red	200	74	240-3062	23.55
Yellow	400	40	240-3063	18.70
White	800	20	240-3064	18.70
Blue	1800	10	240-3065	18.70
K. 6-Piece Set			240-3085	119.95

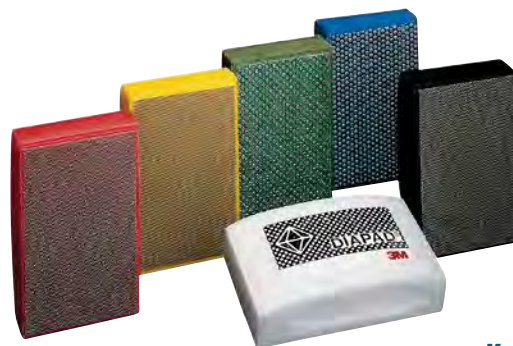

L. 3M™ Sponge Sanding Pads – Aluminium Oxide

Flexible, palm-sized Sponge Sanding Pads from 3M conform to almost any surface contour. Made of long-lasting, closed-cell rubber with micron-graded aluminum oxide abrasive grains, these pads will not gouge the work surface. 3M Sponge Sanding Pads can be used wet or dry for a variety of applications as well as folded or trimmed to fit into detailed areas.

Each pad measures 4 1/2" x 5 1/2". Available in Medium, Fine, Super-Fine, Ultra-Fine and Micro-Fine as well as a Set of all 5.

Description	Item#	EACH Prices		
		1-4	5-19	20+
Medium Pad	108-7020	\$1.95	\$1.79	\$1.71
Fine Pad	108-7015	1.95	1.79	1.71
Super-Fine Pad	108-7010	1.95	1.79	1.71
Ultra-Fine Pad	108-7005	3.35	3.07	2.93
Micro-Fine Pad	108-7000	3.35	3.07	2.93
L. 5-Piece Set	108-7025	SET Price		12.35

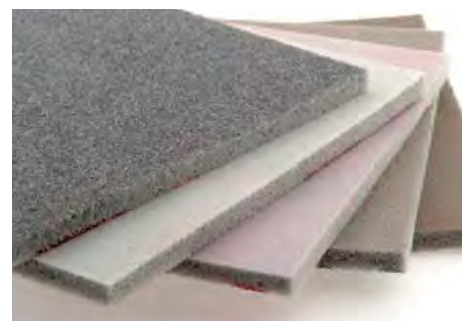

Diamond and CBN Pins

Diamond and CBN (cubic boron nitride) are superior abrasives with material removal rates beyond those of conventional abrasives such as aluminum oxide or silicon carbide. Our diamond pins are ideal for use on carbides and extremely hard steels and ceramics. Our CBN pins are recommended for use on high-carbon, high-chrome, high-speed steels such as M2, M3, M7 and T15; die steels such as D2, D3, HB and A&O; alloy steels harder than 50 HRC; and nickel- and cobalt-based super alloys such as titanium and stainless steel. The cutting edges last longer, resist breakdown better, produce more ground parts per hour and improve the quality of the finished product, helping reduce overall costs. When heat distortion is an important factor, CBN is the wise choice because it runs cooler than diamond.

Diameter	Maximum RPM
.020"-.200"	60,000-120,000
.200"-.500"	45,000-60,000
.500"-1.00"	30,000-45,000

Maximum 1/2" overhang

A. BX and GX Series (BX = CBN, GX = Diamond) - 1/4" Shank

BX are all 80/100 grit. GX are as follows: coarse is 100/120 grit, fine is 140/170 grit. Measure 3" long.

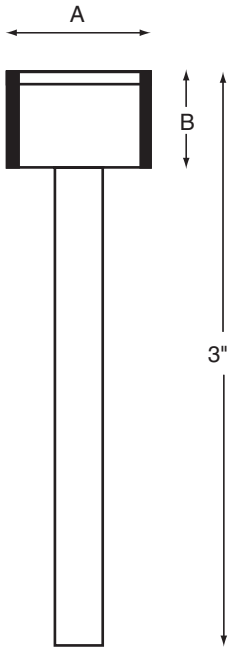

Dimensions		CBN		Diamond				Each
A	B	80/100 BX Series Coarse	Item#	100/120 GX Series Coarse	Item#	140/170 GX Series Fine	Item#	
9/64"	1/4"	BX-141	247-1410	GX-141C	235-3601	GX-141F	235-3600	\$16.10
5/32"	1/4"	BX-156	247-1560	GX-156C	235-3651	GX-156F	235-3650	16.10
3/16"	1/4"	BX-188	247-1880	GX-188C	235-3701	GX-188F	235-3700	16.10
7/32"	1/4"	BX-218	247-2180	GX-218C	235-3751	GX-218F	235-3750	16.10
1/4"	1/8"	BX-250/2	247-2502	GX-250/2C	235-3801	GX-250/2F	235-3800	17.90
1/4"	1/4"	BX-250/4	247-2504	GX-250/4C	235-3851	GX-250/4F	235-3850	17.90
5/16"	1/4"	BX-312/4	247-3124	-	-	GX-312/4F	235-3950	17.90
5/16"	3/8"	BX-312/6	247-3126	GX-312/6C	235-4001	GX-312/6F	235-4000	17.90
3/8"	1/8"	BX-375/2	247-3752	GX-375/2C	235-4051	GX-375/2F	235-4050	23.45
3/8"	1/4"	BX-375/4	247-3754	GX-375/4C	235-4101	GX-375/4F	235-4100	23.45
3/8"	3/8"	BX-375/6	247-3756	GX-375/6C	235-4151	GX-375/6F	235-4150	23.45
1/2"	1/4"	BX-500/4	247-5004	-	-	-	-	27.15
1/2"	3/8"	BX-500/6	247-5006	GX-500/6C	235-4251	GX-500/6F	235-4250	27.00
1/2"	1/2"	BX-500/8	247-5008	GX-500/8C	235-4301	GX-500/8F	235-4300	27.00
3/4"	1/4"	BX-750/4	247-7504	GX-750/4C	235-4351	GX-750/4F	235-4350	40.45
3/4"	1/2"	BX-750/8	247-7508	GX-750/8C	235-4401	GX-750/8F	235-4400	40.45

B. B and G Series (B = CBN, G = Diamond) - 1/8" Shank

Coarse is 140/170 grit, fine is 200/230 grit. Measure 1 3/8" long.

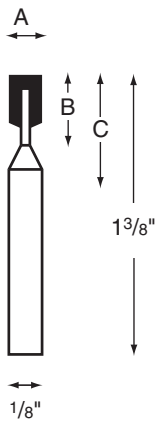

Dimensions			CBN		Each	Diamond				Each
A	B	C	140/170 B Series Coarse	Item#		140/170 Coarse	Item#	200/230 Fine	Item#	
0.02"	1/16"	1/8"	B-20	246-0200	\$10.20	G-20C	235-1451	G-20F	235-1450	\$10.50
0.025"	3/32"	1/4"	B-25	246-0250	10.20	G-25C	235-1501	G-25F	235-1500	10.50
0.03"	3/32"	1/4"	B-30	246-0300	8.85	G-30C	235-1551	G-30F	235-1550	8.85
0.035"	3/32"	1/4"	B-35	246-0350	8.60	G-35C	235-1601	G-35F	235-1600	8.85

Coarse is 100/120 grit, fine is 200/230 grit. Measure 1 3/8" long.

Dimensions			Diamond				Each
A	B	C	100/120 Coarse	Item#	200/230 Fine	Item#	
0.04"	1/8"	3/8"	G-40C	235-1651	G-40F	235-1650	\$8.85
0.045"	1/8"	3/8"	G-45C	235-1701	G-45F	-	8.85
0.05"	1/8"	3/8"	G-50C	235-1751	G-50F	235-1750	8.85
0.055"	1/8"	3/8"	G-55C	235-1801	G-55F	-	8.85
0.06"	1/8"	3/8"	G-60C	235-1851	G-60F	235-1850	8.85
0.07"	5/32"	1/2"	G-70C	235-1901	G-70F	235-1900	8.85
0.08"	5/32"	1/2"	G-80C	235-1951	G-80F	235-1950	8.85
0.09"	5/32"	1/2"	G-90C	235-2001	G-90F	235-2000	8.85
0.1"	5/32"	1/2"	G-100C	235-2051	G-100F	235-2050	8.85
0.11"	5/32"	1/2"	G-110C	235-2101	G-110F	235-2100	8.85
0.125"	5/32"	1/2"	G-125C	235-2151	G-125F	235-2150	8.85

A. BL and GL Series (BL = CBN, GL = Diamond) – 1/8" Shank

BL are all 80/100 grit. GL are as follows: coarse is 100/120 grit, fine is 200/230 grit. Measure 2 1/2" long.

Dimensions A	B	C	CBN		Diamond			Each	
			80/100 Coarse	BL Series Item#	100/120 Coarse	GL Series Item#	200/230 Fine		GL Series Item#
0.04"	1/8"	3/8"	BL-40	246-0400	GL-40C	235-2351	GL-40F	235-2350	\$8.85
0.045"	1/8"	3/8"	BL-45	246-0450	—	—	—	—	8.60
0.05"	1/8"	1"	BL-50/1	246-0501	GL-50/1C	235-2501	—	—	8.60
0.05"	1/8"	3/8"	BL-50	246-0500	GL-50C	235-2451	GL-50F	235-2450	8.85
0.055"	1/8"	3/8"	BL-55	246-0550	—	—	—	—	8.85
0.06"	1/8"	3/8"	BL-60	246-0600	GL-60C	235-2601	GL-60F	235-2600	8.85
0.06"	1/8"	1"	BL-60/1	246-0601	—	—	—	—	10.20
0.07"	5/32"	1/2"	BL-70	246-0700	GL-70C	235-2701	GL-70F	235-2700	8.85
0.07"	5/32"	1"	BL-70/1	246-0701	GL-70/1C	235-2751	GL-70/1F	235-2750	10.40
0.08"	5/32"	1/2"	BL-80	246-0800	GL-80C	235-2801	GL-80F	235-2800	8.85
0.09"	5/32"	1/2"	BL-90	246-0900	GL-90C	235-2901	GL-90F	235-2900	8.85
0.09"	5/32"	1"	BL-90/1	246-0901	—	—	—	—	10.40
0.1"	5/32"	1/2"	BL-100	246-1000	GL-100C	235-3001	GL-100F	235-3000	8.85
0.1"	5/32"	1"	BL 100/1	246-1001	—	—	—	—	10.40
0.11"	5/32"	1/2"	BL-110	246-1100	—	—	—	—	8.85
0.11"	5/32"	1"	BL-110/1	246-1101	—	—	—	—	10.40
0.125"	5/32"	1/2"	BL-125	246-1250	GL-125C	235-3201	GL-125F	235-3200	8.85
0.125"	5/32"	1"	BL-125/1	246-1251	—	—	—	—	10.40
0.141"	1/4"	—	BL-141	246-1410	GL-141C	235-3301	GL-141F	235-3300	10.70
0.156"	1/4"	—	BL-156	246-1561	GL-156C	235-3351	GL-156F	235-3350	10.70
0.188"	1/4"	—	BL-188	246-1880	GL-188C	235-3401	GL-188F	235-3400	15.20
0.218"	1/4"	—	BL-218	246-2180	GL-218C	235-3451	GL-218F	235-3450	15.85
0.25"	1/8"	—	BL-250/2	246-2502	GL-250/2C	235-3501	GL-250/2F	235-3500	16.10
0.25"	1/4"	—	BL-250/4	246-2504	GL-250/4C	235-3551	GL-250/4F	235-3550	16.10

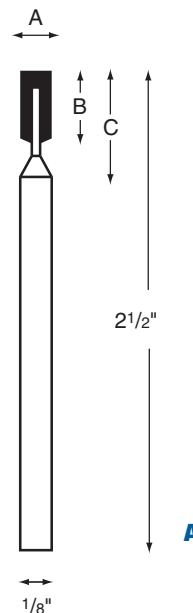

B. SUPER Dresser

Used to dress NSS and SUPER Ceramic Diamond Stones, as well as Cristone stones. Measures 1/8" x 1" x 4" (3 x 25 x 100mm).

Description	Item#	Each
SUPER Dresser	351-0300	\$17.75

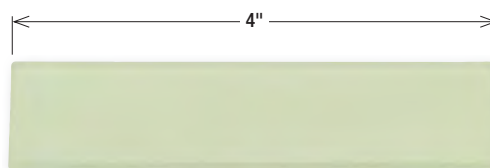

C. Wet Stick Diamond Dresser

Use this dressing stone with water for cleaning diamond points. Measures 2"L x 3/4"W x 1/2" thick.

Description	Item#	Each
Wet Stick	380-1022	\$2.30

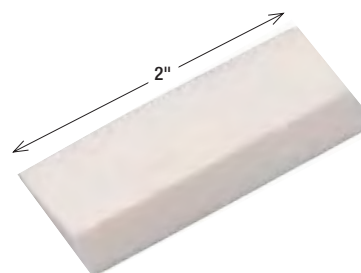

Mounted Diamond Points - 1/8" Shank

Inexpensive yet durable cutting tools with diamond particles nickel-electroplated onto medium carbon steel. Use on carbide, steel, ceramic and wood surfaces. Heads shown actual size. Measure 1 3/4" long with 1/8" shanks. Sold individually and in three sets (see below). Always use with

water or Lubricant/Thinner (see p. 105). All 1–1.5mm diameter points are fine (150 grit); all 2–5mm diameter points are medium (120 grit). Max. operating speeds: 80,000rpm for 1–3mm dia; 60,000rpm for 3.5–4mm dia; 50,000rpm for 5mm dia.

Heads shown actual size.



Style	10A	15A	20A	25A	30A	35A	40A	50A
Dia. x L (mm)	1 x 8	1.5 x 8	2 x 8	2.5 x 8	3 x 10	3.5 x 10	4 x 10	5 x 10
Grit	150	150	120	120	120	120	120	120
Max. RPM	80,000	80,000	80,000	80,000	80,000	60,000	60,000	50,000
Item#	226-1250	226-1251	226-1252	226-1253	226-1254	226-1255	226-1256	226-1257
Each	\$3.50	3.50	3.50	3.50	3.50	3.50	3.75	3.75



Style	20B	30B	50B	15C	20C	25C	30C	35C
Dia. x L (mm)	2	3	5	1.5 x 8	2 x 8	2.5 x 10	3 x 10	3.5 x 10
Grit	120	120	120	150	120	120	120	120
Max. RPM	80,000	80,000	50,000	80,000	80,000	80,000	80,000	60,000
Item#	226-1258	226-1259	226-1260	226-1261	226-1262	226-1263	226-1264	226-1265
Each	\$3.50	3.50	3.75	3.50	3.50	3.50	3.50	3.50



Style	40C	50C	20F	30F	50F	20P	30P
Dia. x L (mm)	4 x 10	5 x 10	2 x 10	3 x 10	5 x 10	2 x 12	3 x 15
Grit	120	120	120	120	120	120	120
Max. RPM	60,000	50,000	80,000	80,000	50,000	80,000	80,000
Item#	226-1266	226-1267	226-1275	226-1276	226-1277	226-1268	226-1269
Each	\$3.75	3.75	3.50	3.50	3.75	3.50	3.50



Style	15R	20R	30R	30S	20T	30T	30V
Dia. x L (mm)	1.5 x 10	2 x 12	3 x 14	3 x 6	2 x 10	3 x 10	3 x 10
Grit	150	120	120	120	120	120	120
Max. RPM	80,000	80,000	80,000	80,000	80,000	80,000	80,000
Item#	226-1270	226-1272	226-1273	226-1274	226-1278	226-1279	226-1280
Each	\$3.50	3.50	3.50	3.50	3.50	3.50	3.50

A. Diamond Mounted Point Sets - 1/8" Shank

Description	Item#	Each
A. 10-Piece Set (styles 10A, 20A, 30A, 30B, 15C, 25C, 20F, 20P, 30P, 20R)	226-1281	\$31.50
20-Piece Set (styles 10A, 15A, 20A, 25A, 30A, 35A, 20B, 30B, 15C, 20C, 25C, 30C, 20F, 30F, 20P, 30P, 15R, 20R, 30R, 20T)	226-1282	63.00
30-Piece Set (one of each style)	226-1283	94.50



Diamond Cutters - 3/32" Shank

Feature medium/fine grit diamond particles electroplated onto stainless steel for unmatched quality and durability. Great for stone carving and cleanup work on glass, ceramics and metals. Cutters shown actual size, although entire shank is not displayed. Measure 1 3/4" long with 3/32"

stainless steel shanks. Sold individually and in three sets (see below). Always use with water or Lubricant/Thinner (see p. 105). Max. operating speed: 30,000rpm.

Heads shown actual size.



Dia. x L (mm)	2 x 1.5	2.7 x 1.5	4 x 1.5	6 x 2	1.5 x 4	2 x 8	3 x 4	7 x 12
Shape	Inverted Cone	Inverted Cone	Inverted Cone	Inverted Cone	Rounded Point	Rounded Point	Cylinder	Rounded Cylinder
Item#	226-1161*	226-1162*	226-1163*	226-1164*	226-1165	226-1166*	226-1167*	226-1168*
Each	\$4.25	4.25	4.50	5.50	4.25	4.25	5.25	12.25

*Items available in 20-Piece Master Set below



Dia. x L (mm)	6 x 7	1.5 x 10	2 x 12	3 x 12	3.5 x 6	1.5 x 10	0.9 x 4	2 x 5
Shape	Cylinder	Point	Rounded Cylinder	Rounded Cylinder	Point	Point	Point	Inverted Cone
Item#	226-1169*	226-1170*	226-1171*	226-1172*	226-1181*	226-1182	226-1183*	226-1184*
Each	\$8.75	4.25	4.25	5.25	6.25	4.25	4.25	4.25

*Items available in 20-Piece Master Set below



Dia. x L (mm)	6 x 10	2.5 x 7	2 x 7	1 x 1	2 x 2	3 x 3	4 x 4	4 x 0.8
Shape	Cylinder	Cylinder	Cylinder	Round	Round	Round	Round	Wheel
Item#	226-1185*	226-1186*	226-1187	226-1188*	226-1189*	226-1190*	226-1191	226-1192*
Each	\$8.75	4.75	4.75	4.25	4.25	4.75	5.50	4.75

*Items available in 20-Piece Master Set below

A, B Diamond Cutter Sets - 3/32" Shank

Description	Item#	Each
A. 12-Piece Set #1 (one each of 226-1161 through 226-1172)	226-1160	\$55.95
12-Piece Set #2 (one each of 226-1181 through 226-1192)	226-1180	49.95
B. 20-Piece Master Set (one each of asterisked above)	226-1159	86.95

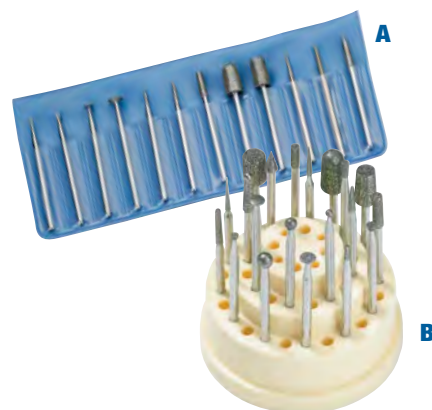

C. Diamond Bit Sets

These economical and functional medium/fine diamond bit sets are a good value for the novice or hobbyist. Can be used on ceramic, glass, metal or stone. Include 20 bits in different shapes and sizes and a handy plastic organizer. Bits measure 1 3/4" (44.5mm) long. Available with 3/32" or 1/8" shanks. Max. operating speed: 30,000rpm. Sold only in the set. Always use with water or Lubricant/thinner (see p. 105).

Description	Shank	Item#	Each
20-Piece Set	3/32"	226-1220	\$8.45
	1/8"	226-1221	8.45





Diamond Wheels and Points - 3/32" Shank

A wide variety of shapes and sizes of diamond wheels convenient for cutting hard metals, ceramics, stones and more. A single layer of diamond is nickel-electroplated to each wheel, ensuring long life when used with only slight pressure. The diamonds are in an exposed position for fast cutting action. All are 140/170 grit with 3/32" shanks. Made in Sweden.

Diameter	Maximum RPM
.020"-.200"	60,000-120,000
.200"-.500"	45,000-60,000
.500"-1.00"	30,000-45,000

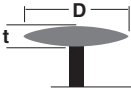
Maximum 1/2" overhang

A		Dimensions (inches)			Item#	Each
		A. Style	D	t		
		DT-109	0.366	0.051	230-2050	\$46.25

B		Dimensions (inches)			Item#	Each
		B. Style	D	t		
		DT-129P	0.248	0.02	230-2850	\$37.75

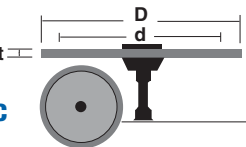
C		Dimensions (inches)			Item#	Each	
		C. Style	D	d			t
		DT-124P	0.602	0.512	0.018	230-2600	\$56.00

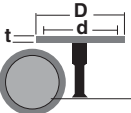
D		Dimensions (inches)			Item#	Each	
		D. Style	D	d			t
			DT-56P	0.342			0.276
	DT-128P	0.354	0.276	0.02	230-2800	46.25	

E		Dimensions (inches)			Item#	Each			
		E. Style	D	t					
			DB-902A	0.051			0.158	230-4050	\$15.00
			DT-95	0.063			0.295	230-1450	17.80
			DT-117	0.094			0.295	230-2450	18.80
	DT-510	0.094	0.394	230-3100	19.85				

F		Dimensions (inches)			Item#	Each	
		F. Style	D	Taper			t
		DT-236	0.287	60°	0.236	230-3000	\$45.00

G		Dimensions (inches)			Item#	Each			
		G. Style	D						
			DB-2/0	0.032				230-3250	\$15.00
			DB-102	0.051				230-3300	15.00
			DB-104	0.067				230-3350	15.00
			DB-105	0.071				230-3400	15.45
			DB-108	0.098				230-3450	15.95
			DT-101	0.118				230-1650	23.95
			DT-119	0.158				230-2550	29.95

H		Dimensions (inches)			Item#	Each
		H. Style	D	t		
			DT-86	0.055		
	DT-100	0.098	0.276	230-1600	18.80	

A-I Diamond Cutters – 3/32" Shank

Feature premium-grade, high-impact-strength industrial diamonds electroplated onto ten different shapes. This process provides a super-abrasive grinding and cutting system. The diamonds protrude from the bond so that only the abrasive crystals are in contact with the workpiece. This greatly reduces frictional heat and thermal distortion of the work surface. The use of a coolant (we recommend Gesswein Stoning and Lubricating Oil—see p. 105) will maximize tool life and be a great aid where minimum heat distortion is required. Max. operating speed: 60,000rpm. All are 150 grit with 3/32" shanks.

Style	Style#	Item#	Each
A. Countersink, 60°	101	226-1010	\$22.60
B. Countersink, 90°	102	226-1020	22.90
C. Ball, 3mm	103	226-1030	23.00
D. Wheel, 6mm x 1mm	104	226-1040	22.90
E. Reamer, 2mm x 1mm taper	105	226-1050	22.60
F. Solid, 1.5mm	106	226-1060	22.60
G. Solid, 2mm	107	226-1070	22.60
H. Core Drill, 2.5mm	109	226-1090	22.60
I. Core Drill, 3mm	110	226-1100	22.60

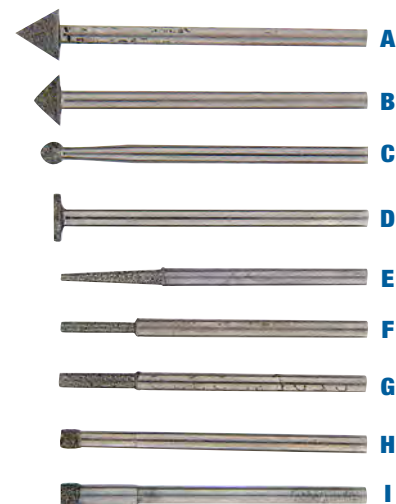

J. Diamond Drilling Compound

Used with Diamond Lapp Drills (below) to drill holes in stones. Base in which diamond is suspended holds particles in place until they become embedded in face of drill.

Size	Item#	Each
1g Syringe	216-0450	\$8.35



K-N Diamond Lapp Drills

Hollow brass drills used with Diamond Drilling Compound (above) to make holes in stones without cracking them. Gently apply drill to surface on which diamond compound has been applied. Use slow speed and let up on drill frequently. Makes perfect holes in onyx, ruby, etc. Due to the 3.75mm shank, use with #30 handpiece. Must be used with Lubricant/Thinner.

Diameter	Item#	Each
K. 1.5mm	813-0100	\$4.75
L. 2mm	813-0200	4.75
M. 2.5mm	813-0300	4.75
N. 3mm	813-0400	4.75
Set of all 4	813-0500	18.25



O, P Sintered Diamond Cut-Off Discs

These discs easily cut carbon fiber, carbide, steels, acrylics and other hard-to-cut materials. The 7/8" disc is sintered diamond throughout; the 1 1/4" disc is sintered diamond on outer edge only (approximately 1/8"). Each has 1/16" arbor hole. Max. operating speed: 20,000rpm.

Dia. x Thickness*	Item#	Each
O. 7/8" x .007"	845-1080	\$35.95
P. 1 1/4" x .040"	845-1085	42.95

*Thickness of each disc may vary slightly.



Q. Diamond Disc Set – 1/8" Shank

Electroplated diamond discs, all medium grit for cutting or sanding stones and glass. Discs measure 1 3/16" (20.25mm) dia. x 0.033" (.84mm) thick x 1/8" AH and have diamond electroplated on both sides. Sold individually or in a 6-piece kit, five discs and a 1/8" mandrel. Max. operating speed: 30,000rpm.

Description	Item#	Each
Diamond Disc 6 pc. Set	226-1225	\$13.95
Diamond Disc	226-1226	3.35





High-Speed Mini Diamond Points - 1/16" Shank

Premium points for use in high-speed, air-driven turbo handpieces with maximum operating speeds up to 80,000rpm. Feature diamond particles electroplated onto surgical-grade steel. Points shown at actual size, although entire shank is not displayed. Measure an average of 3/4" (20mm) long with 1/16" shanks. Sold individually and in sets of 12 and 24. Always use with water or Lubricant/Thinner (see p. 105). Choose from coarse (120 grit) and fine (260 grit). Mount in collet-type handpieces with one of our reducing collets (see below).

Shown actual size



Grit	Item#	226-1602*	226-1603	226-1604*	226-1605*	226-1606*	226-1607
120	Item#	226-1602*	226-1603	226-1604*	226-1605*	226-1606*	226-1607
260	Item#	226-1632*	226-1633	226-1634*	226-1635*	226-1636*	226-1637
Each		\$2.95	2.95	2.95	2.95	2.95	2.95

*Items available in 12-Piece Set below.

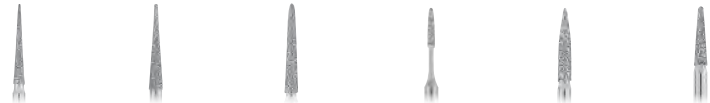

Grit	Item#	226-1608*	226-1609	226-1610*	226-1611	226-1612	226-1613
120	Item#	226-1608*	226-1609	226-1610*	226-1611	226-1612	226-1613
260	Item#	226-1638*	226-1639	226-1640*	226-1641	226-1642	226-1643
Each		\$2.95	2.95	2.95	2.95	2.95	2.95

*Items available in 12-Piece Set below.



Grit	Item#	226-1614	226-1615	226-1616*	226-1617	226-1618*	226-1619
120	Item#	226-1614	226-1615	226-1616*	226-1617	226-1618*	226-1619
260	Item#	226-1644	226-1645	226-1646*	226-1647	226-1648*	226-1649
Each		\$2.95	2.95	2.95	2.95	2.95	2.95

*Items available in 12-Piece Set below.



Grit	Item#	226-1620*	226-1621	226-1622*	226-1623*	226-1624	226-1625*
120	Item#	226-1620*	226-1621	226-1622*	226-1623*	226-1624	226-1625*
260	Item#	226-1650*	226-1651	226-1652*	226-1653*	226-1654	226-1655*
Each		\$2.95	2.95	2.95	2.95	2.95	2.95

*Items available in 12-Piece Set below.



A



B

A, B High-Speed Mini Diamond Point Sets - 1/16" Shank

Description	Coarse 120 Grit Item#	Fine 260 Grit Item#	Each
A. 12-Piece Set (asterisked above)	226-1601	226-1631	\$26.95
B. 24-Piece Set (one each of above)	226-1600	226-1630	53.95

C-E Reducing Collets

Instantly converts your 1/8", 3mm or 3/32" collet to hold a 1/16" tool shank. Simply slip reducing collet into collet on your rotary handpiece to use 1/16" shanked tools. Make sure both the reducing collet and the tool shank are fully inserted into the handpiece collet. Stainless steel.

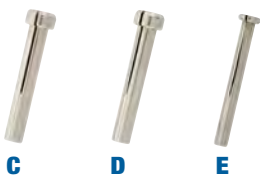

Size	Item#	Each
C. 1/8" to 1/16"	816-1502	\$14.90
D. 3mm to 1/16"	816-1505	14.90
E. 3/32" to 1/16"	816-1503	14.90

Six-piece minimum; please order in multiples of six.

Diamond Grinding Wheels - 150 grit, 100 concentration

Feature man-made diamond, more consistent in shape than natural diamond, for sharp, even cutting action, durability and long life. Resin-bonded to produce a self-sharpening effect and even grit distribution. Can be used wet or dry on carbide, ceramic, glass, welds, quartz and other hard, brittle and short chipping materials.



A. Shape 11V9D

Diameter (D)	Grinding Surface (U)	Diamond Depth (X)	Item#	Each
3.75"	3/8"	1/16"	245-1020	\$98.05
3.75"	3/8"	1/8"	245-1050	117.60
5"	7/16"	1/16"	245-1120	130.20
5"	7/16"	1/8"	245-1150	168.00

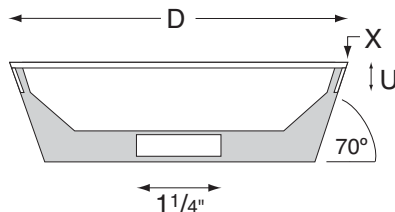

A

B. Shape 6A2C

Diameter	Grinding Surface	Diamond Depth	Item#	Each
6"	3/4"	1/16"	245-1200	\$147.00

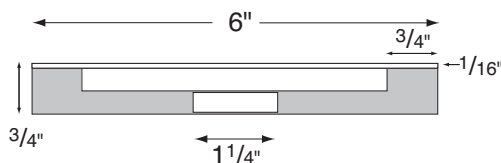

B

C. Shape 11A2

Hole (H)	Grinding Surface (W)	Diamond Depth (X)	Item#	Each
1 1/4"	3/8"	1/16"	245-2150	\$120.75
1 1/4"	3/8"	1/8"	245-2160	128.10
20mm*	3/8"	1/16"	245-2155	104.60
20mm*	3/8"	1/8"	245-2165	135.85

*20mm hole size used for Deckel machines.

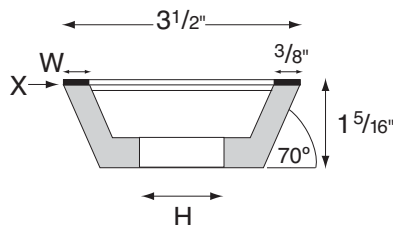

C

D. Shape 12A2

Diameter	Grinding Surface	Diamond Depth (X)	Item#	Each
6"	3/16"	1/16"	245-1250	\$199.00
6"	3/16"	1/8"	245-1255	143.85

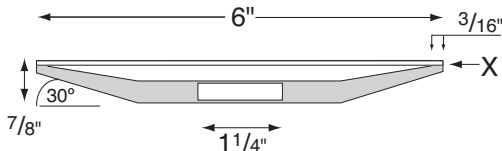

D

E. Shape 1A1

Diameter	Grinding Surface	Diamond Depth	Item#	Each
6"	1/4"	1/8"	245-1450	\$110.25

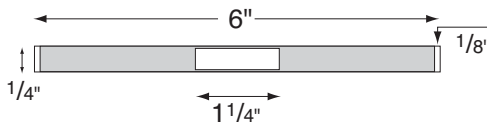

E

F. Shape

Diameter	Grinding Surface	Diamond Depth	Item#	Each
6"	0.035"	.028"	245-1620	\$93.75

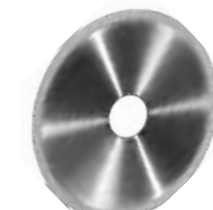
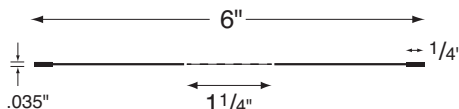

F

Single Point Diamond Tools

For truing and dressing abrasive wheels where precision, close-tolerance, high-finish grinding is required. Straight face, radius and form wheel dressing operations can be performed with accuracy and economy. All natural diamond.

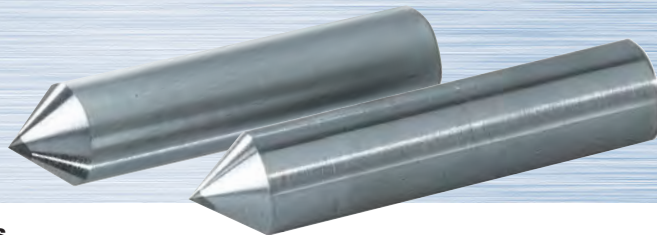

A. Diamond Cone Points

Used for accurate wheel forming.

Style	Dia. x L	Carat Size	Angle (A)	Item#	Each
CP1	3/8" x 2"	0.25	60°	220-2160	\$104.95
CP1	3/8" x 2"	0.25	75°	220-2175	72.30
CP1	3/8" x 2"	0.25	90°	220-2190	68.80
CP2	3/8" x 2"	0.3	60°	220-2260	106.05
CP2	3/8" x 2"	0.3	75°	220-2275	93.80
CP2	3/8" x 2"	0.3	90°	220-2290	77.35
CP3	3/8" x 2"	0.5	60°	220-2360	144.90
CP3	3/8" x 2"	0.5	75°	220-2375	122.85
CP3	3/8" x 2"	0.5	90°	220-2390	166.95

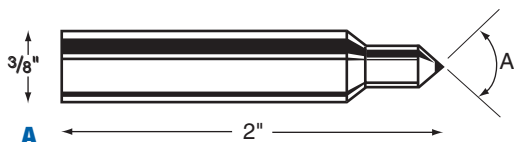

B. Diamond Chisel-Edge Points

Used for accurate wheel forming.

Style	Dia. x L	Carat Size	Angle (A)	Item#	Each
CE1	3/8" x 2"	0.25	60°	220-3160	\$82.70
CE1	3/8" x 2"	0.25	75°	220-3175	77.60
CE1	3/8" x 2"	0.25	90°	220-3190	75.20
CE2	3/8" x 2"	0.3	60°	220-3260	121.40
CE2	3/8" x 2"	0.3	75°	220-3275	106.05
CE2	3/8" x 2"	0.3	90°	220-3290	96.60
CE3	3/8" x 2"	0.5	60°	220-3360	172.20
CE3	3/8" x 2"	0.5	75°	220-3375	153.30
CE3	3/8" x 2"	0.5	90°	220-3390	134.40

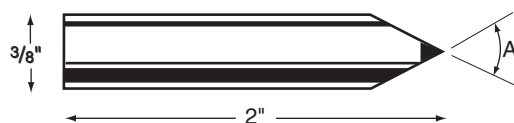

Side View

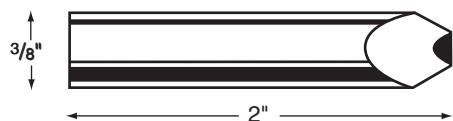

Top View

C. Regular and Select Point Diamond Dressers

Two qualities of diamonds are offered: the select-style stones have four to six usable points, and the regular-style stones have two to three usable points. Both styles can be reset. REG = regular diamond, SEL = select diamond.

Style	Dia. x L	Carat Size	Item#	Each
1REG	3/8" x 2"	0.25	220-1100	\$30.75
1SEL	3/8" x 2"	0.25	220-1150	51.15
2REG	3/8" x 2"	0.35	220-1200	45.85
2SEL	3/8" x 2"	0.35	220-1250	62.50
3REG	3/8" x 2"	0.5	220-1300	60.65
3SEL	3/8" x 2"	0.5	220-1350	85.50
4REG	3/8" x 2"	0.6	220-1400	80.75
4SEL	3/8" x 2"	0.6	220-1450	111.90

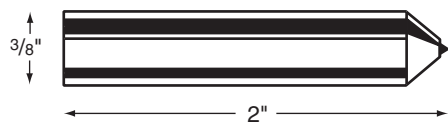

D. Expendable Diamond Dressers

Throwaway economical dressing tools. Each has a natural diamond securely mounted so its sharpest point is exposed.

Style	Dia. x L	Carat Size	Item#	EACH Prices	
				1-11	12+
E41	1/4" x 7/8"	0.25	220-0050	\$17.00	\$16.15
E62	3/8" x 1 7/8"	0.25	220-0100	17.00	16.15
66	3/8" x 6"	0.25	220-1860	17.40	16.53
E72	7/16" x 1 7/8"	0.25	220-0150	17.00	16.15
E82	1/2" x 1 7/8"	0.25	220-0200	17.05	16.20



A. Cluster Diamond Dresser CL-18

A universal cluster tool for small surface and cylindrical grinders. Contains 18 diamonds. Six are exposed for immediate use; others appear as dresser wears down.

Style	Dia. x L	Item#	Each
CL-18	7/16" x 2"	220-4150	\$55.45

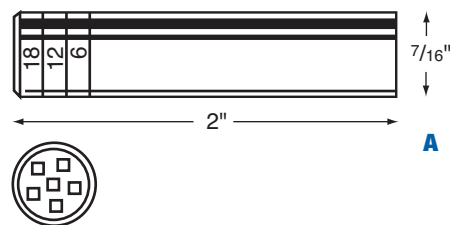

B. Heavy-Duty Cluster Diamond Dresser HD-15

For roughing out or for commercial finish. Nib is loaded with 15 diamonds. Five are exposed for immediate use; others appear as dresser wears down.

Style	Dia. x L	Item#	Each
HD-15	7/16" x 2"	220-4200	\$82.85

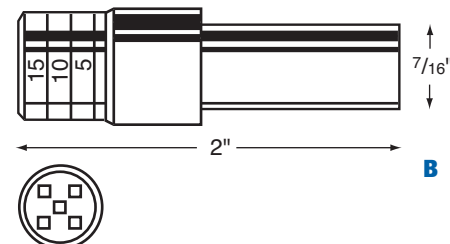

C. Cluster Diamond Dresser CB-24

A bullet-nose carbide bond impregnated dresser randomly set throughout with 24 small diamonds for rough dressing operations on 36 to 60 grit abrasive wheels.

Style	Dia. x L	Item#	Each
CB-24	7/16" x 2"	220-4100	\$53.50

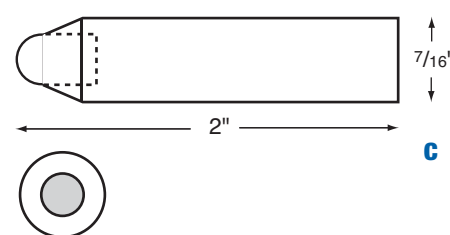

D. Cluster Diamond Dresser PG-4R

A flat-faced nickel alloy matrix dresser containing many particles of diamond sand spaced precisely for dressing operations on 80 grit or finer abrasive wheels.

Style	Dia. x L	Item#	Each
PG-4R	7/16" x 2"	220-4250	\$51.90

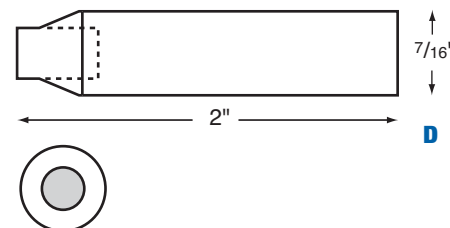

E. Diamond Phono Points

High-quality miniature points with full-size, long-lasting diamonds for accurate wheel forming and intricate, small radius dressing.

Size	Dia. x L	Angle (A)	Item#	Each
Large	1/8" x 1"	60°	220-0550	\$8.20
Large	1/8" x 1"	75°	220-0600	8.30
Large	1/8" x 1"	90°	220-0650	6.60

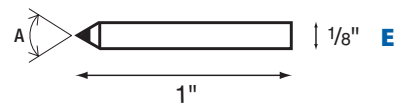

F. Offhand Wheel Dresser

Has 35 to 40 exposed diamond points set in a carbide matrix. Sturdy construction with comfortable, sure-grip plastic handle. Measures 9 3/4" long.

Description	Item#	Each
Wheel Dresser	220-4050	\$77.70



SUPRA® "MM" and "MKM" Brushes

Gesswein miniature mandrel-mounted wheel and cup brushes are made with solid steel ring construction for durability. Brush filaments are permanently anchored in the solid steel ring and uniformly distributed for even wear. Great for flat, curved, small and hard-to-reach surfaces.

Hard and soft bristle types are made of animal hair. Wire brushes constructed of .003" crimped brass, .003" or .005" crimped steel or .005" crimped stainless steel. Maximum operating speed: 15,000rpm. Sold in full dozens; select bristles also available individually. **Items with asterisk also available on 3mm shanks.** Made in USA.



SUPRA® "MM" Bristle Wheel Brushes

Styles 701D, 711D, 702D and 712D each contain two rows of upright bristles. D = Double.



Style, Bristle Type	710, Hard	700, Soft	711, Hard/Gray	711, Hard/Black	711D, Hard	701, Soft
Shank	3/32"	3/32"	3/32"	3/32"	3/32"	3/32"
Dia. (Trim Length)	9/16" (1/8")	9/16" (1/8")	3/4" (3/16")	3/4" (3/16")	3/4" (3/16")	3/4" (3/16")
Item#	112-7100	112-7000	112-7110	112-7109	112-7111	112-7010
DOZEN 1-11	\$9.30	10.80	7.55	6.50	52.80	8.25
DOZEN 12+	\$7.75	9.00	6.29	5.42	44.00	6.87

111-7111 \$5.60/EACH



Style, Bristle Type	701D, Soft	712D, Hard	702D, Soft	713, Hard	703, Soft
Shank	3/32"	1/8"	1/8"	1/8"*	1/8"*
Dia. (Trim Length)	3/4" (3/16")	3/4" (3/16")	3/4" (3/16")	3/4" (3/16")	3/4" (3/16")
Item#	112-7011	112-7120	112-7020	112-7130	112-7030
DOZEN 1-11	\$56.20	48.75	50.50	12.25	14.85
DOZEN 12+	\$46.83	40.62	42.08	10.21	12.37

111-7011 \$5.60/EACH

*Styles also available on 3mm shanks

A, B SUPRA® "MKM" Mounted Wheel Brushes – 1/8" Shank

Feature hard, evenly distributed, converging animal hair bristles mounted on 1/8" shanks. Available in two styles: 1" diameter standard thickness and heavy-duty 1 1/4" diameter double thickness.

Style, Bristle Type	A. Hard	Soft	B. Hard, Double Thick
Shank	1/8"	1/8"	1/8"
Dia. (Trim Length)	1" (1/4")	1" (1/4")	1 1/4" (3/8")
Item#	112-5100	112-5090	112-5200
DOZEN 1-11	\$23.30	29.95	70.85
DOZEN 12+	\$19.42	24.96	59.04

111-5200 \$7.10/EACH

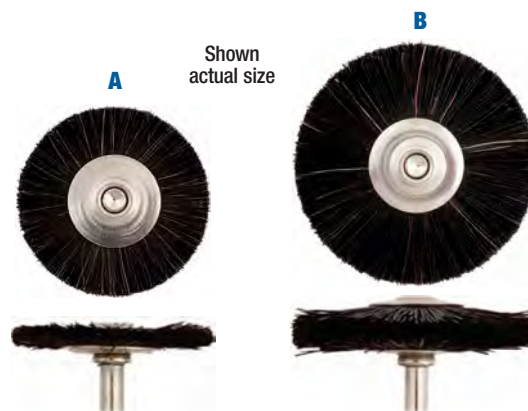

SUPRA® "MM" Wire Wheel Brushes

All made of crimped wire. Styles 722 and 732 each contain two rows of upright wire. D = Double.

Shown
actual size



Style, Bristle Type	721, Brass .003"	731, Steel .003"	731, Stainless .005"	722D, Brass .003"	732D, Steel .003"	723, Brass .003"	733, Steel .003"
Shank	3/32"	3/32"	1/8"*	1/8"	1/8"	1/8"*	1/8"*
Dia. (Trim Length)	3/4" (3/16")	3/4" (3/16")	3/4" (3/16")	3/4" (3/16")	3/4" (3/16")	3/4" (3/16")	3/4" (3/16")
Item#	112-7210	112-7310	112-7315	112-7220	112-7320	112-7230	112-7330
DOZEN 1-11	\$26.95	27.45	40.20	85.70	81.20	27.50	27.65
DOZEN 12+	\$22.46	22.87	33.50	71.41	67.66	22.92	23.04

*Styles also available on 3mm shanks

111-7315 \$4.00/EACH 111-7220 \$8.75/EACH 111-7320 \$8.10/EACH

Style, Bristle Type	734, Steel .005"	734, Stainless .005"
Shank	1/8"*	1/8"*
Dia. (Trim Length)	1" (5/8")	1" (5/8")
Item#	112-7340	112-5115
DOZEN 1-11	\$32.45	40.75
DOZEN 12+	\$27.04	33.96

*Styles also available on 3mm shanks

**SUPRA® "MM" Bristle Cup Brushes**

Hollow center cups will hold compounds when polishing vertically. This construction allows better control of brush movement.

Shown
actual size



Style, Bristle Type	760, Hard	761, Hard	751, Soft	762, Hard	752, Soft	764, Hard	754, Soft
Shank	3/32"	3/32"	3/32"	1/8"*	1/8"*	1/8"*	1/8"*
Dia. (Trim Length)	1/2" (5/32")	9/16" (1/4")	9/16" (1/4")	9/16" (1/4")	9/16" (1/4")	1" (7/16")	1" (7/16")
Item#	112-7600	112-7610	112-7510	112-7620	112-7520	112-7640	112-7540
DOZEN 1-11	\$43.00	30.45	30.40	11.85	13.30	51.45	58.30
DOZEN 12+	\$35.83	25.37	25.33	9.87	11.08	42.87	48.58

*Styles also available on 3mm shanks

SUPRA® "MM" Wire Cup Brushes

All made of .003" diameter crimped wire except 112-7825 which is made of .005" diameter crimped wire.

Shown
actual size



Style, Bristle Type	782, Steel .003"	782, Stainless .005"	771, Brass .003"	772, Brass .003"
Shank	1/8"*	1/8"*	3/32"	1/8"*
Dia. (Trim Length)	5/8" (1/4")	5/8" (1/4")	9/16" (1/4")	9/16" (1/4")
Item#	112-7820	112-7825	112-7710	112-7720
DOZEN 1-11	\$31.60	87.95	36.20	32.65
DOZEN 12+	\$26.33	73.29	30.17	27.21

*Styles also available on 3mm shanks

**A, B SUPRA® Brush Sets**

Twelve of our most popular Supra brushes.

Description	Shank	Item#	Each
A. Set #1	3/32"	112-8000	\$16.50
B. Set #2	1/8"	112-8003	21.90

SUPRA® "ME" Brushes

Gesswein miniature mandrel-mounted end brushes are available in a wide variety of sizes. One-piece ferrule construction ensures that the stem and ferrule will not become separated during use. Plastic ferrules are available to prevent scratching when used for interior polishing work. In the table below, please note that those brushes with a style number containing the letter "P" have plastic ferrules, which are slightly larger than stated diameter. All other ferrules are metal. Hard and soft bristle types are made of animal hair. Nylon end brushes consist of 0.018" strands of 500 grit silicon carbide. Our .003" wire end brushes are straight while .005" diameter wire end brushes are crimped. Maximum operating speed: 15,000rpm. **Items with asterisk also available on 3mm shanks.** Made in USA.



Made in
the USA



SUPRA® "ME" Bristle and Nylon End Brushes

Shown
actual size



Style, Bristle Type	864, Hard	860, Hard	860 ³ / ₈ , Hard	860 ¹ / ₂ , Hard	850, Soft	861, Hard	851, Soft	859, Hard	859PSC, Hard	859P, Hard
Shank	³ / ₃₂ "	³ / ₃₂ "	³ / ₃₂ "	³ / ₃₂ "	³ / ₃₂ "	³ / ₃₂ "	³ / ₃₂ "	¹ / ₈ "*	¹ / ₈ "	¹ / ₈ "
Trim Length.	¹ / ₄ "	¹ / ₄ "	³ / ₈ "	¹ / ₂ "	¹ / ₄ "	³ / ₈ "	³ / ₈ "	¹ / ₄ "	³ / ₁₆ "	¹ / ₄ "
Ferrule Dia.	⁵ / ₃₂ "	³ / ₁₆ "	³ / ₁₆ "	³ / ₁₆ "	³ / ₁₆ "	¹ / ₄ "	¹ / ₄ "	³ / ₁₆ "	³ / ₁₆ "	³ / ₁₆ "
Item#	110-8640	110-8600	110-8603	110-8605	110-8500	110-8610	110-8510	110-8590	111-8593	111-8590
DOZEN 1-11	\$16.10	9.70	10.75	11.00	28.90	26.65	32.95	10.40	12.00	12.00
DOZEN 12+	\$13.42	8.08	8.96	9.17	24.08	22.21	27.46	8.67	10.00	10.00

Shown
actual size



Style, Bristle Type	849, Soft	849P, Soft	862SC, Hard	862PSC, Hard	862, Hard	862P, Hard	862 ¹ / ₂ , Hard	862 ³ / ₄ , Hard	852, Soft	852P, Soft	962SC, Hard	962, Hard
Shank	¹ / ₈ "*	¹ / ₈ "	¹ / ₈ "	¹ / ₈ "	¹ / ₈ "*	¹ / ₈ "	¹ / ₈ "	¹ / ₈ "	¹ / ₈ "*	¹ / ₈ "	¹ / ₈ "	¹ / ₈ "*
Trim Length.	¹ / ₄ "	¹ / ₄ "	³ / ₁₆ "	³ / ₁₆ "	³ / ₈ "	³ / ₈ "	¹ / ₂ "	³ / ₄ "	³ / ₈ "	³ / ₈ "	³ / ₁₆ "	⁹ / ₁₆ "
Ferrule Dia.	³ / ₁₆ "	³ / ₁₆ "	¹ / ₄ "	¹ / ₄ "	¹ / ₄ "	¹ / ₄ "	¹ / ₄ "	¹ / ₄ "	¹ / ₄ "	¹ / ₄ "	⁵ / ₁₆ "	⁵ / ₁₆ "
Item#	110-8490	111-8490	110-8622	111-8622	110-8620	111-8620	110-8625	110-8627	110-8520	111-8520	110-9623	110-9620
DOZEN 1-11	\$15.60	24.10	28.55	18.50	28.55	18.50	20.20	27.35	32.95	28.95	25.40	25.40
DOZEN 12+	\$13.00	20.08	23.79	15.42	23.79	15.42	16.83	22.79	27.46	24.12	21.17	21.17

SUPRA® "ME" Wire End Brushes

Shown
actual size



Style, Bristle Type	870, Brass	880, Steel	869, Brass	879, Steel	879, Stainless	872, Brass	882, Steel	882, Stainless	972, Brass	982, Steel
Shank	³ / ₃₂ "	³ / ₃₂ "	¹ / ₈ "*	¹ / ₈ "*	¹ / ₈ "	¹ / ₈ "*	¹ / ₈ "*	¹ / ₈ "*	¹ / ₈ "	¹ / ₈ "
Wire Diameter	.003"	.003"	.003"	.003"	.003"	.005"	.005"	.005"	.005"	.005"
Trim Length.	¹ / ₄ "	¹ / ₄ "	¹ / ₄ "	¹ / ₄ "	¹ / ₄ "	⁷ / ₁₆ "	⁷ / ₁₆ "	⁷ / ₁₆ "	⁹ / ₁₆ "	⁹ / ₁₆ "
Ferrule Dia.	³ / ₁₆ "	³ / ₁₆ "	³ / ₁₆ "	³ / ₁₆ "	³ / ₁₆ "	¹ / ₄ "	¹ / ₄ "	¹ / ₄ "	⁵ / ₁₆ "	⁵ / ₁₆ "
Item#	110-8700	110-8800	110-8690	110-8790	110-8795	110-8720	110-8820	110-8823	110-9720	110-9820
DOZEN 1-11	\$18.55	17.45	18.55	18.65	38.05	47.25	44.45	58.35	48.90	51.35
DOZEN 12+	\$15.46	14.54	15.46	15.54	31.71	39.37	37.04	48.62	40.75	42.79

*Styles also available on 3mm shanks

SUPRA® “MK”® Bristle Wheel Brushes



The World’s Best Polishing Brushes!

Our most popular unmounted wheel brushes. Feature solid-ring construction for great durability. Contain soft white goat hair bristles, double thick, ideal for applying rouge and compounds. Designed to run true. Mount on our unbreakable SUPRA “MK” Plastic Spindles in seconds, helping speed up production. Can also be mounted on mandrels #20 and #22 (see pp. 584-585 for mandrel specifications). Have brass hubs with 1/8" arbor holes. Maximum operating speed: 15,000rpm. Made in USA.



A-C SUPRA® “MK”® Bristle Wheel Brushes – 1/8" Arbor Hole

Bristle Type	Trim Length	Wheel Dia.	Item#	DOZEN Prices			
				1-11	12-35	36-71	72+
A. Hard	1/8"	5/8"	113-0100	\$6.45	\$5.37	\$5.10	\$4.84
Medium	1/8"	5/8"	113-0150	6.45	5.37	5.10	4.84
Soft	1/8"	5/8"	113-0250	7.35	6.12	5.81	5.51
B. Hard	3/16"	3/4"	113-0400	6.45	5.37	5.10	4.84
Medium	3/16"	3/4"	113-0500	6.45	5.37	5.10	4.84
Soft	3/16"	3/4"	113-0600	6.45	5.37	5.10	4.84
C. Hard	1/4"	1"	113-0800	7.20	6.00	5.69	5.40
Medium	1/4"	1"	113-0850	7.20	6.00	5.69	5.40
Soft	1/4"	1"	113-0950	8.25	6.87	6.52	6.19



D, E Plastic Spindles for SUPRA® “MK”® Wheel Brushes

Threaded steel mandrels mounted in hard plastic spindle bases. Accommodate all SUPRA “MK” Brushes. Fit on tapered spindles. Allow easy mounting of brushes—require only slight pressure and a quarter-turn. Choose for right or left motor shaft.

Description	Item#	Each
D. White Spindle for Right Shaft	840-4950	\$10.30
E. Black Spindle for Left Shaft	840-4900	10.30

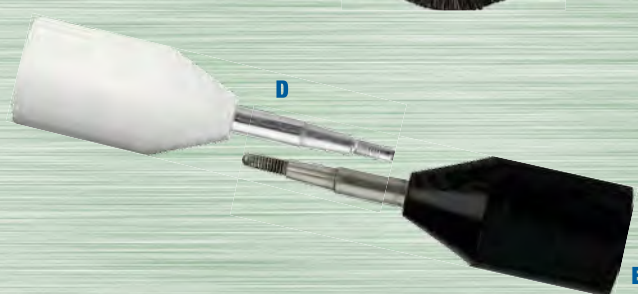

EL-192 Wheel Brush Aluminum Center – 1/4" Arbor Hole

An absolutely unique and extremely popular brush used in many industries. Made of black stiff horsehair (originally 9" long) with bristles converging, securely mounted to a steel hub. The aluminum center measures 1/4" diameter and the EL-192 can be used with a mandrel or with a tapered spindle. This brush is preferred by jewelers, mold polishers, sculptors and metal working factories. Maximum operating speed: 3,450rpm. Made in USA.

F. Wheel Brush, EL-192

Style	Bristle Type	Trim Length	Wheel Dia.	Rows	Item#	EACH Prices		
						1-11	12-143	144+
EL-192	Hard Horsehair	9/16"	2"	2	114-5192	\$9.55	\$7.96	\$6.69



G, H Tampico/Nylon End Brushes, 1/4" Shank

Heavy duty 1/4" shank end brushes for high diamond polishing on larger jobs. 1" diameter helps the polishing get done faster. Available in Tampico for more aggressive polishing and Nylon for higher polishing such as 6 or 3 micron diamond. Brush length is trimmed to the perfect length of 0.75", which eliminates the need for self trimming and provides excellent stability. Plastic rings also provide additional support when applying pressure. Maximum Operating speed: 10,000rpm. Made in USA.

Description	Item#	Each
G. Tampico	114-5400	\$11.95
H. Nylon	114-5405	11.95



I. Bristle End Brush

Small diameter brush made of hard Chungking bristles. Use with or without polishing compounds to clean or polish. Has 3/16" arbor holes for use on tapered spindles. Maximum operating speed: 3,500rpm. Made in USA. Larger sizes also available, please see website.

Bristle Type	Trim Length	Knots	Item#	EACH Prices	
				1-11	12+
I. Hard	7/8"	7	115-3007	\$3.60	\$3.06

Cocker-Weber Brushes

The Cocker-Weber company has been manufacturing brushes in the United States for over 100 years. They are the world's leader in quality and value, unmatched! The hard wood hubs are cured and resist breaking resulting in long life and strong bristle retention. The plastic unbreakable hubs are more narrow and impervious to water or other liquids.

Made in the USA



A. Superior Quality Wood Hub Wheel Brushes

Our premium, highest quality wood hub brushes are clearly superior to all others. They are made with the very best hard Chungking (animal hair) bristles securely mounted in hard wood hubs. Those with two or more rows of bristles are the converging type for faster action. All have 1/4" arbor holes. Recommended for use on tapered spindles. Maximum operating speed: 10,000 RPM. Made in USA.

Hub Dia.	Style	Type	Trim Length	Rows of Bristles	Overall Dia.	Item#	EACH Prices			
							1-11	12-71	72-143	144+
1 1/4"	53	5A	5/8"	1	2 1/2"	115-1530	\$1.50	\$1.20	\$1.13	\$1.05
1 1/4"	54SC	6C	3/8"	2	2"	115-1540	1.90	1.52	1.43	1.33
1 1/4"	55	6A	5/8"	2	2 1/2"	115-1550	2.00	1.60	1.50	1.40
1 1/4"	56	7A	5/8"	3	2 1/2"	115-1560	2.55	2.04	1.91	1.79
1 1/4"	57	8A	5/8"	4	2 1/2"	115-1570	3.65	2.92	2.74	2.56
1 1/2"	62	10	3/4"	2	3"	115-1620	2.65	2.12	1.99	1.86
1 1/2"	63	11	3/4"	3	3"	115-1630	3.45	2.76	2.59	2.42
1 1/2"	64	12	3/4"	4	3"	115-1640	4.95	3.96	3.71	3.47
1 7/8"	70SC	1C	3/8"	1	2 5/8"	115-1700	1.88	1.50	1.41	1.32
1 7/8"	71	1A	5/8"	1	3 1/8"	115-1710	1.88	1.50	1.41	1.32
1 7/8"	72SC	2C	3/8"	2	2 5/8"	115-1720	2.60	2.08	1.95	1.82
1 7/8"	73	2A	5/8"	2	3 1/8"	115-1730	2.45	1.96	1.84	1.72
1 7/8"	73SC	2B	1/2"	2	2 7/8"	115-1732	2.60	2.08	1.95	1.82

SC stands for short cut bristles, which give more aggressive brushing action.

B. Standard Quality Wood Hub Wheel Brushes

The Economy version of Cocker-Weber brushes are marked with a black imprint. They are made with very good quality Chungking bristles, securely mounted in the same high quality wood hubs and are almost as stiff as our Premium type. Those with two rows of bristles are the converging type for faster action. All have 1/4" arbor holes and are recommended for tapered spindles. Maximum operating speed: 10,000 RPM. Made in USA.

Hub Dia.	Style	Type	Trim Length	Rows of Bristles	Overall Dia.	Item#	12pc	EACH Prices		
								12-60	72-132	144+
1 1/4"	54E SC	6C	3/8"	2	2"	115-1800	\$1.55	\$1.40	\$1.24	
1 7/8"	70E SC	1C	3/8"	1	2 5/8"	115-1805	1.30	1.17	1.04	
1 7/8"	72E SC	2C	3/8"	2	2 5/8"	115-1810	1.80	1.62	1.44	
1 7/8"	73E	2A	5/8"	2	3 1/8"	115-1815	1.80	1.62	1.44	
1 7/8"	73E SC	2B	1/2"	2	3"	115-1820	1.80	1.62	1.44	

SC stands for short cut bristles, which give more aggressive brushing action.

12pc Twelve-piece minimum; please order in multiples of 12.

C-F Plastic Hub Superior Quality Wheel Brushes

Consist of extra-hard, premium quality Chungking bristles and are made by Cocker-Weber. Mounted on narrow, unbreakable plastic hubs. Bristles converge especially well eliminating the need for burn-in. All have 1/2" thick hubs with 1/4" arbor holes and recommended for use with tapered spindles. Maximum operating speed: 10,000 RPM.

Hub Dia.	Style	Type	Trim Length	Rows of Bristles	Overall Dia.	Item#	EACH Prices			
							1-11	12-71	72-143	144+
C. 1 1/4"	54P SC	6PC	3/8"	2	2"	115-1541	\$2.75	\$2.20	\$2.06	\$1.93
D. 1 1/4"	55P	6PA	5/8"	2	2 1/2"	115-1551	2.75	2.20	2.06	1.93
E. 2"	72P SC	2PC	3/8"	2	2 5/8"	115-1721	3.15	2.52	2.36	2.21
F. 2"	73P	2PA	5/8"	2	3 1/8"	115-1731	3.05	2.44	2.29	2.14

SC stands for short cut bristles, which give more aggressive brushing action.

Safety Recommendations

For safe operation of motor-driven brushes, comply with the Safety Standards of the Industrial Division of the American Brush Manufacturers Association and of the American National Standards Institute: ANSI B165.1-1991, "Power-Driven Brushing Tools—Safety Requirements."

A-C Wire Scratch Wheel Brushes – .003" diameter crimped wire

This superior construction packs much more wire into each brush, which gives faster action, and longer life when compared to wood hub 'tufted' brushes. Synthetic polymer centers (2203B has an aluminum center), ensure secure retention on tapered spindles. Ideal for cleaning, light deburring and imparting a fine satin finish on nonferrous metals such as gold and silver. Use brass on yellow metals, others on white metals. All have 1/4" arbor holes. Maximum operating speed: 6,000rpm (4,000rpm for 4403B). Made in USA.

Style	.003" Wire Type	Trim Length	Wheel Dia.	Rows	Item#	EACH Prices	
						1-11	12+
2203B	Brass	3/4"	2"	2	116-2203	\$21.90	\$18.62
A. 3203B	Brass	1"	3"	2	116-3203	23.05	19.59
B. 3203S	Steel	1"	3"	2	117-3203	21.45	18.23
C. 3203NS	Nickel Silver	1"	3"	2	118-3203	22.00	18.70
3403B	Brass	1"	3"	4	116-3403	50.50	42.93
4403B	Brass	1 1/4"	4"	4	116-4403	54.45	46.28

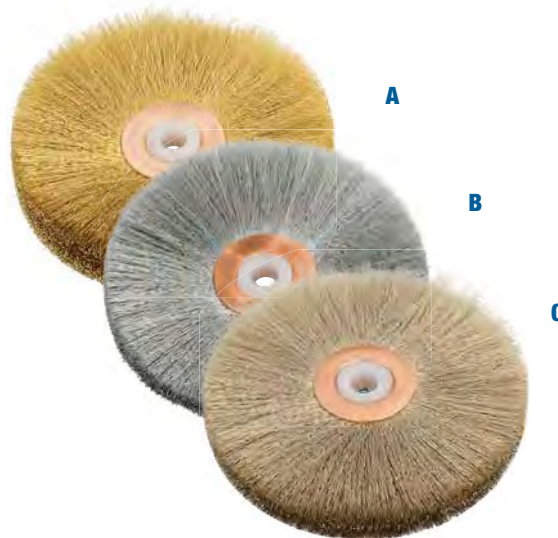
**D. Scotch-Brush, 3" Dia.**

Two ply of 3M™ Scotch-Brite™ are supported by two rows of stiff white Chung King bristle secured onto a plastic hub. The bristles give support to the application of more pressure for faster results. Additionally, both brush and Scotch-Brite™ accept compounds and pastes making this a versatile finishing tool. May be use on tapered spindle. Max operating speed 2,800rpm.

Hub Dia.	Arbor Hole	Trim Length	Item#	EACH
D. 1 1/2"	1/4"	3/4"	114-5199	\$7.85

**E, F Wheel Brushes – Plastic Center, 1 7/8" Diameter**

The black chungking bristle version is very stiff and converges to a 1/8" face. The white goat hair brush is very soft with a polishing face of 1/4". Maximum operating speed: 3,450rpm. Made in Germany.

Style	Bristle Type	Trim Length	Wheel Dia.	Arbor	Item#	EACH Prices		
						1-11	12-143	144+
E. 48CK	Hard	1/2"	1 7/8"	1/4" Plastic	114-5195	\$2.48	\$2.23	\$1.74
F. 48SG	Soft Hair	1/2"	1 7/8"	1/4" Plastic	114-5197	2.80	2.52	1.96

**G, H Mounted Wire Wheel Brushes – 3/32" Shank**

Made of .003" diameter crimped wire. For cleaning and brush finishing with flex shafts. Use brass for yellow metals, steel for white metals. Both have 3/32" shanks. Maximum operating speed: 22,000rpm (recommended 17,000rpm). Imported.

Wire Type	Trim Length	Wheel Dia.	Item#	DOZEN Prices	
				1-11	12+
G. Steel	3/16"	3/4"	113-1000	\$17.85	\$14.87
H. Brass	3/16"	3/4"	113-1050	17.85	14.87

**I, J Double Row Mounted Wheel Brushes – 3/32" Shank**

Both are made of white goat hair bristles, double thick, ideal for applying rouge and compounds. Measure approximately 7/8" diameter x 1/4" thick, with 3/32" shanks. Available with very soft bristles converging to approximately 3/32" for concentrated action or soft straight bristles creating a wider contact area. Maximum operating speed: 8,000rpm. Made in Germany.

Bristle Type	Trim Length	Wheel Dia.	Item#	EACH Prices	
				1-5	6+
I. Very Soft, Converging	1/4"	7/8"	113-1515	\$4.80	\$4.32
J. Soft, Straight	1/4"	7/8"	113-1520	6.60	5.94

**K. Single Row Mounted Wheel Brush – 3/32" Shank**

Features a single row of natural soft bristles mounted securely in a copperplated steel hub. Great for cleaning and polishing tight areas. Measures 1" dia. with 3/32" shank. Maximum operating speed: 25,000rpm. Imported.

Bristle Type	Trim Length	Wheel Dia.	Item#	DOZEN Prices	
				1-11	12+
Soft	1/4"	1"	113-1526	\$4.95	\$4.46





A



B



C



D



E



F



G



H



I



J

A. Double-Ended Brush - Stainless Steel Wire

Great for removing EDM carbon buildup. One end has .005" dia. Straight stainless steel bristles, 1/4" trim, 3/16" dia. The other end has .003" dia. crimped stainless steel bristles, 7/16" trim, 1/4" dia. Wooden handle has finger grip at both ends. Measures 6" overall length.

Material	Handle Length	Style	Item#	EACH Prices	
				1-11	12+
Wood	6"	7982	114-5310	\$10.25	\$8.54

B, C Wire Brushes - Plastic Handles

Use on metals for intermediate finishing, surface preparation or final finishing. Ideal for cleaning bur teeth and for scrubbing and removing carbon buildup found in EDM cavities. Can also be used for texturing. Available with .006" dia. x 7/16"L stainless steel or .004" dia. x 7/16"L brass wire bristles. Both have plastic handles. Measure 7 1/4" long.

Description	Face Size (L x W)	Item#	EACH Prices	
			1-11	12+
B. Stainless Steel	1 3/8" x 1/4"	114-5300	\$2.35	\$1.96
C. Brass	1 3/8" x 1/4"	114-5305	3.55	2.96

D, E Hand-Laced Scratch Brushes - Wooden Handles

Feature three rows of soft, flexible 7/16"L x .003" dia. bristles. Ideal for producing a satin finish. Hand-laced with stainless steel wire to retain maximum bristles and allow handle expansion and contraction when exposed to wetness. Measure 7 3/4" long.

Description	Face Size (L x W)	Item#	EACH Prices	
			1-11	12+
D. Stainless Steel	1 3/8" x 1/4"	114-5320	\$9.25	\$8.33
E. Brass	1 3/8" x 1/4"	114-5315	7.25	6.53

F. Brass Scratch Brush - Wooden Handle

Four rows of 3/4"L x approximately .0035" diameter anchored brass wire. Produces a fine satin finish on soft yellow metals. Measures approximately 8" long.

Description	Face Size (L x W)	Item#	EACH Prices	
			1-11	12+
Brass	3 1/4" x 5/8"	118-3400	\$9.70	\$8.25

G-J Scratch Brush Pens

Excellent for removing rust or corrosion and for reaching into narrow areas. Handy and comfortable to hold. Available in four color-coded types with metal ferrules for durability: steel, nylon, fiberglass and brass. Measure 4 1/2" overall length. Made in Germany.

Description	Color	Item#	EACH Prices	
			1-2	3+
G. Stainless Steel Pen	Orange	115-2310	\$9.45	\$8.98
H. Nylon Pen	Blue	115-2312	7.05	6.70
I. Fiberglass Pen	Green	115-2314	7.15	6.79
J. Brass Pen	Red	115-2316	8.20	7.79

Description	Length	Item#	PKG. of 6	
			1-2	3+
Stainless Steel Refills	1 1/4"	115-2311	\$7.15	\$6.79
Nylon Refills	1 1/4"	115-2313	7.50	7.13
Fiberglass Refills	1 1/4"	115-2315	5.30	5.04
Brass Refills	1 1/4"	115-2317	5.45	5.18

A. Bench Duster – Wooden Handle

Contains four rows of 1½" long medium natural bristles. Ideal for cleaning dust from surfaces. Measures 9¾" long.

Description	Face Size (L x W)	Item#	EACH Prices		
			1-2	3-11	12+
Bench Duster	4" x ¾"	115-2260	\$10.25	\$9.23	\$8.20

**B. Washout Brushes – Wooden Handles**

Have four rows of ¾" long natural bristles. Short-Face has extra-stiff bristles, and Regular has stiff bristles. Measure 8¼" long.

Description	Face Size (L x W)	Item#	EACH Prices		
			1-2	3-11	12+
B. Short-Face	2" x ½"	115-2100	\$5.85	\$5.27	\$4.68
Regular	3½" x ¾"	115-2200	6.25	5.63	5.00

**C. Washout Brushes – Durable Plastic Handles**

Have extra-stiff natural bristles in durable plastic handles. The 3-Row Brush has ⅝" long bristles, and the 4-Row Brush has ¾" long bristles. Measure 7¼" long.

Description	Face Size (L x W)	Item#	EACH Prices		
			1-2	3-11	12+
C. 3-Row	3½" x ½"	115-2060	\$6.45	\$5.81	\$5.16
4-Row	3¼" x ¾"	115-2070	6.55	5.90	5.24

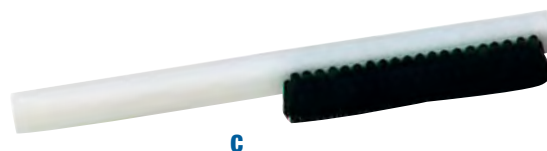
**D. Small Washout Brush – Plastic Handle**

Has four rows of ½" long extra-stiff nylon bristles in an angled handle. Ideal for cleaning small areas. Fits inside most rings. Measures 6⅝" long.

Description	Face Size (L x W)	Item#	EACH Prices		
			1-2	3-11	12+
Small Washout	1¾" x ½"	115-2250	\$2.80	\$2.52	\$2.24

**E-H Watchmaker's Brush – Wooden Handle**

Four uniform rows of ⅝" soft white natural bristles locked in a wood handle are great for cleaning fine jewelry, PC boards, cleaning dusting and other general purpose work. Simply the most popular washout brush available. Measure 10" overall length. Made in Germany.

Description	Face Size (L x W)	Item#	EACH Prices		
			1-2	3-11	12+
E. Hard	4½" x ½"	115-2336	\$5.60	\$5.04	\$4.48
F. Medium	4½" x ½"	115-2338	5.60	5.04	4.48
G. Soft	4½" x ½"	115-2340	5.95	5.36	4.76
H. Extra Soft	4½" x ½"	115-2342	5.95	5.36	4.76

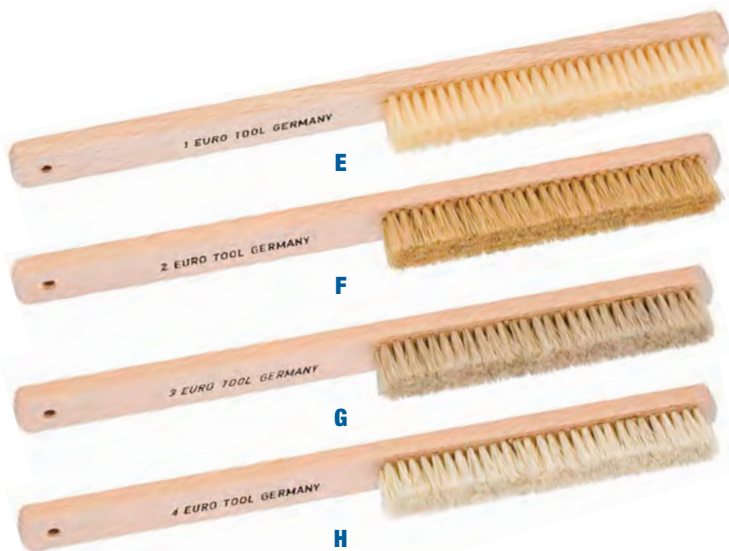
**I. Hand Brush with Enclosed Handle**

Features stiff nylon bristles set in a durable block with enclosed handle for keeping skin and fingernails clean. Ideal for removing investment and more. Measures 4"L x 1½"W.

Description	Item#	EACH Prices	
		1-2	3+
Hand Brush with Enclosed Handle	115-2255	\$3.90	\$3.51



Shown actual size

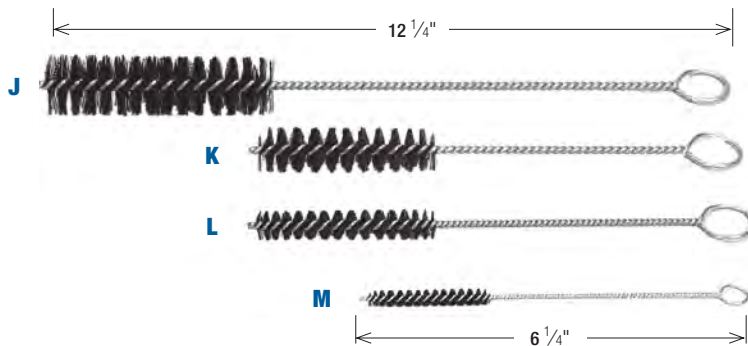
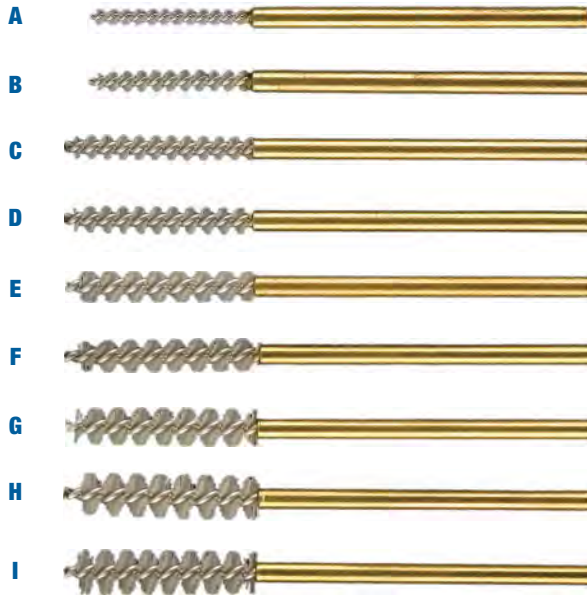

Shown actual size

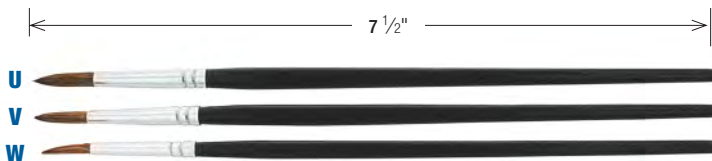
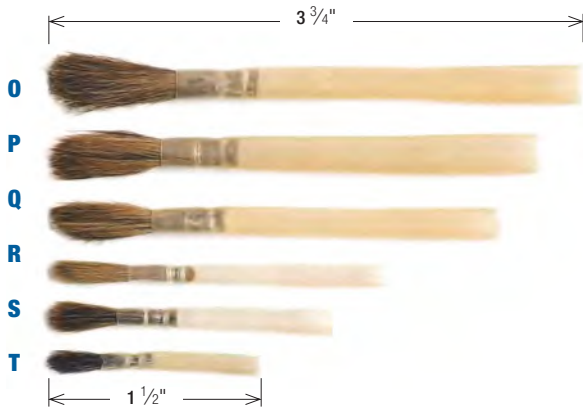

A-I Micro Spiral Brushes – Abrasive Bristle

Nylon bristle with aluminum oxide abrasive. This new brush concept is a perfect tool for cleaning or light bur removal in through holes or on hole edges. The 0.3mm diameter nylon bristle contains 500 grit AIO abrasive grain. Easy to hold and use by hand or can be carefully used in a rotary handpiece if run no faster than 1,500rpm* (3mm shank diameter). Each brush's wire mandrel top (except MSB 2.2 and MSB 2.7) is coated with epoxy resin to protect the work surface from damage.

	Brush Size (Dia. x L)	Overall Length	Shank Dia.	Item#	EACH Price
A.	2.2 x 20mm	65	3mm	115-2288	\$16.70
B.	2.7 x 20mm	65	3mm	115-2289	16.70
C.	3.3 x 25mm	70	3mm	115-2290	16.70
D.	3.8 x 25mm	70	3mm	115-2291	16.70
E.	4.3 x 25mm	70	3mm	115-2292	16.70
F.	4.8 x 25mm	70	3mm	115-2293	16.70
G.	5.3 x 25mm	70	3mm	115-2294	16.70
H.	5.8 x 25mm	70	3mm	115-2295	16.70
I.	6.3 x 25mm	70	3mm	115-2296	16.70

*1,500rpm max when used in a rotary handpiece.

Do not operate until fully inserted into the hole to be processed.

J-M Nylon Tube Brushes

Single-stem, single-spiral nylon tube brushes for cleaning inside rings and grooves. Each has loop handle for sure grip.

Brush Size (Dia. x L)	Overall Length	Item#	EACH Prices		
			1-2	3-11	12+
J. 1" x 4"	12 1/4"	115-2285	\$3.65	\$3.29	\$2.92
K. 3/4" x 3"	8 1/2"	115-2280	2.20	1.98	1.76
L. 1/2" x 3"	8 1/2"	115-2275	2.20	1.98	1.76
M. 1/4" x 2"	6 1/4"	115-2270	1.75	1.58	1.40

N. Econo Flux Brush

Disposable brush with tin ferrule. Use for fluxes and other liquids.

Description	Overall Length	Item#	EACH Prices		
			3pc	3-9	12+
Econo Flux Brush	1 3/4"	115-0100	\$0.60	\$0.51	

3pc Three-piece minimum; please order in multiples of three.

O-T Quill Flux Brushes/Borax Brushes

Inexpensive disposable brushes made of camel hair mounted in hollow quill handles. Use for applying fluxes and other liquids.

Style	Overall Length	Item#	EACH Prices	
			3pc	3-9 12+
O. 1	3 3/4"	115-0010	\$1.83	\$1.56
P. 2	3 1/2"	115-0020	1.83	1.56
Q. 3	3"	115-0030	1.83	1.56
R. 5	2 1/4"	115-0050	1.50	1.28
S. 7	1 3/4"	115-0070	1.50	1.28
T. 9	1 1/2"	115-0090	1.50	1.28

3pc Three-piece minimum; please order in multiples of three.

U-W Wood Flux Brushes

Well-constructed, durable camel hair brushes with wooden handles.

Description	Overall Length	Item#	EACH Prices	
			1-11	12+
U. Large Brush	7 1/2"	115-0400	\$3.35	\$2.85
V. Medium Brush	7 1/2"	115-0500	3.35	2.85
W. Small Brush	7 1/2"	115-0600	2.85	2.42

Texturing Wheels

Whether you want a fine satin finish, a coarse textured surface or something in between, Texturing Wheels have it covered. Choose from a wide variety of sizes and wire diameters to get the exact finish you're looking for. They produce a look similar to a sandblasted finish without the gritty mess or chore of changing sand in the blaster. You don't even have to get up from the bench. Mounted Texturing Wheels ($\frac{3}{32}$ " shanks) can be used on a standard flex shaft handpiece. Unmounted Texturing Wheels can be used on a tapered spindle on your polishing motor. Consist of steel wires firmly attached to plastic hubs. Color-coded for easy selection. Benchtop dust collector or gold saving box strongly recommended to collect gold for refining. Safety goggles or face shield and finger protection required.



A-D Mounted Texturing Wheels – $\frac{3}{32}$ " Shank

Wheels in four different sizes and a variety of wire diameters for use on your flex shaft. Use with safety goggles (face shield and finger guards also recommended). Recommended operating speed: 5,000rpm.

Dia.* x H (mm)	Wire Dia. (mm)	Finish	Color	Item#	EACH Prices	
					1-2	3+
A. 13 x 5	0.2	X-Fine	Yellow	113-1052	\$34.00	\$32.30
	0.3	Fine	Red	113-1053	34.00	32.30
	0.4	M-Fine	Blue	113-1054	34.00	32.30
	0.5	Medium	Green	113-1055	34.00	32.30
B. 16 x 12	0.2	X-Fine	Yellow	113-1062	32.00	30.40
	0.3	Fine	Red	113-1063	32.00	30.40
	0.4	M-Fine	Blue	113-1064	32.00	30.40
C. 35 x 8	0.2	X-Fine	Yellow	113-1072	24.75	23.51
	0.3	Fine	Red	113-1073	22.80	21.66
	0.6	Medium	Green	113-1076	22.80	21.66
	0.7	Coarse	Gray	113-1077	22.80	21.66
D. 40 x 12	0.8	X-Coarse	Black	113-1078	22.80	21.66
	0.2	X-Fine	Yellow	113-1082	26.50	25.18
	0.3	Fine	Red	113-1083	26.50	25.18
	0.45	M-Fine	Blue	113-1084	26.50	25.18
	0.6	Medium	Green	113-1086	26.50	25.18
	0.7	Coarse	Gray	113-1087	26.50	25.18
	0.8	X-Coarse	Black	113-1088	26.50	25.18

*Overall diameter including hub and wire bristles.

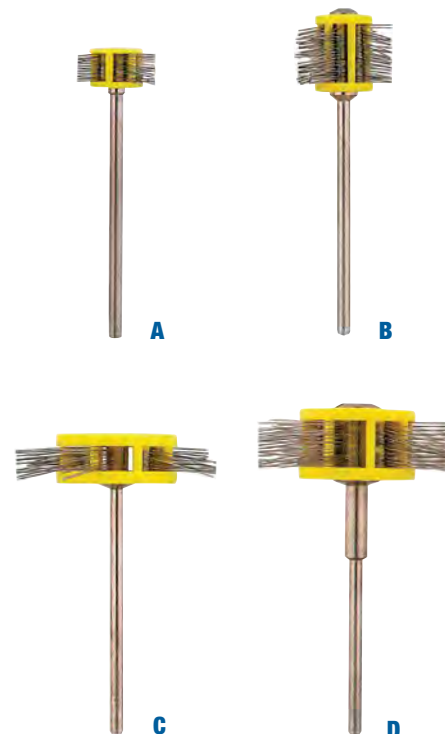

E. Texturing Wheel Set with Stand

A convenient set of our six most popular Texturing Wheels. Includes all 40 x 12mm mounted wheels listed above. Comes complete with plastic stand (color may vary) that keeps wheels organized and at your fingertips. Use with safety goggles (face shield and finger guards also recommended).

Description	Item#	Each
Texturing Wheel Set with Stand	113-1099	\$149.95



F. Unmounted Texturing Wheels

Five different 4" diameter wheels for use with a tapered spindle on your polishing motor. Use with safety goggles (face shield and finger guards also recommended). Maximum operating speed: 5,000rpm.

Dia.* x H (mm)	Wire Dia. (mm)	Finish	Color	Item#	EACH Prices	
					1-2	3+
F. 100 x 25	0.2	X-Fine	Yellow	113-1092	\$41.95	\$39.85
	0.3	Fine	Red	113-1093	41.95	39.85
	0.45	M-Fine	Blue	113-1094	41.95	39.85
	0.6	Medium	Green	113-1096	41.95	39.85
	0.6	Coarse	Gray	113-1097	41.95	39.85

*Overall diameter including hub and wire bristles.



Gesswein® Buff Selection Guide

Muslin, flannel, felt, and cotton materials create buffs with different polishing characteristics. Used with compounds, buffs can handle everything from removing deep scratches to imparting a high luster. Reserve just one buff for each compound to avoid mixtures, which can produce unpredictable finishes. Made in USA except where indicated. When selecting buffs, please consider the following information:

Stitched Buffs: Joined by several rows of stitching for firmer action. Use with cutting or polishing compounds.

Loose Buffs: Joined only at arbor hole for softer action and following contours. Use with rouge for final polishing.

Razor-Edge Buffs: Perfect for reaching into tight areas.

Chemical Treatments: Improve stiffness and provide better compound retention. Use with cutting compounds for fast action.

Combed Edges: Hold compounds well. Require no break-in period.

Centers: Choose from leather reinforced or shellac-hardened pinhole and lead for use on tapered spindles. Also available; 3/8" arbor holes for use on 3/8" arbor shafts.



Made in the USA



A



B



C



D

A. Stitched White Muslin Buffs – Leather Pinhole Center

Made of fine-weave muslin with combed edges and leather centers. For cutting compounds such as Grey Star and Tripoli. For polishing of hard metals such as platinum. Made in USA.

Dia. x Ply	Rows of Stitching	Thread Count	Item#	EACH Prices			
				1-11	12-35	36-143	144+
3" x 40	3	80/80	140-2300	\$2.35	\$2.12	\$1.88	\$1.65
4" x 40	3	80/80	140-2400	3.60	3.24	2.88	2.52
4" x 50	3	80/80	140-2450	4.05	3.65	3.24	2.84
4" x 60	3	80/80	140-2455	5.00	4.50	4.00	3.50
5" x 45	3	80/80	140-2500	5.25	4.73	4.20	3.68
5" x 50	3	80/80	140-2550	5.30	4.77	4.24	3.71
6" x 50	4	80/80	140-2650	7.45	6.71	5.96	5.22
6" x 60	4	80/80	140-2660	7.95	7.16	6.36	5.57
7" x 50	4	80/80	140-2700	10.50	9.45	8.40	7.35
8" x 55	4	80/80	140-2800	14.65	13.19	11.72	10.26

B. Stitched Coarse White Muslin Buffs – Shellac Pinhole Center

Made of coarse-weave muslin with uncombed edges and shellac-hardened centers. For cutting compounds such as Grey Star and Tripoli. For polishing of hard metals such as platinum. Made in USA.

Dia. x Ply	Rows of Stitching	Thread Count	Item#	EACH Prices			
				1-11	12-35	36-143	144+
5" x 45	3	60/60	140-2010	\$3.45	\$3.11	\$2.76	\$2.42
6" x 50	4	60/60	140-2020	5.15	4.64	4.12	3.61

C. Loose White Muslin Buffs – Leather Pinhole Center

Made of fine-weave muslin with combed edges and leather centers. For polishing compounds such as rouge. Made in USA.

Dia. x Ply	Thread Count	Item#	EACH Prices			
			1-11	12-35	36-143	144+
3" x 40	80/80	140-4300	\$2.70	\$2.43	\$2.16	\$1.89
4" x 40	80/80	140-4400	3.99	3.59	3.19	2.79
4" x 50	80/80	140-4350	3.79	3.41	3.03	2.65
5" x 45	80/80	140-4500	4.45	4.01	3.56	3.12
6" x 50	80/80	140-4650	6.30	5.67	5.04	4.41
6" x 60	80/80	140-4660	7.65	6.89	6.12	5.36
7" x 50	80/80	140-4700	10.99	9.89	8.79	7.69
8" x 55	80/80	140-4800	12.80	11.52	10.24	8.96

D. Loose White Muslin Buffs – Lead Center

Made of fine-weave muslin with combed edges and lead centers. A tapered spindle will create threads in the lead, providing a positive seat. For polishing compounds such as rouge. Made in USA.

Dia. x Ply	Thread Count	Item#	EACH Prices			
			1-11	12-35	36-143	144+
4" x 54	80/80	140-6450	\$11.85	\$10.67	\$9.48	\$8.30
5" x 54	80/80	140-6500	13.50	12.15	10.80	9.45
6" x 54	80/80	140-6650	18.50	16.65	14.80	12.95
6" x 63	80/80	140-6560	19.50	17.55	15.60	13.65

Why Choose Gesswein® Buffs?

What makes our Made in USA buffs better than many competitors can be summarized as follows:

Premium quality 100% cotton carded cloth with 80/80 and 86/80 thread counts (the number of threads per square inch in each direction). The yarn size is 30/30. These consistent thread counts and tight weaves make our buffs more wear-resistant and longer lasting.

Our polymer plastic treated buffs give superior performance to starch treatments used by some others.

When processing we take extra care to relieve the folds and wrinkles inherent in a bolt of cloth and use a die cutter that prevents nicks and ensures cuts are not made from the salvage edge of the cloth. We turn every other ply so that it is offset by at least 45 degrees which prevents premature thread fraying, ensures

even and circular wear and improves compound retention. Well turned buffs will outlast unturned buffs by up to 50%.

We regulate tension, stitching, and sewing pattern parameters. Tension is such that when stitches are pulled up, they snap back to the buff. Stitching is kept to 4-6 stitches per inch on the buff, 9-16 on the leather center, and the sewing needle is lifted between each row of stitching to create a truly concentric sewing pattern. All these factors add up to longer lasting buffs.

We inject shellac into the center of each buff making the entire center hard which allows the buffs to be repeatedly taken on and off the spindle without becoming wobbly. Some manufacturers simply dab or stamp shellac onto the center.

For longer life, better cutting and polishing and superior value – use Gesswein Buffs.

A. Loose White Muslin Buffs – 3/8" Arbor Hole

Made of fine-weave muslin with combed edges. Have 3/8" diameter arbor holes for use on 3/8" arbor shafts. Not for use on tapered spindles. Made in USA.

Dia. x Ply	Thread Count	Item#	EACH Prices			
			1-11	12-35	36-14	144+
3" x 20	80/80	140-4315	\$0.90	\$0.81	\$0.72	\$0.63
4" x 20	80/80	140-4320	1.25	1.13	1.00	0.88
5" x 20	80/80	140-4420	1.85	1.67	1.48	1.30
6" x 20	80/80	140-4520	2.40	2.16	1.92	1.68

B. Razor-Edge White Muslin Buffs – Leather Pinhole Center

Made of fine-weave muslin except for #140-8650, which is made of coarse-weave muslin. Can reach into areas where conventional buffs cannot, such as corners, channels and slots. Stitching provides firm edge and maintains buff shape. Buffs with 86/80 thread count are a bit stiffer and more aggressive than buffs with 80/80 thread count. Made in USA.

Dia. x Ply	Rows of Stitching	Thread Count	Item#	EACH Prices			
				1-11	12-35	36-143	144+
2 1/2"	3	86/80	140-8250	\$2.35	\$2.12	\$1.88	\$1.65
3"	4	86/80	140-8300	2.55	2.30	2.04	1.79
4"	6	86/80	140-8400	3.05	2.75	2.44	2.14
5"	8	80/80	140-8500	4.15	3.74	3.32	2.91
6"	10	80/80	140-8600	4.50	4.05	3.60	3.15
6"	10	86/80	140-8650	4.70	4.23	3.76	3.29

C. Stitched Yellow Muslin Buffs – Leather Pinhole Center

Made of chemically treated fine-weave muslin with combed edges and leather centers. Feature a degree of stiffness that serves particularly well for cutting with Tripoli. Last two to three times longer than white muslin buffs. Made in USA.

Dia. x Ply	Rows of Stitching	Thread Count	Item#	EACH Prices			
				1-11	12-35	36-143	144+
4" x 40	3	86/80	141-2400	\$5.20	\$4.68	\$4.16	\$3.64
4" x 50	3	86/80	141-8700	4.35	3.92	3.48	3.05
5" x 45	3	86/80	141-2500	5.85	5.27	4.68	4.10
5" x 50	3	86/80	141-8710	6.99	6.29	5.59	4.89
6" x 30	4	86/80	141-8720	5.85	5.27	4.68	4.10
6" x 50	4	86/80	141-2600	9.00	8.10	7.20	6.30
6" x 60	4	86/80	141-2650	10.25	9.23	8.20	7.18
7" x 50	4	86/80	141-8730	12.75	11.48	10.20	8.93

D. Loose Yellow Muslin Buffs – Leather Pinhole Center

Made of the same treated fine-weave muslin with combed edges and leather centers as our stitched yellow muslin buffs, without the stitching. Can be used with rouge. Works very well with cut-and-color compounds. Made in USA.

Dia. x Ply	Thread Count	Item#	EACH Prices			
			1-11	12-35	36-143	144+
4" x 50	86/80	141-1000	\$4.40	\$3.96	\$3.52	\$3.08
5" x 50	86/80	141-1005	6.50	5.85	5.20	4.55
6" x 50	86/80	141-1010	8.75	7.88	7.00	6.13





Made in the USA



A



B

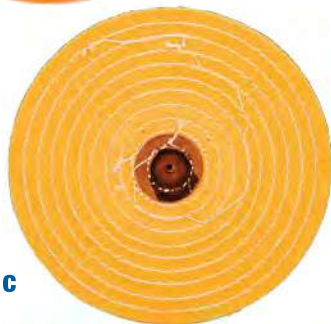

C



D



E

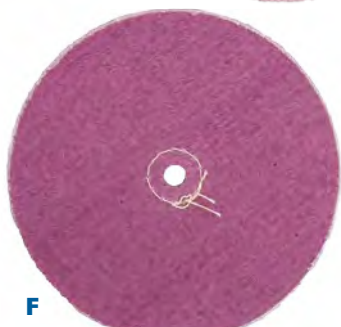

F

A. Loose Yellow Muslin Buffs – 3/8" Arbor Hole

Made of the same treated fine-weave muslin with combed edges as our other yellow buffs. Have 3/8" diameter arbor holes for use on 3/8" arbor shafts. Not for use on tapered spindles. Made in USA.

Dia. x Ply	Thread Count	Item#	EACH Prices			
			1-11	12-35	36-143	144+
4" x 20	86/80	141-0995	\$1.85	\$1.67	\$1.48	\$1.30
5" x 20	86/80	141-1002	2.20	1.98	1.76	1.54
6" x 20	86/80	141-1007	3.35	3.02	2.68	2.35
7" x 20	86/80	141-1009	4.60	4.14	3.68	3.22

B. Spiral Creso Sewed Buff

Unique in look, this "Spiral" buff or also known as the Creso Sewed Buff is a unidirectional buff. Run against the stitching as a cutting buff and run with for polishing action. The stitching creates pockets which increase compound retention. Color may vary. 86/80 thread count, combed edge. Made in USA. Measure 6" diameter by 20 ply with a 1/2" arbor hole.

Description	Item#	Each Price			
		1-11	12-35	36-143	144
Spiral Creso Sewed Buff	142-0005	\$7.75	\$6.98	\$6.20	\$5.43

C. Razor-Edge Yellow Muslin Buffs – Leather Pinhole Center

Made of the same treated fine-weave muslin with leather centers as our other yellow buffs. Can reach into areas where conventional buffs cannot, such as corners, channels and slots. Stitching provides firm edge and maintains buff shape. Made in USA.

Dia. x Ply	Rows of Stitching	Thread Count	Item#	EACH Prices			
				1-11	12-35	36-143	144+
4"	6	86/80	141-8495	\$3.45	\$3.11	\$2.76	\$2.42
5"	8	86/80	141-8500	4.00	3.60	3.20	2.80
6"	11	86/80	141-8600	5.50	4.95	4.40	3.85

D. Stitched Plum Muslin Buffs – Leather Pinhole Center

Made of chemically treated fine-weave muslin with combed edges and leather centers. Outlast yellow and white buffs by a wide margin. Cut fast and provide ultra-high polish when used with yellow glow or rouge. Retain compound extremely well, producing a brighter finish than other buffs. Impart an amazing finish on soft metals. Color variations are normal for this product. Made in USA.

Dia. x Ply	Rows of Stitching	Thread Count	Item#	EACH Prices			
				1-11	12-35	36-143	144+
4" x 40	3	86/80	140-6660	\$4.25	\$3.83	\$3.40	\$2.98
5" x 45	3	86/80	140-6661	5.80	5.22	4.64	4.06
6" x 50	4	86/80	140-6662	8.95	8.06	7.16	6.27

E. Loose Plum Muslin Buffs – Leather Pinhole Center

Made of the same treated fine-weave muslin with combed edges and leather centers as our stitched plum muslin buffs, without the stitching. Color variations are normal for this product. Made in USA.

Dia. x Ply	Thread Count	Item#	EACH Prices			
			1-11	12-35	36-143	144+
4" x 40	86/80	141-1020	\$4.10	\$3.69	\$3.28	\$2.87
5" x 45	86/80	141-1021	5.65	5.09	4.52	3.96
6" x 50	86/80	141-1022	8.99	8.09	7.19	6.29

F. Loose Plum Muslin Buffs – 3/8" Arbor Hole

Made of the same treated fine-weave muslin with combed edges as our other plum buffs. Have 3/8" diameter arbor holes for use on 3/8" arbor shafts. Not for use on tapered spindles. Color variations are normal for this product. Made in USA.

Dia. x Ply	Thread Count	Item#	EACH Prices			
			1-11	12-35	36-143	144+
4" x 20	86/80	141-1025	\$1.99	\$1.79	\$1.59	\$1.39
5" x 20	86/80	141-1030	2.30	2.07	1.84	1.61



Made in the USA

A. Razor-Edge Plum Muslin Buff – Leather Pinhole Center

Made of the same treated fine-weave muslin with a leather center as our other plum buffs. Can reach into areas where conventional buffs cannot, such as corners, channels and slots. Stitching provides firm edge and maintains buff shape. Color variations are normal for this product. Made in USA.

Dia. x Ply	Rows of Stitching	Thread Count	Item#	EACH Prices			
				1-11	12-35	36-143	144+
6"	10	86/80	140-6670	\$5.25	\$4.73	\$4.20	\$3.68

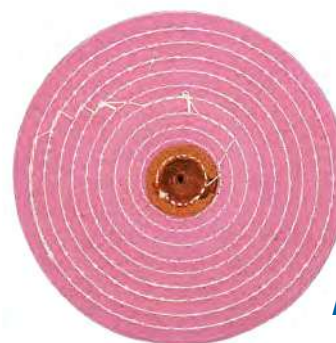

A

B. Stitched Blue Platinum Muslin Buffs – Leather Pinhole Center

Made of chemically treated premium-weave muslin with combed edges and leather centers. More aggressive and durable than yellow and plum buffs. Optimize the effectiveness of all platinum compounds, providing a higher polish on platinum in less time than other buffs. Made in USA.

Dia. x Ply	Rows of Stitching	Thread Count	Item#	EACH Prices			
				1-11	12-35	36-143	144+
4 x 50	3	86/80	140-6701	\$5.60	\$5.04	\$4.48	\$3.92
5 x 50	3	86/80	140-6702	6.35	5.72	5.08	4.45
6 x 50	4	86/80	140-6703	8.95	8.06	7.16	6.27



B

C. Razor-Edge Blue Platinum Muslin Buff – Leather Pinhole Center

Made of the same treated fine-weave muslin with a leather center as our other blue buffs. Can reach into areas where conventional buffs cannot, such as corners, channels and slots. Stitching provides firm edge and maintains buff shape. Made in USA.

Dia. x Ply	Rows of Stitching	Thread Count	Item#	EACH Prices			
				1-11	12-35	36-143	144+
6"	10	86/80	140-6704	\$6.05	\$5.45	\$4.84	\$4.24

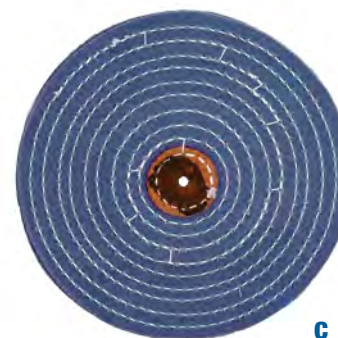

C

D. Stitched Gray Battle Muslin Buffs – Leather Pinhole Center

Made of chemically treated premium-weave muslin with combed edges and leather centers. Aggressive, extremely durable buffs for the toughest polishing jobs. Ideal for production use. Speed up cutting and polishing of hard metals such as platinum and stainless steel. Made in USA.

Dia. x Ply	Rows of Stitching	Thread Count	Item#	EACH Prices			
				1-11	12-35	36-143	144+
4" x 50	3	86/80	140-6801	\$5.35	\$4.82	\$4.28	\$3.75
5" x 50	3	86/80	140-6802	6.40	5.76	5.12	4.48
6" x 50	4	86/80	140-6803	8.85	7.97	7.08	6.20



D

E. Razor-Edge Gray Battle Muslin Buff – Leather Pinhole Center

Made of the same treated fine-weave muslin with a leather center as our other gray buffs. Can reach into areas where conventional buffs cannot, such as corners, channels and slots. Stitching provides firm edge and maintains buff shape. Made in USA.

Dia. x Ply	Rows of Stitching	Thread Count	Item#	EACH Prices			
				1-11	12-35	36-143	144+
6"	10	86/80	140-6804	\$6.10	\$5.49	\$4.88	\$4.27

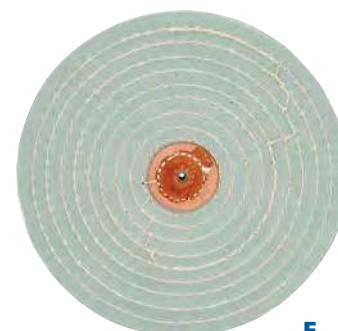

E



A-C Cylinder, Goblet & Tapered Buffs – Made in USA

Three different buffs for specialized jobs. Cylinder buffs polish inside tubular shapes. Tapered buffs polish inside tapered shapes. Goblet buffs polish inside goblets, chalices and other irregular shapes. Made of stitched fine-weave muslin. For use on tapered spindles.

Description	Size	Item#	EACH Prices	
			1-11	12+
A. Cylinder Buff	2" x 2"	143-5200	\$20.45	\$17.04
	3" x 3"	143-5300	26.50	22.08
B. Goblet Buff	2"	143-3200	14.75	12.29
	3"	143-3300	17.90	14.92
	4"	143-3400	25.25	21.04
C. Tapered Buff	2"	143-1200	20.45	17.04
	3½"	143-1350	29.85	24.87



D. Canton Flannel Buffs – Shellac Pinhole Center

Made of soft, thick fabric with combed edges and shellac-hardened centers. Use with rouge to impart a high finish on precious metals. Excellent for high-karat gold and silver.

Dia. x Ply	Rows of Stitching	Item#	EACH Prices	
			1-11	12+
4" x 30	3	142-8400	\$3.85	\$3.21
5" x 30	3	142-8500	5.20	4.33
6" x 30	4	142-8600	6.85	5.71



E. Felt Buffs – Leather Pinhole Center

These wool felt buffs combine the excellent compound retention and long life of a lap with the flexibility and conform ability of a buff. Soft is flexible for following surface contours and is perfect for rouge and other polishing compounds. Medium is semi-flexible and designed for use with tripoli on soft metals. Both have four rows of stitching.

Dia. x Thick	Type	Item#	Each
6" x ¾" (6 ply)	Soft	283-0001	\$14.75
6" x ¾" (6 ply)	Medium	283-0002	18.65



F. Brilliant Buff – No rouge, no mess!

Made of soft, long-strand pure Egyptian cotton treated with an environmentally friendly polishing chemical that creates no mess. Yields a bright shine on platinum, gold and silver without additional compound. After using Tripoli, polish with this buff for a brilliant finish. Leaves behind an undetectable residue that inhibits tarnish. For use on tapered spindles.

Dia. x Thick	Item#	Each
4½" x ¾" (30 ply)	142-0010	\$12.95



G, H Duratex Buffs

Use for cutting and polishing all types of metal and acrylic. Silicon coated on one side, the cotton material does not give off lint and holds compound much longer than normal buffs ½" thick. Brown buffs are meant for use with harder metals: platinum, white gold, and stainless steel. White buffs are best for use with softer metals, like silver and yellow gold. Made in Germany.

Description	Dia. x Ply x Arbor Hole	Item#	Each Price	
			1-11	12+
G. Brown Buff	4" x 15 Ply x ¼"	142-5410	\$10.75	\$9.68
Brown Buff	5" x 15 Ply x ¼"	142-5411	12.25	11.03
Brown Buff	5" x 30 Ply x ¼"	142-5412	20.30	18.27
H. White Buff	4" x 20 Ply x ¼"	142-5420	11.25	10.13
White Buff	5" x 20 Ply x ¼"	142-5421	14.50	13.05
White Buff	5" x 30 Ply x ¼"	142-5422	21.50	19.35



I. Cotton String Buff

This ultra-soft buff imparts a superb finish on gold, especially when used with our Premium Red Rouge. Made of soft cotton string tufts firmly anchored in hub for durability. Can be used with any polishing compound. Made in Italy.

Dia. x Thick	Max. Operating Speed	Recommended Speed	Item#	EACH Prices	
				1-11	12+
4" x 2"	3,000rpm	2,800rpm	142-0001	\$10.75	\$8.96

A-E Mandrel Buffs

Small unmounted stitched buffs for use with flex shaft handpieces. Made of fine-weave muslin with shellac pinhole centers. Mandrels not included (see pp. 149, 584-585 for mandrel selection). Made in USA.

Dia. x Ply	Rows of Stitching	Thread Count	Item#	3pc	EACH Prices		
					3-9	12-141	144+
A. 7/8" x 16	1	80/80	142-0090		\$0.99	\$0.82	\$0.69
B. 1" x 16	2	80/80	142-0100		0.99	0.82	0.69
C. 1 1/4" x 16	2	80/80	142-0125		1.00	0.83	0.70
D. 1 1/2" x 16	3	80/80	142-0150		1.05	0.87	0.74
E. 2" x 16	4	80/80	142-0200		1.15	0.96	0.81

3pc Three-piece minimum; please order in multiples of three.



F. Cotton String Buff – 3/32" Shank

Our ultra-soft buff imparts a superb finish on gold, especially when used with our Premium Red Rouge (see p. 102). Made of soft cotton string tufts firmly anchored in hub for durability. Ideal for accessing tight or recessed areas. Can be used with any polishing compound. Made in Italy.

Dia.	Max. Operating Speed	Recommended Speed	Item#	EACH Prices		
				1-11	12-143	144+
1"	22,000rpm	17,000rpm	142-0300	\$2.40	\$2.00	\$1.68

G, H Duratex Mounted Buffs – 3/32" Shank

Use for cutting and polishing all types of metal and acrylic. Silicon coated on one side, the cotton material does not give off lint and holds compound much longer than normal buffs 1/2" thick. Brown buffs are meant for use with harder metals: platinum, white gold, and stainless steel. White buffs are best for use with softer metals, like silver and yellow gold. Made in Germany.

Description	Dia. x Ply	Item#	Each Price	
			1-11	12+
G. Brown, Mounted*	7/8" 8 ply	142-0026	\$2.80	\$2.38
H. White, Mounted*	7/8" 6 ply	142-0028	3.00	2.55

*3/32" Shank

I-L Mounted Muslin Buffs – 3/32" Shank

Available in firm yellow for cutting and soft white for polishing, both loose or stitched, mounted on 3/32" shanks. Recommended operating speed 5,000 rpm. Made in Germany.

Description	Dia.	Item#	EACH Prices	
			1-11	12+
I. Yellow Stitched	1"	142-0340	\$1.59	\$1.43
J. Yellow Loose	1"	142-0342	1.49	1.34
K. White Stitched	1"	142-0345	1.30	1.17
L. White Loose	1"	142-0347	1.20	1.08

M. Mounted Muslin Buff – 3/32" Shank

Miniature muslin buff for use with flex shaft handpieces. Mounted on a 3/32" shank. Made in Germany.

Dia. x Thick	Recommended Speed	Item#	EACH Prices	
			1-11	12+
7/8" x 1/4"	5,000rpm	142-0325	\$6.15	\$5.54

N, O Faux Chamois Buffs – 3/32" Stainless Steel Shank

Durable artificial one inch diameter chamois buffs that hold compound very well. Choose from perforated yellow and smooth tan styles. Perforated yellow work with tripoli and other aggressive compounds; smooth tan produce a wonderful luster with rouge. Made in India.

Dia. x Thick	Material	Use With	Item#	EACH Prices	
				1-11	12+
N. 1" x 3/8"	Perforated Yellow	Tripoli	142-0020	\$1.70	\$1.53
O. 1" x 3/16"	Smooth Tan	Rouge	142-0024	1.70	1.53

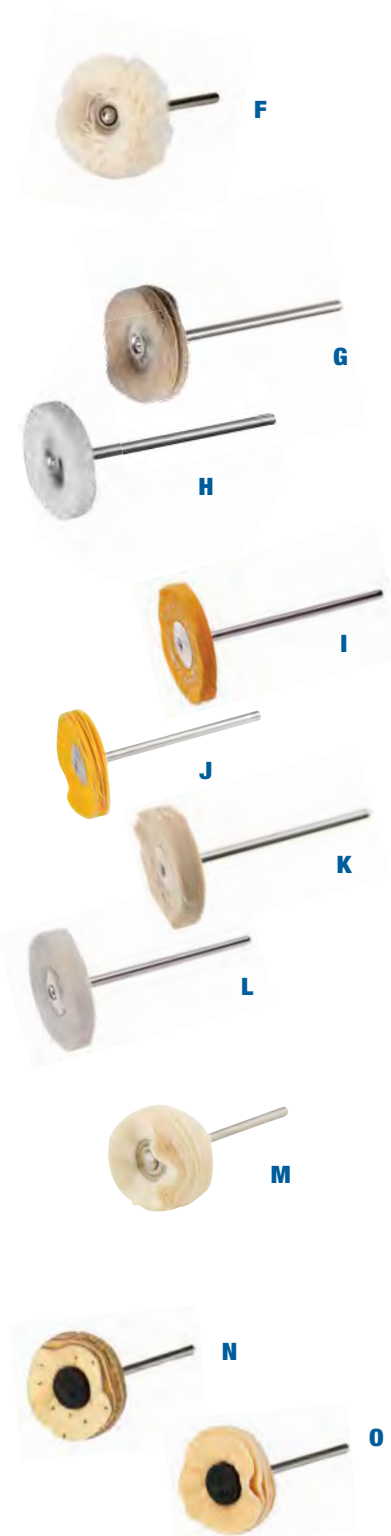

Felt Bobs

Made from the finest 100% wool for long life. Available mandrel-mounted or unmounted. May be used with various polishing compounds or rouges to produce a clean, high finish on molds, dies and models. Hard, medium and soft grades available in most shapes. All 1/8" shank unless otherwise indicated. All measurements in inches. **Items with an asterisk also available on 3mm shanks.** Made in USA.



1/8" Shank (12pc)

Hard (Item#)	286-1010*	286-1011	286-1020*	286-1022	286-1030	286-1031	286-1040	286-1051
Medium (Item#)	290-1010	290-1011	290-1020	290-1022	290-1030	290-1031	290-1040	290-1051
Soft (Item#)	289-1010	289-1011	289-1020	289-1022	289-1030	289-1031	289-1040	289-1051
12-24 (each)	\$2.01	\$2.14	\$1.90	\$1.98	\$1.87	\$2.08	\$1.87	\$1.87
36-60** (each)	1.91	2.03	1.81	1.88	1.78	1.98	1.78	1.78
72+**	1.81	1.93	1.71	1.78	1.68	1.87	1.68	1.68

1/8" Shank (12pc)

Hard (Item#)	286-1060	286-1100*	286-1101*	286-1102*	286-1103*	286-1104*	286-1105*	286-1106*
Medium (Item#)	290-1060	290-1100*	290-1101*	290-1102*	290-1103*	290-1104*	290-1105*	290-1106*
Soft (Item#)	289-1060	289-1100*	289-1101*	289-1102*	289-1103*	289-1104*	289-1105*	289-1106*
12-24 (each)	\$1.87	\$1.24	\$1.29	\$1.29	\$1.34	\$1.46	\$1.60	\$1.75
36-60** (each)	1.78	1.18	1.23	1.23	1.27	1.39	1.52	1.66
72+**	1.68	1.12	1.16	1.16	1.21	1.31	1.44	1.58
Rock Hard (Item#)	-	291-1100	-	291-1102	291-1103	291-1104	291-1105	291-1106
12-24 (each)	-	\$1.38	-	\$1.43	\$1.49	\$1.66	\$1.80	\$2.03
36-60** (each)	-	1.31	-	1.36	1.42	1.58	1.71	1.93
72+**	-	1.24	-	1.16	1.34	1.49	1.62	1.83

1/8" Shank (12pc)

Hard (Item#)	286-1107	286-1108	286-1110*	286-1111*	286-1113*	286-1114*
Medium (Item#)	290-1107	290-1108	290-1110*	290-1111*	290-1113	290-1114*
Soft (Item#)	289-1107	289-1108	289-1110*	289-1111	289-1113	289-1114*
12-24 (each)	\$1.54	\$2.12	\$2.24	\$2.43	\$3.00	\$3.00
36-60** (each)	1.46	2.01	2.13	2.31	2.85	2.85
72+**	1.39	1.91	2.02	2.19	2.70	2.70
Rock Hard (Item#)	-	-	291-1110	-	-	-
12-24 (each)	-	-	\$2.29	-	-	-
36-60** (each)	-	-	2.18	-	-	-
72+**	-	-	2.06	-	-	-

1/4" Shank (12pc)

Hard (Item#)	286-1097	286-1098	286-1099	286-1109	286-1112	286-1115
12-24 (each)	\$1.98	\$2.19	\$2.39	\$2.57	\$3.32	\$3.00
36-60** (each)	1.88	2.08	2.27	2.44	3.15	2.85
72+**	1.78	1.97	2.15	2.31	2.99	2.70
Rock Hard (Item#)	-	-	-	-	-	291-1115
12-24 (each)	-	-	-	-	-	\$3.36
36-60** (each)	-	-	-	-	-	3.19
72+**	-	-	-	-	-	3.02

(12pc) 12-piece minimum; please order in multiples of 12. *Also available on 3mm shanks. **Quantity discount for orders of one item number only; not assorted.

A-C Felt Bob Sets – 1/8" Shank

Choose from six different sets of mounted bobs listed on previous page. Trial Sets in our most popular shapes and sizes. Made in USA.

A. 4-Piece Fancy	#1010	#1020	#1022	#1030
Soft or Medium				
Description	Shapes	Components	Item#	EACH Set
A. 4-Piece Soft Set	Fancy	289-1010, 20, 22, 30	289-1116	\$7.25
4-Piece Medium Set	Fancy	290-1010, 20, 22, 30	290-1117	6.95

B. 7-Piece Fancy	#1010	#1020	#1022	#1030	#1040	#1051	#1060
Hard							
Description	Shapes	Components	Item#	EACH Set			
B. 7-Piece Hard Set	Fancy	286-1010, 20, 22, 30, 40, 51, 60	286-1118	\$10.95			

C. 7-Piece Cylinder	#1100	#1101	#1102	#1103	#1104	#1105	#1106
Soft, Medium or Hard							
Description	Shapes	Components	Item#	EACH Set			
C. 7-Piece Soft Set	Cylinder	289-1100, 1, 2, 3, 4, 5, 6	289-1119	\$11.95			
7-Piece Medium Set	Cylinder	290-1100, 1, 2, 3, 4, 5, 6	290-1120	10.50			
7-Piece Hard Set	Cylinder	286-1100, 1, 2, 3, 4, 5, 6	286-1121	11.90			

D. Countersunk Felt Bob – 3mm Shank

Specially designed for polishing flat surfaces, utilizing the end of the bob. The center hole on the bob helps stabilize it while rotating so it is easy to control and won't "walk." In addition, the tapered sides allow you to polish to the side wall, without it inadvertently being polished. Measures 7/8" dia. x 1"H with a 3/8"D cavity. Mounted on 3mm shank. Made in USA.

Hardness	Size	Item#	EACH Prices	
			1-5	6+
Rock-Hard	3mm shank	295-0012	\$5.10	\$4.85



Shown actual size

E-I Felt Bobs – 3/32" Shank

Made of pure wool. Sold individually and in a set of all five shapes, which comes in a wooden stand with plastic case to keep bobs free of dust and dirt. Mounted on 3/32" shanks. Max. operating speed: 15,000rpm. Made in USA.

Dia. x H	Shape	Medium Item#	Hard Item#	EACH Prices	
				1-11	12+*
E. 1/4" x 3/4"	Point	288-2300	288-2200	\$1.87	\$1.55
F. 3/8" x 3/4"	Flame	288-2301	288-2201	1.87	1.55
G. 5/16" x 3/8"	Ball	288-2302	288-2202	1.87	1.55
H. 5/16" x 5/8"	Bullet	288-2303	288-2203	1.87	1.55
I. 3/8" x 5/8"	Cylinder	288-2305	288-2205	1.87	1.55
5-Piece Set	-	288-2307	288-2207	7.80	-



Shown actual size

*Quantity discount for orders of one item number only; not assorted.

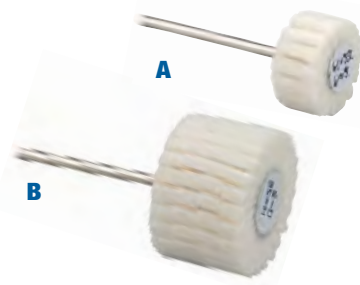

A, B Felt Flap Wheels – 1/8" Shank

Uniquely constructed soft pure felt wheels for use with polishing compounds. Made in Germany.

Dia. x H	Item#	EACH Prices	
		1-2	3+
A. 3/4" x 3/8"	288-2213	\$8.65	\$8.22
B. 1 1/4" x 3/4"	288-2214	9.85	9.36

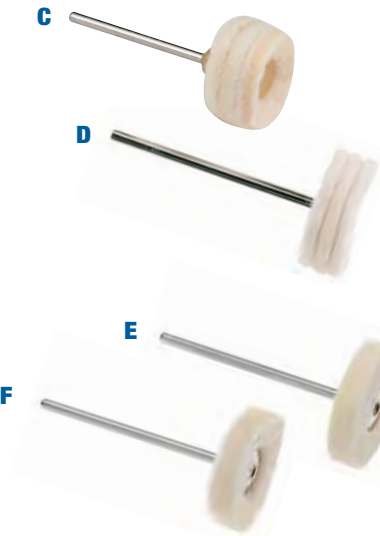

C, D Mounted Felt Wheels – 3/32" Shank

3 ply wheels ideal for cutting and polishing larger surfaces. Mounted on 3/32" shanks.

Dia. x Thick	Recommended Speed	Type	Item#	EACH Prices	
				1-11	12+
C. 7/8" x 1 1/2"	5,000rpm	Very Soft	288-2210	\$3.40	\$3.06
D. 7/8" x 5/16"	5,000rpm	Soft	288-2211	2.20	1.98

E, F Mounted Felt Wheels – 3/32" or 1/8" Shanks

Both hard and soft in either 3/32" or 1/8" shank sizes. Hard provides a more aggressive cutting action while soft produces a higher finish. Made in Germany.

Dia. x Thick	Shank size	Recommended Speed	Type	Item#	EACH Prices	
					1-11	12+
E. 7/8" x 3/16" (5mm)	3/32"	5,000rpm	Hard	288-2221	\$2.50	\$2.00
7/8" x 3/16" (5mm)	1/8"	5,000rpm	Hard	288-2222	2.50	2.00
F. 7/8" x 3/16" (5mm)	3/32"	5,000rpm	Soft	288-2223	1.35	1.08
7/8" x 3/16" (5mm)	1/8"	5,000rpm	Soft	288-2224	1.35	1.08



G. Mounted Felt Wheel with Plastic Hub – 3/32" Shank

Soft felt wheel mounted on a nonscratching plastic hub with 3/32" stainless steel shank. Works so well that it's patented. Use with compound for cutting and polishing. Made in India.

Dia. x Thick	Type	Item#	EACH Prices	
			1-11	12+
1" x 3/16"	Soft	288-2209	\$1.35	\$1.22



H. Compressed Fiber Wheel – 3/32" Shank

Fibers are compressed and bonded with aluminum oxide to make a firm, dense long lasting wheel with some flexibility. Creates a beautiful scratch finish that contrasts well with highly polished areas. Recommended working speed: 5,000rpm. Made in Germany.

Dia. x Thick	Type	Item#	EACH Prices	
			1-11	12+
7/8" x 3/8"	Coarse	288-2250	\$4.95	\$4.46

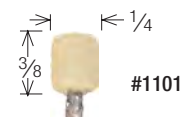
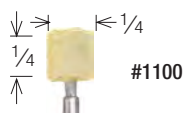

I

All shown actual size

I. Diamond Impregnated Felt Bobs – 1/8" Shank

Diamond abrasive is loaded throughout the wool felt eliminating the need for additional compound. Ready to work immediately, they polish quickly, constantly introducing new diamond abrasive to the work surface. The diamond felts are also *self-lubricating* so no extra lubricant is required. Available in 4 grits from 1 micron to 15 micron in our 2 most popular shapes. All 1/8" shanks. Made in USA.

Diamond Micron	#1100	#1101
1	284-2100	284-2110
6	–	284-2112
9	284-2103	284-2113
15	–	284-2114
1-11 (each)	\$2.86	\$4.11
12+ (each)*	2.72	3.90

*Quantity discount for orders of one item number only; not assorted.



A. Unitized Mounted Points – 1/8" Shank

Ideal for a variety of deburring, blending, finishing and polishing applications. Consist of durable unitized material embedded with either silicon carbide for a fine finish or aluminum oxide for a medium or coarse finish. Mounted on 1/8" shanks. Conform to workpieces for consistent, uniform finishing without undercutting or gouging.

Style	Dia. x H	Max. RPM	Coarse	Medium	Fine	Each
B42	1/2" x 3/4"	33,750	845-0120	845-0110	845-0080	\$6.65
B52	3/8" x 3/4"	45,300	845-0121	845-0111	845-0081	5.60
B90	1/2" x 1/2"	34,500	845-0122	845-0112	845-0082	5.10
W160	1/4" x 1/4"	81,300	845-0123	845-0113	845-0083	3.60
W183	1/2" x 1/4"	51,700	845-0124	845-0114	845-0084	4.20
W185	1/2" x 1/2"	34,500	845-0125	845-0115	845-0085	4.90



B. DUROTEX™ Abrasive Impregnated Composites – 1/8" Shank

DUROTEX composites are made out of a tough and resilient polyurethane type material. Available with Silicone Carbide or Aluminum Oxide grain, the composite bond and abrasive grain wear evenly to ensure consistent performance and surface finishes. DUROTEX is high temperature resistant and will not heat up or melt even under strenuous conditions. Can be used on many materials including all metals, (even brass and titanium), glass and more. Please consult ANSI for speed recommendations. All 1/8" shanks. Made in USA.

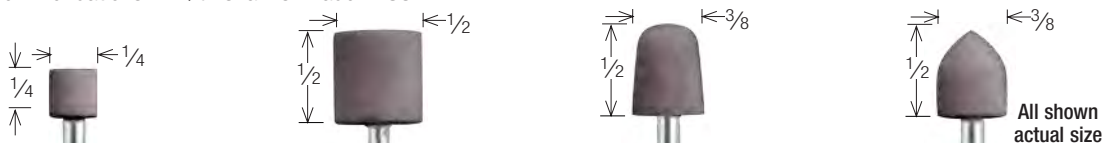

Description	1/4" Cyl	1/2" Cyl	Cone	Bullet
Silicone Carbide Coarse	284-0012	284-0022	284-0032	284-0042
Silicone Carbide Medium	284-0014	284-0024	284-0034	284-0044
Silicone Carbide Fine	–	284-0026	284-0036	284-0046
Aluminum Oxide Coarse	284-0052	284-0062	284-0072	284-0082
Aluminum Oxide Medium	284-0054	284-0064	284-0074	284-0084
Aluminum Oxide Fine	284-0056	284-0066	284-0076	284-0086
1-11 (each)	\$2.60	\$3.07	\$4.11	\$4.11
12+ (each)*	2.08	2.46	3.29	3.29

*Quantity discount for orders of one item number only; not assorted.

C-L Mounted Impregnated Felt Bobs – 1/8" Shank

Felt bobs evenly impregnated with 8000 grit silicon carbide abrasive for uniform removal of light scratches and brightening. Help shorten the final finishing process. Reduce messy compound cleanup. Suitable for all metals, including soft metals such as brass. Available in hard and medium grades. Mounted on 1/8" shanks. Max. operating speed: 10,000rpm. Made in USA.

Dia. x H	Medium Item#	Hard Item#	EACH Prices		
			1-35	36-71*	72+*
C. 3/8" x 1/2"	284-2000	284-1030	\$1.98	\$1.88	\$1.78
D. 1/4" x 1/4"	284-2002	284-1100	1.77	1.68	1.59
E. 1/4" x 3/8"	–	284-1101	1.77	1.68	1.59
F. 3/8" x 3/8"	284-2004	284-1102	1.77	1.68	1.59
G. 3/8" x 1/2"	284-2006	284-1103	1.77	1.68	1.59
H. 1/2" x 1/2"	284-2008	284-1104	1.77	1.68	1.59
I. 1/2" x 3/4"	284-2010	284-1105	1.94	1.84	1.75
J. 1/2" x 1"	–	284-1106	2.85	2.71	2.57
K. 3/4" x 3/4"	284-2012	284-1110	3.02	2.87	2.72
L. 1" x 1"	284-2014	284-1114	4.11	3.90	3.70

*Quantity discount for orders of one item number only; not assorted.





A

Mandrels
See pages 149, 584-585



B

C

D

E



F

G



H

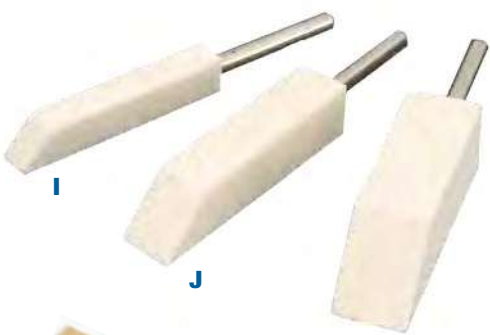

I

J

K



L

M

For Unmounted Felt Sticks
See page 148

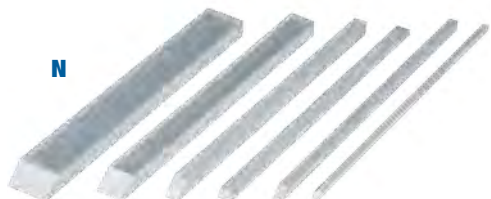

N

A. Unmounted Hard Felt Cylinder Bobs - USA

Made of pure wool. Pinhole centers. Mandrels not included (see pp. 149, 584-585 for mandrel selection). Made in USA.

Dia. x H	Mandrel	Item#	EACH Prices	
			12-132	144+
1/4" x 3/8"	#3 or #13	288-0010	\$1.03	\$0.86
3/8" x 1/2"	#30	288-0020	1.24	1.03
1/2" x 1/2"	#30	288-0030	1.30	1.08
3/4" x 3/4"	#33	288-0040	1.80	1.50
1" x 1"	#33	288-0050	3.00	2.50

12pc Twelve-piece minimum; Please order in multiples of twelve.

B-H Unmounted Hard Felt Cones

Made of the finest pure wool for long life. Great for polishing objects with rounded or curved surfaces. Pinhole centers. Mandrels not included (see pp. 584-585 for mandrel selection). Made in USA.

Dia. x H	Shape	Item#	EACH Prices	
			12-132	144+
B. 1/4" x 1/2"	Pointed	282-0480	\$1.36	\$1.13
C. 3/8" x 3/4"	Pointed	282-0490	1.30	1.08
D. 1/2" x 1"	Pointed	282-0500	1.92	1.60
E. 1/2" x 1"	Blunt	282-0501	1.88	1.57

12pc Twelve-piece minimum; Please order in multiples of twelve.

Dia. x H	Shape	Item#	EACH Prices		
			1-11	12-143	144+
F. 3/4" x 1 1/2"	Pointed	282-0510	\$2.10	\$1.75	\$1.47
G. 3/4" x 1 1/2"	Blunt	282-0511	2.35	1.96	1.65
H. 1" x 2"	Pointed	282-0520	4.35	3.62	3.05

I-K Poli-Felts - 1/8" Shank

Feature end cut at 45° angle for comfort. For use with reciprocating handpieces such as Power Hand PH3 SZX (see p. 429), Di-Profiler (see pp. 431, 448-449, 452) and others. Made in USA.

Dimensions	Style	Type	Item#	EACH Prices		
				1-11	12-143	144+
I. 1/4" sq. x 1 1/2"L	61	Hard	288-4610	\$3.74	\$3.12	\$2.62
J. 3/8" sq. x 1 1/2"L	62	Hard	288-4620	4.20	3.50	2.94
K. 1/2" sq. x 1 1/2"L	63	Hard	288-4630	4.52	3.77	3.16
1/4" sq. x 1 1/2"L	61	Medium	288-4615	3.54	2.95	2.48
3/8" sq. x 1 1/2"L	62	Medium	288-4625	3.95	3.29	2.77
1/2" sq. x 1 1/2"L	63	Medium	288-4635	4.16	3.47	2.91

L, M Soft Pure Wool Felt Hand Buffs

For high finish when used with rouge. Have wooden handles. 12" overall length. Made in India.

Felt Size W x L	Type	Item#	EACH Prices		
			1-11	12-143	144+
L. 3/8" x 6"	Soft	288-1015	\$4.15	\$3.46	\$2.91
M. 7/8" x 6"	Soft	288-1010	4.99	4.16	3.49

N. Acrylic Laps, Individual Sizes - For Diamond Polishing

An excellent alternative to wood and other materials for lapping applications. These acrylic laps can be used by hand or in a reciprocating profiler on flat surfaces, slots and ribs. Produces consistent finishes for mold polishing. Intended for use with diamond compounds, sold separately. Each size has a length of 150mm. Each size is sold in a package of 5. Set of 6 includes one of each size.

N. Description		Item#	SET		
Acrylic Lap Set (one of each size)		825-0250	\$24.95		
Dimensions	Item#	PKG (5)	Dimensions	Item#	PKG (5)
1/8" x 1/8"	825-0251	\$10.50	1/8" x 1/4"	825-0254	\$12.95
3/16" x 3/16"	825-0252	11.25	5/16" x 1/2"	825-0255	23.25
1/4" x 1/4"	825-0253	16.75	5/16" x 3/4"	825-0256	28.25

Felt Wheels

Manufactured from carefully selected wool without synthetic fibers or fillers, ensuring product reliability. Feature uniform density throughout for longer life. Yield high-quality finishes every time. Can be shaped.



A. Soft Felt Wheels – For High Finish

Can be used on irregular surfaces where fast metal removal is unnecessary. Very flexible. Pinhole centers. Mandrel not included (see pp. 149, 584-585 for mandrel selection). Made in USA.

Dia. x Thick	Item#		EACH Prices	
			12-132	144+
1" x 1/8"	280-0005		\$0.45	\$0.37
1" x 1/4"	280-0007		0.62	0.52
1 1/4" x 1/4"	280-0006		1.05	0.87



B. Hard Felt Wheels

Felts in this series have been cut from sheet stock, hardened to appropriate finishing requirements and dressed to size. Pinhole centers. Mandrel not included (see pp. 149, 584-585 for mandrel selection). Use 2" diameter and larger on tapered spindle. Made in USA.

Dia. x Thick	Item#		EACH Prices	
			12-132	144+
1/2" x 1/8"	280-0020		\$0.50	\$0.42
5/8" x 1/8"	280-0041		0.41	0.34
3/4" x 1/8"	280-0060		0.45	0.37
1" x 1/8"	280-0101		0.51	0.42
1" x 1/4"	280-0110		1.24	1.03



Dia. x Thick	Item#	EACH Prices			
		1-2	3-11	12-143	144+
1 1/4" x 1/4"	280-0120	\$1.34	\$1.21	\$1.12	\$0.94
1 1/4" x 3/8"	280-0130	1.98	1.78	1.65	1.39
2" x 1/4"	280-0200	2.50	2.25	2.08	1.75
2" x 1/2"	280-0220	4.06	3.65	3.38	2.84
2 1/2" x 3/8"	280-0260	3.64	3.28	3.03	2.55

C. Knife-Edge Felt Wheels

These felt wheels have tapered edges for polishing joints and crevices. Pin-hole centers. Mandrel not included (see pp. 149, 584-585 for mandrel selection). Use 2" diameter and larger on tapered spindle. Made in USA.

Dia.	Type	Item#		EACH Prices	
				12-132	144+
1/2"	Hard	281-0021		\$0.90	\$0.75
5/8"	Hard	281-0041		0.90	0.75
3/4"	Hard	281-0060		1.20	1.00
1"	Hard	281-0100		1.40	1.17
1"	Rock-Hard	281-0101		1.72	1.43
1 1/4"	Hard	281-0201		2.06	1.72
1 1/2"	Hard	281-0300		2.05	1.71

Dia.	Type	Item#	EACH Prices		
			1-11	12-143	144+
1 3/4"	Hard	281-0400	\$4.05	\$3.65	\$3.24
2"	Hard	281-0501	4.11	3.70	3.29
2 1/2"	Hard	281-0700	6.95	6.26	5.56
3"	Hard	281-0801	5.72	5.15	4.58
3"	Flint-Hard	281-1030	7.50	6.75	6.00
4"	Flint-Hard	281-1040	14.35	12.92	11.48



 12-piece minimum; please order in multiples of 12.

Patented by
F. W. Gesswein in 1872
and still...the ring buffs
of CHOICE!

Gesswein® Felt Ring Buffs

For cutting and polishing insides of rings and curved surfaces. Made of pure wool felt mounted on reinforced wooden mandrels drilled for tapered spindles.



A



B



C

A. Felt Ring Buffs

Patented by F. W. Gesswein in 1872 and still the ring buffs of choice!

For cutting and polishing insides of rings and curved surfaces. Made of pure wool felt mounted on reinforced wooden mandrels drilled for tapered spindles.

Felt Length	Ring Sizes	Taper	For Ring Types*	Item#	EACH Prices			
					1-5	6-11	12-143	144+
3"	1-5	9/16"-5/16"	C	283-0010	\$3.90	\$3.51	\$3.25	\$2.73
3"	5-8	3/4"-9/16"	L	283-0700	3.90	3.51	3.25	2.73
4"	8-11	7/8"-5/8"	L	283-0710	4.20	3.78	3.50	2.94
4"	10-17	1"-3/4"	B	283-0715	5.50	4.95	4.58	3.85
5"	8-17	1"-1 1/16"	B	283-0721	6.80	6.12	5.67	4.76
6"	10-21	1 1/16"-3/4"	M	283-0730	7.60	6.84	6.33	5.32
3"***	6-9	3/4"-9/16"	L	283-1700	3.25	2.93	2.71	2.28
4"***	8-17	7/8"-5/8"	M	283-1710	5.25	4.73	4.37	3.68

*C = children's, L = ladies', M = men's, B = ladies' and men's ***Hardened and treated

B. Soft Felt Ring Buffs

For direct mounting on tapered spindles. Made entirely of pure wool felt.

Felt Length	Ring Sizes	Taper	Item#	EACH Prices			
				1-5	6-11	12-143	144+
B. 3"	5-8	3/4"-9/16"	283-2030	\$3.35	\$3.02	\$2.79	\$2.35
4"	8-12	7/8"-5/8"	283-2040	3.95	3.56	3.29	2.77

C. Combination Felt Ring Buffs

Each consists of pure wool felt square edge wheel buff and inside ring buff mounted on wooden mandrel drilled for tapered spindles. Lets user polish outsides and insides of rings and curved surfaces without changing buffs.

Felt Length	Ring Sizes	Wheel Size	Item#	EACH Prices		
				1-5	6-11	12+
C. 3"	5-8	2" x 1 1/2"	283-4010	\$6.55	\$5.90	\$5.46
4"	7-13	2" x 9/16"	283-4020	8.25	7.43	6.87

For Mounted
Felt Sticks
See page 146



D



E

D, E Felt Sticks

Beveled ends of these solid felt sticks can be used with cutting or polishing compounds, including diamond compounds.

Size	Type	Item#	EACH Prices	
			12pc	72+
4"L x 1/4" sq.	Soft	288-3020	\$0.74	\$0.63
	Medium	288-3015	0.74	0.63
	Hard	288-3010	0.74	0.63

12pc 12-piece minimum; please order in multiples of 12.

Size	Type	Item#	EACH Prices	
			1-11	12+
4"L x 1/2" sq.	Soft	288-3035	\$2.24	\$2.02
	Medium	288-3030	2.24	2.02
	Hard	288-3025	2.24	2.02



F

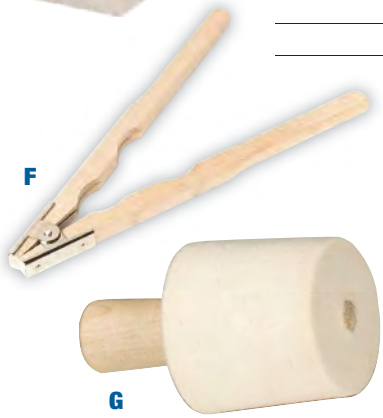

G

F. Outside Wooden Ring Holder

Safely hold rings while polishing with felt ring buffs (above).

Description	Item#	Each
Outside Ring Holder	812-0311	\$5.60

G. Felt Bangle Buff

Made of felt mounted on a wooden mandrel drilled for tapered spindles. Ideal for finishing insides of bangle bracelets and other large pieces. Measures 3 1/2" long. For use on tapered spindles.

Felt Dia. x H	Type	Item#	Each
2"-1 7/8" x 2"	Medium	283-0050	\$9.75

Mandrels

Use in handpieces and hand grinders for holding items such as felt wheels, brushes, rubberized abrasives, cut-off discs and more. Also see Cratex mandrels on p. 92.

A-I Screw Mandrels

For use with Pumice, Cratex and other wheels with a maximum thickness of 1/4". Right-handed threads. Made of steel except 321 1/2, which is stainless steel (excellent for wet operations).

Style	Shank	For Hole	Item#	EACH Prices	
				3pc	12+
A. 321	3/32"	1/16"	840-3170	\$1.20	\$1.00
B. 321 1/2	3/32"	1/16"	840-3160	2.35	1.96
C. 304	3/32"	1/16"	840-3175	2.45	2.04
D. 2	3/32"	1/8"	840-3060	2.10	1.75
E. 311	1/8"	1/16"	840-3150	1.40	1.17
F. 20	1/8"	1/8"	840-3100	2.15	1.79
G. 22	1/8"	1/8"	840-3110	3.15	2.62
H. 24	1/8"	1/4"	840-3112	3.15	2.62
Style	Shank	For Hole	Item#	EACH Prices	
I. 25	1/4"	1/4"	840-3115	\$4.50	\$3.75



J-O Tapered Threaded Mandrels

For use with felt bobs, cones and mandrel buffs. Right-handed threads.

Style	Shank	For Hole	Length of Taper	Item#	EACH Prices	
					3pc	12+
J. 3	3/32"	1/16"	3/16"	840-3070	\$1.25	\$1.04
K. 13	1/8"	1/16"	3/16"	840-3090	1.25	1.04
L. 0	3/32"	1/16"	3/8"	840-3040	1.25	1.04
M. 30	1/8"	1/16"	3/8"	840-3120	1.25	1.04
Style	Shank	For Hole	Length of Taper	Item#	EACH Prices	
N. 33	1/8"	1/4"	3/4"	840-3130	\$3.85	\$3.21
O. 43	1/4"	3/8"	1"	840-3140	6.80	5.67



Shown actual size

P-S Threaded Mandrels with Nuts

For use with rubberized points, cones, and cylinders such as Cratex. Right-handed threads.

Style	Shank	For Hole	Length of Taper	Item#	EACH Prices	
					3pc	12+
P. 1	3/32"	3/32"	1/2"	840-3050	\$1.60	\$1.33
Q. 4	1/8"	3/32"	1/2"	840-3080	1.20	1.00
Style	Shank	Hole	Length of Thread	Item#	EACH Prices	
R. 6	1/8"	1/8"	1/2"	840-3085	\$5.30	\$4.42
S. 1341	1/4"	1/4"	1/2"	840-3180	7.90	6.58



Sun Snap Mandrel - Use with Sunburst Snap-On abrasive see page 80.

Style	Shank	Item#	EACH Prices	
			1-5	6+
T. Single	3/32"	840-3411	11.99	-
Pkg. of 3		840-3410	\$32.95	\$31.30

Three-piece minimum; please order in multiples of three.

Safety Recommendations

Mandrels and mounted accessories improperly used are dangerous. Comply with American National Standards Institute Safety Code B7.1 and Occupational Safety and Health Act covering speed, safety guards, flanges, mounting procedures, general operating rules, handling, storage and inspection. Speeds to use depend on the accessory.

Gesswein® Laps

Lapping maintains integrity of flat surfaces and keeps angles and corners from being rounded off during polishing. Unlike buffs, which are soft, laps are very firm and have a wider area to cover much more of the work surface. Can even be shaped to knife or beveled edges.

When selecting laps, please consider the following information:

Felt Laps: Pure wool felt laps hardened by a process of steaming and pounding. Free of artificial hardeners.

Diamond-Hard Laps: Pure wool felt laps excellent for lapping due to a treatment that results in extreme density.

Split Laps: Slotted in four places to allow user to see finish as work is held on lap. Use on split lapping machines.

Silicone: Superior finish on gold and other precious metals.

GMX: Unique bond of abrasive-impregnated cotton in flexible bond. Excellent for deburring and blending aluminum, stainless steel and exotic alloys.



A

A. Gesswein/Paramount® Felt Laps

Pure wool felt laps uniquely made to ensure proper hardness and performance. All have pinhole centers. Max. operating speed: 3,450rpm. Made in USA.

Dia. x Thick	Type	Item#	EACH Prices		
			1-5	6-11	12-71
4" x 1/4"	Hard	284-4145	\$16.60	\$14.94	\$13.83
	Rock-Hard	284-4147	16.90	15.21	14.08
4" x 1/2"	Soft	284-4121	10.99	9.89	9.16
	Medium	284-4123	15.99	14.39	13.32
	Hard	284-4125	20.55	18.50	17.12
4" x 3/4"	Rock-Hard	284-4127	24.80	22.32	20.67
	Medium	284-4343	26.75	24.08	22.29
	Hard	284-4345	28.99	26.09	24.16
6" x 1/4"	Hard	284-6145	31.40	28.26	26.17
	Flint-Hard	284-6148	40.20	36.18	33.50
6" x 1/2"	Soft	284-6121	26.25	23.63	21.87
	Medium	284-6123	32.60	29.34	27.17
	Hard	284-6125	42.50	38.25	35.42
	Rock-Hard	284-6127	47.70	42.93	39.75
6" x 1"	Flint-Hard	284-6128	56.65	50.99	47.21
	Soft	284-6101	48.50	43.65	40.42
	Medium	284-6103	50.40	45.36	42.00
	Hard	284-6105	59.35	53.42	49.46



B

B. Diamond-Hard Felt Laps

Pure wool felt laps treated and pressed for exceptional durability. Face of lap can be dressed to a knife edge. Max. operating speed: 3,600rpm. Made in USA.

Dia. x Thick x AH	Type	Item#	EACH Prices		
			1-5	6-11	12-71
4" x 1/4" x 1/4"	Diamond-Hard	284-4149	\$15.70	\$14.13	\$13.08
4" x 1/2" x 1/4"	Diamond-Hard	284-4129	20.75	18.68	17.29
6" x 1/4" x 1/4"	Diamond-Hard	284-6149	26.88	24.19	22.40
6" x 1/4" x 1/2"	Diamond-Hard	284-6249	26.88	24.19	22.40

C-F Dedeco® Silicone Split Laps, 6"

Designed to replace felt laps and rouge, these split laps provide a superior finish on gold and other metals. Each wheel is made of silicone rubber and impregnated with silicon-carbide abrasive. Available in 4 grits. Max operating speed: 3,500rpm. 1/2" Arbor Hole.

Coarse: For removing deep scratches

Medium: For smoothing and removing light scratches

Fine: For high-luster polishing

Extra-fine: For super high-luster polishing and final finish

Color	Size	Grit	Item#	Each
C. White	6" x 1/2"	120 (C)	145-0180	\$63.50
D. Black	6" x 1/2"	180(M)	145-0181	63.50
E. Blue	6" x 1/2"	220 (F)	145-0182	63.50
F. Pink	6" x 1/2"	400 (XF)	145-0183	63.50

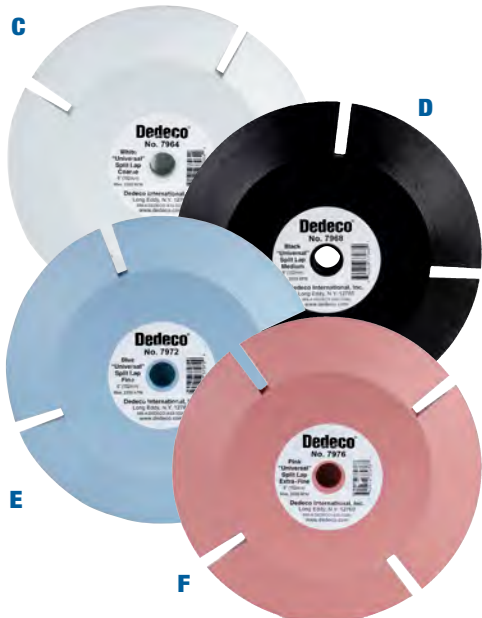

E

F

A. Gesswein®/Paramount® Felt Split Laps

Made of pure wool felt that has been steamed to shrink and thicken, then pounded into specific hardnesses. Feature consistent density throughout for identical polishing results from wheel to wheel, even wear and three to five times the life of conventional split laps. All have pinhole centers. Max. operating speed: 3,450rpm. Made in USA.



Dia. x Thick	Type	Item#	EACH Prices		
			1-5	6-11	12-71
4" x 1/2"	Medium	285-8130	\$38.65	\$34.79	\$32.21
	Hard	285-8131	41.00	36.90	34.17
	Rock-Hard	285-8132	49.05	44.15	40.87
6" x 1/2"	Medium	285-6123	42.25	38.03	35.21
	Hard	285-6125	45.30	40.77	37.75
	Rock-Hard	285-6127	57.25	51.53	47.71
7" x 1/2"	Flint-Hard	285-6128	65.15	58.64	54.29
	Medium	285-7120	57.00	51.30	47.50
	Hard	285-7121	66.70	60.03	55.58
8" x 1/2"	Rock-Hard	285-7122	74.70	67.23	62.25
	Flint-Hard	285-7123	92.70	83.43	77.25
	Medium	285-8123	70.00	63.00	58.33
8" x 1/2"	Hard	285-8125	82.25	74.03	68.54
	Rock-Hard	285-8127	94.00	84.60	78.33
	Flint-Hard	285-8128	102.50	92.25	85.41

B. Marathon Felt Split Laps

100% Australian wool steamed and pounded to form an evenly dense lap to provide consistent finishes from lap to lap. These are high quality felt split laps at an incredible price. Available in Medium and Hard grades. Measure 6" diameter x 1/2" thick with pinhole center. Maximum operating speed: 3,450rpm. Made in India.



Dia. x Thick	Type	Item#	EACH Prices	
			1-11	12+
6" x 1/2"	Medium	285-6134	\$34.65	\$29.11
6" x 1/2"	Hard	285-6135	38.50	32.34

C. Diamond-Hard Felt Split Laps

Made of treated and pressed felt for increased durability. Max. operating speed: 3,450rpm. Made in USA.



Dia. x Thick x AH	Type	Item#	EACH Prices		
			1-5	6-11	12-71
6" x 1/2" x 1/4"	Diamond-Hard	285-6129	\$58.95	\$53.06	\$49.12

D. GMX Split Laps

Contain aluminum oxide abrasive for fast cutting. Feature unique cotton fiber and rubber bond that imparts very smooth finishes. Maximum operating speed: 6,050rpm. Made in USA.



Dia. x Thick x AH	Grit	Item#	EACH Prices	
			1-9	10+
6" x 1/4" x 1/2"	80	206-3350	\$35.80	\$32.22
	120	206-3360	35.80	32.22
	180	206-3370	35.80	32.22

A



A. Gesswein® Royal Gem Cloth

Our high-quality, lint-free gem cloth keeps your jewelry looking its best. Removes dust and fingerprints quickly and easily, bringing back the luster in your finest pieces. Completely free of abrasives and chemicals, so it's safe for all types of gemstones and metals. Leaves no residue behind, so it keeps your jewelry and your hands squeaky clean. Features durable construction with stitched edges that resist fraying even after repeated washing. Available in light blue and ivory.

Size	Color	Item#	EACH Prices	
			1-11	12+
10" x 10"	Light Blue	820-0419	\$5.65	\$4.71
	Ivory	820-0415	5.65	4.71

B



B. Fabulustre® Rouge Cloth

Unique double-sided polishing cloth: inner cloth is impregnated with rouge for removing tarnish; outer cloth lets you apply final polish while keeping your hands clean. For dry use only. Made in USA.

Size	Item#	EACH Prices			
		1-5	6-11	12-143	144+
9" x 11"	820-0052	\$6.95	\$6.26	\$6.26	\$5.56

C



C. Luster Cloth

Cleaner than rouge cloth, this cloth is made of soft, felt-like material with special additives that remove tarnish and dirt—plus, it actually polishes. Works on precious metals, glass, mirrors, ceramic and faceted stones. Won't scratch or stain. Leaves your hands free of chemical and rouge residues. Ideal for cleaning and polishing your own finished jewelry. Economical enough to use as giveaways for your valued customers. For dry use only.

Size	Item#	EACH Prices	
		1-11	12+
5" x 7½"	820-0360	\$2.60	\$1.95

D



D. 3M™ High Performance Cloth

This amazing cloth has oil- and water-absorbing fibers that lift and trap both liquid and solid contaminants. Features a specially knitted design that does a better job of cleaning than conventional wipes. Can be used dry or damp. Removes grease, silicone, solvents, abrasive residues, polishes, waxes and fingerprints. Leaves no smears or streaks and is resistant to common cleaning chemicals. Can be washed in temperatures up to 200°F. Comes in two different colors for easy assignment to specific uses.

Size	Color	Item#	EACH Prices		
			1-4	5-9	10+
12¾" x 14"	Blue	820-0505	\$6.95	\$5.56	\$4.17
	White	820-0500	6.95	5.56	4.17

E



E. Pads Ultra Polishing 2x2

Fast and easy, these convenient sized Ultra-Polish Pads are great for removing tarnish, highlighting when using liver of sulfur or silver black, or polishing to a high luster. Leaves no residue. They are made of thin, tight-bond foam with permanently bonded microabrasives. A handy, economical polisher that is truly amazing. Sold in packs of 20

Size	Item#	PKG. of 20
2" x 2"	820-0380	\$7.95

A, B SELVYT® Professional Cloth

This is the original cloth which made Selvyt famous. It is finely woven cotton and very flexible, allowing easy cleaning of contours and irregular surfaces. A noticeably better quality than other cloths, and has a beautiful smooth nap. Removes smudges, fingerprints and dirt from metals, plastics and glass (optical lenses). Stays lint-free after repeated machine washing and the stitched edges prevent fraying. Made in UK.

Size	Item#	EACH Prices		
		1-5	6-11	12+
A. 10" x 10"	820-0270	\$7.50	\$7.13	\$6.75
B. 14" x 14"	820-0275	9.95	9.45	8.96



C. SELVYT® Microfiber Cloth

Ideal for cleaning diamonds and gemstones. Made of ultra-soft heavy brushed microfiber. Retains softness after repeated washing. Stitched edges prevent fraying. Machine washable. Made in UK.

Size	Item#	EACH Prices		
		1-5	6-11	12+
10" x 10"	820-0260	\$5.50	\$5.23	\$4.95



D. SELVYT® SC Cloth for Silver

Contains an anti-tarnish agent, Selvyt SC removes light tarnish from silverware and silver jewelry. Leaves behind an invisible coating that eliminates oxidation. Stitched edges prevent fraying. Made in UK.

Size	Item#	EACH Prices		
		1-5	6-11	12+
10" x 10"	820-0280	\$5.75	\$5.46	\$5.18



E-G. SELVYT® SR Cloth

Made of pure unbleached cotton. Features no-lint texture that polishes without scratching. Use on precious jewelry, watches, silverware and crystal. Retains its suppleness even after repeated washing. Made in UK.

Size	Item#	EACH Prices		
		1-5	6-11	12+
E. 5" x 5"	820-0100	\$1.50	\$1.43	\$1.35
F. 10" x 10"	820-0155	5.65	5.37	5.09
G. 14" x 14"	820-0205	7.50	7.13	6.75



H. SELVYT® JC Cloth

The Selvyt JC (Jewelry Cleaning) cloth is ideal for cleaning gold and most other metals such as brass, copper, platinum and silver. Manufactured in a chemically impregnated red cotton fabric, Selvyt JC is a professional's cloth that can be used at home too. Non-scratching. Edges are bound to keep them soft. Measures 10" square. Made in UK.

Size	Item#	EACH Prices	
		1-11	12+
10" x 10"	820-0287	\$5.75	\$5.18



I. KIMTECH® Mold Polish Wipes

Use for cleaning the most extreme high polished surfaces. Can be used with diamond compound for the ultimate finishing touch. Engineered for excellent absorbency and low-lint wiping, these disposable wipes are solvent resistant and contain no binders or surfactants. Rayon/polyester spunlace material for cloth-like softness. Applications include mold polishing, aerospace, clean manufacturing areas, DVD manufacturing and printing. 1 roll = 225 sheets. Each sheet measures 7" x 7".

Description	Item#	EACH Prices	
		1-5	6+
Kimtech Mold Polish Wipes	820-0515	\$33.50	\$30.15



J. Cape Cod Anti-Tarnish Polishing Cloth

With easy rubbing, this moist cotton cloth removes dirt and tarnish from sterling silver, gold, brass, bronze, copper, pewter, aluminum and stainless steel. Also leaves behind an invisible coating that protects against tarnish, water stains and corrosion. Keeps jewelry brighter longer.

Size	Item#	PKG. of 2	
		1-11	12+
4" x 6"	820-0370	\$5.15	\$4.29





Busch® Burs 3/32" Shank

Made of tungsten vanadium steel for strength and durability. Feature precision-machined, uniformly spaced teeth for accurate and smooth cutting. Use with a good lubricant such as Gesswein Lube-Stik (see p. 480) to facilitate cutting and prolong tool life.

The 3/32" shanks measure approximately 1 3/4" long. Maximum operating speed varies with bur size and is indicated on each individual box. Burs packaged six to a box and available only in multiples of six unless otherwise indicated. Please consult ANSI (American National Standards Institute) for speed recommendations. Made in Germany. **Please ask for quotes on larger quantities.**



Busch® Round Burs – Fig 1

Dia. (mm)	0.25	0.30	0.35	0.40	0.50	0.60	0.70	0.80	0.90	1.00
Item#	122-2009	122-2008	122-2007	122-2006	122-2005	122-2004	122-2003	122-2002	122-2001	122-2010
EACH 6-66	\$3.13	3.13	3.13	1.66	0.97	0.97	0.97	0.97	0.97	0.97
EACH 72-138	\$2.66	2.66	2.66	1.41	0.82	0.82	0.82	0.82	0.82	0.82

Dia. (mm)	1.10	1.20	1.30	1.40	1.50	1.60	1.70	1.80	1.90	2.00
Item#	122-3015	122-2020	122-3025	122-2030	122-2040	122-2050	122-3055	122-2060	122-3065	122-3066
EACH 6-66	\$0.97	0.97	0.97	0.97	0.97	0.97	0.97	0.97	0.97	0.97
EACH 72-138	\$0.82	0.82	0.82	0.82	0.82	0.82	0.82	0.82	0.82	0.82

Dia. (mm)	2.10	2.20	2.30	2.40	2.50	2.60	2.70	2.80	2.90
Item#	122-2070	122-3075	122-2080	122-3085	122-2090	122-3095	122-2100	122-2105	122-2110
EACH 6-66	\$0.97	0.97	0.97	2.02	2.02	2.02	2.02	2.02	2.02
EACH 72-138	\$0.82	0.82	0.82	1.72	1.72	1.72	1.72	1.72	1.72

Dia. (mm)	3.00	3.10	3.30	3.50	3.70	4.00	4.20	4.50	4.70
Item#	122-2115	122-2120	122-2130	122-2140	122-2150	122-2160	122-2170	122-2180	122-2190
EACH 6-66	\$3.08	3.08	3.08	3.08	3.08	3.91	3.91	3.91	3.91
EACH 72-138	\$2.62	2.62	2.62	2.62	2.62	3.32	3.32	3.32	3.32

Sold Individually								
Dia. (mm)	5.00	5.50	6.00	6.50	7.00	7.50	8.00	8.50
Item#	122-2200	122-2220	122-2240	122-2260	122-2280	122-2300	122-2320	122-2340
EACH 1-71	\$3.91	6.62	6.62	6.62	6.62	8.23	8.23	8.23
EACH 72-143	\$3.32	5.63	5.63	5.63	5.63	7.00	7.00	7.00

Busch® 90° Hart Burs – Fig 156c

Dia. (mm)	0.70	0.80	0.90	1.00	1.10	1.20	1.30	1.40	
Item#	121-8997	121-8999	121-9001	121-9010	121-9315	121-9020	121-9325	121-9030	
EACH 6-66	\$3.22	3.22	2.71	2.71	2.71	2.71	2.71	2.71	
EACH 72-138	\$2.74	2.74	2.30	2.30	2.30	2.30	2.30	2.30	

Dia. (mm)	1.50	1.60	1.70	1.80	1.90	2.00	2.10	2.20
Item#	121-9040	121-9050	121-9355	121-9060	121-9062	121-9365	121-9070	121-9375
EACH 6-66	\$2.71	2.71	2.71	2.71	2.71	2.71	2.71	2.71
EACH 72-138	\$2.30	2.30	2.30	2.30	2.30	2.30	2.30	2.30

Dia. (mm)	2.30	2.40	2.50	2.60	2.70	2.80	2.90	3.00
Item#	121-9080	121-9085	121-9090	121-9095	121-9100	121-9105	121-9110	121-9115
EACH 6-66	\$2.71	4.05	4.05	4.05	4.05	4.05	4.05	4.92
EACH 72-138	\$2.30	3.44	3.44	3.44	3.44	3.44	3.44	4.18

Dia. (mm)	3.10	3.30	3.50	3.70	4.00	4.20	4.50	4.70	5.00
Item#	121-9120	121-9130	121-9140	121-9150	121-9160	121-9170	121-9180	121-9190	121-9200
EACH 6-66	\$4.92	4.92	4.92	4.92	6.07	6.07	6.07	6.07	6.07
EACH 72-138	\$4.18	4.18	4.18	4.18	5.16	5.16	5.16	5.16	5.16



Busch® 90° Hart Bur Sets

Twelve-piece set includes 1.0, 1.2, 1.4, 1.5, 1.6, 1.8, 2.1, 2.3, 2.5, 2.7, 2.9 and 3.1mm sizes. Six-piece set includes 3.3, 3.5, 3.7, 4.0, 4.2 and 4.5mm sizes.

Description	Item#	Each
12-Piece Set	121-9500	\$37.65
6-Piece Set	121-9550	32.15

Six-piece minimum; Please order in multiples of six.

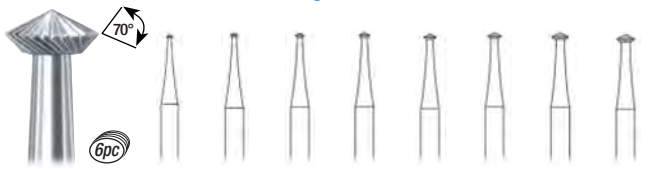
Busch® 70° Hart Burs – Fig 446

Dia. (mm)	0.90	1.00	1.20	1.40	1.60	1.80	2.10	2.30
Item#	121-8205	121-8210	121-8220	121-8230	121-8240	121-8250	121-8260	121-8270
EACH 6-66	\$2.71	2.71	2.71	2.71	2.71	2.71	2.71	2.71
EACH 72-138	\$2.30	2.30	2.30	2.30	2.30	2.30	2.30	2.30

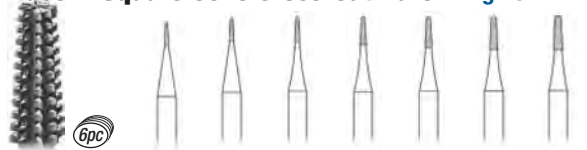

Dia. (mm)	2.50	2.70	2.90	3.10	3.30	3.50	3.70	4.00
Item#	121-8280	121-8290	121-8300	121-8310	121-8320	121-8330	121-8340	121-8350
EACH 6-66	\$4.05	4.05	4.05	4.92	4.92	4.92	4.92	6.07
EACH 72-138	\$3.44	3.44	3.44	4.18	4.18	4.18	4.18	5.16

Busch® Square Cone Cross-Cut Burs – Fig 23

Dia. (mm)	0.50	0.60	0.70	0.80	0.90	1.00	1.20
Item#	121-5005*	121-5004*	121-5003	121-5002	121-5001	121-5010	121-5020
EACH 6-66	\$2.02	1.47	1.47	1.47	1.47	1.47	1.47
EACH 72-138	\$1.72	1.25	1.25	1.25	1.25	1.25	1.25

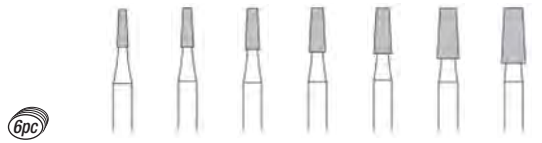

Dia. (mm)	1.40	1.60	1.80	2.10	2.30	2.70	3.10
Item#	121-5030	121-5050	121-5060	121-5070	121-5080	121-5100	121-5120
EACH 6-66	\$1.47	1.47	1.47	1.47	1.47	3.04	3.40
EACH 72-138	\$1.25	1.25	1.25	1.25	1.25	2.58	2.89

* Signifies reinforced neck

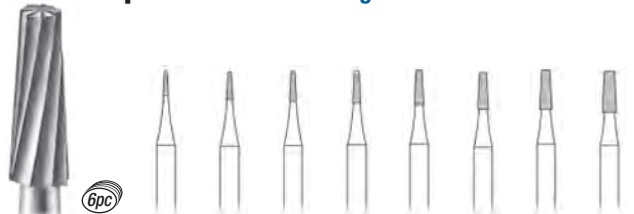
Busch® Square Cone Burs – Fig 17

Dia. (mm)	0.70	0.80	0.90	1.00	1.20	1.40	1.60	1.80
Item#	121-3003	121-3002	121-3001	121-3010	121-3020	121-3030	121-3050	121-3060
EACH 6-66	\$1.47	1.47	1.47	1.47	1.47	1.47	1.47	1.47
EACH 72-138	\$1.25	1.25	1.25	1.25	1.25	1.25	1.25	1.25

Six-piece minimum; Please order in multiples of six.

Busch® Square Cylinder Cross-Cut Burs – Fig 21

Dia. (mm)	0.6	0.7	0.80	0.90	1.00	1.20	1.40	1.60
Item#	121-4004	121-4003	121-4002	121-4001	121-4010	121-4020	121-4030	121-4050
EACH 6-66	\$1.47	1.47	\$1.47	1.47	1.47	1.47	1.47	1.47
EACH 72-138	\$1.25	1.25	\$1.25	1.25	1.25	1.25	1.25	1.25

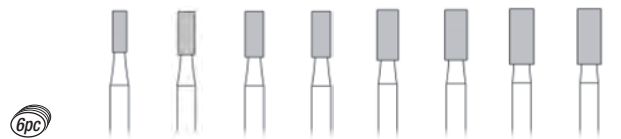

Dia. (mm)	1.80	2.10	2.30	2.50	2.70	2.90	3.10	3.10
Item#	121-4060	121-4070	121-4080	121-4090	121-4100	121-4110	121-4120	121-4120
EACH 6-66	\$1.47	1.47	1.47	3.04	3.04	3.04	3.40	3.40
EACH 72-138	\$1.25	1.25	1.25	2.58	2.58	2.58	2.89	2.89

Busch® Square Cylinder Burs – Fig 15

Dia. (mm)	0.70	0.80	0.90	1.00	1.20	1.40
Item#	121-2003	121-2002	121-2001	121-2010	121-2020	121-2030
EACH 6-66	\$1.47	1.47	1.47	1.47	1.47	1.47
EACH 72-138	\$1.25	1.25	1.25	1.25	1.25	1.25



Dia. (mm)	1.60	1.80	2.10	2.30	2.70*	3.10
Item#	121-2050	121-2060	121-2070	121-2080	121-2090	121-2120
EACH 6-66	\$1.47	1.47	1.47	1.47	1.47	3.40
EACH 72-138	\$1.25	1.25	1.25	1.25	1.25	2.89

*This particular item is NOT manufactured by Busch, when required we are supplying a Panther Bur of similar quality and also made in Germany.

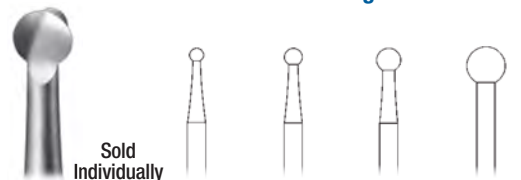
Busch® Wax/Plastic Burs – Fig 260a

Dia. (mm)	1.80	2.30	3.10	5.00
Item#	121-8170	121-8180	121-8190	121-8200
EACH 1-71	\$3.65	3.65	5.89	7.08
EACH 72-143	\$3.10	3.10	5.01	6.02



Busch® Bud Burs – Fig 6



Dia. (mm)	0.60	0.70	0.80	0.90	1.00	1.20	1.40	1.50
Item#	121-0004	121-0003	121-0002	121-0001	121-0010	121-0020	121-0030	121-0040
EACH 6-66	\$1.10	1.10	1.10	1.10	1.10	1.10	1.10	1.10
EACH 72-138	\$0.94	0.94	0.94	0.94	0.94	0.94	0.94	0.94



Dia. (mm)	1.60	1.80	2.10	2.30	2.50	2.70	2.90	3.10
Item#	121-0050	121-0060	121-0070	121-0080	121-0090	121-0100	121-0110	121-0120
EACH 6-66	\$1.10	1.10	1.10	1.10	2.39	2.39	2.39	3.36
EACH 72-138	\$0.94	0.94	0.94	0.94	2.03	2.03	2.03	2.86

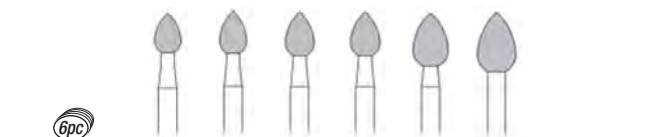

Dia. (mm)	3.30	3.50	3.70	4.00	4.50	5.00
Item#	121-0130	121-0140	121-0150	121-0160	121-0180	121-0200
EACH 6-66	\$3.36	3.36	3.36	4.28	4.28	4.28
EACH 72-138	\$2.86	2.86	2.86	3.64	3.64	3.64

Busch® Wheels – Fig 2



Dia. (mm)	0.60	0.70	0.80	0.90	1.00	1.20	1.40	1.60
Item#	122-4004	122-4003	122-4002	122-4001	122-4010	122-4020	122-4030	122-4050
EACH 6-66	\$0.97	0.97	0.97	0.97	0.97	0.97	0.97	0.97
EACH 72-138	\$0.82	0.82	0.82	0.82	0.82	0.82	0.82	0.82



Dia. (mm)	1.80	2.10	2.30	2.50	2.70	2.90	4.00	5.00
Item#	122-4060	122-4070	122-4080	122-4090	122-4100	122-4110	122-4160	122-4200
EACH 6-66	\$0.97	0.97	0.97	2.02	2.02	2.02	3.91	3.91
EACH 72-138	\$0.82	0.82	0.82	1.72	1.72	1.72	3.32	3.32

Busch® Setting Burs – Fig 413



Dia. (mm)	1.00	1.25	1.75	2.00	2.25	2.50	2.75
Item#	121-8360	121-8370	121-8380	121-8390	121-8400	121-8410	121-8420
EACH 6-66	\$2.76	2.76	2.76	2.76	2.76	4.14	4.14
EACH 72-138	\$2.35	2.35	2.35	2.35	2.35	3.52	3.52

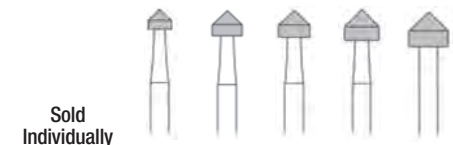

Dia. (mm)	3.00	3.75	4.00	4.50	5.00
Item#	121-8430	121-8440	121-8450	121-8470	121-8490
EACH 1-71	\$5.38	5.38	6.80	6.80	6.80
EACH 72-143	\$4.57	4.57	5.78	5.78	5.78

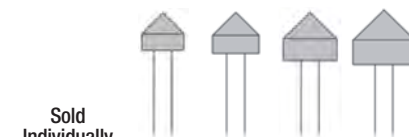

Dia. (mm)	5.50	6.00	7.00	8.00
Item#	121-8510	121-8520	121-8530	121-8540
EACH 1-71	\$7.83	7.83	7.83	9.43
EACH 72-143	\$6.66	6.66	6.66	8.02

Description Item# Each
 16-Piece Set
 (one each) 121-8541 \$79.00



Busch® Saws – Fig 45, Fig 231S



Dia. (mm)	2.30	2.30	4.0	5.00	10.00
Saw Height (mm)	0.15	0.40	0.40	0.50	0.60
Item#	121-7200	121-8025	121-8040	121-8050	121-8100
EACH 1-71	\$1.25	2.48	5.84	5.84	12.24
EACH 72-143	\$1.06	2.11	4.96	4.96	10.40

Busch® Knife-Edge Routers – Fig 161

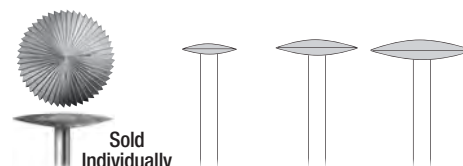

Dia. (mm)	7.00	10.00	14.00
Item#	121-7070	121-7100	121-7140
EACH 1-71	\$12.90	18.97	23.81
EACH 72-143	\$10.97	16.12	20.24

Six-piece minimum; Please order in multiples of six.



Busch® Twin-Cut Cup Burs – Fig 411T



Unique cup burs for fast and safe prong shaping. Feature twin-cut blade geometry. Shorten, round and burnish in one step. Allow easy metal discharge through two slits. See website for smaller sizes.

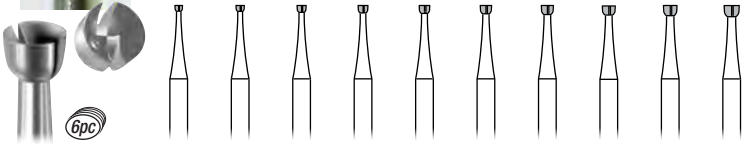

Dia. (mm)	1.00	1.10	1.20	1.30	1.40	1.50	1.60	1.70	1.80	2.00
Item#	121-1530	121-1531	121-1532	121-1533	121-1534	121-1535	121-1536	121-1537	121-1538	121-1540
EACH 6-66	\$3.35	3.35	3.35	3.35	3.35	3.35	3.35	3.35	3.35	3.35
EACH 72-138	\$2.85	2.85	2.85	2.85	2.85	2.85	2.85	2.85	2.85	2.85

Busch® Fast-Cut Cup Burs – Fig 411C

Feature slim blade design for faster cutting, ensuring long bur life. Ideal when prongs are close together.

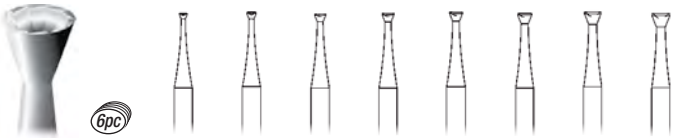

Dia. (mm)	1.00	1.20	1.40	1.50	1.60	1.80	2.10	2.30
Item#	121-1410	121-1420	121-1430	121-1440	121-1450	121-1460	121-1470	121-1480
EACH 6-66	\$2.82	2.82	2.82	2.82	2.82	2.82	2.82	2.82
EACH 72-138	\$2.40	2.40	2.40	2.40	2.40	2.40	2.40	2.40

Busch® Fast-Cut Twin-Cut Cup Burs – Fig 411CT

Fantastic combination of slim blade design Fast-cut burs with twin-cut blade geometry. Two slits eliminate clogging to cut easier and maintain tooth edges longer.

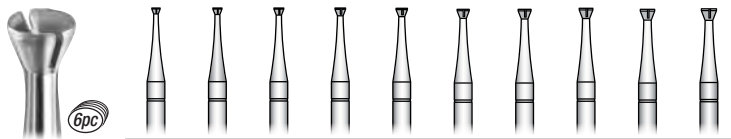

Dia. (mm)	1.10	1.20	1.30	1.40	1.50	1.60	1.70	1.80	1.90	2.00
Item#	121-1551	121-1552	121-1553	121-1554	121-1555	121-1556	121-1557	121-1558	121-1559	121-1560
EACH 6-66	\$3.35	3.35	3.35	3.35	3.35	3.35	3.35	3.35	3.35	3.35
EACH 72-138	\$2.85	2.85	2.85	2.85	2.85	2.85	2.85	2.85	2.85	2.85

Busch® Clean-Cut Cup Burs – Fig 411CCC

Feature four slits for allowing metal particles to fall out. Eliminate clogging to cut easier and maintain tooth edges longer.

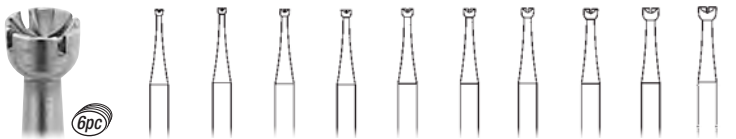

Dia. (mm)	1.00	1.10	1.20	1.30	1.40	1.50	1.60	1.80	2.10	2.30
Item#	121-1510	121-1511	121-1512	121-1513	121-1514	121-1515	121-1516	121-1518	121-1521	121-1523
EACH 6-66	\$3.04	3.04	3.04	3.04	3.04	3.04	3.04	3.04	3.04	3.04
EACH 72-138	\$2.58	2.58	2.58	2.58	2.58	2.58	2.58	2.58	2.58	2.58

Description	Item#	Each
10-Piece Set (one each)	121-1524	\$27.99



6pc Six-piece minimum; Please order in multiples of six.

Busch® Cup Burs – Fig 77b

Uniformly spaced teeth for accurate and smooth cutting.

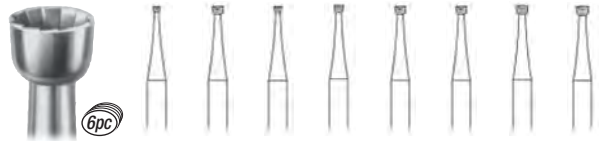

Dia. (mm)	0.90	1.00	1.10	1.20	1.30	1.40	1.50	1.60
Item#	121-1001	121-1010	121-1011	121-1020	121-1013	121-1030	121-1040	121-1050
EACH 6-66	\$2.82	2.82	2.82	2.82	2.82	2.82	2.82	2.82
EACH 72-138	\$2.40	2.40	2.40	2.40	2.40	2.40	2.40	2.40

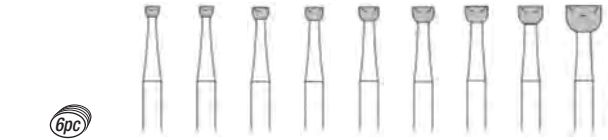

Dia. (mm)	1.70	1.80	2.10	2.30	2.50	2.70	2.90	3.10	4.50
Item#	121-1055	121-1060	121-1070	121-1080	121-1090	121-1100	121-1110	121-1120	121-1126
EACH 6-66	\$2.82	2.82	2.82	2.82	4.78	4.78	4.78	6.44	7.50
EACH 72-138	\$2.40	2.40	2.40	2.40	4.06	4.06	4.06	5.47	6.38

Description	Item#	Each
12-Piece Set* *one each of above except 0.90, 1.10, 1.30, 1.70	121-1130	\$35.99



Busch® Pointed Burs – Fig 5

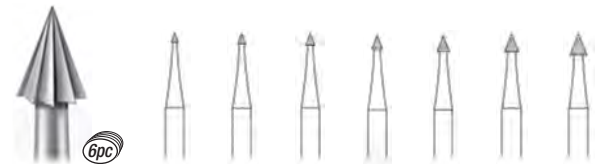

Dia. (mm)	0.90	1.00	1.20	1.40	1.60	1.80	2.10
Item#	122-1001	122-1010	122-1020	122-1030	122-1050	122-1060	122-1070
EACH 6-66	\$1.10	1.10	1.10	1.10	1.10	1.10	1.10
EACH 72-138	\$0.94	0.94	0.94	0.94	0.94	0.94	0.94

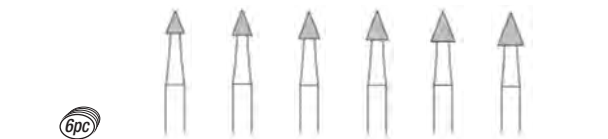

Dia. (mm)	2.30	2.50	2.70	2.90	3.10	3.30
Item#	122-1080	122-1090	122-1100	122-1110	122-1120	122-1130
EACH 6-66	\$1.10	2.39	2.39	2.39	3.36	3.36
EACH 72-138	\$0.94	2.03	2.03	2.03	2.86	2.86

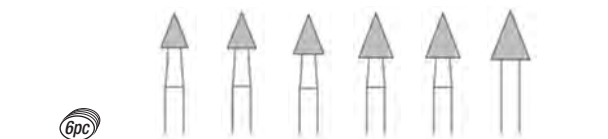

Dia. (mm)	3.50	3.70	4.00	4.50	4.70	5.00
Item#	122-1140	122-1150	122-1160	122-1180	122-1190	122-1200
EACH 6-66	\$3.36	3.36	4.28	4.28	4.28	4.28
EACH 72-138	\$2.86	2.86	3.64	3.64	3.64	3.64



Busch® Inverted Cone Burs – Fig 3

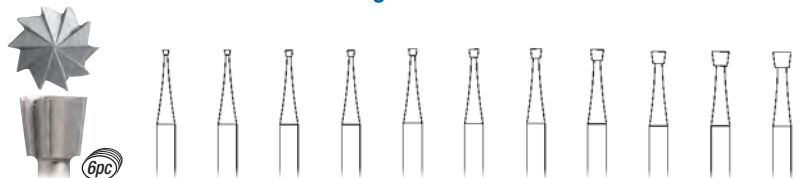

Dia. (mm)	0.60	0.70	0.80	0.90	1.00	1.20	1.40	1.60	1.80	2.10	2.30
Item#	122-0004	122-0003	122-0002	122-0001	122-0010	122-0020	122-0030	122-0050	122-0060	122-0070	122-0080
EACH 6-66	\$0.97	0.97	0.97	0.97	0.97	0.97	0.97	0.97	0.97	0.97	0.97
EACH 72-138	\$0.82	0.82	0.82	0.82	0.82	0.82	0.82	0.82	0.82	0.82	0.82

Busch® Krause Burs – Fig 256



Dia. (mm)	1.00	1.20
Item#	122-6010	122-6020
EACH 6-66	\$3.15	3.15
EACH 72-138	\$2.68	2.68

Busch® High-Speed Twist Drills – Fig 203HSS

Made of high-speed steel. More durable than tungsten vanadium steel when used on hard metals such as white gold, platinum, surgical steel and more. 3/32" shanks.

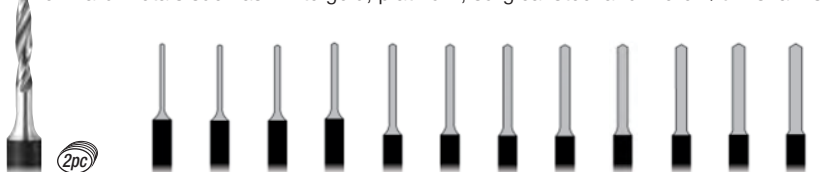

Dia. (mm)	0.50	0.60	0.70	0.80	0.90	1.00	1.10	1.20	1.30	1.40	1.50	1.60
Item#	122-6992	122-6993	122-6994	122-6995	122-6996	122-6997	122-6998	122-6999	122-7000	122-7001	122-7002	122-7003
EACH 2-70	\$5.95	5.95	5.95	5.95	5.95	5.95	5.95	5.95	5.95	5.95	5.95	5.95
EACH 72-142	\$5.06	5.06	5.06	5.06	5.06	5.06	5.06	5.06	5.06	5.06	5.06	5.06

Busch® Reamers – Fig 115A

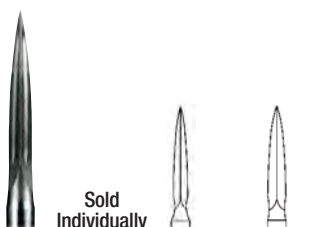

Dia. (mm)	1.80	2.30
Item#	122-7130	122-7132
EACH 1-71	\$6.99	6.99
EACH 72-143	\$5.94	5.94

Busch® Twist Drills – Fig 77

Made of tungsten vanadium steel. Use on yellow gold, silver and other soft metals. Have 3/32" shanks.

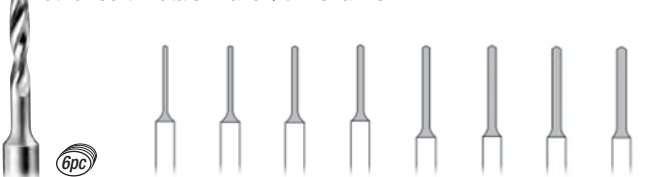

Dia. (mm)	0.50	0.60	0.70	0.80	0.90	1.00	1.10	1.20
Item#	122-7005	122-7006	122-7007	122-7008	122-7009	122-7010	122-7011	122-7012
EACH 6-66	\$2.39	2.39	2.39	2.39	2.39	2.39	2.39	2.39
EACH 72-138	\$2.03	2.03	2.03	2.03	2.03	2.03	2.03	2.03

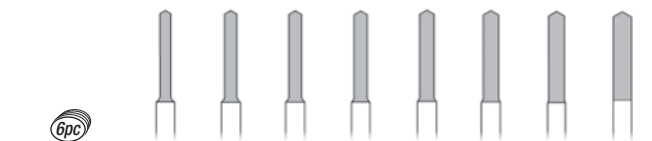

Dia. (mm)	1.40	1.50	1.60	1.70	1.80	1.90	2.10	2.30
Item#	122-7014	122-7015	122-7016	122-7017	122-7018	122-7019	122-7021	122-7023
EACH 6-66	\$2.39	2.39	2.39	2.39	2.39	2.39	2.39	2.39
EACH 72-138	\$2.03	2.03	2.03	2.03	2.03	2.03	2.03	2.03

Busch® Carbide Burnishers – RR426

Exceptionally well made tools used to remove porosity and surface imperfections from cast pieces by moving metal over the defect. Burnisher tip is rounded for safety.

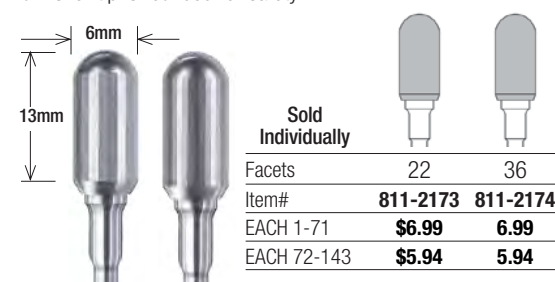

Facets	22	36
Item#	811-2173	811-2174
EACH 1-71	\$6.99	6.99
EACH 72-143	\$5.94	5.94

Busch® Carbide Starlight Burnishers

Made of the finest carbide. Impart a unique high gloss on precious metals such as gold and platinum. 3/32" shanks

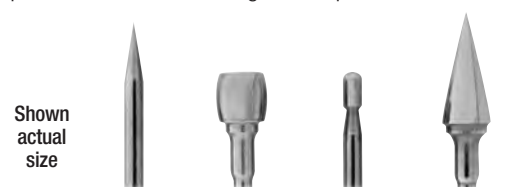

Type	Point	Barrel	Cylinder	Cone
Item#	122-7135	122-7133	122-7136	122-7134
EACH	\$29.84	40.86	29.84	40.86

Description	Item#	Each
4-Piece Set (one each)	122-7137	\$153.00

Use at 25,000-35,000rpm for best results.



Busch® Twist Drill Set – Fig 77

Includes 0.6, 0.7, 0.8, 0.9, 1.0, 1.2, 1.4, 1.5, 1.6, 1.8, 2.1 and 2.3mm sizes. Have 3/32" shanks.

Description	Item#	Each
12-Piece Set	122-7030	\$22.99



For Busch® Carbide Twist Drills (see Page 253)

6pc Six-piece minimum; Please order in multiples of six. 2pc Two-piece minimum; Please order in multiples of two

MAILLEFER Swiss Burs $\frac{3}{32}$ " Shank



Top quality precision burs manufactured in Switzerland Made of the best and long-lasting tungsten vanadium steel. Sold and priced in packages of six. Save money with these valued priced burs. Please consult ANSI (American National Standards Institute) for speed recommendations.

Please ask for quotes on larger quantities.

MAILLEFER Swiss 90° Hart Burs



Dia. (mm)	0.60	0.70	0.80	0.90	1.00	1.10	1.20	1.30	1.40	1.50	1.60	1.70	1.80	1.90	2.00	2.10	2.20	2.30	2.40	2.50	2.60	
Item#	122-8047	122-8048	122-8049	122-8050	122-8051	122-8052	122-8053	122-8054	122-8055	122-8056	122-8057	122-8058	122-8059	122-8060	122-8061	122-8062	122-8063	122-8064	122-8065	122-8066	122-8067	
PKG of 6, 1-2	\$13.50	11.80	11.80	11.80	11.80	11.80	11.80	11.80	11.80	11.80	11.80	11.80	11.80	11.80	11.80	11.80	11.80	11.80	11.80	17.20	17.20	17.20
PKG of 6, 3-5	\$12.42	10.86	10.86	10.86	10.86	10.86	10.86	10.86	10.86	10.86	10.86	10.86	10.86	10.86	10.86	10.86	10.86	10.86	15.82	15.82	15.82	

MAILLEFER Swiss Round Burs



Dia. (mm)	0.50	0.60	0.70	0.80	0.90	1.00	1.10	1.20	1.30	1.40	1.50	1.60	1.70	1.80	1.90	2.00	2.10	2.20	2.30	2.40	2.50	2.60
Item#	122-8080	122-8081	122-8082	122-8083	122-8084	122-8085	122-8086	122-8087	122-8088	122-8089	122-8090	122-8091	122-8092	122-8093	122-8094	122-8095	122-8097	122-8098	122-8099	122-8100	122-8101	122-8102
PKG of 6, 1-2	\$3.85	3.85	3.85	3.85	3.85	3.85	3.85	3.85	3.85	3.85	3.85	3.85	3.85	3.85	3.85	3.85	3.85	3.85	3.85	8.20	8.20	8.20
PKG of 6, 3-5	\$3.54	3.54	3.54	3.54	3.54	3.54	3.54	3.54	3.54	3.54	3.54	3.54	3.54	3.54	3.54	3.54	3.54	3.54	3.54	7.54	7.54	7.54

MAILLEFER Swiss Setting Burs $\frac{3}{32}$ " Shank

Ideal for Stone Setting Applications.

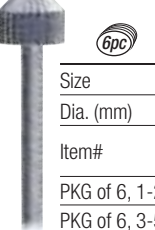

Size	009	010	011	012	013	014	015	016	017	018	019	020	021	022	023
Dia. (mm)	.9	1.0	1.1	1.2	1.3	1.4	1.5	1.6	1.7	1.8	1.9	2.0	2.1	2.2	2.3
Item#	122-8160	122-8161	122-8162	122-8163	122-8164	122-8165	122-8166	122-8167	122-8168	122-8169	122-8170	122-8171	122-8172	122-8173	122-8174
PKG of 6, 1-2	\$12.15	12.15	12.15	12.15	12.15	12.15	12.15	12.15	12.15	12.15	12.15	12.15	12.15	12.15	12.15
PKG of 6, 3-5	\$11.18	11.18	11.18	11.18	11.18	11.18	11.18	11.18	11.18	11.18	11.18	11.18	11.18	11.18	11.18

MAILLEFER Swiss Krause Burs

Use these burs when setting to remove metal for seating the points of marquis, pear, heart and other fancy cut diamonds.



Dia. (mm)	1.00	1.20
Item#	122-8006	122-8007
PKG of Six 1-2	\$10.50	10.50
PKG of Six 3-5	\$9.66	9.66



MAILLEFER Swiss Deluxe Bur Set

Includes (13) Round sizes 0.5, 0.6, 0.7, 0.8, 0.9, 1.0, 1.2, 1.4, 1.5, 1.6, 1.8, 2.1 and 2.3. (9) 90° Hart sizes 0.9, 1.0, 1.2, 1.4, 1.5, 1.6, 1.8, 2.1, and all nine Cup and both Krause burs. Packaged in an attractive wooden box.

Description	Item#	Each
33-Piece Set	122-8005	\$48.95

MAILLEFER KE Burs



Size	009	010	011	012	013	014	015	016	017	018	019	020	021
Dia. (mm)	.9	1.0	1.1	1.2	1.3	1.4	1.5	1.6	1.7	1.8	1.9	2.0	2.1
Item#	122-8139	122-8140	122-8141	122-8142	122-8143	122-8144	122-8145	122-8146	122-8147	122-8148	122-8149	122-8150	122-8151
PKG of 6, 1-2	\$12.15	12.15	12.15	12.15	12.15	12.15	12.15	12.15	12.15	12.15	12.15	12.15	12.15
PKG of 6, 3-5	\$11.18	11.18	11.18	11.18	11.18	11.18	11.18	11.18	11.18	11.18	11.18	11.18	11.18

Reducing Collets

Convert your $\frac{1}{8}$ " or 3mm handpiece collets to hold $\frac{3}{32}$ " shank tools. Easy to use: slip the reducing collet into your handpiece collet, then slip the tool into the reducing collet. Make sure the reducing collet and the tool are fully inserted before operating.

Description	Item#	Each
$\frac{1}{8}$ "- $\frac{3}{32}$ " Collet	816-1501	\$14.90
3mm- $\frac{3}{32}$ " Collet	816-1504	14.90

Swiss Cup Burs



Dia. (mm)	0.90	1.00	1.20	1.40	1.50	1.60	1.80	2.10	2.30	
Item#	122-8010	122-8011	122-8013	122-8016	122-8017	122-8018	122-8022	122-8024	122-8026	
PKG of Six 1-2	\$11.80	11.80	11.80	11.80	11.80	11.80	11.80	11.80	11.80	
PKG of Six 3-5	\$10.86	10.86	10.86	10.86	10.86	10.86	10.86	10.86	10.86	
9-Piece Set (one each)	122-8045		\$19.50							





Cup Burs 3/32" Shank

Cup burs are used to quickly and easily remove burrs and round off the ends of wires and prongs. Much easier than using a file. Measurements are taken from the outside of the head, so good rule of thumb is to select a bur 2 sizes larger than the wire or prong you are using. Please consult ANSI (American National Standards Institute) for speed recommendations.

Busch® Twin-Cut Cup Burs – Fig 411T



Unique cup burs for fast and safe prong shaping. Feature twin-cut blade geometry. Shorten, round and burnish in one step. Allow easy metal discharge through two slits. [See website for smaller sizes.](#)



Dia. (mm)	1.00	1.10	1.20	1.30	1.40	1.50	1.60	1.70	1.80	2.00
Item#	121-1530	121-1531	121-1532	121-1533	121-1534	121-1535	121-1536	121-1537	121-1538	121-1540
EACH 6-66	\$3.35	3.35	3.35	3.35	3.35	3.35	3.35	3.35	3.35	3.35
EACH 72-138	\$2.85	2.85	2.85	2.85	2.85	2.85	2.85	2.85	2.85	2.85

C. Busch® Fast-Cut Cup Burs – Fig 411C

Feature slim blade design for faster cutting, ensuring long bur life. Ideal when prongs are close together.

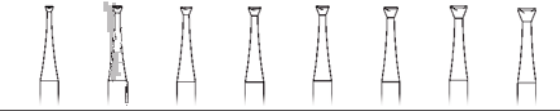

Dia. (mm)	1.00	1.20	1.40	1.50	1.60	1.80	2.10	2.30
Item#	121-1410	121-1420	121-1430	121-1440	121-1450	121-1460	121-1470	121-1480
EACH 6-66	\$2.82	2.82	2.82	2.82	2.82	2.82	2.82	2.82
EACH 72-138	\$2.40	2.40	2.40	2.40	2.40	2.40	2.40	2.40

Busch® Fast-Cut Twin-Cut Cup Burs – Fig 411CT

Fantastic combination of slim blade design Fast-cut burs with twin-cut blade geometry. Two slits eliminate clogging to cut easier and maintain tooth edges longer.



Dia. (mm)	1.10	1.20	1.30	1.40	1.50	1.60	1.70	1.80	1.90	2.00
Item#	121-1551	121-1552	121-1553	121-1554	121-1555	121-1556	121-1557	121-1558	121-1559	121-1560
EACH 6-66	\$3.35	3.35	3.35	3.35	3.35	3.35	3.35	3.35	3.35	3.35
EACH 72-138	\$2.85	2.85	2.85	2.85	2.85	2.85	2.85	2.85	2.85	2.85

Busch® Clean-Cut Cup Burs – Fig 411CCC

Feature four slits for allowing metal particles to fall out. Eliminate clogging to cut easier and maintain tooth edges longer.

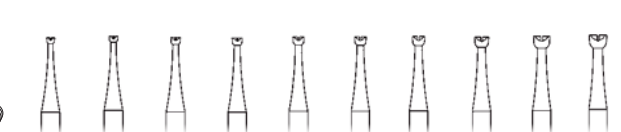

Dia. (mm)	1.00	1.10	1.20	1.30	1.40	1.50	1.60	1.80	2.10	2.30
Item#	121-1510	121-1511	121-1512	121-1513	121-1514	121-1515	121-1516	121-1518	121-1521	121-1523
EACH 6-66	\$3.04	3.04	3.04	3.04	3.04	3.04	3.04	3.04	3.04	3.04
EACH 72-138	\$2.58	2.58	2.58	2.58	2.58	2.58	2.58	2.58	2.58	2.58

Description	Item#	Each
10-Piece Set (one each)	121-1524	\$27.99

Six-piece minimum; Please order in multiples of six.



Busch® Cup Burs – Fig 77b

Uniformly spaced teeth for accurate and smooth cutting.



Dia. (mm)	0.90	1.00	1.10	1.20	1.30	1.40	1.50	1.60
Item#	121-1001	121-1010	121-1011	121-1020	121-1013	121-1030	121-1040	121-1050
EACH 6-66	\$2.82	2.82	2.82	2.82	2.82	2.82	2.82	2.82
EACH 72-138	\$2.40	2.40	2.40	2.40	2.40	2.40	2.40	2.40

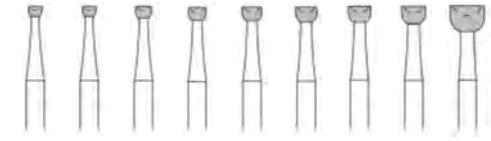

Dia. (mm)	1.70	1.80	2.10	2.30	2.50	2.70	2.90	3.10	4.50
Item#	121-1055	121-1060	121-1070	121-1080	121-1090	121-1100	121-1110	121-1120	121-1126
EACH 6-66	\$2.82	2.82	2.82	2.82	4.78	4.78	4.78	6.44	7.50
EACH 72-138	\$2.40	2.40	2.40	2.40	4.06	4.06	4.06	5.47	6.38

Description	Item#	Each
12-Piece Set* *one each of above except 0.90, 1.10, 1.30, 1.70	121-1130	\$35.99



Fox® Champion Cup Burs – No teeth, two slits



Tooth-free cups that burnish rather than cut. Two slits allow metal particles to escape. To finish & polish prongs at the same time.

Dia. (mm)	0.90	1.00	1.10	1.20	1.30	1.40
Item#	124-7039	124-7040	124-7041	124-7042	124-7043	124-7044
EACH 6-66	\$2.25	2.25	2.25	2.25	2.25	2.25
EACH 72-138	\$1.91	1.91	1.91	1.91	1.91	1.91

Dia. (mm)	1.50	1.60	1.70	1.80	2.10	2.30
Item#	124-7045	124-7046	124-7047	124-7048	124-7050	124-7051
EACH 6-66	\$2.25	2.25	2.25	2.28	2.25	2.25
EACH 72-138	\$1.91	1.91	1.91	1.94	1.91	1.91

Description	Item#	Each
6-Piece Set (1.0, 1.2, 1.4, 1.6, 1.8, 2.1mm)	124-7052	\$13.50



MAILLEFER Swiss Cup Burs



Precision engineered and economically priced. Made in Switzerland.

Dia. (mm)	0.90	1.00	1.20	1.40	1.50	1.60	1.80	2.10	2.30
Item#	122-8010	122-8011	122-8013	122-8016	122-8017	122-8018	122-8022	122-8024	122-8026
PKG of Six 1-2	\$11.80	11.80	11.80	11.80	11.80	11.80	11.80	11.80	11.80
PKG of Six 3-5	\$10.86	10.86	10.86	10.86	10.86	10.86	10.86	10.86	10.86

Description	Item#	Each
9-Piece Set (one each)	122-8045	\$19.50



High Speed Burs $\frac{3}{32}$ " Shank

Made of extremely rugged high-speed steel to withstand heat buildup under the most extreme conditions. On average our High Speed burs have 20% more fluting than other brands which creates a fine surface finish. Cut faster and last longer than vanadium steel dental burs. Please consult ANSI (American National Standards Institute) for speed recommendations. Made in USA.

High-Speed Round Burs



Size	1	2	3	4	5	6	7	8	9	10	11	12
Dia. (mm)	0.90	1.10	1.30	1.50	1.70	1.90	2.10	2.30	2.50	2.70	2.90	3.10
Item#	123-8010	123-8020	123-8030	123-8040	123-8050	123-8060	123-8070	123-8080	123-8090	123-8100	123-8110	123-8120
EACH 1-5	\$3.68	3.68	3.68	3.68	3.68	3.68	3.68	3.68	4.15	4.15	4.15	4.15
EACH 6+	\$3.09	3.09	3.09	3.09	3.09	3.09	3.09	3.09	3.49	3.49	3.49	3.49

Size	13	14	15	16	17	18	19	20	22	23	24
Dia. (mm)	3.30	3.50	3.80	4.00	4.30	4.50	4.70	5.00	5.20	5.40	5.60
Item#	123-8130	123-8140	123-8150	123-8160	123-8170	123-8180	123-8190	123-8200	123-8220	123-8230	123-8240
EACH 1-5	\$4.95	4.95	4.95	4.95	4.95	4.95	5.95	5.95	5.95	5.95	5.95
EACH 6+	\$4.16	4.16	4.16	4.16	4.16	4.16	5.00	5.00	5.00	5.00	5.00

Size	25	26	27	28	29	30	31	32	33	34
Dia. (mm)	5.90	6.30	6.70	7.20	7.60	8.00	8.90	9.60	10.40	11.10
Item#	123-8250	123-8260	123-8270	123-8280	123-8290	123-8300	123-8310	123-8320	123-8330	123-8340
EACH 1-5	\$5.95	6.98	6.98	6.98	6.98	6.98	8.55	8.55	9.29	9.29
EACH 6+	\$5.00	5.86	5.86	5.86	5.86	5.86	7.18	7.18	7.80	7.80

High-Speed 45° Hart Burs

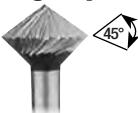

Size	2	3	4	5	6	7	8	9	10
Dia. (mm)	1.10	1.30	1.50	1.70	1.90	2.10	2.30	2.50	2.70
Item#	123-5020	123-5030	123-5040	123-5050	123-5060	123-5070	123-5080	123-5090	123-5100
EACH 1-5	\$3.80	3.80	3.80	3.80	3.80	3.80	3.80	4.89	4.89
EACH 6+	\$3.19	3.19	3.19	3.19	3.19	3.19	3.19	4.11	4.11

Size	11	12	13	14	15	16	17	18
Dia. (mm)	2.90	3.10	3.30	3.50	3.80	4.00	4.30	4.50
Item#	123-5110	123-5120	123-5130	123-5140	123-5150	123-5160	123-5170	123-5180
EACH 1-5	\$4.89	4.89	5.88	5.88	5.88	5.88	5.88	5.88
EACH 6+	\$4.11	4.11	4.94	4.94	4.94	4.94	4.94	4.94

Size	19	20	22	24	26	28	30	34
Dia. (mm)	4.70	5.00	5.20	5.60	6.30	7.20	8.00	11.10
Item#	123-5190	123-5200	123-5220	123-5240	123-5260	123-5280	123-5300	123-5340
EACH 1-5	\$6.65	6.65	6.65	6.65	6.98	6.98	6.98	9.29
EACH 6+	\$5.59	5.59	5.59	5.59	5.86	5.86	5.86	7.80



A. High-Speed Round Bur Sets

Five convenient sets all in wooden boxes.

Bur Qty.	Sizes	Item#	Each
18	1-18	124-4111	\$76.35
25	1-26	124-4112	105.45
29	1-30	124-4113	128.39
33	1-34	124-4114	144.05
36	1-12 (3 each)	124-4115	124.85



B. High-Speed 45° Hart Bur Sets

Select between four convenient sets all in wooden boxes.

Bur Qty.	Sizes	Item#	Each
17	2-18	124-4551	\$77.60
14	2-28 (evens)	124-4552	76.39
24	2-30	124-4553	120.00
33	2-12 (3 each)	124-4554	129.68



C. Reducing Collets

Convert your $\frac{1}{8}$ " or 3mm handpiece collet to hold $\frac{3}{32}$ " shank tools. Easy to use: slip the reducing collet into your handpiece collet, then slip the tool into the reducing collet. Make sure the reducing collet and the tool are fully inserted before operating.

Description	Item#	Each
$\frac{1}{8}$ "- $\frac{3}{32}$ " Collet	816-1501	\$14.90
3mm- $\frac{3}{32}$ " Collet	816-1504	14.90

High Speed Burs continued.



A

A. High-Speed 90° Bearing Bur Sets

Select between five sets all in wooden boxes.

Bur Qty.	Sizes	Item#	Each
18	1-18	124-4441	\$84.85
25	1-26	124-4442	120.10
14	2-28 (evens)	124-4443	76.39
33	1-34	124-4444	166.80
36	1-12 (3 each)	124-4445	138.20

High-Speed 90° Bearing Burs

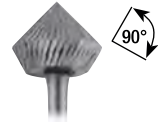

Size	1	2	3	4	5	6	7	8	9	10	11	12
Dia. (mm)	0.90	1.10	1.30	1.50	1.70	1.90	2.10	2.30	2.50	2.70	2.90	3.10
Item#	123-0010	123-0020	123-0030	123-0040	123-0050	123-0060	123-0070	123-0080	123-0090	123-0100	123-0110	123-0120
EACH 1-5	\$3.80	3.80	3.80	3.80	3.80	3.80	2.92	3.80	4.88	4.88	4.88	4.88
EACH 6+	\$3.19	3.19	3.19	3.19	3.19	3.19	2.45	3.19	4.10	4.10	4.10	4.10



Size	13	14	15	16	17	18	19	20	22	23	24
Dia. (mm)	3.30	3.50	3.80	4.00	4.30	4.50	4.70	5.00	5.20	5.40	5.60
Item#	123-0130	123-0140	123-0150	123-0160	123-0170	123-0180	123-0190	123-0200	123-0220	123-0230	123-0240
EACH 1-5	\$5.88	5.88	5.88	4.48	5.88	5.88	4.06	6.65	6.65	6.65	6.65
EACH 6+	\$4.94	4.94	4.94	3.76	4.94	4.94	3.41	5.59	5.59	5.59	5.59



Size	25	26	27	28	29	30	31	32	33	34
Dia. (mm)	5.90	6.30	6.70	7.20	7.60	8.00	8.90	9.60	10.40	11.10
Item#	123-0250	123-0260	123-0270	123-0280	123-0290	123-0300	123-0310	123-0320	123-0330	123-0340
EACH 1-5	\$6.65	6.98	6.98	6.98	6.98	6.98	8.55	8.55	9.29	9.29
EACH 6+	\$5.59	5.86	5.86	5.86	5.86	5.86	7.18	7.18	7.80	7.80



B

B. High-Speed Setting Bur Sets

Four convenient sets all in wooden boxes.

Bur Qty.	Sizes	Item#	Each
18	1-18	124-4661	\$85.25
25	1-26	124-4662	120.10
29	1-30	124-4663	146.15
33	1-34	124-4664	166.80

High-Speed Setting Burs



Size	1	2	3	4	5	6	7	8	9	10	11	12
Dia. (mm)	0.90	1.10	1.30	1.50	1.70	1.90	2.10	2.30	2.50	2.70	2.90	3.10
Item#	124-0010	124-0020	124-0030	124-0040	124-0050	124-0060	124-0070	124-0080	124-0090	124-0100	124-0110	124-0120
EACH 1-5	\$3.85	3.85	3.85	3.85	3.85	3.85	3.85	3.85	3.85	4.89	4.89	4.89
EACH 6+	\$3.23	3.23	3.23	3.23	3.23	3.23	3.23	3.23	3.23	4.11	4.11	4.11



Size	13	14	15	16	17	18	19	20	22	23	24
Dia. (mm)	3.30	3.50	3.80	4.00	4.30	4.50	4.70	5.00	5.20	5.40	5.60
Item#	124-0130	124-0140	124-0150	124-0160	124-0170	124-0180	124-0190	124-0200	124-0220	124-0230	124-0240
EACH 1-5	\$5.88	5.88	5.88	5.88	5.88	5.88	5.88	6.65	6.65	6.65	6.65
EACH 6+	\$4.94	4.94	4.94	4.94	4.94	4.94	4.94	5.59	5.59	5.59	5.59



Size	25	26	27	28	29	30	31	32	33	34
Dia. (mm)	5.90	6.30	6.70	7.20	7.60	8.00	8.90	9.60	10.40	11.10
Item#	124-0250	124-0260	124-0270	124-0280	124-0290	124-0300	124-0310	124-0320	124-0330	124-0340
EACH 1-5	\$6.65	6.98	6.98	6.98	6.98	6.98	8.55	8.55	9.29	9.29
EACH 6+	\$5.59	5.86	5.86	5.86	5.86	5.86	7.18	7.18	7.80	7.80

High-Speed Bud Burs

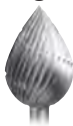

	•	•	•	•	•	•	•	•	•	•	•	•
Size	2	3	4	5	6	7	8	9	10	11	12	13
Dia. (mm)	1.10	1.30	1.50	1.70	1.90	2.10	2.30	2.50	2.70	2.90	3.10	3.30
Item#	123-1020	123-1030	123-1040	123-1050	123-1060	123-1070	123-1080	123-1090	123-1100	123-1110	123-1120	123-1130
EACH 1-5	\$3.50	3.50	3.50	3.68	3.68	3.68	3.68	4.15	4.15	4.15	4.15	4.95
EACH 6+	\$2.94	2.94	2.94	3.09	3.09	3.09	3.09	3.49	3.49	3.49	3.49	4.16



Size	14	16	18	20	22	24	26	28	30	32	34
Dia. (mm)	3.50	4.00	4.50	5.00	5.20	5.60	6.30	7.20	8.00	9.60	11.10
Item#	123-1140	123-1160	123-1180	123-1200	123-1220	123-1240	123-1260	123-1280	123-1300	123-1320	123-1340
EACH 1-5	\$4.95	4.95	4.95	5.95	5.95	5.95	6.98	6.98	6.98	8.55	9.29
EACH 6+	\$4.16	4.16	4.16	5.00	5.00	5.00	5.86	5.86	5.86	7.18	7.80



A

A. High-Speed Bud Bur Sets

Two convenient sets both in wooden boxes.

Bur Qty.	Sizes	Item#	Each
19	2-26	124-4221	\$92.10
23	2-34	124-4222	105.45

High-Speed Cone Burs



	•	•	•	•	•	•	•	•	•	•	•	•
Size	2	3	4	5	6	7	8	9	10	11	12	13
Dia. (mm)	1.10	1.30	1.50	1.70	1.90	2.10	2.30	2.50	2.70	2.90	3.10	3.30
Item#	123-2020	123-2030	123-2040	123-2050	123-2060	123-2070	123-2080	123-2090	123-2100	123-2110	123-2120	123-2130
EACH 1-5	\$3.70	3.70	3.70	3.70	3.70	3.70	3.70	3.70	4.15	4.15	4.15	4.95
EACH 6+	\$3.11	3.11	3.11	3.11	3.11	3.11	3.11	3.11	3.49	3.49	3.49	4.16



Size	14	16	18	20	22	24	26	28	30	32	34
Dia. (mm)	3.50	4.00	4.50	5.00	5.20	5.60	6.30	7.20	8.00	9.60	11.10
Item#	123-2140	123-2160	123-2180	123-2200	123-2220	123-2240	123-2260	123-2280	123-2300	123-2320	123-2340
EACH 1-5	\$4.95	4.95	4.95	5.95	5.95	5.95	6.98	6.98	6.98	8.55	9.30
EACH 6+	\$4.16	4.16	4.16	5.00	5.00	5.00	5.86	5.86	5.86	7.18	7.81



B

B. High-Speed Cone Bur Sets

Two convenient sets both in wooden boxes.

Bur Qty.	Sizes	Item#	Each
19	2-26*	124-4331	\$92.10
23	2-34*	124-4332	105.45

*As available

C. High-Speed Grand Bur Set

Includes all the following 119 burs packaged in an attractive wooden box:

- 25 Round burs, sizes 1-26
- 33 Setting burs, sizes 1-34
- 25 Bearing burs, sizes 1-26
- 17 Hart burs, sizes 2-18
- 19 Bud burs, sizes 2-26.

Description	Item#	Each
119-Piece Set	124-4670	\$553.00



C

High Speed Burs continued.

High-Speed Flame Burs



Size	2	4	6	8	10	12	14
Dia. (mm)	1.10	1.50	1.90	2.30	2.70	3.10	3.50
Item#	123-4020	123-4040	123-4060	123-4080	123-4100	123-4120	123-4140
EACH 1-5	\$3.80	3.80	3.80	3.80	4.89	4.89	5.88
EACH 6+	\$3.19	3.19	3.19	3.19	4.11	4.11	4.94



Size	16	18	20	22	24	26	30
Dia. (mm)	4.00	4.50	5.00	5.20	5.60	6.30	8.00
Item#	123-4160	123-4180	123-4200	123-4220	123-4240	123-4260	123-4300
EACH 1-5	\$5.88	5.88	6.65	6.65	6.65	6.98	6.98
EACH 6+	\$4.94	4.94	5.59	5.59	5.59	5.86	5.86

High-Speed Tree Burs



Size	5	8	13	19	26	30
Dia. (mm)	1.70	2.30	3.30	4.70	6.30	8.00
Item#	124-2050	124-2080	124-2130	124-2190	124-2260	124-2300
EACH 1-5	\$3.80	3.80	5.88	6.65	6.98	6.98
EACH 6+	\$3.19	3.19	4.94	5.59	5.86	5.86

High-Speed 17° Bezel Cone Bur – 3/32" Shank

Use to drill an angled hole that matches the 17° angle on many settings, most notably bezel settings. Solves the problem of inserting a standard tapered prong or bezel setting into a standard shank.



Size	30
Dia. (mm)	8.00
Item#	123-2301
EACH 1-5	\$6.98
EACH 6+	\$5.86

Gesswein® Lube-Stik



Use on grinding, cutting, drilling, piercing or similar tools to speed up production and increase tool life. Reduces both friction and heat buildup so that tools stay sharper, work faster and cut smoother. Easy to use: just run your tools into the soft lubricant every so often. Can also be used to reduce the effort needed for drawing operations. Supplied in handy push-up dispenser tube.

Description	Item#	EACH Prices	
		1-9	10+
Lube-Stik	816-2461	\$5.55	\$5.00

High-Speed Square-Edge Wheels



Size	5	8	13	16	19	26	30	34
Dia. (mm)	1.70	2.30	3.30	4.00	4.70	6.30	8.00	11.10
Item#	124-3050	124-3080	124-3130	124-3160	124-3190	124-3260	124-3300	124-3340
EACH 1-5	\$3.80	3.80	5.88	5.88	6.65	6.98	6.98	9.29
EACH 6+	\$3.19	3.19	4.94	4.94	5.59	5.86	5.86	7.80

High-Speed Round-Edge Wheels



Size	5	8	13	16	19	26	30	34
Dia. (mm)	1.70	2.30	3.30	4.00	4.70	6.30	8.00	11.10
Item#	123-9050	123-9080	123-9130	123-9160	123-9190	123-9260	123-9300	123-9340
EACH 1-5	\$3.70	3.70	5.88	5.88	6.65	6.98	6.98	9.29
EACH 6+	\$3.11	3.11	4.94	4.94	5.59	5.86	5.86	7.80

High-Speed Cylinder Burs



Size	5	8	13	16	19	26	30	34
Dia. (mm)	1.70	2.30	3.30	4.00	4.70	6.30	8.00	11.10
Item#	123-3050	123-3080	123-3130	123-3160	123-3190	123-3260	123-3300	123-3340
EACH 1-5	\$3.85	3.85	5.88	5.88	6.65	6.98	6.98	9.29
EACH 6+	\$3.23	3.23	4.94	4.94	5.59	5.86	5.86	7.80

High-Speed Inverted Cone Burs



Size	5	8	13	19	26	30
Dia. (mm)	1.70	2.30	3.30	4.70	6.30	8.00
Item#	123-6050	123-6080	123-6130	123-6190	123-6260	123-6300
EACH 1-5	\$3.80	3.80	5.88	6.65	6.98	6.98
EACH 6+	\$3.19	3.19	4.94	5.59	5.86	5.86

High-Speed Reamers

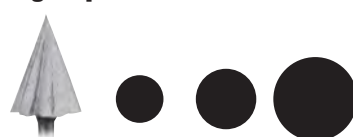

Size	26	30	34
Dia. (mm)	6.30	8.00	11.10
Item#	123-7260	123-7300	123-7340
EACH 1-5	\$6.98	6.98	9.29
EACH 6+	\$5.86	5.86	7.80

High-Speed Slim Reamers



Size	9	13	19
Dia. (mm)	2.50	3.30	4.70
Item#	124-1090	124-1130	124-1190
EACH 1-5	\$4.89	5.88	6.65
EACH 6+	\$4.11	4.94	5.59

TiN (Titanium Nitride) Burs 3/32" Shank

Made of high-speed steel, with a TiN (titanium nitride) coating that increases wear resistance to 10-20 times that of plain steel. Significantly improves corrosion resistance, reduces friction and allows freer chip flow for better workpiece finishes. Sold individually or in convenient, money saving sets,

so you always have the bur you need when you need it. Please consult ANSI (American National Standards Institute) for speed recommendations. Made in USA.

TiN Round Burs



Size	1	2	3	4	5	6	7	8	9
Dia. (mm)	0.90	1.10	1.30	1.50	1.70	1.90	2.10	2.30	2.50
Item#	124-3701	124-3702	124-3703	124-3704	124-3705	124-3706	124-3707	124-3708	124-3709
EACH 1-5	\$7.15	7.15	7.15	7.15	7.15	7.15	7.15	7.15	7.65
EACH 6+	\$6.01	6.01	6.01	6.01	6.01	6.01	6.01	6.01	6.43

Size	10	11	12	13	14	15	16	17	18
Dia. (mm)	2.70	2.90	3.10	3.30	3.50	3.80	4.00	4.30	4.50
Item#	124-3710	124-3711	124-3712	124-3713	124-3714	124-3715	124-3716	124-3717	124-3718
EACH 1-5	\$7.65	7.65	10.80	11.60	11.60	11.60	11.60	11.60	11.60
EACH 6+	\$6.43	6.43	9.07	9.74	9.74	9.74	9.74	9.74	9.74

Description	Item#	Each
18-Piece Set (one each)	130-1006	\$146.85



TiN 90° Bearing Burs



Size	1	2	3	4	5	6	7	8	9
Dia. (mm)	0.90	1.10	1.30	1.50	1.70	1.90	2.10	2.30	2.50
Item#	124-3919	124-3920	124-3921	124-3923	124-3924	124-3925	124-3926	124-3927	124-3928
EACH 1-5	\$7.30	7.30	7.30	7.30	7.30	7.30	7.30	7.30	8.40
EACH 6+	\$6.13	6.13	6.13	6.13	6.13	6.13	6.13	6.13	7.06

Size	10	11	12	13	14	15	16	17	18
Dia. (mm)	2.70	2.90	3.10	3.30	3.50	3.80	4.00	4.30	4.50
Item#	124-3929	124-3930	124-3931	124-3932	124-3933	124-3934	124-3935	124-3936	124-3937
EACH 1-5	\$8.40	8.40	11.55	12.65	12.65	12.65	12.65	12.65	12.65
EACH 6+	\$7.06	7.06	9.70	10.63	10.63	10.63	10.63	10.63	10.63

Description	Item#	Each
18-Piece Set (one each)	130-1013	\$158.45



TiN 45° Hart Burs



Size	2	3	4	5	6	7	8	9	10
Dia. (mm)	1.10	1.30	1.50	1.70	1.90	2.10	2.30	2.50	2.70
Item#	124-3902	124-3903	124-3904	124-3905	124-3906	124-3907	124-3908	124-3909	124-3910
EACH 1-5	\$7.30	7.30	7.30	7.30	7.30	7.30	7.30	8.40	8.40
EACH 6+	\$6.13	6.13	6.13	6.13	6.13	6.13	6.13	7.06	7.06

Size	11	12	13	14	15	16	17	18
Dia. (mm)	2.90	3.10	3.30	3.50	3.80	4.00	4.30	4.50
Item#	124-3911	124-3912	124-3913	124-3914	124-3915	124-3916	124-3917	124-3918
EACH 1-5	\$8.40	11.55	12.65	12.65	12.65	12.65	12.65	12.65
EACH 6+	\$7.06	9.70	10.63	10.63	10.63	10.63	10.63	10.63

Description	Item#	Each
17-Piece Set (one each)	130-1012	\$149.50



TiN Setting Burs



Size	1	2	3	4	5	6	7	8	9
Dia. (mm)	0.90	1.10	1.30	1.50	1.70	1.90	2.10	2.30	2.50
Item#	124-3801	124-3802	124-3803	124-3804	124-3805	124-3806	124-3807	124-3808	124-3809
EACH 1-5	\$7.30	7.30	7.30	7.30	7.30	7.30	7.30	7.30	8.40
EACH 6+	\$6.13	6.13	6.13	6.13	6.13	6.13	6.13	6.13	7.06

Size	10	11	12	13	14	15	16	17	18
Dia. (mm)	2.70	2.90	3.10	3.30	3.50	3.80	4.00	4.30	4.50
Item#	124-3810	124-3811	124-3812	124-3813	124-3814	124-3815	124-3816	124-3817	124-3818
EACH 1-5	\$8.40	8.40	11.55	12.65	12.65	12.65	12.65	12.65	12.65
EACH 6+	\$7.06	7.06	9.70	10.63	10.63	10.63	10.63	10.63	10.63

Description	Item#	Each
18-Piece Set (one each)	130-1000	\$158.45



A. TiN Deluxe Bur Set

Includes one of each bur listed above.

Description	Item#	Each
71-Piece Set	130-1014	\$610.50



A

Jeweler's Carbide Burs 3/32" Shank

Burs individually hand-cut with diamond wheels. All have fine teeth. Outlast and cut faster than any other burs. Sizes 4-8 feature one-piece construction; sizes 9 and larger are securely brazed onto 3/32" steel shanks. Must be run at maximum speed—will chip if started on work at

slow speed or if not removed from work at fast speed. Can be resharpened. Please consult ANSI (American National Standards Institute) for speed recommendations. Made in USA.



Jeweler's Carbide Round Burs

Size	4	5	6	7	8	9
Dia. (mm)	1.50	1.70	1.90	2.10	2.30	2.50
Item#	125-5040	125-5050	125-5060	125-5070	125-5080	125-5090
EACH	\$20.95	20.95	20.95	20.95	20.95	22.25

Size	10	11	12	13	14	16
Dia. (mm)	2.70	2.90	3.10	3.30	3.50	4.00
Item#	125-5100	125-5110	125-5120	125-5130	125-5140	125-5160
EACH	\$22.25	22.25	22.25	23.55	23.55	23.55

Size	18	20	24	26	28	30
Dia. (mm)	4.50	5.00	5.60	6.30	7.20	8.00
Item#	125-5180	125-5200	125-5240	125-5260	125-5280	125-5300
EACH	\$23.55	23.55	23.55	23.55	36.65	36.65



Jeweler's Carbide 90° Bearing Burr

Size	4	5	6	7	8	9	10	11
Dia. (mm)	1.50	1.70	1.90	2.10	2.30	2.50	2.70	2.90
Item#	125-0040	125-0050	125-0060	125-0070	125-0080	125-0090	125-0100	125-0110
EACH	\$20.89	20.89	20.89	20.89	20.89	22.25	22.25	22.25

Size	12	13	14	15	16	18	20	22
Dia. (mm)	3.10	3.30	3.50	3.80	4.00	4.50	5.00	5.20
Item#	125-0120	125-0130	125-0140	125-0150	125-0160	125-0180	125-0200	125-0220
EACH	\$22.25	23.55	23.55	23.55	23.55	23.55	23.55	23.55

Size	23	24	25	26	27	28	29	30
Dia. (mm)	5.40	5.60	5.90	6.30	6.70	7.20	7.60	8.00
Item#	125-0230	125-0240	125-0250	125-0260	125-0270	125-0280	125-0290	125-0300
EACH	\$23.55	23.55	23.55	23.55	36.65	36.65	36.65	36.65



Jeweler's Carbide 45° Hart Burs

Size	4	5	6	7	8	9	10
Dia. (mm)	1.50	1.70	1.90	2.10	2.30	2.50	2.70
Item#	125-4040	125-4050	125-4060	125-4070	125-4080	125-4090	125-4100
EACH	\$20.95	20.95	20.95	20.95	20.95	22.25	22.25

Size	11	12	13	14	15	16	18
Dia. (mm)	2.90	3.10	3.30	3.50	3.80	4.00	4.50
Item#	125-4110	125-4120	125-4130	125-4140	125-4150	125-4160	125-4180
EACH	\$22.25	22.25	23.55	23.55	23.55	23.55	23.55

Size	20	22	24	26	28	30
Dia. (mm)	5.00	5.20	5.60	6.30	7.20	8.00
Item#	125-4200	125-4220	125-4240	125-4260	125-4280	125-4300
EACH	\$23.55	23.55	23.55	23.55	36.65	36.65



Jeweler's Carbide Setting Burs

Size	4	5	6	7	8	9	10	11	12
Dia. (mm)	1.50	1.70	1.90	2.10	2.30	2.50	2.70	2.90	3.10
Item#	125-6040	125-6050	125-6060	125-6070	125-6080	125-6090	125-6100	125-6110	125-6120
EACH	\$20.95	20.95	20.95	20.95	20.95	22.25	22.25	22.25	22.25

Size	13	14	15	16	17	18	19	20
Dia. (mm)	3.30	3.50	3.80	4.00	4.30	4.50	4.70	5.00
Item#	125-6130	125-6140	125-6150	125-6160	125-6170	125-6180	125-6190	125-6200
EACH	\$23.55	23.55	23.55	23.55	23.55	23.55	23.55	23.55

Size	22	23	24	25	26	28	29	30
Dia. (mm)	5.20	5.40	5.60	5.90	6.30	7.20	7.60	8.00
Item#	125-6220	125-6230	125-6240	125-6250	125-6260	125-6280	125-6290	125-6300
EACH	\$23.55	23.55	23.55	23.55	23.55	36.65	36.65	36.65

Jeweler's Carbide Burs continued.

Jeweler's Carbide Bud Burs



Size	4	6	8	10	12	14	16
Dia. (mm)	1.50	1.90	2.30	2.70	3.10	3.50	4.00
Item#	125-1040	125-1060	125-1080	125-1100	125-1120	125-1140	125-1160
EACH	\$20.95	20.95	20.95	22.25	22.25	23.55	23.55

Size	18	20	24	26	28	30
Dia. (mm)	4.50	5.00	5.60	6.30	7.20	8.00
Item#	125-1180	125-1200	125-1240	125-1260	125-1280	125-1300
EACH	\$23.55	23.55	23.55	23.55	36.65	36.65

Jeweler's Carbide Cone Burs



Size	4	6	8	10	12	14	16
Dia. (mm)	1.50	1.90	2.30	2.70	3.10	3.50	4.00
Item#	125-2040	125-2060	125-2080	125-2100	125-2120	125-2140	125-2160
EACH	\$20.95	20.95	20.95	22.25	22.25	23.55	23.55

Size	18	20	24	26	28	30
Dia. (mm)	4.50	5.00	5.60	6.30	7.20	8.00
Item#	125-2180	125-2200	125-2240	125-2260	125-2280	125-2300
EACH	\$23.55	23.55	23.55	23.55	36.65	36.65

Jeweler's Carbide Wheel Burs



Size	26	30
Dia. (mm)	6.30	8.00
Item#	125-7260	125-7300
EACH	\$23.55	36.65

Jeweler's Carbide Cylinder Burs



Size	26	30
Dia. (mm)	6.30	8.00
Item#	125-3260	125-3300
EACH	\$23.55	36.65

BUR SIZE CHART – For High-Speed, Titanium Nitrided and Jeweler's Carbide Burs only

SIZE	1	2	3	4	5	6	7	8	9	10	11	12	13
mm	0.90	1.10	1.30	1.50	1.70	1.90	2.10	2.30	2.50	2.70	2.90	3.10	3.30
inches	.035	.043	.051	.059	.067	.075	.083	.091	.098	.106	.114	.122	.130

SIZE	14	15	16	17	18	19	20	22	23	24	25
mm	3.50	3.80	4.00	4.30	4.50	4.70	5.00	5.20	5.40	5.60	5.90
inches	.138	.150	.157	.169	.177	.185	.197	.205	.213	.220	.232

SIZE	26	27	28	29	30	31	32	33	34
mm	6.30	6.70	7.20	7.60	8.00	8.90	9.60	10.40	11.10
inches	.248	.264	.283	.299	.315	.350	.378	.409	.437

Carbide Cylinder Burs

For cutting and smoothing the inside of rings and cylinders as well as for edge breaking. Available in three styles for a fine, very fine or super fine finish. Are 'double cut' to produce a smooth surface and better operator control of the bur. Solid carbide heads are securely brazed onto steel shanks. Made in USA.

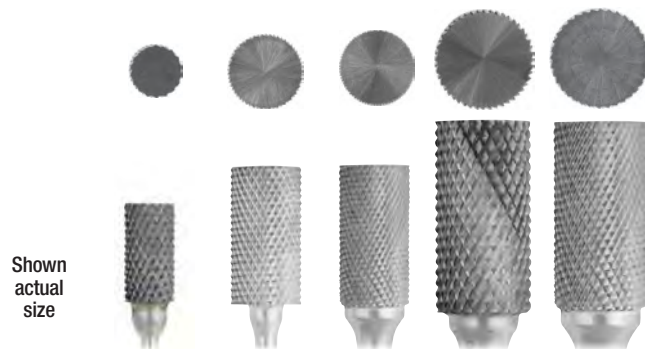

Finish	Fine	Very Fine	Super Fine	Fine	Very Fine
Head Diameter	1/4"	3/8"	3/8"	1/2"	1/2"
Head Length	1/2"	3/4"	3/4"	1"	1"
Shank	3/32"	1/8"	1/8"	1/4"	1/4"
Item#	129-0105	129-0110	129-0115	129-0030	129-0020
EACH	\$12.77	21.10	25.95	31.85	31.85

Primo™ Carbide Burs – 3/32" Shank, 1/2" Head Diameter

Primo Carbide Burs are the right tool to get the job done! Ideal for cutting and smoothing the inside of rings and cylinders as well as for edge breaking. Available in four styles: Fine, Medium, Coarse and Extra Coarse as well as a money saving kit. Made in USA.



Finish	Fine	Medium	Coarse	Extra Coarse	4 Piece Set
Item#	129-0104	129-0103	129-0102	129-0101	129-0100
EACH	\$11.50	11.50	11.50	11.50	39.50

Busch® Carbide TiNitride Coated T426 SPEED – 3/32" Shank



Suitable for cutting and contouring all types of precious metal alloys. Titanium Nitride coating on Carbide produces a tool with an exceptionally long life. The 6mm diameter bur's end is rounded for safety. Made in Germany.

Head Dia. x L (mm)	6.0 x 13.0
Item#	124-3860
EACH	52.09

Wolf Wax High Speed Steel Cylinder Burs



Made of high-speed steel. Coarse cut for rapid removal of wax. Teeth on the end for milling. Longer cutting surface. Shorter shank (25mm) reduces centrifugal wobble.

Dia. (mm)	6.3	8.0	11.1
Shank	3/32"	1/8"	1/8"
Item#	260-2682	260-2683	260-2684
EACH	\$14.82	16.44	21.56



Busch® High Tech Carbide Tools $\frac{3}{32}$ " Shank

Carbide burs and drills are known for their particular hardness and the resultant tool life, as well as their cutting capacity. These advantageous properties now also make it possible to economically process materials, which are very hard and difficult to cut (such as platinum, white gold, titanium, and steel). Let yourself be captivated by reproducible results and smooth, shiny surfaces!

Busch AU style carbide burs cut more aggressively than standard carbides. Edges are more precise (making setting easier) and they produce a brighter finish. Available in Round as well as 90° and 70° Hart shaped burs. Round burs are packaged six to a box, available only in multiples of six. Both 90° and 70° Hart burs are packaged two to a box, available only in multiples of two. Shanks are marked with a gold band for easy identification.

Busch Carbide Twist Drills have a robust 2-blade construction and generously sized chip channels. Made of super-hard fine grain carbide these drills are designed to work both on the harder metals associated with carbide tools and on white gold as well. Numerous perfect drill holes can be replicated with the same tool when using a coolant such as our Lube-Stik #816-2461 (see p. 480). Twist drills are packaged two to a box, available only in multiples of two.

Please consult ANSI (American National Standards Institute) for speed recommendations. Made in Germany.

Please ask for quotes on larger quantities.



Busch® Round Carbide Burs – Fig 1AU



Dia. (mm)	0.30	0.40	0.50	0.60	0.70	0.80	0.90	1.00	1.10	1.20	1.30	1.40	1.50	1.60	1.70	1.80	1.90	2.00	2.10	2.20	2.30
Item#	125-5403	125-5404	125-5405	125-5406	125-5407	125-5408	125-5409	125-5410	125-5411	125-5412	125-5413	125-5414	125-5415	125-5416	125-5417	125-5418	125-5419	125-5420	125-5421	125-5422	125-5423
EACH	\$7.15	7.15	5.15	5.15	5.15	5.15	5.15	5.15	5.15	5.15	5.15	5.15	5.15	5.15	5.15	5.15	5.15	5.15	5.15	5.15	5.15

Busch® 90° Hart Carbide Burs – Fig 414AU



Dia. (mm)	0.90	1.00	1.10	1.20	1.30	1.40	1.50	1.60	1.70	1.80	1.90	2.00	2.10	2.20	2.30
Item#	125-5439	125-5440	125-5441	125-5442	125-5443	125-5444	125-5445	125-5446	125-5447	125-5448	125-5449	125-5450	125-5451	125-5452	125-5453
EACH	\$14.45	14.45	14.45	14.45	14.45	14.45	14.45	14.45	14.45	14.45	14.45	14.45	14.45	14.45	14.45

Busch® 70° Hart Carbide Burs – Fig 446AU



Dia. (mm)	0.90	1.00	1.10	1.20	1.30	1.40	1.50	1.60	1.70	1.80	1.90	2.00	2.10	2.20	2.30
Item#	125-5459	125-5460	125-5461	125-5462	125-5463	125-5464	125-5465	125-5466	125-5467	125-5468	125-5469	125-5470	125-5471	125-5472	125-5473
EACH	\$14.45	14.45	14.45	14.45	14.45	14.45	14.45	14.45	14.45	14.45	14.45	14.45	14.45	14.45	14.45

Busch® Cone Carbide Burs – Fig 38AU



Dia. (mm)	0.60	0.70	0.80	0.90	1.00
Item#	125-5476	125-5477	125-5478	125-5479	125-5480
EACH 2-22	\$9.95	9.95	9.95	9.95	9.95

Busch® Carbide Twist Drills – Fig 4203S

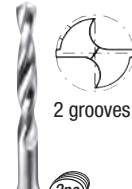

Dia. (mm)	0.50	0.60	0.70	0.80	0.90	1.00	1.10	1.20	1.30	1.40	1.50	1.60
Item#	125-5485	125-5486	125-5487	125-5488	125-5489	125-5490	125-5491	125-5492	125-5493	125-5494	125-5495	125-5496
EACH 2-22	\$14.45	14.45	13.25	13.25	13.25	13.25	13.25	13.25	13.25	13.25	13.25	13.25
EACH 24+	\$12.28	12.28	11.26	11.26	11.26	11.26	11.26	11.26	11.26	11.26	11.26	11.26

Six-piece minimum; Please order in multiples of six.

Two-piece minimum; Please order in multiples of two.



Super Carbide Burs $\frac{3}{32}$ " Shank

Made of the finest tungsten carbide, accurately fluted and honed to sharp cutting edges, end cut. Consist of heads brazed onto $\frac{3}{32}$ " steel Shanks. Have coarse tooth structure. Designed to operate at very high speeds. Cannot be resharpened. Please consult ANSI (American National Standards Institute) for speed recommendations. Made in Germany.



Busch® Round Burs – Fig 1

	•	•	•	•	•	•	•	•
Dia. (mm)	0.70	0.80	1.00	1.20	1.40	1.60	1.80	2.30
Item#	126-0005	126-0010	126-0020	126-0030	126-0040	126-0050	126-0060	126-0080
EACH 1-9	\$3.31	3.31	3.31	3.31	3.31	3.31	3.31	3.31
EACH 10+	\$2.98	2.98	2.98	2.98	2.98	2.98	2.98	2.98



Busch® Square Cone Burs – Fig 17

	•	•	•	•
Dia. (mm)	0.80	0.90	1.00	1.40
Item#	126-7037	126-7038	126-1700	126-1710
EACH 1-9	\$3.31	3.31	3.31	3.31
EACH 10+	\$2.98	2.98	2.98	2.98



Busch® Square Cylinder Burs – Fig 15

	•	•
Dia. (mm)	1.00	1.20
Item#	126-0570	126-0580
EACH 1-9	\$3.31	3.63
EACH 10+	\$2.98	3.27



Busch® Square Cone Cross-Cut Burs – Fig 23

	•	•	•	•
Dia. (mm)	1.00	1.40	1.60	1.80
Item#	126-7000	126-7010	126-7020	126-7030
EACH 1-9	\$3.31	3.31	3.31	3.31
EACH 10+	\$2.98	2.98	2.98	2.98



Busch® Square Cylinder Cross-Cut Burs – Fig 21

	•	•	•	•	•
Dia. (mm)	1.00	1.20	1.40	1.60	1.80
Item#	126-5570	126-5580	126-5590	126-5600	126-5610
EACH 1-9	\$3.31	3.31	3.31	3.31	3.31
EACH 10+	\$2.98	2.98	2.98	2.98	2.98



Busch® Universal Cone Burs – Fig 17U

	•	•
Dia. (mm)	1.00	1.40
Item#	126-1705	126-1715
EACH 1-9	\$3.63	3.63
EACH 10+	\$3.27	3.27



Busch® Universal Cylinder Burs – Fig 15U

	•	•
Dia. (mm)	1.00	1.20
Item#	126-0575	126-0585
EACH 1-9	\$3.63	3.63
EACH 10+	\$3.27	3.27



Busch® Universal Cone Cross-Cut Burs – Fig 23U

	•	•	•	•	•	•
Dia. (mm)	1.00	1.20	1.40	1.60	1.80	2.10
Item#	126-7005	126-7007	126-7015	126-7025	126-7035	126-7045
EACH 1-9	\$3.63	3.63	3.63	3.63	3.63	3.63
EACH 10+	\$3.27	3.27	3.27	3.27	3.27	3.27



Busch® Universal Cylinder Cross-Cut Burs – Fig 21U

	•	•	•	•	•
Dia. (mm)	1.00	1.20	1.40	1.60	1.80
Item#	126-5575	126-5585	126-5595	126-5605	126-5615
EACH 1-9	\$3.63	3.63	3.63	3.63	3.63
EACH 10+	\$3.27	3.27	3.27	3.27	3.27



Busch® Inverted Cone Burs – Fig 3

	•	•	•	•	•	•
Dia. (mm)	0.80	1.00	1.20	1.40	1.60	1.80
Item#	126-0340	126-0350	126-0360	126-0370	126-0380	126-0390
EACH 1-9	\$3.31	3.31	3.31	3.31	3.31	3.31
EACH 10+	\$2.98	2.98	2.98	2.98	2.98	2.98



Busch® Wheel Bur – Fig 2

	•
Dia. (mm)	1.20
Item#	126-0140
EACH 1-9	\$3.31
EACH 10+	\$2.98

WHITE® Carbide Burs $\frac{3}{32}$ " Shank

High-quality tungsten carbide burs securely brazed on heat-treated $\frac{3}{32}$ " steel shanks and approximately $1\frac{3}{4}$ " in length. Bur teeth are reinforced with extra carbide for elimination of premature chipping. Superior fluting improves cutting edges for pinpoint accuracy. All are end cut. Cannot

be resharpened. Please consult ANSI (American National Standards Institute) for speed recommendations. Available only in multiples of five. Made in USA.



Round Burs

. . . .				
Style	W1	W2	W3	W4
Dia. (mm)	0.79	0.99	1.19	1.40
Item#	128-0010	128-0020	128-0030	128-0040
EACH Prices				
5	\$3.20	3.20	3.20	3.20
10+	\$2.72	2.72	2.72	2.72

. . . .				
Style	W5	W6	W7	W8
Dia. (mm)	1.60	1.80	2.10	2.31
Item#	128-0050	128-0060	128-0070	128-0080
EACH Prices				
5	\$3.20	3.20	3.20	3.20
10+	\$2.72	2.72	2.72	2.72



Square Cylinder Burs

. .		
Style	W57	W59
Dia. (mm)	0.99	1.40
Item#	128-0570	128-0590
EACH Prices		
5	\$3.20	3.20
10+	\$2.72	2.72



Square Cylinder Cross-Cut Burs

. . . .				
Style	W557	W558	W559	W560
Dia. (mm)	0.99	1.19	1.40	1.60
Item#	128-5570	128-5580	128-5590	128-5600
EACH Prices				
5	\$3.20	3.20	3.20	3.20
10+	\$2.72	2.72	2.72	2.72



Square Cone Cross-Cut Burs

. . . .				
Style	W700	W701	W702	W703
Dia. (mm)	0.56	0.76	1.11	1.55
Item#	128-7000	128-7010	128-7020	128-7030
EACH Prices				
5	\$3.20	3.20	3.20	3.20
10+	\$2.72	2.72	2.72	2.72



Inverted Cone Burs

.					
Style	W34	W35	W36	W37	W38
Dia. (mm)	0.79	0.99	1.19	1.40	1.60
Item#	128-0340	128-0350	128-0360	128-0370	128-0380
EACH Prices					
5	\$3.20	3.20	3.20	3.20	3.20
10+	\$2.72	2.72	2.72	2.72	2.72



Wheel Bur

.	
Style	W14
Dia. (mm)	1.19
Item#	128-0140
EACH Prices	
5	\$3.20
10+	\$2.72



End Bur – Cut on top only

.	
Style	W957
Dia. (mm)	0.99
Item#	128-9570
EACH Prices	
5	\$3.20
10+	\$2.72



A. Reducing Collets

Convert your $\frac{1}{8}$ " or 3mm handpiece collets to hold $\frac{3}{32}$ " shank tools. Easy to use: slip the reducing collet into your handpiece collet, then slip the tool into the reducing collet. Make sure the reducing collet and the tool are fully inserted before operating.

Description	Item#	Each
$\frac{1}{8}$ "- $\frac{3}{32}$ " Collet	816-1501	\$14.90
3mm- $\frac{3}{32}$ " Collet	816-1504	14.90



B. Gesswein® Lube-Stik

Use on grinding, cutting, drilling, piercing or similar tools to speed up production and increase tool life. Reduces both friction and heat buildup so that tools stay sharper, work faster and cut smoother. Can also be used to reduce the effort needed for drawing operations. Supplied in handy push-up dispenser tube.

Description	Item#	EACH Prices	
		1-9	10+
Lube-Stik	816-2461	\$5.55	\$5.00

Five-piece minimum; Please order in multiples of Five.

WHITE® Friction Grip Carbide Burs 1/16" Shank

Made from super-hard carbide securely brazed onto 1/16" steel shanks. They withstand extremely high speeds up to 350,000rpm but please consult ANSI (American National Standards Institute) for speed

recommendations. Designed to get into small spaces. All fit our NSK Presto Air Turbine 850-7235, (p. 451). See below for reducing collets from 1/8", 3mm or 3/32" to 1/16". Made in USA.



Shown actual size

BURS

Your handpiece doesn't accept 1/16" shanks? Use a reducing collet. (see below)



Round

Dia. (mm)	0.51	0.61	0.79	0.99	1.19
Dia. (inches)	.020	.024	.031	.039	.047
Item#	128-9700	128-9705	128-9710	128-9715	128-9720
EACH 1-4	\$3.60	3.60	3.60	3.60	3.60
EACH 5+	\$3.42	3.42	3.42	3.42	3.42

Dia. (mm)	1.40	1.60	1.80	2.11	2.31
Dia. (inches)	.055	.063	.071	.083	.091
Item#	128-9725	128-9730	128-9735	128-9740	128-9745
EACH 1-4	\$3.60	3.60	3.60	3.60	3.60
EACH 5+	\$3.42	3.42	3.42	3.42	3.42



Cone Square

Dia. (mm)	0.46	0.56	0.76
Dia. (inches)	.018	.022	.030
Item#	128-9840	128-9845	128-9850
EACH 1-4	\$3.60	3.60	3.60
EACH 5+	\$3.42	3.42	3.42



Cone Square Cross Cut

Dia. (mm)	0.46	0.56	0.76	1.12	1.55
Dia. (inches)	.018	.022	.030	.044	.061
Item#	128-9785	128-9790	128-9795	128-9800	128-9805
EACH 1-4	\$3.60	3.60	3.60	3.60	3.60
EACH 5+	\$3.42	3.42	3.42	3.42	3.42



Inverted Cone

Dia. (mm)	0.79	0.99	1.19	1.40	1.60	1.80
Dia. (inches)	.031	.039	.047	.055	.063	.071
Item#	128-9755	128-9760	128-9765	128-9770	128-9775	128-9780
EACH 1-4	\$3.60	3.60	3.60	3.60	3.60	3.60
EACH 5+	\$3.42	3.42	3.42	3.42	3.42	3.42



Pear

Dia. (mm)	0.79	0.99	1.19
Dia. (inches)	.031	.039	.047
Item#	128-9855	128-9860	128-9865
EACH 1-4	\$3.60	3.60	3.60
EACH 5+	\$3.42	3.42	3.42



Cylinder Square

Dia. (mm)	0.79	0.99	1.19
Dia. (inches)	.031	.039	.047
Item#	128-9810	128-9815	128-9820
EACH 1-4	\$3.60	3.60	3.60
EACH 5+	\$3.42	3.42	3.42



Cylinder Square Cross Cut

Dia. (mm)	0.79	0.99	1.19
Dia. (inches)	.031	.039	.047
Item#	128-9825	128-9830	128-9835
EACH 1-4	\$3.60	3.60	3.60
EACH 5+	\$3.42	3.42	3.42



Cylinder Dome Cross Cut

Dia. (mm)	0.79	0.99	1.19
Dia. (inches)	.031	.039	.047
Item#	128-9870	128-9875	128-9880
EACH 1-4	\$3.60	3.60	3.60
EACH 5+	\$3.42	3.42	3.42

A. Reducing Collets

Instantly converts your 1/8", 3mm or 3/32" collet to hold a 1/16" tool shank. Simply slip reducing collet into collet on your rotary handpiece to use 1/16" shanked tools. Make sure both the reducing collet and the tool shank are fully inserted into the handpiece collet. Stainless steel.

Size	Item#	Each
1/8" to 1/16"	816-1502	\$14.90
3mm to 1/16"	816-1505	14.90
3/32" to 1/16"	816-1503	14.90



A

B. Face Shield

Complete protection with excellent optics.

Lightweight plastic shield for full face and neck protection while grinding, drilling or polishing. Can be worn over dust masks, respirators and glasses. Features pivoting visor for easy raising and lowering, molded visor edge for reinforcement, cushioned vinyl comfort band and adjustable headbands. Visor measures 8"L x 12"W x .040" thick. Does not eliminate need for safety glasses.

Description	Item#	Each
B. Face Shield	270-0210	\$21.00
Replacement Visor	270-0212	6.95
Replacement Vinyl Sweatband	270-0214	3.50



B

Gesswein® Solid Carbide Burs

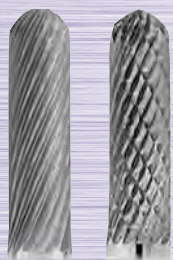

Plain cut Double cut

Gesswein Solid Carbide Burs are made from laboratory-certified raw material. Most are machine-ground by CNC, producing geometric uniformity in shape and depth of flute. Controlled material selection and CNC manufacturing ensure high product consistency from order to order for dependable cutting action and much longer bur life. All Gesswein Solid Carbide Burs feature one-piece construction (head and shank made of one piece of carbide) unless otherwise indicated. Supplied in two fluting styles: plain cut, which provides aggressive cutting action for fast stock removal, leaving a better finish than plain cut. Made in USA.

Maximum Speed Recommendations (rpm):

Bur Cutting Diameter	1/16"	3/32"	1/8"	3/16"	1/4"
Stainless Steel	75,000	65,000	55,000	40,000	35,000
Other Common Materials	50,000	45,000	35,000	27,500	25,000

These are suggested speeds only. Faster and slower speeds may be used for different materials.
Please consult ANSI (American National Standards Institute) for speed recommendations.

Gesswein® Solid Carbide Burs 1/4" Shank; 2" Overall

One-piece construction. 1/4" and 3/16" cutting diameters on 1/4" shanks. Can be resharpened. 6mm shanks and double cut available on special order.

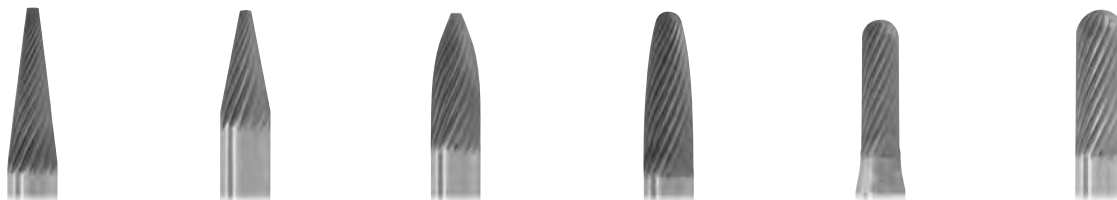

Cutting Diameter	1/4"	1/4"	1/4"	1/4"	3/16"	1/4"
Head Length	3/4"	1/2"	5/8"	5/8"	5/8"	5/8"
Included Angle	14°	22°	—	—	—	—
Plain Cut Item#	129-2840	129-2140	129-2740	129-2640	129-2230	129-2240
1-4 (each)	\$17.05	15.35	15.95	15.95	14.85	14.85
5+	\$16.20	14.58	15.15	15.15	14.11	14.11

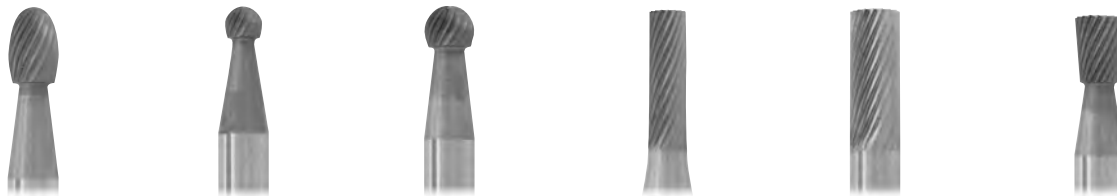

Cutting Diameter	1/4"	3/16"	1/4"	3/16"	1/4"	1/4"
Head Length	3/8"	1/8"	3/16"	5/8"	5/8"	5/16"
Included Angle	—	—	—	—	—	10°
Plain Cut Item#	129-2440	129-2330	129-2340	129-2030	129-2040	129-2940
1-4 (each)	\$17.20	13.90	13.90	13.50	13.50	16.30
5+	\$16.34	13.21	13.21	12.83	12.83	15.49



A

A. Gesswein® Solid Carbide Bur Set – 1/4" Shank; 2" Overall

Includes one each of the twelve burs listed above. Packaged in a sturdy hardwood box.

Description	Item#	Each
Plain Cut Set	129-2000	\$165.00

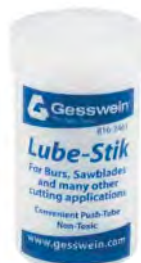

B

B. Gesswein® Lube-Stik

Use on any grinding, cutting, drilling, piercing or similar tool to speed up production and increase tool life. Lube-Stik reduces friction and heat buildup so that tools stay sharper, work faster and cut smoother. Easy to use—just run your tool in the soft lubricant. Supplied in a handy push-up dispenser tube.

Description	Item#	EACH Prices	
		1-9	10+
Lube-Stik	816-2461	\$5.55	\$5.00



Gesswein® Solid Carbide Burs

1/8" Shank; 1 1/2" Overall

One-piece construction. 3/16" and 5/32" cutting diameters on 1/8" shanks. Available in plain and double cut. Can be resharpened. 3mm shanks available on special order. Made in USA.



Cutting Diameter	5/32"	3/16"	5/32"	3/16"	3/16"	3/16"
Head Length	1/2"	1/2"	1/2"	1/2"	5/32"	9/32"
Plain Cut Item#	129-1630	129-1640	129-1650	129-1660	129-1670	129-1680
1-4 (each)	\$18.35	18.35	18.35	18.35	18.35	18.35
5+	\$17.43	17.43	17.43	17.43	17.43	17.43
Double Cut Item#	129-1635	129-1645	129-1655	129-1665	129-1675	129-1685
1-4 (each)	\$20.40	20.40	20.40	20.40	20.40	20.40
5+	\$19.38	19.38	19.38	19.38	19.38	19.38

Cutting Diameter	3/16"	3/16"	3/16"	3/16"	3/16"	3/16"
Head Length	1/2"	1/2"	3/8"	1/2"	1/2"	1/4"
Plain Cut Item#	129-1690	129-1706	129-1710	129-1720	129-1730	129-1740
Included Angle	-	-	-	4°	16°	10°
1-4 (each)	\$18.35	18.35	18.35	18.35	18.35	18.35
5+	\$17.43	17.43	17.43	17.43	17.43	17.43
Double Cut Item#	129-1695	129-1707	129-1715	129-1725	129-1735	129-1745
1-4 (each)	\$20.40	20.40	20.40	20.40	20.40	20.40
5+	\$19.38	19.38	19.38	19.38	19.38	19.38

A. Gesswein® Solid Carbide Bur Sets – 1/8" Shank; 1 1/2" Overall

Each set includes one each of the 12 respective burs listed above. Packaged in a sturdy hardwood box.

Description	Item#	Each
Plain Cut Set	129-0960	\$195.00
Double Cut Set	129-0965	210.00



Gesswein® Solid Carbide Burs 1/8" Shank; 3" Overall

One-piece construction. 1/8" cutting diameter on 1/8" shanks. Available in plain and double cut. Can be resharpened. Made in USA.

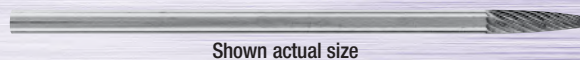

Cutting Diameter	1/8"	1/8"	1/8"	1/8"	1/8"
Head Length	9/16"	1/8"	1/2"	1/2"	7/16"
Plain Cut Item#	129-1210	129-1220	129-1230	129-1240	129-1250
1-4 (each)	\$10.20	10.20	10.20	10.20	10.20
5+	\$9.69	9.69	9.69	9.69	9.69
Double Cut Item#	129-1215	129-1225	129-1235	129-1245	129-1255
1-4 (each)	\$11.20	11.20	11.20	11.45	11.20
5+	\$10.64	10.64	10.64	10.88	10.64

Gesswein® Solid Carbide Burs 1/8" Shank; 1 1/2" Overall

Each features one-piece construction—head and shank are fashioned from a single piece of carbide. Available in two fluting styles: plain cut and double cut. Plain cut provides aggressive cutting action for fast stock removal, leaving a slightly rough finish. Double cut makes small chips for efficient stock removal, leaving a better finish than plain cut. Can be resharpened. Measure 1 1/2" long. Made in USA.



Plain Double

Cutting Diameter	1/16"	3/32"	1/8"	3/32"	1/8"	3/32"	1/8"
Head Length	1/4"	7/16"	9/16"	7/16"	9/16"	3/32"	1/8"
Plain Cut Item#	129-1010	129-1020*	129-1030*	129-1040	129-1050*	129-1060	129-1070*
1-4 (each)	\$6.50	6.50	6.50	6.50	6.50	6.50	6.50
5+	\$6.18	6.18	6.18	6.18	6.18	6.18	6.18
Double Cut Item#	129-1015	129-1025*	129-1035*	129-1045	129-1055*	129-1065	129-1075*
1-4 (each)	\$7.15	7.15	7.15	7.15	7.15	7.15	7.15
5+	\$6.79	6.79	6.79	6.79	6.79	6.79	6.79

*Items available in 12-Piece Set below.

Cutting Diameter	1/8"	1/8"	1/8"	1/8"	1/8"	1/8"	1/8"
Head Length	7/32"	1/2"	1/4"	1/4"	1/4"	5/16"	3/8"
Plain Cut Item#	129-1080*	129-1090*	129-1100*	129-1110*	129-1120*	129-1130	129-1140
1-4 (each)	\$6.50	6.50	6.50	6.50	6.50	6.50	6.50
5+	\$6.18	6.18	6.18	6.18	6.18	6.18	6.18
Double Cut Item#	129-1085*	129-1095*	129-1105*	129-1115*	129-1125*	129-1135	129-1145
1-4 (each)	\$7.15	7.15	7.15	7.15	7.15	7.15	7.15
5+	\$6.79	6.79	6.79	6.79	6.79	6.79	6.79

*Items available in 12-Piece Set below.

Cutting Diameter	1/8"	1/8"	1/8"	1/8"	1/8"	1/8"
Head Length	7/16"	1 1/32"	5/8"	1/2"	1/8"	3/16"
Included Angle	14°	12°	7°	8°	10°	10°
Plain Cut Item#	129-1150	129-1160	129-1170*	129-1180*	129-1190	129-1200*
1-4 (each)	\$6.50	6.35	6.35	6.50	6.50	6.50
5+	\$6.18	6.03	6.03	6.18	6.18	6.18
Double Cut Item#	129-1155	129-1165	129-1175*	129-1185*	129-1195	129-1205*
1-4 (each)	\$7.15	7.15	7.15	7.15	7.15	7.15
5+	\$6.79	6.79	6.79	6.79	6.79	6.79

*Items available in 12-Piece Set below.

-NEW-
Inox Carbide
 Great for Stainless Steel
 See p. 176



A, B Gesswein® Solid Carbide Bur Sets – 1/8" Shank; 1 1/2" Overall

Each set includes one each of the 12 respective burs marked with asterisks above. Packaged in a sturdy hardwood box.

Description	Item#	Each
A. Plain Cut Set	129-1000	\$65.00
B. Double Cut Set	129-1005	71.00



Plain Double

Gesswein® Solid Carbide Burs $\frac{3}{32}$ " Shank; $1\frac{1}{4}$ " Overall

One-piece construction available in plain or double cut. $\frac{1}{16}$ " and $\frac{3}{32}$ " cutting diameters on $\frac{3}{32}$ " shanks. Can be resharpened. Made in USA.



Cutting Diameter	$\frac{1}{16}$ "	$\frac{3}{32}$ "	$\frac{3}{32}$ "	$\frac{3}{32}$ "	$\frac{3}{32}$ "	$\frac{3}{32}$ "	$\frac{3}{32}$ "	$\frac{3}{32}$ "	$\frac{3}{32}$ "
Head Length	$\frac{1}{4}$ "	$\frac{3}{8}$ "	$\frac{3}{8}$ "	$\frac{3}{32}$ "	$\frac{1}{8}$ "	$\frac{1}{4}$ "	$\frac{1}{4}$ "	$\frac{1}{4}$ "	$\frac{1}{8}$ "
Plain Cut Item#	129-1400	129-1410	129-1420	129-1430	129-1440	129-1450	129-1460	129-1470	129-1480
1-4 (each)	\$9.55	9.55	9.55	9.55	9.55	\$9.55	9.55	9.55	9.55
5+	\$9.07	9.07	9.07	9.07	9.07	\$9.07	9.07	9.07	9.07
Double Cut Item#	129-1405	129-1415	129-1425	129-1435	129-1445	129-1455	129-1465	129-1475	129-1485
1-4 (each)	\$10.55	10.55	10.55	10.55	10.55	\$10.55	10.55	10.55	10.55
5+	\$10.02	10.02	10.02	10.02	10.02	\$10.02	10.02	10.02	10.02

A. Gesswein® Solid Carbide Bur Sets – $\frac{3}{32}$ " Shank; $1\frac{1}{4}$ " Overall

Each set includes one each of the nine respective burs above. Packaged in a sturdy hardwood box.

Description	Item#	Each
Plain Cut Set	129-0940	\$69.00
Plain Cut Set	129-0945	79.00



Gesswein® Carbide Burs $\frac{1}{8}$ " Shank; $1\frac{1}{2}$ " Overall

Carbide heads with $\frac{1}{4}$ " cutting diameter securely brazed on heat-treated $\frac{1}{8}$ " steel shanks. Can be resharpened. 3mm shanks available on special order. Available in plain or double cut. Made in USA.



Cutting Diameter	$\frac{1}{4}$ "	$\frac{1}{4}$ "	$\frac{1}{4}$ "	$\frac{1}{4}$ "	$\frac{1}{4}$ "	$\frac{1}{4}$ "	$\frac{1}{4}$ "	$\frac{1}{4}$ "	$\frac{1}{4}$ "
Head Length	$\frac{1}{2}$ "	$\frac{3}{16}$ "	$\frac{1}{2}$ "	$\frac{1}{2}$ "	$\frac{3}{8}$ "	$\frac{1}{4}$ "	$\frac{3}{16}$ "	$\frac{1}{2}$ "	$\frac{1}{4}$ "
Included Angle	22°	–	–	–	–	–	–	–	10°
Plain Cut Item#	129-1820	129-1810	129-1800	129-1770	129-1790	129-1780	129-1750	129-1761	129-1830
1-4 (each)	\$11.75	11.75	11.75	11.75	11.75	11.75	11.75	11.75	11.75
5+	\$11.16	11.16	11.16	11.16	11.16	11.16	11.16	11.16	11.16
Double Cut Item#	129-1825	129-1815	129-1805	129-1775	129-1795	129-1785	129-1755	129-1766	129-1835
1-4 (each)	\$12.95	12.95	12.95	12.95	12.95	12.95	12.95	12.95	12.95
5+	\$12.30	12.30	12.30	12.30	12.30	12.30	12.30	12.30	12.30

B. Gesswein® Carbide Bur Sets – $\frac{1}{8}$ " Shank; $1\frac{1}{2}$ " Overall

Each set includes one each of the nine respective burs above. Packaged in a sturdy hardwood box.

Description	Item#	Each
Plain Cut Set	129-1700	\$98.00
Plain Cut Set	129-1705	108.00



C. Reducing Collets

Instantly converts your $\frac{1}{8}$ " or 3mm collet to hold a $\frac{3}{32}$ " tool shank. Simply slip reducing collet into collet on your rotary handpiece to use $\frac{3}{32}$ " shanked tools. Make sure both the reducing collet and the tool shank are fully inserted into the handpiece collet. Stainless steel.

Size	Item#	Each	Size	Item#	Each
$\frac{1}{8}$ " to $\frac{3}{32}$ "	816-1501	\$14.90	3mm to $\frac{3}{32}$ "	816-1504	\$14.90



Gesswein® Innox Carbide Burs – 1/8" or 1/4" Shanks

Gesswein Innox carbide burs are designed with a special geometry to suit growing market demands for stainless steel applications. This is a cost effective alternative to standard solutions due to the greater rate of stainless steel stock removal as well as on Ferritic, Austenitic & Martensitic based materials.. Made in USA.



Features & Benefits

- Specifically developed cutting geometry—Generating high stock removal on Stainless Steel components
- High performance grinding—Ensuring production savings
- Specifically engineered Stainless Steel cutting geometry—Reduces heat build up at the cutting edge and workpiece
- Manufactured from high quality sintered tungsten carbide—Guaranteed high performance and durability
- CNC Machined—High consistent quality
- Manufactured to strict quality control standards—Incorporates 100% inspection of brazed joints on the 1/4" diameter cutting burs.

1/8" Shank



Style	SA-43	SA-51	SC-42	SC-51	SD-42	SD-51	SF-42	SF-51
Cutting Dia. (D1)	1/8"	1/4"	1/8"	1/4"	1/8"	1/4"	1/8"	1/4"
Length of Cut (L2)	9/16"	1/2"	9/16"	1/2"	1/8"	7/32"	1/2"	1/2"
Overall Length (L1)	1 1/2"	2"	1 1/2"	2"	1 1/2"	2"	1 1/2"	2"
Item #	129-3001	129-3002	129-3003	129-3004	129-3005	129-3006	129-3007	129-3008
Each Price	\$13.20	21.70	13.20	21.70	13.20	21.70	13.20	21.70

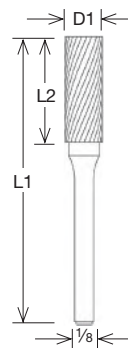

1/4" Shank



Style	SA-1	SC-1	SD-1	SF-1	SG-1
Cutting Dia. (D1)	1/4"	1/4"	1/8"	1/4"	1/4"
Length of Cut (L2)	5/8"	5/8"	7/32"	5/8"	5/8"
Overall Length (L1)	2"	2"	2"	2"	2"
Item #	129-3011	129-3012	129-3013	129-3014	129-3015
Each Price	\$20.20	23.30	21.20	24.30	24.30

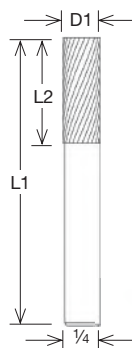

Innox Bur Head Ø	Maximum Operating Speed	Recommended Speed Range
1/8"	100,000	60,000 - 80,000
1/4"	65,000	30,000 - 45,000
3/8"	55,000	19,000 - 30,000
1/2"	35,000	15,000 - 22,000



A, B Innox Carbide Bur Sets

1/8" set contains 2 of SC-42, 2 of SF-42 and 1 of all other 1/8" shank Innox burs. 1/4" set contains one of each of the above respective 1/4" Innox burs.

Description	Shank	Item#	Each
A. Innox Carbide Bur 10 Piece Set	1/8"	129-3000	\$139.00
B. Innox Carbide Bur 5 Piece Set	1/4"	129-3010	89.00

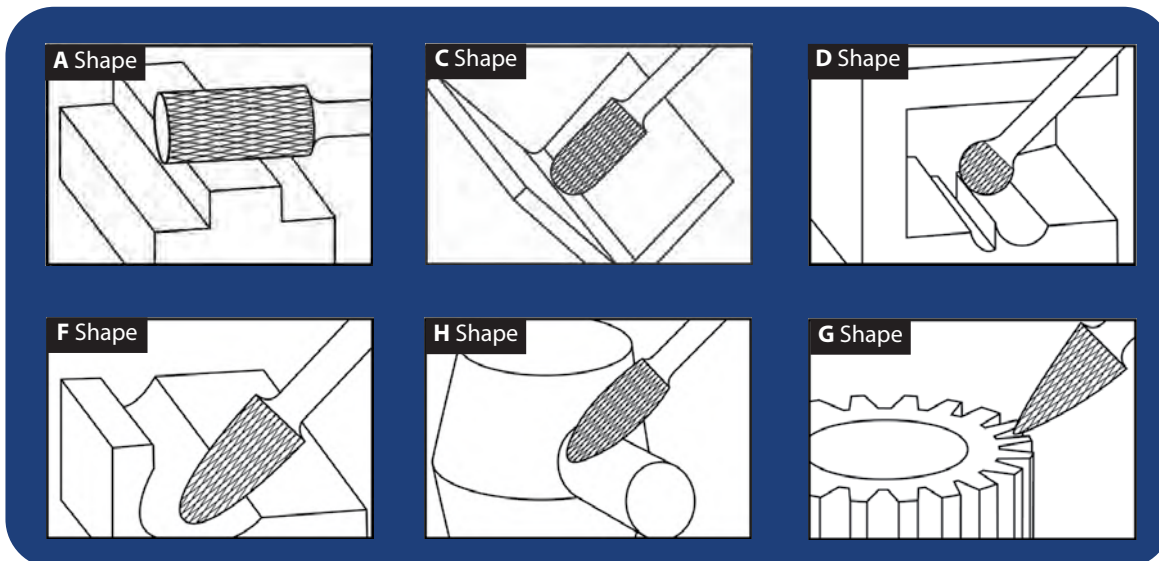

A. Wooden Bur Boxes – For 3/32" Shanks

Sturdy, attractive wooden boxes for holding burs or tools with 3/32" shanks.

Description	Item#	Each
A. 200-Hole Box	814-1200	\$25.75
100-Hole Box	814-1205	14.95
36-Hole Box	814-1210	7.95



A

B. Handy Block – For 3/32" or 1/8" Shanks

Cured hardwood block with 88 holes for burs or tools with 3/32" or 1/8" shanks. Slanted design lets you see all items at a glance. Stay-put rubber pads prevent sliding. Measures 6" x 4 1/2".

Description	Holes	Item#	Each
Handy Block	3/32", 1/8"	814-1215	\$14.95



B

C, D Rotating Bur Holders – For Burs and Tools

Tiered plastic stands rotate on ball bearings for smooth action. Measure 7" dia. x 4"H.

- Style 126
- 45 holes for burs with 1/16" shanks
 - 69 two-step holes for burs with 3/32" or 1/8" shanks
 - 12 holes for burs with 1/4" shanks
- Style 112
- 92 holes for burs with 3/32" or 1/8" shanks
 - 13 holes for burs with 1/4" shanks
 - 7 holes for 1/16" to 5/32" drills
 - 2 3/4" dia. x 3"H center cup for hand tools

Description	Shank Size	Item#	Each
C. Style 126	1/16", 3/32" or 1/8", 1/4"	850-0004	\$16.55
D. Style 112	1/16" to 5/32", 3/32" or 1/8", 1/4"	850-0006	16.55



C



D

E. Econo Rotating Bur Holder – For 3/32" Shanks

Accepts up to 150 burs or tools with 3/32" shanks. Rotates to keep items within easy reach. Measures 6" dia. x 4"H.

Description	Holes	Item#	Each
Econo Rotating Bur Holder	3/32"	124-4720	\$12.75



E

F. Mini Bur Stand with Cover – For 3/32" or 1/8" Shanks

A compact tiered plastic stand for holding up to 24 tools with 3/32" shanks and 24 tools with 1/8" shanks. Clear plastic cover keeps all items dust-free without hiding them from view. Measures 2 1/8" dia. x 2 1/2"H.

Description	Holes	Item#	Each
Mini Bur Stand with Cover	3/32", 1/8"	850-0007	\$4.00



F

G. Plastic Bur Holder – For 3/32" Shanks

Accepts up to 100 burs or tools with 3/32" shanks. Supplied with tilt stand. Measures 5" x 3". Color may vary.

Description	Holes	Item#	EACH Prices	
			1-2	3+
Plastic Bur Holder	3/32"	840-0007	\$4.95	\$3.96



G

A



B



A, B Gesswein® High-Speed Steel Blanks and Cutters

Use with CNC, pantograph or duplicating machines. Made of premium high-speed steel and heat-treated to a hardness of 62–65 HRC in a process that retains toughness. Not as durable as carbide cutters but effective for tasks that require greater tip resiliency, such as making deep, fine cuts. We suggest they be ground by plunge-cut or cross-feed method with a soft grinding wheel. Centerless ground to a tolerance of $+.0000/-0.0002$ ", with flats that are within $.001$ " above center. All have flat length of 0.565 " except #151-9630 and #151-9660, which have flat length of 0.400 ".

Description	Dia. x L	Item#	EACH Prices	
			1-5	6+
A. Single-Split Cutter	$1/8" \times 1 1/2"$	151-9630	\$7.20	\$6.12
	$3/16" \times 2"$	151-9635	8.25	7.01
	$1/4" \times 2 1/4"$	151-9640	10.55	8.97
	$5/16" \times 2 3/8"$	151-9645	16.70	14.20
	$3/8" \times 2 1/2"$	151-9650	24.20	20.57
B. Double-Split Cutter	$1/2" \times 2 1/2"$	151-9655	31.75	26.99
	$1/8" \times 1 1/2"$	151-9660	7.20	6.12
	$3/16" \times 2"$	151-9665	10.90	9.27
	$1/4" \times 2 1/4"$	151-9670	14.55	12.37
	$5/16" \times 2 3/8"$	151-9675	24.20	20.57
	$3/8" \times 2 1/2"$	151-9680	31.10	26.44
	$1/2" \times 2 1/2"$	151-9685	42.50	36.13



C

C. Gesswein® Solid Carbide Drills
Jobbers Length, Fractional Inch Sizes

Standard spiral, two-flute long-life drills with 118° drill points. Use on tool steels, cast steel, aluminum, bronze and nonmetallic materials. All drills are machine-ground (many by CNC). Gesswein Carbide Drills have consistent, uniform flute depths, so they produce dependable results order-to-order.

Tolerances:

Drill diameter: $+.0000/-0.0005$ "

Shank diameter: $+.000/-0.001$ "

Size	Diameter (inches)	Head Length	Overall Length	Item#	Each
$1/32"$.0312	$1/2"$	$1 1/4"$	155-2135	\$11.40
$3/64"$.0468	$3/4"$	$1 1/2"$	155-2140	9.60
$1/16"$.0625	$3/4"$	$1 1/2"$	155-2145	11.05
$5/64"$.0781	$7/8"$	$1 3/4"$	155-2150	12.55
$3/32"$.0937	$1"$	$2"$	155-2155	11.65
$1/8"$.1250	$1 1/4"$	$2 1/4"$	155-2165	13.95
$5/32"$.1562	$1 3/8"$	$2 1/2"$	155-2175	19.99
$3/16"$.1875	$1 5/8"$	$2 3/4"$	155-2185	21.69
$1/4"$.2500	$2"$	$3 1/4"$	155-2205	31.35

C. 6-Piece Set (one each of following popular sizes: $1/16"$, $1/8"$, $3/16"$, $1/4"$, $5/16"$, $3/8"$)	155-2207	180.00
---------------------------------------------------------------------------------------------------------------	-----------------	---------------

D. Busch® Carbide Twist Drills – Fig 4203S – $3/32"$ Shank



D



2 grooves



Dia. (mm)	0.50	0.60	0.70	0.80	0.90	1.00	1.10	1.20	1.30	1.40	1.50	1.60
Item#	125-5485	125-5486	125-5487	125-5488	125-5489	125-5490	125-5491	125-5492	125-5493	125-5494	125-5495	125-5496
EACH 2-22	\$14.45	14.45	13.25	13.25	13.25	13.25	13.25	13.25	13.25	13.25	13.25	13.25
EACH 24+	\$12.28	12.28	11.26	11.26	11.26	11.26	11.26	11.26	11.26	11.26	11.26	11.26

Two-piece minimum; Please order in multiples of two.

A, B Solid Carbide Square-Nose End Mills

Made of premium micro-grain carbide for superior performance and greater wear resistance. Stay sharp longer than regular carbide end mills, with less chipping and breaking. Available in two-flute and four-flute styles. Right-hand, center cutting, 30° spiral.

Tolerances:

Cutting Diameter +.0000/-.0020"
Shank Diameter -.0001/-.0004"

	Cutting Diameter	Shank Diameter	Head Length	Overall Length	Two-Flute Item#	Four-Flute Item#	Each
A.	1/16"	1/8"	3/16"	1 1/2"	156-0070	156-0060	\$10.95
	3/32"	1/8"	3/8"	1 1/2"	156-0150	156-0140	10.50
	1/8"	1/8"	1/2"	1 1/2"	156-0220	156-0210	10.65
	3/16"	3/16"	5/8"	2"	156-0380	156-0370	14.20
	1/4"	1/4"	3/4"	2 1/2"	156-0540	156-0530	16.85
	9/32"	5/16"	3/4"	2 1/2"	156-0620	156-0610	9.55
	5/16"	5/16"	13/16"	2 1/2"	156-0700	156-0690	23.15
	3/8"	3/8"	1"	2 1/2"	156-0860	156-0850	27.80
	1/2"	1/2"	1"	3"	156-1180	156-1170	43.75

B. 6-Piece Set (one each of following popular sizes: 1/8", 3/16", 1/4", 5/16", 3/8", 1/2" diameters) **156-1500 156-1510 151.95**



C-F Gesswein® Super Carbide Blanks and Cutters

Stay sharper and last up to five times longer than standard carbide due to high cobalt content. Ideal for use on tool steel, stainless steel, Inconel and other high-temperature metals. Centerless ground. Overall tolerance: +.0000/-.0005". Split tolerance: +.000/-0.001". Hardness: 91.8 HRC. Density: 14.74g/cc. Transverse rupture strength: 400,000 PSI. Use with pantograph or duplicating machines.

Description	Dia. x L	Item#	EACH Prices	
			1-5	6+
C. Round Blank	1/8" x 1 1/2"	150-4000	\$3.70	\$3.15
	1/8" x 3"	150-4010	7.75	6.59
	1/8" x 6"	150-4016	17.35	14.75
	3/16" x 2"	150-4020	8.60	7.31
	3/16" x 6"	150-4026	24.25	20.61
	1/4" x 2"	150-4030	12.80	10.88
	1/4" x 6"	150-4036	38.80	32.98
D. Half-Round Blank	3/8" x 2"	150-4040	26.50	22.53
	1/8" x 1 1/2"	150-5000	16.55	14.07
	3/16" x 2"	150-5005	36.10	30.69
	1/4" x 2"	150-5010	44.10	37.49
E. Single-Split Cutter	3/8" x 2"	150-5015	72.00	61.20
	1/8" x 1 1/2"	150-3000	5.45	4.63
	3/16" x 1 1/2"	150-3010	10.60	9.01
	1/4" x 2"	150-3020	16.75	14.24
F. Double-Split Cutter	3/8" x 2"	150-3030	34.00	28.90
	1/2" x 3"	150-3100	63.10	53.64
	1/8" x 1 1/2"	150-5100	8.60	7.31
	3/16" x 2"	150-5105	16.60	14.11
	1/4" x 2"	150-5110	24.50	20.83
	3/8" x 2"	150-5115	41.45	35.23



Interested in CAD/CAM but not sure if it is right for you?

If you're already using CAD (Computer Aided Design) you already know the main benefits:

- Easily create custom pieces for your select clients. Respond to local interests making you and your firm the first place customers think of when they want something truly special.
- Quickly show the concept, get immediate customer input for revisions and close the sale while the excitement of the design plan is at its highest.
- Break away from the limitations of hand carving; saving time, effort and providing utmost perfection in your models.

Having both your own CAD and CAM (Computer Aided Manufacturing) also known as 3D Printing, is an extension of this immediacy:

- You control the production schedule: no waiting on your supplier's schedule and complete elimination of delivery time.
- By keeping production in-house, your unique designs are secure.

Gesswein is proud to be teamed up with FormLabs and EnvisionTec. This alliance allows us to offer the latest technologies with the latest capabilities for you and your firm, letting you compete with other designers on a level playing field.

Interested? Call in to speak with one of our specialists to explore how these different options can help you. Also, check out our website, these technologies change quickly and the most up-to-date information will be found on-line.



"...I have worked with and have experience in ALL machines... milling machines, Roland, Solidscape, Perfactory. I gotta tell you honestly...I love my [Aureus] desktop. I would not trade it for anything else."

— Hien Nguyen, Owner
Trademark Jewellery



We offer the machinery and resins you need to save time and money while you keep total control over your intellectual property and unique designs.

Our software is easy to learn and easy to use. You'll quickly be producing intricate models.

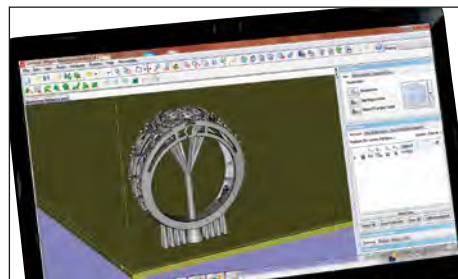

A. 3-D Design Software

We have many different software packages available for you, our specialists can help you determine the right one for your needs. Please see our website, Gesswein.com for full details.

JewelCAD Pro (266-4009) known for its non-engineering approach and simple interface resulting in a fast learning curve.

Firestorm CAD (266-4015) a direct modeling program. Create your design and import it into the system. Training is included in the purchase price.

3DESIGN CAD 7 (262-0119) user friendly software for advanced 3D model creation.

Description	Item#	Each
JewelCAD Pro V5.1	266-4009	\$3,995.00
Firestorm CAD	266-4015	6,500.00
3DESIGN CAD 7	262-0119	6,600.00

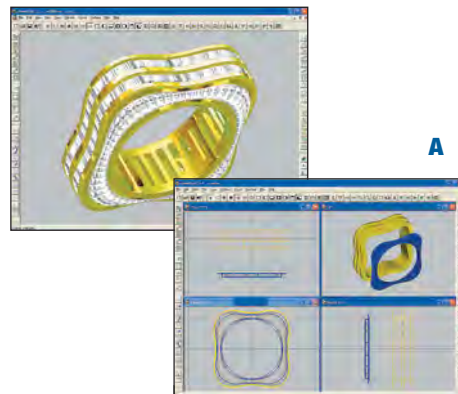

A

B. UV Post Curing Chamber

Designed to cure (harden) 3D printed resin models after production prior to casting. Settings include run times in intervals of 5 and 10 minutes and continuous mode.

Description	Item#	Each
UV Post Curing Chamber 110V	262-0190	\$125.00
UV Post Curing Chamber 220V	262-0191	125.00



B

C. Gesswein UV Curing Chamber 110V

Designed to cure (harden) 3D printed resin models after production prior to casting. Specialty high intensity UV lamp cures models in 3-5 minutes, depending on the resin being cured. Recommended to operate at 2-3 minute intervals to prolong the life of the lamp. Comes installed with a "Cooling" Fan in order to keep the high strength lamp running at the optimal temperature. Replacement lamp sold separately, see related products below. Approximate life of the UV lamp is 800 hours.

Description	Item#	Each
Gesswein UV Curing Chamber 110V	262-0195	\$995.00



C

D. Formlabs Form Wash

Form Wash's impeller agitates isopropyl alcohol (IPA) to flow around every nook and cranny of your part, getting them perfectly clean every time. When washing completes, Form Wash automatically raises parts, making sure your designs never warp. Parts air dry and are ready when you are. BUILT TO FIT THE BUILD PLATFORM: Parts can stay right on the build platform protecting delicate prints, or be removed and placed in the basket. SIMPLE IPA MONITORING: Form Wash can hold up to 8.6 liters (approx. 9 quarts) of IPA, enough to wash approximately 70 prints. The wash bucket is removable. An included hydrometer lets you know when it's time to change out IPA. A siphon pump makes it easy to transfer IPA into and out of the wash bucket. Approximate wash time when using fresh IPA is 15 minutes. Made in China.

Description	W x D x H	Item#	Each
Formlabs Form Wash, 90~264V	10.3" x 11.5" x 13.4"	262-0164	\$499.00



D

E. Formlabs Form Cure

Once your parts are cleaned - see Form Wash above. The parts go to the Form Cure. FINELY TUNED FOR CONSISTENT CURING: An advanced heating system precisely controls curing temperatures up to 80° C. 13 multi-directional LEDs emit the optimal wavelength of light for curing Formlabs materials, 405 nanometers. A rotating turntable provides uniform exposure during post-curing. The heating system preheats the chamber to get parts ready for optimum post-curing. Made in China.

Description	W x D x H	Item#	Each
Formlabs Form Cure, 90~264V	10.3" x 10.3" x 13.4"	262-0165	\$699.00



E

F. EnvisionTEC LED Post Curing Chamber

The LED Post Curing Unit is a light polymerization chamber for the hardening/curing of light curing resins. This final step (curing the model/part) after 3D printing and cleaning a 3D printed model/part results in higher strength and stability as well as ensuring a thorough cure, especially important in parts slated for direct casting. The LED Post Curing Unit features an adjustable shelf, allowing for smaller items to be placed closer to the LED's for faster curing times. Made in India.

Description	Item#	Each
EnvisionTEC LED Post Curing Chamber	262-0108	\$995.00

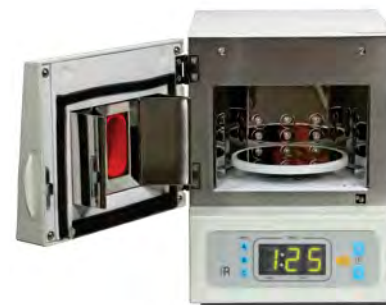

F

EnvisionTEC

EnvisionTEC was founded on a deep understanding of additive manufacturing, a drive to succeed and a commitment to deliver real value. EnvisionTEC's first 3D printer was a hit in the jewelry market – largely because of its ability to deliver incredible precision and surface finish, quickly – and the technology spun out to other sectors from there. Customers who manufacture hearing aids, dental prosthetics and other small and smooth parts followed. For 15 years, EnvisionTEC has been delivering advanced 3D printers and materials to Aerospace Engineers, MCAD designers, Doctors, Dentists, Laboratories, Researchers, Jewelers, Animators and many more.

Today, as the 3D printing market continues to mature, many different processes are used around the world to 3D print objects from digital design files. In order to serve the professional market, you need professionals who get it. EnvisionTEC's leaders have been on the frontlines of the additive movement —and it shows.



A



B

A. Micro Plus Advantage and Micro Plus High-Res

This family of 3D printers provides the ideal desktop companion for a wide variety of 3D printing applications. Available in two configurations, the Micro Plus series is a professional grade 3D printing solution utilizing an industrial UV LED light source and an integrated, embedded PC with Wi-Fi. The touchscreen adds convenience to the user interface, allowing for the necessary files for print to quickly and easily be transferred from any network computer directly to the Micro Plus via Wi-Fi. The Micro Plus 3D printers can produce functional parts with exceptional surface quality without sacrificing speed. The materials available for the Micro Plus line cover a wide range of applications, including jewelry, toy, medical, industrial design and engineering, and more. Micro Plus Advantage (262-0146) and Micro Plus High-Res (262-0148)

B. Aureus Plus

An enhanced version of EnvisionTEC's best-selling machine for the low production of customized jewelry. With its unbeatable price to performance ratio the Aureus PLUS is the perfect choice for the small to medium sized company looking to fill their 3D printing production requirements. Round-the-clock production is achievable due to the ability to run unattended, and with the significant speed increase in the Aureus PLUS model, production is greatly increased as well. Aureus Plus (262-0109)

C-H EnvisionTEC Resins – Visit our website for the most up-to-date information.

C. PIC100

Developed for direct investment casting of products for the Jewelry market. It offers excellent burn out properties and build with the highest quality and crisp detail. The material is processed on all Perfactory® systems. EnvisionTEC PIC100 builds extremely smooth surfaces.

D. EC500

EnvisionTEC's innovative direct investment casting material, Easy-Cast EC500 has 30% faster build times and dramatically improved casting abilities, as well as zero ash content.

E. HTM140V2

Dramatically changing jewelry manufacturing by eliminating the need to make a silver/metal master and then vulcanizing in rubber. The new HTM140V2 photopolymer (stands for High Temperature Mold Version 2) is designed to withstand the heat and pressure of vulcanizing the model in rubber with beautiful detail.

F. EC3000

EnvisionTEC's innovative direct investment casting material, has 3 times more wax than any polymer based material, including EC500. It does not boil during burnout, a leading cause of porosity during casting among competitive products.

G. EPIC

EPIC is a wax-based material which offers the crispness of EnvisionTEC's PIC materials with the castability of its EC-500 materials in a new formulation that delivers a desirable combination of price, performance, and reliability.

H. PHOTOSILVER

is an RP resin that can produce high detail models straight from the machine without the need for finishing. Can be used directly for molding using conventional techniques and materials. Ceramic filled photopolymer material which produces highly detailed parts with crisp features. High temperature resistance allows for the production of vulcanized rubber molds without breaking or melting the master pattern.

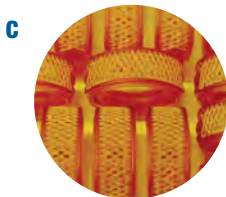

C



D



E



F

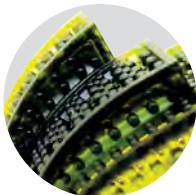

G



H

FORMLABS

Unlock your creativity one build at a time! Gesswein and FormLabs are committed to bringing innovative and sophisticated fabrication tools into the creative hands of designers, engineers, and artists around the world. An unprecedented convergence of design, performance, and accessibility, the Form 2 brings professional-quality 3D printing to a broader audience. We believe in what we do, and we're excited about creating powerful tools that change the way we work and live.

The Technology

Looks-Like: Test design iterations and communicate ideas to stakeholders affordably and quickly.

Works-Like: Reliably develop proofs of concept and test functional prototypes with materials closely matching common injection-molded plastics.

Feels-Like: Simulate a range of materials from rubber to rigid, and create prototypes with the smooth finish and feel of end products.

A. FORMLABS Form 2

From concept to design, the Form 2 is a powerful tool for jewelers, artists, and designers. Quickly prototype new designs and rapidly produce large batches of ready-to-cast parts. (262-0168)

Everything you need to start printing! Form 2 + Finish Kit includes the Form 2 3D printer, Resin Tank (1), Build Platform (1), Finish Kit, and PreForm Software. You also select the appropriate resin for your usage. Jewelers and designers can go directly to investment with their Form 2 Castable Resin. (262-0170)

Specifications:*

Dimensions:	35cm × 33cm × 52cm (13.5" × 13" × 20.5")
Wt:	13kg (28.5 lbs)
Operating Temp. (Suggested):	Auto-heats to 35° C (95° F)
Temp. Control:	Self-heating Resin Tank
Power Requirements:	100–240 V, 1.5 A 50/60 Hz 65 W
Laser Specifications	EN 60825-1:2007 certified, Class 1 Laser Product, 405nm violet laser, 250mW laser
Connectivity USB:	Wi-Fi, Ethernet and USB
Optical Path:	Protected
Printer control	Interactive Touch-screen with Push-button

Description	Item#	Each
FORMLABS Form 2	262-0168	\$3,350.00*

*Must chose resin of choice (not included)

B. FORMLABS Form 2 Resin Materials

Formlabs standard resins available in Black, Clear, Grey and White are formulated to deliver the highest-quality output, our resin captures astonishing detail without sacrificing durability and toughness. Castable Resin burns out cleanly without ash or residue and captures crisp, precise detail and smooth surfaces. Jewelers and designers can go straight from a 3D design to a model for direct investment.

Description	Item#	Each
Black Resin Cartridge	262-0260	\$149.00
Grey Resin Cartridge	262-0240	149.00
White Resin Cartridge	262-0181	149.00
Clear Resin Cartridge	262-0186	149.00
Castable Resin Cartridge	262-0170	299.00

C, D FORMLABS Resin Tanks and Build Platform

Your Resin Tank should be replaced for every two-to-three liters of resin used. If you're planning on working with multiple colors, extra resin tanks allow you to switch quickly and easily between them. You can safely store your other tanks for as many as two months, which means you won't have any wasted material. Chose the Long Term Tank for long rigorous or high volume printing—lasts 20x longer than the standard resin tank. A spare Build Platform can speed up your workflow, whether you're changing resins or starting a new print.

Description	Item#	Each
C. FORMLABS Resin Tank for Form 2	262-0166	\$59.00
D. FORMLABS Build Platform for Form 2	262-0167	99.00
FORMLABS LT Resin Tank for Form 2	262-0163	99.00



*Due to the technical nature of these products, some details may change. Please see our website for the most up-to-date information.

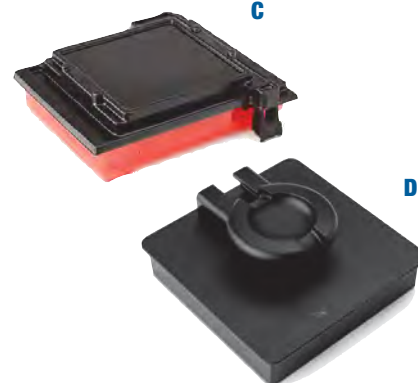

ferris® File-A-Wax® – Ring Tubes, Slices & Blocks

It's the accepted standard for making a wide variety of designs, especially detailed carvings. Easily turned on a lathe and burns out cleanly from flasks. Cannot be steam dewaxed, not recommended for wax injectors.

Blue: Less hard and more flexible than green, purple or turquoise. Melting temperature: 240°F (115.5°C). **Purple:** General purpose, hard with some flexibility. Melting temperature: 240°F (115.5°C). **Green:** A very hard wax, it

can't be flexed. Ideal for sharp edges, intricate carvings and delicate engraving. Melting temperature: 243°F (117°C). **Turquoise:** Not as hard as green—displays exception surface finish, especially in recessed areas. Maintains superior strength, toughness and extreme flexibility. Not brittle and thus making it very forgiving when milling prongs. When roughing out models, it does not clog the tools such as hand files. Melting temperature: 243°F (116.5°C).

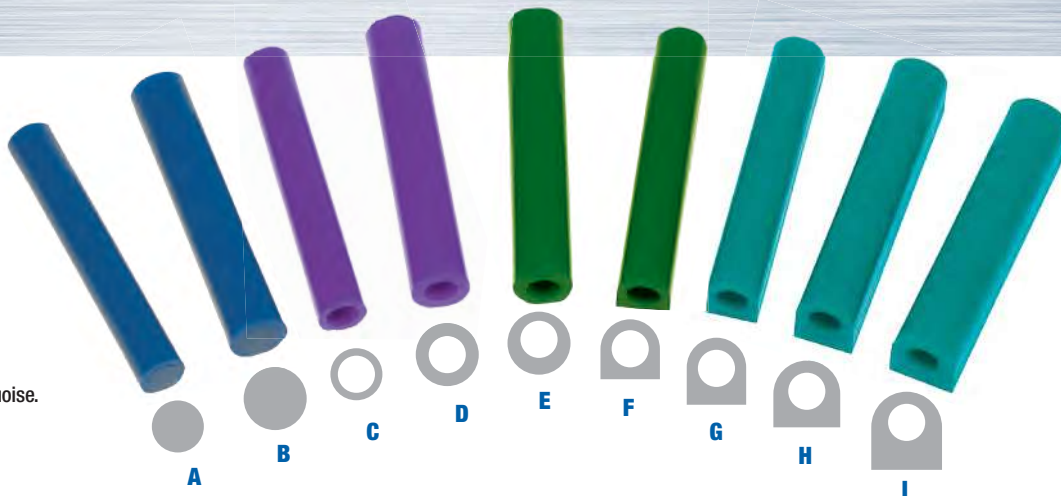

Ferris File-A-Wax available in green, purple blue and turquoise.

See pp. 185, 189 for more Wax Ring Tubes.

A-I Ferris® File-A-Wax® Ring Tubes

All measure 6" long. Tubes have 5/8" diameter hole.

Description	Dimensions (Inches WxH)	Color				Each Prices*		
		Blue	Purple	Green	Turquoise	1-2	3-5*	6+*
A. Solid Round	7/8 O.D.	261-5400	261-5385	261-5380	261-5378	\$6.95	\$6.60	\$6.26
B. Solid Round	1 1/16 O.D.	261-5500	261-5460	261-5450	261-5448	6.95	6.60	6.26
C. Rnd, Centered	7/8 O.D.	261-5650	261-5660	261-5700	261-5548	6.95	6.60	6.26
D. Rnd, Centered	1 1/16 O.D.	261-5820	261-5815	261-5810	261-5698	6.95	6.60	6.26
E. Rnd, Off-Center	1 1/16 O.D.	261-5750	261-5805	261-5800	261-5798	6.95	6.60	6.26
F. Flat-Top	1 x 1	261-5840	261-5836	261-5835	261-5808	6.95	6.60	6.26
G. Flat-Top	1 x 1 1/8	261-5830	261-5826	261-5825	261-5823	6.95	6.60	6.26
H. Med. Flat-Top	1 1/8 x 1 1/8	261-5855	261-5846	261-5845	261-5833	6.95	6.60	6.26
I. Lg. Flat-Top	1 3/16 x 1 9/16	261-5600	261-5555	261-5550	261-5843	6.95	6.60	6.26

O.D. = approximate outside diameter



J, K Ferris® File-A-Wax® Slices

Each slice is 3 5/8" L x 1 1/2" W. Assorted thicknesses come in each box.

Description	Thickness	Color				Each Prices		
		Blue	Purple	Green	Turquoise	1-2	3-5*	6+*
1 lb. of slices (B.S.L.)	3/16" to 1"	261-5015	261-5010	261-5005	261-5003	\$14.75	\$14.01	\$13.28
1/2 lb. of slices (A.S.L.)	1/8" to 1/4"	261-5030	261-5025	261-5020	261-5018	12.75	12.11	11.48

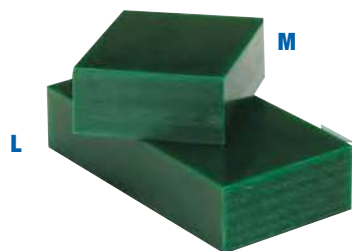

L, M Ferris® File-A-Wax® Blocks

Blocks are available individually in 2 weights: 1/2 lb. and 1lb.

Description	Dimensions (Inches WxH)	Color				Each Prices*		
		Blue	Purple	Green	Turquoise	1-2	3-5*	6+*
1 lb. blocks	6 x 3 5/8 x 1 1/2	261-5300	261-5200	261-5100	261-5098	\$12.75	\$12.11	\$11.48
1/2 lb. blocks	3 1/2 x 3 1/2 x 1 1/8	261-5250	261-5150	261-5050	261-5048	10.50	9.98	9.45

*Quantity discount for orders of one item number only; not assorted.

Matt® Carving Wax

Formulated to meet the demanding specifications of professional wax carvers. Compounded with special care to avoid contamination, pitting and air bubbles. Accurately shaped to minimize preparation time. Choose from three color-coded grades of flexibility. **Green:** (rigid) cuts clean and crisp, excellent for detailed carving and milling. Melting temperature: 230°F. **Purple:** (all-purpose) easy to work, good for chip carving. Melting temperature: 225°F. **Blue:** (bendable) works for items that require flexibility. Melting temperature: 220°F.

A-H Matt™ Ring Tubes

Measure 6" long except 6pc. assortment, precut to 1" lengths. All tubes have 5/8" dia. finger hole.

Description	Dimensions	Green	Purple	Blue	EACH Prices*	
					1-2	3+*
A. Round, Centered	7/8" O.D.	261-7700	261-7660	261-7650	\$9.95	\$8.96
B. Round, Centered	1 1/16" O.D.	261-7810	261-7815	261-7820	8.20	7.38
C. Round, Centered	1 5/16" O.D.	261-7860	261-7865	261-7880	8.20	7.38
D. Round, Off-Center	1 1/16" O.D.	261-7800	261-7805	261-7750	8.20	7.38
E. Flat-Top Tube	1"W x 1 1/8"H	261-7825	261-7826	261-7830	8.20	7.38
F. Med. Flat-Top Tube	1 1/8"W x 1 1/8"H	261-7845	261-7846	261-7855	8.20	7.38
G. Lg. Flat-Top Tube	1 1/4"W x 1 1/4"H	261-7550	261-7555	261-7560	8.20	7.38
H. Pre-cut, 6-Piece Assortment	1"W x 1"L			261-7500	8.95	8.06

O.D. = approximate outside diameter

*Quantity discount for orders of one item number only; not assorted.



I. Matt™ Bracelet Wax Bars

From one blank style you can create round, oval or square bracelets in a variety of sizes. Simply cut 2 slices of the desired thickness to form the bracelet, then trim using the Matt Bracelet Shaper #265-2353 (see pp. 187).

Description	Dimensions (LxWxH)	Green	Purple	Blue	EACH Prices*	
					1-2	3+*
Bracelet Wax Bar	6 1/4" x 3 1/4" x 1 3/4"	265-2339	265-2338	265-2341	\$19.95	\$17.96

*Quantity discount for orders of one item number only; not assorted.



J. Matt™ Smooth Precision Wax Tablet Sets

Sets of rectangular wax tablets with large, flat, incredibly smooth surfaces for designing jewelry directly onto carving wax. Available two, 5mm thick, or two, 7mm thick both sets are 7 1/2" x 6 1/2" in size or a set which contains six 6" x 2 5/8" tablets: three 4.5mm thick tablets, one 6mm thick tablet, one 8mm thick tablet and one 10.5mm thick tablet.

Description	Dimensions (LxWxH)	Green	Purple	Blue	EACH Prices*	
					1-2	3+*
5mm set of 2	7 1/2" x 6 1/2"	261-7940	261-7930	261-7920	\$19.45	\$18.48
7mm set of 2	7 1/2" x 6 1/2"	261-7941	261-7931	261-7921	\$19.45	\$18.48
4.5mm up to 10.5mm set of 6	6" x 2 5/8"	261-7900	261-7912	261-7910	\$26.85	\$25.51

*Quantity discount for orders of one item number only; not assorted.

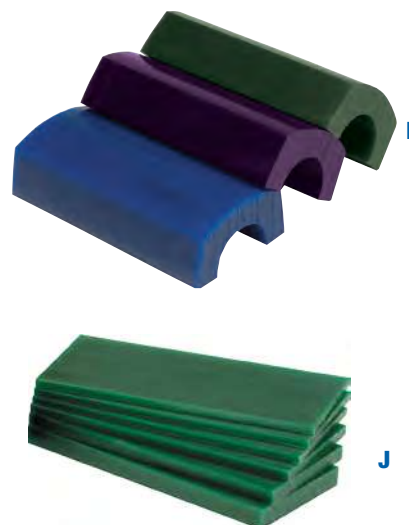

K-N Matt™ Carving Waxes

Bars are available in 1/2 lb. and 1 lb. weights. Half-pound slices are 1/2" thick, while one pound slices are 1" thick.

Description	Color	Dimensions (LxWxH)	Item#	EACH Prices*	
				1-2	3+*
K. Bar, 1/2 lb.	Green	3 3/8" x 3 1/8" x 1 7/16"	261-7520	\$10.30	\$9.27
L. Bar, 1 lb.		6 1/2" x 3 1/8" x 1 7/16"	261-7510	13.35	12.02
M. Slices, box of 1/2 lb.		3 1/8" x 1 7/16" x 1/8"	261-7540	10.95	9.86
N. Slices, box of 1 lb.		3 1/8" x 1 7/16" x 1/8"	261-7530	16.30	14.67
Bar, 1/2 lb.	Purple	3 3/8" x 3 1/8" x 1 7/16"	261-7522	10.30	9.27
Bar, 1 lb.		6 1/2" x 3 1/8" x 1 7/16"	261-7512	13.35	12.02
Slices, box of 1/2 lb.		3 1/8" x 1 7/16" x 1/8"	261-7542	10.95	9.86
Slices, box of 1 lb.		3 1/8" x 1 7/16" x 1/8"	261-7532	16.30	14.67
Bar, 1/2 lb.	Blue	3 3/8" x 3 1/8" x 1 7/16"	261-7524	10.30	9.27
Bar, 1 lb.		6 1/2" x 3 1/8" x 1 7/16"	261-7514	13.35	12.02
Slices, box of 1/2 lb.		3 1/8" x 1 7/16" x 1/8"	261-7544	10.95	9.86
Slices, box of 1 lb.		3 1/8" x 1 7/16" x 1/8"	261-7534	16.30	14.67

*Quantity discount for orders of one item number only; not assorted.

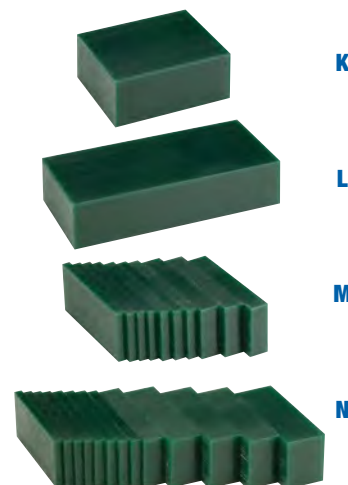

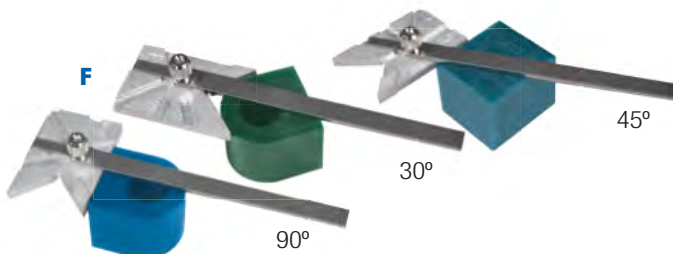
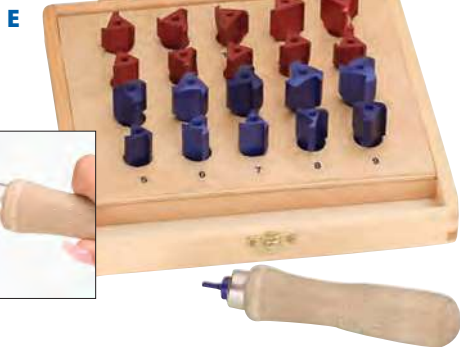
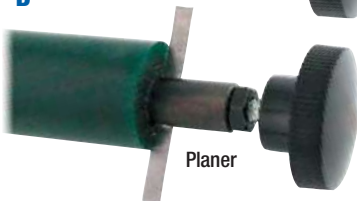
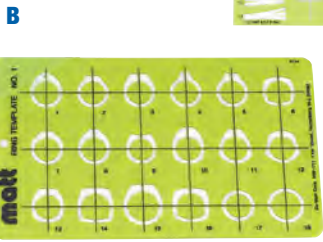
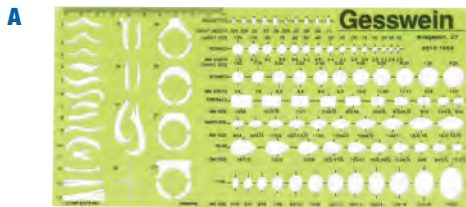

A. Jewelry Drawing Template

An easy-to-use, calibrated template for jewelry designers. Immediately improves your jewelry designs as well as simplify the task of determining the sizes of stones required for your jewelry. Contains stone shape profiles and sizes, as well as shank top and side views. Great for sketches and wax work. Measures 10¼"L x 4¾"W. Complete with instructions.

Description	Item#	Each
Jewelry Drawing Template	812-1660	\$25.00

B. Matt™ Ring Template

Now it's easy to get the precise ring outline you need on your wax blank. Template features 18 different cutouts of both men's and ladies' rings from the most popular styles to some of the more unusual designs. Unbreakable plastic with precision-milled cutouts.

Description	Item#	Each
Matt Ring Template	265-2333	\$12.30

C. Matt™ Wax Trimmer Kit

Trim wax blanks to the exact shape you need. Also use to mill out center of wax rings for sizing. The rotary file is specially designed for wax work. The platform locks at 90° to create a perfectly symmetrical wax pattern and can also be angled for taper cuts. Platform can be adjusted parallel to the handpiece for milling operations to create seats, perfect channels and decorative work. The Matt Trimmer requires a Flexible Shaft machine and 1" diameter handpiece (such as our #30). Comes complete with mounting bracket, adjustable platform, rotary file, ring template (with 18 profiles for men's and ladies' rings), assorted carving wax blanks and instruction book.

Description	Item#	Each
Matt Wax Trimmer Kit	265-2352	\$148.50
Replacement Rotary File (1/8" shank)	265-2357	30.65

D. Matt™ Reamer/Planer

Consists of a precision-ground steel rod with a holding knob and two specially designed carbide blanks. The wing blade is for planing the tube surface, and the boring bit is for boring the finger size. Turn the reamer clockwise and counterclockwise, and the wing blade cuts in both directions, sheering off a thin film of wax with every stroke, leaving a perfectly flat surface. After replacing the wing blade with the boring bit, turn the reamer clockwise to enlarge the finger hole to the precise size with smooth inner walls. Has engraved lines that indicate various finger sizes. Also lets you create bezels for round stones or coin holders.

Description	Item#	Each
Matt Reamer/Planer	261-7905	\$58.90

E. Wax-a-Sizer

Perfect for professional wax carvers. Features machined aluminum bits with sharp blades for cutting accurate finger hole sizes straight through wax ring blanks in one pass. A pilot head on each bit is sized to match the hole in standard wax tubes for stability and symmetry when cutting. You can even hold the whole wax tube in your hand while sizing, making it easier to handle, then simply cut off the desired width after sizing is complete. Wax-a-Sizer includes 20 individual bits in color-coded full-sizes and half-sizes from 5 to 14½, a sturdy wooden handle and wooden storage box. Sizes are clearly marked on bits and box.

Description	Item#	Each
Wax-a-Sizer	265-2319	\$169.00

F. Multi Angle Wax Gauge

Perfect for measuring wax. Make 90°, 45° and 30° pieces. Easy to draw parallel lines or to get circular center. Measures approximately 4 ¾" long.

Description	Item#	Each
Multi Angle Wax Gauge	265-2317	\$39.95

A. Matt™ Miter Box and Saw Set

Includes extruded aluminum miter box with stop-lock and steel back saw. Slices wax bars, rods and ring tubes into tablets with perfectly straight and parallel walls or tapered sides. Miter box holds the ring tube firmly in place. Stop-lock lets you cut multiple tablets of the same thickness. Rugged steel sawblade cuts through tubes with very little effort, leaving a smooth finish. Miter box measures 6"L x 2"W. Sawblade measures 6½"L x 2"D.

Description	Item#	Each
A. Miter Box and Saw Set	265-2346	\$56.95
Replacement Sawblade	265-2348	17.00

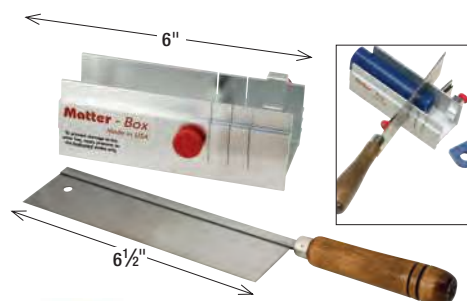

A

B. Matt™ Ring Tube Reamer

Enlarge the finger hole of wax ring models with speed and accuracy. Hardwood mandrel is specially machined to incorporate a steel cutting blade that extends from the handle to the tapered tip. Slide this reamer through the hole of a wax ring or ring tube and gently rotate clockwise. As the blade turns, it scrapes the inner wall, enlarging the ring to the size that is clearly marked on the mandrel and leaving a smooth, shiny, uniform finish on the ring in seconds.

Description	Item#	Each
Matt Ring Tube Reamer	265-2349	\$26.50



B

C, D Matt™ Wax Gun Set and Matt™ Supply Box

A wax extruder for creating unique and intricate jewelry designs. The lightweight gun has a thermostatic control for wax temperatures from 120-300°F. Convenient wax cartridges are used for fast loading. Flow is controlled with your thumb.

Endless design possibilities include macramé, twists, wax weaving and more. Set includes gun, 113-page instruction book, 2 brass nozzles (one small and one large round orifice), nozzle-changing wrench and 15 wax cartridges.

The Matt™ Supply Box includes a highly polished rotating hardwood mandrel mounted on a sturdy steel base, an alcohol lamp, and 120 pieces of wax for the Matt Wax Gun (40 each of green, red and blue).

Description	Item#	Each
C. Matt™ Wax Gun Set, 110V	265-2355	\$150.00
Matt™ Wax Gun Set, 220V	265-2354	150.00
D. Matt™ Supply Box	265-2345	57.95
Blue Pellets, 1 lb.	265-2330	25.90
Green Pellets, 1 lb.	265-2362	25.90
Red Pellets, 1 lb.	265-2363	25.90



C



D

E. Matt™ Mini Lathe with Gauge – use with 1" diameter handpiece

For turning and milling hard carving wax. Ideal for wedding bands, bezels and special settings. Complete with lathe, three wax-holding collets, assorted wax blanks, three hand tools for cutting and shaping wax, cutting tool installed in lathe, two cutting tool blanks for custom shaping, Allen wrench and instruction booklet.

Description	Item#	Each
E. Mini Lathe with Gauge	265-2312	\$170.00
Replacement Parts	Item#	1-11 12+
Wax-Holding Collet	265-2347	\$6.95 \$6.05
Cutting Tools, set of three	265-2344	18.25 15.88



#30 handpiece not included.

E

F. Matt™ Bracelet Shaper – use with 1" diameter handpiece

Fast, precise carving of all kinds of bangle and hinged wax bracelets. Includes a Bracelet Template for round, square or oval bracelet profiles. The large platform can be easily angled for perfect bevel, channel or taper cuts. Two sample pieces of Matt Blue Bracelet Wax are included. You can also use standard wax blocks to make belt buckles, pendants and other large pieces.

Description	Item#	Each
F. Matt Bracelet Shaper	265-2353	\$142.50
Replacement Parts	Item#	Each
Template	265-2336	\$12.85
Rotary File (1/8" shank)	265-2357	30.65



F



A. Electric Waxing Tray

This easy-to-clean, 3-well wax tray is digitally controlled for temperature adjustment up to approximately 260° F. Two compartments measure 1¾" L x 1⅜"W x ¾" deep, large compartment measures 3" L x 2" W x ¾" deep.

Description	Item#	Each
Electric Waxing Tray	265-2358	\$183.00

B, C Transparent Sheet Wax

Pliable sheets of transparent wax with smooth surfaces. Trace designs directly on sheet, then cut with scissors or carving tool. Sheets measure 4" x 4". Sold in boxes of 15 assorted sheets.

Description	B&S Gauge	Item#	Box
B. Pink (soft) Sheet Wax	20, 22 & 24	261-9200	\$22.65
C. Green (firm) Sheet Wax	20, 22 & 24	261-9150	24.25



D. Freeman Sol-U-Carv Wax – A Carvable Wax That is Water Soluble

Sol-U-Carv is both a carvable and soluble wax specifically formulated for the lost wax casting process. Ideal for making hollow beads, hollow pendants, dome rings, or any other configuration where a hollowed area in the finished pattern is desired. Can be carved using conventional carving tools to form cores. Melting temperature: 165° - 170° F. (73.8°-76.7° C.). The melted wax can be poured or injected into a prepared mold to form the desired shape. Other wax can be injected around the Sol-U-Carv wax placed in a metal or rubber mold to produce extremely intricate patterns.

Description	Item#	Each
Freeman Sol-U-Carv Wax (1 lb.)	263-1051	\$22.95



E. Ferris® Mold-A-Wax®

Works like clay when softened in hot water. Melts at 150°F. Sold in 1 lb. blocks. Black Mold-A-Wax is slightly pliable and can be softened in hot water and injected at 150°F. Red Mold-A-Wax is much softer than Black and is not injectable.

Description	Item#	EACH Prices		
		1-2	3-5	6+
Black #5 (med.)	261-5850	\$20.75	\$19.71	\$18.68
Red #6 (soft)	261-5849	19.95	18.95	17.96



F, G Wolf™ Touch-Up and Relief Wax™

Use Touch-Up wax for correcting imperfections such as pits and cracks or filling bezel walls for a tighter fit. Flow temperature: 163°F (73°C). Easily scraped or trimmed for a smooth finish. Use for creating raised detail on carving waxes. Apply molten Relief Wax on wax model surface. Can be easily carved. Flow temperature: 165°F (74°C).

Description	Item#	EACH Prices		
		1-2	3-5	6+
G. Touch-Up Wax, 1.7 oz. tin	261-4940	\$17.15	\$16.29	\$15.44
H. Relief Wax, 1.7 oz. tin	261-4945	17.15	16.29	15.44



A, B Precision Wolf Milling Wax™ By Ferris® – Ideal For Milling Machines!

Wolf Milling Wax withstands extremely high rotational speeds, possesses the toughness to be machined into thin sections and cleans up quickly and easily. Possessing high pliability and toughness, ultra-thin cross sections with the most intricate details and minimal tool path residue can be obtained. Wax models clean up easily and burn out completely. When finished, wax models exhibit a gold-like tone that is easy to read and helpful in visualizing how the finished pieces will look when cast. As a bonus, it has proven to be an excellent hand carving wax, as well. Available in ring tubes and slices. Ring tubes measure 6" long with 5/8" dia. finger hole. Slices measure 53mm square. Melting temperature: 240°F (115.6°C).

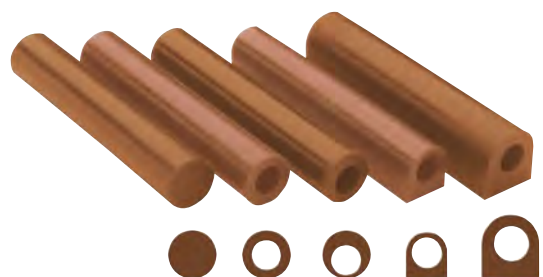

A

Description	Item#	EACH Prices		
		1-2	3-5	6+
A. Tube B-1062, Solid 1 1/16" O.D.	261-4901	\$10.15	\$9.64	\$9.14
Tube T-1062, Center Hole 1 1/16" O.D.	261-4905	10.15	9.64	9.14
Tube T-1062E, Off-Center Hole 1 1/16" O.D.	261-4909	10.15	9.64	9.14
Tube T-100, Flat Top 1"W x 1 1/8"H	261-4913	10.15	9.64	9.14
Tube T-200, High Flat Top 1 3/16"W x 1 5/16"H	261-4917	10.15	9.64	9.14

Description	Item#	EACH Prices		
		1-2	3-5	6+
B. Slices, 1 lb. 5mm, 16 Slices	261-4937	\$21.50	\$20.43	\$19.35
Slices, 1 lb. 10mm, 9 Slices	261-4938	21.50	20.43	19.35
Slices, 1 lb. 5mm, 6 Slices	261-4939	21.50	20.43	19.35



B

C. Wolf Wicked Sticky Positioning Wax

Ideal for securing stones for accurate tracing. Just smear wax on stone, press stone onto wax or metal, and scribe around stone. Flow temperature: 173°F (78°C). Sold in 3 oz. boxes of sticks. Each stick measures 3/16" sq. x 5"L.

Description	Item#	EACH Prices		
		1-2	3-5	6+
Wicked Sticky Positioning Wax, 3 oz. box	261-4936	\$11.90	\$11.31	\$10.71



C

D. Sticky Wax

Fast-setting wax for joining other waxes. Melting temperature: 160°F.

Description	Item#	Each
Sticks (3 oz. - 1/4" dia. x 5"L)	261-6305	\$8.50



D

E. Wax Wire Assortment

Contains 6 oz. of wax wire. Includes half-round (6-, 8-, 12- and 14-gauge), round (10-, 14- and 18-gauge) and half-pear shapes (6-gauge). Sticks measure 4" long.

Description	Item#	Each
Wax Wire Assortment	261-5900	\$13.95

F. Wax Wire – Round

Flexible 4 1/2" long wires can be twisted or bent. Packaged in convenient storage box. Each box contains approximately 2 oz. of round wax wire. Thickest wire is 6-gauge.

Description	B&S Gauge	Item#	Each	B&S Gauge	Item#	Each
Wax Wire	6	261-5945	\$14.50	14	261-6100	\$14.50
	8	261-5950	14.50	16	261-6150	14.50
	10	261-6000	14.50	18	261-6200	14.50
	12	261-6050	14.50	20	261-6250	14.50



E

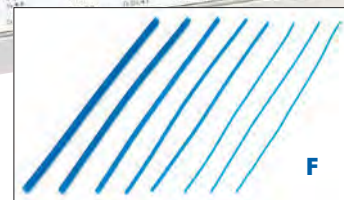

F

G. Wax Wire Spools – Round

Flexible round wax wire (1/4 lb.) spooled for less waste when different lengths of wire are needed. You only cut off the exact length you need. Can be used for decorative wax work such as braids, macramé, scroll work, etc. Thickest wire is 6-gauge.

Description	B&S Gauge	Item#	Each	B&S Gauge	Item#	Each
Wax Wire Spools	6	261-6286	\$21.50	14	261-6290	\$21.50
	8	261-6287	21.50	16	261-6291	21.50
	10	261-6288	21.50	18	261-6292	21.50
	12	261-6289	21.50			



G

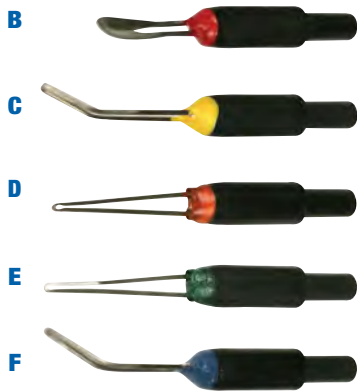

A-F Wax Heat Carver

This easy-to-use carver features a heavy-duty variable-power rheostat that enables precise, consistent temperature control from approx. 100–1,200°F. Includes comfortable handpiece with ultra-flexible 35" power cord, built-in hand-piece holder and blue tip. Measures 4"W x 6"D x 3"H. Made in USA.

Description	Item#	Each
A. Wax Heat Carver, 110V	265-1980	\$145.00
Wax Heat Carver, 220V	265-1981	204.00
B. Red Tip, Broad Spatula	265-1983	12.00
C. Yellow Tip, Bent Needle Nose	265-1984	12.00
D. Orange Tip, Straight Needle Nose	265-1986	12.50
E. Green Tip, Straight Flat Sharp	265-1987	12.50
F. Replacement Blue Tip, Bent Needle Nose Sharp	265-1985	12.00
Replacement Handpiece	265-1982	44.85

G. Bunsen Burner

For heating wax and wax-carving tools. Can be used with artificial or natural gas. Has adjustable needle valve for gas control to produce a hot brush flame down to a needle flame with intense heat. Measures 4½"H, 3" base diameter.

Description	Item#	Each
Bunsen Burner	811-1600	\$49.55

H. Alcohol Lamps

Safety cap to prevent evaporation of fuel. Faceted bowl can be tipped on angle. Each bowl holds 4 oz. of fuel, measures 4" diameter. One wick is supplied.

Description	Item#	EACH Prices	
		1-5	6+
H. Lamp w/ sleeve adjustment	813-1905	\$9.15	\$8.24
Lamp w/ screw adjustment	813-1900	6.99	6.29
Replacement Wicks		Item#	Each
¼" for #813-1905		813-1906	\$0.55
⅜" for #813-1900		813-1901	0.55

 Six-piece minimum; please order in multiples of 6.

I. Wax Ring Mandrel

Step-type aluminum mandrel for full sizes 4-13. Rotates a full 360° and can be detached from base. Measures 12½" long. Use Mold Release Spray (see 816-2915 p. 194) for lubricant.

Description	Item#	Each
Wax Ring Mandrel	260-4250	\$40.45

J. Handy Wax Pen

Whether you are a hobbyist, artisan or a jewelry manufacturer/retailer, the New Handy Wax Pen is the perfect tool for the bench or someone on the go. Small in size but mighty in power, the Handy Wax Pen is a must to have for the beginner to the advanced wax worker. Comfortable to hold and maneuver, the Handy Wax Pen is consistent in temperature (266-284°F/130-140°C) and preheats in just two minutes! Comes complete with one tapered tip that makes it ideal for wax carving, smoothing, shaping, creating textures and buildups and spruing wax pieces for casting. When not in use, wax pen can rest on a handy metal stand for optimal safety. 110V. Made in Taiwan.

Description	Item#	Each
Handy Wax Pen	265-2320	\$19.95
Replacement Tapered Tip	265-2323	6.00

A-G Giles® Precision Waxer

An indispensable tool for wax model making. Great for carving, shaping, texturing and sizing. Graduated dial adjustment has nine settings for accurate temperature modulation. Slim, lightweight handpiece with flexible 26" cord provides fine control for intricate work. Measures 4" long without tip. Weighs 1 oz. Waxer features mounted handpiece holder, pilot light and on/off switch. Includes three tips. Electrical: 110V or 220V, 1A, 15W, 50/60Hz. Measures 4"L x 5"W x 3"H. Made in USA.

Description	Item#	Each	
A. Precision Waxer, 110V	265-2300	\$165.00	
Precision Waxer, 220V	265-2301	195.00	
Replacement Handpiece and Cord	265-2309	51.75	
Tips	Shape	Item#	Each
B. Red* (replacement)	Wide	265-2302	\$14.70
C. Yellow* (replacement)	Wide (grooved)	265-2303	12.90
D. Blue* (replacement)	Narrow (bent)	265-2304	12.90
E. Orange	Flat	265-2305	12.90
F. Green	Needle (fine)	265-2306	13.90
G. Black	Sprue Burning	265-2307	14.99

*Supplied with Precision Waxer.



H-Q Kerr Ultra Waxer 2

The ultimate electronic waxer comes complete with two handpieces and 2 tips (Small PKT and Large PKT) for increased productivity. Now you'll rarely have to stop to change tips; interrupting your creative flow. Handpiece cord measures 34". Features convenient tip holder for eight tips, easy-to-use all digital menu functions such as quick heat and programmable temperature presets.

Features:	Specifications:
Dual Voltage	Electrical: 110/220V
Quick heat up/constant temp	Dimensions: 13"L x 10 1/4"W x 5"H
Sturdy construction	Weight: 3.8 / 6.0 lbs.

Model	Item#	Each
H. Kerr Ultra Waxer 2	265-2563	\$345.00
Tips	Item#	Each
I. Large Denture - Orange	265-2573	\$75.75
J. Small Denture - Pink	265-2572	75.75
K. Short #7 - Gray	265-2440	75.75
L. Large #7 - Green	265-2441	75.75
M. Short 1/2 Hollenback - Black	265-2442	75.75
N. Short Needle - Red	265-2443	75.75
O. Short Beavertail - Purple	265-2444	75.75
P. Short Large PKT (replacement) - Teal	265-2445	75.75
Q. Short Small PKT (replacement) - Blue	265-2446	75.75
Replacement Handpiece and Cord	265-2564	66.95

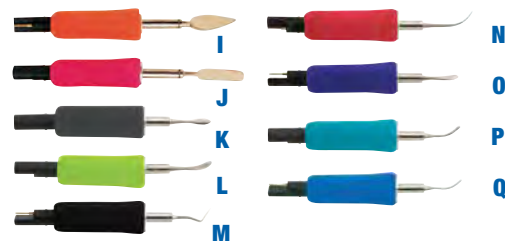

R. PEPETOOLS TouchAmatic Digital Wax Pen

State-of-the-art digital wax pen that provides immediate heating response when you simply touch the contact point on the pen. Features variable control knob for precise temperature control. Low enough to do fine wax work and high enough to burn sprues into silicone molds. Two modes: "Continuous Mode" will output a constant temperature from the pen tip and "Touch Mode" will output heat only when the pen is activated. Immediate heating response. Takes up minimal space on the benchtop with its small footprint. Handpiece cord measures 31" providing necessary maneuverability. Includes four color-coded Nichrome tips.

Specifications:	
Temperature Range:	Up to 800° F (420° C)
Dual Voltage:	110/230V, 50/60 Hz.
Max Power Consumption:	20 VA
Dimensions:	3"W x 7"D x 5 1/4"H

Description	Item#	Each
R. Pepe TouchAmatic Digital Wax Pen	265-2891	\$295.00
TouchAmatic Digital Replacement Pen	265-2892	56.65





A. Wolf Precision Wax Carver Set

Designed by Kate Wolf, master modelmaker and educator. Feature chromium manganese tool steel tips with precise, sharp, durable edges and color-coded, numbered beech handles. Ideal for carving wax, polymer clay and PMC. Set includes 18 tools with heavy-duty plastic canister and 24-page full-color instruction booklet.

Description	Item#	Each
A. Wolf Precision Wax Carvers Full Set	260-2978	\$164.00

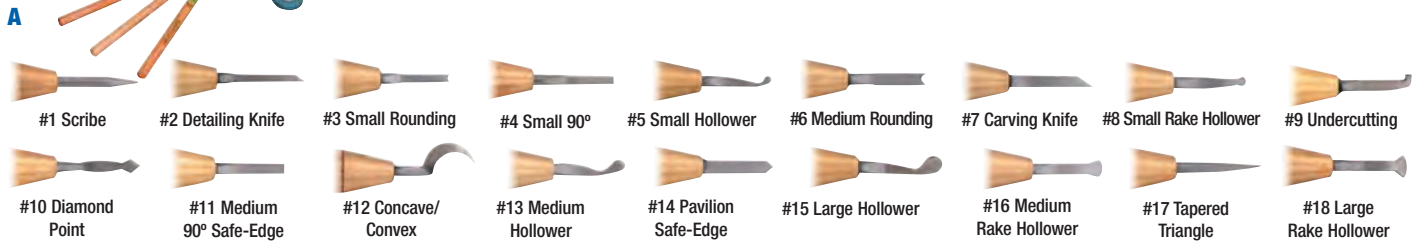

B. Sharp-Edge Wax Carver 6-Piece Set

Made of high-grade stainless steel, this set of 6 carvers feature heads with sharp edges that cut and scrape wax exceptionally well. All have nonroll octagonal handles with cross-grooves for comfortable yet secure grip. Measures approx. 5 3/4" long. See picture for shapes.

Description	Item#	Each
B. 6-Piece Set	260-2919	\$19.95

C-H Wax Carving Tools

Carve, form, shape and patch wax models. Stainless steel tools with hexagonal handles. Double-ended. Measure 6 1/2" long. See picture for shapes.

Description	Item#	Each
C. #7	260-2700	\$6.25
D. #50	260-2900	6.25
E. #1	260-2650	6.25
F. #6	260-2850	6.25
G. #3	260-2800	6.25
H. #1/2	260-2750	6.25
6-Piece Set	260-2600	21.95

I. Busch® Wax Burs – 3/32" Shank

Made of tungsten vanadium steel. Very coarse cut for carving wax. Will not clog with wax like regular burs. Made in Germany.

Shape	Diameter (mm)	Item#	EACH Prices	
			1-71	72+
●	1.8	121-8170	\$3.65	\$3.10
●	2.3	121-8180	3.65	3.10
●	3.1	121-8190	5.89	5.01
●	5.0	121-8200	7.08	6.02

J, K Wax Bur Sets – 3/32" Shank

Each includes 12 different vanadium steel burs with teeth that are widely spaced to prevent clogging. Includes convenient wooden stand that keeps burs organized and accessible.

Description	Item#	Each
J. Small Bur Set of 12	122-7151	\$15.95
K. Large Bur Set of 12	122-7150	25.15

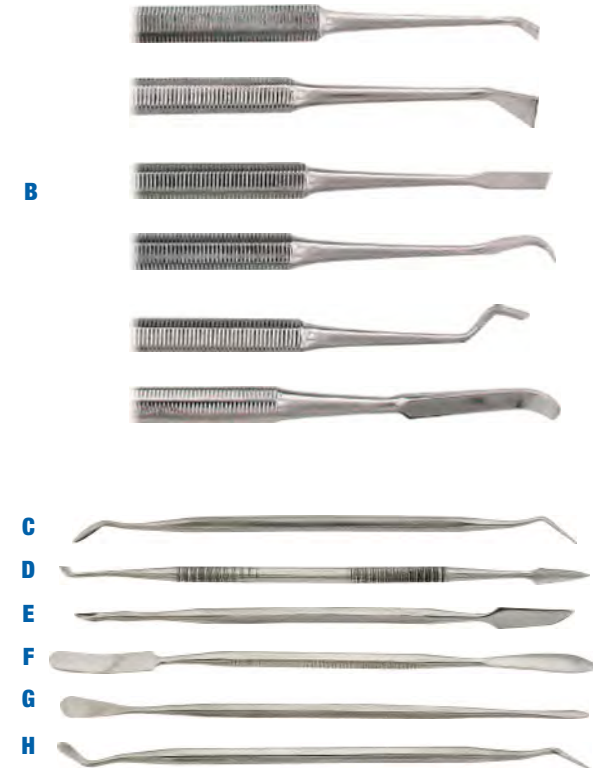

A, B Speedy Wax Pens

These lightweight wax-carving tools offer instant heat. Feature a pointed heating element that operates with fingertip control. Excellent for beads and details, removing flash and repairing mistakes. Tip is easy to replace. Standard Pen measures 6" long and runs on 1 AA battery (supplied). Super Pen measures 8" long and runs on 2 AA batteries (supplied). Made in USA.

Description	Temperature	Item#	EACH Prices	
			1-2	3+
A. Super Pen	2,200°F	265-2881	\$31.39	\$28.25
B. Pen	1,300°F	265-2880	22.95	20.66
Replacement Tip		265-2885	7.15	6.44



C. Smoothy™ Flameless Wax Finisher/Mini Torch

A flameless jet of heated air gives you a smooth, scratch-free surface when passed over wax patterns. Blends parting lines without actually touching the wax. Remove tip and you have a pencil-point torch producing temperatures up to 2,300°F. Great for light soldering or minor casting repairs. Uses standard Butane fuel. UL registered. 6¾" overall.

Description	Temperature	Item#	Each
Smoothy	2,300°F	262-0500	\$174.50

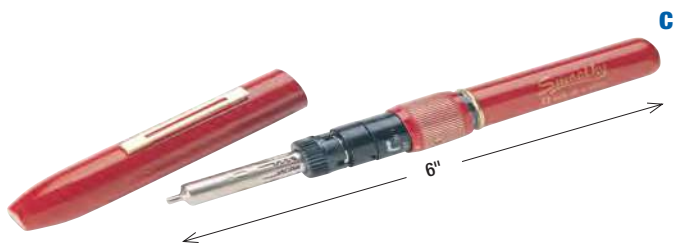

D, E Wax Rasps – The fastest way to rough out wax models!

These rasps feature extra-sharp teeth for a fast cut with no clogging. Open back allows wax shavings to fall away quickly. Available in square or round. Both measure 6" long.

Shape	Item#	Each
D. Square	260-3062	\$8.95
E. Round	260-3060	8.95

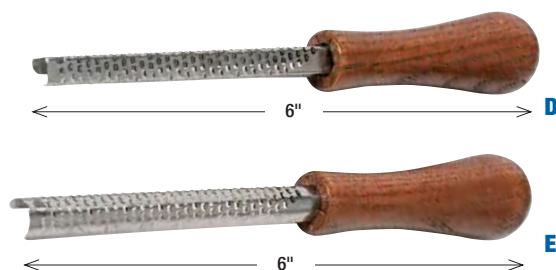

F. Wax Needle File Sets

High quality files for rough filing wax. Each file is 5½" long. Coarse, non-clogging. Set of six: crochet, equalling, half-round, round, square and three-square.

Shape	Item#	Each
F. Wax Needle File Set (Italy)	265-2335	\$60.90
Econo Set (India)	265-2315	9.95

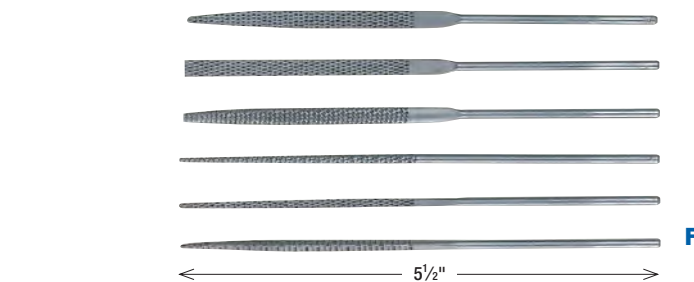

G. Large Wax File Set

Five large sized wax files for shaping wax. Set includes round, half-round, square, pillar and 3-square. Coarse, nonclogging. Measures 8" long. Made in Italy.

Description	Item#	Each
Large Wax File Set	265-2337	\$96.50



H. Wax Carving File Set

Includes four files designed for precision wax carving. Their pen-like design provides optimal control. And their single-cut teeth never clog. Made of stainless steel. Measure 6¾" overall length, 1" cut length.

Description	Item#	Each
Wax Carving File Set	260-2950	\$21.05





A-C Ceramic Plastic Deflashing Tools

Each holds edge indefinitely and provides complete user safety.

These tools feature space-age ceramics that deburr hard plastics effortlessly while eliminating the fear of cutting your hands or fingers in the process. Ideal for curved and complicated shapes. Excellent on ultra-hard resins that defy carbon steel tools. Can also be used on soft metals such as aluminum, copper and brass.

Available in 3 sizes: Large Disposable Deflasher (6 7/8" long with 1 1/2" long cutting edge) has matte cutter-type handles; Small Disposable Deflasher (5 1/4" long with 1" long cutting edge) has a fluted, nonroll design; Micro Deflashing Pen (5 7/8" long with 3/8" long cutting edge) has 2 jaw chuck for easy blade replacement.

Description	Blade	Item#	Each
A. Large Ceramic Deflasher	1 1/2"	351-0295	\$32.95
B. Small Ceramic Deflasher	1"	351-0294	29.95
C. Micro Ceramic Deburring Pen	3/8"	351-0001	29.95
Replacement Micro Blades—5-pack	3/8"	351-0002	29.95

D. All-in-One Swiveling Deburrer – With five tips

Deburs holes as small as 3/32" and removes sharp or rough edges from steel, aluminum, brass or iron parts. Comes with five curved, sharpened, high-speed steel tips made from 1/8" stock for long wear and less chance of breakage. Each tip swivels 360° either way to follow curves and contours. Handle has an internal storage compartment and a quick-tip-release feature. Measures 5" long.

Description	Item#	Each
All-in-One Swiveling Deburrer	846-2050	\$19.98

E. Swiveling Wax Carver/Deburrer

This handy tool is great for radiusing and rounding off corners and edges, especially on insides of rings. Replaceable tip swivels 360° (forward or backward). Comes with large and small hardened tool steel tips. Metal handle measures 1/2" diameter x 5 7/8" overall length.

Description	Item#	Each
Swiveling Wax Carver/Deburrer	846-2055	\$19.95

F. Castaldo® Mold Release Spray

Castaldo mold release spray is pure silicone oil in an aerosol can for use in releasing wax patterns from rubber or metal molds. Safe, non-toxic, colorless, odorless, greaseless. Will not damage molds made of natural mold rubber. Contains no CFCs nor VOCs.

Description	Item#	EACH Prices	
		1-11	12+
Castaldo Mold Release Spray	816-2915	\$13.40	\$12.73

G. Sprints GF Mold Release Spray

Sprints all-purpose GF, gentle formula, mold release spray is a heavy-duty, food grade, non-paintable, silicone spray compatible with solvent-sensitive thermoplastics. Ultra-fine atomization for uniform coverage, fast drying. Contains no CFCs.

Description	Item#	Each
Sprints Mold Release Spray 12 oz. can	816-2925	\$10.95
Sprints Mold Release Spray (case of 12)	816-2938	104.00

H. Talc Powder

Brush or dust onto your rubber molds to permit easy removal of waxes and to open vents. Also used as a separating powder. 5 lb. bag.

Description	Item#	Each
Talc Powder	260-1375	\$16.50

A. Akrovest Wax Wash

Spray on wax pattern to reduce surface tension, allowing complete adherence of investment to wax. Nonhazardous. Sold in 8 oz. spray bottle.

Description	Item#	Each
8 oz. Spray Bottle	260-4520	\$13.30



A

B. Wax Kleen™

Rub this 100% organic solution on your wax patterns to polish them before casting. Removes scratches and leaves a clean, smooth surface. Pleasant citrus scent.



Description	Item#	Each
8 oz. Bottle	261-9004	\$16.50



B

C. Wax Wash

Brush on or dip wax pattern into Wax Wash to reduce surface tension, allowing complete adherence of investment to wax. Can be used whether flask will be vibrated or vacuumed.

Description	Item#	EACH Prices	
		1-3	4+
1 pt. Bottle 	260-4555	\$8.45	-
1 qt. Bottle 	260-4550	12.75	\$10.20



C

D. Dispensing Bottle

Plastic bottle holds Wax wash or other solvents. Special stainless steel lid with one-way valve allows pumping of solution into shallow well on top of bottle. Ideal for dispensing solutions that would otherwise evaporate.

Description	Item#	Each
Dispensing Bottle	830-4525	\$26.45



D

E. Wax Injection Mold Plates

Thick, well-finished aluminum plates for uniform pressure on your rubber mold during wax injection. Each set contains 2 plates, 12-gauge thickness, 3"L x 1 3/4"W.

Description	Item#	Set of 2
Wax Injection Mold Plates	265-2340	\$2.95



E

F. Plating Thermometers

Stainless steel thermometer for measuring stripping and plating bath temperatures. Help eliminate guesswork to improve results. Include metal clip for easy attachment to edges of beakers. Dial reads from 50 to 400°F. Measures 8" long.

Description	Item#	Each
Stainless Steel Dial Thermometer	210-2255	\$15.95



F

 UPS® hazardous shipping surcharge applies. Ships via UPS® Ground only, no air, FedEx® or US Mail shipments. Can't ship to Alaska, Hawaii or Puerto Rico.



A. Kelly Green Injection Wax

Extremely fluid wax easily fills both thick and thin intricate designs. Low ash content produces a very clean burnout for “snow white” flasks resulting in maximum flow when vacuum casting and reducing porosity. Unique color of Kelly Green is very “readable” for fine detail. Injection temperature: 155° to 160°F (68° to 71°C).

Color	Item#	PKG. of 5 lbs.		Item#	BOX of 50 lbs.	
		1	2+		1-4	5+
Kelly Green	261-8149	\$30.95	\$29.40	261-8158	\$250.95	\$238.40



B. Ferris® Turquoise Injection Wax

Super tough, medium-hard wax with built-in release agents. General purpose for both large and small molds. Injection temperature: 150° to 160°F (66° to 71°C).

Color	Item#	PKG. of 5 lbs.		Item#	BOX of 50 lbs.	
		1	2+		1-4	5+
Turquoise	261-8143	\$28.95	\$27.50	261-8152	\$235.95	\$224.15



C. Ferris® NYC Blue Injection Wax

Identical formulation as the Turquoise wax above, but in a bright readable blue made popular in the New York City area. Injection temperature: 150° to 160°F (66° to 71°C).

Color	Item#	PKG. of 5 lbs.		Item#	BOX of 50 lbs.	
		1	2+		1-4	5+
NYC Blue	261-8145	\$28.95	\$27.50	261-8155	\$235.95	\$224.15

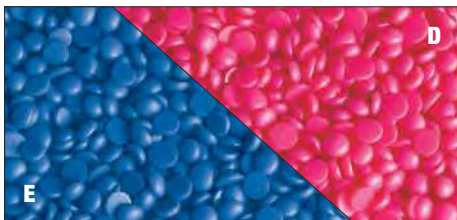

D, E Ferris® Magnaject™ Pink and Blue Injection Waxes

Extremely fluid wax to fill the most intricate patterns—including filigree, even at low pressures. Minimal shrinkage. Durable, nonbrittle with long shelf life. Available in blue or pink. Injection temperature: 150° to 160°F (66° to 71°C).

Color	Item#	PKG. of 5 lbs.		Item#	BOX of 50 lbs.	
		1	2+		1-4	5+
D. Magnaject Pink	261-8144	\$32.95	\$31.30	261-8153	\$280.95	\$266.90
E. Magnaject Blue	261-8146	32.95	31.30	261-8154	280.95	266.90



F. Ferris® Blue Injection Wax

Specially formulated for intricate, detailed molds. Hard wax with excellent memory. Cools quickly, pulls easily from mold. Injection temperature: 150° to 160°F (66° to 71°C).

Color	Item#	PKG. of 5 lbs.		Item#	BOX of 50 lbs.	
		1	2+		1-4	5+
Blue	261-8142	\$29.95	\$28.45	261-8151	\$240.95	\$228.90



G. Ferris® Plastic Injection Wax

This plastic-type wax combines the excellent flow characteristics of wax and the durability of plastic. Minimum shrinkage, excellent memory and flexibility. Long shelf life before and after injection. Releases easily from molds. Melting point: 155°-160°F. Injection temperature: 150° to 160°F (66° to 71°C).

Color	Item#	PKG. of 5 lbs.		Item#	BOX of 50 lbs.	
		1	2+		1-4	5+
Blue	261-8130	\$29.95	\$28.45	261-8132	\$240.95	\$228.90



H. Injector Cleaning Wax

Quick and easy method of eliminating all traces of injection wax from wax pots and injectors. This soft, white, translucent wax removes even the most stubborn wax residues. Excellent purging wax for large injectors. Has a melting temperature of approximately 130°F. Supplied in 5 lb. box.

Description	Item#	PKG. of 5 lbs.	
		1	2+
Injector Cleaning Wax	261-9000	\$41.50	\$37.35

A. Castaldo® Plast-O-Wax®

Castaldo Plast-O-Wax produces patterns that are very flexible, resilient and durable with great memory and does not become brittle over time. Fewer broken patterns equal greater productivity. A unique all-purpose injection wax that combines excellent flow and fill qualities with the stability of plastic while producing smooth glossy surfaces, crisp detail and minimal shrinkage. Great for stone-in-place casting. Injection temperature: 155° to 160°F (68° to 71°C).

Description	Item#	2kg Box	Item#	20kg Box
Plast-O-Wax	261-8137	\$25.75	261-8136	\$207.75

**B. Freeman® General-Purpose Flakes™**

This all-purpose injection wax is Freeman's most popular formulation as it provides the ideal balance of characteristics demanded by most designers and casters. Also recommended for stone in place casting. Low shrinkage with excellent flow and long pattern shelf life. Aqua is the most popular color while Turquoise and Ruby Red are for designers and casters who prefer darker colors for easier visual verification of fine detail. Injection temperature: 150°F (65°C).

Description	Item#	5 lb. Box	Item#	BOX of 50 lbs.		
				1	2-9	10+
Ruby Red	261-9321	\$29.79	261-9320	\$268.00	\$241.20	\$227.80
Turquoise	261-9325	29.79	261-9324	268.00	241.20	227.80
Aqua	261-9323	29.79	261-9322	268.00	241.20	227.80

**C. Freeman® Flexible Blue Flakes™**

Features the longest shelf life and the highest flexibility of the Freeman Flakes line so it will not break during removal from the mold. This unique mixture of wax and plastic is especially well-suited for metal molds and stone in place casting. Injection temperature: 155°F (68°C).

Description	Item#	5 lb. Box	Item#	BOX of 50 lbs.		
				1	2-9	10+
Flexible Blue	261-9327	\$31.50	261-9326	\$280.00	\$252.00	\$238.00

**D. Freeman® Tuf Guy Green Flakes™**

This is the toughest wax of the Freeman Flakes line. Its accuracy and durable, yet flexible characteristics make it ideal for large pieces. Excellent memory and high flexibility allow easy pattern removal from any mold. Low shrinkage, good flow. Injection temperature: 165°F (73°C).

Description	Item#	5 lb. Box	Item#	BOX of 50 lbs.		
				1	2-9	10+
Tuf Guy	261-9329	\$29.79	261-9328	\$268.00	\$241.20	\$227.80

**E. Freeman® Super Pink Flakes™**

Featuring the quickest solidification, this wax will not give, making it ideal for clasps, claws, and bezel settings. Also, the opacity makes this wax superior in readability. Superior flow and fast solidification. Injection temperature: 150°F (65°C).

Description	Item#	5 lb. Box	Item#	BOX of 50 lbs.		
				1	2-9	10+
Super Pink	261-9331	\$31.50	261-9330	\$280.00	\$252.00	\$238.00

**F. Freeman® Filigree Pink Flakes™**

This wax combines the flexibility of Tuf Guy Green with the excellent flow characteristics of Aqua General-Purpose flakes, producing very high detail while enabling easy pattern removal without breakage. Recommended for stone in place casting. Injection temperature: 155°F (68°C)

Description	Item#	5 lb. Box	Item#	BOX of 50 lbs.		
				1	2-9	10+
Filigree Pink	261-9333	\$29.79	261-9332	\$268.00	\$241.20	\$227.80

**G. Freeman® Carvable Purple Flakes™**

Developed for designers and casters who often rework wax patterns, this wax offers superior carvability with minimal filling or clogging of tools. Also, with the highest injection temperatures of the Freeman Flakes line, it will not break under stress and enables easier handling. Excellent flow and flexibility, low shrinkage and long pattern shelf life. Injection temperature: 170°F (77°C).

Description	Item#	5 lb. Box	Item#	BOX of 50 lbs.		
				1	2-9	10+
Carvable Purple	261-9335	\$31.50	261-9334	\$280.00	\$252.00	\$238.00



Made in the USA



A

A. ARBE Hand Pump Wax Injector

A well-built hand pump wax injector with an air pressure gauge that reads up to 30 PSI and an ultra-sensitive thermostat that ensures precise and consistent temperature control up to 250°F. Insert a thermometer in the port on the cover (not included; consider #210-2255 (see p. 195)). Designed for great reliability with ceramic mica heating elements, heated sealed nozzle, fully insulated cast-aluminum pot and powder-coated steel outer drum. Also includes on/off switch, power indicator light and spigot drain. Made in USA.

Specifications:

Wax Capacity 2 ¾ qts. (5½ lbs.)
 Electrical 110V, 6A, 660W, 50/60Hz or 220V, 3A, 660W, 50/60Hz
 Dimensions 10½" dia. by 14"H

Description	Electrical	Item#	Each
Hand Pump Wax Injector	110V	265-4950	\$545.00
Hand Pump Wax Injector	220V	265-4951	545.00



B

C

B, C ARBE Air Pressure Wax Injectors

Extremely well-built units designed for reliability and performance. The 2¾ Quart and 4 Quart models differ only in size and capacity. Both feature: Heated, sealed nozzle which won't leak or clog, large, easy-to-remove and tightly sealed top, fully insulated cast-aluminum chamber with durable stainless steel outer casing, convenient spigot drain for wax change and cleaning, adjustable pressure control with regulator and gauge (max. 15 PSI), automatic pressure release valve to ensure safety, dial-adjustable heater and thermometer well for temperature control up to 250°F (121°C), power indicator light, and an on/off switch. Require an air compressor such as #265-3100 (see p. 249) and a thermometer such as #210-2255 (see p. 195). Made in USA.

Specifications:

	2 ¾-Quart	4-Quart
Wax Capacity	2 ¾ qts. (6 lbs.)	4 qts. (8 lbs.)
Electrical	120V, 9A, 60Hz	120V, 7A, 60Hz
Dimensions	10½" dia. x 14"H	12" dia. x 19½"H

Description	Electrical	Item#	Each
B. 2 ¾-Quart Injector	120V	265-2267	\$475.00
C. 4-Quart Injector	120V	265-2295	625.00

See Website for Digital Version



D

D. ARBE Mini Air Pressure Wax Injector

For the small shop or for special waxes, our Mini Wax Injector has all the features of the larger ARBE injectors in a space-saving unit. Air pressure operation with a 2" diameter easy-to-read gauge, safety release valve, adjustable thermostat to 250°F, and thermometer well (use our #210-2255 Dial Thermometer). Machined aluminum pot, cover and base with durable steel ceramic-mica aluminum heating element. Double sealed, no leak nozzle. 220V unit is special order please allow extra time for delivery. Requires an air compressor that is capable of reaching a minimum of 30 PSI. Made in USA.

Specifications:

Wax Capacity 1⅓ qts. (2.66 lbs.)
 Dimensions 8" dia. x 10"H

Description	Electrical	Item#	Each
D. Mini Injector	110V, 60 Hz, 1Ph	265-2270	\$355.00
Mini Injector	220V, 50/60 Hz, 1Ph	265-2720	375.00



E

E. Universal Debubbler Valve – For Wax Injectors

Are air bubbles ruining your waxes? Attach this valve to your wax injector, hook up to your vacuum pump and vacuum out all the bubbles for perfect wax patterns.

Description	Item#	Each
Universal Debubbler Valve	260-3375	\$64.95

A. MASTERIX Wax Injectors



Injected wax is free of bubbles, even micro bubbles, thus flawlessly and accurately replicating your designs. Especially designed to handle the extremely difficult very thin thicknesses associated with filigree. Both units can easily handle any pattern in a rubber mold measuring up to approximately 5"x4"x1.5"

Available either as the Standard Model (265-2129) or as the Auto Injection System (265-2130) which utilizes AutoStart. AutoStart, first in the world, allows the user to save on the average 2 to 3 seconds per injection cycle, thus ensuring a considerable increase in production. The operator's work becomes so simplified that even the novice operator can use the wax Injector without any issues! No buttons to press, even with molds of different sizes, simply load and the size is detected and centered prior to injection. Once the mold is read, it is automatically injected, thus reducing operator errors on choice of programs.

Both versions utilize RFID technology allowing the operator to quickly load the parameters by scanning the tag on the rubber mold. Made in Italy.

Features

- Automatically injects quickly, accurately and easily saving time
- Rejects are reduced considerably
- Consistent pattern weight

Description	Item#	Each
Standard Wax Injector 	265-2129	\$11,550.00
Auto Start Wax Injector 	265-2130	12,550.00
RFID tags (10)	265-2133	28.50
RFID tags (100)	265-2134	250.00



A

Specifications

Dimensions Machine:
22" x 12.5" x 17.5"
(55 x 32 x 45cm)

Weight: Machine: 62lbs (28kg)
Packaging: 92lbs (42kg)

Power: 110V, 6A, 60Hz

System Pressure: 6 Bar

Tank / Capacity: Aluminum Tank - 10lbs/4.5k (4.75 Qt)

Touch Screen/RFID - 4.3" (11cm) Removable (Std), Fixed (Auto)

Clamp (Max Mold Size): 5.1"W x 4.75"D x 1.75/2.55"H
(130mmW x 120mmD x 45/65mmH)



B. Orange Wax Injector – Ideal for high production manufacturers

Precise, consistent pressure produces perfect repeatable patterns. You are in control of all the variables, temperature of wax in the reservoir and at the nozzle; air pressure, mold holding pressure and vacuum time so your patterns are perfect. Uses standard size rubber molds, approx. 2" x 1.2" and easily handles off-center molds with their patented process, decreasing operator training time. Rejects are reduced considerably.

Features

- Injects quickly and easily saving process time
- Automatically injects the mold accurately producing perfect wax patterns
- Consistent pattern weight

Description	Item#	Each
Orange Wax Injector 	265-4150	\$9,550.00



B

Specifications

Power: 120V

Max Air Pressure: 30PSI

Temp Range: 40° - 99°C (103° - 211°F)

Wax Capacity: 6 lbs (2.7kg)

Vacuum: High Vacuum 27 in HG or Higher

Overall Dimensions (cm): 80W X 60D x 55H

Net/Shipping Weight: 110/216 lbs. (50/98kg)

Rubber Molds: 2" x 1.2" x 0.3"



C. Digital Vacuum Wax Injection System Increases production by eliminating wax pattern defects!

An advanced system delivering consistent, repeatable wax patterns with the best possible surface finish. Draws air out of the mold before injection, eliminating air bubbles that result in wax pattern defects. Injects wax immediately after vacuuming to ensure a complete fill. Performs two-stage injection to compensate for shrinkage.

Offers both manual and automatic modes with the ability to set the following parameters for different molds: wax and nozzle temperatures, vacuum and injection times, injection pressures, clamp holding time, clamp holding pressure and clamp forward pressure.

System consists of digital vacuum wax injector, digital pressure controller auto clamp and foot pedal. Accommodates up to 3 1/8" x 3 7/8" x 1 1/4" rubber molds. Requires air compressor such as SilentAire #265-3100 and vacuum pump such as Oil-less #265-2255 (see p. 250).

Description	Electrical	Item#	Each
C. Complete System	120V	265-4144	\$4,125.00
Wax Injector only	120V	265-4140	2,200.00
Controller/Clamp only	120V	265-4142	2,400.00

See page 249 for
SilentAire Compressors.



C

Specifications:

Wax Capacity: 3 qts. (6 lbs.)

Electrical: 120V, 10A, 60Hz (240V also available)

Dimensions: Wax Injector: 21 1/2"W x 15"D x 17 1/2"H

Controller: 8 1/4"W x 13 1/2"D x 7 1/2"H

Clamp: 6 1/4"W x 7"D x 8 1/4"H

Net Wt.: 72 lbs.



A

A. Castaldo® VLT™ – Silicone Rubber - For Resin Models

Castaldo VLT (Very Low Temperature) Silicone Rubber vulcanizes at 160°F (71°C), allowing you to make long-lasting production molds directly from CAD/CAM and Rapid Proto type plastic resin models, without risk of model damage. Speeds your designs from computer concept to production in hours, not days. Easy to pack and cut. Shrinkage is only 0.1%. Produces highly detailed wax injections with extraordinarily shiny surfaces that require less finishing. Available in 2⁷/₈"W x 18"L x 3⁸/₁₆" thick strips. Sold in boxes of 5 lbs.

Description	Item#	BOX of 5 lbs.		
		1-2	3-5	6+
Strips (2 ⁷ / ₈ " x 18")	260-1487	\$46.25	\$43.94	\$41.63



B

B. Aluminum Mold Frames

Predrilled holes in sides allow excess rubber to escape during vulcanization, helping to prevent model deformation. Measurements denote mold sizes.

Description	L x W x Thickness	Item#	Each
B. Single Frame	2 ⁷ / ₈ " x 1 ⁷ / ₈ " x 3 ⁴ / ₄ "	260-2200	\$12.00
	2 ⁷ / ₈ " x 1 ⁷ / ₈ " x 1"	260-2300	14.00
	2 ⁷ / ₈ " x 1 ⁷ / ₈ " x 1 ¹ / ₄ "	260-2400	17.50



C

C. Castaldo® Mold Locks

Insert one of these brass cones into each corner of your rubber mold. They will form locks to prevent mold shifting during injection. May be used alone or with powder for easier separation after vulcanizing. Each bag contains 1/4 cup (3 oz.) of Mold Locks, equalling approximately 150 pieces.

Description	Item#	EACH Prices		
		1-2	3-9	10+
Castaldo Mold Locks	260-1350	\$18.15	\$17.24	\$16.34



D

D. Sprue Formers and Rods

Machined from solid brass. Slight difference in size of sprue former allows you to select the size that more closely matches your wax injector nozzle making it easier to maintain contact between the mold and nozzle. #9 is 9mm (.35") high and tapers from 3.3mm (1/8") to 11.5mm (.45") while #10 is 10mm (.39") high and tapers from 3.3mm (1/8") to 14mm (.55"). Matching 3mm (.118") diameter by 50mm (approx 2") long rods are included. Sold in packages of 10.

Style	Sprue Former Taper x Height (mm)	Rod Dia x L (mm)	Item #	Pkg of 10
# 9	3.3 – 11.5 x 9	3 x 50	260-3092	\$14.50
#10	3.3 – 14 x 10	3 x 50	260-3093	14.50



E

E. Rubber Mold Locking Pins

This is the fastest, easiest way to automatically form locks in your rubber molds! Pack your mold normally, then push one of these solid stainless steel pins into each corner of the mold before vulcanizing. Use these 23mm pins for 1¹/₈" to 1¹/₂" thick molds. Sold in set of 4 pins.

Description	Dia x L (mm)	Item#	SET Prices	
			1-2	3+
Rubber Mold Locking Pins	7 x 23mm	265-0856	\$13.50	\$10.80



F

Assorted Colors

F. Castaldo® Gelato Super High Strength™ – Silicone Rubber

This silicone-based rubber makes molds that cut like butter. Uncured, it has the consistency of soft putty, making it very easy to pack in undercuts and detailed areas. Produces a firm mold with excellent flexibility and tear strength. Strong enough to make complex multi-part molds. Gives waxes a smooth, shiny finish for easy release from molds. Vulcanize at 330°F for 15 minutes per layer of rubber. Strips measure 2⁷/₈" x 18". Gelato sold individually or in set (yellow/tan not included in set).

Description	Item#	BOX of 5 lbs			Description	Item#	BOX of 5 lbs.		
		1-2	3-5	6+			1-2	3-5	6+
Pistachio	260-1490	\$46.25	\$43.94	\$41.63	Blue	260-1495	\$46.25	\$43.94	\$41.63
Lemon	260-1491	46.25	43.94	41.63	Assorted Colors	260-1496	46.25	43.94	41.63
Peach	260-1492	46.25	41.63	37.00	Yellow/tan	260-1470	46.25	43.94	41.63
Fuchsia	260-1493	46.25	43.94	41.63					
Violet	260-1494	46.25	43.94	41.63					

A, B Castaldo® Gold Label® – Natural Rubber

Contains more pure natural gum rubber than Castaldo White Label, making Castaldo Gold softer and more pliable. The superior qualities of Castaldo Gold make it the ideal rubber for difficult molds containing undercuts, filigree or multiple settings. Easy to pack and highly flexible so that wax patterns release smoothly. Vulcanize at 310°F for 15 minutes per 1/4" of mold frame thickness. Rubber is 1/8" thick. Also available in rolls. Call for more info.

Description	Item#	BOX of 5 lbs.		
		1-2	3-5	6+
A. Strips (2 7/8" x 18")	260-1460	\$46.25	\$43.94	\$41.63
B. Ready Cut (1 7/8" x 2 7/8")	260-1480	49.25	46.79	44.33

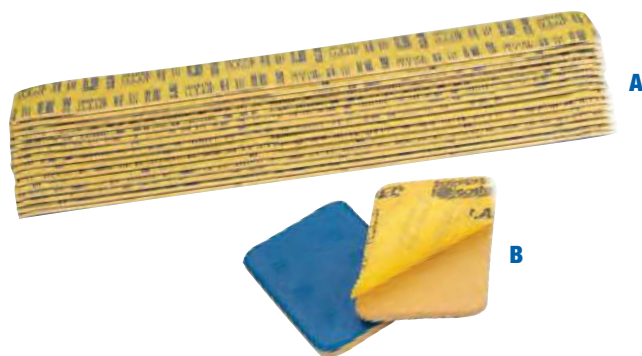

C, D Castaldo® White Label® – Natural Rubber

A high concentration of pure natural gum rubber makes Castaldo White firm but flexible. A good all-purpose mold rubber that cuts well. Well-suited for thin molds. Vulcanize at 310°F for 15 minutes per 1/4" of mold frame thickness. Rubber is 1/8" thick. Also available in rolls. Call for more info.

Description	Item#	BOX of 5 lbs.		
		1-2	3-5	6+
C. Strips (2 7/8" x 18")	260-1450	\$44.25	\$42.04	\$39.83
D. Ready Cut (1 7/8" x 2 7/8")	260-1475	46.50	44.18	41.85

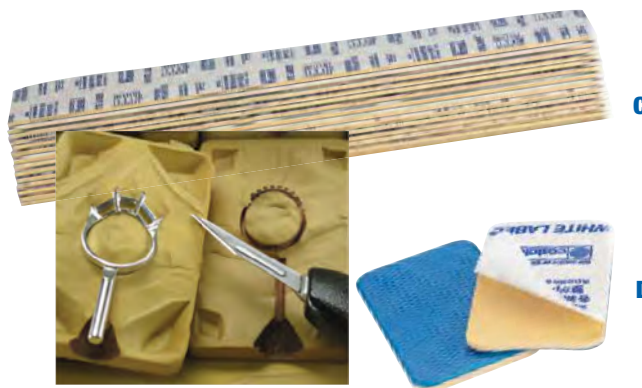

E. Castaldo® No-Shrink Pink® – Natural Rubber

Specially formulated for less than 1% shrinkage! Can be used alone or combined with Castaldo Gold or White rubber to reduce shrinkage and save money. Use No-Shrink Pink around the model and Castaldo White or Gold for the outside of the mold. Vulcanize at 290°F for 12 minutes per layer of rubber. Note: This natural rubber must be vulcanized at precisely 290°F. Use a thermometer to check your vulcanizer accuracy.

Description	Item#	BOX of 5 lbs.		
		1-2	3-5	6+
E. Strips	260-1455	\$52.50	\$49.88	\$47.25
Ready Cut	260-1485	55.25	52.49	49.73



F. Castaldo® SuperStretch™ – Silicone Rubber

SuperStretch™ rubber's high shine finish means less polishing. Cuts like butter. Easy mold packing/easy mold cutting. Low rubber shrinkage-only 1.3%. Compatible with other Castaldo silicone molding rubbers; can be used alone or used as an insert for special projects. Vulcanize at 330°F for 15 minutes per layer.

Description	Item#	BOX of 5 lbs.		
		1-2	3-5	6+
Strips (2 7/8" x 18")	260-1489	\$46.50	\$44.18	\$41.85

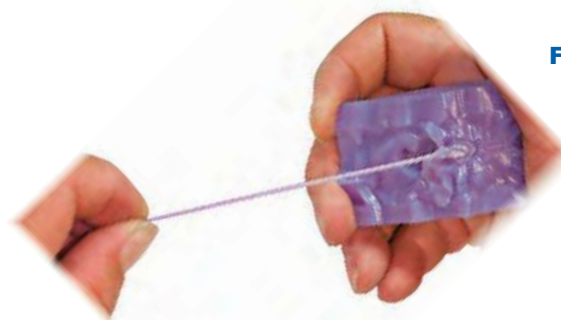

G. Castaldo® Econosil® – Silicone Rubber

This putty-like material is a harder, firmer, more affordable version of Castaldo Super High Strength silicone mold rubber. Makes strong production rubber molds with 1.1% shrinkage. Gives waxes a high-shine finish for easy release from molds without messy sprays or powders. Brick-red in color. Vulcanize at 330°F for 15 minutes per layer of rubber.

Description	Item#	BOX of 5 lbs.		
		1-2	3-5	6+
Strips (2 7/8" x 18")	260-1660	\$49.00	\$46.55	\$44.10



A



A-C Castaldo® Moldmatic® Ready Made Molds™ – Natural Rubber

A two-part system consisting of Ready Made Molds with preformed locks and Moldmatic Mold Frames. Mold cutting time and effort are greatly reduced. The mold halves fit together perfectly in a precision-engineered mold frame for consistently perfect wax patterns. The same high quality natural Castaldo mold rubber known throughout the world, but now prefabricated and ready to use. Mold locks are preformed. Merely remove the protective cloth squares at the center of the mold and insert your model. After vulcanization, simply pull the edges of the mold apart to expose perfectly formed locks. The center of the mold is cut normally. Sold in boxes of 10 molds along with 10 extra pieces of rubber so that any thickness mold can be made. You must use Ready Made Molds with Moldmatic Frames.

White Label	Dimensions	Item#	Box of 10			
			1-2	3-4	5-9	10+
A. Small	1 7/8" x 2 7/8"	260-1430	\$64.25	\$61.04	\$57.83	\$51.40
Medium	2 3/8" x 3"	260-1432	79.50	75.53	71.55	63.60
Gold Label	Dimensions	Item#	1-2	3-4	5-9	10+
Small	1 7/8" x 2 7/8"	260-1440	\$64.25	\$61.04	\$57.83	\$51.40
Large	2 7/8" x 3 3/8"	260-1444	90.65	86.12	81.59	72.52
No-Shrink Pink Label	Dimensions	Item#	1-2	3-4	5-9	10+
Small	1 7/8" x 2 7/8"	260-1416	\$64.25	\$61.04	\$57.83	\$51.40

B

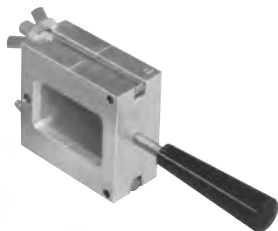

C

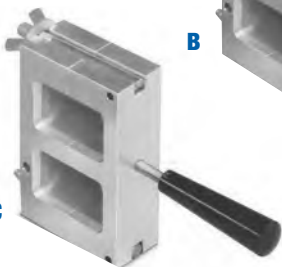

B, C Castaldo® Moldmatic® Ready Made Mold Frames

Size	Mold Dimensions	Item#	Each
B. Small	1 7/8" x 2 7/8"	260-1830	\$250.00
Medium	2 3/8" x 3"	260-1835	195.00
Large	2 7/8" x 3 3/8"	260-1840	216.00
C. Double Small	Both 1 7/8" x 2 7/8"	260-1845	499.50

D



Jewelry not included.

D. Castaldo® Quick-Sil™ RTV Jewelry Molding Rubber – Mold Putty

Two-part silicone mold rubber that cures in just 15 minutes—without heat! Quick-Sil is soft and pliable, so it's easy to mix and easy to pack even complicated models. Because no heat is used, there is absolutely no shrinkage. Tear resistance is equal to any standard silicone mold rubber. Molds require some pressure to make a good impression of the model. Safe, nonhazardous, nontoxic. Use standard mold frames. Available in 2 lb. kit (1 lb. each of Part A and Part B) to make 3-4 standard size molds.

Description	Item#	EACH Prices		
		1-2	3-4	5+
Quick-Sil RTV	260-1675	\$69.95	\$66.45	\$62.96

E



E. Castaldo® Mold Separation Cream – Eliminate or reduce mold cutting.

With Castaldo Mold Separation Cream, you may never have to handle a sharp mold knife again. Pack your model normally. When you have established a parting line between the 2 halves, spread a small amount of Mold Separation Cream on one surface with a fingertip or small brush. After the mold is vulcanized, insert a screwdriver into the parting line and peel the halves apart. Castaldo Mold Separation Cream can be used to separate the entire mold or just part of the mold, including locks. May be used with or without mold lock formers and on any type of mold rubber. Nontoxic, nonhazardous. Net Wt. 1 oz.

Description	Item#	Each
Castaldo Mold Separation Cream	260-1401	\$11.50

F



F. Castaldo® Resin Release™ Spray – Apply to models before packing

Although designed specifically for use on Castaldo VLT silicone mold rubber, Castaldo Resin Release Spray also acts as a protectant on Rapid Prototype models. RP and resin models should be tested before using liquid mold rubber. Some RP and resin model materials will react with the liquid rubber becoming gummy, distorted or bond destructively to their molds. To prevent this problem, spray Resin Release onto models shortly before vulcanizing, helping you make production-quality molds directly from CAD/CAM resin and wax models. Natural soy-based formula, nonflammable, biodegradable. Sold in 340g cans.

Description	Item#	EACH Prices	
		1-2	3+
Resin Release Spray	816-2917	\$14.70	\$14.70

Although no hazardous shipping surcharge applies, these items can only ship via UPS® Ground, no air, FedEx® or US Mail possible. Cannot ship to Alaska, Hawaii or Puerto Rico.

A. Castaldo® LiquaFast™ ICE RTV

New LiquaFast™ ICE from CASTALDO® is a transparent blue two-part 0% shrinkage RTV silicone molding rubber that cures very rapidly at normal room temperature (73°F) and cures even faster at 120°F. You can make a mold from your CAD CAM, RP and SLA models in the morning, inject waxes 30 minutes later and cast them that afternoon. No more waiting.

Features:

- New LiquaFast ICE makes strong, tough, tear-resistant permanent molds that do not decay with age.
- LiquaFast ICE's low viscosity makes it easy to measure, mix and pour.
- Normal cure time: Only 60 - 90 minutes.

Specifications:

Shrinkage: 0.0%
 Working time at 73° F/23° C: 15 minutes
 Setting time at 73° F/23° C: 60 - 90 minutes
 Setting time at 120° F/50° C: 30 minutes
 Mixing Ratio: 1:1 by weight

Description	Item#	1kg Kit	Item#	4kg Kit
A. Castaldo LiquaFast ICE RTV	260-1682	\$57.50	260-1683	\$209.50



B. Castaldo® LiquaCast Long-Life – RTV

LiquaCast Long-Life makes molds that are extremely strong, tough and tear-resistant. Molds will not soften or liquefy over time and will last for decades!

Perfect for complex molds, difficult undercuts, spirals and cores. It is compatible with most computer-generated CAD-CAM resin and difficult to mold CAD-CAM wax patterns. Molds have a glossy, shiny surface that produces waxes with a glossy, shiny surface. Final castings require less polishing. Rubber shrinkage is 0%. Low viscosity makes it easy to measure, easy to mix, easy to vacuum and easy to pour. Mix ratio is 1:1 by weight or volume. Cure time is 24 hours. Rapid cure time @150°F (65°C) is just 90 minutes. Use with Castaldo Liquid Rubber Mold Frames (below).

Description	Item#	Each
B. 1kg Kit	260-1671	\$69.90
8kg Kit	260-1672	184.25
20kg Kit	260-1673	447.00



C. Castaldo® Original LiquaCast™ Liquid RTV Mold Rubber

A two-part liquid mold rubber that vulcanizes without pressure at room temperature. Use it to make molds of waxes, organics, plastics, and anything that cannot withstand the heat/pressure of normal vulcanization. Contains no silicone and makes a stronger, more durable mold than standard liquid mold rubbers. 0% Shrinkage. Cures in 16–24 hrs. Requires vacuuming. Use with Castaldo Liquid Rubber Mold Frames (below). Use Castaldo Resin Release Spray (816-2917) to protect Rapid Prototype models (see facing page).

Description	Item#	Each
C. 1 lb. Set	260-1662	\$43.00
10 lb. Set	260-1664	123.00



D. Freeman Jewel-Sil RTV Molding Rubber

A two-part clear silicone rubber for room temperature vulcanization of your jewelry molds. Reproduces intricate details with close tolerances. Features low viscosity for easy pouring, excellent clarity for precise cutting, high tear strength and ability to endure temperatures up to 350°F. Mix and use within an hour. Cures in 24 hours with less than 0.1% shrinkage.

Description	Item#	Each
D. 1kg Kit	261-9347	\$49.95
5kg Kit	261-9348	265.00



E. Castaldo® Liquid Rubber Mold Frames

Each consists of a solid aluminum U-frame with built-in sprue former, two pieces of heavy-duty clear plastic and industrial bands. Made extra-tall to allow expansion during vacuuming—no more spills. Eliminate need for paper collars. Available in four thicknesses: 3/4", 1", 1 1/4" and 1 1/2". All make molds up to 1 7/8"W x 6"H.

Thickness	3/4"	1"	1 1/4"	1 1/2"	Each
Item#	260-1661	260-1663	260-1665	260-1667	\$17.75





A-C Knife Handles

Hold Swann Morton Knife blades securely.

Description	Item#	Each	
A. B-P #5 USA Contoured Plastic	260-3050	\$27.00	
Description	Item#	EACH Prices	
B. Imported Contoured Plastic	260-3052	\$5.30	\$4.77
C. Stainless Steel Knife Handle	260-3055	3.55	3.20



D-F Swann Morton® Knife Blades

High-carbon steel surgical blades (non-sterilized) for precise mold cutting. Last much longer and are sharper than stainless steel blades. Available in packages of 5 blades or in individually wrapped boxes of 100. Blades fit either Plastic or Stainless Steel Handles (above) Cannot be used with Contoured Heavy-Duty or Soft Grip Knives. Made in the United Kingdom.

Blades	Item#	Pkg. of 5	Item#	BOX of 100		
				1-4	5-9	10+
D. #11 Straight	260-2951	\$1.85	260-2952	\$19.15	\$18.19	\$17.24
E. #12 Curved	260-3001	1.85	260-3002	19.15	18.19	17.24
F. #10A Wide-Angle Straight	260-3006	1.85	260-3005	19.15	18.19	17.24



G, H Heavy-Duty Knife and Blades

Plastic knife handle contoured to fit your hand. The B-P #6 USA knife handle only accepts heavy-duty #25 steel blades. Exclusive "rib-back" design adds strength to these blades, making them the most durable mold cutting blades available.

Description	Item#	Pkg. of 6	Item#	BOX of 150		
				1-4	5-14	15+
G. #25 Blades	260-2999	\$6.00	260-3000	\$116.50	\$108.35	\$104.85
Description	Item#	Each				
H. B-P #6 USA Knife Handle	260-3051	\$27.30				



I-K Soft Grip Knife

Round with comfortable, nonslip, soft grip handle. Blades are held securely and locked or released by turning knurled knob at rear of handle. Comes with one #11 knife blade. Measures 4³/₄" overall length without blade. Color: blue.

Description	Item#	Each
I. Soft Grip Knife with #11 Blade	260-3040	\$5.25
Blades for Soft Grip Knife Handle		Pkg. of 5
J. #11 Steel Blade	260-3045	\$2.10
K. #16 Steel Blade	260-3048	2.10



L. Mold Holder, A/C

A fast and simple way to learn rubber mold cutting. Cut a line about 1/8" to 1/4" deep around the perimeter of the mold. Then fasten the aluminum clamps onto the edges of the mold at the sprue end. The 2 clamps firmly grip each half of the mold, leaving both hands free to finish the cutting. As the cutting progresses, turn the knobs to spread the mold—you'll have no problem seeing or reaching where you want to cut.

Description	Item#	Each
Mold Holder	260-2576	\$109.95



M. Cuttlefish Bone

For casting small objects by pressing model directly into cuttlefish. Soft shell makes a smooth-walled mold. Cut sprues, gates and vents into the wall with a sharp knife. Supplied in random sizes. Package contains 4-6 pieces weighing approx. 1/2 lb. total.

Description	Item#	Each
Cuttlefish Bone	265-3000	\$24.85

A. Dual-Control Deluxe Vulcanizer

No more over- or under-cooked molds! Two independent thermostats control each platen separately, so you get the exact temperature you need for the top and bottom of your mold. Ideal for the new 0% shrinkage rubbers (such as Castaldo No-Shrink Pink, p. 201) that demand precise temperature control. Heavy-duty cast-iron and aluminum construction with 1" diameter pressure screw and heavy guide posts to ensure uniform pressure on mold and perfect alignment of stainless steel platens. On/off toggle switch with pilot light and 2 separate thermostat pilot lights. Accepts both single and double mold frames. Made in USA.

Specifications:

Electrical	110V, 6A, 660W, 50/60Hz 220V, 3A, 660W, 50/60Hz
Dimensions	15½"W x 9½"D x 20½"H
Platens	8¼" x 6"
Max. Temp.	500°F (260°C)
Max. Opening	4¾"
Ship. Wt.	58 lbs.

Model	Item#	Each
110V	265-1950	\$950.00
220V	265-1955	950.00



A

B. Junior Vulcanizer

Heavy-duty cast-iron and aluminum construction. Stainless steel heating platens. Large handle and sturdy 1" diameter pressure screw. Two large diameter guide rods keep platens in alignment. Thermostat with dial for accurate temperature control up to 500°F/260°C. Equipped with power and thermostat pilot lights and on/off switch. Predrilled holes in base for easy mounting. Made in USA.

Specifications:

Electrical	110V, 6A, 660W, 50/60Hz 220V, 3A, 660W, 50/60Hz
Dimensions	13"W x 7"D x 18"H
Platens	8" x 5"
Max. Temp.	500°F (260°C)
Max. Opening	3"
Ship. Wt.	37 lbs.

Model	Item#	Each
110V	265-2225	\$635.00
220V	265-2227	735.00



B

C. Polder Timer/Thermometer – For investing and vulcanizing

This handy countdown timer also measures temperature with a plug-in thermometer on a 48" long wire and independent alarms that can be used separately or together. Perfect for monitoring vulcanizer temperature, timing molds, investing and plating baths.

Shows countdown in hours, minutes and seconds. Reverts to last setting when shut off—great for investing multiple flasks. Displays set temperature, alarm sounds when reached, and actual temperature. Temperature range: 32-392°F (0-200°C).

Description	Item#	Each
Polder Timer/Thermometer	265-1915	\$27.00



C

D. Vulcanizer Mold Plates

Thin aluminum plates for covering aluminum mold frames and rubber when vulcanizing. Keeps platens clean and prevents rubber from sticking to the platens.

Size	Item#	Set of 2
3⅞" x 5⅜"	260-1850	\$9.50
5" x 7⅞"	260-1900	25.90

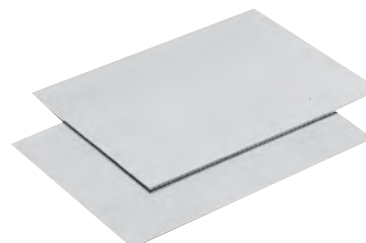

D



A-E Sprue Bases

For setting up wax patterns before investing. Made of durable vulcanized rubber. Flexible enough to fit flasks that have been distorted from use. Creates a leakproof seal. In 3 styles for a wide range of sprue shapes.

	Item#	EACH Prices		
		1-2	3-9	10+
A. Button – For flask diameter				
2½"	260-0600	\$3.25	\$3.09	\$2.76
3"	260-0750	3.65	3.47	3.10
3½"	260-0900	4.15	3.94	3.53
4"	260-1050	5.25	4.99	4.46
B. Donut – For flask diameter				
3½"	260-0950	4.30	4.09	3.66
C. Tree*, Round Center – For flask diameter				
2½"	260-0700	3.25	3.09	2.76
3"	260-0850	4.75	4.51	4.04
3¾"	260-1010	6.15	5.84	5.23
3½"	260-1000	5.60	5.32	4.76
4"	260-1150	5.30	5.04	4.51
5"	260-1170	10.65	10.12	9.05
D. Tree*, Cone Center – For Vacuum Casting Machines				
2"	260-0561	3.20	3.04	2.72
4"	260-1155	3.15	2.99	2.68
E. Universal				
2½" or 3½"	260-1175	3.60	3.42	3.06

*All sprue holes ⅜" diameter except as indicated.

F. Mold Clay

Used for modeling or filling the centers of sprue bases to hold wax patterns. Sold in 2 lb. bars.

Description	Item#	Each
Mold Clay	260-3402	\$24.50

G-I Sprue Wax – 24" Length

Flexible and long, this sprue wax is custom-formulated to our strictest specifications for proper burnout, melts at 120°F. The injectable feature of our sprue wax is a time-saver. If you often use a complicated tree design, make a mold of it and inject multiples using our sprue wax. Your exact tree system is quickly created every time. Sold in 1 lb. boxes.

Diameter	Approx. Qty. per Box	Item#	EACH Prices	
			1-49	50+
G. ¼"	15	261-6260	\$10.65	\$9.59
H. ⅜"	10	261-6265	10.05	9.05
I. ½"	8	261-6270	8.50	7.65

J, K Sprue Wax – 6" Length

Available in 2 grades, flexible is the same as our longer sprue wax (above), melts at 120°F. Hard is very rigid and stable, providing extra support for large trees or patterns, melts at 168°F. Packaged in 1 lb. boxes.

Description	Diameter	Color	Approx. Qty. per Box	Item#	EACH Prices	
					1-49	50+
J. Flexible	⅜"	Red	45	261-6272	\$14.50	\$13.05
K. Hard	⅜"	Aqua	45	261-6273	14.50	13.05

L-N Sprue Wax Wire – 6" Length

These flexible sticks are for spruing and mounting wax patterns. Melts at 155°F.

B&S Gauge	Approx. Qty. per Box	Item#	Box
L. 6 Flexible	75	261-6256	\$19.95
M. 8 Flexible	135	261-6258	20.75
N. 10 Flexible	180	261-6259	20.75

O. Hexagonal Sprue Wax – 6" Length

Six-sided hexagon shape makes for easier spruing and permits more patterns to be sprued than conventional round sprue wax. This is a firm sprue wax with a melting temperature of 154°F. Packaged in 1 lb.

Diameter	Approx. Qty. per Box	Item#	Box
⅜" - Hard	45	261-5890	\$9.50



See page 189 for Wax Wire.

A, B Perforated Flasks

Heavy-duty stainless steel for vacuum chamber casting.

A. Flask with flange		EACH Prices		B. Flask without flange		
Dia.* x H	Item#	1-2	3+	Dia. x H	Item#	Each
3 ³ / ₈ " x 4"	260-0020	\$42.25	\$40.14	4" x 6"	260-0012	\$35.00
3 ¹ / ₂ " x 4"	260-0019	29.00	27.55	5" x 8"	260-0014	50.00
4" x 4"	260-0025	30.00	28.50	6" x 8"	260-0016	55.00
4" x 5 ³ / ₄ "	260-0032	43.75	41.56	<i>*Diameter not including flange.</i>		
4" x 8 ¹ / ₂ "	260-0035	53.90	51.21			
5" x 7"	260-0037	53.90	51.21			



A

B

C. Tivac Paper Flask Liner – Eliminates the need for perforated flasks

Vacuum channels formed by the liners increase the exposed surface area of the investment and create an unobstructed air flow. Provides over 40% more vacuum capacity than wax web, plastic web, or vacuum rods. Burns out cleanly. Completely nonhazardous. Built-in collar replaces flask sleeves. #4 fits 4" x 6", 4" x 7" and 4" x 8" and #5 fits 5" x 6", 5" x 7" and 5" x 8" solid-wall flasks.

Description		10-pc. Sample Pack		Description		50-pc. Pack	
	Item#	Each			Item#	1-4	
C. Tivac #4 for 4" dia. flasks	260-0047	\$8.25		Tivac #4 for 4" dia. flasks	260-0046	\$40.00	
Tivac #5 for 5" dia. flasks	260-0049	8.95		Tivac #5 for 5" dia. flasks	260-0048	45.00	

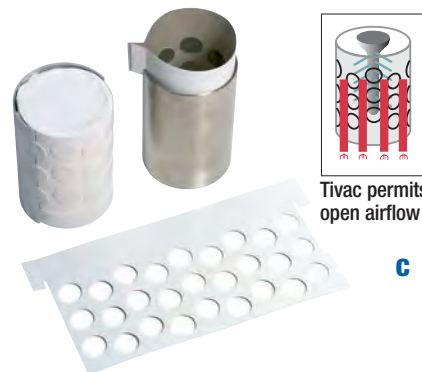

Tivac permits open airflow

C

D. Non-Asbestos Platinum Liner Papers – 75 Foot Roll

Non-asbestos platinum liner papers are available in 5 width sizes; 2.5", 3", 4", 7.25" and 9" and is a 75 foot long roll. Liner papers are used to line the inside of the platinum flask where it helps to absorb the excess binder solution from all platinum investments. Made in the USA.

Width x Length		EACH Prices		Width x Length		EACH Prices	
	Item#	1-2	3+		Item#	1-2	3+
2.5" x 75'	260-0061	\$55.95	\$53.15	7.25" x 75'	260-0066*	\$123.95	\$117.75
3" x 75'	260-0062	58.95	56.00	9" x 75'	260-0067*	169.95	161.45
4" x 75'	260-0063	74.95	71.00	<i>*Non-stock special order only</i>			



D

E. Tape for Perforated Flasks

Wide tape to be applied around perforated flask while investing. Can be burned out.

Width x Length		EACH Prices		Width x Length		EACH Prices	
	Item#	1-9	10+		Item#	1-9	10+
4" x 60 yards	260-0036	\$13.95	\$12.56	7" x 60 yards	260-0045	\$25.95	\$23.36
6" x 60 yards	260-0038	24.95	22.46	8" x 60 yards	260-0039	35.00	31.50



E

F. Rubber Sleeves for Perforated Flasks

Reusable, flexible rubber sleeves for covering perforations when investing.

Dia. x H		EACH Prices		Dia. x H		EACH Prices	
	Item#	Each			Item#	Each	
3 ³ / ₈ " x 4"	260-0003	\$12.50		4" x 8 ¹ / ₂ "	260-0009	\$16.25	
4" x 7"	260-0007	15.75		5" x 8"	260-0011	16.25	



F



G

G. Rubber Flask Extenders – For solid-wall flasks.

Slide flexible sleeve over standard flasks to prevent overflow while vacuuming investment.

Dia. x H		EACH Prices		Dia. x H		EACH Prices	
	Item#	Each			Item#	Each	
2 ¹ / ₂ " x 2 ¹ / ₂ "	260-0401	\$4.95		3 ¹ / ₂ " x 2 ¹ / ₂ "	260-0501	\$6.05	
3" x 2 ¹ / ₂ "	260-0451	5.35		4" x 2 ¹ / ₂ "	260-0551	6.30	

H. Casting Flasks – Heavy-duty 14 Gauge (2mm) Stainless Steel

Designed to withstand thermal shock of casting, quenching and numerous burnouts.

Dia. x H		EACH Prices			Dia. x H		EACH Prices		
	Item#	1-2	3-5	6+		Item#	1-2	3-5	6+
2" x 2 ¹ / ₂ "	260-0040	\$4.65	\$4.42	\$4.42	3 ¹ / ₂ " x 3"	260-0200	\$9.15	\$8.69	\$8.24
2 ¹ / ₂ " x 2 ¹ / ₂ "	260-0050	5.20	4.94	4.68	3 ¹ / ₂ " x 4"	260-0210	10.25	9.74	9.23
2 ¹ / ₂ " x 3"	260-0055	5.95	5.65	5.36	3 ¹ / ₂ " x 5"	260-0115	10.50	9.98	9.45
2 ¹ / ₂ " x 4"	260-0060	7.45	7.08	6.71	4" x 4"	260-0310	10.95	10.40	9.86
3" x 3"	260-0150	7.35	6.98	6.62	4" x 5"	260-0320	13.95	13.25	12.56
3" x 4"	260-0170	7.45	7.08	6.71	4" x 6"	260-0350	14.25	13.54	12.83



H



R&R® Investment

Select Ultra-Vest® when casting non-ferrous metals; Ultra-MAXX® when using white gold and palladium, as well as yellow gold. Plasticast is the ideal investment for plastic pattern materials. All three are available in traditional formulas or with new BANDUST™ Technology for measurable reduction in total respirable dust—up to 99% compared to other brands of jewelry investment. Casting quality is maintained with excellent final casting results and no process changes are required during the investing stage. Full pallet pricing also available.

See our website
for pallet pricing



Bandust reduces
airborne silica dust!



A, B R&R® Ultra-Vest® and Ultra-Vest with BANDUST™

Recognized worldwide as the premium investment for gold, silver, brass, and other non-ferrous jewelry castings. Provides easy quench and easy clean-up reducing your risk of losing valuable gold. Ultra-Vest investment produces smoother surfaces than other investments, resulting in less finishing.

Worldwide, Ultra-Vest is widely accepted as being the most process forgiving product available for your casting needs saving you time and money associated with application-related defects. Whether you are casting a simple piece or an intricate shape, Ultra-Vest investment is the investment of choice.

Description	Size	FOB	Item#	EACH Prices		
				1-2	3-5	6+
A. Ultra-Vest	50 lb. box	CT	260-4012	\$44.95	\$42.70	\$41.58
Ultra-Vest	50 lb. box	OH	260-4015	44.95	42.70	41.58
Ultra-Vest	50 lb. box	CA	260-4017	46.95	44.60	43.43
B. Ultra-Vest Bandust	50 lb. box	CT	260-4180	50.95	48.40	47.13
Ultra-Vest Bandust	50 lb. box	OH	260-4181	50.95	48.40	47.13

C, D R&R® Ultra-Vest MAXX® and Ultra-Vest MAXX with BANDUST™

An excellent choice for casting white gold and plastic or resin pattern materials. maximum thermal stability for high metal melt temperatures, flask temperatures, burnout temperatures, and casting temperatures. Just want to use one investment? Ultra-Vest MAXX can be used with yellow gold too. Eliminates orange peel defects associated with metal/mold reactions. Eliminates flashing & spalling associated with investment breakdown during burnout of plastic & resin pattern materials.

Description	Size	FOB	Item#	EACH Prices		
				1-2	3-5	6+
C. Ultra-Vest MAXX	50 lb. box	CT	260-4048	\$56.95	\$54.10	\$52.68
Ultra-Vest MAXX	50 lb. box	OH	260-4043	56.95	54.10	52.68
D. Ultra-Vest MAXX Bandust	50 lb. box	CT	260-4183	63.95	60.75	59.15
Ultra-Vest MAXX Bandust	50 lb. box	OH	260-4184	63.95	60.75	59.15

E, F R&R® Plasticast and Plasticast with BANDUST™

Plasticast was developed for the investing and burnout of commonly used plastic or wax/plastic pattern materials. Ideal for resin models created in rapid prototype processes. The high expansion of all these pattern materials requires an equally high expanding, extra high strength investment. Plasticast provides a smoother, cleaner casting surface not obtainable with standard brands of investment. Plasticast is designed for easy removal in water. Plasticast also provides a superior casting surface when standard injection waxes are used.

Description	Size	FOB	Item#	EACH Prices		
				1-2	3-5	6+
E. Plasticast	50 lb. box	CT	260-4097	\$52.95	\$50.30	\$48.98
Plasticast	50 lb. box	OH	260-4098	52.95	50.30	50.30
Plasticast	50 lb. box	CA	260-4099	58.50	55.58	55.58
F. Plasticast Bandust	50 lb. box	CT	260-4186	59.95	56.95	56.95
Plasticast Bandust	50 lb. box	OH	260-4187	59.55	56.57	56.57

G. R&R® Plasticast PT Investment

Plasticast PT two-part investment is developed for casting rapid prototype pattern materials. Based on 3rd party industrial hygienist air sampling test results, new BANDUST™ technology significantly reduces total respirable dust — up to 99% compared to other brands of jewelry investment. See our gesswein.com for our complete R&R investment line.

Description	Size	FOB	Item#	EACH Prices		
				1-2	3-5	6+
G. PlasticastPT	50 lb. box	CT	260-4088	\$309.00	\$293.55	\$285.83
PlasticastPT	50 lb. box	OH	260-4089	299.95	284.95	277.45

A, B R&R® Platinum & Binder

PLATINUM by R&R is an acid-based binder mixed with investment for casting platinum alloys. This investment and binder provides platinum casters with a consistent, acid-based mixture that does not separate, resulting in smoother, more consistent casting surface finish than any other two-part platinum product. Investment comes in 50 lb. Box and must be ordered with a 900ml bottle of concentrated Binder 260-4076. Note, 900ml is enough for 100 lbs. of Platinum Investment. Carefully follow all instructions for optimum results and user safety. Made in the USA.

Description	Size	FOB Shipping Point	Item#	1-2	3-5	6+
A. Platinum	50 lb. box	CT	260-4075	\$89.95	\$85.45	\$83.20
B. Binder	900ml bottle	CT 	260-4076	\$39.95	-	-

 *UPS® hazardous shipping surcharge applies. Ships via UPS® Ground only, no air, FedEx®, or US Mail shipments. Cannot ship to Alaska, Hawaii or Puerto Rico.*



C. R&R® Solitaire

High-quality Ransom & Randolph investment that is formulated specially for stone-in-place casting, providing exceptional protection for gemstones that are ideal for casting in place. Solitaire burns out very clean and provides exceptional castings with a cleaner dewax while reducing the possibility of surface imperfections. Made in US

Description	Size	FOB Shipping Point	Item#	1-2	3-5	6+
Solitaire	50 lb. box	CT	260-3953	\$48.95	\$46.50	\$45.28



D. R&R® Rancast™

RANCAST investment is an economical, industrial-grade investment specifically designed for the production of non-ferrous artwork such as small sculptures and trophies and large style class rings. This calcium sulfate bonded investment contains cristobalite and which provides exceptional detail reproduction with superior mold strength. R&R RANCAST™ is idea for small to very large molds using standard methods of investing for conventional solid mold lost wax casting. Made in the USA.

Description	Size	FOB Shipping Point	Item#	1-2	3-5	6+
Rancast™	50 lb. box	CT	260-4072	\$52.95	\$50.30	\$48.98
Rancast™	50 lb. box	OH	260-4073	\$52.95	\$50.30	\$48.98



E. ALL CAST® Investment

A micro-fine grain, "carbon-free" investment for producing ultra-smooth castings. Especially good for RP models. All Cast is a super-fine phosphate-bound, cristobalite investment ideal for use with precious, semi-precious and non-precious alloys (all gold karats in white and yellow, silver, platinum, cobalt, steel, palladium and palladium alloys). Meticulously formulated compound provides the caster with a wide range of burnout temperatures. Burnout Range: 1300°–1800°F (704°–982°C). Sets in just 20 minutes! Burns out in 2 to 4 hours, depending on flask size. Smooth, accurate, strong, and reliable. Available in kits of 25 lb. and 50 lb. boxes that include liquid binder. Not for use with titanium or titanium alloys. Made in USA.

Description	Item#	Each
E. ALL CAST 25 lb. Kit	265-4998	\$120.00
ALL CAST 50 lb. Kit	265-4999	230.00



F, G ALL CAST® Paint-on Pre-Coat Green & White

Gesswein's All Cast Pre-Coat White and Pre-Coat Green are a fine grained liquid investment for the sole purpose of enhancing the sharpness and detail of your castings. Both come in convenient 8 oz. jars with instructions right on the jar label. Use White for Gesswein's All Cast Investment (see above) and Green for all other phosphate based investments.

Description	Size	Item#	EACH Prices	
			1-3	4+
F. All Cast Pre-Coat White	8 oz.	265-4990	\$19.95	\$17.96
G. All Cast Pre-Coat Green	8 oz.	265-4992	20.95	18.86



H. Quatro Ductless Fume Hoods – For those without access to outside ductwork.

Ideal for jewelers located in offices without access to outside ductwork. Features a two-stage filtration system that captures fumes and/or particles, then recirculates clean air back into the room to save on heating and AC costs. Investment Mixing Hood (854-1403) installs directly over your investment mixer. Backed by a two-year manufacturer's warranty. Made in Canada.

Specifications:

Electrical: 120V, 1.6A, 60Hz, Dimensions: 28"W x 18"D x 26"H, Net Wt.: 50 lbs.

Description	Item#	Each
Investment Fume Hood	854-1403	\$1,005.00





A 1,000ml 250ml 500ml

A. Ti-Research Mix-It Investment Mixers

For mixing both standard investments and fast-setting investments by hand. Thick-wall construction and solid stainless steel handle and mixing blade. To remove bubbles while you mix attach to your vacuum pump or the Waterjet Vacuum Pump, connected to a faucet for Venturi effect: producing a vacuum in the Mix-It bowl. Made in Germany.

Description	Item#	Each
250ml (fills a 3" x 3" flask)	265-5030	\$265.00
500ml (fills a 4" x 4" flask)	265-5031	269.00
1,000ml (fills a 5" x 6" flask)	265-5032	284.00
Waterjet Vacuum Pump	265-5033	112.00



Waterjet Vacuum Pump

B, C Timers – Ideal for investing and vulcanizing

Select between our simple 60-minute windup with long ring or our programmable 10-hour timer. Simply key in hours and minutes, then hit start. Loud beeping alarm sounds after time expires. Features repeat timing: within two minutes after alarm, press start to repeat the previous countdown. Built-in magnet allows easy mounting on metal surfaces. Requires one AAA alkaline battery.

Description	Item#	Each
B. 60-Minute Timer	265-1910	\$14.25
C. 10-Hour Timer	265-1912	16.50



B

C

D-G Rubber Mixing Bowls & Spatula

Bowls are made of flexible rubber heavy enough to hold mixtures yet flexible enough for easy pouring. Spatula is made of thick, flexible stainless steel with hardwood walnut handle. Measures 10½" L.

Description	Dia. x H	Capacity	Item#	Each
D. Small Bowl	4" x 3"	¾ pt.	260-3250	\$4.15
E. Medium Bowl	6" x 6"	1½ qts.	260-3300	9.95
F. Large Bowl	9" x 7"	1 gal.	260-3350	18.65
G. Mixing Spatula	6" Blade Length		260-1710	17.95



F

E



G



H

H. Investment Vibrator

This well-built vibrator eliminates air bubbles and voids around wax models. Also adds density to the investment. Has three-speed control and on/off switch and 4" diameter table.

Description	Size	Item#	Each
Investment Vibrator- 110V	4"L x 4"W x 3¾"H	265-1245	\$98.00

I. Investment Scale

This economical yet accurate scale weighs up to 10 lbs. in 2 oz. increments. Features 4" dial with large, easy-to-read numbers that indicate weights and water/investment ratios. Includes scoop.

Description	Item#	Each
Investment Scale	200-2020	\$27.80



I

J-M Graduated Cylinder, Investment Scoop and Measuring Beakers

Polypropylene graduated cylinder with 2ml graduations is used to calculate the amount of metal needed for casting by water displacement method. Investment scoop has high sides to prevent spilling and waste. Measures 8½"L x 4¾"W x 3"H. Made of plastic. Measuring beakers have handles for easy pouring. Made of polypropylene. Small has 1ml graduations and Large has 100ml graduations.

Description	Capacity	Item#	Each
J. Graduated Cylinder	250ml (250cc)	265-1905	\$21.65
K. Investment Scoop	Roughly 3 lbs.	260-1750	8.95
L. Small Measuring Beaker	1,000ml (1,000cc)	210-2425	16.55
M. Large Measuring Beaker	5,000ml (5,000cc)	210-2426	58.95



L

M

J

K

N-P Tripour Disposable Beakers

Polypropylene beakers are disposable and cost effective. Polypropylene plastic for use with acids, alkalis and solvents. Graduated easy-to-read markings. 3 Drip-less pouring spouts. Withstands temperatures up to 250 (121). Disposable. Available in 3 sizes 250 ml, 400 ml, 1000 ml. Sold in packages of 25.

Description	Capacity	Item#	Pkg of 25
N. Small Disposable Beaker	250ml	210-3001	\$15.75
O. Medium Disposable Beaker	400ml	210-3002	20.95
P. Large Disposable Beaker	1,000ml	210-3003	35.65



N

O

P

A. Auto-Vac Investing Machine

Take the worry out of investing with Auto-Vac. This timesaving machine mixes investment and fills flasks under full vacuum, eliminating the air bubbles that hurt casting quality and kill productivity down the line. Produces smooth, crisply detailed molds, which result in better castings. Also helps keep dust out of the air for a healthier workspace. Easy to use and clean: place flasks in vacuum chamber, swivel mixing unit over it, pour water and investment into mixing unit, seal lid and run machine; when done, swivel mixing unit over wash basin and clean out with water gun. Includes two all-metal stands for flexibility. Requires vacuum pump.

Features:

- Mixes and fills in a controlled environment to help reduce casting defects.
- Reduces exposure to harmful investment dust.
- Easy to use and clean.
- Includes 2 stands so you can choose a 47¼" or 55" working height.

Specifications:

Investment Capacity: up to 40 lbs., Max. Flask Height: 11"

Flask Diameter	3"	3½"	3¾"	4"	4½"	5"	6"
No. of Perforated Flasks with flange	6	5	4	4	3	2	1
No. of Flangeless or Solid wall flasks	8	7	7	6	5	4	1

Vacuum Requirement: 10 CFM, 29.5" Hg (300 liter/minute)

Electrical: 220V, 1 Ph, 50/60Hz

Dimensions: 27"W x 26"D x 47¼"H or 55"H (height depends on stand used)

Net/Ship. Wt.: 269/364 lbs.

Description		Item#	Each
Auto-Vac Investing Machine - 220V		265-2181	\$6,495.00



A

B. Investment Vac Model HD – For vacuuming investment

Designed for vacuuming investment in a production environment. Large capacity unit for investing multiple flasks. Reliable, heavy-duty vacuum pump with in-line filter traps to prevent moisture from contaminating vacuum oil. Easy-to-read vacuum gauges. Incorporates a 150 liters/minute, single-stage pump (1/2 HP). Complete with a 12" dia. x 12"H bell jar, 14½" x 14½" rubber investing pad, 1 quart vacuum pump oil and instructions. Bell Jar (#260-4155) is included.

Specifications:

Electrical: 120V, 5A, 60Hz, Dimensions: 23"W x 14"D x 35"H, Ship. Wt.: 261 lbs.

Description		Item#	Each
B. Investment Vac Model HD		265-1550	\$2,195.00
Replacements	Size	Item#	Each
Bell Jar	12" dia. x 12"H	260-4156	\$109.95
Rubber Pad	14½" dia. x 14½"H	265-1551	35.00
Vacuum Pump Oil	1 qt.	265-1700	12.95



B

C. Vac-A-Mix Investment Mixer

With a built-in vacuum pump, Vac-A-Mix vacuums investment while it's mixing to eliminate all bubbles from your investment. A built-in timer and easy-to-use buttons control mixing time and vacuum. Investment is mixed in closed bowls to reduce airborne investment powder. After gently pouring the investment into your flask, place the flask on the built-in vibrating base for a minute to make sure investment is uniformly dispersed and bubble-free.

- Built-in timer
- Built-in vacuum pump
- Adjustable built-in vibrator
- Includes 5 mixing bowls (200, 300, 500, 800 and 1200ml) and mixing paddles
- High vacuum power for bubble-free results

Specifications:

Electrical: 110V, 1.3 Amps, 150 Watts, 60Hz

Vacuum Pump Capacity: <23.6~ 26.7" Hg (<800 ~ 900 mbar)

Dimensions: 12.9" W x 11.8" D x 20.8" H (33 x 30 x 53 cm)

Shipping Weight: 65.8 lbs. (29.8kg)

Description		Item#	Each
C. Vac-A-Mix Investment Mixer		265-1820	\$1,550.00



C

VacuVest - Investment mixing and pouring all under vacuum!

Improve the quality of your casting and save time! VacuVest eliminates investing problems and easily increases your productivity. To operate, place flasks in lower chamber. Add premeasured water and investment into top. Operator controls exact mixing time, then fills each flask—all under full vacuum. Unit is cleaned using built-in automatic water wash and hand water gun. Waste empties into a tub for easy disposal. Backed by a one-year warranty against defects (except pouring taps, which may wear after extended use). Vacuum pump not included. Made in England.



Features:

- Mixes & pour investment under vacuum
- Improves quality for fewer rejects and speeds up production
- Speeds up production
- Reduces airborne investment powder for a healthier environment
- Controls mixing, vacuum and pouring conditions

Specifications:

	VacuVest #3	VacuVest #5-25	VacuVest #12	VacuVest #15	VacuVest #25
Investment (dry) Capacity:	3kg (6.6 lbs.)	5kg (11 lbs.)	12kg (26.5 lbs.)	15kg (33 lbs.)	25kg (55 lbs.)
Flask Chamber Diameter:	10" (250mm)	10.75" (270mm)	14" (350mm)	16.5" (419mm)	21" (533mm)
Max. Flask Height:	7" (177mm)	9" (228mm)	9" (228mm)	10" (254mm)	12" (300mm)
Vac. Requirement:	3-4 CFM	8 CFM	15 CFM	15 CFM	40 CFM
Dimensions:	15"W x 16"D x 20"H	24"W x 23"D x 30"H	28"W x 31"D x 56"H	28"W x 32"D x 60"H	42"W x 28"D x 62"H
Electrical:	220V, 1 Ph, 60Hz	220V, 1 Ph, 60Hz	220V, 1 Ph, 60Hz	220V, 1 Ph, 60Hz	220V, 3 Ph, 60Hz
Net/Ship. Wt.:	55Kg/121 lbs.	150Kg/330 lbs.	255Kg/561 lbs.	280Kg/616lbs.	487Kg/1,070lbs.
Item#	265-2470	265-2472	265-2474	265-2476	265-2478
Price:	\$3,995.00	\$8,495.00	\$11,750.00	\$13,995.00	\$21,595.00

F. Quatro Investment Particle Containment Stations, Small & Large

Ideal for jewelers located in offices without access to outside ductwork. Features a filtration system that captures particles, then recirculates clean air back into the room to save on heating and A/C costs. Large Station installs directly over your investment mixer and has a metal-frame filter area containing dust filters and true HEPA filters, ensuring 99.97% efficiency, to capture investment particles. Backed by a one-year manufacturer's warranty. Media refills are available that contain enough mixture for four refills. Made in Canada.

Features:

- Easy filter access
- Whisper quiet operation
- LED bright illuminated interior
- Top opening doors
- Medical Grade HEPA Filters
- Contains the Following Filters:
HEPA Filters: 854-2093, Dust Filters: 854-1394

Can be ducted to outside with optional 4" diameter collar/hose exhaust kit. (Item is special order)

Description	Overall Dimensions	Item#	Each
F. Small Station	29" x 24" x 17.5"	854-1417	\$1,026.00
Large Station	38.5" x 29" x 20"	854-1418	1,125.00



Electric Burnout Furnaces Comparison

Model	Item	Flask Solid	Capacity	Electrical	Outside Dim. WxDxH	Inside Dim. WxDxH	Maximum Temp.
Heavy Duty Burnout Furnace (FOB CT)	265-1450 265-1451	4X6 / 3X3	8 ea. / 15 ea.	240V, 13A, 1 Ph, 50/60Hz 3.1KW	17.5"W x 17.5"D x 17.5"H	12"W x 12"D x 8"H	2000°F
913 Furnace Programmable	265-1470	4X6 / 3X3	12 ea. / 28 ea.	220V, 13A, 50/60Hz, 3KW	18"W x 21.5"D x 21.5"H	13"W x 13" D x 9"H	1700°F
914 Furnace Programmable	265-1431	4X6 / 3X3	18 ea. / 32 ea.	220V, 17A, 50/60Hz, 3.75KW	19"W x 22"D x 27"H	14"W x 14"D x 14" H	2000°F
918 Furnace Programmable	265-1436	4X6 / 3X3	21 ea. / 42 ea.	220V, 25A, 50/60Hz, 4.84KW	24"W x 27"D x 31"H	18"W x 18"D x 18"H	1700°F
SC3 Furnace Programmable	265-1421	4X6 / 3X3	1 ea. / 7 ea.	120V, 15A, 1 Ph, 60Hz, 1.8KW	13"W x 14"D x 17"H	7.75"W X 8"D X 7.75"H	2000°F
Ney Fiber Furnace (also available in 240V)	265-1525	4X6 / 3X3	4 ea. / 8 ea.	120V, 12A, 1.32KW, 50/60Hz	15"W x 14.5"D x 16.5"H	9"W x 9"D x 6.5"H (tapers 5"H in back to 6"H in front)	2000°F
Ney 3-550A Venturi Exhaust Furnace Programmable	265-1361	4X6 / 3X3	4 ea. / 8 ea.	220-240V, 10A, 1 Ph, 2.8KW, 50/60Hz	16"W x 17"D x 16"H	9"W x 9"D x 7"H	2012°F
Ney Vulcan A-550 Furnace Manual (also available in 200-250V)	265-1350	4X6 / 3X3	4 ea. / 8 ea.	100-125V, 12A, 1.92KW, 50/60Hz	16"W x 17"D x 16"H	9"W x 9"D x 7"H	2012°F
Ney Vulcan 3-550 Furnace Programmable (also available in 200-250V)	265-1362	4X6 / 3X3	4 ea. / 8 ea.	100-120V, 16A, 1.92KW, 50/60Hz	17"W x 16"D x 19"H	9"W x 9"D x 7"H	2012°F



A. Heavy-Duty Electric Burnout Furnace

A compact electric burnout furnace built for heavy-duty use. Features inner chamber lined with 2½" thick firebrick, swing-down door that can be used as a platform for loading and unloading flasks, counterweight for easy opening and closing and dial control with six temperature settings up to 2,000°F. Please see page 216 for our pyrometer and Type K thermocouple (#265-1920).

Electrical: 240V, 13A, 1 Ph, 3.1kW, 50/60Hz.

Measures 17½"W x 17½"D x 17½"H with 12"W x 12"D x 8"H chamber.

Ship. Wt: 136 lbs.

Description	FOB Shipping Point	Item#	Each
C. Heavy-Duty Burnout Furnace	TX 	265-1450	\$1,195.00
Heavy-Duty Burnout Furnace	CT 	265-1451	1,195.00
Replacement Heating Element		265-1448	60.50
Replacement Thermocouple		265-1921	74.50





A



Rear view of exhaust/blower system

A. Ney® 3-550A Venturi Air Furnace – Excellent for use with platinum

The Ney 3-550A Venturi Air Furnace is engineered for the cleanest burnout possible in an electric oven. Gas porosity, also known as pinhole or micro porosity, can ruin platinum castings or require expensive rework such as laser welding later. The Ney 3-550A Venturi Air Furnace tackles gas porosity at its source.

The self-contained Venturi exhaust/blower system continuously introduces fresh air for more complete combustion of your waxes. It substantially reduces carbon residue and other by-products of incomplete combustion, virtually eliminating gas porosity in castings. Great for gold and silver too.

Features:

- Air intensity is user-controlled—increase airflow when you need to hold more flasks.
- Air is preheated before entering furnace to keep temperature constant.
- Flasks are uniformly heated—no hot or cold spots.
- Fully programmable digital temperature controller with LCD readout of temperature and countdown time, delay start and membrane keypad.
- Durable hybrid muffle material for more efficient heating.
- Slide-out heating elements for easy replacement.
- Space-saving vertical rise door with smooth roll-back action for maximum access.

Specifications:

Electrical: 220–240V, 1 Ph, 2800W, 50/60Hz
 Dimensions:
 Outside: 15.8"W x 17.0"D x 16.0"H (25.0"H with door open)
 Chamber: 9.0"W x 9.0"D x 7.0"H
 Max. Temp.: 2,012°F (1,100°C)
 Net/Ship. Wt.: 45/60 lbs.

Description	Item#	Each
Ney 3-550A Venturi Air Furnace	265-1361	\$3,280.00

B. Ney® Vulcan Furnaces

Burnout furnaces designed by Ney to make your burnout more precise and your casting process more convenient. Vulcan's high-performance, hybrid muffle is more durable than fiber and allows faster heating and cooling than firebrick. Two slide-out side element plates make element replacement easy. Vulcan's door opens vertically with a smooth roll-back action to give maximum access to the chamber while using minimum vertical space. Available with your choice of manual or programmable temperature controls.

A-550 Manual Temperature Control:

Temperature is selected using a front panel control knob. Degrees are marked so you can dial the exact temperature you want, up to 2,012°F.

3-550 Programmable Temperature Control:

Features 9 three-stage programs and 1 single-temperature hold program. You can link programs together for a maximum burnout of 6 temperatures, 6 hold times and 6 rate settings. Temperature, countdown time and program number are digitally displayed at all times. Also features delay start. Membrane keypad and LED indicators make this controller easy to program and operate.



B

Specifications:	A-550	3-550
Temp. Control:	Manual	Programmable
Electrical:	100–125V, 50/60Hz or 200–250V, 50/60Hz	100–125V, 50/60Hz or 200–250V, 50/60Hz
Dimensions:		
Outside:	16"W x 17"D x 16"H (25"H with door open)	16"W x 17"D x 16"H (25"H with door open)
Chamber:	9"W x 9"D x 7"H	9"W x 9"D x 7"H
Max. Temp.:	2,012°F	2,012°F
Firing Time:	15 min. to 1000°F	15 min. to 1000°F
Net/Ship. Wt.:	45/50 lbs.	45/50 lbs.

Description	Item#	Each
A-550 Furnace, 100–125V	265-1350	\$1,665.65
A-550 Furnace, 200–250V	265-1355	1,768.15
B. 3-550 Furnace, 100–125V	265-1362	2,644.50
3-550 Furnace, 200–250V	265-1364	2,665.00
Replacement Heating Element	265-1351	194.75

A. Ney® Fiber Furnace

A compact, electric burnout furnace which uses 25% less energy than a standard firebrick design. The secret is a lightweight ceramic insulating fiber muffle throughout the furnace chamber. Heating elements are embedded into fiber muffle for quick heating and even heat distribution throughout chamber. One-piece-construction chamber is replaceable, lightweight, heats faster and uses less energy. Efficient design achieves 4-wall heating for even temperature distribution. Sturdy 20-gauge metal cabinet is coated inside and out with temperature-resistant enamel. Pilot light and temperature control knob included. Tapered chamber fits flasks up to 6"H in the front and 5"H in the back. Includes 8" x 8" ceramic burnout tray.

Specifications:

Electrical: 115V, 12A, 1320W, 50/60Hz or 230V, 6A, 1320W, 50/60Hz

Dimensions:

Outside: 15"W x 14½"D x 16½"H

Chamber: 9"W x 9"D x 6½"H

Max. Temp.: 2,000°F

Firing Time: 15 minutes to 1,000°F

Ship. Wt.: 36 lbs.

Description	Item#	Each
A. Ney Fiber Furnace, 115V	265-1525	\$1,301.75
Ney Fiber Furnace, 230V	265-1526	1,332.50
Optional 4" x 4" x ¾" Ceramic Burnout Tray*	265-1527	46.15
Replacement 8" x 8" x ¾" Ceramic Burnout Tray	265-1528	75.35
Replacement Heating Element, 115V	265-1530	430.50
Replacement Heating Element, 230V	265-1531	430.50

*Four required, sold individually.





A

B. Programmable Burnout Furnaces, Models 913, 914 and 918

These furnaces feature a programmable controller with three built-in, easy-to-use programs plus the ability to be custom-programmed for your own burnout schedule up to 99 hours, with delay start capability. Controller allows you to preset up to six segments or "ramps." Each ramp consists of (1) rate of heating/cooling, (2) temperature setting in °F or °C, and (3) hold time for each temperature. The program you set stays in permanent memory until you reset it. Furnaces are enclosed in tough stainless steel cabinets with firebrick chambers. Easily replaceable heating elements are secured in grooves inside the chambers.

Specifications:	Model #913	Model #914	Model #918
Electrical:	220V, 13A, 50/60Hz	220V, 17A, 50/60Hz	220V, 25A, 50/60Hz
Outside Dim.:	18"W x 21½"D x 21½"H	19"W x 22"D x 27"H	24"W x 27"D x 31"H
Chamber Dim.:	13" x 13" x 9"	14" x 14" x 14"	18" x 18" x 18"
Ship. Wt.:	160 lbs.	209 lbs.	305 lbs.

Description	Item#	Each
#913 Programmable Burnout Furnace 	265-1470	\$2,100.00
#914 Programmable Burnout Furnace 	265-1431	2,425.00
B. #918 Programmable Burnout Furnace 	265-1436	2,795.00



B



A

A. Paragon SC3 Fiber Oven with Controller

The digital SC3 oven from Paragon is used for lost-wax casting and also fires precious metal clay, enamels, and glass in minutes up to 2000°F. The SC3 is popular with seminar teachers because it fires so fast and plugs into a 120 volt outlet (240V also available).

The SC3 fires automatically at the rate and temperature you enter on the built-in controller. A large, brightly lit display prompts for firing rate, temperature and hold time. Use the hold feature to automatically soak any type of precious metal clay to its recommended time or to hold flasks at desired temperature for casting.

The 1/4" thick ceramic fiber firing chamber is wrapped in a steel inner case. The outer steel case remains cool due to the layer of air between it and the inner case. In addition, the case is slotted for air circulation. Electrical components, located in the base, stay cool even at extended hold times. The fast firing element is embedded in the firing chamber shell. The SC3 heats from the two sides and back. It includes a top vent for lost wax casting. Door opens 180 degrees for easy front loading. CE approved.

Specifications:

Electrical: 120V, 15 Amps, 1 Phase, 60Hz, 1800 Watts
 240V, 8 Amps, 1 Phase, 60Hz, 2000 Watts

Overall Dimensions: 13.3"W x 14"D x 17"H

Chamber Dimensions: 7.75"W x 8"D x 7.75"H

Max. Temperature: 2000°F/1093°C

Control Type: Sentry Digital 3-Key Glass Control

Shipping Weight: 40 lbs.

Description	FOB Shipping Point	Item#	Each
Paragon SC3 Fiber Oven - 120V	CT	265-1421	\$1,080.00
Paragon SC3 Fiber Oven - 120V	TX	265-1422	1,055.00
Paragon SC3 Fiber Oven - 240V	CT	265-1425	1,095.00



B

B. Analog Pyrometer and Type K Thermocouple

A high-quality analog pyrometer for exceptional accuracy. Features large needle indicator for easy reading. Measures temperatures from 100°F to 2,400°F. Accurate to within ±2% of total reading. Includes Type K chromel-alumel thermocouple, wall hanging bracket and drilled plug for quick mounting in peephole.

Description	Item#	Each
Analog Pyrometer	265-1920	\$215.00



C

C. Handheld Digital Pyrometer

Enjoy digital accuracy on a modest budget with this reliable handheld unit. Features large LCD for easy reading even in bright light, low battery indicator and on/off switch to save battery life. Measures temperatures up to 1,999°F. Accurate to within ±2% of total reading. Includes easily replaceable Type K thermocouple with 5' wire and wall hanging bracket. Requires 9V battery. Measures 2 3/4"W x 1"D x 4 1/4"H. Weighs 5 oz.

Description	Item#	Each
Digital Pyrometer	265-1914	\$99.95



D

D. Burnout Oven Wax Trays

Two-part steel trays with upper grid for holding flasks during burnout and lower tray for collecting melted wax. After wax has melted out of flasks, remove stainless steel tray to prevent release of wax fumes. Flasks remain undisturbed, heating elements last longer and the furnace floor stays clean.

Description	Fits	Item#	Each
D. 12 5/8" sq. Tray	#914 Furnace	265-1434	\$162.95
16 1/2" sq. Tray	#918 Furnace	265-1438	199.95



E

E. Brick Oven Cement

A permanent high-temperature refractory cement for all types of firebrick kilns. Simply mix with tap water and apply.

Description	Item#	Each
Brick Oven Cement, 1 lb. bag	265-1437	\$7.50

A. Gas Burnout Furnaces

Gesswein is proud to offer guillotine style gas burnout furnaces. Gas is more economical to run as well as providing a cleaner burn out due to the airflow. With no heating elements to burn out, you have less down time and with over 40 years of proven reliability; these furnaces are what you need!

These furnaces are carefully designed to provide many years of virtually trouble-free use and are constructed out of heavy-duty steel with the highest quality firebrick interiors along with a 3" ceramic fiber door and ¼" thick door cable. All units are equipped with a triple port burner to reach the temperatures needed for the complete elimination of all wax necessary for a clean mold. Natural gas connections are standard but propane is also a special order option if desired.

These furnaces are made to order and are customized for your specific use. Contact us to discuss your specific needs and we will prepare an exact price quote for your specifications. Made in USA.

Model	Item#	Each
12 x 12	265-1402	\$10,000.00
14 x 14	265-1403	10,200.00
18 x 18	265-1404	10,700.00
21 x 20	265-1406	11,700.00
26 x 20	265-1407	12,200.00
26 x 26	265-1408	12,700.00



Model	Item #	Overall Dimensions (inches)							Door Opening W x D (inches)	Inner Chamber W x D x H (inches)	Flue	Flask Quantity	Flask Size (inches)
		A	B	C	D	E	F	G					
12 x 12	265-1402	23.5	19.25	57.25	38.25	4	2	75.75	10.25 x 12	14.5 x 12 x 12	4	16 9	3 x 3 4 x 6
14 x 14	265-1403	27.75	21.75	61.25	42	4	2	87	14.75 x 14	18 x 14 x 14	4.5	9	4 x 8.5
18 x 18	265-1404	31.75	26.25	61.25	42	4	2	87	18.75 x 14	20 x 18 x 14	4.5	16	4 x 8.5
21 x 20	265-1406	34.75	28.25	61.25	34.75	4	2	87	21.75 x 17.25	25 x 20 x 19	5.5	28 - 32	4 x 8.5
26 x 20	265-1407	39.75	28.25	60.25	30.25	4	3.25	89.25	26.5 x 20.5	29.5 x 20 x 22	6.5	36 - 40	4 x 8.5
26 x 26	265-1407	39.75	34.75	60.25	30.25	4	3.25	89.25	26.5 x 20.5	29.5 x 26 x 22	6.5	45 - 50	4 x 8.5

All dimensions are in inches. Note: All furnaces (excluding the 26 x 26 model) can fit through a 28.5" door opening after you remove the furnace door and assembly. The model 26 x 26 requires a minimum door opening of 34.5".

*Arched rook allows better flow of exhaust gases and even heat distribution standard due to size of the furnace.

Shipment by truck is required on these furnaces.

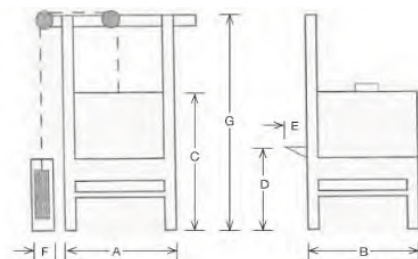



A

A. Paragon® Programmable Controller – For Electric Ovens

Offers ramp-type burnout program with 6 temperature settings, 6 time settings (runs from 0–99 hours) and delay start. Includes detailed instructions with a short form version on the front of the unit so you'll never forget. Made in USA.

Features:

- Digital temperature display in °F or °C
- High-temperature safety shutoff
- Type K thermocouple

Specifications:

Electrical: 120V or 240V, 50/60Hz

Dimensions: 6½"W x 4"D x 15½"H

Ship. Wt.: 10 lbs.

Description	Electrical	Item#	Each
Paragon Controller	120V, 50/60Hz	265-1453	\$699.00
	240V, 50/60Hz	265-1454	825.00



B

B. Kilninder 4.E Programmable Controller – For Electric and Gas Ovens

Offers standard and ramp-type burnout programs with ramp time and dwell time from 0–42 hours in 10-minute increments and delay start from 0–85 hours in 20-minute increments. Boasts 99-program memory (a program can consist of 1–20 stages, each of which controls kiln temperature, ramp time and dwell time). Includes detailed instructions. Made in USA.

Features:

- Digital temperature readout in °F or °C
- Temperature control precision of ±8°F (±5°C)
- Elapsed time display
- Security lock to prevent accidental program changes
- Electronic feedback to eliminate temperature overshoot
- High-temperature safety shutoff & Built-in surge protector
- Power outage return
- Secondary thermocouple accommodation for backup purposes

Specifications:

Electrical: 90–250V, 50/60Hz

Dimensions: 6⅝"W x 8½"D x 4½"H

Ship. Wt.: 6 lbs.

Description	Electrical	Item#	Each
Kilninder 4.E Controller	90–250V, 50/60Hz	265-1514	\$550.00

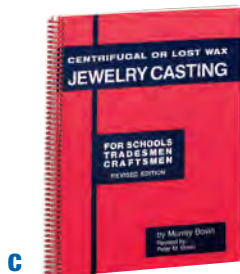

C

C. Centrifugal or Lost Wax Jewelry Casting

By Murray Bovin, Revised by Peter M. Bovin

Entire casting process in step-by-step detail. An excellent reference source for any caster. Covers different methods of casting, describing all processes involved plus tools and equipment. Includes dozens of charts that detail burnout programs, investing procedures, metal and casting temperatures and much more. Photos show work in progress. Softcover, 143 pages.

Description	Item#	Each
Centrifugal or Lost Wax Jewelry Casting - Book	810-2800	\$24.50

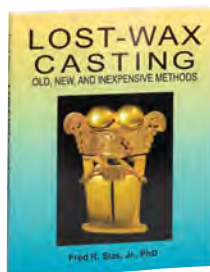

D

D. Lost-Wax Casting: Old, New, and Inexpensive Methods

By Fred R. Sias Jr., Ph.D.

Designed to be used as both a textbook and a reference book, this work is directed primarily at beginners. Places heavy emphasis on understanding the processes involved. Includes chapters on spruing, investing, wax elimination, centrifugal casting, vacuum casting, alloys, finishing and more. Softcover, 201 pages.

Description	Item#	Each
Lost Wax Casting - Book	810-2956	\$22.95



E

E. Basic Wax Carving, Volume 1 – By Spike Cornelius

Learn the basic steps and skills necessary to carve your own wax project or design. Demonstrates proper setup of bench environment, proper use of tools, the act of squaring up a rough block of wax, and accurate design transfer (layout). Intended for the serious student who wants to learn professional wax carving. Color, 1 hour.

Description	Item#	Each
Basic Wax Carving - DVD	810-3000	\$39.95

Representative items pictured;
actual items may vary.



A. Deluxe Vacuum Casting Kit For high-quality production casting.

With the Gesswein Deluxe Casting Kit, you can carve original designs in wax, pack, vulcanize and cut rubber molds, inject the rubber molds to make wax patterns, tree your patterns, mix and vacuum the investment, burn out the flasks and vacuum cast them. This kit offers the flexibility to cast both perforated flasks and standard solid-wall flasks. All you need is a melting torch (see pp. 517-518) or electric melter (see p. 225) to cast from one item to over 50 items per day depending on size. Add extra flasks and cast even more.

Electrical: 115V (220V available).
Ship. Wt: 246 lbs. (Can ship UPS Ground)

Description	Item#	Each
Deluxe Vacuum Casting Kit 	265-1164	\$3,850.00

 Although no hazardous shipping surcharge applies, these items can only ship via UPS® Ground, no air, FedEx® or US Mail possible. Cannot ship to Alaska, Hawaii or Puerto Rico.

Includes:

- Deluxe Vacuum Casting Machine, Model T1.5
- SC3 Fiber Furnace
- Hand Pump Wax Injector (2³/₄ qts.)
- Junior Vulcanizer
- Perforated Flask, 3¹/₂"D x 4"H
- Sprue Base for above
- Perforated Flask Sleeve
- Perforated Flask Tongs
- Solid-Wall Flasks (2)
- Sprue Bases for above (2)
- Rubber Flask Sleeve
- Standard Flask Tongs
- Mold Release Spray
- Sprue Former and Rod (10)
- Dial Thermometer
- Knife Blades (10)
- Knife Handle
- Injection Wax (5 lbs.)
- Injection Mold Plates
- Investment (23kg/50#)
- Investment Scale & Scoop
- Spatula
- Rubber Mixing Bowl
- Graduated Cylinder
- Borax
- Handled Melting Borax
- Heat-Resistant Gloves
- Carbon Stirring Rod
- Mold Rubber (5 lbs.)
- Mold Frames (2)
- Mold Frame Plates (4)
- Wax Wash
- File-A-Wax Set
- Sprue Wax (1 lb.)
- Sticky Wax
- Wax Carving Tools (set of 6)
- Alcohol Lamp
- *Jewelry Casting* book, by Murray Bovin

B. Basic Vacuum Casting Kit

All you need is a melting torch and our Basic Vacuum Casting Kit to cast your own wax patterns one piece at a time or to make small trees to cast several items at once. An excellent casting reference book is included.

Electrical: 115V (220V available).
Ship. Wt: 173 lbs. (Can ship UPS Ground)

Description	Item#	Each
Basic Vacuum Casting Kit	265-1167	\$2,265.00

Includes:

- Vacuum Casting Machine, Model T3
- SC3 Fiber Furnace
- Investment (23kg/ 50#)
- Investment Scale & Scoop
- Rubber Mixing Bowl & Spatula
- Graduated Cylinder
- Heat-Resistant Gloves
- Solid-Wall Flasks (2)
- Flask Tongs
- Sprue Bases (2)
- Sticky & Sprue Waxes
- Wax Carving Tool
- Wax Wash
- Borax
- Alcohol Lamp
- Carbon Stirring Rod
- Handled Melting Crucible
- *Jewelry Casting* book, by Murray Bovin

Representative items pictured;
actual items may vary.



Substitutions: We will be happy to consider substitutions, at your request, of the major pieces of equipment in any of our Casting Kits. For example, if you substitute a larger furnace (which will accommodate more flasks) you can cast dozens or even hundreds of items per day using the same casting machine. Please call our Inside Sales Department for price quotations on kits with substitute items.



A

A. T1.5 Deluxe Vacuum Casting/Investing Machine

For both standard and perforated flasks

Our benchtop caster allows you to invest your flasks under vacuum on the left side of the machine and vacuum cast both perforated and standard flasks on the right side. Turn the control handle to "Investment Table," and the powerful 3 CFM vacuum pump pulls air bubbles from the investment under a 9" dia. x 8½"H bell jar. Turn the handle to "Casting Chamber," and vacuum is redirected to the casting side. Three adapters are included to cast small and large perforated flasks (up to 5" x 7") and standard solid-wall flasks. Use of perforated flasks in the casting chamber allows vacuum to be pulled from both the walls and bottom of the flask, ensuring a complete fill and denser casting. Made in USA.

Includes:

- Two adapter plates to cast 3½" and 4" dia. flasks (no adapter plate needed for 5" flasks)
- Adapter plate to cast solid-wall flasks
- Bell jar, flask tongs, vacuum pad, 1 pt. vacuum pump oil
- 3½" x 4" perforated flask, 3½" sprue base

Specifications:

Electrical	110V, 6A, 60Hz or 220V, 3A, 50Hz
Construction	Steel, powder-coated finish
Motor	1/2 HP
Vacuum Pump	3 CFM
Ship. Wt.	90 lbs.

Description	Item#	Each
A. T1.5 Casting/Investing Machine, 110V	265-1580	\$1,075.00
T1.5 Casting/Investing Machine, 220V	265-1585	1,075.00
Vacuum Pump Oil, 1 quart	265-1700	12.95



B

B. Vacuum Casting/Investing Machine, Model T3 – For standard flasks

An ideal system to use when space is at a minimum! The 1/2 HP, 3 CFM vacuum pump will create a negative pressure equal to 27–29" Hg at sea level to eliminate air bubbles from investment and for vacuum-assist casting. Includes vacuum pump, 6' hose and connections, built-in vacuum gauge, sturdy Plastic bell jar (9"D x 8"H inside), rubber investing pad and silicone casting pad. Recommended for flasks up to 4" x 4". Electrical 110V, 6A, 60Hz. Casting unit measures 12½"L x 12½"W.

Description	Ship. Wt. (lbs.)	Item#	Each
B. T3, complete	55.5	265-1755	\$820.00
T3, without vacuum pump	21	265-1756	425.25
Vacuum Pump only	34.5	265-1757	450.15
Replacement Bell Jar	–	260-4175	68.40



C

C. Neycraft Centrifugal Casting Machine

Features built-in protective safety shield, an easy winding/locking and release mechanism, instant balance with counterbalance weight, universal flask carriage to accommodate flasks up to 4" x 4", and two-way mounting base for quick setup and storage. Complete with 9 troy oz. crucible, flask tongs, 2 flasks (2" x 2" and 4" x 4") and 2 sprue bases. Measures 20" dia. x 12"H.

Description	Item#	Each
C. Neycraft	265-1220	\$993.25
Replacement Main Spring	265-1222	138.40
Replacement Crucible, 9 oz.	260-9020	31.95

D-F Centrifugal Casting Unit #5

Extra-long arm with heavy-duty spring ensures denser, porosity-free casting. Will accept flasks up to 3½" x 5". Complete with 2 cradles and weights for balance, 3 stainless steel flasks (2½" x 2½", 3" x 3", and 3½" x 4"), a 3" sprue base and the universal (2½ + 3½) sprue base, 12½ troy oz. crucible and flask tongs. Caution: mount in Casting Machine Drum #265-1170 or washtub to prevent injury from metal spillage. Measures 21¾"L x 10¼"H.

Description	Item#	Each
D. Unit #5	265-1200	\$525.00
E. Optional #5 Drum	265-1170	115.75
F. Optional #5 Cover for Drum	265-1171	67.05
Replacement Small Cradle	265-1206	9.75
Replacement Large Cradle	265-1205	9.75



D

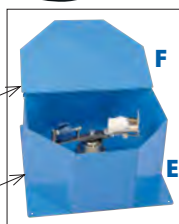

Optional cover

Optional drum

G. 15" Flask Tongs

Specially designed for holding small to large heated flasks. Made of spring-tempered steel.

Description	Item#	Each
15" Flask Tongs	195-0200	\$6.65



G

A, B Ti-Research Cast/T Centrifugal Casting Machine

Cast/T is an award-winning centrifugal casting device designed to make casting more efficient and versatile. The compact machine is designed for torch melting and can cast silver, gold, platinum and stainless steel. In fact, Cast/T can handle any metal or alloy that can be melted and cast under atmospheric conditions. Cast/T can even produce rings with stones in place. A maximum of 450 grams of gold can be cast in one cycle within its compact frame.

In contrast to conventional centrifugal machines, the flask does not sit at the end of a revolving arm. Instead it rotates in place along its own axis. Patterns are not treed but sprued radially onto a wax disk to effectively fill the mold during casting. Because no tree or center sprue is necessary, Cast/T cuts metal waste by about 50% over traditional casting methods.

Don't let Cast/T's small size fool you; it can handle up to 25 ladies' rings per flask. The unique flask design allows you to use less investment and to fit more flasks in your oven. Three different mold sizes are available to accommodate both large and small jewelry models and a wide variety of casting needs.

Cast/T spins the flask at a fast speed of 1,100rpm to ensure complete fills of even high-temperature metals such as platinum and stainless steel. As a result, Cast/T requires a strong investment. Dental investments can be used, but for consistent, predictable results, we recommend All Cast (see p. 211). Both models include small mold ring (flask), large mold ring, 250g crucible, crucible holder, sprue base, five wax sprue disks, pair of tongs and comprehensive instruction manual.

Electrical: 115V, 40W, 60Hz or 230V, 30W, 50Hz. Measures 6.6" dia. x 10"H. Weighs 19 lbs. Meets stringent European safety standards, including CE and TUV. Backed by a two-year manufacturer's warranty (excludes consumables). Made in Germany.

Description	Electrical	Item#	Each
A. Cast/T Tabletop Machine	115V, 60Hz	265-5002	\$2,895.00
	230V, 50Hz	265-5003	3,450.00
B. Cast/T Recessed Machine	115V, 60Hz	265-5000	3,395.00
	230V, 50Hz	265-5001	3,650.00

Description	Size (mm)	Item#	Each
Small Mold Ring	100mm dia. x 30mm H	265-5006	\$69.95
Small Mold Ring Divider*	30mm H	265-5007	89.50
Large Mold Ring	100mm dia. x 60mm H	265-5008	79.00
Mold Base	100mm dia.	265-5009	83.50
Wax Sprue Discs, pkg. of 25	–	265-5010	29.00
150g Crucible, pkg. of 5	–	265-5011	125.00
250g Crucible, pkg. of 5	–	265-5012	139.00
450g Crucible, pkg. of 5	–	265-5013	169.00

*Partitions small mold ring to save investment when casting just one wax model.

C. Heat-Resistant Gloves with Aluminized Back

Gloves are manufactured from 22 oz. basket-weave fiber blended with fiberglass. Aluminized back protects against radiant heat while wool lining protects against contact heat. Specially designed for better cooling, comfort and safety. Gloves have been used in temperatures up to 800°F for brief contact. Wide cuff openings allow gloves to be dropped with the flick of the wrist in case of excess heat buildup. Measure 14" long.

Description	Item#	Each
Heat-Resistant Gloves, pair	816-1020	\$53.95

D-E Heat-Resistant Gloves

For safe, easy handling of hot objects. Gloves are fully lined with black felt and manufactured from 22 oz. basket-weave fiber blended with fiberglass. Ideal for use in temperatures up to 1,000°F for brief contact. Extra-wide cuff openings allow gloves to be dropped with a flick of the wrist in case of molten splash or excess heat buildup.

Description	Item#	Each
D. 14" Gloves, pair	816-1015	\$41.95
E. 23" Gloves, pair	816-1016	76.50



A



B



C



D

E



A-J Crucibles

Long-lasting, quality crucibles. Clay crucibles can be used up to 2,500°F; Wesgo and PLAT (Wesgo style alternative) crucibles used for higher platinum temperatures. Crucibles A-F are designed for use in casting machines.

Description	Capacity	Item#	EACH Prices	
			1-5	6+
A. Wesgo A	3 oz.	260-8700	\$24.50	\$23.28
B. PLAT D	10 oz.	260-8751	55.45	-
C. Ney	9 oz.	260-9020	31.95	30.35
D. Style 1	7 oz.	260-8900	15.95	15.15
E. Style 2	12½ oz.	260-8950	16.95	16.10
F. Style 3	25 oz.	260-8955	30.25	28.74
G. PLAT 8	8 oz.	260-8801	19.00	-
H. PLAT 10	10 oz.	260-8811	28.00	-
I. Burno	100 dwt.	260-8550	18.55	17.62
Burno	50 dwt.	260-8600	19.45	18.48
Burno	25 dwt.	260-8650	15.50	14.73

J. Crucible with Handle

This melting dish has a removable heat-resistant wooden handle for ease in melting and pouring of metal. Made of fused silica with clay bond and is suitable for melting precious metals. 6 oz. capacity.

Description	Item#	Each
J. Crucible with Handle	260-8400	\$19.95
Crucible only, 6 oz.	260-8410	15.85
Handle only	260-9050	7.25

K. Stainless Steel Crucible Tongs

Sturdy stainless steel, with finger grips. Specially formed ends will hold crucibles and small flasks. Measure 18" long.

Description	Item#	Each
Stainless Steel Crucible Tongs	195-0150	\$26.95

L. Bent Crucible Tongs

For picking up and holding crucibles and other hot objects. Measure 19" long.

Description	Item#	Each
Bent Crucible Tongs	195-0225	\$16.95

M. Burno Tongs

Shaped to hold all Burno crucibles. Measure 10" long.

Description	Item#	EACH Prices	
		1-2	3+
Burno Tongs	195-0050	\$3.55	\$3.20

N, O Borax

Glaze your crucibles with borax to extend crucible life and to protect melting metal from oxidation.

Description	Item#	Each
N. 8 oz. powder	811-0700	\$6.50
O. 5 lbs. powder	811-0701	23.95
50 lbs. powder	811-0702	185.00

A Graphite Crucibles

Top-quality crucibles resistant to high heat and thermal shock. Consist of natural flake graphite and silicon carbide bonded with fire clay. Lined with mullite for long life. Include spouts for easy pouring. Dimensions and capacities may vary slightly from those listed.

Style	Dia. x H	18K Gold Capacity (dwt/grams)	Item#	Each
4/0	2 ³ / ₈ " x 3"	600/935	260-8140	\$26.00
1	3 ¹ / ₈ " x 3 ⁵ / ₈ "	1,500/2,330	260-8141	\$32.00
2	3 ¹¹ / ₁₆ " x 4 ¹ / ₂ "	2,400/3,730	260-8142	\$36.00
3	4 ¹ / ₈ " x 5 ⁵ / ₈ "	4,320/6,720	260-8143	\$47.00
4	4 ⁹ / ₁₆ " x 5 ³ / ₄ "	5,120/7,960	260-8144	\$46.00
6	5 ¹ / ₄ " x 6 ¹ / ₂ "	7,830/12,175	260-8146	\$55.00



A

B. Carbon Stirring Rod

Used to stir molten metal in crucibles while helping pick up impurities. Measures 12" long.

Description	Diameter	Item#	Each
B. Carbon Stirring Rods	1/4"	260-3152	\$3.95



B

C. Quartz Stirring Rod

Non-contaminating rod for stirring molten metal. Made of pure fused silica. Stays cool and cleaner and lasts longer than carbon. Electrically nonconductive, perfect for use with induction melters. Measures 3/8" diameter x 12" long.

Description	Diameter	Item#	EACH Prices	
			1-9	10+
C. Quartz Stirring Rod	3/8"	260-3161	\$11.65	\$10.49



C

D. Ceramic Oval Stirring Rod

Very long-lasting. Does not contaminate metal while stirring. Electrically nonconductive—excellent for use with induction melting machines. Measures 12" long.

Description	Diameter	Item#	Each
Ceramic Oval Stirring Rod	3/4"	260-3155	\$8.95





D

E, F ZO Paint for Crucibles

Prevents platinum contamination during casting

ZO Paint is a calcia-stabilized zirconium oxide (ZrO₂) paint which shields platinum from harmful chemicals leached out of silica or quartz crucibles. Preventing platinum contamination and brittle, porous casting. Best applied in several thin coats with an airbrush (sold separately). Quick to dry. Because it allows you to use the same crucible for more melts without worrying about contamination, you get the most out of each crucible. Use Airbrush Set (includes 9 oz. Propel propellant) to apply in multiple thin layers.

Description	Item#	Each
E. ZO Paint, pint	260-9150	\$59.95
ZO Paint, quart	260-9151	115.00
ZO Paint, gallon	260-9152	399.00
F. Air Brush Set	 260-1780	49.99
Replacement Propel can (9 oz.)	 260-1781 	10.40



E

F

 Twelve-piece minimum; Please order in multiples of twelve.

 Although no hazardous shipping surcharge applies, these items can only ship via UPS® Ground, no air, FedEx® or US Mail possible. Cannot ship to Alaska, Hawaii or Puerto Rico.



A		Alloy	10K	14K	18K	Pkg. Wt.	Item#	PKG. Prices
Color	To Make	Liquidus Temp	Liquidus Temp	Liquidus Temp	Liquidus Temp			
White	10K, 14K	2,100°F	1,615°F	1,740°F	—	10 troy oz.	857-2020	\$44.70
White	18K	2,165°F	—	—	1,670°F	10 troy oz.	857-2030	\$59.40
Yellow	10K, 14K	1,715°F	1,555°F	1,545°F	—	5 troy oz.	857-2000	45.22
Hamilton Yellow	18K	1,555°F	—	—	1,585°F	5 troy oz.	857-2010	68.32



B. Re-Cast It

A remarkable alloy additive that restores the fluidity, color and brightness of old or scrap yellow gold before you cast it. Use to eliminate the porosity associated with casting old gold. Add 5% to your gold, melt and stir. Flow temperature: 1,950°F. One jar casts up to 800 dwt of gold. Ship. Wt: 2 oz.

Description	Item#	Each
Re-Cast It	857-3010	\$59.95

C. Manganese Bronze Casting Grain

This nonprecious alloy resembles 14K gold. It can be oxidized, antiqued or plated. Great for sample lines to avoid theft and use of gold. Should only be torch melted. Casting temp: 1,700-2,100°F. Melting point: 1,620°F. Specific gravity: 8.3.

Description	Item#	LB. Prices	
		1-9	10+
Manganese Bronze Casting Grain	857-2995	\$23.75	\$20.19

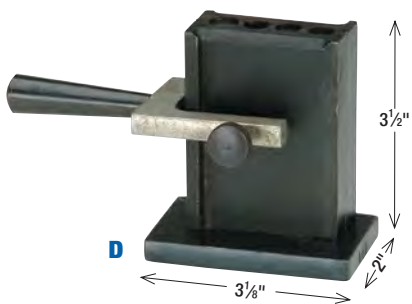

D. Combination Sliding Ingot Mold

High-quality finished steel mold for converting clean scrap metal into convenient and usable shapes. Great versatility—round and different size flat shapes can easily be formed. Flat width adjustable up to 2". Simply melt metal, heat ingot and pour.

Ingot Sizes:
 Round: 3, 4, 5 and 6mm
 Flat: 80 x 50 x 4mm

Description	Item#	Each
Combination Sliding Ingot Mold	268-1100	\$44.05



E. Sliding Ingot Mold

Used to convert clean scrap metal into flat stock for rolling. Molten metal is poured into the mold, which can be parted by removing the clamp. Each mold can be made smaller by adjusting the sides in a horizontal direction. Maximum capacity: 115 dwt. Maximum ingot size: 50 x 45 x 3.5mm.

Description	Item#	Each
Sliding Ingot Mold	268-1260	\$42.75



F. Econo Extra-Long Wire Ingot Mold

One-piece cast-iron mold with handle. Use for making wire ingots. Features three 9 1/4" long depressions: two are approximately 1/8" wide, and the third is approximately 3/8" wide. Measures 15" long.

Description	Item#	Each
Econo Extra-Long Wire Ingot Mold	268-1201	\$29.95

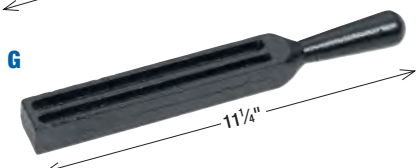

G. Small Wire Ingot Mold

Makes strips in three sizes: 19mm x 8mm x 170mm, 7mm x 8mm x 170mm and 9mm x 9mm x 170mm. Measures 11 1/4" long.

Description	Item#	Each
Small Wire Ingot Mold	268-1250	\$12.75

A. Electric Melting Furnaces

Made with the highest standards, the Electric Melting Furnaces are built with a solid steel construction as well as the finest components. Many years of experience combined with continuous technological updates and a constant search for innovative materials, places them in a quality level of excellence recognized worldwide. Available in 3 sizes/capacities; 0.5kg, 1kg, 3kg and 3kg with a tilt feature. CE certified. All 4 models have auto shut-off at the maximum temperature of 2012° and 110V/60Hz. Includes: Melting furnace complete with pyrometer, graphite crucible, crucible tongs and, graphite stirrer. Made In Italy.

	Fine Gold Capacity	Tilt Item#	Watts	Overall Size (WxDxH)	Weight	Item#	Each
A.	½ kg	No	650W	7" x 7" x 11½"	12 lbs.	265-1600	\$595.00
B.	1 kg	No	850W	8½" x 9" x 13½"	15 lbs.	265-1602	625.00
C.	3 kg	No	1700W	8½" x 9" x 15½"	20 lbs.	265-1604	895.00
D.	3 kg	Yes	1700W	11" x 9" x 16"	25 lbs.	265-1606	1,195.00
	Replacement Crucible for ½ kg (265-1600)					265-1610	15.95
	Replacement Crucible for 1 kg (265-1602)					265-1611	17.95
	Replacement Crucible for 3 kg (265-1604)					265-1612	39.95
	Replacement Crucible for 3 kg, Tilt (265-1606)					265-1613	39.95

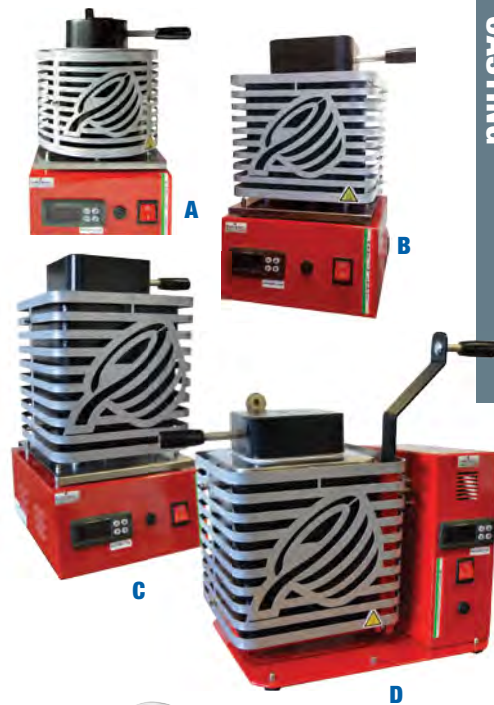

E. Accu-Melt Furnace

Electric melting furnace for melting gold, silver and other nonferrous alloys for casting, ingot or shot making. Graphite crucible has a capacity of 1kg pure gold. Groove in crucible lip makes it easy to remove crucible from melter with special tongs (included). A full 700W of power provides temperatures up to 2,012°F. Digital operation with digital temperature readout. Supplied with one crucible and tongs. Made in Italy.

Specifications:

Electrical: 110V, 700W, 60Hz or 220V, 1 Ph, 700W, 60Hz
 Capacity: 1kg fine gold (32.15 troy oz.)
 Dimensions: 9"W x 9"D x 13½"H

Description	Item#	Each
E. Accu-Melt, 110V	265-2150	\$625.00
Accu-Melt, 220V	265-2149	745.00
Optional Carbon Stirring Rod, 12"L x ¼" dia.	260-3152	3.95
Replacement Crucible	265-2152	42.90
Replacement Tongs	265-2154	48.00



F-I Kerr® Automatic Electro-Melt and Maxi-Melt

These self-contained furnaces offer the additional feature of an electronic controller that holds the temperature you set to within ±5°F! Most importantly, their electronics are designed to eliminate temperature overshoot. Each unit features a bright LCD for °F or °C readouts and a safety switch. CE and UL approved.

Specifications:	Auto Electro-Melt	Auto Maxi-Melt
Electrical:	120V, 6.2A, 50/60Hz or 230V, 3.1A, 50/60Hz	120V, 11.3A, 50/60Hz or 230V, 5.6A, 50/60Hz
Capacity:	30 troy oz.	100 troy oz.
Max. Temp.:	2,050°F	2,050°F
Firing Time:	21 min. to 1,800°F	31 min. to 1,800°F
Dimensions:	8¼"W x 6¼"D x 13½"H	8¼"W x 6¼"D x 15"H

Description	Electrical	Item#	Each
F. Auto Electro-Melt	120V	265-1283	\$885.00
	230V	265-1284	895.00
G. Auto Maxi-Melt	120V	265-1256	1,355.00
	230V	265-1261	1,355.00
H. Replacement Crucible for Electro-Melt, 30 oz.		260-8001	49.75
I. Replacement Crucible for Maxi-Melt, 100 oz.		260-8006	76.95



GALLONI

Induction Casting Machines

ASEG GALLONI Company, established in Italy in 1948, was the first in the world to produce electronic induction machines for melting and casting special metals, precious and non-precious alloys for the global jewelry and dental markets.

Using expertise and experience gained over many years, Galloni manufactures a wide and comprehensive range of electronic casting machines for gold, silver and platinum that are applicable to every type of lost-wax casting requirement.

Galloni Company manufactures its equipment in compliance with the CE standards and is certified according to ISO 9001, CISQ, IQNet.

*GALLONI Product Comparison	Pressovac MAX	Pressovac Optical	Pressovac Dual Pyrometer	G1 Ultimate	G3 Ultimate	Okay Plus
Item #	265-0869	265-0861	265-0890	265-0831	265-0833	265-1121
Platinum	30 to 350g	30 to 110g	30 to 110g	–	–	300g
18K Gold	800g	150g	250g	1.4kg	2.2kg	200g
Silver	500g	100g	220g	1.2kg	2.0kg	130g
Palladium	180g	110g	110g	–	–	–
Steel	400g	90g	90g	–	–	–
Max Flask Size	4" x 5"	3.5" x 3.5"	3.5" x 3.5"	5.9" x 9"	5.9" x 11.75"	3.5" x 3.5"
Page #	228	229	229	227	227	226

*Due to the technical nature of these products, some details may change. Please see our website for the most up-to-date information.

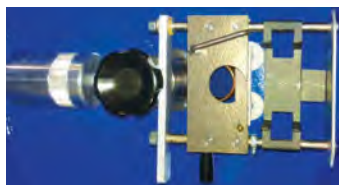

Casting Chamber



Front Panel

Galloni Okay Plus

Introducing Galloni's newest, high performance, fast action, medium-frequency centrifugal vacuum casting machine. Self-stirring for homogenous melts. Cast up to 300 grams of Platinum, 200 grams of 18K Gold and 130 grams of Silver in minutes using special ceramic crucibles.

The solid-state power generator is electronically controlled and the casting arm is easily balanced and accepts flasks up to 3.5" x 3.5" high.

Includes flask, ceramic crucible and cover for gold, ceramic crucible for platinum, melting coil and crucible carriage with holding plate for either gold or platinum, metal stirring rod, eye shield and flask tongs. Backed by a one-year manufacturer's warranty.

Features:

- Automatic movement of coil (pneumatic)
- Vacuum/Gas supply switch
- RPM regulator (adjustable arm acceleration)
- Optical pyrometer

Specifications:

Max. Crucible	300g platinum	Electrical:	230V, 5kW, 1 Ph
Capacity:	200g of 18K Gold 130g of Silver		Full 220V required
Max. Flask Size:	3.5" dia. x 3.5" H; solid wall	Dimensions:	24"W x 27"D x 37"H
Casting Cycle:	4 minutes	Air Requirement:	100-120 PSI
Max. Temp:	3,812°F (2,100°C)	Vacuum Requirement:	20 CFM (Includes Pump)
Water Cooling:	2 liters/minute	Net Wt.:	375 lbs.

Description	Item#	Each
Galloni Okay Plus w/Vac Pump	265-1121	Call for Pricing



G1 Ultimate





G3 Ultimate

Galloni G1 and G3 Ultimate Casting Machines – Pressure Over Vacuum

The Galloni “G” Ultimate casting machines are the latest and most technically advanced induction heated vacuum “over pressure” machines currently available worldwide, featuring low frequency generators and fully proportional computer-controlled power output. The operator has simply to charge the crucible, place the casting flask in position and press one button! Both models are equipped with a touch-screen 3-color LED 3D. The machines lead the operator logically step-by-step through the casting sequence, irrespective of the type and quantity of the alloy. Frequency and power output are automatically and continuously adjusted and, just ahead of attaining the preset casting temperature, the computerized control starts modulation of the heating current by delivering low frequency impulses, thus inductively stirring the melt. Then, when all parameters are achieved and the temperature “spread” is no more that 4°C either side of the set point, pouring starts automatically followed by strong pressurization of the molten metal by inert gas. The complete cycle can be performed in 5 minutes.

Backed by a one-year manufacturer’s warranty.

Specifications:

	G1 Ultimate	G3 Ultimate
Max. Crucible Capacity	1400g 18K Au, 3000g 24K Au, 1200g Ag	2200g 18K Au, 3500g 24K Au, 1900g Ag
Max. Flask Size	5.9" dia. x 9"H	5.9" dia. x 11.75"H
Max. Temperature	2,552°F (1,400°C)	2,552°F (1,400°C)
Air Requirement	8 bar, 90 PSI	8 bar, 90 PSI
Water Requirement*	150 liters/hour	150 liters/hour
Vacuum Requirement	60m3/hr	External 60m3/hr.
Electrical	230/380/415 V – 50/60 Hz 5kW 3 Phase	230/380/415 V – 50/60 Hz 5kW 3 Phase
Dimensions	24"W x 26"D x 47"H	24"W x 26"D x 47"H
Net wt.	463 lbs. 	490 lbs. 
Item	#265-0831 Call for pricing	#265-0833 Call for pricing

*Pipe directly to cold water line, or use a recirculating pump with tank or a chiller.



Crucible





Pressovac MAX

Galloni Pressovac MAX – Pressure Over Vacuum

Incorporates state-of-the-art features for high-production casting of both **platinum and gold** with extremely fast cycle times: 2–3 minutes for gold and platinum.

- Full vacuum casting chamber to radically enhance crucible life and to remove gases from the flask, minimizing or eliminating gas porosity.
- After vacuuming, the casting chamber is flooded with inert gas to prevent oxidation of gold and platinum/cobalt alloys.
- Medium-frequency induction melting with self-stirring effect for homogeneous melts.
- Produces **extremely dense** castings.

Includes one crucible kit and flask cradle. See page 230 for details. Backed by a one-year warranty. CE approved.

Specifications:

Power	5kW
Max. Crucible Capacity	350g Pt, 800g 18K Au, 500g Ag, 180g Pd, 400g Steel
Max. Flask Size	4" dia. x 5"H
Max. Temperature	3,812°F (2,100°C)
Air Requirement	100-120 PSI
Water Requirement	3 liters/minute @ 45 PSI
Vacuum Requirement	7 CFM
Inert Gas Requirement	Nitrogen, helium or argon
Electrical	230V, 400V, 415V, or 440V 3 Ph
Dimensions	26.8"W x 19.7"D x 47.2"H
Net Weight	353 lbs.

Description	Item#	Each
Galloni Pressovac MAX	265-0869	Call for Pricing
Vacuum Pump, 7 CFM, 110V	265-2404	\$610.00
Vacuum Pump, 7 CFM, 220V	265-2406	628.55

Due to the technical nature of these products, some details may change. Please see our website for the most up-to-date information.

Pressovac MAX Crucibles



A

A. Au Kit – for Pressovac MAX

- Graphite crucible cemented with its container for gold and silver (60 cc)
- Lid cover for crucible
- Graphite thermocouple sheath
- Spare thermocouple type "S"
- Melting coil (3647.1)
- Crucible holding plate complete with crucible lid cover holder mechanism

Description	Item#	Each
Au Kit for Pressovac MAX	265-0891	\$1,710.00



B

B. Pt Kit – for Pressovac MAX

- Ceramic crucible (20 cc)
- Melting coil (3650.1)
- Crucible holding plate complete with crucible lid cover holder mechanism

Description	Item#	Each
Pt Kit for Pressovac MAX	265-0892	\$1,125.00

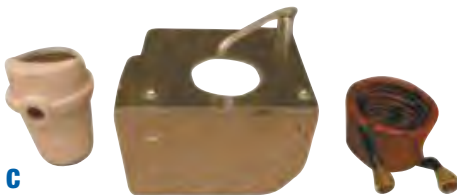

C

C. Steel/Pd Kit – for Pressovac MAX

- Silicon carbide crucible (40 cc)
- Melting coil (3650.1)
- Crucible holding plate complete with crucible lid cover holder mechanism

Description	Item#	Each
Steel/Pd Kit for Pressovac MAX	265-0893	\$1,034.00

Galloni Pressovac – Pressure Over Vacuum

Compact electronic induction vacuum/pressure casting machines scaled down to a smaller size. Pressovac is a perfect entry-level induction casters that will keep up with your production as your business grows. The melting/casting chamber and cover are made of thick anodized aluminum, and both cover and chamber floor are water-cooled so that chamber stays cool even after multiple castings—**there’s no downtime between casts!**

Pressovac can cast gold, silver, platinum, palladium, titanium alloys and steel and handles all types of models. Melts via electronic induction for quick self-stirring homogeneous melt, then casts under vacuum with powerful over-pressure of inert gas to simultaneously pull and push the metal into the flask. Guaranteed dense castings without the brittleness, cracking or subsurface porosity that cause expensive rework or customer returns.

Pressovac Optical includes an optical pyrometer for accurate temperature measurement of platinum, palladium, titanium or steel. Supplied with 3 crucibles (1 each for gold/silver, platinum, and palladium/steel) and a flask adapter for a 3.5" x 3.5" flask along with a metal stirring rod and flask tongs. **Can also cast gold and silver but if accurate temperature measurement is needed for these metals, we recommend the Pressovac Dual below.**

Pressovac Dual includes both an optical pyrometer (for platinum, palladium, titanium alloys or steel) and an immersion thermocouple (for gold/silver) making it suitable for all metals. Supplied with 1 crucible kit (choose from these kits: gold/silver, or platinum/palladium/steel) and a flask adapter for a 3.5" x 3.5" flask along with a metal stirring rod and flask tongs.

See page 230. For crubible kits which you can choose when placing your order.

Backed by a one-year manufacturer's warranty.

Specifications:	Pressovac (Optical)	Pressovac (Dual Pyrometer)
Power	3.0kW	3.0kW
Max. Crucible Capacity	110g Pt,150g 18K Au, 100g Ag, 110g Pd, 90g Steel	110g Pt, 250g 18K Au, 220g Ag, 110g Pd, 90g Steel
Max. Flask Size	3.5" dia. x 3.5"H	3.5" dia. x 3.5"H
Max. Temperature	3,812°F (2,100°C)	3,812°F (2,100°C)
Air Requirement	100-120 PSI	100-120 PSI
Water Requirement	3 liters/minute @ 45 PSI	3 liters/minute @ 45 PSI
* Vacuum Requirement	7 CFM	7 CFM
Inert Gas Requirement	Nitrogen, helium or argon	Nitrogen, helium or argon
Electrical	230V, 1 Ph, 50/60Hz	230V, 1 Ph, 50/60Hz
Dimensions	23.6"W x 19.7"D x 18.9"H	23.6"W x 19.7"D x 18.9"H
Net Weight	199 lbs.	199 lbs.
Item	#265-0861	#265-0890**
	Call for Pricing	Call for Pricing

** Includes one crucible kit and flask cradle.

Description	Item#	Each
* Vacuum Pump, 7 CFM, 110V	265-2404	\$610.00
* Vacuum Pump, 7 CFM, 220V	265-2406	628.55



Pressovac



Casting Chamber



Control Panel



GALONI Induction Casting Machines

Pressovac Dual Pyrometer Crucibles

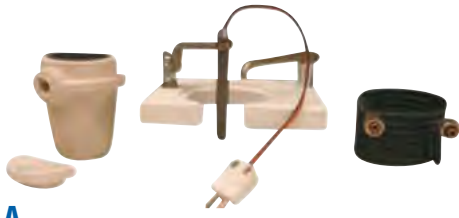

A

A. Au Kit – for Pressovac Dual Pyrometer

- Graphite crucible cemented with its container for gold and silver (20 cc)
- Lid cover for crucible
- Graphite thermocouple sheath
- Spare thermocouple type "S"
- Melting coil (3648)
- Crucible holding plate complete with crucible lid cover holder mechanism

Description	Item#	Each
Au Kit for Pressovac Dual Pyrometer	265-0816	\$1,685.00



B

B. Pt/Pd/Steel Kit – for Pressovac Dual Pyrometer

- Ceramic crucible for platinum (10 cc)
- Silicon carbide crucible (20 cc)
- Melting coil (3645)
- Crucible holding plate complete with crucible lid cover holder mechanism

Description	Item	Each
Pt/Pd/Steel Kit for Pressovac Dual Pyrometer	265-0817	\$1,108.75

Pressovac MAX Crucibles



C

C. Au Kit – for Pressovac MAX

- Graphite crucible cemented with its container for gold and silver (60 cc)
- Lid cover for crucible
- Graphite thermocouple sheath
- Spare thermocouple type "S"
- Melting coil (3647.1)
- Crucible holding plate complete with crucible lid cover holder mechanism

Description	Item#	Each
Au Kit for Pressovac MAX	265-0891	\$1,710.00



D

D. Pt Kit – for Pressovac MAX

- Ceramic crucible (20 cc)
- Melting coil (3650.1)
- Crucible holding plate complete with crucible lid cover holder mechanism

Description	Item#	Each
Pt Kit for Pressovac MAX	265-0892	\$1,125.00

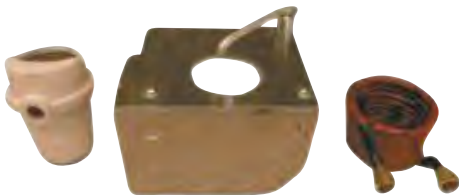

E

E. Steel/Pd Kit – for Pressovac MAX

- Silicon carbide crucible (40 cc)
- Melting coil (3650.1)
- Crucible holding plate complete with crucible lid cover holder mechanism

Description	Item#	Each
Steel/Pd Kit for Pressovac MAX	265-0893	\$1,034.00

GALONI Pressovac Crucibles



Ceramic container for graphite liner (for Au)



Interchangeable graphite liner (10 cc) (for Au)



Ceramic crucible (10 cc) (for Pt)



Silicon carbide crucible (20 cc) (for Steel/Pd)

A. Devesting Machine

Use this high power, heavy-duty system to thoroughly clean investment from castings. Two-piece unit has a rollout catch chamber for removal of accumulated investment. Adjustable water spray nozzle is controlled by a foot pedal. Seam-welded steel frame construction with brushed stainless steel body. Internal work light. Front hinged door for optimal viewing. Heavy-duty replaceable rubber gloves.

Specifications:

Electrical: 240V, 15A, 1 PH, 60Hz

Motor: 3 HP

Dimensions:

Overall: 24³/₈"W x 28³/₈"D x 59"H

Workspace: 23³/₈"W x 13¹/₂"D x 12⁵/₈"H

Max. Water Pressure: 1,700 PSI

Water Flow: 10.5L/min.

Net/Ship. Wt.: 293/440 lbs.

Description	Item#	Each
A. Devesting Machine 	265-2183	\$6,425.00
Replacement Gloves, pair	265-2185	32.95
Replacement Nozzle	265-2187	45.00



A

B, C Hydro Air Wash Gun

Removes investment from castings by using compressed air and water. Made of chrome-plated zinc and brass. Includes heavy-duty, squeeze-trigger air valve, rubber nozzle and hand grips for protection against hot water. Reduces cleaning time and eliminates costly cleaning equipment. Operates on 50–200 PSI. Requires 3/4" dia. x 4"L hose (sold separately) for connection to faucet. Net Wt: 3 lbs.

Description	Item#	Each
B. Hydro Air Wash Gun	260-1800	\$145.00
C. Water Hose	260-1805	10.95



B

C

D. NeyClean SP Investment Remover

Specially formulated NeyClean SP makes quick work of investment removal. The powerful powder formula strips investment from your castings and molds exceptionally fast. If you use it in a heated ultrasonic tank, NeyClean SP works even faster: heat enhances its cleaning power. Better still, the exclusive powder formula can be used over and over again, providing great savings over competitive products. All this and it's even biodegradable! Effective, easy to use, economical and safe for the environment—NeyClean SP is all of these. Supplied in a plastic container. Combined with hot tap water, one container makes 12¹/₂ liters (13 qts.) of solution.

Description	Item#	Each
NeyClean SP Investment Remover	260-4260	\$36.90



D

E. Vest Off

A mildly acidic water-based cleaner for removing investment plaster. Dilute with five parts water in ultrasonic cleaner (use auxiliary pan or beaker). Use cold and undiluted as dip. Rinse off with water. Gives off no fumes. Comes in 1-gallon bottle.

Description	Item#	EACH Prices	
		1-4	5+
1-gallon bottle 	260-4300	\$35.60	\$26.70

 UPS® hazardous shipping surcharge applies. Ships via UPS® Ground only, no air, FedEx® or US Mail shipments. Cannot ship to Alaska, Hawaii or Puerto Rico.



E

F. Hand Brush with Enclosed Handle

Features stiff nylon bristles set in a durable block with enclosed handle for keeping skin and fingernails clean. Ideal for removing investment and more. Measures 4"L x 1¹/₂"W.

Description	Item#	EACH Prices	
		1-2	3+
Hand Brush with Enclosed Handle	115-2255	\$3.90	\$3.51



F



ST-50

A



ST-60

B

Both units includes power pack, lightweight handpiece, on/off foot switch, wrench and instructions. ST-50 includes Carbide Tip only. ST-60 includes all 5 tips.



ST-60

5 Tips Included

A, B SonoCraft Burnishers Ultrasonic Porosity Removers

SonoCraft units were designed especially for professional jewelers to remove porosity and other surface imperfections quickly and easily. But they are also amazing surface finishers with excellent reach into the tiniest areas: polishing under cathedral settings and cleaning up half round rails. You can polish and burnish areas that are almost impossible to reach by hand which traditionally had to be done with a magnetic tumbler. Both units include power pack, lightweight handpiece, on/off foot switch, wrenches and instructions. Made in Japan.

Select between two powerful units:

The **ST-50** comes with one burnishing tip and works on softer metals such as gold and silver. It operates in a continuous mode with a constant fast impact governed by a Variable Rheostat dial. Used for burnishing and polishing.

Our **ST-60** includes five tips and works on the softer metals as well as hard metals such as Platinum. A very versatile machine, the ST-60 has four ultrasonic modes:

- Single Hit Mode: Tightens beads onto stones with minimal or no touch-up needed.
- Intermittent Mode (Slow): Slowly repeating impacts for light engraving.
- Intermittent Mode (Rapid): Rapidly repeating impacts for engraving.
- Continuous Mode: Constant fast impact for burnishing and polishing.

Benefits:

- Advanced ultrasonic technology drastically reduces finishing time for increased productivity.
- Automatic frequency adjustment provides optimal efficiency for excellent finishing results.
- High output power handles all kinds of metals with ease.

Specifications:

Works on	ST-50 Gold, Silver and other soft metals	ST-60 Gold, Silver, Platinum and other hard metals
Max. Power Output	30 Watts	40 Watts
Operating Frequency	24kHz	25kHz
Power Consumption	120VA	120VA
Output Adjustment	Continuously variable	Continuously variable
Handpiece Weight	7 oz.	4.5 oz. (without cord)
Electrical	110V or 220V, 50/60Hz	110V or 220V, 50/60Hz
Power Pack Dimensions	6 ⁷ / ₈ " W x 6 ⁷ / ₈ " D x 3 ³ / ₁₆ " H	5 ³ / ₄ " W x 7 ¹ / ₄ " D x 5" H
Ship. Weight	5.4 lbs.	6.25 lbs.

Description	Item#	Each
A. SonoCraft III Ultrasonic ST-50, 110V	510-0880	\$1,990.00
SonoCraft III Ultrasonic ST-50, 220V	510-0881	1,990.00
B. SonoCraft Ultrasonic ST-60, 110V	510-0885	3,950.00
SonoCraft Ultrasonic ST-60, 220V	510-0886	3,950.00
ST-60 Replacement Handpiece	510-0884	1,715.00
ST-60 Tip, V-shape Chisel, 60 Deg	510-0887	130.00
ST-60 V-shape chisel, 90 Deg	510-0888	130.00
ST-60 Tip, Flat Graver	510-0889	93.00
ST-60 Tip, Round Graver	510-0890	125.00
ST-60 Tip, Burnishing Tool	510-0891	125.00
ST-50 Replacement Handpiece	510-0879	1,215.00
ST-50 Carbide Tip	510-0882	68.00

A-E Carbide Rotary Burnishers Faceted – For platinum, gold & silver

A fast way to remove porosity, firescale and scratches. Made of highly polished tungsten carbide on 3/32" shanks. Measure 1 1/2" long. Select between a 12, 18, or 36-facet sidewall.

- 12-facet burnisher leaves a coarse finish and covers large pinholes on gold and silver
- 18-facet burnishers leave a medium finish and cover moderate pinholes on all metals
- 36-facet burnishers leave a fine finish and cover small pinholes on all metals.

Imported from South Korea.

Facets	Dia. x H	Finish	Max. RPM	Item#	EACH Prices	
					1-9	10+
A. 12	5 x 13mm	Coarse	10,000	811-2170	\$43.50	\$39.15
B. 18	5 x 13mm	Medium	10,000	811-2171	43.50	39.15
C. 36	5 x 13mm	Fine	10,000	811-2172	43.50	39.15
D. 18	10 x 7mm	Medium	8,000	811-2175	43.50	39.15
E. 36	10 x 7mm	Fine	8,000	811-2176	43.50	39.15

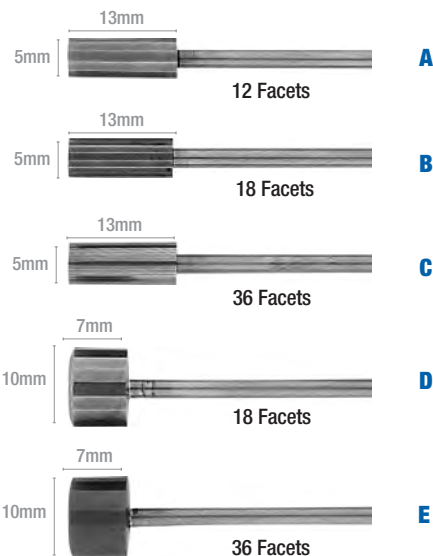

F. Margin Roller Burnisher 3/32" Shank

For burnishing over scratches in gold, making it possible to salvage many pieces without gold loss. Can also be used for burnishing over microporosity in castings. The 3/16" (5mm) head consists of five steel rollers that act as rotating mallets. Measures approximately 1 3/4" long with 3/32" shank for use with handpiece.

Description	Item#	EACH Prices	
		1-2	3+
Margin Roller Burnisher	811-2150	\$21.95	\$19.76

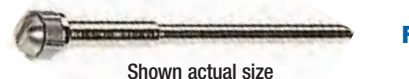

G. Porosity Killer 3/32" Shank

For burnishing over porosity in gold, making it possible to salvage highly porous pieces without gold loss. Similar in operation and effect to a margin roller but more aggressive. The 2mm thick head measures approximately 1/2" x 1/2" with rounded corners. 1 3/4" overall length.

Description	Item#	Each



See pages 158 + 494 for more burnishers.

H, I Busch® Carbide Burnishers 3/32" Shank

Fig. RR426 Carbide Burnishers from Busch. Exceptionally well made tools used to remove porosity and surface imperfections from cast pieces by moving metal over the defect. Burnisher tip is rounded. Dia: 6.0mm, Length 13.0 mm.

Description	Item#	Each
H. Busch Carbide Burnisher, 22 Facet	811-2173	\$42.63
I. Busch Carbide Burnisher, 36 Facet	811-2174	45.34



J. ECO-Torque 280 Rotary Micromotor General Purpose

Our most affordable rotary micromotor system! The ECO-Torque 280 handles a wide range of rotary handpiece applications. Whether you need a system for grinding, drilling, polishing or bright cutting, ECO-Torque 280 will get the job done.

Includes a compact controller with 110/220V selector switch and forward/reverse switch, lightweight 35,000rpm rotary handpiece with 3/32" collet, on/off foot switch, handpiece cradle rest, replacement pair of carbon brushes and collet chuck wrenches. Controller measures 4 1/2"W x 5 3/4"D x 3 3/4"H and weighs 2.75 lbs. Handpiece measures 6" long x 1.1" diameter (tapers to 0.7" dia. at finger grips) and weighs 7.3 oz. An optional reducing collet is available (sold separately, see p. 434) to reduce collet size from 3/32" to 1/16" to run high-speed burs.

Description	Item#	Each
ECO-Torque 280	510-2980	\$199.95



A



A. Niles Pneumatic Sprue Cutters

Heavy-duty air-powered tools for cutting castings from sprues. Feature tapered blades that make it easy to get in between closely spaced castings. Eliminate hand and arm fatigue and increase production. Can be operated by hand when not on stand. Each includes one pair of blades, stand, foot pedal, air hose and hose connectors. Air compressor requirements: 60-85 PSI, 0.8 CFM. Made in Japan.

Specifications:	Model 25	Model 35
Blades:	P6, High-Speed Steel	Z8P, Carbide
Cutting Capacity at Midsection of Blade:	3mm	4mm
Size without Blade:	1 ³ / ₄ " dia. x 9 ¹ / ₂ "L	2 ¹ / ₈ " dia. x 11 ¹ / ₂ "L
Length of Cutting Edge:	1/2"	1 ¹ / ₈ "
Ship. Wt.:	5 lbs., 4 oz.	6 lbs., 4 oz.

Description	Item#	Each
D. Model 25 with P6 Blades	260-3107	\$550.00
Model 35 with Z8P Blades	260-3108	625.00
Replacement Stand	260-3118	120.00
Replacement Foot Pedal	260-3119	177.00
Replacement Hose with Connectors	260-3114	36.60

Blades	For	Item#	Each
Z61, H.S.S. pointed	Model 25	260-3112	\$183.00
S7P, Tool Steel pointed	Model 35	260-3111	99.00
Replacement P6, H.S.S. blunt	Model 25	260-3116	74.00
Replacement Z8P, Carbide blunt	Model 35	260-3117	195.00

B



B. Heavy-Duty Sprue Cutter

A space-saving manual cutter ideal for cutting heavy sprues or the center rod of a tree sprue system. Should be bolted to a bench.

Specifications:	
Cutting Capacity:	3/8" (10mm) thick nonferrous sprues
Dimensions:	6"L x 3"W base with 21" long handle
Ship. Wt.:	10 lbs.

Description	Item#	Each
B. Heavy-Duty Sprue Cutter	260-3120	\$435.00
Replacement Blade	260-3122	129.95

C



C. Power Max Cutters – Cuts gold sprues up to 3mm

Feature leverage-enhancing design and induction-hardened, high-grade steel jaws for extra-close cutting. Have ergonomically shaped handles for preventing fatigue and injuries. Cuts gold and soft wire up to 3mm thick. Measures 6¹/₂" long. Made in Japan.

Description	Item#	EACH Prices		
		1-2	3-9	10+
Flush Cutter	181-4066	\$36.95	\$35.10	\$33.26

Ultrasonic Cleaners

Ultrasonic cleaning technology utilizes high frequency sound waves to agitate a water-based cleaning solution that in turn acts on contaminants adhering to metals, plastics, glass and ceramics. Ultrasonic cleaners remove dust, dirt, oil, pigments, grease, polishing compounds, mold release agents, and biologicals like blood, fingerprints and saliva. Gesswein Cleaning Solutions are formulated for light, medium or heavy-duty cleaning and all reduce surface tension in order to clean more effectively and enhance cavitation (formation of microscopic cleaning bubbles).



A. Sonic Wave IV– Personal Ultrasonic Cleaner – 1¼ pints

The Gesswein Sonic Wave IV is the latest in the family of small ultrasonic cleaners for the home. Powerful and modern looking, the Sonic Wave IV is a professional grade digital Ultrasonic Cleaner with a 1¼ pint capacity half-wave PCB and high power transducers giving a large effective cleaning area—far superior to similar units on the market. Quickly cleans Jewelry, and DVDs, etc. Works well with our Ultrasonic Solution. The price point means it a great gift with purchase or add-on purchase for your customers.

Features:

- Large 2-color LED display.
- Powerful LED Blue Light inside
- Stainless Steel Tank.
- High impact plastic housing.
- See-through half-domed lid.
- Digital timer with 5 setting
- Auto shut-off.
- Frequency=42,000Hz

Specifications:

Capacity: 1¼ pints (600ml) Size: 7¾"W x 7¾"D x 7"H
 Electrical: 100-120V 60Hz Tank 6"W x 5"D x 1¾"H
 Weight: 4 lbs.



Description	Item#	EACH Prices		
		1-2	3-5	6+
Sonic Wave IV	851-4904	\$49.95	\$39.96	\$34.97

B. Digital Ultrasonic Cleaner – 2½ qts.

A moderately sized ultrasonic cleaner for removing dirt and compounds from jewelry. Provides 42kHz of cleaning power. Features integral heater with radiator fan; quiet solid-state circuitry; digital controls with 90, 180, 280, 380 and 480-second cleaning cycles; isolated electronics for protection against moisture; heavy-duty wipe-clean plastic housing; durable stainless steel tank; and auto-shutoff for safety. Includes lid with viewing window and a cleaning basket. CE, GS, NRTL and PSE approved.

Specifications:

Capacity: 2½ qts.
 Electrical: 115V, 160W 50/60Hz
 Dimensions: Overall 13⅜"W x 10"D x 8⅞"H
 Tank 10⅜"W x 6½"D x 3⅞"H
 Weight: 5½ lbs.

Description	Item#	Each
Digital Ultrasonic	851-4906	\$119.95



C. Ultrasonic Ring Rack

Durable plastic-coated wire ring rack with hanging hooks that measure approximately 2" long.

Description	Hooks	Overall Width	W x D	Item#	Each
Ultrasonic Ring Rack	12	12"	5½" x 2"	851-4105	\$3.95

D-F Econo Ultrasonic Ring Racks – 3 sizes

Affordable racks that feature heavy PVC coating and double-sided arms.

Description	Hooks	Overall Width	W x D x H	Item#	Each
D. Sm. Hanging Rack	16	8"	6" x 4½" x 1¼"	851-4107	\$3.95
E. Med. Standing Rack	32	8"	5¼" x 4½" x 4"	851-4108	5.95
F. Lrg. Standing Rack	64	12"	9⅛" x 4½" x 3½"	851-4106	5.95

Ring Rack/Basket compatibility chart on page 591

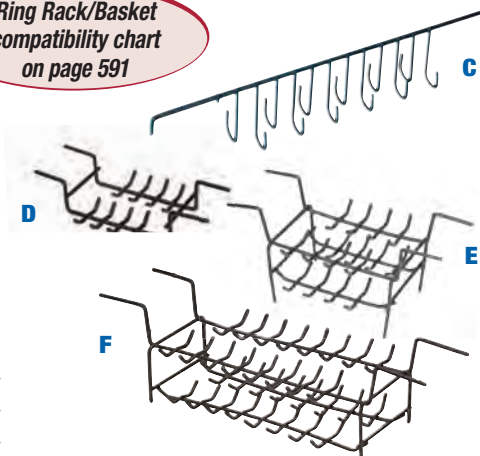

Ultrasonic Cleaner Brand Comparison

Brand	BestBuilt	L&R Quantrex	Digital	GemOro	Elma "Easy" Series	Elma "P" Series
Capacity	2 qts., 3½ qts., 6 qts., 10 qts., or 22 qts.	2 qts., 3¾ qts., 6 qts., 14½ qts., or 26 qts.	2½ qts.	1½ pt., 2 qts., 3 qts.	1 qts., 2 qts., 3 qts., 4 qts., 6 qts., 10 qts., 14 qts., 20 qts. or 30 qts.	3 qts., 4 qts., 6 qts., 14 qts., 20 qts. or 30 qts.
Frequency	40kHz	43kHz	42kHz	40kHz	37kHz	37/80kHz
Workload	Medium to Heavy	Medium to Heavy	Light to Medium	Medium to Heavy	Medium to Heavy	Medium to Heavy
Control	Analog	Analog	Digital	Analog	Analog	Analog & Digital
Timer	0–30 min.	0–60 min.	5 Different Cycles	0–60 min.	0–30 min.	0–30 min.
Timer Bypass	No	No	No	No	Yes	Yes
Heater	Yes	Yes	Yes	Yes (except 1.5)	Yes	Yes
Housing	Powder-Coated Steel	Vinyl-Clad Steel	ABS Plastic	Stainless Steel	Stainless Steel	Stainless Steel
Tank	Stainless Steel	Stainless Steel	Stainless Steel	Stainless Steel	Stainless Steel	Stainless Steel
Lid	Yes	Yes	Yes	Yes	Yes	Sold Separately
Drain	Yes (except 2, 3.5 & 6 qt.)	Yes (except 90)	No	No	Yes (except E15H & E30H)	Yes
Country of Origin	South Korea	USA	China	China	Germany	Germany
Catalog page #	238	239	235	239	237	236



Elma "P" Series Ultrasonics

These top-of-the-line heavy duty cleaners are the most advanced industrial strength tabletop units available. The "P" series are extremely versatile and have 8 special ultrasonic features plus an intuitive, user-friendly operations display. The 2 frequency control allows for either high energy density for deep cleaning applications (37kHz)—or for gentle, quiet cleaning of delicate items such as pearls or small diameter tubes and capillaries (80kHz). Lids sold separately. Two-year Manufacturer's Warranty. Made in Germany.

Features:

- Normal: for general cleaning, mixing, dissolving.
- Pulse Mode: gives additional power through increased peak performance.
- Sweep: distributes the ultrasonic power throughout the tank.
- Degas: quickly degases liquid when freshly added to the tank.
- Power control: optimizes output for special and laboratory applications.
- Pause: interrupts the operation.
- Auto Start: automatic start when temperature is reached.
- Heat control: adjustable.



Model	P30H	P60H	P120H	P180H*	P300H*
Capacity (qts.)	3 Quart	6 Quart	14 Quart	20 Quart	30 Quart
Power Consumption	320/300 watts	680/640 watts	1400 watts	1400 watts	1580 watts
Frequency	37/80 kHz	37/80 kHz	37/80 kHz	37/80 kHz	37/80 kHz
Tank Dimensions (W x D x H, inches)	9.45 x 5.39 x 3.94	11.81 x 5.94 x 5.91	11.81 x 9.45 x 7.87	12.87 x 11.81 x 7.87	19.88 x 11.81 x 7.87
Drain, Hose & Clip	NO	YES	YES	YES	YES
Overall Dimensions (W x D x H, inches)	11.81 x 7.05 x 8.70	14.37 x 7.32 x 10.67	14.37 x 10.94 x 12.64	15.35 x 13.38 x 12.64	22.36 x 13.38 x 12.64
Electrical	110V/60Hz	110V/60Hz	110V/60Hz	110V/60Hz	110V/60Hz
Ship Wt.	8 lbs.	12 lbs.	17 lbs.	19 lbs.	25 lbs.
Manf. Warranty	2 years	2 years	2 years	2 years	2 years
Item#	851-1030	851-1032	851-1033	851-1034	851-1035
Price	\$850.00	1,150.00	2,250.00	2,450.00	2,950.00

*Models P180H and P300H are non-stock items. Please allow extra time for delivery.

Lids	P30H Lid	P60H Lid	P120H Lid	P180H Lid	P300H Lid
Item#	851-1036	851-1037	851-1038	851-1039	851-1040
Price	\$22.50	28.75	35.50	37.50	44.50



A. Elma “EASY” Series Ultrasonics
Superior Cleaning Power and Easy to Use!

The Elma EASY series includes 9 quality units of different sizes and is characterized by simple, user-friendly operation. With 100% ultrasonic power at a frequency of 37 kHz, the Pulse function and visual warning (bath temperature reaches the set limit), the Elma EASY solves typical cleaning tasks in the processing of jewelry and industrial parts quickly and efficiently.

The “Pulse” function can be activated to remove tenacious, mineral soiling and polishing pastes, increasing the ultrasonic power by up to 20%, so that any soiling will be removed easily and quickly. The limit temperature can be adjusted according to individual requirements. When the set temperature limit is reached the unit gives out a visual warning that helps to protect sensitive items from damage due to high temperatures. Made in Germany, 2-Year Manufacturer’s Warranty, 110V/60Hz.

Features:

- More power with Pulse function for removing dirt, polishing compound and hand cream.
- Visual limit temperature warning to protect sensitive parts.
- Easy handling with safety shutdown for more user safety.
- Pulse Function for 20% faster cleaning, removes caked on drift compounds.
- Electronic timer up to 30 minutes and also able to work continuously.
- Thermostatically controlled heating with safety shut off function.
- Programmable visual temperature limit warning protects sensitive parts.

Model	Easy 10H	Easy 20H	Easy 30H	Easy 40H
Capacity (qts.)	1	2	3	4
Frequency	37 kHz	37 kHz	37 kHz	37 kHz
Tank Dimensions (W x D x H, inches)	7.5 x 3.38 x 2.38	5.9 x 5.38 x 4	9.5 x 5.38 x 4	9.5 x 5.38 x 5.9
Drain, Hose & Clip	NO	NO	NO	NO
Overall Dimensions (W x D x H, inches)	8.13 x 4.50 x 7.50	6.88 x 7 x 8.63	11.75 x 7 x 8.63	11.75 x 7 x 10.63
Electrical	110V/60Hz	110V/60Hz	110V/60Hz	110V/60Hz
Ship Wt.	4.4 lbs.	4.63 lbs.	7.25 lbs.	8.8 lbs.
Manf. Warranty	2 years	2 years	2 years	2 years
Item#	851-1060	851-1061	851-1062	851-1063
Price	\$350.00	355.00	430.00	640.00

Model	Easy 60H	Easy 100H	Easy 120H	Easy 180H*	Easy 300H*
Capacity (qts.)	6	10	14	20	30
Frequency	37 kHz	37 kHz	37 kHz	37 kHz	37 kHz
Tank Dimensions (W x D x H, inches)	11.75 x 5.9 x 5.9	11.75 x 9.5 x 5.9	11.75 x 9.5 x 7	12.88 x 11.75 x 8	19.88 x 11.75 x 8
Drain, Hose & Clip	YES	YES	YES	YES	YES
Overall Dimensions (W x D x H, inches)	14.38 x 11 x 10.63	14.38 x 11 x 10.38	14.38 x 11 x 12.63	15.38 x 13.38 x 12.63	22.38 x 13.38 x 12.63
Electrical	110V/60Hz	110V/60Hz	110V/60Hz	110V/60Hz	110V/60Hz
Ship Wt.	11.25 lbs.	13 lbs.	16.5 lbs.	18.75 lbs.	24.25 lbs.
Manf. Warranty	2 years	2 years	2 years	2 years	2 years
Item#	851-1064	851-1065	851-1066	851-1067	851-1068
Price	690.00	\$840.00	1,160.00	1,275.00	1,595.00

*Models E180H and E300H are non-stock items. Please allow extra time for delivery.



See page 541 for Long-Reach Steam Tweezers



BESTBUILT Ultrasonic Cleaners

BestBuilt Ultrasonic Cleaners utilize industrial transducers to create powerful 40KHz ultrasonic wavelengths—short enough to clean the finest details of your jewelry and powerful enough to remove caked-on dirt as well as rouge and other compounds. All BestBuilt models have a 30-minute timer and cover. The 4 largest units feature variable temperature control. All ultrasonics come with a 1 year warranty; 2 year transducer warranty and a sample of Ultrasonic Cleaning Solution. Made in South Korea.

Model	2 Quart	3.5 Quart	6 Quart	10 Quart	22 Quart
Capacity	1.8 liters 0.48 gallon	3.3 liters 0.87 gallon	6 liters 1.58 gallons	10 liters 2.64 gallons	22 liters 5.8 gallons
Power	60 watts	100 watts	150 watts	200 watts	300 watts
Frequency	40KHz	40KHz	40KHz	40KHz	40KHz
Variable Temperature Control	NO	YES	YES	YES	YES
Tank Dimensions	5.9"L x 5.3"W x 3.9"D	9.4"L x 5.5"W x 3.9"D	11.4"L x 5.9"W x 5.9"D	11.4"L x 9.4"W x 5.9"D	19.5" W x 11.75" L x 5.9" H
Drain	NO	NO	NO	YES	YES
Overall Dimensions	7"L x 6.4"W x 8.3"H	11.7"L x 6.4"W x 9.8"H	14.1"L x 6.9"W x 11.9"H	15.5"L x 10.4"W x 14.5"H	23.5"L x 13.75"W x 12.35"H
Electrical	110V	110V	110V	110V	110V
Ship Wt.	8 lbs.	8 lbs.	13 lbs.	17 lbs.	31 lbs.
Item#	851-1000	851-1002	851-1004	851-1006	851-1008
Price	\$265.00	399.00	699.00	999.00	1,599.00

A



A. BestBuilt Deluxe Cleaning Kit

This cleaning kit includes everything you need to return your jewelry to its original spotless shine, at an incredible value! Includes one BestBuilt 3.5 qt. Ultrasonic Cleaner, 1 qt. of Ultrasonic Cleaning Solution, a mesh basket, small parts basket, ring rack, and gem cloth.

Description	Item#	EACH Prices	
		1-2	3+
BestBuilt Deluxe Cleaning Kit	851-0998	\$485.00	\$436.50

B



B. Deluxe Ultrasonic Ring Racks

Easily assembled modular ring racks that can be easily customized to meet your needs. Steel rack with rubber feet rests on top of your ultrasonic, suspending hooks inside tank. Long-lasting solid plastic hooks adjust to hold both large and small items (each hook holds two rings).

Description	Hooks	Length	Item#	Each
8 Hook Rack	8 (holds 16 rings)	11 ³ / ₄ "	851-2050	\$6.95
B. 12 Hook Rack	12 (holds 24 rings)	14 ³ / ₄ "	851-2052	8.95
Replacement Hook	(holds 2 rings)	—	851-2058	0.95

Ring Rack/Basket compatibility chart on page 591

D



C-E Stainless Steel Mesh Baskets

High-quality stainless steel mesh baskets with convenient handles that let you move jewelry pieces into and out of your ultrasonic cleaner with ease. Designed to fit many brands.

	Approx. Overall Width	W x D x H	Item#	Each
C.	8"	5 ¹ / ₄ " x 4 ³ / ₄ " x 2"	851-5099	\$35.20
D.	8"	5 ³ / ₈ " x 5" x 3 ¹ / ₄ "	851-5101	41.85
E.	11 ¹ / ₂ "	9" x 5" x 3 ³ / ₈ "	851-5121	45.50
	13 ¹ / ₂ "	11" x 5 ³ / ₈ " x 5 ¹ / ₄ "	851-5126	77.45
	13 ¹ / ₂ "	11 ¹ / ₈ " x 8 ³ / ₄ " x 4 ⁷ / ₈ "	851-5131	85.00



L&R Quantrex® Ultrasonic Cleaners

Made by L&R, a leader in ultrasonic cleaning technology, Quantrex ultrasonics feature durable stainless steel housing, stainless steel tank and plastic lid, 60-minute timer and a drain with hose & clip (except model 90, which has timer but no drain), EMI (electromagnetic interference) filter for worry-free operation around other electronic equipment, premium system components and contemporary design. Include integral heating elements at a preset temperature of approx. 160°F. Provide quiet yet powerful 43kHz cleaning action. Backed by a 2½-year manufacturer's warranty. 220V also available. Made in USA.

Model	90	140	210	360	650
Capacity (qts.)	2 Quart	3.4 Quart	6 Quart	14.4 Quart	26 Quart
Power	110 watts	150 watts	335 watts	440 watts	815 watts
Frequency	43KHz	43KHz	43KHz	43KHz	43KHz
Tank Dimensions (W x D x H)	5⅞" x 5⅜" x 4"	9⅜" x 5⅜" x 4"	11¾" x 6" x 6"	11½" x 9¼" x 8"	19¾" x 11¾" x 6½"
Drain, Hose & Clip	NO	YES	YES	YES	YES
Overall Dimensions (W x D x H)	7" x 6⅜" x 8¾"	10¼" x 6½" x 8¼"	12¾" x 7" x 11"	12¾" x 10½" x 14"	21¾" x 14" x 12½"
Electrical	110V, 50/60 Hz (220V available)	110V, 50/60 Hz (220V available)	110V, 50/60 Hz (220V available)	110V, 50/60 Hz (220V available)	110V, 50/60 Hz (220V available)
Ship Wt.	8 lbs.	10 lbs.	14 lbs.	22 lbs.	33 lbs.
Manufacturer's Warranty	2.5 years	2.5 years	2.5 years	2.5 years	2.5 years
Item#	851-5230	851-5232	851-5234	851-5236	851-5238
Price	\$315.00	460.00	895.00	1,535.00	2,625.00



#90, 2 Quart



#140, 3.4 Quart



#210, 6 Quart



#360, 14.4 Quart



#650, 26 Quart

A-C. GemOro Ultrasonic Cleaners

The newest line of GemOro ultrasonics combine their proprietary POWER SWEEP with their TURBO SWEEP technologies providing you with the most powerful ultrasonics on the market today. Their rigorous attention to detail, along with their superior electronics, meet every demand for the jewelry industry! Comes supplied with stainless steel basket and steam tweezers. Backed by a 2½-year manufacturer's warranty. (10-year warranty on the transducers). Made in China

Unit Capacity	Unit L x W x H Dimensions (in)	Tank L x W x H Dimensions (in)	Freq. (kHz)	Time (min.)	Heat	Item#	Each
A. 1.5 Pint	6.89 x 4.33 x 7.28	5.9 x 3.35 x 2.56	40	0-60	No	851-1050	\$149.95
B. 2 Quart	7.48 x 6.69 x 8.66	5.9 x 5.51 x 3.94	40	0-60	Yes	851-1052	249.95
C. 3 Quart	10.63 x 6.69 x 7.87	9.45 x 5.51 x 3.94	40	0-60	Yes	851-1054	349.95



D. Universal Stainless Steel Mesh Basket

This fine mesh basket hangs on the side with ½" wide hooks.

Description	W x D x H	Item#	Each
Universal Basket	5" x 4" x 1½"	851-5105	\$14.95



E. Extra-Fine Stainless Steel Mesh Basket

Features stainless steel frame with extra-fine stainless steel mesh that prevents even the smallest items from dropping to the bottom of your ultrasonic. Has two extra-long handles for fitting on many 2, 3 and 6-quart units.

Description	Approx. Overall Width	W x D x H	Item#	Each
Extra-Fine Basket	8½"	4½" x 3" x 1½"	851-5097	\$14.95



F. Stainless Steel Basket

Prevent parts from touching bottoms of tanks. Ends fit over edges of tanks. Rubber feet on lips eliminate vibration. Screened bottom. Stainless steel.

Description	Approx. Overall Width	W x D x H	Item#	Each
Basket #270	13½"	10⅛" x 8½" x 4¾"	851-5130	\$129.00





A



B



C



D

E



F



G

H



I



J

A-F Speed Brite Ionic Cleaners

Speed Brite units use a revolutionary ionic cleaning process to clean precious metal and stones in less than a minute. Safe for emeralds, opals, pearls, turquoise and other soft stones.

Mini Speed Brite has a 6 oz. capacity and outside dimensions are 4" x 5". Fits easily on crowded countertops and can be resold to your customers for home use.

The two turbo units feature a vibrating motor to help circulate the dirt and tarnish away. Large Turbo 309SB has a 36 oz. capacity and outside dimensions of 10³/₄" x 6³/₄", (Tank dimensions 8¹/₂" x 4³/₄") Features push-button to agitate solution for faster cleaning. Standard Turbo 200SB has 12 oz. capacity with outside dimensions 5³/₄" x 5³/₄" Cleans gold and silver in seconds and also softens dirt behind stones

Each unit comes with a generous supply of Gem Sparkle Concentrate, an environmentally safe cleaning solution formulated to gently remove dirt, grime and tarnish. Made In USA.

Description	Electrical	Item#	EACH Prices	
			1-5	6+
A. Large Turbo 309SB	120V	851-4922	\$185.00	-
B. Standard Turbo 200SB	120V	851-4921	125.00	-
C. Mini Speed Brite 100SB (9V battery included or power adapter; see below)	9V/120V	851-4920	59.50	\$53.55
Power Adapter for Mini	120V	851-4924	12.00	10.80
Description	Dia. x H	Item#	Each	
Replacement Stainless Steel Mesh Basket for 200SB	4" x 2"	851-4934	\$25.95	
Description	Item#		Each	
Gem-Sparkle Concentrate				
D. Liquid, 32 oz.	851-4931		\$15.50	
E. Liquid, 1 gallon	851-4932		27.50	

F. Gem-Sparkle Dry Powder

Dry powder crystals with luster enhancers, Pour contents of both vials into dispensing bottle. Add water and mix.

Description	Item#	Each
Gem-Sparkle Powder		
F. Without bottle, 8 oz.	851-4938	\$10.50
Without bottle, 32 oz.	851-4940	14.50
With Bottle, 8 oz.	851-4939	12.50
With Bottle, 32 oz.	851-4941	16.50

G, H 600ml Beaker and Flexible Cover

Safely holds ammonia, acids and other strong chemicals that can ruin your ultrasonic tank.

Description	Item#	Each
G. Flexible Cover	210-2952	\$5.25
H. Beaker	210-2750	10.00

I. Screw-Type Parts Basket

Tiny wire mesh basket for fully securing the smallest parts during ultrasonic cleaning. Prevents costly loss.

Description	Dia. x L	Item#	Each
Screw-Type Basket	5 ⁷ / ₈ " x 7 ⁷ / ₈ "	851-4115	\$10.30

J. UltraBasket™

This unique combo basket features 16 hooks and fine plastic mesh to keep both large and small items from falling to the bottom of your ultrasonic. Includes plastic legs that can be easily trimmed to the ideal height and convenient handle for easy removal. Designed so most ultrasonics can accommodate two. Color may vary.

Description	Dia. x H	Item#	Each
UltraBasket	4 ⁷ / ₈ " x 3 ⁷ / ₈ "	851-5127	\$25.75

Ultrasonic Cleaning Solutions

Gesswein Cleaning Solutions are formulated for light, medium or heavy-duty cleaning and all reduce surface tension in order to clean more effectively and enhance cavitation (formation of microscopic cleaning bubbles).

Ultrasonic cleaning technology utilizes high frequency sound waves to agitate the cleaning solution that in turn acts on contaminants adhering to metals, plastics, glass and ceramics. Ultrasonic cleaners remove dust, dirt, oil, pigments, grease, polishing compounds, mold release agents and biological residue such as blood, fingerprints and saliva.

A-D Gesswein® Classic Ultrasonic Solution

The classics always come back! Gesswein is happy to bring back its original "Classic" Ultrasonic Cleaning Solution. With a 35:1 mixing ratio, the Classic Solution will work hard to remove tough dirt, grease, hand cream and still powerful enough to remove the toughest polishing compounds. Let your jewelry shine as first impressions are important! Available in Pint, Quart, Gallon, and 5 Gallon Pail.

Description	Yield at 40:1	Item#	Each
A. 1 pt. Bottle	4½ gals.	851-5378	\$16.00
B. 1 qt. Bottle	8¾ gals.	851-5376	25.50
C. 1 gal. Bottle	35 gals.	851-5374	78.50
D. 5 gal. Pail	175 gals.	851-5372	295.00
55 gal. Drum 	1,925 gals.	851-5370	2,800.00



Color may appear different in different containers.

E-H SUPRA® FC Ultrasonic Solution



The Gesswein SUPRA FC Ultrasonic Solution is a must for any jeweler or industrial user needing fast cleaning action. Formulated in the USA, FC Ultrasonic Solution is fast and cleans the heaviest of compounds and dirt quickly and effortlessly. Compared to other solutions, Gesswein FC Solution is industrial strength and has minimal odor. It is non-ammoniated, non-flammable, alcohol free, mildly alkaline, environmentally friendly and non-hazardous to ship. Concentrated: use 50:1 in regular tap water and 100:1 in distilled or deionized water. Available in Pint, Quart, Gallon, and 5 Gallon Pail.

Description	Yield at 40:1	Item#	Each
E. 1 pt. Bottle	4½ gals.	851-5388	\$17.50
F. 1 qt. Bottle	8¾ gals.	851-5386	28.50
G. 1 gal. Bottle	35 gals.	851-5384	86.50
H. 5 gal. Pail	175 gals.	851-5382	299.00
55 gal. Drum 	1,925 gals.	851-5380	2,950.00



I. BCR Cleaner – Original buffing compound remover



A fast-acting alkaline cleaning solution developed especially for the removal of buffing compounds such as tripoli, white diamond and rouge. Works effectively on gold, platinum, silver, steel, stainless steel, zinc, magnesium, brass, copper and aluminum. Exceptional rinsability eliminates hand wiping and streaking.

Description	Item#	Each
I. 1 gal. Bottle	812-0650	\$27.95
J. 5 gal. Pail	812-0655	129.95
19 gal. Drum 	812-0656	450.95
51 gal. Drum 	812-0659	1,075.95



J. BCR Plus – Extra-strong buffing compound remover

Ideal for your toughest cleaning jobs. Works effectively on gold, platinum, silver, steel, stainless steel, zinc, magnesium, brass, copper and aluminum. Concentrated: use 3–20% by volume depending on extent of compound buildup. Exceptional rinsability eliminates hand wiping, streaking and discoloration.

Description	Item#	Each
K. 1 gal. Bottle	812-0670	\$29.95
L. 5 gal. Pail	812-0675	135.95
19 gal. Drum 	812-0682	470.95
51 gal. Drum FOB CT 	812-0685	1,095.95



A-B Gesswein® Brite and Ultra Brite Ultrasonic Cleaning Solutions





Pick the right solution for every cleaning application.

Concentrated solutions formulated for specific jewelry applications. Both work well for ultrasonic cleaning, hand brushing and immersion or soak cleaning. Contain no chelating agents. Can be used from room temperature up to 160°F. Use in concentration of 2–20% for best results. Available in 1-quart bottles, 5-gallon pails and 55-gallon drums.

Brite (blue) is a moderately alkaline solution best suited for cleaning plain or stone-set rings (excluding those with delicate stones). Ideal for gold, silver and platinum as well as copper and brass. Perfect for everyday use in the retail store or repair shop.

Ultra Brite (pink) is a heavy-duty cleaning solution designed to quickly remove the most stubborn polishing compound residue. We think Ultra Brite is the strongest cleaner on the market, and it's free of ammonia and other harmful chemicals that could hurt your fine jewelry. Ultra Brite is ideal for all precious metals and stainless steel as well as diamonds and other stones that can withstand normal ultrasonic cleaning. Ultra Brite is considered hazardous to ship.



Description	Item# (1qt. Bottle)	Item# (5 gal. Pail)	Item# (55 gal. Drum)
A. Brite	851-5311 \$16.25	851-5312 \$199.95	851-5313 \$1,527.00
B. Ultra Brite 	851-5317 18.25 	851-5318 229.00 	851-5319 2,199.00 

 Although no hazardous shipping surcharge applies, these items can only ship via UPS® Ground, no air, FedEx® or US Mail possible. Cannot ship to Alaska, Hawaii or Puerto Rico.

 UPS® hazardous shipping surcharge applies. Ships via UPS® Ground only, no air, FedEx® or US Mail shipments. Can't ship to Alaska, Hawaii or Puerto Rico.



C-D Magic Green – Powdered Ultrasonic Soap Concentrate

Magic Green is more economical and occupies much less space than liquid concentrates. Saves on shipping costs, too. And since it won't evaporate, it even keeps longer. Simply mix it to meet needs as product is adjustable for time of run and speed. Start with 1 ounce per gallon and up to 3 ounces per gallon. The stronger the mix, the faster it works and the longer it works. Perfect for gold and silver because it removes rouge and tripoli instantly. Ammonia-free and biodegradable.

Description	Item#	EACH Prices	
		1-5	6+
C. 32 oz. Bottle	812-0701	\$21.50	\$19.35
D. 10 lb. Pail	812-0702	60.50	54.45
E. 50 lb. Pail	812-0703	375.50	337.95

F. Drum Pump – For 5, 15, 30 and 51-gallon drums

A reusable plastic pump that makes it easy to dispense ultrasonic cleaning solution from any standard-size drum. Saves you from having to lift or tilt heavy, awkward containers. Lets you take advantage of bulk pricing. Features raised spout that dispenses liquid at a convenient height. Includes adapters and extension tubing to fit standard 5, 15, 30 and 51-gallon drums. Adjusts to dispense exact quantities of 4, 8, 12 or 16 av. oz.

Description	Item#	Each
Drum Pump	852-0942	\$189.50



G-J Graduated Cylinder, Investment Scoop and Measuring Beakers

Graduated cylinder is made of polypropylene. Capacity: 250ml with 2ml graduations. Investment scoop has high sides to prevent spilling and waste. Holds about 3 lbs. standard investment. Measures 8 1/2"L x 4 3/4"W x 3"H. Made of plastic. Measuring beakers have handles for easy pouring. Made of polypropylene. Available in two sizes: 1,000ml with 1ml graduations and 5,000ml with 100ml graduations.

Description	Capacity	Item#	Each
G. Graduated Cylinder	250ml (250cc)	265-1905	\$21.65
H. Investment Scoop	Roughly 3 lbs.	260-1750	8.95
I. Small Measuring Beaker	1,000ml (1,000cc)	210-2425	16.55
J. Large Measuring Beaker	5,000ml (5,000cc)	210-2426	58.95



A. All-in-One Jewelry Cleaning Kit

Everything you need for professional jewelry cleaning at home in a minimal amount of space.

Components:

- GemOro Diamond Steam Cleaner (853-0095)
- Light Blue 10" x 10" Royal Gem Cloth (820-0419)
- Sonic Wave IV Ultrasonic Cleaner (851-4904)

Description	Electrical	Item#	Each
All-in-One	110V	853-0091	\$145.00



Color of the steamer may vary at times (Slate Gray or Black)

B. Deluxe Professional Cleaning Kit

The Deluxe Professional Cleaning Kit is ideal for the home office or the front end of a retail store.

Components:

- GemOro Diamond Steam Cleaner (853-0095)
- Pint of Gesswein Ultrasonic Solution (851-5378)
- 2.5 qt. Heated Ultrasonic (851-4906)
- High-quality lint-free gem cloth (820-0415)

Description	Electrical	Item#	Each
Deluxe Professional	110V	853-0088	\$199.95



C. GemOro UltraSpa™ Ultimate Pro-Quality Jewelry Cleaning System

The world's only personal combination jewelry cleaning system; utilizing both an ultrasonic cleaner and steam cleaner in one specially designed appliance for the home or jewelry store.

The ingenious UltraSpa provides ultimate cleaning results for sparkling diamonds, gold, silver, platinum jewelry, metal watch bands and more. With a two-stage cleaning process, scrubs away dirt and grime with sound waves then blast away hidden dirt from hard to reach areas using steam power! ETL Listed. 1 Year limited replacement warranty. Electrical: 115V, 60Hz.

- Ultrasonic generates a powerful 42,000 scrubbing waves per second using regular tap water (1 pt. capacity)
- 6-minute timed ultrasonic cleaning cycle with auto shuts off
- Generates 50 PSI of pressurized steam using regular tap water (1 pt. capacity).
- Compact size conveniently fits on counter and stores underneath.
- Includes: Ultrasonic Basket, Steam residue mat, measuring fill cup, jewelry holding tweezers, 2 sizes of handheld mesh baskets and a sample of cleaning solution.
- Designed in the USA, Made in Italy.

Description	Item#	Each
GemOro UltraSpa	853-0089	\$199.95



Color may vary

D. GemOro Diamond Personal Steam Cleaner The best just got better!

New larger capacity steamer with even greater steam pressure! The ultimate personal jewelry steam cleaner with its increased steam pressure will thoroughly amaze you by effortlessly blasting away filth from the dirtiest of jewelry in just seconds. Professionally cleans diamonds, gold, silver and platinum jewelry. Powerful steam cleaner safely generates a robust 50PSI of pressurized steam using regular tap water. Advanced LED indicator lights show when it is ready to steam. Bright blue LED light illuminates jewelry. Features an unrestricted cleaning zone, removable cleaning / drying basket and convenient on / off power switch and easy-lift handles for moving. Cabinet made of durable, long-life ABS. Includes jewelry holding tweezers, basket, steam residue mat and water funnel with measuring fill cup. Built for safety – ETL Listed. 2 Year limited replacement warranty.

Description	Electrical	Item#	Each
GemOro Diamond Steamer	120V	853-0095	\$99.95



D

E. Reliable Pronto 100CH Steamer

The Pronto 100CH is a powerful, 1200 watt and 58 PSI of pressure, hand-held personal steamer that hold 1¼ cups of water with a ready time of 2 minutes and continuous steam for up to 15 minutes! Other features include a patented comfort safety system, ergonomically designed handle, extra-long 19.5 foot long cord and a 15 piece accessory kit for tackling countless tasks in the home needing cleaning and sanitizing. Made in China.

Description	Electrical	Item#	Each
All-in-One	110V	853-0135	\$99.00



E



RELIABLE Steam Cleaners

Elegantly Designed—Built of Stainless Steel



Stainless steel is the #1 choice for pressurized steam cleaners around the world. The elegant design and solid construction of Reliable Cleaners utilizes this unsurpassed material both inside and out. Unlike cast iron, these stainless steel models will not rust. One-year manufacturer's warranty on units, lifetime warranty on tanks. cETLus certified. Made in Italy.

Series Features All of these RELIABLE stainless steel steamers have:

- Pressure switch, probe safety thermostat on the heating element, safety cap with safety valve, automatic low water shut-off.
- Quick release fittings
- Carrying handle for portability
- 12-gauge heavy-duty wiring
- Steam temperature 221°F/105°C
- Adjustable nozzle and foot pedal

Model	5000CJ	6000CJ	7000CJ	8000CJ
Capacity (gals/liters)	0.66/2.5	1.25/4.7	2.37/9	1.3/5
Steam Time (hours)	2-3	4-5	8	Unlimited
Pressure (PSI/bar)	50/3.5	65/4.5	70/4.8	80/5.5
Heat Up (minutes)	10-15	15-20	30-40	20-30
Heating Element	Copper, 1000W	Incoloy, 1200W	1 Incoloy, 1200W (Plus 1 spare)	Incoloy, 1200W
Electrical	120V, 10 Amps	120V, 10 Amps	120V, 10 Amps	120V, 20 Amps
Blow Down Valve	No	Yes	Yes	Yes
Water Level	Stick	Stick	Indicator	Direct Connect**
Dimensions (WxDxH)	14"x8 ³ / ₄ "x11"	13"x8 ³ / ₄ "x15"	12 ¹ / ₂ "x14 ¹ / ₄ "x20 ¹ / ₂ "	12 ¹ / ₄ "x14 ¹ / ₄ "x20 ¹ / ₂ "
Net Wt. (lb/kg)	13.25/6	16.7/7.5	30.35/13.75	26/11.7
Ship Wt. (lb/kg)	15.5/7	23/10.4	33.9/15.37	30/13.6
Drop Ship Item#	853-0127*	853-0128*	853-0129*	853-0130*
Item#	853-0107	853-0108	853-0109	853-0126
Price	\$599.00	899.00	1,199.00	1,899.00

*Ships FOB Cheektowaga, NY

** Water line or portable supply Auto Shut Off and Thermostat Reset Switch.

A. Reliable Steam Gun

Transform pedal/nozzle operation into hand held gun for flexibility.

Description	Item#	Each
Steam Gun	853-0115	\$199.00

B-C Small Parts Baskets

Stainless steel wire mesh baskets with plastic or metal handles. Perfect for holding small parts in your ultrasonic or steamer. Available in three sizes.

Description	Handles	Dia.	Item#	Each
B. Small	Plastic	1 ¹ / ₂ "	851-4110	\$3.45
C. Large	Plastic	2 ¹ / ₂ "	851-4111	3.95

D. Steamostat

The perfect holder for steam cleaning. Features stainless steel box-joint construction with nonscratching PVC tips and lockable handles. Measures 7¹/₂".

Description	Item#	EACH Prices		
		1-2	3-9	10+
Steamostat	181-5010	\$6.25	\$5.94	\$5.31

See Steam Tweezers On Page 541



A. Deluxe Junior Steamer – For moderate production

This compact tabletop unit boasts up to 40% greater effective capacity than similar units, so it provides more steam before needing a water refill. Features a high-limit pressure control switch that regulates heat and pressure automatically. An automatic cutoff shuts the unit down if the water level drops below the heating element. Made of the toughest heavy-duty materials to withstand constant use. Easy to install with no plumbing required. Includes fast-response heating element, foot-controlled solenoid switch, safety relief valve, low-water cutoff with reset switch, steam pressure gauge, lockable blowdown drain valve and water fill funnel and valve. Complies with ASME safety code. UL and CSA approved. Uses ordinary tap water. Optional Mobile Steam Jet Gun available. Fits easily onto the Deluxe Junior Steamer. Trigger-operated gun on 7 feet of sturdy flexible hose. Includes T-fitting for mounting into steam line of steamer. One-year manufacturer's warranty. Made in USA.

Specifications:

Electrical: 120V, 12.5A, 1500W, 60Hz Max. Pressure: 60–85 PSI
 Capacity: 1.5 gals. Dimensions: 16½"W x 12"D x 19"H

Description	Electrical	FOB Point	Item#	Each
A. Jr. Steamer	120V	CT	853-0059	\$1,665.00
Jr. Steamer	120V	VA	853-0072	1,645.00
Jr. Steamer for Texas	120V	VA	853-0067	1,645.00
Mobile Steam Jet Gun			853-7070	270.50
B. Stone saver tray (5" x 5" square)			853-0321	48.50

*Not UL approved.

C. Steam Cleaner Powder

For removing rust and mineral deposits from boiler chamber of steam cleaner. The 4 oz. supply is sufficient for one cleaning, which should be done once a week.

Description	Item#	EACH Prices		
		1-2	3-9	10+
Steam Cleaner Powder, 4 oz.	853-1000	\$5.95	\$4.76	\$4.17

D, E Automatic Water Feed Series Steamers – For high production

These steamers eliminate the need to manually fill and refill. Each model is equipped with an automatic water feeder that injects water as needed into the boiler under full pressure. Eliminates downtime, making steam readily available. Provides constant steam at approx. operating pressure of 50 PSI. Auto-6 is a compact version with one steam jet. Auto-8 has two steam jets. Electrical plugs not supplied. All models plumb to water line. Comply with ASME safety code. Use ordinary tap water.

Specifications:	D. Auto-6	E. Auto-8
Electrical*	208V, 1 Ph, 60Hz	240V, 1 Ph, 60Hz
Watts/Amps	6/8kW / 33 (1 Ph)	10kW / 48/42 (1 Ph)
Jets	1	2
Chamber Size	0.33 cu. ft.	0.92 cu. ft.
Max. Pressure	60–85 PSI	60–85 PSI per jet
Steam Generation	27 lbs./hour	34 lbs./hour
Dimensions	14¼"W x 14¼"D x 18"H	18"W x 30"D x 21"H
Ship. Wt.	76 lbs.	184 lbs.
Item#	853-0209	853-0217*
Each	\$2,895.00	5,495.00

*Other voltages/phase/hertz available. Please call or visit our website.

F. Steam Dragon™ Steamer – Safe for malls, stores and offices

This space-saving unit produces steam on-demand rather than holding it under pressure like boiler-type steamers, so it eliminates the risk of explosion. Performs comparably to much larger machines yet requires no boiler permits, so it is welcome in public locations. Simple to operate: just insert the supplied water feed hose into a bottle of water, step on the foot pedal to feed water into your unit, and watch as water instantly flashes into steam and exits the nozzle. Flow of steam stops when all the water has boiled to steam. Features foot switch, durable 20-gauge stainless steel construction and solid-state controls. UL Listed. **Requires distilled water.**

Specifications:

Electrical: 115V, 11A, 1300W, 60Hz, Max. Pressure: 90–125PSI,
 Dimensions: 9"W x 12"D x 10"H, Ship. Wt.: 26 lbs.

Description	Electrical	Item#	Each
Silver Dragon	115V	853-0042	\$725.00

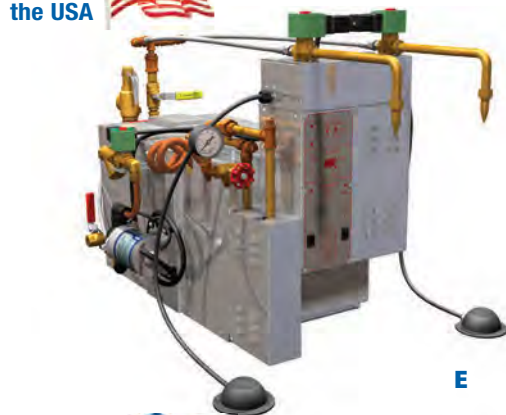



A

See page 407 for Quatro Solder Pure Fume and Particulate Extractor

A. Quatro Fresh-Air Series HEPA Air Purifiers
Ensure optimal gold recovery and air quality.

Polishing operations and bench work create a great deal of dust, some precious, some harmless and some toxic. Many dust collectors pick up much of the dust at the source, but jewelry polishing operations also allow a substantial amount of dust to become airborne and settle around the shop. Fresh-Air Series Air Purifiers capture airborne dust and other contaminants in an advanced three-stage filtration system, then recirculate clean air back into the room. All provide complete room air exchange approx. 15 times per hour. Each includes smooth casters for easy relocation to dusty areas. Electrical: 120V (240V available). Optional odor filter also available by special order. Backed by a one-year manufacturer's warranty. Made in Canada.

Filtration System Features:

- Stage-1 Prefilter – Captures the biggest particles, prolonging the life of subsequent filters. Inexpensive and easy to change.
- Stage-2 HiCap Filter – Provides high-capacity particle retention. (Most precious metal will be captured by stage-1 and 2 filters, which can be sent to your refiner for reclamation.)
- Stage-3 HEPA Filter – Picks up 99.97% of 0.3 micron particulate, including soot and pollen. Recirculates clean air back into the room to help minimize heating and AC costs.

Fresh-Air Model	400	600	1000	2000
Specifications:				
Max. Room Size, (with 8' ceiling):	250 sq.ft.	400 sq.ft.	600 sq.ft.	1200 sq.ft.
Current Draw:	0.6A	1.0A	1.6A	5.4A
Net Wt.:	63 lbs.	119 lbs.	190 lbs.	350 lbs.
Dimensions, (WxDxH):	13"x16"x28½"	22"x16"x37"	22"x16"x52"	24"x26"x71"

EACH Price				
Model Item#	854-1523	854-1522	854-1521	854-1520
	\$948.00	\$1,689.00	\$2,062.00	\$3,755.00
Replacement Filters				
Dust Filter	854-1394	854-2103	854-2103	854-2104
Package Quantity	6 each	8 each	8 each	8 each
	\$48.00	\$76.00	\$76.00	\$79.00
HICAP	854-2105	854-2106	854-2107	854-2108
Package Quantity	2 each	2 each	1 each	1 each
	\$97.00	\$116.00	\$84.00	\$111.00
HEPA	854-2109	854-2180	854-2181	854-2182
Package Quantity	1 each	1 each	1 each	1 each
	\$189.00	\$196.00	\$265.00	\$296.00



B

C

Stand Sold Separately

B, C Quatro Ductless Fume Hoods – For those without access to outside ductwork.

Units feature a two-stage filtration system that captures fumes, then recirculates clean air back into the room to save on heating and AC costs. Burnout fume hood installs right on wall behind burnout furnace. Rhodium fume hood installs directly over plating area. See Optional Stand. Each has a metal-frame filter container that holds an activated charcoal media mixture specifically formulated for the respective application. Backed by a one-year manufacturer's warranty. Made in Canada.

Specifications:

Electrical: 120V, 1.6A, 60Hz, Dimensions: 28"W x 18"D x 26"H, Net Wt.: 50 lbs.

Description	Item#	Each
B. Burnout Fume Hood	854-1525	\$1,164.00
Rhodium Fume Hood	854-1526	1,164.00
Replacement Dust Filters (8)	854-2103	76.00
Stage-2 Media Refills (4) for both fumes	854-1409	122.00
Stage-3 Media Refills (4) for burnout fumes	854-1527	213.00
Stage-3 Media Refills (4) for rhodium fumes	854-1396	169.00
C. Optional Stand	854-1524	299.00

A-C Sprits Mold Sprays

Citrus Mold Cleaner and Mold Cleaner Plus are general-purpose cleaners for removing release agents, greases, oils, fingerprints and other contaminants from molds, tools and machines. Cannot ship air, FedEx or US Mail.

Description	Item#	Each
A. Citrus Mold Cleaner, 12 fl. oz. can	816-2932	\$10.85
Citrus Mold Cleaner, case of 12	816-2939	120.00
B. Mold Cleaner Plus, 12 fl. oz. can	816-2933	7.60
Mold Cleaner Plus, case of 12	816-2940	86.00
C. Mold Protectant, 12 fl. oz. can	816-2934	6.25
Mold Protectant, case of 12	816-2941	70.00



D. JAX Silver Cleaner/Polisher

Cleans and polishes the blackest silver in just one application. Will not strip, streak or dull, making it safe for use on even the most delicate surfaces. Sold by the pint.

Description	Item#	Each
1 pt. Bottle	210-1433	\$14.65



E. KIMTECH® Mold Polish Wipes

Use for cleaning the most extreme high polished surfaces. Can be used with diamond compound for the ultimate finishing touch. Engineered for excellent absorbency and low-lint wiping, these disposable wipes are solvent resistant and contain no binders or surfactants. Rayon/polyester spunlace material for cloth-like softness. Applications include mold polishing, aerospace, clean manufacturing areas, DVD manufacturing and printing. 1 roll = 225 sheets. Each sheet measures 7" x 7".

Description	Item#	EACH Prices	
		1-5	6+
Kimtech Mold Polish Wipes	820-0515	\$33.50	\$30.15



F. SELVYT® SC Cloth for Silver

Contains an anti-tarnish agent, Selvyt SC removes light tarnish from silverware and silver jewelry. Leaves behind an invisible coating that eliminates oxidation. Stitched edges prevent fraying. Made in UK.

Size	Item#	EACH Prices		
		1-5	6-11	12+
10" x 10"	820-0280	\$5.75	\$5.46	\$5.18



G. Cape Cod Anti-Tarnish Polishing Cloth

With easy rubbing, this moist cotton cloth removes dirt and tarnish from sterling silver, gold, brass, bronze, copper, pewter, aluminum and stainless steel. Also leaves behind an invisible coating that protects against tarnish, water stains and corrosion. Keeps jewelry brighter longer. Sold in packages of two.

Size	Item#	PKG. of 2	
		1-11	12+
4" x 6"	820-0370	\$5.15	\$4.29



H. Luster Cloth

Polishes jewelry to an amazing high shine! Cleaner than a rouge cloth, Luster Cloth is a soft, felt-like material with special additives and non-scratching micro-abrasives that remove tarnish and dirt. Polishes silver, gold and many other materials to a like-new high shine. It won't scratch or stain your jewelry or your hands. Perfect for cleaning and polishing your own finished jewelry and economical enough to use as "give-aways" for your valued customers. Packaged in re-sealable plastic bags. Measures 7-1/2" x 5". For dry use only. Made in Japan.

Size	Item#	EACH Prices	
		1-11	12+
10" x 10"	820-0360	\$2.60	\$1.95



I. Tenaris Pro Anti-Tarnish Dip

Tenaris Pro represents the new borderline in the field of anti-tarnish solutions for silver, gold, brass and bronze. Tenaris Pro effectively protects items against tarnish due to a superior surface protection. Internal laboratory tests observed that silver pieces treated with Tenaris Pro do not tarnish when exposed to hydrogen sulfide vapors for more than 65 hours. Tenaris Pro is easy and fast to use since it doesn't require any specific equipment for plating. Possesses low resistance to wearing and scratching. It is therefore particularly recommended for the protection of finished pieces during storage in the display case, safe, and shop window. Sold in 1 liter bottles.

- Works by dipping—no equipment required.
- Possesses low toxicity and is not dangerous to the environment (does not contain chromium.)
- Easy to use.
- Can be easily removed from the surface.
- Does not interact with the substrate.

Description	Item#	Each
Tenaris Pro Anti-Tarnish Dip	210-1361	\$28.50



Although no hazardous shipping surcharge applies, these items can only ship via UPS® Ground, no air, FedEx® or US Mail possible. Cannot ship to Alaska, Hawaii or Puerto Rico.

Compressed Air Filters

Compressed air filters remove water, oil, dirt and dust from compressed air. These contaminants can cause rust or premature wear in air handpieces, clogged lines in sandblasters or wax contamination in injectors. Even if your air compressor has an outlet filter, a long air line allows water vapor to condense downstream. To prevent contamination problems, install filters in the air line as close as possible to the air-driven tool, sandblaster or wax pot. Gesswein filters feature screw-on transparent polycarbonate bowls with automatic drains. Bowls are easily disassembled for cleaning without removal from the air line.



A, B Miniature Filter/Regulator/Lubricator Assembly For air handpieces.

Combines functions of filter, regulator and lubricator. General-purpose filter removes solid and liquid particles down to 5 microns. Regulator allows outlet pressure adjustment from 5 to 100 PSI. Micro-fog lubricator provides oil mist to lubricate moving parts of air handpieces. Has 1 oz. reservoir. Use optional bracket to mount on wall or bench. Maximum inlet pressure: 150 psi. Ports: 1/8".

Description	Item#	Each
A. Filter Assembly	850-7349	\$215.00
B. Mounting Bracket	850-7335	9.30
Lube Oil, 8 oz.	850-0985	25.65
Replacement Filter	850-7369	14.50



C, D Miniature Prefilter/Coalescing Filter Assembly

Ideal for applications requiring dry and extremely clean air. Designed for air compressors rated up to 3.5 CFM. Prefilter removes liquid and solid particles down to 5 microns; coalescing filter removes particles down to 0.01 micron. Use optional bracket to mount on wall or bench. Maximum inlet pressure: 150 PSI. Ports: 1/4".

Description	Item#	Each
C. Filter Assembly	850-7353	\$109.00
D. Mounting Bracket	850-7359	15.60
Replacement Prefilter (white)	850-7337	19.95
Replacement Coalescing Filter (green)	850-7357	65.00



E, F Miniature Filter/Regulator

Combines the functions of filter and regulator. Filter removes solid and liquid particles in compressed air down to 5 microns. Regulator allows outlet pressure adjustment from 5 to 100 psi. Maintains nearly constant outlet pressure despite changes in inlet pressure. Use optional bracket to mount on wall or bench. Maximum inlet pressure: 150 psi. Ports: 1/4".

Description	Item#	Each
E. Filter Assembly	850-7333	\$85.00
F. Mounting Bracket	850-7335	9.30
Replacement Filter	850-7369	14.50



G. Large Prefilter/Coalescing Filter Assembly

Designed for large air compressors rated up to 15 CFM. Ideal for applications requiring greater airflow. Prefilter removes liquid and solid particles down to 5 microns; coalescing filter removes particles down to 0.01 microns. Requires regulator for use with most air tools. Maximum inlet pressure: 150 psi. Ports: 1/4".

Description	Item#	Each
G. Filter Assembly	850-7355	\$160.00
Replacement Prefilter (white)	850-7337	19.95
Replacement Coalescing Filter (green)	850-7365	145.00



H-J Barbed Fitting, Worm Drive Clamp and Reinforced Air Hose

Fitting works with most wax injectors and small vacuum pumps. Worm drive clamp fastens air hose securely to fitting.

Sturdy 1/4" I.D. rubber air hose reinforced to withstand air pressures up to 250 PSI. Use for compressed air and vacuum pumps. Works with barbed fittings. Sold by the foot.

Description	Item#	Each
H. Worm Drive Clamp	265-2274	\$3.95
I. Barbed Fitting, 1/4" NPT	265-2272	5.95
J. Reinforced Air Hose	265-2273	2.50

A. SilentAire Compressors – Quiet yet powerful!

The **Val-Air** is a premium value model with cast aluminum lid with cooling fins for improved ventilation and Filter-Regulator with auto-drain feature and condensate bottle. With a coalescent filter to 0.01 micron.

Sil-Air is the same without the aluminum lid with cooling fins or coalescent filter.

Both versions feature powerful 1/2 HP motors which provide over 2 CFM of air. They can handle up to 10 large Wax Injectors and are fully automatic. Both make about as much noise as a refrigerator, so you can work without distraction. Both measure 14" dia. x 22"H. Weigh 58 lbs. May require additional filter at the air tool to eliminate condensation that can form in very long airlines. Accepts 1/4" male fittings. 220V also available. Made in Italy.

Features:

- Tank and line pressure gauge
- Line pressure regulator
- Moisture trap and filter
- Safety valve
- Air-intake filter

Specifications:

Motor	1/2 HP
Max. Pressure	114 PSI
Tank Capacity	4 gals.
Displacement	2.15 CFM
Noise Level	40 dB

Description	FOB	Electrical	Item#	Each
A. SilentAire Val-Air Compressor	CT	110V	265-3100	\$1,245.00
SilentAire Val-Air Compressor	TX	110V	265-3101	1,225.00
SilentAire Sil-Air Compressor	TX	110V	265-3095	1,045.00
SilentAire Sil-Air Compressor	CT	110V	265-3094	1,065.00
Replacement Oil, 24 oz.			265-3103	27.00



A

B. Oil-Free Air Compressor – 3/4 HP Oil-Free Air Compressor

Engineered and built with the latest technology to provide high quality clean air. The Oil-Free Dual Piston Pump System allows the air compressor to work more efficiently, creating less noise and less wear for a longer pump life. Oil-less operation makes it virtually maintenance free! Includes tank and line pressure gauge, line pressure regulator, moisture trap with filter, safety valve, and air intake filter. Made in China.

Specifications:

Motor:	3/4 HP	Noise level:	52 dB
Max. Pressure:	116 PSI / 8 bar	Airflow:	118 liters per minute
Tank Capacity:	6 gals.	Dimensions:	16"Dia. x 21H"
Displacement:	4.2 CFM	Weight:	61lbs.

Description	FOB	Electrical	Item#	Each
B. Oil-Free Air Compressor	CT	110V, 600 watts	265-3120	\$625.00
Oil-Free Air Compressor	NY	110V, 600 watts	265-3122	595.00



B

C. California Air Tools 4610AC – 1 HP & Oil-Free Air Compressor

Quiet, (60 dB) oil-free and lightweight. Designed to increase duty cycle and allow for longer continuous run times. Powerful 1.0 HP motor is engineered to dissipate heat, allowing for a cooler operation while reducing wear. The Oil-Free Dual Piston Pump System is engineered for high performance and durability. Complete with two pressure control gauges, air filter, two universal 1/4" quick connectors, and thermal overload protector. 220V also available. Made in China.

Specifications:

Motor:	1 HP	Noise level:	60 dB
Max. Pressure:	120 PSI	Dimensions:	19 1/8"L x 16 3/4"W x 19 3/4"H
Tank Capacity:	4.6 gals. (Aluminum Tank)	Weight:	44 lbs.

Description	Electrical	Item#	Each
California Air Tools 4610AC	110V/60Hz	265-3125	\$325.00



C

D-O Quick Disconnect Air Hose and Fittings

Sturdy 1/4" O.D. nylon air hose with .040" wall thickness and a collection of timesaving quick-disconnect fittings. To connect, just push air hose into fitting—it automatically locks in place. To disconnect, push back plastic ring on fitting and pull air hose out.

Description	Item#	Per Foot	Description	Item#	Per Foot
D. Nylon Air Hose, 1/4" O.D.	265-2286	\$0.94	J. Nipple Reducer, 1/4"-1/8"	265-2289	\$ 3.95
E. QD Connector, Male, 1/4"	265-2276	\$6.85	K. Plug for QD 1/4" Connectors	265-2283	1.60
F. QD Elbow, Male, 1/4"	265-2288	7.80	L. Coupling, Female, 1/4" to 1/4"	265-2284	2.75
G. QD Swivel Elbow, Male, 1/8"	265-2291	5.96	M. QD Union (Straight), 1/4"	265-2282	4.65
H. QD Swivel T-Connector, Male, 1/4"	265-2278	7.70	N. QD Union T, 1/4"	265-2281	6.65
I. QD Connector, Male, 1/8"	265-2277	3.75	O. QD Union Elbow, 1/4"	265-2279	5.50



D



A

A. Vacuum Pump

A 1/3 HP unit provides 3 CFM for removing air bubbles from investment or pulling gases from flasks during casting so that molten metal can flow quickly into cavities. Electrical: 110V, 1 Ph, 60Hz. Measures 14¹/₄"L x 5¹/₂"W x 11¹/₂"H. Ship. wt: 31 lbs.

Description	Item#	Each
Vacuum Pump - 1/3 HP	265-1757	\$450.15
High Vacuum Pump Oil, 1qt.	265-1753	16.95



B

B. Thomas Oil-less Vacuum Pump

A quiet, efficient oil-less 1/4 HP unit provides 1.5 CFM designed for continuous use with your wax injector. Creates 29.9" Hg of vacuum. Recommended when maximum vacuum is the critical factor (i.e., when injecting large, complex or filigree molds). Runs cool and has few moving parts for minimal maintenance. Includes thermal overload protector with auto-reset. Measures 10"L x 6"W x 7"H. Ship. wt: 15.5 lbs. 230V 50Hz available by special order.

Description	Electrical	Item#	Each
B. Oil-less Vacuum Pump - 1/4 HP	115V, 4A, 60Hz	265-2255	\$825.00
Repair Kit (two required)		265-2258	195.00





C

C. Busch™ Rotary Vane Vacuum Pumps

Oil-sealed, air-cooled direct-drive pumps excellent for applications in which the vacuum source must be reliable and unobtrusive. Operate quietly with low vibration. Each includes inlet filter assembly.

The 1¹/₄ HP Vacuum Pump #15 provides 15 CFM free air displacement. Ideal for use with VacuVest #10. Measures 17"L x 10¹/₂"W x 9"H. Ship. wt: 60 lbs.

The 2 HP #28 versions provide 28 CFM free air displacement. Ideal for use with VacuVest #20. Measure 28"L x 15"W x 10¹/₂"H. Ship. wt: 173 lbs.

Description	Electrical	Item#	Each
C. Vacuum Pump #15 - 1 1/4 HP	220V, 1 Ph, 50/60Hz	265-2386	\$2,499.00
Vacuum Pump #28 - 2 HP	115/230V, 1 Ph, 60Hz	 265-2381	3,995.00
Vacuum Pump #28 - 2 HP	230V/460V, 3 Ph, 50/60Hz	 265-2387	3,650.00
Oil for #15, 1 qt.		265-1708	32.99
Oil for #28, 1 qt.		265-1707	8.75

*For export only.



D

D. Airtech™ Rotary Vane Vacuum Pumps

Oil-flooded, air-cooled direct-drive vacuum pumps designed for reliability and longevity. Feature durable composite vanes, oil level sight glass, wire mesh inlet filter, exhaust filters and vibration isolators for quiet operation. Choose from 15 CFM and 28 CFM and 45 CFM models.

Specifications:	15 CFM	28 CFM	45 CFM
Motor	1 HP	2 HP	3 HP
Noise Level	62 dBA	67 dBA	70 dBA
Dimensions (L x W x H)	16 ¹ / ₈ " x 10 ³ / ₄ " x 8 ⁵ / ₈ "	27" x 11 ¹ / ₂ " x 11"	28 ⁵ / ₈ " x 17 ¹ / ₄ " x 12 ¹ / ₄ "
Net/Ship. Wt.	42/70	116/140	175/220

Description	Electrical	Item#	Each
15 CFM Vacuum Pump - 1 HP	115/230V, 1 Ph, 60Hz	265-1690	\$2,445.00
28 CFM Vacuum Pump - 2 HP	208-230/460V, 3 Ph, 50/60Hz	265-1691	3,365.00
45 CFM Vacuum Pump - 3 HP	208-230/460V, 3 Ph, 50/60Hz	 265-1692	4,295.00



E

E. Flushing Oil

For optimal service and long life from your vacuum pump, use flushing oil once a year. Just drain all the old oil, fill to normal level with flushing oil, run pump for 30 minutes, drain flushing oil, then fill with appropriate vacuum pump oil. Sold in 1 qt. container.

Description	Item#	Each
Flushing Oil, 1 qt.	265-1706	\$34.00



F

F. Air Gun with Self-Coiling Hose

A high-quality blow gun with responsive spring-loaded trigger. Produces a very narrow air stream on-demand. Includes convenient self-coiling 1/4" hose and 1/4" NPT coupler. Gun tip extends roughly 4" out of molded plastic handle. Color may vary.

Description	Item#	Each
Air Gun with Self-Coiling Hose	265-2325	\$39.50

A. PEPETOOLS Professional Pearl & Bead Drilling Machine

Drilling holes in pearls and beads can present several challenges, mainly when it comes to fixing them in place. This drill press meets those challenges head-on to help save precious time. Features a unique adjustable holding jig for securing multiple sizes of pearls and stones, ensuring you get straight, properly sized holes each and every time. Works in combination with your #30 handpiece (see p. 438) and flex shaft.

Features:

- Double-loop holder for securing your #30 handpiece
- Brass cup jaws for easy and stable mounting of pearls and beads
- 180° rotating jaw table for preventing hole misalignment when drilling from the opposite side
- Water holding post for cooling items while drilling, allows use of diamond drill bits
- Advancing lever for moving items securely into drill

Description	Item#	Each
Drilling Machine	816-1445	\$215.00

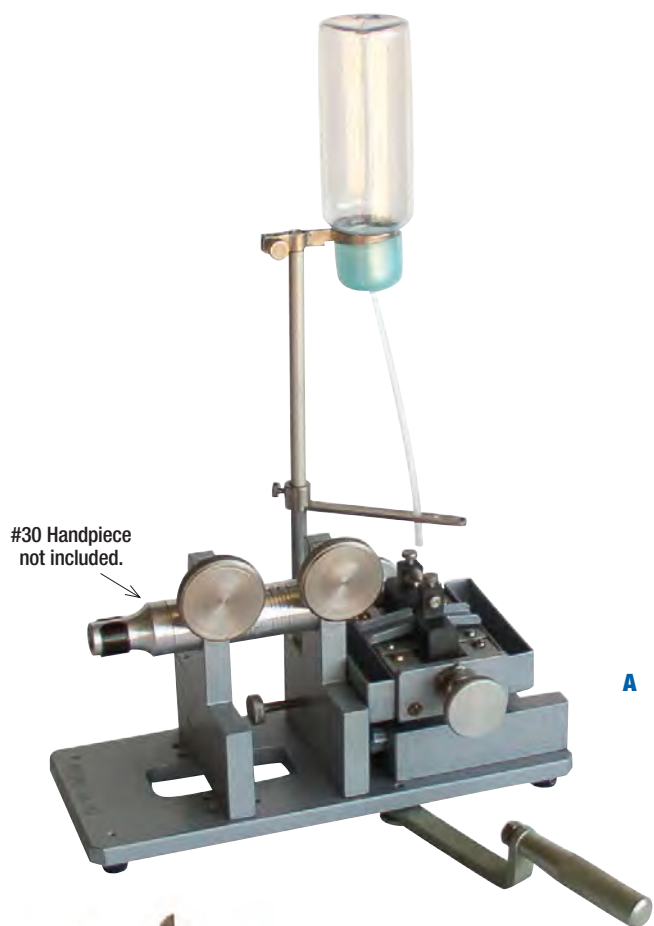

A

B. Pearl Drills – 1/8" Shank

Used to drill setting holes for seed pearls as well as both round and half-round stones. Sold individually and in a set of 12 diameters with plastic stand and cover.

Dia. (mm)	Item#	Each
1.05	816-1425	\$8.45
1.20	816-1426	8.45
1.45	816-1427	8.45
1.65	816-1428	8.45
1.85	816-1429	8.45
2.05	816-1430	8.45
2.26	816-1431	8.45
2.40	816-1432	8.45
3.00	816-1435	8.45

12-Piece Set (1.05, 1.20, 1.35, 1.45, 1.65, 1.85, 2.05, 2.26, 2.40, 2.65, 2.83, 3.00mm)	816-1420	103.95
-----------------------------------------------------------------------------------------------	----------	--------



B

C. Hand Drill

A sturdy, smooth-operating tool for easy control of drilling speed and pressure. Includes keyless chuck with 1/4" capacity. Measures approximately 9 1/2" overall length. Color may vary.

Description	Item#	Each
Hand Drill	816-1410	\$23.95



C

D. Pearl Holding Vise

This steel vise secures all popular sizes of pearls for easy drilling. Has 13 holes for holding pearls or beads and knurled locknuts for fast clamping and releasing. Includes carrying pouch. Measures 1 3/8" in diameter. Imported.

Description	Item#	Each
Pearl Holding Vise	816-1440	\$9.05



D

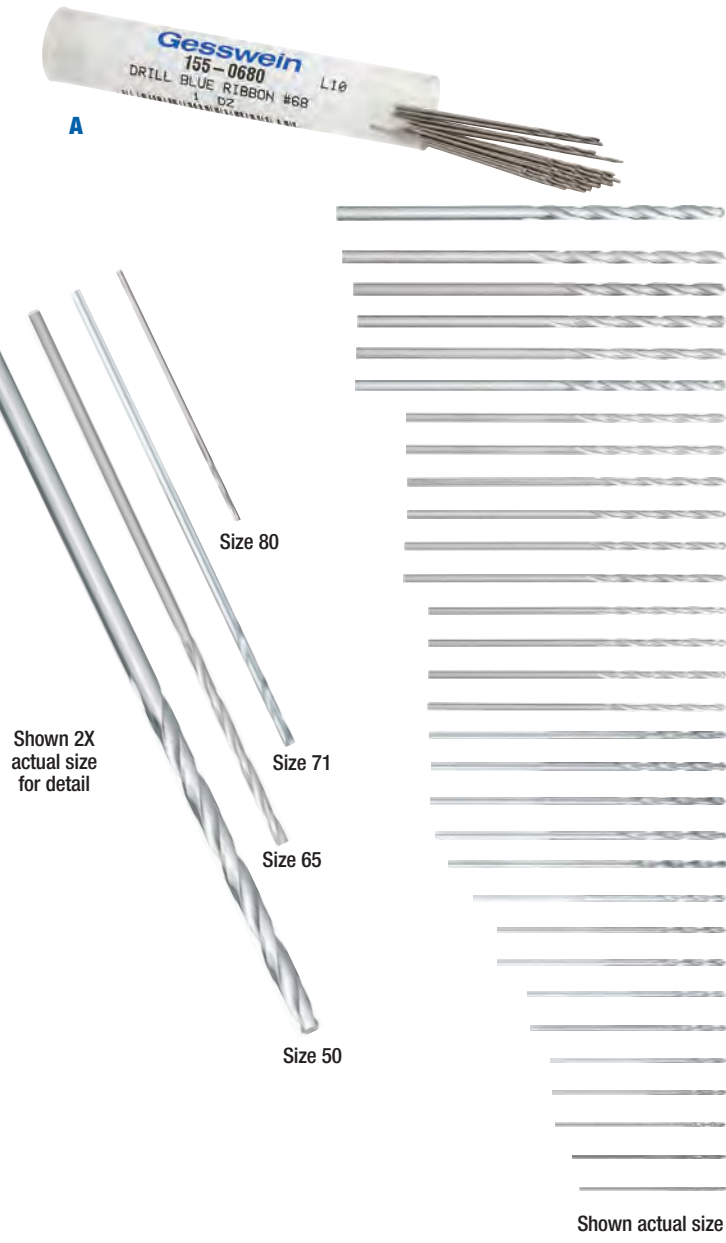

A. Blue Ribbon™ High-Speed Twist Drills – Made in USA.

Jobbers length drills made of the finest high-speed steel, heat-treated to 63–65 HRC and precision-ground to a tolerance of +.0000 to –.0003" for a perfect hole every time. Great on all metals, even surgical steel. Checked under a 20X microscope before shipping. Sold by the dozen.

Size	Dia. (inches)	Item#	DZ. Prices	
			1-11	12+
50	.070	155-0500	\$21.10	\$18.99
51	.067	155-0510	21.10	18.99
52	.0635	155-0520	21.10	18.99
53	.0595	155-0530	21.10	18.99
54	.055	155-0540	21.10	18.99
55	.052	155-0550	21.10	18.99
56	.0465	155-0560	21.10	18.99
57	.043	155-0570	21.10	18.99
58	.042	155-0580	21.10	18.99
59	.041	155-0590	21.10	18.99
60	.040	155-0600	21.10	18.99
61	.039	155-0610	21.10	18.99
62	.038	155-0620	21.10	18.99
63	.037	155-0630	21.10	18.99
64	.036	155-0640	21.10	18.99
65	.035	155-0650	21.10	18.99
66	.033	155-0660	21.10	18.99
67	.032	155-0670	21.10	18.99
68	.031	155-0680	21.10	18.99
69	.0292	155-0690	23.70	21.33
70	.028	155-0700	23.70	21.33
71	.026	155-0710	28.85	25.97
72	.025	155-0720	28.85	25.97
73	.024	155-0730	28.85	25.97
74	.0225	155-0740	28.85	25.97
75	.021	155-0750	28.85	25.97
76	.020	155-0760	28.85	25.97
77	.018	155-0770	28.85	25.97
78	.016	155-0780	28.85	25.97
79	.0145	155-0790	35.15	31.64
80	.0135	155-0800	35.15	31.64



B. Blue Ribbon™ High-Speed Twist Drill Sets

Description	Item#	Each
B. 20-Piece Set (sizes 61–80)	155-2020	\$43.50
12-Piece Set (sizes 55, 57, 60, 62, 64, 65, 66, 68, 70, 72, 73 and 75)	155-2010	23.50

C, D Adapter Chucks – 3/32" Shank

Allow you to use tools with small shanks in standard flex shaft handpieces. Threads are right-hand.

Description	Item#	Each
C. 0-1.00mm Chuck	840-3210	\$13.35
D. 0-2.62mm Chuck	840-3220	15.50

A. Busch® High-Speed Metric Twist Drills – Fig 203HSS, 3/32" Shank

Made of high-speed steel. More durable than tungsten vanadium steel on hard metals such as white gold, platinum, surgical steel and more. Made in Germany.

Diameter		Item#	EACH Prices	
(mm)	(inches)		 2-22	24+
0.50	.0197	122-6992	\$5.95	\$5.06
0.60	.0236	122-6993	5.95	5.06
0.70	.0276	122-6994	5.95	5.06
0.80	.0315	122-6995	5.95	5.06
0.90	.0354	122-6996	5.95	5.06
1.00	.0393	122-6997	5.95	5.06
1.10	.0433	122-6998	5.95	5.06
1.20	.0472	122-6999	5.95	5.06
1.30	.0512	122-7000	5.95	5.06
1.40	.0551	122-7001	5.95	5.06
1.50	.0591	122-7002	5.95	5.06
1.60	.0630	122-7003	5.95	5.06



B. Busch® Metric Twist Drills – 3/32" Shank

Made of tungsten vanadium steel. For handpieces with 3/32" collets. Sold in multiples of six or a set of one each, 12 assorted sizes. Made in Germany.

Diameter		Item#	EACH Prices		
(mm)	(inches)		 6-66	72-138	144+
0.50	.0197	122-7005	\$2.39	\$2.03	\$1.91
0.60	.0236	122-7006	2.39	2.03	1.91
0.70	.0276	122-7007	2.39	2.03	1.91
0.80	.0315	122-7008	2.39	2.03	1.91
0.90	.0354	122-7009	2.39	2.03	1.91
1.00	.0393	122-7010	2.39	2.03	1.91
1.10	.0433	122-7011	2.39	2.03	1.91
1.20	.0472	122-7012	2.39	2.03	1.91
1.30	.0512	122-7013	2.39	2.03	1.91
1.40	.0551	122-7014	2.39	2.03	1.91
1.50	.0591	122-7015	2.39	2.03	1.91
1.60	.0630	122-7016	2.39	2.03	1.91
1.70	.0669	122-7017	2.39	2.03	1.91
1.80	.0709	122-7018	2.39	2.03	1.91
1.90	.0748	122-7019	2.39	2.03	1.91
2.10	.0827	122-7021	2.39	2.03	1.91
2.20	.0866	122-7022	2.39	2.03	1.91
2.30	.0906	122-7023	2.39	2.03	1.91



See Solid Carbide Drills
on pages 178

C. Busch® Metric Twist Drill Set

Made of tungsten vanadium steel. Includes 0.60, 0.70, 0.80, 0.90, 1.00, 1.20, 1.40, 1.50, 1.60, 1.80, 2.10 and 2.30mm sizes. Made in Germany.

Description	Item#	Each
12-Piece Set	122-7030	\$22.99



D. Busch® Carbide Twist Drills – Fig 4203S – 3/32" Shank

Made of carbide for hardness and long life. Carbide Twist Drills are packaged two to a box; available only in multiples of two. Made in Germany.

Diameter		Item#	EACH Prices	
(mm)	(inches)		 2-22	24+
0.50	.0197	125-5485	\$14.45	\$12.28
0.60	.0236	125-5486	14.45	12.28
0.70	.0276	125-5487	13.25	11.26
0.80	.0315	125-5488	13.25	11.26
0.90	.0354	125-5489	13.25	11.26
1.00	.0393	125-5490	13.25	11.26
1.10	.0433	125-5491	13.25	11.26
1.20	.0472	125-5492	13.25	11.26
1.30	.0512	125-5493	13.25	11.26
1.40	.0551	125-5494	13.25	11.26
1.50	.0591	125-5495	13.25	11.26
1.60	.0630	125-5496	13.25	11.26



2 grooves



 Two-piece minimum; Please order in multiples of two.

 Six-piece minimum; Please order in multiples of six.



A



B



C



D



E

A. High Speed Steel Metric Twist Drills

High-speed steel twist drills with matching tip and shank diameters. Feature bright finish, precision tips with the optimal cutting angle and sharp flutes with the proper spiral and finished outer edges. Made in Germany. Sold in packages of 10.

Diameter (mm)	(inches)	Item#	PKG. of 10	
			1-4	5+
0.50	.0197	155-0900	\$10.25	\$9.23
0.60	.0236	155-0902	10.25	9.23
0.70	.0276	155-0904	9.30	8.37
0.80	.0315	155-0906	8.85	7.97
0.90	.0354	155-0908	8.85	7.97
1.00	.0393	155-0910	8.85	7.97
1.10	.0433	155-0912	8.15	7.34
1.20	.0472	155-0914	8.15	7.34
1.30	.0512	155-0916	8.15	7.34
1.40	.0551	155-0918	8.15	7.34
1.50	.0591	155-0920	8.15	7.34
1.60	.0630	155-0922	8.15	7.34

B. High Speed Steel Metric Twist Drill Set

Includes one package of each size listed above.

Description	Item#	Each
120-Piece Set	155-0899	\$82.50

C. MAILLEFER Metric Twist Drills – 3/32" Shank

Made of tungsten vanadium steel. For handpieces with 3/32" collets. Sold in multiples of six or in a set of one each of selected sizes see below. Made in Switzerland.

Diameter (mm)	(inches)	Hole Depth (mm)	Item#	EACH Prices		
				6pc	6-66	72-138
0.50	.0197	5.4	155-2300	\$2.39	\$2.03	\$1.91
0.60	.0236	5.5	155-2301	2.39	2.03	1.91
0.70	.0276	5.6	155-2302	2.39	2.03	1.91
0.80	.0315	5.7	155-2303	2.39	2.03	1.91
0.90	.0354	9.25	155-2304	2.39	2.03	1.91
1.00	.0393	9.35	155-2305	2.39	2.03	1.91
1.10	.0433	9.4	155-2306	2.39	2.03	1.91
1.20	.0472	9.5	155-2307	2.39	2.03	1.91
1.40	.0551	9.7	155-2309	2.39	2.03	1.91
1.50	.0591	9.7	155-2310	2.39	2.03	1.91
1.60	.0630	9.8	155-2311	2.39	2.03	1.91
1.70	.0669	9.85	155-2312	2.99	2.54	2.39
1.80	.0709	9.95	155-2313	2.99	2.54	2.39
1.90	.0748	10.05	155-2314	2.99	2.54	2.39
2.10	.0827	10.3	155-2316	2.99	2.54	2.39
2.30	.0906	10.5	155-2318	2.99	2.54	2.39

6pc Six-piece minimum; Please order in multiples of six.

D. MAILLEFER Metric Twist Drill Set

Includes 0.60, 0.70, 0.80, 0.90, 1.00, 1.20, 1.40, 1.50, 1.60, 1.80, 2.10 and 2.30mm sizes. Made in Switzerland.

Description	Item#	Each
12-Piece Set	155-2319	\$33.65

E. Automatic Center Punch

Delivers a sharp blow when depressed. Lets you vary impressions by simply adjusting the knurled head. Measures 4 3/4" long.

Description	Item#	Each
Automatic Center Punch	814-1100	\$27.95
Replacement Tip	814-1102	7.40

A, B Diamond Twist Drills

High-speed steel twist drills coated at the tips with medium-fine diamond grit for drilling stones, ceramics, glass and other hard, nonmetallic materials. Use water as a lubricant. Available individually or in a set of all 12 sizes.

	Diameter			
	Size (mm)	(inches)	Item#	Each
A. 65	0.90	.035	226-1365	\$6.95
61	0.99	.039	226-1361	6.95
56	1.18	.0465	226-1356	6.95
54	1.39	.055	226-1354	6.95
53	1.51	.0595	226-1353	6.95
52	1.61	.0635	226-1352	6.95
51	1.70	.067	226-1351	6.95
50	1.77	.070	226-1350	6.95
47	1.99	.078	226-1347	6.95
45	2.08	.082	226-1345	6.95
40	2.49	.098	226-1340	6.95
36	2.70	.106	226-1336	6.95
B. 12-Piece Set (one of each size)			226-1300	59.95



A

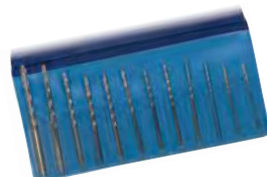

B

See Diamond Drilling Compounds on pages 104, 105

C, D Metric Diamond Twist Drills – 3/32" Shank

Twist drills electroplated with medium-fine diamond grit for drilling stones, pearls, glass and ceramics. Can be used with any standard flex shaft handpiece. Use water as lubricant. Available individually or in a set of all 6 sizes.

	Diameter			
	(mm)	(inches)	Item#	Each
C. 1.00	.0393		226-1241	\$4.95
1.30	.0512		226-1242	4.95
1.40	.0551		226-1243	4.95
1.60	.0630		226-1244	4.95
1.80	.0709		226-1245	4.95
2.10	.0827		226-1246	4.95
D. 6-Piece Set (one of each size)			226-1240	26.95



C

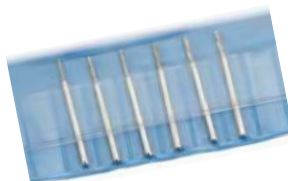

D

E, F Diamond Drill Sticks

Hardened steel drills coated at the tips with diamond grit for fast drilling of stones and ceramics. Run at speeds between 5,000 and 20,000rpm. Use water or light oil as lubricant. Available individually or in a set of all 6 sizes.

	Dia. (mm)	Item#	Each
E. 0.75		226-1455	\$2.95
1.0		226-1460	2.95
1.25		226-1465	2.95
1.5		226-1470	2.95
2.0		226-1475	2.95
2.5		226-1480	2.95
F. 6-Piece Set (one of each size)		226-1450	17.95



E

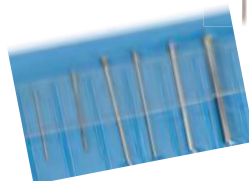

F

See Diamond Lapp Drills on pages 121

G-M Diamond Core Drills – 3mm Shank

Stainless steel drills electroplated with medium-fine diamond grit for cutting holes in stones, ceramics and glass without chipping or cracking. Must use water or light oil as lubricant.

	Dia. (mm)	Item#	Each
	1.5	226-1401	\$5.95
G. 2.0		226-1402	5.95
H. 2.5		226-1403	5.95
I. 3.0		226-1404	5.95
J. 5.0		226-1408	8.95
K. 6.5		226-1411	10.85
L. 9.5		226-1417	14.85
	10.0	226-1418	15.95
M. 11.0		226-1420	18.50

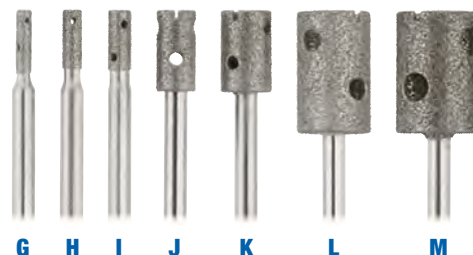

G H I J K L M

Shown actual size



A



B



C



D



E



F



G



H



I

A. Colibri Tap Set with Die Plate

Includes eight replaceable steel taps (see below) for threading insides of holes and matching 4³/₈"L x 7⁷/₈"W steel die plate with clearly marked sizes for threading wires. Lets you make your own screws and ear wire threads. Made in Germany.

Description	Item#	Each
Tap Set with Die Plate	816-2047	\$189.95

Replacements

0.6mm Tap	816-1997	7.95
0.8mm Tap	816-2001	7.95
1.0mm Tap	816-2003	7.95
1.2mm Tap	816-2005	7.95
1.4mm Tap	816-2007	8.40
1.6mm Tap	816-2009	8.40
1.8mm Tap	816-2011	9.90
2.0mm Tap	816-2013	9.90
Die Plate	816-2048	130.00

B. WIRU Watchmakers Tap & Die Set

Precision tap and die set for watch, clock and jewelry repair. The 4EE model consists of 8 taps, one each of 0.70mm, 0.80mm, 0.90mm, 1.00mm, 1.10mm, 1.20mm, 1.30mm, 1.40mm, along with 8 screw dies of corresponding metric threads, die handle and an adjustable tap handle. Supplied in wooden case. Made in Germany.

Description	Item#	Each
Watchmakers Tap & Die Set	816-2050	\$525.00

C-G Reamers

Made of tempered steel, these five-sided cutting broaches are used for cleaning and reaming holes. Sizes are for diameters measured slightly below largest part of cutting edges.

	Stubbs Size	Diameter (mm)	Diameter (inches)	Item#	Each
C.	30	3.226	.127	821-0300	\$5.55
D.	40	2.464	.097	821-0400	3.65
E.	50	1.753	.069	821-0500	2.80
F.	60	0.990	.039	821-0600	1.97
G.	70	0.685	.027	821-0700	1.97
	12-Piece Set (15, 25, 30, 35, 40, 45, 48, 51, 54, 56, 65, 70)			821-1157	39.85
	12-Piece Set (30, 35, 40, 45, 48, 52, 54, 55, 58, 62, 65, 70)			821-1307	39.85

H. Reamer Set

Includes six five-sided cutting broaches in Stubbs sizes 46–72 (2.007–0.610mm in diameter). Comes complete with plastic case. Broaches feature regular taper with excellent finish and comfortable plastic handles. Made in Germany.

Description	Item#	Each
Reamer Set	821-1309	\$13.95

I. Brass Riveting Wire

Used to make pins or rivets in pin findings for jewelry. Sold in packages of 6" lengths in assorted B&S gauge diameters (14–21).

Description	Item#	PKG. Prices	
		1-11	12+
Brass Riveting Wire	816-2600	\$4.65	\$3.95

Why Are Rectifiers Needed?

Rectifiers serve as sources of direct current for electroplating and electrostripping operations. A rectifier that operates on 115V AC and converts it to direct current can be easily regulated to produce the required voltage. When selecting a rectifier, be sure to choose one with sufficient amperage output, which determines the size of the bath as well as the surface area that can be plated. 10A output is recommended for smaller baths and can be used for electrostripping smaller items. For larger baths and electrostripping larger items, 25A output is recommended.



A, B PEPETOOLS IPS Pro 10A/25A and IPS Plus 10A/25A

Available in either 10A or 25A, and choose between the (IPS Pro) or the (IPS Plus) which incorporates a solution coil heater to keep your solutions at a consistent temperature. The IPS - (Intelligent Plating System) - rectifiers from Pepetools are the most user friendly, intuitive and fully programmable systems available.

All versions are fully programmable and user friendly utilizing a "one button" plating system. Two (2) internal counters provide an important measuring function that allows user to properly maintain plating bath, regulate the thickness of the plating and also calculate the amount of material being used. Just set the values you require and press start. IPS also can handle when your work piece accidentally touches the anode causing a short. That would normally shut down a plating system, but with IPS plating is bypassed until the short is eliminated and will self-restore and continue with the preset values entered.

These rectifiers utilize a sequential (staged) process providing an environment for a properly controlled crystal growth with the necessary density of the deposits. Both factors contribute to an exceptionally shiny, non-pitted finish.

Features:

- Ability to set plating voltage and amperage
- Ability to set plating time (1 second to 9 hours and 59 seconds)
- Reverse polarity time
- Integrated Amp hour counter
- Storage space for (5) individual programs (with defined plating time, reverse polarity time, current voltage, current amperage, and delayed start).
- Sequential Programming allows larger plating operations

Both the IPS Plus and the IPS Pro come with the IPS control unit and lead wires. The IPS Pro also includes a solution coil heater that fits a 1000ml beaker (not included) and is accurate up to +/- 1°C. This heater is fully programmable in either Fahrenheit or Celsius and maintains the set temperature perfectly! Made in USA.

Description	Item#	Each
A. IPS Pro 10A	212-0958	\$865.00
IPS Pro 25A	212-0959	865.00
B. IPS Plus 10A	212-0955	575.00
IPS Plus 25A	212-0956	575.00



A



B

C. PEPETOOLS Thermocontroller and Magnetic Mixer Set

Because hotplates and similar heating units for plating heat from underneath, and the glass commonly used for beakers is a very good insulator, these units take a long time to heat and fail to provide accurate, consistent temperature control. This revolutionary set solves these problems by heating your bath from within and constantly stirring it to maintain even temperature. Suitable for small and large baths. Heats a 2-liter bath to 125°F in 30 minutes.

Includes Thermocontroller with coil and sensor and Magnetic Mixer with stirring pellet. Thermocontroller turns blue when bath is not hot enough and green when at temperature, allowing you to see at a glance when solution is ready. Has a control dial and switch for displaying temperature in °F or °C. Measures 4.8"W x 5.9"D x 1.4"H. Magnetic Mixer has a control dial that allows you to fine-tune stirring speed. For consistent even plating the PEPE Thermocontroller and Magnetic Mixer Set is a must! Measures 3.0"W x 6.9"D x 5.1"H. Both units also include 110/220V selector switch. Made in the USA.

Description	Item#	Each
Thermocontroller and Magnetic Mixer Set	212-0732	\$550.00



C

Easy-To-Use Innovative Plating Systems for Every Jeweler

JENTNER
PLATING TECHNOLOGY

Jentner products are used in more than 30 countries wherever quality and precision are required. With over 30 years of experience in the electroplating and surface finishing area they are known for providing innovative technologies. Gesswein is proud to offer a comprehensive range of Jentner electroplating products from the Digital II and Digital V galvanic bath platers to RMGO!, the revolutionary room temperature system (see facing page), to the Picco pen plater (see page 267). Made in Germany.

Digital II & V Compact Electroplating Systems – For pen and bath plating

The Plating Process just got even easier with the Digital II and Digital V Compact Plating Systems. The small, compact Digital II has a volume of (6) 1.5 liter tanks for cleaning and plating whereas the more robust/larger Digital V has a volume of (4) 5 liter and (4) 2 liter tanks for cleaning and plating. These galvanic units can be used for all current galvanic baths e.g. cold electro cleaning, and cold gold plating baths, bright silver and rhodium baths, palladium or ruthenium baths as well as non-precious metals like copper or nickel.

Both have preinstalled electroplating programs for several coating processes that defines a new dimension for easy and high quality plating. Pre-adjusted voltages make electroplating very easy. An integrated time countdown function and minute counter prevents overplating and guarantees energy efficient work. Plating solutions, anodes, heater, plating jigs, and other accessories sold separately.

Features:

- Several flexible programs to adjust and store. Guarantees safe accurate processes for a constant high quality
- Easy to handle and to adjust by digital display of voltage and temperature
- Ampere minute counter guarantees overview in precious metal accounting
- Safety by high quality, metal welded case and integrated splash-guard cap
- Two flexible heaters can be installed
- Efficient electroplating with convertible tanks
- Dual voltage: 110V 60Hz / 220V 50Hz

Description

Description	Item#	Each
A. Digital II Compact Electroplating System	212-0960	\$4,395.00
B. Digital V Compact Electroplating System	212-0960	4,395.00
MOX Anode, 100X40mm, for Digital II	210-2510	79.95
MOX Anode, 150X40mm, for Digital V	210-2511	88.95
MOX Anode, for Beaker, for Digital II	210-2512	95.50
Plating Jig for Rings (12 Hooks, for 1/3L Tanks), for Digital II	210-2556	119.00
Plating Jig for Chains (12 Hooks, for 1/3L Tanks), for Digital II	210-2557	129.00
Plating Jig for Rings (24 Hooks, for 3L Tanks), for Digital V	210-2558	184.95
Plating Jig for Chains (16 Hooks, for 3L Tanks), for Digital V	210-2559	149.95
Plating Jig for Chains (32 Hooks, for 5L Tanks), for Digital V	210-2560	199.95
Plating Jig for Chains (16 Hooks, for 5L Tanks), for Digital V	210-2561	159.95
Plat Anode, for Digital II or Digital V	210-2613	145.95
SS Anode, for Digital II	210-2704	18.95
SS Anode, for Digital V	210-2706	29.95
Optional Heater, 115V	212-0963	399.00
Optional Thermocouple, for Digital II or V	212-0962	280.00

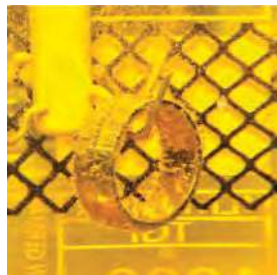
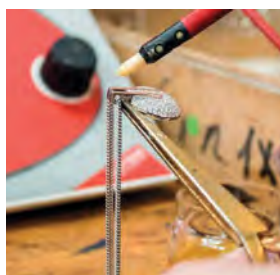

A. RMGO! Plating Kits – (Plating As Easy As 1, 2, Go!)**Cold solutions • room temperature • no heat required**

RMGO! is available for gold or rhodium plating or a deluxe set with all you need for both.

Pre-installed times and voltages allow an exact deposition of the metal. You can choose from 15 sec, 30 sec or 60 sec of plating. There is an automatic power shut-off after the elapsed time. This assures a perfect coating as no precious metal is wasted. Plating solutions sold separately. Made in Germany.

Advantages:

- A deposition time of 36 sec instead of 30 sec costs you 20% more of your expensive rhodium! That is a cost saving of 0.2 g rhodium at 1000 rings if you plate exactly 30 sec.
- Absolutely safe process as the voltage needs not to be set – easy handling by only one GO! button.
- Errors are avoided as no voltage needs to be set.
- More than 1000 rings with 1 ltr. Rhodium solution JE88 and an ultra brilliant white shining surface.
- Select your own appropriate cold bath solutions.
- Return on invested capital within max. three months, depending on your output.

Description	Item#	Each
RMGO! Rhodium Plating Kit (1)	210-0015	\$1,250.00
RMGO! Gold Plating Kit (2)	210-0017	1,225.00
A. RMGO! Deluxe Plating Kit (3)	210-0019	1,375.00

B. Cold Rhodium Bath JE88

2g Rh, makes 1 liter. JE88 deposits brilliant white shining glossy, hard and abrasion-resistant rhodium layers.

Description	Item#	Each
*Cold Rhodium Bath JE88 	210-0906	\$280.00

C. Cold Black Rhodium Bath JE23-1

2g Rh, makes 1 liter. Dark anthracite-grey, abrasion resistant Rhodium layers.

Description	Item#	Each
*Cold Black Rhodium Bath JE23-1 	210-0909	\$280.00



D. Cold Color Gold Baths

Delivered ready to use and allows easy to handle operation at room temperature. 1g gold per liter.

Description	Item#	Each
D. 14K Yellow	210-0913	\$150.00
18K Yellow	210-0912	150.00
24K Yellow	210-0912	150.00
Red	210-0910	150.00

E. Electrocleaner JE610

Cyanide-free, anodic salt degreaser for galvanic degreasing of all conventional metallic objects. Available in 100g and 1kg sizes.

Description	Item#	Each
Cold Electrocleaner JE610, 100g 	210-3301	\$19.95
E. Cold Electrocleaner JE610, 1kg 	210-3302	69.50

*Due to fluctuations in rhodium, prices subject to change daily.



RMGO! Deluxe Kit (#3) Shown

RMGO! Kits	Rhodium Plating 210-0015	Gold Plating 210-0017	Deluxe Rhodium & Gold 210-0019
Rectifier	1	1	1
600/1000ml Beakers & Covers	2/2 (4)	2/2 (4)	3/3 (6)
Red Lead Wires	2	2	3
Black Lead Wire	1	1	1
Black Clip	1	1	1
4 Hook Holder	1	1	1
MOX Anode	1	—	1
SS Anode	1	2	2
Electrocleaner	1	1	1

Must purchase plating solution separately.



B



C



D



E

Gesswein® Plating Kits

If you've never plated before, we are here to help! These Plating Kits are a great introduction to the process and in just a few steps, you can begin plating. Our Plating Kits contain everything you need to get started and Gesswein's knowledgeable technical staff is always ready if you need any help.

The most important considerations when plating are:

- Use lead-free solder on jewelry repairs or you'll need to preplate with copper and nickel.
- Polish and thoroughly clean items before plating.
- Keep the bath covered when not in use to keep it clean.



A



B

A, B Rhodium Plating Kit - 25 Amp

Rhodium plating is used in electronics because of its low electrical resistance, low and stable contact resistance, and high corrosion resistance. Jewelers use rhodium for plating because it is extremely hard, highly resistant to scratching from everyday wear, hypoallergenic and will not tarnish. For these reasons, Rhodium is often plated over white gold, platinum, and palladium jewelry. Kit includes:

- PEPETOOLS™ IPS PLUS 25A digital rectifier with lead wires (115/230V) - (212-0956)
- 1 lb. EarthGold electrocleaner for removing fingerprints and dirt (non-hazardous) - (210-0946)
- 1 lb. EarthGold Acid Activator (non-hazardous) - (210-0939)
- Rhodium Bath Pre-Mixed 1 gram - (210-1018)
- Stainless steel anode for electrocleaning - (210-2701)
- Platinum-clad niobium anode for transmitting current to the rhodium plating bath - (210-2600)
- Three 1,000ml graduated Pyrex beakers with flexible plastic covers for holding and storing electrocleaner and rhodium solutions - (210-2800) + (210-2953)
- 1/2 lb. spool of copper work wire for holding items while plating - (210-2100)

Description		Shipping Weight	Item#	Each
A. Plating Kit - With Rhodium		16 lbs. (7.25kg)	210-0006	\$885.00
B. Plating Kit - Without Rhodium		14 lbs. (6.35kg)	210-0007	795.00

C. EarthGold Plating Kit

A complete line of cleaners, degreasers, stripping and plating solutions. Plating solutions can be plated over nickel, sterling silver, gold, silver, rhodium and most other precious and nonprecious metals. Leave a bright durable deposit. Kit includes everything you need to plate in Nickel, Copper, & 14K Yellow Gold. Made in USA.

The EarthGold Kit includes:

- PEPETOOLS™ IPS PIUS 25A Digital Rectifier with lead wires
- 4 qts of plating solution: 14K Gold, Bright Nickel, Copper Strike, and Bright Copper.
- 1 lb. Acid Activator—Cleans and activates surface of metals that are difficult to plate, such as stainless steel, chrome and metals containing lead or zinc.
- 6 Pyrex Beakers (600ml) with Covers.
- 2 Stainless Steel Anodes, 2 Copper Anodes, and 1 Nickel Anode.
- 1 lb. Electrocleaner—Removes finger marks and dirt.
- 1/2 lb. spool of Copper Work Wire (for making hooks to hold jewelry)
- Plastic Stirring Rod, Plating Thermometer, and Whatman pH Strips.
- Air Agitator (Air pump and Airline tubing 8 ft.)

Description	Shipping Weight	Item#	Each
EarthGold Plating Kit	27.25 lbs. (12.36kg)	210-0903	\$1,025.00

D, E Rhodium Fume Containment System, Small & Large

Quatro Rhodium Containment systems will significantly reduce rhodium odor and vapors migrating throughout your workplace because they utilize a 4 stage filtering process (prefilter, charcoal filter, media filter and HEPA filter). Designed for compact, quiet operation (50-55 dBA). Sizable dimensions allow you to leave your beakers inside the containment area, even running the systems overnight. Can be used as a stand-alone or ducted outside. Complete with acrylic doors, ample soft LED lighting and one year manufacturer's warranty. 120V, 60Hz. Made in Canada.

	Small	Large
Inner Dimensions (W x D x H):	23.875" x 16.875" x 14.75"	29" x 20" x 24"
Overall Dimensions (W x D x H):	24" x 17.5" x 29"	29" x 20" x 39"

Description	Shipping Weight	Item#	Each
D. Rhodium Fume Containment system, Small	78 lbs / 35kg	854-1371	\$1,165.00
E. Rhodium Fume Containment system, Large	98 lbs / 45kg	854-1372	1,245.00

Although no hazardous shipping surcharge applies, these items can only ship via UPS® Ground, no air, FedEx® or US Mail possible. Cannot ship to Alaska, Hawaii or Puerto Rico.

A-J EarthGold Cyanide-Free Plating Solutions

Choose from 10 different cyanide-free plating solutions for leaving bright, durable deposits just as thick as those produced by standard cyanide plating solutions.

Description	Qty.	Item#	Each
A. 14K Yellow	1 qt.	210-0930	\$130.00
	1 gal.	210-0931	475.00
B. 18K Yellow	1 qt.	210-0932	118.50
	1 gal.	210-0933	485.00
C. 24K Yellow	1 qt.	210-0934	118.00
	1 gal.	210-0935	485.00
D. Silver Plating	1 qt.	210-0942	32.60
	1 gal.	210-0943	121.50
E. Bright Nickel	1 qt.	210-0952	29.00
	1 gal.	210-0953	107.50
F. Nickel-Free*	1 qt.	210-0944	31.45
	1 gal.	210-0945	116.80
G. Copper Strike	1 qt.	210-0936	24.10
	1 gal.	210-0937	89.25
H. Bright Copper	1 qt.	210-0948	23.15
	1 gal.	210-0949	85.40
I. Black Plus	1 qt.	210-0959	26.75
	1 gal.	210-0958	99.00

*Hypoallergenic

Prices change with current market value.



J. EarthGold Stripper

Strips gold deposits from rhodium, nickel, stainless steel and steel. Do not use on silver for an extended period of time.

Description	Qty.	Item#	Each
J. Stripper	1 qt.	210-0940	\$15.25
	1 gal.	210-0941	61.30

K. EarthGold Electrocleaner

Provides a completely clean, contaminant-free metal surface prior to electroplating.

Description	Qty.	Item#	Each
K. Electrocleaner	1 lb.	210-0946	\$9.80
	3 lbs.	210-0947	29.75

L. EarthGold Acid Activator

Provides excellent oxide removal and etching properties to help metals bond better when electroplating. Effective on white metals, brass, bronze, nickel, stainless steel, steel, silver and gold. Do not use on zinc.

Description	Qty.	Item#	Each
L. Acid Activator	1 lb.	210-0938	\$8.85
	3 lb.	210-0939	24.20

M. Whatman 0-14 pH Strips

Extra pH strips for checking your EarthGold plating baths. 6 x 80mm, 100/pkg.

Description	Item#	Pkg. of 100
Whatman 0-14 pH Strips	210-2401	\$40.75



Rhodium Solutions

Gesswein offers our own Gesswein brand made in the USA, as well as Umicore J1 and Diamond Brite imported from Umicore in Germany. Both brands are bright, white and tarnish-resistant.

Gesswein brand is the traditional white rhodium popular in the American market and has the distinct advantage of being very easy to use.

Umicore is internationally known as the brightest whitest rhodium and is preferred by the international market. Due to volume purchases, we have extremely competitive prices on Umicore Rhodium. Rhodium can be directly plated on gold, copper and copper alloys, nickel and nickel alloys. When plating over non-precious metals, an intermediate nickel coating of many microns thickness is absolutely essential. Strike nickel or gold plating is advantageous with all substrates. **Rhodium prices fluctuate with metals market.**

No Hazardous
shipping surcharges

Made in
the USA



A-C Gesswein® White Rhodium Solution

This sulfate-type rhodium solution produces a whiter finish than phosphate-type solutions and has the distinct advantage of being very easy to use. Gesswein brand Rhodium requires no heating of the solution, no deionized water and minimal pre- and post-treatment. Made in USA.

It's available either as a ready-to-use Premix, or concentrated. Each produces the same great results but varies in convenience, versatility and shipping rates. Both concentrations use the same Gesswein Replenisher (below) which restores rhodium and acid to the bath as it depletes after use.

Premix is not concentrated so it's ready to use right out of the bottle. Just pour it in your beaker and start plating.

Description	Rh Content	Item#	EACH Prices	
			1	2+
A. Premix (Bath Plating, 1pt)	1g	210-1018	\$89.50	\$85.03

Concentrate requires mixing with your own distilled water which can be purchased at most grocery stores. Concentrate is offered in 2 bottle sizes: 1 gram of Rhodium in 4 oz. liquid or 5 grams of Rhodium in 6½ ounces of liquid.

Description	Rh Content	Item#	EACH Prices	
			1	2+
B. Concentrate (Bath and Pen Plating)	1g	210-1000	\$79.50	\$75.53
C. Concentrate (Bath Plating)	5g	210-1016	\$371.00	\$352.45

Prices change with current market value.

Made in
the USA



See pp. 263, 268 for
Pen Plating Solutions.

Rhodium is non-returnable.
Prices change with
current market value.

D. Gesswein® Rhodium Replenisher

Use to replenish rhodium and other chemicals to your Gesswein white rhodium bath as it depletes after use. Do not use rhodium solution to replenish; doing so will upset the bath's chemical balance. Use our Rhodium Test Kit below to determine correct amount of replenisher to use. Replenisher can also be used for pen plating.

Description	Rh Content	Item#	EACH Prices	
			1	2+
D. Replenisher	1g	210-1010	\$79.50	\$75.53
Replenisher	5g	210-1017	\$371.00	\$352.45

Prices change with current market value.

D



E. Gesswein® Rhodium Test Kit

As your rhodium bath is used, it depletes rhodium as well as other important chemicals. Our Rhodium Test Kit helps you determine when to add replenisher so you can restore the bath to its original condition. Saves money by ensuring you add just enough replenisher, not too much. Easy to use. Includes complete instructions, control and sample vials, pipette and test block. Designed for use only with our rhodium solutions (#210-1000, #210-1016 and #210-1018).

Description	Item#	Each
Rhodium Test Kit	210-2000	\$67.00

E



⚠ Although no hazardous shipping surcharge applies, these items can only ship via UPS® Ground, no air, FedEx® or US Mail possible. Cannot ship to Alaska, Hawaii or Puerto Rico.



Rhodium suppliers all SAY their rhodium is the whitest and brightest, but only Umicore can PROVE it. Measured by spectrophotometer, only Umicore Diamond Bright is as bright as pure rhodium (89.5–90 on the lightness scale), while other brands fall short (86–90). Test results were independently verified by CIE-Lab. There is simply no whiter rhodium available on the market. Rhoduna Diamond Bright plates at a thickness of 5µm for a quality thick plating. Consider using Umicore RH J1 which plates at 0.3µm, if less thickness is acceptable. Umicore Diamond Bright features sulfate-based formula with high deposition capacity, good plating speed and exceptional throwing power. Packaged in shrink-sealed plastic bottles for protection and security. Choose from concentrated solution for rack and barrel plating or pen plating straight out of the bottle.

A. Umicore RHODUNA® Diamond Bright The world's brightest and whitest rhodium

Umicore RHODUNA Diamond Bright deposits brilliant-white, ultra-bright coatings of previously unattained lightness and brilliance. Characterized by high covering speed and excellent throwing power. Layer thicknesses of up to 5µm (micron) can be deposited crack-free with minor porosity. Results have high abrasion resistance. For rack and barrel plating.

Rhodium can be directly deposited on silver, gold, copper and copper alloys, nickel and nickel alloys. When plating tin, lead, zinc, aluminium and iron, intermediate nickel coatings of some thickness are absolutely essential. Strike nickel plating is advantageous with all substrates.

Umicore Diamond Bright Replenisher—To use as Diamond Brite becomes depleted. Do not use rhodium solution itself to replenish; doing so will upset the bath's chemical balance.

Description	Rh Content	Item#	Each
A. Umicore Diamond Bright Rhodium	2g	210-1038	\$285.35
Umicore Diamond Bright Rhodium Replenisher	5g	210-1040	619.02

Rhodium is non-returnable. Prices change with current precious metals market.

B. Umicore J1 RHODUNA® Rhodium Concentrate

Umicore J1 Rhodium Concentrate A long time standard of Umicore, RHODUNA® J1 is an electrolyte slated for the deposition of Brilliant-white, very light, bright coatings. Umicore J1 is suitable for plating jewelry with layers up to 0.3µm thick. Minor porosity, good covering speed, excellent throwing power. Provides high abrasion resistance, good wear resistance, corrosion resistance, and tarnish resistance. J1 is advantageous for rack and barrel plating. Packaged in shrink-sealed plastic bottles for protection and security.

Use J1 replenisher as J1 bath becomes depleted. Do not use rhodium solution itself to replenish; doing so will upset the bath's chemical balance.

Description	Rh Content	Item#	Each
B. Umicore J1 RHODUNA® Rhodium	2g	210-1041	\$280.10
Umicore J1 RHODUNA® Replenisher	5g	210-1042	619.02

Rhodium is non-returnable. Prices change with current precious metals market.

C, D Umicore Ruthuna Black Ruthenium Plating Solutions

Darker than black rhodium

Umicore Ruthuna plates darker than black rhodium because it contains ruthenium, another member of the platinum family. Plates a very dark gray (anthracite) color, almost black. Can be used alone or as a contrast color on both yellow and white metals. Available for bath plating or pen plating.

Ruthuna 475 comes in 4 oz. bottle which has 100ml of solution containing 2 grams of ruthenium. For proper adhesion it is strongly recommended to plate Ruthuna 475 over an undercoat of 18K gold.

Specially formulated for pen plating, Ruthuna 279 contains 2 grams of ruthenium. Can be plated directly over gold, gold plate, silver, platinum and palladium. When pen plating over non-precious metals, plate the item with gold prior to using Ruthuna 279.

Description	Rh Content	Item#	Each
C. Ruthuna 475 Bath Plating Solution	2g	210-1036	\$82.90
D. Ruthuna 279 Pen Plating Solution	2g	210-1037	89.95

Rhodium is non-returnable. Prices change with current precious metals market.



A



B



D

UPS® hazardous shipping surcharge applies. Ships via UPS® Ground only, no air, FedEx®, or US Mail shipments. Cannot ship to Alaska, Hawaii or Puerto Rico.

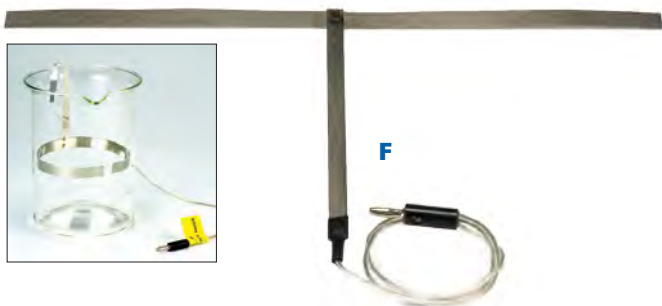
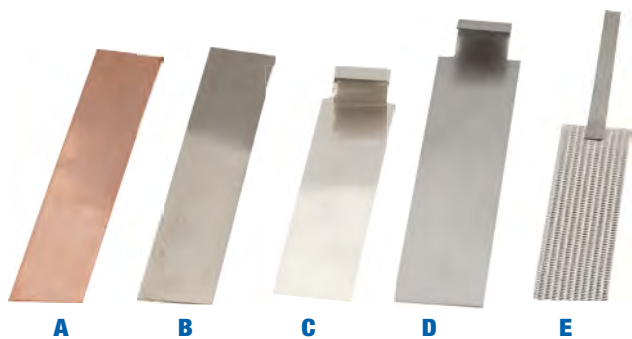

A-F Anodes

Used to introduce electrical current and to replenish metal ions into plating baths. Stems of all standard anodes can be bent to hang on edges of Pyrex beakers (dimensions given do not include stems).

Types:

- Soluble: Copper, nickel and silver anodes dissolve in the bath, replacing metal ions as they are deposited onto the workpiece during plating.
- Inert: Stainless steel and platinum-clad anodes do not dissolve in the plating bath. Serve to introduce electrical current into bath.
Note: A stainless steel beaker can be used as an inert anode.

Description	Size (L x W)	Item#	Each
A. Copper Anode	6" x 1"	210-2500	\$6.99
B. Nickel Anode (depolarized)	6" x 1"	210-2551	7.25
C. Silver Anode (fine)	3 ⁷ / ₈ " x 1"	210-2651	56.00
D. Stainless Steel Anode	6" x 1"	210-2701	5.40
E. Platinum-Clad Niobium Anode*	4" x 1"	210-2600	129.50
Stainless Steel "T" Anode	4" x 12"	210-2710	15.00
F. Platinum-Clad Titanium "T" Anode	4" x 12"	210-2610	79.00

*Performs as well as solid platinum for rhodium and gold plating. Consists of niobium clad at heavy gauge with 99% pure platinum, cold-rolled to a uniform thickness and meshed to expose more surface area. Because of mesh form and high conductivity (3.5 times more than platinized titanium anodes), this platinum-clad anode provides better current distribution for more uniform plating. Costs less than solid platinum and lasts longer than electroplated anodes.

G. Umicore Platinum Anode Systems

Provides current from 2 directions giving a more even and uniform rhodium plate. Sets contain 2 mesh type platinum coated anodes and a titanium holder. Made in Germany.

Description	For Beaker Size	Anode Size	Item#	Each
G. Platinum Anode System 500	500/600ml	3 ¹ / ₂ " x 1 ³ / ₁₆ " (2)	210-2612	\$157.75
Platinum Anode System 1000	1000ml	4" x 1 ¹ / ₂ " (2)	210-2617	162.00

Prices change with current precious metals market.

H, I Plating Thermometers

Two different types for measuring stripping and plating bath temperatures. Help eliminate guesswork to improve results. Include metal clip for easy attachment to edges of beakers. Glass type reads up to 220°F or 100°C (has both scales). Stainless steel dial type reads from 50 to 400°F. Measures 8" long.

Description	Item#	Each
H. Glass Thermometer	210-2310	\$7.25
I. Stainless Steel Dial Thermometer	210-2255	15.95

J. Copper Work Wire

Soft 24-gauge copper wire for holding items to be stripped or plated. Sold in 1/2 lb. spool.

Description	Item#	Each
Copper Work Wire	210-2100	\$12.95

K. Pre-Mixed Silver Bath-Cyanide Free

The Jentner Silver bath (JE60) is an innovative cyanide-free electrolyte for the deposition of very white silver layers. It is characterized by light weight handling and very high consistency and best of all, does not need to be heated (room temperature/cold). Does not contain cyanide and therefore offers environmental and safety benefits. However, it is a corrosive and proper care must be taken with use and disposal. Contains 31g of silver per liter and is pre-mixed (ready to use). The purity of the silver solution is nearly 100% and is suitable for both decorative and most jewelry applications. The electrolyte deposits a maximum thickness 25 µm. Can not be use in conjunction with the RMGO Plating Kits. Made In Germany.

This item cannot ship via Fed Ex or USPS and cannot be shipped outside the contiguous USA.

- Silver content: 31g / L
- Density: 1.13g / ml (1.12-1.20)
- Anode Material: Fine Silver (210-2650)
- Optimal Voltage: 1.5 - 1.6V
- Bath temperature: 68° F - 104° F (20° C - 40° C)
- Deposition Rate: Approx. 0.5 µm / min

Description	Item#	Each
Pre-Mixed Silver Bath-Cyanide Free	210-0905	\$129.95

Non-returnable. Prices change with current precious metals market.

⚠️ UPS® hazardous shipping surcharge applies. Ships via UPS® Ground only, no air, FedEx®, or US Mail shipments. Cannot ship to Alaska, Hawaii or Puerto Rico.

A. Gesswein® Electrocleaner Powder

Removes fingerprints, grease and similar contaminants from the plating surface without removing metal. Promotes optimal adherence of electroplating deposits. Especially useful in place of electrostripping on jewelry parts that are too delicate to withstand metal removal. Sold in a 3 lb. jar, which makes 32 qts. of electrocleaning solution. Cyanide-free. Use with stainless steel beaker or with Pyrex beaker (see beakers on p. 266) and stainless steel anode (see pp. 264).

Description	Item#	Each
Electrocleaner Powder 	210-3300	\$22.80

 UPS® hazardous shipping surcharge applies. Ships via UPS® Ground only, no air, FedEx®, or US Mail shipments. Cannot ship to Alaska, Hawaii or Puerto Rico.



A

B. Carbon Treatment Sets for Rhodium Baths

It eventually happens to every plater: rhodium comes out looking gray instead of white. The usual culprits? Organic contaminants introduced to your plating bath from wax or other stop-offs, electrocleaner or soap, dust or dirt. Once dissolved, these contaminants can't be removed by sieving or straining.

Each money-saving Carbon Treatment Set uses activated charcoal to absorb contaminants so you can filter them out and restore the bath to like-new condition rather than discard it. Includes charcoal (3 oz. in standard set, enough for approx. 48 one-liter bath treatments; 11 oz. in large set, enough for approx. 176 one-liter bath treatments), funnel, treatment tank with cover, glass stirring rod, filtration tank, filter paper and instructions. Use for monthly preventive maintenance and emergency situations. Excellent for gold plating baths. *Note: Will not remove metal contamination, such as that from soft solder.*

Description	Item#	Each
B. Standard Set	210-2020	\$75.00
Large Set	210-2124	117.00



B

C. Rhodium Test Kit

As your rhodium bath is used, it depletes rhodium as well as other important chemicals. Our Rhodium Test Kit helps you determine when to add replenisher so you can restore the bath to its original condition. Saves money by ensuring you add just enough replenisher, not too much. Easy to use. Includes complete instructions, control and sample vials, pipette and test block. Designed for use only with our rhodium solutions.

Description	Item#	Each
Rhodium Test Kit	210-2000	\$67.00



C

D. PD2 Palladium Plating Solution

Ready-to-use palladium plating solution especially designed for flash plating. Features highly compact consistency and resistance of the galvanic layer, making it particularly suitable for pre-rhodium treatment on low-karat gold and silver articles. Also serves as a tough barrier against diffusion of gold deposits on copper and copper alloys. Ideal for use as an intermediate layer between rhodium and white gold, reducing the possibility that scratches and abrasions of the rhodium-plated layer will affect the alloy underneath — very important to prevent release onto skin of white gold alloys containing nickel. Sold by the liter.

Features:

- Cyanide-free
- 2g/L concentration
- Room-temperature plating—no heater required
- Premixed solution—UPS shippable with no hazardous charges
- Nontoxic and noncorrosive
- Neutral pH

Description	Qty.	Item#	Each
PD2 Solution	1L	210-1350	\$247.00



D



A

A. Electric Hot Plates

Choose from single and double models. The double model saves precious plating time by heating two baths simultaneously (includes separate temperature controls). Feature durable chrome tops for resistance to scratching and marring and lift-out heating elements for fast, easy cleaning. Made in USA. *Note: You must provide insulation such as a Solderite Pad (see pp. 507) between stainless steel beaker and hot plate during plating to prevent your rectifier from shorting out.*

Specifications:	Single	Double	
Electrical	120V, 6A, 700W, 60Hz	120V, 12A, 1400W, 60Hz	
Dimensions	8½"W x 8½"D x 3¼"H	17"W x 9¾"D x 3¼"H	
Description	Item#		Each
Single Electric Hot Plate	212-2051		\$59.50
A. Double Electric Hot Plate	212-2050		95.00



B

B. Stainless Steel Beakers and Covers

Stainless steel beakers act as anodes for electrostripping and electroplating—just attach your lead wire directly to the lip of the beaker. Stainless steel covers protect solutions. There is no cover available for 0.6 quart beaker.

Description	Size (I.D. x H)	Item#	Each
0.6 qt. Beaker	3¼" x 4½"	210-2954	\$67.95
1¼ qt. Beaker	4" x 5½"	210-2955	21.95
2 qt. Beaker	4¾" x 6¾"	210-3000	24.50
4¼ qt. Beaker	6½" x 7⅝"	210-2957	32.65
8½ qt. Beaker	8" x 9½"	210-2959	51.80
1¼ qt. Cover		210-2969	12.40
2 qt. Cover		210-3150	13.30
4¼ qt. Cover		210-2967	16.25
8½ qt. Cover		210-2965	18.90



C



D

C, D Pyrex Beakers and Covers

Pyrex beakers feature graduations for fast and accurate liquid measurement and spouts for easy pouring. Available in four sizes. Pyrex covers let you heat and store solutions in the same containers. Plastic covers provide tight seals to prevent solution evaporation.

Description	Item#	Each
250ml Beaker for small bath	210-2749	\$6.65
C. 600ml Beaker for half-pint bath	210-2750	10.00
1,000ml Beaker for pint bath	210-2800	22.95
1,500ml Beaker for quart bath	210-2850	20.25
600/1,000ml Pyrex Cover	210-2900	8.35
1,000/1,500ml Pyrex Cover	210-2950	10.35
D. 600ml Plastic Cover	210-2952	5.25
1,000ml Plastic Cover	210-2953	5.50



E

F

E, F Ribbed Glass Funnel and Filter Paper

Use together for filtering impurities from plating baths. Funnel features ribbed design for better flow of solution. Measures approx. ¼" thick. Paper measures 13" in diameter.

Description	Item#	Each	
E. Ribbed Glass Funnel	210-2450	\$38.95	
Description	Item#	EACH Prices	
F. Filter Paper	210-2400	10-90	100+
		\$1.75	\$1.40

 10-piece minimum; please order in multiples of 10.



G

G. Plastic Stirring Rod

For mixing your electrocleaning, electrostripping and electroplating baths. Will not react with solutions. Measures ½" dia. x 12"L.

Description	Item#	Each
Plastic Stirring Rod	210-2460	\$4.15

A. Rhodnette Pen Plater

Create exciting two-tone effects and make touch-up repairs with our Rhodnette Pen Plater. Takes just minutes to learn how to use like an expert. Features highly absorbent, hard fiber electrode tips that can be easily shaped and will plate the most delicate details and contours with an even deposit of metal (masking may be unnecessary). Plating solutions and concentrates sold separately. Electrical: 110V, 1A, 50/60Hz. Made in Germany.

Includes:

- Compact rectifier base with recesses for holding up to three pens and three plating solutions (not included)
- Plating pen (anode) with six regular felt tips
- Smooth-jaw alligator clip with lead wire (cathode)
- Glass jar with cover for holding plating solution
- Stand for supporting wires

Description	Item#	Each
A. Rhodnette Pen Plater	212-0900	\$675.00
Plating Pen	210-2105	246.00
Black Lead Wire	210-2110	54.00
Glass Jar with Cover (color may vary)	210-2107	28.35

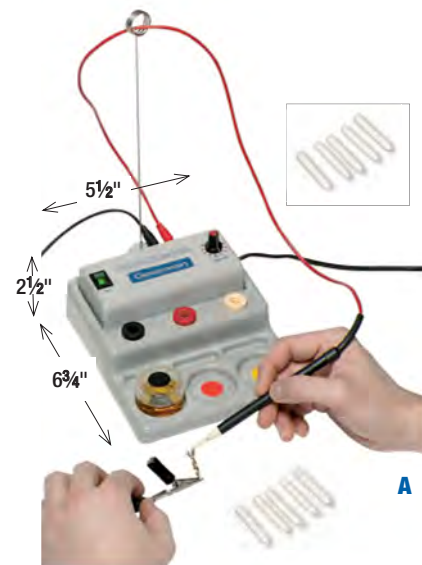

A

B. Picco Pen Plater

The Picco pen plating unit allows for a fast and spotless application of rhodium, gold and silver on small items. Designed for finishing of fancy shaped blanks, findings, settings, and all parts which are normally time-consuming to plate. The rectifier is built in a well designed stainless steel case. Voltages are easily adjusted with the LED display. Dual Voltage. Pen plating solutions sold separately. Made in Germany.

Description	Item#	Each
Picco Pen Plater	212-0715	\$650.00
Replacement Picco Pen Plater Handpiece + Red Cord	212-0716	159.00
Replacement Picco Pen Plater Tweezer + Black Cord	212-0717	59.00

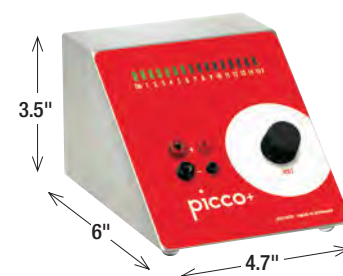

Picco Pen Plater

B

C. PEPETOOLS Digital Pen Plating System

Compact system with precise voltage regulator and clear digital readout. Lets you dial in exact voltage needed from 1.2–17V for perfect results. Plating solutions and concentrates sold separately. Electrical: 110/220V. Made in Europe.

Includes:

- Compact rectifier base with recesses for holding up to two pens and three different plating solutions (not included)
- Plating pen with three felt tips
- Alligator clip with lead wire
- Three plating jars with twist-off lids for avoiding spills.

Description	Item#	Each
Digital Pen Plating System	212-0721	\$225.00
Replacement Plating Pen	212-0714	41.95



C

Wizard Disposable Pen Plater

Portable and easy to use, the Wizard disposable pen plater is a must for anyone needing quick touch ups or portable repair work. The Wizard Disposable Pen Plater is sleek and ergonomic and has a stainless steel body for easy handling. Battery operated for up to one hour of continuous plating and has 6 volts of capacity with no knobs or adjustment needed. Tips can easily be replaced with a Standard Tip (210-2102). The Wizard is a must for portability and precision plating!

Description	Item#	EACH Prices	
		1-2	3+
Wizard Disposable Pen Plater	212-0708	\$58.50	\$52.65
Replacement Felt Tips (Package of 12)	210-2102	6.25	5.31

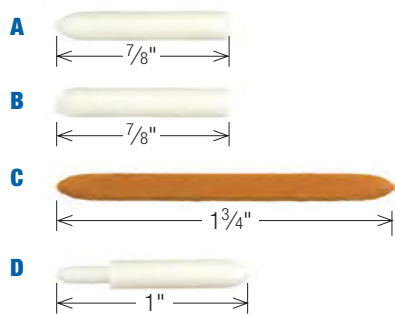

D

**A-D Felt Tips for Plating Pens**

Solid compact tips that can be custom-shaped for any pen plater.

Description	Item#	PKG. of 12	
		1-2	3+
A. Regular Tips	210-2102	\$6.25	\$5.31
B. Chisel Tips	210-2103	6.80	5.78
C. Double-Ended Regular Brown Tips	210-2115	4.25	3.61
D. Double-Ended Point/Bullet Tips	210-2112	6.95	5.91

**E-G Cohler EARTHCOAT™ Gold Pen Plating Solutions**

These cyanide-free solutions deposit a resilient flash plate of gold on nickel, sterling silver, rhodium, gold and most other similar metals. Allow very easy control of color due to their excellent combination of brighteners, which offer excellent coverage and leveling ability.

Description	Au Content	Item#	Each
E. 14K	1 dwt.	210-0926	\$79.00
F. 18K	1 dwt.	210-0927	82.00
G. 24K	1 dwt.	210-0928	82.00

Prices change with current market value.

**H, I Cohler White + Black Rhodium Pen Plating Solutions**

Description	Rh Content	Item#	Each
H. Bright White	Ⓢ 1/4g	210-1021	\$39.00
I. Deep Black	Ⓢ 1/4g	210-1022	46.00

Prices change with current market value.

**J, K Gesswein White + Black Rhodium Pen Plating Solutions**

Our USA made rhodium solution specially formulated for high-speed pen plating. Contains 1/2 gram of rhodium in 33.3 ml of solution. Has less acid than regular concentrate for a thicker application while producing less fumes for operator. Do not dilute. For pen plating only.

Description	Rh Content	Item#	Each
J. White	Ⓢ 1/2g	210-1002	\$65.80
White	Ⓢ 1g	210-1000	79.50
K. Black	Ⓢ 1/2g	210-0977	93.00

Prices change with current market value.

**L, M Jentner Black + White Rhodium Pen Plating**

For the partial deposition of black or brilliant white, abrasion resistant rhodium coatings.

The rhodium is especially suitable for partial plating, for multi-color processing and reparation or restoration. The deposited coatings have a brilliant color and they are hard and abrasion resistant. JE28-1 and JE29-1 deposit uniform rhodium layers and has a strong color consistency.

Features

- Tension: 10-11 Volt
- Bath temperature: room temperature

Description	Rh Content	Item#	Each
L. Jentner White Rhodium Pen Plating Bath JE28-1	Ⓢ 2g	210-1023	\$179.00
Jentner White Rhodium Pen Plating Bath JE28-1	Ⓢ 1g	210-1026	113.40
M. Jentner Black Rhodium Pen Plating Bath JE29-1	Ⓢ 2g	210-1024	192.00
Jentner Black Rhodium Pen Plating Bath JE29-1	Ⓢ 1g	210-1027	117.60

See pp. 260-263 for more Rhodium Solutions.

**N. Earring Post Protectors**

Silicone rubber sleeves protect posts when setting, tumbling or plating. Sold by the gross (144 each).

Description	Item#	GROSS Prices	
		1-49	50+
Earring Post Protectors	852-1155	\$8.10	\$6.08

Ⓢ Although no hazardous shipping surcharge applies, these items can only ship via UPS® Ground, no air, FedEx® or US Mail possible. Cannot ship to Alaska, Hawaii or Puerto Rico.

Ⓢ UPS® hazardous shipping surcharge applies. Ships via UPS® Ground only, no air, FedEx®, or US Mail shipments. Cannot ship to Alaska, Hawaii or Puerto Rico.

A. Liver of Sulphur XL Gel

Real liver of sulphur in premixed gel form, which is much easier to work with. Ready to use after a quick shake (heat up for 15 seconds in a microwave to lessen viscosity if too cold to stir), XL Gel can be brushed on and is thick enough not to run. Convenient dispensing bottle lets you squeeze out just the right amount. Or squeeze out a small drop directly onto a brush. Minimizes odor, reduces waste. Imparts a patina on silver, copper, bronze and more. Mix one teaspoon in 12 oz. of heated water to make dark patina solution, less to make light patina solution. Boasts 4–5 times longer shelf life than dry liver of sulphur. 4 oz. XL Gel makes 24 portions 12 oz. solution.

Description	Qty.	Item#	Each
Liver of Sulphur XL Gel	4 oz.	210-1451	\$16.45



A

B. Liver of Sulphur

Use this product to permanently antique silver and copper. Will not rub off or disappear during ultrasonic or steam cleaning. Just mix a small amount with ordinary tap water in a Pyrex beaker, immerse or paint your jewelry, and watch it turn from brown to blue/green to light gray then dark gray. Stop process when the appropriate color has been obtained by rinsing jewelry thoroughly. For antique effect, buff selected areas to bright shine and leave background dark. Requires no anode. Not suitable for antiquing gold because there is no noticeable effect. Sold in 1/2 lb. container.

Description	Qty.	Item#	Each
Liver of Sulphur	1/2 lb.	210-1450	\$24.00



B

C. JAX Green Antique

Chemical darkener for producing an antique green patina on brass, bronze and copper. Apply to clean metal surface with a bristle brush or immerse entire object. The initial coat is critical: when a dull film appears, that indicates the patina has reacted to the metal. Additional coats can be applied if desired (allow complete air drying in between coats).



Description	Qty.	Item#	Each
Green Antique	1 pt.	210-1430	\$15.85
Green Antique	2 oz.	210-1434	6.75



C

D. JAX Black Antique

Chemical darkener for producing an antique black patina on brass, bronze and copper. Apply to clean metal surface with a bristle brush or immerse entire object. Rinse well with water and dry. To achieve desired finish, highlight with steel wool or Scotch-Brite. You can also over-darken and then relieve with steel wool or polishing cloth.

Description	Qty.	Item#	Each
Black Antique 	1 pt.	210-1431	\$15.85
Black Antique 	2 oz.	210-1435	6.75





D



E

E. JAX Black Antique for Silver

Chemical darkener for producing an antique black patina on silver and gold. Apply to clean metal surface with a bristle brush or immerse entire object. Rinse well with water and dry. To achieve desired finish, buff with rouge. When using on gold, preheat metal before applying solution.

Description	Qty.	Item#	Each
Black Antique for Silver 	1 pt.	210-1432	\$16.25
Black Antique for Silver 	2 oz.	210-1436	6.75

See pp. 472-474 for gloves and more Respirators

F. 3M™ Half-Facepiece Respirator

Protects you from dusts, mists and airborne contaminants. NIOSH rated N95 for protection from respirable silica (in investment, tripoli and more). Also suitable for rhodium plating. Features a soft, pliable silicone face seal for a secure, gap less fit on most every face shape. Extremely comfortable to wear, especially for extended periods of use. Features roomy nose chamber and special 3M Cool Flow valve to ensure easy natural breathing while reducing heat and condensation in the face piece. Complete respirator includes face piece, two deluxe cartridges, two deluxe pre filters and two retainer rings. NIOSH approved.

Description	Item#	Each
F. Half-Facepiece Respirator	805-1035	\$51.40
Deluxe Cartridges, pair	805-1036	15.80
Deluxe Pre filters, pair	805-1037	4.20
Retainer Rings, pair	805-1038	5.50



F

 Although no hazardous shipping surcharge applies, these items can only ship via UPS® Ground, no air, FedEx® or US Mail possible. Cannot ship to Alaska, Hawaii or Puerto Rico.

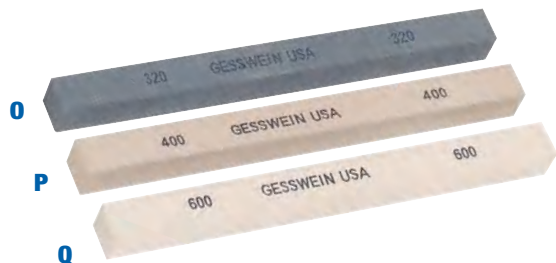

A-N Ceramitation – Resin that cures at a low temperature!

This resin is mixed with a catalyst, then fired at a low temperature to make hard, ceramic-like surfaces similar to kiln-fired enamels in both appearance and physical properties. Simple enough to use for beginners to produce professional work in a short time.

Can be brushed on, sprayed on or applied with a spatula or a squeeze bottle. Apply a single coat, or build up in successive layers to obtain unusual and elegant finishes. Adheres to metal, wood, plastic and ceramic. Cures after being fired at 200°F for one hour by an electric kitchen oven, infrared lamp or forced air blower. Boasts hardness of 60–75 on Sward scale once cured—very close to kiln-fired enamels with hardness of 65–80, which must be fired up to 1,500°F. Can be stoned and polished after curing.

Choose from seven vivid opaque colors and six transparent colors that let the base metal shine through for brilliant jewel-tone effects. Mix colors to obtain an infinite variety of hues. Sold in 2 oz. bottles and in money-saving sets. Opaque set includes all seven colors listed below, transparent clear and a 1-pint bottle of catalyst. Transparent set includes all six colors listed below and a 1-pint bottle of catalyst.

Opaque Ceramitation, 2 oz.	Item#	EACH Prices	
		1-2	3+
A. Black	821-4204	\$6.90	\$5.52
B. White	821-4205	6.90	5.52
C. Red	821-4206	6.90	5.52
D. Chinese Red	821-4207	6.90	5.52
E. Blue	821-4208	6.90	5.52
F. Israeli Blue	821-4209	6.90	5.52
G. Yellow	821-4210	6.90	5.52
Transparent Ceramitation, 2 oz.	Item#	EACH Prices	
H. Red	821-4212	\$6.90	\$5.52
I. Brown	821-4213	6.90	5.52
J. Blue	821-4216	6.90	5.52
K. Green	821-4215	6.90	5.52
L. Yellow	821-4214	6.90	5.52
M. Clear	821-4211	6.90	5.52

Ceramitation Catalyst	Item#	Each
8 oz.	821-4201	\$13.75
1 pint	821-4202	26.99
1 quart	821-4203	37.95

Ceramitation Thinner	Item#	Each
1 pint	821-4194	\$23.75
1 quart	821-4196	33.50

Ceramitation Set	Item#	Each
N. Opaque	821-4200	\$69.99
Transparent	821-4199	58.30

\$ UPS® hazardous shipping surcharge applies. Ships via UPS® Ground only, no air, FedEx®, or US Mail shipments. Cannot ship to Alaska, Hawaii or Puerto Rico.

O-Q Enameling Stones

Can be used for a wide variety of operations, including imparting a matte finish on enameled objects, removing excess enamel, firescale or contamination between firings and leveling uneven enameled surfaces. Measure 6"L x 1/2"W x 1/2" thick.

Description	Grit	Item#	EACH
O. SiC Stone	320	380-0013	\$7.13
P. AIO Stone	400	380-0014	7.30
Q. AIO Stone	600	380-0016	9.47

A-F Thompson Enamel

High-quality lead-free 80 mesh enamel for gold, silver and copper. Medium fusion temperature: 1,450–1,500°F. Sold in 2 oz. bottles with mesh screen tops for sifting and in money-saving sets.

Opaque Enamel, 2 oz.	Item#	Each
A. Black	821-3001	\$11.85
B. Blue	821-3002	11.85
C. Green	821-3003	11.85
D. Red	821-3004	11.85
E. White	821-3005	11.85
F. Yellow	821-3006	11.85
Transparent Enamel, 2 oz.	Item#	Each
Black	821-3040	\$11.85
Blue	821-3038	11.85
Green	821-3037	11.85
Red	821-3039	11.85
White	821-3041	11.85
Yellow	821-3036	16.10
Enamel Set	Item#	Each
Opaque (one of each)	821-3000	\$57.95
Transparent (one of each)	821-3035	59.95



G. Thompson Undercoat White Enamel

Opaque white 80 mesh enamel frequently used as an undercoat on jewelry metals before applying transparent enamels. Provides low acid resistance. Medium fusion temperature: 1,450–1,500°F. Sold in 2 oz. plastic jar with mesh screen top for sifting.

Description	Qty.	Item#	Each
Undercoat White Enamel	2 oz.	821-3310	\$11.85

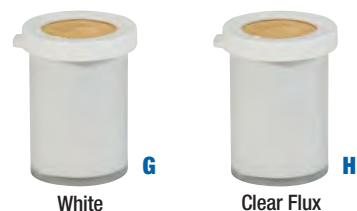

H. Thompson Clear Flux Enamel

Clear 80 mesh flux for transparent enameling over gold, silver, copper and more. Medium fusion temperature: 1,450–1,500°F. Sold in 2 oz. plastic jar with a mesh screen top for sifting.

Description	Qty.	Item#	Each
Clear Flux Enamel	2 oz.	821-3007	\$11.85



I. Thompson Klyr-Fire

Nontoxic adhesive agent for enameling. Paint onto metal, then sift the enamel onto the wet surface, and the enamel adheres fully, even to domed surfaces. Dry thoroughly with heat lamp or air dryer before firing. Sold in 16 oz. bottles.

Description	Qty.	Item#	Each
Klyr-Fire	16 oz.	821-3072	\$9.50

J-L Hot Plate Furnace for Enameling

A popular compact hot plate furnace that's great for beginners. Perfect for enameling jewelry items up to 3" in diameter. Made of stainless steel and cast aluminum with an asbestos-free heating plate. Ample lid opening allows a clear viewing of enamel, helping to prevent over- and under-firing. Requires one hour of preheating before use. Electrical: 120V, 900W. Measures 7¼" dia. x 6"H including lid.

Description	Item#	Each
J. Hot Plate Furnace	265-1325	\$270.00
K. Single-Piece Trivet	821-3070	14.30
L. Stainless Steel Spatula	821-3071	21.65

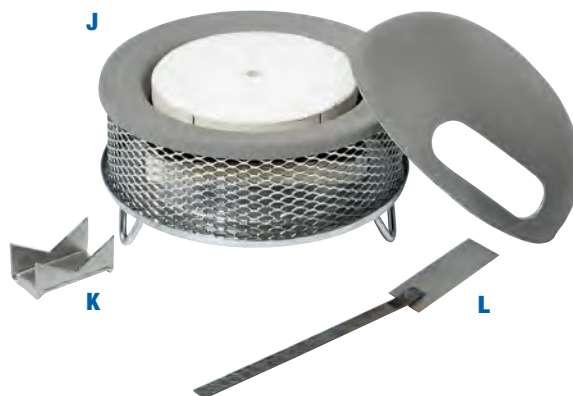

COLORiT

The revolutionary way to add brilliant color to your jewelry!

Add COLORiT ceramic-reinforced composite material to a variety of jewelry and dazzle your customers with its brilliance. When dried with the included curing light, this material cures into a solid polymer network of exceptional strength and durability. Resists both chipping and cracking better than hard-fired enamels. Won't flake and peel like epoxies. Comes in liquid form, making it easy to apply on both flat and curved surfaces. Produces colorfast, nonshrinking design accents.

Use a single color, or mix colors to obtain any hue and shade. Adding White makes them more pastel and opaque, and adding Clear makes them more transparent. Pearl White and Pearl Blue are stunning by themselves, and they create an opalescent or marbled look when added to any of the other colors. Swirl in some Neon for highlights that actually glow under an ultraviolet light. The possibilities are limited only by your imagination.

Features:

- COLORiT gives your jewelry the look and feel of enamel.
- COLORiT can be inlaid into any precious or nonprecious metal, including platinum, silver and stainless steel. Can even be inlaid into more COLORiT.
- COLORiT colors can be used right next to each other to create a cloisonné look. A few seconds of precuring eliminates color bleed. Colors can also be worked uncured to create artistic effects.
- COLORiT colors can be mixed to create any hue, opaque or transparent.
- COLORiT is colorfast—it won't fade over time.
- COLORiT can be carved, sanded, filed, machined, and lathe-turned at high speeds, sandblasted or polished to a high shine right along with the metal.
- COLORiT is highly resistant to scratching, shock and impact. Bright finishes can be restored with a simple re-polishing.
- COLORiT is so durable that it can withstand tumbling, plating and mild ultrasonic, steam and solvent cleaning.
- COLORiT application is easily mastered.
- COLORiT is so versatile, workable and durable, it opens up entirely new design options.



Images courtesy of Annika Bertilsdotter/Sweden.



A. COLORiT DP2 Starter Set

Add COLORiT to your jewelry and dazzle your customers with its brilliance. It doesn't chip or crack like glass-filled enamels, nor does it flake or peel like epoxies. This ceramic-reinforced composite material is resistant to shrinking, scratching and impact. By means of a special LED curing light, it dries into a solid 3-D polymer network with exceptional strength. Because it comes in a liquid form it's easily applied on both flat and curved surfaces. Gives your jewelry the look and feel of enamel.

Colors can be mixed to create any hue, opaque or transparent. Can be carved, sanded, filed, machined, and lathe-turned at high speeds, sandblasted or polished to a high shine right along with the metal. So durable that it can withstand tumbling, electroplating and mild ultrasonic, steam and solvent cleaning.

Use a single color, or mix colors to obtain any hue. Colors included with each set are of medium saturation, so they appear slightly translucent. White makes the colors more opaque. Clear makes them more transparent. Pearl White looks stunning by itself and creates a pearlescent, marbled look when added to any of the other colors.

COLORiT Starter Set includes:

- 8 jars COLORiT (Deep Black, Deep Red, Deep Yellow, Deep Green, Deep Blue, Hi Clear, White & Neon Red)
- 4ml Premium Bond
- LED DP2 Curing Light
- Workplate with Heater
- Light-Protected Workstation, 13¾"W x 10"D x 9½"H
- Micro Brush Regular (10)
- Micro Brush Super Fine (10)
- Applicator Tool
- Instrument Holder
- Ring Holder

Description	Item#	Each
COLORiT Starter Set 	821-3507	\$2,995.00

The COLORiT Process

Both a mechanical bond and a chemical bond are required to ensure COLORiT durability and colorfastness. Inlaid areas must be undercut, and proper application and curing instructions must be followed. COLORiT is easy to apply and dries in just minutes under the special curing light. From cleaning to curing, the complete process usually takes no longer than 30 minutes; curing comprises roughly half that time and requires only minor operator attention.

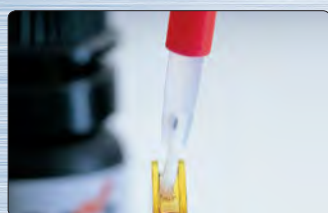

1. Apply Premium bond and let dry.



2. Apply color.



3. Cure with special light source.

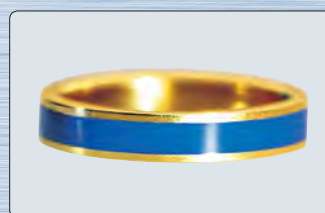

4. File, sand, sandblast or polish.





Images courtesy of Annika Bertilsdotter/Sweden.



A

COLORiT Accessory	Item#	Each
A. DP2 Desklight	821-3509	\$1,295.00

COLORiT Set Component	Item#	Each
Light-Protected Workstation	821-3575	\$218.00
Premium Bond, 4ml 	821-3662	275.00
Bond, 5ml 	821-3663	170.00
Glass Mixing Plate	821-3565	84.00
Regular Micro Brushes (pkg. of 10)	821-3558	10.75
Fine Micro Brushes (pkg. of 10)	821-3559	11.75
Applicator Tool	821-3570	69.95
Ring Holder	821-3576	60.50
Instrument Holder	821-3577	42.00

COLORiT Material, 5-gram Jar	Item#	EACH Prices	
		1-2	3+
Yellow	821-3525	\$65.95	\$59.36
White	821-3521	65.95	59.36
Clear	821-3520	65.95	59.36
Hi-Clear	821-3551	65.95	59.36
Deep Black	821-3584	65.95	59.36
Deep Red	821-3581	65.95	59.36
Deep Blue	821-3580	65.95	59.36
Deep Yellow	821-3582	65.95	59.36
Deep Green	821-3583	65.95	59.36
Night Fever/Neon Red	821-3592	65.95	59.36
Pearl White	821-3522	65.95	59.36



B

B. COLORiT Lite Cube 1

The latest advance in COLORiT technology, the Lite Cube is a compact UV curing chamber with adjustable UV levels and fully-lined metal interior to boost UV reflection and insure homogeneous curing of all COLORiT colors. With a 7" x 7" curing area, Lite Cube is ideal for curing small jewelry items such as rings, pendants and bracelets – one at a time or in multiples.

Lite Cube includes an industrial safety system which protects the user from UV radiation. Effective, efficient and user-friendly. Larger curing options also available; please call for details.

Specifications:

Supply Voltage: 220V (Transformer included for use on 110V)
 Power Input: 100 Watts
 Overall Dimensions: 13.8"L x 10.2"W x 9.8"H
 Curing Area: 7" x 7"

Description	Item#	Each
B. COLORiT Lite Cube 1	821-3502	\$3,595.00
COLORiT Replacement Bulb, for Lite Cube 1	821-3503	385.00



Image courtesy of Heimerle & Meule.

 Although no hazardous shipping surcharge applies, these items can only ship via UPS® Ground, no air, FedEx® or US Mail possible. Cannot ship to Alaska, Hawaii or Puerto Rico.

VivaColor by Jentner

Light-curing high-end acrylic resin

Immerse yourself in the fascinating world of color with VivaColor, powered by Jentner. This light-curing, high-end acrylic resin sets no boundaries to your creativity. The eight standard colors are bright and beautiful right out of the jar. VivaColor is fun and easy to use ... mix and blend colors to create endless effects... The hand-held Curing Light transforms VivaColor into a hard, durable material that can be sanded, carved and polished to a brilliant finish.

The VivaColor Basic Set (821-3402) includes everything that you need to get started. The Viva-Mini Curing Light is slim, powerful and perfect for one-of-a-kind pieces.

The VivaColor Deluxe Set (821-3400) upgrades your curing capabilities with the two-piece Curing Light offering you more flexibility. The addition of the Heater Unit offers you increased versatility for mixing your colors.

Shatter the boundaries to your creativity! Breathe life into your jewelry with VivaColor.



A
VivaColor
Deluxe Set



B
VivaColor
Basic Set



Standard Colors (10g Jars): Provided with either Complete Set and in the Viva Pure Color 8 color set.

Pure Transparent	821-3481	\$58.00
Pure White	821-3482	58.00
Pure Red	821-3483	58.00
Pure Orange	821-3484	58.00
Pure Yellow	821-3485	58.00
Pure Green	821-3486	58.00
Pure Blue	821-3487	58.00
Pure Black	821-3489	58.00

Description	Item#	Each
A. VivaColor Deluxe Set	821-3400	\$2,595.00
B. VivaColor Basic Set	821-3402	1,495.00
Mini-Flashlight	821-3403	795.00
VivaPureColor 8 color Set*	821-3480	440.00
3g Syringe of Bond	821-3414	125.00
1ml Pen of Link	821-3410	99.95
Micro Brush Regular (pkg of 10)	821-3420	8.75
Micro Brush Fine (pkg of 10)	821-3422	8.75
Micro Brush Superfine (pkg of 10)	821-3424	8.75

VivaColor	Basic Set 821-3402	DeluxeSet 821-3400
Deluxe Curing Light		●
Viva Mini-Flashlight	●	
Light Protection Box	●	●
Heating Plate		●
Applicator Bent Tool with Stand	●	●
Ring Holder	●	●
Micro Brushes (10 Ea) / Superfine, Fine and Regular	●	●
3g Syringe of Bond	●	●
1ml Pen of Link	●	●
*8 Standard Color Jars (10gm)	●	●

*Includes 8 Standard Color Jars (10gm): Transparent (821-3481), White (821-3482), Red (821-3483), Orange (821-3484), Yellow (821-3485), Green (821-3486), Blue (821-3487), Black (821-3489)



Upgrade Colors (10g Jars):

Basic Yellow	821-3460	\$58.00
Signal Yellow	821-3461	58.00
Signal Red	821-3462	58.00
Spring Green	821-3463	58.00
Sky Blue	821-3464	58.00
Turquoise	821-3465	58.00
Pure Brown	821-3488	58.00

Effects Colors (5g Jars):

Pearl White	821-3479	\$40.00
Silver	821-3475	40.00
Gold	821-3476	40.00
Green	821-3478	40.00
Blue	821-3477	40.00



⚠ Although no hazardous shipping surcharge applies, these items can only ship via UPS® Ground, no air, FedEx® or US Mail possible. Cannot ship to Alaska, Hawaii or Puerto Rico.



A



B

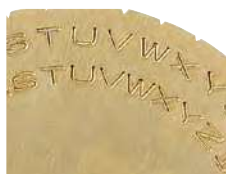

C



D

A-D Gravograph/New Hermes® RV-II Inside Ring Engraver

Point of purchase engraving makes it easy to close a sale, offers your customers instant gratification and turns each ring into a personalized keepsake.

The RV-II is manufactured by Gravograph (New Hermes), a supplier of engraving machines and accessories used by jewelers worldwide for over 70 years. The RV-II's cast metal design and high precision components ensure that you will produce high quality engraving for generations to come.

With the RV-II you can engrave bright initials, dates or phrases on the inside of almost any shape or size ring easily and quickly. Requires no prior engraving experience – an unskilled operator can engrave up to 20 letters in a few minutes. Results are bright, highly readable and completely professional.

The RV-II will easily engrave on wedding bands or stone-set rings. It automatically centers the ring in the clamping jig. Uniform spacing between letters is easily accomplished by pushing a lever.

A replaceable diamond stylus creates bright lettering with a hand-engraved appearance.

The reversible type dial (included) has 2 different type styles. Gothic is simple but fully readable, while Tilted Block presents a more formal appearance. Also available are the Extra-Condensed and 2 Line Block Dials, as well as a Continuous Script Dial for a more romantic look. Made in France.

Description	Item#	Each
A. RV-II Inside Ring Engraver	821-6980	\$2,485.00
B. RV-II Extra-Condensed Block Dial	821-6985	167.50
C. RV-II 2 Line Block Dial	821-6986	167.50
D. RV-II Continuous Script Dial	821-6982	336.00
Replacement Ring Jig	821-6981	66.50
Replacement Diamond Stylus Point	821-6956	37.50



E



F



G



H



I

E-H Inside Ring Engraver

Our easy-to-use inside ring engraver allows you to personalize your customer's purchase on the spot.

Offers bright, legible markings to make every ring a memorable possession. Includes one reversible block type dial and complete instructions. Optional type dials are sold separately increasing the versatility and allowing you to close the sale for many different customers. Made in India.

Features:

- Rugged construction
- Diamond tip
- Automatic X and Y centering
- Reversible dials
- Pressure and depth regulation
- Auto indexing

Description	Item#	Each
E. Inside Ring Engraver with Block Dial	821-6210	\$495.75
Diamond tip Stylus	821-6211	30.00
F. Reversible Block Dial (included with the Engraver)	821-6215	125.00
Optional Connecting Block Dial (not included with the Engraver)	821-6216	180.00
H. Optional Script Dial (not included with the Engraver)	821-6217	125.00
I. Optional Connected Script (not included with the Engraver)	821-6218	180.00

BESTBUILT Engraving Systems – Engrave on Alternative Metals!

All machines are 100~240V 50/60 Hz. One-year manufacturer's Warranty. Made in South Korea.



				
BB-70 – Flat/Ring/Cutter	BB-50 – Flat/Ring	BB-1S – Ring Only	BB-20 – Flat only	BB-5S – Flat/Ring

Specifications:

Acceptable Workpieces

Flat and curved items, flat and domed rings inside and outside.	Flat and domed rings inside and outside	Rings, inside and outside, Max. ID 30mm, Max. OD 40mm	Watches, dog tags, ID bracelets, bar necklaces and more	Flat objects as well as inside and outside rings
-----------------------------------------------------------------	-----------------------------------------	-------------------------------------------------------	---------------------------------------------------------	--------------------------------------------------

Engraves on Flat Areas

Max. Size: 4½" x 4"	Max. Size: 4½" x 4"	N/A	Max. Size: 4½" x 4"	Max. Size: 4½" x 4"
---------------------	---------------------	-----	---------------------	---------------------

Additional Features

<ul style="list-style-type: none"> • Cut into soft metals such as gold, silver, copper, aluminum • Single-line, double-line and hatching-style engraving • Speed up or slow down the process • Engrave JPEG images 	<ul style="list-style-type: none"> • Single-line, double-line and hatching-style engraving • Speed up or slow down the process • Engrave JPEG images 	<ul style="list-style-type: none"> • Create multiple lines of engraving inside the ring • Engraves curved surfaces inside and outside of rings and bands • Provides upgraded program • Tablet controlled 	<ul style="list-style-type: none"> • Engrave on gold, silver, copper, and stainless steel • Features a laser guide for accuracy. • Includes MagicArt Software to easily include logos, images and even photos. 	<ul style="list-style-type: none"> • Includes wireless tablet • Features a laser guide for accuracy. • Includes MagicArt Software to easily include logos, images and even photos.
--------------------------------------------------------------------------------------------------------------------------------------------------------------------------------------------------------------------------------------------------------------	---------------------------------------------------------------------------------------------------------------------------------------------------------------------------------------	----------------------------------------------------------------------------------------------------------------------------------------------------------------------------------------------------------------------------------------------------	-------------------------------------------------------------------------------------------------------------------------------------------------------------------------------------------------------------------------------------------------	---------------------------------------------------------------------------------------------------------------------------------------------------------------------------------------------------------------------

Electrical:

100~240V 50/60 Hz	100~240V 50/60 Hz	100~240V 50/60 Hz	100~240V 50/60 Hz	100~240V 50/60 Hz
-------------------	-------------------	-------------------	-------------------	-------------------

Dimensions:

15½"W x 15½"D x 14¾"H	15½"W x 15½"D x 14¾"H	9¼"W x 11"D x 12¾"H	11¾"W x 14"D x 12"H	11¾"W x 14"D x 12"H
-----------------------	-----------------------	---------------------	---------------------	---------------------

Net Wt.:

72 lbs.	68 lbs.	28 lbs.	54 lbs.	54 lbs.
---------	---------	---------	---------	---------

Item#	821-5903	821-5902	821-5937	821-5936	821-5939
Price	\$8,495.00*	\$5,995.00*	\$3,495.00*	\$3,595.00*	\$5,795.00*

*NOTE: A \$35 packaging fee will be added to your order. This allows us to reduce shipping costs for you by shipping this item via UPS/FedEx instead of by truck.

Please see our website for the most up-to-date information and current BESTBUILT offerings.

Accessories

Description	Item#	Each
Replacement 120° Tip (all models)	821-5914	\$35.00
Optional 90° Tip for BB-50/70	821-5913	\$35.00
F. Optional Vinyl Dust Cover: 10"H x 12"D X 15"W (all models)	821-5909	35.90
G. Optional Mighty Bright LED Mini Task Light	821-5552	18.95
Optional V-cut 25° Tip for BB-70	821-5931	49.95
Optional V-cut 15° Tip for BB-70	821-5932	49.95
Optional .3mm endmill for BB-70	821-5933	39.95
Optional 1.0mm endmill for BB-70	821-5934	59.95
Small Jig Assembly for BB-50/70	821-5918	90.00
Large Jig Assembly for BB-50/70	821-5919	135.00



Established in 1961, Sisma is known worldwide for the design and production of extremely high precision machinery. Innovative by vocation, Sisma combines an independent and cutting edge design and production organization, with a wealth of highly specialized experience and technical expertise, thus guaranteeing top product quality. ISO 9001 certified. Made in Italy.

For basic engraving we offer the LOGO Marker. Compact and affordable, without sacrificing quality or precision. This Nd: YAG laser engraver features an automated motor axis for inside and outside ring making, a variable Z axis for spot precision, and is air cooled for quiet, continuous use. View your work in progress with a large sight glass and internal LED illumination. Additional features include the ability for 900 DPI picture importing and marking, remote assistance for software upgrades and troubleshooting, and hookups for fume extraction and metal reclamation.

For production engraving and light cutting consider the Easy 200 or 300 fiber optic laser markers. Innovative "all-in-one" laser marking system, characterized by ease of use and equipped with a Z motorized axis, these machines operate at high precision and speed. View your work in progress with a large sight glass and LED interior lighting.

For cutting and engraving select between the robust Smarky 500 (50W) and 700 (70W) fiber optic Marker/Cutters use the same principles and fiber optic technology as the Easy 200 and 300 series but boast upgrades such increased speed, larger working chamber and higher working power. A must for any manufacturer looking to do trademarking or mass production, 2D cutting, and engraving on almost any shape or metal.

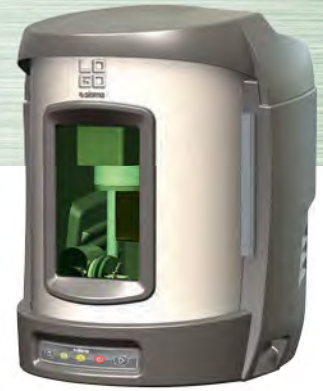

LOGO



Easy



Smarky

*Technical Data	LOGO	Easy 200 / Easy 300	Smarky 500 / Smarky 700
Item #	821-5950	821-5955 / 821-5956	821-5958 / 821-5959
Source Type	Nd: YAG Diode	Yb	Yb
Wavelength	1064nm	1064nm	1064nm
*Average Laser Power	6W	20W / 30W	50W / 70W
Pulse Frequency	Fixed	1-500 kHz	1-500 kHz
Pulse Duration	4 ns	40-260 ns	40-260 ns
Max Pulse Energy	-	0.21-1 mJ	0.21-1 mJ
Beam Quality	-	≤ 1.6 M2	≤ 1.6 M2
Beam Spot Diameter	-	20 μm	20 μm
Max Marking Speed	-	2000 mm/s	2000 mm/s
Z Axis Stroke	-	290 mm	400 mm
Power Supply	230V, 50/60 Hz	230V, +/- 15%, 50/60 Hz	230V, +/- 15%, 50/60 Hz
Dimensions	19" x 17½" x 24" (480 x 445 x 610mm)	22" x 30" x 30⅝" (560 x 760 x 770mm)	21¾" x 37¼" x 37½" (555 x 945 x 955mm)
Weight	78 lbs, 35 kg	187 lbs, 85 kg	330 lbs, 150 kg
Warranty	1 Year	1 Year	1 Year

Please call for current pricing

*Due to the technical nature of these products, details may change. Please see our website for the most up-to-date information.

Accessories

A. Varibench Table

Variable height bench custom made to fit all Sisma tabletop models. Can be raised or lowered (31" - 51") for an ergonomic and comfortable height. Made In USA.

Description	Item#	Each
Varibench Table	830-0788	\$1,295.00

B. Extra Large Saddle Stool

Seat measures 16" by 18" and is 3 inches thick to provide maximum comfort. Star base is 24" wide and provides extra stability. Foot-rest ring is 18" in diameter and height-adjustable 8" to 13½". Seat height ranges from 19" to 26". Five smooth rolling casters allow for easy mobility. Made in China.

Description	Item#	Each
Extra Large Saddle Stool	810-1812	\$199.00



A



B



GRS® Systems – For Engraving, Bright Cutting, Bead Raising and Setting.

Designed for beginners and professionals alike, GRS Power Engravers make clean, sharp cuts in precious metals, steels, crystal, glass, stone, wood and other materials. Transform compressed air into powerful impact action for engraving, texturing, carving and more. Backed by a two-year manufacturer's warranty. Made in USA.



A

A. GRS® GraverMax G8® – Revamped for better performance!

The venerable GraverMax tradition continues with this affordable, compact system. Features adjustable speed of 400–8,000 strokes per minute, adjustable throttle bias for tailoring response to different jobs and advanced valve pulse unit for quiet operation.

Requires air compressor for 1.4 CFM of oil-free air at 45 PSI. Includes foot pedal, dual-stage air regulator, air hoses and quick-disconnect handpiece fittings for all GraverMax handpieces. Measures 5¼"W x 12"D x 8¼"H. Electrical: 100–240V, 50/60Hz. UL approved. Made in USA.

Description	Item#	Each
A. GraverMax G8	856-0311	\$1,350.00
GraverMax G8 w/ #710 QC Handpiece	855-9949	1,630.00
GraverMax G8 w/ #901 QC Handpiece	855-9951	1,625.00
GraverMax G8 w/ #940 QC Handpiece	855-9952	1,650.00



B

B. GRS® GraverMach® AT – All in One System

Never before has an all-in-one system given the user so much versatility and control. Features a selector knob for choice of hand or foot operation of your handpiece: the touch element offers pressure-sensitive hand control for precision work; the traditional foot pedal offers standard foot control when you prefer.

Requires air compressor for 1.4 CFM of oil-free air at 45 PSI. Includes foot pedal, dual-stage air regulator, air hoses and quick-disconnect handpiece fittings for all GraverMach handpieces. Measures 6"W x 13"D x 8¼"H. Electrical: 100–240V, 50/60Hz. UL approved. Made in USA.

Description	Item#	Each
B. GraverMach AT	856-0270	\$1,898.00
GraverMach AT w/ #901 QC Handpiece	856-0102	2,138.00
GraverMach AT w/ #940 QC Handpiece	856-0101	2,178.00



C

C. GRS® GraverSmith® – The budget-oriented choice!

Performs basic engraving and setting for less than its siblings, GraverMach and GraverMax SC. Features regulator with pressure gauge, combo filter and water trap, adjustable speed of 400–8,000 strokes/min. and quick-disconnect handpiece fitting.

Requires air compressor that yields at least 1.4 CFM of air at 45 PSI. Includes foot control, air tubing, and holes for storing accessories. Electrical: 110/220V. Measures 5¾"W x 10"D x 9"H.

Description	Item#	Each
C. GraverSmith	855-9950	\$890.00



D

D. GRS® GraverMeister® – The original standalone machine!

This unit comes ready to use with its own oil-less air compressor, making it readily portable. Features adjustable speed of 1,600–2,400 strokes/min. (sliding lever on front controls stroke rate). Can be used for engraving on precious metals, steels and more, carving, stippling, bright-cutting and bead raising.

Sold alone or with GRS #509 handpiece (see p. 279 for details). Includes foot control, air tubing and four tools. Electrical: 115V, 7A, 60Hz. Measures 14"W x 11½"D x 8½"H.

Description	Item#	Each
D. GraverMeister	856-0049	\$1,788.00
GraverMeister with #509 QC HP	856-0302	2,037.00

A. GRS® #901 Quick-Change Handpiece – For Max/G8/SC, Mach/AT & Smith

Offers a wide power range and fine control. Excellent for stone setting, fine engraving, deep relief work, bead raising and hammer setting. Features heat-treated stainless steel construction, ergonomic handle and adjustable side hose connection. Available with six quick-change holders or in a complete set with quick-change handle, and tool tray. Measures 2.6" long. Weighs 2.6 oz.

Description	Item#	Each
A. #901 Quick-Change Handpiece	855-9991	\$299.00
#901 Quick-Change Handpiece Set	855-9992	349.00



B. GRS® #921 Monarch Quick-Change Handpiece – For Max/G8/SC, Mach/AT & Smith

The top-quality Monarch impact handpiece makes ultra-fine engraving easier than ever, including bulino and banknote styles. Features heat-treated stainless steel construction, graver-style handle and adjustable side hose connection. Includes six quick-change holders. Measures 2.4" long. Weighs 1.8 oz.

Description	Item#	Each
#921 Monarch Quick-Change Handpiece	855-9990	\$299.00



C. GRS® #940 Magnum Quick-Change Handpiece – For Max/G8/SC, Mach/AT & Smith

The compact handpiece with an unmatched combination of power and control—try it and you'll be more than impressed. Offers a better range of power than any other handpiece, from very fine to amazingly heavy. In fact, it exceeds the power of previous models that are twice as large. Also offers fine control with shading capability that's significantly better than any handpiece with this much top-end power. Includes palm knob, head and six quick-change holders. Oval knob available as a special order. Measures 2.8" long. Weighs 6.4 oz.

Description	Item#	Each
#940 Magnum Quick-Change Handpiece	856-0303	\$339.00



D. GRS® #710 Quick-Change Handpiece – For Max/G8/SC, Mach/AT & Smith

Offers plenty of power for working on hard metals such as platinum and steel as well as good control for making smooth cuts in gold and other soft metals. Features stainless steel construction, ergonomic handle and quiet rear exhaust. Includes six quick-change holders. Measures 4.4" long. Weighs 6.4 oz.

Description	Item#	Each
#710 Quick-Change Handpiece	856-0015	\$315.00

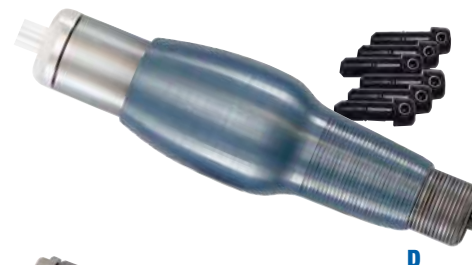

E, F GRS® #610 Hammer Handpiece – For Max/G8/SC, Mach/AT & Smith

This exceptional impact tool offers the power for stone setting and control necessary for light jobs. Operates with tool directly on work rather than loosely above it for reduced stone damage. Built for all-day use. Produces the brightest stippling possible when used with Lazer Point #850-3590 (sold separately). Setscrew chuck holds round tools up to 0.13" (3.3mm) and square tools up to 0.10" (2.5mm). Measures 4.5" long. Weighs 5.5 oz.

Description	Item#	Each	
E. #610 Hammer Handpiece	856-0280	\$319.00	
Description	Item#	1-2	3+
F. Lazer Point	850-3590	\$24.95	\$22.46



G. GRS® #509 Large Quick-Change Handpiece – For GraverMeister only.

The most powerful GraverMeister handpiece available. Great for heavy metal engraving, hammering and wood carving. Includes six quick-change holders. Measures 6.0" long. Weighs 7.9 oz.

Description	Item#	Each
#509 Large Quick-Change Handpiece	856-0301	\$370.00



H. Handpiece Storage Strip

The Handpiece Storage Strip keeps handpieces within easy reach. Four holes provide storage for multiple handpieces of varying size. The storage strip includes clips that fit the side of some commercial benches. It can also be mounted to a flat surface with the included hardware.

Description	Item#	Each
Handpiece Storage Strip	850-0604	\$10.30





A

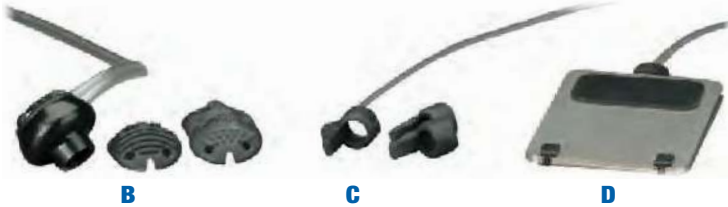

B

C

D



E



F

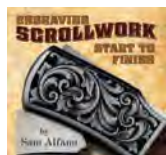

G



H



I

A-D GRS® Airtact® Control System

Airtact replaces the foot control on your GRS machine to provide an incredibly tactile, precise way to control power to your impact handpiece using only the pressure of your palm, thumb/finger or foot, bringing higher precision to engraving work.

Consists of Control System and your choice of Touch Elements: Palm style installs on back of handpiece for those who hold it like a hand engraver, Thumb/Finger style installs on front of handpiece for those who hold it like a pencil and FootPod style is designed for those who prefer tried-and-true foot control.

Airtact works with GraverMax G8, GraverMach, GraverMax SC, GraverSmith, GraverMax or GraverMate, regardless of when it was made (GraverMax and GraverMate require proper Filter Hookup Set). Control System includes tubing and connections for up to two Touch Elements. Measures 3½"W x 7"D x 4½"H. Backed by a two-year manufacturer's warranty.

Description	Item#	Each
A. Control System	855-9957	\$432.00
B. Palm Element Set for #901 HP	855-9961	111.00
Palm Element Set for #921 HP	855-9962	116.00
C. Thumb/Finger Element Set for #901 HP	855-9960	32.80
Thumb/Finger Element Set for #921 HP	855-9959	32.80
D. FootPod Element Set	855-9958	44.65
Filter Hookup Set for GraverMax	855-9955	51.70
Filter Hookup Set for GraverMate	855-9956	51.50

E. GRS® Quick-Change Handpiece System 3

The most affordable, least complicated air impact handpiece system from GRS. Unlike GRS systems which produce special air pulses to control impact handpieces, Handpiece System 3 uses normal compressed air to run a simpler self-oscillating piston-and-port quick-change impact handpiece.

Features a lightweight, cool-running handpiece that reduces fatigue so you can work faster. Delivers good power for engraving, texturing and carving a variety of materials. Includes air filter/regulator, foot control, three quick-change tool holders, air tubing and interchangeable springs for fine to heavy work. Requires air compressor that yields at least 1.2 CFM of air at 50 PSI.

Description	Item#	Each
Quick-Change Handpiece System 3	856-0020	\$552.00

F. Quick-Disconnect Kit – Saves time changing handpieces.

Allows quick changes from one handpiece to another without interrupting workflow. Cuts off airflow immediately when release button is pushed. Installs on vinyl tubing. Includes main body and two quick-disconnect handpiece fittings.

Description	Item#	Each
Quick-Disconnect Kit	856-0282	\$29.95

G-I Sam Alfano Engraving DVDs

Produced by master engraver Sam Alfano, this instructional video has something to offer the novice and professional alike. Teaches basic to advanced ring engraving techniques with close-up video, from a fundamental running leaf border to lumesque scrollwork, relief engraving, sculpting and more. DVD format, 120 minutes.

Description	Item#	Each
G. Engraving Scrollwork Start to Finish	811-0075	\$49.99
H. Lettering Techniques for Hand Engravers	811-0077	49.99
I. Successful Jewelry Engraving	811-0064	49.95

A. Foredom® Power Graver™ – For engraving and setting.

Power Graver is a flexible shaft system specially designed for engraving and hammering. Uses standard gravers to give you the feel of hand engraving with less effort and fatigue. Provides stone setters the power they need for bezel and channel setting, raising beads, turning prongs and chasing.

Includes motor, #9D hammer handpiece with duplex spring, manual speed controller, on/off foot switch, accessory kit, grease, handpiece oil and DVD. Permanently lubricated ball bearing motor provides high torque at low speed for tough jobs. Can be used with hammer handpieces other than #9D. The #9D handpiece comes with 1/16", 3/32", 1/8" and 3mm collets for gravers, beading tools and setting tools. Fits Power Graver motor only. Benchtop manual speed controller runs motor at 500–2,800 strokes/min., keeping selected speed constant. On/off foot switch lets you stop and start again without readjusting speed.

Description	Item#	Each
A. Power Graver, 110V	821-6725	\$552.50
Power Graver, 220V	821-6730	552.50

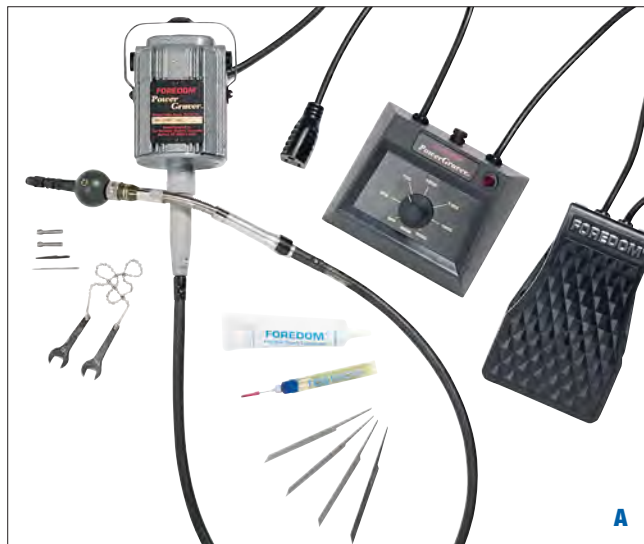

B-D GRS® #850 Ultra-High-Speed Rotary Handpiece

Provides considerably more power and torque than other rotary handpieces. Operates at 300,000–400,000rpm for effortless engraving, decorating and grinding of metal, plastic, glass, stone, wood and many other materials. Runs with virtually no vibration or noise. Needs no lubrication. Accepts only 1/16" tools due to its high operating speed (see below for diamond/stone and carbide bur sets). Includes air tubing, connectors and carbide bur. Connects to auxiliary airport on all GRS systems (excluding GraverSmith and GraverMeister) or any regulated air supply. Requires 1.3 CFM of air at 30–35 PSI. Measures approx. 5/8" dia. x 5 1/8" long. Weighs 2.5 oz.

Description	Item#	Each
B. #850 Ultra-High-Speed Rotary Handpiece	855-9989	\$470.00
C. Diamond/Stone Bur Set - 1/16" shank	856-0289	49.95
D. Carbide Bur Set - 1/16" shank	856-0288	24.95



E, F Magna-Graver® II Vari-Pact™

Vari-Pact is a powerful impact handpiece that attaches to any standard flex shaft except Power Graver. Allows you to do scrollwork, florentine, bead raise, texture and stipple on precious metals as well as brass and steel. Selector button lets the user choose from four impact power settings that range from light to heavy for better cutting control. To protect handpiece from undue wear and tear and improve control, use with a flex shaft that has gear reduction, such as Foredom LX (850-1220 see p. 436). Measures 5 1/4" long. Made in USA. Graver set sold separately.

Description	Item#	Each
E. Magna-Graver II Vari-Pact	821-6042	\$325.00
F. Graver Set for Magna-Gravers*	821-6045	36.35

*Three gravers (square, flat and liner) and round high-speed steel tool blank, all with 1/8" shanks



G-I Dremel® Electric Engraver

An economical adjustable engraver for creating designs on metal, wood, plastic, ceramic, glass and leather. Features stroke adjustment dial and pencil-type grip. Includes hanger and carbide point. Measures 6" long. UL listed.

Description	Item#	Each
G. Electric Engraver, 110V	821-6010	\$31.95
H. Optional Diamond Point	821-6020	16.25
I. Replacement Carbide Point	821-6015	5.30



J, K Brass Practice Rings

Use to practice engraving, bead setting and more. Size 6.

Description	Item#	Pkg. of 10
J. Thin (3mm) Rings	260-3070	\$19.95
K. Wide (8mm) Rings	260-3071	26.50

L. Brass Practice ID Tags

Practice engraving different ratio adjustments on these 30 x 50mm highly polished ID tag style brass plates. Use to make a master set of templates in a range of ratios so you can easily select the right ratio for every job. 15 gauge with 1/8" (3mm) hole. Sold in packages of 10.

Description	Item#	Pkg. of 10
L. Brass ID Tag	260-3072	\$24.00

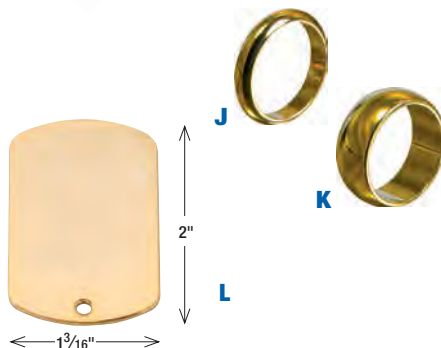

Muller® Swedish Steel Gravers

Made of premium-grade Swedish steel pretempered for work on nonferrous metals such as gold, platinum, silver and copper. Can be retempered to suit individual requirements.



Muller Flat

No.	Item#	EACH Prices	
		1-2	3+
36	165-1360	\$6.65	\$5.99
37	165-1370	6.65	5.99
38	165-1380	6.65	5.99
39	165-1390	6.65	5.99
40	165-1400	6.65	5.99
41	165-1410	6.65	5.99
42	165-1420	6.65	5.99
43	165-1430	6.65	5.99
44	165-1440	6.65	5.99
45	165-1450	6.65	5.99
46	165-1460	6.90	6.21
47	165-1470	6.90	6.21
48	165-1480	6.90	6.21
49	165-1490	6.90	6.21

Muller Round

No.	Item#	EACH Prices	
		1-2	3+
50	165-1500	\$6.65	\$5.99
51	165-1510	6.65	5.99
52	165-1520	6.65	5.99
53	165-1530	6.65	5.99
54	165-1540	6.65	5.99

Muller Point (Onglette)

No.	Item#	EACH Prices	
		1-2	3+
000	165-6003	\$6.65	\$5.99
00	165-6002	6.65	5.99
0	165-6001	6.65	5.99
1	165-6010	6.65	5.99
2	165-6020	6.65	5.99
3	165-6030	6.65	5.99

Muller Half-Point Left

No.	Item#	EACH Prices	
		1-2	3+
2	165-2020	\$3.33	\$3.00

Muller Bevel Edge

No.	Item#	EACH Prices	
		1-2	3+
0	165-0001	\$7.50	\$6.75
1	165-0010	7.50	6.75
2	165-0020	7.50	6.75
3	165-0030	7.50	6.75

Muller Oval

No.	Item#	EACH Prices	
		1-2	3+
63	165-0630	\$6.90	\$6.21
64	165-0640	6.90	6.21
65	165-0650	6.90	6.21

Muller Knife

No.	Item#	EACH Prices	
		1-2	3+
0	165-4000	\$6.65	\$5.99
1	165-4010	6.65	5.99
2	165-4020	6.65	5.99
3	165-4030	6.65	5.99
4	165-4040	6.65	5.99

Muller Square

No.	Item#	EACH Prices	
		1-2	3+
2	165-7020	\$6.98	\$6.28
4	165-7040	6.98	6.28
6	165-7060	6.98	6.28
8	165-7080	6.98	6.28
10	165-7100	6.98	6.28
12	165-7120	7.25	6.53

Muller Tapered Square

No.	Item#	EACH Prices	
		1-2	3+
1	165-8010	\$6.98	\$6.28
2	165-8020	6.98	6.28
3	165-8030	6.98	6.28

Gesswein® High-Speed Red Tang Gravers

Made of high-speed steel. Generally preferred for use on gold, platinum, silver and steel. Hold cutting edges four to five times longer than Swedish tool steel gravers. Made in USA.



Gesswein HS Flat

No.	Item#	EACH Prices	
		1-2	3+
36	166-1360	\$7.85	\$7.07
37	166-1370	7.85	7.07
38	166-1380	7.85	7.07
39	166-1390	7.85	7.07
40	166-1400	7.85	7.07
41	166-1410	7.85	7.07
42	166-1420	7.85	7.07
43	166-1430	7.85	7.07
44	166-1440	7.85	7.07
45	166-1450	7.85	7.07

Gesswein HS Round

No.	Item#	EACH Prices	
		1-2	3+
50	166-1500	\$7.85	\$7.07
51	166-1510	7.85	7.07
52	166-1520	7.85	7.07
53	166-1530	7.85	7.07
54	166-1540	7.85	7.07
55	166-1550	7.85	7.07
56	166-1560	7.85	7.07
57	166-1570	7.85	7.07

Gesswein HS Point (Onglette)

No.	Item#	EACH Prices	
		1-2	3+
0	166-5001	\$7.85	\$7.07
1	166-5010	7.85	7.07
2	166-5020	7.85	7.07
3	166-5030	7.85	7.07
4	166-5040	7.85	7.07

Gesswein HS Bevel Edge

No.	Item#	EACH Prices	
		1-2	3+
1	166-0010	\$8.99	\$8.09
3	166-0030	8.99	8.09

Gesswein HS Knife

No.	Item#	EACH Prices	
		1-2	3+
0	166-4000	\$7.85	\$7.07
1	166-4010	7.85	7.07
2	166-4020	7.85	7.07
3	166-4030	7.85	7.07
4	166-4040	7.85	7.07

Make your own custom grips and handles with JETT SETT— see p. 495

High-Speed Yellow Tang Gravers

Made of high-speed steel specially melted and rolled just for gravers. Suitable for use on precious metals, wood, bone, ivory and onyx. Made in Turkey.



Yellow Tang Flat

No.	Item#	Each
36	166-7210	\$10.60
37	166-7211	10.60
38	166-7212	10.60
39	166-7213	10.60
40	166-7214	10.60
41	166-7215	10.60
42	166-7216	10.60
43	166-7217	10.60

Yellow Tang Point (Onglette)

No.	Item#	Each
4/0	166-7198	\$10.60
2/0	166-7200	10.60
0	166-7201	10.60
1	166-7202	10.60
2	166-7203	10.60
3	166-7204	10.60
4	166-7205	10.60
5	166-7206	10.60
6	166-7207	10.60

Yellow Tang Round

No.	Item#	Each
50	166-7220	\$10.60
51	166-7221	10.60
52	166-7222	10.60
53	166-7223	10.60
54	166-7224	10.60

A. GRS® Combination Tool Carousel – For gravers and small tools.

Spend more time engraving and less time searching for tools with this efficient organizer. Top tray holds up to 30 tools and gravers, and bottom tray has four removable QC (quick-change) tool trays that each hold 10 gravers with GRS QC Holders attached. All trays rotate for easy access. Small footprint occupies very little space on the workbench.

Description	Item#	Each
Combination Tool Carousel	856-0293	\$40.85



Tools not included

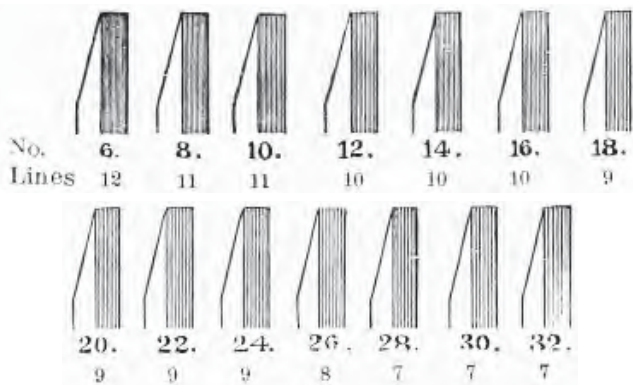

A, B Muller® Line Gravers (Liners)

Every industry knows the adage “time is money” and liners are a terrific time saving tool for engravers. Use to make multiple parallel lines with a single stroke for shading, backgrounds, achieving a Florentine finish and cross-hatch or checkering patterns. Made of premium-grade Swedish steel. Choose from straight and bent styles. Each has a size that represents the distance between lines (the first number) and the number of lines (the second number). The larger the first number, the greater the distance between lines. Size 18/10 creates a standard Florentine finish. Can be used on a variety of metals, woods, plastics etc. Made in USA.

Style	Size	Item#	Each
A. Straight	6/4	167-0604	\$17.00
	6/6	167-0606	17.00
	6/8	167-0608	17.00
	6/10	167-0610	17.00
	8/6	167-0806	17.00
	8/10	167-0810	17.00
	12/10	167-1210	17.85
	14/10	167-1410	17.40
	18/6	167-1806	18.60
	18/8	167-1808	20.00
	18/10	167-1810	20.00
	18/12	167-1812	20.00
	20/10	167-2010	19.70
	24/6	167-2406	19.89
	24/8	167-2408	23.20
	26/10	167-2610	20.00
28/10	167-2810	23.35	
30/10	167-3010	23.35	
32/8	167-3208	23.35	
32/10	167-3210	23.35	
B. Bent	6/4	168-0604	18.65
	6/6	168-0606	18.65
	6/8	168-0608	18.65
	6/10	168-0610	18.65
	8/6	168-0806	18.65
	14/10	168-1410	19.15
	18/10	168-1810	21.70
	18/12	168-1812	21.70

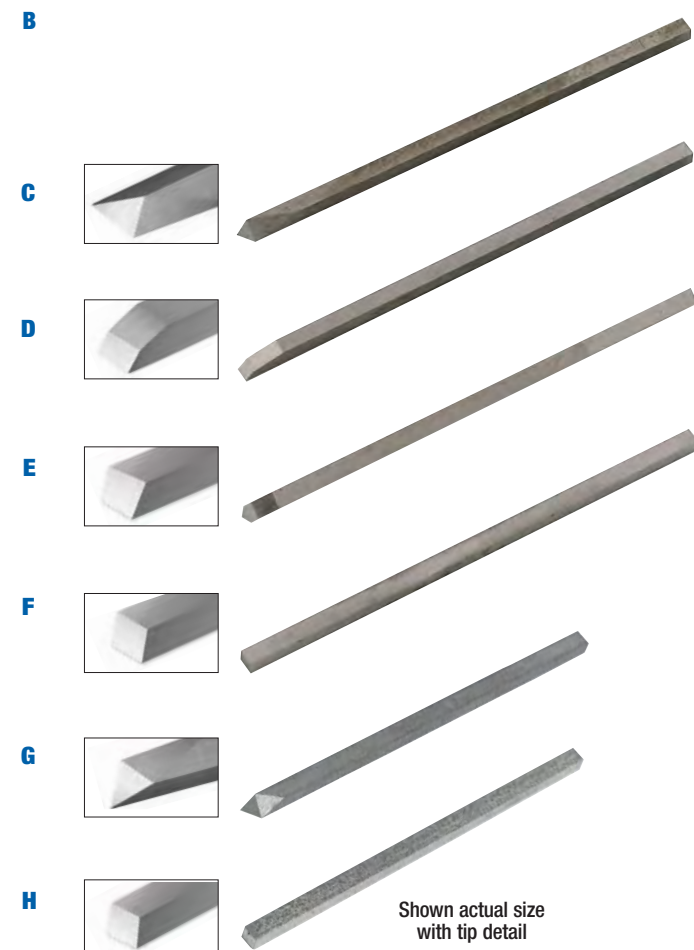
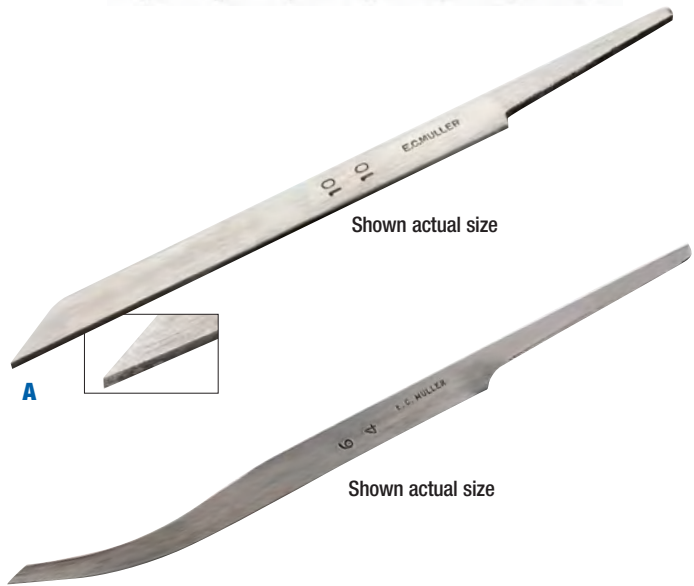

C-F GRS® GlenSteel™ Gravers

Made of GlenSteel, a high-speed tool steel forged exclusively by GRS for engraving, setting and other demanding work. Stay sharp longer and resist breakage better than other gravers and tools. Easier to grind and cobalt-free for increased safety. Measure 0.093" (2.35mm) square x 2.7" (70mm) long. Fit all GRS QC (quick-change) impact handpieces.

Style	Item#	Each
C. Square	856-0001	\$14.95
D. Flat	856-0002	14.95
E. 120° Point	856-0003	18.85
F. Blank	856-0004	13.95

G, H Carbide Gravers

Made of a special grade of extra-fine-grain carbide that withstands impact better than any other grade. Sharpen with Power Hone (see p. 292) and diamond wheel. Square has one end angled at 45°. Blank is unground and ready to be custom-shaped. Measure just under 3/32" square x 2" long.

Style	Item#	Each
G. Square	856-0292	\$9.95
H. Blank	856-0290	7.95

A-D GRS® QC Gravers – In convenient ready-to-go shapes.

Just sharpen and use. Eliminate the need for tedious shaping—think of the time they'll save. Fit all GRS QC (quick-change) impact handpieces when mounted in GRS QC Holders (see below). Also fit many other handpieces, including Power Graver, Magna-Graver and more. Precision-ground from high-speed chrome tool steel. Sold individually and in two kits.

Style	No.	Width	Item#	Each	Setter's Kit	Engraver's Kit
A. Flat	37	0.4mm	855-9975	\$10.95	•	•
	38	0.6mm	855-9976	10.95	•	•
	39	0.8mm	855-9977	10.95	•	•
	40	1.0mm	855-9978	10.95	•	•
	42	1.4mm	855-9979	10.95	•	•
	44	1.8mm	855-9980	10.95	•	•
B. Round	50	0.2mm	855-9981	10.95	•	•
	51	0.4mm	855-9982	10.95	•	•
	52	0.6mm	855-9983	10.95	•	•
	53	0.8mm	855-9984	10.95	•	•
C. Onglette (Point)	2/0	1.45mm	855-9969	10.95	•	•
	0	1.58mm	855-9970	10.95	•	•
	1	1.78mm	855-9971	10.95	•	•
	3	1.94mm	855-9972	10.95	•	•
D. Knife	1	2.0mm	855-9985	10.95	•	•
	2	2.2mm	855-9986	10.95	•	•

See website for CMAX QC gravers which are made out of tungsten carbide.

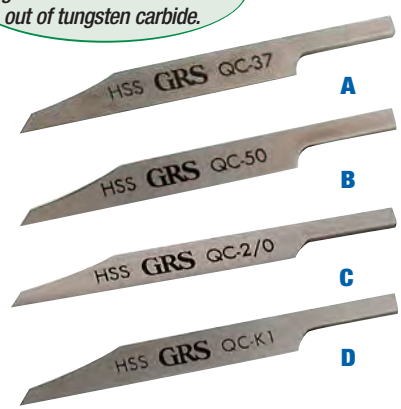

Kit Description	Item#	Each
Setter's Kit	855-9967	\$125.00
Engraver's Kit	855-9968	125.00

E. GRS® QC Holders – For fast tool changes.

Fit GRS QC (quick-change) impact handpieces, QC Handle and QC Sharpening Fixture. Allow fast tool changes. Accept square tools up to 0.10" (2.5mm) thick, round tools up to 0.13" (3.3mm) in diameter and most gravers, including GRS QC Gravers (see above).

Description	Item#	Each	Description	Item#	Each
QC Holders, pkg. of 3	855-9987	\$17.65	QC Holders, pkg. of 10	855-9988	58.20

See p. 29 for ruby stones – the Ultimate Sharpening Stones.



F-I GRS® C-Max Gravers and Holders – Tungsten Carbide, 1/8" Shank, Length: 1.8"

Years of development have produced a tungsten carbide graver with the right blend of hardness and toughness for hand engraving and stone setting applications. C-Max achieves a metallurgical balance like no other carbide. For years, engravers and jewelers have used other carbide gravers that break easily or do not hold a fine edge. This frustration is gone forever, thanks to C-Max carbide. Try these tools and do better work in noticeably less time. Also available as a QC graver. See website for C-MAX QC Gravers.

F. Tapered Round: Tapered Round has angled sides that taper down to a rounded tool bottom (in three sizes).



G. Description	Item#	EACH
Round #51	855-9910	\$18.95
Round #52	855-9911	18.95
Round #53	855-9912	18.95

H. Onglette: For stone setting, and general engraving (in three sizes).



H. Description	Item#	EACH
C-Max Onglette #0	855-9915	\$16.95
C-Max Onglette #2	855-9916	16.95
C-Max Onglette #4	855-9917	16.95

G. Tapered Flat: Tapered Flat has angled sides that taper down to a flat tool bottom (in eight sizes).



G. Description	Item#	EACH
Tapered Flat #36	855-9932	\$16.95
Tapered Flat #37	855-9933	16.95
Tapered Flat #38	855-9934	16.95
Tapered Flat #39	855-9935	16.95
Tapered Flat #40	855-9936	16.95
Tapered Flat #41	855-9937	16.95
Tapered Flat #42	855-9938	16.95
Tapered Flat #44	855-9940	16.95

I. Parallel Flat: Parallel Flat has parallel sides with a flat tool bottom (in six sizes).



I. Description	Item#	EACH
Parallel Flat #38	855-9922	\$17.95
Parallel Flat #39	855-9923	17.95
Parallel Flat #40	855-9924	16.95
Parallel Flat #41	855-9925	16.95
Parallel Flat #42	855-9926	16.95
Parallel Flat #44	855-9928	16.95

J. Tool Holder for 1/8" Round Tools

Description	Item#	EACH
QC Tool Holder, Pack of 3	855-9947	\$15.45
QC Tool Holder, Pack of 10	855-9948	50.90



A



B



C



D



E



F



A. GRS® Low-Profile Vise Assembly

GRS quality along with extra working space. When a workpiece calls for a lower height, the Low-Profile Vise provides a comfortable 6" (150 mm) of space for a proper view and position. This vise has the same jaw size and capacity as the MagnaBlock, yet is 1.5" shorter. Top half of vise rotates while bottom half remains stationary. Gesswein offers a 30-piece attachment set (856-0277) that includes storage for the adapter plates and pins that come with the block. Block weight (26 lbs (12 kg)- Jaw height 1 1/8" (46mm) - Ball diameter 6 1/8" (147mm) - Max opening 3 1/2" (89mm) - Jaw width 3" (76mm). Includes upper jaw plates, 5 pins, base, 1 plastic hex key, and wrench. Made in USA

Description	Item#	Each
A. Low-Profile Vise	856-0315	\$658.00

B, C GRS® Engraver's Blocks

The Magnablock and the Small Block are extremely well-made devices used to hold objects firmly for engraving, stone setting and general-purpose work. Each holds both large and small items. Features heavy weight and adjustable drags for keeping the workpiece in the proper position. Uses two industrial ball bearings and a large roller thrust bearing to eliminate side play and wobble. Includes rubber ring pad with Nylon glides, upper jaw plates, five pins and wrench. Made in USA.

Features:

- Solid steel construction for exceptional durability
- Adjustable friction lock from zero to full lock for crown rotation control
- Nonglare satin finish on body, black oxide finish on jaws for protection
- Precision-machined parts for smooth, efficient operation
- Easily adjustable working angles for comfort

Specifications:

	Magnablock	Small Block
Spherical Diameter	5 3/4"	5 1/8"
Jaw Size	3"W x 1 3/4"H	2 1/2"W x 1 1/2"H
Max. Jaw Opening	3 1/2"	3"
Net/Ship. Wt.	30/33 lbs.	19/22 lbs.

Description	Item#	Each
B. Magnablock	856-0275	\$637.10
Magnablock with 30-Piece Attachment Set	856-0276	746.00
Small Block	821-6000	486.00
C. Small Block with 30-Piece Attachment Set	821-6005	580.00

D. GRS® 30-Piece Attachment Set

30 attachments for all GRS Engraver's Blocks in a wooden storage base. Includes Ring Holding Clamp, shown.

Description	Item#	Each
30-Piece Attachment Set	856-0277	\$109.00

E. GRS® Ring Holding Clamp

Uses leather lining to prevent objects from marring. Fits all GRS Engraver's Blocks (included in above set).

Description	Item#	Each
Ring Holding Clamp	856-0296	\$22.60

F. GRS® Microblock™ Ball Vise

Compact, low-profile design is perfect for microscope work and other jobs where a larger vise is an obstacle. Smooth, self-centering jaw system and adjustable internal brake system lets the user choose the amount of rotational resistance from totally free to fully locked. Machined from solid stainless steel and finished with low-glare treatment to reduce eyestrain. Includes positioning ring, four jaw pins, wrenches and Thermo-Loc Sample Kit (four bars). Measures 3.1" dia. with 1.8"W x .87"H jaws. Max. jaw opening: 2". Made in USA.

Description	Item#	Each
Microblock	856-0304	\$282.00
F. Microblock with 30-Piece Attachment Set	856-0305	378.00

A. GRS® Inside Ring Holder for Vises

Holds rings from the inside for easy stone setting or engraving. Safely handles tapered and delicate designs that can be crushed by ordinary ring clamps. Fits in all GRS Engraver's Blocks and most vises. Includes seven different mandrels for holding ring sizes 4-13 without marring, expansion screw and wrench. Made of solid steel.

Description	Item#	Each
Inside Ring Holder	856-0209	\$67.95



B. GRS® Thermo-Loc®

Very tough work-holding plastic. Softens with heat to clay-like pliable consistency so you can form it around an endless variety of workpieces. Turns rock-hard once it cools to hold items securely. Economical and practical—can be reused again and again. Neutral gray in color to prevent eyestrain, even under bright work lights. Heat in a microwave oven on the pad included with the Starter Kit, in a conventional oven, in hot water or with a heat gun (be sure to follow proper heating instructions).

Description	Item#	Each
Thermo-Loc, 1/2 lb.	816-1592	\$23.70
Thermo-Loc, 1 lb.	816-1593	41.65
Thermo-Loc, 5 lbs.	816-1594	157.40
Thermo-Loc Starter Kit (includes 1 lb. Thermo-Loc and microwave-safe 6" x 6" pad)	816-1597	45.50



Also see JETT SETT page 495

C. GRS® Thermo-Loc® Jaw Sets

Hold irregularly shaped and fragile parts securely without damaging them. Choose from small and large jaw sets for respective GRS Engraving Blocks. Each includes two stainless steel master jaws and four aluminum bonding strips. Easy to use: just set jaws in your Engraving Block, bolt on aluminum bonding strips, apply Thermo-Loc to strips, and form them around your workpiece. Unbolt and save custom jaws for repeat jobs, or resoften the Thermo-Loc to hold another workpiece.

Description	Item#	Each
Thermo-Loc Small (Small Block) Jaw Set	816-1595	\$90.80
Thermo-Loc Large (Magnablock) Jaw Set	816-1596	92.85



D. GRS® Contoured Vise Jaw Set

Ideal for holding odd-shaped parts in GRS Megablock and Small Engraver's Blocks. Fits in top holes of blocks. Has rubber-lined jaws that automatically conform to a part's shape to grip it firmly with minimal clamping force. Provides a fast and safe way to hold shaped mold inserts and irregular items for polishing. Small jaw can be rotated 180° for greater versatility.

Description	Item#	Each
Contoured Vise Jaw Set	821-5997	\$69.00



E, F GRS® Super Pins

Made of heavy-duty plastic to hold large parts without marring. Fit in GRS Magnablock and Small Block. Available with 3/8" and 1/4" steel shanks.

Description	Item#	Each
E. Super Pins with 3/8" shanks, pkg. of 2	821-5999	\$7.95
F. Super Pins with 1/4" shanks, pkg. of 4	821-5998	10.90

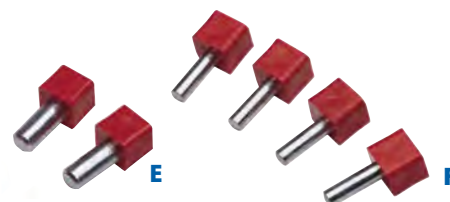



A



B

A, B PEPETOOLS Engraver's Block and Attachments

High-quality nickel-plated block designed to hold workpieces firmly without side motion. Has ball bearings for freedom of movement and smooth swiveling. An adjustable drag keeps the work piece in its proper position. Tight tolerances and precision construction eliminates side shakes. Deep throated jaws slide smoothly on the center screw allowing you to set the most comfortable working angles.

Suggest 35-piece attachment set. Made in USA.

Description	Item#	Each
A. 6" Engraving Block	821-6114	\$382.50
B. 35-Piece Attachment Set (includes Replacement Hex Key)	821-6112	103.20
Long Rubber-Covered Pins, set of 4	821-6150	7.08
Tapered Pins, set of 4	821-6300	8.75
Replacement Hex Key	821-6800	8.50



C

C. GRS® Satellite Turntable & Stand Package

System provides unrestricted mobility, allowing work on larger pieces. It can also be easily stored when not in use. The tripod base provides incredible stability during the most calculated cuts. Height adjusts from 18" to 29". The package includes the Turntable (856-0322) and Stand (856-0323) which are also sold separately, see below. Comes with Brake kit (856-0326) and Low-Friction PTFE Pad (856-0327). Does not include a vise.

Description	Item#	Each
Satellite Turntable & Stand Package	856-0324	\$795.00



D

D. GRS® Satellite Turntable

Robust design provides a completely overhauled bearing system for minimum maintenance and a smooth, quiet glide. Sealed profile promotes a cleaner internal environment and limits contamination from metal chips. The top of the turntable has been marked with easy centering lines to accommodate any GRS vise. Comes with Brake Kit (856-0326) and Low-Friction PTFE Pad (856-0327). Does not include vise, Satellite Stand, or Centering Post

Description	Item#	Each
Satellite Turntable	856-0322	\$405.00

The Satellite Turntable is compatible with all GRS vises. Vise sold separately.



E

E. GRS® Satellite Turntable Stand

Provides unrestricted mobility, allowing work on larger pieces. The stand's height adjusts from 18" to 29", creating ideal work elevations. The gas spring mechanism and included collet wrench make adjustments quick and easy. The tripod base provides stability during the most calculated cuts. The Satellite Turntable Stand is compatible with the Satellite Turntable (856-0322). Turntable and Stand are sold in a money-saving set (856-0324) above.

Description	Item#	Each
Satellite Turntable Stand	856-0323	\$410.00



F

F. GRS® Satellite Fixed Top & Stand

Take control of your work and find freedom from your bench. The Satellite Fixed Top Package is the ultimate work surface for hand engravers that prefer a GRS Positioning Vise. This system provides unrestricted mobility, allowing the artist freedom from their bench to work on larger pieces. The tripod base provides incredible stability that will ease the mind of any engraver during the most calculated cuts. The stand's height adjusts from 18" to 29", accommodating most engravers. The gas spring mechanism and included collet wrench make adjustments quick, easy, and almost effortless. The 10-inch steel surface provides a large area for adjustability and stability of your vise (Not included).

Description	Item#	Each
Satellite Fixed Top & Stand	856-0325	\$499.00

A. Low Profile 5" Ball Vise, 2½" Dia.

With 2½" dia. jaws that are 1½" tall. Need more working space under your microscope? Now you can with the RinGenie Low-Profile Ball Vise. Overall height is 4½". Sturdy construction with jaws that are made of stainless steel with copper face inserts for many years of use. Most vise accessory kits in the market will also fit this model. Made in USA.

Description	Item#	Each
5" Ball Vise 2½" Dia.	816-1507	\$632.50

**B. Low Profile 5" Ball Vise, 3½" Dia.**

With 3½" dia. jaws that are 1" tall. Need more working space under your microscope? Now you can with the RinGenie Low-Profile Ball Vise. Overall height is 3½". Sturdy construction with jaws that are made of stainless steel with copper face inserts for many years of use. Most vise accessory kits in the market will also fit this model. Made in USA.

Description	Item#	Each
5" Ball Vise, 3½" Dia.	816-1508	\$632.50

**C. 5" Positional Vise**

With 2½" dia. jaws which are 1½" tall. Utilizing two stationary pins to easily adjust the working position. Overall height is 6¼". Jaws opening measures 1½". Made in USA.

Description	Item#	Each
5" Positional Vise	816-1509	\$852.50

**D. Positional Rotatory Table & Vise**

With a mounted vise. Great for general work at the bench or any flat surface. Constructed of a Steel 8" work base with drag screw resistance, optional positioning and a 360° rotation. Jaws are 3" dia. and 1" tall. Jaws opening is 4½". Overall height is 3⅝". Made in USA.

Description	Item#	Each
Positional Rotatory Table and Mounted Vise	816-1511	\$984.50

**E, F 3" Vise + Adapter**

With 1.9" dia. jaws which are ¾" tall. Made from stainless steel. Overall height 4". Jaw opening 1¼". Vise Adapter, made from aircraft quality aluminum, allows bench mounting. Made in USA.

Description	Item#	Each
E. Vise	816-1498	\$742.50
F. Vise Adapter	816-1499	192.50

**G. The Expert's Guide to Graver Sharpening – By Sam Alfano**

Created by Sam Alfano, master engraver with over 25 years of experience. Offers step-by-step instructions on how to use the GRS Sharpening System. Covers sharpening of square, 120°, flat, round, brightcut, script lettering, modified flat and Italian bulino engravers, as well as liners. Includes dozens of timesaving tips and tricks. DVD format, 60 minutes.

Description	Item#	Each
The Expert's Guide to Graver Sharpening	811-0051	\$49.00

**H. Easy Step-by-Step Graver Sharpening DVD – By GRS**

Graver and tool sharpening simplified. Using microscopic camera work and special visual aids, you'll see clear, step-by-step sharpening. Each tool is first sharpened and then demonstrated in proper use including metal engraving and stone setting. Everyone using gravers, chisels and similar tools will save time, end frustration and produce finer results with this training. DVD format, 120 minutes.

Description	Item#	Each
The Expert's Guide to Graver Sharpening	856-0059	\$46.00





A, B Pitch Bowls

Made of cast iron. The 5" diameter bowl holds up to 2 lbs. of pitch, and the 8" diameter bowl holds up to 4 lbs. of pitch (not included). Use with ring pad (see below) for stability.

Description	Diameter	Item#	Each
A. Small Bowl	5"	811-1290	\$27.25
B. Large Bowl	8"	811-1310	31.45



C, D Ring Pads

Use with pitch bowls to insulate the workbench surface from heat. Lets you tilt engraver's block or pitch bowl so you can find the best working angle.

Description	Diameter	Item#	Each
C. Small Rubber Pad	5"	811-1291	\$6.55
D. Large Rubber Pad	8"	811-1311	12.95



E. GRS® Pitch Cup

Compact pitch cup for mounting in jaws of any vise or engraver's block. Each comes prefilled with black pitch, a special material that softens when heated and provides firm support for hard-to-hold, irregularly shaped and delicate items. Gently reheat pitch to remove workpiece.

Description	Dimensions	Item#	Each
Pitch Cup	2" diameter	856-0171	\$27.75



F. Black Pitch

Traditional, ready-to-mix pitch for holding and supporting jewelry during engraving and more. Especially useful for holding objects too delicate to hold in an engraver's block. Use in a pitch bowl and set into a ring pad for a handy engraving fixture. Mix with plaster or pumice and linseed oil to vary hardness. Includes instructions for mixing and use. Sold in 8 oz. containers.

Description	Item#	Each
Black Pitch, 8 oz.	811-1805	\$48.95



G. Peg Clamp

A mini handheld tool for holding odd-shaped items for engraving. Features 2" dia. half-round spring-loaded jaws that open and close on twin guides at the turn of a thumb screw. Includes four pegs that can be easily positioned in any of the 30 holes in each jaw. Has wooden handle. Measures 5" long. Max. jaw opening: 7/8".

Description	Item#	Each
G. Peg Clamp	812-0210	\$19.35
Replacement Pegs, pkg. of 4	812-0200	3.20



H-J GRS® BenchMate™ Multipurpose Vise

Attaches to BenchMate or directly to your bench. Tilts left and right and rotates on vertical axis so you can find the best working angle. Features holes in top for holding pins or the padded ring clamp from GRS 30-Piece Attachment Set #856-0277 (see p. 286). Made of satin-finished steel. To mount, fit in Fixed Mounting Plate, secure to Benchtop Mounting Adapter, then screw into bench.

Description	Item#	Each
H. Multipurpose Vise	856-0172	\$170.00
I. Fixed Mounting Plate	856-0196	18.95
J. Benchtop Mounting Adapter	856-0193	27.20

A-H Graver Handles

Six different hardwood handles with metal ferrules for firmly holding gravers.

Description	Style	Item#	3pc	EACH Prices	
				3-9	12-141
A. Small 1/2-Head	4	170-2040		\$1.35	\$1.15
B. Medium 1/2-Head	8	170-2080		1.55	1.32
C. Medium 1/2-Head	8B	170-2082		1.21	-
D. Medium 1/2-Head	8A	170-2081		1.21	-
E. Large 1/2-Head	7	170-2070		1.55	1.32
F. X-Large 1/2-Head	5	170-2050		1.55	1.32
G. Mushroom	9	170-2090		1.55	1.32
H. Ball	11	170-2110		1.55	1.32

 Three-piece minimum; Please order in multiples of three.

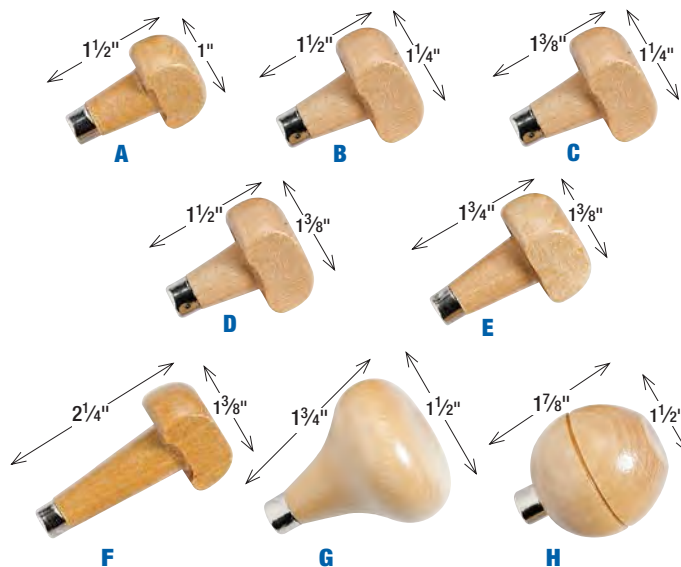

I-L Rosewood Graver Handles

Four different rosewood handles with metal ferrules for firmly holding gravers.

Description	Item#	Each
I. Small 1/2-Head	170-2140	\$2.50
J. Large 1/2-Head	170-2141	2.50
K. Mushroom	170-2143	2.50
L. Ball	170-2142	2.50

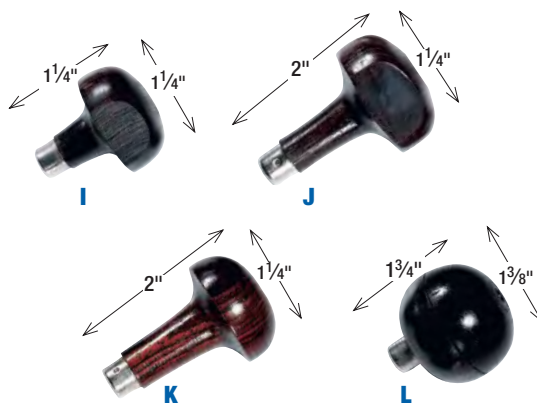

M. Graver Handle with Tool Chucks

Wooden handle with two interchangeable tool chucks for holding gravers and other small tools up to 3mm. To swap tools, just unscrew knurled holder, remove chuck, replace with other chuck and screw holder back on. Graver not included.

Description	Item#	Each
Graver Handle w/ Tool Chucks	840-4210	\$8.95

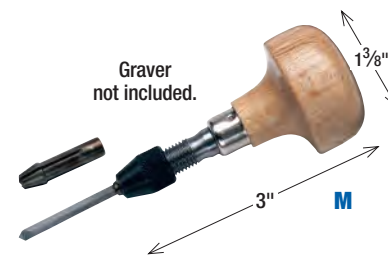

N. GRS® Adjustable Graver Handle Set

Includes three adjustable aluminum handles color-coded for easy graver identification. To adjust, just loosen lock screw, slide graver to desired position and tighten.

Description	Item#	Each
Adjustable Graver Handle Set	170-2201	\$44.40



O. GRS® QC Handle

Rubber-covered handle with short reach and comfortable feel for engraving by hand. Includes three QC (quick-change) holders for fast tool changes. Accepts square tools up to 0.10" (2.5mm) thick, round tools up to 0.13" (3.3mm) in diameter and most gravers.

Description	Item#	Each
QC Handle	856-0264	\$29.95



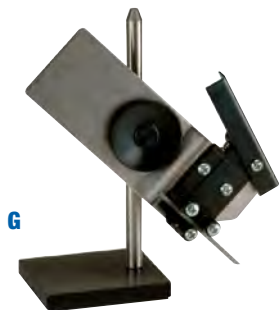
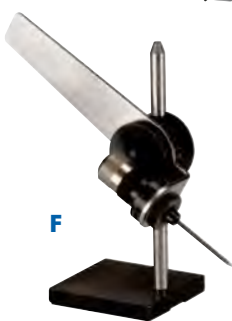

A, B GRS® GraverHone VS Complete Sharpening Systems

Meet the next generation sharpening system from GRS Tools. These complete packages contain the high-torque, variable speed GraverHone VS with your choice of fixtures. Select the Dual Angle System for use with regular Gravers and select the Apex System for use with QC Gravers. Either package includes the GraverHone VS which features variable speed (400-900 RPM), dual direction and time-saving quick lock for diamond wheels (no threads). UL approved. Made in the USA.

Packages also include 3 diamond wheels, 260, 600, and 1200 grit, as well as the handy diamond wheel rack

Description	Item#	Each
A. GraverHone VS with Apex Sharpening System 110V, 60 Hz	856-0332	\$1,215.00
B. GraverHone VS with Dual Angle Sharpening Fixture, Head and Post 110V, 60 Hz	856-0334	\$1,195.00

C. GRS® Apex Sharpening System – for QC Tool Holders only

The Apex Sharpening System is the perfect fixture for anyone from the novice learning to sharpen their first graver to the veteran seeking efficient repeatability. The new shorter fixture nose and longer fixture post easily accommodate longer gravers. Locking knobs have been updated with a quality knurled steel. A quarter-turn locking system works exclusively with GRS QC tool holders to promote ultimate efficiency for loading and locking tools. The post dial has been simplified to promote finding the correct angle setting quickly. Most notably, the fixture now features the ability to switch Apex dials in seconds without tools or screws to turn. A simple switch to the Dual Angle dial and you can make any graver geometry desired. Includes: Apex Sharpening Fixture, color coded 90° dial, 105° dial, 120° dial, Dual Angle dial for unlimited graver geometries, Apex fixture magnetic post, and storage rack. Made in USA.

Description	Item#	Each
Apex Sharpening System	856-0291	\$305.00

D, E GRS® Dual-Angle Sharpening Fixture

Holds gravers with or without handles and those in QC Holders for precise sharpening. Features two large, easy-to-read degree dials for setting both elevation and rotation angles. Available with or without post.

Description	Item#	Each
D. Dual-Angle Sharpening Fixture, head only	856-0299	\$261.00
E. Dual-Angle Sharpening Fixture, head and post	856-0018	286.00

F. GRS® QC Sharpening Fixture

Holds gravers in QC holders for precise sharpening. Features two degree dials for setting both elevation and rotation angles and a post and magnetized base.

Description	Item#	Each
QC Sharpening Fixture, head and post	856-0262	\$222.00

G. GRS® Standard Sharpening Fixture

Holds standard gravers for sharpening. Features one degree dial for setting elevation angle and a post with a magnetized base.

Description	Item#	Each
Standard Sharpening Fixture, head and post	856-0200	\$155.00

A-D GRS® Power Hone Wheels

The low-cost, high-quality Diamond Wheels eliminate heat buildup in gravers and tools, last for years and stay flat for accuracy. Produce a fine, dependable finish. Excellent for sharpening carbide, cobalt and standard steel tools. The solid Cast Iron and Ceramic Laps produce a mirror finish on tools, resulting in bright cuts on your workpieces. Must be periodically charged with Diamond Spray, or Diamond Powder. Can be used with Quick-Change Wheel Conversion Set (see below).

Description	Dia. x AH	Grit	Item#	Each
A. Diamond Wheel	5" x 1/2"	260	856-0259	\$103.00
		600	856-0256	94.00
		1200	856-0032	122.00
Cast Iron	6" x 1/2"		856-0272	107.00
B. Ceramic Lap	6" x 1/2"		856-0258	305.00
C. Diamond Spray - 1 carat diamond			856-0260	29.90
Diamond Powder - 5 carats diamond			856-0271	19.95
D. Wheel Storage Rack			856-0035	22.10

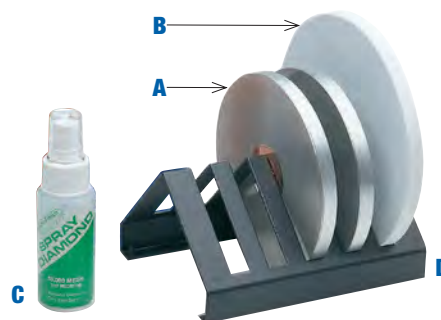

E. GRS® Power Hone Quick-Change Wheel Conversion Set

Easily attaches to the Power Hone without tools. Lets you change wheels in seconds: simply lift wheel off and replace with another. Can be used with all GRS 5" and 6" wheels.

Description	Item#	Each
Quick-Change Wheel Conversion Set	856-0261	\$74.00

F. Crocker-Style Graver Sharpening Fixture

Keeps graver in a fixed position for sharpening on a bench stone. Holds graver at any angle: just set index as desired and lock in for repeated accuracy. Stone and graver not included.

Description	Item#	Each
Crocker-Style Graver Sharpening Fixture	816-1000	\$62.75



Stone and graver not included.

G. Graver Sharpening Holder

A small, inexpensive holder for sharpening. Holds gravers in either of two angled openings. Has roller on bottom for smooth action. Use with a bench stone (see p. 29 for our Ruby Bench Stones). Measures 1 3/8"W x 1 1/2"H.

Description	Item#	Each
Graver Sharpening Holder	816-1012	\$7.35



H-J Scribes

Double-ended steel scriber features one-piece steel construction and twisted center for good grip.

Carbide-tipped scriber can be used on hard metals, glass, stones, and diamond scriber can be used on all metals and most stones. Both have hexagonal aluminum handles that prevent rolling.

Description	Item#	EACH Prices	
		1-2	3+
H. Double-Ended Steel Scriber	816-0890	\$7.15	\$6.44
I. Carbide-Tipped Scriber	816-0950	5.25	4.73
J. Diamond Scriber	220-1900	10.85	9.77

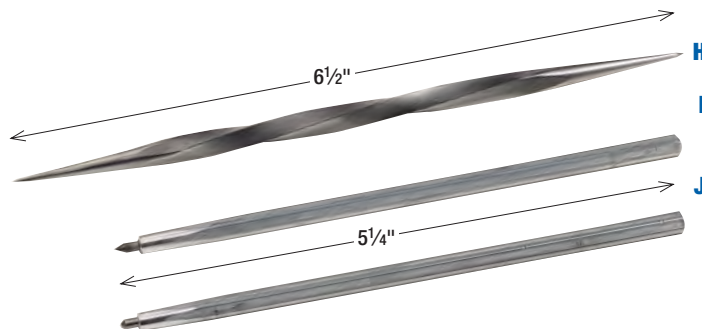

K. Chinese White

A fast-drying, nontoxic, white watercolor for layout work. Forms a background so letters or designs can be drawn on the work surface prior to engraving. To use, simply moisten surface with water using fingertip or soft brush, then apply to workpiece. Sold in 0.175 oz. half-cake packaged in aluminum foil for protection from moisture.

Description	Item#	Each
Chinese White	812-0100	\$16.50



Grobet Swiss Pattern Precision Files

The world's standard for quality and performance!

Manufactured to precise production standards, using a combination of machine cutting and hand craftsmanship to produce the most accurate, best cutting and longest-lasting files in the world. They are made of the finest heat-tempered, chrome alloy steel and have the "right" feel, action and balance desired by all true craftsmen. Swiss Pattern Precision Files deliver superior performance on all metals. Simply the best you can buy. Files are measured in length from the point where the teeth begin to the end of the file. The handle section (tang) is not considered in the file length. Made in Italy.



Barrette

Tapered in width and thickness, coming to a point. Only flat side is double cut, providing safe edge and top.

Length of Cut	Width x Thickness	Cut	Item#	EACH Prices	
				1-11	12+
4"	1 ⁵ / ₃₂ " x 3 ³ / ₃₂ "	00	635-0402	\$19.95	\$17.96
		2	635-0420	22.79	20.51

Length of Cut	Width x Thickness	Cut	Item#	EACH Prices	
				1-11	12+
6"	5 ⁵ / ₈ " x 5 ⁵ / ₃₂ "	00	635-0602	\$23.31	\$20.98
		0	635-0601	24.78	22.30
		1	635-0610	27.20	24.48
		2	635-0620	27.93	25.14
8"	5 ³ / ₆₄ " x 1 ³ / ₆₄ "	0	635-0801	34.13	30.72
		2	635-0820	36.86	33.17



Barrette - Hot Die

Same as regular Barrette files except with ground backs, widely used in making and repairing extrusion dies. Double cut.

Length of Cut	Width x Thickness	Cut	Item#	EACH Prices	
				1-11	12+
4"	5 ⁵ / ₃₂ " x 3 ³ / ₃₂ "	00	635-1402	\$31.09	\$27.98



Checkering Pillar

Parallel in width and gently tapered in thickness. Overcut is parallel to file edges, and upcut is 90° to overcut. Double cut on top and bottom; both edges are safe. Useful for putting serrations on knife edges or for obtaining a checkered design similar to that found on a gun handgrip. Frequently used to create a coarse florentine finish; after initial cut, angle the file 45° or 90° and cut again.

Length of Cut	Width x Thickness	Lines per inch	Cut	Item#	EACH Prices	
					1-11	12+
6"	1 ¹ / ₂ " x 5 ⁵ / ₃₂ "	20	00	646-0602	\$36.23	\$32.61
		30	0	646-0601	35.91	32.32

Length of Cut	Width x Thickness	Lines per inch	Cut	Item#	EACH Prices	
					1-11	12+
6"	1 ¹ / ₂ " x 5 ⁵ / ₃₂ "	50	2	646-0620	\$38.43	\$34.59
		75	4	646-0640	55.55	50.00



Crochet

Tapered in width and gradually tapered in thickness. Used for filling junctions between flat and curved surfaces and for developing slots with rounded edges. Double cut top and bottom - both edges are single cut.

Length of Cut	Width x Thickness	Cut	Item#	EACH Prices	
				1-11	12+
4"	9 ³ / ₃₂ " x 5 ⁵ / ₆₄ "	2	648-0420	\$28.46	\$25.61

Length of Cut	Width x Thickness	Cut	Item#	EACH Prices	
				1-11	12+
6"	2 ⁵ / ₆₄ " x 1 ¹ / ₈ "	0	648-0601	\$31.08	\$27.97
		2	648-0620	33.60	30.24

Grobet Swiss Pattern Precision Files

Each Swiss Pattern Precision File is measured in length from the point where the teeth cross to the end of the file. The Handle section (tang) is not considered in file length.



**American Cut – Bastard
Swiss Cut – 00**

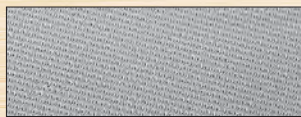

**American Cut – Second
Swiss Cut – 0**



**American Cut – Smooth
Swiss Cut – 2**

Scale of Cuts for Swiss Pattern Precision Files*

Teeth per Inch	Swiss Pattern Precision File			Escapement 14cm	Needle 10 to 20cm	DS Riffers 6" to 7"
	10"+	4" to 8"	3"			
30	00	-	-	-	-	-
41	0	00	-	-	-	-
51	1	0	00	-	-	-
64	2	1	0	0	0	0
79	3	2	1	-	-	-
97	4	3	2	2	2	2
117	-	4	3	3	3	3
142	6	-	4	4	4	4
173	-	6	-	-	-	-
213	-	-	6	6	6	6
295	-	-	-	8	-	-

*Except checkering pillar.



Crossing

Half-round on two sides with one side having a slightly larger radius than the other. Tapered in width and thickness. Cut and usable to the point. Used primarily for filing interior curved surfaces. The double radius allows filing at the junction of two curved surfaces or of a straight and curved surface. Double cut on both sides.

Length of Cut	Width x Thickness	Cut	Item#	EACH Prices		Length of Cut	Width x Thickness	Cut	Item#	EACH Prices	
				1-11	12+					1-11	12+
4"	15/32" X 9/64"	0	*742-0401	\$38.54	\$34.69	6"	5/8" X 11/64"	0	642-0601	\$45.57	\$41.01
		2	*742-0420	41.69	37.52			2	642-0620	49.04	44.14
		4	*742-0440	48.62	43.76			4	*742-0640	57.23	51.51

*Made in Switzerland.

*Made in Switzerland.

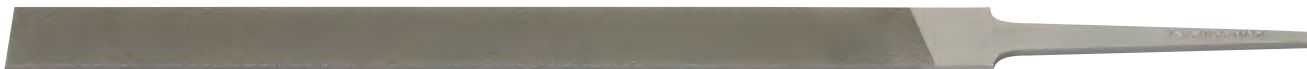

Equalling

Parallel in width and thickness. Used primarily for filing slots and corners. Double cut top and bottom, both edges are single cut.

Length of Cut	Width x Thickness	Cut	Item#	EACH Prices		Length of Cut	Width x Thickness	Cut	Item#	EACH Prices	
				1-11	12+					1-11	12+
4"	25/64" X 5/64"	0	641-0401	\$20.69	\$18.62	6"	5/8" X 11/64"	2	641-0620	\$26.25	\$23.63
		2	641-0420	22.37	20.13			4	641-0640	30.66	27.59
		4	641-0440	26.04	23.44			8"	1/2" X 3/32"	00	641-0802
6"	1/2" X 3/32"	00	641-0602	23.00	20.70	0	641-0801			33.50	30.15
		0	641-0601	24.36	21.92	2	641-0820	36.23	32.61		

Grobet Swiss Pattern Precision Files, continued



American Cut – Bastard
Swiss Cut – 00

American Cut – Second
Swiss Cut – 0

American Cut – Smooth
Swiss Cut – 2

**Half-Round**

Tapered in width and thickness, coming to a point. Double cut on both sides.

Length of Cut	Width x Thickness	Cut	Item#	EACH Prices	
				1-11	12+
4"	1 ⁵ / ₃₂ " x 9 ⁹ / ₆₄ "	00	630-0402	\$25.73	\$23.16
		0	630-0401	27.20	24.48
		2	630-0420	30.35	27.32
		4	630-0440	35.49	31.94
6"	5 ⁵ / ₈ " x 1 ¹¹ / ₆₄ "	00	630-0602	31.19	28.07
		0	630-0601	33.08	29.77
		1	630-0610	34.55	31.10
		2	630-0620	35.70	32.13

Length of Cut	Width x Thickness	Cut	Item#	EACH Prices	
				1-11	12+
6"	5 ⁵ / ₈ " x 1 ¹¹ / ₆₄ "	3	630-0630	\$38.12	\$34.31
		4	630-0640	41.69	37.52
		6	630-0660	68.15	61.34
8"	5 ³ / ₆₄ " x 1 ¹⁵ / ₆₄ "	00	630-0802	43.16	38.84
		0	630-0801	45.57	41.01
		1	630-0810	47.88	43.09
		2	630-0820	49.25	44.33

**Half-Round Slim – Also known as Half-Round Ring**

Tapered in width and thickness, coming to a point. Narrower than regular half-round so that it can be used for filing insides of holes and rings. Double cut on both sides.

Length of Cut	Width x Thickness	Cut	Item#	EACH Prices	
				1-11	12+
6"	1 ⁵ / ₃₂ " x 9 ⁹ / ₆₄ "	00	636-0602	\$32.97	\$29.67
		0	636-0601	34.97	31.47
		1	636-0610	36.54	32.89

Length of Cut	Width x Thickness	Cut	Item#	EACH Prices	
				1-11	12+
6"	1 ⁵ / ₃₂ " x 9 ⁹ / ₆₄ "	2	636-0620	\$37.70	\$33.93
		3	636-0630	40.01	36.01
		4	636-0640	44.00	39.60

**Hand**

Parallel in width and gently tapered in thickness for perfectly flat filing. Double cut top and bottom with one single-cut edge and one safe edge.

Length of Cut	Width x Thickness	Cut	Item#	EACH Prices	
				1-11	12+
4"	1 ⁷ / ₃₂ " x 1 ¹ / ₈ "	0	631-0401	\$14.70	\$13.23
		2	631-0420	15.65	14.09
		4	631-0440	18.27	16.44
6"	3 ³ / ₄ " x 5 ⁵ / ₃₂ "	00	631-0602	17.22	15.50
		0	631-0601	18.27	16.44
		1	631-0610	19.01	17.11
		2	631-0620	19.74	17.77
		3	631-0630	21.00	18.90

Length of Cut	Width x Thickness	Cut	Item#	EACH Prices	
				1-11	12+
6"	3 ³ / ₄ " x 5 ⁵ / ₃₂ "	4	631-0640	\$23.00	\$20.70
		6	631-0660	35.18	31.66
		8"	2 ²⁹ / ₃₂ " x 3 ³ / ₁₆ "	00	631-0802
8"	2 ²⁹ / ₃₂ " x 3 ³ / ₁₆ "	0	631-0801	25.20	22.68
		2	631-0820	27.20	24.48
		4	631-0840	32.34	29.11
		10"	1" x 1 ¹ / ₄ "	00	631-1002
10"	1" x 1 ¹ / ₄ "	0	631-1001	34.44	31.00
		2	631-1020	37.38	33.64

Grobet Swiss Pattern Precision Files, continued



Knife-Edge

Tapered in width and thickness. Knife edge has the same thickness from point to shoulder. The included angle of the sharp edge is approximately 10°. Generally used to file in a slot or wedge-shaped opening. Curved knife edge allows easy filing in restricted areas. Double cut on both sides; top edge is safe while knife edge is single cut.

Length of Cut	Width x Thickness	Cut	Item#	EACH Prices	
				1-11	12+
4"	1 ⁵ / ₃₂ " x 1 ¹ / ₈ "	2	645-0420	\$24.99	\$22.49
6"	2 ³ / ₃₂ " x 5 ⁵ / ₃₂ "	00	*745-0602	26.95	24.26

**Made in Switzerland.*

Length of Cut	Width x Thickness	Cut	Item#	EACH Prices	
				1-11	12+
6"	4 ⁵ / ₆₄ " x 5 ⁵ / ₃₂ "	0	645-0601	\$27.20	\$24.48
	4 ⁵ / ₆₄ " x 5 ⁵ / ₃₂ "	2	645-0620	29.51	26.56
	2 ³ / ₃₂ " x 5 ⁵ / ₃₂ "	4	*745-0640	34.34	30.91

**Made in Switzerland.*



Pillar, Demi-Narrow

Pillar files are more narrow than hand files, yet also parallel in width and tapered in thickness to create perfectly flat filing. Double cut on the flat sides only, both edges are safe.

Length of Cut	Width x Thickness	Cut	Item#	EACH Prices	
				1-11	12+
6"	2 ⁵ / ₆₄ " x 1 ¹¹ / ₆₄ "	0	638-0601	\$64.05	\$57.65
		1	638-0610	36.23	32.61

Length of Cut	Width x Thickness	Cut	Item#	EACH Prices	
				1-11	12+
6"	2 ⁵ / ₆₄ " x 1 ¹¹ / ₆₄ "	2	638-0620	\$39.27	\$35.34



Pillar, Extra-Narrow

These very narrow files are parallel in width and tapered in thickness to create perfectly flat filing. Double cut on the flat sides only, both edges are safe.

Length of Cut	Width x Thickness	Cut	Item#	EACH Prices	
				1-11	12+
3"	1 ¹ / ₈ " x 5 ⁵ / ₆₄ "	2	*740-0320	\$19.01	\$17.11
4"	9 ⁹ / ₆₄ " x 1 ¹ / ₁₆ "	00	640-0402	17.22	15.50
		0	640-0401	18.17	16.35
		2	640-0420	19.64	17.68
		4	640-0440	22.89	20.60
6"	1 ⁵ / ₆₄ " x 1 ¹ / ₈ "	00	640-0602	20.16	18.14
		0	640-0601	21.42	19.28

**Made in Switzerland.*

Length of Cut	Width x Thickness	Cut	Item#	EACH Prices	
				1-11	12+
6"	1 ⁵ / ₆₄ " x 1 ¹ / ₈ "	1	640-0610	\$22.47	\$20.22
		2	640-0620	23.10	20.79
		4	640-0640	26.99	24.29
8"	5 ⁵ / ₁₆ " x 9 ⁹ / ₆₄ "	6	640-0660	47.04	42.34
		00	640-0802	27.93	25.14
		0	640-0801	29.40	26.46
		2	640-0820	31.82	28.64



Pillar, Narrow

Parallel in width and tapered in thickness. Double cut on the flat sides only, both edges are safe.

Length of Cut	Width x Thickness	Cut	Item#	EACH Prices	
				1-11	12+
4"	1 ¹ / ₆₄ " x 3 ³ / ₃₂ "	0	639-0401	\$19.11	\$17.20
		2	639-0420	20.69	18.62
		4	639-0440	24.15	21.74
6"	5 ⁵ / ₁₆ " x 9 ⁹ / ₆₄ "	00	639-0602	21.42	19.28
		0	639-0601	22.58	20.32

Length of Cut	Width x Thickness	Cut	Item#	EACH Prices	
				1-11	12+
6"	5 ⁵ / ₁₆ " x 9 ⁹ / ₆₄ "	1	639-0610	\$23.63	\$21.27
		2	639-0620	24.47	22.02
		4	639-0640	28.56	25.70
8"	2 ⁵ / ₆₄ " x 1 ¹¹ / ₆₄ "	6	639-0660	46.62	41.96
		0	639-0801	31.08	27.97
		2	639-0820	26.25	23.63

Grobet Swiss Pattern Precision Files, continued



American Cut – Bastard
Swiss Cut – 00

American Cut – Second
Swiss Cut – 0

American Cut – Smooth
Swiss Cut – 2



Pillar, Regular

A general-purpose file used primarily for working on flat surfaces. Because pillar files are available in various widths, they are adaptable to filing in slots, keyways, splines and similar areas. Parallel in width and tapered in thickness to provide perfectly flat filing. Double cut top and bottom, both edges are safe.

Length of Cut	Width x Thickness	Cut	Item#	EACH Prices	
				1-11	12+
4"	3/8" x 3/32"	00	637-0402	\$15.23	\$13.71
		0	637-0401	16.07	14.46
		2	637-0420	17.54	15.79
		4	637-0440	20.37	18.33
6"	33/64" x 5/32"	00	637-0602	18.06	16.25
		0	637-0601	19.01	17.11
		1	637-0610	19.95	17.96
		2	637-0620	16.49	14.84

Length of Cut	Width x Thickness	Cut	Item#	EACH Prices	
				1-11	12+
6"	33/64" x 5/32"	3	*737-0630	\$21.95	\$19.76
		4	637-0640	23.84	21.46
8"	19/32" x 13/64"	0	637-0801	26.25	23.63
		2	637-0820	28.46	25.61
10"	45/64" x 15/64"	00	637-1002	34.13	30.72
		0	637-1001	36.12	32.51
		2	*737-1020	38.85	34.97

*Made in Switzerland.



Pippin

Tapered in width and thickness. Combines the cross sections of round and crossing files along with the edge of a knife file. For finishing the junction of two different curved surfaces and for opening slots when a "V" shape is required. Double cut on both sides; top and bottom edges are single cut.

Length of Cut	Width x Thickness	Cut	Item#	EACH Prices	
				1-11	12+
6"	3/8" x 11/64"	0	647-0601	\$59.01	\$53.11

Length of Cut	Width x Thickness	Cut	Item#	EACH Prices	
				1-11	12+
6"	3/8" x 11/64"	2	647-0620	\$63.74	\$57.37



Round, Parallel

Double cut over the entire surface. The 4" length is available in 1/16" and 1/8" diameters. The 6" length is available in 3/32", 1/8", 5/32" and 3/16" diameters.

Length of Cut	Diameter	Cut	Item#	EACH Prices	
				1-11	12+
4"	1/16"	0	633-4501	\$15.65	\$14.09
		2	633-4520	17.54	15.79
4"	7/64"	0	633-4401	18.27	16.44
6"	3/32"	0	633-3601	21.21	19.09
		2	633-3620	23.10	20.79

Length of Cut	Diameter	Cut	Item#	EACH Prices	
				1-11	12+
6"	1/8"	0	633-4601	\$21.21	\$19.09
		2	633-4620	23.10	20.79
6"	11/64"	0	633-6601	22.05	19.85
		2	633-6620	23.21	20.89



Round, Tapered

Gradually tapered. Cut and workable to the point. Used where it is necessary to enlarge a hole or round off a radius. Double cut.

Length of Cut	Diameter	Cut	Item#	EACH Prices	
				1-11	12+
4"	1/4"	1	*732-0410	\$15.23	\$13.71
	5/32"	2	632-0420	15.86	14.27
	5/32"	4	632-0440	18.48	16.63
6"	15/64"	0	632-0601	15.12	13.61
		2	632-0620	18.59	16.73

Length of Cut	Diameter	Cut	Item#	EACH Prices	
				1-11	12+
6"	15/64"	4	632-0640	\$21.63	\$19.47
8"	5/16"	1	632-0810	24.78	22.30
		2	632-0820	25.62	23.06

*Made in Switzerland.

Grobet Swiss Pattern Precision Files, continued



Square

Gradually tapered and double cut on all four sides. Cut and usable to the point. A general-purpose file.

Length of Cut	Diameter	Cut	Item#	EACH Prices		Length of Cut	Diameter	Cut	Item#	EACH Prices	
				1-11	12+					1-11	12+
6"	1 ³ / ₆₄ "	0	643-0601	\$19.85	\$17.87	8"	5 ¹ / ₁₆ "	0	*743-0801	\$26.04	\$23.44
	1 ³ / ₆₄ "	2	643-0620	21.42	19.28		9 ³ / ₃₂ "	2	643-0820	29.72	26.75
	1 ⁵ / ₆₄ "	4	*743-0640	25.83	23.25						<i>*Made in Switzerland.</i>

**Made in Switzerland.*



Three-Square

Triangular profile. Gradually tapered, and cut workable to the point. Double cut on all three sides.

Length of Cut	Size	Cut	Item#	EACH Prices		Length of Cut	Size	Cut	Item#	EACH Prices	
				1-11	12+					1-11	12+
6"	2 ³ / ₆₄ "	0	634-0601	\$21.74	\$19.57	6"	2 ³ / ₆₄ "	2	634-0620	\$23.63	\$21.27
		1	634-0610	22.79	20.51			4	634-0640	27.51	24.76



Warding

Parallel in thickness and tapered in width. Good for deburring. Double cut top and bottom, both edges are single cut.

Length of Cut	Diameter	Cut	Item#	EACH Prices		Length of Cut	Width x Thickness	Cut	Item#	EACH Prices	
				1-11	12+					1-11	12+
4"	3 ¹ / ₆₄ " x 3 ³ / ₆₄ "	00	649-0402	\$18.80	\$16.92	4"	3 ¹ / ₆₄ " x 3 ³ / ₆₄ "	4	649-0440	\$24.99	\$22.49
		0	649-0401	19.95	17.96	6"	5 ⁵ / ₈ " x 5 ⁵ / ₆₄ "	2	649-0620	25.31	22.78
		2	649-0420	21.42	19.28			4	649-0640	29.40	26.46

A-E Grobet Plastic File Handles

Virtually unbreakable plastic handles shaped and textured to fit your hand comfortably and prevent slipping. Feature tempered metal tang-holding inserts that are threaded to ensure proper alignment and positive grip. Allow easy file changes: just unscrew the file in use and screw in another. Have holes at top for hanging near your workbench.

Description	Item#	EACH Prices	
		1-11	12+
A. #2 Handle	170-6002	\$3.25	\$2.93
B. #3 Handle	170-6003	3.25	2.93
C. #4 Handle	170-6004	3.35	3.02
D. #5 Handle	170-6005	3.35	3.02
E. #6 Handle	170-6006	3.50	3.15

Handle Selection Guide:

File Shape	File Length						File Shape	File Length					
	3"	4"	6"	8"	10"	12"		3"	4"	6"	8"	10"	12"
Barrette	2	3	4	5	-	-	Pillar	2	3	4	5	6	6
Checkering	-	-	4	-	-	-	Pippin	-	3	4	5	-	-
Crochet	-	3	4	5	-	-	Round, Parallel	-	-	2	3	-	-
Crossing	-	3	4	5	-	-	Round, Tapered	-	2	3	4	5	-
Equalling	-	3	4	5	-	-	Square	-	2	3	4	5	-
Half-Round	-	3	4	5	6	6	Three-Square	2	3	4	5	6	6
Hand	-	3	4	5	6	6	Warding	-	3	4	5	-	-
Knife-Edge	-	3	4	5	6	6							



A



B



C



D



E

Grobet American Pattern Files

They are uniform in cut to permit fast metal removal. Extremely durable and scientifically balanced, each file is the product of a long tradition of superior craftsmanship combined with the most advanced technology. Every file is heat-treated to exacting standards to provide top performance and long life. Files are unsurpassed in accuracy of shape and size. Handle section (tang) is not considered in file length. Made in China.

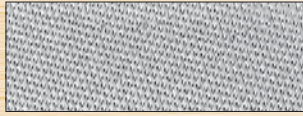

**American Cut – Bastard
Swiss Cut – 00**



**American Cut – Second
Swiss Cut – 0**



**American Cut – Smooth
Swiss Cut – 2**



Flat (End Tapered)

Universally used by all machinists, this file is recommended for fast stock removal where a smooth finish is not required. Double cut top and bottom; edges are single cut. Differs from the mill file in that it has a thicker cross section.

Length of Cut	Width x Thickness	Cut	Item#	Each
6"	5/8" x 5/32"	Bastard	770-0627	\$3.00
		Second	770-0628	3.25
		Smooth	770-0629	3.75
8"	25/32" x 7/32"	Bastard	770-0827	4.10
		Second	770-0828	4.45
		Smooth	770-0829	4.80

Length of Cut	Thickness	Cut	Item#	Each
10"	31/32" x 1/4"	Bastard	770-1027	\$5.30
		Second	770-1028	5.70
		Smooth	770-1029	6.25
12"	1 5/32" x 9/32"	Bastard	770-1227	8.10
		Second	770-1228	8.70
		Smooth	770-1229	9.30



Half-Round

In addition to being widely used by machinists, this file is also popular in foundries where castings must be finished by filing. Rounded to approximately a third of a round on one side and double cut flat on the other. Double cut on both sides.

Length of Cut	Width x Thickness	Cut	Item#	Each
6"	19/32" x 5/32"	Bastard	770-0667	\$4.80
		Second	770-0668	9.90
		Smooth	770-0669	5.45
8"	3/4" x 7/32"	Bastard	770-0867	6.10
		Second	770-0868	6.70
		Smooth	770-0869	7.20

Length of Cut	Width x Thickness	Cut	Item#	Each
10"	15/16" x 9/32"	Bastard	770-1067	\$8.05
		Second	770-1068	9.40
		Smooth	770-1069	9.60
12"	1 1/8" x 11/32"	Bastard	770-1267	12.05
		Second	770-1268	12.90
		Smooth	770-1269	13.85



Hand

Similar to a flat file but tapered in thickness with one safe edge. This uncut edge allows filing of one surface without damaging an adjoining surface. Especially useful when filing up to a sharp corners. Double cut top and bottom. One edge single, the other is safe.

Length of Cut	Width x Thickness	Cut	Item#	Each
6"	5/8" x 5/32"	Smooth	770-0639	\$3.75
8"	25/32" x 7/32"	Bastard	770-0837	4.10
		Second	770-0838	4.45
		Smooth	770-0839	4.80

Length of Cut	Width x Thickness	Cut	Item#	Each
10"	31/32" x 1/4"	Bastard	770-1037	\$5.25
		Second	770-1038	5.70
		Smooth	770-1039	6.25



Mill

Used in machine shops as a general-purpose file and for draw filing, lathe work and finishing operations on hard materials. Often used in conjunction with a flat or hand file as a finishing file after the "hogging off" operation. Single cut.

Length of Cut	Width x Thickness	Cut	Item#	Each
6"	$\frac{9}{32}$ " x $\frac{7}{64}$ "	Bastard	770-0617	\$2.70
		Second	770-0618	2.95
		Smooth	770-0619	3.50
8"	$\frac{25}{32}$ " x $\frac{9}{64}$ "	Bastard	770-0817	3.50
		Second	770-0818	3.85
		Smooth	770-0819	4.10

Length of Cut	Width x Thickness	Cut	Item#	Each
10"	$\frac{31}{32}$ " x $\frac{11}{64}$ "	Bastard	770-1017	\$4.55
		Second	770-1018	4.95
		Smooth	770-1019	5.55
12"	$1 \frac{5}{32}$ " x $\frac{7}{32}$ "	Bastard	770-1217	6.25
		Second	770-1218	6.70
		Smooth	770-1219	6.75



Round

Designed for filing concave surfaces that have a smaller radius than a half-round file, enlarging round holes and making a corner radius. Tapered file is double cut.

Length of Cut	Diameter	Cut	Item#	Each
6"	$\frac{7}{32}$ "	Bastard	770-0677	\$3.00
		Second	770-0678	3.00
		Smooth	770-0679	3.30
8"	$\frac{5}{16}$ "	Bastard	770-0877	3.70
		Second	770-0878	3.70
		Smooth	770-0879	3.75

Length of Cut	Diameter	Cut	Item#	Each
10"	$\frac{3}{8}$ "	Bastard	770-1077	\$4.80
		Second	770-1078	4.80
		Smooth	770-1079	5.20
12"	$\frac{1}{2}$ "	Bastard	770-1277	7.15
		Second	770-1278	7.15
		Smooth	770-1279	7.50



Square

Perfectly square tapering toward the point. Used for enlarging slots, keyways, grooves and holes that have right angles and for filing flat surfaces. All four sides are double cut.

Length of Cut	Width	Cut	Item#	Each
6"	$\frac{7}{32}$ "	Bastard	770-0647	\$3.50
		Second	770-0648	3.75
		Smooth	770-0649	3.85
8"	$\frac{5}{16}$ "	Bastard	770-0847	3.85
		Second	770-0848	4.15
		Smooth	770-0849	4.55

Length of Cut	Width	Cut	Item#	Each
10"	$\frac{3}{8}$ "	Bastard	770-1047	\$5.30
		Second	770-1048	5.55
		Smooth	770-1049	5.85
12"	$\frac{1}{2}$ "	Bastard	770-1247	7.60
		Second	770-1248	8.10
		Smooth	770-1249	16.73



Three-Square

Triangular double cut file. Tapers toward the point and has sharp corners. Used to file acute internal angles that cannot be reached with rectangular files.

Length of Cut	Width	Cut	Item#	Each
6"	$\frac{15}{32}$ "	Bastard	770-0657	\$3.85
		Second	770-0658	4.00
		Smooth	770-0659	4.20
8"	$\frac{5}{8}$ "	Bastard	770-0857	4.95
		Second	770-0858	5.40

Length of Cut	Width	Cut	Item#	Each
8"	$\frac{5}{8}$ "	Smooth	770-0859	\$5.55
10"	$\frac{3}{4}$ "	Bastard	770-1057	6.75
		Second	770-1058	7.15
		Smooth	770-1059	7.60

Grobet Swiss Pattern Needle Files

Swiss Pattern needle files are used for precision work in small areas. Finest quality files made. Made of the highest quality steel, machined and finished for precision shape, accuracy and balance. Teeth are sharp and cross-cut, assuring even filing. Recommended for both soft and hard metals, including platinum. Also used for removing, smoothing and shaping plastic and wood. Round knurled handles to provide a sure grip. Length measurements include handle. Length 4" (10 cm) has cut portion of 1 $\frac{3}{4}$ " (44 mm), Length 6 $\frac{1}{4}$ " (16 cm) has cut portion, Length 5 $\frac{1}{2}$ " (14 cm) has cut portion of 2 $\frac{1}{2}$ " (64 mm), Length 7 $\frac{3}{4}$ " (20 cm) has cut portion of 4 $\frac{1}{8}$ " (105 mm). Made in Italy.



Barrette

Tapered in width and thickness, coming to a point. Only flat side is cut, providing safe edge and top.

Cut	Cut Length (inches)	Overall Length (inches)	Length (cm)	Item#	EACH Prices		Cut	Cut Length (inches)	Overall Length (inches)	Length (cm)	Item#	EACH Prices	
					1-11	12+						1-11	12+
00	3	6 $\frac{1}{4}$	16	615-1029	\$7.98	\$7.18	2	3	6 $\frac{1}{4}$	16	615-1022	\$7.98	\$7.18
0	1 $\frac{3}{4}$	4	10	605-1020	10.82	9.74		4 $\frac{1}{8}$	7 $\frac{3}{4}$	20	620-1022	10.29	9.26
	2 $\frac{1}{2}$	5 $\frac{1}{2}$	14	610-1020	9.03	8.13	4	1 $\frac{1}{2}$	4	10	*705-1024	11.97	10.77
	3	6 $\frac{1}{4}$	16	615-1020	7.98	7.18		2 $\frac{1}{2}$	5 $\frac{1}{2}$	14	610-1024	9.24	8.32
	4 $\frac{1}{8}$	7 $\frac{3}{4}$	20	620-1020	10.29	9.26		3	6 $\frac{1}{4}$	16	615-1024	8.40	7.56
2	1 $\frac{3}{4}$	4	10	605-1022	10.82	9.74		4 $\frac{1}{8}$	7 $\frac{3}{4}$	20	620-1024	11.55	10.40
	2 $\frac{1}{2}$	5 $\frac{1}{2}$	14	610-1022	9.03	8.13	6	3	6 $\frac{1}{4}$	16	615-1026	11.03	9.93

**Made in Switzerland.*



Crochet

Tapered in width and gradually tapered in thickness. Used for filing junctions between flat and curved surfaces and for developing slots with rounded edges.

Cut	Cut Length (inches)	Overall Length (inches)	Length (cm)	Item#	EACH Prices		Cut	Cut Length (inches)	Overall Length (inches)	Length (cm)	Item#	EACH Prices	
					1-11	12+						1-11	12+
0	2 $\frac{1}{2}$	5 $\frac{1}{2}$	14	*710-1080	\$9.35	\$8.42	2	2 $\frac{1}{2}$	5 $\frac{1}{2}$	14	610-1082	\$9.35	\$8.42
	3	6 $\frac{1}{4}$	16	*715-1080	8.51	7.66		3	6 $\frac{1}{4}$	16	615-1082	8.51	7.66

**Made in Switzerland.*



Crossing

Half-round on two sides with one side having a larger radius than the other. Tapered in width and thickness. Cut and usable to the point. Used primarily for filing interior curved surfaces. The double radius allows filing at the junction of two curved surfaces or of a straight and curved surface.

Cut	Cut Length (inches)	Overall Length (inches)	Length (cm)	Item#	EACH Prices		Cut	Cut Length (inches)	Overall Length (inches)	Length (cm)	Item#	EACH Prices	
					1-11	12+						1-11	12+
0	2 $\frac{1}{2}$	5 $\frac{1}{2}$	14	610-1090	\$10.71	\$9.64	2	3	6 $\frac{1}{4}$	16	615-1092	\$9.24	\$8.32
	3	6 $\frac{1}{4}$	16	615-1090	9.24	8.32		4 $\frac{1}{8}$	7 $\frac{3}{4}$	20	620-1092	11.97	10.77
	4 $\frac{1}{8}$	7 $\frac{3}{4}$	20	620-1090	11.97	10.77	4	2 $\frac{1}{2}$	5 $\frac{1}{2}$	14	610-1094	11.34	10.21
2	1 $\frac{1}{2}$	4	10	*705-1092	13.76	12.38		3	6 $\frac{1}{4}$	16	615-1094	10.29	9.26
	2 $\frac{1}{2}$	5 $\frac{1}{2}$	14	610-1092	10.71	9.64		4 $\frac{1}{8}$	7 $\frac{3}{4}$	20	620-1094	13.44	12.10
							6	3	6 $\frac{1}{4}$	16	615-1096	12.71	11.44

**Made in Switzerland.*



Equalling

Parallel in width and thickness. Used primarily for filing slots and corners.

Cut	Cut Length (inches)	Overall Length (inches)	Length (cm)	Item#	EACH Prices		Cut	Cut Length (inches)	Overall Length (inches)	Length (cm)	Item#	EACH Prices	
					1-11	12+						1-11	12+
00	3	6 $\frac{1}{4}$	16	615-1109	\$7.14	\$6.43	2	3	6 $\frac{1}{4}$	16	615-1102	\$7.14	\$6.43
0	1 $\frac{3}{4}$	4	10	605-1100	9.66	8.69		4 $\frac{1}{8}$	7 $\frac{3}{4}$	20	620-1102	9.98	8.98
	2 $\frac{1}{2}$	5 $\frac{1}{2}$	14	610-1100	7.98	7.18	4	1 $\frac{3}{4}$	4	10	605-1104	10.61	9.55
	3	6 $\frac{1}{4}$	16	615-1100	7.14	6.43		2 $\frac{1}{2}$	5 $\frac{1}{2}$	14	610-1104	8.40	7.56
	4 $\frac{1}{8}$	7 $\frac{3}{4}$	20	620-1100	9.98	8.98		3	6 $\frac{1}{4}$	16	615-1104	7.46	6.71
2	1 $\frac{3}{4}$	4	10	605-1102	9.66	8.69		4 $\frac{1}{8}$	7 $\frac{3}{4}$	20	620-1104	10.40	9.36
	2 $\frac{1}{2}$	5 $\frac{1}{2}$	14	610-1102	7.98	7.18	6	3	6 $\frac{1}{4}$	16	615-1106	9.77	8.79

Grobet Swiss Pattern Needle Files, continued



Half-Round

Tapered in width and thickness, coming to a point. Cut on both sides.

Cut	Cut Length (inches)	Overall Length		Item#	EACH Prices		Cut	Cut Length (inches)	Overall Length		Item#	EACH Prices	
		(inches)	(cm)		1-11	12+			(inches)	(cm)		1-11	12+
00	3	6¼	16	615-1039	\$9.24	\$8.32	2	3	6¼	16	615-1032	\$9.24	\$8.32
0	1¾	4	10	605-1030	13.02	11.72		4⅛	7¾	20	620-1032	11.97	10.77
	2½	5½	14	610-1030	10.50	9.45	4	1½	4	10	705-1034	15.65	14.09
	3	6¼	16	615-1030	9.24	8.32		2½	5½	14	610-1034	11.34	10.21
	4⅛	7¾	20	620-1030	11.97	10.77		3	6¼	16	615-1034	10.29	9.26
2	1¾	4	10	605-1032	13.02	11.72		4⅛	7¾	20	620-1034	13.44	12.10
	2½	5½	14	610-1032	10.50	9.45	6	3	6¼	16	615-1036	12.71	11.44



Knife-Edge

Tapered in width and thickness. Knife edge has the same thickness from point to shoulder. The included angle of the sharp edge is approximately 10°. Generally used to file in a slot or wedge-shaped opening. Curved knife edge allows easy filing in restricted areas.

Cut	Cut Length (inches)	Overall Length		Item#	EACH Prices		Cut	Cut Length (inches)	Overall Length		Item#	EACH Prices	
		(inches)	(cm)		1-11	12+			(inches)	(cm)		1-11	12+
0	1¾	4	10	605-1110	\$12.81	\$11.53	2	3	6¼	16	615-1112	\$8.93	\$8.04
	2½	5½	14	610-1110	10.08	9.07		4⅛	7¾	20	620-1112	11.66	10.49
	3	6¼	16	615-1110	8.93	8.04	4	2½	5½	14	610-1114	11.13	10.02
	4⅛	7¾	20	620-1110	11.66	10.49		3	6¼	16	615-1114	9.98	8.98
2	1¾	4	10	605-1112	12.81	11.53		4⅛	7¾	20	*720-1114	13.13	11.82
	2½	5½	14	610-1112	10.08	9.07	6	3	6¼	16	615-1116	12.39	11.15

**Made in Switzerland.*



Marking

Identical to half-round, but cut on round side only. Flat side is safe.

Cut	Cut Length (inches)	Overall Length		Item#	EACH Prices	
		(inches)	(cm)		1-11	12+
2	3	6¼	16	615-1122	\$8.93	\$8.04
4	3	6¼	16	615-1124	9.98	8.98



Oval

Oval shape, gradually tapered to tip. Cut and workable to the point. Used for filing interior curved surfaces.

Cut	Cut Length (inches)	Overall Length		Item#	EACH Prices	
		(inches)	(cm)		1-11	12+
2	3	6¼	16	615-1142	\$8.72	\$7.85
4	3	6¼	16	615-1144	9.77	8.79

Grobet Swiss Pattern Needle Files, continued

**Round**

Gradually tapered. Cut and workable to the point. Used where it is necessary to enlarge a hole or round off a radius.

Cut	Cut Length (inches)	Overall Length (inches) (cm)	Item#	EACH Prices	
				1-11	12+
00	3	6¼ 16	615-1059	\$7.14	\$6.43
0	1¾	4 10	605-1050	10.19	9.17
	2½	5½ 14	610-1050	8.30	7.47
	3	6¼ 16	615-1050	7.14	6.43
2	4⅛	7¾ 20	620-1050	9.14	8.23
	1¾	4 10	605-1052	10.19	9.17
	2½	5½ 14	610-1052	8.40	7.56

Cut	Cut Length (inches)	Overall Length (inches) (cm)	Item#	EACH Prices	
				1-11	12+
2	3	6¼ 16	615-1052	\$7.14	\$6.43
0	4⅛	7¾ 20	620-1052	9.14	8.23
	1¾	4 10	605-1054	12.29	11.06
4	2½	5½ 14	610-1054	8.82	7.94
	3	6¼ 16	615-1054	7.88	7.09
	4⅛	7¾ 20	620-1054	10.19	9.17
6	3	6¼ 16	615-1056	9.77	8.79

*Made in Switzerland.

**Square**

Gradually tapered and cut on all four sides. Cut and usable to the point. A general-purpose file.

Cut	Cut Length (inches)	Overall Length (inches) (cm)	Item#	EACH Prices	
				1-11	12+
00	3	6¼ 16	615-2069	\$7.98	\$7.18
0	1¾	4 10	605-1060	11.13	10.02
	2½	5½ 14	610-1060	9.24	8.32
	3	6¼ 16	615-2060	7.98	7.18
2	4⅛	7¾ 20	620-1060	10.29	9.26
	1¾	4 10	605-1062	11.13	10.02
	2½	5½ 14	610-1062	9.24	8.32

Cut	Cut Length (inches)	Overall Length (inches) (cm)	Item#	EACH Prices	
				1-11	12+
2	3	6¼ 16	615-2062	\$7.98	\$7.18
0	4⅛	7¾ 20	620-1062	10.29	9.26
	1½	4 10	*705-1064	11.13	10.02
4	2½	5½ 14	610-1064	9.98	8.98
	3	6¼ 16	615-2064	8.82	7.94
	4⅛	7¾ 20	620-1064	11.55	10.40
6	3	6¼ 16	615-2066	11.03	9.93

*Made in Switzerland.

**Three-Square**

Gradually tapered and cut to the point.

Cut	Cut Length (inches)	Overall Length (inches) (cm)	Item#	EACH Prices	
				1-11	12+
00	3	6¼ 16	615-1069	\$7.98	\$7.18
0	1¾	4 10	605-1010	11.34	10.21
	2½	5½ 14	610-1010	9.24	8.32
	3	6¼ 16	615-1060	7.98	7.18
2	4⅛	7¾ 20	620-1010	10.29	9.26
	1¾	4 10	605-1012	11.34	10.21
	2½	5½ 14	610-1012	12.30	11.07

Cut	Cut Length (inches)	Overall Length (inches) (cm)	Item#	EACH Prices	
				1-11	12+
2	3	6¼ 16	615-1062	\$7.98	\$7.18
0	4⅛	7¾ 20	620-1012	10.29	9.26
	1½	4 10	*705-1014	11.39	10.25
4	2½	5½ 14	610-1014	9.98	8.98
	3	6¼ 16	615-1064	8.82	7.94
	4⅛	7¾ 20	620-1014	11.55	10.40
6	3	6¼ 16	615-1066	11.03	9.93

*Made in Switzerland.

**Warding**

Parallel in thickness and tapered in width. Good for deburring.

Cut	Cut Length (inches)	Overall Length (inches) (cm)	Item#	EACH Prices	
				1-11	12+
0	2½	5½ 14	610-1070	\$9.03	\$8.13
0	3	6¼ 16	615-1070	7.98	7.18
	4⅛	7¾ 20	620-1070	10.29	9.26
2	2½	5½ 14	610-1072	9.03	8.13
	3	6¼ 16	615-1072	7.98	7.18

Cut	Cut Length (inches)	Overall Length (inches) (cm)	Item#	EACH Prices	
				1-11	12+
2	4⅛	7¾ 20	620-1072	\$10.29	\$9.26
4	2½	5½ 14	610-1074	9.24	8.32
	3	6¼ 16	615-1074	8.40	7.56
6	4	7¾ 20	*720-1074	11.87	10.68

*Made in Switzerland.

A. Grobet Swiss Pattern Needle File Sets

Each includes 12 of our most popular files in one cut. 14mm and 16mm come in a storage pouch. Made in Italy.

Cut	Cut Length (inches)	Overall Length (inches) (cm)	Item#	SET of 12
0	2½	5½ 14	603-1400	\$107.00
	3	6¼ 16	603-1600	114.95
2	2½	5½ 14	603-1420	107.00
	3	6¼ 16	603-1620	113.95
4	2½	5½ 14	603-1440	114.50
	3	6¼ 16	603-1640	124.95
6	3	6¼ 16	603-1660	157.45

6pc. sets also available please see our website for details.



A

B. Plastic Needle File Handle

Durable plastic handle for holding all needle files. Measures 3¼" long.

Description	Item#	EACH Prices	
		1-11	12+
Plastic File Handle	170-4010	\$5.50	\$4.68



B

C. Wooden File Handle with Collet

Wooden handle with metal collet for needle and escapement files. Measures 4½" long.

Description	Item#	Each
Wooden File Handle with Collet	170-4013	\$4.80



C

D. Wooden File Handles

Wooden handles with metal ferrules for needle and escapement files. Measure 4" long.

Description	Diameter	Item#	EACH Prices	
			1-11	12+
D. Wooden File Handle	¾"	170-6010	\$1.10	\$0.99
	⅝"	170-6011	1.10	0.99



D

E. Contoured Wooden File Handles

Polished wooden handles with metal ferrules for needle, escapement and pattern files.

Description	Length	Item#	EACH Prices		
			1-2	3-9	10+
Needle/Escapement File Handle	3½"	170-4011	\$1.10	\$1.05	\$0.99
	4"	170-4012	1.10	1.05	0.99



E



A-G Grobet Inox Needle Files – For hard metals.

Inox files provide excellent performance on hard-to-file surfaces and hard metals. Feature exceptional hardness of 72 HRC and corrosion resistance for long life. Best of all, they won't clog—one knock is enough to remove metal chips. Handles are yellow for quick identification. Measure approx. 18cm (7") long. Made in Italy. Inox hand files are also available (see p. 310).

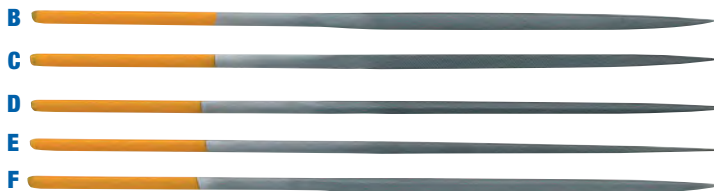

G



N



O



Style	Shape	Cut 0 Item#	Cut 2 Item#	EACH Prices		
				1-2	3-11*	12+*
A. Equalling		602-0021	602-0022	\$13.02	\$12.37	\$11.72
B. Half-Round		602-0026	602-0027	15.38	14.61	13.84
C. Three-Square		602-0031	602-0032	13.60	12.92	12.24
D. Square		602-0036	602-0037	13.60	12.92	12.24
E. Round		602-0041	602-0042	12.97	12.32	11.67
F. Barrette		602-0046	602-0047	14.44	13.72	13.00
G. 6-Piece Set		602-0051	602-0052	81.06	-	-

*Quantity discount for orders of one item number only; not assorted.

H-N Grobet Teborg Needle Files

Economical chrome alloy steel needle files. Measure 5½" (14cm) long. Can be used with file handles (see p. 312). Sold individually and a set of six shapes. Made in Italy.

Description	Shape	Cut	Item#	EACH Prices	
				1-11	12+
H. Barrette		2	604-3012	\$4.48	\$3.73
		4	604-3014	4.66	3.88
I. Equalling		2	604-3022	4.48	3.73
		4	604-3024	4.60	3.83
J. Half-Round		2	604-3032	5.37	4.47
		4	604-3034	5.43	4.52
K. Round		2	604-3042	4.48	3.73
		4	604-3044	4.60	3.83
L. Square		2	604-3052	4.48	3.73
		4	604-3064	4.71	3.92
M. Three-Square		2	604-3062	4.48	3.73
		4	604-3064	4.71	3.92
N. 6-Piece Set		2	604-3002	29.77	-
		4	604-3004	31.97	-

O. Econo Mini Needle File Set

An inexpensive set of 12 miniature needle files in our most popular shapes. Excellent for getting into tight spots and tiny settings. Files measure 4" (10cm) long. Made in China.

Description	Cut	Item#	Each
12-Piece Set	2	705-1000	\$11.45

Swiss Pattern Escapement Files

Sometimes known as square-handled needle files, escapement files are used for filing even smaller items such as fine extrusion dies and making fine repairs. Measure 14cm (5½") long with 1½" to 2½" cut length.



Barrette

Tapered in width and thickness, coming to a point. Only flat side is cut, providing safe edge and top.

Cut	Overall inches	Length cm	Item#	EACH Prices		Cut	Overall inches	Length cm	Item#	EACH Prices	
				1-11	12+					1-11	12+
0	5½	14	725-1100	\$16.17	\$14.55	6	5½	14	725-1106	\$20.58	\$18.52
2			725-1102	16.28	14.65	8			725-1108	21.53	19.38
4			725-1104	17.64	15.88						



Barrette, Parallel

Same as Barrette (above) but with parallel sides.

Cut	Overall inches	Length cm	Item#	EACH Prices		Cut	Overall inches	Length cm	Item#	EACH Prices	
				1-11	12+					1-11	12+
4			725-1114	\$17.64	\$15.88	6	5½	14	725-1116	\$20.58	\$18.52



Crossing

Half-round on two sides with one side having a slightly larger radius than the other. Tapered in width and thickness. Cut and usable to the point. Used primarily for filing interior curved surfaces. The double radius allows filing at the junction of two curved surfaces or of a straight and curved surface.

Cut	Overall inches	Length cm	Item#	EACH Prices		Cut	Overall inches	Length cm	Item#	EACH Prices	
				1-11	12+					1-11	12+
2	5½	14	725-1032	\$19.01	\$17.11	6	5½	14	725-1036	\$23.94	\$21.55
4			725-1034	20.69	18.62						



Equalling

Parallel in width and thickness. Used primarily for filing slots and corners.

Cut	Overall inches	Length cm	Item#	EACH Prices		Cut	Overall inches	Length cm	Item#	EACH Prices	
				1-11	12+					1-11	12+
2	5½	14	725-1082	\$15.12	\$13.61	6	5½	14	725-1086	\$19.95	\$17.96
4			725-1084	16.91	15.22						



Half-Round

Tapered in width and thickness, coming to a point. Cut on both sides.

Cut	Overall inches	Length cm	Item#	EACH Prices		Cut	Overall inches	Length cm	Item#	EACH Prices	
				1-11	12+					1-11	12+
2	5½	14	725-1022	\$19.01	\$17.11	6	5½	14	725-1026	\$23.94	\$21.55
4			725-1024	20.69	18.62	8			725-1028	25.10	22.59

Swiss Pattern Escapement Files, continued



Knife-Edge

Tapered in width and thickness. Knife edge has the same thickness from point to shoulder. The included angle of the sharp edge is approximately 10°. Generally used to file in a slot or wedge-shaped opening. Curved knife edge allows easy filing in restricted areas.

Cut	Overall inches	Length cm	Item#	EACH Prices	
				1-11	12+
2	5½	14	725-1092	\$18.80	\$16.92
4			725-1094	20.58	18.52

Cut	Overall inches	Length cm	Item#	EACH Prices	
				1-11	12+
6	5½	14	725-1096	\$23.73	\$21.36



Round

Gradually tapered. Cut and workable to the point. Used where it is necessary to enlarge a hole or round off a radius.

Cut	Overall inches	Length cm	Item#	EACH Prices	
				1-11	12+
0	5½	14	725-1010	\$13.44	\$12.10
2			725-1012	13.44	12.10
4			725-1014	14.49	13.04

Cut	Overall inches	Length cm	Item#	EACH Prices	
				1-11	12+
6	5½	14	725-1016	\$14.60	\$13.14
8			725-1018	17.01	15.31



Rounding Off

Cut on flat side only.

Cut	Overall inches	Length cm	Item#	EACH Prices	
				1-11	12+
4	5½	14	725-1124	\$19.01	\$17.11

Cut	Overall inches	Length cm	Item#	EACH Prices	
				1-11	12+
6	5½	14	725-1126	\$21.95	\$19.76



Square

Gradually tapered and cut on all four sides. Cut and usable to the point. A general-purpose file.

Cut	Overall inches	Length cm	Item#	EACH Prices	
				1-11	12+
0	5½	14	725-1040	\$16.38	\$14.74
2			725-1042	16.49	14.84
4			725-1044	18.59	16.73

Cut	Overall inches	Length cm	Item#	EACH Prices	
				1-11	12+
6	5½	14	725-1046	\$20.79	\$18.71
8			725-1048	21.74	19.57



Three-Square

Gradually tapered and cut to the point.

Cut	Overall inches	Length cm	Item#	EACH Prices	
				1-11	12+
0	5½	14	725-1050	\$16.17	\$14.55
2			725-1052	16.28	14.65
4			725-1054	17.64	15.88

Cut	Overall inches	Length cm	Item#	EACH Prices	
				1-11	12+
6	5½	14	725-1056	\$20.58	\$18.52
8			725-1058	21.53	19.38



Three-Square, Short and Slim

Cut on all three sides, tapered to a point.

Cut	Overall inches	Length cm	Item#	EACH Prices	
				1-11	12+
4	5½	14	625-1064	\$17.64	\$15.88

Cut	Overall inches	Length cm	Item#	EACH Prices	
				1-11	12+
6	5½	14	625-1066	\$20.58	\$18.52

Swiss Pattern Escapement Files, continued

A. Swiss Pattern Escapement File Sets

Includes 12 popular shapes. Available in cut 2, 4 or 6.

Description	Cut	Item#	Set of 12
Swiss Escapement File Set	2	725-2002	\$194.25
	4	725-2004	190.75
	6	725-2006	240.45



A

B. File Card – Clean files cut faster!

Features steel wire bristles mounted on a wood handle for cleaning particles caught in teeth of files. Measures 8" long.

Description	Item#	EACH Prices	
		1-5	6+
File Card	816-2800	\$7.60	\$6.08



B

C. Grobet American Pattern Utility File Set Six files to match any job perfectly!

Includes six American Pattern Files with wooden handles: square, half-round, three-square, round, flat and warding, all smooth cut. Comes complete with hanging pouch. File including handle measures 7" long with approx. 4" cut length.

Description	Cut	Item#	Set of 6
Utility File Set	Smooth	705-1005	\$17.00



C

Guide to Selecting Grobet Swiss Pattern Precision Files

File selection cannot be reduced to a formula or table but is based to a great degree on experience. However, the chart below gives you a great starting point for file selection.

Basic Application	Type of File Recommended
Corners-holes-edges	Three-Square
Corners-holes	Square
Corners-slots	Equalling
Curved surfaces-corners-holes	Half-Round
Curved surfaces-junctures of curved and flat surfaces-corners-holes	Crossing
Flat surfaces	Hand
Flat surfaces-corners-keyways dovetail ways-gear teeth-deburring	Barrette
Flat surfaces-slots	Pillar
Roughening surfaces for hand grips	Checkering
Rounded corners-slots-flat surfaces-junctures between curved and flat surfaces	Crochet
Rounded corners-holes-"V" slots	Pippin
Rounded inside corners-holes	Round
Slots	Screwhead
Slots	Warding
Slots-wedge-shaped openings	Knife

Keep in mind, there is more to file selection than shape alone. Selecting the correct cut to use is determined by the type of the metal you're working on, as well as the amount of material to be removed and your desired finish. For example, rapid removal of stock often indicates a cut 00, while working on narrow surfaces would suggest a cut 2 and a fine cut such as cut 4 or cut 6 would be used for final finishing operations.

Types of Files

Swiss Pattern Precision Files - The original Swiss Pattern files made in hundreds of shapes and sizes.

Swiss Pattern Needle Files - A group of files of various cross-sections with a knurled, round handle. Knurling gives the file a positive, Non-Slip grip for precision filing.

Escapement Files - Also called small Square Handled Needle Files. A group of files of various cross-sectioned shapes with a length of cut varying from $\frac{3}{4}$ " to $2\frac{1}{2}$ ", with square handles.

Rifflers - Originally used and hand forged by die sinkers, die makers, silversmiths, etc., in shapes and cross-sections appropriate to their work. Teeth are cut on small areas on each end and can have a variety of shapes. A long middle portion serves as the handle.

Grobet Inox Files

For platinum, stainless steel, exotic plastics, and other hard to file materials. The hardest surface known - Rockwell hardness 72HRC. Better performance on hard-to-file surfaces. Little or no clogging; a simple knock is enough to remove the chips. Highly resistant to corrosion. Longer life than standard files. Made in Italy.

Handles are yellow for quick identification. Inox needle files are also available (see p. 306).

Barrette



Tapered in width and thickness, coming to a point. Only flat side is cut, providing safe edge and top.

Cut	Length of cut inches	Item#	EACH Prices			Cut	Length of cut inches	Item#	EACH Prices		
			1-2	3-5	6+				1-2	3-5	6+
0	6	602-0070	\$31.33	\$30.39	\$28.82	2	6	602-0072	\$33.81	\$32.80	\$31.11

Half-Round



Tapered in width and thickness, coming to a point. Cut on both sides.

Cut	Length of cut inches	Item#	EACH Prices			Cut	Length of cut inches	Item#	EACH Prices		
			1-2	3-5	6+				1-2	3-5	6+
0	6	602-0090	\$37.57	\$36.44	\$34.56	2	6	602-0092	\$40.54	\$39.32	\$37.30

Hand

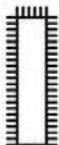

Parallel in width and gently tapered in thickness for perfectly flat filing. Double cut top and bottom with one single-cut edge and one safe edge

Cut	Length of cut inches	Item#	EACH Prices			Cut	Length of cut inches	Item#	EACH Prices		
			1-2	3-5	6+				1-2	3-5	6+
00	6	602-0079	\$21.34	\$20.70	\$19.63	2	6	602-0082	\$24.17	\$23.44	\$22.24
0	6	602-0080	22.40	21.73	20.61						

Half-Round Ring



Gradually tapered. Cut and workable to the point. Used where it is necessary to enlarge a hole or round off a radius.

Cut	Length of cut inches	Item#	EACH Prices			Cut	Length of cut inches	Item#	EACH Prices		
			1-2	3-5	6+				1-2	3-5	6+
0	6	602-0060	\$39.48	\$38.30	\$36.32	2	6	602-0061	43.87	42.55	40.36

Round



Gradually tapered. Cut and workable to the point. Used where it is necessary to enlarge a hole or round off a radius.

Cut	Length of cut inches	Item#	EACH Prices		
			1-2	3-5	6+
2	6	702-0102	\$19.92	\$19.32	\$18.33

Three-Square



Triangular profile. Gradually tapered, and cut workable to the point. Double cut on all three sides.

Cut	Length of cut inches	Item#	EACH Prices		
			1-2	3-5	6+
2	6	702-0112	\$27.57	\$26.74	\$25.36



A

A-E Grobet Ergo Files

Ergo files are designed for those in-between jobs that are too big for needle files and require finer control than heavier files. Shaped for easy handling and balanced for efficient cutting. Feature strong, secure built-in handles. Available in five different shapes for practically every precision filing requirement. Measure 8½" long with 4" cut length. All double cut. Made in Italy.

Style	Shape	Cut 00 Item#	Cut 1 Item#	EACH Prices	
				1-9	10+*
A. Hand		604-1000	604-1001	\$17.33	\$15.60
B. Half-Round		604-1010	604-1011	18.38	16.54
C. Round		604-1040	604-1041	13.81	12.43
D. Square		604-1030	604-1031	21.68	19.51
E. Three-Square		604-1020	604-1021	21.63	19.47
5-Piece Set (one of each)		604-2000	604-2001	82.53	-

*Quantity discount for orders of one item number only; not assorted.



B

C

D

E



F

G

H

F-H Vulcrylic (also known as Vulcanite) Files

Select between high-quality half-round files with open teeth and an economical alternative. Used for filing and shaping plastic, wax, wood, and other soft materials. Double ended: one coarse cut, the other medium cut. Each end is ½" wide tapering to tip. Made in Italy or India.

Description	Length	Item#	Each	Description	Length	Item#	Each
F. Italian	7"	604-0011	\$35.18	H. Econo (India)	8"	704-0020	\$10.85
G. Italian	8"	604-0010	37.80				



I

I. Screwhead File with Tang

High quality steel file with smooth sides to cut only on the edge. Will not widen the slot as it deepens. Used for cleaning up marred slots on hard to replace screws or for filing .022" slots in new small screws. Measures 4¼"L x 23/64"W, with 27/8" cut length. Select appropriate thickness for desired slot size.

Description	Thickness	Item#	1-11	12+	Description	Thickness	Item#	1-11	12+
#2	0.028"	649-1002	\$36.28	\$30.84	#6	0.018"	649-0999	\$36.28	\$30.84
I. #4	0.022"	649-1000	36.28	30.84	#8	0.014"	649-0998	36.28	30.84

J-M Steel Files – For reciprocating handpieces.

High-quality steel files for reciprocating handpieces. All cut 0. Measure 80mm (3¼") long with 3mm shanks.

Style	Shape	Item#	Each
J. Round		701-0500	\$11.24
K. Equalling		701-0520	11.24
L. Half-Round		701-0540	11.24
M. Three-Square		701-0560	11.24



J

K

L

M

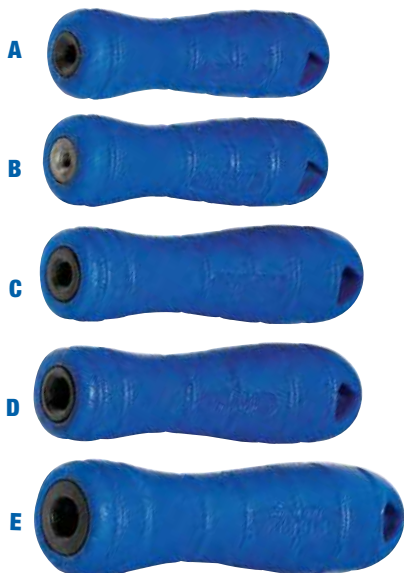

A-E Grobet Plastic File Handles

Virtually unbreakable plastic handles shaped and textured to fit your hand comfortably and prevent slipping. Feature tempered metal tang-holding inserts that are threaded to ensure proper alignment and positive grip. Allow easy file changes: just unscrew the file in use and screw in another. Have holes at top for hanging near your workbench. Made in Italy.

Handle Selection Guide:

File Shape	File Length						File Shape	File Length					
	3"	4"	6"	8"	10"	12"		3"	4"	6"	8"	10"	12"
Barrette	2	3	4	5	—	—	Pillar	2	3	4	5	6	6
Checkering	—	—	4	—	—	—	Pippin	—	3	4	5	—	—
Crochet	—	3	4	5	—	—	Round, Parallel	—	—	2	3	—	—
Crossing	—	3	4	5	—	—	Round, Tapered	—	2	3	4	5	—
Equalling	—	3	4	5	—	—	Square	—	2	3	4	5	—
Half-Round	—	3	4	5	6	6	Three-Square	2	3	4	5	6	6
Hand	—	3	4	5	6	6	Warding	—	3	4	5	—	—
Knife-Edge	—	3	4	5	6	6							

Description	Item#	EACH Prices	
		1-11	12+
A. #2 Handle	170-6002	\$3.25	\$2.93
B. #3 Handle	170-6003	3.25	2.93
C. #4 Handle	170-6004	3.35	3.02
D. #5 Handle	170-6005	3.35	3.02
E. #6 Handle	170-6006	3.50	3.15



F. Plastic Needle File Handle

Durable plastic handle for holding all needle files. Measures 3 $\frac{1}{4}$ " long.

Description	Item#	EACH Prices	
		1-11	12+
Plastic File Handle	170-4010	\$5.50	\$4.68



G. Wooden File Handle with Collet

Wooden handle with metal collet for needle and escapement files. Measures 4 $\frac{1}{2}$ " long.

Description	Item#	Each
Wooden File Handle with Collet	170-4013	\$4.80



H. Wooden File and Burnisher Handle

Hardwood handle with metal ferrule curved to fit in your hand. Measures 3 $\frac{7}{8}$ " L x $\frac{7}{8}$ " dia.

Description	Item#	Each
Wooden File and Burnisher Handle	170-3005	\$2.80



I. Skroo-Zon® File Handle

A white birch handle with heavy-gauge steel ferrule. Features a hardened steel insert inside the handle that cuts a thread on the file tang to grip it firmly. Keeps strain off the handle to prevent it from breaking. Holds 6" files. Measures 4" L x 1 $\frac{1}{8}$ " dia.

Description	Item#	EACH Prices	
		1-11	12+
Skroo-Zon File Handle	170-6000	\$2.70	\$2.43



J. Wooden File Handles

Wooden handles with metal ferrules for needle and escapement files. Measure 4" long.

Description	Diameter	Item#	EACH Prices	
			3pc 3-9	12+
J. Wooden File Handle	$\frac{3}{8}$ "	170-6010	\$1.10	\$0.99
	$\frac{5}{8}$ "	170-6011	1.10	0.99

Must order in quantities of three.



K, L Contoured Wooden File Handles

Polished wooden handles with metal ferrules for needle, escapement and pattern files.

Description	Length	Item#	EACH Prices		
			1-2	3-9	10+
K. Needle/Escapement File Handle	3 $\frac{1}{2}$ "	170-4011	\$1.10	\$1.05	\$0.99
	4"	170-4012	1.10	1.05	0.99
L. Pattern File Handle	3"	170-6012	1.95	1.85	1.76
	4"	170-6013	1.95	1.85	1.76
	5"	170-6014	2.10	2.00	1.89



Swiss Pattern Diemaker's Rifflers

For removing metal and smoothing hard-to-reach surfaces. All are double-ended, both ends identical. Measure approx. 7" overall length. Made in Italy unless otherwise noted.



Swiss Pattern Diemaker's Rifflers

Style Old/New	Cut 0 Item#	Cut 2 Item#	EACH Prices	
			1-11	12+*
710/603	600-7100	600-7102	\$34.76	\$31.28
711/604	600-7110	600-7112	34.76	-
712/605	600-7120	600-7122	34.76	31.28
713/606	600-7130	600-7132	34.76	31.28
731/607	600-7310	600-7312	34.76	31.28
732/608	600-7320	600-7322	34.76	31.28
741/609	600-7410	600-7412	39.59	35.63
750/610	600-7500	600-7502	39.59	35.63
761/611	600-7610	600-7612	39.59	35.63
762/612	600-7620	600-7622	39.59	35.63
763/613	600-7630	600-7632	35.91	32.32
771/615	600-7710	600-7712	35.91	32.32
781/616	600-7810	600-7812	29.40	26.46
796	-	700-7962**	48.30	43.47

*Quantity discount for orders of one item number only; not assorted.

**Made in Switzerland.

All double-ended.





Swiss Pattern Diemaker's Riffler Sets

Styles: 710/603, 711/604, 712/605, 713/606, 731/607, 732/608, 741/609, 750/610, 761/611, 762/612, 771/615, 781/616. Selection subject to change without notice.

Cut 0 Item#	Cut 2 Item#	Set of 12
603-0500	603-0520	\$413.00

Swiss Pattern Diesinker's Rifflers

All are double-ended files. Commonly used to shape and finish curved, unusual, or hard-to-reach surfaces. Illustrations feature one side (both sides are identical except for 905/503, which is straight and curved). All measure 6" long. Available individually or in a set of 12 (p. 316). Made in Italy unless otherwise stated.

	Style Old/New	Cut 0 Item#	Cut 2 Item#	Cut 4 Item#	EACH Prices 1-11	12+*
	900	—	700-9002**	—	\$24.99	\$22.49
	901/502	600-9010	600-9012	—	24.26	21.83
	902	700-9020**	700-9022**	—	23.84	21.46
 <i>Both ends shown of style 905/503.</i>	905/503	600-9050	600-9052	700-9054**	26.67	24.00
	911/505	600-9110	600-9112	700-9114**	27.09	24.38
	912/506	600-9120	600-9122	700-9124**	25.20	22.68
	913/507	600-9130	600-9132	—	27.20	24.48
	914/508	600-9140	600-9142	700-9144**	25.31	22.78
	915/509	600-9150**	600-9152	—	25.52	22.97
	917/511	600-9170	600-9172	—	25.52	22.97
	918/512	700-9180	600-9182	—	27.20	24.48
	919	700-9190**	700-9192**	—	32.66	29.39
	920	700-9200**	—	—	31.82	28.64
	930/515	600-9300	600-9302	—	25.20	22.68
	940/517	600-9400	600-9402	—	29.72	26.75
	941/518	600-9410	600-9412	700-9414**	25.20	22.68
	942/519	700-9420**	600-9422	700-9424**	28.98	26.08
	950	700-9500**	—	—	29.30	26.37

*Quantity discount for orders of one item number only; not assorted.

**Made in Switzerland.

Swiss Pattern Diesinker's Riffilers, continued

Style Old/New	Cut 0 Item#	Cut 2 Item#	Cut 4 Item#	EACH Prices		All double-ended.	
				1-11	12+*		
951/522	600-9510	600-9512	—	\$34.55	\$31.10		
952/523	600-9520	600-9522	—	34.44	31.00		
953	—	700-9532**	—	32.66	29.39		
954	—	700-9542**	—	35.18	31.66		
955/525	600-9550	600-9552	—	37.28	33.55		
956/526	600-9560	600-9562	700-9564**	25.52	22.97		
957/527	—	600-9572	—	28.56	25.70		
958	700-9580**	700-9582**	—	31.08	27.97		
961/529	600-9610	600-9612	—	29.72	26.75		
962	700-9620**	700-9622**	—	26.15	23.54		
963/531	600-9630	600-9632	700-9634**	30.35	27.32		
964/532	600-9640	600-9642	—	22.68	20.41		
965/533	600-9650	600-9652	—	22.68	20.41		
970/534	700-9700**	600-9702	600-9704	25.20	22.68		
971	700-9710**	—	700-9714**	25.20	22.68		
972/536	600-9720	600-9722	—	26.36	23.72		
973/537	600-9730	600-9732	700-9734**	25.20	22.68		
975/539	600-9750	600-9752	—	25.20	22.68		
981/541	600-9810	600-9812	600-9814	22.68	20.41		
982/542	600-9820	600-9822	—	22.68	20.41		

*Quantity discount for orders of one item number only; not assorted.

Swiss Pattern Diesinker's Rifflers, continued



All double-ended.

Style Old/New	Cut 0 Item#	Cut 2 Item#	Cut 4 Item#	EACH Prices	
				1-11	12+*
983/543	600-9830	600-9832	—	\$22.68	\$20.41
984/544	600-9840	600-9842	700-9844**	22.68	20.41
985/545	600-9850	600-9852	700-9854**	22.68	20.41
986/546	600-9860	600-9862	700-9864**	23.52	21.17
987	—	—	700-9874**	22.68	20.41
988	—	700-9882**	—	22.68	20.41
990	—	700-9902**	—	29.72	26.75
996/552	—	600-9962	600-9964	34.86	31.37
997	700-9970**	—	—	19.53	17.58

*Quantity discount for orders of one item number only; not assorted.

**Made in Switzerland.

Swiss Pattern Diesinker's Riffler Sets

A. Set of 12

Styles: 955/525, 956/526, 957/527, 961/529, 963/531, 964/532, 965/533, 972/536, 973/537, 975/539, 981/541, 982/542. Subject to change without notice. Made in Italy.

	Cut 0	Cut 2
Item#	603-0100	603-0120
Set of 12	\$299.25	\$299.25



A

Spectra Diamond Files





High-quality diamond files at economical prices. Feature a combination of natural and synthetic diamonds firmly plated onto durable steel blanks. Cushioned color-coded ends. Made in Germany.

Spectra Grit Chart

Medium	D126	120/140
Fine	D91	170/200
Very Fine	D64	230/270





A-E Spectra Medium Diamond Needle Files

Diamond needle files with 3mm round handles. Measure 5½" (14cm) long. Plated ends measure 2¾" long. Medium grit (D126, or U.S. standard 120/140).

Style	Shape	Item#	EACH Prices		
			1-4	5-9	10+
A. Equalling		241-0010	\$30.25	\$28.74	\$27.23
B. Flat-Pointed		241-0020	30.25	28.74	27.23
C. Half-Round		241-0030	30.25	28.74	27.23
D. Round		241-0040	30.25	28.74	27.23
E. Knife		241-0050	30.25	28.74	27.23
Set of all five		241-0250	141.00	-	-

F-J Spectra Fine Diamond Needle Files

Diamond needle files with 3mm round handles. Measure 5½" (14cm) long. Plated ends measure 2¾" long. Fine grit (D91, or U.S. standard 170/200).

Style	Shape	Item#	EACH Prices		
			1-4	5-9	10+
F. Equalling		241-0012	\$30.25	\$28.74	\$27.23
G. Flat-Pointed		241-0022	30.25	28.74	27.23
H. Half-Round		241-0032	30.25	28.74	27.23
I. Round		241-0042	30.25	28.74	27.23
J. Knife		241-0052	30.25	28.74	27.23
Set of all five		241-0245	141.00	-	-





K. Spectra Very Fine Diamond Escapement File

Diamond escapement file with ¾" square handle. Measures 5½" (14cm) long. Plated end measures 1¾" long with ¼"-1/32" taper. Very fine grit (D64, or U.S. standard 230/270).

Style	Shape	Item#	EACH Prices		
			1-4	5-9	10+
Round (tapered)		241-0150	\$33.00	\$31.35	\$29.70

L-P Spectra Very Fine Diamond Micro Files

Mini diamond files with ⅜" wide handles. Measure approx. 4" long except round, which measures approx. 3¾" long. Plated ends measure approx. 2" long with ¼"-1/32" taper for round only. Very fine grit (D64, or U.S. standard 230/270).

Style	Shape	Item#	EACH Prices		
			1-4	5-9	10+
L. Round (tapered)		241-0500	\$26.00	\$24.70	\$23.40
M. Half-Round		241-0505	26.00	24.70	23.40
N. Square		241-0510	26.00	24.70	23.40
O. Three-Square		241-0515	26.00	24.70	23.40
P. Flat Hand		241-0520	26.00	24.70	23.40
Set of all five		241-0525	123.00	-	-

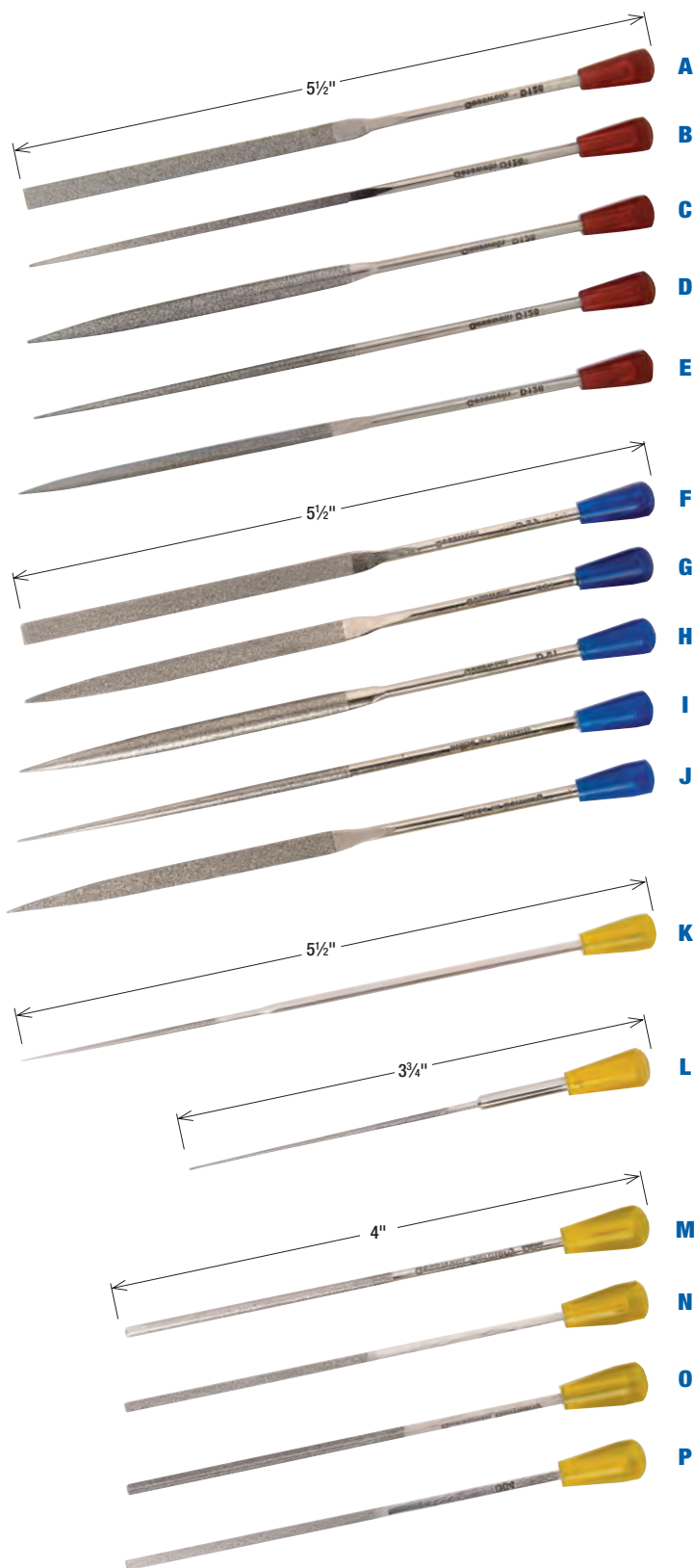

See all our other DIAMOND FILES on pages 109-113.

They include 3M Diamond Hand files, Gesswein Diamond Poli files, Rifflers and Needle files, as well as Diamond Lappers and Hand Sharpeners.



Made in the USA



A



Made in the USA



B



Made in the USA



C



Made in the USA



D



Made in the USA



E

A. Dead-Blow Mallets – With detachable faces

Feature cast-iron heads filled with iron shot. As each mallet is struck, shot moves forward behind the blow to dampen rebound and ensure efficient transmission of force. Includes two replaceable nonmarring polyurethane faces: medium (green) and hard (black). Impervious to oils and most solvents. Grooved hickory handles. Made in USA.

Head Dia. x L	Head Wt.	Length	Item#	Each
1" x 4 1/4"	3/4 lbs.	11"	821-9070	\$38.70
1 1/2" x 5 1/4"	2 lbs.	13 1/8"	821-9080	49.50
2" x 6 1/4"	3 1/2 lbs.	14 1/2"	821-9090	66.70
Replacement Face	Color	Hardness	Item#	Each
1" dia.	Green	Med.	821-9100	\$7.80
	Black	Hard	821-9110	10.50
1 1/2" dia.	Green	Med.	821-9120	10.60
	Black	Hard	821-9130	13.90
2" dia.	Green	Med.	821-9140	15.25
	Black	Hard	821-9150	20.40

B. Weighted Rawhide Mallets

Feature heads made of lead strips surrounded by multiple layers of tough water buffalo hide with screw fastening for great longevity. Deliver extra-strong blows without scratching fine work surfaces. Hickory handles. Made in USA.

Head Dia. x L	Head Wt.	Length	Item#	EACH Prices	
				1-2	3+
1 1/4" x 2 1/2"	8 oz.	9 1/4"	821-8000	\$35.00	\$33.25
1 1/2" x 3"	12 oz.	10"	821-8001	39.00	37.05
1 3/4" x 3 3/8"	16 oz.	11 1/2"	821-8002	45.00	42.75
2" x 3 1/2"	20 oz.	12"	821-8003	60.00	57.00

C. Rawhide Mallets

Compressed rawhide mallets for use when extra care must be taken not to mar the work surface. Hickory handles. Most popular size for general purpose work is 1 1/2" x 3". Made in USA.

Head Dia. x L	Head Wt.	Length	Item#	EACH Prices	
				1-2	3+
1" x 2"	2 1/2 oz.	8"	821-8800	\$17.00	\$15.30
1 1/4" x 2 1/2"	4 1/2 oz.	9"	821-8850	19.00	17.10
1 1/2" x 3"	6 oz.	10"	821-8900	22.00	19.80
1 3/4" x 3 1/2"	9 1/2 oz.	11"	821-8950	28.00	25.20
2" x 3 1/2"	12 oz.	11 3/4"	821-9000	34.00	30.60
2 3/4" x 4 1/4"	1 1/2 lbs.	13 1/2"	821-9050	57.50	51.75

D. Polyurethane Dead-Blow Mallets

One-piece mallets with no exposed metal. Will not mushroom, split or pick up debris. Outlast rawhide, rubber, brass, lead, nylon and plastic mallets 10–20 times over. Made in USA.

Head Dia. x L	Head Wt.	Length	Item#	EACH Prices	
				1-2	3+
7/8" x 2 7/8"	8 oz.	9 3/8"	821-7060	\$28.95	\$26.06
1 1/4" x 4 3/16"	18 oz.	10 5/8"	821-7061	31.95	28.76

E. Polyethylene Mallet

Made of dense, nonporous polyethylene, which is nonmarring and easy to clean. Hickory handle. Made in USA.

Head Dia. x L	Head Wt.	Length	Item#	EACH Prices	
				1-2	3+
1 3/4" x 3 7/8"	8 oz.	11 1/4"	821-8790	\$16.00	\$14.40

A-C Brass and Nylon Mallets

Feature replaceable brass and nylon faces. Hardwood handles. Made in India.

Head Dia. x L	Head Wt.	Length	Item#	Each
A. 9/16" x 2 3/4"	2 1/2 oz.	9"	822-0010	\$16.50
B. 5/8" x 2 3/8"	5 oz.	9"	822-0015	24.75
C. 5/8" x 4"	10 oz.	9"	822-0016	24.99
Replacement Face	Type	Item#	Each	
9/16" dia.	Brass	822-0020	\$1.50	
	Nylon	822-0025	1.50	
5/8" dia.	Brass	822-0030	1.50	
	Nylon	822-0035	1.50	

 Three-piece minimum; please order in multiples of three.

D, E Brass Mallets with Wooden Handles

Feature small brass heads. Will not mar steel. Hardwood handles.

Head Dia. x L	Head Wt.	Length	Item#	Each
D. 1 1/16" x 2" USA	4 oz.	8 1/4"	822-0040	\$11.25
E. 1/2" x 2" Imported	2 oz.	9 1/2"	822-0042	\$4.50

F. Mini Brass Mallet

Features a high-quality solid brass head with flat and ball-peen end threaded onto an anodized aluminum handle. Hexagonal handle prevents slipping. Made in USA.

Head Dia. x L	Head Wt.	Length	Item#	Each
1/2" x 1 3/4"	2 oz.	8"	821-8170	\$14.95

G. Economy Ball-Peen Hammers

Steel hammers with flat and ball-peen faces. Wooden handles. Imported.

Head Dia. x L	Head Wt.	Length	Item#	Each
1/2" x 2"	2 oz.	10 1/2"	821-8050	\$4.40
3/4" x 2 3/4"	4 oz.	10 1/2"	821-8100	5.65
7/8" x 3"	8 oz.	10 1/2"	821-8150	6.95

H. Plastic Mallet

Features nonmarring plastic head with flat faces. Hardwood handle. Made in Germany.

Head Dia. x L	Head Wt.	Length	Item#	Each
3/4" x 2 3/4"	5 1/2 oz.	10 1/2"	821-8795	\$12.50

I. Nylon Mallet with Wooden Handle

Shock-cushioned mallet with replaceable nonmarring nylon faces. Hickory handle. Made in UK.

Head Dia. x L	Head Wt.	Length	Item#	Each
1" x 3 7/8"	10 oz.	10"	821-7080	\$33.60
Replacement Faces		Item#	Pair	
1" dia.		821-7008	\$10.00	

J. Nylon Mallets with Plastic Handles

Shock-cushioned mallets with replaceable nonmarring nylon faces. Plastic handles with rubber nonslip grips impervious to moisture and oil. Made in UK.

Head Dia. x L	Head Wt.	Length	Item#	Each
1 1/4" x 3 7/8"	1 lb.	11 1/2"	821-7100	\$40.50
1 1/2" x 4 3/4"	1 1/2 lbs.	12"	821-7120	46.20
Replacement Faces		Item#	Pair	
1 1/4" dia.		821-7010	\$12.00	
1 1/2" dia.		821-7012	15.60	

K. Brass Mallets

Feature solid brass heads that deliver a hard blow. Ideal for work that requires a solid hit, including stamping, dapping and punching. Metal handles with nonslip grips. Made in USA.

Head Dia. x L	Head Wt.	Length	Item#	Each
1" x 2 5/8"	1 lb.	9 3/4"	821-7050	\$46.15
1 1/4" x 2 5/8"	2 lbs.	9 3/4"	821-7051	55.15



Peddinghaus Hammers

German made Peddinghaus hammers are crafted using the time-tested process of forging. These high-quality hammers are not cast. Finely balanced with curved ash handles, they are the choice of metal smiths for riveting, forming, embossing, grooving and raising. These hammers are manufactured in accordance with strict ISO and DIN standards. Made in Germany.



A. Peddinghaus Planishing Hammer

Fine steel hammer with highly polished flat (24mm dia.) and bowed (24mm dia.) faces. Solid ash handle. Meets strict ISO and DIN standards. Made in Germany.

Head Length	Head Wt.	Length	Item#	EACH Prices	
				1-2	3+
80mm	6 oz.	10 ¹ / ₄ "	821-7024	\$37.95	\$36.05

B. Peddinghaus Polishing Hammer

Fine steel hammer with highly polished lightly bowed (24mm dia.) and heavily bowed (24mm dia.) faces. Solid ash handle. Meets strict ISO and DIN standards. Made in Germany.

Head Length	Head Wt.	Length	Item#	EACH Prices	
				1-2	3+
104mm	8 ³ / ₄ oz.	11 ³ / ₄ "	821-7026	\$37.95	\$36.05

C. Peddinghaus Chasing Hammer

Fine steel hammer with two satin-polished differently bowed (15 and 20mm thick) faces. Solid ash handle. Meets strict ISO and DIN standards. Made in Germany.

Head Length	Head Wt.	Length	Item#	EACH Prices	
				1-2	3+
117mm	14 oz.	12 ¹ / ₄ "	821-7025	\$37.95	\$36.05

D. Peddinghaus Goldsmith's Hammer

Fine chrome-plated steel hammer with highly polished flat and chisel faces. Solid ash handle. Meets strict ISO and DIN standards. Made in Germany.

Head Dia. x L	Head Wt.	Length	Item#	EACH Prices	
				1-2	3+
16 x 90mm	2 ³ / ₄ oz.	11 ¹ / ₂ "	821-7020	\$37.95	\$36.05

E, F Peddinghaus Embossing Hammers

Fine steel HB hammer with two highly polished heavily bowed (18 and 21mm dia.) faces. Fine steel DB hammer with two highly polished differently bowed (11 and 14mm dia.) faces. Solid ash handle. Meets strict ISO and DIN standards. Made in Germany.

Head Length	Head Wt.	Length	Item#	EACH Prices	
				1-2	3+
E. 135mm	7 oz.	11"	821-7021	\$37.95	\$36.05
F. 105mm	3 ¹ / ₂ oz.	10 ¹ / ₄ "	821-7023	37.95	36.05

G. Peddinghaus Bordering Hammer

Fine steel hammer with two satin-polished straight pattern faces. Solid ash handle. Meets strict ISO and DIN standards. Made in Germany.

Head H x L	Head Wt.	Length	Item#	EACH Prices	
				1-2	3+
72 x 140mm	10 ¹ / ₂ oz.	11 ³ / ₄ "	821-7022	\$37.95	\$36.05

A. Goldsmith's Hammer

Well-balanced, polished steel hammer with flat and chisel faces for riveting, shaping and forming. Wooden handle. Made in Germany.

Head Dia. x L	Head Wt.	Length	Item#	Each
5/8" x 3 1/2"	5 oz.	12"	821-8235	\$29.95



A

B. Swiss-Style Riveting Hammer

Polished steel hammer with flat and chisel faces. Wooden handle. Imported.

Head Dia. x L	Head Wt.	Length	Item#	Each
7/16" x 3"	2 oz.	9 1/2"	821-8775	\$7.55



B

C. Premium Chasing Hammers

Feature hardened flat face for striking chisels and chasing tools and ball-peen face for forming rivet heads and more. Well-balanced hardwood handles with oval grip and narrow shaft provide spring when striking, reducing vibration in your hand. Made in Germany.

Head Dia.	Head Wt.	Length	Item#	Each
3/4"	3 1/2 oz.	10"	821-8243	\$49.00
1"	4 oz.	10"	821-8245	49.00
1 1/8"	5 oz.	10"	821-8250	52.00
1 1/4"	6 oz.	10"	821-8255	54.00



C

D. Economy Chasing Hammer

Has flat face for striking chasing tools and polished ball-peen face for hammering directly on metal. Wooden handle. Imported.

Head Dia.	Head Wt.	Length	Item#	Each
1 1/8"	4 oz.	10 1/2"	821-8253	\$12.75



D

E. Riveting Hammers

Polished steel hammers with flat and chisel faces. Wooden handles. Made in USA.

Head Dia. x L	Head Wt.	Length	Item#	Each
3/8" x 2 3/4"	2 1/2 oz.	10"	821-8600	\$31.25
1/2" x 3 1/2"	4 oz.	10"	821-8650	31.25
9/16" x 4"	5 oz.	10"	821-8700	31.25
5/8" x 4 1/4"	7 oz.	10"	821-8750	37.50



E

F. Riveting Hammer

Made of hardened steel for solid striking force. One end flat, other chisel-shaped. Wooden handle. Head length: 80mm long. Face dimensions: 15mm square. Made in Germany.

Head Dia. x L	Head Wt.	Length	Item#	Each
1/2" x 3 5/32"	3.5 oz.	10 1/8"	821-8625	\$10.25



F

G. Planishing Hammer

Precision-ground and hardened steel domed hammer with polished face. Domed style has flat and slightly domed round faces. Solid ash handle. Made in Germany.

Head Dia. x L	Head Wt.	Length	Item#	Each
7/8" x 3 3/4"	12 oz.	11 1/2"	821-8242	\$44.95



G

Fretz Hammers and Miniature Stakes

Fretz Hammers feature beautiful and strong Padauk wood handles, oil finished and tapering to a slender neck for flexibility. Head is cast from 420-grade stainless steel and hardened to 50HRC for maximum durability. Faces are polished to a mirror shine.

The size of the hammer will be dictated by the size of the workpiece. Small, light projects will require small hammers (HMR-1 or 5), and big, heavy projects will require large hammers (HMR-101). Made in Vietnam.



A. Planishing Hammers

For smoothing metal: round head smooths previous raising marks, and flat head smooths marks from round head to a nearly even finish. Can also be used for sizing rings, shaping bezels and forming metal against mandrels and stakes. Made in Vietnam.

Description	Faces	Length	Item#	Each
HMR-1	3/4"	9"	821-7030	\$52.00
HMR-101	7/8"	9 7/8"	821-7035	74.50

B. Chasing Hammer

A modern design chasing hammer of medium weight. The balance of this hammer makes each hammer blow effortless. Features 1 1/32" (29mm) flat face for striking chasing tools and 1/2" (12mm) polished ball-peen face for hammering directly on metal. Made in Vietnam.

Description	Faces	Length	Item#	Each
HMR-17	1 1/8" & 1/2"	9"	821-8265	\$52.00

C. Small Embossing Hammer

For forming small raised areas by hammering from the inside in preparation for chasing or shaping. Imparts a very fine dimpled texture that can be varied by blow strength. Made in Vietnam.

Description	Faces	Length	Item#	Each
HMR-5	3/8" & 1/4"	9"	821-7034	\$52.00

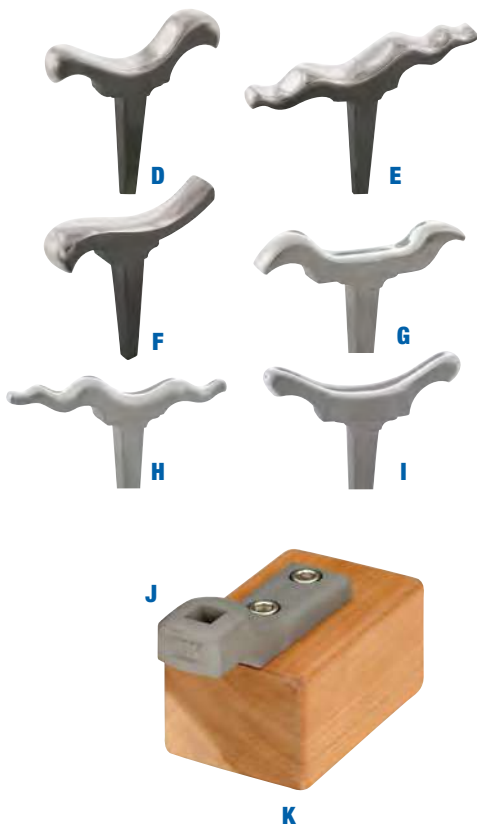

D-I Fretz F-Series Mini Silversmithing Stakes

Give yourself more creative forming options!

F-series stakes to create complex shapes. Stakes are hardened to 38 HRC for easy reshaping. Holders are softer to ensure stakes fit securely. Purchase extra holders to progress from one task to the next without constantly changing stakes. Use with H-1 holder (sold separately, below). All measure approximately 3 3/4"W x 3"H. Made in Vietnam.

Description	Item#	Each
D. F-2 Double Convex, large end forms convex bracelets, smaller end forms domed rings. If you anneal in between hammering, F-2 can make some fairly dramatic curves.	814-1089	\$54.00
E. F-6 An anticlastic shell stake scaled for bracelet-size shell-form, concave or convex shapes.	814-1091	54.00
F. F-9 Has one convex side to make shallow dome. Other side is for making concave bracelets.	814-1090	54.00
G. F-1 Beak stake for making bracelets with rolled edges and transitioning flat surfaces to curved.	814-1092	54.00
H. F-7 Thin shell stake for making spiral shapes and curves.	814-1093	54.00
I. F-8 Horn stake for making beads from tubes and cones and for extreme curves in hollow rings.	814-1094	54.00

J, K Fretz Stake H-1 Holder and VB-1 Vise Block

Use the H-1 holder with the VB-1 cherry vise block for securing all F-series stakes. Vise block measures 3"L x 2"W x 1 1/2"H. Purchase extras to improve workflow. Made in Vietnam.

Description	Item#	Each
J. H-1 Holder	814-1060	\$52.75
K. VB-1 Cherry Vise Block	814-1081	19.95

A. Three-Face Triad Hammer

This clever hammer features rotating head with three different faces: brass, nylon and steel. To change faces, just pull on head and turn. Has ergonomic vibration-dampening handle for comfortable grip. Helps save drawer space. Made in Taiwan.

Description	Head Dia. x H	Head Wt.	Length	Item#	Each
A. Triad Hammer	5/8" x 3/4"	8.5 oz.	9"	822-0046	\$43.90
Replacement Brass Face				822-0047	6.95
Replacement Nylon Face				822-0048	4.95
Replacement Steel Face				822-0049	4.95

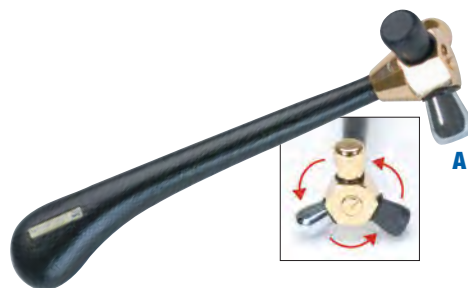

B. UFO Hammer with Three Faces

One hammer that does work of three! This unique hammer features an egg-shaped head with three different removable faces: brass, nylon and steel. Has ergonomic vibration-dampening handle for comfortable grip. Made in Taiwan.

Description	Head Dia. x H	Head Wt.	Length	Item#	Each
B. UFO Hammer	7/8" x 3/8"	4.5 oz.	8 3/4"	822-0050	\$28.19
Replacement Brass Face				822-0051	6.95
Replacement Nylon Face				822-0052	4.95
Replacement Steel Face				822-0053	4.95



C. Thirteen-In-One Texturing Hammer

Make your jewelry come alive by creating designs and textures with this easy-to-use texturing hammer with 13 interchangeable faces. This great bench tool is simplistic and you can work with two designs at a time. Change the textured faces easily by loosening the nut holder and swapping out the texturing face. The 13 faces and head are tool hardened steel, nylon and brass. The head is mounted in a sturdy hardwood handle. The perfect combination to create endless custom designs with five smooth and eight textured faces. Made in India.

Description	Item#	Each
Thirteen-In-One Texturing Hammer	822-0055	\$26.95



D. Letter Stamp Set

Includes 27 steel stamps: one for each letter of the alphabet and one period. Makes 1/16" impressions. Packaged in hardwood storage case with cover.

Description	Item#	Each
Letter Stamp Set	190-0010	\$59.00



E. Number Stamp Set

Includes nine steel stamps: numbers 0-9 (use 9 upside-down to make 6). Makes 1/16" impressions. Packaged in hardwood storage case with cover.

Description	Item#	Each
Number Stamp Set	190-0030	\$20.50

F. Horn Anvil on Base

Made of hardened and tempered steel. Has round and flat horns for flattening and shaping. Measures 4 3/4"W x 3 1/4"H. Made in Italy.

Description	Item#	Each
Horn Anvil on Base	814-1025	\$56.00



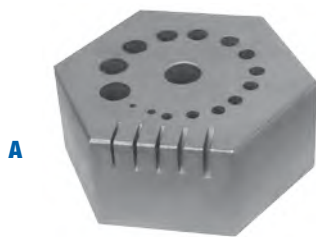

A



B



C



D



E



F

A. Hexagon Anvil

Ideal for drilling, riveting and staking small parts. Case-hardened and ground flat and smooth. Has 16 holes ranging from $\frac{5}{64}$ " to $\frac{1}{4}$ " and five milled slots. Measures $1\frac{5}{8}$ "W x $\frac{3}{4}$ "H.

Description	Item#	Each
Hexagon Anvil	814-1050	\$21.95

B. Machined Bending Block

Used for forming and shaping metal into ring shanks, bezels and much more. Has twelve semicircular grooves. Measures 120x80x30mm ($4\frac{3}{4}$ "L x $3\frac{1}{8}$ "W x $1\frac{1}{4}$ "H.) Made in Italy.

Description	Item#	Each
Machined Bending Block	810-2051	\$85.00

C. Lead Bench Block

Used as a stable base for cutting, stamping, forming and chasing. Measures $3\frac{1}{4}$ "L x $3\frac{1}{4}$ "W x 1"H.

Description	Item#	Each
Lead Bench Block	812-1640	\$18.65

D, E Steel Bench Blocks

Each provides a solid, stable base for workpiece when flattening or laying out designs. Made of high-quality tool steel hardened to 46–50 HRC and ground to a smooth, flat surface. Small block measures $2\frac{1}{2}$ "L x $2\frac{1}{2}$ "W x $\frac{3}{4}$ "H. Large block measures 4"L x 4"W x $\frac{3}{4}$ "H. Made in Europe.

Description	Item#	Each
D. Small Steel Bench Block	812-1650	\$16.95
E. Large Steel Bench Block	812-1655	29.95

F. Bench Block Helper w/Steel & Nylon Blocks

This three piece set includes a thick vulcanized firm rubber base which absorbs shock plus a solid steel block which is $\frac{15}{16}$ " (24mm) thick and 3" (75mm) in diameter. The third piece is a sturdy nylon block the same size that fits into the rubber base for lighter more delicate work. This is a well made set and allows one to hammer without creating excess noise and vibration at the bench. Wt. 2.5 lbs.

Description	Item#	Each
Bench Block Helper Set	812-1645	\$28.95

A - C Durston Finger Gauge & Mandrels

Durston Steel Finger Gauge Set 1-16

Stamped and manufactured from high quality steel stock, the Durston ring gauge set is precisely machined and calibrated to match the Durston ring mandrels: Steel (841-1141) and Aluminum (841-1140) to provide excellent consistency at your bench during manufacturing and also the same consistency when sizing a ring in front of your customer in the retail showroom.

Durston Aluminum and Steel Mandrels

Both the aluminum and steel ring mandrels are machined and calibrated to the Durston steel finger gauge set (820-8059) providing excellent consistency from the showroom/retail counter to the bench for repair and then to the customer. Made of quality machined aluminum or hardened steel both are easy to read as each mandrel is laser engraved with sizes 1-16 US in quarter size increments.

Durston Sizing Kits

- Showroom Kit which includes an Aluminum Mandrel (841-1140) and a Ring Gauge (820-8059)
- Bench/Showroom Kit which includes a Steel Mandrel (841-1141), Aluminum Mandrel (841-1140) and a Ring Gauge Set (820-8059)

Made in the United Kingdom.

Description	Item#	EACH Prices	
		1-2	3+
A. Durston Steel Finger Gauge Set	820-8059	\$26.00	\$24.70
B. Durston Aluminum Mandrel	841-1140	42.00	39.90
C. Durston Steel Mandrel	841-1141	42.00	39.90
Showroom Sizing Kit	841-1144	60.00	57.00
Bench/Showroom Sizing Kit	841-1146	114.00	108.30

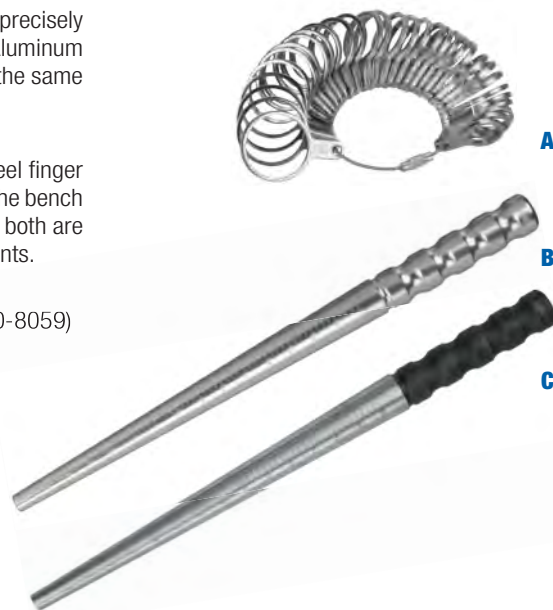

D. PEPETOOLS Square Steel Ring Mandrel

Square steel ring mandrel with rounded corners for holding, shaping and straightening rings. Tapers from 24mm to 12mm square.

Description	Item#	Each
Square Steel Ring Mandrel	841-1109	\$33.50



E, F Steel Ring Mandrels

Round steel ring mandrels. Available in plain style or grooved style for stone-set rings. Graduated in sizes 1–16 by 1/4-size increments.

Description	Item#	Each
E. Plain Style	841-1165	\$35.25
F. Grooved Style	841-1170	36.35



G. Steel Mandrel for Large Rings

Round steel mandrel for holding large rings, bezels, hoop earrings and other items. Graduated in sizes 16–24 by 1/4-size increments. Features knurled handle for solid grip. Measures 8 1/4" long.

Description	Item#	Each
Steel Mandrel for Large Rings	841-1171	\$39.75



H, I Econo Ring Mandrels

Ring Mandrel Steel – Standard + Grooved

Round Steel Ring Mandrels for any type of sizing bench work. Made of solid rolled steel and comes in two variations; Standard and Grooved. Each mandrel is laser engraved with USA sizes 1-15 and with 1/4-size increments. Made in India.

Description	Item#	Each
H. Standard Style	841-1130	\$19.50
I. Grooved Style	841-1131	19.95



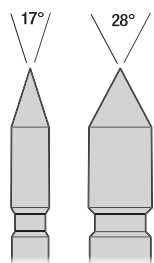
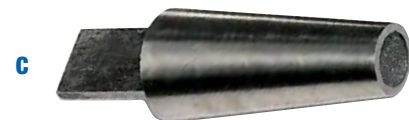

A, B Bracelet Mandrels

Ideal for shaping, stretching and forming bracelets and other items. Made of hardened and polished cast iron. Round mandrel measures 14³/₈"L and tapers from 3¹/₂" to 2". Oval mandrel measures 11³/₄"L and tapers from 3" x 2¹/₂" to 2" x 1¹/₂". Made in Italy.

Description	Item#	Each
A. Round Bracelet Mandrel	841-2050	\$135.00
B. Oval Bracelet Mandrel	841-2060	199.00

C. Bracelet Mandrel with Tang

Ideal for shaping, stretching and forming bracelets and other items. Fits easily in Bench Pin and Anvil #814-1010 (see p. 571) or a vise. Made of cast steel polished to a smooth finish. Measures 5³/₄"L with 3" tang and tapers from 2¹/₂" x 2³/₈" to 1³/₄" x 1¹/₂".

Description	Item#	Each
Oval Bracelet Mandrel with Tang	841-2070	\$71.95

D. Round Wooden Bracelet Mandrels

Round tapered hardwood mandrels for shaping and removing dents and kinks from bracelets and bangles made of soft, nonferrous metals. Will not mar jewelry.

Size	Item#	EACH Prices	
		1-2	3+
15"L x 2 ¹ / ₂ "-1 ¹ / ₂ " dia.	841-3032	\$16.45	\$13.98
14"L x 3 ¹ / ₂ "-2" dia.	841-3031	22.50	19.13

E. Oval Dapping Die and Punch Set

Includes heavyweight steel die with 16 oval depressions ranging from 7/16" x 5/16" up to 1 1/8" x 13/16" and four precisely matched, high-grade hardened steel oval punches. Comes complete with sturdy 7⁵/₈"L x 5 1/2" W wood stand. Made in Italy.

Description	Item#	Each
Oval Dapping Die and Punch Set	815-0550	\$499.00

F. Bezel Block and Punch Sets

Each includes precision-machined block and punch. Used to punch and form bezels from flat stock. Made of hardened, tempered, polished steel. Made in Italy.

Description	Holes	Punch Angle	Item#	Each
F. Round Set	20 (5-20mm)	17°	815-2050	\$105.00
Round Set	20 (5-20mm)	28°	815-2055	105.00
Oval Set	11 (4-14mm)	17°	815-2060	179.00
Heart Set	11 (5-15mm)	17°	815-3000	349.00

G. High-Speed 17° Bezel Cone Bur – 3/32" Shank

Use to drill an angled hole that matches the 17° angle on many settings, most notably bezel settings. Solves the problem of inserting a standard tapered prong or bezel setting into a standard shank.

Size	Item#	EACH Prices	
		1-5	6+
30, 8.00mm diameter	123-2301	\$6.98	\$5.86

H. Dent Remover

A 2 1/4" hardwood block with two wooden punches for shaping and repairing lockets and cases and removing dents. Has six different shallow cups.

Description	Item#	EACH Prices	
		1-9	10+
Dent Remover	815-1010	\$7.55	\$6.04

A. Durston Disc Cutters

Durston Cutters with new tray design. The unique tray is positioned in a "slanted configuration" to slide out with ease. 4 different sets are available allowing you to easily cut discs from 3mm to 34mm in 1mm increments. The punches are made from special high-quality tool steel, hardened and ground at a perfect angle for optimal results. Spring-loaded die plate allows easily clamping of material. Complete with leveling shims and urethane energy absorbing pad. Made in the United Kingdom.

Description	Item#	Each
A. Durston Disc Cutters - 10 punch set (Assorted)	812-1330	\$318.95
Durston Disc Cutters - 17 punch set (3-19)	812-1331	382.75
Durston Disc Cutters - 9 punch set (20-28)	812-1332	362.30
Durston Disc Cutters - 6 punch set (29-34)	812-1333	339.45



A

B. Premium Disc Cutter

Hardened tool steel cutter, machined and tempered to perfection, for cutting flawless circles from 18-gauge and thinner soft metals (such as copper, brass, gold and silver). Set is designed to be easily separated by unscrewing a hex nut with the included hex wrench.

It is recommended to place a rubber pad under the disc cutter during use to help absorb shock. Use of cutting lubricant and a proper mallet are also suggested.

Cutter Dimensions: 4 1/16" x 2 1/2" x 1 3/8"

Wooden Base Dimensions: 5 1/2" x 6 1/2"

Disc cutter includes 11 punches: 1/8", 3/16", 1/4", 5/16", 3/8", 7/16", 1/2", 5/8", 3/4", 7/8", 1".

Description	Item#	Each
Premium Disc Cutter	812-1320	\$140.00



B

C. Chasing Tool Set

Consists of 22 different punches for making decorative designs on sheet metal. The tool ends are struck with a chasing hammer while the work is held in a pitch bowl or on a lead block.

Description	Item#	Each
Chasing Tool Set	815-2000	\$154.85



C



D. High-Speed Steel Chisels

Diesinker style with one-piece construction ground to shape from the finest round high-speed steel stock. Excellent for evenly removing large amounts of material. Will not lose temper when sharpened. Measure 6" long overall. Available individually or in a set of all 12 styles. Shapes: Sizes 1 to 4 are square, 5 to 8 are round, and 9 to 12 are point. Made in USA.

Description	Item#	EACH Prices		Description	Item#	EACH Prices	
		1-11	12+			1-11	12+
Chisel #1	166-9010	\$16.50	\$13.75	Chisel #7	166-9070	\$16.50	\$13.75
Chisel #2	166-9020	16.50	13.75	Chisel #8	166-9080	16.50	13.75
Chisel #3	166-9030	16.50	13.75	Chisel #9	166-9090	16.50	13.75
Chisel #4	166-9040	16.50	13.75	Chisel #10	166-9100	16.50	13.75
Chisel #5	166-9050	16.50	13.75	Chisel #11	166-9110	16.50	13.75
Chisel #6	166-9060	16.50	13.75	Chisel #12	166-9120	16.50	13.75

*Quantity discount for orders of one item number only; not assorted.

Description	Item#	Each
12-Piece Set	166-9990	170.00



D

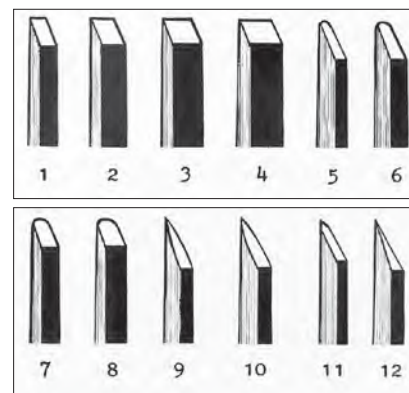

E. Durston Bangle Forming Die Set

This well made product from Durston helps you effortlessly form bangles and cuffs. Fits all standard 4" bench vises (not included see p. 544) these dies and holder are precision ground, highly polished and hardened to last (with proper use).

Set includes, special convex nylon hammer, die mounting bar and six dies for a total of eight shapes. Made in the United Kingdom.

Description	Item#	Each
Durston Bangle Forming Die Set	814-1057	\$225.00



Vise not included.

E



A



B



C



D



E



Side 1



Side 2



Small



Medium



Large

G

A, B Durston Dapping Punch Sets

Dapping Sets are the perfect tool for the Professional Jeweler or Designer. The Durston Small and Large Dapping Sets are hardened, ground and polished to the highest quality. Both sets come with the matching Dapping Block. Small sets consists of 21 Punches (3, 4, 5, 6, 7, 8, 9, 10, 11, 12, 13, 14, 15, 17, 19, 21, 23, 25, 28, 32, 36) and a matching 50mm block. The Large Set consists of 24 punches (3, 4, 5, 6, 7, 8, 9, 10, 11, 12, 13, 14, 15, 17, 19, 21, 23, 25, 28, 32, 36, 40, 45, 50) and a matching 70mm block. Both sets come complete in a unique plastic carrying case. Made in the United Kingdom.

Description	Net Weight	Item#	Each
A. Small 21-Piece Set	11 lbs.	815-1026	\$285.00
B. Large 24-Piece Set	21 lbs.	815-1027	349.00

C, D Durston Dapping Blocks

High-grade tool steel dapping blocks. The 50mm block has 23 half-spheres: 3, 4, 5, 6, 7, 8, 9, 10, 11, 12, 13, 14, 15, 16, 17, 19, 21, 23, 25, 27, 30, 34 and 38mm. The 70mm block has 26 half-spheres: 3, 4, 5, 6, 7, 8, 9, 10, 11, 12, 13, 14, 15, 16, 17, 19, 21, 23, 25, 27, 30, 34, 38, 42, 47, and 52mm. These blocks are included in Dapping Punch Sets (above). Made in the United Kingdom.

Description	Net Weight	Item#	Each
C. 50mm Dapping Block	1.1 lbs.	815-1028	\$134.75
D. 70mm Dapping Block	3.3 lbs.	815-1029	172.15

E. Durston Flat Dapping Block

Made of high-quality tool steel. 23 depressions. Beautifully machined, hardened and high polished. 23 depressions in sizes: 3, 4, 5, 6, 7, 8, 9, 10, 11, 12, 13, 14, 15, 16, 17, 19, 21, 23, 25, 27, 30, 34 and 38mm. Made in the United Kingdom.

Description	Net Weight	Item#	Each
Flat Block	5.06 lbs.	815-1033	\$105.00

F. Durston Designers Forming Block

Machined from high quality tool steel. Hardened and highly polished with 14 half spheres in sizes 5, 6, 7, 8, 9, 10, 11, 13, 15, 16, 17, 22, 23 and 24mm and 8 half cut-outs in sizes 6, 8, 9, 15, 16, 17.5, 22 and 26mm. Made in the United Kingdom.

Description	Net Weight	Item#	Each
Forming Block	1.76 lbs.	815-1032	\$136.00

G. Durston Cupola Sets

Used for forming large spherical shapes. Durston Cupola Sets are made for the professional jeweler who demands the best! All pieces are hardened, ground and highly polished for perfect results. Choose between the four sets: Small (50mm & 57mm), Medium (64mm & 71mm), Large (78mm & 85mm) and the Complete Set, which incorporates all size punches. Each set comes complete with the dapping punch and the matching double-sided die and presented in an unique plastic carrying case. Made in the United Kingdom.

Description	Components	Item#	Each
Small Set	50mm & 57mm	815-1081	\$142.00
Medium Set	64mm & 71mm	815-1082	156.50
Large Set	78mm & 85mm	815-1083	169.70
G. Deluxe Set	All six punches and three dies	815-1084	338.25

A. Roller Marking Machine

Makes precise, uniform impressions quickly and effortlessly.

This machine uses simple roller action to mark up to 46 evenly spaced characters in one impression from engraved steel rollers. Maintains consistent depth even on very thin pieces since variable pressure can only be adjusted mechanically, not by hand. Consider special ordering a die with your trademark and one or two other impressions for marking trademark and karat at once on rings, pendants, charms and stone-set rings. Accommodates ring sizes 4 and larger. Uses nylon ring supports to prevent marring and distortion of work. Includes a set of eight curved shank supports and one flat bar support.

Description	Item#	Each
A. Roller Marking Machine	856-0420	\$1,150.00
Optional 14K Roller Die	856-0430	130.00
Optional 18K Roller Die	856-0435	130.00
Optional Roller Die w/one impression	856-0422	130.00
Optional Roller Die w/two impressions	856-0423	166.50
Optional Roller Die w/three impressions	856-0424	193.20
Replacement Curved Shank Support Set	856-0421	125.00



A

B. Ring and Earpost Marking Pliers

The easiest system for karat-marking rings and earposts. To stamp a ring, position it over the stamp and squeeze the pliers; anvil with felt pad prevents marring. To stamp an earpost, simply insert the earpost jaw set, position the earpost and squeeze the pliers. Stamps make 0.75mm impressions.

Description	Item#	Each
B. Marking Pliers	191-1000	\$196.00
Ring Marking Accessories	Item#	Each
Concave Metal Ring Anvil*	191-1052	19.95
10K Ring Stamp	191-1020	31.00
14K Ring Stamp*	191-1030	35.00
18K Ring Stamp	191-1040	29.99
SS Ring Stamp	191-1010	32.99
Pt Ring Stamp	191-1044	35.60
900 Ring Stamp	191-1041	35.60
925 Ring Stamp	191-1042	32.95
950 Ring Stamp	191-1043	38.65
Earpost Marking Accessories	Item#	Each
Earpost Jaw Set with 14K Earpost Stamp	191-1056	\$119.00

*Included with Pliers



B

C. Ring Stamping Device

A timesaving, accurate stamping device. Accommodates standard ring stamps with approx. 5/16" square bodies. Eliminates the need to hold ring and stamp in one hand. Just position ring over the nonmarring nylon anvil to prevent slipping and tap stamp with mallet. Also ideal for flat stamping. Allows you to use your existing stamps (if not exactly 5/16" square, simply reverse sleeve or file stamp body to fit). Also works with Bent Ring Stamps listed below.

Description	Item#	Each
C. Ring Stamping Device	190-1005	\$39.95
Replacement Nylon Anvil (2)	190-1006	3.60



C

Ring Stamps	#1 (1/24") Item#	#2 (1/32") Item#	#3 (1/45") Item#	EACH Prices	
				1-2	3+*
10K	190-5150	190-5200	190-5250	\$19.85	\$17.87
14K	190-5400	190-5450	190-5500	19.85	17.87
18K	190-5650	190-5700	190-5750	19.85	17.87
PLAT	-	190-5945	190-5950	26.50	23.85
PT900	-	-	190-5965	25.00	22.50
PT950	-	-	190-5980	25.00	22.50
STER	190-6100	190-6150	190-6200	27.85	25.07

*Quantity break for one item# only, not assorted.



Bent Ring Stamp



A. Sherline Metric Lathe

Lets you create precision wax, plastic and metal models and parts like a true pro. Features high-torque DC motor with variable speed control and automatic converter that adjusts between 110V/220V and 50/60Hz without any loss of torque. Made in USA.

Includes: 70mm x 152mm cross slide, 381mm steel bed to allow 203mm between centers, aluminum handwheels, pulleys, belt, faceplate, lathe dog, two dead centers, two hexagonal keys, tool post, high-speed cutting tool, 8' power cord and instructions. Measures 18"L x 7½"W x 6"H. Operating speed range: 70–2,800rpm.

Specifications:

Swing over Bed	90mm (3½")
Swing over Carriage	45mm (1¾")
Distance Between Centers	200mm (8")
Hole Through Spindle	10mm (.405")
Main Spindle Accuracy	0.0127mm (.0005")
Spindle Nose Thread	¾", 16 TPI
Spindle Nose Taper	#1 Morse
Travel of Cross Slide	110mm (4¼")
Handwheel Graduations	0.01mm (.001")

Description	Item#	Each
Metric Lathe	856-1100	\$715.00

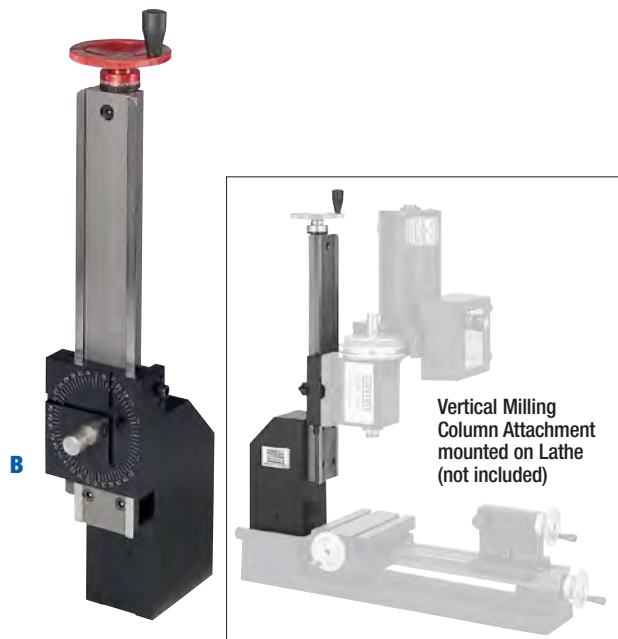

B. Δ Vertical Milling Column Attachment

Turns your Sherline Metric Lathe into a small milling machine for drilling, boring and many other general tasks. Converts lathe to mill in less than one minute. Consists of dovetailed vertical column with aluminum base that fastens to lathe bed in place of headstock; headstock then attaches to dovetailed saddle on vertical column. Turn handwheel to change cutting depth in 0.01mm increments. Mount workpiece on lathe cross slide.

Description	Item#	Each
Vertical Milling Column Attachment	856-1102	\$172.75



C-E Sherline Chucks

Four-jaw chuck (C) holds irregularly shaped parts on or deliberately off center. Clamps tighter than three-jaw chuck. Grips from 2mm (⅜") to 38mm (1½") diameter stock with jaws in normal position, up to 70mm (2¾") with jaws in reverse position. Measures 17mm (.687") dia. through hole with ¾", 16 thread.

Three-jaw chuck (D) centers parts within a few thousandths of an inch. Grips from 2mm (⅜") to 38mm (1½") diameter stock with jaws in normal position, up to 70mm (2¾") with jaws in reverse position. Measures 17mm (.687") dia. through hole with ¾", 16 thread.

Three-jaw tailstock (E) chuck is used for accurate center-line drilling, reaming or tapping of any part mounted in the lathe. Grips from 0.8mm (⅛") to 9.5mm (⅜") diameter stock. Includes key and two arbors: #0 Morse for tailstock and #1 Morse for headstock.

Description	Item#	Each
C. Four-Jaw Chuck	856-1104	\$142.95
D. Three-Jaw Chuck	856-1106	127.50
E. Three-Jaw Tailstock Chuck	856-1108	82.50

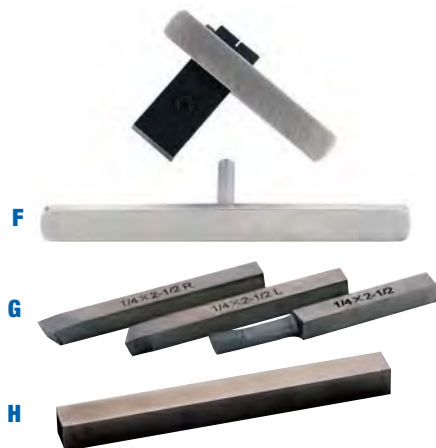

F-H Sherline Accessories

Tool rest mounts on your lathe for steadying chisels and other tools. Tool bit set includes three high-speed steel bits for turning and threading applications: right-hand, left-hand and boring. Tool blank can be easily ground into desired shape for turning and facing applications. Made of high-speed steel. Measures ¼" square.

Description	Item#	Each
F. Tool Rest	856-1114	\$71.25
G. Tool Bit Set of 3, ¼" x ¼" x 2½"	856-1116	32.95
H. Tool Blank, ¼" x ¼" x 2½"	856-1110	4.25

A-J Large Millgrain Wheels

Create decorative borders around edges of rings or bracelets. To use, mount ring on lathe, use turning tool to cut flat shoulder into each ring edge, and bring wheel onto shoulder. Wheels measure 6mm dia. on 1/8" sq. x 2 1/2"L steel shanks. Male wheels have raised beads.

Description	Approx. Design Width (mm)	Item#	Each
A. Female 8	0.65	820-5000	\$65.00
B. Female 10	0.85	820-5002	65.00
C. Female 12	1.05	820-5004	65.00
D. Female 14	1.20	820-5006	65.00
E. Male 8	0.65	820-5008	65.00
F. Male 10	0.85	820-5010	65.00
G. Male 12	1.05	820-5012	65.00
H. Male 14	1.20	820-5013	65.00
I. Rope 1 (medium)	1.25	820-5014	65.00
J. Rope 2 (small)	0.95	820-5016	65.00

Samples of patterns

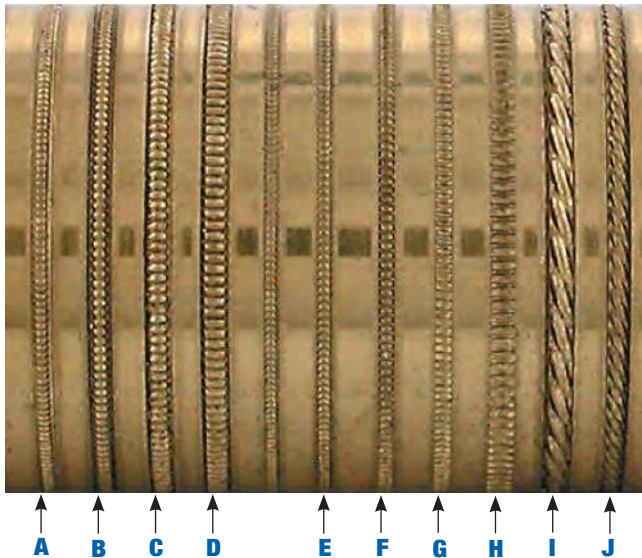

K. Safety Glasses

Comfortable, lightweight safety glasses with high-impact plastic lenses for full eye protection when drilling, polishing and more. One size fits all. Meet ANSI Z87.1 requirements.

Description	Item#	Each
Safety Glasses	270-0205	\$4.30



Large Millgrain Wheel

L. Aspen Safety Glasses

Our Aspen Safety Glasses provide eye protection against most common eye hazards of polishing and benchwork except for severe impacts. Feature polycarbonate lenses, browbar and side shields. Also offer UV protection. Meet ANSI Z87.1 requirements.

Description	Frame	Item#	Each
Aspen Safety Glasses	Clear plastic	270-0123	\$11.15



M. Panaspec Plus Safety Glasses

Feature impact-resistant clear polycarbonate lenses that provide eye protection against most common eye hazards of benchwork, polishing and more. Side panels and browbar help provide protection from the side and from above the eye. Meet ANSI Z87.1 requirements.

Description	Item#	Each
M. Glasses with Brown Frame	270-0102	\$7.25
Replacement Lens (clear)	270-0112	3.60



N. Safety Goggles

A must for polishing, buffing and grinding. Comfortable and lightweight, they easily fit over glasses. Have polycarbonate lens. The sides and top are perforated to reduce fogging. One size fits all. Meet ANSI Z87.1 requirements.

Description	Item#	EACH Prices	
		1-2	3+
Safety Goggles	270-0200	\$9.50	\$9.03





A
Large

Using camera mount and front cover. (camera not included)



B
Medium



C
Small



D
Mini



Accent Lights, Aperture Covers, and Camera Brackets are included.

Gesswein® Photo Imaging Light Boxes

Ideal for capturing digital images of your jewelry!

Designed for use at home, in the workshop or wherever digital photos are needed, the Gesswein Photo Imaging boxes offer a controlled lighting atmosphere to produce the highest quality digital photos. Your jewelry will jump out and sell themselves! Whether you need photos for advertising, catalogs, website or logging repair intake; natural wrap-around lighting is the key to bringing out the best in all your images thus bringing in sales. Easy to use, one rocker switch controls fluorescent lights (5000°K +/-10%) located in the front, base and back panels while another rocker switch controls the super bright LED light panel located at the top/front of the interior of the Light Box.

As some jewelry requires less atmospheric light to control "hot" spots, each Light Box comes with 3 dimmer controls (one for each light panel). Bright white interior side panels and door provide the perfect reflective surfaces to complement the diffused lighting and thus creating a shadow-free atmosphere. Sparkle is added using the white accent light. Shoot from either the top (Brackets Provided) or from the front on a tripod (Not Included). Magnetically hinged door can easily be opened and removed should the camera be mounted on a tripod in the front.

Available in 4 models (Mini, Small, Medium and Large) see comparison chart below. Manufactured with sturdy construction and compact for easy portability. Made in China

Features and Capabilities:

- Camera Bracket short & adjustable (for most cameras)
- Camera Bracket tall & fixed (for SLR cameras)
- Magnetic Front Door and Top Aperture Cover
- Three Accent Lights to add shine and/or color (White, Green and Blue)
- A/C Power Adapter/Cord (100~240V)



Photo taken in Light Box using White Accent Light



Specifications

Description	Overall Dimensions	Platform Dimensions	Gross Weight	Item#	Each
A. Large	16" x 14" x 13" (400 x 360 x 330mm)	13" x 12" x 10½" (332 x 315 x 270mm)	26 LBS (12KG)	817-0703	\$585.00
B. Medium	14" x 12" x 11" (350 x 300 x 280mm)	11½" x 10" x 9" (288 x 260 x 220mm)	20 LBS (9KG)	817-0702	485.00
C. Small	12" x 9½" x 9" (300 x 240 x 230mm)	9½" x 8" x 7" (238 x 200 x 220mm)	15 LBS (7KG)	817-0701	290.00
D. Mini	10" x 8" x 8" (260 x 200 x 200mm)	8" x 6" x 5¾" (200 x 155 x 145mm)	12 LBS (5.5KG)	817-0700	265.00
All Models	Quantity Lights Banks: 2-Front, 1-Base, 1-Back Color Temp: 5000K (+/- 10%)				

E. Dino-Lite Light Box Adapter

Use the Dino-Lite adaptor to easily mount your Dino-Lite Digital Microscope (see p. 347) on any Light Boxes instead of a camera to use measuring software applications.

Description	Item#	Each
Dino-Lite Light Box Adapter	810-0096	\$39.00



E

A, B Dino-Lite Enclosed Lightbox

When lighting and color matters. The Dino-Lite Enclosed Lightbox helps to eliminate outside light pollution and other factors that could interfere with your photos. Compatible with all handheld Dino-Lite Scopes. Generous (up to 14") vertical working distance. For photographing jewelry, the optional table-top stand (810-0091) and extension pole (810-0125) is recommended. Includes two 8" LED light bars and AC adapter. Some assembly required.

Dimensions: 7"W X 9-3/4"D X 12"H. 110V. Made In China.

Description	Platform	Item#	Each
A. Dino-Lite Enclosed Lightbox, MSAK826		810-0120	\$199.00
B. Tabletop Stand, MS35B		810-0091	99.00
Optional Extension Pole, MSA2P for Stand		810-0125	29.00

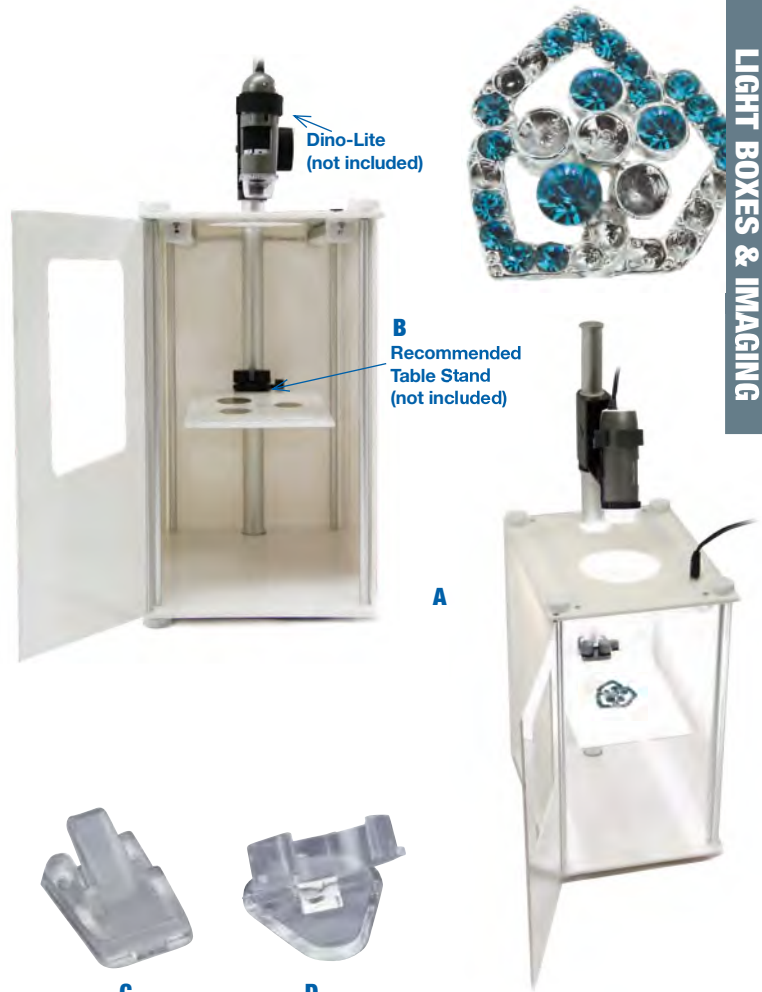

C, D Ring Stands

These small ring stands allow you to position your rings at the perfect angles for photographing from above or from the front. Delta is available in clear, black or white. Marquise is available in clear only. Use black on black or dark-colored backgrounds, white on white or light-colored backgrounds.

Description	Size (W x D)	Color	Item#	Pkg. of 5
C. Delta	5/8" x 7/8"	Clear	817-0860	\$10.99
		White	817-0881	10.99
		Black	817-0883	10.99
D. Marquise	13/16" x 7/8"	Clear	817-0861	9.25

E. Positioning Wax

Allows items in the light box to be placed upright without any visible holding apparatus. Especially useful for rings. Only a tiny bit of this wax is necessary.

Description	Item#	Each
Positioning Wax	817-0767	\$12.85



F. Leatherette Ring Stand

Provides a subtle, classy texturized background. The pad clips easily and securely fits all types of rings. Measures 2 1/2"W x 2 7/8"D x 1"H.

Description	Item#	EACH Prices	
		1-2	3+
Leatherette Ring Stand	857-1485	\$3.95	\$3.36



Light Box Selection Consideration

When choosing a size even a small one will work for relatively large jewelry but it is very hard to arrange something like a necklace as only the larger sizes allow you to move your hands freely and photograph more of the pieces inside. The 3 light wands are a nice addition for adding accent to the jewelry with the white being most useful. The lights are free with the each lightbox and plug into the box directly. Experiment with different ways of holding pieces instead of having to lie flat. Fishing line, wax, and ring stands all can be used to offer a great effect.



A-D Dazor® Fluorescent 43" Reach Floating-Arm Lamps

Dazor's classic 2-tube and 3-tube fluorescent lamps have been stylishly redesigned and now include mirror reflectors providing even more light than original versions. Complete with superior energy efficient electronic ballasts, these lamps are equipped with the classic patented "floating" arm allowing precise positioning with ease without drifting or bouncing. The lamps are still durable, all metal construction with single click rocker style on/off switch for instant response. Both have a 43" reach, 7' cord and 3-prong plug.

Select between 2 bulb (30W) and 3 bulb (45W) lamps in either black or white and 110V or 220V. All supplied with 15W Daylight (6500K) bulbs. Optional 15W Full Spectrum (5500K) bulbs are also available for purchase (see below). Backed by a five-year warranty. Made in USA.

Lamps come complete with a universal clamp which allows the lamp to be clamped or bolted to a horizontal surface up to a 2¼" thick. To bolt to a back splash or to the back of a jewelers workbench, (anything up to 1" in thickness), add the back splash clamp to your order. Available in white or black.

Description	Item	EACH Prices		
		1-2	3-5	6+
A. Dazor 2-Tube, FL 43" White, 110V	821-5590	\$235.00	\$208.55	\$204.25
B. Dazor 2-Tube, FL 43" Black, 110V	821-5592	215.00	208.55	204.25
Dazor 3-Tube, FL 43" White, 110V	821-5594	215.00	208.55	204.25
Dazor 3-Tube, FL 43" Black, 110V	821-5596	215.00	208.55	204.25
C. Optional Back Splash Clamp White	821-5598	215.00	208.55	204.25
D. Optional Back Splash Clamp Black	821-5599	215.00	208.55	204.25

E. Dazor® Clamp On Magnifier

The 5" diameter clamp-on magnifier is designed to be used in conjunction with Dazor fluorescent or LED bench/desk lamps. The magnifier has a 2X power with a 4X power inset. The magnifier is made from optical quality acrylic and includes all mounting hardware. The magnifier can be flipped upwards when not in use. This is an ideal accessory for use in jewelry manufacturing, repair benches, electronics, dental labs or craft/hobby projects. Its clarity will be maintained if the magnifier is cleaned periodically with a lens cleaning tissue. Made in Taiwan.



Description	Item#	EACH Prices	
		1-5	6+
E. Dazor Clamp On Magnifier	821-5551	\$41.95	\$37.76

F, G Dazor® Fluorescent Magnifying Lamps

Ideal for assembly, inspection and other high-precision work. Feature 5" diameter 3-diopter crown optical glass lens with shade and 22W cool white fluorescent tube for total visual freedom with minimal eyestrain. Provide 75% magnification at 13" focal distance along with even, shadow-free light from all angles. Made of steel to endure years of rough use. Can be mounted horizontally or vertically on a bench, machine or wall. Available with a 28" heavy-duty lock-joint arm with three control knobs for reducing vibration or a 42" counterbalanced floating arm for fast, easy positioning. Color: gray. Electrical: 115V, 60Hz with 9 power cord and 3-prong plug. UL approved. Backed by five-year warranty.

Description	Item	EACH Prices		
		1-2	3-5	6+
F. Lamp with 28" Lock-Joint Arm	821-5534	\$235.00	\$227.95	\$223.25
G. Lamp with 42" Floating Arm	821-5517	246.00	238.62	233.70
Optional 22W Circline Full-Spectrum	821-5304	16.80	-	-
Replacement 22W Tube	821-5300	14.40	-	-

H, I Dazor® Full-Spectrum Tubes – For Dazor Floating-Arm, and Magnifying Lamps

Full-spectrum lighting offers several advantages over traditional fluorescent lighting. It displays colors accurately, allowing correct viewing and matching. It produces less glare, reducing eyestrain, headaches and general fatigue, increasing productivity. And it emits less heat, making for a comfortable workplace. Advocates of full-spectrum lighting go so far as to claim it provides health benefits and general feelings of well-being due to its simulation of natural outdoor light. Some even use it to treat a condition known as Seasonal Affective Disorder (SAD).

Jewelers, graphic artists, dentists and other discerning professionals use Dazor's full-spectrum lights to perform their crafts with razor-sharp precision. Now you can as well, without investing a fortune. Just replace the fluorescent tube in your existing Dazor lamp with the appropriate 15W (5900°K) standard or 22W Circline (5000°K) and you can start reaping the benefits of full-spectrum lighting today.

Description	Fits	Item#	Each
H. 15W Standard	Floating-Arm Lamps	821-5303	\$14.15
I. 22W Circline Full-Spectrum	Magnifying Lamps	821-5304	16.80



A, B Dazor® Halogen Lamps

Halogen lamps for producing very intense light at the focal points of assembly and inspection stations. Light from the halogen bulb is more concentrated than that from an incandescent bulb, yet the 20W halogen is a real energy-saver. The 2½" diameter head has a protective shield to guard against bulb breakage. Proper ventilation keeps reflector head cool. The 34" reach industrial-strength, flexible arm works well around most machine tools. Choose from weighted and clamp-on styles. Halogen bulb is rated to 2,000 hours. Color: black. Electrical: 115V, 60Hz with 8 foot power cord and 3-prong plug. UL approved. Backed by a five-year warranty.

Description	Item#	EACH Prices	
		1-2	3+
A. Weighted Desk Lamp	821-5555	\$194.00	\$188.18
B. Clamp-On Lamp	821-5560	204.00	197.88
Replacement 20W Bulb	821-5549	9.30	



C. Dazor® EcoFlex LED Lamp

The EcoFlex by Dazor is an affordable, rugged, environmentally friendly LED bench light. The sleek head rotates 340° vertically and 90° horizontally, and features four 1-watt dimmable high brightness white LEDs optically mixed to produce an even light pattern. The 25" flexible arm exceeds the depth of most jewelry benches and allows you to aim the light exactly where you need it. Dazor's clever thermal engineering allows the LEDs to achieve their rated life of 50,000 hours without the heat! More information found on gesswein.com. Made in China.

Description	Item#	EACH Prices	
		1-2	3+
Dazor EcoFlex LED Light 100-240V	821-5584	\$165.00	\$156.75

**Footcandle: a unit of illuminance on a surface that is everywhere one foot from a uniform point source of light of one candle and equal to one lumen per square foot.*



D. Econo LED Flex Light

Our LED Flex Light uses 28 SMD-LEDs (surface mount and light emitting diodes) and advanced circuitry to produce a natural bright light that is easy on the eyes and reproduces colors as they truly are. A proprietary honeycomb lens cover insets the SMD LEDs by 5mm to reduce glare. Features 2 easy-to-reach light settings, 2-5W (200-500 lumens). Choose the brightness that is best for the task at hand.

LED Flex Light is the new generation of LED lighting and is rated for up to 60,000 hours of use. One-year manufacturer's warranty. cETLus certified UL listed. 110V, 6 foot power cord. More information found on gesswein.com. Made in China.

Description	Item#	Each
Econo LED Flex Light - 110V	821-5588	\$113.95



E. Dual Fiberoptic Light

Micro-Lite® 150W Halogen Light Source with Dual Gooseneck Fiber Optic Light Guide. Included standard are Focusing Spot lenses for the 32½" reach Dual Gooseneck. Features an Integral IR Filter for Cold Performance and long fiber life. Standard model features a .565" ID Bore. All Metal Construction, and 120V with 6 foot power cord and 3-prong plug. ESD Safe. Control unit measures 9½"L x 7½"W x 4½"H.

Description	Item#	Each
Dual Fiberoptic Light	271-3089	\$695.00

F. Mighty Bright LED Mini Task Light

This breakthrough light excels equally as a task, craft or utility light. Two bright white, energy-efficient LEDs make the Mighty Bright LED Mini Task Light very bright, yet the non-glaring glow makes for a comfortable work light. Set the intensity by pressing the button once or twice. Each LED lasts 100,000 hours. Clip and twist the gooseneck to set the perfect angle and clip in place or use the stable free-standing base. Three AAA batteries (included) provide 28 hours of operation. If the batteries run low, simply plug in the 120V AC adaptor (sold separately) with extra long 6 foot power cord and keep on going. Imported.

Description	Item#	EACH Prices	
		1-2	3+
F. Mighty Bright LED Mini Task Light	821-5552	\$18.95	\$17.06
AC Adaptor For Mighty Bright	821-5553	9.95	-





A

A. Magna Deluxe Fluorescent Lamp

Treat yourself to a whole new class of elegant fluorescent lighting with the Magna Deluxe. Features a 55W fluorescent tube in an enclosed 20" head. Provides crisp, flicker-free, uniform light with maximum surface area. Lends a sleek, polished look to your bench. Built-in electronic ballast increases lumens. Head swivels 310° and tilts 210° for great flexibility. Heavy-duty 32" arm with tempered steel springs and smooth-glide tension control knobs allows fast, easy adjustment. Includes C-clamp for mounting on benchtops up to 2" thick. Electrical: 115V, 60Hz with 5 foot power cord and 3-prong plug. UL listed. Backed by a one-year warranty. Imported.

Description	Item#	EACH Prices	
		1-2	3+
Magna Deluxe Lamp	821-5029	\$158.00	\$150.10



B

B. 3-Tube Econo Fluorescent Light

Suitable for a bench, workshop or a desktop, this three-tube bench lamp is economical yet durable. Manufactured of metal construction with a plastic housing allows for a lighter weight with strong durability. Features a universal clamp for easy installation. The innovative "floating arm" was designed to raise, lower or tilt the lamp to direct the light source with a slight touch. Includes (3) 14W (6400K) T5 fluorescent tubes for maximum brightness and high efficiency. Electrical: 110V with 5 foot power cord, UL approved. One-year manufacturer's warranty. Made In China. Dimensions: Reach 36" (91cm) x Head Length: 24" (61cm) x Head Width: 4.5" (11.5cm).

Description	Item#	Each Prices		
		1	2-3	4+
B. 3-Tube Econo Light	821-5007	\$68.95	\$65.50	\$62.06
T5 Replacement Bulb	821-5008	8.05	7.65	-



C

C. Econo Fluorescent Bench Inspection Lamp 1.75X

A great value in this handy inspection lamp! This quality fluorescent lamp boasts a 5" diameter 3 diopter lens rated at 1.75x that makes things 75% bigger than what they actually are thus reducing eye strain. With the focal length at 14", the operator will have plenty of room with a good depth of field. This fully adjustable lamp has an arm reach of nearly 45" and its light source provides outstanding illumination. All metal construction, in a clean white color. Comes supplied with a bench/desk clamp that opens up to a maximum of 2.5" to allow you to work hands-free as well as a 22W cool white Circleline fluorescent bulb is installed (also sold separately as a replacement 821-5300, see related products below) for long hours of use. Convenient on/off switch located on the top of the large 8" head. Cord length is 64.5". 110V. Made in China

Description	Item#	Each Prices		
		1-2	3-5	6+
Econo Fluorescent Bench Inspection Lamp 1.75X	821-5007	\$68.95	\$65.50	\$62.06



D

D. Econo Fluorescent Magnifying Lamp

The affordable solution for viewing small, detailed areas. Uses a 13W fluorescent tube and 5X lens. Provides cool white light and good magnification to reduce eyestrain, helping you work faster. Flexible 11½" gooseneck allows easy positioning. Weighted metal base with nonslip pad ensures stability. Flip-down cover protects 4" diameter lens from dust when not in use. Electrical: 120V, 60Hz with 5 foot power cord and polarized plug. UL listed. Imported.

Description	Item#	Each
Econo Magnifying Lamp	821-5010	\$34.95



E

E. Fluorescent Flip Lamp

A compact 13W fluorescent lamp ideal for the workshop. Unique swivel arm with 180° range delivers light at the precise angle you need: just raise arm to turn on lamp, and lower to turn off. Easy to use on crowded benchtops. Lightweight yet sturdy. Measures 10½" high with ¾" square base. Electrical: 120V, 60Hz with 6 foot power cord and polarized plug. Imported.

Description	Item#	Each
Flip Lamp	821-5006	\$29.95

A. Magna Deluxe LED Lamp

Features 14W LED lights (6000K) for bright, crisp lighting. LED's are placed in the 20" swivel head that has a diffuser installed over the LED lights to provide uniform light with maximum surface area. Another added feature includes the ability to dim the light with dimmer knob installed. The LED Magna Deluxe Lamp with its polished, sleek look will add a new professional look to your bench, work area/space. Head swivels 310° and tilts 210° for great flexibility. Heavy-duty 32" arm with tempered steel springs and smooth-glide tension control knobs allows easy adjustment. Includes C-clamp for mounting on bench tops up to 2" thick and 6 foot power cord. Electrical: 115V, 60Hz. UL listed. Shipping weight: 7.5 lbs. Made in Taiwan.

Description	Item#	Each
Magna Deluxe LED Lamp	821-5026	\$199.00



B, C Tensor Double Reach LED Desk Lamp

A favorite of jewelers and industry, the Tensor Double Reach LED desk lamp has a simple design with a modern touch! Accent your bench or work space with super bright LED lighting. Constructed of durable plastic and metal combined, this LED Lamp uses 10 Watts of power and turns on and off with a simple touch switch. 22" (overall reach) and LED lighting is placed at a 60° beam angle to offer a direct bright LED lighting into your work space. Comes supplied with a weighted desk base and a bench style clamp. Select between black or white. One-year warranty. **Notice: Cannot Be Sold In California.** Made in China.

Description	Item#	Each
B. Tensor Double Reach LED Desk Lamp - Black	821-5018	\$59.95
C. Tensor Double Reach LED Desk Lamp - White	821-5019	\$59.95



D. Tensor LED Desk Lamp

Accent your bench or work space with warm bright LED lighting. Constructed of durable metal, and black in color, this affordable LED Lamp uses a mere 5 Watts of power and comes with a convenient On/Off switch located on the 5 foot power cord. Lamp reaches a 20" (overall reach) and LED lighting is recessed within a reflector at a 60° angle to offer a direct bright beam of LED lighting into your work space. Comes supplied with both a weighted round desk base and a bench clamp. One-year warranty. Made in China.

Description	Item#	EACH Prices	
		1-2	3+
Tensor LED Desk Lamp	821-5584	\$165.00	\$156.75



E. GemOro Horizon LED Task Lamp

Features natural daylight illumination making it ideal for diamond and gemstone color grading. The ultimate task lamp may be placed on your counter for showing jewelry under its super bright, yet cool high-power LED's (6000K Full Spectrum Natural Daylight Illumination) it even has a USB port. Sleek, modern, ergonomic design complete with electronic touch sensor power switch and dimmer, flex-arm and swivel, fully adjustable light angle, 100V-240V, 58" power cord. UL Listed. Made in China.

Description	Item#	Each
GemOro Horizon LED Task Lamp	821-5004	\$69.95



Energy Efficient LED Magnifier Lamps

Green-Lite™ is the most energy efficient, highest output and longest lasting inspection lighting system in the world. Unparalleled quality!

Rather than clusters of old style LEDs, Green-Lite™ employs next generation "surface mount" LEDs (6000K) that produce more light with less glare, consume less power and last longer. The light output of the 8-watt LED array is comparable to a 150-watt halogen. The blended white light is easy on the eyes and the output level is adjustable (dimmable) for maximum operator comfort. Green-Lite™ LED technology quickly pays for itself through lower operating costs, longer lighting lifespan and improved productivity. A lower total cost of ownership provides the greenest solution of all! Manufacturer's ten-year mechanical warranty. Five-year, 50,000 hour pro-rated LED warranty. Made in USA.

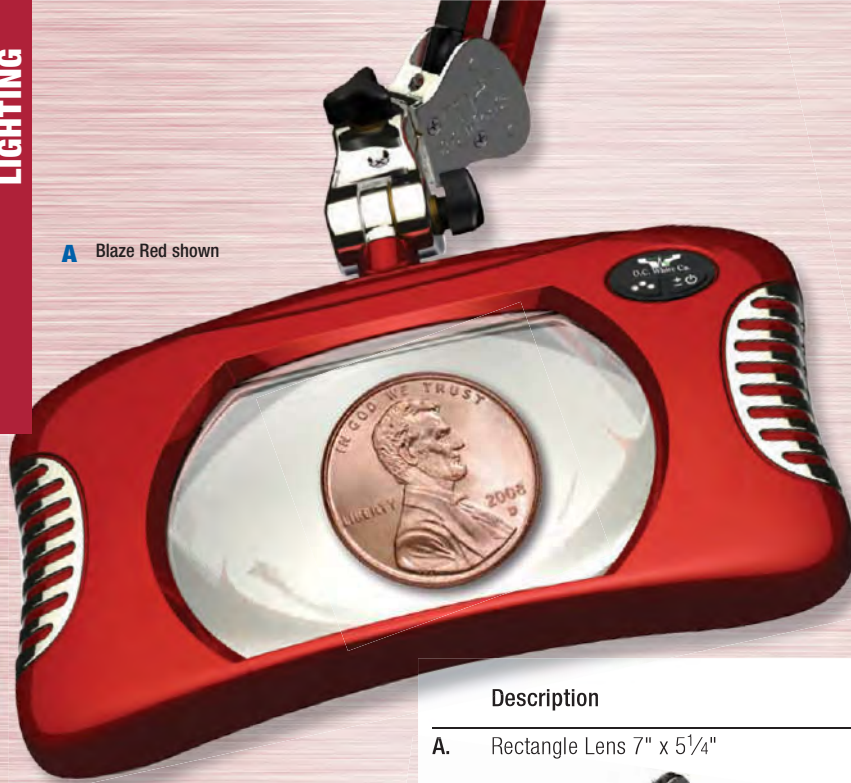

A Blaze Red shown

Features:

- 4X the lumen output of standard magnifier lamps
- Multi-angle LEDs for shadowless lighting at a full range of focal lengths and heights
- Superb dimming software via convenient, reliable membrane switch
- Reduced glare, heat and energy consumption
- 4 diopter (2X) lens
- Patented "Elite" arms are slim but have the greatest holding power of any arm of this type in the world
- Proudly made in the USA and available in eight colors

Specifications:

- 43" Arm Reach
- Mounting Style Table Edge Clamp up to 2½" thick
- Electrical 120 Volt–240 Volt
- Net/Ship.Wt. 20 lbs./22 lbs.



Spectre Blue shown



Blaze Red shown

Description	Color	Item#	Each
A. Rectangle Lens 7" x 5¼"	Carbon Black	821-5360	\$499.00
	Blaze Red	821-5364	499.00
	Blazing Yellow*	821-5361	499.00
	Racing Green*	821-5365	499.00
	Brilliant Orange*	821-5362	499.00
	Silver*	821-5366	499.00
	Spectre Blue*	821-5363	499.00
	Medical White	821-5367	499.00
*2-4 Weeks Delivery			
B. Round Lens 6" dia.	Carbon Black	821-5368	\$399.00
	Blaze Red	821-5372	399.00
	Blazing Yellow*	821-5369	399.00
	Racing Green*	821-5373	399.00
	Brilliant Orange*	821-5370	399.00
	Silver*	821-5374	399.00
	Spectre Blue*	821-5371	399.00
	Medical White	821-5375	399.00
*2-4 Weeks Delivery			
C. Optional Weighted Base - for either round or rectangular styles. Sturdy 36 lb. base Measures 12" x 11" x 2" Allow 2-4 weeks for delivery.	Carbon Black	821-5376	\$126.00
	Blaze Red	821-5380	126.00
	Blazing Yellow	821-5377	126.00
	Racing Green	821-5381	126.00
	Brilliant Orange	821-5378	126.00
	Silver	821-5382	126.00
	Spectre Blue	821-5379	126.00
	Medical White	821-5383	126.00



Carbon Black shown



A. ProVue Super Slim Fluorescent Magnifying Lamp

The innovative 5" ProVue Super Slim Fluorescent Lamp is a durable and powerful magnification lamp. Features a standard T5 Fluorescent Tube ideal for illuminating your work bench and boasts a 5 diopter lens (2.25x magnification) with a 36" spring arm that stays in any position. Runs at a cool operating temperature and only uses 22W of power! Ideal for assembly, workshop or inspection applications and comes supplied with a mounting clamp which allows for easy attachment to a desk or bench top and a 5 foot power cord. 115V. One-year warranty. Made in China.

Description	Item#	Each Prices	
		1-2	3+
A. ProVue Super Slim Fluorescent Magnifying Lamp	821-5048	\$99.95	\$94.95
Replacement T5 Fluorescent Tube	821-5049	6.25	-



B. MightyVue LED Pro Magnifying Lamp with Clamp

MightyVue Pro 3 LED series magnifying lamps are in a class of their own. Featuring adjustable color temperature (3500K-6500K), brightness control (max 1100lm), in addition to an attractive design, the Mighty Vue Pro series lamps are the most advanced available. Touch-sensitive brightness and color temperature controls. Large 7.5 x 6.2 inch, 3-Diopter crystal-clear glass lens for distortion-free viewing. 36 inch spring-balanced arm ensures a large working range. 360° swivel motion allows the head to be placed in any position. Covered spring arm prevents pinching hazards. 110V ~ 240V, complete with clamp and 5 foot power cord. Made in China.

Description	Item#	Each Prices	
		1-2	3+
MightyVue LED Pro Magnifying Lamp with Clamp	821-5047	\$169.50	\$161.03



C. ProVue LED Light

The innovative 5" ProVue Super Slim is a durable and powerful magnification lamp. Featuring 60 energy-efficient LED lights (6500K) for bright, shadow-free illumination for your work bench and boasts a 5 diopter lens (2.25x magnification) with a 36" spring arm that stays in any position. Runs at a cool operating temperature and only uses 6W of power! Ideal for assembly, workshop or inspection applications and comes supplied with a mounting clamp which allows for easy attachment to a desk or bench top and a 5 foot power cord. 115 VAC. One-year warranty.

Description	Item#	Each Prices	
		1-2	3+
ProVue LED Light	821-5039	\$109.95	\$104.45



D. LED Bench Inspection Lamp

This economical lamp bolsters a full 5" diameter lens with 90 Super Bright LED's surrounding the lens to give you optimal brightness. Made of durable metal construction that utilizes an adjustable movable arm. Clamps onto your work station or bench (clamp included). Use this economical LED as a task lamp or for inspection, simply flip up the convenient lens cover which also serves as protection to keep your glass lens clean from dust and debris. 110V with 5 foot power cord, UL approved. One-year manufacturer's warranty. Made in China.

Description	Item#	Each Prices		
		1-2	3-5	6+
LED Bench Inspection Lamp	821-5052	\$78.95	\$75.00	\$71.06



E. LED Table Top Inspection Lamp

Powerful yet economical, this tabletop LED desk light is a must for any bench, table or workstation needing bright LED lighting and superb optics. This lamp boasts a 1.75X magnification with 72 bright white LED's placed around the 5" diameter magnifier giving you the ultimate clear, crisp lighting! For optimal use, the 1.75X (3 Diopeter) viewing of your task should be about 14" from the lens. Lamp flexes side to side and up and down and the viewing area (head) moves side to side with ease on a ball joint. As an extra bonus, the unit has small tool storage areas on its weighted base putting your tools at your fingertips. 110V with 5 foot power cord, UL approved. One-year manufacturer's warranty. Made in China.

Description	Item#	Each Prices		
		1-2	3-5	6+
LED Table Top Inspection Lamp	821-5053	\$69.95	\$66.45	\$62.96



Important Magnifier Characteristics

Magnification Power: The ability of a lens to increase the visual size of an object. The symbol "X" represents power (a 3X magnifier triples the size of an image).

Focal Distance: The distance a magnifier should be from an object for it to be in focus (a 10X magnifier has a focal distance of 1"). Measured from lens unless otherwise noted.



A



UV light



LED light

A. 10X LED & UV Illuminated Ring Light – Rechargeable

Our compact loupe combines a 10X 20.5mm distortion free lens with the convenience of bright LED & UV lights. Easily switch between LED and UV when you want to see the fluorescence in diamonds. Can be used continually for up to thirty minutes and fully recharges in an hour using the provided USB adaptor. Supplied with USB recharge cord, carrying case and convenient neck strap.

Description	Focal Distance	Lens Diameter	Item#	EACH Prices	
				1-2	3+
Ring Light	1"	20.5mm	272-4066	\$69.95	\$ 62.96

B. GemOro® 10X LED Light Loupe™

Features a 10X single lens with one built-in LED light. Lets you view gemstones and jewelry under intense illumination. Includes 3 #389 batteries and carrying case. Made in China.

Description	Focal Distance	Lens Diameter	Item#	Each
10X LED LightLoupe	1"	21mm	272-4039	\$8.95



B

C. 10X LED Triplet Loupe

View gemstones and jewelry under intense illumination. Features a high-quality aplanatic achromatic 10X triplet lens and built-in LED ring light. Includes 3 L936 batteries and carrying case. Imported.

Description	Focal Distance	Lens Diameter	Item#	EACH Prices	
				1-2	3+
10X LED Loupe	1"	20.5mm	272-4065	\$29.95	\$26.96



C

D, E 10X Doublet Loupes

Quality loupes at inexpensive prices. Each has chrome-plated metal swing-away case. Knurled metal grip prevents slipping. Imported.

Description	Focal Distance	Lens Diameter	Item#	EACH Prices	
				1-2	3+
D. 10X Small Loupe	1"	15mm	272-4035	\$7.95	\$7.16
E. 10X Large Loupe	1"	21mm	272-4031	14.50	13.05



D



E

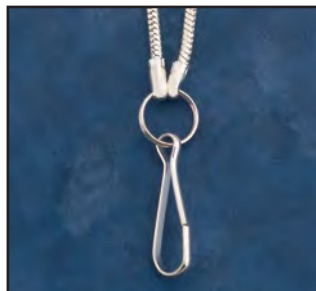

F

F. Silver-Plated Loupe Chain – 39"

This snake-style chain allows you to keep a loupe around your neck so it's always available to use with customers. Highly flexible for comfortable extended wear. Heavily plated in silver and coated with an anti tarnish agent to keep it looking bright. Measures 39" long. Made in USA.

Description	Item#	Each
Silver-Plated Loupe Chain	272-4047	\$8.95

A-D Gems 10X HEX Loupes 22mm Lens

Quality made 10X Loupes are configured in a hex shape for easy secure handling. Each loupe is made with a precision 22mm lens providing excellent color and clarity with no distortion. As an added feature, the lens is made with a **high-grade antireflective optical coating** film that helps eliminate glare. Each loupe comes complete with a fabric pouch for safe keeping as well as a handy lanyard cord. Comes in Black, Chrome, Chrome/Gold and Chrome with Rubber Grip for comfort and control. Made in Taiwan.

Description	Lens Diameter	Item#	EACH Prices		
			1-2	3-5	6+
A. Black	22mm	272-4061	\$59.95	\$56.95	\$53.96
B. Chrome	22mm	272-4062	59.95	56.95	53.96
C. Chrome/Gold	22mm	272-4063	59.95	56.95	53.96
D. Chrome/Rubber Grip	22mm	272-4064	59.95	56.95	56.95



E-G 10X Gesswein 20.5mm Hex Triplet Loupes

Generously sized, 20.5mm diameter 10X Triplet Loupes with hex shape for secure grip. A triplet lens (three lenses bonded together) provides excellent color and clarity. These larger loupes are available in black, silver and gold finishes. Supplied in a leather storage case. Made in China.

Description	Focal Distance	Lens Diameter	Item#	EACH Prices	
				1-2	3+
E. 10X Black Loupe	1"	20.5mm	272-4055	\$17.95	\$16.16
F. 10X Silver Loupe	1"	20.5mm	272-4056	17.95	16.16
G. 10X Gold Loupe	1"	20.5mm	272-4057	19.95	17.96



H-J 10X Gesswein Triplet Loupe – With Rubber Grips

High-quality 18mm triplet pocket loupes, featuring a rubber grip for comfort and control. 18mm diameter triplet lens is actually three lenses bonded together for higher correction. Available in black, chrome and gold finishes. Supplied in a leather storage case. Imported.

Description	Focal Distance	Lens Diameter	Item#	EACH Prices	
				1-2	3+
H. 10X Black Loupe	1"	18mm	272-4058	\$15.50	\$13.95
I. 10X Chrome Loupe	1"	18mm	272-4059	15.50	13.95
J. 10X Gold Loupe	1"	18mm	272-4060	17.50	15.75



K-M 10X Diamond-Cut Triplet Loupes

As practical as they are beautiful, these loupes feature a unique diamond-cut design that offers the user a much better grip than conventional loupes. Each has large lens that provides good depth of field with minimal glare. Complete with leather pouch. Made in India.

Description	Focal Distance	Lens Diameter	Item#	EACH Prices	
				1-2	3+
K. 10X Black Loupe	1"	18mm	272-4036	\$12.95	\$11.66
L. 10X Chrome Loupe	1"	18mm	272-4038	12.95	11.66
M. 10X Gold Loupe	1"	18mm	272-4037	12.95	11.66



Bausch & Lomb Magnifiers

Bausch & Lomb had been renowned for excellence in scientific and ophthalmic optics for well over a century providing the following quality features:

- Application-designed optics with the right balance of magnification, field of view and depth of focus for each magnifier's use.
- Lenses made from pure optical glass or optical plastic, crystal clear and free from internal flaws.
- Lens surfaces are finished to their high standards with no wave or other types of surface defects to distort vision.



A

A. Bausch & Lomb® Hastings Triplet Loupes

The best loupes from Bausch & Lomb. Highly corrected for spherical and chromatic aberrations. Feature three layers of optical glass cemented together and large field of view out to lens edge. Swing-away nickel-plated case protects lens and serves as handle.

Description	Focal Distance	Lens Diameter	Item#	Each
7X Hastings Loupe	1½"	19.8mm	272-2039	\$55.75
10X Hastings Loupe	1"	15.8mm	272-2040	55.29
20X Hastings Loupe	½"	8.3mm	272-2060	68.70



B

B. Bausch & Lomb® Coddington Loupes

Description	Focal Distance	Lens Diameter	Item#	Each
B. 10X Coddington Loupe	1"	19.8mm	272-2010	\$36.35
20X Coddington Loupe	½"	12.5mm	272-2030	43.90



C

C. Bausch & Lomb® 10X Hastings Triplet Eye Loupe

The best eye loupe from Bausch & Lomb. Consists of a Hastings triplet lens in a lightweight watchmaker's style frame. Features three layers of optical glass cemented together and a large field of view out to lens edge. Can be used with headband (see below).

Description	Focal Distance	Lens Diameter	Item#	Each
10X Hastings Eye Loupe	1"	15.8mm	272-1008	\$68.89



D

D. Bausch & Lomb® Eye Loupes

Lightweight, comfortable single lens eye loupes with precision-ground, polished optical glass lenses. Can be used with headband (see below).

Description	Focal Distance	Lens Diameter	Item#	Each
D. 4X	2½"	25.4mm	272-1040	\$20.50
5X	2"	25.4mm	272-1030	20.50
7X	1½"	25.4mm	272-1020	20.50
10X	1"	25.4mm	272-1010	24.25



E

E. Bausch & Lomb® Eye Loupe Headband

For use with single-lens and Hastings Triplet loupes (see above). Frees up your hands so you can work faster. Made of black neoprene with Velcro end closures.

Description	Item#	Each
Eye Loupe Headband	272-1005	\$12.98

A. Eschenbach 10X Aplanatic Precision Metal Loupe

A precision loupe made of matte chrome-plated brass. Features a 10X aplanatic optical glass lens that delivers a distortion-free image over the entire field of view. Meets EN ISO 9001 standards. Backed by a one-year manufacturer's warranty. Made in Germany.

Description	Focal Distance	Lens Diameter	Item#	Each
10X Metal Loupe	1"	23mm	272-3255	\$68.95



B. Eschenbach 10X Aplanatic Precision Fiberglass Loupe

A precision folding loupe made of durable fiberglass-reinforced polyamide. Features a 10X aplanatic optical glass lens that delivers a distortion-free image over the entire field of view. Keeps out dust when closed, protecting lens from damage. Meets EN ISO 9001 standards. Backed by a one-year manufacturer's warranty. Made in Germany.

Description	Focal Distance	Lens Diameter	Item#	Each
10X Fiberglass Loupe	1"	23mm	272-3240	\$57.95



C, D 10X Testers on Stands

Although our linen tester was derived from the textile industry, both these loupes can be used on anything. Both have a magnification power of 10X with focal distance of 1" and a lens diameter of 14.3mm (9/16"). Original Linen Tester stands 1 3/8" high when open and the black surface minimizes glare while allowing easy use of the linen cross hairs on the base as a reference. Folds to a compact 30mmL x 23mmW x 10mmH. Econo version stands 1 1/8" high when open and folds down to 32mmL x 25mmW x 9mmH.

Description	Focal Distance	Lens Diameter	Item#	EACH Prices	
				1-2	3+
C. Original Linen Tester 10X	1"	14.3mm	272-4050	\$31.95	\$26.62
D. Econo Magnifier 10X Silver w/Folding Stand	1"	14.3mm	272-4051	11.95	-



E. Bausch & Lomb® 5X Pocket Magnifier

Pocket magnifier with slide-on plastic carrying case. Features an aspheric lens that offers a wider field of view at higher power than a normal lens, plus edge-to-edge clarity. Ideal for viewing large areas at high power. Measures approx. 2 1/8"L x 1 5/8"W x 5/8"H when closed. Made in USA.

Description	Focal Distance	Lens Diameter	Item#	EACH Prices	
				1-2	3+
5X Pocket Magnifier	2"	36mm	272-5007	\$11.59	\$9.66

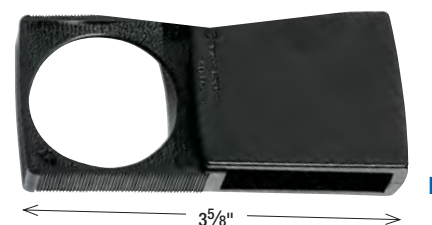

F. Bausch & Lomb® 3.5X Engraver's Magnifier

An engraver's magnifier with two plano-convex lenses. Has near-universal application in precision work. Provides a wide, flat field. Made in USA.

Description	Focal Distance	Lens Diameter	Item#	Each
3.5X Engraver's Magnifier	3"	40mm	272-5015	\$50.95



G. GemOro iView LED Magnifier – 5X and 10X

Features Dual 5X and high power 10X magnification while boasting a crisp 55mm and 20mm high quality optical lens. Its multi-function on/off button controls the super bright illumination consisting of 9 LED's (8 White Natural Daylight LED's and 1 UV LED). Comes supplied with (3) AAA batteries and a protective carrying case. Measures 8" x 3 1/4" and weighs 5 oz.

Description	Item#	EACH Prices	
		1-2	3+
iView LED Magnifier	272-5008	\$19.95	\$18.95



H. Interchangeable LED Magnifier – 2.5X, 5X and 16X

The interchangeable lens magnifier comes supplied with three lenses - 2.5X, 5X and 16X. Easily change magnification by simply depressing the release buttons and attaching the new lens. The reinforced hard acrylic lenses provide edge to edge field of view. Lens diameters are 3.5" (2.5X), 3" (5X) and 1.5" (16X). Features a comfortable ergonomic handle with rubber grips, two super bright LED lights for optimal illumination and a convenient on/off switch. Requires three AAA batteries (not included). Made in China.

Description	Item#	EACH Prices		
		1-2	3-5	6+
Interchangeable LED Magnifier	272-5009	\$15.75	\$14.96	\$14.18





A

A. Primo™ Optical Setting Glasses

Economical setting glasses deliver high quality optics and durability. Eyepieces come mounted on a sporty classic eyeglass frame. Supplied in handy carry case with polishing cloth and a neck cord. Made in China.

Optical Setting Glasses	Mag.	Working Distance	Item#	Each Prices	
				1-2	3+
2.0X-XS	2.0X	8-12"	272-3230	\$240.00	\$216.00
2.5X-XS	2.5X	8-12"	272-3231	250.00	225.00
3.0X-S	3.0X	11-15"	272-3232	290.00	261.00
3.5X-S	3.5X	11-15"	272-3233	295.00	265.50
Replacement Frame			272-3234	29.95	-



B

B. Eschenbach MAXDetail Magnifier

This top-quality headset magnifier with Galilean design provides wide field of view (20°) and independently adjustable magnification and focus for each lens, ensuring excellent clarity for each eye. Objective lenses compensate for ±3-diopter spherical correction or allow adjustment for close-up activities. Lightweight PXM(R) optics, flexible plastic temples and smooth bridge allow extended wear. Frosted objective housing eliminates reflections. Magnifies up to 2X. Includes carrying case and head strap. Made in Germany.

Description	Item#	EACH Prices	
		1-2	3+
MAXDetail	272-3280	\$99.95	\$94.95



C

C. Optisight™ Magnifier with Three Lens Plates

From the makers of OptiVISOR, this lightweight yet tough magnifier features a visor assembly with pivot mechanism and headband with adjustable strap for comfortable extended wear. Provides hands-free magnification. Includes three high-quality 1¾X, 2X and 2½X interchangeable lens plates with focal distances of 14", 10" and 8", respectively. Optional 2¾X lens plate with focal distance of 6" also available for intermittent close-up work.

Description	Item#	Each
Optisight with 3 lens plates	270-0400	\$28.10
Optional 2¾X Lens Plate	270-0404	8.15
Replacement 2½X Lens Plate #3	270-0401	8.15
Replacement 2X Lens Plate #4	270-0402	8.15
Replacement 1¾X Lens Plate #5	270-0403	8.15



D

Auxiliary Lens

D. Magni-Focuser® Mark 2 Magnifiers

Feature interchangeable binocular lenses made of shatter-resistant optical acrylic and adjustable headbands for comfort. #115 includes an auxiliary lens that provides an additional 2½X magnification in one eye.

Description	Power(s)	Focal Distance(s)	Item#	EACH Prices	
				1-2	3+
#105	2¼X	8"	271-1050	\$21.60	\$18.00
#107	2¾X	6"	271-1070	21.60	18.00
#110	3½X	4"	271-1100	22.50	18.75
D. #115	2¼, 4¾X	8", 3"	271-1150	38.15	31.79



E

E. Bausch & Lomb® Premoistened Lens Cleaning Tissues

Anti-fog, anti-static, nonsilicone-based tissues treated with special surfactants for cleaning all glass and plastic lenses. Ideal for cleaning loupes, glasses, mirrors, even computer screens. Sold in convenient cardboard dispensing boxes of 100 that can be bench- or wall-mounted. Each individually wrapped, premoistened tissue measures 5" x 8". Box measures 9"L x 5¾"W x 2¾"H.

Description	Item#	Box of 100
Lens Tissues	272-1001	\$14.99

A, B OptiVISOR® Magnifiers

Each OptiVISOR features an interchangeable binocular lens plate made of high-quality optical glass, ground and polished to precision ophthalmic standards. Lightweight, impact-resistant visor assembly with pivot mechanism and adjustable genuine leather headband allow comfortable extended wear. Available in blue and black. Replacement lenses available separately. Please call or see website for details. Made in USA.



Description	Power	Focal Distance	Item#	EACH Prices	
				1-2	3+
A. DA-2 Blue	1½X	20"	270-1020	\$39.95	\$35.96
DA-3	1¾X	14"	270-1030	39.95	35.96
DA-4	2X	10"	270-1040	39.95	35.96
DA-5	2½X	8"	270-1050	39.95	35.96
DA-7	2¾X	6"	270-1070	43.95	39.56
DA-10	3½X	4"	270-1100	43.95	39.56
B. DA-2 Black	1½X	20"	270-1120	39.95	35.96
DA-3	1¾X	14"	270-1130	39.95	35.96
DA-4	2X	10"	270-1140	39.95	35.96
DA-5	2½X	8"	270-1150	39.95	35.96
DA-7	2¾X	6"	270-1170	43.95	39.56
DA-10	3½X	4"	270-1180	43.95	39.56
Replacement Items			Item#	Each	
Blue Visor Assembly only			270-1010	25.85	
Black Visor Assembly only			270-1115	25.85	

C. OptiVISOR® LX Magnifiers

Available as a complete set of all four lenses with one visor assembly or specific lens with visor. Each features a high-quality optical acrylic lens plate made from a precision-ground, highly polished mold. Lightweight yet tough visor assembly with pivot mechanism and adjustable padded leather headband allow comfortable extended wear. Available in blue only. Replacement lenses available separately. Please call or see website for details. Made in USA.



Description	Focal Power	Distance	Item#	EACH Prices	
				1-2	3+
C. Complete Set	All	All	270-1204	\$59.95	\$53.96
LX3	1¾X	14"	270-1200	30.55	27.50
LX4	2X	10"	270-1201	30.55	27.50
LX5	2½X	8"	270-1202	30.55	27.50
LX7	2¾X	6"	270-1203	30.55	27.50



D. Quasar LED Light Attachment for OptiVISOR®

The revolutionary Quasar LED lighting system is the best possible lighting solution available for your magnifying visor. The fixture snaps over the Optivisor lens plate and significantly increases visibility. Made in China.

Description	Item#	Each
Quasar LED Light Attachment	270-2110	\$29.95

E. OptiVISOR® Xenon Light

Clips onto OptiVISOR (see above) to illuminate the viewing area. Features 6,000-candlepower bright xenon bulb. Swivels for optimal coverage. Runs 5–6 hours on two AA batteries (not included).

Description	Battery Pack Location	Item#	Each
E. LT-06, 10" cord	Visor assembly	270-2150	\$25.35
LT-42, 42" cord	Belt or pocket	270-2151	25.35
Replacement Bulb		270-2152	7.85



Items sold separately.

F. OptiVISOR® Optiloupe

Designed for monocular use the Optiloupe easily attaches to either eye of any OptiVISOR or OptiVISOR LX for additional 2½X magnification.

Description	Power	Item#	EACH Prices	
			1-2	3+
Optiloupe	2½X	270-2200	\$10.95	\$9.86





A



B



C



D



E

A. Eschenbach Precision Galilean Binoculars

These lightweight, well-balanced binoculars provide comfortable hands-free viewing for detailed work. Feature prescription-grade shatter-resistant achromatic 23mm lenses made of PXM optically pure plastic, focusing adjustment and diopter setting for each eyepiece and adjustable nose bridge. Available in 2.5X and 4X powers with 3 1/2" and 1 1/4" fields of view, respectively. Include leather carrying case. Meet EN ISO 9001 standards. Backed by a one-year manufacturer's warranty. Made in Germany.

Description	Power	Focal Distance	Item#	Each
Galilean Binoculars	2 1/2X	14"	272-3245	\$575.00
	4X	10"	272-3246	610.00

B. Telesights®

Binocular magnifiers with optical-quality acrylic lenses coated to resist abrasion. Include half-frame for independent use.

Description	Power	Focal Distance*	Item#	EACH Prices	
				1-2	3+
B. #43	1 3/4X	13 1/2"	270-0430	\$36.99	\$33.29
#44	2X	10"	270-0440	36.99	33.29
#45	2 1/4X	8"	270-0450	36.99	33.29
#46	2 1/2X	6 2/3"	270-0460	36.99	33.29
#48	3X	5"	270-0480	39.99	35.99

*Measured from eye. (not from lens as customary)

C. Donegan Magnifiers – From the Makers of OptiVISOR

Ideal for small jobs that require your hands to be free. Feature lightweight construction with dual-lens system that eases eyestrain by converging on focal point. Include half-frame for independent use and small clip for attachment to eyeglasses.

Description	Power	Focal Distance	Item#	Each
C03	1 3/4X	14"	271-1200	\$25.15
C04	2X	10"	271-1201	25.15
C05	2 1/2X	8"	271-1202	25.15
C07	2 3/4X	6"	271-1203	25.15

D. Eschenbach Clip-On Magnifiers

Feature prescription-grade lenses made of PXM optically pure plastic coated with Cera-Tec for resistance to breakage and scratching and lightweight fiberglass-reinforced plastic clip assembly. Include four soft rubber clip sleeves that protect eyeglasses from abrasion, plastic box and lens cleaning cloth. Meet EN ISO 9001 standards. Backed by a one-year manufacturer's warranty. Made in Germany.

Description	Power	Working Distance	Item#	Each
Clip-On Magnifier	2 1/2X	7"	272-3260	\$63.85
	3X	6"	272-3261	63.85

E. Bausch & Lomb® Clip-On Eyeglass Loupe

Mini loupe with optical glass lens for attachment to wire or plastic eyeglass frames. Swing up when not in use. Focal distance: 3 1/2".

Description	Power	Lens Diameter	Item#	Each
Single-Lens Style	4X	24mm	272-3002	\$45.50

A-D Dino-Lite Digital Handheld Microscopes

Perfect for appraisals, repair, inspection and documentation!

Affordable, compact digital microscopes for a wide range of assembly, repair, inspection and documentation applications. Three of the **Dino-Lite** models also include measuring software that allows you to input a magnification value from the microscope zoom control and then measure length, multiple angles, and circular functions.

The **AD4113TL** boasts enhanced working distance and removable nose cone, which can be swapped with the optional 90° view adapter (810-0093) to look into tight areas with ease. While the new **Edge Series, AM4115ZT** offers high end, higher image quality, exquisite sharpness and enhanced detail (shown at right).

Features:

- Camera with powerful magnification capabilities and remarkable color resolution
- DinoCapture software for capturing both pictures and videos
- Micro-Touch trigger mechanism for shooting without a mouse
- 8 ultra-bright LEDs for strong yet clean lighting
- Compact design for portability
- Includes USB 2.0 cable for fast data transfer
- Backed by a one-year warranty
- CE approved
- Compatible with PC and Mac

View instructional video at www.gesswein.com.

Specifications:

Resolution 1.3 MP (1280 x 1024)
 Illumination 8 white LEDs
 Frame Rate Up to 30fps
 File Format JPEG, BMP, AVI
 Dimensions 1¼"D x 4"L



Model	Zoom	Measuring Software*	Polarizing Filter**	Enhanced Working Distance***	Item#	Each
AM411T	10–50X, 220X	No	No	No	810-0086	\$329.00
Basic model, minimal image blur						
AD4113TL	10–90X	Yes	No	Yes	810-0092	489.00
Enhanced lighting, improved illumination						
AD4113ZTS	10–50X, 220X	Yes	Yes	No	810-0099	509.00
Premier model, adjustable polarization prevents glare and hot spots						
AM4115ZT	10–230X	Yes	Yes	No	810-0110	629.00
Edge series, high end, higher image quality, exquisite sharpness and enhanced detail						
B. Tabletop Stand - Stability					810-0091	99.00
Diffuser F/AM Premier Series (except ZTS)					810-0101	19.00
C. Diffuser F/AMZTS Premier Series					810-0102	19.00
Diffuser F/AM Edge Series					810-0103	19.00
Universal Light Box Adapter					810-0096	39.00
Optional 90° View Adapter for AD4113TL					810-0093	59.00

*Allows point-to-point, curvilinear and angular measurements with accuracy up to 0.001".
 **Allows adjustable glare reduction, useful in many close-up applications.
 ***Allows up to 4" more distance between lens and subject.

D. Dino-Lite MSAK826 Enclosed Light box

Includes two 8" LED light bars and up to 14" vertical internal working distance. The LED Light has a long life of approximately 3 years. Replacement bulbs available. Powered by an included AC Adapter, this photo box helps to eliminate outside light pollution and other interfering factors. Compatible with all Dino-Lite handheld Scopes. For photographing jewelry, it is recommended to use our table stand (810-0091 - see above) and extended pole (810-0125 - see below). Dimensions: 7"W X 9¾"D X 12"H. Some assembly required. 110V. Made In China.

Description	Item#	Each
Dino-Lite MSAK826 Enclosed Light box	810-0120	\$199.00

E. Optional MSA2P Pole for Dino-Lite Table Stand / MSAK826 Light Box

Quickly and easily mount your Dino-Lite on your light box (See p. 332). Made of high-impact plastic.

Description	Item#	Each
Pole for Dino-Lite Table Stand	810-0125	\$29.00

F. Dino-Lite Light Box Adapter – Perfect for use with your MEDALight!

Mount your Dino-Lite on any light box (See p. 332). Made of high-impact plastic.

Description	Item#	Each
Dino-Lite Light Box Adapter	810-0096	\$39.00



Shown with Laptop and Tabletop stand #810-0091 (not included).

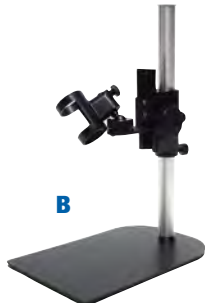

Diffuser for viewing gemstones/diamonds by removing glare. Microscope sold separately.





ProZoom Scopes on Ball Bearing Bases

A-C ProZoom™ — 4.5 Stereo-Zoom Binocular, 6.5 Digital Trinocular Microscope Systems and Binocular Microscopes with GRS Acrobat Stands

Both systems offer the performance and durability required for your most demanding inspection needs. Crystal-clear optics, combined with ultra-bright LED illumination, gives the same performance of much more expensive microscope systems and making them a favorite across many industrial applications. The 10" x 10" robustly built double-ball bearing base/arm assembly makes using either ProZoom effortless, maintaining pinpoint accuracy when locked in. Both versions offer an eye tube inclination of 45°, while the main body rotates 360° in holder. Both feature a dimmable, ultra bright, LED ring light. Both are ESD safe, 120~240V, 50/60Hz and have a shipping weight of 65lbs.

The Digital Trinocular System is a "true" trinocular design because you maintain full functionality of both eyepieces when using the video port. Comes complete with 2 Megapixel (1600x1200) USB 2.0 camera with Image Acquisition and Measurement Software Suite for high-quality analysis and documentation.

The ProZoom Binocular Microscopes combine the same crystal clear optics as the ProZoom 4.5 Stereo-Zoom binocular microscope above with the GRS acrobat stand on the following page to give you the most flexible scope at an affordable price.

Available with either the same extra-bright fluorescent ring light as the Meiji Stereo Zoom scopes on the next page or the dimmable, ultra bright, LED ring light on the Pro-Zoom 4.5 Binocular Microscope above. Additional 2X and 10X lenses are available. Please see our website.

Specifications:

ProZoom	Binocular	Trinocular
Standard Magnification Range	3.5X - 45X	5X - 65X
Standard 10X Eyepiece	22mm	28mm
Objective Lens	0.5X	0.5X
Standard Lens Working Distance	90mm	108mm
Objective Lens Working Distance	160mm	190mm
Eyepiece Adjustments	5 Diopter	6 Diopter
Total Maximum Magnification with optional accessories	225X	390X
Field of View - Diameter	28.6 - 4.8	28.75 - 3.3
Warranty	5 yr Mechanical	5 yr Mechanical, 1 yr Electrical/Video

Description	Item#	Each
A. ProZoom Binocular LED Microscope	271-3080	\$1,995.00
B. ProZoom Digital Trinocular LED Microscope	271-3085	3,945.00
C. ProZoom Binocular Fluorescent Microscope + Acrobat Stand	271-3095	1,750.00
ProZoom Binocular LED Microscope + Acrobat Stand	271-3096	1,855.00



Monitor not included



ProZoom Scope on GRS Acrobat Stand

See Vises on pp. 542-546



D. Bench Setter's Microscope

Lightweight yet durable, the Bench Setter's Microscope boasts an all-metal aluminum alloy body with premium components and chemical-resistant finishes providing stability and durability for a lifetime of dependable use.

The easily maneuverable boom stand with friction arms, focus block and padded headrest ensures superb flexibility and comfort. Entire assembly can be easily positioned and quickly swung away when not in use. Friction arms lock in place when needed. Focus block securely holds microscope body. Dimmable Ring Light (included) with extra-bright LED bulbs provides cool, glare-free illumination. Fits many other competitive microscopes as well. Made In China.

Features: Binocular scope body can be rotated 360° and locked in any position. Standard 10X eyepieces with magnification Range of 3.5X-45X, High-resolution optics for yielding upright and unreversed stereoscopic images, Rugged all-metal bodies and components designed to last a lifetime, Ergonomically positioned bilateral zoom controls.

Description	Item#	Each
D. Bench Setter's Microscope	271-3045	\$925.00

E. GemOro® Elite 1030 Microscope - 10X and 30X Magnification

A precision microscope at a surprisingly affordable price. Field of view 25mm at 10X. Provides true professional darkfield and brightfield with sliding baffle. Has adjustable iris diaphragm for controlling lower light. Features 360° rotating head for easy focus adjustment. Comes complete with full-view gem clip, comfort eye guards and dustcover. For added surface illumination, an optional fluorescent overhead light can be attached. Backed by a five-year mechanical warranty and a two-year electrical warranty. Imported with optics from Japan. Electrical: 110/220V, 50/60Hz. Dimensions: 4½"W x 7½"D x 12½"H. Ship wt. 10 lbs.

Description	Item#	EACH Prices	
		1-2	3+
E. GemOro Elite 1030 Microscope	810-0083	\$299.00	\$269.10
Overhead Light	810-0078	79.95	-



A. Meiji Stereo Zoom Microscopes Standard Binocular and Camera-Ready Trinocular Styles

From the premier optics manufacturer in Japan, these microscopes feature a Greenough optical design and high-resolution optics free of chromatic and spherical aberrations for yielding crystal-clear upright and unreversed stereoscopic images with rich contrast, impressive brightness and true-to-life color. Boast great depth of field and image flatness for accurate viewing and long working distances for ample workspace. Ideal for inspection of fine details.

Lightweight yet durable all-metal aluminum alloy bodies with premium components and chemical-resistant finishes provide stability and durability for a lifetime of dependable use. The 45°-inclined observation tubes with adjustable interpupillary distance and diopter tubes eliminate eyestrain.

GRS acrobat boom stand with friction arms, focus block and padded headrest ensures superb flexibility and comfort. Entire assembly can be easily positioned and quickly swung away when not in use. Friction arms lock in place when needed. Focus block securely holds microscope body. Padded headrest reduces neck and back fatigue. Comes with a protective dusk cover.

Ring light with extra-bright circular fluorescent or LED bulb provides cool, glare-free illumination. Fits many other microscopes besides those from Meiji. Electrical: 115V.

Features:

- Binocular and Trinocular styles that can be rotated 360° and locked in any position
- High-resolution optics for yielding upright and unreversed stereoscopic images
- Ergonomically positioned bilateral zoom controls
- Interpupillary distance adjustment from 54–75mm
- Dual dioptic adjustment (±5 diopters) for maintaining focus throughout zoom range

Binocular and Trinocular Components:

- 10X eyepieces with eye shields
- 0.5X auxiliary objective lens for increased working distance
- GRS Acrobat Boom Stand with focus block and headrest
- LED or Fluorescent (on/off) Ring Light, 115V

Specifications:

Body Style	Binocular or Trinocular, each with 360° rotation
Zoom Control	Dual, graduated, bilateral mount
Zoom Range	0.7–4.5X (0.35–2.25X with 0.5X objective lens)
Magnification	7–45X (3.5–22.5X with 0.5X objective lens)
Field of View	32.8–5.1mm (65.6–10.2mm with 0.5X objective lens)
Working Distance	93mm (Binocular/Trinocular with 0.5X objective lens: 150/170mm)
Interpupillary Distance	Adjustable from 54–75mm
Dioptic Adjustment	Dual (±5 diopters)

Description	Item#	Each
A. Binocular Microscope with Acrobat Stand and LED Ring Light	271-3049	\$2,128.00
Binocular Microscope with Acrobat Stand and Fluorescent Ring Light	271-3029	2,162.00
Trinocular Microscope with Acrobat Stand and Fluorescent Ring Light*	271-3067	2,742.00

*Designed for photo and video applications. When the beam splitter is engaged, it does not obstruct the eye tubes; all three viewing ports are lighted for simultaneous use. Can be used with most cameras, including digital, SLR, digital SLR and CCD. Call for available adapters.

B, C Leica® A60 Microscope and the GRS redesigned Acrobat® Versa Stand

Leica FusionOptics provides a greater depth of field and a high-resolution view of hand engraving, stone setting and jewelry repairs and tasks. The GRS Acrobat Versa stand has been redesigned, specifically for the popular Leica A60 Microscope. It features a rigid frame that makes positioning your work easy, a magnetic document holder and dust cover. The 38° viewing angle on the Leica head allows the user to maintain a natural head posture. The operating elements such as the zoom adjustment, focus knob, and ring light are intuitive and easily accessible, by left and right-handed users alike. Complete Package Includes; Leica A60 Microscope W/10X Fixed Eyepieces/0.63 Objective Lens, GRS Acrobat Versa Stand, Dual Voltage LED Optia LED Light and GRS Headrest. If you already have the older style Acrobat Stand from GRS, but you want to have upgrade to the Leica optics, you can replace your existing scope by purchasing our Leica Scope Head and Adapter package (271-3063). One-year manufacturer's warranty.

Specifications:

	Standard	with Objective Lens 0.63X
Magnification Range	5X to 30X	3.15X to 18.9X
Depth of Field	13.6mm to 0.54mm	n/a
Object Field Diameter	46.0mm to 7.7mm	70.0mm to 11.7mm

Description	Item#	Each
B. GRS Leica Scope System	271-3060	\$2,395.00
C. Leica Scope Head only with retrofit Acrobat adaptor	271-3063	1,850.00

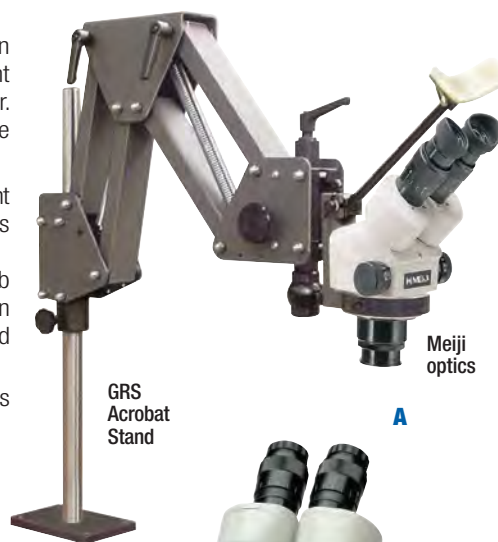

GRS Acrobat Stand

A



Meiji optics with Fluorescent Ring Light



Fluorescent Ring Light Circuline Bulb



B



C



A

A. Premium Digital Caliper – Max 6"/150mm

This extremely accurate caliper can be connected to any computer for recording or printing data. Features large, high-contrast LCD screen for easy readability. Has conversion, zero and hold functions (hold function freezes display for later viewing). Made of hardened stainless steel for durability. Uses setscrew to prevent jaws from moving. Runs for 2–3 years on an efficient lithium wafer battery (included). Measures inside, outside, depth and step. Comes in fitted plastic case with see-through cover.

Specifications:

Resolution 0.0005"/0.01mm Accuracy ± 0.001 "/0.02mm

Description	Item#	Each
Premium Digital Caliper	825-1635	\$180.25

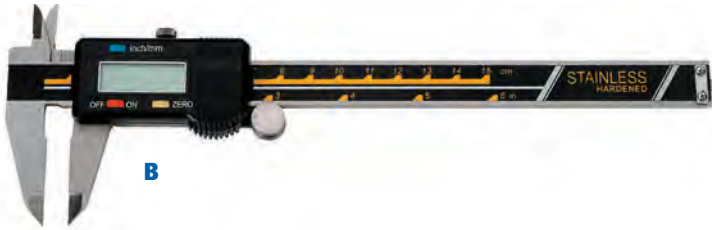

B

B. Econo Digital Caliper – Max 6"/150mm

Provides full digital accuracy at a reasonable price. Features large LCD screen for good readability. Has conversion and zero functions. Uses setscrew to prevent jaws from moving. Runs for one year on 1.5V silver oxide watch battery (included). Measures inside, outside, depth and step. Comes in fitted plastic box. Made in Switzerland.

Specifications:

Resolution 0.0005"/0.01mm Accuracy ± 0.001 "/0.03mm

Description	Item#	Each
Econo Digital Caliper	825-1630	\$77.50



C



C. Digital Caliper with Holding Plate – Max 6"/150mm

This caliper comes standard with a stone holding plate attachment for easy measuring for loose stones, watch crystals, beads etc. Convert measurement from millimeters to inches with a touch of a button. LCD display with auto-off system. Measures inside, outside and depth. Comes with nylon case and spare battery.

Specifications:

Max. Measurement 6"/150mm Accuracy ± 0.0001 "/.01mm

Description	Item#	Each
6" Digital Caliper with Plate	825-1632	\$37.95



D

D. Pocket Digital Caliper – Max 4"/100mm

Provides digital accuracy and portability at a very affordable price. Features large LCD screen as well as conversion and zero functions. Uses setscrew to prevent jaws from moving. Runs for one year on 1.5V silver oxide watch battery (included). Measures inside, outside, depth and step. Comes in fitted plastic box. Made in India.

Specifications:

Resolution 0.0005"/0.01mm Accuracy ± 0.001 "/0.02mm

Description	Item#	Each
4" Pocket Digital Caliper	825-1625	\$35.00



E

E. Mini Digital Thickness Gauge – Max 1"/25mm

Compact gauge (just 3 1/2" overall) is small enough to take everywhere. Features large LCD screen for good readability. Has conversion and zero functions. Takes both inside and outside measurements in inches and millimeters. Uses setscrew to prevent jaws from moving. Runs on a 1.5V silver oxide watch battery (included). Comes with storage case.

Specifications:

Resolution 0.0005"/0.01mm Accuracy ± 0.001 "/0.01mm

Description	Item#	Each
Mini Digital Thickness Gauge	825-1620	\$59.95

A. Swiss Plastic/Fiberglass Dial Caliper – Max 150mm

Made of durable super polyamide plastic and fiberglass. Measuring capacity: 150mm. Dial graduations: 0.1mm. Measures inside, outside, depth and step. Comes complete with fitted plastic case. Made in Switzerland.

Description	Item#	Each
Swiss Plastic/Fiberglass Dial Caliper	825-1660	\$36.95



A

B. Swiss Plastic Dial Caliper – Max 6"/150mm

Made of tough reinforced plastic. Measuring capacity: 6". Dial graduations: 0.01" and 1/64". Measures inside, outside, depth and step. Includes fraction conversion table on back. Comes in plastic case. Made in Switzerland.

Description	Item#	Each
Swiss Plastic Dial Caliper	825-1815	\$39.95



B

C. Econo Vernier Caliper – Max 6"/150mm

Graduations with Vernier: 0.001" and 0.02mm. Depth of jaws: 1.6". Made of hardened stainless steel. Uses setscrew to prevent jaws from moving. Has black graduations on a satin chrome finish for easy inside, outside and depth measurements. Comes in plastic box.

Description	Item#	Each
Econo Vernier Caliper	825-1725	\$39.95



C

D, E Brass Sliding Calipers – inch and mm

High quality Pocket Calipers made of Brass. Both measure up to 3 1/4" (1/16" increments) and to 80mm (1.0mm increments). Notched tips are helpful for measuring internal diameters - ID. Can be used as a conversion tool for inches and millimeters. The Vernier model allows measurements to 0.1 mm - OD. Made in Germany.

Description	Item#	EACH Prices		
		1-2	3-5	6+
D. Pocket Vernier Caliper	813-1200	\$12.40	\$11.78	\$11.16
E. Pocket Caliper	813-1205	11.40	10.83	10.26

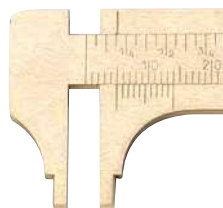

D



E



A



A. Deluxe Combination Degree Gauge

This high-quality, precision steel degree gauge measures in millimeters and lignes. Far superior to ordinary gauges in terms of construction, readability, convenience and finish. Has screw adjustment at base for perfect accuracy even after years of use. Capacity: 13.5mm or 6 lignes (72 douziemes). Graduations: 0.1mm or 1/2 ligne (douzieme). Measures 8" long. Made in Switzerland.

Description	Item#	Each
Deluxe Combination Degree Gauge	813-0905	\$169.00

B



B. Combination Degree Gauge

Made of satin-finished steel with brass index plate. Capacity: 15mm or 6 lignes (72 douziemes). Graduations: 0.1mm or 1/2 ligne (douzieme). Measures 6 1/2" long.

Description	Item#	Each
Combination Degree Gauge	813-0900	\$41.65

C

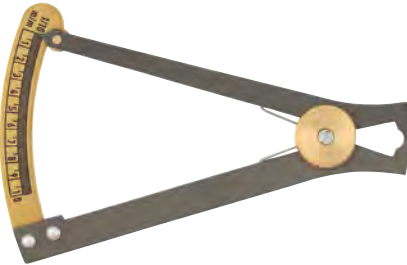

C. Pocket Degree Gauge

An economically priced pocket-size steel gauge. Has easy-to-read black indices on polished brass plate. Capacity: 10mm. Graduations: 0.01mm. Measures 3 7/8" long.

Description	Item#	Each
Pocket Degree Gauge	813-0909	\$15.95

D



D. Mini Degree Gauge

A compact, lightweight gauge made of polished stainless steel. Features easy-to-read indices on both sides. Smaller than conventional gauges yet just as accurate. Capacity: 10mm. Graduations: 0.1mm. Measures 4" long.

Description	Item#	Each
Mini Degree Gauge	813-0850	\$12.35

E



E. Econo Micrometer

This affordable micrometer features 6.5mm diameter satin chrome measuring faces with microfine black graduations, friction thimble, locking lever and durable enamel-coated frame. Carbide-tipped for long wear. Capacity: 25mm. Graduations: 0.01mm. Includes wrench and box.

Description	Item#	Each
Econo Micrometer	825-1827	\$27.95

A. German Divider with Replaceable Tips

Features easily replaceable extra-hard tool steel tips for marking soft and hard metals. Has heavy-duty spring for durability. Measures 3" long. Made in Germany.

Description	Item#	EACH Prices		
		1-2	3-5	6+
3" Replaceable Divider	812-1710	\$11.95	\$11.35	\$10.76
Replacement Tips, pair	812-1711	1.95	-	-



B. German Dividers

Well-balanced, precision-machined steel dividers with ground and hardened points. Use for measuring between points, marking shanks for sizing, scribing circles and more. Sold in three lengths. Made in Germany.

Description	Item#	Each
3" Divider	812-1706	\$10.20
4" Divider	812-1805	10.95
6" Divider	812-1905	12.95



C. Econo Divider

A steel divider with hardened points, knurled pivot handle and adjusting screw. Measures 3" long. Imported.

Description	Item#	EACH Prices	
		1-2	3+
3" Econo Divider	812-1705	\$5.95	\$ 4.96



D. 2" Steel Square

Forms an exact 90° angle for making corners and centering stones. Made of milled steel.

Description	Item#	EACH Prices		
		1-4	5-9	10+
2" Steel Square	811-1715	\$4.45	\$4.01	\$3.78

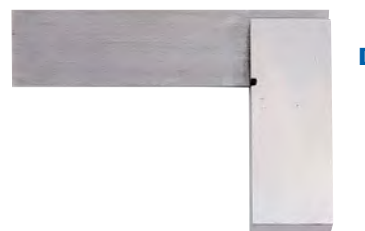

E. Multi Angle Wax Gauge

Perfect for measuring wax. Make 90°, 45° and 30° pieces. Easy to draw parallel lines or to get circular center. Measures approximately 4 3/4" long.

Description	Item#	Each
Multi Angle Wax Gauge	265-2317	\$39.95

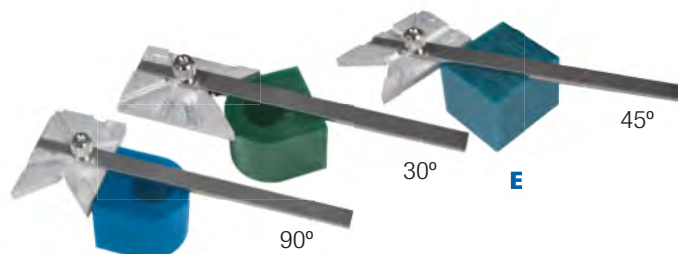

F. Gesswein® 6"/150mm Stainless Steel Ruler

Measures up to 6" (1/32" increments up to 3", 1/16" increments up to 6") or 15.2cm (1mm increments). Features black etched graduations on glare-resistant polished surface for easy reading. Has a table for converting inch fractions to decimal inches or millimeters and a ring length gauge on reverse. Measures 3/4" wide.

Description	Item#	EACH Prices		
		1-4	5-9	10+
6" Stainless Steel Ruler	811-1710	\$5.80	\$5.22	\$4.93





A

A. Bergeon Four-Scale Ring Stick

Heavy-duty anodized aluminum ring stick invaluable for translating foreign sizes. Graduated in four most popular scales: USA sizes 2–15 by 1/4-size increments, French sizes 1–36, English sizes D–Z and EURO sizes 41–76mm. Has laser-etched lines. Measures 10" long. Made in Switzerland.

Description	Item#	Each
Four-Scale Ring Stick	820-8306	\$89.00



B

B. Four-Scale Econo Aluminum Ring Stick

Heavy-duty aluminum ring stick for translating foreign sizes. Graduated in four most popular scales: USA sizes 2–15 by 1/4-size increments, French sizes 1–36, mm diameter 13–24 and EURO sizes 41–76mm. Have laser-etched lines. Measure 9 3/4" long. Imported.

Description	Item#	Each
Four-Scale Econo Ring Stick	820-8309	\$17.95



C

C. Bergeon Aluminum Ring Stick

Heavy-duty aluminum ring stick. Graduated in USA sizes 1 1/2–15 by 1/4-size increments. Features nice heft and glare-free brush finish. Measures 9 7/8" long. Made in Switzerland.

Description	Item#	Each
Aluminum Ring Stick	820-8305	\$82.95



D

D. Grooved Aluminum Ring Stick

Round aluminum ring stick grooved for accepting stone-set rings. Graduated in sizes 1–13 by 1/4-size increments. Has length gauge to measure shank stock for specific ring sizes.

Description	Item#	Each
Grooved Aluminum Ring Stick	841-1250	\$22.55



E

E. Wooden Ring Stick

An extremely accurate, finely finished hardwood ring stick. Graduated in sizes 3–15. Great for wirework because it won't scratch jewelry. Less likely than metal ring sticks to damage glass and other fine surfaces.

Description	Item#	EACH Prices	
		1-2	3+
Wooden Ring Stick	816-0180	\$12.95	\$11.66



F

F. Grooved Plastic Ring Stick

Made of durable black plastic. Has groove for stone-set rings. Graduated in sizes 1–15 by 1/4-size increments.

Description	Item#	Each
Grooved Plastic Ring Stick	820-8310	\$5.25

A. Elma® Ringmeter – For fast, easy ring size measurements!

This revolutionary digital device lets you measure an exact finger circumference in any international standard at the touch of a button. Features a universal ergonomic design for left- or right-handed operation. Capacity: 13–26mm dia. Includes a storage cradle and operating instructions. Runs on just one 9V battery (included). Measures 2½"W x 9¼"L. Weighs 1 lb. Made in Germany.

Description	Item#	Each
Ringmeter	816-0176	\$128.50



B. Four-Scale Metal Ring Sizes

Nickel-plated, brightly polished 3mm wide metal bands (36 total) marked with inside diameters from 13.0–24.2mm, circumferences from 41–76mm and closest equivalents of USA sizes from 1–15½ and French sizes from 1–36. Seamless one-piece construction.

Description	Item#	Each
Four-Scale Metal Ring Sizes	816-0174	\$28.50



C. Wide Metal Ring Sizes

Nickel-plated, polished 7mm wide metal bands (29 total) in sizes 1–15 by ½-size increments. Use to measure fingers for wide rings.

Description	Item#	EACH Prices	
		1-2	3+
Wide Metal Ring Sizes	820-8150	\$14.65	\$13.19



D. Metal Ring Sizes

Durable, highly polished metal bands (20 total) in sizes 4–13 by ½-size increments.

Description	Item#	EACH Prices	
		1-2	3+
Metal Ring Sizes	820-8060	\$13.95	\$12.56



E. Durston Steel Finger Gauge Set 1-16

Stamped and manufactured from high quality steel stock, the Durston ring gauge is precisely machined and calibrated to match the Durston ring mandrels (Steel-#841-1141 and Aluminum-#841-1140) to provide consistent measurements. Includes U.S. sizes 1–16 in clearly marked half-size increments. Made in the United Kingdom.

Description	Item#	EACH Prices	
		1-2	3+
Steel Finger Gauge	820-8059	\$26.00	\$24.70



F. Econo Ring Gauge Sizing Set (1-15) ½ Increments

Standard Width Ring Sizing Set is made out of bright nickel-plated stock and comes in US Sizes 1-15, with ½ increments. Handy to have available when measuring fingers for standard width rings. Made in India.

Description	Item#	EACH Prices		
		1-2	3-5	6+
Econo Plastic Ring Sizes	820-8058	\$10.95	\$9.86	\$9.31



G. Econo Plastic Ring Sizes

Lightweight turquoise plastic bands (29 total) in sizes 1–15 by ½-size increments. Can be given to customers for use at home. Color may vary.

Description	Item#	EACH Prices		
		1-2	3-11	12+
Econo Plastic Ring Sizes	820-8100	\$1.50	\$1.35	\$1.13



H. Disposable Plastic Ring Sizes

Blue plastic bands in sizes 2½–14 by ½-size increments (23 total). Just punch out the one you need for each sizing job to ensure a perfect fit. Sold in sets of 12 sheets (276 bands per set).

Description	Item#	Pkg. of 12 Prices	
		1-11	12+
Disposable Plastic Ring Sizes	820-8105	\$6.55	\$5.90

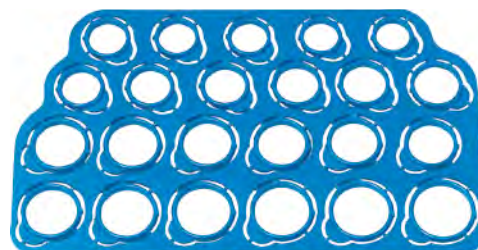



A



B



C



D



E



F



G



H



I



J



K

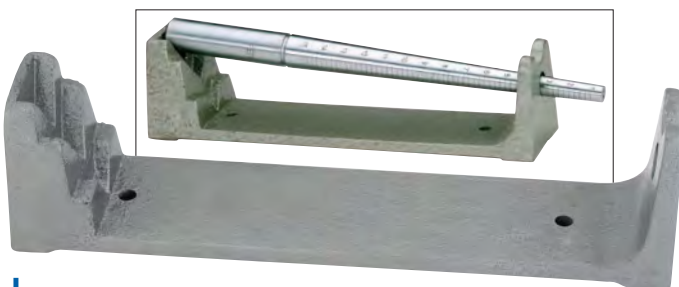

L

A, B Steel Ring Mandrels

Round steel ring mandrels. Available in plain style or grooved style for stone-set rings. Graduated in sizes 1–16 by 1/4-size increments. Made in USA.

Description	Item#	Each
A. Plain Style	841-1165	\$35.25
B. Grooved Style	841-1170	36.35

C-F Econo Ring Mandrel Aluminum – Standard + Grooved

Made of solid rolled aluminum, available Standard or Grooved. Laser engraved with USA sizes 1-15 and with 1/4-size increments. Choose from a Bench/Showroom Sizing kit which includes a Standard Steel Mandrel, Standard Aluminum Mandrel and Ring Gauge Sizing Set OR a Showroom Sizing kit which includes a Standard Aluminum Ring Mandrel and Ring Gauge Sizing Set. Made in India.

Description	Item#	EACH Prices		
		1-2	3-5	6+
C. Aluminum Standard	841-1133	\$17.50	\$15.75	\$14.88
D. Aluminum Grooved	841-1134	17.95	16.16	15.26
E. Econo Showroom Sizing Kit	841-1137	26.95	24.26	-
F. Econo Bench/Showroom Sizing Kit	841-1136	44.95	40.46	-

G-I Durston Finger Gauge & Mandrels

Durston Steel Finger Gauge Set 1-16

Stamped and manufactured from high quality steel stock, the Durston ring gauge set is precisely machined and calibrated to match the Durston ring mandrels: Steel (841-1141) and Aluminum (841-1140) to provide excellent consistency at your bench during manufacturing and also the same consistency when sizing a ring in front of your customer in the retail showroom.

Durston Aluminum and Steel Mandrels

Made of quality machined aluminum or hardened steel both are easy to read as each mandrel is laser engraved with sizes 1-16 US in quarter size increments.

- Showroom Kit includes an Aluminum Mandrel (841-1140) and a Ring Gauge Set (820-8059)

Made in the United Kingdom.

Description	Item#	EACH Prices	
		1-2	3+
G. Durston Steel Finger Gauge Set	820-8059	\$26.00	\$24.70
H. Durston Aluminum Mandrel	841-1140	42.00	39.90
I. Durston Steel Mandrel	841-1141	42.00	39.90
Showroom Sizing Kit	841-1144	60.00	57.00

J. Steel Mandrel for Large Rings

Round steel mandrel for holding large rings, bezels, hoop earrings and other items. Graduated in sizes 16–24 by 1/4-size increments. Features knurled handle for solid grip. Measures 8 1/4" long.

Description	Item#	Each
Steel Mandrel for Large Rings	841-1171	\$39.75

K. PEPETOOLS Square Steel Ring Mandrel

Square steel ring mandrel with rounded corners for holding, shaping and straightening rings. Tapers from 24mm to 12mm square. Imported.

Description	Item#	Each
Square Steel Ring Mandrel	841-1109	\$33.50

L. Mandrel Rest

Holding a ring mandrel while working can be awkward. This rest holds the mandrel at both ends to solve the problem. Also holds bracelet mandrels without tangs. Can be secured to your benchtop. Made of cast iron. Mandrel not included. Measures 11.5" long x 2.5" wide. Made in India.

Description	Item#	Each
Mandrel Rest	841-2080	\$40.40

A-G True-Size Ring System

Sizing Errors Are a Thing of the Past!

This precision calibrated ring sizing set offers consistent, dependable measuring when sizing rings time after time. The high quality and the polished professional look will impress your customers on the other side of the counter! Sold as a complete set with matching aluminum mandrel or you can also purchase just the Ring Sizes only. Standard Steel Mandrel also sold separately comes etched with sizes 1-16 in quarter sizes and calibrated to the Ring Sizers. Sets available in either 3mm or 6mm widths.

Description	Item#	EACH Prices	
		1-4	5+
A. 3mm True-Size with Aluminum Mandrel	841-1122	\$178.50	\$160.65
B. 6mm True-Size with Aluminum Mandrel	841-1116	150.00	135.00
C. 3mm True-Size Set only	841-1123	140.00	126.00
D. 6mm True-Size Set only	841-1115	188.50	169.65
E. Aluminum Mandrel	841-1117	34.00	-
F. Standard Steel Mandrel	841-1118	36.00	-
G. Grooved Steel Mandrel	841-1119	36.00	-



H. True-Size Bangle Gauge

The newest member of the True-Size family has arrived! From the manufacturers of the True-Size Ring Set, the Bangle Gauge is a great addition for obtaining accurate sizes of bangles. Made of solid aluminum, the True-Size Bangle Gauge will measure precisely the inside circumference (6.67" – 9.42") as well as the inside diameter (2.125" – 3.0") of bangles. Also marked accordingly in millimeter sizes. Sits flush on any flat surface with a felt bottom not to scratch your jewelry counter top.

Description	Item#	Each
True-Size Bangle Gauge	841-1120	\$26.95



I, J Bracelet Mandrels

Ideal for shaping, stretching and forming bracelets and other items. Made of hardened and polished cast iron. Round mandrel measures 14³/₈"L and tapers from 3¹/₂" to 2". Oval mandrel measures 11³/₄"L and tapers from 3" x 2¹/₂" to 2" x 1¹/₂". Made in Italy.

Description	Item#	Each
I. Round Bracelet Mandrel	841-2050	\$135.00
J. Oval Bracelet Mandrel	841-2060	199.00



K. Round Wooden Bracelet Mandrels

Round tapered hardwood mandrels for shaping and removing dents and kinks from bracelets and bangles made of soft, nonferrous metals. Will not mar jewelry.

Size	Item#	EACH Prices	
		1-2	3+
15"L x 2 ¹ / ₂ "-1 ¹ / ₂ " dia.	841-3032	\$16.45	\$13.98
14"L x 3 ¹ / ₂ "-2" dia.	841-3031	22.50	19.13



L. Bangle Size Gauge Set

Constructed of solid steel and highly polished, the Bangle Size Gauge Set is a must for any retailer and/or manufacturer with the need to measure and determine bangle sizes. Comes complete with 27 pcs on a solid ring in sizes 1 – 27 (1.80" to 3.20"). Sizes clearly marked (1-27) with European sizes (MM) on the opposite side of the same ring. Made in India.

Description	Item#	EACH Prices	
		1-2	3+
Bangle Size Gauge Set	820-8056	\$24.50	\$22.05



Mettler Toledo – A Market Leading Scale Manufacturer

Mettler is a world leader of top quality instruments. Made in Switzerland.



A

A. Mettler Carat Scale JE-703C/A

Legal for Trade, Pre-sealed – 700ct x 0.001ct

The Mettler Toledo JE Carat Scale features an intuitive menu, easy to read display and 7 built-in applications. Toggle key allows instant switching between carats and grams. Connects to PC or printer with RS232 interface, no additional software needed. Solid metal base, reinforced body and overload protection. Legal for trade. One year warranty. Made in Switzerland.

Specifications:

- Maximum Capacity: 700ct/140g
- Readability: 0.001ct/0.1 mg
- Platform size: 3½" dia.
- Setting time (typical): 2.0 sec.
- Electrical: 115V AC adapter (accepts 2 AA batteries)
- Weight: 10lbs. (4.5kg)

Description	Item#	Each
Mettler Carat Scale JE-703C/A	200-3653	\$1,425.00



B

B. A&D Gold Scale EK-1200i

Legal for Trade, Class 2 – 1200g x 0.1g

A&D Company, based in Japan, has been manufacturing electronic balances for over 30 years and is well known for high accuracy, long life and low cost – ISO 9000 Certified. The EK-1200i compact balance features a large easy to read display, full digital calibration, overload protection, 9 weighing units (g, ct, oz, ozt, dwt, tl, grain, momme) and a counting function. Connects to PC or printer with RS232 interface. Has a security ring to prevent theft. Legal for trade, Class 2. Five year warranty. Made in Japan.

Specifications:

- Maximum Capacity: 1200g
- Readability: 0.1g
- Platform size: 5.2" x 6.7"
- Electrical: 115v AC adapter
- Weight: 3.3lbs. (1.5kg)

Description	Item#	Each
Gold Scale EK-1200i	200-3655	\$345.00



C

C. MY WEIGH Palmscale 8.3 – 300g x 0.01g

The perfect field scale for jewelers, law enforcement, dieticians and anyone who requires portable precision weighing. Features dual line display with price computing functions and the ability to display two modes at the same time (e.g., both grams and ounces). Reverse lit LCD display makes the scale easy to read in all weighing environments. The Hydro Hinge provides easy opening of the scale with just the flick of a button. Powered by two AAA batteries. Sleek chrome body and rubberized form-fitting casing. Measures 3¼"W x 4¾"D overall. Platform is 2.7" x 2.5".

Specifications:

- Capacity x Grad. 300g x 0.01g / 1500.0ct. x 0.1ct.
- 192.90dwt x 0.01dwt / 10.582oz. x 0.001oz.
- 4629.7gn x 0.1gn

Description	Item#	Each
MY WEIGH Palmscale 8.3	200-3630	\$74.99



D

D. Pocket Pan Gram Scale – 500g x 0.01g

Compact Design, portable to go anywhere scale comes with plastic cover to keep weighing pan clean and easy loading.

Cover can be used as a weighing tray. Powered by 2 AAA batteries. Scale features auto-off function with cool blue backlit LED display. Weighs g, oz, gn and ct. Two year warranty. Made in China.

Specifications:

- Maximum Capacity: 500g
- Readability: 0.01g
- Platform size: 4.0" x 4.0"
- Weight: 8.5oz (240g)

Description	Item#	Each
Pocket Pan Scale	200-3642	\$45.00

A. Digital Pocket Scale - 50ct x 0.01ct

This small, portable scale features advanced load cell technology for accurate readings, LCD screen and simple calibration, tare and zeroing functions. Weighs in grams, carats, pennyweights and ounces. Includes calibration weight and carrying case. Runs on two AAA batteries (included). Measures 3"W x 5 1/8"D x 1 1/2"H.

Specifications:

Capacity x Grad. Capacity: 50 carats
Graduation: 0.01ct.

Description	Item#	Each
Digital Pocket Scale	200-3583	\$139.95



A

B. GemOro PCT 101 Premium Class Carat Scale - 100ct x 0.005ct

GemOro has created the next generation of a superior carat scale with unique features, style, precision, durability and more! This extra precision carat scale offers accuracy of 0.005ct, with a capacity of 100ct. The functions are controlled by a convenient, easy to use 4-button control panel. Its innovative, low profile flip up draft shield easily expands to accommodate the weighing of large stones or parcels. The rubberized compact carrying case protects the scale while in transit and holds the scale, calibration weight, Swiss-style diamond tweezers, diamond scoop, stainless steel weighing platform. Comes supplied with a dual-voltage 100-240V AC adapter.

Features:

- 100ct x 0.005, g, dwt, oz, ozt and gn
- Parts counting function
- Large stainless steel weighing platform & bright blue backlit display
- Push button digital calibration, tare, memory, low battery indicator and battery saving auto-off functions
- Innovative low profile tinted draft shield manually expands for weighing large diamonds, gemstones and parcels
- Durable ABS construction with EZ-grip rubberized paint finish
- Includes a rubberized protective travel / storage case with compartments containing scale, stainless steel calibration weight, stainless steel weighing platform, scoop, AC adaptor and Swiss-style locking diamond tweezers
- Powered by (4) long-life included AAA batteries or its supplied universal voltage 100-240V AC adapter
- 5 Year limited replacement warranty

Description	Item#	Each
Gemoro PCT 101 Premium Class Carat Scale	200-3632	\$89.95



B

C. GemOro Platinum XP500 Scale - 500g x 0.01ct

GemOro Platinum XP500 is a precision, high capacity digital scale with an accuracy of 0.01g and can weigh up to 0.5kg on the 4" square stainless steel weighing platform. Scale includes two weighing trays/covers; the large tray serves as a scale cover and the small tray covers the weighing platform. We suggest the purchase of 2 - 200 gram calibration weights item number 200-3592. Powered by 2 AAA batteries. 110V adapter #200-3634 also available, if desired. Scale measures 5.25" D x 4.5" W x 0.94" H. Stainless steel weighing platform measures 4" x 4".

Specifications:

Capacity x Grad. Capacity: 500g
Graduation: 0.01ct.

Description	Item#	Each
GemOro PlatinumXP500 Scale	200-3631	\$29.95

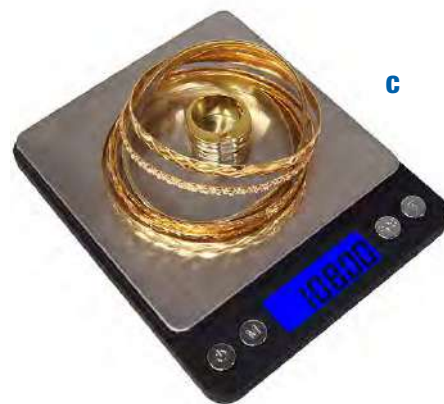

C

D. GemOro V600M Platinum Scale - 600g x 0.01ct

In your pocket and ready to go! The NEW V600M Pocket Scale is a must for anyone on the go! Built with a durable rubber construction and stainless steel weighing platform, the V600M boasts a capacity of 600g x 0.1g and with the touch of a button toggles between grams (g), ozt, oz and dwt. Easy to read, this scale has a bright blue illuminated LCD display. Other features include push button digital calibration, tare, memory, low battery indicator, battery saving auto-off functions and also supplied with a removable protective cover which also serves as a handy weighing tray for your jewelry or findings. Powered by (2) AAA batteries (included) and carries a 2-year limited replacement warranty.

Specifications:

Capacity x Grad. Capacity: 600g
Graduation: 0.01ct.

Description	Item#	Each
GemOro V600M Platinum Scale	200-3633	\$8.35



D

A



A. GemPro 250 - 250ct x 0.01ct; 50g x 0.002g

A compact scale that reads in grams, carats, grains, pennyweights, ounces and troy ounces. Includes calibration weight, stainless steel expansion tray and scoop/bowl. Runs on 4 AAA batteries or 110V AC adaptor (included). Measures 3¾"W x 5¼"D x 2"H.

Features:

- Dual-division capability
- Static-electricity resistance
- 3 calibration settings
- 6 weighing modes
- Programmable auto-off function (1-9 minutes)
- Adjustable stabilization feet with level indicator
- Optional backlight
- Full tare function
- Protective hard plastic storage case

Description	Item#	Each
GemPro 250	200-3628	\$235.00

B



B. GemOro® Platinum PRO501VXP - 500g x 0.01g

The perfect countertop / portable scale for professional jewelers, findings dealers, precious metals scrap buyers and gold wholesalers. The GemOro Platinum PRO501VXP offers the extra precision you want, combined with the durability and features you need. Unmatched performance, low profile contoured design, rock solid stability and more all at a great value. Made in China.

Features:

- Capacity / Readability: 500g x 0.01g, ozt, oz, dwt, ct, gn
- Pushbutton digital calibration, tare, memory, overload protection and battery saving auto-off function
- Parts counting PCS
- Stainless steel 4.25" round weighing platform
- Adjustable height, feet and leveling bubble indicator
- Low battery and weight stability indication
- Large bright blue backlit LCD display
- Powered by (4) AA batteries (supplied) or universal voltage 100V-240V AC adaptor (included)
- Includes (2) 200g calibration weights
- Black EZ-grip rubberized paint finish
- Overall dimensions (W x D x H) 6" x 8.25" x 2"
- 2 Year limited replacement warranty

Description	Item#	Each
GemOro Platinum Pro 501VXP	200-3640	\$74.95
Replacement 110V-240V AC Adaptor	200-3634	9.95

C



C. GemOro® Professional Scale - Pro 1001V - 1000g x 0.01g

The perfect portable scale for professional jewelers, precious metals scrap buyers and gold wholesalers has arrived. Platinum PRO1001V offers the precision you want, combined with the durability and features you need. Unmatched performance, low profile contoured design, rock solid stability and more – all at an affordable price. Requires a calibration weight. We Suggest our 200 gram calibration weight 200-3592.

Features:

- Capacity / Readability: 1000g x 0.1g, oz, ozt, dwt, gn, ct and kg
- Push button digital calibration, tare, memory, overload protection and battery saving auto-off function
- Parts counting PCS
- Large stainless steel weighing platform 5" x 5"
- Adjustable feet and leveling bubble indicator
- Low battery and weight stability indication
- Large bright blue backlit LCD display
- Powered by (4) supplied long-lasting AA alkaline batteries or Optional universal voltage 100V-240V AC adaptor (200-3634)
- 2 Year limited replacement warranty. Made in China.
- Overall Dimensions: 6¼"W x 8¼"D x 2¾"H.

Description	Item#	Each
GemOro Professional Scale	200-3636	\$39.95

D



D. Investment Scale

This economical yet accurate scale weighs up to 10 lbs. in 2 oz. increments. Features 4" dial with large, easy-to-read numbers that indicate weights and water/investment ratios. Includes scoop.

Description	Item#	Each
Investment Scale	200-2020	\$27.80



A



B



C



D



E

A. CZ Master Set Pro 2™ 1.00ct 10 Stone Set

Professionally color grade diamonds in seconds. Each stone in the precision CZ Master Set Pro 2™ is treated with GemOro's proprietary ColorLast™ technology to ensure permanent color saturation. Expertly hand-graded to master diamond color standards using the GIA grading scale. The set comes in GemOro's PATENT PENDING LED illuminated grading and storage case, featuring daylight and UV LED's, powered by rechargeable NiMH batteries and a micro-USB charging/power system.

Features:

- Largest range of reference available: E, F, G, H, I, J, K, L, M and N comparison stones in 1.00ct diamond size
- Standard GIA grading scale with laser inscribed color ID
- Portable LED illuminated grading and storage case with built-in grading tray
- Daylight illumination & UV fluorescence detection
- Includes solitaire ring stone holder set for comparing mounted stones, and 100V-240V AC adapter
- Lifetime Limited Manufacturer's Warranty against color change

Description	Item#	Each
CZ Color Master Set	813-1662	\$429.00

B. Diamond Sieves

A total of 22 chrome-plated brass plates, 50mm in diameter. Use for sorting diamonds, pearls and more. Packaged in leather case.

Description	Item#	Each
Diamond Sieves	816-1300	\$65.00

C. Stone Shovel

Nickel-plated shovel with handle for scooping and handling stones. Measures approx. 3"L x 1³/₄"W.

Description	Item#	Each
Stone Shovel	816-1200	\$3.35

D. Jewelry Appraisal Form

Official insurance appraisal form for jewelers and appraisers. Three-part, carbonless format. Sold in packages of 50. Ship. wt: 1 lb.

Size	Item#	Pkg. of 50
8 ¹ / ₂ " x 11"	810-0430	\$20.85

E. High-Quality Diamond Parcel Paper

Unmatched in sensitivity and protection for handling loose polished or rough diamonds and precious stones. Made of the finest paper stock, then hand-finished for the right touch. Specially developed with the best blue and white flute colors to enhance D-H color diamonds and reflect them in the best light. Measures 3¹/₄" x 1³/₄". Sold in packages of 25 sheets.

Description	Item#	Pkg. of 25
High-Quality Diamond Parcel Paper	810-0460	\$10.15

A



A. GXL NEXT Gold Tester

Introducing the next generation of electronic gold testers... the Tri Electronics GXL NEXT Gold, Silver & Platinum Tester has arrived! The GXL Next has the ability to test gold, silver, & platinum. Made in the USA.

Features:

- No calibration required each time tester is turned on
- Optimal electronic karat determination with full range from 6 to 24 karat (10, 14, 18, 22, 24 and all karats in between)
- Quick mode testing feature instantly measures yellow gold in 10, 14, 18, 20, 22, and 24 karats
- Touch mode testing - no push button - simply touch
- Capable of 1000+ clear and clean tests per cartridge with no mess
- Liquid testing solution is harmless and contains no toxic chemicals
- Operates on 3-AAA batteries (included). AC Adapter Sold Separately
- If sensor (test pen) is left uncapped, it will not deteriorate or dry out

Description	Item#	Each
A. GXL NEXT Gold Tester	817-1054	\$580.00
Gold Test Solution	817-1055	18.90
Silver Test Solution	817-1056	18.90
Sensor Pen - Gold	817-1057	51.45
Sensor Pen - Silver	817-1058	51.45
AC Adapter	817-1059	21.35

B



B. Gold Testers G-XL-18 and G-XL-24 PRO

These testers are small enough to fit in a pocket or attaché case for on-the-spot testing in the field. The G-XL-18 takes four seconds to test from 6 up to 18K yellow, white, red or green gold. Indicates "Not Gold" if the metal is plated or gold-filled and "Platinum" if pure platinum. The G-XL-24 PRO tests from 6 up to 24K yellow, white, red or green gold.

Each unit initiates an electrochemical reaction with the test piece to measure karat content within a half-karat. Displays a reading only to the nearest karat. Intended for use as a first tool for indicating karat content—does not adequately substitute for fire assaying. Runs on two 9V batteries (included).

Description	Item#	Each
B. G-XL-18	817-1022	\$425.00
G-XL-24 PRO	817-1026	405.00
G-XL-18 Gel Refill (off-white)	817-1029	18.45
G-XL-24 PRO Gel Refill (pink)	817-1027	18.45
Replacement Sensor Pen, G-XL-18	817-1028	58.85
Replacement Sensor Pen, G-XL-24 Pro	817-1033	58.85

C



C. Gold Testers GT-3000 and GT-4000

Portable electronic devices for efficient and quick determination of yellow, white, pink and green gold karat values. The GT-3000 tests from 6 up to 18K gold and pure platinum, and the GT-4000 tests from 6 up to 24K gold and pure platinum. Both units can also distinguish solid gold from gold-plated items.

Each unit is easy to use: place drop of conductive gel on test item, touch item with sensor pen, wait just four seconds for reading to appear on the LCD, then match reading to the chart conveniently imprinted on the Gold Tester to find correct karat value. Runs on two 9V batteries (included).

Description	Item#	Each
C. GT-3000 (6-18K)	817-1021	\$195.00
GT-4000 (6-18K, 20K, 22K, 24K)	817-1030	299.00
GT-3000 Gel Refill (off-white)	817-1029	18.45
GT-4000 Gel Refill (pink)	817-1027	18.45
Replacement Sensor Pen, GT-3000	817-1034	56.00
Replacement Sensor Pen, GT-4000	817-1035	56.00

D



D. Glass Acid Bottles

Hold 1/2 oz, each supplied with ground glass stopper and applicator. Needles, stone and acids not available from Gesswein.

Description	Item#	EACH Prices	
		1-2	3+
1/2-oz. Glass Acid Bottle	813-1410	\$6.80	\$6.12

A. GemOro AuRACLE™ Digital AGT3 Gold and Platinum Tester

The new advanced digital AGT3 is the ultimate verification instrument for gold and platinum testing. This state-of-the-art portable handheld tester has exceptional precision, is simple to use and in seconds provides accurate results showing both the digital karat value and gold percentage – PATENTED WITH PATENTS PENDING.

Features:

- Fast and simple one step calibration
- Tests all colors of gold from 6K to 24K and tests platinum
- Alphanumeric LCD display shows both karat value and gold percentage
- Multi-test modes
- Easy one-step calibration using either 14K or 18K yellow gold
- Durable nickel-plated stainless steel testing plate
- Auto-check pen probe function
- Sleek, contoured and ergonomic design
- Easy to read LCD display
- Automatic low battery indicator
- Follow easy steps to identify non-gold, gold plate and gold filled as NA
- Simply touch pen probe to filed gold or platinum and results are shown in seconds
- Replaceable pen probe provides thousands of tests with proper care
- Compact and portable
- Powered by included 9V alkaline battery or 100V-240V AC adaptor
- INCLUDES: AGT3, pen probe, file, battery, AC adaptor and rubberized carrying case
- Shipping weight: 3 lbs.



A

Description	Item#	Each
A. AuRACLE ATG3	817-1046	\$549.00
Replacement Pen Probe for ATG3	817-1048	29.95
Replacement AC Adapter	817-1042	19.95
14K Calibration Disc	817-1043	29.95

B. GemOro AuRACLE™ AGT Blue Mobile Tester

The Auracle family of Gold Testers are now even more advanced! GemOro, the leader in precision gold testing equipment now offers the next generation of Gold Testers on the market. . .AGT Blue! The revolutionary and best performing Auracle gold testers has evolved to a new generation with this Bluetooth Mobile version making it easier and more convenient than ever before! Compact and pocket size (no wires required), the AGT Blue works with any low-energy Bluetooth Apple, Windows and Android device (phone, tablet). With its distinct technology built in, the AGT Blue will calculate your unique buying price while also generating a detailed email receipt for both your business and to your customer almost instantly. Will test all colors of gold (10K, 14K, 18K, 22K, 24K) as well as platinum.

Features:

- One touch easy calibration for consistent results
- May be calibrated using 10K, 14K, 18K, 22K, 24K or platinum
- World's best performing gold testing technology with unmatched accuracy
- Tests all colors of gold in 10K, 14K, 18K, 22K, 24K and platinum
- Follow easy steps to identify non-gold, gold plate and gold filled as NOT GOLD
- Simply touch pen probe to gold or platinum for results
- Pen probe provides thousands of tests with proper care
- No messy gel. No staining chemicals. No dangerous acid.
- Includes AGT BLUE with built-in testing plate, pen probe, file, carrying case and easy to follow tutorial instructions (mobile device not included)
- One Year Limited Warranty
- Made in Singapore



B

Description	Item#	Each
B. AuRACLE AGT Blue Mobile Tester	817-1049	\$399.00



A

A. Presidium® Adamas Diamond Tester

The only diamond and moissanite tester with a replaceable tip, significantly reducing downtime. Accurate testing on colorless diamonds as small as 0.02 carats. Use the micro probe tip, (sold separately) to authenticate colorless diamond melee as small as 0.01 carats. Features a dynamic LED display and a sleek ergonomic grip. Measures approximately 7½"Lx1½"Wx1"H, weighs only 3.5 oz. Powered by 3 AAA batteries (not included) providing about 12 hours of continuous use. Includes USB cable. One year manufacturer's warranty. Made in Singapore

Features:

- In-built memory chip for up to 500 test records
- Dynamic display with super bright micro LED for clear and distinct results
- Retractable thermoelectric probe tip that ensures constant pressure between probe and gemstone, for enhanced accuracy
- Light and portable for convenience

Description	Item#	Each
A. Adamas Diamond Tester	817-1095	\$399.00
Optional Micro Tip	817-1096	69.00
Replacement Tip	817-1094	69.00

B



B. Presidium® (PMuT II) Multi Tester

Instantly separate colorless diamonds from moissanite, colorless sapphire, colorless spinel, cubic zirconia, zircon and other diamond simulants, based on their thermal and electrical properties. Its measuring probes and electronic circuitry detect data from the gemstone being tested via a customized micro-controller.

PMuT III has a retractable probe tip ensuring consistent pressure against the gemstone during testing for reliability. Probe tip size of 0.6mm, tests colorless diamonds as small as 0.02ct. Simple and easy to use with no waiting time between tests.

Complete with metal alert buzzer, low battery indicator, automatic power shut-off and protective case for portability. Ergonomic design with a rubberized anti-slip grip and an all-around LED display for easy readability, ease of handling and reading of results while testing. Runs on 3 AAA batteries (not included) or purchase the optional power adaptor (817-1093) for extended usage. Measures approx. 6½"Lx1"Wx1½"H Weighs just 3.42 oz. without batteries. One year manufacturer's warranty. Made in Singapore.

Description	Item#	Each
B. (PMuT II) Multi Tester	817-1097	\$209.00
Optional Power Adaptor	817-1093	19.95

C



C. Presidium® Synthetic Diamond Screener II (SDSII)

Developed by Presidium to screen out the Type Ila colorless (D to J) diamond, which is likely to be synthetic and created through chemical vapor deposition (CVD) or high pressure high temperature (HPHT) syntheses, from the natural Type Ia colorless diamond. Type Ia and Type Ila diamonds each absorb different amounts of UV light allowing the user to differentiate between these diamonds. Can use on all cuts with a flat surface, even mounted stones with an "open-back" setting, which range in dimension from 1.5 mm in width and up to 5 mm in height (approx. 0.02 to 10 carat size). Runs on 4 AAA alkaline batteries (not included). Measures approx. 5"Lx4"Wx2.5"H (130 x 100x 65mm). Weighs only 3.88 oz. without batteries. One-year manufacturer's warranty. Made in Singapore.

Features:

- Auto shutdown of interior LED light source for safe testing when lid of device is open or when Start Test button is not activated
- Low battery indicator and energy saving auto power-off

Description	Item#	Each
Synthetic Diamond Screener II (SDS II)	817-1092	\$599.00

D



D. Presidium® Gem Tester/Colored Stone Estimator (PGT/CSE)

This desk-top, colored gemstone thermal tester provides a quick and easy way to identify diamonds and separate 15 types of common colored gemstones* from one another based on their thermal conductivity. The PGT/CSE has a retractable probe tip (0.6mm size) which ensures consistent pressure against the gemstone during testing for more reliable results even for stones as small as 0.02ct *Does not differentiate between natural and synthetic colored gemstones.

Complete with metal alert buzzer to ensure that probe tip is in contact with gemstone during testing, easy-to-read analog dial, built-in diamond and simulant test discs for reference, tests both polished and unpolished gemstones. Simple to use, no waiting time between tests. Runs on 2 AAA alkaline batteries (not included). Measures approx. 6½"L x 3"W x 3"H. One-year manufacturer's warranty. Made in Singapore.

Description	Item#	Each
(PGT/CSE) Gem Tester	817-1098	\$199.00

A-C GemOro Ultratester 3+® Diamond & Moissanite Tester

UltraTester 3+ Diamond, moissanite & white sapphire tester identifies, detects and separates diamond from CZ and moissanite. The patented ergonomic design features new advanced exclusive ultraviolet "UV" F1 moissanite testing technology, shown to be the most effective technology for identifying the widest range of the electrically conductive moissanite material available, including the (3) AAA NiMH rechargeable batteries, micro USB cable with universal voltage AC adapter/charger, loose stone holder, and new compact rubberized portable storage / travel case and super low electrically conductive F1 moissanite. Limited Lifetime Manufacturers Warranty. Designed in the USA. Made in China.

Features:

- Precision retractable probe-tip with enhanced durability
- Fast warm-up time
- Unique beep tones & patented glowing probe tip and light pipe indication: GREEN = Diamond, BLUE = Moissanite, PINK = Sapphire and RED = Metal Alert

Description	Item#	Each
A. GemOro Ultratester 3+	817-1036	\$199.00
B. GemOro Ultradock 3	817-1038	24.95
C. Test Stone 5x Magnifier	817-1039	19.95



UltraTester II on Docking Station



D. GemOro Testerosa Diamond Tester

Identifies between diamond, moissanite and white sapphire. Including super-low electrically conductive Forever One, LED stone illumination and UV fluorescence detection light. Comes complete with a precision retractable probe-tip with enhanced durability. Features a fast warm-up time, plus a user programmable, talking (English, German, Italian, Spanish, French, Russian, Chinese, Japanese, Arabic and more) or ringtone sounds, and glowing light bar / probe tip for quick stone identification (Green = Diamond, Blue = Moissanite, Yellow = Sapphire and Red = Metal Alert). The metal alert warning feature informs you if the setting is touched. The auto-off function preserves battery life. Easily identifies genuine sapphire watch crystals too. Powered and charged (rechargeable batteries) by a Micro USB or included AC Adapter. Includes: UltraDock 3 charger, Test Stone Magnifier, loose stone holder and carrying case. Manufacturers 10 year warranty on Probe tip, Lifetime limited replacement warranty. Made in China.

Description	Item#	Each
GemOro Testerosa Diamond Tester	817-1070	\$299.00



E. DiamondNite Dual Tester – Diamond and Moissanite Tester

Performs two tests in sequence: first test determines if the stone is diamond or simulant; half a second later, second test determines if the stone is diamond or Moissanite. Saves time and money over two separate testers. Runs on 9V battery (included). Comes complete with metal holding plate for loose stones and tip cover. Measures 6³/₈"L x 1³/₄"W x 3/4"D. Made in USA.

Description	Item#	EACH Prices	
		1-2	3+
DiamondNite Dual Tester	817-1002	\$228.95	\$217.50



F. Gemlogis Lapis ONE Multi Tester

Highly accurate, rechargeable Lapis ONE multi tester distinguishes between diamond, moissanite, simulant and metal. Uses "Visible Violet Light" technology which excites the atoms and improves electrical conductivity to detect the Forever One™ Moissanite. Features a unique ATC Solution (Ambient Temperature Compensation) for increased accuracy and retractable tip to maintain constant pressure against the stone. Quick & accurate testing of stones as small as 0.02 regardless of shape, rough, loose or mounted. Complete with convenient carrying case, lanyard, metal stone rest and charging adapter. Rechargeable Lithium Battery provides up to 10 hours of continuous operation. Two-year manufacturer's warranty. Made in Hong Kong

Description	Item#	Each
Gemlogis Lapis ONE Multi Tester	817-1081	\$199.00



G. Diamond Tech Pro – Diamond Tester

Offers automatic and manual modes (former requires no adjustments, and latter lets you make adjustments for stone size and environmental conditions). Uses adjustable gain to test even the smallest stones. Features clear linear display, audible diamond signal, metal alert, low battery indicator and automatic shutoff. Runs on 9V battery (included). Measures 6¹/₂"L x 1⁷/₈"W x 3/4"D. Backed by seven-year limited manufacturer's warranty. Made in USA.

Description	Item#	Each
Diamond Tech Pro Tester	817-1008	\$105.95





A



B



C

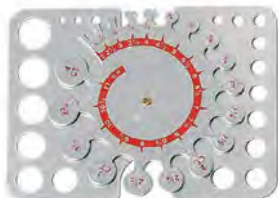

D



E



F



G

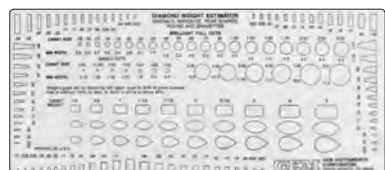

H

A. Gemlogis Saffron Sorting Gauge

Easy-to-use Saffron Sorting Gauge provides a direct clear digital readout. All-in-one motion allows you to use one hand instead of holding tweezers in one hand and a gauge in the other. Simple sorting and measuring all in one motion!

Features:

- Solid state Digital Readout, easy to read.
- Measuring range of 0.00 to 15mm with an accuracy of 0.01 (0.02 tolerance).
- Dual measure methods...handheld or tabletop use.
- Durable angled measuring anvils to pick up stones with the greatest ease, avoiding damage to the surface.
- Uses One (1) A76 Alkaline Battery (Included)
- One-year Manufacturer's Warranty

Description	Item#	Each
Gemlogis Saffron Sorting Gauge	813-0651	\$98.00

B, C Brown & Sharpe Wire and Sheet Gauges

For measuring wire and sheet sizes. Gauge measures B&S sizes 0-36 marked on one side, sizes .325"-.005" on other. Our pocket gauge comes with a protective leather sheath and measures gauge sizes from 8 to 34 (each size also shown in mm and inches).

Description	Item#	Each
B. Wire and Sheet Gauge	813-0700	\$22.35
C. Pocket Wire and Sheet Gauge	813-0702	11.95

D. K&B Stone Gauge

A handy tempered aluminum pocket gauge for measuring loose stones and settings. Marked in carats and millimeters. Features revolving stone size gauge. Has birthstone chart on reverse. Capacity: 1/32 to 4 carats (2 to 11mm). Measures 3 5/8"L x 2 5/8"W.

Description	Item#	Each
K&B Stone Gauge	813-1000	\$7.95

E. Baker Diamond Gauge

An aluminum gauge with holes for measuring stones and round extensions for measuring mountings. Marked in carats on one side and corresponding millimeters on the other. Capacity: 1/32 to 4 carats (2 to 11mm). Measures 4" in diameter.

Description	Item#	Each
Baker Diamond Gauge	813-0600	\$15.50

F. Diamond Gauge

An aluminum gauge for measuring round and baguette stones. Capacity: 1 point to 2 carats. Measures 1 1/2" in diameter when closed.

Description	Item#	Each
Diamond Gauge	813-1120	\$6.50

G. MeasureMate® Fact Card Set and Gauge

Fact card set consists of ten durable plastic double-sided fact cards packaged in a flip-through wallet. Provides information on gemstone grades, shapes, sizes and weights; setting methods; ring, wire gauge and watch battery sizes; hardness scales; metal properties; and more. Fits in shirt pocket for easy access.

Description	Item#	Each
MeasureMate Fact Card Set	813-0561	\$9.95

H. Gem Weight Estimator

Perfect for determining sizes of both loose and mounted stones when other methods fail. Just place estimator on your stone pad, then place selected diamond on the appropriate outline, and you will instantly be able to tell the approximate weight of the stone. Works well for emerald, marquise, pear, round and baguette stones. Made of flexible, transparent plastic. Measures 9"L x 4"W.

Description	Item#	Each
Gem Weight Estimator	813-1919	\$5.95

A. Micromat Gemstone Gauge and Weight Estimator

A precision dial caliper used by jewelers, appraisers and cutters the world over to accurately estimate weights of gemstones and pearls. Takes both inside and outside measurements in millimeters. Features specially designed jaws that fit inside stone settings and prongs for precise measuring without requiring you to remove stones first. Also has ring size scale for reading USA sizes of rings placed in jaws. Includes attractive leatherette-covered metal case with thorough 42-page booklet of tables and complete instructions fully translated in three languages: English, French and German.

Description	Item#	Each
Gemstone Gauge	813-1910	\$230.95



A

B. Sciencetech Digital Gemstone Gauge

This digital gauge takes fast, accurate gemstone measurements in inches or millimeters. Includes high setting attachment and zeroing function for fast and easy calibration of stones in melee settings. Comes with protective case. Measuring range: 0.875"/22.25mm.

Specifications:

Resolution: 0.0005"/0.01mm. Accuracy: ±0.0025"/0.05mm.

Description	Item#	Each
Digital Gemstone Gauge	813-1911	\$153.00



B



C

C. Pearl and Stone Gauge – Works great with baguettes!

A precision-engineered gauge with measuring faces ground level with the back to stay flat for accurate measuring of pearls and stones such as baguettes. Securely holds stones without slipping. Uses rotating dial gauge for fast, easy zeroing. Has enamel-coated metal body for durability. Capacity: 10mm. Graduations: 0.1mm. Measures 3 1/8" long. Made in Germany.

Description	Item#	Each
Pearl and Stone Gauge	813-0650	\$80.95

D. Mini Digital Thickness Gauge – Max 1"/25mm

Compact gauge (just 3 1/2" overall) is small enough to take everywhere. Features large LCD screen for good readability. Has conversion and zero functions. Takes both inside and outside measurements in inches and millimeters. Uses setscrew to prevent jaws from moving. Runs for one year on a 1.5V silver oxide watch battery (included). Comes with storage case.

Specifications:

Resolution 0.0005"/0.01mm Accuracy ±0.001"/0.01mm

Description	Item#	Each
Mini Digital Thickness Gauge	825-1620	\$59.95



D

E. The Meleemeeter® Microgauge Template System

Ideal for gauging inaccessible mounted diamond melee. Eliminates measuring and computing of weights. Consists of 10 transparent polyester gauges with 590 melee shapes and sizes placed around the edges for maximum accessibility. Includes extensive profiles of straight and tapered baguettes, each identified by dimensions and carat weight. Use under a microscope in same position as stone under inspection. Comes in solid brass card case.

Description	Item#	Each
The Meleemeeter	813-1350	\$49.25



E

F. Stone Table Gauge – Millimeter

A standard millimeter scale divided into 0.05mm increments for measuring tables of stones inaccessible by micrometer or caliper. Uses a very fast and accurate scanning method to take measurements without computing between marks, as with a conventional scale. Measures from 1.00 to 10.00mm with accuracy of ±0.01mm. Must be used with 15X or higher magnification. Comes in a protective plastic case. Measures 3 1/2"L x 2"W.

Description	Item#	Each
Stone Table Gauge	813-1360	\$6.55



F

Gesswein® Supra® Swiss Cutters - Ergonomic Handles

Swiss Made Cutters are made of high quality ball bearing steel at 63–65 Rockwell Hardness. All cutters are available as semi-flush, flush or full flush blades. No-scratch/antiglare satin finish.

- 2-component user-friendly **Ergonomic** handles with soft comfortable gripping surface and hard plastic core. Most advanced design for comfort, accuracy and continuous use.
- Dual leaf springs are made of stainless steel.
- Lap joint with a screw to achieve a high level of strength and precision.
 - Nut is made of hardened alloy steel to resist high cutting load.
 - Screw is fine-pitched for perfect joint adjustment.
- Made in Switzerland.

Premium Ergonomic Handles

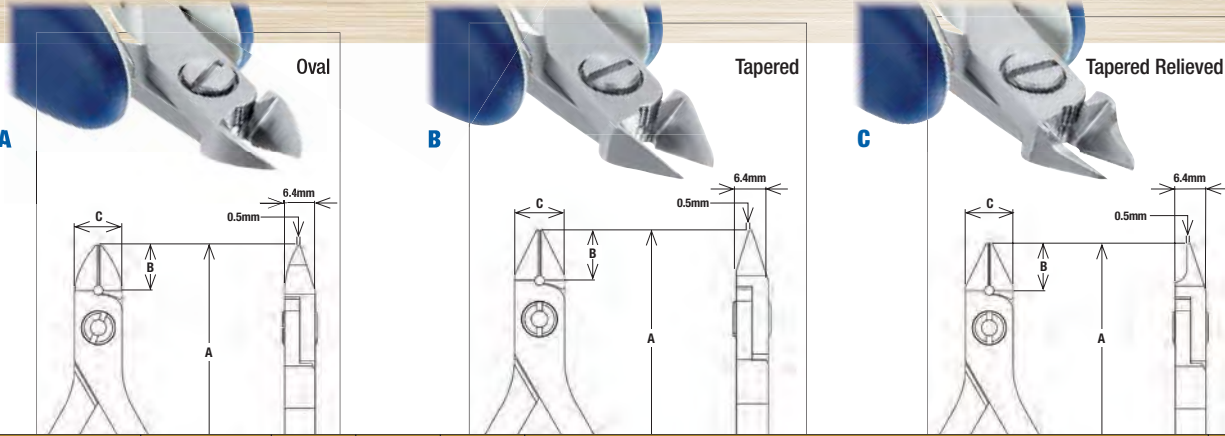

For soft, medium and hard wires



For very precise cutting of soft and medium wires



For perfect cutting of soft and medium wires

Cutting Edges	Head	A (mm)	B (mm)	C (mm)	Cutting Capacity—Wire mm/AWG				Item #	Each	
					Copper wire	Yellow Gold	White Gold	Platinum			
A. Semi-Flush	Oval Sm.	125	10	10	0.2-1.2 / 32-17	0.2-1.1 / 32-17	0.2-1.0 / 32-18	0.2-0.9 / 32-19	182-5140	\$45.50	
	Flush	Oval Sm.	125	10	0.1-1.2 / 38-17	0.1-1.1 / 38-17	0.1-1.0 / 38-18	0.1-0.9 / 38-19	182-5141	45.50	
	Full-Flush	Oval Sm.	125	10	0.1-1.0 / 38-18	0.1-0.9 / 38-19	0.1-0.8 / 38-20	0.1-0.7 / 38-21	182-5142	47.50	
	Semi-Flush	Oval Lrg.	125	12.5	12.5	0.3-1.6 / 29-14	0.3-1.5 / 29-15	0.3-1.4 / 29-15	0.3-1.3 / 29-16	182-5150	34.88
	Flush	Oval Lrg.	125	12.5	12.5	0.2-1.6 / 32-14	0.2-1.5 / 32-15	0.2-1.4 / 32-15	0.2-1.3 / 32-16	182-5151	36.38
	Full-Flush	Oval Lrg.	125	12.5	12.5	0.2-1.2 / 32-17	0.2-1.1 / 32-17	0.2-1.0 / 32-18	0.2-0.9 / 32-19	182-5152	48.50
	Semi-Flush	Oval X Lrg.	130	14	16	0.4-2.0 / 26-12	0.3-1.7 / 29-13	0.3-1.6 / 29-14	0.3-1.4 / 29-15	182-5160	48.50
	Flush	Oval X Lrg.	130	14	16	0.3-1.7 / 29-13	0.3-1.6 / 29-14	0.3-1.5 / 29-15	0.3-1.3 / 29-16	182-5161	49.50
	Full-Flush	Oval X Lrg.	130	14	16	0.3-1.6 / 29-14	0.3-1.3 / 29-13	0.3-1.2 / 29-17	0.3-1.1 / 29-17	182-5162	37.88
B. Semi-Flush	Tapered Sm.	125	10	10	0.2-1.2 / 32-17	0.2-1.1 / 32-17	0.2-1.0 / 32-18	0.2-0.9 / 32-19	182-5340	45.50	
	Flush	Tapered Sm.	125	10	0.1-1.2 / 38-17	0.1-1.1 / 38-17	0.1-1.0 / 38-18	0.1-0.9 / 38-19	182-5341	46.50	
	Full-Flush	Tapered Sm.	125	10	0.1-1.0 / 38-18	0.1-0.9 / 38-19	0.1-0.8 / 38-20	0.1-0.7 / 38-21	182-5342	47.50	
	Full-Flush	Tapered Lrg.	125	12.5	12.5	0.2-1.2 / 32-17	0.2-1.1 / 32-17	0.2-1.0 / 32-18	0.2-0.9 / 32-19	182-5352	48.50
C. Semi-Flush	Tapered Relieved Sm.	125	10	10	0.2-1.2 / 32-17	0.2-1.1 / 32-17	0.2-1.0 / 32-18	0.2-0.9 / 32-19	182-5540	48.50	
	Flush	Tapered Relieved Sm.	125	10	0.1-1.2 / 38-17	0.1-1.1 / 38-17	0.1-1.0 / 38-18	0.1-0.9 / 38-19	182-5541	49.50	
	Full-Flush	Tapered Relieved Sm.	125	10	0.1-0.8 / 38-20	0.1-0.9 / 38-19	0.1-0.8 / 38-20	0.1-0.7 / 38-21	182-5542	50.50	



D

D. Tungsten Carbide – The Ultimate Cutter – Full-Flush

For stents, catheters, braided mesh, guide wires. This new Full-Flush cutter measures 125 mm in length, jaws 7.7mm long x 12.5mm thick with premium ergonomic handles. A superbly manufactured instrument 81 HRC. Cuts up to 2.5mm copper wire.

Description	Item#	Each
Tungsten Carbide – The Ultimate Cutter	182-5360	\$176.00

Gesswein® Supra® Swiss Pliers - Ergonomic Handles

Made of high quality ball bearing steel, hardened to 45 Rockwell feature a superior no-scratch/antiglare satin finish. Lap joint with fine pitched screw for perfect joint adjustment and symmetry, and stainless steel dual leaf springs.

- 2-component ESD safe user friendly **Ergonomic** Handles have a soft comfortable gripping surface – the latest advancement for ease of use.
- Rounded handle for more comfort, correct shape definition for perfect thumb contact and control.
- Easier pickup from table due to biscuit form.
- Made in Switzerland.



A. Gesswein® Supra Swiss Pliers – Flat nose

Flat nose pliers feature a very fine tip, smooth jaws and inner edges. 5 1/8" long.

Jaw Shape	A (mm)	B (mm)	C (mm)	D (mm)	E (mm)	F (mm)	Item#	Each
Smooth	130	20	10	6.4	7.2	4.0	182-6011	\$40.50

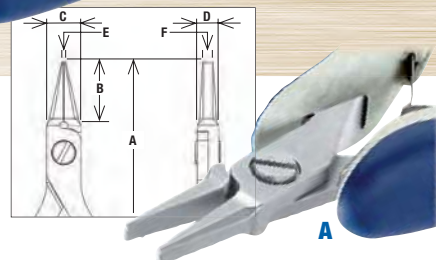

B. Gesswein® Supra Swiss Pliers – Flat nose long

Flat nose pliers feature a very fine tip, smooth jaws and inner edges. 5 1/2" long.

Jaw Shape	A (mm)	B (mm)	C (mm)	D (mm)	E (mm)	F (mm)	Item#	Each
Smooth	140	30	10	6.4	7.5	4.0	182-6013	\$42.50

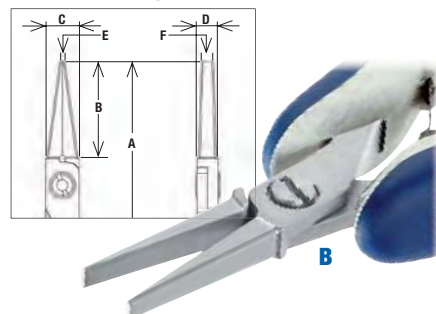

C. Gesswein® Supra Swiss Pliers – Chain nose

Commonly used in electronic assembly and rework, as well as in fine jewelry and beading work. Have flat-faced inner jaws. 5 1/8" long.

Jaw Shape	A (mm)	B (mm)	C (mm)	D (mm)	E (mm)	F (mm)	Item#	Each
Smooth	130	20	10	6.4	7.2	0.5	182-6021	\$42.50

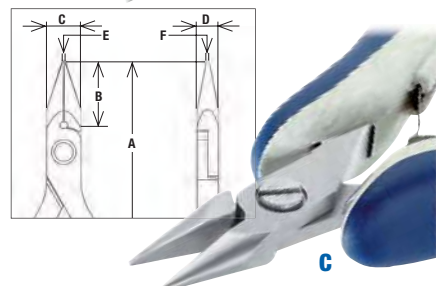

D. Gesswein® Supra Swiss Pliers – Chain nose long

Commonly used in electronic assembly and rework, as well as in fine jewelry and beading work. Have flat-faced inner jaws. 5 1/2" long.

Jaw Shape	A (mm)	B (mm)	C (mm)	D (mm)	E (mm)	F (mm)	Item#	Each
Smooth	140	20	10	6.4	7.2	0.5	182-6023	\$43.50

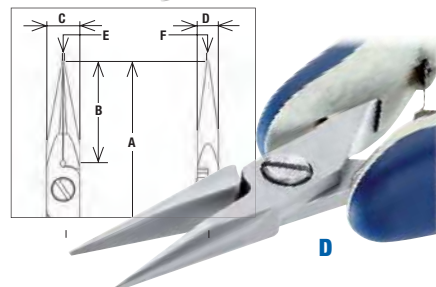

E. Gesswein® Supra Swiss Pliers – Round nose

Round nose pliers have jaws formed by two long cones. A round nose pliers is generally used both to clamp and to form loops on leads or wire. The long jaws also provide increased access. 5 1/8" long.

Jaw Shape	A (mm)	B (mm)	C (mm)	D (mm)	E (mm)	F (mm)	Item#	Each
Smooth	130	20	10	6.4	2.0	0.5	182-6041	\$43.50

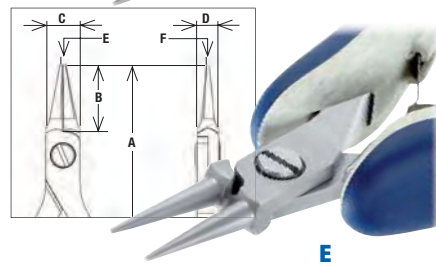

F, G Gesswein® Supra Swiss Cutter and Plier Kits

Money saving kits in a convenient roll up pouch. Cutter kit consists of 4 very useful styles #5142, 5160, 5341 and 5542. Plier kit consists of 1 each of all 5 of the above pliers.

Description	Item#	Each
F. Cutter Kit	182-5163	\$185.50
G. Plier Kit	182-6042	205.00



Lindstrom® Pliers and Nippers - Recognized Worldwide

Unsurpassed in quality materials, design and performance. Made of high-quality steel A grade and are ESD safe. Lindstrom 80-Series nippers they rank among the highest quality of any cutters made with cutting edge hardness of 63-65 Rockwell nippers. They are the most popular choice for the traditional user and offer unsurpassed cutting capacity, covering a wide range of wire dimensions and types. High-quality nippers for jewelry, electronics and other industries. Perfect for accessing narrow, confined spaces. Feature precision-ground, black oxidized cutting edges for exceptional cutting accuracy and durability, adjustable screw lap joints, return springs and yellow plastic grips. The Lindstrom Supreme Series Pliers and Nippers offer a wide selection of the finest lightweight pliers and nippers for general electronics work, jewelry making, repair and fine mechanical work. Adjustable precision screw joint minimizes friction and maximizes jaw alignment. Feature smooth, precision-ground jaws for gripping without marring, spring-loaded handles and white plastic grips. Made in Switzerland.



B Flush

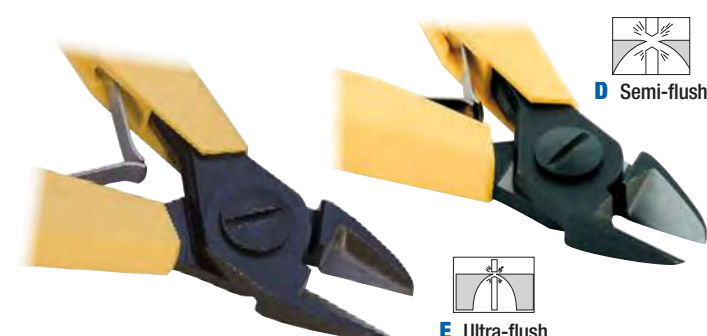

D Semi-flush



F Semi-flush



G Flush



H Ultra-flush

KIT



I

A. Ultra-Flush Diagonal Nipper – #8142

Cut 0.1-1.0mm copper wire. Measures 4¹/₃" long.

Description	Jaw Size (L x W)	Item#	Each
Ultra-Flush	3/8" x 3/8"	182-8142	\$54.50

B. Flush Diagonal Nipper – #8141

Cut 0.1-1.25mm copper wire. Measures 4¹/₃" long.

Description	Jaw Size (L x W)	Item#	Each
Flush	3/8" x 3/8"	182-8141	\$47.50

C. Semi-Flush Small Diagonal Nipper – #8140

Cut 0.2-1.25mm copper or 0.1-0.6mm iron wire. Measures 4¹/₃" long.

Description	Jaw Size (L x W)	Item#	Each
Semi-Flush Small	3/8" x 3/8"	182-8140	\$47.50

D, E Semi-Flush Medium Diagonal Nipper – #8150/#8152

Cut 0.3-1.6mm copper. Measures 4⁷/₁₆" long.

Description	Jaw Size (L x W)	Item#	Each
D. Semi-Flush Medium	1/2" x 1/2"	182-8150	\$48.50
E. Ultra-Flush Medium	1/2" x 1/2"	182-8152	58.50

F-H Semi-Flush Large Diagonal Nipper – #8160/#8161/#8162

#8160 - Cut 0.4-2.0mm copper. Measures 5" long. #8161 - Cut 0.3-2.0mm copper. Measures 5" long. #8162 - Cut 0.3-1.6mm copper. Measures 5" long.

Description	Jaw Size (L x W)	Item#	Each
F. Semi-Flush Large	5/8" x 5/8"	182-8160	\$49.50
G. Flush	5/8" x 5/8"	182-8161	58.50
H. Ultra-Flush	5/8" x 5/8"	182-8162	68.50

I. Lindstrom® Diagonal Nipper Kit

Money Saving Kit of three different Lindstrom Nippers. Includes styles #8142, #8140 and #8150.

Description	Item#	Each
3-piece Kit	182-8170	\$141.30

A. Supreme Long Chain Nose Pliers – #7890

Have screw lap joint and precision-ground jaws. Measures 5¼" long.

Description	Jaw Size (L x W)	Item#	Each
Long Chain Nose	1¼" x ⅓₂"*	182-7890	\$45.50

*Tapers to this width.

B. Supreme Chain Nose – #7893

Chain Nose Bent Pliers – #7892

Have screw lap joint and precision-ground jaws. Measures 4¾" long.

Description	Jaw Size (L x W)	Item#	Each
Chain Nose	¾" x ⅓₂"*	182-7893	\$45.50
Bent Chain Nose	1⅛" x ⅓₂"*	182-7892	47.50

*Tapers to this width.

C. Supreme Flat Nose Pliers – #7490

Have screw lap joint and precision-ground jaws. Measures 4¾" long.

Description	Jaw Size (L x W)	Item#	Each
Flat Nose	¾" x ⅛"	182-7490	\$43.50

D. Supreme Round Nose Pliers – #7590

Have box joint and perfectly round precision-ground jaws. Ideal for making loops, bends and coils. Taper to ⅓₂". Measures 4¾" long.

Description	Jaw Size (L x W)	Item#	Each
Round Nose	¾" x ⅓₂"*	182-7590	\$42.50

*Tapers to this width.

E. Supreme Diagonal Nipper – #7191

Flush-cutting nipper with screw lap joint and tapered, relieved head for reaching tight areas. Cuts 28-18 AWG, .014"-.039" or 0.35-1.0mm diameter copper or annealed 14K gold wire. Measures 4⅓" long.

Description	Jaw Size (L x W)	Item#	Each
Diagonal Flush	¾" x ¾"	182-7191	\$49.50
Diagonal Micro	¾" x ¾"	182-7190	47.50

F. Supreme Oblique Nipper – #7291

Flush-cutting nipper with screw lap joint and 11°-angle head with one rounded and one pointed end. Cuts 28-18 AWG, .014"-.040" or 0.35-1.0mm diameter copper or annealed 14K gold wire. Measures 4¼" long.

Description	Jaw Size (L x W)	Item#	Each
Oblique Flush	9/16" x ⅓"	182-7291	\$56.50

G. Supreme Relieved Oblique Nipper – #7293

Flush-cutting nipper with screw lap joint and 11°-angle relieved head for reaching tight areas. Cuts 28-18 AWG, .014"-.040" or 0.35-1.0mm diameter copper or annealed 14K gold wire. Measures 4¼" long.

Description	Jaw Size (L x W)	Item#	Each
Relieved Oblique Flush	¾" x ⅓"	182-7293	\$59.50

H. Supreme 3-Piece Set

Money saving kit of our most popular Lindstrom® Supreme Lightweight Pliers and Nippers. Includes the style #7893 chain nose plier, #7490 flat plier and #7191 diagonal nippers.

Description	Item#	Each
3-Piece Set	182-7895	\$123.60

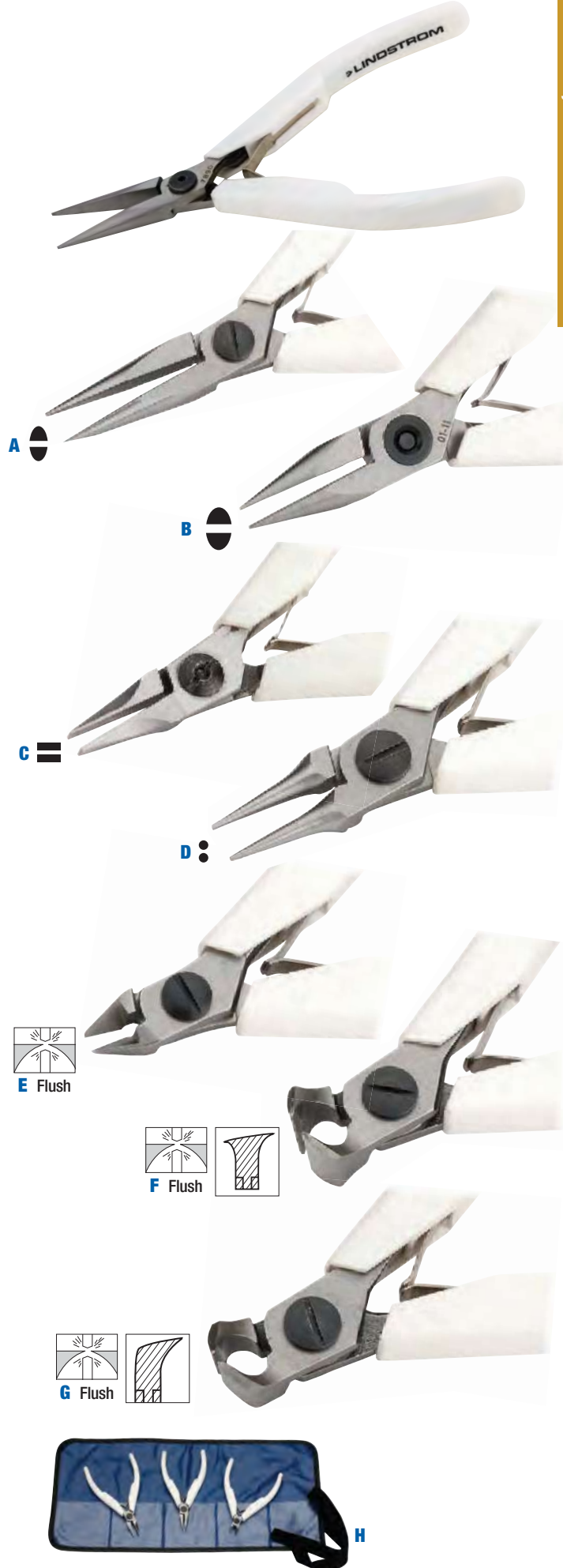

Standard-Weight Pliers and Nippers

Feature box joints that minimize undesirable joint movement for precise jaw alignment. Pliers have smooth jaws for holding work without marring. Plastic non-slip grips. Nippers cut up to 1mm diameter copper or annealed 14K gold wire. Measure 5 1/4" long. Made in Germany.

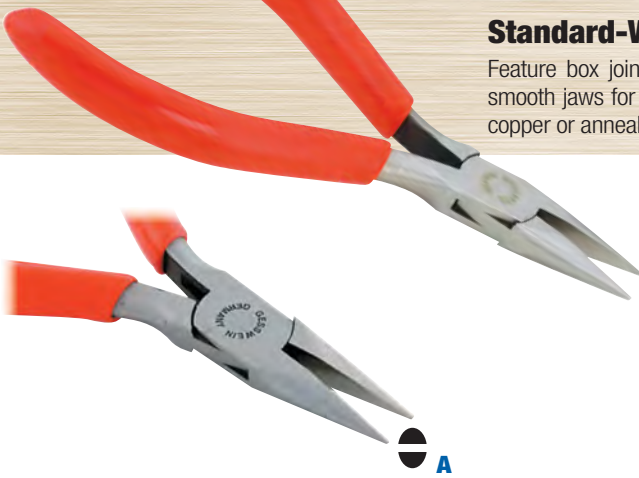

A. Chain Nose Pliers

Description	Jaw Size (L x W)	Item#	EACH Prices		
			1-2	3-9	10+
Chain Nose	7/8" x 1/16" *	180-1221	\$21.65	\$19.49	\$17.32

*Tapers to this width.

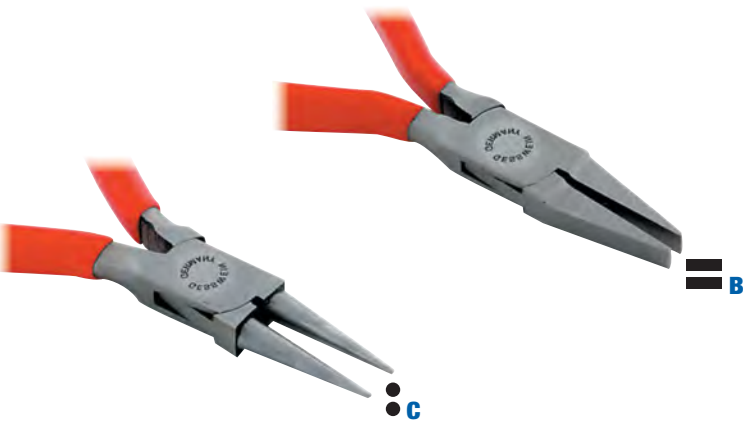

B. Flat Nose Pliers

Description	Jaw Size (L x W)	Item#	EACH Prices		
			1-2	3-9	10+
Flat Nose	1" x 3/16"	180-1220	\$22.65	\$20.39	\$18.12



C. Round Nose Pliers

Description	Jaw Size (L x W)	Item#	EACH Prices		
			1-2	3-9	10+
Round Nose	7/8" x 1/16" *	180-1222	\$22.65	\$20.39	\$18.12

*Tapers to this width.

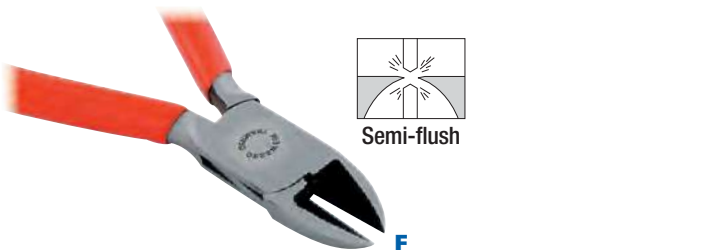

D. Half Round/Flat Pliers

Description	Jaw Size (L x W)	Item#	EACH Prices		
			1-2	3-9	10+
Half Round/Flat	7/8" x 5/16" *	180-1223	\$26.50	\$23.85	\$21.20



E. Round/Flat Pliers

Description	Jaw Size (L x W)	Item#	EACH Prices		
			1-2	3-9	10+
Round/Flat	1" x 1/16"	180-1230	\$26.70	\$25.37	\$22.43

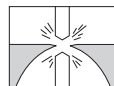

Semi-flush

F. Semi-Flush Diagonal Nipper

Description	Jaw Size (L x W)	Item#	EACH Prices		
			1-2	3-9	10+
Semi-Flush Diagonal	3/4" x 9/16" *	180-1250	\$30.25	\$28.74	\$25.41

*Tapers to this width.

G. Standard-Weight Box-Joint Plier Set

Includes four of our most popular Standard-Weight Box-Joint Pliers: chain, flat, round and half-round/flat pliers. Made in Germany.

Description	Item#	Each
4-Piece Set	180-1225	\$84.00

Slimline Box-Joint Pliers and Nippers

Feature spring-loaded handles with black plastic nonslip grips. Pliers have smooth jaws for holding work without marring. Nippers cut up to 1.5mm diameter copper or annealed 14K gold wire. Measure 4½" long. Made in Germany.

A. Chain Nose Pliers

Description	Jaw Size (L x W)	Item#	1-2	3-9	10+
Chain Nose	7/8" x 1/16" *	180-1722	\$20.50	\$19.48	\$18.45

*Tapers to this width.

B. Flat Nose Pliers

Description	Jaw Size (L x W)	Item#	1-2	3-9	10+
Flat Nose	3/4" x 1/8"	180-1720	\$22.00	\$20.90	\$19.80

C. Round Nose Pliers

Description	Jaw Size (L x W)	Item#	1-2	3-9	10+
Round Nose	7/8" x 1/16" *	180-1721	\$20.50	\$19.48	\$18.45

*Tapers to this width.

D. Diagonal Nipper

Description	Jaw Size (L x W)	Item#	1-2	3-9	10+
Diagonal	1/2"	180-1726	\$26.75	\$25.41	\$24.08

E. Diagonal Nipper with Trap

Description	Jaw Size (L x W)	Item#	1-2	3-9	10+
Diagonal w/ Trap **	1/2"	180-1255	\$27.00	\$25.65	\$22.68

**Traps and holds wire end so it will not fly.

F. Oblique Nipper

Description	Jaw Size (L x W)	Item#	1-2	3-9	10+
Oblique	5/8"	180-1729	\$28.75	\$27.31	\$25.88

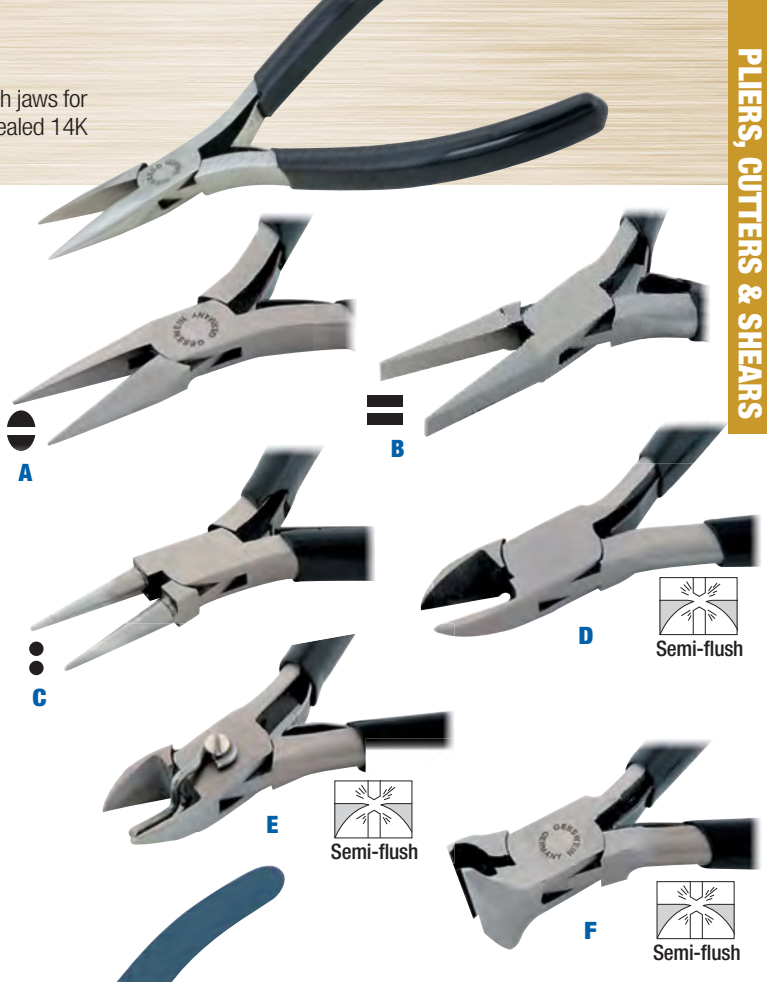

Foam-Grip Stainless Steel Pliers and Nipper

Economical stainless steel box-joint pliers and nipper. Feature spring-loaded handles with extra-thick foam nonslip grips. Measure 4½" long. Imported.

G. Chain Nose Pliers

Description	Jaw Size (L x W)	Item#	1-2	3-9	10+
Chain Nose	7/8" x 1/16" *	180-0330	\$16.40	\$14.76	\$13.67

*Tapers to this width.

H. Flat Nose Pliers

Description	Jaw Size (L x W)	Item#	1-2	3-9	10+
Flat Nose	7/8" x 9/32"	180-0331	\$16.40	\$14.76	\$13.67

I. Round Nose Pliers

Description	Jaw Size (L x W)	Item#	1-2	3-9	10+
Round Nose	3/4" x 1/16" *	180-0332	\$16.40	\$14.76	\$13.67

*Tapers to this width.

J. Bent Chain Nose Pliers

Description	Jaw Size (L x W)	Item#	1-2	3-9	10+
Bent Chain Nose	7/8" x 1/16"	180-0336	\$16.40	\$14.76	\$13.67

K. Diagonal Nipper

Description	Jaw Size (L x W)	Item#	1-2	3-9	10+
Diagonal	1/2"	180-0333	\$16.90	\$15.21	\$14.08

L. Foam-Grip Stainless Steel Plier and Nipper Set

Includes all Foam-Grip Stainless Steel Pliers and Nipper listed above except bent chain pliers.

Description	Item#	Each
4-Piece Set	180-0335	\$59.50



Economy Stainless Steel Pliers

Economical stainless steel pliers for everyday use at the bench. Feature box joints for stability and yellow plastic grip-tight handles. Available individually or in a set of four (see below). Measures 5 1/4" long. Made in Pakistan.

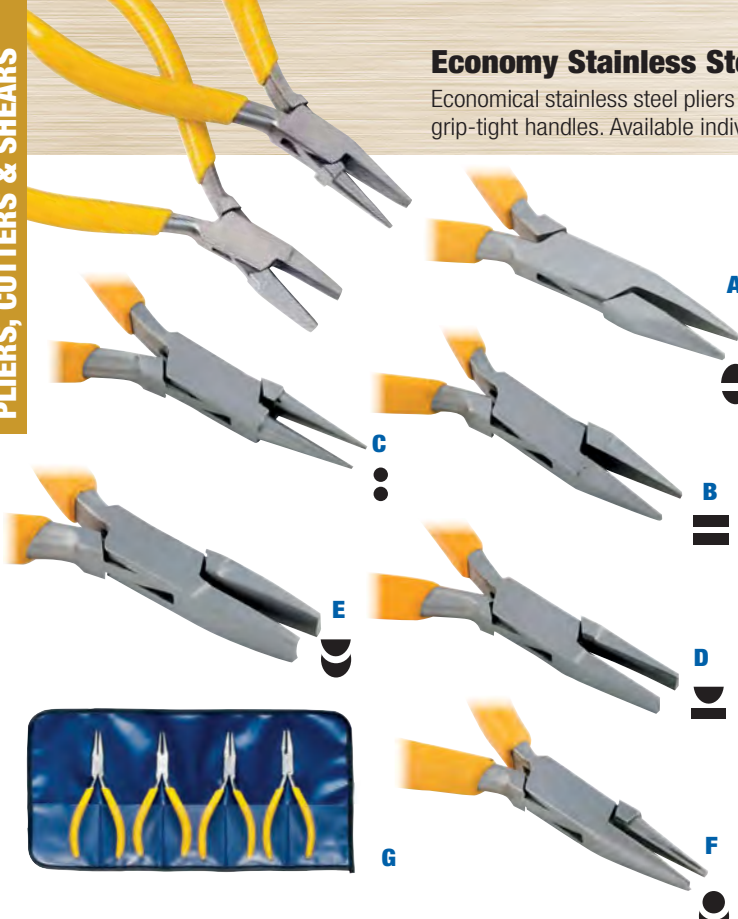

A. Chain Nose Pliers

Description	Jaw Size (L x W)	Item#	EACH Prices 1-2	3+
Chain Nose	3/4" x 1/16" *	180-0352	\$9.95	\$8.96

*Tapers to this width.

B. Flat Nose Pliers

Description	Jaw Size (L x W)	Item#	EACH Prices 1-2	3+
Flat Nose	3/4" x 1/4"	180-0350	\$9.95	\$8.96

C. Round Nose Pliers

Description	Jaw Size (L x W)	Item#	EACH Prices 1-2	3+
Round Nose	3/4" x 1/16" *	180-0351	\$9.95	\$8.96

*Tapers to this width.

D. Half-Round/Flat Pliers

Description	Jaw Size (L x W)	Item#	EACH Prices 1-2	3+
Half-Round/Flat	3/4" x 1/4"	180-0353	\$10.50	\$9.45

E. Half-Round/Hollow Pliers

Description	Jaw Size (L x W)	Item#	EACH Prices 1-2	3+
Half-Round/Hollow	3/4" x 1/4"	180-0357	\$10.50	\$9.45

F. Round/Hollow Pliers

Description	Jaw Size (L x W)	Item#	EACH Prices 1-2	3+
Round/Hollow	3/4" x 1/8"	180-0356	\$10.50	\$9.45

G. Economy Stainless Steel Plier Set

Includes four of our most popular Economy Stainless Steel Pliers: chain, flat, round and half-round/flat pliers. Imported.

Description	Item#	Each
4-Piece Set	180-0360	\$35.95



ValueLine Pliers and Nippers

These inexpensive pliers and nippers feature box joints for stability, double leaf springs for smooth action, green PVC grips and brush finishes. Measures 4 1/2" long. Made in Pakistan.

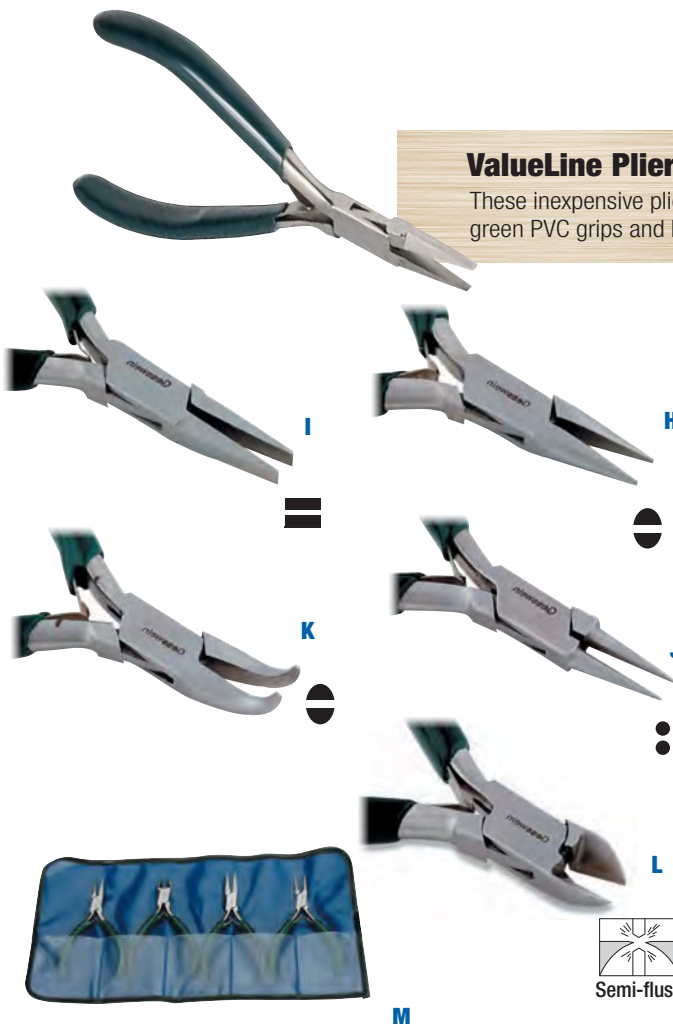

H. Chain Nose Pliers

Description	Jaw Size (L x W)	Item#	Each
Chain Nose	7/8" x 1/32" *	180-0340	\$5.45

*Tapers to this width.

I. Flat Nose Pliers

Description	Jaw Size (L x W)	Item#	Each
Flat Nose	7/8" x 1/8"	180-0341	\$5.45

J. Round Nose Pliers

Description	Jaw Size (L x W)	Item#	Each
Round Nose	7/8" x 1/32" *	180-0342	\$5.45

*Tapers to this width.

K. Bent Chain Nose Pliers

Description	Jaw Size (L x W)	Item#	Each
Bent Chain Nose	3/4" x 1/16"	180-0344	\$5.90

L. Diagonal Nipper

Description	Jaw Size (L x W)	Item#	Each
Side Cutter	1/2"	180-0343	\$6.35

M. ValueLine Plier and Nipper Set

Includes all ValueLine Pliers and Nipper above except bent chain.

Description	Item#	Each
4-Piece Set	180-0345	\$21.95



Semi-flush

A. Wolf™ Groovy Chain Nose Pliers

Single-grooved jaws produce 90° bends in wire and flat pieces. Prevent wire from twisting or slipping when filing. Hold jump rings firmly for easy alignment of ends prior to soldering. Feature durable box-joint construction with dual leaf springs and ergonomic handles with PVC grips. Made of stainless steel. Measures 5¾" long.

Description	Item#	Each
Chain-Nose	180-0382	\$16.95



B. Wolf™ Groovy Looping Pliers

Triple-grooved jaws allow you to repeat three exact sizes of loops when wire wrapping, making earring loops and jump rings. Feature durable stainless steel box-joint construction with dual leaf springs and ergonomic handles with PVC grips. Available with or without grooves; Pliers without grooves are more traditional. Measures 5" long.

Description	Item#	Each
B. Looping with grooves	180-0380	\$16.95
Looping without grooves	180-0381	15.95



C. Loop Opening Pliers

Reverse-action pliers for opening loops, rings and more. Feature yellow nonslip grips. Measures 6¼" long.

Description	Item#	EACH Prices	
		1-2	3+
Loop Opening	180-0354	\$13.50	\$12.15

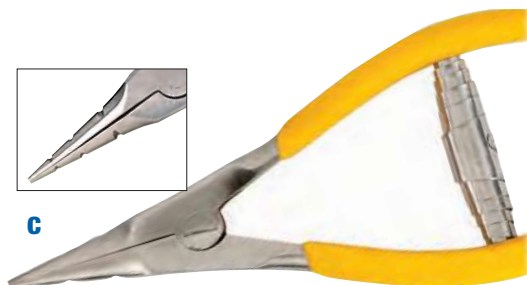

D. Loop Closing Pliers

Feature smooth shaped jaws for closing loops, jump rings, bracelet links and more without distorting or marring, durable box-joint construction and PVC grips. Measures 4½" long.

Description	Item#	EACH Prices	
		1-2	3+
Loop Closing	180-0011	\$15.65	\$14.09



E. Wire Twisting Pliers

Twists wire up to .060-gauge with simple one-pull action. Produces durable strands that won't unravel. Hardened and tempered. Measures 9" long.

Description	Item#	Each
Wire Twisting Pliers	180-4095	\$22.95



F. Clip Spring Removing Pliers

Use for adjusting the length of Seiko style watch bands. The flat jaw rests atop the link, and the pointed tip fits under the clip spring. Gently squeeze the handles, and the clip spring pops up, ready for easy removal. Measure 5½" long.

Description	Item#	Each
Clip Spring Removing Pliers	820-9069	\$9.45



G. Hole Punching Pliers

Punch precise 1.5mm holes in leather watchbands. Feature return spring for smooth action and comfort handles for secure grip. Made of the finest steel for durability. Measure 5¾" long.

Description	Item#	Each
Hole Punching Pliers	820-9074	\$10.95



Xuron Micro-Shear® Flush Cutters and Pliers

Micro-Shear Flush Cutters feature a patented design that keeps blades sharper longer than conventional nippers. Blade edges bypass each other in a shearing motion rather than striking, resulting in clean square cuts with no spikes. Blades stay sharper and last much longer than conventional nippers

because there is no edge-to-edge impact. Greatly reduce mechanical shock delivered to components and require roughly 50% less effort to cut wire than conventional compression-type wire cutters. Have ergonomically shaped, non-slip Xuro-Rubber comfort grips. Made in USA.



A



Flush



B



Flush



C



Flush



D



Flush



E



F



G

A. Xuron 9100 Micro-Shear® Flush Cutter

Made of tough steel alloy with ultra-precise CNC grinding and state-of-the-art heat treating. Features oval head for added durability, Light Touch return spring and glare-free black finish. Comfortable for high-volume applications. Flush cuts soft wire up to 14 AWG (1.6mm). Measures 5" long.

Description	Jaw Size (L x W)	Item#	EACH Prices	
			1-2	3+
9100 Cutter	9 x 12.2mm	181-0202	\$20.25	\$19.24
9100F Cutter	9 x 12.2mm	181-0203	\$20.75	\$19.71

B. Xuron 9200 Micro-Shear® Flush Cutter

Made of tough steel alloy with ultra-precise CNC grinding and state-of-the-art heat treating. Features tapered head for cutting in high-density areas, Light Touch return spring and glare-free black finish. Comfortable for high-volume applications. Flush cuts soft wire up to 14 AWG (1.6mm). Measures 5" long.

Description	Jaw Size (L x W)	Item#	EACH Prices	
			1-2	3+
9200 Cutter	9 x 12.2mm	181-0204	\$20.25	\$19.24

C. Xuron 2175 Maxi-Shear® Flush Cutter

Features elongated and tapered head with extra-tough high-carbon steel blades for cutting in high-density areas. Has nonprotruding flat return spring for excellent feel without excessive tension and glare-free black finish. Flush cuts soft wire up to 12 AWG (1.6mm). Measures 6" long.

Description	Jaw Size (L x W)	Item#	EACH Prices	
			1-2	3+
2175 Cutter	12 x 17mm	181-0208	\$13.75	\$13.06

D. Xuron LX Micro-Shear® Flush Cutter

Features ultra-slim profile and tapered head with precision-ground, extra-tough high-carbon steel blades for cutting in high-density areas with maximum maneuverability. Perfect for small hands. Flush cuts soft wire up to 16 AWG (1.0mm). Measures 4.8" long.

Description	Jaw Size (L x W)	Item#	EACH Prices	
			1-2	3+
LX Cutter	9 x 14mm	181-0200	\$14.85	\$14.11

E. Xuron 450 Tweezers Nose™ Pliers

Ultra-precise, durable needle nose pliers capable of grasping and holding wire less than 1mm thick with the strength for wire forming. Prevent leads from popping free, tip misalignment and blade crossover. Have radiused edges for protecting lead wires. Feature lightweight construction, Light Touch return spring and glare-free black finish. Measures 5" long. Made in USA.

Description	Jaw Size (L x W)	Item#	EACH Prices	
			1-2	3+
450 Pliers	20 x 10mm	181-0206	\$17.95	\$17.05

F, G Xuron 485 and 485 90D Chain Nose Pliers

Strong but not bulky, these chain nose pliers have long jaws that are smooth inside with rounded outer edges for forming, bending and manipulating wire as well as strips or sheets of soft metal. Manufactured from heat-treated high carbon steel with aligned, precision ground tips. A built-in return spring and non-slip soft rubber grips keep these pliers secure in the hand for comfort and control. Available straight or with a 90° bend to keep the wrist in a natural, comfortable position while picking up findings, jump rings and other small components.

Description	Jaw Size (L x W)	Item#	EACH Prices	
			1-2	3+
F. 485 Pliers	17.5 x 10mm	181-0210	\$17.65	\$16.77
G. 485 Pliers	12.5 x 15mm	181-0211	\$19.90	\$18.91

A. Micro Flush Cutter

Hardened tool steel cutter with induction-hardened jaws. Features relieved cutting edges for clean cutting, fine points for tight work, steel return spring and comfort grips. Measures 4¾" long.

Description	Jaw Size (L x W)	Item#	EACH Prices		
			1-2	3-9	10+
Diagonal	½"	180-4090	\$12.95	\$11.66	\$11.01



B. Oblique Nipper

Flush-cutting nipper with 20°-angle head for reaching tight areas. Has return spring for smooth cutting action and nonadjustable lap joint. Cuts 28-18 AWG, .014"-.059" or 0.3-1.25mm diameter copper or annealed 14K gold wire. Measures 4½" long. Made in Sweden.

Description	Jaw Size (L x W)	Item#	EACH Prices		
			1-2	3-9	10+
Oblique	14mm	182-7231	\$89.00	\$84.55	\$80.10



C. Barracuda Diagonal Nipper

Flush-cutting nipper made of tool steel alloy. Features 61-63 HRC cutting edges, lap joint, double leaf springs and cushion-grip handles. Cuts up to 26 AWG or 0.40mm hard wire. Measures 4½" long. Made in Germany.

Description	Jaw Size (L x W)	Item#	EACH Prices	
			1-2	3+
Diagonal	½"	181-4094	\$26.80	\$24.12



D. Stone Setting Pliers

Ideal for tightening prongs. Feature box joints for stability. Available in deluxe and economy styles. Measures 4¾" long.

Description	Jaw Size (L x W)	Item#	EACH Prices		
			1-2	3-9	10+
D. Deluxe German	½" x ¾"	181-2900	\$37.95	\$36.05	\$34.16
Economy Pakistan	½" x ¾"	181-2950	12.95	-	-



E. Jump Ring Opening Pliers

Reverse-action pliers for stretching or opening jump rings as small as 20-gauge, bows, links and rings. Has ridges on outside edges of jaws that hold rings securely in place. Made of chrome vanadium steel with PVC grips. Measures 5¾" long. Taper to 3/16" at the tips. Made in Germany.

Description	Item#	Each
Jump Ring Opening	180-0292	\$29.95



F. Prong Opening Pliers

Open prongs without fracturing stones. Use grooved jaw to hold prong in place and angled jaw to slip under prong and raise it. Avoid putting pressure on top of stone to prevent marring and scratching. Feature box joint for stability, perfectly aligned tapered jaws, double leaf springs and cushion grips. Measures 4½" long. Made in Germany.

Description	Jaw Size (L x W)	Item#	EACH Prices	
			1-2	3+
Prong Opening	¾" x 1/16"	180-0020	\$25.60	\$23.04



G. Prong Closing Pliers

Close prongs over stones without slipping. Use curved, tapered jaws with grooved tips to hold prong securely. Feature box joint for stability, perfectly aligned jaws, double leaf springs and cushion grips. Measures 4½" long. Made in Germany.

Description	Jaw Size (L x W)	Item#	EACH Prices	
			1-2	3+
Prong Closing	¾" x 1/16"	180-0025	\$25.60	\$23.04





A



B



C

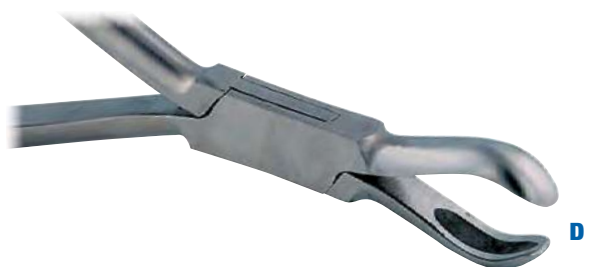

D



E



F

A. Ring Forming Pliers

Feature heavy-duty box-joint construction and two different smooth jaws: concave and convex. Have white plastic grips. Measures 6 1/2" long. Jaw size: 1 1/8"L x 3/16"W. Made in Germany.

Description	Item#	EACH Prices	
		1-2	3+
Ring Forming	180-0100	\$33.40	\$30.06

B. Ring Bending Pliers

Feature heavy-duty box-joint construction and two different smooth jaws: one with wide, rounded V-slot and the other shaped to fit into the slot. For bending wire and strips. Have white plastic grips. Measures 6 1/2" long with 5/8" long jaws. Made in Germany.

Description	Item#	EACH Prices	
		1-2	3+
Ring Bending	180-0050	\$44.80	\$40.32

C. Stone Removal Pliers

Easily remove stones from settings while preventing damage. Can be used on all prong settings, bead settings, clusters, channels, fishtails and baguettes. Feature thin narrow tips that fit into tight recessed areas and very small settings, box joint for perfect alignment of jaws and cushion-grip handles for comfort. Measures 4 3/4" long.

Description	Item#	Each
Stone Removal	181-2975	\$17.75

D. Ring Holding Pliers

Lightweight nickel-plated box-joint pliers with curved, depressed jaws for gripping rings securely. Measures 5 1/2" long. Jaw size: 1 1/8"L x 3/8"W. Made in Pakistan.

Description	Item#	EACH Prices	
		1-2	3+
Ring Holding	180-0200	\$9.80	\$8.82

E. Econo Ring and Bow Closing Pliers

Sturdy box-joint stainless steel pliers for rounding and closing small rings, bows, jump rings, loops and more. Feature one brass jaw to prevent marring. Measures 5 1/2" long with 5/8" long jaws. Made in Pakistan.

Description	Item#	Each
Econo Ring and Bow Closing	180-0006	\$24.50

F. Econo Bow Closing Pliers

Well-made stainless steel box-joint pliers for closing rings, bows and more. Have yellow comfort grips curved to fit in palm. Measures 6 1/2" long with 5/8" long jaws. Made in Pakistan.

Description	Item#	EACH Prices	
		1-2	3+
Econo Bow Closing	180-0355	\$15.95	\$14.36

Nylon-Jaw Pliers

Heavy-duty stainless steel pliers with box joints and plastic comfort grips. Feature replaceable nylon jaws for gripping firmly without marring. Can be easily customized by filing or carving. Measures 5¾" long unless otherwise noted. Made in Pakistan.

A. Flat Pliers

For general-purpose work. Jaw size: 1"L x 7/16"W.

Description	Item#	Each
A. Flat Pliers	180-0001	\$13.95
Replacement Jaws, pair	180-0002	4.15



B. Bracelet Bending Pliers

Feature a gentle arch for shaping and reshaping bracelets.

Description	Item#	Each
B. Bracelet Bending Pliers	180-0282	\$20.95
Replacement Jaws, pair	180-0283	4.15



C. Ring Bending Pliers

Have a pronounced curve for bending ring sizes 6½ and larger.

Description	Item#	Each
C. Ring Bending Pliers	180-0286	\$19.50
Replacement Jaws, pair	180-0287	4.15



D. Ring Closing Pliers

Commonly used to reshape or close rings after sizing. Bottom jaw is nylon with V-groove. Top jaw is polished stainless steel.

Description	Item#	Each
D. Ring Closing Pliers	180-0288	\$21.95
Replacement Jaws, pair	180-0289	4.15



E. Ring Holding Pliers

Feature parallel nylon jaws for holding rings securely while working the inside.

Description	Item#	Each
E. Ring Holding Pliers	180-0284	\$19.60
Replacement Jaws, pair	180-0285	4.15



F. Spring Bar Bending Pliers

These unique and practical spring bar bending pliers delicately bend spring bars of any size to the proper shape. Feature stainless steel box-joint construction with high-impact grooved nylon jaws that hold the spring bar in place while bending. Measure 5" long.

Description	Item#	Each
Spring Bar Bending Pliers	180-0294	\$14.95





A



B



C



D

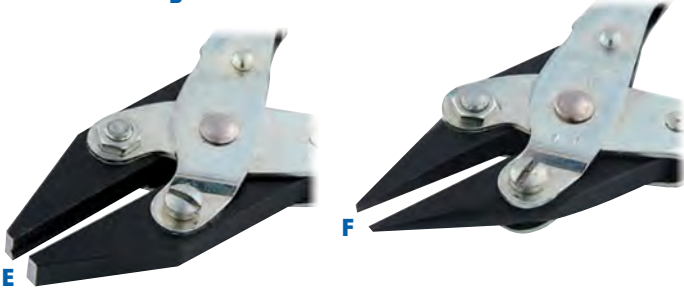

E



F



G



H

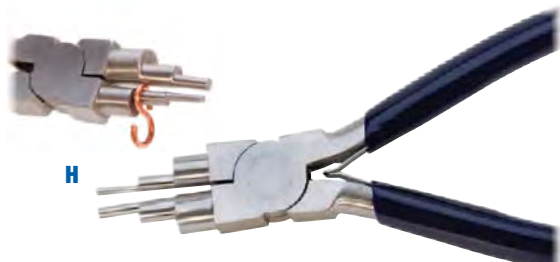

A. Carbide Diagonal Cut Nipper

Cuts up to 12-gauge nonferrous metal. Features PVC cushion grip handles and return springs. Measures 5½" long. Made in Pakistan.

Description	Item#	EACH Prices	
		1-2	3+
Carbide Diagonal Cut Nipper	181-4095	\$26.95	\$24.26

B. Supra® Swiss Tungsten Carbide – The Ultimate Cutter – Full-Flush

For stents, catheters, braided mesh, guide wires. This new Full-Flush cutter measures 123 mm in length, jaws 77mm long x 12.5mm thick with premium ergonomic handles. A superbly manufactured instrument 81 HRC. Cuts up to 2.5mm copper wire. Made in Switzerland.

Description	Item#	Each
Tungsten Carbide – The Ultimate Cutter	182-5360	\$176.00

C. Wire Looping Pliers

These box-joint pliers feature a jaw with three finely polished round sections (5mm, 7mm and 10mm in diameter) and a concave jaw for easily bending wire. Made of stainless steel for durability. Measures 5⅝" long.

Description	Item#	Each
Wire Looping Pliers	180-0035	\$12.35

D-F Parallel-Jaw Pliers

Feature jaws that stay parallel along their entire lengths whether opened or closed for positive grip of square and hexagonal components. Have nickel-plated sealed handles with anti-rust finish and fully heat-treated black jaws.

Available in two styles: flat and chain. Flat pliers come with smooth or serrated jaws that open to 7/16" (11mm). Serrated version has a single longitudinal V-slot. Chain pliers come with smooth jaws that open to 3/8" (10mm) and measures 3/32" (2mm) square at each tip.

Both styles allow wire to be fed through the throats from either end and held firmly over full jaw lengths. Packaged in vinyl sleeves for protection during shipping and storage. Measures 5" long.

Description	Item#	EACH Prices		
		1-2	3-9	10+
D. Flat Pliers w/smooth jaws	181-1035	\$20.48	\$19.46	\$18.23
E. Flat Pliers w/serrated jaws	181-1030	18.50	17.58	16.47
F. Chain Pliers w/smooth jaws	181-1060	22.50	21.38	20.03

G. Wrap-and-Tap Ring Forming Pliers

Use these heavy-duty stainless steel pliers to speed up ring and shank forming: just wrap wire or ring stock around the barrel-shaped solid steel jaw, then gently tap against a mandrel; the PVC-covered small jaw prevents marring of hollow rings and rings with one-sided designs. Form perfect rings, half-shanks and quarter-shanks from stock up to 2mm thick. Have lap joint and smooth, nonslip PVC grips. Measures 6" long. Imported.

Description	Item#	Each
14mm Barrel Pliers	180-0160	\$19.50

H. Multi-Size Wire Looping Pliers

Our versatile Multi-Size Wire Looping Pliers can make a variety of bails and loops in 6 sizes: 2.4, 3.4, 4.4, 6.4, 8.35 and 9.35mm.

These high-quality pliers are made of stainless steel with double leaf springs and box joint for stability.

Measures 6" overall length with 1-1/4" long jaws. Imported.

Description	Item#	Each
Multi-Size Wire Looping Pliers	180-0036	\$17.95

A. Bergeon Heavy-Duty Cutter – Cuts gold sprues up to 3mm

Top-quality cutters with special linkage design that multiples hand pressure many times to provide full, clean cuts. Helps reduce hand fatigue from constant cutting. Features hardened steel jaws with 7/8" (22mm) long cutting edges, extra-long handles for additional leverage and locking system for protection of cutting edges. Pointed ends allow easy access to tight areas. Cuts gold and soft wire up to 3mm thick. Made in Switzerland.

Description	Length	Item#	Each
Side Cutter	10"	181-4075	\$179.00



B. Compound Cutter – Cuts gold sprues up to 3mm

This heavy-duty tool cuts gold sprues and soft wire up to 3mm thick. Features compound joint for cutting with minimal effort and insulated plastic grips. Measures 7 1/4" long with 7/16" long jaws. Made in Germany.

Description	Item#	EACH Prices		
		1-2	3-9	10+
Compound Cutter	181-4060	\$41.95	\$39.85	\$37.76



C. Power Max Cutters – Cuts gold sprues up to 3mm

Feature leverage-enhancing design and induction-hardened, high-grade steel jaws for extra-close cutting. Have ergonomically shaped handles for preventing fatigue and injuries. Cuts gold and soft wire up to 3mm thick. Measures 6 1/2" long. Made in Japan.

Description	Item#	EACH Prices		
		1-2	3-9	10+
Flush Cutter	181-4066	\$36.95	\$35.10	\$33.26



D, E 3-Peaks Sprue Cutters – Cut gold sprues up to 4mm

These compound sprue cutters feature 60–65 HRC hardened alloy steel construction with 15mm long jaws and comfortable handles. Both cut up to 4mm copper or 1.5mm steel. Side cutter is angled for better access to tight areas. Measures approx. 8 1/2" long. Made in Japan.

Description	Item#	Each
D. Standard Cutter	181-4081	\$19.95
E. Side Cutter	181-4082	31.25

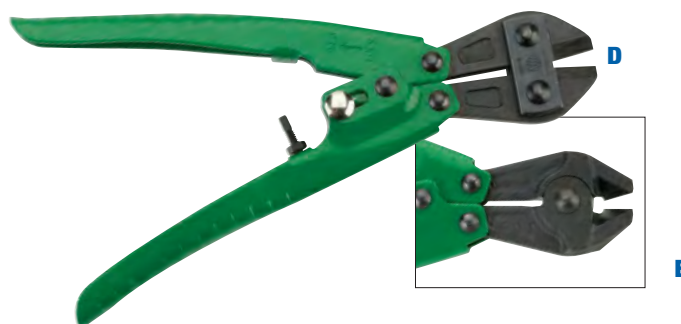

F. Diagonal Cut Nipper

Cut sprues up to 3mm with less hand strain. Features a heavy-duty spring that opens jaws for repetitive use. Measures: 5 1/2" with 15mm long jaws. Comes with nickel-plated handles.

Description	Item#	EACH Prices		
		1-2	3-9	10+
Diagonal Nipper	181-4050	\$36.95	\$35.10	\$32.89





A



A. Bench Shears

Shears for cutting flat bars, sheets or rods, such as the center rod of a sprue tree. Features precision-machined blades, hold-down bar for accurate cutting and long handle for leverage. Made in Germany.

Specifications:	5R	6R
Blade Length	6 ³ / ₃₂ " (160mm)	8" (200mm)
Cutting Capacity	2 ³ / ₈ " x ³ / ₁₆ " flat bar, 5 ³ / ₃₂ " sheet, ⁷ / ₁₆ " rod	2 ³ / ₄ " x ¹ / ₄ " flat bar, 3 ³ / ₁₆ " sheet, ¹ / ₂ " rod
Ship. Wt.	31 lbs.	60 lbs.

Description	5R Item#	Each	6R Item#	Each
Bench Shears	819-0350	\$499.50	819-0355	\$695.00
Replacement Blade Set	819-0357	185.00	819-0358	225.00
Replacement Handle	819-0361	119.00	819-0354	160.00

B. Niles Pneumatic Sprue Cutters

Heavy-duty air-powered tools for cutting castings from sprues. Feature tapered blades that make it easy to get in between closely spaced castings. Eliminate hand and arm fatigue and increase production. Can be operated by hand when not on stand. Each includes one pair of blades, stand, foot pedal, air hose and hose connectors. Air compressor requirements: 60-85 PSI, 0.8 CFM. Made in Japan.

Specifications:	Model 25	Model 35
Blades:	P6, High-Speed Steel	Z8P, Carbide
Cutting Capacity at Midsection of Blade:	3mm	4mm
Size without Blade:	1 ³ / ₄ " dia. x 9 ¹ / ₂ "L	2 ¹ / ₈ " dia. x 11 ¹ / ₂ "L
Length of Cutting Edge:	1 ¹ / ₂ "	1 ¹ / ₈ "
Ship. Wt.:	5 lbs., 4 oz.	6 lbs., 4 oz.



B



Description	Item#	Each
B. Model 25 with P6 Blades	260-3107	\$550.00
Model 35 with Z8P Blades	260-3108	625.00
Replacement Stand	260-3118	120.00
Replacement Foot Pedal	260-3119	177.00
Replacement Hose with Connectors	260-3114	36.60

Blades	For	Item#	Each
Z61, H.S.S. pointed	Model 25	260-3112	\$183.00
S7P, Tool Steel pointed	Model 35	260-3111	99.00
Replacement P6, H.S.S. blunt	Model 25	260-3116	74.00
Replacement Z8P, Carbide blunt	Model 35	260-3117	195.00

C



C. GRS® Ring Size Cutter

This unique unit quickly cuts off a precise amount of ring shank without sawing. Removes metal in one whole piece so there are no particles to lose, saving you time and money. Results in perfectly parallel sides for neat and easy soldering. Includes seven different heat-treated steel blades that can be changed by hand in seconds without tools. Made in USA.

Description	Item#	Each
C. Ring Size Cutter	812-1270	\$307.00
1/2-Size Blade	812-1272	14.55
3/4-Size Blade	812-1273	15.00
1-Size Blade	812-1274	15.45
1 1/4-Size Blade	812-1275	15.35
1 1/2-Size Blade	812-1276	15.80
1 3/4-Size Blade	812-1277	17.10
2-Size Blade	812-1278	18.90
7-Piece Blade Set (one each)	812-1271	89.95

A. Xuron 9180NS HD Scissors/Shear

A heavy-duty pair of scissors (Non serrated blade) - excellent for jewelers and metalsmiths for cutting thin sheets of soft metal or lead up to 0.030"/20 ga. (0.8mm) thick. Also cuts jump rings leaving a flat end on both sides of the wire ring. Manufactured from heat-treated high carbon steel, this pair of scissors is durable and strong. Designed for left or right handed use, the built-in return spring always brings the blades back to the open position. Jaw size: 19mm x 10mm. Overall Length: 6"

Description	Item#	Each
Xuron 9180NS HD Scissors/Shear	181-0218	\$22.15



A

B, C Lightweight Metal Snips

For cutting templates and patterns from medium-hard metal sheet up to B&S 20 or from soft sheet up to B&S 16. Available with either straight blades for making straight cuts or curved blades for cutting circular shapes. Also choose between looped and plain handles. Measure 7" long with 1½" long blades. Made in Germany.

Description	Item#	Each
B. Straight Snips with Looped Handles	819-0150	\$16.50
Straight Snips with Plain Handles	819-0100	16.50
Curved Snips with Looped Handles	819-0200	16.50
C. Curved Snips with Plain Handles	819-0050	15.75



B



C

D. Micro Beading Snips

Use these snips to cut cords and snip apart knotted strands for restringing. Reflex action lets you do light work quickly and easily. Measure 3½" long with 1⅛" long blades.

Description	Item#	Each
Micro Beading Snips	819-0210	\$2.95



D

E. Precision Scissors

Lightweight, maneuverable scissors for easy cutting in tight spaces. Feature small (1¼" long) pointed blades made of high-quality stainless steel, large contoured ABS plastic handles and rivet and nylon washer assembly for smooth action. Measure 4¼" long.

Description	Item#	Each
Precision Scissors	819-0110	\$9.95



E



F

F. Crown Scissors

Stainless steel scissors with small (1" long) blades and large looped handles. Can be used on soft wire and very light metals. Great for cutting around bezels. Measure 4½" long.

Description	Item#	Each
Crown Scissors	819-0115	\$4.20



G

G. Short-Blade Scissors

Feature small (1" long), sharp blades with fine points for easy cutting in the tightest spaces. Excellent for cutting thread, ribbon and bead cord. Measure 3½" long. Stainless Steel.

Description	Item#	Each
Short-Blade Scissors	819-0125	\$3.35

H. Solder Cutting Pliers

These special pliers can be used to consistently cut both sheet and wire solder. Sheet is cut in 1/16" (1.6 mm) squares and wire, up to 18-gauge (1.02 mm), in 1/16" lengths. Cut is consistent time after time. Measures 5½" overall length with plastic comfort grips.

Description	Item#	Each
Solder Cutting Pliers	180-0279	\$11.50



H



A-C Goldwashers
Precious metal recovery systems with automatic filters.

These patented automatic hand-wash sinks recover precious metal from your workshop's soapy water. Feature inexpensive, corrosion-resistant 25 micron cartridge filters, which can be easily replaced and burned. Use powerful 500W motors to pump water through separation compartments at an impressive rate of 30 liters per minute—much faster than other models on the market. Have perfectly watertight covered tanks, which eliminate liquid stagnation and all its accompanying odors. Made of stainless steel and corrosion-resistant material. Include chrome-plated taps with separate handles for hot and cold water and indicator gauges for filter replacement. Made in Italy.

Specifications:

Electrical: 110V, 5A, 1 Ph, 500W, 60Hz
 (220V, 50/60Hz available)
 Cartridge Filter 25 micron

See Our Website for Alternate Style



D



Dimensions	Net/Ship. Wt.				
Description	(W x D x H)	(lbs.)	Item#	Each	
A. 4-Tap Unit	50" x 18½" x 43¼"	172/227	212-1085	\$6,995.00	
B. 2-Tap Unit	34¾" x 18½" x 43¼"	123/172	212-1080	5,995.00	
C. 1-Tap Unit	19¾" x 18½" x 43¼"	90/140	212-1090	4,995.00	
Replacement Filter			212-1087	32.99	

D. Gold Catcher

Recovers all your precious metals before they go down the drain.

By providing room for sedimentation in the tank, Gold Catcher captures your precious metals before they are lost forever, letting you turn them into cash at the refinery. Includes heavy-duty 8-gallon plastic drum with sealed lid, complete external 1½" diameter PVC connections for any sink or drain and easy-to-change, corrosion-resistant 40 micron filter. Has no pumps, moving parts or electrical components. Measures 13" dia. x 20½"H. Weighs just 7 lbs.

Description	Item#	Each
D. Gold Catcher	856-1205	\$275.00
Replacement Filter	856-1206	68.00

E. Reclamation Mats 24" x 36" (30)

Our economical reclamation mat is designed for use as a floor mat in polishing areas. Sticky surface captures and holds onto your precious metal dust without adhesive transfer to your footwear. 30 sheets per mat, each sheet measures 24" x 36". Sold only in multiples of 2 mats for a total of 60 sheets or in boxes of 10 mats for a total of 300 sheets. Due to the size (ships flat) additional shipping charges may apply. Made in China.

Description	Item#	Each
Pkg. of 30 – packages are sold in multiples of 2 only	821-2967	\$29.95

Two-piece minimum; Please order in multiples of two.

Description	Item#	Each
Box of 10 packages of 30	821-2968	\$269.50



E

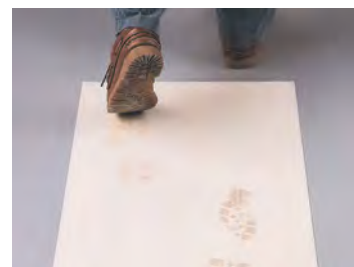

F

F. 3M™ Clean Walk Mat

An adhesive-coated mat that can be used as a bench pan liner or doormat for dust and scrap collection. Includes 30 adhesive sheets on a 2.0mm polyethylene backing. Just peel back top sheet to expose fresh adhesive. Won't adhere to shoes or wheels. Measures 36"L x 18"W.

Description	Item#	EACH Prices	
		1-3	4+
Clean Walk Mat 18" x 36" 30 sheets	821-2965	\$69.50	\$62.55

A. MAX 30 Multi-Function Finishing Machine
Variable-speed unit for wet and dry grinding and polishing!

Mix and match wheels, belts and discs on your MAX 30 finishing machine, and run them wet or dry without any mess or time-consuming tool changes. MAX 30 is 31½" in width and can hold six different abrasives. Just position them in the progressive order that suits your grinding and polishing requirements, then proceed from start to finish, spending less time and effort. MAX 30 can accommodate up to and including 6" wheels. MAX 30 is ideal for most jewelry applications. Features digital control for running abrasive products at speeds conducive to maximum performance and life, durable stainless steel cabinet with front-entry design for easy belt maintenance, 4-gallon recirculating water pump, separate water supply hoses and valves for controlling water flow to each abrasive, clear-view spray reduction shield and four strategically positioned lights for viewing work in progress. Made in Taiwan

See the next page or go to our website for a complete line of wheels and belts specifically developed to get the absolute most out of your MAX unit.

Features

- Smooth digital control for running wheels & belts at speeds conducive to maximum performance and life
- Operating speed range: variable speed from 500 to 3,600rpm
- Digital readout of speed in rpms
- Stainless steel cabinet
- 2 internal fluorescent lights with 2 LED lights for viewing work in progress

Specifications

Electrical: 240V, 50/60Hz
 Motor: 1 HP
 Dimensions: 31½"W x 25½"D x 20¾"H
 Variable speed control 500-3,600rpm
 Recirculating water pump
 Machine Shaft: 1" dia x 27¾" long
 Net/Ship. Wt.: 154/257.4 lbs.

Description	Item#	Each
MAX 30 	854-0013	\$3,950.00
Transformer to 110V	854-0027	298.50

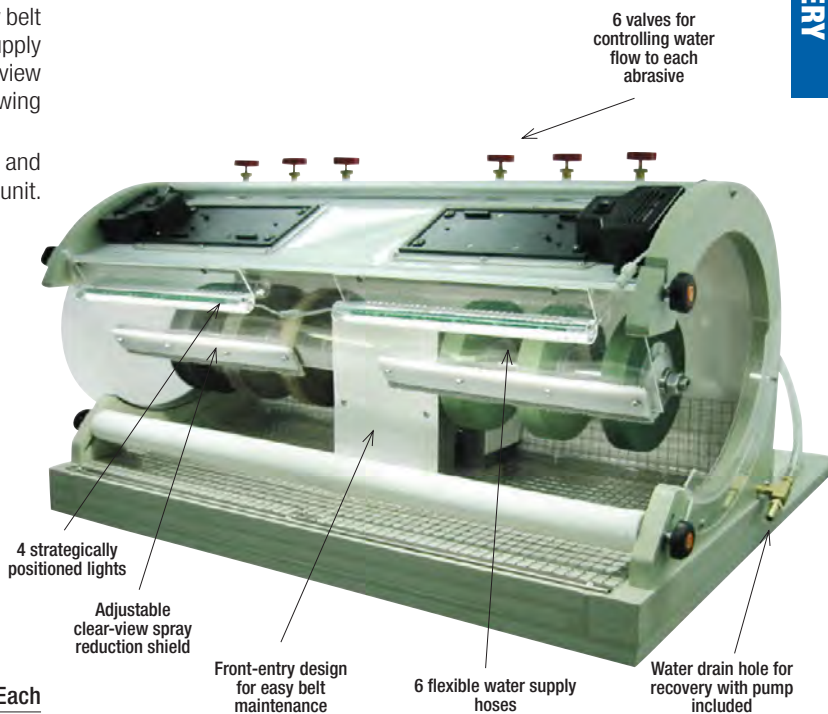

Shown with MAX Wheels (not included)

B. MINI MAX Combo Grinder/Polisher
Variable speed with inside/outside grinding and polishing

The Mini Max Combo is ideal for wet or dry polishing applications! The left side of the machine allows for up to (3) drums/wheels (1" thickness) or (6) 3M bristle discs that when run wet increases performance and profit by means of precious metal reclamation. The right side of the unit includes a buffing station to handle the grinding, blending and polishing of the inside of rings. A must for any small shop, the Mini Max Combo allows the user to mix and match wheels, belts and the specialty inside ring buffs. Small foot print, variable speed motor, water system and LED lights for illuminating the workspace. This model is ideal for use with RA/MX polishing wheels, 3M bristle discs and straight/tapered inside ring polishers (Made out of MX material - see page 94). Accommodates up to a 4" wheel/drum/disc. Made in Taiwan

Specifications

Electrical: 110V, 60Hz
 Motor: 1/2 HP
 Variable speed control: 500-3,600rpm

Dimen: 24½"W x 9½"L x 11"H
 Net/Ship. wt: 25/31 lbs.
 High power 4 gallon/recirculation water pump

Description	Item#	Each
MINI MAX	854-0120	\$1,150.00

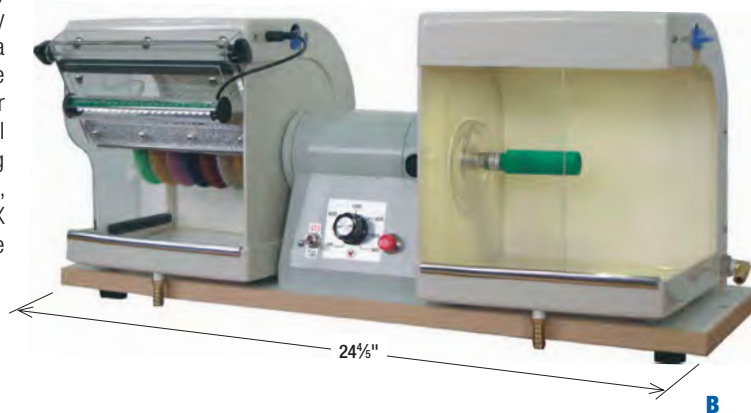

Shown with MAX Wheels and inside Ring Polisher (not included)

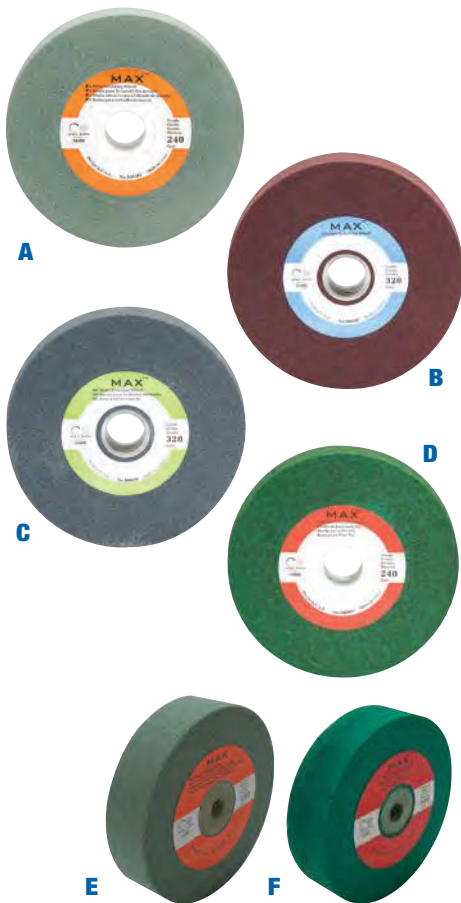

MAX Accessories

A-D MAX Abrasive 6" Wheels

Choose from four types of 6" wheels specifically developed for our MAX 24/30 units: XA grinding, LD light deburring, MF multifinishing and MX polishing. Measure 6" dia. x 1" thick x 1" AH. Recommended operating conditions: 1,200–1,800rpm with medium water flow for XA, LD and MF wheels; 1,200–1,500rpm with light water flow for MX wheels.

Description – 6" dia.	Grit	Item#	EACH Prices		
			1-2	3+	
A. RA Removing Sprues & Parting Lines Lapping Edges and Flat Surfaces	240	845-3060	\$65.95	\$62.65	
B. LD Light Deburring	320	845-3053	33.95	32.25	
C. MF Light Deburring and Prepolishing	320	845-3050	33.95	32.25	
	MF Prepolishing	600	845-3051	33.95	
	MF Polishing	1000	845-3052	33.95	32.25
D. MX Light Deburring	240	845-3055	41.95	39.85	
	MX Prepolishing	600	845-3056	41.95	
	MX Fine Polishing	1500	845-3057	41.95	39.85
	MX High Shine Final Polish	3000	845-3058	41.95	39.85

E, F MINI MAX Abrasive 4" Wheels – For Blending and Polishing

For use with the MINI MAX finishing machine. Measure 4" diameter x 1" thick x 3/8" AH wheels. Operation: 1,200–1,800rpm with medium water flow for RA wheels; 1,200–1,500rpm with light water flow for MX wheels.

Description – 4" dia.	Grit	Item#	Each	
E. RA Removing Sprues & Parting Lines Lapping Edges and Flat Surfaces	240	845-3075	\$23.50	
F. MX Light Deburring	240	845-3071	23.50	
	MX Prepolishing	600	845-3072	23.50
	MX Fine Polishing	1500	845-3073	23.50
	MX High Shine Final Polish	3000	845-3074	23.50

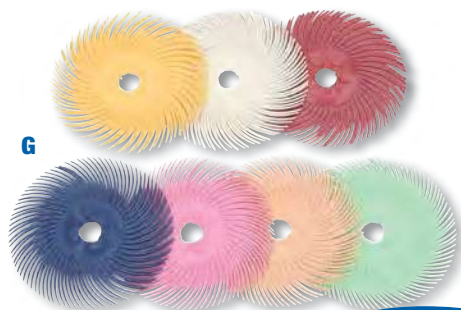

G-I 3M™ Scotch-Brite™ Radial Bristle Discs

The 3" discs are sold with RH tapered spindle adapters in packages of 10 or 40. Used to clean, pre-polish, blend and remove scratches and firescale. Require no compounds, and long lasting and nonloading. Max. operating speed 20,000rpm.

Dia. x AH	Color	Grit	Item#	Pkg. of 10 Each	Pkg. of 40 w/hub Item#	Each
G. 3" x 3/8"	Yellow	80	145-1780	\$34.15	145-1710	\$132.85
	White	120	145-1785	34.15	145-1715	132.85
	Red	220	145-1790	34.15	145-1720	132.85
	Blue	400	145-1795	34.15	145-1725	132.85
	Pink	Pumice	145-1800	34.15	145-1730	132.85
	Peach	6 Micron	145-1805	34.15	145-1735	132.85
	Lt. Green	1 Micron	145-1810	34.05	145-1740	132.85

See More Radial Discs on pages 404, 405



Description	Item#	Each
22-Piece 3" Disc Set	145-1815	\$75.00
H. RH Tapered Spindle Adapter Hub for 2" and 3" discs	145-1921	2.30
I. LH Tapered Spindle Adapter Hub for 2" and 3" discs	145-1922	2.30

J, H 6" 3M™ Scotch-Brite™ Radial Bristle Discs – For use with polishing motors

Each 6" disc consists of eight stacked discs (approx. 1/2" thick) mounted on a plastic hub. Includes adapters for 3/8", 1/2", 5/8" and 3/4" arbors. Max. operating speed 6,000rpm. Use (145-1931) for tapered spindles.

Dia. x Thickness x AH	Color	Grit	Item#	EACH Prices	
				1-2	3+
J. 6" x 1/2" x 1"*	Yellow	80	145-1925	\$63.00	\$59.85
	White	120	145-1926	63.00	59.85
	Red	220	145-1927	63.00	59.85
	Blue	400	145-1928	63.00	59.85
	Peach	6 Micron	145-1929	63.00	59.85
	Lt. Green	1 Micron	145-1930	63.00	59.85
H. Tapered Spindle Adapter			145-1931	5.80	-

*Complete with adapters for 3/8", 1/2", 5/8", and 3/4" arbors.



A. 3M™ Trizact Belt

Our 120 grit Trizact belt was developed specifically to run wet. It's microreplication structure provides a fast consistent finish. Measure 1½"W x 18¹⁵/₁₆"L. Operating speed: 3,600rpm.

Description	Drum Size	Grit	Item#	Each
Trizact Belt	6"	100	109-8450	\$8.45

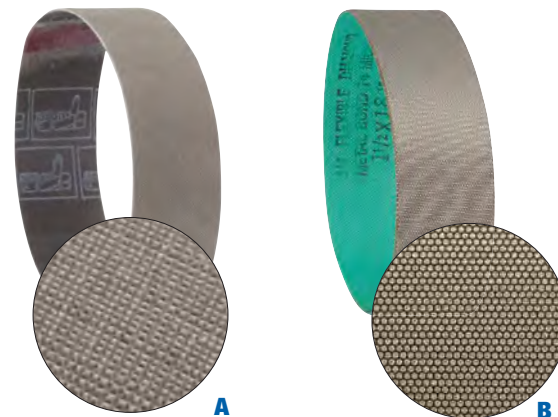

B. 3M™ Flex Diamond Belt

A durable, nonloading belt for cleaning, shaping and prefinishing. Coated with diamond in a honeycomb pattern for fast cutting with no gouging or catching. Run wet or dry on hard and soft metals, including platinum, palladium and white gold, and even soft stones. Measures 1½"W x 18¹⁵/₁₆"L. Use with 6" Expander Drum (see below).

Description	Drum Size	Grit	Item#	Each
Flex Diamond Belt	6"	220	109-8453	\$85.60

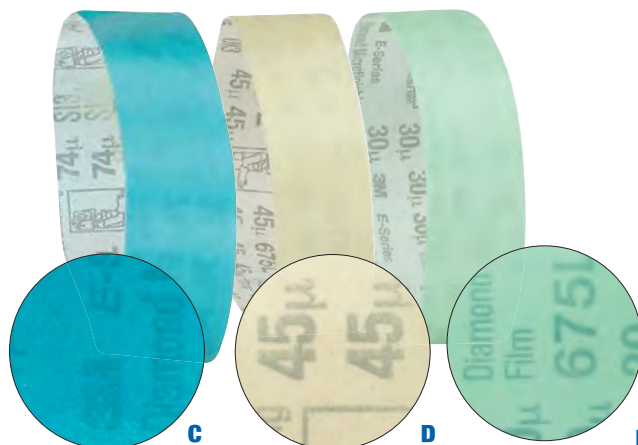

C-E 3M™ Diamond Micro-Finishing Film Belts

Consist of precision-graded diamond abrasive bonded onto flexible film backing. Cut faster than aluminum oxide and silicon carbide. Run wet or dry on metals, stone, glass, enamel, plastic and more. Color-coded for east grit identification. Measure 1½"W x 18¹⁵/₁₆"L. Use with 6" Expander Drum (see below).

Description	Drum Size	Color	Grit	Item#	Each
C. Diamond Film Belt	6"	Aqua	220	109-8452	\$18.10
D.		Yellow	320	109-8454	18.80
E.		Green	400	109-8455	17.90

F. MINI MAX Sanding Belts – For 4" drum

Feature silicon carbide bonded onto cloth backing for fast cutting. Can be used wet or dry on a variety of metals. For 4" expander drum. Measures 1"W x 12⁹/₁₆"L, 4" diameter. Imported

Grit	120	240	320	500	Pkg. of 10
Item#	845-3066	845-3067	845-3068	845-3070	\$12.60

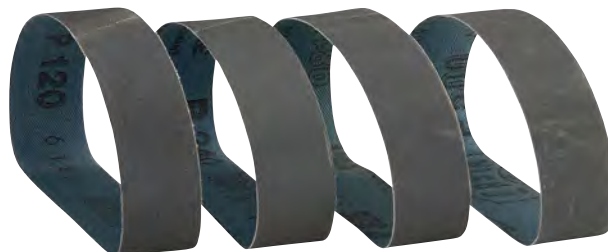

G. Expander Drum – 6" diameter

Our expander drums work perfectly for our customers that use 3M belts to grind and smooth their material. They are designed with angled slots through the rubber rim to allow them to expand while being rotated on machines. In use, they lock the belt in place and remove scratches with their convex shape. Rubber drum expands while running to grip belts securely yet allows simple belt changes. Measure 6" diameter x 1½" wide with 1" arbor hole. Max. operating speed 2,400rpm.

Description	Item#	EACH Prices		
		1-2	3-5	6+
Expander Drum 6"	840-1259	\$52.00	\$46.80	\$44.20



H. MINI MAX Expander Drum – 4" diameter

This rubber drum expands while running to grip belts securely yet allows simple belt removal. Measures 4" dia. x 1" thick x 3/8" AH.

Description	Max. Speed	Item#	Each
Expander Drum 4"	3,600rpm	845-3065	\$49.95





A

A. Gesswein/DCE Vokes Dust Collector #68
The finest in the industry. Provides better suction with less noise.

Equipped with a triple inlet hopper. A quick-release sealer gear provides an airtight seal between the hopper and the dust container. Filter bags are rigidly separated to prevent blockage. The automatic shaker vigorously cleans the filter bags for approximately 60 seconds every time the fan is switched off. Supplied with filter assembly and transition inlet. Backed by a full two-year warranty.

Features:

- Shakers for filter assembly activate automatically every time unit is switched off, keeping filters cleaner so they last longer.
- Fully electronic controller (switch box).
- Wide, flush-fitting front panels for fast, easy access to fan and filter chambers.
- Multi-pad filter assembly provides maximum fabric area for optimal filtration.
- High-quality filter fabric.
- One-piece multiple filter bag system minimizes the number of seals needed between the fabric and frame.
- Flexible wire mesh pad inserts ensure maximum effective use of fabric area.
- Airtight design for maximum efficiency.
- Built-in silencer reduces noise to level well within OSHA specifications: 71 dBA.
- A choice of three inlet positions for convenient location of unit in relation to workstations and for best use of available space.

Specifications:

No. of Stations:	5-8	Dimensions:	
Suction Motor:	5 HP	A (Width)	2' 6 1/8"
Airflow:	2,000 CFM	B (Depth)	2' 6 1/8"
Filter Area:	150 sq. ft.	C (Height)	8' 3 1/2" **
Min. Ceiling Ht.:	9' 1/2"	D	2' 6"
Duct Diameter:	8"	E	3' 1 1/2"
Dust Container:	3 cu. ft.	F	3' 5"
Ship. Wt.:	606 lbs. (approx.)		

Description	Item#	Each
A. Model 68 Dust Collector, 220V, 3 Ph, 60Hz	854-1750*	\$12,766.40
Model 68 Dust Collector, 415V, 3 Ph, 50Hz	854-1765*	11,320.32
Replacement Filter Assembly	854-1753	917.00

*Prices FOB Kentucky. Additional charges for other voltages and for export crating.
 ** Ships flat. Must have dock at your location. Can not use a lift gate, due to length when flat. Double check any turns that need to be made inside your facility.

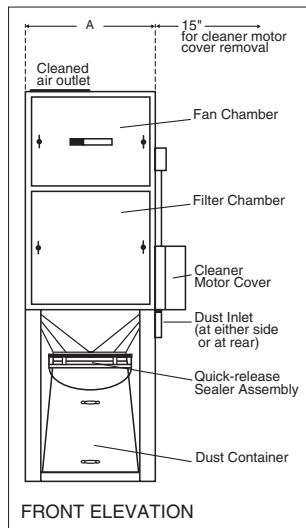
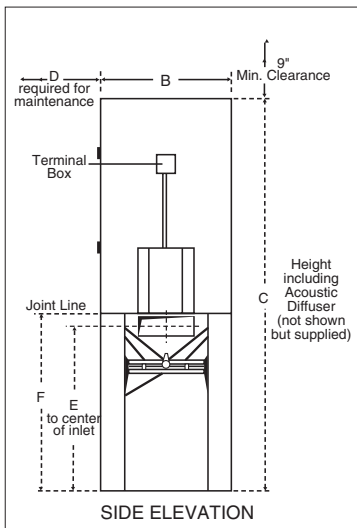

If you are looking for a dust collection system that we are not showing in our catalog, please contact us with your requirements. We will work with you to make sure you have what you need.



A-D Quatro Velocity Dust Collectors

These professional units collect 99.97% of all compound dust and precious metal particulate down to submicron levels. Ideal for grinding and polishing applications. Prefilter (which prolongs filter cartridge life 2–4 years) and state-of-the-art cartridge filter ensure return air is absolutely clean. Built-in collection tray captures your precious metal dust and lets you reclaim it without removing the cartridge filter.

Backed by a one-year manufacturer's warranty. CSA and CE approved. Made in Canada. Both the 1-Port and the 2-Port can be shipped UPS.

Features:

- Unique sub-micron dust collection filtration down to .03 microns. (Category C: 99.97% dust extraction) recirculates clean air back into the workplace eliminating the need for outside ventilation.
- Inlet ports can be positioned on top or side of unit.
- Optional on/off foot switch and silencer (reduces sound 10-15%, easily attaches to unit without tools) also available.

Specifications:	1-Port	2-Port	4-Port	4X4-Port
No. of Stations:	1	1–2	2–4	5–8
Suction Motor				
Electrical:	120V, 5.3A, 50/60Hz	120V, 6.1A, 50/60Hz	120V, 9.2A, 50/60Hz	230V, 18A, 60Hz
Power:	1/2 HP	3/4 HP	1 HP	2 HP
Airflow:	200 CFM	400 CFM	800 CFM	1,600 CFM
Noise level:	56 dBA	56 dBA	58 dBA	70-75 dBA
Filter Area:	25 sq. ft.	35 sq. ft.	60 sq. ft.	60 sq. ft.
Inlet Diameter:	3"	3"	3"	3"
Dimensions, WxDxH:	14"x20"x17"	14"x25"x17"	18"x34"x22"	18"x34"x22"
Net/Ship. Wt.:	65/72 lbs.	73/80 lbs.	120/131 lbs. 	140/233 lbs. 
3" Dia Flex Hose:	6'	12'	25'	50'
Hose Clamps.:	2	4	8	16
Replacement Prefilters (20):	854-1392	854-1392	854-1389	854-1389
Each:	\$44.00	\$49.00	\$55.00	\$55.00
Replacement Cartridge Filter:	854-1398	854-1391	854-1388	854-1388
Each:	\$76.00	\$104.00	\$118.00	\$118.00
Item#:	854-1383	854-1382	854-1380	854-1381
Each:	\$932.00	\$1,205.00	\$1,571.00	\$1,571.00

Description—Optional Equipment	Item#	Each
On/Off Foot Pedal for all units	854-2094	\$98.00
Silencer for Velocity units	854-1528	91.00



E Quatro Multi-Station Power 6 Dust Collector

The high quality Quatro Multi—Station "Power 6" Dust Collector (6 X 1.5" Inlets) is a must for any facility needing one powerful dust collector for up to 6 work stations. Its certified HEPA filtration and high airflow brushless motor works efficiently to capture 99.97% of the dust/submicron particulates while offering "clean air" surroundings and quiet operation (59dBA). The Power 6 is ideal for all grinding and polishing applications at your bench while offering a solution for dust collection and clean air to multiple (up to 6) workstations/benches. Includes a 50 foot 1.5" hose. One-year warranty. 230V, 10A, 1Ph, 50/60Hz. 22"W x 25"D x 39"H. 200 lbs. Made in Canada.

Features:

- Allergy-Safe, high capacity sealable bag filters allow you to safely capture and contain large amounts of debris. Can reclaim your dust and particles for refining. 6 bag filters are required (854-2189) and 2 HEPA filters (854-2079).
- HEPA Filter, 99.97% efficiency on submicron particles
- Two brushless 1HP motors deliver more airflow and greater suction, 900CFM
- Intelligent controls provide constant monitoring and maintenance alerts.

Description	Item#	Each
Quatro Multi-Station Power 6 Dust Collector 	854-1402	\$3,495.00



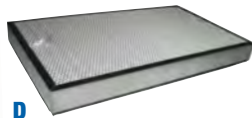

A-C Quatro CollectAll Dust Collectors

Available in two motor options. The #854-2179 uses a 1.5 HP high-speed brushless turbine motor to produce 600CFM of airflow, providing long continuous use without the need to replace motor brushes. The #854-2187 uses two quieter running 1 HP Infinity hybrid motors to produce 450CFM of airflow and will provide 2,000-3,000 hours of use before needing motor replacement.

Both feature a three-stage filtration system that captures fumes and particulate down to 0.3 micron: bag filter captures large particles from grinding and polishing; media filter captures rhodium and soldering fumes; HEPA filter captures the smallest particulate down to submicron levels. Returns 99.97% clean air to your shop, making outside ventilation unnecessary. Perfect for small shops, malls and other places where noise can pose a problem. Includes 12' of 3" dia. flex hose and hose clamps. Backed by a one-year manufacturer's warranty. Made in Canada.

Specifications:

Inlets: Two 3" dia. inlets in top
 Airflow: (854-2179, 600 CFM, 854-2187, 450 CFM)
 Noise Level: (854-2179, 58dBA, 854-2187, 55dBA)
 Electrical: 120V, 12A, 1 Ph, 60Hz
 Dimensions, Net Wt.: 17"W x 14"D x 26"H, 75 lbs.

Description	Item#	Each
A. CollectAll, Brushless Turbine Motor 1.5 HP	854-2179	\$1,924.00
B. CollectAll, 2 Infinity Motors (2) 1HP	854-2187	1,440.00
Optional On/Off Foot Pedal	854-2094	98.00
C. Replacement Bag Filters (6)	854-2189	49.00
Media Refills (4) for rhodium fumes	854-1396	169.00
Media Refills (4) for soldering fumes	854-1409	122.00
D. Replacement HEPA Filter	854-2093	128.00

E. Quatro PGR Dust Collector – Brushless Suction Motor

Superior suction, 900 CFM, in a compact design. Brushless motor and the ability to separate collection materials makes this a must for shops with polishing and grinding applications. Two stage filtration uses bags, then HEPA filters ensuring 99.7% efficiency. Includes 12ft of Heavy Duty 3" diameter hose & clamps. 120V, 10A, 60Hz. 22"W x 14 1/2"D x 29 1/2"H (to top of inlet port). One-year manufacturer's warranty. Made in Canada.

Description	Item#	Each
E. PGR Dust Collector	854-1475	\$1,105.00
C. Replacement Bag Filters (6)	854-2189	49.00
D. Replacement HEPA Filter	854-2093	128.00

F. Dust Collector #60B

Fits neatly under many workbenches, saving precious bench space without taking up too much legroom. Includes silencer for quiet operation, external foot pedal for filter shakedown and removable catch pan for easy reclamation. One-year manufacturer's warranty. Made in USA.

Specifications:

Inlets: Two 3" dia. inlets in back
 Suction Motor: 1/2 HP
 Airflow: 400 CFM
 Noise Level: 50 dBA
 Electrical: 110V, 9A, 1 Ph, 60Hz
 Dimensions: 16"W x 16"D x 20"H, Net Wt.: 75 lbs.

Description	Ship. Wt.	Item#	Each
F. Dust Collector #60B	85 lbs.	854-1370	\$875.00
Replacement Filter Bags, set of 14		854-3152	435.00

A. Quatro Gold Vault Extra

The affordable Gold Vault Series of Dust Collectors by Quatro has evolved to a new level! With safety always being a concern in today's workplace, Quatro has gone a step further and created an "All-In-One" unit to handle both dust debris/particles and odor while still capturing your precious metals.

The Gold Vault Extra comes in two variations: Standard powerful turbine motor that is quiet running, or the model supplied with a long lasting Infinity motor. Infinity motor model costs more but motor brushes will last 4-5 times longer than the standard motor. Both variations still carry the same small footprint for tight spaces as previous Gold Vault models. The high speed turbine style motor allows for fast efficient debris removal and the new filter system ensures 100% capture of ALL precious metals. New filter system that accommodates both dust and odor, consists of disposable filter bags followed by Odor and HEPA filters. A true All-In-One system, will prove to be quiet (49dBA) and effective with variable speed control, and includes a "T" connector and two 6' hoses for two-station use.

Optional on/off hand switch available (854-1368) or on/off foot pedal also available (854-1369). Use your Gold Vault with your 3" Diameter Hoses/Hoods by purchasing a 1½" to 3" adapter (854-1519). Original Gold Vault units can be retrofitted to accept the new filter systems (854-1545). Backed by a one-year manufacturer's warranty. Made in Canada.

Specifications (Standard and Infinity):

- Inlets: One 1½" dia. inlet in top Suction Motor: 1 HP
- Dimensions: 9"W x 9"D x 19"H Airflow: 150 CFM
- Electrical: 120V, 7A, 1 Ph, 60Hz Net Weight: 28 lbs.

Description	Item#	Each
A. Quatro Gold Vault Extra Standard	854-1540	\$645.00
Quatro Gold Vault Extra Infinity	854-1541	720.00
Replacement HEPA Filter	854-1543	49.00
Replacement Odor Filter	854-1544	35.00
On/Off Hand Switch	854-1368	48.00
On/Off Foot Pedal	854-1369	49.95
1.5" to 3" Hose Adapter	854-1519	13.00



B. Quatro Basic

With this tiny unit, you don't have to sacrifice air quality or recovery capability even if your space is limited. Great for grinding, polishing, engraving and much more. Ideal for tight spaces. High-speed turbine for fast collection and replaceable bag filter.

Includes 6' of 1½" diameter hose. Can be used with miniature finishers with 1½" diameter outlets. Use with 3" hoods and hoses by purchasing the optional 1.5" to 3" adapter (854-1519 see below). One-year manufacturer's warranty. Made in Canada.

Specifications:

- Electrical: 120V, 7A, 1 Ph, 60Hz Suction Motor: 1 HP
- Dimensions: 7"W x 9¾"H Airflow: 130-150 CFM
(11"H to top of inlet) x 16"D
- Net Wt.: 20 lbs. Noise Level: 60-64 dBA

Description	Item#	Each
B. Quatro Basic + Foot Switch	854-1367	\$425.00
Replacement Bag Filters	854-1531	30.00



C. Quatro Hose Adapter

Heavy duty plastic adapter fits 2½" hose and widens to 3". Use to attach any dust collector with 1½" inlet (such as Quatro Basic and Gold Vault) to a 3" hose or hood opening.

Description	Item#	Each
Quatro Hose Adapter (1.5" to 3")	854-1519	\$13.00

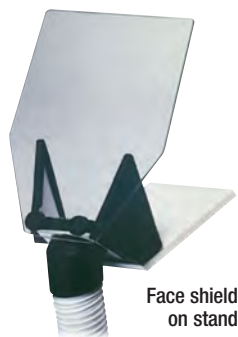

Face shield on stand



A

A. MicroVac III Under-Bench Dust Collector

The sophisticated, powerful MicroVac III provides quiet, efficient dust collection at your bench. Extracts 99.99% of dust from the air. Positioned vertically in an easily accessible door, a bag filter with barrier mat allows dust to settle to the bottom to maintain suction and extend filter life. An extra-fine cartridge filter captures tiniest dust particles.

Features two-stage turbine with muffler that offers enough power to collect dust from two stations at once, control knob for fully adjustable suction and auxiliary outlet that provides the option to operate both your MicroVac III and flex shaft or micromotor at the flip of one switch (manual switch allows override).

Sold with 6'L x 1½" dia. hose only or 6' hose, safety-glass face shield on stand and magnetic handrest. Includes mounting plate and all hardware for optional under-bench attachment and set of filters. Has 1½" dia. inlet in back. Noise level: 52–61 dBA. Electrical: 120V, 60Hz. Measures 10½"W x 14½"D x 15"H. Backed by a one-year warranty. CE approved. Made in Germany.

Description	Ship Wt. (lbs.)	Item#	Each
A. MicroVac III w/ 6' hose only	46	854-2128	\$1,195.00
MicroVac III w/ all accessories	54	854-2127	1,400.00
Optional Standard Bag Filters (3)		854-2119	39.95
Replacement Bag Filters with Mat (3)		854-2117	74.85
Replacement Cartridge Filter		854-2121	74.25



B

B. Foredom® Dust Collector

Whisper quiet at 52 dBA with powerful suction at 115 CFM. The cyclone with polycarbonate collection chamber pre-filters 99% of all debris and HEPA filter eliminates 99.98% of debris up to 0.3micron. It is a stand-alone unit for collecting dust from grinding, polishing, deburring and sanding wood, metal, die stone, plaster and many other materials. Use when working with dry materials ONLY. 2 Year Limited Manufacturer's Warranty.

Includes: 2 HEPA filters with MERV 16 rating 5' flexible 2¼" diameter vacuum hose. Remote on/off switch with 9' cable. Remote Connector for use with Foredom Lighted Work Chamber (850-0645, see page 402), Single station unit with casters for easy portability. 6' power cord. Made in Taiwan.

Specifications:

Weight 30½ lb
 15¼"L x 15¼"W x 19½"H
 Cyclone Height 16½", Width 7½"
 Shipping Dimensions 20¼" x 20¾" x 23¼"
 115 Volt, 6.5 Amp, 750 watt (220V also available)

Description	Ship Wt. (lbs.)	Item#	Each
B. Foredom MADC20	40	854-2200	\$679.15
Replacement DC Hepa Filter (1)		854-2203	9.95
Connector		854-2204	17.95



C

D

C, D ARBE Under-Bench Vacuum System

This compact, efficient, quiet system fits neatly under or next to your bench, removing air contaminants while you work. Features a fish-mouth suction hood that can be placed on top of your bench to pull dust and fumes away from your face. Has on/off switch on top for easy accessibility.

Includes 6'L x 1½" dia. flexible hose and two quick-change filters: disposable bag filter for particulate (send to your refiner when full) and activated charcoal filter for odors (replace every 6–8 months). Optional vacuum bench pin sold separately (see below). Airflow: 110 CFM. Noise level: 56 dB. Electrical: 110V, 4.5A, 50/60Hz Blower Motor: 1/2 HP. Measures 10"W x 15¼"D x 14"H. Backed by a one-year warranty. Made in USA.

Description	Item#	Each
C. Under-Bench Vacuum System	854-1762	\$530.00
D. Optional Vacuum Bench Pin	854-1769	59.00
Replacement Bag Filters (6)	854-1763	29.95
Replacement Charcoal Filter	854-1764	29.95

A-E Quatro SPU Polishing and Dust Collecting Units

These units use 3-stage filtration systems to capture all your precious metal dust, not just a portion of it. Recover more metal for refining and keep your workplace cleaner and healthier than ever before. Choose from Two-Station and Junior Deluxe models.

An excellent choice for many large shops, the Two-Station SPU units are available with Quatro 1/2 HP two-speed double-spindle polishing motor and two tapered spindles in standard or high volume versions OR with 2 polishing motors and 2 hoods OR one polishing motor and one hood along with a split lapper and corresponding split lapper hood.

An ideal fit for small shops, the Junior Deluxe SPU comes with Quatro 1/2 HP two-speed single-spindle polishing motor and tapered spindle. Includes lighted Clearview hood, prefilter, bag filters and HEPA filter.

Clearview hoods fully enclose buff areas, trapping precious metal dust

inside. Energy-efficient, LED, low-heat lights in hoods use much less power than incandescent lights and keep your work area much brighter and cooler. Affordable, easy-to-change prefilters under the hoods collect large particles, and subsequent filters capture tiny particles (as small as 0.3 micron with HEPA filter), after which clean air is recirculated back into the room. Backed by a one-year manufacturer's warranty. Made in Canada.

Features:

- Advanced 3-stage filtration systems and powerful suction motors for maximum metal dust recovery.
- Strategically placed inlet locations right below motor spindles for optimal intake.
- Office-friendly whisper-quiet operation.
- Optional on/off foot pedal for on-the-fly polishing.

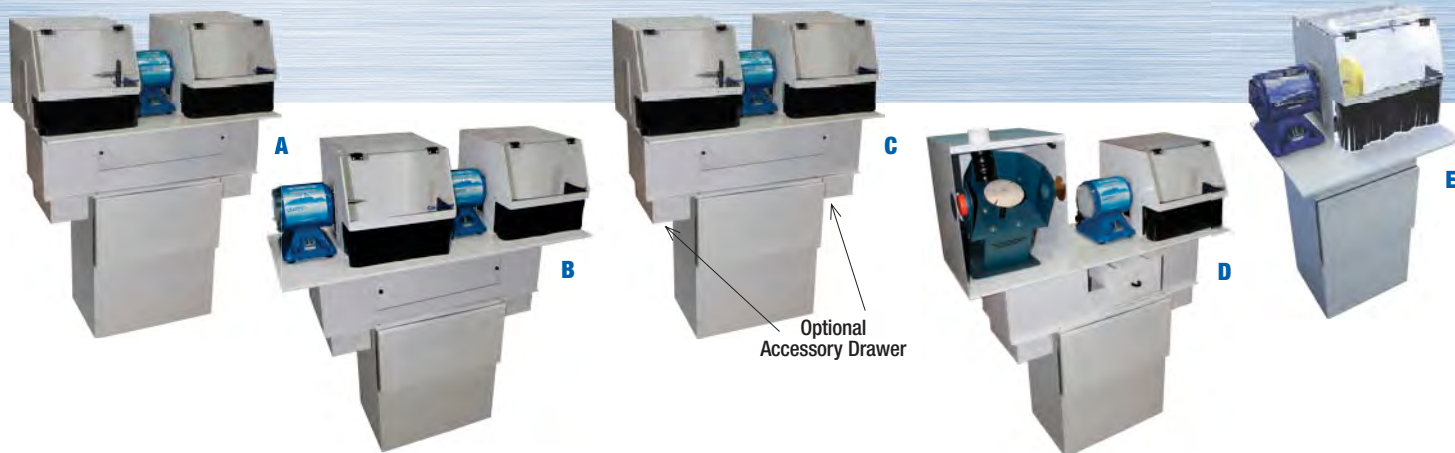

Specifications:	A. SPU High Volume Deluxe Two-Station	B. SPU Double Stand-Up Two-Station	C. SPU Standard Two-Station	D. SPU w/Split Lap Combo Two-Station	E. SPU Junior Deluxe Single-Station
Electrical:	120V, 10A, 60Hz	120V, 4.6A, 1 Ph, 60Hz (240V available)	120V, 9.2A, 1 Ph, 60Hz (240V available)	120V, 9.2A, 1 Ph, 60Hz (240V available)	120V, 4.6A, 1 Ph, 60Hz
Suction Motor: Airflow:	1 HP Brushless 1,000 CFM	1/2 HP Brushless 1,200 CFM	1 HP Brushless 1,200 CFM	1/2 HP 1,200 CFM	1/2 HP Brushless 600 CFM
Noise Level:	55 dBA	60 dBA	60 dBA	60 dBA	56 dBA
Polishing Motor: double spindle motor two-speed: 3,450/1,725rpm	One, Quatro 1/2 HP single spindle motor two-speed: 3,450/1,725rpm	Two, Quatro 1/2 HP double spindle motor two-speed: 3,450/1,725rpm	One, Quatro 1/2 HP single spindle motor and one Split Lapper Split Lapper	One, Quatro 1/2 HP single spindle motor two-speed: 3,450/1,725rpm	One, Quatro 1/2 HP single spindle motor two-speed: 3,450/1,725rpm
Dimensions: (W x D x H):	40" x 20" x 53"	48" x 19" x 53"	40" x 20" x 53"	45" x 19" x 59"	24" x 20" x 50"
Ship wt:	230 lbs.	266 lbs.	229 lbs.	276 lbs.	145 lbs.
Item#	854-2081	854-1404	854-2077	854-2074	854-2183
Price	\$2,695.00	\$2,695.00	\$2,195.00	\$2,995.00	\$1,740.00

Replacement Filters	Item#	Item#	Item#	Item#	Item#	Package
Prefilters (20)	854-2091	854-2091	854-2091	854-2091	854-2091	\$49.95
Bags (6)	854-2189	854-2189	854-2189	854-2189	854-2189	49.00
HEPA	854-2079	854-2079	854-2079	854-2079	854-2093	128.00
Optional Accessory Drawer	854-2073	854-2073	854-2073	854-2073	—	120.00
Optional On/Off Foot Pedal	854-1369	854-1369	854-1369	854-1369	854-1369	49.95
Replacement Clearview Hood	854-2083	854-2083	854-2083	854-2083	854-2083	289.00
Replacement Lapper Hood	—	—	—	854-2072	—	329.00



BEST BUILT
Jewelry Equipment

A. BESTBUILT Polishing and Dust Collecting Unit
For improved dust recovery and workplace cleanliness!

This completely enclosed stand-alone polishing system utilizes a 1/2 HP suction motor in an almost completely sealed work area to capture virtually all your precious metal dust.

Easy to change two-stage filtration system teams a tightly woven cotton bag to collect large precious metal particles and dust with a reusable secondary pleated filter that collects particulate as small as 0.05 micron.

This unit is designed for the retail environment combining sleek modern design with function. Powerful 3/4 HP polishing motor has more than enough torque for any job. For buffs up to 8" in diameter. Made in South Korea.

Features:

- Sturdy 12 gauge steel construction
- Shatter-resistant tempered glass access doors—won't scratch or dull like plastics can—easy to clean
- Two-Stations
- Cool fluorescent light offers a great view of work in progress
- Mounted on wheels for maneuverability
- Shelf conveniently holds supplies

Specifications:

Electrical:	110V, 20A, 60 Hz
Suction Motor:	1/2 HP
Airflow:	550 CFM
Polishing Motor:	3/4 HP, double-spindle, 3450rpm
Dimensions:	Shaft Height 6½"
(W x D x H):	37" x 22" x 52"
Ship wt:	240 lbs.

	Item#	Each
A. BestBuilt Polishing System	854-1601	\$1,850.00
Pleated Replacement Filter	854-1608	99.95
Cotton & Filter Bags, Replacements	854-1611	35.00

B. The Accumulator™

Collects 90–95% of all precious metal dust particles!

A problem-solving prefilter for your current dust collection system. Protects workers and equipment from harm, collecting dust and precious metal before they reach the dust collector. How it works: (1) air with dust and debris enters the swirling vortex inside the Accumulator; (2) dust and debris separate out of air and fall into Accumulator bowl; (3) cleansed air, 95% free of dust and debris, flows out of the Accumulator and into your dust collector.

Installs between your existing dust collector and polishing stations. Adapts easily with PVC fittings and can be mounted anywhere along the line. Creates no noticeable drop in suction. Made of durable polyethylene. Choose from small (for 1 station), medium (for 1–2 stations) and large (for 1–4 stations) styles. Made in USA.

Style	Size (L x W x H)*	Hose Inlets**	Item#	Each
Small	9" x 4½" x 13¾"	1½"	854-0995	\$145.00
D. Medium	11" x 6" x 24"	2½", 3"	854-1000	159.00
Large	13½" x 8" x 30"	4"	854-1005	265.00

*Allow 2" extra height for cup removal. **Adapters available for other hose sizes.



Polishing Safety Measures

- Many polishing compounds contain respirable silica or other hazardous ingredients. Be sure to use a dust collector to pull all polishing dust away from your breathing zone, and wear a properly fitted NIOSH respirator rated for the specific dust or chemicals with which you are working.
- Any grinding operation will remove small amounts of metal from the workpiece. To protect your eyes from flying debris, always wear safety goggles or similar eye protection.
- Tie back loose hair and clothing to prevent entanglement in the polishing motor or spindle.
- Firmly twist the buff onto the tapered spindle before turning on the motor, and keep the buff centered and straight to ensure true running. With the spindle correctly installed, turning force of the motor will keep the buff safely mounted during grinding and polishing.
- Always use the lower quarter of the buff to control the action and to prevent the workpiece from being pulled from your grip. Never entwine your fingers with the workpiece; instead hold it in a manner that will prevent your fingers from being harmed should it be pulled from your grip.



A-B ARBE Benchtop Polisher/Dust Collector

Features suction motor with squirrel-cage turbine, 18-gauge steel construction for longevity, hinged front that tilts up for polishing large pieces and 1/2" lip for storing buffs and compounds. Holds buffs up to 6" in diameter, as well as long ring buffs. Includes replaceable fiberglass filter and double work light (60W bulbs not included). Available with or without (854-1262 sealed or 854-1263 open) polishing motor and tapered spindles (see pp. 400-401 for details on the motors). Backed by a one-year warranty. Made in USA.

Specifications:

Suction Motor: Electrical: 110V, 50/60Hz Airflow: 465 CFM
 Filter Size: 29 3/4" x 11 3/4" x 2"
 Dimensions: 32 1/2"W x 22"D x 12"H

Description	Ship Wt. (lbs.)	Item#	Each
A. Benchtop w/Sealed Motor	82	854-4040	\$665.00
Benchtop w/Open Motor	71	854-4045	600.00
Benchtop w/o Motor	58	854-4009	399.00
B. Replacement Filter		854-4012	12.50
Replacement Motor - Sealed		854-1262	299.00
Replacement Motor - Open		854-1263	230.00



A



B

For Polishing Motors
See pages 400-401

C. ARBE Compact Double-Spindle Polisher/Dust Collector

Ideal for shops with very limited space. Features suction motor with squirrel-cage turbine, 18-gauge steel construction for longevity and 1/2 HP polishing motor. Holds buffs up to 6" in diameter. Includes replaceable fiberglass filter, 1/2" tapered spindles and double work light (60W bulbs not included). Backed by a one-year warranty. Made in USA.

Specifications:

Suction Motor: Electrical: 110V, 50/60Hz Airflow: 165 CFM
 Polishing Motor: 1/2 HP (3,450rpm)
 Filter Size: 22" x 12" x 2"
 Dimensions: 22 1/2"W x 19"D x 12"H

Description	Ship Wt. (lbs.)	Item#	Each
C. Compact Double Spindle	57	854-4006	\$390.00
Replacement Filters (3)		854-4011	28.75
Replacement Motor - Open		854-1263	230.00



C

D. ARBE Compact Single-Spindle Polisher/Dust Collector

Ideal for shops with very limited space. Features suction motor with squirrel-cage turbine, 18-gauge steel construction for longevity and 1/2 HP polishing motor. Holds buffs up to 6" in diameter. Includes replaceable fiberglass filter, 1/2" tapered spindle and work light (60W bulb not included). Backed by a one-year warranty. Made in USA.

Specifications:

Suction Motor: Electrical: 110V, 50/60Hz Airflow: 165 CFM
 Polishing Motor: 1/2 HP (3,450rpm)
 Filter Size: 13" x 9 3/4" x 2"
 Dimensions: 15"W x 17"D x 10"H

Description	Ship Wt. (lbs.)	Item#	Each
D. Compact Single Spindle	47	854-4005	\$335.00
Replacement Filters (3)		854-4010	23.95
Replacement Motor - open		854-1268	215.00



D

FOREDOM®



A



B

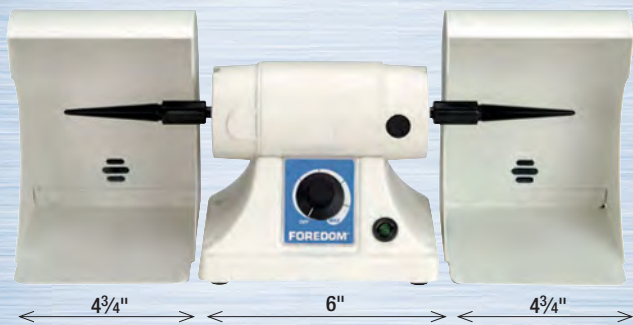

C



D

A. Foredom® Bench Lathe – 1/6 HP; 500–7,000rpm

The high-torque permanent-magnet motor provides ample power for grinding and polishing tasks. Features variable speed control, permanently lubricated ball bearings, fully sealed motor housing, cast-iron base and power light. Includes two tapered spindles for buffs up to 4" diameter.

Available with spindles only (850-0610) or consider our 850-0619 Lathe and Accessory Set which includes lathe with tapered spindles, collet holder with 3/32", 1/8", and 1/4" collets and wheel mandrel.

Specifications:

- 1/6 HP, high torque motor
- 115 Volt, 2A, 50/60 Hz
- 125 Watts (continuous rating)
- Motor shaft diameter: 5/16"
- Shaft height: 3 3/4"
- Height: 5 1/8"
- Width: 13" between spindles
- 6"W x 5"D base
- Weight: 7.5 lbs
- CSA Certified
- One-Year Warranty

Description	Item#	Each
A. Bench Lathe & Spindles Only	850-0610	\$189.50
Bench Lathe & Spindles & Accessories	850-0619	221.00
B. Optional Jacobs Chuck Arbor	850-0629	48.00
Optional Left Wheel Mandrel	850-0613	16.75
Optional 1/8" Collet	* 850-5430	8.95
Optional Right Wheel Mandrel	* 850-0621	16.75
Optional 3/32" Collet	* 850-5420	8.95
Optional 1/4" Collet	* 850-5470	8.95
Optional 1/4" Right Collet Holder	* 850-0624	36.50

* included in 850-0619

C. Foredom® Bench Lathe with Polishing Hoods

Pair Foredom Bench Lathe with spindles only and a pair of polishing hoods. Each hood collects metal particles and polishing dust to help keep your shop clean. Includes 2" connection pipe for most shop-vacs. Polishing hood measures 4 3/4"W x 8"D x 6 3/8"H.

Description	Item#	Each
C. Bench Lathe with 2 Polishing Hoods	850-0625	\$269.50
Polishing Hood only	850-0626	45.00
B. Optional Jacobs Chuck Arbor	850-0629	48.00
Optional Left Wheel Mandrel	850-0613	16.75
Optional 1/8" Collet	850-5430	8.95
Optional Right Wheel Mandrel	850-0621	16.75
Optional 3/32" Collet	850-5420	8.95
Optional 1/4" Collet	850-5470	8.95
Optional 1/4" Right Collet Holder	850-0624	36.50

D. Foredom® Bench Lathe with Filter Hood

The portable dust collector for your bench motor!

Same Foredom Bench Lathe and spindles only with one Filter Hood. The Filter Hood is a compact, powerful unit which collects particles from grinding and polishing. Offers strong suction for collecting both dust and precious metal. Features a variable-speed motor with voltage selector switch, removable watertight metal tray, LED gooseneck lamp and acrylic safety shield. Includes three replaceable filters (each measures 5 13/16" x 5 7/8" x 1/3" thick). Replacement dust filters are available in a convenient 5 pack (850-0641). These filters remove coarse, large dust particles whereas the replacement charcoal filters, also available in a 5 pack (850-0643) removes small, fine intermediate particles. Electrical: 110/220V. Measures 6"W x 12 3/4"D x 7 1/2"H. One-year warranty. CE approved.

Description	Item#	Each
D. Foredom Bench Lathe with Filter Hood	850-0644	\$440.00
Filter Hood only	850-0640	254.15
Replacement Filter 5-pack	850-0641	6.95
Replacement Charcoal Filter 5-pack	850-0643	7.95

A,B Durston Euro Style Dust Collectors

Durston's high-tech Euro Dust Collectors are a must for any small shop looking for a simple but easy way to collect dust particles and debris caused by polishing compounds.

Both models (Single Spindle & Double Spindle) incorporate the correct system of fans for dust/particle collection while maintaining quiet and vibration free operation. Unlike other models on the market, these models run quietly as the suction motors are built in and sealed for maximum performance and no overheating.

Both models include fluorescent lighting for viewing your work and can accommodate up to an 8" buff. Built to last and made in the United Kingdom, both models are constructed from 1.5mm (15 gauge) steel for durability and longevity which Durston has become known for with all their equipment. Filters are easily removed from the side of these units not to take away valuable space and storage. Made in the United Kingdom.



A



B

Description	Item#	Each
A. Single Spindle Dust Collector	854-4021	\$1,262.75
B. Double Spindle Dust Collector	854-4022	1,734.60

C. Gesswein Mini Desktop Polisher

The Gesswein Mini Desk/Bench Polisher is has a small footprint making it ideal for those with limited space or who want to have it near their workbench. Small enough to handle a myriad of tasks like grinding, blending or polishing but rugged enough to work long hours! Comes supplied with (2) Tapered Spindles for easy on/off of your (maximum 4") buffs/wheels or deburring wheels, On/off power switch, left and right vacuum switches (operate one side at a time or both sides at once), (2) removable solid metal catch trays for easy cleaning, storage compartment in the back for your compounds or small wheels and magnetic mount magnifier to aid in your viewing of the polishing process. Air filters also slide in and out for ease of changing when dirty. Made in Taiwan.



C

Description	Item#	Each
Gesswein Mini Desktop Polisher	854-4030	\$495.00

D. Wayne Werner Polishing Set

Wayne Wayner, jeweler, craftsman and Foredom demonstrator, developed this polishing accessory assortment kit for use with Foredom's BL Bench Lathe (850-0619). 57-pc Assortment with Cotton Buffs, Compound, and Scotch-Brite Discs for use on BL Lathe (850-0619) to pre-polish and polish precious metals, finish pewter and white metals. Also remove scratches and sprue marks. Clean insides of rings and solder joints.

Description	Item#	Each
Wayne Werner Polishing Set	810-0042	\$233.75



D

E. Polishing Starter Set

Designed for the Foredom and the Mini Bench Motors. Includes Water-Soluble Compound Set #215-1760 (four 1 lb. bars: Gray Star for fast cutting, Tripoli for removing scratches, Premium Red Rouge for polishing yellow gold and Green Rouge for polishing silver and white gold), two 4" Stitched White Muslin Buffs #140-2450, two 4" Loose White Muslin Buffs #140-4350 and four 3/4" SUPRA "MK" Soft Wheel Brushes #113-0600 for accessing tight areas.

Description	Item#	Each
Polishing Starter Set	810-0045	\$29.00



E

Polishing Safety Measures

- Many polishing compounds contain respirable silica or other hazardous ingredients. Be sure to use a dust collector to pull all polishing dust away from your breathing zone, and wear a properly fitted NIOSH respirator rated for the specific dust or chemicals with which you are working.
- Any grinding operation will remove small amounts of metal from the workpiece. To protect your eyes from flying debris, always wear safety goggles or similar eye protection.
- Tie back loose hair and clothing to prevent entanglement in the polishing motor or spindle.
- Firmly twist the buff onto the tapered spindle before turning on the motor, and keep the buff centered and straight to ensure true running. With the spindle correctly installed, turning force of the motor will keep the buff safely mounted during grinding and polishing.
- Always use the lower quarter of the buff to control the action and to prevent the workpiece from being pulled from your grip. Never entwine your fingers with the workpiece; instead hold it in a manner that will prevent your fingers from being harmed should it be pulled from your grip.

BALDOR • RELIANCE

Motors built to withstand the most demanding workloads. Feature sealed casings to keep internal parts free of dust, prelubricated ball bearings that last for the life of the motor and on/off switch. Backed by a three-year manufacturer's warranty. Can be taken to one of over 3,000 service centers in the USA for quick repairs. UL listed. Made in USA.



A

A. Baldor-Reliance® #75 Sealed Motor – 3/4 HP; 3,600rpm

Very strong motor for buffs up to 8" in diameter. Designed for continuous operation. Has threaded tapered shaft. Supplied with threaded tapered spindle. Motor height: 10 1/2". Width to spindle end: 15 7/8". Shaft height: 7 1/8". Ship. wt: 46 lbs.

Model	Electrical	Base (W x D)	Item#	Each
A. #75R	220/380/415-440V, 3 Ph, 50/60Hz	8" x 8 1/2"	854-1070	\$385.95

Plugs not supplied for 220V models. Other voltages available. Motor speed at 50Hz: 3,000rpm.



B

B. Baldor-Reliance® #50 Sealed Motor – 1/2 HP; 3,600rpm

Heavy-duty motor for buffs up to 8" in diameter. Designed for continuous operation. Has threaded tapered shaft. Supplied with threaded tapered spindle. Motor height: 11 5/8". Width to spindle end: 18". Shaft height: 8 1/8". Ship. wt: 39 lbs.

Model	Electrical	Base (W x D)	Item#	Each
B. #50R	110V, 1 Ph, 50/60Hz	8" x 8 1/2"	854-1050	\$510.95
#50R	220V, 1 Ph, 50/60Hz	8" x 8 1/2"	854-1052	495.00
#50L	110V, 1 Ph, 50/60Hz	8" x 8 1/2"	854-1051	480.95

Plugs not supplied for 220V model. Motor speed at 50Hz: 3,000rpm.



C

C. Baldor-Reliance® #29-1 Sealed Motor – 1/2 HP; 3,600rpm

Double-spindle heavy-duty motor for buffs up to 8" in diameter. Has 5/8" diameter straight shafts. Supplied with two tapered spindles. Motor height: 11 1/2". Shaft height: 8 1/8". Ship. wt: 51 lbs.

Electrical	Width to Spindle Ends	Base (W x D)	Item#	Each
110V, 1 Ph, 50/60Hz	29"	8" x 8 1/2"	854-1250	\$605.50

Motor speed at 50Hz: 3,000rpm.



D

D. Baldor-Reliance® #16 Sealed Motor – 1/2 HP; 3,450rpm

Sealed double-spindle motor for buffs up to 6" in diameter. Slightly tapered 3/8" shaft tips allow quick change of chucks and hold spindles true, preventing buff wobble. Supplied with two Ritter friction-fit tapered spindles. Shaft height: 5". Ship. wt: 37 lbs.

Electrical	Width to Spindle Ends	Base (W x D)	Item#	Each
115V, 1 Ph, 60Hz	20 1/4"	6 1/2" x 7 1/2"	854-1254	\$430.95



E

E. Baldor-Reliance® #25 Sealed Motor – 1/4 HP; 3,450/1,725rpm

Sealed double-spindle two-speed motor for buffs up to 6" in diameter. Slightly tapered 3/8" shaft tips allow quick change of chucks and hold spindles true, preventing buff wobble. Supplied with two Ritter friction-fit tapered spindles. Shaft height: 5 1/4". Ship. wt: 37 lbs.

Electrical	Width to Spindle Ends	Base (W x D)	Item#	Each
115V, 1 Ph, 60Hz	20 1/4"	6 1/2" x 7 1/2"	854-1030	\$415.95



F



G



H



I



J

F-J Arbors

Used to mount wheels with 1/2" arbor holes onto polishing or lapping motors.

Description	I.D. R or L	For Wheel Thickness	Overall Length	Item#	Each
F. For straight shafts. Setscrews.	1/2"L	1"	4 1/4"	840-4500	\$26.95
G. For straight shafts. Setscrews.	1/2"R	1"	4 1/4"	840-4550	26.95
H. For #29-1, Split Lapping Machine.	5/8"L	1 1/2"	6"	840-4660	35.95
I. For #29-1.*	5/8"R	1 1/2"	7"	840-4668	33.95
J. For #50, #75R.**	R	1 1/2"	5 3/4"	840-4670	33.95

*Has extended tapered spindle for cloth buffs.

**Threaded and tapered.

A, B Quatro Cool Blue Motors – 3,450/1,725rpm

Double + Single-spindle motors for buffs up to 8" in diameter. Feature an open casing with filter for resistance to overheating. Have 1/2" diameter straight shaft. Supplied with tapered spindles.

Electrical: 115V, 1 Ph, 60Hz. Motor height: 9 1/4". Shaft height: 6 3/8". Ship wt: 25 lbs. Made in Canada.

Model	Width to Spindle End	Base (W x D)	Item#	Each
A. 1/2 HP Single	14 1/4"	7 1/4" x 8 1/2"	854-1086	\$339.00
3/4 HP Single	14 1/4"	7 1/4" x 8 1/2"	854-1088	349.00
B. 1/2 HP Double	21 1/2"	7 1/4" x 8 1/2"	854-1087	369.00



C-E ARBE Sealed and Open Motors – 1/2 HP; 3,450rpm

These Arbe Pro Series quality motors sit on rubber framed resilient bases to minimize excessive vibration. Come supplied with tapered spindles. Electrical: 110V/60Hz, 1PH. Shaft height is 3" so use with 4" buffs or place on a platform to use with 6" buffs. Made in USA.

Description	Width to Spindle Ends	Base (W x D)	Item#	Each
C. Sealed Double Spindle	17"	6 1/2" x 9 3/4"	854-1262	\$299.00
D. Open Double Spindle	15"	6 1/2" x 9 3/4"	854-1263	\$230.00
E. Open Single Spindle	12"	6 1/2" x 9 3/4"	854-1268	\$215.00



F-S Tapered Spindles

Used to mount soft buffs onto polishing or lapping motors.

Description	I.D. R or L	Thread Length	Overall Length	Item#	Each
F. For #16, #25. Ritter left taper friction fit. No setscrews.	L	2 5/8"	3 5/8"	840-5000	\$9.85
G. For #16, #25. Ritter right taper friction fit. No setscrews.	R	2 5/8"	3 5/8"	840-5050	9.85
H. For #16, #25. Left taper friction fit, brass. No setscrews.	L	2"	3 1/4"	840-5055	32.95
I. For #16, #25. Right taper friction fit, brass. No setscrews.	R	2"	3 1/4"	840-5056	32.95
J. For straight shafts. Setscrews.	1/2"L	2 5/8"	3 1/2"	840-5200	9.95
K. For straight shafts. Setscrews.	1/2"R	2 5/8"	3 1/2"	840-5250	10.95
L. For #29-1, #15. For straight shafts. Setscrews.	5/8"L	2 5/8"	4 3/16"	840-5300	15.25
M. For #29-1, #15. For straight shafts. Setscrews.	5/8"R	2 5/8"	4 3/16"	840-5350	15.25
N. For straight shafts. Setscrews.	1/2"L	2 5/8"	6"	840-5363	34.15
O. For straight shafts. Setscrews.	1/2"R	2 5/8"	6"	840-5362	32.50
P. For #29-1, #15, Split Lapping Machine. For straight shafts. Setscrews.	5/8"L	2 5/8"	6"	840-5361	29.95
Q. For #29-1, #15. For straight shafts. Setscrews.	5/8"R	2 5/8"	6"	840-5360	29.95
R. For #50L, #75L. No setscrews.*	L	2 5/8"	6"	840-4710	25.00
S. For #50R, #75R. No setscrews.*	R	2 5/8"	6"	840-4700	25.00

*Also for Whirlwind and Red Wing motors. Threaded and tapered.

T. Arbor with Bur Chuck

For right side of motor only. Fits 1/2" shafts. Features keyless three-jaw chuck for holding up to 1/4" shanks. Measures 4" long.

Description	Item#	Each
Arbor with Bur Chuck	840-4150	\$33.95

U. Mandrel Chuck

For right side of motor. Screws snugly onto tapered spindle. Holds 3/32" and 1/8" shanks. Measures 3 1/2" long.

Description	Item#	EACH Prices		
		1-2	3-9	10+
Mandrel Chuck	840-4250	\$8.90	\$8.46	\$8.01



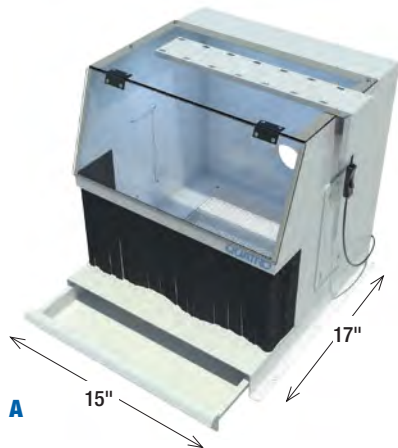

A. Quatro Clearview Hood

Features solid metal construction with top and front made of durable acrylic and LED lighting for optimal viewing of polishing operations. Includes rubber sweeper strips in front and at the spindle inlet to provide maximum containment. Works on left or right side of polishing motor. Has 3" rear inlet for dust collector hose (hose clamp included). Available with or without metal collection drawer with wipe-clean enamel finish (drawer can also be easily retrofitted to any Clearview Hood). Measures 18"W x 18"D x 17"H with drawer and 15"W x 17"D x 14½"H without drawer. Assembly required. Made in Canada.

Description	Item#	Each
A. Clearview Hood with Drawer, Mesh Bottom and Light	854-2188	\$390.00
Clearview Hood only	854-2083	289.00
Clearview Metal Collection Drawer (for retrofit)	854-2097	102.00
Clearview Replacement Sweeper Strips, pair	854-2186	27.00
Replacement LED Light with Bracket	854-2082	99.00

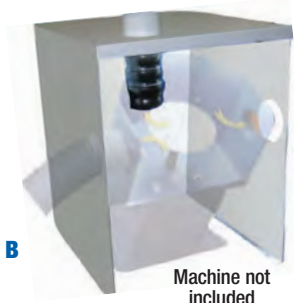

B. Quatro Lapper Hood

Helps contain the polishing dust and collect precious metal dust and scraps Powder coated metal hood has two side capture ports and one additional adjustable capture port to be pointed near the lap for maximum effect. Complete with LED lighting. 120V. Lapping machine sold separately. Made in Canada.

Description	Dimensions	Ship Wt. (lbs.)	Item#	Each
Quatro Lapper Hood	17½"W x 18½"D x 22"H	25	854-2072	\$329.00

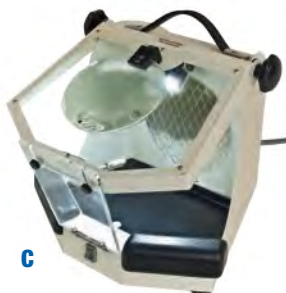

C. Freedom Lighted Work Chamber

Compact, semi-enclosed unit is designed for working with small workpieces that fit in your hand. Features a compressed air nozzle with variable air flow up to 90 PSI or 6 Bars. The air nozzle pivots to funnel dust and debris away from the workpiece, through the back of the chamber. The unit has an inlet for connecting 4mm compressed air tubing and comes with a 4mm to 6mm adapter. The vacuum port on the back fits a 2¼" diameter hose for connection to a dust collector, shop vacuum or other dust collection system. Bright LED light tilts for focus. Complete with 2.5X magnifier with a 10X insert. Two hinged, polycarbonate shields a removable watertight tray and two padded arm rests for comfort. 2-Year manufacturers warranty. Made in Taiwan.

Description	Item#	Each
Lighted Work Chamber	850-0645	\$339.15

See
Jumbo Work Chamber
on page 458.

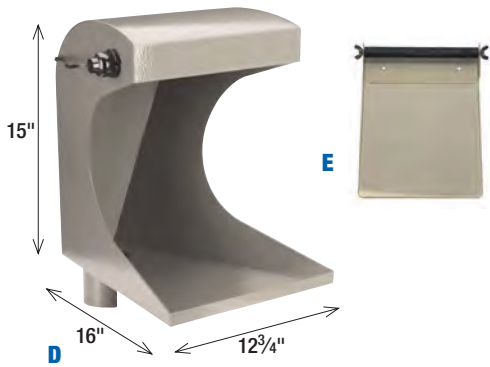

D, E Incandescent Jeweler's Hood

Powder-coated heavy-gauge metal hood with two incandescent light fixtures and 3" screened rear inlet. Requires two 60W incandescent bulbs. Works on either side of motor. Adjustable shield protects the user from flying particles. Fits on any jeweler's hood. Meets OSHA requirements. Made of clear acrylic. Made in USA.

Description	Dimensions	Item#	Each
D. Incandescent Jeweler's Hood	12¾"W x 16"D x 15"	854-3104	\$99.50
E. Jeweler's Hood Shield	6"W x 9"H x 1/8"	854-3135	26.95



F, G Quatro Blast Gate & Hose Adapter

Used for multi-station collection. Shut off suction at one station to increase suction at others. Heavy duty plastic adapter fits 2½" hose and widens to 3". Use to attach any dust collector with 1½" inlet (such as Quatro Basic and Gold Vault) to a 3" hose or hood opening.

Description	Item#	Each
F. Blast Gate, 3"	854-1518	\$47.00
G. Quatro Hose Adapter (1.5" to 3")	854-1519	13.00

A. Quatro Air Wedge Collection Port

A versatile collection port for recovering precious metal dust right at your bench. Pulls dust and contaminants away from your face before you breathe them in. Perforated base ensures particles stay within the work area. Clear plastic shield lifts off for easy access to tray below. Flange can be positioned under or behind unit for connection to hose leading to dust collector. Blast gate lets you cut off airflow when unit is not in use. Measures 12"W x 10"D x 10"H with 3" diameter inlet. Made in Canada.

Description	Item#	Each
Air Wedge Collection Port	854-1386	\$186.00



B. Quatro Airport Collection Port

Allows you to recover precious metal dust right at your bench. Features ergonomic cushioned design. Measures 12"W x 9 1/2"D x 3 1/4"H with 3" diameter inlet. Made in Canada.

Description	Item#	Each
Airport Collection Port	854-1516	\$135.00

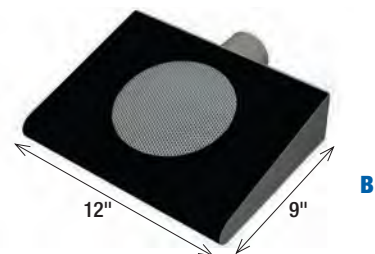

C. Quatro Bench Pin

Keeping your work bench clean and reclaiming precious metal dust/scraps just got a whole lot easier! Standard bench pin equipped with a standard 1 1/2" inlet to hook up to any dust collector accepting this size (fits Quatro Basic Dust Collector and All Gold Vault Models). While in place on your bench, the mesh screen on top collects your dust and scraps whether you are grinding, polishing, or any other bench work needing removal of dust and scraps, and sends it completely into your dust collector bags for future refining. Made in Canada.

Description	Item#	Each
Quatro Bench Pin	854-1364	\$40.00



D. Quatro Fishmouth Collection Port

Allows you to recover precious metal dust right at your bench. Features powder-coated heavy-duty steel construction. Measures 8"W x 9 1/2"D x 5"H with 3" diameter inlet. Made in Canada.

Description	Item#	Each
Fishmouth Collection Port	854-1517	\$95.00

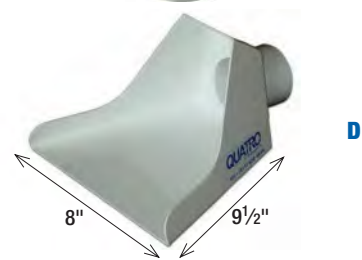

E. Foredom Fishmouth with Shield

Foredom's Fishmouth with bench pin, curved acrylic shield, and adjustable arm rests is the perfect addition to any bench for dust control and debris removal. It mounts to benches with a GRS style mounting bracket (GRS fixed mounting plate not included 856-0196). The exhaust port accommodates a 2 1/4" hose and comes with an elbow to position your dust collector hose in any direction.

The curved acrylic shield gives a clear view of your work and also helps to keep stray dust from flying at you. The inside of the Fishmouth has a mounting bracket for the supplied Wooden Bench Pin. Made in Taiwan.

Description	Item#	Each
Foredom Fishmouth with Shield	854-2215	\$129.95



F, G Flexible Hose and Hose Clamp

Use our heavy-duty 3" diameter hose to connect dust collection equipment. Features low-profile ribs and smooth interior for maximum suction. Sold by the foot. Secure with hose clamps or duct tape.

Description	Item#	Each
F. Flexible Hose, 1' length	854-3050	\$7.40
G. Hose Clamp	854-3060	4.25



H. Polishing Gizmo

Made of select hardwood. Wrap the chain, bracelet or ring (sizes 3-17) around the Gizmo and hold it to the polishing wheel. Large diameter exposes a greater length of chain, allowing for faster and more thorough polishing. Measures 2 1/2" dia. x 6 1/2"L. Made in Pakistan.

Description	Item#	Each
Polishing Gizmo	812-0360	\$10.95



I, J Wooden Drill Sticks

Handy for holding rings while drilling or polishing. Made in India.

Description	Taper	Length	Item#	EACH Prices		
				3pc	3-9	12-141
I. Stick #6	1" to 3/8"	6"	816-1710	\$1.85	\$1.57	\$1.30
J. Stick #7	1 1/8" to 3/8"	7"	816-1700	2.40	2.04	1.68

Three-piece minimum; please order in multiples of three.





SUNBURST Products are designed with specially treated ceramic abrasive grain embedded throughout. This eliminates the need for polishing compound and produces minimal dust and heat. Ideal for finishing, smoothing and high-luster polishing of all precious, semi-precious and non-precious metals, acrylics and ceramics. See p. 80 for Sunburst Midget Points. Made in USA.

See website
for additional
SUNBURST products.

A. 3" Radial Discs – 3/8" Center Hole



Pack of 12

Description (Pack of 12)	Item#	1-5	6-9	10+
80 Grit (yellow)	145-5223	\$32.95	\$31.30	\$29.66
120 Grit (white)	145-5224	32.95	31.30	29.66
220 Grit (red)	145-5225	32.95	31.30	29.66
400 Grit (blue)	145-5226	32.95	31.30	29.66
6 Micron (peach)	145-5228	32.95	31.30	29.66
1 Micron (light green)	145-5229	32.95	31.30	29.66

D. 2" Radial Discs – 3/8" Center Hole

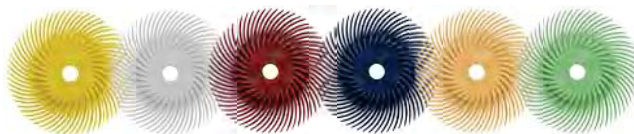

Pack of 12

Description (Pack of 12)	Item#	1-5	6-9	10+
80 Grit (yellow)	145-5163	\$23.95	\$22.75	\$21.56
120 Grit (white)	145-5164	23.95	22.75	21.56
220 Grit (red)	145-5165	23.95	22.75	21.56
400 Grit (blue)	145-5166	23.95	22.75	21.56
6 Micron (peach)	145-5168	23.95	22.75	21.56
1 Micron (light green)	145-5169	23.95	22.75	21.56

B. 3" 3-PLY Radial Discs – 1/4" Center Hole



EACH Prices

Description (EACH)	Item#	1-5	6-9	10+
80 Grit (yellow)	145-5243	\$10.95	\$10.40	\$9.86
120 Grit (white)	145-5244	10.95	10.40	9.86
220 Grit (red)	145-5245	10.95	10.40	9.86
400 Grit (blue)	145-5246	10.95	10.40	9.86
6 Micron (peach)	145-5248	10.95	10.40	9.86
1 Micron (light green)	145-5249	10.95	10.40	9.86
Description	Item#	SET Price		
Assortment (one each of all 6 grits)	145-5240	\$62.95		

E. 2" 3-PLY Radial Discs – 1/4" Center Hole



EACH Prices

Description (EACH)	Item#	1-5	6-9	10+
80 Grit (yellow)	145-5183	\$8.95	\$8.50	\$8.06
120 Grit (white)	145-5184	8.95	8.50	8.06
220 Grit (red)	145-5185	8.95	8.50	8.06
400 Grit (blue)	145-5186	8.95	8.50	8.06
6 Micron (peach)	145-5188	8.95	8.50	8.06
1 Micron (light green)	145-5189	8.95	8.50	8.06
Description	Item#	SET Price		
Assortment	145-5180	\$49.95		

C. 3" 6-PLY Radial Discs – 1/4" Center Hole



EACH Prices

Description (EACH)	Item#	1-5	6-9	10+
80 Grit (yellow)	145-5263	\$17.95	\$17.05	\$16.16
120 Grit (white)	145-5264	17.95	17.05	16.16
220 Grit (red)	145-5265	17.95	17.05	16.16
400 Grit (blue)	145-5266	17.95	17.05	16.16
6 Micron (peach)	145-5268	17.95	17.05	16.16
1 Micron (light green)	145-5269	17.95	17.05	16.16
Description	Item#	SET Price		
Assortment (one each of all 6 grits)	145-5260	\$99.95		

F. 2" 6-PLY Radial Discs – 1/4" Center Hole



EACH Prices

Description (EACH)	Item#	1-5	6-9	10+
80 Grit (yellow)	145-5203	\$13.95	\$13.25	\$12.56
120 Grit (white)	145-5204	13.95	13.25	12.56
220 Grit (red)	145-5205	13.95	13.25	12.56
400 Grit (blue)	145-5206	13.95	13.25	12.56
6 Micron (peach)	145-5208	13.95	13.25	12.56
1 Micron (light green)	145-5209	13.95	13.25	12.56
Description	Item#	SET Price		
Assortment	145-5200	\$79.95		

A. 1" Radial Discs

Suggested Mandrel
1/16" AH Mandrel on 3/32" Shank



Description (Pack of 12)	Item#	12 Pack
36 Grit (brown)	145-5121	\$14.95
50 Grit (green)	145-5122	14.95
80 Grit (yellow)	145-5123	14.95
120 Grit (white)	145-5124	14.95
220 Grit (red)	145-5125	14.95
400 Grit (blue)	145-5126	14.95

Description (Pack of 48)	Item#	Pack of 48		
		1-5	6-9	10+
36 Grit (brown)	145-5141	\$52.95	\$50.30	\$47.66
50 Grit (green)	145-5142	52.95	50.30	47.66
80 Grit (yellow)	145-5143	52.95	50.30	47.66
120 Grit (white)	145-5144	52.95	50.30	47.66
220 Grit (red)	145-5145	52.95	50.30	47.66
400 Grit (blue)	145-5146	52.95	50.30	47.66

Description	Item#	SET Price
Assortment (8 each of all 6 grits plus 2 mandrels)	145-5120	\$54.95

B. 7/8" 4-Ply Discs

Mounted on 3/32" Shank



Description (Pack of 6)	Item#	Pack of 6		
		1-5	6-9	10+
80 Grit (yellow)	145-5103	\$49.95	\$47.45	\$44.96
120 Grit (white)	145-5104	49.95	47.45	44.96
220 Grit (red)	145-5105	49.95	47.45	44.96
400 Grit (blue)	145-5106	49.95	47.45	44.96
600 Grit Pumice (pink)	145-5107	49.95	47.45	44.96
6 Micron (peach)	145-5108	49.95	47.45	44.96
1 Micron (light green)	145-5109	49.95	47.45	44.96

Description	Item#	SET Price
Assortment (one each of all 7)	145-5100	\$54.95

C. All-In-One Assortment



Description	Item#	SET Price
C. 83 piece All-In-One-Assortment 4 each of all grits in sizes 5/8", 7/8", and 1", plus 3 mandrels.	145-5270	\$66.95

D. 7/8" Radial Discs

Suggested Mandrel
1/16" AH Mandrel on 3/32" Shank



Description (Pack of 12)	Item#	12 Pack
80 Grit (yellow)	145-5063	\$10.95
120 Grit (white)	145-5064	10.95
220 Grit (red)	145-5065	10.95
400 Grit (blue)	145-5066	10.95
600 Grit Pumice (pink)	145-5067	10.95
6 Micron (peach)	145-5068	10.95
1 Micron (light green)	145-5069	10.95

Description (Pack of 48)	Item#	Pack of 48		
		1-5	6-9	10+
80 Grit (yellow)	145-5083	\$37.95	\$36.05	\$34.16
120 Grit (white)	145-5084	37.95	36.05	34.16
220 Grit (red)	145-5085	37.95	36.05	34.16
400 Grit (blue)	145-5086	37.95	36.05	34.16
600 Grit Pumice (pink)	145-5087	37.95	36.05	34.16
6 Micron (peach)	145-5088	37.95	36.05	34.16
1 Micron (light green)	145-5089	37.95	36.05	34.16

Description	Item#	SET Price
Assortment (12 each of all 7 grits plus 2 mandrels)	145-5060	\$62.95

E. 5/8" Radial Discs

Suggested Mandrel
1/16" AH Mandrel on 3/32" Shank



Description (Pack of 12)	Item#	12 Pack
80 Grit (yellow)	145-5023	\$10.95
120 Grit (white)	145-5024	10.95
220 Grit (red)	145-5025	10.95
400 Grit (blue)	145-5026	10.95
600 Grit Pumice (pink)	145-5027	10.95
6 Micron (peach)	145-5028	10.95
1 Micron (light green)	145-5029	10.95

Description (Pack of 48)	Item#	Pack of 48		
		1-5	6-9	10+
80 Grit (yellow)	145-5043	\$37.95	\$36.05	\$34.16
120 Grit (white)	145-5044	37.95	36.05	34.16
220 Grit (red)	145-5045	37.95	36.05	34.16
400 Grit (blue)	145-5046	37.95	36.05	34.16
600 Grit Pumice (pink)	145-5047	37.95	36.05	34.16
6 Micron (peach)	145-5048	37.95	36.05	34.16
1 Micron (light green)	145-5049	37.95	36.05	34.16

Description	Item#	SET Price
Assortment (12 each of all 7 grits plus 2 mandrels)	145-5020	\$62.95



A



B

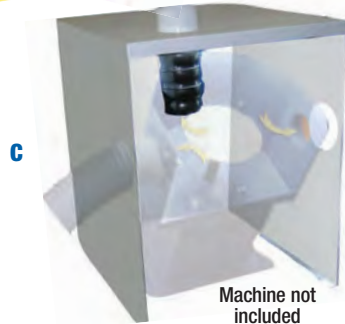

C

Machine not included

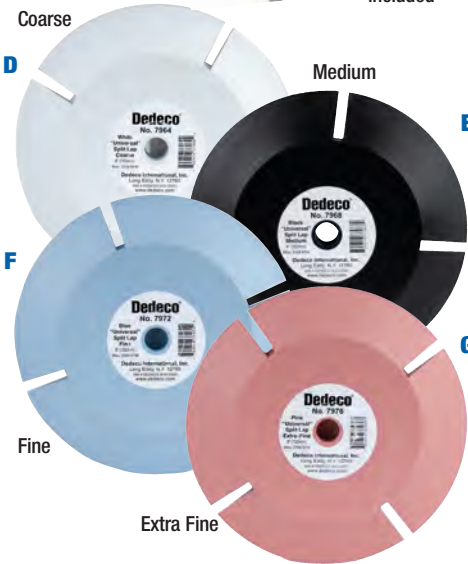

D

Medium

E

F

Fine

Extra Fine

G



H

I

K

J

A. Split Lapping Machine

Features 1/2 HP ball-bearing motor mounted at a 45° angle for great visibility. Lets you see work surface. Includes heavy-gauge steel hood with 3" inlets for your dust collector, tapered spindle and adjustable light. Measures 15"W x 18"D x 20"H. Electrical: 110V, 6.2A, 60Hz (220V, 50Hz available). Max. operating speed: 3,450rpm. Accepts 6", 7" or 8" split laps (see below and p. 99). To improve visibility of work in progress, mark split lap bevels with black crayon (sold separately). Made in USA.

Description	Ship. Wt.	Item#	Each
A. Split Lapping Machine	46 lbs.	854-1802	\$420.00
B. Optional Black Crayon		810-0425	2.39
Replacement Steel Hood only		854-1805	150.00
Replacement Tapered Spindle		840-5361	29.95

C. Quatro Lapper Hood

Quatro, the name in the industry for the best dust collectors on the market for producing the cleanest air now offers that same quality for your lapping machine. The Quatro Lapping Hood helps contain the polishing dust and collect precious metal dust and scraps while mounted on the Quatro Two-Station Dust Collector. Lapping machine sold separately. Made in Canada.

Description	Ship. Wt.	Item#	Each
Quatro Lapper Hood	25 lbs.	854-2072	\$329.00

D-G Dedeco® Silicone Split Laps

Designed to replace felt laps and rouge, these split laps provide a superior finish on gold and other metals. Each wheel is impregnated with silicon-carbide abrasive. Available in 4 color-coded grits. Max operating speed: 3,500rpm. All are 6" diameter with 1/2" arbor hole.

Color	Grit	Application	Item#	Each
D. White	120 (C)	For removing deep scratches	145-0180	\$63.50
E. Black	180 (M)	For smoothing and removing light scratches	145-0181	63.50
F. Blue	220 (F)	For high-luster polishing	145-0182	63.50
G. Pink	400 (XF)	For super high-luster polishing and final finish	145-0183	63.50

H-K Gesswein/Paramount® Felt Split Laps

Made of pure wool felt that has been steamed to shrink and thicken, then pounded into specific hardnesses. Feature consistent density throughout for identical polishing results from wheel to wheel, even wear and three to five times the life of conventional split laps. All have pinhole centers. Max. operating speed: 3,450rpm. Made in USA.

Dia. x Thick	Type	Item#	EACH Prices		
			1-5	6-11	12+
H. 4" x 1/2"	Medium	285-8130	\$38.65	\$34.79	\$32.21
	Hard	285-8131	41.00	36.90	34.17
	Rock-Hard	285-8132	49.05	44.15	40.87
I. 6" x 1/2"	Medium	285-6123	42.25	38.03	35.21
	Hard	285-6125	45.30	40.77	37.75
	Rock-Hard	285-6127	57.25	51.53	47.71
	Flint-Hard	285-6128	65.15	58.64	54.29
J. 7" x 1/2"	Medium	285-7120	57.00	51.30	47.50
	Hard	285-7121	66.70	60.03	55.58
	Rock-Hard	285-7122	74.70	67.23	62.25
	Flint-Hard	285-7123	92.70	83.43	77.25
K. 8" x 1/2"	Medium	285-8123	70.00	63.00	58.33
	Hard	285-8125	82.25	74.03	68.54
	Rock-Hard	285-8127	94.00	84.60	78.33
	Flint-Hard	285-8128	102.50	92.25	85.41

A. Quatro SolderPure Fume and Particulate Extractor

Ideal for brazing, dedrossing, electroforming, electroplating and soldering applications. Removes acid activator, electrocleaner, rhodium, solder, solvent and wax fumes from the air before you breathe them (not suitable for cyanide).

Features a four-stage filtration system that captures fumes and particulate down to 0.3 micron: prefilter captures large particles to extend life of three subsequent filters; high-capacity dust filter captures small particulate; advanced refillable media filter formulated for specific applications captures fumes; HEPA filter captures smallest particulate down to submicron levels.

Returns 99.97% clean air to your workplace, making outside ventilation unnecessary. Includes capture hood with flex arm, which can be flexed and rotated 360° to accommodate any soldering or plating layout. Includes table bracket and 8' flex hose that can be cut to desired length for remote location as well as casters for mobility. Installs quickly and easily. Backed by a one-year manufacturer's warranty. Made in Canada.

Specifications:

Airflow: 125 CFM
 Noise Level: 52 dBA
 Electrical: 120V, 1A, 60Hz
 Dimensions: 13"W x 16"D x 20"H
 Net Wt.: 47 lbs.

Description	Item#	Each
SolderPure for Rhodium, Electrocleaner and Soldering Fumes	854-1375	\$1,325.00
A. SolderPure for Rhodium and Electrocleaner Fumes	854-1387	1,283.00
SolderPure for Soldering and Wax Fumes	854-1376	1,430.00
Optional Blast Gate, 3"	854-1374	41.00
Optional Odor Filter	854-1378	149.00
Replacement Prefilters (6)	854-1393	25.00
Replacement Dust Filters (6)	854-1394	48.00
Media Refills (5) for rhodium fumes	854-1396	169.00
Media Refills (4) for soldering fumes	854-1409	122.00
Replacement HEPA Filter	854-2093	128.00



See page 246 for Quatro Fresh-Air Series HEPA Air Purifiers

B, C Quatro Ductless Fume Hoods – For those without access to outside ductwork.

Units feature a two-stage filtration system that captures fumes, then recirculates clean air back into the room to save on heating and AC costs. Burnout fume hood installs right on wall behind burnout furnace. Rhodium fume hood installs directly over plating area. Each has a metal-frame filter container that holds an activated charcoal media mixture specifically formulated for the respective application. Backed by a one-year manufacturer's warranty. Made in Canada.

Specifications:

Electrical: 120V, 1.6A, 60Hz, Dimensions: 28"W x 18"D x 26"H, Net Wt.: 50 lbs.

Description	Item#	Each
B. Burnout Fume Hood	854-1525	\$1,164.00
Rhodium Fume Hood	854-1526	1,164.00
Replacement Dust Filters (8)	854-2103	76.00
Stage-2 Media Refills (4) for both fumes	854-1409	122.00
Stage-3 Media Refills (4) for burnout fumes	854-1527	213.00
Stage-3 Media Refills (4) for rhodium fumes	854-1396	169.00
C. Optional Stand	854-1524	299.00



Stand Sold Separately



A



B



C



D



E

A. Kagan Wedding Ring Sizer

One of the finest sizers available. Enlarges and reduces on the downstroke, requiring less effort than other models. Features eight-spline mandrel for enlarging rings up to size 14 and reversible reducer plate with 12 countersunk dies (six on each side) for gently compressing rings to smaller sizes. Can be bolted to bench or used as a portable sizer. Measures 16"L x 18"H. Ship. Wt: 17³/₄ lbs. Made in USA.

Description	Item#	Each
A. Kagan Wedding Ring Sizer	856-0350	\$615.00
Replacement Eight-Spline Mandrel	856-0355	180.00

B. Premium Wedding Ring Sizer

Sizes with almost no effort. Enlarges on the upstroke and reduces on the downstroke. Features six-spline mandrel for enlarging rings up to size 15 and reversible reducer plate with 16 countersunk dies (eight on each side) for gently compressing rings to smaller sizes. Also available without reducer plate for use as an enlarger only. Can be bolted to bench or used as a portable sizer. Ship. Wt: 28 lbs. Made in Italy.

Description	Item#	Each
B. Premium Wedding Ring Sizer	856-0375	\$375.00
Wedding Ring Sizer w/o Reducing Plate	856-0370	355.00
Reducing Plate	856-0376	112.00
Replacement Six-Spline Mandrel	856-0377	148.00

C. Durston Wedding Ring Tools

Both of these heavy duty tools feature an 8 spline mandrel and 16 polished countersunk dies. They ensure exceptionally accurate ring sizing. The countersunk polished steel reducing plates will reduce bands up to 12mm wide. For non-ferrous (gold, silver, platinum and palladium etc.) rings and bands from US size 2 to 14. Includes double sided reducing plate for bands up to 12mm wide.

They both measure 16³/₄" tall with a 6³/₄" by 4³/₄" base which has holes for securing to a bench or worktable (mounting hardware not included).

Made in England.

The Ring Stretcher/Reducer and Bender: Heavy duty cast iron construction with hardened steel shaft will bend up to 4mm thick includes 2 precision hardened and ground dies.

Description	Item#	Each
C. Wedding Ring Stretcher/Reducer and Bender	856-0388	\$532.00
D. Wedding Ring Stretcher/Reducer	856-0384	452.00
Replacement 8-Spline Mandrel	856-0386	125.00
Replacement Reducing Plate	856-0387	65.00
Replacement Bender Blocks	856-0389	120.00

E. Kagan Stone-Set Ring Stretcher

Enlarges stone-set rings using parallel rollers to stretch the shank without disturbing the stone. Includes eight dies for knife-edge, half-round, oval and flat shanks. Also works as a mini rolling mill for making filigree wire. Can be bolted to a workbench. Ship. Wt: 8³/₄ lbs. Made in USA.

Description	Item#	Each
E. Kagan Stone-Set Ring Stretcher	856-0300	\$620.00
Replacement Die Set	856-0360	395.00

A, B PEPETOOLS Super Ring Bending/Forming Set

New and improved with extra heavy-duty posts and dies! The most versatile ring bending set on the market. Makes both round and angled bends. Includes bending unit, seven dies and seven matching mandrels, steel block with screws that can be fastened to bottom of unit for vise mounting and an attractive aluminum powder coated base for easy part selection and storage.

Eccentric base and handle provide high torque, requiring user to exert less effort to bend metal. Supplied with 12, 14, 16, 20 and 22mm round dies and 60° and 90° angled dies. Made in USA.

Use with optional 5 piece die set to shape patterned metal without the scratching and distortion that often occur with standard steel dies. Die set includes 5 wear-resistant, low-friction thermoplastic polymer dies in sizes 12, 14, 16, 20 and 22mm round. Made in USA.

Description	Item#	Each
A. PEPETOOLS Super Ring Bender 2	856-0418	\$220.00
B. Optional 5 piece Die Set	810-2021	75.00



A



B

Ring Bender not included with 5 piece Die Set.

C. GRS® Ring Size Cutter

This unique unit quickly cuts off a precise amount of ring shank without sawing. Removes metal in one whole piece so there are no particles to lose, saving you time and money. Results in perfectly parallel sides for neat and easy soldering. Includes seven different heat-treated steel blades that can be changed by hand in seconds without tools. Made in USA.

Description	Item#	Each
C. Ring Size Cutter	812-1270	\$307.00
1/2-Size Blade	812-1272	14.55
3/4-Size Blade	812-1273	15.00
1-Size Blade	812-1274	15.45
1 1/4-Size Blade	812-1275	15.35
1 1/2-Size Blade	812-1276	15.80
1 3/4-Size Blade	812-1277	17.10
2-Size Blade	812-1278	18.90
7-Piece Blade Set (one each)	812-1271	89.95



C



D. Beaver Ring Cutter

Safely cuts ring shanks while on or off finger. Has guarded blade with satin chrome finish and molded plastic handle. Entire unit can be sterilized. Measures 5 7/8" long.

Description	Item#	Each
D. Beaver Ring Cutter	812-0900	\$202.50
Replacement Saw Blade	812-1000	31.50
Replacement Hub	812-0950	21.95



D

E. French Ring Cutting Pliers

Safely cut ring shanks while on or off finger. Have guarded blade and traditional key. Made of fine steel. Measure 4 3/4" long.

Description	Item#	Each
E. French Ring Cutting Pliers	812-1251	\$49.50
Replacement Blade	812-1252	15.95
Replacement Key	812-1253	11.95



E

F. Mark-a-Size

Lets you resize rings accurately. Etches exact amount of material to be removed directly onto the ring shank for correct sizing in 1/4-size increments from 1/4 size up to 3 sizes. Made of tempered steel. Measures only 3"L x 1"W x 3/4" thick when closed.

Description	Item#	Each
Mark-a-Size	816-0170	\$49.65



F

A

**A. Wooden Ring Clamp**

Double-ended (one square, one round) clamp with thick leather-lined jaws that prevent marring. Securely holds rings and other jewelry pieces while filing, polishing and setting. Includes wedge for adjusting grip. Measures 6½" long. Made in India.

Description	Item#	EACH Prices		
		1-2	3-9	10+
Wooden Ring Clamp	812-0300	\$6.75	\$6.41	\$6.08

B

**B. Wooden Ring Clamp with Screw**

Spring-loaded wooden ring clamp with brass screw and wing nut for more precise control, leather-lined jaws that prevent marring and rounded clamp end that allows easy pivoting and rotating. Measures 5¼" long. Made in India.

Description	Item#	Each
Wooden Ring Clamp with Screw	812-0320	\$10.25

C

**C. Plastic Ring Clamp**

High-impact plastic double-ended (one square, one round) clamp with thick leather-lined jaws that prevent marring. Similar in design to our wooden ring clamp. Includes wedge for adjusting grip. Measures 6¼" long. Made in India.

Description	Item#	EACH Prices		
		1-2	3-9	10+
Plastic Ring Clamp	812-0400	\$8.95	\$8.50	\$8.06

D

**D. Outside Metal Ring Clamp**

Metal ring clamp for holding rings securely from the outside so you can easily file, sand and polish the inside. Measures 6" long.

Description	Item#	Each
External Ring Clamp	812-0351	\$29.95

E

**E. Outside/Inside Metal Ring Clamp**

Die-cast high-strength 380 aluminum alloy clamp for holding rings securely from either the outside or the inside. Conducts heat away from rings. Holds ring sizes 1–13. Measures 5½" long.

Description	Item#	EACH Prices	
		1-2	3+
Outside/Inside Metal Ring Clamp	812-0350	\$19.35	\$18.38

F

**F. Inside Wooden Ring Clamp**

Economical wooden clamp for holding rings firmly from the inside so the outside can be worked. Won't mar rings. Shaped for a comfortable grip. Holds ring sizes 5–11. Measures 5¾" long.

Description	Item#	Each
Inside Wooden Ring Clamp	812-0315	\$10.25

Gesswein® Power Ring Cutter

Gesswein has created a ring cutter for emerging high-tech metals such as SK Cobalt BioBlu™ 27 and tungsten carbide. A diamond-plated disc is the secret to cutting these metals, as well as platinum, titanium and stainless steel.

Emergency rooms and medical facilities: please note that an ordinary ring cutter cannot cut these tough metals—they are simply too hard. A diamond-plated disc with motorized drive is truly essential. Such a disc will fit on most ring cutters, but in an emergency time is critical, and a dedicated ring cutter eliminates fumbling with time-consuming retrofits. An instructional video is provided at www.gesswein.com so you can learn safe cutting techniques for these hard metals.

Continued application of water is required while cutting to keep the disc cool, preventing damage from excessive heat. Since the metal is so hard, it cannot be spread, so two cuts are necessary: one on each side of the ring. The diamond handles all the work, so only gentle pressure is required. Power Ring Cutter will remove even the toughest ring in under 4 minutes. Works with most standard power screwdrivers that can accommodate a 1/4" hex bit (optional power screwdriver sold separately). A sturdy cutter arm cradles the rotating blade, preventing harm to the finger.



View instructional video at www.gesswein.com

Features:

- Ring cutter pliers
- Two diamond-plated discs with 1/4" hex drive for power cutting of hard metals
- Steel sawblade with key drive for manual cutting of soft metals
- Lock nut with T-handle
- Water bottle for lubrication during cutting



Description	Item#	Each
A. Power Ring Cutter Set	812-1210	\$94.75
B. Power Screwdriver	812-1213	29.95
Replacement Diamond-Plated Disc	226-1227	19.50
Replacement Steel Sawblade	812-1252	15.95
Replacement 1/4" Hex Drive	812-1214	9.95
Replacement Water Bottle	812-1215	1.25

Diamond disc cuts on cobalt, platinum, titanium and stainless steel. Steel blade cuts on gold, silver and other soft metals.



Power Screwdriver **B**

C. Tungsten Ring Cracker – For Ceramic and Tungsten Rings

Ever had a customer come in with a ceramic or tungsten ring that couldn't be removed? Has this concern prevented you from selling these alternative metals? No need to worry, this tool will allow you to crack any ceramic or tungsten ring with no pain to the customer.

Center the Ring Cracker over the ring, tighten the tip (it's not sharp) and turn the knob a few times. These hard metals will crack fairly easily under pressure at a single point. The Ring Cracker is very easy to use. Anybody can assist with the removal of these alternative metals. Includes 2 pairs of safety glasses and illustrated instructions. Shipping Wt: 17 oz.

Description	Item#	Each
Tungsten Ring Cracker	812-1218	\$93.95

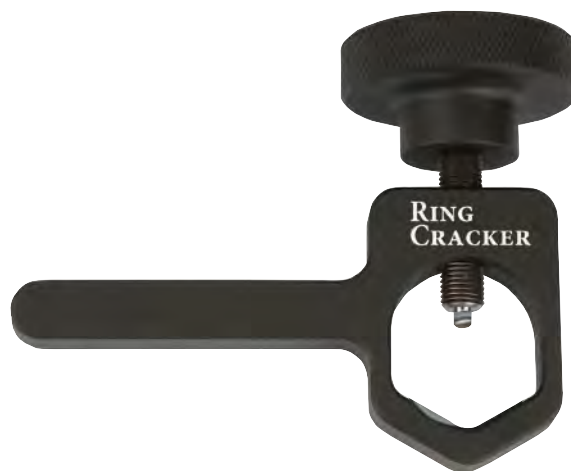

C



Ultra Rolling Mills



Combo

High strength housing is precision constructed out of cast-iron. This allows it to weigh less than other available mills (saving shipping costs) while providing exceptional rigidity. The rollers on all the mills are first induction hardened to 65 HRC and then highly polished to a mirror finish for the finest results. Solid brass bushings allow smooth operation and require no lubrication. All parts are manufactured and assembled in the USA. One year limited manufacturer's warranty against defects in material or workmanship applies to all mills.

Mills are offered in three basic configurations: Flat only, Combo which provides half round (elliptical) and square wire as well as flat, and an All Wire only which allows production of half round (elliptical) and square wire as well as round and comfort wire profiles.

All manual models are equipped with a 4:1 reduction gear box, high strength housing and a forged steel handle. Manual mills are available in Flat, Combo and All Wire only (90mm, 110mm, 130mm and 160mm sizes). Suggest using versatile Pepe stand (855-2088) with the smaller, 90mm, 110mm and 130mm, size mills.

All motorized mills come complete with a feed table and guard rails to protect the rollers as well as an emergency stop button for safety. The motor speed can be adjusted and that same control manages the motor fan. Motorized mills can operate in both forward and reverse. The units will feed in wire slowly, then speed up, whether in forward or reverse, providing consistent rolling.

Both the motor and its cooling fan run quietly. Motorized single mills are available in Flat, Combo and All Wire only (130mm or 160mm sizes). Motorized double mills all have one side Flat and the mill on the other side can be another Flat, or a Combo or an All Wire (double mills would both be either 130mm or 160mm sizes).

Compact design with vertically mounted motor, these mills are available in either 120V or 240V. (See gesswein.com for 240V products).



Electric Combo

Vertical Motor Space Saver

Anodized Aluminum Base



Electric All Wire and Flat



Flat

Combo

All Wire



A. PepeTools Rolling Mill Universal Equipment Stand

- Cast Iron Equipment Stand
- 16" x 7" Mounting Plate
- Equipment stands can be used with Pepetools Bench Shears, Guillotines and 90mm, 110mm and 130mm manual Rolling Mills
- Save valuable Bench Space. Mounting holes provided at base for securing stand in place
- Rolling Mill sold separately
- Adjustable Height 28" - 40.75"

Description	Item#	Each
Rolling Mill Stand	855-2088	\$380.00

Model	Roller Width	Roller Diameter	Max. Opening	Flat Area	Square Wire (mm)	Ring Shank (mm)	Half Round Wire	Comfort Wear Profile	Item #	Price
MANUAL SINGLE MILLS										
90mm Flat	90mm	42.6mm	5mm	90mm	–	–	–	–	855-2090	\$495.00
90mm Combo	90mm	42.6mm	5mm	50mm	1.5, 2.0, 3.0, 4.0	2.5 x 1.0, 3.0 x 1.25, 4.0 x 1.50	–	–	855-2091	525.00
110mm Flat	110mm	55mm	5mm	110mm	–	–	–	–	855-2092	558.00
110mm Combo	110mm	55mm	5mm	61mm	1.0, 1.5, 2.0, 2.5, 3.0, 3.5	2.5 x 1.0, 3.0 x 1.25, 4.0 x 1.50	–	–	855-2093	589.00
130mm Flat	130mm	65mm	7.5mm	120mm	–	–	–	–	855-2094	621.00
130mm Combo	130mm	65mm	7.5mm	66mm	1.0, 1.5, 2.0, 2.5, 3.0, 3.5, 4.0, 4.5	2.5 x 1.0, 3.0 x 1.25, 4.0 x 1.50	–	–	855-2096	650.00
130mm All Wire	130mm	65mm	7.5mm	–	1.0, 1.5, 2.0, 2.5, 3.0, 3.5, 4.0, 4.5	2.5 x 1.0, 3.0 x 1.25, 4.0 x 1.50	2, 3, 4, 5, 6	4, 5, 6, 7, 8	855-2097	995.00
160mm Flat	160mm	65mm	7.5mm	160mm	–	–	–	–	855-2098	1,030.00
160mm Combo	160mm	65mm	7.5mm	77mm	1.0, 1.5, 2.0, 2.5, 3.0, 3.5, 4.0, 4.5	2.5 x 1.0, 3.0 x 1.25, 4.0 x 1.50	–	–	855-2099	1,105.00
160mm All Wire	160mm	65mm	7.5mm	–	1.0, 1.5, 2.0, 2.5, 3.0, 3.5, 4.0, 4.5	2.5 x 1.0, 3.0 x 1.25, 4.0 x 1.50	2, 3, 4, 5, 6	4, 5, 6, 7, 8	855-2100	1,365.00
ELECTRIC SINGLE MILLS - 120V										
130mm Flat	130mm	65mm	7.5mm	130mm	–	–	–	–	855-2105	1,955.00
130mm Combo	130mm	65mm	7.5mm	66mm	1.0, 1.5, 2.0, 2.5, 3.0, 3.5, 4.0, 4.5	2.5 x 1.0, 3.0 x 1.25, 4.0 x 1.50	–	–	855-2106	1,999.00
130mm All Wire	130mm	65mm	7.5mm	–	1.0, 1.5, 2.0, 2.5, 3.0, 3.5, 4.0, 4.5	2.5 x 1.0, 3.0 x 1.25, 4.0 x 1.50	2, 3, 4, 5, 6	4, 5, 6, 7, 8	855-2107	2,295.00
160mm Flat	160mm	65mm	7.5mm	160mm	–	–	–	–	855-2111	2,640.00
160mm Combo	160mm	65mm	7.5mm	77mm	1.0, 1.5, 2.0, 2.5, 3.0, 3.5, 4.0, 4.5	2.5 x 1.0, 3.0 x 1.25, 4.0 x 1.50	–	–	855-2112	2,750.00
160mm All Wire	160mm	65mm	7.5mm	–	–	2.5 x 1.0, 3.0 x 1.25, 4.0 x 1.50	2, 3, 4, 5, 6	4, 5, 6, 7, 8	855-2113	2,995.00
ELECTRIC DOUBLE MILLS- 120V										
130mm Flat and Flat	Both 130mm	Both 65mm	7.5mm	Both 130mm	–	–	–	–	855-2117	2,600.00
130mm Flat and Combo	Both 130mm	Both 65mm	7.5mm	130mm and 65mm	1.0, 1.5, 2.0, 2.5, 3.0, 3.5, 4.0, 4.5	2.5 x 1.0, 3.0 x 1.25, 4.0 x 1.50	–	–	855-2118	2,650.00
130mm Flat and All Wire	Both 130mm	Both 65mm	7.5mm	130mm	1.0, 1.5, 2.0, 2.5, 3.0, 3.5, 4.0, 4.5	2.5 x 1.0, 3.0 x 1.25, 4.0 x 1.50	2, 3, 4, 5, 6	4, 5, 6, 7, 8	855-2119	2,950.00
160mm Flat and Flat	Both 160mm	Both 65mm	7.5mm	Both 160mm	–	–	–	–	855-2123	3,665.00
160mm Flat and Combo	Both 160mm	Both 65mm	7.5mm	160mm and 77mm	1.0, 1.5, 2.0, 2.5, 3.0, 3.5, 4.0, 4.5	2.5 x 1.0, 3.0 x 1.25, 4.0 x 1.50	–	–	855-2124	3,800.00
160mm Flat and All Wire	Both 160mm	Both 65mm	7.5mm	160mm	–	–	2, 3, 4, 5, 6	4, 5, 6, 7, 8	855-2125	4,395.00

240V Electric Mills are also available - Please see gesswein.com for more information.

DURSTON

Rolling Mills

Durston Rolling Mills are recognized for their reliability, robust construction, high quality and fine finish. Primarily used by craftsmen involved in gold and silversmithing as well as manufacturing and wherever there is a need for wire shaping, flattening and rolling down. Durston uses state-of-the-art machinery and manufacturing techniques ensuring strict quality control. Made in the United Kingdom.

- Old world craftsmanship combined with modern technology ensures accuracy and a long life but most of all— **A Great Value!**

- Selected mills have extension rollers
- Manual 100mm, 130mm and 150mm mills have a high precision gear box for higher turn efficiency and smooth operation.

Durston Power Combo Mills incorporate safety with quality. Emergency stop button, safety bars both front and rear as well as guards over the extension rollers are safety features designed with the user in mind. All units have cast iron bases, cast iron gearbox with powerful motors and the same one-piece cast iron mill frames. Heavy-duty roller bearings effortlessly run the high quality steel rolls in forward or reverse at variable speeds. Double Combo mills provide a larger work area for flat rolling and more square wire sizes than Single Combo mills but have a larger footprint.

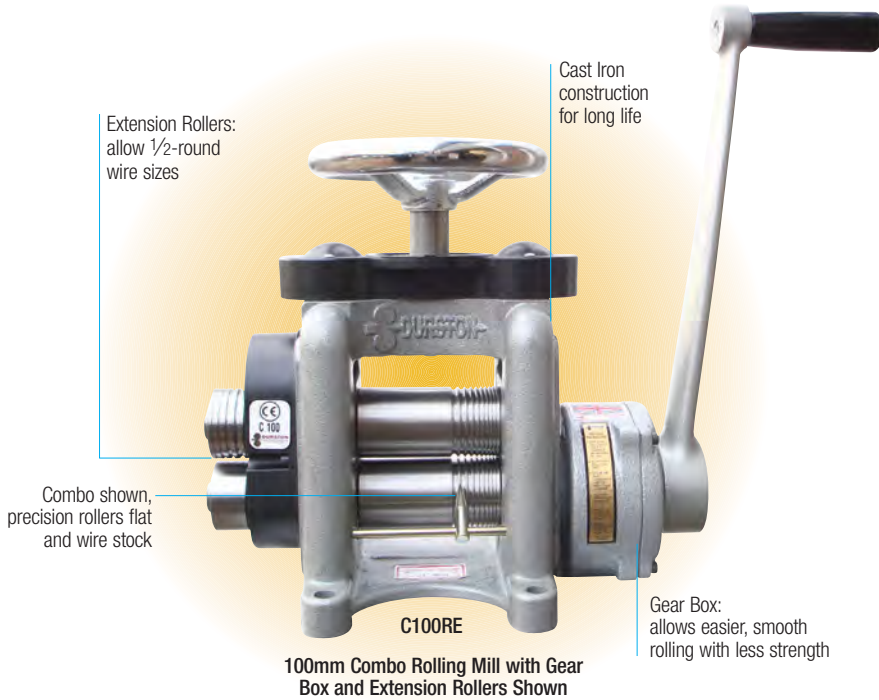

Which Durston Mill Do I Choose?

Sizes available: 80mm, 100mm, 130mm, 150mm
Variations of manual mills:

- Flat
- Combo (Flat and Wire),
- Round,
- Double - space saving

Electric Production Models:

- Combo (Flat and Wire),
- Single Power Mill - space saving
- Double Power Mill

DURSTON	Item #	Flat - Capacity mm Width	Flat - Capacity mm Thickness	Square Wire	Round	1/2-Round Wire	Drive
MANUAL							
Round 150	855-2023	20	6	–	10-1mm (18)	4, 3, 2 + 1.5mm	5 to 1
C80 Econo	855-2001	40	5	6.5-1mm (9)	–	4, 3, 2 + 1.5mm	Direct
Round 100	855-2021	45	5	–	6-1mm (10)	4, 3, 2 + 1.5mm	4 to 1
C80	855-2000	60	5	6.5-1mm (4)	–	4, 3, 2 + 1.5mm	Direct
C100R	855-2002	70	5.5	7-1mm (9)	–	4, 3, 2 + 1.5mm	4 to 1
C100RE	855-2003	70	5.5	7-1mm (9)	–	4, 3, 2 + 1.5mm	4 to 1
Round 130	855-2022	75	6	–	6-1mm (10)	4, 3, 2 + 1.5mm	5 to 1
C130R	855-2006	80	6	8-1mm (11)	–	4, 3, 2 + 1.5mm	5 to 1
C130RE	855-2005	80	6	8-1mm (11)	–	4, 3, 2 + 1.5mm	5 to 1
F100RE	855-2017	100	5.5	–	–	4, 3, 2 + 1.5mm	4 to 1
F130RE	855-2018	130	6	–	–	4, 3, 2 + 1.5mm	5 to 1
C130DBL	855-2011	130	6	10-1mm (19)	–	4, 3, 2 + 1.5mm	7 to 1 sheet 3.5 to 1 wire
POWER							
C100SSP	855-2012	70	5.5	6-1mm (9)	–	4, 3, 2 + 1.5mm	.75kw
C130SSP	855-2014	80	6	8-1mm (11)	–	4, 3, 2 + 1.5mm	1.1kw
100DSP	855-2013	100	5.5	8-1mm (17)	–	8-1.5mm (7)	.75kw
130DSP	855-2015	130	6	10-1mm (19)	–	8-1.5mm (7)	1.1kw

A, B C80 Econo and C80 Combo Mills

80mm combo rolling mill available with and without extension rollers. Compact and economical. Capable of handling flat or round stock.

Specifications:

Gear Ratio Direct drive
 Roller Size 80 x 45mm (W x dia.)
 Sheet Capacity 40 x 5mm (C80 Econo)
 (W x thick) 60 x 5mm (C80)
 Wire Capacity 6.5–1mm square
 (9 grooves C80 Econo)
 (4 grooves C80)
 4, 3, 2 + 1.5mm 1/2-round wire (only on C80)
 Dimensions 8 7/8" W x 6 3/4" D x 10 1/2"H (C80 Econo)
 (w/o handle) 10" W x 6 3/4" D x 10 1/2"H (C80)
 Net Wt. 33 lbs.

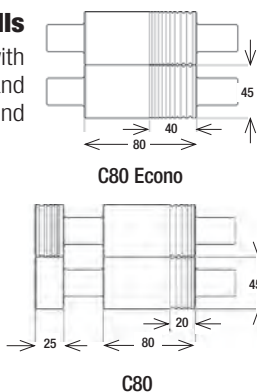

Description	Item#	Each
A. C80 Econo (without extension rollers)	855-2001	\$707.80
B. C80	855-2000	839.00

C, D C100R and C100RE Combo Mills

100mm combo rolling mill with or without extension rollers and both with gearbox.

Specifications:

Gear Ratio 4:1
 Roller Size 100 x 50mm (W x dia.)
 Sheet Capacity 70 x 5.5mm (W x thick)
 Wire Capacity 7–1mm square
 (9 grooves);
 4, 3, 2 + 1.5mm
 1/2-round wire - only
 on C100RE model
 Dimensions 13"W x 7 7/8"D x 12 5/8"H (C100R)
 (w/o handle) 14 1/4"W x 7 7/8" D x 12 5/8"H (C100RE)
 Net Wt. 68 lbs./66 lbs.

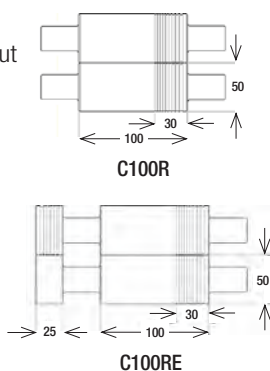

Description	Item#	Each
C. C100R (without extension rollers)	855-2002	\$1,007.50
D. C100RE	855-2003	1,218.25

E. F100RE Flat Mill

100mm flat rolling mill with gear box and extension rollers for 1/2-round wire. Popular mill for those working from a starter mill.

Specifications:

Gear Ratio 4:1
 Roller Size 100 x 50mm (W x dia.)
 Sheet Capacity 100 x 5.5mm (W x thick)
 Wire Capacity 4, 3, 2 + 1.5mm 1/2-round wire
 Dimensions 14 1/4"W x 7 7/8" D x 12 5/8"H (w/o handle)
 Net Wt. 64 lbs.

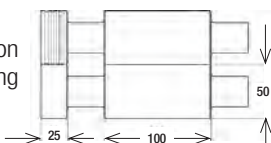

Description	Item#	Each
F100RE	855-2017	\$1,205.00



A

Durston Rolling Mills, Continued

A. C130R and C130RE Combo Mills

130mm combo rolling mill with gear box. Comes with or without extension rollers.

Specifications:

Gear Ratio 5:1
 Roller Size 130 x 60mm (W x dia.)
 Sheet Capacity 80 x 6mm (W x thick)
 Wire Capacity 8–1mm square

(11 grooves)
 4, 3, 2 + 1.5mm
 1/2-round wire only on C130RE model
 Dimensions 15"W x 8 1/2"D x 14 3/8"H (C130R)

16 1/8"W x 8 1/2"D x 14 3/8"H (C130RE)

Net Wt. 95 lbs.

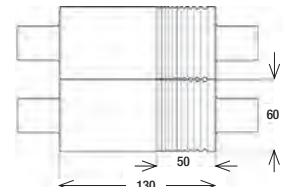

C130R

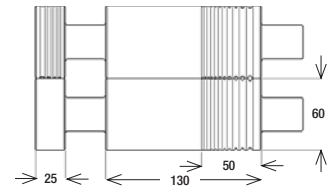

C130RE

Description	Item#	Each
A. C130R (without extension rollers)	855-2006	\$1,155.00
C130RE	855-2005	1,485.00



B

B. F130RE Flat Mill

130mm flat rolling mill with gear box and extension rollers for 1/2-round wire.

Specifications:

Gear Ratio 5:1
 Roller Size 130 x 60mm (W x dia.)
 Sheet Capacity 130 x 6mm (W x thick)
 Wire Capacity 4, 3, 2 + 1.5mm 1/2-round wire
 Dimensions 16 1/8"W x 8 1/2"D x 14 3/8"H (w/o handle)
 Net Wt. 101 lbs.

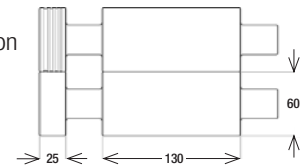

Description	Item#	Each
F130RE	855-2018	\$1,461.35



C

C. C130DBL Combo Mill

Space saving 130mm combo rolling mill, recommended to mount on cabinet stand (see p. 417).

Specifications:

Gear Ratio 7:1 for sheet; 3.5:1 for wire
 Roller Size 130 x 60mm (W x dia.)
 Sheet Capacity 130 x 6mm (W x thick)
 Wire Capacity 10–1mm square

(19 grooves);
 4, 3, 2 + 1.5mm
 1/2-round wire
 Dimensions 16 1/2"W x 8 1/2"D x 22 1/4"H (w/o handle)
 Net Wt. 198 lbs.

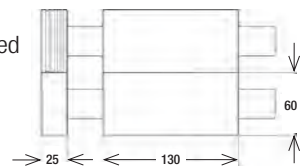

UPPER

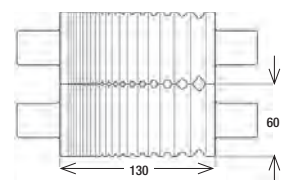

LOWER

Description	Item#	Each
C130DBL 	855-2011	\$2,638.50

Durston Rolling Mills, Continued

Round Rolling Mills

Finally round wire from a rolling mill! With three mills to choose from, you'll find the one that meets your needs. All three mills include a gear reduction to make it easy to roll consistently smooth round wire along with a small flat area and side roller for four half round sizes.

Simply start with a square (or round) wire and use the mill in the same way as any other manual mill. Square wire will gradually compress to round as it passes through consecutively smaller grooves. Note that a round section will be formed before the rollers are fully closed. If you continue to roll and fully close the rollers, this will create a slightly oval wire.

To avoid flashing, rotate the wire 90 degrees on every pass. If flashing forms, reduce the amount of reduction on each pass.



Round 150

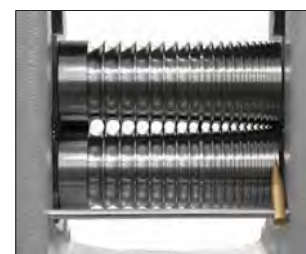

Specifications:

	Round 100	Round 130	Round 150
Gear Ratio:	4 - 1	5 - 1	5 - 1
Roller Size (WxD):	100mm x 50mm	130mm x 60mm	150mm x 60mm
Round Capacity: by 0.5mm increments	10 grooves 1-6mm	10 grooves 1-6mm	18 grooves 1-10mm
Flat/Sheet Capacity: (Width x Thickness)	45mm x 5mm	75mm x 6mm	20mm x 6mm
Side Roller 1/2 Round Sizes:	4,3,2 + 1.5mm	4,3,2 + 1.5mm	4,3,2 + 1.5mm
Dimensions without handle:	14 ¹ / ₄ "W x 7 ⁷ / ₈ "D x 12 ⁵ / ₈ "H	16 ¹ / ₈ "W x 8 ¹ / ₂ "D x 14 ³ / ₈ "H	17"W x 8 ¹ / ₂ "D x 14 ³ / ₈ "H
Net Weight:	64 lbs (29kg)	100 lbs (45.3kg)	104 lbs (47.3kg)
Shipping Weight:	67 lbs (30.3kg)	105 lbs (47.8kg)	110 lbs (49.8kg)
Item#:	855-2021	855-2022	855-2023
Price:	\$1,420.00	\$1,675.00	\$1,874.25

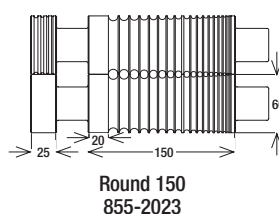
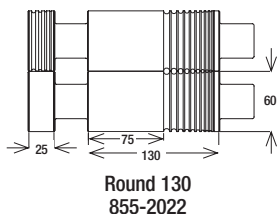
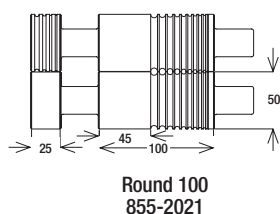

A, B Manual Mill Stands

Choose from pedestal and cabinet types.

Pedestal style is constructed of sturdy 10-gauge steel with a 3/8" top plate and holds all manual mills except C130DBL. Measures 12"W x 14"D x 35 1/2"H. Weighs 22 lbs.

Cabinet style is made of 10-gauge, 1/4" thick plate steel, painted inside and out. Provides locked storage area. Holds all available manual mills. Measures 14"W x 14"D x 35 1/2"H. Weighs 35 lbs.

Description	Item#	Each
A. Pedestal	855-2007	\$270.00
B. Cabinet	855-2010	325.00



A Pedestal



B Cabinet

Durston Rolling Mills, Continued

A. C100SSP Single Combo Mill

Rolls sheet, square wire and half-round wire.

Specifications:

Motor 110V, .75kw
 Speed 5-20rpm
 Roller Size 100 x 50mm (W x dia.)
 Sheet Capacity 70 x 5.5mm (W x thick)
 Wire Capacity 6-1mm square (9 grooves);
 4, 3, 2 + 1.5mm 1/2-round wire

Dimensions 18 1/8"W x 13 3/8"D x 19 5/8"H
 Net Wt. 231 lbs.

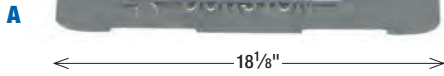
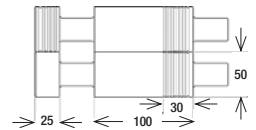

Description	Item#	Each
C100SSP	855-2012	\$3,250.00

FOB United Kingdom

B. 100DSP Double Combo Mill

Rolls sheet, square wire and half-round wire.

Specifications:

Motor 110V, .75kw
 Speed 5-20rpm
 Roller Size 100 x 50mm (W x dia.)
 Sheet Capacity 100 x 5.5mm (W x thick)
 Wire Capacity 8-1mm square (17 grooves);
 8, 6, 4, 3, 2 + 1.5mm 1/2-round wire

Dimensions 27 1/2"W x 13 3/8"D x 19 5/8"H
 Net Wt. 287 lbs.

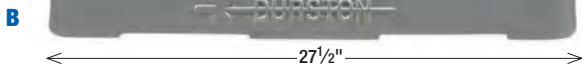
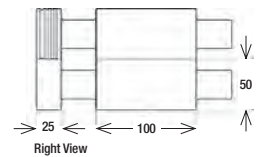
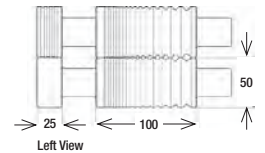

Description	Item#	Each
100DSP	855-2013	\$4,815.00

FOB United Kingdom

C. C130SSP Single Combo Mill

Rolls sheet, square wire and half-round wire.

Specifications:

Motor 110V, 1.1kw
 Speed 5-20rpm
 Roller Size 130 x 65mm (W x dia.)
 Sheet Capacity 80 x 6mm (W x thick)
 Wire Capacity 8-1mm square (11 grooves);
 4, 3, 2 + 1.5mm 1/2-round wire

Dimensions 19 5/8"W x 15 3/8"D x 21 1/4"H
 Net Wt. 287 lbs.

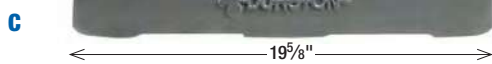
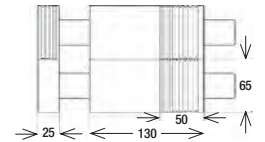

Description	Item#	Each
C130SSP	855-2014	\$3,972.50

FOB United Kingdom

D. 130DSP Double Combo Mill

Rolls sheet, square wire and half-round wire.

Specifications:

Motor 110V, 1.1kw
 Speed 5-20rpm
 Roller Size 130 x 65mm (W x dia.)
 Sheet Capacity 130 x 6mm (W x thick)
 Wire Capacity 10-1mm square (19 grooves);
 8, 6, 4, 3, 2 + 1.5mm 1/2-round wire

Dimensions 32 5/8"W x 15 3/8"D x 21 1/4"H
 Net Wt. 397 lbs.

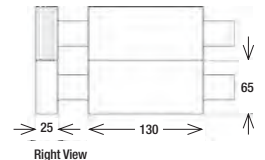
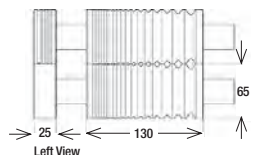

Description	Item#	Each
130DSP	855-2015	\$4,815.00

FOB United Kingdom

A. Durston Draw Bench 1400 - Draw up to 10mm diameter!

Use the handle on one side for direct drive or simply switch to the other side for 4 to 1 reduction. German drawing tongs included. Made in England.

Specifications:

Working Length	950mm (37 ³ / ₈ "	Wire Capacity	10mm
Dimensions	54"L x 22"W x 38 ¹ / ₄ "H	Shipping Wt.	176 lbs.
Two Speeds	Direct 1 to 1 or 4 to 1 reduction		

Description	Item#	Each
Wire Drawing Bench 	268-3051	\$1,145.00



B. Round Carbide Drawplate - Genuine Shenhwa

Allows you to draw extremely bright, smooth round wire. Made of stainless steel with highly polished carbide die inserts for holes. Lasts much longer than steel drawplates. Made in Thailand.

Description	Hole Sizes	No. of Holes	Item#	Each
Round ●	2.2-0.26mm	36	269-3000	\$129.00



C. Steel Drawplates

Economical, durable steel drawplates for reducing wire diameter. Have plenty of holes to make drawing down gradual and easy. Anneal wire occasionally to keep soft, and lubricate with beeswax or Lube-Stik. Made in Italy.

Description	Hole Sizes	No. of Holes	Item#	Each
Round ●	6-3mm	31	268-1500	\$99.95
	3-0.5mm	31	268-1502	85.00
Round ●	3-1mm	20	268-2030	62.00
	2-0.3mm	31	268-1504	85.00
Half-Round ◐	3-1mm	20	268-1506	115.00
Square ■	3-1mm	20	268-1510	96.00
Oval ○	3-1mm	20	268-1508	95.00
8-Point Star ☆	6-3mm	31	268-1514	199.00
Heart ♥	3-1mm	20	268-1516	299.00
Butterfly ⚭	9-6mm	31	268-1512	590.00
Multiform ●◐■	3.5-1mm	60*	268-1518	299.00

*20 round, 20 half-round and 20 square holes.

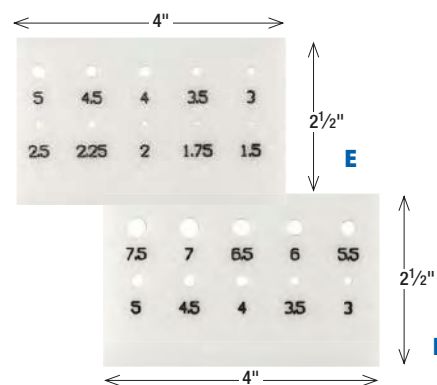

D, E Thermoplastic Drawplates

These thermoplastic drawplates are used to draw woven wire without marring! Gently reduces chain diameter and produces a uniform diameter. Chains stay flexible. Durable, long lasting and non-marring. Made in USA.

Description	Size	Item#	Each
D. Small	1.5 - 5mm	830-1509	\$14.50
E. Medium	3 - 7.5mm	830-1510	29.00

F. Drawing Tongs

Grips wire firmly for pulling through drawplates.

Description	Item#	Each
8" Drawing Tongs	195-0249	\$23.50
F. 10" Drawing Tongs	195-0250	20.95



 Although no hazardous shipping surcharge applies, these items can only ship via UPS® Ground, no air, FedEx® or US Mail possible. Cannot ship to Alaska, Hawaii or Puerto Rico.

Gesswein® Micro Filing and Polishing Solutions

FMR Mini-Filers and Ultrasonic Handpieces

Micro polishing and deburring hard to reach areas is now made so much easier with our new systems. The FMR handpiece from DIPROFIL® in Sweden is configured to fit either a Flexible Shaft machine with QD or a Micromotor. Choose 0.5mm or 1.0mm stroke length and both handpieces have a built-in tool holder accepting up to 3.6mm diameter. Our Ultrasonic Polishers quickly debur and polish even the smallest areas using ceramic stones or diamond tips.



A



B



C



D

A, B FMR Mini-Filers Reciprocating Heads for Flex Shafts and Micromotors

Quickly attaches to a Foredom QD style flexible shaft unit or a Power Hand micromotor after removing the rotary head. Built in holder accepts up to 3.6mm diameter tools including flat ceramic stones. Designed to work on small surfaces in narrow and confined spaces. Choose either the 0.5mm or 1.0mm stroke length handpiece. Recommended speed is 5,000 to 9,000rpm. Caution — maximum speed is 11,000rpm. Measures 5¼" L x 1" dia. Weighs 5 oz.

Length of Stroke	Item#	Each
A. 0.5mm FMR Mini-Filer for Flex Shaft	850-1923	\$650.00
1.0mm FMR Mini-Filer for Flex Shaft	850-1924	599.00
B. 0.5mm FMR Mini-Filer for Power Hand Micromotor	510-2266	650.00
1.0mm FMR Mini-Filer for Power Hand Micromotor	510-2264	650.00

C. Marathon Micromotor – with FMR Mini-Filer

Combining the FMR Mini-Filer with our new Power Hand M-08X micromotor (1,000-8,000rpm) gives improved control and flexibility for filing, deburring and polishing. Use the convenient dial speed control to set reciprocations from 5,000 to 8,000 strokes per minute. Foot rheostat is optional. Marathon controller features an overload protection cut-off switch, forward/reverse switch, voltage selection (110/220V), and produces 0-30V DC (continuously variable). Accepts our full range of Power Hand 3 and standard micromotor handpieces. Three NSS Ceramic Stones, Round, 3mm x 50mm, 800, 1000 and 1200 grits included. Measures 4½"W x 5¼"D x 3¾"H. Weighs 5.5 lbs. 110/220V, 50/60Hz.

Description	Item#	Each
C. 0.5mm Mini-Filer, Micromotor M-08X, Marathon Controller, 3 Ceramic Stones	510-2967	\$1,148.00
1.0mm Mini-Filer, Micromotor M-08X, Marathon Controller, 3 Ceramic Stones	510-2968	1,148.00
Variable Speed Foot Rheostat TPF-77 (optional)	510-2940	60.00

D. POWER/HAND 3 Controller – with FMR Mini-Filer

This Micro Filing System combines most advanced Power Hand 3 Controller with the FMR Mini-Filer and our new M-08X micromotor (1,000-8,000rpm). It gives improved control and flexibility for filing, deburring and polishing. The convenient dial speed control will set reciprocations to 5,000 to 8,000 strokes per minute and a digital readout shows percentage of speed. A built-in micro computer enables smooth operation and automatic torque control. Load indicator shows when too much force is applied. The self-diagnostic function checks operating conditions and activates a cooling fan if ever needed. Controller accepts two handpieces. Forward/reverse switch. Foot rheostat is optional. Accepts our full range of Power Hand 3 Handpieces as well as our standard types. Three NSS Ceramic Stones, Round, 3mm x 50mm, 800, 1000 and 1200 grits included. Measures 7½" x 7½" x 4½"H, 110V (220V available).

Description	Item#	Each
D. 0.5mm Mini-Filer, Micromotor M-08X, Power Hand 3 Controller, 3 Ceramic Stones	510-3387	\$1,465.00
1.0mm Mini-Filer, Micromotor M-08X, Power Hand 3 Controller, 3 Ceramic Stones	510-3386	1,465.00
Variable Speed Foot Rheostat VC90 (optional)	510-3306	118.00

IMPORTANT: See safety recommendations on page 448



**A, B ULTRAMAX® MF with Ultrasonic Handpiece
FMR Mini-Fileur Option**

The very versatile Ultramax MF (Multi Function) Controller is supplied with an Ultrasonic Handpiece for use with Ceramic Stones and other tools for Micro Filing and Polishing. It also accepts the Mini-Fileur with M-08X micromotor giving the operator two choices of how to quickly debur, file and polish. The Ultrasonic Handpiece reciprocates at 16,000 to 26,000 cycles per second — incredibly fast, with a minute stroke length of just 4 to 40 microns, all operator controlled. This allows micro polishing even in deep corners and blind holes. The MF Controller's third receptacle is for our optional Brushless Rotary Handpiece (1,000 to 50,000rpm, #500-0224, see p. 462). All of our standard and Power Hand 3 micromotor handpieces (see pages 423, 429-431) connect to the MF. Included are: MF Controller, Ultrasonic Handpiece (with 6mm thread), tool box, handpiece rest, tool changing wrenches, 1mm and 3mm flat clamp and 3mm round tool holders, and on/off foot switch. Measures 6¾"W x 9½"D x 5½"H. Weighs 5.5lbs. 90-240V, 50/60Hz.

Description	Item#	Each
A. ULTRAMAX MF with Ultrasonic Handpiece	500-0220	\$2,495.00
B. 0.5mm Mini-Fileur with M-08X Micromotor, 3 Ceramic Stones	510-3308	1,072.00
1.0mm Mini-Fileur with M-08X Micromotor, 3 Ceramic Stones	510-3307	1,072.00
Variable Speed Foot Rheostat for Mechanical Handpieces (optional)	500-0221	60.00



See Our Complete Line of Ceramic Stones pages 468-469

C. ULTRAMAX® UM-1200 Ultrasonic Polisher

The most affordable ultrasonic micro polisher for polishing with diamond tools and ceramic stones. The high quality UM-1200 produces 25,000 cycles per second of longitudinal vibration in a small, comfortable handpiece with an invisible minute stroke of 10 to 35 microns from low to high output levels. Maximum output power is 39W.

Includes controller UM-1200, ultrasonic handpiece with 8mm screw thread standard accessory set (two sintered and six plated diamond tools and two ceramic stones), one flat clamp tool holder 1.0mm, two round clamp tool holders 3.0mm, on/off foot switch, handpiece cradle rest, bench jig, wrench and hex key. Measures 7½"W x 5½"D x 3½"H. 90-240V, 50/60Hz. Max. Output 39W.

Description	Item#	Each
ULTRAMAX UM-1200 with Ultrasonic Handpiece	500-1200	\$1,495.00



D. FMR Mini-Fileur Holder – For Ceramic Stones, 1mm

Firmly grips flat ceramic stones 1mm thick, steel jaws are 8mm wide. Made in Sweden.

Description	Item#	Each
FMR Holder - 3mm shank	403-1045	\$34.95



E. New Super Stone (NSS) Set – Round Ceramic Stones, 3mm x 50mm

New Super Stone (NSS) offers an improved cutting ability, increased heat resistance, and longer life. Made of long ceramic fibers that will not break even under the most strenuous conditions, the NSS can be used in ultrasonic polishers, reciprocating profilers or by hand.

Description	Item#	Each
Ceramic Stones, Round Set, 3mm x 50mm, 1 each 180, 300, 600, 800, 1200 grit & Holder	355-1103	\$89.00

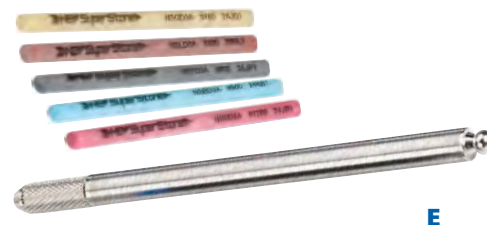

Gesswein® POWER HAND®3 Multifunctional Micromotor System

Designed with the latest technology in micromotor systems, the Power Hand 3 can handle almost any finishing job. This interchangeable system allows the operator to choose from a selection of motors and heads to create the right tool for a variety of polishing applications. With the quick disconnect feature, the operator can switch heads within seconds.

Power Hand 3 is the third generation of its line and comes with several new features such as: convenient on/off switch on each motor case, higher torque output for heavier grinding, and slim lightweight handpiece cable. The Power Hand 3 controller features a load indicator light to warn operator of excessive pressure, and digital RPM display to indicate exact rotational speed of handpiece. Made in Japan.



A. POWER HAND®3 Controller

Power Hand 3 Controller is designed for one-person use. Has 2 output stations with switch to instantly change power from one handpiece to the other. Speed can be adjusted by the dial rheostat on the face of the unit or by an optional variable speed foot rheostat (see below). Output 3-30V DC. Wgt: 5 1/4 lbs (2.3kg)

Description	Item#	Each
A. PH3 Controller, 115V	510-3300	\$495.00
PH3 Controller, 230V	510-3302	495.00

Load Indicator

8 steps of LED display from green to yellow to red. Display lights up when too much force is being applied. For best results and long life, stay within the green.

Digital Rotation Display

2-digit display for easy adjustment of rotation speed. Dialing in the exact RPM for each tool to ensure optimal performance.

Error Code

Displays an error message for easy trouble shooting due to heat build up, overloading the handpiece, or a defective motor cord.

Self Diagnostic Function

PH3 Controller checks condition of motor and controller for safety reasons. When heating up, the fan inside starts automatically to reduce temperature.

Forward/Reverse button

To control the rotational direction for each motor. LED light indicates rotational direction.

PH2X Handpieces

Our previous Power Hand 2X handpieces with 3 prong plug will connect directly into the controller. RPM display, load indicator, and error code message will not be displayed.

Variable Speed Foot Rheostat (optional)

Now with Auto Cruise feature, it is possible to set a fixed speed with the foot pedal, allowing the operator to free their foot from the pedal.



B, C POWER HAND®3 Rotary Kits

Start with these money saving kits. Includes PH3 Controller and handpiece of your choice. All are 115V units.

Description	Item#	Each
PH3 Controller with 8X Handpiece	510-3390	\$1,175.00
PH3 Controller with 15X Handpiece	510-3391	1,175.00
PH3 Controller with 20X Handpiece	510-3392	1,175.00
PH3 Controller with 30X Handpiece	510-3393	1,175.00
PH3 Controller with 35X Handpiece	510-3394	1,175.00
PH3 Controller with 55X Handpiece	510-3396	1,175.00
C. Variable Speed Foot Rheostat VC90 (optional)	510-3306	118.00

Gesswein® POWER HAND® 3 Rotary Handpieces

Choose from six sturdy, true-running, well-balanced handpieces with powerful 30V DC air-cooled motors. Enhanced motor design increases torque by 20% and improves airflow to keep handpieces cool. They operate with minimal vibration and have flexible power cords for easy reach. All handpieces have a quick-tool-change feature and new on/off switch located

on the motor. All six handpieces are two-piece construction and can accept various Power Hand head attachments. Standard Head is included. Supplied with $\frac{3}{32}$ " and $\frac{1}{8}$ " collets, collet wrenches and replacement motor brushes. Please visit www.gesswein.com for handpiece diagram and parts list. Made in Japan.



A. High-Torque Rotary Handpieces

Designed to handle the toughest jobs. These workhorses have the highest torque rating. Available in 3 different speeds: 8,000, 15,000, and our most popular 30,000rpm. Use for hand grinding, heavy deburring, cutting, polishing and finishing all types of material. Supplied with $\frac{3}{32}$ " and $\frac{1}{8}$ " collets. Weight 9.74 oz.

Description	Speed	Torque	Item#	Each
08X	1,000–8,000rpm	9.8	510-3310	\$750.00
15X	1,000–15,000rpm	8.8	510-3320	750.00
30X	1,000–30,000rpm	6.8	510-3340	750.00

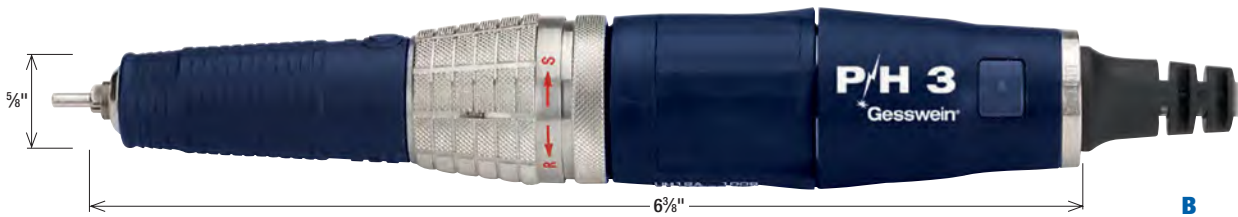

B. Standard Rotary Handpieces

These handpieces are smaller and lighter weight compared to the high-torque handpieces. They fit comfortably in the hand and are well suited for continuous use for general purpose grinding and polishing. Available in 20,000 and 35,000rpm. Supplied with $\frac{3}{32}$ " and $\frac{1}{8}$ " collets. Weight 7.76 oz.

Description	Speed	Torque	Item#	Each
20X	1,000–20,000rpm	6.4	510-3330	\$750.00
35X	1,000–35,000rpm	5.4	510-3350	750.00



C. High Speed Rotary Handpiece

The lightest, fastest and most comfortable of our straight rotary handpieces. This 55,000rpm handpiece is a great choice for tools that perform at high speeds. Use for precision work. Supplied with $\frac{3}{32}$ " and $\frac{1}{8}$ " collets. Weight 6.70 oz.

Description	Speed	Torque	Item#	Each
55X	1,000–55,000rpm	3.6	510-3370	\$750.00

Optional Heads



Mini Filer Head
#510-2266 p. 426
#510-2264 p. 426
#510-2265 p. 426



SZX Swing Head
#510-2256 p. 426



Contra Angle Head 120°
#510-2250 p. 427



Right Angle Head 90°
#510-2240 p. 427



Heavy-Duty Head
#510-2230 p. 426



Slender Head
#510-2220 p. 426



Standard Head
#510-2200 p. 426



Contra Angle Head 120°
#510-2250 p. 427



Right Angle Head 90°
#510-2240 p. 427



Heavy-Duty Head
#510-2230 p. 426



Slender Head
#510-2220 p. 426



Standard Head
#510-2200 p. 426

Create your own handpiece!

All Power Hand 3 rotary handpieces are two-part design so heads and motors can be switched to create new combinations to best suit your particular job. Use the system configuration chart to determine what heads and motors can be used together. Note: Lower RPM motors have more available head options, while higher RPM motors are limited to either the Slender Head or Standard Head configurations.



Slender Head
#510-2220 p. 426



Heavy-Duty Head
#510-2230 p. 426



Slender Head
#510-2220 p. 426



Standard Head
#510-2200 p. 426

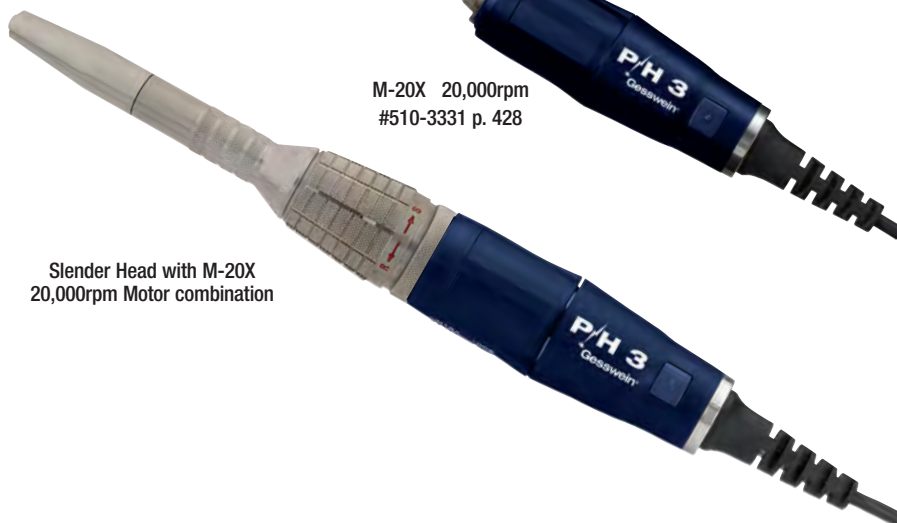

M-20X 20,000rpm
#510-3331 p. 428

Slender Head with M-20X
20,000rpm Motor combination



Slender Head
#510-2220 p. 426



Standard Head
#510-2200 p. 426



Slender Head
#510-2220 p. 426



Standard Head
#510-2200 p. 426

& Motors System Configuration Chart

Motors

Controllers



M-08X 8,000rpm
#510-3311 p. 428



M-15X 15,000rpm
#510-3321 p. 428



M-20X 20,000rpm
#510-3331 p. 428



M-30X 30,000rpm
#510-3341 p. 428



M-35X 35,000rpm
#510-3351 p. 428



M-55X 55,000rpm
#510-3371 p. 428



PH3 Controller
#510-3300 p. 422



PH2X Dual Controller
(no longer available)



PH3 Adapter
#510-3304 p. 435
(for connecting PH3 handpieces to PH2X controllers and Ultramax DF)



PH2X Standard Controller
(no longer available)

Gesswein® POWER HAND® 3 Head Attachments

These Power Hand head attachments will connect to PH3 motors and to the previous version PH2X motors. See System configuration chart on pages 424-425 to select the right head attachment for each motor. Be sure not to exceed the maximum RPM for each head attachment.



A. Standard Head – Provided with all PH3 Rotary Handpieces

This all-purpose rotary head is compatible with all motor assemblies. Supplied with a 3/32" collet; 1/8" and 3mm collets also available (see p. 434).

Description	Max. RPM	Item#	Each
Z-STX	55,000	510-2200	\$325.00

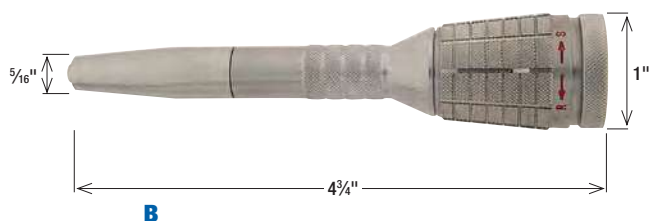

B. Slender Head – For access into deep ribs and holes

Pencil-like design only 3/8" (9.0mm) in diameter at the finger grips gives 1 9/16" (40mm) more reach than a standard rotary head. Ideal for intricate, deep, hard-to-reach cavities and delicate areas. Compatible with all motor assemblies. Supplied with a 1/8" collet; 3/32" and 3mm collets also available (see p. 434).

Description	Max. RPM	Item#	Each
Z-SLX	55,000	510-2220	\$399.00



C. Heavy-Duty Head – For use with 1/4" shanked tools

Use with large tools through 1/4" shank for greater stock removal. Compatible with M-08X, M-15X and M-30X motors. Supplied with a 1/4" collet; 3/32", 1/8" and 6.0mm collets also available (see p. 434).

Description	Max. RPM	Item#	Each
Z-HDX	30,000	510-2230	\$399.00

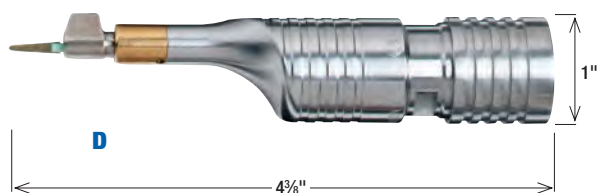

D. Mini Filer Heads – Reciprocating head

Mini filer heads for lightweight profiling. Slim nose design allows polishing and finishing of narrow, confined spaces. Choose from three stroke lengths. All models hold tools up to 3.5mm diameter (such as Diamond Tips on p. 109). For best results, use with M-08X motor.

Fixed Stroke Length	Max. Strokes /Min.	Item#	Each
0.5mm	12,000	510-2266	\$650.00
1.0mm	12,000	510-2264	650.00
1.5mm	12,000	510-2265	650.00

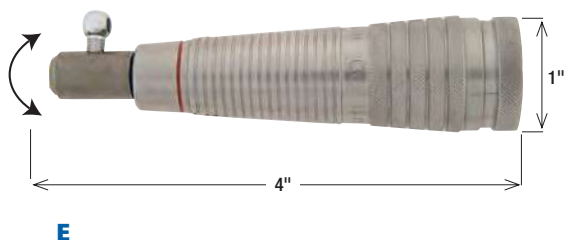

E. SZX Swing Head – For side to side stroke

This head is identical to that on our SZX Profiler. It gives a unique side-to-side reciprocating action with a stroke that is easily adjustable. It's perfect for polishing base areas in deep cavities, corners and deep slots and helps eliminate rounding of sharp corners. Prevents bottoming out in blind holes. Holds 1.5 to 5mm (3/16") diameter tools. Use on M08X motor assembly only.

Description	Max. Strokes /Min.	Item#	Each
SZX	8,000	510-2256	\$495.00

A, B Right-Angle Head

This 90° Angle Head provides more comfortable usage than a straight handpiece in some applications. Available in a money saving kit with the M-15X motor or sold alone to use with either the M-08X or M-15X motors (see p. 428). Employs double spur gear that provides durable power. Supplied with 3mm and 1/8" collets; 3/32" collet also available. Equipped with quick-tool-change feature.

Description	Max. RPM	Item#	Each
A. Z-ANX Right-Angle Head (90°)	15,000	510-2240	\$395.00
B. Z-ANX + M-15X Handpiece Kit		510-3360	685.00

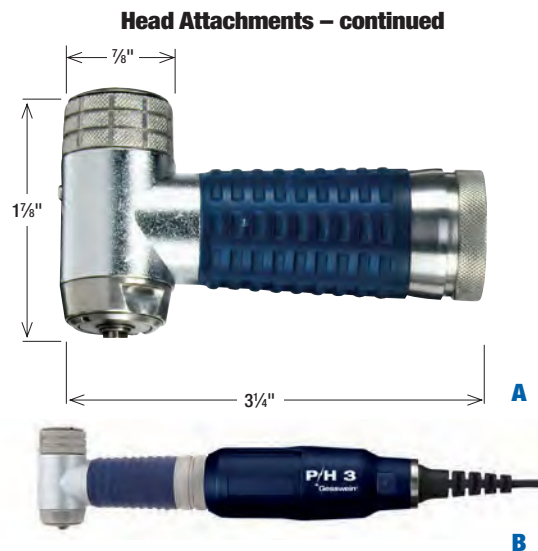

C, D Contra-Angle Head

This 120° Angle Head's unique shape provides more comfortable usage than a straight handpiece in some applications. Available in a money saving kit with the M-15X motor or sold alone to use with either the M-08X or M-15X motors (see p. 428). Employs double spur gear that provides durable power. Supplied with 3mm and 1/8" collets; 3/32" collet also available. Equipped with quick-tool-change feature.

Description	Max. RPM	Item#	Each
C. Z-CNX Contra-Angle Head (120°)	15,000	510-2250	\$395.00
D. Z-CNX + M-15X Handpiece Kit		510-3361	745.00



E-G Disc Holders for Angle Rotaries – 3mm shank

Specially designed for Power Hand angle handpieces and head attachments. Shanks machined to precise dimensions to reduce vibration. Made of soft rubber to work well on flat or contoured surfaces. Precisely made to hold precut abrasive and felt discs. Or use your own abrasives cut to size, such as diamond foil, diamond sheet or diamond film (see p. 114).

Size	Item#	Each
E. 11mm round	510-0260	\$10.00
F. 21mm round	510-0265	10.00
G. 31mm round	510-0270	10.00



G-L Sandpaper and Felt Discs for Angle Rotaries

Precut to fit our disc holders, these discs have pressure-sensitive adhesive backing. Use sandpaper for rough through intermediate finish; use felt for final finish of metal surfaces.

Sandpaper Discs	80 Grit Item#	120 Grit Item#	180 Grit Item#	320 Grit Item#	Pkg. of 10
H. 11mm round	510-0600	510-0605	510-0610	510-0615	\$2.75
I. 21mm round	510-0620	510-0625	510-0630	510-0635	4.25
J. 31mm round	510-0640	510-0645	510-0650	510-0655	6.50
Felt Discs	Item#			Pkg. of 10	
K. 11mm round	510-0245			\$4.50	
L. 21mm round	510-0250			7.55	
M. 31mm round	510-0255			9.75	

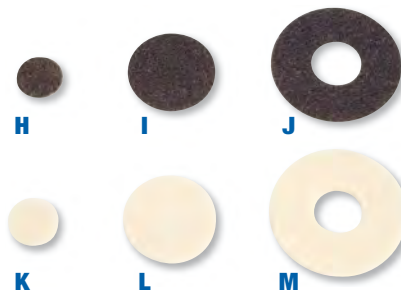

Gesswein® POWER HAND® 3 Motors

Purchase a motor separately to construct your own Power Hand 3 handpiece. Power Hand 3 motors accept all Power Hand head attachments on pages 424, 426-427. Please refer to the maximum rpm speed of the head attachment when pairing with motors. All motors feature a new and convenient on/off switch. RPM speed is indicated on the motor casings. Supplied with a pair of replacement motor brushes.



Motors accept head attachments found on pages 426-427. See System Configuration Chart on pages 424-425.



A. High-Torque Motors

For heavy grinding applications where high torque is required. When selecting a head attachment, please refer to the maximum rpm speed of the head attachment (see pp. 426-427). Weight 6.2 oz.

Description	Speed	Max. Torque (Ncm)	Item#	Each
M-08X	1,000–8,000rpm	9.8	510-3311	\$425.00
M-15X	1,000–15,000rpm	8.8	510-3321	425.00
M-30X	1,000–30,000rpm	6.8	510-3341	425.00



B. Standard Motors

Small, lightweight motors for general purpose finishing. Fits comfortably in hand. For use with Standard Head and Slender Head attachments only (see p. 426). Weight 4.25 oz.

Description	Speed	Max. Torque (Ncm)	Item#	Each
M-20X	1,000–20,000rpm	6.4	510-3331	\$425.00
M-35X	1,000–35,000rpm	5.4	510-3351	425.00



C. High-Speed Motor

The lightest, fastest, and most comfortable high-speed motor. For use with Standard Head and Slender Head attachments only (see p. 426). Weight 3.2 oz.

Description	Speed	Max. Torque (Ncm)	Item#	Each
M-55X	1,000–55,000rpm	3.6	510-3371	\$425.00

Gesswein® POWER HAND® BZX Belt Sander

Ideal for a wide variety of precision finishing applications. Use for deburring, removing EDM and machine tool marks and sanding flat and curved surfaces and narrow slots. Operates with minimal vibration and has flexible power cord for easy reach. Supplied with straight and 45° angle arms for 6 and 8mm wide abrasive belts. Arms are spring-loaded for rapid belt changes. Weighs 16 oz.



Description	Item#	Each
A BZX Belt Sander w/2 arms	510-2131	\$995.00
B. Optional Straight Arm (for 4mm belts)	510-0494	119.00
C. Replacement 45°-Angle Arm (for 6 and 8mm belts)	510-0495	118.30
D. Replacement Straight Arm (for 6 and 8mm belts)	510-0496	126.50
BZX Belt Sander with PH3 Controller - 115V	510-3400	1,415.00

BZX Belt Sander Applications

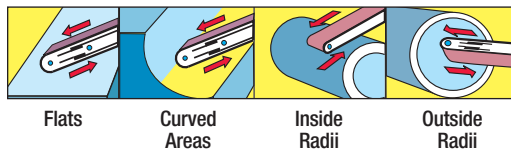

E. Sanding Belts for BZX

Aluminum oxide abrasive belts specially made for use with our Power Hand BZX Belt Sander. Belts fit on either straight or 45°-angle arms.

Size	80 Grit Item#	120 Grit Item#	180 Grit Item#	320 Grit Item#	Pkg. of 10	
					1-2	3+
4mm	510-0501	510-0506	510-0511	510-0517	\$21.95	\$19.76
6mm	510-0521	510-0526	510-0528	510-0532	21.95	19.76
8mm	510-0536	510-0541	510-0546	510-0552	21.95	19.76



Gesswein® POWER HAND® 3 SZX Side-to-Side Profiler

Provides unique side-to-side reciprocating action with adjustable stroke (up to 133 strokes per second). Length of stroke ranges from 0 – 1.6mm (increases with tool length). Perfect for polishing base areas in deep cavities, corners and deep slots. Helps eliminate rounding of sharp corners. Prevents bottoming out in blind holes. Weighs 13 oz. Special V-shaped chucking system firmly secures 1.5 to 5mm (3/16") diameter tools. Sold individually or as a set with Power Hand 3 controller 510-3300.

Description	Item#	Each
F. SZX Profiler	510-3309	\$795.00
SZX Profiler with PH3 Controller - 115V	510-3389	1,225.00

SZX Profiler Applications (side to side)

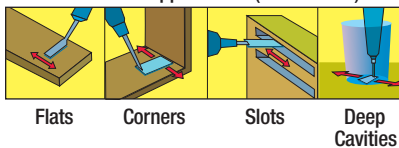

Safety Recommendations – For Z-2X, Z-6X and SZX Profilers.

Prolonged use of vibrating or reciprocating tools may result in vibration-induced circulation problems in the hands. Always follow safe operating procedures. Using hand protection (i.e., insulated gloves) and taking frequent breaks can help minimize but not guarantee against injury. Operating these types of tools in cold weather or with a tight grip will reduce the period of operation before risking potential injury. Individuals with a tendency to suffer from poor circulation, frequently cold fingers or itchy hands should closely monitor the condition of their hands. If symptoms appear, seek medical advice immediately.

Gesswein® POWER HAND® Reciprocating Profilers

These light (24 oz.) reciprocating handpieces come complete with powerful 30V DC air-cooled motors and sealed bearings. Use for polishing flat surfaces, deburring, filing, stoning, scraping, lapping and draw-stoning deep cavities. They operate with minimal vibrations to reduce fatigue and have flexible power cords for easy reach. Special V-shaped chucking system firmly secures a wide variety of abrasives and other tools (see p. 311 for steel files). Reciprocating stroke lengths are adjustable. Use with PH3 controller or PH2X controller, as well as ULTRAMAX DF and ULTRAMAX MF.



A. Z-2X and Z-6X Reciprocating Profilers

Both Z-2X and Z-6X provide standard back-and-forth reciprocating action. Z-2X has a 0-2.0mm length of stroke with a variable strokes per second rate up to 117. Z-6X has a 0-6.0mm length of stroke with a variable strokes per second rate up to 70. They hold 1.5 to 6.35mm (1/4") diameter tools. Secured tools can float freely and be fixed at any position through 360°. Comfortable grips allow prolonged use. See below for tool holders.

Description	Item#	Each
A. Z-2X	510-2150	\$995.00
Z-6X	510-2160	995.00
Z-2X with PH3 Controller - 115V	510-3397	1,415.00
Z-6X with PH3 Controller - 115V	510-3398	1,415.00

Z-2X and Z-6X Recipro Applications (back and forth)

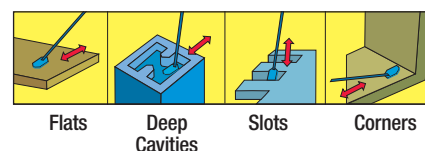

A

B



C



B, C Tool Holders for Z-2X, Z-6X and SZX

These 3mm shank holders are designed to hold precut PSA felt and sandpaper pads (see below) to make your reciprocating handpieces more versatile. You can cut your own abrasives, such as diamond foil and diamond film (see p. 114), to fit the holder pads.

Style	Dimensions (mm)	Item#	Each
B. Fixed Holder	10 x 20 x 40	510-0560	\$6.95
	10 x 20 x 65	510-0410	4.95
C. Free Holder with 180° swivel	10 x 20 x 80	510-0420	18.50

D



E



D, E PSA Sandpaper and Felt Pads

Precut waterproof SiC sandpaper pads, 10 x 20mm, with pressure-sensitive adhesive backing. Precut PSA felt pads can be charged with diamond compound. Excellent for use on flat surfaces. For use with Z-2X, Z-6X and SZX handpiece holders (see above).

Description	Grit	Item#	Pkg. of 10
D. Sandpaper Pad	180	510-0200	\$3.95
	240	510-0210	3.95
	320	510-0220	3.95
	400	510-0230	3.95
	600	510-0240	3.95
E. Felt Pad	-	510-0300	6.50

Micromotor Drive Mark II Di-Profilers

Connect to any Power Hand Controller

Gesswein is proud to offer the NEW Di-Profiler Mark II systems—the most advanced handpiece systems yet. The Professional and Classic MM Drive Di-Profilers are built with a micromotor inside every handpiece and can connect directly to any Gesswein Power Hand controller. Both Professional and Classic Mark II models now incorporate the protective finger sleeve into the handpiece. Made in Sweden.



ROTARY & ULTRASONIC

A, B Professional Micromotor Drive Di-Profiler, Mark II Maximum Efficiency, Minimal Vibrations

Simply the best reciprocating handpiece in the market today, the Professional Di-Profiler combines ergonomic design and heavy duty power. A counter balance weight system located on the opposite end of the tool holder reduces vibration levels. As the tool reciprocates, the counter balance weight reciprocates in the opposite direction thereby stabilizing the handpiece. As a result, vibration in the user's hand is greatly reduced. Comes complete with operations guide, rubber sleeve, storage case, wrench and lubricating oil. Adjustable stroke length 0-6mm. 8,000rpm maximum.

Description	Item#	Each
A. Professional Micromotor Di-Profiler 1/4" chuck capacity	850-1908	\$2,295.00
B. Complete Kit (Includes Professional Di-Profiler 1/4" chuck capacity, Marathon controller and variable speed foot rheostat)	850-1942	2,395.00

Operation Guide is included with profiler for safety and operating instructions.
For information on hand transmitted vibration see ANSI Standard S2.70 2006 (R2011).



C, D Classic Micromotor Drive Di-Profiler

Comes complete with operations guide, rubber sleeve, storage case, wrench and lubricating oil. Adjustable stroke length 0-6mm. 8,000rpm maximum.

Description	Item#	Each
C. Classic Micromoter Di-Profiler 1/4" chuck capacity	850-1915	\$2,090.00
D. Complete Kit (Includes Classic Micromotor Di-Profiler 1/4" chuck capacity, Marathon controller and variable speed rheostat)	850-1947	2,095.00

Operation Guide is included with profiler for safety and operating instructions.
For information on hand transmitted vibration see ANSI Standard S2.70 2006 (R2011).



Safety Recommendations – For all Reciprocating Profilers

Prolonged use of vibrating or reciprocating tools may result in vibration-induced circulation problems in the hands. Always follow safe operating procedures. Using hand protection (i.e., insulated gloves) and taking frequent breaks can help minimize but not guarantee against injury. Operating these types of tools in cold weather or with a tight grip will reduce the period of operation before risking potential injury. Individuals with a tendency to suffer from poor circulation, frequently cold fingers or itchy hands should closely monitor the condition of their hands. If symptoms appear, seek medical advice immediately.



Input for Power Hand Handpieces

A



A. Marathon Handy 700 Brushless Micromotor System

The Handy 700 system features an advanced controller and a 50,000rpm, 230W brushless rotary handpiece for incredible power—even at low speeds! Provides ample torque at all times to ensure fast and smooth metal removal. Ideal for a variety of applications, including grinding, finishing and polishing. Use with Power Hand 3 handpieces (see pp. 423, 429-430) for profile polishing or belt sanding.

System includes Handy 700 controller and BH-60 handpiece with 1/8" or 3/32" collet, variable-speed foot rheostat (FS60), handpiece cradle rest, detachable handpiece holder and replacement fuse. Backed by a two-year handpiece warranty. CE approved.

Features:

- Incredible power—even at low speeds
- Full compatibility with Power Hand 3 brush-type handpieces
- Dial or foot rheostat speed control
- Auto-cruise function for fixed-speed operation with foot rheostat
- Easy-to-read digital speed display for precise speed and torque settings
- Forward/reverse rotation
- Error-checking/troubleshooting system with digital display
- Overload protection

Specifications:

Handy 700 Controller

Electrical: 100–120V, 40W, 50/60Hz
 Dimensions: 5 3/8"W x 9 1/16"D x 7 1/16"H
 Net Wt.: 6 lbs.

BH-60 Handpiece – Brushless

Speed Range: 1,000–50,000rpm
 Max. Power: 230W
 Max. Torque: 7.8 N-cm
 Collet Size: 1/8" or 3/32"
 Dimensions: 6 9/16"L x 1 1/16" to 3/4" dia.
 Net Wt.: 8.4 oz.

Description	Item#	Each
A. Handy 700 System, 1/8" collet	510-2925	\$765.00
Handy 700 System, 3/32" collet	510-2920	765.00
Replacement BH-60 Handpiece with 1/8" Collet	500-0224	525.00
Replacement BH-60 Motor only	500-0225	400.00



B Increase the versatility of your Handy 700.

B. BH-60 Motor Adaptor

This easy-to-use motor adaptor connects PH3 head attachments to the BH-60 Handpiece (included in the Marathon Handy 700 micromotor system). Simply remove the BH-60 head and attach the adaptor to the motor to increase the versatility of your Handy 700. Motor also sold separately (see above). Go to pages 424, 426-427 for PH3 head attachments.

Description	Item#	Each
B. BH-60 Motor Adaptor	500-0223	\$165.00

Possible configurations below

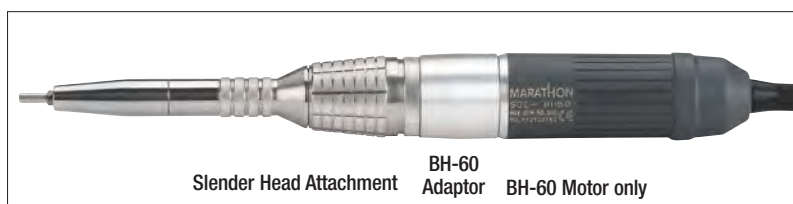
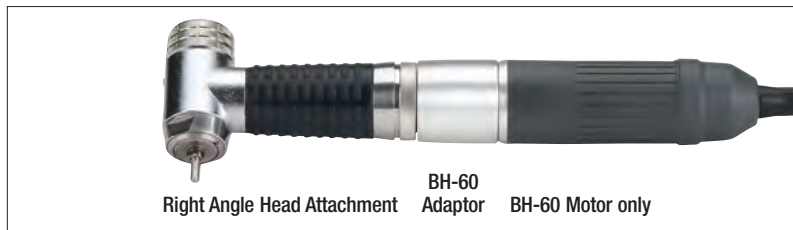

A. Marathon Micromotor System – Do-it-all System!

This extremely affordable rotary micromotor system performs a wide range of grinding, deburring and polishing operations. Includes compact controller, lightweight 35,000rpm rotary handpiece, 1/8", 3mm or 3/32" collet, variable-speed foot rheostat, handpiece cradle rest and safety glasses. Controller features a voltage selector switch, dial speed control, forward/reverse handpiece direction switch and motor overload cutoff switch. Accommodates our full line of Power Hand 3 handpieces. Electrical: 110/220V, 50/60Hz. Output voltage: 0–30V DC (continuously variable). Measures 4 1/2"W x 5 3/4"D x 3 3/4"H. Weighs 2.6 lbs. Handpiece features a well-balanced ergonomic design that fits in your hand like a pen, convenient quick-tool-change mechanism and flexible phone-type cord. Max. operating speed: 35,000rpm. Measures 6"L x 1" to 5/8" dia. Weighs 7.5 oz.



Description	Item#	Each
A. Marathon System with 1/8" Collet	510-2946	\$325.00
Marathon System with 3/32" Collet	510-2956	325.00
Marathon System with 3mm Collet*	510-2971	325.00
Marathon Controller only	510-2960	129.00
Variable-Speed Foot Rheostat TPF-77 only	510-2940	60.00

* Use your Marathon for bright cutting by ordering diamond flywheels on 3mm shanks. See page 446

B, C Marathon Micromotor Systems for Setters

Available as a complete set with the Marathon Controller, 35,000rpm Rotary Handpiece, Freedom Hammer Handpiece and On/Off Rheostat or simply the Marathon Controller with the Freedom Hammer Handpiece only.

The Marathon Micromotor Controller features dial adjustable speed control, overload cutoff switch, forward/reverse switch, and accepts a variable speed foot rheostat and a wide variety of micromotor handpieces. Electrical: 110~220V, 50/60Hz. Output voltage: 0–30V DC (continuously variable). Measures 4 1/2"W x 5 3/4"D x 3 3/4"H. Weighs 2.6 lbs.

The 35,000rpm Rotary Handpiece features a well-balanced ergonomic design that fits in your hand like a pen, convenient quick-tool-change mechanism and flexible phone-type cord. Measures 6"L x 1" to 5/8" dia. Weighs 7.5 oz.

The Freedom Hammer Handpiece is perfect for stone setting - prong work and channel. Also used for texturing and for engraving using the included graver holding attachment. Three anvils with threaded shanks, wrench, tightening pins and an adapter for non threaded anvils, motor brushes and a handpiece tray included. 2 year warranty.



Description	Item#	Each
B. Marathon Controller, Rotary Handpiece with 3/32" Collet, On/Off Rheostat, Freedom Hammer Handpiece	510-2930	\$849.00
C. Marathon Controller, Freedom Hammer Handpiece (no Rheostat)	510-2935	675.00
Optional Variable Speed Rheostat for Marathon	510-2940	60.00
Freedom Hammer Handpiece	510-1280	595.00



D. ECO-Torque Micromotor System

Our most affordable rotary micromotor system! The ECO-Torque 280 handles a wide range of rotary handpiece applications. Whether you need a system for grinding, drilling, polishing or bright-cutting, ECO-Torque 280 will get the job done. Includes a compact controller with 110/220V selector switch and forward/reverse switch, lightweight 35,000rpm rotary handpiece with 3/32" collet, on/off foot switch, dial speed control, handpiece cradle rest, replacement pair of carbon brushes and collet chuck wrenches. An optional reducing collet is available (sold separately) to reduce collet size from 3/32" to 1/16" to run friction grip 1/16" shank burs. Made in South Korea.

Description	Item#	Each
ECO-Torque 280	510-2980	\$199.95



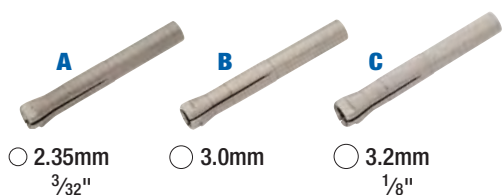

○ 2.35mm $\frac{3}{32}$ " ○ 3.0mm ○ 3.2mm $\frac{1}{8}$ "

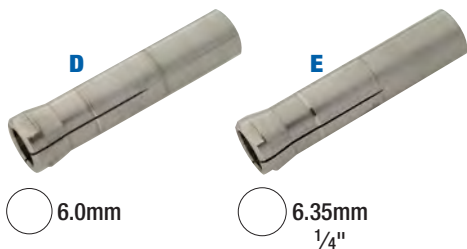

○ 6.0mm ○ 6.35mm $\frac{1}{4}$ "



F G H I J



K L M



N O P

A-C Collets for Straight and Angle Rotary Handpieces PH3, PH2X & Marathon

For all Power Hand Straight and Angle Handpieces except Z-HDX Heavy-Duty Head and Micro-Angle Heads.

Size	Item#	Each
A. $\frac{3}{32}$ " (2.35mm)	501-0100	\$39.95
B. 3.0mm	501-0106	39.95
C. $\frac{1}{8}$ " (3.2mm)	501-0105	39.95

D, E Collets for Z-HDX Heavy-Duty Head

For Power Hand Z-HDX Heavy-Duty Head only.

Size	Item#	Each
$\frac{3}{32}$ " (2.35mm)	501-0103	\$79.95
$\frac{1}{8}$ " (3.2mm)	501-0104	79.95
D. 6.0mm	501-0107	79.95
E. $\frac{1}{4}$ " (6.35mm)	501-0108	79.95

F-J Reducing Collets

Use the proper reducing collet to convert your standard $\frac{1}{8}$ ", 3mm or $\frac{3}{32}$ " collet to hold a $\frac{3}{32}$ " or $\frac{1}{16}$ " tool shank. Simply slip reducing collet into collet on your Power Hand standard or angle head to use smaller shanked tools. Make sure both the reducing collet and the tool shank are fully inserted into the collet. Stainless steel.

Size	Item#	Each
F. $\frac{1}{8}$ " to $\frac{3}{32}$ "	816-1501	\$14.90
G. $\frac{1}{8}$ " to $\frac{1}{16}$ "	816-1502	14.90
H. 3mm to $\frac{3}{32}$ "	816-1504	14.90
I. 3mm to $\frac{1}{16}$ "	816-1505	14.90
J. $\frac{3}{32}$ " to $\frac{1}{16}$ "	816-1503	14.90

K-M Carbon Brushes for all PH3 and PH2X Rotary Motors

For Handpiece Motors	Item#	Set of 2
K. 8,000, 15,000, and 30,000 speeds	510-0163	\$23.70
L. 20,000 and 35,000 speeds	510-0169	23.70
M. 55,000 speed	510-0168	23.70

N POWER HAND® Chuck Joint Wrench

Description	Item#	Each
N. For all Straight and Angle Heads	510-0179	\$3.80

O, P POWER HAND® Collet Wrenches

Description	Item#	Each
O. For all Straight and Angle Heads	510-0180	\$9.90
P. For Z-HDX Heavy-Duty Head	510-0182	10.50

A. POWER/HAND®3 Adaptor

This adaptor will connect new PH3 handpiece motors to our older PH2X controllers. The PH3 motors consist of 5-pronged plugs and the PH2X controllers have 3-prong plug receptacles. Therefore, this adaptor serves as a reducer from a 5 to 3-prong plug.

Description	Item#	Each
Adaptor for PH3 handpieces	510-3304	\$39.00



A

B. POWER/HAND®3 Variable Speed Foot Rheostat VC90

Now with Auto Cruise feature, it is possible to set a fixed speed with the foot pedal, allowing the operator to free their foot from the pedal.

Description	Item#	Each
Variable Speed Foot Rheostat VC90	510-3306	\$118.00



B

C. POWER/HAND®3 Motor Cord

Description	Item#	Each
PH3 Motor Cord	510-3382	\$95.00



C

D. POWER/HAND®3 Handpiece Extension Cord

Description	Item#	Each
PH3 Handpiece Extension Cord - 9'	510-3380	\$75.00



D

E. POWER/HAND®2X 6' Handpiece Extension Cord

Description	Item#	Each
PH2X Handpiece Extension Cord - 6'	510-1120	\$59.00



E

F. POWER/HAND®2X Motor Cords

Description	Item#	Each
F. Second Generation Cord	510-0170	\$48.00
First Generation Cord	510-0171	48.00



F

G. POWER/HAND® Foot Pedals

Description	Item#	Each
Variable Speed Foot Rheostat	510-2995	\$118.00
G. On/Off Foot Switch	510-3105	55.00



G

H. POWER/HAND® Handpiece Cradle Rest

Description	Item#	Each
PH2X Handpiece Cradle Rest	510-1130	\$14.60



H

Gesswein®/Foredom® Flexible Shaft Motors & Kits



Included uses are grinding, carving, drilling, deburring, engraving, polishing and more. Our wide selection of flexible shaft motors, handpieces and accessories allows you to grind and finish almost any material. Each motor comes complete with flexible shaft and sheath. Motors are sold individually, with handpiece, with handpiece and foot pedal or in kits that include motor, handpiece and foot rheostat. Backed by a two-year manufacturer's warranty. All motors have fully grounded wiring. UL listed. Made in USA.

Motor Specifications:	TX and TXH	SR, SRM and SRH	LX
Max. Operating Speed	15,000rpm	18,000rpm	5,000rpm
Power	1/3 HP	1/6 HP	1/10 HP
Applications	Toughest grinding & finishing	General purpose grinding & finishing	Controlled grinding & finishing

A-C Foredom® Series TX – 1/3 HP

Provides full torque and smooth, controlled acceleration throughout the entire speed range. Ideal for stone setting, wax carving, polishing, milling, drilling and other applications that call for high torque. Capable of this torque due to the fact that they use rare earth magnets in place of universal wound magnets. Offer great control under any load. Speed range: 0–15,000rpm. All 50/60Hz. Not available in 230V.

- TX is a hanging-style flexible shaft motor with 39" shaft and sheath (see p.444 for longer (66") replacement shaft and sheath). Use with TXR or SXR foot rheostat or EMX speed controller (see p. 443) and all standard quick disconnect (QD) handpieces (see pp. 438-441).
- TXH is a hanging-style square-drive flexible shaft motor with heavy-duty (HD) 60" flexible shaft with sheath liner/silencer. Ideal for the toughest applications using large stones and tools mounted on 1/4" and 6mm shanks. Use with TXR or SXR foot rheostat or EMX speed controller (see p. 443). Can only use 25H, 30H and 44HT handpieces (see p. 442).

Quick Disconnect (QD) Keyway Drive

Description	Electrical	Item#	Each
A. TX Motor (with shaft & sheath)	115V	850-0381	\$225.25
B. TX + 30 + TXR-1 Kit*	115V	850-0498	353.60
TX + 30 + SXR-1	115V	850-1469	329.00
Replacements		Item#	Each
TX Shaft	-	850-3395	10.95
TX Sheath	-	850-3010	14.95
TX Brushes (pair)	-	850-4119	12.50

*Includes 43-piece flex shaft accessory set and rotating bur holder.

Heavy Duty (HD) Square Drive

Description	Electrical	Item#	Each
C. TXH Motor (with shaft & sheath)	115V	850-0465	\$250.00
TXH + 30H + TXR-1	115V	850-0467	325.00
TXH + 30H + SXR-1	115V	850-1467	360.00
Replacement		Item#	Each
TXH Shaft & Sheath Assembly	-	850-3401	65.00
TXH Brushes (pair)	-	850-4119	12.50

View instructional video at www.gesswein.com.

D. Foredom® Series LX – 1/10 HP

Great for low-speed, high-torque applications that require more control. Prevent tools from slowing under load. Speed range: 0–5,000rpm. 50/60Hz. Available either in Bench-Style or Hanging-style flexible shaft motor with 39" shaft (see p.444 for longer (66") replacement shaft & sheath) and more flexible neoprene sheath. Use with TXR, SXR or FCT-1 or EFC foot rheostats or EMX speed controller (see p. 443) and all standard quick disconnect handpieces (see pp. 438-441).

Quick Disconnect (QD) Keyway Drive

Description	Electrical	Item#	Each
D. LX Motor (with shaft & sheath)	115V	850-1220	\$204.00
LX-2 Motor (with shaft & sheath)	230V	850-1221	204.00
E. LXB Motor+ SXR-1	115V	850-0516	325.00
Replacements		Item#	Each
LX & LX-2 Shaft	-	850-3395	10.95
LX & LX-2 Sheath	-	850-3015	26.50
LX & LX-2 Brushes (pair)	-	850-4119	12.50



A-C Gesswein/Foredom® Series SR – 1/6 HP

These motors combine all the best features: power, reliability and reversibility. Built with a larger commutator, brushes and fan to increase performance and longevity, they provide all you need for general-purpose grinding and finishing. Reverse capability allows both left- and right-handers to control direction of debris. Speed range: 0–18,000rpm. 50/60Hz.

- SR is a hanging-style flexible shaft motor with 39" shaft and sheath (see p.444 for longer (66") replacement shaft and sheath). Use with FCT, SCT or WF-7 foot rheostat or EM speed controller (see p. 443) and all standard quick disconnect handpieces (see pp. 438-441).
- SRM is a bench-mounted flexible shaft motor with 39" shaft and sheath (see p.444 for longer (66") replacement shaft and sheath) and built-in speed control. Use with all standard quick disconnect handpieces (see pp. 438-441).
- SRH is a hanging-style square-drive flexible shaft motor with heavy-duty 60" flexible shaft with sheath liner/silencer. Ideal for tough applications using large stones and tools mounted on 1/4" and 6mm shanks. Use with FCT, SCT or EFC foot rheostats or EM speed controller (see p. 443) and 25H, 30H or 44HT handpieces (see p. 442).



Quick Disconnect (QD) Keyway Drive

Description	Electrical	Item#	Each
SR Motor (with shaft & sheath)	115V	850-0480	\$182.75
SR-2 Motor (with shaft & sheath)	230V	850-0482	212.95
SR + 20 + FCT-1	115V	850-0477	282.20
SR + 20 + FCT-1 Kit*	115V	850-0493	305.15
SR-2 + 20 + FCT-2 Kit*	230V	850-0494	305.15
A. SR + 30 + SCT-1	115V	850-0490	240.75
SR + 30 + SCT-1 Kit*	115V	850-0484	299.00
SR + 30 + FCT-1	115V	850-0475	263.50
B. SR + 30 + FCT-1 Kit*	115V	850-0495	287.30
SR + 20 + 30 + FCT-1	115V	850-0499	351.95
SR-2 + 30 + FCT-2 Kit*	230V	850-0496	287.30
SR-2 + 30 + FCH-2	230V	850-0487	263.50
SR-2 + 30 + SCT-2	230V	850-0492	310.00
C. SRM Motor (with shaft & sheath)	115V	850-0497	245.00
Replacements		Item#	Each
SR, SR-2, SRM Shaft	-	850-3395	\$10.95
SR, SR-2, SRM Sheath	-	850-3010	14.95
SR, SR-2, SRM Brushes (pair)	-	850-4108	8.85

*Includes 43-piece flex shaft accessory set and rotating bur holder.

Alternates		Item#	Each
66" Shaft/Sheath Assembly	-	850-3398	\$38.00
66" Inner Shaft	-	850-3397	16.00
66" Outer Sheath	-	850-3396	18.00

Heavy Duty (HD) Square Drive

Description	Electrical	Item#	Each
SRH Motor (with shaft & sheath)	115V	850-1462	\$239.95
SRH-2 Motor (with shaft & sheath)	230V	850-1466	277.95
SRH + 30H + FCT-1	115V	850-1464	315.00
SRH + 30H + SCT-1	115V	850-1463	345.00
SRH-2 + 30H + FCH-2	230V	850-1465	325.00
SRH-2 + 30H + SCH-2	230V	850-1468	358.00
Replacements		Item#	Each
SRH, SRH-2 Shaft/Sheath Assembly	-	850-3401	\$65.00
SRH, SRH-2 Brushes (pair)	-	850-4108	8.85

View instructional video at www.gesswein.com.

Handpieces for Standard Flexible Shaft Machines – In rotary and reciprocating styles

We offer a wide selection of handpieces to fit your needs, including both rotary and reciprocating handpieces with fixed collets, changeable collets or chucks. Several come with a quick-tool-change mechanism, and many are also available with a duplex spring for better control. All quickly detach from shaft. Compatible with all flexible shaft motors except TXH, TXMH, SRH and H.



A

A. Foredom® #30 Handpiece

Our top-selling model for all-purpose use!

The #30 handpiece features a geared Jacobs chuck that accepts up to 5/32" shanks and maintenance-free pre lubricated ball bearings. Includes chuck key with handle. Choose between blue and traditional silver. Measures 1" dia. x 5"L. Weighs 6 oz.

Color	Silver	Blue	Each
Item#	850-1350	850-1352	\$59.50
		Item#	Each
Chuck Key without Handle		850-3550	\$2.70
Replacement Chuck		850-2220	40.00
Replacement Chuck Key with Handle		850-3545	5.75

View instructional video at www.gesswein.com.



B

B. Foredom Angle Grinder Attachment

Foredom's Angle Grinder Attachment is designed for use with the #30 Handpiece. Can be used to grind, sand, and polish on metal, wood, stone, glass, ceramics, bondo and more. This quality-machined, sturdy, and compact device works with 2" and smaller discs and 2" wheels with 3/8" arbor holes. 73 piece accessory set is sold separately: Contains comprehensive collection of abrasives for metal working.

- Optimum Operated Speed: 10,000 to 15,000rpm
- Maximum Speed: 18,000rpm for short intervals
- Measures 3 1/8" long x 2 1/2" at widest, 2 3/4" Depth
- 0.75 to 1 gear reduction.

Description	Item#	Each
B. Foredom Angle Grinder Attachment	850-1358	\$102.00
Optional 73 Piece Accessory Set	850-0514	65.00

C. Foredom® Power Filer

Foredom's Power Filer is a reciprocating (non rotary) tool that attaches/mates up with your Foredom #30 style hand pieces. Partnered with Foredom Flex Shafts and Hand piece, this great power product offers a great alternative to tiresome continuous hand filing operations and thus can be used to file, hone, polish and lap on straight and curved surfaces. The housing is made of aluminum and has a pistol grip for ergonomic and easy handling/operation.

For those who already own a Hand piece and Flex Shaft, we offer the Foredom Filer Kit with mounting tools, hand piece grip, and a small variety of stones. For those that may be starting out, we offer a money saving all-in-one filer kit that includes the filer, Foredom SR Flex Shaft, #30 Hand Piece and Dual Speed Range Control along with Diamond Needle File Set and small variety of stones, presented in a convenient carrying case.

Features: Holds tools with Shank Sizes of 2.35mm (3/32") to 6.4mm (1/4"). Stroke length can be adjusted from 0mm up to 5mm. Comes pre-lubricated and never requires any further lubrication. Has 2.5:1 belt drive reduction and runs at maximum input motor speed of 10,000rpm, the equivalent of 4,000spm.



C

Description	Item#	Each
C. Foredom Power Filer	850-0020	\$550.00
Foredom Power Filer SR Kit	850-0021	895.00

D. Foredom® #44T Handpiece

Similar to #30 handpiece except that it has a collet-type chuck for holding various shank sizes. Six collets from 1/16" to 1/4" available, plus 3mm and 6mm collets. Includes 3/32", 1/8" and 1/4" collets, pin and chuck wrench. Pre lubricated ball bearings require no maintenance. Measures 1" dia. x 5 1/2"L. Weighs 7 oz.

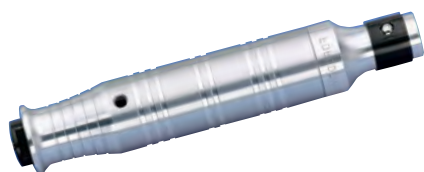

D

Description	Item#	Each				
D. #44T Handpiece with 3/32", 1/8" and 1/4" collets	850-1425	\$56.10				
Collet	5/32"	3/16"	1/4"	3mm	6mm	Each
Item#	850-5440	850-5450	850-5470	850-5475	850-5480	\$8.95
Set of all 7 collets					850-5400	59.95

A. FMR Mini-Filers

Each attaches to any standard Gesswein/Foredom flexible shaft machine except models TXH, TXMH, SRH and H. Designed for light-duty profiling work. Ergonomic design results in effective finishing and polishing. Slim nose is especially useful in tight spaces. Holds tools up to 3.6mm in diameter (see diamond poli files on pp. 109-110). Max. operating speed: 10,000 strokes per minute (5,000–7,000 strokes per minute recommended). Measures 5¼"L x 1" dia. Weighs 5.5 oz.

Length of Stroke	Item#	Each
0.5mm	850-1923	\$650.00
1.0mm	850-1924	599.00
1.5mm	850-1922	650.00



B. Technique Rotary Handpiece

A lightweight, vibration-free, high-precision handpiece with quick-change flip-lever chuck release. Supplied with 3/32" collet. Shaped for the hand. Can be held like a pen. Has all-metal dustproof casing. Includes wrench and screwdriver. Measures approx. 1" dia. x 6"L. Weighs 4½ oz. Made in Switzerland.

Description	Item#	Each
B. Technique Handpiece	850-2054	\$185.00
Optional 1/8" Collet	850-2058	52.00
Replacement 3/32" Collet	850-2057	48.00



C. Foredom® #28 Handpiece

A lightweight handpiece for intricate work and general grinding, polishing, deburring and carving applications. Slim, tapered grip provides comfort and control. Permanently lubricated ball bearings ensure smooth operation. Includes 3/32" and 1/8" collets, pin and collet wrench. Measures 3/4" dia. x 5¾"L. Weighs 2.9 oz.

Description	Item#	Each
C. #28 Handpiece with 3/32" and 1/8" collets	850-1348	\$56.10
Replacement 3/32" Collet	850-5040	8.95
Replacement 1/8" Collet	850-5050	8.95
3mm Collet	850-5060	8.95



D, E Foredom® #20/#20D Quick-Change Handpiece

Lever action allows instant tool changes. Wider metal body is designed to stay cooler. Front-end tapers to a molded plastic grip for close, easy handling. Pre-lubricated ball bearings require no oil. Accepts 3/32" shanks only. Measures 1 1/8"–3/8" dia. x 5 5/8"L (without duplex). Weighs 4 oz.

Description	Item#	Each
D. #20 Handpiece	850-1280	\$79.00
E. #20D Handpiece with Duplex Spring	850-1285	99.45
Replacement 3/32" Collet	850-5425	10.50



View instructional video at www.gesswein.com.

F, G Foredom® #10/#10D Handpiece

Features a quick-release lever for rapid tool changing. Pre-lubricated ball bearings require no maintenance. Accepts 3/32" shanks only. Measures 3/4" dia. x 10 3/4"L (without duplex). Weighs 5 oz.

Description	Item#	Each
F. #10 Handpiece	850-1252	\$237.15
G. #10D Handpiece with duplex spring	850-1253	258.40
Replacement 3/32" Collet	850-1254	56.50



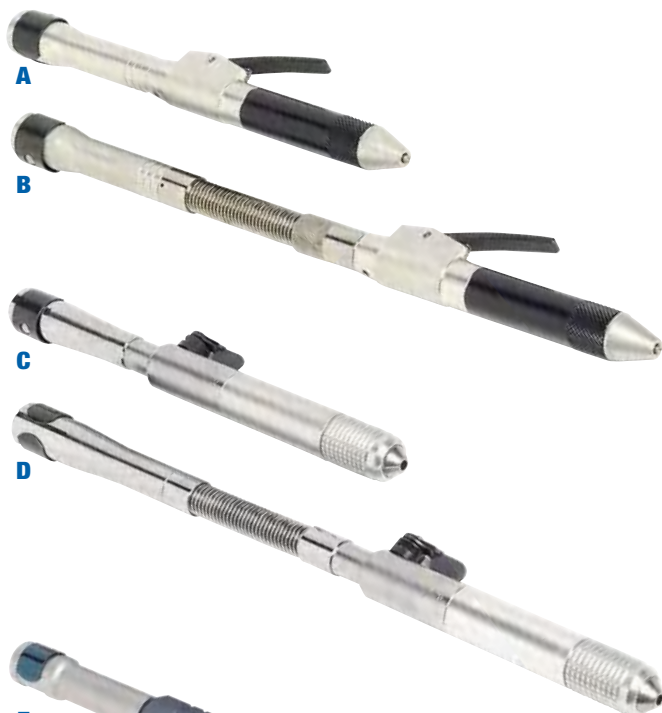

A

B

C

D



E



Telescopic Head



F

G



H

A, B Foredom® #18/#18D Quik Change™ Handpiece

Allows faster bur changes for improved productivity. Ideal for stone setting and applications that require many bur changes. Has permanently lubricated ball bearing for cool and quiet continuous operation. Includes 3/32" collet. Measures 5/8" dia. x 7"L (without duplex). Weighs 3.5 oz.

Description	Item#	Each
A. #18 Handpiece	850-1325	\$127.50
B. #18D Handpiece with duplex spring	850-1320	148.75
Replacement 3/32" Collet	850-5485	28.00

C, D Faro Handpiece

Exceptionally cool-running handpiece with quick-release lever for rapid tool changing. Accepts 3/32" shanks only. Includes 3/32" collet. Measures 1 1/16" dia. x 6 3/4"L (without duplex). Weighs 7 oz. Made in Italy.

Description	Item#	Each
C. Faro Handpiece	850-1960	\$190.00
D. Faro Handpiece with duplex spring	850-1950	255.00
Replacement 3/32" Collet	850-1964	54.00

E. SVTN-S Handpiece

Right angle handpiece with a telescopic head. Maximum extension is 3/4". Excellent for hard-to-reach areas. Complete with 1/8" and 3/32" collets as well as a wrench for changing collets. Replacement collets available. Optional 3mm collet also available. Handpiece measures 3/4" diameter x 7 3/4" long. Weighs 6 1/2 oz. This handpiece is an update to the older VTX model. Imported.

Description	Item#	Each
E. SVTN-S Handpiece	850-2150	\$725.00
Replacement 3/32" Collet	850-5340	31.60
Replacement 1/8" Collet	850-5350	31.60
3mm Collet	850-5255	59.60

F, G 8/#8D Handpiece

Has prelubricated ball bearings for sustained operation at high speeds without overheating. Allows fingertip operation of collet chuck for quick changing of tools. Features sliding protective sleeve for close work. Includes 3/32" collet. Measures 3/4" dia. x 6"L (without duplex). Weighs 4 oz.

Description	Item#	Each
F. #88 Handpiece	850-1250	\$49.75
G. #8D Handpiece with duplex spring	850-1300	60.00
1/16" Collet	850-5030	8.95
Replacement 3/32" Collet	850-5040	8.95
1/8" Collet	850-5050	8.95
3mm Collet	850-5060	8.95
Set of all 4 inch-size collets	850-5010	35.00

H. Chicago Pneumatic Air Scribe®

The Chicago Pneumatic Air Scribe has a carbide stylus that writes as easily as a ballpoint pen on a variety of metals up to 64 HRC. Use with Filter/Regulator/Lubricator (see p. 248). Includes 8' reinforced hose. Requires less than 1 CFM of air. Measures 1 1/16" dia. x 4 3/4"L. Weighs 5 oz.

Description	Item#	Each
H. Pneumatic Air Scribe CP9361	850-7395	\$285.00
On/Off Foot Pedal	850-7394	59.95
Flat Tip*	850-7399	81.00
Round Tip*	850-7397	76.00
Blank Tip*	850-7398	41.20
Anvil (required usage with tips)	850-7413	13.00
Replacement Carbide Stylus	850-7396	31.95

A, B Foredom® Hammer Handpiece #15/#15D – 5,000rpm

Hammer handpiece with reciprocating action for stone setting and decorative work. Has 1/32" stroke with adjustable impact. Includes anvil point. Can also be used with Pavé Point for special texturing or Carbide Stylus for texturing, marking or scribing hardened steel. Speed range for most applications: 0–5,000rpm. Measures 1/2" dia. at tip x 9 1/2"L (without duplex). Weighs 4 oz.

Description	Item#	Each
A. #15 Handpiece	850-1270	\$122.40
B. #15D Handpiece with duplex spring	850-1272	143.65
Optional Pavé Point	850-1275	38.00
Optional Carbide Stylus	850-1274	35.00
Replacement Anvil Point	850-1273	6.00

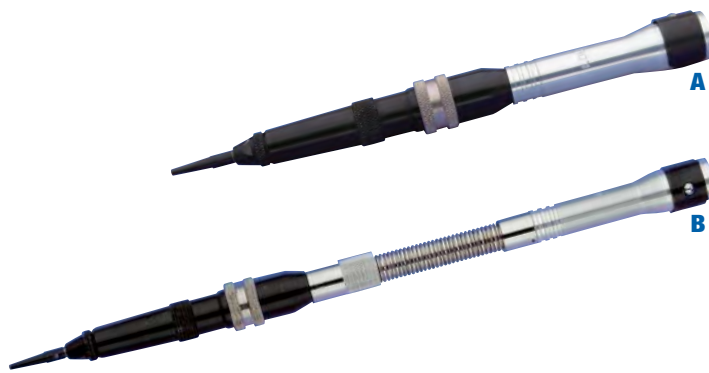

C. Technique Hammer Handpiece – 5,000rpm

Features a lightweight, slender body that you can hold comfortably for long periods. Runs with very little vibration. Includes screw-in pointed tip. Optional tips available (see below). Measures 1/2" dia. x 5 1/2"L. Weighs 2 oz. Precision-made in Switzerland.

Description	Item#	Each
Technique Handpiece	850-1295	\$220.00



D, E Badeco Swiss Hammer Handpiece – 5,000rpm

Provides adjustable striking force for closing bezels and prongs or creating textures. Minimizes vibration for comfortable extended use. Includes Round Flat Tip #850-3720. Additional tips available (see below). Measures 1/2" dia. x 9 1/2"L (without duplex). Weighs 6 oz.

Description	Item#	Each
D. Badeco Swiss Handpiece	850-1333	\$295.00
E. Badeco Swiss Handpiece with duplex spring	850-1330	375.00

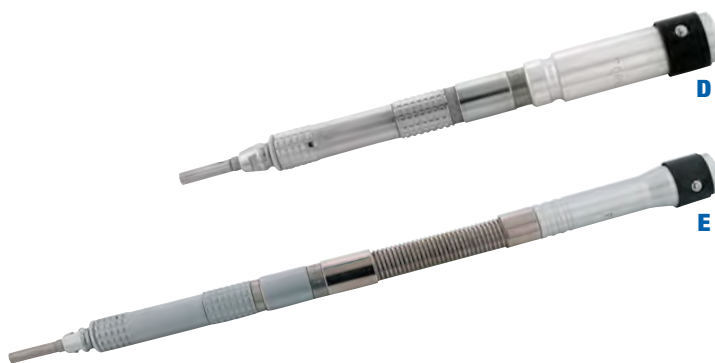

Badeco Hammer Handpiece Tips

For Technique and Badeco Swiss Hammer Handpieces (see above).

Description	Item#	Each
Round Flat Tip, 4mm	850-3720	\$24.90
Round Concave Tip, 1mm	850-3715	49.50
Rectangular Flat Tip, 1 x 2mm	850-3725	49.50
Rectangular Grooved Tip, 1.2 x 2.5mm	850-3730	49.50
Rectangular Smooth Tip, 1.2 x 2.5mm	850-3735	49.50

F. Lazer Point – Produces the brightest stippling possible

Use this unique diamond-pointed tool with our Technique or Badeco Swiss Hammer Handpiece and your flexible shaft machine. Creates a sparkling finish on gold and silver that mimics pavé. Measures 1 1/4" long.

Description	Item#	EACH Prices	
		1-2	3+
Lazer Point	850-3590	\$24.95	\$22.46



G. Foredom Anvil Points

These tips fit all popular brands of hammer handpieces. All 6 tips are made of heat treated solid steel with threaded shanks measuring 3/32" diameter (2.35mm). Fits 1/8-48 US and all standard 3mm threads. Fits Swiss-made Badeco hammer handpiece. Six shapes are included in the set:

- Bezel Rocker
- Slim Rectangle
- Ball Nose
- Wide Rectangle
- Cylinder
- Fine Point

Set of 6 comes in hard plastic storage box that opens to a convenient stand for easy tip selection.

Description	Item#	Each
Foredom Anvil Points	850-3780	\$75.00



Heavy-Duty Rotary Handpieces for TXH, TXMH and SRH only – For a variety of operations

Included uses are grinding, carving, drilling, deburring, engraving, polishing and more. All three handpieces have square drives and attach quickly with positive sheath locking mechanisms to TXH, TXMH and SRH flexible shaft motors (see pp. 436-437), as well as H flexible shaft motors. Have shielded ball bearings that require no lubrication. Feature compact, lightweight designs for accessing tight areas while minimizing hand fatigue.



A

A. Foredom® #25H Handpiece

Features one-piece spindle construction with permanently lubricated, double-sealed ball bearings for cool extended running. Includes 1/8" and 1/4" collets. Measures 1" dia. x 6 1/8"L. Weighs 8 1/2 oz.

Description	Item#	Each
A. #25H Handpiece	850-1340	\$145.00
1/16" Collet	850-5200	18.00
3/32" Collet	850-5210	18.00
Replacement 1/8" Collet	850-5220	18.00
3/16" Collet	850-5230	18.00
Replacement 1/4" Collet	850-5240	18.00
3mm Collet	850-5242	18.00
4mm Collet	850-5245	18.00
Set of all 5 inch-size collets	850-5052	78.95



B

B. Foredom® #30H Handpiece

Chuck-style handpiece with prelubricated ball bearings. Features geared Jacobs chuck that accepts shanks up to 5/32". Includes chuck key without handle. Measures 1" dia. x 5 5/8"L. Weighs 7 1/4 oz.

		Each
B. #30H Handpiece	850-1355	\$63.75
Chuck Key with Handle	850-3545	5.75
Replacement Chuck Key without Handle	850-3550	2.70

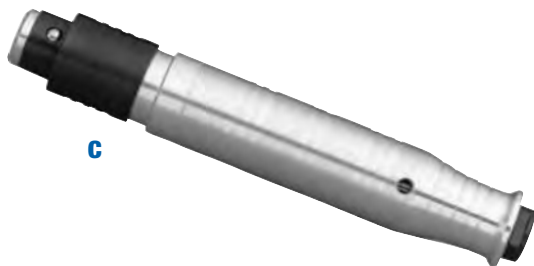

C

C. Foredom® #44HT Handpiece

Collet-type version of #30H handpiece. Includes 3/32" and 1/4" collets. Measures 1" dia. x 6 1/8"L. Weighs 8 1/2 oz.

		Each
C. #44HT Handpiece	850-1455	\$63.75
Replacement 3/32" Collet	850-5420	8.95
1/8" Collet	850-5430	8.95
5/32" Collet	850-5440	8.95
3/16" Collet	850-5450	8.95
Replacement 1/4" Collet	850-5470	8.95
3mm Collet	850-5475	8.95
6mm Collet	850-5480	8.95
Set of all seven collets	850-5400	59.95

A, B Foredom® TXR, FCH and FCT Foot Rheostats

Solid-state foot-operated speed controllers for exceptionally smooth control over the entire speed range. Feature heavy-duty, low-profile Rynite plastic housing with wide footpad and skid-resistant bottom for comfort and stability. Run continuously without heat buildup. Measures 6¾"L x 4½"W x 2½"H. All 50/60Hz.

Model	Electrical	For Flex Shaft	Item#	Each
A. TXR-1*	115V	TX, TXB, TXH, TXBH; LX, LXB	850-3510	\$48.45
FCH-1*	115V	H, HB	850-3460	34.50
FCH-2	230V	1/6 HP SR, SRB, SRH; H, HB	850-3461	34.50
B. FCT-1*	115V	1/6 HP SR, SRB, SRH; 1/8 HP SR, SRB; S, SB; CC; L, LB	850-3480	34.50
FCT-2	230V	1/8 HP SR, SRB; S, SB; CC; L, LB	850-3485	34.50

*CSA Listed



A



B



C

C. Foredom® SXR, SCH and SCT Foot Rheostats

Solid-state foot-operated speed controllers for immediate response with light pressure. Feature heavy-duty, low-profile cast-iron housing with ribbed top and skid-resistant bottom for comfort and stability. Run continuously without heat buildup. Measures 6¼"L x 5"W x 2¼"H. All 50/60Hz.

Model	Electrical	For Flex Shaft	Item#	Each
SXR-1	115V	TX, TXB, TXH, TXBH; LX, LXB	850-3508	\$74.80
SCH-1*	115V	H, HB	850-3455	61.20
SCH-2	230V	1/6 HP SR, SRB, SRH; H, HB	850-3456	61.20
C. SCT-1*	115V	1/6 HP SR, SRB, SRH; 1/8 HP SR, SRB; S, SB; CC; L, LB	850-3503	61.20
SCT-2	230V	1/8 HP SR, SRB; S, SB; CC; L, LB	850-3504	61.20

*CSA Listed

D. Foredom® EMX, EMH and EM Manual Speed Controllers

Dial-operated speed controllers for benchtop use—great alternatives to foot rheostats. Feature tough plastic housing with low profile for stability. Measures 6"L x 5"W x 2½"H. Also available in 230V. All 50/60Hz.

Model	Electrical	For Flex Shaft	Item#	Each
D. EMX-1	115V	TX, TXB, TXH, TXBH; LX, LXB	850-3516	\$74.80
EMH-1	115V	H, HB	850-3515	72.25
EM-1	115V	1/6 HP SR, SRB, SRH; 1/8 HP SR, SRB; S, SB; CC; L, LB	850-3511	72.25



D

E. Foredom® EMF and EM FX Dual Speed Controllers

To further enhance the Foredom Filer, we recommend the new Foredom Dual Speed Range Dial since it has a "LO" setting that restrict speed to the allowable range of the filer between 1,000 – 10,000rpm or 400 – 4,000spm. Can switch back to the optimum speed by flipping a switch and already set at the optimum speed setting. The "HI" setting permits use with rotary hand pieces at regular speeds.

Model	Electrical	For Flex Shaft	Item#	Each
E. EMF	115V	SR + CC	850-3522	\$89.50
EM XF	115V	TX	850-3523	89.50



E

F. EFC - Electronic Foot Control

Heavy-duty, precision-crafted variable-speed foot rheostat with all the features of similar high-end controls at a fraction of the price. Features solid-state electronics, die-cast aluminum housing with chip-resistant enamel finish, mounting holes and grounded electrical cord. Works with any flexible shaft motor with standard three-prong connection (115V only). Measures 7¼"L x 4½"W x 2½"H.

Description	Electrical	For Flex Shafts	Item#	Each
EFC	115V	CC, EE, GG, S/SR, LX/LXB	850-3520	\$49.00



F

A

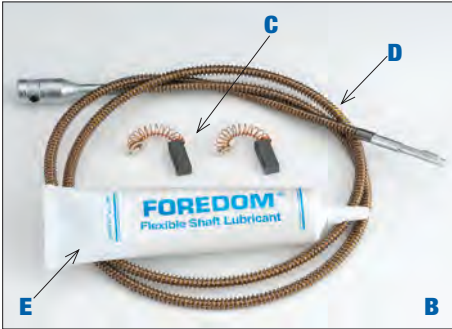

F



G Motor Bale

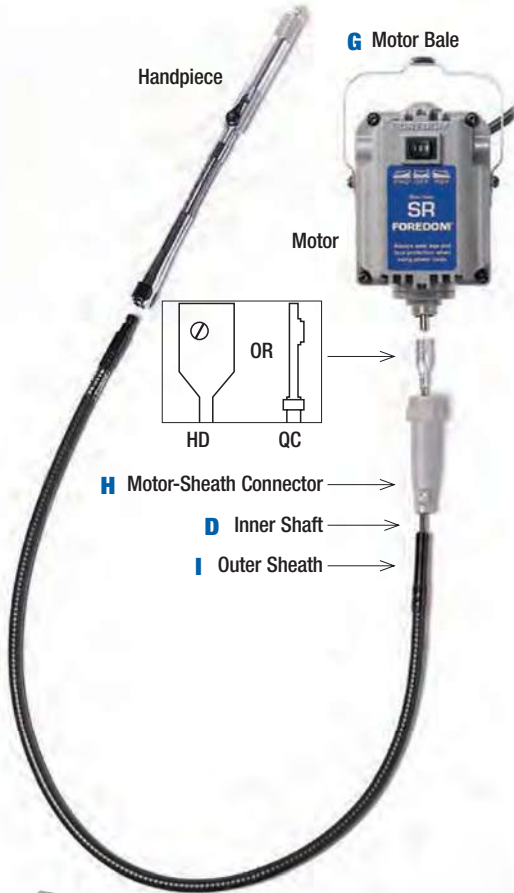

H Motor-Sheath Connector

D Inner Shaft

I Outer Sheath

J



K



A-I Maintenance Supplies and Replacements

Simple maintenance can extend the life of a flexshaft. Freedom has created 2 kits: a comprehensive Tune-Up (over 30 components) as well as a basic Maintenance kit (inner shaft, pair of motor brushes, grease and instructions) for Keyway drive 115V and 230V models (unless otherwise noted).

Description	For Flex Shafts	Item#	Each
A. Tune Up Kit	LX/LXB, TX	850-3410	\$68.00
Tune Up Kit	SR	850-3403	68.00
Tune Up Kit	CC	850-3404	68.00
Maintenance Kit	CC, DD, MM (115V only)	850-4015	17.25
Maintenance Kit	EE, GG	850-4005	23.50
B. Maintenance Kit	S/SR, SM/SRM (1/8 HP)	850-4017	17.25
Maintenance Kit	SR, SRM (1/6 HP)	850-4020	17.25
Maintenance Kit	LX/LXB, TX	850-4006	22.00

Replacements	For Flex Shafts	Item#	Each
Motor Brushes, pair	CC, DD, MM (110V only)	850-4110	\$8.85
Motor Brushes, pair	CC, DD, MM (220V only)	850-4113	10.95
Motor Brushes, pair	EE, GG, R/RB	850-4113	10.95
C. Motor Brushes, pair	H, S/SR, SM/SRM (1/8 HP)	850-4117	8.85
Motor Brushes, pair	SR, SRH, SRM (1/6 HP)	850-4108	8.85
Motor Brushes, pair	L/LB, LX/LXB, PG/PGX, TX, TXH	850-4119	12.50
Brush Cap, individual	CC, EE, GG, L/LB, LX/LXB, PG/PGX, R/RB, S/SR (1/8 HP), SRH (1/8 HP), TX, TXH	850-4120	1.05

Replacements	For Flex Shafts	Item#	Each
D. Inner Shaft	CC, K, L/LB, LX/LXB, PG/PGX, R/RB, S/SR, SM/SRM, TX	850-3395	\$10.95
Inner Shaft	EE, GG	850-3390	10.95
Inner Shaft	SRH, TXH/TXBH/TXMH	850-3405	19.00

Description	For Flex Shafts	Item#	Each
E. Flex Shaft Grease, 1 oz.	All	850-4100	\$3.50
F. Flex Shaft Oil, .25 oz.	All	850-4105	4.50

Replacements	For Flex Shafts	Item#	Each
G. Motor Bale	CC, H, L/LB, LX/LXB, PG/PGX, R/RB, S/SR, TX, TXH	850-2207	\$1.50
H. Motor-Sheath Connector	CC, L/LB, LX/LXB, PG/PGX, R/RB, S/SR, TX	850-2180	3.85

Replacements	For Flex Shafts	Item#	Each
I. Outer Sheath - Standard	CC, K, L/LB, LX/LXB, PG/PGX, R/RB, S/SR, SM/SRM, TX	850-3010	\$14.95
Outer Sheath - Standard	EE, GG	850-3000	16.25
Outer Sheath - Neoprene	L/LB, LX/LXB	850-3015	26.50

Replacements	For Flex Shafts with Square Drives	Item#	Each
Shaft/Sheath Assembly	SRH, TXH/TXBH/TXMH	850-3401	\$65.00
Shaft/Sheath Assembly	H	850-3400	64.15

Extra Long Alternates	For Flex Shafts	Item#	Each
66" Shaft/Sheath Assembly	CC, K, L/LB, R/RB, S/SR, SM/SRM, TX	850-3398	\$38.00
66" Inner Shaft	CC, K, L/LB, R/RB, S/SR, SM/SRM, TX	850-3397	16.00
66" Outer Sheath	CC, K, L/LB, R/RB, S/SR, SM/SRM, TX	850-3396	18.00

J, K Replacements for Handpieces with Duplex Springs

Suitable for all Gesswein/Foredom flexible shaft handpieces except #180/00.

Description	Item#	Each
J. Inner Duplex Spring with connectors	850-2223	\$19.25
K. Outer Duplex Spring Cover	850-3802	23.50

A-G Foredom® Bench System

Keep your most frequently used tools within easy reach. Start with the Foredom Flex Shaft Hanger to hang up to 2 flex shaft motors. Add in the LED Light Bar (100-240V AC) and your choice of 4 Tool Arms: Bur Holder Arm, Magnetic Tool Arm, Cup Holder Arm and Tray Arm. All slide, swing and pivot to create a custom bench set up.

All arms are machined of stainless steel. Pull them in close or push them out of the way as needed. Buy only what you need — just 1 or 2 arms or mix and match multiple arms! Customize to your exact specifications. It's the smart way to organize your bench.

Description	Item#	Each
A. Foredom Bench System Complete Kit – with one of each (B-G) below	850-0530	\$409.95
B. Flex Shaft Hanger – Adjustable height hanger with 2 spring hooks.	850-0531	56.50
C. LED Light Bar – Rotates, swings and raises 90°. Dimensions: 31½"L	850-0532	136.50
D. 2 tier, 95 hole, Bur Holder Arm – For ⅜" (57) and ⅛" (38) shank burs/tools.	850-0533	68.50
E. Magnetic Tool Arm – With non-scratch felt surface. 12"L x ½"W x 1½"H.	850-0535	105.50
F. Jar Holder Arm – With 6 – 1.35oz. (40ml) cups with screw-on plastic tops, 1¼ (3.7cm) in diameter. 12"L x 2¼"W x 2¼"H.	850-0534	54.50
G. Tray Arm – Has movable partitions. 12"L x 2¼"W.	850-0536	58.50

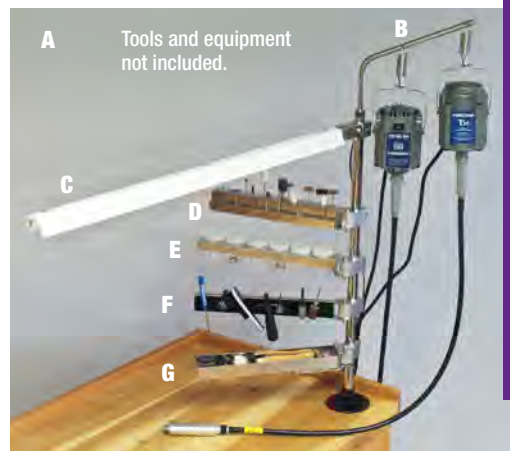

H, I Single and Double Flex Shaft Hangers

Telescoping hanger extends 42" above your work surface. Height adjustments are made easily with the thumbscrew. Includes solid mounting base to screw firmly into your work surface. 10" arm at the top allows you to swing your flex shaft motor back and forth with ease. Made in India.

Double Flex Shaft Hanger attaches to your work surface by using screws or "C" clamps (not included) and allows you to hang one or two Flex Shaft motors. Made of powder coated steel, the flex shaft hanger extends between 25½" and 40". Made in USA.

Description	Item#	Each
H. Flex Shaft Hanger	850-0509	\$19.50
I. Double Flex Shaft Hanger	850-0515	34.95

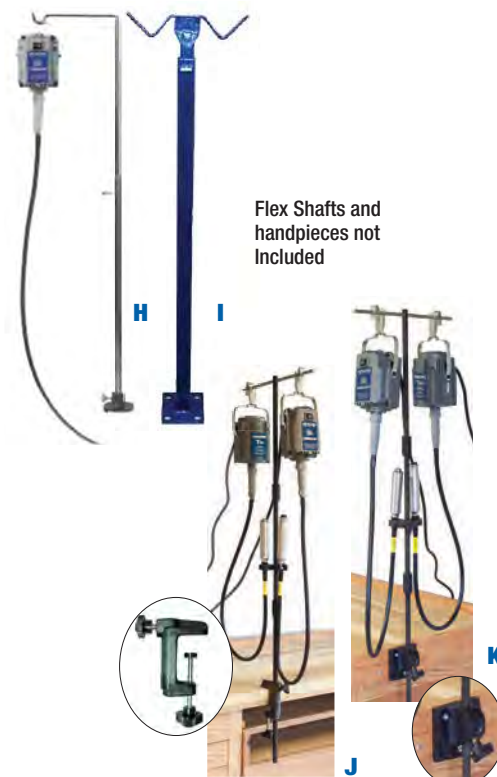

J, K Foredom® Flex Shaft Hangers

Features a 3-piece hexagonal support rod, top safety hook rod for holding one or two motors. Available with a sturdy bench clamp for attaching to any bench top up to 2¼" thick or base which screw into the top or side of your work surface. The rod height can be adjusted with the locking screw built onto the clamp.

Comes with a Handpiece Rest that slides onto the hanger pole and secures your handpieces when not in use. Also has two Spring Safety Clips that slide over the motor bale and on to the hanger rod to keep the motor(s) from jumping and twisting during start up and acceleration.

Description	Item#	Each
J. Foredom Flex Shaft Hanger with Clamp	850-0506	\$48.50
K. Foredom Flex Shaft Hanger with Base	850-0507	68.50

L, M Handpiece Holders – Accept Foredom flexible shaft handpieces

Economical holders let you grind, polish, sand and carve while both hands control the workpiece. Adjust to hold handpieces up to 10" above the work surface and rotates 360°. Clamps up to 1¾" thick.

Description	Item#	Each
L. Holder for #30, #30H, #44T and #44HT and other 1" diameter Handpieces	850-0605	\$37.95
M. Holder for #35 Handpiece	850-0607	37.95



N. Nylon Jiffy Jig – Accepts 1" diameter handpieces

A convenient block for holding jeweler's handpieces in place. Leaves your hands free for cutting, grinding and polishing operations. Just place the block in your vise, pull handpiece through it, tighten the vise and you're ready to go. Tools in the handpiece can be easily changed without removing handpiece from the block. Accepts Foredom #30 handpiece and other 1" diameter handpieces.

Description	Item#	Each
Nylon Jiffy Jig	850-0608	\$13.15

O. GRS Handpiece Storage Strip

Keep handpieces within easy reach. Four different diameter holes provide storage for multiple handpieces of varying size. Clip to the side of your work surface with the included hardware.

Description	Item#	Each
Handpiece Storage Strip	850-0604	\$10.30





A. Foredom® Mini Vise

Securely holds small parts. Has 1 3/4" slotted grooves in the base for mounting on a drill press or bench. Stationary jaw has a perpendicular V-groove, and movable jaw has a horizontal V-groove for holding round stock or tube. Jaw width: 1 3/4". Jaw opening: 1 3/4". Measures 4"L x 2 3/8"W x 1 1/2"H. Glare-free black finish.

Description	Item#	Each
Mini Vise	820-4700	\$24.50

B. Benchtop Drill Press

Small and compact describes this 110V drill press. The base measures 6 3/4" x 6 3/4" with a drill clearance of 5". Drill press has three settings that allow for a range of 0-8,500rpm. When space is an issue, this drill press will perform with ease. The Jacobs chuck accepts bits up to 6mm. One year warranty. Weighs 13 lbs. Canada safety approved.

Description	Item#	Each
Bench Drill Press	850-0595	\$79.95

C. Drill Press Vise

All aluminum vise has slots to attach to benchtop drill press #850-0595 (above) quick jaw release feature for ease of use. Jaw width 2 9/16". Jaw opening 2 3/4". Measures 9 1/2"L x 4 1/2"W x 2 1/4"H.

Description	Item#	Each
Drill Press Vise	850-0594	\$12.95

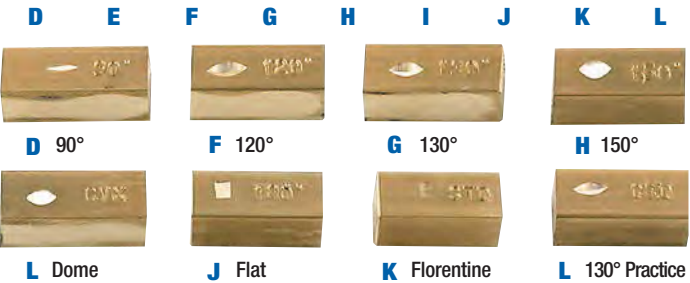
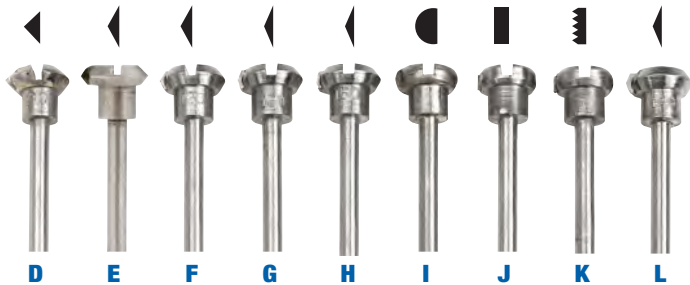
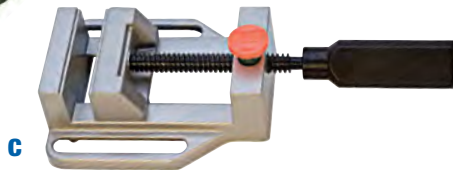

D-L Diamond Flywheels – 3mm Shank

These flywheels produce the most decorative bright cuts you've ever seen, helping your jewelry really stand out from the rest. Contain natural grade-A diamonds for fast, easy bright cutting. When used with a high-speed rotary handpiece (minimum 30,000rpm), these flywheels make bright cuts in seconds. Can be resharpened. Have 3mm shanks. We strongly recommend that you purchase a practice carbide wheel—flywheels are not covered by warranty.

Description	Item#	EACH Prices	
		1-2	3+
D. 90° Flywheel	845-1400	\$46.50	\$41.85
E. 110° Flywheel	845-1407	50.60	45.54
F. 120° Flywheel	845-1401	46.50	41.85
G. 130° Flywheel	845-1404	46.50	41.85
H. 150° Flywheel	845-1405	46.50	41.85
I. Dome Flywheel	845-1406	55.80	50.22
J. Flat Flywheel	845-1402	46.50	41.85
K. Serrated Florentine Flywheel	845-1403	55.80	50.22
L. 130° Practice Carbide Wheel	845-1410	34.20	30.78



M. PEPETOOLS Jump Ringer JRM2 – Better Than Ever!

The perfect set for winding your own jump rings easily in consistent sizes. Use the Rotary Winder and winding rods to wrap wire into a coil, which can then be cut into jump rings using the circular sawblade in your #30 handpiece. Ship. Wt. 8lbs. Made in USA.

- Includes Rotary Winder, 20 steel winding rods, circular sawblade, handpiece holder, precision machined cutting box, and aluminum base (9"L x 4 1/2"W).
- Winding rods are 4" long in mm sizes: 2.5, 3.0, 3.5, 4.0, 4.5, 5.0, 5.5, 6.0, 6.5, 7.0, 7.5, 8.0, 8.5, 9.0, 9.5, 10.0, 10.5, 11.0, 11.5, and 12.0mm.
- Included 1 1/4" circular sawblade cuts up to 18 gauge/1.0mm soft wire. Optional 1 1/2" sawblade cuts up to 16 gauge/1.2mm.

Description	Item#	Each
M. PEPETOOLS Jump Ringer	856-0445	\$200.00
Optional Circular Sawblade 1 1/2"	856-0443	15.50
Replacement Sawblade 1 1/4"	856-0442	12.50

View instructional video at www.gesswein.com.

A. Pro-Flex Econo Flex Shaft

The Pro-Flex Motor comes complete with chuck style handpiece, electronic foot control, extra pair of motor brushes, and a one year warranty against manufacturing defects. 110V. Made in China.

Features:

- 1/8 HP, ball-bearing, 18,000rpm motor
- An electronic foot control with plastic housing for hands-free speed control.
- A key-type chuck hand piece (holds shanks up to 5/32" (4mm) in diameter).

Description	Item#	Each
A. Pro-Flex Econo Flex Shaft Set	850-0660	\$99.00
Replacement Handpiece w/ Chuck Key	850-0661	35.50
Replacement Inner Shaft - 39"	850-0663	8.50
Replacement Outer Sheath Assembly - 34"	850-0664	9.95
Replacement Motor Brushes (2)	850-0665	4.50
Replacement Rheostat	850-0662	39.00



A

B. Suhner MiniFix 25-R and 9-R

The Suhner MiniFix is the most powerful flexible shaft system we offer. These motors boast 2/3 HP and 500 Watts, giving the user consistent rotational speeds even when pressure is applied. The Suhner MiniFix is the ideal choice for heavy stock removal or heavy pressure polishing using brushes or felt bobs. For big jobs, try with our new Tampico and Nylon 1/4" shank brushes. Select between model 9-R (4,000 to 9,000rpm) or 25-R (11,000 to 25,000rpm.) Made in Switzerland.

Features:

- Fully Insulated Motor 120V/50Hz
- Flexible Shaft
- FH4 handpiece with 1/4" collet
- Metal carrying case
- Set of Mounted abrasives

Description	Item#	Each
B. Suhner MiniFix 25-R System	850-0120	\$1,508.95
25-R Motor Only	850-0121	871.10
Suhner MiniFix 9-R System	850-0122	1,714.95
9-R Motor Only	850-0123	988.80
FH4 Handpiece	850-0124	306.70
Replacement 3/32" Collet	850-0125	42.50
Replacement 1/8" Collet	850-0126	42.50
Replacement 1/4" Collet	850-0127	42.50
Replacement Rheostat	850-0128	345.80
Replacement Shaft	850-0129	100.95
Replacement Sheath	850-0130	272.95
Replacement Foot Pedal	850-0131	256.45



B

C. Dumore Series 6 Low Speed

The Pro-Flex Motor comes complete with chuck style handpiece, electronic foot control, extra pair of motor brushes, and a one year warranty against manufacturing defects. 110V. Made in China.

Features:

- 1/8 HP, ball-bearing, 18,000rpm motor
- An electronic foot control with plastic housing for hands-free speed control.
- A key-type chuck hand piece (holds shanks up to 5/32" (4mm) in diameter).

Description	Item#	Each
C. Dumore Series 6 Low Speed	850-0225	\$1,095.00
Foot Peldal	850-0226	350.00
Replacement #6 Handpiece	850-0227	480.00
Replacement #6 Shaft Assembly	850-0228	240.00



C

Flexible Shaft Drive, Mark II Di-Profilers

Gesswein is proud to offer the NEW Di-Profiler Mark II handpiece that attaches to most standard flexible shaft machines. This precise, fast-action, easy-to-operate reciprocating tool is ideal for profile polishing, filing, honing and lapping straight and curved surfaces and finishing complicated dies and molds. Each Di-Profiler allows easy stroke adjustments for fast, precise work. Spring-cushioned to prevent damage to workpiece or tool. All Mark II models now incorporate the protective finger sleeve into the handpiece. Redesigned for improved ergonomics and user flexibility. See page 449 for details. Made in Sweden.



A. Classic Flex Shaft Drive Di-Profilers, Mark II Version

The flex shaft driven Di-Profiler is the tool maker's traditional go-to machine for reciprocating applications. Connects to any standard Gesswein/Foredom flexible shaft machine except models TXH, TXMH, and H. Can be used for light and heavy duty polishing, filing, honing and lapping jobs. For best results and reduced vibration, operate between 5,000 and 7,000rpm with a stroke length between 1-3mm and 1/4" chuck capacity.

Comes complete with operations guide, rubber sleeve, storage case, wrench and lubricating oil. Adjustable stroke length 0-6mm. 8,000rpm Maximum.

Description	Item#	Each
A. Di-Profiler 1/4" chuck capacity for Flex Shaft	850-1905	\$1,295.00
B Complete Kit (Includes Di-Profiler, TX Flex Shaft, TXR-1 foot rheostat)	850-1931	1,495.00
Rubber Grip	850-1937	65.95

C. FMR Mini-Filers

Each attaches to any standard Gesswein/Foredom flexible shaft machine except models TXH, TXMH and H. Designed for light-duty profiling work. Ergonomic design results in effective finishing and polishing. Slim nose is especially useful in tight spaces. Holds tools up to 3.6mm in diameter (see diamond poli files on pp. 109-110). Max. operating speed: 10,000 strokes per minute (5,000-7,000 strokes per minute recommended). Measures 5 1/4"L x 1" dia. Weighs 5.5 oz.

Length of Stroke	Item#	Each
0.5mm	850-1923	\$650.00
1.0mm	850-1924	599.00
1.5mm	850-1922	650.00

D, E Tool Holders – For all Di-Profiler models

Description	Item#	Each
D. Universal Tool Holder (holds up to 6mm thick and 8mm wide) – 3mm shank	403-1050	\$57.50
E. Ceramic Stone Holder (holds up to 1mm thick and up to 8mm wide) – 3mm shank	403-1045	34.95



Safety Recommendations For FPS and FPC Di-Profilers as well as FMR Mini Filers and Micromotor Drive Di-Profilers

Prolonged use of vibrating or reciprocating tools may result in vibration-induced circulation problems in the hands. Always follow safe operating procedures. Using hand protection (i.e., insulated gloves) and taking frequent breaks can help minimize but not guarantee against injury. Operating these types of tools in cold weather or with a tight grip will reduce the period of operation before risking potential injury. Individuals with a tendency to suffer from poor circulation, frequently cold fingers or itchy hands should closely monitor the condition of their hands. If symptoms appear, seek medical advice immediately.

Micromotor Drive Mark II Di-Profilers

Gesswein is proud to offer the NEW Di-Profiler Mark II systems—the most advanced handpiece systems yet. The Professional and Classic MM Drive Di-Profilers are built with a micromotor inside every handpiece and can connect directly to any Gesswein Power Hand controller. Both Professional and Classic Mark II models now incorporate the protective finger sleeve into the handpiece. Made in Sweden.



ROTARY & ULTRASONIC

A, B Professional Micromotor Drive Di-Profiler, Mark II Maximum Efficiency, Minimal Vibrations

Simply the best reciprocating handpiece in the market today, the Professional Di-Profiler combines ergonomic design and heavy duty power. A counter balance weight system located on the opposite end of the tool holder reduces vibration levels. As the tool reciprocates, the counter balance weight reciprocates in the opposite direction thereby stabilizing the handpiece. As a result, vibration in the user's hand is greatly reduced. Comes complete with operations guide, rubber sleeve, storage case, wrench and lubricating oil. Adjustable stroke length 0-6mm. 8,000rpm maximum.

Features:

- Fully Insulated Motor 120V/50Hz
- Flexible Shaft
- FH4 handpiece with 1/4" collet
- Metal carrying case
- Set of Mounted abrasives

Description	Item#	Each
A. Professional Micromotor Di-Profiler 1/4" chuck capacity	850-1908	\$2,295.00
B. Complete Kit (Includes Professional Di-Profiler 1/4" chuck capacity, Marathon controller and variable speed foot rheostat)	850-1942	2,395.00



C, D Classic Micromotor Drive Di-Profiler, Mark II

Comes complete with operations guide, rubber sleeve, storage case, wrench and lubricating oil. Adjustable stroke length 0-6mm. 8,000rpm maximum.

Description	Item#	Each
C. Classic Micromotor Di-Profiler 1/4" chuck capacity	850-1915	\$2,090.00
D. Complete Kit (Includes Classic Micromotor Di-Profiler 1/4" chuck capacity, Marathon controller and variable speed rheostat)	850-1947	2,095.00



E. Protective Finger Sleeve - Retrofit previous 1/4" Models

The finger sleeve will improve guidance of the tool as there is no longer any need for putting your finger on moving tools or machine parts. Simply attach the finger sleeve to the Di-Profiler (instructions included). Now the user can place their fingers over the steady finger sleeve while the tool is reciprocating underneath. Comes with 2 1/8" extension pipe for longer tools. Compatible with all Di-Profilers.

Description	Item#	Each
Finger Sleeve Package for Di-Profiler 1/4"	850-1917	\$264.00
Finger Sleeve Package for Di-Profiler 1/8"	850-1916	223.00



Operation Guide is included with profiler for safety and operating instructions.
For information on hand transmitted vibration see ANSI Standard S2.70 2006 (R2011).



A



B



C



D

E

Air Grinders

Specially selected for mold, tool and die makers

These air-operated rotary handpieces are perfect for precision grinding and deburring. Use reciprocating models for honing and lapping. All require Filter/Regulator-Lubricator except NSK Presto Air Turbine.

A, B Suhner® Swiss Grinders

80,000rpm, right-angle and straight rotary handpieces

These grinders achieve maximum power with minimum air consumption. Rigid rotary-vane motors provide exceptional performance and speeds up to 80,000rpm. Excellent for carbide and CBN tools. Use for milling, grinding, engraving and polishing. Light, well-balanced ergonomic design reduces operator fatigue. Scratch-resistant insulated plastic housing reduces noise level and keeps hands warmer. Additional features include precision sealed bearings, rear speed controls and rugged construction for extended heavy-duty use. Made in Switzerland.

Choose from slim right-angle or straight grinder with rear speed controls. Both supplied with 1/8" collet and wrench. Each requires 1/8" NPT coupler and 1/4" ID hose (see p. 457 for #850-7323). Use with Filter/Regulator-Lubricator (see p. 456). Right-angle handpiece measures 6 3/4"L x 3/4" dia. Weighs 7 oz. Straight handpiece measures 6"L x 3/4" dia. Weighs 4.2 oz.

Model	Max. RPM	PSI	CFM	Item#	Each
A. Right-Angle	80,000	90	6.6	850-7320	\$818.85
B. Straight	80,000	90	6.6	850-7305	815.00
				Collets	Item# Each
				Replacement 1/8" for Right-Angle	850-7329 \$55.60
				Replacement 1/8" for Straight	850-7327 55.60
				Optional 3/32" for Right-Angle	850-7331 55.60
				Optional 3/32" for Straight	850-7325 55.60

C. High-Speed Rotary Air Grinder HS80 – 80,000rpm

High-speed, quiet-running, well-balanced rotary handpiece for deburring and finishing. Ideal for precision grinding. Includes 1/8" collet (optional 3/32" and 3.0mm collets also available). Supplied with air hose, coupler and tool changing wrenches. Requires Filter/Regulator-Lubricator (see p. 456). Measures 5 5/8"L x 1 3/16" dia. Weighs 5.7 oz. Made in Taiwan.

Model	Max. RPM	PSI	CFM	Item#	Each
C. HS80	80,000	90	1.77	850-2235	\$174.00
				Description	Item# Each
				Optional HS80 3/32" Collet	850-2236 \$6.50
				Optional HS80 3.0mm Collet	850-2237 6.50
				Replacement HS80 1/8" Collet	850-2238 6.50

D, E UHT (Ushio) Air Grinders

53,000 and 65,000rpm, slim and lightweight pencil-like design

Quiet running handpieces ideal for many applications, including precision grinding, finishing and polishing. Feature self-lubricating vanes for dependable performance. Unique 1/8" fixed collet design provides extra-long ball bearing life and reduces heat buildup.

The Contra-Angle 120° model allows access to hard-to-reach, deep areas. Both offer rear speed control and rear exhaust. Supplied with 5' of 3/16" air hose, 1/4" NPT coupler, 13" exhaust hose, wrench and pin. Use with Filter/Regulator-Lubricator (see p. 456). Contra-angle handpiece measures 5"L x 5/8" dia. Weighs 5 oz. Straight handpiece measures 5 5/8"L x 5/8" dia. Weighs 4.5 oz. Made in Japan.

Model	Max. RPM	PSI	CFM	Item#	Each
D. Contra-Angle	53,000	85	4.2	850-0905	\$335.00
E. Straight	65,000	85	4.2	850-0900	299.00

A. ROTUS Standard Hand Grinder Set – 30,000rpm

The ROTUS System is a hand-held grinder with an energy saving air motor hand piece weighing only 8.74 oz. Air driven means that there is virtually no heat generation during operation resulting in excellent durability. The motor hand piece produces 30,000 min RPM and uses minimal air consumption. The energy saving mechanism runs quietly with the included Silencer and makes it possible to operate with a 1 HP (0.75kw) air compressor, 55 psi, such as our California Air Tools Compressor (265-3125) (see p. 455). Fine adjustment of variable speed can be controlled by the Foot Control and the Forward/Reverse Rotation Direction Control Ring located at the end of the motor can control the motor speed as well.

System includes: Air grinder motor includes twist free Hose and Silencer, New ring type attachment, 1/8" dia. Collet, Air Line Kit, Foot Control, Piping Hose, Lubricating Oil, and 4 Assorted Wrenches.

Max. RPM	PSI	CFM	Item#	Each
30,000	55	2.65	850-7250	\$1,090.00



B. NSK Impulse Pencil Air Grinder – 60,000rpm

Features a special vane design that maintains speed even under load, providing smooth and stable grinding action. Design allows sensitive control of cutting tool. Exhaust hose with silencer keeps noise to a minimum. Rotating joint prevents hose from twisting. Supplied with 1/8" collet and chuck key; 3/32" and 3mm collets available separately. Use with Filter/Regulator-Lubricator (see p. 456). Warranty 6 months. Subject to inspection. Measures 6 3/4"L x 1" dia. Weighs 5.9 oz.

Max. RPM	PSI	CFM	Item#	Each
B. 60,000	56-85	5.83	850-7230	\$385.00
Collets			Item#	Each
Optional 3/32" Collet			850-7232	\$48.00
Optional 3mm Collet			850-7233	48.00
Replacement 1/8" Collet			850-7231	48.00



C. High-Torque Precision Air Grinder HT60 – 60,000rpm

High-torque, quiet-running, well-balanced rotary handpieces for deburring and finishing work. Supplied with air hose, coupler and tool changing wrenches. Requires Filter/Regulator-Lubricator (see p. 456). Measures 5 5/8"L x 1 1/16" dia. Weighs 6.4 oz.

Model	Max. RPM	PSI	CFM	Item#	Each
HT60 - 3/32"	60,000	90	4.1	850-2225	\$134.00
HT60 - 3mm	60,000	90	4.1	850-2221	134.00
C. HT60 - 1/8"	60,000	90	4.1	850-2230	134.00



D. Nitto Kohki Air Sonic – 35,000rpm, high-torque handpiece

The rugged Nitto Kohki Air Sonic high-torque unit provides maximum power for grinding, deburring, production grinding on small castings and removing welding slag. Rear exhaust and built-in air silencer ensures quiet operation. Supplied with 1/4" to 1/8" reducing collet sleeve, 5' of 1/4" hose with 1/2" NPT coupler, 19" exhaust hose and wrenches. Use with Filter/Regulator-Lubricator (see p. 456). Measures 7"L x 1 1/4" dia. Weighs 1 lb.

Model	Max. RPM	PSI	CFM	Item#	Each
D. L-35B	35,000	85	12.3	850-7012	\$300.00
Reducing Collet Sleeves			Item#	Each	
Optional 1/4" to 3/16"			850-7016	\$15.17	
Replacement 1/4" to 1/8"			850-7015	15.17	



E, F NSK Presto Air Turbine – 320,000rpm, no lubrication required

Use this lightweight, ultra-high-speed, non lube rotary air turbine for delicate, precision applications. Features a unique dust protection mechanism that not only blows away loose powder to improve cutting efficiency but also cools the cutting tool to extend service life. For use with 1/16" tools. Purchase handpiece and hose alone, or purchase set complete with handpiece, hose, air line filter, regulator, foot control and handpiece rest. 6 month manufacturers warranty. Air turbine measures 4 1/2"L x 5/8" dia. Weighs 2.5 oz.

Max. RPM	PSI	CFM	Item#	Each
E. 320,000	35	1.4	850-7236	\$390.00
Description	Item#			Each
F. NSK Set	850-7235			\$720.00



Air Grinders, Continued

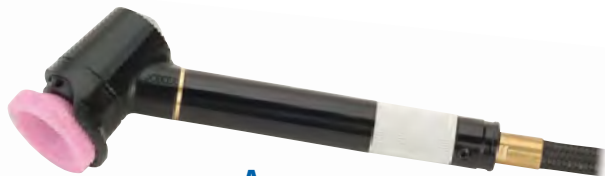

A



B



C

Does not include sanding pad



D



E



F

A, B Angle Surface Air Grinder AG22 – 22,000rpm

A 120°-angle rotary handpiece for grinding, chamfering, deburring and finishing welds and larger surface areas. Includes collet chuck with M7 screw shaft for mounting abrasive cup wheels and abrasive discs. Supplied with air hose, coupler, 30mm cup wheel (60 grit), ten 30mm PSA discs (60, 100 and 150 grit), 30mm PSA disc holder and changing tool for cup wheels and PSA disc holder. Requires Filter/Regulator-Lubricator (see p. 248). Measures 6¾" L x 5/8" dia. Weighs 7 oz. Made in Taiwan.

Max. RPM	PSI	CFM	Item#	Each
A. 22,000	90	3.0	850-2240	\$204.00
Description	Dia.	Grit	Item#	Box of 48
AG22 Cup Wheel	30mm	60	850-2242	\$42.00
		100	850-2243	42.00
		150	850-2244	42.00
Description	Dia.	Grit	Item#	Box of 150
B. AG22 PSA Disc	30mm	60	850-2229	\$27.50
		100	850-2231	27.50
		150	850-2232	27.50
		240	850-2233	27.50
		320	850-2234	27.50
		400	850-2239	27.50
Description	Dia.	Item#	Each	
AG22 PSA Disc Holder	30mm	850-2241	\$3.50	

C. Nitto Kohki MLS-20 Air Angle Disc Sander 22,000rpm, high-torque handpiece

The high-torque handpiece. This 22,000 rpm, powerful 2" right-angle sander has a low profile head which is ideal for sanding dies, molds, steel, aluminum and rubber or finishing welds. Lightweight (1.3 lbs.) and compact (1½" barrel diameter) for continuous sanding in small, confined areas. One-touch twist lock allows efficient abrasive disc holder replacement. The new coated gears and high-life blades are designed to offer extended run-time performance. Includes side exhaust with silencer. Safety lock helps prevent accidents. Requires ¼"-3/8" NPT air connection. Use with Miniature Filter/Regulator-Lubricator. Measures 5" L x 1½" diameter. Made in USA.

Max. RPM	PSI	CFM	Item#	Each
19,000	87	14.2	850-7014	\$395.00

D, E UHT Ushio Micro-Angle Surface Air Grinder

Quiet-running handpieces are ideal for precision grinding, finishing and polishing. Feature self-lubricating vanes for dependable performance. Read speed control and rear exhaust.

Supplied with 5' of 3/16" air hose and 1/4" NPT coupler. Airline filter/regulator/lubricator required. Both 90° and 120° handpieces optimize ergonomics and offer 7mm threaded shaft for delivering maximum torque to 30mm diameter grinding, sanding, and buffing tools. Made in Japan.

Description	Max RPM	CFM	Item#	Each
D. UHT Air Grinder 90°	24,000	4.2	850-0890	\$335.00
E. UHT Air Grinder 120°	23,500	4.2	850-0895	335.00

F. Air-Operated FPD Di-Profil Set – 10,000 strokes/min.

Employs a high-quality, variable-speed, air-driven reciprocating handpiece similar to our popular Di-Profilers on pp. 448-449. In addition to FPD Di-Profiler, set includes air line, filter/regulator-lubricator, lubricating oil, 5' of reinforced flexible hose, quick-disconnect hose connector, wrench, lathe adapter post and molded storage case. Accepts tools up to 1/8" in diameter. Measures 6¾" L x 1¼" dia. Weighs 2 lbs.

Strokes/Minute	Stroke Length	PSI	CFM	Item#	Each
10,000	0-6.0mm	57	0.18-2.3	850-1845	\$2,895.00

A-C Turbo Air Lappers – Reciprocating handpieces

Low-vibration, quiet-running, durable reciprocating handpiece with a short stroke. Perfect for polishing ribs, slots and other tight areas. Produces great results with Diamond Poli Files (see pp. 109-110) and Super Ceramic Stones (see pp. 468-469). These color coded models are supplied with air hose, coupler, foam sleeve and three tool holders for 1mm to 1/8" flat tools and 3mm round tools. Requires Filter/Regulator-Lubricator (see p. 248). UTR-30, measures 7 7/8"L x 1 3/32" dia., weighs 6.7 oz. UTR-70, measures 8"L x 1 1/8" dia. Weighs 6.7 oz.; UR-120, measures 8 3/16"L x 1 3/16" dia. Weighs 6.0 oz. 90 day manufacturers warranty. Made in Taiwan.

Description	Strokes/Minute	Stroke Length	PSI	CFM	Item#	Each
A. UTR-30	30,000	0.3mm	90	1.76	850-2250	\$318.00
B. UTR-70	28,000	0.7mm	90	1.76	850-2245	318.00
C. UR-120	12,000	1.2mm	90	2.83	850-2251	318.00

Description	Accepts Tools	Item#	Each
Holder #64	1mm flat, 3mm round	850-2246	\$8.50
Holder #65	1mm flat	850-2247	8.50
Holder #62	1/8" flat	850-2248	8.50



D-F UHT Ushio TurboLap Air Filers – Reciprocating handpieces

TurboLap delivers high-speed reciprocation with high torque and a short stroke. Ideal for filing, lapping and polishing molds or honing precision parts.

Makes quick work of polishing ribs, slots and intricate areas. Runs quietly and is designed to be operated for long periods without getting hot. Provides optimum results with Diamond Poli Files (see pp. 109-110) and 1mm flat Super Ceramic Stones (see pp. 468-469). Lightweight with good balance and ergonomic soft-grip design.

Three color-coded models, each supplied with hexagonal wrench, 1 Diamond Poli File, 1.5m air hose, overhose, hose bands and quick joint with filter. Accepts up to 1mm flat or 3mm round tools. Requires 1/4" NPT air connection and Filter/Regulator (see p. 248). No oil lubrication required. Measures 7" long x 1" diameter. Weighs 5.9 ounces. Made in Japan.

Description	Stroke Length	Strokes per/Minute	PSI	CFM	Item#	Each
D. Blue	0.3mm	52,000	90	1.65	850-0928	\$425.00
E. Red	0.7mm	28,000	90	1.65	850-0930	425.00
F. Yellow	1.2mm	19,000	90	1.65	850-0932	425.00

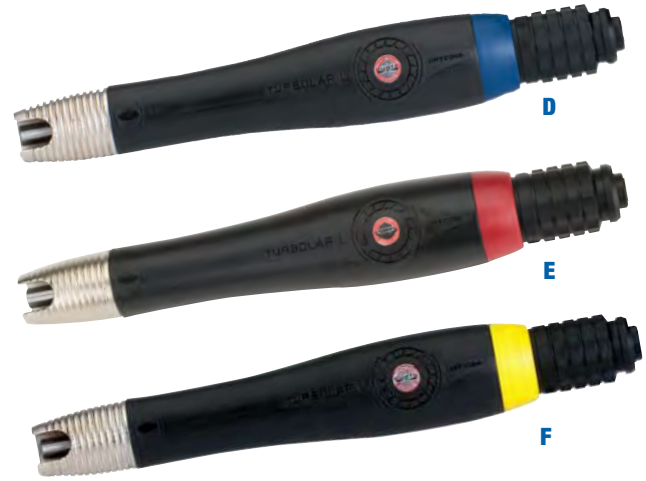

G. Super Hand Pneumatic Filer – 4,000 strokes/min.

A powerful reciprocating tool for an efficient way to file. Vibration-free due to its double-piston design. Accepts tool diameters up to 1/4". Comes complete with 6' hose with 1/4" NPT connector, four coarse files (three-square, half-round, flat and round tapered) and wrench. Use with Filter/Regulator-Lubricator (see p. 248). Measures 6 1/2"L x 1 1/2" dia. Weighs 2.4 lbs. Made in Japan.

Strokes/Minute	Stroke Length	PSI	CFM	Item#	Each
4,000	5.0mm	85.3	6	850-7200	\$320.00



H-M Turbo Lap Diamond Files

These diamond files are perfect for finishing in tight areas. The high quality diamond abrasive performs well in high speed and short stroke applications. Each diamond file has maximum thickness of 1mm and tapers down to 0.5mm thick. Each style is available in three grits.

Description	Item#	Each Prices		
		1-4	5-9*	10+*
Turbo Lap Diamond Files	See chart below	\$7.25	\$6.89	\$6.53

Style	Length x Abrasive (mm)		Grits		
	Size	100 Grit	200 Grit	400 Grit	
H.	60 x 25	3~2	241-0640	241-0641	241-0642
I.	70 x 40	4~2	241-0644	241-0645	241-0646
J.	60 x 25	4~2	241-0648	241-0649	241-0650
K.	60 x 25	4~3	241-0652	241-0653	241-0654
L.	70 x 40	4~3	241-0656	241-0657	241-0658
M.	60 x 25	4	241-0660	241-0661	241-0662



Wider sizes available. Please see p. 112 for full line.

*Quantity discount for orders of one item# only, not assorted.

See Page 455 for Safety Recommendations



A



A. Dremel Power Grinder #100

A 35,000rpm fixed-speed grinder. Includes seven-piece accessory set and collet wrench. Great for a variety of grinding, cutting, sharpening, cleaning and polishing applications. Features double-insulated, shatter-resistant housing with permanently lubricated ball bearings for smooth, dependable operation. Supplied with 1/8" collet (optional 1/32", 1/16" and 3/32" collets available). Collets also fit Dremel #270 and #380. Electrical: 120V, 1.2A, 50/60Hz. Measures 7 1/4" long with 6' power cord. Weight: 18 oz. UL and ETL listed. Two-year manufacturers' warranty.

Description	Item#	Each
A. Dremel Grinder #100 with accessories, 120V	850-8016	\$56.20
Replacement Type 3 Brushes*	850-8035	3.20

*For models manufactured in 1989 and after.

B. Dremel #3000

The Dremel 3000 is a variable 5,000 to 32,000rpm rotary grinder the result of upgrading our most popular model using user-requested features to improve the tool's design and ergonomics. Features the EZ Twist™ nose cap with an integrated wrench that allows the nose cap to be used as a wrench to tighten accessories. The ability to use all existing Dremel accessories and most attachments lets the 3000 complete a wide range of applications including cutting, grinding, sanding, carving and polishing a variety of materials. Includes storage case, sanding guide attachment and cutting attachment as well as 28 genuine Dremel accessories. Supplied with 1/8" collet. Electrical: 120V, 1.2A, 50/60Hz. Measures 7 1/2" long with a 6' power cord. Weight 20 oz. Four-year manufacturer's warranty.

Description	Item#	Each
B. Dremel #3000 with accessories, 120V	850-8027	\$120.00
Replacement Brushes	850-8032	\$5.20

C. Collets For Dremel Grinders – #100 and #3000

These collets fit the new style grinders as well as the Dremel #270 and 380 Grinders.

Size	Item#	Each
1/32"	850-4155	\$2.30
1/16"	850-4150	2.30
3/32"	850-4145	2.30
1/8"	850-4140	2.30

C



D. Dremel® Electric Engraver

Economical, adjustable engraver for personalizing or marking valuable articles. Create unique designs on metal, wood, plastic, ceramic, glass and leather. Features handy hanger for convenient storage, calibrated stroke adjustment dial, comfortable pencil-type grip and easily replaceable carbide point. Measures 6" overall length. Cord measures 6' long. 115V, 0.2A, 60Hz. UL listed.

Description	Item#	Each
D. Engraver, 115V	821-6010	\$31.95
Optional Diamond Point	821-6020	16.25
Replacement Carbide Point	821-6015	5.30

D



A. SilentAire Compressors – Quiet yet powerful!

The **Val-Air** is a premium value model with cast aluminum lid with cooling fins for improved ventilation and Filter-Regulator with auto-drain feature and condensate bottle. With a coalescent filter to 0.01 micron.

Sil-Air is the same without the aluminum lid with cooling fins or coalescent filter.

Both versions feature powerful 1/2 HP motors which provide over 2 CFM of air. They can handle up to 10 large Wax Injectors and are fully automatic. Both make about as much noise as a refrigerator, so you can work without distraction. Both measure 14" dia. x 22"H. Weigh 58 lbs. May require additional filter at the air tool to eliminate condensation that can form in very long airlines. Accepts 1/4" male fittings. 220V also available. Made in Italy.

Features:

- Tank and line pressure gauge
- Line pressure regulator
- Moisture trap and filter
- Safety valve
- Air-intake filter

Specifications:

Motor	1/2 HP
Max. Pressure	114 PSI
Tank Capacity	4 gals.
Displacement	2.15 CFM
Noise Level	40 dB

Description	FOB	Electrical	Item#	Each
A. SilentAire Val-Air Compressor	CT	110V	265-3100	\$1,245.00
SilentAire Val-Air Compressor	TX	110V	265-3101	1,225.00
SilentAire Sil-Air Compressor	TX	110V	265-3095	1,065.00
SilentAire Sil-Air Compressor	CT	110V	265-3094	1,065.00
Replacement Oil, 24 oz.			265-3103	27.00



A

B. Oil-Free Air Compressor – 3/4 HP Oil-Free Air Compressor

Engineered and built with the latest technology to provide high quality clean air. The Oil-Free Dual Piston Pump System allows the air compressor to work more efficiently, creating less noise and less wear for a longer pump life. Oil-less operation makes it virtually maintenance free! Includes tank and line pressure gauge, line pressure regulator, moisture trap with filter, safety valve, and air intake filter. Made in China.

Specifications:

Motor:	3/4 HP	Noise level:	52 dB
Max. Pressure:	116 PSI/ 8 bar	Airflow:	118 liters per minute
Tank Capacity:	6 gals.	Dimensions:	16"Dia. x 21H"
Displacement:	4.2 CFM	Weight:	61 lbs.

Description	FOB	Electrical	Item#	Each
B. Oil-Free Air Compressor	CT	110V, 600 watts	265-3120	\$625.00
Oil-Free Air Compressor	NY	110V, 600 watts	265-3122	595.00



B

C. California Air Tools 4610AC – 1 HP & Oil-Free Air Compressor

Quiet, (60 dB) oil-free and lightweight. Designed to increase duty cycle and allow for longer continuous run times. Powerful 1.0 HP motor is engineered to dissipate heat, allowing for a cooler operation while reducing wear. The Oil-Free Dual Piston Pump System is engineered for high performance and durability. Complete with two pressure control gauges, air filter, two universal 1/4" quick connectors, and thermal overload protector. 220V also available. Made in China.

Specifications:

Motor:	1 HP	Noise level:	60 dB
Max. Pressure:	120 PSI	Dimensions:	19 1/8"L x 16 3/4"W x 19 3/4"H
Tank Capacity:	4.6 gals. (Aluminum Tank)	Weight:	45.5 lbs.

Description	Electrical	Item#	Each
C. California Air Tools 4610AC	110V/60Hz	265-3125	\$325.00



C

Safety Recommendations - For vibrating and reciprocating handpieces.

Prolonged use of vibrating or reciprocating tools may result in vibration-induced circulation problems in the hands. Always follow safe operating procedures. Using hand protection (i.e., insulated gloves) and taking frequent breaks can help minimize but not guarantee against injury. Operating these types of tools in cold weather or with a tight grip will reduce the period of operation before risking potential injury. Individuals with a tendency to suffer from poor circulation, frequently cold fingers or itchy hands should closely monitor the condition of their hands. If symptoms appear, seek medical advice immediately.

Air Tool Accessories

It is extremely important that compressed air be dry, clean and regulated to a pressure suitable for the operation of any air tool. When air tools require lubrication to reduce friction, filters should be installed in the air line as close as possible to the air tool to prevent water vapor condensation.



A, B Miniature Filter/Regulator/Lubricator Assembly For air handpieces.

Combines functions of filter, regulator and lubricator. General-purpose filter removes solid and liquid particles down to 5 microns. Regulator allows outlet pressure adjustment from 5 to 100 PSI. Micro-fog lubricator provides oil mist to lubricate moving parts of air handpieces. Has 1 oz. reservoir. Use optional bracket to mount on wall or bench. Maximum inlet pressure: 150 psi. Ports: 1/8".

Description	Item#	Each
A. Filter Assembly	850-7349	\$215.00
B. Mounting Bracket	850-7335	9.30
Lube Oil, 8 oz.	850-0985	25.65
Replacement Filter	850-7369	14.50

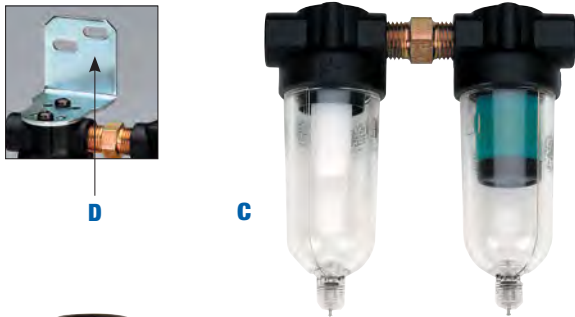

C, D Miniature Prefilter/Coalescing Filter Assembly

Ideal for applications requiring dry and extremely clean air. Designed for air compressors rated up to 3.5 CFM. Prefilter removes liquid and solid particles down to 5 microns; coalescing filter removes particles down to 0.01 micron. Use optional bracket to mount on wall or bench. Maximum inlet pressure: 150 PSI. Ports: 1/4".

Description	Item#	Each
C. Filter Assembly	850-7353	\$109.00
D. Mounting Bracket	850-7359	15.60
Replacement Prefilter (white)	850-7337	19.95
Replacement Coalescing Filter (green)	850-7357	65.00



E, F Miniature Filter/Regulator

Combines the functions of filter and regulator. Filter removes solid and liquid particles in compressed air down to 5 microns. Regulator allows outlet pressure adjustment from 5 to 100 psi. Maintains nearly constant outlet pressure despite changes in inlet pressure. Use optional bracket to mount on wall or bench. Maximum inlet pressure: 150 psi. Ports: 1/4".

Description	Item#	Each
E. Filter Assembly	850-7333	\$85.00
F. Mounting Bracket	850-7335	9.30
Replacement Filter	850-7369	14.50



G. Large Prefilter/Coalescing Filter Assembly

Designed for large air compressors rated up to 15 CFM. Ideal for applications requiring greater airflow. Prefilter removes liquid and solid particles down to 5 microns; coalescing filter removes particles down to 0.01 microns. Requires regulator for use with most air tools. Maximum inlet pressure: 150 psi. Ports: 1/4".

Description	Item#	Each
G. Filter Assembly	850-7355	\$160.00
Replacement Prefilter (white)	850-7337	19.95
Replacement Coalescing Filter (green)	850-7365	145.00

A-K Quick Disconnect Air Hose and Fittings

Sturdy 1/4" O.D. nylon air hose with .040" wall thickness and a collection of timesaving quick-disconnect fittings. To connect, just push air hose into fitting—it automatically locks in place. To disconnect, push back plastic ring on fitting and pull air hose out. The 1/4" and 1/8" male fittings work with a variety of sandblasters, wax injectors, sprue cutters and more. Use 1/4" males for air filters, regulators and vacuum pumps.

Description	Item#	Per Foot
A. Nylon Air Hose, 1/4" O.D.	265-2286	\$0.94
Description	Item#	Each
B. QD Connector, Male, 1/4"	265-2276	\$6.85
C. QD Elbow, Male, 1/4"	265-2288	7.80
D. QD Swivel Elbow, Male, 1/8"	265-2291	5.96
E. QD Swivel T-Connector, Male, 1/4"	265-2278	7.70
F. QD Connector, Male, 1/8"	265-2277	3.75
G. Nipple Reducer, 1/4"-1/8"	265-2289	3.95
H. Plug for QD 1/4" Connectors	265-2283	1.60
I. Coupling, Female, 1/4" to 1/4"	265-2284	2.75
J. QD Union (Straight), 1/4"	265-2282	4.65
K. QD Union T, 1/4"	265-2281	6.65
QD Union Elbow, 1/4"	265-2279	5.50

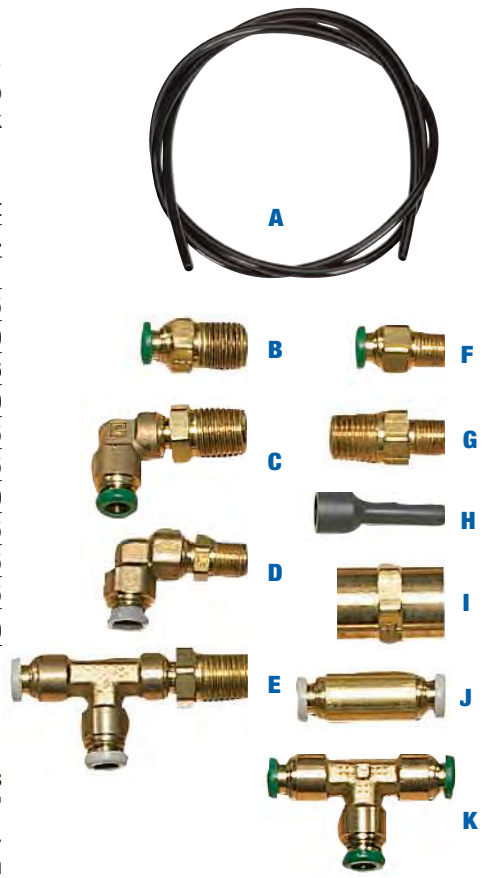

L. Variable Speed Foot Control Pedal

A disk-type foot control for use with any of our air handpieces. Sensitive and variably controls airflow from anywhere the disc is depressed. Low-profile, skid-resistant bottom. Complete with 18" length of 5/32" hose and fitting for input as well as approximately 4' of 5/32" hose for outlet to air tool.

Description	Item#	Each
Variable Speed Foot Control Pedal	850-7385	\$145.00



M. Reinforced Air Hose with Fittings

This 8' long 1/4" I.D. rubber hose comes with 1/8" NPT coupler and 1/4" NPT coupler. Withstands air pressures up to 250 PSI.

Description	Item#	Each
Reinforced Air Hose	850-7323	\$28.85



N, O Barbed Fitting and Worm Drive Clamp

Fitting works with most wax injectors and small vacuum pumps. Worm drive clamp fastens air hose securely to fitting.

Description	Item#	Each
N. Worm Drive Clamp	265-2274	\$3.95
O. Barbed Fitting, 1/4" NPT	265-2272	5.95



P. Reinforced Air Hose

Sturdy 1/4" I.D. rubber air hose reinforced to withstand air pressures up to 250 PSI. Use for compressed air and vacuum pumps. Works with barbed fittings. Sold by the foot.

Description	Item#	Per Foot
Reinforced Air Hose	265-2273	\$2.50



Q, R Air Handpiece Lube Oil

Description	Item#	Each
Q. Air Handpiece Lube Oil, 2 oz.	850-0980	\$16.90
R. Air Handpiece Lube Oil, 8 oz.	850-0985	25.65



FOREDOM® Optimize your Workspace!

Foredom's Mobile Work Station is a unique and versatile solution for small crowded labs, studios and other work spaces. Built-in electrical outlets, allow multiple powered devices that would overwhelm most work surfaces or benches. A motorized lift adjusts the top platform up and down to work sitting or standing. Heavy duty casters provide ease of transport for shared use wherever needed.



Also see the MF Touch Mobile Work Stations on page 463

(Work Station Only. Equipment Sold Separately)

A. Foredom Mobile Work Station

Specifications:

- Height from floor to top of work platform:
- 43½" at highest setting
- 30½" at lowest setting
- Footprint 16" x 22" x 43½"

Top Work Platform:

- 14¾" square. It features extension trays that swing out to hold work pieces and other small objects. Each extension tray is 8" x 4¼".

Middle Shelf:

- 12¼" x 12½". It comes with a removable yoke for mounting a flexible shaft motor. Remove yoke to hold a micromotor or other similar sized equipment.

Lower Platform:

15⅝" x 9¾" tray for tools and storage. When removed, it reveals holes specifically designed for securely mounting Foredom's Dust Collector (854-2200) after you remove those casters. Made in Taiwan.

- Weight: 44 lbs
- Ship Weight: 53 lbs
- Power Cable: 6" Long

Description	Item#	Each
Mobile Work Station	810-1620	\$899.00



B. Foredom Lighted Work Chamber

Foredom's compact Lighted Work Chamber (10"W x 11"D x 11½"H) keeps dust and debris contained when grinding, sanding, polishing and drilling workpieces that fit in your hand. Complete with LED light and 2½" x 5" diameter flip magnifier. Made in Taiwan

Description	Item#	Each
Lighted Work Chamber	850-0645	\$339.15

C. Foredom Dust Collector

Foredom's variable speed MADC20 Dust Collector is whisper quiet at 52dbA with powerful suction at 115CFM. Polycarbonate collection chamber pre-filters 99% of all debris and HEPA filter eliminates 99.98% of debris up to 0.3micron. Complete with 5 feet of 2¼" diameter vacuum hose. Measures 15¼"L x 15¼"W x 19½"H. 2 Year Warranty. Made in Taiwan

Description	Item#	Each
Dust Collector	854-2200	\$679.15



D. Foredom Jumbo Work Chamber

The Jumbo Work Chamber keeps dust and debris contained when grinding, sanding, polishing and drilling. Semi-enclosed unit offers excellent visibility. Designed to provide full range of motion and comfort. Height: 21". Width: 22¾" at bottom, 12⅝" at top. Depth: 23" including 2¼" diameter hose port in back. Made in Taiwan

Description	Item#	Each
Jumbo Work Chamber	850-0659	\$382.50

A. Matt™ Gold Collector Box

Traps gold and other precious metals for easy retrieval. Has side openings that let you keep your hands and arms in a natural, comfortable working position for reduced fatigue. Protects eyes, skin and clothing from flying dust, particles and brush wires. Keeps your work area clean, reducing time-consuming cleanup and increasing productivity while maintaining a healthier work environment. Features high-impact extruded plastic housing and easy-to-remove, nonglare, clear plastic shield. Attaches to bench with integral C-clamp when needed. Stores easily when not in use. Lightweight, sturdy and completely portable. Does not eliminate the need for safety glasses. Measures 7"W x 7½"D x 8¾"H.

Description	Item#	Each
Matt Gold Collector Box	265-2343	\$74.00



B. Klear-Vue Safety Shield

Sturdy, crystal-clear, plastic shield almost 3/8" thick. Protects you from flying debris while you work at the bench. Has cutouts for your wrists that allow you to hold your hands and tools at a normal working angle. More comfortable and convenient than a grinding box—use when gold containment is not a factor. Provides an extra barrier that protects face, neck and clothing from dust and dirt kicked up by abrasive wheels, polishing compounds and more. Does not eliminate the need for safety glasses. Measures 7"W x 6⅞"D x 9⅞"H.

Description	Item#	Each
Klear-Vue Safety Shield	857-1000	\$82.00



C. Face Shield – Complete protection with excellent optics.

This lightweight plastic shield is a must for full face and neck protection against flying chips while grinding, drilling or polishing. Can be worn over dust masks, respirators and glasses with no obstruction of view. Features pivoting visor for easy raising and lowering, molded visor edge for reinforcement, cushioned vinyl comfort band and pin-and-hole adjustable headbands. Visor measures 8"L x 12"W x .040" thick. Does not eliminate need for safety glasses.

Description	Item#	Each
C. Face Shield	270-0210	\$21.00
Replacement Visor	270-0212	6.95
Replacement Vinyl Sweatband	270-0214	3.50



D. Flex Shaft Accessory Set

Includes 90 of our most popular polishing wheels, brushes and buffs, texturing wheels, cut-off discs and felt bobs and brushes, all with 3/32" shanks for your flex shaft. Ideal for grinding, sanding and buffing the insides and outsides of rings and other pieces of jewelry. Use polishing wheels, brushes and buffs for fine polishing, texturing wheels for brushed or satin finishing, cut-off discs for fast sizing of rings and felt bobs and brushes for accessing prongs and other tight areas. Packaged in a convenient 24-compartment plastic storage case.

Description	Item#	Each
Flex Shaft Accessory Set	850-0510	\$69.95





ULTRAMAX® Ultrasonic Polishing Systems

Reduce finishing time by more than 50%!

For more than three decades, Gesswein has brought the benefits of ultrasonic polishing to mold and diemakers. ULTRAMAX units polish slots, ribs and intricate details faster than you could ever do by hand. Feature fast reciprocation and short stroke for making quick work of the most time consuming tasks. Polish everything from milled to rough EDM surfaces to a mirror finish using all grades of finishing stones, diamond tools, ceramic stones and lapping tools with diamond compound (see pp. 104-105). **Choose from four ULTRAMAX units for the right one for your job.**

Our Df and SF units are workhorses; built for power and demanding usage. Our MF unit is an economical, versatile unit capable of ultrasonic, mechanical and brushless operations. The UM-1200 Ultrasonic Polisher is the logical choice for intermittent usage at lower power.

A. ULTRAMAX® SF Power – Ultrasonic Polishing System

Introducing the latest technology in ultrasonic polishing: the new ULTRAMAX SF POWER. The SF POWER is simultaneously the most powerful and a delicate ultrasonic polishing system. From rough grinding to ultra-fine polishing – the ULTRAMAX SF can do it all! With an incredible maximum output of 100W, the ULTRAMAX SF can remove tough, thick EDM scale with large diamond files and ceramic stones. Ultra-fine polishing is achieved with “Nano mode”, which produces a minute stroke length down to 1 micron. A built-in LCD monitor displays the frequency and output settings, and allows the user to select between 3 different power modes: Hard, Soft and Nano.

The frequency, or the number of vibrations per second, is dependent on the type of tool and will range between 17 – 31 kHz, or 17,000 – 31,000 strokes per second. Length of stroke is adjusted by the output and will range from 1 – 30 microns.

3 Modes: Hard, Soft and Nano

Hard Mode – Supplies a constant power (frequency and stroke length) as pressure is applied against the tool, thus allowing for powerful performance.

Soft Mode – Automatically reduces the power (frequency and stroke length) as pressure is applied to the tool, thus preventing over grinding and scratch marks. This mode is suitable for delicate work.

Nano Mode – Allows an ultra-short stroke length of 3 microns or less. This is meant for ultra-fine polishing applications such as mirror finishing that was once only achieved by hand.

Chose between 3 ULTRAMAX SF POWER Sets:

All-Around Set

The All-Around Set can do it all! Set includes SF POWER control box, UF-7401 and UF-9701 handpieces, (details shown on reverse) both the standard attachment tool sets that are available with tough and Nano sets

Ultramax Tough Set

The Tough Set give you the most powerful ultrasonic handpiece (up to 100W of power!) for removing tough EDM scale and heavy duty polishing applications. Includes ULTRAMAX SF POWER control box, UF-7401 handpiece, abrasive tools set and accessory set

Ultramax Nano Set

The Nano Set is meant for general purpose and ultra-fine polishing applications. Set includes ULTRAMAX SF POWER control box, UF-9701 handpiece, abrasive tools set and accessory set.



Optional Control Pedal

Specifications SF POWER (Oscillator)

Frequency: (range)	17- 31 kHz
Frequency Adjustment:	Automatic Feedback System
Ultrasonic Power Output:	100W Maximum
Amplitude:	99
Electrical:	100~250V, 1Ph,50/60Hz
Power Consumption:	300VA
Dimensions: (WxDxH)	9" x 10" x 7" (226 x 252 x 180 mm)
Weight:	11½ lbs. (5.2kg)



Specifications of UF-7401 Handpiece

Tool attachment thread:	M8
Cord length:	Curled cord 5½' (1.7m)
Dimension:	1½" Dia x 6"L (40 Dia x150L mm)
Weight:	13 oz (350g)



Specifications of UF-9701 Handpiece

Tool attachment thread:	M6 (with M6-M4 Adapter)
Cord length:	Curled cord 5½' (1.7m)
Dimension:	1½" Dia x 4⅝"L (28 Dia x118.5L mm)
Weight:	6 oz (150g)

Description	Item#	Each
SF POWER, All-Around Set	500-0244	\$8,195.00
SF POWER, Tough Set	500-0245	6,495.00
SF POWER, Nano Set	500-0247	6,495.00



A

A. ULTRAMAX® DF (Dual-Function) Heavy Duty Polisher

Our most powerful ultrasonic, the DF is the #1 choice for the professional mold polisher. With 45W of max output power, it can handle the most demanding work load and continual use. This dual-function unit gives the versatility of both ultrasonic and mechanical polishing. Supplied with the lightweight, vibration-free UF-9700 ultrasonic handpiece, the DF can also power our full line of Power Hand 3 mechanical handpieces (PH3 adaptor 510-3304 required).

Includes controller, UF-9700 handpiece with 6mm screw thread and the ULTRAMAX tools kit, which consists of 6/4mm tool adaptor #508-3342 (to hold M4 ultrasonic tools on p. 466), handpiece cradle rest and tool box with a 31-piece tool set of four diamond files, three diamond stones, two resin-bonded diamond stones, six ceramic stones, two lapping tools, four flat clamp tool holders, round clamp tool holder, standard handpiece protector sleeve, large beveled handpiece protector sleeve, wrenches, set of earplugs and extra fuse.

Specifications:

Vibration Frequency	20–30kHz
Stroke Length	4–40 microns
Max. Output Power	45W
Electrical	115V or 230V, 1 Ph, 50/60Hz
Controller Measures	6 ³ / ₈ "W x 11"D x 8 ¹ / ₄ "H
Handpiece Measures	5"L x 1 ³ / ₃₂ " dia.

Description	Electrical	Item#	Each
ULTRAMAX DF	115V	500-0210	\$5,395.00
ULTRAMAX DF	230V	500-0211	5,395.00
Replacement UF-9700 Handpiece		500-0205	1,695.00



Tool Set included with purchase of an ULTRAMAX DF.

B. ULTRAMAX® UM-1200 Ultrasonic Polisher

The most affordable ultrasonic polisher for polishing with diamond tools and ceramic stones. The high quality UM-1200 produces 25,000 cycles per second of longitudinal vibration in a small, comfortable handpiece with an invisible minute stroke of 10 to 35 microns from low to high output levels.

Include controller, UM-1200 handpiece with 8mm screw thread standard accessory set (two sintered and six plated diamond tools and two ceramic stones), one flat clamp tool holder, two round clamp tool holders, on/off foot switch, handpiece cradle rest, bench jig, wrench and hex key.

Specifications:

Vibration Frequency	18–25kHz
Stroke Length	10–35 microns
Max. Output Power	39W
Electrical	90–240V, 50/60Hz
Controller Measures	7 ¹ / ₂ "W x 5 ¹ / ₂ "D x 3 ¹ / ₂ "H
Handpiece Measures	5"L x 1 ³ / ₁₆ " dia.

Description	Electrical	Item#	Each
ULTRAMAX UM-1200	90–240V	500-1200	\$1,495.00
Replacement Handpiece	–	500-0101	380.00



B

ULTRAMAX® MF 3-in-1 Complete Package

With either MF TOUCH or MF STANDARD Control Box

The Multi-Function Ultramax MF TOUCH and MF STANDARD are our most versatile polishing systems. They utilize a high-efficiency microprocessor to deliver power to ultrasonic, brushless DC, and brush-type DC handpieces. The MF TOUCH system offers touch screen control and read out while the MF STANDARD has all the same functions utilizing push buttons.

The Complete 3-in-1 Packages Includes:

- MF TOUCH Control Box or MF STANDARD Control Box
- MF Ultrasonic Handpiece: provides 36W of continuously variable power for precision reciprocating action.
- BH-60 Rotary Handpiece: delivers 50,000rpm utilizing a 230W brushless rotary motor for incredible power—even at low speeds! Provides ample torque at all times to ensure fast and smooth metal removal.
- Z-6X or Z-2X Power Hand Reciprocating Profiler: comes complete with powerful 30V DC air-cooled motor and sealed bearings. Use for polishing flat surfaces, deburring, filing, stoning, scraping, lapping and draw-stoning deep cavities. They operate with minimal vibrations to reduce fatigue and have flexible power cords for easy reach. Special V-shaped chucking system firmly secures a wide variety of abrasives and other tools such as steel files.
- 3-in-1 MF Cabinet: Organize your workbench with the 3-in-1 Cabinet. With a separate handpiece holder for each handpiece it's easy to reach your handpieces when you're ready to work. Includes two drawers with plastic inserts for storing your tools and polishing supplies. The cabinet is made of 1 mm thick powder-coated steel sheet to provide a sturdy base. Excellent accessory for those who want to keep the work environment organized!
- Handpiece rest
- Tool changing wrenches
- 1mm & 3mm flat clamp tool holders
- 3mm round tool holder
- Variable speed foot pedal

A. ULTRAMAX® MF TOUCH 3-in-1

Description	Item#	Each
MF TOUCH 3-in-1 Complete (w/ Z-6X Proflier)	500-0232	\$4,395.00
MF TOUCH 3-in-1 Complete (w/ Z-2X Proflier)	500-0233	4,395.00
MF TOUCH Control Box, Ultrasonic Handpiece, and Foot Pedal	500-0237	2,995.00

B. ULTRAMAX® MF STANDARD 3-in-1

Description	Item#	Each
MF STANDARD 3-in-1 Complete (w/ Z-6X Proflier)	500-0230	\$3,895.00
MF STANDARD 3-in-1 Complete (w/ Z-2X Proflier)	500-0231	3,895.00
MF STANDARD Control Box, Ultrasonic Handpiece, and Foot Pedal	500-0220	2,495.00

Accessories and Replacements	Item#	Each
Replacement Ultrasonic Handpiece	500-0222	510.00
Replacement Brushless Rotary Handpiece	500-0224	525.00
Replacement Z-6X Handpiece	510-2160	995.00
Replacement Z-2X Handpiece	510-2150	995.00
Replacement Variable Speed Foot Pedal	500-0221	60.00
Optional - On/Off Foot Switch	500-0227	18.00
MF TOUCH Cabinet Only	500-0236	295.00
MF STANDARD Cabinet Only	500-0229	295.00



A



B



A. ULTRAMAX® MF TOUCH Work Station

Work anywhere in your shop! The combination of the Foredom® Mobile Work Station and the MF TOUCH Complete Package 3-in-1 allows you to quickly and effortlessly maintain your molds around your shop.

The MF TOUCH Complete Package 3-in-1 includes a 36 Watt ultrasonic handpiece, a reciprocating profiler of your choice (Z-2X or Z-6X), a 50,000rpm rotary handpiece, and the 3-in-1 MF TOUCH metal cabinet. The 3-in-1 Consumable Set is also included and contains 83 polishing tools and abrasives specifically selected for the MF TOUCH Complete Package. Pint of Green Stoning Oil included.

The Foredom Mobile Work Station has a motorized lift that adjusts the top platform up and down (from 43½" at the highest, down to 30½" at the lowest) at the touch of a button. Heavy duty casters provide ease of transport throughout your work environment. Pivoting kickstand increases stability for safely managing the Work Station when at a standstill. The Work Station provides 3 electrical outlets for powering the MF TOUCH or other power tools and includes a 6 foot power cable to power the unit itself.

The top platform is a 14¾" square that features extension trays that swing out to hold workpieces and other objects, each tray is 8" x 4¼". These trays are ideal for holding any accessories or other items while operating the Ultramax MF TOUCH. The middle shelf is 12¼" x 12¾" and the bottom shelf measures 15⅝" x 9¾". The Foredom Mobile Work Station comes assembled, except for the middle shelf.

ULTRAMAX® MF TOUCH Work Station Kit includes:

- MF TOUCH Control Box
- Ultrasonic Handpiece, 36 watts
- BH-60 Brushless Rotary Handpiece
- Choice of Reciprocating Profiler Handpieces Z-6X or Z-2X
- 3-in-1 MF TOUCH Cabinet (see previous page for specs.)
- Foredom Mobile Work Station
- Handpiece rest
- Tool changing wrenches
- 1mm & 3mm flat clamp tool holders
- 3mm round tool holder
- Variable speed foot rheostat
- Pint of Supreme Green Stoning Oil
- 3-in-1 Consumable Set

Description	Item#	Each
MF TOUCH Work Station Kit with Z-6X	500-0250	\$5,495.00
MF TOUCH Work Station Kit with Z-2X	500-0251	5,495.00
Foredom Mobile Work Station (only)	810-1620	899.00



A

B. 3-in-1 Consumable Set

Set of polishing supplies for Ultramax MF Complete Packages

This set contains 83 polishing consumables specifically selected for the Ultramax MF 3-in-1 Complete Packages. Provides the full range of abrasive consumables from aggressive polishing and grinding, up to diamond and mirror polishing. Keep your tools in the convenient carrying case or store in the MF metal cabinet.

Includes:

- Diemaker All Grit Stone Set
- Mounted Stone Sampler Set
- New Super Stone All Grit Set
- Round Ceramic Stone Set
- Finishing Stone Holder
- 6 Grades of Diamond Compound
- Soft End Brushes
- Hard End Brushes
- Soft Cup Brushes
- Hard Cup Brushes
- Soft Wheel Brushes
- Hard Wheel Brushes
- Soft Felt Bob Set
- Hard Felt Bob Set
- GMX Soft Cylinders
- Diamond Files
- Rockwood & Soft Sticks
- Supreme Green Stoning Oil

Description	Item#	Each
3-in-1 Consumable Set	500-0234	\$395.00



B

Accessories for ULTRAMAX® DF, SF, and SF Power UF-9701 Handpiece

Create your own polishing tools by inserting stones and lapping tools into the appropriate steel clamp. Use the M6 (6mm thread) clamp tool holders in the UF-9700 ultrasonic handpiece supplied with ULTRAMAX DF and SF units, and the SF Power UF-9701 handpiece. Not for use with SF Power UF-7401 handpiece (8mm thread). For optimum machine performance, choose a medium clamp tool holder for tools up to 6.35mm in width and a large clamp tool holder for tools up to 15mm in width. Replacement screws are available from stock

See website for 8mm thread accessories for SF Power UF-7401 Handpiece

All drawing measurements are in millimeters

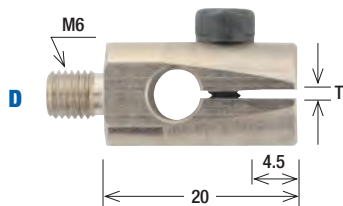
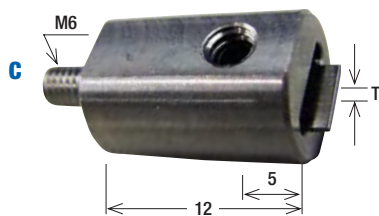
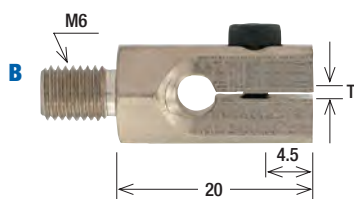
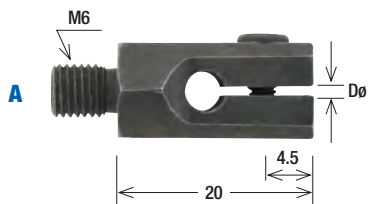

A. 6mm Thread Round Clamp Tool Holder

For round tools

For Dø (Diameter)	Item#	Each
A. 2.0mm round tool	508-3508	\$36.50
2.35mm (3/32") round tool	508-3509	36.50
3.0mm round tool	508-3512*	36.50
3.3mm (1/8") round tool	508-3516	36.50
4.0mm round tool	508-3520	36.50

*Supplied with ULTRAMAX DF/SF

B. 6mm Thread Medium Clamp Tool Holder

For flat tools up to 6.35mm (1/4") wide

For T (Thickness)	Item#	Each
B. 0.5mm flat tool	508-3495	\$36.50
0.8mm flat tool	508-3500*	36.50
1.0mm flat tool	508-3502*	36.50
1.5mm flat tool	508-3504	36.50
2.0mm flat tool	508-3506	36.50
3.0mm flat tool	508-3510*	36.50
3.3mm (1/8") flat tool	508-3514*	36.50

*Supplied with ULTRAMAX DF/SF

C. 6mm Thread Adjustable Clamp Tool Holder

For flat tools 0.1mm to 8.0mm wide

For T (Thickness)	Item#	Each
0.1mm to 1.5mm thick	508-3522	\$69.50

D. 6mm Thread Large Clamp Tool Holder

For flat tools 6.35mm to 15mm wide

For T (Thickness)	Item#	Each
D. 1.0mm flat tool	508-3503	\$36.50
1.5mm flat tool	508-3505	36.50
2.0mm flat tool	508-3507	36.50
3.0mm flat tool	508-3511	36.50
3.3mm (1/8") flat tool	508-3515	36.50
4.0mm flat tool	508-3518	36.50

E, F ULTRAMAX® DF/SF Accessories and Replacements

Not for use with SF Power units

Description	Item#	Each
E. UF-9700 Handpiece only (6mm thread)	500-0205*	\$1,695.00
6/4mm Tool Adapter (to hold M4 ultrasonic tools)	508-3342*	13.25
F. Handpiece Cradle Rest	510-1130*	14.60
Standard Handpiece Protector Sleeve	500-0208*	12.75
G. Variable-Speed Foot Rheostat	500-0206	\$149.00

*Supplied with ULTRAMAX DF/SF

Accessories for ULTRAMAX[®] MF units

Create your own polishing tools by inserting stones and lapping tools into the appropriate steel clamp. Use 6mm thread for the MF handpiece.

A. 6mm Round Tool Holders

For D \varnothing (Diameter)	Item#	Each
2.0mm Round	508-3132	\$32.00
A. 3.0mm Round	508-3133*	32.00
1/8" Round	508-3134	32.00

*Supplied with ULTRAMAX MF

B. 6mm Flat Clamp Tool Holders

For T (Thickness)	Item#	Each
0.5mm Flat	508-3120	\$32.00
B. 1.0mm Flat	508-3122*	32.00
2.0mm Flat	508-3124	32.00
3.0mm Flat	508-3126*	32.00
1/8" Flat	508-3128	32.00

*Supplied with ULTRAMAX MF

C. ULTRAMAX[®] MF Accessories and Replacements

Description	Item#	Each
C. MF Ultrasonic Handpiece	500-0222*	\$510.00
Variable Speed Foot Pedal	500-0221	60.00
50,000 Brushless Rotary Handpiece	500-0224	525.00
6mm to 4mm adapter	508-3114	32.00
Cradle Rest	510-1130*	14.60

*Supplied with ULTRAMAX MF



Accessories for ULTRAMAX[®] UM-1200 units

Create your own polishing tools by inserting stones and lapping tools into the appropriate steel clamp. Use 8mm thread for the UM-1200 handpiece

Important note: Always use bench jig when changing tools or holders to avoid damaging handpiece transducer wires.

D. 8mm Thread Round Tool Holders

For D \varnothing (Diameter)	Item#	Each
1.0mm round tool	500-0134	\$32.00
2.0mm round tool	500-0135	32.00
2.35mm (3/32") round tool	500-0136	32.00
D. 3.0mm round tool	500-0109*	28.00
1/8" round tool	500-0137	32.00

E. 8mm Thread Flat Clamp Tool Holders

For T (Thickness)	Item#	Each
0.5mm flat tool	500-0111	\$28.00
0.8mm flat tool	500-0131	28.00
E. 1.0mm flat tool	500-0108*	28.00
2.0mm flat tool	500-0132	28.00
3.0mm flat tool	500-0110	28.00
1/8" flat tool	500-0133	28.00

*Supplied with ULTRAMAX UM-1200

F, G ULTRAMAX[®] UM-1200 Accessories and Replacements

Description	Item#	Each
F. 8/4mm Tool Adapter (to hold M4 ultrasonic tools)	500-0129	\$35.00
G. Replacement UM-1200 Handpiece, 8mm thread	500-0101*	380.00
Replacement Standard Accessory Set	500-0140*	126.00
Replacement On/Off Foot Switch	500-0107*	45.00
Replacement Handpiece Cradle Rest	510-1130*	14.60

*Supplied with ULTRAMAX UM-1200



ULTRAMAX® Diamond Tools M4 (4mm thread)

All **ULTRAMAX® Diamond Tools** are made to match the resonant frequency of Gesswein ULTRAMAX units. For best results, use only **ULTRAMAX® Diamond Tools**. The manufacturer will not accept any liability for another brand of tools. All measurements in millimeters. All lengths given are cutting lengths. Please check drawings for overall tool dimensions.

- Mount in 6/4mm tool adapter #508-3342 for use with DF, SF
- Use #508-3114 6/4mm tool adapter for MF-ULTRAMAX
- Mount in 8/4mm tool adapter (see #500-0129 p. 465) for use with UM-1200

Diamond Tool Color Coding	
Color	Grit
Red	200
Black	320
Blue	500
White	600

Mounted Diamond Files – For ULTRAMAX® units

Use these fast-cutting diamond files for intermediate finishing. Excellent for finishing slot sidewalls and flat or curved surfaces. Diamond particles, precision-graded to assure consistency, are electrodeposited on threaded steel shanks.



Flat, 5 x 1 x 40 Grit	Item#	Each
200	508-3206*	\$92.80
320	508-3208*	92.80
600	508-3210	92.80

*Supplied with ULTRAMAX DF/SF

Flat, 4 x 1 x 15 Grit	Item#	Each
200	508-3200	\$66.00
320	508-3202	66.00
600	508-3204	66.00

Chisel, 4 x 0.8-0.5 x 15 Grit	Item#	Each
200	508-3362*	\$67.25
320	508-3364*	67.25
600	508-3366	67.25

*Supplied with ULTRAMAX DF/SF

Three-Square, 3 x 15 Grit	Item#	Each
200	508-3212	\$76.00
320	508-3214	76.00
600	508-3213	76.00

Round Taper, 3 x 15 Grit	Item#	Each
200	508-3215	\$59.95
320	508-3217	59.95
600	508-3219	59.95

45° Arm, 1 x 4 x 15 Grit	Item#	Each
200	508-3218	\$61.75
320	508-3220	61.75
600	508-3222	61.75

Mounted Diamond Stones – For ULTRAMAX® units

Precision-graded diamond particles throughout, not just on the surface, give these tools long life. Can be shaped with a diamond wheel or file for easy polishing of tapered or deep, narrow slots. Great for intermediate and fine finishing.

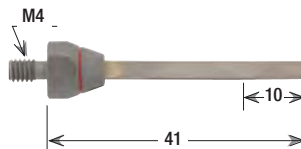

Flat, 3 x 1 x 10 Grit	Item#	Each
200	508-3246*	\$97.25
320	508-3248	97.25

*Supplied with ULTRAMAX DF/SF.

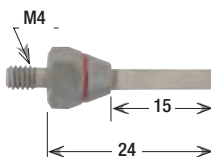

Flat, 3 x 1 x 15 Grit	Item#	Each
200	508-3264	\$88.85
320	508-3266	88.85
500	508-3268	88.85

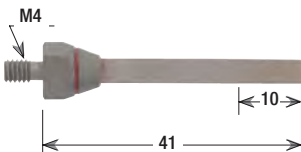

Flat, 4 x 1 x 10 Grit	Item#	Each
500	508-3256	\$102.25

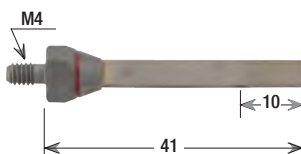

Flat, 5 x 1 x 10 Grit	Item#	Each
200	508-3258*	\$106.75
320	508-3260	106.75

*Supplied with ULTRAMAX DF/SF

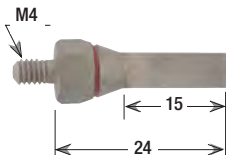



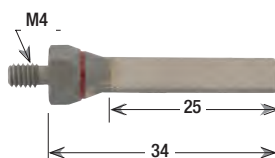



Flat, 5 x 1 x 15 Grit	Item#	Each
200	508-3272	\$73.75
320	508-3274	73.75
500	508-3270	73.75



Flat, 6 x 1.5 x 25 Grit	Item#	Each
200	508-3276	\$107.75
320	508-3278	107.75

A-M Gesswein® Diamond Poli Files – 3mm Shank

Parallel diamond machine files for use in Ultramax Round Tool Holders. All have 3mm shanks. Measure approx. 2" long. Plated ends measure 5/8" long.

Style	Shape	W x Thick	Grit	Item#	Each
A. Flat		2 x 1mm	150	240-1120*	\$12.50
B.		3 x 1mm	150	240-1130	12.50
C.		4 x 1mm	150	240-1140	12.50
D.		5 x 2mm	150	240-1150	12.50
E. Three-Square		2mm	150	240-1520*	12.50
F.		3.5mm	150	240-1535	12.50
G.		4.5mm	150	240-1545	12.50
H. Crossing		2 x 1mm	150	240-1410*	12.50
I. Round		1mm	150	240-1310	12.50
J.		2mm	150	240-1320*	12.50
K.		3mm	150	240-1330	12.50
L. Flat		4 x 1mm	150	240-1230*	12.50
M. Knife		4 x 1mm	150	240-1610*	12.50
*6-Piece Set (one of each asterisked item)				240-1706	71.00
12-Piece Set (one of each except #240-1150)				240-1712	142.00



N-Q Gesswein® Tapered Diamond Poli Files – 3mm Shank

Tapered diamond machine files for use in Ultramax Round Tool Holders. All have 3mm shanks. Plated ends measure 15mm (19/32") long with 1.4–0.3mm taper.

Style	Size (mm)	200 grit Item#	400 grit Item#	600 grit Item#	Each
N. Flat	 3 x 56	241-0814	241-0815	241-0816	\$12.50
O.	6 x 56	241-0817	241-0818	241-0819	13.75
P.	3 x 72	241-0820	241-0821	241-0822	12.50
Q.	6 x 72	241-0823	241-0824	241-0825	13.75
				Item#	Each
12-Piece Set (one of each)				241-0813	\$149.75

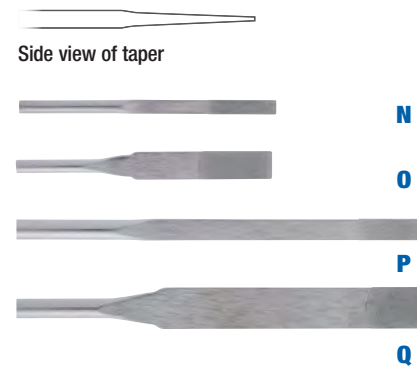

R. ULTRAMAX® UM-1200 Sintered Diamond Machine Files – 3mm Shank

Feature solid diamond portion that measures 20mm (approx. 3/4") long x 1.5mm thick. Shape to reach tight areas. Have 3mm shanks. Use with proper tool holder (500-0109 see p. 465).

Size (W x L)	200 grit Item#	400 grit Item#	600 grit Item#	Each
6 x 72mm	500-0126*	500-0127*	500-0128	\$49.95

*Supplied with ULTRAMAX UM-1200.



S. SUPER Ceramic Diamond Stones

SUPER Ceramic Diamond (SCD) Stones combine ceramic fibers with multiple layers of evenly distributed diamond particles to ensure continuous cutting action. SCD Stones will cut and polish flat to a surface, allowing fast and accurate polishing in open areas. SCD Stones are perfect for polishing ribs, hard-to-reach slots and sidewalls, and milled or EDM flat surfaces. Their strong, durable ceramic fiber construction makes them ideal for use in ultrasonic polishers and mechanical profilers or by hand. Available in flat and round shapes in four color-coded grits.

Style	Size (mm)	Black	Gray	Green	Aqua	EACH Prices*	
		200 Grit Item#	400 Grit Item#	600 Grit Item#	800 Grit Item#	1-4	5+
Flat	1 x 2 x 100	351-0797	351-0798	351-0799	351-0815	\$16.50	\$14.85
	1 x 4 x 100	351-0800	351-0801	351-0802	351-0816	28.00	25.20
	1 x 6 x 100	351-0803	351-0804	351-0805	351-0817	42.00	37.80
	1 x 10 x 100	351-0806	351-0807	351-0808	351-0818	56.00	50.40
Round	3 x 50	351-0809	351-0810	351-0811	351-0819	40.00	36.00
	3 x 100	351-0812	351-0813	351-0814	351-0820	85.00	76.50

*Quantity discount for orders of one item number only; not assorted.

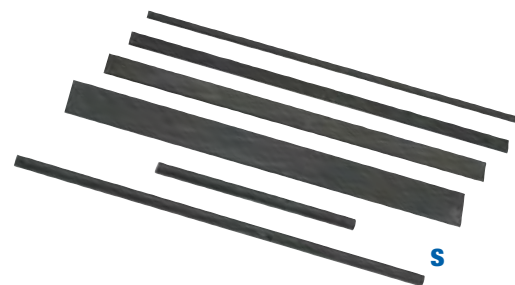



Ceramic Stones *Strong yet incredibly flexible!*

New Super Stone (NSS) offers an improved cutting ability, increased heat resistance, and longer life. Made of long ceramic fibers that will not break even under the most strenuous conditions, the NSS can be used in ultrasonic polishers, reciprocating profilers, or by hand (see Ceramic Stone Holders on p. 469).

These strong yet flexible stones are ideal for polishing small intricate areas on all types of metals producing consistent and uniform surface finishes. NSS is non-loading and can be shaped with the Super Dresser #351-0300 (see p. 26). Available in 9 easy to identify color coded grits from 80 to 1200. Made in Japan.



For our selection of Cristone Ceramic Stones see p. 27.

FLAT Stones

Dimensions (mm)	Violet	Emerald	Gold	Lt. Brown	Orange	Gray	Blue	White	Red	EACH Prices*	
	80 Grit Item#	120 Grit Item#	180 Grit Item#	300 Grit Item#	400 Grit Item#	600 Grit Item#	800 Grit Item#	1000 Grit Item#	1200 Grit Item#	1-4	5+
0.5 x 1 x 100	355-0001	355-0101	355-0201	355-0401	355-0501	355-0601	355-0701	355-0801	355-0901	\$9.95	\$8.96
0.5 x 2 x 100	355-0002	355-0102	355-0202	355-0402	355-0502	355-0602	355-0702	355-0802	355-0902	13.50	12.15
0.5 x 4 x 100	355-0003	355-0103	355-0203	355-0403	355-0503	355-0603	355-0703	355-0803	355-0903	20.90	18.81
0.5 x 6 x 100	355-0004	355-0104	355-0204	355-0404	355-0504	355-0604	355-0704	355-0804	355-0904	31.45	28.31
0.5 x 10 x 100	355-0005	355-0105	355-0205	355-0405	355-0505	355-0605	355-0705	355-0805	355-0905	41.25	37.13
0.8 x 4 x 100	355-0008	355-0108	355-0208	355-0408	355-0508	355-0608	355-0708	355-0808	355-0908	20.90	18.81
0.8 x 6 x 100	355-0009	355-0109	355-0209	355-0409	355-0509	355-0609	355-0709	355-0809	355-0909	31.45	28.31
0.8 x 10 x 100	355-0010	355-0110	355-0210	355-0410	355-0510	355-0610	355-0710	355-0810	355-0910	41.25	37.13
1 x 1 x 100	355-0011	355-0111	355-0211	355-0411	355-0511	355-0611	355-0711	355-0811	355-0911	9.95	8.96
1 x 2 x 100	355-0012	355-0112	355-0212	355-0412	355-0512	355-0612	355-0712	355-0812	355-0912	12.00	10.80
1 x 4 x 100	355-0013	355-0113 ^a	355-0213 ^a	355-0413 ^a	355-0513	355-0613	355-0713 ^a	355-0813	355-0913 ^a	20.90	18.81
1 x 6 x 100	355-0014	355-0114	355-0214	355-0414 ^a	355-0514 ^a	355-0614 ^a	355-0714 ^a	355-0814 ^a	355-0914	31.45	28.31
1 x 10 x 100	355-0015	355-0115	355-0215	355-0415	355-0515	355-0615	355-0715	355-0815	355-0915	41.25	37.13
1.5 x 4 x 100	355-0018	355-0118	355-0218	355-0418	355-0518	355-0618	355-0718	355-0818	355-0918	31.25	28.13
1.5 x 6 x 100	355-0019	355-0119	355-0219	355-0419	355-0519	355-0619	355-0719	355-0819	355-0919	47.30	42.57
1.5 x 10 x 100	355-0020	355-0120	355-0220	355-0420	355-0520	355-0620	355-0720	355-0820	355-0920	62.45	56.21
2 x 4 x 100	355-0023	355-0123	355-0223	355-0423	355-0523	355-0623	355-0723	355-0823	355-0923	41.25	37.13
2 x 6 x 100	355-0024	355-0124	355-0224	355-0424	355-0524	355-0624	355-0724	355-0824	355-0924	62.90	56.61
2 x 10 x 100	355-0025	355-0125	355-0225	355-0425	355-0525	355-0625	355-0725	355-0825	355-0925	82.50	74.25

*Quantity discount for orders of one item number only; not assorted. | ^aSee Stone & Holder Sets; next page

- Non-clogging—beautiful polishing results on all metals
- Available in any dimensions in flat/round profiles
- Incredible strength and flexibility
- Color coded—easy to identify
- Available in grits 120 to 1200
- Improved heat resistance
- Great cutting power
- Very long life



ROUND Stones

Dimensions (mm)	Violet 80 Grit Item#	Emerald 120 Grit Item#	Gold 180 Grit Item#	Lt. Brown 300 Grit Item#	Orange 400 Grit Item#	Gray 600 Grit Item#	Blue 800 Grit Item#	White 1000 Grit Item#	Red 1200 Grit Item#	EACH Prices*	
										1-4	5+
2.35 x 50mm ○	355-0031	355-0131	355-0231	355-0431	355-0531	355-0631	355-0731	355-0831	355-0931	\$18.50	\$16.65
2.35 x 100mm ○	355-0032	355-0132	355-0232	355-0432	355-0532	355-0632	355-0732	355-0832	355-0932	39.00	35.10
3 x 50mm ○	355-0034	355-0134	355-0234 ^b	355-0434 ^b	355-0534	355-0634 ^b	355-0734 ^b	355-0834	355-0934 ^b	20.45	18.41
3 x 100mm ○	355-0035	355-0135	355-0235	355-0435	355-0535	355-0635	355-0735	355-0835	355-0935	39.50	35.55
3.175 x 50mm ○	355-0037	355-0137	355-0237	355-0437	355-0537	355-0637	355-0737	355-0837	355-0937	23.50	21.15
3.175 x 100mm ○	355-0038	355-0138	355-0238	355-0438	355-0538	355-0638	355-0738	355-0838	355-0938	40.00	36.00

SQUARE Stones







Dimensions (mm)	Violet 80 Grit Item#	Emerald 120 Grit Item#	Gold 180 Grit Item#	Lt. Brown 300 Grit Item#	Orange 400 Grit Item#	Gray 600 Grit Item#	Blue 800 Grit Item#	White 1000 Grit Item#	Red 1200 Grit Item#	EACH Prices*	
										1-4	5+
0.5 x 0.5 x 50mm □	355-0041	355-0141	355-0241 ^c	355-0441	355-0541 ^c	355-0641	355-0741 ^c	355-0841	355-0941 ^c	\$7.00	\$6.30
0.9 x 0.9 x 50mm □	355-0043	355-0143	355-0243 ^d	355-0443	355-0543 ^d	355-0643	355-0743 ^d	355-0843	355-0943 ^d	7.00	6.30

PRECUT Stones – For Ultrasonic Handpieces

Dimensions (mm)	Violet 80 Grit Item#	Emerald 120 Grit Item#	Gold 180 Grit Item#	Lt. Brown 300 Grit Item#	Orange 400 Grit Item#	Gray 600 Grit Item#	Blue 800 Grit Item#	White 1000 Grit Item#	Red 1200 Grit Item#	EACH Prices*	
										1-4	5+
0.8 x 4 x 40 ▬	355-0060	355-0160	355-0260	355-0460	355-0560	355-0660	355-0760	355-0860	355-0960	\$9.95	\$8.96
0.8 x 6 x 40 ▬	355-0061	355-0161	355-0261	355-0461	355-0561	355-0661	355-0761	355-0861	355-0961	16.65	14.99
1 x 4 x 40 ▬	355-0065	355-0165	355-0265	355-0465	355-0565	355-0665	355-0765	355-0865	355-0965	9.95	8.96
1 x 6 x 40 ▬	355-0066	355-0166	355-0266	355-0466	355-0566	355-0666	355-0766	355-0866	355-0966	16.10	14.49

*Quantity discount for orders of one item number only; not assorted. | ^{b-d}See Stone & Holder Sets below

STONE & HOLDER Sets

Set	Contents	Item #	Each
a. Flat set, 100mm	10 stones + 2 holders: 1 x 4x100 (120, 180, 300, 800, 1200 grit)  1 x 6x100 (300, 400, 600, 800, 1000 grit) 	355-1100	\$199.00
b. Round set	5 stones + holder: 3x50mm (180, 300, 600, 800, 1200 grit) 	355-1103	89.00
c. Square set, .5mm	4 stones + holder: 0.5x0.5x50mm (180, 400, 800, 1200 grit) 	355-1105	37.00
d. Square set, .9mm	4 stones + holder: 0.9x0.9x50mm (180, 400, 800, 1200 grit) 	355-1109	37.00
e. Square set, 40mm	9 stones: 1 x 4 x 40mm (all 9 grits) or (80, 120, 180, 300, 400, 600, 800, 1000, 1200 grit) 	355-0099	79.95



A. Finger Guard Safety Tape

Made of surgical-grade gauze coated with natural latex rubber. Sticks only to itself – not to your skin, hair or clothing. Ideal skin protection for grinding and buffing. Length 90 feet.

Description	Item#	Each
Safety Tape, 3/4" Green roll	816-0203	\$2.10
Safety Tape, 3/4" pkg. of 16 rolls	816-0202	32.50
Safety Tape, 1" Green roll	816-0199	3.05
Safety Tape, 1" pkg. of 12 rolls	816-0198	34.90

A



B. 3M® Vetrap™ Bandage Tape

This easy-to-use flexible tape wraps securely around fingers. Stays comfortable and cool, helping maintain your sense of touch. Available in four colors. Sold in 15'L x 2"W rolls.

Description	Item#	EACH Prices		
		1-4	5-17	18+
Blue Roll	816-0214	\$2.45	\$2.33	\$1.96
Green Roll	816-0215	2.45	2.33	1.96
Red Roll	816-0217	2.45	2.33	1.96
White Roll	816-0218	2.45	2.33	1.96

B

C. Leather Finger Cots – USA

Protect fingers during polishing operations. Made of soft leather for a comfortable fit. Available in three sizes: small/medium for ladies' fingers, medium/large for men's fingers and large for men's thumbs and large fingers. Also available with an elastic back for a secure fit on any finger size. Sold in multiples of 10 and money-saving boxes of 1,000.

Description	Dimensions (L x W)	Item#	EACH Prices		Item#	BOX of 1,000
			10-90	100+		
Small/Med. Cots	2 1/4" x 1"	816-0205	\$0.79	\$0.71	816-0206	\$615.00

 10-piece minimum; please order in multiples of 10.

Description	Dimensions (L x W)	Item#	EACH Prices		Item#	Box of 1,000
			1-99	100+		
Med./Large Cots	3" x 1 1/2"	816-0190	\$2.80	\$2.52	816-0195	\$2,187.50
Large Thumb Cots**	2 1/2" x 2"	816-0186	1.69	1.52	816-0187	1,312.50
Elastic-Back Cots	2 3/4" x 1 3/4"	816-0188	2.78	2.50	816-0189	1,950.00

**Slightly stiffer leather.



C



D

E

D-G Leather Finger and Thumb Guards

These thick guards offer greatest protection from compounds, abrasives and heat. Available in suede or grain (smoother surface) leather all with elastic cloth back for a comfortable fit. Thumb guard available in over end style. Finger guards available in open, super (open with more leather covering the side of the finger) and closed end styles.

Description	Style	Type	Item#	EACH Prices	
				 10-90	100+
D. Finger	Open	Suede	816-0201	\$0.88	\$0.79
E. Finger	Super	Suede	816-0200	1.29	1.16
F. Finger	Closed	Grain	816-0197	1.43	1.29
G. Thumb	Over End	Grain	816-0196	1.54	1.39

 10-piece minimum; please order in multiples of 10.



F

G

A. Rubber Finger Guards

Superior guards for sure grip and extra-long life. Ventilated for comfort. Protect fingers while polishing and handling workpieces. Sold by the dozen.

Description	Style	Item#	DOZEN Prices		
			1-5	6-11	12+
Small Guards	11	816-0220	\$8.45	\$7.61	\$7.18
Medium Guards	12	816-0225	8.45	7.61	7.18
Large Guards	13	816-0230	8.45	7.61	7.18
X-Large Guards	14	816-0235	8.45	7.61	7.18



A

B, C Latex Finger Cots

Powder-free, antistatic latex finger cots in white or pink for protection from mild chemicals. Available in small, medium and large. Sold by the gross or bulk pack of 1440pcs.

Description	WHITE Item#	GROSS Prices		PINK Item#	GROSS Prices	
		1-2	3+		1-2	3+
B. Small	816-0250	\$4.95	\$4.70	816-0255	\$5.25	\$4.99
Medium	816-0251	4.95	4.70	816-0256	5.25	4.99
Large	816-0252	4.95	4.70	816-0257	5.25	4.99

Description	WHITE Item#	Box of 1440	PINK Item#	BOX of 1440
Medium	816-0261	29.95	816-0266	31.45
Large	816-0262	29.95	816-0267	31.45



B



C

D. Orange Finger Cots

Premium finger cots feature a roughened surface that provides better gripping and anti-slipping. Durable to provide excellent finger protection. Prevents transfer of fingerprints, sweat and other contaminants to the work piece. The bright orange color makes for easy recognition on your bench. Offered in convenient 10 packs or bulk packs of 100.

Description	Item#	Package of 10		Item#	PKG. of 100
		1-2	3+		
D. Small	816-0270	\$4.50	\$4.28	816-0275	\$24.50
Medium	816-0271	4.50	4.28	816-0276	24.50
Large	816-0272	4.50	4.28	816-0277	24.50



D

E. PR-88 Hand Protectant

This glycerine-based compound prevents grease and grime from penetrating your skin. Apply before working to form an invisible shield that lasts for hours. Removes easily with soap and water.

Description	Item#	Each
3.5 oz. Tin	812-0490	\$7.95



E



A



B



C



D



F

E

A. MicroFlex® UltraSense™ Powder-Free Nitrile Glove The alternative to latex!

Powder-free UltraSense is a breakthrough in nitrile technology, providing the fit and feel of latex while eliminating the possibility of natural rubber latex allergic reaction. Provides reliable barrier protection against many hazardous and infectious substances. Highly elastic for easy conformance and reduced fatigue. Textured fingertips offer excellent grip in wet or dry conditions. Ambidextrous. Beaded cuff. Polymer-coated for easy donning. Length: 245mm (9 $\frac{5}{8}$ "). Thicknesses: 5.1mil finger, 3.5mil palm. Color: blue. Sold in dispenser box of 100.

Size	Item#	BOX of 100
Small	805-1072	\$24.75
Medium	805-1071	24.75
Large	805-1070	24.75

B. MicroFlex® NeoPro® EC Glove – Ideal for rhodium plating!

Exceptional comfort in a tough synthetic glove. NeoPro EC offers the barrier protection of a synthetic with the comfort, fit and feel of natural rubber latex. Offers 90% more puncture resistance than natural rubber latex. Resists a broad range of chemicals. Ideal for rhodium plating, electrocleaning and most other plating operations. Textured fingertips provide a secure grip. Extended, beaded cuff guards against splashes and spills. Made of polychloroprene, the generic name for neoprene. Ambidextrous. Powder-free and polymer-coated for easy donning. Length: 300mm (11.8"). Thicknesses: 8.3mil finger, 6.3mil palm, 4.7mil cuff. Color: green. Sold in dispenser box of 50.

Size	Item#	BOX of 50
Small	805-1052	\$26.75
Medium	805-1051	26.75
Large	805-1050	26.75

C. Latex Gloves

Disposable latex gloves for everyday use. Prevent skin problems that arise from chemical reactions caused by constant exposure to soaps, solvents and other mild chemicals. Powdered to go on and off easily. Available in small, medium and large sizes. Sold in boxes of 100.

Size	Item#	BOX of 100
Small	805-1043	\$14.95
Medium	805-1041	14.95
Large	805-1042	13.95

D. Heat-Resistant Gloves with Aluminized Back

Gloves are manufactured from 22 oz. basket-weave fiber blended with fiberglass. Aluminized back protects against radiant heat while wool lining protects against contact heat. Specially designed for better cooling, comfort and safety. Gloves have been used in temperatures up to 800°F for brief contact. Wide cuff openings allow gloves to be dropped with the flick of the wrist in case of excess heat buildup. Measure 14" long.

Description	Item#	Each
Heat-Resistant Gloves, pair	816-1020	\$53.95

E, F Heat-Resistant Gloves

For safe, easy handling of hot objects. Gloves are fully lined with black felt and manufactured from 22 oz. basket-weave fiber blended with fiberglass. Ideal for use in temperatures up to 1,000°F for brief contact. Extra-wide cuff openings allow gloves to be dropped with a flick of the wrist in case of molten splash or excess heat buildup.

Description	Item#	Each
E. 14" Gloves, pair	816-1015	\$41.95
F. 23" Gloves, pair	816-1016	76.50

A. Neoprene Apron

Heavy-duty double-coated yellow neoprene apron for broad-spectrum protection from a wide range of chemicals, including acids, caustics and solvents. Features extra-long neck and waist ties. Measures 35"W x 45"L. Weighs 12½ oz. Recyclable.

Description	Item#	Each
A. Neoprene Apron	827-1509	29.95

B. Bib Apron with Pockets

Protects clothing and holds most frequently used tools close at hand. Includes extra-long waist strings for front tying. Made of machine washable heavyweight cotton. Available with or without pockets. Comes in royal blue with our white, screen-printed Gesswein logo. Measures 18½"W x 25"L. Made in USA.

Description	Item#	Each
B. Bib Apron with pockets	827-1201	\$19.99
Bib Apron without pockets	827-1200	17.95

C. Suede Bib Apron

This durable, comfortable apron protects clothing while you work with power equipment and hand tools. Has no pockets in which debris can be trapped. Made of tanned, split, rust-colored heavyweight suede. Includes adjustable ties with brass grommet reinforcements. One size fits all. Measures 24"W x 36"L.

Description	Item#	Each
Suede Bib Apron	827-1507	\$32.00

D. Fire-Resistant Apron

Made of fire-resistant fabric ideal for welding applications. Features full-coverage design for protection of neck, chest and lap, small chest pocket, large waist pocket, bottom flap for catching runaway parts, comfortable neck band and extra-long waist strings for front tying. Comes in navy blue. One size fits all. Measures 27"W x 36"L.

Description	Item#	Each
Fire-Resistant Apron	827-1508	\$27.80

E. Lab Coat

Full-length coat with long sleeves, notched lapel, hemmed cuffs and bottom. Includes two breast pockets, two hip pockets and reinforced side slit for easy access to inside pocket. Made of permanent-press, washable polyester/cotton blend. Comes in white with royal blue embroidered Gesswein logo. Can be burned to reclaim precious metals. Made in USA.

Description	Fits Sizes	Item#	Each
Small Men's Coat	36-38	827-1500	\$58.50
E. Medium Men's Coat	40-44	827-1501	58.50

F. Klear-Vue Safety Shield

Sturdy, crystal-clear plastic shield almost ¾" thick. Protects you from flying debris while you work at the bench. Has cutouts for your wrists that allow you to hold your hands and tools at a normal working angle. More comfortable and convenient than a grinding box—use when gold containment is not a factor. Provides an extra barrier that protects face, neck and clothing from dust and dirt kicked up by abrasive wheels, polishing compounds and more. Does not eliminate the need for safety glasses. Measures 7"W x 6½"D x 9⅞"H.

Description	Item#	Each
Klear-Vue Safety Shield	857-1000	\$82.00



B



A



C



D



E



F



A. 3M™ Half-Facepiece Respirator

Protects you from dusts, mists and airborne contaminants. NIOSH rated N95 for protection from respirable silica (in investment, quartz, tripoli and more). Also suitable for rhodium plating. Features a soft, pliable silicone face seal for a secure, gapless fit on most every face shape. Extremely comfortable to wear, especially for extended periods of use. Roomy nose chamber and special 3M Cool Flow valve ensure easy natural breathing while reducing heat and condensation in the facepiece. Complete respirator includes facepiece, two deluxe cartridges, two deluxe prefilters and two retainer rings. NIOSH approved.

Description	Item#	Each
Half-Facepiece Respirator	805-1035	\$51.40
Replacement Deluxe Cartridges, pair	805-1036	15.80
Replacement Deluxe Prefilters, pair	805-1037	4.20
Replacement Retainer Rings, pair	805-1038	5.50



B-D 3M™ Disposable Particulate Respirators

Classic disposable N95 *particulate* respirator designed to help provide comfortable and protection against certain non-oil based particles. Features Advanced Electrostatic Media, welded strap attachment, soft nose foam, and an adjustable noseclip to help ensure a custom and secure seal.

Disposable N95 *particulate flatfold* respirator features soft inner material and 3M™ Cool Flow™ Valve to provide comfortable, reliable respiratory protection. Ideally suited for work situations involving heat, humidity, or long periods of wear.

Economical N95 disposable *particulate welding* respirator provides respiratory protection for applications where metal fumes may be present. Features 3M™ Cool Flow™ Valve, braided headband and adjustable M-noseclip providing a custom and secure seal, an economical option for welders.

Description	Item#	CASE Prices	
		1-2	3+
B. Particulate, 20 per case	805-0995	\$19.60	\$18.62
C. Particulate Flatfold, 10 per case	805-0997	22.20	21.09
D. Particulate Welding, 10 per case	805-0999	32.75	31.11

B

C

D



E. Disposable Face Mask with Anti-fog Shield

Protect against airborne particles, mists and fluid splashes with our disposable face mask. Inner and outer facings offer a soft protection barrier while assuring comfort and breathability.

Wraparound eye shield protects against particle. Full-width nose piece provides a custom fit. It is comfortable and fits a wide range of wearers. Lightweight, elastic earloop mask is easy to put on and remove. Filters particulate matter at 99% efficiency

Description	Item#	Each
Disposable Face Mask with Anti-fog Shield, pkg. of 25	805-0998	\$19.95

E



F. Corded Earplugs

These soft foam tapered plugs fit easily and securely in the ear. Made of hypoallergenic material. Have noise reduction rating of 29 dB when used as directed. Connected by a braided plastic cord that prevents loss. Easy to carry and handy to have for visitors who might be exposed to loud noise. Sold in packages of 10 pairs and boxes of 100 pairs (each pair is individually packaged for cleanliness).

Description	Item#	Each
Corded Earplugs, pkg. of 10 pairs	805-1061	\$3.15
Corded Earplugs, box of 100 pairs	805-1060	31.80

F



A. Face Shield – Complete protection with excellent optics.

Lightweight plastic shield for full face and neck protection while grinding, drilling or polishing. Can be worn over dust masks, respirators and glasses. Features pivoting visor for easy raising and lowering, molded visor edge for reinforcement, cushioned vinyl comfort band and adjustable headbands. Visor measures 8"L x 12"W x .040" thick. Does not eliminate need for safety glasses.

Description	Item#	Each
A. Face Shield	270-0210	\$21.00
Replacement Visor	270-0212	6.95
Replacement Vinyl Sweatband	270-0214	3.50



A

B. Safety Glasses

Comfortable, lightweight safety glasses with high-impact plastic lenses for full eye protection when drilling, polishing and more. One size fits all. Meet ANSI Z87.1 requirements.

Description	Item#	Each
Safety Glasses	270-0205	\$4.30



B

C. Aspen Safety Glasses

Our Aspen Safety Glasses provide eye protection against most common eye hazards of polishing and benchwork except for severe impacts. Feature polycarbonate lenses, browbar and side shields. Also offer UV protection. Meet ANSI Z87.1 requirements.

Description	Frame	Item#	Each
Aspen Safety Glasses	Clear plastic	270-0123	\$11.15



C

D. Panaspec Plus Safety Glasses

Feature impact-resistant clear polycarbonate lenses in polycarbonate frames that provide eye protection against most common eye hazards of benchwork, polishing and more. Side panels and browbar help provide protection from the side and from above the eye. Meet ANSI Z87.1 requirements.

Description	Item#	Each
D. Panaspec Plus Safety Glasses	270-0102	7.25
Replacement Lens (clear)	270-0112	3.60



D

E. Safety Goggles

A must for polishing, buffing and grinding. Comfortable and lightweight, they easily fit over glasses. Have polycarbonate lens. The sides and top are perforated to reduce fogging. One size fits all. Meet ANSI Z87.1 requirements.

Description	Item#	EACH Prices	
		1-2	3+
Safety Goggles	270-0200	\$9.50	\$9.03



E

F. Bausch & Lomb® Eye Wash

This eye irrigating solution flushes away foreign particles, chlorine and other eye irritants. Gently cleanses and soothes irritated eyes. Keep on hand for eye emergencies. Includes sterile eye wash cup. Sold in 4 oz. dropper bottles.

Description	Item#	Each
Eye Wash	272-1002	\$5.99



F



A



B

See page 478 for more Sandblasting Medias.



C



A. Benchtop Sandblaster – Dual Entry

Compact unit with solid molded construction for eliminating annoying leaks, large viewing glass, adjustable pressure regulator and self-cleaning nozzle with replaceable orifice. Has left-hand and right-hand heavy-duty rubber gloves and foot pedal blast control. It sits comfortably atop the workbench and can be easily moved when not in use. Holds and recirculates coarse or fine media, including matte sand, crushed ruby or glass beads (see p. 478). Includes two replacement ceramic orifices, internal light bulb and 5 lbs. Quartz abrasive.

Specifications:

Media Capacity: 5 lbs.
 Air requirement: 25–100 PSI at 2.4 CFM
 Dimensions: 11½"W x 12"D x 18"H
 Ship. Wt.: 18 lbs.

Description	Electrical	Item#	Each
A. Dual Sandblaster	110V, 50/60Hz	854-0060	\$560.00
	220V, 50/60Hz	854-0065	\$75.00
Replacement Viewing Panel (no hardware)		854-0056	36.50
Replacement Nozzle Assembly Kit (two ceramic orifices and two setscrews)		854-0057	39.25
Replacement Gloves, pair		854-1278	11.75

B. Wide View Sandblaster – Dual Entry

This compact unit provides all the features you've wanted in a sandblaster: crystal-clear acrylic cabinet lets in plenty of light for easy viewing of work in progress; large lid opens wide to accommodate big pieces and is lined with replaceable Protective Shield to prevent frosting; pivoting nozzle adjusts to differently sized pieces; on/off switch located inside the cabinet offers quick flow control; rear-mounted air filter eliminates clump-causing moisture and includes a quick-disconnect fitting for your air hose; integral dust filter and lid gasket keep hazardous dust out of the workplace; and metal grate holds pieces above the abrasive media. Permits two-handed operation for easy working. Holds and recirculates coarse through fine media, including matte sand, crushed ruby or glass beads (see p. 478). Imported.

Specifications:

Media Capacity: 5 lbs.
 Air Requirement: 42–70 PSI
 Dimensions: 19"W x 17"D x 16"H
 Ship. Wt.: 19 lbs.

Description	Item#	Each
B. Wide View Sandblaster	854-0080	\$555.00
Replacement Protective Shield	854-0081	16.95
Replacement Gloves	854-0082	13.00

C. Crushed Ruby

Synthetic ruby crushed to a 212–300 micron range for imparting a unique matte finish with a subtle sparkle. Provides best results with 60–80 PSI of air pressure. Cannot be used with Microetcher due to micron size. Sold in 5 lb. package.

Description	Micron	Item#	Each
Crushed Ruby, 5 lbs.	212–300	854-1297	\$149.00

A, B Power Sandblaster #20

Our heavy-duty Power Sandblaster #20 features 6 CFM gun for fast, powerful blasting and large front-opening door and work chamber for accommodating large or multiple parts. Holds and recirculates 20 lbs. of abrasive media sold separately (see p. 478). Removes fine dust particles via a built-in dust collector with easily replaceable filter for safe, efficient, clean operation. Requires 1 1/2 HP air compressor.

Can be mounted on a bench or an optional stand at a comfortable working height. Accepts optional pencil gun attachment with 1/16" orifice and optional 12 CFM gun jet for double the blasting power (requires 3 HP air compressor). Made in USA.

Features:



- 14-gauge welded steel construction
- Heavyweight rubber gloves
- Dust collection system
- Fluorescent light
- Double-laminated safety viewing glass
- 6 CFM tungsten carbide nozzle and jet
- Trapdoor for easy media change
- Pressure regulator and gauge
- Safety foot valve blasting control

Specifications:

Airflow: 6 CFM (12 CFM with optional gun jet)

Dimensions:

Overall: 21"W x 18½"D x 38½"H
 Inside: 20"W x 18"D x 18"H
 Door Opening: 20"W x 15"H
 Viewing Glass: 18"W x 10"H
 Dust Collector: 15" dia. x 24"H
 Ship. Wt.: 165 lbs.

Description	Electrical	Item#	Each
A. Sandblaster #20 	115V, 1 Ph, 60Hz	854-0015	\$740.00
	230V, 1 Ph, 50/60Hz	854-0016	1,250.00
B. Optional Stand with Swing-Out Shelf 		854-0025	225.00
Optional Pencil Gun Attachment		854-0035	195.00
Optional 12 CFM Gun Jet		854-0034	18.75
Replacement 24" Gloves, pair		854-0040	36.00
Replacement Dust Filter		854-0036	18.00
Replacement Viewing Glass Shields, pkg. of 10		854-0038	6.50

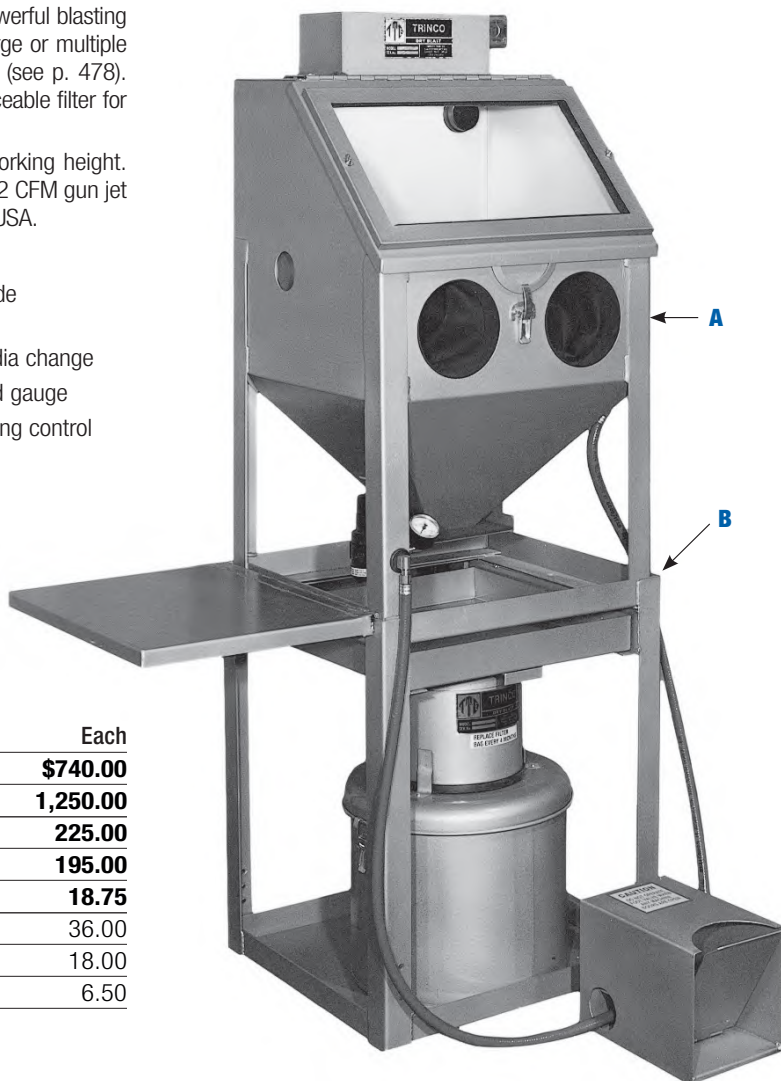

C. Microetcher™ Model E

A reliable, precise miniature tool designed for jewelers. Small in size yet powerful enough for devesting castings, removing oxides, etching, texturing, preparing surfaces for soldering, creating matte surface finishes and detailing, especially in tight areas. Features a 1/2" diameter handpiece with tungsten carbide tip, extra-flexible 6' air line and sensitive finger control valve for precise on/off action. Use a Prefilter/Coalescing Filter #850-7353 (see p. 248) for your compressed air line to prevent moisture from entering the media reservoir and clogging the sandblaster. Recommended for use with Aluminum Oxide #854-1294, Jet Brite Glass Beads #810-1200 or Glass Beads #854-1291 (see p. 478). Requires 60–100 PSI air supply.

Includes:

- Handpiece with replaceable 0.048" carbide tip
- Push-button finger control valve
- Abrasive reservoir with two quick-switch interchangeable jars for rapid media change.
- 6' flexible air line with fittings

Description	Item#	Each
Microetcher Model E	854-1283	Call for Pricing



Sandblasting Medias

Sandblasting abrasive medias have many different applications, including cleaning, peening metal, removing investment from cast parts, removing imperfections, blending surfaces, deburring, finishing, decorating and descaling. Work is cleaned, deburred, decorated and cold-worked without etching, removing surface details or leaving undesirable residues.



A

A. Aluminum Oxide

Aluminum oxide, 90 micron, tan in color. Allows rapid removal of oxides, scales, cements, resins and investment. Excellent for soldering and preparing metallic surfaces for bonding. Can be used in any sandblaster. Sold in 1 lb. package.

Description	Micron	Item#	EACH Prices	
			1-4	5+
Aluminum Oxide, 1 lb.	90	854-1294	\$21.30	\$18.11



B



B. Matte Sand

Graded aluminum oxide in a 300–350 micron range for imparting a beautiful matte finish coarser than glass beads and slightly finer than crushed ruby. Produces a finish similar to the traditional quartz abrasive but contains no silica. Yields best results with 50–80 PSI of air pressure. Cannot be used with Microetcher due to micron size. Sold in 5 lb. package.

Description	Micron	Item#	EACH Prices	
			1-4	5+
Matte Sand, 5 lbs.	300–350	854-1298	\$42.50	\$40.38



C



C. Crushed Ruby

Synthetic ruby crushed to a 212–300 micron range for imparting a unique matte finish with a subtle sparkle. Provides best results with 60–80 PSI of air pressure. Cannot be used with Microetcher due to micron size. Sold in 5 lb. package.

Description	Micron	Item#	Each
Crushed Ruby, 5 lbs.	212–300	854-1297	\$149.00



D



D. Jet Brite Glass Beads

Glass beads in the 50–105 micron range coated with silicone to repel moisture. Stay separated to prevent clogging of sandblaster. Impart an attractive satin-blasted finish. Can be used with any sandblaster. Air pressure must be kept under 45 lbs. to obtain best results and prevent beads from shattering. Sold in 5 lb. package.

Description	Micron	Item#	EACH Prices	
			1-4	5+
Jet Brite Glass Beads, 5 lbs.	50–105	810-1200	\$34.00	\$32.30



E



E. Glass Beads

Glass beads, 100 micron. Actual round beads, not cupels (oval-shaped beads with seams that crack easily), so they cost less in the long run. Impart an attractive satin-blasted finish. Can be used with any sandblaster. Air pressure must be kept under 45 lbs. to obtain best results and prevent beads from shattering. Sold in 5 and 25 lb. packages.

Description	Micron	Item#	Each
Glass Beads, 5 lbs.	100	854-1291	\$18.50
Glass Beads, 25 lbs.	100	854-1292	69.95

A. SilentAire Compressor – Quiet yet powerful!

The **Val-Air** is a premium value model with cast aluminum lid with cooling fins for improved ventilation and Filter-Regulator with auto-drain feature and condensate bottle. With a coalescent filter to 0.01 micron.

Sil-Air is the same without the aluminum lid with cooling fins or coalescent filter.

Both versions feature powerful 1/2 HP motors which provide over 2 CFM of air. They can handle up to 10 large Wax Injectors and are fully automatic. Both make about as much noise as a refrigerator, so you can work without distraction. Both measure 14" dia. x 22"H. Weigh 58 lbs. May require additional filter at the air tool to eliminate condensation that can form in very long airlines. Accepts 1/4" male fittings. 220V units also available. See website for details. Made in Italy.

Features:

- Tank and line pressure gauge
- Line pressure regulator
- Moisture trap and filter
- Safety valve
- Air-intake filter

Specifications:

Motor	1/2 HP
Max. Pressure	114 PSI
Tank Capacity	4 gals.
Displacement	2.15 CFM
Noise Level	40 dB

Description	FOB	Electrical	Item#	Each
A. SilentAire Val-Air Compressor	CT	110V	265-3100	\$1,245.00
SilentAire Val-Air Compressor	TX	110V	265-3101	1,225.00
SilentAire Sil-Air Compressor	TX	110V	265-3095	1,045.00
SilentAire Sil-Air Compressor	CT	110V	265-3094	1,065.00
Replacement Oil, 22 oz.			265-3103	27.00



A

B. Oil-Free Air Compressor – Ultra Quiet & Oil-Free Air Compressor

Engineered and built with the latest technology to provide high quality clean air. The Oil-Free Dual Piston Pump System allows the air compressor to work more efficiently, creating less noise and less wear for a longer pump life. Made in China.

Features:

- Oil-less operation, virtually maintenance free!
- Dual Piston Pump System

Specifications:

Motor:	3/4 HP	Tank Capacity:	6 gals.
Noise level:	52 decibels	Dimensions:	16" dia. x 21H"
Max. Pressure:	116 PSI / 8 bar	Displacement:	4.2 CFM
Airflow:	118 liters per minute		

Description	Electrical	Item#	Each
B. Oil-Free Air Compressor	110V, 600 watts	265-3120	\$625.00
Oil-Free Air Compressor, Drop Ship	110V, 600 watts	265-3122	595.00



B

C. California Air Tools 4610AC – Ultra Quiet & Oil-Free Air Compressor

Ultra-quiet, (60 dB) oil-free and lightweight. Designed to increase duty cycle and allow for longer continuous run times. Powerful 1.0 HP motor is engineered to dissipate heat, allowing for a cooler operation while reducing wear. The motor operators at only 1680 RPM creating less noise and less wear. The Oil-Free Dual Piston Pump System is engineered for high performance and durability. Made in China.

Features:

- Two pressure control gauges
- Comes complete with Air Filter
- Two universal 1/4" quick connectors
- Thermal Overload Protector
- Time to fill tank - 130 Seconds. Recovery time from 90 PSI to 120 PSI - 30 Seconds

Specifications:

Motor:	1 HP	Noise level:	60 decibels
Max. Pressure:	120 PSI	Dimensions:	19 1/8"L x 16 3/4"W x 19 3/4"H
Tank Capacity:	4.6 gals. (Aluminum Tank)		

Description	Electrical	Item#	Each
C. California Air Tools 4610AC	110V/60Hz	265-3125	\$325.00
California Air Tools 4610AC,	220V/60Hz	265-3126	340.00



C

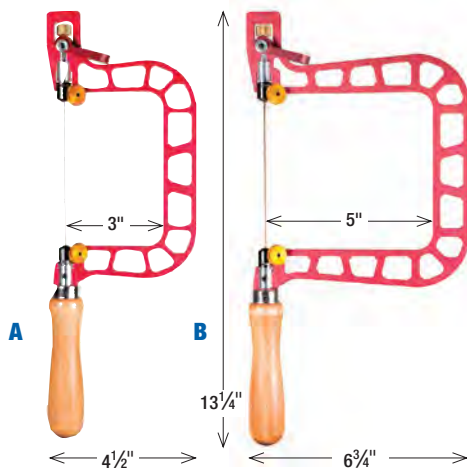

A, B Knew Concepts Precision Saw Frames

Cam Lever Tension

New and improved saws from Knew Concepts. Designed for rapid, repetitive blade changes, when piercing for example. The tension does not change when re-setting the blade. Simply flip the cam lever forward to release tension, re-position and clamp the blade, and flip the lever to the rear, and you are sawing at proper tension.

Knew Concepts Saws are designed for maximum rigidity to eliminate or minimize blade breakage. Frames are made of heat treated aluminum with cutouts to further reduce the weight making these the lightest and most comfortable saw frames in the industry.

The unique blade-tensioning system makes mounting the sawblade extremely fast and easy (and without the usual dents in your sternum).

Clinical trials have shown that the color red promotes accuracy so Knew Concepts has chosen this color for their saw frames. Available in 2 depths, 3" and 5". Both frames accommodate standard 5¹/₈" jeweler's sawblades.

Description	Item#	Each
A. 3" Saw with Cam Lever	812-1297	\$66.95
B. 5" Saw with Cam Lever	812-1298	70.95

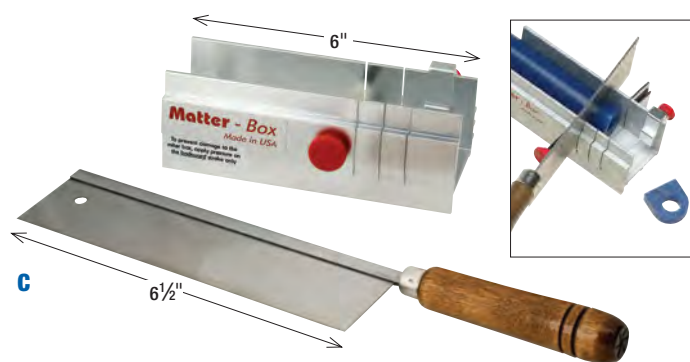

C. Matt™ Miter Box and Saw Set

Includes extruded aluminum miter box with stop-lock and steel back saw. Slices wax bars, rods and ring tubes into tablets with perfectly straight and parallel walls or tapered sides. Miter box holds the ring tube firmly in place to eliminate hand strain. Stop-lock lets you cut multiple tablets of the same thickness. Rugged steel sawblade cuts through tubes with very little effort, leaving a smooth finish. Miter box measures 6"L x 2"W. Sawblade measures 6¹/₂"L x 2"D.

Description	Item#	Each
C. Miter Box and Saw Set	265-2346	\$56.95
Replacement Sawblade	265-2348	17.00



D. Razor Saw

A must for cutting metal, wood and plastic rod and tubing. Features specially hardened, rigid thin blade with fine teeth (32 teeth per inch) ideal for making straight cuts. Lets you cut with light pressure to prevent tubing collapse. Measures 9¹/₈" overall length. Blade measures 4¹/₂"L x 7/16"D.

Description	Item#	Each
Razor Saw	812-1281	\$6.50



E. Gesswein® Lube-Stik

Use on grinding, cutting, drilling, piercing or similar tools to speed up production and increase tool life. Reduces friction and heat buildup so that tools stay sharper, work faster and cut smoother. Easy to use—just run your tools into the soft lubricant every so often. Can also be used to reduce the effort needed for drawing operations. Supplied in a handy push-up dispenser tube.

Description	Item#	EACH Prices	
		1-9	10+
Lube-Stik	816-2461	\$5.55	\$5.00

A. Jeweler's Sawframe – With end screw

Quality steel sawframe with end screw and comfortable wooden handle. Holds sawblades up to 6" long. End screw allows precise adjustment of blade tension. Imported.

Description	Depth	Item#	EACH Prices	
			1-2	3+
Small with End Screw	2 ⁷ / ₈ "	187-1026	\$10.95	\$9.86

B-D Flat Sawframes

Quality adjustable steel frames in four convenient sizes. Feature thumbscrews for quick tightening and loosening of sawblades and hardened steel plates with serrated surfaces for firmly holding sawblades up to 6" in length. Adjust to allow use of broken sawblades. Have comfortably shaped hardwood handles. Imported.

Description	Depth	Item#	EACH Prices	
			1-2	3+
B. Small Flat	2 ¹ / ₄ "	187-1159	\$6.50	\$5.85
Med. Flat	2 ⁷ / ₈ "	187-1160	8.45	7.61
C. Large Flat	3 ³ / ₄ "	187-1170	9.45	8.51
D. X-Large Flat	4 ³ / ₄ "	187-1171	11.15	10.04

E, F Swiss Sawframes

Spring steel frames with aluminum guide posts and guides, holes at both ends for quick blade insertion and perfect alignment every time. Feature easy-lock mechanism that prevents wobble, reducing blade breakage. Have ultra-lightweight rubber-coated sure-grip handles for easier cutting and reduced arm fatigue. Available fixed for standard 5¹/₄" jeweler's sawblades or adjustable for broken blades. Made in Switzerland.

Description	Depth	Item#	EACH Prices	
			1-2	3+
E. Adjustable Swiss	2 ³ / ₄ "	187-1120	\$17.80	\$15.66
F. Fixed Swiss	2 ³ / ₄ "	187-1122	17.85	15.71

G, H Apprentice's Sawframes

Beautiful chrome-plated sawframes priced low enough for students. Feature thumbscrews and slightly oversized polished wooden handles. Slightly more flexible for easier tightening of sawblades. Available in fixed style for holding standard-size blades and adjustable style for holding both standard-size and broken blades.

Description	Depth	Item#	EACH Prices	
			1-2	3+
G. Fixed Apprentice	3 ¹ / ₄ "	187-1180	\$5.80	\$5.22
H. Adjustable Apprentice	3 ¹ / ₄ "	187-1185	6.50	5.85



Sawblade Specifications

Blade Size	Blade Thickness	Blade Depth	Approx. Teeth per inch	Recommended for: (B&S) Gauge	Drill Size for Piercing	Blade Size	Blade Thickness	Blade Depth	Approx. Teeth per inch	Recommended for: (B&S) Gauge	Drill Size for Piercing
8/0	.0063"	.0126"	89	up to 26	80	1	.0118"	.0236"	51	18-20	71
7/0	.0067"	.0134"	86	24-26	80	2	.0134"	.0276"	46	16-18	70
6/0	.0071"	.0142"	81	24	79	3	.0142"	.0295"	41	16-18	68
5/0	.0079"	.0157"	76	22-24	78	4	.0150"	.0315"	38	16-18	67
4/0	.0087"	.0173"	71	22	77	5	.0157"	.0335"	36	16	65
3/0	.0094"	.0189"	66	22	76	6	.0173"	.0374"	33	14	58
2/0	.0102"	.0205"	61	20-22	75	7	.0189"	.0402"	30	12	57
0 (1/0)	.0110"	.0220"	56	18-22	73	8	.0197"	.0441"	28	12	55



A. Pike Platinum Jeweler's Sawblades

These blades are tougher and more durable than standard jeweler's sawblades. Made of steel which is specially treated for hard metals. Ideal for platinum because teeth stay sharper longer. Measure 5 1/4" (13cm) long. Made in Switzerland. Sold by the gross (144 each).

Size	Item#	GROSS Price			Size	Item#	GROSS Price		
		1-2	3-5	6+			1-2	3-5	6+
4/0	187-0500	\$27.20	\$25.84	\$25.02	0 (1/0)	187-0503	\$24.65	\$23.42	\$22.68
3/0	187-0501	24.65	23.42	22.68	1	187-0504	24.65	23.42	22.68
2/0	187-0502	24.65	23.42	22.68	2	187-0505	24.65	23.42	22.68



B. Super Pike Sawblades

These quality Swiss blades stand out as the finest quality and stay sharper far longer (sharper teeth) than competitive saw blades. Manufactured slightly differently with an added heat treatment process which makes these blades harder and quite flexible, but not more fragile thus allowing you to saw harder materials. These blades are also given a thin coating that acts like a cutting lubricant making them cut with less resistance. Made in Switzerland. Sold by the gross (144 each).

Size	Item#	GROSS Price			Size	Item#	GROSS Price		
		1-2	3-5	6+			1-2	3-5	6+
8/0	186-1500	\$29.95	\$28.45	\$26.96	0 (1/0)	186-1507	\$21.95	\$20.85	\$19.76
7/0	186-1501	29.95	28.45	26.96	1	186-1508	21.95	20.85	19.76
6/0	186-1502	26.95	25.60	24.26	2	186-1509	21.95	20.85	19.76
5/0	186-1503	25.95	24.65	23.36	3	186-1510	21.95	20.85	19.76
4/0	186-1504	22.95	21.80	20.66	4	186-1511	21.95	20.85	19.76
3/0	186-1505	21.95	20.85	19.76	5	186-1512	22.95	21.80	20.66
2/0	186-1506	21.95	20.85	19.76	6	186-1513	29.95	28.45	26.96
					8	186-1515	29.95	28.45	26.96



C. Skip-Tooth Sawblade

Designed for smooth wax cutting. Teeth are widely spaced to prevent clogging. Measures 13cm (5 1/4") long. Sold by the dozen (12 each).

Description	Item#	DOZEN Prices	
		1-2	3+
Skip-Tooth Sawblade	186-9060	\$4.20	\$3.36



D. Spiral Sawblade

For cutting hard wax models. Teeth are spaced to prevent clogging. Circular design permits cutting in all directions. Measures 13cm (5 1/4") long. Sold by the dozen (12 each).

Description	Item#	DOZEN Prices	
		1-2	3+
Spiral Sawblade	186-9050	\$4.45	\$3.56



E. Diamond Sawblades

Consist of piano wire electroplated with diamond particles. Make quick work of sawing glass, ceramic and stones. Available in four grits. Fit standard jeweler's sawframes. Measure 5 3/8" long. Plated portion measures approx. 3" long. Sold individually.

Grit	Approx. Diameter	Item#	EACH Prices	
			1-2	3+
60 Coarse	0.058"	226-1500	\$8.95	\$8.06
100 Medium-Coarse	0.048"	226-1505	8.95	8.06
120 Medium	0.045"	226-1510	8.95	8.06
140 Medium-Fine	0.043"	226-1515	8.95	8.06

A. Herkules® “White Label” Piercing Sawblades

High-quality sawblades made of a special alloy steel. Feature teeth that are uniform in size, shape and sharpness for fast, easy cutting. Can be used on both hand- and power-driven tools that have a blade clamping device. Measure 13cm (5¼") long. Made in Germany. Sold by the dozen (12 each) or the gross (144 each).

Size	Item#	Dozen	Size	Item#	GROSS Prices		
					1-2	3-5	6+
8/0	185-0080	\$4.60	8/0	186-0080	\$31.50	\$29.93	\$27.41
7/0	185-0070	4.35	7/0	186-0070	29.50	28.03	25.67
6/0	185-0060	4.20	6/0	186-0060	26.90	25.56	23.40
5/0	185-0050	3.90	5/0	186-0050	25.90	24.61	22.53
4/0	185-0040	3.60	4/0	186-0040	22.90	21.76	19.92
3/0	185-0030	3.35	3/0	186-0030	21.25	20.19	18.49
2/0	185-0020	3.35	2/0	186-0020	21.25	20.19	18.49
0 (1/0)	185-0010	3.35	0 (1/0)	186-0010	21.25	20.19	18.49
1	185-0100	3.35	1	186-0100	21.25	20.19	18.49
2	185-0200	3.35	2	186-0200	21.25	20.19	18.49
3	185-0300	3.35	3	186-0300	21.25	20.19	18.49
4	185-0400	3.35	4	186-0400	21.25	20.19	18.49
5	185-0500	3.35	5	186-0500	22.90	21.76	19.92
6	185-0600	3.35	6	186-0600	25.90	24.61	22.53
7	185-0700	4.50	7	186-0700	26.90	25.56	23.40
8	185-0800	4.90	8	186-0800	29.50	28.03	25.67
10	185-1000	5.25	10	186-1000	41.95	39.85	36.50
12	185-1200	5.95	12	186-1200	49.30	46.84	42.89
14	185-1400	6.95	14	186-1400	55.50	52.73	48.29



A

B. SUPRA® Golden Piercing Sawblades – The world’s finest sawblades at great prices!

Extremely flexible straw-colored sawblades made of the finest steel using the latest technology. Cut straight and stay sharp. Can be used on both hand- and power-driven tools that have a blade clamping device. Measure 13cm (5¼") long. Made in Germany. Sold by the gross (144 each).

Size	Item#	GROSS Prices			Size	Item#	GROSS Prices		
		1-2	3-5	6+			1-2	3-5	6+
6/0	187-0060	\$26.90	\$24.21	\$21.52	0 (1/0)	187-0010	\$21.25	\$19.13	\$17.00
5/0	187-0050	25.90	23.31	20.72	1	187-0100	19.50	17.55	15.60
4/0	187-0040	23.25	20.93	18.60	2	187-0200	19.50	17.55	15.60
3/0	187-0030	21.25	19.13	17.00	3	187-0300	19.50	17.55	15.60
2/0	187-0020	21.25	19.13	17.00					



B

C. Super Q Sawblades

Super Q Saw Blades feature the “5 S” technology... SUPER Flexible, SUPER Precision, SUPER Quality, SUPER Alloy and SUPER Sharpness! Measure 13cm (5¼") long. Made In Germany. Sold by the gross (144 each).

Size	Item#	GROSS Prices			Size	Item#	GROSS Prices		
		1-2	3-5	6+			1-2	3-5	6+
8/0	187-1500	\$32.95	\$31.30	\$29.66	1	187-1508	\$23.95	\$22.75	\$21.56
7/0	187-1501	32.95	31.30	29.66	2	187-1509	23.95	22.75	21.56
6/0	187-1502	29.95	28.45	26.96	3	187-1510	23.95	22.75	21.56
5/0	187-1503	28.95	27.50	26.06	4	187-1511	23.95	22.75	21.56
4/0	187-1504	24.95	23.70	22.46	5	187-1512	25.95	24.65	23.36
3/0	187-1505	23.95	22.75	21.56	6	187-1513	26.95	25.60	24.26
2/0	187-1506	23.95	22.75	21.56	7	187-1514	28.95	27.50	26.06
0 (1/0)	187-1507	23.95	22.75	21.56	8	187-1515	32.95	31.30	29.66

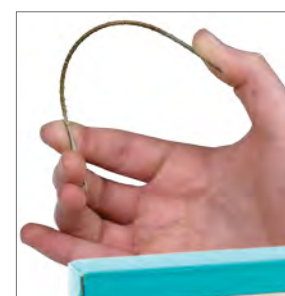

C



A. Pneumatic Stone Setting Machine – The unit of choice for setting diamonds, colored stones and even synthetics with impressive speed and precision.

Available as a table top unit, this machine is a must for all jewelry manufacturers. Represents a big leap forward in stone setting technology letting you quickly and easily tube set, burnish, bezel and bead set both flat and curved surfaces, as well as channel set in single and double rows. Simplifies many complicated procedures, taking the guesswork out of difficult jobs. Offers the precise control you need each and every time to set stones perfectly.

Comes with appropriate holders for both ring and flat items. The Table Top model includes two rollers and two punches for setting round stones. Sizes 1.75, 2.00, 2.25, 2.50, 2.75 and 3.00mm are available standard diameters but other sizes are also available. Please discuss your requirements when placing your order.

Features:

- Easy to learn and operate, even for novices—requires no special stone setting experience.
- Lets you set stones quickly and consistently, making it perfect for high-volume production.
- Eliminates the need for time-consuming manual setting.
- Has precision-machined tooling for easy changing.

Specifications:

Electrical: 220V, 1 Ph, 100W, 50/60Hz
 Dimensions: 15³/₄"W x 9"D x 23⁵/₈"H
 Air Requirement: 90 PSI
 Pressure Readout: Analog
 Net Wt./Ship. Wt.: 115 lbs./132 lbs.
 Item# **265-0348** 

Please Call for Pricing

A



B. Premium Loose Stone Detector – Identify loose stones quickly and definitively.

Efficiently isolate stones that are loose from those that are not. Invaluable for checking settings after ring sizing. Works especially well for clusters of many small stones, such as pavé settings. Saves time over traditional methods.

Easy to use: slide your ring onto the padded mandrel, turn on unit and experiment with different vibration frequency and power settings until you are positively satisfied that every setting is sound. Includes a magnifier with flexible stand for taking a good, close look at potential problem areas as the detector vibrates. Combine that with your own light source, and no loose stone will escape your attention (see lighting pp. 335-339).

Compact enough (13"W x 9"D x 7¹/₄"H) to store out of the way. Finished in matte black to eliminate most distracting reflections. Electrical: 110~240V, 50/60Hz. Weighs 22 lbs.

Description	Item#	Each
Premium Loose Stone Detector	857-0030	\$3,995.00

B



C, D Marathon Micromotor Systems for Setters

Available as a complete set with the Marathon Controller, 35,000rpm Rotary Handpiece, Freedom Hammer Handpiece and On/Off Rheostat or simply the Marathon Controller with the Freedom Hammer Handpiece only.

The Marathon Micromotor Controller features dial adjustable speed control, overload cutoff switch, forward/reverse switch, and accepts a variable speed foot rheostat and a wide variety of micromotor handpieces. Electrical: 110~220V, 50/60Hz. Output voltage: 0~30V DC (continuously variable). Measures 4¹/₂"W x 5³/₄"D x 3³/₄"H. Weighs 2.6 lbs.

The 35,000rpm Rotary Handpiece features a well-balanced ergonomic design that fits in your hand like a pen, convenient quick-tool-change mechanism and flexible phone-type cord. Measures 6"L x 1" to 5/8" dia. Weighs 7.5 oz.

The Freedom Hammer Handpiece is perfect for stone setting - prong work and channel. Also used for texturing and for engraving using the included graver holding attachment. Three anvils with threaded shanks, wrench, tightening pins and an adapter for non threaded anvils, motor brushes and a handpiece tray included. 2 year warranty.

Description	Item#	Each
C. Marathon Controller, Rotary Handpiece with 3/32" Collet, On/Off Rheostat, Freedom Hammer Handpiece	510-2930	\$849.00
D. Marathon Controller, Freedom Hammer Handpiece (no Rheostat)	510-2935	675.00
Optional Variable Speed Rheostat for Marathon	510-2940	60.00
Freedom Hammer Handpiece	510-1280	595.00

C

D



ST-60
B

Micro Polishing
Solutions

A, B SonoCraft Burnishers – Ultrasonic Porosity Removers

SonoCraft units were designed especially for professional jewelers to remove porosity and other surface imperfections quickly and easily. But they are also amazing surface finishers with excellent reach into the tiniest areas: polishing under cathedral settings and cleaning up half round rails. You can polish and burnish areas that are almost impossible to reach by hand which traditionally had to be done with a magnetic tumbler. Both units include power pack, lightweight handpiece, on/off foot switch, wrenches and instructions. Select between two powerful units:

The **ST-50** comes with one burnishing tip and works on softer metals such as gold and silver. It operates in a continuous mode with a constant fast impact governed by a Variable Rheostat dial. Used for burnishing and polishing.

Our **ST-60** includes five tips and works on the softer metals as well as hard metals such as platinum. A very versatile machine, the ST-60 has four ultrasonic modes:

Single Hit Mode: Tightens beads on to stones with minimal or no touch-up needed.

Intermittent Mode (Slow): Slowly repeating impacts for light engraving.

Intermittent Mode (Rapid): Rapidly repeating impacts for engraving.

Continuous Mode: Constant fast impact for burnishing and polishing.

Benefits:

- Advanced ultrasonic technology drastically reduces finishing time for increased productivity.
- Automatic frequency adjustment provides optimal efficiency for excellent finishing results.
- High output power handles all kinds of metals with ease.

Specifications:

	ST-50	ST-60
Works on	Gold, Silver (soft metals)	Gold, Silver, Platinum (hard metals)
Max. Power Output	30 Watts	40 Watts
Operating Frequency	24kHz	25kHz
Power Consumption	120VA	120VA
Output Adjustment	Continuously variable	Continuously variable
Handpiece Weight	7 oz. (without cord)	4.5 oz. (without cord)
Electrical	110V or 220V, 50/60Hz	110V or 220V, 50/60Hz
Power Pack Dimensions	6 ⁷ / ₈ " W x 6 ⁷ / ₈ " D x 3 ³ / ₁₆ " H	5 ³ / ₄ " W x 7 ¹ / ₄ " D x 5" H
Ship. Weight	5.4 lbs.	6.25 lbs.

Description	Item#	Each
A. SonoCraft III Ultrasonic ST-50, 110V	510-0880	\$1,990.00
SonoCraft III Ultrasonic ST-50, 220V	510-0881	1,990.00
B. SonoCraft Ultrasonic ST-60, 110V	510-0885	3,950.00
SonoCraft Ultrasonic ST-60, 220V	510-0886	3,950.00
Replacement Handpiece for ST-60	510-0884	1,715.00
ST-60 Tip, V-shape Chisel, 60°	510-0887	130.00
ST-60 V-shape chisel, 90°	510-0888	130.00
ST-60 Tip, Flat Graver	510-0889	93.00
ST-60 Tip, Round Graver	510-0890	125.00
ST-60 Tip, Burnishing Tool	510-0891	125.00
Replacement Handpiece for ST-50	510-0879	1,215.00
ST-50 Carbide Tip	510-0882	68.00

C. Setting Burnisher Set

Set of 18 setting closers, or burnishers, ranging in size from 1/2 point to 1.75 carats. For burnishing tubes over stones. Includes heavy-duty handle and attractive hardwood box. Made in Europe.

Description	Item#	Each
Setting Burnisher Set	811-2165	\$159.00

Both units includes power pack, lightweight handpiece, on/off foot switch, wrench and instructions. ST-50 includes Carbide Tip only. ST-60 includes all 5 tips.



5 tips included with the ST-60





A. Prong Opening Pliers

Open prongs without fracturing stones. Use grooved jaw to hold prong in place and angled jaw to slip under prong and raise it. Avoid putting pressure on top of stone to prevent marring and scratching. Feature box joint for stability, perfectly aligned tapered jaws, double leaf springs and cushion grips. Measure 4 1/2" long. Made in Germany.

Description	Jaw Length	Item#	EACH Prices	
			1-2	3+
Prong Opening	1 5/16"	180-0020	\$25.60	\$23.04

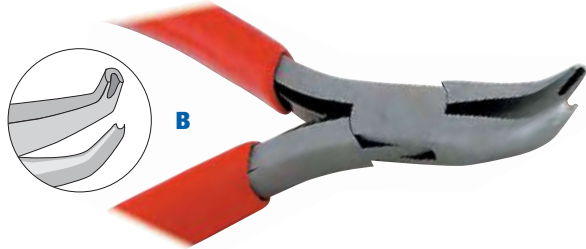

B. Prong Closing Pliers

Close prongs over stones without slipping. Use curved, tapered jaws with grooved tips to hold prong securely. Feature box joint for stability, perfectly aligned jaws, double leaf springs and cushion grips. Measure 4 1/2" long. Made in Germany.

Description	Jaw Length	Item#	EACH Prices	
			1-2	3+
Prong Closing	1 5/16"	180-0025	\$25.60	\$23.04

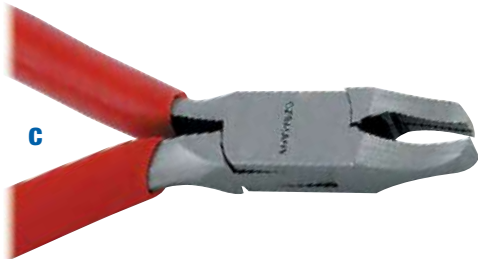

C, D Stone Setting Pliers

Ideal for tightening prongs. Feature box joints for stability. Available in deluxe and economy styles. Measure 4 3/4" long.

Description	Item#	EACH Prices	
		1-2	3+
C. Deluxe German	181-2900	\$37.95	\$36.05
D. Economy Imported	181-2950	12.95	-



E. Prong Pusher

Steel tool with flat end for pushing crown points or prongs onto stone. Also for forcing bezel around stones. Mounted in wooden handle. Measures approximately 3 1/2" long.

Description	Item#	EACH Prices	
		1-2	3+
Prong Pusher	816-0100	\$2.75	\$2.48



F. Bezel Pusher

For pushing and rolling bezel around stone. Polished and grooved tip. Measures approximately 3 1/2" long. Made in USA.

Description	Item#	Each
Bezel Pusher	816-0110	\$12.65



G. Precision Prong Lifter

This highly tempered prong lifter provides easy access to small prongs. Measures only 4"L x 0.079" (2mm) thick, so it's easy to maneuver in even the tiniest settings. Durable and precise. Made in USA.

Description	Item#	Each
Precision Prong Lifter	816-0092	\$12.95



H. Bezel Roller

Has a half-round, highly polished steel head for rolling bezels around stones in rings, pendants and broaches. Measures approximately 4" long.

Description	Item#	EACH Prices	
		1-2	3+
Bezel Roller	816-0120	\$3.25	\$2.93



A. Foredom LX Deluxe Stone Setting Set

Contains just about everything you need to get to work—motor, rheostat, 2 handpieces and accessories. With a total Retail Value of \$554.00, this convenience is also a smart, economical decision. Motor and Rheostat carry a 2 Year Warranty.

Components:

Series LX Motor - This permanent magnet motor is specifically designed for high torque/low speed applications, offering more power for jobs like stone setting, wax modeling, and pearl drilling. Feature full power and torque from start up and throughout the entire speed range up to 5,000rpm. Comes equipped with a motor bale for hanging, and a standard 39" long key tip inner shaft and special/more flexible neoprene outer protective sheath.

TXR Rheostat - The TXR looks the same as our standard foot operated rheostat but it has special electronics that converts AC current from an electrical outlet to DC current, the type required by Series LX and TX motors. Features solid state circuitry in a heavy duty plastic housing with an extra wide footprint, low profile, and non-skid pads on the bottom. Measures 7" long, 4½" wide, 2⅜" high.

#18 Quik Change™ Handpiece - For use with only 2.35mm (⅜") shank burs. A press lever action is all that is required to change accessories. It features a very slim grip and pre-lubricated ball bearings that do not require any lubrication. Measures 7" long, 1⅞" dia. Weighs: 3.65 oz.

#15 Hammer Handpiece - Reciprocating action for use at low speed (0-5,000rpm) by jewelers for stone setting and decorative work. Comes with an anvil point. Requires periodic lubrication. Hammer has ⅜" stroke and its impact can be adjusted from light to heavy by turning the silver knurled adjusting ring. Optional points are available: 6 different shaped Anvil Points in our 850-3780 set.; Pave Point (850-1275), and Stylus with Carbide Tip (850-1274). Measures 6¼" long, ¼" dia. at tip. Weighs: 3.65 oz.

Set comes complete with a 13 piece assortment of step drills and steel engraving burs in small round bur holder and Flexible Shaft Grease.

Description	Item#	Each
Foredom LX Deluxe Stone Setting Set	850-1222	\$498.10

B. Gem Setting Graver Outfit

Includes six shaped gravers for setting diamonds and other stones in modern settings, six comfortably shaped wooden handles for working ease and a model plate that shows various steps needed for project completion.

Description	Item#	Each
Gem Setting Graver Outfit	166-8000	\$76.95

C. Round Tennis Bracelet Holder

This versatile bracelet holder saves time when setting stones. Eliminates messy shellac and firmly holds bracelets up to 7mm wide without marring or distorting. Lets you easily sets stones in prong, channel and pavé settings with the assurance that bracelets will always stay in place. Provides extra space for accommodating clasps. Made of sturdy aluminum. Hex wrench included. Measures 3½" diameter.

Description	Item#	Each
Round Tennis Bracelet Holder	840-4205	\$26.95

D. Setter's Tube Holder Set

Set of seven spring-tempered three-jaw collets with wooden handle. Holds tubes from ⅜" to ¼" in diameter while stone setting without causing them to collapse.

Description	Item#	Each
Setter's Tube Holder Set	840-4225	\$17.90

E. Claw Setting Jig

Easily makes small or large four-, six- and eight-prong claw settings for 0.15-2 carat stones. The base unit holds the chosen jig, and the length of wire used is based upon the size of the stone to be set—larger, deeper stones require longer wires. Filing and soldering can be done with the setting still on the jig.

Description	Item#	Each
Claw Setting Jig	816-1465	\$24.50



A



B



C



D



E

For GRS BenchMate
See page 572.



A



B



C



D



E

A. Busch Beading Tools

Simply the Best! Busch Beading tools form high-quality beads on prongs to create a precise finish to ensure that stones are held securely in place in their mountings. These superior tools from Busch are designed with filigreed beading edges to better protect gemstones and to deliver highly polished beads. The opening at the end of the tool, also known as the calotte, produces a highly polished, consistently round, perfect bead every time. Busch Beading Tools are also scored 10mm from the end of the tool so you can easily snap off the end thus allowing you to have a shorter tool should this be desired. Sold in packages of 10 or 100. Also available in convenient sets consisting of 1 each of the 6 smallest sizes or 1 each of the 6 largest sizes. Made in Germany.

Size	Item#	EACH Prices	
		10pc 1-4	5+
A. 03	810-1423	\$11.50	\$10.93
04	810-1424	11.50	10.93
05	810-1425	11.50	10.93
06	810-1426	11.50	10.93
07	810-1427	11.50	10.93
08	810-1428	11.50	10.93
09	810-1429	11.50	10.93
10	810-1430	11.50	10.93
11	810-1431	11.50	10.93
12	810-1432	11.50	10.93
13	810-1433	11.50	10.93
14	810-1434	11.50	10.93

Size	Item#	100pc	Each
03	810-1453		\$103.50
04	810-1454		103.50
05	810-1455		103.50
06	810-1456		103.50
07	810-1457		103.50
08	810-1458		103.50
09	810-1459		103.50
10	810-1460		103.50
11	810-1461		103.50
12	810-1462		103.50
13	810-1463		103.50
14	810-1464		103.50

Description	Item#	Each
B. Set of 6 Smallest (03-08) Sizes	810-1435	\$8.95
Set of 6 Largest (09-14) Sizes	810-1436	8.95

C-E Beading Tool Accessories

Hardened, tempered and polished steel plates for sharpening or reshaping worn beading tools. Half head wooden tool holder for comfort and control.

Description	Item#	Each
C. 12-Bead Plate	810-1450	\$27.50
D. 40-Bead Plate	810-1500	85.00
E. Beading Tool Holder	816-3096	2.25

A, B French Beading Tools

Used to form beads for holding diamonds, half-pearls and other stones in mountings. Have 2.6mm shanks.

Size	Item#	EACH Prices		
		3pc	3-9	12-141 144+
A. #2	810-1402	\$1.25	\$1.13	\$1.06
#4	810-1404	1.25	1.13	1.06
#6	810-1406	1.25	1.13	1.06
#7	810-1407	1.25	1.13	1.06
#9	810-1409	1.25	1.13	1.06
#10	810-1410	1.25	1.13	1.06
#11	810-1411	1.25	1.13	1.06
#12	810-1412	1.25	1.13	1.06
#13	810-1413	1.25	1.13	1.06
#14	810-1414	1.25	1.13	1.06
#16	810-1416	1.25	1.13	1.06
		EACH Prices		
Set with Wood Handle	Item#	1-2	3+	
B. 12-Piece Set (one each of above, plus #8)	810-1400	\$25.85	\$21.97	



C-E Swiss Beading Tools

Made of fine hardened tool steel with precise concave tips to form smooth beads and make well-defined, consistent size graduations. Have 2.6mm shanks. Measure 2 $\frac{3}{8}$ " long.

Size	Dia. (mm)	Item#	EACH Prices		Item#	Pkg. of 100
			3pc	3-9 12+		
C. #0	0.25	810-1252	\$1.15	\$0.86	810-1300	\$61.25
#1	0.30	810-1254	1.15	0.86	810-1301	61.25
#2	0.35	810-1256	1.15	0.86	810-1302	61.25
#3	0.40	810-1258	1.15	0.86	810-1303	61.25
#4	0.45	810-1260	1.15	0.86	810-1304	61.25
#5	0.50	810-1262	1.15	0.86	810-1305	61.25
#6	0.55	810-1264	1.15	0.86	810-1306	61.25
#7	0.60	810-1266	1.15	0.86	810-1307	61.25
#8	0.65	810-1268	1.15	0.86	810-1308	61.25
#9	0.70	810-1270	1.15	0.86	810-1309	61.25
#10	0.75	810-1272	1.15	0.86	810-1310	61.25
#11	0.80	810-1274	1.15	0.86	810-1311	61.25
#12	0.85	810-1276	1.15	0.86	810-1312	61.25
#13	0.90	810-1278	1.15	0.86	810-1313	61.25
#14	0.95	810-1280	1.15	0.86	810-1314	61.25
#15	1.00	810-1282	1.15	0.86	810-1315	61.25
#16	1.05	810-1284	1.15	0.86	810-1316	61.25
#17	1.10	810-1286	1.15	0.86	810-1317	61.25
#18	1.15	810-1288	1.15	0.86	810-1318	61.25
#19	1.20	810-1290	1.15	0.86	810-1319	61.25
#20	1.25	810-1292	1.15	0.86	810-1320	61.25
#21	1.30	810-1294	1.15	0.86	810-1321	61.25
#22	1.35	810-1296	1.15	0.86	810-1322	61.25
			EACH Prices			
Sets with Wood Handle		Item#	1-2	3+		
D. 12-Piece Set (sizes 5–16 listed above)		810-1250	\$20.80	\$17.68		
E. 23-Piece Set (one each of above)		810-1298	25.95	22.06		



3pc Three-piece minimum; please order in multiples of three.

Samples of patterns

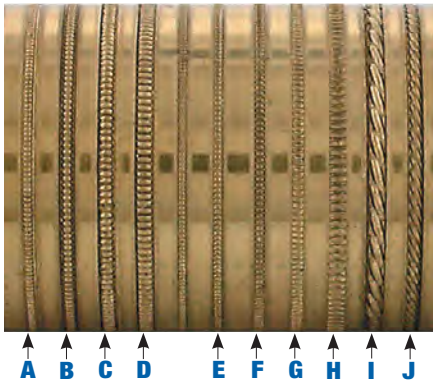

A-J Large Millgrain Wheels

Create decorative borders around edges of rings or bracelets. To use, mount ring on lathe, use turning tool to cut flat shoulder into each ring edge, and bring wheel onto shoulder. Wheels measure 6mm dia. on 1/8" sq. x 2 1/2"L steel shanks. Male wheels have raised beads.

Description	Approx. Design Width (mm)	Item#	Each
A. Female 8	0.65	820-5000	\$65.00
B. Female 10	0.85	820-5002	65.00
C. Female 12	1.05	820-5004	65.00
D. Female 14	1.20	820-5006	65.00
E. Male 8	0.65	820-5008	65.00
F. Male 10	0.85	820-5010	65.00
G. Male 12	1.05	820-5012	65.00
H. Male 14	1.20	820-5013	65.00
I. Rope 1 (medium)	1.25	820-5014	65.00
J. Rope 2 (small)	0.95	820-5016	65.00

For use with Millgrain Machine p. 494



Large Millgrain Wheel

For GRS Bench Mate Setting Packages see page 572.

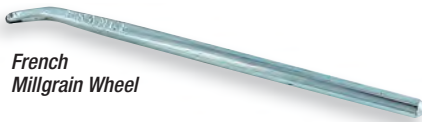

French Millgrain Wheel

K-L French Millgrain Wheels

Cup-shaped wheels with equally spaced depressions for making uniform beaded imprints on jewelry. Mounted on steel shafts. Can be used by hand or with GRS power engravers. Smallest is size 0.



K



L

Size	Depression	Shank	Item#	EACH Prices	
				1-9	10+
0	Oval	Square	820-6060	\$10.85	\$9.04
1	Oval	Square	820-6100	10.85	9.04
2	Oval	Square	820-6150	10.85	9.04
2	Oval	Round	820-6175	10.85	9.04
3	Oval	Square	820-6200	10.85	9.04
4	Oval	Square	820-6250	11.75	9.79
5	Oval	Square	820-6300	10.85	9.04
5R	Round	Square	820-6325	9.95	8.29
6	Oval	Square	820-6350*	9.95	8.29
6R	Round	Square	820-6375	10.85	9.04
7	Oval	Square	820-6400*	10.85	9.04
7R	Round	Square	820-6425	10.85	9.04
8	Oval	Square	820-6450*	11.75	9.79
8R	Round	Square	820-6455	10.85	9.04
9	Oval	Square	820-6500*	10.85	9.04
9	Oval	Round	820-6510	10.85	9.04
9R	Round	Square	820-6505	10.85	9.04
10	Oval	Square	820-6550*	11.75	9.79
10R	Round	Square	820-6551	10.85	9.04
11	Oval	Square	820-6552	10.85	9.04
11	Oval	Round	820-6570	10.85	9.04
11R	Round	Square	820-6555	10.85	9.04
12	Oval	Square	820-6650*	10.85	9.04
13	Oval	Square	820-6651	10.85	9.04
14	Oval	Square	820-6660	10.85	9.04
15	Oval	Square	820-6662	10.85	9.04
K. 7-Piece Set (asterisked wheels and holder #840-4350)			820-6655	79.95	-
L. Millgrain Wheel Holder			840-4350	9.90	-

A. Millrite Plus Millgrain Machine

The Millrite Plus Millgrain Machine cold forms designs on rings, even on angled or perpendicular surfaces, without removing any precious metal. This machine accepts both 1/8" square-shanked lathe millgrain tools and French millgrain tools. It also includes collets for ring sizes 2 - 13. The machine is quality crafted of aluminum alloy with spring action tool holders that ensure clean, crisp, even impressions. Includes 2 millgrain tools (F8 millgrain + 1 French millgrain wheel with holder) Size: 8" x 8" x 7". Weight: 26 lbs. Made in USA.

Description	Item#	Each
A. Millgrain Machine	820-6701	\$640.00
Replacement Collet Set, 10 pc.	820-6705	19.99



A

E. Bezel Block and Punch Sets

Each includes precision-machined block and punch. Used to punch and form bezels from flat stock. Made of hardened, tempered, polished steel. Made in Italy.

Description	Holes	Punch Angle	Item#	Each
E. Round Set	20 (5-20mm)	17°	815-2050	\$105.00
Round Set	20 (5-20mm)	28°	815-2055	105.00
Oval Set	11 (4-14mm)	17°	815-2060	179.00
Heart Set	11 (5-15mm)	17°	815-3000	349.00

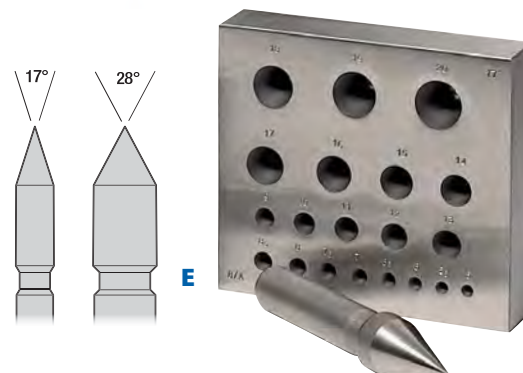

E

F. High-Speed 17° Bezel Cone Bur – 3/32" Shank

Use to drill an angled hole that matches the 17° angle on many settings, most notably bezel settings. Solves the problem of inserting a standard tapered prong or bezel setting into a standard shank.

Size	Dia. (mm)	Item#	EACH Prices	
			1-5	6+
30	8.00	123-2301	\$6.98	\$5.86



F

G. Earring Post Protectors

These silicone rubber sleeves protect ear posts when setting, tumbling or plating. Sold by the gross (144 each).

Description	Item#	GROSS Prices	
		1-49	50+
Earring Post Protectors	852-1155	\$8.10	\$6.08

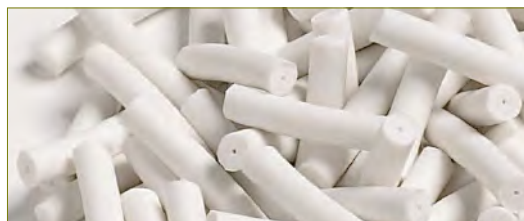

G

H, I Beeswax

A very pliable wax often used to pick up stones when setting. Also can be used as a lubricant for burs and saws and when wire drawing. Rubbed on a surface, beeswax leaves a film on which designs can be marked.

Description	Item#	Each
H. Beeswax, 2 oz. cake	816-2405	\$3.75
I. Beeswax, 1 oz. tube	816-2450	3.30
Beeswax, 1/2 lb. bar	816-2401	12.00



H

I

RinGenie - Engraving and Setting Tool

Right out of the box, the RinGenie has everything you need to make quick and easy work of layout, engraving, inlaying, stone setting, bright cutting, bead setting and any other task a jeweler or engraver may encounter. Unlike other engraver's blocks, its 360 degree rotating spindle makes it easy to move freely or at finely set intervals providing amazing versatility and unparalleled precision. Plus its numerous mounting options make it easy to approach your work at any angle. Hand and power engravers work equally well with the RinGenie.

No matter what your project demands, the RinGenie is engineered to boost speed and accuracy at every phase of the process.

Work faster, work smarter. Be more productive and more creative with the RinGenie.



RingGenie Deluxe Set Features/Benefits:

- Made of aircraft quality aluminum, hard coat anodized for wear resistance, with stainless steel spindles.
- Body measures 4¹/₁₆" wide; 5³/₈" wide including outside adjustment knobs.
- The RinGenie is a money making time saver.
- Layout with precision and speed.
- Accuracy in drilling and milling.
- Precise channel cutting.
- Fine incremental settings with 360 degree rotation.
- A perfect complement to hand or power engravers.
- Easy spindle locking thumb screw
- Use with metal or wax.
- Optional adapter for your BenchMate (see fig. B)
- Optional Side Helper for engraving/setting on sides of rings. (see fig. E)

Includes:

- Drill/Mill/Layout Assembly Tool
- Scriber Assembly
- ³/₃₂" Diameter Hardened Drill Bushing
- 1 Alignment Plate
- 2 Tightening Rods
- 1 Side Pointer
- 1 Drag Adjustment Screw
- 8 Plastic Collets in sizes 5, 6, 7, 8, 9, 10, 11 and 12
- 16 Aluminum Collets in sizes 5, 5.5, 6, 6.5, 7, 7.5, 8, 8.5, 9, 9.5, 10, 10.5, 11, 11.5, 12 and 12.5
- 1 Custom Fitted Wood Case
- Instructional DVD

RingGenie All-in-One Set

Includes everything in the Deluxe Set Plus:

- BenchMate Adapter
- Side Helper
- 3" Vise + Adapter
- Universal Adapter + Adapter Holder

"The RinGenie doesn't replace any human skills it only aids in helping take the ones that a craftsman has to a higher level by its user friendly way of helping to maneuver the piece one is working on."

Robert N. Vertel, owner of Dokan Jewelry Designs LLC, MI



A
Basic Set



B
Deluxe Set



C
All-in-One Set

View instructional video at www.gesswein.com.



E Side Helper



D BenchMate Adapter



F, G 3" Vise + Adapter



H, I Universal Adapter + Helper

Description	Item#	Each
A. RinGenie Basic Starter Set	816-1495	\$439.00
B. RinGenie Deluxe	816-1490	764.50
C. RinGenie All-in-One	816-1500	1,950.75
D. BenchMate Adapter	816-1491	86.25
E. Side Helper	816-1492	97.75
F. 3" Vise	816-1498	742.50
G. Vise Adapter	816-1499	192.50
H. Universal Adapter	816-1487	86.25
I. Universal Adapter Holder	816-1488	80.50

RinGenie - Accessories

A. RinGenie Angle Adapter Kit

Adds the ability to layout and drill holes at precise angles on the RinGenie.

Description	Item#	Each
Angle Adapter Kit	816-1493	\$247.50

B. RinGenie One Degree Ring Kit

Provides one degree adjustments within 360 degrees when using the RinGenie.

Description	Item#	Each
One Degree Ring Kit	816-1494	\$275.00

C. Versatile Ring Holder

Makes engraving and stone setting much easier by allowing 360 degree access to the ring. Has three built in gem trays.

Description	Item#	Each
Versatile Ring Holder	816-1489	\$137.50

D, E Collet Sets

16pc Collet Set comes in sizes 5, 5½, 6, 6½, 7, 7½, 8, 8½, 9, 9½, 10, 10½, 11, 11½, 12, and 12½.

5pc Large Collet Set comes in sizes 13, 13½, 14, 14½, and 15.

Description	Item#	Each
D. 16pc Collet Set (5-12)	816-1496	\$138.00
E. 5pc Collet Set (13-15)	816-1497	86.25

F. Rocker Assembly

Turn your RinGenie into a totally versatile tool that can move (glide) left to right to your desired angle you are looking for and then lock in place to hold that position. It can be mounted on the Positional Rotatory Table (816-1510) or any vise to accommodate the RinGenie at various angles.

Description	Item#	Each
Rocker Assembly	816-1506	\$396.00

G. Positional Rotatory Table

Great for general work at the bench or any flat surface. Constructed of a Steel 8" work base with drag screw resistance, optional positioning, and 360° rotation.

Description	Item#	Each
Positional Rotatory Table	816-1510	\$797.50

H. 10" Turn Table

This solid turntable rotates 360° with a drag screw and positive lock. Can be used at your bench or any solid work table. Overall height is 1⅝".

Description	Item#	Each
10" Turn Table	816-1512	\$511.50

I. Positional Rotatory Table & Vise

With a mounted vise. Great for general work at the bench or any flat surface. Constructed of a Steel 8" work base with drag screw resistance, optional positioning and a 360° rotation. Jaws are 3" dia. and 1" tall. Jaws opening is 4½". Overall height is 3⅝".

Description	Item#	Each
Positional Rotatory Table & Vise	816-1511	\$984.50

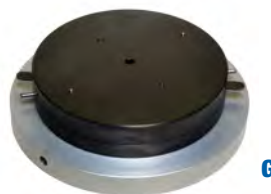
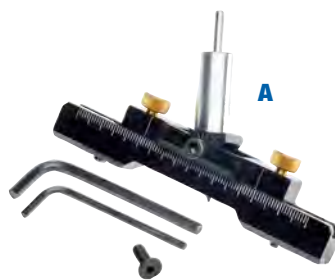

For Microscopes
See pp. 348-349.



RinGenie shown with
Rocker Assembly and
Positional Rotatory Table



See more Vises
starting on page 544



A



B



C



Shown actual size

A. Curved and Slim Burnisher

Curved and slim for hard-to-reach areas. Polished steel tip and wooden handle. Great for jewel settings. Blade measures 1 3/4" long. Made in USA.

Description	Item#	EACH Prices	
		1-2	3+
Curved and Slim Burnisher	811-1880	\$14.35	\$12.92

B, C Steel Burnishers

Polished steel tips with wooden handles. For use on bezels and larger surfaces. Measure approximately 6" overall length. Blades measure 2 long. Made in USA.

Description	Item#	EACH Prices	
		1-2	3+
B. Straight Burnisher	811-2100	\$12.75	\$11.48
C. Curved Burnisher	811-1900	12.75	11.48

D. Margin Roller Burnisher – 3/32" Shank

For burnishing over scratches in gold, making it possible to salvage many pieces without gold loss. Can also be used for burnishing over microporosity in castings. The 3/16" (5mm) head consists of five steel rollers that act as rotating mallets. Measures approximately 1 3/4" long with 3/32" shank for use with handpiece.

Description	Item#	EACH Prices	
		1-2	3+
Margin Roller Burnisher	811-2150	\$21.95	\$19.76

E-I Tungsten Carbide Burnishers and Scrapers

Feature highly polished tungsten carbide tips. Ideal for safe burnishing of platinum because tungsten carbide is noncontaminating. Also produce a brilliant finish on gold. Measure approximately 6 3/8" overall length. Tips measure 1" long. Select between 2mm, 3mm or 4mm burnishers or 3mm and 5mm triangular cut scrapers. Scrapers are extremely sharp on all three sides and come to a sharp point. Also deal for cleanly removing flash and other casting defects from hard-to-reach areas. Measure approx. 6 3/8" overall length, including handle. Tips measure approximately 7/8" long.

Description	Item#	Each
E. 2mm Burnisher	811-1849	\$19.50
F. 3mm Burnisher	811-1850	19.50
G. 4mm Burnisher	811-1851	19.50
H. 3mm Scraper	816-0161	18.50
I. 5mm Scraper	816-0162	20.75
Burnisher/Scraper Set of 5 above	811-2155	84.00

J. Busch® Carbide Starlight Burnishers

Made of the finest carbide. Impart a unique high gloss on precious metals such as gold and platinum. Have 3/32" shanks.

Description	Item#	Each
Point	122-7135	\$29.84
Barrel	122-7133	40.86
Cylinder	122-7136	29.84
Cone	122-7134	40.86
4-Piece Set (one each)	122-7137	153.00

Use high RPM for best results.



Shown actual size



A. JETT BALLISTIC™ Make your own custom tools!

From the creators of Jett Sett comes the Next Generation in fixturing compound...JETT BALLISTIC What makes this product different than anything else on the market is the fact that Jett Ballistic is infused with Kevlar®, an additive that produces a stiffer compound that delivers more durability to your production fixtures.

Here are just some of the things you can make with JETT BALLISTIC:

- Fixturing devices for holding, setting and engraving any jewelry item.
- Custom-grip file and graver handles.
- Nonmarring surfaces for pliers and vises.
- Custom hammer heads that won't mar the metal you hammer.

Easy to use. Simply place a small amount of JETT BALLISTIC into heated water. Remove and mold the putty-like to your specifications. It's that easy! Reusable, dip back into heated water to go back to the soft putty state. Supplied in a 1Lb Jar.

Description	Item#	Each
JETT BALLISTIC, 1 lb. Jar	816-1575	\$35.00

B. JETTBasic

A slightly more tacky form of JETT BALLISTIC. Adheres well to smooth surfaces such as bezels when hot. Hardens and loses tackiness when completely cool. Clear in color, can also be used to make customized tool handles. Sold in 1 lb. bags.

Description	Item#	Each
JETTBasic, 1 lb. pkg.	816-1591	\$21.95

C. GRS® Thermo-Loc®

Very tough work-holding plastic. Softens with heat to clay-like pliable consistency so you can form it around an endless variety of workpieces. Turns rock-hard once it cools to hold items securely. Economical and practical—can be reused again and again. Neutral gray in color to prevent eyestrain, even under bright work lights. Heat in a microwave oven on the pad included with the Starter Kit, in a conventional oven, in hot water or with a heat gun (be sure to follow proper heating instructions).

Description	Item#	Each
Thermo-Loc, ½ lb.	816-1592	\$23.70
Thermo-Loc, 1 lb.	816-1593	41.65
Thermo-Loc, 5 lbs.	816-1594	157.40
Thermo-Loc Starter Kit (includes 1 lb. Thermo-Loc and microwave-safe 6" x 6" pad)	816-1597	45.50

D. Diamond D Cement

Shellac mixed with wax to make it stronger and less brittle. When melted and applied to a wooden dowel, it securely holds diamonds and other stones for polishing. Also holds jewelry that's too small for conventional clamps. Easy to melt and use repeatedly. Can be pulled from setting when work is complete. Sold in 3 oz. cakes.

Description	Item#	Each
Diamond D Cement, 3 oz. cake	811-2600	\$28.55

E. Orange Flake Shellac

Used to hold small objects firmly for stone setting and engraving. Softens when heated. Hardens quickly in cold water. Articles can be removed by dipping in alcohol.

Description	Item#	Each
Orange Flake Shellac, 1 lb.	816-1100	\$32.00
Orange Flake Shellac, ½ lb.	816-1101	16.50

F. Layout Wax Sheets

Place one of these transparent wax sheets on top of your jewelry drawing, then position the stones. Provides an excellent way to visualize your finished design prior to stone setting. Thickness: 24-gauge. Measure 4" x 4". Sold in boxes of 32.

Description	Item#	Each
Layout Wax Sheets, box of 32	263-1000	\$19.25



Fixturing Devices



Custom Grip Handle



Custom Hammer Heads



A



B



C

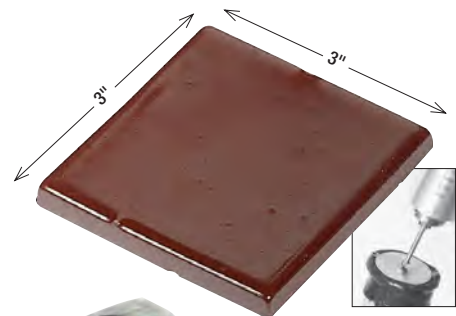

D



E



F



A

A. Attack Epoxy Solvent

Dissolves cured epoxy and polyester resins without affecting surrounding material. Excellent for separating misaligned bonded items. For use on metal, glass, wood and more. Not recommended for use on imitation pearls. Sold in 8 fl. oz. cans.

Description	Item#	EACH Prices	
		1-2	3+
Attack Epoxy Solvent, 8 fl. oz can	821-2800	\$12.50	\$11.25



B

C

B, C Devcon® 5-Minute Epoxy – Clear

High-strength two-part epoxy with a handling time of 5 minutes. Sets in 8-10 minutes. Achieves full bond strength in 1 hour. Works on metal, wood, glass, stones, crystal and ceramic. Clear, nonshrink formula—great for jewelry. Resistant to most chemicals. Available in traditional Dual Pak (one tube each of resin and hardener) with mixing instructions. Also available in convenient Dev-Tube applicator, which dispenses equal portions of resin and hardener with one easy push of the plunger—a quick mix and it's ready to use.

Description	Qty.	Item#	EACH Prices	
			1-2	3+
B. Dual Pak, 1/2 oz. tubes	1 oz. (Net. Wt.)	811-2650	\$4.85	\$4.61
C. Dev-Tube	.85 fl. oz.	811-2651	5.40	5.13
Dev-Tube, box of 6	5.1 fl. oz.	811-2657	29.50	-



D

E

D, E Devcon® 2-Ton Epoxy – Clear

Industrial-strength two-part epoxy designated for heavier items that require an extra-high- strength bond. Works on metal, stones, ceramic, crystal, china and wood. Waterproof and resistant to most chemicals. Strong enough to fill gaps. Sets in 30 minutes. Cures in 8-12 hours to a clear transparent finish. Excellent for jewelry. Available in traditional Dual Pak (one tube each of resin and hardener) with mixing instructions. Also available in convenient Dev-Tube applicator, which dispenses equal portions of resin and hardener with one easy push of the plunger—a quick mix and it's ready to use.

Description	Qty.	Color	Item#	EACH Prices	
				1-2	3+
D. Dual Pak, 1/2 oz. tubes	1 oz. (Net. Wt.)	Clear	811-2652	\$4.25	\$4.04
E. Dev-Tube	.85 fl. oz.	Clear	811-2653	4.85	4.61
Dev-Tube, box of 6	5.1 fl. oz.	Clear	811-2658	26.50	-



F

G

F, G Devcon® Plastic Steel Epoxy – Dual Pak - dark gray, Dev-Tube - black

Steel-filled heavy-duty epoxy for forming a protective backing on turquoise and other stones. Offers extremely high bond strength. Can be used to fill holes and gaps. Sets in 2 hours. Reaches full bond strength in 24 hours. Hardens to a rigid metallic mass. Sandable, chemical-resistant and waterproof. Color: Dual Pak - dark gray, Dev-Tube - black.

Description	Qty.	Item#	EACH Prices	
			1-2	3+
F. Dual Pak - dark gray	2 oz. (Net. Wt.)	811-2655	\$4.95	\$4.70
G. Dev-Tube - black	.85 fl. oz.	811-2656	5.75	5.46

Although no hazardous shipping surcharge applies, these items can only ship via UPS® Ground, no air, FedEx® or US Mail possible. Cannot ship to Alaska, Hawaii or Puerto Rico.

A. Epoxy 220

Has slower setting time for production bonding of gem materials to metal findings. Provides ultimate tensile strength and resists thermal shock. Thickens in 1 hour and hardens in 8 hours without heat. Hardens in 30 minutes under heat lamp. Color: clear amber.

Description	Item#	EACH Prices	
		1-2	3+
1 fl. oz. (one each 1/2 fl. oz. resin and hardener)	821-2850	\$4.50	\$3.96



B, C Epoxy 330

A perfectly clear, fast-curing two-part adhesive. When equal parts are mixed, it thickens in 15 minutes and hardens in 2 hours without heat. Hardens in 10 minutes under heat lamp.

Description	Item#	EACH Prices	
		1-2	3+
B. 1 fl. oz. (one each 1/2 fl. oz. resin and hardener)	821-2900	\$3.95	\$3.48
C. 8 fl. oz. (one each 4 fl. oz. resin and hardener)	821-2910	19.95	17.56



D-H Regular and Qwik-Dry Super Glues

Transparent, high-strength, quick-setting adhesives. No mixing required. Excellent for stone and pearl setting and jewelry repair. Regular Super Glue dries in 45-60 seconds. Qwik-Dry sets up in just 10-20 seconds. Maximum strength is reached after 12 hours.

Description	Item#		EACH Prices	
			5	10+
D. Regular, 2g tube	811-2300		\$2.90	\$2.76
E. Qwik-Dry, 2g tube	811-2310		2.45	2.33

Five-piece minimum; please order in multiples of five.

Description	Item#	EACH Prices		
		1-4	5-9	10+
F. Regular, 2g pen	811-2305	\$2.95	\$2.80	\$2.51
G. Regular, 20g bottle	811-2400	9.70	9.22	8.25
H. Qwik-Dry, 20g bottle	811-2312	9.70	9.22	8.25



I. Crystal Cement

Provides a strong, durable bond between plastic or glass watch crystals and the bezel. Will not flake off or crack plastic. Sold in convenient 1/3 fl. oz. tubes with pinpoint applicator tip.

Description	Item#	EACH Prices	
		1-2	3+
Crystal Cement, 1/3 fl. oz tube	811-2540	\$5.95	\$5.36



J, K Syringe Dispensers

Plastic syringes with 18-gauge stainless steel needle for pinpoint delivery of adhesive or paste solder to the exact place you want. Plunger works smoothly and slides evenly to prevent accidental flooding and sputtering. Constructed of polyethylene and polypropylene. Use with Epoxy 330, Devcon Epoxies, and similar adhesives. Available in sizes: 5cc and 10cc. Each syringe includes tip sheath and cover.

Description	Item#	EACH Prices	
		1-3	4+
J. 5cc Dispenser, pkg. of 6	811-2450	\$18.95	\$15.16
K. 10cc Dispenser, pkg. of 6	811-2451	23.50	18.80





A

A. Noble Easy-Flow White Sheet Solder – For Repair Work

This solder is of lower gold content than the quality of gold for which its use is recommended. There are variations in the exact tone in order to match the karat of the piece to be soldered. All flow easily and uniformly and provide a joint that is as strong and permanent as the metal itself. Sold per dwt. Caution: Contains cadmium; fumes are hazardous, use NIOSH approved respirator and fume hood such as our Solderpure (see p. 407).

Description	Approx. Karat	Melting Point °F (°C)	Flow Point °F (°C)	Item#	Dwt
White Low	1K	1,190 (643)	1,325 (718)	830-1921	\$5.90
10K White	5K	1,205 (652)	1,320 (716)	830-1924	37.25
14K White	9K	1,200 (649)	1,315 (713)	830-1927	45.95
18K White	10K	1,360 (738)	1,450 (788)	830-1930	65.00

Prices subject to change with market prices.

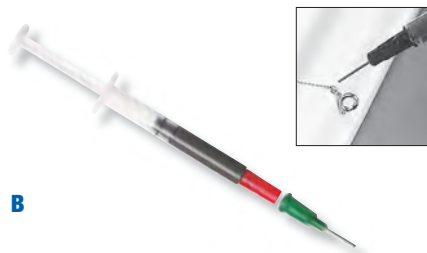

B

B. Silver Solder Pastes – Cadmium/indium-free!

Excellent for soldering fine silver chains and intricate silver jewelry where precise application of solder is critical. Alloy and flux are premixed in paste form and packaged in convenient dispensing syringes. Alloy will not settle to the bottom of the syringe tube. Syringes eliminate waste and improve the appearance of the joint area. Each dwt. of paste contains 55% metal and 45% binder per 1cc syringe.

Description	Melting Point °F (°C)	Flow Point °F (°C)	Item#	Dwt
Silver Easy/Soft	1,125 (607)	1,205 (652)	831-1010	\$28.95
Silver Repair (less silver content)	425 (218)	473 (245)	831-1030	23.10

Prices subject to change with market prices.



C

C. Silver Sheet Solder

Available in three grades, Easy 65%, Medium 70%, and Hard 75% silver.

Description	Melting Point °F (°C)	Flow Point °F (°C)	1 Troy Oz.#	Pkg.	¼ Troy Oz.#	Pkg.
Easy	1,240 (671)	1,325 (718)	830-2050	\$28.57	830-2049	\$7.14
Medium	1,275 (690)	1,360 (738)	830-2100	30.20	830-2099	7.55
Hard	1,365 (740)	1,450 (788)	830-2150	32.82	830-2149	8.20

Prices subject to change with market prices.



D

D. Silver Solder Wire

Round 20-gauge (0.032" dia.) silver solder wire. Cadmium-free. Sold in 1/2 oz. packages.

Description	Silver %	Melting Point °F (°C)	Flow Point °F (°C)	Item#	Pkg.
Extra-Easy	56	1,145 (618)	1,205 (652)	830-2151	\$13.35
Easy	65	1,240 (671)	1,325 (718)	830-2152	15.34
Medium	70	1,275 (690)	1,360 (738)	830-2153	15.53
Hard	75	1,365 (740)	1,450 (788)	830-2154	16.41

Prices subject to change with market prices.

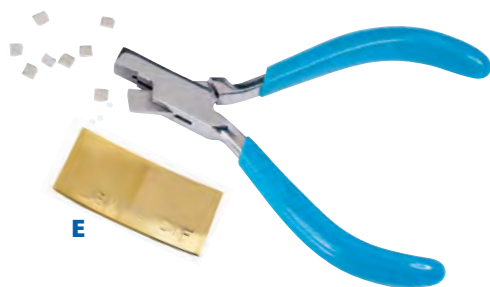

E

E. Solder Cutting Pliers

These special pliers can be used to consistently cut both sheet and wire solder. Sheet is cut in 1/16" (1.6 mm) squares and wire, up to 18-gauge (1.02 mm), in 1/16" lengths. Cut is consistent time after time, Measure 5 1/2" overall length with plastic comfort grips.

Description	Item#	Each
Solder Cutting Pliers	180-0279	\$11.50

A-C Gesswein® Plumb Solders – Cadmium/indium-free!

Manufactured for Gesswein under strict quality guidelines so that composition, temperature and color are consistent and uniform from lot to lot. Contains no cadmium, no indium. Available in sheet, chips and paste. Sheet is sold by the dwt. Chips measure 1 x 1mm and are packaged 1 dwt per vial. Each dwt. of paste contains 55% metal and 45% binder per 1cc syringe.



Description	Melting Point °F (°C)	Flow Point °F (°C)	A. Sheet		B. Chips		C. Paste	
			Item#	Dwt	Item#	Dwt	Item#	Dwt
Yellow 18KY Hard	1,440 (782)	1,530 (832)	830-2172	\$88.55	831-1062	\$89.11	831-1042	\$55.93
Yellow 18KY Medium	1,350 (732)	1,435 (779)	830-2171	88.55	831-1061	89.11	831-1041	55.93
Yellow 18KY Soft	1,300 (704)	1,360 (738)	830-2170	88.55	831-1060	89.11	831-1040	55.93
Yellow 14KY X-Hard	1,420 (771)	1,555 (846)	830-2176	69.06	831-1066	69.62	831-1046	45.29
Yellow 14KY Hard	1,400 (760)	1,440 (782)	830-2175	69.06	831-1065	69.62	831-1045	45.29
Yellow 14KY Medium	1,330 (721)	1,390 (755)	830-2174	69.06	831-1064	69.62	831-1044	45.29
Yellow 14KY Soft	1,265 (685)	1,285 (696)	830-2173	69.06	831-1063	69.62	831-1043	45.29
Yellow 10K Soft	1,290 (699)	1,320 (716)	–	–	–	–	831-1007	34.12
White 18KW Soft	1,575 (857)	1,580 (860)	830-2180	88.55	831-1070	89.11	831-1050	55.93
White 14KW Hard	1,335 (724)	1,445 (785)	830-2182	69.06	831-1071	69.62	831-1051	45.29
White 14KW Soft	1,290 (699)	1,295 (702)	830-2181	69.06	831-1072	69.62	831-1052	45.29

Prices subject to change with market prices.

D. Platinum Solders

1200 Easy contains 0% platinum and is basically a repair solder made of palladium/white gold. 1400 Medium contains 5% platinum with the balance made of palladium/white gold. Normally used in assembling findings. 1700 Hard contains 25% platinum with the balance composed of palladium/white gold. Used for ring sizing and other jobs where joints will be visible. Sold in 1 dwt sheets.

Description	Flow Point °F (°C)	Item#	Each
1700 Hard	2,910 (1,600)	830-2162	\$96.88
1400 Medium	2,660 (1,460)	830-2161	108.82
1200 Easy	2,190 (1,200)	830-2160	87.06

Prices subject to change with market prices.



E. Platinum Solder Paste

Paste solder is ideal for soldering chain and intricate jewelry items where precise application of solder is critical. Now paste solder is available for platinum! Use 1000 for hidden joints (color is a bit too dark to use on visible joints). Use 1300 for production and for a good color match on joints that will be visible in the finished product.

Description	Flow Point °F (°C)	Item#	Each
Platinum Solder Paste 1000, 1 dwt syringe	2,010 (1,110)	831-1031	\$35.00
Platinum Solder Paste 1300, 1 dwt syringe	2,280 (1,250)	831-1032	122.50

Prices subject to change with market prices.



F. Yellow Ochre

Mix with water or alcohol to create a paste that may be brushed onto a workpiece to prevent solder from flowing where you don't want it to. Helps to protect previously soldered areas, moving parts of a catch, etc. Net Wt. 1/2 lb.

Description	Item#	Each
Yellow Ochre	821-2750	\$12.05



G. Cordless Rechargeable Soldering Iron Set

Easily solder in the tightest places with no restricting cord. Iron weighs less than 5 oz and measures 8 1/4" long (with tip installed). Includes a built-in light allowing visibility in hard to reach areas and dark corners. Will solder up to 125 joints before recharging. Partially recharges in 1-2 hours, fully recharges in 3 to 4 hours. Comes complete with soldering iron, charging stand, battery, one fine and one heavy-duty tip and instructions. 110V, UL listed.

Description	Item#	Each
Quick-Charge Soldering Iron Set	816-1920	\$71.85





A. Tix® Solder

Considered to be one of the “hardest” soft solders available. Melts at 275°F and has a holding power of 4,300 lbs. per square inch. Adheres to all ordinary solderable materials and may be used with a soldering gun or torch. Stays white and does not tarnish. Package of 20 rods (3" length, 19-gauge).

Description	Item#	Each
Tix Solder, 20 rods	830-2000	\$18.35

A

B. Tix® Flux

A noncorrosive liquid flux that works with any soft solder. Harmless to skin and clothing. Washes off with water, even when dry. 1/2 oz.

Description	Item#	Each
Tix Flux, 1/2 oz.	830-2340	\$5.65

B

C. Tix® Anti-Flux



Liquid that brushes on to prevent solder from flowing to unwanted areas. Can be used for hard or soft soldering. 1/2 oz.

Description	Item#	Each
Tix Anti-Flux, 1/2 oz.	830-2345	\$5.65

C

D. Stay Bright Soldering Set



Cadmium-free, nontoxic silver bearing solder with a melting point of 430°F. May be used with soldering gun or torch. Includes 1/2 oz. of solder and 1/2 fluid oz. Stay Clean Flux.

Description	Item#	Each
D. Stay Bright Soldering Set 	830-2300	\$30.75
Stay Clean Flux 4 oz. refill 	830-2350	13.50

D

E. Soft Soldering Flux

For use with solders with melting points under 450°F. Will not flame.

Description	Item#	Each
4 oz. 	830-4050	\$10.15
1 pint 	830-4100	13.70
E. 1 quart 	830-4150	21.90

E

F. Pinpoint Dispenser

This handy plastic squeeze dispenser has a needle-point applicator for precise application of flux. No more mess—eliminates dried up flux brushes and dripping flux. An excellent applicator for applying flux to small areas where a flux brush will usually cause a mess; ideal for soldering earring posts, building up prongs, sizing rings and making many similar small repairs. 2 oz. capacity.

Description	Item#	Each
F. Pinpoint Dispenser	830-4520	\$4.79
Pinpoint Dispenser w/16 oz. Anti-Oxidizing Flux (see p. 501)	830-4515	20.00

F

G

G. Dispenser Bottle with Pump

Plastic bottle holds flux, solvents or other liquids. Special stainless steel lid allows pumping of solution into shallow well on top of bottle. One-way valve keeps solution in well, prevents contamination and eliminates odors. Ideal for dispensing solutions that would otherwise evaporate. 4 oz. capacity.

Description	Item#	Each
Dispenser Bottle with Pump	830-4525	\$26.45

H

H. Superior Flux #6

This paste flux for silver brazing and soldering stays exactly where you want it and helps hold solder in place. Contains no potassium bifluoride and will not release boron trifluoride gases during brazing. Gentle on metals. Easier on the hands than regular silver fluxes. Conforms to AMS 3410, AWS A5.31-91 and Type FB3A. Temp. range: 900-1600°F (485-870°C).

Description	Item#	Each
4 oz. Jar	830-4200	\$9.95
H. 8 oz. Jar	830-4201	16.65

I. Flux Dispensing Pens

The Bonkote Pen system provides the most accurate flux application in a pen that is easy to clean and maintain. Dispense flux with ease, even in the most challenging of jobs. Made in Japan.

	Pen & Tip Item#	Each	Replacement Tip Item#	Each
Micro	830-4581	\$21.50	830-4585	\$16.50
Thin	830-4582	17.50	830-4586	13.50
Thick	830-4583	23.50	830-4587	18.50
Flat	830-4584	21.50	830-4588	16.50

I



A-D Gesswein® Hard Soldering Flux

Yellowish-green self-pickling flux for brazing and annealing gold, silver, platinum and other metals with high melting points. Holds solder chips in place. Preserves color and temper of metal. Temp. range: 1,100-1,600°F.

Size	A. 4 oz.	B. 1 pint	C. 1 quart	D. 1 gallon
Item#	830-4250	830-4300	830-4350	830-4400
EACH Price	\$4.50	\$6.50	\$10.95	\$29.95



E-G Handy® Flux

A white paste flux used for hard soldering of silver, gold, platinum, copper, nickel and other nonferrous metals. Apply with borax brush. Holds solder chips in place for easier soldering. Withstands prolonged heating without breaking down. Temp. range: 1,100-1,500°F.

Size	Item#	EACH Prices	
		1-2	3+
E. 7 oz.	830-4465	\$6.85	-
F. 1 lb.	830-4470	11.50	\$10.35
G. 5 lbs.	830-4475	34.50	31.05



H. Borax

Specially prepared for making flux for jewelry soldering. Dissolves easily to make a paste. Inhibits the formation of oxides on metal surfaces and allows solder to flow more easily. Helps prolong the life of melting crucibles. Borax has pH of 6-7. More alkaline than boric acid (pH 3-4).

Size	8 oz. Powder	5 lbs. Powder	50 lbs. Powder
Item#	811-0700	811-0701	811-0702
EACH Price	\$6.50	\$23.95	\$185.00



I. Magic Borax (Granular) Powder

Granular Magic Borax Powder is an excellent, general-purpose flux. Inhibits the formation of oxides on metal surfaces thus allowing solder to flow more easily. Excellent also for glazing clay crucibles to extend crucible life. 16 oz. container.

Size	Item#	EACH Prices	
		1-2	3+
16 oz.	811-0705	\$7.75	\$7.36



J-M Gesswein® Anti-Oxidizing Flux

Completely protects the finish of the piece being soldered from firescale, reducing the need for time-consuming pickling, stripping and, in some cases, sanding and filing. Repolishing becomes easy after soldering. Prevents discoloration and oxidation of all metals that contain copper. Especially recommended for soldering silver. Makes hard soldering tasks easier than ever before. Nonhazardous and nontoxic. Temp. range: 1,100-1,500°F.

Size	Item#	EACH Prices	
		1-2	3+
J. 4 oz. spray bottle	830-4500	\$7.60	\$7.22
K. 16 oz.	830-4505	19.95	18.95
L. 1 gal.	830-4510	74.00	70.30
M. 16 oz. with pinpoint dispenser	830-4515	20.00	-



N. Magic Boric Acid Powder

High-grade, superfine boric acid powder. Can be used as high-grade flux and deoxidizing agent. Dissolve with denatured alcohol in our Glass Cups (830-2320) to make soldering flux. 16 oz. container.

Size	Item#	EACH Prices	
		1-5	6+
16 oz.	830-4575	\$9.25	\$8.79



O. Gesswein® Rectifying Solution

Alcohol-based flux for soldering and annealing. Inhibits firescale. Dip part into Rectifying Solution, set on soldering block and ignite. Alcohol will burn off and leave white borax residue. Part is now ready to be soldered or annealed. Temp. range: 1,100-1,600°F.

Size	Item#	EACH Prices	
		1-3	4+
1 quart	830-4551	\$20.95	\$16.76



P. Boric Acid Powder

Technical grade. Dissolve in Denatured Alcohol in our Glass Alcohol Cup (below) to make soldering flux. Boric acid has pH of 3-4. More acidic than borax (pH 6-7).

Size	1 lb.	5 lbs.	25 lbs.
Item#	830-4569	830-4570	830-4572
EACH Price	\$73.25	\$73.25	\$73.25

Q. Glass Alcohol Cup

For alcohol, solvents, flux or other solutions. Cover fits tightly to protect against evaporation or contamination. Cut glass container. Measures 2 7/8" dia. x 1 7/8" H, capacity 1 1/2 oz.

Description	Item#	Each
Glass Alcohol Cup	830-2320	\$17.65

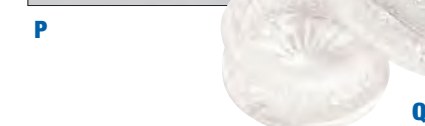

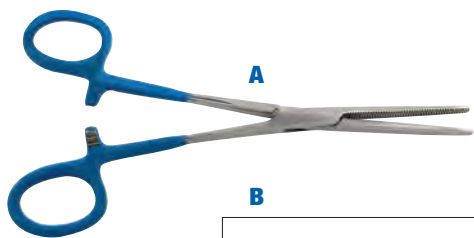

A, B Hemostats

Precision tools ideal for holding small items for soldering. Feature box-joint construction, serrated pointed jaws and heat-resistant two-position self-locking handles. Available in two styles: straight and curved. Made of highly polished stainless steel. Measure 6" long.

Description	Item#	EACH Prices	
		1-2	3+
A. Straight	181-5005	\$6.50	\$5.85
B. Curved	181-5000	6.50	5.85



With Tweezers

C. Third Hand

Cross-locking tweezers, 6½" long, mounted on heavy, nontipping round base. Base's ball joint attachment permits positioning of work at any angle. Handy for positioning pieces to be joined by solder or adhesive, freeing hands from work. Base may vary.

Description	Item#	EACH Prices	
		1-2	3+
Third Hand	816-1800	\$12.10	\$11.50
Replacement Tweezers	195-1400	2.95	2.66



D. Third Hand – Ball Style

This remarkable third hand features incredibly flexible positioning and ease of use to speed up your soldering jobs. Twist and turn the ball joint to any position and it stays fixed without slipping. This economic alternative to the magnetic third hand, automatically provides the right amount of tension to hold and move your work without continuous adjustment. Includes 6" self-locking tweezers.

Description	Item#	Each
Single	816-1822	\$12.00

E. Double Third Hand

Round weighted base with cross bar, two spring-loaded clips, and multiple ball joints for infinite positioning ability. Frees both hands for work. Other accessories such as cross-locking tweezers may be added to increase the versatility of this convenient holding tool. Base measures 3" dia. x ¾"H.

Description	Item#	Each
Double Third Hand	816-1900	\$19.95

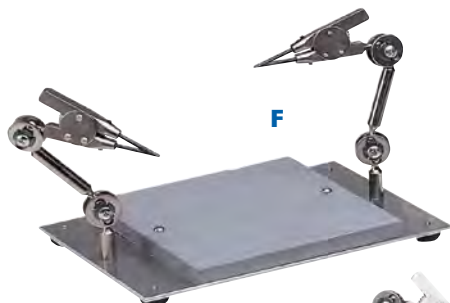

F, G GRS® Soldering Stations

Compact benchtop fixturing devices for handling all your soldering jobs. Available in two styles: Short-arm features double-jointed arms with spring-loaded third hands. Deluxe features triple-jointed arms with spring-loaded third hands and rear tabs for mounting on GRS BenchMate (see p. 572). Both have 6" x 6" nonasbestos soldering boards and metal frames with rubber feet. Made in USA.

Description	Item#	Each
F. Short-Arm Soldering Station	816-1914	\$104.80
G. Deluxe Soldering Station	816-1915	147.80

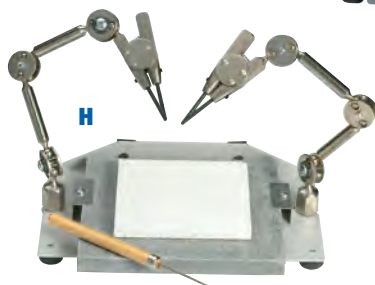

H. Platinum Soldering Station

Platinum soldering must be carried out in an area separate from other metals or solders to prevent contamination of the platinum. Tweezers and solder picks must be made of a non contaminating material such as tungsten carbide. Our Platinum Soldering Station includes: GRS Deluxe Soldering Station (above), 2 pairs of GRS Tungsten Carbide Tweezers Tips (to replace tips in soldering station), 4" x 4" Wesgo Soldering Board (sits on top of GRS board) and Tungsten Solder Pick for worry-free platinum soldering.

Description	Item#	Each
Platinum Soldering Station	816-1916	\$270.00

A. Improved Adjustable Scraper

Hollow three-square double-ended blade measures 3½" long; extend length to fit the job. A simple adjustment knob on the knurled handle allows the blade to slip inside both for safety and for maintaining the tool edge when not in use. Handle has a highly polished finish and measures 3½" long. France.

Description	Item#	Each
Improved Adjustable Scraper	816-0130	\$41.75

B. Bench Knife

An all-purpose bench knife for opening watch cases, scraping and cutting. Has 1¾" thick steel blade mounted in a hardwood handle. Measures 5¼" long.

Description	Item#	Each
Bench Knife	260-3059	\$3.80

C, D Wood Handle Scrapers

High-quality, chrome alloy steel three-square blades are securely mounted in hardwood handles. Approx. overall length 6½".

Description	Blade Length	Item#	Each
C. Hollow-Blade Scraper	2½"	816-0150	\$10.75
D. Solid-Blade Scraper	3"	816-0160	16.55

E. Titanium Solder Pick

Features a Titanium rod to which solder cannot adhere and a nonconductive handle with hexagonal head so pick won't roll away when you put it down. For gold and silver—do not use on platinum. Measures 6¾" long.

Description	Item#	EACH Prices		
		1-2	3-9	10+
Titanium Solder Pick	830-2212	\$4.95	\$4.70	\$4.46

F. Tungsten Solder Pick – Ideal for platinum.

For spreading molten solder and maneuvering it to just the place you want it. Solder will not adhere. Made of a special high melting point tungsten. Will not contaminate or discolor molten gold or silver solder. Wood will not heat up. Measures 6½" long.

Description	Item#	EACH Prices		
		1-2	3-9	10+
Tungsten Solder Pick	830-2210	\$8.50	\$7.65	\$7.08

G. Niobium Solder Pick – Ideal for platinum.

For high-temperature soldering jobs, our Niobium Solder Pick withstands temperatures up to 4,470°F. Noncontaminating for platinum soldering and welding. Can be bent to the desired angle without breaking. Wooden handle. Measures 6½" long.

Description	Item#	EACH Prices		
		1-2	3-9	10+
Niobium Solder Pick	830-2216	\$6.45	\$6.13	\$5.81

H. Solder Pick

Made with a special alloy, the point can be bent to any shape without breaking. Hardwood handle insulates. Metal ferrule. For gold and silver. Measures 6½" long.

Description	Item#	EACH Prices		
		1-2	3-9	10+
Solder Pick	830-2211	\$2.45	\$2.21	\$2.04

I. Titanium Soldering Picks

Feature long-lasting extra-fine titanium tips that collect exact amounts of solder for precise application. Grooved aluminum handles dissipate heat quickly to protect user. Hexagonal heads prevent rolling. Set consists of three colors to allow easy differentiation and help prevent metal contamination. Measure 6¼" long. For use with gold, silver and other metals; not for use with platinum.

Description	Item#	Each
Set of three	830-2219	\$8.75





A

A. Cross Hole Deburring Tool – 3mm Shanks

These specialty rods are designed to remove the hard to reach burrs created by cross-drilled holes. Available in 4 shapes: Oval, Cross, Ring, and Thin, and a variety of diameters for different cross hole sizes and shapes.

The cutting wires are made from a slightly flexible, twisted piano wire and measure approx. 0.027" in wire diameter. The wires are more aggressive than brushes, yet less aggressive than traditional cutting burs. These deburring tools work best on harder metals such as steel. Recommended for use in a rotary power tool. 1,000 Max RPM. All rods measure 4" in OAL. 3mm shank diameter.

Two kits are available. Cross Hole Small Kit * consists of one each of the smallest of the 4 shapes. Cross Hole 6mm Kit † consists of one each of the three 6mm size tools. Made in Japan.

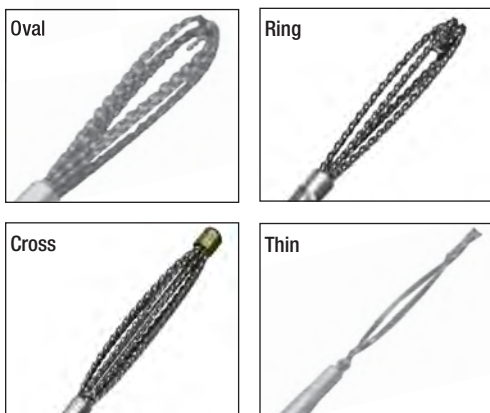
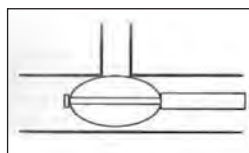

3 and 4mm sizes

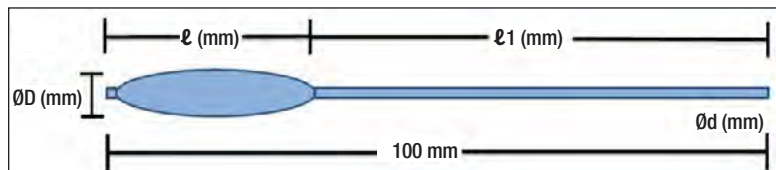

5mm and larger sizes

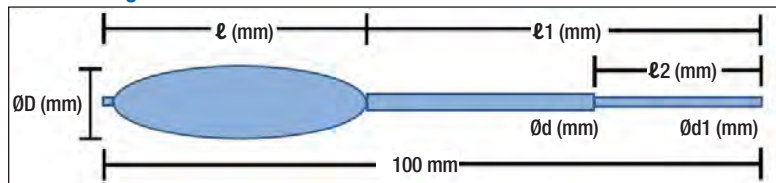

Type/Shape	ℓ	ℓ1	ℓ2	Ød	Ød1	Item#	Each
Oval 3mm *	30	70	-	3	-	846-0103	\$28.85
Oval 4mm	30	70	-	3	-	846-0104	28.85
Oval 5mm	30	50	20	4	3	846-0105	34.30
Oval 6mm †	30	50	20	5	3	846-0106	34.30
Oval 7mm	40	40	20	5	3	846-0107	38.20
Oval 8mm	40	40	20	5	3	846-0108	38.75
Oval 9mm	45	35	20	6	3	846-0109	43.70
Oval 10mm	45	35	20	6	3	846-0110	43.70
Oval 11mm	50	30	20	6	3	846-0111	43.95
Oval 12mm	50	30	20	6	3	846-0112	45.75
Cross 5mm *	30	70	20	4	3	846-0125	33.55
Cross 6mm †	30	70	20	4	3	846-0126	33.55
Cross 7mm	30	50	20	5	3	846-0127	34.30
Cross 8mm	30	50	20	5	3	846-0128	34.30
Cross 9mm	30	50	20	6	3	846-0129	36.15
Cross 10mm	30	50	20	6	3	846-0130	36.15
Cross 11mm	30	50	20	6	3	846-0131	36.90
Cross 12mm	30	50	20	6	3	846-0132	36.90
Ring 3mm *	30	70	-	3	-	846-0143	27.55
Ring 4mm	30	70	-	3	-	846-0144	27.55
Ring 5mm	30	50	20	4	3	846-0145	33.55
Ring 6mm †	30	50	20	4	3	846-0146	33.55
Ring 7mm	30	50	20	5	3	846-0147	34.85
Ring 8mm	35	45	20	5	3	846-0148	35.60
Thin Hole 2mm *	25	75	-	3	-	846-0152	27.05
Cross Hole Small Kit *						846-0095	106.75
Cross Hole 6mm Kit †						846-0096	92.50

B



B. Precision Deburring Tools

Double-ended tools with revolving hardened steel discs for deburring a variety of delicate parts. Feature knurled handles for secure grip. Sold individually and in a set with one of each with storage pouch. Made in Switzerland. Measure approx. 3 3/8" in length.

Tool#	Disc Diameter	Item#	Each
1	0.060" and 0.070"	846-2039	\$14.95
2	0.082" and 0.092"	846-2040	14.95
3	0.106" and 0.116"	846-2041	14.95
4	0.134" and 0.150"	846-2042	14.95
5	0.160" and 0.185"	846-2043	14.95
6	0.198" and 0.208"	846-2044	14.95
D. 6-Piece Set		846-2045	74.75

A. Shaviv Hand Deburring Tools

Shaviv is the internationally recognized choice of leading companies in the mold & die, automotive, aviation, plastics, electronics assembly and other industries.

Shaviv “B” style and “E” style blades are used for efficient deburring. “B” style blades are 2.6mm thick steel for: aluminum, stainless steel, copper, brass, cast iron and plastics. “E” style blades are 3.2mm thick and are useful for heavier duty applications. See chart below for specific blades and their applications.

Sets:

Mango II B Handle with 4 Multi-Purpose “B” Blades

Contains the Mango II B extra-close-reach handle with one each of the B10, B11, B20, & B25 blades.

Mango II E Handle with 5 Heavy Duty “E” Blades

Contains the Mango II E extra-close-reach handle for heavy duty use and one each of the E100, E111, E120, E200, & E300 blades.

Mango II M – The Two in One Telescopic Handle

Contains the Mango II M telescopic long-reach handle for variable extended reach up to 4”.

Accommodates both B+E style blades. Included are one each of the B10, B20, B30, E100, E111, and E200 blades.

Sets:	Item#	Each
Mango II B with 4 Multi-Purpose “B” Blades	846-2060	\$15.75
Mango II E with 5 Heavy Duty “E” Blades	846-2062	19.75
A. Mango II M Telescopic with 6 Blades (3 “B”, and 3 “E”)	846-2064	32.50



Mango II B



Mango II E



Mango II M

A



B. Shaviv Blades for Deburring Tools

“B” blades are 2.6mm thick, while heavy duty “E” blades are 3.2mm thick.

Description	Mfg.#	Blade (All clockwise work direction unless otherwise noted)	Applications			For Use On						Item#	Blades Per Pack	1-2 Pkgs.	3+ Pkgs.	
			Straight Edge	Hole Edge	Cross-Hole Both Edges	Steel	Aluminum	Copper	Brass	Cast Iron	Stainless					Plastics
HSS. Deburs materials with spiral chips.	B10		●	●		●	●	●				●	846-2070	10	\$17.50	\$15.75
PVD TiN coated for high resistance to wear.	B10P		●	●		●	●	●			●	●	846-2075	2	7.25	6.53
Long-lasting, cobalt-enriched.	B10S		●	●		●	●	●			●	●	846-2074	10	19.50	17.55
Extra thin, HSS. Deburs holes with minimum diameter 0.08” (2mm).	B11		●	●		●	●	●			●	●	846-2071	10	18.60	16.74
PVD TiN coated for high resistance to wear.	B11P		●	●		●	●	●			●	●	846-2076	2	7.25	6.53
HSS. Rotates clockwise & counterclockwise.	B20		●	●						●	●	●	846-2072	10	17.50	15.75
PVD TiN coated for high resistance to wear. Rotates clockwise & counterclockwise.	B20P		●	●						●	●	●	846-2077	2	7.25	6.53
HSS. Thin-nosed. Specially designed for plastics.	B25		●	●		●	●	●				●	846-2073	10	17.50	15.75
HSS. Simultaneously deburs the inside and outside of holes up to 0.16” (4 mm) thick.	B30				●	●	●	●				●	846-2078	10	22.70	20.43
Heavy-duty HSS. Deburs materials with spiral chips. Bulk pack available.	E100		●	●		●	●	●				●	846-2080	10	22.70	20.43
Long-lasting, cobalt-enriched.	E100S		●	●		●	●	●			●	●	846-2087	10	25.00	22.50
Thin-nosed. HSS. Deburs holes with minimum diameter 0.06” (1.5mm).	E111		●	●		●	●	●				●	846-2088	10	25.00	22.50
PVD TiN coated for high resistance to wear.	E111P		●	●		●	●	●				●	846-2086	2	12.50	11.25
HSS. E shaft, B20 cutting edge for materials with powdery chips. Rotates clockwise & counterclockwise.	E120		●	●						●	●	●	846-2082	10	22.70	20.43
HSS for materials with powdery chips. Rotates clockwise & counterclockwise.	E200		●	●						●	●	●	846-2085	10	23.00	20.70
PVD TiN coated for high resistance to wear. Rotates clockwise and counterclockwise.	E200P		●	●						●	●	●	846-2083	2	12.50	11.25
HSS for materials with spiral chips. Simultaneously deburs the inside and outside of holes up to 0.24” (6 mm) thick.	E300				●	●	●	●				●	846-2084	10	29.00	26.10

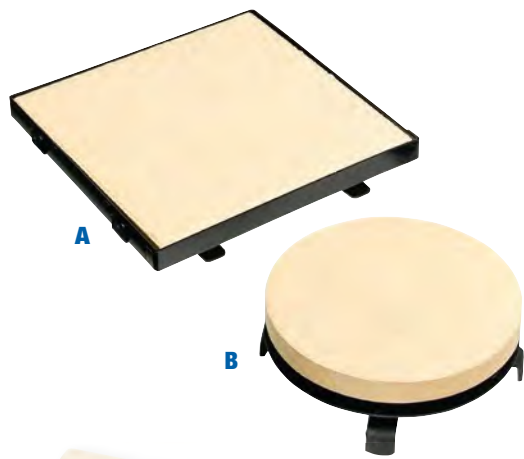

A, B Rotating Solder Tables

Solder & anneal single or multiple parts without having to move your torch.

These handy rotating tables permit 360° access to your parts so that you can work without having to move your torch. Bearings in the base provide smooth, easy movement. The tables are only 1" high, which makes it comfortable to use them on a bench top. Square table is supplied with one 6" x 6" Ceramic Soldering Pad (#830-2222) and also accommodates our Solderite Soldering Pad (#810-0100). Round table is supplied with grooved diameter ceramic soldering disc (#830-2238).

Description	Item#	Each
A. Square Table	830-2228	\$33.50
B. Round Table	830-2237	30.95
Square Solderite Pad, 6" x 6"	810-0100	11.75
Replacement Ceramic Pad, 6" x 6"	830-2222	13.50
Replacement Ceramic Round Disc, 4½" dia.	830-2238	10.75



C. Two-Way Ceramic Soldering Board – Flat/Grooved

Hard ceramic soldering board that is flat on one side and deeply fluted on the other side. Fluted side is ideal for soldering fine chains because air is allowed to circulate under the area not being soldered, reducing the diffusion of heat. Excellent thermal shock resistance. Measures 7"L x 7"W x 7/8"H. Can be heated to 2,000°F.

Description	Item#	EACH Prices	
		1-2	3+
Two-Way Board	830-2220	\$28.95	\$26.06



D, E Annealing Pans with Pumice

Allows positioning of work while annealing or soldering on heat-reflecting pumice. All pans rotate 360° on ball bearings and come with an adequate supply of lump pumice.

Description	Item#	Each
D. 12" dia. Annealing Pan	830-4000	\$75.75
E. 7" Annealing Pan w/ Tweezer	830-3994	35.95
7" Annealing Pan w/o Tweezer	830-3995	28.50
Pumice, 2½ lbs.	830-4001	29.95



F-H Ceramic Soldering Boards

All are nonasbestos and hard. Retain heat nicely and can be easily cleaned. Rubber feet raise boards above work surface. Very durable and smooth. Can be heated up to 2,000°F.

Size (L x W x H)	Item#	EACH Prices	
		1-2	3+
F. 6" x 6" x ½"	830-2222	\$13.50	\$12.15
G. 6" x 12" x ½"	830-2224	17.00	15.30
H. 12" x 12" x ½"	830-2227	26.39	23.75



I. Wesgo® Soldering Boards

Made from the same super refractory material as our popular high-temperature Wesgo crucibles for demanding thermal shock environments. Great for high-temperature soldering jobs such as platinum soldering. The material can be used at 2,642°F (1,450°C) for intermittent service (for platinum soldering, etc.) or at 2,012°F (1,100°C) for more continuous duty. Free of metal-contaminating impurities; contains no readily reducible oxides. Wesgo Soldering Boards offer extremely low thermal conductivity and no loss of strength at high temperatures.

Size (L x W X H)	Item#	Each
I. 4" x 4" x 3/8"	830-2400	\$84.00
4" x 12" x 3/8"	830-2410	219.00

A. Solderite™ Hard and Soft Soldering Pads

Nonasbestos soldering pads which are durable, smooth, and heat-reflective. Fairly hard so that they will not flake or crumble. Highly flame-resistant and noncombustible, these long-lasting, all-purpose pads can be used to protect surfaces from burning. Measure 1/2" thick.

Our popular Solderite Pad is also available in a soft version. You can easily push pins, heads or components into Solderite Soft for quick and easy alignment. Composed of the same material as hard Solderite and will provide the same superior heat reflection, insulating qualities and fast cool-down time. It won't break, crack or crumble as so many other soft products will. Asbestos-free, OSHA approved. Measure 3/4" thick.

Size (L x W)	Hard Item#	Soft Item#	EACH Prices	
			1-2	3+*
6" x 6"	810-0100	810-0335	\$11.75	\$10.58
6" x 12"	810-0200	810-0336	18.50	16.65
12" x 12"	810-0300	810-0337	32.75	29.48

*Quantity discount for orders of one item# only, not assorted.

B. Honeycomb Blocks

Very popular ceramic soldering block that contains hundreds of tiny holes to accelerate heat loss from parts being soldered. Holes also provide anchor points for pins or wires used to hold parts in place on the surface. Withstands heat up to 2,100°F.

Size (L x W x H)	Item#	Each
5 1/4" x 3 3/4" x 1 1/2"	830-2230	\$8.50
5 1/2" x 7 3/4" x 1 1/2"	830-2235	12.50
4 1/2" dia. x 1 1/2" Round	830-2236	12.00

C. Charcoal Soldering Blocks

Made from select, close-grained, knot-free wood. Creates a reducing atmosphere and reflects heat back onto workpiece for effective soldering conditions. Soft enough to allow work to be pinned or pressed into its surface. Available in three sizes. Wrapping binding wire (see p. 508) around the perimeter of the blocks will help them last longer.

Size (L x W x H)	Item#	EACH Prices	
		1-2	3+
3 3/4" x 2 1/4" x 1 1/4"	810-2300	\$9.50	\$8.55
4 1/2" x 3" x 1 1/4"	810-2200	14.50	13.05
7" x 4" x 1 1/4"	810-2100	28.95	26.06

D. Premium Charcoal Blocks

Extra-fine grain charcoal is compressed for a denser charcoal block that holds up better and lasts longer than standard blocks. Our Premium Small Block is 3 times heavier than a standard block of the same size. Our Premium Medium Block weighs almost twice as much as a standard medium block. No chemicals added. Imported.

Size (L x W x H)	Item#	EACH Prices		
		1-2	3-9	10+
3 1/8" x 2 5/16" x 1 1/8"	810-2404	\$10.40	\$9.36	\$8.32
5 1/2" x 2 3/4" x 1 1/4"	810-2405	14.95	13.46	11.96

E. Magnesia Block

Porous, fibrous, fireproof material used as a surface for soldering. Reflects heat. Soft enough to allow work to be pinned or pressed into its surface. Longer lasting than charcoal. Nonasbestos.

Size (L x W x H)	Item#	EACH Prices	
		1-2	3+
6" x 3" x 2"	810-2400	\$4.75	\$4.04

F. Hi-Temp Soldering Boards

This aluminum oxide board is designed specifically for the high temperatures required when working with platinum. Safe for temperatures up to 3,500°.

Size (L x W x H)	Item#	Each
4" x 4" x 1/2"	830-2240	\$23.50
6" x 6" x 1/2"	830-2245	35.00



A

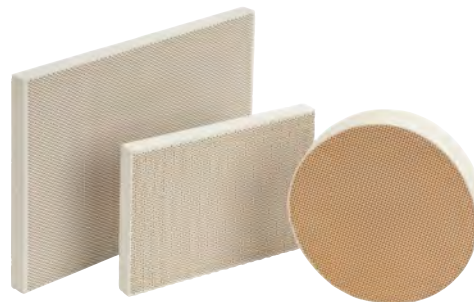

B



C



D



E



F

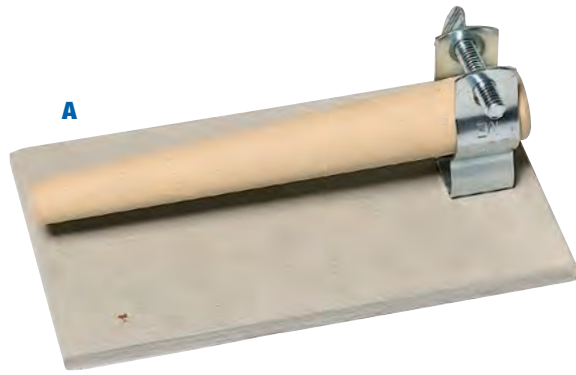

A. Heat-Resistant Ceramic Ring Soldering Stand

Tapered, hard ceramic rod is mounted in one position on a heat-resistant nonasbestos base. Prevents collapse or movement when fitting shank sections together. Cleaner to use than carbon and holds heat better. Rod measures 5³/₄" long.

Description	Item#	EACH Prices	
		1-2	3+
A. Ceramic Ring Soldering Stand	816-0405	\$27.45	\$20.59
Replacement Ceramic Rod	816-0305	13.65	12.29



B. Iron Binding Wire

Available in 10 different sizes for holding workpieces together for soldering or cementing. Also used for binding charcoal blocks in order to retard cracking.

No.	Approx. B & S	Dia.	Item#	EACH Prices	
				1-2	3+
12	24	.020"	820-2050	\$7.85	\$7.07
14	25	.018"	820-2100	8.35	7.52
16	26	.016"	820-2150	8.85	7.97
18	27	.014"	820-2200	11.15	10.04
20	28	.0125"	820-2250	11.45	10.31
22	29	.011"	820-2300	14.45	13.01
24	30	.010"	820-2350	14.85	13.37
26	31	.009"	820-2400	15.15	13.64
28	32	.008"	820-2450	20.65	18.59

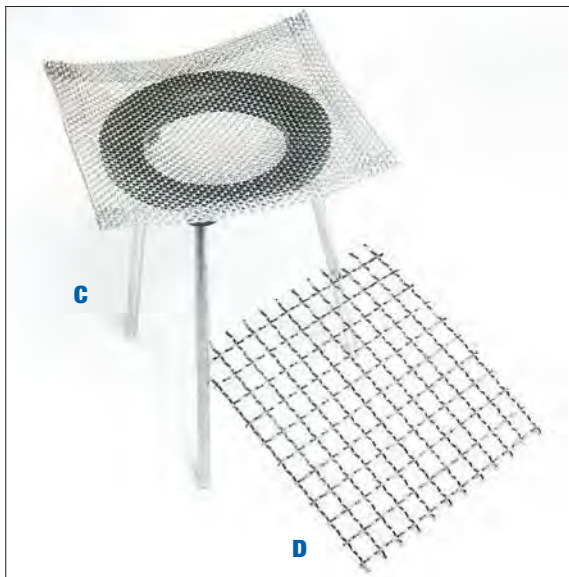

C. Tripod with Mesh Screen

Complete with Fine Mesh Heating Screen to heat work from below while welding, soldering, brazing or enameling. Can be placed over an alcohol lamp or Bunsen burner for heating operations. Complete with 6¹/₂" legs. Ring diameter measures 4³/₄". Mesh screen is 6" square. Use with #830-1290 Heavy-Duty Mesh Screen (below) when working on heavier items.

Description	Item#	EACH Prices	
		1-2	3+
C. Tripod & Screen	830-1295	\$14.75	-
Replacement Fine Screen only	830-1293	6.25	\$5.94

D. Mesh Heating Screens

Use on a tripod for soldering or heating work from below. Also for placing enameled pieces for firing. Available in fine or heavy-duty wire. Measure 6" x 6". Ship. Wt. 8 oz.

Description	Item#	EACH Prices	
		1-2	3+
D. Heavy-Duty	830-1290	\$6.85	\$5.48
Fine	830-1293	6.25	5.94

A-C Pickle Pot – 1 Quart

Made of holistic copper lining, this pickle pot works effectively to remove firescale and oxidation from silver, gold, and other non-ferrous metals. Contains an accurate temperature control to prevent over-boiling. The copper lining eliminates any corrosion even when using acidic solutions. Comes supplied with a plastic basket as shown in the photo.

The "Green" Kit also comes with 2lbs of Gesswein's Citpic, which is safer than most pickle compounds. Citpic is a mild organic citric acid that is colorless and odorless, but still effective for removing firescale and flux after soldering applications. A pair of non-corrosive Copper Tongs are also included.

Specifications Overall Size: 7.7" (195mm) Dia x 6.5" (165mm) High; Pot Size: 4.1" (105mm) Dia x 4.7" (120mm) High; Basket Size: 3.15" (80mm) Dia x 3.74" (95mm) High; 120V, 1.5 Amp, 50/60Hz

Description	Item#	Each
A. Pickle Pot	821-2445	\$225.00
B. "Green" Kit	821-2448	230.50
C. Replacement Basket	821-2446	11.50



D. Magic Pickle Compound

Magic Pickle compound is a dry granular compound that is ideal for cleaning and removing surface oxidation and fire scale from Silver, Gold, Copper and most other non-ferrous metals. The end result is a clean, bright surface. Requires heat to activate. One tablespoon to one pint of liquid. 24 oz. container.

Description	Item#	EACH Prices	
		1-5	6+
Magic Pickle Compound	821-2655	\$7.75	\$7.36

E. Place-It – The soldering fixture.

Safe, asbestos-free material that holds parts together during soldering, welding and brazing. A putty-like material that quickly hardens in any desired form or shape. Will not shrink on setting. Will not rob heat from joints. Ready to use. Withstands heat up to 3,200°F.

Description	Item#	Each
Jar, 4 oz.	810-0360	\$31.75



F. Heat Stop

Our most popular nonasbestos, nontoxic paste that protects precious metals, gems, glass, wood, etc. from heat damage during soldering. Protects up to 1,500°F. Effective up to 2,400°F. May be removed with water after soldering. Net Wt. 14 oz.

Description	Item#	Each
Heat Stop, 14 oz.	813-1850	\$19.75

G. Heat Shield

Protects jewelry components under direct flame so that it's not necessary to remove stones before soldering. Protects up to 5,000°F. Prevents oxidation. Odorless and nontoxic. Washes off with water. Net Wt. 1 lb.

Description	Item#	Each
Heat Shield, 1 lb.	813-1822	\$14.95



H. Kool Jool

Protects against heat while soldering. Lets you solder without removing stones (except opal, turquoise, emerald and other sensitive stones). Thick gel stays where you place it. So easy to use, it's also nontoxic and odorless. Rinses off with water. Net Wt. 8 oz.

Description	Item#	Each
Kool Jool, 8 oz.	813-1855	\$8.88

I. Soldering Grain

Irregularly shaped grains used to hold items for soldering. Acts like a third hand. The granular form allows objects otherwise difficult to position for soldering to be embedded with only the part to be soldered left exposed. Will not discolor gold or silver. Reusable and odorless. May be used wet or dry. If used wet, place in a heat-resistant, nonrusting container. Net Wt. 12 oz.

Description	Item#	Each
Soldering Grain, 12 oz.	830-2310	\$14.95





A

A. Pickler – 12 oz.

Provide a safe and convenient way to heat Gesswein Pickling solution. Our 12oz. capacity pickler achieves pickling temperature in minutes and maintain it without boiling. For removing oxides from the surface of silver, gold, copper and most other nonferrous metals. Supplied with one polypropylene basket for retrieving cleaned workpieces.

Model	Electrical	Dimensions (D x H)		Item#	Each
		Inside	Outside		
A. 400	115V, 125W, 50/60Hz	3" x 4 1/4"	4 7/8" x 5 1/2"	821-2450	\$149.95
Description		Dimensions (D x H)		Item#	Each
Replacement 400 Basket		2 5/8" x 4"		821-2600	\$20.85

B. Gesswein® Pickling Compound

A dry granular acid compound for cleaning and removing surface oxidation and incrustation from silver, gold, copper and most other nonferrous metals. Produces a clean, smooth, bright surface without affecting the tolerance of metals. Long-lasting compound withstands heat up to 300°F (150°C). Use 5 lbs. to make up to 2 gallons.

Description	Item#	Each
B. Gesswein Pickling Compound, 5 lbs.	821-2650	\$22.95
Gesswein Pickling Compound, 25 lbs.	821-2652	49.95



B

C. Citpic – The safer pickling compound.

Citpic is safer to use than standard pickling compound yet just as effective for removing firescale and flux after soldering applications. Citpic is a mild organic citric acid, colorless and odorless. It's gentle on skin and fabrics but tough on firescale and flux residue.

Heat Citpic in your pickle pot for fast, safe, effective cleaning of platinum, gold, silver and steel. You can even use steel tweezers and binding wire—Citpic won't cause copper contamination. Citpic is long-lasting and retains its effectiveness even after repeated use.

Description	Item#	Each
Citpic, 2 lbs.	821-2675	\$12.50
Citpic, 50 lbs.	821-2677	225.00



C

D. Acid Neutralizer

Dissolve approx. 2 oz. in 1 cup of warm water to make neutralizer solution. After removing items from pickling solution, place them into neutralizer solution to stop the pickling process. Wait 30 seconds, remove and rinse well. Do not heat. Sold in 6 oz. container.

Description	Item#	Each
Acid Neutralizer	821-2685	\$4.65



D

E-G Firescoff™ - Prevents Firestain

Revolutionary heat-activated ceramic spray coating. Combines a scale preventer and high-performance non-fluorinated flux for both hard and soft solder in one formula. Leading jewelers and jewelry manufacturers have switched from boric acid, paste flux and pickle solution to Firescoff because it's faster, provides more gemstone protection and cleans up easier. It's also alcohol and fluoride free, offering a real safety improvement over traditional methods. Cleans up easily in warm water, less than two minutes in an ultrasonic cleaner. 1 oz. size protects approx. 60–75 rings.

Description	Item#	EACH Prices		
		1-2	3-5	6+
E. 1 oz. Spray Bottle (30ml)	830-4537	\$9.75	\$9.26	\$8.78
F. 4 oz. Spray Bottle (120ml)	830-4538	24.95	23.70	22.46
G. 34 oz. Bulk Refill (1000ml)	830-4539	205.50	195.23	184.95



E

F

G

H-J Firescoff™ Rh for Rhodium

Firescoff™ Rh ceramic coating technology protects and prevents rhodium plated jewelry from turning black during resizing or repair. Avoid the need, time and cost required to strip and re-electroplate rhodium coatings. Multiple repairs are accomplished with a single application. This fluoride free and alcohol free liquid maintains original metal color and patina. Easy warm water cleanup, no pickling needed. Available in 3 sizes, a 1-ounce (30ml) sample size, 4 ounces (125ml) Ideal for bench jewelers needing to protect 200+ pieces; and for multiple jewelers or large shops 34 ounces (1000ml). Bulk refill also available.

Description	Item#	EACH Prices		
		1-2	3-5	6+
H. 1 oz. Spray Bottle (30ml)	830-4540	\$10.75	\$10.21	\$9.68
I. 4 oz. Spray Bottle (120ml)	830-4541	32.95	31.30	29.66
J. 34 oz. Bulk Refill (1000ml)	830-4542	277.50	263.63	249.75



H

I

J

A. Heetrix

The cleaner, safer way to solder your jewelry.

Space-saving Heetrix is a soldering station that rotates 360° to use in any position you want, then swings out of the way when you aren't using it. Includes a 3³/₄" diameter Hard Solderite disc with a depression underneath that can hold soldering grain (see page 509 830-2310, grain sold separately) for embedding items that need heat protection. Also includes a 4¹/₂" long stainless steel, insulated, cross-lock tweezers in a Third Hand. This all-in-one soldering system is incredibly convenient, which is no surprise since it was designed by master jeweler Jay Whaley. Everything you need to solder is kept neatly in one place which you can swing in and out as needed. Comes with two mounting options: C-Clamp for benches up to 2¹/₄" thick or peg-mount (requires drilling a hole into bench top). Dimensions: 7¹/₂" L x 6" W x 2" H. Net Weight: 3 lbs.

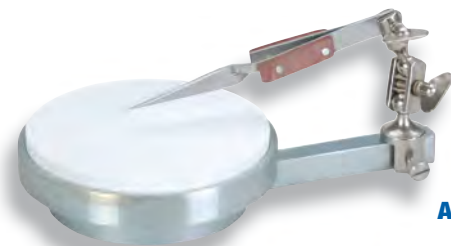

A

Description	Item#	Each
A. Heetrix	812-0851	\$42.95
Replacement Solderite Disc	812-0852	6.90

See also AQUAFLAME
for soldering and welding
on page 555

B. Hydroflux Welder System

The cleaner, safer way to solder your jewelry.

Hydroflux is a complete torch system that manufactures its own fuel from distilled water. Uses hypodermic-type tips to create flames ranging from a pinpoint for fine soldering up to a broad flame for sizing large men's rings.

Hydroflux's hydrogen/oxygen mix produces a clean non-contaminating flame ideal for platinum soldering and welding. Produces flame temperatures up to 4,850°F (2,675°C). Ideal for malls, homes and anywhere compressed gas and oxygen tanks are a concern.

Hydroflux comes complete with one torch with 4' flexible hose, eight-piece tip set, chemicals and in-line dryer. Sight gauges indicate when additional flux and water are needed. Hydroflux is easy to use and easy to set up with complete instructions included. Cabinet measures 16"W x 9"D x 10"H. Ship. wt: 45 lbs. Made in USA.

Description	Item#	Each
B. Complete System, 110V	830-0830	\$1,500.00
Replacement Parts	Item#	Each
Electrolyte Solution, 1 qt.	830-0833	\$31.50
Flux Solution, 1 qt.	830-0834	19.50
Torch Handpiece with 4' hose	830-0835	123.50
8-Piece Tip Set	830-0836	4.65
Cotton Fiber Filter	830-0837	7.75



B

C. Electric Soldering Machine

Electric soldering eliminates the hassles associated with flame soldering: no more firescale, no hazardous compressed gas, minimal oxidation and very little cleanup. Solder right next to most stones and pearls without removing them. Retip prongs, size rings, solder jump rings fast, and do assembly work. Easy to use with a little practice: simply position your work and solder chip in the versatile holders, dial up the power (max. temp. 2,000°F) and step on the foot pedal. The joint is as strong and as permanent as any solder joint made with a flame—but much easier to make. The unit is designed so that both hands can rest comfortably on your workbench.

Comes complete with control box and foot pedal, three large and two small carbon rods, contact rod, small and large clamps and stand for large carbon rods. Measures 10¹/₄" W x 6⁷/₈" D x 4¹/₈" H. Weighs 12 lbs. Made in USA.

Description	Item#	Each
Electric Soldering Machine, 110V	830-2030	\$525.00
Electric Soldering Machine, 220V	830-2035	525.00
Replacement Rods, set of 5	830-2040	32.95



C

D, E Copper Tong

Designed especially for use with pickling and acid solutions. Will not contaminate solutions nor corrode. Fishtail tips are thinner to pick up small or flat items. Measure 9" long.

Description	Item#	EACH Prices	
		1-2	3+
D. Copper Tong	195-0100	\$6.55	\$5.57
E. Copper Fishtail Tong	195-0110	8.85	7.52

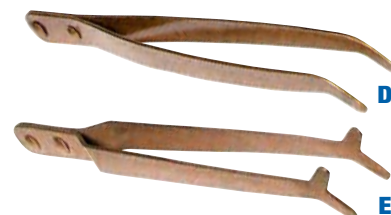

D

E

UPS® hazardous shipping surcharge applies. Ships via UPS® Ground only, no air, FedEx®, or US Mail shipments. Cannot ship to Alaska, Hawaii or Puerto Rico.

G-TEC Superior Torch Performance • Save Money • Safe Workshop

G-TEC Torch Boosters replace acetylene, propane and other fuel gas cylinders. They connect to your low-pressure utility natural gas pipe and boost pressure high enough to make gas flow through a flashback arrestor check valve and give you a hot flame on the torch.

- Never run out of fuel
- Clean natural gas flame improves work quality
- Don't waste time changing empty cylinders
- Make flashback arrestors effective



G-TEC Torch Boosters – Natural gas is up to 10 times cheaper than acetylene and half the cost of propane.

For equal BTUs natural gas costs much less than either acetylene or propane, and because you are connected to the utility natural gas pipe you never have to replace empty cylinders.

Turn the Torch Booster on in the morning and off at the end of the day and that's all you need to do. Torch Boosters automatically supply the right amount of natural gas.

G-TEC boosts utility natural gas to 25 psi, then a natural gas regulator (sold separately) lowers pressure to between 3 and 7 psi, the recommended pressure for most bench torches. The TB-30 and TB-60 models provide the sustained higher pressures needed for casting torches. You can even boost the pressure to 10-15 psi to cast platinum with high-quality results. Platinum casters report better results when heating with natural gas; there is less stress on the metal, less porosity and an overall better quality cast.

Torch Boosters are whisper-quiet and can be installed right next to your bench. G-TEC Torch Boosters are certified by CSA International. OSHA and local fire codes require the use of combination flashback arrestor check valves to protect the gas meter from a torch flashback. The problem is that flashback arrestor check valves need at least 3/4 psi gas pressure to work properly, otherwise they block gas flow. With high pressure natural gas from a G-TEC Torch Booster there is enough pressure to make the flashback arrestor check valve work properly, and still provide a robust flame on the torch.

Quiet and easily maintained.

G-TEC Torch Boosters run in virtual silence and have a very small footprint. Can be easily installed by a licensed plumber in any facility.

View instructional video
at www.gesswein.com.

Made in
the USA



Fitted with
regulator and
flashback
arrestor



Specifications:	TB-15	TB-30	TB-60
Capacity	1-3 bench torches	1-6 bench torches Or 1 casting torch	1-4 bench torches & 1 casting torch simultaneously
Electrical	110V, 15A	110V, 15A	110V, 15A
Gas Supply	1/4-1 PSI	1/4-1 PSI	1/4-1 PSI
Gas Pressure	25 PSI	25 PSI	25 PSI
Gas Flow	15 cu.ft./hr.	30 cu.ft./hr.	60 cu.ft./hr.
W x D x H	12" x 16" x 12"	12" x 16" x 12"	20" x 18" x 16"
Net Wt.	48 lbs.	50 lbs.	75 lbs.
Description	Item#	Each	
TB-15 Torch Booster, FOB Buffalo NY	830-0817	\$1,399.00	
TB-30 Torch Booster, FOB Buffalo NY	830-0818	1,999.00	
TB-60 Torch Booster, FOB Buffalo NY	830-0819	3,650.00	
Harris Natural Gas Regulator	830-1014	249.35	
Smith Flashback Arrestors, set of 2, for regulator	830-0812	75.00	
Smith Flashback Arrestors, set of 2, for torch	830-0816	75.00	
Maintenance Kit	830-0827	206.00	

For larger units and for assistance with New York City's special regulations, please call our Technical Department at 1-800-544-2043 (Mon-Fri, 9am-5pm EST) for additional information.

Please note: A natural gas regulator is required for G-TEC units. We recommend our #830-1014 Harris Natural Gas Regulator.

Airsep Oxygen Generators

The safe and efficient alternative to oxygen cylinders!



Equipped with their own air compressors, these generators require no special installation. Simply connect the oxygen outlet to your oxygen distribution system and the power cord to a grounded electrical outlet. Just turn the unit on and set your oxygen delivery flow.

A, B Onyx and Topaz Plus Oxygen Generators

AirSep Oxygen Generators provide instant oxygen on demand, eliminating the oxygen deliveries or the transportation and storage of pressurized, volatile oxygen cylinders on premises. Provides all the oxygen needed for most jeweler's torches.

- Generates 93% nominal oxygen concentration.
- Generate oxygen at half the cost of cylinders or liquid oxygen.
- Two models are available: the portable Onyx (on rollers) for one-person and smaller shops and the commercial grade Topaz Plus for production shops. Topaz Plus is wall mountable and includes oxygen delivery and cycle pressure gauges, and high temperature, ozone-resistant process tubing.
- Larger models available. Contact us for details.

Both the Onyx and Topaz Plus utilize molecular sieve to separate compressed air into nitrogen and oxygen, allowing the oxygen to pass through to your torch line. The molecular sieve is completely regenerative and will last indefinitely making AirSep the most user-friendly oxygen generator on the market. The generators require minimal regular maintenance, limited to cleaning the system's particulate filter and replacing filter pads.

CSA and CE approved. 1 year manufacturer's parts and factory labor warranty.

Specifications:	Onyx	Topaz Plus
Oxygen Output:	12 SCFH @ 9PSIG	17 SCFH @ 20 PSIG
Oxygen Purity:	93% Nominal	93% Nominal
Noise Level:	49dB	55dB
Operating Conditions:	40-120°F (4-49°C)	40-120°F (4-49°C)
Product Dew Point:	-100°F (-73°C)	-100°F (-73°C)
Gas Outlet:	1/4" NPT/B size Oxy. Adapter	1/4" NPT/B size Oxy. Adapter
Housing:	Plastic Enclosure	Durable Metal Enclosure
Dimensions:	15.7" x 14.5" x 28.5"	17.3" x 10" x 26.8"
Electrical:	120V, 60Hz, 1 Ph, 5A	120V, 60Hz, 1 Ph, 5A
Net/Ship. Weight:	51/60 lbs.	56/64 lbs.

Description	Item#	Each
A. AirSep Onyx	830-0033	\$1,385.00
B. AirSep Topaz Plus	830-0030	2,889.00
Replacement Filter Pads - Onyx - Package of 5	830-0035	8.00
Replacement Filter Pads - Topaz Plus - Package of 5	830-0032	5.90



A AirSep Onyx



B AirSep Topaz Plus

Larger models also available.
Contact us for details.

The Little Torch™

When you pick up The Little Torch, you know immediately that you are holding a superbly balanced torch that will enable you to extend your skills far beyond all previous limits. Whether you are in the first stages of learning your craft or have mastered it completely, The Little Torch will open a new world of possibilities for you. Features a rugged aluminum alloy body that weighs only 1.5 ounces and a thin, flexible, lightweight hose that provides added maneuverability.

Offers unmatched versatility—can be used with several fuels, including acetylene, hydrogen, propane, propylene, MAPP and natural gas. Produces a perfectly controlled, completely stable flame hot enough to melt gold, silver, platinum, glass and even ceramic. Can also be used with special heating tips to melt up to 3 oz. of gold or silver. One year manufacturers warranty.

Tip Size	Gas Pressures (PSI)	
	Oxygen	Fuel Gas
2	2	2
3	4	4
4	4	4
5	6	6
6	6	6
7	8	8

Flame drawings are not actual size. Each tip is capable of a variety of settings, with flame sizes larger and smaller than those shown.

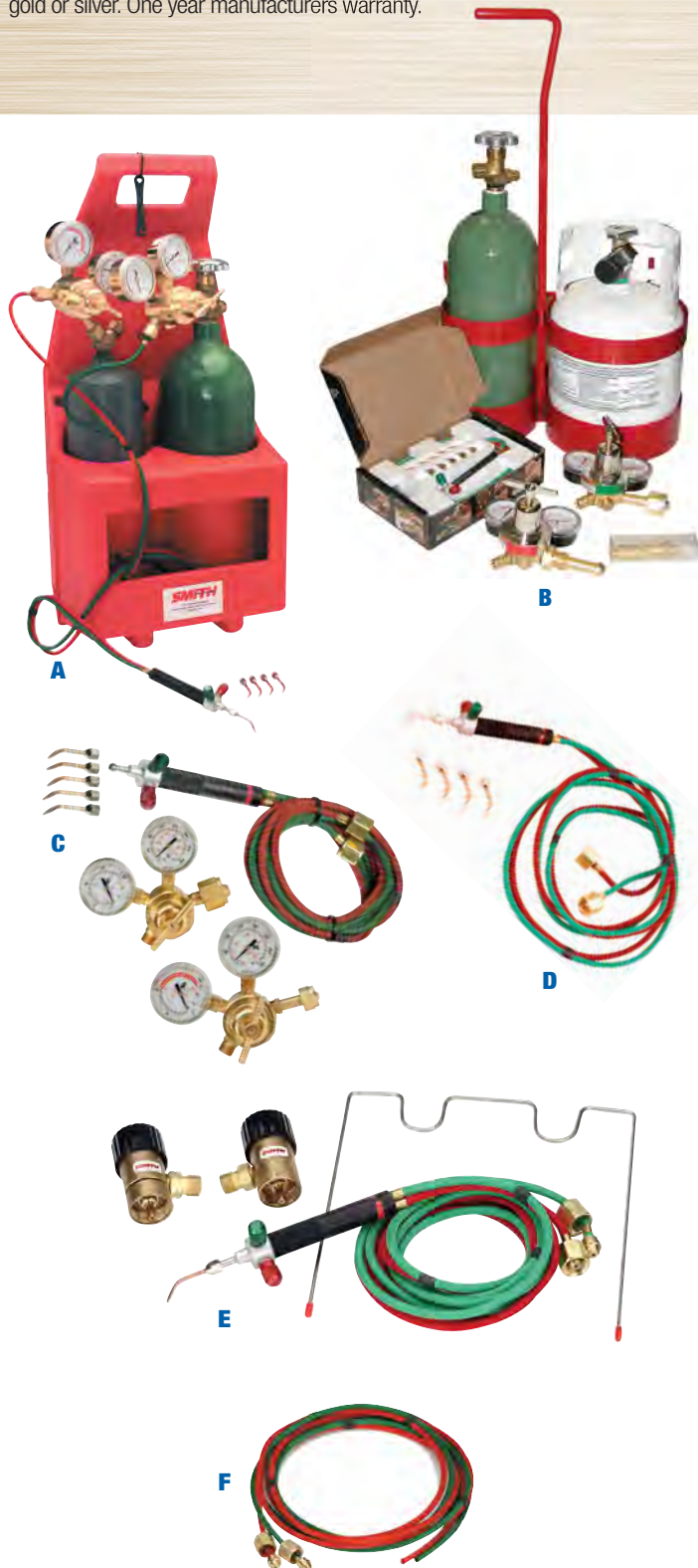

A, B The Little Torch™ Deluxe Sets

Each set includes The Little Torch handpiece, five brazing tips, 8' oxygen and 8' fuel gas twin hose with 9/16" connectors, two single-stage regulators (one for oxygen, one for fuel gas), one (empty) oxygen tank, one (empty) fuel gas tank and a carrier.

Description	Item#	Set
A. For Oxy/Acetylene, plastic carrier	830-1020	\$740.00
B. For Oxy/Propane, metal carrier with 5 lb. tank	830-1018	719.00

C. The Little Torch™ Medium Sets

Includes The Little Torch handpiece, 8' Oxygen and 8' fuel gas twin hose with 9/16" connectors and five brazing tips and two single-stage regulators (one for oxygen and one for fuel gas).

Description	Item#	Set
C. Medium for Oxy/Acetylene (MC tanks)	830-1010	\$370.00
Medium for Oxy/Acetylene (B tanks)	830-1011	370.00
Medium for Oxy/Propane	830-1015	370.00

D. The Little Torch™ Starter Set

The starter set includes The Little Torch handpiece, 8' oxygen and 8' fuel gas twin hose with 9/16" connectors and five brazing tips.

Description	Item#	Set
Starter for Propane or Natural Gas	830-1002	\$145.00

E. The Little Torch™ Set for Disposable Cylinders

Perfect for locations where larger compressed air tanks are not permitted. Includes The Little Torch handpiece, #5 tip, 8' oxygen hose, 8' fuel gas hose, preset oxygen regulator, preset propane regulator, wire stand for disposable oxygen and MAPP/LP cylinders and instruction manual. Disposable cylinders not included.

Description	Item#	Each
E. The Little Torch Set for Disposable Cylinders	830-1245	\$220.00
Replacement Oxygen Regulator	830-1027	54.95
Replacement Propane Regulator	830-1029	54.95

F. The Little Torch™ Hose – 8 feet long

Available in connected Twin Line or individual Oxygen or gas hoses with connectors.

Description	Item#	Set
F. Twin Line (green and red) hose with connector	830-1042	\$61.95
Replacement Green (oxygen) hose with connector	830-1043	30.25
Replacement Red (fuel gas) hose with connector	830-1044	30.25

A-E Little Torch™ Regulators

For single torch use. Compact regulators provide accurate control of oxygen and acetylene or propane for welding, soldering, brazing and heating operations. Contain protective check valves and maintain uniform pressure. Easy-turning T-bars. Made in USA.

Description	CGA Connection	Item#	Each
A. For Oxygen	540	830-1021	\$124.95
B. For Acetylene MC Tank	200	830-1022	132.95
C. For Acetylene B Tank	520	830-1024	124.95
D. For Propane	510	830-1023	119.00
E. For Hydrogen	350	830-1016	127.50

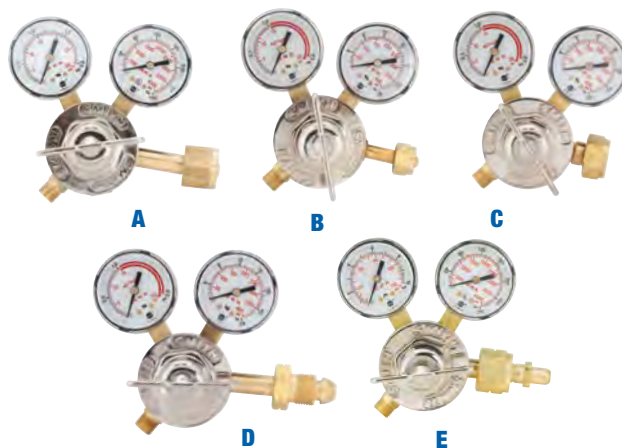

F-K Little Torch™ Brazing Tips

Because of their extraordinarily small orifices, tips 2 and 3 are fitted with synthetic sapphires to assure accurate performance and control.

Tip	Oxygen Pressure (PSI)	Fuel Gas Pressure (PSI)	Item#	EACH Prices	
				1-2	3+
F. 2*	2	2	830-1102	\$26.75	\$24.08
G. 3	3	3	830-1103	26.75	24.08
H. 4	4	4	830-1104	26.75	24.08
I. 5	6	6	830-1105	26.75	24.08
J. 6	6	6	830-1106	26.75	24.08
K. 7	8	8	830-1107	26.75	24.08

*For acetylene or hydrogen only.

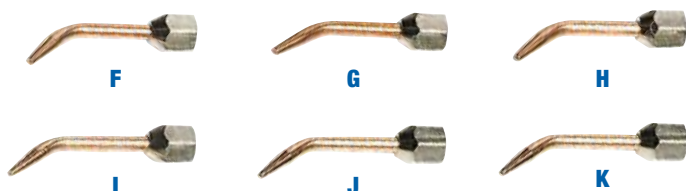

L-Q Uniweld Tips

Curved torch tips. Tip #2 (acetylene or hydrogen only) features a sapphire insert for superior flame control. Tips 3-7 are for use with all fuel gases: acetylene, hydrogen, propane, MAPP, propylene and natural gas.

Tip	Oxy/Fuel PSI	Item#	Each
L. 2*	2/2	830-1446	\$22.50
M. 3	3/3	830-1447	22.65
N. 4	4/4	830-1448	22.65
O. 5	6/6	830-1449	22.65
P. 6	6/6	830-1450	22.65
Q. 7	8/8	830-1451	22.65

*For acetylene or hydrogen only.

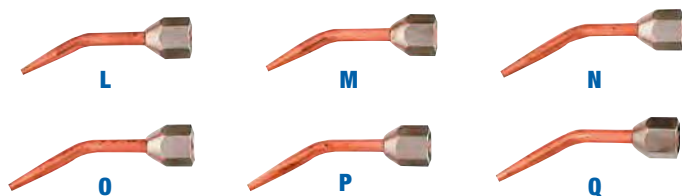

R, S Little Torch™ Heating Tips

For melting up to 3 oz. gold or silver and other work. These tips are specially designed with 4 orifices to produce 4 flames that come together to form one flame. Equal in size to tip 4. Maximum temperature is 3,600°F for propane, 6,000°F for all other fuels.

For	Item#	EACH Prices	
		1-2	3+
R. Propane or Natural Gas	830-1116	\$57.50	\$51.75
S. All other fuels	830-1115	44.15	39.74

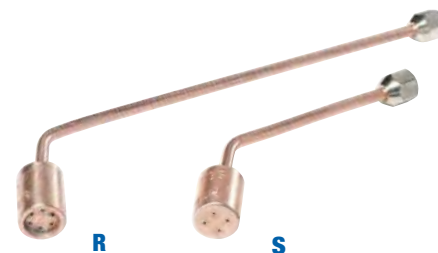

T. Holder for The Little Torch™

Holds The Little Torch at the perfect angle, making it handy and safe to use. Keeps up to six tips conveniently organized. Made with a sturdy cast base and heavy-duty (4mm) steel rod, this torch holder is virtually indestructible. Made in USA.

Description	Item#	Each
Holder for The Little Torch	830-1307	\$11.95



U. Magnetic Torch Stand and Tip Organizer

Solid metal stand with weighted base. Includes holes drilled and numbered for tips 2-7. Just a twist of the wrist removes the torch from the magnet. Magnetic clip mounts easily on The Little Torch body (torch and tips sold separately). Measures 4 1/2" high.

Description	Item#	Each
Magnetic Stand	830-1250	\$39.95



The Small Torch™ by Gentec

This lightweight, durable torch features user-friendly control knobs for quick, precise, one-handed flame adjustments and nickel-plated brass handle with stainless steel inner gas tubes for superior strength. Designed specifically for brazing and soldering at the bench as well as melting small amounts of metal. Provides stable, concentrated feather flames up to 6,000°F. Compatible with accessories listed below and other popular brands of accessories. Backed by a two-year manufacturer's limited warranty. UL approved. Made in China.



A

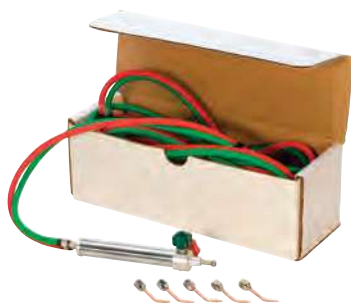

B



C



D



E



F



G



H

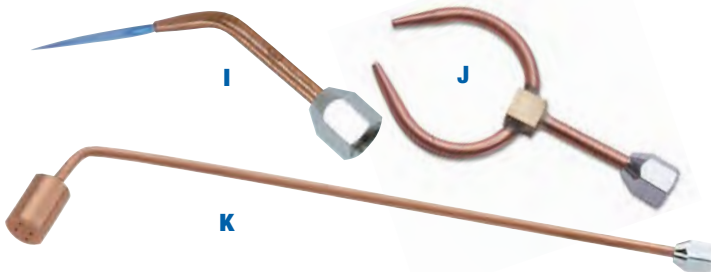

I

J

K

A. The Small Torch™ Caddy Sets

Each kit includes The Small Torch handle, torch tip(s) and 12' dual oxygen and fuel hose with "B" (9/16") fittings and adapter for "A" (3/8") fittings. Oxy/Acetylene Caddy Kit also includes regulators, a convenient carrying caddy and reusable oxygen and fuel tanks, Oxy/Propane Caddy Kit includes a convenient carrying caddy and oxygen tank (only for use with disposable propane tanks not provided). All tanks shipped empty.

Description	Tips	Item#	Each
A. Oxy/Acetylene Caddy Set	#2, 3, 4, 5, 6	830-1604	\$525.00
Oxy/Propane Disposable Tank Caddy Set	#3, 4, 5, 6, 7	830-1603	456.00

B. The Small Torch™ Basic Sets

Each Set contains the Small Torch with easy turn knobs, 5 tips and 12' oxygen and fuel hose.

Description	Tips	Item#	Each
B. Oxy/Acetylene Basic Kit (no regulators/tanks)	#2, 3, 4, 5, 6	830-1601	\$129.00
Oxy/Propane Torch Kit (no regulators/tanks)	#3, 4, 5, 6, 7	830-1600	129.00

The Small Torch™ Disposable Set - For propane and oxygen tanks (not shown)

Comes complete with Small Torch, #4 tip, 6' hoses and regulators.

Description	Tips	Item#	Each
Oxy/Propane Disposable Tank Kit (no regulators/tanks)	#4	830-1602	\$190.50

C. The Small Torch™ Dual Hoses

Each includes flexible green (oxygen) hose and red (fuel) hose with 9/16" fittings.

Description	Item#	Each
C. 6' Dual Hose	830-1605	\$37.25
12' Dual Hose	830-1606	49.95

D-H The Small Torch™ Regulators

Single-stage regulators manufactured using state-of-the-art equipment. Feature chrome-plated housing caps and bodies machined from class "A" brass bar stock. Single-stage, rear-entry design ensures safe, neat fit in caddy systems. Internal safety pressure relief valve and stem-type seat assembly. Imported.

Description	Item#	Each
D. Oxygen Regulator	830-1607	\$84.95
E. Propane Regulator	830-1608	84.95
F. Acetylene Regulator	830-1609	81.95
G. Oxygen Regulator for Disposable Tanks	830-1610	47.75
H. Fuel Gas Regulator for Disposable Tanks	830-1611	47.75

I-K The Small Torch™ Tips

Rosebud melting tips are 6" long and multi-orifice tips for melting up to 3 oz. of gold, silver or bronze.

Tips	Item#	Each
I. 2 (oxy/acetylene use only)	830-1614	\$18.95
3	830-1615	21.50
4	830-1616	21.50
5	830-1617	21.50
6	830-1618	21.50
7	830-1619	21.50
J. Twin 3	830-1620	28.40
K. Propane Rosebud Melting	830-1612	26.50
Acetylene Rosebud Melting	830-1613	26.50

A. TurboTorch Set

Operates on acetylene and air—no oxygen tank required. Includes the TurboTorch handpiece, one #4 torch tip for medium soldering jobs, an acetylene regulator for your B tank (not included, see acetylene B tank 830-0760) and 12' of hose. Adjustable regulator provides steady gas delivery and stable flames.

Description	Item#	Each	
A. TurboTorch Acetylene + Air Set	830-0737	\$250.60	
Tip Size	Flame Size	Item#	Each
1A	Fine	830-0743	\$37.65
3	Light	830-0744	38.65
4 (replacement)	Medium	830-0747	39.65
5	Heavy	830-0748	42.65



A

B. SilverSmith™ Air-Acetylene Torch Kits

Delivers the ultimate in quality and flame control. Produces a soft, consistent flame. Ideal for silversmithing and for melting small amounts of metal for casting. Choose between 2 sets:

830-0732 includes durable Nickel-plated brass handle with a precision #00 tip with jeweled orifice, 12' grade-R hose, acetylene regulator with CGA 520 fitting for acetylene B tank (not included, see p. 520 for acetylene B tank #830-0760) and torch lighter.

830-0753 contains all the items in set 830-0732 as well as an Acetylene B tank, leak detection fluid, wrench and soldering glasses. Sold separately. UL listed. Made in USA.

Description	Item#	Each	
B. Torch Set with one tip #00, Regulator and Hose	830-0732	\$225.00	
C. Torch Set with one tip #00, Regulator, Hose, Tank & Accessories	830-0753	355.00	
Replacement Torch Handle only	830-0998	66.50	
Description	Orifice Size	Item#	Each
#4 Extra-Large Melting Tip	3/8"	830-1465	\$46.50
#3 Large Melting Tip	1/4"	830-1464	46.50
#2 Medium Tip	3/16"	830-1463	40.00
#1 Small Tip	0.147"	830-1462	40.00
#0 Fine Tip	0.095"	830-1461	46.50
Replacement #00 Super-Fine Tip	0.066"	830-1460	46.50

*Included in sets with 3 tips.



B

C

D-F Smith Casting Torch

Whether you need to melt 1 oz. or 12 oz., this versatile torch does the job. Consists of handle and your choice of two different heavy-duty copper 63.5°-angle tips (sold separately). Handle features rugged two-tube silver-brazed construction, forged brass butt and precision-machined brass head. Threaded and soldered inner tube for prevention of cross-leaking. Ball-type needle valves resist uneven wear and allow easy flame adjustment. Drag nut adjustment on knobs for preferred valve resistance. Measures 1 5/16" dia. x 7"L. Weighs 14 oz. Backed by a lifetime warranty. UL listed. Made in USA.

Description	Item#	Each		
D. Torch Handle only (choose a tip below)	830-0999	\$199.95		
Description	Melts up to	Oxy/Fuel PSI	Item#	Each
E. Oxy/Propane Tip	3 oz. platinum	11/11	830-1456	\$74.00
F. Oxy/Acetylene Tip	12 oz. gold/silver	10/10	830-1455	122.65

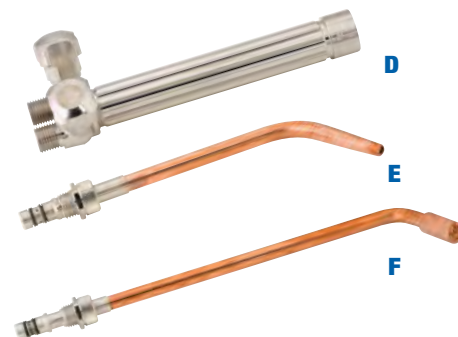

D

E

F

G. Leak Detector Fluid

Safety is always priority when working with torches! Apply this fluid every time you change your torch, hook up a new tank or torch, or simply when you want to check for any leaks that may have formed in any of the connections. Should a leak be present, the liquid will bubble within seconds of application alerting you of a leak. Contains 8 fl. oz. Please Note: CAUTION! Do not use standard soap solutions to test for leaks; these solutions may contain combustible ingredients. Made in USA.

Description	Item#	Each
Leak Detector Fluid	830-0757	\$8.95



G

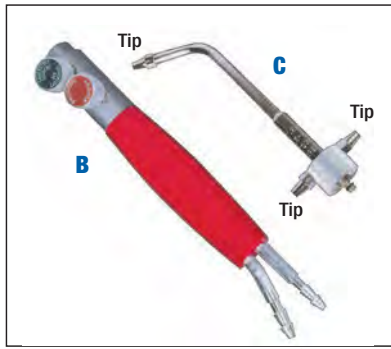

A

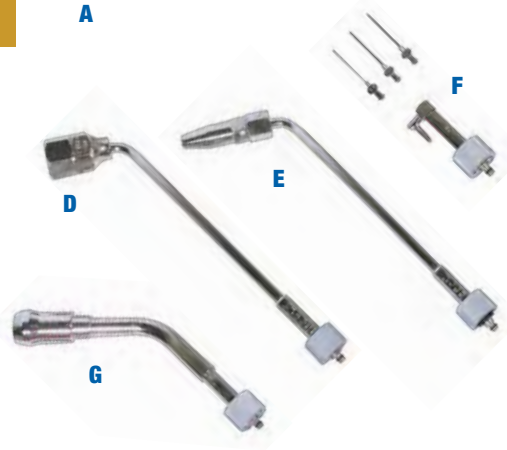

D

E

F

G

See page 520
for Primo™ Fire Resistant
Torch Hoses.

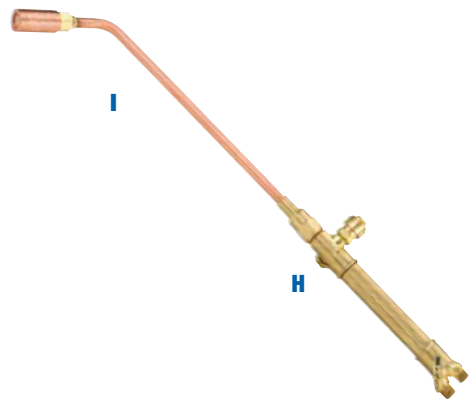

I

H

A. Swiss Torch

The best-selling jeweler's torch in Europe, this versatile and reliable lightweight torch has interchangeable heads for precision light work to casting to larger flames for melting. Use it with propane or natural gas. Not for use with ACETYLENE. The standard torch comes with standard head with three nozzles of graduating tip sizes, each produces a strong and pointed flame. The head features two handy dials (for fuel and oxygen) at the top of the torch where your thumb can easily reach both for tight control and on-the-fly flame adjustments. Made in Switzerland.

PLEASE NOTE: Swiss Torch Casting Head Compress Air (830-1485) is for propane/natural gas and MUST BE USED WITH compressed air ONLY and NO OXYGEN.

Do not use the Swiss Torch with ACETYLENE otherwise damage will occur.

Description	Item#	Each
A. Swiss Torch Kit w/Standard Head and 3 Standard Tips	830-1482	\$250.00
B. Swiss Torch Body Only	830-1480	129.00
C. Swiss Standard Head and 3 Standard Tips	830-1481	179.00
D. Swiss Oxygen Head Ring Flame	830-1483	107.00
E. Swiss Torch Platinum Head	830-1487	119.00
F. Swiss Torch Head w/ 3 Needle Tips	830-1489	150.00
G. Swiss Torch Head Compressed Air	830-1485	107.00

H, I Gentec Casting Torch

Casting torch for use with oxygen/propane or oxygen/natural gas. Features a high-quality forged brass handle with "tube-in-a-tube" design for high strength. Combine with Heating Tip to create a versatile casting, soldering and melting torch. Handle measures 6" long.

Description	Item#	Each
H. Casting Torch Handle only	830-1621	\$99.95
I. #6 Heating Tip with Tube	830-1622	50.85

J, K Original HOKE®-JEWEL Torch

For soldering, brazing, welding and melting. All parts are machined from solid brass stock and seamless brass tubing and completely nickel-plated. Tip tube (neck) is fixed and nonadjustable. Valves are easily and smoothly operated by fingertip. Uses standard 1/4" hose (not included). Includes tips ranging in size from pinpoint to large brush. Measures 9" long. Adapter set includes six micro-tips which produce a nonoxidizing flame so less time is needed in the pickler. Not recommended for use with acetylene

Description	No. of Tips	Item#	Each
Natural Gas	3	830-0221	\$36.75
J. Propane/Butane	4	830-0222	46.00
Acetylene	4	830-0210	36.75
Artificial Gas*	4	830-0220	36.75
K. Adapter Set for HOKE-JEWEL Torches	6	830-1240	21.50

Replacement Tips for Natural Gas and Oxygen	Max. Oxygen PSI	Flame Size	Item#	Each
35-1	2 to 3	Fine	830-1200	\$2.80
35-2	3 to 4	Medium	830-1205	2.80
35-3	4 to 5	Broad	830-1210	2.80

Replacement Tips for Propane or Butane and Oxygen	Max. Oxygen PSI	Flame Size	Item#	Each
1	2 to 4	Pinpoint	830-1220	\$2.80
2	2 to 4	Fine	830-1225	2.80
3	6 to 10	Medium	830-1230	2.80
5	15 to 20	Broad	830-1235	2.80

*Includes pilot that provides continuous flow of gas for quick ignition.

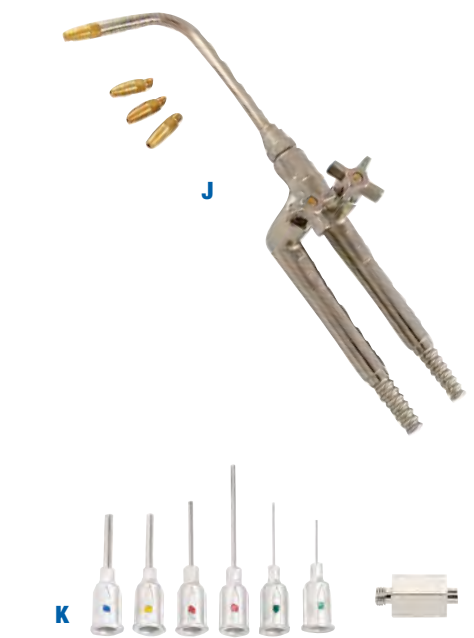

K

A. Harris® Check Valves for Regulators

Oxygen and fuel gas kept separately are not explosive. When mixed in a hose or regulator and then ignited, they can explode. Check valves prevent backup of gases into regulator so they cannot mix. Harris Check Valves may be installed on any regulator outlets with standard $\frac{9}{16}$ "-18 tpi. connections.

Model	Item#	Each
A. Oxygen	830-1417	\$22.50
Fuel Gas	830-1416	22.50



B-E Harris® Single-Stage Regulators with Check Valve

For general use when using one torch. Features all-brass construction to hold up even in corrosive atmospheres. Extra-large $2\frac{3}{4}$ " pressure gauges so you can easily read PSI even when you are at a distance from the cylinder. Large $2\frac{3}{4}$ " diaphragm ensures constant delivery pressure. A check valve is installed on all regulators. Oxygen Regulator is equipped with a Harris Surge Guard for protection against sudden overflow of oxygen into the regulator. Standard $\frac{9}{16}$ " connections. UL listed.

Model	CGA	Item#	Each
B. Oxygen	540	830-1412	\$202.25
C. Acetylene for MC and B tanks*	200, 520	830-1432	95.45
D. Acetylene for large tanks	510	830-1389	184.00
E. Propane	510	830-1411	202.25

*Includes adapter to convert MC regulator to B tank.

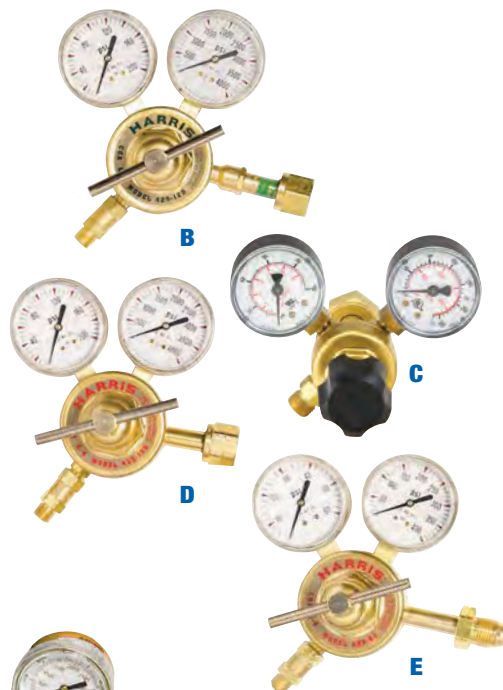

F-H Harris® Two-Stage Regulators with Check Valve

Especially useful when operating more than one torch from the same cylinder. The first stage reduces the inlet gas pressure to relatively constant levels. The second stage further reduces the gas pressure and delivers the gas to the work precisely at the set point pressure. Helps to provide flame stability as the pressure levels change. Features chrome body with large, brass, easy-to-read $2\frac{1}{4}$ " pressure gauges. All regulators include a check valve. Oxygen Regulator is equipped with safety Surge Guard to prevent sudden overflow of oxygen into the regulator. Standard $\frac{9}{16}$ " connections. UL listed.

Model	CGA	Item#	Each
F. Oxygen	540	830-1415	\$361.00
G. Acetylene	300	830-1413	361.00
H. Propane	510	830-1414	361.00



I. Smith Flashback Arrestors for Torch or Regulator

Flashback arrestors with built-in check valves for preventing flashback fires and reverse gas flows. Feature sintered stainless steel filter, high-quality brass construction and rugged corrosion-resistant case. Easy to install on any torch with standard B ($\frac{9}{16}$ ") fittings or regulator. Sold in sets of two: one for oxygen and one for fuel gas. UL listed.

Description	Item#	Set of 2
I. Flashback Arrestors, set of 2, for torch	830-0816	\$75.00
Flashback Arrestors, set of 2, for regulator	830-0812	75.00



J. Y-Connectors

For multiple torch hookups. Complete with shutoff valves. All connections $\frac{9}{16}$ ".

Model	Item#	Each
J. Oxygen	830-0780	\$45.20
Fuel Gas	830-0785	45.20





A-D Tanks and Cylinders

Tanks and Cylinders include valves and are shipped empty.

Description	Capacity	Overall Ht.	Item#	Each
A. Oxygen Tank	60 cu. ft.	23½"	830-0755	\$195.85
B. Oxygen Cylinder	20 cu. ft.	18"	830-0756	139.95
C. Acetylene B Tank	40 cu. ft.	23¼"	830-0760	153.50
Acetylene MC Tank	10 cu. ft.	16"	830-0761	87.00
D. Propane Cylinder #5	5 lbs.	12½"	830-0766	143.95

E. Tuline Hose

Prevents tangling of torch hoses. Consists of two color-coded reinforced hoses (green for oxygen and red for fuel gas) that are uniquely coupled to prevent tangling and can be separated by simply pulling them apart. ¼" I.D. Measures 25' long. Complete with fittings.

Description	Fittings	Fuel Gas	Item#	Each
Premium Grade T	9/16"	All fuel gases	830-0805	\$99.00

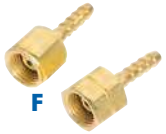

F. Slip-On Hose Connectors

All consist of a nut with stem for use with standard I.D. hoses.

Description	Gas	Item#	Each
9/16" RH nut & stem for ¼" I.D. hose	Oxygen	830-0353	\$2.31
9/16" LH nut & stem for ¼" I.D. hose	Fuel	830-0354	2.31



G-H Reinforced Rubber Hose

Available in Grade T red for propane, acetylene or natural gas. Also available in Grade R green for oxygen. Twin Line consists of one red (gas) hose and one green (oxygen) hose - both Grade R. ¼" I.D. Sold by the foot. Please specify minimum continuous length.

Description	Fuel Gas	Item#	Per Foot
G. Red Hose - Grade T	Propane, Acetylene, Natural Gas	816-2351	\$2.95
H. Green Hose - Grade R	Oxygen	816-2350	2.95
Twin Line - Both Grade R	Oxygen + Acetylene Only	816-2352	5.00

I-K Primo™ Fire Resistant Torch Hoses

Safety is always top priority when operating a torch! Primo has gone that extra step and created Fire Resistant Torch Hoses for Little Torch, Swiss Torch, and Meco Torch. These premium high quality replacement torch hoses are lighter in weight than most competitive hoses and much more flexible in use. This equates to better productivity on the bench. Each hose is complete with quality stainless steel clamp and sold brass fittings making the hookup to your torch fast and easy. Tank end connectors are North American B 9/16"

Description	Hose ID	Torch End Connector	Length	Item#	Each
I. For Little Torch	⅜"	SS Crimp-on (x2)	6ft.	830-1047	\$39.50
			8ft.	830-1048	45.50
			10ft.	830-1049	51.50
J. For Swiss Torch	⅜"	Hose Clamps (x2)	6ft.	830-1050	58.50
			8ft.	830-1051	65.50
			10ft.	830-1052	74.50
K. For Meco Torch	⅜"	N. Amer. B 3/8"	6ft.	830-1053	44.50
			8ft.	830-1054	51.50
			10ft.	830-1055	58.50

L. Carrier for Oxy/Acetylene Tanks

Makes it easy to move entire torch outfit from one place to another. Wheels and single handle provide excellent maneuverability. Built-in box holds wrench, extra tips, and other small accessories so that they are within easy reach. Hose wrap keeps lines neat. Holds our #830-0760 Acetylene B Tank and #830-0755 Oxygen Tank. Measures 19"W x 37½"H. Ship. Wt: 20 lbs.

Description	Item#	Each
Carrier for Oxy/Acetylene Tanks	830-0750	\$102.00

M. Torch Wrench

A multi-use wrench for nuts on torches, regulators and tanks. Measures 8½" overall.

Description	Item#	Each
Torch Wrench	830-0790	\$15.50

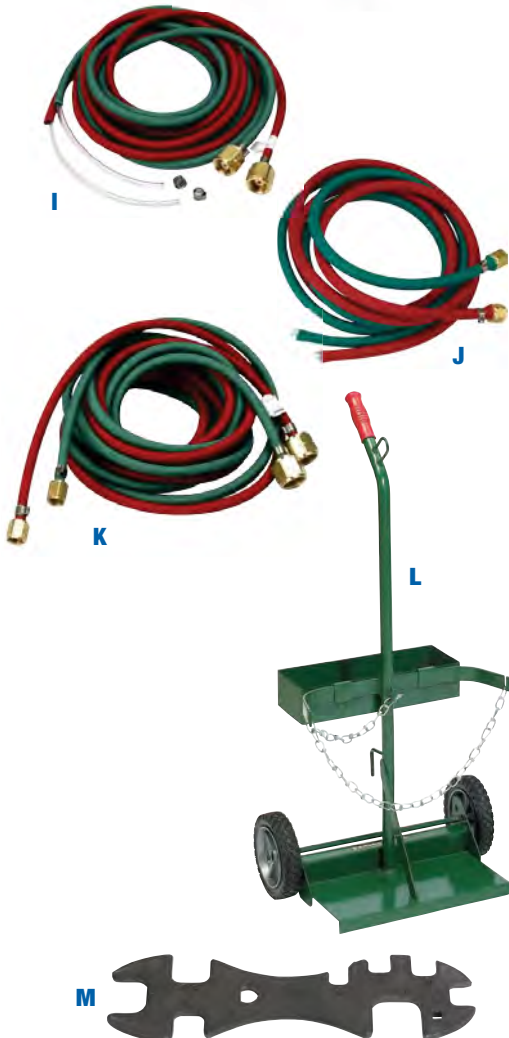

A, B Lighters

Electric Torch Mate simply and automatically lights any torch—using only one hand. Rest the torch on the lighter's ignition switch, and small spark from the electrode immediately lights the torch. This handy benchtop accessory comes complete with two AA batteries.

Torch Lighter produces a spark by friction, supplied with one flint.

Description	Item#	EACH Prices	
		1-2	3+
A. Electric Torch Mate	830-0407	\$36.15	\$32.54
B. Torch Lighter	830-0410	4.45	-
Flints, pkg. of 5	830-0411	4.15	-

**C. Blazer Micro Torch**

Hand-held butane refillable micro torch. Built-in Piezo Quartz Crystal Electronic Ignition is activated with one push. Gas flow is easily adjusted to provide a variety of flame sizes from a maximum length of about 3½" down to a pinpoint. The 26-gram fuel chamber, when filled, can provide heat up to 2,500°F for 90 minutes.

Easy-to-grip size. The main tank body features a diamond grid design for a superior, and extra safe, grip and also includes a detachable base for hands free table-top work. Made in Japan.

We recommend using a triple refined, premium grade butane gas specially designed for use with micro torches. Otherwise the small parts and orifices can become clogged with the dirt and grime found in standard brands of butane gas.

Description	Item#	Each
Blazer Torch without refill	830-0010	\$61.60
Butane Refill Cartridge, 9 fl. oz. 	830-0012	5.70

 **UPS® hazardous shipping surcharge applies. Ships via UPS® Ground only, no air, FedEx®, or US Mail shipments. Cannot ship to Alaska, Hawaii or Puerto Rico.**

**D. Harris® Torch Tip Cleaners**

Set of 13 tip cleaners with individual tip cleaner numbers and drill sizes embossed in case. Covers drill sizes 49 to 77.

Description	Item#	Each
Harris Torch Tip Cleaners	830-1418	\$17.99

**E, F Torch Holders**

Convenient and safe way for hanging your torch when it is not in use. Mount anywhere on workbench and accommodate most torches except The Little Torch.

Description	Length	Item#	Each
E. Bracket-Type Holder	11"	830-1305	\$5.85
Short Bracket-Type Holder	3½"	830-1301	8.50
F. Hook-Type Holder	12"	830-1300	3.95

**G. Soldering Glasses**

Made of black lightweight plastic. Feature adjustable earpieces for comfortable fit and easily replaceable polycarbonate lenses. Lens #7 is approved by the Platinum Guild for platinum soldering. Lens #10 is used for casting. Lens #5 can be used for gold and silver. CE approved. Meet ANSI Z87.1 requirements.

Description	Item#	Each
G. Soldering Glasses with #5 Lens for Gold & Silver	816-1784	\$15.50
Soldering Glasses with #7 Lens for Platinum	816-1785	15.75
Soldering Glasses with #10 Lens for Casting	816-1786	15.70



Tumblers

From finishing castings or small parts to removing burrs and sharp edges on a few pieces or on thousands, Gesswein carries a tumbler to suit any application. Choose from:

Magnetic Finishing – Newer technology featuring fast centrifugal action to finish non-ferrous parts only. Small stainless steel pins (0.3 to 0.5mm in diameter) will polish the tiniest intricate details without lodging. Magnetic tumblers provide a uniform finish in a fraction of the time compared to vibratory or rotary tumblers. Cycle times are generally 30-45 minutes long.

Vibratory Finishing – Debur and finish small or large, detailed or plain parts to a uniform finish. Media moves from the edge of the bowl to the center in an ellipse, abrading and finishing in and around parts. More versatile than a rotary tumbler, Vibratory Tumblers can utilize both abrasive and polishing medias.

Barrel (Rotary) Finishing – The traditional method of tumbling updated to include easier loading and no leaks. Steel Shot is the preferred media which has the advantage of peening and work hardening the parts to a shiny finish. Generally lower operating costs than other methods of tumbling.



A

A. Stainless Steel Shot Pins – For Magnetic Tumblers

Rods in two diameters for reaching into and polishing the tiniest details and settings without lodging. All 5mm long. Blunt ends. 0.5mm is supplied with most magnetic tumblers, 0.3 mm is available for finely detailed parts.

Diameter	Item#	Each
0.5mm Shot, 0.5 lb.	852-1094	\$15.95
0.5mm Shot, 2.2 lbs.	852-1097	55.00
A. 0.3mm Shot, 0.5 lbs.	852-1096	29.90
0.3mm Shot, 2.2 lbs.	852-1099	116.75



B

B. Magnetic Separator Gun – For Steel Shot

Quickly and easily separates metal media from parts—a great time-saver. Eliminates the tedious task of picking media off parts by hand. The gun comes with a collection bowl that holds the media until the job is completed. May be used dry or with media in water. Measures approximately 9" in length.

Description	Item#	Each
Magnetic Separator Gun	852-0320	\$112.75



C

C. Burnishing Compound M – For Stainless Steel Shot

Burnishing Compound M for non-ferrous metals is a liquid burnishing compound for magnetic finishing. This product was specifically designed to keep the magnetic stainless steel pins clean and prevent formation of a "smut" that is often seen with this type of media in a magnetic process. Product can be used to provide cleaning/burnishing of metals such as gold, platinum, silver, brass, copper, aluminum and stainless steel. Product is a non-corrosive acidic mixture. Does not turn water black as others do! Sold by the gallon.

Description	Item#	EACH Prices	
		1	4+
Burnishing Compound M	852-0885	\$40.95	\$36.86



D

D. Burnishing Compound #44S – For Stainless Steel Shot

Specially formulated chemistry for use with stainless steel shot. Use just 1/2 tsp. per 6" diameter bowl in Magnetic Tumbler. Nontoxic, nonhazardous—can be disposed directly to sewer system.

Description	Item#	EACH Prices	
		1-3	4+
Burnishing Compound #44S - 4oz.	852-1029	\$5.95	-
D. Burnishing Compound #44S - 1 Quart	852-1038	28.00	\$25.20



E

E. Soap Powder for Magnetic Tumblers – For Stainless Steel Shot

Mild acid-based soap powder is specifically formulated for magnetic tumblers. It keeps stainless steel shot and jewelry clean.

Description	Item#	Each
3 lbs. Soap Powder	852-1037	\$48.00
E. 1 lb. Soap Powder	852-1039	24.50

Magnetic Tumblers

Feature compact, reliable construction, direct-drive, fan-cooled AC motors, 2-hour timers and auto-shutoff function. All units offer programmable controls for variable-speed and forward/reverse operation. Run ultra-quiet with fast cycle times. Each includes heavy-duty plastic bowl, cover

and complete instructions. CMF-410 and 610 also come complete with stainless steel shot and small sample of burnishing soap. Made in Taiwan. Backed by a one-year manufacturer's warranty.



Model:	A. Mini	B. CMF-410	C. CMF-610	D. CMF-900	E. CMF-1200
Dimensions (WxDxH)	5.5" x 5.5" x 9"	7" x 7" x 11"	10" x 10" x 14"	13" x 13" x 18"	16" x 16" x 20"
Bowl Size	3" dia.	4" dia.	6" dia.	9" dia.	12" dia.
Ring Capacity	5 ring	12 ring	30 ring	100 ring	225 ring
Speed	1,800 rpm	0-2,000rpm	0-2,000rpm	0-2,200rpm	0-2,200rpm
Pin Capacity	1.75 oz. (included)	4 oz. (included)	8 oz. (included)	14 oz. (not included)	28 oz. (not included)
Ship. Wt.	10 lbs.	17 lbs.	25 lbs.	55 lbs.	85 lbs.
110V Item#	852-0350	852-0352	852-0301	852-0342	852-0347
Each	\$395.00	\$665.00	\$1,165.00	\$1,755.00	\$1,755.00
220V Item#	852-0351	852-0353	852-0302	852-0343	852-0345
Each	\$450.00	\$695.00	\$1,195.00	\$1,785.00	\$2,275.00
Replacement Bowl	852-0349	852-0319	852-0318	852-0344	852-0346
Each	\$59.95	\$52.95	\$59.95	\$115.95	\$142.95

F, G Arbe 8 Ring Magnetic Tumblers

Equipped with a heavy duty motor and faceted bowl, which maximizes rotational action, this mini machine is a powerhouse. The magnetic head design incorporates vertical pin action allowing the finisher to add a high polish finish on several pieces even those with filigree work. Made in South Korea

Description	Item#	Each
F. Single Speed	852-0380	\$299.00
G. Variable Speed	852-0381	349.00
Replacement Bowl.	852-0382	35.00

Model:	Single Speed	Variable Speed
Bowl Size (DxH)	4" x 3½" dia.	4" x 3½" dia.
Ring Capacity	8	8
Speed (RPM)	3450	0-3450
Electrical	110V/60Hz/1Ph, 0.4 amps	110V/60Hz/1Ph, 0.4 amps
Watts	25	25
Width x Height	8" x 8" Without Bowl	8" x 8" Without Bowl
Packaged Weight	13 lb	13 lb



F



G

Vibratory Tumblers



Vibratory tumbling can dramatically reduce or even eliminate costly hand-finishing time and, at the same time, maintain the high-quality finish that you require on your parts. Parts are evenly distributed throughout a cascading media, producing an even, identical finish on each piece. There is never any distortion of your parts.

All of the RAYTECH tumblers are heavy-duty for continuous use. Each comes equipped with a drain and hose for flow-through system operation except model #5. Each unit is individually inspected prior to shipping and is backed by a one-year guarantee. Whether your polishing or deburring needs are for an occasional small quantity or for thousands of parts daily, Gesswein has a wide choice of top-quality vibratory tumblers for your exact application.

Specifications

Model	Working Capacity* (cu. ft./gals.)	Max. No. Ladies' Rings**	Vibrations per Min. (60Hz/50Hz)	Bowl Dimensions		
				A	B	C
40	0.35/2.3	200	1,725/1,450	17"	4 1/4"	7"
25SS	0.25/1.875	125	1,500/1,250	14"	3 1/2"	5 3/4"
18	0.15/0.9	90	2,000/1,700	12"	6"	5 1/4"
10	0.10/0.75	50	3,000/2,500	10"	3 1/2"	5"
5	0.05/0.4	25	3,000/2,500	8"	3"	3 3/4"

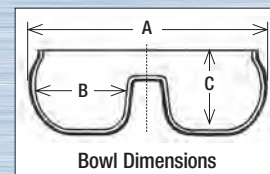

Media Capacities

Vibratory Tumblers must be filled with the correct amount of media in order to achieve the proper tumbling action. Under filling will result in diminished performance of media. Overfilling, especially with Steel Shot, can strain the tumbler motor. Use the following chart as a guide. All media capacities are listed in pounds.

Model	Ceramic Light	Plastic Medias			Dri-Shine		Steel Shot
		Blue	Green	Lt. Green	I	III	
40	30	22	18	22	16	13	100
25SS	17	12	10	12	10	6	50
18	9	8	8	8	4	3	25
10	7	5	4	5	4	2.5	0
5	3.5	2.5	2.5	2.5	2	1.25	0

* Media plus parts. A proper ratio of media to parts (approx. 10 to 1) must be maintained in order to cushion the parts and protect them from striking each other.
**Approximately 1" diameter.



A. Vibratory Tumbler #5

Ideal for small sample test batches as well as for finishing of small parts. Complete with bowl and cover. Will tumble approx. 25 average size ladies' rings. Bowl diameter is 8" with a .05 cu. ft. (3 pts.) capacity. Measures 9" overall height. Cannot be used with Flow-Through System. Made in USA.

Bowl Dia.	Voltage	Item#	Each
A. 8"	115V, 50/60Hz	852-0710	\$104.95
8"	230V, 50Hz	852-0700	125.00
Replacement Bowl & Cover		852-0905	22.95



B. TV-5 Stone Finishing Kit

TV-5 Stone Finishing Kit includes all you need to start finishing agate and similar hard stones (not recommended for soft stones): Vibratory Tumbler #5, extra bowl and four-step finishing media (100/120 grit silicon carbide for rough grinding, 700 grit silicon carbide for fine grinding, lolox 50 for prepolishing and Raybrite TL for final polishing). Finishes 8–10 lbs. Made in USA.

Description	Item#	Each
B. TV-5 Stone Finishing Kit - 8" Bowl	852-0715	\$129.95
Replacement Bowl & Cover	852-0905	22.95

A. Dri-Polisher Vibratory Tumbler

The Dri-Polisher Vibratory Tumbler imparts a bright, high shine on smooth jewelry surfaces. Polishes bracelets, rings, earrings and medium to heavy chains. Comes complete with Dri-Shine III, a crushed cob media treated with red rouge, suitable for gold, gold alloys, silver and silver alloys. Easy to operate: just fill with media, insert jewelry and turn on. Use with dry medias only. Holds 60 small ladies' rings. Measures 10" dia. x 11½"H. Made in USA.



Bowl Dia.	Voltage	Item#	Each
A. 10"	115V, 50/60Hz	852-0746	\$150.00
10"	230V, 1 Ph, 50Hz	852-0749	158.00
Replacement Bowl & Cover		852-0747	43.95



B. Vibratory Tumbler #10

Our smallest heavy-duty tumbler will tumble 50 average size ladies' rings. Can be used with Flow-Through System. Bowl diameter is 10" with a .10 cu. ft. (2.6 qts.) capacity. Measures 15½" overall height. Ship. Wt. 14 lbs. Made in USA.

Bowl Dia.	Voltage	Item#	Each
B. 10"	115V, 50/60Hz	852-0720	\$265.00
10"	230V, 1 Ph, 50Hz	852-0701	280.00
Replacement Bowl & Cover		852-0915	88.95



C. Vibratory Tumbler #18

All the features of the larger tumblers in a midsized unit. Ideal for running small production lots. Strong enough to tumble 25 lbs. of steel shot. Will accommodate up to 90 average size ladies' rings. Flow-Through System (see p. 526) is recommended in order to keep parts clean and bright. Bowl diameter is 12" with a capacity of .15 cu. ft. (3.5 qts.). Measures 16" overall height. Ship. Wt. 13 lbs. Made in USA.

Bowl Dia.	Voltage	Item#	Each
C. 12"	115V, 50/60Hz	852-0751	\$525.00
12"	230V, 1 Ph, 50Hz	852-0752	550.00
Replacement Bowl & Cover		852-0917	199.95



D. Vibratory Tumbler #25SS

For use with all medias including steel shot. Designed with a heavy-duty drive and suspension system. Action is infinitely adjustable through a full range of speed: from a gentle cascade for delicate parts up to a brisk, aggressive tumbling action for rough castings. Will tumble 125 average size ladies' rings. Bowl diameter is 14" with a capacity of .25 cu. ft. (7.5 qts.). Tumbler #25SS includes a discharge port for easy unloading. Measures 16" overall height. Ship. Wt. 22 lbs. Made in USA.

Bowl Dia.	Voltage	Item#	Each
D. 14"	115V, 50/60Hz	852-0723	\$665.00
14"	230V, 1 Ph, 50Hz	852-0722	725.00
Replacement Bowl & Cover #25SS		852-0919	255.00



Made in the USA



A

A. Vibratory Tumbler #40

Adjustable counterweights allow you to control the amplitude (strength of vibration) from a gentle cascade for delicate parts up to a brisk, aggressive tumbling action for rough castings. Includes a 17" diameter, cross-linked polyethylene bowl with a .35 cu. ft. (2.3 gals.) capacity. Will tumble 200 average size ladies' rings. To run Steel Shot, use the optional Shot Bowl, which holds 100 lbs. of shot plus parts. Tilt version features a hinged bowl with handle to allow forward tilting and easy removal of parts and media. Measures 24" overall height. Ship. Wt. 51 lbs. (Tilt version 56 lbs.) Made in USA.

Bowl Dia.	Voltage	Item#	Each
A. 17"	115V, 50/60Hz	852-0726	\$1,210.00
17"	230V, 1 Ph, 50Hz	852-0727	1,235.00
17"	115V with Tilt	852-0728	1,445.00
Replacement Bowl & Cover		852-0922	275.00
Optional Steel Shot Bowl & Cover		852-0918	350.00



B

B. Flow-Through Systems

A Flow-Through System automates your Vibratory Tumbler by automatically dispensing a solution of water and burnishing compound into the tumbler bowl. All plastic, ceramic and steel medias require a slow, steady drip of water and burnishing compound in order to keep parts and media clean, cool and lubricated and to assure a bright, clean finish on the parts. Upper container of Flow-Through gravity-feeds solution into the tumbler bowl by means of an adjustable needle valve. Spent water drains out of tumbler into lower container. Complete with two containers for solution and a heavy-duty steel base with brackets to lock Tumbler in place. Base raises Tumbler to convenient working height. Ship. Wt. 65 lbs. Made in USA.

Description	Item#	Each
For Tumblers #40/#75	852-0934	\$625.00



C

C. Metal Finishing Sets for Vibratory Tumbling

There isn't a better or more complete set of everything you need to handle most of your vibratory finishing needs for raw castings and most jewelry parts. Our Metal Finishing Sets include a complete supply of our three most popular medias—Green and Light Green Plastic Pyramids and Dri-Shine III—plus a supply of Burnishing Soap B. Use Green Pyramids (p. 528) for first cut, Light Green Pyramids (p. 528) for second cut and Dri-Shine III (p. 537) for a bright, high finish on gold and yellow metals. A complete tumbling cycle takes an average of 24 hours—5 hours with Green Pyramids, 3 hours with Light Green Pyramids, and 16 hours with Dri-Shine III.



For Tumbler	Item#	Pkg.
#5	852-0830	\$40.90
#10	852-0835	72.90
#25SS	852-0838	169.00
#40	852-0841	249.00



D

D. Separating Screens

Molded plastic 16" diameter pans with square holes for separating media from parts. Fit on top of bucket. Made in USA.

Description	Item#	Each
Media Screen, 1/4" sq. mesh	852-0893	\$22.50
Media Screen, 3/8" sq. mesh	852-0894	22.50
Media Screen, 1/2" sq. mesh	852-0895	22.50
Media Screen, 3/4" sq. mesh	852-0897	22.50
Media Screen, 1" sq. mesh	852-0898	22.50
Bucket only	852-0899	27.50
D. Set of all five media screens plus bucket	852-0901	109.50

A. Steel Shot Compound #50 – For Carbon Steel Shot

Burnishing compound with a rust preventative to keep your shot (and jewelry) clean and bright. A unique feature of Compound #50 is that it may be used to protect your shot from rust and corrosion after tumbling. Simply empty excess water and add Compound #50 directly to shot. Compound #50 leaves a protective coating you can feel. Your shot is protected for weeks at a time without storing it underwater! Sold in quart containers. Not recommended for use with Stainless Steel Shot.

Qty.	Item#	EACH Prices	
		1-3	4+
1 quart	852-1033	\$18.50	\$15.73



A

B. Burnishing Compound 70L – For Carbon Steel Shot

For use with Carbon Steel Shot tumbling. Contains an excellent rust preventative that can also be used with other media when workpieces are in danger of rusting. Also for steel shot storage. Not recommended for use in rubber-lined barrels or with Stainless Steel Shot.

Qty.	Item#	EACH Prices	
		1	2+
B. 1 quart	852-1030	\$14.95	\$11.96
1 gallon	852-1034	48.50	-



B

⚠ UPS® hazardous shipping surcharge applies. Ships via UPS® Ground only, no air, FedEx®, or US Mail shipments. Cannot ship to Alaska, Hawaii or Puerto Rico.

C. Cutting/Burnishing Soap Liquid B – For Cutting Media

Excellent viscous soap for all of our cutting media. Resists formation of insoluble soap scum. Contains a rust preventative and can be used with Carbon Steel Shot. Recommended for Flow-Through Systems, in which powders are not suitable. Supplied with all Metal Finishing Sets. Not recommended for use with Stainless Steel Shot.

Qty.	Item#	Each
C. 1 pint	852-0875	\$8.25
1 gallon	852-0880	39.95



C

D. Soap Detergent Powder for Rotary Tumbling – For Carbon Steel Shot

Gesswein Soap Detergent Powder acts as a lubricant as well as a cleaner. 3 lb. jar. Recommended for use with Carbon Steel Shot. Not for use with Stainless Steel Shot.

Qty.	Item#	Each
3 lb. jar	852-1250	\$29.95



D

E. Soap Powder – For Carbon Steel Shot

Formulated for use with carbon steel shot in rotary tumblers, these powders are nonhazardous and lighter in weight than liquids, reducing shipping costs. Not for use with Stainless Steel Shot.

- Compound #750 is designed to clean shot that has darkened due to oxidation. Contains a rust inhibitor that protects shot during storage.
- Compound #910 is used during tumbling to keep shot clean and to brighten gold and silver jewelry. Recommended for use in a rotary tumbler, barrel tumbler.

Description	Qty.	Item#	Each	Description	Qty.	Item#	Each
E. Compound #750	5 lbs.	852-1291	\$19.50	Compound #910	5 lbs.	852-1296	\$22.95
	50 lbs.	852-1290	180.00		50 lbs.	852-1295	199.95



E

F, G Soap Powder A – For Cutting Media

Recommended for fine finishing and burnishing brass, bronze and similar materials with plastic and ceramic media. This soap has grease cutter for oil-coated workpieces. Not for use with Stainless Steel Shot.

Qty.	Item#	Each
F. 8 oz.	852-0865	\$4.95
G. 1 lb.	852-0870	6.95



F



G

H. Compound 20L – For Cutting Media

Concentrated, all-purpose liquid compound for all cutting media. Specifically designed for tumbling systems to condition water, clean and lubricate plastic and ceramic media and parts, and suspend grit. Not for use with Stainless Steel Shot.

Qty.	Item#	EACH Prices	
		1-3	4+
H. 1 quart	852-1020	\$9.65	\$8.69
5 gallons (ship. wt: 47 lbs.)	852-1021	135.00	-



H



A

A. Ceramic Media for Light Bur Removal

Efficient, long-life aluminum oxide in a hard ceramic bond for light bur removal and smoothing of rough castings. Deburs both soft and hard metals such as aluminum and steel. 30° ends reach into grooves, corners and openings. Density: 100 lbs. per cu. ft. Shape: 30° cylinders, 5/16" x 9/16".

Qty.	Item#	Pkg.
5 lbs.	852-0432	\$18.00
10 lbs.	852-0433	32.00



B

B. Blue Plastic Pyramids

Aluminum oxide (approx. 220 grit) in a plastic bond. Aggressive cutting media with good but minimum stock removal. Excellent as a first cut-down step for rough castings, stampings, etc. More aggressive than Green Media. Density: 62 lbs. per cu. ft. Shape: pyramid, 1/4".

Qty.	Item#	Pkg.
5 lbs	852-0435	\$26.95
10 lbs.	852-0436	48.95
50 lbs.	852-0437	210.95



C

C. Green Plastic Pyramids

Plastic bond impregnated with fine silica (approx. 320 grit). Provides a light cutting action. Often used as a first cut-down step for delicate and intricate parts, for castings, and for removing sharp edges on stampings. Leaves a smooth, matte finish. Included in all Metal Finish Sets. Density: 56 lbs. per cu. ft. Shape: pyramid, 1/4".

Qty.	Item#	Pkg.
5 lbs.	852-0438	\$27.50
10 lbs.	852-0439	53.00
50 lbs.	852-0440	250.00



D

D. Light Green Plastic Pyramids

Plastic bond with super fine silica (approx. 400 grit). Provides an extra-fine cutting action for smoothing surfaces. A prepolysh media that leaves a very smooth, matte finish ready for the final polish. Included in all Metal Finish Sets. Density: 62 lbs. per cu. ft. Shape: pyramid, 1/4".

Qty.	Item#	Pkg.
5 lbs.	852-0441	\$29.95
10 lbs.	852-0442	53.95
50 lbs.	852-0443	230.95

E



E. Earring Post Protectors

These silicone rubber sleeves protect ear posts when setting, tumbling or plating. Sold by the gross (144 each).

Description	Item#	GROSS Prices	
		1-49	50+
Earring Post Protectors	852-1155	\$8.10	\$6.08

A. Dri-Shine I

Crushed walnut shells with red rouge. Excellent for gold and other metals. Imparts a rouge powder to the surface of the workpiece, which helps to prevent tarnish. Density: 35 lbs. per cu. ft. Shape: irregular particle, 2mm. Made in USA.

Qty.	Item#	Pkg.
5 lbs.	852-0444	\$12.95
10 lbs.	852-0445	22.95
50 lbs.	852-0446	89.95



A

B. Dri-Shine III

Crushed corncob with stain-free rouge. Our most versatile formula for obtaining final finish on gold and other metals. A clean media which leaves no residue. Polishes only—does not remove metal. Run dry for 16 to 48 hours to achieve a bright luster that is close to a hand-buffed finish. Recharge as needed with Simichrome Polish (see p. 107). Included in all Metal Finish Sets. Density: 30 lbs. per cu. ft. Shape: irregular particle, 2mm. Made in USA.

Qty.	Item#	Pkg.
5 lbs.	852-0447	\$12.95
10 lbs.	852-0448	23.95
50 lbs.	852-0449	99.95



B

C. Dri-Shine VII

Dri-Shine VII is crushed, finely graded nutshell media precharged with enhancers for a bright final finish. Made in USA.

Description	Item#	Each
Dri-Shine VII, 5 lbs.	852-0450	\$42.95



C

D. Ground Cob

High quality, pure refined ground cob. For drying jewelry parts. Absorbs moisture and prevents water stains. Made in USA.

Qty.	Item#	Each
3 lb. Box	812-0800	\$6.80
40 lb. Bag	812-0700	54.25



D

E. Tumble Finishing for Handmade Jewelry:

Mass Finishing on a Small Scale – 4th Edition, By Judy Hoch

This handbook shows jewelers how to save time and money while mass finishing handmade jewelry. Provides descriptions of basic equipment and supplies, including rotary and vibratory tumblers, magnetic and centrifugal disc finishers, medias and compounds. Helps readers choose the right process for each application, ensuring optimal results. Passes along the author's firsthand knowledge about preventing disasters and solving problems, all in an easy-to-read informal style. Contains black-and-white photos. A great book for novices. Softcover, 47 pages.

Description	Item#	Each
Tumble Finishing for Handmade Jewelry - Book	811-0041	\$15.00



E

Media Capacities

Vibratory Tumblers must be filled with the correct amount of media in order to achieve the proper tumbling action. Under filling will result in diminished performance of media. Overfilling, especially with Steel Shot, can strain the tumbler motor. Use the following chart as a guide. All media capacities are listed in pounds.

Model	Ceramic Light	Plastic Medias			Dri-Shine I	Steel III	Shot
		Blue	Green	Lt. Green			
40	30	22	18	22	16	13	100
25SS	17	12	10	12	10	6	50
18	9	8	8	8	4	3	25
10	7	5	4	5	4	2.5	0
5	3.5	2.5	2.5	2.5	2	1.25	0

* Media plus parts. A proper ratio of media to parts (approx. 10 to 1) must be maintained in order to cushion the parts and protect them from striking each other.
 **Approximately 1" diameter.

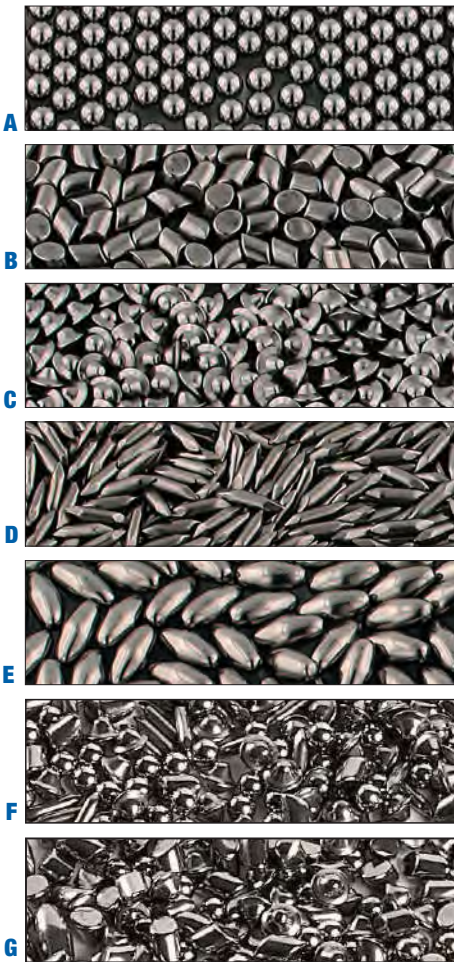

A-G Steel Shot – Small shapes for intricate burnishing.

Media for rotary (barrel) and vibratory tumblers. Burnishes your jewelry to a bright high luster without scratching. Corrosion-resistant stainless steel shot requires no special rust inhibitors or cleaners. Economical carbon steel shot requires rust-preventive compounds for use and storage. Available in packages of individual shapes and two mixtures: rotary and vibratory. Rotary mixture works in rotary tumblers. Contains 20% round balls, 40% diagonals, 20% ball cones and 20% pins. Vibratory mixture works in vibratory tumblers. Contains 40% diagonals, 30% ball cones, 20% round balls and 10% oval balls. Note: 2 lb. packages have 1/2 lb. of each shape. Density: 330 lbs. per cu. ft.

Description	Pkg. Size	Stainless Item#	Each	Carbon Item#	Each
A. Round Balls, 1/8"	2 lbs.	852-1071	\$52.50	852-1045	\$15.50
	10 lbs.	852-1080	245.50	852-1040	69.50
B. Diagonals, 1/8"	2 lbs.	852-1072	36.50	852-1046	25.50
	10 lbs.	852-1079	178.50	852-1041	114.50
C. Ball Cones, 1/8"	2 lbs.	852-1073	62.00	852-1047	25.50
	10 lbs.	852-1078	299.00	852-1042	114.50
D. Pins, 1/16" x 9/32"*	2 lbs.	852-1074	94.50	852-1048	45.50
	10 lbs.	852-1077	460.50	852-1043	205.50
E. Oval Balls, 5/32"	2 lbs.	852-1075	42.50	852-1049	25.50
	10 lbs.	852-1076	225.50	852-1044	120.50
Pre-Mix For:	Pkg. Size	Stainless Item#	Each	Carbon Item#	Each
	F. Rotary	2 lbs.	852-1086	\$62.00	852-1052
	10 lbs.	852-1085	299.00	852-1050	128.50
G. Vibratory	2 lbs.	852-1087	62.00	852-1051	25.50
	10 lbs.	852-1090	299.00	852-1070	112.50

*Not recommended for use in Vibratory Tumblers.

H. Steel Shot Cleaner – For Carbon Steel Shot

Discolored Carbon Steel Shot can discolor the jewelry you tumble in it. Gesswein Steel Shot Cleaner restores your shot to its original shiny luster. Even if your shot has turned gray or black, in most cases Gesswein Steel Shot Cleaner can brighten it again. Keep a gallon on hand and use it at the first sign of discoloration. Not recommended for use with Stainless Steel Shot (use Coca-Cola to clean stainless steel shot, see "Tech Tips" tab above.) Sold in gallon containers.



H

Description	Item#	Each
Steel Shot Cleaner	852-1032	\$32.75

I. Magnetic Separator Gun – For Steel Shot

Quickly and easily separates metal media from parts—a great time-saver. Eliminates the tedious task of picking media off parts by hand. The gun comes with a collection bowl that holds the media until the job is completed. May be used dry or with media in water. Measures approximately 9" in length.



I

Description	Item#	Each
Magnetic Separator Gun	852-0320	\$112.75

J. Universal Jewelry Polishing Set

The ideal set for polishing gold and silver, especially today's popular precious metal charms, charm bracelets, and beads. Set includes rotary tumbler with 4.75" x 4.75" barrel, 2.25 lbs. of stainless steel shot (a mixture of shapes to polish both highly detailed and plain surfaces as well as 4oz. of brushing compound #44S).



J

Description	Item#	Each
Universal Jewelry Polishing Set	852-0045	\$185.00

A-C Motorized Rotary Tumblers

Rotary tumbling is an ideal polishing method for both gold and silver.

Our high quality rotary tumblers have been designed for heavy-duty use as well as for flexibility, with interchangeable barrels of different sizes. Each model features a high/low speed switch for a choice of aggressive or milder tumbling action. All barrels are constructed of tough, heavy-duty plastic. Leakproof, plug-type lid is located on side of barrel for easy access. Barrels have no linings to corrode or rust. You'll save time and money on expensive relining charges.

Barrels are available in 5 capacities from .02 to 1 cu. ft., but not all barrels can be used on every tumbler. Our rotary tumblers are sold without barrels; this way, you can choose only the barrels that will meet your specific requirements. See Rotary Tumbler Barrel Chart (below) for restrictions. All units listed are 110V, 6A, 690W, 60Hz. Made in USA.

Motorized Rotary Tumblers (barrels not included)

Style	A. Mini 2-Bar	B. 2-Bar	C. 3-Bar
Dimensions (without barrels)	23 1/2"L x 16"W x 13"H	36"L x 19"W x 13"H	36"L x 19"W x 13"H
Length of rotary bars	9 1/4"	24"	24"
Distance between bars	4 1/2"	7 1/2"	3 1/2"
Ship. Wt.	43 lbs.	63 lbs.	69 lbs.
Item#	852-0102	852-0100	852-0105
Each (base only, no barrels)	\$995.00	\$1,045.00	\$1,185.00

220V, 50Hz and 220V, 60Hz available by special order.



Rotary Tumbler Barrels (shown on tumblers above)

Include aluminum lids with black rubber seal and wing-nut for leak-free tumbling.

Style	#1	#2	#3	#4	#6
Capacity/Steel Shot Capacity*	.02 cu. ft./3 lbs.	.12 cu. ft./15 lbs.	.2 cu. ft./30 lbs.	.5 cu. ft./50 lbs.	1.0 cu. ft./150 lbs.
Dimensions (W x dia.) / Barrel Opening (dia.)	4 3/4" x 4 3/4" / 3"	4 3/8" x 8 1/4" / 4"	7" x 10" / 4"	10 1/2" x 10 3/4" / 4"	15" x 16" / 7"
RPMs, low/high	90/127	52/80	40/56	38/53	25/40
Max.#: Mini / 2-Bar / 3-Bar	2/0/8	2/3/0	1/3/0	1/2/0	0/1/0
Item#	852-0120	852-0121	852-0125	852-0130	852-0135
Each	\$73.50	\$115.50	\$150.50	\$190.50	\$299.50

*The amount of shot listed fills each barrel about 50%. Optimal working capacity of each barrel should be approximately 60-65% full, including shot and jewelry items.

D. Auto-Reversing Rotary Tumbler

This tumbler allows you to see the tumbling process in action without having to open the barrel. Features auto-reversing function for thorough processing and separate controls for cycle speed and duration. Holds up to 30 rings. Easy to use: fill barrel to roughly 50% capacity with your choice of steel shot, add water to roughly 75% capacity, add 1ml of cleaning or polishing compound, place jewelry in barrel and run tumbler. Remove jewelry from barrel when done and rinse with water. Capacity: 4 1/2 lbs. Electrical: 120V, 5A, 25W, 50/60Hz. Measures 10 7/8"W x 9 7/8"D x 11 7/8"H with 8" dia. x 7 1/2"W clear barrel that has a 4" opening. Weighs approx. 17 1/2 lbs. Made in Taiwan.

Description	Item#	Each
D. Auto-Reversing Rotary Tumbler	852-0110	\$495.00
Replacement Barrel	852-0112	155.00



E-G Economy Rotary Tumblers – Three sizes from which to choose!

Each of our economical rotary tumblers has a sturdy steel base, continuous-duty fan-cooled motor with overload protection, and watertight black rubber barrel with snap-on lid. All 3 sizes are perfect for rock tumbling and for tumble polishing jewelry with steel shot. All are 115V, 1/75 HP, .54A, 60Hz.

Tumbler	# of Barrels	Barrel Capacity (Shot + Parts)	Barrel Shape	Item#	Each
E. Mini-Econo	1	3 lbs.	Round	852-0020	\$128.50
F. Dual-Econo	2	3 lbs. per barrel	Round	852-0025	150.00
G. Large-Econo	1	12 lbs.	Hexagonal	852-0050	230.00
Replacement Barrel Large-Econo	-	-	-	852-0500	140.00
Replacement Barrel for Mini or Dual	-	-	-	852-0530	29.50



Supra® Swiss High-Precision Tweezers

Handcrafted to perfect tip symmetry and balance, polished edges, superior no-scratch/anti-glare satin finish. Many styles and materials are available for the special needs of industry, jewelers, watchmakers, electronic and medical device manufacturers.

SA = Stainless Steel Anti-magnetic. Good corrosion resistance. The alloy is low carbon and contains 16.5% to 18.5% chromium plus nickel and molybdenum.

NC = Super Alloy. SIX times harder than anti-magnetic Stainless Steel these premium tweezers have high shape retention characteristics and are especially high corrosion resistance. Ni-Cr-Mo composition, fully non-magnetic and can be used up to 800°C.

BR = Brass. Especially useful for handling scratch-sensitive mechanical parts such as watch components, magnets, etc. Non-magnetizable with good to excellent corrosion resistance.

C = Carbon Steel. Our cutting tweezers retain sharpness with these heat treated blades. Used in Electronics, Jewelry and Watchmaking. Made in Switzerland.

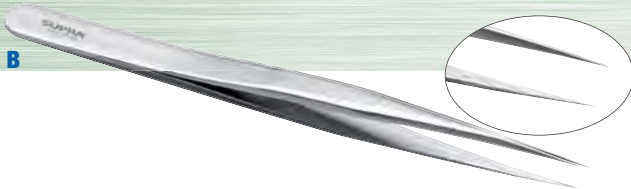
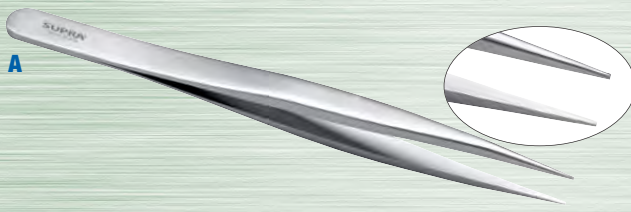

A. Style #00

Strong, flat edges, thick tips.

Material	Length	Item#	Each
SA - Stainless Steel	120mm (4 ³ / ₄ "	195-1176	\$21.50

B. Style #1

Strong, straight, fine tips.

Material	Length	Item#	Each
SA - Stainless Steel	120mm (4 ³ / ₄ "	195-1160	\$16.46

C, D Style #2

Flat, sharp, fine tips.

Material	Length	Item#	Each
C. SA - Stainless Steel	120mm (4 ³ / ₄ "	195-1162	\$21.95
D. BR - Brass	120mm (4 ³ / ₄ "	195-1187	31.35

E, F Style #3C and #3

Very sharp, fine tips.

Material	Length	Item#	Each
E. 3C SA - Stainless Steel	110mm (4 ¹ / ₄ "	195-1164	\$21.95
3C NC - Super Alloy	110mm (4 ¹ / ₄ "	195-3265	36.65
F. 3 SA - Stainless Steel	120mm (4 ³ / ₄ "	195-1166	16.46
3 NC - Super Alloy	120mm (4 ³ / ₄ "	195-3267	27.49

G. Style #4

Extra fine tips.

Material	Length	Item#	Each
SA - Stainless Steel	110mm (4 ¹ / ₄ "	195-1168	\$24.80

H. Style #5

Extra fine tips, superior finish.

Material	Length	Item#	Each
SA - Stainless Steel	110mm (4 ¹ / ₄ "	195-1170	\$26.95

I. Style #7

Very fine, curved.

Material	Length	Item#	Each
I. SA - Stainless Steel	115mm (4 ¹ / ₂ "	195-1172	\$20.90
NC - Super Alloy	115mm (4 ¹ / ₂ "	195-3273	42.90

Supra® Swiss Tweezers (continued)

A. Style #AML.BR

Precision brass tweezers anti-sparking with mirror polished tips.

Material	Length	Item#	Each
BR - Brass	125mm (5")	195-1185	\$31.35



B, C Style #15AGW.C and 15A.C

Cutting tweezers for soft copper, gold, silver and magnetic wires. Cutting capacity for copper, yellow gold, white gold and silver is 0.10-0.25mm. Cutting capacity for magnetic wires is 0.10-0.15mm.

Material	Length	Jaw Width	Item#	Each
B. C - Carbon Steel	120mm (4¾")	10mm	195-1190	\$53.95
C. C - Carbon Steel	120mm (4¾")	12mm	195-1191	\$53.95

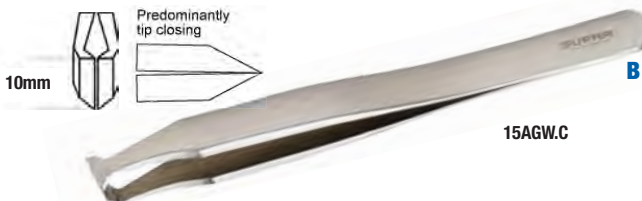

D. Style Super Slim #27

Long and slender tweezers with extra fine tips for multiple precision applications.

Material	Length	Item#	Each
SA - Stainless Steel	140mm (5½")	195-1174	\$24.80



Supra® Swiss Boley Tweezers

Superior no-scratch/antiglare satin finish. Anti-magnetic stainless steel tweezers. Good resistance to corrosion. Made in Switzerland.

E. Style #AA

Straight fine tips.

Material	Length	Item#	Each
SA - Stainless Steel	130mm (5⅛")	195-1178	\$15.50



F. Style #PP

Straight fine tips.

Material	Length	Item#	Each
SA - Stainless Steel	120mm (4¾")	195-1180	\$13.39



G. Style #GG

General purpose strong, fine tips. Anti-Magnetic Anti-Acid Stainless Steel.

Material	Length	Item#	Each
SA - Stainless Steel	130mm (5⅛")	195-1182	\$13.39

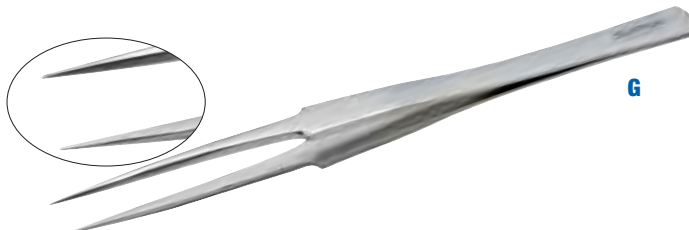

Supra® Swiss Diamond Tweezers

Precision Swiss made jewelry tweezers for holding diamonds, precious stones and small parts. Made of magnetizable stainless steel heat treated to approximately 45 Rockwell "C" and matte finished. Those with a -1 suffix have both serrated and grooved tips to enhance secure holding. All are non-locking except Style MR-1. Made in Switzerland.



A. Style F

Fine serrated tips and serrated handles. 160mm (6¼") long.

Material	Tips	Groove	Item#	Each
S - Stainless Steel	Fine	No	195-0414	\$14.96



B. Style F-EG

Fine tips with special satin finish on tips and grips. 160mm (6¼") long.

Material	Tips	Groove	Item#	Each
S - Stainless Steel	Fine	No	195-0418	\$27.95



C. Style F-1

Fine serrated and grooved tips and serrated handles. 160mm (6¼") long.

Material	Tips	Groove	Item#	Each
S - Stainless Steel	Fine	Yes	195-0415	\$19.95



D. Style M

Medium serrated tips and serrated handles. 160mm (6¼") long.

Material	Tips	Groove	Item#	Each
S - Stainless Steel	Medium	No	195-0411	\$19.95



E. Style M-EG

Medium tips with special satin finish on tips and grips. 160mm (6¼") long.

Material	Tips	Groove	Item#	Each
S - Stainless Steel	Medium	No	195-0417	\$20.96



F. Style M-1

Medium serrated and grooved tips and serrated handles. 160mm (6¼") long.

Material	Tips	Groove	Item#	Each
S - Stainless Steel	Medium	Yes	195-0412	\$14.96



G. Style MR-1 – with slide lock

Medium serrated and grooved tips and serrated handles. 160mm (6¼") long.

Material	Tips	Groove	Locking	Item#	Each
S - Stainless Steel	Medium	Yes	Yes	195-0413	\$24.95

Supra® Tweezers with Replaceable ESD-safe Plastic Tips

These high-precision tweezers feature stainless steel bodies with replaceable Electrostatic Discharge ESD-safe plastic (PA66/CF30 polyamide 66 reinforced with 30 wt% carbon fiber) tips. Heat stabilized with very high rigidity and excellent tensile and flex strength. Good heat capability with continuous use temperature of 266°F (130°C). Not recommended for continuous use with strong acids, alkalis, hot water or steam. Chemically resistant to oils, grease, fuels and non polar solvents. Typical applications include handling of sensitive components and devices such as electronic components, micro-mechanical parts, glass and ceramic substrates, capillary, etc. Made in Switzerland.

A. Supra® Tweezers #3C with Extra Fine Tips

Anti-magnetic anti-acid stainless steel body with ESD-safe tips as described above. #3C is 110mm (4¼") overall length. Tip measures 0.03" (0.8mm) wide x 0.05" (1.3mm) thick.

Description	Item#	Each
A. 3CCF	195-1330	\$24.95
Replacement Tips (Pair)	195-1331	9.55



B. Supra® Tweezers #5 with Very Fine Tips

Anti-magnetic anti-acid stainless steel body with ESD-safe tips as described above. 130mm (5") overall length. Tips measures 0.02" (0.5mm) wide x 0.025" (0.6mm) thick.

Description	Item#	Each
B. 5CF	195-1334	\$24.95
Replacement Tips (Pair)	195-1335	9.55



C. Supra® Tweezers #249 with Strong Tips

Anti-magnetic anti-acid stainless steel body with ESD-safe tips as described above. 130mm (5") overall length. Tip measures 0.09" (2.2mm) wide x 0.09" (2.2mm) thick.

Description	Item#	Each
C. 249CF	195-1336	\$24.95
Replacement Tips (Pair)	195-1337	9.55



D. Supra® Tweezers #259 with Fine Tips

Anti-magnetic anti-acid stainless steel body with ESD-safe tips as described above. 130mm (5") overall length. Tip measures 0.025" (0.6mm) wide x 0.04" (1.0mm) thick.

Description	Item#	Each
D. 259CF	195-1338	\$24.95
Replacement Tips (Pair)	195-1339	9.55



E. Plastic Tweezers

Synthetic nonconductive tweezers ideal for changing watch batteries. Measure 5" long. Imported.

Description	Item#	EACH Prices		
		1-2	3-9	10+
Plastic Tweezers	195-3262	\$1.05	\$0.95	\$0.89



F. Stone Holder

Ideal for picking up small stones and beads. Just press plunger to open, then release to grasp item securely. Made of stainless steel. Measure 4½" long. Imported.

Description	Item#	EACH Prices		
		1-2	3-9	10+
Four-Prong Stone Holder	840-4451	\$5.95	\$5.65	\$5.36



Dumont® High-Tech Tweezers

Manufactured by the original Swiss Dumont factory. Forged from premium-grade stainless steel unless otherwise noted and machined to a smooth satin finish. Extensive hand operations are used in shaping, adjusting and finishing the points. Ideally suited for holding miniature parts, gemstones, etc.



A. Dumont® 3C

For handling all miniature and micro-miniature parts. They have tapered shanks with bevel edges; points have been honed and are very sharp. Measure approximately 4¹/₄" long. Stainless steel.

Description	Item#	EACH Prices		
		1-2	3-9	10+
Style 3C	195-0400	\$36.85	\$33.17	\$31.32

B. Dumont® 5

Very narrow, needle-like points have been extra-honed to extreme sharpness. Ideally suited for handling microscopic parts and delicate work. Indented shanks with bevel edges. Measure approximately 4¹/₄" long. Stainless steel.

Description	Item#	EACH Prices		
		1-2	3-9	10+
Style 5	195-0392	\$34.50	\$31.05	\$29.33

C. Dumont® 7

Excellent tweezers for handling all miniature and micro-miniature parts and components. The curved shanks permit the user to rest active hand on the bench during assembly operations. Points have a plain finish and are very sharp. Measure approximately 4¹/₂" long. Stainless steel.

Description	Item#	EACH Prices		
		1-2	3-9	10+
Style 7	195-0395	\$36.30	\$32.67	\$30.86

D, E Dumont® PP and SS

Style PP is for sorting, assembling and handling miniature parts. Have tapered shanks with bevel edges. Points are sharp. Style SS is similar to PP but is very slim. Measure approximately 5³/₈" long. Stainless steel.

Description	Item#	EACH Prices		
		1-2	3-9	10+
D. Style PP	195-0410	\$34.50	\$31.05	\$29.33
E. Style SS	195-0405	34.50	31.05	29.33

F. Dumont® P

Have extremely hard regular points for general work. Good when rust and corrosion are not significant factors. Measure approximately 4³/₄" long. Carbon steel.

Description	Item#	EACH Prices		
		1-2	3-9	10+
Style P	195-0340	\$41.25	\$37.13	\$35.06

G, H Dumont® Titanium – Lightweight

These 100% nonmagnetic tweezers are made of titanium, which is 60% stronger and 40% lighter than steel, for superior durability and a more delicate touch. Feature finely honed tips.

Description	Length	Item#	Each
G. Style 3	4 ³ / ₄ "	195-3281	\$37.85
H. Style AA	4 ⁷ / ₈ "	195-3282	35.35

Dumont® High-Tech Tweezers (continued)

A-E Dumont® Serrated Tip Diamond Tweezers

The finest in the industry. Precision-made with perfect alignment at the tips. Tips are serrated at a perpendicular angle for the best grip possible. Available in medium (M), medium grooved (MG), or fine (F) points, with or without a locking mechanism. All measure 6 1/2" long except the grooved which is 5 7/8" long. Made of stainless steel. Made in Switzerland.

Tips	Locking	Finish	Item#	EACH Prices		
				1-2	3-9	10+
A. F	No	Stainless	195-0350	\$30.80	\$29.26	-
B. M	No	Stainless	195-0355	29.40	26.46	\$24.99
C. MG	No	Stainless	195-0356	33.95	30.56	28.86
D. F	Yes	Stainless	195-0360	45.75	41.18	38.89
E. M	Yes	Stainless	195-0365	43.50	39.15	36.98



F. Dumont® Titanium Diamond Tweezers

These 100% nonmagnetic tweezers are made of titanium which resists rust and corrosion. These tweezers are 60% stronger and 40% lighter than steel, for superior durability and a more delicate touch. Feature finely honed medium tips. Made in Switzerland.

Tips	Length	Item#	Each
Titanium	6 1/4"	195-0349	\$42.85



G-L Economical Diamond Tweezers

Value-engineered for precision work. Available in locking or non-locking, fine (F) or medium (M) points. All have serrated tips and measure 6 3/8" long.

Tips	Locking	Finish	Item#	EACH Prices		
				1-2	3-9	10+
G. F	No	Stainless	195-0334	\$7.80	\$7.02	\$6.63
H. F	No	Black	195-0335	8.95	8.06	7.61
I. M	No	Stainless	195-0336	7.80	7.02	6.63
J. M	No	Black	195-0337	8.95	8.06	7.61
K. F	Yes	Stainless	195-0330	5.45	-	-
L. M	Yes	Stainless	195-0332	4.90	-	-



M. Diamond Tweezers with Shovel

Stainless steel nonlocking tweezers with medium serrated tips and shovel attached to end for convenient handling of stones and beads. Measure 7 1/8" long.

Description	Item#	Each
Diamond Tweezers with Shovel	195-0331	\$4.95



N, O Dumont® Boley Style Tweezers AA and GG

Superbly machined Swiss tweezers. Made of stainless steel for very fine sorting, inspection and handling of miniature parts. The sharp points have received some finishing at the tips. Excellent for use under low-power magnification. Style AA is for general use. Style GG has pointed indented shanks. Measure approximately 5" long.

Description	Length	Item#	EACH Prices		
			1-2	3-9	10+
N. Style AA	5"	195-1050	\$34.50	\$31.05	\$29.33
O. Style GG	5"	195-1150	43.00	38.70	36.55



A

B

C

D

E

F

G

H

A, B Boley Style Tweezers RR and MM

These stainless steel general-utility tweezers are excellent general utility tweezers for handling miniature parts. All shanks are tapered and have bevel edges. The sharp points have received some finishing at the tips. Style RR is a hefty, heavy-duty tweezers with wide shanks. Style MM is for general use.

Description	Length	Item#	EACH Prices		
			1-2	3-9	10+
A. Style RR	5½"	195-1300	\$5.85	\$5.27	\$4.97
B. Style MM	5"	195-1200	5.85	5.27	4.97

C. Utility Tweezers

Straight nickel plated steel tweezers with smooth tips. Measure 7" long.

Description	Length	Item#	Each
Utility Tweezers	7"	195-3052	\$4.15

D. Bead Stringing Tweezers

Feature narrow tapered ends for easy knot tying. Made of stainless steel with nonglare satin finish. Measure 4½" long.

Description	Item#	Each
Bead Stringing Tweezers	195-1355	\$2.80

E. Economical Tweezers

Economical steel tweezers. Hand-finished, pointed tips. Good for working with miniature parts under low magnification. Measure 5" long.

Description	Length	Item#	EACH Prices		
			1-2	3-9	10+
Economical Tweezers	5"	195-1350	\$2.95	\$2.66	\$2.51

F. Stone Holder

Ideal for picking up small stones and beads. Just press plunger to open, then release to grasp item securely. Made of stainless steel. Measure 4½" long.

Description	Item#	EACH Prices		
		1-2	3-9	10+
Four-Prong Stone Holder	840-4451	\$5.95	\$5.65	\$5.36

G, H Copper Tongs

Designed especially for use with pickling and acid solutions. Will not contaminate solutions nor corrode. Fishtail tips are thinner to pick up small or flat items. Measure 9" long.

Description	Item#	EACH Prices	
		1-2	3+
G. Copper Tongs	195-0100	\$6.55	\$5.57
H. Copper Fishtail Tongs	195-0110	8.85	7.52

A. Supra® Swiss Ceramic Tip Tweezers Acid-Resistant
Won't contaminate your platinum. Non-static.

These lightweight Supra Swiss tweezers feature zirconia ceramic tips attached to an aluminum body. Perfect for working with platinum and for all soldering jobs. Extremely smooth surface. 100% nonmagnetic, nonrusting and nonstatic. Acid-resistant. Six times harder than stainless steel, twice as hard as carbon steel. Tips measure 1¼" long. Made in Switzerland.

Description	Length	Item#	Each
X-Fine	5½"	195-3285	\$62.00
Replacement tips X-Fine	1¼"	195-3287	37.20



B. Stand-Up Cross-Locking Tweezers

Free hands for soldering. Tweezers lie flat to hold piece about 1" off soldering board. Tips are serrated. Made of stainless steel. Measure 6¼" long.

Description	Item#	EACH Prices		
		1-2	3-9	10+
Stand-Up Cross-Locking Tweezers	195-0325	\$4.15	\$3.74	\$3.53



C-E Cross-Locking Tweezers

Tips close automatically when pressure is released from the handles. Most often used to hold objects for soldering; however, also used in a variety of general applications. Excellent heat sink when soldering. Nickel-plated.

Points	Length	Item#	EACH Prices		
			1-2	3-9	10+
C. Pointed	4¾"	195-1375	\$2.89	\$2.60	\$2.46
D. Blunt	6½"	195-1400	2.95	2.66	2.51
E. Pointed	6½"	195-1450	2.95	2.66	2.51



F, G Insulated Cross-Locking Tweezers

Similar to standard cross-locking tweezers, but handles are insulated to protect hands from heat of soldering flame. Stainless steel with serrated tips.

Points	Length	Item#	EACH Prices		
			1-2	3-9	10+
F. Straight	6¾"	195-2050	\$4.15	\$3.74	\$3.53
G. Curved	6¾"	195-2075	4.15	3.74	3.53



H. Third Hand

Ideal for soldering difficult pieces. Leaves hands free. Heavy cast-iron base securely holds a cross-locking tweezers. Tweezers may be angled in any direction for most convenient working position.

Description	Item#	Each
H. Third Hand	816-1800	\$12.10
Replacement Tweezers	195-1400	2.95



I. Third Hand – Ball Style

This remarkable third hand features incredibly flexible positioning and ease of use to speed up your soldering jobs. Twist and turn the ball joint to any position and it stays fixed without slipping. This economic alternative to the magnetic third hand, automatically provides the right amount of tension to hold and move your work without continuous adjustment. Includes 6" self-locking tweezers.

Description	Item#	Each
Single	816-1822	\$12.00



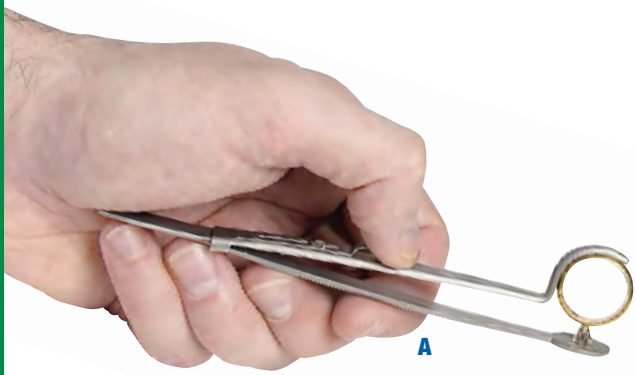

A



B



C



D



E

A. Head-and-Shank Tweezers

Position setting and shank for easy soldering of solitaires. Curved, grooved tip securely holds shank; flat serrated base prevents slippage. Slide-locking. Made of stainless steel. Measure 5½" long. Made in Switzerland.

Description	Item#	Each
H&S Tweezers	195-3000	\$62.95

B. Econo Head-and-Shank Tweezers

Use these slide-locking tweezers to hold rings for easy soldering of solitaires. Curved, grooved tip securely holds ring shank while flat serrated base prevents slippage. Made of steel. Measure 5½" long.

Description	Item#	EACH Prices		
		1-2	3-9	10+
Econo H&S Tweezers	195-3005	\$7.59	\$6.83	\$6.45

C. LaVaque Head & Shank Tweezers with Visual Alignment

If you've ever soldered a head onto a shank only to find it misaligned by a few degrees, you'll love these tweezers. Feature patented LaVaque visual alignment for soldering settings accurately the first time, every time. Curved, grooved tip securely holds the shank in place while the transparent glass base secures the head, allowing you to see from the top and all sides for perfect alignment. Replaceable high-temperature glass withstands direct flame and soldering temperatures required for gold and silver, lasting for dozens of jobs. Not recommended for platinum and other metals that require higher soldering temperatures.

Description	Item#	Each
LaVaque Head & Shank Tweezers	195-3500	\$33.95
LaVaque Replacement Glass	195-3505	7.95

D. Ring Set Soldering Tweezers

Hold two rings being soldered together as a set. Ideal for wedding band sets. Measure 5¾" long.

Description	Item#	Each
Ring Set Tweezers	195-0320	\$4.70

E. Cup-Shaped Pearl Tweezers

Tweezers with cup-shaped ends for holding pearls, beads and more. Coated tips prevent scratching of delicate surfaces. Measure 5¾" long.

Description	Item#	EACH Prices		
		1-2	3-9	10+
Cup-Shaped Pearl Tweezers	195-0310	\$5.95	\$5.36	\$5.06

A. Vacuum Tweezers

Offering unmatched precision over standard tweezers, this self-contained miniature vacuum pump has 2 handpieces for picking up stones and small parts without damaging them. Picks up both cabochons and faceted stones. Because there are no tweezers tips on the girdle of the stone, placement is easier, faster and more precise. This is especially useful when setting small stones and when setting stones in wax.

Comes with 4 stainless steel tips of varying diameters for holding smaller or larger stones. Vacuum is created by placing the forefinger over a hole in the handpiece. To break the vacuum, simply lift your finger from the hole. The vacuum generator measures just 5" long x 3¼" wide x 2" high with an airflow of 125 cu. in./min. 110V. Shipping Weight: 1.2 lbs. Made in Thailand.

Includes :

- 110V vacuum unit with on/off switch
- 2 pencil-thin, lightweight aluminum pens
- 4 stainless steel tips of varying sizes
- 2 flexible air tubes each measuring 36" in length



Description	Item#	Each
Vacuum Tweezers	195-3307	\$65.00
Replacement Pens Set of 2	195-3006	25.00
Replacement Tips Set of 4	195-3007	4.95

B, C Premium Steam Tweezers

The premium coating on tips provides chemical resistance for long wear and use. Use with steam cleaners and ultrasonic cleaners for non-scratch retrieving. Made of Nickel plated steel. Available in 8" or 10" lengths. Rubber coating is 3" length. Made in Pakistan.

Description	Item#	EACH Prices	
		1-5	6+
B. Premium Steam Tweezers, 8"	195-1904	\$11.50	\$10.35
C. Premium Steam Tweezers, 10"	195-1905	12.50	11.25



D. Long-Reach Tweezers

Made of stainless steel. Ideal for holding pieces while they are being cleaned. Heat-resistant plastic-covered tips for firm grip on work piece without scratching. Chrome-plated. Measure 10" long. Made In India.

Description	Item#	EACH Prices		
		1-2	3-9	10+
Long-Reach Tweezers	195-1900	\$7.25	\$6.53	\$6.16

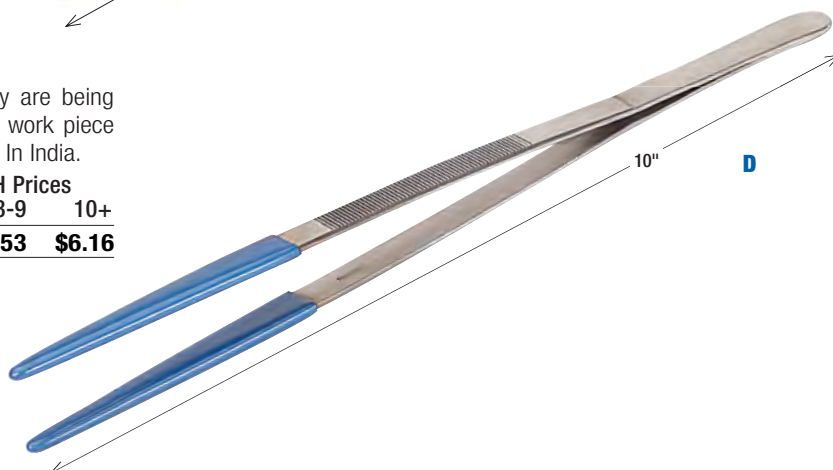



A-I Pin Vises

A wide selection of pin vises for holding small drills, wires, taps, screwdriver blades and more.

Description	Length	Item#	EACH Prices		
			1-2	3-5	6+
A. 5/8" wide jaws, hollow handle opens to 1/4", 3/16" gap. Made in Germany.	4 1/2"	820-4150	\$26.25	\$24.94	-
B. 5/16" wide jaws, hollow handle opens to 1/4", 3/16" gap. Made in Germany.	4 1/2"	820-4050	27.50	26.13	-
C. Extra screw and nut for #820-4150 and #820-4050. Made in Germany.	-	820-4100	8.40	7.98	\$7.14
D. Double-ended with different size steel collets mounted in both ends of hollow handle. Capacity: 0"-0.064". Made in France.	4 1/4"	820-4650	11.15	10.59	10.04
E. Double-ended with reversible steel collets. Capacity: 0"-0.125". Made in India.	4 1/4"	820-4350	5.95	5.65	5.36
F. Two steel chucks with hollow brass handle. Capacity: 0"-0.032". Made in France.	3 3/4"	820-4300	8.50	8.08	7.65
G. Steel four-jaw chuck with hollow aluminum handle. Capacity: 0"-0.032". Made in France.	4 1/4"	820-4250	7.25	6.89	6.53
H. Swivel head pin vise for drilling or tapping. Two double-ended chucks. Capacity: 0"-0.125". Made in India.	3 1/2"	820-4355	4.50	-	-
I. Sliding four-jaw pin vise for one-hand operation. Single end has knurled slide. Capacity: 0"-0.032". Made in India.	4 1/2"	820-4260	4.50	4.28	4.05

J-M Precision Pin Vises

Durable hardened steel pin vises with hollow handles for accommodating long wires. Black finish. Sold individually and in a money-saving set of all four. Made in India.

Length	Collet Capacity	Item#	Each
J. 76mm	0-1.0mm	820-4186	\$3.95
K. 86mm	0-1.5mm	820-4187	3.95
L. 96mm	1.5-3.0mm	820-4188	3.95
M. 105mm	2.7-4.5mm	820-4189	3.95
4-Piece Set (one of each)		820-4185	14.20

N. Setting Bur Chuck with Swivel Handle

For holding burs, reamers and taps. Ball-shaped wooden swivel handle fits in palm of hand. For 3/32" shanks. Measures 4" long.

Description	Item#	Each
Setting Bur Chuck	840-4200	\$11.75

A, B Adapter Chucks – 3/32" Shank

Allow you to use tools with small shanks in standard flex shaft handpieces. Threads are right-hand. Made in France.

Description	Item#	Each
A. 1.00mm Chuck	840-3210	\$13.35
B. 2.62mm Chuck	840-3220	15.50

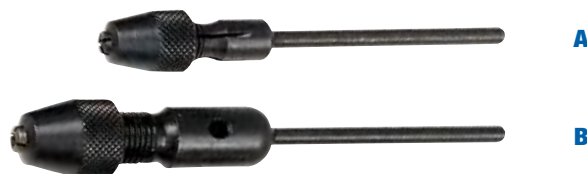

C. Econo 4-Collet Adapter Chuck – 3/32" Shank

Works in standard flex shaft handpieces. Threads are right-hand. Includes a collet that completely closes for holding smallest of tools as well as 1.50, 2.50 and 3.00mm collets. Made in India.

Description	Item#	Each
Econo 4-Collet Adapter Chuck	840-3240	\$6.95



D. Steel Hand Vice

Has spring action in handle to keep jaws open. Serrated jaws are 1/4" wide and open to 1". Measures 4" long.

Description	Item#	EACH Prices	
		1-2	3+
Steel Hand Vice	820-4500	\$44.10	\$41.90



E, F Magnetic Ball Vice

The magnetic ball vise is made of the highest quality anodized aluminum and is used to hold workpieces for polishing, grinding, micro-welding and a variety of other general purpose applications. Tilts from 180 degrees to 90 degrees without losing stability. The permanent magnet is spring loaded. An Allen wrench is used to release the magnet allowing workpieces to be placed on and off the top plate easily. Ball vise sits on a small stand. Available on 4" (Height: 3 1/2", Wt. 9 lbs) and 6" (Height: 4 3/4", Wt. 28 lbs) fine pole magnetic working surface. Allen wrench included. Made in USA.

Description	Item#	Each
E. 4" Magnetic Ball Vice	814-0105	\$1,095.00
F. 6" Magnetic Ball Vice	814-0101	1,200.00



G. Foredom® Mini Vice

Securely holds small parts. Has 1 3/4" slotted grooves in the base for mounting on a drill press or workbench. Stationary jaw has a perpendicular V-groove, and moveable jaw has a horizontal V-groove for holding round stock or tube. Glare-free black finish.

Specifications:

Jaw Width	1 3/4"
Jaw Opening	1 3/4"
Dimensions	4"L x 2 3/8"W x 1 1/2"H
Ship. Wt.	1/2 lb.

Description	Item#	Each
Mini Vice	820-4700	\$24.50

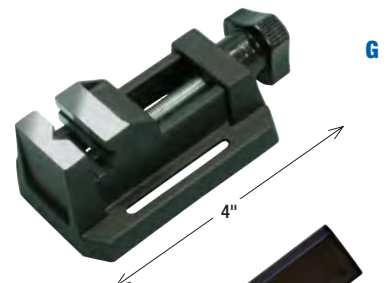

H. Drill Press Vice

All aluminum vise has slots to attach to bench top drill press (850-0595 p. 446). Quick release feature for ease of use. Jaw width 2 9/16". Jaw opening 2 3/4". Measures 9 1/2"L x 4 1/2"W x 2 1/4"H.

Description	Item#	Each
Drill Press Vice	850-0594	\$12.95

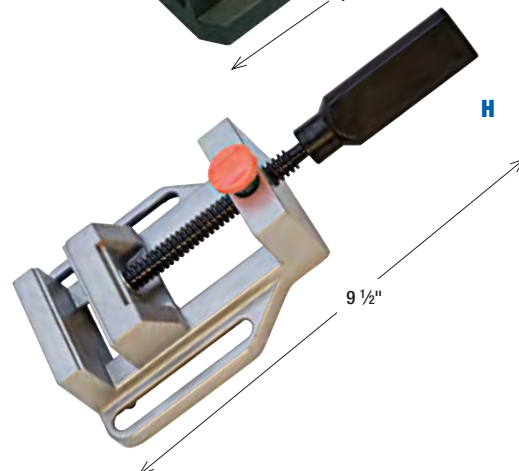



A. Rotating Bench Vise - 3 1/4" Jaw Opening

Base mount for mounting vise on the workbench or table. Table clamp screw that opens to a maximum depth of 2". The clamp vise head can rotate 360 degrees and tilts approximately 90 degrees with lockable handle. Steel jaws have 1 horizontal and vertical V-groove on each. Made in Pakistan.

Specifications:

Jaw Width : 3 1/4"	Clamping Height: 2"	360 Swivel & ~ 90 Degree Tilt
360 Swivel & ~ 90 Degree Tilt	Table Clamp Height : 2"	Weight: 16.25 lbs
Clamping range: 4 1/2"	Table Clamp Depth : 2"	

Description	Item#	Each
Rotating Bench Vise - 3 1/4"	820-4040	\$150.00

B. Panavise Model 301 - 2 1/2" Jaw Opening

An all-purpose vise that tilts, turns and rotates. Vise head can be turned 360°, tilted 90° and locked in any position. When head is locked in desired position, stem can be rotated or locked in place. All movement is controlled by one convenient variable pressure knob. Nonmarring nylon jaws open to 2 1/2".

Description	Item#	Each
B. Panavise Model 301	814-0200	\$55.00
Replacement Nylon Jaws, set of 2	814-0805	2.95

C. Base Mount #311 for Panavise Model 301

Platform base mount for attaching Panavise Model 301 securely to the edge of a workbench or counter. Attaches with a clamp screw that opens to a maximum of 3 1/2" (89mm). Comes with three screws for securing Panavise to base mount.

Description	Item#	Each
Base Mount #311 for Panavise Model 301	814-0700	\$51.00

D. Panavise Model 381 - 2 1/2" Jaw Opening

An all-purpose vise with the same features as Model 301—with the added benefit of portability. A half-turn of the mount lever permits easy mounting of the vise on any smooth, nonporous surface. Suction holds vise to surface until lever is released.

Description	Item#	Each
D. Panavise Model 381	814-0190	\$75.00
Replacement Nylon Jaws, set of 2	814-0805	2.95

E. Swivel Bench Vise - 2 1/2" Jaw Opening

Dual guide rods ensure parallel closing of jaws, rigidity and steady action. Smooth jaws help prevent marring of soft metal. Features sturdy construction with anvil top and enamel-finished body. Fits benchtops up to 2" thick. Can be rotated laterally 360° and locked into position. Jaws are 3" wide and open to 2 1/2". Ship. wt: 5 1/2 lbs.

Description	Item#	Each
Swivel Bench Vise	820-4054	\$79.75

F. Mini Bench Vise - 1" Jaw Opening

Great for small, precision work. Jaws are 1" wide and open to 1". C-clamps to bench or tabletop up to 1 1/8" thick. Body is cast iron with heavy red enamel coating. Ship. Wt: 1 lb.

Description	Item#	Each
Mini Bench Vise	820-4052	\$7.95

G. Freedom® Soff Jaws

Attach to any 3" or 4" bench vise via built-in magnetic strips. Made of resilient ethylene vinyl acetate (soft rubber-like material). Grip odd shapes with ease. Prevent marring of polished and painted surfaces and threaded parts. Measure 3 1/2" long.

Description	Item#	Each
Rubber Soff Jaws, pair	820-4705	\$8.95

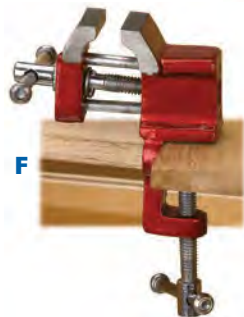

A. Rotating Bench Vise - 3 1/4" Jaw Opening

Sturdy high-quality vise especially suited for tool and die makers and for electronic and general metalworking. The vise head can be rotated a full 360° and tilted from a flat 180° horizontal to a full 90° vertical, then locked securely in place, allowing your work piece to be easily swiveled and angled into the best working position. Supplied with steel jaws. Optional nylon jaws are available. One side of the steel jaws has two V-shaped grooves for holding wire and round or tube stock. Movable vise jaw slides in a brass guide. Jaw clamping screw and joint locking screw work on bronze lead nuts. 3 1/4" jaws and 4 1/8" clamping range. Includes base mount with clamp screw for secure mounting on the edge of a workbench or counter up to 3" thick. Base mount can also be removed for fixing the vise with screws directly to benchtop. Made in Italy.



Bench Vise Jaw Width	Clamping Range	Clamping Height	Net Wt.	Item#	Each
A. 3 1/4" (82mm)	4 1/8" (105mm)	2 7/32" (56mm)	14 lbs.	820-4058	\$576.00
Optional Nylon Jaws for #820-4058				820-4062	67.50

B-D GRS® Engraver's Blocks

The Magnablock and the Small Block are extremely well-made devices used to hold objects firmly for engraving, stone setting and general-purpose work. Each holds both large and small items. Adjustable friction lock from zero to full lock for crown rotation control. Nonglare satin finish on body, black oxide finish on jaws for protection. Precision-machined parts for smooth, efficient operation. Solid steel construction provides heavy weight and adjustable drags for keeping the workpiece in the proper position. Uses two industrial ball bearings and a large roller thrust bearing to eliminate side play and wobble. Includes rubber ring pad with Nylon glides, upper jaw plates, five pins and wrench. Made in USA.

Features:

Adjustable friction lock from zero to full lock for crown rotation control. Nonglare satin finish on body, black oxide finish on jaws for protection. Precision-machined parts for smooth, efficient operation.

Specifications:	Magnablock	Small Block
Spherical Diameter	5 3/4"	5 1/8"
Jaw Size	3"W x 1 3/4"H	2 1/2"W x 1 1/2"H
Max. Jaw Opening	3 1/2"	3"
Net/Ship. Wt.	30/33 lbs.	19/22 lbs.

Description	Item#	Each
B. Magnablock	856-0275	\$637.10
C. Small Block	821-6000	486.00
D. Attachment Set 30-piece	856-0277	109.00



E. GRS® Microblock™ Ball Vise

Compact, low-profile design is perfect for microscope work and other jobs where a larger vise is an obstacle. Smooth, self-centering jaw system and adjustable internal brake system lets the user choose the amount of rotational resistance from totally free to fully locked. Machined from solid stainless steel and finished with low-glare treatment to reduce eyestrain. Includes positioning ring, four jaw pins, wrenches and Thermo-Loc Sample Kit (four bars). Measures 3.1" diameter with 1.8"W x .87"H jaws. Max. jaw opening: 2". Made in USA

Description	Item#	Each
Microblock	856-0304	\$282.00
E. Microblock with 30-Piece Attachment Set	856-0305	378.00



F-H GRS® BenchMate™ Multipurpose Vise

Attaches to BenchMate or directly to your bench. Tilts left and right and rotates on vertical axis so you can find the best working angle. Features holes in top for holding pins or the padded ring clamp from GRS 30-Piece Attachment Set #856-0277 (see p. 545). Made of satin-finished steel. To mount, fit in Fixed Mounting Plate, secure to Benchtop Mounting Adapter, then screw into bench. Made in USA.

Description	Item#	Each
F. Multipurpose Vise	856-0172	\$170.00
G. Fixed Mounting Plate	856-0196	18.95
H. Benchtop Mounting Adapter	856-0193	27.20

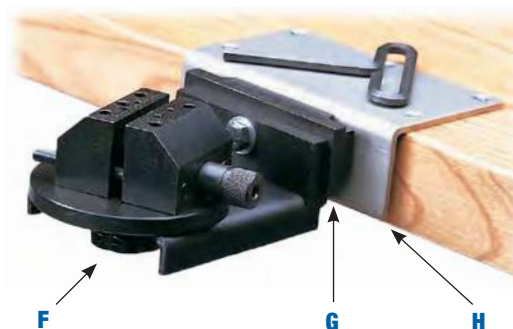



A, B Low Profile 5" Ball Vise – 2½" and 3½" Diameter

Chose between 2½" or 3½" dia. jaws that are 1½" tall. Need more working space under your microscope? Now you can with the RinGenie Low-Profile Ball Vise. Sturdy construction with jaws that are made of stainless steel with copper face inserts for many years of use. Most vise accessory kits in the market will also fit this model.

Description	Overall height	Item#	Each
A. 5" Ball Vise 2½" Dia.	4½"	816-1507	\$632.50
B. 5" Ball Vise 3½" Dia.	3½"	816-1508	\$632.50



C. 5" Positional Vise

With 2½" dia. jaws which are 1½" tall. Utilizing two stationary pins to easily adjust the working position. Jaws opening measures 1½"

Description	Overall height	Item#	Each
5" Positional Vise	6¼"	816-1509	\$852.50



D. Positional Rotatory Table & Mounted Vise

With a mounted vise. Great for general work at the bench or any flat surface. Constructed of a Steel 8" work base with drag screw resistance, optional positioning and a 360° rotation. Jaws are 3" dia. and 1" tall. Jaws opening is 4½".

Description	Overall height	Item#	Each
Positional Rotatory Table and Vise	3⅝"	816-1511	\$984.50



E, F 3" Vise and Adapter

With 1⅞" dia. jaws which are ¾" tall. Made from stainless steel. Jaw opening 1¼". Vise Adapter, made from aircraft quality aluminum, allows bench mounting.

Description	Overall height	Item#	Each
E. Vise	4"	816-1498	\$742.50
F. Vise Adapter		816-1499	192.50



G. 10" Turn Table

This solid turntable rotates 360° with a drag screw and positive lock. Can be used at your bench or any solid work table.

Description	Overall height	Item#	Each
10" Turn Table	1⅝"	816-1512	\$511.50



H. GRS® Positioning Vise for Stereo Zoom Microscopes

Simply pull a lever, and this vise lets you easily reposition its center of rotation to keep the object within your microscope's field of view. Its upper half moves off-center to left or right as desired; after moving, it rotates about set position. Includes upper jaw plates, five pins and wrench. Spherical diameter: 7.1". Jaw size: 3"W x 1.8"H. Max. jaw opening: 3.5". Weighs a massive 42 lbs. for incredible stability.

Description	Item#	Each
Positioning Vise for Stereo Zoom Microscopes	271-3025	\$913.00

Renata Watch Batteries

Gesswein is pleased to offer Superior Swiss quality Renata watch batteries. Renata's lithium and Mercury Free silver oxide batteries are 3V and known for their reliability, high quality and top performance. Five-piece minimum order (tear-strip packages) - must order in multiples of 5. Made in Switzerland.

A. Renata Silver Oxide Watch Batteries

Battery#	Item#	5pc	Each	Battery#	Item#	5pc	Each	Battery#	Item#	5pc	Each
301	809-0301		\$1.99	350	809-0350		\$1.75	381	809-0381		\$1.04
303	809-0303		2.32	357	809-0357		1.65	384	809-0384		0.65
309	809-0309		1.45	361	809-0361		0.57	386	809-0386		1.49
315	809-0315		0.78	362	809-0362		0.52	387	809-0387		2.67
317	809-0317		0.70	364	809-0364		0.38	389	809-0389		1.17
319	809-0319		0.68	365	809-0365		2.22	390	809-0390		0.80
321	809-0321		0.55	366	809-0366		2.22	391	809-0391		1.12
329	809-0329		0.89	370	809-0370		0.77	392	809-0392		0.65
335	809-0335		1.29	371	809-0371		0.57	393	809-0393		1.30
337	809-0337		1.85	373	809-0373		0.80	394	809-0394		1.10
339	809-0339		1.75	376	809-0376		0.53	395	809-0395		0.80
341	809-0341		1.64	377	809-0377		0.38	396	809-0396		0.60
344	809-0344		1.80	379	809-0379		0.43	397	809-0397		0.60
346	809-0346		1.65	380	809-0380		0.97	399	809-0399		0.70



B. Renata Lithium Watch Batteries

Battery#	Item#	5pc	Each	Battery#	Item#	5pc	Each	Battery#	Item#	5pc	Each
CR1025	809-1025		\$0.70	CR1616	809-1616		\$0.67	CR2025	809-2025		\$0.47
CR1216	809-1216		0.75	CR1620	809-1620		0.67	CR2032	809-2032		0.47
CR1220	809-1220		0.60	CR1632	809-1632		0.75				
CR1225	809-1225		0.80	CR2016	809-2016		0.47				

5pc Five-piece minimum; please order in multiples of five.

C. Deluxe Universal Battery Change Set

A handy set for changing watch batteries. Includes everything needed to do the job quickly: case knife for pop-off case backs, spring bar changing tool, scratch brush for cleaning battery cavities, plastic tweezers for handling batteries, screw-back case-opening wrench, 1.0mm and 1.6mm flat-head screwdrivers, 1.2mm Phillips screwdriver and 5" x 5" polishing cloth. Faux leather, zippered case.

Description	Item#	Each
Deluxe Universal Battery Change Set	820-9041	\$26.30



D. Battery and Pulse Tester

A great jeweler's aid. Tests a watch to see whether the step motor is not working or the battery is dead—without opening the watch. Also tests the coil. Just rest the watch across the sensor and watch the readout. Requires no training. Includes 9V battery.

Description	Item#	Each
Battery and Pulse Tester	820-9047	\$39.95



E. Battery Tester

An economical yet accurate tester for checking batteries under design and load conditions. Tests alkaline, carbon zinc, silver oxide, lithium, nickel cadmium and mercury batteries. Includes easy-to-follow instructions.

Description	Item#	Each
Battery Tester	820-9048	\$10.95



F. Battery Clamp Assortment

This assortment contains 50 clamps for many of the most popular watches. Allows you to replace worn or broken clamps in minutes.

Description	Item#	PKG of 50
Battery Clamp Assortment	820-9045	\$28.95

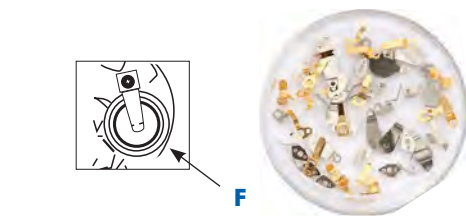

G. Battery Clamp Screw Assortment

This assortment contains 100 screws that will fit most watch brands.

Description	Item#	PKG of 100
Battery Clamp Screw Assortment	820-9046	\$19.95





A



B



C



D



E

Watch not included



F

A. L-G Watchcase Wrench

For waterproof cases. Opens any size and shape case. Features knurled polygon for any number of slots, notches or holes. Tight, nonslip grip will not scratch. Cover can be left in wrench, ready for replacing. Includes four sets of interchangeable jaw pins. Made in USA.

Description	Item#	Each
A. L-G Watchcase Wrench	820-9020	\$85.95
Replacement Pins, set of 12	820-9021	34.95

B. Waterproof Watchcase Wrench

This JAXA-style case wrench meets the highest standards. Includes four sets of pins (three of each style). Packaged in a hardwood box. Imported.

Description	Item#	Each
B. Waterproof Watchcase Wrench	820-9025	\$12.95
Replacement Round Pins, set of 3	820-9026	1.45
Replacement Flat, set of 3	820-9027	1.45
Replacement Square, set of 3	820-9028	1.45
Replacement Curved, set of 3	820-9029	1.45

C, D Watchcase Holders

Both have metal bases with four plastic pins for securely holding watchcases without marring.

Description	Item#	Each
C. Watchcase Holder	820-9030	\$6.95
D. Large Watchcase Holder	820-9035	15.95

E. Rubber Sport Watch Holder

Generally a regular (leather/steel) watch will easily lay flat, but the straps on a rubber sport watch band curl up and make it difficult to work on the watch. This handy watch holder holds rubber watch straps in place while repairing or changing a battery without having to remove the band. Comes with a nylon die that will not mar or scratch crystals.

Description	Item#	Each
Rubber Sport Watch Holder	820-9056	\$17.95

F. Clip Spring Removing Pliers

Use for adjusting the length of Seiko style watch bands. The flat jaw rests atop the link, and the pointed tip fits under the clip spring. Gently squeeze the handles, and the clip spring pops up, ready for easy removal. Measure 5½" long.

Description	Item#	Each
Clip Spring Removing Pliers	820-9069	\$9.45

A. Snap-Back Case Opener

The ultimate in a snap-back case opener. This tool will open even the stubborn friction-fit or snap-back watch cases with a simple turn of the threaded thumb screw. User control of blade alignment and depth ensures no damage to delicate watch inner workings. Replaceable blade.

Description	Item#	Each
A. Snap-Back Case Opener	820-9058	\$101.95
Replacement Blade	820-9059	12.95

View additional details
at www.gesswein.com.



A

B. Snap-Back Case Knife

Special Swiss case knife with hard plastic handle and fixed tempered blade (does not fold into handle). Measures 4" long.

Description	Item#	Each
Snap-Back Case Knife	260-3058	\$23.95



B

C. Snappy Watchcase Opener

Makes watchcase opening a snap! Just position the point between the case back and the case, and push slowly to lift off the back. Easily controlled so blade will not pop into watch movement. Spring-loaded for easy operation. Made of steel with red plastic handle. Measures 5" long. For watchcase closing, use Case Closing Pliers #820-9065 (see p. 550).

Description	Item#	Each
Snappy Watchcase Opener	820-9060	\$11.95



C

D. Medium-Duty Bench Knife

Has slim 1 $\frac{3}{4}$ " long blade set firmly in hardwood handle. Measures 5" long.

Description	Item#	Each
Medium-Duty Bench Knife	260-3057	\$13.95



D

E. Case Knife

Features universally popular shape that gives watchmakers the proper grip for prying open snap-on case backs. Hardwood handle and precisely beveled, tempered steel blade make case opening easier. Measures 4 $\frac{1}{2}$ " long.

Description	Item#	Each
Case Knife	820-9055	\$4.50



E

F. Heavy-Duty Bench Knife

An all-purpose bench knife for opening watchcases, scraping and cutting. Has 1 $\frac{3}{4}$ " long steel blade mounted in hardwood handle. Measures 5 $\frac{1}{4}$ " long.

Description	Item#	Each
Heavy-Duty Bench Knife	260-3059	\$3.80



F

G. Victorinox® Original Swiss Army Knife**The first and finest!**

Includes a cutting blade, scissors, file, tweezers, pick and key ring attachment. Made of stainless steel. Has royal blue enamel handle inlaid with metal Gesswein logo. Measures 2 $\frac{1}{4}$ " closed.

Description	Item#	Each
Victorinox Original Swiss Army Knife	827-1000	\$18.75



G



A. Watchcase Press – Nylon Dies

The best inexpensive case closer available. Includes 14 snap-on nylon dies 7 hollow and 7 flat for 16-36mm diameter cases. Will not scratch or mar crystals. Made of sturdy cast metal. Works with watch lying facedown so user can see case back being closed.

Description	Item#	Each
Watchcase Press	820-9050	\$37.95



B. Watchcase Press – Aluminum Discs

This combination case closer/crystal press beats anything in its price range and beyond. It features: 14 reversible turned aluminum dies with 28 sizes smoothed to a high polish so they will not scratch. Dies screw onto the upper and lower part so that they can be inverted for case closing or crystal fitting. Cast metal body with angled leverage arm for proper closure. Don't destroy watch cases or case backs by using the wrong tool. Our Combo Closer will give you years of satisfaction and service. Shipping weight: 5 lbs.

Description	Item#	Each
Watch Case Press - Aluminum Disc	820-9052	\$54.95



C. Case Closing Pliers

A handy tool for safely closing watchcases. Parallel closing jaws with hinged, rubber-padded discs prevent damage to the watchcase and crystal. Measure 7 1/2" long.

Description	Item#	Each
Case Closing Pliers	820-9065	\$19.75



D. Vinyl Watch Tape

Used as a cover over watch faces and bracelets for protection from scratches during handling or transportation. Although it is called "tape" it has no adhesive. Clings to glass, plastic and metal without glue or gum. Leaves no residue!

Sold in approximately 150 foot in rolls. Available in two widths: 50mm for small to mid-size watches and 80mm for larger watches.

Description	Item#	Each
Vinyl Watch Tape 50mm	820-9290	\$24.95
Vinyl Watch Tape 80mm	820-9295	27.95



E. Flat Case Back Gasket Assortment

This 54-piece assortment includes three pieces each of 18 sizes (15.00-32.00mm ID in 1mm increments). Gaskets measure 2mm wide x 0.5mm thick. Each size comes in its own envelope.

Description	Item#	Each
Flat Case Back Gasket Assortment	808-0010	\$24.95

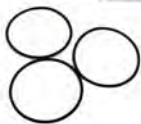

F. Watch Gasket Assortments

Available in four different thicknesses. Each 144-piece assortment includes four pieces each of 36 sizes (14.50-32.00mm ID). Fits Citizen, Seiko and most modern quartz watches.

Description	Thickness	Item#	Each
F. Watch Gasket Assortment	0.40mm	808-0001	\$14.95
	0.50mm	808-0002	14.95
	0.60mm	808-0003	14.95
	0.70mm	808-0004	14.95



G. Thin O-Ring Assortment

This 144-piece assortment includes four pieces each of 36 sizes (14.50-32.00mm ID) in three thicknesses: 0.40, 0.50 and 0.60mm. Envelopes are color-coded by thickness.

Description	Item#	Each
Thin O-Ring Assortment	808-0005	\$59.95



A. Cotter Pin Assortment Set

This comprehensive set gives the jeweler 180 cotter pins (5 each of 36 different sizes) to adjust metal bands either during the sale or for aftermarket service. Many watches need links added or removed to customize size, and this process requires replacement cotter pins such as these to ensure proper strength of the band.

Description	Item#	Set
Cotter Pin Assortment	820-9220	\$29.95



A

B-D Wood Sticks

Great multipurpose items. Can be used as a disposable mixing stick or applicator when gluing. Great for use as a dop stick for placing small parts. Use to accurately apply luminous pigment to watch hands. Available in round soft sticks, 6" in length. Select between pegwood and white birch. Pegwood sticks are easily shaped to fit your specific need. Packaged in bundles of 24.

Pegwood	Diameter	Item#	PKG. of 24	
			1-9	10+
B. Round	2mm	825-1201	\$10.00	\$8.50
	2.5mm	825-1202	10.25	8.71
	3mm	825-1203	10.50	8.93
	4mm	825-1204	10.75	9.14

White birch sticks have one end shaped and include 25 sticks in a package.

White Birch	Diameter	Item#	PKG. of 25	
			1-3	4+
C. Round, pointed	1/8"	825-0551	\$11.85	\$10.67
	1/4"	825-0557	11.85	10.67
D. Round, double-beveled	1/8"	825-0541	12.45	11.21
	1/4"	825-0547	11.85	10.67

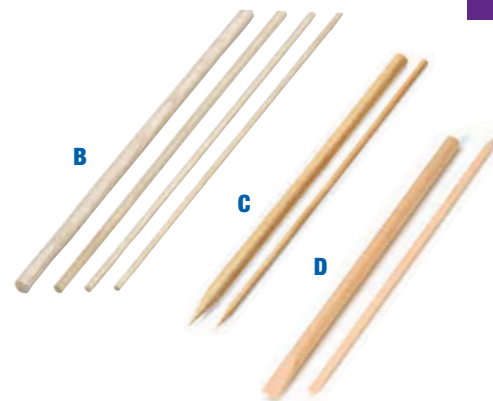

E, F Double-Shoulder Spring Bar Sets

Available in 200-piece extra-thin, thin and regular sets of assorted lengths and 400-piece extra-thin/regular combination set of assorted lengths. Each set includes 20-piece plastic bottles of each length.

Description	Item#	Each
E. 400-Piece Extra-Thin/Regular Combination Set	820-9215	\$29.95
F. 200-Piece Extra-Thin Set	820-9200	16.95
200-Piece Thin Set	820-9205	14.95
200-Piece Regular Set	820-9210	14.95

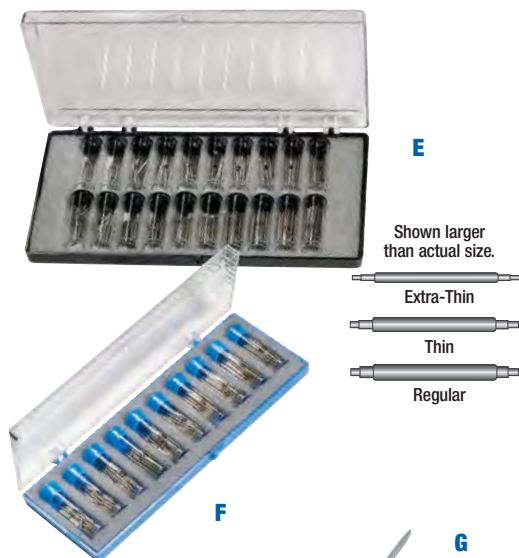

G-I Metal Spring Bar Tool

Tips are stronger than those of conventional spring bar tools but have the same thread for interchangeability. Measures 5 1/8" long.

Description	Item#	Each
G. Metal Spring Bar Tool	820-9192	\$7.50
H. Replacement Forked Tip	820-9194	1.30
I. Replacement Straight Tip	820-9193	1.30

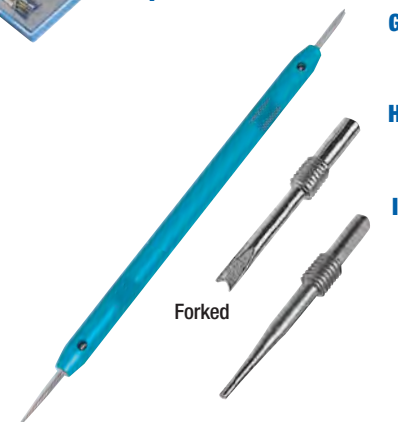

J. Pin Pusher

Handy for pushing stubborn pins out of watch bracelets when changing links for sizing. Slightly flattened tip prevents slipping. Made of hardened tool steel with hardwood handle. Measures 4 3/4" long.

Description	Item#	Each
Pin Pusher	820-9070	\$4.20



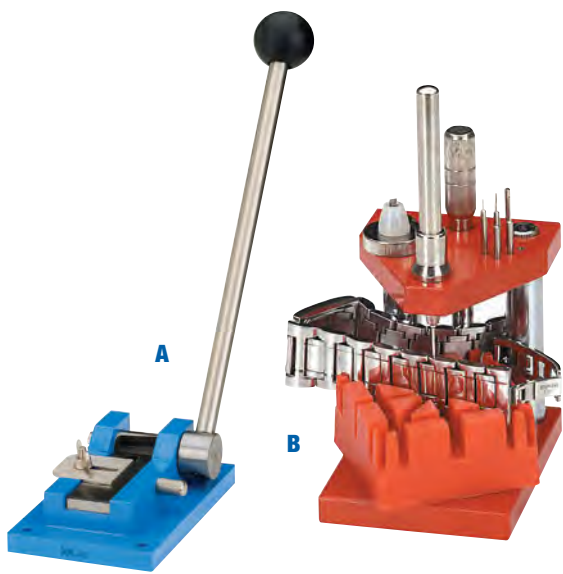

A. Mesh Bracelet Cutter

A beveled-cylinder cutting tool useful for cutting not only mesh bands but also solder wire and small pieces of sheet metal. Provides maximum cutting leverage with its long handle. Cuts much faster than hand saws. Measures 6"L x 4"W.

Description	Item#	Each
Bracelet Cutter	840-4215	\$55.50

B. Link and Spring Bar Remover

An indispensable tool to the watchmaker. Ideal for removing stubborn links and Westar-type spring bars. Includes 0.40, 0.60, 0.80, 1.00, 1.50 and 2.00mm pins for use in all bracelet types. Also includes screwdriver with 2.50mm tip for screw-type spring bar removal. Weighs just over 1 lb.

Description	Item#	Each
B. Link and Spring Bar Remover	820-9275	\$25.50
Replacement Pin Set (6)	820-9276	6.50



C. Pin Removing Set

Perfect for removing friction pins from watch bracelets. Includes grooved wooden block for holding bracelets securely without marring, small ball-peen hammer and 0.80mm and 1.00mm pin removing punches. Just tap punches lightly to remove pins.

Description	Item#	Each
C. Pin Removing Set	820-9075	\$19.95
Replacement 0.80mm Punch Tip	820-9076	0.89
Replacement 1.00mm Punch Tip	820-9077	0.89

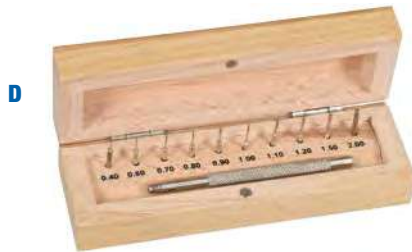

D. Watch Link Pin Remover Set

With its sleek design and compact style, the watch link pin remover set comes complete with 10 pins in sizes: 0.40, 0.60, 0.70, 0.80, 0.90, 1.00, 1.10, 1.20, 1.50 and 2.00mm. Pins are easily interchangeable in the tension fit handle provided. Set is packaged in a premium wood box with magnetic closure. Made In India.

Description	Item#	EACH Prices	
		1-2	3+
Watch Link Pin Remover Set	820-9280	\$14.15	\$12.74



E. Pin Remover

Handy tool for removing pins from metal link bands. Keltec II glass-filled nylon body will not scratch or mar gold or silver. Includes two extra spacers to accommodate all bracelet sizes and two extra push pins. Pusher pin is made of hardened tool steel. Large screw with knurled handle guides the pusher pin into place.

Description	Item#	Each
Pin Remover	820-9071	\$15.15



F. Bracelet Link/Pin Removing Pliers

Removing links and pins just got easier! This link/pin removing pliers are effective and easy to use! By using the adjustable set screw, a wide variety of pin lengths can be easily removed in seconds. Holds a pin pusher made of hardened steel 0.80mm (820-9112) and 1.0mm (820-9111) included) that removes a link or pin in one hand motion. 0.70mm (820-9113), and 0.60mm (820-9114) pin pushers can also be purchased separately (not included). Ergonomic and easy to hold with its soft rubber grip and supplied with a convenient ring on the handle for easy hanging off your bench. Made in India.

Description	Item#	Each
F. Bracelet Link/Pin Removing Pliers	820-9011	\$1.45
Replacement Pin 1.00mm	820-9111	2.95
Replacement Pin 0.80mm	820-9112	2.95
Optional Pin 0.70mm	820-9113	2.95
Optional Pin 0.60mm	820-9114	2.95

A. Screwdriver Set in Rotating Stand

Includes nine color-coded setscrew screwdrivers, 19 spare blades, two extra setscrews and rotating stand for easy access and compact storage. Made in France.

Description	Item#	Each
A. Screwdriver Set in Rotating Stand	820-9010	\$59.95
Description	Item#	Pkg. of 3
0.60mm Blades	820-9011	\$1.45
0.80mm Blades	820-9012	1.45
1.00mm Blades	820-9013	1.75
1.20mm Blades	820-9014	1.75
1.40mm Blades	820-9015	1.75
1.60mm Blades	820-9016	2.15
2.00mm Blades	820-9017	2.15
2.50mm Blades	820-9018	2.65
3.00mm Blades	820-9019	2.65



See Tap & Die Sets
on page 256

B. Screwdriver Set

Includes six precision screwdrivers with replaceable blades that are held firmly in the handles by means of screw chucks. Blades are made of the finest tool steel, which has been heat-treated for toughness and long wear. The hexagonal heads will not roll on bench. Bodies are plated and have a knurled grip for nonslip holding. Screwdrivers measure approximately 4" long. Made in USA.

Description	Item#	Each
B. Screwdriver Set	820-9000	\$29.95
0.100" Blade	 820-9001	2.50
0.080" Blade	820-9002	2.50
0.070" Blade	820-9003	2.50
0.055" Blade	820-9004	2.60
0.040" Blade	820-9005	2.60
0.025" Blade	820-9006	2.60

 Three-piece minimum; please order in multiples of three.



C. JIS Screwdriver Set

Includes four color-coded screwdrivers with hex heads, knurled handles and hardened steel blades with 90°-cornered tips designed for use on watches. Excellent for electronics, computer and camera repair. Screwdrivers measure 4½" long. Made in Europe.

Description	Item#	Each
C. JIS Screwdriver Set	820-9023	\$18.25
1.20mm Gray Screwdriver	820-9024	4.55
1.50mm Violet Screwdriver	820-9032	4.55
2.00mm Green Screwdriver	820-9033	4.55
2.50mm Blue Screwdriver	820-9034	4.80

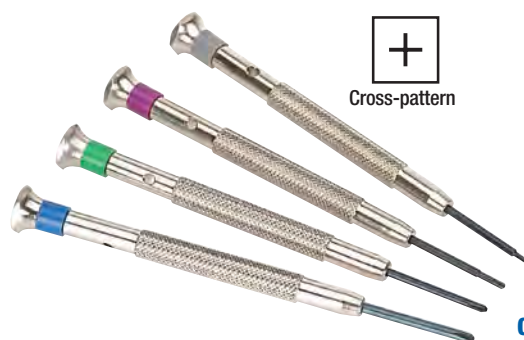

D. Combo Screwdriver Set

Includes four flat-head screwdrivers (1.0, 1.20, 1.80 and 2.40mm) and two Phillips screwdrivers (#0 and #1) with hexagonal swivel heads. Packaged in a hard plastic box.

Description	Item#	Each
Combo Screwdriver Set	820-8900	\$2.95



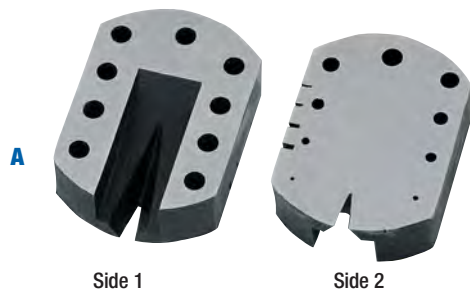

Side 1

Side 2



C



D



E



F

A. V-Slot Anvil

Steel anvil used as a base for staking, riveting and drilling small parts. Case-hardened and ground flat and smooth. Features V-slot for removing pinions and other small items. Has nine graduated holes (one for stumps) and five milled slots. Measures 1 $\frac{3}{4}$ "L x 1 $\frac{1}{4}$ "W x $\frac{1}{2}$ "H.

Description	Item#	Each
V-Slot Anvil	814-1015	\$19.10

B. Screwdriver Sharpener

Stop throwing out screwdriver blades. This handy little device keeps your screwdriver blade locked in place so you can reshape and resharpen. Steel wheels on each end are carefully set into the body to provide even action when wheeled over a stone. Use with our sharpening stones (see page 28-34) to produce a precision-edged blade that's as good as new. Measures less than 2" wide.

Description	Item#	Each
Screwdriver Sharpener	820-8390	\$13.85

C. Watch Tissue

Lint-free anti-tarnish tissue for wrapping and cleaning watch parts, jewelry and much more. Measures 4" x 4". Sold in boxes of 1,000 sheets.

Description	Item#	EACH Prices	
		1-2	3+
Watch Tissue, box of 1,000	813-1725	\$7.15	\$6.79

D. Dust Blower

This rubber dust blower removes specks and lint from hard-to-reach areas. Keeps moisture away from delicate parts. Measures 3 $\frac{3}{4}$ "L x 1 $\frac{3}{4}$ "W.

Description	Item#	Each
Dust Blower	820-9078	\$3.95

E. C-Clear Watch Crystal Compound

Removes scuffs and scratches to make old plastic watch crystals look new again. Sold in $\frac{1}{4}$ lb. bars.

Description	Item#	Each
C-Clear Watch Crystal Compound	215-0041	\$6.50

F. Crystal Cement

Provides a strong, durable bond between plastic and glass watch crystals and the bezel. Will not flake off or crack plastic. Sold in convenient $\frac{1}{3}$ fl. oz. tube with pinpoint applicator tip.

Description	Item#	EACH Prices	
		1-2	3+
Crystal Cement, $\frac{1}{3}$ fl. oz.	811-2540	\$5.95	\$5.36

The next generation in Micro Welding/Soldering

Aquaflame Torches – at the heart of the workshop

The Aquaflame Torch systems are a must for any jeweler/repair facility. Made of the highest quality components the Aquaflame torch systems are proudly made in the United Kingdom with CE approval. Aquaflame is a complete soldering system—bottled gas with pressurized fuel tanks are a thing of the past. Minimal maintenance is required and to prove the exceptional construction and use, Aquaflame Torch Systems boast a full 2 year warranty!

Why Aquaflame? The powerful yet compact generator converts distilled/deionized water into hydrogen and oxygen gases by electrolysis. A wide range of tips are provided from 0.50mm to 1.50mm to perform standard soldering tasks such as re-sizing or re-tipping. The larger tips and extra power of the 800 and 1200 models make them capable of soldering platinum.

A clean precise environmentally friendly flame is obtained by using Methyl-Ethyl-Keytone (MEK). MEK leaves no residue on the surgical steel tips. The operator will find the light-weight torch handle easy to hold and for safety, it contains a built-in Flashback Arrestor. When using liquid flux or flux based paste solders, you will see less fire scale which is commonly found when working on silver.

Though extensively used in the jewelry industry, Aquaflame Systems are also used in the dental and other technical manufacturing industries making them ideal for precision soldering and micro welding. Aquaflame Torches are also widely used for acrylic flame polishing (edge polishing on

acrylic) in plastic fabrication as this method requires no other materials or compounds and can finish intricate shapes quickly and easily.

The Aquaflame is available in (3) models. The Model 500 is ideal for soldering Silver, Gold, Stainless Steel Medical Instruments and some Titanium Alloys. The Models 800 and 1200 are ideal for the above-mentioned metals plus are better suited for soldering Platinum and additional operators can be added by ordering 830-1084.

Complete with 2 year manufacturer's warranty—servicing required every 12 months for warranty to apply. See our website for services kits—Item# 830-1080 for Model 500, 830-1081 for Model 800, and 830-1082 for Model 1200. Made in the United Kingdom.



Acrylic Flame Polishing	500	800	1200
Chemical for flame positioning	MEK	MEK	MEK
Thickness polished in 1 pass	5mm	10mm	15mm
Typical polishing times (per meter)	1 min	2 mins	3 mins

Specifications*	Model 500	Model 800	Model 1200
Gas production	75 lt/h	120 lt/h	240 lt/h
Distilled water use (per day)	30ml	50ml	100ml
Maximum flame temp.	3300c	3300c	3300c
Electrical usage	0.50 kW	0.80 kW	1.20 kW
Torch tips range supplied	20 - 24	18 - 24	17 - 24
Torch tips bore size (mm)	0.60 - 0.31	0.90 - 0.31	1.00 - 0.31
Service recommended	12 months	12 months	12 months
Dimensions LxWxH (inches)	16 x 8 x 12	16 x 11 x 15	17.5x12.5x15.5
Shipping Weight	44lbs/20kg	66lbs/30kg	110lbs/50kg 
Item Number	830-1005	830-1006	830-1007
Price	\$2,450.00	\$2,995.00	\$4,395.00

* Due to the technical nature of these products, some details may change. Please see our website for the most up-to-date information.

Required Electrolytes

Model 500 (1) of (830-0043), Model 800 (1) of (830-0044), and Model 1200 requires (2)* of (830-0044). Each model also requires (1) of MEK (830-0042). All sold separately. See website for convenient Aquaflame Filling Kit (830-1085).

	Model 500	Model 800	Model 1200
Required Electrolyte 	830-0043	830-0044	*(2) 830-0044
Price for each	\$18.45	\$35.00	\$35.00
Required MEK 	830-0042	830-0042	830-0042
Price for each	\$22.95	\$22.95	\$22.95

 Although no hazardous shipping surcharge applies, these items can only ship via UPS® Ground, no air, FedEx® or US Mail possible. Cannot ship to Alaska, Hawaii or Puerto Rico.

 UPS® hazardous shipping surcharge applies. Ships via UPS® Ground only, no air, FedEx®, or US Mail shipments. Cannot ship to Alaska, Hawaii or Puerto Rico.



Model 500



Model 800

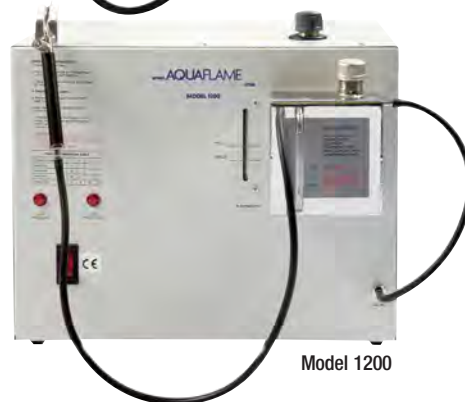

Model 1200

the PUK 5 Jewelry Welder

Precision welding at its finest... developed for goldsmiths.

LAMPERT.



PUK 5 shown with SM5 Microscope Optic Package



Made in Germany!
3 Year Warranty!

Weld on findings, easily add metal, weld adjacent to stones and pearls, weld silver (alloys), fill porosity, attach workpieces prior to soldering, weld seams, and much more - all no problem with the PUK 5.

Compact and versatile impulse welding device:

The PUK 5 is very close to laser welding in terms of working method and range of applications. On workpieces with a thickness of 0.2 mm or greater, it is an effortless process to produce robust welds.

The PUK 5 precision welder puts a whole host of possible applications for jewelry production at your fingertips. Create structures made from sheet or wire elements, tack welds and repairs to jewelry parts, restore missing parts or fill pores by applying welding wire - and many more options, the PUK 5 is able to produce anything from the smallest of repairs to volume production.

PUK's operating principle is as simple as it is ingenious:

If the tip of the electrode on the welding hand piece touches the workpiece, the welding process starts automatically. At the contact point, under an inert gas atmosphere, a melting process with a diameter of between 0.3 and 3.0 mm takes place (depending on material and setting). In addition to many precious metal alloys such as gold, silver and platinum, many non-ferrous metals such as copper and tin alloys, many steels, titanium and aluminum alloys are suitable for welding. All alloys suitable for laser or TIG welding can also be welded with the PUK 5.

Superior characteristics

- Consistently reproducible high-quality welding results with all materials suitable for welding
- Precise positioning of the spot welds
- Very low, controllable development of heat
- Welding possible on even the thinnest of materials
- Welding in protective atmosphere
- Tested product safety: CE conformity
- DIN CERTCO certified eye protection in all Lampert optic systems
- Very low initial costs and for consumer materials, maintenance-free technology - excellent price/performance ratio
- Three year manufacturer's warranty

Compact size

- Fits into every workshop

Patent-pending system for welding process monitoring

- Software for contact monitoring of the hand piece
- Prevention of welding errors through interruption of weld if excessive pressure is applied to the electrode
- Prevention of tungsten inclusions on sensitive surfaces or on workpieces and materials that still require further processing
- Uniform processing creates a quality weld
- Consistent quality for larger quantities

Faster progress to better results

- "Blind operation" with single-handed operation. Concentration remains focused on the workpiece.
- Simple and intuitive to operate
- Preselection of two different welding cycles

Smoothing function responds to rising temperatures on the welding area

- Further improves the flow properties of certain metals (e.g. of highly conductive metals such as silver)

Even higher-performance LED lighting in our new premium welding microscopes

- More uniform illumination of the working area - more flexible use of the microscope. These microscopes can also be used as fully equipped workplace microscopes - not just for welding.

Individual device set-up using the settings menu

- Preselection of welding cycle, calling operating levels up on screen and hiding them again, program memory, expert level, tack welding...

Due to the technical nature of these products, some details may change. Please see our website for the most up-to-date information.

the PUK 5 Jewelry Welder System Packages



A

A. PUK 5 Control System Includes

- PUK 5 Control Unit
- Precision Handpiece
- Argon flow regulator with 9 foot hose
- Set of electrodes with diamond grind wheel, (2) Alligator clips and Fiberglass brush

Description	Item#	Each
PUK 5 Base Unit with Accessories	830-1534	\$3,500.00

Available Packages – to suit your welding applications...

B. Articulated Microscope

- Microscope lens with 10-fold magnification, individual adjustment
- Powerful LED lighting in the head of the microscope that can be controlled with 4 brightness levels, optimum illumination of the working area.
- Hydraulic articulated arm, rotary and pivot action in every direction, making work particular ergonomic, even on bulky objects.
- Bench stand for individual bench mounting.
- Individually adjustable headrest
- Microscope can be used as a workplace or observation microscope.

Description	Item#	Each
Articulated Microscope Only	830-1538	\$2,200.00
B. PUK 5 + Articulated Microscope	830-1543	5,700.00



B

C. SM5 Microscope

- High-caliber microscope with 10-fold magnification, individual adjustment
- Powerful LED lighting that can be controlled with 4 brightness levels, optimum illumination of the working area. LED lighting integrated in the housing of the eye protection system.
- The SM5 can be turned in no time at all into a workplace microscope, simply by swiveling away the hand piece arm from the field of view.
- Hand supports for comfortable and precise operation
- Height and tilt adjustment assure optimum workplace comfort and an ergonomic working position.

Description	Item#	Each
SM5 Microscope Only	830-1537	\$1,295.00
C. PUK 5 + SM5 Microscope	830-1542	4,795.00



C

D. SM03 Microscope

- Low cost for the budget minded person (entry level)
- Microscope lens with 10-fold magnification, individual adjustment
- LED lighting in the hand piece retaining arm, optimum illumination of the working area

Description	Item#	Each
SM03 Microscope Only	830-1536	\$1,100.00
D. PUK 5 + SM03 Microscope	830-1541	4,600.00



D

E. Classic Optic Visor

- Magnifying glass light, equipped with magnifying lens, 2.25-fold magnification (5 dpt)
- Glare-free LED lighting, 7.5 W
- The optic unit is particularly well suited to large workpieces that cannot be processed under the microscope.

Description	Item#	Each
Classic Optic Visor Only	830-1535	\$650.00
E. PUK 5 + Classic Optic Visor	830-1540	4,150.00



E

the PUK U5 Industrial Welder

The Latest Technology for Mold and Die Repair...

LAMPERT.



Pre-programmed and ready to use...
for Steel, Aluminum, and Copper



Steel

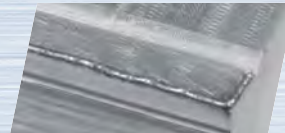

Aluminum



Copper

The PUK U5... developed for Mold and Die Repair.

Incorporating the latest technology, the PUK U5 offers an easy to use solution for precision mold and die repairs. Utilizing micro TIG technology, the welder produces small, consistent spot welds that penetrate the mold surface. The welded areas are strong and can withstand the pressures and working conditions during the molding process. All heat is concentrated at the spot of the weld thereby eliminating the possibility of distortion and metal stress caused by overheating. Backed by a three year manufacturer's warranty.

The Applications:

- Repairing parting lines, mold seams, edges and three point corners
- Filling in pores and deep scratches on the mold surface
- Weld into slots, corners and ribs
- Repair slides, ejectors, and core pins
- For use on all common tool steels, stainless steels, aluminum and copper

PUK U5 Complete Package:

The system comes complete with microscope, LED light, electrode handpiece, sets of 0.6mm and 0.8mm electrodes, electrode sharpener, ground cables, argon gas regulator, tack resistance welder, and foot pedal.

Description	Item#	Each
The PUK U5 - Mold and Die - 110V	830-0957	\$8,745.00
The PUK U5 - Mold and Die - 220V	830-0958	8,745.00

Save Money

- Keep mold repairs in house! Stop sending out for laser welding.
- Affordable alternative to a laser welder, at a fraction of the cost.

Save Time

- Repair your molds the same day.
- No pre-welding heat treatment required.
- Welds quickly: 1 spot weld every 0.8 seconds!
- Small spot welds polish out quickly.

Easy to Use

- Pre-programmed presets for most common applications. Takes out calculations and guess work.
- Extremely accurate weld placement. Sharp electrode tip touches the exact location of weld spot.

Mobility

- Take the U5 welder to the press for repair.
- Magnetic microscope attaches directly to mold while still in the press.

Minimal Heat

- Prevents damaged caused by overheating of mold, increasing tool life.
- All heat is concentrated only at the spot of the weld.

The Microscope... Maximize Mobility

Weld anywhere on any type of mold large OR small! The adjustable and magnetic microscope base affixes to any metal surface. The microscope arm is extremely flexible to allow for comfortable welding on almost any mold surface. Keep the microscope at your bench or take it to the mold for a quick in-press repair. The 10X microscope comes complete with integrated LED lighting for proper illumination of the welding surface. A protective eye shutter built into the microscope provides protection for eyes. Field of view 20mm.

Pre-programmed and ready to use...for Steel, Aluminum, and Copper

Take the guess work out! Simply select the pre-program for your mold repair application and start welding! Each pre-program is set to the optimal weld pulse and time lapse for the specified mold repair application. Or if you prefer, manually override the pre-programmed settings to dial in your preferred setting.



Select with Touch Screen



Virtual Demonstration



PUK POWER Flat Repair



PUK Electrode Sharpener

Using the Electrode Sharpener

See videos at gesswein.com

Technical Data*

PUK U5

Power output (TIG) min./max.	4 - 630 A
Impulse length (TIG) min./max.	0.5 - 34 ms
Power output (Tack welding) min./max.	80 - 850 A
Impulse length (Tack welding) min./max.	0.2ms - 3ms
Welding speed – Setting #1	0.9-1.7 sec
Setting #2	0.7-1.5 sec
Gas consumption	ca. 2 l / min
Shielding Gas	Argon > 99.9 %
Current consumption "maintaining mode"	10 W
Program memory	20 x
Power requirements:	110V or 220V

Technical Data*

Microscope USM M&D

Magnification	10X
Field of vision / diameter	20 mm
Operating distance	145 mm
Integrated-Automatic-LCD-Filter (Glare shield)	+
Degree of luminescence / obscurity	DIN 3 / DIN 11
UV Protection / IR Protection	> UV11 / > IR11
LED lighting	3 W



The Microscope...
Maximize Mobility

*Due to the technical nature of these products, some details may change. Please see our website for the most up-to-date information.

PUK 5 and PUK U5 Replacement Parts



A

B



C



D

E



F

G



H



I



J



A. Argon Gas Regulator - The PUK flow regulator enables the exact setting of the recommended 2 liters per minute flow rate. It's precise and easy but above all, it's reliable! The argon gas allows for clean, oxidation free welds.

Argon Gas Regulator (for PUK 3, 4, 5, U4, U5)	830-1516	\$270.00
-----------------------------------------------	-----------------	-----------------

B. Argon Screw Nut

Argon Screw Nut (for PUK 3, 4, 5, U4, U5)	830-1521	\$8.50
-------------------------------------------	-----------------	---------------

C. Electrode Collets - available in either 0.6mm or 0.8mm sizes.

Electrode Collets - 0.6mm Collet (for PUK 3, 4, 5, U4, U5)	830-0931	\$30.00
------------------------------------------------------------	-----------------	----------------

Electrode Collets - 0.8mm Collet (for PUK 3, 4, 5, U4, U5)	830-0933	\$30.00
------------------------------------------------------------	-----------------	----------------

D. Electrodes - 0.5mm Set (comes with Diamond Wheel), 0.6mm Electrodes or 0.8mm Electrodes: 10 pre-sharpened electrodes for immediate use. The thin electrode increases precision by touching the exact spot of weld. Just prior to weld, the electrode pulls back into the handpiece allowing for a clean and precise weld spot.

D. Electrode Set - 0.5mm Electrodes with Diamond Wheel (for PUK 3, 4, 5)	830-0978	\$49.95
--------------------------------------------------------------------------	-----------------	----------------

Electrodes - 0.6mm Electrodes (for PUK U4, U5)	830-0932	\$55.00
------------------------------------------------	-----------------	----------------

Electrodes - 0.8mm Electrodes (for PUK U4, U5)	830-0934	\$60.00
------------------------------------------------	-----------------	----------------

E. Handpiece Nozzel (Ceramic Tip)

Snap on Nozzel (for PUK 3, 4, 5, U4, U5)	830-1524	\$49.95
------------------------------------------	-----------------	----------------

F. Electrode Sharpener - For simple and rapid sharpening of PUK electrodes. The diamond disc rotates when the button is pressed allowing for quick and convenient electrode sharpening.

Electrode Sharpener (for PUK 4, 5, U4, U5)	830-1528	\$155.50
--------------------------------------------	-----------------	-----------------

G. Electrode Sharpener Diamond Wheel - Replacement diamond wheel for Electrode Sharpener. See video on gesswein.com for instructions.

Electrode Sharpener Diamond Wheel	830-1531	\$17.50
-----------------------------------	-----------------	----------------

H. Microscope Glass

Microscope Glass (for PUK 3, 4, 5, U4, U5)	830-0966	\$21.50
--------------------------------------------	-----------------	----------------

I. Microscope Rubber Eye Flaps

Microscope Rubber Eye Flaps (for PUK 3, 4, 5, U4, U5)	830-1512	\$28.00
-------------------------------------------------------	-----------------	----------------

J. Extension Package for PUK U5 - For some large molds and in-press repairs, a few extra feet of reach may be necessary. This package includes: Extended handpiece cable (measures approximately 84" (2.5m) compared to the 48" handpiece cable included with the PUK U5.) Extended magnet cable (measures 84" in length.) Microscope extension cables (add on an additional 77" in length to the standard PUK microscope.)

PUK Extension Package (for PUK U5 only)	830-0939	\$999.00
-----------------------------------------	-----------------	-----------------

K. PUK U5 Transport Case - The durable and functional Transport Case makes moving the PUK U5 convenient. Whether you are carting between molds or between buildings the PUK U5 will be safe and secure. It also works well for stowing your PUK U5 when not in use.

PUK U5 Transport Case (for PUK U5 only)	830-1558	\$695.00
-----------------------------------------	-----------------	-----------------

Steel, Copper, or Aluminum Welding Wire

Dimensions	Material	Item#	 Each
– STEEL –			
.015"x18"	D-2	830-2540	1.83
.015"x18"	SS-316	830-2544	1.63
.005"x9"	SS-420	830-2561	3.36
.007"x9"	SS-420	830-2562	2.94
.010"x18"	SS-420	830-2563	1.80
.015"x18"	SS-420	830-2564	1.63
.020"x18"	SS-420	830-2565	1.50
.025"x18"	SS-420	830-2566	1.20
.030"x18"	SS-420	830-2567	0.99
.005"x9"	P-20M	830-2591	3.36
.007"x9"	P-20M	830-2592	2.94
.010"x18"	P-20M	830-2593	1.80
.015"x18"	P-20M	830-2594	1.63
.020"x18"	P-20M	830-2595	1.50
.025"x18"	P-20M	830-2596	1.20
.030"x18"	P-20M	830-2597	0.99
.005"x9"	P-20	830-2601	3.36
.007"x9"	P-20	830-2602	2.94
.010"x18"	P-20	830-2603	1.80
.015"x18"	P-20	830-2604	1.63
.020"x18"	P-20	830-2605	1.50
.025"x18"	P-20	830-2606	1.20
.030"x18"	P-20	830-2607	0.99
.005"x9"	H-13	830-2611	3.36
.010"x18"	H-13	830-2613	1.80
.015"x18"	H-13	830-2614	1.63
.020"x18"	H-13	830-2615	1.50
.025"x18"	H-13	830-2616	1.20
.030"x18"	H-13	830-2617	0.99
.005"x9"	H-13M	830-2621	2.45
.010"x18"	H-13M	830-2623	1.80

Dimensions	Material	Item#	 Each
.015"x18"	H-13M	830-2624	1.63
.020"x18"	H-13M	830-2625	1.30
.030"x18"	H-13M	830-2627	0.99
.015"x18"	A-2	830-2634	1.63
.020"x18"	A-2	830-2635	1.50
.030"x18"	A-2	830-2637	0.99
.010"x18"	M-2	830-2643	1.80
.015"x18"	M-2	830-2644	1.63
.020"x18"	M-2	830-2645	1.50
.030"x18"	M-2	830-2647	0.99
.015"x18"	S-7	830-2654	1.96
.020"x18"	S-7	830-2655	2.12
.030"x18"	S-7	830-2657	1.60
– COPPER –			
.005"x9"	BeCu	830-2661	3.36
.007"x9"	BeCu	830-2662	2.94
.010"x18"	BeCu	830-2663	1.80
.015"x18"	BeCu	830-2664	1.63
.020"x18"	BeCu	830-2665	1.50
.025"x18"	BeCu	830-2666	1.20
.030"x18"	BeCu	830-2667	0.99
– ALUMINUM –			
.010"x18"	7075	830-2763	1.80
.015"x18"	7075	830-2764	1.63
.020"x18"	7075	830-2765	1.50
.030"x18"	7075	830-2767	0.99
.015"x18"	QC-10	830-2774	2.38
.020"x18"	QC-10	830-2775	2.12
.030"x18"	QC-10	830-2777	1.88
.015"x18"	4043	830-2734	2.38
.020"x18"	4043	830-2735	2.12



Please see our website for our precious metal welding wire offerings.

Sold in packages of 25 as indicated by  please order in these multiples.

A. Pin Vise, Double Ended Wire holder capacity: 0"-0.064". Overall length 4.25".
 Pin Vise, Double Ended (for PUK 3, 4, 5, U4, U5) **820-4650** **\$11.15**



B. PUK Wire Holder Made of aluminum anodized, the PUK Wire holder feeds wires from 0.004" to 0.025". During the welding process, the ergonomic holder is comfortable to grip and the wire feeds effortlessly by means of two wheels. Measures 5.5" x .25" Diameter and weighs 1.5 oz. Made in Germany. Wire holder capacity: 0.004"-0.025"
 PUK Wire Holder (for PUK 3, 4, 5, U4, U5) **830-2500** **\$99.00**





Established in 1961, Sisma is a worldwide recognized name for the design and production of extremely high precision machinery. We are proud to offer their Laser Welders for the jewelry and industrial markets. Innovative by vocation, Sisma combines an independent and cutting edge design and production organization with a wealth of highly specialized human resources, thus guaranteeing top product quality as well as thorough and prompt assistance throughout the world.

Sisma's philosophy, aimed at satisfying the specific needs of customers, is the result of an inborn strategic imperative that contributes to affirming the role of Sisma as a maker of excellence in the world of industrial mechanics.

At Sisma, their extensive experience and technical know-how blends with productive efficiency and innovative spirit which promptly answers to the ever changing marketplace. The power to create special, customized machines is but another jewel in Sisma's crown of excellence. Look no further... Sisma is the machine of choice for the above-mentioned markets all over the world. Machines are proudly manufactured in Italy to ISO 9001 Standards. Made in Italy.

Sisma Laser Welders for Jewelry

SISMA Series LM-D

Select between the "Easy Access" (LM-D Ready) models available in 150J or 180J maximum pulse energy that feature a broader opening which is covered with hanging rubber strips for your protection.

The next step up is the traditional standard model (LM-D Original) that features a high quality Leica Microscope head and is available in 180J or 210J maximum pulse energy.

Last in the series is the upgrade to the standard model (LM-D Vision) that features an intuitive 10.1 LCD Screen for easy visibility and simplified use and is available in 180J or 210J maximum pulse energy.

Key Features:

- Dedicated Filter that guarantees complete recovery of precious metals.
- Enhanced Cooling System: +60% cooling capacity compared to previous models which allows for reliable operation in high temperature space (except LM-D Ready).
- Smart Spot Technology for repeatable Welding Process; great depth of field and stable laser shot every time (except LM-D Ready).
- Units come with argon & air compressor ports.



LM-D Scope
180 / 210

Sisma Enclosed Laser Welders are excellent for jewelry and other small pieces.



LM-D Ready
150 / 180



LM-D Vision
180 / 210

*Technical Data	LM-D Ready 150 / 180	LM-D Scope 180 / 210	LM-D Vision 180 / 210
Item #	830-1580 / 830-1581	830-1582 / 830-1584	830-1583 / 830-1585
Source Type (same for all)	Nd: YAG (Lamp)	Nd: YAG (Lamp)	Nd: YAG (Lamp)
Wavelength (same for all)	1064nm	1064nm	1064nm
Laser Power	60W / 80W	80W / 85W	80W / 85W
Pulse Duration, (same for all)	0.3-20ms	0.3-20ms	0.3-20ms
Pulse Frequency (same for all)	0-50 Hz	0-50 Hz	0-50 Hz
Max Peak Power	7.5 kW / 9 kW	9 kW / 10.5 kW	9 kW / 10.5 kW
Max Pulse Energy	150J / 180J	180J / 210J	180J / 210J
Spot Diameter (same for all)	0.2/2mm (0.1mm Opt)	0.2/2mm (0.1mm Opt)	0.2/2mm (0.1mm Opt)
Smart Spot Tech	NO	YES	YES
Eco Mode (same for all)	YES	YES	YES
USB/Ethernet Connectivity	NO	YES	YES
Power Supply, (same for all)	230V, +/- 10%, 50/60 Hz	230V, +/- 10%, 50/60 Hz	230V, +/- 10%, 50/60 Hz
Dimensions WxDxH (inches)	22.5 x 29.5 x 20.1	22.5 x 28.75 x 20	22.5 x 28.75 x 24
Dimensions WxDxH (mm)	567 x 744.5 x 512	567 x 730 x 510	567 x 730 x 612
Weight (same for all)	132 lbs / 60 kg	132 lbs / 60 kg	132 lbs / 60 kg
Warranty, (same for all)	2 Year (Flash Lamp Included)	2 Year (Flash Lamp Included)	2 Year (Flash Lamp Included)
Please call for current pricing			

*Due to the technical nature of these products, some details may change.
Please see our website for the most up-to-date information.

Laser Welders for Mold Repair

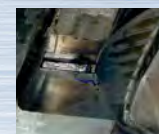

Sisma offers a range of laser welders engineered specifically for the repair and maintenance of molds. The range includes the best-selling SWA series for all mold sizes, the SWT series for medium and small molds, and the LM-B series for small molds. Sisma laser welders are used in premier mold & die shops around the world, carrying an excellent reputation for the highest precision and ease of use. All are made at Sisma's headquarters in Italy, and are backed by a 1-year manufacturer's warranty.

SISMA LM-B 180 and 210

Sisma's High precision Nd:Yag laser Class 4 welding system, the LM-B. Specifically designed for mold repairing. Featured characteristics are ease of use, reduced maintenance and smooth axis movement. The LM-B uses a working motorized table with X-Y-Z axes complete with joystick. View work pieces easily with the 10X stereo microscope with optical protection. Two-year warranty including the flash lamp. Made in Italy.

Key Features:

- Smart Spot technology: great depth of field and stable laser shot starting from the first pulses. For a repeatable welding process.
- ECO mode that switches off unused system components during idle times, thus guaranteeing lower power consumption
- USB and Ethernet conn: for easy download/upload of welding programs, software and firmware updates and remote control through smartphone, tablet or computer
- Full digital control: accurate diagnostics, higher pulse stability and longer lamp life.
- Quick setting of welding parameters by means of the multifunctional mouse



LMB 180 / LMB 210
830-1730 / 830-1735

Technical Data*	LMB 180	LMB 210
Item #	830-1730	830-1735
Source Type	Nd:YAG (flash lamp)	Nd:YAG (flash lamp)
Wavelength	1064 nm	1064 nm
Average Laser Power	80W	85W
Max Peak power	9kW	10.5kW
Max Pulse energy	180J (at 20 ms)	210J (at 20 ms)
Pulse duration	0.3 ms -20 ms	0.3 ms -20 ms
Laser Spot diameter	0.2-2mm 0.1 optional	0.2-2mm 0.1 optional
Axis speed	0.1 mm/s - 15 mm/s	0.1 mm/s - 15 mm/s
X-Y axis stroke	150mm x 150mm	150mm x 150mm
Z axis stroke	175mm	175mm
Max load weight	25kg	25kg
Max mould size	300mm x 300mm	300mm x 300mm
Power Supply	1 Ph 230V±10%, 50/60 Hz	1 Ph 230V±10%, 50/60 Hz
Dimensions (L x W x H)	33" x 48" x 60" (850 x 1200 x 1500 mm)	33" x 48" x 60" (850 x 1200 x 1500 mm)
Weight, Class 4	441 lbs. (200 kg)	441 lbs. (200 kg)

Please call for current pricing

*Due to the technical nature of these products, some details may change. Please see our website for the most up-to-date information.

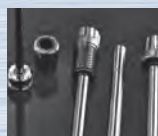

SISMA SWT 100 and SWT 150

Class 4 and Class 1

SWT Class 4 welding laser systems are specifically designed for the maintenance of small/medium-sized molds up to 400mm square (approx. 15.75" square). The robust design and sturdy working table allows the operator to work in outstanding comfort and with minimal vibration. Characterized by a high capacity and axis stroke, the systems have a direct resonator with 3 motorized axes X-Y-Z which are controlled by a joystick. The system contains an optical head with F150 focal lens and a 10X STEREO microscope. The system's ergonomic features allow prolonged or occasional use. The Class I version provides a welding system for closed mold repair. The movement of the axes has been designed to ensure durability over time as well as fluid and precise machining. Internet connection for easy check and/or remote service assistance. In/out input of data through a USB key. Two-year warranty including the flash lamp. Made in Italy.

Key Features:

- Advanced software functions such as welding on circumference, line, filling, and rotating spindle management
- High laser beam quality: new optical design ensures high performance
- Available with fiber laser source: maintenance free and low power consumption
- Internet connection for remote control
- Ergonomic design
- Heavy duty machinery, fluid and precise movements over the high carrying capacity and high axes stroke.
- Safety features include proper functioning verification and control.

Technical Data*	SWT100	SWT 150
Item # Class 4	830-1720	830-1725
Item # Class 1	830-1740	830-1745
Source Type	Nd:YAG (flash lamp)	Nd:YAG (flash lamp)
Wavelength	1064 nm	1064 nm
Average Laser Power	100W	150W
Max Peak power	7.5kW	10.5kW
Max Pulse energy	60J	75J
Pulse duration	0.2 ms -20 ms	0.2 ms -20 ms
Laser Spot diameter	0.3mm - 2mm	0.3mm - 2mm
Axis speed	0.1 mm/s - 25 mm/s	0.1 mm/s - 25 mm/s
X-Y axis stroke	300mm x 200mm	300mm x 200mm
Z axis stroke	320mm	320mm
Max load weight	70kg	70kg
Max mould size	400mm x 400mm	400mm x 400mm
Power Supply	3 Ph 400V±10%, 50/60 Hz	3 Ph 400V±10%, 50/60 Hz
Dimensions (L x W x H)	33" x 48" x 60" (850 x 1200 x 1500 mm)	33" x 48" x 60" (850 x 1200 x 1500 mm)
Weight, Class 4	1,169 lbs. (530kg)	1,169 lbs. (530kg)
Weight, Class 1	1,235 lbs. (560kg)	1,235 lbs. (560kg)

Please call for current pricing



Class 4
SWT100 / SWT 150
830-1720 / 830-1725



Class 1
SWT100 / SWT 150
830-1740 / 830-1745

*Due to the technical nature of these products, some details may change. Please see our website for the most up-to-date information.

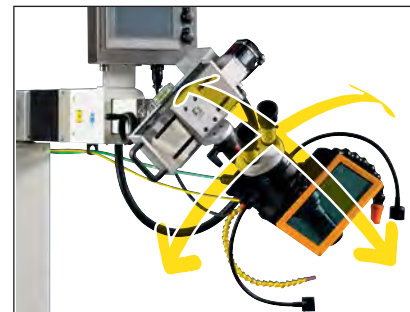

SISMA SWA 150 / SWA 300
830-1710 / 830-1715

SISMA SWA 150 and SWA 300 – With Motorized Welding Arm

Flexibility of the SISMA SWA Class 4 system! The "SWA" is designed for welding and repairing small and large pieces and molds. The laser transport in optical fiber provides great flexibility without significant power loss. Designed and constructed for making modifications and repairs on molds damaged by wear or use.

Material is added allowing repairs to be made without preheating the dies and with minimal heat transfer during the deposit process. Laser welding avoids classic damage caused by TIG welding such as: geometric distortions, burning of the edges and decarbonization. The properties of the laser beam make it possible to weld complex molds with deep and narrow grooves or inner and outer edges.

All steels, bronze and copper alloys, aluminum and titanium can be welded. The hardness of the welding layers can reach very high values depending on the type of filler wire used. Simple operating procedures and accurate visual control of the weld material using a stereomicroscope make this technology accessible to everyone, not just qualified engineers.

The SWA units are powered by a flash lamp-pumped Nd:YAG laser generator with laser pulse transmission through optical fiber and is equipped with a system for movement along the motorized x, y, and z axes controlled by a joystick and button panel. The laser source has been designed to guarantee high operating stability at both low and high power; fiber transport of the laser pulse provides a smaller beam diameter along with high stability of the laser spot, both in the initial transients and at various thermal loads of the laser source.

The fully integrated cooling system is suitable for extended use. Complete with optic head with focal lens F120 and 10X stereomicroscope. Quick selection/setting of work by means of a color touch-screen display and with a memory up to 250 welding parameters. Axis X-Y Z motorized; Axis X stroke 300 mm; Axis Y stroke 150 mm and Axis Z stroke 500 mm. Axis Z is controlled by means of a joystick rotation. One-year warranty. Made in Italy.

Key Features:

- Feeder with integrated water-air cooling system (Without external chiller)
- New interface card for integrators
- Potentiated diagnostic
- In/out data by means of a USB key
- "Pulse Shaping" function for complex welding operations
- Optic fiber length 3 m, core diameter 800 micron
- Axis Controller



Technical Data*	SWA 150	SWA 300
Item #	830-1710	830-1715
Average power	150W	300W
Peak power	10.5kW	12kW
Pulse energy	70J	100J
Pulse frequency	0-50 Hz	0-50 Hz
Pulse duration	0.3-25 ms	0.2-25 ms
Spot diameter	0.2-2mm 0.1 optional	0.6-2mm
Laser beam transport	Fiber-coupled	Fiber-coupled
Focusing optics	120mm	120mm
Vision system	Leica Binocular	Leica Binocular
Moving speed	0-20mm/s	0-20mm/s
X axis stroke	300mm	300mm
Y axis stroke	150mm	150mm
Z axis stroke	500mm	500mm
Cooling	Air	Air
Power Supply SWA 150	230V 50/60Hz 1ph - 1Kw e 400V 50/60Hz 3ph - 3.5Kw	
Power Supply SWA 300	230V 50/60Hz 1ph - 1Kw e 400V 50/60Hz 3ph - 8Kw	
Dimensions (L x W x H)	48" x 84" x 60" 1950 x 1100 x 1610 mm	48" x 84" x 60" 1950 x 1100 x 1610 mm
Weight	596 lbs. (270kg)	596 lbs. (270kg)
Please call for current pricing		

*Due to the technical nature of these products, some details may change. Please see our website for the most up-to-date information.



Representative items pictured; actual items may vary.

A. Professional Jeweler's Bench Tool Set

A money-saving set of basic tools and supplies needed by each bench worker. Includes all items listed below except additional items in bottom-right corner. Can not be shipped US mail due to liquids. All items can also be purchased individually—refer to specific page numbers given for detailed product information.

Description	Item#	Each
Professional Jeweler's Bench Tool Set	810-0050	\$1,695.00

Bench Items:	Page				
Bench Brush	133	Chasing Hammer	321	Graver Handle #5	291
Stiff Hand Brush	133	Rawhide Mallet	318	Soft Arkansas Bench Stone	31
SELVYT Cloth	153	Brass/Nylon Mallet	319	Diamond D Cement	495
Mandrels (6 pcs.)	584	Lube-Stik	164	Millgrain Holder	490
SUPRA Brushes (1 dz.)	126	Automatic Center Punch	254	French Millgrain Wheels (2 pcs.)	490
Silicone Pumice Wheel (100 pcs.)	81	Scriber	293	Diamond Tweezers	537
Safety Goggles	475	Prong Lifter	486	Soldering Items:	Page
Swiss Half-Round Ring File, 6"	296	Adjustable Scraper	503	Solderite Soft Soldering Pad, 6" x 6"	507
File Handle #4	299	Divider	353	Solder Pick	503
Swiss Needle Files (set of 12)	305	Blue Ribbon Drill Set A	252	Flux Brush #3	134
File Card	309	Degree Gauge #5	352	Hard Soldering Flux	501
Emery Hand Buffs (2 pcs.)	68	Pin Vise	542	Optivisor	345
Bobbing Compound (1 lb. bar)	100	Stone Setting Items:	Page	Electric Pickler	510
Red Rouge (1 lb. bar)	101	HS Hart Burs (set of 33)	161	Pickling Compound	510
Wire and Sheet Gauge	366	Krause Burs (6 pcs.)	158	Copper Tongs	511
Baker Diamond Gauge	366	Cup Burs (set of 12)	160	Economical Tweezers	538
Pocket Vernier Caliper	351	Stone Setting Pliers	379	Cross-Locking Tweezers	539
Ruler, 6"	353	Swiss Beading Tools (set of 12)	489	Ring Set Soldering Tweezers	540
Flat Sawframe	481	Beading Plate (holds 12 beads)	488	Head and Shank Tweezers	540
SUPRA Sawblades (4 gross, assorted)	483	Beeswax	491	Additional Items You'll Need	Pages
Curved Snips	385	Curved Burnisher	494	for Setting up a New Shop:	
Chain Pliers, 5 1/4"	372	Bezel Pusher	486	Workbench and Chair	568-569
Flat Pliers, 5 1/4"	372	Prong Pusher	486	Work Lamp	334-339
Round Pliers, 5 1/4"	372	Bezel Roller	486	Torch Kit	514-518
Diagonal Cutting Pliers, 5 1/4"	372	Ring Clamp	410	Flexible Shaft or Micromotor	432-437
Ring Bending Pliers	380	Hastings 10X Triplet Loupe	342	Steam Cleaner	243-245
Ring Forming Pliers	380	HS Round Graver	283	Ultrasonic Cleaner	235-239
Ring Holding Pliers	380	HS Knife Gravers (2 pcs.)	283	Rolling Mill	412-418
Bench Block	324	HS Flat Gravers (2 pcs.)	283	Polishing Equipment	395-399
Ring Mandrel	325				

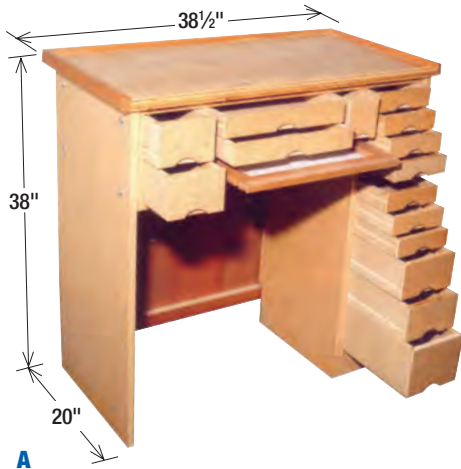

A. Watchmaker's Workbench

A classic, high-quality workbench for watchmakers, jewelers and engravers. Constructed of the finest hardwood, making it perfectly suitable for storefront use. Features solid wood top with railing, full-length side and back panels, fifteen drawers in a range of heights for keeping tools organized and a handy 18" wide cloth tray for catching bench sweeps. Measures 38½"W x 20"D x 38"H. Ship. wt: 140 lbs. *Ships via truck only.* Made in USA.

Description	Item#	Each
Watchmaker's Workbench,	810-1601	\$799.00

See pp. 335-339 for Workbench Lighting.

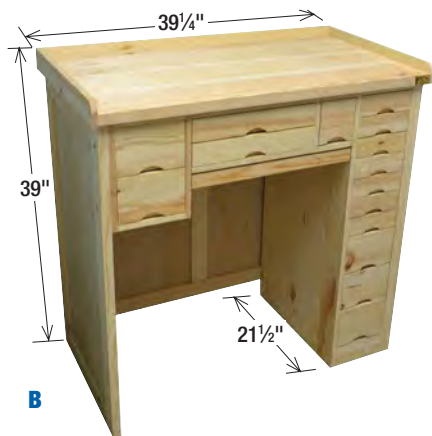

B. Enclosed Watchmakers Bench

Rugged and elegant, the new Watchmakers Workbench is a must for any repair shop or storefront. Features Solid wood top with railing, full-length side and back panels, fifteen drawers in a range of sizes to keep your tools organized, 19" (482.5 mm) catch tray for bench sweeps Made of a solid wood construction, this quality bench measures 39¼" Wide X 21½" Deep X 39" High (Approx. 1m X 0.5m X 1m). Ship. wt: 130 Lbs. Some assembly required. *Ships in two boxes via UPS or FedEx. Oversize shipping rates apply.* Made in China.

Description	Item#	Each
Enclosed Watchmakers Bench	810-1602	\$485.00

Made in the USA



C. Solid Wood Workbench

A fine workbench with a natural finish at an affordable price. Features sturdy wood top with 1" railing, full-length side and back panels, two-tier tool tray, three side drawers and metal-lined pan for catching bench sweeps. Includes two pullout armrests, bench pin and two mandrel holes. Assembly required (instructions supplied). Measures 38¾"W x 19½"D x 39"H. Ship. wt: 84 lbs. *Ships in two boxes via UPS or FedEx. Oversize shipping rates apply.* Imported.

Description	Item#	Each
Solid Wood Workbench	810-1785	\$290.00



D. Workbench – Laminated top!

A great heavy duty workbench perfect for small spaces, 1½" thick, laminated top, 3 spacious drawers, two aluminum catch trays, two pull-out arm rests, pre-drilled slot for a bench pin and a large pull-out workspace. Comes in 1 box; unassembled. Measures 35½"W x 21½"D x 35½"H. Ship. wt: 130 lbs. Made in USA.

Description	Item#	Each
Workbench,	810-1608	\$530.00

A. VariBench Table Perfect for Sisma Welders

This is the only table you will ever need for your Sisma Laser welder! The VariBench is a variable height bench that is custom made to fit all tabletop models made by Sisma. Power – 100/240Vac, 50/60Hz, 8/3.3 amp, 80 watt. Operated by a powered rocker switch, this table can be raised or lowered to your exact height specifications for an ergonomic and comfortable welding height. Height without caster – 27” to 47”, Height with caster – 31” to 51”. Load Max – 246 lbs. / 120kg. The VariBench is set on casters with a beautiful hardwood table top and was designed to precisely fit the machine. Weight – 75 lbs. Essential where space is a commodity. Made in USA.

Description	Item#	Each
VariBench for Sisma Laser Welder, 	830-0788	\$1,295.00



B. SmartStool 61™

The high-quality swiveling chair with ergonomic, adjustable design for unmatched comfort and convenience. Boasts separate controls for seat and backrest height and angle, ultra-soft seat cushions for superior comfort, adjustable foot-ring for lower leg support and steel base with anti-scuff nubs. Measures 18½”W x 20¼”D x 34¼”–39½”H. Seat height from floor: 16”–21¼”. Ship. wt: 47 lbs.

Description	Item#	Each
SmartStool 61	810-1808	\$502.00



C. Adjustable Bench Chair

An economical yet sturdy swiveling chair. Provides ample support for reduced fatigue. Features separate controls for making seat and spring back adjustments, Naugahyde cushions and durable rubber cushioned casters for smooth rolling. Seat height from floor: 16”–24”.

Description	Item#	Each
Adjustable Bench Chair	810-1800	\$282.00



For more chair options visit www.gesswein.com

D. Deluxe Extra-Large Saddle Stool

Seat measures 16” long by 18” wide and the seat is 3 inches thick to provide maximum comfort. The star base is 24” wide and provides extra stability. Foot-rest ring that is 18” in diameter and the height-adjusts from the floor 8” to 13 ½”. Seat height ranges from 19” to 26”. Five smooth rolling casters allow for easy mobility. Made in China.

Description	Item#	Each
Saddle Stool	810-1812	\$199.00



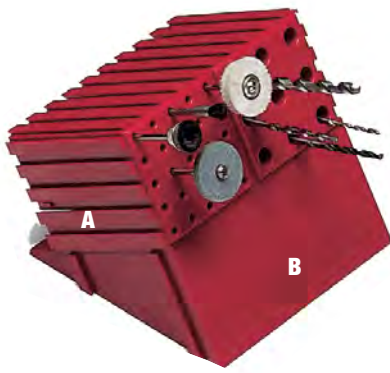

A-B Modular Tool Holder System

Consists of completely modular bur and tool holders that you interlock to form the most efficient configuration for your bench. Lets you design a tool holder for any work surface, no matter how small. Modules slide together and apart neatly for easy reconfiguration. Made of hard, thick plastic durable enough to withstand years of wear and tear.

Description	Item#	Each
A. 2" Square w/ 25 holes, 2.35mm (3/32")	840-0150	\$2.25
B. Wedge (holds Squares/Trays at good working angle)	840-0170	2.95



C. Handy Block – For 3/32" or 1/8" Shanks

Cured hardwood block with 88 holes for burs or tools with 3/32" or 1/8" shanks. Slanted design lets you see all items at a glance. Stay-put rubber pads prevent sliding. Measures 6" x 4 1/2".

Description	Holes	Item#	Each
Handy Block	3/32", 1/8"	814-1215	\$14.95



D. Bench Duster – Wooden Handle

Contains four rows of 1 1/2" long medium natural bristles. Ideal for cleaning dust from surfaces. Measures 9 3/4" long.

Description	Face Size (L x W)	Item#	EACH Prices		
			1-2	3-11	12+
Bench Duster	4" x 3/4"	115-2260	\$10.25	\$9.23	\$8.20



E. Wooden Bur Boxes – For 3/32" Shanks

Sturdy, attractive wooden boxes for holding burs or tools with 3/32" shanks.

Description	Item#	Each
E. 200-Hole Box	814-1200	\$25.75
100-Hole Box	814-1205	14.95
36-Hole Box	814-1210	7.95



F-H Rotating Bur Holders – For Burs and Tools

Tiered plastic stands rotate on ball bearings for smooth action. Measure 7" dia. x 4"H.

- Style 126**
- 45 holes for burs with 1/16" shanks
 - 69 two-step holes for burs with 3/32" or 1/8" shanks
 - 12 holes for burs with 1/4" shanks

- Style 112**
- 92 holes for burs with 3/32" or 1/8" shanks
 - 13 holes for burs with 1/4" shanks
 - 7 holes for 1/16" to 5/32" drills
 - 2 3/4" dia. x 3"H center cup for hand tools

Description	Shank Size	Item#	Each
F. Style 126	1/16", 3/32" or 1/8", 1/4"	850-0004	\$16.55
G. Style 112	1/16" to 5/32", 3/32" or 1/8", 1/4"	850-0006	16.55
H. Style 112	1/16" to 5/32", 3/32" or 1/8", 1/4"	124-4720	12.75

A. Bench Pin

Standard reversible wooden bench pin for both single and double workbenches. Made to fit tightly but may require some minor adjustments. Used for support when filing or sawing. Measures 6¼"L x 2⅝"W x 1⅛" thick. Tang measures approx. 1½"L x 2⅝"W x ½" thick.

Description	Item#	EACH Prices		
		1-11	12-143	144+
Bench Pin	814-1000	\$3.85	\$3.27	\$2.70



A

B. Bench Pin and Anvil

A portable, versatile device for hammering, sawing, filing and flattening. Securely attaches to bench or table with 1½" overhang up to 1¾" thick. Anvil area measures 2¾" x 3". Wooden bench pin measures 4"L x 2¼"W. Tang measures approx. 1½"L x 2¼"W x ⅜" thick.

Description	Item#	Each
Bench Pin and Anvil	814-1010	\$15.95
Replacement Bench Pin	814-1011	2.70



B

C. Bench Pin and Holder

Can be easily screwed into edge of workbench. Bench pin measures 4"L x 2¼"W x 1" thick with 1¼"L x 2¼"W x ¾" tang. Holder measures 4" wide with 2¼"W x ¾"H opening and thumb screw for securing bench pin firmly in place.

Description	Item#	Each
Bench Pin and Holder	814-1005	\$8.95
Replacement Bench Pin	814-1006	2.70



C

D. Ring Sizing Bench Pin

Screws to top of bench. Shaped especially to hold rings. Has channel for guiding sawblade. Measures 5½"L x ¾"W x ⅜" thick.

Description	Item#	Each
Ring Sizing Bench Pin	814-0990	\$3.25



D

E. Slotted Bench Pin with Clamp

This reversible wooden bench pin clamps to the edge of any workbench with a surface up to 1⅞" thick. Has a deep V-slot and a straight slot for drilling, sawing and securing ring clamps. Measures 7½"L x 2¼"W x ½" thick.

Description	Item#	Each
Slotted Bench Pin with Clamp	814-0995	\$5.90



E

F. Rubber Bench Filing Block

Provides a ¾" extension off the workbench. Consists of rubber block, iron frame and steel anvil. Rubber block serves as a rest for work to be filed, prevents work from slipping and protects objects from being marred. Measures 5"L x 2¼"W.

Description	Item#	Each
Filing Block	814-0985	\$19.50
Replacement Rubber Block	814-0986	4.15



F

GRS® BenchMate™ A unique work holding system that no jeweler should be without!

The BenchMate complete holding system makes jewelry fabrication and repair faster and easier. Mounts on the front of the workbench at a convenient height to provide support for workpieces, reducing slippage and user fatigue. Completely adjustable pivoting holder positions workpiece and holds it securely while engraving, setting, soldering and more. Removable hand rest provides extra stability, helping you do better work with less effort. Precision-machined steel construction ensures longevity. Tough plastic jaw inserts help prevent marring. Can be used with both hand and power tools. To make your BenchMate "Left-Hand" simply turn your ring holder 180° and add a Left-Hand Arm Rest #856-0175. Made in USA.



A-D GRS® BenchMate™ Basic Package

The NEW GRS Encore BenchMates have been redesigned with the Bench jeweler in mind! The Encore series now comes in two variations; Encore QC and Encore QCX. The QC now has an arm that measures 6" and has a cut-out for superior access angles and better clearance when using your bench tools. Arm adjustable for maximum comfort.

The QCX is more advanced and delivers the widest range of motion from any hands-free work-holding tool on the market. Can easily be centered under a microscope without losing sight of the workpiece.

Each variation comes in two packages; Basic and Setters. Basic Encore QC/QCX includes newly redesigned BenchMate, fixed mounting plate and Encore Accessory pack. Setter Encore QC/QCX includes newly redesigned BenchMate, fixed mounting plate, horizontal ID ring holder, vertical ID ring holder and Encore accessory pack. All can be adjusted for right or left hand use.

Description	Item#	Each	Description	Item#	Each
A. QC Basic Package	856-0202	\$309.00	C. QCX Basic Package	856-0204	\$350.00
B. QC Stone Setter's Package	856-0203	465.00	D. QCX Stone Setter's Package	856-0205	510.00



GRS® BenchMate™ Replacement Parts

Description	Item#	Each	Description	Item#	Each
Jaw Inserts, 5 pairs	856-0197	\$8.20	Narrow Soldering Clamp	856-0188	\$10.25
Fixed Mounting Plate	856-0196	18.95	Wide Soldering Clamp	856-0194	10.25
Shellac Pad	856-0186	12.95	Soldering Pad Assembly (4" x 4" non asbestos soldering surface)	856-0195	36.30
Third Hand Tweezers	856-0190	47.20	Friction Washer	856-0199	4.60
Bench Pin with Mount	856-0192	29.95			



A-C GRS® BenchMate™ Multipurpose Vise

Attaches to BenchMate or directly to your bench. Tilts left and right and rotates on vertical axis so you can find the best working angle. Features holes in top for holding pins or the padded ring clamp from GRS 30-Piece Attachment Set #856-0277 (see p. 286). Made of satin-finished steel. To mount, fit in Fixed Mounting Plate, secure to Benchtop Mounting Adapter, then screw into bench. Made in USA.

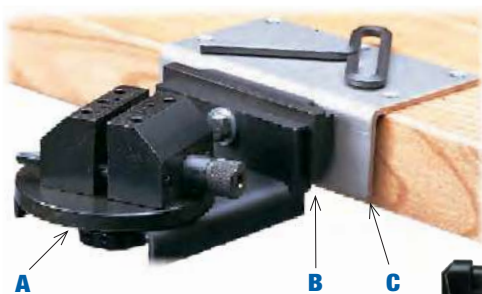

Description	Item#	Each
A. Multipurpose Vise	856-0172	\$170.00
B. Fixed Mounting Plate	856-0196	18.95
C. Benchtop Mounting Adapter	856-0193	27.20

D. GRS® BenchMate™ Inside Ring Mandrel

Expands to hold rings securely.

A valuable, timesaving addition to the workbench. Holds rings from the inside to provide improved access for a variety of applications, especially setting. Easily handles hard-to-hold tapered and delicate designs that can be crushed by ordinary ring clamps. Includes seven different mandrels for holding ring sizes 4-13 without marring. Select the closest mandrel for each ring, then expand it by turning the screw until the ring is secure. Fits into any original BenchMate collar or can be used by itself. Can NOT be used with Encore Series. Made of solid steel. Made in USA.

Description	Item#	Each
Inside Ring Mandrel	856-0210	\$88.00



E, F GRS® BenchMate™ Engraver's Block Shelves

Two different heavy-gauge metal shelves for securely holding your engraver's block at the absolute perfect working height. Let you maintain correct posture for minimizing fatigue throughout the workday. Use Standard Shelf for any engraver's block. Use the Large Shelf with Height Adjustment Bracket for GRS Positioning Vise #271-3025 (see p. 546). Height Adjustment Bracket also sold separately (see "G" below) for retrofit onto Standard Shelf to give you better flexibility. Made in USA.

Description	Item#	Each
E. Standard Shelf	856-0198	\$43.00
F. Large Shelf with Height Adjustment Bracket	856-0173	83.80



G. GRS® BenchMate™ Height Adjustment Bracket

Simply attach this sturdy steel bracket to your Standard Shelf (see above) for improved range of height adjustment. Made in USA.

Description	Item#	Each
Height Adjustment Bracket	856-0174	\$55.10



H. GRS® BenchMate™ Insulated Solder Clamp

Won't absorb heat!

Features unique jaws made of non asbestos solder board material. Perfect for gripping items securely without marring. Keeps heat isolated within the workpiece—where it belongs for maximum safety. One jaw is stationary, and the other opens and swivels for conforming to uneven surfaces. Made in USA.

Description	Item#	Each
Insulated Solder Clamp	856-0212	\$61.00



I. GRS® BenchMate™ Tungsten Tweezers Tips

Replace the standard tips of your BenchMate third hand for soldering platinum without risk of contamination. Medium points. Sold by the pair. Made in USA.

Description	Item#	PKG
Tungsten Tweezers Tips, pair	856-0191	\$24.90

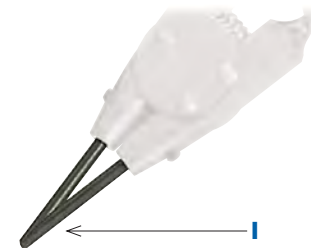

A, B Wooden Tool Holder/Organizer

Let Gesswein help organize your bench! The 6-sided bur & tool holder is made of solid durable wood and rotates like a lazy susan. It's ideal for safe keeping of your various bench tools such as gravers, files, burs and mounted abrasives. Holds an amazing amount of tools in a small 7 1/2" x 7 1/2" footprint. Each of the 6 sides plus the top have a variety of hole sizes to fit just about any tool. Sides have a total of:

- (42) 7.5mm holes
- (48) 4mm holes (which will hold 1/8" and 4mm shank tools)
- (288) 3mm holes (which will hold 3/32" and 3mm shank tools)

Additionally 2 sides feature a 3 1/8" long magnetic strip to hold pliers or other tools.

Top has (37) 12mm holes: 18 shallow holes for graver handles and small tools and 19 holes in the center that perforate the top and extend 8" down into the caddy so you can store long files, gravers, etc. The top can also be removed so you can store larger items inside.

The bur & tool holder stands 9 1/2" high overall and requires a minimum 7 1/2" x 7 1/2" in order to rotate, more with tools in it. Shipping weight: 6 lbs.

Small Caddy has all the features of the large caddy but scaled down to a smaller size: 6"L x 6"W x 8"H. Shipping weight: 3.15 lbs.



All accessories sold separately.

Description	Item#	Each
A. Wooden Tool Holder	816-4058	\$49.50
B. Small Wooden Tool Holder	816-4059	44.35

C. Benchtop Organizer

Fits perfectly on the back of a bench or on a work table. Contains space for findings, tools, accessories and organizes it all. Four drawers are included for stow away items. A great compliment to any work area. Measures 18" L x 4 1/2" W x 7 1/2" H. Shipping weight: 3.5 lbs.

Description	Item#	Each
Benchtop Organizer	816-4056	\$47.95

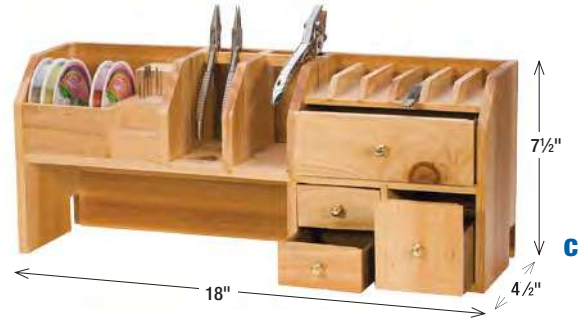

D. Plier and Tool Organizer

Beautifully made yet practical wooden organizer with seven open compartments for pliers, open space below for various small tools and a drawer for those small parts so essential to every bench. Made of hardwood (except pressboard pliers spacers) with dovetailed joints and varnished finish. Measures 7 1/2"W x 6 1/2"D x 3 3/4"H.

Description	Item#	Each
Plier and Tool Organizer	816-4057	\$19.95

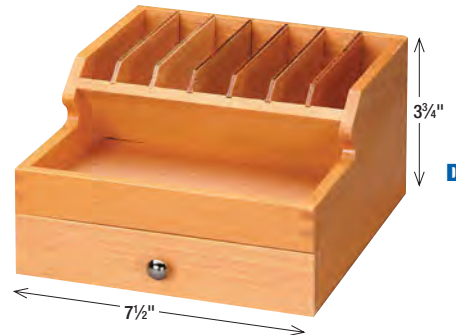

E. Magnetic Tool Holder

A handy 12" strip with permanent magnets for holding pliers, screwdrivers, tweezers and other tools. Helps keep bench clutter-free. Allows easy access to tools. Screws into surface for sturdiness.

Description	Item#	Each
Magnetic Tool Holder	840-0008	\$35.25

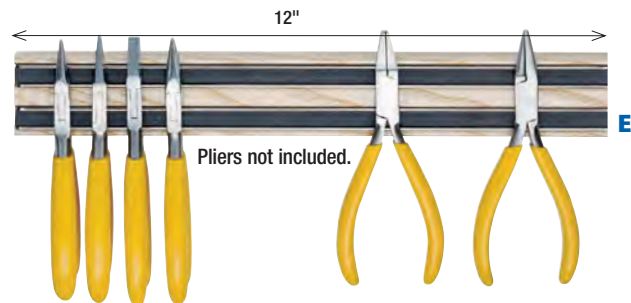

F. Handpiece Storage Strip

The Handpiece Storage Strip keeps handpieces within easy reach. Four holes provide storage for multiple handpieces of varying size. The storage strip includes clips that fit the side of some commercial benches. It can also be mounted to a flat surface with the included hardware.

Description	Item#	Each
Handpiece Storage Strip	850-0604	\$10.30



A. White Cotton Gloves

Keep your jewelry, silverware and small parts fingerprint-free to maintain high luster finish. Very good for handling merchandise for packing. Available in light and medium weight cotton. Small gloves measure 8", medium 9" and extra large are 10" in length.

Description	Item#	DOZEN Prices		
		1-2	3-11	12+
Small/Women (Light Weight), 12 pairs	805-1030	\$7.95	\$7.16	\$6.36
Medium/Men (Light Weight), 12 pairs	805-1032	8.95	8.06	7.16
Extra Large/Men (Light Weight), 12 pairs	805-1033	9.95	8.96	7.96
Small/Women (Medium Weight), 12 pairs	805-1055	10.95	9.86	8.76
Medium/Men (Medium Weight), 12 pairs	805-1056	11.95	10.76	9.56
Extra Large/Men (Medium Weight), 12 pairs	805-1057	12.95	11.66	10.36

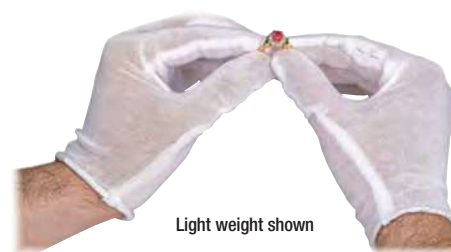

Light weight shown

A

B. Latex Gloves

Disposable latex gloves for everyday use. Prevent skin problems that arise from chemical reactions caused by constant exposure to soaps, solvents and other mild chemicals. Powdered to go on easily.

Description	Item#	Box of 100
Small Gloves	805-1043	\$14.95
Medium Gloves	805-1041	14.95
Large Gloves	805-1042	13.95



B

C. MicroFlex® UltraSense™ Powder-Free Nitrile Glove The alternative to latex!

Powder-free UltraSense is a breakthrough in nitrile technology, providing the fit and feel of latex while eliminating the possibility of natural rubber latex allergic reaction. Provides reliable barrier protection against many hazardous and infectious substances. Highly elastic for easy conformance and reduced fatigue. Textured fingertips offer excellent grip in wet or dry conditions. Ambidextrous. Beaded cuff. Polymer-coated for easy donning. Length: 245mm (9⁵/₈"). Thicknesses: 5.1mil finger, 3.5mil palm. Color: blue. Sold in dispenser box of 100.

Size	Item#	Box of 50
Small	805-1072	\$24.75
Medium	805-1071	24.75
Large	805-1070	24.75



C

D. MicroFlex® NeoPro® EC Glove – Ideal for rhodium plating!

Exceptional comfort in a tough synthetic glove. NeoPro EC offers the barrier protection of a synthetic with the comfort, fit and feel of natural rubber latex. Offers 90% more puncture resistance than natural rubber latex. Resists a broad range of chemicals. Ideal for rhodium plating, electrocleaning and most other plating operations. Textured fingertips provide a secure grip. Extended, beaded cuff guards against splashes and spills. Made of polychloroprene, the generic name for neoprene. Ambidextrous. Powder-free and polymer-coated for easy donning. Length: 300mm (11.8"). Thicknesses: 8.3mil finger, 6.3mil palm, 4.7mil cuff. Color: green. Sold in dispenser box of 50.

Size	Item#	Box of 50
Small	805-1052	\$26.75
Medium	805-1051	26.75
Large	805-1050	26.75



D

More
Finger Cots Available
See pp. 470-471.

E. Latex Finger Cots

Powder-free, antistatic latex finger cots in white or pink for protection from mild chemicals. Available in small, medium and large. Sold by the gross or bulk pack of 1440pcs.

Description	WHITE	GROSS Prices		PINK	GROSS Prices	
	Item#	1-2	3+	Item#	1-2	3+
Small	816-0250	\$4.95	\$4.70	816-0255	\$5.25	\$4.99
Medium	816-0251	4.95	4.70	816-0256	5.25	4.99
Large	816-0252	4.95	4.70	816-0257	5.25	4.99

Description	WHITE	Box of 1440	PINK	Box of 1440
	Item#	Prices	Item#	Prices
Small	816-0260	\$29.95	816-0265	\$31.45
Medium	816-0261	29.95	816-0266	31.45
Large	816-0262	29.95	816-0267	31.45



E



E



A-C Work Processing Tray

A heavy-duty, rigid cardboard tray with 1" high sides for holding work in progress. Can be used alone for large parts or with either of two plastic inserts (round or rectangular) for small parts. Inserts are covered in non marring, nonscratching material. Round insert has 50 round depressions, each measuring approximately 1" dia. x 1/2" deep. Rectangular insert has 32 rectangular depressions, each measuring approximately 1 3/4"L x 1 1/2"W x 1/2"D.

Description	L x W x H	Item#	EACH Prices	
			1-9	10+
A. Work Processing Tray	14 3/4" x 8 1/4" x 1"	807-1170	\$4.25	\$3.83
B. Square Insert (32)	1 3/4" x 1 1/2" x 1/2"	807-1179	4.95	4.46
C. Round Insert (50)	1" Dia. x 1/2"	807-1175	5.05	4.55

D. Shop Work Tray

This large stackable tray is made of flexible yet strong .025" thick plastic. The 100 compartments measure 1 5/8"L x 3/4"W x 5/8"H.

Description	L x W x H	Item#	EACH Prices	
			1-9	10+
Shop Work Tray	21 1/2" x 12 1/8" x 1"	807-1066	\$9.95	\$8.96

E. Black Tray with 50 Gem Jars

Black tray with foam insert to firmly hold 50 gem jars. Each jar contains foam to securely hold gems in place.

Description	L x W x H	Item#	Each
Black Tray	14 3/4" x 8 3/8" x 1"	807-1190	\$11.50

F-I Round Metal Boxes

Tin boxes for storing small stones. Sold in full packages only.

Size	12	72	144
F. 1 5/16"	807-1215	-	807-1210
	\$9.45		\$47.00
G. 1 1/2"	807-1216	-	807-1211
	9.75		48.75
H. 2"	807-1217	807-1212	-
	9.75	\$20.00	-
I. 2 3/8"	807-1218	-	807-1213
	12.15		60.75

J. Sorting Trays

Each has four grooves on one side and assorted sizes of holes on the other for sorting diamonds, colored stones, pearls or beads.

Description	L x W	Item#	EACH Prices	
			1-2	3+
J. Black Sorting Tray	7 1/8" x 3 3/4"	816-2100	\$3.95	\$3.56
White Sorting Tray	7 1/8" x 3 3/4"	816-2105	5.95	5.36

A. Black Ring Cases

Wooden cases with black velvet foam inserts for providing excellent contrast to your sparkling jewelry. Cases feature black vinyl exterior, satin interior and locking lid latches.

Description	L x W x H	Item#	Each
36-Ring Case	8 1/4" x 7 1/4" x 2"	807-1081	\$32.15
72-Ring Case	14 3/4" x 8 1/4" x 2"	807-1080	49.15



B. Black Ring Tray

Wooden tray with black velvet foam inserts for providing excellent contrast to your sparkling jewelry. Trays have decorative hand tooling around their edges.

Description	L x W x H	Item#	Each
72-Ring Tray	14 3/4" x 8 1/4" x 1"	807-1075	\$13.89



C-E Display Trays

Black wooden trays and vibrant velvet pads for holding and providing contrast to your jewelry. Trays available in 1 1/2" and 2" heights.

Description	L x W x H	Item#	Each
C. Display Tray	14 3/4" x 8 1/4" x 1 1/2"	807-1059	\$6.65
Display Tray	14 3/4" x 8 1/4" x 2"	807-1058	6.25

Description	L x W x H	Item#	EACH Prices	
			1-9	10+
D. Square Insert (32)	1 3/4" x 1 1/2" x 1/2"	807-1179	\$4.95	\$4.46
E. Round Insert (50)	1" Dia. x 1/2"	807-1175	5.05	4.55



F. Jewelry Pins

Yellow jewelry pins with long, sharp points for pinning all types of jewelry to beds, trays or easels. Sold in packages of 100 and boxes of 1,000.

Color	Item#	Pkg. of 100		Item#	Box of 1,000	
		1-2	3+		1-2	3+
Yellow	807-1181	\$3.95	\$3.56	807-1180	\$26.95	\$24.26



G. Swinger® Suspended Retractable Mirror System

This innovative hanging mirror system frees up valuable counter space. Works easily with quick pull-down and push-up motion for out-of-the-way storage. Adjustable from 9' ceiling all the way down to counter top. Spring-loaded for neutral buoyancy so it stays at desired level. Can be mounted on any drywall or drop ceiling (hardware included).

Large 9" dia. reversible mirror features true-view optics on both sides. Heavyweight handles help stabilize mirror.

Description	Item#	Each
Brass	807-0710	\$59.50

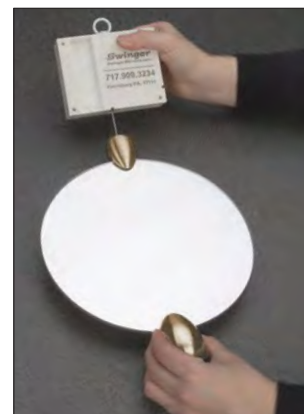
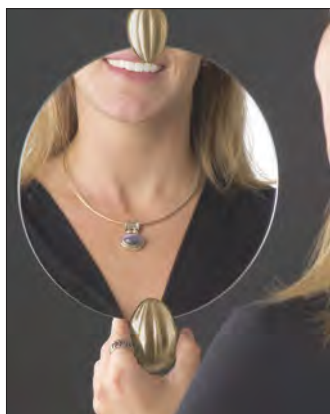



A



B



C

A-B Plastic Storage Boxes

These handy boxes keep findings, gems, sawblades, solders, chuck keys and countless other small items organized at your bench so you can find them when you need them. Made of translucent plastic except #807-1201, which is clear plastic. Hinged tops.

Description	Dimensions (L x W x H)	Item#	EACH Prices		
			1-2	3-5	6+
A. Box w/7 nonadjustable compartments	4 ⁵ / ₈ " x 3 ⁵ / ₈ " x 7/ ₈ "	807-1201	\$1.85	\$1.67	\$1.57
B. Box w/7 adjustable dividers to create up to 18 compartments	8" x 4 ¹ / ₄ " x 1 ¹ / ₄ "	807-1202	3.70	3.33	3.15
C. Box w/24 nonadjustable compartments	12" x 6" x 1 ¹ / ₂ "	807-1205	18.75	16.88	15.94

D, E Stackable Round Tray Sets

These convenient tray sets help you unclutter your bench by making efficient use of vertical space. Let you organize small parts, beads, stones and other small objects. Each tray has a threaded bottom that securely screws to the tray below it, allowing access to any tray at any level. Made of transparent plastic, so contents are always visible. Available in two diameters: 1¹/₄" and 2".



D



E

Description	Item#	Each
D. Small Tray Set (seven 1 ¹ / ₄ " dia. trays)	816-4062	\$2.95
E. Large Tray Set (five 2" dia. trays)	816-4060	2.95

F. Vacuum Tweezers

Offering unmatched precision over standard tweezers, this self-contained miniature vacuum pump has 2 handpieces for picking up stones and small parts without damaging them. Picks up both cabochons and faceted stones. Because there are no tweezers tips on the girdle of the stone, placement is easier, faster and more precise. This is especially useful when setting small stones and when setting stones in wax.

Comes with 4 stainless steel tips of varying diameters for holding smaller or larger stones. Vacuum is created by placing the forefinger over a hole in the handpiece. To break the vacuum, simply lift your finger from the hole. The vacuum generator measures just 5" long x 3¹/₄" wide x 2" high with an airflow of 125 cu. in./min. 110V. Shipping Weight: 1.2 lbs. Made in Thailand.

Includes :

- 110V vacuum unit with on/off switch
- 2 pencil-thin, lightweight aluminum pens
- 4 stainless steel tips of varying sizes
- 2 flexible air tubes each measuring 36" in length

Description	Item#	Each
Vacuum Tweezers	195-3307	\$65.00
Replacement Pens Set of 2	195-3006	25.00
Replacement Tips Set of 4	195-3007	4.95

G. Cup-Shaped Pearl Tweezers

Tweezers with cup-shaped ends for holding pearls, beads and more. Coated tips prevent scratching of delicate surfaces. Measure 5³/₄" long.

Description	Item#	EACH Prices		
		1-2	3-9	10+
Cup-Shaped Pearl Tweezers	195-0310	\$5.95	\$5.36	\$5.06



F



G

A-J Foil Gift Wrap

Choose from 10 different styles! Sold in 7½" x 150' rolls.

Description	Item#	Each PRICES	
		1-2 Rolls	3+ Rolls*
A. Matte Silver	813-1756	\$20.65	\$19.62
B. Cracked Holograph	813-1757	20.65	19.62
C. City Lights Holograph	813-1758	20.65	19.62
D. Dark Green	813-1760	20.65	19.62
E. Red	813-1761	20.65	19.62
F. Floral Silver	813-1763	20.65	19.62
G. Blue Gyro	813-1765	20.65	20.65
H. Blue Taffeta	813-1766	20.65	20.65
I. Floral Gold	813-1767	20.65	20.65
J. Gold Nugget	813-1764	20.65	20.65

*Quantity discount for orders of one item number only; not assorted.

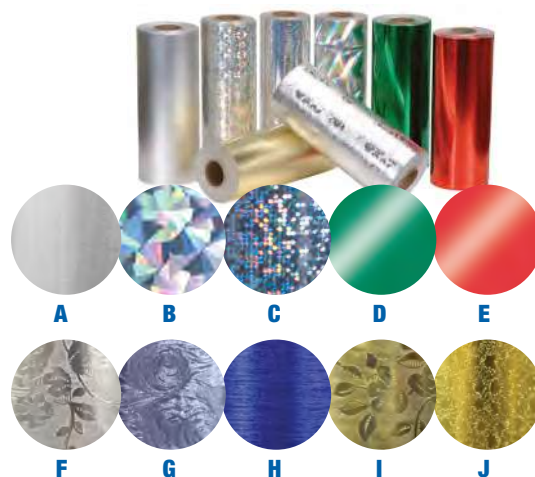

K, L Anti-Tarnish Tissue Roll and Cutter

The finest quality white bleached tissue for wrapping silverware, jewelry and other gifts. Will not tarnish merchandise. Measures 7¾" wide by 1,000 feet. Cutter has steel frame and cutter with wood base that can be screwed to table. For 7¾" wide rolls.

Description	Item#	EACH Prices	
		1-2	3+
K. Anti-Tarnish Tissue Roll	813-1750	\$13.85	\$13.16
L. Cutter for Tissue Roll or Gift Wrap	813-1755	19.15	18.19



M, N Anti-Tarnish Tissue

Lint-free anti-tarnish tissue for wrapping and cleaning watch parts, jewelry and much more. Available in watch size 4" x 4" and sold in boxes of 1,000 sheets. Also available in large 20" x 30" sheets sold by the ream (approximately 500 sheets).

Description	Item#	Box of 1,000	
		1-2	3+
M. Watch Tissue 4" x 4"	813-1725	\$7.15	\$6.79
N. 20" x 30" ream	813-1751	30.85	29.31



O. High-Quality Diamond Parcel Paper

Unmatched in sensitivity and protection for handling loose stones. Made of the finest paper stock, then hand-finished for the right touch. Specially developed with the best blue and white flute colors to enhance D-H color diamonds and reflect them in the best light. Measures 3¼" x 3¼" folded, 7¼" x 6" opened. Sold in packages of 25 sheets.

Description	Item#	Pkg. of 25
High-Quality Diamond Parcel Paper	810-0460	\$10.15





A



B



C



D

A. Economy Clear Zip Bags

Our most economical clear plastic bags with standard zip closure. 2 mil.

W x L	Item#	Pkg. of 1,000
2" x 2"	810-0500	\$6.60
2" x 3"	810-0501	7.35
2" x 6"	810-0496	11.50
2" x 8"	810-0505	11.75
3" x 3"	810-0493	11.50
3" x 4"	810-0502	10.50
3" x 5"	810-0503	11.55
4" x 4"	810-0510	19.99
4" x 6"	810-0504	16.00
5" x 5"	810-0494	21.35
5" x 8"	810-0511	24.95
5" x 12"	810-0497	37.70
6" x 6"	810-0499	21.25
6" x 9"	810-0509	33.95
8" x 10"	810-0506	59.95
10" x 12"	810-0507	62.35

B. Economy Clear Zip Bags with White Write-On Area

Economical clear plastic bags with standard zip closures. Have white block that accepts grease pencil, pen, marker or rubber stamp.

W x L	Item#	Pkg. of 1,000
2" x 3"	810-0524	\$8.40
3" x 4"	810-0525	11.55
3" x 5"	810-0526	15.00
4" x 6"	810-0527	21.00

C. Clear Zip Bags with Red Line

These 2 mil clear plastic bags seal and reseal easily and can be used over and over again. Stronger closure than economy clear bags.

W x L	Item#	Pkg. of 1,000
2" x 2"	810-0530	\$20.50
2" x 3"	810-0531	21.50
3" x 4"	810-0532	27.75
3" x 5"	810-0533	34.50
4" x 6"	810-0534	36.95

D. Clear Zip Bags with Red Line and White Write-On Area

Offer same strong closure and easy sealing and resealing as clear bags with red line above. White block area accepts grease pencil, pen, marker or rubber stamp.

W x L	Item#	Pkg. of 1,000
2" x 3"	810-0550	\$21.75
3" x 4"	810-0551	31.50
3" x 5"	810-0552	33.75
4" x 6"	810-0553	45.50

A, B 3M® Tarni-Shield

Designed to inhibit corrosive gases from tarnishing or staining metal items in transit or storage. Works on silver, copper, gold, brass and solder by absorbing and trapping atmospheric pollutants such as hydrogen sulfide, sulfur dioxide and acetic acid. Easy to use: to protect a metal item, just add Tarni-Shield to the shipping container. Available in strips or tabs. Strips measure 2" x 7" and are sold in packages of 8 or 1,000. Use one strip to protect up to 420 cubic inches of container space. Tabs measure 1" x 1" and are sold in packages of 1,500. Use tabs in small containers.

Description	Size	Pkg. of	Item#	EACH Prices	
				1-11	12+
A. 3M Anti-Tarnish Strips	2" x 7"	8	813-1781	\$3.85	\$3.47
3M Anti-Tarnish Strips	2" x 7"	1000	813-1786	299.00	-
B. 3M Anti-Tarnish Tabs	1" x 1"	1,500	813-1789	56.00	-



A



B

C. Anti Tarnish Bags - The easy way to store and protect jewelry!

Convenient storage bags that prevent jewelry from tarnishing. Feature one translucent side and one side coated with tarnish-absorptive material. When a bag turns black, it's time for a new one. Sold in packages of 10.

Description	Size	Item#	Pkg. of 10	
			1-99	100+
Anti-Tarnish Bag	2" x 3"	817-1740	\$2.50	\$2.25
	4" x 6"	817-1742	3.40	3.06



C

D. Anti-Tarnish Filtration Unit

Never polish your showcase jewelry again!

This simple, effective unit prevents tarnish on sterling silver and all other metals. Place one in a 4' showcase or two in a 6' showcase, especially if opened frequently. If you move your jewelry to a safe each night, place one or two units in there, as well. Includes one filter. Runs 24/7 on two "D" batteries (not included). Used by NASA, the Guggenheim Museum and the British Royal Mint, to name a few.

Not designed for open areas. Note that cabinets and cases with wooden bases may require extra protection from Anti-Tarnish Foil Barrier Film to reduce outgassing common to wood, which greatly contributes to tarnishing if left unchecked.

Features:

- Safe for all jewelry
- Leaves no residue or deposit
- Nontoxic and environmentally safe
- Hides easily behind a necklace stand
- Operates silently

Measures 3¼"W x 3½"D x 4"H. Filter and batteries should be changed every three months.

Description	Item#	Each
Anti-Tarnish Filtration Unit	813-1745	\$57.57
Replacement Filters, pkg. of 3	813-1746	33.25
Description	Item#	Per Foot
Anti-Tarnish Foil Barrier Film, 18"W	813-1747	\$3.00



D



E

E. Jewelry Appraisal Form

Official insurance appraisal form for jewelers and appraisers. Three-part, carbonless format. Sold in packages of 50. Ship. wt: 1 lb.

Description	Size	Item#	Pkg. of 50
Jewelry Appraisal Form	8½" x 11"	810-0430	\$20.85



A



B



C



D



E

A. Bib Apron with Pockets

Protects clothing and holds most frequently used tools close at hand. Includes extra-long waist strings for front tying. Made of machine washable heavyweight cotton. Available with or without pockets. Comes in royal blue with our white, screen-printed Gesswein logo. Measures 18½"W x 25"L. Made in USA.

Description	Item#	Each
A. Bib Apron with pockets	827-1201	\$19.99
Bib Apron without pockets	827-1200	17.95

B. Suede Bib Apron

This durable, comfortable apron protects clothing while you work with power equipment and hand tools. Convenient pencil pocket, no other pockets in which debris can be trapped. Made of tanned, split, rust-colored heavyweight suede. Includes adjustable ties with brass grommet reinforcements. One size fits all. Measures 24"W x 36"L.

Description	Item#	Each
Suede Bib Apron	827-1507	\$32.00

C. Fire-Resistant Apron

Made of fire-resistant fabric ideal for welding applications. Features full-coverage design for protection of neck, chest and lap, small chest pocket, large waist pocket, bottom flap for catching runaway parts, comfortable neck band and extra-long waist strings for front tying. Comes in navy blue. One size fits all. Measures 27"W x 36"L.

Description	Item#	Each
Fire-Resistant Apron	827-1508	\$27.80

D. Lab Coat

Full-length coat with long sleeves, notched lapel, hemmed cuffs and bottom. Includes two breast pockets, two hip pockets and reinforced side slit for easy access to inside pocket. Made of permanent-press, washable polyester/cotton blend. Comes in white with royal blue embroidered Gesswein logo. Can be burned to reclaim precious metals. Made in USA.

Description	Fits Sizes	Item#	Each
Medium Men's Coat	40-44	827-1501	\$58.50

E. Neoprene Apron

Heavy-duty double-coated yellow neoprene apron for frontal body and protection from a wide range of chemicals, including caustics and solvents. Apron features extra-long neck and waist ties. Weighs 12½ oz. Recyclable.

Description	Item#	Each
Apron, 35"W x 45"L	827-1509	\$29.95

Keep Your Customers Coming Back! Gesswein Has the Answer!

Retailers are always looking for a way to keep their customers coming back—check out these great add-on or gift with purchase items.

A, B Glass Nail Files - Made with Swarovski® Elements

Introducing tempered glass nail files made with Swarovski Elements. Elegant yet practical, these files make a great 'add-on' or 'gift with purchase'. Simply place the glass file display on your sales counter and watch the sales happen.

How can I market glass nail files?

10 reasons why you can't miss.

1. A proven seller, makes a great add-on or gift with purchase that you can make at least keystone. They will come back for more and thus keeps your customers coming back into your jewelry store and does not take away from any other purchase.
2. Decorated with genuine elements by Swarovski.
3. Eye catching display that will draw their attention and thus want one!
4. Made of tempered glass for extra strength and safety. Hard cases available for added security.
5. Hygienic, can be washed by using water. Let your customers try one and they will be impressed by its beauty!
6. Can be used on acrylic nails, just simply wet the file!
7. Permitted on airplanes since the file is glass and not metal.
8. Works safely on baby's nails since the sides are not sharp.
9. Will maintain performance since the surface does not wear out.
10. Makes a routine item fun and exciting... remember many customers will buy more than one at a time.

Display Set - Includes acrylic counter display with card, 30 Glass Nail Files with sheaths and 6 hard nail file cases.

15 Piece Refill Pack — Once you start selling the Gesswein Glass Nail Files, refill your counter top display with ease. Includes 15 Glass Nail files with sheaths.

Hard Cases - 6 pack - To prolong the life of your nail file, Gesswein offers hard nail file cases, available in 6 colors (May vary). Available in a set of 6.

Description	Item#	Each
A. Display Set	827-1700	\$199.95
15 Piece Refill Pack	827-1723	93.50
B. Hard Cases - 6 pack	827-1720	8.95



Styles and colors may vary..

C. Sparkle Wand Jewelry Cleaner

The True "On The Go" Jewelry Cleaner! Make your diamond rings and jewelry sparkle. Makes a great add-on or gift with purchase. Quickly cleans and maintains the sparkle of diamonds and gems, plus restores the luster and polish to both fine and costume jewelry. Each wand/pen contains 0.07 fluid oz (2 ml) of cleaning liquid. Comes supplied as a complete Kit of one Retail Acrylic Stand with 12 Sparkle Wands and when you sell out, refill packs of 12 Sparkle Wands available. Easy, convenient and cost effective! Made in USA

Description	Item#	Each
C. Sparkle Wand Kit	812-0699	\$115.95
Sparkle Wand Refill Pack (12)	812-0698	90.50



2 Other Great Retail Products!

**GemOro
Diamond Steamer
(851-0095)
See page 243**



**Sonic Wave 4
(851-4904)
See page 235**





A B C D E F G H I

Shown actual size



J K L M N O P Q

Shown actual size



R S T U V

W

X



A-I Screw Mandrels

Use in handpieces and hand grinders for holding felt wheels, pumice, Cratex and other wheels up to 1/4" thick. Threads are right-hand. Style 321 1/2" is made of stainless steel.

Style	Shank	For Hole	Item#	EACH Prices	
				3-9	12+
A. 321	3/32"	1/16"	840-3170	\$1.20	\$1.00
B. 321 1/2	3/32"	1/16"	840-3160	2.35	1.96
C. 304	3/32"	1/16"	840-3175	2.45	2.04
D. 2	3/32"	1/8"	840-3060	2.10	1.75
E. 311	1/8"	1/16"	840-3150	1.40	1.17
F. 20	1/8"	1/8"	840-3100	2.15	1.79
G. 22	1/8"	1/8"	840-3110	3.15	2.62
H. 24	1/8"	1/4"	840-3112	3.15	2.62

Style	Shank	For Hole	Item#	EACH Prices	
				1-11	12+
I. 25	1/4"	1/4"	840-3115	\$4.50	\$3.75

J-O Tapered Threaded Mandrels

For use with felt buffs, wheels, cylinders, points and more. Threads are right-hand.

Style	Shank	For Hole	Length of Taper	Item#	EACH Prices	
					3-9	12+
J. 3	3/32"	1/16"	3/16"	840-3070	\$1.25	\$1.04
K. 13	1/8"	1/16"	3/16"	840-3090	1.25	1.04
L. 0	3/32"	1/16"	3/8"	840-3040	1.25	1.04
M. 30	1/8"	1/16"	3/8"	840-3120	1.25	1.04

Style	Shank	For Hole	Length of Taper	Item#	EACH Prices	
					1-11	12+
N. 33	1/8"	1/4"	3/4"	840-3130	\$3.85	\$3.21
O. 43	1/4"	3/8"	1"	840-3140	6.80	5.67

P, Q Threaded Mandrels with Nut

For use with rubberized points, cones, and cylinders such as Cratex. Threads are right-hand.

Style	Shank	For Hole	Length of Taper	Item#	EACH Prices	
					3-9	12+
P. 1	3/32"	3/32"	1/2"	840-3050	\$1.60	\$1.33
Q. 4	1/8"	3/32"	1/2"	840-3080	1.20	1.00

R-V Reducing Collets

Instantly convert your collet to the size you need. Simply slip the appropriate reducing collet into your collet to use 3/32" or 1/16" shank tools. Do not use at high speeds, and make sure shank is inserted deeply. Stainless steel.

Description	Item#	Each
R. 1/8"-3/32" Reducing Collet	816-1501	\$14.90
S. 1/8"-1/16" Reducing Collet	816-1502	14.90
T. 3mm-3/32" Reducing Collet	816-1504	14.90
U. 3mm-1/16" Reducing Collet	816-1505	14.90
V. 3/32"-1/16" Reducing Collet	816-1503	14.90

W, X Adapter Chucks - 3/32" Shank

Allow you to use tools with small shanks in standard flex shaft handpieces. Threads are right-hand.

Description	Collet Capacity	Item#	Each
W. Medium Chuck	2.62mm	840-3220	\$15.50
X. Small Chuck	1.00mm	840-3210	13.35

Three-piece minimum; Please order in multiples of three.

A-C Cratex® Small Wheel Mandrels

Fit Cratex small wheels. Max. operating speed with 1/2" overhang (exposed mandrel length) or less: 25,000rpm. With each additional 1/4" of overhang, max. operating speed decreases by at least 20%. Use light working pressure.

Style	Shank	For Hole	Item#	EACH Prices	
				1-11	12+
A. #2	3/32"	1/16"	840-3183	\$4.85	\$4.04
B. #3	1/8"	1/16"	840-3186	6.10	5.08
C. #5	1/8"	1/8"	840-3187	7.05	5.87



D-F Cratex® Cylinder and Point Mandrels

Fit Cratex cylinders and points. Mandrels #1 and #4 have a number 3-48 thread and hex nut flange. Mandrel #6 has a number 5-40 thread and hex nut flange.

Style	Shank	For Hole	Item#	EACH Prices	
				1-11	12+
D. #1	3/32"	3/32"	840-3182	\$3.40	\$2.83
E. #4	1/8"	3/32"	840-3185	4.60	3.83
F. #6	1/8"	1/8"	840-3085	5.30	4.42

Shown actual size

G. Cratex® Cone Mandrel – 1/4" Shank

Fits Cratex cones. Max. operating speed with 1/2" overhang (exposed mandrel length) or less: 20,000rpm. With each additional 1/4" of overhang, max. operating speed decreases by at least 20%. Use light working pressure.

Style	Shank	For Hole	Item#	EACH Prices	
				1-11	12+
1341	1/4"	1/4"	840-3180	\$7.90	\$6.58



Shown actual size

H. Cratex® Large Wheel Mandrel – 1/4" Shank

Fits Cratex wheels up to 3" dia. x 1/2" thick or less. Max. operating speeds with 1/2" overhang or less: 15,000rpm for 1 1/2" wheels; 8,300rpm for 2" wheels; 7,000rpm for 3" wheels (based on 5,500 surface feet per minute). Best results are usually obtained at 30% to 80% of max. operating speed. Use light working pressure.

Style	Shank	For Hole	Item#	EACH Prices	
				1-11	12+
1342	1/4"	1/4"	840-3184	\$12.35	\$10.29

I-K Split Mandrels – 3/32" Shank

For holding strips of abrasive paper. Have 3/32" shanks.

Description	Item#	EACH Prices	
		1-11	12+
I. Straight Head, 1 1/64"	840-3405	\$2.45	\$2.04
J. Straight Head, 9/64"	840-3406	2.45	2.04
K. Tapered Head, 3/32"-3/16"	840-3407	2.45	2.04



L Sun Snap Mandrel -

Use with Sunburst Snap-On abrasive see page 80.

Style	Shank	Item#	EACH Prices	
			1-5	6+
T. Single	3/32"	840-3411	\$11.99	-
Pkg. of 3		840-3410	32.95	\$31.30

Measurement Comparison Chart

inch	mm	B&S Gauge	Stubb's Steel Wire	Drill#
.0030	0.076	-	-	-
.0040	0.102	-	-	-
.0050	0.127	-	-	-
.0059	0.150	-	-	97
.0060	0.152	-	-	-
.0063	0.160	-	-	96
.0067	0.170	-	-	95
.0070	0.178	-	-	-
.0071	0.180	-	-	94
.0075	0.190	-	-	93
.0079	0.200	-	-	92
.0080	0.203	-	-	-
.0083	0.210	-	-	91
.0087	0.220	-	-	90
.0090	0.229	-	-	-
.0091	0.230	-	-	89
.0095	0.241	-	-	88
.0100	0.254	-	-	87
.0105	0.267	-	-	86
.0110	0.279	-	-	85
.0115	0.292	-	-	84
.0120	0.305	-	-	83
.0125	0.320	-	-	82
.0130	0.330	-	80	81
.0135	0.343	-	-	80
.0140	0.356	-	79	-
.0142	0.361	27	-	-
.0145	0.369	-	-	79
.0150	0.381	-	78	-
.0159	0.404	26	-	-
.0160	0.406	-	77	78
.0179	0.455	25	-	-
.0180	0.457	-	76	77
.0200	0.508	-	75	76
.0201	0.511	24	-	-
.0210	0.533	-	-	75
.0220	0.559	-	74	-
.0225	0.572	-	-	74
.0226	0.574	23	-	-
.0230	0.584	-	73	-
.0240	0.610	-	72	73
.0250	0.635	-	-	72
.0253	0.643	22	-	-
.0260	0.660	-	71	71
.0270	0.685	-	70	-
.0280	0.712	-	-	70
.0285	0.724	21	-	-
.0290	0.737	-	69	-
.02925	0.743	-	-	69
.0300	0.762	-	68	-
.0310	0.787	-	67	68
.0320	0.813	20	66	67
.0330	0.838	-	65	66
.0350	0.889	-	64	65
.0359	0.912	19	-	-
.0360	0.914	-	63	64
.0370	0.940	-	62	63
.0380	0.965	-	61	62
.0390	0.990	-	60	61
.0400	1.016	-	59	60

inch	mm	B&S Gauge	Stubb's Steel Wire	Drill#
.0403	1.024	18	-	-
.0410	1.041	-	58	59
.0420	1.067	-	57	58
.0430	1.092	-	-	57
.0450	1.143	-	56	-
.0453	1.151	17	-	-
.0465	1.181	-	-	56
.0500	1.270	-	55	-
.0508	1.290	16	-	-
.0520	1.321	-	-	55
.0550	1.397	-	54	54
.0571	1.450	15	-	-
.0580	1.473	-	53	-
.0595	1.512	-	-	53
.0630	1.600	-	52	-
.0635	1.613	-	-	52
.0641	1.629	14	-	-
.0660	1.676	-	51	-
.0670	1.702	-	-	51
.0690	1.753	-	50	-
.0700	1.778	-	-	50
.0720	1.829	13	49	-
.0730	1.854	-	-	49
.0750	1.905	-	48	-
.0760	1.930	-	-	48
.0770	1.956	-	47	-
.0785	1.994	-	-	47
.0790	2.007	-	46	-
.0808	2.052	12	-	-
.0810	2.057	-	45	46
.0820	2.083	-	-	45
.0850	2.159	-	44	-
.0860	2.184	-	-	44
.0880	2.235	-	43	-
.0890	2.261	-	-	43
.0907	2.304	11	-	-
.0920	2.337	-	42	-
.0935	2.378	-	-	42
.0950	2.413	-	41	-
.0960	2.438	-	-	41
.0970	2.464	-	40	-
.0980	2.489	-	-	40
.0990	2.515	-	39	-
.0995	2.528	-	-	39
.1010	2.565	-	38	-
.1015	2.578	-	-	38
.1019	2.588	10	-	-
.1030	2.616	-	37	-
.1040	2.642	-	-	37
.1060	2.692	-	36	-
.1065	2.705	-	-	36
.1080	2.743	-	35	-
.1100	2.794	-	34	35
.1110	2.819	-	-	34
.1120	2.845	-	33	-
.1130	2.870	-	-	33
.1144	2.906	9	-	-
.1150	2.921	-	32	-
.1160	2.946	-	-	32

inch	mm	B&S Gauge	Stubb's Steel Wire	Drill#
.1200	3.048	-	31	31
.1270	3.226	-	30	-
.1285	3.264	8	-	30
.1340	3.404	-	29	-
.1360	3.454	-	-	29
.1390	3.531	-	28	-
.1405	3.573	-	-	28
.1430	3.636	-	27	-
.1440	3.662	-	-	27
.1443	3.670	7	-	-
.1460	3.712	-	26	-
.1470	3.758	-	-	26
.1480	3.763	-	25	-
.1495	3.802	-	-	25
.1510	3.835	-	24	-
.1520	3.861	-	-	24
.1530	3.886	-	23	-
.1540	3.912	-	-	23
.1550	3.937	-	22	-
.1570	3.988	-	21	22
.1590	4.039	-	-	21
.1610	4.085	-	20	20
.1620	4.111	6	-	-
.1640	4.162	-	19	-
.1660	4.212	-	-	19
.1680	4.263	-	18	-
.1695	4.302	-	-	18
.1720	4.371	-	17	-
.1730	4.396	-	-	17
.1750	4.447	-	16	-
.1770	4.498	-	-	16
.1780	4.523	-	15	-
.1800	4.570	-	14	15
.1819	4.618	5	-	-
.1820	4.621	-	13	14
.1850	4.697	-	12	13
.1880	4.773	-	11	-
.1890	4.799	-	-	12
.1910	4.855	-	10	11
.1935	4.919	-	-	10
.1940	4.932	-	9	-
.1960	4.982	-	-	9
.1970	5.008	-	8	-
.1990	5.059	-	7	8
.2010	5.105	-	6	7
.2040	5.182	-	5	6
.2043	5.189	4	-	-
.2055	5.220	-	-	5
.2070	5.258	-	4	-
.2090	5.309	-	-	4
.2120	5.381	-	3	-
.2130	5.406	-	-	3
.2190	5.559	-	2	-
.2210	5.615	-	-	2
.2270	5.768	-	1	-
.2280	5.793	-	-2	1
.2294	5.829	3	-	-
.2576	6.543	2	-	-
.2893	7.346	1	-	-

Fraction, Inch and Millimeter Conversion Chart

Fraction	inch	mm
1/64	.0156	0.3969
1/32	.0313	0.7937
3/64	.0469	1.1906
1/16	.0625	1.5875
5/64	.0781	1.9843
3/32	.0937	2.3812
7/64	.1094	2.7781
1/8	.1250	3.1750
9/64	.1406	3.5718
5/32	.1562	3.9687
11/64	.1719	4.3656
3/16	.1875	4.7624
13/64	.2031	5.1593
7/32	.2187	5.5562
15/64	.2344	5.9530
1/4	.2500	6.3499

Fraction	inch	mm
17/64	.2656	6.7468
9/32	.2812	7.1437
19/64	.2969	7.5405
5/16	.3125	7.9374
21/64	.3281	8.3343
11/32	.3438	8.7312
23/64	.3594	9.1280
3/8	.3750	9.5249
25/64	.3906	9.9217
13/32	.4062	10.3186
27/64	.4219	10.7155
7/16	.4375	11.1124
29/64	.4531	11.5092
15/32	.4687	11.9061
31/64	.4844	12.3030
1/2	.5000	12.6999

Fraction	inch	mm
33/64	.5156	13.0968
17/32	.5313	13.4936
35/64	.5469	13.8905
9/16	.5625	14.2874
37/64	.5781	14.6842
19/32	.5938	15.0811
39/64	.6094	15.4780
5/8	.6250	15.8749
41/64	.6406	16.2717
21/32	.6563	16.6686
43/64	.6719	17.0655
11/16	.6875	17.4623
45/64	.7031	17.8592
23/32	.7188	18.2561
47/64	.7344	18.6529
3/4	.7500	19.0498

Fraction	inch	mm
49/64	.7656	19.4467
25/32	.7813	19.8436
51/64	.7969	20.2404
13/16	.8125	20.6373
53/64	.8281	21.0342
27/32	.8438	21.4311
55/64	.8594	21.8279
7/8	.8750	22.2248
29/32	.9063	23.0185
59/64	.9219	23.4154
15/16	.9375	23.8123
61/64	.9531	23.2091
31/32	.9688	24.6060
63/64	.9844	25.0029
1	1.0000	25.3998

Metal Thicknesses in Millimeters and B&S Gauge

Ring Size	Circumference in mm	2.1mm 12ga.	1.6mm 14ga.	1.3mm 18ga.	1mm 18ga.	0.8mm 20ga.	0.6mm 22ga.	0.5mm 24ga.
1	39.0	45.5	44.2	43.0	42.1	41.5	40.9	40.5
1¼	39.6	46.2	44.6	43.6	42.7	42.1	41.5	41.1
1½	40.2	46.9	45.2	44.3	43.3	42.7	42.1	41.8
1¾	40.8	47.7	45.8	44.9	44.0	43.3	42.7	42.4
2	41.5	48.0	46.5	45.5	44.6	44.0	43.3	43.0
2¼	42.1	48.7	47.1	46.2	45.2	44.6	44.0	43.6
2½	42.7	49.3	47.7	46.8	45.8	45.2	44.6	44.3
2¾	43.4	49.9	48.4	47.4	46.5	45.8	45.2	44.9
3	44.0	50.6	49.0	48.0	47.1	46.5	45.8	45.6
3¼	44.6	51.2	49.6	48.7	47.7	47.1	46.5	46.2
3½	45.2	51.8	50.2	49.3	48.4	47.7	47.1	46.8
3¾	45.9	52.4	50.9	49.9	49.0	48.4	47.7	47.4
4	46.5	53.1	51.5	50.6	49.6	49.0	48.3	48.0
4¼	47.1	53.7	52.1	51.2	50.2	49.6	49.0	48.7
4½	47.8	54.3	52.8	51.8	50.9	50.2	49.6	49.3
4¾	48.4	55.0	53.4	52.4	51.5	50.9	50.2	49.9
5	49.0	55.6	54.0	53.1	52.1	51.5	50.9	50.6
5¼	49.6	56.2	54.6	53.7	52.8	52.1	51.5	51.2
5½	50.3	56.8	55.3	54.3	53.4	52.7	52.1	51.8
5¾	50.9	57.5	55.9	55.0	54.0	53.4	52.8	52.4
6	51.5	58.1	56.5	55.6	54.6	54.0	53.4	53.1
6¼	52.2	58.7	57.1	56.2	55.3	54.6	54.0	53.7
6½	52.8	59.3	57.8	56.8	55.9	55.3	54.6	54.3
6¾	53.4	60.0	58.4	57.5	56.5	55.9	55.3	55.0
7	54.0	60.6	59.0	58.1	57.1	56.5	55.9	55.6
7¼	54.7	61.2	59.7	58.7	57.8	57.1	56.5	56.2
7½	55.3	61.9	60.3	59.3	58.4	57.8	57.1	56.8
7¾	55.9	62.5	60.9	60.0	59.0	58.4	57.8	57.5
8	56.6	63.1	61.5	60.6	59.7	59.0	58.4	58.1
8¼	57.2	63.7	62.2	61.2	60.3	59.7	59.0	58.7
8½	57.8	64.4	62.8	61.9	60.9	60.3	59.7	59.3
8¾	58.4	65.0	63.4	62.5	61.5	60.9	60.3	60.0
9	59.1	65.6	64.1	63.1	62.2	61.5	60.9	60.6
9¼	59.7	66.3	64.7	63.7	62.8	62.2	61.5	61.2
9½	60.3	66.9	65.3	64.4	63.4	62.8	62.2	61.9
9¾	60.9	67.5	65.9	65.0	64.1	63.4	62.8	62.5
10	61.6	68.1	66.6	65.6	64.7	64.1	63.4	63.1
10¼	62.2	68.8	67.2	66.3	65.3	64.7	64.1	63.7
10½	62.8	69.4	67.8	66.9	65.9	65.3	64.7	64.4
10¾	63.5	70.0	68.5	67.5	66.6	65.9	65.3	65.0
11	64.1	70.7	69.1	68.1	67.2	66.6	65.9	65.6
11¼	64.7	71.3	69.7	68.8	67.8	67.2	66.6	66.3
11½	65.3	71.9	70.3	69.4	68.5	67.8	67.2	66.9
11¾	66.0	72.5	71.0	70.0	69.1	68.5	67.8	67.5
12	66.6	73.2	71.6	70.7	69.7	69.1	68.5	68.1
12¼	67.2	73.8	72.2	71.3	70.3	69.7	69.1	68.8
12½	67.9	74.4	72.8	71.9	71.0	70.3	69.7	69.4
12¾	68.5	75.0	73.5	72.5	71.6	71.0	70.3	70.0
13	69.1	75.7	74.1	73.2	72.2	71.6	71.0	70.7

Conversion Charts

Volume (Liquid)

To convert the following to:	fluid ounces (fl. oz.)	U.S. gallons (gals.)	milliliters (ml)	liters (L)
Multiply number of	By	By	By	By
fluid ounces	1	0.0078125	29.57353	0.02957353
U.S. gallons	128	1	3,785	3.785
milliliters	0.03381402	0.000264172	1	0.001
liters	33.81402	0.2641720	1,000	1

Mass

To convert the following to:	ounces (oz.)	pounds (lbs.)	grams (g)	kilograms (kg)
Multiply number of	By	By	By	By
ounces	1	0.0625	28.34952	0.02834952
pounds	16	1	453.5924	0.4535924
grams	0.03527397	0.002204623	1	0.001
kilograms	35.273952	2.204622	1,000	1

Length

To convert the following to:	meters (m)	centimeters (cm)	millimeters (mm)	inches (in.)	feet (ft.)
Multiply number of	By	By	By	By	By
meters	1	100	1,000	39.37	3.28
centimeters	0.01	1	10	0.394	0.0328
millimeters	0.001	0.1	1	0.0394	0.00328
inches	0.0254	2.540	25.40	1	0.0833
feet	0.3048	30.48	304.8	12	1

Area

To convert the following to:	square meters (m ²)	square inches (in. ²)	square feet (ft. ²)	sq. centimeters (cm ²)	sq. millimeters (mm ²)
Multiply number of	By	By	By	By	By
square meters	1	1,550	10.76	10,000	10 ⁶
square inches	6.452 x 10 ⁻⁴	1	6.94 x 10 ⁻³	6.452	645.2
square feet	0.0929	144	1	929	92,903
square centimeters	0.0001	0.155	0.001	1	100
square millimeters	10 ⁻⁶	0.00155	0.00001	0.01	1

Packaging Conversions

1 kPa = 0.1450377 PSI

1 kPa = 7.5mm Hg

1 psi = 6.9 kPa

625cc ≈ 21 fl. oz.

950cc ≈ 32 fl. oz.

1,000cc = 1 liter ≈ 33.8 fl. oz.

Conversion Charts

Multiply	By	To Calculate
Centimeters	0.3937	Inches
Centimeters	0.0328	Feet
Cubic centimeters	0.0610	Cubic inches
Cubic centimeters	3.531 x 10 ⁶	Cubic feet
Cubic feet	1728	Cubic inches
Cubic feet	0.0283	Cubic meters
Cubic feet	7.4805	Gallons
Cubic feet	28.32	Liters
Cubic feet	59.84	Pints (liq)
Cubic feet	29.92	Quarts (liq)
Cubic inches	0.004329	Gallons
Cubic inches	0.01639	Liters
Cubic inches	0.0346	Pints (liq)
Cubic inches	0.0173	Quarts (liq)
Cubic inches	16.387	Cubic centimeters
Drams	27.34	Grains
Drams	0.0625	Ounces
Drams	1.7718	Grams
Feet	30.48	Centimeters
Gallons	3785	Cubic centimeters
Gallons	3.785	Liters
Gallons	8	Pints (liq)
Gallons	4	Quarts (liq)
Gallons	0.1337	Cubic feet
Gallons	231	Cubic inches
Gallons	0.0038	Cubic meters
Grams	15.4324	Grains
Grams	0.03527	Ounces
Grams	0.03215	Troy ounces
Grams	5	Carats
Inches	2.540	Centimeters
Kilograms	2.2046	Pounds
Liters	2.1133	Pints
Liters	1.0567	Quarts
Liters	0.2642	Gallons
Millimeters	0.03937	Inches
Ounces	0.0625	Pounds
Pints	0.4732	Liters
Pounds	0.4536	Kilograms
Quarts	0.9464	Liters
Square centimeters	0.1550	Square inches
Square centimeters	0.001076	Square feet
Square feet	929.0	Square centimeters
Square feet	92,903.04	Square millimeters
Square inches	6.452	Square centimeters
Square inches	645.2	Square millimeters
Square millimeters	00.153	Square inches

Troy Weight

24 grains	1 pennyweight
20 pennyweights	1 ounce
12 ounces	1 pound
The troy ounce is about 10% heavier than the avoirdupois ounce.	
Troy ounce x 1.0971 = avoirdupois ounce.	

Weight Relationships

1 carat	1/5 gram
3,086 grains	
1 avoird. lb.	14.58 troy oz.
7,000 grains	
1 troy lb.	13.17 avoird oz.
5,760 grains	
1 gram	5 carats
15.432 grains	
1 avoird oz.	.911 troy oz.
28.25 grams	
1 troy oz.	1.097 avoird oz.
31.10 grams	

Douzieme Gauge

The gauge is divided into 72 sections or douziemes.	
1 douzieme =	1 gauge =
.0074 inch	
1 ligne =	12 douzieme =
.0888 inch	

Avoirdupois Weight

27 1/3 grams	1 dram
16 drams	1 ounce
16 ounces	1 pound
The avoirdupois pound is about 2 1/2% heavier than the troy pound.	
Avoirdupois ounce x 0.91146 = troy ounce.	

Temperature Conversion Formulas

To convert from Celsius to Fahrenheit:

$$(^{\circ}\text{C} \times 1.8) + 32 = ^{\circ}\text{F}$$

To convert from Fahrenheit to Celsius:

$$(^{\circ}\text{F} - 32) \div 1.8 = ^{\circ}\text{C}$$

Volume

(Cubic measure calculation)	
Cylinder	$\pi r^2 h$
Cube/Rectangle	L x W x H
Cone	$1/3 \pi r^2 h$
Sphere	$4/3 \pi r^3$

Area Calculations

Circle	πr^2 ($2\pi r$ = circumference)
Square	L x W
Triangle	W x 1/2H

Temperature Conversion Table

Read the reference temperature in boldfaced type in the center column. The corresponding Celsius temperature is at the left, and the corresponding Fahrenheit temperature is at the right.

Temperature Conversion Formulas:

$$^{\circ}\text{C} = \frac{5}{9}(^{\circ}\text{F} - 32)$$

$$^{\circ}\text{F} = \frac{9}{5}^{\circ}\text{C} + 32$$

$^{\circ}\text{C}$	Ref.	$^{\circ}\text{F}$	$^{\circ}\text{C}$	Ref.	$^{\circ}\text{F}$	$^{\circ}\text{C}$	Ref.	$^{\circ}\text{F}$	$^{\circ}\text{C}$	Ref.	$^{\circ}\text{F}$	$^{\circ}\text{C}$	Ref.	$^{\circ}\text{F}$	$^{\circ}\text{C}$	Ref.	$^{\circ}\text{F}$	$^{\circ}\text{C}$	Ref.	$^{\circ}\text{F}$	$^{\circ}\text{C}$	Ref.	$^{\circ}\text{F}$
-17.9	0	32	24.4	76	168.8	321	610	1130	743	1370	2498	1166	2130	3866	1588	2890	5234	2010	3650	6602	2432	4410	7970
-17.2	1	33.8	25.0	77	170.6	327	620	1148	749	1380	2516	1171	2140	3884	1593	2900	5252	2016	3660	6620	2438	4420	7988
-16.7	2	35.6	25.6	78	172.4	332	630	1166	754	1390	2534	1177	2150	3902	1599	2910	5270	2021	3670	6638	2443	4430	8006
-16.1	3	37.4	26.1	79	174.2	338	640	1184	760	1400	2552	1182	2160	3920	1604	2920	5288	2027	3680	6656	2449	4440	8024
-15.6	4	39.2	26.7	80	176.0	343	650	1202	766	1410	2570	1188	2170	3938	1610	2930	5306	2032	3690	6674	2454	4450	8042
-15.0	5	41.0	27.2	81	177.8	349	660	1220	771	1420	2588	1193	2180	3956	1616	2940	5324	2038	3700	6692	2460	4460	8060
-14.4	6	42.8	27.8	82	179.6	354	670	1238	777	1430	2606	1199	2190	3974	1621	2950	5342	2043	3710	6710	2466	4470	8078
-13.9	7	44.6	28.3	83	181.4	360	680	1256	782	1440	2624	1204	2200	3992	1627	2960	5360	2049	3720	6728	2471	4480	8096
-13.3	8	46.4	28.9	84	183.2	366	690	1274	788	1450	2642	1210	2210	4010	1632	2970	5378	2054	3730	6746	2477	4490	8114
-12.8	9	48.2	29.4	85	185.0	371	700	1292	793	1460	2660	1216	2220	4028	1638	2980	5396	2060	3740	6764	2482	4500	8132
-12.2	10	50.0	30.0	86	186.8	377	710	1310	799	1470	2678	1221	2230	4046	1643	2990	5414	2066	3750	6782	2488	4510	8150
-11.7	11	51.8	30.6	87	188.6	382	720	1328	804	1480	2696	1227	2240	4064	1649	3000	5432	2071	3760	6800	2493	4520	8168
-11.1	12	53.6	31.1	88	190.4	388	730	1346	810	1490	2714	1232	2250	4082	1654	3010	5450	2077	3770	6818	2499	4530	8186
-10.6	13	55.4	31.7	89	192.2	393	740	1364	816	1500	2732	1238	2260	4100	1660	3020	5468	2082	3780	6836	2504	4540	8204
-10.0	14	57.2	32.2	90	194.0	399	750	1382	821	1510	2750	1243	2270	4118	1666	3030	5486	2088	3790	6854	2510	4550	8222
-9.44	15	59.0	32.8	91	195.8	404	760	1400	827	1520	2768	1249	2280	4136	1671	3040	5504	2093	3800	6872	2516	4560	8240
-8.89	16	60.8	33.3	92	197.6	410	770	1418	832	1530	2786	1254	2290	4154	1677	3050	5522	2099	3810	6890	2521	4570	8258
-8.33	17	62.6	33.9	93	199.4	416	780	1436	838	1540	2804	1260	2300	4172	1682	3060	5544	2104	3820	6908	2527	4580	8276
-7.78	18	64.4	34.4	94	201.2	421	790	1454	843	1550	2822	1266	2310	4190	1688	3070	5568	2110	3830	6926	2532	4590	8294
-7.22	19	66.2	35.0	95	203.0	427	800	1472	849	1560	2840	1271	2320	4208	1693	3080	5576	2116	3840	6944	2538	4600	8312
-6.67	20	68.0	35.6	96	204.8	432	810	1490	854	1570	2858	1277	2330	4226	1699	3090	5594	2121	3850	6962	2543	4610	8330
-6.11	21	69.8	36.1	97	206.6	438	820	1508	860	1580	2876	1282	2340	4244	1704	3100	5612	2127	3860	6980	2549	4620	8348
-5.58	22	71.6	36.7	98	208.4	443	830	1526	866	1590	2894	1288	2350	4262	1710	3110	5630	2132	3870	6998	2554	4630	8366
-5.00	23	73.4	37.2	99	210.2	449	840	1544	871	1600	2912	1293	2360	4280	1716	3120	5648	2138	3880	7016	2560	4640	8384
-4.44	24	75.2	37.8	100	212.0	454	850	1562	877	1610	2930	1299	2370	4298	1721	3130	5666	2143	3890	7034	2566	4650	8402
-3.89	25	77.0	43	110	230	460	860	1580	882	1620	2948	1304	2380	4316	1727	3140	5684	2149	3900	7052	2571	4660	8420
-3.33	26	78.8	49	120	248	466	870	1598	888	1630	2966	1310	2390	4334	1732	3150	5702	2154	3910	7070	2577	4670	8438
-2.78	27	80.6	54	130	266	471	880	1616	893	1640	2984	1316	2400	4352	1738	3160	5720	2160	3920	7088	2582	4680	8456
-2.22	28	82.4	60	140	284	477	890	1634	899	1650	3002	1321	2410	4370	1743	3170	5738	2166	3930	7106	2588	4690	8474
-1.67	29	84.2	66	150	302	482	900	1652	904	1660	3020	1327	2420	4388	1749	3180	5756	2171	3940	7124	2593	4700	8492
-1.11	30	86.0	71	160	320	488	910	1670	910	1670	3038	1332	2430	4406	1754	3190	5774	2177	3950	7142	2599	4710	8510
-0.56	31	87.8	77	170	338	493	920	1688	916	1680	3056	1338	2440	4424	1760	3200	5792	2182	3960	7160	2604	4720	8528
0	32	89.6	82	180	356	499	930	1706	921	1690	3074	1343	2450	4442	1766	3210	5810	2188	3970	7178	2610	4730	8546
0.56	33	91.4	88	190	374	504	940	1724	927	1700	3092	1349	2460	4460	1771	3220	5828	2193	3980	7196	2616	4740	8564
1.11	34	93.2	93	200	392	510	950	1742	932	1710	3110	1354	2470	4478	1777	3230	5846	2199	3990	7214	2621	4750	8582
1.67	35	95.0	99	210	410	516	960	1760	938	1720	3128	1360	2480	4496	1782	3240	5864	2204	4000	7232	2627	4760	8600
2.22	36	96.8	100	212	413	521	970	1778	943	1730	3146	1366	2490	4514	1788	3250	5882	2210	4010	7250	2632	4770	8618
2.78	37	98.6	104	220	428	527	980	1796	949	1740	3164	1371	2500	4532	1793	3260	5900	2216	4020	7268	2638	4780	8636
3.33	38	100.4	110	230	446	532	990	1814	954	1750	3182	1377	2510	4550	1799	3270	5918	2221	4030	7286	2643	4790	8654
3.89	39	102.2	116	240	464	538	1000	1832	960	1760	3200	1382	2520	4568	1804	3280	5936	2227	4040	7304	2649	4800	8672
4.44	40	104.0	121	250	482	543	1010	1850	966	1770	3218	1388	2530	4586	1810	3290	5954	2232	4050	7322	2654	4810	8690
5.00	41	105.8	127	260	500	549	1020	1868	971	1780	3236	1393	2540	4604	1816	3300	5972	2238	4060	7340	2660	4820	8708
5.56	42	107.6	132	270	518	554	1030	1886	977	1790	3254	1399	2550	4622	1821	3310	5990	2243	4070	7358	2666	4830	8726
6.11	43	109.4	138	280	536	560	1040	1904	982	1800	3272	1404	2560	4640	1827	3320	6008	2249	4080	7376	2671	4840	8744
6.67	44	111.2	143	290	554	566	1050	1922	988	1810	3290	1410	2570	4658	1832	3330	6026	2254	4090	7394	2677	4850	8762
7.22	45	113.0	149	300	572	571	1060	1940	993	1820	3308	1416	2580	4676	1838	3340	6044	2260	4100	7412	2682	4860	8780
7.78	46	114.8	154	310	590	577	1070	1958	999	1830	3326	1421	2590	4694	1843	3350	6062	2266	4110	7430	2688	4870	8798
8.33	47	116.6	160	320	608	582	1080																

ULTRASONIC CLEANER BRAND COMPARISON

Brand	BestBuilt	L&R Quantrex	Digital	GemOro	Elma "Easy" Series	Elma "P" Series
Capacity	2 qts., 3½ qts., 6 qts., 10 qts., or 22 qts.	2 qts., 3¾ qts., 6 qts., 14½ qts., or 26 qts.	2½ qts.	1½ pt., 2 qts., 3 qts.	1 qts., 2 qts., 3 qts., 4 qts., 6 qts., 10 qts., 14 qts., 20 qts. or 30 qts.	3 qts., 4 qts., 6 qts., 14 qts., 20 qts. or 30 qts.
Frequency	40kHz	43kHz	42kHz	40kHz	37kHz	37/80kHz
Workload	Medium to Heavy	Medium to Heavy	Light to Medium	Medium to Heavy	Medium to Heavy	Medium to Heavy
Control	Analog	Analog	Digital	Analog	Analog	Analog & Digital
Timer	0–30 min.	0–60 min.	5 Different Cycles	0–60 min.	0–30 min.	0–30 min.
Timer Bypass	No	No	No	No	Yes	Yes
Heater	Yes	Yes	Yes	Yes (except 1.5)	Yes	Yes
Housing	Powder-Coated Steel	Vinyl-Clad Steel	ABS Plastic	Stainless Steel	Stainless Steel	Stainless Steel
Tank	Stainless Steel	Stainless Steel	Stainless Steel	Stainless Steel	Stainless Steel	Stainless Steel
Lid	Yes	Yes	Yes	Yes	Yes	Sold Separately
Drain	Yes (except 2, 3.5 & 6 qt.)	Yes (except 90)	No	No	Yes (except E15H & E30H)	Yes
Country of Origin	South Korea	USA	China	China	Germany	Germany
Catalog page #	238	239	235	239	237	236

ULTRASONIC COMPARISON CHART		RING RACKS					BASKETS						
		851-4107	851-4106	851-4105	851-2050*	851-2052*	851-5101	851-5099	851-5147	851-5121	851-5126	851-5131	851-5105
ITEM #	DESCRIPTION				8 double sided hooks	12 double sided hooks							
851-4906	Digital 2.5 Quart	1	no	no	no	no	no	1	no	no	no	no	1
851-5230	Quantrex 2 Quart	1	no	no	1	1 remove 2 hooks	no	1	no	no	no	no	1
851-5232	Quantrex 3¾ Quart	1	no	1 diagonally	1	1 remove 2 hooks	no	1	no	1	no	no	2
851-5234	Quantrex 6 Quart	2	2	1 diagonally	2	1	2	2	no	no	1	no	2
851-5236	Quantrex 14.5 Quart	no	2	4	3	3	no	no	2	2	1	1	4
851-1000	BestBuilt 2 Quart	1	no	no	1	1 remove 6 hooks	no	1	no	no	no	no	1
851-1002	BestBuilt 3.5 Quart	1	1	1	1	1 remove 2 hooks	no	1	no	1	no	no	1
851-1004	BestBuilt 6 Quart	2	no	1 diagonally	2	1	2	2	no	no	no	no	1
851-1006	BestBuilt 10 Quart	no	2	4	3	1 remove 2 hooks	no	no	2	2	1	1	2
851-1008	BestBuilt 22 Quart	no	no	no	no	4	no	no	no	no	1	1	6

*Depth of hook from bottom of rod to bottom of hook: 2½" Tank must be deep enough

Ordering from Gesswein is Easy!

Phone Orders: 800-243-4466 (Monday–Friday, 9am–5pm EST)

Fax Orders: 888-454-4377 (24 hours a day, toll-free)

E-mail Orders: sales@gesswein.com

Web Orders: www.gesswein.com

For fastest ordering, please use our 7-digit item numbers.

For in-stock items, orders in by 3:00pm EST are usually shipped the same day.

Thank You for Your Order!

As our business grows, so does our volume of incoming phone calls. We know your time is valuable, so to make sure you always have access to toll-free lines when placing your order, without the annoyance of busy signals, we have reserved a set of toll-free lines for orders only.

Our toll-free numbers can be used in all 50 states. Your order will be taken directly by an Inside Sales representative, entered immediately into our computer system, carefully picked, packaged and shipped.

How to Place an Order

Simply visit our website, phone, fax or E-mail your orders or requests for price quotes. **Orders in by 3:00pm EST are usually shipped the same day.** Of course, nonstock items and special-make items require additional time.

Visit our E-commerce website at www.gesswein.com to view the latest products, sale items and pricing and to place orders on-line whenever convenient for you.

When you phone, please have your account number ready. This will help us enter your order quickly and give you current pricing and availability.

Each item in this catalog is coded with a seven-digit item number. Please use these numbers when placing your orders to ensure that the correct products are sent to you. Having these numbers also speeds up the order entry process. If you don't have your account number or the item numbers, we are ready to assist. Simply let us know what you want and we will make it happen! If you cannot locate an item in our catalog, please be sure to let us know. We might be able to find it specially for you!

Credit Cards

We currently accept Visa®, MasterCard®, American Express®, Discover® cards and PayPal™ for payment. For your security, credit card transactions are verified with the credit card company and/or issuing bank. Card number, expiration date, CVV and billing address are checked for your safety.



Prices

For your convenience, we have included prices of our cataloged products. *Please use as a guide only.* Fluctuations in raw material costs, manufacturing costs or foreign currency exchange rates may require price adjustments without notice. Our buyers constantly seek better prices without sacrificing the quality for which Gesswein is known. When successful, we pass the savings on to our customers, adjusting prices accordingly. Our prices do not include shipping and handling charges. All prices are in U.S. funds. Please feel free to call or fax for price quotes. We collect appropriate state and local sales taxes as required by the current laws of each state.

Opening an Account

If you wish to open an account with us and you have a good rating with Dun & Bradstreet (D&B®) or the Jewelers Board of Trade (JBT®), we will immediately establish an open account with 30 day terms. If you are not listed with either agency, please send us three trade references and one bank reference or request an account application and return it to our office in Bridgeport, CT. We will immediately contact your references and inform you of our decision as soon as they respond (which can take approximately two weeks).

Terms of Payment

Open Accounts We reserve the right to impose a service charge of 1½% (18% APR) on all accounts not paid within 30 days.

All Other Accounts Our terms are net, payable in advance by check, money order, bank wire transfer, Visa®, MasterCard®, Discover® or American Express®. Payments accepted in U.S. funds only.

Leasing Options Available For equipment purchases totaling \$5,000.00 or more, you might want to consider leasing options. While Gesswein does not operate an in-house leasing program, we are certainly happy to work closely with your leasing firm of choice or we can suggest one that we work with regularly. Contact us for details at 203-366-5400.

Sales & Customer Service (9am–5pm EST)

To place an order, check prices or make inquiries:

800-243-4466 or 203-366-5400

FAX 203-366-3953 E-mail: sales@gesswein.com

Technical Services (9am–5pm EST)

For technical service or product information:

800-544-2043 or 203-366-5400

FAX 203-366-3953 E-mail: info@gesswein.com

Credit (9am–5pm EST)

For credit or billing inquiries:

☎ 203-366-5400

FAX 203-331-8870 E-mail: info@gesswein.com



Paul H. Gesswein & Company Inc., Home Office, Bridgeport, Connecticut, USA

An Important Note About Our Products

All products sold by Gesswein are intended for use by professional tradespeople, not the general public. Additional documentation may be requested before shipment can be made. Those not knowledgeable in the usage of hazardous equipment and materials should not purchase these products since noncompliance with safety regulations can be dangerous to health and property.

Safety Data Sheets

Safety Data Sheets (SDSs) are available upon request for all products that contain hazardous ingredients. SDSs contain important information such as safety recommendations and emergency procedures. The fastest way to access SDS information is through our website, www.gesswein.com. Click on the SDS button found on our home page, select SDS and search alphabetically for the product. You can also call us Monday–Friday, 9am–5pm EST at 800-544-2043 or 203-366-5400.

Eye Protection

Goggles or safety glasses with shields are recommended when using abrasive products for polishing, grinding or cutting.

Hand Protection

Gloves are recommended but not required when using most abrasive products. Follow the manufacturer’s guidelines.

Hearing Protection

Earmuffs or earplugs may be required when using some abrasive products. See OSHA 29 CFR 1910.95 for statutory noise limits and requirements.

Respiratory Protection

Consider the abrasive product and material to be ground, then select and use equipment in accordance with OSHA 29 CFR 1910.134 in the USA or CSA Z94.4-M1982 in Canada.

Engineering Controls

Provide process enclosure or local ventilation to keep dust below applicable limits and to meet hearing protection requirements.





Operating Practices

- Safe operating practices must be a part of every operation.
- Be sure to read all safety information provided with applicable products.
- Always check products for damage before use.
- Before mounting wheels, use a tachometer to measure spindle speed.
- Ensure that the mounting flanges, backplate or adapter supplied by the machine manufacturer are used and kept in good condition. ANSI Safety Requirements B7.1 provide wheel mounting requirements. Check mounting flanges for equal, correct diameter, and use blotters when supplied.
- Always mount, true and dress wheels in conformance with the guidelines published in ANSI Safety Requirements B7.1.
- Never exceed the maximum operating speed for any product.
- Avoid dropping or bumping wheels.
- When not using wheels, store in their original packaging materials to prevent chips and cracks and to allow easy wheel identification.

Vibrating and Reciprocating Tools

Prolonged use of vibrating or reciprocating tools may result in vibration-induced circulation problems in the hands. Always follow safe operating procedures. The use of hand protection (i.e., insulated gloves) and taking frequent breaks can help minimize but not guarantee against injury. Operating these types of tools in cold weather or with a tight grip will reduce the period of operation before risking potential injury. Individuals with a tendency to suffer from poor circulation, frequently cold fingers or itchy hands should closely monitor the condition of their hands. If symptoms appear, seek medical advice immediately.

Icons Usage

-  Although no hazardous shipping surcharge applies, these items can only ship via UPS Ground, no air, FedEx or US Mail possible. Cannot ship to Alaska, Hawaii or Puerto Rico.
-  UPS hazardous shipping surcharge applies. Ships via UPS® Ground only, no air, FedEx®, or US Mail shipments. Cannot ship to Alaska, Hawaii or Puerto Rico.
-  Shipment by truck is required.
-  Indicates a minimum order is necessary; in this case orders would be in multiples of 6.

Shipping Policy

Shipping and handling charges are all F.O.B. shipping point. A small handling fee is presently charged on all original orders. The method of shipment will be left to our discretion unless you request a specific method.

Truck Shipments

(All items indicated with this  icon will ship via truck.)

All shipping and handling charges are F.O.B. shipping point. If you request a specific carrier, we will be happy to send your shipment collect via that carrier. Otherwise, we have negotiated lower rates with select carriers and will pass savings on to you. Orders are shipped freight prepaid, and the freight appears on your invoice. If the trucker will have to off-load your shipment to a smaller delivery truck (e.g., if you have limited access to your door because of a narrow alleyway), there may be a delay in delivery. Please make us aware of any potential problems so we can take steps to minimize delays.

Truck Shipment Charges – in Addition to the Freight Charge

(subject to change without notice)

The following services can generate extra charges above the normal trucking rates:

- Residential delivery (minimum \$60.00)
- Liftgate service (minimum \$50.00 to \$80.00 based on carrier)
- Inside delivery. Inside delivery is simply placing the shipment inside your door. If you require further assistance, it can be arranged at a premium rate. (minimum \$100.00)
- Hazardous goods surcharge (minimum \$30.00 per shipment)
- Redelivery due to customer unavailability (minimum \$100.00)
- Any changes to shipment after pickup from F.O.B. point (minimum \$100.00)
- Limited access charge (minimum \$60.00 based on new info)

US Postal Service® (USPS) Shipments

All postage and handling charges are F.O.B. shipping point. Orders are shipped postage prepaid, and the postage appears on your invoice. No hazardous goods or liquids can be shipped by US Mail. Please be aware that USPS shipments are not trackable. No COD Shipments.

FedEx® Shipments

No hazardous items may be shipped via FedEx.

Please note: additional handling charges may also apply when factors regarding package size, unusual/remote delivery locations are factored in by the shipper.

FedEx offers a wide range of guaranteed delivery options to fit your needs. However, not all areas have every service available. Ask your Inside Sales representative to confirm your ZIP code for a specific time-of-day delivery commitment:

FedEx First Overnight® – Delivery by 8:30am.

FedEx Priority Overnight® – Delivery by 10:30am.

FedEx Standard Overnight® – Delivery by 3:00pm.

FedEx 2 Day® – Delivery by the second business day.

FedEx Express Saver® – Delivery within three business days.

FedEx Ground – Delivery to continental U.S. within one to five business days and three to seven days for Alaska and Hawaii.

UPS® Shipments

All shipping and handling charges are F.O.B. shipping point. Orders are shipped freight prepaid, and the freight appears on your invoice along with your UPS tracking number.

UPS Ground service is offered for all 50 states plus Puerto Rico. However Since Alaska, Hawaii and Puerto Rico Ground service actually travels via aircraft, certain items are prohibited from shipment to these areas.

UPS® also charges surcharges for hazardous products, unusual remote locations and for residential deliveries of packages that are considered oversized. These vary based on the ZIP code, length of package and method of shipment.

UPS offers a wide range of guaranteed delivery options to fit your needs. However, not all areas have every service available. Check www.ups.com or ask your Inside Sales representative to confirm your ZIP code™ for a specific time-of-day delivery commitment.

UPS Express Critical® – Next-flight-out service can be same-day if conditions are met.

UPS Next Day Air Early A.M.® – Delivery by 8:00, 8:30, 9:00 or 10:00am depending on location. Some locations not available

UPS Next Day Air® (aka UPS RED) – Delivery to every address coast-to-coast and Puerto Rico by 10:30am, noon or end of day depending on location. Alaska and Hawaii may require additional days.

UPS Next Day Air Saver® – Delivery to specific destinations throughout continental U.S. by 3:00pm, 4:00pm or end of day.

UPS 2nd Day Air A.M.® – Morning delivery on the second business day to most metro-commercial addresses throughout U.S., depending on location.

UPS 2nd Day Air® (aka UPS BLUE) – Delivery by the second business day to every address coast-to-coast and Puerto Rico.

UPS 3-Day Select® (aka UPS ORANGE) – Delivery within three business days throughout 48 contiguous states.

Shipping Damage

Orders always leave our facility in excellent condition. Our shipping terms are F.O.B. shipping point, which means you assume ownership the moment your order is picked up by the carrier. Therefore, in the unfortunate circumstance that you find any damage to your shipment, **you as the owner must file a claim with the carrier.** Gesswein will be happy to assist you in any way possible, but you must file the claim yourself.

- If you see any obvious outside damage to a shipping carton, you must write "Damaged" on the carrier's delivery sheet.
- Save all cartons and packing materials. Do not return shipment.
- If, after initial inspection of the shipment, you discover concealed damage, you must promptly contact the carrier for inspection and **save all shipping materials.**
- Gesswein will not assume responsibility for any losses that occur due to your failure to follow these steps.

Truck Shipments

All carriers are liable for any damages that occur during transit. Please be sure all cartons that are listed on your freight bill have actually been delivered. If you find a shortage or suspect a carton might have been damaged during transit, you or the trucker must make a notation of this on the delivery receipt. Do not sign the receipt without a notation. **Retain all cartons and packing materials until after the inspection is completed.**

If shortages or damages are discovered after the packages are opened (concealed loss or damage), notify the carrier within 15 days and request an inspection. **Also retain all cartons and packing materials** until after the inspection is completed. Gesswein will not assume responsibility for any losses that occur due to your failure to follow all of these steps.

UPS® Shipments

United Parcel Service is liable for any loss or damage that occurs during transit. If a shipment is not delivered to you in proper order, make a notation on the delivery receipt. Contact your local UPS® office within 10 days so that we can submit a claim on your behalf and arrange for a replacement. **Save all cartons and packing materials** until after the inspection is completed.

If shortages or damages are discovered after the packages are opened (concealed loss or damage), notify the carrier within 15 days and request an inspection. **Also save all cartons and packing materials** until after the inspection is completed. Gesswein will not assume responsibility for any losses that occur due to your failure to follow these steps.

FedEx® Shipments

FedEx® is liable for losses or damages that occur during transit. If the shipping cartons are obviously damaged, you must write this on the driver's copy of the delivery receipt. You have 10 days to inspect for hidden damage, so don't delay. **In either case, all cartons and packing materials have to be available for inspection.** Please keep in mind that FedEx® requires written notification of possible claims within 10 days of shipment. **Gesswein will not assume responsibility for any losses that occur due to your failure to follow all of these steps.** (Hazardous items cannot be shipped by air.)

Shipping Hazardous Materials

When shipping of hazardous materials is prohibited by specific means, we will ship by the best method possible. UPS® Ground and most trucking firms charge an additional fee for the transport of hazardous materials, including but not limited to acids and corrosive materials. UPS® limits the quantity and type of hazardous items that may be shipped in one carton. Therefore, multiple cartons may have to be used for your order. UPS® assesses their hazardous surcharges per carton. Most trucking firms charge per shipment. No hazardous items may be shipped via FedEx® or USPS®. **Hazardous items can not be shipped by air.**

Hazardous goods can only be shipped by those companies authorized to do so. Therefore, a return of hazardous items to Gesswein can be made only if your company is an authorized shipper of such goods. Call tags and pickups cannot be issued.

The following icons are used in this catalog to denote hazardous materials and how they can be shipped.

 Although no hazardous shipping surcharge applies, these items can only ship via UPS® Ground, no air, FedEx® or US Mail possible. Cannot ship to Alaska, Hawaii or Puerto Rico.

 UPS® hazardous shipping surcharge applies. Ships via UPS® Ground only, no air, FedEx®, or US Mail shipments. Cannot ship to Alaska, Hawaii or Puerto Rico.

Safety Data Sheets

Safety Data Sheets are available at your request for all products that contain hazardous ingredients. SDS contain important user information such as safety recommendations and emergency procedures.

The fastest way to access our SDS information is via our website, www.gesswein.com. You can also call us Monday through Friday from 9am–5pm EST at 203-366-5400.

Important Warning – Please Read!

All products sold by Gesswein are restricted for use by professional tradespeople only. Additional documentation may be required before shipment can be made. Our products are not intended for use by the general public. Those not knowledgeable in the usage of hazardous materials and equipment should not purchase these products since noncompliance with safety regulations can be dangerous to health and property.

All the data in this catalog is true to our knowledge at the time of writing but subject to change without notice to provide best quality and selection.

Worldwide Service

Our international sales staff are ready and waiting to serve you: they routinely schedule shipments to customers all over the world. Coordinating their efforts with expert knowledge of customs regulations, they ensure orders are expedited and delivered on time.

Our service goes well beyond the point of sale. We pack shipments with care, arrange for letters of credit, prepare all necessary documentation and select the most affordable shipping method.

Returns:

If for any reason you wish to return merchandise, simply refer to your packing slip. If you require assistance, contact our Customer Service associates at 1-800-243-4466, and they will be happy to help. Please have your packing slip or invoice handy. All returns must be shipped prepaid and be in unused and resellable condition. Please make sure you carefully package the merchandise to avoid damage during shipment. We do not accept collect nor C.O.D. shipments. Any items we authorize to be returned at our expense should be via the carrier that we specify.

Return Restrictions:

- We reserve the right to charge a re-stocking fee for cataloged products returned after 30 days.
- Nonstock items ordered specially for you are subject to a re-stocking charge.
- Items made to your specifications are not returnable.
- Returns will be credited in the same manner as paid.
- **Hazardous items can be returned only if you are an authorized hazardous goods shipper.**

Gesswein Represents:

Quality and Value – We offer distinguished products of the best quality as well as affordable products of great value.

Service – A philosophy and way of life. It cannot be attributed to a single department, program or policy, but rather to all the things we do to ensure customers are satisfied. Service means giving customers more than they expect, responding to their needs immediately and shipping their orders promptly.

Honesty – To our customers, ourselves and each other. We are in the business of earning and safeguarding trust, so we must always act honorably.

Respect – We demand respect for our customers, each other and the company. Mutual respect leads to understanding, which in turn leads to efficiency.

Teamwork – Our people are totally committed to working together as a team to reach our common goals.

Investment – We invest resources back into the company in order to keep inventory at optimal levels, to fund a technical support staff and to educate our people so they can better serve our customers.



3 in 1 Hand Finisher	71
3 in 1 Polishing Set	463
3Design Cad7 Software	181
3M Products:	
Bandage Tape	470
Belts	389
Bristle Discs	56, 78-79
Clean Walk Mat	386
Cloths	152
Cubitron	56
Diamond Film	389
Diamond Flex	64, 389
Diamond Hand Files	109
Diamond Hand Pads	115
Discs	56, 78-79
Dust Mask	474
High Performance Cloth	152
Lapping Film	74
Mat	386
Micro-Finishing Film	74, 389
Papers	75
Polishing Cloth	152
Radial Bristle Discs	56, 78-79
Regalite Discs	56
Respirator	474
Roloc	56
Sanding Sponge	77
Scotch-Brite	55, 57-59
Tarni-Shield	581
Vetrap Tape	470
Wetordry Paper	75

A

ABRASIVE SECTION: 2-125

Abrasives:

Adalox Discs	77
Air Flex	86, 95
Bands	64, 66
Bear-Tex	54, 59
Belt Sticks & Bands	72, 73
Blasting Media	478
Brightboy Products	89
Caps	70
Cartridge Rolls & Mandrels	65, 66
Cera Points and Wheels	88
Ceramic Stones	24-26
Cloth	62
Compound - Diamond	104-105
Compounds	100-103
Cord & Tape	72
Cratex	90-92
Cut-Off Discs	60-61
Dedeco	60, 81, 94, 95, 150
Detailer	72
Diamond	108-125
Edenta	82
Elite	86
Emery Hand Buffs	68
Everlast Rod	87
Flap Wheels	58, 59, 69, 144
Gem Polishers	115
Gesswein Stones	2-21
GMX	96-99, 151
GRX	93

Abrasives continued:

Heatless Wheels	83
Metalite Cloth	62, 74
Micro-Finishing Film	74
Micro-Mesh	71
Mounted Points	49-52
Mounted Stones	36-48
Paper	74-75
Paper Bullets and Cones	67
Poly Polishers	84
Premounted Rolls	66
PT Platinum Titanium Polishers	85
Pumice Powder	102
Pumice Wheels	81
Ring Shells & Arbors	68
Rods	87
Rubberized	81-95
Sandblasting Media	478
Sanding Detailer	72
Sanding Sponges	77
Satin Finish Buffs	58, 59
Seamless Caps	70
Silicone Points/Wheels	83, 86
Snap On Discs & Mandrels	76
Sticks/Stones	2-35
SX Polishers	85
Tru-Stone	51
Unitized Mounted Points	95
Accu-Melt	225
Accumulator	396
Acetylene Tank	520
Acid, Boric	501
Acid Bottle	362
Acid Neutralizer	510
Acrylic Lap	146
Adalox Pin Hole Discs	77
Adamas Presidium Tester	364
Adapter Chucks	543
Adhesives	496-497
AGT Tester	363
Air:	
Brush Set	223
Cleaners	246, 407
Compressors	249
Di-Profiler	452
Filter/Regulator	248
Grinders	450-452, 454
Gun	250
Handpieces	450-454
Handpiece Oil	457
Hose and Fittings	249
Hydro Air Wash Gun	231
Profilers	452, 453
Scribe Handpiece	440
Wedge Collection Port	403
Airflex	86, 95
Airport, Quatro Collection Port	403
Airsep Oxygen Generator	513
Airtech Vacuum Pumps	214
Akrovest Wax Wash	195
Alcohol Cups, Glass	501

Alcohol Lamps	190
All Cast Products	209
All Grit Stone Sets	19
All in One Cleaning Kit	243
All in One Swiveling Deburrers	194
Alloys	224
Aluminum Oxide Powder	478
Aluminum Polishing Kit	34
American Pattern Files	300-301
Annealing Pan with Pumice	506
Anode System, Umicore	264
Anodes	258, 264
Anti-Fog Face Mask	474
Anti-Oxidizing Flux	501
Anti-Tarnish:	
3M Tarni-Shield Strips and Tabs	581
Bags	581
Cloth	153
Dip	247
Filtration Unit	581
Tissue	579
Antique, Background	269
Anvils	323, 324, 554, 571
Anvil Point	441
Appraisal Forms	581
Apron	473
AQUAFLAME Welder	555
ARBE:	
Dust Collectors	394, 397
Magnetic Tumblers	523
Motors	401
Wax Injector	198
Arbors:	
Bur Chuck	401
Cartridge Roll	66
Drum	64
Polishing Motor	400
Ring Shell	68
Split Ring	62
Arkansas Stones	30-31
Attack Solvent	496
Auracle, Gold Tester	363
Aureus	182
Auto-Vac Investment Mixer	211
B	
B&L Products	342-344, 346, 475
Background Antique	269
Badeco Handpiece	441
Bags, Anti-Tarnish	581
Bags, Zip	580
Baldor Motors	400
Bands, Abrasive	64, 66, 73
Bands, Detailer	72
Bandust Investment	210

Bangle Buff – Buffs

- Bangle Buff 148
- Bangle Form Die Set 327
- Bangle Gauge Size Set 357
- Battery Clamp/Screws 547
- Battery Tester 547
- Batteries, Watch 547
- BCR and BCR Plus 241
- Bead Reamer 256
- Bead Stringing Tweezers 538
- Beading Tools & Plates 488, 489
- Beads, Glass 478
- Beaker:
- Measuring 210
 - Pyrex 266
 - Stainless Steel 266
 - Tripour 210
- Bear-Tex Products 54, 59
- Beaver Ring Cutter 409
- Beeswax 491
- Bell Jars 213, 220
- Belt Sanders 429, 454
- Belt Sanding 62, 429
- Belt Sticks and Bands 73
- Bench:
- Block Helper 324
 - Blocks 324
 - Brush 133
 - Chair 569
 - Drawing 419
 - Duster 133
 - Filing Blocks, Rubber 571
 - Knife 549
 - Lamps 335-339
 - Lathe 398
 - Microscope 348
 - Motor & Accessories 398
 - Pins, Quatro 403
 - Pins & Anvil 571
 - Shears 384
 - Shield 459
 - Stones 29-31, 33-34
 - System, Foredom 445
 - Tool Set 567
 - Vacuum System 394
 - Vises 543-546
 - Watchmaker's 568
 - Work 568
- Benchmate & Access 572-573
- Benchtop:
- Drill Press 446
 - Dust Collector 397
 - Organizer 574
 - Sandblaster 476
- Bender, Ring 409
- Bending Blocks 324
- Bergeon:
- Cutter 383
 - Ring Stick 354
- BestBuilt:
- Deluxe Cleaning Kit 238
 - Dust Collectors 396
 - Engravers 276
 - Ultrasonic Cleaners 238
- Bezel:
- Block & Punch 326
 - Bur 164
 - Roller & Pusher 486
- BH-60 Brushless Handpiece 432
- Bib Apron 582
- Binding Wire 508
- Binocular:
- Eschenbach 346
 - Magni-Focuser 344
 - Microscope 348-349
 - Optivisor 345
- BL Pins 117
- Black Antique 269
- Black Rhodium 263, 268
- Blades, Knife 204
- Blades, Saw 482-483
- Blanks and Cutters 178-179
- Blaster, Sand & Media 476-478
- Blazer Torch 521
- Blocks:
- Beading 493
 - Bench/Bending 324
 - Bench Filing 571
 - Dapping & Design 328
 - Engraving 288-289
 - Soldering 507
- Blue:
- Bufs 139
 - EDM Stones 8, 19, 20
 - Mounted Stones and Points 44-47, 50
 - Ribbon Drills 252
 - Zirconia Discs 76, 77
- Bobs:
- Diamond Filled 145
 - Durotex 145
 - Felt 142-143, 145-146
 - Wood 107
- Boley Tweezers 533, 537, 538
- Bone, Cuttlefish 204
- Book, Casting 218
- Book, Tumbling 529
- Borax 501
- Borax Brushes 134
- Boric Acid 501
- Boron Carbide Paste, Tetrabor 107
- Bowl:
- Pitch, Cast Iron 290
 - Rubber Mixing 210
- Box:
- Grinding 459
 - for Imaging Systems 332
 - Metal, Round 576
- Box continued:
- Plastic 578
 - Wood for 3/32" Burs 177
- Bracelet Bangle Felt Buff 148
- Bracelet Cutter 552
- Bracelet Holder, Tennis 487
- Bracelet Mandrels 326
- Bracelet Wax and Shaper 185, 187
- Brass Brushes 127, 128, 131, 132
- Brass Hammers and Mallets 319, 323
- Brass Practice Rings + Tags 281
- Brightboy Abrasives 89
- Brilliant Buff 140
- Brilliant Spa 243
- Bristle Disc, 3M 78-19
- Bristle End Brushes 128-129
- Bronze, Manganese 224
- BRUSH SECTION: 126-135**
- Brushes:
- Air 223
 - Bench 133
 - Borax 134
 - Brass 127, 128, 131, 132
 - EL-192 129
 - End 128, 129
 - Fiberglass & Refills 132
 - Flux 134
 - Hand 132, 133
 - Micro Spiral 134
 - Miniature Mandrel 126-128, 131
 - Motor – Foredom 444
 - Motor – PowerHand 434
 - Nylon Tube 134
 - Scratch Pen 132
 - Supra ME, MK, MKM, MM 126-129
 - Tube 134
 - Washout 133
 - Watchmaker 133
 - Wheel 126-127, 129-131
 - Wire Scratch 131
 - Wood Hub 130
- BUFF SECTION: 136-153**
- Buffing Compounds 100-103
- Bufs:
- Battle Gray 139
 - Blue Platinum 139
 - Brilliant 140
 - Canton Flannel 140
 - Cotton String 140, 141
 - Cylinder 140
 - Duratex 140
 - Emery Hand 68
 - Faux Chamois 141
 - Felt Ring 148
 - Felt Wheel 140, 147, 148
 - Goblet 140
 - Lead Center 136
 - Mandrel 141, 144
 - Muslin 136-139, 141
 - Muslin, Mounted 141
 - Plum 138, 139

Bufs continued:

- Razor Edge 137, 138, 139
- Ring, Felt 148
- Ring, Silicone 94
- Satin Finish 58, 59
- Satin Finished, Mounted 58
- Silicone Ring 94
- Spiral 138
- Tapered 140
- Yellow Treated 137,138, 140,141

Bunsen Burner 190

BUR SECTION: 154-179

Bur:

- Bezel Cone 164
- Box, Wood 177
- Busch 154-158,160, 168-169
- Carbide 158, 166-176
- Chuck 401, 542
- Cup 160
- Fox Champion 160
- Friction Grip Carbide 171
- Handy Block 177, 570
- High Speed 161-164
- Holdes 177, 570, 571
- Inox Carbide 176
- Jewelers Carbide 166-167
- Maillefer 159
- S.S. White Carbide 170
- Stand & Holders 177
- Super Carbide 169
- Swiss 159
- TiNitride, H.S. 165
- Wax 192

Burner:

- Bunsen 190
- Electric 266

Burnishers:

- Busch 158
- Carbide 494
- Faceted 233
- Margin Roller 233
- Rotary 233
- Setting 485
- SonoCraft 232
- Steel 490

Burnishing Compounds 522, 527

Burno Tongs 222

Burnout Fume Hood 246

Burnout Ovens/Furnaces 213-217

Burs 154-176, 192

Busch:

- Beading Tools 488
- Burs 154-158, 168-169
- Carbide Burs 168-169
- Carbide Drills 168
- Carbide Starlight Burnishers 158
- High Tech Tools 168
- Polishing Points 51
- Super Carbide Burs 169
- TiNitride Carbide T426 Bur 167
- Twist Drills 158, 168, 253
- Vacuum Pumps 250

Butane Torch, Magic 521

BX Pins 116

BZX Power Hand Handpiece 429

C

Cabinet, Ultramax MF 3 in 1 421

CAD/CAM SECTION: 180-183

California Compressor 249

Calipers 350-351

Canton Flannel Bufs 140

Cap, Seamless Abrasive 70

Cape Cod Cloth 153

Carbide:

- Blanks and Cutters 179
- Burnisher 494
- Burs 166-176
- Cutter 368, 382
- Drawplate 419
- Drill 178, 253
- End Mill 179
- Gravers 286
- Nippers 382
- Scraper 490
- Scriber 293
- Super Carbide Burs 169

Carbon Steel Shot Cleaner 530

Carbon Steel Shot 530

Carbon Treatment Set 265

Card File 309

Cartridge Rolls 65, 66

Carrier for Tank 520

Cartridge Rolls & Mandrels 65-66

Carvers, Wax 192, 194

Carvers, Wax Electric 190-191

Carvers, Waxes 184-185, 189

Case Knife 549

Castaldo Products:

- Injection Wax 197
- Liquacast + Liquafast 203
- Mold Frames 202, 203
- Mold Lock Formers 200
- Moldmatic 202
- Mold Release Sprays 194, 202
- Mold Rubber 200-203
- Mold Separation Cream 202
- Plast-O-Wax 197
- Quick-Sil 202
- Resin Release Spray 202
- RTV 202
- SuperStretch 201
- VLT 200
- Wax 197

CASTING SECTION: 184-234

Casting:

- Flasks & Sleeves 207
- Kits 219
- Machine, Cast/T 221
- Machine, Centrifugal 220
- Machine, Galloni 226-230
- Machine, Neycraft 220

CBN 116, 117

C-Clear 101

Cement 216, 495, 497

Center Punch 254

Centrifugal Casting Mach 220, 221

Cera Points and Wheels 88

Ceramic:

- Cristone 27
- Deflash Tools 194
- Diamond 26
- Grinding Wheels 54, 292
- Lap, GRS Powerhone 292
- Media 528
- NSS 24-25
- Ring Solder Stand 508
- Soldering Board 506
- Super Stones 24-26
- Stirring Rod 223
- Stone Dresser 26
- Tweezers 539

Ceramation & Catalyst 270

Ceres Diamond Testers 363

Chair, Work Bench 569

Champagne, Norton Paper 75

Charcoal Blocks 507

Charts 598-603

Chasing Hammers 320, 321, 322

Chasing Tools 327

Chicago Air Scribe 440

Chinese White 293

Chip, Plumb Gold Solder 499

Chisel Points, Diamond 124

Chisels, HS Die Sinkers 327

Chrome Compound 100

Chuck:

- Adapters 543
- Engravers XT1 30
- Keys 444
- Pin Vises 542
- Swivel Handle 542

Citpic Compound 510

Clamp:

- Peg 290
- Ring 410
- Ring Holding 148, 410

Classic Ultrasonic Cleaning Solution 241

Claw Setting Jig 487

Clay, Crucibles 223

Clay, Mold 208

Clean Walk Mat 386

Cleaner:

- BCR and BCR Plus 241
- BestBuilt 238
- Burnishing Compound M 522
- Classic Ultrasonic Solution 241
- Degreaser 247
- Electro 265
- Elma SX30H 237

Cleaner – Diamond

Cleaner continued:

Elmasonic	237
File	309
Ionic	240
L&R	239
Magic Green	242
Powder, Steam	245
Quantrex	239
Rub & Rinse	35
Sonic Wave	236
Speed Brite, Ionic	240
Steam	243-245
Steel Shot	527, 530
Ultrasonic	241

CLEANING SECTION: 235-247

Clearview Hood	402
Clip-On Binocular	346
Cloth Flap Wheels	69
Cloth Metalite	74
Clothing, Work	473
Cloths, Polishing & Cleaning	152-153
Clover Lapping Compound	107
Cluster Diamond Dressers	125
C-Max Gravers	285
Coat, Lab	582
Coated Abrasives	62-76
Cob, Ground	529
Cobalt Ring Cutter	411
Cocker-Weber Brushes	130
Colibri Tap & Die	256
CollectAll	392
Collet, Reducing	434
Color Master Grading Stones	364
Colorit	272-273
Combo Disc Cutter	327
Compound:	
#20L	527
#750, #910	527
Buffing	241
Burnishing	522, 527
Citpic	510
Clover	107
C-Clear Watch Crystal	101, 554
Dialux	103
Diamond	104-105
for Magnetic Tumblers	522
Pickling	510
Platinum	101
Polishing	100-103
Rouges and Compounds	100-103
Simichrome	107
Steel Shot	522, 527
Tumbling	522, 527
Veggie	102
Water Soluble	103
Zam	100

COMPRESSOR SECTION: 248-250

Cone-Loc Drum	62
Cone Points, Diamond	124

Cone Points, Taper	67
Cones, Felt	142-146
Consumable Set, 3 in 1	463
Controllers:	
Burnout Ovens	218
Micromotor	422, 432-433
Power Hand	422
Cool Blue Motors	401
Copper:	
Anode	264
EarthGold	261
Pickle Pot	509
Pickle Tongs	538
Work Wire	264
Cords + Tapes, Abrasive	72
Cots, Finger	470-471
Cotter Pins	551
Cotton String Buffs	140, 141
Cotton, White Gloves	575
Countersunk Felt Bob	143
Covers:	
Beaker	266
Flask	207
Cracker, Tungsten Ring	411
Cratex	90-92
Crayon	406
Creso Spiral Buff	138
Cristone	27
Crocker Graver Sharpening Fixture	293
Crocus Cords & Tape	77
Cross Hole Deburring Tools	504
Cross-Locking Tweezers	547
Crucible:	
Accu-Melt	225
Burno	222
Cast/T	221
Clay	223
Dish, Platinum Melting	222
Electro/Maxi-Melt	225
Galloni	229
Graphite	223, 225
Machine	222
Tong	222
ZO Paint	223
Crushed Ruby	478
Crystal Cement	497
Cubitron, 3M	56, 389
Cup Burs	160
Cup Wheels, Diamond	123
Cupola Punch and Die	328
Cups, Alcohol	501
Curing Chamber	181
Cut-Off Discs	60-61
Cutters:	
3-Peaks	383
Barracuda	379
Bergeon	383

Cutters continued:

Carbide	179
Compound	383
Diamond	121
Disc	327
GRS Ring Size	384
High Speed Steel	178
Lindstrom	370
Power Max	383
Ring	409, 411
Sprue	383
Supra	368
Watchband	552
Xuron	378

Cuttlefish Bone	204
Cylinder, Oxygen	520
Cylinder, Graduated	212
CZ Color Master Set	361
Czeckpoint Diamond Tester	363

D

Dapping Block, Dies, Punches	328
Dazor Lamps	334-335
DCE Vokes Dust Collector	390
Deadblow Mallet	318
Debubblers	198
Deburrers	194, 504-505
Decorative Finishes:	
Background Antique	269
Colorit	272-273
Diamond Cutting	446
Enamel	271
Liver of Sulphur	269
Millgrain	490, 491
Satin Finish Buffs	58, 59
Texturing Wheels	135
Dedeco Products	60, 81, 94, 95, 150
Deflashing Tools	194, 504-505
Degreaser	247
Degussit	28-29
Dent Removing Set, Wood	326
Desk Light	335, 337, 338
Detail Stones	24-27
Detailer	72
Detergent, Soap	527
Devcon Epoxy	496
Devesting Machine	231
DF, Ultramax	461
Dial Calipers	351
Dialux Compounds	103
Diamond:	
Abrasive Cutters	121
Bright Rhodium	263
Burs	118-122
Chisel Points	124
Cloth	114
Compound	104-105
Cone Points	124

- Diamond continued:
- Cup Wheels 123
 - Cut Off Discs 61
 - Cutters 119, 121
 - D Cake Cement 495
 - Dresser 124, 125
 - Dressing Block 88
 - Dressing Stone 53
 - Drills 121, 255
 - Embedded Polisher 115
 - Escapement Files 108, 317
 - Expendable Dressers 124
 - Felt Bobs 144
 - Film 114
 - Files 108-112
 - Flex Bands 64
 - Fly Wheels 446
 - Foil 114
 - Gauges 366
 - Gem Polishers 115
 - Grinding Pins 116-117
 - Hand Pads 115
 - Hand Lappers 113
 - Lapp Drills 121
 - Lubricant Thinner 105
 - Micro Files 108
 - Mini Points 122
 - Moissanite Tester 364-365
 - Mtd. Points & Wheels 118, 120
 - Needle Files 111
 - Papers 579
 - Phono Points 125
 - Pins and Points 116-118
 - Poli Files 109, 110
 - Polishing Kit 105
 - Poly Film 114
 - PSA Cloth/Film/Foil 114
 - Riffers 109, 110, 112
 - Rubber Wheels and Points 115
 - Sawblades 482
 - Scales & Balances 358, 359
 - Scriber 293
 - Sheets - Foil/Film 114
 - Shovel & Sieve 361
 - Sorting Tray 574
 - Spray Compound, GRS 292
 - Super Ceramic Stones 26
 - Testers 363
 - Thinner 105
 - Tip, Lazer 281
 - Tips, Mini-File 109
 - Tools 124
 - Tweezers 542, 545
 - Ultramax Tools 466
 - Wheel 123
 - Wheel Dresser 125
- Die & Tap 256
- Die Sinkers Chisels, HS 327
- Diemaker Stones 4-5, 19, 20
- Digital II Plating System 258
- Digital Vacuum Wax Injection 199
- Dino-Lite 347
- Di-Profilers 431, 448-449, 452
- Disc Cutters 327
- Disc Sander 452
- Discovery Stone Set 20
- Dishes, Platinum Melting 222
- Dispenser, Flux 500
- Divider 353
- Double Enders 22
- Double Third Hand 502
- Draw Bench, Durston 419
- Drawing Template 186
- Drawplates 419
- Dremel Engraver 281
- Dremel Grinders 454
- Dresser, Diamond Wheel 124
- Dressers 85, 124, 125
- Dressing Block 88
- Dressing Stones 26, 53
- DRILL & TAP SECTION: 251-256**
- Drill:
- Blue Ribbon 252
 - Carbide 253,
 - Diamond 255, 257
 - Hand 251
 - High Speed 253, 254
 - Lapp 121
 - Metric 253, 254, 255
 - Pearl 251
 - Press 446
 - Sticks 403
 - Twist 252 - 255
- Drill Press 446
- Drilling Machine 251
- Dri-Shine 529
- Drum Arbors 64
- Drum, Cone-loc 62
- Drum Sander 62
- Dumont Tweezers 544-545
- Dumore Flexshaft 447
- Duplex Spring Parts 444
- Durite Abrasive Paper 74
- Duratex Buff 140, 141
- Durotex Impregnated Bobs 145
- Durston:
- Bangle Forming Die Set 327
 - Cupola Sets 328
 - Dapping Blocks and Punches 328
 - Disc Cutter 327
 - Draw Bench 419
 - Dust Collector 399
 - Mandrels 356
 - Rolling Mills 414-418
 - Wedding Ring Stretcher & Reducer 408
- Dust:
- Blower 554
 - Masks + Respirators 474
- DUST COLLECTING & POLISHING SECTION: 386-407**
- Dust Collectors:
- #60B 392
 - #68 390
 - Arbe 394, 397
 - Benchtop 397-399
 - BestBuilt 396
 - CollectAll 392
 - Compact 397
 - DCE Vokes 390
 - Ductless Fume Hoods 407
 - Durston 399
 - Foredom 394
 - Fresh-Air 246
 - Gold Vault 393
 - MicroVac III 394
 - Power 6 391
 - Quatro 391-393, 395, 396
 - SolderPure 407
 - SPU 395
 - Under-Bench Vacuum System 394
 - Velocity 391
 - Vokes 390
- DVD Basic Wax Carving 218
- DVD Engraving 280
- DVD Graver Sharpening 289
- E**
- Ear Plugs 474
- Ear Post Protectors 538
- Earthgold Plating Products 260-261
- EcoFlex Dazor Lamp 337
- Econosil Castaldo Rubber 201
- Eco-Torque 433
- Edenta Abrasives 82
- EDM Stones 6-8, 19, 20
- EDM Blue Stones 8, 19, 20
- EL-192 Brush 129
- Elasto Wheels and Cylinders 89
- Electric Engraver 283
- Electric Melters 225
- Electric Vibrator 210
- Electro Cleaner 259, 261, 265
- ELECTROPLATING SECTION: 257-269**
- Elite Abrasives 86
- Elite Microscope 349
- Elma Ringmeter 355
- Elma Ultrasonics 237
- Emery Hand Buffs 68
- ENAMEL SECTION: 270-274**
- Enamel, Jeweler's 271
- Enameling Kiln 271
- Enameling Stones 270
- Encore - GRS Benchmate 572
- End Brush, Cristone 27
- End Brush, Miniature 128
- End Mills 179

Engravers – Furnace

Engravers:

BestBuilt	276
Blocks and Attachments	288-289
Chuck	30
Dremel Electric	283
Foredom Power	283
GRS	280-282
Horizontal	279
Inside Ring	275-277
MagnaGraver	283
New Hermes	278
Points	30, 32, 281
RV-II	275
Sisma	277

ENGRAVING SECTION: 275-293

Engraving Machines	275-281
EnvisionTEC	181-182
Epoxy	496
Ergo Files	311
Escapement Files	108, 307-309
Eschenbach	343, 344, 346
ESD-safe Tweezers	543
Everlast Rod	87
EXL Wheels	55, 57
Expander Drum	64, 389
Expendable Diamond Dressers	124
Extender, Flask	207
Eye Wash	475
EZE-LAP Diamond Sharpeners	113

F

Fabulstre Rouge Cloth	152
Face Shield	475
Faro Handpiece	440
Fast Cut Discs	61
Faux Chamois	141
FC Ultrasonic Solution	241
Felt:	
Bangle Buff	148
Bobs & Cones	142-146
Buff	140
Buff, Mounted	144, 145
Hand Buff	146
Knife Edge	147
Lap & Split Lap	150, 151
Poli-Felts	146
Ring Buffs	148
Sticks	146, 148
Wheels	147
Ferris:	
File-A-Wax	184
Injection Wax	196
Milling Wolf Wax	189
Mold-A-Wax	188
Fiber Discs and Wheels	58-59, 61
Fiber Pads	59
File Card	309
File Handles	312

File-A-Wax	184
------------	-----

Filers:

Air	453
Mechanical	429-431

FILE SECTION: 294-317

Files & Riffles:

American Pattern (AP)	300-301
Arkansas	30, 31
Card	309
Checkering	294
Diamond	108-112
Ergo	311
Escapement	108, 307-309
Glass Nail	583
Grobet	294-312
Handles	312
Hot Die	294
India	32
Inox	306, 311
Nail	583
Micro Mesh	65
Needle	108, 110, 302-306
Poli	109, 110
Riffles	109, 110, 112, 313-316
Ruby	29
Screwhead	311
Steel	311
Swiss Pattern	294-299, 302-309
Teborg	306
Vulcanite/Vulcrylic	311
Wax	193

File-A-Wax	184
------------	-----

Filter:

Compressed Air	248
Masks + Respirators	474
Paper, Plating	266

Finger Cots, Guards & Tape	470-471
----------------------------	---------

Finger Digital Ringmeter	355
--------------------------	-----

Finger Gauge	355
--------------	-----

Finisher Magnetic	523
-------------------	-----

Finishing Stones	21-Apr
------------------	--------

Firescoff	510
-----------	-----

Firestorm CAD Software	181
------------------------	-----

Fixture, GRS Sharpening	292
-------------------------	-----

Flake Shellac	495
---------------	-----

Flannel Buff	140
--------------	-----

Flap Wheels:

Cloth	69
Felt	144
Fiber	58
Scotch-Brite	59

Flash Back Arrestors	519
----------------------	-----

Flask:

Casting	207
Rubber Extenders	207
Tape	207
Tongs	220

Flex Shafts & Access	436-448
----------------------	---------

Flex Shaft Hangers	445
--------------------	-----

Flexies	81
---------	----

Flip Lamp	336
-----------	-----

Florentine File, Checkering	294
-----------------------------	-----

Flow-Through for Vibratory Tumblers	526
-------------------------------------	-----

Flux:

Brushes	134
Dispensers	500
Soldering	501
Superior	500
Tix	500

Fly Wheels, Diamond	446
---------------------	-----

FMR Mini-Filers	420-421
-----------------	---------

Foot Rheostats & Controls	443
---------------------------	-----

Foil, Diamond	114
---------------	-----

Foil, Wrapping Paper	579
----------------------	-----

Foredom:

Bench Motor	398
Bench System	445
Drill Press	446
Dust Collectors:!!	394
Filter Hood	398
Fishmouth	403
Flex Shafts	436-437
Handpieces	438-442
Hangers	445
Maintenance Kits	444
Micromotor Handpiece	433
Mini Vise	446
Mobile Work Station	458
Power Filer	438
Power Graver	281
Rheostats	443
Shafts/Sheaths	444
Soff Jaws	544
Work Chamber	402, 458

Form 2 - Formlabs	322-328
-------------------	---------

Forming Tools	322-328
---------------	---------

Fox Champion Bur	160
------------------	-----

Frames:

Mold	200, 202
Saw	480-481

Freeman Rubber	203
----------------	-----

Freeman Wax	188, 197
-------------	----------

French Beading Tools	489
----------------------	-----

Fretz Hammers	322
---------------	-----

Fume Hood, Quatro	246
-------------------	-----

Funnel, Glass Ribbed	266
----------------------	-----

Furnace:

Accu-Melt	225
Auto Maxi-Melt	225
Burnout #913, #914 & #918	215
Electro-Melt	225
Gas	217
Heavy-Duty Burnout	213
Kerr Melters	225
Melting	225
Ney	214, 215
Paragon SC3	216

- G**
- G20L Burnishing Compound 527
- G-Flex 96-98
- G-Tec 512
- Galloni:
- G1 Ultimate 227
 - G3 Ultimate 227
 - Okay Plus 226
 - Pressovac 228-229
- Gas Boosters 512
- Gas Furnaces 217
- Gauge:
- Baker Diamond 366
 - Bangle Size 357
 - B&S Wire 366
 - Degree 352
 - Diamond 366
 - Finger, 4-Scale 355
 - Gemstone, Digital 367
 - K + B Stone 366
 - Melee Micro Gauge - Meleemeter 367
 - Mold Finish Gauge 34
 - Pearl & Stone 367
 - Sorting, Saffron 366
 - Table Micro 365
 - Wax Model 186
- Gelato Castaldo Rubber 200
- Gem:
- Cloths 152
 - Jars 576
 - Microscopes 348-349
 - Polishers 115
 - Scales 358, 359
 - Setting Graver Set 487
 - Shine Polishing Wheel 89
 - Sparkle Concentrate 240
 - Weight Estimator 366
- GemOro:
- Auracle 363
 - Brilliant Spa 243
 - CZ Master Set 361
 - Diamond Tester 365
 - Elite 1030 349
 - Gold Tester 361
 - Horizon Lamp 337
 - iView Magnifier 343
 - Loupe 340
 - Microscope 348
 - Scales 359, 360
 - Steamer 243
 - Testerossa 365
 - Ultra Spa 243
 - Ultrasonics 239
 - Ultratester 365
- Gemstone Digital Gauge 367
- General Purpose Stones 13, 19, 20
- Generators, Oxygen 513
- Gentec Torch 516, 518
- Gesswein:
- Apron 582
 - Diamond Compound 104, 105
- Gesswein continued:
- Diamond Files 110
 - Finishing Stones 2-21
 - Flux 501
 - Lube Stik 164
 - Mounted Points 49-50, 52
 - Mounted Stones 36-47
 - Photo Light Boxes 332
 - Pickling Compound 510
 - Polisher, Desktop 399
 - Power Ring Cutter 411
 - Rectifying Solution 501
 - Stoning Oil 35
 - UV Curing Chamber 181
- G-Flex 96-98
- Gift With Purchase 583
- Giftwrap 579
- Giles 191
- GIS Style Products 332
- Gizmo, Polishing 403
- GL Pins 117
- Glass Beads 478
- Glass Nail Files 583
- Glasses, Safety 475, 521
- Glasses, Setting 344
- Gloves:
- Heat Resistant 221
 - Inspection 575
 - Latex 472
 - Microflex/Synthetic 472
 - White Cotton 575
- Glues, Cement & Debonder 215, 487, 497
- GMX Abrasives 96-99
- Goggles, Safety 475
- Gold:
- Alloys 224
 - Catcher 386
 - Plating Products 259-261
 - Rubber 201, 202
 - Scales 358-360
 - Solders 498-499
 - Testers 361-362
 - Vault Dust Collectors 393
 - Washer Recovery System 386
- GP Gesswein Stones 13, 19, 20
- GP Plus Convolute Wheels 55
- Grading Stones 364
- Graduated Cylinder 210
- Grain, Soldering 509
- Graphite Crucibles 223, 225
- Graver:
- Carbide 284, 285
 - Carousel 283
 - CMAX 285
 - Dremel Engraver 281
 - Foredom Power 281
 - GlenSteel 284
 - Handles 291
 - High Speed 283
 - Line 284
- Graver continued:
- MagnaGraver II 281
 - Muller 282
 - QC GRS 285
 - Sharpeners 292, 293
 - Swedish Steel 282
 - Yellow Tang, HS 283
- GraverMax/Mach/Smith/Meister 280
- Gray Buffs 139
- Green-Lite Magnifier Lamps 338
- Green Stoning Oil 15
- Grinders:
- Air 450-454
 - Dremel 458
 - Max 387
 - Rotus 451
- Grinding Wheels 54, 55
- Grit Stick Sleeves 68
- Grobet File Handles 312
- Grobet Files 294-312
- Ground Cob 529
- GRS:
- Airtact 280
 - Apex 292
 - BenchMate & Access 572-573
 - Ceramic Lap 293
 - Diamond Spray Comp 293
 - Diamond Wheel 293
 - Encore 572
 - Engravers Blocks 286, 573
 - Graver Carousel 283
 - GraverMach AT 278
 - GraverMax G8 278
 - GraverMeister 278
 - Gravers 284, 285
 - GraverSmith 278
 - Handpiece Storage Strip 445
 - Inside Ring Mandrel 573
 - Leica Scope 349
 - Magnablock 286
 - Meiji Scope 349
 - Pitch Cup 290
 - Power Hone 292
 - QC Gravers 285
 - Quick Connect Kit 280
 - Ring Holding Clamp 287
 - Ring Size Cutter 409
 - Satellite Turntable 288
 - Sharpening System 292
 - Soldering Station 502
 - Thermo-Loc 287
 - Ultra High Speed Rotary Handpiece 281
 - Vise 286, 545, 573, 569
- GRX Abrasives 93
- GTAC Hand Finisher 71
- G-Tec 512
- Guards Finger:
- Cots 471
 - Cotton 471
 - Leather 470
 - Rubber 470

Gun – Junior Vulcanizer

Gun:	
Air Gun for Compressors	250
Hydro Air Wash	231
Matt Wax	187
Shot Separator	522
GX Pins	116
GXL Next Gold Tester	362

H

Halogen Lamps	337, 338
Hammer Handpieces	281, 440, 441, 486
HAMMERING & FORMING SECTION: 318-329	
Hammers & Mallets	318-323
Hammers, Fretz	322
Hammers, Peddinghaus	320
Hand Lappers	113
Handles:	
Burnisher	312
Crucible	222
File	312
Graver	291
Knife	204
Needle File	312
Skroo-Zon File	312
Handpieces:	
Air	450-454
Di-Profilier	420, 448-449, 452
Dremel	458
Dumore	447
Flex Shaft	438-442, 448
GRS	281
Mandrels	584-585
Power Hand	423-430
Proflex	447
QD Flexshaft Handpieces	438-441
Suhner	450
Turbolap	453
Ushio	450, 452, 453
Handy 700	432
Handy Block	570
Handy Flux	501
Handy Portable Wax Pen	190
Hangers for FlexShafts	445
Harris Regulators	519
Head & Shank Tweezers	540
Heat Resistant Gloves	221
Heat Shield & Heat Stop	509
Heating Screen, Mesh	508
Heatless Wheels	83
Heavy-Duty Sprue Cutter	234
Heetrix	511
Hemostats	502
Herkules Sawblades	483
High Speed:	
Blanks and Cutters	178
Burs	161-165, 167
Drills	252, 253, 254
Gravers	285, 286

High Speed continued:	
Mini Diamond Points	122
Rotary Air Grinder	450
Steel Chisels	327
High Tech Carbide Tools	168
High-Torque Air Grinders	451
Hoke Torches	518
Holder:	
Beading Tools	488
Bracelet, Tennis	489
Bur	177
Clamp	205, 290
Double Ender	22
Grit Stick	68
Handpiece	445
Millgrain Wheel	490
Outside Ring	148
Pencil Stone	22
Pliers & Tool	571
Prong, Stone/Diamond	538
Revolving Tool	177, 574
Ring	148, 412
Setters Tube	487
Stone	22-23, 30, 546
Tennis Bracelet	487
Tool System	570
Torch	515, 521
Ultramax	464-465
Watch Case	548
Hole Punching Pliers	377
Hone, Power	292
Hood:	
Bench Lathe	398
Clearview	402
Fume, Quatro	246
Gold Saving	402, 459
Investment	209, 212
Jewelers, Polishing	402
Split Lap Machine	406
Quatro	402
Hose:	
Air Hose	248
Flex, Dust Collectors	403
Torch & Tuline	514, 520
Vacuum	249
Hot Die Barrette File	294
Hot Plate	266
Hot Plate Furnace	271
Hybrid Gesswein Stones	18
Hydro Air Wash Gun	231
Hydroflux Welder System	511
I	
Imaging Systems	332
Imperial Film	74
Impulse Pencil Air Grinder, NSK	451
India Stones	32-33
Ingot Molds	224
Injection Waxes	196-197

Injector Cleaning Wax	196
Injectors Wax	198-199
Inox Carbide Burs	176
Inox Files	306, 311
Inside Ring Clamp	412
Inside Ring Cylinders	86
Inside Ring Engravers	275-277
Inside Ring Polishers, Max	94
Inspection:	
DinoLite	347
Gloves, White Cotton	573
Loupes	340-343
Magnifying Lamps	335-336 338-339
Microscopes	348-349
Mold Finish Gauge	34
Optivisors	344-345
Instant Glue	497
Investment:	
All Cast	209
Mixers	210-212
Platinum	208, 209
R&R	208, 209
Removal	231
Scales	210
Scoop	210
Vacuum Mixers	211-212
Vibrator	210
Invisible Setting Machine	486
Ionic Cleaner, Speed Brite	240
IPS Rectifier	257
Iron Binding Wire	508
IView Magnifier	343
J	
J-1 Solution	263
JAX Patinas and Cleaners	269
Jentner Plating	258-259
Jentner VivaColor	274
Jett Ballistic & Jett Basic Sett	495
Jet Brite	478
JewelCAD Pro Software	181
Jewel-Sil	203
Jeweler's Bench Tools Set	567
Jeweler's Carbide Burs	166-167
Jeweler's Hood	402
Jewelry Drawing Template	186
Jiffy Jig	445
Jig Claw Setting	487
Jig Miter	484
Jump Ring Makers	446
Junior SPU	395
Junior Steamer	245
Junior Vulcanizer	206

- K**
- Kagan Ring Sizers 408
- Kelly Green Wax 196
- Kerr:
- Auto Electro-Melt 225
 - Auto Maxi-Melt 225
 - Ultra Waxer 191
- Kiln, Enameling 271
- Kilnminder 218
- KIMTECH Mold Polishing Wipes 153
- Klear-Vue Shield 459
- Klyr-Fire 271
- Knew Saw Frames 480
- Knife:
- Bench 549
 - Blades, Mold Cutting 204
 - Case 549
 - Handles 204
 - Swiss Army 549
- Kool Jool 509
- Krause Burs 158, 159
- L**
- L&R 239
- Lab Coat 582
- Lamp:
- Alcohol 190
 - Bench 335-339
 - Dazor 334-335
 - Econo 337, 338
 - Gemoro 337
 - Green-Lite 338
 - Magnifying 335-336 338-339
 - Mighty Bright Task Light 335
 - Mighty Vue LED 339
 - ProVue 339
 - Tensor 337
- Lapis Multi Tester 365
- Lapping:
- Compound 107
 - Oil, Diamond 105
 - Sticks 106
- Laps:
- Acrylic 146
 - Dedeco Split 95
 - Felt 150
 - GMX Split 99
 - GRS Power Hone 292
 - Split 150, 151
- Laser Welders - Sisma 562-566
- Latex Finger Cots & Gloves 471, 472
- LATHE SECTION: 330-331**
- Lathes:
- Matt Mini 187
 - Millgrain Tools 331
 - Sherline Metric 330
- LaVaque Tweezers 540
- Lazer Tip 279
- LDW Convolute Wheels 55
- Leak Detector Fluid 517
- Leather Apron 473
- Leather Finger Cots 470
- Leather Jaws 286
- Lens Tissue 344
- Letter Stamp Set 323
- Light Blue Mounted Stones 48
- LIGHT BOXES & IMAGING SECTION: 332-333**
- Light Cube 273
- Lighters, Torch 521
- LIGHTING SECTION: 334-339**
- Lightning Metalite Cloth 62
- Lindstrom Pliers & Nippers 370-371
- Linen Tester 343
- Liners, Engraving 284
- Link and SpringBar Remover 552
- Liquacast/Liquafast 203
- Liquid B Burnishing Soap 527
- Liquid Mold Rubber 202, 203
- Little Torch 514-515, 522
- Liver of Sulphur 269
- LOGO Marker - Sisma 277
- Loose Stone Detector 484
- Loupe Chain 340
- Loupes 340-343
- LT Stone Holders 22, 23
- Lube-Stik 159
- Lubricant Thinner 105
- Luster Cloth 152
- Lustre Bar 101
- M**
- Magic Borax 501
- Magic Green Powder 242
- Magic Pickle 509
- Magna Lamps 336, 377
- Magna-Graver II 281
- Magna-Stone Set Wax 196
- Magnablock, GRS 286
- Magnaject Wax 196
- Magnesia Block 507
- Magnetic Ball Vise 543
- Magnetic Finishers/Tumblers 523
- Magnetic Tool Holder 574
- Magnetic Tumblers 523
- Magni-Focuser Mark 2 Magnifier 344
- MAGNIFIER SECTION: 340-349**
- Magnifiers:
- Aspheric 343
 - B&L 342, 343, 344, 346, 475
 - Donegan 346
- Magnifiers continued:
- Engravers 343
 - Eschenbach 343, 344, 346
 - Illuminated Loupe 340, 343
 - Lamps 335-336, 338-339
 - Magna Visor 344
 - Optisight 344
 - Optivisors 345
 - Telesight 346
 - Maillefer Swiss Burs 159
- Mallets & Hammers 318-323
- Mandrel:
- Abrasive Band (Drum Arbor) 64
 - Bezel 325
 - Bracelet 326, 357
 - Buff 141
 - Cartridge Roll 66
 - Cone Point 69
 - Cratex 92
 - Durston 356
 - Handpiece 584-585
 - Indexing 187
 - PSA Disc 63
 - Rest 356
 - Ring 325, 356, 357
 - Rods 87
 - Sanding 62
 - Silicone Rod 87
 - Snap-On 76
 - Split 461
 - Tapered Cone Point 67
 - True-Size 357
 - Wax Ring 190
- Manganese Bronze 224
- Marathon, Micromotors 420, 432, 433, 484
- Marathon, Split Laps 151
- Mark-A-Size 409
- Marking Pliers, Ring 329
- Mask, Dust 474
- MASTERIX Wax Injectors 199
- Matt Wax & Tools 185, 187, 459, 478, 480
- Max Finishing Machines 387
- Max Inside Ring Polishers 94
- ME Brushes 128
- MEASURING SECTION: 350-367**
- Measuring Beaker & Cylinder 210
- Measuring Stick 354-357
- Media:
- Blasting 478
 - Burnishing Soap 522, 527
 - Metal Finish Sets 526
 - Sandblasting 478
 - Screens 526
 - Tumbling 528-530
- Meiji Microscopes 349
- Melters 225
- Mesh Heating Screen 508
- Metal Forming 322-328
- Metalite Rolls & Cloth 62
- Mettler Scales 358

MF Ultramax Units – Oxygen

MF Ultramax Units	421, 462
MF TOUCH Mobile Workstation	463
Micro Filing & Polishing	420
Micro Spiral Brush	134
Micro-Finishing Film, 3M	74
Micro-Mesh	71
Microetcher	477
Microflex Gloves	472
Micrometers	352
Micromotor Hammer HP	486
Micromotor System	420-433
Microscopes	347-349
MicroVac III Dust Collector	394
Microwelder	514
Mighty Vue Lamp	339
Millgrain Machine	491
Millgrain Wheels	490
Millrite Millgrain Machine	491
Mills, Carbide End	179
Mills, Rolling	412-418
Mini:	
Bench Motor	399
Degree Gauge	352
Filers	420
Filer Tips	109
Lathe	187
Max Combo Polisher	387
Minifix - Suhner	447
Points	122
Polisher Desktop	399
Studio	333
Wax Injector	198
Miniature Brushes	126-129, 131
Mirrors	577
Mitchell's Abrasive Cord + Tape	77
Miter Box, Matt	187
Miter Jig	484
Mixer, Investment	210-212
Mixing Bowls	210
Mix-It Investment Mixers	210
MK Brushes & Spindles	129
MKM Brushes	126
MM Brushes	126-127
Mobile Work Station	458, 463
Moissanite Testers	363
Mold:	
Clay	206
Compound, Liquid	203
Degreaser	247
Finish Gauge	34
Frames	200, 202, 203
Holder	204, 205
Ingot	224
Lock Formers & Pins	200
Mate Junior	204
Plates, Injection	195
Plates, Vulcanizer	205

Mold continued:	
Release Spray	194
Repair Kit	34
Rubber	200-203
Separation Cream	202
Mold-A-Wax	188
Moldmaker Stones	10, 19-20
Moldmaker Plus Stones	11, 19-20
Mold-Mate Junior	204
Moldmatic Frames	202
Molds, Ready Made	202
Moore Snap-On Discs	76
Motors:	
Bench	397-399
Flex Shaft	436-437
Micro	422, 432-433
Polishing	400-401
Mounted Diamond Points	118, 120
Mounted Points & Stones	36-52
MSDS Info	595
Muller Gravers/Liners	284, 286
Multi Angle Wax Gauge	186
Muslin Buffs	136-139, 141

N

Nail Files	583
Needle Scriber	293
Needle Files:	
Diamond	108, 111
Handles	312
Swiss Pattern	302-306
Wax	193
Neon, Plater	267
Neon, Rectifier	259
Neoprene Apron	473
New Hermes	278
Ney Casting Machine	220
Ney Crucible	222
Ney Furnaces	214-215
Neyclean SP Inv. Remover	231
Neycraft	216-217, 220, 231
Nickel Anode	264
Nickel Solution	261
Niles Pneumatic Sprue Cutters	234
Niobium Pick	503
Nippers:	370-375, 379, 382, 383
Nitto Kohki Air Handpieces	451, 452
Non-Asbestos Platinum Liners	207
Norbide	53
Norton:	
Arkansas Stones	30
Bear-Tex Hand Pads	59
Bear-Tex Wheels	54
Blue-Bak	75
Champagne Paper	75

Norton continued:	
Crystolon Stones	34
Durite Paper	74
Grinding Wheels	54
India Stones	32-33
Lightning Metalite Cloth	62
Norbide Dressing Stick	53
Stone Oil	35
Waterproof Paper	75
NSK	451
NSS Ceramic Stones	24-25
Number Stamp Set	323
NYC Injection Wax	196
NYC Tripoli	100
Nylon Jaw Pliers	381
Nylon Jiffy Jig	445
Nylon Tube Brushes	134

O

O-Ring Watch Assortment	550
Ochre, Yellow	499
Off Hand Wheel Dresser	125
Oil:	
Air Handpiece	457
Compressor	249
Diamond	105
Flexshaft	444
Stoning	21
Treated Stones	9
Vacuum Pump	220, 250
Oil Treated Stones	9, 19-20
Okay Plus	230
Onyx Oxygen Generator	513
Optical Setting Glasses	344
Optisight	344
Optivisors	345
Orange Flake Shellac	495
Orange Wax Injector	199
Orangewood (Pegwood)	106
Ordering Information	592-596
Organizer, Plier	574
Organizer, Tool Holder	574
Oval Bezel Mandrel	494
Oval Bezel Punch	326
Oval Bracelet Mandrel	326
Ovens, Burnout	213-217
Oxygen:	
Cylinder, Empty	520
Generators	513
Regulators	514, 515, 516

P

PACKAGING SECTION: 575-583

- Pad:
- Diamond Hand 115
 - for Engraving Blocks 290
 - Fiber 59
 - Micro-Mesh 71
 - Pitch Bowl 290
 - Reclamation Mat 386
 - Solderite 507
 - Sponge 115
 - Ultra Polishing 152
- Paint, Antique 269
- Palladium Plating Solution 265
- Palmscale 358
- Pan, Annealing with Pumice 506
- Panaspec Plus Safety Glasses 475
- Panavise 544
- Paper:
- Abrasive 70, 74-76
 - Champagne 75
 - Cones 67
 - Diamond 579
 - Durite 74
 - Filter 266
 - Liners, Non-Asbestos 207
 - Norton 75
 - Ring Shells 68
 - Waterproof 75
 - WetorDry 75
- Paragon Controller 218
- Paragon Furnace 216
- Paramount 150, 151
- Parflex Nylon Air Hose 249
- Paste, Solder 498-499
- Pearl:
- Drilling Device 251
 - Drills 251
 - Gauge 365
 - Tweezers 540
- Peddinghaus Hammers 320
- Peg Clamp 290
- Pegwood 106
- Pen:
- Flux Dispensing 500
 - Platers & Solutions 267-268
 - Speedy Waxer 193
- Pencil Stones 17
- Pepetools:
- Digital Pen Plating System 267
 - Drilling Machine 251
 - Engraver's Block 288
 - IPS 257
 - Jump Ringer 446
 - Mills 412-413
 - Mixer 257
 - Pearl & Bead Drilling Machine 251
 - Pen Plating System 267
 - Power Mills 412-413
 - Rectifier 257
- Pepetools: continued:
- Ring Bending Forming Set 409
 - Rolling Mills 412-413
 - Square Steel Ring Mandrel 325
 - Stand for Rolling Mills 412
 - Thermocontroller & Magnetic Mixer 257
 - TouchAmatic Wax Pen 191
 - Wax Pen 191
- Perfactory Micro 183
- PGR Dust Collector 396
- PGT Presidium Tester 364
- Phono Points 125
- Photography 332-334
- Picco Pen Plater 267
- Picklers & Pickle Compound 510
- Pike Platinum Saw Blades 482
- Pin:
- Bench 571
 - CBN 116-117
 - Cotter 551
 - Diamond 116-117
 - Hole Discs 63, 76
 - Jewelry 577
 - Pusher 551
 - Removers 552
 - Vises 542
- Pink Mold Rubber 201
- Pink Mounted Stones 40-41
- Pink and Super Pink Wax 196, 197
- Pitch Bowls 290
- Pitch Gesswein 290
- Place-It 509
- Plastic Pyramids 528
- Plastic Tweezers 535
- Plasticast, R&R 208
- Plast-O-Wax 197
- Plater Pens 267
- Plating Kits 259, 260
- Plating RMGO! 259
- Plating Solutions 259, 261-263, 265, 268
- Plating Systems 258-260
- Platinum:
- Anode 264
 - Compounds 101
 - Investment 210, 211
 - Liners, Non-Asbestos 207
 - Melting Dishes 222
 - Polishers 85
 - Pro Scale 360
 - Soldering Station 502
 - Solders 499
 - Tweezers 539
- Platinum-Clad Anode 264
- PLIERS, CUTTERS
& SHEARS SECTION: 368-385**
- Pliers, Cutters and Shears:
- Bergeon 383
 - Case Closing 550
- Pliers continued:
- Hemostat 502
 - Hole Punching 377
 - Jump Ring 379
 - Lindstrom 370-371
 - Loop 377
 - Nylon Jaw 381
 - Organizer 574
 - Parallel-Jaw 382
 - Prong 379
 - Ring Bending/Closing/Forming 380
 - Ring Removal 409, 411
 - Solder Cutting 498
 - Stone Removal 380
 - Stone Setting 486
 - Supra Swiss 369
 - Teborg 374
 - ValueLine 374
 - Wire Looping 375, 382
 - Wire Twisting 375
 - Wolf 375
 - Xuron 378
- Plum Buffs 138-139
- Plumb Gold Solder 499
- PMuT II Presidium Tester 364
- Pneumatic Air Scribe 440
- Pneumatic Stone Setting Machine 484
- Points:
- Blue 50
 - Busch Pink 51
 - Cera 88
 - Cratex 92
 - Diamond 115, 118-120, 122
 - Phono 125
 - Pink 51
 - PT 85
 - Red 49
 - Rubber Diamond 115
 - White 52
- Polder Timer/Thermometer 205
- Poli:
- Felts 146
 - Files 109, 110
- POLISHING & RECOVERY SECTION: 386-407**
- Polishing:
- Aluminum Kit 34
 - Cloths 152-153
 - Compounds 100-103
 - Consumable Set 3 in 1 463
 - Diamond Compounds 104-105
 - Diamond Kit 34
 - Gizmo 403
 - Mini Max Combo 387
 - Mold Kit 34
 - Motors 400-401
 - Points, Blue 50
 - Points, Pink 51
 - Points, Red 49
 - Points, White 52
 - Sets 34, 80, 105, 463
 - Starter Set 399
 - Sticks 62, 73
 - Stones 2-27

Polishing – Ring

Polishing continued:	
Poly Polishers	84
Polyurethane Rods	87
Porosity Burnishers	232
Porosity Killer	233
Positioning Wax	333
Post Protectors	268
Power Cutter	411
Power Graver	281
Power Hand 3 Systems & Accessories	422-430, 434-435
Power Hone & Wheels	292
Power Max Cutters	383
Power Ring Cutter	411
Power Sand Blaster	477
Power Screw Driver	411
Power Sprue Cutter	383
Pre-Coat, All Cast	209
Precision Ring Sizing Set	354
Premium Red Rouge	103
Premium White Stones	14, 19-20
Premounted Abrasive Rolls	66
Presidium Testers	364
Pressovac	226-227
Presto Air Turbine, NSK	451
Primo:	
Carbide Burs	167
Hose	520
Setting Glasses	344
Production Sprue Cutter	234
Profilers:	
Di-Profilers	448-449
Mini Filers	420
Power Hand	429-430
Proflex Flex Shaft	447
Prong Lifter, Pusher	486
Pronto Steamer	243
Protectant, Skin	471, 472
ProVue Magnifying Lamps	339
ProZoom, Microscopes	348
PT Abrasives	85
PUK Welders	556-561
Pumice Paste	102
Pumice Powder	102
Pumice Wheels	81
Pump, Vacuum	212, 250
Punch, Automatic Center	254
Purple Mounted Stones	42-43
Pyrex	266
Pyrometers	216

Q

QC Gravers	287
QC Handle	291
QD Air Fittings	249
QD Flexshaft Handpieces	438-441
Quad-Hone Stone	31
Quantrex Ultrasonic Cleaners	239
Quartz Stirring Rod	223
Quatro:	
Air Purifiers	246
Air Wedge	403
Basic Dust Collector	393
Bench Pin	403
Blast Gate	402
Clearview Hood	402
CollectAll	392
Collection Ports	403
Cool Blue Motors	401
Ductless Fume Hood	407
Dust Collectors	391-393, 395, 396
Fresh-Air Series	246
Fume Hoods	246
Gold Vault	393
Hoods	209, 212, 246, 260, 402
Investment Containment Hood	212
Investment Mixing Hood	209
Junior SPU	395
PGR – Brushless	396
Ports	403
RH Containment Systems	260
SolderPure	407
SPU	395
Velocity	391
Quick-Charge Soldering Iron	499
Quick-Sil	202
Quiet Compressor	249
Quill Flux Brushes	134
Qwik-Dry Glue	497

R

R&R Investments	208-209
RA Finishing Stones	12, 19
Radial Bristle Discs, 3M	78-79
Ransom & Randolph	208-209
Rapid Prototype Finishing Set	102
Rasps, Wax	193
Rawhide Mallets	318
Razor Saw	484
Ready Made Molds	202
Reamers:	
Busch	158
Diamond Coated	256
High Speed	164
India	33
Matt	186
Ring Tube	187
Steel	256
Re-Cast It	224

Reclamation Mats	386
Recovery	386
Rectifiers	257
Rectifying Solution	501
Red Mounted Stones and Points	36-39, 49
Reducing Collets	434
REFERENCE CHARTS: 586-591	
Regulators	514, 515, 516, 519
Reliable Steamers	244
Renata Batteries	547
Repair Mold Kit	34
Resin Release Spray, Castaldo	202
Resinoid Diamond Lappers	113
Respirators	474
Re-Cast It	224
Rheostats for Flex Shafts	443, 447
Rhodinette	267
Rhodium:	
Fume Hood	246
Pen Platers	267
Plating Kits	258, 260
Solution	262-263, 268
Test and Treatment Sets	265
Rhoduna	263
Riffers:	
Diamond	109, 110, 112
Swiss Pattern Diemaker's	313
Swiss Pattern Diesinker's	314-316
Ring:	
Benders	409
Brass Practice	281
Bufs, Cloth & Paper	70
Bufs, Felt	148
Burs, Carbide Cylinder	167
Case	577
Clamps	410
Cracker	411
Cutters	410-411
Digital Ring Device	357
Engraver	275-277
Enlarger	408
Forming Set	409
Gauges	357
Genie	495
Holders	148, 412
Mandrels	190, 354, 356, 357
Marking Pliers	329
Measuring Stick	354-356
Pliers, Bending/Forming/Closing	380
Racks, Ultrasonic	235, 238
Reducer	408
Removal Pliers	410-411
Shells & Arbor	68
Size Cutter	410
Sizes	357
Solder Stand	508
Stamping	329
Sticks	354, 356, 357
Stretchers	408
Tray	577

- Ring continued:
- Tube Reamer 187
 - Tubes, Wax 184, 185, 189
 - RingGenie 492-493
 - Ringmeter 355
- RING TOOL SECTION: 408-411**
- Riveting Wire, Brass 256
 - RMGO! Plating Systems 259
 - Rockwood Sticks 106
 - Roller Marking Machine 329
- ROLLING & DRAWING SECTION: 412-419**
- Rolling Mills Durston 414-418
 - Rolling Mills PepeTools 412-413
 - Roloc Discs, 3M 56
- ROTARY & ULTRASONIC SECTION: 420-469**
- Rotary Tumblers 531
 - Rotating Bench Vise 544, 545
 - Rotating Bur Holder 177
 - Rotating Solder Table 506
 - Rotus Hand Grinder 451
 - Rouges 100-103
 - Rouge Cloth 152
 - Rough Out Stones 15
 - RTV 202, 203
 - Rub and Rinse Cleaner 35
 - Rub-Out Stick 55
- Rubber:
- Bench Block 571
 - Finger Cots 471
 - Mixing Bowl 210
 - Mold 200-203
 - Polishing Points & Wheels 80-88
 - Pumice Wheels 81
 - Rod Dressing Stone 53
 - SIC Polishers 83
- Ruby Stones 28-29
 - Ruby, Crushed 478
 - Ruler, 6" 353
 - Ruthuna 263
 - RV-II Engraver 275
- S**
- Saddle Stool 569
 - Safety Goggles & Glasses 475, 521
- SAFETY PRODUCT SECTION: 470-475**
- Safety Tape & Finger Guard 470-471
 - Saffron Sorting Gauge 366
 - Sampler Stone Sets 19-21
 - Sand Paper 74-75
- SANDBLASTING SECTION: 476-479**
- Sandblasters 476-477
 - Sandblasting Media 478
 - Sander, Air Angle 452
 - Sanding Belts and Sticks 73
 - Sanding Mandrel Set 62
 - Sanding Sponges, 3M 115
 - Satellite Turntable, GRS 288
 - Satin Finish Buffs Pads & Wheels 58, 59
 - Satin Finish Texturing Wheels 135
- SAW SECTION: 480-483**
- Saw:
- Diamond Blades 482
 - Frames 480-481
 - Herkules Blades 483
 - Pike Platinum Blades 482
 - Razor 480
 - Skip Tooth & Spiral 482
 - Super Pike 482
 - Super Q 483
 - Supra Blades 483
- SC3 Oven 216
- Scales:
- A&D 358
 - Carat 358-360
 - GemOro 359
 - GemPro 250 360
 - Gram 358-360
 - Investment 210
 - Mettler 358
 - Palmscale 358
- Scissors & Snips 385
 - Scoop, Investment 210
- Scotch-Brite:
- Brushes 131
 - Bristle Discs 56, 78-79
 - Fiber Discs 57
 - Pads 59
 - Roloc Discs 56
 - Wheels 55, 57, 58, 59
- Scotch-Brush 131
 - Scrapers 494, 503
 - Scratch Pen Brush 132
 - Screen, Heating 508
 - Screwdriver Sharpener 554
 - Screwdrivers 411, 553
 - Screwhead Files 311
 - Scribers 293
 - SDS Information 595
 - Seamless Abrasive Caps 72
 - Selvyt Cloth 153
 - Separating Discs 60-61
 - Separating Gun for Mag Tumb 522
- SETTING SECTION: 484-497**
- Setting Glasses 344
 - Setting Jig 489
 - Setters Grip/Jett Ballistic 495
 - Setters Tube Holder 487
 - Setting Machines 486, 491
 - Setting Pliers 488
 - Setting Tool 488
 - SF, Ultramax 462
- Sharpeners:
- Diamond Hand, EZE-LAP 113
 - Graver 292-293
 - Screwdriver 564
- Sharpening Stones 28-34
 - Shaviv Deburring Tools 505
 - Shears 384-385
 - Sheaths, Flex Shaft 444
 - Sheet Solder 498-499
 - Sheet Wax 188
 - Shellac 495
 - Sherline Metric Lathe 330
 - Shovel & Sieve, Diamond 361
 - SIC Wheels 83
 - Sieves 364, 534
 - SilentAire Compressors 249
 - Silipum Wheels 81
 - Silver Anode 264
 - Silver Bath 264
 - Silver Dragon 245
 - Silver Solder 498
 - Silversmith Stones 33
 - Simichrome Polish 107
 - Sink, Goldwasher 386
- Sisma
- Engraving, Markers, Cutters 277
 - Laser Welders - Jewelry 562-563
 - Laser Welders - Mold Repair 564-566
- Sizers, Wedding & Stone Ring 408
 - Sizes, Ring 357
 - Skip-Tooth Sawblade 482
 - Skroo-Zon File Handle 312
 - Sliding Ingot Molds 224
 - Slurry Coated Polishing Strips 77
 - Small Torch 516
 - Smarmy Sisma Marker 277
 - SmartStool 569
 - Smith Torches 517
 - Smoothy Wax Finisher 193
 - Snap-On Discs/Mandrel 76
 - Snappy Watch Case Opener 549
 - Snips385
 - Soap, Burnishing 522, 527
 - Soap Detergent 527
 - Soap Powder 527
 - Soff Jaws Vise Pads 544
 - Soft Grip Knife 204
- Software:
- 3Design Cad7 181
 - Firestorm 181
 - JewelCad Pro 181
- Solder Cutting Pliers 498
 - Solder Pastes 498, 499
 - Solder Table, Rotating 506

Soldering – Swiss

SOLDERING SECTION: 498-511

- Soldering:
- Blocks 507
 - Boards 506-507
 - Flux 501
 - Glasses 521
 - Grain 509
 - Iron 499
 - Machines 511
 - Pads 506-507
 - Paste 498, 499
 - Picks 503
 - Pliers 498
 - Solder 498-500
 - Soldering Station, GRS 502
 - Tweezers 539-540
- Solderite Pads 507
- SolderPure, Quatro 407
- Solitaire R&R Investment 209
- Sol-U-Carve 188
- Solvent, Attack 496
- Sonic Wave 236
- SonoCraft Burnishers 485
- Sorting Trays 576
- Sparkle Concentrate 240
- Sparkle Wand 583
- Spatulas 109, 210, 271
- Spectra Diamond Files & Riffles 108-109
- Speed Brite & Accessories 240
- Speedy Wax Pen 193
- Spindle, Plastic MK 129
- Spindle Stands 76
- Spindles for Motors 401
- Split Lapping:
- Laps, Felt 151
 - Laps, GMX 99
 - Laps, Silicone/Dedeco 150
 - Machines 406
- Split Mandrels 461
- Split Ring Arbors 62
- Spiral Buff 138
- Spiral Sawblades 482
- Sponge, 3M 115
- Spot Welder, PUK 556-559
- Spring Bar Bending Pliers 381, 561
- Spring Bar Remover 552
- Spring Bars 551
- Sprits Mold Release Spray 194
- Spray Pump Bottle 35
- Springs, Duplex 444
- Sprue:
- Bases, Rubber 206
 - Former & Rod 200
 - Shears & Cutters 234-235
 - Wax 206, 221
- SPU Dust Collectors 395
- SS White 170
- ST-38 Stone Holder 23
- ST-50 + ST-60 Burnishers 485
- Stainless Steel Shot 522, 530
- Stakes 322
- Stamp Sets, Alpha + Numeric 323
- Stamps, Ring 329
- Stands:
- Bur 177
 - Drill Press 446
- Starter Set, Polishing 399
- Stay Bright Solder Set 500
- Stay Clean Flux 500
- Steam Cleaners 243-245
- Steam Dragon 245
- Steam Tweezers 541
- Steamostat Pliers 244
- Steal Shot 522, 530
- Sticks/Stones 2-35
- Sticks, Abrasive 68, 72, 73
- Sticks, Wooden 106
- Sticks, Wooden Drill 403
- Sticky Wax 189
- Stirrer And Heating Set 257
- Stirring Rods 223, 266
- Stone:
- Cleaner, Rub-and-Rinse 21
 - Setting Jig Claw 487
 - Setting Machine 484
 - Setting Pliers 486
 - Setting Tool 488
- Stones:
- Arkansas 30-31
 - Ceramic Super 24-25
 - Chart 2
 - Cristone 27
 - Diemaker 4-5, 19, 20
 - Dresser 26
 - Dressing 53
 - EDM 6-7, 19, 20
 - EDM Blue 8, 19, 20
 - Enameling 270
 - Finishing 4-21
 - General Purpose 13, 19, 20
 - Hybrid 18
 - India 32-33
 - Moldmaker 10, 19, 20
 - Moldmaker Plus 11, 19, 20
 - NSS 24-25
 - Oil Treated 9, 19, 20
 - Pencil 17
 - Premium White 14, 19, 20
 - RA 12, 19
 - Rough Out 15
 - Ruby 28-29
 - Setting Products 484-487, 492-493
 - Super Ceramic 24-25
 - Super Fine 16
 - Tru-Stone 51
 - Ultra-Soft 16, 19
- Stone Holders 22-23, 30, 538
- Stoning Oils 35
- Stools 569
- Storage 570, 574, 576-579
- Stretchers, Ring 408
- Suede Guards 470
- Suhner 447, 450
- Sun Discs 80, 404-405
- Sun Midgets 80
- Sun Snap Mandrels 585
- Super:
- Carbide Blanks and Cutters 179
 - Carbide Burs 169
 - Ceramic Stones & Holders 24-26
 - Dresser 26
 - Fine Stones 16
 - Glues 497
 - Hand Pneumatic Filer 453
 - Pike Sawblades 482
 - Pink Freeman Wax 197
 - Pins, GRS 289
 - Q Sawblades 483
 - Ring Bending/Forming Set 409
 - Speedy Wax Pen 193
- Superior Flux 500
- SuperStretch Mold Rubber 201
- Supra:
- Brite Solution 242
 - Brushes 126-129
 - Cutters 368, 369
 - Diamond Compound 105
 - FC Ultrasonic Solution 241
 - Pliers 369
 - Polishing & Pumice Paste 102
 - Sawblades 483
 - Swiss Pliers and Cutters 368-369
 - Tweezers 532-535, 539
- Supreme, Stoning Oil 15
- Surface Gauge 34
- SVTN-S Handpiece 440
- Swann-Morton 204
- Swedish Gravers, Muller 284, 286
- Sweep Ultrasonic 239
- Swinger Mirrors 577
- Swiss:
- Army Knife 549
 - Beading Tools 489
 - Burs Maillefer 159
 - Cutters 368, 369
 - Grinders, Suhner 450
 - Hammer Handpiece 441
 - Needle Files 302-306
 - Pattern Diemaker's Riffles 313
 - Pattern Diesinker's Riffles 314-316
 - Pattern Escapement Files 307-309
 - Pattern Files 294-299, 302-311
 - Pattern Riffles 313-316
 - Pliers 369
 - Prong Lifter 488
 - Sawblades, Ultra 483
 - Sawframes 481

Swiss continued:	
Torch	518
Tweezers	532-535, 539
SX Polishers	85
Synthetic Diamond Screener - Presidium	364
Syringe Dispensers	35
SZX Power Hand Handpiece	429

T

Tags, Brass ID:	279
Talc	194
Tampico End Brush	129
Tanks and Cylinders	520
Tap & Die Set	256
Tape:	
Abrasive	72
Finger, Safety	470
Perforated Flask	207
Vetrap	470
Vinyl Watch	550
Tapered Cartridge Rolls	66
Tapered Cone Points	67
Tapered Spindles	401
Tarni-Shield 3M Strips	581
Teborg Files	306
Telesights	346
Template, Jewelry Drawing	186
Tenaris Anti-Tarnish Dip	247
Tensor Lamps	337
Test Kit, Gold	362
Testerossa Diamond Tester	365
Testers:	
CZ/Diamond/Moissanite	363
Gold	361, 362
Watch Battery	547
Tetrabor Compound	107
Texturing Hammer	323
Texturing Wheels	135
Thermoplastic Drawplate	419
Thermocouple	215
Thermo-Loc	487
Thermometers	205, 264
Thickness Gauge	367
Thinner, Diamond Compound	105
Third Hands	204, 502, 511
Thompson Enamel	271
Thumb Guard	470
Timers	210
Ti-Research	212, 221
Tissues:	
Anti Tarnish	579
Kimtech Wipes	153
Lens	344
Watch	554

Titanium:	
Edenta Abrasives	82
Nitride Coated Burs	165
Solder Pick	503
Tweezers	537
Tivac Flask Liners	207
Tix Anti-Flux, Flux & Solder	500
Tong:	
Burno	222
Copper Fishtail & Pickle	538
Crucible	222, 225
Draw	419
Flask	220
Tool Holder Magnetic	574
Tool Holder System	574
Tool Room Grinding Wheels	54-55
Tool Set, Jewelers Bench	567
Tooling for Ultramax	466-467
Topaz Oxygen Generator	513
Topstar Polishers	82
Torch Boosters	512
TORCH SECTION: 512-521	
Torches:	
Aquaflame	555
Blazer Butane	521
Disposable	514, 516, 521
Gentec Casting	516
Hoke	518
Holders	515, 521
Hydroflux	511
Lighters	521
Little & Accessories	514-515
Magic Butane	521
Mate, Electric	521
Small	516
Smith	517
Swiss	518
Turbo Torch	517
TouchAmatic	191
Traps, Sink	386
Tray:	
Display	577
Sorting	576
Wax	188
Work Processing	576
Triad Hammer	323
Tripod w/Mesh Screen	508
Tripoli	100, 103
Tripour Beakers	210
389	
True-Size, Bangle & Ring	357
Tru-Stone	51
Tube Brushes	134
Tuf Guy Wax	197
Tuline Hose	520

TUMBLER SECTION: 522-531

Tumblers:	
Magnetic	523
Rotary	531
Vibratory	524-526
Tumbling Media	526-530
Tune-Up Kits for Flex Shaft	444
Tungsten Ring Cracker	411
Turbo Diamond Files	112
TurboLappers	453
TurboTorch	517
Turntable	288
Turquoise Rouge	103
Turquoise Wax	184

TWEEZERS SECTION: 532-541

Tweezers:	
Ceramic Tip	539
Diamond	534, 537
Dumont	536-537
ESD-safe	535
Head & Shank	540
Plastic	535
Soldering	539-540
Steam	541
Supra Swiss	532-535
Utility	538
Vacuum	541
Twist Drills:	
Blue Ribbon	252
Busch	158, 168, 253
Diamond	255
High Speed	252
Metric	253, 254, 255

U

UFO Hammer	323
UHT Air Grinders	450, 452, 453
Ultra Polishing Pads	152
Ultra Thin Separating Discs	60
Ultra Waxer	191
Ultramax - Ultrasonic Polishing Systems	461-467
UltraMaxx, R&R	210
Ultra-Soft Stone	16, 19
Ultrasonic Cleaning	235-239
Ultrasonic Cleaning Solutions	241-242
Ultrasonic Polishing	461-467
UltraSpa	243
UltraTester	365
Ultra-Vest, R&R	208
UM-1200, UltraMax	461
Umicore:	
Anode System	264
Rhodium	263
Ruthuna	263
Under-Bench Dust Collectors	394
Unitized Points	95

Unitized Wheels – Wrench Watchcase

Unitized Wheels	57
Universal Jewelry Polishing Set	530
Uniweld Tips	515
Ushio Handpiece	450, 452, 453
UV Post Curing Chamber	181
UV Ring Light	340

V

Vac-A-Mix	211
Vacuum:	
Casting Kits	219
Casting Mach/Access	220-221
Investment Machine	212-214
Pumps	250
Tweezers	541
Wax Injectors	198-199
VacuVests	212
Val-Air Compressors	249
ValueLine Pliers	375
Varibench	569
Veggie Compounds	102
Velocity Dust Collectors	391
Venturi Furnace	214
Vernier Calipers	351
Vest Off	231
Vetrap Bandage Tape	470
Vibrator, Electric	210
Vibratory Tumblers	524-526
Victorinox Swiss Army Knife	549
Vinyl Watch Tape	550

WISE SECTION: 542-546

Vises:	
Bench	543-546
Benchmate, GRS	545
Drill Press Vise	543
Engravers Blocks	545
Foredom Mini	543
Handvise	543
Magnetic Ball Vise	543
Microblock	545
Mold	205
Panavise	544
Pearl Drilling	251
Pin	542
Positioning/Microscopes	546
Rubber Mold	205
Turntables	546
VivaColor	274
VLT	200
Vokes Dust Collector	390
VS Dressing Stones	53
VTX (now SVTN-S) Handpiece	440
Vulcan Furnaces	214
Vulcanite/Vulcrylic File	311
Vulcanizers	205

W

Wash Gun, Hydro Air	231
Washout Brushes	133

WATCH TOOLS SECTION: 547-554

Watch:	
Batteries	547
Case Press	550
Case Wrench	548
Gaskets	550
Holder	548
Tissue	554
Watchmakers Workbench	568

Water:	
Devesting Machine	231
Soluble Buffing Compound	103
Soluble Carving Wax	188
Soluble Diamond Compound	104
Waterjet Vacuum Pump	212
Waterproof Paper	75

Wax:	
Bees	491
Bracelet Bars	185
Burs	192
Carvers	190-194
Carving, Water Soluble	188
Digital Injection System	199
File-A-Wax	184
Files & Needle Files	193
Finisher, Flameless	193
Freeman	188, 197
Gauges	186
Gun, Matt	187
Heat Carver	190
Injection	196-197
Injector Cleaning	196
Injectors	198-199
Kleen	195
Layout Sheets	495
Matt	185
Model Gauge Set	186
Mold-A-Wax	188
Pens	190
Plast-O	197
Positioning	333
Rasps	193
Ring Mandrel	190
Ring Tubes	184, 185, 189
Saws	482
Sheets	188, 487
Sleeve Set	190
Sprue	206, 221
Sticky	189
Tray	188
Wash	195
Wire	189
Wolf	189

Wax-a-Sizer	186
Waxers, Electric	190-191
Wayne Werner Polishing Set	399
Wedding Ring Sizer	408
Welders	555-559, 562-566

Welding Wire	561
------------------------	-----

WELDING SECTION: 555-566

Werner Polishing Set	399
Wet Stick	53
WetorDry Paper	75
Wheel Brushes	126-127, 129-131
Wheel Dressers	124-125
White:	
Cotton Gloves	575
Mounted Points	52
Muslin Buffs	136, 137, 141
Stones, Premium	14, 19, 20
Wipes, Kimtech	153

Wire:	
Binding	508
Brushes	127, 128, 131, 132, 133, 134
Copper Work	264
Drawing Machines	419
Ingot Mold	224
Looping Pliers	375, 382
Riveting Brass	256
Scratch Brushes	131
Twisting Pliers	377
Wax	189
Welding, PUK	561

Wire & Tube Cutting Jig	484
Wiru Tap & Die Set	256
Wizard Pen Plater	267

Wolf:	
Carvers	192
Cylinder Burs	167
Mill Ring Tubes	189
Pliers	377
Sanding Mandrels	62
Wax	188, 189

Wood:	
Arbor	70
Bobs	107
Bracelet Mandrel	326
Bur Box	177
Dent Remover	326
Drill Stick	403
File Handles	312
Hub Wheel Brushes	130, 131
Polishing Gizmo	403
Ring Clamp	410
Ring Stick	354
Sticks	106

Wooden Tool Organizer	574
Work Benches	568
Work Chambers	458
Work Processing Tray	576

WORKBENCH SECTION: 565-574**WORK PROCESSING & PACKAGING SECTION: 575-583**

Wrap and Tap Pliers	382
Wrapping Paper	579
Wrench Torch	520
Wrench Watchcase	548

X

XT-1 Engravers Chuck 30
 Xuron, Cutters/Pliers 378
 Xuron, Shears 385

Y

Y-Connectors 519
 Yellow:
 Gold Alloy 224
 Ochre Powder 499
 Tang Gravers 283
 Treated Buffs 137, 138, 140, 141

Z

Z-2X + Z-6X Power Hand Handpieces 430
 Zam/Turquoise Rouge 100
 Zip Bags 580
 Zirconia Discs 76, 77
 Zoom Microscopes 348-349
 ZO Paint 223

#

3 in 1 Hand Finisher 71
 3 in 1 Polishing Set 463
 3Design Cad7 Software 181
 3M Products:
 Bandage Tape 470
 Belts 389
 Bristle Discs 56, 78-79
 Clean Walk Mat 386
 Cloths 152
 Cubitron 56
 Diamond Film 389
 Diamond Flex 64, 389
 Diamond Hand Files 109
 Diamond Hand Pads 115
 Discs 56, 78-79
 Dust Mask 474
 High Performance Cloth 152
 Lapping Film 74
 Mat 386
 Micro-Finishing Film 74, 389
 Papers 75
 Polishing Cloth 152
 Radial Bristle Discs 56, 78-79
 Regalite Discs 56
 Respirator 474
 Roloc 56
 Sanding Sponge 77
 Scotch-Brite 55, 57-59
 Tarni-Shield 581
 Vetrap Tape 470
 Wetordry Paper 75

Gesswein Represents:

Quality and Value – We offer distinguished products of the best quality as well as affordable products of great value.

Service – A philosophy and way of life. It cannot be attributed to a single department, program or policy, but rather to all the things we do to ensure customers are satisfied. Service means giving customers more than they expect, responding to their needs immediately and shipping their orders promptly.

Honesty – To our customers, ourselves and each other. We are in the business of earning and safeguarding trust, so we must always act honorably.





Respect – We demand respect for our customers, each other and the company. Mutual respect leads to understanding, which in turn leads to efficiency.

Teamwork – Our people are totally committed to working together as a team to reach our common goals

Investment – We invest resources back into the company in order to keep inventory at optimal levels, to fund a technical support staff and to educate our people so they can better serve our customers.



Icons Usage

-  Although no hazardous shipping surcharge applies, these items can only ship via UPS® Ground, no air, FedEx® or US Mail possible. Cannot ship to Alaska, Hawaii or Puerto Rico.
-  UPS® hazardous shipping surcharge applies. Ships via UPS® Ground only, no air, FedEx®, or US Mail shipments. Cannot ship to Alaska, Hawaii or Puerto Rico.
-  Shipment by truck is required.
-  Indicates a minimum order is necessary; in this case orders would be in multiples of 6.