

# Instruments



**Prestige Dental Products, Inc**

[Prestigedentalproducts.com](http://Prestigedentalproducts.com)

Tel: 877-772-3888 Fax: 714-632-8821

# Instruments

## Endodontic Instruments (ASA Italy)

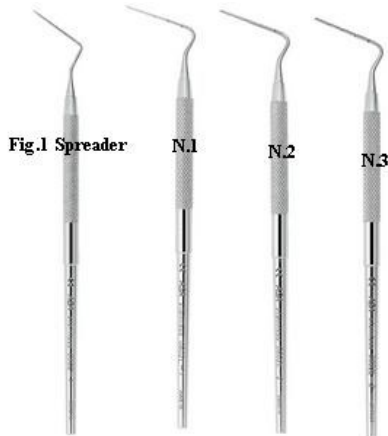

Endodontic Instruments, <b>Fig. 1 Spreader</b>	40-11775
Endodontic Instr.Vertical Condenser, <b>N.1 "Laser S."</b>	40-11776
Endodontic Instr.Vertical Condenser, <b>N.2 "Laser S."</b>	40-11777
Endodontic Instr.Vertical Condenser, <b>N.3 "Laser S."</b>	40-11778

## Piezo Tip Wrenches (Vista)



<b>Universal</b> - Acteon, EMS, Amdent	56-11216
<b>Torque</b> - Acteon (Frosted Beige)	56-11215
<b>Torque</b> - EMS (Blue)	56-11217

## Amalgam Condensers/Pluggers

### Amalgam Condensers (Prestige)



<b>Hollenbach #1</b>	40-90843
<b>Hollenbach #2</b>	40-90844

## Amalgam Condensers - Pluggers (American Eagle)

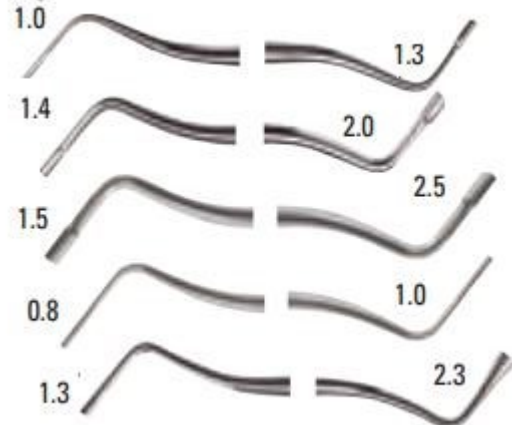

<b>0</b> , each	40-90845
<b>1/2</b> , each	40-90846
<b>3/4</b> , each	40-90847
<b>Oregon 1</b> , each	40-90848
<b>Oregon 3</b> , each	40-90849

## Amalgam Gun (Premier)

Replacement parts are available.



<b>Regular Straight</b>	40-90850
<b>Regular Right Angle</b>	40-90851

## Amalgam Pluggers (Hu-Friedy)



<b>Blacks's #1/2</b> , Serrated	40-90858
<b>Marquette #0/1</b> Non-Serrated	40-90859
<b>Marquette #0/1</b> Serrated	40-90860
<b>Mortonson #2</b> , Serrated	40-90861

## Amalgam Pluggers (Premier)



# Instruments



Prestige Dental Products, Inc.  
 Prestigedentalproducts.com  
 Tel: 877-772-3888

<b>Black's #1/2, Serrated</b>	40-90862
<b>Acorn #21B, Smooth</b>	40-90863

## Burnishers

### Burnishers (DA)

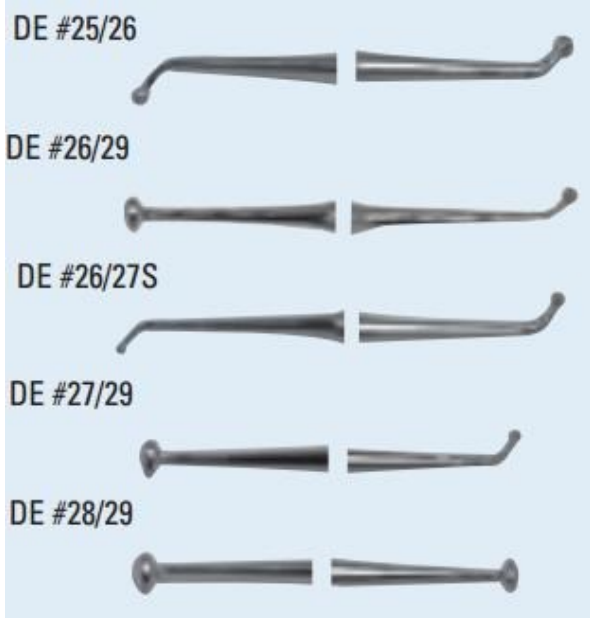

Double End Octagonal Handle

<b>#25/26, each</b>	40-90864
<b>#26/29, each</b>	40-90865
<b>#26/27S, each</b>	40-90866
<b>#27/29, each</b>	40-90867
<b>#28/29, each</b>	40-90868

### Burnishers (Hu-Friedy)



<b>#26/27S, each</b>	40-90869
<b>#27/29, each</b>	40-90870
<b>Ladmore #2, each</b>	40-90871
<b>Mortonson #21B, each</b>	40-90872

## Carvers

### Carvers (American Eagle)

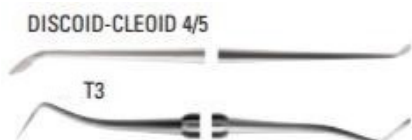

### MINNESOTA 1



Double End

<b>Discoid-Cleiod #4/5</b>	40-90886
<b>T3</b>	40-90887
<b>Minnesota 1</b>	40-90888

### Carvers (DA)



<b>Cleoid-Discoïd 89/89 Small, Octagonal</b>	40-90873
<b>Cleoid-Discoïd 89/89 Small, Round</b>	40-90874
<b>Cleoid-Discoïd 3/6 Large, Octagonal</b>	40-90875
<b>Cleoid-Discoïd 3/6 Large Round</b>	40-90876
<b>Hollenback #1/2, Round</b>	40-90877
<b>Hollenback #3</b>	40-90878
<b>Hollenback #3S Octagonal</b>	40-90879
<b>Hollenback #3S Round</b>	40-90880
<b>Shoshan A</b>	40-90881
<b>Tanner #5T</b>	40-90882
<b>W-A-C-D</b>	40-90883
<b>Walls #1</b>	40-90884
<b>Walls #3</b>	40-90885

**Check our  
 website for  
 more items  
 and  
 variation**

# Instruments



Prestige Dental Products, Inc.  
 Prestigedentalproducts.com  
 Tel: 877-772-3888

## Carvers (Hu-Friedy)

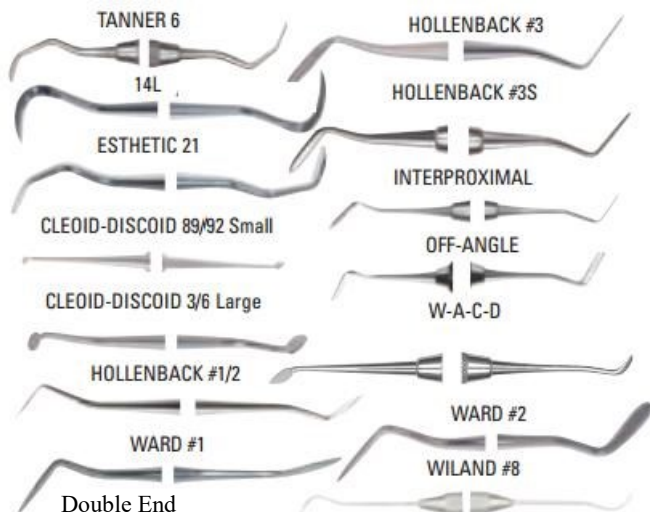

Tanner 6, each	40-90889
14L, each	40-90890
Esthetic 21, each	40-90891
Cleoid-Discoid 89/92 Small, each	40-90892
Cleoid-Discoid 3/6 Large, each	40-90893
Hollenback #1/2, each	40-90894
Hollenback #3, each	40-90895
Hollenback #3S, each	40-90896
Interproximal, each	40-90897
Off-Angle, each	40-90898
W-A-C-D, each	40-90899
Ward #1, each	40-90900
Ward #2, each	40-90901
Wiland #8, each	40-90902

## Carvers (Premier)

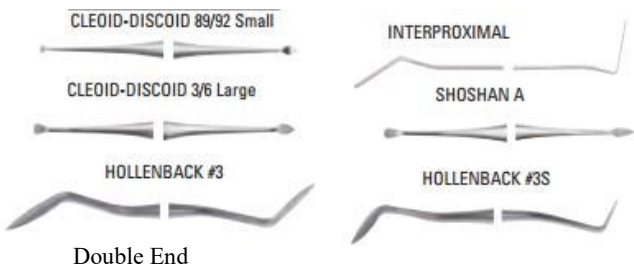

Cleoid-Discoid 89/92 Small, each	40-90903
Cleoid-Discoid 3/6 Large, each	40-90904
Hollenback #3, each	40-90905
Hollenback #3S, each	40-90906
Interproximal, each	40-90907
Shoshan A, each	40-90908

## Carvers - Flexible - Thin Blade

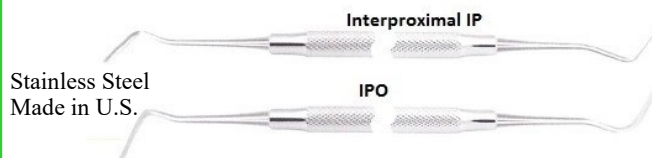

Stainless Steel  
 Made in U.S.

Interproximal IP, each	40-106641
IPO, each	40-106642

## Cavity Liner Applicators

### Cavity Liner Placement (DA)



Each	40-90909
------	----------

### Double Ended Cavity Preparation Instruments (ASA Italy)



D/E Amalgam Carver	40-11628
D/E Amalgam Carver Interp. Off Angle	40-21620
D/E Amalgama Carver	40-21621
D/E Amalgama Carvers	40-21622
Wax & Modeling Carvers Frahm	40-21623

## Chisels

### Gardner 2-Bone Chisel (DA)



Chisel for Oral Surgery Single Bevel	
Each	40-91455

### Wedelstaedt 3/4 (Hu-Friedy)



Cutting Chisel, each	40-90910
----------------------	----------





Prestige Dental Products, Inc.  
 Prestigedentalproducts.com  
 Tel: 877-772-3888

# Instruments

## Composite & Plastic Filing

### Belvedere Composite Contact Former Small (American Eagle)



Each 40-90935

### Composite Contact Instruments (Premier)

SMALL/MEDIUM



Non-stick aluminum establishes positive contacts as you light-cure.

MEDIUM/LARGE



Small/Medium, each 40-90939

Medium/Large, each 40-90940

### Composite Instruments (DA)



No.1 Opaque 40-90911

No.1 Light-Cure 40-90912

No.2 Opaque 40-90913

No.2 Light-Cure 40-90914

Combo Pkg (No. 1 & 2) 10/Pkg 40-90915

### Composite Manipulation Instruments (Premier)

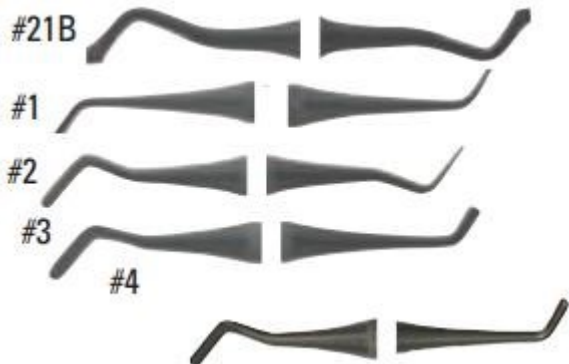

Ultra-Light, Non-Stick Anodized Aluminum The black anodized aluminum surface of Composite Manipulation Instruments (CMI) eliminates composite sticking and does not abrade to discolor the restoration. These tactile, lightweight, aluminum instruments have knurled handles to ensure a firm grip without fatigue.

#21B, each 40-90941

#1, each	40-90942
#2, each	40-90943
#3, each	40-90944
#4, each	40-90945
#5, each	40-90946
Plugger Black 1/2, each	40-90947

### Composite Placement Instruments (Miltex)

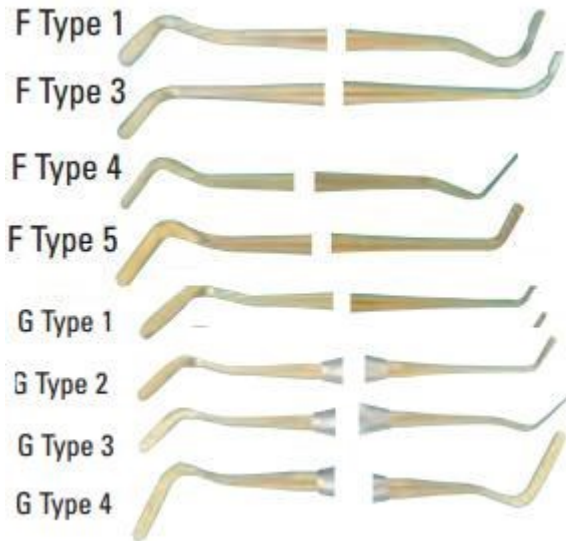

- Titanium nitride tips on the working ends for composite placement and contouring
- Interproximal and subgingival patterns
- Titanium nitride will not discolor or streak composite material
- Composite material will not stick to titanium nitride
- Stainless steel; autoclavable

F Type 1	40-90948
F Type 3	40-90949
F Type 4	40-90950
F Type 5	40-90951
G Type 1	40-90952
G Type 2	40-90953
G Type 3	40-90954
G Type 4	40-90955

### Felt Composite Instruments (Hu-Friedy)



Felt 4 40-90956

# Instruments



Prestige Dental Products, Inc.  
 Prestigedentalproducts.com  
 Tel: 877-772-3888

<b>Felt 5</b>	40-90957
<b>Felt 6</b>	40-90958

### Filling Instrument (Hu-Friedy)

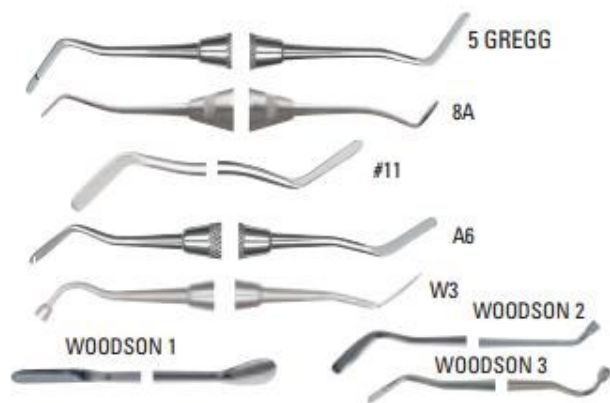

<b>5 Gregg, each</b>	40-90959
<b>8A, each</b>	40-90960
<b>#11, each</b>	40-90961
<b>A6, each</b>	40-90962
<b>W3, each</b>	40-90963
<b>Woodson 1, each</b>	40-90964
<b>Woodson 3, each</b>	40-90966

### Filling Instruments (ASA Italy)



<b>Double Ended Filling Instruments Fig.1</b>	40-12158
<b>Double Ended Filling Instruments Fig.2</b>	40-12172
<b>Double Ended Filling Instruments Fig.3</b>	40-12171
<b>Double Ended Filling Instruments Fig.4</b>	40-12169
<b>Double Ended Filling Instruments Fig.5</b>	40-12170
<b>Filling Instruments Double Ended Serrated Fig.2</b>	40-12168

<b>Filling Instruments</b>	40-12167
Burnishers Westcott Fig.1	

<b>Plastic Double Ended Filling Instruments Fig.1</b>	40-12166
---	----------

<b>Double Ended Filling Instruments Ball Fig.27-29</b>	40-12165
--	----------

<b>Kit: Of No.7 Composite Filling Instruments</b>	40-12174
---	----------

<b>Kit: Of No.15 Composite Filling Instruments</b>	40-12173
--	----------

### Filling Instruments (DA)

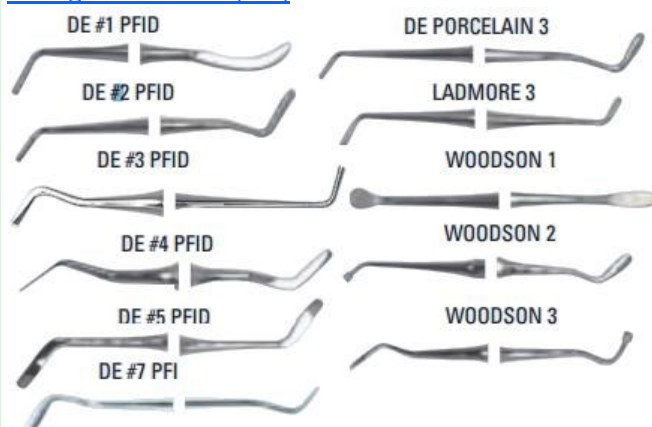

<b>D/E #1 PFID, Octagonal</b>	40-90918
<b>D/E #2 PFID Octagonal</b>	40-90919
<b>D/E #3 PFID Octagonal</b>	40-90920
<b>D/E #4 PFID Octagonal</b>	40-90921
<b>D/E #4 PFID Round</b>	40-90922
<b>D/E #5 PFID Octagonal</b>	40-90923
<b>D/E #7 PFI Octagonal</b>	40-90924
<b>D/E #11 PFI Octagonal</b>	40-90925
<b>D/E Porcelain #1 Octagonal</b>	40-90926
<b>D/E Porcelain #3 Octagonal</b>	40-90927
<b>Ladmore #3 Octagonal</b>	40-90928
<b>Woodson #1, Octagonal</b>	40-90929
<b>Woodson #2, Octagonal</b>	40-90930
<b>Woodson #3, Octagonal</b>	40-90931

### Filling Instruments (Premier)



# Instruments



Prestige Dental Products, Inc.  
 Prestigedentalproducts.com  
 Tel: 877-772-3888

#11, each	40-90967
Woodson 1, each	40-90968
Woodson 2, each	40-90969
Woodson 3, each	40-90970

### Filling Instruments Satin Steel XTS (Hu-Friedy)

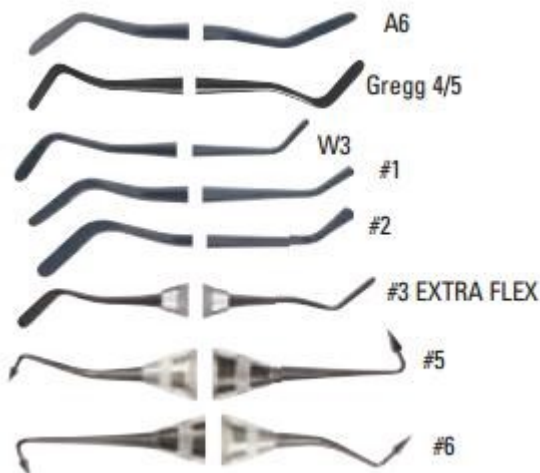

A6, each	40-90971
Gregg 4/5, each	40-90972
W3, each	40-90973
#1, each	40-90974
#2, each	40-90975
#3 extra flex, each	40-90976
Goldenstein Flexi-thin #5, each	40-90977
Goldenstein Flexi-thin #6, each	40-90978

### Goldstein Composite Instrument (Hu-Friedy)



#1, each	40-90979
----------	----------

### Goldstein Flexi-Thin Composite Instrument (Hu-Friedy)



#3 Extra-Flex, each	40-90980
#4 Extra-Flex, each	40-90981
Mini 3 Extra-Flex, each	40-90982

### GTX Titanium Composite Instruments (Miltex)



Revolutionary Tactile Tone Handle offers two unique features: Color and Feel. The permanently color-coded grips allow for immediate recognition between procedures and tray setups. The soft yet firm grip provides a more stable and comfortable feel and reduces hand fatigue and problems associated with carpal tunnel syndrome (CTS) and arthritis.

D/E #2, each	40-90983
D/E #4, each	40-90984
D/E #6, each	40-90985
D/E #9, each	40-90986
D/E #12, each	40-90987

### Heidemann Separating Spatula (ASA Italy)



Heidemann Separating Spatulas Asa Light	40-12536
Heidemann Separating Spatulas. Asa Light	40-12537

### Non-Stick Composite Placement Instruments (DA)

Hard coat anodized non-prorous, non-stick surface. Easy cleaning. Autoclavable. Stainless Steel sure grip handle designed for gloved hands.

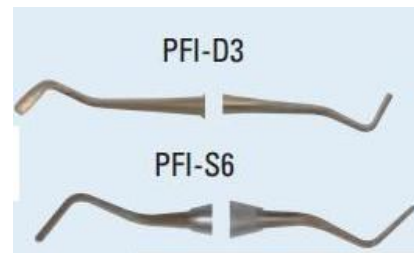

PFI-D3, each	40-90916
PFI-S6, each	40-90917



Like us on Facebook





Prestige Dental Products, Inc.  
 Prestigedentalproducts.com  
 Tel: 877-772-3888

## Instruments

### Plastic Composite Filling Instrument Set (Premier)



**Contains:** Five Instruments, one each of 425/1, 425/2, 425/3, 425/4, 425/5 40-90988

### Slix Composite Manipulation Instruments (Premier)



- Revolutionary protective coating provides ultra lubricity and a lustrous surface for a long-lasting esthetic appearance
- Highly resistant to composite sticking—makes cleanup quick and easy
- The coating is autoclave-safe, will not chip, flake or peel, and gives the tips the appearance of highly polished stainless steel
- The ergonomic handles are manufactured from an advance technology polymer (yellow) with medical-grade silicone grips and offer exceptional lightness, comfort, and durability
- Handle diameter is 1/2" (1.27cm.) to reduce hand fatigue

<b>11, each</b>	40-90996
<b>13, each</b>	40-90997
<b>IPC, each</b>	40-90998
<b>Ladmore 3, each</b>	40-90999
<b>Woodson 2, each</b>	40-91000
<b>W3, each</b>	40-91001

### Titan Composite Instruments (DA)

Titan Composite Instruments feature a special coating that eliminates the problems of composite discoloration inherent in the use of steel instruments. Titan Composite Instruments are specially designed for use with composite and glass ionomer restorative materials, although their use with amalgam is also recommended. The instruments have been proven in long-term trials, in general practice, and in hospital use.



<b>T11, Ball Burnisher</b>	40-90932
<b>T179S, Plastic Filling Instrument</b>	40-90933
<b>TKCI, Burnisher</b>	40-90934



## Cotton Pliers - Tweezers

### Cotton & Dressing Pliers (DA)



Instruments are handcrafted in England of the highest quality corrosion-resistant stainless steel. Each instrument is triple heat-treated and individually hand-finished for optimum performance and durability. Stainless Steel.

<b>College Deluxe #17, Smooth Handle</b>	40-90000
<b>College Economy #317, Serrated Handle</b>	40-90001
<b>College Deluxe #317, Serrated Handle</b>	40-90002
<b>Endo Locking Deluxe, Smooth Handle</b>	40-90003
<b>Endo Locking, Serrated Handle</b>	40-90004
<b>Meriam Deluxe #318, Serrated Handle</b>	40-90005
<b>Meriam #318, Smooth Handle</b>	40-90006
<b>Perry Deluxe #1, Smooth Handle</b>	40-90007
<b>Perry Economy, Serrated Handle</b>	40-90008
<b>Rat Tooth Forceps, Serrated Handle</b>	40-90009
<b>Self-Locking Economy, Serrated Handle</b>	40-90010
<b>Self-Locking Deluxe #18L, Smooth Handle</b>	40-90011
<b>Straight Cotton, Serrated Handle</b>	40-90012

### Cotton & Dressing Pliers (Miltex)





# Instruments



Prestige Dental Products, Inc.  
 Prestigedentalproducts.com  
 Tel: 877-772-3888

<b>23/QOW ENDDONTIC</b> Stainless Steel	<b>PERRY ANGLED</b> Stainless Steel
Self-Locking Handle, Grooved Tips	Serrated Handle, Serrated Tips
<b>COLLEGE VANTAGE</b>	<b>SELF-LOCKING</b> Stainless Steel
Serrated Tips	Stainless Steel
<b>College #317, Serrated Handle</b>	40-90019
<b>College Vantage</b>	40-90020
<b>Endodontic 23/QOW, Self-Locking Handle, Grooved Tips</b>	40-90021
<b>Meriam #318, Serrated Handle</b>	40-90022
<b>Perry Angled, Serrated Handle, Serrated Tips</b>	40-90023
<b>Self-Locking, Serrated Tips</b>	40-90024
<b>Self-Locking, Serrated Tips</b>	40-90025

## Cotton & Dressing Pliers (ASA)

Fig.2 Cm.16 College	Fig.1 Cm.15 Flag	Fig.2 Cm.15 London College	Fig.3 Cm.16 Meriam	Fig.1 Cm.15 Self Locking
<b>College Fig.2 Cm.16</b>				40-11409
<b>Flag Fig.1 Cm.15</b>				40-11410
<b>London College Fig.2 Cm.15</b>				40-11411
<b>Meriam Fig.3 Cm.16</b>				40-11412
<b>Self Locking Fig.1 Cm.15</b>				40-11413

## Cotton - Dressing Pliers (Hu-Friedy)

<b>COLLEGE #2</b> Stainless Steel	<b>COLLEGE #17</b> Stainless Steel	<b>Stainless Steel</b>
Smooth Handle	Smooth Handle	
<b>COLLEGE #317</b> Stainless Steel	<b>LOCKING 18L</b> Stainless Steel	
Serrated Handle	Serrated Handle	
<b>MERIAM #318</b> Stainless Steel	<b>PERRY DELUXE #1</b> Stainless Steel	
Smooth Handle	Smooth Handle	

<b>College #2, Smooth Handle</b>	40-90013
<b>College #17, Smooth Handle</b>	40-90014
<b>College #317, Serrated Handle</b>	40-90015
<b>Locking 18L, Serrated Handle</b>	40-90016
<b>Meriam #318, Smooth Handle</b>	40-90017
<b>Perry Deluxe #1, Smooth Handle</b>	40-90018

## Crown Remover

### Christensen Crown Remover (Hu-Friedy)

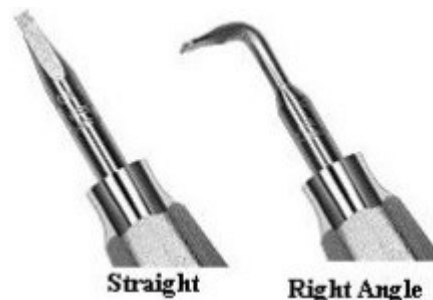

<b>#1 Straight</b>	24-99672
<b>#2 Right Angle</b>	24-99673

### CoronaFlex 2005 Crown & Bridge Remover (Kavo)



- Pneumatically operated instrument removes crowns and bridges
- Can also be used for recommendation of a loose bridge anchor, endodontic treatment, et
- MULTiflex connection
- Operates between 35-660psi; 1 bar=14.50psi

<b>Tools crown Forceps</b>	24-99675
<b>Contains: CORONAflex 2005, crown forceps, 2 small clamps, 2 large clamps, loop holder, 2 loops</b>	24-99674
<b>Clamp, Small</b>	24-99676
<b>Clamp, Large</b>	24-99677
<b>Loop Holder</b>	24-99678
<b>Loop</b>	24-99679



Prestige Dental Products, Inc.  
 Prestigedentalproducts.com  
 Tel: 877-772-3888

## Instruments

### Flashing Crown Remover (Premier)



Ideal for removing provisionally cemented crowns without damaging margins and is less traumatic to the patient.

**Each** 24-99681

### Nemetz Crown Remover (Gingi-Pak)



Removes plastic or ceramic faced crowns and bridges easily and safely. Uses a unique double action that opens the crown with both frontal and lateral displacement for easy removal.

**Each** 24-99680

### Wynman Crown Gripper (Miltex)



For removal of temporary crowns

**6" with Carbide Jaws** 24-99682

### Curettes

#### After Five Gracey Curettes (Hu-Friedy)

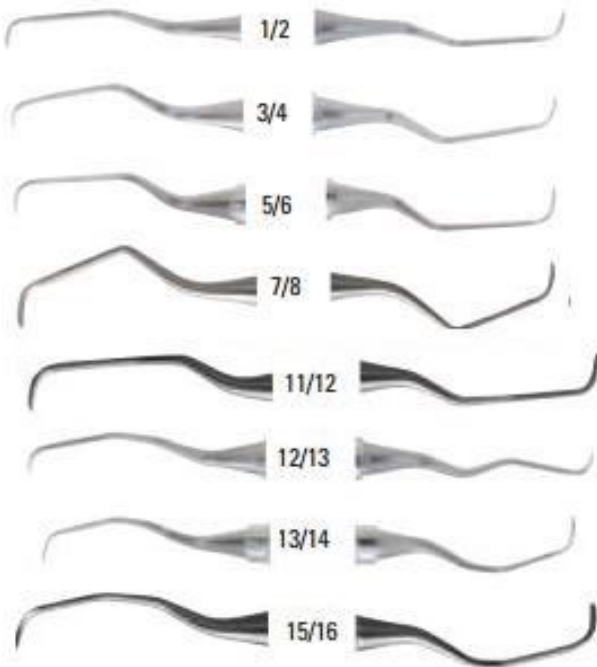

**1/2, #2 Octagonal Handle** 40-90291  
**1/2, Rigid #6 Satin Steel Handle** 40-90292  
**1/2, #6 Satin Steel Handle** 40-90293

**1/2, #9 EverEdge Handle** 40-90294  
**3/4, #6 Satin Steel Handle** 40-90295  
**3/4, #9 EverEdge Handle** 40-90296  
**5/6, #6 Satin Steel Handle** 40-90297  
**5/6, Rigid** 40-90298  
**7/8, #6 Satin Steel Handle** 40-90299  
**7/8, Rigid** 40-90300  
**7/8, #9 EverEdge Handle** 40-90301  
**11/12, #2 Octagonal Handle** 40-90302  
**11/12, #4 Round Handle Rigid** 40-90303  
**11/12, #6 Satin Steel Handle** 40-90304  
**11/12, #6 Satin Steel Handle Rigid** 40-90305  
**11/12, ResinEight Handle** 40-90306  
**11/12, #9 EverEdge Handle** 40-90307  
**11/12, #9 EverEdge Handle Rigid** 40-90308  
**11/12, ResinEight Colors Handle-Orange** 40-90309  
**12/13 Mesial/Distal, #2 Octagonal Handle** 40-90310  
**13/14, #2 Octagonal Handle** 40-90311  
**13/14, #4 Round Handle Rigid** 40-90312  
**13/14, #6 Satin Steel Handle** 40-90313  
**13/14, #6 Satin Steel Handle Rigid** 40-90314  
**13/14, ResinEight Handle** 40-90315  
**13/14, ResinEight Colors Handle-Blue** 40-90316  
**13/14, #9 EverEdge Handle** 40-90317  
**13/14, #9 EverEdge Handle Rigid** 40-90318  
**15/16, #6 Satin Steel Handle Rigid** 40-90319  
**15/16, #9 EverEdge Handle** 40-90320  
**15/16, #9 EverEdge Handle Rigid** 40-90321

#### Barnhart Curette (PDT)

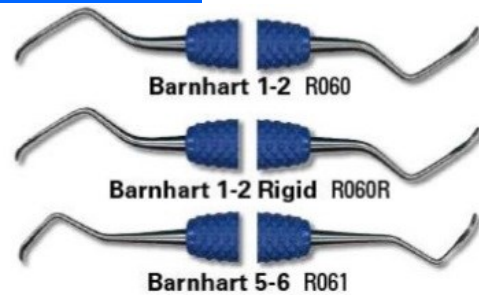

**PDT Barnhart Curette D/E #5-6 Each** 40-11246  
**PDT Barnhart Curette D/E #1-2 Rigid Each** 40-11247  
**PDT Barnhart Curette D/E #1-2 Each** 40-11245

# Instruments



Prestige Dental Products, Inc.  
 Prestigedentalproducts.com  
 Tel: 877-772-3888

## Barnhart Curettes (Nordent)

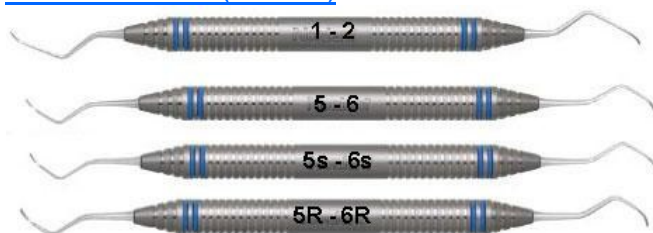

<b>DE #1-2</b> DuraLite <sup>™</sup> ColorRings, Ñ¢	40-11257
<b>DE #1-2</b> DuraLite <sup>™</sup> ROUND	40-11256
<b>DE #1-2</b> DuraLite <sup>™</sup> HEX	40-11255
<b>DE #1-2</b> Medium Round	40-11254
<b>DE #1-2</b> Standard	40-11253
<b>DE #5-6 Slender Blades</b> Medium	40-11259
<b>DE #5-6 Slender Blades</b> Standard	40-11248
<b>DE #5-6</b> DuraLite <sup>™</sup> ColorRings, Ñ¢	40-11260
<b>DE #5-6 Slender Blades</b> DuraLite <sup>™</sup>	40-11258
<b>DE #5-6</b> Standard	40-11249
<b>DE #5-6</b> Medium Round	40-11250
<b>DE #5-6</b> DuraLite <sup>™</sup> HEX	40-11251
<b>DE #5-6</b> DuraLite <sup>™</sup> ROUND	40-11252

## Columbia Curette (PDT)



<b>D/E #13-14</b> Each	40-11373
<b>D/E #2L/2R</b> Each	40-11374
<b>D/E #4L-4R</b> Each	40-11375

## Columbia Curettes (Nordent)



<b>DE #2R-2L</b> DuraLite <sup>™</sup> ColorRings, Ñ¢	40-11380
<b>DE #2R-2L</b> DuraLite <sup>™</sup> ROUND	40-11381
<b>DE #2R-2L</b> DuraLite <sup>™</sup> HEX	40-11382
<b>DE #2R-2L</b> Medium Round	40-11383

<b>DE #2R-2L</b> Standard	40-11384
<b>DE #4R-4L</b> DuraLite <sup>™</sup> ColorRings, Ñ¢	40-11385
<b>DE #4R-4L</b> DuraLite <sup>™</sup> ROUND	40-11386
<b>DE #4R-4L</b> DuraLite <sup>™</sup> HEX	40-11387
<b>DE #4R-4L</b> Standard	40-11389
<b>DE #13-14</b> DuraLite <sup>™</sup> ColorRings, Ñ¢	40-11376
<b>DE #13-14</b> DuraLite <sup>™</sup> ROUND	40-11379
<b>DE #13-14</b> DuraLite <sup>™</sup> HEX	40-11378
<b>DE #13-14</b> Medium Round	40-11377
<b>DE #13-14</b> Standard	40-11390
<b>DE #4R-4L</b> Medium Round	40-11388

## Cone Socket Curettes (G. Hartzell & Son)

University of California/Rule

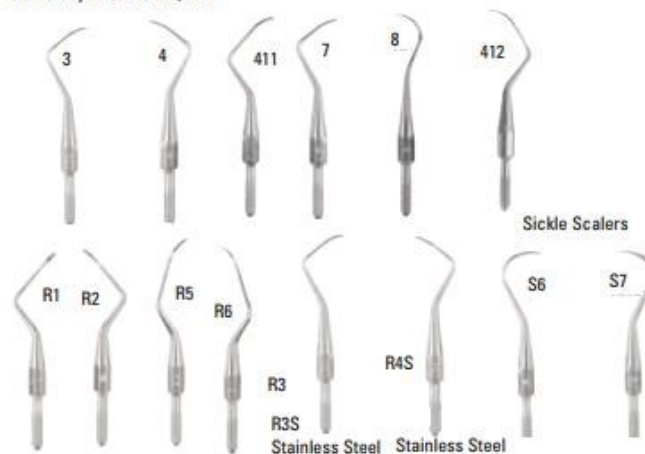

- Carbon Steel
- Tips Only
- Uni. Of California/Ratcliff

<b>R1</b>	40-90322
<b>R2</b>	40-90323
<b>R3</b>	40-90324
<b>R4</b>	40-90325
<b>R3S, Stainless Steel</b>	40-90326
<b>R4S, Stainless Steel</b>	40-90327
<b>R5</b>	40-90328
<b>R6</b>	40-90329
<b>S6, Sickles</b>	40-90330
<b>S7, Sickles</b>	40-90331
<b>3, University of California/Rule</b>	40-90332
<b>4, University of California/Rule</b>	40-90333
<b>7, University of California/Rule</b>	40-90334
<b>8, University of California/Rule</b>	40-90335

# Instruments



Prestige Dental Products, Inc.  
 Prestigedentalproducts.com  
 Tel: 877-772-3888

<b>411, University of California/Rule</b>	40-90336
<b>412, University of California/Rule</b>	40-90337

### Cone Socket Gracey Curettes (G. Hartzell & Son)



- Carbon Steel
- Tips Only

<b>G1</b>	40-90339
<b>G2</b>	40-90340
<b>G7</b>	40-90341
<b>G8</b>	40-90342
<b>G11</b>	40-90343
<b>G12</b>	40-90344
<b>G13</b>	40-90345
<b>G14</b>	40-90346

### Cone Socket Handle & Wrench (Hartzell)



**Each** 40-90338

### Curette (J & J Instrument)

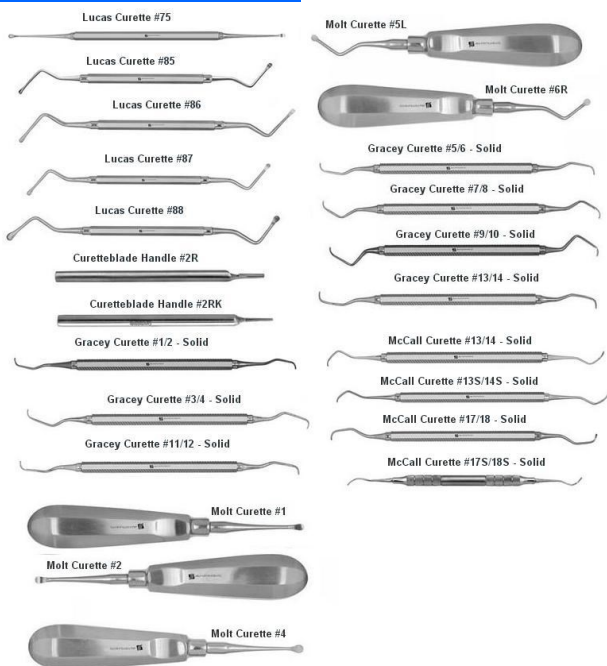

<b>Molt Curette #6R</b>	40-11436
<b>Gracey Curette #13/14 9.5Mm</b>	40-11437
<b>Gracey Curette #11/12 9.5Mm</b>	40-11438
<b>Gracey Curette #9/10 9.5Mm</b>	40-11439
<b>Gracey Curette #7/8 9.5Mm</b>	40-11440
<b>Gracey Curette #5/6 9.5Mm</b>	40-11442
<b>Gracey Curette #3/4 9.5Mm</b>	40-11441
<b>Gracey Curette #1/2 9.5Mm</b>	40-11443
<b>Mccalls Hollow Core Curette #17S/18S 8mm</b>	40-11444
<b>Mccalls Hollow Core Curette #17/18 8mm</b>	40-11445
<b>Mccalls Hollow Core Curette #13S/14S 8mm</b>	40-11446
<b>Mccalls Hollow Core Curette #13/14 8mm</b>	40-11447
<b>Columbia Hollow Core Curette #13/14 8mm</b>	40-11448
<b>Columbia Hollow Core Curette #4L/4R 8mm</b>	40-11466
<b>Gracey Curette #15/16 9.5Mm</b>	40-11450
<b>Columbia Curette #4R/4L 9.5Mm</b>	40-11451
<b>Columbia Curette #13/14 9.5Mm</b>	40-11452
<b>Molt Curette #5L</b>	40-11453
<b>Molt Curette #4</b>	40-11454
<b>Molt Curette #2</b>	40-11455
<b>Molt Curette #1</b>	40-11456
<b>Lucas Curette #88</b>	40-11457
<b>Lucas Curette #87</b>	40-11458
<b>Lucas Curette #86</b>	40-11459
<b>Lucas Curette #85</b>	40-11460
<b>Lucas Curette #75</b>	40-11461
<b>Mccall Curette #17S/18S 9.5Mm</b>	40-11462
<b>Mccall Curette #17 / 18 9.5Mm</b>	40-11463
<b>Mccall Curette #13S/14S 9.5Mm</b>	40-11464
<b>Mccall Curette #13/14 9.5Mm</b>	40-11465
<b>Columbia Hollow Core Curette #2L/2R 8mm</b>	40-11449
<b>Towner Hollow Core Double End #15/33 8mm</b>	40-11467
<b>Mccall Curette #17/18</b>	40-11468
<b>Mccall Curette #13S/14S</b>	40-11469
<b>Columbia Curette #4L/4R</b>	40-11472



# Instruments



Prestige Dental Products, Inc.  
 Prestigedentalproducts.com  
 Tel: 877-772-3888

Columbia Curette #13/14	40-11471
Mccall Curette #13/14	40-11470
Columbia Curette #2L/2R	40-11473
Gracey Curette #11/12	40-11478
Gracey Curette #13/14	40-11475
Gracey Curette #15/16	40-11474
Gracey Curette #9/10	40-11477
Gracey Curette #5/6	40-11479
Gracey Curette #7/8	40-11476
Gracey Curette #3/4	40-11480
Mccall Curette #17S/18S	40-11481
Hollow Core #H6/7 8mm Diameter Handle	40-11482
Hollow Core #204S 8mm	40-11496
Towner Hollow Core Double End #15/30 8mm	40-11484
Gracey Hollow Core Curette #15/16 8mm	40-11485
Gracey Hollow Core Curette #13/14 8mm	40-11486
Gracey Hollow Core Curette #11/12 8mm	40-11487
Gracey Hollow Core Curette #9/10 8mm	40-11488
Gracey Hollow Core Curette #3/4 8mm	40-11491
Gracey Hollow Core Curette #5/6 8mm	40-11490
Gracey Hollow Core Curette #7/8 8mm	40-11489
Gracey Hollow Core Curette #1/2 8mm	40-11492
Jacquette Hollow Core #2/3 8mm	40-11493
Jacquette Hollow Core #2S/3S 8mm	40-11494
Jacquette Hollow Core #1S/1S 8mm	40-11495
Hollow Core #H5/33 8mm	40-11483
Gracey Curette #1/2	40-11497



## Curettes - Magic Color (ASA Italy)

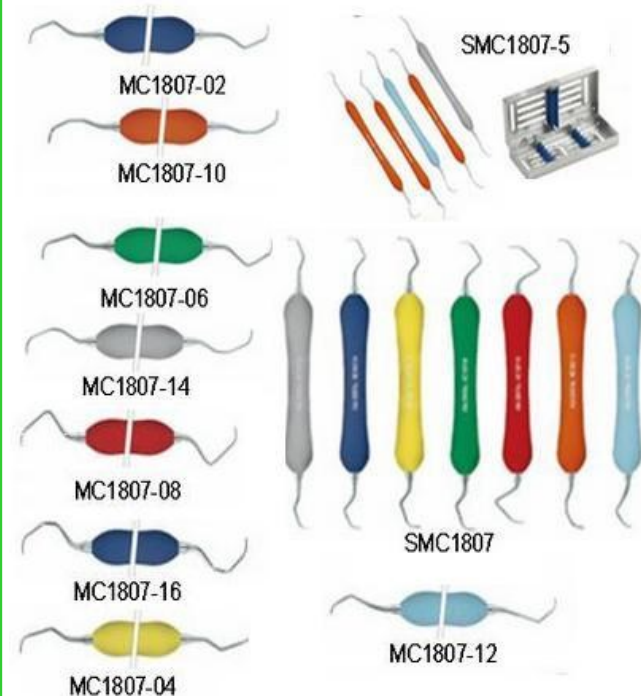

1/2 - Grey	40-11498
3/4 - Blue	40-11508
5/6 - Yellow	40-11505
7/8 - Green	40-11506
9/10 - Red	40-11504
11/12 - Orange	40-11503
13/14 - Light Blue	40-11501
15/16 - Grey	40-11502
17/18 - Blue	40-11500
Magic Color Set Of 7 Gracey Curettes	40-11499
Magic Color Periodontia Instruments Set	40-11507

## Debridement Curettes (Nordent)



DE #1-2 DuraLite™ ColorRings, Nc	40-11519
DE #1-2 DuraLite™ ROUND	40-11518
DE #1-2 DuraLite™ HEX	40-11526
DE #1-2 Medium Round	40-11527



Prestige Dental Products, Inc.  
 Prestigedentalproducts.com  
 Tel: 877-772-3888

## Instruments

DE #1-2 Standard	40-11510
DE #3-4 DuraLite-Æ ColorRings, Ñç	40-11511
DE #3-4 DuraLite-Æ ROUND	40-11512
DE #3-4 DuraLite-Æ HEX	40-11513
DE #3-4 Medium Round	40-11514
DE #3-4 Standard	40-11515
DE #5-6 DuraLite-Æ ColorRings, Ñç	40-11516
DE #5-6 DuraLite-Æ ROUND	40-11528
DE #5-6 DuraLite-Æ HEX	40-11517
DE #5-6 Medium Round	40-11520
DE #5-6 Standard	40-11521
DE #7-8 DuraLite-Æ ColorRings, Ñç	40-11522
DE #7-8 DuraLite-Æ ROUND	40-11523
DE #7-8 DuraLite-Æ HEX	40-11524
DE #7-8 Medium Round	40-11525
DE #7-8 Standard	40-11509

### Gracey +3 Access Double End (American Eagle)

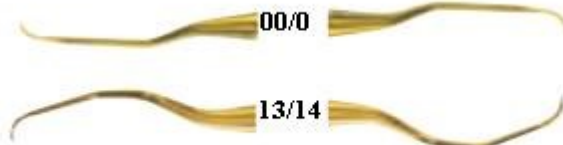

00/0 XP w/EagleLite Stainless Steel Handle	40-90368
00/0 XP w/EagleLite Resin Handle	40-90369
00/0 XP w/EagleLite Resin Handle	40-90370
XP w/EagleLite Stainless Steel Handle	40-90371
13/14, XP w/ EagleLite Resin Handle	40-90372

### Gracey +3 Deep Pocket Curettes Double End (American Eagle)

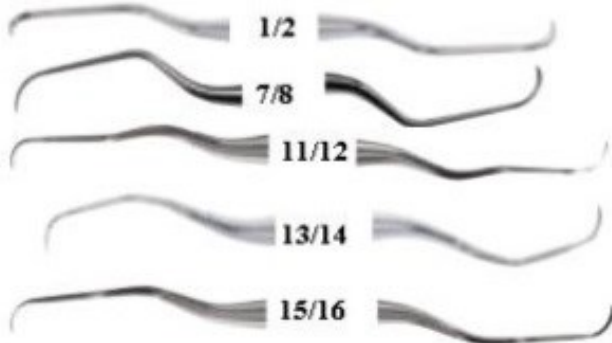

1/2, EagleLite Handle	40-90373
1/2, XP w/EagleLite Stainless Steel Handle	40-90374
7/8, EagleLite Handle	40-90375

11/12, EagleLite Handle	40-90376
11/12, XP w/ EagleLite Resin Handle	40-90377
13/14, EagleLite Resin Handle	40-90378
13/14, XP w/ EagleLite Resin Handle	40-90379
13/14, XP w/EagleLite Stainless Steel Handle	40-90380
15/16, EagleLite Resin Handle	40-90381

### Gracey Curette (PDT)



- Lightest Instrument Reduced risk of carpal tunnel syndrome
- Improved knurling (grips glove better)
- Lightens your grasp

Color Coding:

- Purple Passion-Anterior
- Sunshine Yellow-Mesial Gracey & Posterior
- Caribbean Green-Distal
- Orca Black-Buccal Lingual
- Nautical Blue-Universal
- Pacific Blue-Diagnostic

Gracey Curette D/E #13-14 Each	40-12334
Gracey Curette D/E #11-14 ER	40-12320
Gracey Curette D/E #11-14 ER Rigid	40-12319
Gracey Curette D/E #11-12 ER Rigid	40-12318
Gracey Curette D/E #11-12 EX Mini	40-12317
Gracey Curette X-Rigid D/E #15-16 Each	40-12316

### Gracey Curettes - Long Shank (Nordent)



# Instruments



Prestige Dental Products, Inc.  
 Prestigedentalproducts.com  
 Tel: 877-772-3888

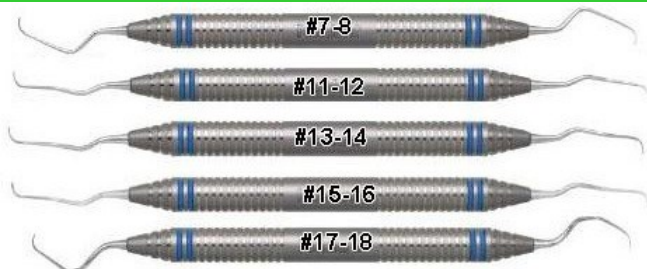

<b>DE #1-2 DuraLite-Æ ColorRings,</b>	40-12378
<b>DE #1-2 DuraLite-Æ ROUND</b>	40-12379
<b>DE #1-2 DuraLite-Æ HEX</b>	40-12376
<b>DE #1-2 Medium Round</b>	40-12375
<b>DE #1-2 Standard</b>	40-12374
<b>DE #3-4 DuraLite-Æ ColorRings,Ñç</b>	40-12373
<b>DE #3-4 DuraLite-Æ ROUND</b>	40-12372
<b>DE #3-4 DuraLite-Æ HEX</b>	40-12371
<b>DE #3-4 Medium Round</b>	40-12360
<b>DE #3-4 Standard</b>	40-12359
<b>DE #5-6 DuraLite-Æ ColorRings,Ñç</b>	40-12348
<b>DE #5-6 DuraLite-Æ ROUND</b>	40-12347
<b>DE #5-6 DuraLite-Æ HEX</b>	40-12346
<b>DE #5-6 Medium Round</b>	40-12345
<b>DE #5-6 Standard</b>	40-12344
<b>DE #7-8 DuraLite-Æ ColorRings,Ñç</b>	40-12343
<b>DE #7-8 DuraLite-Æ ROUND</b>	40-12342
<b>DE #7-8 DuraLite-Æ HEX</b>	40-12341
<b>DE #7-8 Medium Round</b>	40-12349
<b>DE #7-8 Standard</b>	40-12350
<b>DE #11-12 DuraLite-Æ ColorRings,Ñç</b>	40-12358
<b>DE #11-12 DuraLite-Æ ROUND</b>	40-12357
<b>DE #11-12 DuraLite-Æ HEX</b>	40-12356
<b>DE #11-12 Medium Round</b>	40-12355
<b>DE #11-12 Standard</b>	40-12354
<b>DE #13-14 DuraLite-Æ ColorRings,Ñç</b>	40-12353
<b>DE #13-14 DuraLite-Æ ROUND</b>	40-12352
<b>DE #13-14 DuraLite-Æ HEX</b>	40-12351
<b>DE #13-14 Medium Round</b>	40-12377
<b>DE #13-14 Standard</b>	40-12370
<b>DE #15-16 DuraLite-Æ ColorRings,Ñç</b>	40-12369
<b>DE #15-16 DuraLite-Æ ROUND</b>	40-12361

<b>DE #15-16 DuraLite-Æ HEX</b>	40-12362
<b>DE #15-16 Medium Round</b>	40-12363
<b>DE #15-16 Standard</b>	40-12364
<b>DE #17-18 DuraLite-Æ ColorRings,Ñç</b>	40-12365
<b>DE #17-18 DuraLite-Æ ROUND</b>	40-12366
<b>DE #17-18 DuraLite-Æ HEX</b>	40-12367
<b>DE #17-18 Medium Round</b>	40-12368
<b>DE #17-18 Standard</b>	40-12340

## Gracey Curettes - Mini Blade, Long Shank (Nordent)



<b>DE #1-2 DuraLite-Æ ColorRings,Ñç</b>	40-12418
<b>DE #1-2 DuraLite-Æ ROUND</b>	40-12419
<b>DE #1-2 DuraLite-Æ HEX</b>	40-12416
<b>DE #1-2 Medium Round</b>	40-12415
<b>DE #1-2 Standard</b>	40-12414
<b>DE #3-4 DuraLite-Æ ColorRings,Ñç</b>	40-12413
<b>DE #3-4 DuraLite-Æ ROUND</b>	40-12412
<b>DE #3-4 DuraLite-Æ HEX</b>	40-12411
<b>DE #3-4 Medium Round</b>	40-12400
<b>DE #3-4 Standard</b>	40-12399
<b>DE #5-6 DuraLite-Æ ColorRings,Ñç</b>	40-12388
<b>DE #5-6 DuraLite-Æ ROUND</b>	40-12387
<b>DE #5-6 DuraLite-Æ HEX</b>	40-12386
<b>DE #5-6 Medium Round</b>	40-12385
<b>DE #5-6 Standard</b>	40-12384
<b>DE #7-8 DuraLite-Æ ColorRings,Ñç</b>	40-12383
<b>DE #7-8 DuraLite-Æ ROUND</b>	40-12382
<b>DE #7-8 DuraLite-Æ HEX</b>	40-12381
<b>DE #7-8 Medium Round</b>	40-12389
<b>DE #7-8 Standard</b>	40-12390



# Instruments



Prestige Dental Products, Inc.  
 Prestigedentalproducts.com  
 Tel: 877-772-3888

<b>DE #11-12 DuraLite™ Color-Rings, Ñ</b>	40-12398
<b>DE #11-12 DuraLite™ ROUND</b>	40-12397
<b>DE #11-12 DuraLite™ HEX</b>	40-12396
<b>DE #11-12 Medium Round</b>	40-12395
<b>DE #11-12 Standard</b>	40-12394
<b>DE #13-14 DuraLite™ Color-Rings, Ñ</b>	40-12393
<b>DE #13-14 DuraLite™ ROUND</b>	40-12392
<b>DE #13-14 DuraLite™ HEX</b>	40-12391
<b>DE #13-14 Medium Round</b>	40-12417
<b>DE #13-14 Standard</b>	40-12410
<b>DE #15-16 DuraLite™ Color-Rings, Ñ</b>	40-12409
<b>DE #15-16 DuraLite™ ROUND</b>	40-12401
<b>DE #15-16 DuraLite™ HEX</b>	40-12402
<b>DE #15-16 Medium Round</b>	40-12403
<b>DE #15-16 Standard</b>	40-12404
<b>DE #17-18 DuraLite™ Color-Rings, Ñ</b>	40-12405
<b>DE #17-18 DuraLite™ ROUND</b>	40-12406
<b>DE #17-18 DuraLite™ HEX</b>	40-12407
<b>DE #17-18 Medium Round</b>	40-12408
<b>DE #17-18 Standard</b>	40-12380

### Gracey Curettes - Rigid (Nordent)



<b>DE #1-2 DuraLite™ ColorRings, Ñ</b>	40-12458
<b>DE #1-2 DuraLite™ ROUND</b>	40-12459
<b>DE #1-2 DuraLite™ HEX</b>	40-12456
<b>DE #1-2 Medium Round</b>	40-12455
<b>DE #1-2 Standard</b>	40-12454
<b>DE #3-4 DuraLite™ ColorRings, Ñ</b>	40-12453
<b>DE #3-4 DuraLite™ ROUND</b>	40-12452

<b>DE #3-4 DuraLite™ HEX</b>	40-12451
<b>DE #3-4 Medium Round</b>	40-12440
<b>DE #3-4 Standard</b>	40-12439
<b>DE #5-6 DuraLite™ ColorRings, Ñ</b>	40-12428
<b>DE #5-6 DuraLite™ ROUND</b>	40-12427
<b>DE #5-6 DuraLite™ HEX</b>	40-12426
<b>DE #5-6 Medium Round</b>	40-12425
<b>DE #5-6 Standard</b>	40-12424
<b>DE #7-8 DuraLite™ ColorRings, Ñ</b>	40-12423
<b>DE #7-8 DuraLite™ ROUND</b>	40-12422
<b>DE #7-8 DuraLite™ HEX</b>	40-12421
<b>DE #7-8 Medium Round</b>	40-12429
<b>DE #7-8 Standard</b>	40-12430
<b>DE #9-10 DuraLite™ Color-Rings, Ñ</b>	40-12438
<b>DE #9-10 DuraLite™ ROUND</b>	40-12437
<b>DE #9-10 DuraLite™ HEX</b>	40-12436
<b>DE #9-10 Medium Round</b>	40-12435
<b>DE #9-10 Standard</b>	40-12434
<b>DE #11-12 DuraLite™ Color-Rings, Ñ</b>	40-12433
<b>DE #11-12 DuraLite™ ROUND</b>	40-12432
<b>DE #11-12 DuraLite™ HEX</b>	40-12431
<b>DE #11-12 Medium Round</b>	40-12457
<b>DE #11-12 Standard</b>	40-12450
<b>DE #13-14 DuraLite™ Color-Rings, Ñ</b>	40-12449
<b>DE #13-14 DuraLite™ ROUND</b>	40-12441
<b>DE #13-14 DuraLite™ HEX</b>	40-12442
<b>DE #13-14 Medium Round</b>	40-12443
<b>DE #13-14 Standard</b>	40-12444
<b>DE #15-16 DuraLite™ Color-Rings, Ñ</b>	40-12445
<b>DE #15-16 DuraLite™ ROUND</b>	40-12446
<b>DE #15-16 DuraLite™ HEX</b>	40-12447
<b>DE #15-16 Medium Round</b>	40-12448
<b>DE #15-16 Standard</b>	40-12420

### Gracey Curettes - Standard (Nordent)





# Instruments



Prestige Dental Products, Inc.  
 Prestigedentalproducts.com  
 Tel: 877-772-3888

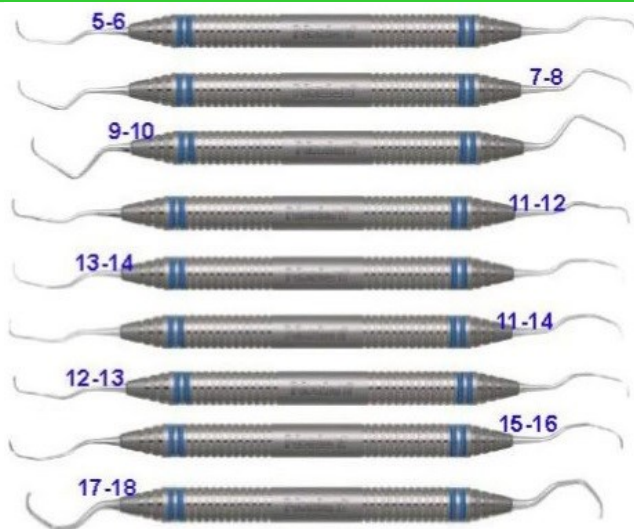

<b>DE #1-2 DuraLite-Æ ColorRings, Ñç</b>	40-12489
<b>DE #1-2 DuraLite-Æ ROUND</b>	40-12500
<b>DE #1-2 DuraLite-Æ HEX</b>	40-12501
<b>DE #1-2 Medium Round</b>	40-12502
<b>DE #1-2 Standard</b>	40-12513
<b>DE #3-4 DuraLite-Æ ColorRings, Ñç</b>	40-12514
<b>DE #3-4 DuraLite-Æ ROUND</b>	40-12511
<b>DE #3-4 DuraLite-Æ HEX</b>	40-12510
<b>DE #3-4 Medium Round</b>	40-12509
<b>DE #3-4 Standard</b>	40-12508
<b>DE #5-6 DuraLite-Æ ColorRings, Ñç</b>	40-12507
<b>DE #5-6 DuraLite-Æ ROUND</b>	40-12506
<b>DE #5-6 DuraLite-Æ HEX</b>	40-12505
<b>DE #5-6 Medium Round</b>	40-12504
<b>DE #5-6 Standard</b>	40-12503
<b>DE #7-8 DuraLite-Æ ColorRings, Ñç</b>	40-12488
<b>DE #7-8 DuraLite-Æ ROUND</b>	40-12487
<b>DE #7-8 DuraLite-Æ HEX</b>	40-12486
<b>DE #7-8 Medium Round</b>	40-12471
<b>DE #7-8 Standard</b>	40-12470
<b>DE #9-10 DuraLite-Æ ColorRings, Ñç</b>	40-12469
<b>DE #9-10 DuraLite-Æ ROUND</b>	40-12468
<b>DE #9-10 DuraLite-Æ HEX</b>	40-12467
<b>DE #9-10 Medium Round</b>	40-12466
<b>DE #9-10 Standard</b>	40-12465
<b>DE #11-12 DuraLite-Æ ColorRings, Ñç</b>	40-12464
<b>DE #11-12 DuraLite-Æ ROUND</b>	40-12463

<b>DE #11-12 DuraLite-Æ HEX</b>	40-12462
<b>DE #11-12 Medium Round</b>	40-12461
<b>DE #11-12 Standard</b>	40-12472
<b>DE #11-14 DuraLite-Æ ColorRings, Ñç</b>	40-12473
<b>DE #11-14 DuraLite-Æ ROUND</b>	40-12474
<b>DE #11-14 DuraLite-Æ HEX</b>	40-12485
<b>DE #11-14 Medium Round</b>	40-12484
<b>DE #11-14 Standard</b>	40-12483
<b>DE #12-13 DuraLite-Æ ColorRings, Ñç</b>	40-12481
<b>DE #12-13 DuraLite-Æ ROUND</b>	40-12480
<b>DE #12-13 DuraLite-Æ HEX</b>	40-12479
<b>DE #12-13 Medium Round</b>	40-12478
<b>DE #12-13 Standard</b>	40-12482
<b>DE #13-14 DuraLite-Æ ColorRings, Ñç</b>	40-12477
<b>DE #13-14 DuraLite-Æ ROUND</b>	40-12476
<b>DE #13-14 DuraLite-Æ HEX</b>	40-12475
<b>DE #13-14 Medium Round</b>	40-12460
<b>DE #13-14 Standard</b>	40-12490
<b>DE #15-16 DuraLite-Æ ColorRings, Ñç</b>	40-12491
<b>DE #15-16 DuraLite-Æ ROUND</b>	40-12492
<b>DE #15-16 DuraLite-Æ HEX</b>	40-12493
<b>DE #15-16 Medium Round</b>	40-12494
<b>DE #15-16 Standard</b>	40-12495
<b>DE #17-18 DuraLite-Æ ColorRings, Ñç</b>	40-12496
<b>DE #17-18 DuraLite-Æ ROUND</b>	40-12497
<b>DE #17-18 DuraLite-Æ HEX</b>	40-12498
<b>DE #17-18 Medium Round</b>	40-12499
<b>DE #17-18 Standard</b>	40-12512

## Gracey Curettes Double End (American Eagle)

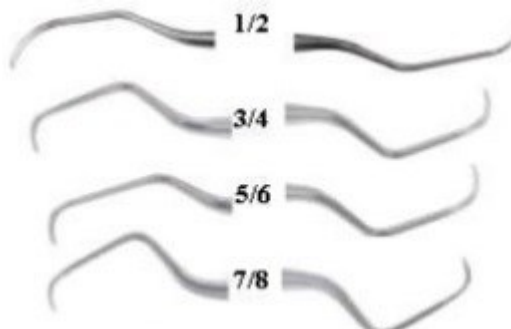



Prestige Dental Products, Inc.  
 Prestigedentalproducts.com  
 Tel: 877-772-3888

## Instruments

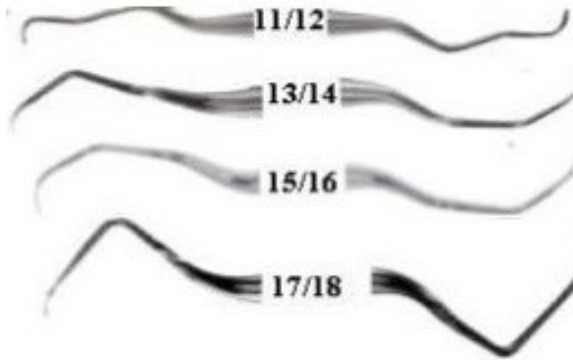

<b>1/2 EagleLite Purple Resin Handle</b>	40-90347
<b>1/2 XP w/ EagleLite Purple Resin Handle</b>	40-90348
<b>3/4 EagleLite Handle</b>	40-90349
<b>5/6 EagleLite Handle</b>	40-90350
<b>7/8 EagleLite Handle</b>	40-90351
<b>11/12 EagleLite Handle</b>	40-90352
<b>11/12 XP w/ EagleLite Resin Handle</b>	40-90353
<b>11/12 XP w/ EagleLite Stainless Steel Handle</b>	40-90354
<b>13/14 EagleLite Handle</b>	40-90355
<b>13/14 XP w/ EagleLite BLue Sure-Grip Handle</b>	40-90356
<b>13/14 XP w/ EagleLite Stainless Steel Handle</b>	40-90357
<b>15/16 EagleLite Handle</b>	40-90358
<b>17/18 EagleLite Handle</b>	40-90359

### Gracey Curettes Double End (Premier)

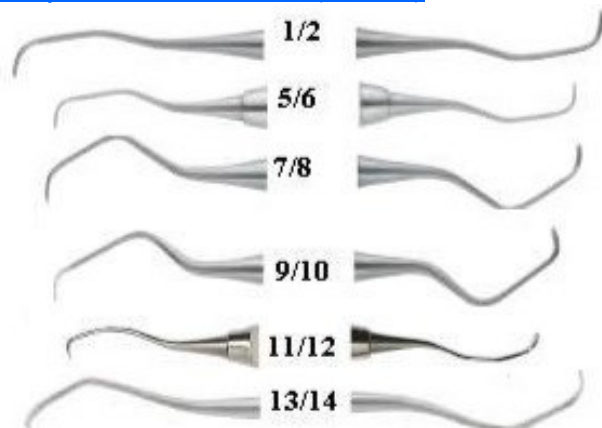

<b>1/2, Big Easy Ultralite Handle</b>	40-90360
<b>5/6, Big Easy Ultralite Handle</b>	40-90361
<b>7/8, Big Easy Ultralite Handle</b>	40-90362
<b>9/10, Big Easy Ultralite Handle</b>	40-90363
<b>11/12, Big Easy Handle</b>	40-90364

<b>11/12, Big Easy Ultralite Handle</b>	40-90365
<b>13/14, Big Easy Handle</b>	40-90366
<b>13/14, Big Easy Ultralite Handle</b>	40-90367

### Gracey Curettes Standard (Hu-Friedy)

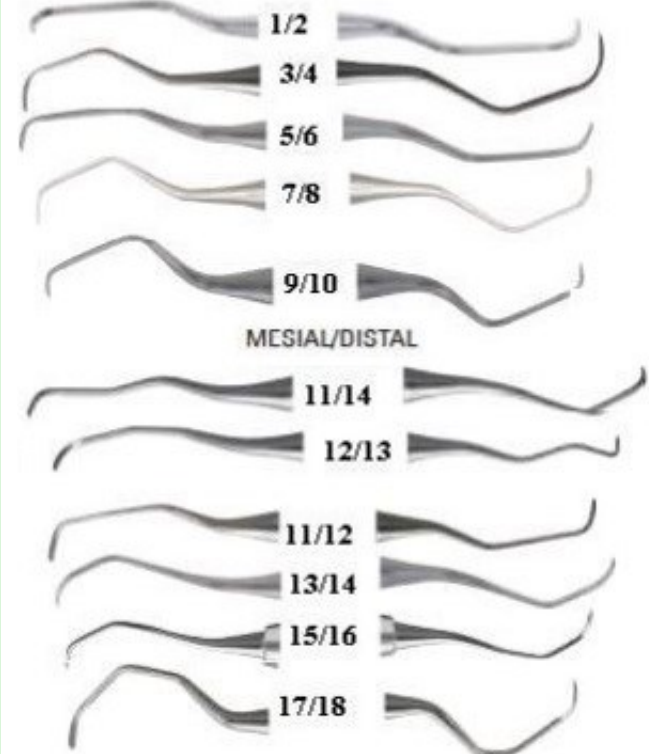

<b>1/2, #2 Octagonal Handle</b>	40-90382
<b>1/2 Rigid</b>	40-90383
<b>1/2 #4 Round Handle Rigid</b>	40-90384
<b>1/2 #6 Satin Steel Handle</b>	40-90385
<b>1/2 Rigid</b>	40-90386
<b>1/2 #7 Satin Steel Colours Handle</b>	40-90387
<b>1/2 ResinEight Handle</b>	40-90388
<b>1/2,#9 EverEdge Handle</b>	40-90389
<b>1/2 Rigid</b>	40-90390
<b>3/4 #2 Octagonal Handle</b>	40-90391
<b>3/4 #4 Round Handle Rigid</b>	40-90392
<b>3/4, #6 Satin Steel Handle</b>	40-90393
<b>3/4, #9 EverEdge Handle</b>	40-90394
<b>5/6 #2 Octagonal Handle</b>	40-90395
<b>5/6 Rigid</b>	40-90696
<b>5/6 #6 Satin Steel Handle</b>	40-90697
<b>5/6 Rigid</b>	40-90398

# Instruments



Prestige Dental Products, Inc.  
 Prestigedentalproducts.com  
 Tel: 877-772-3888

5/6 #9 EverEdge Handle	40-90399
5/6 Rigid	40-90400
5/6 ResinEight Colors Handle-Blue	40-90401
7/8 #2 Octagonal Handle	40-90402
7/8 Rigid	40-90403
7/8 #4 Round Handle Rigid	40-90404
7/8 #6 Satin Steel Handle	40-90405
7/8 Rigid	40-90406
7/8 #7 Satin Steel Colours Handle	40-90407
7/8 #9 EverEdge Handle	40-90408
7/8 Rigid	40-90409
9/10 #6 Satin Steel Handle	40-90410
9/10 Rigid	40-90411
9/10 #9 EverEdge Handle	40-90412
11/12 #2 Octagonal Handle	40-90413
11/12 Rigid	40-90414
11/12 Rigid	40-90415
11/12 #7 Satin Steel Colours Handle	40-90416
11/12 ResinEight Handle	40-90417
11/12 #9 EverEdge Handle	40-90418
11/12 Rigid	40-90419
11/12 ResinEight Colors Handle-Orange	40-90420
13/14 #2 Octagonal Handle	40-90421
13/14 Rigid	40-90422
13/14 #4 Round Handle Rigid	40-90423
13/14 #6 Satin Steel Handle	40-90424
13/14 Rigid	40-90425
13/14 #7 Satin Steel Colours Handle	40-90426
13/14 ResinEight Handle	40-90427
13/14 #9 EverEdge Handle	40-90428
13/14 Rigid	40-90429
13/14 ResinEight Colors Handel-Blue	40-90430
13/14 ResinEight Colors Handle-Blue Rigid	40-90431
15/16 #2 Octagonal Handle	40-90432
15/16 #6 Satin Steel Handle	40-90433
15/16 Rigid	40-90434
15/16 ResinEight Handle	40-90435
15/16 #9 EverEdge Handle	40-90436

15/16 Rigid	40-90437
15/16 ResinEight Colors Handle-Orange	40-90438
17/18 #2 Octagonal Handle	40-90439
17/18 #6 Satin Steel Handle	40-90440
17/18 Rigid	40-90441
17/18 #7 Satin Steel Colours Handle	40-90442
17/18 #9 EverEdge Handle	40-90443
17/18 ResinEight Colors Handel-Blue	40-90444
11/14 Mesial/Distal #6 Satin Steel Handle	40-90445
11/14 Mesial/Distal #9 EverEdge Handle	40-90446
12/13 Mesial/Distal #6 Satin Steel Handle	40-90447
12/13 Mesial/Distal #9 EverEdge Handle	40-90448

## Gracey Periodontal Curettes (DA)

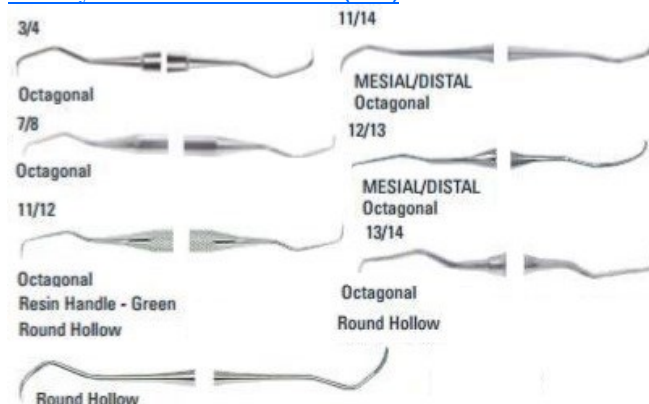

3/4 Octagonal	40-90276
7/8 Octagonal	40-90277
11/12 Octagonal	40-90278
11/12 Resin Handle- Green	40-90279
11/12 Round	40-90280
11/14 Mesial/Distal, Octagonal	40-90281
12/13 Mesial/Distal, Octagonal	40-90282
13/14 Octagonal	40-90283
13/14 Round Hollow	40-90284

## Langer Curette (PDT)



# Instruments



Prestige Dental Products, Inc.  
 Prestigedentalproducts.com  
 Tel: 877-772-3888



<b>PDT Langer Curette D/E #5-6 Each</b>	40-12812
<b>PDT Langer Curette D/E #3-4 Each</b>	40-12811
<b>PDT Langer Curette D/E #1-2 Each</b>	40-12810
<b>PDT Langer 5-6 Mini</b>	40-12814
<b>PDT Langer 17-18</b>	40-12813

### Langer Curettes (Nordent)

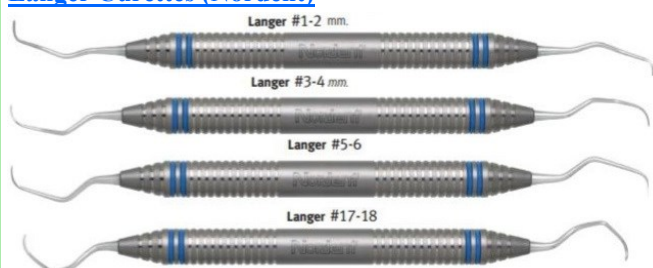

<b>DE #1-2 DuraLite™ ColorRings, N¢</b>	40-12830
<b>D #1-2 DuraLite™ ROUND</b>	40-12831
<b>DE #1-2 DuraLite™ HEX</b>	40-12834
<b>DE #1-2 Medium Round</b>	40-12833
<b>DE #1-2 Standard</b>	40-12825
<b>DE #3-4 DuraLite™ ColorRings, N¢</b>	40-12824
<b>DE #3-4 DuraLite™ ROUND</b>	40-12816
<b>DE #3-4 DuraLite™ HEX</b>	40-12817
<b>DE #3-4 Medium Round</b>	40-12818
<b>DE #3-4 Standard</b>	40-12819
<b>DE #5-6 DuraLite™ ColorRings, N¢</b>	40-12820
<b>DE #5-6 DuraLite™ ROUND</b>	40-12821
<b>DE #5-6 DuraLite™ HEX</b>	40-12822
<b>DE #5-6 Medium Round</b>	40-12823
<b>DE #5-6 Standard</b>	40-12832
<b>DE #17-18 DuraLite™ ColorRings, N¢</b>	40-12829
<b>DE #17-18 DuraLite™ ROUND</b>	40-12828
<b>DE #17-18 DuraLite™ HEX</b>	40-12827
<b>DE #17-18 Medium Round</b>	40-12826
<b>DE #17-18 Standard</b>	40-12815

[www.prestigedentalproducts.com](http://www.prestigedentalproducts.com)

### McCall Curette (PDT)

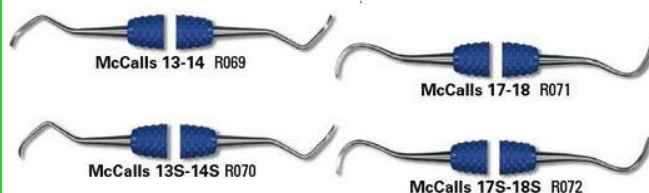

<b>PDT McCall Curette D/E #13-14 Each</b>	40-12941
<b>PDT McCall Curette D/E #13S-14S Each</b>	40-12940
<b>PDT McCall Curette D/E #17-18 Each</b>	40-12943
<b>PDT McCall Curette D/E #17S-18S Each</b>	40-12942

### McCall Curettes (Nordent)

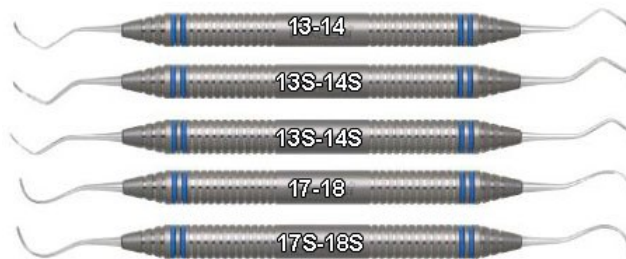

<b>DE #13-14 DuraLite™ ColorRings, N¢</b>	40-12968
<b>DE #13-14 DuraLite™ ROUND</b>	40-12967
<b>DE #13-14 DuraLite™ HEX</b>	40-12966
<b>DE #13-14 Medium Round</b>	40-12957
<b>DE #13-14 Standard</b>	40-12956
<b>DE #13S-14S DuraLite™ ColorRings, N¢</b>	40-12955
<b>DE #13S-14S DuraLite™ ROUND</b>	40-12945
<b>DE #13S-14S DuraLite™ HEX</b>	40-12946
<b>DE #13S-14S Medium Round</b>	40-12947
<b>DE #13S-14S Standard</b>	40-12948
<b>DE 13S-14S Modified (long blade) DuraLite™ ColorRings, N¢</b>	40-12949
<b>DE 13S-14S Modified (long blade) DuraLite™ ROUND</b>	40-12950
<b>DE 13S-14S Modified (long blade) DuraLite™ HEX</b>	40-12951
<b>DE 13S-14S Modified (long blade) Medium Round</b>	40-12952
<b>DE 13S-14S Modified (long blade) Standard</b>	40-12953
<b>DE #17-18 DuraLite™ ColorRings, N¢</b>	40-12954
<b>DE #17-18 DuraLite™ ROUND</b>	40-12965
<b>DE #17-18 DuraLite™ HEX</b>	40-12964



# Instruments



Prestige Dental Products, Inc.  
 Prestigedentalproducts.com  
 Tel: 877-772-3888

<b>DE #17-18 Medium Round</b>	40-12963
<b>DE #17-18 Standard</b>	40-12962
<b>DE #17S-18S DuraLite-Æ Color-Rings, Ñç</b>	40-12961
<b>DE #17S-18S DuraLite-Æ ROUND</b>	40-12960
<b>DE #17S-18S DuraLite-Æ HEX</b>	40-12959
<b>DE #17S-18S Medium Round</b>	40-12958
<b>DE #17S-18S Standard</b>	40-12944

## Mini-Five Gracey Curettes Double End (Hu-Friedy)

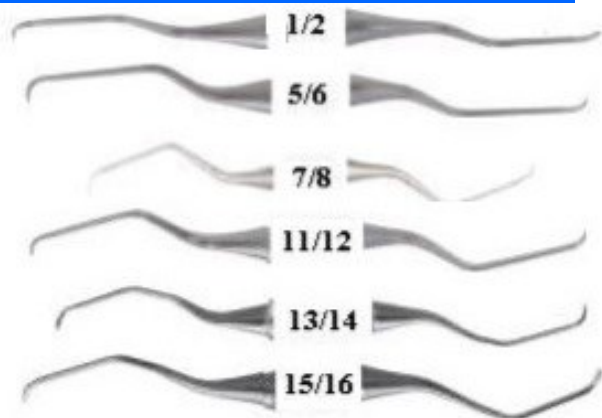

<b>1/2 #2 Octagonal Handle</b>	40-90449
<b>1/2 #6 Satin Steel Handle</b>	40-90450
<b>1/2 Rigid</b>	40-90451
<b>1/2 ResinEight Handle</b>	40-90452
<b>1/2 #9 EverEdge Handle</b>	40-90453
<b>1/2 ResinEight Colors Handle-Grey</b>	40-90454
<b>5/6 #6 Satin Steel Handle</b>	40-90455
<b>5/6 #9 EverEdge Handle</b>	40-90456
<b>5/6 Rigid</b>	40-90457
<b>7/8 #6 Satin Steel Handle</b>	40-90458
<b>7/8 #9 EverEdge Handle</b>	40-90459
<b>11/12 #6 Satin Steel Handle</b>	40-90460
<b>11/12 Rigid</b>	40-90461
<b>11/12 ResinEight Colors Handle-Orange Rigid</b>	40-90462
<b>11/12 #9 EverEdge Handle</b>	40-90463
<b>11/12 Rigid</b>	40-90464
<b>13/14 #2 Octagonal Handle</b>	40-90465
<b>13/14 #6 Satin Steel Handle</b>	40-90466
<b>13/14 Rigid</b>	40-90467
<b>13/14 #9 EverEdge Handle</b>	40-90468
<b>15/16 #9 EverEdge Handle</b>	40-90469

## O'Hehir New Millenium Curettes (PDT)

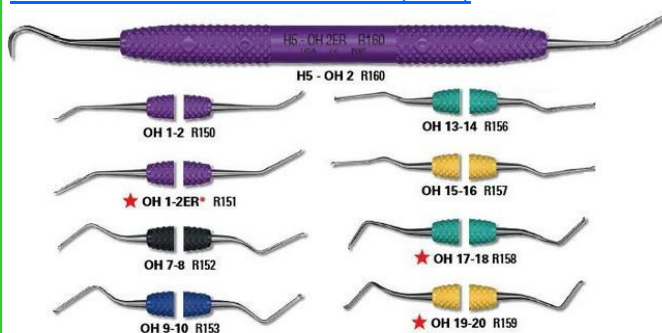

- These unique curettes have small scoop blades with 310° radius cutting edges
- It's like having the toe of a curette without the interference of the remaining unused portion of a traditional blade
- This radical departure from traditional curette design allows the clinician to reach areas missed by traditional curette blades
- Designed for access and effectiveness
- Can be used with either a push or pull motion, in vertical, horizontal or diagonal directions
- Perfect for flutings, fractions and line angles

<b>PDT O'Hehir Millenium Curettes 1-2</b>	40-13111
<b>PDT O'Hehir Millenium Curettes 1-2 ER</b>	40-13110
<b>PDT O'Hehir Millenium Curettes 7-8</b>	40-13109
<b>PDT O'Hehir Millenium Curettes 9-10</b>	40-13108
<b>PDT O'Hehir Millenium Curettes 13-14</b>	40-13112
<b>PDT O'Hehir Millenium Curettes 15-16</b>	40-13113
<b>PDT O'Hehir Millenium Curettes 17-18</b>	40-13114
<b>PDT O'Hehir Millenium Curettes 19-20</b>	40-13116
<b>PDT O'Hehir Millenium Curettes H5 - OH2</b>	40-13115

## Piezo Ultrasonic Gracey Mini Curette Tips (Vista)

The long shank and slender design allow these tips to be used in places that are out of reach with regular sized tips. For instance, when furcations are present or when teeth overlap (crowding) because the bite was never corrected with braces.

- Longer shank than regular curettes for better access into deeper pockets
- Shorter blades (on average 1.2 mm) permit better scaling in NARROW pockets, reduce tissue damage and offer great adaptation to the root surface
- Slender blades aid in tactile sensitivity and enhance deep pocket access and adaptation to the root surfaces



- Tips will fit: EMS\* STYLE: Mini Piezon\*, Scalex 880\*, Bonart\*, SuperSon EIE\*, Master 400\*, Parkel (Piezo)\*, Dent America\* - Acteon\* STYLE: Vista P5\*, NSK\*, ENAC\*, Sybron Endo\*, Obtura Spartan\*, ADEC\*, J.Morita\*, Dentsply/Tulsa\*, Amdent\*



Prestige Dental Products, Inc.  
 Prestigedentalproducts.com  
 Tel: 877-772-3888

## Instruments

HC-Mini-1 (Acteon Style)	56-11243
HC-Mini-2 (Acteon Style)	56-11242
HC-Mini-3 (Acteon Style)	56-11241
HC-Mini-4 (Acteon Style)	56-11240
HC-Mini-7 (Acteon Style)	56-11239
HC-Mini-8 (Acteon Style)	56-11238
HC-Mini-1 (EMS Style)	56-11237
HC-Mini-2 (EMS Style)	56-11236
HC-Mini-3 (EMS Style)	56-11232
HC-Mini-4 (EMS Style)	56-11233
HC-Mini-7 (EMS Style)	56-11234
HC-Mini-8 (EMS Style)	56-11235

### Rules Curette (PDT)



Rules 3-4 R076

PDT Rules Curette D/E #3-4 Each 40-13609

### Sinus Lift Curette (Nordent)

Nordent Sinus Lift instruments are designed to give practitioners improved access to the internal aspects of the sinus. Sinus Lift Curettes have spoons with smooth non-cutting edges and are available in various shank configurations and spoon widths to detach the delicate sinus membrane from lateral walls. Bone Condensers have fine serrations and diameters to compact bone graft material.

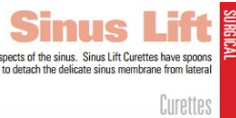

#911 DuraLite-Æ ColorRings, Ñç	36-11263
#912 DuraLite-Æ ColorRings, Ñç	36-11264
#913 DuraLite-Æ ColorRings, Ñç	36-11262
#914 DuraLite-Æ ColorRings, Ñç	36-11261
#915 DuraLite-Æ ColorRings, Ñç	36-11260
#917 DuraLite-Æ ColorRings, Ñç	36-11259
#918 DuraLite-Æ ColorRings, Ñç	36-11258
#919 DuraLite-Æ ColorRings, Ñç	36-11257

### Sinus Lift Curettes (Miltex)

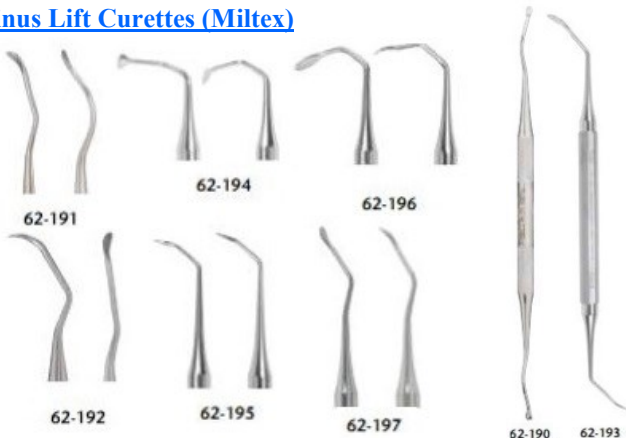

Miltex® Sinus Curettes feature a cutting edge for scraping purposes, but can also be used to lift sinus in preparation for implant procedures

Lift No. 1	36-11270
Lift No. 2	36-11269
Lift No. B1	36-11268
#1	36-11267
#4	36-11266
#5	36-11265
Mills #2	36-11271
Mills #1	36-11272

### Universal Curettes (Nordent)



DE #3-4 University of California DuraLite-Æ ColorRings, Ñç	40-13979
DE #3-4 University of California DuraLite-Æ ROUND	40-13980
DE #3-4 University of California DuraLite-Æ HEX	40-13981
DE #3-4 University of California Medium Round	40-13985
DE #3-4 University of California Standard	40-13984
DE #31-32 DuraLite-Æ ColorRings, Ñç	40-13983
DE #31-32 DuraLite-Æ ROUND	40-13971
DE #31-32 DuraLite-Æ HEX	40-13970
DE #31-32 Medium Round	40-13957
DE #31-32 Standard	40-13958
DE University of California Rule #3-4 DuraLite-Æ ColorRings, Ñç	40-13959
DE University of California Rule #3-4 DuraLite-Æ ROUND	40-13960
DE University of California Rule #3-4 DuraLite-Æ HEX	40-13961
DE University of California Rule #3-4 Medium Round	40-13962
DE University of California Rule #3-4 Standard	40-13963
DE Indiana University #13-14 DuraLite-Æ ColorRings, Ñç	40-13964
DE Indiana University #13-14 DuraLite-Æ ROUND	40-13965

# Instruments



Prestige Dental Products, Inc.  
 Prestigedentalproducts.com  
 Tel: 877-772-3888

<b>DE Indiana University #13-14</b> DuraLite™Æ HEX	40-13966
<b>DE Indiana University #13-14</b> Medium Round	40-13967
<b>DE Indiana University #13-14</b> Standard	40-13968
<b>DE Indiana University #17-18</b> DuraLite™Æ ColorRings, Ñ¢	40-13969
<b>DE Indiana University #17-18</b> DuraLite™Æ ROUND	40-13982
<b>DE Indiana University #17-18</b> DuraLite™Æ HEX	40-13978
<b>DE Indiana University #17-18</b> Medium Round	40-13977
<b>DE Indiana University #17-18</b> Standard	40-13976
<b>DE #7-8 DuraLite™Æ ColorRings, Ñ¢</b>	40-13975
<b>DE #7-8 DuraLite™Æ ROUND</b>	40-13974
<b>DE #7-8 DuraLite™Æ HEX</b>	40-13973
<b>DE #7-8 Medium Round</b>	40-13972
<b>DE #7-8 Standard</b>	40-13956

## Universal Curettes (DA)



<b>2L/2R Octagonal</b>	40-90285
<b>4L/4R Octagonal</b>	40-90286
<b>4L/4R Resin Handle-Pink</b>	40-90287
<b>13/14 Octagonal</b>	40-90288
<b>13/14 Resin Handle-Green</b>	40-90289
<b>13S/14S Octagonal</b>	40-90290

## Prestige Dental Products



**Excellent Qualities  
 at Affordable Prices**

**877-772-3888**

[www.prestigedentalproducts.com](http://www.prestigedentalproducts.com)

## Universal Curettes Double End (American Eagle)



<b>Barnhart 1/2 EagleLite Handle</b>	40-90470
<b>Barnhart 5/6 EagleLite Handle</b>	40-90471
<b>Barnhart 5/6 XP</b> w/ EagleLite Stainless Steel Handle	40-90472
<b>Barnhart 5/6 XP w/ EagleLite Red Handle</b>	40-90473
<b>Columbia 4L/4R XP w/EagleLite Handle</b>	40-90474
<b>Columbia 4L/4R EagleLite Handle</b>	40-90475
<b>Columbia 4L/4R XP</b> w/ EagleLite Resin Handle	40-90476
<b>Columbia 13/14 EagleLite Handle</b>	40-90477
<b>Columbia 13/14 XP w/ EagleLite Handle</b>	40-90478
<b>Columbia 13/14 XP</b> w/ EagleLite Stainless Steel Handle	40-90479
<b>Langer 1/2 EagleLite Red Handle</b>	40-90480
<b>Langer 3/4 XP w/EagleLite Resin Handle</b>	40-90481
<b>McCall 13/14 EagleLite Handle</b>	40-90482
<b>McCall 13/14S EagleLite Handle</b>	40-90483
<b>McCall 13/14S XP</b> w/EagleLite Stainless Steel Handle	40-90484
<b>McCall 17/18 EagleLite Handle</b>	40-90485



# Instruments



Prestige Dental Products, Inc.  
 Prestigedentalproducts.com  
 Tel: 877-772-3888

<b>Rules 3/4 XP w/EagleLite Yellow Handle</b>	40-90486
<b>7/8 EagleLite Handle</b>	40-90487

### Universal Curettes Double End (Hu-Friedy)

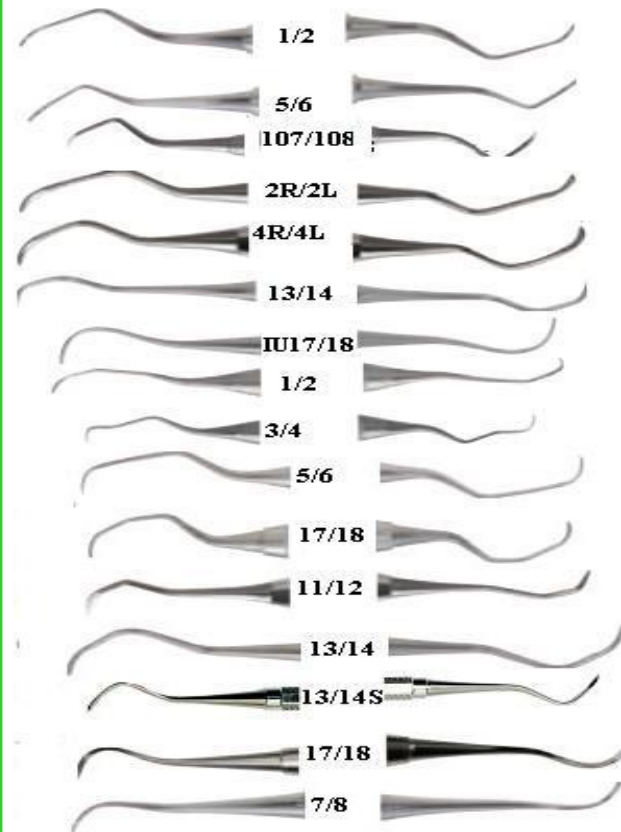

<b>Barnhart 1/2 #2 Octagonal Handle</b>	40-90488
<b>Barnhart 1/2 #4 Round Handle Rigid</b>	40-90489
<b>Barnhart 1/2 #6 Satin Steel Handle</b>	40-90490
<b>Barnhart 1/2 ResinEight Handle</b>	40-90491
<b>Barnhart 1/2 ResinEight Colors Handle-Lavender</b>	40-90492
<b>Barnhart 1/2 #9 EverEdge Handle</b>	40-90493
<b>Barnhart 1/2 Rigid</b>	40-90494
<b>Barnhart 5/6 ResinEight Colors Handle- Lavender</b>	40-90495
<b>Barnhart 5/6 #2 Octagonal Handle</b>	40-90496
<b>Barnhart 5/6 Rigid</b>	40-90497
<b>Barnhart 5/6 #4 Round Handle</b>	40-90498
<b>Barnhart 5/6 Rigid</b>	40-90499
<b>Barnhart 5/6 #6 Satin Steel Handle</b>	40-90500
<b>Barnhart 5/6 ResinEight Colors Handle-Lavender Rigid</b>	40-90501
<b>Barnhart 5/6 Rigid</b>	40-90502

<b>Barnhart 5/6 ResinEight Handle</b>	40-90503
<b>Barnhart 5/6 #9 EverEdge Handle</b>	40-90504
<b>Barnhart 5/6 Rigid</b>	40-90505
<b>Cattoni 107/108 #6 Satin Steel handle</b>	40-90506
<b>Columbia 2R/2L #6 Satin Steel Handle</b>	40-90507
<b>Columbia 4R/4L #2 Octagonal handle</b>	40-90508
<b>Columbia 4R/4L #4 Round Handle Rigid</b>	40-90509
<b>Columbia 4R/4L #6 Satin Steel Handle</b>	40-90510
<b>Columbia 4R/4L #7 satin Steel Colours Handle</b>	40-90548
<b>Columbia 4R/4L ResinEight Handle</b>	40-90549
<b>Columbia 4R/4L ResinEight Colors Handle-Lavender</b>	40-90550
<b>Columbia 4R/4L #9 EverEdge Handle</b>	40-90551
<b>Columbia 13/14 #2 Octagonal handle</b>	40-90552
<b>Columbia 13/14 #4 Round Handle</b>	40-90553
<b>Columbia 13/14 #6 Satin Steel handle</b>	40-90517
<b>Columbia 13/14 #7 Satin Steel Colours Handle</b>	40-90518
<b>Columbia 13/14 ResinEight Handle</b>	40-90519
<b>Columbia 13/14 #9 EverEdge Handle</b>	40-90520
<b>Columbia 13/14 ResinEight Colors Handle-Lavender</b>	40-90521
<b>Indiana University IU 17/18 #6 satin Steel Handle</b>	40-90522
<b>Langer 12 #6 Satin Steel Handle</b>	40-90523
<b>Langer 3/4 #6 Satin Steel handle</b>	40-90524
<b>Langer 3/4 #9 EverEdge Handle</b>	40-90525
<b>Langer 5/6 #6 Satin Steel Handle</b>	40-90526
<b>Langer 5/6 #9 EverEdge Handle</b>	40-90527
<b>Langer 17/18 #6 Satin Steel handle</b>	40-90528
<b>Langer 17/18 #9 EverEdge handle</b>	40-90529
<b>McCall 11/12 #6 Satin Steel Handle</b>	40-90530
<b>McCall 13/14, Rounded Tip, #2 Octagonal handle</b>	40-90531
<b>McCall 13/14, Rounded Tip, #6 Satin Steel Handle</b>	40-90532
<b>McCall 13/14, Rounded Tip, #9 EverEdge Handle</b>	40-90533
<b>McCall 13/14, Rounded Tip, ResiEight Colors handle-Lavender</b>	40-90534





Prestige Dental Products, Inc.  
 Prestigedentalproducts.com  
 Tel: 877-772-3888

## Instruments

<b>McCall 13/14S, Pointed Tip,</b> #2 Octagonal handle	40-90535
<b>McCall 13/14S, Pointed Tip,</b> #4 Round Handle	40-90536
<b>McCall 13/14S, Pointed Tip,</b> #6 Satin Steel Handle	40-90537
<b>McCall 13/14S, Pointed Tip,</b> #9 EverEdge handle	40-90538
<b>McCall 17/18 #2 Octagonal handle</b>	40-90539
<b>McCall 17/18 #6 Satin Steel Handle</b>	40-90540
<b>McCall 17/18 #9 EverEdge handle</b>	40-90541
<b>McCall 17/18</b> ResinEight Colors Handle-lavender	40-90542
<b>Younger-Good 7/8 #2 Octagonal handle</b>	40-90543
<b>Younger-Good 7/8 #6 Satin Steel Handle</b>	40-90544
<b>Younger-Good 7/8 ResinEight handle</b>	40-90545
<b>Younger-Good 7/8</b> ResinEight Colors handle-Lavender	40-90546
<b>Younger-Good 7/8</b> #9 EverEdge Handle	40-90547

### Universal Curettes Double End (PDT)

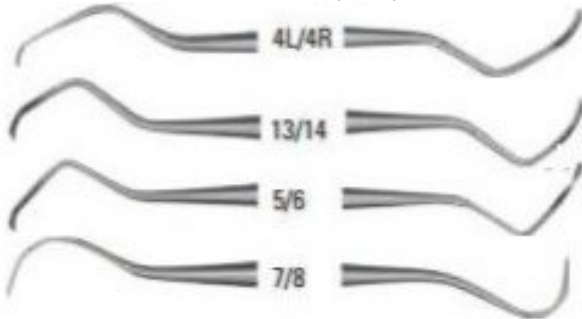

<b>Columbia 4L/4R Blue</b>	40-90554
<b>Columbia 13/14 Blue</b>	40-90555
<b>Barnhart 5/6 Blue</b>	40-90556
<b>Younger-Good 7/8 Blue</b>	40-90557

### Universal Curettes Double End (Premier)



<b>Columbia 4L/4R Big Easy handle</b>	40-90558
<b>Columbia 4L/4R</b> Big Easy ultralite handle	40-90559
<b>Columbia 13/14 Big Easy handle</b>	40-90560
<b>Columbia 13/14 Big Easy ultralite handle</b>	40-90561
<b>McCall 13S/14S Big Easy Handle</b>	40-90562
<b>McCall 13S/14S</b> Big Easy Ultralite Handle	40-90563
<b>McCall 17/18 Big Easy handle</b>	40-90564
<b>McCall 17/18 Big Easy Ultralite handle</b>	40-90565
<b>McCall 17S/18S Big Easy handle</b>	40-90566
<b>McCall 17S/18S</b> Big Easy Ultralite handle	40-90567

### Younger-Good Curette (PDT)



<b>PDT Younger-Good Curette D/E</b> #YG 7-8 Each	40-14032
---	----------

## Elevators & Root Picks

### Beck Root Elevators (Miltex)



- Made from the highest quality German stainless steel
- Permanent weld in handle preserves instrument integrity and longevity
- Finger platform on the handle provides a better grip
- Sharp, thin rounded tip with luxating step for easy penetration in the interdental space as well as 180° access to luxate in four directions, two mesial and two distal

<b>2.8mm, Straight Tip each</b>	40-91503
<b>3.5mm, Straight Tip each</b>	40-91504
<b>4mm, Straight Tip each</b>	40-91505
<b>35mm, Curved Right Tip each</b>	40-91506
<b>3.5mm, Curved Left Tip each</b>	40-91507

**Call Us Today 833-733-6825**



Prestige Dental Products, Inc.  
 Prestigedentalproducts.com  
 Tel: 877-772-3888

## Instruments

### Bone Preservation Elevator Kit (A. Titan)

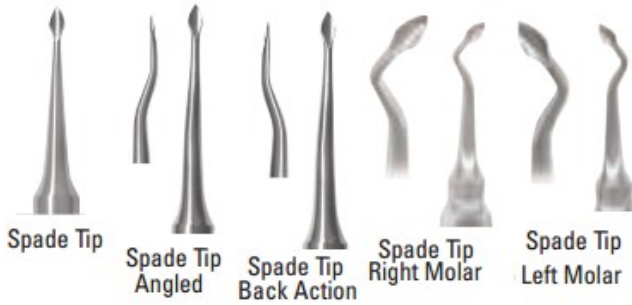

Spade Tip	40-91508
Spade Tip Angled	40-91509
Spade Tip Back Action	40-91510
Spade Tip Right Molar	40-91511
Spade Tip Left Molar	40-91512

### Elevators (DA)



#14L CrossBar, Stainless Steel each	40-91456
#14R CrossBar, Stainless Steel each	40-91457
#34 Gouge, Stainless Steel each	40-91458
#34S Gouge, Stainless Steel each	40-91459
#46 Gouge, Stainless Steel each	40-91460
#301 Apical Gouge, Stainless Steel each	40-91461
#302 Apical Gouge, Stainless Steel each	40-91462
#303 Apical Gouge, Stainless Steel each	40-91463
#304 Apical Gouge, Stainless Steel each	40-91464
Crane Pick 341, each	40-91465

### Elevators (Miltex)



77R Serrated, each	40-91551
#34 Gouge, Stainless Steel each	40-91552
#34S Gouge, Stainless Steel each	40-91553
#46 Gouge, Stainless Steel each	40-91554
#301 Apical Gouge, Stainless Steel each	40-91555
#302 Apical Gouge, each	40-91556
#303 Apical Gouge, each	40-91557
Heidbrink 4 Root Tip Pick, Stainless Steel each	40-91558
Heidbrink 5 Root Tip Pick, Stainless Steel each	40-91559
Heidbrink 13/14 Root Tip Pick, Stainless Steel each	40-91560

### Elevators - Cryer Root (DA)



#31, Cryer Root Elevator Large	40-91466
#32, Cryer Root Elevator Large	40-91467
#25, Cryer Root Elevator Medium	40-91468
#26, Cryer Root Elevator Medium	40-91469
#44, Cryer Root Elevator Small	40-91470
#5, Cryer Root Elevator Small	40-91471

### Elevators— Apexo (Hu-Friedy)

All elevators come with a #510 handle unless otherwise indicated.



#301 Apexo, each	40-91517
#302 Apexo, each	40-91518
#303 Apexo, each	40-91519



Prestige Dental Products, Inc.  
 Prestigedentalproducts.com  
 Tel: 877-772-3888

# Instruments

## Elevators— Cryer Root Elevator (Hu-Friedy)

All elevators come with a #510 handle unless otherwise indicated.



- #44 Small**, Cryer Root Elevator, each 40-91520
- #45 Small**, Cryer Root Elevator, each 40-91521
- #25 Medium**, Cryer Root Elevator each 40-91522
- #26 Medium**, Cryer Root Elevator each 40-91523
- #31 Large**, Cryer Root Elevator each 40-91524
- #32 Large**, Cryer Root Elevator each 40-91525
- #E21 Left**, Cryer Root Elevator Mini each 40-91526
- #E22 Left**, Cryer Root Elevator Mini each 40-91527

## Elevators— Davis Root Tip (Hu-Friedy)

All elevators come with a #510 handle unless otherwise indicated.



- #2 S/E Davis Root Tip**, each 40-91528
- #3 S/E Davis Root Tip**, each 40-91529

## Elevators— General (Hu-Friedy)

All elevators come with a #510 handle unless otherwise indicated.



- General #190**, each 40-91530
- General #191**, each 40-91531

## Elevators— Gouge (Hu-Friedy)

All elevators come with a #510 handle unless otherwise indicated.



- #34 Gouge**, Stainless Steel each 40-91532

## Elevators— Howard (Hu-Friedy)

All elevators come with a #510 handle unless otherwise indicated.



- Howard #2**, each 40-91541
- Howard #3**, each 40-91542

## Elevators— Potts (Hu-Friedy)

All elevators come with a #510 handle unless otherwise indicated.



- #6 Potts**, each 40-91543
- #7 Potts**, each 40-91544
- #6 X Potts**, Stainless Steel each 40-91545
- #7 X Potts**, Stainless Steel each 40-91546

## Elevators— Schmeckebier (Hu-Friedy)

All elevators come with a #510 handle unless otherwise indicated.



- Schmeckebier #4**, each 40-91547
- Schmeckebier #5**, each 40-91548

## Elevators— Seldin (Hu-Friedy)

All elevators come with a #510 handle unless otherwise indicated.



- #34 Seldin**, Stainless Steel each 40-91513
- #34S Seldin**, Stainless Steel each 40-91514
- #46** Stainless Steel, each 40-91515

# Instruments



Prestige Dental Products, Inc.  
 Prestigedentalproducts.com  
 Tel: 877-772-3888

## Elevators—Serrated (Hu-Friedy)

All elevators come with a #510 handle unless otherwise indicated.



**77R Serrated**, each 40-91516

## Elevators—West Apical Root Pick (Hu-Friedy)

All elevators come with a #510 handle unless otherwise indicated.



**#2 West Apical Root Pick**, each 40-91549

**#3 West Apical Root Pick**, each 40-91550

## Elevators—Davis Root (DA)

All elevators are offered with the large handles.

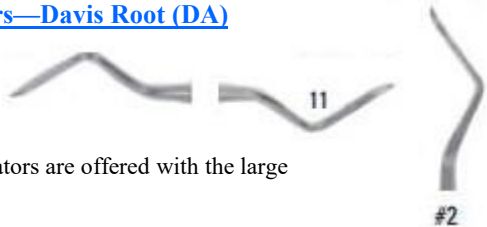

**#2 Davis Root Tip**, each 40-91472

**Davis Root Tip Teaser D/E 11**, each 40-91473

## Elevators—General (DA)

All elevators are offered with the large handles.



**General 190**, each 40-91474

**General 191**, each 40-91475

## Elevators—Heidbrink (DA)

All elevators are offered with the large handles.



**Heidbrink 1**, each 40-91476

**Heidbrink 2**, each 40-91477

**Heidbrink 40**, Stainless Steel each 40-91478

**Heidbrink 41**, each 40-91479

**Heidbrink 80**, each 40-91480

## Elevators—Heidbrink Ejector (DA)

All elevators are offered with the large handles.

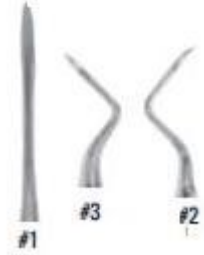

**Heidbrink Ejector #1**, each 40-91481

**Heidbrink Ejector #2**, each 40-914862

**Heidbrink Ejector #3**, each 40-91483

## Elevators—Howard (DA)

All elevators are offered with the large handles.



**Howard #1**, each 40-91484

**Howard #2**, each 40-91485

**Howard #3**, each 40-91486

## Elevators—Miller 74 (DA)

All elevators are offered with the large handles.



**Miller 74**, each 40-91487

## Elevators—Potts Crossbar (DA)

All elevators are offered with the large handles.



**#6 X Potts Crossbar**, Stainless Steel each 40-91488

**#7 X Potts Crossbar**, Stainless Steel each 40-91489





# Instruments



Prestige Dental Products, Inc.  
 Prestigedentalproducts.com  
 Tel: 877-772-3888

## Elevators—Schmeckeber (DA)

All elevators are offered with the large handles.



<b>#4 Schmeckeber</b> , each	40-91490
<b>#5 Schmeckeber</b> , each	40-91491
<b>Schmeckeber 81</b> , each	40-91492

## Elevators—Seldin Gouge (DA)

All elevators are offered with the large handles.



<b>#1L Seldin #1 Gouge</b> , Stainless Steel each	40-91493
<b>#1R Seldin #1 Gouge</b> , Stainless Steel each	40-91494
<b>#3 Seldin Gouge</b> , Stainless Steel each	40-91495
<b>#4L Seldin #4 Gouge</b> , Stainless Steel each	40-91496
<b>#4R Seldin #4 Gouge</b> , Stainless Steel each	40-91497

## Elevators—Stout (DA)

All elevators are offered with the large handles.



<b>Stout 11A</b> , each	40-91498
-------------------------	----------

## Elevators—West Apical Root Pick (DA)

All elevators are offered with the large handles.



<b>West Apical Root Pick 1</b> , each	40-91499
<b>#2 West Apical Root Pick</b> , each	40-91500
<b>#3 West Apical Root Pick</b> , each	40-91501

## Ergo Dynamic Elevators (Hu-Friedy)



- Small handled elevator provides better leverage and better fit in your hand
- Handcrafted from Immunity Steel® and heat treated to provide optimal sharpness and durability
- Offers an alternative to standard size elevator handles

<b>Apexo #301</b> , each	40-91561
<b>#77R Serrated</b> , each	40-91562
<b>Cogswell #8</b> , each	40-91563
<b>Luxating 3mm Straight</b> , each	40-91564
<b>Curved</b> , each	40-91565
<b>Luxating 5mm Straight</b> , each	40-91566

## Root Tip Pick (DA)



<b>Heidbrink 3</b> , each	40-91502
---------------------------	----------

## Root Tip Pick Elevators (Hue-Friedy)

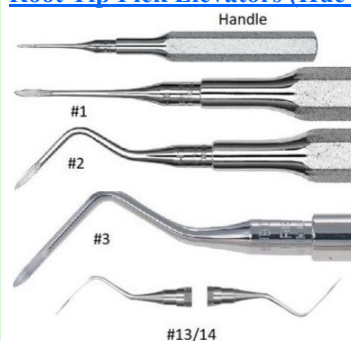

All elevators come with a #510 handle unless otherwise indicated.

<b>Heidbrink 1</b> , each	40-91537
<b>Heidbrink 2</b> , each	40-91538
<b>Heidbrink 3</b> , each	40-91539
<b>13/14 Heidbrink Root Tip Pick</b> , each	40-91540

## Spade Elevators (Miltex)

Spade elevators are used to loosen the tooth from the periodontal socket, separate the periodontal ligament from the tooth, and help expand the socket for easier extraction.



# Instruments



Prestige Dental Products, Inc.  
 Prestigedentalproducts.com  
 Tel: 877-772-3888

Spade Tip #1, Right Molar	40-91567
Spade Tip #2, Angled	40-91568
Spade Tip #3, Left Molar	40-91569
Spade Tip #4, Straight	40-91570

## Excavators

### Double Ended Excavators (ASA Italy)



D/E Excavators Fig.0	40-11639
D/E Excavators Fig.1	40-11629
D/E Excavators Fig.2	40-11637
D/E Excavators Fig.3	40-11638
D/E Excavators Fig.4	40-11636
D/E Excavators Fig.17	40-11635
D/E Excavators Fig.18	40-11634

### Excavators

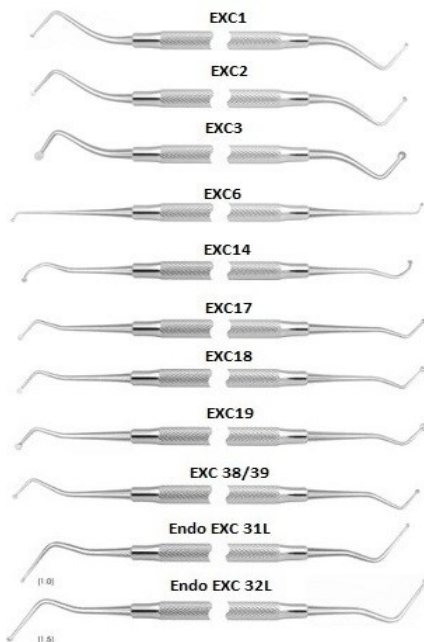

#1, each	40-106621
#2, each	40-106622
#3, each	40-106623
#6, each	40-106624
#14, each	40-106625
#17, each	40-106626
#18, each	40-106627
#19, each	40-106628
#38/39, each	40-106629
Endo 31L, each	40-106630
Endo 32L, each	40-106631

### Excavators (American Eagle)



42/43 (15-8-14), each	40-91022
70/71, each	40-91023

### Excavators (Hartzell)



Each	40-91024
------	----------

### Excavators (Hu-Friedy)

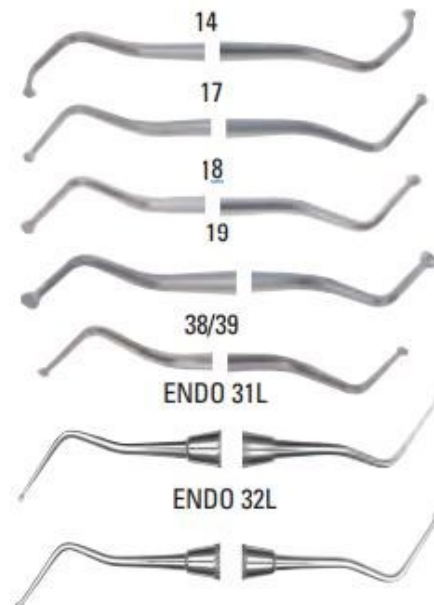



Prestige Dental Products, Inc.  
 Prestigedentalproducts.com  
 Tel: 877-772-3888

# Instruments

14, each	40-91025
17, each	40-91026
17, each	40-91027
18, each	40-91028
18, each	40-91029
19, each	40-91030
19, each	40-91031
38/39, each	40-91032
38/39, each	40-91033
Endo 31L, each	40-91034
Endo 32L, each	40-91035

## Excavators (Premier)

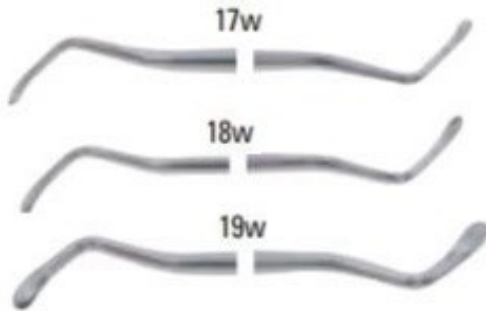

17W each	40-91050
18W each	40-91051
19W each	40-91052

## Excavators - Double End (Nordent)

Each blade is hollow ground for maximum sharpness. DuraLite® handles increase tactile sensitivity and control.  
 Standard - Spoons



### Long Shank - Spoons

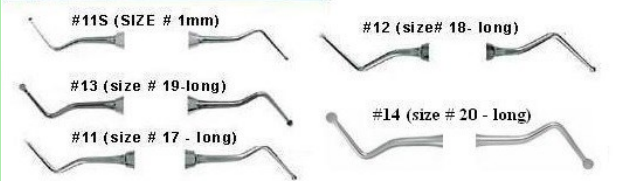

### Blades



#1 (Size #17) Spoon DuraLite® ColorRings™	40-11865
#1 (Size #17) Spoon DuraLite® ROUND	40-11866

#1 (Size #17) Spoon DuraLite® HEX	40-11867
#1 (Size #17) Spoon Standard	40-11883
#1S (1 mm Head Size)(#38-39) Spoon DuraLite® ColorRings™	40-11884
#1S (1 mm Head Size)(#38-39) Spoon DuraLite® ROUND	40-11885
#1S (1 mm Head Size)(#38-39) Spoon DuraLite® HEX	40-11901
#1S (1 mm Head Size)(#38-39) Spoon Standard	40-11902
#2 (Size #18) Spoon DuraLite® ColorRings™	40-11903
#2 (Size #18) Spoon DuraLite® ROUND	40-11904
#2 (Size #18) Spoon DuraLite® HEX	40-11905
#2 (Size #18) Spoon Standard	40-11906
#3 - (Size #19) Spoon DuraLite® ColorRings™	40-11907
#3 - (Size #19) Spoon DuraLite® ROUND	40-11908
#3 - (Size #19) Spoon DuraLite® HEX	40-11909
#3 - (Size #19) Spoon Standard	40-11910
#4 (Size #20) Spoon DuraLite® ColorRings™	40-11911
#4 (Size #20) Spoon DuraLite® ROUND	40-11912
#4 (Size #20) Spoon DuraLite® HEX	40-11900
#4 (Size #20) Spoon Standard	40-11899
#5 DuraLite® Anterior Spoon ColorRings™	40-11898
#5 DuraLite® Anterior Spoon ROUND	40-11886
#5 DuraLite® Anterior Spoon HEX	40-11887
#5 Anterior Spoon Standard	40-11888
#6 DuraLite® Anterior Spoon ColorRings™	40-11889
#6 DuraLite® Anterior Spoon ROUND	40-11890
#6 DuraLite® Anterior Spoon HEX	40-11891
#6 Anterior Spoon Standard	40-11892
#7 DuraLite® Anterior Spoon ColorRings™	40-11893
#7 DuraLite® Anterior Spoon ROUND	40-11894
#7 DuraLite® Anterior Spoon HEX	40-11895
#7 Anterior Spoon Standard	40-11896



## Instruments



Prestige Dental Products, Inc.  
 Prestigedentalproducts.com  
 Tel: 877-772-3888

<b>#8 Back Action Anterior</b> Spoon DuraLite® ColorRings™	40-11897
<b># Back Action Anterior</b> Spoon DuraLite® ROUND	40-11913
<b>#8 Back Action Anterior</b> Spoon DuraLite® HEX	40-11854
<b>#8 Back Action Anterior</b> Spoon Standard	40-11795
<b>#11 (size #17) Long Shank Spoon Du-</b> <b>raLite® ColorRings™</b>	40-11811
<b>#11 (size #17)</b> Long Shank Spoon DuraLite® ROUND	40-11812
<b>#11 (size #17)</b> Long Shank Spoon DuraLite® HEX	40-11813
<b>#11 (size #17)</b> Long Shank Spoon Standard	40-11814
<b>#11L Endodontic</b> Extra Long Shank Spoon DuraLite® ColorRings™	40-11815
<b>#11L Endodontic</b> Extra Long Shank Spoon DuraLite® ROUND	40-11816
<b>#11L Endodontic</b> Extra Long Shank Spoon DuraLite® HEX	40-11817
<b>#11L Endodontic</b> Extra Long Shank Spoon Standard	40-11818
<b>#11S (1 mm Head Size) Long Shank</b> Spoon DuraLite® ColorRings™	40-11819
<b>#11S (1 mm Head Size) Long Shank</b> Spoon DuraLite® ROUND	40-11820
<b>#11S (1 mm Head Size)</b> Long Shank Spoon DuraLite® HEX	40-11821
<b>#11S (1 mm Head Size)</b> Long Shank Spoon Standard	40-11822
<b>#12 (size #18) Long Shank Spoon Du-</b> <b>raLite® ColorRings™</b>	40-11810
<b>#12 (size #18)</b> Long Shank Spoon DuraLite® ROUND	40-11809
<b>#12 (size #18)</b> Long Shank Spoon DuraLite® HEX	40-11808
<b>#12 (size #18)</b> Long Shank Spoon Standard	40-11796
<b>#12L Endodontic</b> Extra Long Shank Spoon DuraLite® ColorRings™	40-11797
<b>#12L Endodontic</b> Extra Long Shank Spoon DuraLite® ROUND	40-11798
<b>#12L Endodontic</b> Extra Long Shank Spoon DuraLite® HEX	40-11799

<b>#12L Endodontic</b> Extra Long Shank Spoon Standard	40-11800
<b>#13 (size #19) Long Shank Spoon</b> DuraLite® ColorRings™	40-11801
<b>#13 (size #19) Long Shank Spoon</b> DuraLite® ROUND	40-11802
<b>#13 (size #19) Long Shank Spoon</b> DuraLite® HEX	40-11803
<b>#13 (size #19) Long Shank Spoon</b> Standard	40-11804
<b>#14 (Size #20) Long Shank Spoon</b> DuraLite® ColorRings™	40-11805
<b>#14 (Size #20) Long Shank Spoon</b> DuraLite® ROUND	40-11806
<b>#14 (Size #20)</b> Long Shank Spoon DuraLite® HEX	40-11807
<b>#14 (Size #20)</b> Long Shank Spoon Standard	40-11823
<b>#15 Small Blade DuraLite®</b> <b>ColorRings™</b>	40-11824
<b>#15 Small Blade DuraLite®</b> ROUND	40-11825
<b>#15 Small Blade DuraLite®</b> HEX	40-11841
<b>#15 Small Blade</b> Standard	40-11842
<b>#16 Medium Blade DuraLite®</b> <b>ColorRings™</b>	40-11843
<b>#16 Medium Blade DuraLite®</b> ROUND	40-11844
<b>#16 Medium Blade DuraLite®</b> HEX	40-11845
<b>#16 Medium Blade</b> Standard	40-11846
<b>#17L Large Blade DuraLite®</b> <b>ColorRings™</b>	40-11847
<b>#17L Large Blade DuraLite®</b> ROUND	40-11848
<b>#17L Large Blade DuraLite®</b> HEX	40-11849
<b>#17L Large Blade</b> Standard	40-11850
<b>#31L Endodontic</b> Extra Long Shank Blade DuraLite® ColorRings™	40-11851
<b>#31L Endodontic</b> Extra Long Shank Blade DuraLite® ROUND	40-11852
<b>#31L Endodontic</b> Extra Long Shank Blade DuraLite® HEX	40-11840
<b>#31L Endodontic</b> Extra Long Shank Blade Standard	40-11839
<b>#31LR Endodontic</b> Extra Long Shank Spoon DuraLite® ColorRings™	40-11838
<b>#31LR Endodontic</b> Extra Long Shank Spoon Standard	40-11827

# Instruments



Prestige Dental Products, Inc.  
 Prestigedentalproducts.com  
 Tel: 877-772-3888

#32L Endodontic Extra Long Shank Blade DuraLite® ColorRings™	40-11828
#32L Endodontic Extra Long Shank Blade DuraLite® ROUND	40-11829
#32L Endodontic Extra Long Shank Blade DuraLite® HEX	40-11830
#32L Endodontic Extra Long Shank Blade Standard	40-11831
#33L Endodontic Extra Long Shank Blade DuraLite® ColorRings™	40-11832
#33L Endodontic Extra Long Shank Blade DuraLite® ROUND	40-11833
#33L Endodontic Extra Long Shank Blade DuraLite® HEX	40-11834
#33L Endodontic Extra Long Shank Blade Standard	40-11835
#125-126 English Pattern Spoon DuraLite® ColorRings™	40-11836
#125-126 English Pattern Spoon DuraLite® ROUND	40-11837
#125-126 English Pattern Spoon DuraLite® HEX	40-11853
#125-126 English Pattern Spoon Standard	40-11880
#128-128 English Pattern Spoon DuraLite® ColorRings™	40-11881
#128-128 English Pattern Spoon DuraLite® ROUND	40-11864
#128-128 English Pattern Spoon DuraLite® HEX	40-11863
#128-128 English Pattern Spoon Standard	40-11862
#129-130 English Pattern Spoon DuraLite® ColorRings™	40-11861
#129-130 English Pattern Spoon DuraLite® ROUND	40-11860
#129-130 English Pattern Spoon DuraLite® HEX	40-11859
#129-130 English Pattern Spoon Standard	40-11858
#131-132 English Pattern Spoon DuraLite® ColorRings™	40-11857
#131-132 English Pattern Spoon DuraLite® ROUND	40-11856
#131-132 English Pattern Spoon DuraLite® HEX	40-11868
#131-132 English Pattern Spoon Standard	40-11869

#133-134 English Pattern Spoon DuraLite® ColorRings™	40-11870
#133-134 English Pattern Spoon DuraLite® ROUND	40-11882
#133-134 English Pattern Spoon DuraLite® HEX	40-11879
#133-134 English Pattern Spoon Standard	40-11878
#153-154 English Pattern Spoon DuraLite® ColorRings™	40-11877
#153-154 English Pattern Spoon DuraLite® ROUND	40-11876
#153-154 English Pattern Spoon DuraLite® HEX	40-11875
#153-154 English Pattern Spoon Standard	40-11874
#155-156 English Pattern Spoon DuraLite® ColorRings™	40-11873
#155-156 English Pattern Spoon DuraLite® ROUND	40-11872
#155-156 English Pattern Spoon Standard	40-11855
#31LR Endodontic Extra Long Shank Spoon DuraLite® ROUND	40-11826
#155-156 English Pattern Spoon DuraLite® HEX	40-11871

## Root Elevators (ASA Italy)

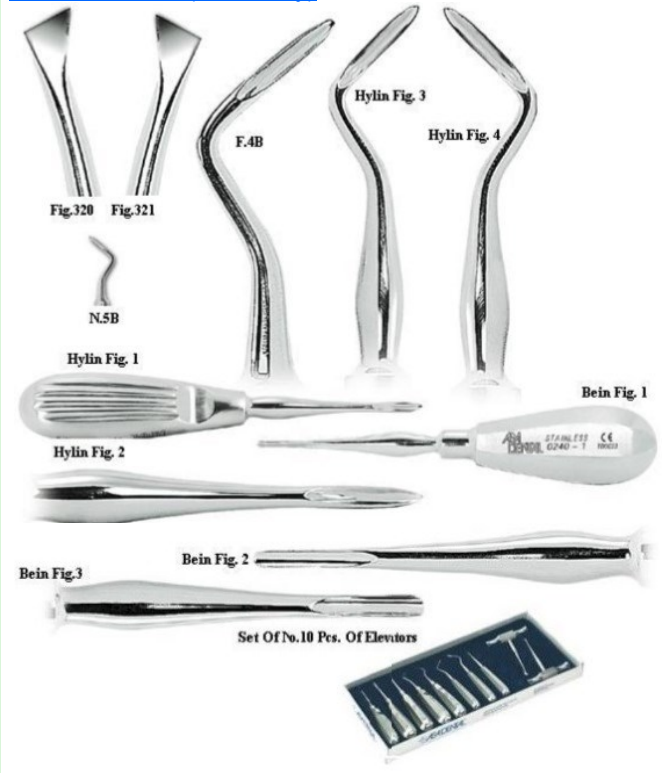

# Instruments



Prestige Dental Products, Inc.  
 Prestigedentalproducts.com  
 Tel: 877-772-3888

<b>Root Elevators Fig.1B Bein</b>	40-13575
<b>Root Elevators Fig.2B Bein</b>	40-13566
<b>Root Elevators Fig.3B Bein</b>	40-13567
<b>Root Elevators Fig.4B Bein</b>	40-13568
<b>Root Elevators Fig.5B Bein</b>	40-13569
<b>Root Elevators Fig.6B Bein</b>	40-13570
<b>Root Elevators Fig.1F Flohr</b>	40-13571
<b>Root Elevators Fig.2F Flohr</b>	40-13572
<b>Root Elevators Fig.3F Flohr</b>	40-13573
<b>Walter F. Barry Root Elevators Fig. 320 Cross-Bar</b>	40-13564
<b>Walter F. Barry Root Elevators Fig.321 Cross-Bar</b>	40-13563
<b>Root Elev. Schmeckebier-Apexo F.4Bsa Concave Point</b>	40-13562
<b>Root Elevators Schmeckebier-Apexo N.5B Flat Point</b>	40-13553
<b>Root Elevators Cryer Fig.44</b>	40-13555
<b>Root Elevators Cryer Fig.45</b>	40-13554
<b>Root Elevators Hylin Fig. 1</b>	40-13556
<b>Root Elevators Hylin Fig. 2</b>	40-13557
<b>Root Elevators Hylin Fig. 3</b>	40-13558
<b>Root Elevators Hylin Fig. 4</b>	40-13559
<b>Root Elevators Bein Fig. 1</b>	40-13561
<b>Root Elevators Bein Fig. 2</b>	40-13560
<b>Root Elevators Bein Fig.3</b>	40-13574
<b>Set Of No.10 Pcs. Of Elevators</b>	40-13565

## Root Tip Pick (Miltex)



<b>Heidbrink Root Tip Pick #1</b>	40-18000
<b>Heidbrink Root Tip Pick #2</b>	40-18001
<b>Heidbrink Root Tip Pick #3</b>	40-18002
<b>Heidbrink Root Tip Pick #2/3</b>	40-18003
<b>Root Tip Pick #78</b>	40-18004
<b>Root Tip Pick #79</b>	40-18005
<b>Root Tip Pick #80</b>	40-18006

## Root-Tip Picks (ASA Italy)

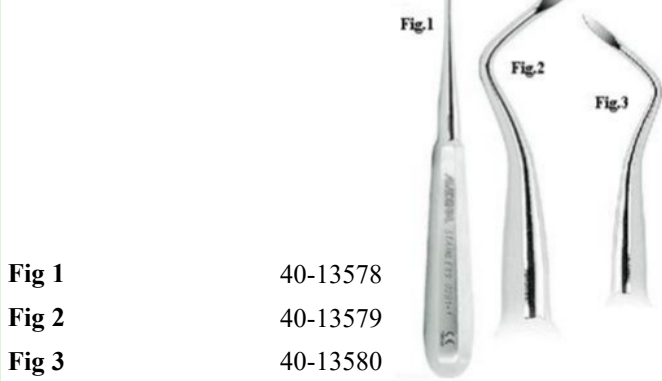

<b>Fig 1</b>	40-13578
<b>Fig 2</b>	40-13579
<b>Fig 3</b>	40-13580

## Explorer Probes

### Explorer Probes (American Eagle)

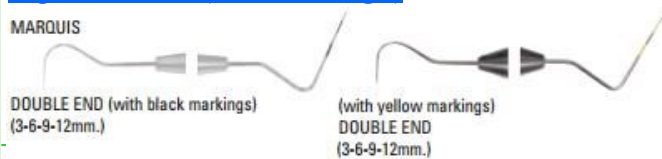

<b>Marquis, Double End</b> (with black markings 3-6-9-12mm)	40-90030
<b>Double End</b> (with yellow markings 3-6-9-12mm)	40-90031

### Explorer Probes (DA)



<b>Double End Michigan 0 #23</b> (3-6-8mm)	40-90027
<b>Williams Round #23</b> (1-2-3-5-7-8-9-10mm)	40-90028
<b>Williams Round DE #6</b> (1-2-3-5-7-8-9-10mm)	40-90029

# Prestige Dental Products



**Excellent Qualities  
 at Affordable Prices**

**877-772-3888**

[www.prestigedentalproducts.com](http://www.prestigedentalproducts.com)

# Instruments



Prestige Dental Products, Inc.  
 Prestigedentalproducts.com  
 Tel: 877-772-3888

## Explorers (Hu-Friedy)

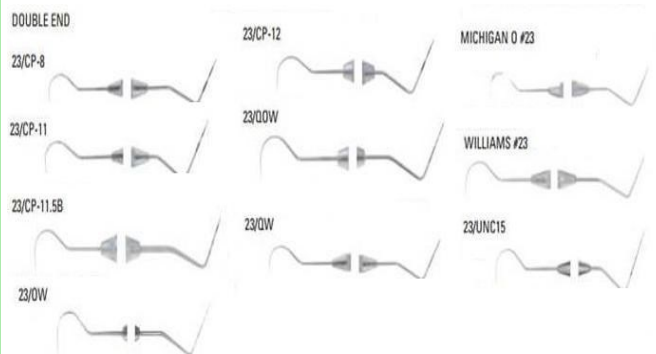

**Double End, Color-Coded** (3-6-8-11mm) Standard Diagnostic Handle 40-90032

**Color-Coded** (3-6-8-11mm) Standard Diagnostic Handle 40-90033

**PSR Screening Probe, Color-Coded** (3.5-5.5-8.5-11.5mm), #6 Satin Steel Handle 40-90034

**PSR Screening Probe, Color-Coded** (3.5-5.5-8.5-11.5mm), Standard Diagnostic Handle 40-90035

**Color-Code** (3-6-9-12mm) ResinEight Handle 40-90036

**Color-Code** (3-6-9-12mm) Standard Diagnostic Handle 40-90037

**Michigan 0 w/Williams markings** (1-2-3-5-7-8-9-10mm) 40-90038

**Michigan 0 w/Williams markings** (1-2-3-5-7-8-9-10mm) Standard Diagnostic Handle 40-90039

**Michigan 0 w/Williams markings** (1-2-3-5-7-8-9-10mm) #6 Satin Steel Handle 40-90040

**Michigan 0 w/Williams markings** (1-2-3-5-7-8-9-10mm) ResinEight Handle 40-90041

**Williams Color-Coded** (1-2-3-5-7-8-9-10mm) Standard Diagnostic Handle 40-90042

**Univ of N. Carolina Color-Coded** (1-2-3-4-5-6-7-8-9-10-11-12-13-14-15mm) #6 Satin Steel Handle 40-90043

**Univ of N. Carolina Color-Coded** (1-2-3-4-5-6-7-8-9-10-11-12-13-14-15mm) Standard Diagnostic Handle 40-90044

**Michigan O #23** (3-6-8mm) Standard Diagnostic Handle 40-90045

**Williams #23** (1-2-3-5-8-9-10mm) #6 Satin Steel Handle 40-90046

**Williams #23** (1-2-3-5-8-9-10mm) Standard Diagnostic Handle 40-90047

**Color-Code** (3-6-9-12mm) #6 Satin Steel Handle 40-90048

## Exproler-Probes

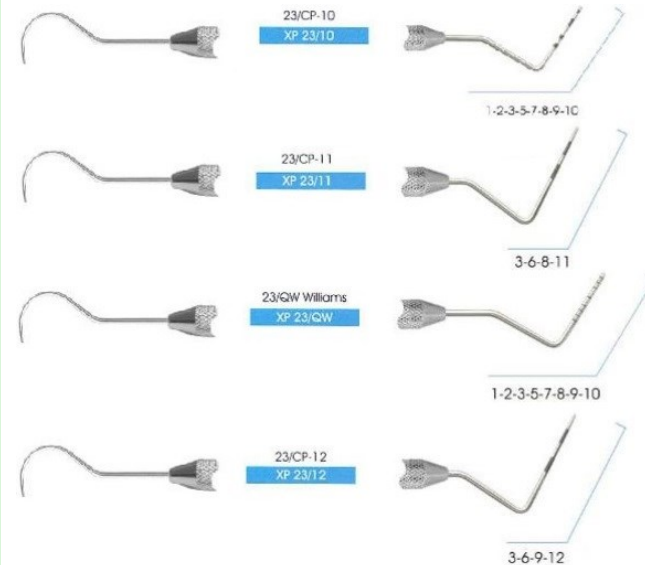

**23/CP-11** 40-30971

**23/CP-10** 40-30972

**23/QW Williams** 40-30973

**23/Cp-12** 40-30974

## Extracting Forceps For Children with Non Slip Jaws (ASA Italy)



**N.1 Upper Incisors** 40-12034

**N.2 Upper Premolars** 40-12027

**N.3 Upper Molars** 40-12028



# Instruments



Prestige Dental Products, Inc.  
 Prestigedentalproducts.com  
 Tel: 877-772-3888

<b>N.4 Upper Roots</b>	40-12029
<b>N.5 Lower Incisors</b>	40-12030
<b>N.6 Lower Molars</b>	40-12031
<b>N.7 Lower Roots</b>	40-12032

### Probes (Premier)



<b>DE Goldman-Fox</b> (1-2-3-5-7-8-9-10mm) Light Touch Round Handle	40-90254
<b>SE Williams</b> (1-2-3-5-7-8-9-10mm) Light Touch Round Handle	40-90255

### XTS Explorers (Hu-Friedy)

Xts coating offers enhanced contrast between instrument and tooth structure. Non-stick coating is perfect for carving anatomy during composite restorations—the added benefit of an XTS explorer as opposed to a regular stainless explorer. Made from Duraspond for flexibility and resilience.

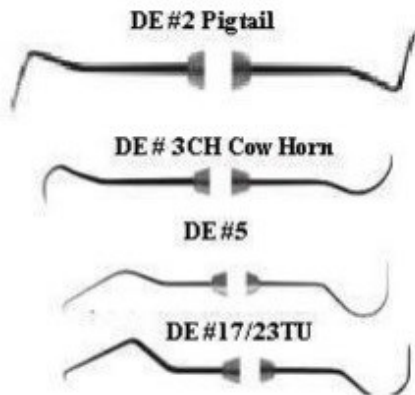

<b>DE #2, Pigtail</b> , #6 Satin Steel Handle	40-90106
<b>DE #3CH</b> , Cow Horn, #6 Satin Steel Handle	40-90107
<b>DE #5</b> , #6 Satin Steel Handle	40-90108
<b>DE #17/23TU</b> , #6 Satin Steel Handle	40-90109

### Explorers

### Cavity Finders Double End (Premier)

- Improved tactile sensitivity via multi-piece construction
- Thin, yet durable tips
- mad of top quality surgical grade stainless steel machined and heat-treated to perfection
- Excellent tactile sensitivity

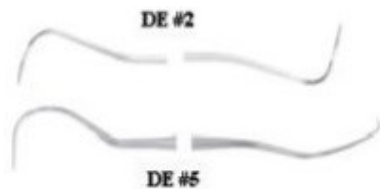

<b>DE #2</b> , 12/Pkg	40-90098
<b>DE #5</b> , Knurled Round Handle	40-90099

### Cavity Finders Single End (Premier)

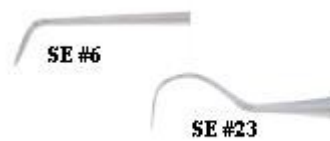

- Improved tactile sensitivity via multi-piece construction
- Thin, yet durable tips
- mad of top quality surgical grade stainless steel machined and heat-treated to perfection
- Excellent tactile sensitivity

<b>SE #6</b> , Knurled Round Handle	40-90100
<b>SE #23</b> , Set of 12	40-90101
<b>SE #23</b> Knurled Round Handle	40-90102

### Double Ended Explorers (ASA Italy)



<b>Double Ended Explorers</b> Fig 0710-6D1	40-11643
<b>Root Canal Explorers</b> Fig.0704-23D2	40-11641
<b>Double Ended Explorers</b> Fig. 0704-23D1	40-11642

### Explorer 17-23 (ATW)

High Quality



<b>With Solid Handle</b> , each	40-97872
<b>With Hollow Handle</b> , each	40-97871

### Explorer 23-16



- High Quality
- Light weight w/ hollow handle
- Made in USA

<b>With Hollow Handle</b> , each	40-908622
----------------------------------	-----------



Like us on Facebook

# Instruments



Prestige Dental Products, Inc.  
 Prestigedentalproducts.com  
 Tel: 877-772-3888

## Explorer 23-6 (ATW)

High Quality



With Solid Handle, each 40-97852  
 With Hollow Handle, each 40-97851

## Explorer 5 (ATW)

High Quality



With Solid Handle, each 40-97862  
 With Hollow Handle, each 40-97861

## Explorer DG16



- High Quality  
 - Light weight w/ hollow handle  
 - Made in USA

With Hollow Handle, each 40-908623

## Explorer Double End Cavity Finder (Premier)

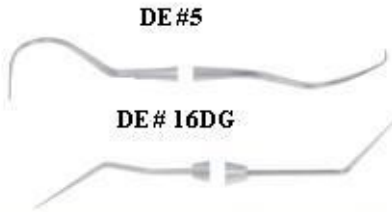

DE #5, Octagonal Handle 40-90103  
 DE #16DG, Stainless Steel Knurled Round Handle 40-90104

## Explorer No 6 (Prestige)



Single End With Hollow Handle, each 40-106161

## Explorer Probes (American Eagle)



MARQUIS  
 DOUBLE END (with black markings)  
 (3-6-9-12mm.)

(with yellow markings)  
 DOUBLE END  
 (3-6-9-12mm.)

## Marquis, Double End

(with black markings 3-6-9-12mm) 40-90030

## Double End

(with yellow markings 3-6-9-12mm) 40-90031

## Explorer Probes (DA)



Double End Michigan 0 #23 (3-6-8mm) 40-90027

Williams Round #23 (1-2-3-5-7-8-9-10mm) 40-90028

Williams Round DE #6 (1-2-3-5-7-8-9-10mm) 40-90029

## Explorer Single End Cavity Finder (Premier)



SE #23, Octagonal Handle 40-90105

## Explorers (Hu-Friedy)

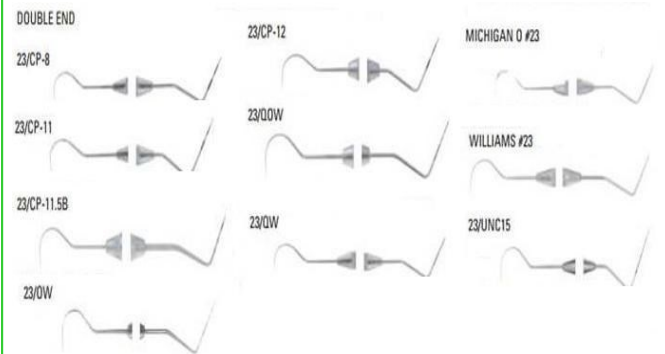

Double End, Color-Coded (3-6-8-11mm) Standard Diagnostic Handle 40-90032

Color-Coded (3-6-8-11mm) Standard Diagnostic Handle 40-90033

PSR Screening Probe, Color-Coded (3.5-5.5-8.5-11.5mm), #6 Satin Steel Handle 40-90034

PSR Screening Probe, Color-Coded (3.5-5.5-8.5-11.5mm), Standard Diagnostic Handle 40-90035



Prestige Dental Products, Inc.  
 Prestigedentalproducts.com  
 Tel: 877-772-3888

# Instruments

<b>Color-Code</b> (3-6-9-12mm) ResinEight Handle	40-90036
<b>Color-Code</b> (3-6-9-12mm) Standard Diagnostic Handle	40-90037
<b>Michigan 0 w/Williams markings</b> (1-2-3-5-7-8-9-10mm)	40-90038
<b>Michigan 0 w/Williams markings</b> (1-2-3-5-7-8-9-10mm) Standard Diagnostic Handle	40-90039
<b>Michigan 0 w/Williams markings</b> (1-2-3-5-7-8-9-10mm) #6 Satin Steel Handle	40-90040
<b>Michigan 0 w/Williams markings</b> (1-2-3-5-7-8-9-10mm) ResinEight Handle	40-90041
<b>Williams Color-Coded</b> (1-2-3-5-7-8-9- 10mm) Standard Diagnostic Handle	40-90042
<b>Univ of N. Carolina Color-Coded</b> (1-2-3-4-5-6-7-8-9-10-11-12-13-14- 15mm) #6 Satin Steel Handle	40-90043
<b>Univ of N. Carolina Color-Coded</b> (1-2-3-4-5-6-7-8-9-10-11-12-13-14- 15mm) Standard Diagnostic Handle	40-90044
<b>Michigan O #23</b> (3-6-8mm) Standard Diagnostic Handle	40-90045
<b>Williams #23</b> (1-2-3-5-8-9-10mm) #6 Satin Steel Handle	40-90046
<b>Williams #23</b> (1-2-3-5-8-9-10mm) Standard Diagnostic Handle	40-90047
<b>Color-Code</b> (3-6-9-12mm) #6 Satin Steel Handle	40-90048

## Explorers (J & J Instrument)

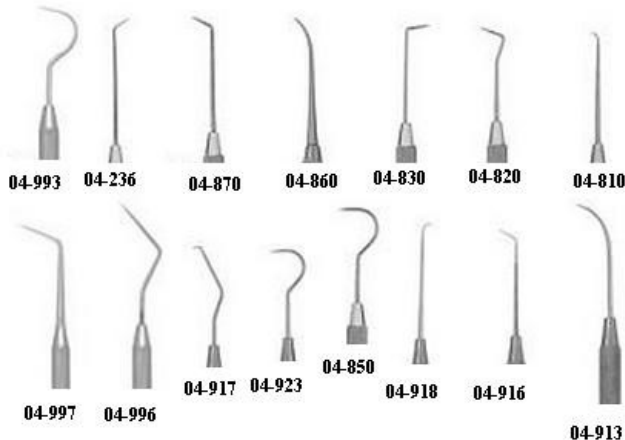

Several components are necessary to provide a fine and functional dental explorer. First, the tips must be sharp so that dental caries and calculus can be precisely located. Next, the tips must be both malleable and durable. The correct steel hard-end to consistent and exacting standards will ensure the tactile sensitivity that the

practitioner demands. Finally, these tips must be joined to a handle that is lightweight and comfortable, yet sturdy. The meticulous marriage of these elements makes the J&J Explorer a most effective diagnostic tool.

<b>Explorer #1</b> - Double Ended	40-11931
<b>Explorer #2</b> - Double Ended	40-11932
<b>Explorer #3</b> - Double Ended	40-11930
<b>Explorer #6</b> - Double Ended	40-11928
<b>Explorer #7</b> - Double Ended	40-11929
<b>Explorer #23/6</b> - Double Ended	40-11918
<b>Explorer #3</b> - Single Ended	40-11927
<b>Explorer #6</b> - Single Ended	40-11926
<b>Explorer #7</b> - Single Ended	40-11925
<b>Explorer #23</b> - Single Ended	40-11924
<b>Explorer #17</b> - Single Ended	40-11923
<b>Explorer #DG16/23</b> Double Ended	40-11922
<b>Endodontic Explorer #DG16</b> Double Ended	40-11921
<b>Endodontic Explorer #DG16/17</b> Double Ended	40-11920
<b>Explorer #5</b> - Double Ended, #23 Explorer tip on one end and a #17 tip on the other	40-11919

## Explorers (Nordent)

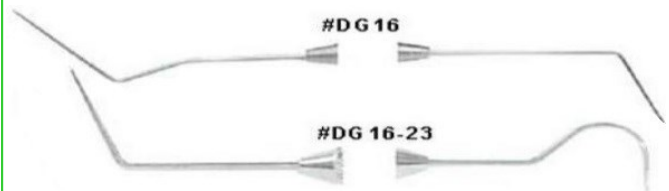

<b>#DG16</b> Double End DuraLite® ColorRings™	40-11774
<b>#DG16</b> Double End DuraLite® ROUND	40-11773
<b>#DG16</b> Double End Standard	40-11772
<b>#DG16-23</b> Double End DuraLite® ColorRings™	40-11771
<b>#DG16-23</b> Double End DuraLite® ROUND	40-11769
<b>#DG16-23</b> Double End Standard	40-11770







## Explorers - DE





Prestige Dental Products, Inc.  
 Prestigedentalproducts.com  
 Tel: 877-772-3888

# Instruments

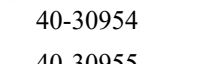
	5 EXD 5	
	WTU17/23 EXD U17/23	
	23/6 EXD 23/6	
	11/12 EXD 11/12	
<b>DG16</b>		40-30954
<b>2</b>		40-30955
<b>3CH</b>		40-30956
<b>5</b>		40-30957
<b>WTU17/23</b>		40-30958
<b>23/6</b>		40-30959
<b>11/12</b>		40-30960

## Explorers - Magic Color (ASA Italy)

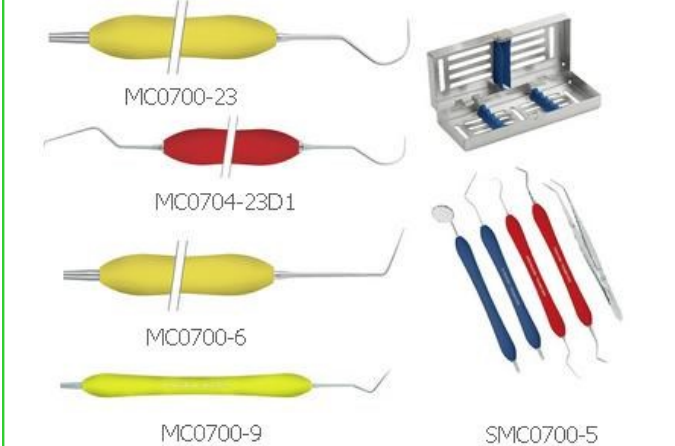

<b>Magic Color Single Ended Explorers</b> Fig. MC0700-23 Yellow	40-11933
<b>Magic Color Single Ended Explorer</b> Fig. MC0700-6 Yellow	40-11936
<b>Magic Color Single Ended Explorers</b> Fig. MC0700-9 Yellow	40-11934
<b>Magic Color Diagnostic Instruments Set</b>	40-11935
<b>D/E Explorers - Magic Color</b> Fig. 11/12Af -Red	40-11937
<b>D/E Magic Color Explorers</b> Fig. 23/17 -Red	40-11938

## Explorers - SE

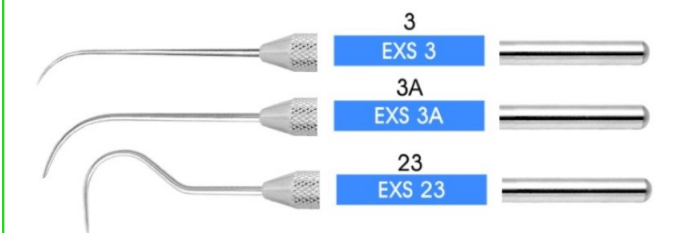

<b>#3</b>	40-30951
<b>#3A</b>	40-30952
<b>#23</b>	40-30953

## Explorers Single End (Nordent)

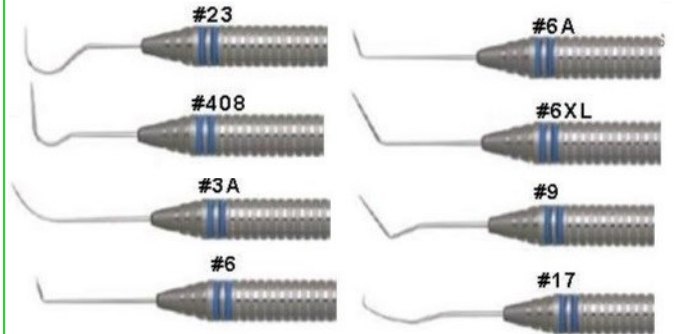

<b>#3A DuraLite® ColorRings™</b>	40-11978
<b>#3A DuraLite® ROUND</b>	40-11993
<b>#3A Standard</b>	40-11994
<b>#3 DuraLite® ColorRings™</b>	40-11995
<b>#3 DuraLite® ROUND</b>	40-11996
<b>#3 Standard</b>	40-11997
<b>#6A DuraLite® ColorRings™</b>	40-11998
<b>#6A DuraLite® ROUND</b>	40-11999
<b>#6A Standard</b>	40-12000
<b>#6 DuraLite® ColorRings™</b>	40-12001
<b>#6 DuraLite® ROUND</b>	40-12002
<b>#6 Standard</b>	40-12003
<b>#6XL DuraLite® ColorRings™</b>	40-11992
<b>#6XL DuraLite® ROUND</b>	40-11991
<b>#6XL Standard</b>	40-11990
<b>#9 DuraLite® ColorRings™</b>	40-11979
<b>#9 DuraLite® ROUND</b>	40-11980
<b>#9 Standard</b>	40-11981
<b>#17 DuraLite® ColorRings™</b>	40-11982
<b>#17 DuraLite® ROUND</b>	40-11983
<b>#17 Standard</b>	40-11984
<b>#23 Shepherds Hook DuraLite® ColorRings™</b>	40-11985
<b>#23 Shepherds Hook DuraLite® ROUND</b>	40-11986
<b>#23 Shepherds Hook Standard</b>	40-11987
<b>#408 DuraLite® ColorRings™</b>	40-11988
<b>#408 DuraLite® ROUND</b>	40-11989
<b>#408 Standard</b>	40-12004



# Instruments



Prestige Dental Products, Inc.  
 Prestigedentalproducts.com  
 Tel: 877-772-3888

## Explorers Double End (American Eagle)

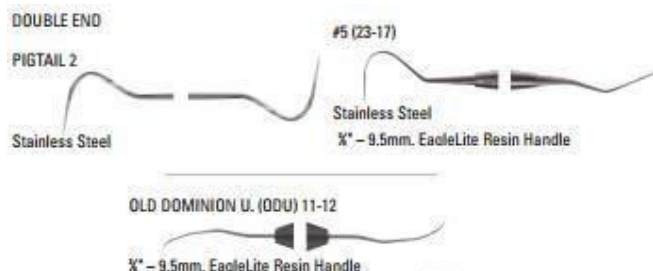

<b>Pigtail 2</b> , Stainless Steel	40-90068
<b>#5 (23-17)</b> , Stainless Steel	40-90069
<b>#5 (23-17)</b> , 3/8"-9.5mm. EagleLite Resin Handle	40-90070
<b>Old Dominion U. (ODU) 11-12</b> , 3/8"- 9.5mm EagleLite Resin Handle	40-90071

## Explorers Double End (Hu-Friedy)

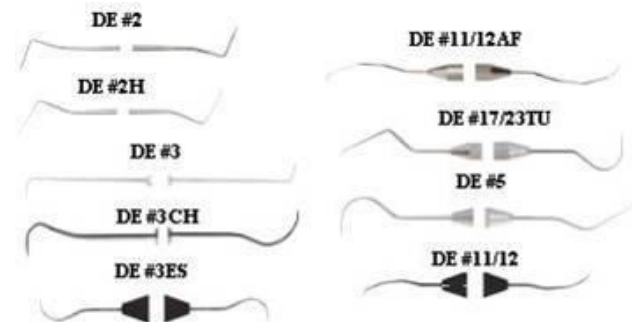

- Maximum diameter handle with exclusive Comfort Zone, and extra-wide, gradual taper between the handle and the tip which reduces pressure points
- Made of unique. Richly textured stainless steel for greater rotational control
- Hu-Friedy tips ensure sharpness, sharpness retention, and consistency in design and angulations

<b>DE #2</b> , #6 Satin Steel Handle	40-90072
<b>DE #2</b> , Standard Diagnostic Handle	40-90073
<b>DE #2H</b> , Standard Diagnostic Handle	40-90074
<b>DE #3</b> , Standard Diagnostic Handle	40-90075
<b>DE #3CH, Cow Horn</b> , #6 Satin Steel Handle	40-90076
<b>DE #3CH, Cow Horn</b> , Standard Diagnostic Handle	40-90077
<b>DE #3ES</b> , #6 Satin Steel Handle	40-90078
<b>DE #5</b> , ResinEight Handle	40-90079
<b>DE #5</b> , #7 Satin Steel Colours Handle	40-90080
<b>DE #5</b> , #6 Satin Steel Handle	40-90081
<b>DE #5</b> , Standard Diagnostic Handle	40-90082
<b>DE #11/12</b> , ResinEight Handle	40-90083
<b>DE #11/12</b> , #6 Satin Steel Handle	40-90084

<b>DE #11/12</b> , #7 Satin Steel Colours Handle	40-90085
<b>DE #11/12</b> , Standard Diagnostic Handle	40-90086
<b>DE #11/12AF</b> , #6 Satin Steel Handle	40-90087
<b>DE #11/12AF</b> , Standard Diagnostic Handle	40-90088
<b>DE #17/23TU</b> , #6 Satin Steel Handle	40-90089

## Explorers Double End (Miltex)



Octagonal-handled explorers have one-piece construction for durability.

<b>DE #3</b> , Stainless Steel	40-90094
<b>DE #5</b> , Stainless Steel	40-90095

## Explorers Double End (Nordent)

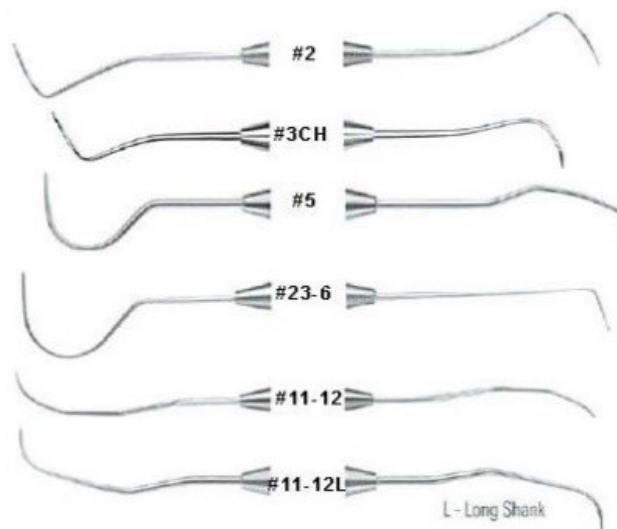

<b>#2 Pig Tail DuraLite</b> ColorRings, $\tilde{N}\phi$	40-11973
<b>#2 Pig Tail DuraLite</b> ROUND	40-11974
<b>#2 Pig Tail Standard</b>	40-11975
<b>#2A DuraLite</b> ColorRings, $\tilde{N}\phi$	40-11976
<b>#2A DuraLite</b> ROUND	40-11959
<b>#2A Standard</b>	40-11958
<b>#2XL DuraLite</b> ColorRings, $\tilde{N}\phi$	40-11957
<b>#2XL DuraLite</b> ROUND	40-11940
<b>#2XL Standard</b>	40-11941
<b>#3CH Cow Horn</b> DuraLite ColorRings, $\tilde{N}\phi$	40-11942

# Instruments



Prestige Dental Products, Inc.  
 Prestigedentalproducts.com  
 Tel: 877-772-3888

#3CH Cow Horn DuraLite <sup>™</sup> Æ ROUND	40-11943
#3CH Cow Horn Standard	40-11944
#3 DuraLite <sup>™</sup> Æ ColorRings, Ñ¢	40-11945
#3 DuraLite <sup>™</sup> Æ ROUND	40-11948
#3 Standard	40-11947
#5 (17/23) DuraLite <sup>™</sup> Æ ColorRings, Ñ¢	40-11946
#5 (17/23) DuraLite <sup>™</sup> Æ ROUND	40-11949
#5 (17/23) Standard	40-11950
#11-12 Old Dominion University (ODU) DuraLite <sup>™</sup> Æ ColorRings, Ñ¢	40-11951
#11-12 Old Dominion University (ODU) DuraLite <sup>™</sup> Æ Standard	40-11952
#11-12 Old Dominion University (ODU) Long DuraLite <sup>™</sup> Æ ROUND	40-11955
#11-12 Old Dominion University (ODU) Long Standard	40-11956
#DG16 Endodontic DuraLite <sup>™</sup> Æ ColorRings, Ñ¢	40-11977
#DG16 Endodontic DuraLite <sup>™</sup> Æ ROUND	40-11972
#DG16 Endodontic Standard	40-11971
#DG16-23 Endodontic DuraLite <sup>™</sup> Æ ColorRings, Ñ¢	40-11970
#DG16-23 Endodontic DuraLite <sup>™</sup> Æ ROUND	40-11969
#DG16-23 Endodontic Standard	40-11968
#23/6 DuraLite <sup>™</sup> Æ ColorRings, Ñ¢	40-11967
#23/6 DuraLite <sup>™</sup> Æ ROUND	40-11966
#23/6 Standard	40-11965
#6 DuraLite <sup>™</sup> Æ ColorRings, Ñ¢	40-11964
#6 DuraLite <sup>™</sup> Æ ROUND	40-11963
#6 Standard	40-11962
#17-23 Tufts DuraLite <sup>™</sup> Æ Color-Rings, Ñ¢	40-11961
#17-23 Tufts DuraLite <sup>™</sup> Æ ROUND	40-11960
#17-23 Tufts Standard	40-11939
#11-12 Old Dominion University (ODU) DuraLite <sup>™</sup> Æ ROUND	40-11953
#11-12 Old Dominion University (ODU) Long DuraLite <sup>™</sup> Æ Color-Rings, Ñ¢	40-11954



## Explorer Single End (Hu-Friedy)

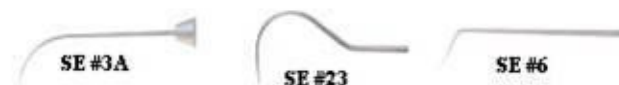

SE #3A, #6 Satin Steel Handle	40-90090
SE #6, Standard Diagnostic Handle	40-90091
SE #23, #6 Satin Steel Handle	40-90092
SE #23, Standard Diagnostic Handle	40-90093

## Explorers Single End (Miltex)

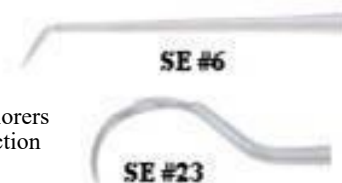

Octagonal-handled explorers have one-piece construction for durability.

SE #6, Stainless Steel	40-90096
SE #23, Stainless Steel	40-90097

## Exproler-Probes

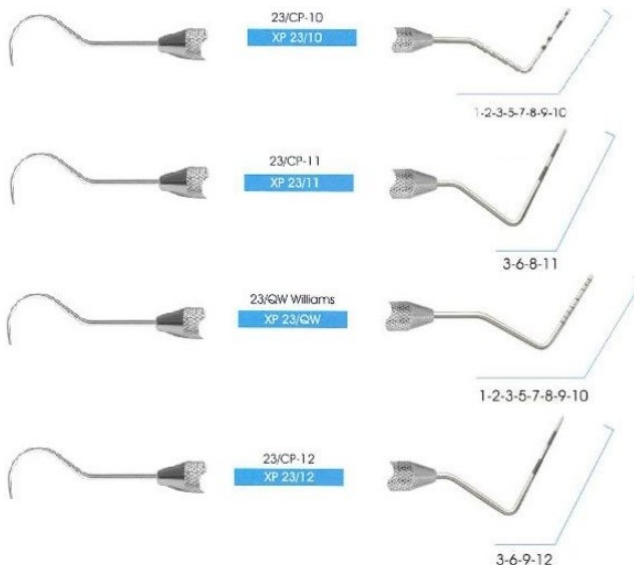

23/CP-11	40-30971
23/CP-10	40-30972
23/QW Williams	40-30973
23/Cp-12	40-30974

## XTS Explorers (Hu-Friedy)

Xts coating offers enhanced contrast b/w instrument and tooth structure. Non-stick coating is perfect for carving anatomy during composite restorations—the added benefit of an XTS explorer as opposed to a regular stainless explorer.

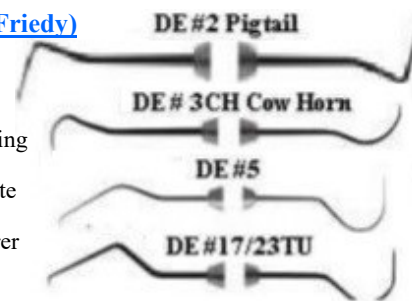

# Instruments



Prestige Dental Products, Inc.  
 Prestigedentalproducts.com  
 Tel: 877-772-3888

Made form Duraspond for flexibility and resilience.

- DE #2, Pigtail, #6 Satin Steel Handle** 40-90106
- DE #3CH, Cow Horn, #6 Satin Steel Handle** 40-90107
- DE #5, #6 Satin Steel Handle** 40-90108
- DE #17/23TU, #6 Satin Steel Handle** 40-90109

## Extracting Forceps

### Extracting Forcep (J & J Instrument)



**Molar Extraction Forcep** 40-12026

### Extracting Forceps For Children with Non Slip Jaws (ASA Italy)



- N.1 Upper Incisors** 40-12034
- N.2 Upper Premolars** 40-12027
- N.3 Upper Molars** 40-12028
- N.4 Upper Roots** 40-12029
- N.5 Lower Incisors** 40-12030
- N.6 Lower Molars** 40-12031
- N.7 Lower Roots** 40-12032

### Extracting Forcep (American Pattern) (ASA Italy)



0120-150 0120-151 0120-16 0120-18L 0120-18R 0120-222

- N.150 Cryer Upper Inc.Prem.Root** 40-12035
- N.151 Lower Inc.Pre.Roots** 40-12037
- N.16 Lower Molars** 40-12039
- N.18L Upper Molar Right** 40-12040
- N.18R Upper Molar Right** 40-12036
- Fig.222 Lower Third Molars** 40-12038

### Extracting Forcep American Pattern - Economy

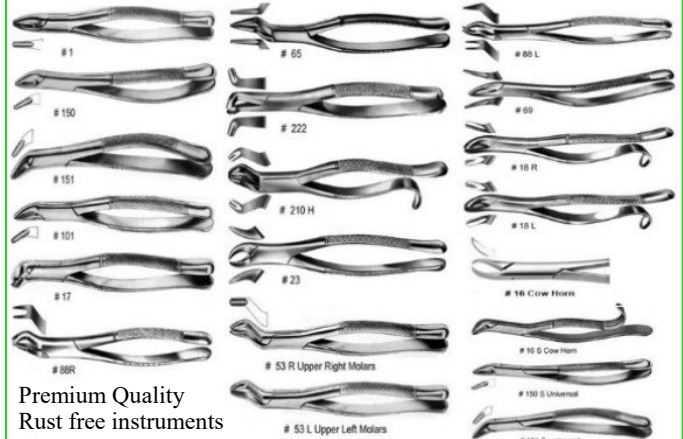

Premium Quality  
 Rust free instruments

- #1** 40-108551
- #150** 40-108552
- #151** 40-108553
- #101** 40-108554
- #17** 40-108555
- #88R** 40-108556
- #65** 40-108557
- #222** 40-108558
- #210H** 40-108559
- #23** 40-108560
- #53R, Upper Right Molars** 40-108561
- #53L, Upper Left Molars** 40-108562
- #88L** 40-108563
- #69** 40-108564
- #18R** 40-108565
- #18L** 40-108566
- #16, Cow Horn** 40-108568
- #16S, Cow Horn** 40-108568
- #150S, Universal** 40-108569
- #151S, Universal** 40-108570



[www.prestigedentalproducts.com](http://www.prestigedentalproducts.com)



# Instruments



Prestige Dental Products, Inc.  
 Prestigedentalproducts.com  
 Tel: 877-772-3888

## Extraction Forceps (Nordent)

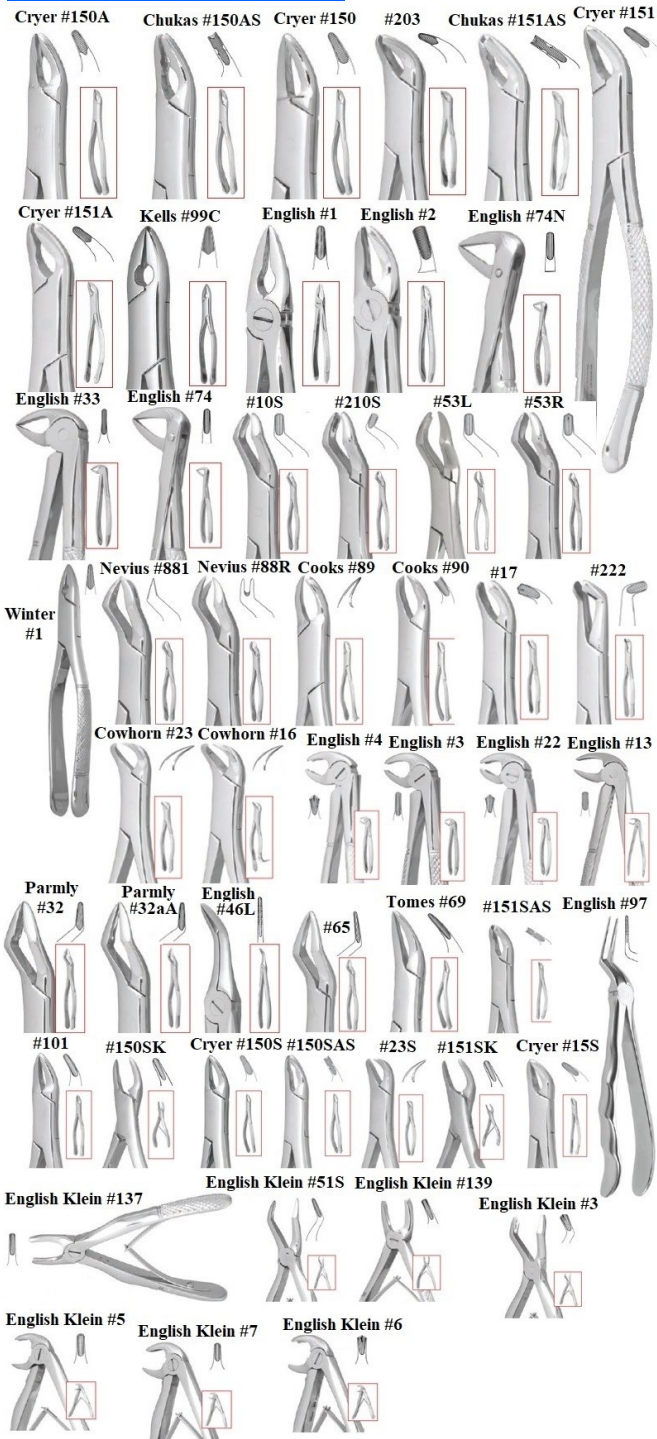

<b>#1 Upper Incisor Standard</b>	40-12109
<b>#1 Upper Incisor Standard Serrated</b>	40-12095
<b>#10S Upper Molar Universal</b>	40-12094
<b>#10S Upper Molar Universal Serrated</b>	40-12093
<b>#16 Lower Molar Cowhorn (Hook Handle)</b>	40-12092
<b>#17 Lower Molar Universal</b>	40-12091

<b>#17 Lower Molar Universal Serrated</b>	40-12090
<b>#23 Lower Molar CowHorn (Straight Handle)</b>	40-12089
<b>#32 Upper Bicuspid Universal</b>	40-12088
<b>#32 Upper Bicuspid Universal Serrated</b>	40-12087
<b>#32A Upper Bicuspid &amp; Roots Universal</b>	40-12086
<b>#32A Upper Bicuspid &amp; Roots Serrated Universal</b>	40-12085
<b>#46L Lower Root Fragments (Handform Handle)</b>	40-12096
<b>#53L Upper Left Molar 1st &amp; 2nd</b>	40-12097
<b>#53L Upper Left Molar 1st &amp; 2nd Serrated</b>	40-12108
<b>#53R Upper Right Molar 1st &amp; 2nd</b>	40-12107
<b>#53R Upper Right Molar 1st &amp; 2nd Serrated</b>	40-12106
<b>#65 Upper Incisors &amp; Roots</b>	40-12105
<b>#65 Upper Incisors &amp; Roots Serrated</b>	40-12104
<b>#69 Upper Incisors &amp; Roots</b>	40-12103
<b>#69 Upper Incisors &amp; Roots Serrated</b>	40-12102
<b>#88L Upper Molar 1st &amp; 2nd Anatomical</b>	40-12101
<b>#88R Upper Molar 1st &amp; 2nd Anatomical</b>	40-12100
<b>#89 Upper Molar 1st &amp; 2nd Cooks Left</b>	40-12099
<b>#90 Upper Molar 1st &amp; 2nd Cooks Right</b>	40-12098
<b>#97 Upper Root Fragments (Handform Handle)</b>	40-12084
<b>#99C Upper Incisor Cuspids &amp; Bicuspid</b>	40-12083
<b>#99C Upper Incisor Cuspids &amp; Bicuspid Serrated</b>	40-12069
<b>#150 Upper Cryer Universal</b>	40-12068
<b>#150 Upper Cryer Universal Serrated</b>	40-12067
<b>#150AS Upper Anatomical Beaks Universal</b>	40-12066
<b>#150 Upper Parallel Beaks Universal</b>	40-12065
<b>#150A Upper Parallel Beaks Universal Serrated</b>	40-12064
<b>#151 Lower Cryer Universal</b>	40-12063
<b>#151 Lower Cryer Universal Serrated</b>	40-12062
<b>#151A Lower Parallel Beaks Universal</b>	40-12061
<b>#151A Lower Parallel Beaks Universal Serrated</b>	40-12060
<b>#151AS Lower Anatomical Beaks Universal</b>	40-12059
<b>#203 Lower Bicuspid</b>	40-12070





Prestige Dental Products, Inc.  
 Prestigedentalproducts.com  
 Tel: 877-772-3888

# Instruments

#203 Lower Bicuspid Serrated	40-12071
#210S Upper Middle Third Universal	40-12082
#210S Upper Molar Third Universal Serrated	40-12081
#222 Lower Molar Third Universal	40-12080
#222 Lower Molar Third Universal Serrated	40-12079
#1 Upper Anterior Mead	40-12078
#1 Upper Anterior Mead Serrated	40-12077
#2 Upper Bicuspid Mead	40-12076
#2 Upper Bicuspid Mead Serrated	40-12075
#3 Lower Anterior Mead English Style	40-12074
#3 Lower Anterior Lower Anterior Mead English Style Serrated	40-12073
#4 Lower Molar Mead English Style	40-12072
#4 #4 Lower Molar Mead English Style Serrated	40-12058

## Extracting Forceps English Pattern (Nordent)

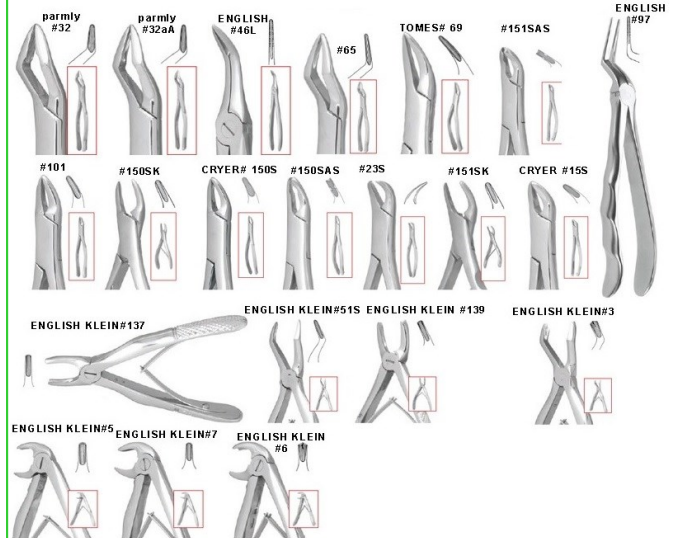
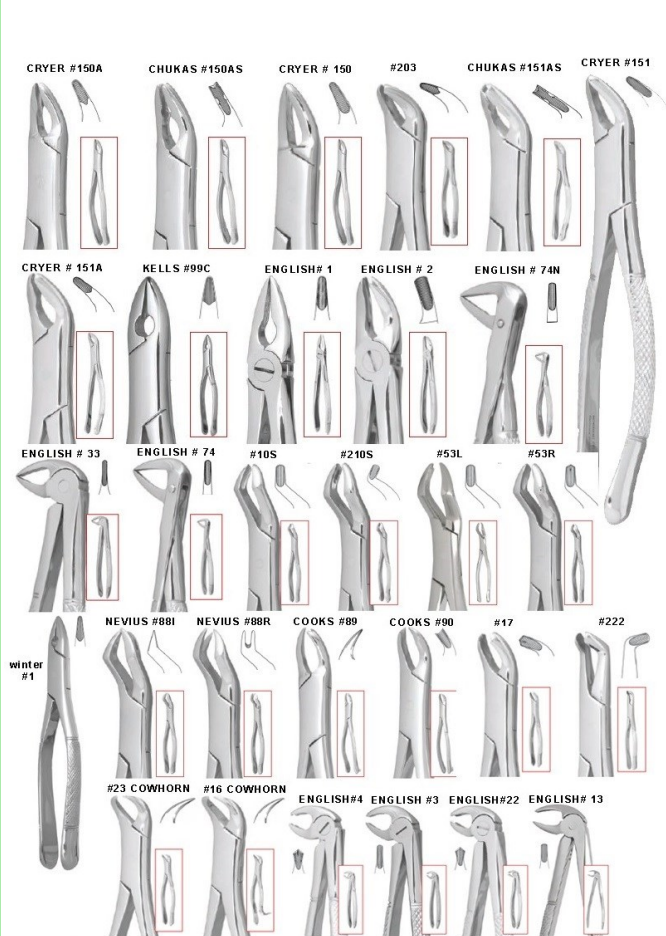

#13 Lower Bicuspid English Pattern	40-12129
#13 Lower Bicuspid English Pattern Serrated	40-12130
#22 Lower Molar English Pattern	40-12131
#22 Lower Molar English Pattern Serrated	40-12132
#33 Lower Roots English Pattern	40-12133
#33 Lower Roots English Pattern Serrated	40-12134
#74 Lower Roots English Pattern	40-12135
#74 Lower Roots English Pattern Serrated	40-12124
#74N Lower Roots English Pattern Narrow Beak	40-12123
#74N Lower Roots English Pattern Narrow Beak Serrated	40-12122
#1X Upper Anterior English Pattern	40-12111
#1X Upper Anterior English Pattern Serrated	40-12112
#7X Upper Pre-Molars English Pattern	40-12113
#7X Upper Pre-Molars English Pattern Serrated	40-12114
#17X Upper Molars Right English Pattern	40-12115
#17X Upper Molars Right English Pattern Serrated	40-12116
#18X Upper Molars Left English Pattern	40-12117
#18X Upper Molars Left English Pattern Serrated	40-12118
Upper Tapered Beak English Pattern Universal	40-12119
Lower Anterior Tapered Beak English Pattern	40-12120
Upper Anterior Tapered Beak English Pattern	40-12121



Prestige Dental Products, Inc.  
 Prestigedentalproducts.com  
 Tel: 877-772-3888

# Instruments

Upper Root Fragments E English Pattern	40-12136
Upper Root Fragments E English Pattern Serrated	40-12128
#67A Upper Molars Third English Pattern Universal	40-12127
#67A English Pattern Serrated	40-12126
#79X Lower Molars Third English Pattern	40-12125
#79X Lower Molars Third English Pattern Serrated	40-12110

## Extraction Forceps Pedodontic (Nordent)

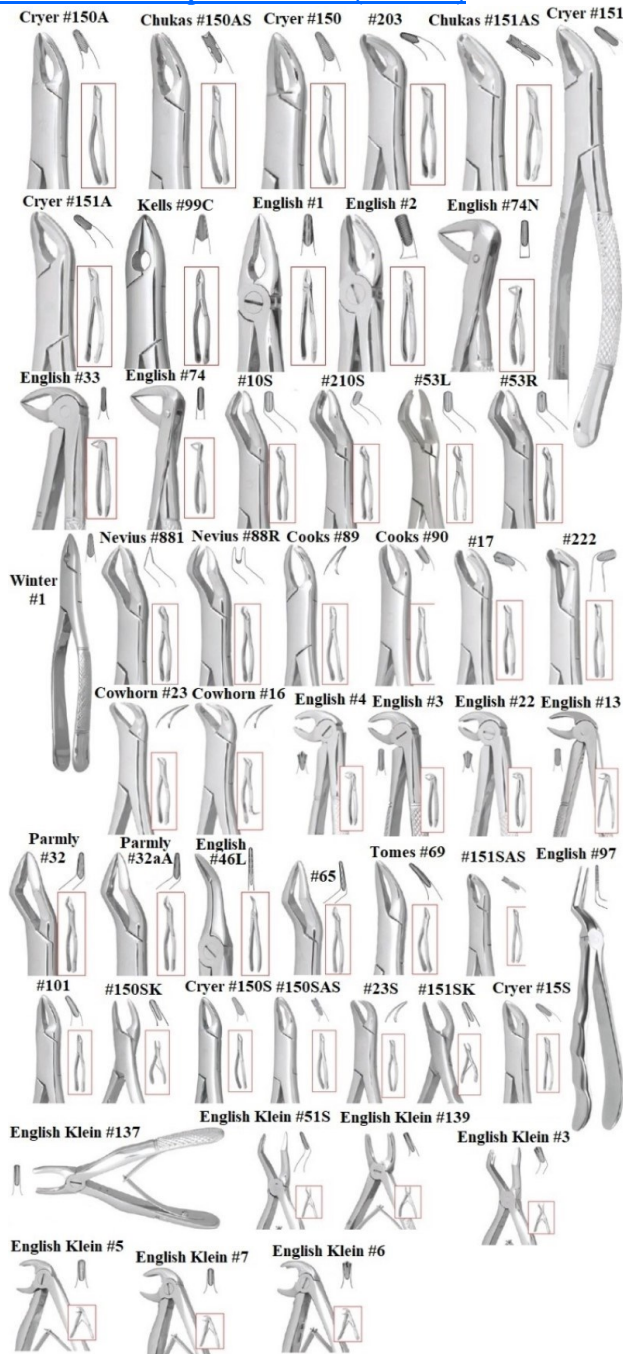

#23S Lower Molar Pedodontic Cowhorn	40-12149
#101 Upper Pedodontic Universal	40-12138
#101 Upper Pedodontic Universal Serrated	40-12139
#150S Upper Pedodontic Cryer Universal	40-12140
#150S Upper Pedodontic Cryer Universal Serrated	40-12141
#150S Upper Pedodontic Cryer Universal Anatomical Beaks	40-12142
#150SK Pedodontic (Spring Handle 120mm)	40-12123
#150SK Pedodontic (Spring Handle 120mm) Serrated	40-12144
#151SK Pedodontic (Spring Handle 120mm)	40-12145
#151SK Pedodontic (Spring Handle 120mm) Serrated	40-12146
#151S Pedodontic Lower Universal	40-12147
#151S Pedodontic Lower Universal Serrated	40-12148
#151S Pedodontic Lower Universal Anatomical Beaks	40-12137

## Extraction Forceps Pedodontic English Pattern (Nordent)

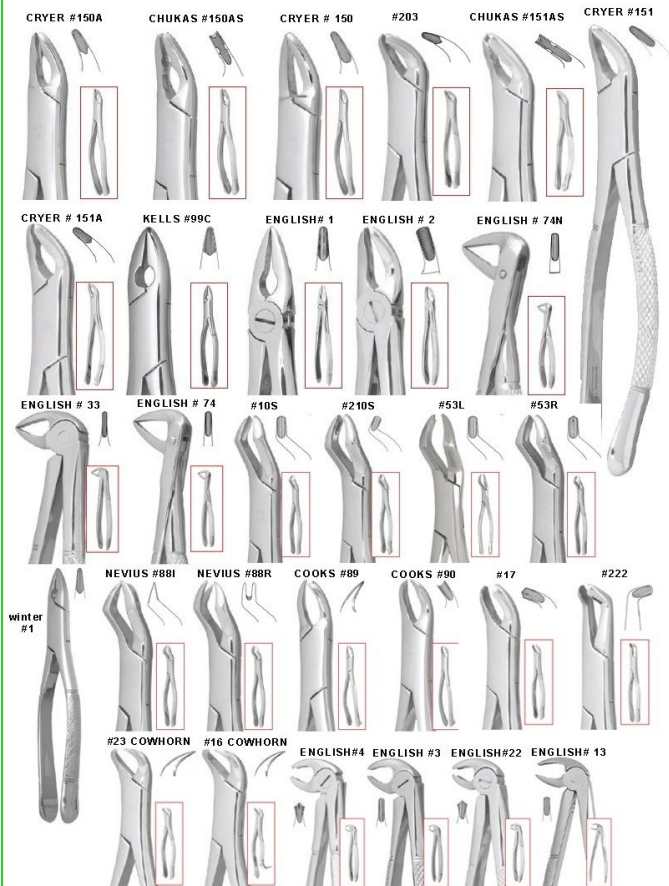



# Instruments



Prestige Dental Products, Inc.  
 Prestigedentalproducts.com  
 Tel: 877-772-3888

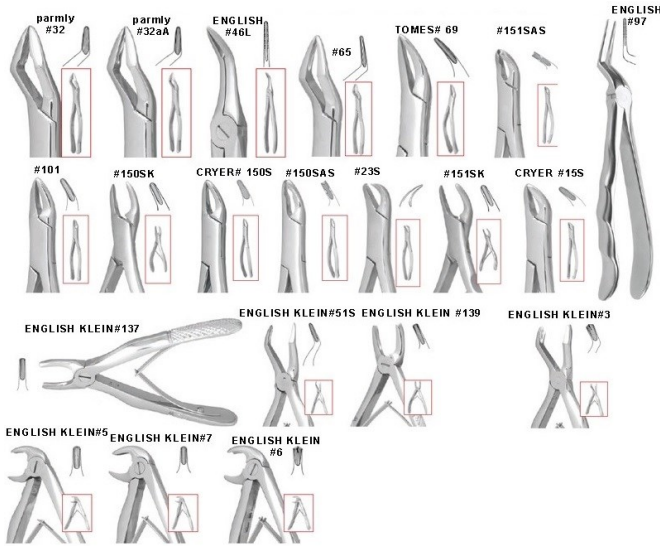

<b>Upper Molars Universal English Pattern</b>	40-12156
<b>Lower Incisors English Pattern</b>	40-12155
<b>Lower Molars English Pattern</b>	40-12154
<b>Lower Roots English Pattern</b>	40-12153
<b>Upper Roots English Pattern</b>	40-12152
<b>Upper Incisors English Pattern</b>	40-12151
<b>Upper Premolars English Pattern</b>	40-12150

## Miltex Grip Deep Extracting Forceps (Integra Miltex)

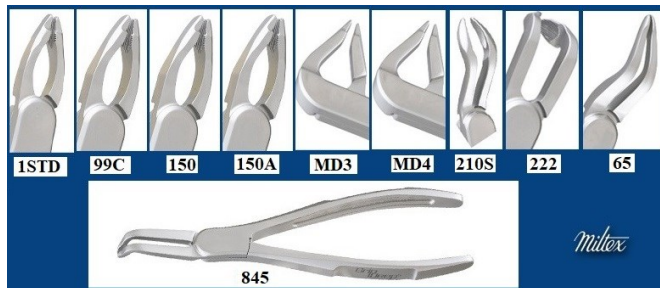

Grip deep extracting forceps have been designed to allow subgingival access to the root while removing the tooth. The beaks are tapered, which allows them to penetrate deeper into the tooth socket and maximize the tooth-to-forceps contact.

<b>1STD</b>	40-20013
<b>99C</b>	40-20014
<b>150</b>	40-20015
<b>150A</b>	40-20016
<b>MD3</b>	40-20017
<b>MD4</b>	40-20018
<b>210S</b>	40-20019
<b>222</b>	40-20020
<b>65</b>	40-20021
<b>845</b>	40-20022

## Miltex Xcision Extracting Forceps (Integra Miltex)

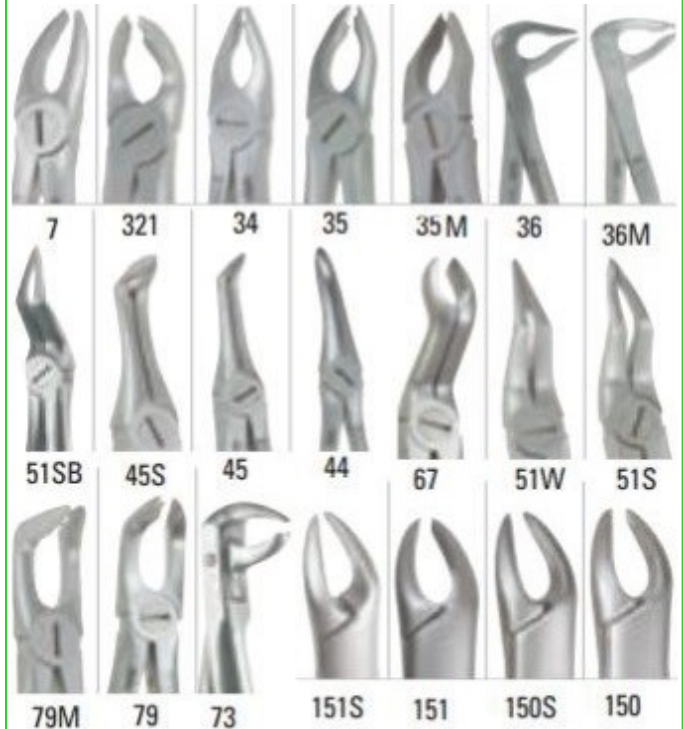

- Tapered, anatomically shaped, and serrated beaks are designed to perfectly match teeth and allow for subgingival access to the tooth
- Manufactured of high quality German stainless steel
- Smooth handle with circular openings reduces instrument weight and aids in cleaning

<b>No.7, Upper Premolar Universal</b>	each	40-91620
<b>No.321, Lower Premolars</b>	each	40-91621
<b>No.34, Upper Anteriors</b>	each	40-91622
<b>No.35, Upper Premolars</b>	each	40-91623
<b>No.35M, Upper Premolars, Modified Beak</b>	each	40-91624
<b>No.36, Lower Anteriors</b>	each	40-91625
<b>No.36M, Lower Anteriors, Modified Beak</b>	each	40-91626
<b>No.44, Upper Roots Universal</b>	each	40-91627
<b>No.45, Lower Roots</b>	each	40-91628
<b>No.45S, Lower Roots w/Serrations</b>	each	40-91629
<b>No.51SB, Upper Roots Universal</b>	each	40-91630
<b>No.51S, Upper Roots w/Serrated Edges</b>	each	40-91631
<b>No.51W, Upper Roots w/Serrated Beaks</b>	each	40-91632
<b>No.67, Upper 3rd Molars</b>	each	40-91633
<b>No.73, Lower Molars</b>	each	40-91634
<b>No.79, Lower 3rd Molars</b>	each	40-91635



Prestige Dental Products, Inc.  
 Prestigedentalproducts.com  
 Tel: 877-772-3888

# Instruments

<b>No.79M</b> , Lower 3rd Molars, Modified Beck each	40-91636
<b>No.150</b> , Upper Anterior, Universal each	40-91637
<b>No.150S</b> Upper Anterior, Pedro Universal each	40-91638
<b>No.151</b> , Lower Anterior, Universal each	40-91639
<b>No.151S</b> , Lower Anterior, Pedro Universal each	40-91640

## Forceps

### Easy X-Trac System (A. Titan)

- Intended for immediate implant placement
- No pressure, pulling or rotary movements
- No post traumatic swelling
- No bone restoration



**Easy Kit Contains:** the 63, 60R, 60L, and 60U. All elevators have a sharp spade tip to create space between bone and root and are great for removal of root tips and fragments

### Forceps (DA)



<b>#1 Economy</b> , each	40-91571
<b>#10S Economy</b> , each	40-91572
<b>#16</b> , each	40-91573
<b>#17</b> , each	40-91574
<b>#18R</b> , each	40-91575
<b>#18L</b> , each	40-91576
<b>#23</b> , each	40-91577
<b>#53R</b> , each	40-91578
<b>#53L</b> , each	40-91579
<b>#69</b> , each	40-91580
<b>#85</b> , each	40-91581
<b>#88L</b> , each	40-91582
<b>#101</b> , each	40-91583
<b>#150</b> , each	40-91584
<b>#150S</b> , each	40-91585
<b>#150A</b> , each	40-91586
<b>#151</b> , each	40-91587
<b>#151S</b> , each	40-91588
<b>#151A</b> , each	40-91589
<b>#210</b> , each	40-91590
<b>#222</b> , each	40-91591
<b>#286</b> , each	40-91592
<b>Cow Horn #16S</b> , each	40-91593
<b>English Pattern #13</b> , each	40-91594
<b>MD3</b> , each	40-91595
<b>MD4</b> , each	40-91596

### Forceps (Hu-Friedy)





# Instruments



Prestige Dental Products, Inc.  
 Prestigedentalproducts.com  
 Tel: 877-772-3888



- #13 Lower Bicuspid, each 40-91597
- #16 Lower 1st/2nd Molar each 40-91598
- #23 Lower 1st/2nd Molars on Either Side, each 40-91599
- #53R Upper 1st/2nd Molars on Right Side, each 40-91600
- #53L Upper 1st/2nd Molars on Left Side, each 40-91601
- #69 For Fragments/Small Roots, each 40-91602
- #88R Upper 1st/2nd Molar, Right Side 40-91603
- #88L Upper 1st/2nd Molar, Left Side, each 40-91604
- #150 Upper Bicuspid, Cuspids, Incisors/Roots on Either Side, each 40-91605
- #150S Pedro Upper Incisor, Bicuspid/Root 40-91606
- #151 Lower Bicuspid, Cuspids, Incisors/Roots on Both Sides, each 40-91607
- #151S Pedro Lower Incisor, Bicuspid/Root, each 40-91608
- #222 Lower 3rd Molar, each 40-91609
- #X74N European Style Narrow Beaks, Serrated Lower Roots, each 40-91610
- #X46L European Style Serrated, Lower Roots each 40-91611
- #X49 Upper Roots, each 40-91612
- #150AS Upper Anterior/Posterior each 40-91613
- #150AS Lower Anterior/Premolar, each 40-91614

### Miltex Carbide Jaw Upper Anteriors Forceps (Integra Miltex)



- #1STD 40-50090
- #150 40-50091

### Miltex Forceps (Integra Miltex)



- #150 Upper Bicuspid, Cuspids, Incisors/Roots on Either Side, each 40-91617
- #150S Pedro, Upper Incisor, Bicuspid/Root each 40-91618
- #151 Lower Bicuspid, Cuspids, Incisors/Roots on Either Side each 40-91619
- Pedo Lower Root, Universal, Mini, 4 3/4" each 40-91615
- Pedo Upper, Front, Mini, 4 3/4" each 40-91616

### Miltex Xcision Extracting Forceps (Integra Miltex)

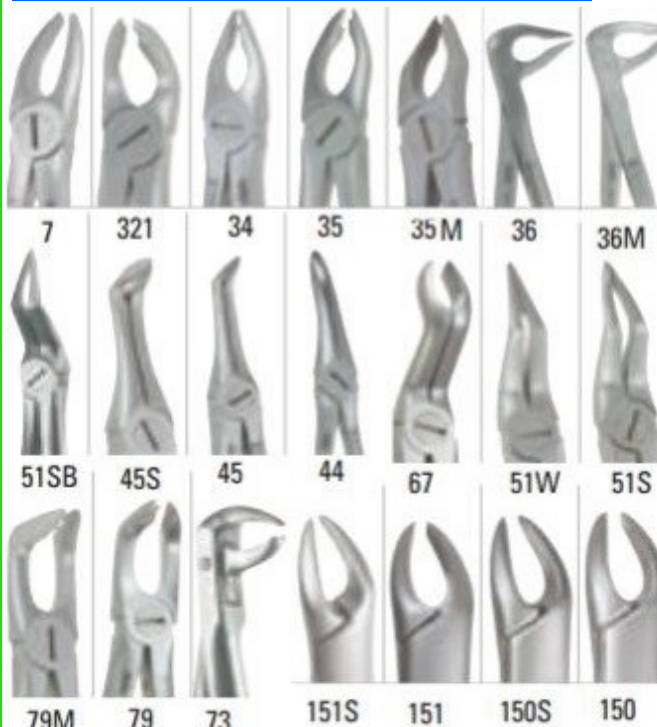

- Tapered, anatomically shaped, and serrated beaks are designed to perfectly match teeth and allow for subgingival access to the tooth
- Manufactured of high quality German stainless steel
- Smooth handle with circular openings reduces instrument weight and aids in cleaning

- No.7, Upper Premolar Universal each 40-91620
- No.321, Lower Premolars each 40-91621
- No.34, Upper Anteriors each 40-91622
- No.35, Upper Premolars each 40-91623

# Instruments



Prestige Dental Products, Inc.  
 Prestigedentalproducts.com  
 Tel: 877-772-3888

<b>No.35M</b> , Upper Premolars, Modified Beak each	40-91624
<b>No.36</b> , Lower Anteriors each	40-91625
<b>No.36M</b> , Lower Anteriors, Modified Beak each	40-91626
<b>No.44</b> , Upper Roots Universal each	40-91627
<b>No.45</b> , Lower Roots each	40-91628
<b>No.45S</b> , Lower Roots w/Serrations each	40-91629
<b>No.51SB</b> , Upper Roots Universal each	40-91630
<b>No.51S</b> , Upper Roots w/Serrated Edges each	40-91631
<b>No.51W</b> , Upper Roots w/Serrated Beaks each	40-91632
<b>No.67</b> , Upper 3rd Molars each	40-91633
<b>No.73</b> , Lower Molars each	40-91634
<b>No.79</b> , Lower 3rd Molars each	40-91635
<b>No.79M</b> , Lower 3rd Molars, Modified Beck each	40-91636
<b>No.150</b> , Upper Anterior, Universal each	40-91637
<b>No.150S</b> Upper Anterior, Pedo Universal each	40-91638
<b>No.151</b> , Lower Anterior, Universal each	40-91639
<b>No.151S</b> , Lower Anterior, Pedo Universal each	40-91640

## Miltex Xcision Roba Forceps (Integra Miltex)



- Complements the Miltex Xcision™ forceps product line
- Designed to allow subgingival access to the root while removing a tooth
- Anatomically shaped, tapered, serrated and notched to penetrate deeper into the tooth socket

<b>No.34M</b> Upper Incisors & Cuspids Wide, each	40-91641
<b>No.35N</b> Upper Premolars, each	40-91642
<b>No.35M</b> Upper Premolars Wide, each	40-91643
<b>No.36N</b> Lower Incisors & Premolars, each	40-91644

<b>No.67A</b> Upper Wisdom Teeth, each	40-91645
<b>No.79</b> Lower Wisdom Teeth Modified, each	40-91646

## X-Trac Forceps (A. Titan)



<b>Upper Universal</b> , each	40-91648
<b>Lower Universal w/Notches</b> , each	40-91649
<b>Upper Anterior</b> , each	40-91650
<b>Upper Root Tip</b> , each	40-91651
<b>Lower Root Tip</b> , each	40-91652
<b>Upper Root Fragment</b> , each	40-91653
<b>Lower Root Fragment</b> , each	40-91654
<b>Universal Maxillary Root</b> , each	40-91655
<b>Upper Universal w/Beveled Beaks</b> , each	40-91656
<b>Lower Universal w/Beveled Beaks</b> , each	40-91657
<b>Lower Anterior w/Beveled Beaks</b> , each	40-91658
<b>Upper Molar, Left</b> each	40-91659
<b>Upper Molar, Right</b> each	40-91660
<b>Lower Molar</b> , each	40-91661
<b>Cowhorn</b> , each	40-91662
<b>Lower 3rd Molar Forceps</b> , each	40-91663
<b>Upper Left 3 Prong Forceps</b> , each	40-91664
<b>Upper Right 3 Prong Forceps</b> , each	40-91665



**We Work Hard  
 So You Don't Have To.  
 833PDENTAL**



Prestige Dental Products, Inc.  
 Prestigedentalproducts.com  
 Tel: 877-772-3888

# Instruments

## Gingival & Retraction Cord Packages

### Cord Packers (Hu-Friedy)

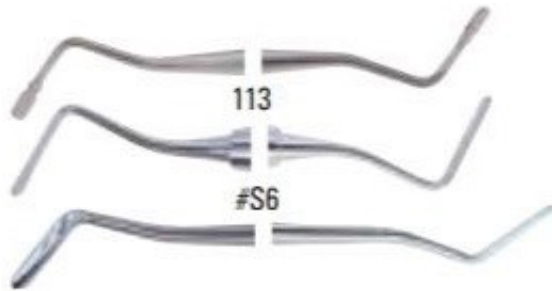

CSI-1 Serrated, Each	40-91053
113 Serrated, each	40-91059
113 Non-Serrated, each	40-91060
S6, each	40-91058

### Cord Packers (Coltene)



Smooth	40-91056
Serrated	40-91057

### Cord Packers (DA)

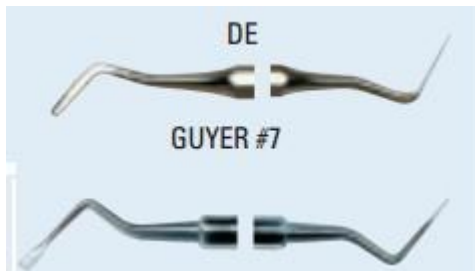

Each	40-91054
Guyer #7, each	40-91055

### Cord Packers (HB)



For atraumatic and accurate cord placement  
 Made in USA

#1/2	40-106491
#CPYD7	40-106492
#CPBAL	40-106493
#EXC6	40-106494
#CPYD1	40-106495
#CPS6	40-106496
#CP113	40-106497

## Grips/Rings/Tapes

### Color Rings- Duralite Handle (Nordent)



Assorted 13 Colors 4 Each Color	40-11661
Black 48/Pkg	40-11675
Blue 48/Pkg	40-11674
Brown 48/Pkg	40-11673
Fuscia 48/Pkg	40-11672
Green 48/Pkg	40-11671
Gray 48/Pkg	40-11670
Light Green 48/Pkg	40-11669
Orange 48/Pkg	40-11668
Pink 48/Pkg	40-11667
Purple 48/Pkg	40-11666
Red 48/Pkg	40-11665
Teal 48/Pkg	40-11664
White 48/Pkg	40-11663
Yellow 48/Pkg	40-11662
Remover Single End	40-11676

### E-Z ID Ring System (Zirc)

Prepackaged in an easy-to-use dispenser, just slip the instrument into an E-Z ID ring and remove it from the dispenser.



<b>Contains:</b> 200 rings in 8 different Colors, Small, Pastel	40-91123
<b>Contains:</b> 200 rings in 8 different Colors, Small, Neon	40-91124



## Instruments



Prestige Dental Products, Inc.  
 Prestigedentalproducts.com  
 Tel: 877-772-3888

<b>Contains:</b> 200 rings in 8 different Colors, Large, Neon	40-91125
<b>Small, White</b> 25/Pkg	40-91126
<b>Small, Blue</b> 25/Pkg	40-91127
<b>Small, Yellow</b> 25/Pkg	40-91128
<b>Small, Beige</b> 25/Pkg	40-91129
<b>Small, Mauve</b> 25/Pkg	40-91130
<b>Small, Gray</b> 25/Pkg	40-91131
<b>Small, Teal</b> 25/Pkg	40-91132
<b>Small, Lilac</b> 25/Pkg	40-91133
<b>Small, Neon Blue</b> 25/Pkg	40-91134
<b>Small, Neon Yellow</b> 25/Pkg	40-91135
<b>Small, Neon Green</b> 25/Pkg	40-91136
<b>Small, Neon Orange</b> 25/Pkg	40-91137
<b>Small, Neon Purple</b> 25/Pkg	40-91138
<b>Small, Neon Pink</b> 25/Pkg	40-91139
<b>Large, White</b> 25/Pkg	40-91140
<b>Large, Blue</b> 25/Pkg	40-91141
<b>Large, Yellow</b> 25/Pkg	40-91142
<b>Large, Green</b> 25/Pkg	40-91143
<b>Large, Mauve</b> 25/Pkg	40-91144
<b>Large, Teal</b> 25/Pkg	40-91145
<b>Large, Lilac</b> 25/Pkg	40-91146
<b>Large, Neon Blue</b> 25/Pkg	40-91147
<b>Large, Neon Yellow</b> 25/Pkg	40-91148
<b>Large, Neon Green</b> 25/Pkg	40-91149
<b>Large, Neon Orange</b> 25/Pkg	40-91150
<b>Large, Neon Purple</b> 25/Pkg	40-91151
<b>Large, Neon Pink</b> 25/Pkg	40-91152

### E-Z ID Tape System (Zirc)



- Tape dispenser has built-in tape cutter
- Dispenser roller prevents tape from twisting
- System dispenser rack holds tape securely and organized
- Tape is autoclavable

<b>Dispenser of 8 Colors, Pastel</b>	40-91153
--------------------------------------	----------

<b>Dispenser of 8 Colors, Neon</b>	40-91154
<b>White, 10Ft Roll each</b>	40-91155
<b>Blue, 10Ft Roll each</b>	40-91156
<b>Yellow, 10Ft Roll each</b>	40-91157
<b>Green, 10Ft Roll each</b>	40-91158
<b>Beige, 10Ft Roll each</b>	40-91159
<b>Mauve, 10Ft Roll each</b>	40-91160
<b>Gray, 10Ft Roll each</b>	40-91161
<b>Teal, 10Ft Roll each</b>	40-91162
<b>Lilac, 10Ft Roll each</b>	40-91163
<b>Neon Blue, 10Ft Roll each</b>	40-91164
<b>Neon Yellow, 10Ft Roll each</b>	40-91165
<b>Neon Green, 10Ft Roll each</b>	40-91166
<b>Neon Orange, 10Ft Roll each</b>	40-91167
<b>Neon Purple, 10Ft Roll each</b>	40-91168
<b>Neon Pink, 10Ft Roll each</b>	40-91169

### Instrument Code Rings (Pac-Dent)

- Specifically made for use with Orthodontic Instruments
- Designed to fit orthodontic plier handles, scalers, band seaters, hemostats, and other orthodontic instruments
- Made from high temperature silicone that can withstand heat sterilization and autoclaving up to 370 degrees



<b>Yellow, 100/Pkg</b>	40-12639
<b>Mixed Colors, 100/Pkg</b>	40-12627

### Instrument Management System Color-Coded Instrument Rings (Hu-Friedy)

Silicone rings for identifying and organizing instruments. Useful for maintaining proper instrument order in cassettes and identifying instruments by procedure. Will withstand all heat sterilization methods.



<b>Regular Gray, 50/Pkg</b>	40-91170
<b>Regular White, 50/Pkg</b>	40-91171
<b>Regular Orange, 50/Pkg</b>	40-91172
<b>Regular Yellow, 50/Pkg</b>	40-91173
<b>Regular Red, 50/Pkg</b>	40-91174
<b>Regular Green, 50/Pkg</b>	40-91175



## Instruments

Regular Blue, 50/Pkg	40-91176
Regular Black, 50/Pkg	40-91177
Regular Pink, 50/Pkg	40-91178
Regular Purple, 50/Pkg	40-91179
Large Gray, 50/Pkg	40-91180
Large White, 50/Pkg	40-91181
Large Orange, 50/Pkg	40-91182
Large Yellow, 50/Pkg	40-91183
Large Red, 50/Pkg	40-91184
Large Green, 50/Pkg	40-91185
Large Blue, 50/Pkg	40-91186
Large Black, 50/Pkg	40-91187
Large Pink, 50/Pkg	40-91188
Large Purple, 50/Pkg	40-91189
Assorted Regular 90/Pkg	40-91190
Assorted Large 90/Pkg	40-91191

### Large Color Code Rings Silicone



White Color, 60 pcs/box	40-50626
Blue Color, 60 pcs/box	40-50627
Yellow Color, 60 pcs/box	40-50628
Green Color, 60 pcs/box	40-50629
Red Color, 60 pcs/box	40-50630
Gray Color, 60 pcs/box	40-50631
Mauve Color, 60 pcs/box	40-50632
Purple Color, 60 pcs/box	40-50633
Assorted Color, 80 pcs/box	40-50634

# Dental Supplies



Prestige Dental Products, Inc.  
Prestigedentalproducts.com  
Tel: 877-772-3888

### Silicone Instrument Grips



Large Silicone Grips For #6 Handle	40-50600
White Silicone Grip for #2 & #4 Handle, 20 pcs/bag single color	40-50601
Blue Silicone Grip for #2 & #4 Handle, 20 pcs/bag single color	40-50602
Yellow Silicone Grip for #2 & #4 Handle, 20 pcs/bag single color	40-50603
Green Silicone Grip for #2 & #4 Handle, 20 pcs/bag single color	40-50604
Red Silicone Grip for #2 & #4 Handle, 20 pcs/bag single color	40-50605
Purple Silicone Grip for #2 & #4 Handle, 20 pcs/bag single color	40-50606
Mauve Silicone Grip for #2 & #4 Handle, 20 pcs/bag single color	40-50607
Assorted Silicone Grip for #2 & #4 Handle, 20 pcs/bag single color	40-50608
Assorted Colors, 24 pcs/bag	40-50609

### Silicone Instrument Grips (PacDent)

- Silicone color-coded instrument grips
- Unique textures ensure firm gripping while maximizing comfort



ComforGrip F for #2 & #4 handles



ComforGrip M for #4 & #6 handles

M grip assorted for #4 and #6 handles, 20/Box	40-15560
F grip assorted for #2 and #4 handles, 20/Box	40-15561
M grip blue for #4 and #6 handles, 20/Box	40-15562

## Instruments



Prestige Dental Products, Inc.  
 Prestigedentalproducts.com  
 Tel: 877-772-3888

<b>F grip blue for #2 and #4 handles. ,</b> 20/Box	40-15563
<b>M grip purple for #4 and #6 handles,</b> 20/Box	40-15564
<b>F grip purple for #2 and #4 handles. ,</b> 20/Box	40-15565
<b>M grip green for #4 and #6 handles,</b> 20/Box	40-15566
<b>F grip green for #2 and #4 handles. ,</b> 20/Box	40-15567
<b>M grip pink for #4 and #6 handles,</b> 20/Box	40-15568
<b>F grip pink for #2 and #4 handles. ,</b> 20/Box	40-15569
<b>M grip yellow for #4 and #6 handles,</b> 20/Box	40-15570
<b>F grip yellow for #2 and #4 handles. ,</b> 20/Box	40-15571
<b>M grip clear for #4 and #6 handles,</b> 20/Box	40-15572
<b>F grip clear for #2 and #4 handles. ,</b> 20/Box	40-15573

### Silitone Code Rings (Miltex)

- Withstand temperatures up to 450F
- Medical grade silicone
- Expandable from 4mm to 12mm



<b>Kit Contains:</b> 480 rings of 12 different colors	40-91192
<b>Pink 50/Pkg</b>	40-91193
<b>Purple 50/Pkg</b>	40-91194
<b>Red 50/Pkg</b>	40-91195
<b>Gray 50/Pkg</b>	40-91196
<b>Gold 50/Pkg</b>	40-91197
<b>Black 50/Pkg</b>	40-91198
<b>Yellow 50/Pkg</b>	40-91199
<b>White 50/Pkg</b>	40-91200
<b>Green 50/Pkg</b>	40-91201
<b>Brown 50/Pkg</b>	40-91202
<b>Blue 50/Pkg</b>	40-91203
<b>Light Blue 50/Pkg</b>	40-91204
<b>Kit 12 colors 50 each color total of 600 rings</b>	40-912041

### Small Color Code Rings Silicone



<b>White, 60 pcs/box Single Color</b>	40-50610
<b>Blue, 60 pcs/box Single Color</b>	40-50611
<b>Yellow, 60 pcs/box Single Color</b>	40-50612
<b>Green, 60 pcs/box Single Color</b>	40-50613
<b>Red, 60 pcs/box Single Color</b>	40-50614
<b>Mauve, 60 pcs/box Single Color</b>	40-50616
<b>Purple, 60 pcs/box Single Color</b>	40-50617
<b>Assorted Color, 80 pcs/box</b>	40-50618

### Tape-N-Tell Instrument Identification



<b>Set of 8 Colors</b>	40-91087
<b>Individual Roll, Black</b>	40-91088
<b>Individual Roll, Blue</b>	40-91089
<b>Individual Roll, Brown</b>	40-91090
<b>Individual Roll, Green</b>	40-91091
<b>Individual Roll, Orange</b>	40-91092
<b>Individual Roll, Red</b>	40-91093
<b>Individual Roll, White</b>	40-91094
<b>Individual Roll, Yellow</b>	40-91095

### **Hatchets**

#### Hatchets (American Eagle)



<b>10/11, each</b>	40-91061
--------------------	----------

#### Hatchets (Hu-Friedy)

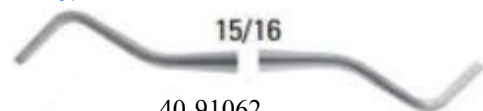

<b>15/16, each</b>	40-91062
--------------------	----------

# Instruments



Prestige Dental Products, Inc.  
 Prestigedentalproducts.com  
 Tel: 877-772-3888

## Hemostats

### Hemostats (DA)

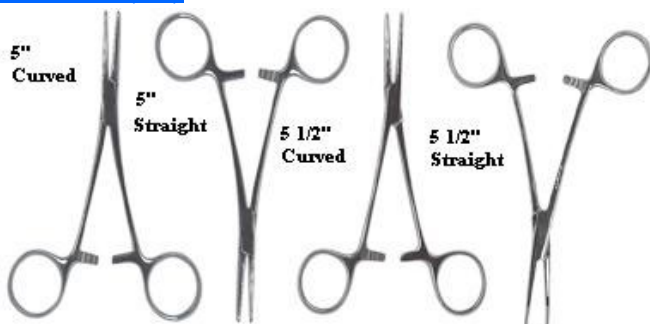

Halstead Mosquito 5" Curved	40-91666
Halstead Mosquito 5" Straight	40-91667
Kelly 5 1/2" Curved	40-91668
Kelly 5 1/2" Straight	40-91669

### Hemostats (Hu-Friedy)



Kelly 5", 1-Straight	40-91670
Kelly 5", 2-Curved	40-91671
Halsted Mosquito 4", 3-Curved	40-91672
Halsted Mosquito 4", 4-Straight	40-91673

### Hemostats (Miltex)



Halstead 5" Straight, each	40-91674
Halstead 5" Curved, each	40-91675
Kelly 5 1/2" Straight, each	40-91676
Kelly 5 1/2" Curved, each	40-91677

## Implant Instruments

### Implant Instruments (ASA Italy)



Bone Injectors Diam. 2,5 Mm	40-12589
Bone Injectors Diam. 4,5 Mm	40-12590
Bone Thickness Gauge	40-12591
Suction Tip With Bone Filter Mm. 200	40-12593
Spare Filter Medium Grid	40-12592
Bone Scraper Cm. 15	40-12595
Spare Blade For Bone Scraper	40-12594
Bone Scraper Curved Cm 15	40-12597
Spare Blade For Curved Bone Scraper	40-12596

### Periotomes (ASA Italy)



Fig.1 Leonardo - Straight	40-13244
Fig.2 Leonardo - Straight	40-13243
Fig.3 Leonardo - Curved	40-13245



Prestige Dental Products, Inc.  
 Prestigedentalproducts.com  
 Tel: 877-772-3888

# Instruments

## Instrument Cleaners/Lubricant

### Barrier Milk (L & R)

- Helps prevent corrosion of instruments when used prior to sterilization
- Protects and extends the life of instruments during autoclaving
- Lubricates and maintains smooth working of hinged instruments
- Nitrate-free, chromate-free, phenolic-free
- Non-irritating
- Neutral pH
- Mild, pleasant odor



**8oz Ready-to-Use Spray** 40-90750

**Gal** 40-90751

### Instrument Lubricant Spray (Hu-Friedy)

- Prevents instrument discoloration and buildup of mineral deposits, and keeps hinged instruments moving freely
- Should be applied to instruments after cleaning and prior to sterilization
- Does not contain silicone
- Packaged in a convenient non-aerosol pump bottle



**8oz** 40-90752

### Lorvic Surgical Milk (Young Dental)

A concentrated pre-autoclave dip. Inhibits rust and lubricates all hinged instruments.



**Qt.** 40-90754

**Gal.** 40-90755

## Instrument Miscellaneous

### Tooth Slooth Fracture Detector (Professional Results Inc.)

This simple but effective diagnostic device is used for detection of cracked teeth. It specifically pinpoints suspected cusps that cause pain during chewing, or teeth that are sensitive to hot or cold due to cracks. Replaces the use of cotton rolls, bite sticks, Q-tips and other devices. Autoclavable. Color: White



**4/Pkg** 40-90745



# Order Online!

## Tooth Slooth II Crown Seater (Professional Results Inc.)

This two-ended instrument is beneficial for cementation purposes or for diagnosing fractures of difficult-to-reach molars or for use in small mouths.

Features include:

- Smaller Tooth Slooth head for fracture detection
- Slot for holding anterior crowns in place during the cementation process
- Pointed end for testing for sensitivity in the fossa area or for cementation purposes
- Knurled, slip-resistant surface
- Autoclavable
- Color: **BLUE**



**4/Pkg** 40-90746

## Instrument Towel Clamps

### Clamps (DA)



**Backhaus 3 1/2"** 40-90812

**Backhaus 5 1/4"** 40-90813

## Luxators

### Highlights Luxating Elevator (Miltex)



DELLUXC2

**#S2 Straight 2mm** 40-8001

**#C2 Curved 2mm** 40-8002

**#S3 Straight 3mm** 40-8003

**#C3 Curved 3mm** 40-8004

**#S4 Straight 4mm** 40-8005

**#C4 Curved 4mm** 40-8006

**#S5 Straight 5mm** 40-8007

**#C5 Curved 5mm** 40-8008

### Luxator (Directa)





# Instruments



Prestige Dental Products, Inc.  
 Prestigedentalproducts.com  
 Tel: 877-772-3888

<b>Luxator Starter Kit, 4pc,</b> (3S, 3C, 5S, 5C,& stone)	40-12904
<b>Luxator Kit, 7pc,</b> (2S,3S,3C,3CA,3IC,5S,5C,& stone)	40-12921
<b>Luxator Kit, 5pc,</b> (1S, 2S , 3S, 3C, 3CA, & stone)	40-12920
<b>Luxator 1mm Straight</b> (Light Green Stripes), 1/Pkg	40-12919
<b>Luxator 2mm Straight</b> (Dark Green Stripes), 1/Pkg	40-12922
<b>Luxator 3mm Straight</b> (Gray Stripes), 1/Pkg	40-12905
<b>Luxator 3mm Curved</b> (Black Stripes), 1/Pkg	40-12906
<b>Luxator 3mm ContraAngle</b> (Dark Blue Stripes), 1/Pkg	40-12907
<b>Luxator 3mm Inv. Curv.</b> (Light Blue Stripes), 1/Pkg	40-12908
<b>Luxator 5mm Straight</b> (Tan Stripes), 1/Pkg	40-12909
<b>Luxator 5mm Curved</b> (Brown Stripes), 1/Pkg	40-12910
<b>Luxator Sharpening Stone,</b> 1/Pkg	40-12911
<b>Luxator 3 / 1.5mm Straight</b> (Aqua Handle/Gray Stripes), 1/Pkg	40-12912
<b>Luxator 5 / 3mm Straight</b> (Aqua Handle/Tan Stripes), 1/Pkg	40-12913
<b>Luxator Forte 2.5mm Straight</b> (Black Handle/Green Stripes), 1/Pkg	40-12914
<b>luxator Forte 3.2mm Straight</b> (Black Handle/Grey Stripes), 1/Pkg	40-12915
<b>Luxator Forte 4.0mm Straight</b> (Black Handle/Tan Stripes), 1/Pkg	40-12916
<b>Fixus 1 (tray for 1 Luxator),</b> 1/Pkg	40-12917
<b>Fixus 6 (tray for six Luxators),</b> 1/Pkg	40-12918

## Luxating Elevators (Hu-Friedy)



Luxating elevators feature thin, sharp blades that are used to cut periodontal ligaments. The elevator tips are permanently fixed to a satin finished, stainless steel handle for increased comfort and control. Luxating elevators reduce pressure on adjacent teeth, as they are used in a rocking motion for cutting as opposed to a standard elevator that lifts and pries.

<b>2mm Straight, each</b>	40-91678
<b>3mm Straight, each</b>	40-91679
<b>4mm Straight, each</b>	40-91680
<b>5mm Straight, each</b>	40-91681
<b>2mm Curved, each</b>	40-91682
<b>3mm Curved, each</b>	40-91683
<b>4mm Curved, each</b>	40-91684
<b>5mm Curved, each</b>	40-91685

## Luxation Blades (Nordent)

Designed to be easily inserted along the root surface and cut the periodontal ligament prior to extraction.

### Features

- Long
- Slender profile
- Ultra-Sharp blades
- NiTi coating to retain sharpness longer
- Comfortable form-fit stainless steel handle.



<b>3ST 3mm Straight</b>	40-80010
<b>3CT 3mm Curved</b>	40-80011
<b>5CT 3mm Curved</b>	40-80012
<b>5ST 3mm Straight</b>	40-80013

## Luxating Elevators (ATW)



**Titanium Nitride** Coating to retain sharpness longer comfortable stainless steel handle. **2 years warranty**

- Minimize tissue trauma & promote quicker healing

<b>Kit of 7, one each size</b>	40-105761
<b>1S 1mms straight, each</b>	40-105762
<b>2S 2mm straight, each</b>	40-105763
<b>3C 3mm curved up, each</b>	40-105764
<b>3C 3mm curved down, each</b>	40-105765
<b>3CA 3mm contra angle, each</b>	40-105766
<b>5C 5mm curved, each</b>	40-105767
<b>5mm straight, each</b>	40-105768



Prestige Dental Products, Inc.  
 Prestigedentalproducts.com  
 Tel: 877-772-3888

# Instruments

## Magnabar & Mats

### Instrument Mats (DA)

- Opaque plastic, color-coded
- 7 1/2" L x 3 1/2" W
- Holds 12 instruments
- Autoclavable

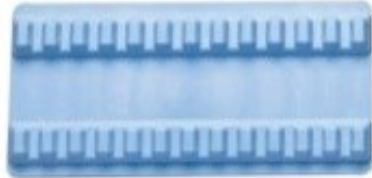

<b>Flexible Blue</b>	40-91205
<b>Flexible White</b>	40-91206
<b>Rigid Blue</b>	40-91207
<b>Rigid White</b>	40-91208
<b>Rigid Mauve</b>	40-91209

### Instrument Mats (Zirc)

- Non-slip soft material
- Holds 10 hand instruments, or reverse side holds 14 surgical instruments
- Small size allows easy access to instruments
- Can be cut to fit a mini-tray
- Contains Microban Antimicrobial Protection to reduce the growth of bacteria
- 6 3/4" x 2" x 3/8"



<b>Standard Blue</b>	40-91210
<b>Standard Yellow</b>	40-91211
<b>Standard Green</b>	40-91212
<b>Standard Mauve</b>	40-91213
<b>Standard Teal</b>	40-91214
<b>Standard Lilac</b>	40-91215
<b>Neon Blue</b>	40-91216
<b>Neon Yellow</b>	40-91217
<b>Neon Pink</b>	40-91218
<b>Neon Purple</b>	40-91219

### Magnabar (C & R Supply)

*Magnetic instrument holder*



<b>12" Long</b>	40-91220
<b>18" Long</b>	40-91221

### Mini Matt (Zirc)



- Locking strap
- Holds 8 instruments
- Non-slip rubber feet for stability
- Quick ultrasonic cleaning
- Contains Microban Antimicrobial Protection to reduce the growth of bacteria
- 3 7/8" x 3 1/2" x 1/2"

**Blue, each** 40-91222

### Steri-Mats (Dux Dental)

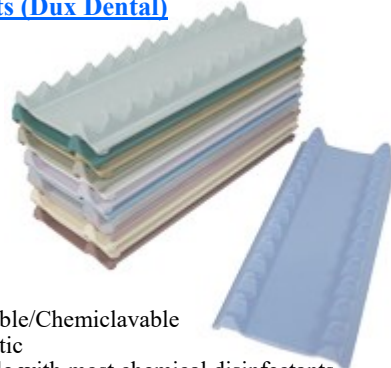

- Autoclavable/Chemiclavable
- Rigid plastic
- Compatible with most chemical disinfectants
- Can be ultrasonically cleaned 8 1/2" W x 3" D x 5/8" H
- Capacity: Up to 12 instruments. For A, B and E flat trays.

**White** 40-91223

## Margin Trimmers

### Margin Trimmers (American Eagle)



**28, each** 40-91063

## Mouth Gags & Props

### Mouth Gags (DA)



Stainless Steel

**Child, each** 40-90757

**Adult, each** 40-90758

### Mouth Gags (Hu-Friedy)



**Adult, Gag** 40-90765



Prestige Dental Products, Inc.  
 Prestigedentalproducts.com  
 Tel: 877-772-3888

## Instruments

Child, Gag	40-90766
Adult, Rubber Ends	40-90767
Child, Rubber Ends	40-90768

### Non-Latex Mouth Props (DA)



Non-Latex

Small Child, 2/Box	40-90759
Child, 2/Box	40-90760
Adult, 2/Box	40-90761

### Sterilizale Silicone (Tan) Mouth Props (DA)



Small Child, 2/Box	40-90762
Child, 2/Box	40-90763
Adult, 2/Box	40-90764

## Needle Holders

### Needle Holders (Hu-Friedy)



Castroviejo 5 1/2" each	40-91700
Crile-Wood 6" each	40-91701
Mayo-Hegar 6" each	40-91702
Perma-Sharp Mayo Hegar 6" each	40-91703

### Needle Holders (DA)



Abbey 5" each	40-91694
Boynton 5" each	40-91695
Castroviejo 5 1/2" Straight each	40-91696
Crile-Wood 5 1/2" Straight, each	40-91697

Hegar-Baumgartner 5 1/4", each	40-91698
Mathieu 5", each	40-91699

## Periodontal Knives

### Periodontal Knives Double End (Hu-Friedy)

ORBAN 1/2



KIRKLAND 15/16



Orban 1/2	40-90568
Kirkland 15/16	40-90569

## Periodontal Tissue Nippers

### Periodontal Tissue Nippers (DA)



Each	40-91704
------	----------

## Periosteal Elevators

### Periosteal Elevators (DA)

WEST ELEVATOR #2



MOLT ELEVATOR/RETRACTOR #9



ELEVATOR/RETRACTOR #22



ELEVATOR/RETRACTOR #23



West Elevator #2 each	40-91705
Molt Elevator/Retractor #9 each	40-91706
Elevator/Retractor #22 each	40-91707
Elevator/Retractor #23 each	40-91708

### Periosteal Elevators (Hu-Friedy)

HOURIGAN #2



MOLT ELEVATOR #9



# Instruments



Prestige Dental Products, Inc.  
 Prestigedentalproducts.com  
 Tel: 877-772-3888

## SELDIN ELEVATOR #23



Hourigan #2, each	40-91709
Molt Elevator #9, each	40-91710
Seldin Elevator #23, each	40-91711

### Periosteals (Miltex)



- Used to retract the mucosa and periosteum from underlying bone
- Stainless steel; autoclavable
- Length: 7 3/4 "

Each	40-91712
------	----------

### Periosteals (Premier)



Molt Elevator #9, each	40-91714
------------------------	----------

## Periotomes

### Periotomes (A. Titan)

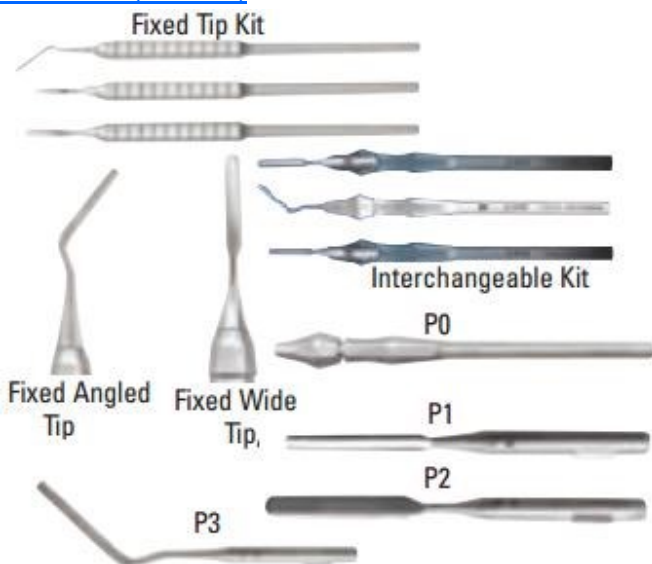

<b>Fixed Tip Kit Contains:</b> 100% stainless steel. 3 exclusive instruments w/fixed blades for all areas of the mouth, 3 different blade shapes are slightly rounded and paper thin to slide easily below the gumline	40-91717
<b>Fixed Wide Tip, Universal</b>	40-91718
<b>Fixed Angled Tip for Posterior</b>	40-91719
<b>Interchangeable Kit Contains:</b> #P0 Handle, #P1 Tip, P2 Tip, #P3 Tip	40-91720
<b>Fixed Wide Tip, Universal</b>	40-91718

<b>Fixed Angled Tip for Posterior</b>	40-91719
<b>Interchangeable Kit Contains:</b> #P0 Handle, #P1 Tip, P2 Tip, #P3 Tip	40-91720
<b>P0 Interchangeable Handle</b>	40-91721
<b>P1 Interchangeable Blade</b>	40-91722
<b>P2 Narrow Blade</b>	40-91723
<b>P3 Angled Blade</b>	40-91724

### Periotomes (ASA Italy)



<b>Fig.1 Leonardo - Straight</b>	40-13244
<b>Fig.2 Leonardo - Straight</b>	40-13243
<b>Fig.3 Leonardo - Curved</b>	40-13245

### Periotomes (Hu-Friedy)



These instruments provide a unique way to aid in tooth extraction. Unlike forceps, which tear the ligaments by stretching them laterally, the periotome cuts the ligaments, preventing damage to the alveolar bone. This is a great instrument for any dentist doing implant cases because it leaves behind more natural bone structure than an extraction done with forceps.

<b>PT 1,</b> D/E Angled blades for posterior use	40-91715
<b>PT 2,</b> D/E Straight blades for anterior use	40-91716

### X-Otome (A. Titan)

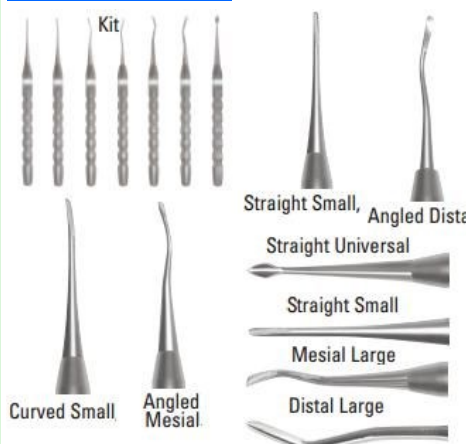

The X-Otome is a hybrid, i.e., a cross between the periotome and a root elevator. Severing the PDL and creating space along the mesio distal plane is executed with precision and accuracy due to the thin, honed ends.



# Instruments



Prestige Dental Products, Inc.  
 Prestigedentalproducts.com  
 Tel: 877-772-3888

**Kit Contains:** XO-10, XO-20, XO-30, 40-91725  
 XO-40, XO-50, XO-60, XO-70, and  
 Tray 10

**Straight Small, X-Fine** 40-91726

**Curved Small, X-Fine** 40-91727

**Angled Mesial, X-Fine** 40-91728

**Angled Distal, X-Fine** 40-91729

**Straight Universal** 40-91730

**Straight Small** 40-91731

**Mesial Large** 40-91732

**Distal Large** 40-91733

## Pluggers

### Root Canal Pluggers (Prestige)



**High Quality**  
 - Light weight with hollow handle  
*Made in USA*

**9/11 w/ Hollow Handle, each** 40-908621

**1/3 w/ Hollow Handle, each** 40-309841

**3/5 w/ Hollow Handle, each** 40-309851

## Probes

### Calibrated Probes Magic Color (ASA Italy)

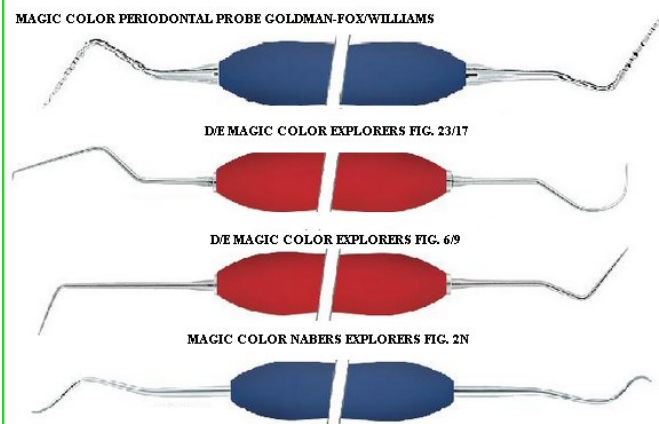

**Magic Color Periodontal Probe Goldman-Fox/William Blue** 40-11321

**D/E Magic Color Explorers Fig. 23/17 Red** 40-21322

**D/E magic Color Explorers Fig. 6/9, Red** 40-21323

**Magic Color Nabers Explorers Fig. 2N, Blue** 40-21324

### Colorvue Plastic Probes (Hu-Friedy)

- Enhanced visibility with vivid yellow tip and black markings
- Optimal flexibility with a rounded tip
- Safe for use with implants
- Probes feature the lightweight, ergonomically designed Satin Steel™ handle for the balance and control you prefer



**Contains:** 12 Tips 2 Handles, #11 Kit 40-90228  
 (3-6-8-11mm) 12/Pkg

**#12 Kit** 40-90229

**Contains:** 7 Tips 1Handle, #11 Kit 6/ 40-90230  
 Pkg

**#12 Kit (3-6-9-12mm)** 40-90231

**Replacement Tips,** 40-90232  
 Set of 12, #11 Kit (3-6-8-11mm)

**#12 Kit (3-6-9-12mm)** 40-90233

**Satin Steel Probe Handle, each** 40-90234

### Furcation Probes (Hu-Friedy)

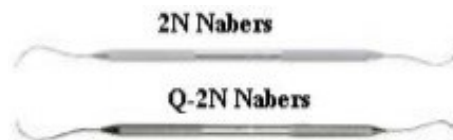

**2N Nabers, Standard Diagnostic Handle** 40-90235

**Q-2N Nabers, Both ends have the same markings Color Coded**  
 (3-6-9-12mm), #6 Satin Steel Handle 40-90236

### Microlux Transilluminator (AdDent)

Provides a focused beam of cool white light for use in clinical diagnosis of caries, calculus, and crown fractures. The light is powered by a high-intensity, light-emitting diode (LED) and transmitted through a focused glass fiber optic element. By using the technique of fiber optic transillumination, the scope of oral diagnosis can be greatly improved without the introduction of additional X-rays. It also functions as an auxiliary light source which aids in general operative procedures, preventive dentistry, and patient education.



**Warranty: 1 year, excluding batteries.**

**Kit Contains:** 1 LED Transilluminator, 40-90237  
 1 Glass Light Guide, 3 Batteries, 1 Pocket Clip

### Novatech Color-Coded Probes (Hu-Friedy)



Unique right-angle design allows for superior adaptability in areas of limited access.

# Instruments



Prestige Dental Products, Inc.  
 Prestigedentalproducts.com  
 Tel: 877-772-3888

**SE, CP-12 (3-6-9-12mm) Standard Diagnostic Handle** 40-90238

### Perowise (Premier)

*"The Friendly Probe"*



Ideal for full examination or a quick screening. Easy to read 3mm. green band indicates periodontal health. Reaching a red mark indicates the presence of periodontal disease. Safe around implants. Autoclavable.

- SE (3-5-7-10mm) 3/Pkg 40-90239
- SE (3-5-7-10mm) 6/Pkg 40-90240
- SE (3-5-7-10mm) 12/Pkg 40-90241
- (3-6-9-12mm) 3/Pkg 40-90242
- (3-6-9-12mm) 6/Pkg 40-90243
- (3-6-9-12mm) 12/Pkg 40-90244

### Probes (American Eagle)



- #12 Probe** (3-6-9-12mm. Black Markings) 40-90245
- Black Probe W.H.O Ball Tip** (0.5-3.5-5.5-8.5-11.5) EagleLite Handle 40-90246
- Yellow Probe 12** (3-6-9-12mm) Stainless Steel Handle 40-90247

### Probes (DA)



Instruments are handcrafted in England of the highest quality corrosion-resistant stainless steel. Each instrument is triple heat-treated and individually hand-finished for optimum performance and durability.

- SE CP-11, Color Coded (3-6-8-11mm)** 40-90222
- Goldman-Fox (1-2-3-5-7-8-9-10mm)** 40-90223

- Michigan O (3-6-8mm)** 40-90224
- Williams (1-2-3-5-7-8-9-10mm)** 40-90225
- Williams-Fox (1-2-3-5-7-8-9-10mm)** 40-90226
- Williams (1-2-3-5-7-8-9-10mm)** 40-90227

### Probes (Hu-Friedy)

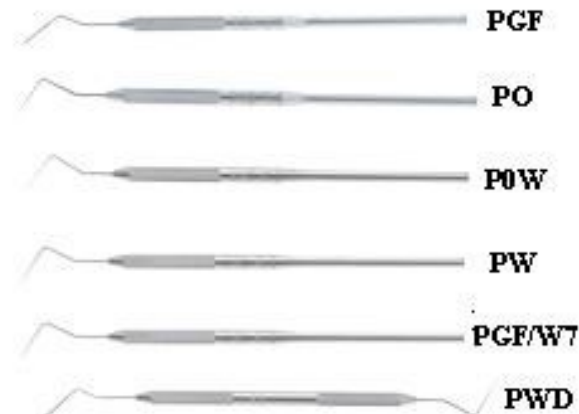

- SE Goldman-Fox Flat (1-2-3-5-7-8-9-10mm) Standard Diagnostic Handle** 40-90248
- SE Michigan O (3-6-8mm) Standard Diagnostic Handle** 40-90249
- SE Michigan O w/Williams Markings (1-2-3-5-7-8-9-10mm) Standard Diagnostic Handle** 40-90250
- SE Williams (1-2-3-5-7-8-9-10mm) Standard Diagnostic Handle** 40-90251
- DE Goldman-Fox (1-2-3-5-7-8-9-10mm) #7 Stain Steel Colours Handle** 40-90252
- DE Williams Offset, (1-2-3-5-7-8-9-10mm) Standard Diagnostic Handle** 40-90253

### Probes (J & J Instruments)



It is essential that the tips on a periodontal probe be polished to a smooth and fine finish. This is to assure ease and comfort in subgingival access. These tips must have clear, precise, and consistent markings to provide an accurate diagnosis. Once these

# Instruments



Prestige Dental Products, Inc.  
 Prestigedentalproducts.com  
 Tel: 877-772-3888

properties are crafted onto every probe tip they are affixed to a handle with the left and knurling that enables the clinician to enjoy a tactile sensitivity in every procedure. Our color coding process employs an electro-etching technique that yields markings that are easily discernable and long lasting.

- Michigan "OW" Probe-Single Ended, with Williams marking** 40-13421  
(1-2-3-5-7-8-9-10mm markings)
- Michigan "O" Probe- Single Ended, Round, (3-6-8mm markings)** 40-13420
- Williams Probe-Round** 40-13419  
(1-2-3-5-7-8-9-10mm markings)
- Williams/Fox Probe-Double Ended,** 40-13418  
(1-2-3-5-7-8-9-10 markings)
- Goldman-Fox Probe-Flat, Single Ended** 40-13417  
(1-2-3-5-7-8-9-10 markings)
- Periodontal Probe #11** 40-13416  
(3-6-8-11mm markings)
- Periodontal Probe #12** 40-13415  
(3-6-9-12m markings)
- W.H.O. Probe** 40-13414  
(3.5-5.5-8.5-11.5mm markings)
- W.H.O. Probe Color Coded Ball Tip** 40-13413  
(3.5-5.5-8.5-11.5mm markings)
- Periodontal Probe #CP11-ColorCoded** 40-13412  
(3-6-8-11mm markings)
- Michigan "O" Probe-Single Ended, Color Coded, (3-6-8mm markings)** 40-13410
- Williams Probe-Round, Color Coded** 40-13411  
(1-2-3-5-7-8-9-10mm markings)

## Probes (Premier)



- DE Goldman-Fox (1-2-3-5-7-8-9-10mm) Light Touch Round Handle** 40-90254
- SE Williams (1-2-3-5-7-8-9-10mm) Light Touch Round Handle** 40-90255

## Probes - DE

Made in USA



- CP-12/Thin Williams** 40-30969
- Goldman-Fox Williams** 40-30970

## Probes-Double End (Nordent)

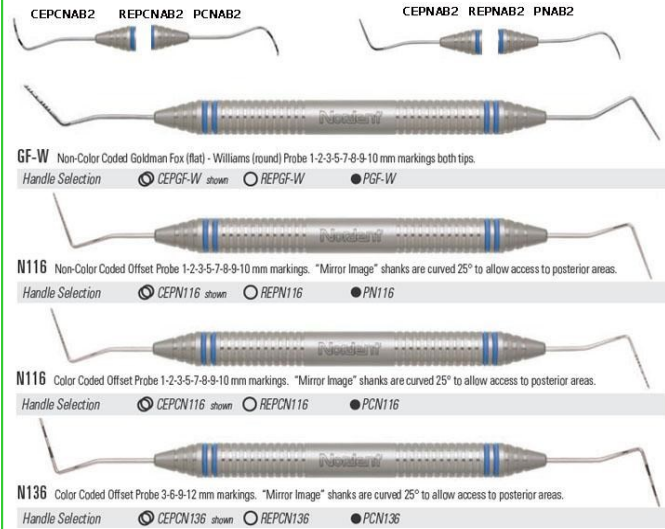

- Goldman Fox Williams** 40-13438  
DuraLite™Æ ColorRings,Ñç
- Goldman Fox Williams** 40-13423  
DuraLite™Æ ROUND
- Goldman Fox Williams Standard** 40-13424
- Nabors Bifurcation** 40-13425  
DuraLite™Æ ColorRings,Ñç
- Nabors Bifurcation** 40-13426  
DuraLite™Æ ROUND
- Nabors Bifurcation Standard** 40-13427
- Nabors Bifurcation (3-6-9-12mm) Color Coded DuraLite™Æ ColorRings,Ñç** 40-13428
- Nabors Bifurcation (3-6-9-12mm) Color Coded DuraLite™Æ ROUND** 40-13429
- Nabors Bifurcation (3-6-9-12mm) Color Coded Standard** 40-13430
- Williams (1-2-3-5-7-8-9-10mm) Left-Right Offset DuraLite™Æ ColorRings,Ñç** 40-13431
- Williams (1-2-3-5-7-8-9-10mm) Left-Right Offset DuraLite™Æ ROUND** 40-13432
- Williams (1-2-3-5-7-8-9-10mm) Left-Right Offset Standard** 40-13433
- Williams (1-2-3-5-7-8-9-10mm) Left-Right Offset Color Coded DuraLite™Æ ColorRings,Ñç** 40-13434
- Williams (1-2-3-5-7-8-9-10mm) Left-Right Offset Color Coded DuraLite™Æ ROUND** 40-13435
- Williams (1-2-3-5-7-8-9-10mm) Left-Right Offset Color Coded Standard** 40-13436





Prestige Dental Products, Inc.  
 Prestigedentalproducts.com  
 Tel: 877-772-3888

# Instruments

<b>Left-Right Offset (3-6-9-12 mm) Color Coded DuraLite™ Color-Rings, N¢</b>	40-13437
<b>Left-Right Offset (3-6-9-12 mm) Color Coded DuraLite™ ROUND</b>	40-13439
<b>Left-Right Offset (3-6-9-12 mm) Color Coded Standard</b>	40-13422

## Probes - SE

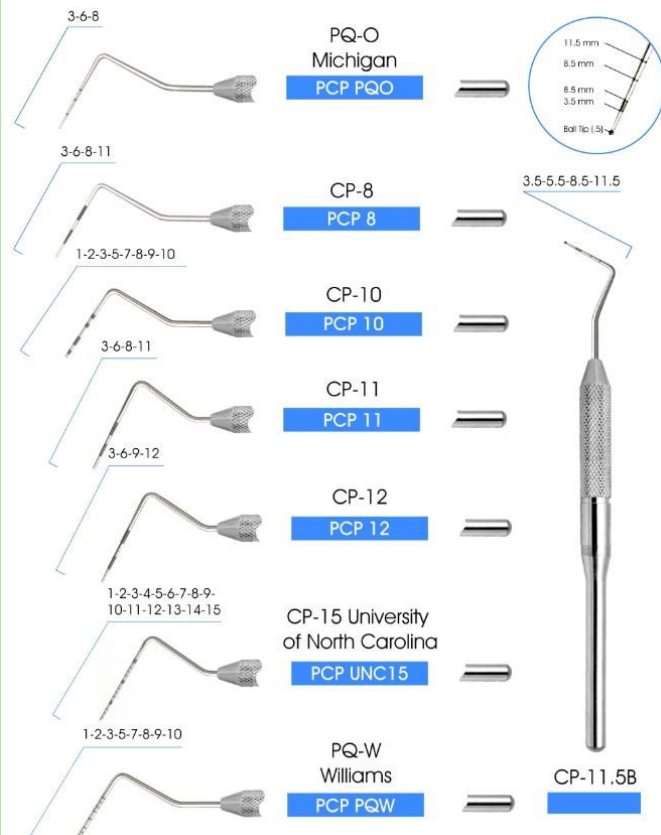

<b>PQ Michigan</b>	40-30961
<b>CP-8</b>	40-30962
<b>CP-10</b>	40-30963
<b>CP-11</b>	40-30964
<b>CP-12</b>	40-30965
<b>CP-15 University of North Carolina</b>	40-30966
<b>PQ-W Williams</b>	40-30967
<b>CP-11.5B</b>	40-30968

## Probes-Single End (Nordent)



Probes are used to measure periodontal pocket depth in millimeter increments. All Nordent Probe tips are made from spring tempered stainless steel and machine ground to exacting tolerances. The millimeter measurements are precisely cut into the Probe tips. Color coding is applied to Probes under extreme temperatures so that the

color penetrates the surface of the tip. Probe tips undergo additional tight tolerance grinding to achieve the desired readability for each marking. All tips are then hand formed into their final shape by expert craftsmen.

<b>Williams (1-2-3-5-7-8-9-10 mm) DuraLite™ ColorRings, N¢</b>	40-13462
<b>Williams (1-2-3-5-7-8-9-10 mm) DuraLite™ ROUND</b>	40-13450
<b>Williams (1-2-3-5-7-8-9-10 mm) Standard</b>	40-13449
<b>(3-6-8-11 mm) Color Coded DuraLite™ ColorRings, N¢</b>	40-13448
<b>(3-6-8-11 mm) Color Coded DuraLite™ ROUND</b>	40-13447
<b>(3-6-8-11 mm) Color Coded Standard</b>	40-13446
<b>UNC12 (1-12mm) Color Coded DuraLite™ ColorRings, N¢</b>	40-13445
<b>NC12 (1-12mm) Color Coded DuraLite™ ROUND</b>	40-13444
<b>UNC12 (1-12mm) Color Coded Standard</b>	40-13443
<b>UNC (1-15 mm) Color Coded DuraLite™ ColorRings, N¢</b>	40-13442
<b>UNC (1-15 mm) Color Coded DuraLite™ ROUND</b>	40-13441
<b>UNC (1-15 mm) Color Coded Standard</b>	40-13451
<b>12 mm (2-4-6-8-10-12 mm) Color Coded DuraLite™ ColorRings, N¢</b>	40-13452
<b>12 mm (2-4-6-8-10-12 mm) Color Coded DuraLite™ ROUND</b>	40-13463
<b>12 mm (2-4-6-8-10-12 mm) Color Coded Standard</b>	40-13461
<b>12 mm (3-6-9-12 mm) Color Coded DuraLite™ ColorRings, N¢</b>	40-13460
<b>12 mm (3-6-9-12 mm) Color Coded DuraLite™ ROUND</b>	40-13459
<b>12 mm (3-6-9-12 mm) Color Coded Standard</b>	40-13458
<b>Williams (1-2-3-5-7-8-9-10 mm) Color Coded DuraLite™ ColorRings, N¢</b>	40-13457
<b>Williams (1-2-3-5-7-8-9-10 mm) Color Coded DuraLite™ ROUND</b>	40-13456
<b>Williams (1-2-3-5-7-8-9-10 mm) Color Coded Standard</b>	40-13455
<b>WHO (3.5-5.5-8.5-11.5 mm) Color Coded Ball Tip DuraLite™ ColorRings, N¢</b>	40-13454

# Instruments



Prestige Dental Products, Inc.  
 Prestigedentalproducts.com  
 Tel: 877-772-3888

<b>WHO (3.5-5.5-8.5-11.5 mm) Color Coded Ball Tip DuraLite™Æ ROUND</b>	40-13453
<b>WHO (3.5-5.5-8.5-11.5 mm) Color Coded Ball Tip Standard</b>	40-13440
<b><u>Qulix Color-Coded Probes (Hu-Friedy)</u></b>	
Color-Coding provides easy-to-read markings which will not chip, flake or fade.	
<b>SE, CP-8 (3-6-8-11mm) Standard Diagnostic Handle</b>	40-90256
<b>CP-10 (1-2-3-5-7-8-9-10mm) Standard Diagnostic Handle</b>	40-90257
<b>CP-11 (3-6-8-11mm) #6 Satin Steel Handle</b>	40-90258
<b>CP-11 (3-6-8-11mm) Standard Diagnostic Handle</b>	40-90259
<b>CP-11.5B (3.5-5.5-8.5-11.5mm) #6 Satin Steel Handle</b>	40-90260
<b>CP-11.5B (3.5-5.5-8.5-11.5mm) Standard Diagnostic Handle</b>	40-90261
<b>CP-12 Marquis (3-6-9-12mm) ResinEight Handle</b>	40-90262
<b>CP-12 Marquis (3-6-9-12mm) #6 Satin Steel Handle</b>	40-90263
<b>CP-12 Marquis (3-6-9-12mm) Standard Diagnostic Handle</b>	40-90264
<b>CP-12UNC (1-2-3-4-5-6-7-8-9-10-11-12mm) #6 Satin Steel Handle</b>	40-90265
<b>CP-12UNC (1-2-3-4-5-6-7-8-9-10-11-12mm) UNC Color Coded</b>	40-90266
<b>CP-15UNC (1-2-3-4-5-6-7-8-9-10-11-12-13-14-15mm) ResinEight Handle</b>	40-90267
<b>CP-15UNC (1-2-3-4-5-6-7-8-9-10-11-12-13-14-15mm) #6 Satin Steel Handle</b>	40-90268
<b>CP-15UNC (1-2-3-4-5-6-7-8-9-10-11-12-13-14-15mm) Standard Diagnostic Handle</b>	40-90269
<b>PQ-OW Thin Tip Michigan 0 W/ Williams Markings (1-2-3-5-7-8-9-10mm) ResinEight Handle</b>	40-90270
<b>PQ-OW Thin Tip Michigan 0 W/ Williams Markings (1-2-3-5-7-8-9-10mm) #6 Satin Steel Handle</b>	40-90271

<b>PQ-OW Thin Tip Michigan 0 W/ Williams Markings (1-2-3-5-7-8-9-10mm) Standard Diagnostic Handle</b>	40-90272
<b>PQ-W Williams (1-2-3-5-7-8-9-10mm) #6 Satin Steel Handle</b>	40-90273
<b>PQ-W Williams (1-2-3-5-7-8-9-10mm) Standard Diagnostic Handle</b>	40-90274

## Retractors Lip & Cheek

**Cheek Retractor (Hu-Friedy)**

**University of Minnesota**

**Columbia**

<b>University of Minnesota, each</b>	40-90772
<b>Columbia, each</b>	40-90773

**Comfortview Lip & Cheek Retractor (Premier)**

Innovatively designed lip and cheek retractor that provides even retraction of the lips and cheeks for buccal and gingival access at the same time. Hands-free, 2-in-1 anatomic design with cushioned lip supports/ensures wearing comfort during longer procedures and facilitates placement of the saliva ejector. Allows for visual and instrument access in diagnostic, therapeutic and preventive dental applications such as photography, prophylaxis, tooth preparation, bleaching, occlusal analysis plus other dental procedures. Autoclavable at 273°F/134°C.

<b>Small, 2/Box</b>	40-90774
<b>Universal, 2/Box</b>	40-90775
<b>Refill Cushion, 10/Pkg</b>	40-90776

**Expando (O.S.E. Co. Inc.)**

Gives access to the whole oral cavity. Holds tongue back and protects lips, cheek and tongue. Proven in practice on adults and children. Made of sturdy transparent plastic that makes work easier.

<b>#1 Small</b>	40-90777
<b>#2 Medium</b>	40-90778
<b>#3 Large</b>	40-90779

[www.prestigedentalproducts.com](http://www.prestigedentalproducts.com)

# Instruments



Prestige Dental Products, Inc.  
 Prestigedentalproducts.com  
 Tel: 877-772-3888

## Extraoral Cheek Retractor (Ortho Technology)

- Full view for direct bonding of anterior and posterior teeth
- Does not reflect light from flash
- Cold sterilizable
- Few adjustments are required during use



Teen, 2/Pkg	40-90780
Adult, 2/Pkg	40-90781
Pedo, 2/Pkg	40-90782

## Lip & Cheek Retractor (DA)

Medium Disposable, Green 10/Pkg	40-90769
Large Disposable, Red 10/Pkg	40-90770

## Mirahold Cheek Retractor (Select Dental)



With plastic handle

Adult, 2/Set	40-90783
Child, 2/Set	40-90784

## Soft-Dex Retractor (Select Dental)

- Provides a full view of the anterior and posterior regions
- Soft and pliable
- Autoclavable



Adult, 2/Set	40-90787
--------------	----------

## Spandex Lip & Retractor (Select Dental)



Adult, 2/Set	40-90788
Child, 2/Set	40-90789

## University of Minnesota Lip & Cheek Retractors (DA)



Each	40-90771
------	----------

## Rongeurs

### Rongeur (W&H)

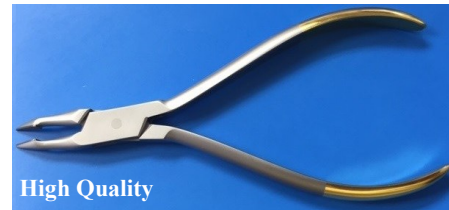

Each	40-108151
------	-----------

### Rongeurs (DA)



MEAD #1A    CLEVELAND #4    CLEVELAND #4A    BLUMENTHAL SLIGHTLY ANGLED JAWS    FRIEDMAN

Mead #1A, 6 1/2" Long	40-91737
Cleveland #4, 5 1/2" Long	40-91738
Cleveland #4A, 6 1/2" Long	40-91739
Blumenthal Slightly Angled Jaws 6 1/2" Long	40-91740
Friedman, 5 1/2" Long	40-91741

### Rongeurs (Hu-Friedy)



Blumenthal 5 3/4"	40-91742
Cleveland #4, 5 1/2" Long	40-91743
Friedman 5 1/2" Long	40-91744
Mead #1A 6 1/2" Long	40-91745
Mini Friedman 5 1/4"	40-91746

Find Us On Social Media



# Instruments



Prestige Dental Products, Inc.  
 Prestigedentalproducts.com  
 Tel: 877-772-3888

## Rongeurs (Miltex)



**Cleveland**

**Blumenthal**

**Blumenthal 30° Standard, 6" Long** 40-91747

**Cleveland #4, 5 1/2" Long** 40-91748

## Scalers

### Anterior Scalers - DE Sickles (Nordent)



**DE University of Texas 103-106** 40-11166  
 DuraLite™ ColorRings, Ñ

**DE University of Texas 103-106** 40-11167  
 DuraLite™ ROUND

**DE University of Texas 103-106** 40-11168  
 DuraLite™ HEX

**DE University of Texas 103-106** 40-11177  
 Medium Round

**DE University of Texas 103-106 Standard** 40-11178

**DE N5-N5S Thin** 40-11179  
 DuraLite™ ColorRings, Ñ

**DE N5-N5S Thin DuraLite™** 40-11175  
 ROUND

**DE N5-N5S Thin DuraLite™** 40-11174  
 HEX

**DE N5-N5S Thin Medium Round** 40-11173

**DE N5-N5S Thin Standard** 40-11172

**DE N5 - Younger-Good #15** 40-11171  
 DuraLite™ ColorRings, Ñ

**DE N5 - Younger-Good #15** 40-11170  
 DuraLite™ ROUND

**DE N5 - Younger-Good #15** 40-11169  
 DuraLite™ HEX

**DE N5 Younger Good #15** 40-11155  
 Medium Round

**DE N5 Younger-Good #15 Standard** 40-11154

**DE N67 Offset (H6-H7)** 40-11140  
 DuraLite™ ColorRings, Ñ

**DE N67 Offset (H6-H7)** 40-11139  
 DuraLite™ ROUND

**DE N67 Offset (H6-H7)** 40-11138  
 DuraLite™ HEX

**DE N67 Offset (H6-H7)** 40-11137  
 Medium Round

**DE N67 Offset (H6-H7) Standard** 40-11136

**DE Offset NMJ Universal R138** 40-11135  
 DuraLite™ ColorRings, Ñ

**DE Offset NMJ Universal R138** 40-11134  
 DuraLite™ ROUND

**DE Offset NMJ Universal R138** 40-11133  
 DuraLite™ HEX

**DE Offset NMJ Universal R138** 40-11132  
 Medium Round

**DE Offset NMJ Universal R138** 40-11131  
 Standard

**DE Towner U15-109** 40-11141  
 DuraLite™ ColorRings, Ñ

**DE Towner U15-109** 40-11142  
 DuraLite™ ROUND

**DE Towner U15-109** 40-11143  
 DuraLite™ HEX

**DE Towner U15-109 Medium Round** 40-11153

**DE Towner U15-109 Standard** 40-11152

**DE Towner U15-N5 Anterior (H5-U15)** 40-11151  
 DuraLite™ ColorRings, Ñ

**DE Towner U15-N5 Anterior (H5-U15)** 40-11150  
 DuraLite™ ROUND

**DE Towner U15-N5 Anterior (H5-U15)** 40-11149  
 DuraLite™ HEX

**DE Towner U15-N5 Anterior (H5-U15)** 40-11148  
 Medium Round

**DE Towner U15-N5 Anterior (H5-U15)** 40-11147  
 Standard

**DE Towner U15-Whiteside W2** 40-11146  
 DuraLite™ ColorRings, Ñ

# Instruments



Prestige Dental Products, Inc.  
 Prestigedentalproducts.com  
 Tel: 877-772-3888

<b>DE Towner U15-Whiteside W2</b> DuraLite-Æ ROUND	40-11145
<b>DE Towner U15-Whiteside W2</b> DuraLite-Æ HEX	40-11144
<b>DE Towner U15-Whiteside W2</b> Medium Round	40-11130
<b>DE Towner U15-Whiteside W2</b> Standard	40-11156
<b>DE Ivory C11-Whiteside #2</b> DuraLite-Æ ColorRings,Ñç	40-11157
<b>DE Ivory C11-Whiteside #2</b> DuraLite-Æ ROUND	40-11158
<b>DE Ivory C11-Whiteside #2</b> DuraLite-Æ HEX	40-11159
<b>DE Ivory C11-Whiteside #2</b> Medium Round	40-11160
<b>DE Ivory C11-Whiteside #2</b> Standard	40-11161
<b>DE University of Southern California #3-4</b> DuraLite-Æ ColorRings,Ñç	40-11162
<b>DE University of Southern California #3-4</b> DuraLite-Æ ROUND	40-11163
<b>DE University of Southern California #3-4</b> DuraLite-Æ HEX	40-11164
<b>DE University of Southern California #3-4</b> Medium Round	40-11165
<b>DE University of Southern California #3-4</b> Standard	40-11176

## Anterior Scalers - Lingual Hoes (Nordent)



<b>DE Stain Remover</b> DuraLite-Æ ColorRings,Ñç	40-11200
<b>DE Stain Remover</b> DuraLite-Æ ROUND	40-11204
<b>DE Stain Remover</b> DuraLite-Æ HEX	40-11203
<b>DE Stain Remover</b> Medium Round	40-11202
<b>DE Stain Remover</b> Standard	40-11193
<b>DE Orban #7-9</b> DuraLite-Æ ColorRings,Ñç	40-11192

<b>DE Orban #7-9</b> DuraLite-Æ ROUND	40-11191
<b>DE Orban #7-9</b> DuraLite-Æ HEX	40-11181
<b>DE Orban #7-9</b> Medium Round	40-11182
<b>DE Orban #7-9</b> Standard	40-11183
<b>DE Cumine #152</b> DuraLite-Æ ColorRings,Ñç	40-11184
<b>DE Cumine #152</b> DuraLite-Æ ROUND	40-11185
<b>DE Cumine #152</b> DuraLite-Æ HEX	40-11186
<b>DE Cumine #152</b> Medium Round	40-11187
<b>DE Cumine #152</b> Standard	40-11188
<b>DE Straight #45-46</b> DuraLite-Æ ColorRings,Ñç	40-11189
<b>DE Straight #45-46</b> DuraLite-Æ ROUND	40-11190
<b>DE Straight #45-46</b> DuraLite-Æ HEX	40-11201
<b>DE Straight #45-46</b> Medium Round	40-11199
<b>DE Straight #45-46</b> Standard	40-11198
<b>DE Contra-Angle #45A-46A</b> DuraLite-Æ ColorRings,Ñç	40-11197
<b>DE Contra-Angle #45A-46A</b> DuraLite-Æ ROUND	40-11196
<b>DE Contra-Angle #45A-46A</b> DuraLite-Æ HEX	40-11195
<b>DE Contra-Angle #45A-46A</b> Medium Round	40-11194
<b>DE Contra-Angle #45A-46A</b> Standard	40-11180

## Anterior Scalers - Sickle-Hoe Combinations (Nordent)



<b>DE Sickle/Spoon #1</b> DuraLite-Æ ColorRings,Ñç	40-11220
<b>DE Sickle/Spoon #1</b> DuraLite-Æ ROUND	40-11224
<b>DE Sickle/Spoon #1</b> DuraLite-Æ HEX	40-11223
<b>DE Sickle/Spoon #1</b> Medium Round	40-11222
<b>DE Sickle/Spoon #1</b> Standard	40-11215
<b>DE N5-Contra Angle Hoe #48</b> DuraLite-Æ ColorRings,Ñç	40-11214

# Instruments



Prestige Dental Products, Inc.  
 Prestigedentalproducts.com  
 Tel: 877-772-3888

<b>DE N5-Contra Angle Hoe #48</b> DuraLite-Æ ROUND	40-11206
<b>DE N5-Contra Angle Hoe #48</b> DuraLite-Æ HEX	40-11207
<b>DE N5-Contra Angle Hoe #48</b> Medium Round	40-11208
<b>DE N5-Contra Angle Hoe #48</b> Standard	40-11209
<b>DE Towner U15-Large Contra-Angle Hoe #47</b> DuraLite-Æ ColorRings, Ñç	40-11210
<b>DE Towner U15-Large Contra-Angle Hoe #47</b> DuraLite-Æ ROUND	40-11211
<b>DE Towner U15-Large Contra-Angle Hoe #47</b> DuraLite-Æ HEX	40-11212
<b>DE Towner U15-Large Contra-Angle Hoe #47</b> Medium Round	40-11213
<b>DE Towner U15-Large Contra-Angle Hoe #47</b> Standard	40-11221
<b>DE Towner U15-Kirkland #13</b> DuraLite-Æ ColorRings, Ñç	40-11219
<b>DE Towner U15-Kirkland #13</b> DuraLite-Æ ROUND	40-11218
<b>DE Towner U15-Kirkland #13</b> DuraLite-Æ HEX	40-11217
<b>DE Towner U15-Kirkland #13</b> Medium Round	40-11216
<b>DE Towner U15-Kirkland #13</b> Standard	40-11205

### Diamondtec (Hu-Friedy)

- Full 360° of diamond coating for horizontal, vertical and oblique stroke pattern
- Used to enhance definitive scaling in furcations and root depressions
- Double-ended design for more efficient scaling
- Large diameter handles provide an ergonomic grip to reduce symptoms of carpal tunnel syndrome
- Color Signature Series™ grips for immediate identification



**Universal application for** furcations/root depressions 40-90586

**For mesial/distal** line angles and developmental grooves 40-90587

### Goldman Fox Scalers - Curettes (Nordent)

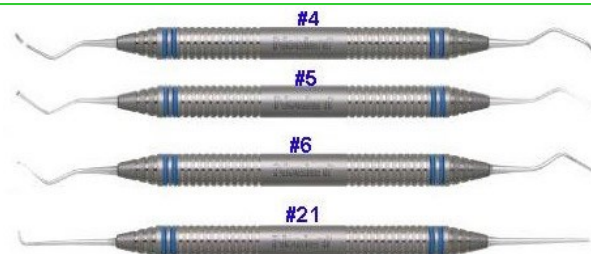

<b>Scaler DE #1</b> DuraLite-Æ ColorRings, Ñç	40-12285
<b>Scaler DE #1</b> DuraLite-Æ ROUND	40-12284
<b>Scaler DE #1</b> DuraLite-Æ HEX	40-12283
<b>Scaler DE #1</b> Medium Round	40-12282
<b>Scaler DE #1</b> Standard	40-12281
<b>Curette DE #2</b> DuraLite-Æ ColorRings, Ñç	40-12280
<b>Curette DE #2</b> DuraLite-Æ ROUND	40-12279
<b>Curette DE #2</b> DuraLite-Æ HEX	40-12294
<b>Curette DE #2</b> Medium Round	40-12295
<b>Curette DE #2</b> Standard	40-12296
<b>Curette DE #3</b> DuraLite-Æ ColorRings, Ñç	40-12311
<b>Curette DE #3</b> DuraLite-Æ ROUND	40-12310
<b>Curette DE #3</b> DuraLite-Æ HEX	40-12309
<b>Curette DE #3</b> Medium Round	40-12308
<b>Curette DE #3</b> Standard	40-12307
<b>Curette DE #4</b> DuraLite-Æ ColorRings, Ñç	40-12306
<b>Curette DE #4</b> DuraLite-Æ ROUND	40-12305
<b>Curette DE #4</b> DuraLite-Æ HEX	40-12304
<b>Curette DE #4</b> Medium Round	40-12303
<b>Curette DE #4</b> Standard	40-12302
<b>Scaler DE Hoe #5</b> DuraLite-Æ ColorRings, Ñç	40-12301
<b>Scaler DE Hoe #5</b> DuraLite-Æ ROUND	40-12300
<b>Scaler DE Hoe #5</b> DuraLite-Æ HEX	40-12299
<b>Scaler DE Hoe #5</b> Medium Round	40-12298
<b>Scaler DE Hoe #5</b> Standard	40-12297
<b>Scaler DE Hoe #6</b> DuraLite-Æ ColorRings, Ñç	40-12278
<b>Scaler DE Hoe #6</b> DuraLite-Æ ROUND	40-12286
<b>Scaler DE Hoe #6</b> DuraLite-Æ HEX	40-12287
<b>Scaler DE Hoe #6</b> Medium Round	40-12288



## Instruments



Prestige Dental Products, Inc.  
Prestigedentalproducts.com  
Tel: 877-772-3888

Scaler DE Hoe #6 Standard	40-12289
Scaler DE #21 DuraLite™ ColorRings, N/A	40-12290
Scaler DE #21 DuraLite™ ROUND	40-12291
Scaler DE #21 DuraLite™ HEX	40-12292
Scaler DE #21 Medium Round	40-12293
Scaler DE #21 Standard	40-12312

### Implacare (Hu-Friedy)



Implant maintenance instrument. Sterilizable Immunity Steel® handle with disposable Plasteel™ curette tips. Superior for removing plaque and calculus without damaging titanium abutments.

**Columbia Kit** Contains: 10 pair 4R/4L tips and #6 handle 40-90588

**Double End #6 Satin Steel Handle** 40-90589

### Implacare II (Hu-Friedy)



**Langer 1/2 Kit, Implacare II LG1/2 Kit, Handle & 12 Pairs** 40-90590

**Barnhart 5/6 Kit Implacare II BH5/6 Kit, Handle & 12 Refill Pairs** 40-90591

**Columbia 4R/4L Implacare II 4L/4R Kit, Handle & 12 Refill Pairs** 40-90592

**H6/H7 Kit: Implacare II H6/H7 Kit, Handle & 12 Refill Pairs** 40-90593

**204S Kit Implacare II 204S Kit, Handle & 12 Refill Pairs** 40-90594

**Implacare II Assorted Kit Includes:** 4 Columbia 4R/4L pairs, 4 204S pairs, 4 H6/H7 pairs, handle 40-90595

**Implacare II Langer 1/2 Refill, 12/pairs** 40-90596

**Implacare II Barnhart 5/6 Refill, 12/pairs** 40-90597

**Implacare II H6/H7 Refill, 12/Pairs** 40-90598

**Implacare II Columbia 4L/4R Refill, 12/pairs** 40-90599

**Implacare II 204S Refill, 12/Pairs** 40-90600

**Assorted Tip package Includes:** 4 Columbia 4R/4L pairs, 4 204S pairs, 4 H6/H7 pairs 40-90601

**Implacare II Intro Kit Includes:** 1 40-90602  
Implacare II handle, 1 Columbia 4r/4L pair, 1 204S pair, 1 H5/H7 pair, 1 Barnhart 5/6 pair, 1 Langer 1/2 pair

**Implant Maintenance Starter Kit** 40-90603  
**Includes:** Colorvue Handle, 3 Colorvue tips, 1 Implacare II Handle, 5 Implacare II tip pairs

### ImplaKlean Implant Deplaquer –Scaler Set (Pac-Dent)



Designed to fulfill the requirements of dental implant maintenance, Implaklean scalers are made of high performance autoclavable carbon reinforced resin. The unique rigidity allows conventional re sharpening and because of the unique resin material will not scratch abutments surfaces. The handles are ergonomically designed with a pair of color-coded silicone grips for comfort and easy identification. Each set includes three scalers; optional sharpening stone is specifically chosen for optimal re sharpening results.

Available in 3 types for different implant deplaquing/cleaning purposes: 4R/4L is the universal tip for use on all implant surfaces; H6/H7 is a sickle scaler for the removal of supra-gingival calculus; 204S is a sickle scaler for the removal of posterior supra-gingival calculus.

- Unique resin material does not scratch implant surfaces
- Resharpenable w/ conventional methods
- Comfortable color-coded silicone grips
- 3 types to satisfy different scaling needs
- Optional sharpening stone for optimal resharpening results

**Intro pack (1 of each)** 40-25571

**3 X 4R/4L** 40-25572

**3 X H6/H7** 40-25573

**3 X 204S** 40-25574

**Intro pack (1 of each) with sharpening stone** 40-25575

**1 X Sharpening stone** 40-25576

### Implant Scalers (Premier)



Thin, flexible and easily sharpened. Unique high density graphite, autoclavable.

**Facial 2/Pkg** 40-90604

**Universal 2/Pkg** 40-90605

**Universal 5/Pkg** 40-90606

# Instruments



Prestige Dental Products, Inc.  
 Prestigedentalproducts.com  
 Tel: 877-772-3888

## Jacquette Scalers (Nordent)



<b>DE #1-Towner U15 (U15-30)</b> DuraLite™ ColorRings, Ⓝ	40-12787
<b>DE #1-Towner U15 (U15-30)</b> DuraLite™ ROUND	40-12795
<b>DE #1-Towner U15 (U15-30)</b> DuraLite™ HEX	40-12805
<b>DE #1-Towner U15 (U15-30)</b> Medium Round	40-12797
<b>DE #1-Towner U15 (U15-30) Standard</b>	40-12798
<b>DE #1-1S (30-33)</b> DuraLite™ ColorRings, Ⓝ	40-12799
<b>DE #1-1S (30-33) DuraLite™</b> ROUND	40-12800
<b>DE #1-1S (30-33) DuraLite™</b> HEX	40-12801
<b>DE #1-1S (30-33) Medium Round</b>	40-12802
<b>DE #1-1S (30-33) Standard</b>	40-12803
<b>DE #1S - N5 (5-33)</b> DuraLite™ ColorRings, Ⓝ	40-12804
<b>DE #1S - N5 (5-33) DuraLite™</b> ROUND	40-12786
<b>DE #1S - N5 (5-33) DuraLite™</b> HEX	40-12785
<b>DE #1S - N5 (5-33) Medium Round</b>	40-12774
<b>DE #1S - N5 (5-33) Standard</b>	40-12773
<b>DE #1S - Towner U15 (U15-33)</b> ColorRings, Ⓝ	40-12772
<b>DE #1S - Towner U15 (U15-33) HEX</b>	40-12770
<b>DE #1S - Towner U15 (U15-33)</b>	40-12768
<b>DE #2-3 (31-32)</b> DuraLite™ ColorRings, Ⓝ	40-12767
<b>DE #2-3 (31-32) DuraLite™</b> ROUND	40-12775
<b>DE #2-3 (31-32) DuraLite™</b> HEX	40-12776
<b>DE #2-3 (31-32) Medium Round</b>	40-12784
<b>DE #2-3 (31-32) Standard</b>	40-12783
<b>DE #2S-3S (34-35)</b> DuraLite™ ColorRings, Ⓝ	40-12782
<b>DE #2S-3S (34-35) DuraLite™</b> ROUND	40-12781
<b>DE #2S-3S (34-35) DuraLite™</b> HEX	40-12780
<b>DE #2S-3S (34-35) Medium Round</b>	40-12779

<b>DE #2S-3S (34-35) Standard</b>	40-12778
<b>DE Goldman Fox 21S</b> Towner U15 DuraLite™ Color- Rings, Ⓝ	40-12777
<b>DE Goldman Fox 21S Towner U15</b> DuraLite™ ROUND	40-12796
<b>DE Goldman Fox 21S</b> Towner U15 DuraLite™ HEX	40-12788
<b>DE Goldman Fox 21S</b> Towner U15 Medium Round	40-12789
<b>DE Goldman Fox 21S</b> Towner U15 Standard	40-12790
<b>DE Morse #0-00</b> DuraLite™ ColorRings, Ⓝ	40-12791
<b>DE Morse #0-00 DuraLite™</b> ROUND	40-12792
<b>DE Morse #0-00 DuraLite™</b> HEX	40-12793
<b>DE Morse #0-00 Medium Round</b>	40-12794
<b>DE Morse #0-00 Standard</b>	40-12766

## Nevi Scalers (Hu-Friedy)



- Thin curved straight sickle, paired with an elongated disk end for anterior lingual stain and calculus removal
- Super thin posterior curved sickle scaler
- Unique contra-angle design, great for interproximal reach and ergonomic hand positioning

<b>Nevi 1, Anterior #6 Satin Steel Handle</b>	40-90607
<b>Nevi 1, Anterior ResinEight Handle</b>	40-90608
<b>Nevi 1, Anterior #9 EverEdge Handle</b>	40-90609
<b>Nevi 1/H5, Anterior #9 EverEdge Han- dle</b>	40-90610
<b>Nevi 2, Posterior #6 Satin Steel Handle</b>	40-90611
<b>Nevi 2, Posterior ResinEight Handle</b>	40-90612
<b>Nevi 2, Posterior ResinEight Colors</b> Handle-Red	40-90613
<b>Nevi 2, Posterior #9 EverEdge Handle</b>	40-90614
<b>Nevi 4, Posterior ResinEight Colors</b> Handle-Red	40-90615

## Posterior Scalers - Sickles (Nordent)

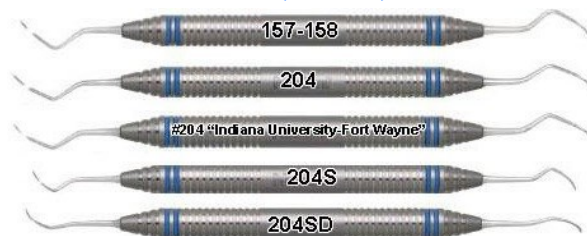

# Instruments



Prestige Dental Products, Inc.  
 Prestigedentalproducts.com  
 Tel: 877-772-3888



<b>DE Offset Universal #2</b> DuraLite-Æ ColorRings,Ñç	40-13392
<b>DE Offset Universal #2</b> DuraLite-Æ ROUND	40-13405
<b>DE Offset Universal #2</b> DuraLite-Æ HEX	40-13406
<b>DE Offset Universal #2</b> Medium Round	40-13407
<b>DE Offset Universal #2</b> Standard	40-13408
<b>DE University of Texas #107-108</b> DuraLite-Æ ColorRings,Ñç	40-13403
<b>DE University of Texas #107-108</b> Medium Round	40-13400
<b>DE University of Texas #107-108</b> Standard	40-13399
<b>DE #157-158</b> DuraLite-Æ ColorRings,Ñç	40-13398
<b>DE #157-158</b> DuraLite-Æ ROUND	40-13397
<b>DE #157-158</b> DuraLite-Æ HEX	40-13396
<b>DE #157-158</b> Medium Round	40-13395
<b>DE #157-158</b> Standard	40-13394
<b>DE #204</b> DuraLite-Æ ColorRings,Ñç	40-13393
<b>DE #204</b> DuraLite-Æ ROUND	40-13374
<b>DE #204</b> DuraLite-Æ HEX	40-13373
<b>DE #204</b> Medium Round	40-13354
<b>DE #204</b> Standard	40-13353
<b>DE #204IPFW</b> DuraLite-Æ ColorRings,Ñç	40-13352
<b>DE #204IPFW</b> DuraLite-Æ ROUND	40-13351
<b>DE #204IPFW</b> DuraLite-Æ HEX	40-13350
<b>DE #204IPFW</b> Medium Round	40-13349
<b>DE #204IPFW</b> Standard	40-13348

<b>DE #204S</b> DuraLite-Æ ColorRings,Ñç	40-13347
<b>DE #204S</b> DuraLite-Æ ROUND	40-13346
<b>DE #204S</b> DuraLite-Æ HEX	40-13345
<b>DE #204S</b> Medium Round	40-13344
<b>DE #204S</b> Standard	40-13343
<b>DE Distal #204SD</b> DuraLite-Æ ColorRings,Ñç	40-13342
<b>DE Distal #204SD</b> DuraLite-Æ ROUND	40-13341
<b>DE Distal #204SD</b> DuraLite-Æ HEX	40-13340
<b>DE Distal #204SD</b> Medium Round	40-13355
<b>DE Distal #204SD</b> Standard	40-13356
<b>DE Taylor #2-3</b> DuraLite-Æ ColorRings,Ñç	40-13357
<b>DDE Taylor #2-3</b> DuraLite-Æ ROUND	40-13372
<b>DE Taylor #2-3</b> DuraLite-Æ HEX	40-13371
<b>DE Taylor #2-3</b> Medium Round	40-13370
<b>DE Taylor #2-3</b> Standard	40-13369
<b>DE Ivory #CI2-3</b> DuraLite-Æ ColorRings,Ñç	40-13368
<b>DE Ivory #CI2-3</b> DuraLite-Æ ROUND	40-13367
<b>DE Ivory #CI2-3</b> DuraLite-Æ HEX	40-13366
<b>DE Ivory #CI2-3</b> Medium Round	40-13365
<b>DE Ivory #CI2-3</b> Standard	40-13364
<b>DE Crane Kaplan #6</b> DuraLite-Æ ColorRings,Ñç	40-13363
<b>DE Crane Kaplan #6</b> DuraLite-Æ ROUND	40-13362
<b>DE Crane Kaplan #6</b> DuraLite-Æ	40-13361
HEX	
<b>DE Crane Kaplan #6</b> Medium Round	40-13360
<b>DE Crane Kaplan #6</b> Standard	40-13359
<b>DE Remington Anterior/Posterior #3</b> -4 DuraLite-Æ ColorRings,Ñç	40-13358
<b>DE Remington Anterior/Posterior #3</b> -4 DuraLite-Æ ROUND	40-13339
<b>DE Remington Anterior/Posterior #3</b> -4 DuraLite-Æ HEX	40-13391
<b>DE Remington Anterior/Posterior #3</b> -4 Medium Round	40-13390
<b>DE Remington Anterior/Posterior #3</b> -4 Standard	40-13375



# Instruments



Prestige Dental Products, Inc.  
 Prestigedentalproducts.com  
 Tel: 877-772-3888

<b>DE Remington K</b> DuraLite→Æ ColorRings,Ñç	40-13376
<b>DE Remington K</b> DuraLite→Æ ROUND	40-13377
<b>DE Remington K</b> DuraLite→Æ HEX	40-13378
<b>DE Remington K</b> Medium Round	40-13379
<b>DE Remington K</b> Standard	40-13380
<b>DE Doeppler #M-23</b> DuraLite→Æ ColorRings,Ñç	40-13381
<b>DE Doeppler #M-23</b> DuraLite→Æ ROUND	40-13382
<b>DE Doeppler #M-23</b> DuraLite→Æ HEX	40-13383
<b>DE Doeppler #M-23</b> Medium Round	40-13384
<b>DE Doeppler #M-23</b> Standard	40-13385
<b>DE Universal Anterior/Posterior</b> #N129 DuraLite→Æ ColorRings,Ñç	40-13386
<b>DE Universal Anterior/Posterior</b> #N129 DuraLite→Æ ROUND	40-13387
<b>DE Universal Anterior/Posterior</b> #N129 DuraLite→Æ HEX	40-13388
<b>DE Universal Anterior/Posterior</b> #N129 Medium Round	40-13389
<b>DE Universal Anterior/Posterior</b> #N129 Standard	40-13404

## Relyant Curettes (Nordent)



<b>Curette, DE, Barnhart #1-2</b>	40-13481
<b>Curette, DE, Barnhart #5-6</b>	40-13474
<b>Curette, DE, Columbia #13-14</b>	40-13480
<b>Curette, DE, Columbia #4R-4L</b>	40-13478
<b>Curette, DE, Gracey #11-12</b>	40-13477
<b>Curette, DE, Gracey #1-2</b>	40-13476
<b>Curette, DE, Gracey #13-14</b>	40-13475
<b>Curette, DE, Gracey #3-4</b>	40-13473
<b>Curette, DE, Gracey #5-6</b>	40-13471
<b>Curette, DE, Gracey #7-8</b>	40-13470
<b>Curette, DE, McCall #13S-14S</b>	40-13469
<b>Curette, DE, McCall #17-18</b>	40-13472
<b>Curette, DE, Younger-Good #7-8</b>	40-13479

## Relyant Scalers (Nordent)



<b>Scaler, DE, Posterior Sickle, #204</b>	40-13491
<b>Scaler, DE, Posterior Sickle #204S</b>	40-13490
<b>Scaler, DE,</b> Anterior Lingual Stain Remover	40-13487
<b>Scaler, DE, Jacquette #1S</b> Sickle N5 (5-33)	40-13489
<b>Scaler, DE, Jacquette #2S-3S (34-35)</b>	40-13488
<b>Scaler, DE, Posterior #N129</b>	40-13486
<b>Scaler, DE, Anterior, N5-5 Slim</b>	40-13485
<b>Scaler, DE, N5-Contra Angle Hoe</b> #48	40-13484
<b>Scaler, DE, N67 Offset Sickle (H6-</b> H7)	40-13483
<b>Scaler, DE,</b> Offset Sickle NMJ Universal R138	40-13482
<b>Saler, DE, Remington 3-4</b>	40-13492

## Scalers (ASA Italy)

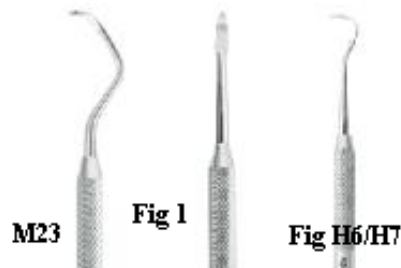

<b>Universal Scaler M23</b>	40-13653
<b>Scalers Fig.1</b>	40-13652
<b>Scalers Fig. H6/H7</b>	40-13654

## Scalers – Anterior (PDT)

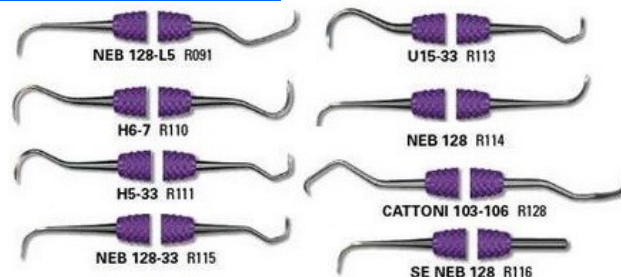

<b>NEB 128-L5</b>	40-11123
<b>U15-33</b>	40-11124
<b>NEB 128-33</b>	40-11125
<b>H5-33</b>	40-11129
<b>NEB 128</b>	40-11128

# Instruments



Prestige Dental Products, Inc.  
 Prestigedentalproducts.com  
 Tel: 877-772-3888

<b>CATTONI 103-106</b>	40-11126
<b>SE NEB 128</b>	40-11127
<b>H6-7</b>	40-11122

## Scalers - Single End (Nordent)



<b>SE B, DuraLite-Æ ColorRings, Ñ¢</b>	40-13671
<b>SE B, DuraLite-Æ Round</b>	40-13670
<b>SE B, Standard</b>	40-13669
<b>SE Ivory CI1, DuraLite-Æ ColorRings, Ñ¢</b>	40-13668
<b>SE Ivory CI1, DuraLite-Æ Round</b>	40-13667
<b>SE Ivory CI1 Standard</b>	40-13666
<b>SE Jacquette J1S (33) DuraLite-Æ ColorRings, Ñ¢</b>	40-13677
<b>SE Jacquette J1S (33) DuraLite-Æ ROUND</b>	40-13678
<b>SE Jacquette J1S (33) Standard</b>	40-13679
<b>SE Sickle N5 (H5) DuraLite-Æ ColorRings, Ñ¢</b>	40-13656
<b>SE Sickle N5 (H5) DuraLite-Æ ROUND</b>	40-13657
<b>SE Sickle N5 (H5) Standard</b>	40-13658
<b>SE Towner U15 DuraLite-Æ ColorRings, Ñ¢</b>	40-13659
<b>SE Towner U15 DuraLite-Æ ROUND</b>	40-13660
<b>SE Towner U15 Standard</b>	40-13661
<b>SE Whiteside #2 DuraLite-Æ ColorRings, Ñ¢</b>	40-13662
<b>SE Whiteside #2 DuraLite-Æ ROUND</b>	40-13663
<b>SE Whiteside #2 Standard</b>	40-13664
<b>SE Sickle #109 DuraLite-Æ ColorRings, Ñ¢</b>	40-13681
<b>SE Sickle #109 DuraLite-Æ ROUND</b>	40-13680
<b>SE Sickle #109 Standard</b>	40-13665
<b>SE University of Southern California #128 DuraLite-Æ ColorRings, Ñ¢</b>	40-13672
<b>SE University of Southern California #128 DuraLite-Æ ROUND</b>	40-13673

<b>SE University of Southern California #128 Standard</b>	40-13674
<b>SE Younger-Good #15 DuraLite-Æ ColorRings, Ñ¢</b>	40-13675
<b>SE Younger-Good #15 DuraLite-Æ ROUND</b>	40-13676
<b>SE Younger-Good #15 Standard</b>	40-13655

## Scalers Double End (DA)

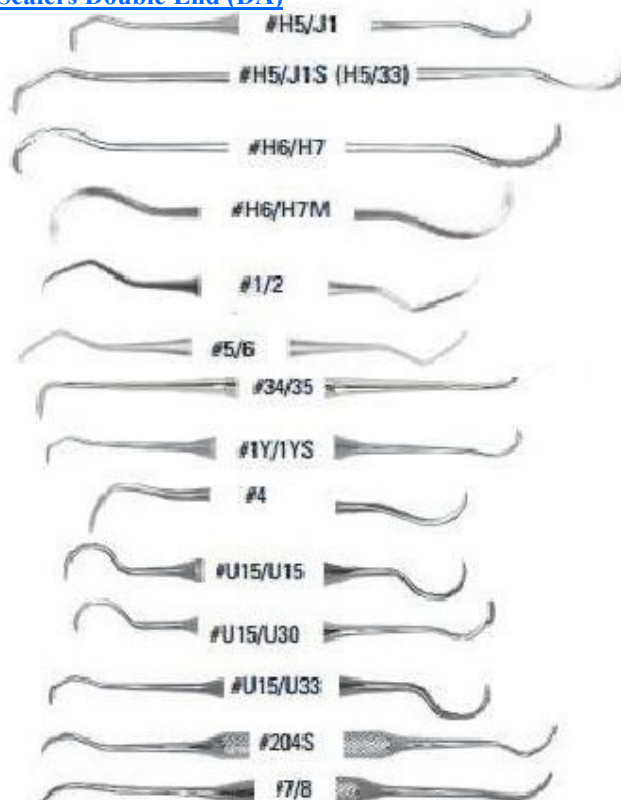

<b>#H/J1, Octagonal Handle</b>	40-90570
<b>#H5/J1S, Octagonal Handle</b>	40-90571
<b>#H/J1S, Round Hollow</b>	40-90572
<b>#H6/H7, Octagonal Handle</b>	40-90573
<b>#H6/H7, Resin Handle-Blue</b>	40-90574
<b>#H6/H7, Round Hollow</b>	40-90575
<b>Barnhart 1/2</b>	40-90576
<b>Barnhart 1/2, Round Hollow</b>	40-90578
<b>Jacquette #1Y/1YS, Octagonal Handle</b>	40-90579
<b>Sickle #4, Octagonal Handle</b>	40-90580
<b>Towner #U15/U15, Octagonal Handle</b>	40-90581
<b>Towner #U15/U30, Octagonal Handle</b>	40-90582
<b>Towner #U15/U33, Octagonal Handle</b>	40-90583
<b>#204S, Octagonal Handle</b>	40-90584
<b>Younger-Good 7/8, Octagonal Handle</b>	40-90585

# Instruments



Prestige Dental Products, Inc.  
 Prestigedentalproducts.com  
 Tel: 877-772-3888

## Scalers Double End (American Eagle)

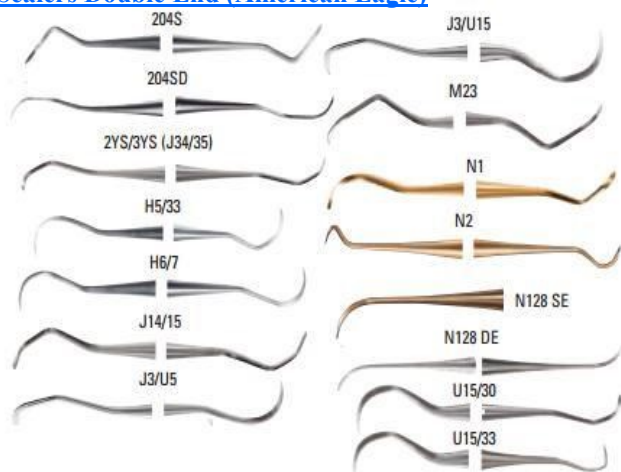

<b>204S</b> EagleLite Handle	40-90616
<b>204S XP</b> w/EagleLite Resin Handle	40-90617
<b>204S</b> EagleLite Stainless Steel Handle	40-90618
<b>204SD</b> EagleLite Handle	40-90619
<b>204SD XP</b> w/EagleLite Handle	40-90620
<b>2YS/3YS (J34/35)</b> EagleLite Handle	40-90621
<b>2YS/3YS (J34/35)</b> Purple ResinEight Handle	40-90622
<b>H5/33</b> EagleLite Handle	40-90623
<b>H5/33 XP</b> w/EagleLite Handle	40-90624
<b>H5/33</b> XP w/EagleLite Stainless Steel Handle	40-90625
<b>H6/7</b> EagleLite Handle	40-90626
<b>H6/7 XP</b> w/EagleLite Resin Handle	40-90627
<b>H6/7 XP</b> w/EagleLite Stainless Steel Handle	40-90628
<b>J14/15</b> EagleLite Handle	40-90629
<b>J3/U5</b> EagleLite Handle	40-90630
<b>J3/U15</b> EagleLite Handle	40-90631
<b>J3/U15 XP</b> w/EagleLite Handle	40-90632
<b>M23 XP</b> w/EagleLite Blue Handle	40-90633
<b>M23 XP</b> w/EagleLite Stainless Steel Handle	40-90634
<b>N1 XP</b> w/EagleLite Orange Handle	40-90635
<b>N2 XP</b> w/EagleLite Red Handle	40-90636
<b>N2 XP</b> w/EagleLite Stainless Steel Handle	40-90637
<b>N128 SE XP</b> w/EagleLite Orange Handle	40-90638
<b>N128 XP</b> w/EagleLite Stainless Steel Handle	40-90639

<b>N128 XP</b> w/EagleLite Resin Handle	40-90640
<b>N128 XP</b> w/EagleLite Stainless Steel Handle	40-90641
<b>U15/30</b> EagleLite Handle	40-90642
<b>U15/33</b> EagleLite SureGrip Handle	40-90643

## Scalers Double End (Miltex)



Revolutionary Tactile Tone Handle offers two unique features:  
 Color and Feel the permanently color-coded grips allow for immediate recognition between procedures and tray setups the soft yet firm grip provides a more stable and comfortable feel and reduces hand fatigue and problems associated with Carpal Tunnel Syndrome (CTS) and arthritis.

<b>204S</b> Tactile Tone Handle	40-90644
<b>H6/7</b> Tactile Tone Handle	40-90645
<b>Barnhart 5/6</b> Tactile Tone Handle	40-90646
<b>Jacquete 30/U15</b> Tactile Tone Handle	40-90647
<b>33/H5</b> Tactile Tone Handle	40-90648
<b>34/35</b> Tactile Tone Handle	40-90649
<b>Towner U15/30</b> Tactile Tone Handle	40-90650

## Scalers Double End (Premier)

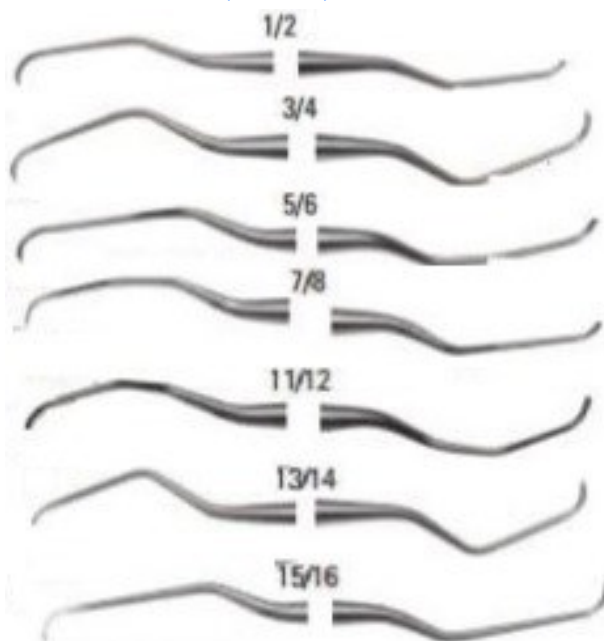



# Instruments



Prestige Dental Products, Inc.  
 Prestigedentalproducts.com  
 Tel: 877-772-3888

Pocket scalers and mini pocket scalers have a slender and longer terminal shank to provide access into deeper pockets. MPS has the same slender tip design as PS, but with half the blade length. InSite PS & MPS have a depth gauge at 5mm. through 10mm., offering an excellent visual guide. Big Easy UltraLite Pocket scalers and mini pocket scalers do not feature the depth gauge found in InSite scalers

<b>1/2, Big Easy UltraLite Mini Pocket Scaler</b>	40-90651
<b>1/2 Big Easy UltraLite Pocket Scaler</b>	40-90652
<b>1/2 Insite Big Easy Pocket Scaler</b>	40-90653
<b>3/4 Big Easy Ultralite Mini Pocket Scaler</b>	40-90654
<b>3/4 Big Easy Ultralite Pocket Scaler</b>	40-90655
<b>3/4 Insite Big Easy Pocket Scaler</b>	40-90656
<b>5/6 Big Easy Ultralite Mini Pocket Scaler</b>	40-90657
<b>5/6 Big Easy Ultralite Pocket Scaler</b>	40-90658
<b>7/8 Big Easy Ultralite Mini Pocket Scaler</b>	40-90659
<b>11/12, Big Easy Ultralite Mini Pocket Scaler</b>	40-90660
<b>11/12 Big Easy Ultralite Pocket Scaler</b>	40-90661
<b>11/12 Insite Big Easy Pocket Scaler</b>	40-90662
<b>13/14, Big Easy Ultralite Mini Pocket Scaler</b>	40-90663
<b>13/14 Big Easy Ultralite Pocket Scaler</b>	40-90664
<b>13/14, Insite Big Easy Ultralite Pocket Scaler</b>	40-90665
<b>15/16, Big Easy Ultralite Mini Pocket Scaler</b>	40-90666
<b>15/16 Insite Big Easy Pocket Scaler</b>	40-90667

## Scalers Posterior (PDT)



<b>MT 4-5</b>	40-13333
<b>J 35-35</b>	40-13335
<b>Cattoni 107-108</b>	40-13334
<b>204S</b>	40-13336
<b>204SD</b>	40-13337
<b>220</b>	40-13338

**Call Us Today 833-733-6825**

## Scalette Anterior Double End (Nordent)



Combines the design characteristics of a scaler and a curette into one easier-to-use instrument. Using a Scalette® will save time during the procedure, space on the tray, and will reduce instrument replacement costs. ANTERIOR combines a sickle scaler and anterior universal (sharp on both sides of the blade) curette.

**Each** 40-90743

## Scalette Posterior Double End (Nordent)



POSTERIOR combines the pointed tip of a scaler and the narrow profile of a very fine universal curette. The terminal shank is 11mm. long and the blades are set over the centerline of the instrument to enable easier access into hard-to-reach posterior areas.

**Each** 40-90744

## Sickle Scalers Double End (Hu-Friedy)

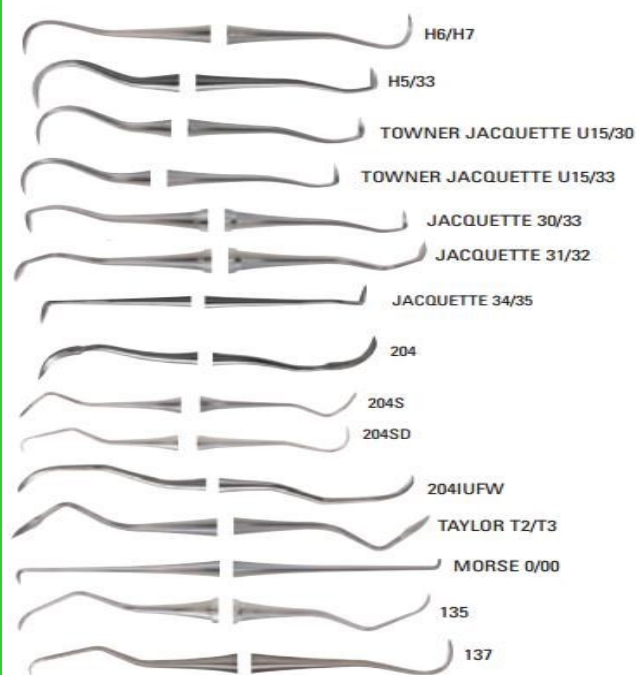

<b>H6/H7 #2 Octagonal Handle</b>	40-90671
<b>H6/H7 #4 Round Handle</b>	40-90672
<b>H6/H7 #6 Satin Steel Handle</b>	40-90673
<b>H6/H7 #7 Satin Steel Colours Handle</b>	40-90674
<b>H6/H7 ResinEight Handle</b>	40-90678
<b>H6/H7 ResinEight Colors Handle-Blue</b>	40-90676
<b>H6/H7 #9 EverEdge Handle</b>	40-90677

# Instruments



Prestige Dental Products, Inc.  
 Prestigedentalproducts.com  
 Tel: 877-772-3888

<b>H5/33 #2</b> Octagonal Handle	40-90678
<b>H5/33 #4</b> Round Handle	40-90679
<b>H5/33 #6</b> Satin Steel Handle	40-90680
<b>H5/33 #7</b> Satin Steel Colours Handle	40-90681
<b>H5/33</b> ResinEight Handle	40-90682
<b>H5/33 #9</b> EverEdge Handle	40-90683
<b>Towner Jacquette U15/30 #2</b> Octagonal Handle	40-90684
<b>Towner Jacquette U15/30 #4</b> Round Handle	40-90685
<b>Towner Jacquette U15/30 #6</b> Satin Steel Handle	40-90686
<b>Towner Jacquette U15/30 #9</b> EverEdge Handle	40-90687
<b>Towner Jacquette U15/33 #2</b> Octagonal Handle	40-90688
<b>Towner Jacquette U15/33 #6</b> Satin Steel Handle	40-90689
<b>Towner Jacquette U15/33 #7</b> Satin Steel Colours Handle	40-90690
<b>Towner Jacquette U15/33 #9</b> EverEdge Handle	40-90691
<b>Jacquette 30/33 #2</b> Octagonal Handle	40-90692
<b>Jacquette 30/33 #6</b> Satin Steel Handle	40-90693
<b>Jacquette 30/33 #9</b> EverEdge Handle	40-90694
<b>Jacquette 31/32 #2</b> Octagonal Handle	40-90695
<b>Jacquette 31/32 #6</b> Satin Steel Handle	40-90696
<b>Jacquette 31/32</b> Resin Eight Colors-Red	40-90697
<b>Jacquette 34/35 #2</b> Octagonal Handle	40-90698
<b>Jacquette 34/35 #6</b> Satin Steel Handle	40-90699
<b>Jacquette 34/35</b> ResinEight Handle	40-90700
<b>Jacquette 34/35 #9</b> EverEdge Handle	40-90701
<b>204 #2</b> Octagonal Handle	40-90702
<b>204S #2</b> Octagonal Handle	40-90703
<b>204S #6</b> Satin Steel Handle	40-90704
<b>204S #7</b> Satin Steel Colours Handle	40-90705
<b>204S</b> ResinEight handle (American Dental Design)	40-90706
<b>204S</b> ResinEight Handle	40-90707
<b>204S #9</b> EverEdge Handle	40-90708
<b>204S</b> ResinEight Colors Handle-Red	40-90709
<b>204SD #2</b> Octagonal Handle	40-90710

<b>204SD</b> ResinEight Colors Handle-Red	40-90711
<b>204SD #6</b> Satin Steel Handle	40-90712
<b>204SD #9</b> EverEdge Handle	40-90713
<b>204IUFW #6</b> Satin Steel Handle	40-90714
<b>204IUFW #7</b> Satin Steel Colours Handle	40-90715
<b>204IUFW #9</b> EverEdge Handle	40-90716
<b>Taylor T2/T3 #6</b> Satin Steel Handle	40-90717
<b>Morse 0/00 #6</b> Satin Steel Handle	40-90718
<b>Morse 0/00 #7</b> Satin Steel Colours Handle	40-90719
<b>Morse 0/00 #9</b> EverEdge Handle	40-90720
<b>135 #6</b> Satin Steel Handle	40-90721
<b>135</b> ResinEight Handle	40-90722
<b>135 #9</b> EverEdge Handle	40-90723
<b>135</b> ResinEight Handle-Purple	40-90724
<b>137</b> ResinEight Handle	40-90725
<b>137</b> ResinEight Handle-Purple	40-90726
<b>137 #9</b> EverEdge Handle	40-90727

### Sickle Scalers Double End (Premier)

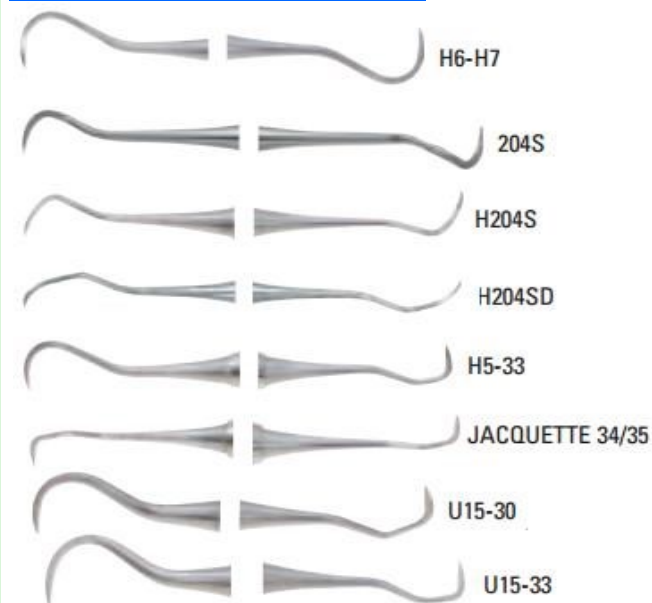

<b>H6-H7</b> Big Easy Handle	40-90728
<b>204S</b> Big Easy Handle	40-90729
<b>H204S</b> Big Easy Handle	40-90730
<b>H204SD</b> Big Easy Handle	40-90731
<b>H5-33</b> Big Easy Handle	40-90732
<b>Jacquette 34/35</b> Big Easy Handle	40-90733
<b>U15-30</b> Big Easy Handle	40-90734

# Instruments



Prestige Dental Products, Inc.  
 Prestigedentalproducts.com  
 Tel: 877-772-3888

**U15-33 Big Easy Handle** 40-90735

### Sickle Scalars Single End (Hu-Friedy)



**Towner U15** 40-90668

**Towner U15 #6 Satin Steel Handle** 40-90669

**Younger-Good 15 #1 Octagonal Handle** 40-90670

### Titanium Implant Scalars (A.Titan)

- Made from same titanium alloy as implant and abutment
- Won't scratch implant or abutment
- Stays sharp for an extended period of time

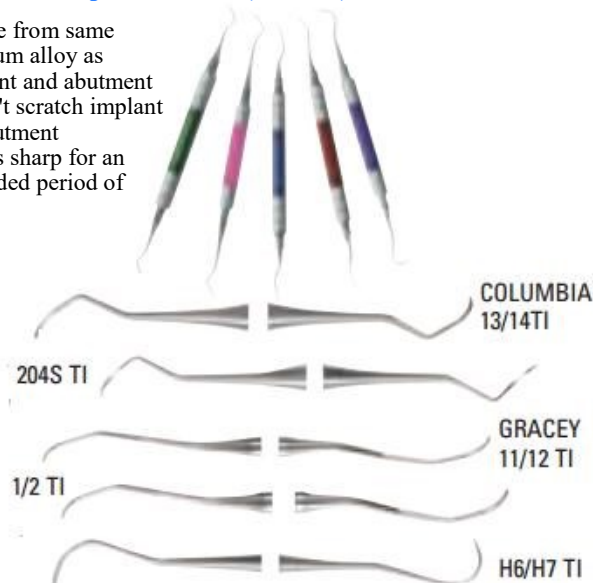

**Scaler Kit Contains:** Columbia 13/14TI, 204S Ti, Gracey 11/12TI, Gracey 13/14TI, H6/H7TI, Sterilization Tray 40-90740

**Columbia 13/14 TI** 40-90741

**204S TI** 40-90742

**Gracey 11/12 TI** 40-90736

**13/14 TI** 40-90737

**1/2 TI** 40-90738

**H6/H7 TI** 40-90739

## Scissors

### Gum and Suture Scissors (DA)

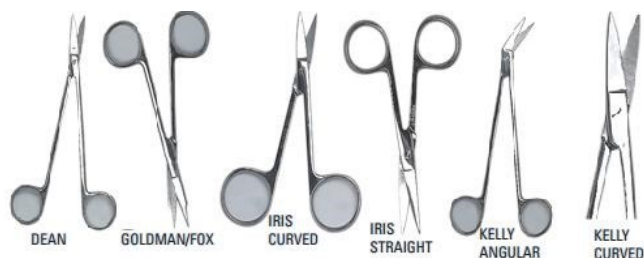

**Dean 6 1/2"** 40-91752

**Goldman/Fox 5"** 40-91753

**Iris Curved 4 1/2"** 40-91754

**Iris Straight 4 1/2"** 40-91755

**Kelly Angular 6 1/4"** 40-91756

**Kelly Curved 6 1/4"** 40-91757

**Kelly Straight 6 1/4"** 40-91758

**Spencer Stitch 4 3/4"** 40-91759

**Littauer Stitch 5 1/2"** 40-91760

**Quimby Curved 5"** 40-91761

**Quimby Straight 5"** 40-91762

**Spencer 4"** 40-91763

### Gum and Suture Scissors (Hu-Friedy)

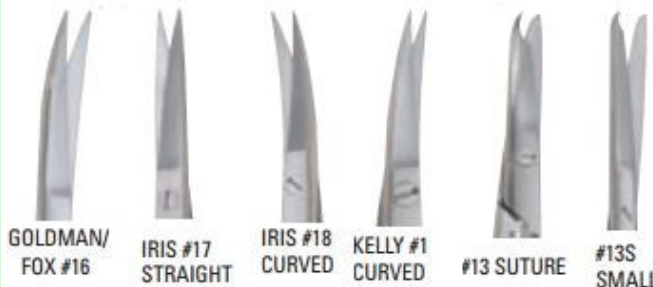

**Goldman/Fox #16, 1 Serrated Blade 5"** 40-91764

**Iris #17 Straight, 4 1/2"** 40-91765

**Iris #18 Curved, 4 1/2"** 40-91766

**Kelly #1 Curved, 1 Serrated Blade 6 1/4"** 40-91767

**#13 Suture 6"** 40-91768

**#13S Small, 4 3/4"** 40-91769

### Gum and Suture Scissors (Miltex)



**Dean, 1 Serrated Blade 6 3/4"** 40-91749

**Iris Curved 4 1/2"** 40-91750

**Iris Straight 4 1/2"** 40-91751



# Instruments



Prestige Dental Products, Inc.  
 Prestigedentalproducts.com  
 Tel: 877-772-3888

## Gum and Suture Scissors (Premier)



**Iris Curved, Delicate 4 1/2"** 40-91770  
**Iris Straight, Delicate 4 1/2"** 40-91771

## Gum Scissors with Tungsten Carbide Inserts (ASA Italy)

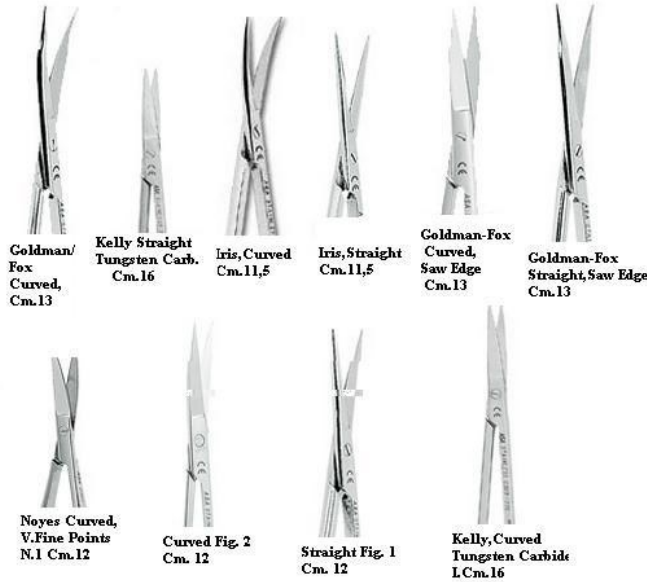

**Goldman-Fox Curved, Cm.13**  
**Kelly Straight Tungsten Carb. Cm.16**  
**Iris, Curved Cm.11,5**  
**Iris, Straight Cm.11,5**  
**Goldman-Fox Curved, Saw Edge Cm.13**  
**Goldman-Fox Straight, Saw Edge Cm.13**  
**Noyes Curved, V.Fine Points N.1 Cm.12**  
**Curved Fig. 2 Cm. 12**  
**Straight Fig. 1 Cm. 12**  
**Kelly, Curved Tungsten Carbide I.Cm.16**

**Gum Scissors, Straight Fig. 1 Cm. 12** 40-12515  
**Gum Scissors, Curved Fig. 2 Cm. 12** 40-12524  
**Gum Scissors Noyes Curved, V.Fine Points N.1 Cm.12** 40-12521  
**Gum Scissors, Goldman-Fox Straight, Saw Edge Cm.13** 40-12522  
**Gum Scissors, Goldman-Fox Curved, Saw Edge Cm.13** 40-12520  
**Gum Scissors Goldman-Fox Curved, Saw Edge Cm.13** 40-12519  
**Gum Scissors Iris, Straight Cm.11,5** 40-12518  
**Gum Scissors Iris, Curved Cm.11,5** 40-12517  
**Gum Scissors, Kelly Straight Tungsten Carb. Cm.16** 40-12516  
**Gum Scissors Kelly, Curved Tungsten Carbide I.Cm.16** 40-12523

[www.PrestigeDentalProducts.com](http://www.PrestigeDentalProducts.com)

## Iris Scissor (Prestige)



**Straight 4.5"** 40-106821

## Spatulas

### Cement Spatula (Miltex)



**#24, each** 40-91077

### Cement Spatula (Prestige)



**#24, standard flexible blade with hollow handle** 40-106151  
**#24, standard flexible blade with hollow handle, 5/Pkg** 40-106152

### Plastic Spatula (GC America)

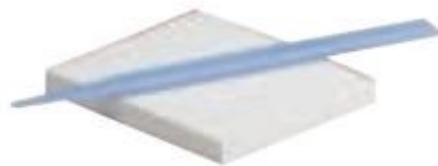

**Blue, each** 40-91078

### Spatulas (DA)



**Alginate Plastic, each** 40-91064  
**Cement #22, Flexible, each** 40-91065  
**Cement #24, Flexible, each** 40-91066



Prestige Dental Products, Inc.  
 Prestigedentalproducts.com  
 Tel: 877-772-3888

## Instruments

<b>Cement #322, Semi-Rigid, each</b>	40-91067
<b>Cement #324, each</b>	40-91068
<b>Cement #336, Semi-Rigid, each</b>	40-91069
<b>Composite Plastic, 100/Pkg</b>	40-91070
<b>Composite Plastic, 100/Pkg</b>	40-91071
<b>Stainless Steel #313, Rigid, each</b>	40-91072
<b>Wax #5, each</b>	40-91073
<b>Wax #7, each</b>	40-91074
<b>Wax #7A, each</b>	40-91075
<b>Wax #31, each</b>	40-91076

### Spatulas (Hu-Friedy)



<b>Cement #24, each</b>	40-91079
<b>Wax #7, each</b>	40-91080

### Spatulas (Premier)

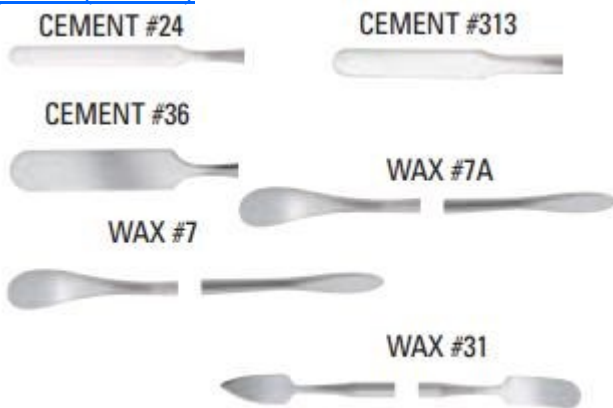

<b>Cement #24, each</b>	40-91081
<b>Cement #36, each</b>	40-91082
<b>Cement #313, each</b>	40-91083
<b>Wax #7, each</b>	40-91084
<b>Wax #7A, each</b>	40-91085
<b>Wax #31, each</b>	40-91086

### Spectrum Aliginate Spatulas (PlasDent)



<b>BLUE, each</b>	45-14253
<b>YELLOW, each</b>	45-14254

<b>RUBY RED, each</b>	45-14256
<b>PURPLE, each</b>	45-14257
<b>PINK, each</b>	45-14258
<b>ORANGE, each</b>	45-14259

### Specialty

#### Endodontic (DA)



<b>S/E D11, Root Canal Spreader</b>	40-91419
<b>S/E D11T, Root Canal Spreader</b>	40-91420
<b>S/E MA57, Root Canal Spreader</b>	40-91421
<b>D/E 16/17 Explorer Root Canal Spreader</b>	40-91422
<b>D/E 23/16 Explorer</b>	40-91423

#### Endodontic (Hu-Friedy)

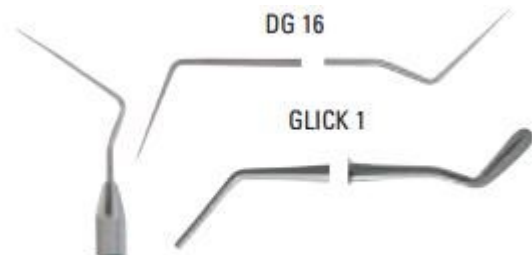

#### ROOT CANAL SPREADERS

<b>D/E DG16, Endo Explorer, each</b>	40-91431
<b>DG16, each</b>	40-91432
<b>D/E Glick 1, each</b>	40-91433
<b>D11 Root Canal Spreaders</b>	40-91434
<b>D11T Root Canal Spreaders</b>	40-91435
<b>MA57 Root Canal Spreaders</b>	40-91436

#### Root Canal Spreaders (Premier)



<b>D11</b>	40-91424
<b>D11T</b>	40-91425

# Instruments



Prestige Dental Products, Inc.  
 Prestigedentalproducts.com  
 Tel: 877-772-3888

## Spreaders

### Plugger Spreader Machtou Magic Color (ASA Italy)



- RED** 40-13330
- GREEN** 40-13329

### Spreader Magic Color (ASA Italy)

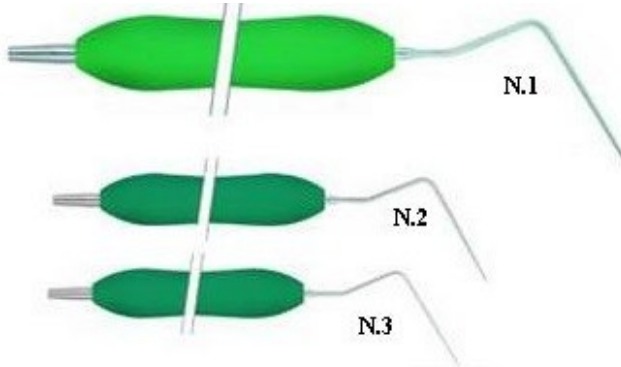

- Magic Color Spreader No. 1 -Green** 40-13792
- Spreader No. 2 Magic Color -Green** 40-13791
- Spreader No. 3 Magic Color -Green** 40-13793

## Sterilization Cassettes

### Compact 9 Instrument Cassettes (Zirc)

- Autoclavable 9 instrument containers that hold instruments during procedures.
- They fit standard ultrasonic cleaners & autoclaves



- White color, each** 40-110611
- Blue color, each** 40-110612

### Compact Steri-Container (Zirc)

- Snap lid fits in all Statims or other sterilizers
- Statim 2000 holds 7 compact steri-containers
- 7 1/8" x 1 1/2" x 1 1/2"



- Yellow, each** 40-91283

### Exam Cassette with Rack PDT-5 (PDT)

- Compact. Fixed rack holds 5 instruments
- Will hold 7" ultrasonic inserts
- Ideal for the Wingrove™ Titanium Implant "Go-To" set, specialty set-ups and exam kits
- Cotton plier retainer and an air/water clip



- Fixed rack holds 5 instruments** 40-13153
- 7-1/16" X 2-7/16" X 7/8"

### EZ Jett Cassette 10-Place (Zirc)

- Holds 10 instruments
- Easy to open covers that fold back
- Compartment in the middle for holding various dental instruments
- Superior water flow – open top, round holes and radiused corners
- Autoclavable and made with Microban®
- Available in 15 colors



- Blue, each** 40-91224
- Green, each** 40-91225
- Mauve, each** 40-91226
- Teal, each** 40-91227
- Neon Blue, each** 40-91228
- Neon Yellow, each** 40-91229
- Neon Green, each** 40-91230
- Neon Orange, each** 40-91231
- Neon Purple, each** 40-91232
- Neon Pink, each** 40-91233

### FlipTop Cassette 'A' (PDT)

- T005A-F Fixed rack holds 5 instruments. Cotton plier retainer and an air/water clip.
- T008A-U Utility box with silicone retainer strips. No instrument rack. Ideal for handpiece, 8" ultrasonic inserts, syringes, etc.



- Fixed rack holds 5 instruments** 40-12207
- 8" X 2-7/16" X 7/8"
- Utility box with silicone retainer strips** 40-12208
- 8" X 2-7/16" X 7/8"

### FlipTop Cassette 'B' (PDT)

- T0007B-D FlipTop Cassette 'B' - Double Rack holds 14 instruments. Fixed rack below and LiftOut rack above. Small accessory area will hold PDT sharpening stone, clamps, napkin chains, or other small items. Cotton plier retainer, needle







Prestige Dental Products, Inc.  
 Prestigedentalproducts.com  
 Tel: 877-772-3888

# Instruments

recapper and an air/water clip.

- T007B-F FlipTop Cassette 'B' - Fixed Rack holds 7 instruments. Small accessory area will hold PDT sharpening stone, clamps, napkin chains, or other small items. Cotton plier retainer, needle recapper and an air/water clip.
- T007B-U FlipTop Cassette 'B' - Utility box with silicone retainer strips. No instrument rack. Needle recapper and an air/water clip.
- T007B-L FlipTop Cassette 'B' - LiftOut Rack holds 7 instruments. Space below with silicone retainer strips will hold more instruments, 7" ultrasonic inserts, or hinged items. Small accessory area will hold PDT sharpening stone, clamps, napkin chains, or other small items. Cotton plier retainer, needle recapper and an air/water clip.

**Double Rack holds 14 instruments** 40-12209  
 8" X 3-5/8" X 1-1/4"

**Fixed Rack holds 7 instruments** 40-12210  
 8" X 3-5/8" X 1-1/4"

**Utility box with silicone retainer strips** 40-12211  
 8" X 3-5/8" X 1-1/4"

**LiftOut Rack holds 7 instruments** 40-12223  
 8" X 3-5/8" X 1-1/4"

## FlipTop Cassette 'C' (PDT)

'C' FlipTop™



•T009C-D FlipTop Cassette 'C' - Double Rack hold 18 instruments. Fixed rack below and LiftOut rack above with one position each for an 8" ultrasonic insert or amalgam carrier. Small accessory area will hold PDT sharpening stone, clamps, napkin chains, or other small items. Cotton plier retainer, needle recapper and an air/water clip.

•T009C-F FlipTop Cassette 'C' - Fixed Rack holds 9 instruments with one position for an 8" ultrasonic insert or amalgam carrier. Small accessory area will hold PDT sharpening stone, clamps, napkin chains, or other small items. Cotton plier retainer, needle recapper and an air/water clip.

•T009C-L FlipTop Cassette 'C' - LiftOut Rack holds 9 instruments with one position for an 8" ultrasonic insert or amalgam carrier. Space below with silicone retainer strips will hold more instruments, ultrasonic inserts, or hinged items. Small accessory area will hold PDT sharpening stone, clamps, napkin chains, or other small items. Cotton plier retainer, needle recapper and an air/water clip.

•T009C-U FlipTop Cassette 'C' - Utility box with silicone retainer strips. No instrument rack. Needle recapper and an air/water clip.

**Double Rack hold 18 instruments** 40-12212  
 8" X 4-11/16" X 1-1/4"

**Fixed Rack holds 9 instruments** 40-12213  
 8" X 4-11/16" X 1-1/4"

**LiftOut Rack holds 9 instruments** 40-12214  
 8" X 4-11/16" X 1-1/4"

**Utility box with silicone retainer strips** 40-12215  
 8" X 4-11/16" X 1-1/4"



## FlipTop Cassette 'D' (PDT)

'D' FlipTop

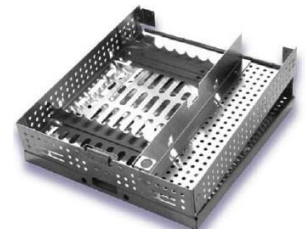

- T009D-D FlipTop Cassette 'D' - Double Rack holds 18 instruments. Fixed rack below and LiftOut rack above will hold 8" ultrasonic inserts or amalgam carriers. Accessory area is 2-1/4" wide and is ideal for syringes, forceps, elevators or larger hinged items. Sharpening stone clip. Cotton plier retainer, needle recapper and an air/water clip.
- T009D-F FlipTop Cassette 'D' - Fixed Rack holds 9 instruments. Rack will hold 8" ultrasonic inserts or amalgam carriers. Accessory area is 2-1/4" wide and is ideal for syringes, forceps, elevators or larger hinged items. Sharpening stone clip. Cotton plier retainer, needle recapper and an air/water clip.
- T009D-L FlipTop Cassette 'D' - LiftOut Rack holds 9 instruments. Rack will hold 8" ultrasonic inserts or amalgam carriers. Space below with silicone retainer strips will hold more instruments, ultrasonic inserts, or hinged items. Accessory area is 2-1/4" wide and is ideal for syringes, forceps, elevators or larger hinged items. Sharpening stone clip. Cotton plier retainer, needle recapper and an air/water clip.
- T009D-U FlipTop Cassette 'D' - Utility box with silicone retainer strips. No instrument rack. Needle recapper and an air/water clip.

**Double Rack holds 18 instruments** 40-12216

**Fixed Rack holds 9 instruments** 40-12217

**LiftOut Rack holds 9 instruments** 40-12218

**Utility box with silicone retainer strips** 40-12219

## FlipTop Cassette 'E' (PDT)



**Utility** 40-12221

**Std Divider & Fixer Rack 15** 40-12222

## Handpiece/Accessory Cassette (Miltex)



- Excellent for small specialized setups
- Single hinge lid

**8" x 2 3/16" x 1 7/16"** 40-91298

## Instrument Large Cassette (Nordent)

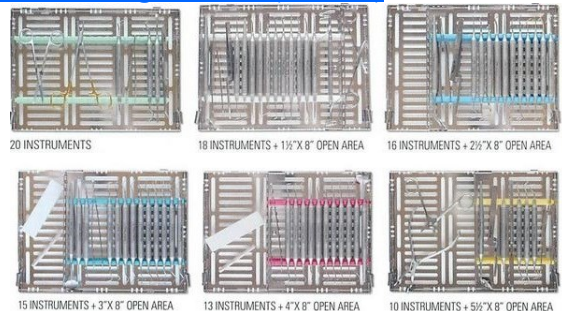

20 INSTRUMENTS

18 INSTRUMENTS + 1 1/2" X 8" OPEN AREA

16 INSTRUMENTS + 2 1/4" X 8" OPEN AREA

15 INSTRUMENTS + 3" X 8" OPEN AREA

13 INSTRUMENTS + 4" X 8" OPEN AREA

10 INSTRUMENTS + 5 1/2" X 8" OPEN AREA

# Instruments



Prestige Dental Products, Inc.  
 Prestigedentalproducts.com  
 Tel: 877-772-3888



8 INSTRUMENTS + 6½" X 8" OPEN AREA

<b>20 Instruments Blue</b>	40-12681
<b>20 Instruments Teal</b>	40-12669
<b>20 Instruments Fuscia</b>	40-12668
<b>20 Instruments Yellow</b>	40-12667
<b>20 Instruments Light Green</b>	40-12666
<b>20 Instruments White</b>	40-12665
<b>18 Instruments + 1½" x 8" Open Area Blue</b>	40-12664
<b>18 Instruments + 1½" x 8" Open Area Teal</b>	40-12663
<b>18 Instruments + 1½" x 8" Open Area Fuscia</b>	40-12662
<b>18 Instruments + 1½" x 8" Open Area Yellow</b>	40-12670
<b>18 Instruments + 1½" x 8" Open Area Light Green</b>	40-12671
<b>18 Instruments + 1½" x 8" Open Area White</b>	40-12672
<b>16 Instruments + 2½" x 8" Open Area Blue</b>	40-12680
<b>16 Instruments + 2½" x 8" Open Area Teal</b>	40-12679
<b>16 Instruments + 2½" x 8" Open Area Fuscia</b>	40-12678
<b>16 Instruments + 2½" x 8" Open Area Yellow</b>	40-12677
<b>16 Instruments + 2½" x 8" Open Area Light Green</b>	40-12676
<b>16 Instruments + 2½" x 8" Open Area White</b>	40-12675
<b>15 Instruments + 3" x 8" Open Area Blue</b>	40-12674
<b>15 Instruments + 3" x 8" Open Area Teal</b>	40-12673
<b>15 Instruments + 3" x 8" Open Area Fuscia</b>	40-12661
<b>15 Instruments + 3" x 8" Open Area Yellow</b>	40-12660
<b>15 Instruments + 3" x 8" Open Area Light Green</b>	40-12648

<b>15 Instruments + 3" x 8" Open Area White</b>	40-12647
<b>13 Instruments + 4" x 8" Open Area Blue</b>	40-12646
<b>13 Instruments + 4" x 8" Open Area Teal</b>	40-12645
<b>13 Instruments + 4" x 8" Open Area Fuscia</b>	40-12644
<b>13 Instruments + 4" x 8" Open Area Yellow</b>	40-12643
<b>13 Instruments + 4" x 8" Open Area Light Green</b>	40-12642
<b>13 Instruments + 4" x 8" Open Area White</b>	40-12641
<b>10 Instruments + 5½" x 8" Open Area Blue</b>	40-12649
<b>10 Instruments + 5½" x 8" Open Area Teal</b>	40-12650
<b>10 Instruments + 5½" x 8" Open Area Fuscia</b>	40-12651
<b>10 Instruments + 5½" x 8" Open Area Yellow</b>	40-12659
<b>10 Instruments + 5½" x 8" Open Area Light Green</b>	40-12658
<b>10 Instruments + 5½" x 8" Open Area White</b>	40-12657
<b>8 Instruments + 6½" x 8" Open Area Blue</b>	40-12656
<b>8 Instruments + 6½" x 8" Open Area Teal</b>	40-12655
<b>8 Instruments + 6½" x 8" Open Area Fuscia</b>	40-12654
<b>8 Instruments + 6½" x 8" Open Area Yellow</b>	40-12653
<b>8 Instruments + 6½" x 8" Open Area Light Green</b>	40-12652
<b>8 Instruments + 6½" x 8" Open Area White</b>	40-12640

## Instrument Management System-Accessories (Hu-Friedy)

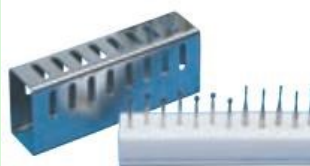

Burs Cushion



Air/Water Syringe Clip

**Air/Water Syringe Clips:** Clips hold air/water syringe tip

# Instruments



Prestige Dental Products, Inc.  
 Prestigedentalproducts.com  
 Tel: 877-772-3888

securely in place throughout cleaning and sterilization.  
**Bur Cushion:** A hollow, rectangular, silicone base with a stainless steel lid designed to hold burs securely in place during cleaning and sterilization. Hollow design allows drainage and proper cleaning.

- For:** Signature Series Cassettes 40-91234
- For:** Double-Decker Series Cassettes 40-91235
- Bur Cushion;** Holds 12 Burs 40-91236



## Instrument Medium Cassette (Nordent)



10 INSTRUMENTS



8 INSTRUMENTS + 1" X 8" OPEN AREA



5 INSTRUMENTS + 2 1/2" X 8" OPEN AREA



- 10 Instruments Blue** 40-12742
- 10 Instruments Teal** 40-12758
- 10 Instruments Fuscia** 40-12757
- 10 Instruments Yellow** 40-12756
- 10 Instruments Light Green** 40-12755
- 10 Instruments White** 40-12754
- 8 Instruments + 1" x 8" Open Area Blue** 40-12753

- 8 Instruments + 1" x 8" Open Area Teal** 40-12752
- 8 Instruments + 1" x 8" Open Area Fuscia** 40-12751
- 8 Instruments + 1" x 8" Open Area Yellow** 40-12750
- 8 Instruments + 1" x 8" Open Area Light Green** 40-12749
- 8 Instruments + 1" x 8" Open Area White** 40-12748
- 5 Instruments + 2 1/2" x 8" Open Area Blue** 40-12747
- 5 Instruments + 2 1/2" x 8" Open Area Teal** 40-12746
- 5 Instruments + 2 1/2" x 8" Open Area Fuscia** 40-12745
- 5 Instruments + 2 1/2" x 8" Open Area Yellow** 40-12744
- 5 Instruments + 2 1/2" x 8" Open Area Light Green** 40-12743
- 5 Instruments + 2 1/2" x 8" Open Area White** 40-12759

## Instrument Small Cassette (Nordent)



5 INSTRUMENTS



- 5 Instruments Blue** 40-12764
- 5 Instruments Teal** 40-12765
- 5 Instruments Fuscia** 40-12763
- 5 Instruments Yellow** 40-12762
- 5 Instruments Light Green** 40-12761
- 5 Instruments White** 40-12760

## Large - Small Parts Boxes (Nordent)



Large



Small

Parts Boxes fit into the cassette and will keep small items safe and secure during sterilization. Constructed of perforated stainless steel with a sliding lid that secures when closed.

- Small 1.4"L x 1.25" W x 1" H** 40-12835
- Large 3" L x 1.25" W x 1" H** 40-12836



# Instruments



Prestige Dental Products, Inc.  
 Prestigedentalproducts.com  
 Tel: 877-772-3888

## Replacement Instrument Holders (Nordent)



Nordent Cassette Instrument Holders are made of medical grade silicone and hold up to years of repeating sterilization cycles. They are designed to be easy to install in the practice setting. Each complete set contains bottom and top rails. Choose the correct instrument holder set in your choice of 6 colors below.

- |   |          |
|---|----------|
| <b>Blue 5 Instrument Holder Set,</b><br>Fits Cassettes C1-5N & C2-5D      | 40-13494 |
| <b>Teal 5 Instrument Holder Set,</b><br>Fits Cassettes C1-5N & C2-5D      | 40-13495 |
| <b>Fuscia 5 Instrument Holder Set,</b><br>Fits Cassettes C1-5N & C2-5D    | 40-13496 |
| <b>Yellow 5 Instrument Holder Set,</b><br>Fits Cassettes C1-5N & C2-5D    | 40-13497 |
| <b>Green 5 Instrument Holder Set,</b><br>Fits Cassettes C1-5N & C2-5D     | 40-13498 |
| <b>White 5 Instrument Holder Set,</b><br>Fits Cassettes C1-5N & C2-5D     | 40-13499 |
| <b>Blue 8 Instrument Holder Set,</b><br>Fits Cassettes C2-8D & C3-8D      | 40-13500 |
| <b>Teal 8 Instrument Holder Set,</b><br>Fits Cassettes C2-8D & C3-8D      | 40-13501 |
| <b>Fuscia 8 Instrument Holder Set,</b><br>Fits Cassettes C2-8D & C3-8D    | 40-13502 |
| <b>Yellow 8 Instrument Holder Set,</b><br>Fits Cassettes C2-8D & C3-8D    | 40-13503 |
| <b>Green 8 Instrument Holder Set,</b><br>Fits Cassettes C2-8D & C3-8D     | 40-13504 |
| <b>White 8 Instrument Holder Set,</b><br>Fits Cassettes C2-8D & C3-8D     | 40-13505 |
| <b>Blue 10 Instrument Holder Set,</b><br>Fits Cassettes C2-10N & C3-10D   | 40-13506 |
| <b>Teal 10 Instrument Holder Set,</b><br>Fits Cassettes C2-10N & C3-10D   | 40-13507 |
| <b>Fuscia 10 Instrument Holder Set,</b><br>Fits Cassettes C2-10N & C3-10D | 40-13508 |
| <b>Yellow 10 Instrument Holder Set,</b><br>Fits Cassettes C2-10N & C3-10D | 40-13509 |

- |  |          |
|--|----------|
| <b>Green 10 Instrument Holder Set,</b><br>Fits Cassettes C2-10N & C3-10D | 40-13510 |
| <b>White 10 Instrument Holder Set,</b><br>Fits Cassettes C2-10N & C3-10D | 40-13511 |
| <b>Blue 16 Instrument Holder Set,</b><br>Fits Cassettes C3-16D           | 40-13512 |
| <b>Teal 16 Instrument Holder Set,</b><br>Fits Cassettes C3-16D           | 40-13513 |
| <b>Fuscia 16 Instrument Holder Set,</b><br>Fits Cassettes C3-16D         | 40-13514 |
| <b>Yellow 16 Instrument Holder Set,</b><br>Fits Cassettes C3-16D         | 40-13515 |
| <b>Green 16 Instrument Holder Set,</b><br>Fits Cassettes C3-16D          | 40-13516 |
| <b>White 16 Instrument Holder Set,</b><br>Fits Cassettes C3-16D          | 40-13517 |

## Signature Series Cassettes-Exam (Hu-Friedy)

- Made of long-lasting, low-maintenance stainless steel
- Soft, colored silicone rails securely hold instruments throughout the processing



- |  |          |
|--|----------|
| <b>Red, Exam Holds 5 Instruments</b>   | 40-91247 |
| <b>Blue, Exam Holds 5 Instruments</b>  | 40-91248 |
| <b>Green, Exam Holds 5 Instruments</b> | 40-91249 |

## Signature Series Cassettes-Double Decker (Hu-Friedy)

- Made of long-lasting, low-maintenance stainless steel
- Soft, colored silicone rails securely hold instruments throughout the processing



- |                                     |          |
|-------------------------------------|----------|
| <b>Purple, Holds 14 Instruments</b> | 40-91250 |
| <b>Blue, Holds 14 Instruments</b>   | 40-91251 |

## Signature Series Cassettes-Large (Hu-Friedy)

- Made of long-lasting, low-maintenance stainless steel
- Soft, colored silicone rails securely hold instruments throughout the processing



- |   |          |
|---|----------|
| <b>Red, Large Holds 16 Instruments</b>    | 40-91237 |
| <b>Orange, Large Holds 16 Instruments</b> | 40-91238 |
| <b>Yellow, Large Holds 16 Instruments</b> | 40-91239 |

# Instruments



Prestige Dental Products, Inc.  
 Prestigedentalproducts.com  
 Tel: 877-772-3888

- Purple**, Large Holds 16 Instruments 40-91240
- Blue**, Large Holds 16 Instruments 40-91241
- Green**, Large Holds 16 Instruments 40-91242

### Signature Series Cassettes-Small (Hu-Friedy)

- Made of long-lasting, low-maintenance stainless steel
- Soft, colored silicone rails securely hold instruments throughout the processing



- Red**, Small Holds 8 Instruments 40-91243
- Gray**, Small Holds 8 Instruments 40-91244
- Orange**, Small Holds 8 Instruments 40-91245
- Purple**, Small Holds 8 Instruments 40-91246

### Signature Series Collection-Composite/Crown Prep (Hu-Friedy)

Features a compilation of the clinician's most popular procedural set-ups.



- Contains:** 1 Large Signature Series 16 Instrument Cassette Blue, 1 Satin Steel Mirror Handle, 1 #5 Front Surface Mouth Mirror, 1 #5 Explorer w/Satin Steel Handle, 1 #18 Excavator w/Satin Steel Handle, 1 #113 Serrated Gingival Cord Packer w/Satin Steel Handle, 1 IPC Interproximal XTS Carver, 1 #2 Goldstein Flexi-Thin XTS Composite Instrument, 1 #3 Goldstein Flexi-Thin XTS Composite Instrument, 1 #24 Spatula w/ Satin Steel Handle, 2 College Dressing Pliers, 1 Miller Articulating Paper Forceps, 1 CW Aspirating Anesthetic Syringe, 1 #18 Curved Iris Scissors, 1 Bur Cushion Short Lid (holds 12), 2 Hinged Instrument Clips, 1 A/W Syringe Tip Clip

### Signature Series Collection- Endo (Hu-Friedy)

Features a compilation of the clinician's most popular procedural set-ups.



- Contains:** 1 Large Signature Series 12 Instrument Cassette Gray, 1 Satin Steel Mirror Handle, 1 #4 Front Surface Mouth Mirror, 1 DG16 Endo Explorer w/Satin Steel Handle, 1 Locking Endo Pliers, 1 31L Excavator w/Satin Steel Handle, 1 #D11 Nickel Titanium Endo Spreader, 1 1/3 Endo Plugger, 1 5/7 Endo Plugger, 1 9/11 Endo Plugger, 1 Glick Blade/Endo Plugger, 1 Miller Articulating Paper Forceps 1 CW Aspirating Anesthetic Syringe 1 Rubber Dam Forceps, 1 #1 Satin Steel Rubber Dam Clamp, 1 #2 Satin Steel Rubber Dam Clamp, 1 #9 Satin Steel Rubber Dam Clamp, 1 #26N Satin Steel Rubber Dam Clamp, 1 Endo Stand (holds 24 files and reamers), 1 Small Parts Box, 1 Bur Cushion Short Lid (holds 12) 1 A/W Syringe Tip Clip

### Signature Series Collection- Exam (Hu-Friedy)

Features a compilation of the clinician's most popular procedural set-ups.



- Contains:** 1 Exam Signature Series, 5 Instrument Cassette Yellow, 1 Satin Steel Mirror handle, 1 #5 Front Surface Mouth Mirror, 1 #5 Explorer w/Satin Steel handle, 1 Cp-12 Color Coded Probe q/Satin Steel handle, 1 U17 Utility Pick-Up Dressing Pliers

### Signature Series Collection-Perio (Hu-Friedy)

Features a compilation of the clinician's most popular procedural set-ups.



- Contains:** 1 Double-Decker Signature Series 14 Instrument Cassette Blue, 1 Satin Steel Mirror Handle, 1 #5 Front Surface Mouth Mirror, 1 11/12 Old Dominion University Explorer w/Satin Steel Handle, 1 CP-12 Color-Coded Probe w/Satin Steel Handle, 1 EverEdge 1 EverEdge 204S Sickle Scaler, 1 EverEdge 1/2 Gracey Curette, 1 EverEdge 7/8 Gracey Curette, 1 EverEdge 11/12 Gracey Curette, 1 EverEdge 13/14 Gracey Curette, 1 EverEdge 13/14 Columbia University Curette, 1 3C Ceramic

# Instruments



Prestige Dental Products, Inc.  
 Prestigedentalproducts.com  
 Tel: 877-772-3888

## Signature Series Collection– Prophy (Hu-Friedy)

Features a compilation of the clinician's most popular procedural set-ups.



**Contains:** 1 Small Signature Series 10 Instrument Cassette Purple, 1 Satin Steel Mirror Handle, 1 #5 Front Surface Mouth Mirror, 1 11/12 Old Dominion University Explorer w/SatinSteel handle, 1 CP-12 Color-Coded Probe w/ Satin Steel handle, 1 EverEdge H6/H7 Hygienist Scaler, 1 EverEdge 11/12 Gracey Curette, 1 EverEdge 13/14 Gracey Curette, 1 EverEdge 13/14 Columbia University Curette, 1 3C Ceramic Sharpening Stone, 1 A/W Syringe Tip Clip

40-91257

## Small Cassette (Hu-Friedy)

- Holds 10 instruments
- Exterior Dimensions: 5.5" x 8" x 1.25"



**Blue, Holds 10 Instruments** 40-91252

## Steri Instrument Container (Zirc)

- Used to organize instruments during ultrasonic and sterilization procedures
- Durable, self-lubricating plastic box snap lid fits in the Statim 5000 autoclave and standard size ultrasonic cleaners for maximum instrument sterilization
- 8 7/8 " x 2" x 2 1/8 "



**Blue, each** 40-91269  
**Green, each** 40-91271  
**Neon Pink, each** 40-91280

## Sterilization Cassettes– Double Nine Cassette (Miltex)

- Folds in half to fit in small ultrasonic
- Single hinge lid



**8" x 5" x 1 7/16"** 40-91296

## Sterilization Cassettes– Fourteen Cassette (Miltex)

- Designed for larger setups
- Double-hinged
- Holds 14 instruments
- Includes a utility bin for storing syringes and ring-handled instruments



**8" x 10 7/8" x 1 3/16"** 40-91297

## Sterilization Cassettes– Seven Cassette (Miltex)

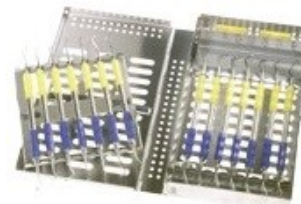

**Single Rack 8" x 4 7/8" x 1 1/8"** 40-91294

## Sterilization Cassettes– Nine Cassette (Miltex)

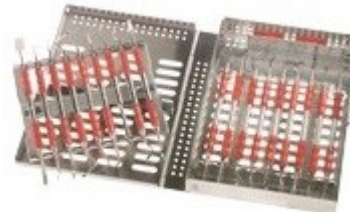

**Single Rack 8" x 6" x 1 3/16"** 40-91295

## Sterilization Trays (Miltex)

- Helps organize and protect instruments from damage during sterilization
- Can also be used for transportation and storage of delicate instruments
- Each tray includes a raised silicone mat for ventilation and protection
- Clear lid allows for easy instrument/procedure identification



**Single Layer Tray 4" x 8"** 40-91258

## Surgical Curettes

### Bone Curettes Lucas



**#11 D/E Lucas 86** 40-91772  
**#12 D/E Lucas 86** 40-91773











Prestige Dental Products, Inc.  
 Prestigedentalproducts.com  
 Tel: 877-772-3888

# Instruments

## Surgical Curettes (Hu-Friedy)

#84 D/E Lucas 86	40-91774
#85 D/E Lucas 86	40-91775
#86 D/E Lucas 86	40-91776
#87 D/E Lucas 86	40-91777
#88 D/E Lucas 86	40-91778

## Surgical Mallet

### Surgical Mallet (DA)



Each 40-91779

## Tissue Pliers

### Tissue Nippers (Nordent)

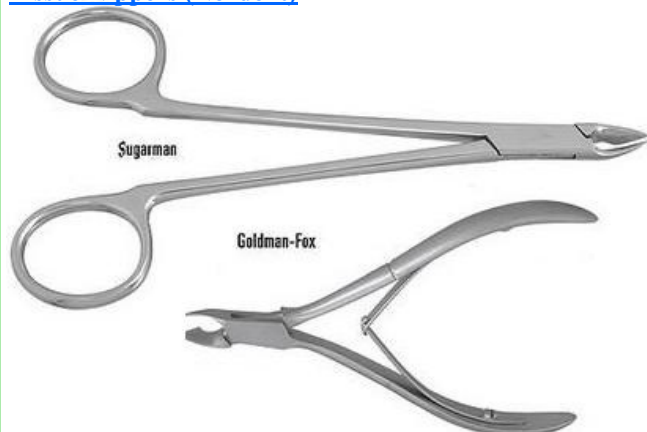

Sugarman 40-13927  
 Goldman-Fox 40-13928

### Tissue Pliers (ASA Italy)

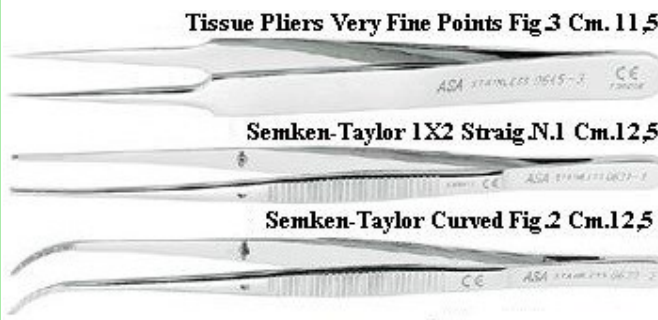

Tissue Pliers Very Fine Points Fig.3 Cm. 11,5

Semken-Taylor 1X2 Straig.N.1 Cm.12,5

Semken-Taylor Curved Fig.2 Cm.12,5

Adson Fig.1 Cm.12



Adson 1X2 Cm.12



Adson Fig.1 Cm.12	40-13929
Adson 1X2 Cm.12	40-13930
Semken-Taylor Curved Fig.2 Cm.12,5	40-13931
Semken-Taylor 1X2 Straig.N.1 Cm.12,5	40-13932
Very Fine Points Fig.3 Cm. 11,5	40-13933

### Tissue Pliers (Hu-Friedy)



Adson-Brown #43, 7x7 4 3/4" 40-91780

### Tissue Pliers (Premier)

- Serrated Handle
- Stainless Steel



Adson-Brown #43, each 40-91781

## Tubs

### Complete Tub with Locking Cover (Zirc)



Plastic

White w/ Locking Cover each	40-91408
Blue w/ Locking Cover each	40-91409
Yellow w/ Locking Cover each	40-91410
Green w/ Locking Cover each	40-91411
Beige w/ Locking Cover each	40-91412
Mauve w/ Locking Cover each	40-91413
Gray w/ Locking Cover each	40-91414
Lilac w/ Locking Cover each	40-91415
Teal w/ Locking Cover each	40-91416
Neon Blue w/ Locking Cover each	40-91417
Neon Green w/ Locking Cover each	40-91418



Prestige Dental Products, Inc.  
 Prestigedentalproducts.com  
 Tel: 877-772-3888

## Instruments

### Locking Tub Cover

- 12 3/4 " x 11 3/16 " x 1 3/8 "
- Clear Plastic



Each 40-91391

### Procedure Tub Only (Zirc)



Plastic

- Blue, each 40-91398
- Yellow, each 40-91399
- Green, each 40-91400
- Beige, each 40-91401
- Mauve, each 40-91402
- Gray, each 40-91403
- Teal, each 40-91404
- Neon Blue, each 40-91405
- Neon Orange, each 40-91406
- Neon Pink, each 40-91407

### Tub Cup & Cover (Zirc)



**Tub Divider**

Holds and organizes brushes, clamps, cotton pellets, prophy angle tips, prophy paste, pumice, syringe tips, implant tools. Cup is autoclavable. Do not sterilize cover; cold sterile only.

Single 2 1/2 " x 1 5/8 " x 1 1/2 "  
 Double 3 3/8 " x 2 1/4 " x 1 1/4 "

- Single, Gray each 40-91392
- Double, Gray each 40-91393
- Tub Divider, Gray each 40-91394

### Tub Slide Tray (Zirc)

Dimensions: 9 3/4 " x 5 3/8 " x 1 1/8 " 1/2 "  
 Flange for cabinet guides. Microban Protection



- Tub Slide Tray, 1/2 Divider, Clear 40-91396
- Tub Slide Tray, 1/2 Flat, Clear 40-91397

### Instrument Kits

#### First Examination Instrument Kits (ASA Italy)



Each 40-12175

#### ImplaKlean Implant Deplaquer – Scaler Set (Pac-Dent)



Designed to fulfill the requirements of dental implant maintenance, ImplaKlean scalers are made of high performance autoclavable carbon reinforced resin. The unique rigidity allows conventional re sharpening and because of the unique resin material will not scratch abutments surfaces. The handles are ergonomically designed with a pair of color-coded silicone grips for comfort and easy identification. Each set includes three scalers; optional sharpening stone is specifically chosen for optimal re sharpening results.

Available in 3 types for different implant deplaquing/cleaning purposes: 4R/4L is the universal tip for use on all implant surfaces; H6/H7 is a sickle scaler for the removal of supra-gingival calculus; 204S is a sickle scaler for the removal of posterior supra-gingival calculus.

- Unique resin material does not scratch implant surfaces
- Resharpenable w/ conventional methods
- Comfortable color-coded silicone grips
- 3 types to satisfy different scaling needs
- Optional sharpening stone for optimal resharpening results

**Intro pack** (1 of each) 40-25571

**3 X 4R/4L** 40-25572

**3 X H6/H7** 40-25573

**3 X 204S** 40-25574

**Intro pack**  
 (1 of each) with sharpening stone 40-25575

**1 X Sharpening stone** 40-25576



**Order  
 Online!**

**We Work Hard  
 So You Don't  
 Have To.**



Prestige Dental Products, Inc.  
 Prestigedentalproducts.com  
 Tel: 877-772-3888

# Instruments

## Standard Endodontic Kit

- |  |                                |
|--|--------------------------------|
| 12 - Mouth Mirror                      | 1 - Plugger 3                  |
| 3 - Mouth Mirror Handle                | 6 - Glick #1                   |
| 3 - 23 Explorer/Perio Probe            | 3 - Woodson #3                 |
| 3 - Scissors                           | 3 - Cleoid-Discoid 3/6 DE      |
| 6 - Cotton Pliers Self-Locking Grooved | 3 - Interproximal Carver       |
| 1 - Endo Excavator #31                 | 4 - Cement Spatula             |
| 3 - 16 Endodontic Explorer             | 6 - Articulating Paper Forceps |
| 1 - Plugger 2                          | 6 - Toffierrimire              |
|  | 3 - Rubber Dam Forceps         |

**One Standard Kit** 40-106101

**Two Standard Kit** 40-106102

## Standard Prophy Kit

- 12 - Mouth Mirror
- 6 - 23 Explorer/PSR Probe
- 10 - S204S Sickle Scaler
- 10 - 15/33 Sickle Scaler
- 10 - 1/2 Gracey Curette
- 10 - 11/12 Gracey Curette
- 10 - 13/14 Gracey Curette

**One Standard Kit** 40-106091

**Two Standard Kits** 40-106092

**Three Standard Kits** 40-106093

## Diagnostic Instruments

### Broach Removal Pliers (Nordent)

BROACH REMOVERS - REMOVES BROKEN BROACHES AND FILES FROM ROOT CANALS.



PLIERS - LOCKING (6" / 150MM)



**#3 Locking College Plier Locking with grooved tips (6"/150mm)** 40-11293

**Angular Broach Remover (5 1/2" 140mm)** 40-11294

**Straight Broach Remover (5 1/2" 140mm)** 40-11292

### Clear Dip Mirror Defogger Solution (Butler)

- Prevents fogging and image distortion on mouth mirrors
- Pleasant tasting, non-toxic



**Pint w/ Jar** 40-91971

## Crystal HD Double-Sided Mirror Head (Zirc)

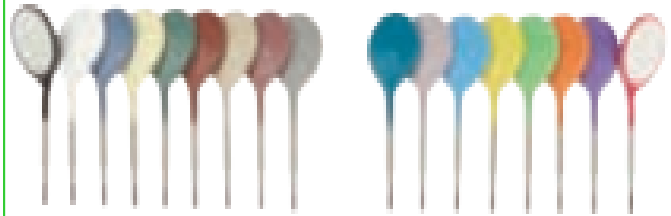

- Made up of 42 alternating layers of three oxides
- 40% brighter than rhodium
- Delivers exceptional color accuracy due to its unprecedented 99% reflection factor
- Eliminates galvanic shock
- Lens is flush with mirror frame for reduced risk of corrosion
- Contains Microban antimicrobial protection
- Cone socket

**#4, White, 12/Pkg** 40-90136

**#4, Blue, 12/Pkg** 40-90137

**#4, Yellow, 12/Pkg** 40-90138

**#4, Gray, 12/Pkg** 40-90139

**#4, Teal, 12/Pkg** 40-90140

**#4, Neon Blue, 12/Pkg** 40-90141

**#4, Neon Yellow, 12/Pkg** 40-90142

**#4, Neon Orange, 12/Pkg** 40-90143

**#4, Neon Purple, 12/Pkg** 40-90144

**#4, Assorted Pink, 12/Pkg** 40-90145

**#5, White, 12/Pkg** 40-90146

**#5, Blue, 12/Pkg** 40-90147

**#5, Yellow, 12/Pkg** 40-90148

**#5, Green, 12/Pkg** 40-90149

**#5, Beige, 12/Pkg** 40-90150

**#5, Mauve, 12/Pkg** 40-90151

**#5, Teal, 12/Pkg** 40-90152

**#5, Lilac, 12/Pkg** 40-90153

**#5, Neon Blue, 12/Pkg** 40-90154

**#5, Neon Yellow, 12/Pkg** 40-90155

**#5, Neon Green, 12/Pkg** 40-90156

**#5, Neon Orange, 12/Pkg** 40-90157

**#5, Neon Purple, 12/Pkg** 40-90158

**#5, Assorted Pink, 12/Pkg** 40-90159

### Crystal HD Stainless Steel Mirror Head (Zirc)

- Cone socket
- Innovative coating technology increases clarity and reduces eye strain
- 99% color correction





# Instruments

#0, 1/Pkg	40-90160
#3, 12/Pkg	40-90161
#4, 12/Pkg	40-90162
#5, 12/Pkg	40-90163

## Crystal Mouth Mirrors (Zirc)

New Crystal Mirror uses innovative coating technology to increase clarity and reduce eye strain. Antimicrobial products in handle inhibit growth of bacteria, mold & mildew.



- 40% brighter & clearer images: less eye strain & stress
- 99% color correction: antimicrobial protection
- No gap between mirror & plastic which prevents build-up

Soft Grip, # 4, Small, 4/Pkg	40-92130
Soft Grip, #5, Large, 4/Pkg	40-92131
Soft Grip, #4, Small, 12/Pkg	40-92132
Soft Grip, #5, Large, 12/Pkg	40-92134

## Dee Fog Anti-Fog Treatment (Cetylite)

- Provides clear, undistorted mirror vision. Specially formulated to prevent fogging, distortion, and bubbling on glass and front surface mirrors
- Pleasant aroma & taste
- Great economy & convenience



2oz Spray	40-91991
1oz Bottle Treatment Liquid	40-941992

## Denlite (Miltex)

One-watt LED for shadow free glare free illumination portable, cordless, and lightweight. Disposable mirror eliminates the risk of cross contamination between patients. Fully charged set of new batteries runs for approximately 45 minutes. Ergonomic hand piece balances evenly and comfortably.



Single Use Mirror, 50/Pkg	40-88722
AAA Battery Charged Set Contains: 1 15 minute Battery Charger (x2) 4 NiMH AAA IC3 Rechargeable Batteries	40-88724
Handpiece Collet Assembly	40-88725
LED Light Cartridge	40-88726



Prestige Dental Products, Inc.  
Prestigedentalproducts.com  
Tel: 877-772-3888

## Diagnostic Instruments (PDT)

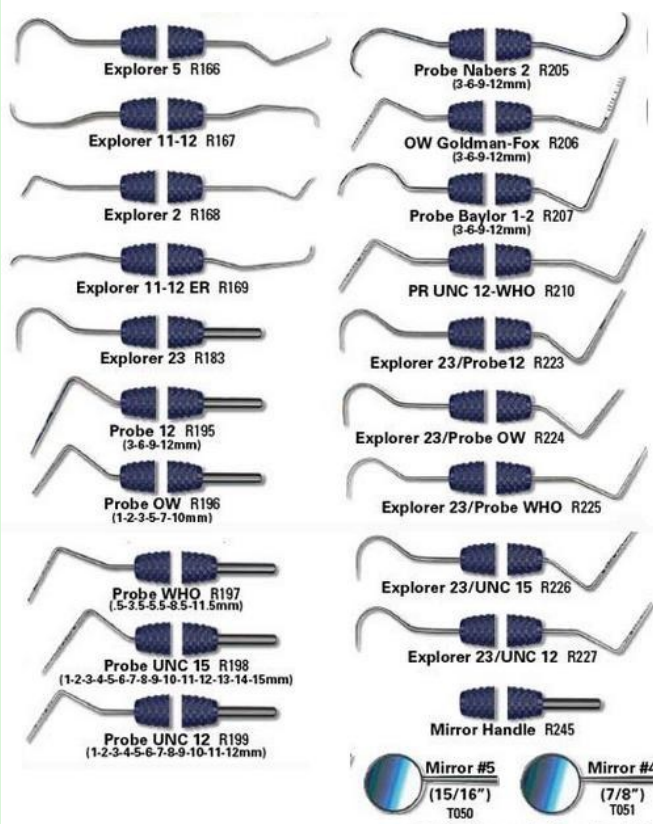

Montana Explorer	40-11553
Explorer 5	40-11554
Explorer 11-12	40-11555
Explorer 2	40-11559
Explorer 11-12 ER	40-11552
Explorer 23	40-11573
Probe 12 (3-6-9-12mm)	40-11561
Probe OW (1-2-3-5-7-10mm)	40-11560
Probe WHO (.5-3.5-5.5-8.5-11.5mm)	40-11556
Probe UNC 15 (1-2-3-4-5-6-7-8-9-10-11-12-13-14-15mm)	40-11557
Probe UNC 12 (1-2-3-4-5-6-7-8-9-10-11-12mm)	40-11562
Probe Nabers 2 (3-6-9-12mm)	40-11563
OW Goldman-Fox (3-6-9-12mm)	40-11564
Probe Baylor 1-2 (3-6-9-12mm)	40-11574
PR UNC 12-WHO	40-11572
Explorer 23/Probe12	40-11571
Explorer 23/Probe OW	40-11570
Explorer 23/Probe WHO	40-11569



Prestige Dental Products, Inc.  
 Prestigedentalproducts.com  
 Tel: 877-772-3888

## Instruments

<b>Explorer 23/UNC 15</b>	40-11568
<b>Explorer 23/UNC 12</b>	40-11567
<b>Mirror Handle</b>	40-11566
<b>Mirror #5 (15/16, Åù)</b> SS Rhodium-coated Cone-Socket	40-11565
<b>Mirror #4 (7/8, Åù)</b> SS Rhodium-coated Cone-Socket	40-11558

### Disposable Mirrors (DA)

- One-piece handle and mirror (6¼" long)
  - Poly film protector with pull-off tab
  - High quality front surface mirror at an economical price
  - Disposable product that requires no sterilization
  - ABS Plastic
- Plane surface. Precision acrylic mirror with poly-film protectant and pull-off tab. One-piece handle and frame with finger manipulation. White, non-autoclavable ABS plastic.



<b>Green, 100/Box</b>	40-90182
<b>72/Box</b>	40-90183

### Disposable Mouth Mirror (Plasdent)

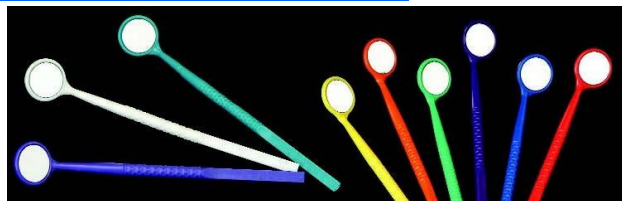

<b>Turquoise, 100pcs/bag</b>	40-11581
<b>Viola, 100pcs/bag</b>	40-11580
<b>White, 100pcs/bag</b>	40-11579
<b>Asst 6 Bright Colors, 48pcs/bag</b>	40-11578

### Disposable Mouth Mirrors (Vista)

- Ideal for high-volume offices where interim sterilization is not practical
- Highly reflective surface
- Ultra-thin glass for enhanced imaging
- Lightweight ergonomic handle functions as a cheek retractor



<b>60/Box</b>	40-90186
---------------	----------

### Double-Sided CS FS Mirror Heads (Hu-Friedy)

- Double-sided mirror allows clinicians to maintain indirect vision or indirect illumination
- Allows clinicians to maintain indirect vision while comfortably retracting
- Provides a sharp, distortion-free image
- Ensures a secure fit with all cone socket mirror handles
- Sleek, smooth construction
- A crevice-free assembly design allows for efficient cleaning and care



<b>#4, 3/Box</b>	40-90164
<b>#5, 3/Box</b>	40-90165
<b>#5, 6/Box</b>	40-90166

### E-Bite Portable



Portable intraoral lighting system that will illuminate the oral cavity with no shadows

<b>Full Unit</b>	30-102681
------------------	-----------

### Ergo Grip Mirror Handles (Zirc)

- May be used with any cone socket mirror head
- Autoclavable



<b>White Color, each</b>	40-92021
<b>Blue Color, each</b>	40-9202
<b>Yellow Color, each</b>	40-92023
<b>Green Color, each</b>	40-92024
<b>Coral Color, each</b>	40-92025
<b>Beige Color, each</b>	40-92026
<b>Mauve Color, each</b>	40-92027
<b>Gray Color, each</b>	40-92028
<b>Teal Color, each</b>	40-92029
<b>Lilac Color, each</b>	40-92030
<b>Neon Blue Color, each</b>	40-92031
<b>Neon Yellow Color, each</b>	40-92032
<b>Neon Orange Color, each</b>	40-92033
<b>Neon Purple Color, each</b>	40-92034
<b>Neon Pink Color, each</b>	40-92035
<b>Black Color, each</b>	40-92036
<b>Neon Green Color, each</b>	40-92037

# Instruments



Prestige Dental Products, Inc.  
 Prestigedentalproducts.com  
 Tel: 877-772-3888

## Examination Mirror (Miltex)

Simple Stem

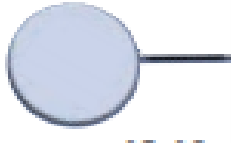

1 1/2" Diameter

40-90167

## Flecta Disposable Mirrors (Pulpdent)



- No more scratches and blotches
- Elongated mirror with 40% larger viewing surface
- Pull tab easily removes protective film from mirror surface
- Double-sided with back side light reflector
- Lightweight comfort handle reduces stress and fatigue
- Offset handle design is a better tongue guard and cheek retractor
- For in-office and take-home use

200/Box

40-90188

## Foamez Mirror Wipes (Richmond)



- Removes fog and debris easily and quickly with one wipe against the mirror
- Eliminates the need to remove mirror from mouth or turn mirror against the cheek
- Slides easily onto the metal or disposable syringe tip

200/Pkg

40-90189

## Front Surface Double-Sided Mouth Mirror (Miltex)



#5 Cone Socket, 6/Pkg

40-90177

## Front Surface Mirror Heads (DA)

Stainless Steel. Autoclavable

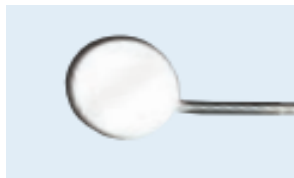

#3 Front Surface, Cone Socket, 12/Pkg 40-90118

#4 Front Surface, Cone Socket, 12/Pkg 40-90119

- #5 Front Surface, Cone Socket, 12/Pkg 40-90120
- #3 Front Surface, Simple Stem, 12/Pkg 40-90121
- #4 Front Surface, Simple Stem, 12/Pkg 40-90122
- #5 Front Surface, Simple Stem, 12/Pkg 40-90123

## Front Surface Mirror Heads (Hu-Friedy)

Cone Socket Stainless Steel



#4, 12/Pkg

40-90168

#5, 12/Pkg

40-90169

## Front Surface Mirror Heads (Kerr)

Cone Socket Chromium



#4, Front Surface Autoclavable, 12/Pkg 40-90170

#5, Front Surface Autoclavable, 12/Pkg 40-90171

## Front Surface Mirror Heads (Miltex)

- Reflecting layer is on surface, not behind the glass
- Rhodium surface reflects only once, guaranteeing clear vision, free from all distortion
- Mirror can also be used as a cheek retractor



#3, Cone Socket, 12/Pkg 40-90172

#4, Cone Socket, 12/Pkg 40-90173

#5, Cone Socket, 12/Pkg 40-90174

#4, Simple Stem, 12/Pkg 40-90175

#5, Simple Stem, 12/Pkg 40-90176

## Illuminator Mouth Mirror (Zirc)

- Superior clarity, less eye fatigue
- High grade rhodium-coated glass front surface lenses are not disposable
- Autoclavable/Chemoclavable
- Made with Microban Protection



#4 White, 10/Pkg 40-90194

#4 Blue, 10/Pkg 40-90195

#5 White, 10/Pkg 40-90196

#5 Blue, 10/Pkg 40-90197

## Hand Mirrors (Newo Plastics LTD)







Prestige Dental Products, Inc.  
 Prestigedentalproducts.com  
 Tel: 877-772-3888

# Instruments

<b>3 1/2" Hand Size, 1-Sided Magnified, 1-Sided Plane</b>	40-90190
<b>2-Sided Plane</b>	40-90191
<b>5" Hand Size</b>	40-90192
<b>2-Sided Plane</b>	40-90193

## Indian Head Mirror Heads (Miltex)

Eliminates the "ghost image" altogether because the reflecting layer is no longer behind the glass, but on its surface. It reflects only once, providing clear vision, free from all distortion.



#6, 12/Pkg 40-90178

## Magnifying Mirrors (DA)

Boilable Optical Glass

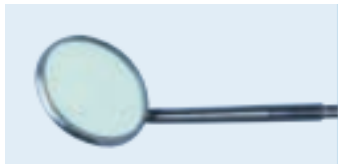

<b>#3 Magnifying Mirrors, Cone Socket, 12/Pkg</b>	40-90124
<b>#4 Magnifying Mirrors, Cone Socket, 12/Pkg</b>	40-90125
<b>#5 Magnifying Mirrors, Cone Socket, 12/Pkg</b>	40-90126
<b>#3 Magnifying Mirrors, Simple Stem, 12/Pkg</b>	40-90127
<b>#4 Magnifying Mirrors, Simple Stem, 12/Pkg</b>	40-90128
<b>#5 Magnifying Mirrors, Simple Stem, 12/Pkg</b>	40-90129

## Mega Mirror (Zirc)



- Its 2.5" lens can replace any operatory hand mirror
- Great for patients to view their own teeth
- Measures 15.5"

Platinum, each 40-90198

## Microlux Diagnostic System (AdDent)



Detect anterior caries, place the probe on the labio-cervical region of the tooth band examine from the lingual with a mouth mirror.

<b>Lighted Mirror for Microlux, 5/Pkg</b>	40-12983
<b>Microlux Protective Sleeve, 250/Box</b>	40-12984
<b>Microlux Glass Light Guide 2mm Micro Tip</b>	40-12981
<b>Microlux Glass Light Guide 3mm Standard Tip</b>	40-12982
<b>Microlux Transilluminator Includes: 1 - 2mm Micro Tip Glass Light Guide and 3 N Size Batteries</b>	40-12985
<b>Microlux Transilluminator Includes: 1 - 3mm Standard Tip Glass Light Guide and 3 N Size Batteries</b>	40-12987
<b>Microlux Perio Probe Attachment Refill, 25/Pkg</b>	40-22987
<b>Microlux Perio Probe Attachment with 5 Perio Guides</b>	40-22986
<b>Microlux Endo-Lite Attachment Re- fill 25/Pkg</b>	40-22985
<b>Microlux Endo-Lite Attachment with 5 Fiber Light Guides</b>	40-22984
<b>Microlux DL Lightguide</b>	40-22988
<b>Batteries Set of 3</b>	40-22989

## Miltex Cone Socket Mirros

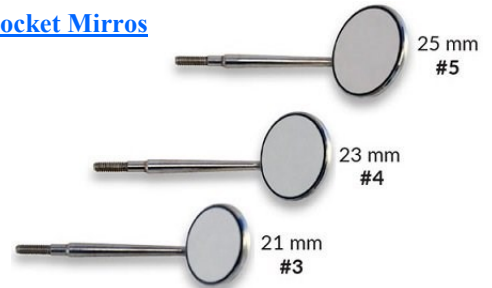

Cone socket mirrors assure you distortion free images  
 Stainless steel Rhodium coated  
**High Quality Front Surface**

<b>Size 3, 12/Box</b>	40-106661
<b>Size 4, 12/Box</b>	40-106662
<b>Size 5, 12/Box</b>	40-106663

## Miltex Front Surface Mirror

Eliminates the ghost image altogether because the reflecting layer is no longer behind the glass but on the surface. The mirror can also be used as a cheek retractor

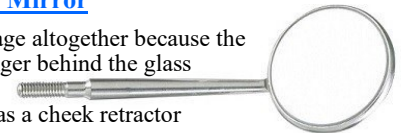

### **Features & Benefits**

- Reflecting layer is on the surface
- Free from distortion
- Clear Vision

<b>#3, Cone Socket, 12/Box</b>	40-106671
<b>#4, Cone Socket, 12/Box</b>	40-106672

# Instruments



Prestige Dental Products, Inc.  
 Prestigedentalproducts.com  
 Tel: 877-772-3888

#5, Cone Socket, 12/Box	40-106673
#4, Simple Stem, 12/Box	40-106674
#5, Simple Stem, 12/Box	40-106675

### Mirro-Vac Saliva Ejector Mirror (IndiGreen)

Reduce number of hands needed, instruments used and procedure time! Our Mirro-Vac Saliva Ejector Mirror combines evacuator and mirror functions into one efficient instrument. Ideal for sealants, air abrasion, bonding and other dry field procedures. Upper suction inlet relieves tissue grab and ensures anti-fog acrylic mirror stays clear—even under direct exhalation. Size 4 lens with 35° inclination delivers standard mouth mirror feel and function without compromise.



- Easy-lift film protects mirror surface until use
  - Soft blue color eases patient anxiety
  - Round, knurled handle improves grip.
- Fully disposable, one-piece construction eliminates need for sterilization. 6" long

50/Pkg 50-87861

### Mirror Handles (DA)

#### Cone Socket Mirror Handles



Round Knurled



Octagonal Serrated

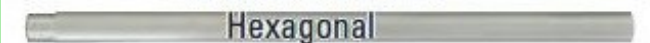

Hexagonal

#### Simple Stem Mirror Handles



Round Knurled

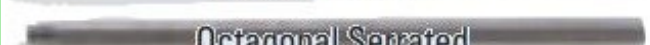

Octagonal Serrated

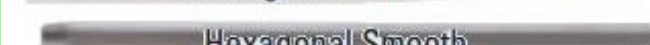

Hexagonal Smooth

Cone Socket Mirror Handles, Round Knurled 40-90111

Cone Socket Mirror Handles, Octagonal Serrated 40-90112

Cone Socket Mirror Handles, Hexagonal 40-90113

Simple Stem Mirror Handles, Round Knurled 40-90114

Simple Stem Mirror Handles, Octagonal Serrated 40-90115

Simple Stem Mirror Handles, Hexagonal Smooth 40-90116

# Dental Supplies

### Mirror Handles (Hu-Friedy)



#1 Cone Socket Handle	40-92001
#6 Cone Socket Handle	40-92002
#7 Cone Socket Handle	40-92003
#8 Cone Socket Handle	40-92004
#24 Cone Socket Handle	40-92005

### Mirror Handles (Miltex)



Simple Stem



Cone Socket Octagonal



Cone Socket Octagonal w/ Millimeter Rule

Simple Stem Octagonal 40-92011

Cone Socket Octagonal 40-92012

Cone Socket Octagonal w/Millimeter Rule Handle 40-92013

### Mirror Handles CS (Prestige)



Octagonal Solid Handle



Hollow Handle

**High Quality**  
**Cone socket Only**

Octagonal Solid Handle, each 40-97972

Hollow Handle, each 40-97971

### Mirror Handles SS (Prestige)



Octagonal Solid Handle



Hollow Handle

**High Quality**  
**Simple Stem Only**

Octagonal Solid Handle, each 40-106681

# Instruments



Prestige Dental Products, Inc.  
 Prestigedentalproducts.com  
 Tel: 877-772-3888

**Hollow Handle, each** 40-106682

### Mirrorlite Illuminated Mouth Mirror (Defend)

The perfect adjunct to the Mouth Mirror. The MirrorLite is now coated in titanium which resists corrosion and tarnishing. The Mirrorlite is ideal for: oral diagnosis, oral cancer exams, restorative dentistry, air abrasion and trans-illumination. The illuminated mouth mirror is ergonomic and compact which leads to less eye and back strain. The mirror uses LED light which allows you to see in true color and it is portable and autoclavable.

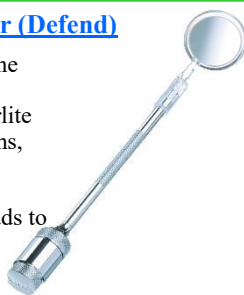

**Intro Kit:** 1 Mirrorlite, 3 Batteries, and 50 Mirror Refills. 40-12991

**Refill Pack:** 50 Mirror refills, and 1 battery 40-12990

**Mirror Light Only** 40-12988

**Refill Double Sided #5** 40-12989

### Mouth Mirror Handles (J & J Instrument)



Mirror Handle - S.S., Octagonal



Mirror Handle - C.S., Octagonal



Mirror Handle - S.S., Round



Mirror Handle - C.S., Round

**Simple Stem, Octagonal** 40-13043

**Cone Socket, Octagonal** 40-13042

**Simple Socket, Round** 40-13041

**Cone Socket, Round** 40-13040

### Mouth Mirror Handles (Nordent)

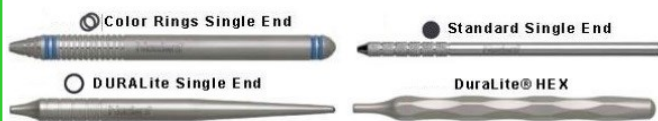

**Mirror Cone Socket** 40-13050  
 DuraLite® ColorRings™

**Mirror Simple Stem** 40-13051  
 DuraLite® ColorRings™

**Mirror Cone Socket DuraLite®** 40-13049  
 ROUND

**Mirror Simple Stem DuraLite®** 40-13048  
 ROUND

**Mirror Cone Socket DuraLite® HEX** 40-13047

**Mirror Simple Stem DuraLite® HEX** 40-13046

**Mirror Cone Socket Standard** 40-13045

**Mirror Simple Stem Standard** 40-13044

### Plane Surface (DA)

Boilable Optical Glass

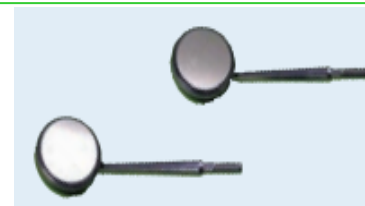

**#3 Plane Surface, Cone Socket, 12/Pkg** 40-90130

**#4 Plane Surface, Cone Socket, 12/Pkg** 40-90131

**#5 Plane Surface, Cone Socket, 12/Pkg** 40-90132

**#3 Plane Surface, Simple Stem, 12/Pkg** 40-90133

**#4 Plane Surface, Simple Stem, 12/Pkg** 40-90134

**#5 Plane Surface, Simple Stem, 12/Pkg** 40-90135

### Plane Surface Mirror Heads (Miltext)



**#4, Plane, Simple Stem, 12/Box** 40-90179

**#4, Plane, Cone Socket, 12/Box** 40-90180

**#5, Plane, Cone Socket, 12/Box** 40-90181

### Plastic Mirrors (DA)

- Autoclavable
- Rugged fiberglass plastic
- Lightweight construction
- Top quality
- Easy to hold handle design

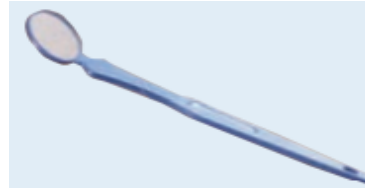

**#4 White, 24/Pkg** 40-90184

**#5 White, 24/Pkg** 40-90185

### Rite-Lite LED Shade Matching Device (AdDent)



*Rated Best out of 4 hand held shade matching lights by the University of Texas*

L.E.D. Shade Matching Light Designed to eliminate costly re-makes, the Rite-Lite shade matching light incorporates LED technology to provide simulated north sky daylight with a standardized color temperature of 5500K. The small, handheld, portable unit comes with neutral color tabs for placement behind the teeth to eliminate environmental color distractions.

**Rite-Lite Device** 23-11524



# Instruments



Prestige Dental Products, Inc.  
 Prestigedentalproducts.com  
 Tel: 877-772-3888

## Silicone Mirror Handles

Autoclavable

Cone Socket

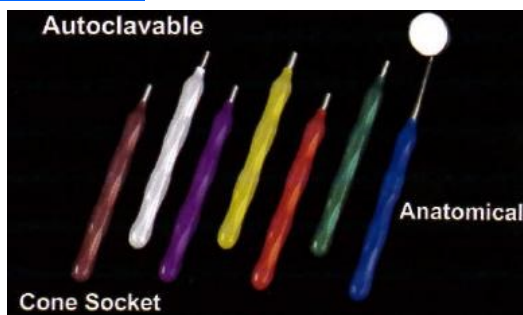

<b>White Color</b>	41-98021
<b>Blue Color</b>	41-98022
<b>Yellow Color</b>	41-98023
<b>Green Color</b>	41-98024
<b>Red Color</b>	41-98025
<b>Mauve Color</b>	41-98026
<b>Purple Color</b>	41-98027

## Sunlight LED Illuminated Magnifier Lighting Unit (Meta)

It Illuminates and Magnifies with the Most Natural Color Used for measuring accurate shading level for porcelain works

### Features:

- Most natural LED Lighting Source
- Surface emitting Light; illuminates equally that prevent Shadows
- Detachable 2x & 3x Magnifier with preventable shape distortion
- Three Step dimmer makes it easy to control the Brightness
- Use USB for easy charging and usage
- Most comfortable observation rate for both eyes; 16:9 ratio rectangle



**Kit Includes:** Light Unite, 2x Magnifier, 3x Magnifier Lens, USB Charging cable and manual

## Super-Dip Mirror Defogger (DA)



32oz

40-91981

**Call Us Today 833-733-6825**

## Tooth & Hand Mirror (PlasDent)



**Tooth Curing Shield 5 1/2"W x 11"L**, each 40-35648

**Hand Mirror 4 7/8"W x 10"L**, each 40-35649

**Tooth Hand Mirror 5 1/2"W x 11"L**, each 40-35650

## Composite Instruments

### Trimax Composite Instrument (AdDent)

- Gives a better way to create posterior composite restorations.
- Improved polymerization and tight anatomically correct contact area.

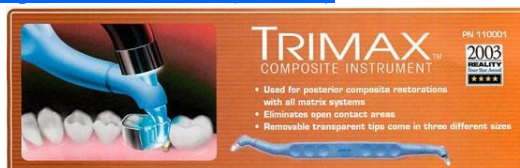

**Trimax Kit:** of 2 Handles & 60 Tips 40-13947

**Refill Kit:** 60 Tips, Premolar 40-13948

**Refill Kit:** 60 Tips Molar, Standard 40-13949

**Refill Kit:** 60 Tips Molar, Large 40-13950

**Handles, Kit of 2** 40-13951

## Operative Instruments

### Amalgam Applicator (Arnel)



- Can be used with amalgam, composites and condensable resins
- Compatible with all sterilization methods

**D/E, Regular/Large** 40-90830

**D/E/, Large/Jumbo** 40-90831

### CF II Amalgam Carrier (Hu-Friedy)



**Regular/Mini, Barrel Size** 40-90832

**Regular/Large, Barrel Size** 40-90833

**Regular/Jumbo, Barrel Size** 40-90834

# Instruments



Prestige Dental Products, Inc.  
 Prestigedentalproducts.com  
 Tel: 877-772-3888

## Amalgam Carriers



<b>D/E Regular/Mini, Barrel Size, Delrin Tip</b>	40-90814
<b>D/E Regular/Large, Barrel Size, Delrin Tip</b>	40-90815
<b>D/E Regular/Jumbo, Barrel Size, Delrin Tip</b>	40-90816
<b>D/E Jumbo/Jumbo, Barrel Size, Delrin Tip</b>	40-90817
<b>D/E Carbide Tip</b>	40-90818
<b>S/E Steel Tip, Mini, Barrel Size</b>	40-90819
<b>S/E Steel Tip, Regular, Barrel Size</b>	40-90820
<b>S/E Steel Tip, Large, Barrel Size</b>	40-90821
<b>S/E Steel Tip, Jumbo, Barrel Size</b>	40-90822
<b>D/E Regular/Large Barrel Size</b>	40-90823
<b>D/E Carbide Tip</b>	40-90824
<b>D/E Regular/Jumbo, Barrel Size</b>	40-90825
<b>D/E Carbide Tip</b>	40-90826
<b>D/E Jumbo/Jumbo, Barrel Size</b>	40-90827
<b>D/E Featherweight, Delrin Barrel &amp; Handle, Regular/Large, Barrel Size</b>	40-90828
<b>D/E Featherweight, Regular/Jumbo, Barrel Size</b>	40-90829

## Composite Sculpting System (PDT)



<b>CSS-2</b>	40-12276
<b>CSS-3</b>	40-12277
<b>CSS-4</b>	40-12275
<b>CSS-5</b>	40-12274
<b>CSS-6</b>	40-12273
<b>IPC-T</b>	40-12272
<b>IPC-L</b>	40-12271
<b>8A</b>	40-12270

## Excavators - Double End (Nordent)

Each blade is hollow ground for maximum sharpness. DuraLite® handles increase tactile sensitivity and control.

### Standard - Spoons

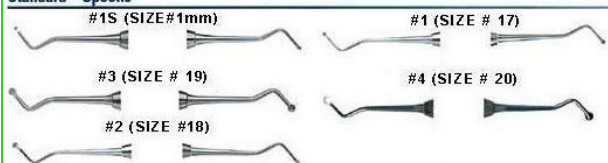

### Long Shank - Spoons

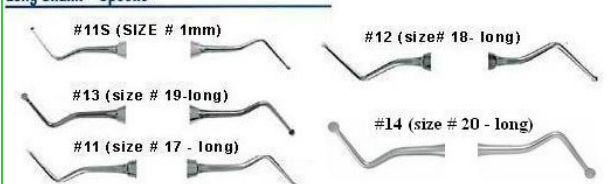

### Blades



<b>#1 (Size #17) Spoon</b> DuraLite® ColorRings™	40-11865
<b>#1 (Size #17) Spoon</b> DuraLite® ROUND	40-11866
<b>#1 (Size #17) Spoon</b> DuraLite® HEX	40-11867
<b>#1 (Size #17) Spoon</b> Standard	40-11883
<b>#1S (1 mm Head Size)(#38-39)</b> Spoon DuraLite® ColorRings™	40-11884
<b>#1S (1 mm Head Size)(#38-39)</b> Spoon DuraLite® ROUND	40-11885
<b>#1S (1 mm Head Size)(#38-39)</b> Spoon DuraLite® HEX	40-11901
<b>#1S (1 mm Head Size)(#38-39)</b> Spoon Standard	40-11902
<b>#2 (Size #18)</b> Spoon DuraLite® ColorRings™	40-11903
<b>#2 (Size #18) Spoon</b> DuraLite® ROUND	40-11904
<b>#2 (Size #18) Spoon</b> DuraLite® HEX	40-11905
<b>#2 (Size #18) Spoon</b> Standard	40-11906

# Instruments



Prestige Dental Products, Inc.  
 Prestigedentalproducts.com  
 Tel: 877-772-3888

#3 - (Size #19) Spoon DuraLite® ColorRings™	40-11907	#11L Endodontic Extra Long Shank Spoon DuraLite® ColorRings™	40-11815
#3 - (Size #19) Spoon DuraLite® ROUND	40-11908	#11L Endodontic Extra Long Shank Spoon DuraLite® ROUND	40-11816
#3 - (Size #19) Spoon DuraLite® HEX	40-11909	#11L Endodontic Extra Long Shank Spoon DuraLite® HEX	40-11817
#3 - (Size #19) Spoon Standard	40-11910	#11L Endodontic Extra Long Shank Spoon Standard	40-11818
#4 (Size #20) Spoon DuraLite® ColorRings™	40-11911	#11S (1 mm Head Size) Long Shank Spoon DuraLite® ColorRings™	40-11819
#4 (Size #20) Spoon DuraLite® ROUND	40-11912	#11S (1 mm Head Size) Long Shank Spoon DuraLite® ROUND	40-11820
#4 (Size #20) Spoon DuraLite® HEX	40-11900	#11S (1 mm Head Size) Long Shank Spoon DuraLite® HEX	40-11821
#4 (Size #20) Spoon Standard	40-11899	#11S (1 mm Head Size) Long Shank Spoon Standard	40-11822
#5 DuraLite® Anterior Spoon ColorRings™	40-11898	#12 (size #18) Long Shank Spoon DuraLite® ColorRings™	40-11810
#5 DuraLite® Anterior Spoon ROUND	40-11886	#12 (size #18) Long Shank Spoon DuraLite® ROUND	40-11809
#5 DuraLite® Anterior Spoon HEX	40-11887	#12 (size #18) Long Shank Spoon DuraLite® HEX	40-11808
#5 Anterior Spoon Standard	40-11888	#12 (size #18) Long Shank Spoon Standard	40-11796
#6 DuraLite® Anterior Spoon ColorRings™	40-11889	#12L Endodontic Extra Long Shank Spoon DuraLite® ColorRings™	40-11797
#6 DuraLite® Anterior Spoon ROUND	40-11890	#12L Endodontic Extra Long Shank Spoon DuraLite® ROUND	40-11798
#6 DuraLite® Anterior Spoon HEX	40-11891	#12L Endodontic Extra Long Shank Spoon DuraLite® HEX	40-11799
#6 Anterior Spoon Standard	40-11892	#12L Endodontic Extra Long Shank Spoon Standard	40-11800
#7 DuraLite® Anterior Spoon ColorRings™	40-11893	#13 (size #19) Long Shank Spoon DuraLite® ColorRings™	40-11801
#7 DuraLite® Anterior Spoon ROUND	40-11894	#13 (size #19) Long Shank Spoon DuraLite® ROUND	40-11802
#7 DuraLite® Anterior Spoon HEX	40-11895	#13 (size #19) Long Shank Spoon DuraLite® HEX	40-11803
#7 Anterior Spoon Standard	40-11896	#13 (size #19) Long Shank Spoon Standard	40-11804
#8 Back Action Anterior Spoon DuraLite® ColorRings™	40-11897	#14 (Size #20) Long Shank Spoon DuraLite® ColorRings™	40-11805
# Back Action Anterior Spoon DuraLite® ROUND	40-11913	#14 (Size #20) Long Shank Spoon DuraLite® ROUND	40-11806
#8 Back Action Anterior Spoon DuraLite® HEX	40-11854	#14 (Size #20) Long Shank Spoon DuraLite® HEX	40-11807
#8 Back Action Anterior Spoon Standard	40-11795	#14 (Size #20) Long Shank Spoon Standard	40-11823
#11 (size #17) Long Shank Spoon Du- raLite® ColorRings™	40-11811		
#11 (size #17) Long Shank Spoon DuraLite® ROUND	40-11812		
#11 (size #17) Long Shank Spoon DuraLite® HEX	40-11813		
#11 (size #17) Long Shank Spoon Standard	40-11814		



# Instruments



Prestige Dental Products, Inc.  
 Prestigedentalproducts.com  
 Tel: 877-772-3888

<b>#15 Small Blade DuraLite® ColorRings™</b>	40-11824
<b>#15 Small Blade DuraLite® ROUND</b>	40-11825
<b>#15 Small Blade DuraLite® HEX</b>	40-11841
<b>#15 Small Blade Standard</b>	40-11842
<b>#16 Medium Blade DuraLite® ColorRings™</b>	40-11843
<b>#16 Medium Blade DuraLite® ROUND</b>	40-11844
<b>#16 Medium Blade DuraLite® HEX</b>	40-11845
<b>#16 Medium Blade Standard</b>	40-11846
<b>#17L Large Blade DuraLite® ColorRings™</b>	40-11847
<b>#17L Large Blade DuraLite® ROUND</b>	40-11848
<b>#17L Large Blade DuraLite® HEX</b>	40-11849
<b>#17L Large Blade Standard</b>	40-11850
<b>#31L Endodontic Extra Long Shank Blade DuraLite® ColorRings™</b>	40-11851
<b>#31L Endodontic Extra Long Shank Blade DuraLite® ROUND</b>	40-11852
<b>#31L Endodontic Extra Long Shank Blade DuraLite® HEX</b>	40-11840
<b>#31L Endodontic Extra Long Shank Blade Standard</b>	40-11839
<b>#31LR Endodontic Extra Long Shank Spoon DuraLite® ColorRings™</b>	40-11838
<b>#31LR Endodontic Extra Long Shank Spoon Standard</b>	40-11827
<b>#32L Endodontic Extra Long Shank Blade DuraLite® ColorRings™</b>	40-11828
<b>#32L Endodontic Extra Long Shank Blade DuraLite® ROUND</b>	40-11829
<b>#32L Endodontic Extra Long Shank Blade DuraLite® HEX</b>	40-11830
<b>#32L Endodontic Extra Long Shank Blade Standard</b>	40-11831
<b>#33L Endodontic Extra Long Shank Blade DuraLite® ColorRings™</b>	40-11832
<b>#33L Endodontic Extra Long Shank Blade DuraLite® ROUND</b>	40-11833
<b>#33L Endodontic Extra Long Shank Blade DuraLite® HEX</b>	40-11834
<b>#33L Endodontic Extra Long Shank Blade Standard</b>	40-11835
<b>#125-126 English Pattern Spoon DuraLite® ColorRings™</b>	40-11836

<b>#125-126 English Pattern Spoon DuraLite® ROUND</b>	40-11837
<b>#125-126 English Pattern Spoon DuraLite® HEX</b>	40-11853
<b>#125-126 English Pattern Spoon Standard</b>	40-11880
<b>#128-128 English Pattern Spoon DuraLite® ColorRings™</b>	40-11881
<b>#128-128 English Pattern Spoon DuraLite® ROUND</b>	40-11864
<b>#128-128 English Pattern Spoon DuraLite® HEX</b>	40-11863
<b>#128-128 English Pattern Spoon Standard</b>	40-11862
<b>#129-130 English Pattern Spoon DuraLite® ColorRings™</b>	40-11861
<b>#129-130 English Pattern Spoon DuraLite® ROUND</b>	40-11860
<b>#129-130 English Pattern Spoon DuraLite® HEX</b>	40-11859
<b>#129-130 English Pattern Spoon Standard</b>	40-11858
<b>#131-132 English Pattern Spoon DuraLite® ColorRings™</b>	40-11857
<b>#131-132 English Pattern Spoon DuraLite® ROUND</b>	40-11856
<b>#131-132 English Pattern Spoon DuraLite® HEX</b>	40-11868
<b>#131-132 English Pattern Spoon Standard</b>	40-11869
<b>#133-134 English Pattern Spoon DuraLite® ColorRings™</b>	40-11870
<b>#133-134 English Pattern Spoon DuraLite® ROUND</b>	40-11882
<b>#133-134 English Pattern Spoon DuraLite® HEX</b>	40-11879
<b>#133-134 English Pattern Spoon Standard</b>	40-11878
<b>#153-154 English Pattern Spoon DuraLite® ColorRings™</b>	40-11877
<b>#153-154 English Pattern Spoon DuraLite® ROUND</b>	40-11876
<b>#153-154 English Pattern Spoon DuraLite® HEX</b>	40-11875
<b>#153-154 English Pattern Spoon Standard</b>	40-11874
<b>#155-156 English Pattern Spoon DuraLite® ColorRings™</b>	40-11873

## Instruments

#155-156 English Pattern Spoon DuraLite® ROUND	40-11872
#155-156 English Pattern Spoon Standard	40-11855
#31LR Endodontic Extra Long Shank Spoon DuraLite® ROUND	40-11826
#155-156 English Pattern Spoon DuraLite® HEX	40-11871

### Lever Type Delrin Barrel (PulpDent)



D/E Non-Stick Plastic Barrels Regular/Large, Barrel Size	40-90835
D/E Large/Jumbo, Barrel Size	40-90836

### Root Canal Plugger (Nordent)



Double End Glick #1 DuraLite® ColorRings™	40-13550
Double End Glick #1 DuraLite® ROUND	40-13551
Double End Glick #1 Standard	40-13552

### SCT Solid Carbide Tip (Miltex)



Non-Clogging Color-Coded  
 White: Medium, for most routine applications.  
 Yellow: Large, twice the capacity of White.  
 Red: Jumbo, three times the capacity of White.

D/E Medium/Large Barrel Size	40-90840
------------------------------	----------

### Steel Tip (Miltex)



D/E Regular/Large Barrel Size	40-90841
D/E Medium/Jumbo Barrel Size	40-90842

# Dental Supplies



Prestige Dental Products, Inc.  
 Prestigedentalproducts.com  
 Tel: 877-772-3888

### Trimax Composite Instrument (AdDent)

- Gives a better way to create posterior composite restorations.
- Improved polymerization and tight anatomically correct contact area.

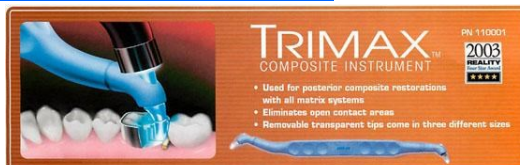

Trimax Kit: of 2 Handles & 60 Tips	40-13947
Refill Kit: 60 Tips, Premolar	40-13948
Refill Kit: 60 Tips Molar, Standard	40-13949
Refill Kit: 60 Tips Molar, Large	40-13950
Handles, Kit of 2	40-13951

### Restorative Instruments

### Ainsworth Rubber Dam Punches (Prestige)



Each	40-106131
------	-----------

### Amalgam Carriers



D/E Regular/Mini, Barrel Size, Delrin Tip	40-90814
D/E Regular/Large, Barrel Size, Delrin Tip	40-90815
D/E Regular/Jumbo, Barrel Size, Delrin Tip	40-90816
D/E Jumbo/Jumbo, Barrel Size, Delrin Tip	40-90817

# Instruments



Prestige Dental Products, Inc.  
 Prestigedentalproducts.com  
 Tel: 877-772-3888

<b>D/E Carbide Tip</b>	40-90818
<b>S/E Steel Tip, Mini, Barrel Size</b>	40-90819
<b>S/E Steel Tip, Regular, Barrel Size</b>	40-90820
<b>S/E Steel Tip, Large, Barrel Size</b>	40-90821
<b>S/E Steel Tip, Jumbo, Barrel Size</b>	40-90822
<b>D/E Regular/Large Barrel Size</b>	40-90823
<b>D/E Carbide Tip</b>	40-90824
<b>D/E Regular/Jumbo, Barrel Size</b>	40-90825
<b>D/E Carbide Tip</b>	40-90826
<b>D/E Jumbo/Jumbo, Barrel Size</b>	40-90827
<b>D/E Featherweight, Delrin Barrel &amp; Handle, Regular/Large, Barrel Size</b>	40-90828
<b>D/E Featherweight, Regular/Jumbo, Barrel Size</b>	40-90829

## Articulating Paper Forcep (J & J Instrument)



<b>Curved Serrated</b>	40-11228
<b>Straight Grooved</b>	40-11227
<b>Straight Serrated</b>	40-11225

## Burnishers (J & J Instrument)

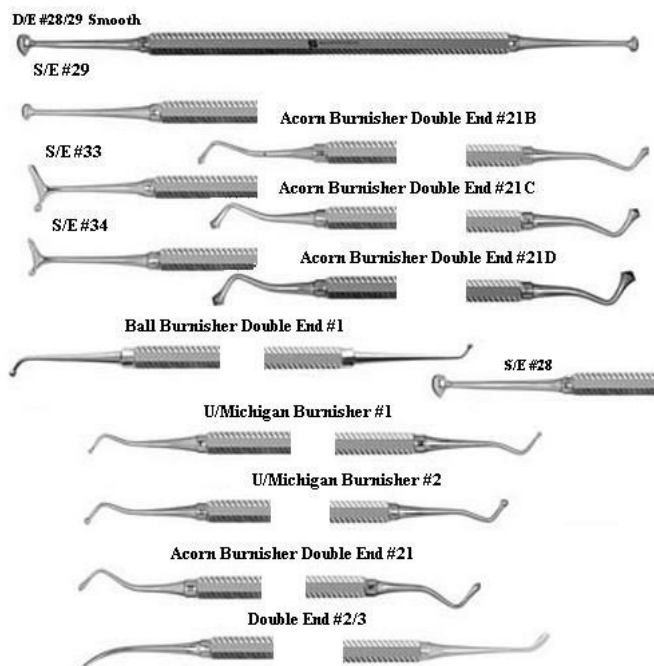

<b>Double End #2/26</b>	
<b>Double End #2/34</b>	
<b>Double End #25/26 (13A)</b>	
<b>Double End #26/27S</b>	
<b>Double End #29/34</b>	
<b>Double End #26/29</b>	
<b>Double End #26/29</b>	
<b>Double End #28/29 Smooth</b>	40-11295
<b>Single End #29</b>	40-11296
<b>Single End #33</b>	40-11297
<b>Single End #34</b>	40-11298
<b>Acorn Burnisher Double End #21B</b>	40-11299
<b>Acorn Burnisher Double End #21C</b>	40-11300
<b>Acorn Burnisher Double End #21D</b>	40-11301
<b>Ball Burnisher Double End #1</b>	40-11302
<b>U/Michigan Burnisher #1</b>	40-11303
<b>U/Michigan Burnisher #2</b>	40-11304
<b>Single End #28</b>	40-11305
<b>Acorn Burnisher Double End #21</b>	40-11306
<b>Double End #2/3</b>	40-11307
<b>Double End #2/26</b>	40-11308
<b>Double End #2/34</b>	40-11309
<b>Double End #25/26 (13A)</b>	40-11310
<b>Double End #26/27S</b>	40-11311
<b>Double End #29/34</b>	40-11312
<b>Double End #26/29</b>	40-11313
<b>Acorn Burnisher #21B 9.5Mm</b>	40-11316
<b>Acorn Burnisher Single End #21</b>	40-11315
<b>Double End #27/29</b>	40-11314



# Order Online!



# Instruments



Prestige Dental Products, Inc.  
 Prestigedentalproducts.com  
 Tel: 877-772-3888

## Caliper (J & J Instrument)



- Iwansson Caliper Blunt Tip for Wax 40-11327
- Iwansson Caliper Sharp Tip for Metal 40-11326

## Carver (J & J Instrument)

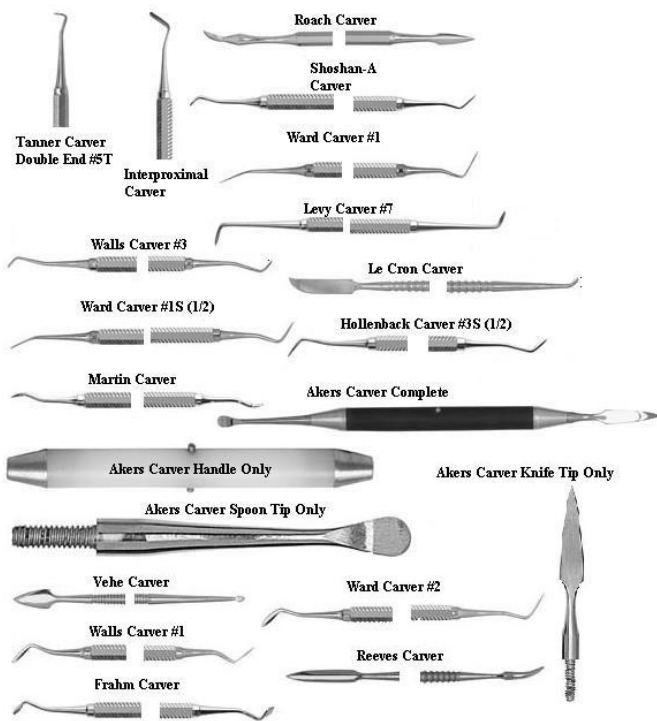

- Hollenback Carver #3S 9.5Mm 40-11349
- Martin Carver 40-11347
- Le Cron Carver 40-11348
- Hollenback Carver #3S (1/2) 40-11346
- Hollenback Carver #3 40-11345
- Frahm Carver 40-11344
- Akers Carver Knife Tip Only 40-11343
- Akers Carver Spoon Tip Only 40-11342
- Akers Carver Handle Only 40-11341
- Akers Carver Complete 40-11340
- Reeves Carver 40-11339

- Levy Carver #7 40-11338
- Ward Carver #2 40-11337
- Ward Carver #1S (1/2) 40-11336
- Ward Carver #1 40-11334
- Walls Carver #3 40-11335
- Walls Carver #1 40-11333
- Vehe Carver 40-11332
- Shoshan-A Carver 40-11331
- Roach Carver 40-11330
- Interproximal Carver 40-11329
- Tanner Carver Double End #5T 40-11328

## Carvers (ASA Italy)

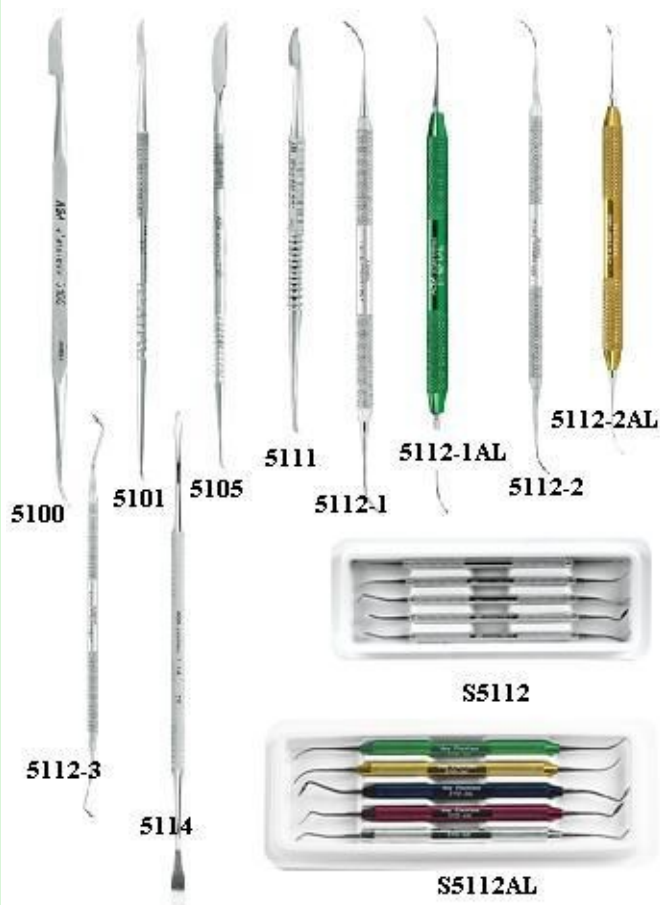

- Hysin Wax And Modelling Carvers N.5100 40-13994
- Hysin-Le Cron Wax And Modelling Carvers N.5101 40-13997
- Le Cron Wax And Modeling Carvers N.5105 40-13996
- Zahle Wax And Modeling Carvers N.5111 40-13993

# Instruments



Prestige Dental Products, Inc.  
 Prestigedentalproducts.com  
 Tel: 877-772-3888

<b>P.K. Thomas Wax And Modeling Carvers Fig.1 N.5112-1</b>	40-13995
<b>P.K. Thomas Wax And Modeling Carvers Fig.1 Green N. 5112-1AL</b>	40-13991
<b>P.K. Thomas Wax And Modeling Carvers Fig.2 N. 5112-2</b>	40-13992
<b>P.K. Thomas Wax And Modeling Carvers Fig.2 Gold N.5112-2AL</b>	40-13990
<b>P.K. Thomas Wax And Modeling Carvers Fig.3 N. 5112-3</b>	40-13989
<b>Beale Wax And Modeling Carvers N.5114</b>	40-13988
<b>Set Of 5 P.K. Thomas Spatulas N. S5112</b>	40-13987
<b>Set Of 5 Color-Coded Aluminum P.K. Thomas Spatulas N.S5112AL</b>	40-13998

## Carvers-Amalgam-Double Ended (ASA Italy)

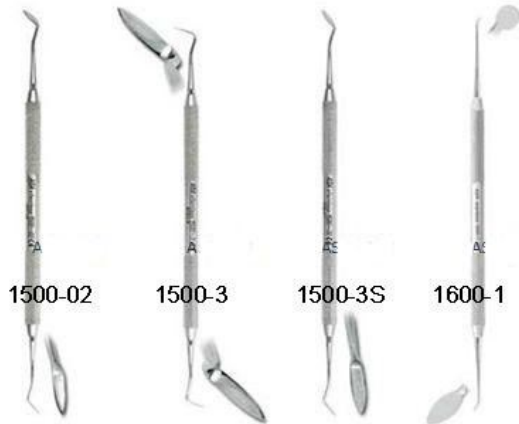

<b>Wax And Modelling Carver Hollenback Fig.1/2 N.1500-02</b>	40-11624
<b>Wax And Modelling Carver Hollenback Fig.3 N.1500-3</b>	40-11626
<b>Wax And Modelling Carver Hollenback Fig.3S N.1500-3S</b>	40-11625
<b>Cleoids--Discoids Fig.1 N.1600-1</b>	40-11627

## Cavity Liner (J & J Instrument)



<b>Cavity Liner 4.25" Regular Tip</b>	40-11350
<b>Cavity Liner 4.25" Gross Price</b>	40-11351
<b>Cavity Liner 5.5" Long-Tip</b>	40-11352
<b>Cavity Liner 6" Double End Reg/Long</b>	40-11353

## Cleoid Discoid (J & J Instrument)

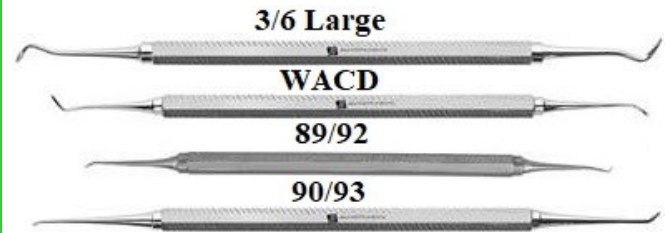

<b>#3/6 Large</b>	40-11364
<b>#WACD</b>	40-11365
<b>#89/92</b>	40-11366
<b>#90/93</b>	40-11367

## Condenser (J & J Instrument)

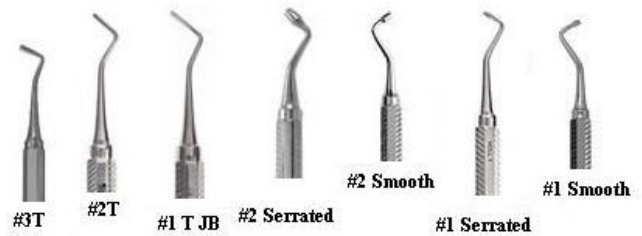

<b>Hollenback Condenser #1 Smooth</b>	40-11392
<b>Hollenback Condenser #1 Serrated</b>	40-11393
<b>Hollenback Condenser #2 Smooth</b>	40-11395
<b>Hollenback Condenser #2 Serrated</b>	40-11394
<b>Tanner Double End Condenser #1T JB</b>	40-11397
<b>Tanner Double End Condenser #2T</b>	40-11396
<b>Tanner Double End Condenser #3T</b>	40-11391

## Endo Forceps Stieglitz (Nordent)

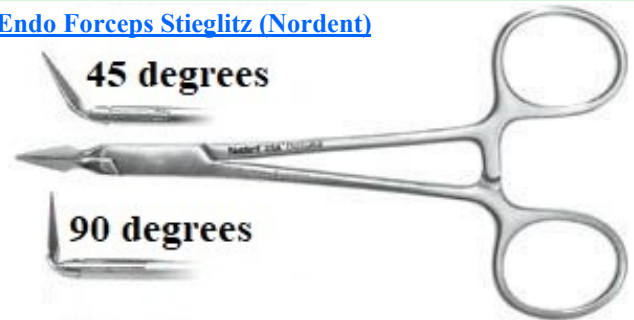

<b>45 Degrees</b>	40-11744
<b>90 Degrees</b>	40-11743

## Endodontic Excavator (Nordent)

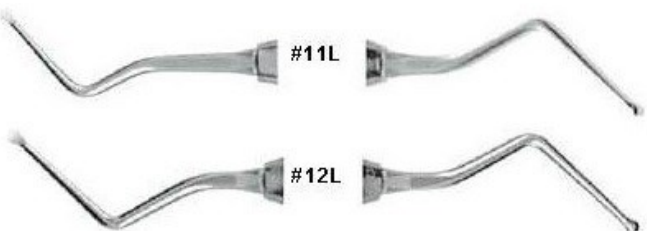

# Instruments



Prestige Dental Products, Inc.  
 Prestigedentalproducts.com  
 Tel: 877-772-3888

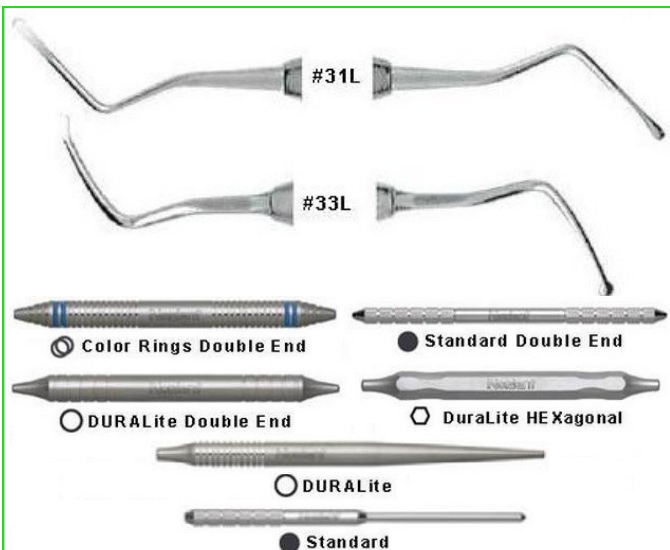

- #31L Long Shank Double End Spoon DuraLite** →Æ ColorRings,Ñç 40-11768
- #31L Long Shank Double End Spoon DuraLite** →Æ ROUND 40-11754
- #31L Long Shank Double End Spoon DuraLite** →Æ HEX 40-11753
- #31L Long Shank Double End Spoon Standard** 40-11751
- #31L Long Shank Double End Spoon DuraLite** →Æ ColorRings,Ñç- 40-11752
- #31L Long Shank Double End Spoon DuraLite** →Æ ROUND 40-11750
- #31L Long Shank Double End Spoon DuraLite** →Æ HEX 40-11749
- #31L Long Shank Double End Spoon Standard** 40-11748
- #31L Long Shank Double End Blade DuraLite** →Æ ColorRings,Ñç 40-11747
- #31L Long Shank Double End Blade DuraLite** →Æ HEX 40-11746
- #31L Long Shank Double End Blade DuraLite** →Æ ROUND 40-11745
- #31L Long Shank Double End Blade Standard** 40-11755
- #31LR Long Shank Double End Spoon DuraLite** →Æ ColorRings,Ñç 40-11756
- #31LR Long Shank Double End Spoon DuraLite** →Æ ROUND 40-11767
- #31LR Long Shank Double End Spoon DuraLite** →Æ HEX 40-11766
- #31LR Long Shank Double End Spoon Standard** 40-11765

- #32L Long Shank Double End DuraLite** →Æ ColorRings,Ñç 40-11763
- #32L Long Shank Double End DuraLite** →Æ ROUND 40-11762
- #32L Long Shank Double End DuraLite** →Æ HEX 40-11761
- #32L Long Shank Double End Standard** 40-11760
- #33L Long Shank Double End Spoon DuraLite** →Æ ColorRings,Ñç 40-11759
- #33L Long Shank Double End Spoon DuraLite** →Æ ROUND 40-11758
- #33L Long Shank Double End Spoon DuraLite** →Æ HEX 40-11757
- #33L Long Shank Double End Spoon Standard** 40-11764

## Excavator (J & J Instrument)

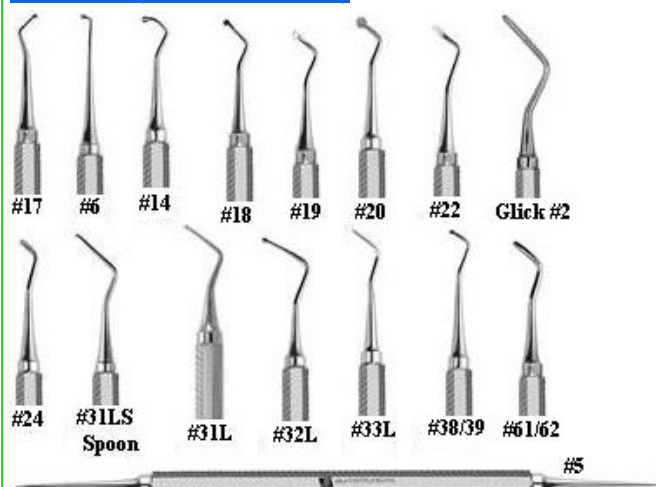

- #6** 40-11793
- #14** 40-11792
- #17** 40-11790
- #18** 40-11789
- #19** 40-11788
- #20** 40-11787
- #22** 40-11786
- #24** 40-11785
- #31LS Spoon** 40-11784
- #31L** 40-11783
- #32L** 40-11782
- #33L** 40-11781
- #38/39** 40-11780
- #61/62** 40-11791



# Instruments



Prestige Dental Products, Inc.  
 Prestigedentalproducts.com  
 Tel: 877-772-3888

**Glick #2** 40-11794

**#5** 40-11779

### Extracting Forcep (J & J Instrument)



**Molar Extraction Forcep** 40-12026

### Gingival Cord Packers (Nordent)



**#113, Plain Tip, Duralite® ColorRings™** 40-12268

**#113, Plain Tip, Duralite® Round** 40-12269

**#113, Plain Tip, Standard** 40-12267

**#113, Serrated Tip, Duralite® ColorRings™** 40-12266

**#113, Serrated Tip, Duralite® Round** 40-12265

**#113, Serrated Tip, Standard** 40-12264

**#122, Plain Tip, Duralite® ColorRings™** 40-12263

**#122, Plain Tip, Duralite® Round** 40-12262

**#122, Plain Tip, Standard** 40-12261

**#122, Serrated Tip, Duralite® ColorRings™** 40-12260

**#122, Serrated Tip, Duralite® Round** 40-12259

**#122, Serrated Tip, Standard** 40-12258

**#213, Plain Tip, Duralite® ColorRings™** 40-12257

**#213, Plain Tip, Duralite® Round** 40-12256

**#213, Plain Tip, Standard** 40-12255

**#213, Serrated Tip, Duralite® ColorRings™** 40-12254

**#213, Serrated Tip, Duralite® Round** 40-12253

**#213, Serrated Tip, Standard** 40-12252

**#222, Plain Tip, Duralite® ColorRings™** 40-12251

**#222, Plain Tip, Duralite® Round** 40-12250

**#222, Plain Tip, Standard** 40-12249

**#222, Serrated Tip, Duralite® ColorRings™** 40-12248

**#222, Serrated Tip, Duralite® Round** 40-12247

**#222, Serrated Tip, Standard** 40-12246

### Morrell Crown Remover (J & J Instrument)



**Morrell Crown Remover w/ 3 Tips** 40-11433

### Plastic Filling (J & J Instrument)

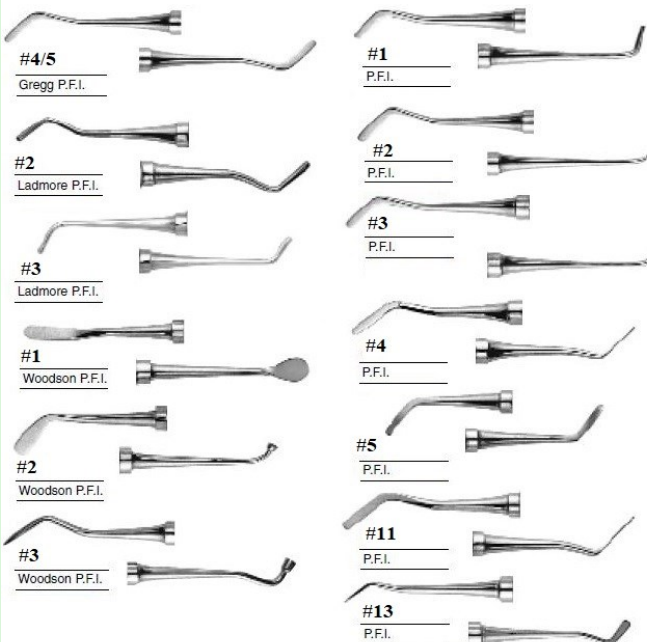

**#4/5 Gregg Plastic Filling Instrument** 40-13304

**#2 Ladmore Plastic Filling Instrument** 40-13303

**#3 Ladmore Plastic Filling Instrument** 40-13302

**#1 Plastic Filling Instrument** 40-13301

**#2 Plastic Filling Instrument** 40-13299

**#3 Plastic Filling Instrument** 40-13300

**#4 Plastic Filling Instrument** 40-13298

**#5 Plastic Filling Instrument** 40-13297

**#11 Plastic Filling Instrument** 40-13296

**#13 Plastic Filling Instrument** 40-13295

**#1 Woodson Plastic Filling Instrument** 40-13294

**#2 Woodson Plastic Filling Instrument** 40-13292

**#3 Woodson Plastic Filling Instrument** 40-13293

# Instruments



Prestige Dental Products, Inc.  
 Prestigedentalproducts.com  
 Tel: 877-772-3888

## Pluggers– Root Canal (Nordent)



#5-7 Double End DuraLite® ColorRings™	40-13549
#5-7 Double End DuraLite® ROUND	40-13548
#5-7 Double End Standard	40-13547
#9-11 Double End DuraLite® ColorRings™	40-13546
#9-11 Double End DuraLite® ROUND	40-13545
#9-11 Double End Standard	40-13544

## Root Canal Plugger (Nordent)



Double End Glick #1 DuraLite® ColorRings™	40-13550
Double End Glick #1 DuraLite® ROUND	40-13551
Double End Glick #1 Standard	40-13552

## Root Canal Pluggers

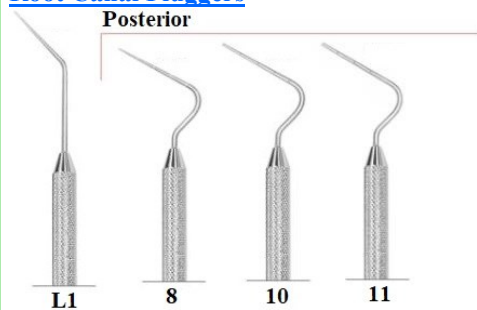

### Glick Blade/Plugger



L1	40-30979
8	40-30980
10	40-30981

11	40-30982
21mm, 1/3	40-30984
21 mm, 5/7	40-30985
21 mm, 9/11	40-30986

## Rubber Dam Clamp Forcep

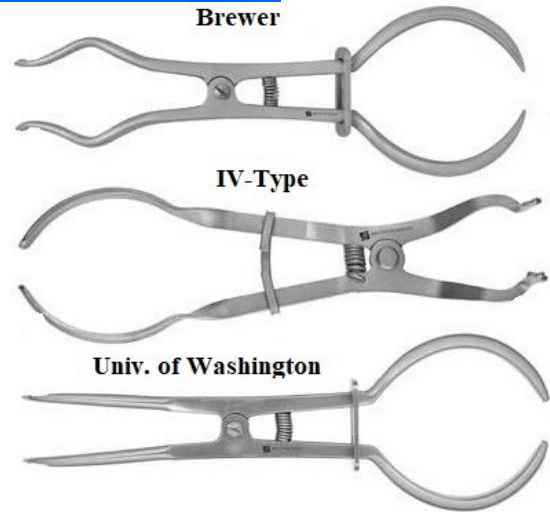

Brewer	40-13604
Iv-Type	40-13605
Univ. of Washington	40-13603

## Rubber Dam Holder Frame (J & J Instrument)

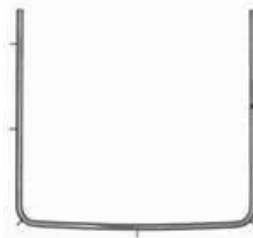

5", each	40-13606
----------	----------

## Rubber Dam Punch (J & J Instrument)

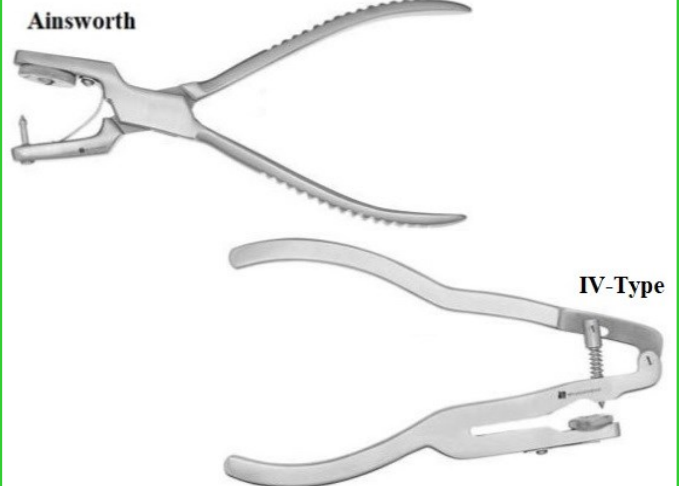

# Instruments



Prestige Dental Products, Inc.  
 Prestigedentalproducts.com  
 Tel: 877-772-3888

**Ainsworth Rubber Dam Punch** 40-13608

**Iv-Type Rubber Dam Punch** 40-13607

### Scissors (Nordent)



4 1/2" Iris Straight  
 4 1/2" Iris Curved  
 4 1/2" Suture Angular  
 4 3/4" Spencer Suture  
 4" Castroviejo Curved  
 5" Goldman Fox  
 4 1/2" LaGrange



5 1/2" Sullivan  
 6 1/4" Kelly Straight  
 6 1/4" Kelly Curved  
 6 1/4" Kelly Angular  
 6 3/4" Dean Gum  
 5" Goldman Fox  
 6 1/4" Straight Suture

4 1/2" (115 mm) Iris Straight	40-13776
4 1/2" (115 mm) Iris Curved	40-13762
4 1/2" (115 mm) Iris Angular	40-13763
4 1/2" (115 mm) Suture Angular	40-13764
4 3/4" (120 mm) Spencer Suture	40-13765
4" (100 mm) Castroviejo Curved	40-13766
5" (130 mm) Goldman Fox 1 Blade Serrated	40-13767
4 1/2" (115 mm) LaGrange 1 Blade Serrated	40-13768
5 1/2" (140 mm) Sullivan	40-13769
6 1/4" (160 mm) Kelly Straight	40-13770
6 1/4" (160 mm) Kelly Curved	40-13771
6 1/4" (160 mm) Kelly Angular	40-13772
6 3/4" (170 mm) Dean Gum 1 Blade Serrated	40-13773
5" (130 mm) Goldman Fox Curved Handle	40-13774
6 1/4" (160 mm) Straight Suture	40-13775
4" (100 mm) Crown and Collar Straight	40-13777
4" (100 mm) Crown and Collar Curved	40-13761

[www.prestigedentalproducts.com](http://www.prestigedentalproducts.com)

### Spreader (J & J Instrument)

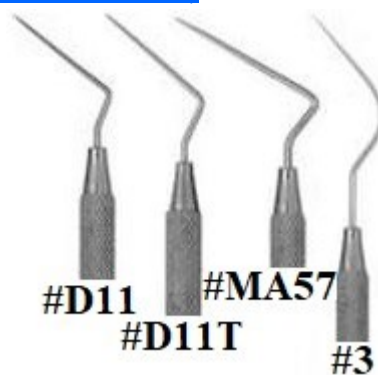

#D11	40-13787
#D11T	40-13788
#MA57	40-13789
#3	40-13790

### Spreader - NiTi (Nordent)

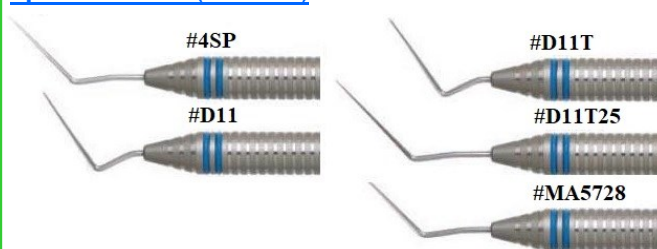

4SP Single End Nickle Titanium DuraLite® ColorRings™	40-13543
4SP Single End Nickle Titanium DuraLite® ROUND	40-13530
4SP Single End Nickle Titanium Standard	40-13531
#D11 Single End Nickle Titanium DuraLite® ColorRings™	40-13532
#D11 Single End Nickle Titanium DuraLite® ROUND	40-13533
#D11 Single End Nickle Titanium Standard	40-13535
#D11T (Thin) Single End Nickle Titanium DuraLite® ColorRings™	40-13534
#D11T (Thin) Single End Nickle Titanium DuraLite® ROUND	40-13536
#D11T (Thin) Single End Nickle Titanium Standard	40-13538
D11T Single End 25MM Nickle Titanium DuraLite® ColorRings™	40-13537
D11T Single End 25MM Nickle Titanium DuraLite® ROUND	40-13539
D11T Single End 25MM Nickle Titanium Standard	40-13540



# Instruments



Prestige Dental Products, Inc.  
 Prestigedentalproducts.com  
 Tel: 877-772-3888

**D11T Single End 28MM Nickle Titanium DuraLite® ColorRings™** 40-13541

**D11T Single End 28MM Nickle Titanium DuraLite® Standard** 40-13529

**D11T Single End 28MM Nickle Titanium DuraLite® ROUND** 40-13542

### Spreaders

Made in USA



#57	40-30975
#11	40-30976
#11T	40-30977
#11TS	40-30978

### Tofflemire (J & J Instrument)

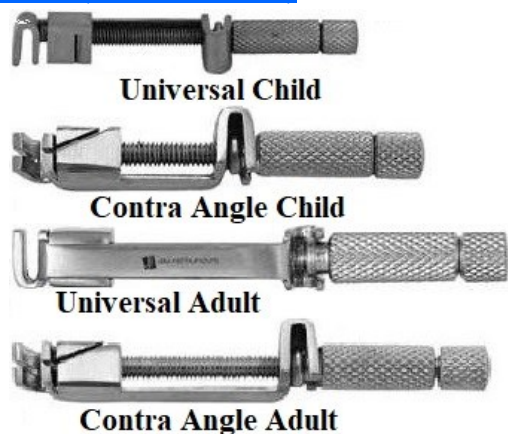

Universal Child	40-13934
Universal Adult	40-13935
Contra Angle Child	40-13936
Contra Angle Adult	40-13937

### Wax Instrument (J & J Instrument)

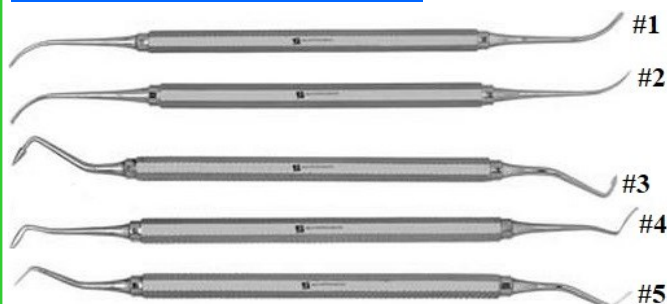

<b>Pk Thomas Wax #1</b>	40-14004
<b>Pk Thomas Wax #2</b>	40-14005
<b>Pk Thomas Wax #3</b>	40-14006
<b>Pk Thomas Wax #4</b>	40-14007
<b>Pk Thomas Wax #5</b>	40-14008
<b>Pk Thomas Wax #1-#5 (Set Of 5)</b>	40-14003

### Periodontic Instruments

#### Hollow Handle Periodontal Instruments (ASA Italy)



<b>Gracey Curette Fig.1/2 Handle Mm 10</b>	40-12572
<b>Gracey Curette Fig.1/2 Af Handle Mm 10</b>	40-12558
<b>Gracey Curette Fig.1/2 Mf Handle Mm 10</b>	40-12573
<b>Gracey Curette Fig. 3/4 Handle Mm 10</b>	40-12574
<b>Gracey Curette Fig. 3/4 Af Handle Mm 10</b>	40-12575
<b>Gracey Curette Fig. 3/4 Mf Handle Mm 10</b>	40-12576
<b>Gracey Curette Fig. 5/6 Handle Mm 10</b>	40-12577
<b>Gracey Curette Fig. 5/6 Af Handle Mm 10</b>	40-12578
<b>Gracey Curette Fig. 5/6 Mf Handle Mm 10</b>	40-12579
<b>Gracey Curette Fig. 7/8 Handle Mm 10</b>	40-12580
<b>Gracey Curette Fig. 7/8 Af Handle Mm 10</b>	40-12581
<b>Gracey Curette Fig. 7/8 Mf Handle Mm 10</b>	40-12582
<b>Gracey Curette Fig. 9/10 Handle Mm 10</b>	40-12583
<b>Gracey Curette Mes.Distal Fig. 11/14 Handle Mm 10</b>	40-12571
<b>Gracey Curette Fig. 11/12 Handle Mm 10</b>	40-12569
<b>Gracey Curette Fig. 11/12 Af Handle Mm 10</b>	40-12557
<b>Gracey Curette Fig. 11/12 Mf Handle Mm 10</b>	40-12559

# Instruments



Prestige Dental Products, Inc.  
 Prestigedentalproducts.com  
 Tel: 877-772-3888

<b>Gracey Curette Mes.Distal</b> Fig. 12/13 Handle Mm 10	40-12560
<b>Gracey Curette Fig. 13/14</b> Handle Mm 10	40-12562
<b>Gracey Curette</b> Fig. 13/14 Af Handle Mm 10	40-12561
<b>Gracey Curette Fig. 13/14 Mf</b> Handle Mm 10	40-12563
<b>Gracey Curette Fig. 15/16</b> Handle Mm 10	40-12564
<b>Gracey Curette</b> Fig. 15/16 Af Handle Mm 10	40-12566
<b>Gracey Curette</b> Fig. 15/16 Mf Handle Mm 10	40-12565
<b>Gracey Curette Fig. 17/18</b> Handle Mm 10	40-12567
<b>Scaler Taylor Fig. 2/3</b> Handle Mm 10	40-12568
<b>Scaler Taylor Fig. 204S</b> Handle Mm 10	40-12570
<b>Scaler Cranekaplan Fig. 6</b> Handle Mm 10	40-12584

### Miltex Pedo Forceps with Spring (Integra Miltex)

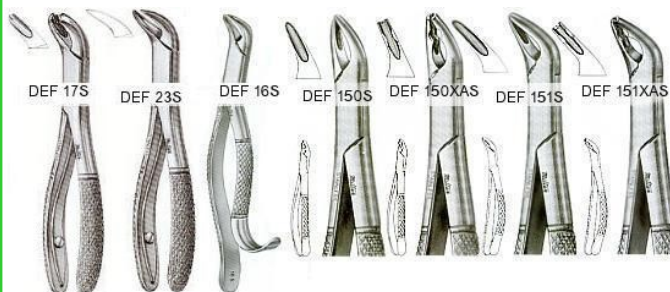

<b>16S</b>	40-20100
<b>17S</b>	40-20101
<b>23S</b>	40-20102
<b>150S</b>	40-20103
<b>150S-SG</b>	40-20104
<b>Vantage 150S</b>	40-20105
<b>Vantage 150S-SG</b>	40-20106
<b>150 XAS</b>	40-20107
<b>150 1/2S</b>	40-20108
<b>151S</b>	40-20109
<b>151S-SG</b>	40-20110
<b>Vantage 151S</b>	40-20111
<b>Vantage 151S-SG</b>	40-20112
<b>151 XAS</b>	40-20113
<b>151 1/2S</b>	40-20114
<b>1511/2S-SG</b>	40-20115
<b>150 1/2S Serrated</b>	40-20116

<b>English Pattern Forceps #73</b>	40-20117
------------------------------------	----------

### Montana Jack (PDT)



<b>Mini NEB 128-L5</b>	40-13004
<b>Mini H5-L5</b>	40-13000
<b>Scaler/Curette</b>	40-13001
<b>Sickle</b>	40-13002
<b>Jack Rigid</b>	40-13003

### Periodontal Files (Nordent)

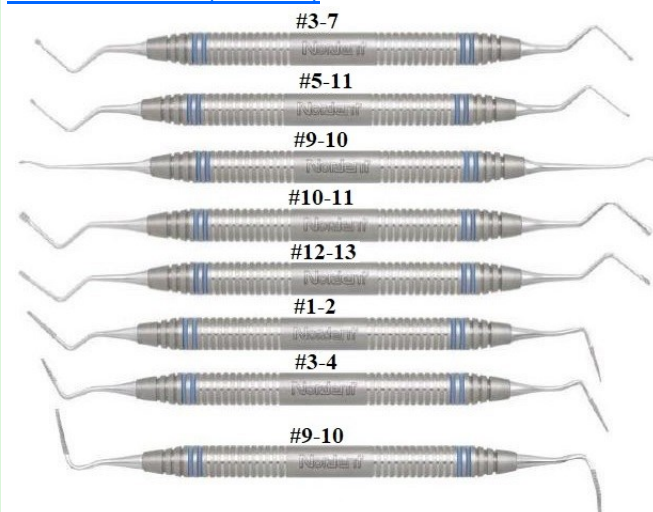

<b>#3-7 Double Ended Hirschfeld</b> DuraLite® ColorRings™	40-13189
<b>#3-7 Double Ended Hirschfeld</b> DuraLite® ROUND	40-13190
<b>#3-7 Double Ended Hirschfeld</b> Standard	40-13191
<b>#5-11 Double Ended Hirschfeld</b> DuraLite® ColorRings™	40-13192
<b>#5-11 Double Ended Hirschfeld</b> DuraLite® ROUND	40-13193
<b>#5-11 Double Ended Hirschfeld</b> Standard	40-13194
<b>#9-10 Double Ended Hirschfeld</b> DuraLite® ColorRings™	40-13184

# Instruments



Prestige Dental Products, Inc.  
 Prestigedentalproducts.com  
 Tel: 877-772-3888

#9-10 Double Ended Hirschfeld DuraLite® ROUND	40-13183
#9-10 Double Ended Hirschfeld Standard	40-13173
#10-11 Double Ended Orban DuraLite® ColorRings™	40-13174
#10-11 Double Ended Orban DuraLite® ROUND	40-13175
#10-11 Double Ended Orban Standard	40-13176
#12-13 Double Ended Orban DuraLite® ColorRings™	40-13177
#12-13 Double Ended Orban DuraLite® ROUND	40-13178
#12-13 Double Ended Orban Standard	40-13179
#1-2 Double Ended Sugarman DuraLite® ColorRings™	40-13180
#1-2 Double Ended Sugarman DuraLite® ROUND	40-13181
#1-2 Double Ended Sugarman Standard	40-13182
#3-4 Double Ended Sugarman DuraLite® ColorRings™	40-13195
#3-4 Double Ended Sugarman DuraLite® ROUND	40-13188
#3-4 Double Ended Sugarman Standard	40-13187
#9-10 Double Ended Schluger DuraLite® ColorRings™	40-13186
#9-10 Double Ended Schluger DuraLite® ROUND	40-13185
#9-10 Double Ended Schluger Standard	40-13172

### Piezo Ultrasonic Gracey Mini Curette Tips (Vista)

The long shank and slender design allow these tips to be used in places that are out of reach with regular sized tips. For instance, when furcations are present or when teeth overlap (crowding) because the bite was never corrected with braces.

- Longer shank than regular curettes for better access into deeper pockets
- Shorter blades (on average 1.2 mm) permit better scaling in NARROW pockets, reduce tissue damage and offer great adaptation to the root surface
- Slender blades aid in tactile sensitivity and enhance deep pocket access and adaptation to the root surfaces



• Tips will fit: EMS\* STYLE: Mini Piezon\*, Scalex 880\*, Bonart\*, SuperSon EIE\*, Master 400\*, Parkel (Piezo)\*, Dent America\*  
 - Acteon\* STYLE: Vista P5\*, NSK\*, ENAC\*, Sybron Endo\*, Obtura Spartan\*, ADEC\*, J.Morita\*, Dentsply/Tulsa\*, Amdent\*

HC-Mini-1 (Acteon Style)	56-11243
HC-Mini-2 (Acteon Style)	56-11242
HC-Mini-3 (Acteon Style)	56-11241
HC-Mini-4 (Acteon Style)	56-11240
HC-Mini-7 (Acteon Style)	56-11239
HC-Mini-8 (Acteon Style)	56-11238
HC-Mini-1 (EMS Style)	56-11237
HC-Mini-2 (EMS Style)	56-11236
HC-Mini-3 (EMS Style)	56-11232
HC-Mini-4 (EMS Style)	56-11233
HC-Mini-7 (EMS Style)	56-11234
HC-Mini-8 (EMS Style)	56-11235

### Pumice Cup (J & J Instrument)



Lester Pumice Cup 40-13467

### Scaler (J & J Instrument)



Towner Scaler #U15/33 9.5Mm	40-13611
Darby-Perry Scaler	40-13610
Barnhart Scaler #5/6	40-13612
Barnhart Scaler #1/2	40-13613
Universal Scaler Single End #34	40-13614
Universal Scaler Single End #33	40-13616
Universal Scaler Single End #3	40-13615
U/Puerto Rico Scaler	40-13617



## Instruments

Towner Scaler Double End #15/33	40-13630
Jacquette Hollow Core Single End #1S	40-13619
Jacquette Hollow Core Single End #2S	40-13620
Jacquette Hollow Core Single End #3S	40-13621
Towner Scaler #U15/30 9.5Mm	40-13622
Jacquette Scaler 31/32	40-13623
Jacquette Scaler #34/35 9.5Mm	40-13624
Scaler #S5/33 9.5Mm	40-13626
Towner Scaler Double End #15/30	40-13646
Younger-Good Scaler #7/8	40-13644
USC Scaler #3/4	40-13618
Goldman-Fox Scaler #2	40-13642
Goldman-Fox Scaler #1	40-13636
Crane-Kaplan Scaler #6	40-13641
Scaler #H5/33	40-13640
Scaler #204S	40-13639
Scaler #H6/7	40-13651
Jacquette Scaler #2S/3S	40-13633
Jacquette Scaler #2/3	40-13634
Jacquette Scaler Single End #1S	40-13635
Jacquette Scaler Single End #2S	40-13638
Jacquette Scaler Single End #3S	40-13637
Universal Scaler Double End #12	40-13643
Towner Scaler Single End #15	40-13631
Scaler #S6/S7 Silk	40-13629
Scaler #204Sd 9.5Mm	40-13625
Scaler #204S 9.5Mm	40-13627
Towner Hollow Core Single End #15	40-13628
Taylor Scaler #2/3	40-13645
Goldman-Fox Scaler #6	40-13647
Goldman-Fox Scaler #5	40-13648
Goldman-Fox Scaler #4	40-13649
Goldman-Fox Scaler #3	40-13650
Jacquette Scaler #1S/1S	40-13632

**Best Quality  
Dental Supplies**



Prestige Dental Products, Inc.  
Prestigedentalproducts.com  
Tel: 877-772-3888

### Sharpening Systems (PDT)



PingRing Sharp Tester	40-13781
Diamond Head Ceramic Stone (Maintain Edge)	40-13782
Transformation Sharpening Stone (Reshape Blade)	40-13780
PDT/Gleason Guide *Patent No. 6,852,014	40-13779

### Stone (J & J Instrument)



Silicon Carbide Sharp Stone	40-13893
Arkansas Flat Fine Grit Stone	40-13894
Ceramic Medium Grit Red Stone	40-13892

### Tissue Nipper (J & J Instrument)



# Instruments



Prestige Dental Products, Inc.  
 Prestigedentalproducts.com  
 Tel: 877-772-3888

- Goldman-Fox Tissue Nipper 4" 4Mm 40-13924
- Goldman-Fox Tissue Nipper 4" 8Mm 40-13925
- Goldman-Fox Tissue Nipper 4" 12Mm 40-13926

### Ultimate Edge Kits (PDT)



- |   |   |
|---|---|
| <b>Ultimate Edge<br/>Sharpening Kit</b> | <b>Ultimate Edge<br/>Transformation Kit</b> |
| Sharpening Kit                          | 40-13954                                    |
| Transformation Kit                      | 40-13955                                    |

### Orthodontic Instruments

#### Band Contouring Pliers (DSC)

High quality  
 Made in Japan



- Each 40-98481

#### Band Pusher (J & J Instrument)



- #300, each 40-88481

#### Band Pusher - Black (Nordent)



Band Pusher - Black's #6-7 Two identical oval-shaped, serrated blades set at opposing angles. The blades measure 3.5mm wide and 1.5mm thick.

Handle Selection  ECNB6-7  RECNB6-7  ECNB6-7  CNB6-7

- #6-7 Double Ended Black's Oval Shaped (3.5-1.5mm) Serrated Standard 40-16681

#### Band Pusher - Ligature Director (ATW)

High Quality

- Each 44-97951

#### Band Pusher - Ligature Director (J & J Instrument)



- Double End 40-11231  
 Hollow Core, handle diameter is 3/8" 40-11230

#### Band Pusher - Scaler (J & J Instrument)



- #300S 40-11233  
 #300S Hollow Core, handle diameter is 3/8" 40-11232

#### Band Pusher - Scaler (Nordent)

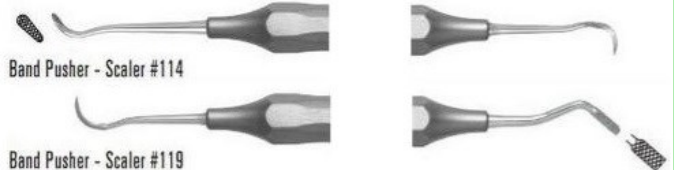

- Band Pusher - Scaler #114 40-16701  
 #114 Double Ended DuraLite® ROUND  
 #114 Double Ended DuraLite® HEX 40-16702  
 #114 Double Ended Standard 40-16703  
 #119 Double Ended DuraLite® HEX 40-16704  
 #119 Double Ended Standard 40-16705

#### Band Removing Plier (J & J Instrument)



- Baade Band Remover #255 40-11236

#### Band Removers Pliers - Posterior (J & J Instrument)

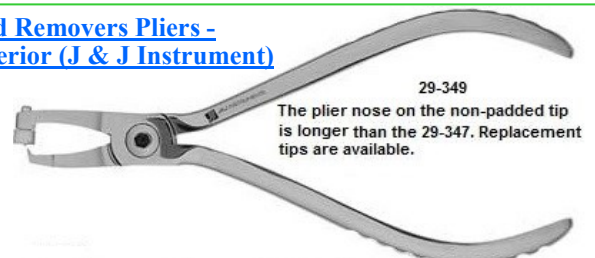

29-349  
 The plier nose on the non-padded tip is longer than the 29-347. Replacement tips are available.

# Instruments



Prestige Dental Products, Inc.  
 Prestigedentalproducts.com  
 Tel: 877-772-3888



#348 - ELITE  
Direct Bracket Remover

#347L - Long, ELITE  
Posterior Band Remover

- Posterior Band Remover #347L 40-88471
- Direct Bracket Remover #348 40-88472
- Posterior Band Remover #347 Short 40-88473

### Band Removing Pliers (Shioda-Japan)



- Band Removing Pliers 40-11242
- Peek Tip (3pcs) for #1046T & 1046TL 40-11241
- Band Removing Pliers - Long 40-11240
- Band Removing Plier 40-11239
- Peek Tip (3pcs) for #1046 40-11238

### Band Seater (J & J Instrument)



- #1400 W / Tin Insert 40-11243
- 6" Autoclavable (290- $\bar{f}$ ) Plastic Band Seater W/Stainless Steel Insert 40-11244

### Bird Beak Plier



Each 40-1426

### Bird Beak Plier (Hu-Friedy)

Stainless Steel  
**Made in USA**



Plier, 139 angle, each 40-106951

### Bird Beak Plier (J & J Instrument)

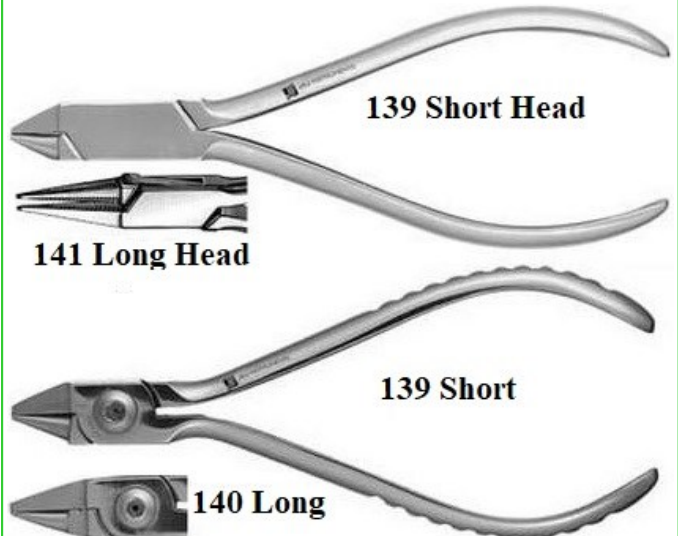

- #139 Short 40-11264
- #140 Long 40-11263
- #139 Short Head Elite Fluted Handle Snub nose, one round cone beak, one pyramid beak For working round wire 40-11262
- #141 Long Head Elite Fluted Handle Snub nose, one round cone beak, one pyramid beak For working round wire 40-11261

### Bracket Placer with Slot Aligner (ATW)

High Quality

Each 44-97881



# Instruments



Prestige Dental Products, Inc.  
 Prestigedentalproducts.com  
 Tel: 877-772-3888

## Bird Beak Pliers (Shioda-Japan)

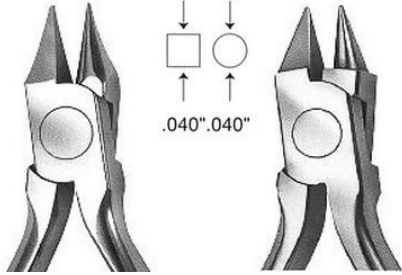

Regular, Max Bending: .032 40-11265

Regular, Max Bending : .030 40-11266

## Bond Removing Pliers (Shioda-Japan)

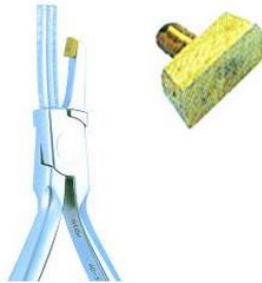

Plier 40-11268

Metal Tip 40-11267

## Bracket Holder (Hu-Friedy)

Direct Bond  
Bracket Holder



Each 40-106941

## Bracket Placing Tweezer (ATW)

High Quality

Each 44-97891

## Bracket Remover (J & J Instrument)

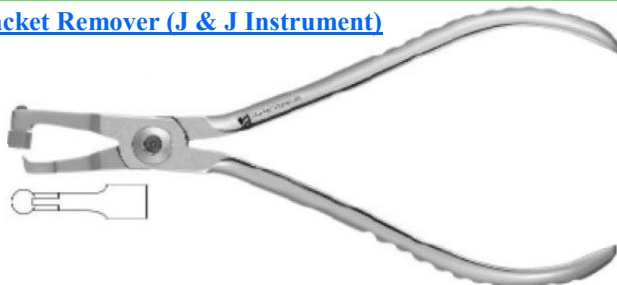

#348 Elite Fluted Handle the plier nose 40-11287  
 is thinner than the nose on #29-347

## Bracket Removing Pliers (Shioda-Japan)

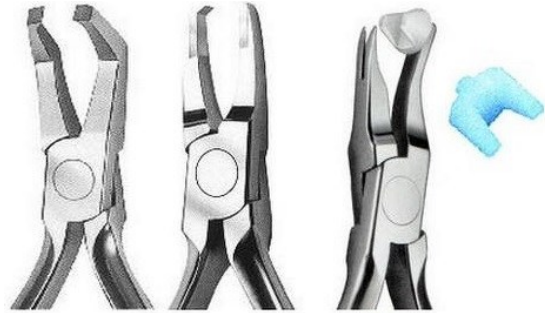

Angled Straight Pliers

Bracket Removing Pliers - Angled 40-11288

Bracket Removing Pliers - Straight 40-11289

Bracket Removing Pliers 40-11290

## Buccal Tube Tweezers (ATW)

High Quality

Each 44-97921

## Clasp Adjusting Plier (J & J Instrument)



Clasp Adjusting  
Plier



ELITE

Clasp Adjusting Plier 40-11362

Elite Clasp Adjusting Plier Fluted  
 Handle 3 Jaw plier, Straight aligned  
 tips for delicate, consistent bending 40-11363

## Collar Plier (J & J Instrument)



Robinson Collar  
Plier

# Instruments



Prestige Dental Products, Inc.  
 Prestigedentalproducts.com  
 Tel: 877-772-3888



**Peeso Collar Plier**

**Peeso Collar Plier #118** 40-11369

**Robinson Collar Plier #120** 40-11368

**Cone & Socket Plier (J & J Instrument)**



**Cone & Socket Plier**

To tighten and remove cone socket points.

**#102** To tighten and remove cone socket points 40-11398

**Contouring Plier (J & J Instrument)**



**#114 Johnson Contouring Plier**



**Abell Contouring Plier #112**

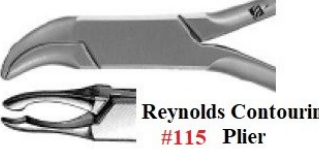

**Reynolds Contouring Plier #115**



**Gordon Contouring Plier #137**



**#301 Triplex Contouring Plier**



**#136 Goslee Contour Plier**

- #114 For contouring bands and crowns
- #112 Ball and socket beaks. Used for crown and band contouring
- #115 Falcon beaks. For contouring bands and crowns
- #137 For general contouring
- #301 Three in one

<b>Abell Contouring Plier #112</b>	40-11399
<b>Johnson Contour Plier #114</b>	40-11400
<b>Reynolds Contour Plier #115</b>	40-11401
<b>Goslee Contouring Plier #136</b>	40-11402
<b>Gordon Contouring Plier #137</b>	40-11404
<b>Triplex Contouring Plier #301</b>	40-11403

**Contouring Pliers (Shioda-Japan)**

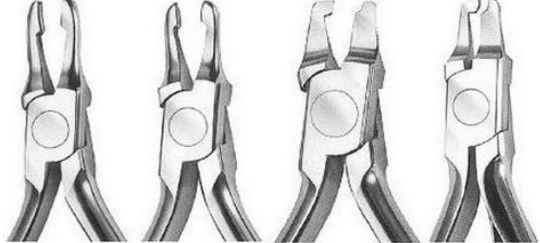

**Band Contouring Pliers** 40-11408

**Crown Contouring Pliers** 40-11405

**Crown Crimping Pliers** 40-11406

**Crown Crimping Pliers - Slim** 40-11407

**Cotton Plier (ATW)**

**High Quality**

<b>Without lock, each</b>	40-97961
<b>With lock, each</b>	40-97962

**Cotton Plier (J & J Instrument)**



**Plier Serrated Tips**

**Plier Serrated, Narrow Tips**

**Plier Self-Locking, Serrated**

**Plier Self-Locking Serrated, Narrow Tip**

**Plier Self-Locking, Grooved**

**Markley Plier Lock Groove 6"**

**Meriam Plier 6.25" Serrated**

**Perry Plier 5" Serrated**

# Instruments



Prestige Dental Products, Inc.  
 Prestigedentalproducts.com  
 Tel: 877-772-3888

<b>College Plier Serrated Tips</b>	40-11417
<b>College Plier Serrated, Narrow Tips</b>	40-11418
<b>College Plier Self-Locking, Serrated</b>	40-11420
<b>College Plier Self-Locking, Serrated, Narrow Tips</b>	40-11423
<b>College Plier Self-Locking, Grooved</b>	40-11422
<b>Markley Plier Lock Groove 6" Self-Locking, 1 Grooved Tip, 1 Serrated Tip</b>	40-11424
<b>Meriam Plier 6.25" Serrated</b>	40-11425
<b>Perry Plier 5" Serrated</b>	40-11419

### CP Instrument (Shioda-Japan)

<b>Very Thin Carver</b>	40-11427
<b>Curved Very Thin Carver</b>	40-11428
<b>Very Thin &amp; Spatula</b>	40-11429
<b>Large Ball &amp; Small Ball</b>	40-11430
<b>Large Cone &amp; Small Cone</b>	40-11426
<b>Spatula</b>	40-11431

### Crown Contouring Pliers (DSC)

High Quality  
 Made in Japan



Each 40-98491

### Dela-Rosa Plier (J & J Instrument)

Forms inner bows & loops

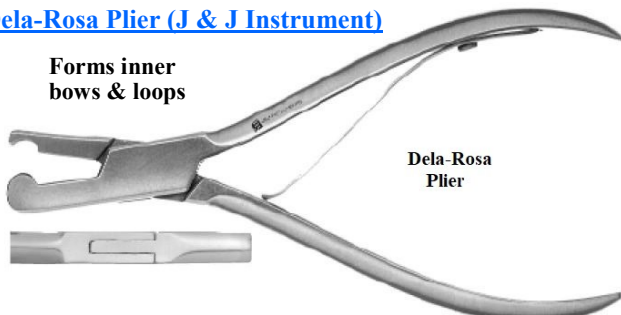

Dela-Rosa Plier

#858 Forms Inner Bows and Loops 40-11529

### Deluxe Bracket Holders



Stainless steel holder is designed for accurate placement of

anterior and posterior direct bond brackets and buccal tubes. Excellent field of vision.

Each 44-11855

### Direct Bonding Bracket Holder (ASA Italy)



Direct Bonding Bracket Holder CM. 13.5 40-13143

### Direct Bracket Holders



Unique reverse action tweezers with finely serrated beaks for a non-slip grip. Easy release of both metal and plastic direct bond brackets. (fits narrow to wide twin)

Each 44-11857

### Direct Bracket Holders (ATW)



Each 44-97901

### Direct Bracket Holders (Hu-Friedy)



Each 40-89211

### Distal End Cutter (J & J Instrument)



Distal End Cutter #16 - ELITE

#16 Reg. Head

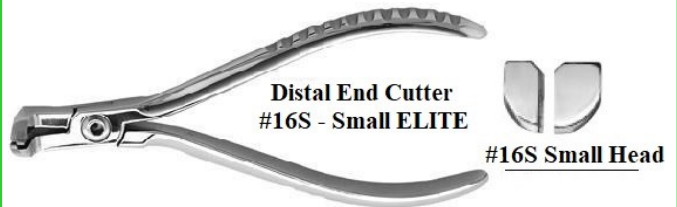

Distal End Cutter #16S - Small ELITE

#16S Small Head

#116 Distal End Cutter. With safety hold and inserted steel tips. Cuts hard round and rectangular arch wire. Holds loose distal end wire

#16S Small Small head with safety hold and inserted tool steel tips. Cuts hard round and rectangular arch wire. Holds loose distal end wire. Smaller head than 09-016.

#16 With: safety hold and inserted steel tips Cut hard round and rectangular arch wire Holds loose distal end wire 40-11584



# Instruments



Prestige Dental Products, Inc.  
 Prestigedentalproducts.com  
 Tel: 877-772-3888

**#16S Small head, With:** safety hold and inserted steel tips Cut hard round and rectangular arch wire Holds loose distal end wire 40-11583

**#16 Regular Head Elite Fluted Handle With:** Safety hold and inserted tool steel tips Cuts hard, round and Rectangular arch wires Holds loose distal end wire Comes with wrench Fluted Handle, Regular Head 40-11582

**#16S Small Head Elite Fluted Handle With:** Safety hold and inserted tool steel tips Cuts hard, round and Rectangular arch wires Holds loose distal end wire Comes with wrench Fluted Handle, Regular Head 40-11585

**Distal End Cutter Cut and Hold (Hu-Friedy)**



Cuts to: .012" & .021" x .025"

**With Hold, Short Handle, each** 40-89201

**With Hold, Long Handle, each** 40-89202

**Distal End Cutter Flush (Hu-Friedy)**



**Each** 40-89221

**Distal End Cutter Plier - Flash Cut (W&H)**

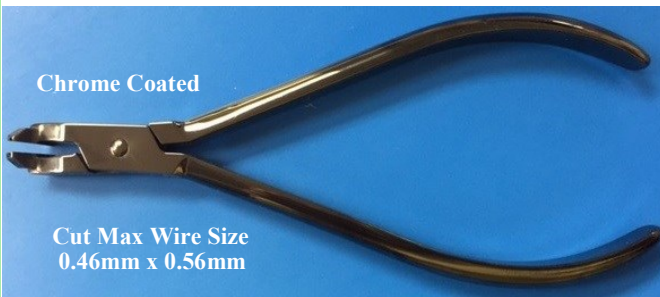

Chrome Coated

Cut Max Wire Size  
 0.46mm x 0.56mm

**Each** 44-108161

**Distal End Safety Cutters Slim (Shidoa - Japan)**

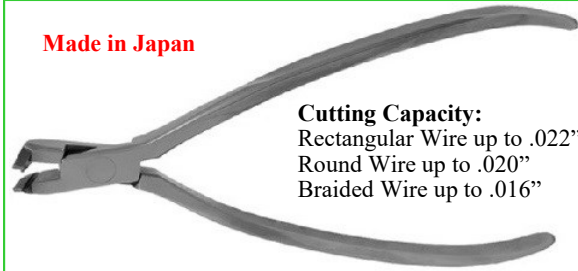

**Made in Japan**

**Cutting Capacity:**  
 Rectangular Wire up to .022" x .028"  
 Round Wire up to .020"  
 Braided Wire up to .016"

**Standard Handle, each** 40-109491

**Long Handle, each** 40-109492

**Distal End Safety Cutters Slim - Flush Cut (Shioda-Japan)**



**Cutting Capacity:**  
 Rectangular Wire up to .022" x .028"  
 Round Wire up to .020"  
 Braided Wire up to .016"

**Made in Japan**

**Each** 40-115901

**Replacement Ring for 550SF, 10Rings/Pkg** 40-115871

**Face Bow (ASA Italy)**



**Asa Easy Bow, Complete Set** 40-12157

**Force Module Separator (J & J Instrument)**



**#101 Hold, Spread and Place Elastics** 40-12224  
 Adjustable screw for control of width opening

[www.prestigedentalproducts.com](http://www.prestigedentalproducts.com)

# Instruments



Prestige Dental Products, Inc.  
 Prestigedentalproducts.com  
 Tel: 877-772-3888

## Forming Plier (J & J Instrument)



- V-form wire contouring plier with double notched tip 40-12225
- Ribbon Arch Plier #142A 40-12226
- Tweed Loop Forming Plier 40-12227
- #352 Elite Fluted Handle Comes with wrench 40-12228

## Forming Pliers - Facebook Adjusting Pliers (Shioda-Japan)



- Ligature Forming Pliers 40-12229
- Hollow Chop Pliers Max Bending: .022 40-12230
- Arch Turret 40-12231
- Head Gear Pliers Max Bending : .051 40-12232

## Hard Wire Cutter (J & J Instrument)



- Diagonal Hard Wire Cutter 40-12529

## Hard Wire Cutters (Shioda-Japan)



- 1- Max Cutting : .020 40-12531

- 2- Power Cutter, Max Cutting : 1.5 40-12530

## How Pliers (Shioda-Japan)

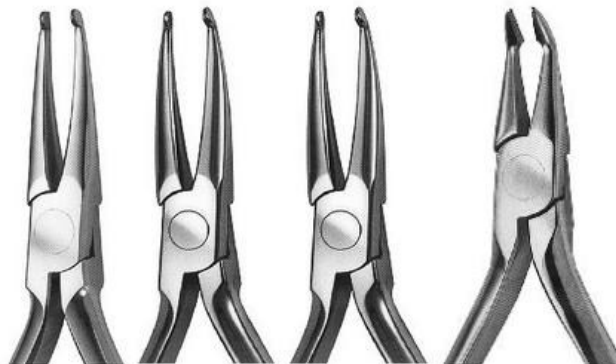

- 1-Regular Tip Diameter: . 1/8' 40-12587
- 2-Regular Tip Diameter: . 1/8' 40-12586
- 3- Small Tip Diameter: . 3/32' 40-12585
- 4- Offset Tip Diameter: . 1/8' 40-12588

## Lab/Office Plier (J & J Instrument)

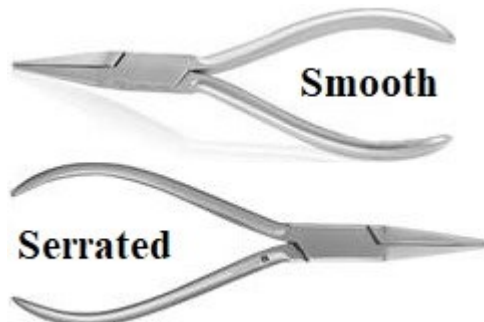

- #121 Serrated 40-12807
- #122 Smooth 40-12808
- Mckellop Clasp Plier #134 40-12806

## Ligating Instruments (Shioda-Japan)

- Ligature Tying Pliers - Coon Type 40-12839
- Ligature Tying Pliers 40-12847
- Ligature Tying Pliers - Mathieu Type 40-12846
- Elastic Placing Pliers - Hook Tip 40-12845
- Ligating Pliers 40-12844
- Elastic Placing Pliers 40-12843
- Ligating Utility Pliers 40-12842
- Mosquito Forceps - Straight 40-12841
- Mosquito Forceps - Curved 40-12840
- Ligature Director 40-12848

# Instruments



Prestige Dental Products, Inc.  
 Prestigedentalproducts.com  
 Tel: 877-772-3888

## Ligature Cutter (Hu-Friedy)



**Micro-Mini Pin & Ligature Cut Long Handle, each** 40-89231

**Mini Pin & Ligature Cutter Handle, each** 40-89232

## Ligature Director (J & J Instrument)

### Single End



### Double End

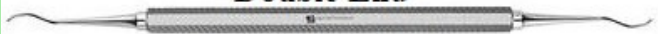

### Double End, Hollow



### Single Ended, Hollow



**Ligature Director Single End** 40-12849

**Ligature Director Double End** 40-12850

**Single End Hollow Core, The handle diameter is 3/8"** 40-12851

**Double End Hollow Core, The handle diameter is 3/8"** 40-12852

## Ligature Director (Nordent)



**N120 Curved Single Ended Standard** 40-16721

## Ligature Director - Director (J & J Instrument)

**Hollow Core, The handle diameter is 3/8"** 40-12853

## Ligature Director - Scaler (Prestige) High Quality



**Each** 44-97931

## Ligature Tie Plier (J & J Instrument)

**Mosquito Forcep 5" Straight W/ Hook** 40-12865

**Mosquito Forcep 5" Curved** 40-12864

**Mosquito Forcep 5" Curved W / Hook** 40-12863

**Mathieu, 5.5" Elastomeric** 40-12862

**Mathieu, 5.5" W/ Notched Tip** 40-12861

**Mathieu, 5.5" W/ Hook** 40-12859

**Mathieu 4.75" Elastomeric** 40-12860

**Mathieu 4.75" W / Hook** 40-12858

**Crile-Wood N / H 6" Carbide Gator Grip** 40-12857

**Mathieu Stainless Steel 5.5" Regular Tip** 40-12866

**Mathieu Stainless Steel 5.5" Delicate Tip** 40-12856

## Light Wire Pliers (Shioda-Japan)



**Grooved Square Tip, Max Bending: .020** 40-12870

**Grooved Square Tip, Max Bending: .018** 40-12869

**Max Bending : .020** 40-12868

**Max Bending : .018** 40-12867

**Max Bending : .016** 40-12871

## Lingual Bending Plier (J & J Instrument)



Lingual Bar & Wire Bending Plier

**#100 To bend and shape lingual bars and wires** 40-12874

## Lingual Instruments (Shioda-Japan)

**Tie-Back (Cynch-Back) Pliers** 40-12876

**Lingual Utility Pliers** 40-12875

**Lingual Ligature Cutters Max Cutting: .015** 40-12877

**Distal End Safety Cutters - Slim, Long-Handle, Flush Cut, Max Cutting: .022 x .028** 40-12878



# Instruments



Prestige Dental Products, Inc.  
 Prestigedentalproducts.com  
 Tel: 877-772-3888

## Loop Forming Pliers (Shioda-Japan)

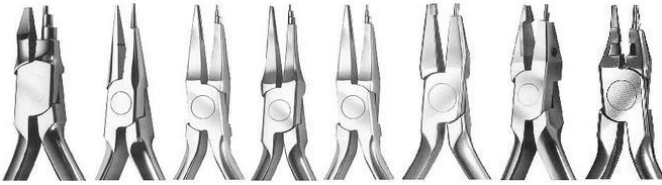

<b>Young Pliers Max Bending</b> : 0.04	40-12902
<b>Jarabak Pliers Max Bending:</b> .040	40-12901
<b>Tweed Loop Forming Pliers Max Bending:</b> .022	40-12900
<b>Omega Loop Forming Pliers Max Bending:</b> .022	40-12899
<b>Loop Forming Pliers Max Bending:</b> .022	40-12898
<b>Quad Helix Bending Pliers Max Bending</b> : .036	40-12897
<b>Hex Wrench</b>	40-12896
<b>Tweed Loop Forming Pliers, Max Bending</b> .022 x .028	40-12903
<b>Kim Pliers w/t Cutters, Max Cutting</b> : .016 x .022	40-12894
<b>Replacement Tip</b>	40-12895

## Nose Plier (J & J Instrument)

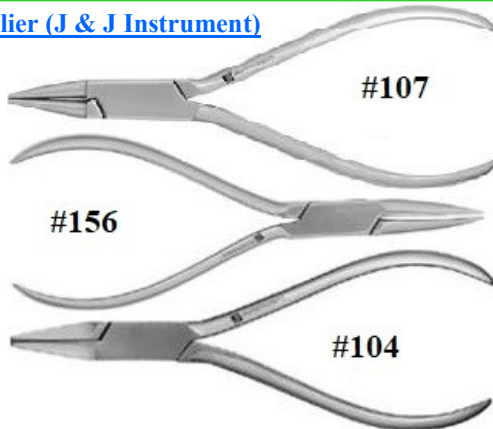

<b>Flat Nose Plier # 104</b>	40-13106
<b>Round Nose Plier #107</b>	40-13107
<b>Fischer Flat Nose Plier #156</b>	40-13105

## Pin and Ligature Cutters (Shioda-Japan)



<b>1 -Max Cutting:</b> .015	40-13278
<b>2 -Miniature, Max Cutting:</b> .016	40-13279

<b>3- Max Cutting:</b> .016	40-13280
<b>4-Miniature, Max Cutting:</b> .015	40-13277
<b>5-Max Cutting:</b> .015	40-13276
<b>6- 45 Angle Max Cutting:</b> .015	40-13275

## Pin and Ligature Cutter (J & J Instrument)



<b>#1002 - ELITE</b>			
<b>#150S</b>			
<b>#150</b>			
<b>#150 - CARBIDE</b>			
<b>#150</b> For close cutting of pins and ligatures		40-13272	
<b>#150S Small handle. For</b> close cutting of pins and ligatures		40-13273	
<b>#1002 Elite Fluted Handle</b>		40-13274	
<b>#150 Carbide Tips. For</b> close cutting of pins and ligatures with tungsten-carbide inserted tips		40-23275	
<b>#151 Small Carbide</b>		40-23276	

## Posterior Bracket Holders

Designed for direct bonding of posterior teeth. Small head for excellent field of vision. Serrated tips for a positive grip.



<b>Each</b>	44-13602
-------------	----------

## Posterior Bracket Holders (ATW)



Designed for direct bonding of posterior teeth. Small head for excellent field of vision. Serrated tips for a positive grip.

<b>Each</b>	44-97911
-------------	----------

## Posterior Bracket Placing Tweezers (ATW)



Stainless steel holder is designed for accurate placement of anterior and posterior direct bond brackets and buccal tubes. Excellent field of vision.

<b>Each</b>	44-97902
-------------	----------

# Instruments



Prestige Dental Products, Inc.  
 Prestigedentalproducts.com  
 Tel: 877-772-3888

## Power Cutters (Shioda-Japan)

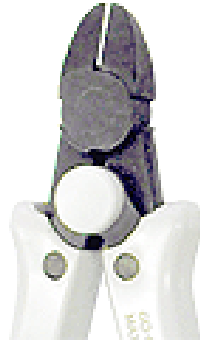

Max Cutting: 1.5      40-13409

## Scaler - Ligature Director (Nordent)



#115 Double Ended DuraLite® HEX      40-16711

#115 Double Ended Standard      40-16712

## Schure Band Seater (ATW)

High Quality

Each      44-97941

## Separator Plier (J & J Instrument)



#103 To easily hold, spread, and place  
 elastics      40-13778

## Side Cutting Plier (J & J Instrument)



#70 Cuts around hardwire      40-13783

## Tube Contouring Pliers (DSC)

High Quality  
 Made in Japan



Each      40-98501

## Tube Crimping Pliers (Shioda-Japan)

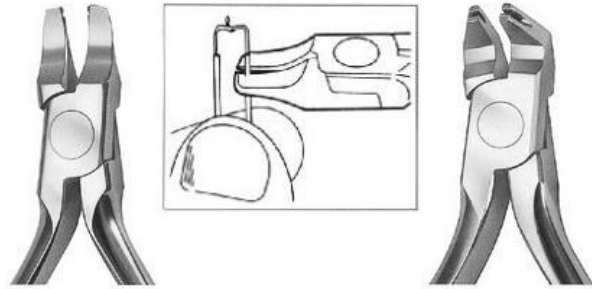

Tube Crimping Plier      40-13953

Hook Crimping Plier      40-13952

## Utility & Wire Forming Pliers (Hu-Friedy)



- Weingart Slim
- Adhesive Removing
- Replacement Blade
- Replacement Tips

Weingart Slim      40-106961

Adhesive Removing      40-106962

Replacement Blade      40-106963

Replacement Tips      40-106964

## Utility Plier (J & J Instrument)



Weingart Plier #861      40-13986

## Weingart Plier (J & J Instrument)



#158 Elite Fluted Handle Utility plier      40-14012  
 with offset tips and serrated pads



# Instruments



Prestige Dental Products, Inc.  
 Prestigedentalproducts.com  
 Tel: 877-772-3888

## Weingart Utility Plier (Shioda-Japan)



Each 40-14013

## Wire Bending Plier (J & J Instrument)

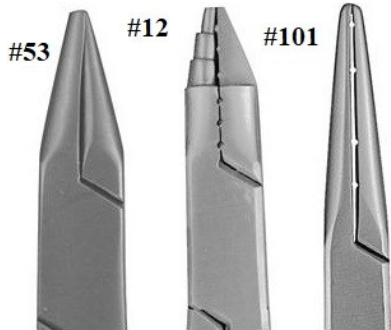

**#12** Makes various bends and loops for wire bending 40-14016  
**#53** One concave beak and one round beak 40-14017  
**#101** For bending wire 40-14018

## Wire Bending Pliers (Shioda-Japan)

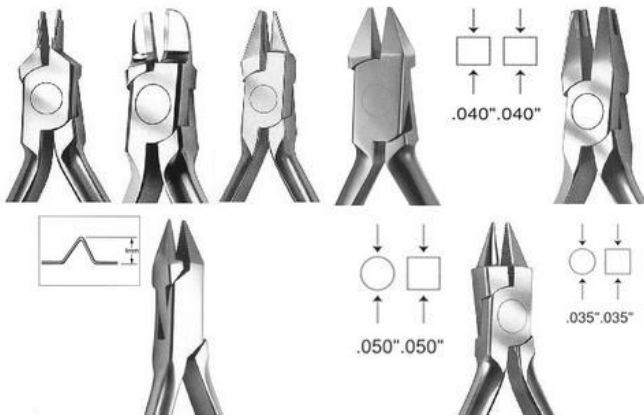

**Nance Closing Loop Pliers Max Bending: .022** 40-14019  
**Tweed Arch Bending Pliers Max Bending: .022 x .028** 40-14020  
**Three Jaw Pliers Max Bending: .028** 40-14021  
**Adams Pliers Max Bending: .040** 40-14024  
**Stop Pliers Max Bending: .025** 40-14022  
**Heavy Wire Bending Pliers Max Bending: .047** 40-14023

**Wire Bending Pliers Max Bending: .028** 40-14025

## Wire Bending Pliers- Forming Pliers (Shioda-Japan)

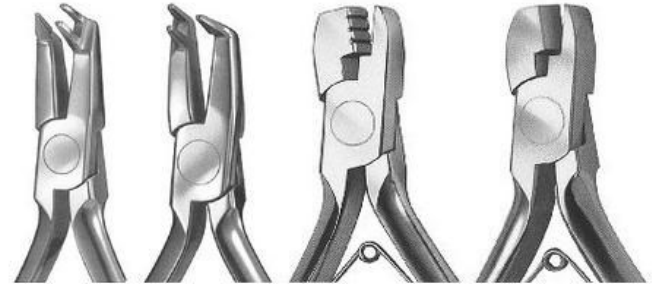

**Angled Three Jaw Pliers Left Max Bending: .036** 40-14026  
**Angled Three Jaw Pliers Right Max Bending: .036** 40-14028  
**Arch Forming Pliers Grooved Grooves of: .016, .018, .022** 40-14027  
**Arch Forming Pliers** 40-14029

## Wire Cutter (Hu-Friedy)



Micro-Mini Pin & Ligature Cut Long Handle

Each 40-106971

## Wire Cutter (J & J Instrument)



**#7001 Elite Fluted Handle** 40-14031  
**#7001 Screw & Wrench Kit for Wire Cutter** 40-14030

## Wire Pliers with TC Cutters- Light (Shioda-Japan)

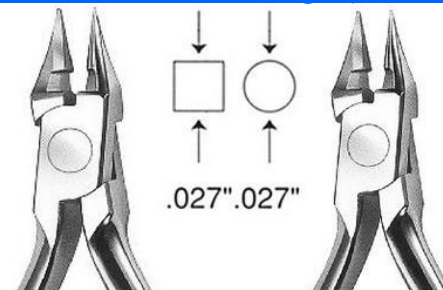



# Instruments



Prestige Dental Products, Inc.  
 Prestigedentalproducts.com  
 Tel: 877-772-3888

**Grooved Square Tip Max Cutting: .020** 40-12872  
**Max Cutting: .020** 40-12873

## Surgical Instruments

### Blade Handles (Nordent)

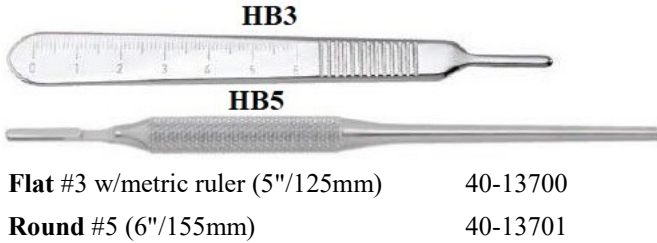

### Bone Chisel (J & J Instrument)

**Coupland Bone Chisel, #1** 40-11269  
**Coupland Bone Chisel, #2** 40-11270  
**Gardner Bone Chisel, #51** 40-11271  
**Gardner Bone Chisel, #52** 40-11272  
**Wakefield Bone Chisel, #1W** 40-11273  
**Wakefield Bone Chisel, #2W** 40-11274

### Bone Expander Kit (Surgident)



**Full Set** 40-103301  
**Expander Drill 1.8/2.5, each** 40-103302  
**Expander Drill 2.0/3.0, each** 40-103303  
**Expander Drill 2.5/3.5, each** 40-103304  
**Expander Drill 2.8/4.0, each** 40-103305  
**Expander Drill 3.0/4.5, each** 40-103306

### Bone File (DA)



### Bone File (J & J Instrument)



**Bone File #12A Cross-Serrated** 40-11275  
**Bone File #10** 40-11277  
**Howard Bone File #12** 40-11276  
**Miller Bone File #21** 40-11278  
**Miller Bone File #64** 40-11280  
**Miller Bone File #45** 40-11279

### Bone File (Miltex)



**Howard #12** 40-22222  
**Miller #45** 40-22221  
**Miller #64** 40-22220

### Bone Files (Nordent)

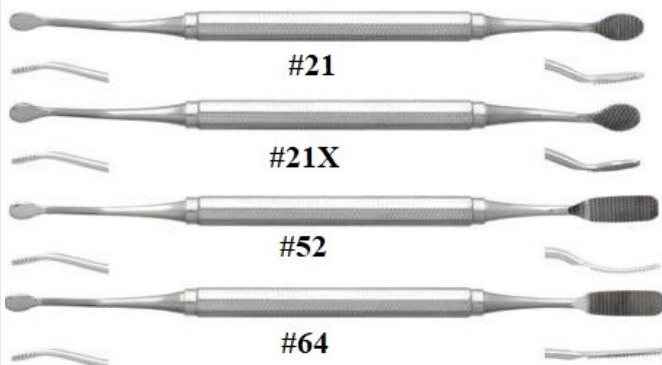

**#21, Bone Double Ended Miller** 40-11281

# Instruments



Prestige Dental Products, Inc.  
 Prestigedentalproducts.com  
 Tel: 877-772-3888

#21, Bone Double Ended Miller-Cross Cut	40-11282
#52, Bone Double Ended Miller	40-11283
#64, Bone Double Ended Miller	40-11284

### Bone Ronguers (Miltex)

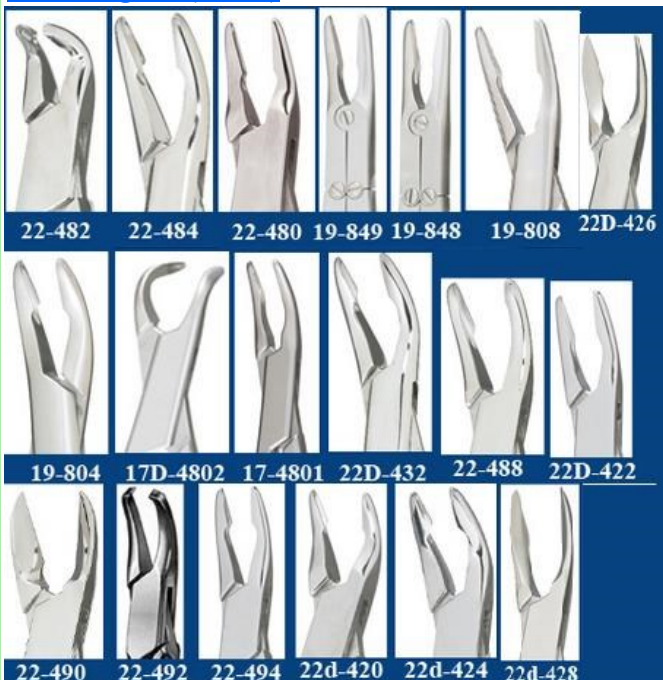

Miltex Blumenthal Ronguers 30°	40-20000
Miltex Blumenthal Ronguers 45°	40-20001
Miltex Blumenthal Ronguers 90°	40-20002
Miltex Blumenthal Ronguers 90°	40-20003
Miltex Blumenthal Ronguers Mini 45°	40-20004
Miltex Friedman Ronguers	40-20005
Miltex Side Cutting Ronguers, 6-3/4"	40-20006
Miltex Side Cutting Ronguers, 6"	40-20007
Miltex Blumenthal Ronguers 30° 7"	40-20008
Miltex Micro Friedman Ronguers 5 1/2"	40-20009
Miltex Micro Friedman Ronguers 90° 5 1/2"	40-20010
Miltex Ruskin 6" long Ronguers Streight	40-20011
Miltex Bit Jaw Curved Ronguers 3mm	40-20012
Miltex Bain Mastoid Ronguers 7"	40-22000
Miltex Hartman Mastoid Ronguers 5 3/4"	40-22001
Miltex Gardner End Cutting Ronguers 6 1/2"	40-22002

Miltex Mead Ronguers 6 1/2"	40-22003
Miltex #1 Ronguers 6 1/2"	40-22004
Miltex Cleveland 4 Ronguers 5 1/2"	40-22005
Miltex Cleveland 4A Ronguers 6 1/2"	40-22006
Miltex Cleveland 5A Ronguers 6 1/2"	40-22007

### Cheek Retractors



Great for initial bonding giving you a full view of anterior and posterior teeth  
 - Breakage resistant  
 - Autoclavable up to 225F

Small, 2/Pkg	44-98361
Medium, 2/Pkg	44-98362
Large, 2/Pkg	44-98363
Assorted sizes, 3/Pkg (1x Large, 1x Medium and 1 x Small)	44-98364

### Double Ended Cheek Retractors (PlasDent)



Large Size, Clear, 2pcs/box	40-12885
Small Size, Clear, 2pcs/box	40-12886

### Double Ended Retractor (Dentsply)



Autoclavable 2 Pair Kit	44-11895
Heat Sterilizable 2 Pair Kit	44-11894
Cold Sterilizable 2 Pair Kit	44-11892
Large Autoclavable 1 Pair	44-11893
Large Heat Sterilizable 1 Pair	44-11891

# Instruments



Prestige Dental Products, Inc.  
 Prestigedentalproducts.com  
 Tel: 877-772-3888

<b>Large Cold Sterilizable 1 Pair</b>	44-11890
<b>Pedo Autoclavable 1 Pair</b>	44-11889
<b>Pedo Heat Sterilizable 1 Pair</b>	44-11887
<b>Pedo Cold Sterilizable 1 Pair</b>	44-11888

### Dress Forcep (J & J Instrument)



**Adson Dressing Forcep Serrated 4.75"** 40-11656

### Dressing Forcep (J & J Instrument)

<b>5", Dressing Forcep Serrated</b>	40-11657
<b>5.5", Dressing Forcep Serrated</b>	40-11658
<b>6", Dressing Forcep Serrated</b>	40-11659
<b>8", Dressing Forcep Serrated</b>	40-11660

### Elevator (J & J Instrument)

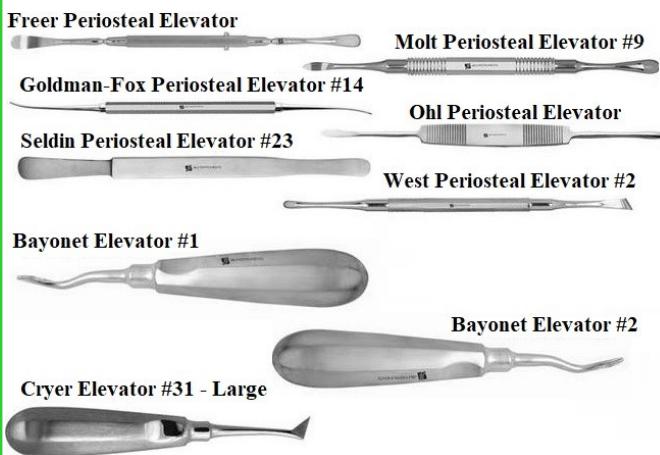

<b>General Elevator #191</b>	40-11704
<b>Cross-Bar Elevator #12L</b>	40-11683
<b>Cross-Bar Elevator #11R</b>	40-11684
<b>Cross-Bar Elevator #11L</b>	40-11685
<b>Cryer Elevator #45 Small Right</b>	40-11686
<b>Cryer Elevator #44 Small Left</b>	40-11687
<b>Heidbrink Elevator #41</b>	40-11688
<b>Heidbrink Elevator #40</b>	40-11689
<b>Root Tip Elevator #341</b>	40-11690
<b>Cryer Elevator #26 Medium</b>	40-11691
<b>Cryer Elevator #25 Medium</b>	40-11693

<b>Stout Elevator #11A</b>	40-11692
<b>Stout Elevator #11</b>	40-11695
<b>Seldin Elevator #3</b>	40-11694
<b>Cross-Bar Elevator #12R</b>	40-11696
<b>Cross-Bar Elevator #14L</b>	40-11697
<b>General Elevator #190</b>	40-11682
<b>Howard Elevator #3</b>	40-11699
<b>Howard Elevator #2</b>	40-11700
<b>Howard Elevator #1</b>	40-11698
<b>Heidbrink Elevator #80</b>	40-11701
<b>Miller Elevator #74</b>	40-11702
<b>Miller Elevator #73</b>	40-11703
<b>Miller Elevator #72</b>	40-11705
<b>Miller Elevator #71</b>	40-11706
<b>Schmeckebier Elevator #5</b>	40-11707
<b>Schmeckebier Elevator #4</b>	40-11708
<b>Schmeckebier Elevator #81</b>	40-11709
<b>Cross-Bar Elevator #14R</b>	40-11710
<b>Heidbrink Elevator #1</b>	40-11729
<b>Heidbrink Elevator #2</b>	40-11711
<b>Potts Cross-Bar Elevator #2</b>	40-11730
<b>Crane Pick Elevator #41 (8)</b>	40-11714
<b>Spear Elevator #36</b>	40-11715
<b>Gouge Elevator #34</b>	40-11717
<b>Gouge Elevator #34S</b>	40-11716
<b>Cryer Elevator #32 Large</b>	40-11718
<b>Cryer Elevator #31 Large</b>	40-11719
<b>Bayonet Elevator #2</b>	40-11720
<b>Bayonet Elevator #1</b>	40-11721
<b>West Periosteal Elevator #2</b>	40-11722
<b>Seldin Periosteal Elevator #23</b>	40-11723
<b>OHL Periosteal Elevator</b>	40-11724
<b>Goldman-Fox Perio Elevator #14</b>	40-11725
<b>Freer Periosteal Elevator</b>	40-11742
<b>Gouge Elevator #46</b>	40-11727
<b>Universal Elevator #50</b>	40-11728
<b>Potts Cross-Bar Elevator #1</b>	40-11713
<b>Seldin Elevator #4R</b>	40-11712
<b>Seldin Elevator #4L</b>	40-11731
<b>Seldin Elevator #1R</b>	40-11732



# Instruments



Prestige Dental Products, Inc.  
 Prestigedentalproducts.com  
 Tel: 877-772-3888

Seldin Elevator #1L	40-11733
Apical Elevator #304	40-11734
Apical Elevator #303	40-11735
Apical Elevator #302	40-11736
Apical Elevator #301	40-11737
Root Tip Elevator #80	40-11738
Root Tip Elevator #79	40-11739
Root Tip Elevator #78	40-11740
Universal Elevator #51	40-11741
Molt Periosteal Elevator #9	40-11726

## Elevator (Miltex)

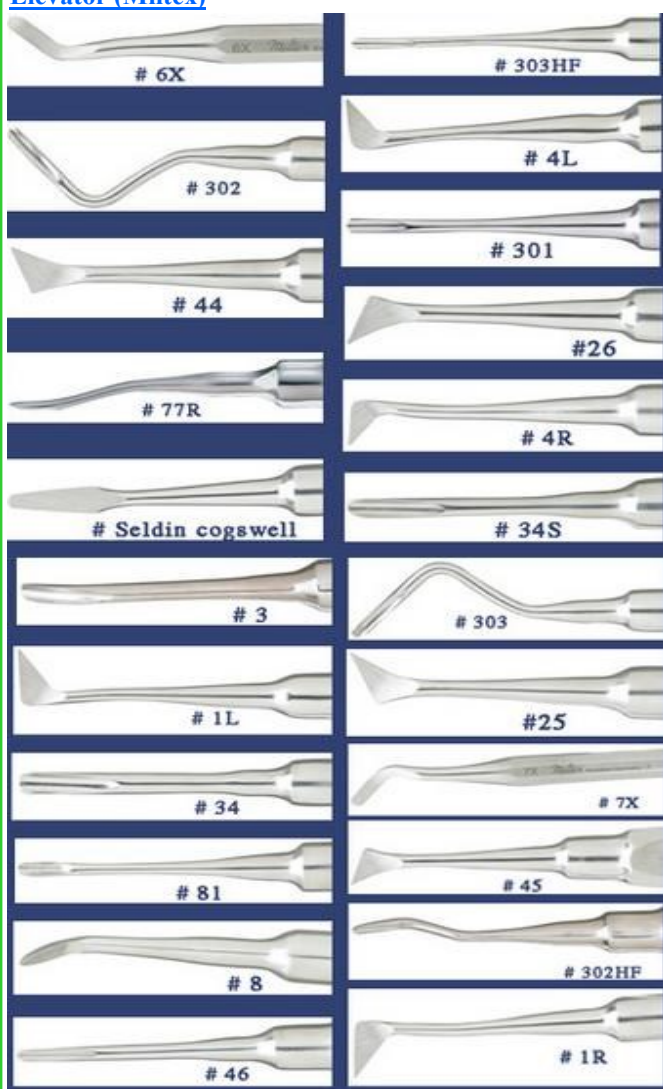

#3	40-2500
#81	40-2501
#34	40-2502
#34S	40-2503

#46	40-2504
Cryer #25	40-2505
Cryer #26	40-2506
Cryer #44	40-2507
Cryer #45	40-2508
Apical #301	40-2509
Apical #302	40-2510
Apical #303	40-2511
Crane Pick #8	40-2512
Seldin #1L	40-2513
Seldin #1R	40-2514
Seldin #4L	40-2515
Seldin #4R	40-2516
Miltex Potts T-Bar #6X	40-2517
Miltex Potts T-Bar #7X	40-2518
Seldin #302HF	40-2519
Seldin #303HF	40-2520
Seldin #77R	40-2521
Seldin Cogswell	40-2522

## Elevator (Nordent)



Nordent offers a complete selection of American Made Elevators for every extraction procedure. You will find all of your "old favorites" and several unique patterns listed in this section. We can also assist you with special modification and design services if you have specific application requirements.

Crane Pick #8 Four sided blade used for segmenting teeth	40-60000
Apexo #E301	40-60001
Cryer #25 Large flag - Left	40-60002
Cryer #26 Large flag - Right	40-60003
#46R Back-Action bend with a 3.2mm blade	40-96004
#77R Back-Action bend with a 3.7mm blade	40-60005
#E80 Straight gouge with a 3.0mm blade	40-60006
#E81 Modified Apexo straight with a 3.0mm blade	40-60007
Miller #72 Right Shank & compound blade angle allows easy access to 3rd molars	40-60008

# Instruments



Prestige Dental Products, Inc.  
 Prestigedentalproducts.com  
 Tel: 877-772-3888

Miller #71 Left Shank & compound blade angle allows easy access to 3rd molars	40-60009
Miller #73 Left	40-60010
Miller #74 Right	40-60011
Seldin #1L Left	40-60012
Seldin #1R Right	40-60013
Seldin #4L Left	40-60014
Woodward #15 Left	40-60015
Woodward # E16	40-60016
Seldin #E34S	40-60017
Seldin # E34	40-60018
Cryer #44 Medium flag - Left	40-60019
Cryer #45 Medium flag - Right	40-60020
Apexo #E4	40-60021
Apexo #E5	40-60022
Stout # E11A	40-60023
#E190	40-60024
#E191	40-60025
Potts # E6	40-60026
Potts # E7	40-60027
Seldin #301 (TIN)	40-60028
Seldin #E80 (TIN)	40-60029
Seldin #E81 (TIN)	40-60030
Seldin #1 (TIN)	40-60031
Seldin #40 (TIN)	40-60032
Seldin #41 (TIN)	40-60033
Seldin #34 (TIN)	40-60034
Seldin #34S (TIN)	40-60035
Seldin #4R Right. (TIN)	40-60036
Seldin #303	40-60037
Seldin #303 (TIN)	40-60038
Seldin #46R (TIN)	40-60039
Seldin # 77R (TIN)	40-60040
Seldin # 11A (TIN)	40-60041
Seldin # 8 (TIN)	40-60042
Seldin # 46 (TIN)	40-60043
Seldin # 25 (TIN)	40-60044
Seldin # 26 (TIN)	40-60045
Seldin # 44 (TIN)	40-60046

Seldin # 45 (TIN)	40-60047
Seldin # 71 (TIN)	40-60048
Seldin # 72 (TIN)	40-60049
Seldin # 4 (TIN)	40-60050
Seldin # 5 (TIN)	40-60051
Seldin # 190 (TIN)	40-60052
Seldin # 191 (TIN)	40-60053
Seldin # 77 (TIN)	40-60054

## Extnd Autoclavable Cheek Retractors (PlasDent)



Large Size, Clear, 2pcs/box	44-94621
Medium Size, Clear, 2pcs/box	44-94622
Small Size, Clear, 2pcs/box	44-94623

## Extnd Disposable Cheek Retractors (PlasDent)

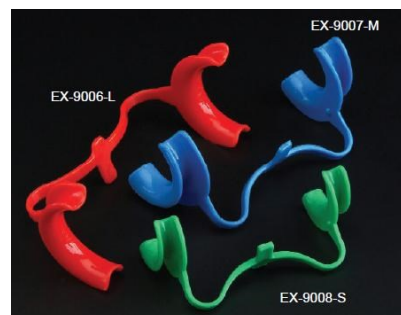

Large Size, Red, 10pcs/bag	44-94611
Medium Size, Blue, 10pcs/bag	44-94612
Small size, Green, 10pcs/bag	44-94613

## Extnd Disposable Mouth Props (PlasDent)



Large (Adult) White, 48pcs/bag	40-88530
--------------------------------	----------

# Instruments



Prestige Dental Products, Inc.  
 Prestigedentalproducts.com  
 Tel: 877-772-3888

**Medium (Child) White, 48pcs/bag** 40-88531

**Small (Pedo) White, 48pcs/bag** 40-88532

### Extra Oral Cheek Expander (Dentsply)

Designed to prevent  
 brakeage, with extra long  
 buccal extension that  
 allows greater access to  
 posterior region.  
 - comes autoclavable or  
 disposable for single use  
 only.



**Autoclavable, for child with tabs individually** 40-12024

**Autoclavable, for adults with tabs individually** 40-12021

**Autoclavable, for child individually** 40-12025

**Autoclavable, for adult individually** 40-12023

**Disposable, for child with tabs, 10/Pkg** 40-12020

**Disposable, for adult with tabs, 10/Pkg** 40-12018

**Disposable, for child, 10/Pkg** 40-12022

**Disposable, for adult, 10/Pkg** 40-12019

### Extracting Forceps For Children with Non Slip Jaws (ASA Italy)



**N.1 Upper Incisors** 40-12034

**N.2 Upper Premolars** 40-12027

**N.3 Upper Molars** 40-12028

**N.4 Upper Roots** 40-12029

**N.5 Lower Incisors** 40-12030

**N.6 Lower Molars** 40-12031

**N.7 Lower Roots** 40-12032

### Extracting Forcep (American Pattern) (ASA Italy)



**0120-150 0120-151 0120-16 0120-18L 0120-18R 0120-222**

**N.150 Cryer Upper Inc.Prem.Root** 40-12035

**N.151 Lower Inc.Pre.Roots** 40-12037

**N.16 Lower Molars** 40-12039

**N.18L Upper Molar Right** 40-12040

**N.18R Upper Molar Right** 40-12036

**Fig.222 Lower Third Molars** 40-12038

### Extracting Forceps with Non Slip Jaws (ASA Italy)



**N.1, Upper Incisors & Canines** 40-12055

**Fig.13, Lower Premolars** 40-12042

**Fig.17, Upper Right Molars** 40-12056

**Fig.18, Upper Molars Left** 40-12054

**Fig.22, Lower Molars** 40-12053

**Fig.22L, Routurier** 40-12051

**Fig.33, Lower Roots** 40-12050

**Fig.4, Lower Incisors Canines** 40-12052

**Fig.45, Lower Roots** 40-12049



# Instruments



Prestige Dental Products, Inc.  
 Prestigedentalproducts.com  
 Tel: 877-772-3888

<b>Fig.51, Upper Roots</b>	40-12048
<b>Fig.51A, Upper Roots</b>	40-12046
<b>Fig.67, Upper Third Molars</b>	40-12047
<b>Fig.67A, Upper Third Molars</b>	40-12043
<b>Fig.7, Upper Premolars</b>	40-12045
<b>Fig.79, Lower Third Molars</b>	40-12044
<b>Fig.86C, Lower Molars</b>	40-12057
<b>Set of N.8, Extracting Forceps</b>	40-12041

## Extraction Forceps (Nordent)

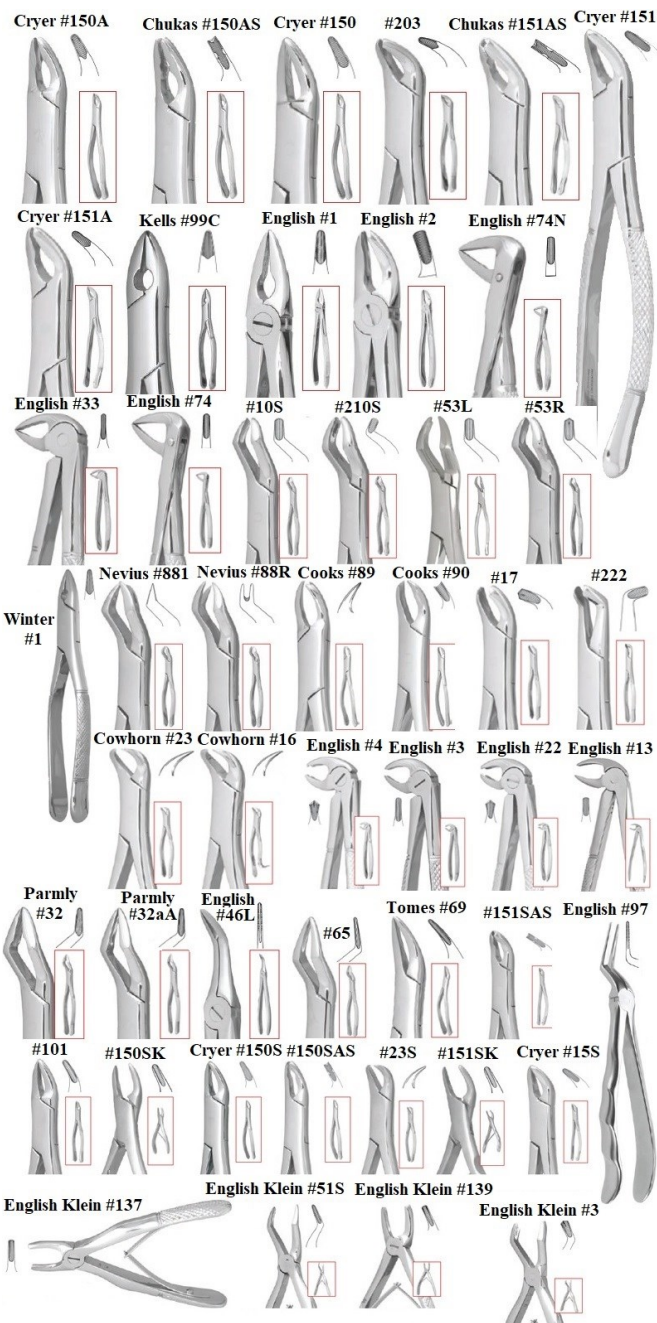

## English Klein #5 English Klein #7 English Klein #6



<b>#1 Upper Incisor Standard</b>	40-12109
<b>#1 Upper Incisor Standard Serrated</b>	40-12095
<b>#10S Upper Molar Universal</b>	40-12094
<b>#10S Upper Molar Universal Serrated</b>	40-12093
<b>#16 Lower Molar Cowhorn (Hook Handle)</b>	40-12092
<b>#17 Lower Molar Universal</b>	40-12091
<b>#17 Lower Molar Universal Serrated</b>	40-12090
<b>#23 Lower Molar CowHorn (Straight Handle)</b>	40-12089
<b>#32 Upper Bicuspid Universal</b>	40-12088
<b>#32 Upper Bicuspid Universal Serrated</b>	40-12087
<b>#32A Upper Bicuspid &amp; Roots Universal</b>	40-12086
<b>#32A Upper Bicuspid &amp; Roots Serrated Universal</b>	40-12085
<b>#46L Lower Root Fragments (Handform Handle)</b>	40-12096
<b>#53L Upper Left Molar 1st &amp; 2nd</b>	40-12097
<b>#53L Upper Left Molar 1st &amp; 2nd Serrated</b>	40-12108
<b>#53R Upper Right Molar 1st &amp; 2nd</b>	40-12107
<b>#53R Upper Right Molar 1st &amp; 2nd Serrated</b>	40-12106
<b>#65 Upper Incisors &amp; Roots</b>	40-12105
<b>#65 Upper Incisors &amp; Roots Serrated</b>	40-12104
<b>#69 Upper Incisors &amp; Roots</b>	40-12103
<b>#69 Upper Incisors &amp; Roots Serrated</b>	40-12102
<b>#88L Upper Molar 1st &amp; 2nd Anatomical</b>	40-12101
<b>#88R Upper Molar 1st &amp; 2nd Anatomical</b>	40-12100
<b>#89 Upper Molar 1st &amp; 2nd Cooks Left</b>	40-12099
<b>#90 Upper Molar 1st &amp; 2nd Cooks Right</b>	40-12098
<b>#97 Upper Root Fragments (Handform Handle)</b>	40-12084
<b>#99C Upper Incisor Cuspids &amp; Bicuspid</b>	40-12083
<b>#99C Upper Incisor Cuspids &amp; Bicuspid Serrated</b>	40-12069
<b>#150 Upper Cryer Universal</b>	40-12068
<b>#150 Upper Cryer Universal Serrated</b>	40-12067



Prestige Dental Products, Inc.  
 Prestigedentalproducts.com  
 Tel: 877-772-3888

# Instruments

#150AS Upper Anatomical Beaks Universal	40-12066
#150 Upper Parallel Beaks Universal	40-12065
#150A Upper Parallel Beaks Universal Serrated	40-12064
#151 Lower Cryer Universal	40-12063
#151 Lower Cryer Universal Serrated	40-12062
#151A Lower Parallel Beaks Universal	40-12061
#151A Lower Parallel Beaks Universal Serrated	40-12060
#151AS Lower Anatomical Beaks Universal	40-12059
#203 Lower Bicuspid	40-12070
#203 Lower Bicuspid Serrated	40-12071
#210S Upper Middle Third Universal	40-12082
#210S Upper Molar Third Universal Serrated	40-12081
#222 Lower Molar Third Universal	40-12080
#222 Lower Molar Third Universal Serrated	40-12079
#1 Upper Anterior Mead	40-12078
#1 Upper Anterior Mead Serrated	40-12077
#2 Upper Bicuspid Mead	40-12076
#2 Upper Bicuspid Mead Serrated	40-12075
#3 Lower Anterior Mead English Style	40-12074
#3 Lower Anterior Lower Anterior Mead English Style Serrated	40-12073
#4 Lower Molar Mead English Style	40-12072
#4 #4 Lower Molar Mead English Style Serrated	40-12058

## Extracting Forceps English Pattern (Nordent)

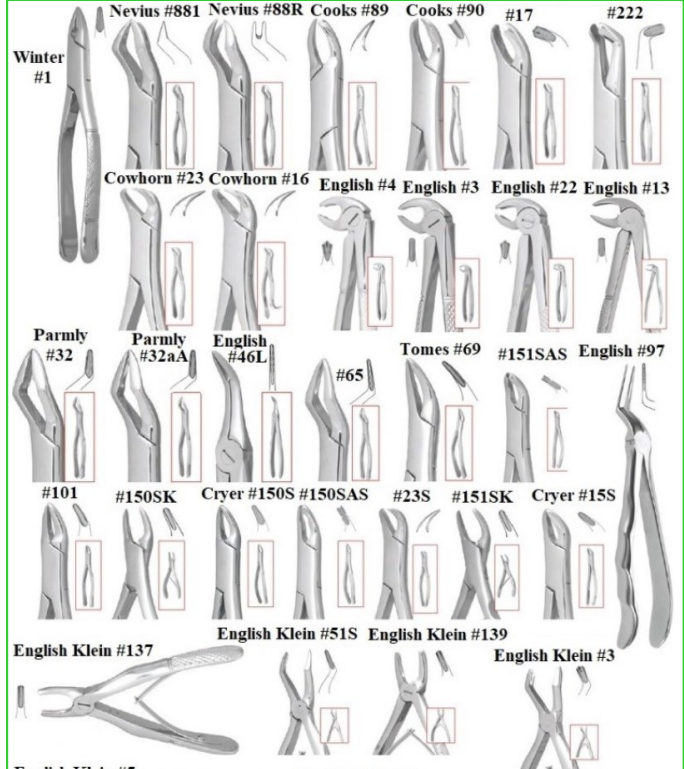
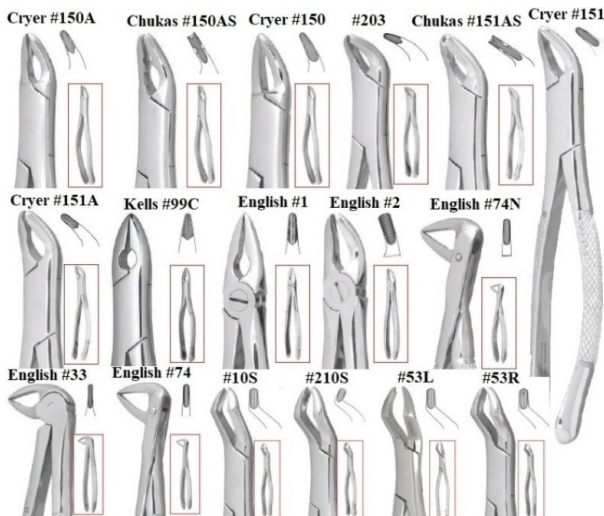

#13 Lower Bicuspid English Pattern	40-12129
#13 Lower Bicuspid English Pattern Serrated	40-12130
#22 Lower Molar English Pattern	40-12131
#22 Lower Molar English Pattern Serrated	40-12132
#33 Lower Roots English Pattern	40-12133
#33 Lower Roots English Pattern Serrated	40-12134
#74 Lower Roots English Pattern	40-12135
#74 Lower Roots English Pattern Serrated	40-12124
#74N Lower Roots English Pattern Narrow Beak	40-12123
#74N Lower Roots English Pattern Narrow Beak Serrated	40-12122
#1X Upper Anterior English Pattern	40-12111
#1X Upper Anterior English Pattern Serrated	40-12112
#7X Upper Pre-Molars English Pattern	40-12113
#7X Upper Pre-Molars English Pattern Serrated	40-12114
#17X Upper Molars Right English Pattern	40-12115
#17X Upper Molars Right English Pattern Serrated	40-12116





Prestige Dental Products, Inc.  
 Prestigedentalproducts.com  
 Tel: 877-772-3888

# Instruments

#18X Upper Molars Left English Pattern	40-12117
#18X Upper Molars Left English Pattern Serrated	40-12118
Upper Tapered Beak English Pattern Universal	40-12119
Lower Anterior Tapered Beak English Pattern	40-12120
Upper Anterior Tapered Beak English Pattern	40-12121
Upper Root Fragments E English Pattern Serrated	40-12128
#67A Upper Molars Third English Pattern Universal	40-12127
#67A English Pattern Serrated	40-12126
#79X Lower Molars Third English Pattern	40-12125
#79X Lower Molars Third English Pattern Serrated	40-12110

## Extraction Forceps Pedodontic (Nordent)

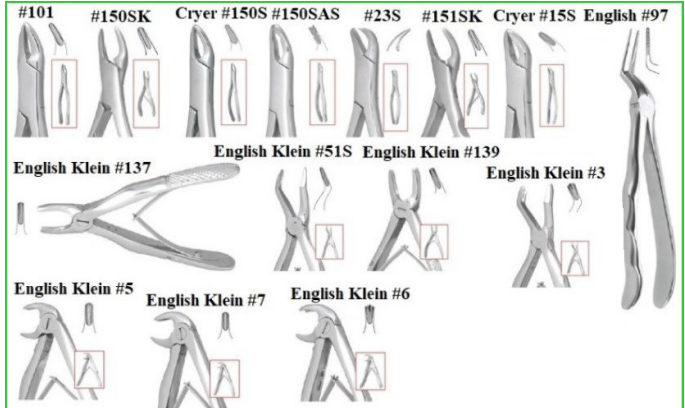
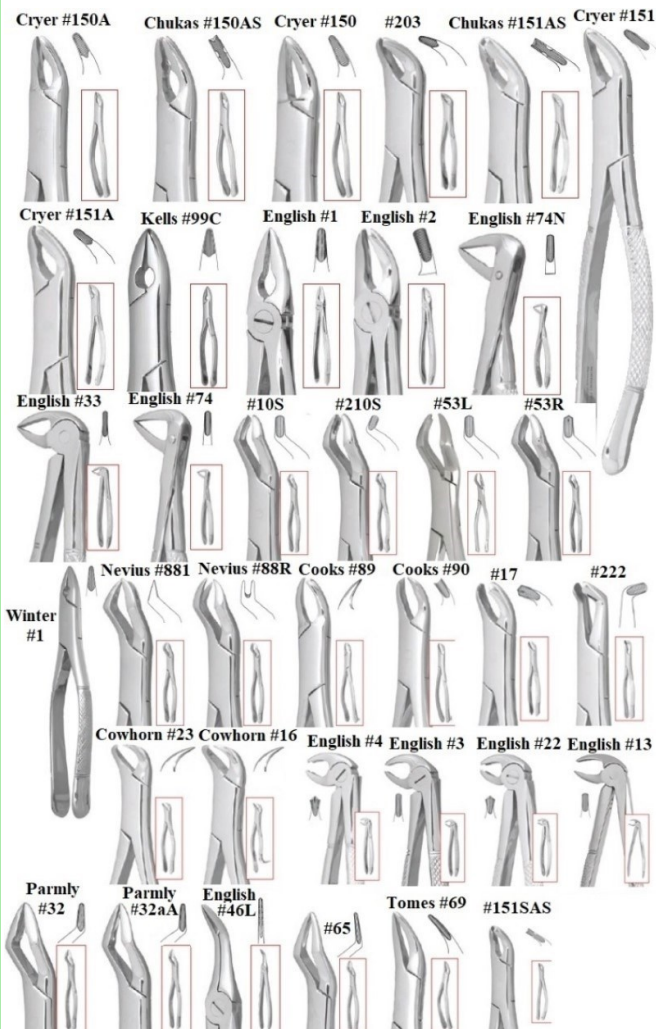

#23S Lower Molar Pedodontic Cowhorn	40-12149
#101 Upper Pedodontic Universal	40-12138
#101 Upper Pedodontic Universal Serrated	40-12139
#150S Upper Pedodontic Cryer Universal	40-12140
#150S Upper Pedodontic Cryer Universal Serrated	40-12141
#150S Upper Pedodontic Cryer Universal Anatomical Beaks	40-12142
#150SK Pedodontic (Spring Handle 120mm)	40-12123
#150SK Pedodontic (Spring Handle 120mm) Serrated	40-12144
#151SK Pedodontic (Spring Handle 120mm)	40-12145
#151SK Pedodontic (Spring Handle 120mm) Serrated	40-12146
#151S Pedodontic Lower Universal	40-12147
#151S Pedodontic Lower Universal Serrated	40-12148
#151S Pedodontic Lower Universal Anatomical Beaks	40-12137

## Extraction Forceps Pedodontic English Pattern (Nordent)

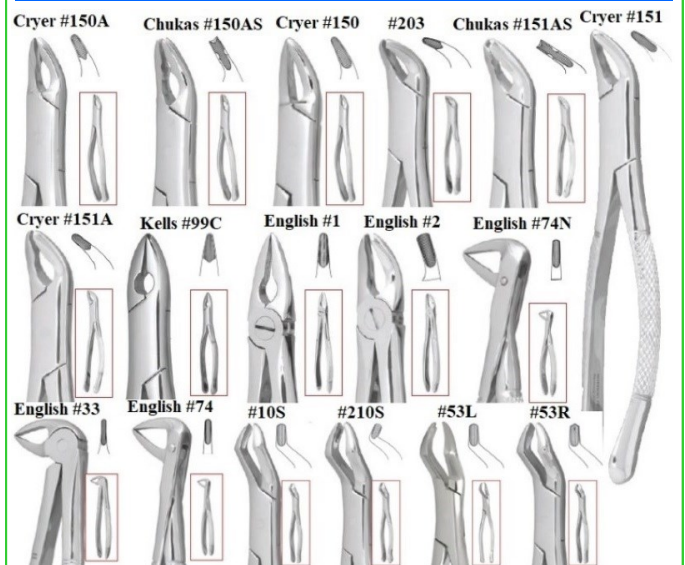



# Instruments



Prestige Dental Products, Inc.  
 Prestigedentalproducts.com  
 Tel: 877-772-3888

<b>Upper Molars Universal English Pattern</b>	40-12156
<b>Lower Incisors English Pattern</b>	40-12155
<b>Lower Molars English Pattern</b>	40-12154
<b>Lower Roots English Pattern</b>	40-12153
<b>Upper Roots English Pattern</b>	40-12152
<b>Upper Incisors English Pattern</b>	40-12151
<b>Upper Premolars English Pattern</b>	40-12150

**Stieglitz Fragment Forceps (J & J Instrument)**

<b>5" 45° Tip</b>	40-12234
<b>5" 90° Tip</b>	40-12235
<b>5" Straight Tip</b>	40-12233

**Furnace Tongs (J & J Instrument)**

<b>10" Furnace Tongs Serrated</b>	40-12237
<b>12" Furnace Tongs Serrated</b>	40-12236

**Heidbrink Root Tip Pick (J & J Instrument)**

<b>#2/3</b>	40-12533
<b>#1</b>	40-12534
<b>#2</b>	40-12535
<b>#3</b>	40-12532

**Hemostat (J & J Instrument)**

<b>Rochester Pean 6.25" Straight Forcep</b>	40-12552
<b>Mosquito Curved Forcep 3.5"</b>	40-12551
<b>Mosquito Straight Forcep 5"</b>	40-12550
<b>Rochester Pean 6.25" Curved Forcep</b>	40-12549
<b>Kelly Straight Forcep 5.5"</b>	40-12548
<b>Kelly Curved Forcep 5.5"</b>	40-12547
<b>Rankin-Kelly Straight Forcep 6.25"</b>	40-12546
<b>Rankin-Kelly Curved Forcep 6.25"</b>	40-12545
<b>Crile Straight Forcep 5.5"</b>	40-12544
<b>Crile Curved Forcep 5.5"</b>	40-12543
<b>Rankin-Crile Straight Forcep 6.25"</b>	40-12542
<b>Rankin-Crile Curved Forcep 6.25"</b>	40-12541
<b>Rochester Pean 5.5" Straight Forcep</b>	40-12540
<b>Rochester Pean 5.5" Curved Forcep</b>	40-12539



Prestige Dental Products, Inc.  
 Prestigedentalproducts.com  
 Tel: 877-772-3888

## Instruments

### Haemostatic Forceps (ASA Italy)

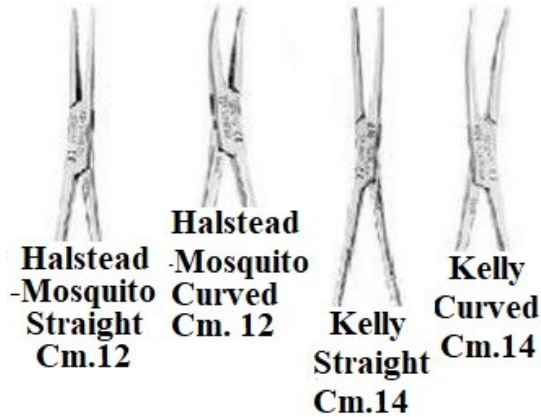

Halstead-Mosquito Straight Cm.12	40-12525
Halstead-Mosquito Curved Cm.12	40-12526
Kelly Straight Cm.14	40-12527
Kelly Curved Cm.14	40-12528

### Hemostats (Nordent)

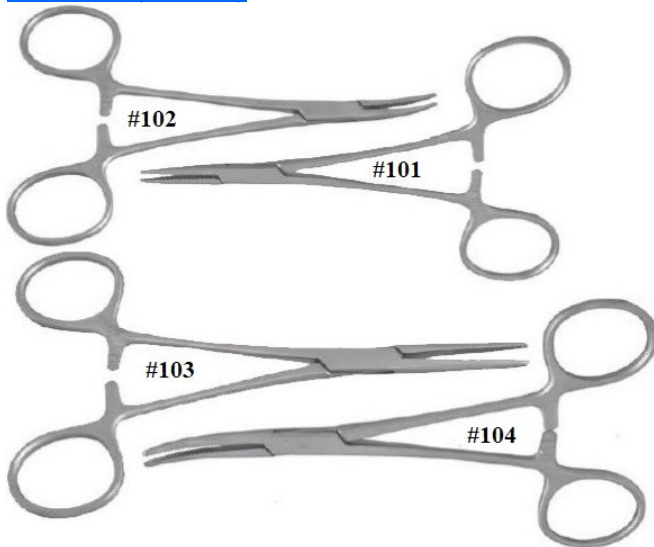

Mosquito Straight N.101 (4-3/4"/120mm)	40-12553
Mosquito Curved N. 102(4-3/4"/120mm)	40-12554
Kelly Straight N.103 (5-3/4"/145mm)	40-12555
Curved N. 104 (5 3/4"/145mm)	40-12556

### Highlights Luxating Elevator (Miltex)



DELLUXC2

Shape & size of handle creates less force on tooth reducing chance of fracture. One piece construction stainless steel, can be sharpened.

#S2 Straight 2mm	40-8001
#C2 Curved 2mm	40-8002

#S3 Straight 3mm	40-8003
#C3 Curved 3mm	40-8004
#S4 Straight 4mm	40-8005
#C4 Curved 4mm	40-8006
#S5 Straight 5mm	40-8007
#C5 Curved 5mm	40-8008

### Lip & Cheek Retractors (Plasdent)



Extnd Handfree Adult Autoclavable to 250 of Clear 2 pcs/box	40-12893
Extnd Handfree Child Autoclavable to 250oF Clear 2 pcs/box	40-12882
Extnd Handhold Adult Autoclavable to 250oF Clear 2 pcs/box	40-12883
Extnd Handhold Child Autoclavable to 250oF Clear 2 pcs/box	40-12884

### Lip Retractors (Pac-Dent)



Disposable plastic cheek retractors expand mouths vertically for unobstructed view of oral cavity.

- Unobstructed view of oral cavity
- In bright, attractive colors

2 x Adult lip retractors, pearlescent red/mauve	44-45441
2 x Adult lip retractors, pearlescent blue	44-45442
2x Adult lip sterilizable retractors, pearlescent white	44-45443



877-772-3888



Prestige Dental Products, Inc.  
 Prestigedentalproducts.com  
 Tel: 877-772-3888

# Instruments

## Luxating Elevators (Hu-Friedy)



Luxating elevators feature thin, sharp blades that are used to cut periodontal ligaments. The elevator tips are permanently fixed to a satin finished, stainless steel handle for increased comfort and control. Luxating elevators reduce pressure on adjacent teeth, as they are used in a rocking motion for cutting as opposed to a standard elevator that lifts and pries.

<b>2mm</b> Straight, each	40-91678
<b>3mm</b> Straight, each	40-91679
<b>4mm</b> Straight, each	40-91680
<b>5mm</b> Straight, each	40-91681
<b>2mm</b> Curved, each	40-91682
<b>3mm</b> Curved, each	40-91683
<b>4mm</b> Curved, each	40-91684
<b>5mm</b> Curved, each	40-91685

## Luxation Blades (Nordent)

Designed to be easily inserted along the root surface and cut the periodontal ligament prior to extraction.

### Features

- Long
- Slender profile
- Ultra-Sharp blades
- NiTi coating to retain sharpness longer
- Comfortable form-fit stainless steel handle.

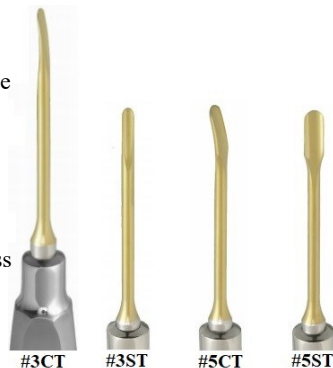

<b>3ST 3mm Straight</b>	40-80010
<b>3CT 3mm Curved</b>	40-80011
<b>5CT 3mm Curved</b>	40-80012
<b>5ST 3mm Straight</b>	40-80013

## Luxator (Directa)

DUAL EDGE 3mm/1.5mm



<b>Luxator Starter Kit, 4pc,</b> (3S, 3C, 5S, 5C, & stone)	40-12904
---	----------

<b>Luxator Kit, 7pc,</b> (2S,3S,3C,3CA,3IC,5S,5C,& stone)	40-12921
<b>Luxator Kit, 5pc,</b> (1S, 2S , 3S, 3C, 3CA, & stone)	40-12920
<b>Luxator 1mm Straight</b> (Light Green Stripes), 1/Pkg	40-12919
<b>Luxator 2mm Straight</b> (Dark Green Stripes), 1/Pkg	40-12922
<b>Luxator 3mm Straight</b> (Gray Stripes), 1/Pkg	40-12905
<b>Luxator 3mm Curved</b> (Black Stripes), 1/Pkg	40-12906
<b>Luxator 3mm ContraAngle</b> (Dark Blue Stripes), 1/Pkg	40-12907
<b>Luxator 3mm Inv. Curv.</b> (Light Blue Stripes), 1/Pkg	40-12908
<b>Luxator 5mm Straight</b> (Tan Stripes), 1/Pkg	40-12909
<b>Luxator 5mm Curved</b> (Brown Stripes), 1/Pkg	40-12910
<b>Luxator Sharpening Stone,</b> 1/Pkg	40-12911
<b>Luxator 3 / 1.5mm Straight</b> (Aqua Handle/Gray Stripes), 1/Pkg	40-12912
<b>Luxator 5 / 3mm Straight</b> (Aqua Handle/Tan Stripes), 1/Pkg	40-12913
<b>Luxator Forte 2.5mm Straight</b> (Black Handle/Green Stripes), 1/Pkg	40-12914
<b>luxator Forte 3.2mm Straight</b> (Black Handle/Grey Stripes), 1/Pkg	40-12915
<b>Luxator Forte 4.0mm Straight</b> (Black Handle/Tan Stripes), 1/Pkg	40-12916
<b>Fixus 1 (tray for 1 Luxator),</b> 1/Pkg	40-12917
<b>Fixus 6 (tray for six Luxators),</b> 1/Pkg	40-12918

## Mallet (J & J Instrument)

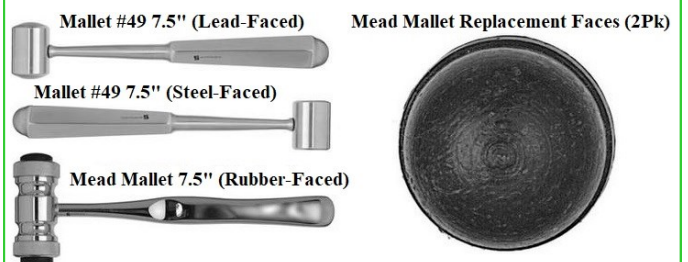

<b>Mallet #49 7.5" Lead-Faced</b>	40-12923
<b>Mallet #49 7.5" Steel-Faced</b>	40-12924
<b>Mead Mallet 7.5" Rubber-Faced</b>	40-12925
<b>Mead Mallet Replacement Facing, 2/Pk</b>	40-12926





Prestige Dental Products, Inc.  
 Prestigedentalproducts.com  
 Tel: 877-772-3888

## Instruments

### Mallets (Miltex)



**19-790      19-793      19-796**

**GERZOG Mallet, 7-1/2"** (19.7 cm), 36-11211  
 Head 8 oz. (227g) lead filled with stainless jacket for N.19-790

**Miltex Mallet, 7-1/2"** (19.1 cm), light-weight 7.5 oz. (213g), stainless head 1" diameter with 2 replaceable nylon caps 36-11210

**Nylon Cap Replacement,** 36-11209  
 for No.19-793 and 19-794 Mallets

**Mead Mallet, 7-1/2"** (19.1 cm), head 8 oz. (227g), with 2 replaceable nylon caps 36-11208

**Nylon Cap** for No. 19-796 Mallet 35-11212

### Miltex Carbide Jaw Forceps (Integra Miltex)



- High quality made in Germany
- Tungsten-Carbide jaws
- Better grip
- Longer wear
- Permanent Serrations

**#849S/TC** 40-51003

**#849/TC** 40-51004

**#845/TC** 40-51005

### Miltex Carbide Jaw Lower Molars Forceps (Integra Miltex)



High Quality, Made in Germany

**#17** 40-50080

### Miltex Carbide Jaw Pedo Forceps (Integra Miltex)



High Quality,  
 Made in Germany

**#150S** 40-51000

**#151S** 40-51001

### Miltex Carbide Jaw Upper Anteriors Forceps (Integra Miltex)

High Quality, Made in Germany



**#1STD** 40-50090

**#150** 40-50091 **#150** **#1STD**

### Miltex Ceram-A-Grip Lower Anteriors Forceps (Integra Miltex)



High Quality, Made in Germany

**#151** 40-50063

**#151AS** 40-50064

**#62** 40-50066

### Miltex Ceram-A-Grip Lower Molar Forceps (Integra Miltex)



High Quality, Made in Germany

**#16** 40-50060

**#17** 40-50061

**#23** 40-50062

### Miltex Ceram-A-Grip Pedo Forceps (Integra Miltex)

High Quality, Made in Germany



**#150S** 40-50070

# Dental Supplies

# Instruments



Prestige Dental Products, Inc.  
 Prestigedentalproducts.com  
 Tel: 877-772-3888

## Miltex Ceram-A-Grip Roots Forceps (Integra Miltex)



High Quality, Made in Germany

#69	40-50056
#65	40-50057

## Miltex Ceram-A-Grip Upper Anteriors Forceps (Integra Miltex)

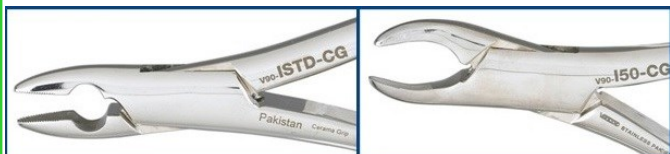

High Quality, Made in Germany

#1STD	40-50065
#150	50-50066

## Miltex Ceram-A-Grip Upper Molars Forceps (Integra Miltex)



#10S	40-50050
#53L	40-50051
#53R	40-50052
#88L	40-50053
#88R	40-50054

## Miltex Grip Deep Extracting Forceps (Integra Miltex)



Grip deep extracting forceps have been designed to allow subgingival access to the root while removing the tooth. The breaks are tapered, which allows them to penetrate deeper into the tooth socket and maximize the tooth-to-forceps contact.

#1STD	40-20013
-------	----------

99C	40-20014
150	40-20015
150A	40-20016
MD3	40-20017
MD4	40-20018
210S	40-20019
222	40-20020
65	40-20021
845	40-20022

## Miltex Lower Anteriors Forceps (Integra Miltex)



High Quality, Made in Germany

#151	40-50030
#151AS	40-50031
#203	40-50032
#62	40-50033
#101	40-50034

## Miltex Lower Molar Forceps (Integra Miltex)



#3FS	40-50012
#16	40-50013
#17	40-50014
#23	40-50015
#217	40-50016
#222	40-50017

## Miltex Mead Pattern Forceps (Integra Miltex)



High Quality, Made in Germany

#MD1	4050050
#MD2	4050051

# Instruments



Prestige Dental Products, Inc.  
 Prestigedentalproducts.com  
 Tel: 877-772-3888

#MD3	4050052
#MD4	4050053

### Miltex Pedo Forceps (Integra Miltex)



High Quality,  
 Made in Germany

#150S	40-50040
#151S	40-50041
#150-1/2S	40-50042
#151-1/2S	40-50053

### Miltex Root Forceps (Integra Miltex)



High Quality,  
 Made in Germany

#69	40-50020
#65	40-50021

### Miltex Upper Anterior Forceps (Integra Miltex)



High Quality, Made in Germany

#1STD	40-50023
#99C	40-50024
#150	40-50025
#150A	40-50026
#150AS	40-50027
#286	40-50028

**ORDER ONLINE** [www.PrestigeDentalProducts.com](http://www.PrestigeDentalProducts.com)

### Miltex Upper Molar Forceps (Integra Miltex)



High Quality, Made in Germany

#10S	40-50001
#18L	40-50002
#18R	40-50003
#24	40-50004
#53L	40-50005
#53R	40-50006
#88L	40-50007
#88R	40-50008
#89	40-50009
#210S	40-50010
#210H	40-50011

### Miltex Xcision Forceps (Integra Miltex)



The Miltex Xcision brand of forceps are the original forceps featuring a unique, light weight, ergonomic handle. They feature a smooth handle with circular openings. This helps reduce hand and wrist fatigue and makes the instrument easier to clean. The Xcision forceps have a resistant Teflon disc which helps reduce wear in the joint of the instruments. They also feature a slim, compact design for easy access to molars.

The Miltex Xcision Extracting Forceps have been designed to allow subgingival access to the root while removing the tooth. The beaks are anatomically shaped and tapered, which allows them to penetrate deeper into the tooth socket and maximize the tooth-to-forceps contact. Serrated breaks allow for better gripping of the



# Instruments



Prestige Dental Products, Inc.  
 Prestigedentalproducts.com  
 Tel: 877-772-3888

tooth surface, which helps aid in the a traumatic extraction of the tooth and reduces the risk of featuring the tooth structure or causing trauma to the surrounding hard and soft tissues.

<b>7 Xcision Forceps,</b> Upper Premolar Universal	40-52000
<b>17 Xcision Forceps,</b> Upper Molars Right	40-52001
<b>18 Xcision Forceps,</b> Upper Molars Left	40-52002
<b>321 Xcision Forceps</b> Lower Premolar	40-52003
<b>35 Xcision Forceps,</b> Upper Premolar	40-52004
<b>35M Xcision Forceps,</b> Upper Premolars Modified Beak	40-52005
<b>23 Xcision Forceps,</b> Cowhorn Lower Molar	40-52006
<b>36 Xcision Forceps,</b> Lower Anterior	40-52007
<b>36M Xcision Forceps,</b> Lower Anteriors Modified Beak	40-52008
<b>44 Xcision Forceps,</b> Upper Roots Universal	40-52009
<b>45 Xcision Forceps,</b> Lower Root	40-52010
<b>45S Xcision Forceps,</b> Lower Root w/ Serration	40-52011
<b>51S Xcision Forceps,</b> Lower Root w/ Serrated Edge	40-52012
<b>51W Xcision Forceps,</b> Upper Root w/ Serrated Beak	40-52013
<b>51SB Xcision Forceps,</b> Upper Root Universal	40-52014
<b>67 Xcision Forceps,</b> Upper 3rd Molar	40-52015
<b>67L Xcision Forceps,</b> Upper 3rd Molar Left	40-52016
<b>67R Xcision Forceps,</b> Upper 3rd Molar Right	40-52017
<b>79 Xcision Forceps,</b> Lower 3rd Molar	40-52018
<b>79M Xcision Forceps,</b> Lower 3rd Molar Modified Beak	40-52019
<b>73 Xcision Forceps,</b> Lower Molar	40-52020
<b>CS Xcision Forceps,</b> Crown Spreading	40-52021

### Miltex Carbide Jaws Roots Forceps (Integra Miltex)

High Quality, *Made in Germany*



#69	40-50082
#65	40-50083

### Mouth Gag (J & J Instrument)



<b>Molt Mouth Gag</b> Child W / Tips N/07-900	40-13030
<b>Molt Mouth Gag Silicon Replace-</b> <b>ment Tip 2 / Pk N.07-905</b>	40-13031
<b>Molt Mouth Gag</b> Adult W / Tips N. 07-910	40-13032

### Mouth Props (PlasDent)



<b>Rubber Mouth Props Large Adult,</b> Dark Gray, Autoclavable to 260 F, 2/ Pkg	40-88521
<b>Rubber Mouth Props Medium Child,</b> Dark Gray, Autoclavable to 260 F, 2/ Pkg	40-88522
<b>Rubber Mouth Props Small Pedo,</b> Dark Gray, Autoclavable to 260 F, 2/ Pkg	40-88523
<b>Silicone Mouth Props Large Adult,</b> Orange, Autoclavable & Dry Heat to 500 F, 2/Pkg	40-88524
<b>Silicone Mouth Props Medium Child,</b> Orange, Autoclavable & Dry Heat to 500 F, 2/Pkg	40-88525
<b>Silicone Mouth Props Small Pedo,</b> Orange, Autoclavable & Dry Heat to 500 F, 2/Pkg	40-88526
<b>Silicone Mouth Props Large Adult,</b> Dark Purple, Autoclavable & Dry Heat to 500 F, 2/Pkg	40-88527

# Instruments



Prestige Dental Products, Inc.  
 Prestigedentalproducts.com  
 Tel: 877-772-3888

**Silicone Mouth Props Medium Child,** 40-88528  
 Turquoise, Autoclavable & Dry Heat to  
 500 F, 2/Pkg

**Silicone Mouth Props Small Pedo,** 40-88529  
 Neon Yellow, Autoclavable & Dry  
 Heat to 500 F, 2/Pkg

### Needle Holder (J & J Instrument)

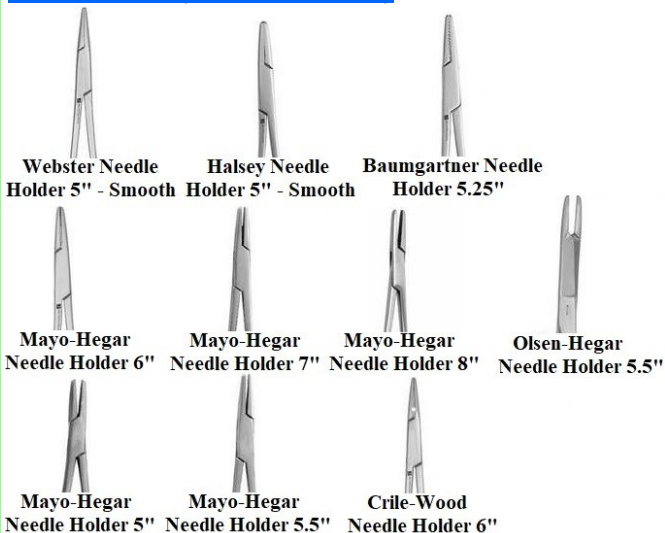

- Dorf Needle Holder Serrated 4.75"** 40-13074
- Webster Needle Holder Smooth 5"** 40-13075
- Halsey Needle Holder Smooth 5"** 40-13076
- Baumgartner Needle Holder 5.25"** 40-13077
- Mayo-Hegar Needle Holder 5"** 40-13078
- Mayo-Hegar Needle Holder 5.5"** 40-13079
- Mayo-Hegar Needle Holder 6"** 40-13080
- Mayo-Hegar Needle Holder 7"** 40-13081
- Crile-Wood Needle Holder 6"** 40-13082
- Olsen-Hegar Needle Holder 5.5"** 40-13083
- Olsen-Hegar Needle Holder 6.5"** 40-13084
- Collier Fenestrated Jaws 5"** 40-13085
- Abbey Needle Holder 5"** 40-13072
- Boynton Needle Holder 5"** 40-13071
- Mathieu Needle Holder 4.75" Delicate** 40-13070
- Castroviejo Needle Holder 5.75" No Lock** 40-13057
- Castroviejo Needle Holder 5.75" W/ Lock** 40-13058
- Dorf Needle Holder Tungsten Serrated 4.75" Carbide** 40-13059
- Mayo-Hegar Tungsten Needle Holder 5.5" Gator Grip Carbide** 40-13060

- Mayo-Hegar Needle Holder Tungsten 6" Carbide** 40-13061
- Mayo-Hegar Needle Holder Tungsten Gator Grip 7" Carbide** 40-13062
- Mayo-Hegar Needle Holder Tungsten Gator Grip 8" Carbide** 40-13063
- Olsen-Hegar Needle Holder Tungsten 5.5" Carbide** 40-13064
- Olsen-Hegar Tungsten Needle Holder 6.5" Carbide** 40-13065
- Olsen-Hegar Tungsten Needle Holder 7.5" Carbide** 40-13066
- Boynton Needle Holder Tungsten Gator Grip 5" Carbide** 40-13067
- Mathieu Gator Grip Tungsten 5.5" Carbide** 40-13068
- Mathieu Gator Grip 5.5" Delicate Carbide** 40-13069
- Mathieu Needle Holder Gator Grip 4.75" Delicate Carbide** 40-13086
- Castroviejo Needle Holder Gator Grip Tungsten 5.75" Carbide** 40-13073
- Castroviejo Gator Grip Tungsted Needle Holder 7" Carbide** 40-13056

### Needle Holders (ASA Italy)



# Instruments



Prestige Dental Products, Inc.  
 Prestigedentalproducts.com  
 Tel: 877-772-3888

<b>Crile-Wood Needle Holders Cm.15</b>	40-13103
<b>Gillies Needle Holders Cm. 16</b>	40-13087
<b>Crile-Wood Needle Holders Tungsten Carbide Cm.15</b>	40-13101
<b>Mayo-Hegar Needle Holders Cm.16</b>	40-13102
<b>Mathieu Needle Holders Cm.17</b>	40-13098
<b>Mathieu Needle Holders Tc Tungsten Carbide Cm.14</b>	40-13099
<b>Mathieu Needle Holders Tungsten Carbide I.Cm.17</b>	40-13096
<b>Lichtenberg Needle Holders Tungsten Carb.I. Cm.17</b>	40-13097
<b>Castroviejo Needle Holder Straight Cm.14</b>	40-13095
<b>Castroviejo Needle Holder Straight Cm. 18</b>	40-13093
<b>Castroviejo Needle Holders Curved Cm.14</b>	40-13094
<b>Castroviejo Needle Holders, Curved Cm. 18</b>	40-13092
<b>Castroviejo Needle Holders Tungsten Carbide Cm.14</b>	40-13091
<b>Castroviejo Needle Holders Tungst. Car. Curved Cm.14</b>	40-13090
<b>Castroviejo Needle Holders Tc Tungsten C.Cm.14/60-∞</b>	40-13088
<b>Barraquer Needle Holder, Straight Tc Cm. 18</b>	40-13104
<b>Barraquer Needle Holders, Curved Tc Cm.18</b>	40-13089
<b>Mathieu Needle Holders Cm.14</b>	40-13100

## Osteotome Concave R-Set



Tools for Osteotome Technique

**Full Set** 40-103321

## Osteotome Concave S-Set



Tools for Osteotome Technique

**Full Set** 40-103311

## Piezo Bone Surgery Tips (Vista)

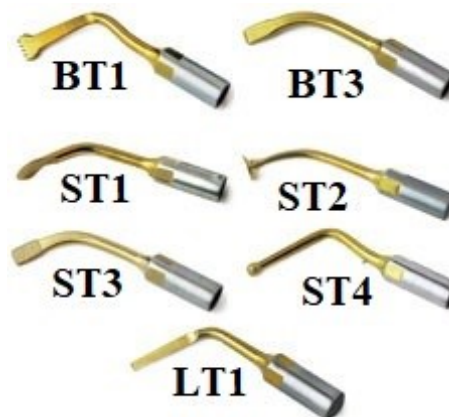

- Acteon\* Style  
 - Mectron\* Style

<b>BT1, (Acteon Style)</b>	56-11160
<b>BT3, (Acteon Style)</b>	56-11161
<b>ST1, (Acteon Style)</b>	56-11159
<b>ST2, (Acteon Style)</b>	56-11158
<b>ST3, (Acteon Style)</b>	56-11157
<b>ST4, (Acteon Style)</b>	56-11156
<b>LT1, (Acteon Style)</b>	56-11155
<b>BT1, (Mectron Style)</b>	56-11154
<b>BT3, (Mectron Style)</b>	56-11153
<b>ST1, (Mectron Style)</b>	56-11152
<b>ST2, (Mectron Style)</b>	56-11151
<b>ST3, (Mectron Style)</b>	56-11150
<b>ST4, (Mectron Style)</b>	56-11149
<b>LT1, (Mectron Style)</b>	56-11148





# Instruments



Prestige Dental Products, Inc.  
 Prestigedentalproducts.com  
 Tel: 877-772-3888

## Ridge Split Set

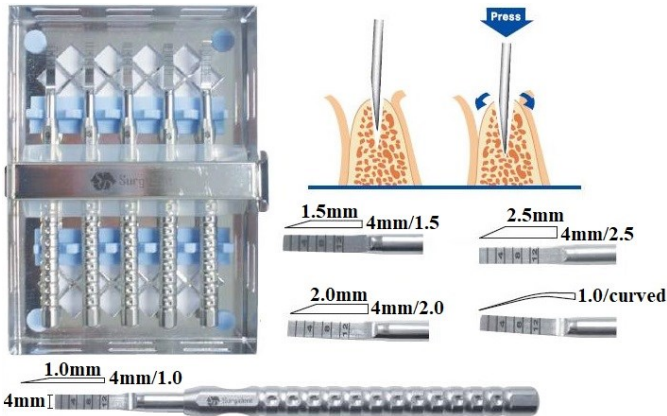

Chisels are used to open up narrow bone ridge

**Full Set** 40-103291

## Rongeurs (Nordent)

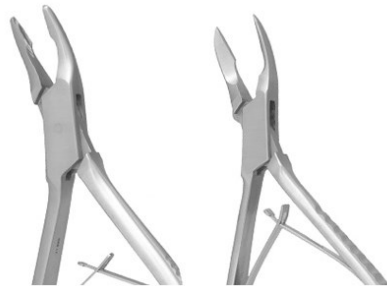

- #1 (5-1/2"/140 mm) Friedman 40-13527
- #2 (6-1/4"/160 mm) Blumenthal Standard 40-13528
- #3 (5-1/2"/140 mm) Niro Side Cutting 40-13526
- #4 (5-1/2"/140 mm) Cleveland 40-13525
- (5"/125mm) Friedman Mini 40-13524

## Scapel Blade Remover (ASA Italy)



- Scapel Blades Remover Cm.16,5 40-13683
- Set Scapel Blade Remover + Orient. Blade Scapel Han. 40-13682

## Scalpel Handle (J & J Instrument)



- #3 for Blades 10, 11, 12, 12B, 15, 15C 40-13684
- #4 for Blades 20-23 40-13685
- #7 40-13686

## Scalpel Handle Size 3 (Prestige)



- #3 for Blades 10, 11, 12, 12B, 15, 15C 40-105651

## Scissor (J & J Instrument)

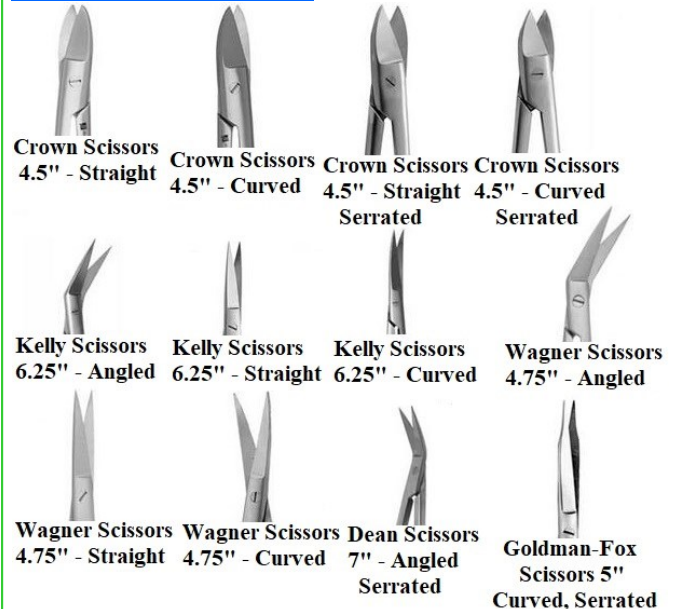

- Crown Scissors 4.5" - Straight 40-13718
- Crown Scissors 4.5" - Curved 40-13704
- Crown Scissors 4.5" - Straight Serrated 40-13705
- Crown Scissors 4.5" - Curved Serrated 40-13706
- Kelly Scissors 6.25" - Angled 40-13708
- Kelly Scissors 6.25" - Straight 40-13707
- Kelly Scissors 6.25" - Curved 40-13711
- Wagner Scissors 4.75" - Angled 40-13710
- Wagner Scissors 4.75" - Curved 40-13709
- Dean Scissors 7" - Angled Serrated 40-13756
- Goldman-Fox Scissors 5" Curved, Serrated 40-13757
- Kelly Scissor 6.25" Curved, Carbide 40-13755
- Lister Bandage Scissor 5.5" 40-13711
- Lister Bandage Scissor 4.5" 40-13710
- Lister Bandage Scissor 3.5" 40-13709
- Wire Cutting Scissor 4.75" Angled 40-13756
- Northbent Stitch Scissor 4.75" Curved 40-13707
- Extra Long Stitch Scissor 6.25" 40-13711
- Littauer Stitch Scissor 5.5" 40-13710
- Littauer Stitch Scissor 4.5" 40-13709
- Shortbent Stitch Scissor 3.5" 40-13756
- Spencer Stitch Scissor 3.5" 40-13757
- Mayo Scissor 6.75" Cvd 40-13755

## Instruments



Prestige Dental Products, Inc.  
 Prestigedentalproducts.com  
 Tel: 877-772-3888

<b>Mayo Scissor 6.75" Str</b>	40-13754
<b>Lister Bandage Scissor 7.25"</b>	40-13703
<b>Knowles Bandage Scissor 5.5"</b>	40-13715
<b>Utility Scissor 7.5" Black</b>	40-13716
<b>Kelly Scissor 6.25" Straight, Carbide</b>	40-13719
<b>Kelly Scissor 6.25" Angle Carbide</b>	40-13721
<b>Mayo Scissor 5.5" Curved, Carbide</b>	40-13720
<b>Mayo Scissor 5.5" Straight, Carbide</b>	40-13722
<b>Iris Scissor 4.5" Curved, Carbide</b>	40-13723
<b>Iris Scissor 4.5" Straight, Carbide</b>	40-13725
<b>Goldman-Fox Scissor 5" Curved, Carbide</b>	40-13724
<b>Dean Scissor 7" Angled, Carbide</b>	40-13726
<b>Us Army Gauze Scissor 8"</b>	40-13727
<b>Utility Scissor 7.5" Green</b>	40-13728
<b>Utility Scissor 7.5" Grey</b>	40-13729
<b>Utility Scissor 7.5" Blue</b>	40-13717
<b>Mayo Scissor 5.5" Straight</b>	40-13758
<b>Mayo Scissor 5.5" Curved</b>	40-13753
<b>Castroviejo Scissor 4.75" Curved</b>	40-13751
<b>Wagner Scissor 4.75" Angled</b>	40-13733
<b>Kelly Scissor 6.25" Curved Serrated</b>	40-13735
<b>Kelly Scissor 6.25" Angled W/1 Serrated Blade</b>	40-13737
<b>Kelly Scissor 6.25" Straight W/ 1 Serrated Blade</b>	40-13740
<b>Kelly Scissor 6.25" Angle</b>	40-13736
<b>Kelly Scissor 6.25" Straight</b>	40-13739
<b>Crown Scissor 4.5" Straight</b>	40-13760
<b>Wagner Scissor 4.75" Angled W/1 Serrated Blade</b>	40-13746
<b>Wagner Scissor 4.75" Curved W/1 Serrated Blade</b>	40-13758
<b>Quimby Scissor 5" Straight</b>	40-13759
<b>Iris Scissor 4.5" Straight</b>	40-13730
<b>Operating Scissor 5.5" Straight, Sharp/Blunt</b>	40-13714
<b>Operating Scissor 5.5" Straight, Sharp/Sharp</b>	40-13713
<b>Quimby Scissor 5" Curved</b>	40-13712
<b>Iris Scissor 4.5" Curved</b>	40-13731
<b>La Grange Scissor 4.5" Curved</b>	40-13732

<b>Castroviejo Scissor 3.5" Straight</b>	40-13748
<b>Castroviejo Scissor 3.5" Angled</b>	40-13749
<b>Castroviejo Scissor 4.75" Straight</b>	40-13750
<b>Wagner Scissor 4.75" Straight Serrated</b>	40-13738
<b>Wagner Scissor 4.75" Curved</b>	40-13745
<b>Wagner Scissor 4.75" Straight</b>	40-13734
<b>Crown Scissor 4.5" Curved</b>	40-13744
<b>Crown Scissor 4.5" Straight Serrated</b>	40-13742
<b>Crown Scissor 4.5" Curved Serrated</b>	40-13743
<b>Dean Scissor 7" Angled, 1 Serrated Blade</b>	40-13747
<b>Goldman-Fox Scissor 5" Curved, 1 Serrated Blade</b>	40-13741
<b>Kelly Scissor 6.25" Curved</b>	40-13702

### Spand-Ezz Cheek Expander (Dentsply)

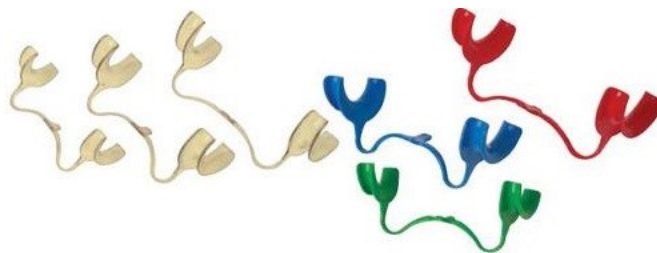

Flexible plastic cheek expanders allow access to the whole mouth by holding it open and depressing the tongue.

<b>Autoclavable, Small, Clear color, individually</b>	44-14236
<b>Autoclavable, Medium, Clear color, individually</b>	44-14236
<b>Autoclavable, Large, Clear color, individually</b>	44-14234
<b>Disposable, Small - Green, 10/Pkg</b>	44-14239
<b>Disposable, Medium - Blue, 10/Pkg</b>	44-14238
<b>Disposable, Large - Red, 10/Pkg</b>	44-14237

### Suction Tube (J & J Instrument)

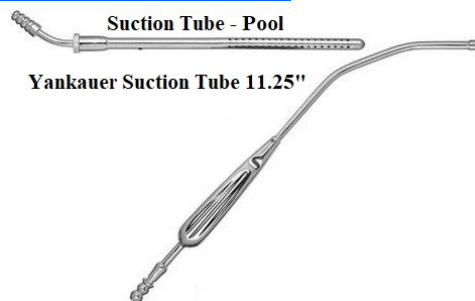

<b>Pool Suction Tube 8.75"</b>	40-13896
<b>Yankauer Suction Tube 11.25"</b>	40-13895

# Instruments



Prestige Dental Products, Inc.  
 Prestigedentalproducts.com  
 Tel: 877-772-3888

## Surgical Mallets (ASA Italy)



**Spare  
Parts**

### **Partsch Mead**

<b>Partsch Cm.19</b>	40-13897
<b>Mead Cm.19,5</b>	40-13898
<b>Spare Parts For 1881</b>	40-13899

## Surgical Scissors (ASA Italy)

**Gum Scissors Metzebaum-Delikat Curved, Cm. 14.5**

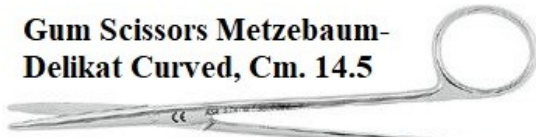

**Gum Scissors Metzebaum-Delikat Straight, Cm. 14.5**



**Ligature Gum Scissors Metzebaum Curved, Cm. 14.5**

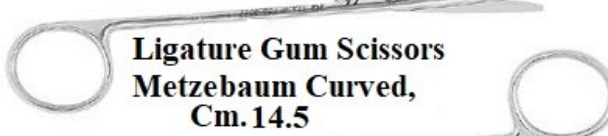

**Ligature Gum Scissors Spencer, Cm.13**

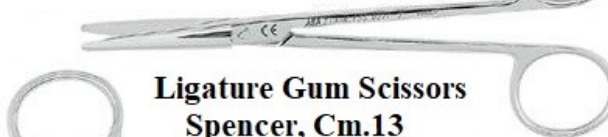

<b>Ligature Gum Scissors Spencer Cm.13</b>	40-13901
<b>Ligature Gum Scissors Metzenbaum Curved Cm.14,5</b>	40-13903
<b>Gum Scissors Metzenbaum-Delikat Straight Cm.14,5</b>	40-13900
<b>Gum Scissors Metzebaum-Delikat Curved Cm.14,5</b>	40-13904

## Tissue Forcep (J & J Instrument)

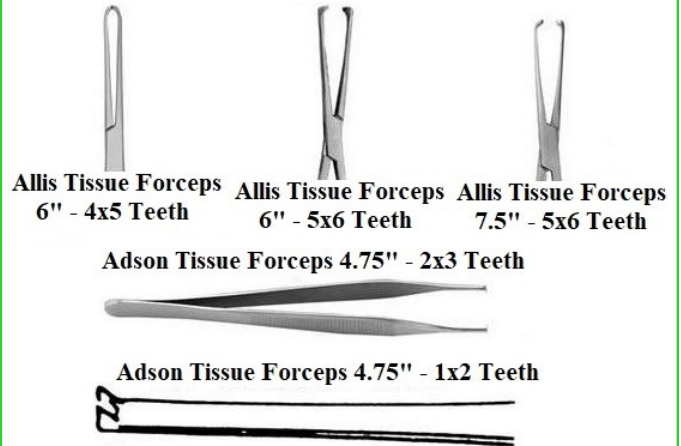

**Allis Tissue Forceps 6" - 4x5 Teeth**      **Allis Tissue Forceps 6" - 5x6 Teeth**      **Allis Tissue Forceps 7.5" - 5x6 Teeth**

**Adson Tissue Forceps 4.75" - 2x3 Teeth**



**Adson Tissue Forceps 4.75" - 1x2 Teeth**



<b>Allis Tissue Forcep 6" 4X5</b>	40-13912
<b>Allis Tissue Forcep 6" 5X6</b>	40-13913
<b>Allis Tissue Forcep 7.5" 5X6</b>	40-13914
<b>5" Tissue Forcep 1X2</b>	40-13915
<b>5.5" Tissue Forcep 1X2</b>	40-13916
<b>6" Tissue Forcep 1X2</b>	40-13917
<b>Adson Tissue Forcep 4.75" 1X2</b>	40-13918
<b>Adson Tissue Fcp 4.75" 2X3</b>	40-13919
<b>Adson-Brown Tissue Forcep 4.75" 7X7</b>	40-13911

## Tissue Forceps (Nordent)



<b>Suture Pliers Non-Locking (6" / 150 mm) Corn</b>	40-13922
<b>#108 Rat Tooth (1 x 2) Adson (125 mm)</b>	40-13923
<b>#109 (9 x 9) Adson-Brown (125 mm)</b>	40-13921
<b>#110 Curved (1 x 2) Semkin-Taylor (125 mm)</b>	40-13920

# Find Us On Social Media



# Instruments



Prestige Dental Products, Inc.  
 Prestigedentalproducts.com  
 Tel: 877-772-3888

## Tongue Holder (J & J Instrument)

### Young Tongue Holding Forceps 6"



Young Tongue Holder  
 W/rubber tips 6.26"

40-13939

## Towel Clamps (J & J Instrument)

Backhaus Towel Forceps 5.25"



Backhaus Towel Forceps 3.5"

Backhaus Towel Clamp 3.5"

40-13940

Backhaus Towel Clamp 5.25"

40-13941

Jones Towel Clamp 3.5"

40-13942

## Towel Forcep (J & J Instrument)

Lorna Towel Forceps 3.5"

Lorna Towel Forceps 5.25"



Lorna Towel Fcp 3.5"

40-13943

Lorna Towel Fcp 5.25"

40-13944

## Trimmer Kit (Surgident)

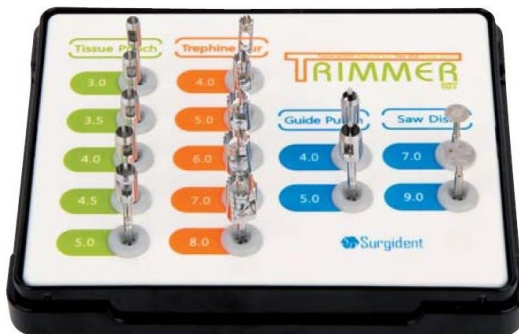

## Tissue Punch



## Trephine Bur



## Guide Punch



## Saw Disk



Featuring easy-to-store, lost proven & various selection of useful tools.

- convenient storage
- trephine bur
- guide punch
- saw disk

**Full Kit**

40-103281

## Hygiene Instruments

### Diamond Coated Furcation Files (Nordent)

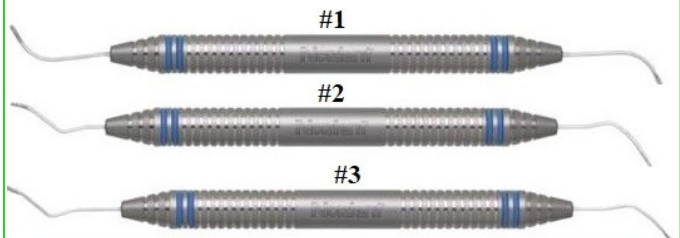

Mirror image tips for facial and lingual adaptation.

The blade has a round shape and is 1.0mm in diameter.



The blades are set at opposing angles and have a round shape that is 1.0mm in diameter set on a 14mm terminal shank.



Excellent for mesial and distal adaptation.

**#1 Diamond Furcation**  
 DuraLite™ ColorRings, Ñ¢

40-11575

**#2 Diamond Furcation**  
 DuraLite™ ColorRings, Ñ¢

40-11576

**#3 Diamond Furcation**  
 DuraLite™ ColorRings, Ñ¢

40-11577



Prestige Dental Products, Inc.  
 Prestigedentalproducts.com  
 Tel: 877-772-3888

## Instruments

### Ultrasonic Piezo Tips (Vista)

#### **SU1 Light to Medium - Heavy Cases of Supra-Gingival Calculus**

Utilizing the side radius of the initial 2-3mm of the top of the tip in a sweeping motion on the tooth enamel provides a smooth scaled surface with minimal need for secondary hand instrumentation.

#### **SU2 Scaling of High Density Supra-Gingival Calculus Deposits**

Utilizing the flat edge of the top of the tip and the side of the tip perpendicular to the tooth surface, use an up-and-down motion on the tooth surface to shear off calculus.

#### **SU3 Removal of Stains (Tobacco, Coffee & Other Similar Stains)**

Utilizing both the round edge of the top of the tip and the side of the tip on the tooth surface, use an up and down motion on the tooth surface to shear off stains.

#### **SU4 General Scaling of Sensitive Areas**

Less abrasive than the SU1 - SU3 tips, this tip is ideal for use in the periodontal pockets and with other sensitive locations.

#### **SU5 Designed for Easy Interproximal Scaling**

The thin design of the SU5 tip allows for entry into most interproximal spaces.

#### **SU6 Designed for Subgingival Scaling**

Long and thin design allows for a less evasive entry into subgingival pockets resulting in minimal patient sensitivity and reduced bleeding.

**EMS\* Style:** Mini Piezon\*, Scalex 880\*, Bonart\*, SuperSon EIE\*, Master 400\*, Parkell (Piezo)\*, Dent America\*

**Amdent\* Style:** Piezo +

**Satelec\* Style:** Vista P5\*, NSK\*, ENAC\*, Sybron Endo\*, Obtura Spartan\*, ADEC\*, J.Morita\*, Dentsply/Tulsa\*, Amdent\*

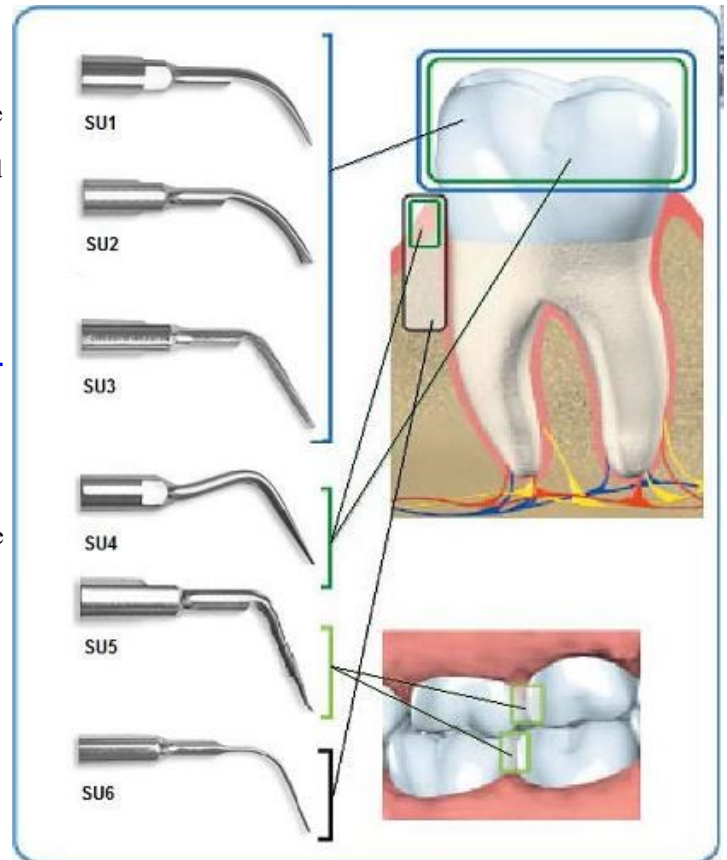

<b>SU1 - Advantage / Amdent™ Thread Style, each</b>	56-11328
<b>SU1 - P5 Thread Style, each</b>	56-11327
<b>SU1 - EMS™ Thread Style, each</b>	56-11325
<b>SU2 - P5 Thread Style, each</b>	56-11323
<b>SU2 - Advantage / Amdent™ Thread Style, each</b>	56-11324
<b>SU2 - EMS™ Thread Style, each</b>	56-11322
<b>SU3 - P5 Thread Style, each</b>	56-11321
<b>SU3 - Advantage / Amdent™ Thread Style, each</b>	56-11320
<b>SU3 - EMS™ Thread Style, each</b>	56-11319
<b>SU4 - P5 Thread Style, each</b>	56-11318
<b>SU4 - Advantage / Amdent™ Thread Style, each</b>	56-11317
<b>SU4 - EMS™ Thread Style, each</b>	56-11316
<b>SU5 - P5 Thread Style, each</b>	56-11315
<b>SU5 - Advantage / Amdent™ Thread Style, each</b>	56-11314
<b>SU5 - EMS™ Thread Style, each</b>	56-11329
<b>SU6 - P5 Thread Style, each</b>	56-11330
<b>SU6 - Advantage / Amdent™ Thread Style, each</b>	56-11331
<b>SU6 - EMS™ Thread Style, each</b>	56-11332

# Instruments



Prestige Dental Products, Inc.  
 Prestigedentalproducts.com  
 Tel: 877-772-3888

## Implant Scaler (Nordent)

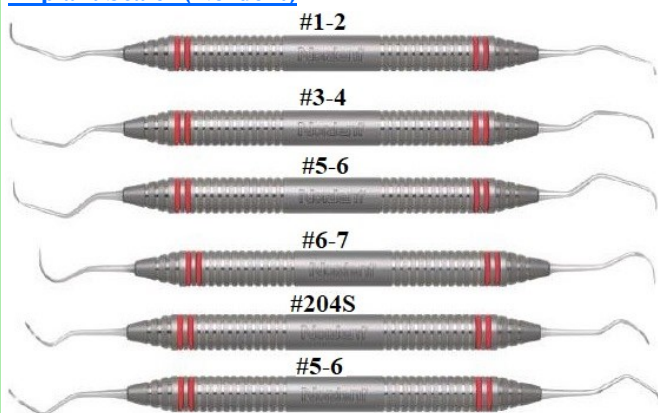

<b>#1-2 Langer Double Ended</b> DuraLite-Æ ColorRings, Ñç	40-12603
<b>#3-4 Langer Double Ended</b> DuraLite-Æ ColorRings, Ñç	40-12604
<b>#5-6 Langer Double Ended</b> DuraLite-Æ ColorRings, Ñç	40-12602
<b>#N67 Offset Sickle Double Ended</b> DuraLite-Æ ColorRings, Ñç	40-12601
<b>#N137 Anterior Double Ended</b> DuraLite-Æ ColorRings, Ñç	40-12600
<b>#204S Posterior Sickle Double Ended</b> DuraLite-Æ ColorRings, Ñç	40-12599
<b>#5-6 Barnhart Curette Double Ended</b> Universal DuraLite-Æ ColorRings, Ñç	40-12598

## Plaster Spatula (J & J Instrument)



<b>#8R - 4" Stiff Blade</b>	<b>#10R - 4.25" Extra Stiff Blade</b>
<b>#3R - 3.75" Stiff Blade</b>	<b>#11R - 3.5" Flexible Blade</b>
<b>#3R - 3.75" Stiff Blade</b>	40-13289
<b>#8R - 4" Stiff Blade</b>	40-13288
<b>#10R - 4.25", Extra Stiff Blade</b>	40-13286
<b>#11R - 3.5" Flexible Blade</b>	40-13287

## Rhodes Back Action C36/37 (Hu-Friedy)



**DE, #4 Round Handle** 40-90275

## Soldering Tweezer

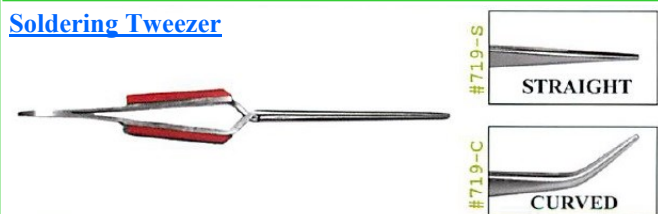

**Straight, each** 40-99061  
**Curved, each** 40-99062

## Instrument Cassettes

### Exam Cassette with Rack PDT-5 (PDT)

- Compact. Fixed rack holds 5 instruments
- Will hold 7" ultrasonic inserts
- Ideal for the Wingrove™ Titanium Implant "Go-To" set, specialty set-ups and exam kits
- Cotton plier retainer and an air/water clip



**Fixed rack holds 5 instruments** 40-13153  
 7-1/16" X 2-7/16" X 7/8"

### FlipTop Cassette 'A' (PDT)

- T005A-F Fixed rack holds 5 instruments. Cotton plier retainer and an air/water clip.
- T008A-U Utility box with silicone retainer strips. No instrument rack. Ideal for handpiece, 8" ultrasonic inserts, syringes, etc.

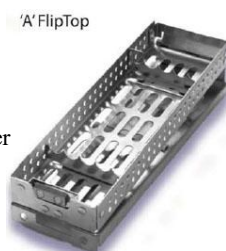

**Fixed rack holds 5 instruments** 40-12207  
 8" X 2-7/16" X 7/8"

**Utility box with silicone retainer strips** 40-12208  
 8" X 2-7/16" X 7/8"

### FlipTop Cassette 'B' (PDT)

- T0007B-D FlipTop Cassette 'B' - Double Rack holds 14 instruments. Fixed rack below and LiftOut rack above. Small accessory area will hold PDT sharpening stone, clamps, napkin chains, or other small items. Cotton plier retainer, needle recapper and an air/water clip.
- T007B-F FlipTop Cassette 'B' - Fixed Rack holds 7 instruments. Small accessory area will hold PDT sharpening stone, clamps, napkin chains, or other small items. Cotton plier retainer, needle recapper and an air/water clip.
- T007B-U FlipTop Cassette 'B' - Utility box with silicone retainer strips. No instrument rack. Needle recapper and an air/water clip.
- T007B-L FlipTop Cassette 'B' - LiftOut Rack holds 7 instruments. Space below with silicone retainer strips will hold more instruments, 7" ultrasonic inserts, or hinged items. Small accessory area will hold PDT sharpening stone, clamps, napkin chains, or other small items. Cotton plier retainer, needle recapper and an air/water clip.



**Double Rack holds 14 instruments** 40-12209  
 8" X 3-5/8" X 1-1/4"

**Fixed Rack holds 7 instruments** 40-12210  
 8" X 3-5/8" X 1-1/4"

**Utility box with silicone retainer strips** 40-12211  
 8" X 3-5/8" X 1-1/4"





Prestige Dental Products, Inc.  
 Prestigedentalproducts.com  
 Tel: 877-772-3888

# Instruments

**LiftOut Rack holds 7 instruments** 40-12223  
 8" X 3-5/8" X 1-1/4"

**FlipTop Cassette 'C' (PDT)**

'C' FlipTop™

•T009C-D FlipTop Cassette 'C' - Double Rack hold 18 instruments. Fixed rack below and LiftOut rack above with one position each for an 8" ultrasonic insert or amalgam carrier. Small accessory area will hold PDT sharpening stone, clamps, napkin chains, or other small items. Cotton plier retainer, needle recapper and an air/water clip.



•T009C-F FlipTop Cassette 'C' - Fixed Rack holds 9 instruments with one position for an 8" ultrasonic insert or amalgam carrier. Small accessory area will hold PDT sharpening stone, clamps, napkin chains, or other small items. Cotton plier retainer, needle recapper and an air/water clip.

•T009C-L FlipTop Cassette 'C' - LiftOut Rack holds 9 instruments with one position for an 8" ultrasonic insert or amalgam carrier. Space below with silicone retainer strips will hold more instruments, ultrasonic inserts, or hinged items. Small accessory area will hold PDT sharpening stone, clamps, napkin chains, or other small items. Cotton plier retainer, needle recapper and an air/water clip

•T009C-U FlipTop Cassette 'C' - Utility box with silicone retainer strips. No instrument rack. Needle recapper and an air/water clip.

**Double Rack hold 18 instruments** 40-12212  
 8" X 4-11/16" X 1-1/4"

**Fixed Rack holds 9 instruments** 40-12213  
 8" X 4-11/16" X 1-1/4"

**LiftOut Rack holds 9 instruments** 40-12214  
 8" X 4-11/16" X 1-1/4"

**Utility box with silicone retainer strips** 40-12215  
 8" X 4-11/16" X 1-1/4"

**FlipTop Cassette 'D' (PDT)**

'D' FlipTop

•T009D-D FlipTop Cassette 'D' - Double Rack holds 18 instruments. Fixed rack below and LiftOut rack above will hold 8" ultrasonic inserts or amalgam carriers. Accessory area is 2-1/4" wide and is ideal for syringes, forceps, elevators or larger hinged items. Sharpening stone clip. Cotton plier retainer, needle recapper and an air/water clip.

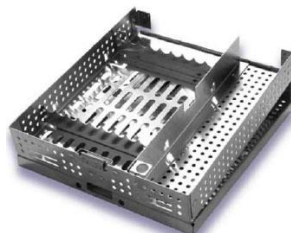

•T009D-F FlipTop Cassette 'D' - Fixed Rack holds 9 instruments. Rack will hold 8" ultrasonic inserts or amalgam carriers. Accessory area is 2-1/4" wide and is ideal for syringes, forceps, elevators or larger hinged items. Sharpening stone clip. Cotton plier retainer, needle recapper and an air/water clip.

•T009D-L FlipTop Cassette 'D' - LiftOut Rack holds 9 instruments. Rack will hold 8" ultrasonic inserts or amalgam carriers. Space below with silicone retainer strips will hold more instruments, ultrasonic inserts, or hinged items. Accessory area is 2-1/4" wide and is ideal for syringes, forceps, elevators or larger hinged items. Sharpening stone clip. Cotton plier retainer, needle recapper and an air/water clip.

•T009D-U FlipTop Cassette 'D' - Utility box with silicone retainer strips. No instrument rack. Needle recapper and an air/water clip.

**Double Rack holds 18 instruments** 40-12216

**Fixed Rack holds 9 instruments** 40-12217

**LiftOut Rack holds 9 instruments** 40-12218

**Utility box with silicone retainer strips** 40-12219

**FlipTop Cassette 'E' (PDT)**



**Utility** 40-12221

**Std Divider & Fixer Rack 15** 40-12222

**Instrument Compact Cassettes (Zirc)**

Microban Multi-Instrument Sterilization-Fits standard size ultrasonic cleaners and autoclaves. 8" chamber holds up to 12 cassettes. 4" x 7" x 5/8"



**Blue** 40-11547

**White** 40-11541

**Instrument Large Cassette (Nordent)**



20 Instruments

18 Instruments

16 Instruments



15 Instruments

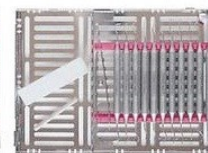

13 Instruments

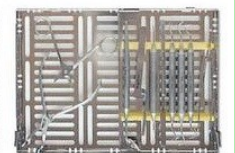

10 Instruments

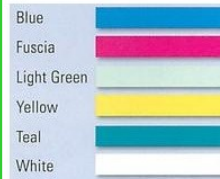

8 Instruments

**20 Instruments Blue** 40-12681

**20 Instruments Teal** 40-12669

**20 Instruments Fuscia** 40-12668

**20 Instruments Yellow** 40-12667

**20 Instruments Light Green** 40-12666

**20 Instruments White** 40-12665

**18 Instruments + 1 1/2" x 8" Open Area Blue** 40-12664

# Instruments



Prestige Dental Products, Inc.  
 Prestigedentalproducts.com  
 Tel: 877-772-3888

<b>18 Instruments + 1½" x 8"</b> Open Area Teal	40-12663
<b>18 Instruments + 1½" x 8"</b> Open Area Fuscia	40-12662
<b>18 Instruments + 1½" x 8"</b> Open Area Yellow	40-12670
<b>18 Instruments + 1½" x 8"</b> Open Area Light Green	40-12671
<b>18 Instruments + 1½" x 8"</b> Open Area White	40-12672
<b>16 Instruments + 2½" x 8"</b> Open Area Blue	40-12680
<b>16 Instruments + 2½" x 8"</b> Open Area Teal	40-12679
<b>16 Instruments + 2½" x 8"</b> Open Area Fuscia	40-12678
<b>16 Instruments + 2½" x 8"</b> Open Area Yellow	40-12677
<b>16 Instruments + 2½" x 8"</b> Open Area Light Green	40-12676
<b>16 Instruments + 2½" x 8"</b> Open Area White	40-12675
<b>15 Instruments + 3" x 8"</b> Open Area Blue	40-12674
<b>15 Instruments + 3" x 8"</b> Open Area Teal	40-12673
<b>15 Instruments + 3" x 8"</b> Open Area Fuscia	40-12661
<b>15 Instruments + 3" x 8"</b> Open Area Yellow	40-12660
<b>15 Instruments + 3" x 8"</b> Open Area Light Green	40-12648
<b>15 Instruments + 3" x 8"</b> Open Area White	40-12647
<b>13 Instruments + 4" x 8"</b> Open Area Blue	40-12646
<b>13 Instruments + 4" x 8"</b> Open Area Teal	40-12645
<b>13 Instruments + 4" x 8"</b> Open Area Fuscia	40-12644
<b>13 Instruments + 4" x 8"</b> Open Area Yellow	40-12643
<b>13 Instruments + 4" x 8"</b> Open Area Light Green	40-12642
<b>13 Instruments + 4" x 8"</b> Open Area White	40-12641
<b>10 Instruments + 5½" x 8"</b> Open Area Blue	40-12649

<b>10 Instruments + 5½" x 8"</b> Open Area Teal	40-12650
<b>10 Instruments + 5½" x 8"</b> Open Area Fuscia	40-12651
<b>10 Instruments + 5½" x 8"</b> Open Area Yellow	40-12659
<b>10 Instruments + 5½" x 8"</b> Open Area Light Green	40-12658
<b>10 Instruments + 5½" x 8"</b> Open Area White	40-12657
<b>8 Instruments + 6½" x 8"</b> Open Area Blue	40-12656
<b>8 Instruments + 6½" x 8"</b> Open Area Teal	40-12655
<b>8 Instruments + 6½" x 8"</b> Open Area Fuscia	40-12654
<b>8 Instruments + 6½" x 8"</b> Open Area Yellow	40-12653
<b>8 Instruments + 6½" x 8"</b> Open Area Light Green	40-12652
<b>8 Instruments + 6½" x 8"</b> Open Area White	40-12640

### Instrument Medium Cassette (Nordent)



**10 Instruments**



**8 Instruments**



**5 Instruments**

<b>10 Instruments Blue</b>	40-12742
<b>10 Instruments Teal</b>	40-12758
<b>10 Instruments Fuscia</b>	40-12757
<b>10 Instruments Yellow</b>	40-12756
<b>10 Instruments Light Green</b>	40-12755
<b>10 Instruments White</b>	40-12754
<b>8 Instruments + 1" x 8"</b> Open Area Blue	40-12753
<b>8 Instruments + 1" x 8"</b> Open Area Teal	40-12752





Prestige Dental Products, Inc.  
 Prestigedentalproducts.com  
 Tel: 877-772-3888

## Instruments

<b>8 Instruments + 1" x 8" Open Area</b> Fuscia	40-12751
<b>8 Instruments + 1" x 8" Open Area</b> Yellow	40-12750
<b>8 Instruments + 1" x 8"</b> Open Area Light Green	40-12749
<b>8 Instruments + 1" x 8" Open Area</b> White	40-12748
<b>5 Instruments + 2½" x 8" Open Area</b> Blue	40-12747
<b>5 Instruments + 2½" x 8" Open Area</b> Teal	40-12746
<b>5 Instruments + 2½" x 8"</b> Open Area Fuscia	40-12745
<b>5 Instruments + 2½" x 8"</b> Open Area Yellow	40-12744
<b>5 Instruments + 2½" x 8"</b> Open Area Light Green	40-12743
<b>5 Instruments + 2½" x 8"</b> Open Area White	40-12759

### Instrument Small Cassette (Nordent)



**5 Instruments**

Blue	
Fuscia	
Light Green	
Yellow	
Teal	
White	

<b>5 Instruments Blue</b>	40-12764
<b>5 Instruments Teal</b>	40-12765
<b>5 Instruments Fuscia</b>	40-12763
<b>5 Instruments Yellow</b>	40-12762
<b>5 Instruments Light Green</b>	40-12761
<b>5 Instruments White</b>	40-12760

### Large - Small Parts Boxes (Nordent)



**Large**



**Small**

Parts Boxes fit into the cassette and will keep small items safe and secure during sterilization. Constructed of perforated stainless steel with a sliding lid that secures when closed.

<b>Small 1.4"L x 1.25" W x 1" H</b>	40-12835
<b>Large 3" L x 1.25" W x 1" H</b>	40-12836

### Plastic Instrument Cassettes (JS Dental)

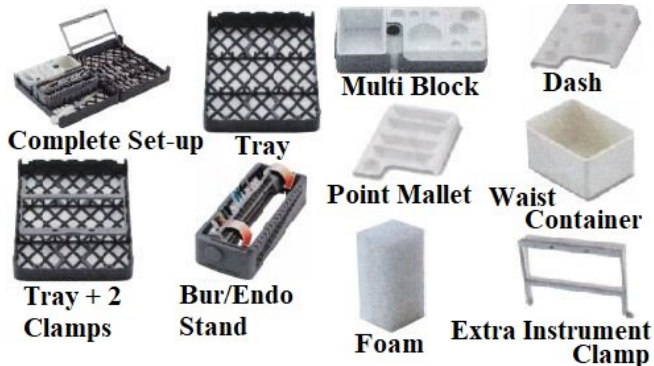

<b>Complete Set Up</b>	40-13311
<b>Tray (2 Clips)</b>	40-13310
<b>Tray w/Instrument Clamp (2 Clips)</b>	40-13309
<b>Bur/Endo Stand</b>	40-13306
<b>Multi Block</b>	40-13307
<b>Multi Dash Pallet (300)</b>	40-13316
<b>Point Mallet (300)</b>	40-13312
<b>Waist Container (300)</b>	40-13313
<b>Foam (300)</b>	40-13314
<b>Extra Instrument clamp</b>	40-13315
<b>Extra Clips</b>	40-13308

### Replacement Air Water Syringe Clip Holder (Nordent)



Use an Air Water Syringe Clip to safety secure your Air & Water Syringe Tips, Scissor and Needle Holders to the inside of the Cassette. Will fit all Nordent Cassette configurations. Made of spring tempered stainless steel.

<b>Each</b>	40-13493
-------------	----------

### Replacement Instrument Holders (Nordent)



*Blue*



*Teal*



*Fuscia*



*Yellow*



*Lt. Green*



*White*



## Instruments



Prestige Dental Products, Inc.  
 Prestigedentalproducts.com  
 Tel: 877-772-3888

Nordent Cassette Instrument Holders are made of medical grade silicone and hold up to years of repeating sterilization cycles. They are designed to be easy to install in the practice setting. Each complete set contains bottom and top rails. Choose the correct instrument holder set in your choice of 6 colors below.

<b>Blue 5 Instrument Holder Set,</b> Fits Cassettes C1-5N & C2-5D	40-13494
<b>Teal 5 Instrument Holder Set,</b> Fits Cassettes C1-5N & C2-5D	40-13495
<b>Fuscia 5 Instrument Holder Set,</b> Fits Cassettes C1-5N & C2-5D	40-13496
<b>Yellow 5 Instrument Holder Set,</b> Fits Cassettes C1-5N & C2-5D	40-13497
<b>Green 5 Instrument Holder Set,</b> Fits Cassettes C1-5N & C2-5D	40-13498
<b>White 5 Instrument Holder Set,</b> Fits Cassettes C1-5N & C2-5D	40-13499
<b>Blue 8 Instrument Holder Set,</b> Fits Cassettes C2-8D & C3-8D	40-13500
<b>Teal 8 Instrument Holder Set,</b> Fits Cassettes C2-8D & C3-8D	40-13501
<b>Fuscia 8 Instrument Holder Set,</b> Fits Cassettes C2-8D & C3-8D	40-13502
<b>Yellow 8 Instrument Holder Set,</b> Fits Cassettes C2-8D & C3-8D	40-13503
<b>Green 8 Instrument Holder Set,</b> Fits Cassettes C2-8D & C3-8D	40-13504
<b>White 8 Instrument Holder Set,</b> Fits Cassettes C2-8D & C3-8D	40-13505
<b>Blue 10 Instrument Holder Set,</b> Fits Cassettes C2-10N & C3-10D	40-13506
<b>Teal 10 Instrument Holder Set,</b> Fits Cassettes C2-10N & C3-10D	40-13507
<b>Fuscia 10 Instrument Holder Set,</b> Fits Cassettes C2-10N & C3-10D	40-13508
<b>Yellow 10 Instrument Holder Set,</b> Fits Cassettes C2-10N & C3-10D	40-13509
<b>Green 10 Instrument Holder Set,</b> Fits Cassettes C2-10N & C3-10D	40-13510
<b>White 10 Instrument Holder Set,</b> Fits Cassettes C2-10N & C3-10D	40-13511
<b>Blue 16 Instrument Holder Set,</b> Fits Cassettes C3-16D	40-13512
<b>Teal 16 Instrument Holder Set,</b> Fits Cassettes C3-16D	40-13513
<b>Fuscia 16 Instrument Holder Set,</b> Fits Cassettes C3-16D	40-13514
<b>Yellow 16 Instrument Holder Set,</b> Fits Cassettes C3-16D	40-13515

<b>Green 16 Instrument Holder Set,</b> Fits Cassettes C3-16D	40-13516
<b>White 16 Instrument Holder Set,</b> Fits Cassettes C3-16D	40-13517

### Signature Series Instrument Cassettes (Hu-Friedy)

Hu-Friedy now offers IMS Signature Series Thin Orthodontic Cassettes. The Thin Ortho Cassettes are 40-50% thinner than our existing cassettes allowing for more cassettes to fit into processing equipment (you can now fit 8 thin ortho cassettes in the same amount of space as 5 standard cassettes).



These cassette features a brand new design of an ultra low profile silicone rail that gently holds pliers in place during processing; therefore, reducing the chance for instrument damage and allowing for easy accessibility.

<b>Large, Thin, fits up to 7 pliers</b> Standard configuration has rails for 4 hand instruments Available in blue rail color. Each	40-89191
<b>Small, Thin, fits up to 4 pliers</b> Standard configuration has rails for 3 hand instruments Available in blue rail color. Each	40-89192

### Steri Autoclavable Instrument Containers (Plasdent)

203SCS

*Autoclavable to  
250F*



<b>Neon Blue, 8" x 1 3/4" x 1 3/4" each</b>	40-13868
<b>Neon Yellow, 8" x 1 3/4" x 1 3/4" each</b>	40-13879
<b>Neon Green, 8" x 1 3/4" x 1 3/4" each</b>	40-13878
<b>Neon Pink, 8" x 1 3/4" x 1 3/4" each</b>	40-13877
<b>Neon Purple, 8" x 1 3/4" x 1 3/4" each</b>	40-13876
<b>Neon Tangerine, 8" x 1 3/4" x 1 3/4" each</b>	40-13875
<b>Neon Orange Red, 8" x 1 3/4" x 1 3/4" each</b>	40-13874
<b>Vanilla, 8" x 1 3/4" x 1 3/4" each</b>	40-13873
<b>Baby Blue, 8" x 1 3/4" x 1 3/4" each</b>	40-13872
<b>Seagreen, 8" x 1 3/4" x 1 3/4" each</b>	40-13871
<b>Sand, 8" x 1 3/4" x 1 3/4" each</b>	40-13869
<b>Light Mauve, 8" x 1 3/4" x 1 3/4" each</b>	40-13870
<b>Lilac, 8" x 1 3/4" x 1 3/4" each</b>	40-13880

# Instruments



Prestige Dental Products, Inc.  
 Prestigedentalproducts.com  
 Tel: 877-772-3888

## Steri Instrument Containers (PlasDent)

Autoclavable to 250F



<b>White</b> , 8" x 1 3/4" x 1 3/4"	40-13881
<b>Black</b> 8" x 1 3/4" x 1 3/4"	40-13882
<b>Mauve</b> 8" x 1 3/4" x 1 3/4"	40-13883
<b>Gray</b> 8" x 1 3/4" x 1 3/4"	40-13884
<b>Beige</b> 8" x 1 3/4" x 1 3/4"	40-13885
<b>Coral</b> 8" x 1 3/4" x 1 3/4"	40-13886
<b>Flame</b> 8" x 1 3/4" x 1 3/4"	40-13887
<b>Green</b> 8" x 1 3/4" x 1 3/4"	40-13888
<b>Yellow</b> 8" x 1 3/4" x 1 3/4"	40-13889
<b>Blue</b> 8" x 1 3/4" x 1 3/4"	40-13890
<b>Teal</b> 8" x 1 3/4" x 1 3/4"	40-13891

## Steri-System Cassette AA-Shadow (DUX)

Stackable - 8 instrument holder  
 Closed: 7½W x 5½D x 1½H  
 (199mm x 140mm x 39mm)  
 Open: 7½W x 10¼D x ¾H  
 (199mm x 274mm x 20mm)



<b>8 instrument holder</b> , French Vanilla, each	40-90511
<b>8 instrument holder</b> , Light Mauve, each	40-90512
<b>8 instrument holder</b> , Seafoam, each	40-90513
<b>8 instrument holder</b> , Lilac, each	40-90514
<b>8 instrument holder</b> , Baby Blue, each	40-90515
<b>8 instrument holder</b> , Beige color, each	40-90516

## Sharpening System

### Sharpening Systems (PDT)



No need for oil or water  
 Guaranteed not to pit or groove!

<b>PingRing Sharp Tester</b>	40-13781
------------------------------	----------

**Diamond Head Ceramic Stone** (Maintain Edge) 40-13782

**Transformation Sharpening Stone** (Reshape Blade) 40-13780

**PDT/Gleason Guide** \*Patent No. 6,852,014 40-13779

### InstRenew Sharpening Assistant (Nordent)



InstRenew Sharpening Assistant comes complete with everything you'll need to begin sharpening with professional results.

#### **Includes:**

- Diamond Coated Sharpening Cone (installed)
- Wrench with Diamond Smoother
- Plastic Test Stick
- 110vUS - Prong Power Cord
- InstRenew Training DVD

**Sharpening Assistant InstRenew 2v3** 40-12615

**Sharpening Cone InstRenew (FINE)** 40-12606

**Wrench InstRenew** 40-12607

**Kit InstRenew 2 Updated Tip Clamp and Cones** 40-12608

**Cone Dressing (1 oz. Bottle)** 40-12609

**(4" x 1/2") Test Stick Plastic Non-Autoclavable** 40-12610

**Updated tip clamp for SSM2V3** 40-12611

**110 Volt Power Adapter InstRenew Standard US** 40-12612

**240V Transformer for Australia/New Zealand** 40-12613

**220V European type Power Adapter InstRenew2** 40-12614

**220V UK type Power Adapter InstRenew2** 40-12605

### Neivert Whittler Instrument Sharpener (Temrex)

Sharpens any metal tool or instrument to razor edge in seconds. It can be used on knives, scissors, curettes, scalers, spoon excavators, and chisels. Sharpener is made of tungsten carbide. Autoclavable.



# Instruments



Prestige Dental Products, Inc.  
 Prestigedentalproducts.com  
 Tel: 877-772-3888

Each 40-90793

## Sharpening Stone (DA)



- Arkansas, 3" x 1 x 3/16" 40-90790
- Arkansas in wood box, 3" x 1" x 3/16" 40-90791
- India Combo, Fine/Coarse 4" x 1 3/4" x 5/8" 40-90792

## Sharpening Stone (Hu-Friedy)



- Arkansas Flat, Fine No. 4 40-90794
- Arkansas Thick Wedge, Fine No. 6A 40-90795
- Arkansas Conical, Superfine No.299 40-90796
- Ceramic, Medium No. 3 40-90797
- Composite Stone for: handpieces, coarse, made of white aluminum oxide 40-90798
- India Fine No.309 40-90799
- India Medium MS-22 40-90800
- India Wedge Medium No.6 40-90801
- Plastic Test Stick, 6/Pkg 40-90802
- Sharpening Oil, 1oz Bottle 40-90803

## Sharpening Stone (Miltex)



Provides clinicians with the proper tools for re-establishing an instrument's proper cutting edge.

### HONING OIL

Provides proper lubrication during sharpening, reducing friction and metallic particles from embedding into the stone.

- Arkansas Stones 40-90804
  - Natural Stones, No.4 Flat
- Arkansas Stones-Natural Stones 40-90805
  - Conical
- India Stones-Aluminum Oxide No.1 40-90806
  - Flat, Fine Grit
- India Stones-Aluminum Oxide No.6 40-90807
  - Wedge, Medium Grit
- India Stones-Aluminum Oxide 40-90808
  - No.309, Fine Grit
- Honing Oil, 1 oz 40-90809

## Sharpening Stone (Nordent)



- Non-Autoclavable Test Stick
- Autoclavable Test Stick
- Medium Grit Ceramic Stone #6
- Hard Arkansas Stone #2
- Hard Arkansas Stone #4
- Hard Arkansas Stone #1 (Slip Shape)
- Hard Arkansas Stone #3
- India Medium Stone #5 (Slip Shape)
- Ultra-Hard Arkansas Stone #22 (Mini Slip)
- Arkansas Hard Slip (4" x 2-1/2" x 1/8") 40-12936
- Arkansas Hard Rectangular (4" x 1" x 1/2") 40-12928
- Arkansas Hard Triangular (4" x 3/8") 40-12929
- Arkansas Hard Round (4" x 1/4") 40-12930
- India Medium Slip (4-1/2" x 2" x 3/8") 40-12931
- 3 x 1.25 x .25 inches Medium Grit Ceramic 40-12932
- Honing Oil 1 Oz. Bottle 40-12934



# Instruments



Prestige Dental Products, Inc.  
 Prestigedentalproducts.com  
 Tel: 877-772-3888

<b>Arkansas Ultra-Hard Mini Slip</b> (2" x 7/8" x 3/16")	40-12933
<b>(4" x 1/2") Test Stick Non-Autoclavable</b>	40-12935
<b>(4" x 1/4") Test Stick Autoclavable</b>	40-12937
<b>Nordent Blade Gauge</b>	40-12927

### Sidekick (Hu-Friedy)

Designed to perform routine maintenance sharpening of scalers and currettes, this sharpener is the only power device with instrument guide channels and vertical backstops to help control blade angulations.

These template-like features allow virtually effortless positioning of your scalers/currettes and provide consistent sharpening results. Correct routine sharpening will help extend the life of your instruments. The Sidekick is small, compact, cordless, can be placed anywhere and requires minimal counter space—perfect for anywhere in the dental office.



Hu-Friedy, at its sole option, will repair or replace for a period of one year following the date of purchase, Sidekick Sharpener that fails as a result of a defect in materials or workmanship. Purchaser must return the defective Sidekick Sharpener (postage prepaid) and must have previously provided Hu-Friedy with the Sidekick warranty registration card.

**Kit Contains:** Sidekick unit, user manual and CD-ROM, ceramic sharpening stone, plastic test stick, magnifying lens and 2 AA batteries

**Replacement Stone for Sidekick** 40-90811

### Ultimate Edge Kits (PDT)



**Ultimate Edge Sharpening Kit**

Sharpening Kit 40-13954

**Ultimate Edge Transformation Kit**

Transformation Kit 40-13955

## Instrument Trays & Accessories

### Color Rings— Duralite Handle (Nordent)



<b>Assorted 13 Colors 4 Each Color</b>	40-11661
<b>Black 48/Pkg</b>	40-11675
<b>Blue 48/Pkg</b>	40-11674
<b>Brown 48/Pkg</b>	40-11673
<b>Fuscia 48/Pkg</b>	40-11672
<b>Green 48/Pkg</b>	40-11671
<b>Gray 48/Pkg</b>	40-11670
<b>Light Green 48/Pkg</b>	40-11669
<b>Orange 48/Pkg</b>	40-11668
<b>Pink 48/Pkg</b>	40-11667
<b>Purple 48/Pkg</b>	40-11666
<b>Red 48/Pkg</b>	40-11665
<b>Teal 48/Pkg</b>	40-11664
<b>White 48/Pkg</b>	40-11663
<b>Yellow 48/Pkg</b>	40-11662
<b>Remover Single End</b>	40-11676

### Divide Tray Size B (PlasDent)



<b>Neon Blue, (13 1/2" x 9 5/8" x 7/8")</b>	40-11640
<b>Neon Yellow, (13 1/2" x 9 5/8" x 7/8")</b>	40-11653
<b>Neon Green, (13 1/2" x 9 5/8" x 7/8")</b>	40-11654
<b>Neon Pink, (13 1/2" x 9 5/8" x 7/8")</b>	40-11655
<b>Neon Purple, (13 1/2" x 9 5/8" x 7/8")</b>	40-11644
<b>Neon Tangerine, (13 1/2" x 9 5/8" x 7/8")</b>	40-11645
<b>Neon Orange Red, (13 1/2" x 9 5/8" x 7/8")</b>	40-11646
<b>Vanilla, (13 1/2" x 9 5/8" x 7/8")</b>	40-11647
<b>Baby Blue, (13 1/2" x 9 5/8" x 7/8")</b>	40-11648
<b>Seagreen, (13 1/2" x 9 5/8" x 7/8")</b>	40-11649
<b>Sand, (13 1/2" x 9 5/8" x 7/8")</b>	40-11650
<b>Light Mauve, (13 1/2" x 9 5/8" x 7/8")</b>	40-11651
<b>Lilac, (13 1/2" x 9 5/8" x 7/8")</b>	40-11652

# Instruments



Prestige Dental Products, Inc.  
 Prestigedentalproducts.com  
 Tel: 877-772-3888

## Divided Tray

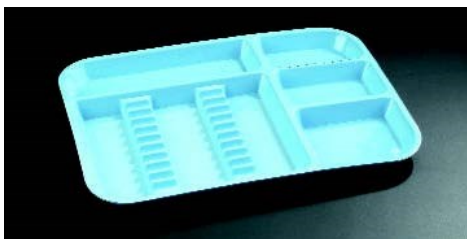

- Size B** (Ritter)(13 1/2" x 9 5/8" x 7/8") 40-11610  
Color: White
- Size A** (Chayes)(13 3/4" x 10 5/8" x 7/8") Color: White 40-11619
- Size E** (Midwest)(15" x 10 1/2" x 7/8") 40-11596  
Color: White
- Size E** (Midwest)(15" x 10 1/2" x 7/8") 40-11597  
Color: Blue
- Size E** (Midwest)(15" x 10 1/2" x 7/8") 40-11598  
Color: Yellow
- Size E** (Midwest)(15" x 10 1/2" x 7/8") 40-11599  
Color: Green
- Size E** (Midwest)(15" x 10 1/2" x 7/8") 40-11600  
Color: Flame
- Size E** (Midwest)(15" x 10 1/2" x 7/8") 40-11601  
Color: Coral
- Size E** (Midwest)(15" x 10 1/2" x 7/8") 40-11602  
Color: Beige
- Size E** (Midwest)(15" x 10 1/2" x 7/8") 40-11603  
Color: Gray
- Size E** (Midwest)(15" x 10 1/2" x 7/8") 40-11604  
Color: Mauve
- Size E** (Midwest)(15" x 10 1/2" x 7/8") 40-11605  
Color: Black
- Size E** (Midwest)(15" x 10 1/2" x 7/8") 40-11623  
Color: Teal
- Size B** (Ritter)(13 1/2" x 9 5/8" x 7/8") 40-11609  
Color: Blue
- Size B** (Ritter)(13 1/2" x 9 5/8" x 7/8") 40-11591  
Color: Yellow
- Size B** (Ritter)(13 1/2" x 9 5/8" x 7/8") 40-11611  
Color: Green
- Size B** (Ritter)(13 1/2" x 9 5/8" x 7/8") 40-11612  
Color: Flame
- Size B** (Ritter)(13 1/2" x 9 5/8" x 7/8") 40-11613  
Color: Coral
- Size B** (Ritter)(13 1/2" x 9 5/8" x 7/8") 40-11614  
Color: Beige
- Size B** (Ritter)(13 1/2" x 9 5/8" x 7/8") 40-11615  
Color: Gray

- Size B** (Ritter)(13 1/2" x 9 5/8" x 7/8") 40-11616  
Color: Mauve
- Size B** (Ritter)(13 1/2" x 9 5/8" x 7/8") 40-11617  
Color: Black
- Size B** (Ritter)(13 1/2" x 9 5/8" x 7/8") 40-11618  
Color: Teal
- Size A** (Chayes)(13 3/4" x 10 5/8" x 7/8") Color: Blue 40-11620
- Size A** (Chayes)(13 3/4" x 10 5/8" x 7/8") Color: Yellow 40-11621
- Size A** (Chayes)(13 3/4" x 10 5/8" x 7/8") Color: Green 40-11622
- Size A** (Chayes)(13 3/4" x 10 5/8" x 7/8") Color: Flame 40-11608
- Size A** (Chayes)(13 3/4" x 10 5/8" x 7/8") Color: Coral 40-11607
- Size A** (Chayes)(13 3/4" x 10 5/8" x 7/8") Color: Beige 40-11606
- Size A** (Chayes)(13 3/4" x 10 5/8" x 7/8") Color: Gray 40-11592
- Size A** (Chayes)(13 3/4" x 10 5/8" x 7/8") Color: Mauve 40-11593
- Size A** (Chayes)(13 3/4" x 10 5/8" x 7/8") Color: Black 40-11594
- Size A** (Chayes)(13 3/4" x 10 5/8" x 7/8") Color: Teal 40-11595

## Divided Type Trays (Zirc)



**B-Lok:** (13 1/2" x 9 5/8" x 7/8")  
**B-Lok Neon:** (13 1/2" x 9 5/8" x 7/8")

- Blue B-lok**, each 40-91342
- Yellow B-lok**, each 40-91343
- Green B-lok**, each 40-91344
- Mauve B-lok**, each 40-91345
- Yellow B-lok Neon**, each 40-91346
- Green B-lok Neon**, each 40-91347
- Purple B-lok Neon**, each 40-91348
- Pink B-lok Neon**, each 40-91349

## Flat Trays Side D (PlasDent)

(A-Den-Tal-Ez)



## Instruments



Prestige Dental Products, Inc.  
 Prestigedentalproducts.com  
 Tel: 877-772-3888

<b>White</b> , (12 3/8" x 7 3/4" x 3/4")	40-16001
<b>Blue</b> , (12 3/8" x 7 3/4" x 3/4")	40-16000

### Flat Trays In Neon & Pastel Colors



Size B 13 1/2" x 9 5/8" x 7/8" (Ritter)  
 Size F 9 5/8" x 6 5/8" x 7/8" (Mini)

<b>Size B Neon Blue</b>	40-12176
<b>Size B Neon Yellow</b>	40-12190
<b>Size B Neon Green</b>	40-12191
<b>Size B Neon Pink</b>	40-12192
<b>Size B Neon Purple</b>	40-12193
<b>Size B Neon Tangerine</b>	40-12194
<b>Size B Flame</b>	40-12195
<b>Size B Vanilla</b>	40-12196
<b>Size B Baby Blue</b>	40-12197
<b>Size B Seagreen</b>	40-12198
<b>Size B Sand</b>	40-12199
<b>Size B Light Mauve</b>	40-12200
<b>Size B Lilac</b>	40-12189
<b>Size F Neon Blue</b>	40-12188
<b>Size F Neon Yellow</b>	40-12177
<b>Size F Neon Green</b>	40-12178
<b>Size F Neon Pink</b>	40-12179
<b>Size F Neon Purple</b>	40-12180
<b>Size F Neon Tangerine</b>	40-12181
<b>Size F Neon Orange Red</b>	40-12182
<b>Size F Vanilla</b>	40-12183
<b>Size F Baby Blue</b>	40-12184
<b>Size F Seagreen</b>	40-12185
<b>Size F Sand</b>	40-12186
<b>Size F Light Mauve</b>	40-12187
<b>Size F Lilac</b>	40-12201

### Flat Type Trays (Zirc)

- B-Lok Neon 13 1/2' x 9 5/8" x 7/8"
- B-Lok 13 1/2' x 9 5/8" x 7/8"



<b>White, B-lok</b> each	40-91363
<b>Blue, B-lok</b> each	40-91364
<b>Yellow, B-lok</b> each	40-91365
<b>Green, B-lok</b> each	40-91366
<b>Beige, B-lok</b> each	40-91367
<b>Mauve, B-lok</b> each	40-91368
<b>Gray, B-lok</b> each	40-91369
<b>Lilac, B-lok</b> each	40-91370
<b>Blue, B-Lok Neon</b> each	40-91371
<b>Yellow, B-Lok Neon</b> each	40-91372
<b>Green, B-Lok Neon</b> each	40-91373
<b>Orange, B-Lok Neon</b> each	40-91374
<b>Purple, B-Lok Neon</b> each	40-91375
<b>Pink, B-Lok Neon</b> each	40-91376

### Instrument Mats (Plasdent)

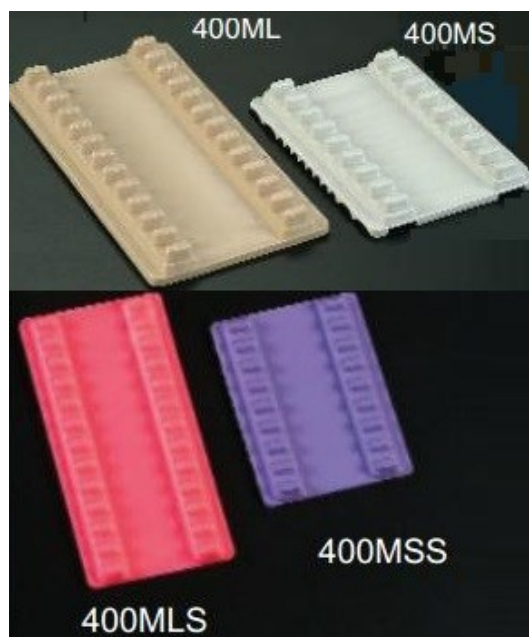

<b>Large Capacity: 12 (7 1/2" x 4")</b> Color: White	40-12721
<b>Small Capacity: 8 or 12 (5 3/16" x 4 1/8")</b> Reversible Color: Blue	40-12722
<b>Small Capacity: 8 or 12 (5 3/16" x 4 1/8")</b> Reversible Color: Yellow	40-12723
<b>Small Capacity: 8 or 12 (5 3/16" x 4 1/8")</b> Reversible Color: Green	40-12724
<b>Small Capacity: 8 or 12 (5 3/16" x 4 1/8")</b> Reversible Color: Flame	40-12725
<b>Small Capacity: 8 or 12 (5 3/16" x 4 1/8")</b> Reversible Color: Coral	40-12726



# Instruments



Prestige Dental Products, Inc.  
 Prestigedentalproducts.com  
 Tel: 877-772-3888

<b>Small Capacity:</b> 8 or 12 (5 3/16" x 4 1/8") Reversible Color: Beige	40-12727
<b>Small Capacity:</b> 8 or 12 (5 3/16" x 4 1/8") Reversible Color: Gray	40-12720
<b>Small Capacity:</b> 8 or 12 (5 3/16" x 4 1/8") Reversible Color: Mauve	40-12728
<b>Small Capacity:</b> 8 or 12 (5 3/16" x 4 1/8") Reversible Color: Black	40-12729
<b>Small Capacity:</b> 8 or 12 (5 3/16" x 4 1/8") Reversible Color: White	40-12730
<b>Large Capacity:</b> 12 (7 1/2" x 4") Color: Teal	40-12731
<b>Large Capacity:</b> 12 (7 1/2" x 4") Color: Blue	40-12732
<b>Large Capacity:</b> 12 (7 1/2" x 4") Color: Yellow	40-12733
<b>Large Capacity:</b> 12 (7 1/2" x 4") Color: Green	40-12734
<b>Large Capacity:</b> 12 (7 1/2" x 4") Color: Flame	40-12735
<b>Large Capacity:</b> 12 (7 1/2" x 4") Color: Coral	40-12736
<b>Large Capacity:</b> 12 (7 1/2" x 4") Color: Beige	40-12737
<b>Large Capacity:</b> 12 (7 1/2" x 4") Color: Gray	40-12738
<b>Large Capacity:</b> 12 (7 1/2" x 4") Color: Mauve	40-12739
<b>Large Capacity:</b> 12 (7 1/2" x 4") Color: Black	40-12740
<b>Small Capacity:</b> 8 or 12 (5 3/16" x 4 1/8") Reversible Color: Teal	40-12741

## Mini Tray Rack



Chrome for size F Tray

**Capacity:** 8 (10"W x 6 1/4"D x 13"H) 26-11818

## Mini Type Trays (Zirc)



- Mini 9 1/4" x 6 5/16" x 7/8"
- Mini Neon 9 1/4" x 6 5/16" x 7/8"

<b>White, Mini</b> each	40-91350
<b>Blue, Mini</b> each	40-91351
<b>Yellow, Mini</b> each	40-91352
<b>Green, Mini</b> each	40-91353
<b>Beige, Mini</b> each	40-91354
<b>Lilac, Mini</b> each	40-91355
<b>Teal, Mini</b> each	40-91356
<b>Blue, Mini Neon</b> each	40-91357
<b>Yellow, Mini Neon</b> each	40-91358
<b>Green, Mini Neon</b> each	40-91359
<b>Orange, Mini Neon</b> each	40-91360
<b>Purple, Mini Neon</b> each	40-91361
<b>Pink, Mini Neon</b> each	40-91362

## Multi-Mod Rack (Zirc)



- Adjustable to hold Trays, Tubs, and Cassettes
- Sturdy metal construction; chrome plated
- Non-Slip feet
- Surface Disinfect Only

<b>6 Places, each</b>	40-91299
<b>8 Places, each</b>	40-91300

## Operation Tubs



<b>Neon Blue</b>	40-13142
<b>Neon Yellow</b>	40-13129
<b>Neon Green</b>	40-13128



Prestige Dental Products, Inc.  
 Prestigedentalproducts.com  
 Tel: 877-772-3888

## Instruments

Neon Pink	40-13127
Neon Purple	40-13126
Neon Tangerine	40-13125
Vanilla	40-13124
Baby Blue	40-13123
Seagreen	40-13122
Sand	40-13121
Light Mauve	40-13130
Lilac	40-13131
White	40-13133
Blue	40-13132
Yellow	40-13141
Green	40-13140
Flame	40-13139
Coral	40-13138
Beige	40-13137
Gray	40-13136
Mauve	40-13135
Teal	40-13134

### Plastic Cabinet Trays (Zirc)

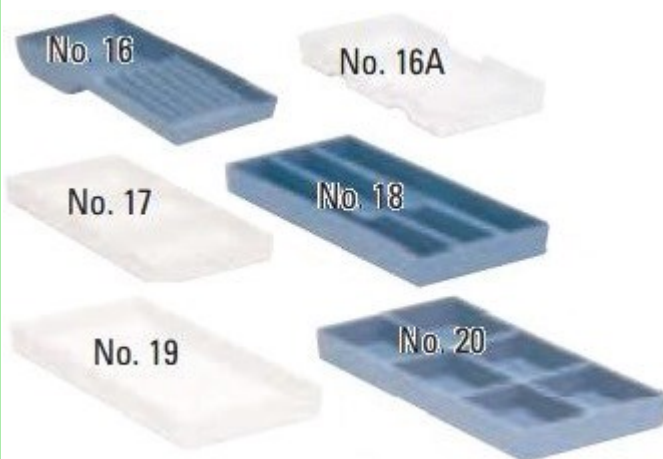

White, No.16 each	40-91302
Blue, No.16A each	40-91303
White, No.17 each	40-91304
Blue, No.17 each	40-91305
Blue, No.18 each	40-91306
White, No.19 each	40-91307
White, No.20 each	40-91308
Blue, No.20 each	40-91309

### Procedure Set Up Trays - Size A, B, E, F

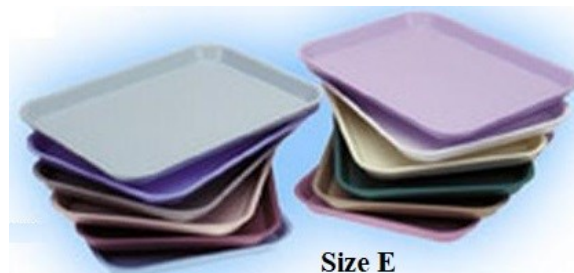

<b>Size E (Midwest) White,</b> 15" x 10 1/2" x 7/8	40-25002
<b>Size E (Midwest) Blue,</b> 15" x 10 1/2" x 7/8	40-25003
<b>Size E (Midwest) Yellow,</b> 15" x 10 1/2" x 7/8	40-25004
<b>Size E (Midwest) Green,</b> 15" x 10 1/2" x 7/8	40-25005
<b>Size E (Midwest) Flame,</b> 15" x 10 1/2" x 7/8	40-25006
<b>Size E (Midwest) Coral,</b> 15" x 10 1/2" x 7/8	40-25007
<b>Size E (Midwest) Beige,</b> 15" x 10 1/2" x 7/8	40-25008
<b>Size E (Midwest) Gray,</b> 15" x 10 1/2" x 7/8	40-25009
<b>Size E (Midwest) Mauve,</b> 15" x 10 1/2" x 7/8	40-25010
<b>Size E (Midwest) Black,</b> 15" x 10 1/2" x 7/8	40-25026
<b>Size E (Midwest) Teal,</b> 15" x 10 1/2" x 7/8	40-25027
<b>Size F (Mini) White,</b> 9 5/8" x 6 5/8" x 7/8	40-25013
<b>Size F (Mini) Blue,</b> 9 5/8" x 6 5/8" x 7/8	40-25014
<b>Size F (Mini) Yellow,</b> 9 5/8" x 6 5/8" x 7/8	40-25015
<b>Size F (Mini) Green,</b> 9 5/8" x 6 5/8" x 7/8	40-25016
<b>Size F (Mini) Flame,</b> 9 5/8" x 6 5/8" x 7/8	40-25017
<b>Size F (Mini) Coral,</b> 9 5/8" x 6 5/8" x 7/8	40-25018
<b>Size F (Mini) Beige,</b> 9 5/8" x 6 5/8" x 7/8	40-25019
<b>Size F (Mini) Gray,</b> 9 5/8" x 6 5/8" x 7/8	40-25020
<b>Size F (Mini) Mauve,</b> 9 5/8" x 6 5/8" x 7/8	40-25028

# Instruments



Prestige Dental Products, Inc.  
 Prestigedentalproducts.com  
 Tel: 877-772-3888

<b>Size F (Mini) Black,</b> 9 5/8" x 6 5/8" x 7/8	40-11677
<b>Size F (Mini) Teal,</b> 9 5/8" x 6 5/8" x 7/8	40-11678
<b>Size B (Ritter) Blue,</b> 13 1/2" x 9 5/8" x 7/8	40-25029
<b>Size B (Ritter) Yellow,</b> 13 1/2" x 9 5/8" x 7/8	40-25030
<b>Size B (Ritter) Green,</b> 13 1/2" x 9 5/8" x 7/8	40-25051
<b>Size B (Ritter) Flame,</b> 13 1/2" x 9 5/8" x 7/8	40-25032
<b>Size B (Ritter) Coral,</b> 13 1/2" x 9 5/8" x 7/8	40-25033
<b>Size B (Ritter) Beige,</b> 13 1/2" x 9 5/8" x 7/8	40-25034
<b>Size B (Ritter) Gray,</b> 13 1/2" x 9 5/8" x 7/8	40-25035
<b>Size B (Ritter) Mauve,</b> 13 1/2" x 9 5/8" x 7/8	40-25036
<b>Size B (Ritter) Black,</b> 13 1/2" x 9 5/8" x 7/8	40-25037
<b>Size B (Ritter) Teal,</b> 13 1/2" x 9 5/8" x 7/8	40-25038
<b>Size B (Ritter) White,</b> 13 1/2" x 9 5/8" x 7/8	40-25039
<b>Size A (Chayes) White,</b> 13 3/4" x 10 5/8" x 7/8	40-25040
<b>Size A (Chayes) Blue,</b> 13 3/4" x 10 5/8" x 7/8	40-25041
<b>Size A (Chayes) Yellow,</b> 13 3/4" x 10 5/8" x 7/8	40-25042
<b>Size A (Chayes) Green,</b> 13 3/4" x 10 5/8" x 7/8	40-25043
<b>Size A (Chayes) Flame,</b> 13 3/4" x 10 5/8" x 7/8	40-25044
<b>Size A (Chayes) Coral,</b> 13 3/4" x 10 5/8" x 7/8	40-25045
<b>Size A (Chayes) Beige,</b> 13 3/4" x 10 5/8" x 7/8	40-25046
<b>Size A (Chayes) Gray,</b> 13 3/4" x 10 5/8" x 7/8	40-25047
<b>Size A (Chayes) Mauve,</b> 13 3/4" x 10 5/8" x 7/8	40-25048
<b>Size A (Chayes) Black,</b> 13 3/4" x 10 5/8" x 7/8	40-25049

[www.prestigedentalproducts.com](http://www.prestigedentalproducts.com)

## Set-Up Tray Cover/Mini-Tray Lock Cover



<b>Tray Cover, each</b>	40-91340
<b>Mini Tray, each</b>	40-91341

## Set-Up Trays B-Flat (Dux Dental)

Size B Trays adapt well to all individual set-up configurations.



<b>Baby Blue, each</b>	40-91310
<b>Beige, each</b>	40-91311
<b>French Vanilla, each</b>	40-91312
<b>Gray, each</b>	40-91313
<b>Lilac, each</b>	40-91314
<b>Mauve, each</b>	40-91315
<b>Sand, each</b>	40-91316
<b>Seafoam, each</b>	40-91317
<b>Sky Blue, each</b>	40-91318
<b>Teal, each</b>	40-91319
<b>White, each</b>	40-91320

## Set-Up Trays-B Divided (Dux Dental)

B Trays fit bracket table/control head surfaces and cabinets manufactured by A-Dec, Belmont, Biotec, Celebrity, Pelton & Crane, Siemens, etc.



<b>Baby Blue, each</b>	40-91321
<b>Beige, each</b>	40-91322
<b>French Vanilla, each</b>	40-91323
<b>Lilac, each</b>	40-91324
<b>Light Mauve, each</b>	40-91325
<b>Mauve, each</b>	40-91326
<b>Sand, each</b>	40-91327
<b>Seafoam, each</b>	40-91328
<b>Sky Blue, each</b>	40-91329



# Instruments



Prestige Dental Products, Inc.  
 Prestigedentalproducts.com  
 Tel: 877-772-3888

<b>Teal, each</b>	40-91330
<b>White, each</b>	40-91331

### Set-Up Trays-Mini Flat F (Dux Dental)

Size F (Mini) Trays are ideal for quick exams and/or prophylaxis procedures



<b>Baby Blue, each</b>	40-91332
<b>Gray, each</b>	40-91333
<b>Lilac, each</b>	40-91334
<b>Sand, each</b>	40-91335
<b>Seafoam, each</b>	40-91336
<b>Sky Blue, each</b>	40-91337
<b>Teal, each</b>	40-91338
<b>White, each</b>	40-91339

### Stainless Trays (Tech-Med)



**Size: 13 5/8" x 9 3/4" x 5/8"** 40-91301

### Tray Lids (Plasdent)

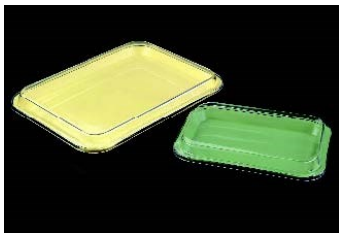

<b>Size B</b>	40-13945
<b>Size F</b>	40-13946

### Tray Racks (Dux Dental)

- Chromed steel
  - All racks accommodate a minimum of 8 trays
  - Easy assembly without tools
  - Size B (Ritter)
- Long Side Loading Rack  
**14 1/2" W x 9 3/4" D x 14 1/8" H**  
 Short Side Loading Rack  
**10 3/4" W x 13 1/2" D x 14 1/8" H**



<b>Long Side, each</b>	40-91377
<b>Short Side, each</b>	40-91378

### Tray Racks (PlasDent)



**Capacity: 8**

<b>Size A Tray,</b> 15" W x 9 3/4" D x 14 1/8"H	26-11822
<b>Size B Tray,</b> 14 1/2" W x 9 3/4" D x 14 1/8"H	26-11821
<b>Size D Tray,</b> 14 1/2" W x 9 3/4" D x 14 1/8"H	26-11820
<b>Size E Tray,</b> 16 1/4" W x 9 3/4" D x 14 1/8"H	26-11819

### Tub & Lid Rack



<b>W/Lid, Capacity 4,</b> 15"W x 10 3/8"D x 18 3/4"H	40-25601
<b>W/Lid, Capacity 4,</b> 15"W x 9 3/4"D x 14 1/8"H	SKU103691

### Tub Accessory Tray



**White, 7 7/8" x 3 7/8" x 1 1/8", each** 40-13118

# Instruments



Prestige Dental Products, Inc.  
 Prestigedentalproducts.com  
 Tel: 877-772-3888

## Tub Divider



6pcs/set, white 40-13117

## Tub Insert Tray



White, 11 1/4" x 9" x 1 1/8" 40-13119

## Tub Lid



Each 40-13120

## Tub Rack

Capacity: 4



15"W x 9 3/4"D x 14 1/8"H, each 40-25600

## Instrument Care

### Instrument Brushes (Miltex)

- Nylon
- Cleans all types of instruments.
- Will not harm instrument surfaces.
- Ideal for delicate instruments.
- **Stainless Steel** Ideal for cleaning rasps, files and burs.



Nylon, 3/Pkg 40-90748

Stainless Steel, 3/Pkg 40-90749

### Instrument Care System (Miltex)



**Kit Contains :** Spray lube, instrument cleaner, stain remover, & instructional videotape 40-12616

**Spray Lube** Pre mixed non-silicone formula in a pump spray bottle. Lubricates all moving parts on dental instruments 40-12622

**Cleaner 8oz** Specially formulated for use in ultrasonic or manual cleaning of dental instruments, glassware, plastic, or metal 40-12621

**Cleaner 1 Gallon** Specially formulated for use in ultrasonic or manual cleaning of dental instruments, glassware, plastic, or metal 40-12623

**Instrument Prep Enzyme Foam Spray Bottle** Ready to use foaming spray for pre-cleaning of solid instruments & scopes 40-12618

**Miltex® Instrument Care DVD** 40-12625

**Instrument Cleaning Brushes 7-1/4" (18.4cm), Stainless Steel Bristles (Set of 3)** 40-22626

**Instrument Cleaning Brushes 7-1/4" (18.4cm), Nylon Bristles (Set of 3)** 40-22629

**Packets, Dispenser box of 80** 40-22627

**Surgical Instrument Stain Remover, 3 oz. (85 grams), (case of 12)** 40-22628

# Instruments



Prestige Dental Products, Inc.  
 Prestigedentalproducts.com  
 Tel: 877-772-3888

## Instrument Coding

### Color Rings- Duralite Handle (Nordent)



<b>Assorted 13 Colors 4 Each Color</b>	40-11661
<b>Black 48/Pkg</b>	40-11675
<b>Blue 48/Pkg</b>	40-11674
<b>Brown 48/Pkg</b>	40-11673
<b>Fuchsia 48/Pkg</b>	40-11672
<b>Green 48/Pkg</b>	40-11671
<b>Gray 48/Pkg</b>	40-11670
<b>Light Green 48/Pkg</b>	40-11669
<b>Orange 48/Pkg</b>	40-11668
<b>Pink 48/Pkg</b>	40-11667
<b>Purple 48/Pkg</b>	40-11666
<b>Red 48/Pkg</b>	40-11665
<b>Teal 48/Pkg</b>	40-11664
<b>White 48/Pkg</b>	40-11663
<b>Yellow 48/Pkg</b>	40-11662
<b>Remover Single End</b>	40-11676

### E-Z ID Ring System (Zirc)

Prepackaged in an easy-to-use dispenser, just slip the instrument into an E-Z ID ring and remove it from the dispenser.



<b>Contains: 200 rings in 8 different Colors, Small, Pastel</b>	40-91123
<b>Contains: 200 rings in 8 different Colors, Small, Neon</b>	40-91124
<b>Contains: 200 rings in 8 different Colors, Large, Neon</b>	40-91125
<b>Small, White 25/Pkg</b>	40-91126
<b>Small, Blue 25/Pkg</b>	40-91127
<b>Small, Yellow 25/Pkg</b>	40-91128
<b>Small, Beige 25/Pkg</b>	40-91129
<b>Small, Mauve 25/Pkg</b>	40-91130
<b>Small, Gray 25/Pkg</b>	40-91131

<b>Small, Teal 25/Pkg</b>	40-91132
<b>Small, Lilac 25/Pkg</b>	40-91133
<b>Small, Neon Blue 25/Pkg</b>	40-91134
<b>Small, Neon Yellow 25/Pkg</b>	40-91135
<b>Small, Neon Green 25/Pkg</b>	40-91136
<b>Small, Neon Orange 25/Pkg</b>	40-91137
<b>Small, Neon Purple 25/Pkg</b>	40-91138
<b>Small, Neon Pink 25/Pkg</b>	40-91139
<b>Large, White 25/Pkg</b>	40-91140
<b>Large, Blue 25/Pkg</b>	40-91141
<b>Large, Yellow 25/Pkg</b>	40-91142
<b>Large, Green 25/Pkg</b>	40-91143
<b>Large, Mauve 25/Pkg</b>	40-91144
<b>Large, Teal 25/Pkg</b>	40-91145
<b>Large, Lilac 25/Pkg</b>	40-91146
<b>Large, Neon Blue 25/Pkg</b>	40-91147
<b>Large, Neon Yellow 25/Pkg</b>	40-91148
<b>Large, Neon Green 25/Pkg</b>	40-91149
<b>Large, Neon Orange 25/Pkg</b>	40-91150
<b>Large, Neon Purple 25/Pkg</b>	40-91151
<b>Large, Neon Pink 25/Pkg</b>	40-91152

### E-Z ID Ring System (Zirc)

First color code tape in the industry with a dispensing system. Tape dispenser has built-in taper cutter dispenser contains roller wheel available in all 15 colors. Works just like a scotch taper dispenser



<b>Pastel comes w/ 8 colors A-1</b>	40-105861
<b>Neon: comes w/ 8 colors A, J, N-S</b>	40-105862
<b>A-White Refill, 10 ft long</b>	40-105863
<b>B-Blue Refill, 10 ft long</b>	40-105864
<b>C-Yellow Refill, 10 ft long</b>	40-105865
<b>D-Green Refill, 10 ft long</b>	40-105866
<b>G-Beige Refill, 10 ft long</b>	40-105867
<b>H-Mauve Refill, 10 ft long</b>	40-105868
<b>I-Gray Refill, 10 ft long</b>	40-105869
<b>J-Green Refill, 10 ft long</b>	40-105870
<b>N-Neon Blue Refill, 10 ft long</b>	40-105871





Prestige Dental Products, Inc.  
 Prestigedentalproducts.com  
 Tel: 877-772-3888

## Instruments

<b>O-Neon Yellow Refill, 10 ft long</b>	40-105872
<b>P-Neon Green Refill, 10 ft long</b>	40-105873
<b>Q-Neon Orange Refill, 10 ft long</b>	40-105874
<b>R-Neon Purple Refill, 10 ft long</b>	40-105875
<b>S-Neon Pink Refill, 10 ft long</b>	40-105876

### Instrument Code Rings (Pac-Dent)

- Specifically made for use with Orthodontic Instruments
- Designed to fit orthodontic plier handles, scalars, band seaters, hemostats, and other orthodontic instruments
- Made from high temperature silicone that can withstand heat sterilization and autoclaving up to 370 degrees



<b>Yellow, 100/Pkg</b>	40-12639
<b>Mixed Colors, 100/Pkg</b>	40-12627

### Instrument Management System Color-Coded Instrument Rings (Hu-Friedy)

Silicone rings for identifying and organizing instruments. Useful for maintaining proper instrument order in cassettes and identifying instruments by procedure. Will withstand all heat sterilization methods.



<b>Regular Gray, 50/Pkg</b>	40-91170
<b>Regular White, 50/Pkg</b>	40-91171
<b>Regular Orange, 50/Pkg</b>	40-91172
<b>Regular Yellow, 50/Pkg</b>	40-91173
<b>Regular Red, 50/Pkg</b>	40-91174
<b>Regular Green, 50/Pkg</b>	40-91175
<b>Regular Blue, 50/Pkg</b>	40-91176
<b>Regular Black, 50/Pkg</b>	40-91177
<b>Regular Pink, 50/Pkg</b>	40-91178
<b>Regular Purple, 50/Pkg</b>	40-91179
<b>Large Gray, 50/Pkg</b>	40-91180
<b>Large White, 50/Pkg</b>	40-91181
<b>Large Orange, 50/Pkg</b>	40-91182
<b>Large Yellow, 50/Pkg</b>	40-91183
<b>Large Red, 50/Pkg</b>	40-91184
<b>Large Green, 50/Pkg</b>	40-91185
<b>Large Blue, 50/Pkg</b>	40-91186

<b>Large Black, 50/Pkg</b>	40-91187
<b>Large Pink, 50/Pkg</b>	40-91188
<b>Large Purple, 50/Pkg</b>	40-91189
<b>Assorted Regular 90/Pkg</b>	40-91190
<b>Assorted Large 90/Pkg</b>	40-91191

### Large Color Code Rings Silicone



<b>White Color, 60 pcs/box</b>	40-50626
<b>Blue Color, 60 pcs/box</b>	40-50627
<b>Yellow Color, 60 pcs/box</b>	40-50628
<b>Green Color, 60 pcs/box</b>	40-50629
<b>Red Color, 60 pcs/box</b>	40-50630
<b>Gray Color, 60 pcs/box</b>	40-50631
<b>Mauve Color, 60 pcs/box</b>	40-50632
<b>Purple Color, 60 pcs/box</b>	40-50633
<b>Assorted Color, 80 pcs/box</b>	40-50634

### Silicone Instrument Grips



<b>Large Silicone Grips For #6 Handle</b>	40-50600
<b>White Silicone Grip for #2 &amp; #4 Handle, 20 pcs/bag single color</b>	40-50601
<b>Blue Silicone Grip for #2 &amp; #4 Handle, 20 pcs/bag single color</b>	40-50602

# Instruments



Prestige Dental Products, Inc.  
 Prestigedentalproducts.com  
 Tel: 877-772-3888

<b>Yellow Silicone Grip for #2 &amp; #4 Handle, 20 pcs/bag single color</b>	40-50603
<b>Green Silicone Grip for #2 &amp; #4 Handle, 20 pcs/bag single color</b>	40-50604
<b>Red Silicone Grip for #2 &amp; #4 Handle, 20 pcs/bag single color</b>	40-50605
<b>Purple Silicone Grip for #2 &amp; #4 Handle, 20 pcs/bag single color</b>	40-50606
<b>Mauve Silicone Grip for #2 &amp; #4 Handle, 20 pcs/bag single color</b>	40-50607
<b>Assorted Silicone Grip for #2 &amp; #4 Handle, 20 pcs/bag single color</b>	40-50608
<b>Assorted Colors, 24 pcs/bag</b>	40-50609

## Silicone Instrument Grips (PacDent)

- Silicone color-coded instrument grips
- Unique textures ensure firm gripping while maximizing comfort



ComforGrip F for #2 & #4 handles

ComforGrip M for #4 & #6 handles

<b>M grip assorted for #4 and #6 handles, 20/Box</b>	40-15560
<b>F grip assorted for #2 and #4 handles, 20/Box</b>	40-15561
<b>M grip blue for #4 and #6 handles, 20/Box</b>	40-15562
<b>F grip blue for #2 and #4 handles. , 20/Box</b>	40-15563
<b>M grip purple for #4 and #6 handles, 20/Box</b>	40-15564
<b>F grip purple for #2 and #4 handles. , 20/Box</b>	40-15565
<b>M grip green for #4 and #6 handles, 20/Box</b>	40-15566
<b>F grip green for #2 and #4 handles. , 20/Box</b>	40-15567
<b>M grip pink for #4 and #6 handles, 20/Box</b>	40-15568
<b>F grip pink for #2 and #4 handles. , 20/Box</b>	40-15569
<b>M grip yellow for #4 and #6 handles, 20/Box</b>	40-15570
<b>F grip yellow for #2 and #4 handles. , 20/Box</b>	40-15571

<b>M grip clear for #4 and #6 handles, 20/Box</b>	40-15572
<b>F grip clear for #2 and #4 handles. , 20/Box</b>	40-15573

## Silitone Code Rings (Miltex)

- Withstand temperatures up to 450F
- Medical grade silicone
- Expandable from 4mm to 12mm



<b>Kit Contains: 480 rings of 12 different colors</b>	40-91192
<b>Pink 50/Pkg</b>	40-91193
<b>Purple 50/Pkg</b>	40-91194
<b>Red 50/Pkg</b>	40-91195
<b>Gray 50/Pkg</b>	40-91196
<b>Gold 50/Pkg</b>	40-91197
<b>Black 50/Pkg</b>	40-91198
<b>Yellow 50/Pkg</b>	40-91199
<b>White 50/Pkg</b>	40-91200
<b>Green 50/Pkg</b>	40-91201
<b>Brown 50/Pkg</b>	40-91202
<b>Blue 50/Pkg</b>	40-91203
<b>Light Blue 50/Pkg</b>	40-91204
<b>Kit 12 colors 50 each color total of 600 rings</b>	40-912041

## Small Color Code Rings Silicone



<b>White, 60 pcs/box Single Color</b>	40-50610
<b>Blue, 60 pcs/box Single Color</b>	40-50611
<b>Yellow, 60 pcs/box Single Color</b>	40-50612
<b>Green, 60 pcs/box Single Color</b>	40-50613
<b>Red, 60 pcs/box Single Color</b>	40-50614
<b>Mauve, 60 pcs/box Single Color</b>	40-50616
<b>Purple, 60 pcs/box Single Color</b>	40-50617

# Instruments



Prestige Dental Products, Inc.  
Prestigedentalproducts.com  
Tel: 877-772-3888

Assorted Color, 80 pcs/box 40-50618

### Tape-N-Tell Instrument Identification



Set of 8 Colors	40-91087
Individual Roll, Black	40-91088
Individual Roll, Blue	40-91089
Individual Roll, Brown	40-91090
Individual Roll, Green	40-91091
Individual Roll, Orange	40-91092
Individual Roll, Red	40-91093
Individual Roll, White	40-91094
Individual Roll, Yellow	40-91095

**Our Website has  
many more, please  
check it at**



[www.prestigedentalproducts.com](http://www.prestigedentalproducts.com)



Find Us On Social Media



Find us on  
**Facebook**



**Pinterest**

Call us for Quarterly Promotion







**Prestige Dental Products, Inc**

3031 E. Coronado St., #D  
Anaheim, Ca 92806  
Tel:877-772-3888 Fax:714-632-8821

[www.prestigedentalproducts.com](http://www.prestigedentalproducts.com)

