

Fully electronic system for producing reverberation from 0.4 to 4.5 s. With remote control facilities; for rack mounting.

# EMT 244 Digital Reverberation Unit

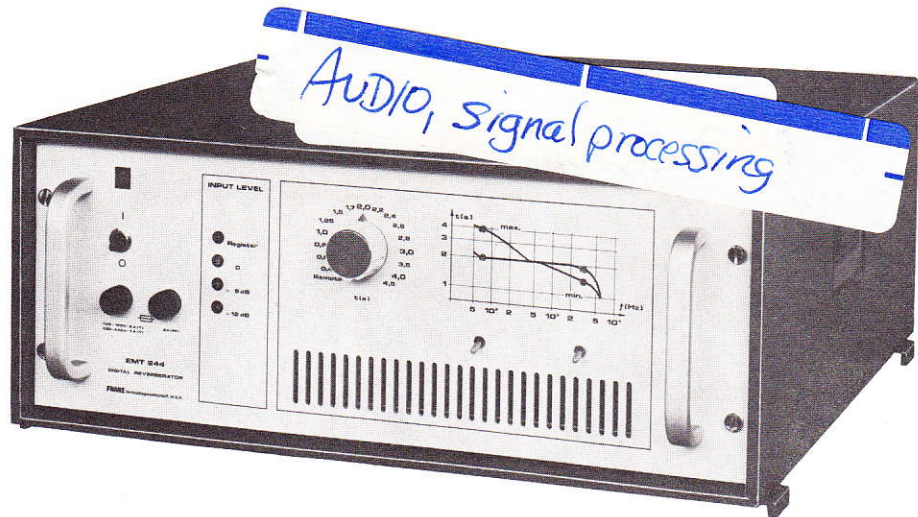

## Functions and application

This unit is a simplified version of the well known EMT 250 Electronic Reverberation Unit. It utilizes the same programming principles but was designed for applications where size and space are of critical importance, e.g. as remote recording vehicles, stage work, or entertainment halls. Wherever space is limited, but special acoustic effects are required, the EMT 244 will prove an excellent choice.

Reverberation time is selectable in 16 steps from 0.4 s to 4.5 s. A two position switch changes the response curve of the high and low frequencies. Low frequency response may be flat or boosted and high frequency response may be flat or rolled off.

## Electronics and circuitry

All the analog and digital electronics are located on a single large Printed Circuit Board. The input signal is fed to a newly developed, hybrid A/D converter where a digital word of 13 bits is produced. This digital signal is fed to the CPU which uses both discrete and LSI components. Its Random-Access-Memory has a capacity of 85 kbits. The stored program which controls the reverberation processor consists of Read-Only-Memories (ROM). Following the processor is a time shared digital/analog converter with two outputs (stereo).

All inputs and outputs are symmetrically balanced above ground. Unbalanced lines may also be used with a simple modification.

## Remote control

The reverberation time can be changed remotely by using an 8 or 16 position switch connected via a 4 or 5 conductor cable. A special interface board makes it possible to remotely operate the unit with the EMT 140 or EMT 240 remote controls.

## Technical data

Reverberation time (f = 500 Hz)	0.4 s ... 4.5 s, selectable in 16 steps
Reverberation time at low frequencies (f = 100 Hz)	selectable in two steps linear or boost
Reverberation time at high frequencies (f = 6 kHz)	selectable in two steps linear or roll off
Digital coding A/D and D/A converters	13 bit
<b>Analog section</b>	
a) input	balanced, input impedance greater than 5 kohms. Nominal input level +6 dB, adjustable between -10 and +15 dB
b) output	2 balanced outputs, output impedance less than 60 ohms. Output level normally +6 dB, adjustable between -10 and +15 dB
c) overload margin	6 dB greater than the adjusted nominal level, maximum +21 dB
d) signal-to-noise ratio at t = 2 sec	65 dB
e) frequency response 30 Hz ... 8 kHz	+1/ -3 dB
Remote control	5 conductor electrical cable for DC control
Dimensions	505 x 210 x 480 mm (20.1" x 8.4" x 19.1")
Weight	approx. 20 kilogram (44 lbs.)
Power consumption	70 VA

## Order No.

### Models

9 244 021	Digital Reverberator, chassis ready for 19" rack mounting, with 2 outputs, reverb time 0.4 ... 4.5 s.
9 244 020	Case to use unit 9 244 021 as a table model.
9 244 000	Digital Reverberator, in table model case 9 244 020, with two outputs, reverb time 0.4 ... 4.5 s.
7 244 900	Interface board for remote control part 7 140 202 of EMT 140 and EMT 240.



741 Washington St., New York, NY 10014  
(212) 741-7411  
1710 N. LaBrea Ave., Hollywood, CA 90046  
(213) 874-4444



ELEKTRONIK-  
MESS- UND  
TONSTUDIOTECHNIK

AUDIO/SIGNAL  
PROCESSING

# Electronic Reverberator Unit **EMT 250**

**with Digital  
Processor**

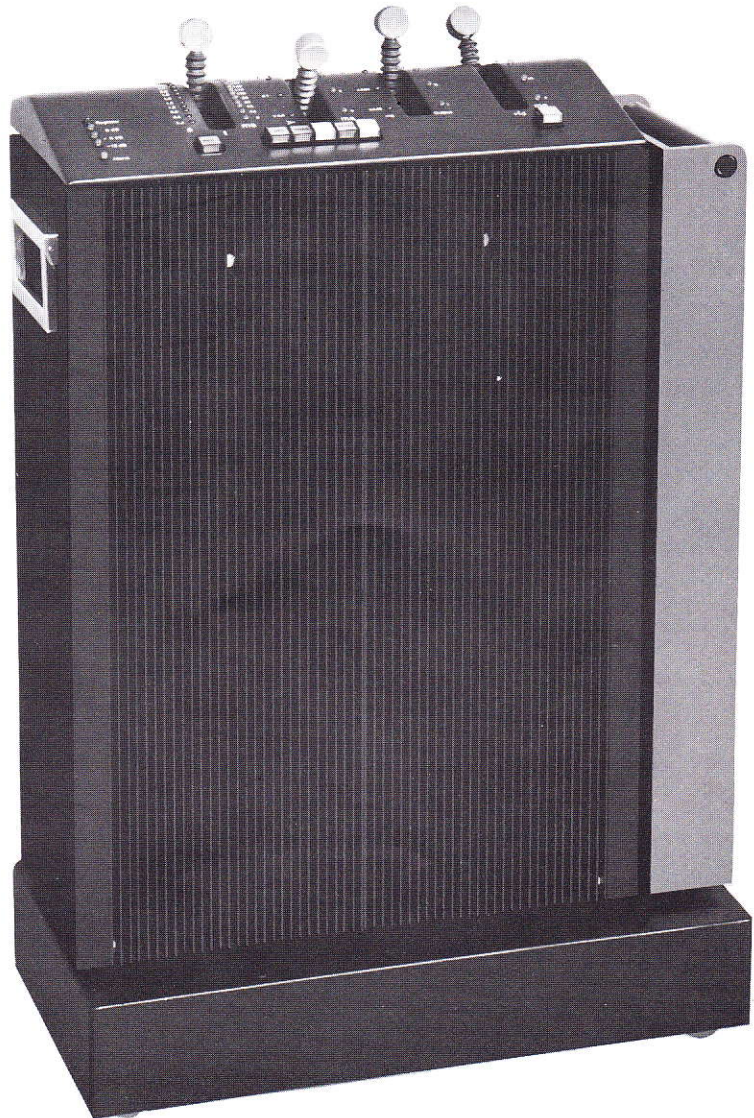

- Completely electronic, no moving parts; ruggedly built and insensitive to shock or vibrations.
- Extremely versatile; many programming possibilities and adjustment of parameters.
- High-value digital words (12 bit, quasi 15 bit) virtually eliminate intrinsic and quantizing noise.
- Approx. 500 integrated circuits, 125 K bits stored in RAM and 16 K bits in ROM. Operating speed, 50 ns per instruction.

# Programs:

## Reverberation

The program memory is a circuit comprising a configuration of 19 different delay elements each having a different delay time. Some are connected with feedback, the feedback factors being dependent on the switch settings on the control panel. The circuit corresponds to the following block diagram:

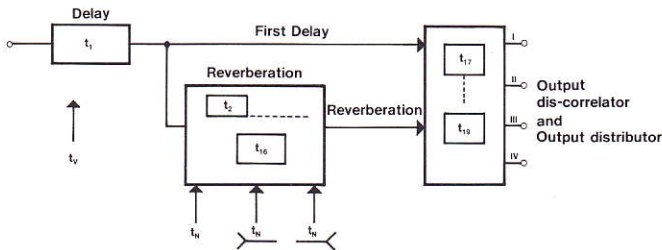

Block diagram of the electronic reverberator.

## Delay

This program produces four delay channels. Each of the four outputs can be shifted in steps of 5 ms over the complete range from 0 to 315 ms and without affecting any of the other outputs.

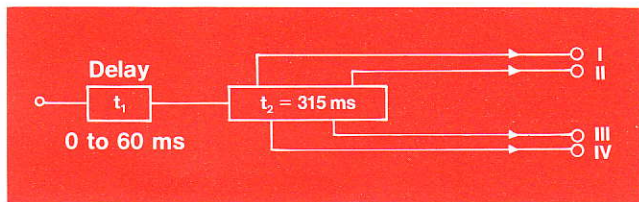

Block diagram DELAY

## Echo

One variable length delay element is fed back in a way such that the output level is reduced by approx. 1 dB per circulation of the loop. There is a repetitive signal with decreasing intensity: the slap echo program.

The repeating frequency can be varied between approx. 3 Hz ( $\approx 315$  ms) and 200 Hz ( $\approx 5$  ms).

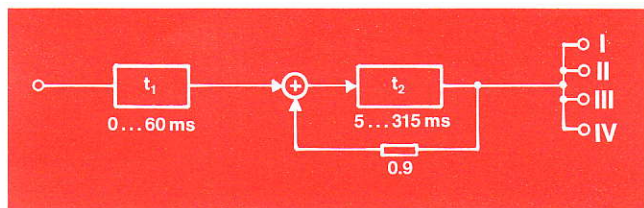

Block diagram ECHO

## „Space“

The program „Space“ is a reverberation program of extremely long reverberation time (about 10s) and with linear distribution of the reverberation time with frequency. Because of atmospheric absorption neither exists in nature, and since the program is intended, amongst others, for science fiction productions, it is designated „Space“ (Reverberation in outer Space).

The block diagram of this program basically corresponds to that applied in „Reverberation“; but the number of delay elements and their connections within the true reverberation generator are, in fact, noticeably different.

## Chorus Effect

The chorus program results from the consideration that the impression of a large music ensemble is brought about by a certain imprecision, referred to a main microphone. Under the assumption that all musicians of an orchestra are playing absolutely simultaneously, the sound signals originating from each of their positions arrive at the microphone one after the other.

There are continuous variations in pitch and positions of tones relative to one another. These variations, of course, are very minor, but they are present and are necessary to enable a correct musical impression of a large musical ensemble.

The corresponding block diagram shows four time different delay elements which are being continuously changed through four random signals  $K_1$  to  $K_4$ .

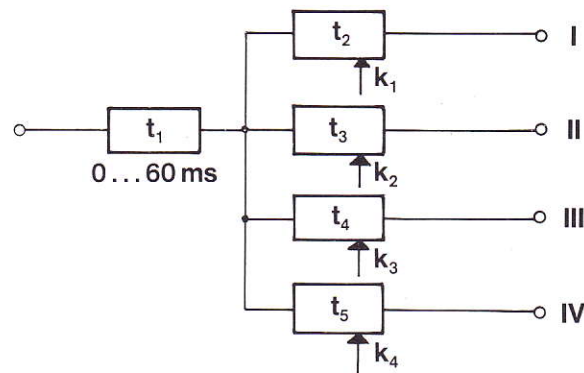

Block diagram „CHORUS“

Outputs I to IV follow in consecutive order in time and should be mixed together so that the level decreases with increasing delay time.

## Stereo Phasing

The phasing effect originates by means of a small shift in time of two signals to one another and by the comb filter curve which is thereby formed.

The block diagram of the circuit used is as follows:

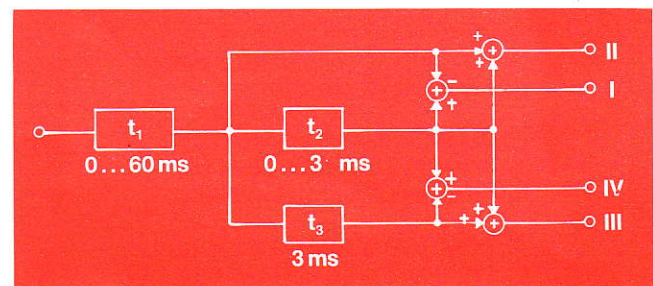

Block diagram „Stereo Phasing“

Changing the delay time is done by means of a 16 step switch through a low-pass filter. The speed of the phasing effect, therefore, can be controlled, within a certain framework, through the speed at which the switch is changed.

Stereo phasing is a new application allowing interesting, shifts of perceptual location to be achieved.

## Functions:

The block diagram shown below is used for all programs. The input signal is chopped with a pulse repetition frequency of 24 kHz. Every portion resulting from the chopping process is analyzed with respect to its amplitude by a comparator having very high resolution. In twelve discrete steps, it is determined whether the amplitude is located above or below one-half of the comparative value. Thus, twelve YES/NO items of information are produced or  $2^{12} \cong 4096$  possibilities. These are put out as 12 bit digitally encoded signals.

As soon as the input signal falls 6dB below full signal drive, the input amplifier gain is raised by 6dB. This gain change occurs at -6, -12 and -18dB; it occurs without time delay within the 40μs sampling period. Within a fraction of this time, the amplifier responds to the new value. However, this change of gain must be compensated at the output of the unit: an inverse gain change is used for compensating. For that purpose, the information relevant to the gain status also in binary coded form written into the shift register, is delayed together with the signal and then is used as correcting variable for the output amplifier.

After the A/D converter, there follows a dynamic MOS shift register of approx. 24 K bits which permits setting a fixed pre-delay of 0, 20, 40 or 60ms for all programs. Then the digital signal is fed to the actual processor. Owing to the extremely high operating speed of about 6 MHz per process step, it permits approx. 250 processing steps to be executed within the sampling time of 40μs, during which the digital word is available. Therefore, many calculating operations can be carried out at every step.

The sequences and types of these calculating operations and therewith the selected program are determined by the program memory. It comprises ROM's (Read Only

Memory) with a capacity of 16K bits, addressed in increasing sequence by means of the clock-pulse generator.

Intermediate data are stored in a read/write memory made up of RAM's (Random Access Memory) having a capacity of approx. 125 K bits. If these intermediate data are to be first extracted for use again in later process periods, then by this means the delay chains or delay loops could be set-up and become available for use when needed in the diverse programs.

From the central processor, a D/A converter takes the signals, and in time-sharing mode supplies signal drive to the four different outputs I to IV.

## Physical and Mechanical Setup

The EMT 250 Electronic Reverberator Unit is constructed as a free standing unit. The power supply is assembled in a chassis placed at the bottom of the Unit; thereby preventing the AC power line from passing through sensitive sections of the Unit. At the center of the Unit, separated by the internal partition, there is the analog section placed at one side, and the digital section at the other side. Both side panels can be tilted out for servicing purposes; thus assuring excellent access to all electronic components. The four panels of the EMT 250 are made of black anodized extruded aluminium that guarantees perfect heat sink for the heat generated within the power stages.

At the upper part of the EMT 250, is placed the control electronics with the control hardware on the top panel. This was planned to permit placing the EMT 250 directly next to the audio engineer at the control console. As a result, the control hardware must be arranged so that the engineer can handle the controls without looking at the knobs and switches. For that reason, the four most important switches are of a type of „stick” control.

Block diagram of the complete EMT 250

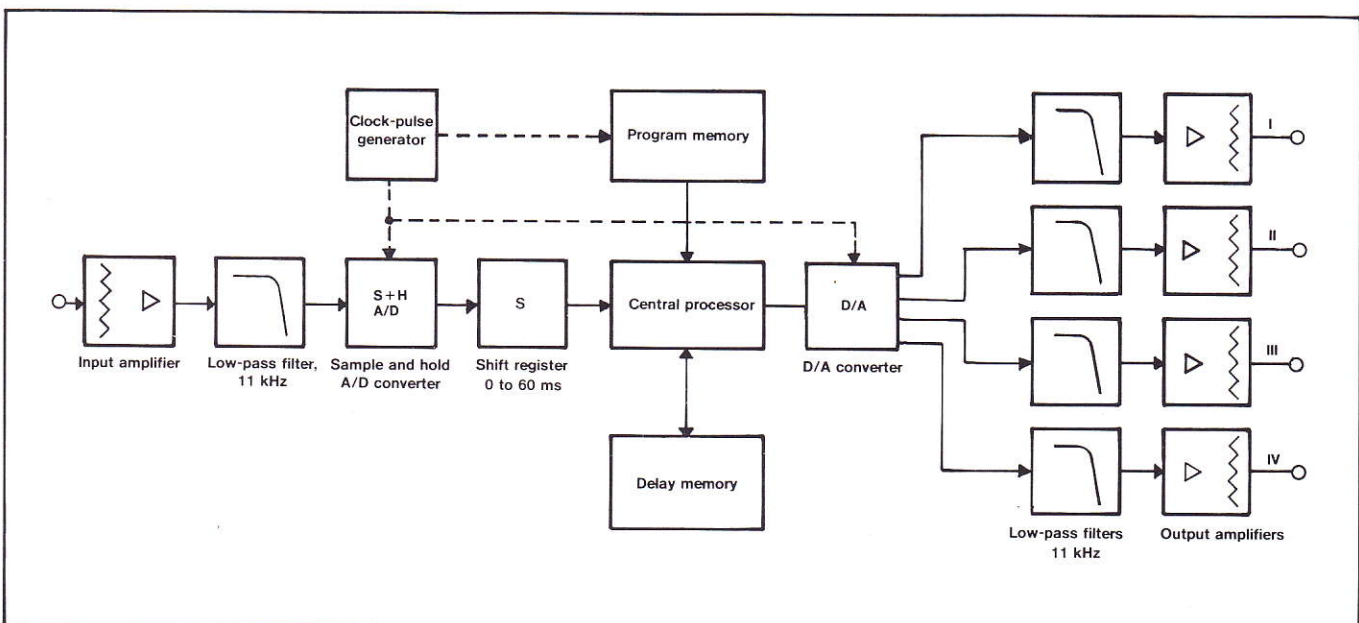

# Technical Data

## Operating Modes (Program)

a) Reverberation program	
Reverberation time (f = 1000 Hz)	0.4 s to 4.5 s, controllable in 16 steps.
Reverberation time at bass frequencies (f = 300 Hz)	Factor of 0.5 to 2.0 referred to the basic reverberation time; controllable in 4 steps.
Reverberation time at treble frequencies (f = 6 kHz)	Factor of 0.25 to 1 referred to the basic reverberation time; controllable in 4 steps.
Basic delay of first reflection	0, 20, 40, 60 ms
Outputs	4, useable as mono, stereo or quadrophonic outputs
b) Delay program	
Delay times	0 to 315 ms, selectable in 5 steps, additionally 0 to 60 ms, selectable in 20 ms steps.
Outputs	4, each programmable with freely selectable delay times
c) Special programs PHASING	Changing of the amplitudes of the harmonics
CHORUS	Tonal duplications
SPACE	Extremely long reverberation time of 10 s
ECHO	Repetitive slap-back with an attenuation of 10% in the time intervals between 5 ms and 315 ms

## Digital coding

a) A/D and D/A converter	12 bit, quasi 15 bit by triple switching of the quantizing ladder (flying comma)
Sampling frequency	24 kHz
b) Processor	
Operating speed per instruction	50 ns
Clock frequency	20 MHz
c) Memory capacity	
RAM (Random Access Memory)	128 Kbits
ROM (Read Only Memory)	16 Kbits
MOS delay (shift register)	60 ms

## Analog section

a) Input	balanced, input impedance $\geq 5 \text{ k}\Omega$ , input level; nominal +6 dB, adjustable from -10 dB to +15 dB
----------	---

b) Outputs	4, balanced, output impedance $\leq 60 \Omega$ , output level; nominal +6 dB, adjustable from -10 dB to +15 dB
c) Overload margin (head room)	max. +21 dB
d) Signal-to-noise ratio: in reverberation program	70 dB <sub>RMS</sub> (unweighted), referred to nominal value 76 dB <sub>RMS</sub> (unweighted), referred to full drive signal
in delay program	75 dB <sub>RMS</sub> (unweighted), referred to nominal value 81 dB <sub>RMS</sub> (unweighted), referred to full drive signal
e) Frequency response 30 Hz to 10.8 kHz	+1 } dB -3 }
f) Total Harmonic Distortion Delay program	$\leq 0.5\%$ at normal level (f = 1 kHz)
Remote control	possible through 30 conductor DC cable
Dimensions	53.5 x 83 x 28 cm (w x h x d) (21" x 32.6" x 11")
Weight	approx. 45 kg (99.2 lbs)
Power consumption	300 VA
Subject to change without notice	

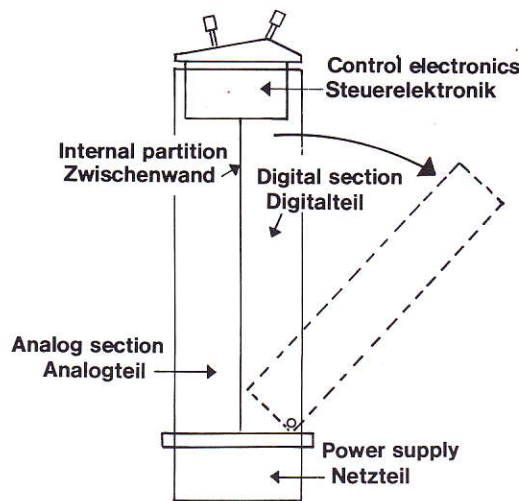

Sketch of EMT 250 assembly; both side panels tilt out.



741 Washington St., New York, NY 10014  
(212) 741-7411  
1710 N. LaBrea Ave., Hollywood, CA 90046  
(213) 874-4444