



KRD3

CONTROLLER AND MINI-PROGRAMMER



Engineering Manual

22/04 - Code: ISTR_M_KRD3_E_00_--

Ascon Tecnologic S.r.l.

Viale Indipendenza 56, 27029 Vigevano (PV) - ITALY

Tel.: +39 0381 69871/FAX: +39 0381 698730

www.ascontecnologic.com

e-mail: info@ascontecnologic.com

1. OUTLINE DIMENSIONS (mm)

1.1 Dimensions

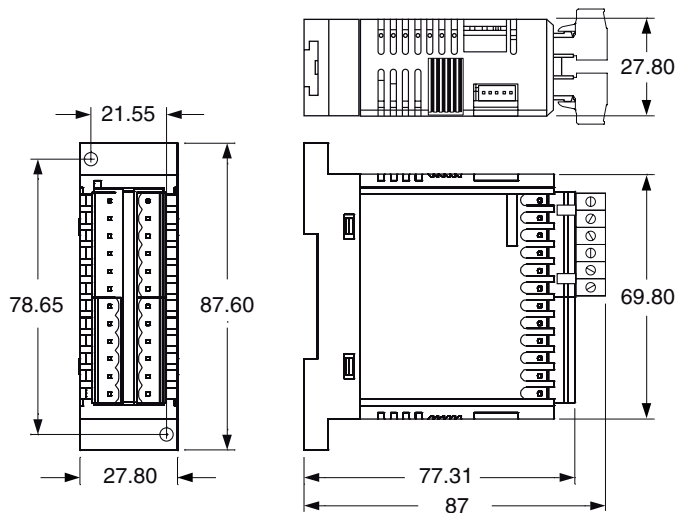

1.2 Mounting requirements

This instrument is intended for permanent installation, indoor use only, in an electrical panel which encloses the instrument, the terminals and wirings specific for a DIN rail mounting.

Select a mounting location having the following characteristics:

1. It should be easily accessible;
2. There are minimum vibrations and no impacts;
3. There are no corrosive gases;
4. There are no water or other fluids (i.e. condensation);

5. The ambient temperature is in accordance with the operative temperature (0... 50°C);
6. The relative humidity is in accordance with the instrument specifications (20... 85%);

The instrument can be mounted on a DIN rail or wall.

2. CONNECTION DIAGRAM

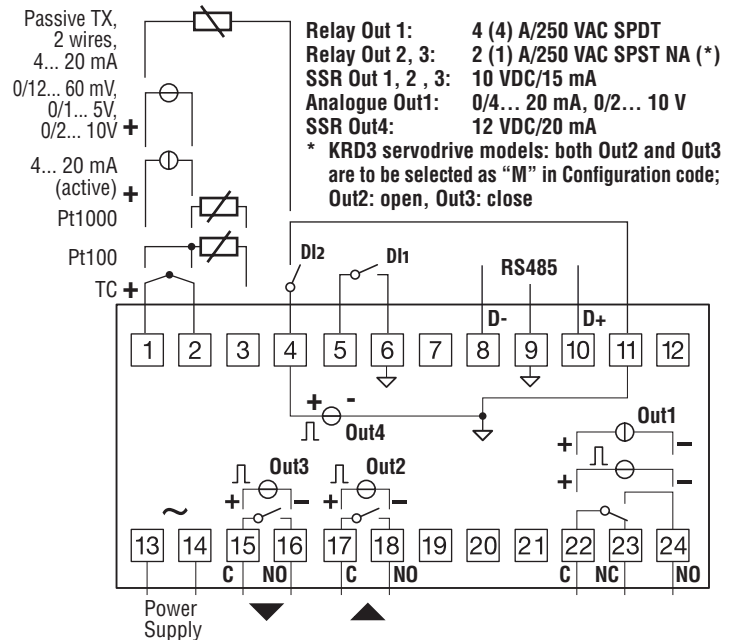

2.1 General notes about wiring

1. Do not run input wires together with power cables.
2. External components (like zener barriers, etc.) connected between sensor and input terminals may cause errors in measurement due to excessive and/or not balanced line resistance or possible leakage currents.
3. When a shielded cable is used, it should be connected at one point only.
4. Pay attention to the line resistance; a high line resistance may cause measurement errors.

2.2 Inputs

2.2.1 Thermocouple Input

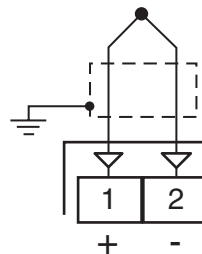

External resistance: 100Ω max., maximum error 25 μV.

Cold junction: automatic compensation between 0... 50°C.

Cold junction accuracy: 0.05°C/°C after a warm-up of 20 minutes.

Input impedance: > 1 MΩ.

Calibration: According to EN 60584-1.

Note: For TC wiring use proper compensating cable preferable shielded.

2.2.2 Infrared Sensor Input

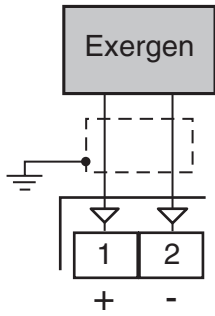

External resistance: Not relevant.

Cold junction: automatic compensation between 0... 50°C.

Cold junction accuracy: 0.05°C/°C.

Input impedance: > 1 MΩ.

2.2.3 RTD Pt 100 Input

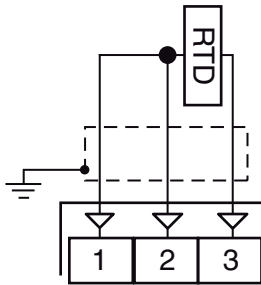

Input circuit: Current injection (150 µA).

Line resistance: Automatic compensation up to 20Ω/wire with maximum error ±0.1% of the input span.

Calibration: According to EN 60751/A2.

Note: The resistance of the 3 wires must be the same.

2.2.4 RTD Pt 1000, NTC and PTC Input

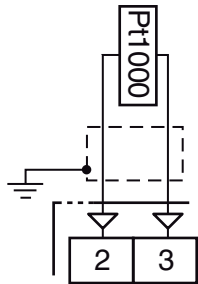

Line resistance: Not compensated.

Pt 1000 input circuit: Current injection (15 µA).

Pt 1000 calibration: According to EN 60751/A2.

2.2.5 V and mV Input

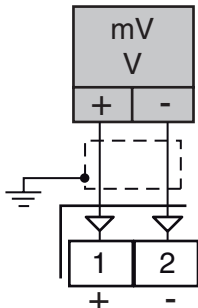

Input impedance: > 1 MΩ for mV Input
500 kΩ for Volt Input.

2.2.6 mA Input

0/4... 20 mA Input wiring for passive transmitter using the auxiliary pws

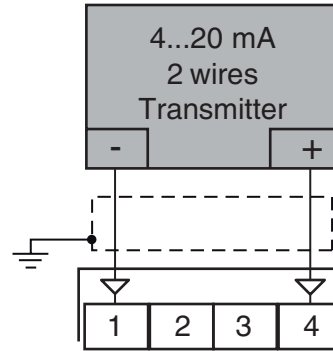

Input impedance: < 53Ω.

Internal auxiliary PWS: 12 VDC (±10%), 20 mA max..

0/4... 20 mA Input wiring for passive transmitter using an external pws

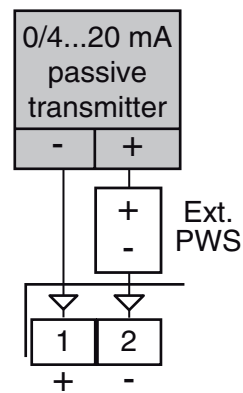

0/4... 20 mA Input wiring for active transmitter

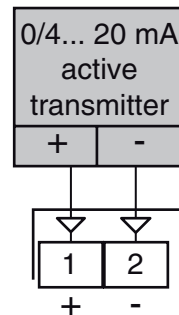

2.2.7 Logic Inputs

Safety notes:

- Do not run logic input wiring together with power cables;
- The instrument needs 150 ms to recognize a contact status variation;
- Logic inputs are **NOT** isolated by the measuring input. A double or reinforced isolation between logic inputs and power line must be assured by the external elements.

Logic input driven by dry contact

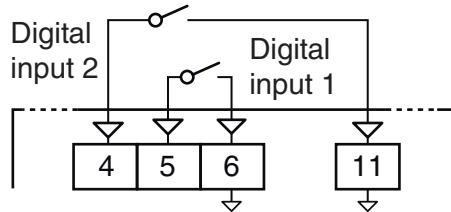

Maximum contact resistance: 100Ω.

Contact rating: DI1 = 10 V, 6 mA;
DI2 = 12 V, 30 mA.

Logic inputs driven by 24 VDC

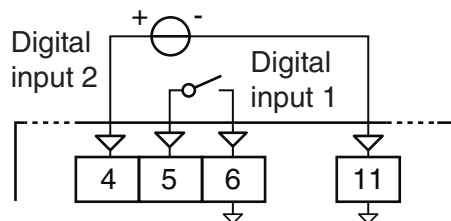

Logic status 1: 6... 24 VDC;

Logic status 0: 0... 3 VDC.

2.3 Outputs

Safety notes:

- To avoid electrical shocks, connect power line at last.
- For supply connections use No. 16 AWG or larger wires rated for at least 75°C.
- Use copper conductors only.
- SSR outputs are not isolated. A reinforced isolation must be assured by the external solid state relays.
- For SSR, mA and V outputs if the line length is longer than 30 m use a shielded wire.

WARNING! Before connecting the output actuators, we recommend to configure the parameters to suit your application (e.g.: input type, Control strategy, alarms, etc.).

2.3.1 Output 1 (OP1)

Relay Output

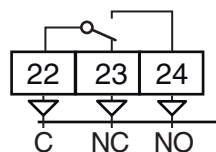

OP1 contact rating: - 4 A /250 V $\cos\phi = 1$
- 2 A /250 V $\cos\phi = 0.4$

Operation: 1×10^5

SSR Output

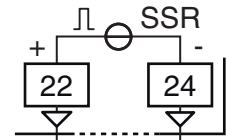

Logic level 0: $V_{out} < 0.5$ VDC

Logic level 1: $12 \text{ V} \pm 20\%$, 15 mA max.

Current Analogue Output

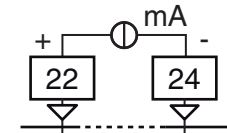

mA output: 0/4... 20 mA, galvanically isolated, R_L max. 600Ω.

Voltage Analogue Output

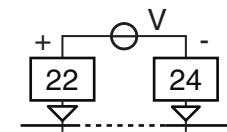

V output: 0/2... 10 V, galvanically isolated, R_L min.: 500Ω.

2.3.2 Output 2 (OP2)

Relay Output

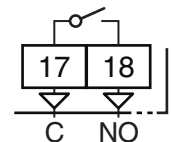

OP1 contact rating: - 2 A /250 V $\cos\phi = 1$
- 1 A /250 V $\cos\phi = 0.4$

Operation: 1×10^5

SSR Output

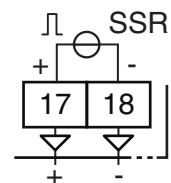

Logic level 0: $V_{out} < 0.5$ VDC

Logic level 1: $12 \text{ V} \pm 20\%$, 15 mA max.

2.3.3 Output 3 (OP3)

Relay Output

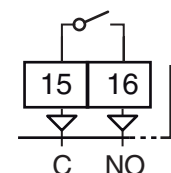

OP1 contact rating: - 2 A /250 V $\cos\phi = 1$
- 1 A /250 V $\cos\phi = 0.4$

Operation: 1×10^5

SSR Output

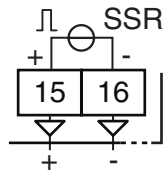

Logic level 0: $V_{out} < 0.5 \text{ VDC}$
Logic level 1: $12 \text{ V} \pm 20\%$, 15 mA max.

2.3.4 Output 2 and Output 3 Servomotor Drive

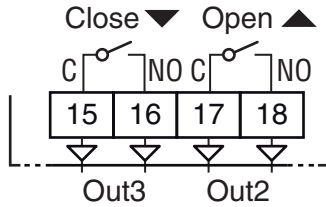

OP2/3 contact rating: - 2 A /250 V $\cos\phi = 1$;
 - 1 A /250 V $\cos\phi = 0.4$.

Operation: 1×10^5 .

2.3.5 Output 4 (OP4)

SSR Output

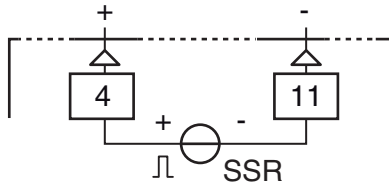

Logic level 0: $V_{out} < 0.5 \text{ VDC}$;
Logic level 1: $12 \text{ V} \pm 20\%$, 20 mA max..

Note: Overload protected.

2.4 Serial Interface

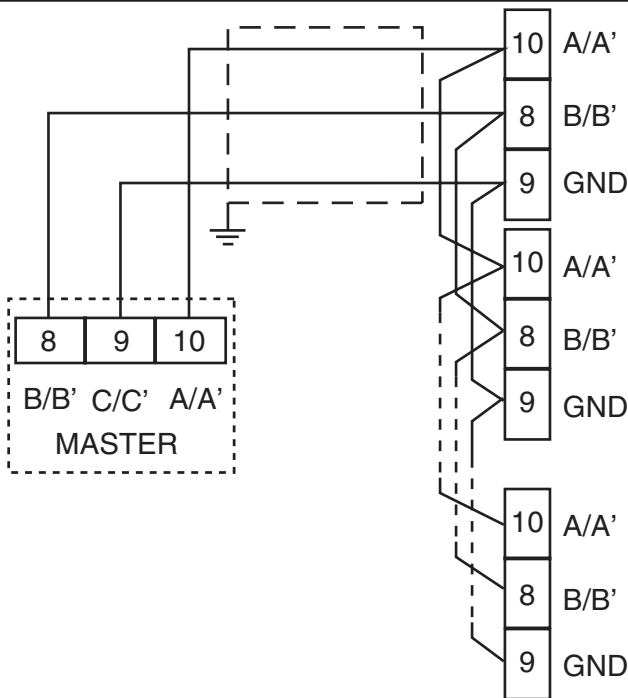

Interface type: Isolated (50 V) RS-485;
Voltage levels: According to EIA standard;
Protocol type: MODBUS RTU;
Byte format: 8 bit with no parity;

Stop bit: 1 (one);
Baud rate: Programmable between 1200... 38400 baud;
Address: Programmable between 1... 255.
Notes: 1. RS-485 interface allows to connect up to 30 devices with one remote master unit.
 2. The cable length must not exceed 1500 m at 9600 baud;
 3. Follows the description of the signal sense of the voltage appearing across the interconnection cable as defined by EIA for RS-485:

- A** The "A" terminal of the generator must be negative with respect to the "B" terminal for a binary 1 (MARK or OFF) state;
- B** The "A" terminal of the generator must be positive with respect to the "B" terminal for a binary 0 (SPACE or ON).

4. This instrument allows to set serial link parameters (address and baud rate) in two different way:

A Programmable parameters: all the dip-switches present in the back side of the instrument must be set to OFF:



The instrument uses the values programmed with parameters [134] Add and [135] bAud;

B Fixed parameters: the DIP switches present in the back side of the instrument must be set according to the following tables:

| DIP switch | Function |
|------------|----------------|
| 1 | Address bit 0 |
| 2 | Address bit 1 |
| 3 | Address bit 2 |
| 4 | Address bit 3 |
| 5 | Address bit 4 |
| 6 | Address bit 5 |
| 7 | Baudrate bit 0 |
| 8 | Baudrate bit 1 |

In other words:

- "Address" is a 6 bit binary word and uses a standard codification; e.g.: address **23** is set by switching to **ON** the DIP switches: **5, 3, 2** and **1** ($16 + 4 + 2 + 1 = 23$);
- The baud rate is a 2 bit binary word which values are described in the following table:

| Switch 7 | Switch 8 | Baud rate |
|----------|----------|-----------|
| OFF | OFF | 2400 |
| ON | OFF | 9600 |
| OFF | ON | 19200 |
| ON | ON | 38400 |

Parameters [134] Add and [135] bAud become read only.

2.5 Power Supply

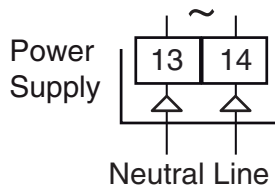

Supply Voltage:

- 24 VAC/DC ($\pm 10\%$)
- 100... 240 VAC (-15... +10%)

- Notes:**
1. Before connecting the instrument to the power line, make sure that line voltage is equal to the voltage shown on the identification label;
 2. The polarity of the power supply has no importance;
 3. The power supply input is NOT fuse protected. Please, provide a T type 1A, 250 V fuse externally.
 4. When the instrument is powered by the A01 key, the outputs are NOT supplied and the instrument can show the *ouLd* (Out 4 Overload) indication.

3. TECHNICAL CHARACTERISTICS

Case: Plastic, self-extinguishing degree: V-0 according to UL 94;

Terminals protection: IP20 according to EN 60070-1;

Installation: Rear panel on DIN rail;

Terminal block: 24 M3 screw terminals, for cables from 0.25... 2.5 mm² (AWG 22... AWG 14) with connection diagram;

Dimensions: (H x L x D): 75 x 33 x 75.5 mm
(2.95 x 1.30 depth 2.97 in.)

Weight: 180 g max..

Power supply:

- 24 VAC/DC ($\pm 10\%$ of the nominal value);
- 100... 240 VAC (-15... +10% of the nominal value);

Power consumption: 5 VA max.;

Insulation voltage:

- Simple insulation (models with Power supply 24 VAC/DC);
- 3000 Vrms according to EN 61010-1 (models with 100... 240 VAC/DC of Power Supply),

Sampling time: 130 ms;

Resolution: 30000 counts;

Total Accuracy: $\pm 0.5\%$ F.S.V. ± 1 digit @ 25°C of room temperature;

Electromagnetic compatibility and safety requirements

Compliance: EMC 2004/108/CE (EN 61326-1) directive,
LV 2006/95/CE (EN 61010-1) directive;

Installation category: II;

Pollution category: 2;

Temperature drift: It is part of the global accuracy;

Operating temperature: 0... 50°C (32... 122°F);

Storage temperature: -30... +70°C (-22... +158°F);

Humidity: 20... 85% RH, not condensing.

4. HOW TO ORDER

Model

KRD3 = Controller

KRD3T = Controller+ timer

KRD3P = Controller + timer + programmer

Power supply

H = 100... 240 VAC

L = 24 VAC/DC

Analogue input + Digital Input DI1 (standard)

C = J, K, R, S, T, PT100, PT 1000 (2 wires), mA, mV, V

Output 1

I = 0/4... 20 mA, 0/2... 10 V

R = Relay SPDT 4 A/250Vac (resistive load)

O = VDC for SSR 12 Vdc/20 mA

Output 2

- = Not available

R = Relay SPST NO 2 A/250Vac (resistive load)

O = VDC for SSR 12 Vdc/20 mA

M = Relay SPST 2 A/250Vac (**servomotor drive**)(*)

Output 3

- = Not available

R = Relay SPST NO 2 A/250Vac (resistive load)

O = VDC for SSR 12 Vdc/20 mA

M = Relay SPST 2 A/250Vac (**servomotor drive**)(*)

Input/Output 4

D = Output 4 (VDC for SSR)/Pow. Supply/Dig. Input DI2

Serial Communications

S = RS485 Modbus + TTL Modbus

Connection type

- = Standard (screw terminals not removable)
- E** = Removable screw terminals
- M** = Removable spring terminals
- N** = Removable terminals (the fixed part only)

Note: For servomotor drive, both **Output 2** and **Output 3** codes must be selected as "M".

5. CONFIGURATION PROCEDURE

5.1 Introduction

When the instrument is powered, it starts immediately to work according to the parameters values loaded in its memory.

The instrument behaviour and its performance are governed by the value of the stored parameters.

At the first start up the instrument will use a “default” parameter set (factory parameter set); this set is a generic one (e.g. a TC J input is programmed).



Before connecting the output actuators, we recommend to configure the parameters to suit your application (e.g.: input type, Control strategy, alarms, etc.).



Do not change the [6] **Unit (Engineering Unit)** value during process control as the temperature values inserted by the user (thresholds, limits etc.) are not automatically rescaled by the instrument.

To change these parameters you need to enter the “Configuration mode”.

5.2 Instrument behaviour at Power ON

At Power ON the instrument can start in one of the following mode depending on its configuration:

Auto mode without program functions.

- [12B] address 527 = 1;
- [19B] address 580 = 0 or 1;
- The instrument is performing the standard closed loop control.

Manual mode (oPLo).

- [12B] address 527 = 3;
- The instrument does not perform Automatic control;
- The control output is equal to 0% and it can be modified by [28B] address 592.

Stand by mode (St.bY).

- [12B] address 527 = 0;
- The instrument does not perform any control (the control outputs are OFF);
- The instrument is working as an indicator (analogue to digital converter).

Auto mode with automatic program start up.

- [12B] address 527 = 1;
- [19B] address 580 different from 0, 1 or 7.
- We define all the above described conditions as “Standard Display”.

5.3 Factory reset

5.3.1 Default parameters loading procedure

Sometime, e.g. when you re-configure an instrument previously used for other works or from other people or when you have made too many errors during configuration and you decided to re-configure the instrument, it is possible to restore the factory configuration.

This action allows you to put the instrument in a defined condition (in the same condition it was at the first power ON).

The default data are the typical values loaded in the instrument prior to shipment from factory.

To load the factory default parameter set it is sufficient to

send to the [19A] address 19 the $-4B1$ value.

Note: The complete list of the default parameter is available in Appendix A.

5.4 Configuring all the parameters

In the following pages we are going to describe all the parameters of the instrument. However, the instrument shows only the parameters applicable to its hardware options in accordance with the specific instrument configuration (i.e. setting *AL 1E* [Alarm 1 type] to *nonE* [not used], all parameters related to alarm 1 will be skipped).

inP Group - Main and auxiliary input configuration

[1] address 10240

SEnS - Input type

Available: Always.

| | | | |
|---------------|----|---|-----------------------------------|
| Range: | 0 | TC J | (-50... +1000°C/-58... +1832°F); |
| | 1 | TC K | (-50... +1370°C/-58... +2498°F); |
| | 2 | TC S | (-50... +1760°C/-58... +3200°F); |
| | 3 | TC R | (-50... +1760°C/-58... +3200°F); |
| | 4 | TC T | (-70... +400°C/-94... +752°F); |
| | 5 | Exergen IRS J | (-46... +785°C/-50... +1445°F); |
| | 6 | Exergen IRS K | (-46... +785°C/-50... +1445°F); |
| | 7 | RTD Pt 100 | (-200... +850°C/-328... +1562°F); |
| | 8 | RTD Pt 1000 | (-200... +500°C/-328... +932°F); |
| | 9 | 0... 60 mV linear; | |
| | 10 | 12... 60 mV linear; | |
| | 11 | 0... 20 mA linear; | |
| | 12 | 4... 20 mA linear; | |
| | 13 | 0... 5 V linear; | |
| | 14 | 1... 5 V linear; | |
| | 15 | 0... 10 V linear; | |
| | 16 | 1... 10 V linear; | |
| | 17 | From serial link with Burn-out strategy 1 (**); | |
| | 18 | From serial link with Burn-out strategy 2 (***) | |

(**) 17 - SEr1

This mode is designed for PLC interface. It requires that a master writes continuously a “measured” value.

Note: The master MUST send a WRITE command at the 200H or 1H address even if the value is the same.

If the instrument does NOT receive a write command on one of this two addresses for more than 5 seconds, the instrument will operate as for a burn out condition.

(***) 18 - SEr2

The previous mode is NOT usable when you use a supervisor or an operator panel.

This kind of “master” does NOT “write” a value equal to the previous one.

In other words, if the value does not change the master does not write in the specific location.

The SEr2 operates as follows:

The instrument looks to the line activity and:

- If a correct line activity is present, considers the master as connected and works with the last received “measured” value.
- If NO activity or a wrong activity is detected for more than 5 seconds, the instrument operate as in presence of a burn out condition.

Notes: 1. When a TC input is selected and a decimal figure is programmed (see the next parameter) the maximum displayed value become 999.9°C or 999.9°F.

- All changes to SE_nS parameter setting forces [2] dP = 0 and this causes a change to all parameters related with it (e.g. set points, proportional band, etc.).

[2] address 10241
dP - Decimal point position

Available: Always

Range: • When [1] SenS = Linear input: 0... 3.
• When [1] SenS different from linear input: 0 or 1

Note: All changes to dP parameter setting causes a change to all parameters related with it (e.g.: Set Points, proportional band, etc.).

[3] address 10242
SSc - Initial scale read-out for linear inputs

Available: When a linear input is selected by [1] SenS.

Range: -1999... 9999.

- Notes:**
- It allows the scaling of the analogue input to set the minimum displayed/measured value
The instrument will show a measured value up to 5% less than [3] SSc value and then it will show an underrange error.
 - When a measured value from serial link is selected the [3] SSc parameter becomes a fixed limit (no 5% less).
 - It is possible to set a initial scale read-out higher than the full scale read-out in order to obtain a reverse read-out scaling
E.g. 0 mA = 0 mBar and 20 mA = -1000 mBar (vacuum).

[4] address 10243
FSc - Full scale read-out for linear input

Available: When a linear input is selected by [1] SenS.

Range: -1999...9999.

- Notes:**
- It allows the scaling of the analogue input to set the maximum displayed/measured value.
The instrument will show a measured value up to 5% higher than [4] FSc value and then it will show an overrange error.
 - When a measured value from serial link is selected, the [4] FSc parameter becomes a fixed limit (no 5% more).
 - It is possible to set a initial scale read-out higher than the full scale read-out in order to obtain a reverse read-out scaling
E.g. 0 mA = 0 mBar and 20 mA = -1000 mBar (vacuum).

[5] address 10244
unit - Engineering unit

Available: When a temperature sensor is selected by [1] SenS parameter.

Range: 0 Centigrade;
1 Fahrenheit.

[6] address 10245
FiL - Digital filter on the measured value

Available: Always.

Range: oFF (No filter);
0.1... 20.0 s.

- Notes:**
- This is a first order digital filter applied on the measured value. For this reason it will affect the

measured value but also the control action and the alarms behaviour.

- This filter affect the measured value even if a measured value from serial link is selected.

[7] address 10246
inE - Selection of the Sensor Out of Range type that will enable the safety output value

Available: Always

Range: 0 When an overrange or an underrange is detected, the power output will be forced to the value of [8] oPE parameter.

- When an overrange is detected, the power output will be forced to the value of [8] oPE parameter.
- When an underrange is detected, the power output will be forced to the value of [8] oPE parameter.

[8] address 10247
oPE - Safety output value

Available: Always.

Range: -100... 100% (of the output).

- Notes:**
- When the instrument is programmed with one control action only (heat or cool), setting a value outside of the available output range, the instrument will use Zero.
E.g. when heat action only has been programmed, and oPE is equal to -50% (cooling) the instrument will use the zero value.
 - When ON/OFF control is programmed and an out of range is detected, the instrument will perform the safety output value using a fixed cycle time equal to 20 seconds.

[9] address 10248
io4.F - I/O4 function selection

Available: Always.

Range: 0 Output 4 is always ON (used as a transmitter power supply);
1 Used as digital output 4;
2 Digital input 2 for contact closure;
3 Digital input 2 driven by 12 to 24 VDC;

- Notes:**
- Setting [9] io4.F = 2 or 4, the [22] O4F parameter becomes not visible while [11] diF2 parameter will become visible.
 - Setting [9] io4F = 0 the [22] O4F parameter and the [11]diF2 parameter will NOT be visible.
 - Setting [9] io4F different from 2 or 3, the instrument will force [12] diF2 parameter equal to 0.
 - The transfer from [9] io4F = 0 to [9] io4F = 1 will make the [22] O4F parameter visible equal to 0.

[10] address 10249
diF1 - Digital input 1 function

Available: Always.

Range: 0 No function;
1 Alarm Reset [status];
2 Alarm acknowledge (ACK) [status];
3 Hold of the measured value [status];
4 Stand by mode of the instrument [status]
When the contact is closed the instrument operates in stand by mode;
5 Manual mode;
6 HEAt with SP1 and Cool with "SP2" [status]

- (see "Note about digital inputs");
- 7 Timer Run/Hold/Reset [transition]
Short closure allows to start timer execution and to suspend it while a long closure (longer than 10 seconds) allows to reset the timer;
 - 8 Timer Run [transition] a short closure allows to start timer execution;
 - 9 Timer reset [transition] a short closure allows to reset timer count;
 - 10 Timer run/hold [Status]
- Contact closure = timer RUN
- Contact open = timer Hold;
 - 11 Timer run/reset [status];
 - 12 Timer run/reset with a special "lock" at the end of the time count (in order to restart the time count the instrument must detect a run command coming from serial link keyboard or digital input 2).;
 - 13 Program Run [transition]
The first closure allows to start program execution but a second closure restart the program execution from the beginning;
 - 14 Program Reset [transition]
A contact closure allows to reset program execution;
 - 15 Program Hold [transition]
The first closure allows to hold program execution and a second closure continue program execution;
 - 16 Program Run/Hold [status]
When the contact is closed the program is running;
 - 17 Program Run/Reset [status]
- Contact closed - Program run
- Contact open - Program reset;
 - 18 Sequential set point selection [transition] (see "Note about digital inputs");
 - 19 SP1/SP2 selection [status];
 - 20 Binary selection of the set point made by digital input 1 (less significant bit) and digital input 2 (most significant bit) [status].

Note: When [11] diF2 is not available the item 20 is not visible.

[11] address 10250

diF2 - Digital input 2 function

Available: When the instrument is equipped with digital inputs.

- Range:** 0 OFF = No function
- 1 Alarm Reset [status]
 - 2 Alarm acknowledge (ACK) [status].
 - 3 Hold of the measured value [status].
 - 4 Stand by mode of the instrument [status]
When the contact is closed the instrument operates in stand by mode.
 - 5 Manual mode
 - 6 HEAt with SP1 and Cool with "SP2" [status] (see "Note about digital inputs")
 - 7 Timer Run/Hold/Reset [transition]
Short closure allows to start timer execution and to suspend it while a long closure (longer than 10 seconds) allows to reset the timer.
 - 8 Timer Run [transition] a short closure allows to start timer execution.
 - 9 Timer reset [transition] a short closure allows to reset timer count.
 - 10 Timer run/hold [Status]
- Contact closure = timer RUN
- Contact open = timer Hold

- 11 Timer run/reset [status]
- 12 Timer run/reset with a special "lock" at the end of the time count (in order to restart the time count the instrument must detect a run command coming from serial link keyboard or digital input 2).
- 13 Program Run [transition]
The first closure allows to start program execution but a second closure restart the program execution from the beginning.
- 14 Program Reset [transition]
A contact closure allows to reset program execution.
- 15 Program Hold [transition]
The first closure allows to hold program execution and a second closure continue program execution.
- 16 Program Run/Hold [status]
When the contact is closed the program is running.
- 17 Program Run/Reset [status]
- Contact closed - Program run
- Contact open - Program reset
- 18 Sequential set point selection [transition] (see "Note about digital inputs")
- 19 SP1/SP2 selection [status]
- 20 Binary selection of the set point made by digital input 1 (less significant bit) and digital input 2 (most significant bit) [status].

Notes about digital inputs:

1. When [10] diF1 or [11] diF2 (e.g. diF1) are equal to 6 the instrument operates as follows:
 - When the contact is open, the control action is an heating action and the active set point is SP.
 - When the contact is closed, the control action is a cooling action and the active set point is SP2.
2. When [10] diF1 is equal to 20, [11] diF2 setting is forced to 20 and diF2 cannot perform another function.
3. When [10] diF1 and [11] diF2 are equal to 20, the set point selection will be in accordance with the following table:

| Dig In 1 | Dig. In 2 | Operative set point |
|----------|-----------|---------------------|
| Off | Off | Set point 1 |
| On | Off | Set point 2 |
| Off | On | Set point 3 |
| On | On | Set point 4 |

4. When a "Sequential set point selection" is used (diF1 or diF2 = 18), every closure of of the logic input increase the value of SPAT (active set point) of one step. The selection is cyclic -> SP1 -> SP2 -> SP3 -> SP4

[12] address 10251

di.A - Digital Input Action

Available: When [9] io4F = 2 or 3.

- Range:** 0 Dig. In 1 direct and Dig. In 2 direct;
- 1 Dig. In 1 reverse and Dig. In 2 direct;
 - 2 Dig. In 1 direct and Dig. In 2 reverse;
 - 3 Dig. In 1 reverse and Dig. In 2 reverse.

Output Group - Output parameters

[13] address 10252

o1.t - Out 1 type

Available: When the out 1 is a linear output.

Range: 0 0... 20 mA;
1 4... 20 mA;
2 0... 10 V;
3 2... 10 V.

[14] address 10253

o1.F - Out 1 function

Available: Always.

Range: • When the out 1 is a linear output:

- 0 Output not used. With this setting the status of this output can be driven directly from serial link;
- 1 Heating output;
- 2 Cooling output;
- 3 Measured value Analogue retransmission.
- 4 Analogue retransmission of the measured error (PV-SP);
- 5 Analogue retransmission of the operative set point;
- 6 Analogue retransmission of a value coming from serial link;

• When the out 1 is a digital output (relay or SSR):

- 0 Output not used. With this setting the status of this output can be driven directly from serial link;
- 1 Heating output;
- 2 Cooling output;
- 3 Alarm output;
- 4 Timer output;
- 5 Timer out - OFF in Hold;
- 6 Program end indicator;
- 7 Program hold indicator;
- 8 Program wait indicator;
- 9 Program run indicator;
- 10 Program Event 1;
- 11 Program Event 2;
- 12 Out-of-range or burn out indicator;
- 13 Power failure indicator;
- 14 Out-of-range, Burnout and Power failure indicator;
- 15 Stand By status indicator;
- 16 Repeats the digital input 1 status;
- 17 Repeats the digital input 2 status;
- 18 Out1 always ON;
- 19 Inspection request.

Notes: 1. When two or more outputs are programmed in the same way, these outputs will be driven in parallel.

2. The power failure indicator will be reset when the instrument detect an alarm reset command by digital input or serial link.

3. When no control output is programmed, all the relative alarm (when present) will be forced to *none* (not used).

[15] address 10254

A.o1L - Initial scale value of the analogue retransmission

Available: When Out 1 is a linear output and [14] O1F is equal to 3, 4, 5 or 6

Range: -1999 to [16] Ao1H.

[16] address 10255

A.o1H - Full scale value of the analogue retransmission

Available: When Out 1 is a linear output and [14] O1F is equal to 3, 4, 5 or 6.

Range: [15] Ao1L to 9999.

[17] address 10256

o1.AL - Alarms linked up with the out 1

Available: When out 1 is a digital output and [14] o1F = 3.

Range: 0... 63 with the following rules:

- +1 Alarm 1;
- +2 Alarm 2;
- +4 Alarm 3;
- +8 Loop break alarm;
- +16 Sensor break (burn out);
- +32 Overload on Out4 (short circuit on the Out4).

Example 1: Setting 3 (2+1) the output will be driven by the alarm 1 and 2 (OR condition).

Example 2: Setting 13 (8+4+1) the output will be driven by alarm 1 + alarm 3 + loop break alarm.

[18] address 10257

o1.Ac - Out 1 action

Available: When [14] o1F is different from 0.

Range: 0 Direct action;
1 Reverse action;
2 Direct action with revers LED indication;
3 Reverse action with reverse LED indication.

Notes: 1. **Direct action:** the output repeats the status of the driven element.

Example: the output is an alarm output with direct action. When the alarm is ON, the relay will be energized (logic output 1).

2. **Reverse action:** the output status is the opposite of the status of the driven element.

Example: the output is an alarm output with reverse action. When the alarm is OFF, the relay will be energized (logic output 1). This setting is usually named "fail-safe" and it is generally used in dangerous process in order to generate an alarm when the instrument power supply goes OFF or the internal watchdog starts.

[19] address 10258

o2F - Out 2 function

Available: When the instrument has out 2 option.

Range: 0 Output not used. With this setting the status of this output can be driven directly from serial link;

- 1 Heating output;
- 2 Cooling output;
- 3 Alarm output;
- 4 Timer output;
- 5 Timer out - OFF in Hold;
- 6 Program end indicator;
- 7 Program hold indicator;
- 8 Program wait indicator;
- 9 Program run indicator;
- 10 Program Event 1;
- 11 Program Event 2;
- 12 Out-of-range or burn out indicator;
- 13 Power failure indicator;
- 14 Out-of-range, Burnout and Power failure indicator;
- 15 Stand By status indicator;

- 16 Repeats the digital input 1 status;
- 17 Repeats the digital input 2 status;
- 18 Out1 always ON;
- 19 Inspection request.

For other details see [14] O1F parameter.



When using the servomotor control, **both Out2 and Out3** are to be selected as Heating or Cooling (o2F = o3F = 1 **or** o2F = o3F = 3); Parameter **[56] cont** must be set as **3**.

[20] address 10259
o2.AL - Alarms linked up with Out 2

Available: When [18] o2F = 3.

Range: 0... 63 with the following rule:

- +1 Alarm 1;
- +2 Alarm 2;
- +4 Alarm 3;
- +8 Loop break alarm;
- +16 Sensor break (burn out);
- +32 Overload on Out4 (short circuit on the Out4).

For more details see [17] o1.AL parameter.

[21] address 10260
o2Ac - Out 2 action

Available: When [19] o2F is different from 0.

Range: 0 Direct action;

- 1 Reverse action;
- 2 Direct action with reverse LED indication;
- 3 Reverse action with reverse LED indication.

For more details see [18] o1.Ac parameter.

[22] address 10261
o3F - Out 3 function

Available: When the instrument has out 3 option.

Range: 0 Output not used. With this setting the status of this output can be driven directly from serial link;

- 1 Heating output;
- 2 Cooling output;
- 3 Alarm output;
- 4 Timer output;
- 5 Timer out - OFF in Hold;
- 6 Program end indicator;
- 7 Program hold indicator;
- 8 Program wait indicator;
- 9 Program run indicator;
- 10 Program Event 1;
- 11 Program Event 2;
- 12 Out-of-range or burn out indicator;
- 13 Power failure indicator;
- 14 Out-of-range, Burnout and Power failure indicator;
- 15 Stand By status indicator;
- 16 Repeats the digital input 1 status;
- 17 Repeats the digital input 2 status;
- 18 Out1 always ON;
- 19 Inspection request.

For other details see [14] O1F parameter.

[23] address 10262
o3.AL - Alarms linked up with Out 3

Available: When [21] o3F = 3.

Range: 0... 63 with the following rule:

- +1 Alarm 1;
- +2 Alarm 2;
- +4 Alarm 3;

- +8 Loop break alarm;
- +16 Sensor break (burn out);
- +32 Overload on Out4 (short circuit on the Out4).

For more details see [17] o1.AL parameter.

[24] address 10263
o3Ac - Out 3 action

Available: When [21] o3F is different from 0.

Range: 0 Direct action;

- 1 Reverse action;
- 2 Direct action with reverse LED indication;
- 3 Reverse action with reverse LED indication.

For more details see [18] o1.Ac parameter.

[25] address 10264
o4F - Out 4 function

Available: When the [9] io4.F = 1.

Range: 0 Output not used;

- 1 Heating output;
- 2 Cooling output;
- 3 Alarm output;
- 4 Timer output;
- 5 Timer out - OFF in Hold;
- 6 Program end indicator;
- 7 Program hold indicator;
- 8 Program wait indicator;
- 9 Program run indicator;
- 10 Program Event 1;
- 11 Program Event 2;
- 12 Out-of-range or burn out indicator;
- 13 Power failure indicator;
- 14 Out-of-range, Burnout and Power failure indicator;
- 15 Stand By status indicator;
- 16 Repeats the digital input 1 status;
- 17 Repeats the digital input 2 status;
- 18 Out1 always ON;
- 19 Inspection request.

For other details see [14] O1F parameter.

[26] address 10265
o4.AL - Alarms linked up with Out 4

Available: When [25] o4F = 3.

Range: 0... 63 with the following rule.

- +1 Alarm 1;
- +2 Alarm 2;
- +4 Alarm 3;
- +8 Loop break alarm;
- +16 Sensor break (burn out);
- +32 Overload on Out4 (short circuit on the Out4).

For more details see [17] o1.AL parameter.

[27] address 10266
o4Ac - Out 4 action

Available: When [25] o4F is different from 0.

Range: 0 Direct action;

- 1 Reverse action;
- 2 Direct action with reverse LED indication;
- 3 Reverse action with reverse LED indication.

For more details see [18] o1.Ac parameter.

AL1 Group - Alarm 1 parameters

[28] address 10267

AL1t - Alarm 1 type

Available: Always.

Range: • When one or more outputs are programmed as control output:

- 0 Alarm not used;
 - 1 Absolute low alarm;
 - 2 Absolute high alarm;
 - 3 Absolute band alarm with alarm indication out of the band;
 - 4 Absolute band alarm with alarm indication inside the band;
 - 5 Sensor break;
 - 6 Deviation low alarm (relative);
 - 7 Deviation high alarm (relative);
 - 8 Relative band alarm with alarm indication out of the band;
 - 9 Relative band alarm with alarm indication inside the band;
- When no output is programmed as control output;
- 0 Alarm not used;
 - 1 Absolute low alarm;
 - 2 Absolute high alarm;
 - 3 Absolute band alarm with alarm indication out of the band;
 - 4 Absolute band alarm with alarm indication inside the band;
 - 5 Sensor break.

Notes: 1. The relative and deviation alarms are “relative” to the operative set point value.

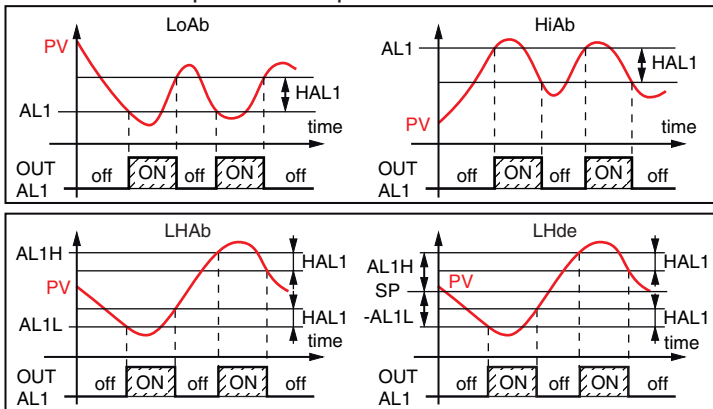

2. The (SE.br) sensor break alarm will be ON when the display shows ---- indication.

[29] address 10268

Ab1 - Alarm 1 function

Available: When [28] AL1t is different from 0.

Range: 0... 15 with the following rule:

- +1 Not active at power ON;
- +2 Latched alarm (manual reset);
- +4 Acknowledgeable alarm;
- +8 Relative alarm not active at set point change.

Example: Setting Ab1 equal to 5 (1+4) the alarm 1 will be “not active at power ON” and “Acknowledgeable”.

Notes: 1. The “not active at power ON” selection allows to inhibit the alarm function at instrument power ON or when the instrument detects a transfer from:

- Manual mode (oplo) to auto mode;
- Stand-by mode to auto mode.

The alarm will be automatically enabled when the

measured value reaches, for the first time, the alarm threshold \pm hysteresis (in other words, when the initial alarm condition disappears).

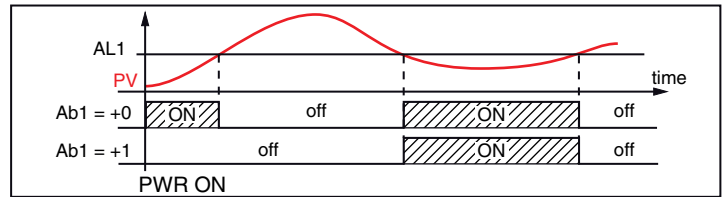

2. A “Latched alarm” (manual reset) is an alarm that will remain active even if the conditions that generated the alarm no longer persist. Alarm reset can be done only by an external command (digital inputs or serial link).

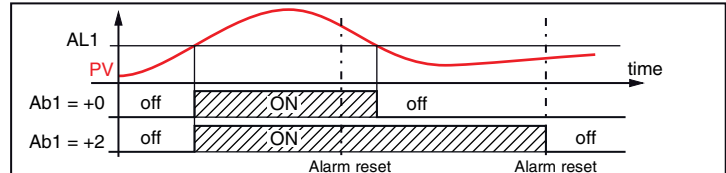

3. An “Acknowledgeable” alarm is an alarm that can be reset even if the conditions that generated the alarm are still present. Alarm acknowledge can be done only by an external command (digital inputs or serial link).

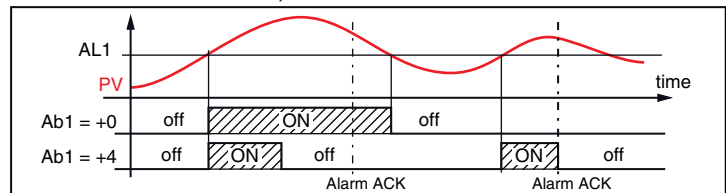

A “relative alarm not active at set point change” is an alarm that masks the alarm condition after a set point change until process variable reaches the alarm threshold \pm hysteresis.

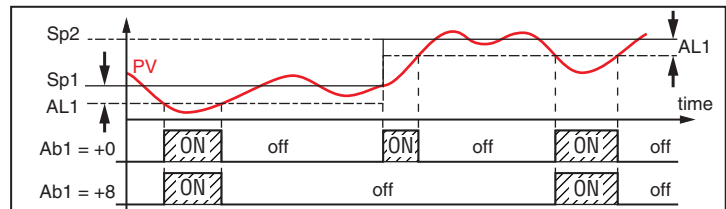

4. The instrument does not store in EEPROM the alarm status. For this reason, the alarm status will be lost if a power down occurs.

[30] address 10269 - AL1L

-For High and low alarms, it is the low limit of the AL1 threshold

-For band alarm, it is low alarm threshold

Available: When [28] AL1t is different from 0 or [28] AL1t is different from 5.

Range: From -1999 to [31] AL1H engineering units.

[31] address 10270 - AL1H

-For High and low alarms, it is the high limit of the AL1 threshold

-For band alarm, it is the high alarm threshold

Available: When [28] AL1t is different from 0 or [28] AL1t is different from 5.

Range: From [30] AL1L to 9999 engineering units.

[32] address 10271

AL1 - Alarm 1 threshold

Available: When:

- [28] AL1t = 1 - Absolute low alarm;
- [28] AL1t = 3 - Absolute high alarm;
- [28] AL1t = 3 - Deviation low alarm (relative);
- [28] AL1t = 4 - Deviation high alarm (relative).

Range: From [30] AL1L to [31] AL1H engineering units.

[33] address 10272

HAL1 - Alarm 1 hysteresis

Available: When [28] AL1t is different from \square or [28] AL1t is different from 5.

Range: 1... 9999 engineering units.

Notes: 1. The hysteresis value is the difference between the Alarm threshold value and the point the Alarm automatically resets.

2. When the alarm threshold plus or minus the hysteresis is out of input range, the instrument will not be able to reset the alarm.

Example: Input range 0... 1000 (mBar).

- Set point equal to 900 (mBar);
- Deviation low alarm equal to 50 (mBar);
- Hysteresis equal to 160 (mBar) the theoretical reset point is $900 - 50 + 160 = 1010$ (mBar) but this value is out of range. The reset can be made only by turning the instrument OFF, removing the condition that generate the alarm and then turn the instrument ON again.
- All band alarms use the same hysteresis value for both thresholds;
- When the hysteresis of a band alarm is bigger than the programmed band, the instrument will not be able to reset the alarm.

Example: Input range 0... 500 (°C).

- Set point equal to 250 (°C);
- Relative band alarm;
- Low threshold equal to 10 (°C);
- High threshold equal to 10 (°C);
- Hysteresis equal to 25 (°C).

[34] address 10273

AL1d - Alarm 1 delay

Available: When [28] AL1t is different from \square .

Range: From OFF (0) to 9999 seconds.

Note: The alarm goes ON only when the alarm condition persists for a time longer than [34] AL1d time but the reset is immediate.

[35] address 10274

AL1o - Alarm 1 enabling during Stand-by mode and out of range indications

Available: When [28] AL1t is different from none.

- Range:**
- 0 Never;
 - 1 During stand by;
 - 2 During overrange and underrange;
 - 3 During overrange, underrange and stand-by.

AL2 Group - Alarm 2 parameters

[36] address 10275

AL2t - Alarm 2 type

Available: Always

Range: • When one or more outputs are programmed as control output:

- 0 Alarm not used;
 - 1 Absolute low alarm;
 - 2 Absolute high alarm;
 - 3 Absolute band alarm with alarm indication out of the band;
 - 4 Absolute band alarm with alarm indication inside the band;
 - 5 Sensor break;
 - 6 Deviation low alarm (relative);
 - 7 Deviation high alarm (relative);
 - 8 Relative band alarm with alarm indication out of the band;
 - 9 Relative band alarm with alarm indication inside the band;
- When no output is programmed as control output:
- 0 Alarm not used;
 - 1 Absolute low alarm;
 - 2 Absolute high alarm;
 - 3 Absolute band alarm with alarm indication out of the band;
 - 4 Absolute band alarm with alarm indication inside the band;
 - 5 Sensor break.

Note: The relative alarm are “relative” to the current set point (this may be different from the Target set point if you are using the ramp to set point function).

[37] address 10276

Ab2 - Alarm 2 function

Available: When [36] AL2t is different from \square .

Range: 0... 15 with the following rule:

- +1 Not active at power ON;
- +2 Latched alarm (manual reset);
- +4 Acknowledgeable alarm;
- +8 Relative alarm not active at set point change.

Example: Setting Ad2 equal to 5 (1+4) the alarm 2 will be “not active at power ON” and “Acknowledgeable”.

Note: For other details see [28] Ab1 parameter.

[38] address 10277 - AL2L

-For High and low alarms, it is the low limit of the AL2 threshold

-For band alarm, it is low alarm threshold

Available: When [36] AL2t is different from \square or [36] AL2t is different from 5.

Range: -1999 to [39] AL2H engineering units.

[39] address 10278 - AL2H

-For High and low alarms, it is the high limit of the AL2 threshold

-For band alarm, it is high alarm threshold

Available: When [36] AL2t is different from \square or [36] AL2t is different from 5.

Range: From [38] AL2L to 9999 engineering units.

[40] address 10279

AL2 - Alarm 2 threshold

Available: When:

- [36] AL2t = 1 Absolute low alarm;
- [36] AL2t = 2 Absolute high alarm;
- [36] AL2t = 3 Deviation low alarm (relative);
- [36] AL2t = 4 Deviation high alarm (relative).

Range: From [38] AL2L to [39] AL2H engineering units.

[41] address 10280

HAL2 - Alarm 2 hysteresis

Available: When [36] AL2t is different from 0 or [36] AL2t is different from 5.

Range: 1... 9999 engineering units.

Note: For other details see [33] HAL1 parameter.

[42] address 10281

AL2d - Alarm 2 delay

Available: When [36] AL2t different from 0.

Range: From OFF (0) to 9999 seconds.

Note: The alarm goes ON only when the alarm condition persist for a time longer than [42] AL2d time but the reset is immediate.

[43] address 10282

AL2o - Alarm 2 enabling during Stand-by mode and out of range indications

Available: When [36] AL2t different from 0.

- Range:** 0 Never;
- 1 During stand by;
 - 2 During overrange and underrange;
 - 3 During overrange, underrange and stand-by.

AL3 Group - Alarm 3 parameters

[44] address 10283

AL3t - Alarm 3 type

Available: Always.

- Range:** • When one or more outputs are programmed as control output:
- 0 Alarm not used;
 - 1 Absolute low alarm;
 - 2 Absolute high alarm;
 - 3 Absolute band alarm with alarm indication out of the band;
 - 4 Absolute band alarm with alarm indication inside the band;
 - 5 Sensor break;
 - 6 Deviation low alarm (relative);
 - 7 Deviation high alarm (relative);
 - 8 Relative band alarm with alarm indication out of the band;
 - 9 Relative band alarm with alarm indication inside the band.
- When no output is programmed as control output;
- 0 Alarm not used;
 - 1 Absolute low alarm;
 - 2 Absolute high alarm;
 - 3 Absolute band alarm with alarm indication out of the band;
 - 4 Absolute band alarm with alarm indication inside the band;
 - 5 Sensor break.

Note: The relative alarm are “relative” to the current set point (this may be different to the Target set point if you are using the ramp to set point function).

[45] address 10284

Ab3 - Alarm 3 function

Available: When [43] AL3t is different from 0.

Range: 0... 15 with the following rule:

- +1 Not active at power ON;
- +2 Latched alarm (manual reset);
- +4 Acknowledgeable alarm;
- +8 Relative alarm not active at set point change.

Example: Setting Ad3 equal to 5 (1+4) the alarm 3 will be “Not active at power ON” and “Acknowledgeable”.

Note: For other details see [29] Ab1 parameter.

[46] address 10285 - AL3L

-For High and low alarms, it is the low limit of the AL3 threshold

-For band alarm, it is low alarm threshold

Available: When [44] AL3t is different from 0 or [44] AL3t is different from 5.

Range: -1999 to [47] AL3H engineering units.

[47] address 10286 - AL3H

-For High and low alarms, it is the high limit of the AL3 threshold

-For band alarm, it is high alarm threshold

Available: When [44] AL3t is different from 0 or [44] AL3t is different from 5.

Range: From [46] AL3L to 9999 engineering units.

[48] address 10287

AL3 - Alarm 3 threshold

Available: When:

- [44] AL3t = 1 Absolute low alarm;
- [44] AL3t = 2 Absolute high alarm;
- [44] AL3t = 3 Deviation low alarm (relative);
- [44] AL3t = 4 Deviation high alarm (relative).

Range: From [46] AL3L to [47] AL3H engineering units.

[49] address 10288

HAL3 - Alarm 3 hysteresis

Available: When [44] AL3t is different from 0 or [44] AL3t is different from 5.

Range: 1... 9999 engineering units.

Note: For other details see [33] HAL1 parameter.

[50] address 10289

AL3d - Alarm 3 delay

Available: When [44] AL3t different from 0.

Range: From OFF (0) to 9999 seconds.

Note: The alarm goes ON only when the alarm condition persist for a time longer than [50] AL3d time but the reset is immediate.

[51] address 10290

AL3o - Alarm 3 enabling during Stand-by mode and out of range indications

Available: When [44] AL3t is different from 0 or [44] AL3t is different from 5.

- Range:** 0 Never;
- 1 During stand by;
 - 2 During overrange and underrange;
 - 3 During overrange, underrange and stand-by.

3 LbA group - Loop break alarm

General note about LBA alarm

The LBA operate as follows: applying the 100% of the power output to a process, the process variable, after a time due to the process inertia, begins to change in a known direction (increases for an heating action or decreases for a cooling action).

Example: If I apply 100% of the power output to a furnace, the temperature must go up unless one of the component in the loop is faulty (heater, sensor, power supply, fuse, etc...)

The same philosophy can be applied to the minimum power. In our example, when I turn OFF the power to a furnace, the temperature must go down, if not the SSR is in short circuit, the valve is jammed, etc..

LBA function is automatically enabled when the PID requires the maximum or the minimum power.

When the process response is slower than the programmed limit the instrument generates an alarm.

- Notes:**
1. When the instrument is in manual mode, the LBA function is disabled.
 2. When LBA alarm is ON the instrument continues to perform the standard control. If the process response comes back into the programmed limit, the instrument automatically resets the LBA alarm.
 3. This function is available only when the programmed control algorithm is equal to PID (Cont = PID).

[52] address 10291 LbAt - LBA time

Available: When [56] Cont = 0 (PID) or 3 (3Pt).

Range: 0 = LBA not used;
1... 9999 seconds.

[53] address 10292 LbSt - Delta measure used by LBA during Soft start

Available: When [52] LbAt is different from 0.

Range: 0 = loop break alarm is inhibit during soft start;
1... 9999 engineering units.

[54] address 10293 LbAS -Delta measure used by loop break alarm (loop break alarm step)

Available: When [52] LbAt is different from 0.

Range: 1... 9999 engineering units.

[55] address 10294 LbcA - Condition for LBA enabling

Available: When [52] LbAt is different from 0.

- Range:**
- 0 Enabled when the PID requires the maximum power only;
 - 1 Enabled when the PID requires the minimum power only;
 - 2 Enabled in both condition (when the PID requires the maximum or the minimum power).

LBA application example:

- LbAt (LBA time) = 120 seconds (2 minutes);
- LbAS (delta LBA) = 5°C.

The machine has been designed in order to reach 200°C in 20 minutes (20°C/min).

When the PID demands 100% power, the instrument starts the time count.

During time count if the measured value increases more

than 5°C, the instrument restarts the time count. Otherwise if the measured value does not reach the programmed delta (5°C in 2 minutes) the instrument will generate the alarm.

3 rEG group - Control parameters

The rEG group will be available only when at least one output is programmed as control output (H.rEG or C.rEG).

[56] address 10295 cont - Control type

Available: When at least one output is programmed as control output (H.rEG or C.rEG).

- Range:**
- When two control actions (heat AND cool) are programmed:
 - 0 PID (heat and cool);
 - 1 Heat/Cool ON/OFF control with neutral zone;

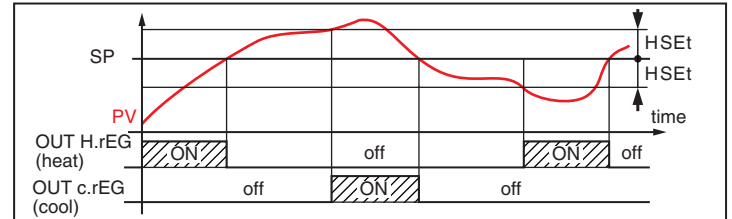

- When one control action (heat OR cool) is programmed:
 - 0 PID (heat or cool);
 - 1 ON/OFF asymmetric hysteresis;
 - 2 ON/OFF symmetric hysteresis;
 - 3 Servomotor control (available when Output 2 and Output 3 have been ordered as "M").

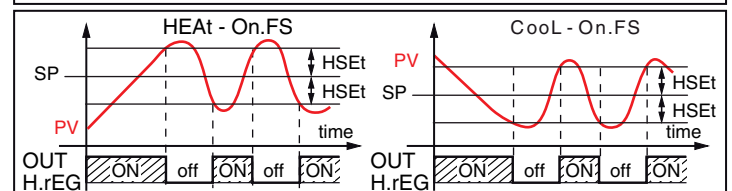
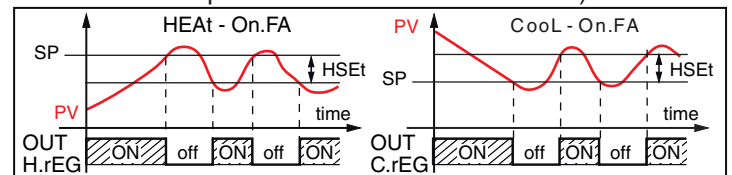

- Notes:**
1. ON/OFF control with asymmetric hysteresis:
 - OFF when $PV \geq SP$;
 - ON when $PV \leq (SP - \text{hysteresis})$.
 2. ON/OFF control with symmetric hysteresis:
 - OFF when $PV \geq (SP + \text{hysteresis})$;
 - ON when $PV \leq (SP - \text{hysteresis})$.

[57] address 10296 Auto - Auto tune selection

Ascon TecnoLogic has developed three auto-tune algorithms:

- Oscillating auto-tune;
- Fast auto-tune;
- EvoTune.

1. The **oscillating** auto-tune is the usual auto-tune and:
 - It is more accurate;
 - Can start even if PV is close to the set point;
 - Can be used even if the set point is close to the ambient temperature.
2. The **fast type** is suitable when:
 - The process is very slow and you want to be operative in a short time;

- When an overshoot is not acceptable;
- In multi-loop machinery where the fast method reduces the calculation error due to the effect of the other loops.

3. The **EvoTune** type is suitable when:

- You have no information about your process;
- You can not be sure about the end user skills;
- You desire an auto tune calculation independently from the starting conditions (e.g. set point change during tune execution, etc).

Note: Fast auto-tune can start only when the measured value (PV) is lower than (SP + 1/2SP).

Available: When [56] cont = PID.

Range: -4... 8 where:

- 4 Oscillating auto-tune with automatic restart at all set point change;
- 3 Oscillating auto-tune with manual start;
- 2 Oscillating auto-tune with automatic start at the first power ON only;
- 1 Oscillating auto-tune with automatic restart at every power ON;
- 0 Not used;
- 1 Fast auto tuning with automatic restart at every power ON;
- 2 Fast auto-tune with automatic start at the first power ON only;
- 3 FAST auto-tune with manual start;
- 4 FAST auto-tune with automatic restart at all set point change.
- 5 EvoTune with automatic restart at every power ON;
- 6 EvoTune with automatic start at the first power ON only;
- 7 EvoTune with manual start;
- 8 EvoTune with automatic restart at all set point change.

Note: All auto-tunes are inhibited during program execution.

[58] address 10297

tunE - Manual start of the auto-tune

Available: When [56] cont = 0.

Range: off = The instrument is not performing the auto-tune;
on = The instrument is performing the auto-tune.

[59] address 10298

SELF - Self-tune enable

The self-tuning is an adaptive algorithm able to optimise continuously the PID parameter value.

This algorithm is specifically designed for all process subjected to big load variation able to change heavily the process response.

Available: When [56] cont = 0.

Range: 1 Self-tune active;
0 Self-tune not active.

[60] address 10299

HSEt - Hysteresis of the ON/OFF control

Available: When [56] cont is different from 0.

Range: 0... 9999 engineering units.

[61] address 10300

cPdt - Time for compressor protection

Available: When [56] cont = 1.

Range: OFF = Protection disabled;
1... 9999 seconds.

[62] address 10301

Pb - Proportional band

Available: When [56] cont = 0 and [59] SELF = 0.

Range: 1... 9999 engineering units.

Note: Auto-tune functions calculate this value.

[63] address 10302

ti - Integral time

Available: When [56] cont = 0 and [59] SELF = 0.

Range: 0 Integral action excluded;
1... 9999 seconds.

Note: Auto-tune functions calculate this value.

[64] address 10303

td - Derivative time

Available: When [56] cont = 0 and [59] SELF = 0.

Range: 0 Derivative action excluded;
1... 9999 seconds.

Note: Auto-tune functions calculate this value.

[65] address 10304

Fuoc - Fuzzy overshoot control

This parameter reduces the overshoot usually present at instrument start up or after a set point change and it will be active only in this two cases.

Setting a value between 0.00 and 1.00 it is possible to slow down the instrument action during set point approach.

Setting **Fuoc = 1** this function is disabled.

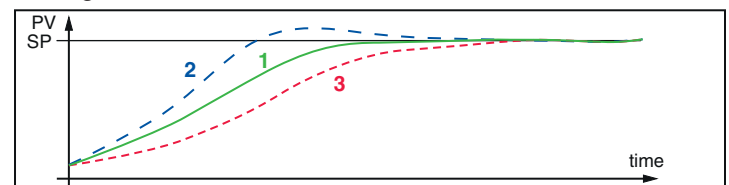

Available: When [56] cont = 0 and [59] SELF = 0.

Range: 0... 2.00.

Note: Fast auto-tune calculates the Fuoc parameter while the oscillating one sets it equal to 0.5.

[66] address 10305

tch - Cycle time of the heating output

Available: When at least one output is programmed in order to be the heating output,

[56] cont = 0 and [59] SELF = 0.

Range: 1.0... 130.0 seconds.

[67] address 10306

rcG - Power ratio between heating and cooling action (relative cooling gain)

The instrument uses the same PID parameter set for heat and for cool action but the efficiency of the two actions are usually different.

This parameter allows to define the ratio between the efficiency of the heating system and the efficiency of the cooling one.

An example will help us to explain you the philosophy.

Consider one loop of a plastic extruder. The working temperature is equal to 250°C.

When you want to increase the temperature from 250 to 270°C ($\Delta T = 20^\circ C$) using 100% of the heating power (resistor), you will need 60 seconds.

On the contrary, when you want to decrease the temperature from 250 to 230°C ($\Delta T = 20^\circ C$) using 100% of the cooling

power (fan), you will need 20 seconds only.

In our example the ratio is equal to $60/20 = 3$ ([67] rcG = 3) and it says that the efficiency of the cooling system is 3 times more efficient than the heating one.

Available: When two control actions are programmed (H.rEG and c.rEG) and [56] cont = PID and [59] SELF = no.

Range: 0.01... 99.99

Note: Auto-tune functions calculate this value.

[68] address 10307

tcc - Cycle time of the cooling output

Available: When at least one output is programmed in order to be the cooling output (c.rEG), [56] cont = PID and [59] SELF = no.

Range: 1.0... 130.0 seconds.

[69] address 10308

rS - Manual reset (integral pre-load)

It allows to drastically reduce the undershoot due to a hot restart. When your process is steady, the instrument operates with a steady power output (e.g.: 30%).

If a short power down occurs, the process restarts with a process variable close to the set point while the instrument starts with an integral action equal to zero.

Setting a manual reset equal to the average power output (in our example 30%) the instrument will start with a power output equal to the value it will use at steady state (instead of zero) and the undershoot will become very little (in theory equal to zero).

Available: When [56] cont = 0.

Range: -100.0... +100.0%.

[70] address 10309

Str.t - Servomotor stroke time

Available: When [56] cont = 3.

Range: 5... 1000 seconds.

[71] address 10310

db.S - Servomotor dead band

Available: When [56] cont = 3.

Range: 0.0... 10.0.

[72] address 10311

oPL - Min. output power

Available: When [56] cont = 3.

Range: From -100% to [73] OPH.

[73] address 10312

oPH - Max. output power

Available: When [56] cont = 3.

Range: From [72] OPL to 100%.

[74] address 10313

od - Delay at power ON

Available: When at least one output is programmed as control output.

Range: 0 Function not used;
0.01... 99.59 hh.mm.

- Notes:**
1. This parameter defines the time during which (after a power ON) the instrument remains in stand by mode before to start all other functions (control, alarms, program, etc.).
 2. When a program with automatic start at power ON and od function are programmed, the

instrument performs od function before to start the program execution.

3. When an auto-tune with automatic start at power ON and od function are programmed, the auto-tune will start at the end of od delay.

[75] address 10314

St.P - Max. output power used during soft start

Available: When at list one output is programmed as control output.

Range: -100... +100%.

- Notes:**
1. When [75] St.P parameter have a positive value, the limit will be applied to the heating output(s) only.
 2. When [75] St.P parameter have a negative value, the limit will be applied to the cooling output(s) only.
 3. When a program with automatic start at power ON and soft start function are programmed, the instrument performs the soft start and then the program function.
 4. The auto-tune function will be performed after soft start function.
 5. The Soft start function is available also when ON/OFF control is used.

[76] address 10315

SSt - Soft start time

Available: When at list one output is programmed as control output.

Range: 0 Function not used;
0.01... 7.59 hh.mm;
8.00 Soft start always active.

[77] address 10316

SS.tH - Threshold for soft start disabling

Available: When at list one output is programmed as control output.

Range: -1999... 9999 engineering units.

- Notes:**
1. When the power limiter has a positive value (the limit is applied to the heating action) the soft start function will be aborted when the measured value is greater or equal to [77] SS.tH parameter.
 2. When the power limiter has a negative value (the limit is applied to the cooling action) the soft start function will be aborted when the measured value is lower or equal to [77] SS.tH parameter.

SP Group - Set point parameters

The SP group will be available only when at least one output is programmed as control output (H.rEG or C.rEG).

[78] address 10317

nSP - Number of used set points

Available: When at least one output is programmed as control output.

Range: 1... 4.

Note: When you change the value of this parameter, the instrument operates as follows:

- [85] A.SP parameter will be forced to SP.
- The instrument verifies that all used set point are within the limits programmed by [79] SP.LL and [80] SP.HL. If an SP is out of this range, the instrument forces it to the maximum acceptable value.

[79] address 10318

SPLL - Minimum set point value

Available: When at least one output is programmed as control output.

Range: From -1999 to [80] SPHL engineering units

- Notes:**
1. When you change the [79] SPLL value, the instrument checks all local set points (SP, SP2, SP3 and SP4 parameters) and all set points of the program ([99] Pr.S1, [104] Pr.S2, [109] Pr.S3, [114] Pr.S4 parameters). If an SP is out of this range, the instrument forces it to the maximum acceptable value
 2. A [79] SPLL change produces the following actions:
 - When [86] SP.rt = 0 the remote set point will be forced to be equal to the active set point.
 - When [86] SP.rt = 1 the remote set point will be forced to zero.
 - When [86] SP.rt = 2 the remote set point will be forced to zero.

[80] address 10319

SPHL - Maximum set point value

Available: When at least one output is programmed as control output.

Range: From [79] SPLL to 9999 engineering units.

Note: For other details see [79] SPLL parameter.

[81] address 10320

SP - Set Point 1

Available: When at least one output is programmed as control output.

Range: From [79] SPLL to [80] SPHL engineering units.

[82] address 10321

SP 2 - Set Point 2

Available: When at least one output is programmed as control output and [78] nSP \geq 2.

Range: From [79] SPLL to [80] SPHL engineering units.

[83] address 10322

SP 3 - Set Point 3

Available: When at least one output is programmed as control output and [78] nSP \geq 3.

Range: From [79] SPLL to [80] SPHL engineering units.

[84] address 10323

SP 4 - Set Point 4

Available: When at least one output is programmed as control output and [78] nSP = 4.

Range: From [79] SPLL to [80] SPHL engineering units.

[85] address 10324

A.SP - Selection of the active Set point

Available: When at least one output is programmed as control output.

Range: From 1 to [76] nSP.

- Notes:**
1. A [85] A.SP change produces the following actions:
 - When [86] SP.rt = 0 - the remote set point will be forced to be equal to the active set point;
 - When [86] SP.rt = 1 - the remote set point will be forced to zero;
 - When [86] SP.rt = 2 - the remote set point will be forced to zero.
 2. SP2, SP3 and SP4 selection will be shown only when the relative set point is enabled (see [78] nSP parameter).

[86] address 10325

SP.rt - Remote set point type

These instruments will communicate with each other, using RS 485 serial interface without a PC. An instrument can be set as a Master while the other are (as usual) Slave units. The Master unit can send his operative set point to the slave units.

In this way, for example, it is possible to change simultaneously the set point of 20 instruments by changing the set point of the master unit (e.g. hot runner application). [86] SP.rt parameter defines how the slaves units will use the value coming from serial link.

The [135] tr.SP [selection of the value to be retransmitted (Master)] parameter allows to define the value sent by master unit.

Available: When at least one output is programmed as control output and the serial interface is present.

- Range:** 0 The value coming from serial link is used as remote set point (RSP).
- 1 The value coming from serial link will be algebraically added to the local set point selected by A.SP and the sum becomes the operative set point.
 - 2 The value coming from serial will be scaled on the input range and this value will be used as remote set point.

Note: A [86] SPrt change causes the following actions:

- When [86] SP.rt = 0 - the remote set point is forced to be equal to the active set point;
- When [86] SP.rt = 1 - the remote set point is forced to zero;
- When [86] SP.rt = 2 - the remote set point is forced to zero.

Example: A 6 zone reflow-oven for PCB. The master unit sends its set point value to 5 other zones (slave controllers). The Slave zones use it as a set point trim.

The first zone is the master zone and it uses a set point equal to 210°C.

The second zone has a local set point equal to -45°C.

The third zone has a local set point equal to -45 (°C).

The fourth zone has a local set point equal to -30.

The fifth zone has a local set point equal to +40.

The sixth zone has a local set point equal to +50.

In this way, the thermal profile will be the following:

- Master SP = 210°C;
- Second zone SP = 210 - 45 = 165°C;
- Third zone SP = 210 - 45 = 165°C;
- Fourth zone SP = 210 - 30 = 180°C;
- Fifth zone SP = 210 + 40 = 250°C;
- Sixth zone SP = 210 + 50 = 260°C.

Changing the SP of the master unit, all the other slave units will immediately change their operative set point.

[87] address 10326

SPLr - Local/remote set point selection

Available: When at list one output is programmed as control output.

- Range:** 0 Local set point selected by [83] A.SP;
- 1 Remote set point (coming from serial link).

[88] address 10327

SP.u - Rate of rise for positive set point change (ramp up)

Available: When at list one output is e programmed as control output.

Range: 0.01... 99.99 units per minute;
10000 = Ramp disabled (step transfer).

[89] address 10328

SP.d - Rate of rise for negative set point change (ramp down)

Available: When at list one output is e programmed as control output.

Range: 0.01... 99.99 units per minute;
10000 = Ramp disabled (step transfer).

General note about remote set point:

When the remote set point (RSP) with trim action is programmed, the local set point range becomes: from [79] SPLL + RSP to [80] SPHL - RSP.

PrG group - Timer function parameters

Five timer types are available:

1. Delayed start with a delay time and a “end of cycle” time.

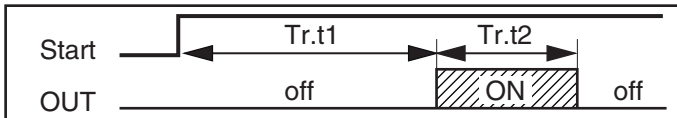

Setting [93] tr.t2 = 99.59 the timer out remains in ON condition until a reset command is detected.

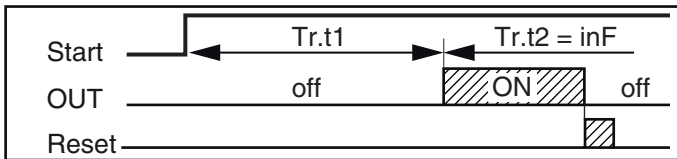

2. Delayed start at power ON with a delay time and a “end of cycle” time.

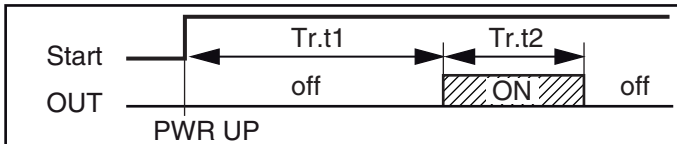

3. Feed-through.

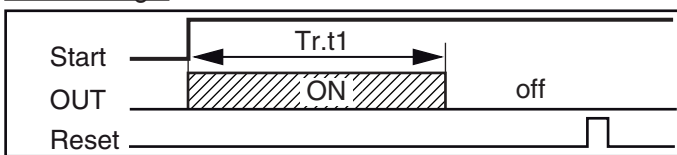

4. Asymmetrical oscillator with start in OFF.

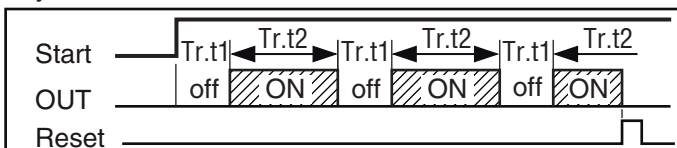

5. Asymmetrical oscillator with start in ON.

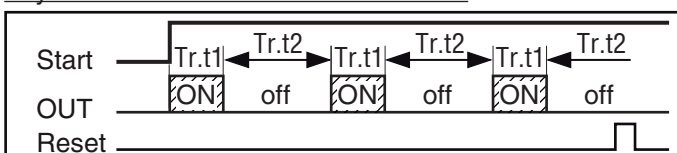

- Notes:**
1. The instrument can receive the start, hold and reset commands by logic inputs and/or by serial link.
 2. An HOLD command can suspend the time count.

[90] address 10329

tr.F= Independent timer function

Available: Always.

- Range:**
- 0 Timer not used;
 - 1 Delayed start timer;
 - 2 Delayed start at power ON;
 - 3 Feed-through timer;
 - 4 Asymmetrical oscillator with start in OFF;
 - 5 Asymmetrical oscillator with start in ON.

[91] address 10330

tr.u - Engineering unit of the time

Available: When [90] tr.F is different from 0.

- Range:**
- 0 Hours and minutes;
 - 1 Minutes and seconds;
 - 2 Seconds and tenth of seconds.

Note: When the timer is running, you can see the value of this parameter but you can NOT modify it.

[92] address 10331

tr.t1 - Time 1

Available: When [88] tr.F is different from nonE.

- Range:**
- When [89] tr.u = 0 = hh.nn = 00.01... 99.59;
 - When [89] tr.u = 1 = nn.SS = 00.01... 99.59;
 - When [89] tr.u = 2 = SSS.d = 000.1... 995.9.

[93] address 10332

tr.t2 - Time 2

Available: When [88] tr.F is different from nonE.

- Range:**
- When [89] tr.u = 0 = hh.nn = 00.01... 99.59 + inF;
 - When [89] tr.u = 1 = nn.SS = 00.01... 99.59 + inF;
 - When [89] tr.u = 2 = SSS.d = 000... 995.9 + inF.

Note: Setting [91] tr.t2 = 99.60 = inF, the second time can be stopped by a reset command only.

[94] address 10333

tr.St - Timer status

Available: When [88] Tr.F is different from 0.

- Range:**
- 0 Timer reset.
 - 1 Timer Run;
 - 2 Timer Hold.

Note: This parameter allows to manage timer execution by a parameter (without digital inputs).

PrG Group - Programmer function parameters

These instruments are able to perform a set point profile compounded of 4 groups of 2 steps (8 step total).

The first step is a ramp (used to reach the desired set point), the second is a soak (on the desired set point).

When a RUN command is detected the instrument aligns the operative set point to the measured value and starts to execute the first ramp.

In addition, each soak is equipped with a wait band which suspends the time count when the measured value goes out of the defined band (guaranteed soak).

Moreover, for each segment it is possible to define the status of two events. An event can drive an output and make an action during one or more specific program steps.

Some additional parameters allow to define the time scale, the automatic RUN conditions and the instrument behaviour at the end of the program.

- Notes:**
1. All steps can be modified during program execution.
 2. During program execution the instrument stores

the segment currently in use and, by a 30 minutes interval, stores also the elapsed time of the soaks. If a power down occurs during program execution, at the next power ON the instrument is able to continue the program execution starting from the segment in progress at power down and, if the segment was a soak, it is also capable to restart from the soak time minus the stored elapsed time. In order to obtain this features, the [121] dSPu "Status of the instrument at power ON" parameter must be set to "AS.Pr". If [121] dSPu value is different from 0, the memorization function will be inhibited.

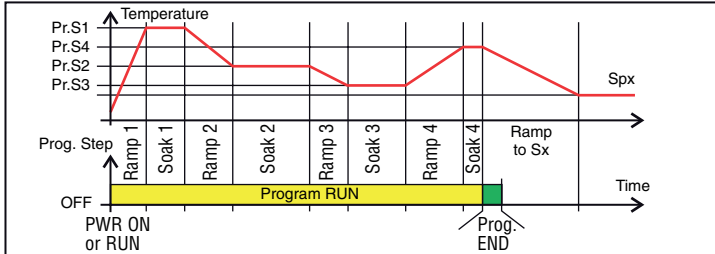

[95] address 10334

Pr.F = Programmer action at Power ON

Available: Always.

- Range:** 0 Program not used;
 1 Start at power ON with a first step in stand by;
 2 Start at power ON;
 3 Start at RUN command detection only;
 4 Start at RUN command detection with a first step in stand by.

[96] address 10335

Pr.u = Engineering units of the soaks

Available: When [95] Pr.F is different from 0:

- Range:** 0 hh.nn = Hours and minutes;
 1 nn.SS= Minutes and seconds.

Note: During program execution, this parameter can not be modified.

[97] address 10336

Pr.E = Instrument behaviour at the End of the program execution

Available: When [95] Pr.F is different from 0.

- Range:** 0 = cnt = Continue (the instrument uses the set point of the last soak until a reset command is detected);
 1 = SPAt = Go to the set point selected by [83] A.SP parameter;
 2 = St.bY = Go in stand by mode.

- Notes:** 1. Setting [97] Pr.E = 0 (cnt) the instrument operates as follows: at program end, it will use the set point of the last soak.
 2. When a reset command is detected, it goes to the set point selected by [85] A.SP parameter. The transfer will be a step transfer or a ramp according to the [88] SP.u (maximum rate of rise for positive set point change) and [89] SPd (maximum rate of rise for negative set point change).
 3. Setting [97] Pr.E = 1 (SPAt) the instrument goes immediately to the set point selected by [85] A.SP parameter. The transfer will be a step transfer or a ramp according to the [88] SP.u (maximum rate of rise for positive set point change) and [89] SPd (maximum rate of rise for negative set point change).

[98] address 10337

Pr.Et = Time of the End program indication

Available: When [97] Pr.F is different from 0.

- Range:** 0 = Function not used;
 00.01... 99.59 minutes and seconds;
 99.60 = Forced to ON.

Note: Setting [98] Pr.Et = 99.60 (inF) the end program indication will go OFF only when a reset command or a new RUN command is detected.

[99] address 10338

Pr.S1 = Set point of the first soak

Available: When [95] Pr.F is different from 0 or [95] Pr.F is different from 1.

Range: From [79] SP.LL to [80] SP.HL.

[100] address 10339

Pr.G1 = Gradient of the first ramp

Available: When [95] Pr.F is different from 0 or [95] Pr.F is different from 1.

- Range:** 0.1... 999.9 engineering units per minute;
 10000 = Step transfer.

[101] address 10340

Pr.t1 = Time of the first soak

Available: When [95] Pr.F is different from 0.

Range: 0.00... 99.59 Time units.

[102] address 10341

Pr.b1 = Wait band of the first soak

Available: When [95] Pr.F is different from 0 or [95] Pr.F is different from 1.

Range: OFF... 9999 engineering units.

Note: The wait band suspends the time counting when the measured value goes out of the defined band (guaranteed soak).

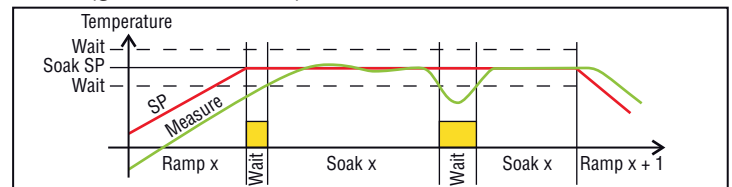

[103] address 10342

Pr.E1 = Events of the first group

Available: When [95] Pr.F is different from 0 or [95] Pr.F is different from 1.

Range: 00.00... 11.11 where:

- 0 Event OFF;
 1 Event ON.

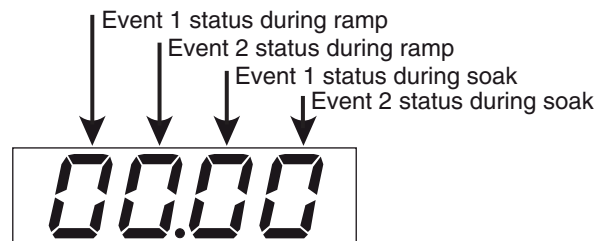

| Display | Ramp | | Soak | |
|---------|---------|---------|---------|---------|
| | Event 1 | Event 2 | Event 1 | Event 2 |
| 0000 | off | off | off | off |
| 1000 | on | off | off | off |
| 0 100 | off | on | off | off |
| 1 100 | on | on | off | off |

| Display | Ramp | | Soak | |
|---------|---------|---------|---------|---------|
| | Event 1 | Event 2 | Event 1 | Event 2 |
| 00.10 | off | off | on | off |
| 10.10 | on | off | on | off |
| 01.10 | off | on | on | off |
| 11.10 | on | on | on | off |
| 0001 | off | off | off | on |
| 1001 | on | off | off | on |
| 0101 | off | on | off | on |
| 1101 | on | on | off | on |
| 0011 | off | off | on | on |
| 1011 | on | off | on | on |
| 0111 | off | on | on | on |
| 1111 | on | on | on | on |

[104] address 10343

Pr.S2 - Set point of the second soak

Available: When [95] Pr.F $\neq 0$.

Range: From [79] SPLL to [80] SPHL;
-8000 = Program end.

Note: It is not necessary to configure all steps.
To use for example 2 groups only, it is sufficient to set the set point of the third group equal to -8000 (OFF).
The instrument masks all the following parameters of the programmer.

[105] address 10344

Pr.G2 - Gradient of the second ramp

Available: When [95] Pr.F $\neq 0$ and [104] Pr.S2 $\neq -8000$.

Range: 0.1... 999.9 engineering units per minute;
10000 = Step transfer.

[106] address 10345

Pr.t2 - Time of the second soak

Available: When [95] Pr.F $\neq 0$ and [104] Pr.S2 $\neq -8000$.

Range: 0.00... 99.59 time units.

[107] address 10346

Pr.b2 - Wait band of the second soak

Available: When [95] Pr.F $\neq 0$ and [104] Pr.S2 $\neq -8000$.

Range: 0 (OFF)... 9999 engineering units.

Note: For more details see [102] Pr.b1 parameter.

[108] address 10347

Pr.E2 - Events of the second group

Available: When [95] Pr.F $\neq 0$ and [104] Pr.S2 $\neq -8000$.

Range: 00.00... 11.11 where:

- 0 Event OFF;
- 1 Event ON.

Note: For more details see [103]Pr.E1 parameter.

[109] address 10348

Pr.S3 - Set point of the third soak

Available: When [95] Pr.F $\neq 0$ and [104] Pr.S2 $\neq -8000$.

Range: from [79] SPLL to [80] SPHL;
-8000 = Program end.

Note: For more details see [104] Pr.S2 parameter.

[110] address 10349

Pr.G3 - Gradient of the third ramp

Available: When [95] Pr.F $\neq 0$, [104] Pr.S2 $\neq -8000$ and [109] Pr.S3 $\neq -8000$.

Range: 0.1... 999.9 engineering units per minute;
10000 = Step transfer.

[111] address 10350

Pr.t3 - Time of the third soak

Available: When [95] Pr.F $\neq 0$, [104] Pr.S2 $\neq -8000$ and [109] Pr.S3 $\neq -8000$.

Range: 0.00... 99.59 time units.

[112] address 10351

Pr.b3 - Wait band of the third soak

Available: When [95] Pr.F $\neq 0$, [104] Pr.S2 $\neq -8000$ and [109] Pr.S3 $\neq -8000$.

Range: 0 (OFF)... 9999 engineering units.

Note: For more details see [102] Pr.b1 parameter.

[113] address 10352

Pr.E3 - Events of the third group

Available: When [95] Pr.F $\neq 0$, [104] Pr.S2 $\neq -8000$ and [109] Pr.S3 $\neq -8000$.

Range: 00.00 to... 11.11 where:

- 0 Event OFF;
- 1 Event ON.

Note: For more details see [103] Pr.E1 parameter.

[114] address 10353

Pr.S4 - Set point of the fourth soak

Available: When [95] Pr.F $\neq 0$, [104] Pr.S2 $\neq -8000$ and [109] Pr.S3 $\neq -8000$.

Range: From [79] SPLL to [80] SPHL;
-8000 = Program end.

Note: For more details see [104]Pr.S2 parameter.

[115] address 10354 - Pr.G4

Gradient of the fourth ramp

Available: When [95] Pr.F $\neq 0$, [104] Pr.S2 $\neq -8000$, [109] Pr.S3 $\neq -8000$ and [114] Pr.S4 $\neq -8000$.

Range: 0.1... 999.9 engineering units per minute;
10000 = Step transfer.

[116] address 10355

Pr.t4 - Time of the fourth soak

Available: When [95] Pr.F $\neq 0$, [104] Pr.S2 $\neq -8000$, [109] Pr.S3 $\neq -8000$ and [114] Pr.S4 $\neq -8000$.

Range: 0.00... 99.59 time units.

[117] address 10356

Pr.b4 - Wait band of the fourth soak

Available: When [95] Pr.F $\neq 0$, [104] Pr.S2 $\neq -8000$, [109] Pr.S3 $\neq -8000$ and [114] Pr.S4 $\neq -8000$.

Range: From 0 (OFF) to 9999 engineering units.

Note: For more details see [102] Pr.b1 parameter.

[118] address 10357

Pr.E4 - Event of the fourth segment

Available: When [95] Pr.F $\neq 0$, [104] Pr.S2 $\neq -8000$, [109] Pr.S3 $\neq -8000$ and [114] Pr.S4 $\neq -8000$.

Range: 00.00... 11.11 where:

- 0 Event OFF;
- 1 Event ON.

Note: For more details see [103]Pr.E1 parameter.

[119] address 10358

Pr.St - Program status

Available: When [93] Pr.F ≠ 0.

Range: 0 rES = Program reset;
1 run = Program Run;
2 HoLd = Program Hold;

Note: This parameter allows to manage program execution by a parameter.

2 PAn group - Operator HMI

[120] address 10359

FiLd - Filter on the displayed value

Available: Always.

Range: oFF = Filter disabled;
From 0.0 (oFF) to 20.0 engineering units.

Note: This is a “window filter” related to the set point, it is applied to the displayed value only and has no effect on the other functions of the instrument (control, alarms, etc.).

[121] address 10360

dSPu - Status of the instrument at power ON

Available: Always.

Range: 0 AS.Pr = Starts in the same way it was prior to the power down;
1 Auto = Starts in Auto mode;
2 oP.0 = Starts in manual mode with a power output equal to zero.
3 St.bY = Starts in stand-by mode

Notes: 1. When you change the value of [122] oPr.E, the instrument forces [123] oPEr parameter equal to Auto.

2. During program execution the instrument stores the segment currently in use and, by a 30 minutes interval, it stores also the elapsed time of the soaks. If a power down occurs during program execution, at the next power ON the instrument is able to continue the program execution starting from the segment in progress at power down and, if the segment was a soak, it is also capable to restart from the soak time minus the stored elapsed time.

In order to obtain this features, the “[121] dSPu - Status of the instrument at power ON” parameter must be set to 0 (AS.Pr).

If the “[121] dSPu” parameter is different from 0 (AS.Pr) The memorization function is inhibited.

[122] address 10361

oPr.E - Operative modes enabling

Available: Always.

Range: 0 ALL = All modes will be selectable by the next parameter.
1 Au.oP = Auto and manual (oPLo) mode only will be selectable by the next parameter;
2 Au.Sb = Auto and Stand-by modes only will be selectable by the next parameter.

Note: Manual changing the value of [122] oPr.E, the instrument forces parameter [123] oPEr = Auto.

[123] address 10362

oPEr - Operative mode selection

Available: Always.

Range: When [122] oPr.E = 0 (ALL):
1 = Auto = Auto mode;

2 = oPLo = Manual mode;
3 = St.bY = Stand by mode.

When [122] oPr.E = 1 (Au.oP):

1 = Auto = Auto mode;
2 = oPLo = Manual mode.

When [122] oPr.E = Au.Sb:

1 = Auto = Auto mode;
3 = St.bY = Stand by mode.

2 Ser group - Serial link parameter

Note: [124] Add and [125] bAud parameters will be used only when all dip-switches are set to OFF otherwise the instrument will use the address and the baud rate set by dip-switches.

[124] address 10363

Add - Instrument address

Available: Always.

Range: 0 = oFF = Serial interface not used;
1... 254.

[125] address 10364

bAud - Baud rate

Available: When [124] Add different from 0.

Range: 0 2400 = 2400 baud;
1 9600 = 9600 baud;
2 19.2 = 19200 baud;
3 38.4 = 38400 baud.

[126] address 10365

trSP - Selection of the value to be retransmitted (Master)

Available: When [124] Add different from 0.

Range: 0 nonE = Retransmission not used (the instrument is a slave);
1 rSP = The instrument become a Master and it retransmits the operative set point;
2 PErc = The instrument become a Master and it retransmits the power output.

Note: For more details see [86] SP.rt (Remote set point type) parameter.

2 COn Group - Consumption parameters

[127] address 10366

Co.tY - Count type

Available: Always.

Range: 0 Not used;
1 Instantaneous power (kW);
2 Consumed energy (kWh);
3 Energy used during program execution. This measure starts from zero when a program runs end stops at the end of the program. A new program execution will reset the value.
4 Total worked days: Number of hours the instrument is turned ON divided by 24.
5 Total worked hours: Number of hours that the instrument is turned ON.
6 Total worked days with threshold: Number of hours the instrument is turned ON divided by 24, the controller is forced in stand-by when Co.ty value reaches the threshold set in [130] h.Job.
7 Total worked hours with threshold: number of hours that the instrument is turned ON, the controller is forced in stand-by when Co.ty value

- reaches the threshold set in [130] h.Job.
- 8 Totalizer of control relay worked days: Number of hours the control relay has been in ON condition, divided by 24.
 - 9 Totalizer of control relay worked hours: Number of hours the control relay has been in ON condition.
 - 10 Totalizer of control relay worked days with threshold: Number of hours the control relay has been in ON condition divided by 24, the controller is forced in stand-by when Co.ty value reaches the threshold set in [130] h.Job.
 - 11 Totalizer of control relay worked hours with threshold: Number of hours the control relay has been in ON condition, the controller is forced in stand-by when Co.ty value reaches the threshold set in [130] h.Job.

Notes:

1. When the control action is made using the linear output or the servomotor, the valid counting methods are 4, 5, 6, 7.
2. Selections 4... 11 represent an internal count: these modes calculate the instrument work in hours or days. When the count reaches the threshold set with parameter [130] h.Job the instrument activate the "Inspection Requested" indications.

The count reset can be done only by changing the threshold value - parameter [130] h.Job.

Using counting methods 6, 7, 10, 11, the count reset causes the controller to exit the stand-by status returning to the control status.

[128] address 10367
UoLt - Nominal Voltage of the load

Available: When [127] Co.tY = 1, 2 or 3.
Range: 1... 9999 (V).

[129] address 10368
cur - Nominal current of the load

Available: When [127] Co.tY = 1, 2 or 3.
Range: 1... 999 (A).

[130] address 10369
h.Job - Threshold of the working period

Available: When [127] Co.tY = 4, 5, 6, 7, 8, 9, 10 or 11.
Range: 0 = Threshold not used;
 1... 9999 days when [127] Co.tY = 4, 6, 8 or 10;
 1... 9999 hours when [127] Co.tY = 5, 7, 9 or 11.

[131] address 10370
t.Job - Worked time (not resettable)

Available: Always.
Range: 1... 9999 days.

2 CAL group - User calibration group

This function allows to calibrate the complete measuring chain and to compensate the errors due to:

- Sensor location;
- Sensor class (sensor errors);
- Instrument accuracy.

[132] address 10371
AL.P - Adjust Low Point

Available: Always.
Range: -1999... ([134] AH.P - 10) engineering units.
Note: The minimum difference between [132] AL.P and [134] AH.P is equal to 10 Engineering Units.

[133] address 10372
AL.o - Adjust Low Offset

Available: Always.
Range: -300... +300 engineering units.

[134] address 10373
AH.P - Adjust High Point

Available: Always.
Range: From ([132]AL.P + 10) to 9999 engineering units.
Note: The minimum difference between [132] AL.P and [134] AH.P is equal to 10 Engineering Units.

[135] address 10374
AH.o - Adjust High Offset

Available: Always.
Range: -300... +300 Engineering Units.
Example:

- Environmental chamber with an operative range: 10... 100°C.
1. Insert in the chamber a reference sensor connected with a reference instrument (usually a calibrator).
 2. Start the control of the instrument, and set a set point equal to the minimum value of the operative range (e.g.: 10°C). When the temperature in the chamber is steady, take note of the temperature measured by the reference system (e.g.: 9°C).
 3. Set [132] AL.P = 10 (low working point) and [133] ALo = -1 (it is the difference between the reading of the instrument and the reading of the reference system). Note that after this set the measured value of the instrument is equal to the measured value of the reference system.
 4. Set a set point equal to the maximum value of the operative range (e.g. 100°C). When the temperature in the chamber is steady, take note of the temperature measured by the reference system (e.g. 98°C).
 5. Set [134] AH.P = 100 (low working point) and [135] AHo = +2 (it is the difference between the reading of the instrument and the reading of the reference system). Note that after this set the measured value of the instrument is equal to the measured value of the reference system.

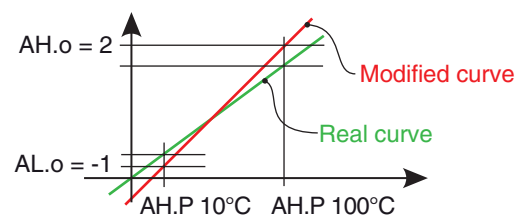

The most important step of the configuration procedure is completed.

6. OPERATIVE MODES

As we said at paragraph 5.1, when the instrument is powered ON, starts immediately to operate according to the stored parameters value.

In other words, the instrument has one status only, the “run time” status.

During “run time” we can force the instrument to operate in three different modes: Automatic mode, Manual mode, or Stand by mode:

In Auto mode without program functions

- [12B] address 527 = 1;
- [19B] address 580 = 0 or 1;
- The instrument drives automatically the control output according to the parameter value set and the set point/measured value.

In Manual mode (oPLo)

- [12B] address 527 = 3
- The instrument does not perform Automatic control and the instrument allows you to set manually the control output power.

No Automatic action will be made.

In Stand by mode

- [12B] address 527 = 0;
- The instrument does not perform any control (the control outputs are OFF);
- The instrument is working as an indicator (analogue to digital converter).

As we have seen, it is always possible to modify the value assigned to a parameter independently from the operative modes selected.

In Auto mode with automatic program start up

- [12B] address 527 = 1;
- [19B] address 580 different from 0, 1 or 7;
- The instrument perform the control following the programmed SP profile.

6.4.1 The programmer function

In paragraph 4 we have described all parameters related with the programmer and their action during program execution.

In this paragraph we will give you some additional information and some application examples.

Application Example 1: Spray Paint Drying Booth

When the operator is in the booth and painting the car, the internal temperature must be 20°C and the air, used for booth ventilation, comes from outside.

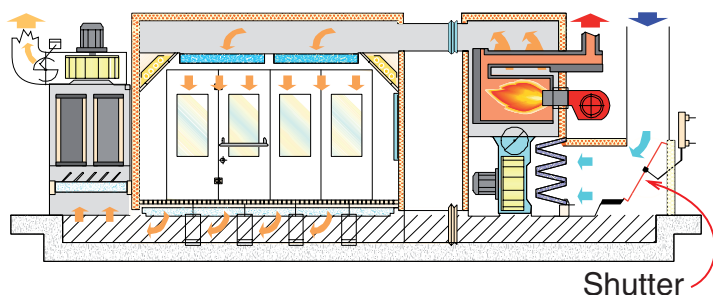

During the passivation and drying phases, the operator is out of the booth and the system closes the shutter of the air

and recycles the internal air in order to reduce the power consumption.

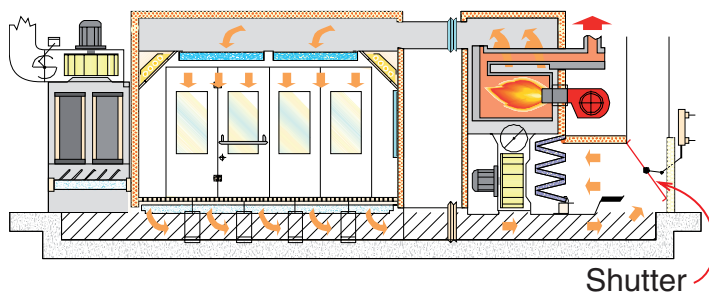

When the drying time is finished, before the operator is allowed to enter into the booth, you must be sure that:

1. The air in the booth has been refreshed
The temperature is lower than a limit.

So that you need a profile like the one that follows:

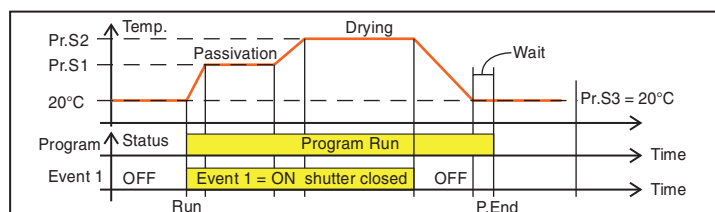

- Out 1 = H.rEG (heating output)
- Out 2 = P.Et1 (program event 1)
- Out 3 = P.run (program running)
- Pr.E1 and Pr.E2 = 10.10
(event 1 goes ON during ramp 1, soak 1, ramp 2 and soak 2)

When the program is running the door is locked

Application Example 2:

edge bending machine with glue tank (for wood)

At the working temperature the hot melt rapidly oxidizes and runs down from the “dispenser”.

For this reason, when the machine does not work for a certain time, it is suitable to move the temperature of the dispenser to a lower value to idle.

In this cases the configuration is the following:

- Out 1 = h.reg (heating output)
- Out 2 = AL (alarm used to enable the dragger)
- diF.1 = P.run (digital input 1 used for Program run/restart)
- Pr.F = S.uP.S (start at power ON)
- Pr.E = cnt (Instrument behaviour at the end of the program execution = continue).

Connect a proximity switch to Dig. In 1 for panel detection.

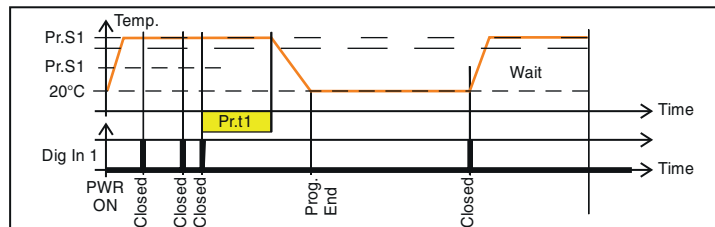

When a new panel is detected before the end of the first soak time, the program restarts and the set point remains equal to Pr.S1.

If no panel is detected, the instrument goes to Pr.S2 (idle temp) and remain there until a new panel arrives.

6.1 Manual mode

This operative mode allows you to deactivate automatic control and manually program the percentage power output to the process.

When manual control is selected, the instrument will start to operate with the same power output as the last one supplied by automatic mode and can be modified using parameter [28B] at address 592.

In case of ON/OFF control, 0% corresponds to the deactivated output while any value different from 0 corresponds to the activated output.

- Notes:**
1. During manual mode, the alarms are operative.
 2. If you set manual modes during program execution, the program will be frozen and it will restart when the instrument will come back to Auto mode.
 3. If you set manual modes during self-tune execution, the self-tune function will be aborted.
 4. During manual mode, all functions not related with the control (wattmeter, independent timer, "worked time", etc.) continue to operate normally.

6.2 Stand by mode

This operative mode also deactivates the automatic control but forces the control output to zero.

In this mode the instrument operates as an indicator.

- Notes:**
1. During stand by mode, the relative alarms are disabled while the absolute alarms are operative or not according to the ALxo (Alarm x enabling during Stand-by mode) parameter setting.
 2. If you set stand by mode during program execution, the program will be aborted.
 3. If you set stand by mode during self-tune execution, the self-tune function will be aborted.
 4. During stand by mode, all functions not related with the control (wattmeter, independent timer, "worked time", etc.) continue to operate normally.
 5. When the instrument is swapped from stand by to auto modes, the instrument will start automatically the alarm masking, the soft start functions and the auto-tune (if programmed).

7. GENERAL NOTES

7.1 Proper use

Every possible use not described in this manual must be considered as a improper use.

This instrument is in compliance with EN 61010-1 "Safety requirements for electrical equipment for measurement, control and laboratory use"; for this reason it could not be used as a safety equipment.

Whenever a failure or a malfunction of the control device may cause dangerous situations for persons, things or animals, please remember that the plant has to be equipped with additional safety devices.

Ascon Tecnologic S.r.l. and its legal representatives do not assume any responsibility for any damage to people, things or animals deriving from violation, wrong or improper use or in any case not in compliance with the instrument's features.

7.2 Maintenance

This instrument does not require periodical recalibration and it has no consumable parts so that no particular maintenance is required.

Sometimes it is advisable to clean the instrument.

1. **SWITCH THE EQUIPMENT OFF** (power supply, relay output, etc.).
2. Using a vacuum cleaner or a compressed air jet (max. 3 kg/cm²) remove all deposits of dust and dirt which may be present on the case and on the internal circuits being careful not to damage the electronic components.
3. To clean external plastic or rubber parts use only a cloth moistened with:
 - Ethyl Alcohol (pure or denatured) [C₂H₅OH] or
 - Isopropyl Alcohol (pure or denatured) [(CH₃)₂CHOH] or
 - Water (H₂O).
4. Make sure that there are no loose terminals.
5. Before turning ON the instrument make sure it is perfectly dry.
6. Apply the power supply to the instrument.

7.3 Disposal



The appliance (or the product) must be disposed of separately in compliance with the local standards in force on waste disposal.

8. WARRANTY AND REPAIRS

This product is under warranty against manufacturing defects or faulty materials that are found within 18 months from delivery date. The warranty is limited to repairs or to the replacement of the instrument.

The tampering of the instrument or an improper use of the product will bring about the immediate withdrawal of the warranty effects.

In the event of a faulty instrument, either within the period of warranty, or further to its expiry, please contact our sales department to obtain authorisation for sending the instrument to our company.

The faulty product must be shipped to Ascon Tecnologic with a detailed description of the faults found, without any fees or charge for Ascon Tecnologic, except in the event of alternative agreements.

9. ACCESSORIES

The instrument has a lateral socket into which a special tool can be inserted.



This tool, named A01, allows:

- To store a complete instrument configuration and to use it for other instruments.
- To transfer a complete instrument configuration to a PC or from a PC to an instrument
- To transfer from a PC to an instrument a complete instrument configuration
- To transfer a configuration from an A01 to another one.
- To test serial interface of the instruments and to help the OEM during machine start up.

Note: When the instrument is powered by the A01 key, the outputs are NOT supplied and the instrument can show the *oULd* (Out 4 Overload) indication.

Appendix A

³inP GROUP - Main and auxiliary input configuration

| no. | Param. | Description | Dec. Point | Values | Default | |
|-----|--------|---|------------|---|---------|---|
| 1 | SEnS | Sensor selection (according to the HW) | | | | J |
| | | Model C | 0 | 0 = J TC J (-50...+1000°C/-58...+1832°F); 1 = CrAL TC K (-50...+1370°C/-58...+2498°F); 2 = S TC S (-50...+1760°C/-58...+3200°F); 3 = r TC R (-50...+1760°C/-58...+3200°F); 4 = t TC T (-70...+400°C/-94...+752°F); 5 = Ir.J Exergen IRS J(-46...+785°C/-50...+1445°F); 6 = Ir.cA Exergen IRS K(-46...+785°C/-50...+1445°F); 7 = Pt1 RTD Pt 100(-200...+850°C/-328...+1562°F); 8 = Pt10 RTD Pt 1000(-200...+850°C/-328...+1562°F); 9 = 0.60 0... 60 mV; 10 = 12.60 12... 60 mV; 11 = 0.20 0... 20 mA; 12 = 4.20 4... 20 mA; 13 = 0.5 0... 5 V; 14 = 1.5 1... 5 V ; 15 = 0.10 0... 10 V; 16 = 2.10 2... 10 V. 17 = From serial link with Burn-out strategy 1; 18 = From serial link with Burn-out strategy 2. | | |
| 2 | dp | Decimal Point Position (linear inputs) | 0 | 0... 3 | 0 | |
| | | Decimal Point Position (different than linear inputs) | | 0/1 | | |
| 3 | SSC | Initial scale read-out for linear inputs | dp | -1999... 9999 | 0 | |
| 4 | FSc | Full Scale Readout for linear inputs | dp | -1999... 9999 | 1000 | |
| 5 | unit | Engineer unit | | °C/°F | °C | |
| 6 | Fil | Digital filter on the measured value | 1 | 0 (= OFF)... 20.0 s | 1.0 | |
| 7 | inE | Sensor error used to enable the safety output value | | 0 = or Over range; 1 = ou Under range; 2 = our Over and under range. | our | |
| 8 | oPE | Safety output value (% of the output) | | -100... 100 | 0 | |
| 9 | IO4.F | I/O 4 function | | 0 = on Output used as PWS for TX; 1 = out4 Output 4 (digital output 4); 2 = dG2c Digital input 2 driven by contact; 3 = dG2U Digital input 2 driven by voltage. | out4 | |
| 10 | diF1 | Digital Input 1 function | | 0 = oFF Not used; 1 = Alarm reset; 2 = Alarm acknowledge (ACK); 3 = Hold of the measured value; 4 = Stand by mode; 5 = Manual mode; 6 = HEAt with SP1 and Cool with SP2; 7 = Timer RUN/Hold/Reset; 8 = Timer Run; 9 = Timer Reset; | oFF | |
| | | | | 10 = Timer Run/Hold; 11 = Timer Run/Reset; 12 = Timer Run/Reset with lock; 13 = Program Start; 14 = Program Reset; 15 = Program Hold; 16 = Program Run/Hold; 17 = Program Run/Reset; 18 = Sequential SP selection; 19 = SP1 - SP2 selection; 20 = SP1... SP4 binary selection. | | |
| 11 | diF2 | Digital Input 2 function | | 0 = DI1 direct action, DI2 direct action; 1 = DI1 reverse action, DI2 direct action; 2 = DI1 direct action, DI2 reverse action; 3 = DI1 reverse action, DI2 reverse action. | 0 | |

Out group

| no. | Param. | Description | Dec. Point | Values | Default |
|-----|--------|--|------------|--|---------|
| 13 | o1t | Output 1 type (when Out 1 is an analogue output KR3 only) | | 0 = 0-20 0... 20 mA; 1 = 4-20 4... 20 mA; 2 = 0-10 0... 10 V; 3 = 2-10 2... 10 V. | 0-20 |
| 14 | o1F | Out 1 function (when Out 1 is a linear output) | 0 | 0 = NonE Output not used; 1 = H.rEG Heating output; 2 = c.rEG Cooling output; 3 = r.inP Measure retransmission; 4 = r.Err Error (SP - PV) retransmission; 5 = r.SP Set point retransmission ; 6 = r.SEr Serial value retransmission. | H.reG |
| | | Out 1 function (when Out1 is a digital output) | 0 | 0 = NonE Output not used; 1 = H.rEG Heating output; 2 = c.rEG Cooling output; 3 = AL Alarm output; 4 = t.out Timer output; 5 = t.HoF Timer out -OFF in hold; 6 = P.End Program end indicator; 7 = P.HLd Program hold indicator; 8 = P.uit Program wait indicator; 9 = P.run Program run indicator; 10 = P.Et1 Program Event 1; 11 = P.Et2 Program Event 2; 12 = or.bo Out-of-range or burn out indicator; 13 = P.FAL Power failure indicator; 14 = bo.PF Out of range, burn out, power failure indicator; 15 = St.bY Stand by status indicator; 16 = diF.1 The output repeats the digital input 1 status; 17 = diF.2 The output repeats the digital input 2 status; 18 = on Out 1 always ON; 19 = riSP Inspection request | |
| 15 | Ao1L | Initial scale value of the analog retransmission (KR3 only) | dP | -1999 ... Ao1H | -1999 |
| 16 | Ao1H | Full scale value of the analog retransmission (KR3 only) | dP | Ao1L ... 9999. | 9999 |
| 17 | o1AL | Alarms linked up with the out 1 | 0 | 0... 63: +1 Alarm 1; +2 Alarm 2; +4 Alarm 3; +8 Loop break alarm; +16 Sensor Break; +32 Overload on output 4. | AL1 |
| 18 | o1Ac | Out 1 action | 0 | 0 = dir Direct action; 1 = rEU Reverse action; 2 = dir.r Direct with reversed LED; 3 = ReU.r Reverse with reversed LED | dir |
| 19 | o2F | Out 2 function | 0 | 0 = NonE Output not used; 1 = H.rEG Heating output; 2 = c.rEG Cooling output; 3 = AL Alarm output; 4 = t.out Timer output; 5 = t.HoF Timer out -OFF in hold; 6 = P.End Program end indicator; 7 = P.HLd Program hold indicator; 8 = P.uit Program wait indicator; 9 = P.run Program run indicator; 10 = P.Et1 Program Event 1; 11 = P.Et2 Program Event 2; 12 = or.bo Out-of-range or burn out indicator; 13 = P.FAL Power failure indicator; 14 = bo.PF Out of range, burn out, power failure indicator; 15 = St.bY Stand by status indicator; 16 = diF.1 The output repeats the digital input 1 status; 17 = diF.2 The output repeats the digital input 2 status; 18 = on Out 2 always ON; 19 = riSP Inspection request | AL |

| no. | Param. | Description | Dec. Point | Values | Default |
|-----|--------|---------------------------------|------------|--|-----------|
| 20 | o2AL | Alarms linked up with the out 2 | 0 | 0... 63: +1 Alarm 1; +2 Alarm 2; +4 Alarm 3; +8 Loop break alarm; +16 Sensor Break; +32 Overload on output 4. | AL1 |
| 21 | o2Ac | Out 2 action | 0 | 0 = dir Direct action; 1 = rEU Reverse action; 2 = dir.r Direct with reversed LED; 3 = ReU.r Reverse with reversed LED. | dir |
| 22 | o3F | Out 3 function | 0 | 0 = NonE Output not used; 1 = H.rEG Heating output; 2 = c.rEG Cooling output; 3 = AL Alarm output; 4 = t.out Timer output; 5 = t.HoF Timer out -OFF in hold; 6 = P.End Program end indicator; 7 = P.HLd Program hold indicator; 8 = P.uit Program wait indicator; 9 = P.run Program run indicator; 10 = P.Et1 Program Event 1; 11 = P.Et2 Program Event 2; 12 = or.bo Out-of-range or burn out indicator; 13 = P.FAL Power failure indicator; 14 = bo.PF Out of range, burn out, power failure indicator; 15 = St.bY Stand by status indicator; 16 = diF.1 The output repeats the digital input 1 status; 17 = diF.2 The output repeats the digital input 2 status; 18 = on Out 3 always ON; 19 = riSP Inspection request | AL |
| 23 | o3AL | Alarms linked up with the out 3 | 0 | 0... 63: +1 Alarm 1; +2 Alarm 2; +4 Alarm 3; +8 Loop break alarm; +16 Sensor Break; +32 Overload on output 4. | AL2 |
| 24 | o3Ac | Out 3 action | 0 | 0 = dir Direct action; 1 = rEU Reverse action; 2 = dir.r Direct with reversed LED; 3 = ReU.r Reverse with reversed LED. | dir |
| 25 | o4F | Out 4 function | 0 | 0 = NonE Output not used; 1 = H.rEG Heating output; 2 = c.rEG Cooling output; 3 = AL Alarm output; 4 = t.out Timer output; 5 = t.HoF Timer out -OFF in hold; 6 = P.End Program end indicator; 7 = P.HLd Program hold indicator; 8 = P.uit Program wait indicator; 9 = P.run Program run indicator; 10 = P.Et1 Program Event 1; 11 = P.Et2 Program Event 2; 12 = or.bo Out-of-range or burn out indicator; 13 = P.FAL Power failure indicator; 14 = bo.PF Out of range, burn out, power failure indicator; 15 = St.bY Stand by status indicator; 16 = diF.1 The output repeats the digital input 1 status; 17 = diF.2 The output repeats the digital input 2 status; 18 = on Out 4 always ON; 19 = riSP Inspection request | AL |
| 26 | o4AL | Alarms linked up with the out 4 | 0 | 0... 63: +1 Alarm 1; +2 Alarm 2; +4 Alarm 3; +8 Loop break alarm; +16 Sensor Break; +32 Overload on output 4. | AL1 + AL2 |
| 27 | o4Ac | Out 4 action | 0 | 0 = dir Direct action; 1 = rEU Reverse action; 2 = dir.r Direct with reversed LED; 3 = ReU.r Reverse with reversed LED. | dir |

AL1 group

| no. | Param. | Description | Dec. Point | Values | Default |
|-----|--------|---|------------|--|---------|
| 28 | AL1t | Alarm 1 type | 0 | 0 = nonE Alarm not used; 1 = LoAb Absolute low alarm; 2 = HiAb Absolute high alarm; 3 = LHAo Windows alarm in alarm outside the windows; 4 = LHAI Windows alarm in alarm inside the windows; 5 = SE.br Sensor Break; 6 = LodE Deviation low alarm (relative); 7 = HidE Deviation high alarm (relative); 8 = LHdo Relative band alarm in alarm out of the band; 9 = LHdi Relative band alarm in alarm inside the band. | HiAb |
| 29 | Ab1 | Alarm 1 function | 0 | 0... 15: +1 Not active at power up; +2 Latched alarm (manual reset); +4 Acknowledgeable alarm; +8 Relative alarm not active at set point change. | 0 |
| 30 | AL1L | - For High and low alarms is the low limit of the AL1 threshold; - For band alarm is the low alarm threshold | dp | From -1999 to AL1H (E.U.) | -1999 |
| 31 | AL1H | - For High and low alarms is the high limit of the AL1 threshold; - For band alarm is the high alarm threshold | dp | From AL1L to 9999 (E.U.) | 9999 |
| 32 | AL1 | AL1 threshold | dp | From AL1L to AL1H (E.U.) | 0 |
| 33 | HAL1 | AL1 hysteresis | dp | 1... 9999 (E.U.) | 1 |
| 34 | AL1d | AL1 delay | 0 | 0 = oFF; 1... 9999 (s). | oFF |
| 35 | AL1o | Alarm 1 enabling during Stand-by mode and out of range conditions | 0 | 0 = Alarm 1 disabled during Stand by and out of range; 1 = Alarm 1 enabled in stand by mode; 2 = Alarm 1 enabled in out of range condition; 3 = Alarm 1 enabled in stand by and overrange. | 0 |

AL2 group

| no. | Param. | Description | Dec. Point | Values | Default |
|-----|--------|---|------------|--|---------|
| 36 | AL2t | Alarm 2 type | 0 | 0 = nonE Alarm not used; 1 = LoAb Absolute low alarm; 2 = HiAb Absolute high alarm; 3 = LHAo Windows alarm in alarm outside the windows; 4 = LHAI Windows alarm in alarm inside the windows; 5 = SE.br Sensor Break; 6 = LodE Deviation low alarm (relative); 7 = HidE Deviation high alarm (relative); 8 = LHdo Relative band alarm in alarm out of the band; 9 = LHdi Relative band alarm in alarm inside the band. | Loab |
| 37 | Ab2 | Alarm 2 function | 0 | 0... 15: +1 Not active at power up; +2 Latched alarm (manual reset); +4 Acknowledgeable alarm; +8 Relative alarm not active at set point change. | 0 |
| 38 | AL2L | - For High and low alarms is the low limit of the AL2 threshold; - For band alarm is the low alarm threshold | dp | From -1999 to AL2H (E.U.) | -1999 |
| 39 | AL2H | - For High and low alarms is the high limit of the AL2 threshold; - For band alarm is the high alarm threshold | dp | From AL2L to 9999 (E.U.) | 9999 |
| 40 | AL2 | AL2 threshold | dp | From AL2L to AL2H (E.U.) | 0 |
| 41 | HAL2 | AL2 hysteresis | dp | 1... 9999 (E.U.) | 1 |
| 42 | AL2d | AL2 delay | 0 | 0 = oFF; 1... 9999 (s). | oFF |
| 43 | AL2o | Alarm 2 enabling during Stand-by mode and out of range conditions | 0 | 0 = Alarm 2 disabled during Stand by and out of range; 1 = Alarm 2 enabled in stand by mode; 2 = Alarm 2 enabled in out of range condition; 3 = Alarm 2 enabled in stand by and overrange. | 0 |

AL3 group

| no. | Param. | Description | Dec. Point | Values | Default |
|-----|--------|---|------------|--|---------|
| 44 | AL3t | Alarm 3 type | 0 | 0 = nonE Alarm not used; 1 = LoAb Absolute low alarm; 2 = HiAb Absolute high alarm; 3 = LHAo Windows alarm in alarm outside the windows; 4 = LHAI Windows alarm in alarm inside the windows; 5 = SE.br Sensor Break; 6 = LodE Deviation low alarm (relative); 7 = HidE Deviation high alarm (relative); 8 = LHdo Relative band alarm in alarm out of the band; 9 = LHdi Relative band alarm in alarm inside the band. | nonE |
| 45 | Ab3 | Alarm 3 function | 0 | 0... 15: +1 Not active at power up; +2 Latched alarm (manual reset); +4 Acknowledgeable alarm; +8 Relative alarm not active at set point change. | 0 |
| 46 | AL3L | - For High and low alarms is the low limit of the AL3 threshold; - For band alarm is the low alarm threshold | dp | From -1999 to AL3H (E.U.) | -1999 |
| 47 | AL3H | - For High and low alarms is the high limit of the AL3 threshold; - For band alarm is the high alarm threshold | dp | From AL3L to 9999 (E.U.) | 9999 |
| 48 | AL3 | AL3 threshold | dp | From AL3L to AL3H (E.U.) | 0 |
| 49 | HAL3 | AL3 hysteresis | dp | 1... 9999 (E.U.) | 1 |
| 50 | AL3d | AL3 delay | 0 | 0 = oFF; 1... 9999 (s). | oFF |
| 51 | AL3o | Alarm 3 enabling during Stand-by mode and out of range conditions | 0 | 0 = Alarm 3 disabled during Stand by and out of range; 1 = Alarm 3 enabled in stand by mode; 2 = Alarm 3 enabled in out of range condition; 3 = Alarm 3 enabled in stand by and overrange. | 0 |

LBA group - Loop Break Alarm Parameters

| no. | Param. | Description | Dec. Point | Values | Default |
|-----|--------|---|------------|---|---------|
| 52 | LbAt | LBA time | 0 | 0 = oFF 1... 9999 (s) | oFF |
| 53 | LbSt | Delta measure used by LBA during Soft start | dP | 0 = oFF 1... 9999 (E.U.) | 10 |
| 54 | LbAS | Delta measure used by LBA | dP | 1...9999 (E.U.) | 20 |
| 55 | LbcA | Condition for LBA enabling | 0 | 0 = uP Active when Pout = 100%; 1 = dn Active when Pout = -100%; 2 = both Active in both cases. | both |

rEG group - Control Parameters

| no. | Param. | Description | Dec. Point | Values | Default |
|-----|--------|--------------|------------|--|---------|
| 56 | cont | Control type | 0 | 0 = Pid PID (heat and/or); 1 = On.FA ON/OFF asymmetric hysteresis; 2 = On.FS ON/OFF symmetric hysteresis; 3 = nr Heat/Cool ON/OFF control with neutral zone; 4 = 3Pt Servomotor control. | Pid |

| no. | Param. | Description | Dec. Point | Values | Default |
|-----|--------|--|------------|--|---------|
| 57 | Auto | Autotuning selection | 0 | -4 Oscillating auto-tune with automatic restart at power up and after all point change; -3 Oscillating auto-tune with manual start; -2 Oscillating -tune with automatic start at the first power up only; -1 Oscillating auto-tune with automatic restart at every power up; 0 Not used; 1 Fast auto tuning with automatic restart at every power up; 2 Fast auto-tune with automatic start the first power up only; 3 FAST auto-tune with manual start; 4 FAST auto-tune with automatic restart at power up and after a set point change; 5 Evo-tune with automatic restart at every power up; 6 Evo-tune with automatic start the first power up only; 7 Evo-tune with manual start; 8 Evo-tune with automatic restart at power up and after a set point change. | 7 |
| 58 | Aut.r | Manual start of the Autotuning | 0 | 0 = oFF Not active; 1 = on Active. | oFF |
| 59 | SELF | Self tuning enabling | 0 | 0 = no The instrument does not perform the self-tuning; 1 = YES The instrument is performing the self-tuning. | no |
| 60 | HSEt | Hysteresis of the ON/OFF control | dP | 0... 9999 (E.U.) | 1 |
| 61 | cPdt | Time for compressor protection | 0 | 0 = oFF 1... 9999 (s) | oFF |
| 62 | Pb | Proportional band | dP | 1... 9999 (E.U.) | 50 |
| 63 | ti | Integral time | 0 | 0 = oFF 1... 9999 (s) | 200 |
| 64 | td | Derivative time | 0 | 0 = oFF 1... 9999 (s) | 50 |
| 65 | Fuoc | Fuzzy overshoot control | 2 | 0.00... 2.00 | 0.50 |
| 66 | tcH | Heating output cycle time | 1 | 0.1... 130.0 (s) | 20.0 |
| 67 | rcG | Power ratio between heating and cooling action | 2 | 0.01... 99.99 | 1.00 |
| 68 | tcc | Cooling output cycle time | 1 | 0.1... 130.0 (s) | 20.0 |
| 69 | rS | Manual reset (Integral pre-load) | 1 | -100.0... +100.0 (%) | 0.0 |
| 70 | Str.t | Servomotor stroke time | 0 | 5...1000 seconds | 60 |
| 71 | db.S | Servomotor dead band | 1 | 0.0...10.0 | 0.5 |
| 72 | oP.L | Minimum output power | 1 | -100 to oP.H (%) | |
| 73 | oP.H | Maximum output power | 1 | oP.L to100% | |
| 74 | od | Delay at power up | 2 | 0 = oFF 1... 9999 (s) | oFF |
| 75 | St.P | Maximum power output used during soft start | 0 | -100... 100 (%) | 0 |
| 76 | SSt | Soft start time | 2 | 0 = Function not used; 0.01... 7.59 hh.mm; 8.00 Soft start always active. | oFF |
| 77 | SS.tH | Threshold for soft start disabling | dP | -1999... +9999 (E.U.) | 9999 |

³SP group - Set point parameters

| no. | Param. | Description | Dec. Point | Values | Default |
|-----|--------|-----------------------------------|------------|---|---------|
| 78 | nSP | Number of used set points | 0 | 1... 4 | 1 |
| 79 | SPLL | Minimum set point value | dP | From -1999 to SPHL | -1999 |
| 80 | SPHL | Maximum set point value | dP | From SPLL to 9999 | 9999 |
| 81 | SP | Set point 1 | dP | From SPLL to SPLH | 0 |
| 82 | SP 2 | Set point 2 | dP | From SPLL to SPLH | 0 |
| 83 | SP 3 | Set point 3 | dP | From SPLL to SPLH | 0 |
| 84 | SP 4 | Set point 4 | dP | From SPLL to SPLH | 0 |
| 85 | A.SP | Selection of the active set point | 0 | From 1 (SP 1) to nSP | 1 |
| 86 | SP.rt | Remote set point type | 0 | 0 = The value coming from serial link is used as remote set point (RSP); 1 = The value will be added to the local set point selected by A.SP and the sum becomes the operative set point; 2 = The value will be scaled on the input range and this value will be used as remote SP. | trin |

| no. | Param. | Description | Dec. Point | Values | Default |
|-----|--------|---|------------|--|---------|
| 87 | SPLr | Local/remote set point selection | 0 | 0 = Local; 1 = Remote. | Loc |
| 88 | SP.u | Rate of rise for POSITIVE set point change (ramp UP) | 2 | 0.01... 99.99 (inF) engineering units per minute | inF |
| 89 | SP.d | Rate of rise for NEGATIVE set point change (ramp DOWN) | 2 | 0.01... 99.99 (inF) engineering units per minute | inF |

³TIN group - Timer function parameters

| no. | Param. | Description | Dec. Point | Values | Default |
|-----|--------|----------------------------|------------|---|---------|
| 90 | tr.F | Independent timer function | 0 | 0 = NonE Timer not used; 1 = i.d.A Delayed start timer; 2 = i.uP.d Delayed start at power up; 3 = i.d.d Feed-through timer; 4 = i.P.L Asymmetrical oscillator with start OFF; 5 = i.L.P Asymmetrical oscillator with start ON. | nonE |
| 91 | tr.u | Timer unit | 0 | 0 = hh.nn Hours and minutes; 1 = nn.SS Minutes and seconds; 2 = SSS.d Second and tenth of seconds. | nn.SS |
| 92 | tr.t1 | Time 1 | 2 | When tr.u < 20: 0.01... 99.59 | 1.00 |
| | | | 1 | When tr.u 200: 0.1... 995.9 | |
| 93 | tr.t2 | Time 2 | 2 | When tr.u < 2: From 00.00 (oFF) to 99.59 (inF) | 1.00 |
| | | | 1 | When tr.u 2: From 000.0 (oFF) to 995.9 (inF) | |
| 94 | tr.St | Timer status | 0 | 0 = rES Timer reset; 1 = run Timer run; 2 = HoLd Timer hold. | rES |

³PRG group - Programmer function parameters

| no. | Param. | Description | Dec. Point | Values | Default |
|-----|--------|--|------------|---|---------|
| 95 | Pr.F | Program action at power up | 0 | 0 = nonE Programmer not used; 1 = S.uP.d Start at power up with a first step in stand-by; 2 = S.uP.S Start at power up; 3 = u.diG Start at Run command detection only; 4 = u.dG.d Start at Run command with a first step in stand-by. | nonE |
| 96 | Pr.u | Engineering unit of the soaks | 2 | 0 = hh.nn Hours and minutes; nn.SS Minutes and seconds | hh.nn |
| 97 | Pr.E | Instrument behaviour at the end of the program execution | 0 | 0 = cnt Continue; 1 = A.SP Go to the set point selected by A.SP; 2 = St.by Go to stand-by mode | A.SP |
| 98 | Pr.Et | Time of the end program indication | 2 | From 0.00 (oFF) to 99.59 (inF) minutes and seconds | oFF |
| 99 | Pr.S1 | Set point of the first soak | dP | From SPLL to SPHL | 0 |
| 100 | Pr.G1 | Gradient of the first ramp | 1 | 0.1... 999.9 (inF= Step transfer) Engineering Unit/minute | inF |
| 101 | Pr.t1 | Time of the 1 st soak | 2 | 0.00... 99.59 | 0.10 |
| 102 | Pr.b1 | Wait band of the 1 st soak | dP | From 0 (oFF) to 9999 (E.U.) | oFF |
| 103 | Pr.E1 | Events of the 1 st group | 2 | 00.00... 11.11 | 00.00 |
| 104 | Pr.S2 | Set point of the 2 nd soak | dP | OFF or from SPLL to SPHL | 0 |
| 105 | Pr.G2 | Gradient of the 2 nd ramp | 1 | 0.1... 999.9 (inF= Step transfer) Engineering Unit/minute | inF |
| 106 | Pr.t2 | Time of the 2 nd soak | 2 | 0.00... 99.59 | 0.10 |
| 107 | Pr.b2 | Wait band of the 2 nd soak | dP | From 0 (oFF) to 9999 (E.U.) | oFF |
| 108 | Pr.E2 | Events of the 2 nd group | 2 | 00.00... 11.11 | 00.00 |
| 109 | Pr.S3 | Set point of the 3 rd soak | dP | OFF or from SPLL to SPHL | 0 |
| 110 | Pr.G3 | Gradient of the 3 rd ramp | 1 | 0.1... 999.9 (inF= Step transfer) Engineering Unit/minute | inF |
| 111 | Pr.t3 | Time of the 3 rd soak | 2 | 0.00... 99.59 | 0.10 |
| 112 | Pr.b3 | Wait band of the 3 rd soak | dP | From 0 (oFF) to 9999 (E.U.) | oFF |
| 113 | Pr.E3 | Events of the 3 rd group | 0 | 00.00... 11.11 | 00.00 |
| 114 | Pr.S4 | Set point of the 4 th soak | dP | OFF or from SPLL to SPHL | 0 |
| 115 | Pr.G4 | Gradient of the 4 th ramp | 1 | 0.1... 999.9 (inF= Step transfer) Engineering Unit/minute | inF |
| 116 | Pr.t4 | Time of the 4 th soak | 2 | 0.00... 99.59 | 0.10 |
| 117 | Pr.b4 | Wait band of the 4 th soak | dP | From 0 (oFF) to 9999 (E.U.) | oFF |
| 118 | Pr.E4 | Events of the 4 th group | 0 | 00.00... 11.11 | 00.00 |

| no. | Param. | Description | Dec. Point | Values | Default |
|-----|--------|----------------|------------|--|---------|
| 119 | Pr.St | Program status | 0 | 0 = rES Program reset; 1 = run Program start; 2 = HoLd Program hold. | rES |

³ PAn group - Operator HMI parameters

| no. | Param. | Description | Dec. Point | Values | Default |
|-----|--------|-------------------------------|------------|--|---------|
| 120 | fiLd | Filter on the displayed value | 1 | 0 oFF (filter disabled); 0.1... 20.0 (E.U.). | oFF |
| 121 | dSPu | Instrument status at power ON | | 0 = AS.Pr Starts in the same way it was prior to the power down; 1 = Auto Starts in Auto mode; 2 = oP.0 Starts in manual mode with a power output equal to zero; 3 = St.bY Starts in stand-by mode. | AS.Pr |
| 122 | oPr.E | Operative modes enabling | | 0 = ALL All modes will be selectable by the next parameter; 1 = Au.oP Auto and manual (oPLo) mode only will be selectable by the next parameter; 2 = Au.Sb Auto and Stand-by modes only will be selectable by the next parameter | ALL |
| 123 | oPEr | Operative mode selection | | If oPr.E ALL: 1 Auto Auto mode; 2 oPLo Manual mode; 3 St.bY Stand by mode; If oPr.E Au.oP: 1 Auto Auto mode; 2 oPLo Manual mode; If oPr.E Au.Sb: 1 Auto Auto mode; 3 St.bY Stand by mode. | Auto |

³ Ser group - Serial link parameters

| no. | Param. | Description | Dec. Point | Values | Default |
|-----|--------|---|------------|--|---------|
| 124 | Add | Instrument address | | 0 = oFF; 1... 254. | 1 |
| 125 | bAud | baud rate | | 0 = 2400 2400 baud; 1 = 9600 9600 baud; 2 = 19.2 19200 baud; 3 = 38.4 38400 baud | 9600 |
| 126 | trSP | Selection of the value to be retransmitted (Master) | | 0 = nonE Retransmission not used (the instrument is a slave); 1 = rSP The instrument becomes a Master and retransmits the operative set point; 2 = PErc The instrument become a Master and it retransmits the power output | nonE |

COOn group - Consumption parameters

| no. | Param. | Description | Dec. Point | Values | Default |
|-----|--------|---------------------------------|------------|--|---------|
| 127 | Co.tY | Count type | | 0 = oFF Not used; 1 = Instantaneous power (kW); 2 = Power consumption (kW/h); 3 = Energy used during program execution. This measure starts from zero when a program runs end stops at the end of the program. A new program execution will reset the value; 4 = Total worked days: number of hours the instrument is turned ON divided by 24; 5 = Total worked hours: number of hours that the instrument is turned ON; 6 = Total worked days with threshold: number of hours the instrument is turned ON divided by 24, the controller is forced in stand-by when Co.ty value reaches the threshold set in [137] h.Job; 7 = Total worked hours with threshold: number of hours that the instrument is turned ON, the controller is forced in stand-by when Co.ty value reaches the threshold set in [137] h.Job; 8 = Totalizer of control relay worked days: number of hours the control relay has been in ON condition, divided by 24; 9 = Totalizer of control relay worked hours: number of hours the control relay has been in ON condition; 10 = Totalizer of control relay worked days with threshold: number of hours the control relay has been in ON condition divided by 24, the controller is forced in stand-by when Co.ty value reaches the threshold set in [137] h.Job; 11 = Totalizer of control relay worked hours with threshold: number of hours the control relay has been in ON condition, the controller is forced in stand-by when Co.ty value reaches the threshold set in [137] h.Job. | oFF |
| 128 | UoLt | Nominal Voltage of the load | | 1... 9999 (V) | 230 |
| 129 | cur | Nominal current of the load | | 1... 999 (A) | 10 |
| 130 | h.Job | Threshold of the working period | | 0 = oFF Threshold not used; 1... 9999 days (when [134] cotY 4); 1... 9999 hours (when [134] cotY 5). | 0 |
| 131 | t.Job | Worked time (not resettable) | | 0... 9999 days | |

CAI group - User calibration parameters

| no. | Param. | Description | Dec. Point | Values | Default |
|-----|--------|--------------------|------------|--|---------|
| 132 | AL.P | Adjust Low Point | | From -1999 to (AH.P - 10) in engineering units | 0 |
| 133 | AL.o | Adjust Low Offset | | -300... +300 (E.U.) | 0 |
| 134 | AH.P | Adjust High Point | | From (AL.P + 10) to 9999 engineering units | 9999 |
| 135 | AH.o | Adjust High Offset | | -300... +300 | 0 |

Appendix B

9. COMMUNICATION PROTOCOL

9.1 Preface

Ascon Tecnologic uses ModBUS® RTU communication protocol.

It is a royalty free protocol that is easy to be implemented.

For ModBus RTU a vast literature is available (also in internet).

The ModBus protocol represents the data in hexadecimal format.

All the communication strings end with a CRC type check sum (CRC = Cyclic Redundancy Check).

Each device connected to a line must have a unique address.

The protocol allows one master only and up to 255 slaves.

Only the Master unit can start the transmission by sending the address of the unit and the command to execute. Only the unit that has the specified address, answers to the master.

The transmission characteristics are usually programmable:

Device address: From 1 to 255;

baud rate: bit per second.

Byte format: - 1 start bit;
- 8 data bits;
- 2 final bits composed as follows:
 1 parity bit (even or odd);
 1 stop bit;

or

no parity bit;
2 stop bits.

The KRD3 allows to configure:

– address (1 – 254);

– Baud rate (1200 – 2400 – 9600 – 19200 – 38400).

The byte format is fixed: 8 bits without parity and 1 stop bit.

This document is intended to describe the KRD3 controllers using the MODBUS protocol in their communication capability and is mainly directed to technicians, system integrators and software developers.

9.2 Physical connection

9.2.1 Interface

Kube series controllers are provided with a RS485 serial communication interface, insulated so that any problem arising from ground potential is removed.

While at rest, the instruments are in a receive condition and are revert to transmission after a correct message has been decoded that matches the configured address.

9.2.2 Line

The instruments are equipped with 2 terminals named A and B.

The connection between Kube s has to be carried on in parallel, i.e. all A terminals have to be connected between them so as B terminals.

A termination resistor of 120Ω is required to maintain the quiescent condition on the line.

Adopted baud rates range 1200... 38400 baud, that is very satisfactory for application performances, yet very slow for RS485 interface. This fact allows the wiring of the line with a medium quality twisted pair cable: total capacity of the line should not exceed 200 nF.

The line can be up to 1000 meters in length.

9.3 Communication protocol

The protocol adopted by KRD3 is a subset of the widely used MODBUS RTU (JBUS, AEG Schneider Automation, Inc. registered trademark) protocol, so that connections are easy for many commercial PLCs and supervisory programs.

For users needing to develop their own communications software, all information is available as well as implementation hints.

The MODBUS RTU (JBUS) communication functions implemented in Kube series are:

- Function 3 Read n register;
- Function 6 Preset one register;
- Function 16 Preset multiple registers.

These functions allow the supervisory program to read and modify any data of the controller. The communication is based on messages sent by the master station (host) to the slave stations (KRD3) and viceversa. The slave station that recognises the message as sent to it, analyses the content and, if it is formally and semantically correct, generates a reply message directed back to the master.

The communication process involves five types of messages:

| From master to slave | From slave to master |
|--|--|
| Function 3: read n registers request | Function 3: read n registers reply |
| Function 6: preset one register request | Function 6: preset one register reply |
| Function 16: preset multiple registers request | Function 16: preset multiple registers reply |
| | Exception reply (as reply to all functions in abnormal conditions) |

Every a message contains four fields:

- ◇ Slave address (from 1 to 255): MODBUS RTU (JBUS) reserves address 0 for broadcasting messages and it is implemented in the Kube series;
- ◇ Function code: contains 3, 6 or 16 for specified functions;
- ◇ Information field: contains data like word address and word value as required by the function in use;
- ◇ Control word: a cyclic redundancy check (CRC) performed with particular rules for CRC16.

The characteristics of the asynchronous transmission are 8 bits, no parity, one stop bit.

9.3.1 Function code 3: read multiple registers (maximum 16 registers)

This function code is used by the master to read a group of sequential registers present in the slave.

| Master request | |
|--|------|
| Data | Byte |
| Slave address (1... 255) | 1 |
| Function code (3) | 1 |
| First register address (MSB = Most Significant Byte) | 1 |
| First register address (LSB = less Significant Byte) | 1 |
| Number of requested registers (MSB) | 1 |
| Number of requested registers (LSB) | 1 |
| CRC-16 (LSB) | 1 |
| CRC-16 (MSB) | 1 |

| Slave reply | |
|--------------------------|------|
| Data | Byte |
| Slave address (1... 255) | 1 |
| Function code (3) | 1 |
| Byte number (n) | 1 |
| Data | n |
| CRC-16 (LSB) | 1 |
| CRC-16 (MSB) | 1 |
| | |
| | |

In the "Data" field the values of the requested registers are presented in word format [2 bytes]: the first byte represent the MSB (Most Significant Byte) while the second byte represent the LSB (Less Significant Byte). This mode will be the same for all requested locations.

Example: The master requires to address 1 slave device the value of locations 25 and 26 (0x19 and 0x1A).

| Master request | |
|-------------------------------------|------------|
| Data | Byte (Hex) |
| Slave address | 01 |
| Function code (3 = read) | 03 |
| First register address (MSB) | 00 |
| First register address (LSB) | 19 |
| Number of requested registers (MSB) | 00 |
| Number of requested registers (LSB) | 02 |
| CRC-16 (LSB) | 15 |
| CRC-16 (MSB) | CC |

| Slave reply | |
|------------------------------------|------------|
| Data | Byte (Hex) |
| Slave address | 01 |
| Function code (3 = read) | 03 |
| Byte number | 04 |
| Value of the first register (MSB) | 00 |
| Value of the first register (LSB) | 0A |
| Value of the second register (MSB) | 00 |
| Value of the second register (LSB) | 14 |
| CRC-16 (LSB) | DA |
| CRC-16 (MSB) | 3E |

The slave replay means: The value of the location 25 = 10 (0x000A hexadecimal)
The value of the location 26 = 20 (0x0014 hexadecimal)

9.3.2 Function code 6: write a single word (one location)

| Master request | |
|------------------------|------------|
| Data | Byte (Hex) |
| Slave address | 01 |
| Function code (6) | 06 |
| Register address (MSB) | 03 |
| Register address (LSB) | 02 |
| Value to write (MSB) | 00 |
| Value to write (LSB) | 0A |
| CRC-16 (MSB) | A8 |
| CRC-16 (LSB) | 49 |

| Slave reply | |
|------------------------|------------|
| Data | Byte (Hex) |
| Slave address (1-255) | 1 |
| Function code (6) | 1 |
| Register address (MSB) | 1 |
| Register address (LSB) | 1 |
| Written value (MSB) | 1 |
| Written value (LSB) | 1 |
| CRC-16 (MSB) | 1 |
| CRC-16 (LSB) | 1 |

Example: The master unit asks to the slave 1 to write in the memory location 770 (0x302) the value 10 (0x0A).

| Master request | |
|------------------------|------------|
| Data | Byte (Hex) |
| Slave address | 01 |
| Function code (6) | 06 |
| Register address (MSB) | 03 |
| Register address (LSB) | 02 |
| Value to write (MSB) | 00 |
| Value to write (LSB) | 0A |
| CRC-16 (MSB) | A8 |
| CRC-16 (LSB) | 49 |

| Slave reply | |
|------------------------|------------|
| Data | Byte (Hex) |
| Slave address | 01 |
| Function code (6) | 06 |
| Register address (MSB) | 03 |
| Register address (LSB) | 02 |
| Written value (MSB) | 00 |
| Written value (LSB) | 0A |
| CRC-16 (MSB) | A8 |
| CRC-16 (LSB) | 49 |

9.3.3 Function code 16: preset multiple registers (maximum 16 registers)

This function code allows to preset 16 registers at a time.

| Master request | |
|-------------------------------------|------------|
| Data | Byte (Hex) |
| Slave address (1-254) | 1 |
| Function code (16) | 1 |
| First register address (MSB) | 1 |
| First register address (LSB) | 1 |
| Number of requested registers (MSB) | 1 |
| Number of requested registers (LSB) | 1 |
| Byte count | 1 |
| Values | n |
| CRC-16 (LSB) | 1 |
| CRC-16 (MSB) | 1 |

| Slave reply | |
|-----------------------------------|------------|
| Data | Byte (Hex) |
| Slave address (1-254) | 1 |
| Function code (16) | 1 |
| First register address (MSB) | 1 |
| First register address (LSB) | 1 |
| Number of written registers (MSB) | 1 |
| Number of written registers (LSB) | 1 |
| CRC-16 (LSB) | 1 |
| CRC-16 (MSB) | 1 |
| | |
| | |

Example: The master unit requires to the slave 1 to write in the registers 10314 (0x284A) and 10315 (0x284B) the values 100 (0x64) and 200 (0xC8)

| Master request | |
|-------------------------------------|------------|
| Data | Byte (Hex) |
| Slave address | 01 |
| Function code (16) | 10 |
| First register address (MSB) | 28 |
| First register address (LSB) | 4A |
| Number of requested registers (MSB) | 00 |
| Number of requested registers (LSB) | 02 |
| Byte count | 4 |
| Value 1 (MSB) | 00 |
| Value 1 (LSB) | 64 |
| Value 2 (MSB) | 00 |
| Value 2 ((LSB) | C8 |
| CRC-16 (LSB) | C9 |
| CRC-16 (MSB) | A8 |

| Slave reply | |
|-----------------------------------|------------|
| Data | Byte (Hex) |
| Slave address | 01 |
| Function code (16) | 10 |
| First register address (MSB) | 28 |
| First register address (LSB) | 4A |
| Number of written registers (MSB) | 00 |
| Number of written registers (LSB) | 02 |
| CRC-16 (LSB) | 69 |
| CRC-16 (MSB) | BE |
| | |
| | |

9.3.4 The exception reply

Kube instruments reply with an exception when the request is formally correct, but cannot be satisfied standing particular situations; the reply contains a code indicating the cause of the missing regular reply, the frame is:

| Exception replay | |
|------------------|------------|
| Data | Byte (Hex) |
| Slave address | 1 |
| Function code | 1 |
| Error code | 1 |
| CRC-16 (LSB) | 1 |
| CRC-16 (MSB) | 1 |

Kube series adopts a subset of MODBUS RTU (JBUS) exception code:

- unknown function code 1
- invalid memory address 2
- invalid data field 3
- controller not ready 6

9.3.5 Cyclic redundancy check (CRC)

CRC is a check word that permits to verify the integrity of a message. Every message, sent or received, has in the two last characters the CRC check word.

After receiving a request, the controller checks the validity of the received message comparing the received CRC with the calculated one. When a reply is ready the controller calculates the CRC word and adds two characters to the prepared message.

CRC calculation is performed on every character of the message, excluding the last two.

Being MODBUS RTU (JBUS) compatible, Kube series controllers adopt an identical algorithm for CRC calculation, sketched in following diagram:

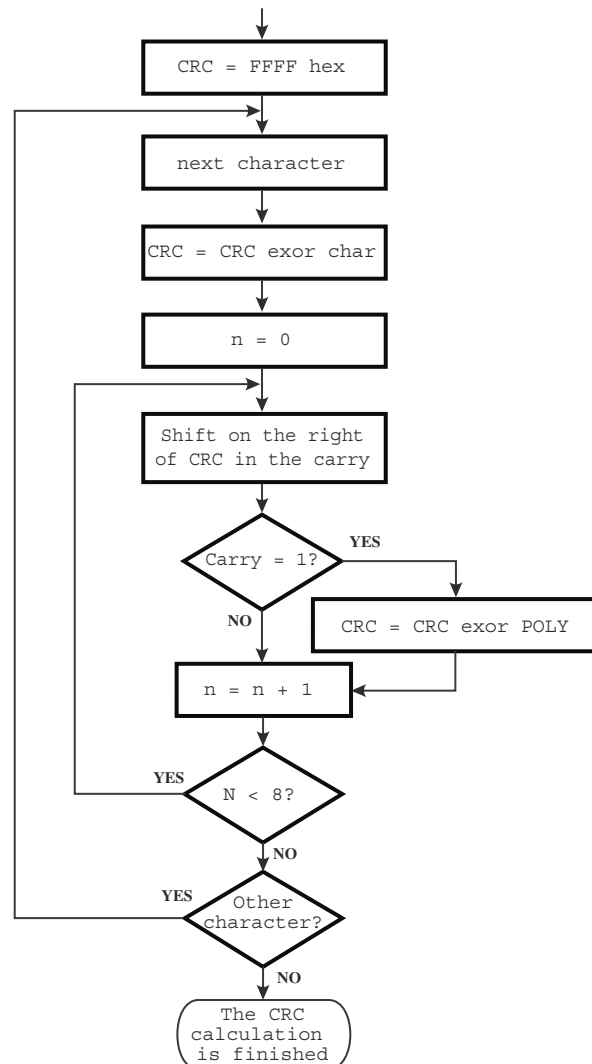

The polynomial adopted by MODBUS RTU (JBUS) is 1010 0000 0000 0001.

Note: The first transmitted character of the CRC word is the least significant between calculated bytes.

Follows a "C" language subroutine that calculates the CRC-16.

```
/* -----  
crc_16      CRC-16 calculation  
  
Input:  
    buffer:    character string on which CRC is calculated  
    length:    string length in bytes  
  
Output:      crc_16  
----- */  
unsigned int crc_16 (unsigned char *buffer, unsigned int length)  
{  
    unsigned int i, j, temp_bit, temp_int, crc;  
    crc = 0xFFFF;  
    for (i = 0; i < length; i++){  
        temp_int = (unsigned char) *buffer++;  
        crc ^= temp_int;  
        for ( j = 0; j < 8; j++ ) {  
            temp_bit = crc & 0x0001;  
            crc >>= 1;  
            if ( temp_bit != 0 )  
                crc ^= 0xA001;  
        }  
    }  
    return (crc);  
}
```

Note: All numerical values in the format 0x... are expressed in hexadecimal format.

9.4 Data exchange

This section contains informations about data exchanged with Kube series controllers concerning numerical and not numerical data, with their formats and limits.

9.4.1 Some definitions

All exchanged data are in the form of 16 bit words.

Two types of data are distinguished: numerical and symbolic (or not numerical).

Numerical data represents the value of a quantity (e.g. the measured variable, the set point).

Symbolic data represents a particular value in a set of values (e.g. the thermocouple type in the set of available ones: J, K, S ...).

Both types are coded as integers number : signed numbers for numerical and unsigned numbers for symbolic.

A numerical data, coded as an integer, is coupled with appropriate number of decimal digits to represent a quantity with the same engineering units adopted aboard the instrument.

Numerical data are in fixed point representation; however we make a distinction between two kinds of data:

- ◇ The first kind has determined and unmodifiable decimal point position;
- ◇ The second has programmable decimal point position (dP parameter).

9.4.2 Memory zones

All readable and writable data appear to be allocated as 16 bit words in the memory of the instrument.

The memory map has three zones:

- ◇ Variables,
- ◇ Parameters,
- ◇ Instrument identification code.

Following parameters explore the characteristics of each zone.

9.4.3 Variables zones

In this zone there is a collection of main Kube controller variables, it is a group of frequently computed or updated data residing in volatile memory.

9.4.4 Most important changes

- A) During parameter modification **by push-button**, the serial interface continue to operate without any “limit” (you can see by serial link the value of all parameters and you can set it also).
- B) When you write a value in a location the instrument will operate as follows:
- B.1) If you write a value within parameter range, the instrument will accept it; the new value will be memorized and the instrument will send back the standard answer.
- B.2) If you try to write a value OUT of parameter range, the instrument will refuse the new value; the new value will NOT be registered and the instrument will send an exception message to the master.

9.5 Address map

All Kube instruments use only words:

| Initial address | | Final address | | Meaning |
|-----------------|-------|---------------|-------|---|
| Hex | Dec | Hex | Dec | |
| 1 | 1 | 1D | 29 | Group of variables common to all new Ascon Tecnologic's instruments: numeric values calculated and dinamically updated. Available in read and write operations |
| 200 | 512 | 250 | 592 | Group of variables compatible with the old Ascon Tecnologic's instruments (before Kube series): numeric values calculated and dinamically updated. Available in read and write operations |
| 280 | 640 | 31B | 795 | Configuration parameters: Numeric and symolic values. Available in read and write operations |
| 2800 | 10240 | 289B | 10395 | Repetition of the configuration parameters: Numeric and symbolic values. Available in read and write operations |

9.5.1 Common Variables

| no. | Address | | Description | Dec. Point | r/w |
|-----|---------|------|---|------------|-----|
| | Hex. | Dec. | | | |
| 0A | 0 | 0 | Broadcast enabling 0x44BB = broadcast enabled 0x55AA = broadcast disabled | 0 | w |
| 1A | 1 | 1 | PV: Measured value Note: When a measuring error is detected the instrument send: ◇ 10000 = Underrange ◇ 10000 = Ovrerrange ◇ 10001 = Overflow of the A/D converter ◇ 10003 = Variable not available | | r |
| 2A | 2 | 2 | Number of decimal figures of the measured value | 0 | r |
| 3A | 3 | 3 | Operative set point (value) | dP | r |
| 4A | 4 | 4 | Power output Range: -100.00 ÷ 100.00 (%) Note: This parameter is ever writeable but it will be active only when the instrument operate in Manual mode. | 2 | r/w |
| 5A | 5 | 5 | Active set point selection 0 = SP 1 = SP 2 2 = SP 3 3 = SP 4 | 0 | r/w |
| 6A | 6 | 6 | SP Range: SPLL ÷ SPLH | dP | r/w |
| 7A | 7 | 7 | SP 2 Range: SPLL ÷ SPLH | dP | r/w |
| 8A | 8 | 8 | SP 3 Range: SPLL ÷ SPLH | dP | r/w |
| 9A | 9 | 9 | SP 4 Range: SPLL ÷ SPLH | dP | r/w |

| no. | Address | | Description | Dec. Point | r/w |
|-----|---------|------|---|------------|-----|
| | Hex. | Dec. | | | |
| 10A | A | 10 | Alarms status bit 0 = Alarm 1 status bit 1 = Alarm 2 status bit 2 = Alarm 3 status bit 3 = reserved bit 4 = auto tuning error bit 5 = calibration error bit 6 ÷ 8 = reserved bit 9 = LBA status bit 10 = power failure indicator bit 11 = Generic error bit 12 = Overload alarm bit 13 = Inspection request bit 14 ÷ 15 = reserved | 0 | r |
| 11A | B | 11 | Outputs status (physical outputs) bit 0 = Output 1 status bit 1 = Output 2 status bit 3 = Output 3 status bit 4 = Output 4 status bit 5 ÷ 15 = Reserved When a linear output is driven by serial link, the relative bit will remain equal to 0. | 0 | r |
| 12A | C | 12 | Instrument status bit 0 = Automatic bit 1 = manual bit 2 = Standby bit 3 = Remote Set point (temporary) used bit 4 = Auto-tuning active bit 5 = Self tuning active bit 6 = Reserved bit 7 = Timer running bit 8 = Soft start running bit 9 = Ramp for set point change (up or down) running bit 10 = Delay at start up (od) running bit 11 = Program running bit 12 = Measure status (0 = OK while 1 = error). bit 13 ÷ 15 = Reserved | 0 | r |
| 13A | D | 13 | Alarms reset 0 = Not resetted 1 = Resetted | 0 | r/w |
| 14A | E | 14 | Alarms acknowledge 0 = Not acknowledge 1 = acknowledge | 0 | r/w |
| 15A | F | 15 | Control status 0 = Automatic 1 = Manual 2 = Stand-by | 0 | r/w |
| 16A | 10 | 16 | Remote set point (temporary) (from serial link) Range: SPLL ÷ SPLH Note: the remote set point is stored in RAM | dP | r/w |
| 17A | 11 | 17 | Auto tuning activation 0 = not active 1 = active | 0 | r/w |
| 18A | 12 | 18 | Power output used when a measuring error is detected. Range: -100 ÷ 100 Note: This value is stored in RAM | 0 | r/w |
| 19A | 13 | 19 | Default parameters loading. -481 = Default parameter loading | 0 | r/w |
| 20A | 14 | 20 | Parameters table identification code Range: 0 ÷ 65535 Note: The word is composed by two parts: - Low byte – Version of the parameter table - High byte – Version of the family protocol | 0 | r |
| 21A | 15 | 21 | Instrument identification code 31 = KRD3 | 0 | r |
| 26A | 1A | 26 | Time to end of running program segment Range: 0 ÷ 9959 (hh.mm or mm.ss) Note: When the program is not active, the return value is 0. | 0 | r |
| 27A | 1B | 27 | Manual autotuning start request pending for Od or Soft start Range: 0 = No pending request waiting for the execution; 1 = Pending request waiting for the execution | 0 | r |

| no. | Address | | Description | Dec. Point | r/w |
|-----|---------|------|---|------------|-----|
| | Hex. | Dec. | | | |
| 28A | 1C | 28 | Autotuning start request pending for setpoint change for Od or Soft start Range: 0 = No pending request waiting for the execution; 1 = Pending request waiting for the execution | 0 | r |
| 29A | 1D | 29 | Value to be retransmitted on the analogue Output Range: Ao1L ÷ Ao1H | 0 | r/w |
| 30A | 23 | 35 | Status of the "inspection request" Range: 0 = function disabled or threshold NOT reached; 1 = threshold reached | 0 | r |
| 21A | 15 | 21 | Node address (RS 485) selected by dip-switches Range: 0 (the instruemnt will use the [124] Add parameter) ÷ 64 | 0 | r |
| 21A | 15 | 21 | Baud rate (RS 485) selected by dip-switches Range: 0 (2.400) ÷ 4 (38.400) | 0 | r |

9.5.2 Group of variables compatible with the old Ascon Tecnologic's instruments (before Kube series)

| no. | Address | | Description | Dec. Point | r/w |
|-----|---------|------|--|------------|-----|
| | Hex. | Dec. | | | |
| 1B | 0200 | 512 | PV: Measured value As address 1 | dP | r |
| 2B | 0201 | 513 | Number of decimal figure of the measured value As address 2 | 0 | r |
| 3B | 0202 | 514 | Power output As address 4 | 2 | r |
| 4B | 0203 | 515 | Power output of the heating output Range: 0 ÷ 100.00 (%) | 2 | r |
| 5B | 0204 | 516 | Power output of the cooling output Range: 0 ÷ 100.00 (%) | 2 | r |
| 6B | 0205 | 517 | Alarm 1 status 0 = OFF 1 = ON | 0 | r |
| 7B | 0206 | 518 | Alarm 2 status 0 = OFF 1 = ON | 0 | r |
| 8B | 0207 | 519 | Alarm 3 status 0 = OFF 1 = ON | 0 | r |
| 9B | 0208 | 520 | Operative set point As address 3 | DP | r |
| 10B | 020A | 522 | LBA status 0 = OFF 1 = ON | 0 | r |
| 11B | 020E | 526 | Overload alarm status 0 = OFF 1 = ON | | |
| 12B | 020F | 527 | Controller status 0 = Stand-by 1 = Auto 2 = Tuning 3 = Manual | 0 | r |
| 13B | 0224 | 548 | Status/remote control of the Output 1 0 = OFF 1 = ON Note: This parameter is writeable when out 1 is "not used" by the controller (o1F output 1 function = nonE). This parameter is stored in RAM. | 0 | r/w |
| 14B | 0225 | 549 | Status/remote control of the Output 2 0 = OFF 1 = ON Note: This parameter is writeable when out 2 is "not used" by the controller (o2F output 1 function = nonE). This parameter is stored in RAM | 0 | r/w |
| 15B | 0226 | 550 | Status/remote control of the Output 3 0 = OFF 1 = ON Note: This parameter is writeable when out 3 is "not used" by the controller (o3F output 1 function = nonE). This parameter is stored in RAM | 0 | r/w |

| no. | Address | | Description | Dec. Point | r/w |
|-----|---------|------|--|------------|-----|
| | Hex. | Dec. | | | |
| 16B | 0227 | 551 | Status/remote control of the Output 4 0 = OFF 1 = ON Note: This parameter is writeable when out 4 is "not used" by the controller (o4F output 1 function = nonE). This parameter is stored in RAM | 0 | r/w |
| 17B | 0240 | 576 | Digital input 1 status 0 = OFF 1 = ON Note: Digital input 1 status can be read from the serial port even if the input is not used by the controller | 0 | r/w |
| 18B | 0241 | 577 | Digital input 2 status 0 = OFF 1 = ON Note: Digital input 2 status can be read from the serial port even if the input is not used by the controller | 0 | r/w |
| 19B | 0244 | 580 | Program status 0 = Not configured 1 = Reset (not running) 2 = Run 3 = Hold 4 = Wait (system) 5 = End (system) 6 = Hold + Wait (system) 7 = Continue | 0 | r/w |
| 20B | 0245 | 581 | Timer status 0 = Not configured 1 = Reset (stop) 2 = Run 3 = Hold 4 = End (Read only) | 0 | r/w |
| 21B | 0246 | 582 | Program step in execution 0 = Program not active 1 = ramp - step 1 2 = soak - step 1 3 = ramp - step 2 4 = soak - step 2 5 = ramp - step 3 6 = soak - step 3 7 = ramp - step 4 8 = soak - step 4 9 = END | 0 | r |
| 22B | 0247 | 583 | Remaining time to program end Range: 0 ÷ 65535 (minutes when [96] Pru=hh.mm, seconds when [96] Pru=mm.ss) Note: When the program is not running the return code is 0 | 2 | r |
| 23B | 248 | 584 | Program events status 0 > E1 = 0 E2 = 0 1 > E1 = 1 E2 = 0 2 > E1 = 0 E2 = 1 3 > E1 = 1 E2 = 1 | 0 | r |
| 24B | 249 | 585 | Remaining time to the timer end Range: 0 ÷ 65535 (Hours when [91] Tru=hh.mm, Minutes when [91] Tru=mm.ss) | 2 | r |
| | | | 0 ÷ 9959 (tenth of seconds when [91] Tru=SSS.d) Note: When the timer is not active the return code is 0. | 1 | |
| 25B | 24A | 586 | Wattmeter: The meaning of this parameter is defined by the Co.ty parameter setting. Co.ty = 0 = Off Co.ty = 1 = kW Co.ty = 2 = kWh Co.ty = 3 = Energy used during program execution (kWh) Co.ty = 4 = Worked days Co.ty = 5 = Worked hours | 0 | r |
| 26B | 24B | 587 | Duration of first program ramp Range: 0 ÷ 9999 s | 0 | r |
| 27B | 24C | 588 | Days counted with the controller Powered ON Range: 0 ÷ 9999 | 0 | r |
| 28B | 250 | 592 | Power output when the instrument is in manual mode Range: -10000 ÷ 10000 (%) | 2 | r/w |

9.5.3 Parameters Setting: Addresses form 280 hex (640 dec) and 2800 hex (10240 dec)

³inP GROUP - Main and auxiliary input configuration

| no. | Param. | Address | | Description | Values | Dec. Point | r/w |
|-----|--------|-------------|--------------|---|---|------------|-----|
| | | Hex | Dec | | | | |
| 1 | SEnS | 280 2800 | 640 10240 | Model C (Pt100, Pt1000) | 0 = TC J (-50... +1000°C/-58... +1832°F); 1 = TC K (-50... +1370°C/-58... +2498°F); 2 = TC S (-50... +1760°C/-58... +3200°F); 3 = TC R (-50... +1760°C/-58... +3200°F); 4 = TC T (-70... +400°C/-94... +752°F); 5 = Exergen IRS J (-46... +785°C/-50... +1445°F); 6 = Exergen IRS K (-46... +785°C/-50... +1445°F); 7 = RTD Pt 100 (-200... +850°C/-328... +1562°F); 8 = RTD Pt 1000 (-200... +500°C/-328... +932°F); 9 = 0.60 = 0... 60 mV, 10 = 12.60 = 12... 60 mV, 11 = 0.20 = 0... 20 mA, 12 = 4.20 = 4... 20 mA, 13 = 0.5 = 0... 5 V, 14 = 1.5 = 1... 5 V, 15 = 0.10 = 0... 10 V, 16 = 2.10 = 2... 10 V 17 = From serial link with Burn-out strategy 1; 18 = From serial link with Burn-out strategy 2. | 0 | r/w |
| 2 | dp | 281 2801 | 641 10241 | Decimal Point Position (linear inputs) | 0... 3 | 0 | r/w |
| | | | | Decimal Point Position (different than linear inputs) | 0 or 1 | | |
| 3 | SSC | 282 2802 | 642 10242 | Initial scale read-out for linear inputs | -1999... 9999 | dP | r/w |
| 4 | FSc | 283 2803 | 643 10243 | Full Scale Readout for linear inputs | -1999... 9999 | dP | r/w |
| 5 | unit | 284 2804 | 644 10244 | Engineer unit | 0 = C = °C 1 = F = °F | 0 | r/w |
| 6 | Fil | 285 2805 | 645 10245 | Digital filter on the measured value Note: This filter affects the control action, the PV retransmission and the alarms action. | 0 = (OFF) 1... 200 (seconds) | 1 | r/w |
| 7 | inE | 286 2806 | 646 10246 | Sensor error used to enable the safety output value | 0 = or = Over range 1 = ou = Under range 2 = our = Over and under range | 0 | r/w |
| 8 | oPE | 287 2807 | 647 10247 | Safety output value (% of the output) | -100... 100 | 0 | r/w |
| 9 | IO4.F | 288 2808 | 648 10248 | I/O 4 function | 0 = on = Output used as PWS for TX, 1 = out4 = Output 4 (digital output 4), 2 = dG2c = Digital input 2 driven by contact, 3 = dG2U = Digital input 2 driven by voltage | 0 | r/w |
| 10 | diF1 | 289 2809 | 649 10249 | Digital Input 1 function | 0 oFF = Not used, 1 Alarm reset, 2 Alarm acknowledge (ACK), 3 Hold of the measured value, 4 Stand by mode, 5 Manual mode, 6 HEAt with SP1 and Cool with SP2, 7 Timer RUN/Hold/Reset, 8 Timer Run, 9 Timer Reset, 10 Timer Run/Hold, 11 Timer Run/Reset, 12 Timer Run/Reset with lock, 13 Program Start, 14 Program Reset, 15 Program Hold, 16 Program Run/Hold, 17 Program Run/Reset, 18 Sequential SP selection, 19 SP1 - SP2 selection, 20 SP1 to SP4 binary selection, | 0 | r/w |

| no. | Param. | Address | | Description | Values | Dec. Point | r/w |
|-----|--------|-------------|--------------|--------------------------|---|------------|-----|
| | | Hex | Dec | | | | |
| 11 | diF2 | 28A 280A | 650 10250 | Digital Input 2 function | 0 oFF = Not used, 1 Alarm reset, 2 Alarm acknowledge (ACK), 3 Hold of the measured value, 4 Stand by mode, 5 Manual mode, 6 HEAt with SP1 and Cool with SP2, 7 Timer RUN/Hold/Reset, 8 Timer Run, 9 Timer Reset, 10 Timer Run/Hold, 11 Timer Run/Reset, 12 Timer Run/Reset with lock, 13 Program Start, 14 Program Reset, 15 Program Hold, 16 Program Run/Hold, 17 Program Run/Reset, 18 Sequential SP selection, 19 SP1 - SP2 selection, 20 SP1 to SP4 binary selection, | 0 | r/w |
| 12 | di.A | 28B 280B | 651 10251 | Digital input action | 0 DI1 direct, DI2 direct 1 DI1 reverse, DI2 direct 2 DI1 direct, DI2 reverse 3 DI1 reverse, DI2 reverse | 0 | r/w |

Out group

| no. | Param. | Address | | Description | Values | Dec. Point | r/w |
|-----|--------|-------------|--------------|---|---|------------|-----|
| | | Hex | Dec | | | | |
| 13 | o1t | 28C 280C | 652 10252 | Output 1 type (when Out 1 is an analogue output) | 0 0-20 = 0... 20 mA 1 4-20 = 4... 20 mA 2 0-10 = 0... 10 V 3 2-10 = 2... 10 V | 0 | r/w |
| 14 | o1F | 28D 280D | 653 10253 | Out 1 function (when Out 1 is a linear output) | 0 = NonE = Output not used 1 = H.rEG = Heating output 2 = c.rEG = Cooling output 3 = r.inP = Measure retransmission 4 = r.Err = Error (sp - PV) retransmission 5 = r.SP = Set point retransmission 6 = r.SEr = Serial value retransmission | 0 | r/w |
| | | | | Out 1 function (when Out1 is a digital output) | 0 = NonE = Output not used 1 = H.rEG = Heating output 2 = c.rEG = Cooling output 3 = AL = Alarm output 4 = t.out = Timer output 5 = t.HoF = Timer out -OFF in hold 6 = P.End = Program end indicator 7 = P.HLd = Program hold indicator 8 = P.uit = Program wait indicator 9 = P.run = Program run indicator 10 = P.Et1 = Program Event 1 11 = P.Et2 = Program Event 2 12 = or.bo = Out-of-range or burn out indicator 13 = P.FAL = Power failure indicator 14 = bo.PF = Out-of-range, burn out and Power failure indicator 15 = St.bY = Stand by status indicator 16 = diF.1 = The output repeats the digital input 1 status 17 = diF.2 = The output repeats the digital input 2 status 18 = on = Out 1 always ON 19 = Inspection request | | |
| 15 | Ao1L | 28E 280E | 654 10254 | Initial scale value of the analog retransmission | -1999 to Ao1H | dp | r/w |
| 16 | Ao1H | 28F 280F | 655 10255 | Full scale value of the analog retransmission | Ao1L to 9999 | dp | r/w |

| no. | Param. | Address | | Description | Values | Dec. Point | r/w |
|-----|--------|-------------|--------------|---------------------------------|--|------------|-----|
| | | Hex | Dec | | | | |
| 17 | o1AL | 290 2810 | 656 10256 | Alarms linked up with the out 1 | 0... 63 +1 Alarm 1 +2 Alarm 2 +4 Alarm 3 +8 Loop break alarm +16 Sensor Break +32 Overload on output 4 | 0 | r/w |
| 18 | o1Ac | 291 2811 | 657 10257 | Out 1 action | 0 = dir = Direct action 1 = rEU = Reverse action 2 = dir.r = Direct with reversed LED 3 = ReU.r = Reverse with reversed LED | 0 | r/w |
| 19 | o2F | 292 2812 | 658 10258 | Out 2 function | See the values of [14] o1F parameter | 0 | r/w |
| 20 | o2AL | 293 2813 | 659 10259 | Alarms linked up with the out 2 | See the values of [17] o1AL parameter | 0 | r/w |
| 21 | o2Ac | 294 2814 | 660 10260 | Out 2 action | See the values of [18] o1Ac parameter | 0 | r/w |
| 22 | o3F | 295 2815 | 661 10261 | Out 3 function | See the values of [14] o1F parameter | 0 | r/w |
| 23 | o3AL | 296 2816 | 662 10262 | Alarms linked up with the out 3 | See the values of [17] o1AL parameter | 0 | r/w |
| 24 | o3Ac | 297 2817 | 663 10263 | Out 3 action | See the values of [18] o1Ac parameter | 0 | r/w |
| 25 | o4F | 298 2818 | 664 10264 | Out 4 function | See the values of [14] o1F parameter | 0 | r/w |
| 26 | o4AL | 299 2819 | 665 10265 | Alarms linked up with the out 4 | See the values of [17] o1AL parameter | 0 | r/w |
| 27 | o4Ac | 29A 281A | 666 10266 | Out 4 action | See the values of [18] o1Ac parameter | 0 | r/w |

³ AL1 group

| no. | Param. | Address | | Description | Values | Dec. Point | r/w |
|-----|--------|-------------|--------------|---|--|------------|-----|
| | | Hex | Dec | | | | |
| 28 | AL1t | 29B 281B | 667 10267 | Alarm 1 type | 0 = nonE = Alarm not used 1 = LoAb = Absolute low alarm 2 = HiAb = Absolute high alarm 3 = LHAo = Windows alarm in alarm outside the windows 4 = LHAi = Windows alarm in alarm inside the windows 5 = SE.br = Sensor Break 6 = LodE = Deviation low alarm (relative) 7 = HidE = Deviation high alarm (relative) 8 = LHdo = Relative band alarm in alarm out of the band 9 = LHdi = Relative band alarm in alarm inside the band | 0 | r/w |
| 29 | Ab1 | 29C 281C | 668 10268 | Alarm 1 function | 0... 15 +1 Not active at power ON +2 Latched alarm (manual reset) +4 Acknowledgeable alarm +8 Relative alarm not active at set point change | 0 | r/w |
| 30 | AL1L | 29D 281D | 669 10269 | - For High and low alarms is the low limit of the AL1 threshold; - For band alarm is the low alarm threshold | From -1999 to AL1H (E.U.) | dP | r/w |
| 31 | AL1H | 29E 281E | 670 10270 | - For High and low alarms is the high limit of the AL1 threshold; - For band alarm is the high alarm threshold | From AL1L to 9999 (E.U.) | dP | r/w |
| 32 | AL1 | 29F 281F | 671 10271 | AL1 threshold | From AL1L to AL1H (E.U.) | dP | r/w |
| 33 | HAL1 | 2A0 2820 | 672 10272 | AL1 hysteresis | 1... 9999 (E.U.) | dP | r/w |
| 34 | AL1d | 2A1 2821 | 673 10273 | AL1 delay | From 0 (oFF) to 9999 (s) | 0 | r/w |
| 35 | AL1o | 2A2 2822 | 674 10274 | Alarm 1 enabling during Stand-by mode and out of range conditions | 0 = Alarm 1 disabled during Stand by and out of range 1 = Alarm 1 enabled in stand by mode 2 = Alarm 1 enabled in out of range condition 3 = Alarm 1 enabled in stand by mode and in over range condition | 0 | r/w |

AL2 group

| no. | Param. | Address | | Description | Values | Dec. Point | r/w |
|-----|--------|-------------|--------------|---|--|------------|-----|
| | | Hex | Dec | | | | |
| 36 | AL2t | 2A3 2823 | 675 10275 | Alarm 2 type | 0 = nonE = Alarm not used 1 = LoAb = Absolute low alarm 2 = HiAb = Absolute high alarm 3 = LHAo = Windows alarm in alarm outside the windows 4 = LHAI = Windows alarm in alarm inside the windows 5 = SE.br = Sensor Break 6 = LodE = Deviation low alarm (relative) 7 = HidE = Deviation high alarm (relative) 8 = LHdo = Relative band alarm in alarm out of the band 9 = LHdi = Relative band alarm in alarm inside the band | 0 | r/w |
| 37 | Ab2 | 2A4 2824 | 676 10276 | Alarm 2 function | 0... 15 +1 Not active at power ON +2 Latched alarm (manual reset) +4 Acknowledgeable alarm +8 Relative alarm not active at set point change | 0 | r/w |
| 38 | AL2L | 2A5 2825 | 677 10277 | - For High and low alarms is the low limit of the AL2 threshold; - For band alarm is the low alarm threshold | From -1999 to AL2H (E.U.) | dP | r/w |
| 39 | AL2H | 2A6 2826 | 678 10278 | - For High and low alarms is the high limit of the AL2 threshold; - For band alarm is the high alarm threshold | From AL2L to 9999 (E.U.) | dP | r/w |
| 40 | AL2 | 2A7 2827 | 679 10279 | AL2 threshold | From AL2L to AL2H (E.U.) | dP | r/w |
| 41 | HAL2 | 2A8 2828 | 680 10280 | AL2 hysteresis | 1... 9999 (E.U.) | dP | r/w |
| 42 | AL2d | 2A9 2829 | 681 10281 | AL2 delay | From 0 (oFF) to 9999 (s) | 0 | r/w |
| 43 | AL2o | 2AA 282A | 682 10282 | Alarm 2 enabling during Stand-by mode and out of range conditions | 0 = Alarm 2 disabled during Stand by and out of range 1 = Alarm 2 enabled in stand by mode 2 = Alarm 2 enabled in out of range condition 3 = Alarm 3 enabled in stand by mode and in over range condition | 0 | r/w |

AL3 group

| no. | Param. | Address | | Description | Values | Dec. Point | r/w |
|-----|--------|-------------|--------------|---|--|------------|-----|
| | | Hex | Dec | | | | |
| 44 | AL3t | 2AB 282B | 683 10283 | Alarm 3 type | 0 = nonE = Alarm not used 1 = LoAb = Absolute low alarm 2 = HiAb = Absolute high alarm 3 = LHAo = Windows alarm in alarm outside the windows 4 = LHAI = Windows alarm in alarm inside the windows 5 = SE.br = Sensor Break 6 = LodE = Deviation low alarm (relative) 7 = HidE = Deviation high alarm (relative) 8 = LHdo = Relative band alarm in alarm out of the band 9 = LHdi = Relative band alarm in alarm inside the band | 0 | r/w |
| 45 | Ab3 | 2AC 282C | 684 10284 | Alarm 3 function | 0... 15 +1 Not active at power ON +2 Latched alarm (manual reset) +4 Acknowledgeable alarm +8 Relative alarm not active at set point change | 0 | r/w |
| 46 | AL3L | 2AD 282D | 685 10285 | - For High and low alarms is the low limit of the AL3 threshold; - For band alarm is the low alarm threshold | From -1999 to AL3H (E.U.) | dP | r/w |
| 47 | AL3H | 2AE 282E | 686 10286 | - For High and low alarms is the high limit of the AL3 threshold; - For band alarm is the high alarm threshold | From AL3L to 9999 (E.U.) | dP | r/w |
| 48 | AL3 | 2AF 282F | 687 10287 | AL3 threshold | From AL3L to AL3H (E.U.) | dP | r/w |
| 49 | HAL3 | 2B0 2830 | 688 10288 | AL3 hysteresis | 1 to 9999 (E.U.) | dP | r/w |

| no. | Param. | Address | | Description | Values | Dec. Point | r/w |
|-----|--------|-------------|--------------|---|--|------------|-----|
| | | Hex | Dec | | | | |
| 50 | AL3d | 2B1 2831 | 689 10289 | AL3 delay | From 0 (oFF) to 9999 (s) | 0 | r/w |
| 51 | AL3o | 2B2 2832 | 690 10290 | Alarm 3 enabling during Stand-by mode and out of range conditions | 0 = Alarm 3 disabled during Stand by and out of range 1 = Alarm 3 enabled in stand by mode 2 = Alarm 4 enabled in out of range condition 3 = Alarm 4 enabled in stand by mode and in over range condition | 0 | r/w |

³ LBA group - Loop Break Alarm Parameters

| no. | Param. | Address | | Description | Values | Dec. Point | r/w |
|-----|--------|-------------|--------------|---|--|------------|-----|
| | | Hex | Dec | | | | |
| 52 | LbAt | 2B3 2833 | 691 10291 | LBA time | From 0 (oFF) to 9999 (s) | 0 | |
| 53 | LbSt | 2B4 2834 | 692 10292 | Delta measure used by LBA during Soft start | From 0 (oFF) to 9999 (E.U.) | dP | |
| 54 | LbAS | 2B5 2835 | 693 10293 | Delta measure used by LBA | 1... 9999 (E.U.) | dP | |
| 55 | LbcA | 2B6 2836 | 694 10294 | Condition for LBA enabling | 0 = uP = Active when Pout = 100% 1 = dn = Active when Pout = -100% 2 = both = Active in both cases | 0 | |

³ rEG group - Control Parameters

| no. | Param. | Address | | Description | Values | Dec. Point | r/w |
|-----|--------|-------------|--------------|--|--|------------|-----|
| | | Hex | Dec | | | | |
| 56 | cont | 2B7 2837 | 695 10295 | Control type: when one heating and one cooling output are programmed. | 0 = Pid = PID (heat and/or cool) 1 = nr = Heat/Cool ON/OFF control with neutral zone | 0 | r/w |
| | | | | Control type: when heating or cooling output are programmed and no servomotor control can not programmed. | 0 = Pid > PID (heat and/or cool) 1 = On.FA > ON/OFF asymmetric hysteresis 2 = On.FS > ON/OFF symmetric hysteresis | | |
| | | | | Control type: when heating or cooling output are programmed and servomotor control can programmed. | 0 = Pid > PID (heat and/or cool) 1 = On.FA > ON/OFF asymmetric hysteresis 2 = On.FS > ON/OFF symmetric hysteresis 3 = 3Pt. > open loop 3 point valve control (no feedback) | | |
| 57 | Auto | 2B8 2838 | 696 10296 | Autotuning selection | -4 = Oscillating auto-tune with automatic restart at power ON and after all point change -3 = Oscillating auto-tune with manual start -2 = Oscillating -tune with auto-matic start at the first power ON only -1 = Oscillating auto-tune with automatic restart at every power ON 0 = Not used 1 = Fast auto tuning with automatic restart at every power ON 2 = Fast auto-tune with automatic start the first power ON only 3 = FAST auto-tune with manual start 4 = FAST auto-tune with automatic restart at power ON and after a set point change 5 = Evo-tune with automatic restart at every power ON 6 = Evo-tune with automatic start the first power ON only 7 = Evo-tune with manual start 8 = Evo-tune with automatic restart at power ON and after a set point change | 0 | r/w |
| 58 | Aut.r | 2B9 2839 | 697 10297 | Manual start of the Autotuning | 0 = oFF = Autotuning Not active 1 = on = Autotuning Active | 0 | r/w |
| 59 | SELF | 2BA 283A | 698 10298 | Self tuning enabling | 0 = no = The instrument does not perform the self-tuning 1 = YES = The instrument is performing the self-tuning | 0 | r/w |
| 60 | HSEt | 2BB 283B | 699 10299 | Hysteresis of the ON/OFF control | 0... 9999 (E.U.) | dP | |
| 61 | cPdt | 2BC 283C | 700 10300 | Time for compressor protection | 0 (oFF) 1... 9999 (s) | 0 | r/w |
| 62 | Pb | 2BD 283D | 701 10301 | Proportional band | 1... 9999 (E.U.) | dP | |

| no. | Param. | Address | | Description | Values | Dec. Point | r/w |
|-----|--------|-------------|--------------|--|--|------------|-----|
| | | Hex | Dec | | | | |
| 63 | ti | 2BE 283E | 702 10302 | Integral time | 0 (oFF) 1... 9999 (s) | 0 | r/w |
| 64 | td | 2BF 283F | 703 10303 | Derivative time | 0 (oFF) 1... 9999 (s) | 0 | r/w |
| 65 | Fuoc | 2C0 2840 | 704 10304 | Fuzzy overshoot control | 0... 200 | 2 | r/w |
| 66 | tcH | 2C1 2841 | 705 10305 | Heating output cycle time | 10... 1300 (s) | 1 | r/w |
| 67 | rcG | 2C2 2842 | 706 10306 | Power ratio between heating and cooling action | 1... 9999 | 2 | r/w |
| 68 | tcc | 2C3 2843 | 707 10307 | Cooling output cycle time | 1... 1300 (s) | 1 | r/w |
| 69 | rS | 2C4 2844 | 708 10308 | Manual reset (Integral pre-load) | -1000... +1000 (%) | 1 | r/w |
| 70 | Str.t | 2C5 2845 | 709 10309 | Servomotor stroke time | 5... 1000 seconds | 0 | r/w |
| 71 | db.S | 2C6 2846 | 710 10310 | Servomotor dead band | 0.0... 10.0 | 1 | r/w |
| 72 | oPL | 2C7 2847 | 711 10311 | Minimum power output | -100 to oPH % | 1 | r/w |
| 73 | oPH | 2C8 2848 | 712 10312 | Maximum power output | oPL to 100% | 1 | r/w |
| 74 | od | 2C9 2849 | 713 10313 | Delay at power ON | 0 = Function not used 0.01... 99.59 hh.mm | 2 | r/w |
| 75 | St.P | 2CA 284A | 714 10314 | Maximum power output used during soft start | -100... +100 (%) | 0 | r/w |
| 76 | SSt | 2CB 284B | 715 10315 | Soft start time | 0 = Function not used 0.01... 7.59 hh.mm 8.00 Soft start always active | 2 | r/w |
| 77 | SS.tH | 2CC 284C | 716 10316 | Threshold for soft start disabling | -2000 (oFF) -1999... 9999 (E.U.) | dP | r/w |

³ SP group - Set point parameters

| no. | Param. | Address | | Description | Values | Dec. Point | r/w |
|-----|--------|-------------|--------------|-----------------------------------|--|------------|-----|
| | | Hex | Dec | | | | |
| 78 | nSP | 2CD 284D | 717 10317 | Number of used set points | 1... 4 | 0 | r/w |
| 79 | SPLL | 2CE 284E | 718 10318 | Minimum set point value | From -1999 to SPHL | dP | r/w |
| 80 | SPHL | 2CF 284F | 719 10319 | Maximum set point value | From SPLL to 9999 | dP | r/w |
| 81 | SP | 2D0 2850 | 720 10320 | Set point 1 | From SPLL to SPLH | dP | r/w |
| 82 | SP 2 | 2D1 2851 | 721 10321 | Set point 2 | From SPLL to SPLH | dP | r/w |
| 83 | SP 3 | 2D2 2852 | 722 10322 | Set point 3 | From SPLL to SPLH | dP | r/w |
| 84 | SP 4 | 2D3 2853 | 723 10323 | Set point 4 | From SPLL to SPLH | dP | r/w |
| 85 | A.SP | 2D4 2854 | 724 10324 | Selection of the active set point | 0 = SP 1 = SP 2 2 = SP 3 3 = SP 4 | 0 | r/w |
| 86 | SP.rt | 2D5 2855 | 725 10325 | Remote set point type | 0 = RSP = The value coming from serial link is used as remote set point 1 = trin = The value will be added to the local set point selected by A.SP and the sum becomes the operative set point 2 = PErc = The value will be scaled on the input range and this value will be used as remote SP | 0 | r/w |
| 87 | SPLr | 2D6 2856 | 726 10326 | Local/remote set point selection | 0 = Loc = local 1 = rEn = remote | 0 | r/w |

| no. | Param. | Address | | Description | Values | Dec. Point | r/w |
|-----|--------|-------------|--------------|---|---|------------|-----|
| | | Hex | Dec | | | | |
| 88 | SP.u | 2D7 2857 | 727 10327 | Rate of rise for POSITIVE set point change (ramp UP) | 0.01... 99.99 (inF) Eng. units per minute | 2 | r/w |
| 89 | SP.d | 2D8 2858 | 728 10328 | Rate of rise for NEGATIVE set point change (ramp DOWN) | 0.01... 99.99 (inF) Eng. units per minute | 2 | r/w |

TIN group - Timer function parameters

| no. | Param. | Address | | Description | Values | Dec. Point | r/w |
|-----|--------|-------------|--------------|----------------------------|---|------------|-----|
| | | Hex | Dec | | | | |
| 90 | tr.F | 2D9 2859 | 729 10329 | Independent timer function | 0 = NonE = Timer not used 1 = i.d.A = Delayed start timer 2 = i.uP.d = Delayed start at power ON 3 = i.d.d = Feed-through timer 4 = i.P.L = Asymmetrical oscillator with start OFF 5 = i.L.P = Asymmetrical oscillator with start ON | 0 | r/w |
| 91 | tr.u | 2DA 285A | 730 10330 | Timer unit | 0 = hh.nn = Hours and minutes 1 = nn.SS = Minutes and seconds 2 = SSS.d = Second and tenth of seconds | 0 | r/w |
| 92 | tr.t1 | 2DB 285B | 731 10331 | Time 1 | When [91] tr.u = 0: 1... 9959 (hh.mm) | 2 | r/w |
| | | | | | When [91] tr.u = 1: 1... 9959 (mm.ss) | | |
| | | | | | When [91] tr.u = 2: 1... 9959 (tenth of seconds) | | |
| 93 | tr.t2 | 2DC 285C | 732 10332 | Time 2 | When [91] tr.u = 0: From 0 (oFF) to 9959 (inF)(hh.mm) | 2 | r/w |
| | | | | | When [91] tr.u = 1: From 0 (oFF) to 9959 (inF) (mm.ss) | | |
| | | | | | When [91] tr.u = 2: From 0000 (oFF) to 9959 (inF)(tenth of seconds) | | |
| 94 | tr.St | 2DD 285D | 733 10333 | Timer status | 0 = rES = Timer reset 1 = run = Timer run 2 = HoLd = Timer hold | 0 | r/w |

PRG group - Programmer function parameters

| no. | Param. | Address | | Description | Values | Dec. Point | r/w |
|-----|--------|-------------|--------------|--|--|------------|-----|
| | | Hex | Dec | | | | |
| 95 | Pr.F | 2DE 285E | 734 10334 | Program action at power ON | 0 = nonE = Programmer not used 1 = S.uP.d = Start at power ON with a first step in stand-by 2 = S.uP.S = Start at power ON 3 = u.diG = Start at Run command detection only 4 = u.dG.d = Start at Run command with a first step in stand-by | 0 | r/w |
| 96 | Pr.u | 2DF 285F | 735 10335 | Engineering unit of the soaks | 0 = hh.nn = Hours and minutes 1 = nn.SS = Minutes and seconds | 0 | r/w |
| 97 | Pr.E | 2E0 2860 | 736 10336 | Instrument behaviour at the end of the program execution | 0 = cnt = Continue 1 = A.SP = Go to the set point selected by A.SP 2 = St.by = Go to stand-by mode | 0 | r/w |
| 98 | Pr.Et | 2E1 2861 | 737 10337 | Time of the end program indication | From 0 (oFF) to 9959 (inF) minutes and seconds | 2 | r/w |
| 99 | Pr.S1 | 2E2 2862 | 738 10338 | Set point of the first soak | From SPLL to SPHL -8000 Program End | dP | r/w |
| 100 | Pr.G1 | 2E3 2863 | 739 10339 | Gradient of the first ramp | 1... 999 Engineering Unit/minute 10000 (inF = Step transfer) | 1 | r/w |
| 101 | Pr.t1 | 2E4 2864 | 740 10340 | Time of the 1 st soak | 0... 9959 (hh.mm or mm.ss) | 2 | r/w |
| 102 | Pr.b1 | 2E5 2865 | 741 10341 | Wait band of the 1 st soak | 0 = (oFF) 1... 9999 (E.U.) | 0 | r/w |
| 103 | Pr.E1 | 2E6 2866 | 742 10342 | Events of the 1 st group | 0000... 1111 | 2 | r/w |
| 104 | Pr.S2 | 2E7 2867 | 743 10343 | Set point of the 2 nd soak | From SPLL to SPHL -8000 Program End | dP | r/w |
| 105 | Pr.G2 | 2E8 2868 | 744 10344 | Gradient of the 2 nd ramp | 1... 999 Engineering Unit/minute 10000 (inF = Step transfer) | 1 | r/w |
| 106 | Pr.t2 | 2E9 2869 | 745 10345 | Time of the 2 nd soak | 0... 9959 (hh.mm or mm.ss) | 2 | r/w |
| 107 | Pr.b2 | 2EA 286A | 746 10346 | Wait band of the 2 nd soak | 0 = (oFF) 1... 9999 (E.U.) | 0 | r/w |

| no. | Param. | Address | | Description | Values | Dec. Point | r/w |
|-----|--------|-------------|--------------|---------------------------------------|---|------------|-----|
| | | Hex | Dec | | | | |
| 108 | Pr.E2 | 2EB 286B | 747 10347 | Events of the 2 nd group | 0000... 1111 | 2 | r/w |
| 109 | Pr.S3 | 2EC 286C | 748 10348 | Set point of the 3 rd soak | From SPLL to SPHL -8000 Program End | dP | r/w |
| 110 | Pr.G3 | 2ED 286D | 749 10349 | Gradient of the 3 rd ramp | 1... 999 Engineering Unit/minute 10000 (inF = Step transfer) | 1 | r/w |
| 111 | Pr.t3 | 2EE 286E | 750 10350 | Time of the 3 rd soak | 0... 9959 (hh.mm or mm.ss) | 2 | r/w |
| 112 | Pr.b3 | 2EF 286F | 751 10351 | Wait band of the 3 rd soak | 0 = (oFF) 1... . 9999 (E.U.) | 0 | r/w |
| 113 | Pr.E3 | 2F0 2870 | 752 10352 | Events of the 3 rd group | 0000... 1111 | 2 | r/w |
| 114 | Pr.S4 | 2F1 2871 | 753 10353 | Set point of the 4 th soak | From SPLL to SPHL -8000 Program End | dP | r/w |
| 115 | Pr.G4 | 2F2 2872 | 754 10354 | Gradient of the 4 th ramp | 1... 999 Engineering Unit/minute 10000 (inF = Step transfer) | 1 | r/w |
| 116 | Pr.t4 | 2F3 2873 | 755 10355 | Time of the 4 th soak | 0... 9959 (hh.mm or mm.ss) | 2 | r/w |
| 117 | Pr.b4 | 2F4 2874 | 756 10356 | Wait band of the 4 th soak | 0 = (oFF) 1... 9999 (E.U.) | 0 | r/w |
| 118 | Pr.E4 | 2F5 2875 | 757 10357 | Events of the 4 th group | 0000... 1111 | 2 | r/w |
| 119 | Pr.St | 2F6 2876 | 758 10358 | Program status | 0 = rES = Program reset 1 = run = Program start 2 = HoLd = Program hold | 0 | r/w |

³ PAn group - Operator HMI parameters

| no. | Param. | Address | | Description | Values | Dec. Point | r/w |
|-----|--------|-------------|--------------|-------------------------------|--|------------|-----|
| | | Hex | Dec | | | | |
| 120 | fiLd | 2F7 2877 | 759 10359 | Filter on the displayed value | 0 oFF (filter disabled) to 100 | Dp | r/w |
| 121 | dSPu | 2F8 2878 | 760 10360 | Instrument status at power ON | 0 = AS.Pr = Starts in the same way it was prior to the power down 1 = Auto = Starts in Auto mode 2 = oP.0 = Starts in manual mode with a power output equal to zero 3 = St.bY = Starts in stand-by mode | 0 | r/w |
| 122 | oPr.E | 2F9 2879 | 761 10361 | Operative modes enabling | 0 = ALL = All modes will be selectable by the next parameter 1 = Au.oP = Auto and manual (OPLO) mode only will be selectable by the next parameter 2 = Au.Sb = Auto and Stand-by modes only will be selectable by the next parameter | 0 | r/w |
| 123 | oPEr | 2FA 287A | 762 10362 | Operative mode selection | 0 = Auto = Auto mode 1 = oPLo = Manual mode 2 = St.bY = Stand by mode | 0 | r/w |

³ Ser group - Serial link parameters

| no. | Param. | Address | | Description | Values | Dec. Point | r/w |
|-----|--------|-------------|--------------|---|--|------------|-----|
| | | Hex | Dec | | | | |
| 124 | Add | 2FB 287B | 763 10363 | Instrument address | 0 = (oFF) 1... 254 | 0 | r/w |
| 125 | bAud | 2FC 287C | 764 10364 | baud rate | 0 = 2400 = 2400 baud 1 = 9600 = 9600 baud 2 = 19.2 = 19200 baud 3 = 38.4 = 38400 baud | 0 | r/w |
| 126 | trSP | 2FD 287D | 765 10365 | Selection of the value to be retransmitted (Master) | 0 = nonE = Retransmission not used (the instrument is a slave) 1 = rSP = The instrument becomes a Master and retransmits the operative set point 2 = PErc = The instrument become a Master and it retransmits the power output | 0 | r/w |

COOn group - Consumption parameters

| no. | Param. | Address | | Description | Values | Dec. Point | r/w |
|-----|--------|-------------|--------------|---------------------------------|--|------------|-----|
| | | Hex | Dec | | | | |
| 127 | Co.tY | 2FE 287E | 766 10366 | Measurement type | 0 = oFF = Not used 1 = Instantaneous power (kW) 2 = Power consumption (kW/h) 3 = Energy used during program execution. This measure starts from zero when a program runs end stops at the end of the program. A new program execution will reset the value 4 = Total worked days with threshold. It is the number of hours that the instrument is turned ON divided for 24 5 = Total worked hours with threshold. It is the number of hours that the instrument is turned ON 6 = Total worked days with threshold: Number of hours the instrument is turned ON divided by 24, the controller is forced in stand-by when Co.ty value reaches the threshold set in [130] h.Job. 7 = Total worked hours with threshold: number of hours that the instrument is turned ON, the controller is forced in stand-by when Co.ty value reaches the threshold set in [130] h.Job. 8 = Totalizer of control relay worked days: Number of hours the control relay has been in ON condition, divided by 24. 9 = Totalizer of control relay worked hours: Number of hours the control relay has been in ON condition. 10 = Totalizer of control relay worked days with threshold: Number of hours the control relay has been in ON condition divided by 24, the controller is forced in stand-by when Co.ty value reaches the threshold set in [130] h.Job. 11 = Totalizer of control relay worked hours with threshold: Number of hours the control relay has been in ON condition, the controller is forced in stand-by when Co.ty value reaches the threshold set in [130] h.Job. | 0 | r/w |
| 128 | UoLt | 2FF 287F | 767 10367 | Nominal Voltage of the load | 1... 9999 (V) | 0 | r/w |
| 129 | cur | 300 2880 | 768 10368 | Nominal current of the load | 1... 999 (A) | 0 | r/w |
| 130 | h.Job | 301 2881 | 769 10369 | Threshold of the working period | 0 (oFF) 1... 999 | 0 | r/w |
| 131 | t.Job | 302 2882 | 770 10370 | Worked time (not resettable) | 0... 9999 | 0 | r |

CAI group - User calibration parameters

| no. | Param. | Address | | Description | Values | Dec. Point | r/w |
|-----|--------|-------------|--------------|--------------------|----------------------------------|------------|-----|
| | | Hex | Dec | | | | |
| 132 | AL.P | 303 2883 | 771 10371 | Adjust Low Point | From -1999 to (AH.P - 10) (E.U.) | dP | r/w |
| 133 | AL.o | 304 2884 | 772 10372 | Adjust Low Offset | -300... +300 (E.U.) | dP | r/w |
| 134 | AH.P | 305 2885 | 773 10373 | Adjust High Point | From (AL.P + 10) to 9999 (E.U.) | dP | r/w |
| 135 | AH.o | 306 2886 | 774 10374 | Adjust High Offset | -300... +300 (E.U.) | dP | r/w |

9.5.4 Identification code zone

This zone provides only informations for identifying model, order code and software release of the Kube series instrument. Starting from the address 0800H it is possible to read the instrument name (KRD3, etc.) and from the address 0x80A (up to 0x818) it is possible to read the instrument sales code.

9.6 Performance

After receiving a valid request the instrument prepares the reply, then sends it back to the master station according to the following specifications:

- A minimum time is granted greater or equal 3 characters time (depending on adopted baud rate, allowing line direction reversal);
- The reply is ready to be transmitted in less then 20 ms except in case 3;

A 20 ms silence on the line is necessary to recover from abnormal conditions or erroneous messages; this means that a time less than 20 ms is allowed between any two characters in the same message.



All rights reserved. No parts of this publication may be reproduced, in any form, without Ascon Tecnologic S.r.l. written permission.

Every care has been taken preparing this manual; the document has been carefully reviewed for technical accuracy. In the event that technical or typographical errors exist Ascon Tecnologic S.r.l. reserves the right to make changes without any notice.

In no event shall Ascon Tecnologic S.r.l. be liable for any damages arising out of or related to this document or the information contained in it.

If errors are suspected, please contact Ascon Tecnologic S.r.l. at the above address.

Ascon Tecnologic S.r.l.
Via Indipendenza, 56
27029 Vigevano (PV) Italia

Tel. ++39/0381/69871
Fax ++39/0381/698730
www.ascontecnologic.com
support@ascontecnologic.com
info@ascontecnologic.com