

Milwaukee®

2014/2015

CORDED POWER TOOLS & ACCESSORIES



Nothing but **HEAVY DUTY.**®



TABLE OF CONTENTS

CUTTING

SAWZALL®	1
SAWZALL® BLADES	4
SAWZALL® BLADES CROSS REFERENCE	8
BAND SAWS	18
BAND SAW BLADES	20
MITER SAWS	21
CIRCULAR SAWS	22
CIRCULAR SAW BLADES	24
JIG SAWS	25
JIG SAW BLADES	26
PANEL SAWS	27
PANEL SAW BLADES	27

DRILLING & FASTENING

CORDED DRILLS	29
THUNDERBOLT® TWIST DRILL BITS	36
WOOD BORING BITS	39
METAL DRILLING BITS	41
HOLE SAWS	43
BI-METAL HOLE SAW CROSS-REFERENCE CHART	46
HOLE SAW ARBOUR CROSS-REFERENCE CHART	48
D-HANDLE DRILLS	50
HOLE-HAWG® DRILLS	53
SUPER HAWG™ DRILLS AND CHUCK KEYS	54
WOOD BORING SELFEEED BITS	55
SELFEEED BIT CROSS REFERENCE	57
BIG HAWG™ WOOD BORING	58
RIGHT ANGLE DRILLS	59
SPECIALTY DRILLS	61
ADJUSTABLE CLUTCH SCREWDRIVERS	64
SCREWDRIVERS	65
SHOCKWAVE™ DRIVING	68
SHOCKWAVE™ NUT DRIVERS	71
SHOCKWAVE™ HOLE SAWS	71
IMPACT WRENCHES	72
SHOCKWAVE™ SOCKETS & ADAPTERS	75
AUGERS & EXTENSIONS	76

CONCRETE DRILLING

HAMMER DRILLS	77
HAMMER DRILL BITS	79
HAMMER DRILL BITS CROSS-REFERENCE	80
ROTARY HAMMERS	81
SDS-PLUS MASONRY BITS	85
SDS-PLUS CROSS-REFERENCE	87
SDS-MAX BITS	90

SDS-MAX & SPLINE CROSS-REFERENCE	91
ROTARY AND DEMOLITION HAMMERS	93
CORE BITS, TUNNEL BITS AND EXTENSIONS	95
MULTI-BIT CORE BITS	96
LHS COMPONENT SYSTEM	97
DEMOLITION HAMMER ACCESSORIES	98
DEMO BITS CROSS-REFERENCE	99
DYMO DRILLS (DIAMOND CORING)	101
DIAMOND CORING ATTACHMENTS	107
DIAMOND CORE BITS AND ACCESSORIES	108

METAL WORKING

METAL CUTTING CIRCULAR SAWS & BLADES	109
ABRASIVE SAWS	110
CUT-OFF BLADES & WHEELS	111
SHEARS	112
SHEARS & NIBBLERS	113
ELECTROMAGNETIC DRILL PRESSES	115
ELECTROMAGNETIC DRILL PRESS MOTORS	119
COMPACT ELECTROMAGNETIC DRILL PRESS	121
ANNULAR CUTTERS	122
STEEL HAWG® CUTTERS	123
STEEL HAWG® CUTTER ARBORS	124

GRINDING & SANDING

LARGE ANGLE GRINDERS	125
SMALL ANGLE GRINDERS	127
NEW SMALL ANGLE GRINDERS	132
ABRASIVE WHEELS	139
ABRASIVE SANDING DISCS	140
FLAP DISCS & WIRE BRUSHES/WHEELS	141
FLAP DISCS & UNIVERSAL GRINDING DUST SHROUDS	142
SANDERS	143
DIE GRINDERS	146
DIE GRINDERS & BANDFILE	148
ROUTERS	149
ROUTER ACCESSORIES	152

OTHER SECTION

VACUUM CLEANERS	153
VACUUM ACCESSORIES	155
HEAT GUNS	158
HEAT GUNS & ACCESSORIES	159
HOISTS	160
TOOL INDEX BY CATALOG NUMBER	164
WARRANTY INFORMATION	165



6509-31 12A SAWZALL® 3/4" Stroke



FEATURES

- Powerful 12 Amp Motor: Delivers 0-3,000 SPM for high performance cutting in a variety of materials
- 3/4" Stroke Length: Provides maximum cut control
- Gear Protecting Clutch*: Extends gear and motor life by absorbing high impact forces caused by blade lock-ups
- Counter Weighted Mechanism*: Provides reduced vibration for smoother operation
- Reverse The Blade: For cutting with no starting hole
- QUIK-LOK™ Blade Clamp: Provides fast, tool-free blade changes

Includes: (1) Carrying Case

SPECIFICATIONS

Length	19"
Weight	7.1 lbs
Voltage	120V AC
Tool Warranty	5 Years
Amps	12
Keyless Blade Clamp	Yes
Stroke Length	3/4"
SPM	0-3,000

* Patented

6519-30 12A SAWZALL® 1-1/8" Stroke



FEATURES

- Powerful 12 Amp Motor: Delivers 0-3,000 SPM for high performance cutting in a variety of materials
- 1-1/8" Stroke Length: Provides maximum cutting speed
- Gear Protecting Clutch*: Extends gear and motor life by absorbing high impact forces caused by blade lock-ups
- Counter Weighted Mechanism*: Provides reduced vibration for smoother operation
- QUIK-LOK™ Blade Clamp: Provides fast, tool-free blade changes
- Adjustable Pivot Shoe*: Allows more efficient use of blade and depth-of-cut control
- Reverse The Blade: For cutting with no starting hole

Includes: (1) 12 Amp Sawzall® Recip Saw (6519-30)

SPECIFICATIONS

Length	19"
Weight	7.1 lbs
Voltage	120V AC
Tool Warranty	5 Years
Amps	12
Keyless Blade Clamp	Yes
Stroke Length	1-1/8"
SPM	0-3,000

* Patented

THE BEST JUST GOT BETTER



SAWZALL® Blades

Pg 4

6519-31 12A SAWZALL® 1-1/8" Stroke with Case

Includes: (1) 12 Amp Sawzall® Recip Saw (6519-30); (1) Carrying Case

6520-21 13A Orbital SAWZALL®



FEATURES

- 13 amp Milwaukee built motor
- 0-2,800 strokes per minute, variable speed trigger
- 1-1/8 in. Stroke
- Orbital cutting action for faster cuts
- Exclusive gear protecting clutch
- QUIK-LOK™ Blade Clamp: Provides fast, tool-free blade changes
- 9-Position Orbit Selector: Allows the user to set the degree of orbital versus straight reciprocating action
- Gear Protecting Clutch*: Unique gear clutch absorbs high impact forces caused by sudden blade lock-ups. Extends life of tool in extreme cutting applications
- Pivot Shoe*: For maximum support against work surface
- Reverse The Blade: For cutting with no starting hole

Includes: (1) 13 Amp Orbital Sawzall® Recip Saw (6520-21); (1) Carrying Case

SPECIFICATIONS

Length	18-3/4"
Weight	8.8 lbs
Voltage	120V AC
Tool Warranty	5 Years
Cord Type	8' Fixed
Amps	13
Construction Type	Grounded
Dial Speed Control	No
Adjustable Handle	No
Keyless Adjustable Shoe	Yes
Keyless Blade Clamp	Yes
Orbital Action	Yes
Stroke Length	1-1/8"
SPM	0-2,800

* Patented

6523-21 13A Rotating Handle Orbital Super SAWZALL®



FEATURES

- 13 Amp Milwaukee Built Motor
- 360° Rotating Handle, locks at 45° increments
- Orbital Cutting Action
- Variable Speed Trigger, 0-3000 SPM
- 1-1/4 in. Stroke
- Counter Balanced*: For reduced vibration and smoother operation
- Gear Protecting Clutch*: Unique gear clutch absorbs high impact forces caused by sudden blade lock-ups. Extends life of tool in extreme cutting applications
- Speed Dial for repetitive cuts
- QUIK-LOK™ Blade Clamp: Larger, heavy-duty, with new gripping ribs, provides fast and easy blade changes
- QUIK-LOK® Cord for easy field replacement
- Heavy-Duty Double Bearing Wobble Plate Mechanism*: For extra long life
- Reverse The Blade: For cutting with no starting hole
- Constant Power Technology™ – maintains constant speed under load for unmatched cutting performance

Includes: (1) 360° Rotating Handle Orbital Super Sawzall® Recip Saw (6523-21); (1) Carrying Case

SPECIFICATIONS

Length	19"	Adjustable Handle	Yes
Weight	10.0 lbs	Keyless Adjustable Shoe	Yes
Voltage	120V AC	Keyless Blade Clamp	Yes
Tool Warranty	5 Years	Orbital Action	Yes
Cord Type	10' QUIK-LOK®	Stroke Length	1-1/4"
Amps	13	SPM	0-3,000
Construction Type	Double Insulated		
Dial Speed Control	Yes		

* Patented

ATTACHMENTS



48-76-5010: 10' Quik-Lok®



48-76-5025: 25' Quik-Lok®



6536-21 13A Orbital Super SAWZALL®



FEATURES



- 13 Amp Milwaukee Built Motor
- Orbital Cutting Action
- Variable Speed Trigger, 0-3000 SPM
- 1-1/4 in. Stroke
- QUIK-LOK™ Blade Clamp: Larger, heavy-duty, with new gripping ribs, provides fast and easy blade changes.
- Constant Power Technology™ – maintains constant speed under load for unmatched cutting performance
- 9-Position Orbit Selector*: Allows the user to set the degree of orbital versus straight reciprocating action.
- Counter Balanced*: For reduced vibration and smoother operation.
- Gear Protecting Clutch*: Unique gear clutch absorbs high impact forces caused by sudden blade lock-ups. Extends life of tool in extreme cutting applications.
- Heavy-Duty Double Bearing Wobble Plate Mechanism*: For extra long life.
- Reverse The Blade: For cutting with no starting hole
- Pivot Shoe*: For maximum support against work surface.

Includes: (1) 13 Amp Orbital Super Sawzall® Recip Saw (6536-21); (1) Carrying Case

SPECIFICATION

Length	18-3/4"
Weight	9.8 lbs
Voltage	120V AC
Tool Warranty	5 Years
Cord Type	8' Fixed
Clutch	Yes
Amps	13
Construction Type	Grounded
Adjustable Handle	No
Keyless Adjustable Shoe	Yes
Keyless Blade Clamp	Yes
Orbital Action	Yes
Stroke Length	1-1/4"
SPM	0-3,000

* Patented

6538-21 15A Super SAWZALL®



FEATURES



- 15.0 Amp Milwaukee Motor – highest overload protection in the industry; prevents motor burn up / failure
- Constant Power Technology™ – maintains constant speed under load for unmatched cutting performance
- Gear Protecting Clutch* – extends gear and motor life by absorbing high impact forces caused by sudden blade lock-ups
- Counter Balanced Mechanism* – smoothest running, lowest vibrating reciprocating saw in the industry
- Variable Speed Trigger and Dial Speed Control – maximum speed control
- Quik-Lok™ Blade Clamp System – provides fast and easy blade changes
- Reverse The Blade: For cutting with no starting hole
- Heavy-Duty Double Bearing Wobble Plate Mechanism*: For extra long life.

Includes: (1) 15.0 Amp Super Sawzall® Recip Saw (6538-21); (1) Carrying Case

SPECIFICATIONS

Length	18-3/4"
Weight	9.8 lbs
Voltage	120V AC
Tool Warranty	5 Years
Amps	15
Adjustable Handle	No
Keyless Adjustable Shoe	Yes
Keyless Blade Clamp	Yes
Orbital Action	Yes
Stroke Length	1-1/4"
SPM	0-2,800

* Patented

SAWZALL® BLADE SELECTION GUIDE

- Identify the material to be cut in the columns below
 - Follow the column down to find **BEST PERFORMANCE** or **ACCEPTABLE PERFORMANCE**
 - Follow the row to the left to identify the appropriate teeth per inch (TPI) or specialty blade
- Note: Fewer TPI cut faster but rougher, while more TPI cut smoother but slower

WOOD CUTTING	4/6 TPI	FASTER/ ROUGHER	WOOD WITH NAILS				CLEAN WOOD	
	5 TPI		WOOD WITH NAILS				CLEAN WOOD	TIMBER & GREEN WOOD
	6 TPI		WOOD WITH NAILS				CLEAN WOOD	TIMBER & GREEN WOOD
GENERAL PURPOSE	8 TPI		WOOD WITH NAILS	PVC & PLASTICS	ALUMINUM & OTHER NON-FERROUS METALS	THICK METAL (3/8" - 9/16")		
	8/12 TPI		WOOD WITH NAILS	PVC & PLASTICS	ALUMINUM & OTHER NON-FERROUS METALS	THICK METAL (3/8" - 9/16")		
METAL CUTTING	10 TPI			PVC & PLASTICS	ALUMINUM & OTHER NON-FERROUS METALS	THICK METAL (3/8" - 9/16")	MEDIUM METAL (1/4" - 7/16")	
	14 TPI				THICK METAL (3/8" - 9/16")	MEDIUM METAL (1/4" - 7/16")	THIN METAL (1/8" - 5/16")	
	18 TPI					MEDIUM METAL (1/4" - 7/16")	THIN METAL (1/8" - 5/16")	SHEET METAL (1/16" - 3/16")
	24 TPI						THIN METAL (1/8" - 5/16")	SHEET METAL (1/16" - 3/16")
								THIN METAL (1/8" - 5/16")
SPECIALTY	PRUNING						CLEAN WOOD	TIMBER & GREEN WOOD
	CLEAN WOOD						CLEAN WOOD	TIMBER & GREEN WOOD
	PLASTER	PLASTER/ DRYWALL						
	CARBIDE GRIT	PLASTER/ DRYWALL	TILE	FIBERGLASS	BRICK			
	DIAMOND GRIT	PLASTER/ DRYWALL	TILE	FIBERGLASS	BRICK	CAST IRON		

- Choose the Blade Length (Width of Material + 3" = Minimum Blade Length)

EXAMPLE



- Choose the Blade Profile



DEMO BLADES FOR TOUGH STRAIGHT CUTS:

MAXIMUM DURABILITY

- A thicker, more rigid blade body resists fracturing and bending.

STRAIGHTER CUTS

- The 1" tall blade body reduces blade twisting for straighter, more accurate cuts.



THIN KERF BLADES FOR FAST FLEXIBLE CUTS:

FASTER CUTS

- A thinner kerf and blade body allow for faster cutting through material.

FLEXIBLE CUTS

- The 3/4" tall blade body and thinner blade width allow for flexible cutting like flush or scroll cuts.

SAWZALL® BLADES



METAL CUTTING SAWZALL® BLADES

DOUBLE DUTY UPGRADE™
LONGEST LIFE OF ANY SAWZALL® BLADE EVER
STRONGEST SAWZALL® TONG FOR INCREASED DURABILITY
STIFFEST BOREYCHAM STRUCTURE FOR RIGIDITY



The Torch™ metal-cutting blades are designed to provide tough, straight cuts in all metal materials. Choose The Torch™ blades when you need straight cuts in pipe or tube, or when you need greater tooth durability in hollow materials like strut or conduit. The Torch™ blades are 1" tall and .042" thick.

Thin Kerf metal-cutting blades are designed to provide fast, flexible cuts in all metal materials. Choose Thin Kerf blades when you need flexibility for flush cuts or scroll cuts, or when you want faster cuts in solid materials like threaded rod or bar stock. Thin Kerf metal-cutting blades are 3/4" tall and .035" thick.

TPI	Length	Materials	THE TORCH™ TOUGH STRAIGHT CUTS					THIN KERF FAST FLEXIBLE CUTS				
			5 Packs	25 Packs	50 Packs	Bulk (25)	Bulk (100)	5 Packs	25 Packs	50 Packs	Bulk (25)	Bulk (100)
10	4"		-	-	-	-	-	48-00-5090	-	-	-	-
10	6"		48-00-5712	48-00-8712	-	48-01-2712	48-01-7712	48-00-5092	-	48-01-6092	-	48-01-7092
10	9"		48-00-5713	48-00-8713	-	48-01-2713	48-01-7713	-	-	-	-	-
10	12"		48-00-5714	-	-	48-01-2714	-	-	-	-	-	-
14	4"		-	-	-	-	-	48-00-5181	-	-	-	-
14	6"		48-00-5782	48-00-8782	-	48-01-2782	48-01-7782	48-00-5182	48-00-8182	48-01-6182	48-01-2182	48-01-7182
14	9"		48-00-5787	48-00-8787	-	48-01-2787	48-01-7787	48-00-5187	-	48-01-6187	48-01-2187	48-01-7187
14	12"		48-00-5794	-	-	48-01-2794	-	-	-	-	-	-
18	4"		-	-	-	-	-	48-00-5183	-	-	-	-
18	6"		48-00-5784	48-00-8784	-	48-01-2784	48-01-7784	48-00-5184	48-00-8184	48-01-6184	48-01-2184	48-01-7184
18	9"		48-00-5788	48-00-8788	-	48-01-2788	48-01-7788	48-00-5188	-	48-01-6188	48-01-2188	48-01-7188
18	12"		48-00-5789	48-00-8789	-	48-01-2789	48-01-7789	48-00-5189	-	48-01-6189	-	48-01-7189
24	4"		-	-	-	-	-	48-00-5185	-	-	-	-
24	6"		48-00-5786	-	-	-	-	48-00-5186	48-00-8186	48-01-6186	48-01-2186	48-01-7186
24	9"		48-00-5790	-	-	-	-	-	-	-	-	-
24	12"		48-00-5791	-	-	-	-	-	-	-	-	-

ice hardened
 Up to 50% Longer Life

Ice Hardened™ cryogenic treatment is available on both Thin Kerf and The Torch™ metal-cutting blades. Choose Ice Hardened™ blades when cutting thick or hard materials like angle iron, rebar and Schedule 80 pipe that cause excessive heat build up. In these extreme applications, Ice Hardened™ cryogenics will extend the wear life of the blade.

TPI	Length	Materials	THE TORCH™ TOUGH STRAIGHT CUTS					THIN KERF FAST FLEXIBLE CUTS				
			5 Packs	25 Packs	50 Packs	Bulk (25)	Bulk (100)	5 Packs	25 Packs	50 Packs	Bulk (25)	Bulk (100)
10	6"		48-00-4712	-	48-01-8712	-	48-01-9712	-	-	-	-	-
10	9"		48-00-4713	-	48-01-8713	-	48-01-9713	-	-	-	-	-
14	6"		48-00-4782	-	48-01-8782	-	48-01-9782	48-00-4182	-	48-01-8182	-	48-01-9182
14	9"		48-00-4787	-	48-01-8787	-	48-01-9787	48-00-4187	-	48-01-8187	-	48-01-9187
18	6"		48-00-4784	-	48-01-8784	-	48-01-9784	48-00-4184	-	48-01-8184	-	48-01-9184
18	9"		48-00-4788	-	48-01-8788	-	48-01-9788	48-00-4188	-	48-01-8188	-	48-01-9188
18	12"		-	-	-	-	-	48-00-4189	-	-	-	-
24	6"		-	-	-	-	-	48-00-4186	-	48-01-8186	-	48-01-9186

DUCTWORK
48-00-1630

IDEAL FOR INSTALLING TAKE-OFFS

DRYWALL ACCESS
48-00-1640

IDEAL FOR SERVICING PLUMBING AND ELECTRICAL



SAWZALL® BLADES

WOOD CUTTING SAWZALL® BLADES

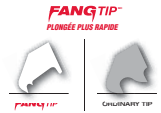

The Ax™ wood-cutting blades are designed to provide tough, straight cuts in nail-embedded wood and engineered lumber. Choose The Ax™ blades for straighter door and window cut-outs or for greater tooth durability when cutting a lot of nails. The Ax™ blades are 1" tall and .060" thick.

Thin Kerf wood-cutting blades are designed to provide fast, flexible cuts in nail-embedded wood and engineered lumber. Choose Thin Kerf blades for flush cuts and scroll cuts or for slightly faster cutting in dimensional lumber, plywood and OSB. Thin Kerf wood-cutting blades are 3/4" tall and .050" thick.

TPI	Length	Materials	THE AX™ TOUGH STRAIGHT CUTS				THIN KERF FAST FLEXIBLE CUTS				
			5 Packs	25 Packs	Bulk (25)	Bulk (100)	5 Packs	25 Packs	50 Packs	Bulk (25)	Bulk (100)
5	6"		48-00-5021	48-00-8021	48-01-2021	48-01-7021	48-00-5035	—	48-01-6035	48-01-2035	48-01-7035
5	9"		48-00-5026	48-00-8026	48-01-2026	48-01-7026	48-00-5036	48-00-8036	48-01-6036	48-01-2036	48-01-7036
5	12"		48-00-5027	48-00-8027	48-01-2027	48-01-7027	48-00-5037	—	48-01-6037	48-01-2037	48-01-7037

ROUGH-IN
48-00-1610

IDEAL FOR TIGHT RADIUS CUTS

FLUSH CUT
48-00-1600

IDEAL FOR DOOR CUT-OUTS

GENERAL PURPOSE SAWZALL® BLADES

Both Thin Kerf and The Wrecker™ general purpose blades are designed to handle the broadest spectrum of applications. Choose general purpose blades when cutting wood, plastic and metal at the same time or when you need to quickly switch between applications without changing your blade.

WRECKER™

TACKLE ANYTHING



The Wrecker™ general purpose blades are designed for true demolition work. Choose The Wrecker™ blades when you need tough cuts in nail-embedded wood, plaster and ferrous and non-ferrous metals. The Wrecker™ blades are 1" tall and .060" thick.



Thin Kerf general purpose blades are designed to provide fast, flexible cuts in woods, plastics and metals. Thin Kerf general purpose blades are 3/4" tall and .050" thick.

TPI	Length	Materials	THE WRECKER™ TOUGH STRAIGHT CUTS				THIN KERF FAST FLEXIBLE CUTS				
			5 Packs	25 Packs	Bulk (25)	Bulk (100)	5 Packs	25 Packs	50 Packs	Bulk (25)	Bulk (100)
8	6"		48-00-5701	48-00-8701	48-01-2701	48-01-7701	—	—	—	—	—
8	9"		48-00-5706	48-00-8706	48-01-2706	48-01-7706	—	—	—	—	—
8	12"		48-00-5711	48-00-8711	48-01-2711	48-01-7711	—	—	—	—	—
8/12	6"		—	—	—	—	48-00-5091	—	48-01-6091	—	48-01-7091
8/12	8"		—	—	—	—	48-00-5093	48-00-8093	48-01-6093	48-01-2093	48-01-7093
8/12	12"		—	—	—	—	48-00-5094	—	48-01-6094	48-01-2094	—













The same Ice Hardened™ cryogenic treatment that is available in metal cutting blades is also available in general purpose blades.

TPI	Length	Materials	THE WRECKER™ TOUGH STRAIGHT CUTS				THIN KERF FAST FLEXIBLE CUTS				
			5 Packs	25 Packs	Bulk (25)	Bulk (100)	5 Packs	25 Packs	50 Packs	Bulk (25)	Bulk (100)
8/12	6"		—	—	—	—	48-00-4091	—	48-01-8091	—	48-01-9091
8/12	8"		—	—	—	—	48-00-4093	—	48-01-8093	—	48-01-9093

SAWZALL® BLADES



SPECIALTY SAWZALL® BLADES

Description	TPI	Length	Height	Width	1 Pack	3 Pack	5 Pack	50 Pack	Bulk (100)
 DUCTWORK	30	3.33"	0.75"	0.050"	—	—	48-00-1630	—	—
 DRYWALL ACCESS	—	2.5"	0.75"	0.062"	48-00-1640	—	—	—	—
 FLUSH CUT	5	12"	2-1/8"	0.062"	48-00-1600	—	—	—	—
 ROUGH-IN	5	7-3/8"	1/2"	0.062"	—	—	48-00-1610	—	—
 THE TORCH™ DIAMOND GRIT	GRIT	6"	1"	0.042"	48-00-1440	—	—	—	—
	GRIT	9"	1"	0.042"	48-00-1450	—	—	—	—
 CARBIDE GRIT	GRIT	6"	3/4"	0.032"	48-00-1421	48-00-1420	—	48-01-6420	—
	GRIT	9"	3/4"	0.032"	48-00-1431	48-00-1430	—	48-01-6430	—
 PRUNING	5	9"	3/4"	0.049"	48-00-1304	—	48-00-1301	—	—
	5	12"	3/4"	0.049"	48-00-1305	—	48-00-1303	—	—
 CLEAN WOOD	6	6"	3/4"	0.050"	—	—	48-00-5015	—	48-01-7015
	6	9"	3/4"	0.050"	—	—	48-00-5016	—	48-01-7016
	6	12"	3/4"	0.050"	—	—	48-00-5017	—	—
 PLASTER	6	5"	3/4"	0.050"	—	—	48-00-5052	—	—
 METAL SCROLLING	10	3-5/8"	5/16"	0.035"	—	—	48-00-5161	—	—
	14	3-5/8"	5/16"	0.035"	—	—	48-00-5162	—	—
	18	3-5/8"	5/16"	0.035"	—	—	48-00-5163	—	—
 WOOD SCROLLING	4/6	6"	1/2"	0.050"	—	—	48-00-5041	—	—

DIAMOND GRIT THE TORCH™
48-00-1440 and 48-00-1450



IDEAL FOR CAST IRON

SCRAPER BLADES
49-00-5455, 49-00-5456 and 49-00-5463



IDEAL FOR MATERIAL REMOVAL

SAWZALL® / HACKZALL™ UTILITY BLADES

	Description	1 Pack		Description	1 Pack		Description	1 Pack	Bulk (5)		Description	1 Pack	Bulk (5)
	GROUT REMOVAL TOOL	49-00-5450		5" SCRAPER BLADE	49-00-5455		3" SCRAPER BLADE	49-00-5456	49-01-5456		1-1/2" SCRAPER BLADE	49-00-5463	49-01-5463

SAWZALL® BLADE SETS



Product No.	49-22-5403	49-22-0240	49-22-1145	49-22-0220
Description	3 PC MATERIAL REMOVAL SET	8 PC THIN KERF SAWZALL® BLADE SET	9 PC THIN KERF SAWZALL® BLADE SET	10 PC M12™ HACKZALL™ BLADE SET
Contents	(1) 1-1/2" scraper blade (1) 3" scraper blade (1) grout removal tool	(2) 6" 5TPI Thin Kerf wood blades (2) 9" 5TPI Thin Kerf wood blades (2) 6" 14TPI Thin Kerf Ice Hardened™ metal blades (2) 6" 18TPI Thin Kerf Ice Hardened™ metal blades	(3) 6" 24TPI Thin Kerf metal blades (3) 6" 14TPI Thin Kerf metal blades (2) 6" 5TPI Thin Kerf wood blades (1) 9" 5TPI Thin Kerf wood blade	(2) wood blades (3) EMT blades (2) duct blades (3) PVC blades



SAWZALL® BLADES CROSS REFERENCE

SAWZALL® BLADES CROSS REFERENCE CHART

CATEGORY	TPI	LENGTH	QTY	LENOX	DeWALT	MORSE	BOSCH	IRWIN	GREENLEE	STARRETT	MILWAUKEE	
WOOD STANDARD	3	6	2							BT63-2		
	3	6	5		DW4801					BT63-5		
	3	12	2							BT123-2		
	3	12	5							BT123-5		
	4	6	1		20574							
	4	6	5		20575							
	6	6	1						372645F			
	6	6	5					RW66				48-00-5015
	6	6	25					RW66-25B				
	6	6	100									48-01-7015
	6	9	5					RW96				48-00-5016
	6	9	25					RW96-25B				
	6	9	100									48-01-7016
	6	12	5					RW126				48-00-5017
	6	12	25					RW126-25B				
	6/10	8	5					RPRW8				
	6/10	8	25					RPRW8-25B RPRW8-25P				
	Progressive	8	5							353-234		
	5.5	6	5				RBMC65005T05					
	5.5	6	25				RBMC65005T25					
	5.5	9	5				RBMC95005T05					
	5.5	9	25				RBMC95005T25					
	5.5	12	5				RBMC125005T05					
	5.5	12	25				RBMC125005T25					
	6	6	1		20559				372606			
	6	6	2				RB65006CC2				B66-2	
	6	6	2				RB606STC2					
	6	6	2						372606P2			
	6	6	5		20560		RB606STT05				B66-5	
	6	6	5				RB63506T05	RN66				
	6	6	5						372606P5			
	6	6	15				RB63506T15					
	6	6	20								B66-20	
	6	6	25		20492		RB63506T25	RN66-25B	372606B			
	6	6	50				RB606STT50				B66-50	
	6	6	50				RB63506T50					
	6	6	1		20573				372656			
	6	6	2			DW4802-2	RB65006C2		372656P2		BT66-2	
	6	6	5			DW4816						
	6	6	5			DW4850				353-646		48-00-5012
	6	6	5		20572	DW4802	RB65006T05		372656P5	353-656	BT66-5	48-00-5035 (5TPI)
	6	6	10			DW4802-10						
	6	6	15				RB65006T15					
	6	6	25		20530	DW4802B25	RB65006T25		372656B			48-01-2035 (5TPI)
	6	6	50		22750		RB65006T50		372656BB			48-01-6035 (5TPI)
	6	6	100			DW4802B						48-01-7035 (5TPI)
	6	6	1		20557							
	6	6	5		20556		RB65006CT05					
	6	6	50				RB65006CT50					
	6	6	5		21060							
6	6	5		21063								
6	6	25		21074								
6	6	25		21077								
6	9	5				RB93506T05	RN96					
6	9	25					RN96-25B					
6	9	50				RB93506T50						
6	9	1		20587				372956				
6	9	2				RB95006C2		372956P2				
6	9	5							353-956			
6	9	5		20582	DW4803	RB95006T05		372956P5		BT96-5	48-00-5036 (5TPI)	
6	9	15				RB95006T15						
6	9	25		20558	DW4803B25	RB95006T25		372956B			48-00-8036 (5TPI) 48-01-2036 (5TPI)	
6	9	50		22752		RB95006T50		372956BB			48-01-6036 (5TPI)	
6	9	100			DW4803B						48-01-7036 (5TPI)	
6	9	5		21062								

SAWZALL® BLADES CROSS REFERENCE



CATEGORY	TPI	LENGTH	QTY	LENOX	DeWALT	MORSE	BOSCH	IRWIN	GREENLEE	STARRETT	MILWAUKEE
WOOD STANDARD	6	9	25	21076							
	6	12	5			RB123506T05	RN126				
	6	12	25				RN126-25B				
	6	12	50			RB123506T50					
	6	12	1	20586				372156			
	6	12	2		DW4804-2	RB125006C		372156P2		BT126-2	
	6	12	5	20585	DW4804	RB125006T05		372156P5	353-156	BT126-5	48-00-5037 (5TPI)
	6	12	15			RB125006T15					
	6	12	25	20495	DW4804B25	RB125006T25		372156B			48-01-2037 (5TPI)
	6	12	50	22755		RB125006T50		372156BB			48-01-6037 (5TPI)
	6	12	100		DW4804B						48-01-7037 (5TPI)
	6	12	5	21061							
	6	12	25	21075							
	2/3	12	5			RB125023T05					
	2/3	12	50			RB125023T50					
	4/6	6	5								48-00-5041
	5/8	6	5				RB658T05				
	5/8	6	50				RB658T50				
	5/8	6	2		DW4847-2	RB65058C2					
	5/8	6	5		DW4847	RB65058T05		RSN6V			
	5/8	6	25		DW4847B25			RSN6V-25B RSN6V-25P			
	5/8	6	50				RB65058T50				
	5/8	6	100								
	5/8	9	5		DW4848			RSN9V			
	5/8	9	25					RSN9V-25B RSN9V-25P			
	5/8	12	5				RB125058STT05				
	5/8	12	50				RB125058STT50				
	5/8	12	5		DW4849	RB125058T05					
	5/8	12	50			RB125058T50					
	6/10	6	2								BT6610-2
	6/10	6	5								BT6610-5
	6/10	12	2								BT12610-2
	6/10	12	5								BT12610-5
6/12	6	5					RPRAP6				
6/12	6	10					RPRAP6-10B				
6/12	6	25					RPRAP6-25B RPRAP6-25P				
6/12	8	5					RPRAP8				
6/12	9	10					RPRAP8-10B				
6/12	9	25					RPRAP8-25B RPRAP8-25P				
WOOD DEMOLITION	6	6	5		DW4862						
	6	6	1			RB66206C		372666			
	6	6	2	20512							
	6	6	3			RB66206T03					
	6	6	5	20370			RHN66	372666P5			
	6	6	10				RHN66-10B				
	6	6	20			RB66206T20					
	6	6	25	20514			RHN66-25B RHN66-25P				
	6	6	50	22763				372666BB			
	6	6	5	21088							
	6	6	25	21220							
	6	9	5		DW4863						
	6	9	25		DW4863B25						
	6	9	100		DW4863B						
	6	9	1			RB96206C		372966			
	6	9	2	20598					353-966		
	6	9	3			RB96206T03					
	6	9	5	20371			RHN96	372966P5			
	6	9	20			RB96206T20					
	6	9	25	20523			RHN96-25B RHN96-25P				
	6	9	50					372966BB			
	6	9	5	21090							
	6	9	25	21222							
	6	12	5		DW4860						
	6	12	20			RB126206T20					
	6	12	1			RB126206C					



SAWZALL® BLADES CROSS REFERENCE

CATEGORY	TPI	LENGTH	QTY	LENOX	DeWALT	MORSE	BOSCH	IRWIN	GREENLEE	STARRETT	MILWAUKEE
WOOD DEMOLITION	6	12	2	20500							
	6	12	3			RB126206T03					
	6	12	5	20373			RHN126				
	6	12	25	20485			RHN126-25B RHN126-25P				
	6	12	5	21091							
	6	12	25	21223							
	5/8	6	5				RDN6V				48-00-5021 (5TPI)
	5/8	6	25				RDN6V-25B RDN6V-25P				48-00-8021 (5TPI) 48-01-2021 (5TPI)
	5/8	6	100								48-01-7021 (5TPI)
	5/8	9	5				RDN9V				48-00-5026 (5TPI)
	5/8	9	25				RDN9V-25B RDN9V-25P				48-00-8026 (5TPI) 48-01-2026 (5TPI)
	5/8	9	100								48-01-7026 (5TPI)
	5/8	12	5				RDN12V				48-00-5027 (5TPI)
	5/8	12	25				RDN12V-25B RDN12V-25P				48-00-8027 (5TPI) 48-01-2027 (5TPI)
	5/8	12	100								48-01-7027 (5TPI)
	6/10	6	2							BTR6610-2	
	6/10	6	5							BTR6610-5	
	6/10	6	20							BTR6610-20	
	6/10	6	50							BTR6610-50	
	6/10	8	2							BTR8610-2	
	6/10	8	5							BTR8610-5	
	6/10	8	20							BTR8610-20	
	6/10	8	50							BTR8610-50	
	6/10	9	2							BTR9610-2	
	6/10	9	5							BTR9610-5	
	6/10	9	20							BTR9610-20	
	6/10	9	50							BTR9610-50	
	6/10	12	2							BTR12610-2	
	6/10	12	5							BTR12610-5	
	6/10	12	20							BTR12610-20	
6/10	12	50							BTR12610-50		
GENERAL PURPOSE STANDARD	10	4	5								48-00-5090
	10	6	1	20561				372610			
	10	6	2			RB610C2		372610P2		B610-2	
	10	6	5	20562		RB610T05 RBMC610T05	RAP610	372610P5		B610-5	48-00-5092
	10	6	20							B610-20	
	10	6	25	20493		RB610T25 RBMC610T25	RAP610-25B	372610B			
	10	6	50	22761		RB610T50		372610BB		B610-50	48-01-6092
	10	6	100								48-01-7092
	10	6	5	21064							
	10	6	25	21078							
	10	6	2		DW4806-2						
	10	6	5		DW4806	RB65010T05					
	10	6	25		DW4806B25						
	10	6	50			RB65010T50					
	10	6	100		DW4806B						
	10	8	5			RB810T05 RBMC810T05	RAP810				
	10	8	25			RB810T25 RBMC810T25	RAP810-25B				
	10	8	50			RB810T50					
	10	8	1	20581				372810			
	10	8	2					372810P2			
	10	8	5	20580				372810P5			
	10	8	25	20590				372810B			
	10	8	50	22753				372810BB			
	10	8	5	21065							
	10	8	25	21079							
	10	9	5					RAP910			
	10	9	25					RAP910-25B			
	10	9	2							BT910-2	
	10	9	5							BT910-5	
	10	10	5			RB1010T05					
10	10	50			RB1010T50						
10	12	5			RB1210T05	RAP1210					

SAWZALL® BLADES CROSS REFERENCE



CATEGORY	TPI	LENGTH	QTY	LENOX	DeWALT	MORSE	BOSCH	IRWIN	GREENLEE	STARRETT	MILWAUKEE	
GENERAL PURPOSE STANDARD	10	12	25				RAP1210-25B					
	10	12	50			RB1210T50						
	10	12	50	22758								
	10	3-5/8	5								48-00-5161	
	8/12	6	5								48-00-4091	
	8/12	6	50								48-01-8091	
	8/12	6	100								48-01-9091	
	8/12	6	5								48-00-5091	
	8/12	6	50								48-01-6091	
	8/12	6	100								48-01-7091	
	8/12	8	5								48-00-4093	
	8/12	8	5			RB850812T05					48-00-5093	
	8/12	8	25								48-01-2093	
	8/12	8	50			RB850812T50					48-01-6093	
	8/12	8	100								48-01-7093	
	8/12	8	50								48-01-8093	
	8/12	8	100								48-01-9093	
	8/12	8	500								48-01-6000	
	8/12	12	50				RB1250812T50					
	8/12	12	5				RB1250812T05				48-00-5094	
	8/12	12	25								48-01-2094	
	8/12	12	50								48-01-6094	
	8/14	6	5					RPRM6				
	8/14	6	25					RPRM6-25B RPRM6-25P				
	9/12	10	5					RFM10V				
	9/12	10	25					RFM10V-25B				
	9/12	10	25					RFM10V-25P				
	10/14	4	5				RB41014T05					
	10/14	4	50				RB41014T50					
	10/14	6	2				RB61014C2				BR61014-2	
	10/14	6	5	12112			RB61014T05	RAP6V			BR61014-5	
	10/14	6	20								BR61014-20	
	10/14	6	25					RAP6V-25B				
	10/14	6	50				RB61014T50				BR61014-50	
	10/14	6	2	20592			RB6501014C2					
	10/14	6	5	20374			RB6501014T05 RB6501014TT05	RRD6V				
	10/14	6	25	20515				RRD6V-25P				
	10/14	6	50				RB6501014T50 RB6501014TT50					
	10/14	8	2				RB81014C2					
	10/14	8	5	12130			RB81014T05					
	10/14	8	15				RB81014T15					
	10/14	8	25				RB81014T25					
	10/14	8	50				RB81014T50					
	10/14	8	5									48-00-5193
	10/14	8	1	20588						353-804		
	10/14	8	2				RB8501014C2				BR81014-2	
	10/14	8	5	20577			RB8501014T05				BR81014-5	
	10/14	8	20								BR81014-20	
	10/14	8	25	20535								
	10/14	8	50				RB8501014T50				BR81014-50	
	10/14	9	5					RAP9V				
	10/14	9	25					RAP9V-25B				
	10/14	9	2								BR91014-2	
	10/14	9	5			DW4846		RD9V			BR91014-5	
	10/14	9	20								BR91014-20	
	10/14	9	25			DW4846B25		RRD9V-25P				
	10/14	9	100			DW4846B						
10/14	9	25					RD9V-25B RD9V-25P					
10/14	9	50								BR91014-50		
10/14	12	1				RB121014C						
10/14	12	5				RB121014T05	RAP12V					
10/14	12	25			DW4839B25		RAP12V-25B					
10/14	12	50				RB121014T50						
10/14	12	100			DW4839B							
10/14	12	5									48-00-5194	
10/14	12	1		20584				372110				



SAWZALL® BLADES CROSS REFERENCE

CATEGORY	TPI	LENGTH	QTY	LENOX	DeWALT	MORSE	BOSCH	IRWIN	GREENLEE	STARRETT	MILWAUKEE
GENERAL PURPOSE DEMOLITION	10/14	12	2			RB12501014C		372110P2		BR121014-2	
	10/14	12	5	20583		RB12501014STT05 RB12501014T05	RRD12V	372110P5		BR121014-5	
	10/14	12	20							BR121014-20	
	10/14	12	25	20491	DW4839B25	RB12501014T25	RRD12V-25P	372110B			
	10/14	12	25				RD12V-25B RD12V-25P				
	10/14	12	50			RB12501014STT50 RB12501014T50		372110BB		BR121014-50	
	10/14	12	100		DW4839B						
Progressive	8	1							353-345		
GENERAL PURPOSE DEMOLITION	8	6	2	24900							
	8	6	5	20192							
	8	6	25	20196							
	8	6	5	21092							
	8	6	25	21224							
	8	6	5								48-00-5701
	8	6	25								48-00-8701
	8	6	100								48-01-2701
	8	9	2	24904							48-01-7701
	8	9	5	20193							
	8	9	25	20195							
	8	9	5	21096							
	8	9	25	21228							
	8	9	5								48-00-5706
	8	9	25								48-00-8706
	8	9	100								48-01-2706
	8	9	25								48-01-7706
	8	12	2	24908							
	8	12	5	20194							
	8	12	25	20197							
	8	12	5								
	8	12	25								48-00-5711
	8	12	100								48-00-8711
	10	4	5			DW4861					48-01-2711
	10	9	5				RBMC95010T05				48-01-7711
	10	9	25				RBMC95010T25				
	10	9	2	20597							
	10	9	5	20372							
	10	9	25	20524							
	10	9	50	22762							
	10	9	1						372960		
	10	9	5						372960P5		
	10	9	50						372960BB		
	10	9	5	21089							
	10	9	25	21221							
	10	12	25				RBMC125010T25				
	8/10	6	5					RSM62			
	8/10	6	25					RSM62-25B RSM62-25P			
	8/10	6	5					RDM62			
	8/10	6	25					RDM62-25P			
	8/10	7	5					RSM72			
	8/10	7	25					RSM72-25B RSM72-25P			
8/10	9	5					RSM92				
8/10	9	25					RSM92-25B RSM92-25P				
8/10	9	5					RDM92				
8/10	9	25					RDM92-25P				
8/10	9	2							353-969		
8/10	12	5					RSM122				
8/10	12	25					RSM122-25B RSM122-25P				
10/14	6	2								BTR61014-2	
10/14	6	5								BTR61014-5	
10/14	6	20								BTR61014-20	
10/14	6	50								BTR61014-50	

SAWZALL® BLADES CROSS REFERENCE



CATEGORY	TPI	LENGTH	QTY	LENOX	DeWALT	MORSE	BOSCH	IRWIN	GREENLEE	STARRETT	MILWAUKEE	
	10/14	8	2							BTR81014-2		
	10/14	8	5							BTR81014-5		
	10/14	8	20							BTR81014-20		
	10/14	8	50							BTR81014-50		
	10/14	9	2							BTR91014-2		
	10/14	9	5							BTR91014-5		
	10/14	9	20							BTR91014-20		
	10/14	9	50							BTR91014-50		
	10/14	12	2							BT121014-2		
										BTR121014-2		
	10/14	12	5							BT121014-5		
										BTR121014-5		
	10/14	12	20							BTR121014-20		
	10/14	12	50							BTR121014-50		
METAL STANDARD	14	4	1	20551								
	14	4	2			RB414C2		372414P2		B414-2		
	14	4	5	20550	DW4807	RB414T05		372414P5		B414-5	48-00-5181	
	14	4	20							B414-20		
	14	4	25	20488	DW4807B25							
	14	4	50	22760		RB414T50				B414-50		
	14	4	100		DW4807B							
	14	4	2							SB414-2		
	14	4	5							SB414-5		
	14	4	20							SB414-20		
	14	6	1	20565					372614			
	14	6	2		DW4808-2	RB614C2			372614P2		B614-2	
	14	6	5	20564	DW4808	RB614T05 RBM614T05		RM614	372614P5	353-614	B614-5	48-00-5182
	14	6	15				RB614T15					
	14	6	20								B614-20	
	14	6	25	20494	DW4808B25	RB614T25 RBM614T25		RM614-25B	372614B			48-00-8182 48-01-2182
	14	6	50	22756		RB614T50			372614BB		B614-50	48-01-6182
	14	6	100		DW4808B							48-01-7182
	14	6	5				RB65014T05					
	14	6	50				RB65014T50					
	14	8	2				RB814C2					
	14	8	5	21519	DW4809	RB814T05 RBM814T05						
	14	8	25		DW4809B25	RB814T25 RBM814T25						
	14	8	50			RB814T50						
	14	8	100		DW4809B							
	14	8	2							353-814		
	14	9	5				RB914T05	RM914				48-00-5187
	14	9	25					RM914-B25				48-01-2187
	14	9	50				RB914T50					48-01-6187
	14	9	100									48-01-7187
	14	9	2	20511								
	14	12	5		DW4838	RB1214T05						
	14	12	50			RB1214T50						
	14	3-5/8	5	20520	DW4814							48-00-5162
	18	4	1	20553								
	18	4	2		DW4810-2	RB418C2			372418P2		B418-2	
	18	4	5	20552	DW4810	RB418T05			372418P5	353-418	B418-5	48-00-5183
	18	4	20								B418-20	
	18	4	25	20489	DW4810B25							
	18	4	50	22759			RB418T50				B418-50	
	18	6	1	20567					372618			
	18	6	2		DW4811-2	RB618C2			372618P2		B618-2	
18	6	5	20566	DW4811	RB618T05 RBM618T05		RM618	372618P5	353-618	BR618-5 B618-5	48-00-5184	
18	6	10		DW4811-10			RM618-10B					
18	6	15				RB618T15						
18	6	20								BR618-20 B618-20		
18	6	25	20529	DW4811B25	RB618T25 RBM618T25		RM618-25B	372618B			48-00-8184 48-01-2184	



SAWZALL® BLADES CROSS REFERENCE

CATEGORY	TPI	LENGTH	QTY	LENOX	DeWALT	MORSE	BOSCH	IRWIN	GREENLEE	STARRETT	MILWAUKEE	
METAL STANDARD	18	6	50	22751		RB618T50		372618BB		B618-50 BR618-50	48-01-6184	
	18	6	100		DW4811B						48-01-7184	
	18	6	5			RB65018T05						
	18	6	50			RB65018T50						
	18	8	1	20563				372818				
	18	8	2					372818P2		BR818-2 B818-2		
	18	8	5	20578	DW4821	RB818T05 RBMC818T05		372818P5		B818-5 BR818-5		
	18	8	20							B818-20 BR818-20		
	18	8	25	20487	DW4821B25	RB818T25 RBMC818T25		372818B				
	18	8	50	22754		RB818T50		372818BB		B818-50 BR818-50		
	18	8	100		DW4821B							
	18	8	2						353-818			
	18	9	5			RB918T05		RM918			48-00-5188	
	18	9	25					RM918-25B			48-01-2188	
	18	9	50			RB918T50					48-01-6188	
	18	9	100								48-01-7188	
	18	10	5			RB1018T05						
	18	10	50			RB1018T50						
	18	12	5	21510		RB1218T05 RBMC1218T05		RM1218	372118P5			48-00-5189
	18	12	25	21511	DW4822B25	RB1218T25 RBMC1218T25		RM1218-25B				
	18	12	50			RB1218T50					48-01-6189	
	18	12	100								48-01-7189	
	18	3-5/8	1	20522								
	18	3-5/8	2			RB318SC2						
	18	3-5/8	5	20521	DW4815	RB318ST05		RSM418		353-318		48-00-5163
	18	3-5/8	50			RB318ST50						
	24	4	1	20555								
	24	4	2			RB424C2			372424P2		B424-2	
	24	4	5	20554	DW4812	RB424T05			372424P5		B424-5	48-00-5185
	24	4	20								B424-20	
	24	4	25	20490	DW4812B25							
	24	4	50			RB424T50					B424-50	
	24	6	1	20569					372624			
	24	6	2		DW4813-2	RB624C2			372624P2		B624-2	
	24	6	5	20568	DW4813	RB624T05 RBMC624T05		RM624	372624P5	353-624	B624-5	48-00-5186
	24	6	10					RM624-10B				
	24	6	15			RB624T15						
	24	6	20								B624-20	
	24	6	25	20496	DW4813B25	RB624T25 RBMC624T25		RM624-25B	372624B			48-00-8186 48-01-2186
	24	6	50	22757		RB624T50			372624BB			48-01-6186
	24	6	100		DW4813B							48-01-7186
	24	8	5	20579								
	24	9	5					RM924				
	24	9	25					RM924-25B				
	24	3-5/8	2								SB424-2	
24	3-5/8	5								SB424-5		
24	3-5/8	20								SB424-20		
Progressive	6	5							353-123			
	6	2	24901									
10	6	5	20170			RBMC64210T05					48-00-5712	
10	6	25	20171			RBMC64210T25					48-00-8712 48-01-2712	
10	6	100									48-01-7712	
10	6	5			DW4864							
10	6	25			DW4864B25							
10	6	100			DW4864B							
10	6	20				RB66210T20						

SAWZALL® BLADES CROSS REFERENCE



CATEGORY	TPI	LENGTH	QTY	LENOX	DeWALT	MORSE	BOSCH	IRWIN	GREENLEE	STARRETT	MILWAUKEE	
METAL DEMOLITION	10	6	3			RB66210T03 RBFR66210WT03						
	10	6	5			RB66210C RBFR66210WC						
	10	6	20			RBFR66210WT20						
	10	9	2	24905								
	10	9	5	20176		RBMC94210T05					48-00-5713	
	10	9	25	20177		RBMC94210T25					48-00-8713 48-01-2713	
	10	9	100								48-01-7713	
	10	9	5			DW4865						
	10	9	25			DW4865B25						
	10	9	100			DW4865B						
	10	9	20				RB96210T20					
	10	9	1				RB96210C RBFR96210WC					
	10	9	3				RB96210T03 RBFR96210WT03					
	10	9	20				RBFR96210WT20					
	10	12	2	24909								
	10	12	5	20182			RBMC124210T05					48-00-5714
	10	12	25	20183			RBMC124210T25					48-01-2714
	10	12	5			DW4870	RBMC125010T05					
	10	12	20				RB126210T20 RBFR126210WC					
	10	12	1				RB126210C					
	10	12	3				RB126210T03 RBFR126210WT03					
	10	12	20				RBFR126210WT20					
	14	6	2	24902								
	14	6	5	20172			RBMC64214T05					48-00-5782
	14	6	25	20173			RBMC64214T25					48-00-8782 48-01-2782
	14	6	100									48-01-7782
	14	6	50	22764								
	14	6	5			DW4866						
	14	6	100			DW4866B						
	14	6	3				RBFR66214WT03					
	14	6	5				RBFR66214WC					
	14	6	20				RBFR66214WT20					
	14	9	2	24906								
	14	9	5	20178			RBMC94214T05					48-00-5787
	14	9	25	20179			RBMC94214T25					48-00-8787 48-01-2787
	14	9	100									48-01-7787
	14	9	50	22766								
	14	9	5			DW4868						
	14	9	25			DW4868B25						
	14	9	100			DW4868B						
	14	9	5				RBMC95014T05					
	14	9	25				RBMC95014T25					
	14	9	1				RBFR96214WC					
	14	9	3				RBFR96214WT03					
	14	9	20				RBFR96214WT20					
	14	12	2	24910								
	14	12	5	20184			RBMC124214T05					
	14	12	25	20185			RBMC124214T25					
14	12	5				RBMC125014T05					48-01-2794	
14	12	25				RBMC125014T25						
14	12	1				RBFR126214WC						
14	12	3				RBFR126214WT03						
14	12	25				RBMC124214T05					48-00-5794	
18	6	2	24903									
18	6	5	20174			RBMC64218T05					48-00-5784	
18	6	25	20175			RBMC64218T25					48-00-8784 48-01-2784	
18	6	50	22765									
18	6	100									48-01-7784	
18	6	5			DW4867							
18	9	2	24907									



SAWZALL® BLADES CROSS REFERENCE

CATEGORY	TPI	LENGTH	QTY	LENOX	DeWALT	MORSE	BOSCH	IRWIN	GREENLEE	STARRETT	MILWAUKEE
	18	9	5	20180		RBMC94218T05					48-00-5788
	18	9	25	20181		RBMC94218T25					48-00-8788 48-01-2788
	18	9	100								48-01-7788
	18	9	50	22767							
	18	9	5		DW4869	RBMC95018T05					
	18	9	25			RBMC95018T25					
	18	12	2	24911							
	18	12	5	20190		RBMC124218T05					48-00-5789
	18	12	25	20191		RBMC124218T25					48-00-8789 48-01-2789
	18	12	100								48-01-7789
	18	12	5		DW4871	RBMC125018T05					
	18	12	25			RBMC125018T25					
	24	6	5			RBMC64224T05					48-00-5786
	24	6	25			RBMC64224T25					
	24	9	5								48-00-5790
	24	12	5								48-00-5791
	14/18	6	5				RCTM62				
	14/18	6	10				RCTM62-10B				
	14/18	6	25				RCTM62-25B RCTM62-25P				
	14/18	6	5				RCM62				
	14/18	6	25				RCM62-25B RCM62-25P				
	14/18	9	5				RCM92				
	14/18	9	25				RCM92-25B RCM92-25P				
	14/18	12	5				RCM122				
	14/18	12	25				RCM122-25B RCM122-25P				
	10	6	5	21093							48-00-4712
	10	6	25	21225							
	10	6	50								48-01-8712
	10	6	100								48-01-9712
	10	9	5	21097							48-00-4713
	10	9	25	21229							
	10	9	50								48-01-8713
	10	9	100								48-01-9713
	10	12	5	21100							
	10	12	25	21237							
	14	6	5	21094							48-00-4782
	14	6	25	21226							
	14	6	50								48-01-8782
	14	6	100								48-01-9782
	14	9	5	21098							48-00-4787
	14	9	25	21235							
	14	9	50								48-01-8787
	14	9	100								48-01-9787
	14	12	5	21101							
	14	12	25	21238							
	18	6	5	21095							48-00-4784
	18	6	25	21227							
	18	6	50								48-01-8784
	18	6	100								48-01-9784
	18	9	5	21099							48-00-4788
	18	9	25	21236							
	18	9	50								48-01-8788
	18	9	100								48-01-9788
	18	12	5	21102							
	18	12	25	21239							
	14	4	5	21066							
	14	4	25	21080							
	14	6	5	21067							48-00-4182
	14	6	25	21081							
	14	6	50								48-01-8182
	14	6	100								48-01-9182
	14	9	5								48-00-4187
	14	9	50								48-01-8187
	14	9	100								48-01-9187
	18	4	5	21068							
	18	4	25	21082							

METAL DEMOLITION

SAWZALL® BLADES CROSS REFERENCE



CATEGORY	TPI	LENGTH	QTY	LENOX	DeWALT	MORSE	BOSCH	IRWIN	GREENLEE	STARRETT	MILWAUKEE
	18	6	5	21069							48-00-4184
	18	6	25	21083							
	18	6	50								48-01-8184
	18	6	100								48-01-9184
	18	8	5	21070							
	18	8	25	21084							
	18	9	5								48-00-4188
	18	9	50								48-01-8188
	18	9	100								48-01-9188
	18	12	5								48-00-4189
	24	4	5	21071							
	24	4	25	21085							
	24	6	5	21072							48-00-4186
	24	6	25	21086							
	24	6	50								48-01-8186
	24	6	100								48-01-9186
	24	8	5	21073							
	24	9	25	21087							
SPECIALTY	-	2-1/2"	1								48-00-1640
	5	7-3/8"	5								48-00-1610
	5	9	1								48-00-1304
	5	9	5			RC905T05	RP95				48-00-1301
	5	9	25			RC905T25	RP95-25B				
	5	12	1								48-00-1305
	5	12	5					RP125			48-00-1303
	5	12	25					RP125-25B			
	5	12	1								48-00-1600
	4/5	9	1						372945F		
	3	8	1	20599					372803C		
	3	9	2					RCFP93-2			
	3	12	2					RCFP123-2			
	6	4	5	20449							
	6	5	5								48-00-5052
	6	6	2				RB606PC2				VB66-2
	6	6	5				RB606PT05				VB66-5
	6	6	50				RB606PT50				
	6	6	2					RCFP66-2			
	6	6	1	20571							
	6	6	5	20570	DW4851			RDW66			
	6	6	25	20497							
	6	6	1	20596							
	6	6	1	20595							
	18	4	2					RS418-2			
	18	6	2					RS618-2			
	30	3	5								48-00-1630
	Carbide Grit	4	3				RTCG4T03				
	Carbide Grit	4	1				RTCG4				
	Carbide Grit	4	25				RTCG4T25				
	Carbide Grit	6	1				RTCG6			R6-1	48-00-1421
	Carbide Grit	6	2	20505				RCB6G-2			
	Carbide Grit	6	3				RTCG6T03				48-00-1420
	Carbide Grit	6	5		DW4844						
	Carbide Grit	6	20							R6-20	
	Carbide Grit	6	25				RTCG6T25				
	Carbide Grit	6	50								48-01-6420
	Carbide Grit	8	1	10833			RTCG8				
	Carbide Grit	8	2	20576							
	Carbide Grit	8	3				RTCG8T03				
Carbide Grit	8	5		DW4843							
Carbide Grit	8	25				RTCG8T25					
Carbide Grit	9	1								48-00-1431	
Carbide Grit	9	3								48-00-1430	
Carbide Grit	9	50								48-01-6430	
Carbide Grit	9	2					RCB9G-2				
Carbide Grit	10	2	20506								
Diamond Grit	6	1				RBDG6C					
Diamond Grit	6	1								48-00-1440	
Diamond Grit	8	1	10833				RCB8DG				
Diamond Grit	9	1				RBDG9C					
Diamond Grit	9	1								48-00-1450	

6225 Band Saw AC 6/5A



FEATURES

- Cuts up to 3-1/2 in. x 4-1/2 in. rectangular stock and 3-1/2 in. round stock
- 6.0/5.0 amp, AC only
- Two-speeds: 200 and 250 sfpm
- Uses standard 44-7/8 in. x 1/2 in. x .020 in. band saw blades

Includes: (1) Portable Band Saw (6225)

SPECIFICATIONS

Length	20"
Weight	16 lbs
Voltage	120V AC
Tool Warranty	5 Years
Cord Type	Grounded
Cord Length	8'
Amps	6-5
Blade Length	44-7/8" x 1/2" x .02"
Capacity	3-1/2" x 4-1/2"

6226 Band Saw AC 6/5A with Case



Includes: (1) Portable Band Saw (6225); (1) Carrying Case

Portable Band Saw



Blades Pg 20

6232-20 Deep Cut Band Saw



FEATURES

- Powerful 11 Amp Motor w/ CPT™ : Provides maximum performance and durability
- Job Site Armor™ Technology: Proprietary composite material and crush zone barriers provide long lasting rugged protection
- All Metal Direct Drive: Delivers maximum tool life with all metal direct drive gearing system, while requiring less servicing than a chain drive
- Gear Protecting Clutch: Extends gear and motor life by absorbing high impact forces caused by blade lock-ups
- CPT™ Constant Power Technology: Maintains cut speed in the toughest applications for optimal performance
- Revolutionary Cut Visibility: Slimmer motor housing increases user line of site delivering superior cut accuracy
- Balanced Body Design: Allows tool to rest naturally and comfortably in users hands
- Lighter Weight, 14.5 Lbs.: Delivers more control over the tool and less fatigue at the conclusion of the work day
- LED Light: Illuminates work surface for increased accuracy and productivity
- Tool-Free Locking Adjustable Shoe: Button actuated tool-free design allows user to quickly adjust from extended shoe to no shoe in seconds
- Industry's Largest Cut Capacity: Versatility to cut up to 5" by 5" material in one pass and adjustable shoe allows for less tool rotation when cutting material above 5"
- Debris Protection System: Delivers longer pulley life by removing debris during use

Includes: (1) Deep Cut Variable Speed Band Saw (6232-20)

SPECIFICATIONS

Length	21"	Cord Type	Grounded
Weight	14.5 lbs	Capacity	5" X 5"
Voltage	120V AC	SFPM	0-380
Amps	11	Blade Length	44-7/8" x 1/2" x .020"

6232-21 Deep Cut Band Saw with Case



Includes: (1) Deep Cut Variable Speed Band Saw (6232-20); (1) Carrying Case

BAND SAWS



6238-20 Deep Cut Band Saw (AC/DC)



FEATURES



- Powerful 11 Amp Motor: Provides maximum performance and durability
- Job Site Armor™ Technology: Proprietary composite material and crush zone barriers provide long lasting rugged protection
- All Metal Direct Drive: Delivers maximum tool life with all metal direct drive gearing system, while requiring less servicing than a chain drive
- Gear Protecting Clutch: Extends gear and motor life by absorbing high impact forces caused by blade lock-ups
- Revolutionary Cut Visibility: Slimmer motor housing increases user line of site delivering superior cut accuracy
- Balanced Body Design: Allows tool to rest naturally and comfortably in users hands
- Lighter Weight, 14.5 Lbs.: Delivers more control over the tool and less fatigue at the conclusion of the work day
- Tool-Free Locking Adjustable Shoe: Button actuated tool-free design allows user to quickly adjust from an extended shoe to no shoe in seconds
- Industry's Largest Cut Capacity: Versatility to cut up to 5" by 5" material in one pass and adjustable shoe allows for less tool rotation when cutting material above 5"
- Debris Protection System: Delivers longer pulley life by removing debris during use

Includes: (1) Deep Cut AC/DC Band Saw (6238-20)

SPECIFICATIONS

Length	21"	Construction Type	Grounded
Weight	14.5 lbs	Capacity	5" X 5"
Voltage	120 AC/DC	SFPM	300/380
Amps	11	Blade Length	44-7/8" x 1/2" x .020"

6242-6 Band Saw Compact



FEATURES



- 45% Lighter than Deep Cut - 9.5 Lbs compact light weight design for cutting overhead and in tight places
- 200-360 SFPM Variable Speed Dial - adjusts the speed for more accurate cuts and hard materials
- 3-1/4" Cut Capacity - cuts most common materials for Electrician, Plumber and Mechanical cutting applications. Single pass cut on 3" copper, 3" angle iron, 2-1/2" conduit
- Tool-Free Adjustable Material Shoe - quickly adjusts the shoe and allows flush cuts when working with installed materials against walls and ceilings
- LED Work Light - illuminates the cut line in tight spaces and dark areas
- Blade Ejection System-Quickly change the blade by moving the material guide into the up position and depressing the blade ejection button
- Drop Resistant Pulley Guard-Engineered geometries & high impact polymer
- Cast Aluminum Gear Case-Withstands jobsite abuse & maintains gear positioning

Includes: (1) Compact Band Saw (6242-6); (1) Carrying Case

SPECIFICATIONS

Length	16"	Capacity	3-1/4" X 3-1/4"
Weight	9.5 lbs	Keyless Adjustable Shoe	Yes
Voltage	120V AC	Blade	35-3/8"
Cord Type	3-Wire	SFPM	200/360
Cord Length	8'	Blade Length	35-3/8" x 1/2" x .020"
Amps	7		

6238-21 Deep Cut Band Saw (AC/DC) with Case



Includes: (1) Deep Cut AC/DC Band Saw Kit (6238-20); (1) Carrying Case



BAND SAW BLADES

BAND SAW BLADE SELECTION GUIDE

- 1** Identify the work piece thickness in the columns
Follow the column down to find work piece type:

MOST SOLID MATERIALS or

VERY HARD SOLID MATERIALS (like stainless steel) or

INTERRUPTED CUTTING (like structurals and profiles)

Follow the row to the left to identify the appropriate teeth per inch (TPI)

Note: Fewer TPI cut faster but rougher, while more TPI cut smoother but slower

		WORK PIECE THICKNESS			
		5/16" - 1/2"	3/16" - 5/16"	5/32" - 3/16"	UP TO 5/32"
BAND SAW BLADES	10 TPI	SOFTEST MATERIAL			
	14 TPI	HARDEST MATERIAL	SOFTEST MATERIAL		
	18 TPI		HARDEST MATERIAL	SOFTEST MATERIAL	
	24 TPI			HARDEST MATERIAL	
	10/14 TPI				
	14/18 TPI				

BI-METAL PORTABLE BAND SAW BLADES

MAXIMUM DURABILITY

- Matrix II high speed steel protects teeth from chipping and breaking

EXTENDED LIFE

- Alloy backing steel resists kinking and snapping

CLEAN CUTS

- Precision formed teeth cut quickly and smoothly

Deep Cut Blades

- Designed to maximize performance of any portable band saw that takes a 44-7/8" blade

Length	TPI	1 Pack	2 Pack	3 Pack	Bulk	Qty
44-7/8"	10	48-39-0500	—	48-39-0501	48-39-0502	100
44-7/8"	14	48-39-0510	48-39-0514	48-39-0511	48-39-0512	100
44-7/8"	18	48-39-0520	48-39-0524	48-39-0521	48-39-0522	100
44-7/8"	24	48-39-0530	48-39-0534	48-39-0531	48-39-0532	100
44-7/8"	10/14	48-39-0550	48-39-0554	48-39-0551	48-39-0552	100
44-7/8"	14/18	48-39-0560	—	48-39-0561	48-39-0562	100

Compact Blades

- Designed to maximize performance of Milwaukee® Compact Band Saws

Length	TPI	1 Pack	3 Pack	Bulk	Qty
35-3/8"	10	48-39-0508	48-39-0509	48-39-0507	100
35-3/8"	14	48-39-0518	48-39-0519	48-39-0517	100
35-3/8"	18	48-39-0528	48-39-0529	48-39-0527	100
35-3/8"	24	48-39-0538	48-39-0539	48-39-0537	100

48-08-0260

Portable Bandsaw Table (fits all Milwaukee band saws)



FEATURES

- Converts all Milwaukee portable band saws to stationary units
- Can be mounted on work bench or used with 3/4" diameter pipe for legs
- Heavy-duty clamping chain and crank nut easily secures all shapes of material
- Additional block and arm now included fits all new Milwaukee band saw designs

MITER SAWS



6955-20

12" Sliding Dual Bevel Compound Miter Saw



FEATURES



- Miter Angle Digital Readout- provides repeatable accuracy to 0.1°
- Miter Angle Fine Adjust with Detent Override- makes it simple to dial-in precise miter angles
- Dual Integral Jobsite Lights- fully illuminate the work piece and cut line from either side of the blade
- Powerful 15.0 Amp, 3.3 Max HP Direct Drive Motor- provides increased power for high performance cutting in hard lumber
- Constant Power Technology with Soft Start -maintains constant cutting speed under load and decreases start up head movement
- Integral Dust Channel- captures up to 75% of the dust and debris cut
- Dual Horizontal Steel Rails with Three Large Linear Bearings-deliver smooth sliding action
- Oversized Single Lever Bevel Adjustment with (9) Positive Bevel Stops allows the saw to easily bevel left and right 0°- 48°and provides fast and accurate adjustments

Includes: (1) 12" Dual-Bevel Sliding Compound Miter Saw (6955-20); (1) Blade Wrench; (1) Carbide Tipped Blade; (1) Dust Bag

SPECIFICATIONS

Weight	65 lbs
Voltage	120V AC
Tool Warranty	5 Years
No Load Speed	3,200 RPM
Amps	15
Arbor Size	5/8" or 1"
Blade	12"
Maximum Bevel Capacity	48 degrees

48-08-0550S

Miter Saw Stand



FEATURES

- Guide Rollers
- Wheels
- Quick Release Mounting Brackets
- Approximately 12' Extension Arm Span
- Levelling Foot

SPECIFICATIONS

Standard Dimensions	55" x 24" x 39.5"
Extended Dimensions	119" x 24" x 39.5"
Folded Dimensions	48" x 14" x 9"
Load Capacity	550 lbs.
Stand Weight	56.3 lbs.

ATTACHMENTS

48-03-0200

Vacuum Hose Adapter





CIRCULAR SAWS

6390-20 Tilt-Lok™ Circular Saw 7-1/4"



FEATURES



- Exclusive TILT-LOK™ main handle adjusts to the work or most comfortable work position
- 10.4 pounds net weight - lightest 7-1/4 inch, 3.25 maximum horsepower saw reduces operator fatigue, easier to handle
- 15 amp, 3.25 peak horsepower motor - most powerful circle saw cuts tough materials including headers, microlams and wet lumber with ease
- Wide, clear sight line - superior blade visibility from either side

Includes: (1) TILT-LOK™ 7-1/4" Circular Saw (6390-20); (1) Blade Wrench; (1) Circular Saw Blade

SPECIFICATIONS

Length	13-3/4"	Adjustable Handle	Yes
Weight	10.4 lbs	Arbor Size	5/8"
Voltage	120 AC/DC	Depth of Cut at 45°	1-13/16"
Tool Warranty	5 Years	Depth of Cut at 50°	1-11/16"
Cord Type	9' Fixed	Depth of Cut at 90°	2-7/16"
No Load RPM	5,800	Electrical Brake	No
Amps	15	Blade Position	Right
Spindle	5/8"	Blade	7-1/4"
Construction Type	Double Insulated	Tool Free Bevel	Yes
Soft Grip Handle	Yes	Maximum Bevel Capacity	50°
Spindle Lock	Yes		

6390-21 Tilt-Lok™ Circular Saw 7-1/4"
Left Blade with Case



Includes: (1) TILT-LOK™ 7-1/4" Circular Saw with Case (6390-21); (1) Blade Wrench; (1) Carrying Case; (1) Circular Saw Blade

6391-21

Tilt-Lok™ Circular Saw 7-1/4"
Left Blade with Case



FEATURES



- Blade is mounted on the left for superior visibility to the cut line
- 3.25 max. horsepower exceeds worm drive saws with 35% less weight
- Full 50 degree bevel capacity
- Exclusive Tilt-Lok™ main handle adjusts to the work for most comfortable work position

Includes: (1) 7-1/4" Left Blade Circular Saw with Case (6391-21); (1) Blade Wrench; (1) Circular Saw Blade

SPECIFICATIONS

Length	13-3/4"	Adjustable Handle	Yes
Weight	10.4 lbs	Arbor Size	5/8"
Voltage	120 AC/DC	Depth of Cut at 45°	1-13/16"
Tool Warranty	5 Years	Depth of Cut at 50°	1-11/16"
Cord Type	9' Fixed	Depth of Cut at 90°	2-7/16"
No Load RPM	5,800	Electrical Brake	No
Amps	15	Blade Position	Left
Spindle	5/8"	Blade	7-1/4"
Construction Type	Double Insulated	Tool Free Bevel	Yes
Soft Grip Handle	Yes	Maximum Bevel Capacity	50°
Spindle Lock	Yes		

Construction Circular



Saw Blades Pg 24

CIRCULAR SAWS



6394-21

Circular Saw 7-1/4" with QUIK-LOK® Cord, Brake and Case



FEATURES



- Exclusive TILT-LOK™ main handle adjusts to the work for most comfortable work position
- Patented power assisted electric brake stops blade in seconds
- Quik-Lok® cord makes job site replacement fast and easy
- Powerful 3.0 max. horsepower, 15 amp motor

Includes: (1) 7-1/4" Circular Saw with QUIK-LOK® cord, Brake and Case (6394-21); (1) Blade Wrench; (1) Circular Saw Blade

SPECIFICATIONS

Length	13-3/4"	Adjustable Handle	Yes
Weight	10.6 lbs	Arbor Size	5/8"
Voltage	120V AC	Depth of Cut at 45°	1-13/16"
Tool Warranty	5 Years	Depth of Cut at 50°	1-11/16"
Cord Type	10' QUIK-LOK®	Depth of Cut at 90°	2-7/16"
No Load RPM	5,800	Electrical Brake	Yes
Amps	15	Blade Position	Right
Spindle	5/8"	Blade	7-1/4"
Construction Type	Double Insulated	Tool Free Bevel	Yes
Soft Grip Handle	Yes	Maximum Bevel Capacity	50°
Spindle Lock	Yes		

ATTACHMENTS



48-76-5110: 10' Quik-Lok® (standard equipment for 6394-21)



48-76-5125: 25' Quik-Lok® (optional for 6394-21)

6470-21

Circular Saw 10-1/4" 15A



FEATURES



- Powerful 15 Amp, 5,200 RPM Motor – delivers maximum power for high performance cutting without bogging down under load
- 3-13/16" Depth of Cut Capacity – Provides enough capacity to cut 4" material in a single pass
- Aircraft Aluminum Shoe – will not bend or warp in extreme cutting applications
- Electric Brake - increases productivity by stopping the blade in seconds
- 60° Bevel Capacity – provides maximum bevel capacity for cutting roof rafters, trusses and joists

Includes: (1) 10-1/4" Circular Saw (6470-20); (1) Rip Fence; (1) Case

SPECIFICATIONS

Length	17-1/2"	Spindle Lock	Yes
Weight	17.8 lbs	Arbor Size	5/8"
Voltage	120V AC	Depth of Cut at 45°	2-3/4"
Tool Warranty	5 Years	Depth of Cut at 60°	1-3/4"
Cord Type	2-Wire	Depth of Cut at 90°	3-13/16"
No Load RPM	5,200	Electrical Brake	Yes
Amps	15	Blade Position	Right
Spindle	5/8"	Blade	10-1/4"
Construction Type	Double Insulated	Tool Free Bevel	Yes
Soft Grip Handle	Yes	Maximum Bevel Capacity	60°



CIRCULAR SAWS

6477-20 Worm Drive Circular Saw 7-1/4"



FEATURES



- 15.0 Amp, 4,400 RPM Motor – delivers maximum cutting performance and does not bog down, even under heavy loads
- Hardened steel worm gearing – provides maximum torque in the toughest applications
- Magnesium Construction – durable, lightweight
- Heavy-Duty Composite Shoe – will not warp, bend or kick up a burr
- Exclusive Oil Site Glass – instantly gauge current oil level

Includes: (1) 7-1/4" Worm Drive Circular Saw (6477-20);
(1) Carbide Tipped Blade

SPECIFICATIONS

Length	19"	Spindle Lock	Yes
Weight	15 lbs	Depth of Cut at 45°	1-25/32"
Voltage	120 AC/DC	Depth of Cut at 50°	1-9/16"
Tool Warranty	5 Years	Depth of Cut at 90°	2-7/16"
Cord Type	2-Wire	Blade Position	Left
No Load RPM	4,400	Blade	7-1/4"
Amps	15	Maximum Bevel Capacity	51.5°

6577-20 Worm Drive Circular Saw 7-1/4" with Twist Plug (6577-20)



FEATURES



- 15.0 Amp, 4,400 RPM Motor – delivers maximum cutting performance and does not bog down, even under heavy loads
- Hardened steel worm gearing – provides maximum torque in the toughest applications
- Magnesium Construction – durable, lightweight
- Heavy-Duty Composite Shoe – will not warp, bend or kick up a burr
- Exclusive Oil Site Glass – instantly gauge current oil level
- Folding Rafter Hook – Allows quick, convenient storage of tool from a rafter, joist or nail
- Highly Visible Depth and Bevel Scales – visible from behind the body of the saw; provides quick, accurate adjustments

Includes: (1) 7-1/4" Worm Drive Circular Saw with Twist Plug (6577-20); (1) Carbide Tipped Blade

SPECIFICATIONS

Length	19"	Spindle Lock	Yes
Weight	14.3 lbs	Adjustable Handle	No
Voltage	120 AC/DC	Depth of Cut at 45°	1-25/32"
Tool Warranty	5 Years	Depth of Cut at 50°	1-9/16"
Cord Type	Double Insulated	Depth of Cut at 90°	2-7/16"
No Load RPM	4,400	Blade Position	Left
Amps	15	Blade	7-1/4"
Soft Grip Handle	Yes	Maximum Bevel Capacity	51.5°

CONSTRUCTION CIRCULAR SAW BLADES

	Diameter	Part Number	# of Teeth	Tooth Material	Arbor	Max RPM	Pkg Qty	Materials	
CORDLESS	6-1/2"	48-40-4108	24	Carbide	5/8"	7,000	1		Framing
	6-1/2"	48-40-4112	40	Carbide	5/8"	7,000	1		Trim
CORDED & CORDLESS	7-1/4"	48-40-4116	16	Carbide	5/8"	7,000	1		Framing
	7-1/4"	48-40-4120	24	Carbide	5/8"	7,000	1		Ripping
	7-1/4"	48-40-4123	24	Carbide	5/8"	7,000	25		Ripping
	7-1/4"	48-40-4126	40	Carbide	5/8"	7,000	1		Trim
	7-1/4"	48-40-4132	48	Carbide	5/8"	7,000	1		Non-Ferrous
	7-1/4"	48-40-4138	140	Steel	5/8"	7,000	1		Plywood
	7-1/4"	48-40-4140	—	Steel	5/8"	7,000	1		Ferrous
AC	10-1/4"	48-40-4170	28	Carbide	5/8"	6,000	1		Ripping
	10-1/4"	48-40-4172	40	Carbide	5/8"	6,000	1		Trim

JIG SAWS



6268-21 Orbital Jig Saw



FEATURES



- LED light for improved sightline
- Powerful 6.5 amp motor
- Orbital action with 4 adjustment levels and 1 in. stroke length for faster cutting
- Variable speed trigger – 0-3,000 SPM
- Variable speed dial for repetitive cuts
- QUIK-LOK™ blade change system
- Keyless Shoe Adjustment – 45° in both directions
- Precision roller blade guide for accurate cuts
- Counter balanced for reduced vibration
- Tachometer feedback for constant cutting speed
- Cushion grip for superior gripping and control

Includes: (1) Orbital Jig Saw (6268-21); (2) Blade; (1) Carrying Case; (1) Dust Shield

SPECIFICATIONS

Length	9-1/2"
Weight	6.4 lbs
Voltage	120V AC
Tool Warranty	5 Years
Cord Type	12-2/3' Fixed
Amps	6.5
Construction Type	Double Insulated
Keyless Blade Clamp	Yes
Orbital Action	Yes - 4 Position
Stroke Length	1"
Blade	T-Shank
SPM	0-3,000
Tool Free Bevel	Yes
Maximum Bevel Capacity	45°

6276-21 Body Grip Orbital Jig Saw



FEATURES



- Powerful 6.2 amp motor
- Orbital action with 4 adjustment levels for faster cutting
- 7 setting dial speed control 500-3000 SPM
- Quik-Lok™ blade change system
- Keyless 45° bevel adjustment
- 10 position dust blower and built-in dust collection port for easy attachment to vacuum
- Die cast aluminum shoe and all metal gear case
- Low position roller guide for blade stability and precision cuts
- Counter balanced for reduced vibration

Includes: (1) Body Grip Orbital Jig Saw (6276-21); (2) Blade

SPECIFICATIONS

Length	11-3/4"
Weight	5.0 lbs
Voltage	120V AC
Tool Warranty	5 Years
Construction Type	Double Insulated
Keyless Blade Clamp	Yes
Orbital Action	Yes - 4 Position
Stroke Length	1"
Blade	T-Shank
SPM	500-3,000
Tool Free Bevel	Yes
Maximum Bevel Capacity	45°

48-08-0531 Anti-Splintering Device

- Fits 6276-21 and 6268-21
- For clean cutting edge

48-08-0533 Plastic Shoe Cover

- Fits 6276-21 and 6268-21
- Prevents scratches on delicate surfaces



JIG SAW BLADES

JIG SAW BLADES

BI-METAL BLADES

- Combines high speed steel and high carbon steel for extreme versatility

HIGH SPEED STEEL BLADES

- Fully hardened blade for cutting ferrous and non-ferrous metals

HIGH CARBON STEEL BLADES

- Good for soft materials like wood and plastic

T-Shank



U-Shank



	Length	TPI	Part Number	Qty	Blade Material	Recommended Use	Shank
GENERAL PURPOSE	4"	6	48-42-5300	5	Bi-Metal	Fast cutting, nail embedded wood	T-Shank
	4"	10	48-42-5310	5	Bi-Metal	Fast cutting, nail embedded wood	T-Shank
	3"	12	48-42-5390	5	Bi-Metal	Scroll cutting in wood & metal	T-Shank
	4"	6	48-42-5200	5	High Carbon Steel	Very fast rough cutting, wood	T-Shank
	4"	8	48-42-5220	5	High Carbon Steel	Fast straight cutting, wood	T-Shank
	4"	6	48-42-2300	5	Bi-Metal	Fast cutting, nail embedded wood	U-Shank
	4-1/8"	10	48-42-2310	5	Bi-Metal	Fast cutting, nail embedded wood	U-Shank
	2-3/4"	12	48-42-2390	5	Bi-Metal	Scroll cutting in wood & metal	U-Shank
	4"	6	48-42-0200	5	High Carbon Steel	Very fast rough cutting, wood	U-Shank
4"	8	48-42-0220	5	High Carbon Steel	Fast straight cutting, wood	U-Shank	
WOOD CUTTING	4"	6	48-42-5302	5	Bi-Metal	Very fast clean cutting	T-Shank
	4"	10	48-42-5311	5	Bi-Metal	Fast clean cutting	T-Shank
	3"	20	48-42-5385	5	Bi-Metal	Scroll cutting in wood & laminates	T-Shank
	4"	6	48-42-5421	5	High Carbon Steel	Very fast rough cutting	T-Shank
	4"	6	48-42-5500	5	High Carbon Steel	Very fast clean cutting	T-Shank
	4"	6	48-42-5512	5	High Carbon Steel	Very fast, rough curve cutting	T-Shank
	4"	10	48-42-5240	5	High Carbon Steel	Clean cutting	T-Shank
	4"	10	48-42-5540	5	High Carbon Steel	Reverse tooth, no top splinters	T-Shank
	3"	12	48-42-5640	5	High Carbon Steel	Clean scroll cutting	T-Shank
	4"	6	48-42-2302	5	Bi-Metal	Very fast clean cutting	U-Shank
	4"	10	48-42-2311	5	Bi-Metal	Fast clean cutting	U-Shank
	2-3/4"	20	48-42-2385	5	Bi-Metal	Scroll cutting in wood & laminates	U-Shank
	4"	6	48-42-0421	5	High Carbon Steel	Very fast rough cutting	U-Shank
	4"	6	48-42-0500	5	High Carbon Steel	Very fast clean cutting	U-Shank
	3-1/8"	8	48-42-0240	5	High Carbon Steel	Clean cutting	U-Shank
	3-5/8"	10	48-42-0540	5	High Carbon Steel	Straight clean cutting	U-Shank
	4"	10	48-42-0640	5	High Carbon Steel	Reverse tooth, no top splinters	U-Shank
	2-3/4"	12	48-42-0650	5	High Carbon Steel	Clean scroll cutting	U-Shank
METAL CUTTING	4"	8	48-42-5850	5	Bi-Metal	Aluminum, non-ferrous metals	T-Shank
	3"	14	48-42-5190	5	Bi-Metal	Thick metal over 1/4 inch thick	T-Shank
	5-1/4"	14	48-42-5192	5	Bi-Metal	Thick metal, tubing, etc.	T-Shank
	3"	18	48-42-5121	5	Bi-Metal	Metal over 1/8 inch thick	T-Shank
	3"	24	48-42-5161	5	Bi-Metal	Metal under 1/8 inch thick	T-Shank
	5-1/4"	24	48-42-5166	5	Bi-Metal	Thin metal under 1/8 inch thick	T-Shank
	3"	14	48-42-5101	5	High Speed Steel	Metal over 1/4 inch thick	T-Shank
	4"	8	48-42-0850	5	Bi-Metal	Aluminum, non-ferrous metals	U-Shank
	3-5/8"	14	48-42-2190	5	Bi-Metal	Thick metal over 1/4 inch thick	U-Shank
	5"	14	48-42-2192	5	Bi-Metal	Thick metal, tubing, etc.	U-Shank
	2-3/4"	18	48-42-2120	5	Bi-Metal	Metal over 1/8 inch thick	U-Shank
	2-3/4"	24	48-42-2160	5	Bi-Metal	Metal under 1/8 inch thick	U-Shank
	5"	24	48-42-2166	5	Bi-Metal	Thin metal under 1/8 inch thick	U-Shank
	2-3/4"	14	48-42-0101	5	High Speed Steel	Metal over 1/4 inch thick	U-Shank
	2-3/4"	18	48-42-0120	5	High Speed Steel	Metal over 1/8 inch thick	U-Shank
	2-3/4"	24	48-42-0140	5	High Speed Steel	Metal under 1/8 inch thick	U-Shank
SPECIALTY	2-3/4"	GRIT	48-42-0801	5	Carbide-Tipped	Ceramics, tile	U-Shank

JIG SAW BLADE SETS

5 Pk T-Shank Blade Assortment 49-22-1178	5 Pk U-Shank Blade Assortment 49-22-1168
Includes: <ul style="list-style-type: none"> 48-42-5121 Metal cutting blade 48-42-5190 Metal cutting blade 48-42-5310 General purpose blade 48-42-5161 Metal cutting blade 48-42-5300 General purpose blade 	Includes: <ul style="list-style-type: none"> 48-42-2120 Metal cutting blade 48-42-2300 General purpose blade 48-42-2310 General purpose blade 48-42-2160 Metal cutting blade 48-42-2190 Metal cutting blade

PANEL SAWS



6480-20 Panel Saw 15 Amp



FEATURES



- Powerful 15 amp (3-1/4 max hp) Milwaukee motor (AC/DC)
- Rigid all steel frame, square tubing is electrically welded to prevent warping or twisting
- Comfortable horizontal handle for convenient on/off operation
- 20 amp commercial-grade paddle switch for durability and long life
- Cutting accuracy to within 1/32 in. in either cross-cutting or ripping directions
- The Perfect Tool For: Lumber Yards, Building Contractors, Building Material Suppliers, Cabinet Shops, Remodelers, Sign Shops, Rental Outlets

Includes: (1) 15 Amp (3-1/4 Max HP) 8-1/4 in. Panel Saw (6480-20); (1) Blade Wrench; (1) Blade (48-40-4152)

ACCESSORIES

49-22-8100 Hold Down Bar Kit

Holds thin, flexible material in place.

49-22-8102 Quick Stop Gauging Kit

Allows you to quickly and accurately position a sliding aluminum stop block without the need for a wrench. Best suited when custom cutting dimensions are always changing.

49-22-8105 Dust Collecting Kit

Self-contained kit collects dust and debris. Consists of blade guard, dust tube, vinyl hose and roller assembly. Vacuum not included.

49-22-8106 Wheel Kit

Includes two wheels and allows the Panel Saw to be wheeled from one location to another.

SPECIFICATIONS

Length	60"
Weight	180.0 lbs
Voltage	120V AC/DC
Tool Warranty	5 Years
Cord Type	20' Fixed
No Load RPM	5,800
Amps	15
Spindle	5/8"
Construction Type	Steel, Square Tube
Arbor Size	5/8"
Blade	8-1/4"
Height	70"
Capacity Thickness	1-3/4"

REPLACEMENT MOTOR

6486-20 Panel Saw Replacement Motor 15A

49-22-8108 Extension Kit

Should be purchased whenever material over 6' in length will be cut frequently. Extends the roller material carriage 18" on each end, making the overall roller material carriage 8' in length.

49-22-8110 Mid-Way Fence Kit

Allows you to cut small panels waist high on the panel saw frame. System includes both right and left sides. 30" rulers, a manual stop block and quick change wood fences.

48-50-0030 Motor Upgrade Kit For 6480

Includes 15.0 Amp motor, 20.0 Amp paddle switch, handle, blade guard, saw base and mounting hardware.

CONSTRUCTION PANEL SAW BLADES

Diameter	Part Number	# of Teeth	Tooth Material	Arbor	Max RPM	Pkg Qty	Materials
8-1/4"	48-40-4148	18	Carbide	5/8"	7,000	1	Framing
8-1/4"	48-40-4150	24	Carbide	5/8"	7,000	1	Ripping
8-1/4"	48-40-4152	40	Carbide	5/8"	7,000	1	Trim



CUTTING & FASTENING HAND TOOLS



ULTIMATE PRODUCTIVITY. SUPERIOR PERFORMANCE.



SAWS



FASTBACK KNIVES
& BLADES



SNAP KNIVES &
UTILITY KNIVES



SNIPS & PLIERS



SCREWDRIVERS



NUTDRIVERS



TAPE MEASURES



INKZALL® MARKERS

Contact your Milwaukee Sales Rep or visit www.milwaukeetool.ca for a complete listing of Milwaukee Hand Tools.

CORDED DRILLS



0100-20 1/4" Magnum® Drill, 2,500RPM



FEATURES



- Powerful 7.0-amp motor: Delivers up to 2500 RPM with variable-speed control and reverse
- Heavy-duty keyed chuck with holder: Provides an industrial hold during drilling and fastening
- 360° Locking Side Handle: Produces maximum maneuverability and control
- QUIK-LOK® Cord: 8-ft. 3-wire grounded rubber cord provides easy storage and field replacement

Includes: (1) 1/4" Magnum Drill, 0-2500 RPM with QUIK-LOK® Cord (0100-20); (1) Chuck Key with Holder; (1) Side Handle

SPECIFICATIONS

Length	11-1/2"	Chuck Type	Keyed
Weight	4.7 lbs	Construction Type	Grounded
Cord Type	8' QUIK-LOK®	Gear Train	Double
No Load RPM	0-2,500	Soft Grip Handle	Yes
Amps	7	Spindle Lock	No
Trigger Lock	Yes	Capacity in Steel	Twist Bit 1/4"
Spindle	3/8" -24	Capacity in Wood	Flat Boring Bit 1-1/2"
Chuck Size	1/4"		

ATTACHMENTS



48-76-4008: 8' Quik-Lok®



48-76-4025: 25' Quik-Lok®

0101-20 1/4" Magnum® Drill, 4000RPM



FEATURES



- Powerful 7.0-amp motor: Delivers up to 4000 RPM with variable-speed control and reverse
- Heavy-duty keyed chuck with holder: Provides an industrial hold during drilling and fastening
- QUIK-LOK® Cord: 8-ft. 3-wire grounded rubber cord provides easy storage and field replacement

Includes: (1) 1/4" Magnum Drill, 0-4000 RPM with QUIK-LOK® Cord (0101-20); (1) Chuck Key with Holder

SPECIFICATIONS

Length	10-13/64"	Chuck Type	Keyed
Weight	3.8 lbs	Construction Type	Grounded
Cord Type	8' QUIK-LOK®	Gear Train	Single
No Load RPM	0-4,000	Soft Grip Handle	Yes
Amps	7	Spindle Lock	No
Trigger Lock	Yes	Capacity in Steel	Twist Bit 1/4"
Spindle	3/8" - 24	Capacity in Wood	Flat Boring Bit 1-1/2"
Chuck Size	1/4"		

ATTACHMENTS



48-76-4008: 8' Quik-Lok®



48-76-4025: 25' Quik-Lok®



CORDED DRILLS

0200-20 3/8" Magnum® Drill, 1200 RPM



FEATURES

- Powerful 7.0-amp motor: Delivers up to 1200 RPM with variable speed control and reverse
- Heavy-duty keyed chuck with holder: Provides an industrial hold during drilling and fastening
- 360° Locking Side Handle: Produces maximum maneuverability and control
- 8-ft. 3-wire fixed rubber cord: Durable construction for longer tool life

Includes: (1) 3/8" Magnum Drill, 0-1200 RPM (0200-20); (1) Chuck Key with Holder

SPECIFICATIONS

Length	12"	Gear Train	Double
Weight	4.2 lbs	Soft Grip Handle	Yes
Cord Type	8' Fixed	Spindle Lock	No
No Load RPM	0-1,200	Capacity in Wood	Flat Boring Bit 1-1/2"
Amps	7		Hole Saw 3-1/4"
Trigger Lock	Yes		Auger 1"
Spindle	1/2" - 20		
Chuck Size	3/8"		
Chuck Type	Keyed		
Construction Type	Grounded		

0201-20 3/8" Magnum® Drill, 2500RPM



FEATURES

- Powerful 7.0-amp motor: Delivers up to 2500 RPM with variable speed control and reverse
- GRIP-LOK™ chuck: All-metal, two-sleeve keyless chuck with hardened jaws for high grip strength and reduced slippage
- 360° Locking Side Handle: Produces maximum maneuverability and control
- 10-ft. 2-wire fixed rubber cord: Durable construction for longer tool life

Includes: (1) 3/8" Magnum Drill, 0-2500 RPM with All Metal Chuck (0201-20); (1) Side Handle

SPECIFICATIONS

Length	12"	Soft Grip Handle	Yes
Weight	4.1 lbs	Spindle Lock	No
Cord Type	10' Fixed	Capacity in Steel	Twist Bit 1/2"
No Load RPM	0-2,500	Capacity in Wood	Flat Boring Bit 1-1/2"
Amps	7		Hole Saw 2-1/4"
Trigger Lock	Yes		Auger 7/8"
Spindle	3/8" -24		
Chuck Size	3/8"		
Construction Type	Double Insulated		
Gear Train	Double		

Thunderbolt® Twist Drill Bits



B/Ox, Titn, Cobalt Bits Pg 36

Metal Drilling Bits



Step Bits Pg 41

CORDED DRILLS



0202-20

3/8" Magnum® Drill, 1200RPM with All Metal Chuck



FEATURES



- Powerful 7.0-amp motor: Delivers up to 1200 RPM with variable speed control and reverse
- GRIP-LOK™ chuck: All-metal, single-sleeve keyless chuck with hardened jaws for high grip strength and reduced slippage
- 360° Locking Side Handle: Produces maximum maneuverability and control
- QUIK-LOK® Cord: 8-ft. 3-wire grounded rubber cord provides easy storage and field replacement

Includes: (1) 3/8" Magnum® Drill, 0-1200 RPM with All Metal Chuck and QUIK-LOK® cord (0202-20); (1) Side Handle

SPECIFICATIONS

Length	12"	Construction Type	Grounded
Weight	4.9 lbs	Gear Train	Double
Voltage	120V AC	Soft Grip	Yes
Tool Warranty	5 Years	Spindle Lock	Yes
Cord Type	8' QUIK-LOK®	Capacity in Wood	Flat Boring Bit 1-1/2"
No Load RPM	0-1,200		Hole Saw 3-1/4"
Amps	7		Auger 1"
Trigger Lock	Yes		
Spindle	1/2" -20		
Chuck Size	3/8"		
Chuck Type	Single Sleeve		

ATTACHMENTS



48-76-4008: 8' Quik-Lok®



48-76-4025: 25' Quik-Lok®

0233-20

3/8" Magnum® Drill, 2800RPM with Keyless Chuck



FEATURES



- Powerful 5.5-amp motor: Delivers up to 2800 RPM, with trigger speed control and reverse
- Heavy-duty keyless chuck: Single sleeve all metal chuck for high grip strength and reduced slippage
- 8-ft. 2-wire fixed rubber cord: Durable construction for longer tool life
- Exclusive brush cartridge system: Changes brushes in less than one minute, and includes a spare set of brushes

Includes: (1) 3/8" Magnum® Drill, 0-2800 RPM with Keyless Chuck (0233-20); (1) Side Handle

SPECIFICATIONS

Length	10"	Construction Type	Double Insulated
Weight	4.0 lbs	Gear Train	Single
Voltage	120V AC	Soft Grip Handle	No
Tool Warranty	5 Years	Spindle Lock	No
Cord Type	8' Fixed	Capacity in Wood	Flat Boring Bit 1"
No Load RPM	0-2,800		Hole Saw 1-3/4"
Amps	5.5		Auger 1"
Trigger Lock	Yes		
Spindle	3/8" - 24		
Chuck Size	3/8"		

Wood Boring Drill Bits



Speed Feed Bits Pg 39



CORDED DRILLS

0234-6 1/2" Magnum® Drill, 950RPM



FEATURES

- Powerful 5.5-amp motor: Delivers up to 950 RPM, with trigger-speed control and reverse
- Heavy-duty keyed chuck with holder: Provides an industrial hold during drilling and fastening
- QUIK-LOK® Cord: 8-ft. 3-wire grounded rubber cord provides easy storage and field replacement
- Exclusive brush cartridge system: Changes brushes in less than one minute, and includes a spare set of brushes

Includes: (1) 1/2" Magnum® Drill, 0-950 RPM (0234-6); (1) Chuck Key with Holder; (1) Side Handle

SPECIFICATIONS

Length	10-1/2"	Construction Type	Grounded
Weight	4.8 lbs	Gear Train	Double
Voltage	120V AC	Soft Grip Handle	No
Tool Warranty	5 Years	Spindle Lock	No
Cord Type	8' QUIK-LOK®	Capacity in Wood	Flat Boring Bit 1-1/2"
No Load RPM	0-950		Hole Saw 4-1/2"
Amps	5.5		Auger 1-1/2"
Trigger Lock	Yes	Chuck Size	1/2"
Spindle	1/2"- 20	Chuck Type	Keyed

ATTACHMENTS



48-76-4008: 8' Quik-Lok®



48-76-4025: 25' Quik-Lok®

0235-21 1/2" Magnum® Drill, 950RPM with All Metal Keyless Chuck



FEATURES

- Powerful 5.5-amp motor: Delivers up to 950 RPM, with trigger-speed control and reverse
- Heavy-duty keyless chuck: Single sleeve all-metal chuck for high grip strength and reduced slippage
- QUIK-LOK® Cord: 8-ft. 3-wire grounded rubber cord provides easy storage and field replacement
- Exclusive brush cartridge system: Changes brushes in less than one minute, and includes a spare set of brushes

Includes: (1) 1/2" Magnum® Drill, 0-950 RPM with All Metal Keyless Chuck (0235-21); (1) Side Handle

SPECIFICATIONS

Length	10-1/2"	Construction Type	Grounded
Weight	4.9 lbs	Gear Train	Double
Voltage	120V AC	Soft Grip Handle	No
Tool Warranty	5 Years	Spindle Lock	Yes
Cord Type	8' QUIK-LOK®	Capacity in Wood	Flat Boring Bit 1-1/2"
No Load RPM	0-950		Hole Saw 4-1/2"
Amps	5.5		Auger 1-1/2"
Trigger Lock	Yes	Chuck Size	1/2"
Spindle	1/2"- 20	Chuck Type	Keyless

ATTACHMENTS



48-76-4008: 8' Quik-Lok®



48-76-4025: 25' Quik-Lok®

CORDED DRILLS



0240-20 3/8" Drill



FEATURES



- Powerful 8.0-amp motor: Delivers up to 2800 RPM, with variable-speed trigger and reverse
- Heavy-duty keyless chuck: All-metal chuck for high grip strength and reduced slippage
- 8-ft. 2-wire fixed rubber cord: Durable construction for longer tool life

Includes: (1) 3/8" Drill (0240-20)

SPECIFICATIONS

Length	10.25"	Trigger Lock	No
Weight	4.25 lbs	Chuck Size	3/8"
Voltage	120V AC	Spindle Lock	No
Tool Warranty	5 Years	Capacity in Steel	Twist bit 3/8"
Cord Type	2-Wire	Capacity in Wood	Flat Boring Bit 1"
Cord Length	8'		Hole Saw 1-3/4"
No Load RPM	0-2,800		
Amps	8		

0244-1 1/2" Magnum® Drill, 700RPM



FEATURES



- Powerful 5.5-amp motor: Delivers up to 700 RPM, with trigger speed control and reverse
- Heavy-duty keyed chuck with holder: Provides an industrial hold during drilling and fastening
- QUIK-LOK® Cord: 8-ft. 3-wire grounded rubber cord provides easy storage and field replacement
- Exclusive brush cartridge system: Changes brushes in less than one minute, and includes a spare set of brushes

Includes: (1) 1/2" Magnum® Drill, 0-700 RPM (0244-1); (1) Chuck Key with Holder; (1) Side Handle

SPECIFICATIONS

Length	10-1/2"	Construction Type	Grounded
Weight	4.8 lbs	Gear Train	Double
Voltage	120V AC	Soft Grip Handle	No
Tool Warranty	5 Years	Spindle Lock	No
Cord Type	8' QUIK-LOK®	Capacity in Wood	Flat Boring Bit 1-1/2"
No Load RPM	0-700		Hole Saw 4-1/2"
Amps	5.5		Auger 1-1/2"
Trigger Lock	Yes		
Spindle	1/2"- 20		
Chuck Size	1/2"		
Chuck Type	Keyed		

Hole Saw Bits



See Page 43

ATTACHMENTS



48-76-4008: 8' Quik-Lok®



48-76-4025: 25' Quik-Lok®



CORDED DRILLS

0299-20 1/2" Magnum® Drill, 850RPM



FEATURES ⓘ ⚡ AC

- Powerful 8.0-amp motor: Delivers up to 850 RPM with variable-speed control and reverse
- Heavy-duty keyed chuck with holder: Provides an industrial hold during drilling and fastening
- 360° Locking Side Handle: Produces maximum maneuverability and control
- 8-ft. 3-wire fixed rubber cord: Durable construction for longer tool life

Includes: (1) 1/2" Magnum® Drill, 0-850 RPM (0299-20); (1) Chuck Key with Holder; (1) Side Handle

SPECIFICATIONS

Length	12-13/64"	Construction Type	Grounded
Weight	5.4 lbs	Gear Train	Double
Voltage	120V AC	Soft Grip Handle	No
Tool Warranty	5 Years	Spindle Lock	No
Cord Type	8' Fixed	Capacity in Wood	Flat Boring Bit 1-1/2"
No Load RPM	0-850		Hole Saw 3-5/8"
Amps	8		Auger 1-1/2"
Trigger Lock	Yes	Chuck Size	1/2"
Spindle	1/2"- 20	Chuck Type	Keyed

0300-20 1/2" Magnum® Drill, 850RPM



FEATURES ⓘ ⚡ AC

- Powerful 8.0-amp motor: Delivers up to 850 RPM with variable speed control
- Heavy-duty keyed chuck with holder: Provides an industrial hold during drilling and fastening
- 360° Locking Side Handle: Produces maximum maneuverability and control
- 8-ft. 3-wire fixed rubber cord: Durable construction for longer tool life

Includes: (1) 1/2" Magnum® Drill, 0-850 RPM (0300-20); (1) Chuck Key with Holder; (1) Side Handle

SPECIFICATIONS

Length	12-13/64"	Construction Type	Grounded
Weight	5.4 lbs	Gear Train	Double
Voltage	120V AC	Soft Grip Handle	Yes
Tool Warranty	5 Years	Spindle Lock	No
Cord Type	8' Fixed	Capacity in Wood	Flat Boring Bit 1-1/2"
No Load RPM	0-850		Hole Saw 3-5/8"
Amps	8		Auger 1-1/2"
Trigger Lock	Yes	Chuck Size	1/2"
Spindle	1/2"- 20	Chuck Type	Keyed



CORDED DRILLS



0302-20

1/2" Magnum® Drill, 850RPM with All Metal Chuck



FEATURES



- Powerful 8.0-amp motor: Delivers up to 850 RPM with variable speed control and reverse
- GRIP-LOK™ chuck: All-metal, single-sleeve keyless chuck with hardened jaws for high grip strength and reduced slippage
- 360° Locking Side Handle: Produces maximum maneuverability and control
- QUIK-LOK® Cord: 8-ft. 3-wire grounded rubber cord provides easy storage and field replacement

Includes: (1) 1/2" Magnum® Drill, 0-850 RPM with All Metal Chuck and QUIK-LOK® cord (0302-20); (1) Side Handle

SPECIFICATIONS

Length	12-1/2"	Construction Type	Grounded
Weight	5.6 lbs	Gear Train	Double
Voltage	120V AC	Soft Grip Handle	Yes
Tool Warranty	5 Years	Spindle Lock	Yes
Cord Type	8' QUIK-LOK®	Capacity in Wood	Flat Boring Bit 1-1/2"
No Load RPM	0-850		Hole Saw 3-5/8"
Amps	8		Auger 1-1/2"
Trigger Lock	Yes		
Spindle	1/2"- 20		
Chuck Size	1/2"		
Chuck Type	Single Sleeve		

ATTACHMENTS



48-76-4008: 8' Quik-Lok®



48-76-4025: 25' Quik-Lok®

0370-20

3/8" Close Quarter Angle Drill



FEATURES



- 3.5-amp motor: Produces up to 1300 RPM with reverse
- Metal frame gear train: Provides longer service life
- Textured palm grip: Offers comfort, control and reduces slippage
- Angle cord exit: Keeps the durable 8-ft. fixed rubber cord out of the work area

Includes: (1) 3/8" Close Quarter Angle Drill (0370-20); (1) Chuck Key with Holder

SPECIFICATIONS

Length	11"	Chuck Type	Keyed
Weight	3.9 lbs	Construction Type	Double Insulated
Voltage	120V AC	Gear Train	Double
Tool Warranty	5 Years	Soft Grip Handle	Yes
Cord Type	8'	Spindle Lock	No
No Load RPM	0-1,300	Capacity in Steel	Twist bit 3/8"
Amps	3.5		
Spindle	1/2"- 20		
Chuck Size	3/8"		



THUNDERBOLT® TWIST DRILL BITS

METAL DRILLING SELECTION GUIDE

1 Identify the material to be cut in the columns below

2 Follow the column down to find the accessory with **BEST PERFORMANCE** or **ACCEPTABLE PERFORMANCE**

	CLEAN WOOD	PVC & PLASTICS	ALUMINUM & OTHER NON-FERROUS METALS	PLATE STEEL (1" - 2")	PLATE STEEL (1/2" - 1")	PLATE STEEL (1/4" - 1/2")	METAL (3/16" - 1/4")	METAL (1/8" - 3/16")	SHEET METAL (UP TO 1/8")	CAST IRON	STAINLESS STEEL	PLASTER/ DRYWALL	MILD STEEL	HIGH ALLOY STEEL
BLACK OXIDE														
TITANIUM														
COBALT														
STEP BITS														
CARBIDE TOOTH SHEET METAL CUTTERS														
CARBIDE TOOTH PLATE STEEL CUTTERS														
1" ANNULAR CUTTERS														
2" ANNULAR CUTTERS														
1 PC STEEL HAWG® CUTTER														
THREADED STEEL HAWG® CUTTER														
QUICK CHANGE TANG STEEL HAWG® CUTTER														

THUNDERBOLT® BLACK OXIDE DRILL BITS

LONG LIFE

- THUNDERBOLT® drill bits are designed with a thicker web, providing greater strength and longer life

EFFICIENT CHIP REMOVAL

- Parabolic flute clears chips fast

PRECISION STARTS, NO WALKING

- 135° split point geometry starts fast, on contact

CORROSION RESISTANT

- Black oxide coating provides lubricity and resists corrosion of the bit

NO SPIN SECURE-GRIP™

- 3-Flat shank holds bit secure in drill chuck



Size	Part Number	Qty/Card	Bulk Pack	Bulk Qty
1/16"	48-89-2710	2	48-89-2820	12
5/64"	48-89-2711	2	48-89-2821	12
3/32"	48-89-2712	2	48-89-2822	12
7/64"	48-89-2713	2	48-89-2823	12
1/8"	48-89-2714	2	48-89-2824	12
9/64"	48-89-2715	1	48-89-2825	12
5/32"	48-89-2716	1	48-89-2826	12
11/64"	48-89-2717	1	48-89-2827	12
3/16"	48-89-2718	1	48-89-2828	12
13/64"	48-89-2719	1	48-89-2829	12
7/32"	48-89-2720	1	48-89-2830	12
15/64"	48-89-2721	1	48-89-2831	12
1/4"	48-89-2722	1	48-89-2832	12
17/64"	48-89-2723	1	48-89-2833	6
9/32"	48-89-2724	1	48-89-2834	6
19/64"	48-89-2725	1	48-89-2835	6
5/16"	48-89-2726	1	48-89-2836	6
21/64"	48-89-2727	1	48-89-2837	6
11/32"	48-89-2728	1	48-89-2838	6
23/64"	48-89-2729	1	48-89-2839	6
3/8"	48-89-2730	1	48-89-2840	6
25/64"	48-89-2731	1	48-89-2841	6
13/32"	48-89-2732	1	48-89-2842	6
27/64"	48-89-2733	1	48-89-2843	6
7/16"	48-89-2734	1	48-89-2844	6
29/64"	48-89-2735	1	48-89-2845	6
15/32"	48-89-2736	1	48-89-2846	6
31/64"	48-89-2737	1	48-89-2847	6
1/2"	48-89-2738	1	48-89-2848	6

THUNDERBOLT® TWIST DRILL BITS



THUNDERBOLT® BLACK OXIDE DRILL BIT SETS



14 Pc THUNDERBOLT® Black Oxide Drill Bit Set 48-89-2800	15 Pc THUNDERBOLT® Black Oxide Drill Bit Set 48-89-2803	21 Pc THUNDERBOLT® Black Oxide Drill Bit Set 48-89-2801	29 Pc THUNDERBOLT® Black Oxide Drill Bit Set 48-89-2802
Includes: <ul style="list-style-type: none"> 1/16", 5/64", 3/32", 7/64", (2) 1/8", 9/64", 5/32", 3/16", 7/32", 1/4", 5/16", 3/8", 1/2" 	Includes: <ul style="list-style-type: none"> 1/16", 5/64", 3/32", 7/64", 1/8", 9/64", 5/32", 11/64", 3/16", 13/64", 7/32", 1/4", 9/32", 5/16", 3/8" 	Includes: <ul style="list-style-type: none"> (2) 1/16", (2) 5/64", 3/32", 7/64", (2) 1/8", 9/64", 5/32", 11/64", (2) 3/16", 13/64", 7/32", 15/64", (2) 1/4", 5/16", 3/8", 1/2" 	Includes: <ul style="list-style-type: none"> 1/16", 5/64", 3/32", 7/64", 1/8", 9/64", 5/32", 11/64", 3/16", 13/64", 7/32", 15/64", 1/4", 17/64", 9/32", 19/64", 5/16", 21/64", 11/32", 23/64", 3/8", 25/64", 13/32", 27/64", 7/16", 29/64", 15/32", 31/64", 1/2"

BLACK OXIDE S&D DRILL BITS



Size	Part Number	Qty/Card
17/32"	48-89-2739	1
9/16"	48-89-2740	1
19/32"	48-89-2741	1
5/8"	48-89-2742	1
21/32"	48-89-2743	1
11/16"	48-89-2744	1
23/32"	48-89-2745	1
3/4"	48-89-2746	1
25/32"	48-89-2747	1
13/16"	48-89-2748	1
27/32"	48-89-2749	1
7/8"	48-89-2750	1
29/32"	48-89-2751	1
15/16"	48-89-2752	1
31/32"	48-89-2753	1
1"	48-89-2754	1
1-1/16"	48-89-2755	1
1-1/8"	48-89-2756	1
1-3/16"	48-89-2757	1
1-1/4"	48-89-2758	1

BLACK OXIDE 12" AIRCRAFT LENGTH BITS



Size	Part Number	Qty/Card
1/8"	48-89-2770	1
3/16"	48-89-2771	1
1/4"	48-89-2772	1
5/16"	48-89-2773	1
3/8"	48-89-2774	1
7/16"	48-89-2775	1
1/2"	48-89-2776	1

SHOCKWAVE IMPACT DUTY™ HEX SHANK DRILL BITS



LONG LIFE

- THUNDERBOLT® drill bits are designed with a thicker web, providing greater strength and longer life

EFFICIENT CHIP REMOVAL

- Parabolic flute clears chips fast

PRECISION STARTS, NO WALKING

- 135° split point geometry starts fast, on contact

QUICK CHANGE

- 1/4" Hex power groove shank

Up To
10x
Life



Description	Individual Part Number	Qty	Bulk Part Number	Qty
1/16" Shockwave™ Impact Hex Drill Bit	48-89-4401	1		
3/32" Shockwave™ Impact Hex Drill Bit	48-89-4403	1		
1/8" Shockwave™ Impact Hex Drill Bit	48-89-4405	1	48-89-4705	10
9/64" Shockwave™ Hex Drill Bit	48-89-4406	1		
5/32" Shockwave™ Impact Hex Drill Bit	48-89-4407	1		
11/64" Shockwave™ Hex Drill Bit	48-89-4408	1		
3/16" Shockwave™ Impact Hex Drill Bit	48-89-4409	1		
7/32" Shockwave™ Impact Hex Drill Bit	48-89-4411	1		
1/4" Shockwave™ Impact Hex Drill Bit	48-89-4413	1	48-89-4713	10
5/16" Shockwave™ Hex Drill Bit	48-89-4414	1		
3/8" Shockwave™ Hex Drill Bit	48-89-4415	1		
1/2" Shockwave™ Hex Drill Bit	48-89-4417	1		
4Pc Shockwave™ Impact Hex Drill Bit Set	48-89-4444	4		
(5) 10Pc Shockwave™ Hex Drill Bit Set	48-89-4445	10		



THUNDERBOLT® TWIST DRILL BITS

THUNDERBOLT® TITANIUM DRILL BITS

LONG LIFE

- Titanium coating reduces heat build-up for up to 3X life

EFFICIENT CHIP REMOVAL

- Parabolic flute clears chips fast

PRECISION STARTS, NO WALKING

- 135° split point geometry starts fast, on contact

CORROSION RESISTANT

- Titanium coating provides added protection from heat build-up

NO SPIN

- 3-Flat shank holds bit secure in drill chuck



Size	Part Number	Qty/Card
1/16"	48-89-2201	2
5/64"	48-89-2202	2
3/32"	48-89-2203	2
7/64"	48-89-2204	2
1/8"	48-89-2205	2
9/64"	48-89-2206	1
5/32"	48-89-2207	1
11/64"	48-89-2208	1
3/16"	48-89-2209	1
13/64"	48-89-2210	1
7/32"	48-89-2211	1
15/64"	48-89-2212	1
1/4"	48-89-2213	1
17/64"	48-89-2214	1
9/32"	48-89-2215	1

Size	Part Number	Qty/Card
19/64"	48-89-2216	1
5/16"	48-89-2217	1
21/64"	48-89-2218	1
11/32"	48-89-2219	1
23/64"	48-89-2220	1
3/8"	48-89-2221	1
25/64"	48-89-2222	1
13/32"	48-89-2223	1
27/64"	48-89-2224	1
7/16"	48-89-2225	1
29/64"	48-89-2226	1
15/32"	48-89-2227	1
31/64"	48-89-2228	1
1/2"	48-89-2229	1

THUNDERBOLT® TITANIUM DRILL BIT SETS



14 Pc THUNDERBOLT® Titanium Drill Bit Set 48-89-0011	20 Pc Titanium Drill Bit Set 48-89-1105	29 Pc THUNDERBOLT® Titanium Drill Bit Set 48-89-0012
Includes: <ul style="list-style-type: none"> ▪ 1/16", 5/64", 3/32", 7/64", (2) 1/8", 9/64", 5/32", 3/16", 7/32", 1/4", 5/16", 3/8", 1/2" 	Includes: <ul style="list-style-type: none"> ▪ (2) 1/16", (2) 5/64", (2) 3/32", (2) 7/64", (2) 1/8", 9/64", 5/32", 11/64", 3/16", 13/64", 7/32", 1/4", 5/16", 3/8", 1/2" 	Includes: <ul style="list-style-type: none"> ▪ 1/16", 5/64", 3/32", 7/64", 1/8", 9/64", 5/32", 11/64", 3/16", 13/64", 7/32", 15/64", 1/4", 17/64", 9/32", 19/64", 5/16", 21/64", 11/32", 23/64", 3/8", 25/64", 13/32", 27/64", 7/16", 29/64", 15/32", 31/64", 1/2"

THUNDERBOLT® COBALT DRILL BITS

LONG LIFE

- THUNDERBOLT® drill bits are designed with a thicker web, providing greater strength and longer life

EFFICIENT CHIP REMOVAL

- Parabolic flute clears chips fast

PRECISION STARTS, NO WALKING

NO SPIN

- 3-Flat Shank holds bit secure



THUNDERBOLT® COBALT DRILL BIT SET



Size	Part Number	Qty/Card
3/32"	48-89-2303	1
7/64"	48-89-2304	1
1/8"	48-89-2305	1
9/64"	48-89-2306	1
5/32"	48-89-2307	1
3/16"	48-89-2309	1
1/4"	48-89-2313	1
5/16"	48-89-2317	1
3/8"	48-89-2321	1
7/16"	48-89-2325	1
1/2"	48-89-2329	1

14 Pc THUNDERBOLT® Cobalt Drill Bit Set 48-89-0026
Includes: <ul style="list-style-type: none"> ▪ 1/16", 5/64", 3/32", 7/64", (2) 1/8", 9/64", 5/32", 3/16", 7/32", 1/4", 5/16", 3/8", 1/2"

WOOD BORING BITS



FLAT BORING BITS

FAST CUTTING

- Cutting edge designed for fast, easy wood boring

CLEAN HOLES

- Double wing spurs for clean hole cutting

Size	Part Number	Length
1/2"	48-27-0070	3-1/2"
5/8"	48-27-0075	3-1/2"
3/4"	48-27-0080	3-1/2"
7/8"	48-27-0085	3-1/2"
15/16"	48-27-0090	3-1/2"
1"	48-27-0095	3-1/2"
1-1/8"	48-27-0100	3-1/2"
1-1/4"	48-27-0200	3-1/2"
1-1/2"	48-27-0205	3-1/2"
1/4"	48-27-0251	6"
5/16"	48-27-0311	6"

Size	Part Number	Length
3/8"	48-27-0371	6"
7/16"	48-27-0441	6"
1/2"	48-27-0501	6"
9/16"	48-27-0561	6"
5/8"	48-27-0621	6"
11/16"	48-27-0681	6"
3/4"	48-27-0751	6"
13/16"	48-27-0811	6"
7/8"	48-27-0871	6"
15/16"	48-27-0941	6"
1"	48-27-1001	6"

Size	Part Number	Length
1-1/8"	48-27-1121	6"
1-1/4"	48-27-1251	6"
1-3/8"	48-27-1371	6"
1-1/2"	48-27-1501	6"
3/8"	48-27-0170	16"
1/2"	48-27-0175	16"
5/8"	48-27-0180	16"
3/4"	48-27-0185	16"
7/8"	48-27-0190	16"
1"	48-27-0195	16"



FLAT BORING BIT SETS



6 Pc Stubby Flat Boring Bit Set
(3-1/2")
49-22-0185

Includes:

- 3/4", 7/8", 15/16", 1", 1-1/8" and 6" QUIK-LOK™ extension



8 Pc Universal QUIK-LOK™
Flat Boring Set (6")
49-22-0175

Includes:

- 3/8", 1/2", 5/8", 3/4", 7/8", 1", 1-1/8", and 6" QUIK-LOK™ extension



6 Pc Flat Boring Bit Kit (6")
49-22-0071

Includes:

- 3/8", 1/2", 5/8", 3/4", 7/8", 1"

SPEED FEED™ SELF-FEEDING WOOD BITS

FAST CUTTING

- Up to 10X faster than flat boring bits

CLEAN HOLES

- Double wing spurs for clean hole cutting

FAST CHIP REMOVAL

- Coated flutes for fast chip removal



Size	Part Number
1/2"	48-13-0048
5/8"	48-13-0058
3/4"	48-13-0068
7/8"	48-13-0078
1"	48-13-0088
1-1/4"	48-13-0108

SPEED FEED™

SPEED FEED™ SELF-FEEDING WOOD BIT SET

4 Pc Speed Feed™ Self-Feeding Wood Bit Set
48-13-0400

Includes:

- 1/2", 5/8", 3/4", 1"

USER NEEDS

- Speed of Cut
- Clean Holes
- Low Effort



MILWAUKEE SOLUTION



Self Feed Tip = Less Drilling Force & Faster Drilling



Double Wing Spurs

Clean Hole Cutting & Increases Life of Bit

Feed Screw and Tapered Design

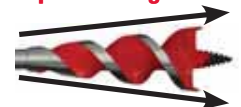

Minimizes Drag = Effortless & Faster Hole Cutting

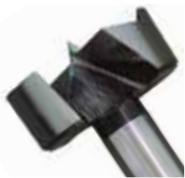

WOOD BORING BITS

BELLHANGER BITS

VERSATILE

- Wire pulling hole for easy wire installation

FAST CHIP REMOVAL

- Coated flutes for fast chip removal

NO SPIN **FLAT SECURE-GRIP™**

- 3-Flat shank holds bit secure in drill chuck

Size	Part Number	Length
1/4"	48-13-7125	12"
5/16"	48-13-7131	12"
3/8"	48-13-7137	12"
3/16"	48-13-7218	18"
1/4"	48-13-7225	18"
5/16"	48-13-7231	18"
3/8"	48-13-7237	18"
7/16"	48-13-7243	18"
1/2"	48-13-7249	18"
1/4"	48-13-7325	24"
3/8"	48-13-7337	24"



CABLE BITS

FLEXIBLE

- Flexible steel shaft allows user to reach areas between or behind walls

VERSATILE

- Wire pulling holes at both ends for easy wire installation

Size	Part Number	Length
3/8"	48-13-8237	54"
1/2"	48-13-8250	54"
9/16"	48-13-8256	54"
3/4"	48-13-8275	54"
3/8"	48-13-8337	72"
1/2"	48-13-8350	72"
9/16"	48-13-8356	72"
3/4"	48-13-8375	72"

Placement Guide 48-08-0275



BRAD POINT BITS

EASY VISUAL REFERENCE

- 1/4" depth marks for easy identification

ACCURATE, CLEAN HOLES

- Brad point style tip for accurate hole placement

LONG LASTING

- Precision ground tip maintains a sharp cutting edge

Size	Part Number
1/8"	48-15-0125
3/16"	48-15-0185
1/4"	48-15-0250
5/16"	48-15-0312
3/8"	48-15-0375
7/16"	48-15-0437
1/2"	48-15-0500



FORSTNER BITS

ACCURATE HOLES

- Precision ground kerf cutters create accurate holes

CLEAN HOLE FINISH

- Polished surface finish makes very clean, flat holes

PRECISION CONTROL

- Round shank style reduces runout for more precise holes

Size	Part Number
3/8"	48-14-0376
1/2"	48-14-0501
5/8"	48-14-0626
3/4"	48-14-0751
1"	48-14-1001
1-3/8"	48-14-1374
35 mm	48-14-1376



FORSTNER BIT SET



4 Pc Forstner Bit Set
48-14-0004

Includes:

- 1/4", 1/2", 5/8", 3/4"

METAL DRILLING BITS



STEP BITS

JAM-FREE*
PERFORMANCE

UP TO
2x FASTER
WITH RAPID STRIKE™ TIP

UP TO
4x LIFE

UP TO
50% MORE HOLES
PER CHARGE*

Model #	Description	Holes
48-89-9201	#1 Step Drill Bit 1/8" - 1/2"	13
48-89-9202	#2 Step Drill Bit 3/16" - 1/2"	6
48-89-9203	#3 Step Drill Bit 1/4" - 3/4"	9
48-89-9204	#4 Step Drill Bit 3/16" - 7/8"	12
48-89-9205	#5 Step Drill Bit 1/4" - 1-3/8"	10
48-89-9206	#6 Step Drill Bit 3/8" & 1/2"	2
48-89-9207	#7 Step Drill Bit 7/8"	1
48-89-9208	#8 Step Drill Bit 1/2" - 1"	9
48-89-9209	#9 Step Drill Bit 7/8" & 1-1/8"	2
48-89-9211	#11 Step Drill Bit 7/8", 1-1/8", 1-7/32"	13
48-89-9212	#12 Step Drill Bit 7/8", 1-1/8", 1-7/32", 1-3/8"	5
48-89-9221	3 Pc Step Drill Bit Set (#1, #2, #4)	-
48-89-9223	4 Pc Step Drill Bit Set (#1, #4, #7, #12)	-
48-89-9224	6 Pc Step Drill Bit Set (#1, #4, #6, #7, #8, #9)	-

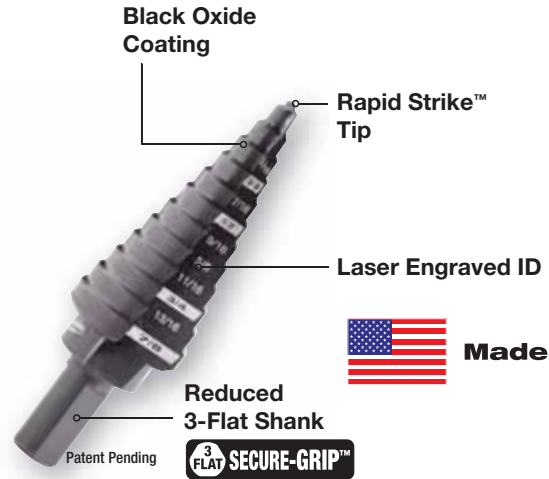

Made in USA

* in cordless drill

CROSS REFERENCE FOR STEP BITS

Milwaukee® Part #	Description	Holes	Lenox® Part #	Irwin® Part #	Greenlee® Part #	DeWalt® Part #
48-89-9201	#1 Step Drill Bit 1/8" - 1/2"	13	VB1	10231	34401	DWA1783IR
48-89-9202	#2 Step Drill Bit 3/16" - 1/2"	6	VB4	10232	36402	DWA1784IR
48-89-9203	#3 Step Drill Bit 1/4" - 3/4"	9	VB3	10233	30005	-
48-89-9204	#4 Step Drill Bit 3/16" - 7/8"	12	VB8	10234	34403	DWA1786IR
48-89-9205	#5 Step Drill Bit 1/4" - 1-3/8"	10	-	10235	-	-
48-89-9206	#6 Step Drill Bit 3/8" & 1/2"	2	VB6	-	34410	-
48-89-9207	#7 Step Drill Bit 7/8"	1	VB7	10311	34411	-

Milwaukee® Part #	Description	Holes	Lenox® Part #	Irwin® Part #	Greenlee® Part #	DeWalt® Part #
48-89-9208	#8 Step Drill Bit 1/2" - 1"	9	VB2	10220	-	-
48-89-9209	#9 Step Drill Bit 7/8" & 1-1/8"	2	VB11	10239	30008	DWA1789IR
48-89-9211	#11 Step Drill Bit 7/8", 1-1/8", 1-7/32"	13	VB9	-	-	-
48-89-9212	#12 Step Drill Bit 7/8", 1-1/8", 1-7/32", 1-3/8"	5	VB12	-	36414	-
48-89-9221	3 Pc Step Drill Bit Set (#1, #2, #4)	-	30889	10502	3607	DWA1790IR
48-89-9223	4 Pc Step Drill Bit Set (#1, #4, #7, #12)	-	30929	-	-	-
48-89-9224	6 Pc Step Drill Bit Set (#1, #4, #6, #7, #9)	-	30927	-	35884	-

FASTEST HOLE SPEED

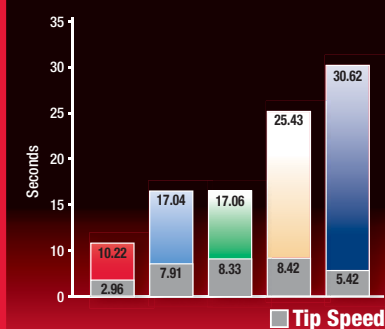

Average Completed Hole Speed

*Tested with #9 1-1/8" Step Bits or equivalent with M18 FUEL™ 2604-22 1/2" Hammer Drill/Driver in 14 gauge 1008 steel

LONGEST LIFE

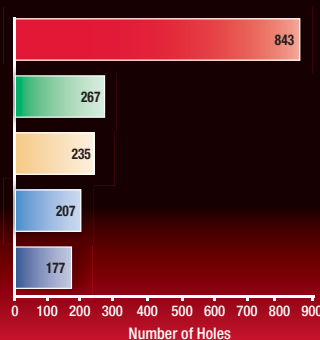

Completed Holes Over Bit Life

*Tested with #1 1/2" Step Bit or equivalent with slide fixture in 14 gauge 1008 steel

HIGHEST PRODUCTIVITY

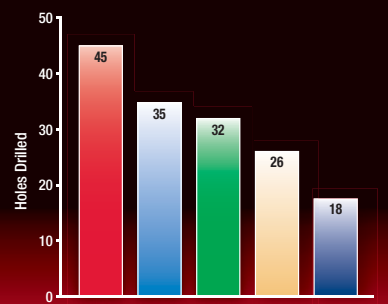

Completed Holes Per Battery Charge

*Tested with #9 1-1/8" Step Bits or equivalent with M18 FUEL™ 2604-22 1/2" Hammer Drill/Driver in 14 gauge 1008 steel

■ Milwaukee® ■ Lenox® ■ Greenlee® ■ Irwin® ■ DeWalt®



METAL DRILLING BITS

CARBIDE TOOTH CUTTERS FOR SHEET METAL

CLEAN HOLES

- Drills burr-free holes
- Specifically designed for hand held applications to produce drill press quality holes

LONG LIFE

- Carbide tips stay sharper longer than high-speed steel or bi-metal cutters

VERSATILE

- For material up to 3/16" thick
- Ideal for stainless steel, structural steel studs and electrical boxes



Size	Metric	Part Number
3/4"	19 mm	49-57-8305
7/8"	22 mm	49-57-8309
1"	25 mm	49-57-8311
1-1/8"	29 mm	49-57-8315
1-7/32"	31 mm	49-57-8317
1-1/4"	32 mm	49-57-8319
1-5/16"	33 mm	49-57-8321
1-3/8"	35 mm	49-57-8323
1-7/16"	37 mm	49-57-8325
1-1/2"	38 mm	49-57-8327
1-3/4"	44 mm	49-57-8329
2"	51 mm	49-57-8331
2-1/8"	54 mm	49-57-8333
2-1/4"	57 mm	49-57-8335
2-3/8"	60 mm	49-57-8337
2-1/2"	64 mm	49-57-8339
2-5/8"	67 mm	49-57-8341
3"	76 mm	49-57-8343

CARBIDE TOOTH CUTTERS FOR STEEL PLATE

CLEAN HOLES

- Drills burr-free holes

LONG LIFE

- Carbide tips stay sharper longer than high-speed steel or bi-metal cutters

VERSATILE

- For material up to 1/2" thick
- Ideal for stainless steel, structural steel studs and electrical boxes



Size	Metric	Part Number
11/16"	18 mm	49-57-8201
3/4"	19 mm	49-57-8203
13/16"	21 mm	49-57-8205
7/8"	22 mm	49-57-8207
15/16"	24 mm	49-57-8209
1"	25 mm	49-57-8211
1-1/16"	27 mm	49-57-8213
1-1/8"	29 mm	49-57-8215
1-3/16"	30 mm	49-57-8217
1-1/4"	32 mm	49-57-8219
1-5/16"	33 mm	49-57-8221
1-3/8"	35 mm	49-57-8223
1-7/16"	37 mm	49-57-8225
1-1/2"	38 mm	49-57-8227

SHEET METAL CARBIDE TOOTH CUTTER KITS



5 Pc Electrician's Kit 49-22-8300	7 Pc Electrician's Kit 49-22-8310
Includes: <ul style="list-style-type: none"> 7/8", 1-1/8", 1-3/8" carbide steel plate cutters Arbor with pilot bit and one additional pilot bit 	Includes: <ul style="list-style-type: none"> 7/8", 1-1/8", 1-3/8", 1-3/4" & 2" carbide sheet metal cutters Arbor with pilot bit and one additional pilot bit

STEEL PLATE CARBIDE TOOTH CUTTER KITS



5 Pc Contractor's Kit 49-22-8200	7 Pc Contractor's Kit 49-22-8210
Includes: <ul style="list-style-type: none"> 11/16", 13/16" & 15/16" carbide steel plate cutters Arbor with pilot bit and one additional pilot bit 	Includes: <ul style="list-style-type: none"> 11/16", 13/16", 15/16", 1-1/8" & 1-3/8" carbide steel plate cutters Arbor with pilot bit and one additional pilot bit

ARBORS AND PILOT BITS FOR CARBIDE TOOTH CUTTERS

QUICK CHANGE ARBOR



Description	Part Number
Quick Change Arbor For All Carbide Cutters	49-57-0035
Pilot Bit For 49-57-0035 Quick Change Arbor	49-57-0038
Ejector Spring For 49-57-0035 Quick Change Arbor	40-50-8780

RETRACTABLE PIN ARBOR



Description	Part Number
Centering Pin Arbor With Detachable Drill Cap*	49-57-0037
Drill Cap For 49-57-0037 Quick Change Arbor*	42-52-1015

*Drill cap is for drilling a pilot hole if used in a hand held application

HOLE SAWS



HOLE SAW SELECTION GUIDE

- 1 Identify the material to be cut in the columns below
- 2 Follow the column down to find **RECOMMENDED** or **ACCEPTABLE**

		METAL	STAINLESS STEEL	ALUMINUM & OTHER NON-FERROUS METALS	WOOD WITH NAILS	CLEAN WOOD	PVC & PLASTICS	CEILING TILE	PLASTER/DRYWALL	FIBERGLASS	CEMENT BOARD	BRICK & BLOCK	SOFT TILE (CERAMIC)	SOFT STONE (MARBLE)	HARD TILE (PORCELAIN)	HARD STONE (GRANITE)	GLASS	CAST IRONS	COMPUTER FLOORING
HOLE SAWS	BI-METAL																		
	CARBIDE GRIT																		
	CARBIDE TIPPED																		
	DIAMOND HOLE SAWS																		
	DIAMOND TILE BITS																		
PILOT BITS	THUNDERBOLT®																		
	CARBIDE TIPPED																		

BI-METAL HOLE SAWS

Size	Metric	Hanging Container	Shrink Wrap	Packaged with Arbor	Bulk Package		Conduit & Pipe	Pipe Tap	Copper Tube
					Item	Qty			
5/8"	16 mm	49-56-0012	49-56-9603						1/4"
11/16"	18 mm	49-56-0017	49-56-9604						3/8"
3/4"	19 mm	49-56-0023	49-56-9605		49-56-5090	25	3/8"	1/2"	1/2"
13/16"	21 mm	49-56-0027	49-56-9606						
7/8"	22 mm	49-56-0032	49-56-9607		49-56-5100	25	1/2"	3/4"	5/8"
15/16"	24 mm	49-56-0037	49-56-9608						
1"	25 mm	49-56-0043	49-56-9609	49-56-9662	49-56-5110	25			3/4"
1-1/16"	27 mm	49-56-0047	49-56-9610						
1-1/8"	29 mm	49-56-0052	49-56-9611	49-56-9663	49-56-5120	25	3/4"	1"	
1-3/16"	30 mm	49-56-0057	49-56-9612						
1-1/4"	32 mm	49-56-0062	49-56-9613	49-56-9664	49-56-5130	25			1"
1-5/16"	33 mm	49-56-0067	49-56-9614						
1-3/8"	35 mm	49-56-0072	49-56-9615		49-56-5140	25	1"		
1-7/16"	37 mm	49-56-0077	49-56-9616						
1-1/2"	38 mm	49-56-0082	49-56-9617	49-56-9665	49-56-5150	25		1-1/4"	1-1/4"
1-9/16"	40 mm	49-56-0087	49-56-9618						
1-5/8"	41 mm	49-56-0092	49-56-9619		49-56-5152	25			
1-11/16"	43 mm	49-56-0097	49-56-9620						
1-3/4"	44 mm	49-56-0102	49-56-9621	49-56-9666	49-56-5155	25	1-1/4"	1-1/2"	1-1/2"
1-13/16"	46 mm	49-56-0107	49-56-9622						
1-7/8"	48 mm	49-56-0112	49-56-9623						
2"	51 mm	49-56-0117	49-56-9624	49-56-9667	49-56-5160	25	1-1/2"		
2-1/16"	52 mm	49-56-0122	49-56-9625						
2-1/8"	54 mm	49-56-0127	49-56-9626	49-56-9668	49-56-5165	25			
2-1/4"	57 mm	49-56-0132	49-56-9628		49-56-5167	25		2"	2"
2-5/16"	59 mm	49-56-0137	49-56-9629						
2-3/8"	60 mm	49-56-0142	49-56-9630						
2-1/2"	64 mm	49-56-0147	49-56-9631	49-56-9669	49-56-5170	25	2"		
2-9/16"	65 mm	49-56-0153	49-56-9632						
2-5/8"	67 mm	49-56-0158	49-56-9633		49-56-5175	16		2-1/2"	
2-3/4"	70 mm	49-56-0163	49-56-9635						
2-7/8"	73 mm	49-56-0167	49-56-9636						
3"	76 mm	49-56-0173	49-56-9637	49-56-9670	49-56-5180	16	2-1/2"		2-1/2"
3-1/8"	79 mm	49-56-0177	49-56-9638						
3-1/4"	83 mm	49-56-0183	49-56-9639					3"	
3-3/8"	86 mm	49-56-0187	49-56-9640						
3-1/2"	89 mm	49-56-0193	49-56-9641		49-56-5190	9			
3-5/8"	92 mm	49-56-0197	49-56-9642		49-56-5195	9	3"		
3-3/4"	95 mm	49-56-0203	49-56-9643					3-1/2"	
3-7/8"	98 mm	49-56-0207	49-56-9644						
4"	102 mm	49-56-0213	49-56-9645		49-56-5200	9			
4-1/8"	105 mm	49-56-0217	49-56-9646		49-56-5205	9	3-1/2"		3-1/2"
4-1/4"	108 mm	49-56-0223	49-56-9647					4"	4"
4-3/8"	111 mm	49-56-0227	49-56-9648						
4-1/2"	114 mm	49-56-0233	49-56-9649					4"	
4-3/4"	121 mm	49-56-0237	49-56-9650						
5"	127 mm	49-56-0243	49-56-9652						
5-1/2"	140 mm	49-56-0247	49-56-9654				5"		5"
6"	152 mm	49-56-0253	49-56-9656						



LONG LIFE

- ICE HARDENED™ cryogenically treated for up to 50% longer life
- Bi-metal construction with 8% cobalt for increased wear resistance

FAST CUTTING

- Optimized tooth form for up to 2X faster cutting

EASY PLUG REMOVAL

- Wide, angled and offset slots for easy plug access

GENERAL PURPOSE CUTTING

- Designed for cutting machinable and non-ferrous metals, wood products and plastics

ice hardened

Up to 50% Longer Life

67% Hard Metal

Standard Heat Treatment

87% Hard Metal

Surface Cooling

97% Hard Metal

ICE Hardening



HOLE SAWS

BI-METAL HOLE SAW KITS



Contents	8 Pc General Purpose Kit 49-22-4005	13 Pc General Purpose Kit 49-22-4025	15 Pc General Purpose Kit 49-22-4175	28 Pc General Purpose Kit 49-22-4185	10 Pc Plumber's Kit 49-22-4145	18 Pc Plumber's Kit 49-22-4155	10 Pc Electrician's Kit 49-22-4095	19 Pc Electrician's Kit 49-22-4105	Door Lock Kit 49-22-4073
Hole Saws	3/4" 7/8" 1" 1-1/8" 1-1/2"	3/4" 7/8" 1-1/8" 1-3/8" 1-1/2" 1-3/4" 2" 2-1/8" 2-1/4" 2-1/2"	3/4" 7/8" 1" 1-1/8" 1-3/8" 1-1/2" 1-3/4" 2" 2-1/8" 2-1/4" 2-1/2"	3/4" 7/8" 1" 1-1/4" 1-1/2" 2" 2-1/4" 2-1/2" 2-5/8" 3" 3-1/4" 3-5/8" 4-1/8" 4-1/4" 4-3/4"	3/4" 7/8" 1-1/8" 1-1/2" 1-3/4" 1-1/2" 1-3/4" 2-1/4"	3/4" 7/8" 1-1/8" 1-1/2" 1-3/4" 2-1/4" 2-5/8" 3-1/2" 4" 4-1/4" 4-1/2"	7/8" 1-1/8" 1-3/8" 1-3/4" 2-1/2" 2-5/8" 3" 3-1/2" 4-1/4" 4-1/2"	3/4" 7/8" 1-1/8" 1-1/2" 1-3/4" 2" 2-1/4" 2-5/8" 3" 3-5/8" 4-1/8" 4-3/4"	1" 2-1/8"
Arbors	49-56-7210 PUSH TO RELEASE™	49-56-7010 49-56-7250	49-56-7010 49-56-9100	49-56-7000 49-56-7010 49-56-9100	49-56-7010 49-56-9100	49-56-7010 49-56-9100	49-56-7010 49-56-9100	49-56-7010 49-56-9100	49-56-7010
Pilot Bits	Additional 49-56-8010	(2) 49-56-8010	(2) Additional 49-56-8010	(3) Additional 49-56-8010	(2) Additional 49-56-8010	(3) Additional 49-56-8010	(2) Additional 49-56-8010	(3) Additional 49-56-8010	(2) 3/32" Drill Bit (2) 1/8" Drill Bit
Other	49-56-6560 Adapter 49-67-0120 Spacer 1/8" Hex Key		49-56-6560 Adapter 49-67-0120 Spacer		49-56-6560 Adapter 49-67-0120 Spacer	49-56-6560 Adapter 49-67-0120 Spacer	49-56-6560 Adapter 49-67-0120 Spacer	49-56-6560 Adapter 49-67-0120 Spacer	49-56-6560 Adapter 49-67-0120 Spacer 49-56-6571 Installation Guide 49-56-6572 Breakthrough Stop

CARBIDE GRIT HOLE SAWS

SPECIALTY APPLICATIONS

- Designed for cutting abrasive materials such as brick, block, cement board, fiberglass and tile

FAST CUTTING

- Coarse grit and segmented edge for fast cutting

EASY PLUG REMOVAL

- Wide, angled and offset slots for easy plug access



Size	Metric	Individual Package	Conduit & Pipe	Copper Tube
3/4"	19 mm	49-56-0405	3/8"	1/2"
7/8"	22 mm	49-56-0409	1/2"	5/8"
1"	25 mm	49-56-0413		3/4"
1-1/8"	29 mm	49-56-0417	3/4"	
1-1/4"	32 mm	49-56-0422		1"
1-3/8"	35 mm	49-56-0426	1"	
1-3/4"	44 mm	49-56-0437	1-1/4"	1-1/2"
2"	51 mm	49-56-0444	1-1/2"	
2-1/4"	57 mm	49-56-0449		2"
2-1/2"	64 mm	49-56-0456	2"	

All sizes include carbide tipped pilot bit

RECESSED LIGHT HOLE SAWS

SMOOTH CUTS

- Continuous grit edge for smooth cuts

ACCURATE HOLE SIZES

- Solid, welded construction provides accurately sized holes

EASY PLUG REMOVAL

- Open back for easy plug removal

Size	Metric	Individual Package
3-1/8"	79 mm	49-56-0296
4-3/8"	111 mm	49-56-0300
5-3/8"	137 mm	49-56-0303
6-3/8"	162 mm	49-56-0305
6-5/8"	168 mm	49-56-0310
6-7/8"	175 mm	49-56-0315



CARBIDE TIPPED HOLE SAWS

SPECIALTY APPLICATIONS

- Designed for cutting cement board, ceramic tiles, fiberglass, cast iron and wood products such as fiberboard, flakeboard and plywood

LONG LIFE

- Tungsten carbide tipped for long life

FAST CUTTING

- Aggressive tooth form for fast cutting

EASY PLUG REMOVAL

- Wide, angled and offset slots for easy plug access



Size	Metric	Individual Package	Conduit & Pipe	Pipe Tap	Copper Tube
5/8"	16 mm	49-56-0623			
3/4"	19 mm	49-56-0753	3/8"	1/2"	1/2"
7/8"	22 mm	49-56-0873	1/2"	3/4"	5/8"
1"	25 mm	49-56-1003			3/4"
1-1/8"	29 mm	49-56-1123	3/4"	1"	
1-1/4"	32 mm	49-56-1253			1"
1-3/8"	35 mm	49-56-1373	1"		
1-1/2"	38 mm	49-56-1503		1-1/4"	1-1/4"
1-5/8"	41 mm	49-56-1623			
1-3/4"	44 mm	49-56-1753	1-1/4"	1-1/2"	1-1/2"
1-7/8"	48 mm	49-56-1873			
2"	51 mm	49-56-2003	1-1/2"		
2-1/8"	54 mm	49-56-2123			
2-1/4"	57 mm	49-56-2253		2"	2"
2-3/8"	60 mm	49-56-2373			
2-1/2"	64 mm	49-56-2503	2"		
2-5/8"	67 mm	49-56-2623		2-1/2"	
2-3/4"	70 mm	49-56-2753			
2-7/8"	73 mm	49-56-2873			
3"	76 mm	49-56-3003	2-1/2"		2-1/2"
3-1/4"	83 mm	49-56-3253		3"	
3-1/2"	89 mm	49-56-3503			
3-5/8"	92 mm	49-56-3623	3"		
3-3/4"	95 mm	49-56-3753		3-1/2"	
4"	102 mm	49-56-4003			
4-1/4"	108 mm	49-56-4253		4"	4"
4-1/2"	114 mm	49-56-4503	4"		
5"	127 mm	49-56-5003			
6"	152 mm	49-56-6003			

HOLE SAWS



ARBORS FOR HOLE SAWS

UNIVERSAL FIT

- Works with all major brands of hole saws
- Accepts any 1/4" straight or 3-flat shank pilot bit

DURABLE

- Made from hardened steel and alloy steel for greater durability

QUICK CHANGE ARBORS

- Tool-free operation
- Universal, quick change with all brands of hole saws
- No adapters required



TOOL FREE OPERATION



	49-56-7210	49-56-7010	49-56-7000	49-56-6950	49-56-7055	49-56-7040	49-56-9100	49-56-7250	49-56-7240
	Quick Change				Quick Change			Quick Change	Quick Change
Hole Saw Size Range	Up to 1-3/16"								
Minimum Chuck Size	3/8"	3/8"	1/2"	1/4"	1/2"	3/8"	1/2"	3/8"	1/2"
Works with Pilot Bits	49-56-8000, 49-56-8010, 49-56-8005			49-56-8000, 49-56-8005		49-56-8000, 49-56-8010, 49-56-8005			

PILOT BITS FOR HOLE SAWS

DURABLE

- THUNDERBOLT® tapered web resists breaking

UNIVERSAL FIT

- Will work with most brands of arbors

STARTS ON CONTACT

- 135° split point for precision start and no walking

No SPIN

- 3-Flat shank won't slip in arbor or chuck on THUNDERBOLT® bits



Description	Length	Diameter	Individual Package	Bulk Package		For Use With
				Item	Qty	
HSS THUNDERBOLT® Bit	3-1/2"	1/4"	49-56-8010	49-56-8033	12	Metal, wood, drywall, plaster, plastics, fiberglass
HSS THUNDERBOLT® Bit	4"	1/4"	49-56-8000	49-56-8031	12	
Carbide Tipped Bit	4"	1/4"	49-56-8005			Fiberglass, cement board, tile, brick, block

DIAMOND TILE BITS



Size	Metric	Individual Package
3/16"	4.76 mm	49-56-0503
1/4"	6.35 mm	49-56-0505
5/16"	7.94 mm	49-56-0507
3/8"	9.53 mm	49-56-0509
1/2"	12.7 mm	49-56-0511
5/8"	15.88 mm	49-56-0513
3/4"	19.05 mm	49-56-0515
1"	25.4 mm	49-56-0517



- Higher Grade Diamonds
- Improved Braze
- Large Slot Geometry

DIAMOND HOLE SAWS



Size	Metric	Individual Package
7/8"	4.76 mm	49-56-5605
1-1/8"	6.35 mm	49-56-5615
1-1/4"	7.94 mm	49-56-5620
1-3/8"	9.53 mm	49-56-5625
1-1/2"	12.7 mm	49-56-5630
2"	15.88 mm	49-56-5645
2-1/2"	19.05 mm	49-56-5660



Retractable Pilot Bit w/ Arbor
49-56-7135

Retractable Pilot Bit
49-56-8025



5/8" - 18" Grinder Adaptor
49-56-7105

1/2" - 20" Grinder Adaptor
49-56-7103



BI-METAL HOLE SAW CROSS-REFERENCE CHART

Hole Saw Diameter	Milwaukee Ice Hardened	Lenox		MK Morse		DeWalt	Bosch	Irwin	Klein	Disston Blu-Mol
		Boxed	Clamshell	Boxed	Carded					
5/8"	49-56-0012	30010-10L	30010-K10L	AV10	AVC10	D180010	PC58	373058BX	31510	510
11/16"	49-56-0017	30011-11L		AV11	AVC11	D180011	PC1116	373011BX		511
3/4"	49-56-0023	30012-12L	30012-K12L	AV12	AVC12	D180012	PC34	373034BX	31512	512
3/4"	49-56-5090									
13/16"	49-56-0027	30013-13L		AV13	AVC13	D180013		373013BX		513
7/8"	49-56-0032	30014-14L	30014-K14L	AV14	AVC14	D180014	PC78	373078BX	31514	514
7/8"	49-56-5100			AV14B25						
15/16"	49-56-0037	30015-15L		AV15	AVC15	D180015		373015BX		515
1"	49-56-0043	30016-16L	30016-K16L	AV16	AVC16	D180016	PC1	373100BX	31516	516
1"	49-56-5110			AV16B25						
1-1/16"	49-56-0047	30017-17L	30017-K17L	AV17	AVC17	D180017	PC116	373110BX		517
1-1/8"	49-56-0052	30018-18L	30018-K18L	AV18	AVC18	D180018	PC118	373118BX	31518	518
1-1/8"	49-56-5120			AV18B25						
1-3/16"	49-56-0057	30019-19L		AV19	AVC19	D180019	PC1316	373130BX		519
1-3/16"	49-56-5125									
1-1/4"	49-56-0062	30020-20L	30020-K20L	AV20	AVC20	D180020	PC114	373114BX	31520	520
1-1/4"	49-56-5130			AV20B25						
1-5/16"	49-56-0067	30021-21L		AV21	AVC21	D180021	PC1516	373150BX		521
1-3/8"	49-56-0072	30022-22L	30022-K22L	AV22	AVC22	D180022	PC138	373138BX	31522	522
1-3/8"	49-56-5140									
1-7/16"	49-56-0077	30023-23L		AV23	AVC23	D180023	PC1716	373170BX		523
1-1/2"	49-56-0082	30024-24L	30024-K24L	AV24	AVC24	D180024	PC112	373112BX	31524	524
1-1/2"	49-56-5150			AV24B25						
1-9/16"	49-56-0087	20025-25L		AV25	AVC25	D180025	PC1916	373190BX		525
1-5/8"	49-56-0092	30026-26L	30026-K26L	AV26	AVC26	D180026	PC158	373158BX	31526	526
1-5/8"	49-56-5152									
1-11/16"	49-56-0097	30027-27L		AV27	AVC27	D180027	PC11116	373111BX		527
1-3/4"	49-56-0102	30028-28L	30028-K28L	AV28	AVC28	D180028	PC134	373134BX	31528	528
1-3/4"	49-56-5155									
1-13/16"	49-56-0107	30029-29L		AV29	AVC29	D180029	PC11316	373113BX		529
1-7/8"	49-56-0112	30030-30L	30030-K30L	AV30	AVC30	D180030	PC178	373178BX		530
2"	49-56-0117	30032-32L	30032-K32L	AV32	AVC32	D180032	PC2	373200BX	31532	532
2"	49-56-5160			AV32B25						
2-1/16"	49-56-0122	30033-33L		AV33	AVC33	D180033	PC2116	373210BX		533
2-1/8"	49-56-0127	30034-34L	30034-K34L	AV34	AVC34	D180034	PC218	373218BX	31534	534
2-1/8"	49-56-5165									
2-1/4"	49-56-0132	30036-36L	30036-K36L	AV36	AVC36	D180036	PC214	373214BX	31536	536
2-1/4"	49-56-5167									
2-5/16"	49-56-0137	30037-37L		AV37	AVC37		PC2516	373250BX		537
2-3/8"	49-56-0142	30038-38L	30038-K38L	AV38	AVC38	D180038	PC238	373238BX	31538	538
2-1/2"	49-56-0147	30040-40L	30040-K40L	AV40	AVC40	D180040	PC212	373212BX	31540	540
2-1/2"	49-56-5170									
2-9/16"	49-56-0153	30041-41L		AV41	AVC41	D180041	PC2916	373290BX		541
2-5/8"	49-56-0158	30042-42L	30042-K42L	AV42	AVC42	D180042	PC258	373258BX	31542	542
2-5/8"	49-56-5175									
2-3/4"	49-56-0163	30044-44L	30044-K44L	AV44	AVC44	D180044	PC234	373234BX	31544	544
2-7/8"	49-56-0167	30046-46L		AV46	AVC46	D180046	PC278	373278BX		546
3"	49-56-0173	30048-48L	30048-K48L	AV48	AVC48	D180048	PC3	373300BX	31548	548
3"	49-56-5180									
3-1/8"	49-56-0177	30050-50L	30050-K50L	AV50	AVC50	D180050	PC318	373318BX		550
3-1/4"	49-56-0183	30052-52L	30052-K52L	AV52	AVC52	D180052	PC314	373314BX	31552	552
3-3/8"	49-56-0187	30054-54L		AV54	AVC54	D180054	PC338	373338BX		554
3-1/2"	49-56-0193	30056-56L	30056-K56L	AV56	AVC56	D180056	PC312	373312BX	31556	556
3-1/2"	49-56-5190									
3-5/8"	49-56-0197	30058-58L	30058-K58L	AV58	AVC58	D180058	PC358	373358BX	31558	558
3-5/8"	49-56-5195									
3-3/4"	49-56-0203	30060-60L		AV60	AVC60	D180060	PC334	373334BX		560
3-7/8"	49-56-0207	30062-62L		AV62	AVC62	D180062	PC378	373378BX		562
4"	49-56-0213	30064-64L	30064-K64L	AV64	AVC64	D180064	PC4	373400BX	31564	564
4"	49-56-5200									
4-1/8"	49-56-0217	30066-66L	30066-K66L	AV66	AVC66	D180066	PC418	373418BX	31566	566
4-1/8"	49-56-5205									
4-1/4"	49-56-0223	30068-68L	30068-K68L	AV68	AVC68	D180068	PC414	373414BX	31568	568
4-3/8"	49-56-0227	30070-70L		AV70	AVC70		PC438	373438BX		570
4-1/2"	49-56-0233	30072-72L	30072-K72L	AV72	AVC72	D180072	PC412	373412BX	31572	572
4-3/4"	49-56-0237	30076-76L	30076-K76L	AV76	AVC76	D180076	PC434	373434BX	31576	576
5"	49-56-0243	30080-80L		AV80	AVC80	D180080	PC5	373500BX	31580	580
5-1/2"	49-56-0247	30088-88L		AV88	AVC88	D180088	PC512	373512BX		588
6"	49-56-0253	30096-96L		AV96	AVC96	D180096	PC6	373600BX	31596	596

BI METAL HOLE SAW CROSS-REFERENCE CHART



Hole Saw Diameter	Milwaukee Ice Hardened	Greenlee		Ideal	Starrett		Simmons	Bahco	
		Boxed	Clamshell		Variable Pitch	Straight 6 TPI		Box	Display Package
5/8"	49-56-0012	825-5/8		35-341	VH0058	SH0058	36-000900	3830-16-US	3830-16-C
11/16"	49-56-0017	825-11/16		35-342	VH1016	SH1016	36-001100	3830-17-US	3830-17-C
3/4"	49-56-0023	825-3/4	826-3/4	35-343	VH0034	SH0034	36-001200	3830-19-US	3830-19-C
3/4"	49-56-5090								
13/16"	49-56-0027	825-13/16		35-344	VH1036	SH1036	36-001300	3830-21-US	3830-21-C
7/8"	49-56-0032	825-7/8	826-7/8	35-345	VH0078	SH0078	36-001400	3830-22-US	3830-22-C
7/8"	49-56-5100								
15/16"	49-56-0037	825-15/16		35-346	VH1056	SH1056	36-001500	3830-24-US	3830-24-C
1"	49-56-0043	825-1		35-347	VH0100	SH0100	36-001600	3830-25-US	3830-25-C
1"	49-56-5110								
1-1/16"	49-56-0047	825-1-1/16		35-348	VH0116	SH0116	36-001700	3830-27-US	3830-27-C
1-1/8"	49-56-0052	825-1-1/8	826-1-1/8	35-349	VH0118	SH0118	36-001800	3830-29-US	3830-29-C
1-1/8"	49-56-5120								
1-3/16"	49-56-0057	825-1-3/16		35-350	VH0136	SH0136	36-001900	3830-30-US	3830-30-C
1-3/16"	49-56-5125								
1-1/4"	49-56-0062	825-1-1/4		35-351	VH0114	SH0114	36-002000	3830-32-US	3830-32-C
1-1/4"	49-56-5130								
1-5/16"	49-56-0067	825-1-5/16		35-352	VH0156	SH0156	36-002100	3830-33-US	3830-33-C
1-3/8"	49-56-0072	825-1-3/8	826-1-3/8	35-353	VH0138	SH0138	36-002200	3830-35-US	3830-35-C
1-3/8"	49-56-5140								
1-7/16"	49-56-0077	825-1-7/16		35-354	VH0176	SH0176	36-002300	3830-37-US	3830-37-C
1-1/2"	49-56-0082	825-1-1/2		35-355	VH0112	SH0112	36-002400	3830-38-US	3830-38-C
1-1/2"	49-56-5150								
1-9/16"	49-56-0087	825-1-9/16		35-356	VH0196	SH0196	36-002500	3830-40-US	3830-40-C
1-5/8"	49-56-0092	825-1-5/8		35-357	VH0158	SH0158	36-002600	3830-41-US	3830-41-C
1-5/8"	49-56-5152								
1-11/16"	49-56-0097	825-1-11/16		35-358	VH1116	SH1116	36-002700	3830-43-US	3830-43-C
1-3/4"	49-56-0102	825-1-3/4	826-1-3/4	35-359	VH0134	SH0134	36-002800	3830-44-US	3830-44-C
1-3/4"	49-56-5155								
1-13/16"	49-56-0107	825-1-13/16		35-360	VH1136	SH1136	36-002900	3830-46-US	3830-46-C
1-7/8"	49-56-0112	825-1-7/8		35-361	VH0178	SH0178	36-003000	3830-48-US	3830-48-C
2"	49-56-0117	825-2	826-2	35-362	VH0200	SH0200	36-003200	3830-51-US	3830-51-C
2"	49-56-5160								
2-1/16"	49-56-0122	825-2-1/16		35-363	VH0216	SH0216	36-003300	3830-52-US	3830-52-C
2-1/8"	49-56-0127	825-2-1/8		35-364	VH0218	SH0218	36-003400	3830-54-US	3830-54-C
2-1/8"	49-56-5165								
2-1/4"	49-56-0132	825-2-1/4		35-365	VH0214	SH0214	36-003600	3830-57-US	3830-57-C
2-1/4"	49-56-5167								
2-5/16"	49-56-0137	825-2-5/16		35-366	VH0256	SH0256	36-003700	3830-59-US	3830-59-C
2-3/8"	49-56-0142	825-2-3/8		35-367	VH0238	SH0238	36-003800	3830-60-US	3830-60-C
2-1/2"	49-56-0147	825-2-1/2	826-2-1/2	35-368	VH0212	SH0212	36-004000	3830-64-US	3830-64-C
2-1/2"	49-56-5170								
2-9/16"	49-56-0153	825-2-9/16		35-369	VH0296	SH0296	36-004100	3830-65-US	3830-65-C
2-5/8"	49-56-0158	825-2-5/8		35-370	VH0258	SH0258	36-004200	3830-67-US	3830-67-C
2-5/8"	49-56-5175								
2-3/4"	49-56-0163	825-2-3/4		35-371	VH0234	SH0234	36-004400	3830-70-US	3830-70-C
2-7/8"	49-56-0167	825-2-7/8		35-372	VH0278	SH0278	36-004600	3830-73-US	3830-73-C
3"	49-56-0173	825-3	826-3	35-373	VH0300	SH0300	36-004800	3830-76-US	3830-76-C
3"	49-56-5180								
3-1/8"	49-56-0177	825-3-1/8		35-374	VH0318	SH0318	36-005000	3830-79-US	3830-79-C
3-1/4"	49-56-0183	825-3-1/4		35-375	VH0314	SH0314	36-005200	3830-83-US	3830-83-C
3-3/8"	49-56-0187	825-3-3/8		35-376	VH0338	SH0338	36-005400	3830-86-US	3830-86-C
3-1/2"	49-56-0193	825-3-1/2		35-377	VH0312	SH0312	36-005600	3830-89-US	3830-89-C
3-1/2"	49-56-5190								
3-5/8"	49-56-0197	825-3-5/8	826-3-5/8	35-378	VH0358	SH0358	36-005800	3830-92-US	3830-92-C
3-5/8"	49-56-5195								
3-3/4"	49-56-0203	825-3-3/4		35-379	VH0334	SH0334	36-006000	3830-95-US	3830-95-C
3-7/8"	49-56-0207	825-3-7/8		35-380	VH0378	SH0378	36-006200	3830-98-US	3830-98-C
4"	49-56-0213	825-4		35-381	VH0400	SH0400	36-006400	3830-102-US	3830-102-C
4"	49-56-5200								
4-1/8"	49-56-0217	825-4-1/8	826-4-1/8	35-382	VH0418	SH0418	36-006600	3830-105-US	3830-105-C
4-1/8"	49-56-5205								
4-1/4"	49-56-0223	825-4-1/4		35-383	VH0414	SH0414	36-006800	3830-108-US	3830-108-C
4-3/8"	49-56-0227	825-4-3/8		35-384	VH0438	SH0438	36-007000	3830-111-US	3830-111-C
4-1/2"	49-56-0233	825-4-1/2	826-4-1/2	35-385	VH0412	SH0412	36-007200	3830-114-US	3830-114-C
4-3/4"	49-56-0237	825-4-3/4		35-386	VH0434	SH0434	36-007600	3830-121-US	3830-121-C
5"	49-56-0243	825-5		35-387	VH0500	SH0500	36-008000	3830-127-US	3830-127-C
5-1/2"	49-56-0247	825-5-1/2		35-388	VH0512	SH0512	36-008800	3830-140-US	3830-140-C
6"	49-56-0253	825-6		35-390	VH0600	SH0600	36-009600	3830-152-US	3830-152-C



HOLE SAW ARBOUR CROSS-REFERENCE CHART

Hole Saw Diameter	Milwaukee Ice Hardened	Lenox		MK Morse		DeWalt	Bosch	Irwin	Klein
		Boxed	Clamshell	Boxed	Carded				
Twist Release™, Quick Change Arbour	49-56-7210								
Arbour; 3/8" Hex Shank 1/2-20	49-56-7010	30005-5L		M34	M34C	DW1801		373001	31655
Arbour; 7/16" Hex Shank 1/2-20	49-56-7000	30001-1L		M44	M44C				31660
Arbour; 1/4" Shank 1/2-20	49-56-6950	30004-4L		M24K	M24KC	DW1800			31650
Arbour; 1/2" Hex Shank 5/8-18; Drive Pins by Round Nut	49-56-7055			M45P	M45PC				31670
Arbour; 3/8" Hex Shank 5/8-18	49-56-7040								
Quick Change Arbour; 1/2" Hex Shank 5/8-18; Drive Pins w/ Hex Push Plate	49-56-9100	30003-3L							
Arbour; 3/8" Hex Shank 5/8-18; Snap-In Drive Pins		30006-6L							
Arbour; 7/16" Hex Shank 5/8-18; Snap-In Drive Pins									31168
Quick Change Arbour; 3/8" Hex Shank 5/8-18; Drive Pins	49-56-7250								
Quick Change Arbour; 1/2" Hex Shank 5/8-18; Drive Pins	49-56-7240								
Long Pilot Bit; Split Point	49-56-8000	30850-4321		MPD4N01	TACPD4	DW1808			31672
Long Pilot Bit; Split Point; 12-pack	49-56-8031								
Long Pilot Bit; Split Point with Short Pilot Bit Flutes for Sheet Metal	49-56-8002								
Short Pilot Bit; Split Point	49-56-8003	30851-56PD			TACPD325	DW1807		373000	31674
Short Pilot Bit; Split Point; 12-pack	49-56-8032								
Short Pilot Bit; Split Point	49-56-8010			MPD4S01	TACPD4S				
Short Pilot Bit; Split Point; 12-pack	49-56-8033								
Long Pilot Bit; Carbide Tipped	49-56-8005	30297-123CT		MPD4CT01					

BI-METAL & CARBIDE TIP HOLE SAWS



HOLE SAW ARBOUR CROSS-REFERENCE CHART



Hole Saw Diameter	Milwaukee Ice Hardened	Greenlee		Ideal	Starrett		Simmons	Bahco	
		Boxed	Clamshell		Variable Pitch	Straight 6 TPI		Box	Display Package
Twist Release™, Quick Change Arbour	49-56-7210								
Arbour; 3/8" Hex Shank 1/2-20	49-56-7010			35-392	A1		36-010050	3834-ARBR-930	3834-ARBR-930-C
Arbour; 7/16" Hex Shank 1/2-20	49-56-7000	37155	38505	35-393			36-010100	3834-ARBR-1130	3834-ARBR-1130-C
Arbour; 1/4" Shank 1/2-20	49-56-6950	37157	38507	35-391	A4		36-010000	3834-ARBR-730	3834-ARBR-730-C
Arbour; 1/2" Hex Shank 5/8-18; Drive Pins by Round Nut	49-56-7055			35-394			36-010200		
Arbour; 3/8" Hex Shank 5/8-18	49-56-7040								
Quick Change Arbour; 1/2" Hex Shank 5/8-18; Drive Pins w/ Hex Push Plate	49-56-9100	37156	38506		A17-12		36-010300		
Arbour; 3/8" Hex Shank 5/8-18; Snap-In Drive Pins				35-537	A10		36-010080	3834-ARBR-9100QC	3834-ARBR-9100QC-C
Arbour; 7/16" Hex Shank 5/8-18; Snap-In Drive Pins				35-536	A2			3834-ARBR-11152QC	3834-ARBR-11152QC-C
Quick Change Arbour; 3/8" Hex Shank 5/8-18; Drive Pins	49-56-7250								
Quick Change Arbour; 1/2" Hex Shank 5/8-18; Drive Pins	49-56-7240								
Long Pilot Bit; Split Point	49-56-8000	37623	39873	35-397	A014CE				
Long Pilot Bit; Split Point; 12-pack	49-56-8031								
Long Pilot Bit; Split Point with Short Pilot Bit Flutes for Sheet Metal	49-56-8002								
Short Pilot Bit; Split Point	49-56-8003	38526	39893	35-398	A014C		36-015150	3834-DRL	
Short Pilot Bit; Split Point; 12-pack	49-56-8032								
Short Pilot Bit; Split Point	49-56-8010								
Short Pilot Bit; Split Point; 12-pack	49-56-8033								
Long Pilot Bit; Carbide Tipped	49-56-8005	10082							

CARBIDE GRIT & DIAMOND PLUS™ HOLE SAWS





D-HANDLE DRILLS

1001-1 1/2" D-Handle Drill, 600RPM



FEATURES



- Powerful 7.0-amp motor: Delivers up to 600 RPM, with trigger speed control and reverse
- Torque: Offers 1/2" capacity in steel
- Heavy-duty keyed chuck with holder: Provides an industrial hold during drilling and fastening
- 8-ft. fixed rubber cord: Durable construction for longer tool life

Includes: (1) 1/2 in. D-Handle Drill 0-600 RPM (1001-1); (1) Chuck Key with Holder; (1) Side Handle

SPECIFICATIONS

Length	14-3/4"	Construction Type	Grounded
Weight	6.8 lbs	Gear Train	Triple
Voltage	120V AC	Soft Grip Handle	No
Tool Warranty	5 Years	Spindle Lock	No
Cord Type	8' Fixed	Capacity in Wood	Flat Boring Bit 1-1/2"
No Load RPM	0-600		Hole Saw 5"
Amps	7		Auger 1-1/2"
Spindle	1/2"- 20		Self-Feed 3-5/8"
Chuck Size	1/2"		
Chuck Type	Keyed		

1007-1 1/2" D-Handle Drill, 600RPM



FEATURES



- Powerful 7.0-amp motor: Delivers up to 600 RPM, with trigger speed control and reverse
- Torque: Offers 1/2" capacity in steel
- Heavy-duty keyed chuck with holder: Provides an industrial hold during drilling and fastening
- QUIK-LOK® Cord: 8-ft. 3-wire grounded rubber cord provides easy storage and field replacement

Includes: (1) 1/2 in. D-Handle Drill 0-600 RPM (1007-1); (1) Chuck Key with Holder; (1) Side Handle

SPECIFICATIONS

Length	14-3/4"	Construction Type	Grounded
Weight	6.8 lbs	Gear Train	Triple
Voltage	120V AC	Soft Grip Handle	No
Tool Warranty	5 Years	Spindle Lock	No
Cord Type	8' QUIK-LOK®	Capacity in Wood	Flat Boring Bit 1-1/2"
No Load RPM	0-600		Hole Saw 5"
Amps	7		Auger 1-1/2"
Spindle	1/2"- 20		Self-Feed 3-5/8"
Chuck Size	1/2"		
Chuck Type	Keyed		

ATTACHMENTS



48-76-4008: 8' Quik-Lok®



48-76-4025: 25' Quik-Lok®

D-HANDLE DRILLS



1101-1

1/2" D-Handle Drill, 500RPM



FEATURES



- Powerful 7.0-amp motor: Delivers up to 500 RPM, with reverse
- Torque: Offers 1/2" capacity in steel
- Heavy-duty keyed chuck with holder: Provides an industrial hold during drilling and fastening
- 8-ft. fixed rubber cord: Durable construction for longer tool life

Includes: (1) 1/2 D-Handle Drill 500 RPM (1101-1); (1) Chuck Key with Holder; (1) Side Handle

SPECIFICATIONS

Length	14-3/4"	Construction Type	Grounded
Weight	6.8 lbs	Gear Train	Triple
Voltage	120V AC	Soft Grip Handle	No
Tool Warranty	5 Years	Spindle Lock	No
Cord Type	8' Fixed	Capacity in Wood	Flat Boring Bit 1-1/2"
No Load RPM	500		Hole Saw 5"
Amps	7		Auger 1-1/2"
Spindle	1/2"- 20		Self-Feed 3-5/8"
Chuck Size	1/2"		
Chuck Type	Keyed		

1107-6

1/2" D-Handle Drill, 500RPM



FEATURES



- Powerful 7.0-amp motor: Delivers up to 500 RPM, with trigger speed control and reverse
- Torque: Offers 1/2" capacity in steel
- Heavy-duty keyed chuck with holder: Provides an industrial hold during drilling and fastening
- QUIK-LOK® Cord: 8-ft. 3-wire grounded rubber cord provides easy storage and field replacement

Includes: (1) Chuck Key with Holder, (1) Side Handle

SPECIFICATIONS

Length	14-3/4"	Construction Type	Grounded
Weight	6.8 lbs	Gear Train	Triple
Voltage	120V AC	Soft Grip Handle	No
Tool Warranty	5 Years	Spindle Lock	No
Cord Type	8' QUIK-LOK®	Capacity in Wood	Flat Boring Bit 1-1/2"
No Load RPM	0-500		Hole Saw 5"
Amps	7		Auger 1-1/2"
Spindle	1/2"- 20		Self-Feed 3-5/8"
Chuck Size	1/2"		
Chuck Type	Keyed		

ATTACHMENTS



48-76-4008: 8' Quik-Lok®



48-76-4025: 25' Quik-Lok®



Milwaukee

D-HANDLE DRILLS

1250-1 1/2" D-Handle Drill, 1000RPM



FEATURES



- Powerful 7.0-amp motor: Delivers up to 1000 RPM, with trigger speed control and reverse
- Torque: Offers 1/2" capacity in steel
- Heavy-duty keyed chuck with holder: Provides an industrial hold during drilling and fastening
- 8-ft. fixed rubber cord: Durable construction for longer tool life

Includes: (1) 1/2" D-Handle Drill 0-1000 RPM (1250-1); (1) Chuck Key with Holder; (1) Side Handle

SPECIFICATIONS

Length	14-3/4"	Construction Type	Grounded
Weight	6.5 lbs	Gear Train	Double
Voltage	120V AC	Soft Grip Handle	No
Tool Warranty	5 Years	Spindle Lock	No
Cord Type	8' Fixed	Capacity in Wood	Flat Boring Bit 1-1/2"
No Load RPM	0-1,000		Hole Saw 3-1/8"
Amps	7		Auger 1-1/2"
Spindle	1/2"- 20		Self-Feed 2-1/4"
Chuck Size	1/2"		
Chuck Type	Keyed		

ATTACHMENTS

48-06-2860 33° Angle Drive Kit (tool not included)

- Stretches drilling reach up to 30 in.
- Allows drilling up to 2-9/16 in. diameter holes
- Use 33 degree angle drive with 30 in. extension only
- For use with Drills 1001-1, 1007-1, 1101-1, 1107-6, 1201-1, and 1250-1
- Length: 30"



48-06-2871 Right Angle Drive Unit

- For use with Milwaukee 1/2" D-Handle Drills
- Provides 2 Additional Drilling Speeds
- Includes coupling No. 42-90-0175 for 0234-6 and 0244-1
- For 50% More Torque or 50% More Speed
- Length: 5-1/2"



QUIK-LOK® CORDS



2-WIRE QUIK-LOK® CORD SETS FOR DOUBLE INSULATED TOOLS



Cat. No.	Description	NEMA Plug Type
48-76-5010	2-Wire 10' Quik-Lok®	1-15P
48-76-5025	2-Wire 25' Quik-Lok®	1-15P

3-WIRE QUIK-LOK® CORD SETS



Cat. No.	Description	NEMA Plug Type
48-76-4008	3-Wire 8' Quik-Lok®	5-15P
48-76-4025	3-Wire 25' Quik-Lok®	5-15P

3-WIRE QUIK-LOK® CORD SETS WITH TWIST LOCK PLUG



Cat. No.	Description	NEMA Plug Type
48-76-4108	3-Wire 8' Quik-Lok® With Twist Lock Plug	L5-20P
48-76-4125	3-Wire 25' Quik-Lok® With Twist Lock Plug	L5-20P

2-WIRE AND 3-WIRE QUIK-LOK® CORD SETS

- Premium Grade Hi-Flex Wire And Insulating System
- Quick Detachment From Tool For Tangle Free Carrying And Storage
- Instant Field Repair
- Quik-Lok With Twist Lock Plug Cord Sets Also Available

Recommended Minimum Wire Gauge For Extension Cords*

Nameplate Amperes	Extension Cord Length					
	25'	50'	75'	100'	150'	200'
0 - 5.0	16	16	16	14	12	12
5.1 - 8.0	16	16	14	12	10	-
8.1 - 12.0	14	14	12	10	-	-
12.1 - 15.0	12	12	10	10	-	-
15.1 - 20.0	10	10	10	-	-	-

*Based on limiting the line voltage drop to five volts at 150% of the rated amperes.



HOLE-HAWG® DRILLS



1670-1 1/2" Hole Hawg® Drill, 900 RPM



FEATURES AC

- Powerful 7.5-amp motor: Delivers 900 RPM with reverse
- Self-Feed Bit Capacity: Handles up to a 2-9/16" bit
- Reinforced nylon resin casing: Provides durability and a reduced weight with greater heat dissipation and resistance to chemicals

Includes: (1) 1/2" Hole Hawg® Drill 900 RPM (1670-1);
(1) Pipe Handle

SPECIFICATIONS

Length	6-1/2"	Construction Type	Grounded
Weight	11.5 lbs	Gear Train	Triple
Voltage	120V AC	Soft Grip Handle	No
Tool Warranty	5 Years	Spindle Lock	No
Cord Type	8' Fixed	Capacity in Steel	Twist Bit 7/16"
No Load RPM	900	Capacity in Wood	Auger 1-1/2" Self-Feed 2-9/16"
Amps	7.5	Chuck Type	Keyed
Spindle	5/8" - 16		
Chuck Size	1/2"		
Chuck Type	Keyed		

1675-6 1/2" Hole Hawg® Drill 300/1200RPM



FEATURES AC

- Powerful 7.5-amp motor: Delivers 300 RPM - 1,200 RPM with reverse
- Self-Feed Bit Capacity: Handles up to a 4-5/8" bit
- Reinforced nylon resin casing: Provides durability and a reduced weight with greater heat dissipation and resistance to chemicals

Includes: (1) 1/2" Hole-Hawg® Drill 300/1200 RPM (1675-6);
(1) Pipe Handle

SPECIFICATIONS

Length	6-1/2"	Construction Type	Grounded
Weight	11.5 lbs	Gear Train	Triple
Voltage	120V AC	Soft Grip Handle	No
Tool Warranty	5 Years	Spindle Lock	No
Cord Type	8' Fixed	Capacity in Steel	Twist Bit 1/2"
No Load RPM	300 and 1,200	Capacity in Wood	Auger 1-1/2" Self-Feed 4-5/8"
Amps	7.5	Chuck Type	Keyed
Spindle	5/8" - 16		
Chuck Size	1/2"		
Chuck Type	Keyed		

1676-6 1/2" Hole Hawg® Drill, 300/1200RPM with Carrying Case

AC

Includes: (1) 1/2 in. Hole-Hawg® Drill 300/1200 RPM KIT (1676-6);
(1) Carrying Case; (1) Pipe Handle

SUPER HAWG™ DRILLS AND CHUCK KEYS

1680-20 1/2" Super Hawg™



FEATURES



- Powerful 13.0-amp motor: Delivers 450 RPM - 1,750 RPM with a clutch in low gear
- Roto-Lok® handle: Features 90° left-right rotations for maximum comfort in all applications
- Reinforced nylon resin casing: Provides durability and less weight than metal with greater heat dissipation and resistance to chemicals

Includes: (1) 1/2" Super Hawg™ (1680-20); (1) Side Handle

SPECIFICATIONS

Length	22"	Construction Type	Gounded
Weight	14.7 lbs	Gear Train	Triple
Voltage	120V AC	Soft Grip Handle	Yes
Tool Warranty	5 Years	Spindle Lock	No
Cord Type	8' Fixed	Capacity in Steel	Twist Bit 1/2"
No Load RPM	450-1,750	Capacity in Wood	Auger 1-1/2" Self-Feed 4-5/8"
Amps	13	Chuck Type	Keyed
Spindle	5/8" - 16		
Chuck Size	1/2"		

1680-21 1/2" Super Hawg™ with Carrying Case



Includes: (1) 1/2" Super Hawg™ (1680-20); (1) Side Handle

CHUCK KEYS AND CHUCK KEY HOLDERS

48-66-2110 Chuck Key & 48-66-4040 Chuck Key Holder

- For use with 5378-20, 5380-20, 5381-20

48-66-3080 Chuck Key & 48-66-4040 Chuck Key Holder

- For use with 0200-20

48-66-3160 Chuck Key & 48-66-4020 Chuck Key Holder

- For use with 1854-1, 4262-1

48-66-3200 Chuck Key & 48-66-4080 Chuck Key Holder

- For use with 0100-20, 0101-20

48-66-3240 Chuck Key & 48-66-4040 Chuck Key Holder

- For use with 0370-20

48-66-3280 Chuck Key & 48-66-4040 Chuck Key Holder

- For use with 0234-6, 0244-1, 0299-20, 0300-20, 1001-1, 1007-1, 1101-1, 1107-6, 1250-1, 3002-1, 3102-6, 3107-6, 1610-1, 1630-1, 1660-6, 1663-20

SWITCHBLADE™ BITS



SEE PAGE 55

BIG HAWG® HOLE CUTTERS



SEE PAGE 58

WOOD BORING SELFEED BITS



WOOD BORING SELECTION GUIDE

- 1 Identify the material to be cut in the columns below
- 2 Follow the column down to find **BEST PERFORMANCE** or **ACCEPTABLE PERFORMANCE**

	CLEAN WOOD	WOOD WITH NAILS	HOLE FINISH	FAST DRILLING	DRILLS POCKET HOLES	WIRE PULLING	IMPACT RATED
SELFEED BIT			ROUGH				
BIG HAWG®							
SHIP AUGER							
SPUR AUGER							
SPEED FEED™							
FLAT BORING							
BRAD POINT							
FORSTNER			FINE				
BELLHANGER							
CABLE							

SWITCHBLADE™ SELFEED BITS

LONG LIFE

- Cutting edge is replaceable, made with hardened steel to increase bit life

FAST DRILLING

- Aggressive feed screw design allows the bit to pull through the wood faster

EASY SIZE REFERENCE

- Bit and blades are engraved for quick and easy size identification

SWITCHBLADE™



Size	Part Number	Qty	Shank Type	Entrance For Pipe and Rigid Conduit	Entrance For Tubing
1-3/8"	48-25-5120	1	7/16" Hex	1"	1-1/4"
1-1/2"	48-25-5125	1	7/16" Hex		1-3/8"
2"	48-25-5135	1	7/16" Hex	1-1/2"	1-7/8"
2-1/8"	48-25-5140	1	7/16" Hex		2"
2-1/4"	48-25-5143	1	7/16" Hex		2-1/8"
2-9/16"	48-25-5150	1	7/16" Hex	2"	2-1/2"

SWITCHBLADE™ SELFEED BIT KIT



5 Pc SWITCHBLADE™ Plumber's Kit 49-22-5100

Includes:

- (1) Each SWITCHBLADE™ selffeed bits (1-3/8", 1-1/2", 2-1/8", 2-9/16")
- (1) 5-1/2" QUIK-LOK™ extension
- (1) Each replacement blades
- (4) Feed screws
- (4) Set screws
- (1) Hex wrench
- Case with bulk storage container

SWITCHBLADE™ REPLACEMENT BLADES

Size	Part Number	Qty	Size	Part Number	Qty
1-3/8"	48-25-5420	1	2-1/8"	48-25-5240	3*
1-1/2"	48-25-5425	1	2-9/16"	48-25-5250	3*
2"	48-25-5435	1	1-3/8"	48-25-5320	10*
2-1/8"	48-25-5440	1	1-1/2"	48-25-5325	10*
2-1/4"	48-25-5443	1	2"	48-25-5335	10*
2-9/16"	48-25-5450	1	2-1/8"	48-25-5340	10*
1-3/8"	48-25-5220	3*	2-9/16"	48-25-5350	10*
1-1/2"	48-25-5225	3*			
2"	48-25-5235	3*			

*Includes hex wrench and case



Replacement Feedcrew Pack
48-25-5275



SWITCHBLADE™ Accessory
Service Kit
48-25-5280

WOOD BORING SELFEED BITS

STANDARD SELFEED BITS

FAST DRILLING

- Aggressive feed screw design allows the bit to pull through the wood faster

CLEAN HOLES

- Alloy steel kerf cutters provide clean holes

RESHARPENABLE

- Cutting edge can be resharpened



Size	Part Number	Qty	Shank Type	Entrance For Pipe and Rigid Conduit	Entrance For Tubing	Package Type
1"	48-25-1001	1	7/16" Hex	1/2"	7/8"	Carton
1"	48-25-1002	1	7/16" Hex	1/2"	7/8"	Clamshell
1-1/8"	48-25-1121	1	7/16" Hex	1/2"	1"	Carton
1-1/8"	48-25-1122	1	7/16" Hex	1/2"	1"	Clamshell
1-1/4"	48-25-1251	1	7/16" Hex	3/4"	1-1/8"	Carton
1-1/4"	48-25-1252	1	7/16" Hex	3/4"	1-1/8"	Clamshell
1-3/8"	48-25-1371	1	7/16" Hex	1"	1-1/4"	Carton
1-3/8"	48-25-1372	1	7/16" Hex	1"	1-1/4"	Clamshell
1-1/2"	48-25-1501	1	7/16" Hex		1-3/8"	Carton
1-1/2"	48-25-1502	1	7/16" Hex		1-3/8"	Clamshell
1-3/4"	48-25-1751	1	7/16" Hex	1-1/4"	1-1/2"	Carton
1-3/4"	48-25-1752	1	7/16" Hex	1-1/4"	1-1/2"	Clamshell
2"	48-25-2001	1	7/16" Hex	1-1/2"	1-7/8"	Carton
2"	48-25-2002	1	7/16" Hex	1-1/2"	1-7/8"	Clamshell
2-1/8"	48-25-2121	1	7/16" Hex		2"	Carton
2-1/8"	48-25-2122	1	7/16" Hex		2"	Clamshell
2-1/4"	48-25-2251	1	7/16" Hex		2-1/8"	Carton
2-1/4"	48-25-2252	1	7/16" Hex		2-1/8"	Clamshell
2-9/16"	48-25-2561	1	7/16" Hex	2"	2-1/2"	Carton
2-9/16"	48-25-2562	1	7/16" Hex	2"	2-1/2"	Clamshell
3"	48-25-3001	1	3-Flat	2-1/2"	2-7/8"	Carton
3-5/8"	48-25-3621	1	3-Flat	3"	3-1/2"	Carton
4-1/8"	48-25-4125	1	3-Flat	3**		Carton
4-5/8"	48-25-4621	1	3-Flat	4"	4-1/2"	Carton

STANDARD SELFEED BIT KITS

7 Pc Plumber's Kit 49-22-0065	7 Pc Contractor's Kit 49-22-0130	4 Pc Contractor's Kit 49-22-0135
Includes: <ul style="list-style-type: none"> (1) Each augers (7/8", 1-1/8", 1-1/4", 1-1/2") (1) Each selffeed bits (1-3/4", 2-1/8", 2-9/16") (1) 5-1/2" Hex key extension 	Includes: <ul style="list-style-type: none"> (2) Each augers (7/8", 1-1/8", 1-1/4", 1-1/2") (1) Each selffeed bits (1", 1-1/8", 1-1/4", 1-1/2", 1-3/4", 2-1/8", 2-9/16") (1) 5-1/2" Hex key extension 	Includes: <ul style="list-style-type: none"> (1) Each selffeed bits (1-3/8", 1-1/2", 2-1/8", 2-9/16") (1) 5-1/2" Hex key extension

STANDARD SELFEED BIT ACCESSORIES

Small Standard Selffeed Bit Accessory Kit 48-25-6000	Coarse Thread Feed Screw for Selffeed Bit 48-28-6870	1/8" Hex Wrench for Selffeed Bit 49-96-0060
Includes set screws, feed screws and hex key for sizes: <ul style="list-style-type: none"> 1" - 2-9/16" 	Includes feed screw for sizes: <ul style="list-style-type: none"> 1" - 2-9/16" 	Includes hex wrench for sizes: <ul style="list-style-type: none"> 1" - 2-9/16"
Large Standard Selffeed Bit Accessory Kit 48-25-7000	Replacement Feed Screw for Selffeed Bit 48-28-6880	5/32" Hex Wrench for Selffeed Bit 49-96-0070
Includes set screws, feed screws and hex key for sizes: <ul style="list-style-type: none"> 3" - 4-5/8" 	Includes feed screw for sizes: <ul style="list-style-type: none"> 3" - 4-5/8" 	Includes hex wrench for sizes: <ul style="list-style-type: none"> 3" - 4-5/8"

EXTENSIONS

UNIVERSAL FIT

- All extensions work with all major brands

QUIK-LOK™ EXTENSIONS

- Fits any 1/4" or 7/16" hex shank product
- Impact rated for maximum durability
- Releases by hand for quick operation



HEX WRENCH



QUIK-LOK™

Part Number	Shank Size	Length	Type	Accepts Shank Size
48-28-1000	1/4"	3"	QUIK-LOK™	1/4"
48-28-1010	1/4"	6"	QUIK-LOK™	1/4"
48-28-1020	1/4"	12"	QUIK-LOK™	1/4"
48-28-4008	3/8"	12"	Hex Wrench	3/8"
48-28-1030	7/16"	5-1/2"	QUIK-LOK™	7/16"
48-28-1040	7/16"	12"	QUIK-LOK™	7/16"
48-28-1050	7/16"	18"	QUIK-LOK™	7/16"
48-28-1060	7/16"	24"	QUIK-LOK™	7/16"
48-28-4001	7/16"	5-1/2"	Hex Wrench	7/16"
48-28-4006	7/16"	12"	Hex Wrench	7/16"
48-28-4011	7/16"	18"	Hex Wrench	7/16"
48-28-4016	7/16"	24"	Hex Wrench	7/16"

SELFEED BIT CROSS REFERENCE



SELFEED BIT CROSS-REFERENCE CHART

	DIAMETER	LENOX	IRWIN		DeWALT	BOSCH	MK MORSE	MILWAUKEE CLAMSHELL	MILWAUKEE BOX
SELFEED BITS	1"	33100	43016	3046004	DW1630	SF1001	WSF1000	48-25-1002	48-25-1001
	1-1/8"	33112	43018	3046005	DW1631	SF1121	WSF1125	48-25-1122	48-25-1121
	1-1/4"	33125	43020	3046006	DW1632	SF1251	WSF1250	48-25-1252	48-25-1251
	1-3/8"	33137	43022	3046007	DW1633	SF1371	WSF1375	48-25-1372	48-25-1371
	1-1/2"	33150	43024	3046008	DW1634	SF1501	WSF1500	48-25-1502	48-25-1501
	1-3/4"	33175	43028	3046009	DW1635	SF1751	WSF1750	48-25-1752	48-25-1751
	2"	33200	43032	3046010	DW1636	SF2001	WSF2000	48-25-2002	48-25-2001
	2-1/8"	33212	43034	3046011	DW1637	SF2121	WSF2125	48-25-2122	48-25-2121
	2-1/4"	33225	43036	3046012	DW1638	SF2251	WSF2250	48-25-2252	48-25-2251
	2-9/16"	33256	43041	3046013	DW1639	SF2561	WSF2562	48-25-2562	48-25-2561
	3"	33300	43047	3046014	DW1640	SF3001	WSF3000		48-25-3001
	3-5/8"	33362	43058	3046015	DW1641	SF3621	WSF3625		48-25-3621
	4-1/8"								48-25-4125
	4-5/8"	33462	43074	3046016	DW1642	SF4621	WSF4625		48-25-4621
	BIT SELFEED SERV. KIT SM						WSFRKIT1	48-25-6000	
	BIT SELFEED SERV. KIT LG						WSFRKIT2	48-25-7000	
	3 PC PLUMBERS SELFEED KIT							49-22-0030	
8 PC BIT KIT PLUMBERS (3 SELFEED & 4 AUGER & Extension)	31700						49-22-0065		
8 PC BIT KIT CONTRACTOR	33700			DW1649		WSFKIT2	49-22-0130		
5 PC BIT KIT CONTRACTOR	33400			DW1648		WSFKIT1	49-22-0135		
SWITCHBLADE SELFEED BITS	1-3/8"						48-25-5120		
	1-1/2"						48-25-5125		
	2"						48-25-5135		
	2-1/8"						48-25-5140		
	2-9/16"						48-25-5150		
	5 PC SWITCHBLADE™ SET						49-22-5100		



BIG HAWG™ WOOD BORING

BIG HAWG™ HOLE CUTTERS

FAST CUTTING

- Aggressive tooth geometry for up to 10X faster cutting than hole saws

LONG LIFE

- Cuts up to 600 holes in wood without needing to be resharpened

DURABLE

- Three hardened steel teeth provide maximum durability against unintended nail impacts

EASY PLUG REMOVAL

- Wide and deep gullets for easy plug removal

Size	Part Number	With Pilot Bit
1-3/8"	49-56-8995	49-56-9110
2-1/8"	49-56-9000	49-56-9120
2-1/4"	49-56-9005	-
2-9/16"	49-56-9010	49-56-9130
3"	49-56-9020	-
3-3/8"	49-56-9025	-

Size	Part Number	With Pilot Bit
3-5/8"	49-56-9030	-
4-1/4"	49-56-9045	-
4-5/16"	49-56-9047	-
4-5/8"	49-56-9050	-
5-1/4"	49-56-9055	-
6-1/4"	49-56-9065	-

BIG HAWG™ HOLE CUTTER KITS



7 Pc BIG HAWG™ Hole Cutter Kit 49-56-9075	8 Pc Plumbers BIG HAWG™ Hole Cutter Kit 49-56-9080	10 Pc BIG HAWG™ Hole Cutter Kit 49-56-9085
Includes: <ul style="list-style-type: none"> (1) Each BIG HAWG™ hole cutters (2-1/8", 2-9/16", 3-5/8") (1) Arbor with pilot bit (2) Additional pilot bits (1) Diamond file (1) Hex wrench 	Includes: <ul style="list-style-type: none"> (1) Each BIG HAWG™ hole cutters (2-1/8", 2-9/16", 3-5/8", 4-5/8") (1) Arbor with pilot bit (2) Additional pilot bits (1) Diamond file (1) Hex wrench 	Includes: <ul style="list-style-type: none"> (1) Each BIG HAWG™ hole cutters (2-1/8", 2-1/4", 2-9/16", 3", 3-5/8", 4-1/4") (1) Arbor with pilot bit (2) Additional pilot bits (1) Diamond file (1) Hex wrench

BIGHAWG™



**DESIGNED FOR
ROUGH WOOD
DRILLING**

UP TO
10x
FASTER THAN
HOLE SAWS

UP TO
600
HOLES WITHOUT
RESHARPENING

BIG HAWG™ HOLE CUTTER ACCESSORIES

Description	Part Number
Big Hawk™ File	48-09-5055
Big Hawk™ Pilot Bit	48-27-1401
Big Hawk™ Hole Cutter Arbor	49-56-9105

BIG HAWG™ CROSS-REFERENCE CHART

DIAMETER	LENOX ONE-TOOTH	MILWAUKEE BIG HAWG
1-3/8"	25422	49-56-8995
2-1/8"	25434	49-56-9000
2-1/4"	25436	49-56-9005
2-9/16"	25441	49-56-9010
2-3/4"	25444	
3"		49-56-9020
3-3/8"	25454	49-56-9025
3-5/8"	25456	49-56-9030
4"	25464	
4-1/4"		49-56-9045
4-5/16"	25469	49-56-9047
4-5/8"	25474	49-56-9050
5"	25480	
5-1/4"		49-56-9055
5-1/2"	25487	
6-1/4"	25500	49-56-9065
Hole Cutter Pilot Bit	25310	48-27-1401
Hole Cutter Diamond File	25312	48-09-5055
Hole Cutter Arbor	30002	49-56-9105
7-Piece Hole Cutter Kit	25476	49-56-9075
8 Pc Plumbers Big Hawk® Hole Cutter Kit		49-56-9080
10-Piece Hole Cutter Kit	25477	49-56-9085

SPEED PERFORMANCE

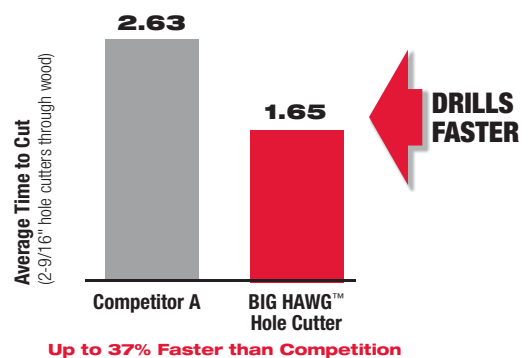

PLUG REMOVAL

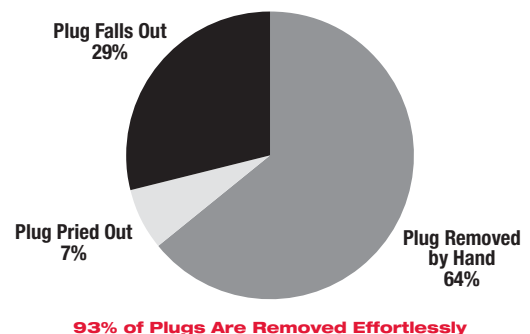

RIGHT ANGLE DRILLS



3002-1 1/2" D-Handle Right Angle Drill Kit



FEATURES



- Powerful 7-amp motor: Delivers trigger speed control in two ranges – 0-600/0-900 RPM – plus reverse
- Torque: Offers 1/2" capacity in steel
- Heavy-duty 1/2" keyed chuck with holder: Provides an industrial hold during drilling and fastening
- Versatile: Handles up to a 2-9/16" Selffeed bit
- Unrestricted Access: Head and handle swivel 360°

Includes: (1) 1/2" D-Handle Right Angle Drill Kit (3002-1); (1) RAD Assembly; (1) Side Handle

SPECIFICATIONS

Length	16-3/4"
Weight	10.3 lbs
Voltage	120V AC
Tool Warranty	5 Years
Cord Type	8' Fixed
No Load RPM	0-600
Amps	7
Chuck Size	1/2"
Chuck Type	Keyed
Construction Type	Grounded
Gear Train	Quadruple
Soft Grip Handle	No
Spindle Lock	No

3102-6 1/2" D-Handle Right Angle Drill Kit



FEATURES



- Powerful 7-amp motor: Delivers trigger speed control in two ranges – 0-335/0-750 RPM – plus reverse
- Torque: Offers 1/2" capacity in steel
- Heavy-duty 1/2" keyed chuck with holder: Provides an industrial hold during drilling and fastening
- Versatile: Handles up to a 2-9/16" Selffeed bit
- Unrestricted Access: Head and handle swivel 360°

Includes: (1) 1/2" D-Handle Right Angle Drill Kit (3102-6); (1) 3/16" Socket Wrench; (1) 9/16" Open End Wrench; (1) RAD Assembly; (1) Side Handle

SPECIFICATIONS

Length	16-3/4"
Weight	10.3 lbs
Voltage	120V AC
Tool Warranty	5 Years
Cord Type	8' Fixed
No Load RPM	0-500
Amps	7
Chuck Size	1/2"
Chuck Type	Keyed
Construction Type	Grounded
Gear Train	Quadruple
Soft Grip Handle	No
Spindle Lock	No



RIGHT ANGLE DRILLS

3107-6 1/2" D-Handle Right Angle Drill Kit



FEATURES



- Powerful 7-amp motor: Delivers trigger speed control in two ranges – 0-335/0-750 RPM – plus reverse
- Torque: Offers 1/2" capacity in steel
- Heavy-duty 1/2" keyed chuck with holder: Provides an industrial hold during drilling and fastening
- Versatile: Handles up to a 4-5/8" Selffeed bit
- Unrestricted Access: Head and handle swivel 360°
- QUIK-LOK® Cord: 8-ft. 3-wire grounded rubber cord provides easy storage and field replacement

Includes: (1) 1/2" D-Handle Right Angle Drill Kit (3107-6); (1) 3/16" Socket Wrench; (1) 9/16" Open End Wrench; (1) RAD Assembly; (1) Side Handle

SPECIFICATIONS

Length	16-3/4"	Chuck Type	Keyed
Weight	10.3 lbs	Construction Type	Grounded
Voltage	120V AC	Gear Train	Quadruple
Tool Warranty	5 Years	Soft Grip Handle	No
Cord Type	8' QUIK-LOK®	Spindle Lock	No
No Load RPM	0-500		
Amps	7		
Chuck Size	1/2"		

ATTACHMENTS



48-76-4008: 8' Quik-Lok®



48-76-4025: 25' Quik-Lok®

QUIK-LOK® CORDS



2-WIRE QUIK-LOK® CORD SETS FOR DOUBLE INSULATED TOOLS



Cat. No.	Description	NEMA Plug Type
48-76-5010	2-Wire 10' Quik-Lok®	1-15P
48-76-5025	2-Wire 25' Quik-Lok®	1-15P

3-WIRE QUIK-LOK® CORD SETS



Cat. No.	Description	NEMA Plug Type
48-76-4008	3-Wire 8' Quik-Lok®	5-15P
48-76-4025	3-Wire 25' Quik-Lok®	5-15P

3-WIRE QUIK-LOK® CORD SETS WITH TWIST LOCK PLUG



Cat. No.	Description	NEMA Plug Type
48-76-4108	3-Wire 8' Quik-Lok® With Twist Lock Plug	L5-20P
48-76-4125	3-Wire 25' Quik-Lok® With Twist Lock Plug	L5-20P

2-WIRE AND 3-WIRE QUIK-LOK® CORD SETS

- Premium Grade Hi-Flex Wire And Insulating System
- Quick Detachment From Tool For Tangle Free Carrying And Storage
- Instant Field Repair
- Quik-Lok With Twist Lock Plug Cord Sets Also Available

Recommended Minimum Wire Gauge For Extension Cords*

Nameplate Amperes	Extension Cord Length					
	25'	50'	75'	100'	150'	200'
0 – 5.0	16	16	16	14	12	12
5.1 – 8.0	16	16	14	12	10	–
8.1 – 12.0	14	14	12	10	–	–
12.1 – 15.0	12	12	10	10	–	–
15.1 – 20.0	10	10	10	–	–	–

*Based on limiting the line voltage drop to five volts at 150% of the rated amperes.



SPECIALTY DRILLS



1610-1 1/2" Compact Drill, 650RPM



FEATURES



- Powerful 7.0-amp motor: Delivers up to 650 RPM with reverse
- Torque: Offers 1/2" capacity in steel
- Heat-treated gears: Helical-cut for quiet performance
- 8-ft. 3-wire fixed rubber cord: Durable construction for longer tool life

Includes: (1) 1/2" Compact Drill 650 RPM (1610-1); (1) Pipe Handle

SPECIFICATIONS

Length	12-1/4"
Weight	11.2 lbs
Voltage	120V AC
Tool Warranty	5 Years
Cord Type	8' Fixed
No Load RPM	0-650
Amps	7
Spindle	5/8" - 16
Chuck Size	1/2"
Chuck Type	Keyed
Construction Type	Grounded
Gear Train	Double
Soft Grip Handle	No
Spindle Lock	No
Capacity in Wood	Flat Boring Bit 1-1/2"
	Hole Saw 3-1/2"
	Auger 1-1/2"
	Self-Feed 2-9/16"

1630-1 1/2" Compact Drill, 900RPM



FEATURES



- Powerful 7.0-amp motor: Delivers up to 900 RPM with reverse
- Torque: Offers 1/2" capacity in steel
- Heat-treated gears: Helical-cut for quiet performance
- 8-ft. 3-wire fixed rubber cord: Durable construction for longer tool life

Includes: (1) 1/2" Compact Drill 900 RPM (1630-1); (1) Pipe Handle

SPECIFICATIONS

Length	12-1/4"
Weight	11.2 lbs
Voltage	120V AC
Tool Warranty	5 Years
Cord Type	8' Fixed
No Load RPM	0-1,000
Amps	7
Spindle	5/8" - 16
Chuck Size	1/2"
Chuck Type	Keyed
Construction Type	Grounded
Gear Train	Double
Soft Grip Handle	No
Spindle Lock	No
Capacity in Steel	Twist Bit 1/2"
	Hole Saw 1-3/4"
Capacity in Wood	Flat Boring Bit 1-1/2"
	Hole Saw 3"
	Auger 1-1/2"
	Self-Feed 2-1/4"



SPECIALTY DRILLS

1660-6 1/2" Compact Drill, 450 RPM



1663-20 1/2" Compact Drill, 115-450RPM



FEATURES



- Powerful 7.0-amp motor: Delivers up to 450 RPM with reverse
- Torque: Offers 1/2" capacity in steel
- Heat-treated gears: Helical-cut for quiet performance
- 8-ft. 3-wire fixed rubber cord: Durable construction for longer tool life

Includes: (1) 1/2" Compact Drill 450 RPM (1660-6); (1) Pipe Handle

SPECIFICATIONS

Length	12-1/4"
Weight	11.4 lbs
Voltage	120 AC/DC
Tool Warranty	5 Years
Cord Type	8' Fixed
No Load RPM	0-450
Amps	7
Spindle	5/8" - 16
Chuck Size	1/2"
Chuck Type	Keyed
Construction Type	Grounded
Gear Train	Triple
Soft Grip Handle	No
Spindle Lock	No
Capacity in Wood	Flat Boring Bit 1-1/2"
	Hole Saw 4"
	Auger 1-1/2"
	Self-Feed 3"

FEATURES



- Powerful 7.0-amp motor: Delivers up to 450 RPM with reverse
- Speed control dial: Vary speed from 115 to 450 RPM depending on your material
- Torque: Offers 1/2" capacity in steel
- QUIK-LOK® Cord: 8-ft. 3-wire grounded rubber cord provides easy storage and field replacement

Includes: 1/2" Compact Drill 115-450 RPM (1663-20); (1) Pipe Handle

SPECIFICATIONS

Length	12-1/4"	Construction Type	Grounded
Weight	11.9 lbs	Gear Train	Triple
Voltage	120V AC	Soft Grip	No
Tool Warranty	5 Years	Spindle Lock	No
Cord Type	8' QUIK-LOK®	Capacity in Wood	Flat Boring Bit 1-1/2"
No Load RPM	115-450		Hole Saw 4"
Amps	7		Auger 1-1/2"
Spindle	5/8" - 16		Self-Feed 3"
Chuck Size	1/2"		
Chuck Type	Keyed		

ATTACHMENTS



48-76-4008: 8' Quik-Lok®



48-76-4025: 25' Quik-Lok®

SPECIALTY DRILLS



1854-1 3/4" Large Drill, 350RPM



FEATURES



- Powerful 10.0-amp motor: Delivers up to 350 RPM with reverse
- Torque: Offers 3/4" capacity in steel
- Heat-treated gears: Helical-cut for quiet performance
- 8-ft. fixed rubber cord: Durable construction for longer tool life

Includes: (1) 3/4" Large Drill, 350 RPM (1854-1); (1) Pipe Handle

SPECIFICATIONS

Length	18-1/2"
Weight	19.0 lbs
Voltage	120 AC/DC
Tool Warranty	5 Years
Cord Type	8' Fixed
No Load RPM	350
Amps	10
Spindle	#3 J.T.
Chuck Size	3/4"
Chuck Type	Keyed
Construction Type	Grounded
Gear Train	Triple
Soft Grip Handle	No
Spindle Lock	No
Capacity in Steel	Twist Bit 3/4"
Capacity in Wood	Flat Boring Bit 1-1/2"
	Hole Saw 6"
	Auger 1-1/2"
	Self-Feed 4-5/8"

2404-1 1-1/4" Large Drill, 250RPM



FEATURES



- Powerful 10.0-amp motor: Delivers up to 250 RPM with reverse
- Torque: Offers 1-1/4" capacity in steel
- Heat-treated gears: Helical-cut for quiet performance
- 8-ft. fixed rubber cord: Durable construction for longer tool life

Includes: 1-1/4" Large Drill, 250 RPM (2404-1); (1) Pipe Handle

SPECIFICATIONS

Length	18-3/4"
Weight	23.8 lbs
Voltage	120 AC/DC
Tool Warranty	5 Years
Cord Type	8' Fixed
No Load RPM	250
Amps	10
Spindle	#3 M.T.
Chuck Size	1-1/4"
Construction Type	Grounded
Gear Train	Triple
Soft Grip Handle	No
Spindle Lock	No
Capacity in Steel	Twist Bit 1-1/4"
Capacity in Wood	Flat Boring Bit 1-1/2"
	Hole Saw 6"
	Auger 1-1/2"
	Self-Feed 4-5/8"



ADJUSTABLE CLUTCH SCREWDRIVERS

6580-20 Adjustable Clutch Screwdriver



FEATURES



- Powerful 6.5-amp motor: Delivers up to 1,200 RPM of driving power
- Multi-position clutch: Easily adjusts from 10 to 140 in-lbs of torque
- All metal gearcase and diaphragm: Provides high durability
- Ergonomic grip and two-finger trigger: Optimize user comfort and balance
- QUIK-LOK® Cord: 10-ft. 2-wire grounded rubber cord provides easy storage and field replacement

Includes: (1) Adjustable Clutch Screwdriver (6580-20); (1) Belt Clip

SPECIFICATIONS

Voltage	2.4 DC
Tool Warranty	5 Years
Length	12-3/4"
Weight	0.9 lbs
Trigger Lock	Yes
Drive Size	1/4" Hex
Max HP	0.9
Construction Type	Double Insulated
Cord Type	10' QUIK-LOK®
Soft Grip Handle	Yes
Clutch	Adjustable
Spindle Offset	0.92"

ATTACHMENTS



48-76-5010: 10' Quik-Lok®



48-76-5025: 25' Quik-Lok®

6780-20

Metal Fastening Adjustable Clutch Screwdriver



FEATURES



- Powerful 6.5-amp motor: Delivers up to 2,500 RPM of driving power and 140 in-lbs of torque
- 21-position clutch: Provides maximum fastening control with minimum reaction force
- Ergonomic grip and two-finger trigger: Optimize user comfort and balance
- 10-ft. 2-wire fixed rubber cord: Durable construction for longer tool life

Includes: (1) Metal Fastening Adjustable Clutch Screwdriver (6780-20); (1) Belt Clip

SPECIFICATIONS

Length	12-1/4"
Weight	3.8 lbs
Voltage	120V AC
Tool Warranty	5 Years
Cord Type	10' Fixed
Amps	6.5
Trigger Lock	Yes
Construction Type	Double Insulated
Soft Grip Handle	Yes
Drive Size	1/4" Hex
Max HP	0.9
Spindle Offset	0.92"

SCREWDRIVERS



6740-20

Decking, Drywall and Framing Screwdriver



FEATURES



AC

- Powerful 6.5-amp motor: Delivers up to 2,500 RPM with variable-speed control and reverse
- Ramp-off depth locator: Provides easy, no-slip depth adjustments
- Ergonomic grip and two-finger trigger: Optimize user comfort and balance
- 10-ft. 2-wire fixed rubber cord: Durable construction for longer tool life

Includes: (1) Decking, Drywall and Framing Screwdriver (6740-20); (1) Belt Clip

SPECIFICATIONS

Length	13-1/8"
Weight	3.7lbs
Voltage	120V AC
Tool Warranty	5 Years
Cord Type	10' Fixed
Clutch	Snap-Action
Amps	6.5
Trigger Lock	Yes
Construction Type	Double Insulated
Soft Grip Handle	Yes
Drive Size	1/4" Hex
Max HP	0.9
Spindle Offset	0.92"

6742-20

Drywall Screwdriver



FEATURES



AC

- Powerful 6.5-amp motor: Delivers up to 4,000 RPM with variable-speed control
- Ramp-off depth locator: Provides easy, no-slip depth adjustments
- Ergonomic grip and two-finger trigger: Optimize user comfort and balance
- 10-ft. 2-wire fixed rubber cord: Durable construction for longer tool life

Includes: (1) Drywall Screwdriver (6742-20); (1) Belt Clip

SPECIFICATIONS

Length	12-3/4"
Weight	3.5 lbs
Voltage	120V AC
Tool Warranty	5 Years
Cord Type	10' Fixed
Amps	6.5
Trigger Lock	Yes
Construction Type	Double Insulated
Soft Grip Handle	Yes
Drive Size	1/4" Hex
Max HP	0.9
Spindle Offset	0.92"



SCREWDRIVERS

6790-20 Self Drill Fastener Screwdriver



FEATURES

- Powerful 6.5-amp motor: Delivers up to 2,500 RPM with variable-speed control and reverse
- Ramp-off depth locator: Provides easy, no-slip depth adjustments
- Ergonomic grip and two-finger trigger: Optimize user comfort and balance
- 10-ft. 2-wire fixed rubber cord: Durable construction for longer tool life

Includes: (1) Self Drill Fastener Screwdriver (6790-20); (1) Belt Clip

SPECIFICATIONS

Length	12-1/8"
Weight	3.7 lbs
Voltage	120V AC
Cord Type	10' Fixed
Amps	6.5
Trigger Lock	Yes
Construction Type	Double Insulated
Soft Grip Handle	Yes
Drive Size	1/4" Hex
Max HP	0.9
Spindle Offset	0.92"

6791-21 Remodeler's Screwdriver Kit



FEATURES

- Powerful 6.5-amp motor: Delivers up to 2,500 RPM with variable-speed control and reverse
- Two ramp-off depth locators: Provide easy, no-slip depth adjustments
- Ergonomic grip and two-finger trigger: Optimize user comfort and balance
- QUIK-LOK® Cord: 10-ft. 2-wire grounded rubber cord provides easy storage and field replacement

Includes: (1) Self Drill Fastener Screwdriver (6790-20); (1) Belt Clip; (1) Carrying Case

SPECIFICATIONS

Length	12-1/8"
Weight	3.7 lbs
Voltage	120V AC
Tool Warranty	5 Years
Cord Type	10' QUIK-LOK®
Amps	6.5
Trigger Lock	Yes
Construction Type	Double Insulated
Soft Grip Handle	Yes
Drive Size	1/4" Hex
Max HP	0.9
Spindle Offset	0.92"

ATTACHMENTS



48-76-5010: 10' Quik-Lok®



48-76-5025: 25' Quik-Lok®

SCREWDRIVERS



6792-20 Screwdriver Power Unit



FEATURES



- Powerful 6.5-amp motor: Delivers up to 2,500 RPM with variable-speed control
- Metal gearcase and heat-treated steel gears: Designed for durability
- Ergonomic handle: Aligns hand pressure with center axis of drill for efficient driving force
- 10-ft. 2-wire fixed rubber cord: Durable construction for longer tool life

Includes: (1) Screwdriver Power Unit (6792-20)

SPECIFICATIONS

Length	10-1/4"
Weight	3.2 lbs
Voltage	120V AC
Tool Warranty	5 Years
Cord Type	10' Fixed
Amps	6.5
Trigger Lock	Yes
Construction Type	Double Insulated
Soft Grip Handle	Yes
Max HP	0.9
Spindle Offset	0.92"



SHOCKWAVE™ DRIVING

Compression Forged Tip
Ideal fit and reduces breakage

Shock Zone Geometry**
Designed to flex with spring-like action
Reduces stress at the tip

Custom Engineered Steel & Heat Treatment
High shock resistance

Up To
10x
Life

* patent pending

ENGINEERED FOR IMPACT DRIVERS

SHOCKWAVE™ IMPACT DUTY

DRIVER BITS INCLUDING **EXPAND**

PHILLIPS® BITS

Bit	Length	1 Pack	2 Pack	5 Pack	15 Pack	25 Pack	25 Pack + Compact Magnetic Bit Holder	Bulk 10 Pack	Bulk 25 Pack	Bulk 250 Pack
P1	1"	-	48-32-4411	48-32-4661	-	-	-	-	48-32-4711	48-32-4880
	2"	48-32-4461	-	-	-	-	-	-	48-32-4760	-
P2	1"	-	48-32-4412	48-32-4601	48-32-5003	48-32-4604	48-32-5009	-	48-32-4712	48-32-4881
	2"	48-32-4462	-	48-32-4602	48-32-5004	-	-	-	48-32-4762	48-32-4862
	3.5"	48-32-4562	-	48-32-4564	-	-	-	-	48-32-4791	-
	6"	48-32-4802	-	-	-	-	-	48-32-4807	-	-
P2R	1"	-	48-32-4444	-	-	-	-	48-32-4746	-	
P3	1"	-	48-32-4413	48-32-4663	-	-	-	-	48-32-4713	48-32-4882
	2"	48-32-4463	-	-	-	-	-	-	48-32-4763	48-32-4863
	3.5"	48-32-4563	-	-	-	-	-	-	48-32-4792	-
	6"	-	-	-	-	-	-	48-32-4808	-	-

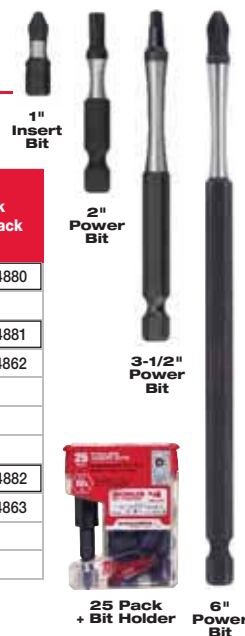

SQUARE RECESS BITS

Bit	Length	1 Pack	2 Pack	5 Pack	10 Pack	Bulk 10 Pack	Bulk 25 Pack
SQ1	1"	-	48-32-4421	48-32-4621	-	-	48-32-4761
	2"	48-32-4471	-	-	-	-	48-32-4771
	3.5"	-	-	-	-	-	48-32-4794
SQ2	1"	-	48-32-4422	48-32-4605	48-32-5008	-	48-32-4722
	2"	48-32-4472	-	48-32-4606	-	-	48-32-4772
	3.5"	48-32-4572	-	-	-	-	48-32-4795
	6"	48-32-4805	-	-	-	48-32-4815	-
SQ3	1"	-	48-32-4423	-	-	-	48-32-4723
	2"	48-32-4473	48-32-4910	-	-	-	48-32-4773
	3.5"	48-32-4573	-	-	-	-	48-32-4796
	6"	-	-	-	-	48-32-4816	-

ECX™ BITS

Bit	Length	2 Pack	5 Pack	Bulk 25 Pack
ECX1	1"	48-32-4441	-	48-32-4741
	2"	-	48-32-4491	48-32-4744
ECX2	1"	48-32-4442	-	48-32-4742
	2"	-	48-32-4492	48-32-4745
ECX Combo (#1, #2)	2"	48-32-4443	-	-

ANTI-STRIP TIP
Designed for Phillips, Slotted, and Square combination on electrical fasteners



* TORX® is a registered trademark of Acument Intellectual Properties, LLC.
** Phillips® is a registered trademark of Phillips Screw Company.

SHOCKWAVE™ DRIVING



TORX® BITS

Bit	Length	1 Pack	2 Pack	5 Pack	7 Pack	Bulk 10 Pack	Bulk 25 Pack
T10	2"	48-32-4482	-	-	-	-	48-32-4782
	1"	-	-	-	-	-	48-32-4734
T15	2"	48-32-4483	-	-	-	-	48-32-4783
	3.5"	-	-	-	-	-	48-32-4594
T20	1"	-	48-32-4414	-	-	-	48-32-4735
	2"	48-32-4484	48-32-4984	-	-	-	48-32-4784
	3.5"	-	-	-	-	-	48-32-4595
T25	1"	-	48-32-4436	-	-	-	48-32-4736
	2"	48-32-4485	48-32-4985	48-32-4685	-	-	48-32-4785
	3.5"	48-32-4561	-	-	-	-	48-32-4596
	6"	-	-	-	-	48-32-4846	-
T27	2"	48-32-4486	-	-	-	-	48-32-4786
	3.5"	-	-	-	-	-	48-32-4597
T30	2"	48-32-4487	48-32-4914	-	-	-	48-32-4787
	3.5"	-	-	-	-	-	48-32-4598
T40	2"	-	-	-	-	-	48-32-4788
7 Pc Torx® Insert Bits (T10, T15, T20, T25, T27, T30, T40)		-	-	-	48-32-4615	-	-

SLOTTED BITS

Bit	Length	1 Pack	2 Pack	Bulk 25 Pack
SL 7/64" (3-4)	1"	-	-	48-32-4715
	2"	-	-	48-32-4755
SL 1/8" (4-5)	1"	-	48-32-4416	48-32-4716
	2"	48-32-4916	-	48-32-4756
SL 3/16" (6-8)	1"	-	48-32-4417	48-32-4717
	2"	48-32-4919	-	48-32-4757
SL 1/4" (8-10)	1"	-	48-32-4418	48-32-4718
	2"	48-32-4918	-	48-32-4758
SL 9/32" (10-12)	1"	-	-	48-32-4719
	2"	-	-	48-32-4759

EXPAND

COMPETITIVE OFFERING

OVER 100 ITEMS

VS

SHOCKWAVE IMPACT DUTY™

31 ITEMS

DO MORE CARRY LESS

MAGNETIC BIT HOLDERS INCLUDING EXPAND

Size	1 Pack	10 Pack	11 Pack	Bulk 250 Pack
Compact Bit Holder	48-32-4502	48-32-4504	-	-
3" Bit Holder	48-32-4503	48-32-4505	-	48-32-4803
3" Drive Guide	48-32-4508	48-32-4509	-	-
6" Bit Holder	48-32-4511	48-32-4521	-	-
12" Bit Holder	48-32-4512	48-32-4522	-	-
11 Pc 30°KNUCKLE™ Pivoting Bit Holder	-	-	48-32-2301	-





SHOCKWAVE™ & STANDARD DRIVING

SHOCKWAVE™ IMPACT DUTY SETS

15 Pc SHOCKWAVE™ 1" Insert Bit Phillips #2 Set 48-32-5003	15 Pc SHOCKWAVE™ 2" Power Bit Phillips #2 Set 48-32-5004	10 Pc SHOCKWAVE™ 1" Square Recess Insert Bit #2 Set 48-32-5008	25 Pc SHOCKWAVE™ 1" Insert Bit Phillips #2 Set 48-32-5009	10 Pc SHOCKWAVE™ 1" Square Recess Insert Bit Phillips #2 Set 48-32-4607
Includes: ■ (15) 1" Phillips #2 (Gravity Feed Merchandiser)	Includes: ■ (15) 2" Phillips #2 (Gravity Feed Merchandiser)	Includes: ■ (10) 1" Square Recess #2 (Gravity Feed Merchandiser)	Includes: ■ (25) 1" Phillips #2 ■ (1) SHOCKWAVE™ 2.36" Magnetic Bit Tip Holder	Includes: ■ (10) 1" Square Recess #2 (PDQ Tray Merchandiser)

25 Pc SHOCKWAVE™ 1" Insert Bit Phillips #2 Set 48-32-4604	12 Pc SHOCKWAVE™ Drive Guide Set 48-32-4507	22 Pc SHOCKWAVE™ Puck (10 per Tube) 48-32-4011	22 Pc SHOCKWAVE™ Puck 48-32-4012
Includes: ■ (25) 1" Phillips #2 (PDQ Tray Merchandiser)	Includes: ■ 1" ECX™ Bits: (1) ECX #1, (1) ECX #2 ■ 1" Phillips Bits: (2) PH #2, (1) PH #3 ■ 1" Slotted Bits: (1) SL 1/4", (1) SL 3/16" ■ 1" Square Bits: (1) SQ #2 ■ 1" TORX® Bits: (1) TX15, (1) TX20, (1) TX25 ■ (1) SHOCKWAVE™ 3" Magnetic Drive Guide ■ (1) Drive Guide Case	Includes: ■ 1" Slotted Bits: (1) SL 1/8", (1) SL 3/16", (1) SL 1/4", (1) SL 9/32" ■ 1" Phillips Bits: (1) PH #1, (3) PH #2, (2) PH #3 ■ 1" Square Bits: (1) SQ #1, (3) SQ #2, (1) SQ #3 ■ 1" TORX® Bits: (1) TX10, (1) TX15, (1) TX20, (1) TX25, (1) TX27, (1) TX30 ■ (1) SHOCKWAVE™ 2.36" Magnetic Bit Holder (Gravity Feed Merchandiser)	Includes: ■ 1" Slotted Bits: (1) SL 1/8", (1) SL 3/16", (1) SL 1/4", (1) SL 9/32" ■ 1" Phillips Bits: (1) PH #1, (3) PH #2, (2) PH #3 ■ 1" Square Bits: (1) SQ #1, (3) SQ #2, (1) SQ #3 ■ 1" TORX® Bits: (1) TX10, (1) TX15, (1) TX20, (1) TX25, (1) TX27, (1) TX30 ■ (1) SHOCKWAVE™ 2.36" Magnetic Bit Holder (PDQ Tray Merchandiser)

18 Pc SHOCKWAVE™ Driver Bit Set 48-32-4403	26 Pc SHOCKWAVE™ Drive and Fasten Set 48-32-4408	29 Pc SHOCKWAVE™ Driver Bit Set 48-32-4401	35 Pc SHOCKWAVE™ Drill and Drive Set 48-32-4402
Includes: ■ Phillips Bits: 1" - (1) PH #1, (1) PH #2, (1) PH #3; 2" - (2) PH #2, (1) PH #3; 3-1/2" - (1) PH #2 ■ Slotted Bits: 1" - (1) SL 1/4", (1) SL 3/16" ■ Square Bits: 1" - (1) SQ #1, (1) SQ #2; 2" - (2) SQ #2, (1) SQ #3; 3-1/2" - (1) SQ #2 ■ TORX® Bits: 2" - (1) TX15, (1) TX20 ■ (1) Case with Bulk Storage Container ■ (1) SHOCKWAVE™ Magnetic Bit Holder	Includes: ■ Phillips Bits: 1" - (1) PH #1, (3) PH #2, (1) PH #3; 2" - (1) PH #2 ■ Square Bits: 1" - (1) SQ #1, (2) SQ #2, (1) SQ #3; 2" - (1) SQ #2 ■ TORX® Bits: 1" - (2) TX20, (2) TX25, (1) TX30; 2" - (1) TX20, (1) TX25 ■ Slotted Bits: 1" - (1) SL 3/16" ■ (1) 1/4" Hex to 3/8" Square Adapter ■ Magnetic Nut Drivers: (1) 1/4", (1) 3/8", (1) 5/16" ■ 3/8" Drives: (1) 1/2" Socket, (1) 9/16" Socket ■ (1) SHOCKWAVE™ Compact Magnetic Bit Holder	Includes: ■ Phillips Bits: 1" - (1) PH #1, (7) PH #2, (2) PH #3; 2" Power - (2) PH #2, (1) PH #3 ■ Square Bits: 1" - (1) SQ #1, (4) SQ #2, (1) SQ #3; 2" Power - (2) SQ #2 ■ Torx® Bits: 1" - (1) TX15, (1) TX20, (1) TX25; 2" Power - (1) TX25 ■ Magnetic Nut Drivers: (1) 1/4" Red, (1) 5/16" Amber, (1) 3/8" Blue ■ Magnetic Bit Holder ■ Case with Bulk Storage Container	Includes: ■ Phillips Bits: 1" - (1) PH #1, (2) PH #2, (1) PH #3; 2" - (1) PH #2, (1) PH #3; 3-1/2" - (1) PH #2 ■ Square Bits: 1" - (1) SQ #1, (2) SQ #2, (1) SQ #3; 2" - (1) SQ #1, (1) SQ #2, (1) SQ #3; 3-1/2" - (1) SQ #2 ■ 1" ECX™ Bits: (1) ECX #1, (1) ECX #2 ■ 1" Slotted Bits: (1) SL 1/8", (1) SL 3/16", (1) SL 1/4" ■ 2" TORX® Bits: (1) TX15, (1) TX20, (1) TX25, (1) TX 30 ■ (1) 1/4" Hex to 3/8" Square Adapter; (1) 1/4" Hex to 1/2" Square Adapter ■ Compact Magnetic Bit Holder ■ Impact Drill Bits: (1) 7/32", (1) 1/4", (1) 1/8", (1) 5/32", (1) 3/16" ■ 7/8" Impact Magnetic Nut Drivers: (1) 1/4", (1) 5/16", (1) 3/8"

STANDARD DRIVING BIT SETS

21 Pc Driver Bit Set 48-32-0221	21 Pc Drive Guide Set 48-32-1700	38 Pc QUIK-LOK™ Drill and Drive Set 48-32-1500	40 Pc Drive Guide Set 48-32-1505

SHOCKWAVE™ NUT DRIVERS & SHOCKWAVE™ HOLE SAWS



MAGNETIC NUT DRIVERS INCLUDING **EXPAND**

- **Color Coded Band**
For easy identification
- **Chamfered Edge**
For improved clearance
- **Radius Corners**
Drives on flats to reduce stripping and breakage



Hex Size	Color Identification Band
1/4"	Red
5/16"	Yellow
3/8"	Blue
7/16"	Brown
1/2"	Red
7 mm	Orange/Gray
8 mm	Yellow/Gray
10 mm	Blue/Gray
12 mm	Red/Gray
13 mm	Orange/Gray



Length	Size	1 Pack	3 Pack	Bulk 10 Pack	Bulk 250 Pack
Insert	1/4"	-	49-66-4512	49-66-4712	-
	5/16"	-	49-66-4513	49-66-4713	-
	3/8"	-	49-66-4515	49-66-4715	-
	7/16"	-	49-66-4516	49-66-4716	-
	1/2"	-	49-66-4517	49-66-4717	-
1-7/8"	1/4"	49-66-4502	49-66-4522	49-66-4702	-
	5/16"	49-66-4503	49-66-4523	49-66-4703	-
	3/8"	49-66-4505	49-66-4525	49-66-4705	-
	7/16"	49-66-4506	49-66-4526	49-66-4706	-
2-9/16"	1/4"	49-66-4532	-	49-66-4732	49-66-4832
	5/16"	49-66-4533	-	49-66-4733	49-66-4833
	3/8"	49-66-4535	-	49-66-4735	49-66-4835
	7/16"	49-66-4536	-	49-66-4736	-
	1/2"	49-66-4537	-	49-66-4737	-
	7mm	-	-	49-66-4607	-
	8mm	-	-	49-66-4608	-
	10mm	-	-	49-66-4610	-
	12mm	-	-	49-66-4612	-
	13mm	-	-	49-66-4613	-



Product No.	49-66-4561	49-66-4562	49-66-4563
Description	3 Pc Set	4 Pc Set	5 Pc Insert Set
Length	1-7/8"	1-7/8"	Insert
Contents	1/4", 5/16", 3/8"	1/4", 5/16", 3/8", 7/16"	1/4", 5/16", 3/8", 7/16", 1/2"

SHOCKWAVE™ HOLE SAWS



ENGINEERED FOR IMPACT DRIVERS



Milwaukee® Part #	Description	CROSS REFERENCE	
		DeWalt® Part #	Bosch® Part #
49-22-4800	3 Pc Shockwave™ Thin Wall Hole Saw Kit	D18001R5	HTWS
49-56-9805	3/4" Shockwave™ Thin Wall Hole Saw	D180012IR	HTW34
49-56-9810	7/8" Shockwave™ Thin Wall Hole Saw	D180014IR	HTW78
49-56-9815	1" Shockwave™ Thin Wall Hole Saw	D180016IR	HTW1
49-56-9820	1-1/8" Shockwave™ Thin Wall Hole Saw	D180018IR	HTW118
49-56-9825	1-1/4" Shockwave™ Thin Wall Hole Saw	D180020IR	HTW114
49-56-9830	1-3/8" Shockwave™ Thin Wall Hole Saw	D180022IR	HTW138
49-56-9835	1-1/2" Shockwave™ Thin Wall Hole Saw	D180024IR	HTW112



IMPACT WRENCHES

9070-20

1/2" Impact Wrench with
Rocker Switch and Detent Pin



FEATURES



- Powerful 7.0 amp motor: Produces 300 ft-lbs of torque and 1800 RPM for maximum productivity
- AC/DC rocker switch: Enables quick selection of forward and reverse
- Detent pin: Provides secure retention of sockets and adapters
- 8-ft. fixed rubber cord: Durable construction for longer tool life

Includes: (1) 1/2 in. Impact Wrench with Rocker Switch and Detent Pin Socket Retention (9070-20)

SPECIFICATIONS

Length	11-5/8"
Weight	6.0 lbs
Voltage	120 AC/DC
Tool Warranty	5 Years
No Load Speed	0-1,800 RPM
Cord Type	8' Fixed
Peak Torque	300 ft-lbs
No Load IPM	0-2,600
Anvil Size and Type	1/2" Square - Pin Detent

9071-20

1/2" Impact Wrench with
Rocker Switch and Friction Ring



FEATURES



- Powerful 7.0-amp motor: Produces 300 ft-lbs of torque and 1800 RPM for maximum productivity
- AC/DC rocker switch: Enables quick selection of forward and reverse
- Friction ring socket retention system: Reduces downtime on applications involving frequent changing of accessories
- 8-ft. fixed rubber cord: Durable construction for longer tool life

Includes: (1) 1/2 in. Impact Wrench with Rocker Switch and Friction Ring Socket Retention (9071-20)

SPECIFICATIONS

Length	11-5/8"
Weight	6.0 lbs
Voltage	120 AC/DC
Tool Warranty	5 Years
No Load Speed	0-1,800 RPM
Cord Type	8' Fixed
Peak Torque	300 ft-lbs
No Load IPM	0-2,600
Anvil Size and Type	1/2" Square - Friction Ring with Thru Hole

IMPACT WRENCHES



9072-20

1/2" VSR Impact Wrench with Detent Pin



FEATURES



- Powerful 7.0 amp motor: Produces 300 ft-lbs of torque and 1800 RPM for maximum productivity
- Variable-speed reversing switch with speed dial setting: Offers added control in drilling and heavy-duty driving applications
- Detent pin: Provides secure retention of sockets and adapters
- QUIK-LOK® Cord: 10-ft. 2-wire grounded rubber cord provides easy storage and field replacement

Includes: (1) 1/2 in. VSR Impact Wrench with Detent Pin Socket Retention (9072-20)

SPECIFICATIONS

Length	11-5/8"
Weight	6.0 lbs
Voltage	120V AC
Tool Warranty	5 Years
No Load Speed	0-1,800 RPM
Cord Type	10' QUIK-LOK®
Peak Torque	300 ft-lbs
No Load IPM	0-2,600
Anvil Size and Type	1/2" Square - Pin Detent

9072-22

1/2" VSR Impact Wrench with Case and 6 Sockets



Includes: (1) 1/2 in. VSR Impact Wrench with Case and 6 Sockets (9072-22), (1) 6 Socket Set

9075-20

3/4" Impact Wrench with Rocker Switch and Friction Ring



FEATURES



- Powerful 7.0-amp motor: Produces 380 ft-lbs of torque and 1750 RPM for maximum productivity
- 3/4" square anvil: More resistant to long term fatigue than a 1/2" anvil
- AC/DC rocker switch: Enables quick selection of forward and reverse
- Friction ring socket retention system: Reduces downtime on applications involving frequent changing of accessories
- 8-ft. fixed rubber cord: Durable construction for longer tool life

Includes: (1) 3/4 in. Impact Wrench with Rocker Switch and Friction Ring Socket Retention (9075-20)

SPECIFICATIONS

Length	11-5/8"
Weight	6.2 lbs
Voltage	120 AC/DC
Tool Warranty	5 Years
No Load Speed	600-1,800 RPM
Cord Type	8' Fixed
Peak Torque	380 ft-lbs
No Load IPM	1,000-2,600
Anvil Size and Type	3/4" Square - Friction Ring with Thru Hole

ATTACHMENTS



48-76-5010: 10' Quik-Lok®



48-76-5025: 25' Quik-Lok®



IMPACT WRENCHES

9092-20

7/16" Hex Quick-Change Impact Wrench



FEATURES

- Milwaukee-built motor with large ram and anvil: Produce 315 ft-lbs of torque and 1800 RPM for maximum productivity
- Variable-speed switch: Offers added control in heavy-duty drilling and driving applications
- 7/16" hex quick-change system: Provides fast yet secure insertion and removal of auger bits and socket adaptors
- QUIK-LOK® Cord: 10-ft. 2-wire grounded rubber cord provides easy storage and field replacement

Includes: (1) 7/16 in. Hex Quick-Change Impact Wrench (9092-20)

SPECIFICATIONS

Length	12-1/4"
Weight	6.5 lbs
Voltage	120 AC/DC
Tool Warranty	5 Years
No Load Speed	600-1,800 RPM
Cord Type	10' QUIK-LOK®
Peak Torque	315 ft-lbs
No Load IPM	1,000-2,600
Anvil Size and Type	7/16" Hex Quick Change

ATTACHMENTS



48-76-5010: 10' Quik-Lok®



48-76-5025: 25' Quik-Lok®

9096-20

5/8" Hex Quick Change Impact Wrench



FEATURES

- Milwaukee-built motor with large ram and anvil: Produce 315 ft-lbs of torque and 1800 RPM for maximum productivity
- Variable-speed switch: Offers added control in heavy-duty drilling and driving applications
- 7/16" hex quick-change system: Provides fast yet secure insertion and removal of auger bits and socket adaptors
- QUIK-LOK® Cord: 10-ft. 2-wire grounded rubber cord provides easy storage and field replacement

Includes: (1) 7/16 in. Hex Quick-Change Impact Wrench (9092-20)

SPECIFICATIONS

Length	12-1/4"
Weight	6.5 lbs
Voltage	120 AC/DC
Tool Warranty	5 Years
No Load Speed	600-1,800 RPM
Cord Type	10' QUIK-LOK®
Peak Torque	315 ft-lbs
No Load IPM	1,000-2,600
Anvil Size and Type	7/16" Hex Quick Change

ATTACHMENTS



48-76-5010: 10' Quik-Lok®



48-76-5025: 25' Quik-Lok®

SHOCKWAVE™ SOCKETS & ADAPTERS



DEEP WELL IMPACT SOCKETS



Chromoly Steel & Custom Heat Treat
Maximum Durability in High Torque Applications



Radius Corners
Drives on Flats to Reduce Stripping & Breakage



Thin Wall Construction
Impact Strength in Tight Clearance Applications

Size	3/8" Drive 1 Pack	1/2" Drive 1 Pack
5/16"	49-66-4422	-
3/8"	49-66-4424	49-66-4461
7/16"	49-66-4425	49-66-4462
1/2"	49-66-4426	49-66-4463
9/16"	49-66-4427	49-66-4464
5/8"	49-66-4428	49-66-4465
11/16"	49-66-4429	49-66-4466
3/4"	49-66-4430	49-66-4467
13/16"	49-66-4431	49-66-4468
7/8"	49-66-4432	49-66-4469
1"	-	49-66-4471
1-1/16"	-	49-66-4472
1-1/8"	-	49-66-4473
1-1/4"	-	49-66-4475



ADAPTERS

Size	1 Pack	3 Pack	Bulk 10 Pack
1/4" Hex to 1/4" Socket	48-32-5030	-	48-32-5730
1/4" Hex to 3/8" Socket	48-32-5031	-	48-32-5731
1/4" Hex to 1/2" Socket	48-32-5032	-	48-32-5732
3/8" Socket to 1/4" Hex	48-03-4405	-	-
1/2" Socket to 1/4" Hex	48-03-4410	-	-
3 Pc Socket Adapters (1/4", 3/8", 1/2")	-	48-32-5033	-



DEEP WELL IMPACT SOCKET SETS



Product No.	49-66-4301	49-66-4419	49-66-4484
Description	12 Pc Deep Well Impact Socket Set	8 Pc Deep Well Impact Socket Set	9 Pc Deep Well Impact Socket Set
Drive	1/4"	3/8"	1/2"
Measurement Standard	Metric	SAE	SAE
Contents	5.5mm, 6mm, 7mm, 8mm, 9mm, 10mm, 11mm, 12mm, 13mm, 14mm, 15mm, 1/4" Hex to 1/4" Square Adapter	5/16", 3/8", 7/16", 1/2", 9/16", 5/8", 11/16", 3/4"	3/8", 7/16", 1/2", 9/16", 5/8", 11/16", 3/4", 7/8", 1/4" Hex to 1/2" Square Adapter

AUGERS & EXTENSIONS

SHIP AUGERS

Size	Part Number	Shank	Overall Length	Twist Length	Size	Part Number	Shank	Overall Length	Twist Length
3/8"	48-13-0373	5/16"	6"	3"	7/16"	48-13-5520	5/16"	18"	15"
1/2"	48-13-0503	5/16"	6"	3"	1/2"	48-13-5540	5/16"	18"	15"
5/8"	48-13-0623	7/16"	6"	3"	9/16"	48-13-5560	7/16"	18"	15"
11/16"	48-13-0683	7/16"	6"	3"	5/8"	48-13-5620	7/16"	18"	15"
3/4"	48-13-0753	7/16"	6"	3"	11/16"	48-13-5680	7/16"	18"	15"
13/16"	48-13-0813	7/16"	6"	3"	3/4"	48-13-5750	7/16"	18"	15"
7/8"	48-13-0873	7/16"	6"	3"	13/16"	48-13-5810	7/16"	18"	15"
15/16"	48-13-0933	7/16"	6"	3"	7/8"	48-13-5870	7/16"	18"	15"
1"	48-13-1003	7/16"	6"	3"	15/16"	48-13-5930	7/16"	18"	15"
1-1/16"	48-13-1063	7/16"	6"	3"	1"	48-13-6000	7/16"	18"	15"
1-1/8"	48-13-1123	7/16"	6"	3"	1-1/16"	48-13-6010	7/16"	18"	15"
1-1/4"	48-13-1253	7/16"	6"	3"	1-1/8"	48-13-6120	7/16"	18"	15"
1-3/8"	48-13-1373	7/16"	6"	3"	1-1/4"	48-13-6250	7/16"	18"	15"
1-1/2"	48-13-1503	7/16"	6"	3"	1-3/8"	48-13-6370	7/16"	18"	15"
3/8"	48-13-5500	5/16"	18"	15"	1-1/2"	48-13-6500	7/16"	18"	15"



- DURABLE**
■ Hardened tip for added nail durability
- FAST CHIP REMOVAL**
■ Coated flutes for fast chip removal
- IMPACT RATED**



SHIP AUGER SET

3 Pc Ship Auger Bit Set (18")
49-13-3000

- Includes:**
■ 1/2", 3/4", 1"



SPUR AUGERS

- CLEAN HOLES**
■ Double wing spurs for clean hole cutting
- FAST CHIP REMOVAL**
■ Coated flutes for fast chip removal
- IMPACT RATED**



Size	Part Number	Shank	Overall Length	Twist Length
1/2"	48-13-0700	5/16"	6-1/2"	4"
5/8"	48-13-0725	7/16"	6-1/2"	4"
3/4"	48-13-0750	7/16"	6-1/2"	4"
7/8"	48-13-0870	7/16"	6-1/2"	4"
1"	48-13-1000	7/16"	6-1/2"	4"
1-1/8"	48-13-1120	7/16"	6-1/2"	4"
1-1/4"	48-13-1250	7/16"	6-1/2"	4"
1-3/8"	48-13-1370	7/16"	6-1/2"	4"
1-1/2"	48-13-1500	7/16"	6-1/2"	4"

SPUR AUGER SET



4 Pc Spur Auger Bit Set (6-1/2")
48-13-4000

- Includes:**
■ 1/2", 3/4", 7/8", 1"

EXTENSIONS

- UNIVERSAL FIT**
■ All extensions work with all major brands
- QUIK-LOK™ EXTENSIONS**
■ Fits any 1/4" or 7/16" hex shank product
- Impact rated for maximum durability
- Releases by hand for quick operation



HEX WRENCH



QUIK-LOK™

Part Number	Shank Size	Length	Type	Accepts Shank Size
48-28-1000	1/4"	3"	QUIK-LOK®	1/4"
48-28-1010	1/4"	6"	QUIK-LOK®	1/4"
48-28-1020	1/4"	12"	QUIK-LOK®	1/4"
48-28-4008	3/8"	12"	Hex Wrench	3/8"
48-28-1030	7/16"	5-1/2"	QUIK-LOK®	7/16"
48-28-1040	7/16"	12"	QUIK-LOK®	7/16"
48-28-1050	7/16"	18"	QUIK-LOK®	7/16"
48-28-1060	7/16"	24"	QUIK-LOK®	7/16"
48-28-4001	7/16"	5-1/2"	Hex Wrench	7/16"
48-28-4006	7/16"	12"	Hex Wrench	7/16"
48-28-4011	7/16"	18"	Hex Wrench	7/16"
48-28-4016	7/16"	24"	Hex Wrench	7/16"

HAMMER DRILLS



5376-20 1/2" Hammer Drill



FEATURES   **AC**

- Powerful 8-amp motor: Delivers 0-2,800 RPM and 0-48,000 BPM for superior performance
- Compact 11.5" length: Allows for work in tight spaces
- All-metal gear case: Provides 2X more durability than the leading competitor
- 2-Mode operation: Hammer Drill and drill-only modes for concrete, wood and metal
- Heavy-duty metal chuck: Provides superior durability and bit retention
- Over-mold: Increases grip and reduces vibration
- 360° Locking side handle with depth gauge: Permits maximum maneuverability and control

Includes: (1) 1/2" Hammer Drill (5376-20); (1) Side Handle

SPECIFICATIONS

Length	11-1/2"	Trigger Lock	Yes
Weight	4.9 lbs	Chuck Type	Keyed
Voltage	120V	Capacity in Steel	Twist Bit 1/2"
Tool Warranty	5 Years	Capacity in Wood	Hole Saw 1-1/4"
No Load BPM	48,000	Capacity in Concrete	5/8"
Cord Type	8' Fixed		
No Load RPM	0-2,800		
Amps	8		

5378-20 1/2" Pistol Grip Dual Torque Hammer Drill, 0-1350/0-2500RPM



FEATURES   **AC**

- Powerful 7.5-amp dual-torque motor: Optimized for concrete fastening with overload protection. Choose trigger-speed control in two ranges: 0-1,350 RPM/0-22,000 BPM or 0-2,500 RPM/0-40,000 BPM
- 2-Mode operation: Drill-only mode for wood, steel and plastic; hammer and rotation setting easily sets concrete screw fasteners and drills small holes for anchors
- 2-Speed gear box: Select the correct drilling speed for the material and accessory
- Self-stopping brushes: Protects the motor and increases the life of the tool

Includes: (1) 1/2" Pistol Grip Dual Torque Hammer Drill, 0-1350/0-2500RPM (5378-20); (1) Chuck Key; (1) Side Handle

SPECIFICATIONS

Length	13"	Amps	7.5
Weight	6.0 lbs	Trigger Lock	Yes
Voltage	120V AC	Chuck Type	Keyed
Tool Warranty	5 Years	Capacity in Steel	Twist Bit 1/2"
No Load BPM	0-20,000, 0-40,000	Capacity in Wood	Hole Saw 3-3/4"
Cord Type	8' Fixed	Selfeed Bit Capacity	1-3/4"
Cord Length	8'	Capacity in Concrete	3/4"
No Load RPM	0-1,350, 0-2,500		

5378-21 1/2" Pistol Grip Dual Torque Hammer Drill, 0-1350/0-2500RPM with Case

   **AC**

Includes: 1/2" Pistol Grip Dual Torque Hammer Drill, 0-1350/0-2500 RPM (5378-20); (1) Chuck Key; (1) Side Handle; (1) Carrying Case



HAMMER DRILLS

5380-21 1/2" Hammer Drill with Carrying Case



FEATURES



- Powerful 9.0-amp motor: Delivers 0-1,500 RPM/0-24,000 BPM and 0-3,500 RPM/0-56,000 BPM
- Anti-Vibration System (AVS): Delivers maximum comfort by minimizing vibration
- 2-Mode operation: Hammer drill/drill for maximum versatility in wood, metal and concrete
- 2-Speed gear box: Select the correct drilling speed for the material and accessory
- Self-stopping brushes: Protects the motor and increases the life of the tool
- 360° Locking side handle with depth gauge: Permits maximum maneuverability and control

Includes: (1) 1/2" Hammer Drill (5380-21); (1) Carrying Case; (1) Chuck Key; (1) Side Handle

SPECIFICATIONS

Length	14"	Chuck Type	Keyed
Weight	7.3 lbs	Soft Grip Handle	Yes
Voltage	120V AC	Capacity in Steel	Twist Bit 1/2"
Tool Warranty	5 Years	Capacity in Wood	Hole Saw 3-1/2"
No Load BPM	0-24,000, 0-56,000		Hole Saw 1-3/4"
Cord Type	8' Fixed	Selffeed Bit Capacity	1-3/4"
Cord Length	8'	Capacity in Concrete	3/4"
No Load RPM	0-1,500, 0-3,500		
Trigger Lock	Yes		

5387-20 1/2" Dual Speed Hammer Drill



FEATURES



- Powerful 8.5-amp dual-speed motor: Optimized for concrete fastening with overload protection. Choose 0-1,000 RPM/0-16,000 BPM or 0-2,500 RPM/0-40,000 BPM
- Heavy-duty metal gear case: Withstands daily jobsite use, yet is light enough to reduce operator fatigue
- QUIK-LOK® Cord: 10-ft. 2-wire grounded rubber cord provides easy storage and field replacement

Includes: (1) 1/2 in. Dual Speed Hammer-Drill (5387-20); (1) Chuck Key; (1) Side Handle

SPECIFICATIONS

Length	14-3/4"	Amps	8.5
Weight	6.4 lbs	Trigger Lock	No
Voltage	120V AC	Chuck Type	Keyed
Tool Warranty	5 Years	Capacity in Steel	Twist Bit 1/2"
No Load BPM	0-16,000, 0-40,000	Selffeed Bit Capacity	2"
Cord Type	10' QUIK-LOK®	Capacity in Concrete	3/4"
No Load RPM	0-1,000, 0-2,500		

5387-22 1/2" Dual Speed Hammer-Drill Kit

Includes: (1) 1/2 in. Dual Speed Hammer-Drill (5387-20); (1) Carrying Case; (1) Chuck Key; (1) Side Handle

ATTACHMENTS



48-76-5010: 10' Quik-Lok®















48-76-5025: 25' Quik-Lok®

HAMMER DRILL BITS



MILWAUKEE MASONRY BIT RANGE

HAMMER DRILL 	ROTARY HAMMERS   	DEMOLITION HAMMERS      
		
HAMMER DRILL / PERCUSSION BITS	ROTARY HAMMER DRILL BITS	DEMOLITION STEEL

HAMMER DRILL BITS

FASTER DRILLING

- Unique flute geometry provides efficient dust and debris removal

STARTS ON CONTACT & EXACT SPOT DRILLING

- Patented self-centering carbide tip maintains hole placement

INCREASED TIP STRENGTH

- Patented Rebar Chamfers for increased strength and reduced wear

OPTIMIZED IMPACT ENERGY TRANSFER

- Reinforced and patented high volume KVS flute for higher resistance to breaking

NO SPIN

- 3-Flat shank holds bit secure in drill chuck

DESIGNED FOR DRILLING

- in brick, block and softer aggregate concrete

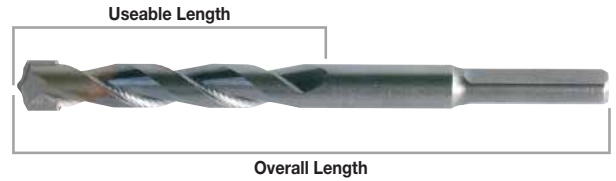

Size	Part Number	Useable Length	Overall Length	Pack Qty
1/8"	48-20-8800	1-1/2"	3"	2
5/32"	48-20-8801	4"	6"	2
3/16"	48-20-8805	2"	4"	2
3/16"	48-20-8806	4"	6"	2
1/4"	48-20-8810	2"	4"	1
1/4"	48-20-8811	4"	6"	1
1/4"	48-20-8812	10"	12"	1
5/16"	48-20-8816	4"	6"	1
5/16"	48-20-8817	10"	12"	1
3/8"	48-20-8821	4"	6"	1
3/8"	48-20-8822	10"	12"	1
3/8"	48-20-8823	16"	18"	1
7/16"	48-20-8825	4"	6"	1
1/2"	48-20-8830	4"	6"	1
1/2"	48-20-8831	10"	12"	1
1/2"	48-20-8832	16"	18"	1
9/16"	48-20-8835	4"	6"	1
5/8"	48-20-8840	4"	6"	1
5/8"	48-20-8841	10"	12"	1
5/8"	48-20-8842	16"	18"	1

Size	Part Number	Useable Length	Overall Length	Pack Qty
3/4"	48-20-8845	4"	6"	1
3/4"	48-20-8846	10"	12"	1
7/8"	48-20-8847	4"	6"	1
7/8"	48-20-8848	10"	12"	1
1"	48-20-8849	4"	6"	1
1"	48-20-8854	10"	12"	1
3/16"	48-20-8957	4"	6"	5
1/4"	48-20-8961	2"	4"	5
1/4"	48-20-8962	4"	6"	5
1/8"	48-20-8900	1-1/2"	3"	25
5/32"	48-20-8901	4"	6"	25
3/16"	48-20-8905	2"	4"	25
3/16"	48-20-8906	4"	6"	25
1/4"	48-20-8910	2"	4"	25
1/4"	48-20-8911	4"	6"	25
5/16"	48-20-8916	4"	6"	25
3/8"	48-20-8921	4"	6"	20
7/16"	48-20-8925	4"	6"	20
1/2"	48-20-8930	4"	6"	15
5/8"	48-20-8940	4"	6"	10

HAMMER DRILL BIT SETS

3 Pc 3-Flat SECURE-GRIP™ Hammer Drill Bit Set 48-20-8850	5 Pc 3-Flat SECURE-GRIP™ Hammer Drill Bit Set 48-20-8851
Includes: <ul style="list-style-type: none"> ■ 5/32" x 6" ■ 3/16" x 6" ■ 1/4" x 6" 	Includes: <ul style="list-style-type: none"> ■ 5/32" x 6" ■ 3/16" x 6" ■ 1/4" x 6" ■ 5/16" x 6" ■ 3/8" x 6"
6 Pc 3-Flat SECURE-GRIP™ Hammer Drill Bit Set 48-20-8856	7 Pc 3-Flat SECURE-GRIP™ Hammer Drill Bit Set 48-20-8852
Includes: <ul style="list-style-type: none"> ■ (2) 1/4" x 6" ■ 5/32" x 6" ■ 3/16" x 6" ■ 5/16" x 6" ■ 3/8" x 6" 	Includes: <ul style="list-style-type: none"> ■ (2) 3/16" x 6" ■ (2) 1/4" x 6" ■ 5/32" x 6" ■ 5/16" x 6" ■ 3/8" x 6"



HAMMER DRILL BITS CROSS-REFERENCE

HAMMER DRILL BITS

Diameter	Useable Length	Overall Length	Qty	Milwaukee	Bosch	DeWalt	Metabo
1/8	1-1/2	3	2	48-20-8800	HCBG01	DW5221	74 004
5/32	4	6	2	48-20-8801	HCBG02	DW5227	
3/16	2	4	2	48-20-8805	HCBG03	DW5222	74 006
3/16	4	6	2	48-20-8806	HCBG04	DW5223	74 206
1/4	2	4	1	48-20-8810		DW5224	74 008
1/4	4	6	1	48-20-8811	HCBG06	DW5225	74 108
1/4	10	2	1	48-20-8812	HCBG08	DW5226	
5/16	4	6	1	48-20-8816	HCBG09	DW5228	74 010
5/16	10	2	1	48-20-8817	HCBG11	DW5229	74 410
3/8	4	6	1	48-20-8821	HCBG12	DW5230	74 012
3/8	10	2	1	48-20-8822	HCBG14	DW5231	74 412
3/8	16	8	1	48-20-8823		DW5232	
7/16	4	6	1	48-20-8825	HCBG15	DW5234	74 014
1/2	4	6	1	48-20-8830	HCBG16	DW5235	74 016
1/2	10	2	1	48-20-8831	HCBG18	DW5236	74 416
1/2	16	8	1	48-20-8832		DW5237	
9/16	4	6	1	48-20-8835		DW5217	74 018
5/8	4	6	1	48-20-8840	HCBG20	DW5241	74 020
5/8	10	2	1	48-20-8841	HCBG21	DW5242	74 420
5/8	16	18	1	48-20-8842			
3/4	4	6	1	48-20-8845	HCBG22	DW5244	74 024
3/4	10	2	1	48-20-8846	HCBG23	DW5245	74 424
7/8	4	6	1	48-20-8847	HCBG24		74 028
7/8	10	2	1	48-20-8848	HCBG25	DW5219	
1	4	6	1	48-20-8849	HCBG26		74 100
1	10	2	1	48-20-8854	HCBG27	DW5249	
3/16	4	6	5	48-20-8957	HCBG0405		
1/4	4	3	5	48-20-8961			
1/4	4	6	5	48-20-8962	HCBG0605		
1/8	1-1/2	3	25	48-20-8900	HCBG01B25	DW5221B25	
5/32	4	6	25	48-20-8901	HCBG02B25	DW5227B25	74 475
3/16	2	4	25	48-20-8905	HCBG03B25	DW5222B25	74 456
3/16	4	6	25	48-20-8906	HCBG04B25	DW5223B25	74 256
1/4	2	4	25	48-20-8910		DW5224B25	74 058
1/4	4	6	25	48-20-8911	HCBG06B25	DW5225B25	74 158
5/16	4	6	25	48-20-8916	HCBG09B25	DW5228B25	
3/8	4	6	20	48-20-8921	HCBG12B25	DW5230B25	
7/16	4	6	20	48-20-8925	HCBG15B25		
1/2	4	6	15	48-20-8930	HCBG16B25	DW5235B25	
5/8	4	6	10	48-20-8940	HCBG20B25		
3 PC. BIT KIT			SET	48-20-8850			
5 PC. BIT KIT			SET	48-20-8851		DW5205	
7 PC. BIT KIT			SET	48-20-8852			
6 PC. BIT KIT			SET	48-20-8856			

ROTARY HAMMERS



5263-21 5/8" SDS Plus Rotary Hammer Kit



FEATURES



- Powerful 5.5-amp motor: Delivers 0-3,700 RPM, 0-4,400 BPM and 1.5 ft-lbs of torque, providing up to 65% faster drilling speeds
- Lightweight 4.6-lb design: Reduces fatigue when you drill overhead and in horizontal applications
- Compact 10.9" profile: Lets you work more efficiently in tight spaces
- 2-Mode operation: Choose rotary hammer or rotation only for added versatility
- AVS Anti-Vibration System: Minimizes vibration for maximum comfort
- Mechanical clutch: Protects the motor when the bit binds

Includes: (1) 5/8" SDS Plus Rotary Hammer Kit (5263-21); (1) Carrying Case; (1) Depth Rod; (1) Side Handle

SPECIFICATIONS

Length	10.9"	Drilling Mode	2-Mode: Rotary Hammer, Rotation Only
Weight	4.6 lbs	Handle Style	Drop Motor
Voltage	120V	Vibration Reduction	Yes
Tool Warranty	5 Years	Cord Length	10'
No Load Speed	0-3,700	No Load RPM	0-3,700
No Load BPM	0-4,400	Amps	5.5
Cord Type	Double Insulated	Trigger Lock	NO
Electronic Feedback	No	Solid Bit Capacity	5/8"
Bit Shank	SDS-PLUS	Thin Wall Core Bit Capacity	2-1/8"
Blow Energy	1.5 ft-lbs		
Clutch	Yes		

5262-21 7/8" SDS Plus Rotary Hammer Kit



FEATURES



- Powerful 7-amp motor: Delivers 0-1,500 RPM, 0-5,625 BPM with up to 40% faster drilling speeds than the competition
- 1.8 Ft-lbs of torque: Provides 10% faster drilling and up to 35% harder hits
- 3-Mode operation: Choose rotary hammer, hammer only and rotation only for added versatility
- Mechanical clutch: Protects the motor when the bit binds
- Variable Position Chisel Stop: Allows material to be adjusted, regardless of orientation

Includes: (1) 7/8" SDS Plus Rotary Hammer Kit (5262-21); (1) Carrying Case; (1) Depth Rod; (1) Side Handle

SPECIFICATIONS

Length	17"	Drilling Mode	3-Mode: Rotary Hammer, Hammer Only, Rotation Only
Weight	5.8 lbs	Handle Style	D-Handle
Voltage	120V	Vibration Reduction	No
Tool Warranty	5 Years	Cord Length	10'
No Load Speed	0-1,500	No Load RPM	0-1,500
No Load BPM	0-5,625	Amps	7
Cord Type	Double Insulated	Trigger Lock	Yes
Electronic Feedback	No	Solid Bit Capacity	7/8"
Bit Shank	SDS-PLUS	Thin Wall Core Bit Capacity	2-1/2"
Blow Energy	1.8 ft-lbs		
Clutch	Yes		

ALSO AVAILABLE IN CORDLESS



2416

FUEL M12

5/8" SDS+ Rotary Hammer



2612

M18

5/8" SDS+ Rotary Hammer



2605

M18

7/8" SDS+ Rotary Hammer



ROTARY HAMMERS

5363-21

1" SDS Plus Rotary Hammer with Anti-Vibration System



FEATURES



- Powerful 7-amp reversible motor: Delivers a hard-hitting 2 ft-lbs of impact energy, 0-1,400 RPM and 0-5,980 BPM
- All-metal gear case and block construction: Provides optimal bearing and gear seating for long-term durability
- Rotating brush plate: Provides equal power in forward and reverse for easy removal of jammed bits, plus extends brush life
- Compact, lightweight design: L-shape provides excellent balance and hand position for maximum control, especially overhead

Includes: (1) 1" SDS Plus Rotary Hammer with Anti-Vibration System (5363-21); (1) Carrying Case; (1) Side Handle

SPECIFICATIONS

Length	12-1/4"	Drilling Mode	3-Mode: Rotary Hammer, Hammer Only, Rotation Only
Weight	8.0 lbs		
Voltage	120V AC	Handle Style	D-Handle
Tool Warranty	5 Years	Vibration Reduction	Yes - AVS™
No Load Speed	0-1,400	No Load RPM	0-1,400
No Load BPM	0-5,980	Amps	7
Cord Type	Double Insulated	Trigger Lock	No
Electronic Feedback	No	Solid Bit Capacity	1"
Bit Shank	SDS-PLUS	Thin Wall Core Bit Capacity	2-1/2"
Blow Energy	2.0 ft-lbs		
Clutch	Yes		

5359-21

1-1/8" SDS Plus L-Shape Rotary Hammer



FEATURES



- Powerful 7.4-amp motor: Delivers a hard-hitting 2.5 ft-lbs of blow energy
- Speed control switch: You control the starts for less bit walk and more accurate hole positioning
- 10-ft. 3-wire fixed rubber cord: Durable construction for longer tool life

Includes: (1) 1-1/8" SDS Plus L-Shape Rotary Hammer (5359-21); (1) Carrying Case; (1) Depth Rod; (1) Side Handle

SPECIFICATIONS

Length	14"	Drilling Mode	3-Mode: Rotary Hammer, Hammer Only, Rotation Only
Weight	8.3 lbs		
Voltage	120V AC	Handle Style	D-Handle
Tool Warranty	5 Years	Vibration Reduction	Yes - AVS™
No Load Speed	0-980	No Load RPM	0-980
No Load BPM	0-4,200	Amps	7.4
Cord Type	Double Insulated	Trigger Lock	No
Electronic Feedback	No	Solid Bit Capacity	1-1/8"
Bit Shank	SDS-PLUS	Thin Wall Core Bit Capacity	4"
Blow Energy	2.5 ft-lbs		
Clutch	Yes		

COMING FALL 2014

5268-21

1-1/8" SDS Plus Rotary Hammer



- High Performance 8 amp motor
- Mechanical clutch protects the tool during bit bind up
- Anti-Vibration System (AVS): minimizes vibration for less operator fatigue
- 3 mode for maximum versatility in concrete, masonry or other materials

ALSO AVAILABLE IN CORDLESS COMING FALL 2014



2712

FUEL M18
1" SDS Plus*



2715

FUEL M18
1-1/8" SDS Plus*

*dedicated dust extractors will also be available

ROTARY HAMMERS



5316-21 1-9/16" Spline Rotary Hammer



FEATURES



- Powerful 10.5 Amp Motor: Delivers 450 RPM and 3,000 BPM
- Powerful Hammer Mechanism: Delivers 5.5 ft-lbs (7.5J) of impact energy for drilling in hard aggregate
- CPT™ - Constant Power Technology: Delivers consistent performance in tough applications
- Mechanical Clutch: Protects the tool when the bit binds up
- 2-Mode Operation: Rotary hammer and hammer only for maximum versatility
- 12-Position Chipping Adjustment: Allows the user to maintain the desired hammer position while chipping in any orientation

Includes: (1) 1-9/16" Spline Rotary Hammer (5316-21); (1) Carrying Case; (1) Side Handle

SPECIFICATIONS

Length	17-3/4"	Drilling Mode	2-Mode: Rotary Hammer and Hammer Only
Weight	15 lbs		
Voltage	120V AC	Handle Style	Drop Motor
Tool Warranty	5 Years	Vibration Reduction	No
No Load Speed	450	Cord Length	13'
No Load BPM	3,000	No Load RPM	0-450
Cord Type	Grounded	Amps	10.5
Electronic Feedback	Yes	Trigger Lock	No
Bit Shank	Spline	Thick Wall Core Bit Capacity	4"
Blow Energy	5.5 ft-lbs	Solid Bit Capacity	1-9/16"
Clutch	Yes		

5317-21 1-9/16" SDS Max Rotary Hammer



FEATURES



- Powerful 10.5 Amp Motor: Delivers 450 RPM and 3,000 BPM
- Powerful Hammer Mechanism: Delivers 5.5 ft-lbs (7.5J) of impact energy for drilling in hard aggregate
- CPT™ - Constant Power Technology: Delivers consistent performance in tough applications
- Mechanical Clutch: Protects the tool when the bit binds up
- 2-Mode Operation: Rotary hammer and hammer only for maximum versatility
- 12-Position Chipping Adjustment: Allows the user to maintain the desired hammer position while chipping in any orientation

Includes: (1) 1-9/16" SDS Max Rotary Hammer (5317-21); (1) Carrying Case; (1) Depth Rod; (1) Side Handle

SPECIFICATIONS

Length	17-3/8"	Drilling Mode	2-Mode: Rotary Hammer and Hammer Only
Weight	15 lbs		
Voltage	120V AC	Handle Style	Drop Motor
Tool Warranty	5 Years	Vibration Reduction	No
No Load Speed	450	Cord Length	13'
No Load BPM	3,000	No Load RPM	0-450
Cord Type	Grounded	Amps	10.5
Electronic Feedback	Yes	Trigger Lock	No
Bit Shank	SDS Max	Thick Wall Core Bit Capacity	4"
Blow Energy	5.5 ft-lbs	Solid Bit Capacity	1-9/16"
Clutch	Yes		



ROTARY DEMOLITION HAMMERS

5426-21 1-3/4" SDS Max Rotary Hammer



5446-21 1-3/4" SDS Max Demolition Hammer



FEATURES



- Powerful 14-amp 1,300 MWO Milwaukee motor: Provides best-in-class power and highest overload protection
- Two-speed impact mode: Use low (350 RPM/2,200 BPM) for light materials or high (450 RPM/2,840 BPM) for the toughest concrete
- Durable hammer mechanism: Provides 8.8 ft-lbs of torque for hard hitting performance
- CPT™ Constant Power Technology: Delivers consistent performance when the tool is under load
- Mechanical clutch: Protects the motor when the bit binds
- AVS Anti-Vibration System: Minimizes vibration for maximum comfort

Includes: (1) 1-3/4" SDS Max Rotary Hammer (5426-21); (1) Carrying Case; (1) Side Handle

SPECIFICATIONS

Length	18"	Drilling Mode	2-Mode: Rotary Hammer and Hammer Only
Weight	16.2 lbs		
Voltage	120V AC	Handle Style	Drop Motor
Tool Warranty	5 Years	Vibration Reduction	Yes - AVS™
No Load Speed	350/450	No Load RPM	350/450
No Load BPM	2,200/2,840	Amps	14
Cord Type	Grounded	Trigger Lock	No
Electronic Feedback	Yes	Thick Wall Core Bit Capacity	4.5"
Bit Shank	SDS Max	Solid Bit Capacity	1-3/4"
Blow Energy	8.8 ft-lbs		
Clutch	Yes		

FEATURES



- Powerful 14-amp 1,300 MWO Milwaukee motor: Provides best-in-class power and highest overload protection
- Two-speed impact mode: Use low (2,200 BPM) for light materials or high (2,840 BPM) for the toughest concrete
- Heavy-duty crank piston mechanism: Provides 8.8 ft-lbs of torque for hard hitting performance
- CPT™ Constant Power Technology: Delivers consistent performance when the tool is under load
- Variable-position chisel stop: Fixes the chisel in 12 positions for various applications
- Mechanical clutch: Protects the motor when the bit binds
- AVS Anti-Vibration System: Minimizes vibration for maximum comfort

Includes: (1) 1-3/4" SDS Max Demolition Hammer (5446-21); (1) Carrying Case; (1) Side Handle

SPECIFICATIONS

Length	18"	Bit Shank	SDS Max
Weight	15.9 lbs	Blow Energy	8.8 ft-lbs
Voltage	120V AC	Drilling Mode	Single Mode: Hammer Only
Tool Warranty	5 Years	Handle Style	Drop Motor
No Load Speed	350/450	Vibration Reduction	Yes - AVS™
No Load BPM	2,200/2,840	Amps	14
Cord Type	Grounded	Trigger Lock	Yes
Electronic Feedback	Yes		

SDS-PLUS MASONRY BITS



SDS+ ROTARY HAMMER BITS

2-CUTTER SDS+ CARBIDE BITS

ACCURATE STARTS

- Centering point ensures correct hole placement

FAST DRILLING

- Chisel shaped head for fast drilling in hard materials
- High volume flute entrance quickly channels debris to the flute



4 FLUTED SPIRAL IN SMALL DIAMETERS

- Fast debris removal
- Minimizes bending and breaking
- Minimizes vibrations



Size	Useable Length	Overall Length	Individual Part Number	Bulk Part Number	Bulk Qty	Monster Pack Part Number	Qty
5/32"	2"	4-1/2"	48-20-7400	48-20-7500	25	-	-
5/32"	4"	6"	48-20-7401	48-20-7501	25	-	-
3/16"	2"	4-1/2"	48-20-7410	48-20-7510	25	48-20-7810	200
3/16"	4"	6"	48-20-7411	48-20-7511	25	48-20-7811	200
3/16"	6"	8"	48-20-7412	48-20-7512	25	-	-
3/16"	8"	10"	48-20-7413	48-20-7513	25	-	-
3/16"	10"	12"	48-20-7414	48-20-7514	25	-	-
3/16"	12"	14"	48-20-7415	48-20-7515	25	-	-
3/16"	14"	16"	48-20-7416	48-20-7516	25	-	-
7/32"	4"	6"	48-20-7421	48-20-7521	25	-	-
7/32"	6"	8"	48-20-7422	48-20-7522	25	-	-
7/32"	9"	11"	48-20-7424	48-20-7524	25	-	-
7/32"	12"	14"	48-20-7425	48-20-7525	25	-	-
7/32"	14"	16"	48-20-7426	48-20-7526	25	-	-
1/4"	2"	4-1/2"	48-20-7430	48-20-7530	25	48-20-7830	200
1/4"	4"	6"	48-20-7431	48-20-7531	25	48-20-7831	200
1/4"	6"	8"	48-20-7432	48-20-7532	25	-	-
1/4"	9"	11"	48-20-7434	48-20-7534	25	-	-
1/4"	12"	14"	48-20-7435	48-20-7535	25	-	-
1/4"	14"	16"	48-20-7436	48-20-7536	25	-	-
1/4"	18"	20"	48-20-7438	-	-	-	-
5/16"	4"	6"	48-20-7441	48-20-7541	25	48-20-7841	150
5/16"	10"	12"	48-20-7444	-	-	-	-
3/8"	4"	6"	48-20-7451	48-20-7551	20	48-20-7851	125
3/8"	6"	8"	48-20-7452	-	-	-	-
3/8"	8"	10"	48-20-7453	-	-	-	-
3/8"	10"	12"	48-20-7454	48-20-7554	20	-	-
3/8"	16"	18"	48-20-7457	-	-	-	-
3/8"	22"	24"	48-20-7459	-	-	-	-

Size	Useable Length	Overall Length	Individual Part Number	Bulk Part Number	Bulk Qty	Monster Pack Part Number	Qty
7/16"	4"	6"	48-20-7461	-	-	-	-
7/16"	10"	12-1/2"	48-20-7464	-	-	-	-
7/16"	16"	18"	48-20-7467	-	-	-	-
1/2"	4"	6"	48-20-7471	48-20-7571	15	48-20-7871	100
1/2"	8"	10"	48-20-7473	-	-	-	-
1/2"	10"	12"	48-20-7474	48-20-7574	15	-	-
1/2"	16"	18"	48-20-7477	-	-	-	-
1/2"	22"	24"	48-20-7479	-	-	-	-
9/16"	4"	6-1/2"	48-20-7481	-	-	-	-
9/16"	10"	12-1/2"	48-20-7484	-	-	-	-
9/16"	16"	18"	48-20-7487	-	-	-	-
5/8"	4"	6"	48-20-7601	-	-	-	-
5/8"	6"	8"	48-20-7602	48-20-7702	10	-	-
5/8"	10"	12"	48-20-7604	-	-	-	-
5/8"	16"	18"	48-20-7607	-	-	-	-
5/8"	22"	24"	48-20-7609	-	-	-	-
11/16"	6"	8"	48-20-7058	-	-	-	-
3/4"	6"	8"	48-20-7061	-	-	-	-
3/4"	8"	10"	48-20-7063	-	-	-	-
3/4"	10"	12"	48-20-7065	-	-	-	-
3/4"	16"	18"	48-20-7066	-	-	-	-
3/4"	22"	24"	48-20-7067	-	-	-	-
27/32"	6"	8"	48-20-7069	-	-	-	-
7/8"	6"	8"	48-20-7071	-	-	-	-
7/8"	10"	12"	48-20-7072	-	-	-	-
7/8"	16"	18"	48-20-7075	-	-	-	-
1"	8"	10"	48-20-7080	-	-	-	-
1"	16"	18"	48-20-7085	-	-	-	-

2-CUTTER SDS+ CARBIDE BIT SETS

5 Pc SDS+ Kit 48-20-7490	6 Pc SDS+ Kit 48-20-7495
Includes: <ul style="list-style-type: none"> 3/16" x 4-1/2" 1/4" x 6" 5/16" x 6" 3/8" x 6" 1/2" x 6" 	Includes: <ul style="list-style-type: none"> (2) 3/16" x 6" (2) 1/4" x 6" (1) 3/8" x 6" (1) 1/2" x 6"

2-CUTTER SDS+ BITS WITH HEX SHOULDER

- Fits hex 5/16" CONDRIVE™ sleeve for Tap-Con® screw system

Size	Useable Length	Overall Length	Individual Part Number	Bulk Part Number	Bulk Qty
5/32"	2"	5"	48-20-7090	-	-
5/32"	3"	6"	48-20-7096	48-20-7196	25
5/32"	4"	7"	48-20-7091	48-20-7191	25
3/16"	2"	5"	48-20-7097	-	-
3/16"	3"	6"	48-20-7098	48-20-7198	25
3/16"	4"	7"	48-20-7092	48-20-7192	25

SDS+ STOP BITS

Overall Length	Diameter	Individual Part Number
1-1/16"	3/8" (1/4" Drop-in)	48-20-7651
13/16"	1/2" (3/8" Drop-in, Short)	48-20-7652
1-11/16"	1/2" (3/8" Drop-in)	48-20-7653
1-1/16"	5/8" (1/2" Drop-in, Short)	48-20-7654
2-1/16"	5/8" (1/2" Drop-in)	48-20-7655



MAXIMIZES PRODUCTIVITY WHEN USING DROP-IN ANCHORS

- Drill accurate depths repeatedly
- Patented flute geometry to rapidly remove debris and maximize impact energy
- Centering tip for exact spot drilling
- Common applications: hanging unistrut, pipe, cable trays, duct





SDS-PLUS MASONRY BITS

SDS+ ROTARY HAMMER BITS

4-CUTTER PREMIUM MX4 SDS+ CARBIDE BITS

LONG LIFE

- 4-Cutter solid carbide tip for up to 3X life in rebar



ACCURATE HOLES

- Centering tip and 4-Cutter design drills more accurate holes for anchoring applications



Size	Useable Length	Overall Length	Individual Part Number	Bulk Part Number	Bulk Qty
3/16"	2"	4"	48-20-7310	-	-
3/16"	4"	6"	48-20-7311	48-20-7911	15
3/16"	6"	8"	48-20-7312	-	-
3/16"	8"	10"	48-20-7313	-	-
3/16"	10"	12"	48-20-7314	-	-
1/4"	2"	4"	48-20-7330	-	-
1/4"	4"	6"	48-20-7331	48-20-7931	15
1/4"	6"	8"	48-20-7332	-	-
1/4"	8"	10"	48-20-7334	-	-
1/4"	10"	12"	48-20-7335	-	-
5/16"	4"	6"	48-20-7341	-	-
3/8"	4"	6"	48-20-7351	48-20-7951	10
3/8"	10"	12"	48-20-7354	-	-
3/8"	16"	18"	48-20-7357	-	-
1/2"	4"	6"	48-20-7371	48-20-7971	10
1/2"	10"	12"	48-20-7374	-	-
1/2"	16"	18"	48-20-7377	-	-

4-CUTTER SDS+ BITS

DURABLE

- 4-Cutter design lasts longer when encountering small diameter rebar and mesh

ACCURATE STARTS

- Centering point ensures correct hole placement

FASTER DRILLING

- Unique face design directs dust through the 4 fluted spiral for faster drilling

Size	Part Number	Useable Length	Overall Length
5/8"	48-20-7200	6"	8"
5/8"	48-20-7203	10"	12"
5/8"	48-20-7206	16"	18"
3/4"	48-20-7210	6"	8"
3/4"	48-20-7215	10"	12"
3/4"	48-20-7220	16"	18"
7/8"	48-20-7225	6"	8"
7/8"	48-20-7230	10"	12"
7/8"	48-20-7236	16"	18"
1"	48-20-7240	8"	10"
1"	48-20-7246	16"	18"
1-1/8"	48-20-7250	8"	10"
1-1/8"	48-20-7256	16"	18"

INDUSTRY'S ONLY UNIVERSAL DUST EXTRACTOR

Compatible with major power tool brands of SDS Plus Rotary Hammers and AC/DC Hammer Drills, the M12™ HAMMERVAC™ Universal Dust Extractor is the industry's only UNIVERSAL dust extractor.



99.97% EFFICIENT AT REMOVING PARTICLES 0.3µM AND ABOVE



HAMMERVAC™ Universal Dust Extractor Kit (2306-22)

Universal Handle System:

Compatible with major brands of SDS Plus Rotary Hammers and AC & DC Hammer Drills

Replaceable Certified HEPA Filter:

High quality debris filtration and lowest cost of ownership

Self-Powered by M12™ REDLITHIUM™ Batteries:

No cords or hoses for maximum portability

3-Mode Switch with Auto-On:

Auto-on mode turns HAMMERVAC™ on and off automatically

Powerful Suction for Dust Extraction:

Reduces the potential for silica dust inhalation by user

SDS-PLUS CROSS-REFERENCE



	DIAMETER	USEABLE LENGTH	OVERALL LENGTH	QTY	MILWAUKEE	BOSCH	DEWALT	METABO	VULCAN	HILTI
SDS+ 2-CUTTER BITS	5/32	2	4	1	48-20-7400	HC2000	DW5400		VC100	
	5/32	4	6	1	48-20-7401	HC2001	DW5401		VC101	
	3/16	2	4	1	48-20-7410	HC2010	DW5402		VC102	
	3/16	4	6	1	48-20-7411	HC2011	DW5403	74606	VC103	
	3/16	6	8	1	48-20-7412	HC2012	DW5404		VC104	
	3/16	8	10	1	48-20-7413	HC2013	DW5405		VC105	
	3/16	10	12	1	48-20-7414	HC2014	DW5406		VC106	
	3/16	12	14	1	48-20-7415	HC2015	DW5407			
	3/16	14	16	1	48-20-7416		DW5408			
	7/32	4	6	1	48-20-7421	HC2031	DW5410		VC112	
	7/32	6	8	1	48-20-7422	HC2032			VC113	
	7/32	9	11	1	48-20-7424	HC2034	DW5412		VC114	
	7/32	12	14	1	48-20-7425					
	7/32	14	16	1	48-20-7426					
	1/4	2	4	1	48-20-7430	HC2040	DW5416		VC115	
	1/4	4	6	1	48-20-7431	HC2041	DW5417	74708	VC116	
	1/4	6	8	1	48-20-7432	HC2042	DW5418	74808	VC117	
	1/4	9	11	1	48-20-7434	HC2043	DW5420		VC118	
	1/4	12	14	1	48-20-7435	HC2045	DW5421		VC119	
	1/4	14	16	1	48-20-7436					
	1/4	18	20	1	48-20-7438					
	5/16	4	6	1	48-20-7441	HC2051	DW5424		VC120	
	5/16	10	12	1	48-20-7444	HC2054	DW5426		VC121	
	3/8	4	6	1	48-20-7451	HC2061	DW5427	74512	VC124	
	3/8	6	8	1	48-20-7452				VC122	
	3/8	8	10	1	48-20-7453		DW5429	74712		
	3/8	10	12	1	48-20-7454	HC2064	DW5430		VC123	
	3/8	16	18	1	48-20-7457	HC2067	DW5431		VC125	
	3/8	22	24	1	48-20-7459	HC2068	DW5432			
	7/16	4	6	1	48-20-7461	HC2071	DW5433	74514		
	7/16	10	12	1	48-20-7464	HC2074	DW5435			
	7/16	16	18	1	48-20-7467		DW5436			
	1/2	4	6	1	48-20-7471	HC2081	DW5437	74516	VC128	
	1/2	8	10	1	48-20-7473		DW5438	74716	VC127	
	1/2	10	12	1	48-20-7474	HC2084	DW5439		VC129	
	1/2	16	18	1	48-20-7477	HC2087	DW5440		VC130	
	1/2	22	24	1	48-20-7479	HC2088	DW5441			
	9/16	4	6	1	48-20-7481	HC2091	DW5442			
	9/16	10	12	1	48-20-7484	HC2094	DW5443		VC131	
	9/16	16	18	1	48-20-7487	HC2097	DW5444			
	5/8	4	6	1	48-20-7601				VC140	
	5/8	6	8	1	48-20-7602	HC2102	DW5446		VC137	
5/8	10	12	1	48-20-7604	HC2104	DW5447	74620	VC138		
5/8	16	18	1	48-20-7607	HC2107	DW5448	74720	VC139		
5/8	22	24	1	48-20-7609	HC2108	DW5449				
11/16	6	8	1	48-20-7058	HC2112	DW5450				



SDS-PLUS CROSS-REFERENCE

SDS+ 2-CUTTER BITS

DIAMETER	USEABLE LENGTH	OVERALL LENGTH	QTY	MILWAUKEE	BOSCH	DEWALT	METABO	VULCAN	HILTI
3/4	6	8	1	48-20-7061	HC2122	DW5453	74524		
3/4	8	10	1	48-20-7063					
3/4	10	12	1	48-20-7065	HC2124	DW5455	74624		
3/4	16	18	1	48-20-7066	HC2127	DW5456	74724		
3/4	22	24	1	48-20-7067	HC2128	DW5457	74824		
27/32	6	8	1	48-20-7069					
7/8	6	8	1	48-20-7071	HC2142	DW5460			
7/8	10	12	1	48-20-7072	HC2144	DW5461			
7/8	16	18	1	48-20-7075	HC2147	DW5462	74728		
1	8	10	1	48-20-7080	HC2163	DW5464	74600		
1	16	18	1	48-20-7085	HC2167	DW5466	74800		
5/32	2	4	25	48-20-7500					
5/32	4	6	25	48-20-7501	HC2001B25	DW5401B25			
3/16	2	4	25	48-20-7510	HC2010B25	DW5402B25			
3/16	4	6	25	48-20-7511	HC2011B25	DW5403B25			
3/16	6	8	25	48-20-7512	HC2012B25	DW5404B25			
3/16	8	10	25	48-20-7513	HC2013B25	DW5405B25			
3/16	10	12	25	48-20-7514	HC2014B25	DW5406B25			
3/16	12	14	25	48-20-7515	HC2015B25				
3/16	14	16	25	48-20-7516					
7/32	4	6	25	48-20-7521	HC2031B25	DW5410B25			
7/32	6	8	25	48-20-7522	HC2032B25				
7/32	9	11	25	48-20-7524	HC2034B25				
7/32	12	14	25	48-20-7525					
7/32	14	16	25	48-20-7526					
1/4	2	4	25	48-20-7530	HC2040B25	DW5416B25			
1/4	4	6	25	48-20-7531	HC2041B25	DW5417B25			
1/4	6	8	25	48-20-7532	HC2042B25	DW5418B25			
1/4	9	11	25	48-20-7534					
1/4	12	14	25	48-20-7535					
1/4	14	16	25	48-20-7536					
5/16	4	6	25	48-20-7541	HC2051B25	DW5424B25			
3/8	4	6	20	48-20-7551	HC2061B25	DW5427B25			
3/8	10	12	20	48-20-7554	HC2064B25				
1/2	4	6	15	48-20-7571	HC2081B25	DW5437B25			
1/2	10	12	15	48-20-7574	HC2084B25				
5/8	6	8	10	48-20-7702	HC2102B25	DW5446B25			
3/16	2	4	200	48-20-7810					
3/16	4	6	200	48-20-7811					
1/4	2	4	200	48-20-7830					
1/4	4	6	200	48-20-7831					
5/16	4	6	150	48-20-7841					
3/8	4	6	125	48-20-7851					
1/2	4	6	100	48-20-7871					

SDS-PLUS CROSS-REFERENCE



	DIAMETER	USEABLE LENGTH	OVERALL LENGTH	QTY	MILWAUKEE	BOSCH	DEWALT	METABO	VULCAN	HILTI
SDS+ 2-CUTTER BITS WITH HEX SHOULDER	5/32	2	5	1	48-20-7090		DW5359	74505		
	5/32	3	6	1	48-20-7096	HC2301	DW5360			
	5/32	4	7	1	48-20-7091	HC2302	DW5361	74605		
	3/16	2	5	1	48-20-7097	HC2310	DW5362			
	3/16	3	6	1	48-20-7098	HC2311	DW5363			
	3/16	4	7	1	48-20-7092	HC2312	DW5364	74606		
	5/32	3	6	25	48-20-7196	HC2301B25				
	5/32	4	7	25	48-20-7191	HC2302B25				
	3/16	3	6	25	48-20-7198	HC2311B25				
	3/16	4	7	25	48-20-7192	HC2312B25	DW5364B25			
SDS+ 4-CUTTER BITS	5/8	6	8	1	48-20-7200					
	5/8	10	12	1	48-20-7203					
	5/8	16	18	1	48-20-7206					
	3/4	6	8	1	48-20-7210	HC2222				
	3/4	10	12	1	48-20-7215	HC2224				
	3/4	16	18	1	48-20-7220	HC2227				
	7/8	6	8	1	48-20-7225	HC2242				
	7/8	10	12	1	48-20-7230	HC2244				
	7/8	16	18	1	48-20-7236	HC2247				
	1	8	10	1	48-20-7240	HC2263				
	1	16	18	1	48-20-7246	HC2267				
	1-1/8	8	10	1	48-20-7250	HC2283	DW5468			
	1-1/8	16	18	1	48-20-7256	HC2287	DW5469			
PREMIUM SDS+ 4-CUTTER BITS	3/16	2	4		48-20-7310	HCFC2010				206662
	3/16	4	6		48-20-7311	HCFC2011				206663
	3/16	6	8		48-20-7312	HCFC2012				206664
	3/16	8	10		48-20-7313					
	3/16	10	12		48-20-7314	HCFC2014				206665
	1/4	2	4		48-20-7330	HCFC2040				206667
	1/4	4	6		48-20-7331	HCFC2041				206668
	1/4	6	8		48-20-7332	HCFC2042				206669
	1/4	8	10		48-20-7334					
	1/4	10	12		48-20-7335	HCFC2044				206670
	5/16	4	4		48-20-7341	HCFC2051				206671
	3/8	4	6		48-20-7351	HCFC2061				206674
	3/8	10	8		48-20-7354	HCFC2064				206675
	3/8	16	10		48-20-7357	HCFC2067				206676
	1/2	4	12		48-20-7371	HCFC2081				206711
	1/2	10	12		48-20-7374	HCFC2084				206712
	1/2	16	18		48-20-7377	HCFC2087				206713
	3/16	4	6	15	48-20-7911					
	1/4	4	6	15	48-20-7931					
	3/8	4	6	10	48-20-7951					
1/2	4	6	10	48-20-7971						



SDS-MAX BITS

SDS-MAX ROTARY HAMMER BITS

LONG LIFE

- Brazing formula optimizes drilling for up to 20% longer life

FAST DUST REMOVAL

- Unique flute geometry provides efficient dust removal

PRECISE ROUND HOLES

- Centering point and 4-Cutter design provide accurate and precise round holes

4-CUTTER WITH 4X90° SYMMETRY

- Will not lock-up in rebar



Size	Useable Length	Overall Length	2-Cutter Part Number	4-Cutter Part Number
3/8"	7-1/2"	13"	48-20-3901	
1/2"	7-1/2"	13"	48-20-3902	
1/2"	11-1/2"	17"	48-20-3903	
1/2"	15-1/2"	21"	48-20-3904	
1/2"	22-1/2"	28"	48-20-3905	
1/2"	30-1/2"	36"	48-20-3906	
1/2"	54"	60"	48-20-3909	
9/16"	7-1/2"	13"	48-20-3910	
9/16"	15-1/2"	21"	48-20-3912	
5/8"	7-1/2"	13"		48-20-3916
5/8"	11-1/2"	17"		48-20-3917
5/8"	15-1/2"	21"		48-20-3918
5/8"	30-1/2"	36"		48-20-3922
5/8"	54"	60"		48-20-3923
11/16"	15-1/2"	21"		48-20-3926
3/4"	8"	13"		48-20-3930
3/4"	12"	17"		48-20-3931
3/4"	16"	21"		48-20-3932
3/4"	31"	36"		48-20-3936

Size	Useable Length	Overall Length	2-Cutter Part Number	4-Cutter Part Number
13/16"	16"	21"		48-20-3938
7/8"	8"	13"		48-20-3944
7/8"	12"	17"		48-20-3945
7/8"	16"	21"		48-20-3946
7/8"	31"	36"		48-20-3949
1"	8"	13"		48-20-3952
1"	12"	17"		48-20-3953
1"	16"	21"		48-20-3954
1"	31"	36"		48-20-3956
1-1/16"	18"	23"		48-20-3958
1-1/8"	12"	17"		48-20-3964
1-1/8"	16"	21"		48-20-3966
1-3/16"	18"	23"		48-20-3968
1-1/4"	10"	15"		48-20-3970
1-1/4"	18"	23"		48-20-3972
1-1/4"	31"	36"		48-20-3974
1-3/8"	12"	17"		48-20-3975
1-3/8"	18"	23"		48-20-3980
1-3/8"	31"	36"		48-20-3983
1-7/16"	18"	23"		48-20-3984
1-1/2"	12"	17"		48-20-3986
1-1/2"	18"	23"		48-20-3988
1-9/16"	18"	23"		48-20-3990
1-5/8"	18"	23"		48-20-3991
1-3/4"	18"	23"		48-20-3992
2"	18"	23"		48-20-3993

SPLINE ROTARY HAMMER BITS

LONG LIFE

- Brazing formula optimizes drilling for up to 20% longer life

FAST DUST REMOVAL

- Unique flute geometry provides efficient dust removal

ACCURATE PRECISE ROUND HOLES

- Centering point and 4-Cutter design provides accurate and precise round holes



Size	Useable Length	Overall Length	2-Cutter	4-Cutter
3/8"	4"	10"	48-20-4037	
1/2"	4"	10"	48-20-4050	
1/2"	10"	16"	48-20-4051	
1/2"	16"	22"	48-20-4052	
1/2"	22"	27"	48-20-4053	
1/2"	31"	36"	48-20-4054	
9/16"	4"	10"	48-20-4056	
9/16"	18"	23"	48-20-4057	
5/8"	5"	10"	48-20-4062	48-20-4300
5/8"	11"	16"	48-20-4063	48-20-4305
5/8"	16"	22"	48-20-4064	48-20-4310
5/8"	24"	29"		48-20-4315
5/8"	31"	36"		48-20-4320
11/16"	11"	16"	48-20-4068	48-20-4325
3/4"	5"	10"	48-20-4075	48-20-4330
3/4"	11"	16"	48-20-4076	48-20-4335
3/4"	17"	22"	48-20-4078	48-20-4340
3/4"	24"	29"		48-20-4345
3/4"	31"	36"		48-20-4350

Size	Useable Length	Overall Length	2-Cutter	4-Cutter
13/16"	11"	16"	48-20-4081	
7/8"	11"	16"	48-20-4087	48-20-4360
7/8"	17"	22"	48-20-4088	48-20-4365
7/8"	31"	36"		48-20-4367
1"	11"	16"	48-20-4100	48-20-4370
1"	17"	22"	48-20-4101	48-20-4375
1"	31"	36"		48-20-4380
1-1/8"	11"	16"	48-20-4112	48-20-4385
1-1/8"	17"	22"	48-20-4113	48-20-4390
1-1/4"	11"	16"	48-20-4125	48-20-4395
1-1/4"	17"	22"	48-20-4126	48-20-4400
1-1/4"	31"	36"		48-20-4405
1-3/8"	11"	16"	48-20-4137	
1-3/8"	17"	22"	48-20-4138	48-20-4410
1-1/2"	11"	16"	48-20-4150	
1-1/2"	17"	22"	48-20-4151	48-20-4415
1-5/8"	17"	22"	48-20-4153	
1-3/4"	18"	23"		48-20-4418
2"	18"	23"		48-20-4419

SDS-MAX & SPLINE CROSS-REFERENCE



	DIAMETER	USEABLE LENGTH	OVERAL LENGTH	QTY	MILWAUKEE	BOSCH	DEWALT	METABO	VULCAN
SDS-MAX BITS	3/8	7-1/2	13	1	48-20-3901				
	1/2	7-1/2	13	1	48-20-3902	HC5010	DW5803	76516	VC211
	1/2	11-1/2	17	1	48-20-3903				
	1/2	15-1/2	21	1	48-20-3904	HC5011	DW5804	76716	VC212
	1/2	22-1/2	28	1	48-20-3905				
	1/2	30-1/2	36	1	48-20-3906				
	1/2	54	60	1	48-20-3909				
	9/16	7-1/2	13	1	48-20-3910	HC5015	DW5801		VC215
	9/16	15-1/2	21	1	48-20-3912	HC5016	DW5802		VC216
	5/8	7-1/2	13	1	48-20-3916	HC5020	DW5806	76520	VC219
	5/8	11-1/2	17	1	48-20-3917				
	5/8	15-1/2	21	1	48-20-3918	HC5021	DW5809	76720	VC220
	5/8	30	36	1	48-20-3922	HC5023	DW5807	76820	
	11/16	15-1/2	21	1	48-20-3926	HC5026	DW5808	76722	
	3/4	8	13	1	48-20-3930	HC5030	DW5810	76624	VC224
	3/4	12	17	1	48-20-3931				
	3/4	16	21	1	48-20-3932	HC5031	DW5812	76724	VC225
	3/4	31	36	1	48-20-3936	HC5033	DW5813	76824	
	13/16	16	21	1	48-20-3938	HC5036	DW5814		
	7/8	8	13	1	48-20-3944	HC5040	DW5815	76528	VC230
	7/8	12	17	1	48-20-3945				
	7/8	16	21	1	48-20-3946	HC5041	DW5816	76728	VC231
	7/8	31	36	1	48-20-3949				
	1	8	13	1	48-20-3952	HC5050	DW5818	76700	VC233
	1	12	17	1	48-20-3953				
	1	16	21	1	48-20-3954	HC5051	DW5819	76900	VC234
	1	31	36	1	48-20-3956	HC5053	DW5820		VC236
	1-1/16	18	23	1	48-20-3958	HC5056	DW5823		
	1-1/8	12	17	1	48-20-3964	HC5060	DW5821	76804	VC239
	1-1/8	16	21	1	48-20-3966	HC5061	DW5822	76904	VC240
	1-3/16	18	23	1	48-20-3968				
	1-1/4	10	15	1	48-20-3970	HC5070	DW5824	76808	VC241
	1-1/4	18	23	1	48-20-3972	HC5071	DW5825		VC242
	1-1/4	31	36	1	48-20-3974	HC5073	DW5826		
	1-3/8	12	17	1	48-20-3975				
	1-3/8	18	23	1	48-20-3980	HC5081	DW5827	76912	VC245
	1-7/16	18	23	1	48-20-3984	HC5086	DW5829		
	1-1/2	12	17	1	48-20-3986				
	1-1/2	18	23	1	48-20-3988	HC5091	DW5828	76916	VC247
	1-9/16	18	23	1	48-20-3990	HC5096	DW5861		
1-5/8	18	23	1	48-20-3991				VC248	
1-3/4	18	23	1	48-20-3992	HC5098	DW5830		VC250	
2	18	23	1	48-20-3993	HC5099	DW5831		VC251	
	3/8	4	10	1	48-20-4037	HC4501	DW5700		VC191
	1/2	4	10	1	48-20-4050	HC4510	DW5703	76 016	VC192
	1/2	10	16	1	48-20-4051	HC4511	DW5704	76116	VC194
	1/2	16	22	1	48-20-4052	HC4512	DW5705		VC195
	1/2	22	27	1	48-20-4053	HC4513	DW5706		
	1/2	31	36	1	48-20-4054	HC4514	DW5707		



SDS-MAX & SPLINE CROSS-REFERENCE

	DIAMETER	USEABLE LENGTH	OVERAL LENGTH	QTY	MILWAUKEE	BOSCH	DEWALT	METABO	VULCAN
SPLINE BITS	9/16	4	10	1	48-20-4056		DW5708		
	9/16	18	23	1	48-20-4057		DW5735		
	5/8	5	10	1	48-20-4062	HC4520	DW5709		VC198
	5/8	11	16	1	48-20-4063	HC4521	DW5710		VC199
	5/8	16	22	1	48-20-4064	HC4522	DW5711		VC200
	11/16	11	16	1	48-20-4068				
	3/4	5	10	1	48-20-4075	HC4530	DW5714		VC201
	3/4	11	16	1	48-20-4076	HC4531	DW5715		VC202
	3/4	17	22	1	48-20-4078	HC4532	DW5716		VC203
	13/16	11	16	1	48-20-4081				
	7/8	11	16	1	48-20-4087	HC4540	DW5719		VC204
	7/8	17	22	1	48-20-4088	HC4541	DW5720		VC205
	1	11	16	1	48-20-4100	HC4550	DW5721		VC206
	1	17	22	1	48-20-4101	HC4551	DW5722		VC207
	1-1/8	11	16	1	48-20-4112		DW5725		
	1-1/8	17	22	1	48-20-4113	HC4561	DW5726		
	1-1/4	11	16	1	48-20-4125		DW5727		VC208
	1-1/4	17	22	1	48-20-4126	HC4571	DW5728		VC209
	1-3/8	11	16	1	48-20-4137		DW5729		
	1-3/8	17	22	1	48-20-4138		DW5730		
	1-1/2	11	16	1	48-20-4150		DW5731		
	1-1/2	17	22	1	48-20-4151	HC4591	DW5732		VC210
	5/8	5	10	1	48-20-4300	HC4020	DW5740	76 020	
	5/8	11	16	1	48-20-4305	HC4021	DW5741	76120	VC168
	5/8	16	22	1	48-20-4310	HC4022	DW5742		VC169
	5/8	24	29	1	48-20-4315	HC4023	DW5743		
	5/8	31	36	1	48-20-4320	HC4024	DW5744		
	11/16	11	16	1	48-20-4325	HC4026	DW5745		
	3/4	5	10	1	48-20-4330	HC4030	DW5746		
	3/4	11	16	1	48-20-4335	HC4031	DW5747	76 124	VC174
	3/4	17	22	1	48-20-4340	HC4032	DW5748	76324	VC175
	3/4	24	29	1	48-20-4345	HC4033	DW5749		
	3/4	31	36	1	48-20-4350	HC4034	DW5750		
	7/8	11	16	1	48-20-4360	HC4040	DW5752	76128	
	7/8	17	22	1	48-20-4365	HC4041	DW5753	76 328	
	7/8	31	36	1	48-20-4367				
	1	11	16	1	48-20-4370	HC4050	DW5755	76 200	VC181
	1	17	22	1	48-20-4375	HC4051	DW5756	76 400	VC182
	1	31	36	1	48-20-4380	HC4053	DW5757		VC182-36
	1-1/8	11	16	1	48-20-4385	HC4060	DW5758	76 204	
	1-1/8	17	22	1	48-20-4390	HC4061	DW5759	76 404	
	1-1/4	11	16	1	48-20-4395	HC4070	DW5760	76 208	
	1-1/4	17	22	1	48-20-4400	HC4071	DW5761	76 408	
	1-1/4	31	36	1	48-20-4405	HC4073	DW5762		
1-3/8	17	22	1	48-20-4410	HC4081	DW5765	76 412		
1-1/2	17	22	1	48-20-4415	HC4091	DW5764	76 416	VC190	
1-5/8	17	22	1	48-20-4153					
1-3/4	18	23	1	48-20-4418	HC6001	DW5768			
2	18	23	1	48-20-4419		DW5769			

DEMOLITION HAMMERS



5337-21 2" 3/4" Hex Demolition Hammer



FEATURES



- Powerful 14-amp motor: Delivers 19.9 ft-lbs of blow energy
- Heavy-duty robust construction: Digs and drills under the most demanding jobsite conditions
- Comfortable inline design: Three side handle positions plus soft-grip D-handle offer greater user comfort
- Variable-speed dial: Maximizes user control
- AVS Anti-Vibration System: Minimizes vibration for maximum comfort
- Service reminder light: Indicates when service will be needed
- Lock-on trigger: Enhances safety and peace of mind

Includes: (1) 2" 3/4" Hex Demolition Hammer (5337-21); (2) Auxilliary Handle; (1) Carrying Case

SPECIFICATIONS

Length	27-1/2"	Bit Shank	3/4" Hex
Weight	27.75 lbs	Blow Energy	19.9 ft-lbs
Voltage	120V AC	Drilling Mode	Single Mode: Hammer Only
Tool Warranty	5 Years	Handle Style	D-Handle
No Load Speed	125-250	Vibration Reduction	Yes- AVS™
No Load BPM	975-1,950	Amps	14
Cord Type	Double Insulated	Trigger Lock	Yes
Electronic Feedback	Yes		

5339-21 2" SDS Max Demolition Hammer



FEATURES



- Powerful 14-amp motor: Delivers 19.9 ft-lbs of blow energy
- Heavy-duty robust construction: Digs and drills under the most demanding jobsite conditions
- Comfortable inline design: Three side handle positions plus D-handle offer greater user comfort
- Variable-speed dial: Maximizes user control
- AVS Anti-Vibration System: Minimizes vibration for maximum comfort
- Service reminder light: Indicates when service will be needed
- Lock-on trigger: Enhances safety and peace of mind

Includes: (1) 2" SDS Max Demolition Hammer (5339-21); (1) Carrying Case; (1) Depth Rod; (1) Side Handle

SPECIFICATIONS

Length	27-1/2"	Bit Shank	SDS Max
Weight	27.75 lbs	Blow Energy	19.9 ft-lbs
Voltage	120V AC	Drilling Mode	Single Mode: Hammer Only
Tool Warranty	5 Years	Handle Style	D-Handle
No Load Speed	125-250	Vibration Reduction	Yes- AVS™
No Load BPM	975-1,950	Amps	14
Cord Type	Double Insulated	Trigger Lock	Yes
Electronic Feedback	Yes		



ROTARY DEMOLITION HAMMERS

5340-21 2" Spline Rotary Hammer

5342-21 2" SDS Max Rotary Hammer



FEATURES



- Powerful 15-amp motor: Delivers 19.9 ft-lbs of blow energy
- Heavy-duty robust construction: Digs and drills under the most demanding jobsite conditions
- Comfortable inline design: Three handle positions offer greater user comfort
- Variable-speed dial: Maximizes user control
- Vibration Isolation System: Minimizes vibration for less operator fatigue

Includes: (1) 2" Spline Rotary Hammer (5340-21); (1) Carrying Case; (1) Side Handle

SPECIFICATIONS

Length	27-1/2"	Drilling Mode	2-Mode: Rotary Hammer and Hammer Only
Weight	27.75 lbs		
Voltage	120V AC	Handle Style	D-Handle
Tool Warranty	5 Years	Vibration Reduction	Yes - AVS™
No Load Speed	125-250	No Load RPM	125-250
No Load BPM	975-1,950	Amps	15
Cord Type	Double Insulated	Trigger Lock	No
Electronic Feedback	Yes		6"
Bit Shank	Spline	Solid Bit Capacity	2"
Blow Energy	19.9 ft-lbs		
Clutch	Yes		

FEATURES



- Powerful 15-amp motor: Delivers 19.9 ft-lbs of blow energy
- Heavy-duty robust construction: Digs and drills under the most demanding jobsite conditions
- Comfortable inline design: Three handle positions offer greater user comfort
- Variable-speed dial: Maximizes user control
- Vibration Isolation System: Minimizes vibration for less operator fatigue
- Service reminder light: Indicates when service will be needed

Includes: (1) 2" SDS Max Rotary Hammer (5342-21); (1) Carrying Case; (1) Side Handle

SPECIFICATIONS

Length	27-1/2"	Drilling Mode	2-Mode Rotary Hammer and Hammer Only
Weight	27.75 lbs		
Voltage	120V AC	Handle Style	D-Handle
Tool Warranty	5 Years	Vibration Reduction	Yes - AVS™
No Load Speed	125-250	No Load RPM	125-250
No Load BPM	975-1,950	Amps	15
Cord Type	Double Insulated	Trigger Lock	No
Electronic Feedback	Yes	Thick Wall Core Bit Capacity	6"
Bit Shank	SDS Max	Solid Bit Capacity	2"
Blow Energy	19.9 ft-lbs		
Clutch	Yes		

CORE BITS, TUNNEL BITS AND EXTENSIONS



ONE-PIECE CORE BITS

IDEAL FOR LARGE DIAMETER HOLES

- Asymmetrical and alternating teeth for faster material pulverization
- Thick-wall core body for durability



Diameter	Inner Core Depth	Overall Length	SDS-MAX Part No.	SPLINE Part No.
1-1/2"	3"	11-3/8"	48-20-5400	48-20-5450
1-1/2"	3"	22"	48-20-5402	48-20-5452
1-3/4"	3"	11-3/8"	48-20-5404	48-20-5454
1-3/4"	3"	22"	48-20-5406	48-20-5456
2"	3"	11-3/8"	48-20-5408	48-20-5458
2"	3"	22"	48-20-5410	48-20-5460
2-5/8"	3"	11-3/8"	48-20-5412	48-20-5462
2-5/8"	3"	22"	48-20-5414	48-20-5464
3-1/8"	3"	11-3/8"	48-20-5420	48-20-5470
3-1/8"	3"	22"	48-20-5422	48-20-5472
3-9/16"	3"	11-3/8"	48-20-5428	48-20-5478
3-9/16"	3"	22"	48-20-5430	48-20-5480
4"	3"	11-3/8"	48-20-5432	48-20-5482
4"	3"	22"	48-20-5434	48-20-5484
5"	3"	11-3/8"	48-20-5436	48-20-5486
5"	3"	22"	48-20-5438	48-20-5488
6"	3"	22"	48-20-5440	48-20-5490

SDS-MAX TUNNEL BITS

IDEAL FOR LARGE DIAMETER HOLES

- Centering tip for exact spot drilling
- Three wide flutes for fast debris removal and true round holes
- Chisel and Raker teeth for fast material penetration and pulverization



Diameter	Overall Length	Part No.
1-1/2"	12-1/4"	48-20-5300
1-1/2"	22"	48-20-5302
1-3/4"	12-1/4"	48-20-5304
1-3/4"	22"	48-20-5306
1-3/4"	39"	48-20-5308
2-1/8"	12-1/4"	48-20-5310
2-1/8"	22"	48-20-5312
2-1/8"	39"	48-20-5314
2-1/2"	12-1/4"	48-20-5316
2-1/2"	22"	48-20-5318
2-1/2"	39"	48-20-5320
3-1/8"	12-1/4"	48-20-5322
3-1/8"	22"	48-20-5324

MUST BE ORDERED SEPARATELY FOR ONE-PIECE CORE BITS

Replacement Parts	Part No.
1Pc Core Centering Pin	48-20-5495
1Pc Core Drift Pin	48-20-5497

MAX-LOK™ EXTENSION SYSTEM

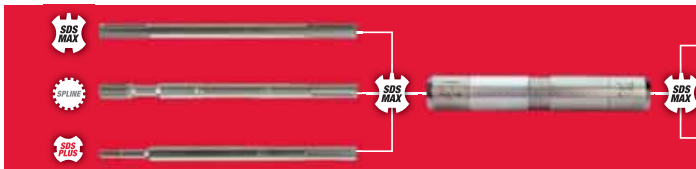

EXTEND BIT REACH UP TO 82"

- Drill deeper holes
- Leverage shorter, less expensive bits
- Maximum energy transfer



CONNECTION

Part No.	Description
48-20-6950	Max-Lok™ Connection, includes grease 49-08-5385



SDS-MAX EXTENSIONS



48-20-6960	12-1/2"
48-20-6962	29-1/2"
48-20-6964	43"
48-20-6966	63"
48-20-6968	82-1/2"

SPLINE EXTENSIONS



48-20-6970	12-1/2"
48-20-6972	29-1/2"
48-20-6974	43"



SDS-PLUS EXTENSIONS



Part No.	Length
48-20-6980	12-1/2"
48-20-6982	29-1/2"

GREASE

Part No.	Description
49-08-5385	Max-Lok™ Replacement Grease



MULTI-BIT CORE BITS

SDS+ THIN WALL CARBIDE TIPPED CORE BITS



Size	Depth	Core Body w/ Guide Plate & Centering Pin*	8" SDS+ Adapter Shank	12" SDS+ Adapter Shank	7-1/2" Extension	Replacement Guide Plate	Replacement Centering Pin
1"	3-3/16"	48-20-5005*	48-03-3545	48-03-3551	48-95-6070	-	-
1-1/8"	3-3/16"	48-20-5010*	48-03-3545	48-03-3551	48-95-6070	-	-
1-1/4"	3-3/16"	48-20-5015	48-03-3545	48-03-3551	48-95-6070	48-20-6151	48-20-6150
1-3/8"	3-3/16"	48-20-5020	48-03-3545	48-03-3551	48-95-6070	48-20-6152	48-20-6150
1-1/2"	3-3/16"	48-20-5025	48-03-3545	48-03-3551	48-95-6070	48-20-6153	48-20-6150
1-3/4"	2-13/16"	48-20-5030	48-03-3555	48-03-3561	48-95-6075	48-20-6156	48-20-6155
2"	2-13/16"	48-20-5035	48-03-3555	48-03-3561	48-95-6075	48-20-6157	48-20-6155
2-1/2"	2-13/16"	48-20-5040	48-03-3555	48-03-3561	48-95-6075	48-20-6158	48-20-6155
3"	2-13/16"	48-20-5045	48-03-3555	48-03-3561	48-95-6075	48-20-6159	48-20-6155
3-1/2"	2-13/16"	48-20-5050	48-03-3555	48-03-3561	48-95-6075	48-20-6160	48-20-6155
4"	2-13/16"	48-20-5055	48-03-3555	48-03-3561	48-95-6075	48-20-6161	48-20-6155

*Guide plate and centering pin not included with 1" & 1-1/8" diameter core bits

SDS-MAX AND SPLINE THICK WALL CARBIDE TIPPED CORE BITS



Size	Depth	Core Body w/ Guide Plate & Centering Pin	12" SPLINE Adapter Shank	18" SPLINE Adapter Shank	12" SDS-MAX Adapter Shank	18" SDS-MAX Adapter Shank	7-1/2" Extension	Replacement Guide Plate	Replacement Centering Pin
1-1/2"	4-1/16"	48-20-5125	48-03-3564	48-03-3565	48-03-3572	48-03-3573	48-95-6085	48-20-5168	48-20-5199
1-3/4"	4-1/16"	48-20-5130	48-03-3564	48-03-3565	48-03-3572	48-03-3573	48-95-6085	48-20-5169	48-20-5199
2"	4-1/16"	48-20-5135	48-03-3564	48-03-3565	48-03-3572	48-03-3573	48-95-6085	48-20-5170	48-20-5199
2-1/2"	4-1/16"	48-20-5140	48-03-3564	48-03-3565	48-03-3572	48-03-3573	48-95-6085	48-20-5171	48-20-5199
3"	4-1/16"	48-20-5145	48-03-3564	48-03-3565	48-03-3572	48-03-3573	48-95-6085	48-20-5172	48-20-5199
3-1/2"	4-1/16"	48-20-5150	48-03-3564	48-03-3565	48-03-3572	48-03-3573	48-95-6085	48-20-5173	48-20-5199
4"	4-1/16"	48-20-5155	48-03-3564	48-03-3565	48-03-3572	48-03-3573	48-95-6085	48-20-5174	48-20-5199
5"	4-1/16"	48-20-5160	48-03-3564	48-03-3565	48-03-3572	48-03-3573	48-95-6085	48-20-5175	48-20-5199
6"	4-1/16"	48-20-5165	48-03-3564	48-03-3565	48-03-3572	48-03-3573	48-95-6085	48-20-5176	48-20-5199
THIN WALL	5"	2-13/16"	48-20-5060	-	48-03-3574	-	48-95-6075	48-20-6162	48-20-6155
	6"	2-13/16"	48-20-5065	-	48-03-3574	-	48-95-6075	48-20-6163	48-20-6155

LHS COMPONENT SYSTEM



LHS SYSTEM

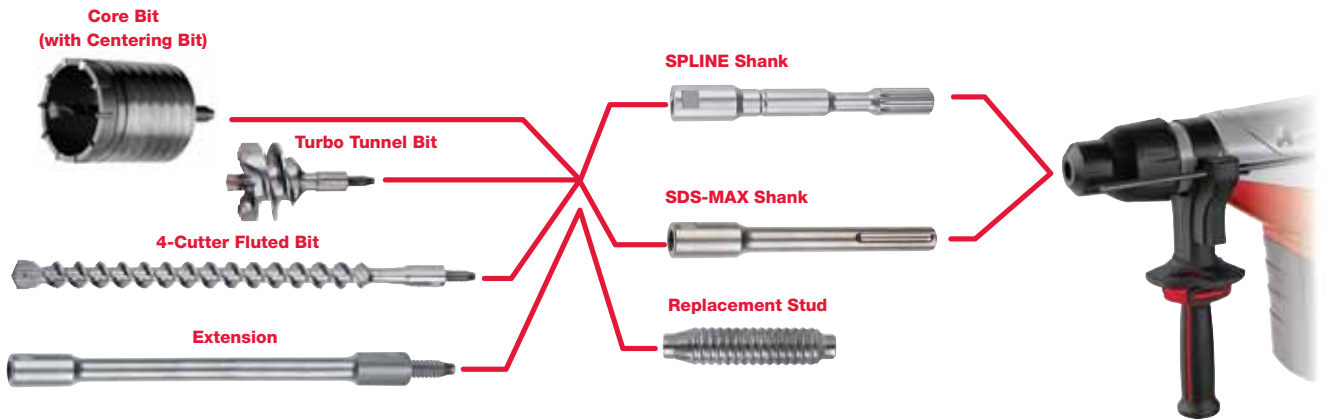

LHS 4-CUTTER FLUTED BITS



Size	Part Number	Depth
1-1/8"	48-20-5070	18"
1-1/4"	48-20-5071	18"

TURBO TUNNEL BITS

Size	Part Number	Depth
1-3/8"	48-20-5082	35 mm
1-1/2"	48-20-5083	40 mm
1-3/4"	48-20-5084	45 mm
2-1/8"	48-20-5085	55 mm
2-5/8"	48-20-5087	68 mm
3-1/8"	48-20-5089	80 mm



LHS THICK WALL CARBIDE-TIPPED CORE BITS

Size	Part Number	Depth	Metric
1-1/2"	48-20-5090	3"	40 mm
1-3/4"	48-20-5091	3"	45 mm
2-1/8"	48-20-5092	3"	55 mm
2-5/8"	48-20-5093	3"	68 mm
3-1/8"	48-20-5094	3"	80 mm
3-1/2"	48-20-5095	3"	90 mm
4"	48-20-5096	3"	100 mm
5"	48-20-5097	3"	120 mm
	48-20-5099	Replacement Centering Bit	



LHS REPLACEMENT PARTS

Description	Part Number
7" SPLINE Shank	48-20-5075
7-1/2" SDS-MAX Shank	48-20-5077
11" Extension	48-20-5079
2-1/2" Replacement Threaded Stud	48-20-5081

CARBIDE BIT ADAPTERS

Description	Part Number
SPLINE to "B" Taper Adapter	48-66-6503
SPLINE to "A" Taper Adapter	48-66-6502
SPLINE TO SDS MAX	48-03-3010
SDS MAX TO SPLINE	48-03-3012
SPLINE To SDS+ Bit Adapter	48-03-3015
SDS-MAX To SDS+ Bit Adapter	48-03-3025
SDS+ to 3-Jaw Chuck Adapter Kit	48-66-1370
SDS+ Dust Shield	48-03-3030



DEMOLITION HAMMER ACCESSORIES

DEMOLITION HAMMER ACCESSORIES (SDS+, SDS-MAX, SPLINE, 3/4" HEX)

Type	Description	Size	SDS+			SDS-MAX (Slotted 18 mm Round)			SPLINE or Round Hex (3/4" Hex with 21/32" Round)			3/4" Hex		
			Individual Part Number	Bulk Part Number	Qty	Individual Part Number	Bulk Part Number	Qty	Individual Part Number	Bulk Part Number	Qty	Individual Part Number	Bulk Part Number	Qty
	Starts holes in concrete slabs, general chipping and breaking	10"	48-62-6010	48-62-6110	25				-	-	-	-	-	-
		12"	-	-	-	48-62-4075	48-62-4175	25	48-62-2000	48-62-2100	25	48-62-3000	-	-
		18"	-	-	-	48-62-4077	48-62-4177	25	48-62-2010	48-62-2110	25	48-62-3005	-	-
	General chipping and breaking	3/4" x 10"	48-62-6015	48-62-6115	25				-	-	-	-	-	-
		1" x 12"	-	-	-	48-62-4079	48-62-4179	25	48-62-2020	48-62-2120	25	48-62-3010	48-62-3110	25
		1" x 18"	-	-	-	48-62-4081	48-62-4181	25	48-62-2030	48-62-2130	25	48-62-3015	-	-
	Cleans concrete, scale, rust, cuts troughs and some asphalt	1-1/2" x 10"	48-62-6020	48-62-6120	25				-	-	-	-	-	-
		1-1/2" x 12"	-	-	-	48-62-4082	-	-	48-62-2040	-	-	48-62-3020	-	-
		2" x 12"	-	-	-	48-62-4085	48-62-4185	25	48-62-2050	48-62-2150	25	48-62-3035	-	-
		3" x 12"	-	-	-	48-62-4087	48-62-4187	25	48-62-2055	48-62-2155	25	48-62-3030	48-62-3130	25
	Scrapes surface rather than breaking material on top	2" x 12"	-	-	-	48-62-4089	-	-	48-62-2065	-	-	48-62-3025	-	-
	Breaks out the "web" between closely spaced drilled holes to make a large opening	1-1/4" x 15"	-	-	-	48-62-4073	-	-	-	-	-	-	-	-
		1-1/2" x 12"	-	-	-	-	-	-	48-62-2060	-	-	-	-	-
	Removes mortar between brick or block, cuts narrow channels	1" x 15"	-	-	-	48-62-4080	-	-	48-62-2080	-	-	-	-	-
	Removes excess concrete, produces exterior finish, roughens surface before surface coating	1-3/4" Sq. x 10-1/2"	-	-	-	48-62-4065	-	-	-	-	-	-	-	-
		1-3/4" Sq. x 9-3/4"	-	-	-	-	-	-	48-62-2070	48-62-2170	15	48-62-3085	48-62-3185	15
	Cuts asphalt or hard packed gravel (Do NOT use for concrete)	5" x 16-1/2"	-	-	-	48-62-4066	-	-	-	-	-	48-62-3090	-	-
	Digging clay, hard packed gravel (Do NOT use for concrete)	4-1/2" x 16-5/8"	-	-	-	48-62-4068	48-62-4168	12	-	-	-	-	-	-
		4-1/2" x 16-3/4"	-	-	-	-	-	-	48-62-2095	-	-	48-62-3040	48-62-3140	12
	Drives soft ground rods. Socket depth - 2-3/4", inner dia. - .906"	9-3/4"L - 5/8" & 3/4" Rod Dia.	-	-	-	48-62-4091	-	-	-	-	-	48-62-3070	-	-
		10"L - 5/8" & 3/4" Rod Dia.	-	-	-	-	-	-	48-62-2046	-	-	-	-	-
	Used to mount tamper plate	12"	-	-	-	48-62-4092	-	-	48-62-2097	-	-	48-62-3065	-	-
	Compacts dirt, tamps asphalt	5" x 5"	-	-	-	48-62-3060	-	-	48-62-3060	-	-	48-62-3060	-	-

DEMOLITION HAMMER ACCESSORIES (1-1/8" COLLARED HEX WITH NOTCH)

Type	Description	Size	Individual Part Number	Bulk Part Number	Qty
	Starts holes in concrete slabs, general chipping and breaking	20"	48-62-4000	48-62-4100	8
	General chipping and breaking	20-1/2"	48-62-4005	48-62-4105	8
	Wide chisel with two 60° cutting angles cleans concrete, scale, rust, cuts troughs and some asphalt	3" x 20-1/2"	48-62-4010	48-62-4110	8
	Cuts asphalt or hard ground (DO NOT use for concrete)	5" x 17-1/2"	48-62-4020	48-62-4120	6
	Digs clay, hard packed gravel, dirt (DO NOT use for concrete)	5-1/2" x 20"	48-62-4030	48-62-4130	5
	Drives anchoring pins for concrete forms	14-1/2"	48-62-4040	-	-
	Drives ground rods	15-1/2" long / 3" Depth	48-62-4045	-	-
	Compacts dirt, tamps asphalt. Use with 48-62-4060	6" x 6"	48-62-4050	-	-
		8" x 8"	48-62-4055	-	-
	For use with 48-62-4050, 48-62-4055 and 48-62-4061	15-1/2"	48-62-4060	-	-
	Used to drive in large tent stakes. Use with 48-62-4060	5-1/2" L / 3-1/2" OD / 2-3/4" ID	48-62-4061	-	-

Demolition Accessory Set
48-20-4200

Includes: 48-20-4051, 48-20-4063, 48-20-4076, 48-62-2000, 48-62-2020

DEMO BITS CROSS-REFERENCE



	Description	Qty	Category	Milwaukee	Bosch	DeWalt	
SDS+ DEMO STEEL	BULL PT.10	1	SDS+ Demo Steel Bits	48-62-6010	HS1415	DW5348	
	FLAT CHISEL 3/4X10	1	SDS+ Demo Steel Bits	48-62-6015	HS1420	DW5350	
	SCAL. CHISEL 1-1/2X8	1	SDS+ Demo Steel Bits	48-62-6020	HS1425	DW5349	
	CHISEL BULL POINT	25	SDS+ Demo Steel Bits	48-62-6110			
	CHISEL NARROW	25	SDS+ Demo Steel Bits	48-62-6115			
	CHISEL WIDE	25	SDS+ Demo Steel Bits	48-62-6120			
SDS-MAX DEMO STEEL	BUSHING TOOL1-3/4X10-1/2	1	SDS-Max Demo Steel Bits	48-62-4065	HS1909	DW5843	
	ASPHALT CUTTER5X16-1/2	1	SDS-Max Demo Steel Bits	48-62-4066	HS1906	DW5846	
	CLAY SPADE4-1/2X16-5/8	1	SDS-Max Demo Steel Bits	48-62-4068	HS1922	DW5848B	
	SLOTING TOOL, 1-1/4X15	1	SDS-Max Demo Steel Bits	48-62-4073	HS1921	DW5842	
	12 BULL POINT,	1	SDS-Max Demo Steel Bits	48-62-4075	HS1913	DW5832	
	BULL POINT, 18	1	SDS-Max Demo Steel Bits	48-62-4077	HS1914	DW5833	
	FLAT CHISEL, 1 X 12	1	SDS-Max Demo Steel Bits	48-62-4079	HS1911	DW5834	
	SEAM TOOL, 1 X 15	1	SDS-Max Demo Steel Bits	48-62-4080	HS1920		
	FLAT CHISEL, 1 X 18 ,	1	SDS-Max Demo Steel Bits	48-62-4081	HS1912	DW5835	
	SCALING CHISEL, 1-1/2X12	1	SDS-Max Demo Steel Bits	48-62-4082	HS1916		
	SCALING CHISEL, 2 X12	1	SDS-Max Demo Steel Bits	48-62-4085	HS1917	DW5837	
	SCALING CHISEL, 3 X12	1	SDS-Max Demo Steel Bits	48-62-4087	HS1910	DW5838	
	SCRAPING CHISEL, 2X12	1	SDS-Max Demo Steel Bits	48-62-4089	HS1915		
	GROUND ROD DRIVER 9-3/4	1	SDS-Max Demo Steel Bits	48-62-4091	HS1924	DW5847	
	TAMPER PLATE SHANK 12	1	SDS-Max Demo Steel Bits	48-62-4092	HS1927		
	CLAY SPADE4-1/2X16-5/8	12	SDS-Max Demo Steel Bits	48-62-4168		0	
	BULL POINT, 12	25	SDS-Max Demo Steel Bits	48-62-4175	HS1913B25	DW5832B15	
	BULL POINT, 18	25	SDS-Max Demo Steel Bits	48-62-4177	HS1914B25	DW5833B15	
	FLAT CHISEL, 1 X12	25	SDS-Max Demo Steel Bits	48-62-4179	HS1911B25	DW5834B15	
	FLAT CHISEL, 1 X18	25	SDS-Max Demo Steel Bits	48-62-4181	HS1912B25	DW5835B15	
	SCALING CHISEL 2X12	25	SDS-Max Demo Steel Bits	48-62-4185			
	SCALING CHISEL 3X12	25	SDS-Max Demo Steel Bits	48-62-4187		DW5838B10	
	SPLINE & ROUND/HEX DEMO STEEL	12 BULL POINT CHISEL	1	Spline & Round/Hex Demo Steel Bits	48-62-2000	HS1813	DW5770
		BULL POINT, 18	1	Spline & Round/Hex Demo Steel Bits	48-62-2010	HS1814	DW5771
		FLAT CHISEL, 1 X12	1	Spline & Round/Hex Demo Steel Bits	48-62-2020	HS1811	DW5779
FLAT CHISEL, 1 X18		1	Spline & Round/Hex Demo Steel Bits	48-62-2030	HS1812	DW5780	
SCALING CHISEL 1-1/2X12		1	Spline & Round/Hex Demo Steel Bits	48-62-2040	HS1816	DW5773	
GROUND ROD DRIVER 10		1	Spline & Round/Hex Demo Steel Bits	48-62-2046	HS1824	DW5785	
SCALING CHISEL 2X12		1	Spline & Round/Hex Demo Steel Bits	48-62-2050	HS1817	DW5774	
SCALING CHISEL 3X12		1	Spline & Round/Hex Demo Steel Bits	48-62-2055	HS1810	DW5775	
SLOTING TOOL 1-1/2 X12		1	Spline & Round/Hex Demo Steel Bits	48-62-2060	HS1821	DW5772	
SCRAPING CHISEL 2X12		1	Spline & Round/Hex Demo Steel Bits	48-62-2065	HS1815		
BUSHING TOOL 1-3/4X9-3/4		1	Spline & Round/Hex Demo Steel Bits	48-62-2070	HS1809	DW5783	
SEAM TOOL, 1 X 12		1	Spline & Round/Hex Demo Steel Bits	48-62-2080	HS1820		
CLAY SPADE 4-1/2X16-3/4		1	Spline & Round/Hex Demo Steel Bits	48-62-2095	HS1822	DW5786B	
TAMPER PLATE SHANK 12		1	Spline & Round/Hex Demo Steel Bits	48-62-2097	HS1827		
BULL POINT, 12		25	Spline & Round/Hex Demo Steel Bits	48-62-2100	HS1813B25	DW5770B15	
BULL POINT 18		25	Spline & Round/Hex Demo Steel Bits	48-62-2110	HS1814B25	DW5771B15	
FLAT CHISEL, 1 X12		25	Spline & Round/Hex Demo Steel Bits	48-62-2120	HS1811B25	DW5779B15	
FLAT CHISEL, 1 X18		25	Spline & Round/Hex Demo Steel Bits	48-62-2130	HS1812B25	DW5780B15	
SCALING CHISEL 2X12		25	Spline & Round/Hex Demo Steel Bits	48-62-2150	HS1817B25		



DEMO BITS CROSS-REFERENCE

	Description	Qty	Category	Milwaukee	Bosch	DeWalt
	SCALING CHISEL3X12	25	Spline & Round/Hex Demo Steel Bits	48-62-2155	HS1810B25	DW5775B10
	BUSHING TOOL1-3/4X9-3/4	15	Spline & Round/Hex Demo Steel Bits	48-62-2170	HS1809B15	DW5783B10
ALL	TAMPER PLATE 5 IN X 5 IN		Max / Spline / 3/4" Hex Demo Steel Bit	48-62-3060	HS1828	
3/4" HEX DEMO STEEL	BULL POINT, 12 3/4 HEX	1	3/4" Hex Demo Steel Bits	48-62-3000	HS1515	DW5950
	BULL POINT, 18	1	3/4" Hex Demo Steel Bits	48-62-3005	HS1516	DW5951
	FLAT CHISEL, 1 X12	1	3/4" Hex Demo Steel Bits	48-62-3010	HS1517	DW5953
	FLAT CHISEL, 1 X18	1	3/4" Hex Demo Steel Bits	48-62-3015	HS1518	DW5954
	SCALING CHISEL1-1/2X12	1	3/4" Hex Demo Steel Bits	48-62-3020		
	SCRAPING CHISEL,2X12	1	3/4" Hex Demo Steel Bits	48-62-3025		
	SCALING CHISEL,3X12	1	3/4" Hex Demo Steel Bits	48-62-3030	HS1503	DW5952
	SCALING CHISEL,2X12	1	3/4" Hex Demo Steel Bits	48-62-3035	HS1502	
	CLAY SPADE4-1/2X16-	1	3/4" Hex Demo Steel Bits	48-62-3040	HS1504	DW5959B
	TAMPER PLATE SHANK,12	1	3/4" Hex Demo Steel Bits	48-62-3065	HS1527	
	GROUND ROD DRIVER9-3/4	1	3/4" Hex Demo Steel Bits	48-62-3070	HS1524	DW5958
	BUSHING TOOL1-3/4X9-3/4	1	3/4" Hex Demo Steel Bits	48-62-3085	HS1520	DW5949
	ASPHALT CUTTER5X16-1/2	1	3/4" Hex Demo Steel Bits	48-62-3090	HS1506	DW5957
	FLAT CHISEL, 1 X12	25	3/4" Hex Demo Steel Bits	48-62-3110	HS1517B25	DW5953B15
	SCALING CHISEL3X12	25	3/4" Hex Demo Steel Bits	48-62-3130	HS1503B25	DW5952B10
	CLAY SPADE4-1/2X16-	12	3/4" Hex Demo Steel Bits	48-62-3140		
	BUSHING TOOL1-3/4X9-	25	3/4" Hex Demo Steel Bits	48-62-3185	HS1520B15	DW5949B10
1-1/8" COLLARED HEX DEMO STEEL	MOIL PT 20 IN.	1	1-1/8" Collared Hex Demo Steel Bits	48-62-4000	HS2161	DW5960
	NARROW CHISEL	1	1-1/8" Collared Hex Demo Steel Bits	48-62-4005	HS2163	DW5962
	3 IN CHISEL 20-1/2 IN	1	1-1/8" Collared Hex Demo Steel Bits	48-62-4010	HS2164	DW5961
	5 IN ASPHALT CUTTER	1	1-1/8" Collared Hex Demo Steel Bits	48-62-4020	HS2167	DW5963
	5-1/2 CLAY SPADE 20 IN	1	1-1/8" Collared Hex Demo Steel Bits	48-62-4030	HS2169	DW5965
	SPIKE DRIVER 14-1/2 IN	1	1-1/8" Collared Hex Demo Steel Bits	48-62-4040	HS2171	
	GROUND ROD DRIVER151/2	1	1-1/8" Collared Hex Demo Steel Bits	48-62-4045	HS2172	DW5964
	TAMPER 6 IN X 6 IN	1	1-1/8" Collared Hex Demo Steel Bits	48-62-4050	HS2124	DW5966
	TAMPER 8 IN X 8IN	1	1-1/8" Collared Hex Demo Steel Bits	48-62-4055	HS2125	
	TAMPER SHANK 15-1/2 IN	1	1-1/8" Collared Hex Demo Steel Bits	48-62-4060	HS2173	DW5967
	TENT STAKE DRIVER-HEAD ONLY	1	1-1/8" Collared Hex Demo Steel Bits	48-62-4061	HS2126	
	MOIL POINT 20	8	1-1/8" Collared Hex Demo Steel Bits	48-62-4100	HS2161B8	
	CHISEL NARROW 18	8	1-1/8" Collared Hex Demo Steel Bits	48-62-4105	HS2163B8	
	CHISEL WIDE 3	8	1-1/8" Collared Hex Demo Steel Bits	48-62-4110	HS2164B8	
	ASPHALT CUTTER	6	1-1/8" Collared Hex Demo Steel Bits	48-62-4120	HS2167B6	
	CLAY SPADE	5	1-1/8" Collared Hex Demo Steel Bits	48-62-4130	HS2169B5	

DYMO DRILLS (DIAMOND CORING)



4079

Diamond Coring Motor, 300/600RPM,
20 Amp with Shear Pin



FEATURES



- Two speeds: 300 and 600 rpm
- 20 amp motor
- Shear pin protection protects gears and motor against overload
- Built-in water swivel
- For diamond coring in reinforced concrete, tile, masonry or natural stone

Includes: (1) Diamond Coring Motor, 300/600 RPM, 20 Amp with Shear Pin (4079); (1) Built-In Water Swivel; (6) Extra Shear Pins; (1) Open End Wrench; (1) Water Control Valve; (1) Water Hose Adapter

SPECIFICATIONS

Weight	24.0 lbs
Voltage	120V
Tool Warranty	5 Years
No Load RPM	300-600
Amps	20
Spindle	1-1/4"-7
Max HP	4.8
Motor Protection	Shear Pin
Plug Type	L5-20P
Suggested Dia in Med Aggregate	7"-14"/4"-7"

4090

Diamond Coring Motor, 375/750 RPM,
15 Amp with Shear Pin



FEATURES



- Two speeds: 375 and 750 rpm
- 15 amp motor
- Shear pin protection protects gears and motor against overload
- Built-in water swivel
- For diamond coring in reinforced concrete, tile, masonry or natural stone

Includes: (1) Diamond Coring Motor, 375/750 RPM, 15 Amp with Shear Pin (4090); (1) Built-In Water Swivel; (6) Extra Shear Pins; (1) Open End Wrench; (1) Water Control Valve; (1) Water Hose Adapter

SPECIFICATIONS

Weight	26.0 lbs
Voltage	120V
Tool Warranty	5 Years
No Load RPM	375-750
Amps	15
Spindle	1-1/4"-7
Max HP	2.5
Motor Protection	Shear Pin
Plug Type	L5-20P
Suggested Dia in Med Aggregate	5"-8"/2-1/2"-5"



DYMO DRILLS (DIAMOND CORING)

4094

Diamond Coring Motor 450/900RPM,
20 Amp with Shear Pin



FEATURES



- Two speeds: 450 and 900 rpm
- 20 amp motor
- Shear pin protection protects gears and motor against overload
- Built-in water swivel
- For diamond coring in reinforced concrete, tile, masonry or natural stone

Includes: (1) Diamond Coring Motor 450/900 RPM, 20 Amp with Shear Pin (4094); (1) Built-In Water Swivel; (6) Extra Shear Pins; (1) Open End Wrench; (1) Water Control Valve; (1) Water Hose Adapter

SPECIFICATIONS

Weight	24.0 lbs
Voltage	120V
Tool Warranty	5 Years
No Load RPM	450-900
Amps	20
Spindle	1-1/4"-7
Max HP	4.8
Motor Protection	Shear Pin
Plug Type	L5-20P
Suggested Dia in Med Aggregate	6"-10"/2"-6"

4004

Diamond Coring Motor, 300/600RPM,
20 Amp with Clutch



FEATURES



- Two speeds: 300 and 600 rpm
- 20 amp motor
- Clutch protection protects gears and motor against overload
- Built-in water swivel
- For diamond coring in reinforced concrete, tile, masonry or natural stone

Includes: (1) Diamond Coring Motor, 300/600 RPM, 20 Amp with Clutch (4004); (1) Built-In Water Swivel; (1) Open End Wrench; (1) Water Control Valve; (1) Water Hose Adapter

SPECIFICATIONS

Weight	24.0 lbs
Voltage	120V
Tool Warranty	5 Years
No Load RPM	300-600
Amps	20
Spindle	1-1/4"-7
Max HP	4.8
Motor Protection	Clutch
Plug Type	L5-20P
Suggested Dia in Med Aggregate	7"-14"/4"-7"

DYMO DRILLS (DIAMOND CORING)



4005

Diamond Coring Motor,
600/1200RPM, 20 Amp with Clutch



FEATURES

- Two speeds: 600 and 1200 rpm
- 20 amp motor
- Clutch protection protects gears and motor against overload
- Built-in water swivel
- For diamond coring in reinforced concrete, tile, masonry or natural stone

Includes: (1) Diamond Coring Motor, 600/1200 RPM, 20 Amp with Clutch (4005); (1) Built-In Water Swivel; (1) Open End Wrench; (1) Water Control Valve; (1) Water Hose Adapter

SPECIFICATIONS

Weight	24.0 lbs
Voltage	120V
Tool Warranty	5 Years
Amps	20
Spindle	1-1/4"-7"
Max HP	4.8
Motor Protection	Clutch
Plug Type	L5-20P
Suggested Dia in Med Aggregate	At 600RPM the capacity is 4"-7"

4096

Diamond Coring Motor 450/900RPM,
20 Amp with Clutch



FEATURES

- Two speeds: 450 and 900 rpm
- 20 amp motor
- Clutch protection protects gears and motor against overload
- Built-in water swivel
- For diamond coring in reinforced concrete, tile, masonry or natural stone

Includes: (1) Diamond Coring Motor 450/900 RPM, 20 Amp with Clutch (4096); (1) Built-In Water Swivel; (1) Open End Wrench; (1) Water Control Valve; (1) Water Hose Adapter

SPECIFICATIONS

Weight	24.0 lbs
Voltage	120V
Tool Warranty	5 Years
No Load RPM	450-900
Amps	20
Spindle	1-1/4"-7"
Max HP	4.8
Motor Protection	Clutch
Plug Type	L5-20P
Suggested Dia in Med Aggregate	6"-10"/2"-6"



DYMO DRILLS (DIAMOND CORING)

4097-20

Diamond Coring Motor
500/1000RPM, 15 Amp with Clutch



FEATURES



- Two speeds: 500 and 1000 rpm
- 15 amp motor
- Clutch protection protects gears and motor against overload
- Built-in water swivel
- For diamond coring in reinforced concrete, tile, masonry or natural stone

Includes: (1) Diamond Coring Motor 500/1000 RPM, 15 Amp with Clutch (4097-20); (1) Built-In Water Swivel; (1) Open End Wrench; (1) Water Control Valve; (1) Water Hose Adapter

SPECIFICATIONS

Weight	26.0 lbs
Voltage	120V
Tool Warranty	5 Years
Amps	15
Spindle	1-1/4"-7
Max HP	2.5
Motor Protection	Clutch
Plug Type	L5-20P
Suggested Dia in Med Aggregate	3"-5"/1-1/4"-3"

4125

Diamond Coring Small Base Stand



FEATURES

- Small base for confined drilling situations
- Right or left hand operation
- Capable of 45° angle drilling – columns can be set at any angle up to 45°
- Small base stand only

Includes: (1) Diamond Coring Small Base Stand (4125)

SPECIFICATIONS

Weight	71.0 lbs
Tool Warranty	5 Years
Angle Drilling	Yes
Meter Box	No
Vac Base and Pump	No
Wheels	Yes
Height	47"

48-10-0080

Replacement Small Base

- Included with Dymo-Rig 4125
- May be used with 4130 and 4136 for work in restricted areas
- Includes two wheels and four leveling screws
- Dimensions (without wheels) 7-1/4 in. x 13 in.

DYMO DRILLS (DIAMOND CORING)



4130

Diamond Coring Large Base Stand



FEATURES

- Cast aluminum base with four leveling screws for fast accurate leveling adjustment
- Adjustable, tilting 2-7/8" x 43-1/2" steel column
- Four spoke wheel feed control
- Motor mount cradle
- Bubble level
- Jackscrew
- Large base with wheels
- Base can be floor or wall mounted with bolt type anchor

Includes: (1) Diamond Coring Large Base Stand (4130)

SPECIFICATIONS

Weight	82.5 lbs
Tool Warranty	5 Years
Angle Drilling	Yes
Meter Box	No
Vac Base Pump	No
Wheels	Yes
Height	47"

48-10-0090

Replacement Large Base

- Included with Dymo-Rig 4130 and Vac-U-Rig® 4136
- May be used with 4125 for greater support
- Includes two wheels and four leveling screws
- Dimensions (without wheels) 13-1/4 in. x 17-1/8 in.

4136

Diamond Coring Rig with Large Base Stand. Vac-U-Rig® Kit and Meter Box



FEATURES

- Cast aluminum base with four leveling screws for fast accurate leveling adjustment
- Adjustable, tilting 2-7/8" x 43-1/2" steel column
- Four spoke wheel feed control
- Motor mount cradle
- Bubble level
- Jackscrew
- Large base with wheels
- Base can be floor or wall mounted with bolt type anchor

Includes: (1) Diamond Coring Rig with Large Base Stand, Vac-U-Rig® Kit and Meter Box (4136); (1) Meter Box

SPECIFICATIONS

Weight	106.0 lbs
Tool Warranty	5 Years
Angle Drilling	Yes
Meter Box	Yes
Vac Base and Pump	Yes
Wheels	Yes
Height	47"



DYMO DRILLS (DIAMOND CORING)

4115 Diamond Coring Small Base Stand



4115

4115-22
Comes with 4096
Diamond Coring Motor

FEATURES

- Cast aluminum base with four leveling screws for fast accurate leveling adjustment
- Durable precision-ground 2-1/2 in. steel column, 43-1/2 in. high
- Rear mounted rack and pinion feed
- Jackscrew for ceiling and backwall bracing
- Lightweight, portable coring stands for the contractor with heavyweight applications
- Reversible feed handle
- Locking carriage
- Heavy-duty, solid rubber 5" wheels
- Universal motor adapter plate

Includes: (1) Diamond Coring Small Base Stand (4115)

SPECIFICATIONS

Weight	54.0 lbs
Tool Warranty	5 Years
Angle Drilling	No
Meter Box	No
Vac Base and Pump	No
Wheels	Yes
Height	43-1/2"

4115-22 Diamond Coring Rig with Small Base Stand, Vac-U-Rig®, Meter Box and Diamond Coring Meter

- Weight: 111.5 lbs.

Includes: (1) Diamond Coring Small Base Stand (4115); (1) Diamond Coring Motor; (1) Meter Box; (1) Small Base Stand; (1) Vac-U-Rig® Kit

See motor specs on page 103.

4120 Diamond Coring Large Base Stand



4120

4120-22
Comes with 4096
Diamond Coring Motor

FEATURES

- Cast aluminum base with four leveling screws for fast accurate leveling adjustment
- Durable precision-ground 2-1/2 in. steel column, 43-1/2 in. high
- Rear mounted rack and pinion feed
- Jackscrew for ceiling and backwall bracing
- Lightweight, portable coring stands for the contractor with heavyweight applications
- Reversible feed handle
- Locking carriage
- Heavy-duty, solid rubber 5" wheels
- Universal motor adapter plate

Includes: (1) Diamond Coring Large Base Stand (4120)

SPECIFICATIONS

Weight	67.0 lbs
Tool Warranty	5 Years
Angle Drilling	No
Meter Box	No
Vac Base and Pump	Yes
Wheels	Yes
Height	43-1/2"

4120-22 Diamond Coring Rig with Small Base Stand, Vac-U-Rig®, Meter Box and Diamond Coring Meter

- Weight: 115.3 lbs.

Includes: (1) Diamond Coring Small Base Stand (4120); (1) Diamond Coring Motor; (1) Meter Box; (1) Large Base Stand; (1) Vac-U-Rig® Kit; (1) Diamond Coring Rig

See motor specs on page 103.

DIAMOND CORING ATTACHMENTS



48-51-0100* Meter Boxes 30 AMP 120 Volt

Supplied with No. 4136. Ammeter and power switch on front panel receptacle for motor's plug. One outlet also located on back of unit.

NET WEIGHT 4.8 lbs.
SHIPPING WEIGHT 6 lbs.

* Not Available In Canada



48-51-0120 20 AMP 120 Volt

Supplied with Nos. 4115-22, and 4120-22. Also available as an accessory. Ammeter and power switch on front panel with single 20 amp twist lock receptacle for drill motor's plug.

NET WEIGHT 3.8 lbs.
SHIPPING WEIGHT 5.3 lbs.



48-10-0080 Small Base Assembly

Small base is included with No. 4125 and can be used with Nos. 4130 and 4136. Works well in restricted areas. Includes two wheels and four leveling screws.

SMALL BASE DIMENSIONS (Less Wheels) 7-1/4" x 13"

NET WEIGHT 22 lbs.
SHIPPING WEIGHT 26 lbs.

48-10-0090 Large Base Assembly

Large base is included with Nos. 4130 and 4136. Can be used with No. 4125 for greater support. Includes two wheels and four leveling screws.

LARGE BASE DIMENSIONS (Less Wheels) 13-1/4" x 17-1/8"

NET WEIGHT 33.5 lbs.
SHIPPING WEIGHT 37.5 lbs.



49-76-0055 Water Tank

3-112 gallon heavy-duty, impact resistant poly tank. For use where a regular tap water supply is not available.

SHIPPING WEIGHT 4 lbs.

48-70-0060 Water Collecting Ring

For use where water flow from drilling operation must be trapped and drained. Dike-type collector ring holds water for last disposal when used with bits up to 10" in diameter. A built-in vacuum hose fitting permits use with a wet or dry vacuum cleaner.

SHIPPING WEIGHT 8.8 lbs.

49-50-0200 Vacuum Pump Assembly 115 Volt

Heavy-duty 1/3 H.P. pump complete with vacuum gauge, air filter, air hose and cord. May be mounted to base of unit if desired. Same as furnished with Nos. 4115-22 and 4120-22. Can be used with No. 4120 and 4136.

RECOMMENDED ONLY FOR SINGLE PAD USE

NET WEIGHT 19.5 lbs.
SHIPPING WEIGHT 26.5 lbs.



43-44-0660 Collector Ring Gasket

Replacement gasket for 48-70-0060.

49-18-0055 Water Hose 5/8" I.D. x 8'

8 foot water hose with standard brass male and female water hose fittings.

SHIPPING WEIGHT 1.8 lbs.

44-60-0032 Hardened Shear Pin

Standard Equipment

44-60-0065 Shear Pin

Optional Equipment

49-08-4220 Type "J" Grease For All Two Speed Motors

1 lb. can

49-22-7100 Vacuum Pad Assembly (Single Pad)

For use with models with detachable vacuum pads 4115, 4125, 4130 and 4135. Single vacuum pad which provides approximately 1800 lbs. of holding force. Same as supplied with Nos. 4136 VAC-U-RIG®, 4115-22 and 4120-22.

NET WEIGHT 8.8 lbs.
SHIPPING WEIGHT 13 lbs.



DIAMOND CORE BITS AND ACCESSORIES

DIAMOND CORE BITS

FEATURES

- **MILWAUKEE Diamond Coring Bits** – “Dymbobits” are designed to optimize drilling performance over a broad range of applications. We define drilling performance as the best balance of speed, life and overall drilling costs. State-of-the-art manufacturing techniques and the latest diamond matrix technology result in a complete line of bits to meet your most demanding requirements.
- **For Wet Diamond Coring In Cured Concrete, Reinforced Concrete And Pre-Stressed Concrete**
- **14" Coring Depth**
- **Segments' Widths Provide Interior And Exterior Clearance For Easy Bit And Core Removal**
- **1-1/4"-7 Threads** – For bits 2" and larger for direct connection to Milwaukee Dymodrill motors.
- **5/8"-11 Threads** – For bits 2" (use 48-04-0160 thread adapter)

Premium Series

- Designed to offer exceptional drilling life and speed in cured concrete with hard aggregate and medium steel reinforcement



Contractor Series

- Optimized to provide value for coring fewer holes in cured concrete with no reinforcement or with small diameter steel mesh and rebar



Pre-Stressed Series

- Designed specifically for the extra demands of drilling pre-stressed concrete



Size	Thread	Premium	Contractor	Pre-Stressed
3/4"	5/8" - 11	48-16-0756	-	-
7/8"	5/8" - 11	48-16-0876	-	-
1"	5/8" - 11	48-16-1006	-	48-16-1007
1-1/4"	5/8" - 11	48-16-1260	-	-
1-1/2"	5/8" - 11	48-16-1506	-	48-16-1507
2"	1-1/4" - 7	48-16-2013	48-16-2007	48-16-2014
2-1/2"	1-1/4" - 7	48-16-2513	48-16-2507	48-16-2514
2-3/4"	1-1/4" - 7	48-16-2756	-	-
3"	1-1/4" - 7	48-16-3013	48-16-3007	48-16-3014
3-1/2"	1-1/4" - 7	48-16-3511	48-16-3507	48-16-3512
4"	1-1/4" - 7	48-16-4013	48-16-4007	48-16-4014
4-1/4"	1-1/4" - 7	-	48-16-4257	-
4-1/2"	1-1/4" - 7	48-16-4506	-	48-16-4507
5"	1-1/4" - 7	48-16-5013	48-16-5007	48-16-5014
6"	1-1/4" - 7	48-16-6013	48-16-6007	48-16-6014
7"	1-1/4" - 7	48-16-7006	-	-
8"	1-1/4" - 7	48-16-8006	-	-
9"	1-1/4" - 7	48-16-9006	-	-
10"	1-1/4" - 7	48-16-9506	-	-
12"	1-1/4" - 7	48-16-9605	-	-
14"	1-1/4" - 7	48-16-9705	-	-

DIAMOND CORE BIT ACCESSORIES



Threaded Adaptor 48-04-0160	Copper Spindle Spacer 45-88-8565
■ Reduces 1-1/4"-7 threads to 5/8"-11 for diamond core bits and extensions	■ Minimizes friction lock

Spacer Assembly 49-67-0110	Spacer Assembly 49-67-0115
<ul style="list-style-type: none"> ■ For use with models: 4125, 4130, and 4136 ■ Mounts between cradle and DYMODRILL motor to increase DYMO-RIG bit capacity from 10" to 14" ■ Net weight 3 lbs. Shipping weight 5 lbs 	<ul style="list-style-type: none"> ■ For use with models 4115, 4120, 4115-21, 4115-22, 4120-21 and 4120-22 to increase bit capacity from 10" to 14" ■ Net weight 3-1/2 lbs. Shipping weight 5-1/2 lbs



9" Bit Extension 48-95-1500	10-1/2" Bit Extension 48-95-2100
<ul style="list-style-type: none"> ■ Extension threaded on both ends with 1-1/4"-7 thread, for use with Diamond Core Bits over 2" diameter with 1-1/4"-4 thread ■ Extension mounts directly to DYMODRILL – up to two can be coupled together for extended coring 	<ul style="list-style-type: none"> ■ Extension threaded on both ends with 5/8"-11 thread, for use with 1-1/4" and 1-1/2" diameter Diamond Core bits with 5/8"-11 thread ■ Extension requires 48-04-0160 threaded adaptor for mounting to DYMODRILLS – up to two can be coupled together for extended coring

METAL CUTTING CIRCULAR SAWS & BLADES



6370-20 8" Metal Cutting Saw



FEATURES



- Dry-cut technology provides faster, cleaner, more affordable metal cutting
- Durable blade shield with integral chiptank deflects/collects hot chips and sparks
- Plunge lever for fast, effective plunge cuts
- Exclusive quick-release shield latch for fast waste disposal and blade changes
- 2-9/16 in. cut depth for one-pass cuts through most common materials
- Powerful 13.0 amp, 3,700 rpm motor
- Premium cermet-tipped blades cut faster, cleaner, and longer than other carbide-tipped or friction blades

Includes: (1) 8" Metal Cutting Saw (6370-20); (1) Blade Wrench; (1) Circular Saw Blade

SPECIFICATIONS

Length	16-1/2"	Spindle Lock	Yes
Weight	13.3 lbs	Adjustable Handle	No
Voltage	120V AC	Arbor Size	5/8"
No Load RPM	3,700	Depth of Cut at 90°	2-9/16"
Amps	13	Electrical Brake	No
Spindle	5/8"	Blade Position	Right
Construction Type	Grounded	Blade	8"
Soft Grip Handle	Yes		

6370-21 8" Metal Cutting Saw Kit with Case



Includes: (1) 8" Metal Cutting Saw Kit (6370-21); (1) Blade Wrench; (1) Carrying Case; (1) Circular Saw Blade

DRY CUT METAL CIRCULAR SAW BLADES

LONG LIFE

- Micro ground carbide teeth stay sharper longer

ACCURATE CUTS

- Fully hardened, tensioned steel plate prevents warping

FAST CUTTING

- Extra thin kerf for faster, cleaner cuts



	Diameter	Part Number	# of Teeth	Tooth Material	Arbor	Max RPM	Pkg Qty	Materials
CORDLESS	5-3/8"	48-40-4070	30	Carbide	20mm	4,200	1	Ferrous
	5-3/8"	48-40-4075	50	Carbide	20mm	4,200	1	Non-Ferrous
	6-1/2"	48-40-4005	60	Carbide	5/8"	4,200	1	Non-Ferrous
	6-1/2"	48-40-4015	48	Carbide	5/8"	4,200	1	Ferrous
	6-7/8"	48-40-4006	52	Carbide	20mm	4,200	1	Non-Ferrous
	6-7/8"	48-40-4016	36	Carbide	20mm	4,200	1	Ferrous
CORDED	8"	48-40-4515	42	Cermet	5/8"	5,000	1	Ferrous
	8"	48-40-4520	50	Cermet	5/8"	5,000	1	Ferrous
	8"	48-40-4530	60	Carbide	5/8"	5,000	1	Non-Ferrous
	8"	48-40-4540	60	Carbide	5/8"	5,000	1	Non-Ferrous



ABRASIVE SAWS

6177-20 14" Abrasive Cut-Off Machine



FEATURES



- Powerful 15-amp, 4.0 maximum horsepower motor: Delivers maximum cutting performance in various materials
- Large cutting capacity: Accommodates a wide range of cutting applications up to 5"
- Durable, lightweight design: Permits portability without sacrificing durability
- Oversized wheel guards: Provides added protection from debris
- 45° Miter capacity with adjustable fence: Allows for quick and accurate miter cuts without flipping heavy material
- Large spindle lock button: Make quick and easy blade changes wearing gloves
- Quick-adjust vise clamp: Adjusts quickly for different material sizes
- All-ball-bearing construction: Delivers maximum durability

Includes: (1) 14" Abrasive Cut-Off Machine (6177-20); (1) Abrasive Wheel; (1) Hex Wrench; (1) Vise

SPECIFICATIONS

Length	16"
Voltage	120 AC/DC
Tool Warranty	5 Years
No Load RPM	3,900
Amps	15
Spindle	1"
Spindle Lock	Yes
Wheel Diameter	14"
Capacity	4-5/8 X 4-5/8"
Arbor Size	1"
Maximum Bevel Capacity	45 degrees

6185-20 14" Hand Held Cut-Off Machine



FEATURES



- Powerful 15-amp, 4.8 maximum horsepower motor: Delivers maximum cutting performance for heavy-duty concrete and metal cutting
- 20-amp overload protection switch: Trips the tool, not a remote breaker, for greater convenience and minimal downtime
- Downward cutting rotation: Pulls the tool through the work to minimize jamming and kickback while providing a clear sight-line
- Externally accessible brushes and brush cutout feature: Protect the epoxy-coated armature as the brushes wear down

Includes: (1) 14" Hand Held Cut-Off Machine (6185-20); (1) Allen Wrench; (1) Back Flange; (1) Flange Nuts; (1) Top Flange

SPECIFICATIONS

Length	19-1/4"
Weight	27.3 lbs
Voltage	120 AC/DC
No Load RPM	4,600
Amps	15
Spindle	1"
Spindle Lock	Yes
Capacity	HVAC 1/2" to 1-1/8" OD Plumbing 3/8" to 1" ID
Arbor Size	1"

CUT-OFF BLADES & WHEELS



DRY CUT METAL CIRCULAR SAW BLADES

LONG LIFE

- Micro ground carbide teeth stay sharper longer

ACCURATE CUTS

- Fully hardened, tensioned steel plate prevents warping

FAST CUTTING

- Extra thin kerf for faster, cleaner cuts



Diameter	Part Number	# of Teeth	Tooth Material	Arbor	Max RPM	Pkg Qty	Materials
14"	48-40-4505	72	Carbide	1"	1,800	1	Ferrous
14"	48-40-4510	90	Carbide	1"	1,800	1	Ferrous

TYPE 1 PREMIUM ABRASIVE CUT-OFF WHEELS FOR CUT-OFF MACHINES



TYPE 1 CUT-OFF WHEELS

- Designed for fast cutting and long life
- Type 1 cut-off wheels are designed for cutting only



TYPE 27 DEPRESSED CENTER WHEELS

- Designed for fast cutting and long life

TYPE 27 GRINDING WHEELS

- Designed for grinding, blending and other general purpose applications



TYPE 27 DEPRESSED CENTER WHEELS WITH 5/8"-11 THREADED HUB

- Designed for grinding, blending and other general purpose applications

Size	Thickness	Arbor	Part Number	Abrasive Type	Abrasive Spec.	Application	Max RPM	Qty
For Stationary Abrasive Cut-Off Machines (Not intended for use on hand held cut-off machines)								
12"	3/32"	1"	49-94-1220	Aluminum Oxide	A36P	General Purpose - Metal	5,095	10
14"	3/32"	1"	49-94-1405	Aluminum Oxide	A36P	General Purpose - Metal (Double Reinforced)	4,365	5
14"	3/32"	1"	49-94-1410	Aluminum Oxide	A36P	Metal Stud	4,365	10
14"	3/32"	1"	49-94-1415	Aluminum Oxide	A36P	General Purpose - Metal (Center Reinforced)	4,365	5
For Hand Held Abrasive Cut-Off Machines (Not intended for use on stationary cut-off machines)								
12"	1/8"	20mm	49-94-1270	Aluminum Oxide	A24R	General Purpose - Metal	6,360	10
12"	1/8"	1"	49-94-1275	Aluminum Oxide	A24R	General Purpose - Metal	6,360	10
12"	1/8"	20mm	49-94-1280	Silicon Carbide	C24T	Masonry	6,360	10
12"	1/8"	1"	49-94-1285	Silicon Carbide	C24T	Masonry	6,360	10
14"	1/8"	20mm	49-94-1470	Aluminum Oxide	A24R	General Purpose - Metal	5,400	10
14"	1/8"	1"	49-94-1475	Aluminum Oxide	A24R	General Purpose - Metal	5,400	10
14"	1/8"	20mm	49-94-1480	Silicon Carbide	C24T	Masonry	5,400	10
14"	1/8"	1"	49-94-1485	Silicon Carbide	C24T	Masonry	5,400	10



Milwaukee

SHEARS

6805

16 Gauge Shear



FEATURES



- 4 amps, 4,000 SPM
- Clear unobstructed visibility
- Cuts close curves either left or right
- Blade design eliminates jamming

Includes: (1) 16 Gauge Shear (6805); (1) Allen Wrench; (1) Feeler Gauge

SPECIFICATIONS

Length	10-1/4"
Voltage	120 AC/DC
Tool Warranty	5 Years
Cord Type	8' Fixed
Amps	4
Trigger Lock	On/Off
Capacity in Steel	16ga
Construction Type	Double Insulated
Capacity in Stainless	18ga
Minimum Radius Left	1-2"
Minimum Radius Right	1"

6815

14 Gauge Shear



FEATURES



- 5 amps, 4,000 SPM
- Clear unobstructed visibility
- Cuts close curves either left or right
- Blade design eliminates jamming

Includes: (1) 14 Gauge Shear (6815); (1) Allen Wrench; (1) Feeler Gauge

SPECIFICATIONS

Length	10-1/4"
Weight	5.0 lbs
Voltage	120 AC/DC
Tool Warranty	5 Years
Cord Type	8' Fixed
Amps	5
Trigger Lock	On/Off
Capacity in Steel	14ga
Construction Type	Double Insulated
Capacity in Stainless	16ga
Minimum Radius Left	3-4"
Minimum Radius Right	1"

SHEARS & NIBBLERS



6852-20 18 Gauge Shear



FEATURES



AC

- 6.8 amp Milwaukee motor, trigger speed control: 0-2,500 rpm spindle speed
- 360° swivel head
- Ergonomic tactile grip for optimal user comfort
- 10 ft. flexible durable runner cord

Includes: (1) 18 Gauge Shear (6852-20); (1) Hex Wrench

SPECIFICATIONS

Length	12-1/4"
Tool Warranty	5 Years
Cord Type	10' Fixed
Trigger Lock	On
Construction Type	Double Insulated

6880 10 Gauge Nibbler



FEATURES



AC/DC

- 4.0 amp, 1,000 SPM
- Cuts up to 8.75 ft. per minute
- 1.65 in. starting hole required
- AC-DC toggle switch allows for two-handed operation

Includes: (1) 10 Gauge Nibbler (6880); (1) Allen Wrench; (1) Side Handle

SPECIFICATIONS

Length	12-1/4"
Voltage	120 AC/DC
Tool Warranty	5 Years
Cord Type	8' Fixed
Amps	4
Trigger Lock	On/Off
Capacity in Steel	10ga
Construction Type	Double Insulated
Capacity in Stainless	12ga
Minimum Cutting Radius	2 -1/2"
Starting Hole	1-2/3"



Milwaukee

SHEARS

6890**16 Gauge Nibbler****FEATURES**

- 3.8 amp, 1,900 spm
- Cuts up to 7 ft. per minute
- 0.87 in. starting hole required
- AC-DC paddle switch

Includes: (1) 16 Gauge Nibbler (6890); (1) Allen Wrench;
(1) Plate Wrench

SPECIFICATIONS

Length	11-1/4"
Voltage	120 AC/DC
Tool Warranty	5 Years
Cord Type	8' Fixed
Amps	4
Capacity in Steel	16ga
Construction Type	Double Insulated
Capacity in Stainless	18ga
Minimum Cutting Radius	1-3/4"
Starting Hole	7/8"

SHEAR AND NIBBLER ACCESSORIES**SHEAR ACCESSORIES**

Description	Part Number	For Use With
14 Gauge Shear Blade Set	48-44-0112	6815
16 and 18 Gauge Shear Blade Set	48-44-0122	6805
Shear Blade Set	48-44-0070	6800
Center Blade	48-44-0150	6852-20
Left Blade	48-44-0160	6852-20
Right Blade	48-44-0170	6852-20



Replacement Swivel Shear
Head Assembly
48-08-0500

NIBBLER ACCESSORIES

Description	Part Number	For Use With
16ga Replacement Punch	48-44-0260	6890
10ga Replacement Punch	48-44-0265	6880
16ga Replacement Die	48-44-0270	6890
10ga Replacement Die	48-44-0275	6880

ELECTROMAGNETIC DRILL PRESSES



4202

Electromagnetic Drill Press Base, Fixed Position



FEATURES



- 120 Volt AC only, 12.5 amp max. rating
- 9 inch drill travel
- Fixed position, variable speed base
- For use on any flat ferrous material, 1/2 inch and thicker

Includes: (1) Electromagnetic Drill Press Base, Fixed Position (4202)

SPECIFICATIONS

Length	11"
Weight	41.0 lbs
Voltage	120V AC
Tool Warranty	5 Years
Electric Feedback	Yes
Construction Type	Grounded
Adjustable Base	No
Drill Travel	9"
Height	15"
Width	4-1/4"

4203

Electromagnetic Drill Press Base, Adjustable Position



FEATURES



- 120 Volt AC only, 12.5 amp max. rating
- 11 inch drill travel
- Adjustable position, variable speed base
- For use on any flat ferrous material, 1/2 inch and thicker

Includes: (1) Electromagnetic Drill Press Base, Adjustable Position (4203)

SPECIFICATIONS

Length	11"
Weight	49.0 lbs
Voltage	120V AC
Tool Warranty	5 Years
Electronic Feedback	Yes
Construction Type	Grounded
Adjustable Base	Yes
Drill Travel	11"
Height	17-1/4"
Width	4-1/4"

Select one of these 4 Milwaukee motors for your 4202 or 4203 Electromagnetic Drill Stand.



4253-1

- 600 NO LOAD RPM



4262-1

- 350 NO LOAD RPM



4292-1

- TWO SPEED
- 750/375 NO LOAD RPM



4297-1

- TWO SPEED
- 500/250 NO LOAD RPM



ELECTROMAGNETIC DRILL PRESSES

4204-1

Adjustable Position Electromagnetic Drill Press with 1/2" Motor



* arbour and cutter not included

4206-1

Adjustable Position Electromagnetic Drill Press with 3/4" Motor



* arbour and cutter not included

FEATURES



- Powerful 7.2-amp motor: Engineered for the toughest applications, delivering 600 RPM
- Dual-Mount Gear Case/Reverse Mount: Permits tight quarter drilling
- 1/2" Capacity: Taps up to 5/8-inch/18 threaded holes (5/8-11 and 1/2-13 taps are not recommended.)
- Maximum force: Develops up to 1650 pounds of drill point pressure with a 1-inch steel plate
- Solid state electronic switching: Offers faster, smoother and quieter switching for a longer product lifespan
- Line Lockout: Prevents tool from operating if voltage is restored to an interrupted line

Includes: (1) Electromagnetic Drill Press Base, Adjustable Position (4203); (1) 1/2" Motor (4253-1) for Electromagnetic Drill Press

SPECIFICATIONS

Weight	57.0 lbs
Voltage	120V AC
Cord Type	9' Fixed
Electronic Feedback	Yes
No Load RPM	0-600
Amps	7.2
Construction Type	Grounded
Adjustable Base	Yes
Drill Travel	9"
Chuck or Taper	Chuck
Drill Capacity	1/2"
Drill Point Pressure	1,610/1,650 lbs
Tap Capacity	5/8" - 18

Replacement Chuck (48-66-1360)
Replacement Chuck Key (48-66-3280)

FEATURES



- Powerful 11.5-amp motor: Engineered for the toughest applications, delivering 350 RPM
- Dual-Mount Gear Case/Reverse Mount: Permits tight quarter drilling
- 3/4" Capacity: Taps up to 1-inch, 14-threaded holes
- Maximum force: Develops up to 1670 pounds of drill point pressure with a 1-inch steel plate
- Solid state electronic switching: Offers faster, smoother and quieter switching for a longer product lifespan
- Line Lockout: Prevents tool from operating if voltage is restored to an interrupted line

Includes: (1) Electromagnetic Drill Press Base, Adjustable Position (4203); (1) 3/4" Motor for Electromagnetic Drill Press (4262-1)

SPECIFICATIONS

Weight	70.0 lbs
Voltage	120V AC
Cord Type	9' Fixed
Electronic Feedback	Yes
No Load RPM	0-350
Amps	12.5
Construction Type	Grounded
Adjustable Base	Yes
Drill Travel	11"
Chuck or Taper	Chuck
Drill Capacity	3/4"
Drill Point Pressure	1,630/1,670 lbs
Tap Capacity	1" - 14

Replacement Chuck (48-66-2085)
Replacement Chuck Key (48-66-3160)

ELECTROMAGNETIC DRILL PRESSES



4208-1

Adjustable Position Electromagnetic Drill Press with No. 3 MT Motor



* arbour and cutter not included

4209-1

Adjustable Position Electromagnetic Drill Press with No. 3MT Motor



* arbour and cutter not included

FEATURES



AC

- Powerful, 11.5-amp motor: Engineered for the toughest applications, delivering 250/500 RPM
- Dual-Mount Gear Case/Reverse Mount: Permits tight quarter drilling
- 1-1/4" Capacity: Taps up to 1-inch, 14-threaded holes
- Maximum force: Develops up to 1600 pounds of drill point pressure with a 1-inch steel plate
- Solid state electronic switching: Offers faster, smoother and quieter switching for a longer product lifespan
- Line Lockout: Prevents tool from operating if voltage is restored to an interrupted line

Includes: (1) Electromagnetic Drill Press Base, Adjustable Position (4203), (1) #3 Morse Motor (4297-1)

SPECIFICATIONS

Weight	72.0 lbs
Voltage	120V AC
Cord Type	9' Fixed
Electronic Feedback	Yes
No Load RPM	0-500, 0-250
Amps	12.5
Construction Type	Grounded
Adjustable Base	Yes
Drill Travel	11"
Chuck or Taper	No. 3MT
Drill Capacity	1-1/4"
Drill Point Pressure	1,530/1,600 lbs
Tap Capacity	1" - 14

FEATURES



AC

- Powerful 11.5-amp motor: Engineered for the toughest applications, delivering 375/750 RPM
- Dual-Mount Gear Case/Reverse Mount: Permits tight quarter drilling
- 1-1/4" Capacity: Taps up to 1-inch, 14-threaded holes
- Maximum force: Develops up to 1600 pounds of drill point pressure with a 1-inch steel plate
- Solid state electronic switching: Offers faster, smoother and quieter switching for a longer product lifespan
- Line Lockout: Prevents tool from operating if voltage is restored to an interrupted line

Includes: (1) Electromagnetic Drill Press Base, Adjustable Position (4203), (1) #3 Morse Motor (4292-1)

SPECIFICATIONS

Weight	72.0 lbs
Voltage	120V AC
Cord Type	9' Fixed
Electronic Feedback	Yes
No Load RPM	0-750, 0-375
Amps	12.5
Construction Type	Grounded
Adjustable Base	Yes
Drill Travel	11"
Chuck or Taper	No. 3MT
Drill Capacity	1-1/4"
Drill Point Pressure	1,530/1,600 lbs
Tap Capacity	1" - 14



ELECTROMAGNETIC DRILL PRESSES

4210-1

Fixed Position Electromagnetic Drill Press with 3/4" Motor



* arbour and cutter not included

FEATURES



- Powerful 12.5-amp motor: Engineered for the toughest applications, delivering 350 RPM
- Dual-Mount Gear Case/Reverse Mount: Permits tight quarter drilling
- 3/4" Capacity: Taps up to 1-inch-14 threaded holes
- Maximum force: Develops up to 1670 pounds of drill point pressure with a 1-inch steel plate
- Solid state electronic switching: Offers faster, smoother and quieter switching for a longer product lifespan
- Line Lockout: Prevents tool from operating if voltage is restored to an interrupted line

Includes: (1) Electromagnetic Drill Press Base, Fixed Position (4202); (1) No. 3 MT Motor for Electromagnetic Drill Press (4262-1)

SPECIFICATIONS

Weight	62.0 lbs
Voltage	120V AC
Cord Type	9' Fixed
Electronic Feedback	Yes
No Load RPM	0-350
Amps	12.5
Construction Type	Grounded
Adjustable Base	No
Drill Travel	9"
Chuck or Taper	Chuck
Drill Capacity	3/4"
Drill Point Pressure	1,630/1,670 lbs
Tap Capacity	1"-14

Replacement Chuck (48-66-2085)
Replacement Chuck Key (48-66-3160)

ELECTROMAGNETIC DRILL ATTACHMENTS

Description	Part #	Motor Compatibility	Cutter Compatibility
#3 Morse Taper Quick Change w/Chip Breaker	49-57-0012	4292-1, 4297-1	Quick Change Tang Drive
#3 Morse Taper Quick Change	49-57-0013	4292-1, 4297-1	Quick Change Tang Drive
3/4" Straight Shank Quick Change	49-57-0032	4262-1	Quick Change Tang Drive
3/4" Straight Shank Threaded	49-57-0030	4262-1	Threaded Steel Hawg® cutters
#3 Morse Taper Threaded	49-57-0010	4292-1, 4297-1	Threaded Steel Hawg® cutters
#3 Morse Taper Weldon Shank	49-57-0025	4208-1, 4209-1	HSS Annular
1/2" Drill Chuck Adapter	48-66-2125	4270-20, 4270-21	All 1/2" Shanks
Hawg Wash®	49-32-0081	All Motors	All Tools
#3 Morse Taper, 3/4" Chuck Adapter	49-22-1550	4292-1, 4297-1	All 3/4" Shanks

ELECTROMAGNETIC DRILL PRESS MOTORS



4253-1

1/2" Motor for Electromagnetic Drill Press



FEATURES

AC

- Powerful 6.2-amp motor: Engineered for the toughest applications, delivering 600 RPM
- Dual-Mount Gear Case/Reverse Mount: Permits tight quarter drilling
- 1/2" Capacity: Taps up to 5/8-inch, 18-threaded holes. (5/8-11 and 1/2-13 taps are not recommended.)
- Maximum force: Develops up to 1650 pounds of drill point pressure with a 1-inch steel plate

Includes: (1) 1/2" Motor for Electromagnetic Drill Press (4253-1)

SPECIFICATIONS

Weight	8.0 lbs
Voltage	120V AC
Tool Warranty	5 Years
Amps	6.2
Chuck or Taper	Chuck
Drill Capacity	1/2"
Drill Point Pressure	1,610/1,650 lbs
Tap Capacity	5/8"-18

Replacement Chuck (48-66-1360)
Replacement Chuck Key (48-66-3280)

CHUCK CENTER DISTANCE FROM BASE

	IN	OUT
Magnetic Stand 4202	1-1/4"	*
Plate Forward 4203	1-23/32"	*
Plate Back 4203	31/32"	*

IN = Closest to Base **OUT** = Farthest away from base
* Motor 4253-1 has only one chuck position.
Stand 4203 is adjustable 3/4" in direction of base length and 20° right or left.
All models furnished with 6 ft. safety chain.

4262-1

No. 3MT Motor for Electromagnetic Drill Press



FEATURES

AC

- Powerful 11.5-amp motor: Engineered for the toughest applications, delivering 350 RPM
- Dual-Mount Gear Case/Reverse Mount: Permits tight quarter drilling
- 3/4" Capacity: Taps up to 1-inch, 14-threaded holes
- Maximum force: Develops up to 1670 pounds of drill point pressure with a 1-inch steel plate

Includes: (1) No. 3 MT Motor for Electromagnetic Drill Press (4262-1)

SPECIFICATIONS

Weight	21.0 lbs
Voltage	120V AC
Tool Warranty	5 Years
No Load RPM	0-350
Amps	11.5
Chuck or Taper	Chuck
Drill Capacity	3/4"
Drill Point Pressure	1,630/1,670 lbs
Tap Capacity	1"-14

Replacement Chuck (48-66-2085)
Replacement Chuck Key (48-66-3160)

CHUCK CENTER DISTANCE FROM BASE

	IN	OUT
Magnetic Stand 4202	1-23/32"	4-11/16"
Plate Forward 4203	2-1/8"	5-3/32"
Plate Back 4203	1-3/8"	4-11/32"

IN = Closest to Base **OUT** = Farthest away from base
Stand 4203 is adjustable 3/4" in direction of base length and 20° right or left.
All models furnished with 6 ft. safety chain.



ELECTROMAGNETIC DRILL PRESS MOTORS

4292-1

No. 3MT Motor for Electromagnetic Drill Press



FEATURES

AC

- Powerful 11.5-amp motor: Engineered for the toughest applications, delivering 375/750 RPM
- Dual-Mount Gear Case/Reverse Mount: Permits tight quarter drilling
- 1-1/4" Capacity: Taps up to 1-inch, 14-threaded holes
- Maximum force: Develops up to 1600 pounds of drill point pressure with a 1-inch steel plate

Includes: (1) No. 3 MT Motor for Electromagnetic Drill Press (4292-1)

SPECIFICATIONS

Weight	23.0 lbs
Voltage	120V AC
Tool Warranty	5 Years
No Load RPM	0-750, 0-375
Amps	11.5
Chuck or Taper	No. 3MT
Drill Capacity	1-1/4"
Drill Point Pressure	1,530/1,600 lbs
Tap Capacity	1" - 14

CHUCK CENTER DISTANCE FROM BASE

	IN	OUT
Magnetic Stand 4202	2-3/16"	4-3/8"
Plate Forward 4203	2-9/16"	4-11/16"
Plate Back 4203	1-13/16"	3-15/16"

IN = Closest to Base **OUT** = Farthest away from base
 Stand 4203 is adjustable 3/4" in direction of base length and 20° right or left.
 All models furnished with 6 ft. safety chain.

4297-1

No. 3MT Motor for Electromagnetic Drill Press



FEATURES

AC

- Powerful 11.5-amp motor: Engineered for the toughest applications, delivering 250/500 RPM
- Dual-Mount Gear Case/Reverse Mount: Permits tight quarter drilling
- 1-1/4" Capacity: Taps up to 1-inch, 14-threaded holes
- Maximum force: Develops up to 1600 pounds of drill point pressure with a 1-inch steel plate

Includes: (1) No. 3 MT Motor for Electromagnetic Drill Press (4297-1)

SPECIFICATIONS

Weight	23.0 lbs
Voltage	120V AC
Tool Warranty	5 Years
No Load RPM	0-500, 0-250
Amps	11.5
Chuck or Taper	No. 3MT
Drill Capacity	1-1/4"
Drill Point Pressure	1,530/1,600 lbs
Tap Capacity	1" - 14

CHUCK CENTER DISTANCE FROM BASE

	IN	OUT
Magnetic Stand 4202	2-3/16"	4-3/8"
Plate Forward 4203	2-9/16"	4-11/16"
Plate Back 4203	1-13/16"	3-15/16"

IN = Closest to Base **OUT** = Farthest away from base
 Stand 4203 is adjustable 3/4" in direction of base length and 20° right or left.
 All models furnished with 6 ft. safety chain.

COMPACT ELECTROMAGNETIC DRILL PRESS



4270-20 Compact Electromagnetic Drill Press

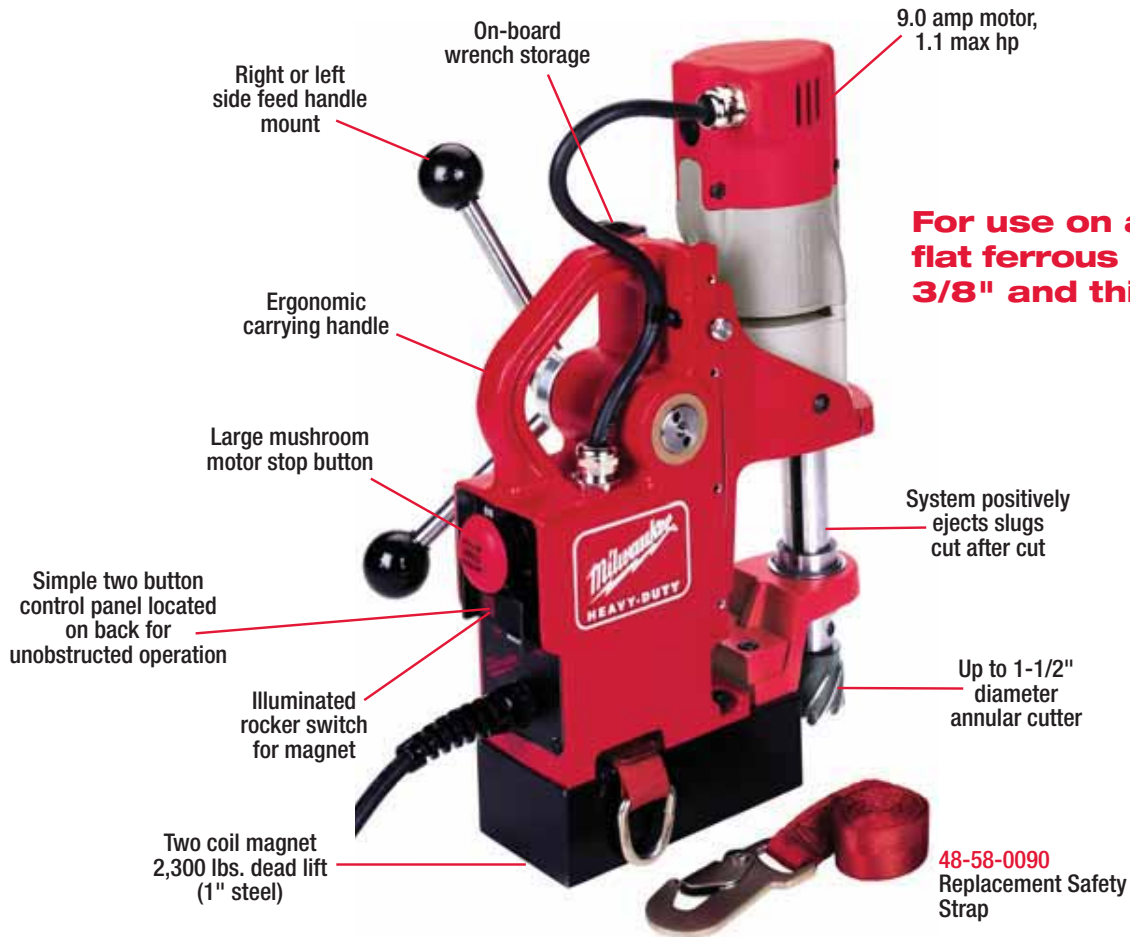

FEATURES



- Powerful 9.0-amp, 1.1 max HP motor: Maneuvers easily and conveniently
- Lightweight design: Only 26.5 pounds, with a comfortable carrying handle
- Superior capacity: Cuts up to 1-1/2-in. diameter holes through 2-in. steel with annular cutters, or 1/2-in. diameter holes, 4-1/4-in. deep with twist drill bits
- Strong two-coil magnet: Engineered to stay in place with 2,300 of dead-lift force
- Flexible feed handle: Switch between two feed handle positions without using tools
- Accessible and comfortable operation: Simple two-button control panel, unobstructed by feed handle

Includes: (1) Compact Electromagnetic Drill Press (4270-20); (1) Lubricant Spray Bottle; (1) Nylon Safety Strap; (1) Two Hex Wrenches

SPECIFICATIONS

Weight	26.5 lbs	Adjustable Base	No
Voltage	120V AC	Drill Travel	6.6"
Cord Type	8' Fixed	Chuck or Taper	Weldon
Electronic Feedback	Yes	Drill Capacity	1/2"
No Load RPM	450	Drill Point Pressure	750 lbs
Amps	9		
Construction Type	Grounded		

4270-21

Compact Electromagnetic Drill Press Kit with Case



Includes: (1) Compact Electromagnetic Drill Press Kit (4270-21); (1) Carrying Case; (1) Lubricant Spray Bottle; (1) Nylon Safety Strap; (1) Two Hex Wrenches



ANNULAR CUTTERS

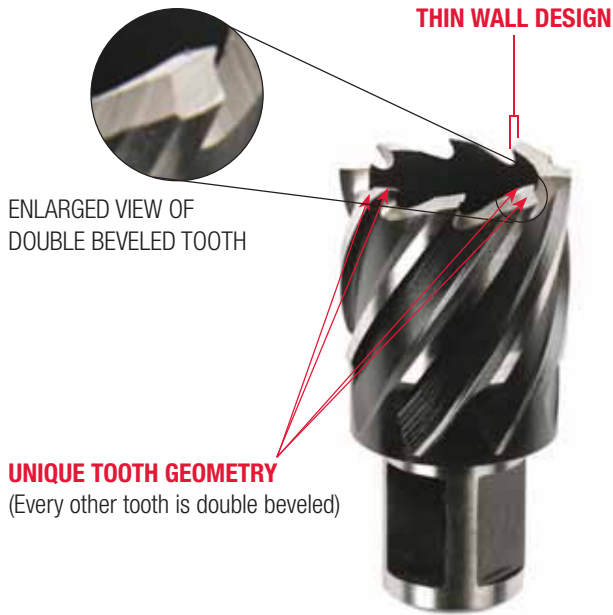

1" AND 2" DEPTH ANNULAR CUTTERS FEATURING 3/4" SHANK

- Fit Directly Into Milwaukee's 4270-20 Compact Magnetic Drill Stand
- Use Arbor 49-57-0025, To Fit Cutters Into Milwaukee's Large Stands 4208-2 and 4209-1
- 3/4" Diameter Shank – Industry standard.
- Unique Tooth Geometry – Allows for better centering and faster cutting.
- Thin Wall Design – Enables cutters to cut faster and more efficiently by removing less material during drilling.
- Ejector Pins Can Be Used On All Diameters – (44-60-1720 for 1" depth and 44-60-1721 for 2" depth). Ejector pin sold separately.
- Ejector Pin Extends 1/2" Beyond Tooth Tip – Allows for easier/faster location of pin on hole.
- Flute Design – Shorter flute design allows chips to fall freely from cutter.

ANNULAR CUTTERS



FASTER CUTTING

- Thinner wall design for faster, more efficient cutting

LONG LIFE

- Proprietary steel, optimized for steel cutting

UNIVERSAL SHANK

- Fits directly into Milwaukee® compact magnetic drill press
- Works with 3/4" Weldon® style shank arbor

Size	1" Depth	2" Depth
1/2"	49-59-0500	49-59-2050
9/16"	49-59-0562	49-59-2056
5/8"	49-59-0625	49-59-2063
11/16"	49-59-0687	49-59-2069
3/4"	49-59-0750	49-59-2075
13/16"	49-59-0812	49-59-2081
7/8"	49-59-0875	49-59-2089
15/16"	49-59-0937	49-59-2094
1"	49-59-1000	49-59-2100
1-1/16"	49-59-1062	49-59-2106
1-1/8"	49-59-1125	49-59-2113
1-3/16"	49-59-1187	49-59-2119
1-1/4"	49-59-1250	49-59-2125

Size	1" Depth	2" Depth
1-5/16"	49-59-1312	49-59-2131
1-3/8"	49-59-1375	49-59-2138
1-7/16"	49-59-1437	49-59-2144
1-1/2"	49-59-1500	49-59-2150
1-9/16"	49-59-1562	49-59-2156
1-5/8"	49-59-1625	49-59-2163
1-11/16"	49-59-1687	49-59-2169
1-3/4"	49-59-1750	49-59-2175
1-13/16"	49-59-1812	49-59-2181
1-7/8"	49-59-1875	49-59-2188
1-15/16"	49-59-1937	49-59-2194
2"	49-59-2000	49-59-2200

ANNULAR CUTTER SETS



6 Pc Annular Cutter Set (1" Depth) 49-22-8400	9 Pc Annular Cutter Set (2" Depth) 49-22-8410
Includes: <ul style="list-style-type: none"> ■ 9/16", 5/8", 11/16", 13/16", 15/16", 1-1/16" and ejector pin 	Includes: <ul style="list-style-type: none"> ■ 1/2", 9/16", 5/8", 11/16", 3/4", 13/16", 7/8", 15/16", 1-1/16" and (2) ejector pins

ANNULAR CUTTER ACCESSORIES

Description	Part Number
#3 Morse Taper To Weldon® Shank Arbor	49-56-0025
Arbor Wrench Set	49-96-0010
(2) 1" Ejector Pins	44-60-1720
(2) 2" Ejector Pins	44-60-1721
HAWG WASH® Lubricant (16 Oz Bottle)	49-32-0081
HAWG WASH® Hand Pump	44-46-0090
HAWG WASH® Hand Pump Oil Hose	43-75-0010

STEEL HAWG® CUTTERS



THREADED STEEL HAWG® CUTTERS

FAST CUTTING

- Alternating tooth geometry for up to 3X faster cutting

LONG LIFE

- Hardened carbide steel teeth provide longer life

2" CUTTING DEPTH



Size	Part Number
3/4"	49-57-0750
13/16"	49-57-0812
7/8"	49-57-0875
15/16"	49-57-0937
1"	49-57-1000
1-1/16"	49-57-1062
1-1/8"	49-57-1125
1-3/16"	49-57-1187
1-1/4"	49-57-1250
1-5/16"	49-57-1312
1-3/8"	49-57-1375
1-7/16"	49-57-1437
1-1/2"	49-57-1500
1-9/16"	49-57-1562
1-5/8"	49-57-1625
1-11/16"	49-57-1687
1-3/4"	49-57-1750
1-13/16"	49-57-1812
1-7/8"	49-57-1875
1-15/16"	49-57-1937
2"	49-57-2000
2-1/16"	49-57-2060
2-1/8"	49-57-2120
2-1/4"	49-57-2250
2-5/16"	49-57-2310

Size	Part Number
2-3/8"	49-57-2370
2-1/2"	49-57-2500
2-9/16"	49-57-2560
2-5/8"	49-57-2620
2-3/4"	49-57-2750
2-7/8"	49-57-2870
3"	49-57-3000
3-1/8"	49-57-3120
3-1/4"	49-57-3250
3-3/8"	49-57-3370
3-1/2"	49-57-3500
3-5/8"	49-57-3620
3-3/4"	49-57-3750
3-7/8"	49-57-3870
4"	49-57-4000
4-1/8"	49-57-4120
4-1/4"	49-57-4250
4-3/8"	49-57-4370
4-1/2"	49-57-4500
4-5/8"	49-57-4620
4-3/4"	49-57-4750
5"	49-57-5000
5-1/2"	49-57-5500
6"	49-57-6000

FOR USE WITH MILWAUKEE ELECTROMAGNETIC DRILL PRESSES AND DRILL STANDS

- **Two Styles: Threaded Or Quik-Lok With Appropriate Arbor Assemblies**
- **Carbide-Tipped Multiple Cutting Edges** – MILWAUKEE steel hawg cutters are high efficient carbide-tipped cutting tools. Alternating inside and outside cutting edges are carefully honed to cut holes rapidly with great precision.
- **Hardened Carbide** – Last longer than regular twist drills. The steel hawg cutters' multiple cutting edges uniformly distribute cutting over a wider area than a two flute twist drill tip.
- **Large Hole Cutters, Maximum 2" Depth, Up To 6" Diameter For Steel Plate, Stainless Steel, Cast Iron Or Aluminum**
- **3 Times Faster Than Twist Drills In Steel, Stainless Or Non-Ferrous Metals**

ARBORS



#3 Morse Taper Arbor 49-57-0010	3/4" Shank Arbor 49-57-0030
<ul style="list-style-type: none"> ▪ Works with threaded STEEL HAWG® cutters ▪ Use with motors 4292-1 and 4297-1 	<ul style="list-style-type: none"> ▪ Works with threaded STEEL HAWG® cutters ▪ Use with 4262-1 motor
Includes: <ul style="list-style-type: none"> ▪ Oil hose and hand pump 	Includes: <ul style="list-style-type: none"> ▪ Oil hose and hand pump

QUICK CHANGE TANG STEEL HAWG® CUTTERS

FAST CUTTING

- Alternating tooth geometry for up to 3X faster cutting with less pressure and better results than twist drill bits
- No pre-punching or pilot holes

LONG LIFE

- Hardened carbide steel teeth provide longer life

QUICK CHANGE

- Tool-free operation for fast changes

1" CUTTING DEPTH



Size	Part Number
1/2"	49-57-0251
9/16"	49-57-0564
5/8"	49-57-0626
11/16"	49-57-0689
3/4"	49-57-0752
13/16"	49-57-0814
7/8"	49-57-0877
15/16"	49-57-0939
1"	49-57-1002
1-1/16"	49-57-1064
1-1/8"	49-57-1127
1-3/16"	49-57-1189
1-1/4"	49-57-1252

Size	Part Number
1-5/16"	49-57-1314
1-3/8"	49-57-1377
1-7/16"	49-57-1439
1-1/2"	49-57-1502
1-9/16"	49-57-1564
1-5/8"	49-57-1627
1-11/16"	49-57-1689
1-3/4"	49-57-1752
1-13/16"	49-57-1814
1-7/8"	49-57-1877
1-15/16"	49-57-1939
2"	49-57-2002

ARBORS



#3 Morse Taper Quick Change Arbor 49-57-0012	#3 Morse Taper Quick Change Arbor w/Chip Breaker 49-57-0013	3/4" Straight Shank Quick Change Arbor 49-57-0032
<ul style="list-style-type: none"> ▪ Works with quick-change tang STEEL HAWG® cutters ▪ Use with motors 4292-1 and 4297-1 	<ul style="list-style-type: none"> ▪ Works with quick-change tang STEEL HAWG® cutters ▪ Use with motors 4292-1 and 4297-1 	<ul style="list-style-type: none"> ▪ Works with quick-change tang STEEL HAWG® cutters ▪ Use with 4262-1 motor
Includes: <ul style="list-style-type: none"> ▪ Oil hose and hand pump 	Includes: <ul style="list-style-type: none"> ▪ Oil hose and hand pump 	Includes: <ul style="list-style-type: none"> ▪ Oil hose and hand pump

ONE PIECE STEEL HAWG® CUTTERS

1/2" CUTTING DEPTH

- Recommended for use with Milwaukee® electromagnetic drill presses or hand drill



Size	Part Number
11/16"	49-57-8068
13/16"	49-57-8081
Pilot Bit	49-57-0038



STEEL HAWG® CUTTER ARBORS

ARBOR ASSEMBLIES FOR THREADED SHANK STEEL HAWG CUTTERS

(Metric thread size M 18 x 1.5, 4 Lead)

49-57-0030 3/4" Shank Arbor Assembly



FEATURES

- For use on Motor 4262-1

Includes: (1) 3/4" Shank to Threaded Steel Hawk® Cutter Arbor (49-57-0030); (1) Hand Pump; (1) Oil Hose

49-57-0020 No. 2 Morse Taper Arbor Assembly



FEATURES

- For threaded shank Steel HAWG® cutters

Includes: (1) #2 Morse Taper to Threaded Steel Hawk® Cutter Arbor (49-57-0020); (1) Hand Pump; (1) Oil Hose

49-96-0010 Arbor Wrench Set

Necessary to disassemble arbor body.

44-46-0090 Hawg Wash® Hand Pump

43-75-0010 HAWG Wash® Hand Pump Oil Hose

49-57-0010 No. 3 Morse Taper Arbor Assembly



FEATURES

- For use on Motor 4292-1 and 4297-1

Includes: (1) #3 Morse Taper to Threaded Steel Hawk® Cutter Arbor (49-57-0010); (1) Hand Pump; (1) Oil Hose

49-57-0025 No. 3 Morse Taper Assembly

FEATURES

- For use on Motor 4292-1 and 4297-1. #3 Morse Taper Assembly will allow 3/4" Weldon® Style Shank cutters to be used with Milwaukee's large magnetic drill stands.
- Oil Hose and hand pump NOT included.

Includes: (1) #3 Morse Taper to Weldon Shank Arbor (49-57-0025)

49-32-0081 HAWG Wash®



FEATURES

Twelve 16 oz. bottles per case (Sold only in case lots). **ELIMINATE CUTTING FLUID EXPERIMENTATION – USE HAWG WASH® WITH STEEL HAWG CUTTERS.** Hawg Wash® is a water soluble chemical fluid concentrate containing stable sulphur and chlorine additives. This product is designed for extreme pressure applications (tough alloys and severe operations) but is also excellent for general machining assignments. Hawg Wash® is very efficient due to its combination of high cooling and strong lubricating characteristics. One 16 oz. bottle makes one gallon of solution. Proper mixing of concentrate requires mixing the concentrate into the water.

LARGE ANGLE GRINDERS



6088-30

15 Amp 7"/9" Large Angle Grinder with Lock-on



FEATURES



- 15.0 Amp, 4.2 HP Motor -high overload protection and power for difficult applications
- 6,000 RPM- optimal wheel speed for material removal
- Debris Baffles- protect internal components by deflecting damaging debris out of the airflow at the intake vents
- External Brush Doors- reduces service time by providing easy access to brushes
- Soft-Grip Main Handle-provides better control and comfort
- Tool Free, Burst Resistant Guard-quickly adjust the guard without a tool
- 7" & 9" Type 27 Guard Included-for added productivity
- Compatible with multiple Grinder Guards and Flanges

Includes: (1) 15 Amp 7"/9" Large Angle Grinder w/ Lock-on (6088-30); (1) Flange; (1) Spanner Wrench; (1) Type 27 Guard

SPECIFICATIONS

Length	21"	Max HP	4.2
Voltage	120 AC/DC	Adjustable Handle	Yes
Tool Warranty	5 Years	Wheel Diameter	7"/9"
No Load Speed	6,000 RPM	Burst Resistant Guard	Yes
Cord Type	2-Wire	Easy Actuation Spindle Lock	Yes
Cord Length	8'	Exhaust System	Multi-Port
No Load RPM	6,000	Gears	Spiral Bevel
Amps	15	Max Watts Out	3,130 MWO
Spindle	5/8"-11	Spindle Thread	5/8"-11
Construction Type	Double Insulated	Use Wheels RPM Above	6,600 RPM
Soft Grip Handle	Yes		

6088-31

15 Amp 7"/9" Large Angle Grinder (Non Lock-on)



FEATURES



- 15.0 Amp, 4.2 HP Motor-high overload protection and power for difficult applications
- 6,000 RPM- optimal wheel speed for material removal
- Debris Baffles- protect internal components by deflecting damaging debris out of the airflow at the intake vents
- External Brush Doors-reduces service time by providing easy access to brushes
- Soft-Grip Main Handle-provides better control and comfort
- Tool Free, Burst Resistant Guard-quickly adjust the guard without a tool
- 7" & 9" Type 27 Guard Included- for added productivity
- Compatible with multiple Grinder Guards and Flanges

Includes: (1) 15 Amp 7"/9" Large Angle Grinder (Non Lock-on) (6088-31); (1) Flange; (1) Side Handle; (1) Spanner Wrench; (1) Type 27 Guard

SPECIFICATIONS

Length	21"	Max HP	4.2
Voltage	120 AC/DC	Adjustable Handle	Yes
Tool Warranty	5 Years	Wheel Diameter	7"/9"
No Load Speed	6,000 RPM	Burst Resistant Guard	Yes
Cord Type	2-Wire	Easy Actuation Spindle Lock	Yes
Cord Length	8'	Epoxy Motor Protection	25 Longer Lasting
No Load RPM	6,000	Exhaust System	Multi-Port
Amps	15	Gears	Spiral Bevel
Spindle	5/8"-11	Max Watts Out	3,130 MWO
Construction Type	Double Insulated	Spindle Thread	5/8"-11
Soft Grip Handle	Yes	Use Wheels RPM Above	6,600 RPM



LARGE ANGLE GRINDERS

6089-30

15 Amp 7"/9" ROTO-LOK® Large Angle Grinder with Lock-on



6089-31

15 Amp 7"/9" ROTO-LOK® Large Angle Grinder (Non Lock-on)



FEATURES



- 15.0 Amp, 4.2 HP Motor- high overload protection and power for difficult applications
- 6,000 RPM- optimal wheel speed for material removal
- 9-Position Rotating Handle-allows the user to adjust the main handle for better control
- Debris Baffles- protect internal components by deflecting damaging debris out of the airflow at the intake vents
- External Brush Doors- reduces service time by providing easy access to brushes
- Soft-Grip Main Handle-provides better control and comfort
- Tool Free, Burst Resistant Guard-quickly adjust the guard without a tool
- 7" & 9" Type 27 Guard Included- for added productivity
- Compatible with multiple Grinder Guards and Flanges

Includes: (1) 15 Amp 7"/9" ROTO-LOK® – Large Angle Grinder w/ Lock-on (6089-30); (1) Flange; (1) Side Handle; (1) Spanner Wrench; (1) Type 27 Guard

SPECIFICATIONS

Voltage	120 AC/DC	Adjustable Handle	Yes
Tool Warranty	5 Years	Wheel Diameter	7"/9"
No Load Speed	6,000 RPM	Burst Resistant Guard	Yes
Cord Type	2-Wire	Easy Actuation Spindle Lock	Yes
Cord Length	8'	Epoxy Motor Protection	25 Longer Lasting
No Load RPM	6,000	Exhaust System	Multi-Port
Amps	15	Gears	Spiral Bevel
Spindle	5/8"-11	Max Watts Out	3,130 MWO
Construction Type	Double Insulated	Spindle Thread	5/8"-11
Soft Grip Handle	Yes	Use Wheels RPM Above	6,600 RPM
Max HP	4.2		

FEATURES



- 15.0 Amp, 4.2 HP Motor- high overload protection and power for difficult applications
- 6,000 RPM- optimal wheel speed for material removal
- 9-Position Rotating Handle-allows the user to adjust the main handle for better control
- Debris Baffles- protect internal components by deflecting damaging debris out of the airflow at the intake vents
- External Brush Doors- reduces service time by providing easy access to brushes
- Soft-Grip Main Handle- provides better control and comfort
- Tool Free, Burst Resistant Guard- quickly adjust the guard without a tool
- 7" & 9" Type 27 Guard Included- for added productivity
- Compatible with multiple Grinder Guards and Flanges

Includes: (1) 15 Amp 7"/9" ROTO-LOK® – Large Angle Grinder (Non Lock-on) (6089-31); (1) Flange; (1) Side Handle; (1) Spanner Wrench; (1) Type 27 Guard

SPECIFICATIONS

Voltage	120 AC/DC	Adjustable Handle	Yes
Tool Warranty	5 Years	Wheel Diameter	7"/9"
No Load Speed	6,000 RPM	Burst Resistant Guard	Yes
Cord Type	2-Wire	Easy Actuation Spindle Lock	Yes
Cord Length	8'	Epoxy Motor Protection	25 Longer Lasting
No Load RPM	6,000	Exhaust System	Multi-Port
Amps	15	Gears	Spiral Bevel
Spindle	5/8"-11	Max Watts Out	3,130 MWO
Construction Type	Double Insulated	Spindle Thread	5/8"-11
Soft Grip Handle	Yes	Use Wheels RPM Above	6,600 RPM
Max HP	4.2		

SMALL ANGLE GRINDERS



6121-30

11 Amp 4-1/2" Small Angle Grinder
Trigger Grip, Lock-On



FEATURES



- Powerful 11 Amp, 11,000 RPM Motor: Provides maximum performance and durability
- Overload Protection: Maximizes motor life
- Electronic Clutch: Extends tool life and prevents bind-up
- Tool-Free Accessory Change: Easily change "All Accessories" without a wrench
- Tool-Free Adjustable Guard: Provides quick guard installations and adjustments
- Advanced Airflow System: Maximizes airflow and reduces debris ingress, improving motor life and performance
- Debris Baffles – protect internal components by deflecting damaging debris out of the airflow at the intake vents
- External Brush Doors – reduces service time by providing easy access to brushes
- Trigger Grip Handle – provides better control, reach and leverage
- Compatible with multiple Grinder Guards and Flanges

Includes: (1) 11 Amp 4-1/2" Small Angle Grinder Trigger Grip, Lock-On (6121-30); (1) Flange; (1) Side Handle; (1) Spanner Wrench; (1) Type 27 Guard

SPECIFICATIONS

Length	15.6"	Spindle	5/8"-11
Voltage	120V AC	Construction Type	Double Insulated
Tool Warranty	5 Years	Adjustable Handle	Yes
No Load Speed	11,000 RPM	Wheel Diameter	4-1/2"
Cord Type	2-Wire	Overload Protection	Yes
Electronic Feedback	Yes	Burst Resistant Guard	Yes
Cord Length	8'	Max Watts Out	1,400 MWO
Amps	11	Spindle Thread	5/8"-11

6121-31

11 Amp 4-1/2" Small Angle Grinder
Trigger Grip, No-Lock



FEATURES



- Powerful 11 Amp, 11,000 RPM Motor: Provides maximum performance and durability
- Overload Protection: Maximizes motor life
- Electronic Clutch: Extends tool life and prevents bind-up
- Tool-Free Accessory Change: Easily change "All Accessories" without a wrench
- Tool-Free Adjustable Guard: Provides quick guard installations and adjustments
- Advanced Airflow System: Maximizes airflow and reduces debris ingress, improving motor life and performance
- Debris Baffles – protect internal components by deflecting damaging debris out of the airflow at the intake vents
- External Brush Doors – reduces service time by providing easy access to brushes
- Trigger Grip Handle – provides better control, reach and leverage
- Compatible with multiple Grinder Guards and Flanges

Includes: (1) 11 Amp 4-1/2" Small Angle Grinder Trigger Grip, No-Lock (6121-31); (1) Flange; (1) Side Handle; (1) Spanner Wrench; (1) Type 27 Guard

SPECIFICATIONS

Length	15.6"	Construction Type	Double Insulated
Voltage	120V AC	Adjustable Handle	Yes
Tool Warranty	5 Years	Wheel Diameter	4-1/2"
Cord Type	2-Wire	Overload Protection	Yes
Electronic Feedback	Yes	Burst Resistant Guard	Yes
Cord Length	8'	Max Watts Out	1,400 MWO
Amps	11	Spindle Thread	5/8"-11
Spindle	5/8"-11		



SMALL ANGLE GRINDERS

6121-31A

11 Amp 5" Small Angle Grinder
Trigger Grip, AC/DC



FEATURES



- Powerful 11 Amp, 11,000 RPM Motor: Provides maximum performance and durability
- AC/DC : Versatility to be used with AC or DC power supplies
- Tool-Free Accessory Change: Easily change "All Accessories" without a wrench
- Tool-Free Adjustable Guard: Provides quick guard installations and adjustments
- Advanced Airflow System: Maximizes airflow and reduces debris ingress, improving motor life and performance
- Debris Baffles – protect internal components by deflecting damaging debris out of the airflow at the intake vents
- External Brush Doors – reduces service time by providing easy access to brushes
- Trigger Grip Handle – provides better control, reach and leverage
- Compatible with multiple Grinder Guards and Flanges

Includes: (1) 11 Amp 5" Small Angle Grinder Trigger Grip, AC/DC (6121-31A); (1) Flange; (1) Side Handle; (1) Spanner Wrench; (1) Type 27 Guard

SPECIFICATIONS

Voltage	120 AC/DC	Construction Type	Double Insulated
Tool Warranty	5 Years	Adjustable Handle	Yes
Cord Type	2-Wire	Wheel Diameter	5"
Electronic Feedback	No	Overload Protection	No
Cord Length	8'	Burst Resistant Guard	Yes
No Load RPM	11,000	Max Watts Out	1,400 MWO
Amps	11	Spindle Thread	5/8"-11
Spindle	5/8"-11		

6130-33

7.0 AMP 4-1/2" Small Angle Grinder



FEATURES



- Compact, Lightweight Design: At 10.2" long and 3.5 lbs it is the most compact & lightest grinder in the Milwaukee line
- 7.0 Amp, 750 MWO Motor- powerful for daily applications
- Debris Baffles- protect internal components by deflecting damaging debris out of the airflow at the intake vents
- Multi-Port Exhaust-reduces motor burn-up by efficiently venting hot air out of the grinder
- Tool Free, Burst Resistant Guard- the only grinder in its class with a tool free guard
- Compatible with multiple Grinder Guards and Flanges

Includes: (1) 7.0 AMP 4-1/2" Small Angle Grinder (6130-33); (1) Spanner Wrench; (1) Type 27 Guard

SPECIFICATIONS

Length	10.25"	Spindle	5/8"-11
Weight	3.5 lbs	Adjustable Handle	Yes
Voltage	120V AC	Wheel Diameter	4-1/2"
Tool Warranty	5 Years	Overload Protection	No
No Load Speed	11,000 RPM	Burst Resistant Guard	Yes
Cord Type	Double Insulated	Easy Actuation Spindle Lock	Yes
Electronic Feedback	No	Epoxy Motor Protection	Yes
Cord Length	8'	Exhaust System	Multi-Port
No Load RPM	11,000	Max Watts Out	750 MWO
Amps	7		

SMALL ANGLE GRINDERS



6140-30 7.5 Amp 4-1/2" Small Angle Grinder



FEATURES



- 7.5 Amp, 825 MWO Motor-overload protection and power for daily applications
- 25% Longer Lasting Epoxy Protection-extends motor life by protecting the copper wire from abrasion
- Debris Baffles- protect internal components by deflecting damaging debris out of the airflow at the intake vents
- Multi-Port Exhaust-reduces motor burn-up by efficiently venting hot air out of the grinder
- X-Large Paddle Switch-increased comfort and ease-of-use when operating in various positions
- Multi-Port Exhaust-reduces motor burn-up by efficiently venting hot air out of the grinder
- Tool Free, Burst Resistant Guard- the only grinder in its class with a tool free guard
- Compatible with multiple Grinder Guards and Flanges

Includes: (1) 7.5 Amp 4-1/2" Small Angle Grinder (6140-30); (1) Flange; (1) Side Handle; (1) Spanner Wrench; (1) Wheel Guard

SPECIFICATIONS

Length	11.8"	Soft Grip Handle	No
Weight	6.52 lbs	Adjustable Handle	Yes
Voltage	120V AC	Wheel Diameter	4-1/2"
Tool Warranty	5 Years	Burst Resistant Guard	Yes
No Load Speed	10,000 RPM	Easy Actuation Spindle Lock	Yes
Cord Type	2-Wire	Epoxy Motor Protection	25 Longer Lasting
Cord Length	8'	Exhaust System	Multi-Port
No Load RPM	10,000	Gears	Spiral Bevel
Amps	7.5	Max Watts Out	825 MWO
Spindle	5/8"-11		

6146-30 11 Amp 4-1/2" Small Angle Grinder Paddle, Lock-On



FEATURES



- Powerful 11 Amp, 11,000 RPM Motor: Provides maximum performance and durability
- Overload Protection: Maximizes motor life
- Electronic Clutch: Extends tool life and prevents bind-up
- Tool-Free Accessory Change: Easily change "All Accessories" without a wrench
- Tool-Free Adjustable Guard: Provides quick guard installations and adjustments
- Advanced Airflow System: Maximizes airflow and reduces debris ingress, improving motor life and performance
- Debris Baffles – protect internal components by deflecting damaging debris out of the airflow at the intake vents
- Compatible with multiple Grinder Guards and Flanges

Includes: (1) 11 Amp 4-1/2" Small Angle Grinder Paddle, Lock-On (6146-30); (1) Contractor Bag; (1) Flange; (1) Grinding Wheel; (1) Side Handle; (1) Spanner Wrench; (1) Type 27 Guard

SPECIFICATIONS

Weight	8.16 lbs	Amps	11
Tool Warranty	5 Years	Spindle	5/8"-11
Cord Type	2-Wire	Adjustable Handle	Yes
Electronic Feedback	Yes	Overload Protection	Yes
Cord Length	8'	Burst Resistant Guard	Yes



SMALL ANGLE GRINDERS

6146-31

11 Amp 4-1/2" Small Angle Grinder Paddle, No-Lock



6146-33

11 Amp 4-1/2" Small Angle Grinder Slide, Lock-On



FEATURES



- Powerful 11 Amp, 11,000 RPM Motor: Provides maximum performance and durability
- Overload Protection: Maximizes motor life
- Electronic Clutch: Extends tool life and prevents bind-up
- Tool-Free Accessory Change: Easily change "All Accessories" without a wrench
- Tool-Free Adjustable Guard: Provides quick guard installations and adjustments
- Advanced Airflow System: Maximizes airflow and reduces debris ingress, improving motor life and performance
- Debris Baffles – protect internal components by deflecting damaging debris out of the airflow at the intake vents
- Compatible with multiple Grinder Guards and Flanges

Includes: (1) 11 Amp 4-1/2" Small Angle Grinder Paddle, No Lock (6146-30); (1) Flange; (1) Side Handle; (1) Spanner Wrench; (1) Type 27 Guard

SPECIFICATIONS

Weight	8.16 lbs	Amps	11
Tool Warranty	5 Years	Spindle	5/8"-11
Cord Type	2-Wire	Adjustable Handle	Yes
Electronic Feedback	Yes	Overload Protection	Yes
Cord Length	8'	Burst Resistant Guard	Yes

FEATURES



- Powerful 11 Amp, 11,000 RPM Motor: Provides maximum performance and durability
- Overload Protection: Maximizes motor life
- Electronic Clutch: Extends tool life and prevents bind-up
- Tool-Free Accessory Change: Easily change "All Accessories" without a wrench
- Tool-Free Adjustable Guard: Provides quick guard installations and adjustments
- Advanced Airflow System: Maximizes airflow and reduces debris ingress, improving motor life and performance
- Debris Baffles – protect internal components by deflecting damaging debris out of the airflow at the intake vents
- Compatible with multiple Grinder Guards and Flanges

Includes: (1) 11 Amp 4-1/2" Small Angle Grinder Slide, Lock-On (6146-33); (1) Flange; (1) Side Handle; (1) Spanner Wrench; (1) Type 27 Guard

SPECIFICATIONS

Weight	8.16 lbs	Amps	11
Tool Warranty	5 Years	Spindle	5/8"-11
Cord Type	2-Wire	Adjustable Handle	Yes
Electronic Feedback	Yes	Overload Protection	Yes
Cord Length	8'	Burst Resistant Guard	Yes

SMALL ANGLE GRINDERS



6147-30

11 Amp 4-1/2" Small Angle Grinder
Paddle, Lock-On



FEATURES



- Powerful 11 Amp, 11,000 RPM Motor: Provides maximum performance and durability
- Tool-Free Accessory Change: Easily change "All Accessories" without a wrench
- Tool-Free Adjustable Guard: Provides quick guard installations and adjustments
- Advanced Airflow System: Maximizes airflow and reduces debris ingress, improving motor life and performance
- Debris Baffles – protect internal components by deflecting damaging debris out of the airflow at the intake vents
- Compatible with multiple Grinder Guards and Flanges

Includes: (1) 11 Amp 4-1/2" Small Angle Grinder Paddle, Lock-On (6147-30); (1) Side Handle; (1) Spanner Wrench; (1) Type 27 Guard

SPECIFICATIONS

Tool Warranty	5 Years	Spindle	5/8"-11
Cord Type	2-Wire	Adjustable Handle	Yes
Electronic Feedback	No	Overload Protection	No
Cord Length	8'	Burst Resistant Guard	Yes
Amps	11		

6147-31

11 Amp 4-1/2" Small Angle Grinder
Paddle, No-Lock



FEATURES



- Powerful 11 Amp, 11,000 RPM Motor: Provides maximum performance and durability
- Tool-Free Accessory Change: Easily change "All Accessories" without a wrench
- Tool-Free Adjustable Guard: Provides quick guard installations and adjustments
- Advanced Airflow System: Maximizes airflow and reduces debris ingress, improving motor life and performance
- Debris Baffles – protect internal components by deflecting damaging debris out of the airflow at the intake vents
- Compatible with multiple Grinder Guards and Flanges

Includes: (1) 11 Amp 4-1/2" Small Angle Grinder Paddle, No-Lock (6147-31); (1) Side Handle

SPECIFICATIONS

Tool Warranty	5 Years	Spindle	5/8"-11
Cord Type	2-Wire	Adjustable Handle	Yes
Electronic Feedback	No	Overload Protection	No
Cord Length	8'	Burst Resistant Guard	Yes
Amps	11		



NEW SMALL ANGLE GRINDERS

MILWAUKEE® METALWORKING. THE INDUSTRIAL STANDARD.

UP TO 3X MORE DURABLE



Milwaukee® Gear
Leading Competitor

Small Angle Grinder Gear Durability

Large gears allow maximum protection and longest life

Anti-Vibration Side Handle

Reduces vibration, increasing user comfort during extended use

Advanced Airflow System

Maximizes airflow, improving motor performance and life



Oversized Brush

Extends use-life of the tool before repair needed

Debris Baffles

Engineered L-shape intake vents protect the motor and other components by deflecting debris particles out of the airflow before entering the grinder

UP TO 50% MORE POWER

NEW POWERFUL MILWAUKEE® BUILT MOTOR



NEW Milwaukee® Motor



Leading Competitor

100% TOOL-FREE

100% Tool-Free Adjustable Guard

Allows the user to quickly adjust the guard without the use of a tool



100% Tool-Free Accessory Change

5-piece spindle assembly allows user to change "All Accessories" without a wrench



NEW SMALL ANGLE GRINDERS



MILWAUKEE® ELECTRONICS ADVANTAGE

Overload Protection

Maximizes motor life by reducing motor burn-up

Electronic Clutch

Extends life of tool and helps reduce bind-up

Line Lock-Out

Helps reduce automatic start-up after power loss

Soft Start

Allows maximum control at start-up

ADVANCED ELECTRONICS

CPT — Constant Power Technology™

Maintains speed under load

Electronic Brake

Rapidly stops grinding wheel when trigger is released

Dial Speed Control

Flexibility to adjust speed range for specific applications



NEW SMALL ANGLE GRINDERS

6117-30

13 Amp 5" Small Angle Grinder Paddle, Lock-On



FEATURES



- Powerful 13 Amp, 11,000 RPM Motor: Provides maximum performance and durability
- Overload Protection: Maximizes motor life
- Electronic Clutch: Extends tool life and prevents bind-up
- Constant Power Technology™: Maintains constant speed under load
- Tool-Free Accessory Change: Easily change "All Accessories" without a wrench
- Tool-Free Adjustable Guard: Provides quick guard installations and adjustments
- Advanced Airflow System: Maximizes airflow and reduces debris ingress, improving motor life and performance
- Anti-Vibration Side Handle: Reduces vibration, increasing user comfort during extended use
- Soft Start: Allows maximum control at start-up
- Compatible with multiple Grinder Guards and Flanges

Includes: (1) 13 Amp 5" Small Angle Grinder Paddle, Lock-On (6117-30); (1) Flange; (1) Side Handle; (1) Spanner Wrench; (1) Type 27 Guard

SPECIFICATIONS

Length	12.2"	Spindle	5/8"-11
Voltage	120V AC	Construction Type	Double Insulated
Tool Warranty	5 Years	Adjustable Handle	Yes
No Load Speed	11,000 RPM	Wheel Diameter	5"
Cord Type	2-Wire	Overload Protection	Yes
Electronic Feedback	Yes	Burst Resistant Guard	Yes
Cord Length	8'	Max Watts Out	2,100 MWO
Amps	13	Spindle Thread	5/8"-11

6117-31

13 Amp 5" Small Angle Grinder Paddle, No-Lock



FEATURES



- Powerful 13 Amp, 11,000 RPM Motor: Provides maximum performance and durability
- Overload Protection: Maximizes motor life
- Electronic Clutch: Extends tool life and prevents bind-up
- Constant Power Technology™: Maintains constant speed under load
- Tool-Free Accessory Change: Easily change "All Accessories" without a wrench
- Tool-Free Adjustable Guard: Provides quick guard installations and adjustments
- Advanced Airflow System: Maximizes airflow and reduces debris ingress, improving motor life and performance
- Anti-Vibration Side Handle: Reduces vibration, increasing user comfort during extended use
- Soft Start: Allows maximum control at start-up
- Compatible with multiple Grinder Guards and Flanges

Includes: (1) 13 Amp 5" Small Angle Grinder Paddle, No-Lock (6117-31); (1) Flange; (1) Side Handle; (1) Spanner Wrench; (1) Type 27 Guard

SPECIFICATIONS

Length	12.2"	Construction Type	Double Insulated
Voltage	120V AC	Adjustable Handle	Yes
Tool Warranty	5 Years	Wheel Diameter	5"
Cord Type	2-Wire	Overload Protection	Yes
Electronic Feedback	Yes	Burst Resistant Guard	Yes
Cord Length	8'	Max Watts Out	2,100 MWO
Amps	13	Spindle Thread	5/8"-11
Spindle	5/8"-11		

NEW SMALL ANGLE GRINDERS



6117-33

13 Amp 5" Small Angle Grinder Slide, Lock-On



FEATURES



- Powerful 13 Amp, 11,000 RPM Motor: Provides maximum performance and durability
- Overload Protection: Maximizes motor life
- Electronic Clutch: Extends tool life and prevents bind-up
- Constant Power Technology™: Maintains constant speed under load
- Tool-Free Accessory Change: Easily change "All Accessories" without a wrench
- Tool-Free Adjustable Guard: Provides quick guard installations and adjustments
- Advanced Airflow System: Maximizes airflow and reduces debris ingress, improving motor life and performance
- Anti-Vibration Side Handle: Reduces vibration, increasing user comfort during extended use
- Soft Start: Allows maximum control at start-up
- Compatible with multiple Grinder Guards and Flanges

Includes: (1) 13 Amp 5" Small Angle Grinder Slide, Lock-On (6117-33); (1) Flange; (1) Side Handle; (1) Spanner Wrench; (1) Type 27 Guard

SPECIFICATIONS

Length	12.2"	Spindle	5/8"-11
Voltage	120V AC	Construction Type	Double Insulated
Tool Warranty	5 Years	Adjustable Handle	Yes
No Load Speed	11,000 RPM	Wheel Diameter	5"
Cord Type	2-Wire	Overload Protection	Yes
Electronic Feedback	Yes	Burst Resistant Guard	Yes
Cord Length	8'	Max Watts Out	2,100 MWO
Amps	13	Spindle Thread	5/8"-11

6117-33D

13 Amp 5" Small Angle Grinder Slide, Lock-On With Dial Speed



FEATURES



- Powerful 13 Amp, 2,800 - 11,000 RPM Motor: Provides maximum performance and durability
- Dial Speed Control: Provides flexibility to adjust speed range for specific applications
- Overload Protection: Maximizes motor life
- Electronic Clutch: Extends tool life and prevents bind-up
- Constant Power Technology™: Maintains constant speed under load
- Tool-Free Accessory Change: Easily change "All Accessories" without a wrench
- Tool-Free Adjustable Guard: Provides quick guard installations and adjustments
- Advanced Airflow System: Maximizes airflow and reduces debris ingress, improving motor life and performance
- Anti-Vibration Side Handle: Reduces vibration, increasing user comfort during extended use
- Compatible with multiple Grinder Guards and Flanges

Includes: (1) 13 Amp 5" Small Angle Grinder Slide, Lock-On (6117-33D); (1) Flange; (1) Side Handle; (1) Spanner Wrench; (1) Type 27 Guard

SPECIFICATIONS

Length	12.2"	Spindle	5/8"-11
Voltage	120V AC	Construction Type	Double Insulated
Tool Warranty	5 Years	Adjustable Handle	Yes
No Load Speed	2,800-11,000 RPM	Wheel Diameter	5"
Cord Type	2-Wire	Overload Protection	Yes
Electronic Feedback	Yes	Burst Resistant Guard	Yes
Cord Length	8'	Max Watts Out	2,100 MWO
Amps	13	Spindle Thread	5/8"-11



NEW SMALL ANGLE GRINDERS

6124-30

13 Amp 5" Small Angle Grinder
Trigger Grip, Lock-On



6124-31

13 Amp 5" Small Angle Grinder
Trigger Grip, No-Lock



FEATURES



- Powerful 13 Amp, 9,000 RPM Motor: Provides maximum performance and durability
- Overload Protection: Maximizes motor life
- Electronic Clutch: Extends tool life and prevents bind-up
- Constant Power Technology™: Maintains constant speed under load
- Tool-Free Accessory Change: Easily change "All Accessories" without a wrench
- Tool-Free Adjustable Guard: Provides quick guard installations and adjustments
- Advanced Airflow System: Maximizes airflow and reduces debris ingress, improving motor life and performance
- Anti-Vibration Side Handle: Reduces vibration, increasing user comfort during extended use
- Trigger Grip Handle – provides better control, reach and leverage
- Compatible with multiple Grinder Guards and Flanges

Includes: (1) 13 Amp 5" Small Angle Grinder Trigger Grip, Lock-On (6124-30); (1) Flange; (1) Spanner Wrench; (1) Type 27 Guard

SPECIFICATIONS

Length	15.6"	Spindle	5/8"-11
Voltage	120V AC	Construction Type	Double Insulated
Tool Warranty	5 Years	Adjustable Handle	Yes
No Load Speed	9,000 RPM	Wheel Diameter	5"
Cord Type	2-Wire	Overload Protection	Yes
Electronic Feedback	Yes	Burst Resistant Guard	Yes
Cord Length	8'	Max Watts Out	2,100 MWO
Amps	13	Spindle Thread	5/8"-11

FEATURES



- Powerful 13 Amp, 9,000 RPM Motor: Provides maximum performance and durability
- Overload Protection: Maximizes motor life
- Electronic Clutch: Extends tool life and prevents bind-up
- Constant Power Technology™: Maintains constant speed under load
- Tool-Free Accessory Change: Easily change "All Accessories" without a wrench
- Tool-Free Adjustable Guard: Provides quick guard installations and adjustments
- Advanced Airflow System: Maximizes airflow and reduces debris ingress, improving motor life and performance
- Anti-Vibration Side Handle: Reduces vibration, increasing user comfort during extended use
- Trigger Grip Handle – provides better control, reach and leverage
- Compatible with multiple Grinder Guards and Flanges

Includes: (1) 13 Amp 5" Small Angle Grinder Trigger Grip, No-Lock (6124-31); (1) Flange; (1) Spanner Wrench; (1) Type 27 Guard

SPECIFICATIONS

Voltage	120V AC	Construction Type	Double Insulated
Tool Warranty	5 Years	Adjustable Handle	Yes
No Load Speed	9,000 RPM	Wheel Diameter	5"
Cord Type	2-Wire	Overload Protection	Yes
Electronic Feedback	Yes	Burst Resistant Guard	Yes
Cord Length	8'	Max Watts Out	2,100 MWO
Amps	13	Spindle Thread	5/8"-11
Spindle	5/8"-11		

NEW SMALL ANGLE GRINDERS



6161-30

13 Amp 6" Small Angle Grinder
Paddle, Lock-On



FEATURES



- Powerful 13 Amp, 9,000 RPM Motor: Provides maximum performance and durability
- Overload Protection: Maximizes motor life
- Electronic Clutch: Extends tool life and prevents bind-up
- Constant Power Technology™: Maintains constant speed under load
- Tool-Free Accessory Change: Easily change "All Accessories" without a wrench
- Tool-Free Adjustable Guard: Provides quick guard installations and adjustments
- Advanced Airflow System: Maximizes airflow and reduces debris ingress, improving motor life and performance
- Anti-Vibration Side Handle: Reduces vibration, increasing user comfort during extended use
- Soft Start: Allows maximum control at start-up
- Compatible with multiple Grinder Guards and Flanges

Includes: (1) 13 Amp 6" Small Angle Grinder Paddle, Lock-On (6161-30); (1) Flange; (1) Side Handle; (1) Spanner Wrench; (1) Type 27 Guard

SPECIFICATIONS

Length	12.2"	Spindle	5/8"-11
Voltage	120V AC	Construction Type	Double Insulated
Tool Warranty	5 Years	Adjustable Handle	Yes
No Load Speed	9,000 RPM	Wheel Diameter	6"
Cord Type	2-Wire	Overload Protection	Yes
Electronic Feedback	Yes	Burst Resistant Guard	Yes
Cord Length	8'	Max Watts Out	2,100 MWO
Amps	13	Spindle Thread	5/8"-11

6161-31

13 Amp 6" Small Angle Grinder
Paddle, No-Lock



FEATURES



- Powerful 13 Amp, 9,000 RPM Motor: Provides maximum performance and durability
- Overload Protection: Maximizes motor life
- Electronic Clutch: Extends tool life and prevents bind-up
- Constant Power Technology™: Maintains constant speed under load
- Tool-Free Accessory Change: Easily change "All Accessories" without a wrench
- Tool-Free Adjustable Guard: Provides quick guard installations and adjustments
- Advanced Airflow System: Maximizes airflow and reduces debris ingress, improving motor life and performance
- Anti-Vibration Side Handle: Reduces vibration, increasing user comfort during extended use
- Soft Start: Allows maximum control at start-up
- Compatible with multiple Grinder Guards and Flanges

Includes: (1) 13 Amp 6" Small Angle Grinder Paddle, No-Lock (6161-31); (1) Flange; (1) Spanner Wrench; (1) Type 27 Guard

SPECIFICATIONS

Length	12.2"	Spindle	5/8"-11
Voltage	120V AC	Construction Type	Double Insulated
Tool Warranty	5 Years	Adjustable Handle	Yes
No Load Speed	9,000 RPM	Wheel Diameter	6"
Cord Type	2-Wire	Overload Protection	Yes
Electronic Feedback	Yes	Burst Resistant Guard	Yes
Cord Length	8'	Max Watts Out	2,100 MWO
Amps	13	Spindle Thread	5/8"-11



NEW SMALL ANGLE GRINDERS

6161-33

13 Amp 6" Small Angle Grinder Slide, Lock-On



SPECIFICATIONS

Length	12.2"	Spindle	5/8"-11
Voltage	120V AC	Construction Type	Double Insulated
Tool Warranty	5 Years	Adjustable Handle	Yes
No Load Speed	9,000 RPM	Wheel Diameter	6"
Cord Type	2-Wire	Overload Protection	Yes
Electronic Feedback	Yes	Burst Resistant Guard	Yes
Cord Length	8'	Max Watts Out	2,100 MWO
Amps	13	Spindle Thread	5/8"-11

FEATURES



- Powerful 13 Amp, 9,000 RPM Motor: Provides maximum performance and durability
- Overload Protection: Maximizes motor life
- Electronic Clutch: Extends tool life and prevents bind-up
- Constant Power Technology™: Maintains constant speed under load
- Tool-Free Accessory Change: Easily change "All Accessories" without a wrench
- Tool-Free Adjustable Guard: Provides quick guard installations and adjustments
- Advanced Airflow System: Maximizes airflow and reduces debris ingress, improving motor life and performance
- Anti-Vibration Side Handle: Reduces vibration, increasing user comfort during extended use
- Soft Start: Allows maximum control at start-up
- Compatible with multiple Grinder Guards and Flanges

Includes: (1) 13 Amp 6" Small Angle Grinder Slide, Lock-On (6161-33; (1) Flange; (1) Spanner Wrench; (1) Type 27 Guard

SAG APPLICATION GUIDE

■ **OPTIMAL**
For Application

○ **GOOD**
For Application

	Surface Conditioning				Cutting				Material Removal			
	Bevel Removal (Shop)	Bevel Removal (Jobsite)	Large Surface Area	Weld Bead Blending	Small Diameter Pipe (Below 8')	Large Diameter Pipe (Above 8')	Sheet Plate	Construction Material (Angle Iron, Threaded Rod, Unistrut, Concrete/Masonry)	Tuck Pointing	Surface Grinding / Prep (All Metal)	Surface Grinding / Prep (Concrete)	Surface Grinding / Prep (Granite)

11.0 Amp SAG

6147-30	4-1/2" SAG – Paddle, Lock-On	■	■	○	■	○	○	○	○	○	○	■	○	○
6147-31	4-1/2" SAG – Paddle, Non-Lock	■	■	○	■	○	○	○	○	○	○	■	○	○
6146-30	4-1/2" SAG – Paddle, Lock-On	■	■	○	■	○	○	○	○	○	○	■	○	○
6146-31	4-1/2" SAG – Paddle, Non-Lock	■	■	○	■	○	○	○	○	○	○	■	○	○
6146-33	4-1/2" SAG – Slide, Lock-On	■	■	○	■	○	○	○	○	○	○	■	○	○
6121-30	4-1/2" SAG – Trigger Grip, Lock-On	■	■	○	■	○	○	○	○	○	○	■	○	○
6121-31	4-1/2" SAG – Trigger Grip, Non-Lock	■	■	○	■	○	○	○	○	○	○	■	○	○
6121-31A	5" SAG – Trigger Grip, Non-Lock AC/DC	○	■	○	■	○	○	○	○	○	○	■	○	○

13.0 Amp SAG

6117-30	5" SAG – Paddle, Lock-On	■	■	○	■	○	○	○	○	○	○	■	○	○
6117-31	5" SAG – Paddle, Non-Lock	■	■	○	■	○	○	○	○	○	○	■	○	○
6117-33	5" SAG – Slide, Lock-On	■	■	○	■	○	○	○	○	○	○	■	○	○
6117-33D	5" SAG – Slide, Lock-On w/Dial Speed	○	○	○	○	○	○	○	○	○	○	■	■	■
6161-30	6" SAG – Paddle, Lock-On	■	■	○	■	■	■	■	■	■	■	■	○	○
6161-31	6" SAG – Paddle, Non-Lock	■	■	○	■	■	■	■	■	■	■	■	○	○
6161-33	6" SAG – Slide, Lock-On	■	■	○	■	■	■	■	■	■	■	■	○	○
6124-30	6" SAG – Trigger Grip, Lock-On	■	■	○	■	■	■	■	■	■	■	■	○	○
6124-31	6" SAG – Trigger Grip, Non-Lock	■	■	○	■	■	■	■	■	■	■	■	○	○

ABRASIVE WHEELS



TYPE 1 PREMIUM ABRASIVE CUT-OFF WHEELS FOR CUT-OFF MACHINES



TYPE 1 CUT-OFF WHEELS

- Designed for fast cutting and long life
- Type 1 cut-off wheels are designed for cutting only

TYPE 27 DEPRESSED CENTER WHEELS

- Designed for fast cutting and long life

TYPE 27 GRINDING WHEELS

- Designed for grinding, blending and other general purpose applications



TYPE 27 DEPRESSED CENTER WHEELS WITH 5/8"-11 THREADED HUB

- Designed for grinding, blending and other general purpose applications

Size	Thickness	Arbor	Part Number	Abrasive Type	Abrasive Spec.	Application	Max RPM	Qty
FOR STATIONARY ABRASIVE CUT-OFF MACHINES (NOT INTENDED FOR USE ON HAND HELD CUT-OFF MACHINES)								
12"	3/32"	1"	49-94-1220	Aluminum Oxide	A36P	General Purpose - Metal	5,095	10
14"	3/32"	1"	49-94-1405	Aluminum Oxide	A36P	General Purpose - Metal (Double Reinforced)	4,365	5
14"	3/32"	1"	49-94-1410	Aluminum Oxide	A36P	Metal Stud	4,365	10
14"	3/32"	1"	49-94-1415	Aluminum Oxide	A36P	General Purpose - Metal (Center Reinforced)	4,365	5
FOR HAND HELD ABRASIVE CUT-OFF MACHINES (NOT INTENDED FOR USE ON STATIONARY CUT-OFF MACHINES)								
12"	1/8"	20mm	49-94-1270	Aluminum Oxide	A24R	General Purpose - Metal	6,360	10
12"	1/8"	1"	49-94-1275	Aluminum Oxide	A24R	General Purpose - Metal	6,360	10
12"	1/8"	20mm	49-94-1280	Silicon Carbide	C24T	Masonry	6,360	10
12"	1/8"	1"	49-94-1285	Silicon Carbide	C24T	Masonry	6,360	10
14"	1/8"	20mm	49-94-1470	Aluminum Oxide	A24R	General Purpose - Metal	5,400	10
14"	1/8"	1"	49-94-1475	Aluminum Oxide	A24R	General Purpose - Metal	5,400	10
14"	1/8"	20mm	49-94-1480	Silicon Carbide	C24T	Masonry	5,400	10
14"	1/8"	1"	49-94-1485	Silicon Carbide	C24T	Masonry	5,400	10

TYPE 1 AND TYPE 27 REINFORCED DEPRESSED CENTER WHEELS

Size	Thickness	Arbor	Part Number	Abrasive Spec.	Applications	Characteristics	Max RPM	Case Qty
TYPE 1 CUT-OFF WHEELS								
4-1/2"	0.045"	7/8"	49-94-4500	A60T	Metal/Stainless Cutting	Fast Cut/Long Life	13,580	25
5"	0.045"	7/8"	49-94-5000	A60T	Metal/Stainless Cutting	Fast Cut/Long Life	12,225	25
6"	0.045"	7/8"	49-94-6300	A60T	Metal/Stainless Cutting	Fast Cut/Long Life	10,185	25
7"	3/32"	5/8**	49-94-7050	A24R	General Purpose - Metal	Fast Cut/Long Life	8,730	25
7"	1/8"	5/8**	49-94-7055	C24T	Masonry Cutting	Fast Cut/Long Life	8,730	25
TYPE 27 CUT-OFF WHEELS								
4-1/2"	0.045"	7/8"	49-94-4505	A60T	Metal/Stainless Cutting	Fast Cut/Long Life	13,580	25
5"	0.045"	7/8"	49-94-5005	A60T	Metal/Stainless Cutting	Fast Cut/Long Life	12,225	25
6"	0.045"	7/8"	49-94-6305	A60T	Metal/Stainless Cutting	Fast Cut/Long Life	10,185	25
TYPE 27 GRINDING WHEELS								
4-1/2"	1/8"	7/8"	49-94-4510	A30S	Pipeline - Light Grinding/Cutting	Fast Cut	13,580	10
4-1/2"	1/4"	5/8"-11	49-94-4515	A24R	Metal/Stainless Grinding	Long Life	13,580	5
4-1/2"	1/4"	7/8"	49-94-4520	A24R	Metal/Stainless Grinding	Long Life	13,580	10
4-1/2"	1/8"	5/8"-11	49-94-4525	A30S	Pipeline - Light Grinding/Cutting	Fast Cut	13,580	5
4-1/2"	1/4"	7/8"	49-94-4570	C24T	Concrete Grinding	Aggressive Material Removal	13,580	10
4-1/2"	1/4"	7/8"	49-94-4580	ZA24R	Metal Grinding	Extra Long Life	13,580	10
4-1/2"	1/4"	5/8"-11	49-94-4585	ZA24R	Metal Grinding	Extra Long Life	13,580	5
5"	1/8"	7/8"	49-94-5010	A30S	Pipeline - Light Grinding/Cutting	Fast Cut	12,225	10
5"	1/4"	7/8"	49-94-5020	A24R	Metal/Stainless Grinding	Long Life	12,225	10
5"	1/4"	7/8"	49-94-5730	C24T	Concrete Grinding	Aggressive Material Removal	12,225	10
5"	1/8"	7/8"	49-94-5740	C24T	Concrete Grinding	Aggressive Material Removal	12,225	10
5"	1/4"	7/8"	49-94-5080	ZA24R	Metal/Stainless Cutting	Extra Long Life	12,225	10
6"	1/4"	5/8"-11	49-94-6330	A24R	Metal/Stainless Grinding	Long Life	10,185	5
6"	1/4"	5/8"	49-94-6340	A24R	Metal/Stainless Grinding	Long Life	10,185	10
6"	1/8"	5/8"-11	49-94-6360	A30S	Pipeline - Light Grinding/Cutting	Fast Cut	10,185	5
7"	1/8"	5/8"-11	49-94-7015	A30S	Pipeline - Light Grinding/Cutting	Fast Cut	8,600	5
7"	1/4"	7/8"	49-94-7020	A24R	Metal/Stainless Grinding	Long Life	8,600	10
7"	1/4"	5/8"-11	49-94-7025	A24R	Metal/Stainless Grinding	Long Life	8,600	5
7"	1/4"	5/8"-11	49-94-7735	C24T	Concrete Grinding	Aggressive Material Removal	8,600	5
7"	1/8"	5/8"-11	49-94-7075	ZA24R	Pipeline - Light Grinding/Cutting	Extra Long Life	8,600	5
7"	1/4"	5/8"-11	49-94-7085	ZA24R	Metal Grinding	Extra Long Life	8,600	5
9"	1/8"	5/8"-11	49-94-9015	A30S	Pipeline - Light Grinding/Cutting	Fast Cut	6,600	10
9"	1/4"	5/8"-11	49-94-9025	A24R	Metal/Stainless Grinding	Long Life	6,600	10
9"	1/4"	5/8"-11	49-94-9735	C24T	Concrete Grinding	Aggressive Material Removal	6,600	10
9"	1/4"	5/8"-11	49-94-9085	ZA24R	Metal Grinding	Extra Long Life	6,600	10
ALUMINUM OXIDE RESINOID BOND GRINDING WHEELS (FOR USE WITH STRAIGHT GRINDERS ONLY)								
2-1/2"	1/2"	3/8"	49-92-0200	60 Grit	For use with Straight Grinders	Long Life	21,000	1
2-1/2"	1/2"	3/8"	49-92-0250	36 Grit	For use with Straight Grinders	Long Life	21,000	1
3"	1/2"	3/8"	49-92-0500	36 Grit	For use with Straight Grinders	Long Life	18,000	1
3"	1/2"	3/8"	49-92-0510	60 Grit	For use with Straight Grinders	Long Life	18,000	1
5"	1"	5/8"	49-92-2240	24 Grit	For use with Straight Grinders	Long Life	7,260	1
6"	1"	5/8"	49-92-3260	24 Grit	For use with Straight Grinders	Long Life	6,000	1

*Includes diamond knockout

ABRASIVE SANDING DISCS

BACKING PAD ASSEMBLIES

POLYPROPYLENE PAD



**RUBBER PAD
STANDARD
PHENOLIC
DISC**



RUBBER PAD



**SPIRAL
RUBBER
PAD**



**ABRASIVE
SANDING DISC**

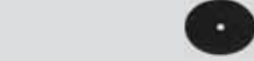

DISC NUT

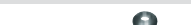
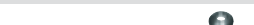

Part Number	Diameter	Thread	Max RPM
SPIRAL RUBBER PAD ASSEMBLIES (INCLUDES RUBBER PAD AND DISC NUT)			
49-36-3800	7"	5/8"-11	7,500
49-36-3850	9"	5/8"-11	6,000
49-40-0360	Disc Nut Only	5/8"-11	-
RUBBER PAD ASSEMBLIES (INCLUDES RUBBER PAD AND DISC NUT)			
49-36-3700	7"	5/8"-11	8,500
49-36-3750	9"	5/8"-11	7,500
49-40-0360	Disc Nut Only	5/8"-11	-
STANDARD PHENOLIC DISC ASSEMBLIES (INCLUDES RUBBER PAD AND DISC NUT)			
49-36-6000	7"	5/8"-11	6,000
49-36-6050	9"	5/8"-11	5,000
49-40-0350	Disc Nut Only	5/8"-11	-
PHENOLIC DISC ONLY (WHEN PURCHASED SEPARATELY)			
48-80-6000	7"	5/8"-11	7,000
48-80-6050	9"	5/8"-11	7,000
49-36-3500	Rubber Pad Only	-	7,000
49-40-0350	Disc Nut Only	5/8"-11	-

Part Number	Diameter	Thread	Max RPM
POLYPROPYLENE PAD KITS (INCLUDES BACKING PAD AND DISC NUT)			
49-36-3455	4-1/2"	5/8"-11	13,000
49-36-3450	4-1/2"	1/2"-13	13,000
49-36-3465	5"	5/8"-11	13,000
49-36-3460	5"	1/2"-13	13,000
POLYPROPYLENE PADS			
49-36-3452	4-1/2"	1/2"-13	13,000
49-36-3453	4-1/2"	5/8"-11	13,000
49-36-3462	5"	1/2"-13	13,000
49-36-3463	5"	5/8"-11	13,000
49-36-3900	7"	5/8"-11	10,000
49-36-3950	9"	5/8"-11	5,000
49-40-0350	Disc Nut	5/8"-11	-
49-40-0360	Disc Nut	5/8"-11	-
49-40-0370	Disc Nut	1/2"-13	-

RESIN BONDED ABRASIVE SANDING DISCS

Grit	4-1/2" 13,000 MAX RPM	5" 13,000 MAX RPM	7" 7,000 MAX RPM	9" 7,000 MAX RPM	Qty
ALUMINA ZIRCONIA RESIN FIBRE DISCS - FOR HEAVY WELD AND METAL GRINDING - IDEAL FOR ALL FERROUS METALS					
24	48-80-0681	48-80-0693	48-80-0705	48-80-0717	25
36	48-80-0683	48-80-0695	48-80-0707	48-80-0719	25
50	48-80-0685	48-80-0697	48-80-0709	48-80-0723	25
60	48-80-0687	48-80-0699	48-80-0713	48-80-0725	25
80	48-80-0689	48-80-0703	48-80-0715	48-80-0727	25
ALUMINUM OXIDE RESIN FIBRE DISCS - FOR ALUMINUM AND NON-FERROUS METALS, WOOD AND FIBERGLASS					
24	48-80-0622	48-80-0636	48-80-0652	-	5
24	48-80-0623	48-80-0637	48-80-0653	48-80-0667	25
36	48-80-0626	48-80-0642	48-80-0656	-	5
36	48-80-0627	48-80-0643	48-80-0657	48-80-0673	25
50	48-80-0632	48-80-0646	48-80-0662	-	5
50	48-80-0633	48-80-0647	48-80-0663	48-80-0677	25
CERAMIC RESIN FIBRE DISCS - FOR CARBON ALLOY APPLICATIONS ONLY - LONG LASTING AND SUPERIOR PERFORMANCE					
24	48-80-0770	48-80-0812	48-80-0820	48-80-0830	5
36	48-80-0780	48-80-0814	48-80-0822	48-80-0832	5
50	48-80-0790	48-80-0815	48-80-0824	48-80-0834	5
60	48-80-0800	48-80-0816	48-80-0826	48-80-0836	5
80	48-80-0810	48-80-0817	48-80-0828	48-80-0838	5
ALUMINUM OXIDE RESIN FIBRE DISCS - GENERAL PURPOSE - FOR RUST AND SCALE REMOVAL LIGHT GRINDING OF VARIOUS METALS					
ASSORT*	48-80-0501	48-80-0534	48-80-0572	-	5
16	-	-	48-80-0575	-	5
16	-	-	48-80-0576	48-80-0603	25
24	48-80-0504	48-80-0536	48-80-0579	-	5
24	48-80-0505	48-80-0537	48-80-0580	48-80-0605	25
36	48-80-0508	48-80-0542	48-80-0583	-	5
36	48-80-0509	48-80-0543	48-80-0584	48-80-0607	25
50	48-80-0514	48-80-0548	48-80-0587	-	5
50	48-80-0515	48-80-0549	48-80-0588	48-80-0609	25
60	48-80-0518	48-80-0554	48-80-0591	-	5
60	48-80-0519	48-80-0555	48-80-0592	48-80-0613	25
80	48-80-0524	48-80-0560	48-80-0595	-	5
80	48-80-0525	48-80-0561	48-80-0596	48-80-0615	25
120	48-80-0528	48-80-0566	48-80-0599	-	5
120	48-80-0529	48-80-0567	48-80-0601	48-80-0617	25

DISC TRIMMER



Disc Trimmer
49-80-1000

Upper and Lower Blade Set
49-80-1155

*Includes one each of: 36, 50, 60, 80 and 120 grit discs

FLAP DISCS & WIRE BRUSHES/WHEELS



FLAP DISCS



TYPE 27







TYPE 27 EXTRA THICK







TYPE 29

Size	Arbor	Part Number	Abrasive Spec.	Grit Spec.	Applications	Max RPM	Case Qty
TYPE 27							
4-1/2"	7/8"	48-80-8100	Zirconia Alumina	36	Stock removal, deburring, blending welds, edge chamfering	13,300	5
4-1/2"	7/8"	48-80-8101	Zirconia Alumina	60	Surface preparation, cleaning and finishing	13,300	5
4-1/2"	7/8"	48-80-8102	Zirconia Alumina	80	Surface preparation, cleaning and finishing	13,300	5
4-1/2"	5/8"-11	48-80-8110	Zirconia Alumina	36	Stock removal, deburring, blending welds, edge chamfering	13,300	5
4-1/2"	5/8"-11	48-80-8111	Zirconia Alumina	60	Surface preparation, cleaning and finishing	13,300	5
4-1/2"	5/8"-11	48-80-8112	Zirconia Alumina	80	Surface preparation, cleaning and finishing	13,300	5
TYPE 27 - EXTRA THICK							
4-1/2"	7/8"	48-80-8200	Zirconia Alumina	36	Stock removal, deburring, blending welds, edge chamfering	13,000	5
4-1/2"	7/8"	48-80-8201	Zirconia Alumina	60	Surface preparation, cleaning and finishing	13,000	5
4-1/2"	7/8"	48-80-8202	Zirconia Alumina	80	Surface preparation, cleaning and finishing	13,000	5
TYPE 29							
4-1/2"	7/8"	48-80-8000	Zirconia Alumina	36	Stock removal, deburring, blending welds, edge chamfering	13,300	5
4-1/2"	7/8"	48-80-8001	Zirconia Alumina	60	Surface preparation, cleaning and finishing	13,300	5
4-1/2"	7/8"	48-80-8002	Zirconia Alumina	80	Surface preparation, cleaning and finishing	13,300	5
4-1/2"	5/8"-11	48-80-8010	Zirconia Alumina	36	Stock removal, deburring, blending welds, edge chamfering	13,300	5
4-1/2"	5/8"-11	48-80-8011	Zirconia Alumina	60	Surface preparation, cleaning and finishing	13,300	5
4-1/2"	5/8"-11	48-80-8012	Zirconia Alumina	80	Surface preparation, cleaning and finishing	13,300	5
5"	7/8"	48-80-8020	Zirconia Alumina	36	Stock removal, deburring, blending welds, edge chamfering	12,000	5
5"	7/8"	48-80-8021	Zirconia Alumina	60	Surface preparation, cleaning and finishing	12,000	5
5"	7/8"	48-80-8022	Zirconia Alumina	80	Surface preparation, cleaning and finishing	12,000	5
7"	7/8"	48-80-8030	Zirconia Alumina	36	Stock removal, deburring, blending welds, edge chamfering	8,600	5
7"	7/8"	48-80-8031	Zirconia Alumina	60	Surface preparation, cleaning and finishing	8,600	5
7"	7/8"	48-80-8032	Zirconia Alumina	80	Surface preparation, cleaning and finishing	8,600	5
7"	5/8"-11	48-80-8040	Zirconia Alumina	36	Stock removal, deburring, blending welds, edge chamfering	8,600	5
7"	5/8"-11	48-80-8041	Zirconia Alumina	60	Surface preparation, cleaning and finishing	8,600	5
7"	5/8"-11	48-80-8042	Zirconia Alumina	80	Surface preparation, cleaning and finishing	8,600	5

WIRE BRUSHES

Description	Diameter	Thread	Wire Thickness	Max RPM	Carbon Steel	Stainless Steel
 KNOT WIRE CUP BRUSH	2-3/4"	5/8"-11	0.020"	12,000	48-52-5040	48-52-5050
	3-1/2"	5/8"-11	0.020"	13,000	48-52-5067	-
	4"	5/8"-11	0.020"	7,000	48-52-1350	-
	6"	5/8"-11	0.020"	6,000	48-52-1650	-
 CRIMPED WIRE CUP BRUSH	3"	5/8"-11	0.012"	12,000	48-52-5060	-
	3-1/2"	5/8"-11	0.014"	12,000	48-52-5065	-
	4"	5/8"-11	0.014"	7,000	48-52-1300	-
	5"	5/8"-11	0.020"	8,000	48-52-1400	-
 BEVEL KNOT BRUSH	4"	5/8"-11	0.020"	12,000	48-52-1305	48-52-1315
	 BEVEL CRIMPED BRUSH	4"	5/8"-11	0.014"	12,000	48-52-1325

WIRE WHEELS

Description	Diameter	Thread	Wire Thickness	Max RPM	Carbon Steel	Stainless Steel
 STRINGER BEAD WIRE WHEEL	4"	5/8"-11	0.020"	12,000	48-52-5010	48-52-5000
	4"	1/2"-13	0.020"	12,000	-	-
	5"	5/8"-11	0.020"	12,500	48-52-1700	-
	6"	5/8"-11	0.020"	9,500	48-52-1715	-
 FULL CABLE TWIST KNOT WIRE WHEEL	4"	5/8"-11	0.020"	12,000	48-52-5030	48-52-5020
	4"	1/2"-13	0.020"	12,000	-	-
	5"	5/8"-11	0.020"	12,500	-	-
 RADIAL CRIMPED WIRE WHEEL	4"	5/8"-11	0.014"	12,000	48-52-5070	-
	4"	1/2"-13	0.014"	12,000	-	-
	 KNOT WIRE WHEEL - FOR USE WITH STRAIGHT GRINDERS ONLY	3"	3/8"-1/2"	0.014"	25,000	-
5"		5/8"	0.014"	8,000	-	-
	6"	1/2"-5/8"	0.014"	8,000	-	-

THREADED ADAPTERS

Part Number	Description
48-03-1005	5/8"-11 - M10 x 1.25
48-03-1010	5/8"-11 - M10 x 1.50



FLAP DISCS & UNIVERSAL GRINDING DUST SHROUDS

HOOK AND LOOP FOAM PADS, BLENDED WOOL PADS, AND TWISTED, TUFTED WOOL PADS



Diameter	Depth of Pile	Part Number	Description	Application
8"	2"	49-36-0650*	White Foam Polishing Pad	Removes swirls on clearcoat, gelcoat and most finishes. Produces medium to high gloss
7-1/2"	1-3/8"	49-36-1550*	Yellow Foam Compounding Pad	Compounding removes 1500-2000 sand scratches. Produces low to medium gloss
8"	2"	49-36-0670*	Red Foam Finishing Pad	Final finishing on clearcoat, gelcoat and most finishes. For applying waxes and polish/sealants, produces high gloss finish
7-1/2"	1-1/2"	49-36-0600*	Blended Wool Pad	For polishing clearcoat, gelcoat and most finishes. Produces medium gloss
7-1/2"	1-1/2"	49-36-0500**	Blended Wool Pad	For polishing clearcoat, gelcoat and most finishes. Produces medium gloss
9"	1-1/2"	49-36-0700**	Blended Wool Pad	For polishing clearcoat, gelcoat and most finishes. Produces medium gloss
7-1/2"	1-1/2"	49-36-1500*	Twisted, Tufted 100% Wool Pad	Deep cleaning and compounding removes 1200-1500 sand scratches on clearcoat, gelcoat and most finishes. Produces low gloss
7-1/2"	1-1/2"	49-36-1450**	Twisted, Tufted 100% Wool Pad	Deep cleaning and compounding removes 1200-1500 sand scratches on clearcoat, gelcoat and most finishes. Produces low gloss
7-1/2"	2"	49-36-1455**	Twisted, Tufted 100% Wool Pad	Deep cleaning and compounding removes 1200-1500 sand scratches on clearcoat, gelcoat and most finishes. Produces low gloss
9"	1-1/2"	49-36-1600**	Twisted, Tufted 100% Wool Pad	Deep cleaning and compounding removes 1200-1500 sand scratches on clearcoat, gelcoat and most finishes. Produces low gloss
7"	1-1/2"	48-48-0500**	Blended Wool Acrylic Pad (tie on)	For polishing clearcoat, gelcoat and most finishes. Produces medium gloss
9"	1-1/2"	48-48-1000**	Blended Wool Acrylic Pad (tie on)	For polishing clearcoat, gelcoat and most finishes. Produces medium gloss
6-1/4"	-	49-36-2175	Hook and Loop Molded Urethane Back Up Plate	Flexible molded urethane provides forgiving flexibility lowering risk of spot heating and finish burning (includes centering tool)
7"	-	49-36-2500	Molded Rubber Backing Pad	Specifically designed to bolt buffing/polishing pads onto 5460-6, 5540 and 5455 speed control polishers (nut and washer sold separately)
8-1/2"	-	49-36-2200	Molded Rubber Backing Pad	Specifically designed to bolt buffing/polishing pads onto 5460-6, 5540 and 5455 speed control polishers (nut and washer sold separately)
-	-	49-67-0130	Pad Centering Tool	

*Hook and loop attachment, no disc nut needed

**Traditional bolt-on and tie attachment, requires appropriate rubber backing pad (49-36-2500 or 49-36-2200)

49-40-6100 4"-5" Universal Surface Grinding Dust Shroud



FEATURES

- Provides a dust free environment during concrete finishing, concrete material removal and Paint/Surface coating removal
- 5" shroud fits on most 4-1/2" to 6" Small Angle Grinders (maximum accessory size of 5")
- Quick and easy installation – attach, tighten and go
- Removable front edge clip for grinding against walls
- High density bristles provide maximum dust collection and containment

ATTACHMENTS



49-40-6190: 18" Hose Adaptor

49-40-6105 7" Universal Surface Grinding Dust Shroud



FEATURES

- Provides a dust free environment during concrete finishing, concrete material removal and Paint/Surface coating removal
- 7" shroud fits on most 7" to 9" Large Angle Grinders (maximum accessory size of 7")
- Quick and easy installation – attach, tighten and go
- Removable front edge clip for grinding against walls
- High density bristles provide maximum dust collection and containment

ATTACHMENTS



49-40-6190: 18" Hose Adaptor

SANDERS



6020-21 1/4" Sheet Palm Sander



FEATURES



- 3.0 Amp Permanent Magnet Motor with 14,000 Orbits Per Minute – Powerful, light weight motor produces dependable speed and power
- Pad Cushioning and Break- Reduces swirl marks and ensures a smoother finish
- Tactile Rubber Top and Body Grip Surface and Narrow Sander Body- Ergonomic design provides added comfort and control and reduces user fatigue from any angle
- Large Paper Clamp Tabs -Allows for effortless paper changes
- Integrated Vacuum Ports -Fits 1-1/4" or 2-1/4" hoses for efficient dust removal
- In-Line Dust Port with Flexible Dust Collection Bag- Captures maximum amount of dust without compromising site line
- Removable Top- Allows for easy service and brush replacement

Includes: (1) 1/4" Sheet Palm Sander (6020-21); (1) 1/4" Sheet Punch Pad; (1) Carrying Case; (1) Dust Bag; (3) Pieces of 1/4" Sheet Sandpaper: 180 Grit, 200 Grit, 220 Grit

SPECIFICATIONS

Length	5-1/2"
Weight	3.3 lbs
Voltage	120V AC
Cord Type	8' Fixed
Amps	3
Construction Type	Double Insulated
No Load OPM	14,000
Pad Size	4-1/4" x 4"
Dust Collection	Yes
Dia of Orbit	1/16"
Sandpaper Size	1/4" Sheet
Motor	Permanent Magnet

6021-21 5" Random Orbit Palm Sander



FEATURES



- 3.0 Amp Permanent Magnet Motor- Powerful, light weight motor produces dependable speed and power
- Variable Speed Dial: 7,000-12,000 Orbits Per Minute- Match optimal sanding speed to various applications
- Electronic Soft Start- quickly, steadily ramps the motor up in stages, thus reducing tool jerking and wear on the brushes and bearings
- Pad Cushioning and Break- Reduces swirl marks and ensures a smoother finish
- Integrated Vacuum Ports- Fits 1-1/4" or 2-1/4" hoses for efficient dust removal
- Tactile Rubber Top and Body Grip Surface and Narrow Sander Body – Ergonomic design provides added comfort and control and reduces user fatigue from any angle

Includes: (1) 5" Random Orbit Palm Sander (6021-21); (1) Carrying Case; (1) Dust Bag

SPECIFICATIONS

Length	5-1/2"
Weight	3.3 lbs
Voltage	120V AC
Tool Warranty	5 Years
Cord Type	8' Fixed
Amps	3
Construction Type	Double Insulated
No Load OPM	7,000-12,000
Pad Size	5"
Dust Collection	Yes
Dia of Orbit	3-32"
Sandpaper Size	5"
Motor	Permanent Magnet



SANDERS

6065-6 3.5 max HP, 7"/9" Sander, 5000 RPM

6066-6 3.5 max HP, 7"/9" Sander, 6000RPM



FEATURES



- 3.5 maximum horsepower, 15 amp motor
- 7 inch or 9 inch capacity, 5,000 RPM, AC-DC
- Spiral bevel gearing for performance and durability
- Sander may be converted to grinder by using the proper wheel guard

Includes: (1) 3.5 max HP, 7"/9" Sander, 5000 RPM (6065-6); (1) Flange; (1) Nylon Washer; (1) Side Handle

SPECIFICATIONS

Length	17-1/2"
Weight	12.0 lbs
Voltage	120 AC/DC
Cord Type	9' Fixed
Electronic Feedback	No
No Load RPM	5,000
Amps	15
Trigger Lock	Yes
Spindle	5/8"-11
Construction Type	Grounded
Max HP	3.5
Spindle Lock	Yes
Adjustable Handle	No
Wheel Diameter	7"/9"

FEATURES



- 3.5 maximum horsepower, 15 amp motor
- 7 inch or 9 inch capacity, 6000 RPM, AC-DC
- Spiral bevel gearing for performance and durability
- Sander may be converted to grinder by using the proper wheel guard

Includes: (1) 3.5 max HP, 7"/9" Sander, 6000 RPM (6066-6); (1) Flange; (1) Nylon Washer; (1) Side Handle

SPECIFICATIONS

Length	17-1/2"
Weight	12.0 lbs
Voltage	120 AC/DC
Cord Type	9' Fixed
Electronic Feedback	No
No Load RPM	6,000
Amps	15
Trigger Lock	Yes
Spindle	5/8"-11
Construction Type	Grounded
Max HP	3.5
Spindle Lock	Yes
Adjustable Handle	No
Wheel Diameter	7"/9"

SANDERS



6072

2.25 max HP, 7"/9" Sander, 5000RPM



FEATURES



- 2.25 maximum horsepower, 13 amp motor
- 7 inch or 9 inch capacity, 5,000 RPM, AC-DC
- Spiral bevel gearing for performance and durability
- Sander may be converted to grinder by using the proper wheel guard

Includes: (1) 2.25 max HP, 7"/9" Sander, 5000 RPM (6072); (1) Flange; (1) Nylon Washer; (1) Side Handle

SPECIFICATIONS

Length	17"
Weight	9.3 lbs
Voltage	120 AC/DC
Cord Type	9' Fixed
Electronic Feedback	No
No Load RPM	5,000
Amps	13
Trigger Lock	Yes
Spindle	5/8"-11
Construction Type	Double Insulated
Max HP	2.2
Spindle Lock	Yes
Adjustable Handle	No
Wheel Diameter	7"/9"

6078

2.25 max HP, 7"/9" Sander, 6000RPM



FEATURES



- 2.25 maximum horsepower, 13 amp motor
- 7 inch or 9 inch capacity, AC only
- Dial speed control 0-6000 RPM
- 10 ft., 2-wire Quik-Lok® cord set

Includes: (1) 2.25 max HP, 7"/9" Sander, 6000 RPM (6078); (1) Flange; (1) Nylon Washer; (1) Side Handle

SPECIFICATIONS

Length	17"
Weight	9.3 lbs
Cord Type	10' QUIK-LOK®
Electronic Feedback	No
No Load RPM	0-6,000
Amps	13
Trigger Lock	Yes
Spindle	5/8"-11
Construction Type	Double Insulated
Max HP	2.2
Spindle Lock	Yes
Adjustable Handle	No
Wheel Diameter	7"/9"

ATTACHMENTS



48-76-5010: 10' Quik-Lok®



48-76-5025: 25' Quik-Lok®



DIE GRINDERS

5192

4.5-Amp Die Grinder



FEATURES



- Powerful 4.5-amp motor: Delivers up to 21,000 RPM for faster grinding
- All ball and roller bearings: Built for endurance
- Versatile chuck: Accepts 1/4" and 1/8" collets for greater utility
- 8-ft. fixed rubber cord: Durable construction for long tool life

Includes: (1) 4.5-Amp Die Grinder (5192); (1) 11/16" Open End Wrench; (1) 1/2" Open End Wrench

SPECIFICATIONS

Length	13-1/2"
Weight	4.5 lbs
Voltage	120 AC/DC
Tool Warranty	5 Years
No Load Speed	21,000 RPM
Cord Type	8' Fixed
No Load RPM	21,000

5194

4.5-Amp Die Grinder



FEATURES



- Powerful 4.5-amp motor: Delivers up to 21,000 RPM for faster grinding
- All ball and roller bearings: Built for endurance
- Versatile chuck: Accepts 1/4" and 1/8" collets for greater utility
- 8-ft. fixed rubber cord: Durable construction for long tool life

Includes: (1) 4.5-Amp Die Grinder (5194); (1) 11/16" Open End Wrench; (1) 1/2" Open End Wrench

SPECIFICATIONS

Length	13-1/2"
Weight	4.5 lbs
Voltage	120 AC/DC
Tool Warranty	5 Years
No Load Speed	21,000 RPM
Cord Type	8' Fixed
No Load RPM	21,000

DIE GRINDERS



5196

11-Amp Die Grinder



FEATURES



AC/DC

- Powerful 11-amp motor: Delivers up to 14,500 RPM for faster grinding
- All ball and roller bearings: Built for endurance
- Versatile chuck: Accepts 1/4" and 1/8" collets for greater utility
- 8-ft. fixed rubber cord: Durable construction for long tool life

Includes: (1) 11-Amp Die Grinder (5196); (1) 1" Open End Wrench; (1) 11/16" Open End Wrench; (1) 1/2" Open End Wrench

SPECIFICATIONS

Length	21-1/2"
Weight	7.8 lbs
Voltage	120 AC/DC
Tool Warranty	5 Years
No Load Speed	14,500 RPM
No Load RPM	14,500
Amps	11
Trigger Lock	On

5211

3" Diameter Straight Grinder



FEATURES



AC/DC

- Powerful 11-amp motor: Delivers up to 14,500 RPM for faster grinding
- 3 in. diameter wheel
- Coated spindle housing for cool gripping surface
- Hinged face plate for quick easy wheel replacement

Includes: (1) 1" Wrench; (1) 3" Diameter Straight Grinder (5211); (1) 9/16" Wrench; (1) Wheel Guard

SPECIFICATIONS

Length	21"
Weight	7.8 lbs
Voltage	120 AC/DC
Tool Warranty	5 Years
No Load Speed	14,500 RPM
Cord Type	9' Fixed
No Load RPM	14,500
Amps	11
Trigger Lock	On
Spindle	3/8"-24
Wheel Diameter	3"



DIE GRINDERS & BANDFILE

5243 6" Diameter Straight Grinder



FEATURES



- 5500 rpm, 15 amp
- 6 in. diameter wheel
- Coated spindle housing for cool gripping surface
- Hinged face plate for quick easy wheel replacement

Includes: (1) 6" Diameter Straight Grinder (5243); (1) 1-1/16" Inch Wrench; (1) Grinding Wheel; (1) Spanner Wrench; (1) Wheel Guard

SPECIFICATIONS

Length	22"
Weight	16.5 lbs
Voltage	120 AC/DC
Tool Warranty	5 Years
No Load Speed	5,500 RPM
Cord Type	9' Fixed
No Load RPM	5,500
Amps	15
Trigger Lock	On
Spindle	5/8"-11
Wheel Diameter	6"

6101-6 5.5 Amp Bandfile



FEATURES



- 5.5 amp, 2,300 SFPM, AC/DC
- 1/2 inch x 18 inch Contact Arm
- 180° adjustable head
- 3 position side handle

Includes: (1) 5.5 Amp Bandfile (6101-6); (1) 1/2" Arm; (1) Bandfile Belt Assortment; (1) Side Handle

SPECIFICATIONS

Length	18-1/2"
Weight	6.0 lbs
Voltage	120 AC/DC
Tool Warranty	5 Years
Cord Type	8' Fixed
Amps	5.5
Spindle	5/8"-11
Construction Type	Double Insulated
Capacity	1/2" x 18"

ROUTERS



5615-20 1-3/4 Max HP BodyGrip® Router



FEATURES



- Exclusive BodyGrip® Design
- 1-3/4 Max HP, 11 Amp, 24,000 RPM Milwaukee Motor
- Exclusive Linear Depth Adjustment System
- 1/4" and 1/2" premium self-releasing collets

Includes: (1) 1-3/4 Max HP BodyGrip® Router (5615-20); (2) 1-1/8" Collet Wrenches; (1) 1/2" Collet; (1) 1/4" Collet

SPECIFICATIONS

Weight	8.8 lbs
Voltage	120 AC/DC
Tool Warranty	5 Years
Cord Type	8' Fixed
Electronic Feedback	No
No Load RPM	24,000 RPM
Amps	11
Construction Type	Double Insulated
Max HP	1.7
Base	6" Body Grip
Depth Adjustment	1-21/32"
Collet Diameter	1/4"-1/2"
Dial Speed Control	No
Height	8-1/2"

5615-21 1-3/4 Max HP BodyGrip® Router Kit



Includes: (1) 1-3/4 Max HP BodyGrip® Router (5615-20); (2) 1 1/8" Collet Wrenches; (1) 1/2" Collet; (1) 1/4" Collet; (1) Carrying Case

5615-24 1-3/4 Max HP Multi-Base Router Kit



FEATURES



- Premium plunge system with exclusive four-point PM bushing design and constant spring tension to deliver smooth, non-binding plunge action throughout the entire plunge range (2-7/8 in.)
- Patented BodyGrip® design with precise macro/micro linear depth adjustment system and patented above the table height adjustment
- Precise macro/micro depth adjustment system to 1/64 in. increment, 3 in. metal depth scale, adjustable pointer, and 6-position (1/8 in. increment) adjustable metal turret stops for precise, multiple-pass routing

Includes: (1) 1-3/4 Max HP BodyGrip® Router (5615-20); (2) 1 1/8" Collet Wrenches; (1) 1/2" Collet; (1) 1/4" Collet; (1) Carrying Case; (2) Clear Sub-Bases; (1) Concentricity Gauge; (1) Dust Shield; (1) Fixed Based Assembly; (1) Plunge Base Assembly

SPECIFICATIONS

Weight	8.8 lbs
Voltage	120 AC/DC
Tool Warranty	5 Years
Cord Type	8' Fixed
Electronic Feedback	No
No Load RPM	24,000 RPM
Amps	11
Construction Type	Double Insulated
Max HP	1.7
Base	6" Plunge
Depth Adjustment	1-21/32"
Collet Diameter	1/4"-1/2"
Plunge Stroke	2-7/8"
Dial Speed Control	No
Height	8-1/2"



ROUTERS

5616-20 2-1/4 Max HP EVS BodyGrip® Router



FEATURES



- Exclusive BodyGrip® design
- Powerful 13 amp, 2-1/4 max hp Milwaukee motor
- Premium electronic motor feedback maintains speed and power under load
- Electronic variable speed with soft start (10,000-24,000 rpm)
- Micro-fine linear depth adjustment to within 1/64 in.
- Exclusive above-the-table depth adjustment system
- Exclusive motor contamination shield minimizes damage, maximizes airflow

Includes: (1) 2-1/4 Max HP EVS BodyGrip® Router (5616-20); (2) 1 1/8" Collet Wrenches; (1) 1/2" Collet; (1) 1/4" Collet; (1) T-Handle Wrench

SPECIFICATIONS

Weight	8.8 lbs
Voltage	120V AC
Tool Warranty	5 Years
Cord Type	8' Fixed
Electronic Feedback	Yes
No Load RPM	10,000-24,000
Amps	13
Construction Type	Double Insulated
Max HP	2.2
Depth Adjustment	1-21/32"
Collet Diameter	1/4"-1/2"
Height	8-1/2"

5616-24 2-1/4 Max HP EVS Multi-Base Router Kit



FEATURES



- Premium plunge system with exclusive four-point PM bushing design and constant spring tension to deliver smooth, non-binding plunge action throughout the entire plunge range (2-7/8 in.)
- Patented BodyGrip® design with precise macro/micro linear depth adjustment system and patented above the table height adjustment
- Precise macro/micro depth adjustment system to 1/64 in. increment, 3 in. metal depth scale, adjustable pointer, and 6-position (1/8 in. increment) adjustable metal turret stops for precise, multiple-pass routing
- Exclusive motor shield design
- Electronic variable speed with soft start (10,000 - 24,000 RPM)

Includes: (1) 2-1/4 Max HP EVS Multi-Base Router Kit (5616-24); (2) 1-1/8" Collet Wrenches; (1) 1/2" Collet; (1) 1/4" Collet; (1) Carrying Case; (2) Clear Sub-Bases; (1) Concentricity Gauge; (1) Dust Shield; (1) Fixed Based Assembly; (1) Plunge Base Assembly

SPECIFICATIONS

Weight	8.8 lbs
Voltage	120V AC
Tool Warranty	5 Years
Cord Type	8' Fixed
Electronic Feedback	Yes
No Load RPM	10,000-24,000
Amps	13
Construction Type	Double Insulated
Max HP	2.2
Base	6" Plunge
Depth Adjustment	1-21/32"
Collet Diameter	1/4"-1/2"
Plunge Stroke	2-7/8"
Dial Speed Control	Yes
Height	8-1/2"

5616-21 2-1/4 Max HP EVS BodyGrip® Router Kit with Case



Includes: (1) 2-1/4 Max HP EVS BodyGrip® Router (5616-20); (2) 1-1/8" Collet Wrenches; (1) 1/2" Collet; (1) 1/4" Collet; (1) Carrying Case; (1) T-Handle Wrench

ROUTERS



5619-20 1-3/4 Max HP D-Handle Router



FEATURES



- 1-3/4 Max HP, 11 Amp, 24,000 RPM Milwaukee Motor
- Soft-Grip D-Handle with lock-on trigger switch
- Exclusive Linear Depth Adjustment System
- 1/4 in. and 1/2 in. premium self-releasing collets

Includes: (1) 1-3/4 Max HP D-Handle Router (5619-20); (2) 1-1/8" Collet Wrenches; (1) 1/2" Collet; (1) 1/4" Collet

SPECIFICATIONS

Weight	9.2 lbs
Voltage	120 AC/DC
Tool Warranty	5 Years
Cord Type	8' Fixed
Electronic Feedback	No
No Load RPM	24,000 RPM
Amps	11
Construction Type	Double Insulated
Max HP	1.7
Base	D-Handle
Depth Adjustment	1-21/32"
Collet Diameter	1/4"-1/2"
Height	8-1/2"

5625-20 3-1/2 Max HP Fixed-base Production Router



FEATURES



- Powerful 15 Amp, 3-1/2 max hp EVS Milwaukee Motor
- Electronic variable speed (10,000-22,000 rpm)
- Premium electronic feedback circuitry
- Exclusive Linear Depth Adjustment System with Above-the-Table Access

Includes: (1) 3-1/2 Max HP Fixed-Base Production Router (5625-20); (2) 1-1/8" Collet Wrenches; (1) 1/2" Collet; (1) 2-1/2" Sub-base; (1) T-Handle Wrench

SPECIFICATIONS

Weight	11.8 lbs
Voltage	120V AC
Tool Warranty	5 Years
Cord Type	8' Fixed
Electronic Feedback	Yes
No Load RPM	10,000-22,000
Amps	15
Construction Type	Double Insulated
Max HP	3.5
Base	7" Fixed 2 Handle
Depth Adjustment	1-21/32"
Collet Diameter	1/4"-1/2"
Dial Speed Control	Yes
Height	9-1/4"



ROUTER ACCESSORIES

IMAGE	CATALOG NO.	PURPOSE	QTY PKG*		(A) INNER DIM.	(B) OUTER DIM.	(C) DISTANCE PAST BASE	WIDTH	DEPTH	HEIGHT	WEIGHT (LBS.)
	49-54-0715	General Routing + lock-nut	1		9/32"	3/8"	5/16"	5.6"	3.8"	.8"	0.15
	49-54-0720	Dovetail 1/2" & General Routing + lock-nut	1		11/32"	7/16"	5/32"	5.6"	3.8"	.8"	0.15
	49-54-0730	General Routing + lock-nut	1		17/32"	5/8"	9/16"	5.6"	3.8"	.8"	0.15
	49-54-0740	Lock Face Routing + lock-nut	1		21/32"	3/4"	9/16"	5.6"	3.8"	.8"	0.15
	44-40-0170	Lock Nut For Template Guides	1		-	-	-	5.6"	3.8"	.8"	0.15

* Not available in Masterpacks

49-54-0700 Template Guide Kit - 9 Piece

Kit includes case, 7 template guides - 1 of each and 2 lock-nuts.

Note: Template guides must be used with 1-3/16" sub-base



Collet & Nut Assemblies

For Milwaukee Routers: 5615, 5616, 5619, 5625

48-66-1015 1/4" Collet & Nut Assemblies

48-66-1020 1/2" Collet & Nut Assemblies



Collets For Previous Milwaukee Routers 1.5 & 2.0 Max. HP Models

For Milwaukee Routers: 5610, 5620, 5650, 5660, 5670, 5680, 5681, 5682

48-66-0985 1/4" Collet

48-66-1000 3/8" Collet

48-66-1010 1/2" Collet



49-96-0370 Above-The-Table Depth Wrench

3/8" Hex drive wrench for use with above-the-table depth adjustment system - all models.

49-54-0101 Door And Jamb Butt Template Kit

Includes case, template, link rail assemblies, template nails, end gauges and hinge butt guide (49-54-0730) for use with MILWAUKEE Routers. Will mortise any 6'6", 6'8" or 7' door and any hinge size 2-1/2" to 5-1/2". Detailed instructions included. Additional template nails (12 per package) are available (49-54-0600).



49-96-0365 Collet Wrench

1-1/8" Forged collet wrench.



48-10-5615 Bodygrip® Base Assembly

For all BodyGrip® units (5615 & 5616 series). Base includes D-Handle, 2-1/2" center hole sub-base, two handles and motor lock lever.

48-10-5619 D-Handle Base Assembly

For 1-3/4" max horsepower D-Handle units (5619). Base includes D-Handle, 2-1/2" center hole sub-base, one handle and motor lock lever.

48-10-5600 Plunge Base Assembly

For 5615-24 or 5616-24.

48-10-5625 Base Assembly

For 3-1/2" max horsepower fixed base unit (5625-20). Base includes two tactile grip, removable handles, 2-1/2" center hole sub-base and motor lock lever.



Sub-Bases

Black

49-54-1040* 6" dia., 1-3/16" Center hole sub-base

49-54-1045* 6" dia., 2-1/2" Center hole sub-base

* For use with 5615, 5616, 5619

Clear

49-54-1026** 7" dia., 1-3/16" Center hole clear sub-base

** For use with 5625

VACUUM CLEANERS



8950

1-Stage Wet/Dry Vacuum Cleaner



FEATURES



- 8 gal., 7/8 bu. recovery capacity, 8.0 amp motor
- Positive water shut-off
- Can be used as a blower
- One-stage bypass motor for wet/dry operation

8955

1-Stage Wet/Dry Vacuum Cleaner



FEATURES



- 10 gal., 1-1/8 bu. recovery capacity, 8.0 amp motor
- Positive water shut-off
- Can be used as a blower
- One-stage bypass motor for wet/dry operation

8965

1-Stage Wet/Dry Vacuum Cleaner



FEATURES



- 10 gal., 1-1/8 bu. recovery capacity, 6.2 amp motor
- Positive water shut-off
- Three Wheel Dolly
- One-stage bypass motor for wet/dry operation

8911

2-Stage Wet/Dry Vacuum Cleaner



FEATURES



- 11 gal., 1-1/2 bu. recovery capacity, 7.5 amp motor
- For Wet or Dry pick-up with Positive water shut-off
- Heavy-duty filter system
- Two-stage bypass motor for wet/dry operation

8912

3-Stage Wet/Dry Vacuum Cleaner



FEATURES



- 11 gal., 1-1/2 bu. recovery capacity, 9.2 amp motor
- For Wet or Dry pick-up with Positive water shut-off
- Heavy-duty filter system
- Three-stage bypass motor for wet/dry operation

8925

3-Stage Wet/Dry Vacuum Cleaner



FEATURES



- 15 gal., 2 bu. recovery capacity, 9.2 amp motor
- For Wet or Dry pick-up with Positive water shut-off
- Stainless Steel Tank
- Three-stage bypass motor for wet/dry operation
- Bottom drain valve for easy water removal

8926

3-Stage Wet/Dry Vacuum Cleaner



FEATURES



- 21 gal., 2-1/4 bu. recovery capacity, 9.2 amp motor
- Front drain valve with hose connector
- Polyethylene tank resists rust and corrosive materials
- Three-stage bypass motor for wet/dry operation
- Use as blower – switch hose to exhaust for cleaning inaccessible areas

SPECIFICATIONS

CATALOG NUMBER	WEIGHT	VOLTAGE	AMPS	CAPACITY	SEALED SUCTION IN WATER	MAX AIR FLOW	MOTOR	MATERIAL	HEIGHT	WIDTH
8950	20 lbs	120V AC	8	8 Gal and 7/8 Bu	45"	143 CFM	1 Stage Bypass	Wet/Dry	22-1/2"	16-3/4"
8955	30.5 lbs	120V AC	8	10 Gal and 1-1/8 Bu	45"	143 CFM	1 Stage Bypass	Wet/Dry	38-1/2"	19-1/2"
8965	44.5 lbs	120V AC	6.2	10 Gal and 1-1/8 Bu	45"	133 CFM	1 Stage Bypass	Wet/Dry	35-5/8"	19-1/2"
8911	56.0 lbs	120V AC	7.5	11 Gal and 1-1/2 Bu	—	94 CFM	2 Stage Bypass	Wet/Dry	37"	22"
8912	56.0 lbs	120V AC	9.2	11 Gal and 1-1/2 Bu	134"	92 CFM	3 Stage Bypass	Wet/Dry	37"	22"
8925	56.0 lbs	120V AC	9.2	15 Gal and 2 Bu	134"	92 CFM	3 Stage Bypass	Wet/Dry	41"	22"
8926	56.0 lbs	120V AC	9.2	21 Gal and 2-1/4" Bu	134"	92 CFM	3 Stage Bypass	Wet/Dry	40"	21"

STANDARD EQUIPMENT: All models are equipped with 1-1/2" O.D. hose connections, cord with 3-prong grounded plug, 3 hold-down clamps and 3 or 4-wheel caddie (except no. 8950) with non-marring wheels. **FOR 8911, 8912 AND 8925** – Three paper filter bags, cloth filter, wire frame assembly, wet pick-up conversion pan, swivel connector and store-all tool bag. **FOR 8950** – 1-1/2" O.D. hose connections, cord with 3-prong grounded plug, 3 hold-down clamps, 7' x 1-1/2" I.D. vinyl hose, hose adapter and filter cartridge. **FOR 8955** – 1-1/2" O.D. hose connections, cord with 3-prong grounded plug, 3 hold-down clamps, 7' x 1-1/2" I.D. vinyl hose, hose adapter, filter cartridge and 3 wheel dolly. **FOR 8965** – 7' x 1-1/2" I.D. vinyl hose, hose adapter, cloth filter assembly, foam filter sleeve, 3 wheel dolly and three paper filter bags. **FOR 8926** – Five paper filter bags, cloth filter, wire frame assembly, wet pick-up conversion pan, swivel connector and store-all tool pouch.



VACUUM CLEANERS

8936-20 1-Stage Wet/Dry Vacuum Cleaner



FEATURES

- Easily Maneuverable
- High Efficiency Filtration System
- Durable Polypropylene Tank
- Handy Tool Caddy
- Ideal Applications – Manufacturing Plants, Utility Plants, Schools, Construction Sites, Service Stations, Warehouses, Shopping Malls, Hotels and many more.
- 3-Position Switch –On/Off/On Demand
- Built-In Sensor relay – Activates Vacuum When Power is Turned On
- 8.0 Amp Outlet Accepts 3-Prong Plug
- 12.0 Amp Circuit Breaker

Includes: (1) 1-Stage Wet/Dry Vacuum Cleaner (8936-20); (1) 1-1/2" Conversion Unit; (1) 7' x 1 1/2" Hose; (1) Filter Cartridge; (1) Dolly Caster Assembly; (1) Filter Bag; (1) Tool Basket

SPECIFICATIONS

Weight	20.94 lbs
Voltage	120VAC
Amps	9.5
Capacity	7-1/2 Gal and 7/8 Bu
Sealed Suction In Water	59"
Max Air Flow	143 CFM
Motor	1-Stage Bypass
Material	Wet/Dry
Height	20-3/4"
Width	14-5/8"

8938-20 2-Stage Wet/Dry Vacuum Cleaner



FEATURES

- Easily Maneuverable
- High Efficiency Filtration System
- Durable Polypropylene Tank
- Handy Tool Caddy
- Ideal Applications – Manufacturing Plants, Utility Plants, Schools, Construction Sites, Service Stations, Warehouses, Shopping Malls, Hotels and many more.
- Rear Drain Plug
- 35' Cord Set

Includes: (1) 2-Stage Wet/Dry Vacuum Cleaner (8938-20); (1) 1 1/2" Conversion Unit; (1) 7' x 1 1/2" Hose; (1) Filter Cartridge; (1) Filter Bag; (1) Tool Basket; (1) Vac Dolly

SPECIFICATIONS

Weight	39.16 lbs
Voltage	120VAC
Amps	7.4
Capacity	9 Gal and 1 Bu
Sealed Suction In Water	84"
Max Air Flow	102 CFM
Motor	2 Stage Bypass
Material	Wet/Dry
Height	33-1/2"
Width	16-1/8"

VACUUM ACCESSORIES



8945 3-Stage Vacuum Cleaner Motor Head

More powerful 3-stage motor head adapts to all 16" diameter. 11 gallon units and larger for extra-duty applications. Same as furnished with models 8912, 8925 and 8926. Maximum airflow is 92 Cu. Ft./Min. with sealed suction water lift of 134". Unit comes with a 30' cord and requires the use of 16" diameter conversion pan for wet pickup. Wire frame filter cage, cloth filter, gasket assembly and 16" dacron filter bag required for dry pickup. Order these and all accessories separately. Unit includes a swivel end connector, No. 49-90-0150. Net weight 19.0 lbs. Shipping weight 21.0 lbs.



49-90-1590 Drum Adapter

Fits your 55 gallon drum. Gasket secures tightly to drum when vacuum is in operation. Adaptable to Motor Head No. 8945 and those on Nos. 8911, 8912, 8925, 8926, 8927 and previous model 8916. Use 16" diameter accessories. Net weight 10.0 lbs. Shipping weight 11.0 lbs.

49-90-1100 Dolly

For 55 gallon drum. Sturdy steel construction with 4 wheels and long hinged handle. Drum easily tips off or on. Net weight 43.0 lbs. Shipping weight 45.0 lbs.

49-90-1670 Wet and Dry Cleaning Kit

A complete kit of accessories for the maintenance department.

Kit consists of 1 of each of the following:

- 49-90-0060 10' Hose
- 49-90-0550 Major Floor Tool
- 49-90-0580 Squeegee Shoe
- 49-90-0400 15" Crevice Tool
- 49-90-0600 14" Carpet Insert
- 49-90-0740 Utility Nozzle
- 49-90-1000 Double Bend Floor Wand



49-90-1810 Vacuum Accessory Kit

Accessories for general cleanup applications.

Kit consists of 1 pt each of the following:

- 49-90-1865 Wand
- 49-90-1770 Crevice Tool
- 49-90-1775 6" Nozzle
- 49-90-1845 14" Squeegee Shoe
- 49-90-1850 14" Rug Shoe
- 49-90-1840 Master Nozzle
- 49-90-1860 3" Round Brush
- 49-90-1855 14" Brush Insert



49-90-1650 Furnace Cleaning Kit

All accessories needed for cleaning furnaces.

Kit consists of 1 of each of the following:

- 49-90-0020 10' Hose
- 49-90-0080 6" Metal Hose
- 49-90-0410 27" Crevice Tool
- 49-90-0460 Rubber Blower Nozzle
- 49-90-0740 Utility Nozzle



49-90-1660 Automotive Kit

A kit especially designed for automotive cleanup work.

Kit consists of 1 of each of the following:

- 49-90-0060 10' Hose
- 49-90-0400 15" Crevice Tool
- 49-90-0740 Utility Nozzle



49-90-0020 Canvas Hose 10'

Canvas covered, wire reinforced, rubber lined vacuum hose. 1-1/2" I.D. Two straight molded cut ends. Order swivel-end connector separately.



49-90-0030 Black Canvas Hose 10'

Canvas covered, wire reinforced, rubber lined vacuum hose, Strong, resilient. 1-1/2" I.D. with two straight molded cuff ends. Order swivel-end connector separately.



49-90-0040 15' Black Neoprene Hose

49-00-0050 25' Black Neoprene Hose

Neoprene lined, oil resistant, wire reinforced. 1-1/2" I.D. with two straight molded cuff ends. Order swivel-end connector separately.



49-90-0195 Steel Hose Connector

Used to connect 1-1/2" hoses.



49-90-0150 Swivel-End Connector

Quick connect/disconnect feature for attaching hoses to MILWAUKEE vacuum cleaners, except Models 8950, 8955, 8936-20 and 8938-20. Fits into 1-1/2" I.D. hoses. Same as furnished with each unit.



49-90-0155 Hose Adapter

Adapts 1-1/2" I.D. hose to Models 8936-20, 8938-20, 8950 and 8955. Same as furnished with each unit.

49-90-0090 7" Wireless Vinyl Hose

49-90-0060 10' Wireless Vinyl Hose

49-90-0070 25' Wireless Vinyl Hose

Crushproof multi-flex hose with no wire reinforcement. 1-1/2" I.D. with two molded cuff ends. Order swivel-end connector or hose adapter separately.



49-90-0080 Metal Hose 6'

For cleaning boiler tubes and furnaces. 1-1/4" O.D. fits into standard 1-1/2" I.D. hoses.



Hose Carrier

49-90-0170 For Model 8935

49-90-0180 For Models 8911, 8912 and 8925

Ideal for neat, safe storage of vacuum hoses. Makes moving from one location to another easier.

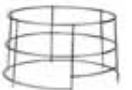

Store-All Tool Pouch

49-90-0250 For Models 8911, 8912 and 8925

49-90-0295 For Models 8924, 8926 and 8927.

Strong durable vinyl pouch... makes toting extra tools easy.





VACUUM ACCESSORIES

49-90-1000 Double Bend Floor Wand

Built-in swivel connection adapts with compression fitting to the major floor tool 49-90-0550. Wand connects to 1-1/2" I.D. hose. Made of chrome plated steel.



49-90-0550 Major Floor Tool

Major floor tool with two "quick turn" thumb screws for quick tool changing. Accommodates interchangeable 14" inserts and replacements. Supplied with No. 49-90-0010 bumper. Attaches to 49-90-1000 wand.



49-90-0610 14" Replacement Bumper

Attaches to Major Floor Tool 49-90-0550.



49-90-0560 14" Brush Insert

For rough floors, large well and ceiling area. Attaches to Major Floor Tool 49-90-0550.



49-90-0630 14" Replacement Brush Strips (2)

49-90-0580 14" Squeegee Insert

For fast drying of washed floors. Attaches to Major Floor Tool 49-90-0550.



49-90-0640 Replacement squeegee blades (3).

49-90-0600 14" Carpet Insert

Bottom plate perfectly designed for cleaning rugs, carpeting. Attaches to major floor tool 49-90-0550.



49-90-0570 14" Fabric Attachment Shoe

Suited for cleaning cement and concrete floors. Attaches to Major Floor Tool 49-90-0550.



49-90-0620 14" replacement fabric strips (2).

49-90-0590 14" Felt Attachment Shoe

For walls and smooth hard floors such as tile, hardwood. Attaches to Major Floor Tool 49-90-0550.



49-90-0760 10" Nylon Bristle Brush

Heavy-duty cast aluminum, wide mouth nozzle. 10" cleaning path. Compression type. Attaches to Double Bend Floor Wand No. 49-90-1000.



49-90-0540 12" Wide Mouth Gulper

Ideal for use on bare floors or rugs. 12" cleaning path. Compression type. Attaches to Double Bend Floorwand No. 49-90-1000.



49-90-1865 Two Piece Double Bend Floor Wand

Two piece construction for easy storage. Made of chrome, plated steel. Adapts to all MILWAUKEE 1-1/2" I.D. hose. Snap lock connector accommodates Major Floor Tool 49-90-1840.



49-90-1840 14" Major Floor Tool

Economical, high impact, durable plastic construction. Master Nozzle with snap lock feature for use with rug shoe and squeegee shoe listed below. Attaches to 49-90-1965 wand.



49-90-1850 14" Carpet Insert

Ideal for cleaning rugs and carpets. Attaches to Major Floor Tool 49-90-1840.



49-90-1845 14" Squeegee Insert

For fast drying of wet floors. Attaches to for Major Floor Tool 49-90-1840.



49-90-1855 14" Brush Insert

Ideal for dry pick-up on hard surfaces. Attaches to Major Floor Tool 49-90-1840.



49-90-1150 Dolly

For use with Model 8950 only.

VACUUM ACCESSORIES



49-90-0740 Aluminum 6" Utility Nozzle

Taper fit utility and upholstery nozzle. Fits 1-1/2" I.D. hose. 6" cleaning path.



Clamp-On Nylon Bristle

49-90-0480 Brush With Bumper

Attach directly to utility nozzle.



49-90-0730 3" Round Dust Brushes

3" round dust brush with nylon bristles. Fits 1-1/2" I.D. hose.



49-90-0660 Nylon Brush Insert

Replacement brush insert for round dust brush.



49-90-1860 Round Dust Brush 3"

For all purpose dry pick-up of dirt and saw dust. Ideal for cleaning furniture, venetian blinds, etc. Fits 1-1/2" I.D. hoses.



49-90-0460 Rubber Blower Nozzle

For blowing dust and dirt out of cracks and inaccessible areas. Excellent for machinery. Fits 1-1/2" I.D. hose.



FILTER CAGES & CONVERSION PANS

Wire Frame Filter Cage, Cloth Filter And Gasket Assembly

Available for both 14" and 16" dia. tanks. The filter assembly acts as a final filter for air leaving tank.

Tub Style Filters And Wire Frames

49-90-0290 Wire Filter Cage 14" Dia. Fits: 8935 only

49-90-0270 Wire Filter Cage 16" Dia.
Fits: 8911, 8912, 8925, 8945

49-90-0280 Cloth Filter and Gasket 14" Dia.
Fits: 8935 and 8965

49-90-0260 Cloth Filter and Gasket 16" Dia.
Fits: 8911, 8912, 8925, 8945



Saucer Style Filter And Frame

49-90-0265 Cloth filter and gasket 16" dia.

49-90-0275 Wire Filter Cage 16" dia.
Fits: 8911, 8912, 8925, 8945

Above Filter and Wire Frame Fits: 8911, 8912, 8925, 8926, 8927 and 8945.



Wet Pick-Up Conversion Pans

49-90-1610 Wet Pick-Up Conversion Pan 16" Dia. (Standard on Models 8911, 8912, 8925 and 8945).

49-90-1620 Wet Pick-Up Conversion Pan 14" Dia. (Standard on Model 8935).

49-90-1640 Wet Pick-Up Conversion Pan 16" Dia. (Standard on Models 8926 and 8927).



49-90-1755 6" Plastic Utility Nozzles

Economical, high impact, durable plastic construction. Fits 1-1/4" I.D. hose for upholstery cleaning and other small jobs. Fits 8934-6, 49-90-0095 and 49-90-0100 hose only.



49-90-1775 Economical, high impact, durable plastic construction. Fits 1-1/2" I.D. hose for upholstery cleaning and other small jobs.

49-90-0400 15" / 49-90-0410 27" Metal Crevice Tools

For cleaning behind radiators, other hard to reach areas, corners and crevices. Fits 1-1/2" I.D. hose.



49-90-1745 Plastic Crevice Tool

Fits 1-1/4" on hoses 49-90-0095 and 49-90-0100 hose only.



49-90-1770 Plastic Crevice Tool

Economical, high impact, durable plastic construction. Ideal for cleaning around equipment, behind radiators, hard to reach corners and crevices. Fits 1-1/2" I.D. hose.



FILTERS

Disposable High Efficiency Micro-Ply Paper Filter Bags

FILTERS DUST PARTICLES DOWN TO 0.1 MICRON

49-90-0302 5-pack. For Vacuum Cleaner Nos. 8911, 8912 and 8965.

49-90-0312 5-pack. For Vacuum Cleaner No. 8935.

49-90-0351 5-pack. For Vacuum Cleaner No. 8925.

49-90-0445 5-pack. For Vacuum Cleaner Nos. 8950, 8955, 8936-20 and 8938-20.



Disposable High Efficiency Micro-Ply Paper Filter

FILTERS DUST PARTICLES DOWN TO 0.1 MICRON

49-90-0332 5-pack. For 8911, 8912, 8925, 8926, 8927, 8935, 8945 and 8965. Quick and easy to install on vacuum tank. Suited for vacuuming extremely fine dust directly into vacuum tank. Fits over cloth filter assembly.



Disposable Filter Bags

49-90-0305 3-pack. For Vacuum Cleaner No. 8934-6.

Dacron Filter

49-90-0320 For 8911, 8912, 8925, 8926, 8927, 8935, 8945 and 8965. Bag is suited for pick-up of medium fine dust and coarse, sharp material. Fits over cloth filter assembly.

Wet/Dry Pick-Up Cartridge Filter

49-90-1830 For 8950, 8955, 8936-20 and 8938-20. Interchangeable with Cloth Filter Assembly and Foam Filter Sleeve.



Foam Filter Sleeves

49-90-0770 Motor Filter for 8950, 8955, 8936-20 and 8938-20.

49-90-1820 For 8926, 8927 and 8965.





Milwaukee

HEAT GUNS

8975-6 Dual Temperature Heat Gun



8977-20 Variable Temperature Heat Gun



FEATURES

**AC**

- Dual temperature 570 and 1000 degrees F, 11.6 amp motor
- Unique impact resistant heating element
- Three position rocker switch – off, high and low
- Efficient Soft Air Velocity – Increases surface temperature to the required working temperature faster than conventional hot air heat guns. Maintains higher surface temperature, allowing faster completion of standard commercial or industrial applications.
- Cool Air Inlet Design – Allows air movement at peak efficiency, even when resting on support stand.
- Support Stand – Enables gun to be stationary for workbench or assembly work, freeing both hands for use.
- Users – Plumbers, Painters, Floor Covering Installers, Technicians, Boat Builders, Food Processing, Industry, Mechanics Contractors, Body Shops, Photographers, Schools, Laboratories.
- Applications – Softens, molds, bends and forms plastics. Pre-dries surfaces for fast preparation, softens caulking, putty and plastics, strips paint, varnish and lacquer. Repairs auto top vinyl, thaws frozen pipes, shrink fits plastic tubing, dries electric lines and cables, removes tiles, floor covering materials, loosens over-tightened screws and joints, welds plastics, PVC coated fabrics and foils.

SPECIFICATIONS

Length	10-1/2"
Weight	1.8 lbs
Voltage	120V AC
Tool Warranty	5 Years
Amps	11.6
Air Temperature	570 and 1,000 Degrees F

FEATURES

**AC**

- Variable temperature 100 to 1,040 degrees F, 11.6 amp tool
- Unique impact resistant heating element
- Dial control to select temperature
- Efficient Soft Air Velocity – Increases surface temperature to the required working temperature faster than conventional hot air heat guns. Maintains higher surface temperature, allowing faster completion of standard commercial or industrial applications.
- Cool Air Inlet Design – Allows air movement at peak efficiency, even when resting on support stand.
- Support Stand – Enables gun to be stationary for workbench or assembly work, freeing both hands for use.
- Users – Plumbers, Painters, Floor Covering Installers, Technicians, Boat Builders, Food Processing, Industry, Mechanics Contractors, Body Shops, Photographers, Schools, Laboratories.
- Applications – Softens, molds, bends and forms plastics. Pre-dries surfaces for fast preparation, softens caulking, putty and plastics, strips paint, varnish and lacquer. Repairs auto top vinyl, thaws frozen pipes, shrink fits plastic tubing, dries electric lines and cables, removes tiles, floor covering materials, loosens over-tightened screws and joints, welds plastics, PVC coated fabrics and foils.

SPECIFICATIONS

Length	10-1/2"
Weight	1.8 lbs
Voltage	120V AC
Tool Warranty	5 Years
Amps	11.6
Air Temperature	100 to 1,040 Degrees F

HEAT GUNS & ACCESSORIES



8988-20 Variable Temperature Heat Gun with LCD Digital Readout Display



FEATURES



- Ceramic encapsulated heating element found only in the highest quality heat guns. Maintains shape of helix and uniform coil which results in longer tool life.
- LCD Digital Readout Display shows present temperature in increments of 10° F
- One hand operation with lightweight and easy grip handle
- Upright stationary use with pads on back cap and lower handle
- Removable air filter keeps debris out
- Thermo Protected – Automatically prevents the tool from overheating by maintaining set temperature.
- Users – Aerospace Industries. Defense Department. Computer Industries. Harness Shops.
- Applications – Plastic Curing on Aircraft. Solder Sleeve Splicing Devices. Shrink Tube Insulator Applications. Wire Harnessing. Welding Thermoplastics. Shaping and Bending Plastics.

SPECIFICATIONS

Length	11-1/2"
Weight	2.8 lbs
Voltage	120V AC
Tool Warranty	5 Years
Amps	12.5
Air Temperature	90 to 1050 Degrees F

FOR USE WITH HEAT GUN: 8988-20

49-80-0305 Reduction Nozzle 3/8"

- Intensified, spot directed for corners, bending plexiglass, soldering



49-80-0306 Reduction Nozzle 9/16"

- Intensified, spot directed for corners, bending plexiglass, soldering
- Similar to 49-80-0305 but for larger work areas



49-80-0307 Reflector Nozzle 3/8"

- For small diameter tubing, wires, shrink wrap tubing



49-80-0308 Still Nozzle

- Intensified air flow for lap welding PVC canvasses and sheets
- Must be used with 49-80-0305 Air Reduction Nozzle



FOR USE WITH ALL HEAT GUNS: 8988-20, 8975-6, 8977-20

49-80-0297 Air Reducer Nozzle

- Intensified heat for removing floor coverings, paint burning, vinyl top removal



49-80-0292 Hook Nozzle

- When heat is needed to surround-bending, soldering pipe, shrinking tubing.



49-80-0293 Deflector Nozzle

- Deflects air away from glass when stripping paint or softening putty



49-80-0294 Air Spreader Nozzle

- Intensified heat for removing floor coverings, paint burning, vinyl top removal



49-80-0300 Heat Gun Accessory Assortment

- Includes 49-80-0292 Hook Nozzle, 49-80-0293 Deflector Nozzle, 49-80-0294 Air Spreader Nozzle, 49-80-0297 Air Reduction Nozzle
- For most common applications



Milwaukee

HOISTS

ELECTRIC CHAIN HOISTS



CATALOG NUMBER

- 9560
- 9561
- 9562
- 9565
- 9566
- 9567
- 9568
- 9570
- 9571
- 9572
- 9573



FEATURES

- **Built-in, Multiple-Disc, Magnetic Brake**
Provides positive load holding and spotting.
- **Adjustable Upper And Lower Limit Switches**
For maximum flexibility in regulating load travel.
- **Duty Service Classification**
H-3 on time up to 25% of work period. 3-phase on time up to 33% of work period.
- **Overload Limiting Clutch**
Guards against lifting damaging overloads while operating hoist.
- **Single or Three-Phase Dual Voltage Motors**
Choose between 115V/230V and 230V/460V (AC) units to meet your operation power requirements.
- **Latch-Type Ridged Top Hook On All Models**
- **Rugged, Lightweight, Aluminum Housing**
Corrosion-resistant. Reduced weight allows greater portability.
- **24-Volt Pushbutton Station**
Fits user's hand to allow thumb, trigger or two-handed operation.

See specifications on page 162

HAND CHAIN HOISTS

1/2 – 5 TON CAPACITY



CATALOG NUMBER

- 9667-20
- 9668-20
- 9669-20
- 9670-20
- 9671-20
- 9672-20
- 9673-20
- 9674-20
- 9675-20
- 9676-20
- 9677-20
- 9678-20
- 9679-20
- 9680-20
- 9681-20

FEATURES

- **Hardened Load Chain For Flexibility And Long Wear**
- **Weston-Type Load Brake Requires No Lubrication**
- **Wheel Cover with Guide Slots Minimizes Jamming And Slipping**
- **Forged Swivel Hooks With Latches Reduces Twisting Of Chain And Unhooking Of Load When Chain Is Slack**
- **Standard Hand Chain Drop Is 2 Feet Less Than Lift**
(Example: 8 foot lift hoist has 6 foot hand chain drop.)
- **Simple, Efficient, Compact Design, Lightweight For Easy Installation, Even In Confined Spaces**

See specifications on page 162

HOISTS



LEVER HOISTS

3/4 - 3 TON CAPACITY



CATALOG NUMBER

9682-20
9683-20
9684-20
9685-20
9686-20
9687-20
9688-20
9689-20
9690-20
9691 -20

FEATURES

- Weston-Type Automatic Braking System For Positive Load Control
- Forged Upper And Lower Hooks With Cast Steel Latches Standard
- Steel Chain Guide Roller And Chain Stripper For Smooth Chain Feed
- Double Reduction Dual Load Sharing Steel Gears
- Double Pawl Arrangement For Optimum Load Control
- Impact Resistant All-Steel Frame, Gear Case And Cover
- Minimal Maintenance With No Special Tools
- Hardened Link Type Alloy Steel Load Chain For Strength And Long Wear Life
- Free Wheeling Chain For Fast Load Attachment

See specifications on page 162

SLINGS

EYE AND EYE STYLE
SYNTHETIC WEB SLINGS

FEATURES

- **Heavy-Duty Synthetic Webbing**
Features Red Core Warning Yarn System And Abrasion Resistant Treatment
- **Polymer coated Edge Yarns**
67% more resistant to edge abrasion and 30% more resistant to edge cutting.
- **Silver Colored Web Treatment**
Fights abrasion for additional sling life.
- **Tuff-Tag Identification Tag**
Provides required OSHA And ANSI requirement information for the life of the sling. Serial numbered identification for traceability.



SLINGS

MILWAUKEE SLING WEBBING

FEATURES

- Sling Webbing Has Its Surface Yarns Connected From Side To Side, Which Not Only Protects The Core Yarns, But Positions All Surface And Tensile Yarns To Work Together To Support The Load
- **Wear Or Damage To Sling Webbing Face Yarns Cause An Immediate Strength Loss.** This Is Why Sling Webbing Has Red Gore Yarns To Visually Reveal Damage And Act As A Basis For Sling Rejection

See specifications on page 162



Milwaukee

HOISTS

ELECTRIC CHAIN HOISTS

Model	Rated Load	Lifting Speed	Lift Height*	A	B	C	D	E
9560	1/2 ton	16 FPM	10'	18"	7/8"	1"	1-1/16"	9-11/16"
9561	1/2 ton	16 FPM	15'	18"	7/8"	1"	1-1/16"	9-11/16"
9562	1/2 ton	16 FPM	20'	18"	7/8"	1"	1-1/16"	9-11/16"
9565	1 ton	16 FPM	10'	18"	7/8"	1"	1-1/16"	9-11/16"
9566	1 ton	16 FPM	10'	18"	7/8"	1"	1-1/16"	9-11/16"
9567	1 ton	16 FPM	15'	18"	7/8"	1"	1-1/16"	10-11/16"

Model	Rated Load	Lifting Speed	Lift Height*	A	B	C	D	E
9568	1 ton	16 FPM	20'	18"	7/8"	1"	1-1/16"	10-11/16"
9570	2 tons	8 FPM	10'	19-3/4"	1"	1-1/16"	1-1/16"	10-11/16"
9571	2 tons	8 FPM	10'	19-3/4"	1"	1-1/16"	1-1/16"	10-11/16"
9572	2 tons	8 FPM	15'	19-3/4"	1"	1-1/16"	1-1/16"	10-11/16"
9573	2 tons	8 FPM	20'	19-3/4"	1"	1-1/16"	1-1/16"	10-11/16"

* Push-button cable length: 4' less than lift.

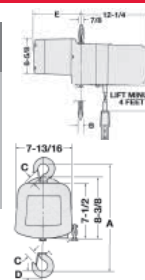

CHAIN HOISTS

Model	Rated Capacity	Std. Lift	Chain Pull to Lift Rated Load	Feet of Chain Overhauled to Lift Load One Foot
9667-20	1/2 ton	8'	53 lbs	29 lbs
9668-20	1/2 ton	15'	53 lbs	29 lbs
9669-20	1/2 ton	20'	53 lbs	29 lbs
9670-20	1 ton	8'	77 lbs	37 lbs
9671-20	1 ton	15'	77 lbs	37 lbs
9672-20	1 ton	20'	77 lbs	37 lbs
9673-20	1 ton	25'	77 lbs	37 lbs
9674-20	2 tons	8'	82 lbs	80 lbs
9675-20	2 tons	15'	82 lbs	80 lbs
9676-20	2 tons	20'	82 lbs	80 lbs
9677-20	3 tons	8'	65 lbs	154 lbs
9678-20	3 tons	15'	65 lbs	154 lbs
9679-20	3 tons	20'	65 lbs	154 lbs
9680-20	5 tons	8'	105 lbs	147 lbs
9681-20	5 tons	20'	105 lbs	147 lbs

Rated Capacity	A Headroom	B Width	C Depth	D Diameter	E Hook Openings
1/2 ton	11-5/8"	4-15/16"	4-5/16"	4-15/16"	1-1/16"
1 ton	13"	5-19/32"	5-1/16"	5-19/32"	1-1/32"
2 ton	18-1/8"	8-5/16"	6-5/8"	8-5/16"	1-1/4"
3 ton	21-29/32"	8-5/16"	6-5/8"	8-5/16"	1-5/16"
5 ton	23-7/8"	8-5/16"	6-5/8"	8-5/16"	1-13/16"

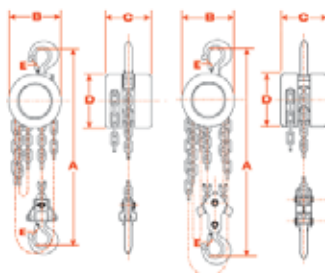

LEVER HOISTS

Model	Rated Capacity	Std. Lift	Chain Pull to Lift Rated Load
9682-20	3/4 ton	5'	33 lbs
9683-20	3/4 ton	10'	33 lbs
9684-20	3/4 ton	20'	33 lbs
9685-20	1-1/2 ton	5'	51 lbs
9686-20	1-1/2 ton	10'	51 lbs
9687-20	1-1/2 ton	20'	51 lbs
9688-20	1-1/2 ton	25'	51 lbs
9689-20	3 tons	5'	77 lbs
9690-20	3 tons	10'	77 lbs
9691-20	3 tons	20'	77 lbs

Rated Capacity	A Headroom	B Outside Clearance	C Width	D Outside Clearance	E Outside Clearance	F Lever Length	G Hook Opening
3/4 ton	12-5/8"	2-3/16"	4-3/8"	3-9/16"	5-15/16"	11"	1-1/8"
1-1/2 ton	14-13/16"	2-3/8"	4-3/4"	3-15/16"	6-7/8"	16-1/4"	1-1/4"
3 ton	18-11/16"	4-3/16"	7-1/2"	4-9/16"	7-7/8"	16-1/4"	1-9/16"

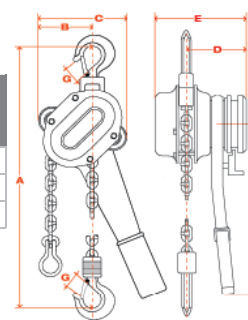

HEAVY DUTY SLINGS

Model	Width	Length A	Minimum Tensile Strength (Vertical Hitch)	Capacity		
				Vertical Hitch	Choker Hitch	Basket Hitch
49-58-0030	1"	3' ± 1"	8,000 lbs	1,600 lbs	1,250 lbs	3,200 lbs
49-58-0035	1"	4' ± 1"	8,000 lbs	1,600 lbs	1,250 lbs	3,200 lbs
49-58-0040	1"	6' ± 1.5"	8,000 lbs	1,600 lbs	1,250 lbs	3,200 lbs
49-58-0045	1"	8' ± 2"	8,000 lbs	1,600 lbs	1,250 lbs	3,200 lbs
49-58-0050	2"	6' ± 1.5"	16,000 lbs	3,200 lbs	2,500 lbs	6,400 lbs
49-58-0055	2"	8' ± 2"	16,000 lbs	3,200 lbs	2,500 lbs	6,400 lbs

Model	Width	Length A	Minimum Tensile Strength (Vertical Hitch)	Capacity		
				Vertical Hitch	Choker Hitch	Basket Hitch
49-58-0060	2"	10' ± 2.5"	16,000 lbs	3,200 lbs	2,500 lbs	6,400 lbs
49-58-0065	2"	12' ± 3"	16,000 lbs	3,200 lbs	2,500 lbs	6,400 lbs
49-58-0070	4"	10' ± 2.5"	32,000 lbs	6,400 lbs	5,000 lbs	12,800 lbs
49-58-0075	4"	12' ± 3"	32,000 lbs	6,400 lbs	5,000 lbs	12,800 lbs
49-58-0080	4"	15' ± 3"	32,000 lbs	6,400 lbs	5,000 lbs	12,800 lbs





FULL SYSTEM COMPATIBILITY

Milwaukee continues to lead the industry – delivering a steady stream of advanced solutions for the trades that offer increased productivity and unmatched durability.





TOOL INDEX BY MODEL NUMBER

MODEL #	PAGE	MODEL #	PAGE	MODEL #	PAGE	MODEL #	PAGE
0100-20	29	4270-20	121	6130-33	128	8926	153
0101-20	29	4270-21	121	6140-30	129	8936-20	154
0200-20	30	4292-1	115	6146-30	129	8938-20	154
0201-20	30	4297-1	115	6146-31	130	8945	155
0202-20	31	5192	146	6146-33	130	8950	153
0233-20	31	5194	146	6147-30	131	8955	153
0234-6	32	5196	147	6147-31	131	8965	153
0235-21	32	5211	147	6161-30	137	8975-6	158
0240-20	33	5243	148	6161-31	137	8977-20	158
0244-1	33	5262-21	81	6161-33	138	8988-20	159
0299-20	34	5263-21	81	6177-20	110	9070-20	72
0300-20	34	5268-21	82	6185-20	110	9071-20	72
0302-20	35	5316-21	83	6225	18	9072-20	73
0370-20	35	5317-21	83	6226	18	9072-22	73
1001-1	50	5337-21	93	6232-20	18	9075-20	73
1007-1	50	5339-21	93	6232-21	18	9092-20	74
1101-1	51	5340-21	94	6238-20	19	9096-20	74
1107-6	51	5342-21	94	6238-21	19	9560	160
1250-1	52	5359-21	82	6242-6	19	9561	160
1610-1	61	5363-21	82	6268-21	25	9562	160
1630-1	61	5376-20	77	6276-21	25	9565	160
1660-6	62	5378-20	77	6370-20	109	9566	160
1663-20	62	5378-21	77	6370-21	109	9567	160
1670-1	53	5380-21	78	6390-20	22	9568	160
1675-6	53	5387-20	78	6390-21	22	9570	160
1676-6	53	5387-22	78	6391-21	22	9571	160
1680-20	54	5426-21	84	6394-21	23	9572	160
1680-21	54	5446-21	84	6470-21	23	9573	160
1854-1	63	5615-20	149	6477-20	24	9667-20	160
2404-1	63	5615-21	149	6480-20	27	9668-20	160
3002-1	59	5615-24	149	6486-20	27	9669-20	160
3102-6	59	5616-20	150	6509-31	1	9670-20	160
3107-6	60	5616-21	150	6519-30	1	9671-20	160
4004	102	5616-24	150	6519-31	1	9672-20	160
4005	103	5619-20	151	6520-21	2	9673-20	160
4079	101	5625-20	151	6523-21	2	9674-20	160
4090	101	6020-21	143	6536-21	3	9675-20	160
4094	102	6021-21	143	6538-21	3	9676-20	160
4096	103	6065-6	144	6577-20	24	9677-20	160
4097-20	104	6066-6	144	6580-20	64	9678-20	160
4115	106	6072	145	6740-20	65	9679-20	160
4115-22	106	6078	145	6742-20	65	9680-20	160
4120	106	6088-30	125	6780-20	64	9681-20	160
4120-22	106	6088-31	125	6790-20	66	9682-20	161
4125	104	6089-30	126	6791-21	66	9683-20	161
4130	105	6089-31	126	6792-20	67	9684-20	161
4136	105	6101-6	148	6805	112	9685-20	161
4202	115	6117-30	134	6815	112	9686-20	161
4203	115	6117-31	134	6852-20	113	9687-20	161
4204-1	116	6117-33	135	6880	113	9688-20	161
4206-1	116	6117-33D	135	6890	114	9689-20	161
4208-1	117	6121-30	127	6955-20	21	9690-20	161
4209-1	117	6121-31	127	6955-20HP	21	9691-20	161
4210-1	118	6121-31A	128	8911	153		
4253-1	115	6124-30	136	8912	153		
4262-1	115	6124-31	136	8925	153		

WARRANTY INFORMATION

Milwaukee Electric Tool (Canada) Ltd. ("Milwaukee", "we" or similar pronouns) sells its products (the "Products") through authorized distributors appointed on a non-exclusive, market oriented basis to provide coverage for the various trades and industries for which we make tools. Milwaukee's authorized distributors ("Distributors") are defined as those firms that have been selected by Milwaukee to represent it in their respective areas of responsibility and who are responsible for carrying a sufficient stock of tools and accessories, both in quantity and assortment, to properly service the type of trade in their respective areas, and who actively promote and sell Products. Milwaukee retains the right to determine the retail environment in which the Products are distributed and sold. Milwaukee desires to support only resellers that add value and service to Milwaukee's existing distribution structure and enhance the Milwaukee brand.

INTELLECTUAL PROPERTY: Milwaukee considers its corporate name, Milwaukee logo, the red and black colours and the red, gray, and black colours for power tools and accessories and its trademarks (e.g. Sawzall, Magnum, and Heavy Duty), trade names, domain names, and other intellectual property, to be valuable corporate assets and Distributors acknowledge that Milwaukee is the exclusive owner of all right, title and interest in all such intellectual property. A Distributor may use Milwaukee's trademarks, trade names and trade dress colours only in the advertisement of authentic Milwaukee Products, and then only with the prior authorization of Milwaukee or in accordance with Milwaukee's corporate identity guidelines as they are amended from time to time, and shall not use them in a false, misleading, or objectionable manner. Milwaukee retains the right of ultimate approval or disapproval, in the exercise of its sole discretion, of the use of any of its intellectual property.

No Distributor shall register, attempt to register, or use Milwaukee's name, trademarks, trade names or confusingly similar names or marks, as part of the Distributor's business or corporate name or as part of the Distributor's domain name and/or its internet website name, without the prior written consent of Milwaukee.

No Distributor shall directly or indirectly represent that it has any connection or affiliation with Milwaukee other than as an authorized Distributor in accordance with this Sales Policy. When requested in writing by Milwaukee, a Distributor will promptly discontinue any use, or take such steps as Milwaukee deems appropriate to modify its use of, any Milwaukee trademark, trade name, trade dress or any confusingly similar imitation of the same.

No Distributor will do, or cause to be done, any act or thing contesting, or in any way impairing or tending to impair, any part of Milwaukee's exclusive ownership and right, title and interest in Milwaukee's trademarks, trade names, trade dress colours or other intellectual property.

ORIGINAL PACKAGING: Milwaukee allows Distributors to resell only finished goods in their original packaging, which includes original UPC codes, warranty statements and user manuals. Dismantling or breaking up combo kits, including the sale of individual components of a combo kit, is not allowed and constitutes an infringement of Milwaukee's trademark rights. No Distributor shall remove from any Products any of Milwaukee's trademarks or product identification, nor will it affix to the Products any other trade name or trademarks.

TERMS OF SALE: All purchases of Products accepted by Milwaukee will be at prices, discounts and rebates and on terms and conditions which are established by Milwaukee and in effect at the time of acceptance of the order. A copy of the current version of such standard terms and conditions of sale is available upon request. All purchase orders must be in a form acceptable to Milwaukee. Any provisions contained in any purchase order or any other document which are inconsistent with, different from or in addition to Milwaukee's standard terms and conditions of sale which are then in effect shall be inapplicable, void and of no effect unless expressly accepted by Milwaukee in writing.

CREDIT POLICY: New accounts must furnish satisfactory credit references and financial information. Past records of payment will largely influence our extension of credit to present distributors. All discrepancies must be reported within 90 days of invoice date. No orders will be shipped to delinquent accounts.

DELIVERY: All orders will be shipped promptly in the most economical way as determined by Milwaukee. We are not liable for delays in shipment occasioned by strike, fire, accidents or other conditions beyond our control. At the Distributor's request, orders can be shipped air collect.

FREIGHT: Freight is prepaid on all single orders that are shipped from the Distribution Centre to one destination within the limits of Canada (whether shipped partial or complete) with a TOTAL NET value of \$1,000 or more where there is at least one tool, or if the order contains \$250 or more of Accessories, Hand Tools and/or Parts only. All shipments are F.O.B. our Distribution Centre. All risk of loss or damage shall be upon the Distributor after delivery to the carrier. We reserve the right to ship in the most economical way and to make complete shipment where maximum discount and freight allowances apply. Any claims for packing shortages must be made within 30 days. Claims for shipping damage or loss must be made with the carrier.

ADDITIONS TO ORDERS: Additions to orders cannot be accepted to apply against orders already placed.

MINIMUM ORDER: Net billing value of \$30.00.

DROP SHIPMENTS: Drop Shipments made to resale accounts that are not approved by Milwaukee's Customer Service Department will be assessed a 5% Drop Ship fee.

PAYMENT: We will allow a 2% cash discount on all payments made to us by the 10th of the month following (prox 26th). No cash discount is allowed when a past due status exists or on C.O.D. shipments. All obligations are due NET by the 25th of the month following. Milwaukee may offset any amounts owed by Distributor to Milwaukee against amounts owed by Milwaukee. All accounts not paid in accordance with these terms will be assessed a service fee at the maximum amount permitted by law, not to exceed 1 - 1/2% per month. In addition, Distributor shall be liable for all costs and deficiencies that may result from the repossession and/or resale of the Tools. Payment terms are governed by invoice date, not by the date of receipt of material or invoice. All disputed invoices and payments will be reviewed by us provided that written notice is received by us within 60 days of the statement due date.

TAXES: All taxes are extra.

PRICING REBATES AND SPECIFICATIONS: Milwaukee reserves the right to change the construction, specifications, prices, discounts, rebates or terms of sale of its Products without notice, and without obligation as to Products previously shipped or sold. Refunds or rebates will not be made on Distributor's shelf stock due to price decreases. Milwaukee reserves the right at any time without notice to add Products and lines of Products to the coverage of a Distributor, to change Products and lines of Products covered by a Distributor and to discontinue Products and lines of Products from the coverage of a Distributor.

RETURNED MERCHANDISE: Distributors must contact their Milwaukee Territory Manager to request a "Returned Goods Authorization." The authorization will include instructions as to where the merchandise is to be returned. Merchandise returned must be new (e.g. a current model), listed in the current product brochure/catalogue, in good, useable/saleable condition and accompanied by a purchase order for other Products of equivalent value. Acceptance of the merchandise by Milwaukee is final only after inspection. Transportation charges must be paid by the Distributor on all goods returned for credit. Credit will be based upon lowest price paid in previous 12 months less a 10% handling charge. Any waiver for the handling charge must be approved by the VP of Sales and Marketing. For Annual Returns, refer to the Stock Adjustment Policy.

Any returned merchandise received that does not follow or otherwise does not meet the above policy will be returned to the Distributor, freight collect.

ACCEPTANCE OF ORDERS: All orders are subject to acceptance by Milwaukee and shall be binding on Milwaukee only when accepted in writing or by shipment.

CANCELLATIONS: Cancellations from unshipped or partially shipped orders will result in a charge back to the Distributor if the resulting order no longer meets the quantity and freight requirements at which the original order was discounted.

SPECIAL PRODUCTS: A Distributor may not quote price or delivery on any Product not listed as standard in the Milwaukee Electric Tool Catalogue or literature. All specifications of products other than standard shall be forwarded to Milwaukee. If orders for special products are accepted, they are not subject to cancellation. Milwaukee is not responsible for any commitments or specifications not presented for approval.

GOVERNMENT AND O.E.M. BUSINESS: Milwaukee reserves the right to quote and sell direct on requirements for any government or governmental authority or agency. Milwaukee reserves the right to quote on and sell direct to any firm using standard or special Milwaukee product as an Original Equipment Manufacturer.

NEW DISTRIBUTOR QUALIFICATION: A minimum total net order of \$5,000 including tools and accessories must be purchased to qualify as an authorized Distributor.

ACCESSORY MERCHANDISERS: All Accessory Merchandisers are provided at no additional cost when they are ordered complete with contents.

ACCESSORY SHIPMENTS: For greatest protection in shipment, it is suggested that you plan your Accessory orders in multiples of recommended MASTER PACK QUANTITIES. See MASTER PACK QUANTITY column.

OPERATOR/OWNER MANUALS AND SERVICE PARTS LISTS are available at no charge on our website, www.milwaukeeetool.com. In the Parts & Service section, you will need to enter the catalogue number and serial or ID number of the product.

RESTRICTION ON PURCHASES: A Distributor shall only purchase Products from Milwaukee or an authorized wholesaler unless prior authorization is obtained from the Vice President of Sales and Marketing. A Distributor shall only purchase Products for its own account. A Distributor is required to disclose where all products are purchased from upon request by Milwaukee. A failure to do so will be considered a violation of this sales policy.

RESTRICTION ON SALES: A Distributor may not sell any Products to any other person or firm other than final end users located in Canada unless prior authorization is obtained from the Vice President of Sales and Marketing. Also, a Distributor shall not advertise the retail of any product for less than the acquisition cost. Doing so would contradict Milwaukee's definition of a value added customer.

BONUS ITEMS: Finished goods that are sold to a Distributor on promotion as a "bonus" are to be treated as such and are to be advertised as value added items. At no time are these items authorized to be sold individually at a reduced retail.

INTERNET SALES: To qualify as an authorized on-line distributor, a Distributor must first sign the Authorized Internet Retailer Registration form and agree to the Canadian Internet Brand Integrity Policy.

REPORTS: A Distributor shall provide such reports to Milwaukee as Milwaukee shall request from time to time.

WARRANTIES: A Distributor shall make no warranty or representation on behalf of Milwaukee, its parent, subsidiaries or its affiliates with respect to the Products, except as provided in any written materials specifically relating to Limited Product Warranties that are supplied to the Distributor by Milwaukee. If a Distributor elects to afford any additional warranty to its customers, Milwaukee shall have no liability whatsoever in connection therewith. THE WARRANTIES SET FORTH IN MILWAUKEE'S MANUFACTURER'S WARRANTY ARE OFFERED EXCLUSIVELY TO END-USERS (NOT TO THE DISTRIBUTOR OR ANY OTHER INTERMEDIATE PURCHASER) AND ARE IN LIEU OF AND SUPERCEDE, EXCLUDE AND EXTINGUISH ANY AND ALL OTHER WARRANTY, REPRESENTATION OR CONDITION WHATSOEVER, WHETHER EXPRESS OR IMPLIED, ORAL OR WRITTEN, IN RELATION TO THIS POLICY, ANY AGREEMENT, THE PRODUCTS AND THE SALE OF SUCH PRODUCTS HEREUNDER, AND MILWAUKEE EXPRESSLY DISCLAIMS, TO THE MAXIMUM EXTENT PERMITTED BY APPLICABLE LAW, ANY AND ALL OTHER REPRESENTATIONS, WARRANTIES, COVENANTS OR CONDITIONS, INCLUDING, WITHOUT LIMITATION, THE WARRANTIES OR CONDITIONS OF MERCHANTABILITY QUALITY AND FITNESS FOR A PARTICULAR PURPOSE, THAT THE PRODUCTS WILL MEET THE END USER'S REQUIREMENTS, AND THOSE ARISING BY STATUTE OR OTHERWISE IN LAW FROM A COURSE OF DEALING OR USAGE OF TRADE. Milwaukee's limited warranties shall not be enlarged or affected by and no liability or obligation shall arise from Milwaukee's rendering of technical or other advice, or of service, in connection with the Products.

PROPRIETARY INFORMATION: A Distributor shall use Milwaukee's Confidential Information, as well as reproduce or create materials containing such Confidential Information, only as necessary to advertise and sell the Products in accordance with this Sales Policy. A Distributor shall restrict disclosure of Milwaukee's Confidential Information to the Distributor's employees, agents and independent contractors who have a need to know such information to advertise and sell the Products in accordance with this Sales Policy and who have been informed of the confidential nature of such information. A Distributor shall be liable for any unauthorized disclosure or use of Milwaukee's Confidential Information by the Distributor or any of the Distributor's current and former employees, agents and independent contractors. Within 10 days after receiving a written request from Milwaukee, a Distributor shall destroy or return (as instructed by Milwaukee) any materials containing Milwaukee's Confidential Information. In this policy, "Confidential Information" shall consist of: (i) all information relating to Products, marketing and sales information, pricing, cost, inventory, operations, plans and programs; (ii) all trade secrets, including any and all customer lists, customer survey responses and any other information concerning Milwaukee's customers; (iii) patent applications, copyrights and other intellectual property; and (iv) any other information that is not publicly available and designated by Milwaukee as Confidential Information, provided that Confidential Information will not include information which is or becomes publicly available without the Distributor's breach of this Sales Policy, is independently developed by the Distributor without using any of Milwaukee's Confidential Information as established by documentary evidence or is received by the Distributor from a third party that does not have an obligation of confidentiality to Milwaukee.

TERMINATION: Milwaukee reserves the right to terminate the right of a Distributor to advertise and sell the Products at any time for any reason or no reason upon giving the Distributor 60 days prior written notice provided that Milwaukee may terminate a Distributor immediately in any of the following events: (i) any act of insolvency or bankruptcy by the Distributor; (ii) the appointment of a receiver for all or any part of the property of Distributor or an assignment for the benefit of creditors by Distributor; (iii) any breach by the Distributor of this Sales Policy, any other present or future policy of Milwaukee that is or becomes applicable to the Distributor or any present or future agreement between Milwaukee and the Distributor, each as it may be amended from time to time; or (iv) the Distributor provides false information to Milwaukee. Milwaukee shall not be liable in any manner whatsoever on account of any termination permitted hereunder.

CONSEQUENCES OF TERMINATION: In the event of the termination the right of a Distributor to advertise and sell the Products, (i) Distributor shall be immediately obligated to pay Milwaukee for all Products received by Distributor prior to termination; (ii) Milwaukee may withhold or set-off any payments due to the Distributor until all amounts or obligations otherwise due from the Distributor to Milwaukee have been paid or satisfied, (iii) for a period of 60 days following such termination, Milwaukee shall have the option but not the obligation to repurchase all or any Products held by the Distributor in inventory at the net price paid by the Distributor to Milwaukee and Distributor shall allow Milwaukee reasonable access to the places in which Products are stored for the purpose of inspecting the Products, (iv) all pending orders which have not been shipped shall be terminated but the obligations of the parties with respect to orders which have been shipped shall continue, and (v) the Distributor shall immediately deliver to Milwaukee the originals and copies of all of Milwaukee's Confidential Information, demonstration equipment, advertising material and other property provided by Milwaukee to the Distributor.

www.milwaukeeetool.ca / Telephone: 1-800-268-4015. Fax: 1-866-285-9049 / custservcanada@ttigroupna.com



Nothing but **HEAVY DUTY.**[®]



MILWAUKEE[®] FACTORY SERVICE

Repair/Tech Line **1-877-948-2360**

ONTARIO

140 Fernstaff Crt. Unit 4
Toronto, ON
L4K 3L8

EDMONTON

14506 – 115 Ave NW
Edmonton, AB
T5M 3B9

SASKATOON

3530 Millar Avenue,
Unit 630,
Saskatoon, SK
S7P 0B6

HALIFAX

50 Akerley Boulevard,
Unit 102,
Dartmouth, NS
B3B 1R8

VANCOUVER

9000 Bill Fox Way
Burnaby, BC
V5J 5J3

**Tool Repairs by Factory Trained Technicians
Reconditioned Tool Sales & Accessories**

Milwaukee[®] Electric Tool Corp.

7303 Warden Avenue, Suite 202
Markham, ON. Canada L3R 5Y6
Customer Service Tel: 1.800.268.4015
Fax: 1.866.285.9049

Email: custservcanada@ttigroupna.com
Website: www.milwaukeetool.ca