

PEGASUS

Auto Racing Supplies 2019 - Our 39th Year

“Your IN STOCK source”



Page 11



Pages 10, 12 and 13



Pages 2, 16 to 25, 27,
121, 123, 130, 137 & 138



Page 14



Pages 11, 12, 20,
21, 25 and 123



Page 15



Pages 26 and 137



Page 79



Pages 73, 74, 76 and 151



Pages 81 to 95



Pages 28 to 31, 138



Pages 2, 17, 21 to 23



Pages 141, 142 and 143



Pages 102 and 106



Pages 60, 127,
130, 146 and 147



Pages 128 and 129



Pages 132 and 133



Pages 131, 132 and 133



Pages 118, 119 and 163



Pages 43 and 77



Pages 40, 42 and 43



Pages 34 to 39



Pages 153 to 155



Page 46

Jabroc Skid Plate Material
Page 108



Silicone Hose - Pages 78 and 79

AN Hardware
Pages 96 to 100



Custom Throttle Cables
Page 51



Apex Universal Joints
Page 139

Quality racing supplies and friendly, helpful
service from experienced, active racers.

1-800-688-6946

PegasusAutoRacing.com

Free Shipping on most \$199 orders in the continental USA!

Only a few exceptions - see website for details.

See website for 24,000
additional products!

We pack thousands of products into
this 164 page catalog. It would take
more than 600 pages to show every-
thing that's available on our website
(and that's if we used small type and
a limited number of pictures)!

Sabelt Driving Suits and Gloves

Sabelt



Sabelt Hero TS-9 Suit
Part No. SAB-RFTITS9
Black, Blue, Red, White



Sabelt Diamond TS-7 Suit
Part No. SAB-RFTITS7
Anthracite, Blue, Green, Red, White



Sabelt Challenge TS-3 Suit
Part No. SAB-RFTITS3
Black/White, Black/Yellow, Blue, Red, White



Sabelt Hero TG-9 Glove
Part No. SAB-RFTG09



Sabelt Diamond TG-7 Glove
Part No. SAB-RFTG07



Sabelt Challenge TG-3 Gloves
Part No. SAB-RFTG03

OMP Driving Suits and Gloves

OMP



OMP One Evo Suit
Part No. 2670-002
Yellow, Silver, Green, Blue, Black



OMP Tecnica Evo Suit
Part No. OMP1859
Yellow, White, Navy, Black/White, Black/Red



OMP First Evo Suit
Part No. OMP1854
Silver, Red, Blue, Black, Anthracite



OMP One Evo Glove, Part No. 2627-001
Yellow, White, Green, Blue, Black



OMP Tecnica Evo Glove, Part No. OMP-756E
Yellow, White, Red, Navy, Black



OMP First Evo Glove, Part No. OMP-757E
Yellow, Red, Navy, Black

Index

0 – 9

044 Fuel Pump	47
12 Point Nuts, H20 Series	98
32/36 DGV Weber Carburetors	55
37 Degree Flaring Tool	117
811 PTFE Racing Hose	85
910 PTFE Racing Hose	85

A

A-Arm Spherical Bearing Cups	141
About Us	Back Cover
AccuLevel Digital Inclinometer	113
Accusump Oil Accumulators	71
Adapter Fittings, AN	87-88, 92
Adapter Fittings, AN to NPT Pipe	89, 91
Adapter Fittings, Brake	82, 93-94
Adapter Fittings, BSP	93
Adapter Fittings, Carburetor	92
Adapter Fittings, for Gauges	45
Adapter Fittings, Metric	45, 82-83, 94
Adapter Fittings, O-Ring Boss	75, 90
Adapter Fittings, Plumbing	75, 82-83, 87-95
Adapters, Oil Filter	72
Adel Clamps	86
Adhesive Backed Heat Barrier	109
Adhesives	109, 156-158
Adjuster Cables, Sway Bar	51
AeroCatch Panel Latches	106
Aeroduct Hose	136
Aeroloc Fasteners	103
Aeromotive A1000 Fuel Pump	47
Aeromotive Fuel Filters	46
Aeroquip Hose	81, 84-86
Aeroquip Hose Assembly Lube	154
Aeroquip Port and Fitting ID Kit	117
AFFF Fire Suppression Systems	28
Afterburner Rain/Brake Light	65
AiM MultiChron Stopwatch	34
AiM Senders and Accessories	39
AiM SmartyCam HD	38
AiM Solo2 In-Car Timer	35
AiM Sports Digital Dashes	35-37
Air Density Gauge	116
Air Ducting Hose	136
Air Filter Foam Sheets	52
Air Filters	52-53
Air Horns	53
Air Inlet Ducts	31, 136
Air Jack System	120
Air Jets, Weber	54-55
Air Scoops	31, 136
Air Tank	114
Air/Fuel Ratio Monitors	37, 40
Aircraft Cable, 1/16 inch diameter	51
Aircraft Grade Hardware	96-100
Aircraft Rivets, Solid	100
Airframe Bolts	96-97
Alcon Brake Calipers	131
Alignment Equipment	112-113
Allen Head NPT Pipe Plugs	91
Allen Head Screws	99
Alternator, Ultra-Mini, Single Wire	60
Aluminized Heat Barrier Cloth	109
Aluminum Crush Washers	95
Aluminum Stat-O-Seals	95
Aluminum Tape	108
Aluminum Vise Jaw Inserts	117
AMB Transponders	34
American Flag Decal	33
Ammeter	42
AN 37° Flaring Tool	117
AN 37° SECO 7 Seals	95
AN Bolt Gauge	98
AN Bolts	96-97
AN Fitting Torque Specs	see Website
AN Hardware	96-100
AN Hardware Assortments	98-99
AN Hardware Torque Specs	see Website
AN Hose End Wrenches	117

AN Plumbing Fittings	87-95
AN Thread Size Chart	95
AN to BSP Adapters	93
AN to Metric Adapters	82, 94
AN to NPT Pipe Adapters	89, 91
AN310 Castellated Nuts	98
AN316 Jam Nuts	98
AN364 Reduced Height Lock Nuts	98
AN365 Full Height Lock Nuts	98
AN416 Retainer Pin	107
AN804 Bulkhead Run Tee	87
AN806 Flare Plug	91
AN814 Port Plug	91
AN815 Union	87
AN816 NPT to AN Adapters	89
AN818 Tube Nut	88
AN819 Tube Sleeve	88
AN821 90° Elbow	87
AN822 NPT to AN 90° Elbow	89
AN823 NPT to AN 45° Elbow	89
AN824 Tee	87
AN825 NPT to AN Tee	89
AN826 NPT to AN Tee	89
AN827 Cross (4-Way) Union	87
AN832 Bulkhead Union	87
AN833 Bulkhead 90° Elbow	87
AN834 Bulkhead Branch Tee	87
AN837 Bulkhead 45° Elbow	87
AN894 Reducer	88
AN911 NPT Nipple	89
AN912 NPT Reducer Bushing	89
AN914 NPT Elbow	89
AN917 Female NPT Tee	89
AN919 Un-Equal Union	87
AN920 O-Ring Boss Adapter	90
AN924 Bulkhead Mounting Nut	87
AN929 Flare Cap	91
AN932 NPT Allen Head Plug	91
AN938 Female Tee	88
AN960 Washers	99
AN970 Large Area Washers	99
AN971 Aluminum Weld Fitting	87
Anaerobic Thread Lock Compounds	156
Anderson Plugs	57
Annular Piston Slave Cylinders	147
Anti-Fog Shield Inserts	13
Anti-heat° Compound	140
Anti-Sabotage Lacquer	98
Anti-Seize Compounds	156-157
Antigravity Lithium Batteries	56
AP Brake Fluids	155
AP Master Cylinder Rebuild Kits	126
Apex Universal Joints	139
Arai Helmet Shields	11
Arai Helmets, SA2015	11
Aramid Braided Fuel Hose	85
Aramid Braided Oil Hose	84
Aramid Braided PTFE Hose	85
Ardrox Dye Penetrant Kits	157
ARE Dry Sump Oil Pans	70
Arm Restraints	25
ARP Assembly Lube	154
ARP Rod Bolt Stretch Gauge	116
ART Laser Alignment Equipment	113
ART Laser Scale Pad Leveling System	112
Assembly Grease for Brakes	126
Assembly Instructions, Brake Hose	81
Assembly Instructions, Racing Hose	84-85
Assembly Lube, Aeroquip	154
Assembly Lube, ARP	154
Assembly Lube, Red Line	154
Assortments, AN Hardware	98-99
Assortments, Caps & Plugs, AN	91
Assortments, Dzus Fasteners	101
Assortments, Electrical Connectors	59, 63
Assortments, Metric Hardware	99
ATC Style Fuse Blocks	59
ATE Brake Fluid	155
ATF, Red Line	153
Aurora Rod Ends	142-143

Aurora Spherical Bearings	141
Auto Dolly System	120
Auto Meter Gauges	40, 42-43
Automatic Transmission Fluid	153
Autopower Roll Bars & Cages	32
Auxiliary Battery Connectors	57
Axle Savers	152
Axle Straps	122

B

B-G Racing Pit Equipment	113, 120
Baby Tornado Mirrors	30
Baby Turbo Mirrors	30
Backsaver Energy Absorbing Pad	24
Backup Washers, Rivet	105
Bags, Helmet and Gear	12, 19
Baker Pad	24
Balaclavas, CarbonX	19
Balaclavas, Nomex®	18
Balance Bar, Brake	130
Bald Spot Sports Seat Kits	162
Ball Joint, Stud Type, 10-32	51
Ball Joints, Renault-style	140
Ball Joints, Rod Ends	142-143
Ball Joints, Spherical Bearing Inserts	141
Band Clamps, Stainless Steel	111
Banjo Bolts, Brake (Steel)	83
Banjo Bolts, Fuel / Oil (Aluminum)	94
Banjo Fittings, Brake (Steel)	81-82
Banjo Fittings, Fuel / Oil (Aluminum)	94
Barbed Plumbing Fittings	80, 86, 92
Batteries, Racing	56
Battery Accessories	56-58
Battery Boxes	58
Battery Cable	58
Battery Cable Tools	58
Battery Chargers	56
Battery Connectors	57
Battery Cut-Off Switches	57
Battery Relocation Kit	58
Battery Terminals	58
Battery Wrap Kit	58
Bead Seat Insert Kits	162
Bearing Clearance Chart, Ford 1.6L	67
Bearing Clearance Chart, Ford 2.0L	69
Bearings, Engine, Ford 1.6L	67
Bearings, Engine, Ford 2.0L	69
Bearings, Nadella	141
Bearings, Rod End	142-143
Bearings, Spherical	141
Bearings, Wheel	144
Bell Helmet Bags	12
Bell Helmet Shields	13
Bell Helmets, SA2015	10
Belts, Driver Restraint	22-23
Belts, Pump, Oil & Water	67, 69
Beta Tools	118-119, 163
Bias Bar, Brake	130
Black Light	157
Bladder, Fuel	48
Bleeder Bottles for Brakes	124
Bleeder Screws	83, 124
Blind Rivets	105
Blower Fans	15
Blue Oil Hose	86
Bobbins, Clutch, Ford 1.6L & 2.0L	146, 149
Bodywork Fasteners	101-104, 106
Bolt Extractors, Drill-Out	118
Bolt Gauge, AN	98
Bolts, Airframe (AN Bolts)	96-97
Bolts, Banjo	83, 94
Boost Gauges	42
Booster Pumps, Electric	77
Boots for Battery Terminals	58
Boots for CV & Tripod Joints	152
Boots for Toggle Switches	61
Boots, Driving	21
Borgeson Universal Joints	139
Bosch 044 Fuel Pump	47
Bosch Blue Ignition Coil	64

Quick Tab Edge Index

Safety, Seats	10 to 27
Fire Systems	28 to 29
Mirrors	30 to 31
Roll Bars	32
Graphics	33
Timing & Scoring	34 to 35
Data Acquisition, Gauges	36 to 45
Air & Fuel Delivery	46 to 55
Ignition & Electrical	56 to 65
Engine Parts	66 to 69
Oiling Systems	70 to 76
Cooling Systems	77 to 79
Plumbing	80 to 95
Hardware	96 to 108
Exhaust	109 to 111
Tools & Pit Equipment	112 to 123
Brakes & Brake Pads	124 to 137
Steering	138 to 140
Suspension	141 to 145
Transaxle/Differential	146 to 152
Fluids & Supplies	153 to 159
Ordering Information	160 to 161
Custom Seat Inserts	162
Technical Information	Website

© 1982 - 2019 Pegasus Auto Racing Supplies, Inc. - All rights reserved.

Index

INDEX

Bosch Fuel Pumps 47
 Bosch Ignition Parts 64-65
 Bottle Mounts 28
 Boxes, Parts Storage 123
 Braided Hose, Brake and Clutch 81
 Braided Hose, Oil 84
 Braided Hose, Oil and Fuel 85
 Braided Sleeve for Wires 62
 Brake & Parts Cleaner, Loctite 156
 Brake & Parts Cleaner, Wurth 158
 Brake Adapter Fittings 82, 93-94
 Brake Assembly Grease 126
 Brake Balance Bar 130
 Brake Bias Adjusters 130
 Brake Bleeder Bottles 124
 Brake Bleeder Screws 83, 124
 Brake Bleeding Tools 124
 Brake Caliper Tools 124
 Brake Calipers & Caliper Parts 131
 Brake Cooling Ducts 136
 Brake Discs for Formula Cars 134-135
 Brake Fluid 155
 Brake Fluid Reservoirs 126
 Brake Hats 134-135
 Brake Hoses & Hose Kits 81, 125
 Brake Hoses, Custom Made 125
 Brake Hoses, DOT Approved 125
 Brake Hydraulics 124-131
 Brake Light Switches, Hydraulic 82-83
 Brake Lights 65
 Brake Line Kits, G-Stop 125
 Brake Line Quick Disconnects 79
 Brake Master Cylinders 126-127, 129
 Brake Pad Application Chart see Website
 Brake Pad Compound Descriptions 132
 Brake Pad Spreading Tool 124
 Brake Pad Tracings 133
 Brake Pads 132-133
 Brake Parts 124-136
 Brake Pedal Assemblies 128-130
 Brake Proportioning Valves 130
 Brake Pyrometers 114
 Brake Repair Components 126-127, 130-131
 Brake Rotors for Formula Cars 134-135
 Brake Temperature Paints 137
 Brake Tubing Tools 117
 BrakeOMeter Brake Bias Adjuster 130
 Break-In Additives 153-154
 Breakerless Ignition Systems 65
 Breather Tanks 77
 Breathers, Crankcase 53, 77, 151
 Broken Bolt Extractors 118
 Brushes, Engine Cleaning 116
 BSP Hose Ends 81, 93
 BSP Pipe Fittings 93
 BSP Thread Size Chart 95
 BSS Bead Seat Kits 162
 Bulkhead Connector, Battery Cable 58
 Bulkhead Mounted Bleeder Screw 83
 Bulkhead Mounting Nuts 87
 Bulkhead Unions, AN 87
 Bump Steer Gauges 113
 Bungs, AN, Weld-In and Braze-On 87, 90
 Bungs, NPT, Weld-In 89
 Bushings for Rod Ends & Shock Eyes 144
 Bushings, Hole 107
 Business Hours 160

C

Cabinets, Trailer & Shop 119, 163
 Cable Support Clamps 107
 Cable Ties & Cable Tie Tools 62
 Cable, Aircraft, 1/16 inch diameter 51
 Cable, Battery 58
 Cables, Push-Pull Type 51
 Cables, Throttle 51
 Cage Kits, Autopower 32
 Cage Nets 25
 Californian Mirrors 30
 Caliper Parts, Brake 131

Caliper Piston Tools 124
 Caliper Pistons 131
 Caliper Rebuild Kits 131
 Calipers, Alcon 131
 Calipers, Aluminum 131
 Calipers, FF/F2000 131
 Calipers, MSE Gem LD 19 131
 Calipers, Performance Friction 131
 Calipers, Willowood 131
 Calipers, ZR55 131
 Cam Bearings, Ford 1.6L Engine 67
 Cam Bearings, Ford 2.0L Engine 69
 Camber Gauges 113
 Camera Mounts, In-Car 38
 Camera Systems, In-Car Video 38
 Camloc Fasteners 102, 106
 Camlock Installation Tools 102
 Camlock Harnesses 22-23
 Camshaft and Lifter Lube (Ford) 154
 Canadian Flag Decal 33
 Canister Type Fuel Filters 46, 75
 Canister Type Oil Filters 74-75
 Canton Racing Products 71-75, 77
 Caps, AN 91
 Caps, BSP 93
 Caps, Radiator 77
 Car Numbers, Custom-Cut Vinyl 33
 Carbon Fiber Headlight Covers 31
 Carbon Fiber Sheet 44
 CarbonX Fabric 162
 CarbonX Underwear & Hoods 19
 Carburetor Adapter Fittings 92
 Carburetor Air Horns 53
 Carburetor Linkage Kit 51
 Carburetor Synchronizer 116
 Carburetors, Ford 1.6L & 2.0L 55
 Carburetors, Weber 54-55
 Catek Automotive Electronics 43-44, 57, 65, 138
 Catek Battery Isolators 57
 Catek Rain Lights 65
 Catek Shift Lights 44
 Case for Intercomp Scales 112
 Castellated Nuts 98
 Caster/Camber Gauges 113
 Castrol LMA Brake Fluid 155
 Castrol SRF Racing Brake Fluid 155
 Catch Bottles, High-Temp Plastic 77
 Catch Tanks 77
 Cells, Fuel 48
 Center Mirrors 31
 Chamfered Washers 99
 Champion Racing Spark Plugs 64-65
 Chargers, Battery 56
 Chassis Setup Tools 112-115
 Chassis Springs 145
 Chassis Stands 120
 Chassis Wear Blocks 108
 Check Valves, Fluid, In-Line 91
 Check Valves, Fuel Vent 48
 Checkered Flags 121
 Chocks, Trailer 123
 Chronographs 34
 CHT Gauges 40
 Cibielé Headlamps 31
 Circles for Racecar Numbers 33
 Clamps, Cable Support 107
 Clamps, Cleco 105
 Clamps, Hose Support 86
 Clamps, Lined Hose Clamps 79
 Clamps, Oetiker 86
 Clamps, Stainless Band Clamps 111
 Clamps, Support, Cushioned Metal 86
 Clamps, T-Bolt for Mufflers 111
 Class Letters, Custom-Cut Vinyl 33
 Classic Mirrors 30
 Clean Break Couplings 79-80
 Cleaners 156, 158-159
 Clear Racer's Tape 108
 Clearance Sale Items see Website
 Cleco Clamps 105

Clipboard with Storage Compartment 34
 Clutch Alignment Tools 146
 Clutch Components, Formula Ford 146-147
 Clutch Components, Twin Plate 146
 Clutch Discs, Ford 1.6L & 2.0L 146
 Clutch Hoses 81
 Clutch Line Quick Disconnects 79
 Clutch Master Cylinders 126-127, 129
 Clutch Release Bearings, Hydraulic 147
 Clutch Slave Cylinders 147
 Clutches 146
 Coil Springs 145
 Coils, Ignition 64
 Collars, Neck Support 13-14
 Collector Pipes, 4 into 1 110
 Color Photos of Driving Gloves 2
 Color Photos of Driving Suits 2
 Compression Tester 116
 Connecting Rod Bolt Stretch Gauge 116
 Connectors, Auxiliary Battery 57
 Connectors, Wire 59, 63
 Constant Velocity Joints 152
 Contact OL by Wurth 158
 Control Cables for Sway Bars 51
 Controller, Coolant Pump 77
 Cool Collar 15
 Cool Shirt™ Driver Cooling Systems 15
 Cool Suits 15
 Coolant Hose 78-79
 Coolant Pumps, Electric 77, 151
 Coolers, Engine Oil 76
 Coolers, Transaxle / Differential 151
 Cooling Pump, Differential 151
 Cooling System Components 77-79
 Cooling System Treatment 154
 Cooling Systems for Drivers 15
 Copaslip 157
 Copper Crush Washers 83, 95
 Corner Worker Flags 121
 Cotter Pins 98, 107
 Countersinking Tool 100-101
 Couplers, AN 87-88
 Couplers, Coolant Hose 78
 Couplers, Fluid, Quick Connect 79-80
 Couplers, NPT Pipe 89
 Covers, Headlight 31
 Crack Testing Kits 157
 Craig, Davies Coolant Pumps 77
 Crankcase Breathers 53, 77, 151
 Crayon, Tire Marking 115
 Creafom Bead Seat Kits 162
 Crimping Tools for Weather Pack 59, 63
 Crimping Tools for Wire Terminals 63
 Cross Check Inspection Lacquer 98
 Crush Washers 95
 Cups for Spherical Bearings 141
 Custom Brake Hoses 125
 Custom Driving Suits see Website
 Custom Fuel Hoses see Website
 Custom Graphics 33
 Custom Hoses see Website
 Custom Oil Hoses see Website
 Custom Steering Racks 140
 Custom Throttle Cables 51
 Custom-Cut Vinyl Graphics 33
 Cut-Off Switches, Fuel Pump 46
 Cut-Off Switches, Master Battery 57
 CV Joint Grease, GKN 152
 CV Joint Grease, Red Line 154
 CV Joints & Boots 152
 Cylinder Head Gaskets, 1.6L 67
 Cylinder Head Gaskets, 2.0L 69
 Cylinder Head Work Stands 116

D

D-Rings for Trailers 122
 D-Shape Steering Wheels 137
 Damaged Fastener Extractors 118
 Damaged Goods Instructions 160
 Damaged Thread Repair Kits 118

Dash Display Systems 35-37
 Dash Systems, Data Logging 35-37
 Dashboard Labels 44
 Data Acquisition Systems 35-39
 Data Keeping Notebook 34
 Davies Craig Electric Water Pumps & Fans 77
 Davies Craig Low Coolant Level Alarm 43
 Deburring Tools 100, 118
 Decals, Headlight 31
 Decals, SCCA 33
 Decals, Tow & Jack 123
 Decimal Equivalent Chart see Website
 Degree Wheel 116
 Depth Gauge, Tire Tread 115
 DGV Carburetors 55
 Dielectric Grease 158
 Diesel Fuel Additives, Red Line 155
 Differential Carrier, Mk 9 149
 Differential Cooling Pump 151
 Differential Oil Coolers 151
 Digital Camber Gauge Kits 113
 Digital Data Logging Dashes 35-37
 Digital Levels 113
 Digital Panel Gauges 40
 Digital Pyrometers 114
 Digital Rev Limiters 64
 Digital Tire Pressure Gauges 115
 Disclaimer, Liability 160
 Disconnect Fluid Fittings 79-80
 Discs, Brake 134-135
 Discs, Clutch, Ford 1.6L & 2.0L 146
 Distributor, FF1600 65
 Dividers, Spring 145
 DIY Air Filters 52
 DMS/Varley Racing Batteries 56
 Do It Yourself Air Filters 52
 Dog Rings, Hewland 150
 Dog Rings, Webster 148
 Dolly System for Vehicles 120
 Donuts, Rubber Drive Couplings 152
 Double Flaring Tool 117
 Dowty Sealing Washers 93, 95
 Dream Stick Toe Gauge by ART 113
 Drill Jigs for Safety Wire 120
 Drill Size Chart see Website
 Drill-Out Bolt Extractors 118
 Drive Donuts 152
 Driver Cooling Systems 15
 Driver Restraint Mounting Hardware 24
 Driver Restraints 22-25
 Driving Gloves 2, 20
 Driving Gloves, Color Photos 2
 Driving Shoes 21
 Driving Suits 2, 16-17
 Driving Suits, Color Photos 2
 Driving Suits, Custom Made see Website
 Dry Cell Batteries 56
 Dry Disconnect Couplings 79-80
 Dry Disconnect Fueling Valves 49
 Dry Sump Equipment, Ford 1.6L 70
 Dry Sump Equipment, Ford 2.0L 70
 Dry Sump Oil Pans 70
 Dry Sump Oil Tanks 71
 Dry Sump Tank Heaters 71
 Dual Gauges 40-41
 Duct Tape, Colored & Clear 108
 Ducting, Aeroduct Hose 136
 Dump Cans, Fuel 49
 Duplicate Catalogs 160
 Durometer, Tire 115
 Dye Penetrant Test Kits 157
 Dzus 1500 Slide Latch 106
 Dzus Fastener Tools 101
 Dzus Fasteners 101, 106

E

E (Extinguisher) Decal 33
 E-Track & Fittings 122
 E-Z Weigh Scale, Intercomp 112
 Ear Plugs 18

INDEX

Index

Easy Clean Oil Tanks	71
Edge Trim	107
EFI Adapters	92, 94
EGT Gauges	40
EGT Probes	39-40
Eject Helmet Removal System	12
Elbows, AN	87-88
Elbows, Coolant Hose	78-79
Elbows, NPT Pipe	89
Electric Blower Fans	15
Electric Coolant Pumps	77, 151
Electric Fans, In-Line	15
Electric Fans, Radiator	77
Electric Fuel Pumps	46-47
Electric Wire	61
Electric Wire Capacity Chart	see Website
Electric Wiring Supplies	57-63, 107
Electrical Connector for Steering Wheel	138
Electrical Formulas	see Website
Electrical Gauges	40-43
Electrical Terminals	58-59, 63
Electronic Ignition Systems	65
Electronic Scales	112
End Gap Filer for Piston Rings	116
Engine Bearings, Ford 1.6L	67
Engine Bearings, Ford 2.0L	69
Engine Building & Tuning Tools	116
Engine Cleaning Brushes	116
Engine Compression Tester	116
Engine Gaskets, Ford 1.6L	67
Engine Gaskets, Ford 2.0L	69
Engine Leak Down Tester	116
Engine Oil Analysis	116
Engine Oil Coolers	76
Engine Parts, Ford 1.6L & 2.0L	65-70
Engine Stands, Ford 1.6L & 2.0L	116
Engine Timing Degree Wheel	116
Epoxy, Hysol	158
Epoxy, Loctite Fast Cure Mixer Cups	156
ETFE Wire, Mil Spec	61
E-Track & Fittings	122
EVO4S Data Acquisition System	36
EVO5 Data Acquisition System	36
Exhaust Collectors, 4 into 1	110
Exhaust Components	110-111
Exhaust Gas Temperature Gauges	40
Exhaust Wrap	110
Expansion Tanks, Radiator	77
Extinguishers	28-29
Extinguishers, AFFF	28
Extinguishers, Automatic	29
Extinguishers, FE-36™	29
Extinguishers, Novex™ 1230	29
Extractors for Damaged Bolts & Nuts	118
Eyebolts	24
EZ Tear Tear-Off Ramp	13
EZ Weigh Scale, Intercomp	112

F

Fabric, CarbonX	162
Fabric, Nomex®	17, 162
Facet Fuel Filters	46
Facet Fuel Pumps	46
Fans, Electric Radiator	77
Fans, In-Line Blower	15
Fast Forward Uprights	144
Fastener Assortment Kits	98-99, 101
Fasteners	96-106
Fasteners, Aeroloc	103
Fasteners, AN	96-99
Fasteners, Camloc	102, 106
Fasteners, Cleco	105
Fasteners, Dzus	101, 106
Fasteners, Metric	98-99
Fasteners, MS	98-100
Fasteners, Pop Rivets	105
Fasteners, Quarter-Turn	101-103
Fasteners, Rubber Draw Latches	106
Fasteners, Solid Rivets	100
Fasteners, Spring Type	106

Fasteners, Temporary	105
Fasteners, Toggle Latches	106
FE Drive Belts	69
FE-36™ Fire Systems	29
Female Weld Bungs	89-90
Fender Washers, AN970	99
FF Engine Parts	65-67, 70
FFI Engine Parts	66
FHR Head & Neck Restraints	14
FIA Approved Driver Restraints	22-23
FIA Approved Driver's Suits	2, 16-17
FIA Approved Fire Systems	28-29
FIA Approved Fuel Sampling Port	79
FIA Approved Gloves	2, 20
FIA Approved Head & Neck Restraints	14
FIA Approved Helmets	10-11
FIA Approved Quick Release Steering Hub	138
FIA Approved Racing Seats	26-27
FIA Approved Rain Lights	65
FIA Approved Seats	26-27
FIA Approved Shoes	21
FIA Approved Tow Hooks and Loops	123
FIA Approved Underwear	18
FIA-Approved Roll Bar Padding	32
Fill Valves and Accessories	49
Filler Neck, Radiator	77
Filter Assemblies, Weber 32/36 DGV	52-53
Filter Cutting Tool	74
Filter Mounts for Remote Oil Filters	72
Filter Screens	74-75
Filters, Air	52-53
Filters, Fuel	46-47, 74-75
Filters, Oil	74-75
Fire Suppression Systems	28-29
FireBottle Fire Suppression Systems	29
Firecharger Fire Suppression Systems	28
Fireleeve	109
Firewall Seals	58
Fitting Identification Kit	117
Fittings, AN Adapters	87-89, 91-92
Fittings, Banjo	81-83, 90, 92, 94
Fittings, Brake Adapter	82, 93-94
Fittings, BSP Pipe Fittings	93
Fittings, Hose Ends	81-86
Fittings, Metric	45, 82-83, 94
Fittings, NPT Pipe Fittings	89, 91
Flag Decals	33
Flag, Remove Before Flight	28
Flags, Racing	121
Flange Sealants	156-157
Flare Caps & Plugs, AN	117
Flaring Tool for Brake Tubing	91
Flat Bottom Steering Wheels	36, 137
Flat Washers	99
Flexible Trim	107
FlipCom Pit Board	121
Flo-Fast Fluid Transfer Pumps	50
Flow-Ezy In-Line Fuel Filter	46
Fluid Film Penetrating Oil	158
Fluid Quick Connect Fittings	79-80
Flywheels, Ford 1.6 & 2.0L	146
Foam Fire Suppression Systems	28
Foam, Fuel Cell	48
Fog-Free Helmet Shields	13
Folding Chassis Stands	120
Ford 1.6L & 2.0L Clutch Parts	146-147
Ford 1.6L & 2.0L Engine Parts	65-70, 146
Ford 1.6L & 2.0L Ignition Parts	65
Ford 1.6L & 2.0L Plug Wire Sets	65
Ford 1.6L & 2.0L Spark Plugs	65
Ford Racing Engine Parts	66
Forged Hose Ends	81, 84-85
Formula 2000 Engine Parts	65, 68-70, 146
Formula Ford Air Filters	52-53
Formula Ford Engine Parts	65-70, 146
Formula Ford Tools	116, 150-151
Formula Ford Uprights	144
Formula SCCA Drive Belts	69
Formula V Tire Treatment	158
Formulas, Electrical	see Website

Fraction to Decimal Chart	see Website
Fram Fuel Filters	46
Fram Oil Filters	74
Friction Modifier, Red Line	153
Fuel Cells	48
Fuel Distribution Block	92
Fuel Dump Cans	49
Fuel Fillers	49
Fuel Filters, Aeromotive	46
Fuel Filters, Aluminum	46, 74-75
Fuel Filters, Canton	75
Fuel Filters, Facet	46
Fuel Filters, Flow Ezy	46
Fuel Filters, Fram	46
Fuel Filters, In-Line	46, 74
Fuel Funnels	50
Fuel Hose, Aramid Braided	85
Fuel Hose, Steel Braided	85
Fuel Hoses, Custom Made	see Website
Fuel Injection Adapters	92, 94
Fuel Jugs	49-50
Fuel Level Gauge	48
Fuel Pressure Gauges	41-42, 45
Fuel Pressure Regulators	47
Fuel Pump Safety Cut-Off Switches	46
Fuel Pumps, Electric	46-47
Fuel Safe Accessories	47-49
Fuel Safe Fuel Cells	48
Fuel Sampling Ports	79-80, 92
Fuel Transfer Pumps	50
Fuel Vent Check Valves	48
Fuel/Air Ratio Monitors	37, 40
Funnels	50, 154
Fuseblocks	59

G

G-Load Activated Switch	46
G-Load Sensors	35-38
G-Stop Brake Line Kits	125
Gaffer's Tape	108, 162
Gas Fire Suppression Systems	29
Gasket Eliminator	156-157
Gaskets, Ford 1.6L Engine	67
Gaskets, Ford 2.0L Engine	69
Gauge Accessories	37, 40-41, 44-45
Gauge Adapters	45, 89
Gauge for AN Bolts	98
Gauge Isolator, High Pressure	45
Gauge Senders	45
Gauge, Bearing Clearance	116
Gauge, Fuel Level	48
Gauges	36-37, 40-45
Gauges, Auto Meter	40, 42-43
Gauges, Digital Panel	40
Gauges, Racetech	41
Gauges, Stack	41
Gauges, Tire Pressure	115
GB1000 Brake Paint	137
Gear Bags	12, 19
Gear Change Tray	150
Gear Lubricants, Red Line	153
Gear Position Indicator	44
Gear Ratios, Hewland	150
Gearbox Manuals	151
Gearbox Parts	148-151
Gearbox Seal Kits	151
Gearbox Stud Kits	150
Gearsets, Hewland	150
Gift Certificates	see Website
Gift Ideas for Racers	see Website
Gilmer Belts	67, 69
Girling Brake Caliper Parts	131
Girling Master Cylinder Rebuild Kits	126
Girling Master Cylinders	126
GKN CV Joint Grease	152
GKN Tripod Grease	152
Glasspack Mufflers	111
Gloves, Driving/Nomex®	20
GMT Batteries	56
Gold Heat Barrier Film	109

GPS-Based In-Car Timer	35
Graphics, Custom-Cut Vinyl	33
Grease, Brake Assembly	126
Grease, CV Joint, GKN	152
Grease, CV Joint, Red Line	154
Grease, Rubber	126
Grease, Synthetic	154
Grease, Tripod Joint, GKN	152
Grease, Wheel Bearing, Red Line	154
Grid Umbrellas	121
Grommet Strip	107
Grooving Iron	115
Ground Pad	121

H

H2O Series 12 Point Nuts	98
Halfshaft Joints	152
Handbrakes	129
Handy Reference Data	see Website
HANS® -Friendly Cool Shirts	15
HANS® -Friendly Harnesses	22-23
HANS® Head & Neck Restraints	14
HANS® Helmet Bags	12
Hardness Tester, Rubber	115
Hardware	96-106
Hardware Assortments, AN	98-99
Hardware Assortments, Dzus	101
Hardware Assortments, Metric	99
Hardware for Driver Restraints	24
Hardware Organizers	123
Hardware, AN	96-100
Hardware, Brake Hat Bolts	135
Hardware, Metric	98-99
Harness Pads	24
Harnesses, Driver Restraint	22-23
Hats, Brake Rotor	134-135
Hawk Pad Application Chart	see Website
Hawk Performance Brake Pads	132-133
Head & Neck Restraints	14
Head Bolt Socket, Ford 1.6L	116
Head Gaskets, Ford 1.6L Engine	67
Head Gaskets, Ford 2.0L Engine	69
Head Nets	25
Head Socks, CarbonX	19
Head Socks, Nomex®	18
Header Paint	110
Header Wrap	110
Headlamps, Cibiel	31
Headlight Covers	31
Headlight Decals	31
Headrest Padding	24
Hearing Protection	18
Heat Barrier Compound for Welding	140
Heat Barrier Film	109
Heat Barrier for Batteries	58
Heat Barrier for Spark Plug Boots	64
Heat Barrier for Starters	109
Heat Barrier Products, Thermo-Tec®	109-110
Heat Barrier Sleeve for Hoses	109
Heat Barrier Tape	109
Heat Shield Materials	109-110
Heat Shrink Tubing, Black	63
Heat Shrink Tubing, Clear	61
Heater Blankets, Oil Tank	71
Heim Joints	142-143
Heli-Coil® Thread Repair	118
Helicopter Joints	139
Helicopter Tape	108
Hella Battery Cut-Off Switch	57
Helmet Accessories	11-14
Helmet Aero Kits	12
Helmet Bags	12, 19
Helmet Blowers (Ventilation)	15
Helmet Fresh Spray	12
Helmet Hooks	12
Helmet Removal System, Eject	12
Helmet Restraints	14
Helmet Shield Storage Sleeve	13
Helmet Shields, Arai	11
Helmet Shields, Bell	13

Index

INDEX

INDEX

INDEX

INDEX

Helmet Shields, RaceQuip	11
Helmet Spoilers	12
Helmet Tearoffs	13
Helmet Visors	11-13
Helmets, Arai SA2015	11
Helmets, Bell SA2015	10
Helmets, FIA 8859-2015	10-11
Helmets, RaceQuip SA2015	11
Helmets, Snell SA2015	10-11
Helper Springs, Zero-Rate	145
Helpful Data	see Website
Hewland & Webster Parts	148-151
Hewland Gear Change Tools	150-151
Hewland Gearbox Manuals	151
Hewland Gears	150
High Misalignment Rod Ends	142
High Misalignment Spherical Bearings	141
High-Temperature Paint	110
High-Temperature Spray Adhesive	109
Hitch-Mounted Vise	118
Hole Bushings	107
Hood Pins	106
Hoods, CarbonX	19
Hoods, Nomex®	18
Hook and Loop, Nomex®	17
Hook and Loop, Self-Adhesive	108
Hooks, Helmet	12
Hooks, Steering Wheel	32
Hooks, Tow (Ring Style)	123
Hookup Wire	61
Hose Assemblies, Custom Made	see Website
Hose Assembly Instructions	81, 84-85
Hose Assembly Lube	154
Hose Assembly Tools	81, 86, 117
Hose Clamps, Cushioned Support	86
Hose Clamps, Lined Worm Drive	79
Hose Clamps, Oetiker	86
Hose Clamps, Pro-Clamps	86
Hose Ends, AN	81, 84-86
Hose Ends, Barbed	86
Hose Ends, BSP	81, 93
Hose Ends, Jiffy-tite	80
Hose Ends, O-Ring Boss	90
Hose Ends, Reusable	80-85, 90, 92-93
Hose Ends, Setrab Oil Cooler Adapters	76
Hose Sleeve, Insulating	109
Hose Support Clamps	86
Hose, Air Ducting	136
Hose, AN	81, 84-85
Hose, Braided Racing Hose	84-85
Hose, Brake	81
Hose, Coolant	78-79
Hose, Custom Made	see Website
Hose, Elbows	78-79
Hose, Fuel Filler	49
Hose, Oil	84-86
Hose, PTFE, Brake & Clutch	81
Hose, PTFE, Fuel & Oil	85
Hose, Reducers	78-79
Hose, Rubber Oil Hose	86
Hose, Scavenge	85-86
Hose, Silicone	78-79
Hose, Textile-Reinforced Oil Hose	86
Hose, Turbo Intake	78-79
Hot Knife	162
Hour Meter	42
Hours of Operation	160
How to Find Us	160
How to Order	160
How-To Guides	see Website
Hub Carriers (Uprights)	144
Hubs, Steering Wheel	138
Hump Hose, Silicone	78
Hunsaker QuikFill Dump Cans	49
HV-350 Flexible Adhesive	158
Hybrid Cooling Vest	15
Hybrid Head & Neck Restraints	14
Hydraulic Brake Light Switches	82-83
Hydraulic Handbrakes	129
Hydraulic Release Bearings	147

Hydraulic Spring Perches	145
Hylomar Sealant	157
Hyper Shield Anti-Fog Insert	13
Hyperco Chassis Springs	145
Hysol Epoxy	158

I

Ice Vest	15
Identification Plates for Switches	44
Ignition Coils	64
Ignition Parts	64-65
Ignition Parts, Ford 1.6L & 2.0L	65
Ignition Switches	60-61
Ignition Wire Sets, Ford 1.6L & 2.0L	65
Ignition Wire Sets, Universal	64
Ignitor Breakerless Ignition System	65
In-Car Timers	35
In-Car Video	38
In-Line Blower Fans	15
In-Line Check Valves, Fluid	91
In-Line Check Valves, Fuel Vent	48
In-Line Filters, Fuel	46, 74
In-Line Filters, Oil	74
In-Line Fuel Pumps	46
In-Line Gauge Adapters	45, 79, 89
In-Tank Fuel Pumps	47
Inclinometer, Digital Level	113
Inertia Activated Cut-Off Switch	46
Inflation Tool for Shock Absorbers	144
Infrared Pyrometers	114
Injector Cleaner, Red Line	155
Injector Grade Fuel Filter	75
Inlet Ducts, Air	31, 136
Insert Nuts	100
Inspector's Lacquer	98
Installation Tools, Camloc	102
Instruction Sheets	see Website
Instructions, PTFE Brake Hose	81
Instructions, Racing Hose	84-85
Instruments and Gauges	36-45
Insulating Materials, Thermal	58, 64, 109-110
Insulating Sleeve for Hoses	109
Insulator Boots for Battery Terminals	58
Intercomp Alignment Gauges	113
Intercomp Pyrometers	114
Intercomp Scale Systems	112
Intercomp Shock Dynos	see Website
Intercomp Spring Rate Checker	145
Intercomp Tire Pressure Gauges	115
Internal Hydraulic Clutch Cylinders	147
Inventory Stock Status	see Website
Isolator Mounts, Rubber	107
Isolator, Pressure Gauge	45
ITG Air Filters	52

J

Jabroc Skid Plate Material	108
Jack Decal	123
Jacks, Air	120
Jacks, Quick-Lift	120
Jam Nuts	98
Jet Holder	54
Jetnuts	98
Jets, Carburetor	54-55
Jiffy-tite Quick Connects	80
Joints, Drive Axle	152
Joints, Shift Linkage	139
Joints, Steering	139
Jump Plugs	57
Jump Starter Batteries	56

K

K & N Air Filters	53
K & N Oil Filters	74
Kaynuts	98
Kevlar® Cage Nets	25
Kill Switches, Battery Cut-Off	57
Kits, AN Hardware	98-99
Kits, Dzus Fasteners	101
Kits, Electrical Connectors	59, 63

Kits, Metric Hardware	99
KOUL Tools Hose Assembly Tools	117

L

Labels, Switch	44
Lacing Cord	62
Lacquer, Inspector's	98
Lap Timers	35
Lap Timing Sheets	34
Lapping Compound	157
Large Area Washers, AN970	99
Laser Alignment Equipment	113
Laser Scale Leveling System	112
Laser String Alignment Tool	113
Laser Toe Gauge	113
Latches	106
Lateral G Sensors	35-38
LCU-One Lambda Controller	37
LD 19 Caliper	131
LD200 Dog Rings	150
LD200 Gearsets	150
LD200 Manual	151
LD200 Tools	150
Lead Substitute, Red Line	155
Leading Edge Tape	108
Leak Down Tester	116
LED Rain Lights	65
Left-Hand Jam Nuts	98
Left-Hand Thread Taps	118
Level, Digital Readout	113
Leveling Systems for Scale Pads	112
Lexan Cleaners and Polishes	159
Liability Disclaimer	160
Lifeline Fire Suppression Systems	29
LifePo4 Batteries	56
Lights, Cibié	31
Lights, Rain	65
Lights, Shift	43-44
Lights, Warning	43
Lightweight Batteries	56
Linkage Kit, Carburetor	51
Lithium-Iron Batteries	56
Load Centering Spring Perches	145
Lobro-Style CV Joints	152
Lockheed Master Cylinder Rebuild Kits	126
Locknuts	98, 100
Locks for Trailers	123
Loctite Products	156-158
Longacre Alignment Gauges	113
Longacre Battery Cut-Off Switches	57
Longacre Brake Line Kits	81
Longacre Mirrors	31
Longacre Pyrometers	114
Longacre Switch Panels	60
Loom, Wire	62
Lord Mounts	107
Low Coolant Level Sensors	43
Lubricant Pump for Bottles	154
Lubricants, Red Line	153-154
Lucas Battery Cut-Off Switch	57
Lucas Ignition Coil	64
Lucas Starters	60
Lug Nuts & Studs	124

M

Magnetic Number Circles	33
Magnetic Plugs	95
Magnifying Flashlight	116
Mailing Policy	160
Main Bearings, Ford 1.6L Engine	67
Main Bearings, Ford 2.0L Engine	69
Main Jets, Weber	54-55
Manuals, Mk 9 & LD200	151
Map, How to Find Us	160
Marine Type Battery Box	58
Marking Pens for Tires	115
Master Battery Switches	57
Master Cylinder Kits, Rebuild	126-127
Master Cylinder Repair Parts	126-127
Master Cylinders, Brake & Clutch	126-127, 129

Mechanical Gauges	40-42
Merit Battery Cut-Off Switches	57
Mesh, Stainless Steel Wire	55
Metric Adapters	45, 82-83, 94
Metric Adapters, Gauge	45
Metric Banjo Bolts	83, 94
Metric Hardware	98-99
Metric Hardware Kits	99
Metric Jam Nuts	98
Metric Jetnuts	98
Metric Rod End Bearings	143
Metric to Inch Chart	see Website
Micro Dynamics Digital Rev Limiter	64
Micro-Start Personal Power Supply	56
Mil Spec ETFE Wire	61
Mil Spec Hardware	96-100
Mil Spec Wire Lacing Cord	62
Milbar Safety Wire Twisters	120
Military Switch Guard	61
Mirrors, Racing	30-31
Mk 9 Dog Rings	150
Mk 9 Gear Change Tray	150
Mk 9 Gearbox Parts	148-151
Mk 9 Gearsets	150
Mk 9 Manual	151
Mk 9 Shifter Seals	151
Mk 9 Stud Kits	150
Mk 9 Tools	150-151
Molecule Labs Suit Treatment	17
MOMO Racing Seats	26
MOMO Steering Wheels	137
Mother's Cleaning Products	159
Motul 600 & 660 Racing Brake Fluids	155
Mounting Bars, Window Nets	25
Mounting Brackets, Roll Bar	28, 32, 50
Mounting Hardware for Restraints	24
Mounting Kits for Seats	26-27
Mounts for Cable Ties	62
Mounts for Video Cameras	38
MS20002C Chamfered Washers	99
MS20271 Universal Joints	139
MS20364 Reduced Height Lock Nuts	98
MS20365 Full Height Lock Nuts	98
MS21042 Jetnuts	98
MS21047 Nut Plates	100
MS21051 Single Lug Nut Plates	100
MS21055 Corner Nut Plates	100
MS21059 Floating Nut Plates	100
MS24665 Cotter Pins	98
MSE Gem LD 19 Caliper	131
Mufflers	111
MXG Data Logging Dash	37
MXL 2 Data Logging Dash	37
MXS Data Logging Dash	37
MXS Strada Street Dash	37
MyLaps Transponders	34

N

NACA Ducts	136
Nadella Needle Bearings	141
NAS1097 Solid Rivets	100
Neck Support Collars	13-14
Needle Bearings, Combined	141
Nets, Window & Cage	25
New Product Updates	see Website
NGK Spark Plugs	65
Nibbler, Hand-Operated	118
Nipples, Splicing, for Coolant Hose	78
No-Bleed Quick Disconnects	79
Nomex® Care System	17
Nomex® Driving Suits	16-17
Nomex® Fabric	17, 162
Nomex® Gloves	20
Nomex® Hoods	18
Nomex® Hook and Loop	17
Nomex® Lined Shoes	21
Nomex® Suit Repair Materials	17
Nomex® Thread	17
Nomex® Underwear	18
Nomex® Zippers	17

Index

Non-Destructive Test Kits 157
 Non-Skid Tape, Self-Adhesive 108
 Note Pad for Tire Temperatures 114
 Notebooks, Racing Data 34
 Novect™ 1230 Fire Systems 29
 NPT Adapter Fittings 89, 93
 NPT Magnetic Plugs 95
 NPT Thread Size Chart 95
 Number Boards (Pit Boards) 121
 Number Circles 33
 Numbers, Racecar 33
 Nut Plates & Nut Plate Rivets 100
 Nuts, 12 point H20 Series 98
 Nuts, Aircraft Grade 98, 100
 Nuts, Captive 100
 Nuts, Castellated 98
 Nuts, Jam 98
 Nuts, Lug 124
 Nuts, Tube, AN818 88
 Nuts, Tube, Torque Specs see Website
 Nutserts 100
 Nylock Nuts 98
 Nylon Sealing Washers 95

O

O-Ring Boss Adapters 75-76, 90
 O-Ring Boss Plug 91
 O-Ring Boss, Weld-In 90
 O-Ring Maker Kit, Loctite 157
 O-Rings 95
 OBP Hydraulic Handbrakes 129
 OBP Master Cylinders 129
 OBP Pedal Assemblies, Model-Specific 129
 OBP Pedal Assemblies, Universal 128
 Oetiker Clamp Installation Tool 86
 Oetiker Hose Clamps 86
 Off Decal for Kill Switch 33
 Ohm's Law Formulas see Website
 Oil Accumulators 71
 Oil Analysis 116
 Oil Catch Tanks 77
 Oil Cooler Adapter Fittings 76, 93
 Oil Cooler Screen, Stainless 55
 Oil Coolers, Setrab Pro Line 76
 Oil Coolers, Setrab SLM Series 151
 Oil Filter Cutting Tool 74
 Oil Filter Mounts 72
 Oil Filter Thread Application Chart 73
 Oil Filters 74-75
 Oil Filters, Aluminum 74-75
 Oil Filters, Cannister 75
 Oil Filters, In-Line 74
 Oil Filters, Spin-On 74-75
 Oil Hose, Aramid Braided 84-85
 Oil Hose, Rubber, Textile Reinforced 86
 Oil Hose, Steel Braided 84-85
 Oil Hoses, Custom Made see Website
 Oil Pans, Ford 1.6L Dry Sump 70
 Oil Pans, Ford 2.0L Dry Sump 70
 Oil Pressure Gauges 41-42
 Oil Pressure Switches 43
 Oil Pump Drive Belts 69
 Oil Pumps, Ford 1.6L Dry Sump 70
 Oil Pumps, Ford 2.0L Dry Sump 70
 Oil System Components 69-76
 Oil System Parts, Ford 1.6L 70
 Oil System Parts, Ford 2.0L 69-70
 Oil Tank Heaters 71
 Oil Tanks 71
 Oil Temperature Gauge Adapters 45
 Oil Temperature Gauges 41-42
 Oil Thermostats 76
 Oil, Air Filter Conditioning 52-53
 Oil, Engine, Red Line 153
 Oil, Gear and Transmission, Red Line 153
 Oil, Penetrating 158
 Oil, Red Line Synthetic 153
 Oil, Suspension, Red Line 154
 Oilstats 76
 OMP Driver Restraints 22

OMP Driving Gloves 2, 20
 OMP Driving Shoes 21
 OMP Driving Suits 2, 16
 OMP Harness Accessories 24
 OMP Pedal Pad Kits 130
 OMP Quick Release Steering Wheel Hubs 138
 OMP Racing Seats 27
 OMP Rain Gear 121
 OMP Sport Driving Shoes 21
 OMP Sport Driving Suits 16
 OMP Sport Gloves 20
 OMP Steering Wheels 137
 OMP Tow Hooks and Loops 123
 OMP Underwear 18
 One-Way Valves, Fluid, In-Line 91
 One-Way Valves, Fuel Vent 48
 Order Form 161
 Order Form for Custom Suits see Website
 Order Tracking see Website
 Ordering Information 160
 Organizers, Trailer & Shop 123
 Oxygen Sensor Monitors 37, 40

P

Pace Dry Sump Equipment 70
 Pad Tracings, Brake 133
 Padding, Headrest 24
 Padding, Roll Bar 32
 Pads, Backsaver 24
 Pads, Brake 132-133
 Pads, Harness 24
 Paint, Exhaust Header 110
 Paint, Temperature Indicating 137
 Panel Bulkhead Connector, Battery Cable 58
 Panel Latches, AeroCatch 106
 Panels, Switch 60
 Parker Tube Beader 117
 Parts Cleaner, Loctite 156
 Parts Cleaner, Wurth 158
 Patch, SCCA Suit Patch 33
 Payment Options 160
 Pedal Assemblies 127-130
 Pedal Pad Kits, OMP 130
 Pedal Tape 108
 Pen, Tire Marking 115
 Performance Friction Brake Calipers 131
 Performance Friction Brake Pads 132-133
 Perma-Coil Thread Repair Kits 118
 Permatex Products 157
 Personal Power Supply Jump Starters 56
 Pertronix 600 Digital Rev Limiter 64
 Pertronix Distributor for FF1600 65
 Pertronix Ignitor Systems 65
 PFC Brake Calipers 131
 PFC Brake Pads 132-133
 Pins, Cotter 98, 107
 Pins, Hood 106
 Pins, Quick-Release (Pip) 104
 Pinto Engine Parts 65, 68-69
 Pip Pins 104
 Pipe Adapter Fittings 89, 91-93
 Pipe Fitting Identification Kit 117
 Pipe Fittings, BSP 93
 Pipe Fittings, NPT 89, 92-93
 Pipe Plugs 91, 93, 95
 Pipe Reducers (NPT) 89
 Pipercross Air Filters 52
 Piston Ring Compressor 116
 Piston Ring Gap Filer 116
 Piston Tools for Brakes 124
 Pistons, Brake Caliper 131
 Pit Boards 121
 Pit Equipment 112-122, 163
 Pivot Kits for Helmets 11-13
 Plastic Caps & Plugs 91, 93
 Plastigauge 116
 Plate Nuts 100
 Pliers, Brake Tube 117
 Pliers, Camloc 102

Pliers, Cleco 105
 Pliers, Safety Wire Twisting 120
 Plug Wire Sets, Ford 1.6L & 2.0L 65
 Plug Wire Sets, Universal 64
 Plugs, AN 91
 Plugs, BSP 93
 Plugs, NPT Pipe 91, 95
 Plugs, Pipe 91, 93, 95
 Plumbing Products 78-95
 Pneumatic Riveter 118
 Polishes, Bodywork & Trim 159
 PonchoWheels Rain Poncho 121
 Pop Rivets 105
 Porsche Oil Adapter Fittings 94
 Port, Fuel Sampling 79-80, 92
 Power Steering Fluid, Red Line 154
 Pre-Assembled Brake Hoses 81, 125
 Pre-Oilers, Accumump 71
 Pre-Wired Switch Panels 60
 Pressure Gauges 41-42, 45
 Pressure Gauges, Tire 115
 Pressure Plate, Clutch 146
 Pressure Relief Valves, Tire 115
 Pressure Senders 39, 43
 Pressure Switches 43, 46
 Pricing Policy 160
 Privacy Policy 160
 Pro-Clamps for Barbed Hose Ends 86
 Proportioning Valves, Brake 130
 Prospeed RS683 Racing Brake Fluid 155
 Protractors, Digital 113
 PTFE Hose, Braided, Brake & Clutch 81
 PTFE Hose, Braided, Fuel & Oil 85
 Pulleys, Water & Oil Pump Drive 67, 69
 Pumps for Oil or Gear Lube Bottles 154
 Pumps, Electric Coolant 77, 151
 Pumps, Fuel Transfer 50
 Pumps, Fuel, Electric 46-47
 Pumps, Fuel, Formula Ford 46, 66
 Pumps, Oil 70
 Push-Pull Cables 51
 PX300 Formula Ford Air Filter 52
 PX400 Air Filters 52
 Pyrometer and Stopwatch Combined 114
 Pyrometers, Tire & Brake 114

Q

Quarter-Turn Fasteners 101-103
 Quick Connect Fluid Fittings 79-80
 Quick Release (Pip) Pins 104
 Quick Release Fasteners 101-106
 Quick Release Steering Hubs 138
 Quick-Disconnect Fluid Couplers 79-80
 Quick-Lift Jacks 120
 QuickStix, Loctite 156
 QuickTape, Loctite 156

R

R3 Racing Rubber Remover 159
 Race Bags 12, 19
 Race Glaze Polish 159
 RaceQuip Cage Net 25
 RaceQuip Driving Gloves 20
 RaceQuip Driving Shoes 21
 RaceQuip Helmet Bag 12
 RaceQuip Helmet Shields 11
 RaceQuip Helmets, SA2015 11
 RaceQuip Tow Loops 123
 RaceQuip Window Nets 25
 Racer's Tape 108
 Racetech Gauges 41
 Racing Data Notebook 34
 Racing Flags 121
 Racing Optics Tearoffs 13
 Racing Seats 26-27
 Racing Spirit Clothing by OMP 163
 Radi-Cal Racing Brake Fluids 155
 Radiator Caps, Stant 77
 Radiator Expansion Tanks 77

Radiator Fans 77
 Radiator Filler Neck 77
 Radiator Hose, Silicone 78-79
 Radiator Neck, Aluminum 77
 Radiator Screen, Stainless 55
 Rain Gear 121
 Rain Lights 65
 Ramps, Scale 112
 Ratchet Tie Downs 122
 RBF Streamer 28
 RBF600 & RBF660 Racing Brake Fluids 155
 Real-time Stock Status see Website
 Rear View Mirrors 30-31
 Rebuild Kits, Brake Caliper 131
 Rebuild Kits, Master Cylinder 126-127
 Record Keeping Notebook 34
 Red Line Diesel Additives 155
 Red Line Fuel Additives 154-155
 Red Line Injector Cleaner 155
 Red Line Suspension Fluids 154
 Red Line Synthetic Lubricants 153-154
 Red Line Water Wetter 154
 Red Top® Racing Batteries 56
 Redhead Fueling Valves 49
 Reducer Bushings, NPT Pipe 89
 Reducer Bushings, Rod Ends 144
 Reducer Fittings, AN 87
 Reducers, Silicone Hose 78-79
 Reducing Elbows, Silicone Hose 79
 Reference Data Charts see Website
 Reference Data, Ford 1.6L 67
 Reference Data, Ford 2.0L 69
 Reference Data, Mk 9 Gearbox 151
 Relays 60
 Relief Valves, Tire Pressure 115
 Remote Filter Heads 72
 Remote Reservoirs, Brake Fluid 126
 Remote Starter Switches 116
 Removable Key Cut-Off Switches 57
 Removal Tool for Caliper Pistons 124
 Removal Tools for Damaged Fasteners 118
 Remove Before Flight Streamer 28
 Repack Kits for Mufflers 111
 Repair and Maintenance Products 156-159
 Reservoirs, Brake Fluid 126
 Restraints, Arm 25
 Restraints, Driver 22-25
 Restraints, Head & Neck 14
 Restraints, Helmet 14
 Retainer Clips 107
 Retainer Pin, AN416 107
 Retainer Pins, Cotter 107
 Retainer Pins, Quick Release 104
 Retainer Washers for Rod Ends 99
 Retracting Tool for Caliper Pistons 124
 Return Springs, Throttle 54
 Returns, Easy Return Policy 160
 Rev Limiters 64
 RG Batteries (Recombinant Gas) 56
 Ride Height Gauge 112
 Ring Compressor 116
 Ring Gap Filer 116
 Ring Gears, Ford 1.6L & 2.0L 146
 Ring Terminals 58, 63
 Rivet Backup Washers 105
 Rivet Nuts 100
 Rivet Setting Dies 100
 Rivet Squeezer Tool 100
 Riveting Tool, Pneumatic 118
 Riveting Tools, Manual 100, 105
 Rivets, Blind 105
 Rivets, Solid Aircraft 100
 Rivnuts 100
 Robic Stopwatches 34
 Rod Bearings, Ford 1.6L Engine 67
 Rod Bearings, Ford 2.0L Engine 69
 Rod Bolt Stretch Gauge 116
 Rod End Bearings 142-143
 Rod End Reducer Bushing 144

Index

INDEX

Rod End Seals 141
 Roll Bar Brackets 28, 32, 50
 Roll Bar Mounted Mirrors 31
 Roll Bar Padding 32
 Roll Bars & Cages 32
 Roll-Arounds for Vehicles 120
 Rolling Tool Cabinets 119, 163
 Rollover Valves 48
 Rost Off Penetrant Oil, Wurth 158
 Rotoflex Couplings 152
 Rotors, Brake 134-135
 Roundels for Racecar Numbers 33
 RS683 Racing Brake Fluid 155
 RTV Sealants 157
 Rub Strips, Chassis 108
 Rubber Draw Latches 106
 Rubber Drive Donuts 152
 Rubber Edge Trim 107
 Rubber Grease 126
 Rubber Hardness Tester 115
 Rubber Isolator Mounts 107
 Rubber Lined Support Clamps 86
 Rubber Shock & Vibration Mounts 107

S

S2000 Engine Parts 65, 68-70, 146
 Sabelt Driver Restraints 22-23
 Sabelt Driving Gloves 2, 20
 Sabelt Driving Shoes 21
 Sabelt Driving Suits 2, 17
 Saddle Mounts, Clamp-On 50
 Saddle Washers 139
 SAE J2044 to AN Adapters 92
 Safety Equipment 10-29
 Safety Harnesses 22-23
 Safety Retainer Washers 99
 Safety Switch, Fuel Pump 46
 Safety Wire, Drill Jigs, & Pliers 120
 Safety Wiring Tips see Website
 Sampling Ports, Fuel 79-80, 92
 Sandwich Plates, Oil Filter 73
 Scale Pad Levelers 112
 Scale Ramps 112
 Scale Storage/Transport Case 112
 Scales 112
 SCAT Crankshaft, FF1600 66
 SCCA Crank, Formula Ford 66
 SCCA Decals 33, 123
 SCCA E Decal 33
 SCCA Fire Systems 28-29
 SCCA Fuel Sampling Port 80, 92
 SCCA Head & Neck Restraints 14
 SCCA Off Decal 33
 SCCA Pro Racing Decal 33
 SCCA Rain Lights 65
 SCCA Solo Decal 33
 SCCA Spec Racer Battery 56
 SCCA Spec Racer Brake Hose Kit 81
 SCCA Spec Racer Cool Shirt System 15
 SCCA Suit Patch 33
 SCCA Tow Hook Decals 123
 SCCA Washers 99
 Schroth Driver Restraints 22-23
 Scotchcal® Vinyl 33
 Screen Filters, Air 52-53
 Screen Filters, Fuel & Oil 74-75
 Screen Material, Stainless 55
 Screws, Allen Head 99
 Screws, Bleeder 83, 124
 Screws, Button Head (Allen) 99
 Screws, Flat Head (Allen) 99
 Screws, Socket Head (Allen) 99
 Seal Kits, Gearbox 151
 Sealants 156-157
 Sealing Washers 95
 Seals for Rod Ends 141
 Seals for Toggle Switches 61
 Seals, 37° SECO 7 AN Seals 95
 Seals-It Firewall Grommets 58
 Seals-It Rod End Seals 141

INDEX

INDEX

INDEX

Seat Back Brace 26
 Seat Mount Brackets 26-27
 Seat Pads, Backsaver 24
 Seats, Racing 26-27
 Sebring Mirrors 30
 SECO 7 AN Seals, 37° 95
 Self Wrapping Split Sleeve 62
 Self-Bonding Silicone Tape 58, 156
 Self-Ejecting Fasteners 101-103
 Self-Sealing Quick Connect Fittings 79-80
 Senders, Fuel Level 48
 Senders, Gauge 45
 Senders, Pressure 39
 Senders, Temperature 39, 45
 Setrab In-Line Filters 74
 Setrab Oil Filters 74
 Setrab Pro Line Engine Oil Coolers 76
 Setrab Sandwich Plates 73
 Setrab SLM Oil Coolers 151
 Setting Dies, Rivet 100
 Setup Tools 112-115
 SFI 17.1 Fire Systems 29
 SFI 27.1 Window Nets 25
 SFI 3.2A/1 Driver's Suit 16
 SFI 3.2A/5 Driver's Suit 16
 SFI 3.2A/5 Driver's Suits 17
 SFI 3.3 Arm Restraints 25
 SFI 3.3 Underwear 18-19
 SFI 3.3/5 Gloves 20
 SFI 3.3/5 Shoes 21
 SFI 37.1 Cage Nets 25
 SFI 38.1 Head & Neck Restraints 14
 SFI 45.1 Roll Bar Padding 32
 SFI 45.2 Headrest Padding 24
 Sheet Metal Nibbler 118
 Shield Storage Sleeve 13
 Shields, Helmet, Arai 11
 Shields, Helmet, Bell 13
 Shields, Helmet, RaceQuip 11
 Shift Lights 43-44
 Shift Linkage Joints 139
 Shifter Boot Cover, CarbonX 109
 Shifter Cables 51
 Shifter Joints 139
 Shifter Seal Kits 151
 Shipping Damage Instructions 160
 Shipping Information 160
 Shock Absorber Bearings 141
 Shock Absorber Mounting Brackets 144
 Shock Absorber Oil, Red Line 154
 Shock Doctor Eject System 12
 Shock Mounts, Rubber 107
 ShockProof Gear Oil, Red Line 153
 Shoes, Driving, Fire-Resistant 21
 Shoulder Bushings for Rod Ends 144
 Shut-Off Valves 71, 91
 Side Cage Nets 25
 Side Mirrors 30
 Signal Boards (Pit Boards) 121
 Silencers, Exhaust 111
 Silicone Hose Cutter 117
 Silicone Hose 78-79
 Silicone Rubber Heater Blankets 71
 Silicone Tape, Self Bonding 58, 156
 Simpson Custom Driving Suits see Website
 Simpson Driving Shoes 21
 Simpson Gear Bags 12, 19
 Simpson Harness Accessories 24
 Simpson Helmet Bag 12
 Simpson Hybrid Head & Neck Restraints 14
 Skid Plates for Chassis 108
 Slave Cylinders, Clutch 147
 Sleeve, Braided, for Wires 62
 Sleeve, for Helmet Shield 13
 Sleeve, Insulating for Hoses 109
 Sleeves, Harness 24
 Sleeves, Tube, AN819 88
 Slide Latch 106
 SmartCamber Kit 113
 SmartyCam HD, AiM 38

Snell SA2015 Helmets 10-11
 Socket Drivers 119
 Socket Head Cap Screws 99
 Socket Set Organizers 118
 Socketless Hose 86
 Socketroll Socket Organizer 118
 Socks, CarbonX 19
 Socks, Nomex® 18
 Softcut Digital Rev Limiter 64
 Solderless Terminals 63
 Solenoids, Starter 60
 Solid Aircraft Rivets 100
 Solo2 In-Car Timer 35
 Sound Control Products 18, 111
 SPA Fire Suppression Systems 28-29
 SPA Mirrors 30-31
 SPA Quick Release Steering Wheel Hubs 138
 Spare Parts Boxes 123
 Spare Tire Inflation Systems 114
 Spark Plug Boot Protector 64
 Spark Plug Magnifying Flashlight 116
 Spark Plug Wire Separators 64
 Spark Plug Wire Sets 64-65
 Spark Plugs, Champion 64-65
 Spark Plugs, Ford 1.6L & 2.0L 65
 Spark Plugs, NGK, for Ford 2.0L 65
 Spec Racer Battery 56
 Spec Racer Brake Hose Kit 81
 Spec Racer Cool Shirt System 15
 Special Order Policies 160
 Speed Bleeders 83, 124
 Speedstack™ Tearoffs 13
 Spherical Bearings 141
 Spin-on Adapters, Oil Filter 72
 Spiral Wrap 62
 Splices, Wire 63
 Splicing Nipples for Coolant Hose 78
 Splined Steering Shafts 139
 Split Sleeve, for Wires 62
 Spoilers, Helmet 12
 Sport Gloves by OMP 20
 Sport Shoes by OMP 21
 Sport Suits by OMP 16
 Sports 2000 Engine Parts 65, 68-70, 146
 Spray Adhesives 109, 156
 Spray Lubricants 158
 Spring Dividers 145
 Spring Latches 106
 Spring Perches, Load Centering 145
 Spring Platform Wrenches 145
 Spring Rate Tester 145
 Spring Receptacles, Dzus 101
 Spring Tabs, Camloc 106
 Springs, Hyperco 145
 Springs, Throttle Return 54
 Squeezer for Solid Rivets 100
 SRF Brake Fluid 155
 Stack Tachometers 41
 Stage 8 Locking Fasteners 66, 68
 Stagger Tape 115
 Stainless Braided PTFE Hose 81, 85
 Stainless Braided Racing Hose 84-85
 Stainless Screen Material 55
 Stainless Steel Wire Cloth 55
 Stands, Chassis 120
 Stands, Cylinder Head 116
 Stands, Engine 41-42
 Stant Racing Radiator Caps 77
 Starter Battery Connectors 57
 Starter Heat Shield 109
 Starter Solenoids (Relay) 60
 Starter Switches 60-61
 Starters, Ford 1.6L & 2.0L 60
 Starters, Tilton 60
 Startlite Racing Hose 84
 Stat-O-Seals, Aluminum 95
 Stäubli Quick Disconnects 79
 Steel Braided Brake & Clutch Hose 81
 Steel Braided Fuel & Oil Hose 85
 Steel Braided Oil Hose 84

Steering Column Joints 139
 Steering Joints 139-143
 Steering Racks 140
 Steering Shaft Support Bearings 139
 Steering Shafts, Splined 139
 Steering Turntables 113
 Steering Wheel Electrical Connector 138
 Steering Wheel Hooks 32
 Steering Wheels 36, 137
 Stock Status see Website
 Stopwatch and Pyrometer Combined 114
 Stopwatches 34, 114
 Stopwatches, AiM 34
 Stopwatches, Robic 34
 Storage Boxes 123
 Storage Sleeve, Helmet Shield 13
 Straps, Tie Down 122
 Street Elbows 89
 Stretch Gauge for Rod Bolts 116
 String Alignment Kit 113
 Stripped Screw Removers 118
 Stripped Thread Repair Kits 118
 Stripping Tools, Wire 61, 63
 Stud Kits, Gearbox 150
 Stud Type Ball Joint, 10-32 51
 Suit Cleaning Kit 17
 Suit Patch, SCCA 33
 Suits, Nomex® 16-17
 Sumps, Ford 1.6L Dry Sump 70
 Sumps, Ford 2.0L Dry Sump 70
 Super Starters, Tilton 60
 SuperTrapp Mufflers 111
 Supplies, Tape 108
 Support Clamps, Cushioned Metal 86
 Support Collars, Neck 13-14
 Surge Tanks, Fuel 47
 SurSeat Mini Line Lapper 117
 Suspension Bearings, Nadella 141
 Suspension Bearings, Rod End 142-143
 Suspension Bearings, Spherical 141
 Suspension Fluids, Red Line 154
 Suspension Springs 145
 Sway Bar Adjuster Cables 51
 Sway Bar Adjuster Handles 144
 Swift FF1600 Oil Pan 70
 Swift Uprights 144
 Swirl Pot 77
 Switch Accessories 61
 Switch Guard, Military 61
 Switch Identification Labels 44
 Switch Panels, Pre-Wired 60
 Switches, Battery Cut-off 57
 Switches, Fuel Pump Cut-Off 46
 Switches, High Temperature Warning 43
 Switches, Hydraulic Brake Light 82-83
 Switches, Low Coolant Level Warning 43
 Switches, Low Pressure Warning 43
 Switches, Starter 60-61
 Switches, Toggle & Push Button 60-61
 Synchronizer, Carburetor 116
 Synthetic Lubricants, Red Line 153-154

T

T & B Cable Ties 62
 T-Bolt Clamps, Stainless Steel 111
 T-Handle Socket Drivers 119
 Tachometers 41-42
 Tail Lights 65
 Talbot Mirrors 30
 Tank Trolley by Beta Tools 119, 163
 Tanks, Breather 77
 Tanks, Dry Sump Oil Tanks 71
 Tanks, Overflow 77
 Tanks, Water Expansion 77
 Tape, Aluminum 108
 Tape, E-Z Read Stagger Tape 115
 Tape, Gaffer's 108
 Tape, Leading Edge 108
 Tape, Racer's 108
 Tape, Silicone Self Bonding 58, 156

Bell Auto Racing Helmets, Snell SA2015

Bell Pro Series Helmets

Bell Pro Series helmets feature lightweight carbon-composite shells with moisture-wicking fabric lining. Fractional helmet sizing provides the best possible fit.



The **RS7** is based on the advanced Bell HP7 helmet currently used in F1. A total of 14 inlet and exhaust vents provide maximum cooling. The shield pivot shape is designed to minimize wind noise at speed. Includes one clear dual-pane anti-fog shield (Bell SE07 size). Snell SA2015 and FIA 8859-2015 approved. Available in white or flat black. Specify size: 7 1/8 through 7 5/8.

Bell RS7 Helmet, Snell SA2015 / FIA 8859-2015
Part No. BE141-S15-Size-Color..... \$829.95



The **Dominator.2** is designed for aerodynamic stability at high speeds in open-cockpit cars. The front chin spoiler and rear wicker combat lift, and trip strips molded into the shell fight buffeting. The result is a very distinctive, aggressive look. Includes one clear anti-fog shield (Bell SRV287 size). Snell SA2015 approved. Available in white or flat black. Specify size: 7 1/8 through 7 5/8.

Bell Dominator.2 Helmet, Snell SA2015
Part No. BE142-S15-Size-Color..... \$829.95



Bell Pro Series Helmet Sizing Chart

Inches	CM	Helmet Size
22 3/8	57	7 1/8
22 3/4	58	7 1/4
23 1/8	59	7 3/8
23 1/2	60	7 1/2
23 7/8	61	7 5/8

Use this chart for SA2015 Bell Pro Series Helmets ONLY!



The **GP.3** has F1 styling and performance at a club racing price. Features an integrated front chin spoiler and Bell's narrowest eyepoint. Three forehead intake scoops can be closed off when cooling is not needed. Includes one clear shield (Bell SE03 size). Snell SA2015 and FIA 8859-2015 approved. Available in white or flat black. Specify size: 7 1/8 through 7 5/8.

Bell GP.3 Helmet, Snell SA2015 / FIA 8859-2015
Part No. BE143-S15-Size-Color.....\$729.95



The **GTX.3** delivers great aerodynamic stability at high speeds. An integrated front chin spoiler and removable rear wing reduce helmet lift. Venturi chin vents extract air rather than pulling in, making it ideal for dirt or clay tracks. Includes one clear shield (Bell SE03 size). Snell SA2015 and FIA 8859-2015 approved. Available in white or flat black. Specify size: 7 1/8 through 7 5/8.

Bell GTX.3 Helmet, Snell SA2015 / FIA 8859-2015
Part No. BE144-S15-Size-Color.....\$729.95



The **GT5 Touring** is perfect for use in closed cars. It can be worn as an open helmet with a peak visor (shown), or as a closed helmet with a face shield. Small vents in the chin bar reduce fogging. Includes one peak visor and one clear shield (Bell SE05 size). Snell SA2015 and FIA 8859-2015 approved. Available in white or flat black. Specify size: 7 1/8 through 7 5/8.

Bell GT5 Touring Helmet, Snell SA2015 / FIA 8859-2015
Part No. BE145-S15-Size-Color..... \$699.95

Bell Racer Series Helmets

Bell Racer Series helmets feature standard composite shells. General fit sizing keeps costs lower.



The **K.1 Pro** is Bell's least expensive helmet with aerodynamic countermeasures. The chin spoiler reduces lift while forehead and chin vents minimize shield fogging at speed. The medium-size eyepoint falls between the GP.3 and M.8. Includes one clear shield (Bell 287SRV size). Snell SA2015 approved. Available in white or flat black. Specify size: XX-Small through Extra-Large.

Bell K.1 Pro Helmet, Snell SA2015
Part No. BE162-S15-Size-Color.....\$529.95



The **BR.1** features an extra-large eyepoint. The innovative modular ventilation system incorporated into the chin bar and top vent allows you to install a side or top forced air port (sold separately) without affecting the integrity of the helmet. Includes one clear shield (Bell 281SRV size). Snell SA2015 approved. Available in white or flat black. Specify size: Small through Extra-Large.

Bell BR.1 Helmet, Snell SA2015
Part No. BE163-S15-Size-Color.....\$529.95



The **M.8** is the latest generation of the always-popular Bell M helmet family. Features chin vents, adjustable forehead vent intake scoops, and an extra-large eyepoint. The M.8 has long been a favorite of drivers who wear glasses. Includes one clear shield (Bell SRV-8 size). Snell SA2015 approved. Available in white or flat black. Specify size: XX-Small through 4X-Large.

Bell M.8 Helmet, Snell SA2015
Part No. BE164-S15-Size-Color.....\$529.95



The **Sport EV** boasts the largest eyepoint in the Bell line. The huge Extended Vision (EV) eyepoint is great for drivers with glasses. The lowered chin bar provides better gauge visibility and a less claustrophobic feel than most other helmets. Includes one clear shield (Bell SRV288 size). Snell SA2015 approved. Available in white or flat black. Specify size: Small through Extra-Large.

Bell Sport EV Helmet, Snell SA2015
Part No. BE167-S15-Size-Color..... \$429.95



The **Sport** is our least expensive SA2015 rated full-face Bell helmet. The medium-size eyepoint, chin vents, and adjustable forehead vents have made the Sport a great value and a top seller for many years. Includes one clear shield (Bell 281SRV size). Snell SA2015 approved. Available in white, gloss black, or non-vented orange for marine use. Specify size: Small through Extra-Large.

Bell Sport Helmet, Snell SA2015
Part No. BE169-S15-Size-Color.....\$399.95



The **Sport Mag** is designed for drivers who prefer an open face helmet. The great price tag has made the Sport Mag extremely popular with Solo and HPDE drivers. Includes a black peak visor. This helmet is not designed to accept a face shield. Snell SA2015 approved. Available in white, gloss black, or orange for marine use. Specify size: Small through 4X-Large.

Bell Sport Mag Helmet, Snell SA2015
Part No. BE171-S15-Size-Color..... \$299.95

Bell Helmet Sizing Chart for Racer Series

Inches	21 1/4 to 21 5/8	22	22 3/8	22 3/4 to 23 1/8	23 1/2	23 7/8 to 24 1/4	24 3/4 to 25 1/8	25 1/2 to 25 7/8	26 1/4 to 26 3/8
CM	54 - 55	56	57	58 - 59	60	61 - 62	63 - 64	65 - 66	67 - 68
Helmet Size	XX-Small	X-Small	Small	Medium	Large	X-Large	XX-Large	XXX-Large	XXXX-Large

Use this chart for SA2015 Bell Racer Series Helmets ONLY!

The Snell SA2015 and FIA 8859-2015 helmet ratings each indicate that a helmet is approved for auto racing. All Snell SA2015 rated helmets have a flame-retardant lining and threaded inserts in the shell for head restraint anchors (sold separately).

Arai and RaceQuip Auto Racing Helmets, Snell SA2015

Arai Auto Racing Helmets, Snell SA2015 and FIA 8859-2015 Approved

Arai started manufacturing helmets in 1950 and quickly became a preferred choice of professional racers. Unlike some other companies that offer "custom" products to the pros and "standard" products to the rest of us, Arai only supplies professional drivers with the same off-the-shelf helmets that you can buy. The exclusive Complex Laminate Construction arranges and orients the laminate fibers for maximum strength with maximum flexibility and minimum weight. Each Arai helmet is handmade in Japan.



Arai Helmet Sizing Chart

Inches	CM	Helmet Size
20 5/8 to 21 3/8	52.5 to 54.5	X-Small
21 3/8 to 22 1/8	54.5 to 56.5	Small
22 1/8 to 23	56.5 to 58.5	Medium
23 to 23 3/4	58.5 to 60.5	Large
23 3/4 to 24 1/2	60.5 to 62.5	X-Large

Use this chart for SA2015 Arai Helmets ONLY!

Please visit our website for the full range of Arai helmets and accessories:
PegasusAutoRacing.com/Arai

The **GP-6S** is the same design as the GP-6RC (carbon fiber) helmet used in F1 and IndyCar, but with a hand-laid fiberglass shell. A single forehead inlet, two chin inlets, and one exhaust outlet provide venturi cooling. The narrow eyepoint has a unique shield lifting lever that makes it easy to open the shield. Snell SA2015 and FIA 8859-2015 approved. Available in white only. Specify size: Extra Small through Extra Large.



- Arai GP-6S Helmet, Snell SA2015 / FIA 8859-2015**
- Part No. AR-GP6S-S15-Size-White..... \$859.99
- Standard Shield, specify Clear, Light, or Dark tint**
- Part No. AR-GP6-001-Tint \$78.99
- Dual-Pane Anti-Fog Shield: Amber, Clear, Light, or Yellow**
- Part No. AR-GP6-002-Tint \$123.99
- Mirrored Shield, specify Blue, Green, Red, or Silver**
- Part No. AR-GP6-005-Color \$120.99
- Tear-off Shields, pack of 5, specify Clear or Smoke**
- Part No. AR-GP6-011-Tint \$10.49

The **GP-5W** has a larger eyepoint than the GP-6S (90mm tall). This allows better visibility of rollbar-mounted center mirrors in sedans, but the flow-through ventilation system (2 chin inlets, 2 forehead inlets, and 2 rear exhaust outlets) makes the GP-5W equally at home in open cockpits. Snell SA2015 and FIA 8859-2015 approved. Available in white only. Specify size: Extra Small through Extra Large.



- Arai GP-5W Helmet, Snell SA2015 / FIA 8859-2015**
- Part No. AR-GP5W-S15-Size-White..... \$809.99
- Standard Shield, specify Clear, Light, or Dark tint**
- Part No. AR-GP5W-001-Tint \$74.99
- Dual-Pane Anti-Fog Shield: Clear or Light**
- Part No. AR-GP5W-002-Tint \$123.99
- Dual-Pane Anti-Fog Shield: Yellow only**
- Part No. AR-GP5W-002-Yellow \$146.99
- Tear-off Shields, pack of 5 (Clear only)**
- Part No. AR-GP5-011-Clear \$9.99

RaceQuip Auto Racing Helmets, Snell SA2015 Approved



RaceQuip PRO15 Helmet

This is our least expensive SA2015 rated full-face helmet. The fiberglass shell features a very large eyepoint and a small chin spoiler. Channels molded into the shell help to extract hot air through two rear exhaust vents. Available in Gloss White, Gloss Black, Flat

Black, or Steel (metallic grey). Specify size: XX-Small through 3X-Large.

RaceQuip PRO15 Helmet, Snell SA2015

- White, Black, or Flat Black**
- Part No. RQP273-S15-Size-Color \$219.95
- Steel only**
- Part No. RQP273-S15-Size-Steel \$239.95

Face Shields for SA2015 RaceQuip PRO15 Helmet:

- Clear**
- Part No. RQP204001 \$34.95
- Dark Smoke**
- Part No. RQP204004 \$39.95
- Amber**
- Part No. RQP204006 \$39.95
- Blue Iridium**
- Part No. RQP204007 \$49.95
- Mirrored**
- Part No. RQP204009 \$49.95
- Tear-off Shields, pack of 20**
- Part No. RQP203213 \$6.95
- Pivot Hardware Kit**
- Part No. RQP204111 \$14.95



RaceQuip VESTA15 Helmet

This new design represents a departure from traditional helmet styling, but not from traditional RaceQuip value! The hand-laminated fiberglass shell has an aggressive fighter-pilot look, with a peak in the chin bar that covers the driver's nose. Special ridges molded in the shell aid in aerodynamic stability. Outlet slots in the crown aid cooling and ventilation by drawing air in from below the chin bar. Available in Pearl White or Flat Black. Specify size: Small through 2X-Large.

- RaceQuip VESTA15 Helmet, Snell SA2015**
- Pearl White or Flat Black**
- Part No. RQP283-S15-Size-Color \$349.95

Face Shields for SA2015 RaceQuip VESTA15 Helmet:

- Clear**
- Part No. RQP205001 \$49.95
- Dark Smoke**
- Part No. RQP205004 \$49.95
- Amber**
- Part No. RQP205006 \$49.95
- Blue Iridium**
- Part No. RQP205007 \$59.95
- Mirrored**
- Part No. RQP205009 \$59.95
- Tear-off Shields, pack of 20**
- Part No. RQP203218 \$7.95
- Pivot Hardware Kit**
- Part No. RQP204111 \$14.95



RaceQuip SA2015 Helmet Sizing Chart

Inches	CM	Helmet Size
20 to 20 1/2	51 to 52	XX-Small
20 7/8 to 21 1/4	53 to 54	X-Small
21 1/2 to 22 1/8	55 to 56	Small
22 3/8 to 22 7/8	57 to 58	Medium
23 1/8 to 23 3/4	59 to 60	Large
24 to 24 1/2	61 to 62	X-Large
24 3/4 to 25 1/4	63 to 64	XX-Large
25 1/2 to 26 1/8	65 to 66	XXX-Large

Use this chart for SA2015 RaceQuip Helmets ONLY!

Helmet Fitting Guidelines: All Helmets

Measuring for size

Helmets should fit as tightly as possible without causing discomfort. Measure head circumference around the largest part of the head approximately one inch above the eyebrows and just above the ears. Measure several times and use the largest measurement.

Head socks

If a Nomex® hood will be worn with the helmet, it should be worn when measuring head circumference. If a hood is not available, add about 1/4 inch to the circumference measurement for a single-layer hood and 1/2 inch for a double-layer hood.

Verifying fit

Try on your new helmet and buckle the chin strap. Grasp the bottom edge at the back and try to roll the helmet forward. If you can pull the helmet off of your head, it is too large. Shake your head back and forth. The helmet should move with you.

The Snell SA2015 and FIA 8859-2015 helmet ratings each indicate that a helmet is approved for auto racing. All Snell SA2015 rated helmets have a flame-retardant lining and threaded inserts in the shell for head restraint anchors (sold separately).

Helmet Accessories

Bell Helmet Parts and Accessories

SAFETY

Helmet Rear Spoiler
V.06 for helmets with
smooth shells
Part No. BE204-Clear



Helmet Rear Spoiler
V.09 for helmets
with rear vents
Part No. BE205-Clear



Helmet Rear Spoilers make your helmet less prone to aerodynamic lift. They are especially effective in open cars with a cowling behind the driver's head. Clear spoilers mount to any Bell helmet using double-sided tape (provided).

Rear Spoiler, Clear, V.06 for helmets without vents ... Part No. BE204-Clear \$79.95
Rear Spoiler, Clear, V.09 for helmets with rear vents ... Part No. BE205-Clear \$79.95



Left: Helmet Top Wicker (Small)
Part No. BE208-Small

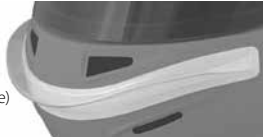

Right:
Chin Bar Gurney Flap (Large)
Part No. BE207-Large

Helmet Top Wickers and **Chin Bar Gurney Flaps** combat helmet lift and buffeting. Three sizes have been developed for the different aerodynamics at different speeds. **Large** is effective at speeds below 150mph. **Medium** is for speeds between 150 and 180mph, and **Small** is best for speeds above 180mph. Clear plastic mounts to your helmet using double-sided tape (provided).

Helmet Top Wickers separate airflow from the top of the helmet to fight buffeting. They are especially recommended for open vehicles with no rear cowling, such as Prod cars, sprint cars, and karts. Top Wicker is not for use with the Rear Spoilers shown above.

Top Wicker, Clear, specify size Part No. BE208-Size \$29.95
Mounts to top of helmet to combat buffeting. Can be adapted to most helmets.

Chin Bar Gurneys provide downforce on the front of the helmet. Designed to fit Bell GP3 / K.1 Pro / M.8 (SA2015) and Star GP / GP2 (SAH2010) helmets.

Chin Bar Gurney Flap, Clear, specify size Part No. BE207-Size \$29.95
Mounts to chin bar to create front downforce. Fits listed Bell helmet models only.

Arai PED Kit for Full-Face Helmets



Improve the aerodynamic stability of your Arai full-face helmet with the Performance Enhancing Device kit from Arai. The kit includes a front spoiler (to mount just below the chin bar vent inlets) and a rear spoiler (to mount at the top rear of the helmet) to combat buffeting and lift at high speeds. Clear plastic lets your custom paint show through. Two-sided tape is pre-applied for easy mounting. Fits Arai GP-5W, GP-6, and SK-6 helmets.

Arai PED Kit Part No. AR-PED KIT \$85.49

Helmet Fresh Spray

Keep your helmet smelling like new with **Helmet Fresh**. Just spray the inside of your helmet after use and let it air dry. Helmet Fresh attacks bacteria and mildew - the source of odors - leaving a fresh, clean smell. One 4 ounce bottle can last all season.

Helmet Fresh, handy 4 oz. spray bottle Part No. 3396 \$7.99

Bell Visor Hardware and Accessories

- Bell Hex Wrench for Shield Pivots** Part No. 2258 \$12.95
- Bell SRV1 (SA10/SA15) Spare Parts Kit** Part No. 2239-007-Color \$17.95
For Bell helmets with SRV287 shields only. Specify Black, Blue, Red, or Silver.
- Bell SRV2 (SA10/SA15) Spare Parts Kit** Part No. 2239-008-Color \$17.95
For Bell helmets with SRV276, SRV281, SRV288, or SRV-8 shields. Black, Blue, Red, or Silver.
- Bell SV SE03/05 (SA10/SA15) Spare Parts Kit** Part No. 2239-011-Color \$19.95
For Bell helmets with SE03 or SE05 shields. Available in Black, Blue, Red, or Silver.
- Bell SV SE07 (SA10/SA15) Spare Parts Kit** Part No. 2239-012-Color \$19.95
For Bell helmets with SE07 shields. Available in Black, Blue, Red, or Silver.
- Bell Visor Strips, Black, pkg of 2** Part No. 2283 \$12.95
- Peak Visor for Sport Mag (SA10/SA15), Black** Part No. 2239-005 \$49.95
- Peak Visor for GT5 (SA10/SA15), Black or White** Part No. BE221-Color \$69.95

Bell BR.1 (SA2010/SA2015) Vent Plates and Intake Port Plates

- BR.1 Chin Bar Vent Plate Kit** Part No. BE211-Color \$39.95
- BR.1 Chin Bar Forced Air Port Plate Kit** Part No. BE214-Color \$39.95
- BR.1 Chin Bar Block-Off Plate Kit** Part No. BE209-Color \$39.95
- BR.1 Top Forced Air Port Kit** Part No. BE213-Color \$39.95
- BR.1 Top Vent Outlet Plate Kit** Part No. BE212-Color \$39.95
- Screw Kit only for any BR.1 Plate above** Part No. BE216-Color \$9.95
The above plates and screws are available in White or Matte Black.

Bell Forced Air Hose Inlet Adapter, Straight Part No. BE219-Straight \$9.95
Bell Forced Air Hose Inlet Adapter, 90 Degree Part No. BE219-90 \$12.95
These adapters connect your 1 1/2" blower hose to the small 1" inlet nozzle on certain SA2010 and SA2015 Bell forced air helmets.

BR.1 Chin Bar Forced Air Kit, Large Nozzle, White ... Part No. BE220 \$39.95
BR.1 Chin Bar Forced Air Kit, Large Nozzle, Black ... Part No. BE222 \$39.95
These forced air kits have the more common 1 1/2" nozzle. and do not require an adapter.

Cheek Pad Inserts Four different thicknesses are available to tighten the helmet fit. Choose 5mm (slightly tighter), 10mm, 15mm, or 20mm (much tighter). Fits Bell SA2010/SA2015 helmets only. Kits include 2 inserts of the same size (one set covers one helmet).

Cheek Pad Insert Kit, set of 2, specify size Part No. BE203-Size \$9.95

Shock Doctor Eject Helmet Removal System



The **Shock Doctor Eject Helmet Removal System** allows safety workers or EMTs to remove your helmet while keeping your spine immobilized. Inflating a small bag inside the helmet safely pushes your helmet off, reducing the risk of post-crash injuries. The bag weighs about one ounce and will not affect the fit of your helmet. You won't even know it's there.

Shock Doctor Eject Helmet Removal Device, no inflator Part No. SD-300 .. \$49.99
Shock Doctor Eject Inflator Bulb Only (not shown) Part No. SD-302 .. \$39.99

Helmet Hooks

Never waste time searching for your helmet again! These lightweight aluminum hooks clamp onto your roll bar to hang your helmet on between sessions. Sold individually.

Helmet Hook for 1 1/2 inch roll bar Part No. HH1003 \$19.99
Helmet Hook for 1 3/4 inch roll bar Part No. HH1004 \$19.99

Helmet Bags



The **Bell HANS® Pro Helmet Bag** is big enough to hold your helmet, HANS® device, and more. Two zippered external pockets hold small items. A mesh pocket on the outside can hold damp items. Includes a removable interior divider. Measures a generous 13" W x 14" H x 22" L. Black with red trim and quilt stitching.

Bell HANS® Pro Helmet Bag... Part No. 2148-006. . \$59.95



The **Bell Victory Helmet Bag** matches the styling of the Bell HANS® Pro Bag, but the lightly padded, vented interior is sized to fit just your helmet. A single zippered outer pocket on one side can hold small items. Dual top carrying handles. Black with grey Bell logos, red zipper trim, and red quilt stitching.

Bell Victory Helmet Bag Part No. 2148-007. . \$49.95



The **Simpson Raceway HANS® Helmet Bag** has a padded, vented interior to protect your helmet. The roomy main compartment has plenty of space for your HANS® device. A zippered pocket on the side holds small items.

Includes a removable shoulder strap with metal hardware. Measures 20" L x 11" W x 13" D. Black with red, orange, and yellow stripes and red-on-white Simpson logo.

Simpson Raceway Bag ... Part No. 2143-018 \$54.99



The **Bell Vented Helmet Bag** is lined with a soft fleece material to protect your helmet and shield. A small vent allows the bag to breathe. Dual top handles for easy carrying. Black with red trim and silk-screened Bell logo.

Bell Vented Helmet Bag Part No. 2132-001 .. \$29.95



The **Bell Drawstring Helmet Bag** is the same lightweight bag included with many Bell helmets. Protects your expensive custom paint job against minor scratches. May not fit helmets with large spoilers or forced air ports. Black knit cloth with white Bell logo.

Bell Drawstring Helmet Bag .. Part No. 2147. \$12.95



The **RaceQuip Helmet Bag** is lined with fleece to protect your helmet and shield. One exterior pocket can hold earplugs or hardware. The dual carrying handles wrap all the way to the bottom for extra strength. Black with red and white RaceQuip logo.

RaceQuip Helmet Bag Part No. RQP300003 ... \$19.95

Bell Helmet Shields

SAFETY

Shields for Bell SA2015 Helmets – Please visit our website for shields for older helmets

Bell Helmet Model	Snell Rating	Bell Ref. No.	Shield Part No.	Standard Shield Colors						Hyper Shield Anti-Fog Inserts		
				Clear	Light Smoke	Dark Smoke	Amber	Blue Chrome	Silver Chrome	Add a Hyper Shield insert to make any shield fog-free!		
BR.1, Sport	2015	281SRV	2312-002	\$59.95	\$59.95	\$59.95	\$59.95	\$59.95	\$79.95	\$79.95	Part No. 2239-050-281	\$39.95
Dominator.2, K.1 Pro	2015	287SRV	2312-008	\$59.95	\$59.95	\$59.95	\$59.95	\$79.95	\$79.95	\$79.95	Part No. 2239-050-287	\$39.95
Sport EV	2015	288SRV	2312-010	\$59.95	\$59.95	\$59.95	\$59.95	\$79.95	\$79.95	\$79.95	Part No. 2239-050-281	\$39.95
M.8	2015	SRV-8	2312-032	\$59.95	\$59.95	\$59.95	\$59.95	\$79.95	\$79.95	\$79.95	Part No. 2239-050-281	\$39.95
GP3, GTX.3	2015	SE03	2312-016	\$99.95	\$99.95	\$99.95	N/A	\$149.95	\$129.95	<i>The SE03 is a dual-pane fog-free shield.</i>		
GT5 Touring	2015	SE05	2312-011	\$79.95	\$79.95	\$79.95	N/A	\$109.95	\$109.95	Part No. 2239-050-281	\$39.95	
RS7	2015	SE07	2312-012	\$99.95	\$99.95	\$99.95	\$99.95	\$129.95	\$129.95	<i>The SE07 is a dual-pane fog-free shield.</i>		

SRV1 (SA10-SA15)



The **SRV1** pivot system (left) is only used on SA2010/SA2015 helmets with the 287SRV shield.

SRV2 (SA10-SA15)



The **SRV2** pivot system (left) is used on SA2010/SA2015 helmets with 276SRV, 281SRV, or 288SRV shields.

SV SE03/05 (SA10-SA15)



The **SV SE03/05** pivot system (left) is used on SAH2010/SA2015 and FIA 8859/8860 helmets with SE03 or SE05 shields.

SV SE07 (SA10-SA15)



The **SV SE07** pivot system (left) is used on SAH2010/SA2015 and FIA 8859/8860 helmets with the SE07 shield.

SRV1 (10 version) Spare Parts Kit, specify color Part No. 2239-007-Color.....\$17.95

SRV2 (10 version) Spare Parts Kit, specify color Part No. 2239-008-Color\$17.95

The SRV1 and SRV2 kits are available in Black, Blue, Red, or Silver.

SV SE03/05 (10 version) Spare Parts Kit Part No. 2239-011-Color \$19.95

SV SE07 (10 version) Spare Parts Kit Part No. 2239-012-Color \$19.95

The SV SE03/05 and SV SE07 kits are available in Black, Blue, Red, or Silver.

We also have shields for SA2005 and SA2010 Bell helmets in stock. Please see our website for a complete list!

Molecule Labs Shield Care



First Molecule Labs revolutionized driver's suit care. Now their expertise has been put to work on keeping your vision clear. Rain Repel is formulated to prevent rain droplets from sticking to the outside of your shield. Anti-Fog prevents moisture from condensing on the inside of the shield. Each is packaged in a 4 ounce pump spray bottle, small enough to fit in your helmet bag.

Molecule Labs Rain Repel Part No. MOL-142-4 oz \$5.99

Note: Not for use on mirrored shields.

Molecule Labs Anti-Fog Treatment . Part No. MOL-143-4 oz \$5.99

Shield Storage Sleeve



Don't let your expensive helmet shields get scratched and ruined in your gear bag. Our soft felt sleeve protects your spare shield from the minor bumps and scrapes that cause distorted vision. A drawstring closure at one end keeps your spare helmet shield secure. Universal design fits most shields.

Pegasus Exclusive!

Helmet Shield Storage Sleeve Part No. 2136 \$6.99

Tear-Off Shields

XStack and Speedstack Laminated Tear-Off System

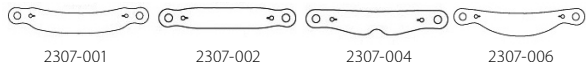

The **Speedstack Laminated Tear-Off System** is clearer than anything else you have ever tried! Multiple thin layers are laminated together into a single stack. Each stack has the clarity of just one conventional tear-off. No possibility of trapping dust, fog, or water between the layers because the stack installs as one piece. **XStack** includes 3 stacks of 10 clear layers for a total of 30. XStack is available in clear only. **Speedstack7** includes 4 stacks of 7 layers for a total of 28. Speedstack7 is available in Clear, or with a Smoke or Amber tinted base layer.

XStack Tear-Offs for Bell, clear only Part No. 2307-001-Clear \$29.99

XStack Tear-Offs for Bell 287 SRV, clear only Part No. 2307-007-Clear \$29.99

XStack Tear-Offs for Bell SE07, clear only Part No. 2307-008-Clear ... \$29.99

XStack Tear-Offs for Arai GP-5W, clear only Part No. 2307-014-Clear \$29.99

XStack Tear-Offs for Arai GP-6, clear only Part No. 2307-015-Clear..... \$29.99

Speedstack7™ for Simpson Voyager Part No. 2307-002-Color ... \$29.99

Speedstack7™ for Bandit, RX (11.5" w/ nose notch) . Part No. 2307-004-Color \$29.99

Speedstack7™ for Simpson Shark, VUDO (13") Part No. 2307-006-Color \$29.99

Tear-Offs for Bell and Pyrotec Helmets



Left: Bell / Pyrotec Tear-Offs, Part No. BE251
Right: Bell 287 Tear-Offs, Part No. BE250



These quality tear-offs are made to fit **Bell** and **Pyrotec** helmet shields.

Bell / Pyrotec Tear-Offs, 5 mil thickness, 10 pack Part No. BE251 \$5.99

Fits most Bell and Pyrotec helmets (except certain SA2010/SA2015 Bell shields).

Bell 287SRV Tear-Offs, 2 mil thickness, 20 pack Part No. BE250 \$5.99

Fits Bell 287SRV shields only.

Bell SE03/SE05 Tear-Offs, 2 mil thickness, 12 pack Part No. BE252 \$4.99

Fits Bell SE03 and SE05 shields only.

Adjustable Tear-Off Posts



These offset posts can be used to fit tear-off strips to most flat face shields. Set of two posts and two screws is enough for one shield.

Adjustable Tear-Off Posts, pair Part No. 2253\$4.29

EZ Tear Single-Pull Tear-Off Ramp

Grab just one tear-off at a time, every time! The innovative EZ Tear guides your hand to the top tear-off, while protecting the rest of the stack from being grabbed by accident. Installs easily on most full-face helmet shields. Use with your own tear-off posts, or get the full kit with a pair of silver anodized aluminum posts. EZ Tear is available in Black or White.

EZ Tear Ramp Kit with Silver Tear-Off Posts Part No. EZT-S102P-Color ... \$29.99

EZ Tear Ramp only (no posts) Part No. EZT-S101-Color..... \$19.99

Aluminum Tear-Off Posts, pair Part No. EZT-ATP001-Color... \$14.99

Black, Blue, Gold, Red, or Silver. Includes a set of 10-24 (UNC) mounting screws.

EZ Tear Single-Pull Tear-Off Ramp Kit with Posts, Part No. EZT-S102P-Black

Kit includes EZ Tear ramp, silver-anodized aluminum tear-off posts, and 10-24 (UNC) mounting screws



Neck Support Collars

Neck Support Collars reduce fatigue by taking some of the weight of the helmet off the neck. These foam rubber collars each have a removable soft knit Nomex® cover and a wide range of adjustment. Available in Black, Blue, or Red.

Simpson Neck Collar, SFI 3.3 Approved Part No. 2120-Color \$39.95

OMP Anatomical Neck Collar Part No. 2123-Color \$99.00

Note: These neck collars are not safety devices. They are not intended to take the place of a Head and Neck Restraint device. They will not satisfy requirements for an SFI 38.1 or FIA 8858 Frontal Head Restraint (FHR). See page 14 for SFI and FIA Head and Neck Restraints.



Above: Simpson SFI 3.3 Neck Collars Part No. 2120-Color

Below: OMP Anatomical Neck Collar Part No. 2123-Color



The anatomical shape extends down between the shoulders for additional support

Head and Neck (FHR) Restraint Systems

Whether you prefer the history behind the HANS Device or the fit of the Hybrid, we urge all racers to wear some form of head and neck restraint device meeting SFI or FIA specs!

HANS® Head and Neck Restraints, SFI 38.1 and FIA Approved



All HANS Devices meet SCCA requirements.



HANS Adjustable with Post Anchors
Part No. 9597-002-Size



HANS Pro Ultra Lite, Model 30 with Post Anchors
Part No. 9558-030-Size



HANS III, Model 20 with M61 Anchors
Part No. 9598-004-Size

The **HANS® Device** is the result of over 30 years of research, development, testing, and actual racing use. Many organizations currently require the HANS Device and will not accept any other head and neck restraint. All of these HANS Devices are SFI 38.1 certified and FIA 8858-2010 homologated. Each HANS Device includes Vision Advantage PLUS sliding tethers, helmet anchors, black contour padding, and full instructions.

The unique **Adjustable Series** can be set up to suit any seating angle from 10 to 40 degrees. The Adjustable is ideal for anyone who drives more than one type of car. Injection-molded magnesium alloy construction weighs just over 2 pounds.

The top-of-the-line **Pro Ultra Lite Series** features high-modulus carbon fiber construction and a lower, rounded backboard to bring the weight to under 1 pound.

The economical **HANS III Series** features injection-molded composite construction, but the distinctive F1-style cut-out backboard reduces weight to below two pounds.



PA (Post) Anchor.

Post Anchors allow the HANS Device to be disconnected from the helmet by pressing and sliding the tether tab. This is the most popular anchor style.



M61 FIA Quick-Release Anchor.

M61 Anchors allow the HANS Device to be quickly disconnected from the helmet by simply pulling a lanyard. This style is popular in cramped cockpits.

How to select a HANS Device

- Step 1:** Determine your seating angle. Sit in your car and measure the angle between your sternum and a vertical line. Alternatively, start with the Adjustable series to fit any angle from 10 degrees to 40 degrees.
- Step 2:** Measure your neck size. Medium fits 13.5" to 17"; Large fits 16" to 20".
- Step 3:** Decide which Series you prefer: Pro Ultra Lite, HANS III, or Adjustable. (Note that not all seating angles or sizes are available in all series.)
- Step 4:** Try on the HANS Device you have selected for comfort and proper fit. Very thin drivers may find that they need a more upright version than the seat angle indicates, while barrel-chested drivers may be more comfortable with a more reclined model. Driver comfort is always the deciding factor.

Adjustable Series HANS Devices with Vision Advantage PLUS Sliding Tethers:
HANS Adjustable, for All Cars, Post Anchors Part No. 9597-002-Med \$559.00
HANS Adjustable, for All Cars, M61 Anchors Part No. 9597-004-Med \$559.00

Pro Ultra Lite Series HANS Devices with Vision Advantage PLUS Sliding Tethers:
HANS Pro Ultra Lite, Model 20 for Sedans, PA Part No. 9558-020-Size... \$1,009.00
HANS Pro Ultra Lite, Model 20 for Sedans, M61 Part No. 9560-020-Size... \$1,009.00
HANS Pro Ultra Lite, Model 30 for Layback, PA Part No. 9558-030-Size... \$1,109.00
HANS Pro Ultra Lite, Model 30 for Layback, M61 Part No. 9560-030-Size... \$1,109.00

HANS III Series HANS Devices with Vision Advantage PLUS Sliding Tethers:
HANS III, Model 20 for Sedans, Post Anchors Part No. 9598-002-Size..... \$459.00
HANS III, Model 20 for Sedans, M61 Anchors Part No. 9598-004-Size..... \$459.00
HANS III, Model 30 for Formula Cars, PA Part No. 9598-008-Size..... \$559.00
HANS III, Model 30 for Formula Cars, M61 Part No. 9598-010-Size..... \$559.00

HANS Device Accessories:
 Upgrade or update your HANS Device. **Note:** These tether kits do not include anchors.
HANS Vision Advantage PLUS Sliding Tether Kit Part No. 9589-041 \$59.99
 Upgrade any Pro, Extra, or Sport I Series HANS Device for a full range of head movement and unrestricted vision. Requires Post Anchors, sold separately.
HANS PA Pro Post Anchors, specify color Part No. 9589-002-Color..... \$64.99
 Pro Post Anchors have anodized aluminum bases in Black or Silver. FIA 8858-2010 and SFI 38.1 approval is engraved in the anchor base.
HANS M61 Tether Kit, for Adjustable or Pro Ultra Lite . Part No. 9589-511 \$39.99
HANS M61 Tether Kit, for HANS III only Part No. 9589-519 \$39.99
HANS M61 Quick-Release Anchors, black only Part No. 9599-102 \$70.00
 Low-profile M61 anchors release from the tether with a pull of a lanyard. FIA 8858-2010 approval is engraved into the anchor.

HANS Soft Gel Padding Kit, specify color Part No. 9586-Color..... \$79.99
 Softer than the Contour padding supplied with new HANS Devices. Gel padding is preferred by drivers who have had collarbone injuries. Available in Black, Blue, Red, or Yellow.

SCCA Head & Neck Restraint Requirements

SCCA requires SFI 38.1 or FIA 8858 approved head and neck restraint devices for all Club Racing and Pro Racing events. All of the restraints shown on this page satisfy SCCA requirements.

Simpson Hybrid Head and Neck Restraints, FIA Approved

Simpson Hybrid Sport
Part No. 9599-002



Hybrid Sizing Chart	
Chest*	Size
32" - 36"	X-Small
36" - 40"	Small
40" - 44"	Medium
44" - 48"	Large
48" - 52"	X-Large

* Measured over the driver's suit.

Simpson Hybrid S
Part No. 9599-002



Note: The Hybrid does not include helmet anchors. The required PA Post Anchors are sold separately.

The Simpson Hybrid meets SCCA requirements.

The **Simpson Hybrid** is perfect for drivers who just can't get comfortable with a HANS Device. The Hybrid straps to your torso, so it moves with you. This also makes the Hybrid more tolerant of incorrect shoulder belt spacing. The backboard is much lower than the HANS Device, which can make exiting the car easier in a panic situation. We offer two models, both with sliding PA tethers (anchors sold separately). Both are FIA 8858-2010 approved and legal for SCCA Club and Pro racing.

The **FIA Hybrid Sport** uses injection-molded composite construction for a low price, yet it only weighs about 2 pounds.
FIA Hybrid SportPart No. 9599-002-Size \$664.00

The **FIA Hybrid S 3-Point** is designed to work with 6-, 5-, 4-, or even 3-point belts. It is also FIA homologated, which makes it ideal for wheel-to-wheel racers who instruct at HPDE and track day events!
FIA Hybrid S 3-Point Part No. 9599-006-Size \$1,095.00
 To find your size: Put on your driver's suit and measure your chest, just under the pectoral muscles. Do not pull the tape too tight. You should be able to take a deep breath.
HANS PA Post AnchorsPart No. 9589-002-Color.....\$64.99

Driver Cooling

Hybrid Phase Change / Evaporative Sport Cooling Vest



Hybrid Sport Cooling Vest This is the same system used by many F1 drivers and pit crews. Unlike other cool vests which require you to freeze ice packs prior to use, the Hybrid Vest uses cool packs filled with a special TechKewl phase-changing material that freezes at 58°F (cool but not too cold). No freezer necessary! Simply charge the packs by putting them into the ice water in your cooler for about 45 minutes. Your vest will be cool and comfortable for up to 2 hours in a 100°F environment. When worn as an outer garment (not under a driver's suit), the Hybrid can also be dipped in water and used as an evaporative cooling vest. Use the cool packs during the race and wet the vest in Impound after the race. The Hybrid comes complete with one cooling pack set plus a soft-sided cooler to keep it ready for use. Replacement packs are also available separately. White with blue front and back panels and black trim. Available in sizes XS through XXXL.

Hybrid Sport Cooling Vest, specify size Part No. 2745-003-Size \$199.99
Replacement Cool Packs, Set of 4 (enough to fill one vest) Part No. 2745-022 \$135.99

Techni-Ice Cool Collar



Freeze the **Cool Collar** to keep you comfortable for up to two hours on the hottest days. This is not a dime-store collar that drips water down your neck. The secret is the special Techni-Ice core that remains flexible down to -50°F. Buy several collars and rotate to stay cool all day. The removable fabric shell has an additional insulating layer on one side to fine-tune the rate of heat transfer. Extended ends can be tied around your neck to keep the collar in place.

Techni-Ice Cool Collar Part No. 2127 \$23.99

SAFETY

Cool Shirt® Personal Cooling Systems

COOLSHIRT SYSTEMS

Cool Shirt® Personal Cooling Systems (shirt sold separately)

Cooler, Hose, and Shirt are now sold separately! Mix and match components to build exactly the system you need!



Perform better with **Cool Shirt® Personal Cooling Systems**. Reduce fatigue, react faster, and make fewer errors by keeping your core body temperature in its optimum operating range regardless of the environment.

The economical **Club Systems** (pictured here with a short sleeve white cotton shirt and hose set, sold separately) are based on a leak-proof Platinum-Series cooler with built-in 2 amp pump. The hinges and latches on the cooler can be reversed to allow for the most efficient routing of the hose outlets. Shirt and hoses sold separately. Complete your system by adding a

hose set plus any size and style Cool Water Shirt from the selection shown at right.

Cool Shirt 13 Quart Club Cooler only Part No. CS012 \$295.00
 Cooler measures 14" long x 9.5" wide x 11" high and provides up to 3 hours of cooling.

Cool Shirt 19 Quart Club Cooler only Part No. CS024 \$302.00
 Cooler measures 15.5" long x 10.5" wide x 13" high and provides up to 6 hours of cooling.

The **Round System** is similar to the Club Systems above, but instead of a rectangular Platinum-Series cooler, it uses a compact 10-quart round cooler. The 9" diameter x 13" tall cooler fits behind the left front wheel on the SCCA Spec Racer (SRF). Hose and Cool Water Shirt sold separately.

Cool Shirt 10-Quart Round Cooler only Part No. CS505 \$248.00
 Cooler measures 9" diameter x 13" high and provides up to 2 hours of cooling.

The compact and convenient **Portable Bag Systems** use a soft-sided cooler for easy mounting in crowded cockpits. They are also ideal for track days and solo events – just strap the cooler to your passenger seat! Because they are easy to mount near the driver, hoses are not included with these systems. Hose set and Cool Water Shirt sold separately.

Cool Shirt 6 Quart Portable Bag Cooler only Part No. CS021 \$325.00
 Cooler measures 12" long x 6" wide x 10" high and provides up to 2 hours of cooling.

Cool Shirt 12 Quart Portable Bag Cooler only Part No. CS022 \$343.00
 Cooler measures 18" long x 7" wide x 13" high and provides up to 3 hours of cooling.

The **Waist Pack System** is small enough for formula cars or even karts! The 2-quart soft-sided cooler and compact battery can be strapped to chassis tubes or worn like a belt around your waist. A rechargeable battery and charger are included. Ideal for pit crew and workers, too! This system is designed to be located close to the driver, so hoses are not included. Cool Water Shirt sold separately at right.



Cool Shirt Waist Pack Cooler and Battery Set Part No. CS2013 \$660.00
 Cooler measures 10" long x 3" deep x 6" high and provides up to 2 hours of cooling.



The **Dry-Cool Air** adds a cool air helmet blower to your Cool Shirt system. Simply connect the special Dry-Cool Air heat exchanger in series between your cooler and your shirt, and connect the blower hose to your helmet (requires ported forced air helmet, sold separately). It can

be added to any Cool Shirt water cooling system above. You can even use it without your shirt on cool days. Includes heat exchanger, 235 CFM blower, hose, and connectors. Requires Cool Shirt water-cooled shirt system, sold separately.

Cool Shirt Dry-Cool Air add-on for Cool Shirt system Part No. CS2505 \$590.00



All Cool Shirts are now HANS®-Friendly!

Unique design keeps the cooling tubes away from the driver's shoulders, which avoids interference with shoulder harnesses. Specifically designed for use with HANS® devices.

Cool Shirt® Fresh Air Blower Systems

Cool Shirt® Fresh Air Blower Systems blow fresh, filtered air directly into your helmet. All systems include a HEPA-4 air filter to ensure the air is clean and particle free down to 4 microns. *Requires ported (forced air) helmet, sold separately.*

The **Pro Fresh Air & Water Systems** include a 235 CFM blower that sends filtered air through a Platinum-Series cooler. The water-cooled shirt system provides maximum cooling in the most brutal climates. Requires a Cool Water Shirt, sold separately below.

Cool Shirt Pro Fresh Air & Water System, 13 Qt. Part No. CS2300 \$1,412.00
Cool Shirt Pro Fresh Air & Water System, 19 Qt. Part No. CS2310 \$1,416.00

The **Fresh Air Systems** include a filtered blower only, with no cooler or water pump.

Cool Shirt Fresh Air Blower System, 135 CFM. Part No. CS209 \$124.00
Cool Shirt Fresh Air Blower System, 235 CFM. Part No. CS211 \$169.00

In-Line Blower Fan only, 135 CFM, 3" dia. Part No. CS470 \$39.99
In-Line Blower Fan only, 235 CFM, 4" dia. Part No. CS471 \$50.99

Blower Filter Housing Adapter, 4" x 3" ID. Part No. CS472 \$29.00
Blower Hose End Fitting, 3" to 1.5" Part No. CS462 \$28.00

Replacement HEPA-4 Air Filters, pack of 10 Part No. CS478 \$15.00

Cool Shirt® Cool Water Shirts (cooler systems sold separately)

All shirts are HANS®-friendly, with tubes routed away from the shoulders to avoid interference with HANS® devices. Available in sizes Small through XX-Large. Cotton shirts are available with the hoses exiting the shirt on the left side or the right side of the driver.

White Cotton Short Sleeve Cool Shirt Part No. CS410-Size-Side \$159.00
Black Cotton Short Sleeve Cool Shirt Part No. CS417-Size-Side \$159.00

Black cotton fabric hides dirt and minor stains better than white fabric.

2Cool FR Long Sleeve Cool Shirt, SFI 3.3 Part No. CS406-Size \$286.00

This flame-retardant shirt has the cooling tubes inside the shirt. It runs a little small as a result. We recommend ordering one size larger than your usual T-shirt size. Black only. Available with hoses exiting on the driver's left side only.

See page 18 for the first and only
FIA-approved Cool Shirt from OMP!

Cool Shirt® Accessories and Replacement Components

Temperature Control Unit (single) Part No. CS450 \$245.00
Adjust the flow rate for best comfort while avoiding the sudden, wide temperature swings inherent with simple on/off pump switching.

Mounting Tray with Straps for 12 qt. Cooler Part No. CS500-12 \$86.00

Mounting Tray with Straps for 24 qt. Cooler Part No. CS500-24 \$92.00

Insulated Water Hose Kit, 12 foot (cut to length) Part No. CS475-12 \$172.00

Maintenance Additive, 16 oz bottle Part No. CS483 \$11.00
Keeps hoses clean and free of algae. Simply add a little to the cooler before each use.

Universal Drain Kit Part No. CS484 \$83.00
Includes all the fittings you need to drain a shirt, hoses, and cooler for long-term storage.

O-Ring Kit, pack of 6 Part No. CS469 \$8.00
O-rings should be inspected once a year. Includes enough O-rings to rebuild all of the male fittings on a single-shirt system, with a pair left over for spares.

Endurance Ice, 12 oz. Part No. CS497 \$6.00

Endurance Ice, 24 oz. Part No. CS496 \$6.00

Endurance Ice, 32 oz. Part No. CS499 \$6.00

These economical, reusable freezer packs outlast ice cubes in any Cool Shirt system.

OMP Driving Suits, FIA 8856-2000

OMP One Evo Suit



The **OMP One Evo** suit sets new standards in driver comfort. Breathable OMP "Dry System" knit inserts in the small of the back, down the sides of the torso, and along the sleeves and thighs allow heat and perspiration to escape while maintaining FIA-rated fire protection. Knit inserts around the shoulders, hips and back of the waist provide great freedom of movement. The 3-layer suit has an outer layer of sateen-finish (slightly shiny) Nomex®. FIA approved. Available in Silver, Navy, Red, or black with neon Green or neon Yellow accents. Sizes 44 through 64, see chart below.

OMP Tecnica Evo Suit



The **OMP Tecnica Evo** suit is the result of decades of experience supplying suits to Formula 1 drivers. The OMP "Dry System" positions breathable knit inserts in the small of the back, down the sides of the torso, and along the sleeves for ventilation while maintaining fire protection. The result is an amazingly comfortable and cool 3-layer suit. The outer layer is sateen-finish (slightly shiny) Nomex® for a professional look. FIA approved. Available in Black/Yellow, Black/Red, Black/White, White, or Navy. Sizes 44 through 64, see chart below.

OMP First Evo Suit



The **OMP First Evo** has comfort features you won't find in suits at twice the price. The 2-layer suit has an outer layer of matte (not shiny) Nomex® and an inner layer of soft knit Nomex®. Knit bellows around the shoulders allow freedom of movement and ventilation. Knit inserts inside the arms, in the groin, and across the small of the back provide even more ventilation. FIA approved. Available in Black, Blue, Red, Anthracite (grey) or Silver. Sizes 44 through 64, see chart below.

OMP One Evo Suit

Part No. 2670-002-Size-Color.....\$1,799.00

OMP Tecnica Evo Suit

Part No. OMP-1A01859-Size-Color.....\$1,299.00

OMP First Evo Suit

Part No. OMP1854-Size-Color.....\$739.00



OMP Standard Suit Sizing Chart – European Sizing (all dimensions in inches)											
Size	44	46	48	50	52	54	56	58	60	62	64
Chest	34	36	37	39	41	42	44	45	47	48	50
Waist	29	32	33	34	36	37	39	40	42	44	46
Hips	34	36	37	39	41	42	44	45	47	48	50
Height	59 - 62	62 - 67	65 - 69	67 - 71	68 - 75	70 - 74	72 - 75	73 - 77	74 - 78	75 - 79	76 - 80
Weight Pounds	121 - 140	132 - 154	141 - 165	154 - 176	165 - 187	183 - 194	187 - 200	200 - 213	213 - 226	226 - 244	231 - 253

SFI-Rated Driving Suits

OMP Sport OS20 Suit, FIA and SFI-5

The **OMP Sport OS20** suit is an SFI- and FIA-approved 2-layer suit with the quality and feel of a much more expensive suit. The Nomex® outer layer is surprisingly soft, with a matte (not shiny) finish. The inner layer is a soft knit fire-retardant material that increases fire protection without sacrificing comfort. Features vertical quilting, front patch pockets on each leg, 360° knit shoulder gussets, knit wrist and ankle cuffs, and elastic in the lumbar panel. SFI 3.2A/5 rated and FIA 8856-2000 homologated. Fire-retardant underwear is **not required** with this suit for SCCA Club Racing. Available in Black, Blue, or Red.



OMP Sport OS20 Suit, FIA & SFI-5

Part No. OMP1847-Size-Color.....\$439.00
 OMP Sport OS20 Suit, FIA & SFI-5, XXL only
 Part No. OMP1847-XXL-Color.....\$505.00

OMP Sport OS10 Suit, SFI-1

The **OMP Sport OS10** suit is an SFI-rated single-layer suit designed just for the occasional racer on a tight budget. The treated cotton material has a finite life span (25 cleaning cycles maximum), enough for two to three seasons. This suit is the perfect solution for anyone who needs an SFI-rated suit for just a season — or even for just one race! Features a matte (not shiny) finish, front patch pockets on each leg, a double-pleated back panel, and elastic in the lumbar panel. SFI 3.2A/1 rated. Fire-retardant underwear **is required** with this suit by SCCA and most other sanctioning bodies (please check your rulebook). Available in Black, Blue, or Red.



OMP Sport OS10 Suit, SFI 3.2A/1

Part No. 2634-Size-Color.....\$149.00
 OMP Sport OS10 Suit, SFI 3.2A/1, XXL only
 Part No. 2634-XXL-Color.....\$171.35

RaceQuip 120 Suit, SFI-5

The **RaceQuip 120** suit is a 3-layer suit at an unbeatable price. The outer layer is shiny woven Pyrovatex® fabric. A middle layer of Nomex® is backed up by a lining of moisture-wicking soft knit Pyrovatex. Boot-cut cuffs and contrasting stripes around the biceps give the suit a custom look. Concealed thigh pockets and a black stripe down the outside of the leg make it look like a much more expensive suit. SFI 3.2A/5 rated. Fire-retardant underwear is **not required** with this suit for SCCA Club Racing. Available in Black, Blue, or Red.



RaceQuip 120 Suit, SFI-5

Part No. RQP120-Size-Color.....\$259.95
 RaceQuip 120 Suit, SFI-5, XXL only
 Part No. RQP120-XXL-Color.....\$279.95
 RaceQuip 120 Suit, SFI-5, XXXL only
 Part No. RQP120-XXXL-Color.....\$299.95

OMP Sport Suit Sizing Chart

Size	Small	Medium	Large	X-Large	XX-Large*
Hip	36-39"	39-42"	42-45"	45-48"	48-51"
Waist	31-34"	34-37"	37-40"	41-43"	44-47"
Chest	36-39"	39-42"	42-45"	45-48"	48-51"
Inseam	28-31"	30-32"	32-34"	33-35"	34-36"
Thigh	20-22"	22-24"	23-25"	25-27"	26-28"
Height	5'1" - 5'7"	5'5" - 5'11"	5'8" - 6'2"	6' - 6'5"	6'2" - 6'6"
Wt (lb.)	132 - 165	154 - 187	183 - 203	192 - 220	209 - 254

* XX-Large is priced 15% higher than smaller sizes.

RaceQuip Suit Sizing Chart

Size	Small	Medium	Med-Tall	Large	X-Large	XX-Large*	XXXL**
Waist	30-32"	34-36"	34-36"	36-38"	40-42"	44-46"	48-52"
Chest	34-36"	38-40"	38-40"	42-44"	46-48"	50-52"	54-56"
Inseam	28"	29"	30"	31"	32"	33"	33"
Shoulders	17"	18"	18"	19"	20"	21"	23"
Sleeve	31-32"	33-34"	33-34"	34-35"	36"	37"	38"
Height	5'6" - 5'8"	5'8" - 5'10"	5'10" - 6'	5'10" - 6'	6' - 6'2"	6'2" - 6'4"	6'4" - 6'6"
Wt (lb.)	125 - 140	140 - 165	150 - 175	165 - 195	200 - 225	225 - 250	250 - 265

* XX-Large is priced \$20 higher than Small through XL.

** XXX-Large is priced \$40 higher than Small through XL.

Sabelt Driving Suits, FIA 8856-2000

SAFETY

Sabelt Hero TS-9 Suit

The **Sabelt Hero TS-9** is built for lightness. This three-layer suit has no waist belt or contrasting-color panels which would add seams and excess material. The accent stripes are printed on the fabric, not embroidered. The outer layer is made of superlight and breathable Sabelt "S-Dry" fabric with a matte finish. FIA approved. Available in Black, Blue, Red, or White. Sizes 46 through 66, see chart below. **Note:** Sabelt suits are cut to be a slim fit. If you are between sizes, we recommend ordering the larger size.



Sabelt Hero TS-9 Suit

Part No. SAB-RFTITS9-Size-Color\$1,695.00

Sabelt Diamond TS-7 Suit

The **Sabelt Diamond TS-7** is a 3-layer suit with professional features and style. The matte (not shiny) outer layer is constructed of long-wearing Sabelt "Diamond" woven fabric. Knit panels around the arms and in the small of the back provide ventilation, and precurved sleeves prevent bunching. FIA approved. Available in Anthracite (dark grey), Blue, Green, Red, or White. Sizes 46 through 66. **Note:** Sabelt suits are cut to be a slim fit. If you are between sizes, we recommend ordering the larger size.



Sabelt Diamond TS-7 Suit

Part No. SAB-RFTITS7-Size-Color\$1,495.00

Sabelt Challenge TS-3 Suit

The **Sabelt Challenge TS-3** may have a mid-level price tag, but it delivers professional-level comfort. This three-layer suit has a sateen (slightly shiny) outer layer. Knit panels around the arms and in the small of the back provide ventilation and freedom of movement. FIA approved. Available in Black with White, Black with Yellow, Blue with White, Red with White, or White with Red. Sizes 46 through 66. **Note:** Sabelt suits are cut to be a slim fit. If you are between sizes, we recommend ordering the larger size.



Sabelt Challenge TS-3 Suit

Part No. SAB-RFTITS3-Size-Color \$895.00

Sabelt Standard Suit Sizing Chart – European Sizing (all dimensions in inches)

Size	46	48	50	52	54	56	58	60	62	64	66
Chest	34 - 35.5	35.5 - 37	37 - 38.5	38.5 - 40	40 - 41.75	41.75 - 43.25	43.25 - 45	45 - 46.5	46.5 - 48	48 - 49.5	49.5 - 51.25
Waist	28.75 - 30.25	30.25 - 31.75	31.75 - 33.5	33.5 - 35	35 - 36.5	36.5 - 38.25	38.25 - 39.75	39.75 - 41.25	41.25 - 43	43 - 44.5	44.5 - 46
Hips	33.5 - 35	35 - 36.5	36.5 - 38.25	38.25 - 39.75	39.75 - 41.25	41.25 - 43	43 - 44.5	44.5 - 46	46 - 47.5	47.5 - 49.25	49.25 - 51
Height	64 - 65	65 - 66.5	67 - 68	68 - 69	69.25 - 70.5	71 - 72.5	72.5 - 73.5	74 - 75	75 - 76	76 - 77	77 - 78
Weight Pounds	108 - 119	121 - 132	134 - 145	147 - 158	160 - 172	174 - 185	187 - 198	200 - 211	213 - 224	226 - 237	240 - 251

Note: Sabelt suits are cut to be a slim fit. If you are between two sizes, we recommend ordering the larger size.

Sabelt®

Driving Suit Care

Molecule™ Labs Nomex® Care System



Molecule™ Labs Fabric Treatment

Racing suits made from Nomex® fabric offer protection from flames and heat; however, Nomex® is not meant to repel flammable liquids. Severe burns occur more often than they should because combustible spills and stains remain in the porous material of protective clothing and can ignite during flash fires. The Molecule™ Fabric Care System makes Nomex® suits virtually impervious to flammable liquids, while cleaning and refreshing your suit in the wash. Molecule™ has been designed for the unique soils of the racing environment, and removes even the most difficult stains, protecting the wearer against flash fires. The easy-to-use suit treatment kit is a four-step system that you can use in your home washing machine and dryer, making expensive dry cleaning a

thing of the past. The full kit (shown) includes enough to treat and maintain two suits. The Wash kit includes bottles of Wash and Spot Cleaner only. Refill bottles of each component are also available to keep your kit stocked up.

Molecule™ Labs suit care kits:

Molecule™ Labs Suit Care Kit, CompletePart No. MOL-100..... \$69.99
Includes 16 oz. Wash, 16 oz. Protector Spray, 16 oz. Refresh Spray, and 4 oz. Spot Cleaner.

Molecule™ Labs Wash KitPart No. MOL-125..... \$38.38
Includes 16 oz. Wash and 16 oz. Spot Cleaner.

Refill components available separately:

Molecule™ Labs 16 oz. Protector Spray onlyPart No. MOL-120-16oz \$29.99
Repels liquids to keep your suit clean without affecting breathability. It also blocks the sun's UV rays to prevent colors from fading. Suits should be re-treated once a season.

Molecule™ Labs 16 oz. Refresh Spray onlyPart No. MOL-121-16oz \$19.99
Use the Refresh Spray between washings to keep your suit smelling fresh and clean. Keep one in your gear bag for use between sessions and you won't dread getting suited up!

Molecule™ Labs 16 oz. Wash onlyPart No. MOL-122-16oz \$19.99
The Wash works in your washing machine to keep your suit clean and smelling great! Use it on your suit, Nomex® or CarbonX undergarments, and balaclava.

Molecule™ Labs 16 oz. Spot Cleaner onlyPart No. MOL-123-16oz \$19.99

Molecule™ Labs 4 oz. Spot Cleaner onlyPart No. MOL-123-4oz \$5.99
Spot Cleaner is specifically formulated to remove the kinds of stains found in racing, including oil, grease, brake dust, and tire rubber.

Nomex® Fabric, Thread, Zippers, and Hook & Loop Material

We have all the materials you need to keep your Nomex® driving suit in top condition.

Nomex® Fabric We stock flat woven Nomex® fabric in popular colors. The 6 ounce material is long-wearing and tough, making it a great choice for reinforcing high-wear areas. It is also ideal for covering custom seat inserts. Available in Black, Royal Blue, Safety Orange, Red, and Natural (off-white). Sold by the running foot from a roll 60 inches wide.

Nomex® Fabric, per foot, specify colorPart No. 2134-Color..... \$19.99/ft.

Note: This fabric has a coarse weave. It is not the soft, shiny fabric used on OMP suits.

Nomex® Hook and Loop Material Racing suits make extensive use of hook and loop material. When this material wears out, it should not be replaced with generic material from the fabric store. Our flame-retardant hook and loop material is sold by the running foot (you get both the hook and the loop material). Natural off-white only. Hook and loop material is also great for holding arm restraints in place!

Nomex® Hook and Loop, per footPart No. 2152-200..... \$13.29/ft.

Nomex® Zippers Our zippers feature metal teeth for strength and flame resistance. The teeth are set into fire-retardant black Nomex® fabric. Zippers include two pulls to open from either end for access. Specify length: 22", 23", 24", 26", or 30".

Nomex® Zipper, specify lengthPart No. 2152-300-Length \$19.99

Note: The most common cause of zipper failure is unzipping the suit only partway to let it hang around your waist. This puts all the weight of the top half of your suit on just a few zipper teeth, causing them to pull out of the fabric. It is better practice to unzip the suit past your waist. You can use the belt or the arms tied around your waist to hold the suit up. Better yet, leave the suit all the way on until you're ready to take it off!

Nomex® Thread We stock Nomex® thread in the most popular colors for alterations or repairs. Available in Black, Blue, Grey, Orange, Red, White (natural off-white), or Yellow. **Now an even better value!** Approximately 100 yards per spool, for the same low price as our old 60-yard spools.

Nomex® Thread, specify colorPart No. 2131-Color..... \$10.79

Nomex® Undergarments

SAFETY

OMP Nomex® Undergarments, FIA and SFI Approved



OMP Undergarment Measurements		
	Top	Bottom
Order Size	Chest Size	Waist Size
S	34 - 36"	29 - 32"
M	37 - 39"	33 - 34"
L	40 - 42"	35 - 37"
XL	43 - 46"	38 - 40"
XXL	47 - 50"	41 - 46"

OMP Nomex® Undergarments are constructed of a very smooth, soft knit fabric. This is not the typical "waffle weave" long underwear! External seams further enhance comfort and reduce pressure points. The **Top** features long sleeves and a short mock turtleneck. The **Bottoms** have full-length legs, a narrow elastic waist for comfort, and no fly to compromise safety. The two-layer **Balacava** features a single large eye opening and a sculpted neck to prevent bunching above the shoulders. All are FIA 8856-2000 and SFI 3.3 approved. Natural off-white color only.

- OMP Nomex® Underwear Top, FIA & SFI Part No. 2153-005-Size \$109.00
 - OMP Nomex® Underwear Bottom, FIA & SFI ... Part No. 2153-006-Size \$89.00
 - OMP Nomex® 2-Layer Balacava, FIA & SFI..... Part No. 2153-001 \$49.00
 - OMP Nomex® Socks, FIA & SFI, pair Part No. 2153-002-Size \$29.00
- Socks are available in Small (shoe sizes 5 1/2 - 8), Medium (8 - 10), and Large (10 - 13).

OMP Nomex® Cool Shirt, FIA Approved

COOLSHIRT SYSTEMS

OMP



OMP Cool Shirt Measurements	
Order Size	Chest Size
XS/S	34 - 38"
M/L	39 - 42"
XL	43 - 47"
XXL	48 - 50"

OMP and Cool Shirt are proud to announce the introduction of the first and only FIA-Approved water-cooled shirt! This long-sleeved shirt features two layers of Nomex® to completely cover the tubing, per FIA regulations. Available in natural off-white color or black. See page 15 for compatible Cool Shirt systems.

- OMP FIA-Approved Cool Shirt Part No. 2153-050-Size-Color.... \$799.00

Nomex® Socks

Note: These socks do not carry FIA or SFI certification. Please see the OMP socks above if you require FIA or SFI approval.



Sock Sizing	
Order Size	Shoe Size
S	5 - 8
M	8 - 9 1/2
L	9 - 11
XL	10 - 13

Nomex® Socks help to protect your feet against burns in the event of a fire. Our mid-calf socks are proudly made in the USA. Available in sizes S, M, L, and XL.

- Nomex® Socks, pair..... Part No. 2112-Size \$19.99

OMP Sport Nomex® Undergarments, FIA and SFI Approved



OMP SPORT

OMP Sport Undergarment Measurements

	Top	Bottom	
Order Size	Chest Size	Waist Size	Inseam
S	36 - 39"	29 - 32"	28 - 31"
M	39 - 42"	33 - 34"	30 - 32"
L	42 - 45"	35 - 37"	32 - 34"
XL	45 - 48"	38 - 40"	33 - 35"
XXL	48 - 51"	41 - 46"	34 - 36"

OMP Sport Nomex® Undergarments are designed and manufactured with the American weekend racer in mind. The smooth, soft knit fabric is cut to be a slightly more roomy fit than the undergarments at left, and the value cannot be beat. The **Top** has long sleeves and a mock turtleneck for coverage. The **Bottoms** have full-length legs, a narrow elastic waist for comfort, and no fly opening to compromise safety. The **Balacava** has a single large eye opening, flat seams, and an extended neck to tuck into your suit collar. The **Socks** are mid-calf length with a turned heel. All are tagged as complying with SFI 3.3 and FIA 8856-2000 standards. Natural off-white color only.

- OMP Sport Nomex® Underwear Top, FIA & SFI Part No. 2153-012-Size.... \$79.00
 - OMP Sport Nomex® Underwear Bottom, FIA & SFI Part No. 2153-013-Size.... \$75.00
 - OMP Sport Nomex® 2-Layer Balacava, FIA & SFI..... Part No. 2153-016 \$39.00
 - OMP Sport Nomex® Socks, FIA & SFI Part No. 2153-014-Size.... \$27.00
- Socks are available in Small (shoe sizes 5 1/2 - 8), Medium (8 - 10), and Large (10 - 13).

Nomex® Hoods (Balacavas)



Left:
Single-Layer
Nomex® Hood,
Single Opening
Part No. 2119



Right:
Simpson 2-Layer
Nomex® Hood,
2 Eye Openings
Part No. 2114-Color

Balacavas (hoods or head socks) are required by many sanctioning bodies to cover a driver's facial hair or long hair, but they also provide an additional layer of protection against burns. We offer balacavas in several different styles.

- Single-Layer Nomex® Hood, single opening Part No. 2119..... \$19.99
 - Double-Layer Nomex® Hood, single opening Part No. 2113..... \$29.99
- The above two hoods are available in natural off-white only.
- Simpson 2-Layer Nomex® Hood, two eye openings.. Part No. 2114-Color \$79.99
- Available in white or black.

Hearing Protection

Protect your ears! Exposure to sound levels as low as 97 decibels (well below many race tracks' sound limits) for just 30 minutes can cause permanent hearing loss. Many race cars can exceed this level even at idle. If your hearing has already been damaged, you should still wear earplugs to minimize further hearing loss.

*NRR = Noise Reduction Rating - a higher number means more protection.

Cylindrical Foam Ear Plugs block loud noises, yet permit normal conversation and car sounds to be heard. Just roll them between your fingers to compress the diameter, then place into ear. They gently expand in seconds to form a snug fit. These inexpensive ear plugs are intended to be discarded after each use. Some drivers try to make a pair last a full race weekend, but we do not recommend it. Sold in pairs. NRR* = 29.

- Cylindrical Foam Ear Plugs, pair..... Part No. 2139-Refill..... 29¢



Contoured No-Rolling Foam Ear Plugs stay cleaner and last longer than rolled ear plugs. Simply insert them in the ear. The soft material conforms to the shape of the ear canal. Available plain (separate) or corded for convenience (no more hunting for the other ear plug). Sold in pairs. NRR* = 26.

- Contoured Ear Plugs, pair Part No. 2196 99¢
- Contoured Ear Plugs, pair, with cord..... Part No. 2197 \$1.99



CarbonX Undergarments

SAFETY

Unlike many other fire-retardant fabrics on the market today, **CarbonX** won't char, shrink, or burn. When exposed to intense heat or flame, CarbonX fibers expand, dramatically reducing the oxygen content within the fabric. Its soft knit construction is very comfortable and effective at wicking moisture away from your skin.

The long-sleeve **CarbonX Underwear Top** has a short mock turtleneck for coverage without bulk. SFI 3.3 approved. Available in sizes Small through XXLarge. Black only.

CarbonX Underwear Top, SFI 3.3, Small - XL..... Part No. 2103-Size..... \$99.99
CarbonX Underwear Top, SFI 3.3, XXL only..... Part No. 2103-XXL..... \$114.99

Our **CarbonX Short-Sleeve Top** has a crew neck like a T-shirt. It does not carry SFI 3.3 approval, but it is still a much safer choice for a base layer than a cotton tee. Available in sizes Small through XXLarge. Black only. **Not SFI approved.** Although it is fire resistant, this short-sleeve top does not fulfill requirements for "fire resistant underwear."

CarbonX Short-Sleeve Top, not SFI, Small - XL..... Part No. 2151-001-Size.... \$99.99
CarbonX Short-Sleeve Top, not SFI, XXL only..... Part No. 2151-001-XXL... \$114.99

CarbonX Underwear Bottoms have a wide elastic waistband that is covered in CarbonX for extra comfort. For added safety, these pants do not have a front fly opening. SFI 3.3 approved. Available in sizes Small through XXLarge. Black only.

CarbonX Underwear Bottom, SFI 3.3, Small - XL..... Part No. 2104-Size..... \$99.99
CarbonX Underwear Bottom, SFI 3.3, XXL only..... Part No. 2104-XXL..... \$114.99

Our **CarbonX Socks** are an over-the-calf design. The elastic hem band is knit using ultra-soft (and naturally flame-retardant) merino wool. SFI 3.3 approved. One size fits all. Black with red hem band. Sold in pairs.

CarbonX Socks, SFI 3.3, one size..... Part No. 2106..... \$44.99

CarbonX Balacivavs (head socks) feature flat-sewn seams for comfort. Choose single opening or dual eye opening style. Both are SFI 3.3 approved. Black only.

CarbonX Balacivava, Single Opening..... Part No. 2151-002..... \$79.99
CarbonX Balacivava, Dual Openings..... Part No. 2151-003..... \$79.99



Left: CarbonX Underwear Top Part No. 2103

Below: CarbonX Underwear Bottom Part No. 2104



Below: CarbonX Short-Sleeve Top Part No. 2151-001
Not SFI approved

New!



CarbonX Undergarment Measurements		
	Top	Bottom
Order Size	Chest Size	Waist Size
S	34 - 36"	30 - 32"
M	38 - 40"	34 - 36"
L	42 - 44"	38 - 40"
XL	46 - 48"	42 - 44"
XXL*	49 - 52"	44 - 47"

*XXL is priced 15% higher than smaller sizes.



CarbonX Socks Part No. 2106



Single Eye Opening Part No. 2151-002



CarbonX Balacivavs Part No. 2151-003

Dual Eye Openings Part No. 2151-003

Driver's Gear Bags and Storage



The **Simpson Super Speedway Roller Bag** will hold all of your gear, and more! Helmet, suits, underwear, shoes, gloves, street clothes – keep packing and there's still more room! Features a huge vented main compartment with adjustable dividers, plus two zippered exterior pockets for small items that need to be accessed quickly. Compression straps allow you to overstuff it and still close the heavy-duty zippers. Hard plastic wheels and multiple handles make it easy to maneuver, even when full. Measures 33.5" L x 18" W x 16.5" D. Black with red, orange, and yellow stripes and red-on-white Simpson logo.

Simpson Super Speedway Roller Bag..... Part No. 2145-018..... \$199.99



Measures 27" L x 13" W x 15" H. Black with red, orange, and yellow stripes and red-on-white Simpson logo.

Simpson Speedway Duffel Bag..... Part No. 2140-018..... \$89.99



The **Simpson Driving Suit Tote Bag** is a great way to protect your suit and keep your investment clean and dry. Constructed of durable woven nylon with a 2-piece carrying handle and a one-half wrap-around zipper. This is the perfect bag for drivers who prefer to travel light, but it also helps keep things organized inside a larger gear bag. Measures 15" H x 18" L x 4.5" D (about the size of a briefcase). Black red, orange, and yellow stripes and red-on-white Simpson logo.

Simpson Driving Suit Tote Bag..... Part No. 2152-403..... \$19.99



The **Simpson Multi-Equipment Dryer** blows heated, ozonated air into your driver's gear to dry and disinfect it, keeping it dry and smelling fresh. No more pulling on wet, clammy, stinky gear on the second day of a race weekend! Simply place your shoes, gloves, or helmet on the specially-designed stands and turn it on. Auto start-stop makes it just that easy, but a manual override lets you set it just the way you want it. 110VAC (310W power supply recommended). Takes up just 11" x 7" of counter space. Indoor use only.

Simpson Multi-Equipment Dryer..... Part No. SIMP97100..... \$129.95

Cedar-Filled, Deodorizing Glove Dogs, Shoe Dogs, and Helmet Dog



Above: Helmet Dog Part No. 2099-003

Below: Shoe Dogs Part No. 2099-001



These pouches are filled with aromatic cedar to pull moisture and odors out of your gloves, shoes, or helmet. Their soft felt construction won't snag delicate knit linings. Glove Dogs and Shoe Dogs are tethered to keep pairs together.

Shoe Dogs, fits one pair..... Part No. 2099-001..... \$11.99

Glove Dogs, fits one pair..... Part No. 2099-002..... \$11.99

Helmet Dog, single..... Part No. 2099-003..... \$13.99



Glove Dogs Part No. 2099-002

See page 12 for helmet and HANS Device bags from Bell, Simpson, and RaceQuip.

Fire-Retardant Driving Gloves

OMP Driving Gloves, FIA Approved



OMP One Evo Driving Gloves were developed with input from leading pro drivers. Features include external seams and thin leather patches in the cloth palm to reinforce high-wear areas. Leather patches on the first 2 fingers protect against wear from paddle shifters. Printed grip material on the thumb and fingers is also printed inside to keep the glove firmly in place on your hand. Available in Black, Blue, Gray, Green, White, or Yellow. FIA approved.

OMP One Evo Gloves
Part No. 2627-001-Size-Color.....\$195.00



OMP Tecnica Evo Driving Gloves deliver professional comfort and performance. External seams, precurved fingers, and padded knuckles offer great comfort. Printed grip material on the fingers is complemented by thin leather patches on the cloth palm that cushion and reinforce high-wear areas. A hook-and-loop wrist strap provides additional security. Available in Black, Black/Anthracite, Navy/Cyan, Red/Black, or White/Black. FIA approved.

OMP Tecnica Evo Gloves
Part No. OMP-1B756E-Size-Color.....\$159.00



OMP First Evo Driving Gloves are made with a special stretchy knit fire-resistant fabric for a very close fit without pressure points. The black cloth palm has printed silicone rubber for excellent grip without bunching. Small suede leather patches on the fingertips provide additional grip with wear resistance. The straight-cut gauntlet is shorter than on other OMP gloves. Available in Black, Navy, Red, or Yellow. FIA approved.

OMP First Evo Gloves
Part No. OMP-757E-Size-Color.....\$119.00

Glove Sizing - All Brands

To find your glove size, use a cloth measuring tape to measure around the largest part of your hand while making a fist. The tape should go over your knuckles but should exclude your thumb. Use the size chart at right to find your size.



Glove Size Chart

Measurement (inches)	Glove Size
7 1/2 - 8 1/2	Small
8 1/2 - 9 1/2	Medium
9 1/2 - 10 1/2	Large
10 1/2 - 11 1/2	X-Large

New!

Sabelt Driving Gloves, FIA Approved



Sabelt Hero TG-9 Driving Gloves feature precurved fingers with external seams to reduce bunching and pressure points. Printed grip material covers the cloth palm and fingers to provide maximum traction without adding weight or bulk. Available in Black, Blue, Red, White, or Yellow. FIA approved.

Sabelt Hero TG-9 Gloves
Part No. SAB-RFTG09-Size-Color.....\$190.00



Sabelt Diamond TG-7 Driving Gloves feature precurved fingers with external seams to reduce pressure points. Small embossed leather patches in the cloth palm and fingers grip the wheel without bunching. The leather on the fingers also lasts longer with paddle shifters than silicone. Available in Black, Blue, or Red. FIA approved.

Sabelt Diamond TG-7 Gloves
Part No. SAB-RFTG07-Size-Color.....\$145.00



Sabelt Challenge TG-3 Driving Gloves have internally-stitched (conventional) seams for a cleaner, sleeker look. Suede patches are strategically placed on the cloth palm and fingers to provide a good grip on the wheel and to reinforce high-wear areas. Available in Black, Blue, or Red. FIA approved.

Sabelt Challenge TG-3 Gloves
Part No. SAB-RFTG03-Size-Color.....\$93.00

RaceQuip Gloves, SFI Approved



RaceQuip 356 Driving Gloves feature external seams to reduce pressure points. The suede palm has a black suede patch for additional padding. The 2-layer Nomex® back and gauntlet are all black; the suede fingers, knuckle padding, and wrist highlight are the color indicated. Available with Gray or Red suede areas. SFI 3.3/5 approved.

RaceQuip 356 Gloves, SFI 3.3/5
Part No. RQP356-Size-Color.....\$69.95



RaceQuip 355 Driving Gloves offer a great value. The back has 2 layers of flame-retardant knit fabric. The suede leather palm and the knuckles are both reinforced with padded suede leather patches. A hook-and-loop wrist strap keeps the gloves secure. Available in Black, Blue, or Red. All colors have a black palm, black knuckle padding, and black wrist strap. SFI 3.3/5 approved.

RaceQuip 355 2-Layer Gloves, SFI 3.3/5
Part No. RQP3550-Size-Color.....\$49.95



RaceQuip 351 Driving Gloves are our least expensive flame-retardant gloves. The back has 1 layer of flame-retardant knit fabric, and the suede leather palm and the knuckles both have padded suede leather patches. Hook-and-loop wrist strap keeps the gloves in place. Available in Black, Blue, or Red. Wrist strap, palm, and knuckles are grey suede on all colors. SFI 3.3/1 approved.

RaceQuip 351 Single-Layer Gloves, SFI 3.3/1
Part No. RQP3510-Size-Color.....\$39.95

OMP Sport Gloves, FIA and SFI Approved



OMP Sport Driving Gloves bring you professional quality at a club racing price! The cloth palm and fingers have sculpted black suede leather patches for grip without bunching. Available in Black, Blue, or Red, each with a black palm and white OMP Sport logo and graphics. Made in Italy, FIA and SFI 3.3/5 approved.

OMP Sport Gloves
Part No. OMP762-Size-Color.....\$88.00

Our commitment to being your IN-STOCK source for safety gear means that when new glove styles arrive, we usually have some of the older style still in our inventory.

**Please see our website for many more current and discontinued gloves:
PegasusAutoRacing.com/Gloves**

Fire-Retardant Driving Shoes

OMP One S Shoes, FIA Approved



2EE Wide Available!

The **OMP One S** is a mid-top shoe with a smooth leather upper. Soft rear bellows allows comfortable ankle motion. The oil-resistant sole features a special 4-layer construction for support during heel-and-toe downshifts. Lace closure with a single Velcro® ankle strap. FIA 8856-2000 approved. Black, Blue, Red, White or Yellow. European sizes 37 to 48.

OMP One S Shoes Part No. *OMP807-Size-Color*.....\$299.00
OMP One S Shoes, 2EE Wide (42 - 47 only) . Part No. *OMP801-Size-Black*..... \$299.00

OMP Carrera Shoes, FIA Approved



The **OMP Carrera** is a vintage-style racing shoe constructed of the softest leather for a broken-in feel. The high lace-up design recalls racing shoes from decades ago. 21st-century features include an oil-resistant outsole, hook-and-loop ankle closure, and FIA 8856-2000 approval. Available in Brown with dark brown stripes or Dark brown with light brown stripes. European sizes 37 to 46.

OMP Carrera Shoes..... Part No. *OMP002-Size-Color*.....\$329.00

European Shoe Size Chart													
US Size	4.5	5	6	6.5	7.5	8	9	10	10.5	11.5	12	13	13.5
Euro Size	36	37	38	39	40	41	42	43	44	45	46	47	48

Women drivers please note:
 To estimate what men's (US) size will fit you best, subtract 2 from your normal shoe size.

Sabelt Hero TB-9 Shoes, FIA Approved

New!



Sabelt Hero TB-9 Shoes have perforated smooth leather uppers with three contrasting stripes on the side. The ankle strap is positioned low enough to work with your ankle, not against it. Available in Black, Red, or White. European sizes 36 to 48. FIA approved.

Sabelt Hero TB-9 Shoes..... Part No. *SAB-RFTB09-Size-Color*.....\$295.00

Sabelt Challenge TB-3 Shoes, FIA Approved

New!



Sabelt Challenge TB-3 Shoes have suede leather uppers with three contrasting stripes on the side. Available in Black/Red, Black/Yellow, Blue, or Red European sizes 36 to 48. FIA approved.

Sabelt Challenge TB-3 Shoes..... Part No. *SAB-RFTB03-Size-Color*.....\$205.00

Simpson Mid-Top Shoes, SFI Approved



Simpson Mid-Top Shoes have a black suede leather upper with grey suede reinforcement caps for a subtle 2-tone look. Laces are backed up by a single hook-and-loop ankle strap. Black with grey accents only, whole and half sizes 6 through 14. SFI 3.3/5 approved.

Simpson Mid-Top Shoes..... Part No. *2187-001-Size-Black*..... \$99.99

Simpson High-Top Shoes, SFI Approved



Simpson Hi-Top Shoes have solid-color suede leather uppers. The high-top design features dual ankle straps for excellent retention. Available in Black in whole and half sizes 4 through 13; sizes 8-11 1/2 are also available in Blue or Red. SFI 3.3/5 approved.

Simpson Hi-Top Shoes..... Part No. *2182-Size-Color*..... \$99.99

OMP Sport Shoes, SFI Approved



OMP Sport Shoes have suede leather uppers with no ankle strap to restrict motion. The oil-resistant black rubber soles provide great traction, even on wet pedals. Available in Black, Blue, or Red in whole and half sizes 7-13; sizes 5-6 1/2 are available in Black only. SFI 3.3/5 approved.

OMP Sport Shoes
 Part No. *2650-Size-Color*\$99.00

RaceQuip Shoes, SFI Approved



RaceQuip 305 Euro Carbon-L Shoes have a black suede leather upper with "carbon look" reinforcement caps on either side of the toe. Black only, whole sizes 1 through 20 plus half sizes 6 1/2 to 12 1/2. SFI 3.3/5 approved.

RaceQuip 305 Shoes
 Part No. *RQP3050-Size-Black*.....\$89.95



RaceQuip 303 Shoes have suede leather uppers and an incredibly low price. High-top design has laces plus a single hook-and-loop ankle strap. Black only, whole sizes 8 through 13. SFI 3.3/5 approved.

RaceQuip 303 Shoes
 Part No. *RQP3030-Size-Black*.....\$69.95

We have many more styles of shoes in stock. Please visit our website:
PegasusAutoRacing.com/Shoes

FIA 8853/2016 Approved 6-Point Camlock Driver Restraint Systems

The new FIA standard 8853/2016 for driver restraint harnesses is much tougher than the old 8853/98 standard it replaces. Harnesses must withstand nearly twice as much impact energy, and tests are now done at an angle rather than straight on. While many well-established harness manufacturers struggled with the new tests, Sabelt, Schroth, and OMP

were among the first to receive homologations to the new standard. Harnesses certified to FIA 8853/2016 are still tagged with an expiration date 5 years after the date of manufacture, making them very cost-competitive against SF1 16.1 belts. SCCA accepts FIA 8853/98 and 8853/2016 harnesses for all club racing classes and honors the 5-year expiration date.

The FIA 8853/2016 standard requires at least 6 attachment points (no 5-point harnesses) and a Camlock-type buckle (no old-fashioned latch/link buckles). FIA-approved harnesses are only sold in full sets. The FIA does not allow the sale of individual belts.

Formula Car Harnesses, HANS only

These formula car harnesses all have "D-ring" lap belts with looped sub straps. Each sub strap passes through a ring or loop on the lap belt and gets captured by the buckle tab from a shoulder belt. This spreads the sub straps apart and holds them firmly against

the driver's thighs to control lower body motion in a crash. This setup is most effective in single-seater cars with layback seating. All of these harnesses have 2" lap belts and 2" shoulder belts. They are only approved for use with a HANS Device.

Schroth Formula 2x2



To reduce weight and bulk, this 2x2 harness has no quick-adjusters on the lap belt. Length is set on installation. Instead of metal D-rings, the sub straps pass through fabric loops sewn on the lap belt. All 6 belts include bolt-in end plates that can convert to wrap mount. FIA 8853/2016 approved. Black or Red.

Schroth Formula 2x2 Harness

Part No. SCH-94620-Color..... \$448.00

Sabelt A622F and S622F



These 2x2 harness have a pull-up lap belt with a 3" wide spreader pad behind the buckle. Instead of metal D-rings, the sub straps pass through fabric loops sewn on the lap belt. The shoulder straps and sub straps include bolt-in end plates that can convert to wrap mount. The lap belt has bolt-in end plates sewn in. FIA 8853/2016 approved. Black, Blue, or Red.

Sabelt Silver Series A622F Formula Car Harness

Part No. SAB-CCA622F-UN-Color..... \$395.00

Sabelt Steel Series S622F Formula Car Harness

Part No. SAB-CCS622F-UN-Color..... \$270.00

OMP 206B-HSL and 206-HSL



This 2x2 harness has a pull-up lap belt with bolt-in end plates sewn in. The sub straps include bolt-in end plates that can convert to wrap-mount. The shoulder straps have bolt-in end plates sewn in or a sewn loop to accept a cross bolt. FIA 8853/2016 approved. Black or Red.

OMP 206B-HSL Formula Car Harness, Bolt-In (shown)

Part No. OMP-DA0206B-HSL-Color.....\$359.00

OMP 206-HSL Formula Car Harness, Sewn Loop

Part No. OMP-DA0206-HSL-Color.....\$359.00

OMP Sedan Harnesses, HANS only



OMP sedan harnesses feature a unique 2-pin T-bar buckle tab for the sub straps. Both sub straps are attached to a single tab, but the tab engages two pins in the buckle for added strength. The new T-bar design is also rounded to follow the curvature of the buckle for greater comfort. The buckle is permanently attached to the sub strap tab for convenience and quick driver changes (no more sitting on the buckle). The new aluminum/magnesium buckle

release has a very stiff detent to prevent accidental opening. Once you get past the detent, the buckle operates smoothly and easily. The 202-HSL and 203-HSL harnesses both feature the ultralight aluminum adjusters developed by OMP for their F1 harnesses. The 204-H harness uses more economical steel adjusters. All of these harnesses have 2" shoulder belts. They are only approved for use with a HANS Device.

OMP 202-HSL and 202B-HSL



This 2x2 harness has a pull-up or pull-down (shown) lap belt with compact carabiner mounts sewn in. The shoulder belts have wrap-mount hardware and the sub straps have snap-in end plates that can convert to wrap mount. FIA 8853/2016 approved. Black or Red.

OMP 202-HSL 2x2 Sedan Harness, pull-down (shown)

Part No. OMP-DA0202-HSL-Color..... \$499.00

OMP 202B-HSL 2x2 Sedan Harness, pull-up

Part No. OMP-DA0202B-HSL-Color..... \$499.00

OMP 203-HL



This 3/2x3 harness has a 3" wide pull-up lap belt with compact carabiner mounts sewn in. The 3" shoulder straps neck down to 2" above the adjusters and have wrap-mount hardware. The sub straps include snap-in end plates that can convert to wrap mount. FIA 8853/2016 approved. Black or Red.

OMP 203-HSL 3/2x3 Sedan Harness

Part No. OMP-DA0203-HL-Color..... \$399.00

OMP 204-EH



This economy 3/2x3 harness uses slightly heavier steel adjusters to fit a club racer's budget. The 3" wide lap belt has pull-up adjusters. The 3" shoulder straps neck down to 2" above the adjusters. All 6 belts include snap-in end plates that can convert to wrap mount. FIA 8853/2016 approved. Black, Blue, Red, or Black with neon Yellow trim.

OMP 204-H 3/2x3 Sedan Harness

Part No. OMP-DA0204-EH-Color..... \$349.00

FIA 8853/2016 Approved 6-Point Camlock Driver Restraint Systems

SAFETY

Sabelt Sedan Harnesses

Sabelt sedan harnesses have a unique, compact sub strap attachment. Rather than sewing the sub straps to a separate tab that plugs into the buckle, the tab is machined as an integral part of the buckle housing itself. This eliminates play, wear, and a potential weak point. It also results in the least intrusive sub strap mounting you'll find.

The top-of-the-line Silver Series harnesses feature lightweight aluminum adjusters. The Steel Series harnesses use budget-conscious steel adjusters. Both are available with either 3" wide or 2" shoulder belts. The 3" belts can be used with or without a HANS Device. The 2" belts are only approved for use with a HANS Device.

Sabelt®

Sabelt Silver Series A633S



The Silver Series A633S has full 3" wide shoulder belts for use with or without a HANS Device. The 3" lap belt has pull-up adjusters and snap-in end plates sewn in. The shoulder belts and 2" sub

straps include snap-in end plates that can convert to wrap mount. This harness is an ideal choice for any racing organization that still specifies 3" lap and shoulder belts. FIA 8853/2016 approved. Black, Blue, or Red.

Sabelt Silver Series A633S 3x3 Sedan Harness
Part No. SAB-CCA633S-UN-Color \$470.00

Sabelt Silver Series A622S "Porsche"



The Silver Series A622S Porsche harness is built specifically for Porsche GT2/GT3 Cup cars. The 2" pull-down lap belt has compact bolt-in end plates designed specifically to accept the OEM Porsche mounting

bolt (bolts not included). The 2" shoulder belts have wrap mount hardware, and the 2" sub straps have snap-in end plates that can convert to wrap mount. FIA 8853/2016 approved. Black or Red, each with yellow loops.

Sabelt Silver Series A622S 2x2 Porsche Harness
Part No. SAB-CFCI-00024-Color \$550.00

Sabelt Silver Series A622S Endurance



This harness is optimized for endurance racing. The 2" shoulder and sub straps include snap-in end plates that can convert to wrap mount. The 2" lap belts have compact carabiner mounts sewn in. Both pull-up and pull-down lap belts

are included. The shoulder belts have Velcro patches for quicker driver changes, plus buttonholes for radio wiring and drinking straws. Lap belts and shoulder belts have sewn loops at the free end for easier tightening. FIA 8853/2016 approved. Black or Red, each with yellow loops.

Sabelt Silver Series A622S 2x2 Endurance Harness
Part No. SAB-CFCI-301-Color \$520.00

Sabelt Steel Series S633S



The S633S has full 3" wide shoulder belts for use with or without a HANS Device. The 3" lap belt has pull-up adjusters and snap-in end plates sewn in. The shoulder belts and 2" sub straps include snap-in end plates

that can convert to wrap mount. This harness is an ideal choice for organizations that still specify 3" lap and shoulder belts. FIA 8853/2016 approved. Black, Blue, or Red.

Sabelt Steel Series S633S 3x3 Sedan Harness
Part No. SAB-CCS633S-UN-Color \$295.00

Sabelt Steel Series S632S



The S632S has full 3" wide shoulder belts for use with or without a HANS Device. The 2" lap belt has compact pull-down adjusters built into the buckle tabs to reduce weight and bulk. The lap belt has snap-in

end plates sewn in. The shoulder belts and 2" sub straps include snap-in end plates that can convert to wrap mount. FIA 8853/2016 approved. Black, Blue, or Red.

Sabelt Steel Series S632S 3x2 Sedan Harness
Part No. SAB-CCS632S-DN-Color \$370.00

Sabelt Steel Series S622S



The Sabelt Steel Series S622S 2x2 Sedan Harness has narrow 2" shoulder belts for use with a HANS Device. The narrow 2" lap belt has pull-up adjusters and snap-in end plates sewn in. The shoulder belts

and 2" sub straps include snap-in end plates that can convert to wrap mount. FIA 8853/2016 approved. Black, Blue, or Red.

Sabelt Steel Series S622S 2x2 Sedan Harness
Part No. SAB-CCS622S-UN-Color \$295.00

Schroth Sedan Harnesses

Schroth sedan harnesses come standard with pull tabs on the adjusters for easy loosening. All of these harnesses mount the buckle to the sub straps. We offer several

Schroth harnesses with either 3" wide or 2" shoulder belts. The 2" belts are only approved for use with a HANS Device; 3" belts can be used with or without a HANS Device.

SCHROTH® RACING

Schroth Profi XLT 2x2 Pull-Down

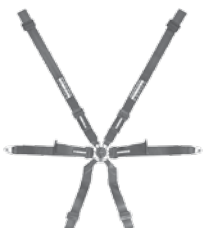

The Profi XLT 2x2 is all about light weight. The 2" lap belt has compact carabiner mounts sewn in, and the pull-down adjusters are incorporated into the buckle tabs to reduce bulk. The 2" shoulder and sub straps include wrap mount hardware only. FIA 8853/2016 approved. Black only.

Schroth Profi XLT 2x2 Sedan Harness, Pull-Down
Part No. SCH-94580 \$549.00

Schroth Profi XLT 2x2 Pull-Up



The Profi XLT 2x2 is all about light weight. The 2" pull-up lap belt has lightweight, compact carabiner mounts sewn in. The 2" shoulder and sub straps include wrap mount hardware only. The buckle tabs have lightening holes to reduce weight even further. FIA 8853/2016 approved. Black only.

Schroth Profi XLT 2x2 Sedan Harness, Pull-Up
Part No. SCH-94581 \$549.00

Schroth Enduro 2x2



The Enduro is optimized for endurance racing. The 2" shoulder and 2" sub straps include snap-in end plates that can convert to wrap mount. The 2" lap belt has snap-in plates sewn in. The pull-down lap belt adjusters are built into the buckle tabs to reduce bulk, and contrasting sewn loops at the free ends allow easier

tightening. FIA 8853/2016 approved. Black or Red.
Schroth Enduro 2x2 Sedan Harness, Pull-Down
Part No. SCH-94510-Color \$599.00

Schroth Profi 3x2 Pull-Up



This harness has 3" wide shoulder belts for use with or without a HANS Device. The 2" lap belt has pull-up adjusters and snap-in end plates sewn in. The shoulder belts and 2" sub straps include snap-in end plates that can convert to wrap mount. FIA 8853/2016 approved. Black or Red.

Schroth Profi 3x2 Sedan Harness, Pull Up
Part No. SCH-94540-Color \$399.00

Schroth Profi 2x2 Flexi



This harness has 2" narrow shoulder belts for use with a HANS Device. The 2" lap belt has snap-in end plates and can be installed as pull-up or pull-down to suit your needs. The shoulder belts and 2" sub straps include snap-in end plates that can convert to wrap mount. FIA 8853/2016

approved. Black, Blue, or Red.
Schroth Profi 2x2 Sedan Harness, Flexi
Part No. SCH-94530-Color \$459.00

Schroth Enduro 3x2



The Enduro is optimized for endurance racing. The 3" shoulder and 2" sub straps have snap-in end plates that can convert to wrap mount. The 2" lap belt has snap-in plates sewn in. Pull-down lap belt adjusters are built into the buckle tabs to reduce bulk, and contrasting sewn loops at the free ends allow

easier tightening. FIA 8853/2016 approved. Black or Red.
Schroth Enduro 3x2 Sedan Harness, Pull-Down
Part No. SCH-94500-Color \$599.00

Driver Restraint Mounting Accessories

End Plates



Flat Bolt-In Part No. 2382-6 Bent Bolt-In Part No. 2388-6 Flat Bolt-In Part No. 2385 Snap-In Part No. 2386

Bolt-In End Plates Available either flat or bent with $\frac{3}{8}$ " or $\frac{1}{2}$ " mounting hole.

For two or three inch wide straps (see diagram below right for installation):
 $\frac{3}{8}$ inch Mounting Hole **FLAT Bolt-In End Plate** Part No. 2382-6 \$4.99
 $\frac{3}{8}$ inch Mounting Hole **BENT Bolt-In End Plate** Part No. 2388-6 \$4.99

For 3" wide straps – has a 3" wide slot and should NOT be used with 2 inch straps.
 $\frac{1}{2}$ inch Mounting Hole **FLAT Bolt-In End Plate** Part No. 2385 \$4.49
 With 3 inch wide slot - for 3 inch straps only.

Snap-In End Plate To be used with an eyebolt such as our Part Nos. 2384 or 2389 (sold separately at right). A spring-loaded retainer tab provides secure attachment yet allows easy removal when necessary. Can be used to convert a wrap-around mount or bolt-in belt to snap-in (not recommended if the existing bolt-in end plate is sewn on).

Snap-In End Plate Only, each Part No. 2386 \$5.99

Hardware Kits



Above: Bolt-in Hardware Kit Part No. 2383

Above: Eyebolt Hardware Kit Part No. 2384



Left: Short Forged Eyebolt Part No. 2389



Right: Eyebolt Backing Plate Part No. OMP-DB418/6 (Set of 6; one shown)

These items may come in handy when installing your harness or when converting a wrap-around mount to a bolt-in or snap-in mount.

Bolt-In Hardware Kits Each kit includes two fully threaded high-strength bolts, two AN365 locknuts, and two AN970 large area backup washers. One kit is enough to install both ends of one lap belt.

$\frac{3}{8}$ inch Bolt-In Hardware Kit Part No. 2383-6 \$5.59
 With $\frac{3}{8}$ - 24 x 2" fully threaded bolts.

$\frac{1}{2}$ inch Bolt-In Hardware Kit Part No. 2383-8 \$9.89
 With $\frac{1}{2}$ - 20 x 2.5" fully threaded bolts.

Forged Eyebolt Hardware Kit Includes 1 each forged eyebolt with $\frac{7}{16}$ -20 thread (1 $\frac{1}{2}$ " thread length), AN365 locknut, and AN970 large area backup washer. One kit is enough for one end of a lap belt. Never use bent eyebolts!

Forged Eyebolt Hardware Kit, one side Part No. 2384 \$5.99
 Note: Mounts only a single point.

Short Forged Eyebolt This high-quality $\frac{7}{16}$ -20 forged eyebolt from OMP has a Shank length of about 0.85". This short eyebolt is ideal for vehicles that already have $\frac{7}{16}$ -20 welded nuts in the chassis for seat belt mounting. FIA approved.

Short $\frac{7}{16}$ -20 Forged Eyebolt, each Part No. 2389 \$4.89

Eyebolt Backing Plates These FIA-approved plates are perfect for mounting either of the forged eyebolts above. The beefy 2" x 3" x $\frac{1}{8}$ " thick steel plates are designed to spread out the load from your harness and reinforce the floor of your car. The integral $\frac{7}{16}$ -20 female nut accepts a standard eyebolt. FIA approved. Set of 6 is enough to install one complete 6-point harness.

Eyebolt Backing Plates, set of 6 Part No. OMP-DB418/6 \$32.00

Miscellaneous Hardware



Wide 3 Bar Adjuster Part No. 2381

Narrow 3 Bar Adjuster Part No. 2380

Anti-Vibration Spring Part No. 2387

3 Bar Adjuster for 1.75" or 2" wide straps, each Part No. 2380 \$6.49
3 Bar Adjuster for 3" wide straps, each Part No. 2381 \$6.99
Anti-Vibration Spring for 3" quick-adjusters, each Part No. 2387 \$2.99
 Helps to prevent shoulder harness or lap belt adjuster slippage.



Follow these steps to convert a wrap-around mount to a bolt-in or snap-in mount.

Harness Sleeves

Simpson Harness Sleeves Part No. 2129-Color



OMP Harness Sleeves Part No. OMP-DB450-3-Color



Harness Sleeves are padded to cushion against bruises and discomfort from your shoulder straps. These pads wrap around the belts and are secured with Velcro® for quick and easy installation or removal. All of these sleeves are designed to fit standard 3" wide shoulder straps. They are typically not used with a HANS® device. Available in Black, Blue, or Red. Sold in pairs.

Simpson Woven Nomex® Harness Sleeves, Pair Part No. 2129-Color \$49.99
OMP Brushed Nylon Harness Sleeves, Pair Part No. OMP-DB450-3-Color \$25.00

Backsaver Pads



See page 162 for Creafoam Bead Seat Insert Kits and Two-part Seat Foam Kits to customize the fit of your seat!

The Backsaver was originally developed for military combat pilots. Its fluid yet firm support minimizes discomfort and greatly reduces fatigue under grueling conditions. Backsaver foam absorbs up to 97% of impact energy resulting in low rebound. Although the cushion is only 1" thick, it will not bottom out because of its high energy absorption. A rubberized, high-friction bottom surface keeps the pad in place on the seat. A satiny material is bonded to the top of the pad to provide a comfortable surface for the driver. The Backsaver acts like a gasket between driver and seat to ensure perfect contact for precise feedback. We now offer a larger size that costs nearly 15% less per square inch than the standard size pad. Pads can be cut with a scissors or sharp knife.

Standard Backsaver Pad, 16" x 18" Part No. 3439 \$74.99
Extra Large Backsaver Pad, 18" x 36" Part No. 3438 \$141.99

Headrest Padding, SFI 45.2 Approved



See page 34 for SFI 45.1 Approved Roll Bar Padding

SFI 45.2 Headrest Padding EIS (Energy Impact Systems) W50 is a high-density foam developed specifically to meet the headrest material standards for CART and other pro racing organizations. This highly-engineered open-cell foam is very resilient, bouncing back instead of permanently crushing when hit. Its resiliency allows it to absorb repeated impacts in a crash. EIS W50 is perfect for use as a headrest padding, but it can be used anywhere a rigid protective pad is needed. Meets and exceeds SFI 45.2 specifications for energy-managing padding. Supplied in 1 inch thick sheets. Machinable and sandable, cuts with a shop knife. Black only.

SFI 45.2 Headrest Padding, 9" x 16" x 1" Part No. 2396-9x16 \$19.99
SFI 45.2 Headrest Padding, 16" x 18" x 1" Part No. 2396-16x18 \$32.99
SFI 45.2 Headrest Padding, 16" x 36" x 1" Part No. 2396-16x36 \$63.99

Window Nets, Cage Nets, and Arm Restraints

Window Nets

Window Nets keep the driver's arms inside the vehicle in the event of a rollover. They can also help to prevent debris from entering the cockpit. Our SFI 27.1-approved rectangular nets fit most sedans. Mounting kits are sold separately.

Ribbon Window Net, Pocket Type Part No. 2301-Color \$19.99
 Measures 18" x 24" with 1" wide webbing. Full-length pockets top and bottom accept mounting rods (sold separately) up to 9/16" diameter. Available in Black, Blue, or Red.

Ribbon Window Net, Loop Type Part No. RQP7250-Color \$18.95
 Measures 18" x 24" with 1" wide webbing. The webbing is looped top and bottom so the mounting rods (sold separately) are exposed. Available in Black, Blue, Green, Orange, Platinum, Purple, Red, or Yellow.

Mesh Window Net, Black only Part No. 2304-010-Black \$32.99
 Measures 17" x 23" with see-through Black mesh.

The following three black mesh window nets have pockets for mounting rod at the top and bottom, with 2" wide yellow mounting straps built into the bottom to attach to a low door bar. The straps are individually adjustable for length, so they will work with horizontal, diagonal, or X-brace door bars. Top and bottom mounting rods (sold separately below) are still required with these nets. Black mesh only.

Mesh Window Net with Bottom Straps, Large Part No. RQP824005 \$79.95
 Measures 18" x 24" with three yellow mounting straps.

Mesh Window Net with Bottom Straps, Medium . Part No. RQP824003 \$69.95
 Measures 18" x 18" with two yellow mounting straps.

Mesh Window Net with Bottom Straps, Small Part No. RQP824001 \$59.95
 Measures 15" x 18" with two yellow mounting straps.

Window Net Mounting Kits Complete kits include both top and bottom window net rods. All of these kits require welding to the rollcage tubing.

Our **Buckle Type Mount Kits** include a GM-style seat belt buckle for quick and easy use. Both of these kits include bushings that must be welded into holes in your rollcage.

Mount Kit, Buckle Type, Unwelded Part No. 2304-001 \$41.99
 The female side of the buckle must be welded to the top rod in this kit.

Mount Kit, Buckle Type, Welded Part No. 2304-002 \$49.99
 The female side of the buckle is already professionally TIG welded to the top rod in this kit.

Our **Spring Pin Type Mount Kit** has one spring-loaded end on the top rod. Push that end into its bracket to compress the spring, then slip the other end into its bracket. Kit includes four brackets to be welded to your rollcage, plus a handle for the sprung rod.

Mount Kit, Spring Pin Type Part No. 2304-003 \$29.95

Our **Strap Mount Kit** works with any of the mount kits shown above. Six nylon straps connect your lower window net mount rod (sold separately) to a door bar on your roll cage. The straps are individually adjustable for length, so this kit will work with horizontal, diagonal, or X-brace bars. The lower mounting rod must be exposed between the net ribbons (not for use with a mesh or pocket-type ribbon net). Requires a Loop Type ribbon window net such as our Part No. RQP7250 above.

Strap Mount Kit for Lower Bar Part No. RQP705005 \$26.95

Below: Ribbon Window Net, Pocket Type
 Part No. 2301-Color

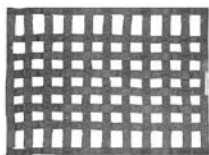

Below: Ribbon Window Net, Loop Type
 Part No. RQP7250-Color

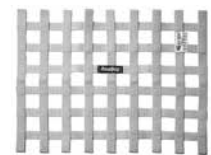

Below: Mesh Window Net
 Part No. 2304-010-Black



Left: Mesh Window Net, With Bottom Straps, Large
 18" x 24"
 Part No. RQP824005



Right: Mesh Window Net with Bottom Straps, Small
 15" x 18"
 Part No. RQP824001

Below: Unwelded Buckle Type Mount Kit
 Net Mount Kit
 Part No. 2304-001



Left: Detail of buckle welded to top rod in our Welded Buckle Type Mount Kit
 Part No. 2304-002

Above: Spring Pin Type Window Net Mount Kit
 Part No. 2304-003

Above: Strap Mount Kit
 Part No. RQP705005
 Loop Type Net and Mounting Rod Kit sold separately



Cage Nets

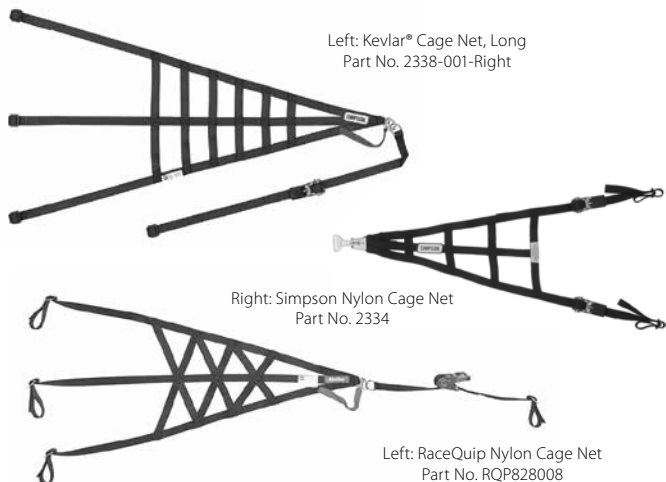

Left: Kevlar® Cage Net, Long
 Part No. 2338-001-Right

Right: Simpson Nylon Cage Net
 Part No. 2334

Left: RaceQuip Nylon Cage Net
 Part No. RQP828008

Cage Nets are used to help restrain the driver's head during side impacts and rollovers. More and more sanctioning bodies are requiring cage nets, but the requirements vary widely. Please check your rule book to ensure you will be in compliance!

Kevlar® Cage Nets Some sanctioning bodies such as IMSA now require cage nets with Kevlar® construction. Our SFI 37.1-approved nets feature 1" wide Kevlar® webbing and a quick-release buckle. The **Long** version adjusts to a maximum of 57 inches for sedans like the Corvette or Porsche 911. The **Short** version adjusts to a maximum of 30 inches for vehicles with smaller cockpits such as Prototypes. Both sizes are available for right or left side. Available in Black only.

SFI 37.1 Kevlar® Cage Net, Long, specify Right or Left Side
 Part No. 2338-001-Side \$187.99

SFI 37.1 Kevlar® Cage Net, Short, specify Right or Left Side
 Part No. 2338-002-Side \$187.99

Simpson Nylon Cage Net This SFI 37.1-approved side cage net features 1" wide nylon-webbing and a quick-release buckle. Can be used on the right or left side. Black only.

Simpson Nylon Cage Net, Black Part No. 2334 \$99.99

RaceQuip Nylon Cage Net This SFI 37.1-approved side cage net is constructed of 1" wide nylon webbing. The quick-release buckle has a high-visibility red pull handle, and a ratcheting mechanism lets you tension the net after the buckle is fastened. Adjusts to a maximum of 47 inches long. Can be used on the right or left side. Black only.

RaceQuip Nylon Cage Net, Black Part No. RQP828008 \$79.95

Arm Restraints

Arm Restraints are used in open-cockpit cars to keep the driver's arms inside the vehicle during a roll-over. Each arm cuff has an adjustable-length strap with a loop at the end. The buckle tab of your lap belt gets inserted through this loop when the belt is fastened. The arms should be free as soon as the belt buckle is released. We offer arm restraints from OMP Sport and Simpson in Black, Blue, or Red. Both brands are SFI 3.3 approved.

OMP Sport Arm Restraints, Pair Part No. 2660-Color \$29.00

Simpson Arm Restraints, Pair Part No. 2322-Color \$39.99



Above: OMP Sport Arm Restraints
 Part No. 2660-Color



Below: Simpson Arm Restraints
 Part No. 2322-Color

MOMO Racing Seats

SEATS

MOMO Lesmo One Seat

Features low side head bolsters and raised areas on the back of the seat for air circulation. The breathable Airnet fabric on the raised cushions helps perspiration to evaporate, while special high-traction material in the seat bottom keeps you firmly in place. Black upholstery with exposed black fiberglass shell. Uses side-mount brackets (sold separately). FIA 8855-1999 approved.



MOMO Daytona Evo Seat

Features high side head bolsters and raised cushions on the back of the seat for air circulation. The raised areas are covered in breathable Airnet fabric to help perspiration evaporate, while special high-traction material in the seat bottom helps keep you firmly in place. Black upholstery with exposed black fiberglass shell. Uses side-mount brackets (sold separately). FIA 8855-1999 approved.



MOMO Daytona Seat

Features high side head bolsters to help control the motion of the driver's head in a crash. A breathable Airnet fabric insert on the seat back helps perspiration to evaporate. Special high-traction material in the seat bottom helps keep you firmly in place. Black upholstery with exposed black fiberglass shell. Uses side-mount brackets (sold separately). FIA 8855-1999 approved.

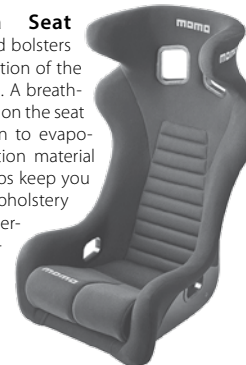

MOMO Lesmo One Fiberglass Seat, Black Only
Part No. MO-1077 \$849.00
MOMO Lesmo One XL Fiberglass Seat, Black Only
Part No. MO-1078 \$849.00

MOMO Daytona Evo Fiberglass Seat, Black Only
Part No. MO-1075 \$799.00
MOMO Daytona Evo XL Fiberglass Seat, Black Only
Part No. MO-1076 \$799.00

MOMO Daytona Fiberglass Seat, Black Only
Part No. MO-1073 \$729.00
MOMO Daytona XL Fiberglass Seat, Black Only
Part No. MO-1074 \$729.00

MOMO Supercup Seat

A breathable Airnet fabric insert on the seat back helps perspiration to evaporate, while special high-traction material in the seat bottom help keep you firmly in place. The elimination of head bolsters makes the Supercup easier to fit in many smaller cars. Black upholstery with exposed black fiberglass shell. Uses side-mount brackets (sold separately). FIA 8855-1999 approved.



MOMO Start Seat

Unlike other MOMO racing seats, the Start has black fabric upholstery all the way around, covering the fiberglass shell for a more finished appearance. The lower hip bolsters and thinner thigh cushion make this a great choice for dual-purpose cars. Uses side-mount brackets (sold separately). FIA 8855-1999 approved. Black only.



MOMO Supercup Fiberglass Seat, Black Only
Part No. MO-1071 \$629.00
MOMO Supercup XL Fiberglass Seat, Black Only
Part No. MO-1072 \$629.00

MOMO Start Fiberglass Seat, Black Only
Part No. MO-1070 \$449.99

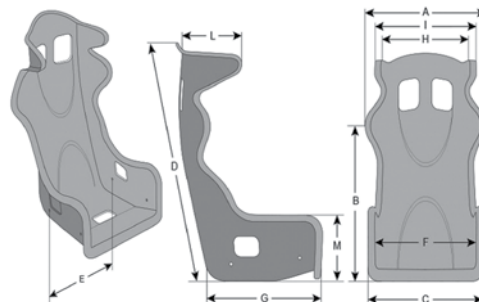
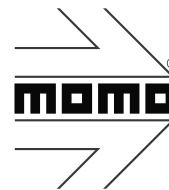

MOMO Racing Seat Dimensions

Dimension	A	B	C	D	E	F	G	H	I	L	M	Weight (pounds)
	Width at shoulder	Height at shoulder	Ext. base width	Overall height	Mount spacing	Int. hip width	Ext. base depth	Int. helmet width	Ext. helmet width	Helmet depth	Hip bolster height	
Lesmo One	21.5"	22.4"	18.1"	35.2"	15.4"	15"	19.7"	15"	18.1"	9.3"	9.8"	22.7
Lesmo One XL	23.6"	22.4"	19.7"	35.2"	16.9"	16.5"	19.7"	15"	18.1"	9.3"	9.8"	23.1
Daytona Evo	22.8"	22.8"	18.1"	34.6"	15.9"	15.6"	18.9"	13.2"	16.3"	11.4"	8.7"	20.7
Daytona Evo XL	23.6"	22.4"	18.9"	35.8"	16.7"	16.3"	18.9"	15.2"	18.3"	11.4"	8.7"	22
Daytona	22.8"	22.8"	18.1"	34.6"	15.9"	15.6"	18.9"	13.2"	16.3"	11.4"	8.7"	20.7
Daytona XL	23.6"	22.4"	18.9"	35.8"	16.7"	16.3"	18.9"	15.2"	18.3"	11.4"	8.7"	22
Supercup	22.4"	21.3"	18.5"	34.6"	15.7"	15.4"	17.7"	N/A	N/A	N/A	N/A	19.6
Supercup XL	25.6"	24"	20.5"	35.8"	17.7"	17.3"	19.3"	N/A	N/A	N/A	N/A	22.4
Start	22.4"	22"	20.5"	34.6"	15.7"	15.6"	19.7"	N/A	N/A	N/A	N/A	17.8

Please Note: Due to their large size, a Large Package Surcharge will be charged for each seat shipped.

MOMO Side-Mount Seat Brackets



MOMO Side-Mount Seat Brackets These brackets fit most racing seats with side mounting points. Six holes at the rear and 6 slots at the front let you choose as many as 36 different seating positions: High or low, tilted forward or tilted back. Two sets of mounting holes on the bottom allow choices in the fore-and-aft position. Black powdercoated 5mm thick aluminum. Sold in pairs (one pair is enough for one seat). Complies with FIA Appendix J.

MOMO Side-Mount Seat Brackets, Aluminum Part No. MO-USM15AL01... \$159.99

Seat Back Brace



Adjustable Seat Back Brace This strong aluminum brace is designed to be bolted to the back of your seat and clamped to the roll bar. No welding is required. The brace can be set to any length from 2 1/2" up to 15" (you drill the cross-pin holes where you want them), making it ideal for multi-driver cars. It can be used with just about any seat at almost any angle. Using two braces can provide added safety in side impacts.

Seat Back Brace Part No. 5176-001 \$129.99

OMP Racing Seats

OMP HTE-R Seat This seat has five harness slots, high side bolsters, and built-in side helmet supports for safety. The breathable cloth upholstery enhances comfort by allowing perspiration to evaporate. Uses side-mount brackets (sold separately). Available with a carbon fiber shell, a fiberglass shell, or an "XL" fiberglass shell for larger drivers. FIA 8855/1999 approved. Black only.

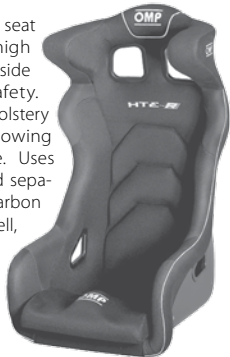

OMP WRC-R Seat This popular seat features five harness slots and high side bolsters. The breathable cloth upholstery enhances comfort by allowing perspiration to evaporate. Uses side-mount brackets (sold separately). Available with a carbon fiber shell, a fiberglass shell, or an "XL" fiberglass shell for larger drivers. FIA 8855/1999 approved. Black only.



OMP RS-P.T. 2 Racing Seat

This racing seat has five seat belt holes and high side bolsters. The distinctive side head bolsters combine with a fully-upholstered fiberglass shell for a unique look. This is a great choice for dual-purpose cars that see extreme track duty. Uses side-mount brackets (sold separately). FIA 8855/1999 approved. Black only.



OMP HTE-R Carbon Seat, Black only

Part No. 3454-768\$2,549.00

OMP HTE-R Fiberglass Seat, Black only

Part No. 3454-772E \$959.00

OMP HTE-R XL Fiberglass Seat, Black only

Part No. 3454-771 \$979.00

OMP WRC-R Carbon Seat, Black only

Part No. 3454-769\$2,249.00

OMP WRC-R Fiberglass Seat, Black only

Part No. 3454-773 \$799.00

OMP WRC-R XL Fiberglass Seat, Black only

Part No. 3454-778\$819.00

OMP RS-P.T. 2 Fiberglass Seat, Black only

Part No. 3454-762E\$759.00

OMP Champ-R Seat

This racing seat has five seat belt holes. The low side bolsters allow easier entry and exit, making this seat suitable for road use too! The velour upholstery features special gripping dots in the shoulders and on the bottom cushion for maximum feedback. Uses side-mount brackets (sold separately). Fiberglass shell with velour upholstery. FIA 8855/1999 approved. Black only.



OMP Champ-R Fiberglass Seat, Black only

Part No. 3454-766 \$659.00

OMP First-R Racing Seat

This economical racing seat features five seat belt holes and slightly higher side bolsters than the Champ-R seat above. The velour upholstery covers the seat all the way around. The fiberglass shell is not exposed on the backside as on other OMP seats. Uses side-mount brackets (sold separately). FIA 8855/1999 approved. Black only.



OMP First-R Fiberglass Seat, Black only

Part No. 3454-790 \$549.00

OMP Racing Seat Dimensions

Dimension	A	B	C	D	E	F	Weight (pounds)	Mounts
	Width at shoulder	Height at shoulder	External width at base	Internal width at waist	Overall height	Depth at base, front to back		
HTE-R Carbon	21.5"	22.1"	18.3"	14.6"	34.6"	18.5"	16.1	Side
HTE-R Fiberglass	22.1"	22.5"	20.3"	15.4"	34.6"	19.3"	22.8	Side
HTE-R XL	22.8"	24"	20.9"	16.3"	36.2"	21.7"	25.5	Side
WRC-R Carbon	23.3"	23.6"	19.5"	14.4"	35.1"	19.3"	13.5	Side
WRC-R Fiberglass	24.4"	23.6"	20.1"	15.4"	35.1"	18.9"	21.3	Side
WRC-R XL	26.2"	23.6"	20.5"	16.4"	36.2"	18.9"	23.6	Side
RS-P.T. 2	22.3"	22"	20.1"	15.5"	34.7"	18.9"	23	Side
Champ-R	23.2"	22.6"	20.5"	14.2"	35.1"	19.3"	19.4	Side
First-R	24.4"	23.6"	20.1"	15.4"	35.1"	18.9"	25	Side

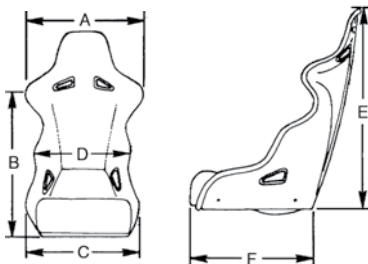

Shipping Note: Due to their large size, UPS and FedEx charge a Large Package Surcharge for each racing seat shipped.

We can ship 2 (or more) seats on a single pallet anywhere in the 48 states via Truck Freight for a flat rate of \$149. That's less than the two Large Package Surcharges alone!

Please visit our website for many more OMP Racing Seats!

OMP Side-Mount Seat Brackets



OMP Low Seat Brackets These low brackets fit most racing seats with side mounting points. Multiple holes and slots at each end let you choose as many as 16 different seating positions: High or low, tilted forward, tilted back, even fore-and-aft position. Four sets of holes in the bottom flanges provide even more options. Black powder coated finish. 400mm long. Sold in pairs (one pair is enough for one seat).

Complies with FIA Appendix J.

OMP Low Side-Mount Brackets, pair (mounts one seat)

Steel (shown) Part No. OMP-HC922 \$89.00

Aluminum Part No. OMP-HC924 \$149.00

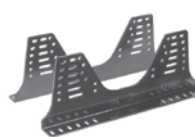

OMP Tall Seat Brackets These tall brackets fit most side-mount racing seats. An array of holes and slots at each end let you choose no fewer than 36 different seating positions! Front and rear have 6 height options plus up to 3 fore-and-aft. Six sets of holes in the bottom flanges provide even more positions. Black powder coated finish. 495mm long. Sold in pairs (one pair is enough for one seat). Complies

with FIA Appendix J.

OMP Tall Side-Mount Brackets, pair (mounts one seat)

Steel Part No. OMP-HC923 \$99.00

Aluminum (shown) Part No. OMP-HC925 \$185.00

AFFF (Foam) Fire Suppression Systems

SPA FireSense-Response AFFF Fire Suppression Systems (FIA Approved)

FIRE SYSTEMS



What is AFFF ?

AFFF is short for Aqueous Film Forming Foam. AFFF uses no halogen or greenhouse gases, so it has zero ozone depletion potential. It is even biodegradable, so any spilled material will have negligible environmental impact. AFFF coats the area within the spray pattern to extinguish the fire and prevent reignition. It is non-corrosive and non-conductive, and cleans up easily by rinsing with water. **Pressurized AFFF fire systems must be inspected and serviced every two years.** We can provide this service. Please call or visit our website for full details.

We are proud to be an authorized refill center for SPA AFFF Fire Suppression Systems. Please visit our website for details.

NOTE: All pressurized fire bottles are classified as HAZARDOUS by the US Department of Transportation. A HAZARDOUS shipping charge will apply. Hazardous items can be shipped to U.S. customers only.

FIA and SFI certification both require pressurized fire bottles to be serviced by factory-trained personnel every two years. SCCA and other organizations that require certification also enforce the 2 year service rule. Bottles which are past their service date cannot be recertified.

SPA Design was one of the first manufacturers to earn FIA homologation on their fire systems back in 1998. Their latest systems are the culmination of those early systems plus 20 years of product improvement, including lessons learned during the development of fire suppression systems for industries outside of racing.



Above:
SPA 4.0L FireSense-Response Electrical System (aluminum bottle)
Part No. 2427-4.0-Elec/Alum



Below:
SPA 4.0L FireSense-Response Mechanical System (steel bottle)
Part No. 2427-4.0-Mech/Stl

The SPA FireSense-Response systems listed below are FIA Homologated (Homologation No. Ex.045.17) per FIA Technical List No. 16. They are SCCA legal in all cars regardless of the vehicle's racing class and registration date. Each complete system consists of a filled and fully charged AFFF cylinder, mounting brackets, four discharge nozzles, sixteen feet of Dekabon polyethylene-coated aluminum tubing, and three push-on tee connectors. Electrical Systems also include a power pack, two actuation switches, and electrical connectors. Mechanical Systems also include one 6 foot and one 12 foot actuating cable and hardware.

***See note concerning shipment of hazardous materials.**

SPA 4.0L Electrical System, Aluminum Bottle . . . Part No. 2427-4.0-Elec/Alum . . . \$979.00
Measures 6" diameter x 12.8" long (14.9" including firing head). Weighs 11.2 pounds.

SPA 4.0L Mechanical System, Steel Bottle Part No. 2427-4.0-Mech/Stl \$410.00
Measures 5.9" diameter x 13.8" long (17" long including actuating handles). Weighs 15 pounds.

Our website lists several more SPA fire suppression systems which are not FIA Homologated. Non-FIA systems can be a great choice when a fire system is not mandatory.

Billet Bottle and Bar Mounts



Above: Bottle Mount
Part No. 2035-300-Size

Below: Bar Mount
Part No. 2035-306-Size



These mounts are machined from 1/2" thick billet aluminum. Bolt them to a flat surface, or add the optional Bar Mounts (sold separately) to mount to rollcage tubing. Sold individually.

Note: These mounts have no adjustment. The bottle mounts fit the diameter listed +/- 1/8" only.

Bottle Mount for 4" Bottle Part No. 2035-300-4.00 \$61.99
Fits 5 pound FireBottle and Phoenix fire bottles

Bottle Mount for 5 1/4" Bottle Part No. 2035-300-5.25 \$51.99
Fits 10 pound FireBottle and Phoenix fire bottles.

Bottle Mount for 6.2" Bottle Part No. 2035-300-6.20 \$76.99
Fits 4.0L SPA Aluminum fire bottles (not steel bottles)

Bar Mount for 3/4" Tubing Part No. 2035-306-.75 \$36.99

Bar Mount for 1" Tubing Part No. 2035-306-1.00 \$36.99

Bar Mount for 1 1/4" Tubing Part No. 2035-306-1.250 \$36.99

Bar Mount for 1 3/8" Tubing Part No. 2035-306-1.375 \$36.99

Bar Mount for 1 1/2" Tubing Part No. 2035-306-1.50 \$36.99

Bar Mount for 1 5/8" Tubing Part No. 2035-306-1.625 \$36.99

Bar Mount for 1 3/4" Tubing Part No. 2035-306-1.750 \$36.99

Bar Mount for 2" Tubing Part No. 2035-306-2.00 \$36.99

Safety Pin Streamers



A reminder flag is recommended by SCCA for marking fire bottle safety pins. They are great for marking anything that you need to remove before a race. They even make great key rings. Our bright red woven nylon flags have "REMOVE BEFORE FLIGHT" or "REMOVE BEFORE RACE" in bold white letters. Each includes a split ring for fastening.

Remove Before Flight Streamer, 8" x 1"
Part No. 1100-RBF08 \$6.99

Remove Before Race Streamer, 6" x 1.25"
Part No. 1100-RBR \$3.99

Firecharger AFFF Fire Suppression Systems



Firecharger AFFF Fire Suppression Systems are fully approved by many sanctioning bodies and are approved in SCCA for cars registered prior to 01/01/2009. They are the **only** systems available that **you** can refill at the track! Pressure is held in an external CO₂ cartridge. One pull of the cable and the CO₂ pressurizes and aerates the AFFF, totally discharging the unit. Firecharger systems include the cylinder with actuator, CO₂ cartridge, mounting bracket, 8 foot actuating cable, 8 feet of aluminum tubing, and two discharge nozzles.

Firecharger 2.3L AFFF System* Part No. 2018 \$349.99
2.3L system includes 2 nozzles. (System can support up to 3 nozzles.) Total weight filled: 7.38 lbs. Measures 14.5" Long x 4.25" OD x 6" High.

Recharge Kits contain everything you need to completely refill/recharge your 2.3 liter Firecharger system. Includes 1 "non-fragmenting" rupture disc, 1 new CO₂ cartridge, and 1 bottle of AFFF solution. One kit is for one refill only, so stock up.

2.3L Firecharger Recharge Kit* Part No. 2025-2.3 \$52.99

Replacement CO₂ Cartridge only* Part No. 2015 \$29.99

*** These items are hazardous only when shipped by air.**

See note above concerning shipment of hazardous materials.

Note: Firecharger systems **do not** incur a hazardous material shipping charge when shipped by ground transportation!

FE-36™ and Novec™ 1230 (Gas) Fire Suppression Systems

FIRE SYSTEMS

FireBottle FE-36™ Fire Suppression Systems (SFI 17.1 Approved)

FireBottle Pull Systems with 4 foot pull cable A single pull on the actuating cable will completely discharge the contents of the bottle. These complete systems include a fully-pressurized bottle, a manual actuating head, a 4 foot pull cable for remote activation, 8 feet of aluminum tubing, a bottle mounting bracket with clamps, tube fittings, and 2 nozzles (3 nozzles with the 10 lb. system). SFI approved and SCCA legal in all cars.

***See note concerning shipment of hazardous materials.**

FireBottle 5 lb. FE-36™ Pull System (shown)Part No. 2035-003 \$419.99
 Aluminum bottle measures 17.25" long (including head) by 4" diameter.

FireBottle 10 lb. FE-36™ Pull SystemPart No. 2035-007 \$629.00
 Aluminum bottle measures 18.25" long (including head) by 5.25" diameter.

Replacement FE-36™ Bottles for all Mechanical FireBottle Systems These are the same fully-pressurized aluminum bottles as included with the full systems above. They are 100% interchangeable with the old FireBottle Halon bottles as well as the older Phoenix Halon bottles. Simply unscrew your old actuating head, retract the firing pin and insert the safety pin, and screw the head onto the new bottle. SFI approved and SCCA legal in all cars.

***See note concerning shipment of hazardous materials.**

5 lb. FE-36™ Manual Replacement Bottle onlyPart No. 2035-006 \$294.99
10 lb. FE-36™ Manual Replacement Bottle onlyPart No. 2035-012 \$499.00

Automatic / Manual FE-36™ Fire Suppression Systems

These FE-36™ fire suppression systems are ideal for your trailer, shop, and race car! The system can be activated manually by a pull cable, or it can activate itself automatically if you can't. If the temperature in the cockpit exceeds 155° F, a special thermal bulb automatically discharges the system. Each system includes an aluminum cylinder (fully charged with FE-36™), mounting bracket, two discharge nozzles, aluminum tubing, one manual pull cable, and a thermal head connected to the bottle by a 3 foot long flame-resistant, flexible, braided stainless steel line. Requires no electrical power, so it's great for trailers and parked RVs.

***See note concerning shipment of hazardous materials.**

5 lb. Automatic / Manual System (shown)Part No. 2035-032 \$539.00
 Bottle measures 17.25" long by 4" diameter.

10 lb. Automatic / Manual SystemPart No. 2035-033 \$759.00
 Bottle measures 18.5" long by 5.25" diameter.

What is FE-36™ ?

FE-36™ is DuPont's™ clean replacement for Halon. FE-36 has zero ozone depletion potential and performs comparably to Halon 1211, but with lower toxicity. It is stored as a liquid under pressure and releases as a gas. The gas smothers the fire to disrupt the combustion process. It also cools the area to prevent spontaneous reignition. FE-36 is non-corrosive, leaves no residue, and requires no cleanup.

5 lb. SFI-Approved
 FE-36™ Mechanical
 Fire System
 Part No. 2035-003

5 lb. SFI-Approved
 FE-36™ Automatic/
 Manual Fire System
 Part No. 2035-032



NOTE:

All pressurized fire bottles are classified as HAZARDOUS by the US Department of Transportation. A HAZARDOUS shipping charge will apply. Hazardous items can be shipped to U.S. customers only.

SPA Extreme Novec™ 1230 Fire Suppression Systems (FIA Approved)

The three SPA systems listed below are FIA Homologated (Homologation No. Ex.029.09) per FIA Technical List No. 16. They are SCCA legal in all cars regardless of the vehicle's racing class and registration date. Each complete system includes an aluminum bottle filled and fully charged with Novec™ 1230, mounting brackets, electrical power pack, two pushbutton actuation switches, electrical connector plugs, Dekabon tubing, tubing connectors, and discharge nozzles. The 2.5 kg and 3.0 kg systems each include 2 cockpit nozzles and 2 engine bay nozzles. The 4.0 kg system includes 2 cockpit nozzles and 4 engine bay nozzles.

***See note concerning shipment of hazardous materials.**

2.5 kg (5.5 lb) Electrical SystemPart No. 2481-2.5-Elec \$1,299.00
 Bottle measures 6.3" OD x 11.5" including firing head. Total weight 9.1 lb.

3.0 kg (6.6 lb) Electrical SystemPart No. 2481-3.0-Elec \$1,399.00
 Bottle measures 6.3" OD x 11.5" including firing head. Total weight 10.2 lb.

4.0 kg (8.8 lb) Electrical SystemPart No. 2481-4.0-Elec \$1,799.00
 Bottle measures 6.3" OD x 13" including firing head. Total weight 12.7 lb.

What is Novec™ 1230 ?

Novec™ 1230 is the clean Halon replacement from 3M™. Novec is stored as a liquid under pressure and discharges as a gas. The gas smothers the fire to disrupt combustion and pulls heat out of the fire to prevent re-ignition. Novec has zero ozone depletion potential and an atmospheric lifetime of about 1 week, so it has less global warming potential than pure CO₂. Novec is non-corrosive and completely safe for use around sensitive electronics. It leaves no residue and requires no cleanup. Novec is effective on petroleum fires (gasoline and oil) as well as alcohol fires (ethanol and methanol).

NOTE:

All pressurized fire bottles are classified as HAZARDOUS by the US Department of Transportation. A HAZARDOUS shipping charge will apply. Hazardous items can be shipped to U.S. customers only.

FIA and SFI certification both require pressurized fire bottles to be serviced by factory-trained personnel every two years. SCCA and other organizations that require certification also enforce the 2 year service rule. Bottles which are past their service date cannot be recertified.

Lifeline Fire Marshal Novec™ 1230 Fire Suppression System (FIA Approved)

The Lifeline Fire Marshal fire system is the smallest fire suppression system we offer. It is also far more economical than any other FIA-approved system we have seen in this size. The 2.25kg Fire Marshal is a perfect replacement for the old European 5.5 pound Halon bottles installed in so many formula cars from the 1980s through the 1990s. This system is FIA Homologated (Homologation No. Ex. 042.17) per FIA Technical List No. 16. It is SCCA legal in all cars regardless of the vehicle's racing class and registration date. The complete system includes a compact aluminum bottle (filled and fully charged with Novec™ 1230), mounting brackets, one 6 foot pull cable, one 12 foot pull cable, discharge tubing, tubing connectors, 3 engine bay nozzles, and 2 cockpit nozzles.

***See note concerning shipment of hazardous materials.**

2.25kg (5.5 lb) Mechanical SystemPart No. LL106-001-004 \$699.00
 Bottle measures 4.9" OD x 7.1" Long (10.6" including actuation handles).



Replaces old European 5.5 lb Halon bottles in small formula cars!

Racing Side Mirrors

SPA Design Mirrors are strong yet lightweight, just like a racing mirror should be. All three styles have a ball joint at the base and a left-to-right pivot on the housing. We offer 10 different combinations of housing sizes, housing materials, and lens types to fit everything from small formula cars to large sedans.

SPA Formula Car Side Mirrors



2" H x 4 7/16" W Lens
(52mm x 113mm)
8 7/8 sq. in. (5876mm²)

Note: To save weight and bulk, SPA mirrors do not have spring-loaded joints for adjustments "on the fly" like OEM mirrors do. You must lock the mirror down AFTER the mirror is adjusted. This results in a very stable, solid mirror which will not vibrate out of position. A third hole is required in the body panel between the two mounting screws for access to the ball joint set screw after installation.

SPA GT / Sedan Side Mirrors



2 5/8" H x 5 3/4" W Lens
(68mm x 148mm)
15 sq. in. (10,064mm²)

SPA Design Formula Car Mirrors have a rectangular lens measuring 2" high x 4 7/16" wide (52mm x 113mm), ideal for small formula cars. A ball joint at the base and a left-to-right pivot at the housing provide a wide range of adjustment. Sold individually.

Carbon Fiber Housing, Convex Lens:
Right or Left Side (specify side) Part No. 5129-Side \$194.99

Paintable Black Nylon Housing, Convex Lens:
Left Side Part No. 5121-Black \$75.99
Right Side Part No. 5122-Black \$75.99
Replacement Convex Lens Only Part No. 5124-Lens \$40.99

Carbon Fiber Housing, Flat Lens:
Right or Left Side (specify side) Part No. 5114-Side \$162.99

Paintable Black Nylon Housing, Flat Lens:
Left Side Part No. 5116-Black \$56.99
Right Side Part No. 5117-Black \$56.99
Replacement Flat Lens Only Part No. 5118-Lens \$27.99

SPA Design GT / Sedan Mirrors have a rectangular lens measuring 2 5/8" high x 5 3/4" wide (68mm x 148mm) for sedans and larger sports cars. A ball joint at the base and a left-to-right pivot at the housing provide a wide range of adjustment. Sold individually.

Carbon Fiber Housing, Convex Lens:
Right or Left Side (specify side) Part No. 5198-Side \$219.99

Paintable Black Nylon Housing, Convex Lens:
Left Side Part No. 5196-Black \$111.99
Right Side Part No. 5197-Black \$111.99
Replacement Convex Lens Only Part No. SP MM15 \$44.99

Carbon Fiber Housing, Flat Lens:
Right or Left Side (specify side) Part No. 5192-Side \$189.99

Paintable Black Nylon Housing, Flat Lens:
Left Side Part No. 5190-Black \$84.99
Right Side Part No. 5191-Black \$84.99
Replacement Flat Lens Only Part No. SP MM08 \$28.99

FIA-Approved SPA Design GP3 Formula Car Mirrors



1.97" H x 5.9" W Lens
(50mm x 150mm)
11.6 sq. in. (7500mm²)

FIA-Approved GP3
Formula Car Mirrors

Part No. 5181-003



Part No. 5181-004

Sold individually

These racing mirrors are designed to meet FIA requirements for all formula cars, from F4 to F1. The extra-wide lens measures 50mm high x 150mm wide (1.97" x 5.9") to comply with Section 14.3.2 rules. The ball joint at the base and the left-to-right pivot at the housing must be locked down after adjustments. Sold individually.

FIA-Approved GP3 Formula Car Mirrors, Carbon Fiber Housing:
Convex Lens, Right Side Part No. 5183-004 \$202.99
Convex Lens, Left Side Part No. 5183-003 \$202.99
Flat Lens, Right Side Part No. 5183-002 \$187.99
Flat Lens, Left Side Part No. 5183-001 \$187.99

FIA-Approved GP3 Formula Car Mirrors, Black Nylon Housing:
Convex Lens, Right Side Part No. 5181-004 \$110.99
Convex Lens, Left Side Part No. 5181-003 \$110.99
Flat Lens, Right Side Part No. 5181-002 \$86.99
Flat Lens, Left Side Part No. 5181-001 \$86.99

Vintage-Style Racing Mirrors

Vitaloni Baby Turbo



The **Baby Turbo** has been used on a wide variety of racing vehicles. The compact, aerodynamic shape looks great and adjusts easily with a sprung ball joint at the base. It can be used for right or left side mounting, so just one spare can cover both sides of the car. The large rectangular lens (3" x 5") and wide range of adjustability allow better rearward vision than many other mirrors. Sold individually.
Baby Turbo Mirror, flat lens ... Part No. 5110 \$85.99

Vitaloni Sebring Mach 1



These flat-bottomed, teardrop-shaped mirrors can be mounted directly on a fender or door (as on the Porsche 911RSR) or on a raised platform (as on Can-Am, the original SCCA Spec Racer, and countless formula cars). The mirror glass pivots inside the black plastic housing. Fits right or left side, so just one spare can cover both sides of the car. Lens measures 3" x 4.5". Choose flat or convex glass. Sold individually.

Sebring Mirror, flat lens Part No. 5108 \$89.99
Sebring Mirror, convex lens ... Part No. 5109 \$92.99

Vitaloni Californian



These classic teardrop mirrors have been used on many formula cars, sports racers, and sedans. The flat lens pivots inside the housing, and the stem is hinged at the base. (The housing and stem are one piece.) The black matte finish can be painted if desired. Specify right or left side. Teardrop-shaped lens measures 3" x 5". Sold individually.

Californian, Left side Part No. 5105 \$85.99
Californian, Right side Part No. 5106 \$85.99

Spun Aluminum Mirror



Our **Spun Aluminum Mirror** gives you the classic "Raydyot" look for a fraction of the cost! This high-quality reproduction has a spun aluminum housing with a clear anodized finish, just like the original. The flat lens measures 3 1/2" diameter. The mirror mounts with a single 1/4" stud and pivots on a ball-and-socket joint with a 1 1/2" diameter base. Fits right or left side.

Sold individually.

Aluminum Mirror, flat lens ... Part No. 5173-300 .. \$59.99

Talbot Berlin 300 Mirrors



If you are restoring a 100-point show car, settle for nothing less than genuine Talbot Sport mirrors. These beautifully finished mirrors feature flawless chrome plating over a polished brass shell. The special J-bolt mounting system can be installed without requiring access to the backside of the panel. Sold individually.

Talbot Junior, 3.5" flat lens .. Part No. 5173-001 .. \$424.99
Talbot Senior, 4" flat lens Part No. 5173-004 .. \$474.99
Talbot Senior, 4" convex Part No. 5173-003 .. \$489.00

Chrome Bullet Mirror



Get a period-correct racing look without breaking the bank! This reproduction mirror is perfect for classic racing vehicles and vintage sports cars. The two-bolt mount is simple but requires access to the backside of the panel. Ball-and-cup design allows the 3.5" mirror to pivot independently of the housing. Flat lens only. Sold individually.

Chrome Bullet Mirror Part No. 5173-401 .. \$59.99
Note: This mirror is not for trailer queens! If you are picky about finish, please see the Talbot mirrors to the left.

Racing Center Mirrors, Headlights, and Headlight Covers

Longacre Clamp-On Mirrors

This convex interior mirror mounts easily to your roll bar with an anodized aluminum clamp-on bracket at each end. The 0.5"-2.5" bracket is slotted, allowing easy adjustment. The 2.0"-5.5" bracket is drilled for ten different positions. Kits include 2 clamp-on brackets, one mirror, and all hardware. Mirrors and brackets are also available separately.

17 Inch Convex Mirror Kits:

17" Mirror Kit for 1.5" OD Bar, 0.5"-2.5" Length.....	Part No. 22531.....	\$72.99
17" Mirror Kit for 1.5" OD Bar, 2.0"-5.5" Length.....	Part No. 22533.....	\$72.99
17" Mirror Kit for 1.75" OD Bar, 0.5"-2.5" Length.....	Part No. 22530.....	\$72.99
17" Mirror Kit for 1.75" OD Bar, 2.0"-5.5" Length.....	Part No. 22532.....	\$72.99
17" Mirror Only (no brackets).....	Part No. 22547.....	\$37.99

14 Inch Convex Mirror Kits:

14" Mirror Kit for 1.5" OD Bar, 0.5"-2.5" Length.....	Part No. 22535.....	\$62.99
14" Mirror Kit for 1.5" OD Bar, 2.0"-5.5" Length.....	Part No. 22537.....	\$62.99
14" Mirror Kit for 1.75" OD Bar, 0.5"-2.5" Length.....	Part No. 22534.....	\$62.99
14" Mirror Kit for 1.75" OD Bar, 2.0"-5.5" Length.....	Part No. 22536.....	\$62.99
14" Mirror Only (no brackets).....	Part No. 22544.....	\$29.99

Clamp-On Brackets Only, sold in pairs:

Brackets Only for 1.5" OD Bar, 0.5"-2.5" Length, pair.....	Part No. 22539.....	\$42.99
Brackets Only for 1.5" OD Bar, 2.0"-5.5" Length, pair.....	Part No. 22541.....	\$42.99
Brackets Only for 1.75" OD Bar, 0.5"-2.5" Length, pair.....	Part No. 22538.....	\$42.99
Brackets Only for 1.75" OD Bar, 2.0"-5.5" Length, pair.....	Part No. 22540.....	\$44.99

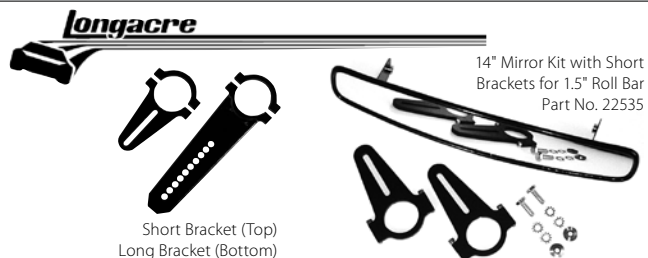

MIRRORS

Longacre Clamp-On Spot Mirrors

This 3.75" diameter convex mirror mounts on the side of your roll cage for extra side vision. The mirror is easily adjustable, but the bracket clamps solidly in place so it won't vibrate loose during the race. Compact, lightweight design can be placed entirely inside the bodywork for less aero drag. Sold individually.

Longacre 3.75" Spot Mirror with Bolt-On Roll Bar Bracket	
For 1.5" Diameter Bar.....	Part No. 22549..... \$49.99
For 1.75" Diameter Bar.....	Part No. 22548..... \$49.99



Wink Multi-Panel Wide-Angle Mirror

Wink Mirror Eliminate blind spots and get up to 300% more rear vision without distorting the distance to objects behind you. Five separate flat panels combine to form a continuous, wide-angle image. Wink mirrors are so effective they have been prescribed by doctors for drivers with neck pain! Mounting brackets are supplied for screwing to a panel or clamping to a rollcage (clamps sold separately). Windshield Mount Kits (sold separately) allow you to attach to the windshield glass with the same adhesive used by auto manufacturers on OEM mirrors.

Wink 5 Panel Mirror, 36" long.....	Part No. 5101.....	\$26.99
Optional Windshield Mount Kit, each (2 required).....	Part No. 5103.....	\$8.59



SPA Design Dash-Mount Center Mirrors



Dash-Mount Center Mirrors These mirrors feature a long convex glass lens for a clear, wide-angle view. Originally designed for open-cockpit two-seat sports racers, they are also popular as fender mirrors on center-seat sports racers and closed-cockpit prototypes. The housing attaches to the center mounting stem by a single ball joint for great adjustability. The aluminum stem has a very stable 3-bolt rigid mounting foot at the bottom. The housing measures 8 1/2" x 2 1/4". Height of mounting stem including ball joints is 5 inches.

Dash-Mount Center Mirror, Carbon Fiber.....	Part No. 5126.....	\$329.99
Dash-Mount Center Mirror, Black Nylon.....	Part No. 5125-Black.....	\$187.99
Each of these kits includes the mirror housing with ball joint and lens installed, and a black powder coated stem.		
Dash-Mount Center Mirror Kit with Unfinished Stem, Black Nylon.....	Part No. 5181-102.....	\$187.99
This kit includes the mirror housing with ball joint and lens installed, 3-bolt mounting foot, threaded top stem end, and a 12" length of raw tubing. Cut the tubing to your desired stem height and braze the two ends on for a custom-height mirror.		
Replacement Lens, Convex.....	Part No. SP MM01.....	\$44.99
Replacement Stem only (finished), 5".....	Part No. 5171-Stem-Black.....	\$88.99
This is the same pre-assembled, black powder coated stem supplied with standard mirrors.		

Cibié Oscar SC Driving Lamps

Cibié designed and manufactured the world's first aircraft landing lights in 1913. Cibié driving lamps have lit up the 24 Hours of Le Mans since 1926!

Cibié Oscar SC Driving Lamp "VA" Cornering Beam shown Part No. 5099-002



Note: An acrylic or polycarbonate fairing is highly recommended with these lamps to protect the lens from damage. Many racing organizations also require such a cover to contain any glass shards in the event of breakage.

The **Cibié Oscar SC** is the perfect size for sports racing prototypes. The 6 inch diameter glass lens is completely flat and clear to maximize light output. The beam shape is entirely controlled by the aluminized steel reflector. Two different beam patterns are available.

The **LP** Driving Beam shines straight ahead with minimal spread. A 100W H1 halogen bulb (not included) will illuminate up to 3/8 mile ahead and 100 feet side-to-side.

The **VA** Cornering Beam shines a broad, even beam to light up track edges and corner apexes. A 100W H1 halogen bulb (not included) will illuminate approximately 1/8 mile ahead and 250 feet side-to-side.

Cibié Oscar SC Headlamp, LP Driving Beam, each.....	Part No. 5099-001.....	\$207.99
Cibié Oscar SC Headlamp, VA Cornering Beam, each.....	Part No. 5099-002.....	\$194.99
Each lamp includes the reflector/lens assembly, bulb holder, and aiming ring. H1 halogen bulb not included. Not DOT-approved for use as primary lighting.		

Headlight Covers and Decals

Our **Carbon Fiber Headlight Covers** are made by the leading American manufacturer of composites for motorsports. These hand-made parts feature the same high-quality materials and attention to detail that has made them a favorite of top pro teams and manufacturers. These covers are constructed of 2 x 2 weave carbon fiber. They are not plastic with a carbon fiber pattern printed on. Choose 6 or 7 inch diameter. Sold individually.

Carbon Fiber Headlight Cover, Plain, specify size.....	Part No. CF005-Size.....	\$199.99
--	--------------------------	----------



Our **Venturi-Style Covers** feature the same construction as the solid covers above, but with an intake opening in the center. A flange is provided for attaching a 3" diameter hose (hose sold separately). Choose 6 or 7 inch diameter. Sold individually.

Carbon Fiber Headlight Cover, Venturi Style, specify size.....	Part No. CF006-Size.....	\$209.99
--	--------------------------	----------

Our **Spun Aluminum Headlight Covers** add a great finishing touch to your vintage race car! These lightweight covers replace most 7" round sealed-beam headlights and are held in place by your stock headlight retainer rings. The durable all-weather **Headlight Simulator Decals** are printed in full color to simulate the classic Lucas PL-700 Tri-pod series 7" round headlight found on vintage British cars. These decals are a classy way to dress up your standard headlight covers and can be applied to just about any 7" round head lamp blanking plate. Apply them to curved headlight covers as shown by carefully cutting the decal along the tripod "bars" and overlapping the decal sections slightly to conform to the surface.

Spun Aluminum 7" Headlight Covers, pair.....	Part No. 3610-007.....	\$35.99
Headlight Simulator Decals, pair.....	Part No. 3610-002.....	\$21.99



Autopower Roll Bars and Roll Cages



Autopower is the leader in quality roll bars and cages. Their high standards of workmanship are unsurpassed. Autopower was the first manufacturer of roll bars to be licensed and certified by the SCCA. Roll bars include backup plates and grade 5 mounting hardware. Autopower roll bars are constructed of 1.75 O.D. x .120 wall DOM (Drawn Over Mandrel) mild steel tubing. Roll cages are constructed of 1.50 O.D. x .120 wall or 1.75 O.D. x .120 wall DOM mild steel tubing, depending on car weight.

Note: The SCCA now requires DOM tubing in all cars regardless of vehicle weight and racing class.

Important Information About Ordering Your Roll Bar or Roll Cage

- Allow 4 to 8 weeks for delivery depending upon the time of year.
- Don't be disappointed - ORDER EARLY!
- Bars and cages are shipped freight collect directly from the factory via truck freight.
- When ordering, give us the year, make, model, racing class and specify whether or not your car has a factory installed sunroof.
- Give us a call if you have ANY questions!

ROLL BARS

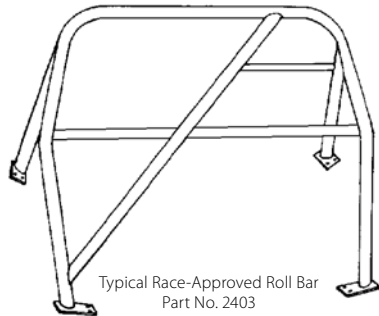

Typical Race-Approved Roll Bar
Part No. 2403

Race-Approved Roll Bar This bar has a diagonal brace, a horizontal seat back brace, and a small restraint bar behind the driver's seat. The cross braces are normally welded in place; however, bolt-in options are available to allow rear seat use off the track; see below.

Race-Approved Roll Bar, 1.75" O.D. DOM
Part No. 2403-1.75-DOM \$669.00
Note: SCCA requires a full cage in all road racing classes.

Bolt-In Cross Brace Option This option must be ordered at the same time as your roll bar.

Bolt-In Cross Brace Option Part No. 2408 ... \$109.99
Replaces the welded braces included with roll bar; can be removed when not racing to allow use of the back seat.



Typical Complete U-Weld Roll Cage Kit
Part No. 2405

Complete U-Weld Roll Cage Kit Includes DOM race-approved roll bar, 2 forward support braces, top windshield cross bar, under-dash cross bar, left and right door guards, mounting plates, and hardware. Parts are precision cut and bent for each individual model; however, final fitting and welding is required.

U-Weld Roll Cage Kit, 1.5" Tubing for cars up to 3000 lbs.
Part No. 2405-1.50-DOM \$1,039.00
U-Weld Roll Cage Kit, 1.75" Tubing for cars up to 4000 lbs.
Part No. 2405-1.75-DOM \$1,039.00

U-Weld Front Cage Kit Add this kit to an existing Autopower Race-Approved Roll Bar to make a legal 6-point roll cage. Tube size will be determined by Autopower when you place your order. Kit includes 4 top corner gussets, under-dash bar, 4 door bars, forward support braces, a top windshield cross tube, and all necessary hardware.

U-Weld Front Cage Kit Part No. 2413-001 . \$529.00

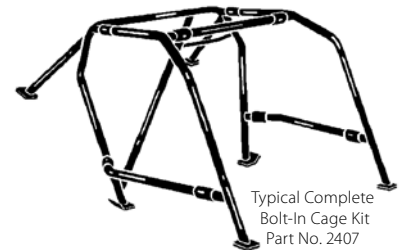

Typical Complete Bolt-In Cage Kit
Part No. 2407

Complete Bolt-In Cage Kit These six-point cage kits include a race-approved roll bar, double door bars, sleeves, backing plates, and hardware. Requires a 3/8" drill and hand tools for installation.

Bolt-In Cage Kit, 1.5" Tubing for cars up to 3000 lbs.
Part No. 2407-1.50-DOM \$1,179.00
Bolt-In Cage Kit, 1.75" Tubing for cars up to 4000 lbs.
Part No. 2407-1.75-DOM \$1,179.00

Roll Bar Padding



side is about 1" thick. The padding is easily slipped onto any removable brace. S simply slit it along the thin side to snap it over a permanently installed bar. Hold it in place with racer's tape or cable ties. The one-size-fits-most padding fits 1.50" to 1.75" diameter bars. It can be made to fit smaller bars with a little trimming. Available in Black, Blue, Red, Yellow, or Grey. Sold in 3 foot lengths.

Roll Bar Padding Part No. 2390-Color \$4.99

High-Density Roll Bar Padding

This basic padding has an offset hole to fit where clearance is tight on one side and to position the padding where it will do the most good. The thin side is about 1/2" thick, and the thick



Note:
SFI 45.1 padding is C-shaped to cover only the one side of the bar that your helmet may contact

SFI 45.1 Rated Roll Bar Padding This super-rigid padding is strongly recommended by the SCCA. It is designed for use wherever your helmet can contact the roll bar, so the C-shape profile covers just **one side** of the bar (order 2 pieces if you want full coverage around the bar). A self-adhesive lining makes installation easy. Two sizes are available to fit bars from 1.12" to 1.5", and from 1.625" to 2" OD. Available in Black, Blue, or Red. Sold in 3 foot lengths.

SFI Rated Roll Bar Padding, 1.12" - 1.5" bars Part No. 2391-Color \$1.99
SFI Rated Roll Bar Padding, 1.625" - 2" bars Part No. 2395-Color \$1.99



FIA 8857-2001 Type A Roll Bar Padding This super-rigid padding is similar to the SFI-rated padding (above right), but it carries FIA approval. It is designed for use wherever your helmet can contact the roll bar, so the C-shape profile covers just **one side** of the bar (order 2 pieces if you want full coverage around the bar). A self-adhesive lining makes installation easy. Two sizes are available to fit bars from 1.12" to 1.5", and from 1.625" to 2" OD. Available in Black only. Sold in 3 foot lengths.

FIA-Approved Roll Bar Padding, 1.125" - 1.5" bars Part No. 2398 \$22.99
FIA-Approved Roll Bar Padding, 1.625" - 1.75" bars Part No. 2399 \$22.99

SFI 45.1 Dual-Density Padding Get the best of both types of roll bar padding! A base layer of SFI 45.1 roll bar padding is covered by a removable layer of high-density comfort padding to absorb more minor impacts. Use just the base layer around your helmet, and both layers where your arms are more likely to hit the bar. As with the SFI 45.1 padding at left, the C-shape profile covers just **one side** of the bar (order 2 pieces if you want full coverage around the bar). Fits 1.5" to 2" diameter bars. Black only. Sold in 3 foot lengths.

SFI Rated Dual-Density Padding Part No. 2397-Black \$32.99

Clamp-On Roll Bar Mounts



Steering Wheel Hook This black anodized aluminum hook clamps onto your roll bar to hang your removable steering wheel between sessions. Available in two sizes to fit 1.50" or 1.75" roll bar tubing.

Wheel Hook for 1.50" roll bar Part No. LA22577 \$19.99
Wheel Hook for 1.75" roll bar Part No. LA22576 \$19.99



Universal Roll Bar Brackets These aluminum clamp-on brackets can mount panels, mirrors, almost anything to your roll bar. Holds items 3/4" from bar. Available in two sizes, 1.50" and 1.75". Sold individually.

Universal Bracket for 1.50" bar Part No. 22757 \$19.99
Universal Bracket for 1.75" bar Part No. 22755 \$19.99

Open-End Clamp-On Roll Bar Mount Bracket

This anodized aluminum bracket clamps onto your roll bar tube without requiring access to the back side of the bar. The 3/8" thick bracket has two 1/4" through parallel to the tubing (for mounting mirrors or other lightweight items) and a single 8-32 threaded hole perpendicular to the tubing (for mounting panels). Specify 1.5" or 1.75" bar OD.

Open-End Roll Bar Mount Part No. 2035-320-1.75 ... \$24.99



Clamp-On Bracket Reducers Use these clever aluminum adapter sleeves to reduce 1 3/4" ID clamp-on brackets to fit 1 1/4", 1 1/2", or 1 5/8" OD tubing. Just install your clamp-on accessory right over the reducer. The 1/4" wide U-channel groove in the reducer prevents the bracket from slipping off. Sold in pairs; one pair fits one clamp-on bracket. (Note: Does not fit the Open-End Clamp-On Roll Bar Mount Bracket at left.)

Clamp-On Reducers, pair (for one bracket) Part No. 1318-025-1.250 ... \$9.99



Custom-Cut, Pre-Spaced Vinyl Graphics

We have computerized equipment for manufacturing custom, self-adhesive vinyl graphics. Only the highest quality 3M Scotchcal® materials are used. Graphics are pre-spaced (except Font #3 and #4 when combining numbers with letters) with an overlay of low-tack application tape that makes it easy for even a first time user to get professional results. If you want numbers that are temporary and reusable, apply the numbers to the magnetic circles as shown below.

When ordering please specify:

- Size (letter height in inches)
- Color **Standard Colors are: black, flat black, blue, red, white, and yellow.**
Neon Colors are: neon orange, neon yellow, and neon green.
- Type style (Font #0, #1, #2, #3, #4, #5, or #6 – See samples at right).
- Exact text, including punctuation (be sure to specify what is to be capitalized).
- Special effects, if any (such as italics, reverse type for applying to the inside of glass, etc).
- Be sure to tell us the maximum length allowable so that we can force the width to ensure a proper fit if necessary.
- **Vinyl graphics are not returnable.**
- **Order Part No. 33-Size-Standard Color or Part No. 32-Size-Neon Color.** See chart below for prices.

NOTE: Please allow 24 hours for custom graphics to be made.

Make your own numbers or letters - Colored vinyl by the running foot (24 inches wide).

Standard Colored Vinyl, per foot..... Part No. 3352-Color\$4.99 per foot
Neon Colored Vinyl, per foot..... Part No. 3351-Color\$9.99 per foot

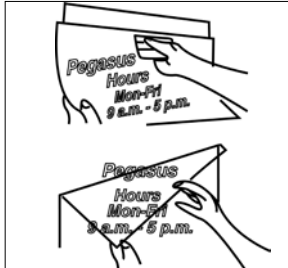

Low-tack application tape makes it easy to get perfect alignment and spacing. Larger numbers may not be pre-spaced but will still be taped to help prevent wrinkles during application.

Price Per Character		
Letter Height (in inches)	Per Character Standard Color	Per Character Neon Colors
1 *	99¢	\$1.19
1.5 *	\$1.19	\$1.39
2 *	\$1.39	\$1.59
3	\$1.79	\$1.99
4	\$2.09	\$2.39
5	\$2.49	\$2.89
6	\$2.89	\$3.49
7	\$3.19	\$3.99
8	\$3.69	\$4.69
9	\$4.19	\$5.49
10	\$4.69	\$6.19
11	\$4.99	\$6.99
12	\$5.69	\$7.89

* Note: 3 inch minimum size for Font #1 only.

Font #0 – Helvetica Medium
0123ABCdef

Font #1 – Times Bold *
0123ABCdef

* Note: 3 inch minimum size for Font #1 only.

Font #2 – Optima Semi Bold
0123ABCdef

Font #3 – Clarendon Bold
123ABCdef

Font #4 – Brush Script Connected
(can not use all upper case letters)
0123ABCdef

Font #5 – American Typewriter
123ABCdef

Font #6 – Helvetica Bold
0123ABCdef

GRAPHICS

Circles for Racecar Numbers: Magnetic or Adhesive (White Only)

Note: Circles are sold in white only. The black line drawn around the circles shown below is for catalog clarity only. **Numbers and circles are sold separately.**



This is how a single 12" Font #0 number looks inside an 18" circle. This is the minimum size for a single 12" digit.



This is how two 12" Font #1 numbers fit inside a 21" circle. Note how tight the fit is. The '72' as shown at left would not fit in this circle.



This is how two 12" Font #6 numbers fit inside a 24" circle. This is the recommended size for two 12" numbers.

Magnetic and Adhesive Circles (White Only)						
Material	Diameter	Part No.	Price Each	Recommended Graphic Size		
Magnetic	15 inch	3365-15	\$11.99	1 of 10"	2 of 7"	3 of 5"
	18 inch	3365-18	\$14.49	1 of 12"	2 of 8"	3 of 6"
	21 inch	3365-21	\$17.99	1 of 12"	2 of 10"	3 of 7"
	24 inch	3365-24	\$21.29	1 of 12"	2 of 12"	3 of 8"
Self Adhesive	15 inch	3367-15	\$10.49	1 of 10"	2 of 7"	3 of 5"
	18 inch	3367-18	\$12.49	1 of 12"	2 of 8"	3 of 6"
	21 inch	3367-21	\$14.49	1 of 12"	2 of 10"	3 of 7"
	23.25 inch	3367-23.25	\$16.49	1 of 12"	2 of 12"	3 of 8"

Extra Material (sold by the running foot)

White Magnetic Material, 24 inches wide..... Part No. 3363-White...\$8.49 per foot
White Self-Adhesive 3M Scotchcal® Material, 24 inches wide .. Part No. 3362-White...\$4.99 per foot

SCCA Decals, Suit Patches, and Flag Decals



These vinyl decals and cloth suit patch all satisfy SCCA requirements. The "Off" and "E" decals also meet IMSA requirements.

"Off" Decal for Master Switch, 1 3/4" x 3"..... Part No. 3356..... 54¢
White background has a red lightning bolt on a blue triangle (the "international marking of a spark in a blue triangle") required by SCCA and others.

Red "E" for Extinguisher, 3" diameter..... Part No. 3357..... 69¢
White circular background has a red "E" and a red border.

"SCCA Solo" Decal, 3 1/2" x 7"..... Part No. 3358-03 \$2.99
"SCCA Pro Racing" Decal, 2 3/4" x 9 1/2"..... Part No. 3358-05 \$2.99
"SCCA" Cloth Suit Patch, 2" x 4 5/8"..... Part No. 3359-Blue \$5.29

Minimum Weight Decal, Positive, 2 3/4" x 5"..... Part No. Weight-A-Color... \$5.99
Specify Black, Blue, Red, White, Yellow, or Neon Orange numbers. Your car color will show through as the background color.

Minimum Weight Decal, Negative, 1 3/4" x 4 1/4"..... Part No. Weight-B-Color... \$5.99
Specify Black, Blue, Red, White, Yellow, or Neon Orange background. Your car color will show through as the number color.

American Flag Decal, 1 1/2" x 2 1/4"..... Part No. 3610-101 99¢
Canadian Flag Decal, 1 1/2" x 2 1/4"..... Part No. 3610-102 99¢

See page 123 for "Tow" and "Jack" decals.



Above: Weight-A-Black (Positive Style)
Numbers and border are vinyl color; the background is your car color.

Below: Weight-B-Black (Negative Style)
The background is vinyl color; the numbers are your car color.



Timing and Scoring

MYLAPS (formerly AMB) Transponders

AMB / MYLAPS Transponders are required by many auto racing organizations, from club to pro. A unique identification number encoded in each transponder is transmitted to a receiving loop embedded in the track at the start/finish line. Each time the transponder passes the loop, the MYLAPS timing and scoring system recognizes the transponder and matches it to the correct car. Some organizations specify the transponder mounting location on the car (check your rule book). The transponder must be mounted upright, with a clear view of the track surface. AMB / MYLAPS transponders are required by SCCA, NASA, PCA, MCSCC, VSCDA, and many others.



X2 Rechargeable Transponder, Part No. 5001-50x
Clockwise from lower left: X2 Transponder, USB cable, quick-release mounting bracket. The X2 RaceKey is in the center of the photo.



X2 Direct-Wire Transponder Kit, Part No. 5001-51x
Clockwise from lower left: X2 RaceKey Mount, power cable, USB cable, X2 RaceKey, X2 Transponder, permanent-mount hardware, quick-release mount bracket. The cable in the center connects the X2 Transponder to the X2 RaceKey Mount in the car.

The **X2 Rechargeable Transponder** mounts to a quick-release bracket. Just 4 hours of charging using the included X2 RaceKey provides 4 days of run time. A 2-color LED indicates battery condition and subscription status. The X2 Rechargeable can be used on any car, but it is required for cars running an electrical system other than 12 volts (6V, 16V, 24V, or magneto with no battery). Includes X2 Transponder, quick-release mounting bracket, X2 RaceKey, and USB cable.

- X2 Rechargeable Transponder, 5 Year Subscription Part No. 5001-505 \$410.28
- X2 Rechargeable Transponder, 2 Year Subscription Part No. 5001-502 \$234.58
- X2 Rechargeable Transponder, 1 Year Subscription Part No. 5001-501 \$159.81
- Includes X2 Transponder, X2 RaceKey, USB cable, and transponder mounting bracket.
- Extra Mounting Bracket only for X2 Transponder Part No. 5001-531 \$8.49

The flexible **X2 Direct-Wire Transponder** includes the X2 Transponder, plus everything needed to power it from your car's 12 volt battery. Requires only 2 connections to your car's 12 volt electrical system (power and ground). Current draw is 0.15 amps at 12 volts. The included X2 RaceKey has a 2-color LED to indicate subscription status. **Hint:** Wire the transponder to your ignition switch. You will never forget to turn it on or off! Kit includes X2 Transponder, quick-release mounting bracket, permanent mount hardware, X2 RaceKey, X2 RaceKey Mount, USB cable, and cables to connect the X2 RaceKey Mount to the X2 Transponder and to the car's electrical system.

- X2 Direct-Wire Transponder, 5 Year Subscription Part No. 5001-515 \$475.70
- X2 Direct-Wire Transponder, 2 Year Subscription Part No. 5001-512 \$283.18
- X2 Direct-Wire Transponder, 1 Year Subscription Part No. 5001-511 \$215.89
- Includes X2 Transponder, X2 RaceKey, X2 RaceKey mount, transponder mount, and cables.

Handheld Timers



The **AiM Multichron** is a top-of-the-line handheld timer designed to time up to four cars at once. Start and stop lap times separately or simultaneously. If the cars pass within a few seconds of each other, you can just press the Lap button and sort them out later! The backlit display shows lap times for all four cars with a flag if a driver records a personal best lap. Memory can recall 99 laps for each car with up to 9 splits per lap. Fastest lap times for all drivers can also be quickly displayed. A secondary backup battery protects the memory of the primary battery dies. Titanium grey only.

- AiM Multichron Timer Part No. MC-999 \$159.99



The versatile **Robic SC-899** can time up to three cars at once on a single screen. Each line displays lap or split time, with either speed or a lap counter to 999. Each car can store up to 180 laps in memory for a total of 540 laps. Three countdown timers can be set in 0.1 second increments up to 24 hours and started separately or simultaneously. The wide-case design fills your hand comfortably, with buttons right at your fingers and thumb. Accurate to 0.001 second over 1 hour. Royal blue with black trim.

- Robic SC-899 Timer Part No. 5078-106 \$58.99

See page 121 for pit signalling boards!

See our website for many more Robic timers!

Racing Record Keeping

"Record keeping is totally ignored by 90% of all racers. It is **not** ignored by the 10% of racers who win 90% of the races." — Carroll Smith, **Prepare to Win**

Accurate records of every race weekend and test day are a valuable asset for any driver or race team. They can even help increase the resale value of your racecar! Our **Racing Data Notebook** help you to keep a clear, permanent record of every adjustment made to the car and every lap time recorded. **Lap timing sheets** have space for up to 6 sessions of 20 laps each (or 3 sessions of 40 laps each), adjustment and handling notes, and a pre-race checklist. **Data sheets** have sections on engine, tire data, and chassis settings as well as room for general notes. The sheets are printed on heavy card stock for durability and longevity. The card stock is tinted a very light grey to avoid eyestrain on sunny days at the track. The **Deluxe Notebook** set consists of a 3-ring binder stocked with 30 lap timing sheets and 30 vehicle data sheets.

- Racing Data Notebook, Deluxe Edition Part No. 5205-01 \$14.99
- Includes 30 sets of data and timing sheets (total of 60 sheets)

Refill Packs contain 30 lap timing and 30 vehicle data sheets printed on heavy index card stock. They are unbound, 3-hole punched, and arranged with the lap sheets and data sheets in an alternating sequence.

- Refill Pack, printed on heavy index card stock Part No. 5205-Refill \$9.99
- Contains 30 sets of vehicle data sheets and lap timing sheets (total of 60 sheets). Will also fit the Storage Clipboard at right.



A Pegasus Exclusive!

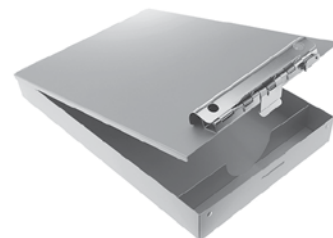

Clipboard with Storage Compartment The cover of this handy clipboard lifts up to expose a 1.5" deep storage compartment. The storage area is divided into a section for 8 1/2" x 11" (letter size) papers and a section for pens and pencils. Lightweight yet sturdy aluminum construction. Measures 13 3/4" Long x 9" Wide x 1 5/8" Thick (2 3/4" overall including clip).

- Clipboard with Storage Compartment
Part No. 5014 \$31.99

Timing and Scoring

AiM Solo2 GPS-Based On-Board Lap Timer

The original AiM Solo is so accurate, it is used by the SCCA to monitor vehicle performance for competition adjustments. Many enthusiast magazines also use it when testing vehicles for review articles. The Solo2 is even quicker and more accurate than the original!

Solo2 Features

- Fully automatic operation, just turn it on and go
- Measures and logs position, speed, acceleration, lap time, and more
- Uses both GPS and Glonass satellites for unmatched speed and accuracy
- Internal 3-axis accelerometer (acceleration to ±5 g)
- Internal 3-axis gyroscope (pitch/roll/yaw)
- Internal 3-axis magnetometer (compass heading)
- 8 configurable pages of information
- Predictive lap timer, running lap timer, static lap timer, and more
- Configurable backlight in 7 colors
- 10 fully-configurable LED warning/shift/notification lights
- Huge 4GB internal memory for hours of data
- Review performance and graphs on-screen without a laptop
- Wi-Fi data transfer means no USB cable to forget at home
- Internal rechargeable battery means no wiring needed
- Small enough to fit on the smallest steering wheel
- Weighs just 8.5 oz complete with battery
- Waterproof (IP67 sealed, submersible to 3 feet)
- Over 3000 tracks currently in worldwide database
- Add more tracks easily, at home or at the track
- Circuit, Point-to-Point (Solo II / hillclimb), and Performance Test modes



AiM Solo2 Lap Timer (stand-alone version)
Part No. MC-670

The ultimate lap timer - and more! You won't believe that something so easy to use can be so powerful. The amazing **AiM Solo2** uses satellite signals (both GPS and Glonass) to start and stop lap times at the start/finish line. No other equipment is required. The Solo2 automatically recognizes the track from memory, or you can add the track to the database when you arrive. Solo2 also logs extensive GPS data (exact track position, speed, acceleration rates in 3 directions, and more) for detailed analysis later. The included Race Studio software can even generate track maps and replay any two laps together for comparison. The internal rechargeable battery means no wiring connections are needed. Measures only 3.9" x 3.1" x 1.2" thick - small enough to mount directly on your steering wheel, even in a formula car.

AiM Solo2 Lap Timer, stand-alone version Part No. MC-670 \$399.99
Includes mounting bracket, AC charging cord, DC power cord, and Race Studio software.

Note: This version can only be used in stand-alone mode. It will not connect to anything else (except vehicle power, if desired).

Suction Cup Mount for temporary windshield mounting Part No. MC-573 \$35.99

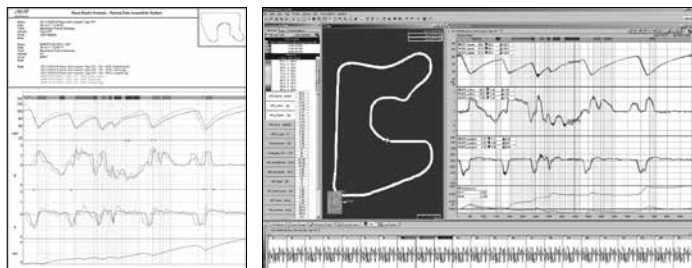

The printed report (above left) compares a single lap by two different drivers. The screen shot (above right) compares three laps by the same driver. Both were generated using only the GPS data logged by a stand-alone AiM Solo.

The traces, from top to bottom, show speed, lateral acceleration, acceleration/braking, and the time lost or gained between specific laps. The track map (black background) shows the actual lines driven on each lap.

Living with the Solo2

Driving on established tracks: If the track is already in the worldwide database, simply use GPS Manager (included) to transmit the track to the Solo2. When you arrive at the track, the Solo2 will automatically recognize when it is within 5 km (3 miles) of a known start-finish line and will ready itself to race on that track. (In the case of multiple tracks or multiple configurations, you will have to choose which one to use.) Each time you cross the start / finish line, the Solo2 starts a new lap. You don't have to do anything but turn it on!

If an established track is not in the database, you can add it from the comfort of your own home. Find the track in the satellite view of Google Maps. Zoom in until you can pick out the start / finish line. Right-click on the line and select "What's here?" from the drop-down menu to get the GPS coordinates. Enter these coordinates in the AiM GPS Manager software and transmit the new track to the Solo2. When you arrive at the track, the Solo2 will recognize the track and you're ready to run.

Driving on new or temporary tracks: Take the Solo2 to the starting line. Navigate to the Tracks page and press OK. For point-to-point (Solo II and hillclimbs), go to the finish line and repeat. The Solo2 now knows when and where to start and stop each lap or run.

If your chosen track does not have a map in GPS Manager, you can create one by running (or even walking) a single lap with the Solo2. As you go around the track, the Solo2 will record your position 10 times a second (using powerful algorithms and other data to fill in the gaps between). Download the lap to Race Studio, and GPS Manager will let you import the track shape that was recorded on that lap. You can now use that track map on your SmartyCam's video overlay!



AiM Solo2 DL Lap Timer / Data Logger
Part No. MC-671 / MC-672 / MC-673

The **Solo2 DL** has all of the features of the Solo2, but it can also log engine data! When connected to your engine, the 10 LED lights on the Solo2 DL can be configured to act as multi-stage shift lights, or as warning lights for any engine parameter coming from the ECU. You can also connect it to your AiM SmartyCam (sold separately) to overlay data on your videos. Choose your connection: K-Line to plug into your production car's OBD-II diagnostic port, CAN for hard-wiring to a racing ECU, or RPM to simply get a coil signal from a car without an ECU.

AiM Solo2 DL, with K-Line (OBD-II port) connector Part No. MC-671 \$699.00
The K-Line connector plugs directly into an OBD-II diagnostic port, found on 1997 and later production vehicles (2002 and later outside North America).

AiM Solo2 DL, with CAN / RS232 wiring Part No. MC-672 \$699.00
The CAN/RS232 is used when no OBD port is available (typically used with racing ECUs). Two wires must be spliced into the ECU wiring.

AiM Solo2 DL, with RPM wiring Part No. MC-673 \$699.00
If no ECU is available (or if the AiM software cannot decode the ECU protocol), this version will let you tap into the RPM signal from the coil or the ECU.

Note: The Solo2 DL can connect to the AiM SmartyCam and/or the LCU-One Lambda Controller (sold separately), but it will not connect to any other sensors or expansions. Connecting to both the SmartyCam and an LCU-One requires a Can Expansion Hub, sold separately on page 38.

AiM Sports EVO Series Data Loggers and Displays

For simple, economical, and easy-to-use data acquisition systems and digital dash displays, nothing beats AiM!



Visit our website for more AiM systems, sensors, and accessories.

AiM EVO4S and EVO5 Data Loggers

AiM EVO4S Data Logger
Part No. MC-700-Length



AiM EVO5 Data Logger
Part No. MC-705-Length



DATA ACQUISITION

The **AiM EVO4S and EVO5 Data Loggers** are powerful yet compact data loggers. Add Data Hubs, Channel Hubs, and TC Hubs (all sold separately, see next page) for virtually unlimited expansion potential. Or simply add sensors (sold separately, see page 39) to use the analog and digital input channels. Both can communicate with thousands of different OEM and aftermarket ECUs to log engine data without adding any other sensors.

AiM EVO4S Data Logger only, no display Part No. MC-700-Length \$1,199.00
Includes RPM harness, ECU harness, GPS antenna (specify 1.3m or 4.0m cable), USB download cable, and Race Studio software. **Display sold separately.**

AiM EVO5 Data Logger only, no display Part No. MC-705 \$1,699.00
Includes 37-pin Primary harness (analog channels 1-4, speed channel 1, power / ground, coil RPM input, and CAN/K-Line wiring), GPS antenna with 4.0m cable, USB download cable, and Race Studio software. **Display sold separately.**

22-pin Auxiliary Harness only for EVO5 Part No. MC-711 \$354.99
Required for analog channels 5-8, speed channels 2-4, both digital outputs, and RS232 ECU wiring connection. Not for EVO4S.

AiM EVO4S and EVO5 Feature Comparison

Specification	EVO4S	EVO5
ECU Connections	CAN, RS232, K-Line	CAN, K-Line (RS232 with Auxiliary Harness)*
Display	None**	None**
Analog Channels	5	4 (8 with Auxiliary Harness)*
Wheel Speed Channels	2	1 (4 with Auxiliary Harness)*
Digital Outputs	1	0 (2 with Auxiliary Harness)*
Internal Memory	4 MB	4 MB (Expandable up to 128 MB by adding an SD card)
Connectors	13 Screw-in ports	2 Deutsch connectors
Data download	Wired via USB cable	Wireless via secure Wi-Fi
Dimensions	5.2" L x 1.9" H x 1.4" D	4.5" L x 1.9" H x 2.3" D

* Access to these features requires the addition of the Auxiliary Harness (sold separately).

** Compatible with GS-Dash or Formula v3 Wheel (sold separately).

AiM Displays for EVO4S and EVO5



NOTE: These displays can only display data gathered by an AiM EVO4S or EVO5 Data Logger. They have no data gathering or logging capability and cannot be used alone.



The **AiM GS-Dash** is a flexible, customizable LCD display designed to be driven by the latest generation AiM EVO4S or EVO5 data loggers. The compact (5.1" x 3.2") aluminum housing is small enough to mount on any steering wheel. Five LED shift lights, four LED warning lights, and the screen backlight can all be set to any of seven different colors. The screen offers up to 8 different customizable pages of information.

AiM GS-Dash, display only Part No. MC-232 \$429.99
Requires AiM EVO4S or EVO5 Data Logger, sold separately.

The **AiM Formula Car Wheel** has a built-in GS-Dash display. The 10.7" wide D-shaped wheel is perfect for formula cars and sports racers. The grips are covered in black suede leather, and 3 studs on the back fit your "European" quick-release hub (50mm bolt circle).

AiM Formula Car Wheel v3 Dash Display only Part No. MC-307 \$999.00
Requires AiM EVO4S or EVO5 data logger, sold separately.

Paddle Shifter Kit for Formula Car Wheel Display Part No. MC-309 \$274.99
Bolts to the back of the AiM Formula Car Wheel. No additional wiring required.

NOTE: EVO5 will require a CAN Data Hub (sold separately) to connect either of these displays. EVO4S will only require a CAN Data Hub if another CAN Expansion or CAN Peripheral is added.

AiM CAN Expansions and Peripherals (see page 39 for analog and digital sensors)

AiM loggers make extensive use of the CAN communication protocol developed by Bosch. The CAN bus allows everything on the network to work side-by-side, with virtually no limit to the number of units working together. AiM CAN expansions and peripherals are plug-and-play. There is no math or special wiring required. Just connect the 5-pin "712" (screw-in) connector and go! All of the latest AiM dashes and data loggers (except MXm), as well as the previous generation (MXL, EVO4) can use these CAN accessories.

CAN Expansions

4-Port CAN Data Hub for CAN Port, 0.4m cable Part No. MC-329 \$59.99

4-Port CAN Data Hub for CAN Port, 1.5m cable Part No. MC-351 \$59.99
Connects 4 CAN accessories to a single CAN port. Hubs can be connected in series for virtually unlimited expansion potential. All ports are 5-pin "712" (screw-in) type.

4-Port Channel Expansion Hub for CAN Port Part No. MC-331 \$249.99
Connects 4 analog sensors (or 2 digital sensors and 2 analog sensors) to a single CAN port. Input ports are 4-pin "712" (screw-in) type. Requires adapter cables for each sensor.

4-Port TC (Thermocouple) Hub for CAN Port Part No. MC-223 \$249.99
Connects 4 thermocouples to a single CAN port. Input ports are 3-pin "712" (screw-in) type. Requires adapter cables for each thermocouple.

CAN Extension Cable, male 5-pin to female 5-pin Part No. MC-261-Length .. \$39.99
Specify 1 meter, 2 meters, or 3 meters.

CAN Peripherals

GPS08 Module, specify 1.4m or 4m cable Part No. MC-257-Length \$299.99

GPS08 Module, Roof-Mount, 4m cable Part No. MC-258-4.0m... \$299.99

GPS08 is the latest GPS module, able to communicate with both GPS and Glonass satellites. This doubles the number of available satellites for unmatched precision and signal reliability. All electronics are built into the antenna, with no separate box to connect.

LCU-One Lambda Controller with Bosch O2 Sensor ... Part No. MC-219 \$399.99
Provides air-fuel mixture information, Lambda values and stoichiometric point (configurable for 4-stroke gasoline, diesel, or alternative fuel engines), and oxygen sensor temperature and diagnostics.

MemoryKey for MXL or EVO4 only Part No. MC-315 \$124.99
32MB memory expansion. Unplug it with the engine on or off and it will save the session. Assign one to each driver on your endurance racing team and switch them during driver changes to keep track of what's happening (or for the drivers to compare their techniques). Rotate them while making chassis adjustments on test days and you'll see the effect of changes before the driver can even give you his opinion!

Memory Module for MXL2, MXS/MXG, EVO4S/EVO5 . Part No. MC-720 \$179.99
This memory expansion accepts an SD memory card up to 128 GB (4GB included). Cards can be removed while the engine is running with no loss of data.

AiM Sports Data Logging Dash Systems

AiM data logging dashes feature ECU connectivity, plug-and-play sensors, and setup software that is so easy to use, you could be up and running in a weekend or less! All AiM data loggers can connect to any of several thousand OEM or racing ECUs. All of the dashes shown on this page feature wireless data downloads via a secure Wi-Fi connection.

The MX Series are so powerfully flexible, it would take a book to list everything they can do. Instead of trying to explain hundreds of different capabilities that you may not need, send us an email or give us a call and tell us what you want your dash to do. In most cases, we'll be able to tell you two or three different ways that an AiM dash can accomplish it!

AiM MXL2 LCD Data Logging Dash



The **AiM MXL2** has a backlit LCD display with an easy-to-read scalable RPM bar graph at the top. The left side of the screen shows any 4 channels, and the right side can scroll through up to 8 pages of information, each with up to 4 channels. Except for the LCD display, the MXL2 has all the same features and functions as the rest of the MX Series dash loggers. Auxiliary Wiring Harness sold separately below.

MXL2 Data Logging Dash, LCD Display Part No. MC-247 \$1,999.00
Includes Primary Wiring Harness and GPS08 Module.

AiM MXS, MXP, and MXG Full-Color TFT Data Logging Dashes

While the MXL 2 shows you the data you want, the **AiM MXS, MXP, and MXG** show you the data you want, exactly the way you want to see it! The high-resolution full-color TFT displays can be set up with totally different graphics. Choose from 8 screen styles (with more to come) and configure up to 8 different pages of information. You can use

the same screen style for all 8 pages, or rotate between the various styles to make it clear which page is which. (Note that all of the graphic options shown below are available to all of the three dashes.) Each dash includes the Primary Wiring Harness and your choice of GPS08 Module. Auxiliary Wiring Harness sold separately below.



New!



MXS 1.2 Data Logging Dash, 5" TFT Display

1.3m cable GPS08 Part No. MC-370 \$2,299.00
2m cable GPS08 Part No. MC-371 \$2,299.00
4m cable GPS08 Part No. MC-372 \$2,299.00
2m roof-mount GPS08 ... Part No. MC-373 \$2,299.00
4m roof-mount GPS08 ... Part No. MC-374 \$2,299.00
Street Icons, 4m GPS08 ... Part No. MC-375 \$2,299.00

MXP Data Logging Dash, 6" TFT Display

1.3m cable GPS08 Part No. MC-440 \$2,299.00
2m cable GPS08 Part No. MC-441 \$2,299.00
4m cable GPS08 Part No. MC-442 \$2,299.00
2m roof-mount GPS08 ... Part No. MC-443 \$2,299.00
4m roof-mount GPS08 ... Part No. MC-444 \$2,299.00

MXG 1.2 Data Logging Dash, 7" TFT Display

1.3m cable GPS08 Part No. MC-430 \$2,599.00
4m cable GPS08 Part No. MC-431 \$2,599.00
2m roof-mount GPS08 ... Part No. MC-432 \$2,599.00
4m roof-mount GPS08 ... Part No. MC-433 \$2,599.00



All three of the above MX Series dashes can be configured to display any of the screen styles shown!

Add-On Wiring Harnesses for AiM MX Series

MXL2 / MXS / MXG Auxiliary Wiring Harness Part No. MC-249 \$354.99
This add-on harness is required for access to speed channels 1 - 4, analog channels 5 - 8, RS232 ECU wiring, and both digital outputs on the MXL2 and MXS / MXG data logging dashes. 22-pin Deutsch connector. Not compatible with any other dash or data logger.

MXL Pista to MXL2 / MXS / MXG Conversion Harness .. Part No. MC-251 \$364.99
This special harness makes it easy to upgrade from an MXL Pista dash logger to either an MXL2 or MXS / MXG. Simply unplug your existing harness from your MXL Pista and plug it into this adapter harness. No rewiring needed!

AiM MXm LCD Data Logging Dash

The super-compact **AiM MXm** bridges the gap between the AiM Solo2 DL lap timer and the more powerful MX Series. The MXm has a built-in GPS receiver like the Solo2 DL (no external antenna required), as well as the same ECU connectivity as all other AiM devices. The MXm even has two digital outputs to control other accessories. Unlike the rest of the MX Series, the MXm will not accept any Channel Expansion hubs. (The only CAN expansions that it will accept are the LCU-One and SmartyCam.) But with 4 analog channels, 2 speed channels, and on-board math channels — on top of the GPS data and all of the channels coming from your ECU — the MXm is more logger than many pro racers need!

MXm Data Logging Dash, mini LCD Display Part No. MC-395 \$1,099.00



rear view



New!

AiM MXS Strada, MXP Strada, and MXG Strada Full-Color TFT Street Dash Displays

For street applications and dual-purpose vehicles, the AiM MX Strada Series give you the look of a modern racing dash, but without the racing features. AiM has taken the popular MXS, MXP, and MXG dashes and stripped all of the data logging functions out. The result is a trio of sleek, modern display-only dashes that can replace a cockpit full of gauges.

All of these street dashes can communicate with all of the same OEM and aftermarket ECUs as the dash loggers. Sensors and CAN expansions can also be added, but Strada dashes cannot be converted into data loggers. "Street Icons" versions replace the rectangular LED warning lights with ISO-type icons for oil, fuel, high beams, signals, etc.

MXS 1.2 Strada Street Dashes, 5" TFT Display

Plain Warning Lights, CAN ECU Wiring Part No. MC-363-CAN . \$1,139.00
Plain Warning Lights, OBD-2 Plug Part No. MC-363-OBD . \$1,139.00
Street Icons, CAN/RS232 ECU Wiring (shown) Part No. MC-361-CAN . \$1,139.00
Street Icons, OBD-2 Plug Part No. MC-361-OBD . \$1,139.00

MXP Strada Street Dash, 6" TFT Display

Plain Warning Lights, CAN ECU Wiring Part No. MC-450 \$1,159.00
Plain Warning Lights, OBD-2 Plug (shown) Part No. MC-451 \$1,159.00
Street Icons, CAN/RS232 ECU Wiring Part No. MC-452 \$1,159.00
Street Icons, OBD-2 Plug Part No. MC-453 \$1,159.00

MXG 1.2 Strada Street Dash, 7" TFT Display

Plain Warning Lights, CAN ECU Wiring Part No. MC-438-CAN . \$1,399.00
The MXG 1.2 Strada can be configured with street icons across the bottom of the screen.



Plain warning lights

Street icons

(MXP Strada shown)

In-Car Video

Studying a video of a race or practice session can have many benefits. You can time sections of a track to determine the fastest line through a particular corner. You may become aware of a bad habit that you were too busy to notice. A video can provide invaluable evidence in the event of a protest. A visible onboard camera can even serve as a deterrent against "overly optimistic" passing attempts! Sharing exciting racing moments with family, friends, and sponsors can also be great fun.

AiM SmartyCam HD Video Cameras with Data Overlay

The **AiM SmartyCam HD** is a solid-state digital video camera designed specifically for racing. Connect it to your AiM data logger, and any parameters gathered by the logger can also be included on the video. If you don't have an AiM logger, you can add an SMC Bridge (sold separately) to gather basic engine data from your car. Or connect it to the GPS08B GPS receiver (sold separately) to display speed, acceleration, position, and lap



AiM SmartyCam HD 2.1 (67° Lens)
Part No. MC-558
Measures less than 3 1/2" x 2 1/2" x 2"
Weighs less than 9 ounces
including battery

The **AiM SmartyCam HD** kits include a SmartyCam HD 2.1 camera with built-in rechargeable battery, 2 meter CAN cable for connection to your AiM logger, USB cable, AC charging adapter, 4GB SD memory card, and SmartyManager software.

AiM SmartyCam HD 2.1, 67° Lens Part No. MC-558 \$999.00
Standard 67° lens is ideal for use inside sedans.

AiM SmartyCam HD 2.1, 84° Lens Part No. MC-599 \$999.00
Wide-angle 84° lens shows a lot of roof when mounted to the main roll hoop in a sedan.

times on the DVD-quality video footage. The data is recorded as part of the video image, so there is no syncing required afterwards. The rechargeable battery runs up to 2 hours when not connected to vehicle power. Features a built-in microphone and front LCD monitor screen for setup and real-time image preview. Waterproof to 1 meter.

AiM SMC Bridges connect the AiM SmartyCam to your car's engine. Information gathered by the ECU (or RPM only in the case of the RPM Bridge) is sent to the SmartyCam and can be included in the data overlay in your videos. SMC Bridges do not have any measuring or data logging capability.

AiM ECU Bridge, OBD-II K-Link Connector Part No. MC-401 \$209.99
Plugs directly into your car's OBD-II diagnostic port for easy installation.

AiM ECU Bridge, CAN/RS232 Wiring Part No. MC-402 \$249.99
Splices into the ECU wiring. Used primarily with racing ECUs.

AiM RPM Bridge for vehicles without OBD-II ECU Part No. MC-539 \$214.99
Vehicles without a compatible ECU (or 1989-95 cars with an OBD-I ECU) can use the RPM Bridge to gather engine RPM only.

The **AiM GPS08B Module** uses position data from GPS and Glonass satellites to calculate speed and acceleration and to start and stop lap times. All data, plus a track map, can be included in the data overlay in your SmartyCam videos.

AiM GPS08B GPS Module for SmartyCam HD Part No. MC-591-Length \$149.99
Required for Speed, Lap Timing, and Track Mapping functions when not connected to a GPS-equipped AiM data logger. Specify 1.4m or 4.0m cable length.

AiM GPS08B GPS Module, Roof-Mount (4.0m cable) Part No. MC-592-4.0m \$149.99

AiM SmartyCam HD GP 2.2 Video Cameras for Formula Cars

The **AiM SmartyCam HD GP 2.2** has a lightweight, compact "bullet" camera connected to a separate remote recording unit. This version is designed specifically for formula cars, motorcycles, and karts. The 2.2 revision accepts the same GPS08 Module as AiM loggers (not the GPS08B) and can accept a direct connection to an ECU without an SMC Bridge. Each kit includes a 2 meter CAN cable and 4GB SD memory card.

AiM SmartyCam HD GP 2.2 Kit, 84° Lens Part No. MC-586-2.2 \$1,099.00
Standard 84° lens is ideal for use on open vehicles.

AiM SmartyCam HD GP 2.2 Kit, 67° Lens Part No. MC-554-2.2 \$1,099.00
Narrow 67° lens can eliminate the car and driver from the picture.



AiM SmartyCam HD GP 2.2 (84° Lens)
Part No. MC-586-2.2
Bullet camera measures
2" x 0.95" and weighs only 2 oz.
Recording unit measures
4.1" x 3.1" x 1.1".

Video Camera Mounts

We offer a variety of camera mounts with an industry-standard 1/4"-20 male threaded stud. Most cameras and camcorders (including SmartyCam HD) are equipped with a matching female thread. Note that some very small cameras (such as GoPro) and "bullet" cameras

(such as SmartyCam HD GP) do not have a female thread and in most cases will require an adapter. All of our mounts are recommended for compact cameras weighing less than 8 ounces unless noted.



Left:
V-Base Mount Kit
Part No. MC-560

Right:
Suction Cup Mount Kit
Part No. MC-557
Includes 1/4"-20 male stud
and collar adapter for
SmartyCam HD GP
bullet camera



Left:
Collar Mount Adapter
Part No. MC-589
Fits remote "bullet" cameras
measuring 24mm (0.95") diameter



Left:
Roll Bar Mount for
Mini Cameras
Part No. 2421-001

Right:
Camcorder Mount
Part No. 2420
Includes SCCA-mandated
security strap.



All of our camera mounts accept cameras or adapters with the industry-standard 1/4"-20 female thread.

The AiM **V-Base Mount Kits** include two different band clamps to fit any size tubing from 1" to 2" OD. Dual ball joints provide great adjustability.

V-Base Compact Camera Mount Kit Part No. MC-560 \$39.99
Top ball joint has a 1/4"-20 male threaded stud.

V-Base Mount plus Bullet Cam Adapter Collar Part No. MC-556 \$71.99
This version includes a collar mount adapter for the SmartyCam HD GP bullet camera.

V-Base Mount for SmartyCam HD GP Base Unit Part No. MC-579 \$67.99
Top ball joint has a special adapter plate to fit the SmartyCam HD GP recording unit.

Collar Mount Adapter Only for SmartyCam HD GP Part No. MC-589 \$31.99
Female 1/4"-20 threads allow you to mount your SmartyCam HD GP bullet camera to any camera mount with an industry-standard 1/4"-20 male stud.

The AiM **Suction Cup Mount Kit** replaces the V-Base and clamps with a suction cup for temporary window mounting. Note that this type of mount is not legal for SCCA.

Suction Cup Mount Kit with Bullet Cam Collar Part No. MC-557 \$65.99
Includes both a standard 1/4"-20 male stud for SmartyCam HD and a collar mount adapter for SmartyCam HD GP.

Our **Roll Bar Mounts** have a 4-bolt saddle clamp base to fit roll bar tubing from 1.25" to 2" OD.

Roll Bar Mount for Mini Video Cameras Part No. 2421-001 \$54.99
Supports cameras up to 12 ounces (note that SCCA requires cameras over 8 ounces to have a security strap which is sold separately). Dual balljoint adjustments.

Camcorder Mount with Security Strap Part No. 2420 \$99.99
This sturdy mount can support any handheld camcorder-type camera. Three-axis adjustments with a poly bushing to isolate vibrations. Includes SCCA security strap.

SCCA Security Strap Only Part No. 2422 \$5.99
SCCA rules require a security strap or tether on cameras over 8 ounces in case the mount fails. Our 1" wide red nylon strap has a metal friction buckle to adjust quickly up to 17" diameter. This is the same strap included with our Camcorder Mount above.

AiM Sensors and Accessories

- Optical Lap Timing Transmitter Beacon** Part No. MC-001 \$49.99
Optical Lap Timing Receiver (4-pin 712) Part No. MC-019 \$74.99
The 2.8m cable on this receiver works with MXL Strada, MXL Pista, EVO4, and EVO4S.
Optical Lap Timing Receiver (4-pin 719) Part No. MC-213 \$74.99
The 2.8m cable on this receiver works with MXL Pro, MXL 2, MXG/MXS, and EVO5.
ARPO3 RPM Filter Part No. MC-207 \$79.99
ARPO5 Inductive RPM Pickup for Auto Dashes Part No. MC-222 \$81.99

The following AiM sensors all have a 4-pin 719 (plastic push-on) plug.
Wheel Speed Sensor, Proximity Type Part No. MC-217 \$74.99

This sensor is triggered by ferrous objects passing close to it. The objects do not have to be magnetic, so wheel studs, brake hat bolts, or CV bolt heads can be used.

- Wheel Speed Sensor, Magnet Type** Part No. MC-216 \$66.99
This sensor requires one or more trigger magnets on the wheel, axle, or driveshaft. Sensor kit includes one trigger magnet. More triggers will provide a smoother signal.
Extra Trigger Magnet, each Part No. MC-005 \$7.99

- Fluid Temp Sensor, specify thread size** Part No. MC-201-Size \$44.99
"PT100 Thermoresistance." Available with 1/8 NPT, 5mm, or 10mm male threads.

- 0-50 psi KA-Type Fluid Pressure Sensor, 1/8 NPT** Part No. MC-346 \$159.99
0-150 psi KA-Type Oil Pressure Sensor, 1/8 NPT Part No. MC-347 \$159.99

- 50 psi KA-Type Absolute Pressure Sensor, 1/8 NPT** Part No. MC-349 \$159.99
This sensor measures pressure as well as vacuum. It will read atmospheric pressure at rest.

- 0-30 psi VDO Fluid Pressure Sensor, 1/8 NPT** Part No. MC-204 \$88.99
0-72 psi VDO Fluid Pressure Sensor, 1/8 NPT Part No. MC-323 \$88.99
0-150 psi VDO Oil Pressure Sensor, 1/8 NPT Part No. MC-320 \$88.99

- 0-2000 psi KA-Type Brake Pressure Sensor, 1/8 NPT** Part No. MC-327 \$159.99
1/8 NPT Female to -3 Hose End Tee Part No. MC-344 \$33.99

- Linear (Plunger) Brake Pedal Position Sensor** Part No. MC-321 \$118.99
Installs in front of brake pedal to measure 10mm of travel.

- Rotary (String Type) Throttle Position Sensor** Part No. MC-202 \$119.99
Connects with a string to measure 25mm of travel. If the sensor ever sticks, the string can collapse to prevent holding the throttle open.

- Steering Angle Sensor, Belt Type** Part No. MC-215 \$141.99
Includes a 7/8" ID pulley to mount on your steering shaft.

- Steering Angle Sensor, Cable Type** Part No. MC-280 \$254.99
The pull cable measures up to 10" of travel. Ideal if a 7/8" OD steering shaft is not available.

- Linear Travel Sensor, 50mm Travel (193-253mm)** Part No. MC-206-50mm \$254.99
Linear Travel Sensor, 75mm Travel (218-293mm) Part No. MC-206-75mm \$254.99
Linear Travel Sensor, 100mm Travel (243-343mm) Part No. MC-206-100mm \$259.99
Linear Travel Sensor, 150mm Travel (293-443mm) Part No. MC-206-150mm \$279.99
Linear Travel Sensor, 200mm Travel (343-543mm) Part No. MC-206-200mm \$284.99
These compact 1/2" diameter sensors include rod end eyelets at each end for #10 (5mm) mounting screws. They are ideal for measuring suspension travel, but some builders like to use them for pedal position or steering angle.

- Infra-Red Tire Temperature Sensor** Part No. MC-352 \$99.99
This non-contact sensor measures the surface temperature of just about any object from -20 to 120°C (-4 to 248°F). 35 degree field of view.

The following AiM thermocouples all have a K-Type (flat yellow 2-pin) connector.

- Fluid Thermocouple, 5mm threads** Part No. MC-006 \$44.99
EGT Thermocouple, 5mm threads Part No. MC-003 \$44.99
EGT Thermocouple, Open-Tip, clamp-on/weld-on Part No. MC-214 \$64.99
CHT Thermocouple, 14mm ID ring Part No. MC-007 \$44.99

- 1 Meter Standard Patch Cable (719 to 719)** Part No. MC-211-1M \$28.99
2 Meter Standard Patch Cable (719 to 719) Part No. MC-211-2M \$33.99
3 Meter Standard Patch Cable (719 to 719) Part No. MC-211-3M \$36.99
719 to 719 cables connect AiM sensors to MX Series, EVO3, and EVO5.

- 1 Meter Adapter Cable for EVO4S (719 to 4-pin 712)** Part No. MC-210-1M \$38.99
2 Meter Adapter Cable for EVO4S (719 to 4-pin 712) Part No. MC-210-2M \$38.99
3 Meter Adapter Cable for EVO4S (719 to 4-pin 712) Part No. MC-210-3M \$38.99
719 to 4-pin 712 cables connect AiM sensors to MyChron3 XG-Log, EVO4, and EVO4S.

- 1 Meter EVO4S Patch Cable (712 to 712)** Part No. MC-260-1M \$39.99
2 Meter EVO4S Patch Cable (712 to 712) Part No. MC-260-2M \$39.99
3 Meter EVO4S Patch Cable (712 to 712) Part No. MC-260-3M \$39.99
4-pin 712 to 4-pin 712 cables extend the reach of an Optical Lap Timing Receiver. Other sensors with 719 connectors will also require an MC-210 Adapter Cable above.

- 712 Screw-In Dust Cap** Part No. MC-360 \$3.99
This threaded metal cap has an O-ring to seal off an unused 712 port from dust or water.

- Adapter Cable for TC Hub (K-Type to 3-pin 712)** Part No. MC-008 \$34.99
Connects an AiM thermocouple to the TC Hub or to a kart dash. 1.5 meter length only.

- 1.5 Meter Patch Cable (K-Type to K-Type)** Part No. MC-203 \$34.99
Extends the reach of an AiM thermocouple. 1.5 meter length only.

Below: Optical Lap Timing Transmitter Beacon Part No. MC-001



Above: Optical Lap Timing Receiver (4-pin 719) Part No. MC-213

Below: Magnetic Wheel Speed Sensor Part No. MC-216



Please visit our website for important information about mounting VDO pressure sensors!

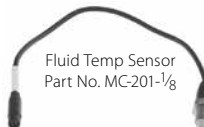

Fluid Temp Sensor Part No. MC-201-1/8



KA-Type Fluid Pressure Sensor (Typical)



Above: Typical VDO Fluid Pressure Sensor



Left: Linear (Plunger) Brake Pedal Position Sensor Part No. MC-321

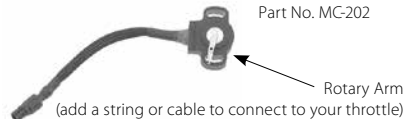

Below: Rotary (String Type) Throttle Position Sensor Part No. MC-202

Rotary Arm (add a string or cable to connect to your throttle)



Left: Belt-Type Steering Angle Sensor Part No. MC-215



Right: Cable-Type Steering Angle Sensor Part No. MC-280



Above: Linear Travel Sensor Part No. MC-206-Length



Right: Infra-Red Tire Temperature Sensor Part No. MC-352



Left: EGT Thermocouple 5mm male threads Part No. MC-003



Above: Open-Tip EGT Thermocouple includes clamp-on and weld-on hardware Part No. MC-214

Detail of a Male 719 (push-in) connector



Detail of a Male 712 (screw-in) connector



Detail of a Male K-Type (thermocouple) connector



Please visit our website for detailed information on the different connectors used on AiM dashes and sensors.

1 meter = 39.37" (3' 3.37") • 1.5 meters = 59" (4' 11") • 2 meters = 78.74" (6' 6.75") • 3 meters = 118.11" (9' 10.11")

Exhaust Gas Temperature (EGT) and Cylinder Head Temperature (CHT) Gauges

Westach EGT and CHT gauges are self-powered and require no battery or connection to vehicle wiring. This makes them ideal for use on cars with total-loss electrical systems. The difference in temperature between the thermocouple probe tip and the other end of the probe cable causes the gauge needle to move. (Note that these gauges are calibrated for 75° F ambient temperature. Higher ambient temperature will cause a proportionally lower reading on the gauge, and lower temperatures will cause a higher reading.) We offer single and dual gauges in the standard 2 1/16" diameter.

EGT (Exhaust Gas Temperature) measurement is still one of the most accurate methods of determining if an engine is operating with an optimum air/fuel ratio. EGT gauges have long been used by successful racing teams to keep their engines running at peak power, without having to worry about running too lean and thus risking engine damage. A too-lean condition will be instantly indicated by an excessively high EGT reading. EGT gauges do not rely on an easily-fouled oxygen sensor, so they can be used with leaded gasoline on 2-stroke, 4-stroke, or rotary engines.

A dual EGT gauge is particularly useful on engines that have certain cylinders fed by the primary carburetor venturi and other cylinders fed by the secondary. Ford FF1600 and 2.0L engines fall into this category: Cylinders 1 and 4 are most sensitive to changes of primary jets while cylinders 2 and 3 are most affected by changes in secondary jetting. Using a dual gauge to monitor one cylinder in each group can help balance the carb for optimum power and maximum reliability. You can also add a selector switch to read up to 4 probes with a single gauge (or one side of a dual gauge). The 700° F to 1700° F range is suitable for most 4-stroke engines. The extended 2000° F range is recommended for rotary engines.

Our EGT probes are only .161" diameter and 1" long. They cause no measurable power loss and thus can be used at all times. Each probe has a 44" armored cable. Mated to the standard 18" cable included with each gauge, the probe can be mounted as far as 62" from the gauge. If more length is needed, three different extension cables are available to replace the 18" harness on the gauge. If none of the standard length extensions fit your requirements, you can also make your own custom extension cable using our connector pin kit.

EGT Gauges (order probes separately):

Single EGT Gauge, 700-1700°F (no probe) Part No. 1081 \$76.99

Dual EGT Gauge, 700-1700°F (no probes)..... Part No. 1082 \$149.99

Dual EGT Gauge, 500-2000°F (no probes)..... Part No. 1057 \$149.99

Note: When ordering a dual EGT gauge, you must order **two** probes.

EGT Probes (sold individually)

Clamp-On EGT Probe for 1" to 1 1/8" OD pipe Part No. 1080 \$56.99

Clamp-On EGT Probe for 1 1/8" to 2 1/2" OD pipe..... Part No. 1084 \$56.99

Screw-In EGT Probe with 1/8 NPT male threads..... Part No. WBT-712-4D2K... \$69.99

All of these probes will work with any of our EGT gauges. Each probe has a 44 inch armored cable for 62" total reach.

CHT (Cylinder Head Temperature) is often monitored on air-cooled engines because there is no coolant. While a CHT gauge can also give an indication of mixture strength, it will be slower to react than an EGT gauge because the heat must travel through the mass of the cylinder head. High CHT readings can also be caused by running too much ignition advance.

CHT Gauge (order probe separately):

Single CHT Gauge, 100-700°F (no probe) Part No. WBT-2C1 \$76.99

CHT Thermocouple Probes (sold individually):

CHT Probe with 14mm ring (12" cable)..... Part No. WBT-712-4..... \$31.99

CHT Probe with 12mm ring (44" cable)..... Part No. WBT-712-8WK... \$38.49

EGT / CHT Gauge Wiring Accessories:

Replacement 18" harness (2-wire) for single gauge..... Part No. 1083-2..... \$12.99

Replacement 18" harness (4-wire) for dual gauge..... Part No. 1083-4..... \$14.99

Optional gauge backlight kit..... Part No. 1085..... \$8.19

Extension cable, 4 foot (replaces 18" gauge harness) Part No. 1086-48 \$12.99

Extension cable, 6 foot (replaces 18" gauge harness) Part No. 1086-72 \$15.99

Extension cable, 8 foot (replaces 18" gauge harness) Part No. 1086-96 \$17.99

Connector pin kit only (to make your own extension cable) Part No. 1087 \$2.99

Four position selector switch Part No. 1088..... \$52.99

Allows up to 4 probes to be read with a single gauge – or with one side of a dual gauge. Comes pre-wired with 8 foot long cables for each probe.



Left: Single EGT Gauge Part No. 1081



Right: Dual EGT Gauge Part No. 1082



Left: Clamp-on EGT probe for 1 1/8" to 2 1/2" pipe Part No. 1084



Right: Screw-in EGT probe with 1/8 NPT male threads Part No. WBT-712-4D2K



Single CHT Gauge Part No. WBT-2C1



Right: CHT Probe with 14mm Ring Part No. WBT-712-4 Note that this probe has a short 12" cable



Left: Replacement 18" Harness for Dual Gauge Part No. 1083-4



Right: Four position selector switch Part No. 1088

Auto Meter Wideband Air/Fuel Ratio Gauge Kits

Auto Meter Wideband Air/Fuel Ratio Gauge Kits combine the accuracy of a wideband air/fuel ratio monitor with the style and performance of an Auto Meter gauge. Programmable range and stoichiometric ratio make these kits suitable for use with different fuels including methanol, LP, and CNG. Dash-mount 2 1/16" diameter gauges are easy to fit in most applications. Gauges are available in either the **Sport-Comp** black face - silver bezel style or the **Ultra-Lite** silver face - silver bezel style. Both styles feature a dual display LED readout for accuracy and a radial graphic display for quick and easy reading. A linear 0-4v output lets you connect to your data logger or ECU. Each kit includes the proven Bosch LSU 4.2 wideband oxygen sensor and a weld-in sensor bung.

Auto Meter Sport-Comp Wideband Air/Fuel Gauge Kit, Pro.... Part No. AM3378 \$319.99

Auto Meter Ultra-Lite Wideband Air/Fuel Gauge Kit, Pro..... Part No. AM4378 \$319.99

Auto Meter Ultra-Lite Wideband Air/Fuel Gauge Kit, Street.... Part No. AM4379 \$214.95

The economical Street version (not shown) is not programmable for range or ratio. It is suitable for use with unleaded gasoline only.

Replacement Broadband Sensor for Auto Meter gauges only ... Part No. AM2243 \$133.95

Auto Meter Wideband Air/Fuel Ratio Gauges



Sport-Comp Style Part No. AM3378



Ultra-Lite Style Part No. AM4378

Stack Tachometers and Racetech Mechanical Gauges

Stack ST400 Professional Tachometer

**STACK
STACK
STACK**



ST400 RPM Ranges

- 0-8000 RPM
- 0-3-8500 RPM
- 0-4-10,500 RPM
- 0-6-13,000 RPM

ST400 Professional Tachometers use microprocessor-controlled stepper motor movements for rock-steady operation throughout the RPM range, with zero needle bounce. This technology also permits the dial to be compressed at the low end and expanded at the top end for more accurate reading in the engine's normal operating range. The ST400 can record and play back up to 25 minutes of run time, and a tell-tale function recalls peak RPM. White backlighting allows night use. Mounts in an 80mm (3 1/16") opening (bezel measures 3.47" OD). Includes a panel-mount shift light, switch kit, and wiring harness. Please specify RPM range from the chart at left.

ST400 Professional Tachometer Part No. ST400-(RPM range)..... \$559.99

Stack ST200 Clubman and Classic Tachometers

The **ST200 Clubman Tachometer** provides the exceptional reliability and accuracy of stepper motor movement in a sealed, waterproof case. Compatible with points, HEI, and magneto ignitions. Mounts in an 80mm (3 1/16") opening. Available in three RPM ranges: 0-8000, 0-4-10,500, and 0-6-15,000. Please specify RPM range when ordering.

ST200 Clubman Tach, Black Face (shown) Part No. ST200-(RPM Range)..... \$364.99
 ST200W Clubman Tach, White Face Part No. ST200W-(RPM Range)..... \$364.99

The **Stack ST200C Classic Tachometer** has all of the same features as the ST200 Clubman model, but with a chrome bezel, lighter needle, and vintage Stack logo for a period-correct look.

ST200C Classic Tachometer, 0-8000 RPM only Part No. ST200C-0-8000 \$499.99

The **Stack Chronotronic Tachometer** takes the Classic model one step further by recreating the jumping needle movement of the original Smiths Chronometric tach, but only below 5000 RPM. From 5000 to 10,000 RPM you get the same rock-steady needle as on other Stack tachometers. Fits the same 3.5" (88mm) cutout as the original Smiths.

Stack Chronotronic Tach, 0-10,000 RPM only Part No. ST901096 \$599.99
 Red Shift Light for any Stack Tach Part No. ST536 \$44.99



Stack ST200 Clubman Tachometers

Left: Black, Part No. ST200-RPM
 Right: White, Part No. ST200W-RPM



Stack ST200C Classic Tachometer
 Part No. ST200C-RPM



Stack Chronotronic Tachometer
 Part No. ST901096



Stack Red Shift Light
 Part No. ST536
 Compact panel-mount light works with all Stack Clubman, Classic, and Chronotronic tachometers

GAUGES

Racetech Competition Mechanical Gauges by Raceparts

Racetech Gauges are supplied as original equipment on many British-made formula cars. They are rugged and accurate, and their reliability has been proven over many decades of racing use all over the world. All gauges in the line are 2 1/16" diameter and have black faces with bright white markings (green faces are no longer available). All Racetech gauges are mechanical - electric versions are not available. These gauges are not illuminated.

Temperature gauges are available with either 7 or 9 foot capillary tubes. Capillary tubes on temperature gauges must be handled with care. If the tube is cracked or broken, the gauge is not repairable. You must avoid excessive flexing or twisting of the capillary tube, particularly when installing the sensor bulb. Be sure to use a backup wrench to prevent the sensor bulb from turning when tightening the gland nut. The capillary tube has a 3/8 BSP female threaded gland nut permanently installed. A 3/8 BSP male x 3/8 BSP male adapter fitting is provided with the gauge. An optional 5/8-18 male x 3/8 BSP male adapter is also available (5/8-18 has become much more common, particularly on cars manufactured outside of England).

Pressure gauges do not include tubing kits. Hookup kits using plastic tubing are available for street use, but competition use requires metal-braided (AN) hose at a minimum. Pressure gauge isolators are preferred for fuel pressure gauges. Our pressure gauges all have a 1/8 BSP male inlet fitting with a flat sealing face. This requires the use of a special hose end. Standard BSP hose ends have a convex seat and will not seal properly. We stock this special hose end for use with common -3 PTFE-lined stainless steel braided hose.

15 psi Fuel Pressure Gauge, 1/8 BSP male Part No. 1090-15 \$86.99
 Never use plastic tubing to connect fuel pressure gauges! Only use braided stainless AN hose or a Pressure Gauge Isolator (such as our Part No. AM5282 on page 45).

100 psi Oil Pressure Gauge, 1/8 BSP male Part No. 1091-100psi ... \$83.99
 160 psi Oil Pressure Gauge, 1/8 BSP male Part No. 1091-160psi ... \$84.99
 The pressure gauges above have a 1/8 BSP male fitting with a flat sealing face. See below for our special hose end to connect -3 steel braided hose to these gauges.

110°C Water Temperature Gauge, 84" capillary tube Part No. 1092-84 \$141.99
 110°C Water Temperature Gauge, 108" capillary tube Part No. 1092-108 \$141.99

140°C Oil Temperature Gauge, 84" capillary tube Part No. 1093-84 \$140.99
 140°C Oil Temperature Gauge, 108" capillary tube Part No. 1093-108 \$140.99

Dual 100 psi Oil Press./110°C Water Temp., 84" tube Part No. 1094-84 \$219.99
 Dual 100 psi Oil Press./110°C Water Temp., 108" tube Part No. 1094-108 \$219.99

Dual 100 psi Oil Press./140°C Oil Temp., 84" tube Part No. 1095-84 \$219.99
 Dual 100 psi Oil Press./140°C Oil Temp., 108" tube Part No. 1095-108 \$219.99
 The pressure gauges above have a 1/8 BSP male fitting with a flat sealing face. See below for our special hose end to connect -3 steel braided hose to these gauges.

3/8 BSP x 3/8 BSP male temp bulb adapter (standard) Part No. 1097 \$15.99
 Racetech temperature gauges include this adapter.

5/8-18 male x 3/8 BSP male temperature bulb adapter Part No. 1098 \$16.49
 5/8-18 is now the most common size for mechanical temperature sensing bulbs. It is so close to 3/8 BSP that they are hard to tell apart. A 3/8 BSP fitting will not quite fit in a 5/8-18 hole. A 5/8-18 fitting will be a loose fit in a 3/8 BSP hole.

Replacement 10mm Copper Washer for temp bulb Part No. 1096 \$4c
 This washer is used to seal the 3/8 BSP female gland nut to the male-to-male adapter on Racetech temperature gauges.

7 foot plastic oil pressure hose, 1/8 BSP female* Part No. 1099-7 foot ... \$24.99
 9 foot plastic oil pressure hose, 1/8 BSP female* Part No. 1099-9 foot ... \$24.99

*Note: These hookup kits are not SCCA legal for road racing! SCCA requires any oil line in the driver's compartment to be metal braided hose.

Special 1/8 BSP Hose End for -3 Braided PTFE Hose, Strt ... Part No. 3268-1/8-00... \$16.99

Special 1/8 BSP Hose End for -3 Braided PTFE Hose, 45° ... Part No. 3268-1/8-45... \$21.99

Special 1/8 BSP Hose End for -3 Braided PTFE Hose, 90° ... Part No. 3268-1/8-90... \$18.99

These hose ends have a flat sealing surface for Racetech (or Smith's) pressure gauges. See page 83 for PTFE hose.



100 psi Oil Pressure Gauge
 Part No. 1091-100psi



140°C Oil Temperature Gauge
 Part No. 1093-xx



Dual Oil Pressure/Water Temperature
 Part No. 1094-xx



Typical temperature sensing bulb with 3/8 BSP adapter

Standard BSP hose end has a convex seat and will not seal on our Racetech pressure gauges.



Our special BSP hose end (Part No. 3268) has a flat sealing surface to work with our Racetech pressure gauges.

If you don't want to use a plastic tubing kit to connect Racetech pressure gauges, we stock special reusable hose ends for -3 stainless steel braided PTFE Hose!

Auto Meter Gauges

Pegasus is proud to be an authorized distributor of Auto Meter competition instruments. Since their beginning in 1957, Auto Meter has become the industry leader in reliable, quality instrumentation for every facet of motorsports. In addition to the broad range of products listed in our catalog, anything not shown can be special ordered.



AM2606



AM2609



AM2612



AM2645



AM3401



AM3421



AM3432



AM3522 (electric)

Z-Series Gauges

The **Z-Series** line of instruments have a bezel design similar to the unique shape originally introduced in the Sport-Comp gauges. Other features are a cleaner, full pointer for easy legibility, a 270° sweep angle on the mechanical gauges, and a rugged, fast responding air core meter on the electrical units (90° sweep angle on electric gauges). All gauges fit into a 2 1/16" mounting hole. With this compact size and the available black mounting panels (sold separately on page 43), the Z-Series instruments are the perfect choice for any application. **All gauges are mechanical unless noted.**

Boost Gauge, 30" Hg vacuum, 20 psi boost	Part No. AM2601.....	\$73.99
Vacuum Gauge, 30" Hg.....	Part No. AM2610.....	\$68.99
Fuel Pressure Gauge, 15 psi.....	Part No. AM2603.....	\$68.99
Fuel Pressure Gauge, 100 psi.....	Part No. AM2612.....	\$69.99
Oil Pressure Gauge, 100 psi, 6 feet	Part No. AM2604.....	\$66.99
Oil Pressure Gauge, 200 psi, 6 feet	Part No. AM2605.....	\$69.99
Water Temp., 140° to 280°, 6 foot capillary tube	Part No. AM2606.....	\$91.99
Oil Temp Gauge, 140° to 280°, 6 foot capillary tube.....	Part No. AM2609.....	\$88.99
Oil Pressure Gauge, 100 psi, Electric	Part No. AM2634.....	\$82.99
Water Temp. Gauge, 100° to 250°, Electric	Part No. AM2635.....	\$63.99
Oil Temp. Gauge, 100° to 250°, Electric.....	Part No. AM2638.....	\$62.99
Oil Temp. Gauge, 140° to 300°, Electric.....	Part No. AM2639.....	\$62.99
Ammeter, Electric	Part No. AM2644.....	\$54.99
Voltmeter, Electric.....	Part No. AM2645.....	\$53.99
Tachometer, 3 3/4" Electric, 8,000 RPM in-dash	Part No. AM2699.....	\$162.99

Sport-Comp Gauges

Sport-Comp Gauges were first introduced over twenty years ago. The trademarked competition appearance and reliable performance have made them the standard in racing today. The bold, easy-to-read dial faces include fluorescent red pointers for quick-glance monitoring. The mechanical gauges are quality engineered with a sealed bourdon tube and full 270° sweep angle, and the electrical gauges utilize a rugged air core meter movement for maximum accuracy and quick response time (90° sweep angle on electric gauges). Sport-Comp gauges are all available in 2 5/8" size. **All gauges are mechanical unless noted.**

Boost Gauge, 30" Hg vacuum, 20 psi boost	Part No. AM3401.....	\$92.95
Fuel Pressure Gauge, 15 psi.....	Part No. AM3411.....	\$77.95
Fuel Pressure Gauge, 100 psi.....	Part No. AM3412.....	\$79.95
Fuel Pressure Gauge, 15psi, with isolator	Part No. AM3413.....	\$194.95
<i>The isolator keeps fuel out of the cockpit.</i>		
Oil Pressure Gauge, 100 psi, 6 feet	Part No. AM3421.....	\$79.95
Oil Pressure Gauge, 200 psi, 6 feet	Part No. AM3422.....	\$79.95
Water Temp. Gauge, 140° to 280°, 6 foot capillary	Part No. AM3431.....	\$107.95
Water Temp. Gauge, 120° to 240°, 6 foot capillary	Part No. AM3432.....	\$107.95
Water Temp. Gauge, 120° to 240°, 12 foot capillary	Part No. AM3433.....	\$117.95
Oil Temp. Gauge, 140° to 280°, 6 foot capillary	Part No. AM3441.....	\$109.95
Oil Temp. Gauge, 140° to 280°, 12 foot capillary	Part No. AM3443.....	\$117.95
Oil Pressure Gauge, 100 psi, Electric	Part No. AM3522.....	\$97.95
Water Temp. Gauge, 100° to 250°, Electric	Part No. AM3531.....	\$82.95
Voltmeter, Electric.....	Part No. AM3592.....	\$69.95

A Note about Mechanical Temperature Gauges All mechanical temperature gauges (regardless of manufacturer) have a sensor bulb connected to the gauge by a thin capillary tube. This tube is rather fragile and must be handled and routed carefully to prevent damage. These **temperature gauges** actually measure the **pressure** of the gas that is sealed within the sensor bulb. Since the volume of the capillary tube is insignificant compared to the volume within the sensor bulb, the pressure of the sealed gas is proportional to the temperature of the sensor bulb. As long as the capillary tube is not damaged, these gauges are quite rugged and dependable. In fact, if properly installed to prevent vibration damage, they tend to be more reliable than many electric temperature sending units that are prone to vibration damage.



AM4411



AM4421



AM6856



AM4494



AM5421



AM5433



AM5443



AM6809

Ultra-Lite Gauges

Ultra-Lite Gauges are the hottest instruments for sportsmen and professional racers in any motorsport. They make perfect sense because the aluminum construction greatly reduces weight while satin anodized aluminum and bright red fluorescent pointers make them easy to read. Bourdon tube mechanisms are part of the mechanical units, while air core meter movements are the standard on electrical gauges. Use an electric gauge if you prefer to route a wire rather than a pressure tube or capillary tube as used on mechanical temperature gauges. All gauges are 2 5/8" except for tachometers which are available in 3 3/8" and 5" depending on model. All mechanical gauges have a full 270° sweep angle; electric gauges have a 90° sweep angle. **All gauges are mechanical unless noted.**

Boost Gauge, 30" Hg vacuum, 20 psi boost	Part No. AM4401.....	\$92.95
Fuel Pressure Gauge, 15 psi.....	Part No. AM4411.....	\$79.95
Fuel Pressure Gauge, 100 psi.....	Part No. AM4412.....	\$79.95
Oil Pressure Gauge, 100 psi, 6 feet	Part No. AM4421.....	\$84.95
Oil Pressure Gauge, 200 psi, 6 feet	Part No. AM4422.....	\$84.95
Oil Pressure Gauge, 100 psi, Electric	Part No. AM4427.....	\$97.95
Water Temp. Gauge, 140° to 280°, 6 ft. capillary tube.....	Part No. AM4431.....	\$117.95
Water Temp. Gauge, 120° to 240°, 6 ft. capillary tube.....	Part No. AM4432.....	\$122.95
Water Temp. Gauge, 100° to 250°, Electric	Part No. AM4437.....	\$84.95
Oil Temp. Gauge, 140° to 280°, 6 foot capillary tube.....	Part No. AM4441.....	\$117.95
Oil Temp. Gauge, 140° to 300°, Electric	Part No. AM4447.....	\$84.95
Voltmeter, Electric, 90° sweep angle.....	Part No. AM4491.....	\$73.95
Tachometer, 5" Electric, 10,000 in-dash, with telltale	Part No. AM4494.....	\$359.95
Tachometer, 3 3/4" Electric, 10,000 RPM in-dash	Part No. AM4497.....	\$169.95
Tachometer, 5" Electric, 10,000 RPM in-dash.....	Part No. AM4498.....	\$229.95
Tachometer, 5" Electric, 9,000 RPM pedestal mount.....	Part No. AM6856.....	\$379.95
<i>AM6856 includes shift light and telltale.</i>		

Pro-Comp & Pro-Comp Liquid Filled Gauges

Pro-Comp Liquid Filled Gauges are designed for racing applications with extreme vibrations or violent pounding. The bourdon tube gauge mechanism is encased in a special dampening fluid that absorbs vibrations. This protection not only provides steadiness to the pointer, but also adds longer life to the instrument. Electrical gauges match the appearance of the mechanical units with bright numbers and fluorescent red pointers on a 2 5/8" face, but are not available liquid filled. Tachometers are also not available liquid filled. Standard size for tachometers is 5". All gauges except the voltmeter have a full 270° sweep angle. **All gauges are mechanical unless noted.**

Liquid Filled Boost Gauge, 30" Hg vacuum, 20 psi boost.....	Part No. AM5401.....	\$104.95
Liquid Filled Boost Gauge, 0 to 35 psi boost	Part No. AM5404.....	\$104.95
Liquid Filled Fuel Pressure Gauge, 15 psi.....	Part No. AM5411.....	\$104.95
Liquid Filled Fuel Pressure Gauge, 100 psi.....	Part No. AM5412.....	\$104.95
Liquid Filled Oil Pressure Gauge, 100 psi.....	Part No. AM5421.....	\$102.95
Liquid Filled Water Temp. Gauge, 140° to 280°, 6 ft.....	Part No. AM5431.....	\$142.95
Liquid Filled Water Temp. Gauge, 120° to 240°, 12 ft.....	Part No. AM5433.....	\$142.95
Liquid Filled Oil Temp. Gauge, 140° to 280°, 6 ft.....	Part No. AM5441.....	\$142.95
Liquid Filled Oil Temp. Gauge, 140° to 280°, 12 ft.....	Part No. AM5443.....	\$152.95
Voltmeter, Electric, 90° sweep angle.....	Part No. AM5492.....	\$73.95
Tachometer, 3 3/4" Electric, 10,000 RPM with telltale	Part No. AM6601.....	\$339.95
Tachometer, 5" Electric, 9,000 RPM with telltale	Part No. AM6809.....	\$319.95
Tachometer, 5" Electric, 10,000 RPM in-dash.....	Part No. AM5100.....	\$229.95

Auto Meter Hour Meter displays up to 100,000 hours of total engine run time in 6 minute increments. Non-resettable quartz movement runs on 8 to 32 VDC. 2 1/16" only.
Auto Meter Hour Meter, chrome bezel..... Part No. AM2587..... \$69.95

Early Warning Devices



Auto Meter DPSS Shift Light
Part No. AM5343



Auto Meter Large Pro-Lite
Part No. AM3240

Auto Meter DPSS Shift Light

The Auto Meter **Digital Pro-Shift System (DPSS) Light** is a programmable stand-alone amber LED shift light with an integrated digital RPM readout. The shift point is easy to set with no "pills" required. The shift light brightness is adjustable, and the RPM readout can be turned off to minimize distractions. A peak RPM recall lets you see exactly how fast you spun the engine. The tubular housing measures 5.1" long by 2.1" diameter (3.1" high with mounting bracket). The swiveling, rotating bracket makes it easy to mount to your dash, steering column, or rollcage tube. Compatible with most 4 through 12 cylinder engines with 12 volt ignition systems. Note that some distributorless systems require the DIS Adapter, sold separately.

Black Tube DPSS Shift Light, Level 1 Part No. AM5343 \$182.95

Level 1 shift lights have single-color LEDs, a single shift point, and a single peak RPM recall. See our website for multi-stage Level 2 DPSS lights.

DIS Adapter for distributorless ignition systems..... Part No. AM9117..... \$109.95

Auto Meter Pro-Lite Warning Lights and Switches

Pro-Lite Warning Lights are too big to be ignored! They are so bright, a plastic cover is provided to avoid blinding you at night. The Large light measures 5" long x 1.6" diameter. The Mini measures 4.25" long x 0.75" diameter. A built-in bracket makes it easy to mount either one to the top of your dash. Simple 2-wire hookup works with any 2-terminal or single-terminal (grounding) switch. Supplied with a red lens; see our website for blue and yellow lenses. Both lights require a switch (sold separately).

Large Pro-Lite Warning Light, red lens..... Part No. AM3240 \$57.95

Mini Pro-Lite Warning Light, red lens..... Part No. AM3239 \$57.95

Pro-Lite Pressure Switch, 15 psi, 1/8 NPT..... Part No. AM3241 \$26.95

Pro-Lite Pressure Switch, 30 psi, 1/8 NPT..... Part No. AM3242 \$26.95

Pro-Lite Pressure Switch, 50 psi, 1/8 NPT..... Part No. AM3243 \$26.95

Pro-Lite Temperature Switch, 220° (Off: 190°), 1/2 NPT.. Part No. AM3247 \$30.95

Pro-Lite Temperature Switch, 275° (Off: 245°), 1/2 NPT.. Part No. AM3248 \$27.99

Compact Panel-Mount Warning Lights

Our **Compact Warning Lights** measure less than 1" OD, making them perfect for crowded formula car dashes where an Auto Meter Pro-Lite just won't fit. Each mounts in a 3/4 inch hole and requires just 1.5 inch clearance behind the mounting panel. Includes a compact two-terminal (non-grounding) socket assembly, high-brightness 12 volt bulb, and a colored lens. Actuating switch and wiring are sold separately.



Compact Warning Light, White..... Part No. LA41801 \$9.99

Compact Warning Light, Red..... Part No. LA41802 \$9.99

Compact Warning Light, Amber..... Part No. LA41803 \$9.99

Compact Warning Light, Green..... Part No. LA41804 \$9.99

Compact Warning Light, Blue..... Part No. LA41805 \$9.99

Spare 12 volt high brightness bulb..... Part No. 1031 \$2.49

Low Pressure Switches

Our **Low Pressure Switches** are designed to turn on a warning light (sold separately) if system pressure falls below the set pressure. For highest reliability, we recommend that all pressure switches (and senders for electric oil pressure gauges) should be isolated from engine heat and vibration. All of these switches are single-terminal (grounding type) and must be used with a 2-wire (non-grounding) warning light. All have 1/8 NPT male threads for easy installation.



20 psi Oil Pressure Switch, 1/8 NPT..... Part No. LA4308..... \$29.99

15-50 psi Adjustable Oil Pressure Switch, 1/8 NPT..... Part No. LA4808..... \$39.99

2-7 psi Adjustable Fuel Pressure Switch, 1/8 NPT..... Part No. 1064..... \$24.99

3 psi Coolant Pressure Switch, 1/8 NPT..... Part No. LA43241 \$19.99

A great way to detect loss of coolant. This switch will activate long before your temperature gauge registers a problem. In fact, temperature gauges often show a lower temperature when cooler air hits the sender.

High Temperature Switches

Our **High Temperature Switches** are designed to turn on a light if the fluid temperature exceeds the set point. All of these switches are single-terminal (grounding type) and must be used with a 2-wire (non-grounding) warning light. **Note:** Temperature switches and senders must be exposed to the fluid flow.



225°F Temperature Switch, 1/4 NPT..... Part No. 1005..... \$49.99

225°F Temperature Switch, 1/2 NPT..... Part No. 1006..... \$44.99

250°F Temperature Switch, 1/2 NPT..... Part No. 1007..... \$45.49

Note: Temperature switches (and temperature gauge senders) will only read accurately if they are directly exposed to the flow of the fluid. They cannot be mounted remotely in an area not exposed to constant fluid flow.

Cartek Low Coolant Level Sensors

The **Cartek Low Coolant Level Sensor** detects and alerts you if air is present in your cooling system. The sensor comes pre-assembled in a special inline adapter that fits into your radiator hose. Red and green LED indicators are built directly into the unit so you will be alerted to problems if you're watching from under the hood. A signal output wire can trigger your ECU, dash, or an LED warning light (not included). The signal wire is normally open but switches to ground when the sensor detects coolant loss. Works with 12V or 24V electrical systems. To reduce the chance of false alarms from minor air bubbles or pump cavitation, the sensor only trips after being exposed to air for 3 seconds. Each kit includes inline adapter with pre-installed sensor, wiring pigtail, and hose clamps.

Cartek Low Coolant Level Sensor, 32mm (1 1/4") ID hose..... Part No. 1068-138.. \$197.95

Cartek Low Coolant Level Sensor, 38mm (1 1/2") ID hose..... Part No. 1068-139.. \$197.95

Note: This sensor does not put out enough amperage to turn on an incandescent bulb, so it will not work with any of our warning lights above. The low-amperage signal can only turn on an LED or provide a signal to a logic circuit.



New!

Davies Craig Low Coolant Level Alarm



Red warning LED can be mounted away from the alarm module

The **Davies Craig Low Coolant Level Alarm** is an all-in-one kit that provides an audible and visual warning if it detects loss of coolant. The kit includes a sensor pre-assembled in an inline adapter and an external alarm module. Mount the adapter in your top radiator hose, mount the alarm module to your dash, and connect the two (plus power and ground) using the wiring harness in the kit. Once the system is refilled, the alarm module will sound a buzzer and light up a red LED within 10 seconds of sensing a drop in coolant level. The inline adapter is designed to fit 35mm (1 3/8") ID hose, and sleeves (included) adapt it to fit 41mm (1 5/8") hose. Works on 12V or 24V electrical systems.

Davies Craig Low Coolant Level Alarm..... Part No. DC1030..... \$149.24

Cartek Sequential Shift Lights

Cartek 5-Stage Sequential LED Shift Light

This high-tech shift light uses 7 very bright LEDs to warn you, in 5 steps, as you approach your shift point:

- Stage 1: Outer Green LEDs come on
- Stage 2: Outer Yellow LEDs come on
- Stage 3: Inner Orange LEDs come on
- Stage 4: Center Red LED comes on
- Stage 5: All 7 LEDs flash together



The clever programming routine is a quick, 2-step process. Simply bring the RPMs to your desired "Stage 1" level (outer green LEDs lit) and back off the throttle. Next, bring the RPMs to your desired "Stage 5" level (all LEDs flashing) and back off. The microprocessor stores those two values and automatically calculates the intermediate levels for you. The compact housing (70mm x 30mm x 20mm high / 2.75" x 1.18" x 0.75" high) is designed to mount on top of your dash panel. Compatible with conventional and electronic ignitions with an RPM signal output. Instructions included.

Cartek 5-Stage Sequential LED Shift LightPart No. 1068-101..... \$162.95

Cartek LCD Gear Indicator with Sequential LED Shift Light



Never get caught in the wrong gear again! This clever unit displays the engaged gear on virtually any vehicle with an RPM signal and a speed signal. The large backlit LCD window shows the gear number (up to 7), while a row of 7 LEDs above provides a bonus 5-stage sequential shift light.

Programming is just as easy as programming the Sequential Shift Light at left. To program the gear display, simply drive for a few seconds at a constant speed (*any* speed) in each gear. The unit will calculate and store the ratio of RPM to road speed for each gear. The compact housing is designed to be mounted to the front of your dash panel. It is small enough (50mm tall x 40mm wide x 21mm thick / 2" x 1.6" x 0.82") to fit into the most crowded dash. Compatible with conventional and electronic ignitions with an RPM signal output. Instructions included.

Cartek Gear Indicator with Sequential Shift LightPart No. 1068-102..... \$182.95
Requires a pulse-type road speed signal (not just a sender), such as a speedometer signal.

Cartek CAN-BUS Signal Converter

Vehicles with an OBD-II compliant ECU can still take advantage of the Cartek shift lights shown above, even if they have no dedicated RPM or road speed signal output. Just plug in a Cartek CAN-BUS Signal Converter! This advanced translator box plugs into the OBD-II diagnostic port and interprets the ECU information into signals that the Cartek shift lights can understand. No extra programming is required! Compatible with most OEM OBD-II ECUs that support CAN communication protocols.

Cartek CAN-BUS Signal Converter, OBD-II Plug-InPart No. 1068-121..... \$146.95
Plugs directly into the OBD-II diagnostic port on stock vehicles.

Note: This converter has been designed and tested to work with Cartek shift lights and gear position indicators only. If your shift lights require you to program the number of cylinders, or your gear indicator requires you to program tire diameter or the number of pulses per wheel revolution, it will not work for you.



Cartek CAN-BUS Signal Converter
Part No. 1068-121

Carbon Fiber Sheet



Above: Close-up of 2 x 2 carbon fiber weave. This is genuine carbon fiber, not a cosmetic dress-up with a carbon fiber pattern!

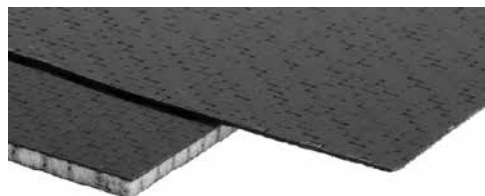

Cored Carbon Fiber Sheet
Part No. CF002
(bottom)

Non-Cored Carbon Fiber Sheet
Part No. CF001
(top)

Pegasus is proud to carry the finest products in carbon fiber from the leading American manufacturer of composites for motorsports. These hand-laid carbon fiber sheets are the preferred choice of ALMS, Daytona Prototypes, F2000, BMW Motorsports, and other top teams and manufacturers. They can be cut easily with a bandsaw, jigsaw, or hacksaw with a fine-tooth blade (minimum 24 teeth per inch) and finished with a file or sandpaper. Dust masks are recommended when cutting or sanding carbon fiber.

Note: This is genuine carbon fiber, not plastic with a carbon fiber print. It is not intended as a cosmetic dress-up for show cars. It is manufactured with the optimal resin content for strength with the lightest weight possible. Small pinholes and other minor imperfections in the finish are normal. Adding more resin for a cosmetically smoother finish would result in excess weight without contributing any strength.

The **Non-Cored Carbon Fiber Sheet** is a single layer (approximately 1/32" thick) of 2x2 carbon fiber weave with a smooth, glossy clear coat on one side. The back side is unfinished, with a rough, matte texture. It is very lightweight but somewhat flexible, which makes it perfect for block-off plates, cockpit interior panels, small enclosures, and other applications which will not require it to carry any load.

Non-Cored Carbon Fiber Sheet, 12" x 18" Part No. CF001-12x18 \$57.99
Non-Cored Carbon Fiber Sheet, 18" x 24" Part No. CF001-18x24 \$110.99
Non-Cored Carbon Fiber Sheet, 24" x 36" Part No. CF001-24x36 \$217.99

The **Cored Carbon Fiber Sheet** has a lightweight honeycomb core which has been vacuum-bagged between two layers of 2x2 carbon fiber weave. The resulting sheet is approximately 1/8" thick. It has a smooth, glossy clear coat on one side. The other side is unfinished, with a rough, matte texture. It is not much heavier than the non-cored sheet, but the core makes it very strong and rigid, which makes it a great choice for gauge panels, switch plates, wing end plates, or just about any non-structural application.

Cored Carbon Fiber Sheet, 12" x 18" Part No. CF002-12x18 \$95.99
Cored Carbon Fiber Sheet, 18" x 24" Part No. CF002-18x24 \$187.99
Cored Carbon Fiber Sheet, 24" x 36" Part No. CF002-24x36 \$369.99

Dashbadge Switch Identification Plates

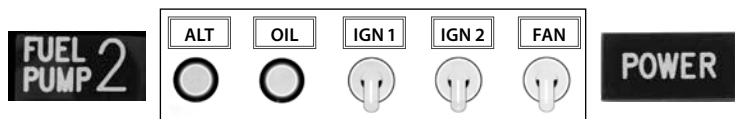

Ditch those old "Dymo" labels and get a more professional look! Our **Dashbadge Switch Identification Plates** have bright red lettering against a black background to identify switches and warning lights on your dash quickly and clearly. Each Dashbadge is made from high-quality plastic and backed with reliable 3M adhesive. The front surface is covered with a smooth, glossy clear layer to prevent dust and dirt from collecting in the engraved letters. This also makes your dash much easier to clean! Available Dashbadges are shown in the chart at right. Each measures 1" wide by 1/2" high.

Dashbadge Switch Identification Plate, eachPart No. 1100-Name..... \$4.29

Dashbadge Availability

ACCUSUMP	HAZARDS	OIL PRESSURE	RAIN LIGHT
ALT	IGN	OIL TEMP	STARTER
COOL SHIRT	IGN 1	ON	TAIL LIGHTS
DIFF PUMP	IGN 2	POWER	TCS
FAN	LIGHTS	PULL FIRE	TRANS FAN
FUEL PUMP	OFF	PUSH FIRE	TRANS PUMP
FUEL PUMP 1	OIL	RAD FAN	WATER
FUEL PUMP 2	OIL FAN	RADIO	WIPERS

Gauge Accessories

In-Line Water Temperature Gauge Adapters



Left: 1/8 NPT Gauge Sender
In-Line Adapter
Part No. AM2280



Right: 3/8 NPT Gauge
In-Line Adapter
Part No. AM2283

These in-line adapters make it easy to install an electrical or mechanical temperature gauge in a coolant hose. Our **1/8 NPT Gauge Sender In-Line Adapters** are machined brass with a 1/8 NPT female port for installing an electrical gauge sender. Our **3/8 NPT Gauge In-Line Adapters** are machined aluminum with a 3/8 NPT port. This style also includes an adapter with female 5/8-18 threads to accept an Auto Meter or Stewart-Warner mechanical temperature gauge.

Hint: The end of the temperature sensing bulb or sender must not touch the opposite side of the adapter. Modify the adapter for clearance if necessary.

1/8 NPT Gauge Adapter for 5/8" (16mm) I.D. Hose Part No. AM2280 \$43.95
1/8 NPT Gauge Adapter for 3/4" (19mm) I.D. Hose Part No. AM2281 \$43.95
These brass adapters have a 1/8 NPT female port. A ground wire is included for use with electrical gauge senders and switches. Includes two hose clamps.

3/8 NPT Gauge Adapter for 1" & 1 1/4" (25 and 32mm) Part No. AM2282 \$53.95
3/8 NPT Gauge Adapter for 1 1/2" (38mm) I.D. Hose Part No. AM2283 \$53.95
These aluminum adapters have a 3/8 NPT female port. An adapter for use with 5/8-18 mechanical gauges and a ground wire for use with electrical senders are included.

Temperature Gauge to Hose Tee Adapters



These aluminum adapter plugs are designed to fit the 1" ID branch of any of our silicone coolant hose tees (sold separately). Choose 1/8 NPT female threads for electrical gauge senders or 5/8-18 female threads for mechanical temperature gauges.

Electrical Gauge Adapter Plug, 1/8 NPT threads Part No. 3228-110-02 .. \$13.99
Mechanical Gauge Adapter Plug, 5/8-18 threads Part No. 3228-111 \$17.99

In-Line Oil Temperature Gauge Adapters

These in-line adapters have a female 5/8-18 threaded port. The hose connection ports are available with male threads in various sizes as shown below. Use Part No. 1209 Extender Nut (sold separately) when using a Stewart-Warner or Auto Meter mechanical gauge.



8AN In-Line Oil Temperature Gauge Adapter Part No. 1227-8AN \$92.99
10AN In-Line Oil Temperature Gauge Adapter Part No. 1227-10AN \$92.99
12AN In-Line Oil Temperature Gauge Adapter Part No. 1227-12AN \$92.99
1/2 BSP In-Line Oil Temperature Gauge Adapter Part No. 1227-1/2 BSP \$92.99
5/8-18 Extender Nut Part No. 1209 \$19.99

Mechanical Temperature Gauge to AN Tee Adapters



These adapters have female AN threads in one end and a female 5/8-18 port for your mechanical temperature gauge in the other. Just add a male AN Tee (sold separately) for an instant in-line gauge adapter!

8AN Female to 5/8-18 Female Adapter Part No. 3497-010-08 .. \$18.99
10AN Female to 5/8-18 Female Adapter Part No. 3497-010-10 .. \$21.49
12AN Female to 5/8-18 Female Adapter Part No. 3497-010-12 .. \$23.49
16AN Female to 5/8-18 Female Adapter Part No. 3497-010-16 .. \$25.99

Mechanical Temperature Gauge Adapters

All of these fittings have a 5/8-18 female port with the proper seat for the sensing bulb on Auto Meter or Stewart-Warner mechanical temperature gauges. Adapter Nuts are brass with male threads in the sizes indicated. The Weld-In Bung is steel and can be welded or brazed into any steel tube, tank, or pan.



1/4 NPT Adapter Nut (not for 144" capillary tubes) Part No. 1074-1/4 NPT .. \$16.99
3/8 NPT Adapter Nut Part No. AM2263 \$10.95
1/2 NPT Adapter Nut Part No. AM2264 \$10.95
16x1.5mm Adapter Nut Part No. AM2275 \$14.95
5/8-18 Female Weld-In Bung, Steel Part No. AM2261 \$14.95

Temperature Senders for Stewart-Warner Electric Gauges

Each kit includes a 1/8 NPT sender with adapters for 1/4 NPT, 3/8 NPT, and 1/2 NPT ports. Water temp senders have a range of 100-280°F. Oil temp senders have a range of 140-320°F.

Water Temperature Sender Kit
Part No. 1075-NPT \$32.99
Oil Temperature Sender Kit
Part No. 1076-NPT \$29.99



Liquid-Filled, Direct-Mounted Fuel Pressure Gauges



These 1.5 inch diameter pressure gauges can be mounted in the engine compartment to monitor fuel pressure. The male 1/8 NPT fitting on the back makes it easy to install in your fuel system using the adapters below or on pages 91-92. Gauge face design may vary from photo.

15 psi Fuel Pressure Gauge, 1/8 NPT male
Part No. 1039 \$37.99
100 psi Fuel Pressure Gauge, 1/8 NPT male
Part No. 1063 \$37.99

Pressure Adapter Fittings

We offer many adapters to connect 1/8 NPT hose fittings and pressure switches to a variety of threaded ports, or to connect a gauge and pressure switch at a single port.



1/8-28 BSP Male / Female Adapter Tee 1/8-28 BSP threads are used on some Japanese engines. This tee can be used to connect an aftermarket pressure gauge or sender and the original pressure switch to the same port. The tee has one male BSP end, one female BSP end, and one female NPT port. Simply screw the male BSP end into your engine, screw the original switch into the female BSP end, and connect your gauge to the female NPT port.

1/8-28 BSP Male / Female to NPT Adapter Tee Part No. 1073-001 \$17.99
1/8-28 BSP Male to 1/8-27 NPT Female Adapter only Part No. AM2269 \$14.95
Use this fitting if you do not plan to retain the stock pressure switch.

Metric Adapters Each of these adapters has a male metric fitting on one end and a female 1/8-27 NPT port on the opposite end. A crush washer is included for the metric side.



M10x1.0 Male to 1/8 NPT Female Adapter Part No. AM2265 \$14.95
M12x1.5 Male to 1/8 NPT Female Adapter Part No. AM2277 \$14.95
M16x1.5 Male to 1/8 NPT Female Adapter Part No. AM2268 \$14.95
M12x1.25 Banjo Bolt with 1/8 NPT Female Port Part No. AM2276 \$15.95
This banjo bolt fits the underhood fuel filter on some import applications.

1/8-27 NPT Female to 4AN Bulkhead Mount Adapter

This adapter allows you to mount a pressure switch or gauge sender in a convenient spot away from engine heat and vibration. Includes bulkhead mounting nut. Connect to your engine using a standard 4AN brake hose (sold separately).

1/8-27 NPT Female to 4AN Bulkhead Mount Adapter Part No. 3208-02-04S ... \$9.99

In-Line AN Adapters with 1/8-27 NPT Female Port

These aluminum fittings are most often used to connect an electric fuel pressure sender (or our Part No. 2542 Fuel Sampling Test Port) to a fuel system that has been plumbed with braided steel racing hose. We offer a variety of fitting sizes and configurations.



6AN Male to Male Straight Adapter with 1/8 NPT port Part No. 1069-6AN \$12.79
6AN Male to Female Straight Adapter with 1/8 NPT port Part No. 1069-06MF \$10.99
8AN Male to Male Straight Adapter with 1/8 NPT port Part No. 1069-8AN \$17.99
8AN Male to Female Straight Adapter with 1/8 NPT port Part No. 1069-08MF \$11.49
10AN Male to Male Straight Adapter with 1/8 NPT port Part No. 1069-10AN \$19.99
10AN Male to Female Straight Adapter with 1/8 NPT port Part No. 1069-10MF \$21.45
6AN Male to Male 90° Elbow with 1/8 NPT port Part No. 3228-305-06 .. \$14.99
8AN Male to Male 90° Elbow with 1/8 NPT port Part No. 3228-305-08 .. \$17.99
10AN Male to Male 90° Elbow with 1/8 NPT port Part No. 3228-305-10 .. \$21.99

High-Pressure Gauge Isolator Kit

This gauge isolator kit allows the use of a mechanical pressure gauge while keeping dangerous fuel and hot fluids out of the cockpit. The isolator mounts in the engine compartment, and a 4 foot 4AN hose (included) filled with an antifreeze solution safely transmits pressure to the gauge. This kit will work with most gauges that can be adapted to accept 4AN fittings. Working pressure is 200psi, with a 300psi maximum peak. Compatible with gasoline, oil, and antifreeze. Not compatible with alcohol or nitromethane fuels.



High Pressure Gauge Isolator Kit Part No. AM5282 \$154.95
Caution: Do not use with alcohol or nitromethane fuels.

In-Line Electric Fuel Pumps and Accessories

Facet Solid-State Electric Fuel Pumps

We stock many different models of high-performance **Facet** electric fuel pumps for carbureted engines. These economical and rugged pumps have a proven track record of reliability and are popular with professional racing teams around the world. For moderate fuel requirements of engines up to about 150 horsepower, a single Cube-Style pump is usually sufficient. For higher volume requirements, we offer the high-performance Cylindrical pumps. Both types keep the fuel cool to prevent vapor

lock and improve performance. Both have low power requirements (about 1 amp at 12 volts) and operate without troublesome seals or diaphragms. Internal pressure relief valves prevent flooding after shut-off. The Cylindrical pumps (formerly "Interrupter" pumps) now have solid-state internals instead of points for even greater reliability. Both types are compact, with two-bolt mounting for easy installation. All Facet fuel pumps are negative ground.



Facet Cube-Style Fuel Pump
Only 2.43 inches high
Part No. 1103

Facet 12 Volt* Fuel Pumps								
Pump Type	Max. Pressure psi	Typical Flow gallons/hour	Max. Flow gallons/hour	Fitting Size	Facet Part No.	Pegasus Part No.	Price	Common Name or Other Notes
Cube-Style	1 to 2	3 @ 0.5 psi	7	1/8 NPT female	40177	FAC-40177	\$79.99	
Cube-Style	2.5 to 4.5	15 @ 1 psi	28	1/8 NPT female	40104	FAC-40104	\$49.99	
Cube-Style	4 to 7	15 @ 3 psi	32	1/8 NPT female	40106	FAC-40106	\$49.99	FF1600
Cube-Style	4 to 6	15 @ 3 psi	32	6AN male	40108	FAC-40108	\$58.99	FF1600
Cube-Style	9 to 11.5	15 @ 5 psi	32	1/8 NPT female	40185	FAC-40185	\$62.99	
Cylindrical	4 to 5	23 @ 2 psi	36	1/8 NPT female	476087	FAC-476087	\$97.99	"Silver Top"
Cylindrical	6.5 to 7.5	35 @ 2 psi	45	1/4 NPT female	480534	FAC-480534	\$102.99	"Blue Top"
Cylindrical	6 to 8	35 @ 3 psi	45	1/4 NPT female	480532	FAC-480532	\$101.99	"Red Top"
Cylindrical	2.75 to 4	10 @ 2 psi	34	1/8 NPT female	477060	FAC-477060	\$97.99	low pressure (Onan RV Gen.)



High-Performance Cylindrical Fuel Pump
Only 5.37 inches long
Part No. 1105

*For many more models of Facet cube-style and cylindrical fuel pumps, please call or visit our website. We also offer several other types of Facet fuel pumps, including the quiet and economical Posi-Flo series, the self-priming Dura-Lift series, and 24 volt cube-style and cylindrical pumps for marine use.

All Facet Cube-Style, Cylindrical, Posi-Flo, and Dura-Lift pumps are compatible with gasoline, alcohol blends (up to and including E85), diesel, biodiesel, and fuel additives.

• Electric fuel pump tips •

1. Fuel pumps push more efficiently than they pull. Always mount the pump as close to the tank and as low as possible.
2. Bigger is not always better. A fuel pump that is much too large for the application can aerate and overheat the fuel, damaging performance.
3. To estimate fuel demand in gallons per hour for 4-stroke engines, divide horsepower output by 10. For example: a 110 HP engine will consume about 11 GPH at full throttle.
4. Negative-ground pumps can often be installed in positive-ground cars. Please visit our website for illustrated instructions.

We can often help identify an existing Facet pump based on the part number on the original pump. Facet part numbers are always stamped on the mounting flange of Cube-Style and Cylindrical pumps (see photo below). The part number is never printed on a label. You will need to remove the mounting bolt to see the part number.

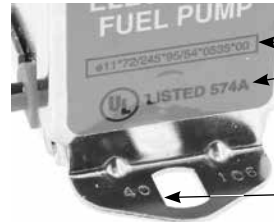

Ignore all numbers printed on the label (these numbers appear on every Facet pump)

Look for a 5-digit or 6-digit number with 2 to 3 digits on either side of the mounting hole (usually hidden by a bolt head)

Electric Fuel Pump Accessories



Left: Inertia Activated
Part No. 1108

Right: Oil Pressure Activated
Part No. 1109



Fuel Pump Cut-Off Switches Automatically cut power to your electric fuel pump to reduce the fire hazard in case of an accident. Use with any electric fuel pump.

Inertia Activated Fuel Pump Cut-Off Switch Part No. 1108 \$59.99
Cuts power following a heavy impact (10 to 12 G's). Push button reset.

Oil Pressure Activated Fuel Pump Cut-Off Switch Part No. 1109 \$29.99
Cuts power when oil pressure drops below 12 psi. 1/8 NPT male threads.

Fuel Pump Mounting Kit Includes two rubber shock mounts, lock nuts and ground strap. Provides quieter operation and isolates the pump body from the chassis to allow the use of a negative-ground pump in a positive-ground installation.



Fuel Pump Mounting Kit Part No. 1130 \$11.49



Mechanical Fuel Pump Block-Off Plate For converting from a mechanical pump. This plate fits many different engines including FF1600 (does not fit Ford 2.0L SOHC Pinto engine). Includes gasket.

Mechanical Fuel Pump Block-Off Plate with Gasket

Part No. 1131 \$2.09

Facet Fuel Filters

Replacement Fuel Filters for Cylindrical Pumps



74 Micron Filter Element only (most common)
Part No. FAC-479729 \$5.49

400 Micron Filter Element with Gasket
Part No. 1132 \$9.99
For Facet pumps 40053, 40133, 40159, 40220, and 480534.



Metal Thread-On Fuel Filter This 74 micron filter has a 3/16" inlet barb. The 1/8 NPT male outlet threads right into the inlet port of many Facet pumps. Compact metal housing measures 3/4" OD with a 1 5/16" hex.

Metal Thread-On Fuel Filter Part No. 1120 \$5.29

Clear Fuel Filters These 74 micron filters have a clear polymer body for easy inspection. The body on all versions measures 2 1/8" OD x 2 1/16" Long. To minimize the length they add to your pump, the threaded inlet is positioned deep inside a recess which fits over the inlet spigot on Facet Cube-Type and Posi-Flo pumps. In-line versions with hose barbs at each end are also available.



Inlet Type to Outlet Type	Part No.	Price
3/16" Hose Barb to 1/8 NPT Male	FAC-43175	\$11.49
3/8" Hose Barb to 1/8 NPT Male	FAC-43178	\$11.49
1/2" Hose Barb to 1/8 NPT Male	FAC-43176	\$11.49
SAE J0244 Male to 1/8 NPT Male	FAC-43177	\$11.49
3/16" Hose Barb to 3/16" Hose Barb	FAC-43400	\$9.49
1/4" Hose Barb to 1/4" Hose Barb	FAC-43419	\$9.49

Aeromotive Fuel Filters



Left: Aeromotive Remote Fuel Filter, Part No. AEI-12308

Below: Aeromotive In-Line Fuel Filter, Part No. AEI-12379



High-flowing **Aeromotive Fuel Filters** are available in either Remote (cannister) style or compact In-Line style. The 10 micron filters should only be used after the fuel pump. The 100 micron filters flow well enough to be used on the suction side of the pump.

10 Micron Remote Filter, 3/8 NPT AEI-12308 \$97.99
100 Micron Remote Filter, 3/8 NPT AEI-12318 \$133.99
100 Micron In-Line Filter, 8AN AEI-12379 \$143.33
Please see our website for more configurations, as well as for replacement elements.

AIR & FUEL DELIVERY

In-Tank Electric Fuel Pumps and Accessories

In-Tank Electric Fuel Pumps

Low Pressure In-Tank Fuel Pump
Part No. FS FPLP



We offer several different 12 volt in-tank electric fuel pumps to cover a wide variety of applications.



High Pressure In-Tank Fuel Pump
Part No. FS FPHP

Bosch 979 Fuel Pump
Part No. 1124-101



Bosch 044 Fuel Pump
Part No. FS FP044



Aeromotive
A1000 Fuel Pump
Part No. AEI-11101

In-Tank Fuel Pump Specifications

Pump Type	Inlet	Outlet	Max. Flow GPH	Typical Flow	Part No.	Price	Comments
Low Pressure	Sock Filter	3/8" barb	35	20 GPH @ 2 psi	FS FPLP	\$220.99	Includes sock filter
High Pressure	Sock Filter	5/16" barb	70	51 GPH @ 60 psi	FS FPHP	\$239.99	Includes sock filter
Bosch 979 (FP165)	M14 x 1.5	M12 x 1.5	60	53 GPH @ 40 psi	1124-101	\$299.99	US F2000, Star Mazda
Bosch 044 (FP200)	M18 x 1.5	M12 x 1.5	79	53 GPH @ 72 psi	FS FP044	\$229.99	See below for inlet filters and outlet adapters
Aeromotive A1000	-10 (7/8-14) ORB	-10 (7/8-14) ORB	150	115 GPH @ 45 psi or 140 GPH @ 8 psi	AEI-11101	\$411.99	For carbureted or fuel injected, blown or NA

Accessories for Bosch 044 Fuel Pumps

The Bosch 044 pump has a proven track record of reliability as OEM equipment on many high-performance vehicles. It's now the go-to high-output racing fuel pump.

6AN Male Banjo Outlet Adapter Kit for stock check valve ..Part No. 3275-059 \$31.99

This banjo fitting kit fits over the stock outlet check valve assembly (valve not included).

8AN Male Outlet Adapter with Integral Check ValvePart No. FS ILPCV08... \$175.99

This adapter replaces the stock outlet check valve.

-10 ORB Female Outlet Adapter for stock check valvePart No. 3275-051 \$54.99

This adapter screws onto the stock outlet check valve assembly (valve not included).

Rubber-Lined T-Bolt Mounting ClampPart No. AEI-12702..... \$19.94

Sock Inlet Filter Kit for Bosch 044 PumpPart No. 1124-050..... \$44.99

This 31 micron sock filter is only used when the pump is mounted in the tank.

Male AN Inlet Filter Kit for Bosch 044 PumpPart No. 3275-052-Size-M18 ... \$82.99

120 micron screen filter can be used in-tank or in-line. Specify 4AN, 6AN, 8AN, or 10AN.

See page 94 for many more metric to AN adapters for the inlet and outlet!

In-Tank Surge Tanks



Surge Tank with 6AN
Male Fitting
Part No. 2538-6AN



Surge Tank with Aeromotive
Stealth 340 Fuel Pump
Part No. FS ST100-HPA



Lightweight Surge Tank
Part No. FS ST110

These **Surge Tanks** mount inside your fuel cell to trap fuel around the pickup to prevent starvation. Being able to get the last bit of fuel in your cell allows you to run a lower fuel level for less weight. Surge tanks can even help with weight transfer due to fuel slosh. One-way inlet valves on 3 sides let fuel flow in but not out.

Surge Tank with 6AN Male Fitting Part No. 2538-6AN..... \$229.99

Surge Tank with 8AN Male Fitting Part No. 2538-8AN..... \$229.99

Surge Tank with Aeromotive Stealth 340 Pump..... Part No. FS ST100-HPA..... \$539.00

The rigid plastic surge tanks above measure 6" x 6" x 4" high with 3 one-way ball valves.

Lightweight Surge Tank, no pickup..... Part No. FS ST110 \$132.99

This semi-rigid tank measures 5.4" x 5.4" x 5.8" high with 3 plastic flapper doors.

obp Motorsport FST In-Line Surge Tanks

FST series fuel surge tanks from obp Motorsport are easy to install in just about any fuel system because they require no modification to your fuel tank. You can even use your stock

in-tank pump to feed the pump inside the FST tank. The FST series are designed to interchange with similar pump clusters from Fuelab, Protec, and the Aeromotive "Stealth" Series.

2.0L FST Tank with single 340 LPH pump Part No. OBP-FST20..... \$469.99

2.0L FST Tank with dual 340 LPH pumps..... Part No. OBP-FST21..... \$599.00

2.6L FST Tank with single 200 LPH pump Part No. OBP-FSTB1..... \$519.00

2.6L FST Tank with single 340 LPH pump Part No. OBP-FST30..... \$479.99

2.6L FST Tank with dual 340 LPH pumps..... Part No. OBP-FST31..... \$619.00

2.0L FST Tank only (no pump cluster)..... Part No. OBP-FST185..... \$189.99

The 2.0L FST tank measures 125mm OD x 200mm High (internal height 185mm).

2.6L FST Tank only (no pump cluster)..... Part No. OBP-FST240..... \$204.99

The 2.6L FST tank measures 125mm OD x 255mm High (internal height 240mm).

FST Pump Cluster only, Single 200 LPH pump..... Part No. OBP-FST03..... \$329.99

The 200 LPH pump cluster will only fit the taller 2.6L tank. It is too tall for the 2.0L tank.

FST Pump Cluster only, Single 340 LPH pump..... Part No. OBP-FST01..... \$279.99

FST Pump Cluster only, Dual 340 LPH pumps..... Part No. OBP-FST02..... \$429.99



obp FST pump clusters have five -6 (9/16-18) O-ring ports for inlet, outlet, and return

obp 2.6L FST tank only
Part No. OBP-FST240

obp FST Pump Cluster,
Single 200 LPH pump
Part No. OBP-FSTB1

obp FST Pump Cluster,
Single 340 LPH pump
Part No. OBP-FST01

Aeromotive Fuel Pressure Regulators

Aeromotive fuel pressure regulators are the most accurate and dependable we have ever found. Each one uses its own proprietary needle and seat design for more consistency

and less pressure creep than other brands. The quality is evident from the outside, with anodizing (not heavy plating) over beautifully machined (not cast) aluminum housings.

1.5 to 5 psi Dead-Head Carb Regulator, -6 O-Ring Ports AEI-13222 \$191.00

Perfect for Weber, Solex, and Mikuni carburetors that demand less than 3 psi!

5 psi to 12 psi Dead-Head Carb Regulator, 3/8 NPT Ports AEI-13205 \$115.99

Ideal for hard-launching carbureted drag cars that tend to leave the fuel behind.

30 to 70 psi Bypass EFI Regulator, -6 O-Ring Ports AEI-13129 \$146.99

Suitable for most modern EFI systems.

3 to 60 psi Bypass Universal Regulator, 3/8 NPT Ports AEI-13301 \$160.55

This ultra-flexible regulator can be used in most carbureted or fuel injected applications.



1.5 to 5 psi Carb
Part No. AEI-13222



5 to 12 psi Carb
Part No. AEI-13205



30 to 70 psi EFI
Part No. AEI-13129



3 to 60 psi Universal
Part No. AEI-13301

Fuel Safe Racing Fuel Cells and Accessories

Ultra-durable **Fuel Safe Pro Cells** are designed to exceed the requirements of nearly all sanctioning bodies including SCCA. The FIA-FT3 certified bladder is constructed of ballistic nylon fabric, impregnated and twice coated with fire retardant polyurethane elastomers. This super-tough construction results in a bladder with 3540 psi tensile strength, 218 lb. tear strength and 245 lb. puncture resistance. Polyurethane safety foam baffling is installed to suppress explosions. All of the complete cells shown below are furnished with a standard fill plate (not remote) with rollover valve, a 6AN fuel pickup, and an 8AN vent with built-in check valve. Other configurations such as 8AN pickups are readily available.

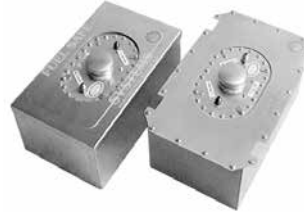

Left: Aluminum containers have tops that slip over bottom like a shoe box. Mounting straps are usually used to hold the top in place. A top bolt flange similar to the steel cell is available by special order.

Right: Steel containers have a bolted flange at the top. The top plate is bolted to the lower portion.

In 2006, Fuel Safe changed the sizes of a number of their cells. Those listed in the table below with "pre '06" and "'06+" in the size column were affected by this change. The '06+ sizes are now standard. Please be aware when ordering replacement parts for older cells.



Special bladders such as those required for formula car or vintage applications can be quoted. An accurate, detailed, dimensioned drawing must be sent. The drawing must also show the location and type of filler, pickup, and vent. Allow 6 to 8 weeks for delivery.



Capacity in Gallons	Size in Inches L x W x H	Complete Cell with Steel Container	Complete Cell with Aluminum Container	Bladder and Foam Only	Foam Baffling Only	Steel Container Only	Aluminum Container Only
8 gallon	20.1 x 12.1 x 8.6	2501-08-STL \$899.00	2502-08-ALU \$979.00	2505-08 \$659.00	2506-08 \$99.99	2508-08-STL \$265.99	2509-08-ALU \$341.99
10 gallon	25.6 x 10.1 x 10.1	2501-10-STL \$944.00	2502-10-ALU \$1,019.00	2505-10 \$679.00	2506-10 \$119.99	2508-10-STL \$284.99	2509-10-ALU \$356.99
12 gallon	pre '06: 20.1 x 17.1 x 9.1 '06+: 20.75 x 17.88 x 9.5	2501-12-STL \$999.00	2502-12-ALU \$1,079.00	2505-12 \$739.00	2506-12 \$139.99	2508-12-STL \$295.99	2509-12-ALU \$371.99
15 gallon	pre '06: 24.6 x 17.1 x 9.1 '06+: 26 x 17.88 x 9.5	2501-15-STL \$1,039.00	2502-15-ALU \$1,109.00	2505-15 \$754.00	2506-15 \$157.99	2508-15-STL \$316.99	2509-15-ALU \$409.00

Fuel Safe Wedge Fuel Cells for Formula Cars



Pro Cell for Reynard FF/FC
Part No. FS CB300

Please visit our website for full dimensions on these wedge cells.



Enduro Cell, Wide Shoulder with Shifter Notches
Part No. FS CB401

These semi-custom wedge cells from Fuel Safe fit some of the most common formula car applications. The CB300-series cells feature the same construction as the Pro Cells above. The CB400-series cells are constructed using the economical rotary-molding techniques perfected on the Enduro Cell line. Both types are fully FIA-FT3 certified and SCCA legal.

Fuel Safe Pro Cells	Part No.	Price
Reynard FF/FC, Right Filler	FS CB300	\$659.00
16" W x 15" L x 9" H Wedge, Right Filler	FS CB301	\$619.00
Crossle 35F/40F/45F, Center Fill Nipple	FS CB302	\$659.00
Crossle 35F/40F/45F, Center Bolt-On Filler	FS CB303	\$659.00
14" W x 17" L x 9" H Wedge, Right Filler	FS CB304	\$659.00

Fuel Safe Enduro Cells	Part No.	Price
Wide-Shoulder Wedge w/Shifter Notches, Left Filler	FS CB401	\$599.00

Metal enclosures available separately. Please see our website for full dimensions on all of these wedge cells.

Fuel Safe Accessories



Corner Pickup Fitting
Part No. 2521-3/8



In-Line Check Valve
Part No. 3216



8AN 90 Degree Bulkhead Fitting with Check Valve, Part No. FS ITVV08-90



Fuel Level Gauge
Part No. AM2641



12 inch Sender
Part No. FS SU12-0-90



Economy Dipstick Gauge (bulkhead fitting detail)
Part No. 2536-24

Standard Fuel Cell Pickup Add a second pickup to a cell by drilling an extra hole in the fill plate. Kits include a bulkhead union, 2 feet of hose, and fittings.

3/8 inch Fuel Pickup (6AN) with filter screen	Part No. 2520-3/8	\$79.99
1/2 inch Fuel Pickup (8AN) with filter screen	Part No. 2520-1/2	\$87.99
Sock Filter Only for 6AN Pickup (3/8 inch barb)	Part No. FS FS38	\$22.49
Sock Filter Only for 8AN Pickup (1/2 inch barb)	Part No. FS FS12	\$33.99

Corner Pickup Fitting Replaces the filter end of the standard pickup and allows more fuel to be used. However, it does not have any provision for attaching a filter screen.

3/8 inch Corner Pickup Fitting Only (no hose).....Part No. 2521-3/8..... \$59.99

2 Gallon Fuel Foam Block, 8 x 8 x 8 Inches Use to replace deteriorated fuel cell foam. Can be trimmed and used as replacement foam for custom or formula car cells. See above for replacement foam baffling kits for standard rectangular fuel cells.

2 Gallon Fuel Foam Block, 8 x 8 x 8 inches.....Part No. 2541..... \$68.99

Fuel Vent Check Valves These valves allow air into the cell but close off when turned upside-down to prevent fuel spillage in a rollover. We offer in-line valves for installation in the vent hose as well as bulkhead fittings for installation in the fuel cell fill plate.

In-line Check Valve, push-fit in 3/8" ID or 8AN hose	Part No. 3216	\$25.99
In-line Check Valve, male 8AN fittings each end	Part No. FS ILVV08	\$109.99
In-Line Pressure Relieving Check Valve, male 6AN	Part No. FS TPV6	\$179.99

This vent valve is normally closed to prevent vapors from escaping. It opens to let air in at 0.08 psi. It opens to relieve pressure in the tank at 0.725 psi.

6AN Bulkhead Vent Fitting w/ Check Valve	Part No. FS ITVV06	\$64.99
6AN Bulkhead Vent Fitting w/ Check Valve, Sprung	Part No. FS ITVV06S	\$64.99
8AN Bulkhead Vent Fitting w/ Check Valve	Part No. 2522	\$64.99
8AN Bulkhead Vent Fitting w/ Check Valve, 90 Degree	Part No. FS ITVV08-90	\$99.99

Fuel Displacement Blocks If your fuel cell holds more fuel than you need to finish a race, you are carrying extra weight. One extra gallon of fuel adds about 6 pounds! These lightweight hollow blocks take up space to reduce the fuel capacity of the cell. They make it easy to put less fuel in the cell without having to measure the fuel level or the amount of fuel being added. Simply fill the cell to the top as you normally would.

1/8 Gallon Displacement Block	Part No. FS DB025	\$29.99
1/2 Gallon Displacement Block	Part No. FS DB050	\$46.99
1 Gallon Displacement Block	Part No. 2539	\$92.99

Fuel Level Senders and Gauges

Fuel Cell Fuel Level Senders These unique senders are designed specifically for use in racing fuel cells. They are fully enclosed, which makes them very rugged and dependable. They are not affected by baffling foam or by acceleration or cornering forces. All sizes will work with any GM-compatible ('65 and up GM, 0 - 90 ohm range) gauge including Part No. AM2641 shown above. Other ohm range senders are also available by special order to work with other gauges. Note: These senders cannot be shortened. Please see our website for more length options.

8" Fuel Level Sender	Part No. FS SU08-0-90	\$101.99
12" Fuel Level Sender	Part No. FS SU12-0-90	\$101.99
Fuel Level Gauge, 2 1/16" diameter	Part No. AM2641	\$52.99

Economy Dipstick Fuel Level Gauge If you don't need to monitor your fuel level during the race, this dipstick is a convenient, economical alternative. The dipstick is built into an 8AN fitting for mounting in the most crowded fill plate. It is stored in the fuel cell, so you'll never have to go hunting for it. Universal 24 inch stick can be cut to any length.

Economy Dipstick Fuel Gauge, 24 inch	Part No. 2536-24	\$58.99
--------------------------------------	------------------	---------

Fuel Cell Accessories



Remote Fill Plate
Part No. 2510



45° Remote Fill Valve
Part No. 2514



Standard Fill Plate
Part No. FS SF6x10E



Recessed Fender Filler
Part No. 2515



Remote Filler with
Aircraft Style Flush Cap
Part No. FS A36NS2



2 1/4" ID Filler Hose, 45° Elbow
Part No. FSH-E45-2.25

Fuel Cell Fill Plates, Gaskets, and Hardware

Remote Fill Plate Allows the cell to be filled from a remote location.

Remote Fill Plate, 8AN pickup, 8AN check valve vent. Part No. 2510 \$184.99
6x10 oval, 24-bolt plate. Requires 5 1/2" round, 12-bolt fill valve (sold separately).

Remote Fill Valve Accepts a hose from a remote filler. A flapper-type check valve minimizes fuel loss even if the filler hose is torn from the cell.

45° angled Remote Fill Valve for 2 1/4" Hose Part No. 2514 \$209.99

Standard Fill Plate No provision for a remote filler, so you must have direct access to the fuel cell for filling. Includes a threaded filler cap and a flapper valve on the filler neck.

Standard Fill Plate, dual 8AN p/u, 8AN check valve vent . . Part No. FS SF6x10E. . . \$284.99
This plate is drilled for a fuel level sending unit (sold separately); includes a blanking plate).

Gaskets and Hardware

6 x 10 inch Oval Gasket, 24 Bolt (standard fill plate) Part No. 2526 \$23.49

4 x 6 inch Oval Gasket, 12 Bolt (compact fill plate) Part No. 2527 \$20.49

5 1/2" OD Round Gasket, 4 3/4" 12 Bolt Circle (fill valve) Part No. 2525 \$20.49

Bolt and Washer Kit, 12 bolts and 12 nylon washers Part No. 2532 \$28.99

Nylon Sealing Washer only, each Part No. 2529 15¢

Fill Plate Holding Tab, each Part No. 2528 \$1.19

These tabs keep the fill plate from falling down below the top surface of the container.

Remote Fillers and Accessories

Remote Fillers Mount in the fender for convenient filling from outside the car. Requires a remote fill plate and remote fill valve (sold separately at left).

Recessed Fender Filler with 1/4-Turn Cap, for 2 1/4" hose . . Part No. 2515 \$189.99

Replacement Cap with Lanyard for Recessed Filler Part No. 2518 \$54.99

Recessed Remote Fender Filler Kit Part No. 2516 \$271.99

Includes #2515 fender filler, 2 feet of hose, 2 feet of aluminum tubing, and 4 hose clamps.

Remote Filler only with Aircraft Style Flush Cap. Part No. FS A36NS2. \$284.99

Accepts both 2" and 2 1/4" hose. 3" round bolt circle.

Remote Filler Hose Connects your remote filler to your remote fill valve. Our flexible silicone rubber hose has a single layer of fabric reinforcement and a fuel-resistant inner liner. Black only. For low-pressure applications only.

2 1/4" ID Straight Filler Hose, 1 meter Part No. FSH-SHL-2.25 . . . \$141.99

45° Elbow, 2 1/4" ID Part No. FSH-E45-2.25 \$51.99

90° Elbow, 2 1/4" ID Part No. FSH-E90-2.25 \$51.99

1 1/2" ID Straight Filler Hose, 1 meter Part No. FSH-SHL-1.50 . . . \$97.99

45° Elbow, 1 1/2" ID Part No. FSH-E45-1.50 \$36.99

90° Elbow, 1 1/2" ID Part No. FSH-E90-1.50 \$36.99

Straight Reducer, 2 1/4" to 1 1/2" ID Part No. FSH-SR2.25-1.50 . . . \$92.99

Redhead Push-Pull Refueling Valves



Female Receptacle Valve
Part No. RHV-PP20FRM



Male Probe Valve
Part No. RHV-PP20M

Redhead Refueling Valves We stock genuine Redhead Push-Pull valves, originally designed for quick and safe refueling of Indy cars. The Female receptacle mounts on the vehicle and gets connected to the remote fill valve on your fuel cell. The Male probe attaches to your dump can or fuelling rig. When pushed together, both valves open to allow up to 2 gallons per second of spill-free fuel flow. When pulled apart, both valves close automatically to stop the flow instantly.

Note: We stock only the original Redhead brand. These are *not* interchangeable with some of the other brands on the market. Do not attempt to mate a Redhead valve with any other brand!

Redhead 2" Male Probe Valve Part No. RHV-PP20M \$324.99

Connects to your dump can or fueling rig outlet with 2.25" ID hose (sold separately).

Redhead 2" Female Remote Receptacle Valve Part No. RHV-PP20FRM \$299.99

Connects to your fuel cell inlet using 2.5" ID hose (sold separately). Mounts to your bodywork with a 5.75" OD undrilled aluminum mounting flange.

Redhead 2" Female Tank-Mount Receptacle Valve Part No. RHV-PP20FTM \$227.99

Mounts directly in your fuel cell with a 9 x 4" bolt circle (5mm bolts). Requires 3.25" deep recess in the foam.

Redhead Dual 2" Male Probe Valves, 4.5" (114mm) centers Part No. RHV-PP20DVM4.5 \$799.00

Two RHV-PP20M probes mounted in an oval "basket" handle, spaced 4.5" center-to-center.

Note: A tighter 100mm (3.9") spacing is also available. Please measure your receptacle spacing before ordering!

Redhead Dual 2" Female Receptacle Valves, 4.5" centers Part No. RHV-PP20DVR4.5 \$799.00

Two RHV-PP20FRM receptacles mounted in a 16-bolt oval plate. Designed for mounting to the bodywork.

Rebuild Kit for Redhead 2.0" Male Probe Valve Part No. RHV-PRK \$26.99

Rebuild Kit for Redhead 2.0" Female Receptacle Valve Part No. RHV-RRK \$62.99

Each kit rebuilds one valve. Rebuild kits are compatible with gasoline only.

Redhead 1.25" Male Compact Probe Valve Part No. RHV-PP125M \$329.99

Connects to your dump can with 1.5" ID hose (not included).

Redhead 1.25" Female Compact Receptacle Valve Part No. RHV-PP125FRM \$319.99

Connects to your fuel cell inlet using 1.5" ID hose (not included). Mounts to your bodywork with a 3.75" OD undrilled aluminum mounting flange.

Hunsaker QuikFill Dump Cans

Dump Cans For the fastest refueling without a fueling tower, dump cans are the way to go. They are used in virtually every racing series where refueling rigs are not allowed in pit lane. Hunsaker QuikFill plastic dump cans feature a long, large-diameter vent "chimney" that doubles as a carrying handle. The patented 3-step neck has 1.25" OD threads to accept a cap (included). For quicker fueling, cut the threaded section off and use the non-threaded 2.25" OD portion (perfect for adding a Redhead refueling valve with 2.25" ID hose, both sold separately). For maximum flow, cut the neck all the way down to the 3" OD portion. The vent chimney has a 1 3/8" threaded cap to keep out dust and debris. The molded plastic jugs are available in three sizes, each measuring 12" square. Translucent white only.

Note: For off-road refueling use only. Not for use as a portable fuel container in states requiring spill-proof systems.

5 gallon QuikFill Dump Can, 25" tall. Part No. HUN-3005 \$49.99

8 gallon QuikFill Dump Can, 29" tall. Part No. HUN-3008 \$79.99

11 gallon QuikFill Dump Can, 37" tall. Part No. HUN-3011 \$119.99

Hose Kits If you do not plan to add a Redhead Refueling Valve, we offer two different hose options for QuikFill dump cans.

1" Hose Kit for QuikFill Dump Can Part No. HUN-H100-HK \$19.99

Clear 16" long 1" ID hose has a threaded adapter to fit the 1.25" OD threads on the Hunsaker QuikFill jug. Includes a 1" to 3/4" OD reducer to fit unleaded filler openings.

2.25" to 1.5" Hose Kit for QuikFill Dump Can Part No. HUN-H225-150 \$38.99

Clear 16" long 2.25" ID hose clamps over the 2.25" OD neck on the Hunsaker QuikFill jug.

The 2.25" to 1.5" OD reducer fits common fuel cell filler openings.



Hunsaker QuikFill Dump Can
5 Gallon
Part No. HUN-3005



Hunsaker QuikFill Dump Can
8 Gallon
Part No. HUN-3008



Hunsaker QuikFill Dump Can
11 Gallon
Part No. HUN-3011



Left: 1" Hose Kit for
QuikFill Dump Can
Part No. HUN-H100-HK

Right: 2.25" to 1.5" Hose Kit
for QuikFill Dump Can
Part No. HUN-H225-150



Heavy-Duty Utility Jugs and Fluid Transfer Pumps

Heavy-Duty Utility Jugs and Accessories

There are many five gallon jugs on the market and though they may look similar, quality varies widely. Our square utility jugs are made to DOT Specification CFR 49, Part 178.19-6. This is a very tough specification that cannot be met by lightweight jugs. These jugs also exceed worldwide UN performance standards. The caps are heavy-duty, thick-walled construction with a 3/4 NPT pipe plug for hose attachment and a flat machined gasket sealing surface. Each jug measures 9 1/4" square x 22" high including the cap. These jugs are not to be used as a portable fuel container in states that require spill-proof systems or have spill-proof system regulations. Available in Red, translucent White, Blue, Yellow, or Green.

5 gallon Square Utility Jug, specify colorPart No. 2558-Color.... \$24.99

Accessories and Replacement Parts

- 18" Filler Hose with 3/4 NPT pipe thread (attaches to cap) ..Part No. 2565 \$8.49
- Replacement Cap Assembly only with gasket and plug....Part No. 2561 \$9.99
- This durable, heavy-duty cap will work on most jugs that use a 3.5" dia. thread.
- Replacement Cap Gasket OnlyPart No. 2562 \$3.29
- Replacement 3/4 inch Pipe Plug for capPart No. 2564 \$1.99
- Replacement Vent Cap Only for jugPart No. 2563 \$1.29

Cool-Fuel Jackets block radiant heat and reflect damaging UV rays to prevent degradation and keep your fuel up to 20° cooler. Sold individually.

- Cool-Fuel Jacket for Square 5 Gallon JugPart No. 2577-200..... \$36.47
- Note: Requires modification to fit our Scribner jugs.
- Cool-Fuel Jacket for Round 5 Gallon Jug (VP, Jaz)Part No. 2577-201..... \$36.47

None of the utility jugs shown on this page are to be used as portable fuel containers in states that require spill-proof venting systems. Compliance with local regulations is the responsibility of the user.



Funnels and Funnel Screens

Our sturdy, high-quality funnels are molded from the same polymer as our red utility jugs. We also offer a very fine 115 micron screen filter (sold separately) to clean your fuel as you pour.

- 8" Round Funnel, without screen (14" high)Part No. 2569 \$12.49
- 8" D-shaped Anti-Swirl Funnel, no screen (14" high).....Part No. 2570 \$13.79
- 14" D-shaped Anti-Swirl Funnel, no screen (17" high).....Part No. 2571 \$15.99
- 14" D-shaped Anti-Swirl Funnel, 45° neck, no screen (15" h)Part No. 2572 \$17.99
- 115 micron Filter Screen for above funnels.....Part No. 2575 \$6.29

Flo-Fast Fluid Transfer Pumps and Accessories

Save your back! **Flo-Fast Fluid Pumps** allow you to quickly and easily transfer fluids without straining or spilling. Simply screw the integral cap onto your utility jug and turn the crank. The clear 7 foot long filler hose has a long enough reach so that you won't have to lift the jug. A clamp-on tether is included to help to keep the hose in place while pumping. Pumps 5 gallons in 1 minute without spilling or straining — you can't pour that fast through a funnel!

Turn the crank backwards to draw fuel back out of your fuel cell after the race. Your cell bladder and foam baffling will last much longer if they are not continuously exposed to fuel. The potential savings in fuel cell replacement costs can pay for your Flo-Fast pump many times over! The pump is compatible with fuels, lubricants, water, and coolant — even most commercial cleaning fluids. (Viscous lubricants and fluids will pump more slowly than 5 gallons per minute.) **Note: Pump kits do not include jugs.**

- Flo-Fast 5 Gallon Fluid Extraction Pump onlyPart No. 2577-005 \$159.99
- Flo-Fast 15 Gallon Fluid Extraction Pump onlyPart No. 2577-015..... \$159.99
- Flo-Fast Combo 5 Gallon /55 Gallon Pump onlyPart No. 2577-010..... \$179.99
- Includes draw tubes to fit 5 gallon jugs and 55 gallon drums.

- Flo-Fast Pro Series 5 Gallon Pump only.....Part No. 2577-105..... \$209.99
- Flo-Fast Pro Series 15 Gallon Pump only.....Part No. 2577-115 \$209.99
- Flo-Fast Pro Series 5 Gallon / 55 Gallon Pump onlyPart No. 2577-110 \$239.99
- The Flo-Fast Pro Series pumps are built for the rigorous demands of professional use!
- Features a metal crank arm for increased strength, PTFE pump vanes for increased efficiency, dual shaft support bearings for increased service life, and dual shaft seals (PTFE and Viton) for increased resistance to corrosive fuels such as ethanol and methanol.

- Fold-Up Cart for Flo-Fast Pump Systems.....Part No. 2577-020 \$48.99
- Lightweight but strong (200 pound capacity) cart has large wheels to carry two 5-gallon jugs or one 15-gallon jug (sold separately) through the roughest paddock terrain.

- 15 Gallon Red Utility Jug for Flo-Fast SystemsPart No. 2577-030 \$89.99
- 15 Gallon Clear Utility Jug for Flo-Fast Systems.....Part No. 2577-031..... \$89.99
- 15 Gallon Blue Utility Jug for Flo-Fast Systems.....Part No. 2577-032 \$89.99
- Replacement Cap Only for above 15 Gallon Jugs.....Part No. 2577-041 \$8.99

- Filler Hose 5 foot Extension Kit for Flo-Fast Pumps.....Part No. 2577-050 \$14.99
- Combine with standard 7 foot filler hose for 12 foot total length.

- Extraction Wand for Flo-Fast PumpsPart No. 2577-040 \$11.99
- This 18" long tube clamps to the end of your filler hose to reach the bottom of your fuel cell. Simply crank the pump backwards to empty your cell for off-season storage.

Please see our website for many more Flo-Fast pump accessories.

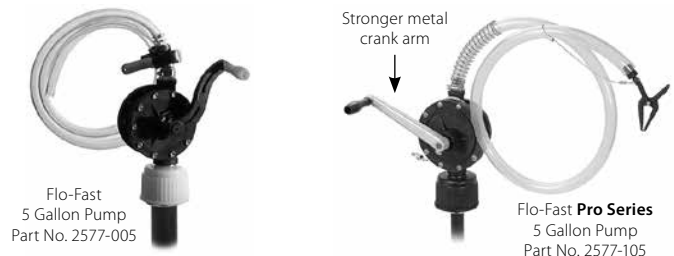

Please Note:
Flo-Fast pump systems do not include jugs or drums.



Left: 15 Gallon Clear Utility Jug Part No. 2577-031

Right: Fold-Up Cart for Flo-Fast Pump Systems Part No. 2577-020 (shown with 15 Gallon Jug, sold separately)



Floating Saddle Mounts



Above: Floating Saddle Mount Part No. 1825-100-Size



Above: Floating Saddle Mount shown installed on a chassis tube (T-Bolt clamps not included)

Put a mounting tab anywhere you want on a chassis tube with no welding required! Simply clamp a **Floating Saddle Mount** to your tube using two hose clamps (not included). The 1/8" thick chromoly tab is TIG-welded perpendicular to the 1/16" thick saddle (a bolt through the hole will be parallel to the tube). Generous gussets on both sides keep the tab upright. The 3/8" diameter hole is perfect for mounting control cables, but these mounts can be used in many other light-duty applications as well.

- Floating Saddle Mount for 1" OD Tubing Part No. 1825-100-1.000 \$35.99
- Floating Saddle Mount for 1 1/8" OD Tubing Part No. 1825-100-1.125 \$36.99
- Floating Saddle Mount for 1 1/4" OD Tubing..... Part No. 1825-100-1.250 \$36.99
- Floating Saddle Mount for 1 3/8" OD Tubing Part No. 1825-100-1.375..... \$36.99
- Floating Saddle Mount for 1 1/2" OD Tubing Part No. 1825-100-1.500 \$36.99
- Floating Saddle Mount for 1 5/8" OD Tubing Part No. 1825-100-1.625..... \$36.99

Warning: These mounts are very strong, but they are for mounting non-critical items only. They are **never** to be used for mounting suspension parts or driver restraints! The SCCA also specifically forbids the use of hose clamps for mounting window nets.

Custom-Made Throttle Cables

These throttle cables use a PTFE lined casing for long-wearing, smooth, low-friction operation and are covered by an extruded jacket. A 5/16-24 threaded bulkhead fitting is attached to each end of the jacket for maximum adjustment range. The inner cable is 1/16 inch diameter, 49 strand stainless steel aircraft cable with swaged 10-32 threaded studs at each end (8-32 and 1/4-28 studs are also available). Rated breaking strength of the cable is 400 pounds. These cables are for use in tension only. They are not meant for push-pull applications. A variety of fittings are available to adapt the 10-32 cable end to your carburetor or pedal assembly. **We just need three dimensions from you to complete the assembly: the jacket length, the inner cable length and the total travel required**

on the finished assembly. Please note that **the most critical measurement is the difference between the casing length and the inner cable length.** If this difference is too small, you may not get the required travel. The threaded fittings will give only about three inches of total adjustment so please measure carefully to avoid errors. We suggest either measuring your old cable or taking measurements on the car with the pedal held to the floor and the throttle held fully opened since this is the most critical adjustment position. **Be sure to allow for the fittings you plan to add to the cable ends** (see the listing below for length allowances for various ends). Mounting hardware is furnished. **Note:** It is neither necessary nor desirable to lubricate these PTFE lined cables!

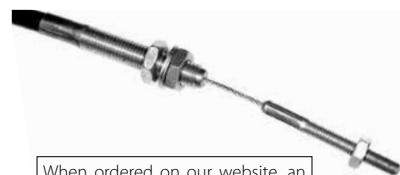
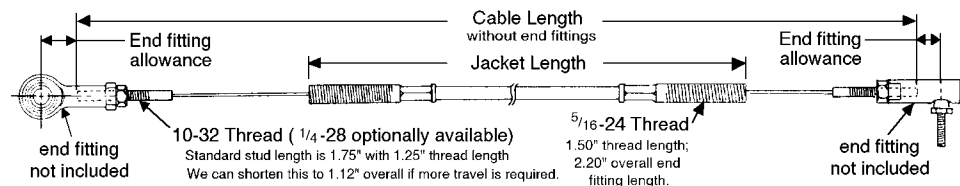

When ordered on our website, an interactive form will guide you and calculate maximum cable travel!!

Example: A 1270-Basic throttle cable with 54 inch inner cable and 44 inch jacket would cost \$55.99 + (44 x 21¢) = \$65.23

How to order a Custom-Made Throttle Cable

- Step 1. Based upon which ends are required on the inner cable, use the chart below to determine which basic part number to order.
- Step 2. Determine the proper measurements for the jacket and cable lengths.
- Step 3. Calculate the jacket length cost and add it to the basic Part No. price.

Custom-made items can not be returned for credit.

Cable Ends Terminated	Size of Cable Ends	Part No. of Complete Assembly	Base Price	Add 21¢ per inch of Jacket Length
2	10-32	1270-Basic	\$55.99	+ 21¢ per inch
2	1/4-28	1270-Basic2	\$61.99	+ 21¢ per inch
2 (1 of each)	10-32 1/4-28	1270-Basic3 (mixed ends)	\$58.99	+ 21¢ per inch
1	10-32	1270-Basic4	\$43.99	+ 21¢ per inch
1	1/4-28	1270-Basic5	\$46.99	+ 21¢ per inch
1	8-32	1270-Basic6	\$41.99	+ 21¢ per inch
0	none	1270-Basic7	\$31.99	+ 21¢ per inch
2	8-32	1270-Basic8	\$52.49	+ 21¢ per inch

* One end of the 1/16 inch diameter inner cable is not terminated on the Basic4, Basic5 and Basic6 versions. Neither end is terminated on the Basic7.

Carburetor Linkage Kit

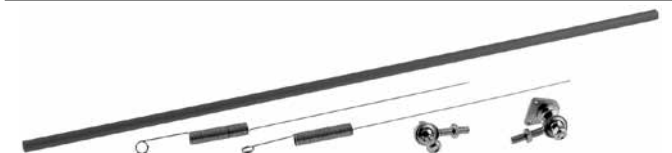

Easily forms to any front-engine car. Just bend to clear obstructions, cut to length and thread one end (requires a 1/4-28 tap). Complete with two rod ends, aircraft aluminum anodized tube, Holley Carb bushing, two return springs, bolts and nuts.

Carburetor Linkage Kit Part No. 4680 \$39.99

Individual Throttle Cable Parts

- 8-32 Cable Stud End (1.5" approx. overall length) Part No. 1271-2-Stud \$5.49
 - 10-32 Cable Stud End (1.8" approx. overall length) Part No. 1271-3-Stud \$6.99
 - 10-32 Clamp-On Cable Stud End (1.5" overall length) Part No. 1579-105 \$7.49
- This stud end can be installed in the field to finish or repair your cable.
- 1/4-28 Cable Stud End (2.1" approx. overall length) Part No. 1271-4-Stud \$9.99
 - 5/16-24 Brass Housing End (2.2" overall length) Part No. 1271-Ends \$6.49
 - Labor Charge to terminate one end fitting Part No. Termination \$4.79
 - Labor Charge to shorten one cable end stud Part No. 1270-Shorten \$1.99

Items below are priced per inch.

- 1/16 inch diameter Stainless Steel Cable, per inch Part No. 1271-Cable 7¢/in
- A 49 strand, aircraft quality flexible cable.
- Cable Housing, Unlined, per inch Part No. 1271-Housing 13¢/in
- PTFE Liner Tubing for above housing, per inch Part No. 1271-Liner 13¢/in

Throttle Cable End Fittings



Female Rod Ends These rod ends are made slightly loose so the cable can pivot freely on the pedal or carburetor linkage. A PTFE lined rod end can be too stiff for this application. The end fitting allowance to be used in determining cable length is shown below.

- 10-32 with 3/16 inch hole (.62" end fitting allowance) Part No. 1275 \$8.49
- Same as above with Left-Hand 10-32 female thread. Part No. 1272 \$8.49
- 1/4-28 with 1/4 inch hole (.75" end fitting allowance) Part No. 1279 \$8.99



Quick-Release Stud Type Ball Joints Choose either 10-32 or 1/4-28 threads. The male stud thread size matches the female body thread size. We also offer the 10-32 size in a fixed (non-QR) version.

- 10-32 Quick Release Ball Joint (.56" end fitting allowance) Part No. 1274 \$8.99
- 1/4-28 Quick Release Ball Joint (.56" end fitting allowance) Part No. 1033 \$9.29
- 10-32 Fixed type Ball Joint (.56" end fitting allowance) Part No. 1276 \$8.99



Forged Yoke and Clevis Pin This quality, high-strength fitting works well in many applications. A dimensioned drawing of this part is available on our website.

- 10-32 Forged Yoke and Pin Assembly Part No. 1273 \$14.49

Push-Pull and Vernier Control Cables

These heavy-duty cables are often used on adjustable sway bars. All have 3 inch maximum travel. Cable ends have 10-32 threads. The housing ends (except the vernier end) are grooved for easy clip-in attachment. The vernier control option eliminates the need for a special detent mechanism for input control. The vernier control moves the cable 3/16 inch for each full turn of the control knob. Depressing the button on the control allows rapid travel to either end of travel. Then just count turns to the desired setting. These cables have a working load rating of 60 pounds in compression and 120 pounds in tension.

Standard Push-Pull Cables, length measured end-to-end (see our website for many more lengths):

- 48" Standard Push-Pull Cable, 3" travel, 10-32 ends Part No. 3460-48 \$53.99
 - 60" Standard Push-Pull Cable, 3" travel, 10-32 ends Part No. 3460-60 \$58.99
 - 72" Standard Push-Pull Cable, 3" travel, 10-32 ends Part No. 3460-72 \$64.99
 - 84" Standard Push-Pull Cable, 3" travel, 10-32 ends Part No. 3460-84 \$69.99
 - 96" Standard Push-Pull Cable, 3" travel, 10-32 ends Part No. 3460-96 \$72.99
 - 108" Standard Push-Pull Cable, 3" travel, 10-32 ends Part No. 3460-108 \$75.99
- See page 144 for cockpit sway bar adjusters for these standard push-pull cables.

Vernier Control Cables, length measured panel-to-end (see our website for many more lengths):

- 48" Vernier Control Cable, 3" travel, 10-32 at output end Part No. 3462-48 \$97.99
- 60" Vernier Control Cable, 3" travel, 10-32 at output end Part No. 3462-60 \$98.99
- 72" Vernier Control Cable, 3" travel, 10-32 at output end Part No. 3462-72 \$101.99
- 84" Vernier Control Cable, 3" travel, 10-32 at output end Part No. 3462-84 \$104.99
- 96" Vernier Control Cable, 3" travel, 10-32 at output end Part No. 3462-96 \$107.99
- 108" Vernier Control Cable, 3" travel, 10-32 at output end Part No. 3462-108 \$110.99
- Replacement Vernier Control Head only (no cable) Part No. 3463 \$49.99
- Bolt down kit for grooved housing end with cable fitting Part No. 3464 \$16.99
- Quick release bracket for grooved housing end Part No. 3465 \$18.99

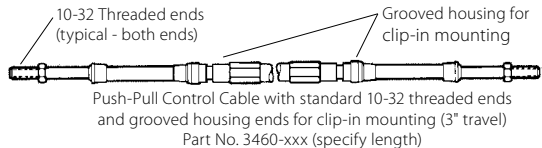

Push-Pull Control Cable with standard 10-32 threaded ends and grooved housing ends for clip-in mounting (3" travel)
Part No. 3460-xxx (specify length)

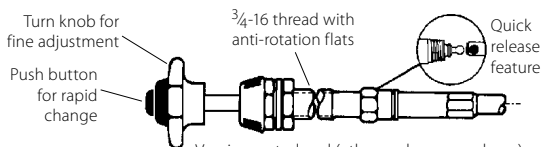

Vernier control end (other end same as above)
Part No. 3462-xxx (specify length)



Bolt-Down Kit for Grooved Housings
Part No. 3464

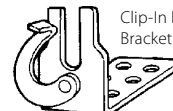

Clip-In Housing Bracket Part No. 3465

Sway bars can be difficult to adjust if the bar is heavily loaded and if the car is not moving. To minimize wear to the cable and vernier, avoid making adjustments under these conditions.

Foam Air Filters

ITG Foam Air Filters

ITG Megaflow Air Filters



JC20 Part No. 3817-020-xxx
 JC40 Part No. 3817-040-xxx
 JC50 Part No. 3817-050-xxx



ITG has been manufacturing high-quality foam air filters for all levels of motorsport since 1987. ITG Megaflow filters feature 3-stage foam to combine efficient filtration and very high dust holding capacity with excellent airflow. A heavily-soiled ITG Megaflow filter can outflow just about equivalent paper air filter! ITG Raceair filters are designed just for racing use, with 2-stage foam for even better airflow at the expense of filtration and dust holding. Both styles mount to the base plate with quick-release quarter-turn fasteners.

ITG Megaflow Series air filters feature 3-stage foam supported by a distinctive red band. The number after the slash indicates the internal height in millimeters (e.g., JC20/65 measures 65mm high inside; JC100/40 measures 40mm high inside). Filter elements are sold individually. Matching base plates are sold separately.

JC20 "Single Carburetor" measures 7.6" x 5.8":
 JC20/25, 50mm (2") tall Part No. 3817-020-25 \$62.99
 JC20/40, 65mm (2.6") tall..... Part No. 3817-020-40..... \$62.99
 JC20/65, 90mm (3.5") tall..... Part No. 3817-020-65..... \$62.99
 JC20/100, 125mm (4.9") tall Part No. 3817-020-100..... \$62.99
 Blank Base Plate only for JC20, aluminum..... Part No. 3817-021 \$22.99

JC30 "Dual-Throat Carburetor" measures 11.7" x 5.8":
 JC30/25, 50mm (2") tall Part No. 3817-030-25 \$86.99
 JC30/40, 65mm (2.6") tall..... Part No. 3817-030-40..... \$86.99
 JC30/65, 90mm (3.5") tall..... Part No. 3817-030-65..... \$86.99
 JC30/100, 125mm (4.9") tall Part No. 3817-030-100..... \$86.99
 Blank Base Plate only for JC30, aluminum..... Part No. 3817-031 \$21.49

JC40 "Small Twin Carburetor" measures 14.9" x 5.6":
 JC40/25, 50mm (2") tall Part No. 3817-040-25 \$124.99
 JC40/40, 65mm (2.6") tall..... Part No. 3817-040-40..... \$124.99
 JC40/65, 90mm (3.5") tall..... Part No. 3817-040-65..... \$124.99
 JC40/100, 125mm (4.9") tall Part No. 3817-040-100..... \$124.99
 Blank Base Plate only for JC40, aluminum..... Part No. 3817-041 \$23.99

JC50 "Large Twin Carburetor" measures 17.2" x 5.8":
 JC50/25, 50mm (2") tall Part No. 3817-050-25 \$133.99
 JC50/40, 65mm (2.6") tall..... Part No. 3817-050-40..... \$133.99
 JC50/65, 90mm (3.5") tall..... Part No. 3817-050-65..... \$133.99
 JC50/100, 125mm (4.9") tall Part No. 3817-050-100..... \$133.99
 Blank Base Plate only for JC50, aluminum..... Part No. 3817-004 \$23.99

JC100 "Multi Carburetor" measure 23.9" x 5.6":
 JC100/25, 50mm (2") tall Part No. 3817-100-25 \$249.99
 JC100/40, 65mm (2.6") tall..... Part No. 3817-100-40 \$249.99
 JC100/65, 90mm (3.5") tall Part No. 3817-100-65 \$249.99
 JC100/100, 125mm (4.9") tall Part No. 3817-100-100..... \$249.99
 Blank Base Plate only for JC100, aluminum..... Part No. 3817-009 \$29.99



Above: ITG Megaflow JC90 Filter
 Part No. 3815
 Sold in pairs with base plates drilled for Weber IDA Triple

Below: ITG Raceair JC70 "Sausage" Filter
 Part No. 3817-070
 Sold individually with undrilled base plate



ITG Megaflow JC90 Kit for Weber IDA3 (Porsche 911) This complete kit includes two JC90 elements and two predrilled base plates. The red powdercoated steel base plates are drilled to fit 3-throat Weber 40 IDA3 and 46 IDA3 carburetors, typically fitted to early Porsche 911. JC90 filter elements measure 15" x 5.6" x 4.125" H.

JC90 Kit for Dual Weber IDA3..... Part No. 3815..... \$319.99/pair
 Complete kit includes 2 filter elements and 2 base plates. For genuine Weber carbs only.
 JC90 Filter Element only, each..... Part No. 3817-090 \$124.99/ea
 JC90 Base Plate only for Weber IDA3, each Part No. 3817-001 \$89.99/ea
 Pre-drilled to fit Weber IDA3 carburetor. Red powdercoated steel.

ITG Raceair JC70 "Sausage" This special 2-stage foam filter was originally developed for the Cosworth DFV Formula 1 engine, which makes it a natural choice for Cosworth BDA/BDD and similar racing engines. It can be used on twin dual-throat carburetors or four throttle bodies. The distinctive rounded "sausage style" filter measures 19.8" x 5.3" x 3.3" H. Includes an undrilled aluminum base plate.

JC70 Raceair with Blank Base Plate, each..... Part No. 3817-070 \$254.99
 Includes undrilled aluminum base plate. Sold individually.

Parts and Accessories for ITG Filters

Quarter-Turn Fastener for all Megaflow Series..... Part No. 3817-003 \$12.99/ea
 Clip-On Receptacle for Megaflow Base Plate Part No. 3817-002 \$2.99/ea
 JC20 filters use 1 fastener. JC30 uses 2. JC40, JC50, and JC90 use 3. JC100 uses 4.

Rock Oil Factory Eco Foam Air Filter Oil Part No. 3818-001 \$14.99
 ITG filters are supplied dry and must be oiled prior to use. This water-soluble oil has been found to protect ITG foam filters better than other brands. 400ml aerosol spray can.

AIR & FUEL DELIVERY

Pipercross Air Filters for Formula Ford 1600, F2000, and S2000



Left: Pipercross PX300 Filter Kit for Weber 32/36 DGV Part No. 1265-001 Includes Filter Element (Part No. 1265-002) and Base plate (Part No. 1265-003)



Pipercross PX400 Filter for Weber 32/36 DGV Part No. 1265-005 Includes foam base gasket and hold-down O-rings

Pipercross Air Filters have been used on winning vehicles at all levels of motorsports. The 3-layer foam traps and holds more dust and dirt than other filter media. This filters air more thoroughly while also allowing longer service intervals. These filters draw air through the top as well as the sides for maximum airflow. The foam can be deformed if needed to fit within tight bodywork.

We offer two different styles of Pipercross filters to fit the Weber 32/36 DGV in Formula Ford 1600 and F2000/S2000 applications:

The **Pipercross PX300** filter is designed to be cleaned and oiled when needed. The foam is supported by an inner wire mesh cage for strength and long life. The domed filter element gets mounted to an aluminum base plate with a single quarter-turn fastener.

Pipercross PX300 Air Filter Kit for Weber 32/36 DGV..... Part No. 1265-001 \$91.99
 Includes 7 1/2" Long x 6 1/2" Wide x 4 1/2" High PX300 domed filter element and base plate for Weber 32/36 DGV.
 Pipercross PX300 Air Filter Element only..... Part No. 1265-002..... \$65.99
 Pipercross PX300 Aluminum Base Plate only for Weber 32/36 DGV . Part No. 1265-003..... \$29.29
 Mounts parallel to the valve cover on FF1600 and F2000 engines. 7 1/2" Wide including hold-down tabs.

The economical **Pipercross PX400** filter is designed to be used dry and discarded when the engine is rebuilt. The plastic base plate is integrated into the filter and mounts to the carburetor with two O-rings (included). No inner wire support cage.

Pipercross PX400 Air Filter for Weber 32/36 DGV..... Part No. 1265-005..... \$49.99
 Measures 5 1/2" W x 7" L x 3 1/2" H. Mounts parallel to the valve cover on FF1600 and F2000 engines.

Universal Air Filter Foam Sheets

Top: Fine 65 PPI (Green)
 Part No. 1265-201
 Center: Medium 40 PPI (Red)
 Part No. 1265-202
 Bottom: Coarse 30 PPI (Black)
 Part No. 1265-203

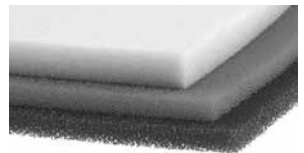

This foam is designed specifically for engine air filtration. It is ideal for making your own custom 3-stage air filter or for replacing the worn-out foam in an old filter. Cuts easily with scissors or a sharp knife. Use a flexible adhesive such as Hylomar HV-350 to glue the edges together.

The **Fine 65 PPI** foam is recommended for use alone or as the last (inner) layer of a multi-layer filter. It is a very close replacement for the old "Filtron" brand air filter foam. Full sheet measures 12" x 16" x 5/8".

Fine 65 PPI (Green) Part No. 1265-201..... \$13.99

The **Medium 40 PPI** can be used as the middle layer in a 3-stage filter, as the outer layer in relatively clean conditions, or as the inner layer in a racing-only filter. Full sheet measures 12" x 16" x 3/8".

Medium 40 PPI (Red) Part No. 1265-202..... \$13.99

The **Coarse 30 PPI** is recommended as the outer layer of a multi-stage filter. It can also be used as an outer wrap on an existing filter for very dusty conditions. Not recommended for use alone. Full sheet measures 12" x 24" x 3/8".

Coarse 30 PPI (Black) Part No. 1265-203..... \$14.99

Hylomar HV-350 Flexible Adhesive ..Part No. 3435-001 \$7.99

3.35 oz tube

Rock Oil Foam Air Filter Oil, 400 ml ..Part No. 3818-001 \$14.99

Air Filters and Carburetor Air Horns

K&N Filterchargers are constructed with a unique multi-layered washable cotton grid fabric that retains K&N air filter oil in suspension to trap dirt and dust without clogging air flow passages. The pleated fabric and bonded wire mesh straightens air flow and reduces turbulence – in some cases actually increasing air flow and horsepower.

K&N Cone-Style Racing Air Filters

Cone-Style Racing Air Filters These versatile filters were originally designed for use in air scoops of specific formula and sports racing cars. The large end is round but flexible enough that it can easily be formed into an oval shape to fit the inlet of most any scoop design. The small end has a hole to allow debris to pass through the scoop.

- 5.87" inlet dia. x 2" small end dia. x 10" L. (Lola S2000) ... Part No. 3801 \$71.99
- 5.87" x 2" x 8" (short version of above) Part No. 3802 \$64.99
- 5.50" x 2" x 16" (Tiga S2000) Part No. 3803 \$66.99
- 6.12" x 3" x 16" (83-85 Tiga S2000) Part No. 3804 \$80.99
- 4.87" x 2" x 16" (Ralt FA, Van Diemen Zetec F2000) Part No. 3805 \$55.99
- 5.75" x 2" x 16" (Swift S2000) Part No. 3806 \$66.99

Air Filter Assemblies for Specific Carburetors We stock these K&N custom filter assemblies for many common road race applications. All of these assemblies include a chrome plated top plate and replaceable elements (except for the VW Solex / FV clamp-mount type).

Weber DCOE plus some Mikuni/Solex/Dellorto These oval filters each fit one carburetor. The short (1.75" high) size is too short to allow the use of the stock air horns. The Small Oval version measures 4.5" x 7" and fits 40, 45, and 48 DCOE carburetors.

- Small Oval, Short, 4.5" x 7" x 1.75" high* Part No. 3810-1.75 \$84.99
- Small Oval, Tall, 4.5" x 7" x 3.25" high (fits stock airhorns) Part No. 3810-3.25 \$71.99

Weber 32/36 DGV, DGV5A, DGAV, DGEV & DPS These oval filters fit the Weber 32/36 DGV and variants as used on Formula Ford 1600 and F2000 / S2000 cars.

- Small Oval, Short, 4.5" x 7" x 1.75" high* Part No. 3812-1.75 \$98.99
- Small Oval, Tall, 4.5" x 7" x 3.25" high* Part No. 3812-3.25 \$98.99

* Note: The above part numbers mount **perpendicular** to the valve cover on the updated Formula Ford engine.

Solex 40 P11 (Porsche 356/912/914, air cooled Super Vee) These oval filters each fit one carburetor.

- Solex 40 P11 (Porsche 356, Super Vee), 5.5" x 9" x 3.25" high . Part No. 3816 \$102.99

VW Solex / Formula Vee These clamp-mount filters have a 2 1/16" ID flange to fit common VW Solex carburetors (including FV). These filters have a chrome end cap except where noted. The element is not replaceable.

- FV, 3 1/2" dia. x 4" high, rubber end cap Part No. KN RU-0500 \$40.99

Replacement Elements for Above Assemblies All of the above assemblies (except the VW Solex / FV clamp-mount filter above) have replaceable elements.

- Small oval element only, short, 4.5" x 7" x 1.75" high Part No. KN E-3321 \$34.99
- Small oval element only, tall, 4.5" x 7" x 3.25" high Part No. 3859-10 \$33.99
- Large oval element only, tall, 5.5" x 9" x 3.25" high Part No. 3859-04 \$45.99

K&N Filter Maintenance Supplies K&N filters are designed to be cleaned and re-oiled for up to a million miles of service.

- Filter Care Service Kit, 6.5 oz. spray oil, 12 oz. cleaner Part No. 3850 \$10.99
- Filtercharger Oil, 12 oz. aerosol can Part No. 3851 \$6.99
- Filtercharger Cleaner, 12 oz. pump spray bottle Part No. 3852 \$6.49

Carburetor Air Horns (Velocity Stacks)



- For 40 DCOE Part No. 3891
- For 45 DCOE Part No. 3892
- 48mm Flange Mount Part No. 3893
- For 1.75" SU Part No. 3894-01
- For Weber 32/36 DGV Part No. 3890

These beautifully machined aluminum air horns can improve air flow into the carburetor resulting in significant power improvements. Each size is designed and constructed to exacting standards for optimum flow in the shortest possible height, allowing them to out-perform cheap, mass produced stock air horns. Sold individually.

- Carburetor Air Horn for 40mm DCOE Part No. 3891 \$39.99

The 40 DCOE air horn has a 40mm throat ID and is mounted in a sleeve with a 45mm OD. Exposed height of the horn is only 20mm (.95") with an exponential radius.

- Carburetor Air Horn for 45mm DCOE Part No. 3892 \$36.99

The 45 DCOE air horn has a 45mm throat ID and is mounted in a sleeve with a 48mm OD. Exposed height of the horn is only 20mm (.95") with an exponential radius.

- Full Radius Carburetor Air Horn, 48mm, Flange Mount ... Part No. 3893 \$59.99

Fits 45-47mm DCOE, 45-48mm SK, 44mm Mikuni and 45-48mm Dellorto. This air horn has a 48mm throat ID and a two-bolt mounting flange with 65mm bolt spacing. Only 40mm (1.57") high including the flange.

- Full Radius Carb Air Horn for SU and Zenith-Stromberg .. Part No. 3894-01. \$69.99

Fits 1.75" SU and Zenith-Stromberg carburetors. Also fits the Hitachi clone of the SU (H56 and H6) on Datsuns.

- Carburetor Air Horn for Weber 32/36 DGV Part No. 3890 \$299.99

Dyno proven to increase horsepower. Requires removal of the choke assembly. SCCA legal for FF1600 and F2000 / S2000.

K&N makes over 1,000 different air filters and replacement elements. We stock the sizes that are most often used in road racing and will gladly order any size you may need. Additional sizes not shown here are available on our website. A replacement for almost any OEM application is available.



Left: Cone Filter for Lola S2000 (short version) Part No. 3802



Below: Cone Filter for Ralt FA, Van Diemen Zetec F2000, Part No. 3805



Filter Care Kit Part No. 3850



Filter Assembly for Weber 32/36 DGV Part No. 3813-3.25 Top and bottom view shown (sold individually)

K&N Breather Filters



Left: Part No. KN 62-2470



Right: Part No. KN 62-1340

These compact filters are great for all breather applications, from crankcases and oil tanks to transmissions. Each has a chrome end cap and a rubber flange at the base to clamp onto metal or rigid plastic tubing.

- K&N Breather Filter, 1 1/8" H x 1 3/8" OD, 5/16" ID flange ... Part No. KN 62-2470 \$21.49

- K&N Breather Filter, 1 1/2" H x 2" OD, 3/8" ID flange Part No. KN 62-1320 \$19.99

- K&N Breather Filter, 1 1/2" H x 2" OD, 1/2" ID flange Part No. KN 62-1330 \$20.49

- K&N Breather Filter, 1 1/2" H x 2" OD, 5/8" ID flange Part No. KN 62-1340 \$20.49

This size also fits the Longacre Roll Bar Mount Breathers shown on page 151 (Part No.'s 22564 and 22566).

- K&N Breather Filter, 2 1/2" H x 3" OD, 1 1/2" ID flange Part No. KN 62-1460 \$20.99

This size fits the Canton Breather Catch Tank shown on page 79 (Part No. 2583).

Custom Velocity Stack Air Filters



Left: Velocity Stack Air Filters Part No. 3894-57



Velocity Stack Air Filter for Weber 32/36 DGV Air Horn Part No. 3894-DGV



Velocity Stack Filters Part No. 3894-83 Four sets shown (velocity stacks and Hilborn injected 427 Ford engine not included)

These great-looking filters are constructed with a gauze filter layer sandwiched between two layers of stainless steel screen reinforcement. The silicone rubber base ring fits securely over conventional bell-mouthed air horns (not full-radius type). The super-low-profile design requires less than 1 inch clearance. Excellent for vintage applications.

- Velocity Stack Air Filters, 57mm (2 1/4"), per pair Part No. 3894-57 \$49.99

This size fits our #3891 air horn for the Weber 40 DCOE.

- Velocity Stack Air Filters, 64mm (2 1/2"), per pair Part No. 3894-64 \$49.99

This size is a slightly loose fit on our #3892 air horn for the Weber 45 DCOE. We recommend adding a small bead of silicone sealant if a tighter fit is desired.

- Velocity Stack Air Filters, 70mm (2 3/4"), per pair Part No. 3894-70 \$49.99

- Velocity Stack Air Filters, 76mm (3"), per pair Part No. 3894-76 \$55.99

- Velocity Stack Air Filters, 83mm (3 1/4"), per pair Part No. 3894-83 \$57.99

- Velocity Stack Air Filter, for 32/36 DGV, each Part No. 3894-DGV \$79.99

This size fits our #3890 air horn for the Weber 32/36 DGV.

Weber Calibrated Parts (see the following page for 32/36 DGV parts)

Carburetor Type	Main Jets	Air Jets	Accelerator Pump Jets	Emulsion Tubes	Idle Jets F6	Idle Jets F8	Idle Jets F9	Accelerator Pump Discharge Valve	Venturi	Needle Valve
40 DCOE	73401	77401	76801	61450	74819	74821	74822	79701	72302	1498
45 DCOE	73401	77401	76801	61450	74819	74821	74822	79701	72116	1498
48 DCOE	73401	77401	76801	61450	74819	74821	74822	79701	72136	1498
50 DCOE	73401	77401	76801	61450	74819	74821	74822	79701	72136	1498
55 DCOE	73401	77401	76801	61450	74819	74821	74822	79701	72136	1498
40 IDF	73401	77401		61450	74405			79701	71506	
44 IDF	73401	77401		61450	74405			79701	71507	
48 IDF	73401	77401		61450	74405			79701		
IDA Dual	73401	77401		61450				79701	72128	
IDA Triple*	1583	1584		1585	1587					



*Note: The 3-barrel IDA Triple (Porsche 911) carburetor uses the same jets and emulsion tubes as the Weber DGV on the next page.

New Complete Weber Carburetor Assemblies

New 32/36 DGV Carburetor	Part No. 1580-Stock	\$399.00
New 40 DCOE Carburetor, 40mm throat size	Part No. 40 DCOE	\$549.00
New 45 DCOE Carburetor, 45mm throat size	Part No. 45 DCOE	\$549.00
New 48 DCOE Carburetor, 48mm throat size	Part No. 48 DCOE	\$649.00
New 50 DCOE Carburetor, 50mm throat size	Part No. 50 DCOE	\$649.00
New 55 DCOE Carburetor, specify Left or Right	Part No. 55 DCOE-Side	\$699.00
New 40 IDF Carburetor, 40mm throat size	Part No. 40 IDF	\$469.00
New 44 IDF Carburetor, 44mm throat size	Part No. 44 IDF	\$469.00
New 48 IDF Carburetor, 48mm throat size	Part No. 48 IDF	\$499.00

Weber Repair Kits and Floats

"Old Style" repair kits include standard fiber gaskets and are suitable for all normally aspirated engines. "New Style" kits include rubber seals for increased resistance to blowout in forced induction applications. **Note: Repair kits do not include floats.**

DCOE Old Style Repair Kit-200 needle valve, no float	Part No. 92.1047.05	\$49.99
DCOE New Style Repair Kit-175 needle valve, no float	Part No. 93.0015.05	\$34.99

Replacement Floats for Weber Carburetors

DCOE Brass Float	Part No. 1497-Brass	\$29.99
DCOE Plastic Float	Part No. 1497-Plastic	\$24.99
IDF Plastic Float	Part No. 41030.008	\$21.99

Throttle Return Springs

Throttle Return Springs Our throttle return springs are precision-wound from high-quality music wire for consistent rate and long life. These are not generic hardware-store springs of unknown quality. Bright zinc plating looks good and prevents corrosion. Three sizes to choose from. Sold individually.

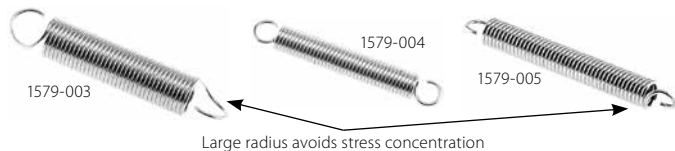

Throttle Return Springs

Part No.	Free Length	Coil OD	Wire OD	Rate (lbs/in)	Initial Tension	Max Length	Max Load	Price
1579-003	2"	3/8"	0.037"	2.0	0.850 lb	4.55"	5.8 lb	\$2.39
1579-004	1 3/4"	1/4"	0.034"	4.9	0.850 lb	2.96"	6.8 lb	\$2.39
1579-005	2"	1/4"	0.037"	6.7	1.0 lb	3.12"	8.0 lb	\$2.39

Vacuum Cap Kit



Vacuum Cap Kit Cap off unused vacuum port fittings on your carburetor or intake manifold with these flexible vinyl caps. They are also handy for plugging disconnected hoses and tubes in storage, and for covering the exposed ends of bolts. Each size is color-coded for quick identification. Full 20-piece kit includes 2 Black (1/8" ID), 6 White (3/16" ID), 6 Red (1/4" ID), 2 Blue (3/16" ID), and 4 Yellow (3/8" ID) caps.

Vacuum Cap Kit	Part No. 3990-001	\$7.49
----------------	-------------------	--------

Weber Calibrated Parts Chart (please specify size)

Description	Part No.	Available Sizes	Price
Main Jet	73401-Size	100-240 by 5's	\$6.49
IDA 3 Main Jet	1583-Size	115-210 by 5's	\$6.49
Air Jet	77401-Size	120-230 by 5's	\$6.99
IDA 3 Air Jet	1584-Size	130-210 by 5's	\$6.49
Accelerator Pump Jet	76801-Size	035-060 by 5's	\$13.99
Emulsion Tube	61450-Size	F2, F7, F9, F11, F16	\$21.99
IDA 3 Emulsion Tube	1585-Size	F6, F66, F50	\$18.99
Idle Jet, F6	74819-F6-Size	40-65 by 5's	\$6.39
Idle Jet, F8	74821-F8-Size	40-65 by 5's	\$8.99
Idle Jet, F9	74822-F9-Size	40-65 by 5's	\$6.99
IDF Idle Jet	74405-Size	35, 40, 45, 50, 60, 70	\$5.99
IDA 3 Idle Jet	1587-Size	45-80 by 5's	\$6.49
Pump Discharge Valve	79701-Size	000, 35, 40, 45, 50, 55, 60, 100	\$10.99
Venturi	72302-Size	28, 30, 32, 34, 36mm	\$26.49
Venturi	72116-Size	32, 34, 36, 38, 40mm	\$23.49
Venturi	72136-Size	40, 42mm	\$27.99
Venturi	71506-Size	30, 32mm	\$22.99
Venturi	71507-Size	34mm	\$23.99
Venturi	72128-Size	40, 42mm	\$25.99
Needle Valve	1498-Size	150, 175, 200, 250, 300mm	\$15.99



DCOE Heat Shield



Weber DCOE Stainless Steel Heat Shield This stainless steel heat shield fits both the 40 DCOE and 45 DCOE to shield the carburetor from radiant exhaust header heat in non-crossflow applications. Requires no modifications to the carburetor. Attaches using four existing screws in the bottom of the carb body. One required per carburetor; sold individually.

DCOE Stainless Steel Heat Shield, each	Part No. 3899	\$19.99
--	---------------	---------

Carburetor Jet Holder



Compact Jet Holder Easily store and organize up to 50 air and fuel jets. Accepts any brand or design of jets measuring up to 5/16" (0.315") diameter. Ten different slots keep different sizes separated. The unique twist cap dispenser design allows quick removal of just the sizes you need, while keeping the others tightly stored away. Translucent plastic construction lets you quickly identify any missing sizes. Measures 2" diameter by 1 3/4" high.

Compact Jet Holder	Part No. JET-HOLDER	\$39.99
--------------------	---------------------	---------

Stainless Steel Wire Cloth

The drawings below represent actual mesh size.

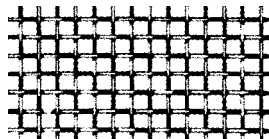

#10 Mesh
0.025" wire diameter
0.075" opening size
56% open area
Part No. 3640

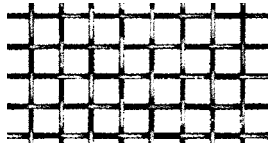

#6 Mesh
0.035" wire diameter
0.132" opening size
63% open area
Part No. 3641

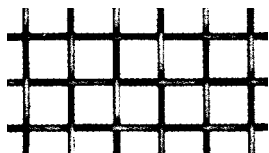

#4 Mesh
0.047" wire diameter
0.203" opening size
66% open area
Part No. 3642

This heavy-duty, corrosion-resistant woven material has many uses. The stainless steel wire cloth is excellent for protecting radiators, oil coolers, air intakes, lights, and the passenger compartment from debris such as stones, bolts or other road hazards. For larger panels or panels of any size that are in especially vulnerable positions, use the coarsest mesh. If you need to protect from larger, heavy objects as well as smaller, lightweight objects, you may want to combine more than one mesh in a sandwich. Fabricate it into just about any shape using standard sheet metal techniques. To make a rigid, self-supporting screen, the edge of the panel can be riveted into a sheet metal frame using a backup strip.

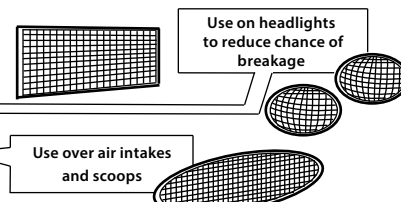

Type 304 Stainless Steel Wire Cloth:

Fine Mesh, 10 openings per inch, .025" wire, 12" x 18" sheet	Part No. 3640-12x18	\$11.99
Fine Mesh, 10 openings per inch, .025" wire, 18" x 24" sheet	Part No. 3640-18x24	\$17.99
Fine Mesh, 10 openings per inch, .025" wire, 24" x 36" sheet	Part No. 3640-24x36	\$29.99
Medium Mesh, 6 openings per inch, .035" wire, 12" x 18" sheet	Part No. 3641-12x18	\$12.49
Medium Mesh, 6 openings per inch, .035" wire, 18" x 24" sheet	Part No. 3641-18x24	\$18.99
Medium Mesh, 6 openings per inch, .035" wire, 24" x 36" sheet	Part No. 3641-24x36	\$34.99
Coarse Mesh, 4 openings per inch, .047" wire, 12" x 18" sheet	Part No. 3642-12x18	\$12.99
Coarse Mesh, 4 openings per inch, .047" wire, 18" x 24" sheet	Part No. 3642-18x24	\$19.99
Coarse Mesh, 4 openings per inch, .047" wire, 24" x 36" sheet	Part No. 3642-24x36	\$36.99

Weber 32/36 DGV Carburetors and Parts

Complete Weber 32/36 DGV Carburetors

Description	Part No.	Price
Stock 32/36 DGV Carburetor (see chart below)	1580-Stock	\$399.00

The stock carburetor is shipped with the following calibrated parts:

	Primary	Secondary
Main Jet	140	135
Air Jet	165	160
Idle Jet	55	50
Emulsion Tube	F50	F6

Farley Prepared 32/36 DGV Carb for Formula Ford 1600	1580-Prep-16	\$679.00
Farley Prepared 32/36 DGV Carb for Ford 2.0L (FC / S2000)	1580-Prep-20	\$679.00

Calibrated Parts for Weber 32/36 DGV Carburetors

Description	Part No.	Price
Main Jet, specify size (items 24 & 24-A in drawing)	1583-Size	\$6.49
Stocked sizes: 115 to 210 by 5's.		
Air Jet, specify size (items 79 & 79-A in drawing)	1584-Size	\$6.49
Stocked sizes: 130 to 210 by 5's.		
DGV Idle Jet, specify size (items 38 & 38-A in drawing)	1587-Size	\$6.49
DGAV Primary Idle Jet, specify size (item 38 in drawing)	74409-Size	\$6.39
Stocked idle jet sizes: 45 to 80 by 5's.		
F6 Emulsifying Tube, 14 holes near bottom	1585-F6	\$18.99
F66 Emulsifying Tube, 12 holes near top	1585-F66	\$12.99
F50 Emulsifying Tube, 16 holes even higher	1585-F50	\$12.99
(Emulsifying Tubes are items 78 & 78-A in drawing.)		

Other Parts for Weber 32/36 DGV Carburetors

Description	Part No.	Price
Rebuild Kit (includes 3 items listed below)	1588	\$26.99
Needle and Seat Assembly, 200 size	1586-18	\$16.99
Accelerator Pump Diaphragm Assembly	1586-36	\$12.99
Gasket Set	1582	\$12.99
Gasket set includes top cover gasket, paper base gasket, sealing washers, and O-rings.		
Phenolic Carb Spacer Plate with two gaskets (0.225" thick)	164-14	\$21.99
Thin Carb to Manifold Gasket only (approx. 0.032" thick)	1586-Gasket	\$3.49

The suffix on the following part numbers (1586-xx) are identified in the exploded view drawing shown to the left. Please see our website for more!

Top Plate Screw	1586-03	\$2.29
Weber Internal Fuel Filter Element	1586-11	\$5.49
Top Plate gasket	1586-13	\$5.29
Plastic Float	1586-20-Plastic	\$29.99
Brass Float	1586-20-Brass	\$49.99
Full Power Needle Valve Assembly	1586-21	\$14.49
Shaft Retaining Bushing	1586-25	\$3.49
Throttle Shaft Bearing Kit	1579-001	\$19.99
Prevents wear to the carburetor body and vacuum leaks. No machining required!		
Throttle Plate Screw, Stock (cheese head)	1586-31	\$1.99
Throttle Plate Screw, Low-Profile (button head)	1579-050	19c
Accelerator Pump Diaphragm Assembly	1586-36	\$12.99
Idle Jet O-Ring	1586-39	\$1.49
Idle Jet Holder, small size (item 40-A in drawing)	WC-52570.005	\$9.79
Idle Adjusting Screw	1586-56	\$4.29
Spring for Idle Adjusting Screw	1586-57	\$1.89
Washer for Loose Lever	1586-59	\$1.49
Bushing for Loose Lever	1586-62	\$4.49
Synchronous Throttle Linkage Kit	1579-002	\$49.99
Throttle Control Lever	1586-63	\$6.99
Secondary Return Spring	1586-64	\$2.49
Primary Shaft Nut	1586-65	\$2.59
Primary Shaft Lock Tab	1586-66	\$1.49
Loose Lever for Primary Shaft	1586-67	\$6.99
Accelerator Pump Jet Gasket, each	1586-80	\$1.49
Accelerator Pump Jet, Dual Outlet	1586-81	\$10.29
Accelerator Pump Delivery Valve Assembly	1586-82	\$8.39
Auxiliary Venturi (primary or secondary)	1586-83	\$27.99

Exploded view drawing of the Weber 32/36 DGV Carburetor (Some of the parts shown in this drawing are no longer available separately.)

Part No. 1586-xx

Above:
Synchronous Throttle Linkage Kit
Part No. 1579-002
Converts the progressive DGV carburetor to open the primary and secondary throttles together for better throttle response

Stock 32/36 DGV Carburetor
Part No. 1580-Stock

Antigravity Lightweight Lithium Batteries

Antigravity Batteries are lighter than conventional lead-acid batteries, but the lithium-ferrous technology delivers a huge burst of energy quickly for amazing cranking power! They do not self-discharge as fast as lead-acid batteries, which eliminates worries about maintenance charging during the off-season. They are also totally dry, so they cannot leak under any circumstances. These batteries are recommended for use with alternators only (**not for use in total-loss electrical systems**), but they make great jumper batteries for starting. Antigravity Batteries are made in the USA.

NOTE: Our lithium batteries can **only** be shipped via UPS Ground service. They cannot be shipped outside the 48 states.



Left: Antigravity Small Case Battery, 4 Cell
Part No. 1178-408
Measures 4.38 x 3.5 x 1.38", weighs 1 pound, delivers 120 cranking amps

Right: Antigravity OEM-Case YTX-12 Battery, 24 Cell
Part No. 1178-403
Same case size as a YTX-12 battery, but with 720 cranking amps and just 3.3 pounds



Antigravity Lithium Batteries									
Battery Type	CA Amps	Length Inches	Width Inches	Height Inches	Weight Pounds	Terminals	Pos. Term. Location	Part No.	Price
Small Case, 4 Cell	120	4.38	1.38	3.5	1.0	M6 Female	Right	1178-408	\$119.99
Small Case, 8 Cell	240	4.38	2.38	3.5	1.8	M6 Female	Right	1178-407	\$179.99
Small Case, 12 Cell	360	4.63	3.25	4.24	2.3	M6 Female	Right	1178-406	\$219.99
Small Case, 16 Cell	480	4.63	3.25	5.25	3.5	M6 Female	Right	1178-405	\$289.99
OEM YTX7-S, 8 Cell	240	4.5	2.75	4.5	1.9	M5 Bolt	Right	1178-410	\$179.99
OEM YTX-12, 24 Cell	720	6.0	3.4	5.13	3.3	M6 Female	Right	1178-403	\$399.99

Please see our website for many more sizes, including 16v and left-positive terminal versions!

12 Volt Lithium Battery Charger

Never use a lead-acid charger on your lithium battery! This charger is designed just for 12-volt lithium (LiFeP04 / LFP) batteries. The advanced multi-step charger tests and monitors battery condition before, during, and after charging. Fully automatic, with no programming required. Suitable for use with all of the 12 volt lithium batteries we carry.



12 Volt Lithium Battery Charger
Part No. 1178-430 \$115.99

Antigravity Micro-Start Personal Power Supply Kits



Left: Micro-Start SPORT
Part No. 1178-420-Black

Right: Micro-Start XP-10
Part No. 1178-424



Never get stuck with a dead battery again! These Micro-Start kits use lithium-ferrous technology to deliver enough power to jump start a V-8 engine or to recharge your cell phone or tablet. Each kit includes a Micro-Start, Smart Clamp jumper cables, assorted charging cords for popular electronics, and a carrying case.

Micro-Start SPORT Kit Part No. 1178-420-Color \$95.99
Measures 5" x 2.8" x 0.87" thick, delivers 300 peak amps. Specify White or Black.

Micro-Start XP-3 Kit Part No. 1178-422 \$119.99
Measures 5.2" x 3" x 1" thick, delivers 400 peak amps.

Micro-Start XP-1 Kit Part No. 1178-421 \$149.99
Measures 6.25" x 3" x 1" thick, delivers 400 peak amps.

Micro-Start XP-10 Kit Part No. 1178-424 \$199.99
Measures 9" x 3.5" x 1.25" thick, delivers 600 peak amps.

Varley Red Top® High-Performance Racing Batteries

The rugged **Varley Red Top®** batteries are specifically designed for the high shocks and vibrations of racing. They have the highest energy density of just about any battery available. Many race cars manufactured in England have battery compartments designed to accept these batteries and nothing else fits properly. These sealed, maintenance-free batteries resist leakage in any position, even if the outer casing gets damaged. All Varley batteries have M6 female terminals, with the positive terminal on the right side of the battery. **These batteries are considered non-hazardous freight and can be shipped by air or ground.**



Sealed 12 volt Varley Red Top® High-Performance Racing Batteries								
Battery Type	Capacity Amp-Hr.	CCA Amps	Length Inches	Width Inches	Height Inches	Weight Pounds	Part No.	Price
Red Top® 15	15 Ah	156	7.88	3.04	5.52	11.1	1175	\$279.99
Red Top® 20	20 Ah	185	6.93	3.31	5.12	10.9	1177-002	\$309.99
Red Top® 25	20 Ah	230	7.17	3.04	6.62	13.5	1177-003	\$284.99
Red Top® 30	27 Ah	450	9.85	3.82	6.15	19.9	1173	\$409.99
Red Top® 40	39 Ah	500	9.85	3.82	8.12	27.6	1174	\$519.00

Please visit our website for the full Varley Red Top line.

Varley Red Top® Battery Mounting Brackets



These sturdy aluminum brackets make it easy to mount your Varley battery. They are made by Varley specifically to fit Varley Red Top batteries without any modification required.

Bracket for Red Top® 15 Part No. 1177-102 \$69.99
Bracket for Red Top® 20 Part No. 1177-107 \$52.49
Bracket for Red Top® 25 Part No. 1177-103 \$55.49
Bracket for Red Top® 30 Part No. 1177-104 \$58.49
Bracket for Red Top® 40 Part No. 1177-105 \$63.99

Varley Red Top® 3-Stage Battery Charger



This 8 amp charger is designed for Varley Red Top® batteries, but it is perfect for any lead-acid battery we sell. Automatic 3-stage charging can charge a Red Top® 15 from zero to 95% capacity in less than 2 hours, yet is safe for long-term battery maintenance.

DMS/Varley Battery Charger Part No. 1177-050 \$184.99

High-Quality, Economical Recombinant Gas Sealed Racing Batteries

Recombinant Gas (RG) Sealed Racing Batteries use Glass Mat Technology (GMT) for leak-free operation in any position. The electrolyte is trapped in fiberglass separator mats so they won't leak even if cut in half. The rugged internal construction allows them to survive high-vibration environments much better than flooded batteries. Proper charging with an automatic charger can provide reliable service for one or more seasons of hard racing. Total-loss applications (without an on-board charging system) should use an auxiliary battery for starting in order to save the battery for the race. Batteries are load tested and fully charged before shipment. **These batteries are considered non-hazardous freight and can be shipped by air or ground.**

RG Sealed 12 volt Racing Batteries										
Capacity Amp-Hr.	CCA Amps	Length Inches	Width Inches	Height Inches	Weight Pounds	Terminals	Pos. Term. Location*	Part No.	Price	Comments
12 Ah	200	6.0	3.5	5.81	11.0	¼" Ring	Left	1169	\$107.99	FF and FC
15 Ah	265	7.87	2.99	4.84	11.4	M5 Bolt	Right	1172	\$179.99	Van Diemen & others
18 Ah	180	7.13	2.99	6.57	14.3	#10 Ring	Right	1170	\$89.99	FF and FC
33 Ah	275	7.75	5.19	7.31	25.5	¼" Ring	Left	1171	\$134.99	SCCA Spec Racer Ford

* Location of positive battery terminal when viewing the side of the battery with terminals closest to observer (see photos).

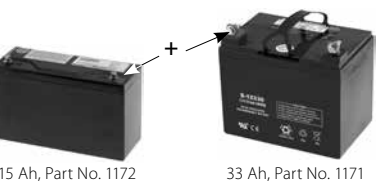
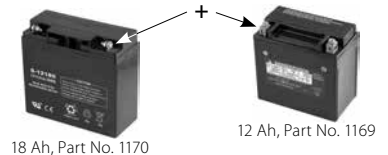

These sealed racing batteries are ideal for total-loss electrical systems in formula cars. Please visit our website for many more sizes!

Battery Connectors and Disconnects

Auxiliary Battery Connectors (Jumper Plugs)

Save your battery for the race by using an auxiliary battery for starting and warm-up! These heavy-duty connectors allow quick, reliable connection without the risk of reverse polarity. The Standard 175 amp size (3.1 x 2.1 x 1 inch) has terminals which accept up to 1/0 cable. Reducer bushings are available to adapt this size to our 4 gauge battery cable. The Compact 50 amp size (1.9 x 1.4 x .6 inch) accepts our 6 gauge cable. To assemble, crimp or solder the contacts to the battery cable and snap the contacts into the housing. Connectors are grey. **Both halves are identical** for optimum versatility.

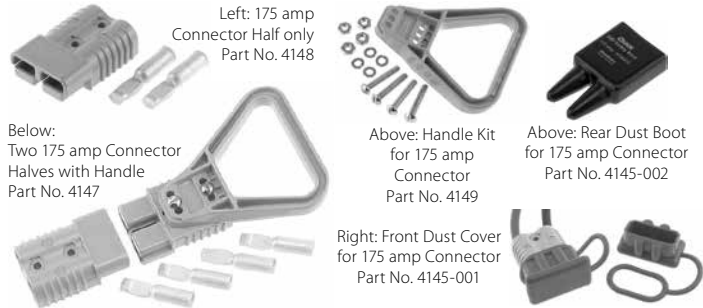

Standard 175 Amp Connectors, 3.1" x 2.1" x 1"	Part No.	Price
Two Connector Halves and Handle, 175 amp capacity.....	4147.....	\$29.49
Single Connector Half, 175 amp capacity (without handle).....	4148.....	\$14.99
Handle Kit for 175 amp connector (with mounting hardware).....	4149.....	\$6.89
Front Dust Cover for 175 amp connector.....	4145-001.....	\$6.49
Rear Dust Boot for 175 amp connector.....	4145-002.....	\$5.99
Reducing Bushing for 4 gauge cable (2 required per half).....	4156.....	\$3.59
Replacement Terminal only for 1/0 cable, each (2 required).....	4157.....	\$2.99

Compact 50 Amp Connectors, 1.9" x 1.4" x 0.6"	Part No.	Price
Single Connector Half, 50 amp capacity.....	4146.....	\$5.69
Handle Only for 50 amp connector (w/ mounting hardware).....	4145-005.....	\$2.49
Front Dust Cover for 50 amp connector.....	4145-004.....	\$2.19
Rear Dust Boot for 50 amp connector.....	4145-003.....	\$4.69
Replacement Terminals for 50 amp connector, pair.....	4145-006.....	\$3.99



Master Battery Cut-Off Switches

We carry the highest quality removable key master battery switches available!

If you're not sure if you have the genuine article or a lower quality clone, take a look at the main terminals. The terminals of our switches are plated with a tin-alloy which gives them a silver color. Lower quality clones have unplated brass terminals. Over the years we've heard about dozens of DNF's caused by unreliable master battery switches that were purchased elsewhere. Is saving a few dollars worth risking a DNF?

See the following page for terminal insulating boots

Removable Key Master Battery Cut-Off Switches

These top-quality switches may cost more than other brands but their quality sets them apart. Part No. 4430 has three sets of contacts for cars with alternators. The main contacts disconnect the battery while the auxiliary contacts disconnect the ignition coil and short the alternator output to ground through a 3 ohm resistor (included). Installation instructions are included. The single circuit cut-off switches are for vehicles without alternators. A removable actuating key and a weather-proof cap are furnished with both switches. Both use 3/8 inch ring terminals. See page 58 for terminal insulating boots.

Removable Key Cut-Off Switch with Alternator Protection.....	Part No. 4430.....	\$69.99
Removable Key Single Circuit Cut-Off Switch.....	Part No. 4431.....	\$39.99
Replacement Key (for either switch).....	Part No. 4433.....	\$15.49
Replacement Resistor for 4430.....	Part No. 4434.....	\$2.19
Mounting Tab for Removable Key Cut-Off Switches.....	Part No. 4375-001.....	\$3.99

This steel weld tab is pre-drilled to fit the above switches for easy installation on your roll cage.
Oversized 4" long x 3" wide at the peak allows you to trim to fit your application.



Lucas-Style and Hella Battery Cut-Off Switches

Many older cars were originally equipped with Lucas or Hella cut-off switches and nothing else fits properly. Only available in a single circuit configuration. Both use 3/8 inch ring terminals.

Lucas-Style Single Circuit Cut-Off Switch.....	Part No. 4436.....	\$99.99
Hella Single Circuit Cut-Off Switch with removable key.....	Part No. 4439-001.....	\$57.99

Longacre Battery Cut-Off Switches

These NHRA-legal switches from Longacre feature metal bodies and non-removable metal keys. The two-terminal switch is appropriate for cars running a total-loss electrical system. The four-terminal switch includes an alternator interrupt circuit for cars with alternators. When the switch is turned off, power from the alternator is cut off to prevent the alternator from feeding back into the ignition system. Wiring instructions are included. Both use 3/8 inch ring terminals.

Longacre 2-Terminal Battery Cut-Off Switch.....	Part No. LA45760.....	\$39.99
Longacre 4-Terminal Battery and Alternator Cut-Off Switch.....	Part No. LA4578.....	\$34.99
Longacre HD 4-Terminal Battery and Alternator Cut-Off Switch.....	Part No. LA45782.....	\$69.99

The HD version can handle 125 amps through the alternator terminals for one-wire alternators.

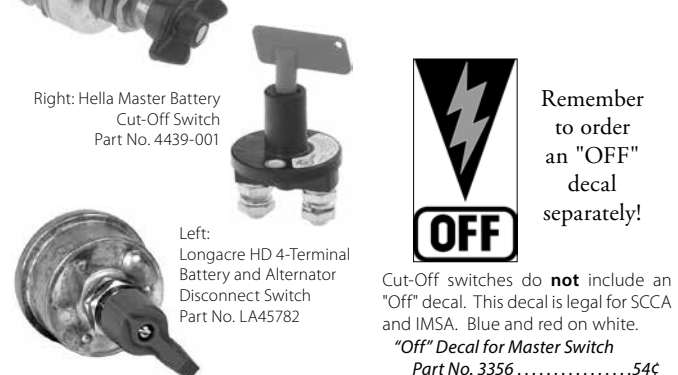

Cartek Solid-State Battery Isolators

You can eliminate long runs of heavy battery cable with a Cartek battery isolator. These solid-state switches are triggered by remote push button switches connected to the base unit using standard 16 gauge hookup wire. Any number of trigger switches can be added to comply with your rule book. Cartek battery isolators are made in England to meet FIA requirements.

The **Cartek GT Battery Isolator** is designed for sedans and prototypes with high-amperage electrical systems. Triggering the GT isolates the battery while also switching off a 30 amp circuit for ignition or fuel pumps. Maximum 450 amp battery circuit, 0.03 amp draw when off.

Cartek GT Battery Isolator with Blue Switches.....	Part No. 1068-107.....	\$379.95
--	------------------------	----------

The **Cartek XR Battery Isolator** is perfect for cars with pushbutton-start. Triggering the XR sends an "engine kill" signal to the ECU and then isolates the battery, giving the ECU time to shut down properly. Maximum 450 amp battery circuit, 0.1 mA draw when off.

Cartek XR Battery Isolator with Blue Switches.....	Part No. 1068-119.....	\$439.95
--	------------------------	----------

Additional Sealed Switch for either Cartek Isolator.....	Part No. 1068-110-Color.....	\$38.95
--	------------------------------	---------

Normally-Closed switches, sealed for use inside or outside the cockpit. Specify Blue, Red, or Yellow.



Battery Cables, Terminals, Insulating Boots, and Other Cable Accessories

6 Gauge and 4 Gauge Super Flexible Battery Cable



A large number of fine copper strands and a tough yet flexible jacket makes this the best battery cable available. The insulation is rated from -50°C to +105°C (-58°F to 221°F).

- 6 gauge Cable, Black, per foot.....Part No. 4036-FT.....\$1.49/ft.
 6 gauge Cable, Red, per foot.....Part No. 4038-FT.....\$1.49/ft.
 4 gauge Cable, Black, per foot.....Part No. 4032-FT.....\$1.99/ft.
 4 gauge Cable, Red, per foot.....Part No. 4034-FT.....\$1.99/ft.

Side and Top Post Battery Terminals



Solder-Type Top Post Terminal (left) is made of lead-plated solid brass and fits 4 or 6 gauge cable.

Bolt-On Terminals (right) are great for quick emergency repairs.



- Top Post Terminal, solder-type.....Part No. 4150.....\$6.49
 Top Post Terminal, bolt-on to cable.....Part No. 4153.....\$3.49
 For Side Terminal, bolt-on to cable.....Part No. 4154.....\$3.49

M6 Female Battery Terminal Adapter Kits



Many racing batteries now come with M6 female terminals, which can make installation tricky in production-based cars. These adapters make it easy to connect a racing battery with M6 female terminals in just about any application. Each kit is enough for one battery.



- M6 Female to GM Side Terminal Adapter Kit.....Part No. 4156-101.....\$26.99
 M6 Female to Brass Top Post Adapter Kit (above, left).....Part No. 4156-102.....\$13.99
 M6 Female to 3/8" Stud Adapter Kit (above, right).....Part No. 4156-103.....\$13.99
 M6 Female to 5/16" and 3/8" Stud Adapter Kit.....Part No. 4156-104.....\$27.99

Ring Terminals for 6 Gauge and 4 Gauge Battery Cable



These rugged terminals help to prevent fatigue failures in high-vibration environments. They can be crimped or soldered onto our battery cable. Made from high-purity copper with heavy-duty tin plating for excellent conductivity and corrosion resistance.

Ring Terminals for 6 Gauge Battery Cable:

- 6 Gauge #10 Stud Size.....Part No. 4139-3.....89¢
 6 Gauge 1/4" Stud Size.....Part No. 4139-4.....89¢
 6 Gauge 5/16" Stud Size.....Part No. 4139-5.....89¢
 6 Gauge 3/8" Stud Size.....Part No. 4139-6.....89¢
 6 Gauge 1/2" Stud Size.....Part No. 4139-8.....\$1.19

Ring Terminals for 4 Gauge Battery Cable:

- 4 Gauge #10 Stud Size.....Part No. 4140.....\$1.09
 4 Gauge 1/4" Stud Size.....Part No. 4141.....99¢
 4 Gauge 3/16" Stud Size.....Part No. 4142.....\$1.09
 4 Gauge 3/8" Stud Size.....Part No. 4143.....\$1.09
 4 Gauge 1/2" Stud Size.....Part No. 4144.....\$1.69

Battery Terminal Insulating Boots for 4 gauge Battery Cable



These large insulating boots will cover traditional top post or side terminals on automotive batteries. They can be folded back to allow a battery charger or jumper cables to be attached. Fits 4 gauge battery cable (0.4" insulation OD). Available in red or black. Sold individually.

- Battery Terminal Boot, Black.....Part No. 4151.....\$2.59
 Battery Terminal Boot, Red.....Part No. 4152.....\$2.49

Bolted Terminal Insulating Boots for 4 gauge Battery Cable



These boots work great on bolted cable connections such as on battery cut-off switch studs (as shown in photo) or on the through-panel bulkhead connector shown below. The boots are flexible enough so that they can be folded back to attach a charger or jumper cables. Sized to be a snug fit on 4 gauge battery cable (0.4" insulation OD). Available in red or black. Sold individually.

- Bolted Terminal Boot, Black.....Part No. 4435-Black.....\$2.49
 Bolted Terminal Boot, Red.....Part No. 4435-Red.....\$2.49

Battery Cable Through-Panel Bulkhead Connector



This insulated bulkhead connector allows you to safely run battery cable through your firewall. Prevents battery cable shorts where the cable passes through body panel. A double 3/8" stud assembly with a threaded plastic collar helps to insulate power from the surrounding panel. Mounts in a 1 1/4" diameter hole.

- Through Panel Connector.....Part No. 4570.....\$14.99

Seals-It Firewall Grommet Seals

Seals-It One-Piece Firewall Grommet Part No. 4336-001-Size



Seals-It Two-Piece Firewall Grommet Part No. 4336-005-Size

Seal the holes around hoses and wires to keep heat, fumes, and flame out of the driver's compartment. The one-piece seals can stretch around hose ends or wire harness plugs. The two-piece seals can be installed without disconnecting hoses or wires and feature a tab-and-slot design for a reliable seal. Available in 3/8", 1/2", 5/8", 3/4", or 1" ID, all with 3" OD aluminum mounting flange. Sold individually.

- Seals-It One-Piece Firewall Grommet, specify size.....Part No. 4336-001-Size.....\$17.79
 Seals-It Two-Piece Firewall Grommet, specify size.....Part No. 4336-005-Size.....\$29.79

Battery Cable Tools



These special tools make assembling new battery cables a breeze. Our **Battery Cable Cutter** (left) easily chops through stranded copper cable up to 2/0 gauge. Our **Battery Terminal Crimper** (right) lets you install ring terminals (such as our



Part Nos. 4139 through 4144 listed at left) with a single hammer blow. Both are made with pride in the USA.

- Battery Cable Cutter.....Part No. 4159-001.....\$24.99
 Battery Terminal Crimper.....Part No. 4159-002.....\$35.99

Battery Wrap and Battery Mounting

Battery Wrap Heat Barrier Kit



Prolong the life of your expensive battery by protecting it from damaging heat and vibration. Our **Battery Wrap Kit** includes one 8" x 12" and one 8" x 40" felt pad and one 8" x 40" aluminumized thermal barrier. The black felt material is treated to absorb and neutralize acid. The adhesive-backed heat barrier blocks conductive and radiant heat. The 8" x 12" felt pad goes underneath the battery. The 40" long felt pad and the heat barrier are wrapped around the battery to finish the installation.

- Battery Wrap Kit.....Part No. 1829.....\$35.05

Aluminum Battery Box



This very sturdy and secure box is perfect for mounting the battery in the passenger compartment (meets NHRA rules for sealed battery boxes). Measures 11.25" long x 9.50" wide x 8.75" tall. Three piece .040" aluminum construction allows easy access without removing battery from box. Fits a wide range of batteries including group 34/78 and 75/25 sizes. Includes all mounting hardware, battery hold-down, and vent hose.

- Aluminum Battery Box.....Part No. 4158-001.....\$124.99
 Also available as part of our Battery Relocation Kit at right.

Marine-Type Battery Box



A non-conductive battery box isolates the battery from the driver and from short-circuiting against metal components in the car. Our SCCA-approved **Marine-Type Battery Box** is made of sturdy black plastic to fit up to a group 24 size battery (nominal battery dimensions: 10 1/4" long, 6 13/16" wide, 8 7/8" high including terminals). Includes security strap.

- Standard Marine Battery Box.....Part No. 4155.....\$18.99

Battery Relocation Kit



Move your heavy battery where you want it for better weight distribution. Our complete **Battery Relocation Kit** includes everything you need.

- 2 feet of 4 gauge black battery cable, Part No. 4032
- 16 feet of 4 gauge red battery cable, Part No. 4034
- 1 Aluminum Battery Box, Part No. 4158-001
- 2 Top-Post Battery Terminals, Part No. 4150
- 4 Ring Terminals, 3/8" size, Part No. 4143

- Battery Relocation Kit.....Part No. 4158-050.....\$143.99

Weather Pack Sealed Electrical Connectors

The Weather Pack series of high-quality environmentally sealed automotive connectors is well proven in tough, long-term, real world street car applications. Self-lubricating silicone connector seals, cable seals, and cavity plugs exclude moisture, dust, dirt, and a variety of automotive chemicals to ensure a reliable electrical connection. Heat stabilized polyamide housings combined with the heat resistant silicone seals withstand the high temperatures and harsh conditions of a vehicle's engine compartment. With a positive snap latch and hinged, locking seal retainers, these connectors are immune to problems caused by extremely high shock and vibration environments.

- Available in 1, 2, 3, 4, and 6 terminal configurations.
- Rated to 16.0 volts and 20 Amps DC.
- Terminals available for 20 gauge to 10 gauge wire.
- Terminal seals available for wire insulation OD from 0.051" to 0.169".

Weather Pack Tower Connector Bodies Weather Pack connector bodies are not referred to as being male or female because you can use either male pins or female sockets in either half of the connector (or even mix pins and sockets in any combination). However, female terminals are usually used in these tower bodies.

Single Pin Tower Connector Body.....	Part No. 4185-001.....	79¢
Two Pin Tower Connector Body.....	Part No. 4185-002.....	79¢
Three Pin Tower Connector Body.....	Part No. 4185-003.....	89¢
Four Pin Tower Connector Body.....	Part No. 4185-004.....	99¢
Six Pin Tower Connector Body.....	Part No. 4185-005.....	\$1.19

Weather Pack Shroud Connector Bodies Male pin terminals are usually used in these shroud bodies.

Single Pin Shroud Connector Body.....	Part No. 4185-011.....	59¢
Two Pin Shroud Connector Body.....	Part No. 4185-012.....	59¢
Three Pin Shroud Connector Body.....	Part No. 4185-013.....	69¢
Four Pin Shroud Connector Body.....	Part No. 4185-014.....	79¢
Six Pin Shroud Connector Body.....	Part No. 4185-015.....	89¢

Weather Pack Terminals Male pin terminals are usually used in shroud bodies and female socket terminals are usually used in tower bodies. However, you can swap their position if desired. Spring tabs on either side of the terminal hold it firmly in place in the connector body.

Male Pin Terminal for 20 to 18 gauge wire.....	Part No. 4185-030.....	24¢
Male Pin Terminal for 16 to 14 gauge wire.....	Part No. 4185-031.....	29¢
Male Pin Terminal for 12 to 10 gauge wire.....	Part No. 4185-032.....	32¢
Female Socket Terminal for 20 to 18 gauge wire.....	Part No. 4185-040.....	24¢
Female Socket Terminal for 16 to 14 gauge wire.....	Part No. 4185-041.....	29¢
Female Socket Terminal for 12 to 10 gauge wire.....	Part No. 4185-042.....	32¢

Weather Pack Silicone Terminal Seals These seals not only exclude dirt and moisture, they also help to provide a strain relief for the wire. Note: The terminal insulation crimp must capture the terminal seal as shown in the photos below.

Seal for 0.051 to 0.067" insulation dia., Red.....	Part No. 4185-070.....	23¢
Seal for 0.062 to 0.085" insulation dia., Purple.....	Part No. 4185-071.....	15¢
Seal for 0.080 to 0.112" insulation dia., Green.....	Part No. 4185-072.....	32¢
Seal for 0.111 to 0.137" insulation dia., Grey.....	Part No. 4185-073.....	32¢
Seal for 0.136 to 0.169" insulation dia., Blue.....	Part No. 4185-074.....	34¢

Weather Pack Silicone Cavity Plug Any unused pins in a Weather Pack body should be sealed with one of these cavity plugs. You can fill a connector body with cavity plugs to make a dust cap to seal disconnected Weather Pack connectors.

Terminal Cavity Plug.....	Part No. 4185-090.....	34¢
---------------------------	------------------------	-----

Weather Pack Assortment Kit This 608-piece assortment includes 4 each of 2, 3, 4, and 6 pin tower and shroud bodies; 50 of each size male and female terminals; 50 of each size terminal seals; and 25 cavity plugs, all in a large plastic organizer box. A huge value!

Weather Pack Assortment Kit, 608 Piece.....	Part No. 3029-001.....	\$152.99
---	------------------------	----------

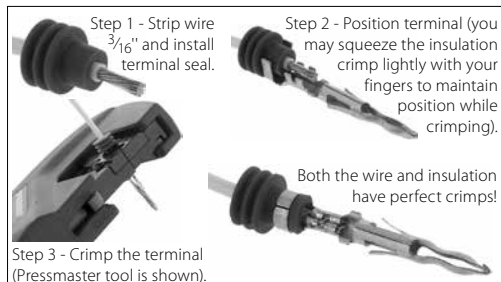

608-Piece Weather Pack Assortment Kit Part No. 3029-001



You can make your own dust cap by filling a connector body with cavity plugs.



Weather Pack Tools

Using the proper tools helps to ensure a reliable electrical connection and makes assembling your Weather Pack connectors quick and easy.

Weather Pack Terminal Extraction Tool



Use this handy tool to compress the locking tabs on either male pin terminals or female socket terminals to remove a wire and terminal from a connector body without damage.

Terminal Extraction Tool.....	Part No. 4185-093.....	\$10.99
-------------------------------	------------------------	---------

Pressmaster Crimp Tool Frame and Dies



Pressmaster Tool Frame Part No. 4185-094

Weather Pack Die Set Part No. 4185-095



The **Pressmaster** crimping system uses a universal squeezer frame that accepts a variety of die sets (sold separately) for crimping a wide variety of terminals. A ratcheting function ensures that every crimp is complete and uniform. The **Weather Pack die set crimps both the wire and insulation in a single operation!**

Pressmaster Ratcheting Squeezer.....	Part No. 4185-094.....	\$84.99
Weather Pack Die Set, 20 to 12 ga.....	Part No. 4185-095.....	\$169.99

Other Pressmaster Die Sets The Pressmaster crimping frame can accept a number of interchangeable dies to handle different types of electrical terminals.

Die Set for Insulated Terminals.....	Part No. 4185-096.....	\$53.99
For 22-14 gauge insulated terminals (red and blue terminals).		
Die Set for Non-insulated Terminals. Part No. 4185-097.....		\$53.99
For 22-10 gauge non-insulated terminals and splices.		
Die Set for Insulated Terminals.....	Part No. 4185-098.....	\$61.99
For 26-22 and 12-10 gauge insulated terminals and splices.		

Other Weather Pack Crimping Tools



Weather Pack Pro Crimping Tool Part No. 4185-099



Weather Pack Dual Action Tool Part No. 4185-150

These economical tools will crimp most sizes of Weather Pack terminals and cable seals. The **Pro Tool** requires two separate operations to crimp the terminal and the seal. Many professionals prefer the extra level of control this allows. The **Dual Action Tool** crimps both terminal and seal in one single operation. Both tools have a ratcheting function to ensure consistent, uniform crimps. For 20-14 gauge terminals.

Weather Pack Pro Crimping Tool.....	Part No. 4185-099.....	\$139.99
Weather Pack Dual Action Tool.....	Part No. 4185-150.....	\$119.99

Fuse Blocks for ATC Blade Type Fuses

These compact fuse panels are a great way to organize your wiring. They use standard ATC blade type fuses (not included) that are available at any auto parts store. The 10-32 input stud is rated for 150 amps. Each individual fuse position is rated for 30 amps. The output terminals are standard male push-on spades and accept standard female push-on terminals. We recommend using fully insulated terminals to avoid accidental shorts when working near the fuse block (our Part No. 4110, 4123 or 4135). Each fuse block has 4 recessed mounting holes that will accept a 10-32 mounting screw. The black thermoplastic housing is UL rated 94VO for flame resistance. The recommended temperature range is from -20 to 150°F.

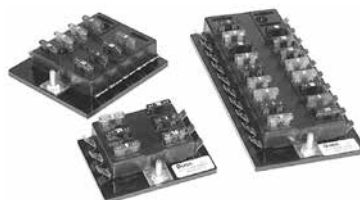

We stock these fuse blocks in 6, 10 and 20 circuit configurations. All are 3.37" wide. The lengths are given below. **Hint:** Choose a size that will leave a few spare circuits available for future additions to your electrical system.

6 position fuse block, 2.47" long	Part No. 4402-06.....	\$16.79
10 position fuse block, 3.72" long	Part No. 4402-10.....	\$20.49
20 position fuse block, 6.87" long	Part No. 4402-20.....	\$34.49

Starters, Relays, and Alternators

Tilton Super Starter® for Ford 1.6L and 2.0L



The Tilton Super Starter® is the closest thing to bulletproof that you can get. This gear reduction starter delivers greater torque and higher cranking speed, **and** draws less current! The pre-engaged pinion is easier on the flywheel than the original inertia-type starter, too. The three-bolt mounting flange is machined from solid aluminum billet. The housing can be clocked to three different positions on the mounting flange so the starter can clear obstructions. This allows its use on many chassis that use the Lucas starter. It will **not** fit '91 & later Van Diemen or most Reynards with the oil tank between engine and transaxle. Weighs 11.4 lbs.

- Super Starter® for Ford 1.6L / 2.0L.....Part No. 1165-002..... \$412.25
 - Replacement mounting flange.....Part No. 1158..... \$114.75
 - Replacement pinion assembly.....Part No. 1157-01..... \$80.75
 - Replacement solenoid.....Part No. 1156..... \$42.50
- Replacement solenoid includes spring and plunger.

XLT Starters for FF1600, Sports 2000, and FA

The compact and lightweight Tilton XLT starter fits many applications that can't be accommodated with the Super Starter® sold above. It fits Ford 4-cylinder engines with 110 tooth ring gears mated to Hewland Mk 5 and Mk 8/9 gearboxes (Formula Ford 1600, Sports 2000, and some vintage Formula Atlantic). The housing can be clocked to 15 different positions (24° increments) on the mounting flange to clear obstructions. Weighs only 6.9 pounds!



- XLT Starter for FF with Mk 8/9.....Part No. 1151..... \$505.75
 - Replacement mounting flange.....Part No. TE 54-530..... \$106.25
 - Replacement pinion assembly.....Part No. TE 54-5401..... \$191.25
 - Replacement solenoid.....Part No. 1159..... \$59.50
- Replacement solenoid includes spring and plunger.

50 Amp Ultra-Mini Alternator

This super-compact 12 volt alternator is suitable for use on virtually any formula car or sports racer. It weighs only 6 pounds and is compact enough to fit in the smallest engine bay. Despite its size, it still puts out 50 amps. That's enough power to run an engine management system, data acquisition, on-board video, even driving lights for endurance racing. The single-wire design is simple to hook up. Just ground the body through the mount and connect the wire to the positive side of your battery — no other electronics or relays needed! Can be safely driven up to 15,000 rpm. Includes 2.5" diameter V-belt pulley. Measures approximately 5.5" front-to-back and 4.5" wide (6.5" including mounting ears).



- 50 Amp Ultra-Mini Alternator, Single Wire.....Part No. 1177-501..... \$202.99

Lucas Starters

We stock Lucas inertia-type starters, factory rebuilt by Delco Remy. These starters will have either a 9 or 10 tooth pinion. Either pinion will work properly with standard 110 tooth ring gears as used on Ford 1.6L and 2.0L engines (FF1600 and Sports 2000) and other common racing applications. Both mounting flanges have bolt holes located on a 4 1/2" bolt circle.



- Lucas Starter, 2 bolt flange.....Part No. 1140..... \$169.99
- Lucas Starter, 3 bolt flange.....Part No. 1141..... \$179.99

Lucas Starter Relays

3-Terminal
Starter Relay
Part No. 1160-3



4-Terminal
Starter Relay
Part No. 1160-4

These quality, heavy-duty relays are standard equipment on most British race cars. The four-terminal version has an auxiliary switch contact to bypass a series ignition resistor during starting on cars that have a resistor in-line with the ignition coil.

- Lucas Starter Relay, 3 Terminal.....Part No. 1160-3..... \$41.99
- Lucas Starter Relay, 4 Terminal.....Part No. 1160-4..... \$41.99

See page 109 for a
Starter Heat Shield Kit!

Change-Over Relays



Change-Over Relays
Left: Plain Style
Part No. 4411-001
Right: With Mounting Tab
Part No. 4411-002



Relays are designed to switch high-amperage loads using a compact switch with a lower amp rating. Our change-over relays offer 3-way operation for great versatility. Normally Open (50 amp max) turns on when the switch is on. Normally Closed (30 amp max) turns off when the switch is on. NO/NC (change-over) transfers power from the 30 amp circuit to the 50 amp circuit when the switch is off, and vice-versa. Maximum 20 millisecond make/break time. Requires 8 to 16 volts to operate (the 5v output on most data loggers is too low to trigger these relays). Standard ISO 5-pin connection. Sold individually.

- Change Over Relay, plain.....Part No. 4411-001..... \$4.69
 - Change Over Relay, with mounting tab.....Part No. 4411-002..... \$4.39
 - Pre-Wired Relay Socket, ISO 5-Pin.....Part No. 4411-021..... \$2.19
- ISO 5-Pin arrangement works with either relay above, or with any other relay using the standard ISO 5-pin or 4-pin arrangement.

Longacre Pre-Wired Switch Panels and Accessories

Longacre Pre-Wired Switch Panels are an easy and good-looking alternative to building and assembling your own dashboard. Each panel is pre-wired to plug directly into the wiring harness sold separately at the bottom of this page. All of these panels include high-capacity 40 amp toggle switches with silicone rubber switch covers. Starter switches are heavy-duty push button type with a weatherproof cover. Each panel measures 3 5/8" high and is pre-drilled to match the Roll Bar Brackets sold separately at right. These panels are for regular (non-magneto) ignitions. Graphic designs may vary.

- Ignition Switch and Start Button only, 3 3/8" wide
Part No. LA44861..... \$39.99
- 4 Accessory Switches with Pilot Lights only, 5 1/4" wide
Part No. LA44865..... \$59.99

The following three panels also include a red military-style flip-up switch guard that can replace the rubber cover on the Ignition switch. All toggle switches (including the ignition switch) have pilot lights.

- Ignition Switch with Pilot Light and Start Button, 3 3/8" wide
Part No. LA44863..... \$44.99
- Ignition Switch, Start Button, 2 Accessory Switches w/Lights, 6 3/8" wide
Part No. LA44867..... \$64.99
- Ignition Switch, Start Button, 4 Accessory Switches w/Lights, 8 5/8" wide
Part No. LA44869..... \$99.99

Longacre 12 Gauge Wiring Harness

Save the hassle of assembling your own harness from scratch. This harness has the 4 basic circuits: power in, start, ignition, and accessory. Comes ready to install. Color-coded wires match all Longacre switch panels for an easy-to-understand and professional-looking job.

- Heavy-Duty 12 Gauge Wiring Harness.....Part No. 4493..... \$29.99



Roll Bar Brackets for Switch Panels



Ignition switch and start button only
Part No. LA44861



Four Accessory switches with pilot lights only
Part No. LA44865



Ignition switch with pilot light and start button
Part No. LA44863



Below: Ignition switch, start button, and 4 accessory switches
Part No. LA44869

Roll Bar Bolt-On Switch Panel Mounting Brackets

Mount switch and gauge panels easily. Comes in 1 1/2" and 1 3/4" bar diameters, 3" center to center mounting fits all Longacre switch panels shown here. Sold in pairs.

- Roll Bar Brackets for 1 3/4" bar.....Part No. LA22783..... \$49.99
- Roll Bar Brackets for 1 1/2" bar.....Part No. LA22787..... \$49.99

Starter Switch with Weatherproof Cover



The same pushbutton starter switch Longacre installs in their pre-wired switch panels is also available separately. The heavy-duty 40 amp switch mounts in a 5/8" diameter hole and includes a sturdy weatherproof rubber cover. Two solderless ring terminals are included for quick installation.

- Starter Switch with rubber cover.....Part No. 4546..... \$14.99

Ignition & Momentary Start Switch with Cover



Save dash space with this slick little switch! Standard-size 40 amp toggle switch has three positions to cover both ignition and starting: Down is off, Center is on, and Up is a momentary-contact on for the starter. Includes aircraft-style switch guard cover and pre-wired pigtail lead with quick-disconnect plug.

- Ignition & Momentary Start Switch.....Part No. LA4549..... \$39.99

Heavy-Duty Switches

SPST Switch with Push-on Terminals Part No. 4416



SPST Switch with Solder Terminals Part No. 4420



DPDT Switch with Push-on Terminals Part No. 4418



Momentary Push-Button Switch Part No. 4423-001



Military Switch Guard Part No. 4429



Toggle Switch Boot Part No. 4419



Anti-rotation locking ring Part No. 4428

Heavy-Duty Switches – Now with your choice of terminals!

These highly reliable switches are rated at 15 amps. Contacts are made of solid, fine silver. The mounting bushing diameter and bushing length are both $1\frac{15}{32}$ inch. Toggle switches feature nickel plated, $1\frac{11}{16}$ inch long actuators. Mounting hardware is furnished.

Toggle Switch, SPST (single pole, single throw) This two-terminal switch is perfect for controlling ignition power, switching lights or any other simple on-off type function.

Toggle Switch, SPST 1/4" Push-on Terminals Part No. 4416 \$6.99
Toggle Switch, SPST Solder Lug Terminals Part No. 4420 \$5.99

Toggle Switch, DPDT (double pole, double throw, on-off-on) This six-terminal switch is for more complex switching applications.

DPDT with center off position 1/4" Push-on Terminals Part No. 4418 \$10.49
DPDT with center off position Solder Lug Terminals Part No. 4424 \$7.99

Toggle Switch, SPST Momentary On This SPST switch has an internal spring that returns the switch to the off position. It is ideal for a starter switch or other momentary switching function. This switch is custom-made with a special "Reverse Keyway" so that it will work properly with our Military Switch Guard (Part No. 4429).

SPST Momentary on 1/4" Push-on Terminals Part No. 4417 \$10.49
SPST Momentary on Solder Lug Terminals Part No. 4422 \$7.99

Push-Button Switch, SPST Momentary On This switch can be used for the same applications as the above momentary toggle switch for those who prefer a push-button.

Push-Button Switch 1/4" Push-on Terminals Only Part No. 4423-001 \$11.99

Switch Accessories

Military Switch Guard This guard was designed for critical aerospace and military applications to prevent accidental switch actuation. It can be used with any of the switches at left and is especially recommended for use on starter switches. Sold individually.

Switch Guard, MilSpec MS25224-1 (available in Red only) Part No. 4429 \$18.99

Toggle Switch Boot Use to seal the switch toggle to prevent dust, dirt and moisture from getting into the switch.

Toggle Switch Boot Part No. 4419 \$5.39

Locking Ring Use to ensure against unwanted rotation of the switches at left. A $1/8$ inch hole must be drilled in the panel to accept the tab on the locking ring.

Anti-Rotation Locking Ring Part No. 4428 49¢



Miscellaneous Switch Hardware:

Hex Nut for switch mounting Part No. 4425 33¢
Knurled Nut for switch mounting Part No. 4438 39¢
Vertical Switch Plate (on/off) Part No. 4426 37¢
Horizontal Switch Plate (on/off) Part No. 4427 59¢

Mil Spec MIL-W-22759/16 Extruded ETFE Insulated Wire (white only)

This top-quality stranded wire is standard on military aircraft. It is also the wire of choice for F1 constructors. Each strand of the copper conductor is individually tin plated for corrosion resistance and for excellent soldering qualities. The flame-retardant ETFE insulation

is rated for 150°C (302°F) operation and offers exceptional resistance to most fluids as well as cuts and abrasion. The insulation is very thin, but it is so tough it is nearly impossible to strip without damaging the wire unless the correct stripping tool (sold below) is used.

Wire Size (AWG)	Current Rating *	Insulation Diameter	Part No.	Price per Foot
24 gauge	5.1 amps	0.045 inch / 1.14mm	5005	19¢
22 gauge	6.3 amps	0.052 inch / 1.32mm	5006	21¢
20 gauge	8.9 amps	0.060 inch / 1.52mm	5007	23¢
18 gauge	11.4 amps	0.071 inch / 1.80mm	5008	29¢
16 gauge	13.9 amps	0.079 inch / 2.01mm	5009	32¢
14 gauge	17.7 amps	0.095 inch / 2.41mm	5003-14	64¢
12 gauge	24.0 amps	0.120 inch / 3.05mm	5003-12	99¢
10 gauge	32.9 amps	0.138 inch / 3.51mm	5003-10	\$1.39

* Current capacity is based on continuous duty for wires in bundles, harnesses or conduits at sea level. Multiply the currents shown by 0.97 to derate for 5,000 ft elevation. Source: FAA AC 43.13-1B, Table 11-9 corrected for sea level (divided by .79).

ETFE insulation is available in white only.

Clear Heat Shrink Tubing

This tough, clear heat shrink tubing shrinks to half its original diameter when heat is applied. It is perfect for making wire labels as shown in the photo. Just print two rows of numbers or other identifiers using a word processing program (a font size of 5 points is shown). Cut out the labels, wrap around the wire, and then cover with clear heat shrink tubing. Labels like this are handy for any wiring harness, but essential with ETFE wiring.

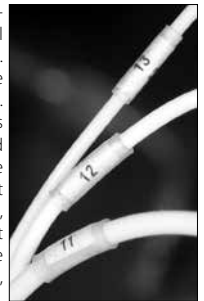

Custom Wire Stripping Tool for 26 to 16 gauge MIL-W-22759/16 Wire



Left: A counterbore on the stripping die centers the wire to prevent the cutting blade from contacting the copper conductor.



Trying to strip the tough, thin ETFE insulation from MIL-W-22759/16 wire without the proper tool is sure to damage the stranded conductor. This quality tool makes the job fast and easy. The close tolerance stripping dies are sized for our ETFE insulated wire and will not work with any other insulation thickness. A close look at one of the stripping dies says much about the quality of the entire tool. When the dies close, the cutting blades stop just short of the center conductor at which time tension is applied to snap the insulation. A special latch prevents disturbing the strands as the tool releases its grip on the wire.

Mil Spec Wire Stripping Tool Part No. 5004 ... \$284.99

Clear Heat Shrink Tubing

Original Diameter Inches	Shrunk Diameter Inches	Part No.	Price per foot
0.062	0.031	4029	59¢
0.094	0.047	4030	59¢
0.125	0.062	4031	59¢

High-Quality General Purpose Hookup Wire



This is an excellent quality stranded wire. The thick wall cross-linked SXL insulation is rated for 125°C and is resistant to oil, gas, grease, and acid.

This wire is not as tough or as lightweight as the Mil Spec wire shown above, but it is much easier to strip without a special (expensive) stripping tool.

See page 63 for Solderless Crimp Terminals

Wire Size (AWG)	Current Rating *	Insulation Color	Part No.	Price per Foot
18 gauge	9.3 amps	Black	4000	17¢
		Red	4001	17¢
		Orange	4002	17¢
		Yellow	4003	17¢
		Green	4004	17¢
		Blue	4005	17¢
White	4006	17¢		
16 gauge	11.1 amps	Black	4007	21¢
14 gauge	14.9 amps	Black	4008	29¢
12 gauge	19.8 amps	Black	4009	39¢
10 gauge	26.6 amps	Black	4010	44¢

* Current capacity is based on continuous duty for wires in bundles, harnesses or conduits at sea level. Source: FAA AC 43.13-1B, Table 11-9 corrected for sea level (divided by .79) and for 125°C temperature rating.

Buy more and save! See our website for quantity discounts on wire.

Thomas & Betts Cable Ties and Accessories

T & B Cable Ties — Military Specification Quality

We only stock top-quality **Thomas & Betts** nylon cable ties with a **Stainless Steel Locking Tab**. They conform to government specification MS3367 (Part No.'s. 4332 and 4333 also conform to MIL-S-23190E). Available in natural (white) or ultraviolet-resistant black. Use black for longer life in outdoor exposure applications.

Standard T & B Cable Ties (without mounting hole)



Length x Width Inches	Minimum Unlocking Strength	Maximum Bundle Diameter	Color (White or Black)	Package Quantity	Part No.	Price
5.0 x 0.12	18 lbs.	1.25 inch	White	100	4331-100-White	\$6.99
				1000	4331-1000-White	\$62.99
				100	4331-100-Black	\$8.99
5.0 x 0.12	18 lbs.	1.25 inch	Black	1000	4331-1000-Black	\$80.99
				100	4332-100-White	\$7.99
				1000	4332-1000-White	\$71.99
7.0 x 0.19	50 lbs.	1.75 inch	White	100	4332-100-Black	\$9.49
				1000	4332-1000-Black	\$85.99
				10	4333-10-White	\$2.49
7.0 x 0.19	50 lbs.	1.75 inch	Black	100	4333-100-White	\$22.49
				1000	4333-1000-White	\$12.99
				10	4333-10-Black	\$2.69
15.5 x 0.19 *	50 lbs.	4.00 inch	White	100	4333-100-Black	\$24.29
				1000	4333-1000-Black	\$229.99
				10	4334-10-White	\$9.99
15.5 x 0.19 *	50 lbs.	4.00 inch	Black	50	4334-50-White	\$44.99
				10	4334-10-Black	\$11.99
				50	4334-50-Black	\$53.99

* This size is suitable for securing Roll Bar Padding.

Cable Tie Installation Tools



Installing cable ties with the proper tool makes any wiring job faster and more uniform. These easy-to-use tools pull each cable tie to a repeatable tension for professional results. The tool then cuts the tail off flush with the head to minimize the sharp edge that is left by other methods.

Basic Cable Tie Installation Tool Part No. 3728 \$39.99
Plastic tool automatically cuts the tail when a pre-set tension is reached. Works on 0.09" to 0.19" wide cable ties (our part numbers 4331 through 4333 and 4340).

Beta Tools 1743 Cable Tie Installation Tool Part No. BT-017430001 ... \$60.02
Steel tool lets you pull as much tension as you want before cutting the tail. Works on cable ties up to 0.35" wide, including all of the cable ties we carry.

Nylon Cable Tie Mounting Base

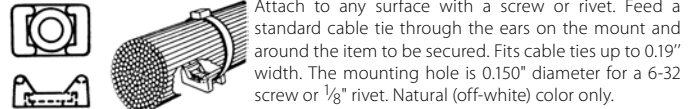

Attach to any surface with a screw or rivet. Feed a standard cable tie through the ears on the mount and around the item to be secured. Fits cable ties up to 0.19" width. The mounting hole is 0.150" diameter for a 6-32 screw or 1/8" rivet. Natural (off-white) color only.

Nylon Cable Tie Mounts, package of 10 Part No. 4360-10 pk \$3.49
Nylon Cable Tie Mounts, package of 100 Part No. 4360-100 pk \$27.99

Aluminum Cable Tie Mounting Base

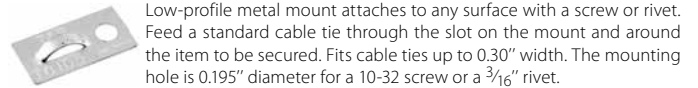

Low-profile metal mount attaches to any surface with a screw or rivet. Feed a standard cable tie through the slot on the mount and around the item to be secured. Fits cable ties up to 0.30" width. The mounting hole is 0.195" diameter for a 10-32 screw or a 3/16" rivet.

Aluminum Cable Tie Mount, each Part No. 4335-1 35¢
Aluminum Cable Tie Mounts, package of 10 Part No. 4335-10 \$2.79
Aluminum Cable Tie Mounts, package of 100 Part No. 4335-100 \$22.79

MIL-T-43435B Nylon Lacing Cord

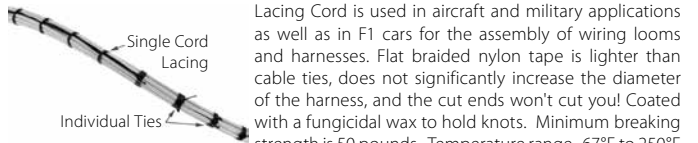

Lacing Cord is used in aircraft and military applications as well as in F1 cars for the assembly of wiring looms and harnesses. Flat braided nylon tape is lighter than cable ties, does not significantly increase the diameter of the harness, and the cut ends won't cut you! Coated with a fungicidal wax to hold knots. Minimum breaking strength is 50 pounds. Temperature range -67°F to 250°F (-55°C to 121°C). 500 yard (457 meter) spool. Choose natural off-white or black color.

MIL-T-43435B Nylon Lacing Cord, Natural (off-white) ... Part No. 4041-Natural ... \$24.99
MIL-T-43435B Nylon Lacing Cord, Black Part No. 4041-Black \$29.99

T & B Mounting Type Cable Ties (with hole for #10 screw)



Length x Width Inches	Minimum Unlocking Strength	Maximum Bundle Diameter	Color (White or Black)	Package Quantity	Part No.	Price
7.0 x 0.19	50 lbs.	1.75 inch	White	10	4340-10-White	\$1.79
				100	4340-100-White	\$16.29
				1000	4340-1000-White	\$152.99
7.0 x 0.19	50 lbs.	1.75 inch	Black	10	4340-10-Black	\$3.49
				100	4340-100-Black	\$31.49
				1000	4340-1000-Black	\$299.99

Spiral Wrap and Split Braided Sleeve

Spiral Wrap

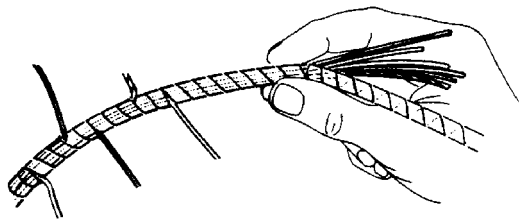

Not just for wires, use Spiral Wrap and Split Braided Sleeve to protect hoses too!

Polyethylene material wraps on like tape. The elastic memory of the material holds wires and hoses in neat, tight bundles and protects them from abrasion. Great for protecting Aeroquip lines from chafing. Available in black as well as translucent white. The black material has better UV resistance for continuous outdoor exposure.

1/4 inch diameter for 3/16 to 1 inch bundles:

Translucent White, per foot Part No. 4016-Wht-Ft 59¢
Translucent White, per 100 foot spool Part No. 4016-Wht-Spool ... \$41.49
Black, per foot Part No. 4016-Blk-Ft 59¢
Black, per 100 foot spool Part No. 4016-Blk-Spool \$41.49

1/2 inch diameter for 3/8 to 3 inch bundles:

Translucent White, per foot Part No. 4017-Wht-Ft 99¢
Translucent White, per 100 foot spool Part No. 4017-Wht-Spool ... \$69.99
Black, per foot Part No. 4017-Blk-Ft 89¢
Black, per 100 foot spool Part No. 4017-Blk-Spool \$62.99

Self-Wrapping Split Braided Sleeve

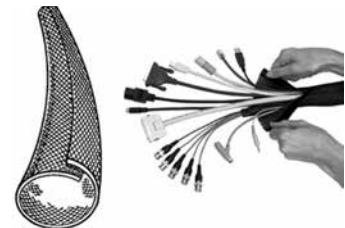

This unique laterally split, semi-rigid braided sleeving is as easy to install as common corrugated loom, but provides much better cut and abrasion resistance and a more professional appearance. It is lighter weight, more flexible and does not trap moisture inside. It is also highly resistant to petroleum based fluids and is unaffected by exposure to UV light. Rated for continuous operation from -75°C to 125°C (-103°F to 257°F). The nominal diameter shown below allows for a 25% overlap.

1/8 inch dia. Split Braided Sleeve, per foot Part No. 4011-Ft 59¢
1/8 inch dia. Split Braided Sleeve, per 100 foot spool Part No. 4011-Spool \$44.49
1/4 inch dia. Split Braided Sleeve, per foot Part No. 4012-Ft 84¢
1/4 inch dia. Split Braided Sleeve, per 100 foot spool Part No. 4012-Spool \$62.99
1/2 inch dia. Split Braided Sleeve, per foot Part No. 4013-Ft \$1.29
1/2 inch dia. Split Braided Sleeve, per 100 foot spool Part No. 4013-Spool \$96.99
3/4 inch dia. Split Braided Sleeve, per foot Part No. 4014-Ft \$1.49
3/4 inch dia. Split Braided Sleeve, per 100 foot spool Part No. 4014-Spool \$111.99
1.00 inch dia. Split Braided Sleeve, per foot Part No. 4015-Ft \$1.99
1.00 inch dia. Split Braided Sleeve, per 100 foot spool ... Part No. 4015-Spool \$149.99

Terminals, Splices and Heat Shrink Tubing

Solderless Terminals

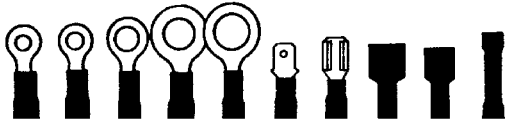

These crimp-on terminals feature insulated barrels. The insulator color identifies the wire size. All push-on terminals are for standard .032 x .25 inch (1/4") spade connectors.

Red Insulation, 22-18 AWG:

#4 (0.112") Ring Terminal	Part No. 4100	14c
#6 (0.138") Ring Terminal	Part No. 4101*	19c
#8 (0.164") Ring Terminal	Part No. 4102*	19c
#10 (0.190") Ring Terminal	Part No. 4103*	18c
1/4 inch Ring Terminal	Part No. 4104	19c
3/16 inch Ring Terminal	Part No. 4105	19c
3/8 inch Ring Terminal	Part No. 4106	19c
Male 1/4" Push-on Terminal	Part No. 4107*	21c
Female 1/4" Push-on Terminal	Part No. 4108*	21c
Fully-insulated male 1/4" Push-on	Part No. 4109	29c
Fully-insulated female 1/4" Push-on	Part No. 4110	29c
Butt Splice Terminal	Part No. 4111*	12c

Blue Insulation, 16-14 AWG:

#6 (0.138") Ring Terminal	Part No. 4114	13c
#8 (0.164") Ring Terminal	Part No. 4115*	15c
#10 (0.190") Ring Terminal	Part No. 4116*	13c
1/4 inch Ring Terminal	Part No. 4117*	21c
5/16 inch Ring Terminal	Part No. 4118	17c
3/8 inch Ring Terminal	Part No. 4119	24c
Male 1/4" Push-on Terminal	Part No. 4120*	14c
Female 1/4" Push-on Terminal	Part No. 4121*	16c
Fully-insulated male 1/4" Push-on	Part No. 4122	25c
Fully-insulated female 1/4" Push-on	Part No. 4123	25c
Butt Splice Terminal	Part No. 4124*	13c

Yellow Insulation, 12-10 AWG:

#8 (0.164") Ring Terminal	Part No. 4127	16c
#10 (0.190") Ring Terminal	Part No. 4128*	17c
1/4 inch Ring Terminal	Part No. 4129*	27c
5/16 inch Ring Terminal	Part No. 4130*	24c
3/8 inch Ring Terminal	Part No. 4131	29c
Male 1/4" Push-on Terminal	Part No. 4132*	21c
Female 1/4" Push-on Terminal	Part No. 4133*	21c
Fully-insulated male 1/4" Push-on	Part No. 4134	49c
Fully-insulated female 1/4" Push-on	Part No. 4135	49c
Butt Splice Terminal	Part No. 4136*	21c

* Indicates items included in Assortment Kit sold below.

Solderless Terminal Assortment



This handy kit contains the most popular 18 sizes and types indicated above. (Contains 18 each of indicated red 22-18 AWG terminals, 15 each of indicated blue 16-14 AWG terminals, and 12 each of indicated yellow 12-10 AWG terminals.) Total of 270 insulated terminals in a molded plastic organizer. The lid is labeled with each size for easy identification.

Solderless Terminal Assortment Part No. 4165 \$38.99

In-Line Splice

Make quick splices without any stripping. Simply insert both wires and squeeze the metal insert with pliers. The plastic cover snaps in place for a fully insulated splice. Excellent for temporary repairs but reliable enough for permanent installations.

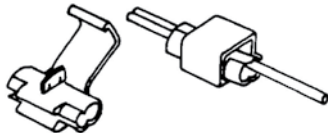

For 18-14 gauge wire Part No. 4160 22c
 For 12-10 gauge wire Part No. 4161 64c

T-Tap Splice Kit



Use to form a mid-span splice that can be disconnected. Press the T-Tap terminal onto an 18 to 14 gauge wire with pliers. Crimp the furnished, fully insulated male push-on terminal to the branch wire and plug it into the T-Tap terminal.

T-Tap Splice Kit Part No. 4162 99c

Please see our website for many more styles of electrical terminals!

3M Scotchlok® Wire Crimping Tool



This high-quality, long-lasting tool is designed for reliable crimping. Cuts and strips wire and crimps insulated or non-insulated solderless terminals from 22 to 10 gauge. Cuts #6, #8, and #10 screws. The cushioned grip reduces operator fatigue.

3M Scotchlok® Wire Crimping Tool Part No. 3101 \$44.99

Quick-Change Ratcheting Terminal Crimping Kit

Crimp most automotive terminals, from small Weather Pack terminals to spark plug wire, and nearly everything in between with this complete kit! The ratcheting handle ensures a perfect crimp every time. The fitted plastic case contains the ratcheting handle plus seven sets of interchangeable jaws: Weather Pack (22-10 AWG),* insulated (22-10 AWG), mini insulated (26-16 AWG), fully-insulated (22-10 AWG), non-insulated (22-8 AWG), coaxial cable (RG-6 and RG-8), and spiral-core spark plug wires (8mm and 8.5mm).** Instructions included inside the lid.



Quick-Change Ratcheting Terminal Crimping Kit Part No. 4185-200 \$137.99

* Crimps the Weather Pack terminal to the wire and to the seal in one operation.

** Strips the insulation, crimps the terminal to the spiral core, and crimps the terminal to the insulation in three separate operations.

Terminal Strip



This versatile terminal strip is great for cleaning up the wiring under the hood or behind the dash. Each position will connect two wires from 20 to 12 gauge. Smaller size wires can be grouped together allowing up to 8 wires to be connected at each position. The terminal strip can be screwed or riveted to almost any surface. Supplied in 10 position size but it is easily cut to the exact length needed. Overall length is about 4.5 inches.

Terminal Strip Part No. 4415 \$15.99

Raychem DR-25 Heat Shrink Tubing



This flame-retardant heat-shrink tubing meets MIL-I-23053/16 specifications. It is resistant to abrasion and hydrocarbons, so it makes a great covering for hoses. Shrinks to half its original diameter when heated to 350°F. Temperature range -103° to +302°F. Black only.

Raychem DR-25 Heat Shrink Tubing				
Nominal Size	Original Diameter	Shrunk Diameter	Part No.	Price per foot
1/4"	0.250"	0.125"	4019-001-.250	\$4.99
3/8"	0.375"	0.187"	4019-001-.375	\$6.99
1/2"	0.500"	0.250"	4019-001-.500	\$7.99
3/4"	0.748"	0.375"	4019-001-.750	\$11.79
1"	1.00"	0.500"	4019-001-1.00	\$12.49

PVC Heat Shrink Tubing

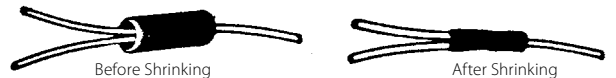

This economical, light-duty black tubing shrinks to half its original diameter when heated. Insulates and protects individual connections or entire wiring harnesses. Provides a strain relief that protects against vibration damage. A hot air gun is recommended for shrinking, but a high-wattage hair dryer can also be used.

Black PVC Heat Shrink Tubing

Nominal Size	Original Diameter	Shrunk Diameter	Part No.	Price per foot	Price per 100 foot spool
1/8"	0.125"	0.062"	4020	39c	\$25.49
3/16"	0.187"	0.094"	4021	45c	\$29.29
1/4"	0.250"	0.125"	4022	59c	\$38.49
3/8"	0.375"	0.187"	4023	69c	\$44.99
1/2"	0.500"	0.250"	4024	79c	\$51.49
3/4"	0.750"	0.375"	4025	99c	\$64.99

Black PVC Heat Shrink Tubing Assortment

You will always have the right size on hand and save money off the normal per foot cost. Contains three feet of each of the above sizes of black PVC tubing.

Black Heat Shrink Tubing Assortment, 3 feet each of 6 sizes Part No. 4028 \$9.99

Champion Racing Spark Plugs

Electrode Design Details

J-Gap Non-Projected Tip This gap style positions the spark approximately 1/16 inch into the combustion chamber. Very cold heat ranges such as C53CX spark plugs have modified (shortened) ground electrodes. This helps expose the spark to the mixture and protects against pre-ignition from an overheated ground electrode.

J-Gap Projected Tip This gap style positions the spark an additional 1/8 inch into the chamber and, providing there is sufficient clearance to valves and piston, provides the ultimate in performance. Initiating the flame front closer to the piston top at a given spark has the same effect as advancing the timing. Therefore, maximum timing may be reduced, which helps to reduce detonation and octane requirement and still provides good part throttle response. For normally aspirated engines only; not recommended for turbocharged, supercharged, nitrous oxide or nitro burners.

Fine Wire J-Gap Non-Projected Tip Spark plugs with small-diameter center electrodes were originally designed to improve starting and anti-fouling characteristics in small two-stroke engines such as snowmobiles and dirt bikes. The small (fine wire) center electrode requires less voltage to fire the gap. This same characteristic can "band-aid" poor performance at very high rpm, or at part throttle, when mixtures are either too rich or too lean. This happens frequently as racing carburetor calibration is extremely difficult. As programmable fuel injection systems and electronic ignition systems become more available, the use of this configuration will diminish. Standard gap or projected gap types are all that is necessary when fuel/air mixtures and ignition output and timing are correct.



J-Gap Non-Projected Tip



J-Gap Projected Tip



Fine Wire J-Gap Non-Projected Tip



When ordering plugs, add "CH" to the Champion Part No. (for example: CH N6YC)

Champion Spark Plug price list and replacement part list (price each)

BL57use V55C	C59YC.....\$4.29	L82C.....\$2.49	N84 or N84G.....use C57
BL60use V59C	C61.....\$4.89	N2C.....\$1.29	N86 or N86G.....use C59
C53.....use C53CX	C61YC.....\$4.29	N3C.....\$2.39	N87 or N87G.....use C61
C53C.....use C53CX	C63C.....use C63CX	N4YC.....use RN4YC	N539C.....use C53CX
C53CX.....\$4.99	C63CX.....\$4.99	N6YC.....\$2.59	N541C.....use C57CX
C53VC.....\$4.99	C63YC.....\$4.29	N7YC.....\$2.39	N542C.....use C59CX
C55.....\$4.89	FN507Y.....use C61YC	N57.....use C57CX	RC9YC.....\$2.99
C57.....\$4.99	FN508Y.....use C63YC	N60.....use C59CX	RC12YC.....\$2.49
C57C.....use C57CX	G54V.....\$7.99	N60Y.....use C57YC	RN4YC.....\$2.79
C57CX.....\$4.99	G57C.....\$4.69	N63Y.....use C59YC	RN7YC.....\$2.59
C57YC.....\$4.29	G58.....use G57C	N80.....use C53CX	RV15YC4.....\$3.49
C59.....\$4.99	G59C.....\$4.99	N80G.....use C53CX	V4C.....use V59C
C59C.....use C59CX	G61.....use G59C	N82.....use C55	V55C.....\$3.59
C59CX.....\$4.89	L78C.....\$2.39	N82G.....use C55	V59C.....\$3.89

Champion Racing Spark Plugs — Heat Range Chart

Plug Series	G Series 10 x 1.0mm Thread 0.750" Reach 5/8" Hex		L Series 14 x 1.25mm Thread 0.472" Reach 13/16" Hex	V Series 14mm Thread 0.460" Reach Conical Seat 5/8" Hex	C Series 14 x 1.25mm Thread 0.750" Reach 5/8" Hex				N Series 14 x 1.25mm Thread 0.750" Reach 13/16" Hex	
	Tip Style	J-Gap Non-projected	Surface Gap	J-Gap Non-projected	J-Gap Projected	Fine Wire* J-Gap Non-projected	Cut Back Ground Non-projected	Surface Gap	J-Gap Projected	J-Gap Non-projected
Hot ↑			L82C	RV15YC4	RC12YC				(R)N7YC	
		G59C		L78C	RC9YC				N6YC	
↓ Cold		G57C			C63YC		C63CX		RN4YC	N3C
				V59C	C61YC	C61				N2C
				C59YC	C59	C59CX				
				C57YC	C57	C57CX				
		G54V		V55C	C55	C55				
							C53CX	C53VC		

* Fine wire designs may run slightly hotter than standard center electrodes.

Miscellaneous Ignition Components

High-Performance Ignition Coils (general use)

These high-output, 12 volt coils are perfect for most 4 and 6 cylinder applications. The **Bosch Blue Coil** has become virtually standard on FF1600 engines because of its reliability. It offers excellent output up to about 7500 RPM on a 4 cylinder engine or with MSD type ignition systems. The **Lucas Sports Coil** offers slightly better high RPM performance. Neither of these coils require a series ignition resistor. Many hard-to-diagnose ignition problems are eventually traced back to a failed coil, so it's a good idea to carry a spare.



- Bosch "Blue" Coil (shown at right)Part No. 1300 \$59.99
- Lucas Super Energy Sports CoilPart No. 1305 \$49.99

Billet Aluminum Clamp-On Coil Mounts



Mount your ignition coil to a frame or roll cage tube with these anodized aluminum clamp-on mounts. Accepts any ignition coil we sell, as well as most round ignition coils from 2 to 2 1/8 inch diameter or square coils from 2 1/8 to 2 1/4 inch corner-to-corner. Coil is positioned 90 degrees to the frame tube.

- Clamp-On Coil Mount for 1.5" tubingPart No. 1318-001 \$29.99
- Clamp-On Coil Mount for 1.75" tubingPart No. 1318-002 \$29.99

Pertronix 600 Digital Rev Limiter



The **Pertronix Flame-Thrower Digital Rev Limiter** is designed for use with any 4, 6, or 8 cylinder engine using points, OEM electronic (GM HEI, Ford, Chrysler) or aftermarket inductive type ignition systems including the Ignitor and Ignitor II points replacement systems. (Not compatible with CD ignition systems). Rotary switches allow setting of the RPM limit without chips or jumper wires. A combination of random and sequential spark stealing reduces plug fouling and detonation from unburned fuel.

- Pertronix 600 Digital Rev LimiterPart No. 1346 \$199.99

Universal Fit Spark Plug Wire Sets with Spiro-Pro Wire

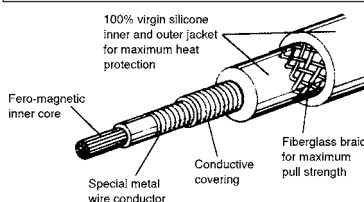

Spiro-Pro 8mm wire provides up to 10 times the conductivity of standard resistor wire without RFI (radio frequency interference). Two layers of 100% silicone insulation protect up to 600°F (315°C). This set includes the coil wire. One end of each wire must be cut and terminated to fit the application. Standard wire color is blue.

- Universal 4 cyl. Spiro-Pro Set with straight plug bootsPart No. 1310-4-00 \$42.99
- Universal 6 cyl. Spiro-Pro Set with straight plug bootsPart No. 1310-6-00 \$59.99
- Universal 8 cyl. Spiro-Pro Set with straight plug bootsPart No. 1310-8-00 \$73.99

Spark Plug Wire Separators and Boot Protectors

Use our clamp-on **Spark Plug Wire Separators** to prevent inductive cross firing. Blue plastic matches the Spiro-Pro plug wire sets we carry. Fits any 7mm or 8mm plug wires.

- Clamp-Style Wire Separators, BluePart No. 1335-001 \$13.49
- Woven **Spark Plug Boot Protectors** fit most boots (even 90°) to insulate up to 1200°F. 1200°F Protective Sleeve, sold individuallyPart No. 1311 \$6.99

MicroDynamics "Softcut" Rev Limiter

The **MicroDynamics DRL 3 Digital Rev Limiter** features "Softcut" technology to eliminate backfiring and reduce drive train stresses. Full Throttle Gear Change circuitry allows shifting without lifting the throttle. This rev limiter can be easily calibrated at the track by holding the engine at half the required RPM — the limiter stores twice that value as the selected limit. The DRL 3 is compatible with points, electronic ignition, and computerized engine management systems. It is NOT compatible with capacitive discharge (CD) ignitions.



- MicroDynamics DRL 3 Digital Rev LimiterPart No. 1342 \$229.99

Ignition Parts for Ford 1.6L and 2.0L

Pertronix FlameThrower Distributor for Ford 1.6L



The **Pertronix FlameThrower HP Distributor** is SCCA legal for Formula Ford. This compact, high-performance distributor features the proven Ignitor II electronic ignition, with no points to adjust or replace. Installs without any modifications to the block. Simple three-wire hookup: Power In, Ground, and Coil Negative. Distributor includes low-profile side-entry cap, rotor, O-ring seal, drive gear (installed), and instructions. The Pertronix FlameThrower II ignition coil (sold separately) is highly recommended with this distributor.

Pertronix FlameThrower HP Distributor for Ford 1.6L/FF1600..... 168-01-Compact... \$284.99

Replacement Side-Entry Cap..... 168-02-Pert..... \$32.99

Optional Top-Entry Cap..... 1335-101..... \$12.49

Replacement Rotor..... 168-03-Pert..... \$9.49

Replacement Ignitor II Module... 1335-010..... \$119.99

FlameThrower II Ignition Coil..... 1315-201..... \$51.99
Highly recommended for all Pertronix Ignitor II applications.

Pertronix Ignitor Module for Autolite 1.6L Distributor Part No. 1335-012



Pertronix Ignitor II Module for Bosch 2.0L Distributor Part No. 1335-011



Pertronix FlameThrower II Coil for Ignitor II applications Part No. 1315-201



Pertronix Breakerless Ignition Modules

Replace your points and condenser with the solid-state reliability and precision of an electronic ignition. Eliminate points bounce, burned points, and adjustments forever. The Pertronix Ignitor breakerless ignition system mounts entirely inside the distributor, replacing the points and condenser without extensive modifications. It's as easy as installing a new set of points. No tricky wiring or exposed sensors to damage. No "black box" or other electronics are required. Legal for SCCA FF1600 and FC / S2.

Pertronix Ignitor for 1.6L Autolite Distributor..... 1335-012..... \$164.99

Pertronix Ignitor for 1.6L Bosch Distributor..... 1335-005..... \$169.99

Pertronix Ignitor for 1.6L Lucas (25D4) Distributor..... 1335-008..... \$107.99

The 25D4 was used on some vintage Formula Ford 1600 engines.

Pertronix Ignitor for 1.6L Lucas (23D4) Distributor..... 1335-007..... \$129.99

The 23D4 was used on the 1600cc Lotus Twin Cam engine.

Pertronix Ignitor for 1.6L Lucas (43D4) Distributor..... 1335-009..... \$109.99

The 43D4 was used on the Cosworth BDD engine.

Pertronix Ignitor II for 2.0L Bosch Distributor..... 1335-011..... \$169.99

Pertronix Flame-Thrower II Ignition Coil..... 1315-201..... \$51.99

This coil is highly recommended for all Pertronix Ignitor II applications.

Service Parts for Ford 1.6L Distributors

The original **Autolite** (Ford Motorcraft) distributor is identified by the 3.35" diameter cap.

Autolite Distributor Cap for Ford 1.6L..... 168-02-ATLT..... \$53.99

Autolite Points for Ford 1.6L..... 168-04-ATLT..... \$24.99

Please note: These Autolite distributor parts are available only while current stock lasts.

The more popular **Bosch** distributor is identified by the smaller 2.87" diameter cap.

Bosch Distributor Cap for Ford 1.6L..... 168-02-Bosch..... \$16.99

Bosch 90 Degree Side-Entry Cap for Ford 1.6L..... 168-09-Bosch..... \$53.99

Bosch Rotor for Ford 1.6L..... 168-03-Bosch..... \$13.99

Please note: Bosch no longer makes breaker points or a condenser for this distributor.

The following parts fit all distributors used on the Ford 1.6L engine.

Attachment Pin for Distributor Drive Gear..... 168-06-Pin..... \$3.99

Distributor O-Ring Seal for Ford 1.6L..... 168-07..... \$3.79

Custom-Made Ignition Wire Sets for Ford 1.6 and 2.0L

We stock custom-made sets in 8mm Spiro-Pro wire. This gives 10 times the conductivity of regular resistance wire yet will not interfere with sensitive radios, electronic ignition systems or computers. **Note:** Since coil location varies widely, our custom-made wire sets do not include the coil wire. Order the coil wire separately to suit your installation.

Ford 1.6L Plug Wire Set, Short (over valve cover)**..... 168-11-Short..... \$29.99

Ford 1.6L Plug Wire Set, Long (around front)**..... 168-11-Long..... \$32.99

Ford 2.0L Plug Wire Set, Short (over valve cover)**..... 178-13..... \$29.99

**** 12 inch Coil Wire (to complete the above sets)**..... 168-16-12 inch..... \$6.99

**** 20 inch Coil Wire (to complete the above sets)**..... 168-16-20 inch..... \$6.99

**** 28 inch Coil Wire (to complete the above sets)**..... 168-16-28 inch..... \$7.99

Universal Coil Wire Kit, make your own wire up to 36" long..... 168-16-Repair..... \$9.99

Service Parts for Ford 2.0L Distributors

The points, cap, rotor and condenser listed below are all genuine Bosch replacement parts, not generic parts of unknown quality.

Bosch Cap for Ford 2.0L..... 168-02-Bosch..... \$16.99

Bosch Rotor for Ford 2.0L..... 168-03-Bosch..... \$13.99

Bosch Points for Ford 2.0L..... 178-04-Bosch..... \$11.99

Bosch Condenser for Ford 2.0L..... 168-05-Bosch..... \$13.99

Distributor Drive Gear for Ford 2.0L..... 178-06..... \$28.99

Distributor O-Ring Seal for Ford 2.0L..... 178-07..... \$2.29

Hold-Down Clamp for Ford 2.0L..... 178-08..... \$12.99

Spark Plugs for Ford 1.6 and 2.0L

We stock the most popular and reliable plugs for Ford 1.6 and 2.0L use.

Champion N6YC Spark Plug for Ford 1.6L..... CH N6YC..... \$2.59 ea.

Champion RC9YC Spark Plug for FF1600 (Aluminum Head).. CH RC9YC..... \$2.99 ea.

The RC9YC plug has a smaller 5/8" hex for easier wrench access in the aluminum head.

NGK Spark Plug for Ford 2.0L (hot)..... 178-22-AP8FS..... \$3.99 ea.

Rain Lights, Tail Lights, and Brake Lights

The Ultimate Rain Light

The **Ultimate Rain Light** has 50 vibration-resistant red LEDs. The body is angled up at a 10° angle for visibility. A Sure Seal connector on the wiring harness makes it easy to disconnect the light for gear changes. Three mounting ears offer maximum security. Measures 2.1" diameter not including the mounting ears. Meets SCCA specifications. Not DOT approved for street use. Made in USA.



The Ultimate Rain Light.....Part No. 1303..... \$52.99

The **Ultimate Rain/Brake Light** is similar to the Ultimate Rain Light above except that it has provisions for two levels of brightness to fulfill the requirements for both the rain light and brake light in a sports racer. Not DOT approved for street use.

The Ultimate Rain/Brake Light.....Part No. 1307..... \$72.99

Afterburner Star Mazda / US F2000 Rain Light

30 high-intensity red LEDs and epoxy potting make this rain light vibration-resistant and totally waterproof. The 2 1/16" mounting hole spacing fits the original Star Mazda bracket. This is the spec rain light for the US F2000 series. Not DOT approved for street use.



Afterburner Star Mazda / US F2000 Rain Light.....Part No. 1315-003..... \$92.99

Dual Bulb Incandescent Rain Light

Our economical **Dual Bulb Rain Light** offers reliability through redundancy. One burned-out bulb won't cost you a race! Includes 2 standard #193 automotive bulbs. The single-wire design grounds through the mounting bolts. Measures approximately 4" x 2".



Dual Bulb Oblong Rain Light.....Part No. 1302..... \$6.99

FIA-Approved Afterburner Rain / Brake Light



The **Afterburner** can be used as a high-intensity brake light, **FIA-approved flashing rain light**, or both! Each of the 18 red LEDs is isolated on its own circuit to prevent one failed LED from knocking out any others. Epoxy potting provides extreme vibration protection and makes the unit completely waterproof. The Afterburner has a wider viewing angle than many other brands (30° vs. less than 20°). A Weather Pack connector set on the wiring harness allows easy disconnection for gear changes. Measures 2 9/16" x 2 3/4" x 1 5/16". The brake light circuit draws 0.23 amps. The flashing rain light circuit draws only 0.08 amps. Meets SCCA and FIA specifications. Not DOT approved for street use. Made in USA.

Afterburner Flashing Rain / Brake Light Kit.....Part No. 1315-001..... \$87.99

FIA-Approved Cartek F3 Rain Light Kits



Cartek rain lights each have 15 very large, high-intensity red LEDs to exceed FIA requirements. Multiple circuits ensure that the light will still meet FIA standards even if any one LED should fail. The integrated flashing circuitry and included 3-way switch let you select a 4 Hz flashing (or steady) rain light or an attention-grabbing hazard flashing pattern. Choose from Vertical orientation (shown) or Horizontal orientation to fit your installation. Both versions measure 3 9/16" x 2 1/4". Two stainless steel M6 studs on the back make mounting easy. Draws less than 0.3 amps when used as a steady rain light and just 0.15 amps when flashing. Meets SCCA and FIA requirements. Not DOT approved for street use. Made in the UK.

Cartek F3 Rain Light Kit, Vertical (shown).....Part No. 1068-125..... \$182.95

Cartek F3 Rain Light Kit, Horizontal.....Part No. 1068-126..... \$182.95

Ford 1.6L Engine Parts

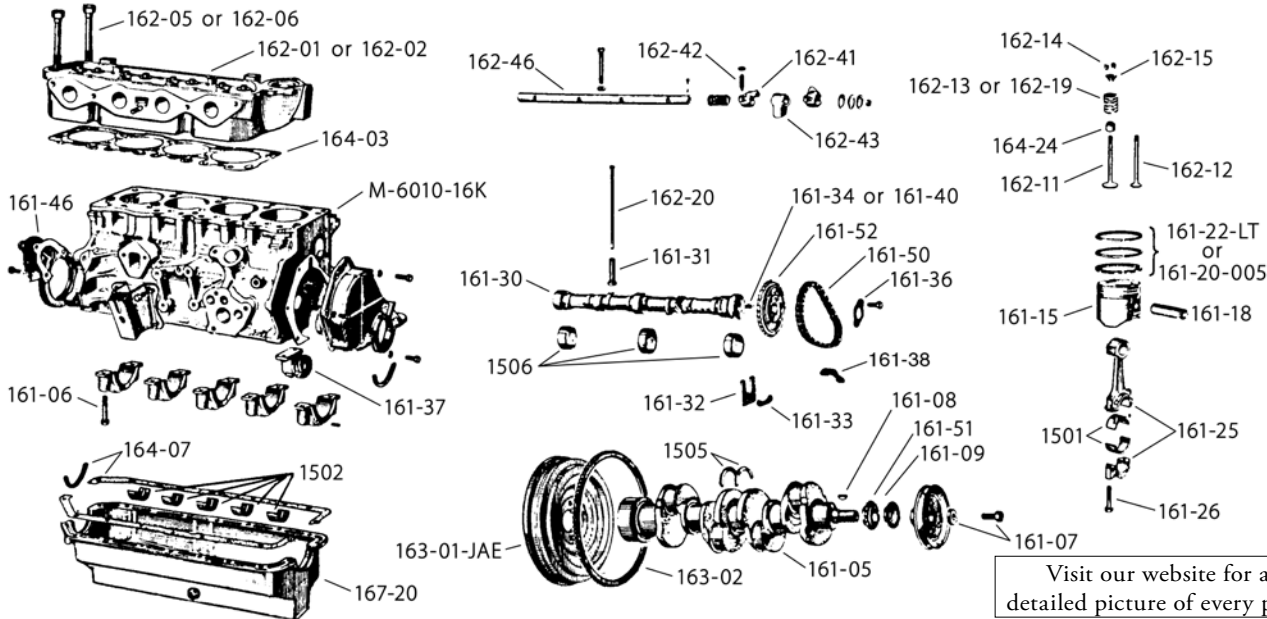

Visit our website for a detailed picture of every part!

Ford 1.6L Engine Parts, Bottom End

Description	Part No.	Price
NEW FF1600 Engine Block by Ford Racing	M-6010-16K	\$1,439.00
<i>Brand-new, SCCA-legal "711M" block. Cylinders are unfinished; final machining required.</i>		
Oil Gallery Plug, Large	161-03-Lg	\$8.99
Oil Gallery Plug, Small	161-03-Sm	\$7.99
New SCAT Crankshaft, drop-in (modified counterweights)	161-05-SCAT-CCW	\$859.00
Main Bearing Cap Bolt	161-06	\$5.99
Crankshaft Front Bolt	161-07-Bolt	\$4.29
Crankshaft Front Washer	161-07-Washer	\$4.69
Crankshaft Woodruff Key	161-08	\$13.99
Crankshaft Oil Slinger	161-09	\$22.99
Pilot Bearing for Clutch Shaft	161-10	\$23.99
Oil Pump Gear	167-15	\$99.99
Pin for Oil Pump Gear	161-12	\$1.59
Set of 4 Forged Pistons with Spirolocs (no Rings or Pins)	161-15-Forged	\$679.00
Set of 4 Forged Pistons w/Spirolocs, 0.005" Oversize	161-15-005	\$669.00
Wrist Pin, each	161-18	\$15.99
Spiral Lock Wrist Pin Retainer, each	161-19-Sprl	\$1.29
<i>These spiral retainers can't work loose like the stock circlips can</i>		
Piston Ring Set for Standard-Size Pistons (stock or forged)	161-20-Std	\$91.99
Piston Ring Set for 0.005" Oversize Forged Pistons	161-20-005	\$154.99
New SCAT Connecting Rods with ARP Bolts, set of 4	161-25-SCAT	\$599.00
Connecting Rod Bolt, Standard, each	161-26-Std	\$7.99
Connecting Rod Bolt, ARP 12 point, each	161-26-12pt	\$20.49
Connecting Rod Bolt, 12 point, ea. 0.008 oz heavier than above	161-26-12pt Hvy	\$16.99
Alignment Dowel for Connecting Rod large end cap	161-27	\$2.99
New Stock Camshaft by Formula Ford International	161-30-Stk	\$419.99
Camshaft and Lifter Lubricant, 4 oz., Ford Motorsport	3312	\$8.49
Cam Follower, 0.436 dia. (original Cortina), each	161-31-.436	\$26.99
Cam Follower, 0.516 dia. (Uprated engine), each	161-31-.516	\$21.99
Camshaft Thrust Plate	161-32	\$62.99
Lock Tab for Cam Thrust Plate Bolts	161-33	\$7.49
Dowel, Camshaft to Sprocket, stock	161-34	\$6.49
Offset Cam Dowel, specify 1, 2, 3, 4, 5, 6, 7, 8, or 9° offset	161-40-()	\$9.99
Lock Tab for Cam Sprocket	161-36	\$11.99
Timing Chain Tensioner	161-37	\$149.99
Chain Rubbing Block	161-38	\$31.99
Timing Chain Tensioner and Pad Kit	161-41-Kit	\$159.99
Rear Crankshaft Cover, used	161-46	\$89.99
Timing Chain	161-50	\$119.99
Crankshaft Timing Chain Sprocket	161-51	\$109.99
Camshaft Timing Chain Sprocket	161-52	\$114.99
Dowel, Block to Head	161-55	\$4.99
Dowel, Block to Bell Housing	161-56	\$8.49
Small Freeze Plug for block, 1.62" dia.	161-61-1.62	\$7.99
Block Plug for breather hole above fuel pump, 0.9375" dia.	161-61-9375	\$1.49
Mechanical Fuel Pump, clockable top, 6AN male fittings	161-79	\$89.99
Mechanical Fuel Pump, standard (fixed push-on fittings)	161-80	\$329.99
Water Pump with stock pulley flange	161-82	\$139.99
44 tooth Gilmer Pulley for Water Pump	166-02-.62	\$125.99
Crank Scraper	161-90	\$24.99

To keep your Formula Ford 1600 engine competitive *and legal*, we offer stock engine parts from **Ford Motor Company**; parts made to Ford OEM specifications by **Formula Ford International**; and race prepared parts from **Ivey Engines**, **SCAT Crankshafts**, and **CP Pistons**. All of the parts listed here are for the "Uprated" version of the Formula Ford 1600 engine. We don't carry any parts for the "Cortina" version although most parts are interchangeable (except for pistons, rings, head, valves, intake manifold, and carb).

See page 65 for ignition parts.
See page 71 for dry sump parts.
See page 146 for flywheel and clutch parts.

Ford 1.6L Engine Parts, Top End

Description	Part No.	Price
Unmodified Aluminum Cylinder Head, bare	162-01-Alum	\$939.00
<i>Ready for prep work. Does not include valves, springs, or rocker shaft assembly.</i>		
Ivey Prepared Aluminum Cylinder Head	162-02-Prep	\$2,599.00
<i>Includes valves and springs. Does not include the rocker shaft assembly.</i>		
Cylinder Head Bolt, Long	162-05	\$18.99
Cylinder Head Bolt, Short	162-06	\$15.99
Head Bolt Washers for aluminum head, set of 10	APR200-8532	\$8.52
Intake Manifold Bolts, flange head, set of 5 with washers	ARP622-1250	\$13.15
Carburetor Mounting Stud for Intake Manifold	162-09	\$2.29
Stock Intake Manifold, used	162-10-Stk	\$479.99
Intake Valve	162-11	\$24.79
Exhaust Valve	162-12	\$37.99
Heavy-Duty Valve Spring Set	162-13	\$79.99
Formula Ford Valve Spring Set (Ivey), for FF1600-legal cam only	162-19	\$102.99
Valve Keeper, each	162-14	\$3.99
Valve Spring Retainer	162-15	\$19.99
Bronze Valve Guide, .439 dia, .420 seal dia.	162-17	\$11.49
Cast Aluminum Valve Cover by Ford Racing	M-6582-16K	\$169.99
<i>This finned valve cover uses the stock cork gasket (sold separately). You must drill the cover for a breather outlet. As-cast finish is ready for sanding and polishing or painting.</i>		
Valve Cover Hold-downs, per set	162-33	\$7.99
Rocker Arm Adjuster, late style (self-locking)	162-42	\$32.99
Rocker Stand, Aftermarket Aluminum, Set of 4	162-43-Alum	\$149.99
Rocker Stand Flat Washer	162-45	79¢
Rocker Shaft Only	162-46	\$119.99
Rocker Shaft Washer, flat	162-48	79¢
Rocker Shaft Washer, wavy	162-49	79¢

Stage 8 Locking Header Bolts for Ford 1.6L

Forget safety wire! The Stage 8 system uses a specially designed 12-point bolt with a clip-on locking retainer. The header pipe prevents the retainer from turning, which stops the bolt from loosening. Easily removed for service and reusable. Set of 8 bolts, tabs, and retainer clips is more than enough for one Ford 1600 engine (you get 2 spares of each).
Stage 8 Locking Header Bolt Set for 1.6L Ford.....ST8-6100.....\$44.99

Gaskets and Bearings for the Ford 1.6L Engine

Some of the gaskets shown below are manufactured by Ivey Engines. They are very high-quality, designed for racing and fit perfectly.

Most of our engine bearings are manufactured by ACL. These steel-backed bearings provide excellent strength and wear in Formula Ford engines.

Engine Gaskets for 1.6L Ford Engines

Description	Part No.	Price
Cylinder Head Set <i>Includes head gasket, cork valve cover gasket, intake gasket, 3 piece exhaust manifold gasket, and water outlet gasket. Also includes a set of 8 standard Ford valve stem seals.</i>	164-02	\$159.99
Head Gasket Only, stock Ford	164-03	\$109.99
Cork Valve Cover Gasket	164-04	\$11.99
Water Outlet Gasket	164-05	\$3.99
Water Pump Gasket	164-06	\$4.99
Oil Pan Gasket with cork end seals (for cast pan)	164-07	\$18.99
Oil Pan Gasket with rubber end seals (for steel pan)	164-34	\$42.99
Intake Manifold Gasket	164-08	\$10.49
Single Piece Exhaust Header Gasket (Ivey mfg)	164-09	\$8.99
Single Piece Graphite Exhaust Header Gasket	164-16	\$18.49
Front Timing Chain Cover Gasket	164-10	\$5.99
Rear Crank Cover Gasket	164-11	\$3.99
Fuel Pump Block	164-12	\$15.99
Fuel Pump Gasket only (not block)	164-15	\$2.49
Oil Pump Gasket	164-13	\$4.99
Phenolic Carb Spacer Plate with two gaskets	164-14	\$21.99
Carb Base Gasket only (not block)	1586-Gasket	\$3.49
Front Crank Seal	164-20	\$32.99
Rear Crank Seal	164-21	\$67.99
PTFE Valve Seals, 8 pieces	164-22	\$39.99
Standard Ford Valve Stem Seals, 8 pieces	164-24	\$19.99

Engine Bearings for Ford 1.6L

Description	Part No.	Price
1.6L Connecting Rod Bearings		
Standard ID (crank journal OD 1.9372")	1501-Std	\$84.99
.010" undersize ID (journal OD 1.9272")	1501-010	\$84.99
.020" undersize ID (journal OD 1.9172")	1501-020	\$84.99
.030" undersize ID (journal OD 1.9072")	1501-030	\$84.99
.040" undersize ID (journal OD 1.8972")	1501-040	\$84.99
1.6L Main Bearings (standard OD)		
Standard ID (crank journal OD 2.1254")	1502-Std	\$99.99
.010" undersize ID (journal OD 2.1154")	1502-010	\$119.99
.020" undersize ID (journal OD 2.1054")	1502-020	\$119.99
.030" undersize ID (journal OD 2.0954")	1502-030	\$119.99
.040" undersize ID (journal OD 2.0854")	1502-040	\$119.99
1.6L Main Bearings (+.015 OD) These special bearings are designed for blocks that have been line-bored .015" oversize to correct alignment problems. Use these bearings if the main bearing bores in your block measure 2.286" (58.07mm) ID. <i>Specify Standard, .010, or .020 undersize ID</i>		
	1504-Size/15	\$124.99
1.6L Thrust Bearing Washers Sold in pairs. .005" oversize is per side (.010" total). <i>Specify Standard or .005" oversize thickness</i>		
	1505-Size	\$18.99
1.6L Miscellaneous Bearings		
Cam Bearings (all round style), set of 3	1506	\$39.99
Small End Bushing (wrist pin bushing), set of 4	1507	\$22.99

Water Pump Drives and Tach Drives for the Ford 1.6L Engine

Water Pump Drive Belts and Pulleys for Ford 1.6L



44 tooth Water Pump Pulley, Part No. 166-02-62 (left)
30 tooth Crankshaft Pulley, Part No. 166-03 (right)
and 180XL050 Drive Belt, Part No. 166-01-180

Our toothed-belt water pump pulleys feature a large setback to minimize the cantilevered load on the water pump. Combining a 44 tooth pump pulley with a 30 tooth crank pulley will slow the pump down to 68% of crankshaft speed. This reduces cavitation at high RPM operation. Standard water pump belts are 1/2 inch wide, but some older cars used narrower 3/8 inch wide belts.

Description (pump rpm = 68% of crank rpm)	Part No.	Price
44 tooth pump pulley for .62" dia. pump shafts	166-02-62	\$125.99
44 tooth pump pulley for aftermarket 16mm pump shafts	166-02-16mm	\$124.99
<i>Some imported replacement water pumps now have a 16mm shaft (0.62" = 15.88mm)</i>		
30 tooth crankshaft pulley	166-03	\$179.99
180XL050 belt for above pulleys (90 teeth)	166-01-180	\$12.99

Some older Ford 1.6L's use shorter or narrower belts:

170XL050 (85 teeth), 1/2 inch belt width	166-01-170	\$10.99
150XL037 (75 teeth), 3/8 inch belt width	166-05-150	\$11.99
160XL037 (80 teeth), 3/8 inch belt width	166-05-160	\$12.99
170XL037 (85 teeth), 3/8 inch belt width	166-05-170	\$11.99
180XL037 (90 teeth), 3/8 inch belt width	166-05-180	\$11.99

Tach Drive Parts for Ford 1.6L

When using a side mounted oil pump, the tach is usually driven from the front of the camshaft by mounting the tach drive gearbox on the front timing chain cover. The tach drive gearbox must be accurately aligned or it will fail in a very short time. One alternative is to mount the tach drive directly on the 5 port oil pump. We also carry the parts needed to convert a pump to this option. When using the front mounted pump, the tach drive is mounted on the side of the block using a special adapter (Part No. 166-22, shown here).



Description	Part No.	Price
Tach drive mount for 5 port pump w/ 1" scavenge rotor	166-21	\$42.49
<i>Replaces the end cover on the standard Titan 5-port oil pump. This special plate lets you mount a tach drive gearbox (not included) on the pump. Requires extended pump shaft, Part No. 167-11-Tach (sold separately on page 71 under Service Parts).</i>		
Replacement seal for above	166-21-Seal	\$8.99
Tach drive mount for side of block, with gear	166-22	\$199.99
<i>Mounts in place of the side-mount oil pump. This assembly lets you mount a tach drive gearbox (not included) on the side of the block, driven by the scroll gear on the camshaft. For use with front mounted oil pump.</i>		

Technical Data for the Ford 1.6L Engine

Race Engine Specs

Main Bearing Clearance	0.002"
Connecting Rod Bearing Clearance	0.0015" - 0.002"
Camshaft Bearing Clearance	0.002" - 0.0023"
Piston to Cylinder Wall Clearance	0.004" - 0.0045"
Top Ring End Gap	0.015"
Crankshaft End Float	0.005" - 0.011"
Camshaft End Float	0.004" - 0.0075"
Wrist Pin Clearance	0.0002" - 0.0003"
Intake Valve Stem Clearance	0.002"
Exhaust Valve Stem Clearance	0.0025"
Intake Valve Lash (hot)	0.010"
Exhaust Valve Lash (hot)	0.018"
Max. Intake Valve Lift @ 0° clearance	0.356"
Max. Exhaust Valve Lift @ 0° clearance	0.358"
Firing Order	1 - 2 - 4 - 3
Ignition Timing	38° - 40° BTDC
Points Gap, Bosch	0.020" - 0.022"
Points Gap, Autolite	0.024" - 0.025"

Recommended Race Engine Torque Specs

Head Bolts75 lbs. ft.	Front Cover Bolts7 lbs. ft.
Main Cap Bolts70 lbs. ft.	Rear Cover Bolts15 lbs. ft.
Rod Cap Bolts (standard)35 lbs. ft.	Water Pump Bolts7 lbs. ft.
Rod Cap Bolts (competition)43 lbs. ft.	Water Neck Bolts15 lbs. ft.
Flywheel Bolts55 lbs. ft.	Crankshaft Pulley Bolt	28 lbs. ft.
Pressure Plate Bolts (clutch cover)	15 lbs. ft.	Fuel Pump Bolts15 lbs. ft.
Rocker Shaft Bolts	30 lbs. ft.	Rocker Cover Screws	3.5 lbs. ft.
Camshaft Bolt	15 lbs. ft.	Intake Manifold Bolts18 lbs. ft.
Thrust Plate Bolts	3.5 lbs. ft.	Intake Manifold Nut15 lbs. ft.
Chain Tensioner Bolts7 lbs. ft.	Exhaust Manifold Bolts15 lbs. ft.
Oil Pump Bolts15 lbs. ft.	Carb to Manifold Nuts15 lbs. ft.
Oil Sump Bolts8 lbs. ft.	Spark Plugs25 lbs. ft.

Valve Adjusting Sequence

Valve Order:	1 EX	2 IN	3 IN	4 EX	5 EX	6 IN	7 IN	8 EX
When this valve is depressed:	1 EX	6 IN	4 EX	2 IN	8 EX	3 IN	5 EX	7 IN
Adjust this valve:	8 EX	3 IN	5 EX	7 IN	1 EX	6 IN	4 EX	2 IN

Ford 2.0L Engine Parts

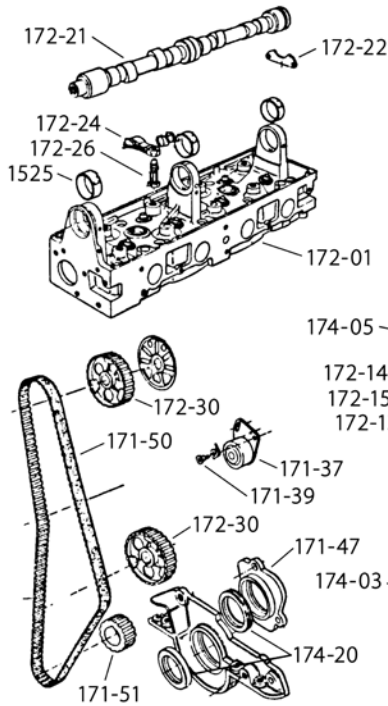

We carry stock engine parts as well as race prepared components from Ivey Engines.

See page 65 for ignition parts.
See page 70 for dry sump parts.
See page 146 for flywheel and clutch parts.

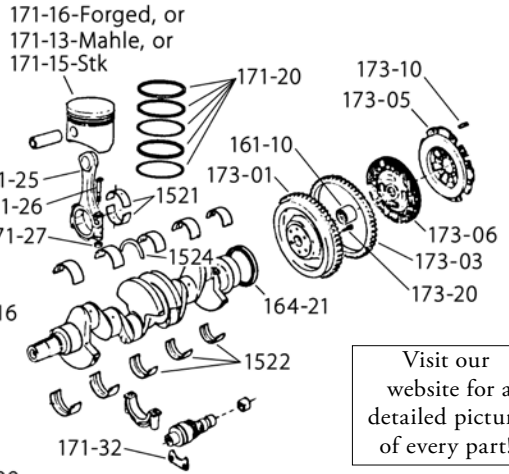

Visit our website for a detailed picture of every part!

Ford 2.0L Engine Parts, Bottom End

Description	Part No.	Price
Main Bearing Cap Bolt	171-06	\$7.99
Crankshaft Front Bolt	171-07-Bolt	\$4.99
Main Bearing Cap Dowel, short	171-09	\$1.49
Pilot Bearing for Clutch Shaft (same as 1.6L engine)	161-10	\$23.99
Set of 4 Forged CP Pistons with Wrist Pins and Clips	171-16-Forged	\$699.00
<i>These forged pistons do not include piston rings.</i>		
Mahle '85 Piston with Wrist Pin, WITHOUT rings, each	171-13-Mahle	\$124.99
Stock '85 AE Piston with Rings and Wrist Pin, each	171-15-Stk	\$159.99
Ivey Prepared Piston Ring Set for Forged pistons (for 4)	171-20-JE	\$179.99
<i>These rings fit CP or JE forged pistons only. They do not fit Ford AE or Mahle pistons.</i>		
Connecting Rod Bolt, Standard	171-26-Std.	\$5.89
Connecting Rod Bolt, Competition, SPS, each	171-26-Comp.	\$15.99
Connecting Rod Nut	171-27	\$6.99
Heavy-Duty Competition Rod Bolt and Nut Set, 16 piece kit	171-28-Set	\$41.04
<i>Fits stock Ford rods only (not Ford Motorsport/Oliver rods).</i>		
Auxiliary Shaft Front Bearing	171-31-Front	\$29.99
Auxiliary Shaft Thrust Plate	171-32	\$11.99
Timing Belt Tensioner	171-37	\$199.99
Tensioner Spring Retaining Bolt	171-39	\$21.49
Auxiliary Shaft Seal Housing	171-47	\$18.99
Timing Belt (camshaft drive belt)	171-50	\$46.99
Crankshaft Timing Belt Pulley	171-51	\$99.99
Crankshaft to Pulley Key, 1 piece (late style)	171-52-Late	\$3.69
Dowel, Block to Bell Housing	171-55	\$5.79
Thermostat O-Ring Seal (square cross-section quad-ring)	171-57-Seal	\$5.99
Thermostat Retaining Clip	171-57-Clip	\$6.99
48mm (1.89 inch) Freeze Plug, one required	171-60	\$9.99
Mechanical Fuel Pump, adjustable fitting orientation	171-79	\$94.99
<i>Fittings are adjustable in 60° increments. See website for detailed photo.</i>		
Mechanical Fuel Pump, standard (fixed fittings)	171-80	\$159.99
Fuel Pump Push Rod	171-81	\$36.99
Fuel Pump Block off Plate, for electric pump	174-14	\$13.99
44 tooth Gilmer Pulley for Water Pump	166-02-62	\$125.99
Crank Scraper	171-90	\$24.99

Visit our website for a detailed picture of every part!

Ford 2.0L Engine Parts, Top End

Description	Part No.	Price
Heavy-Duty Cylinder Head Stud and 12-point Nut Kit	172-06-Kit	\$121.82
<i>Kit includes 10 each Studs, 12 Point Nuts, Lock Washers and a packet of assembly lube.</i>		
Intake Manifold, used (for Weber 32/36 DGV Carb)	172-09-Stk	\$299.99
Intake Valve	172-11	\$48.99
Exhaust Valve	172-12	\$56.99
Heavy-Duty Valve Spring Set	172-13	\$69.99
Super-Duty Valve Spring Set (Ivey)	172-19	\$172.99
Valve Keeper, each (not pair - 2 required per valve)	172-14	\$1.69
Cam Spray bar	172-16	\$89.99
Bronze Valve Guide, .502 dia, .474 seal dia.	172-17	\$8.99
Valve Spring Shims, .06 thick	172-18-060	89¢
Stock Ford Camshaft and Eight Followers	172-21	\$469.99
Camshaft and Lifter Lubricant, 4 oz., Ford Motorsport	3312	\$8.49
Camshaft Thrust Plate	172-22	\$22.49
Camshaft Thrust Plate Screw, each	172-23	\$1.49
Cam Follower (rocker arm), each	172-24	\$79.99
Cam Follower Spring Clip, Heavy Duty, each	172-25-HD	\$5.99
Cam Follower Adjusting Stand Nut, each	172-27	\$3.99
Cam or Auxiliary Shaft Pulley	172-30	\$89.99
Front Bolt for Cam or Auxiliary Shaft, w/ locking patch	172-32-Bolt	\$1.59
Front Washer for Cam or Auxiliary Shaft	172-32-Washer	\$2.49
Cam or Auxiliary Shaft to Pulley Key, standard	172-33	\$1.99
Offset Cam Key, specify 1, 2, 3, 4 or 5°	172-34-()	\$18.99
Offset Cam Key Set, includes 1 thru 5° keys	172-34-Set	\$90.99
Valve Cover Hold-downs, per set	172-43	\$10.99

Stage 8 Locking Fastener Kit



Lose the safety wire - keep the header! The innovative **Stage 8 Locking Fastener System** uses a special 6-point bolt and a clip-on locking retainer to keep your exhaust header on tight. The clip-on retainer can be positioned so that the header tube will prevent the bolt from turning. Bolts, retainers, and E-clips are easily removed for service and are reusable indefinitely. Kit includes eight 6-point double hex head bolts measuring 8mm-1.25 x 25mm, 8 locking retainers, and 8 E-clips, enough for one Ford 2.0L ("Pinto") header.



Stage 8 Locking Fastener Kit for 2.0L Ford Header Part No. ST8-6101 ... \$47.99

Gaskets and Engine Bearings for the Ford 2.0L Engine

Engine Gaskets for 2.0L Ford Engines

Some of the gaskets listed below are manufactured by Ivey Engines specifically for racing use.

Description	Part No.	Price
Bottom End Gasket Set <i>Includes oil pan gasket set, front cover gasket, water pump gasket, front and rear crank seals, auxiliary shaft seal, fuel pump block, and distributor O-ring seal.</i>	174-02	\$49.99
Head Gasket Only	174-03	\$39.99
Valve Cover Gasket, narrow (old style - not very common)	174-04	\$13.49
<i>The "old style" gasket has 3 locating tabs sticking out of each long side.</i>		
Valve Cover Gasket, wide (.60" side, .72" rear) see note below	174-05	\$25.99
<i>The current "wide" gasket has 4 locating tabs sticking out of each long side.</i>		
Water Outlet Gasket	174-06	\$2.49
Water Pump Gasket	174-07	\$7.79
Stock Ford Oil Pan Gasket Set	174-08	\$32.99
Ivey Oil Pan Gasket Set with Cork End Pieces	174-13	\$12.99
Intake Manifold Gasket	174-09	\$16.99
Single Piece Exhaust Manifold Gasket (Ivey mfg)	174-10	\$9.99
Single Piece Graphite Exhaust Header Gasket	174-18	\$18.49
Phenolic Carb Spacer Plate with 2 gaskets (same as 1.6L)	164-14	\$21.99
Carb Base Gasket only	1586-Gasket	\$3.49
Front Seal for Crankshaft, Cam or Auxiliary Shaft	174-20	\$18.99
Rear Crankshaft Seal (same as 1.6L engine)	164-21	\$67.99
Standard Ford Valve Stem Seals, 8 pieces	174-22	\$22.29
Distributor O-Ring Seal	178-07	\$2.29

Engine Bearings for Ford 2.0L

Most of our engine bearings for the Ford 2.0L engine are manufactured by ACL. A few sizes are still stocked in AE or Vandervell (while supplies last). If a specific size is not available from our regular source, we will continue our attempts to find an alternate source.

2.0L Rod Bearings

Standard Size	Part No. 1521-Std	\$79.99
.25mm undersize I.D.	Part No. 1521-.25mm	\$79.99
.50mm undersize I.D.	Part No. 1521-.50mm	\$79.99
.75mm undersize I.D.	Part No. 1521-.75mm	\$79.99
1.0mm undersize I.D.	Part No. 1521-1.0mm	\$79.99

2.0L Main Bearings (standard O.D.)

Standard Size	Part No. 1522-Std	\$100.99
.25mm undersize I.D.	Part No. 1522-.25mm	\$109.99
.50mm undersize I.D.	Part No. 1522-.50mm	\$109.99
.75mm undersize I.D.	Part No. 1522-.75mm	\$109.99
1.0mm undersize I.D.	Part No. 1522-1.0mm	\$109.99

2.0L Thrust Bearing Washers

Standard Size	Part No. 1524-Std	\$24.99
----------------------------	-------------------	---------

2.0L Cam Bearings

Cam Bearings (all round style)	Part No. 1525	\$26.99
---	---------------	---------

2.0L Auxiliary Shaft Bearing

Auxiliary Shaft Front Bearing	Part No. 171-31-Frnt	\$29.99
--	----------------------	---------

Water and Oil Pump Belts and Pulleys for the Ford 2.0L Engine



44 tooth Water Pump Pulley
Part No. 166-02-62 (left)

38 tooth Crankshaft Pulley
Part No. 176-03 (right)

190XL050 Drive Belt
Part No. 166-01-190

30 tooth Pump Pulley for
Titan Series 2 pump
Part No. 176-14 (left)

15 tooth Crankshaft Pulley
for Titan Series 2 pump
Part No. 176-09 (right)

225L075 Drive Belt
Part No. 176-10-225



Water Pump Drive Belts and Pulleys for 2.0L

Our water pump pulleys have a large setback to eliminate the cantilevered load on the water pump. Standard water pump belts are 1/2 inch wide.

Description (pump rpm = 86% of crank rpm)	Part No.	Price
44 tooth pump pulley for .62 inch dia. pump shafts	166-02-62	\$125.99
38 tooth crankshaft pulley	176-03	\$96.99
190XL050 belt for above pulleys, 95 teeth, 1/2" wide	166-01-190	\$12.99

For more toothed belt sizes, see Ford 1.6L water pump drive section on page 67.

Poly-Vee Belt and Pulleys

The Poly-Vee pulley design has 5 vee-grooves around the circumference that grip matching grooves in the Poly-Vee belt. This provides less slippage than a standard V-belt, without the vibrations inherent with a toothed belt. The pulleys below were specifically designed for Titan crank-driven dry sump pump installations in the Swift chassis.

Poly-Vee Water Pump Pulley (5 grooves)	176-07	\$104.99
Poly-Vee Crank Pulley for Water Pump Drive	176-08	\$79.99

The two pulleys above combine to drive the water pump at 64% of crankshaft speed.

19 inch Poly-Vee Belt for above pulleys (5 vees)	176-06-19.0	\$44.99
---	-------------	---------

Oil Pump Pulleys and Belts for 2.0L

Description	Part No.	Price
15 tooth crankshaft drive pulley for Titan Series 2 pump	176-09	\$106.99
30 tooth Titan Series 2 pump pulley (crankshaft driven)	176-14	\$179.99
225L075 belt for above pulleys (60 teeth), 3/4" wide	176-10-225	\$121.99
22 tooth jackshaft drive pulley for Titan Series 2 pump	176-12	\$99.99
22 tooth Titan Series 2 pump pulley (jackshaft driven)	176-13	\$119.99
187L050 belt for above pulleys (50 teeth), 1/2" wide	176-11-187	\$15.49

Other Oil Pump Belts used on 2.0L Engines:

210L075 oil pump belt (56 teeth), 3/4" wide	176-10-210	\$20.99
<i>Use with crankshaft-driven Titan Series 1 pump</i>		
187L075 oil pump belt (50 teeth), 3/4" wide	176-10-187	\$19.99
218L075 oil pump belt (58 teeth), 3/4" wide	176-10-218	\$22.99

Oil Pump and Alternator Belts for FE (Formula SCCA)

Description	Part No.	Price
322L075 oil pump belt (86 teeth), 3/4" wide	176-10-322	\$32.49
195L050 alternator belt (52 teeth), 1/2" wide	176-11-195	\$26.99

Technical Data for the Ford 2.0L Engine

Recommended Race Engine Clearances

Main Bearings	0.002"
Con Rod Bearings	0.0015" - 0.002"
Camshaft Bearings	0.0018" - 0.0026"
Piston to Cylinder Wall	0.005"
Top Ring End Gap	0.015"
Crankshaft End Float	0.0032" - 0.011"
Camshaft End Float	0.0016" - 0.0047"
Wrist Pin	0.0007" - 0.00153"
Intake Valve Stem	0.002"
Exhaust Valve Stem	0.0025"
Intake Valve Lash	0.010" Cold
Exhaust Valve Lash	0.012" Cold

Recommended Race Engine Torque Specs

Head Bolt	85 lbs. ft.
Main Cap Bolt	75 lbs. ft.
Rod Cap Nut	35 lbs. ft.
Flywheel Bolt	50 lbs. ft.
Pressure Plate Bolt	15 lbs. ft.
Oil Sump Bolt	8 lbs. ft.
Rocker Cover Bolt	5 lbs. ft.
Front Cover Bolt	13 lbs. ft.
Water Neck Bolt	15 lbs. ft.
Camshaft Sprocket Bolt	35 lbs. ft.
Crankshaft Pulley Bolt	28 lbs. ft.
Intake Manifold Bolt	15 lbs. ft.
Exhaust Manifold Bolt	15 lbs. ft.
Carb to Manifold Nut	15 lbs. ft.
Spark Plug	20 lbs. ft.

Ford 1.6L Dry Sump Equipment

Titan 5 Port Side Mounted Pump for Ford 1.6L

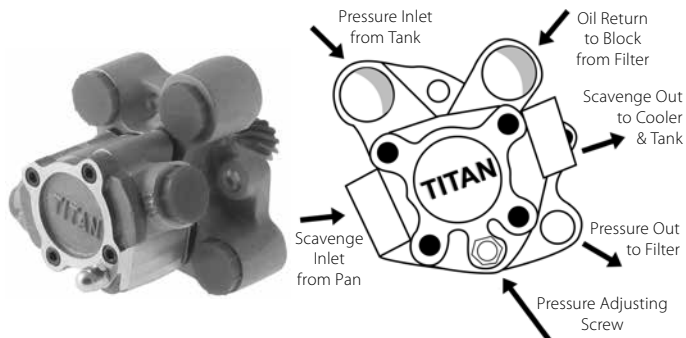

This is the standard Formula Ford dry sump pump. We stock the version with a 1 inch wide scavenge rotor and 3/4 inch diameter scavenge inlet because dyno tests show that this configuration results in a power advantage. The four female threaded ports all have 1/2 BSP threads. Adapter fittings and scavenge pipe are sold separately.

Titan 5 Port Side Mounted Pump Part No. 167-01-Side \$699.00
3/4 inch Scavenge Inlet Pipe with O-rings and clip.... Part No. 167-42 \$81.99

Titan Front Mounted Pump for Ford 1.6L



This unique pump is built into a special front timing chain cover and is driven directly from the front of the cam. This eliminates the frictional losses associated with driving the pump through scroll gears. It also allows a narrower chassis layout. The scavenge rotor is 1 inch wide and has a clip-retained 3/4 inch diameter scavenge inlet pipe (included). The scavenge outlet and pressure inlet ports have 1/2 BSP female threads. The pressure outlet port has 3/8 BSP female threads. A 10AN male adapter is included for each of the three threaded ports. Requires only 3 1/2" more room than a standard front cover.

Titan Front Mounted 4 Port Pump Part No. 167-01-Front \$899.00
Oldham Coupling for above pump Part No. 167-08 \$83.99
Drive Key for front mounted pump Part No. 167-09 \$34.99

Pace Side Mounted Pump with Integral Filter



This great little pump mounts the filter right on the pump, eliminating the need for a remote oil filter head and the associated oil lines. This saves weight, complexity, and several potential leak points. With its .624" wide pressure rotor and 1.125" wide scavenge rotor, this pump has enough capacity for a Ford Atlantic engine. (We recommend a larger oil filter for an Atlantic.) The flanged, bolt-on fittings allow the pump to be configured for different hose sizes. **Note:** The pump is sold without any inlet or outlet fittings. You must add a total of three fittings (sold separately below) to complete the pump.

Pace Oil Pump with Integral Filter, less fittings..... Part No. 167-02 \$1,019.00
Replacement Filter for above pump Part No. 167-05 \$19.99
10AN Flanged Bolt-on Fitting..... Part No. 167-03-10AN \$51.99
12AN Flanged Bolt-on Fitting..... Part No. 167-03-12AN \$49.99

Titan and ARE Cast Aluminum Dry Sump Oil Pans for Ford 1.6L



These super strong cast aluminum dry sump pans have mounting bosses at the front and rear which are used as engine mounts on certain chassis. The Titan pan is designed to tie into the Titan gearbox adapter. The ARE Swift and Van Diemen pans are made in the USA.

Description	Part No.	Price
Titan Cast Aluminum Oil Pan, complete	167-20-Cast	\$999.00
<i>Complete with 3/4 inch scavenge outlet pipe and filter screen.</i>		
ARE Oil Pan for Swift FF1600, no outlet fitting	167-25	\$1,079.00
ARE Oil Pan for Van Diemen FF1600, no outlet fitting	167-26	\$859.00
ARE Filtered 45° Scavenge Outlet Fitting, for 5/8" ID hose ..	167-47-5/8	\$64.99
ARE Filtered 45° Scavenge Outlet Fitting, for 3/4" ID hose	167-47-3/4	\$64.99

Ford 2.0L Dry Sump Equipment

TDC / Fast Forward Dry Sump Pump for 2.0L Ford



TDC / Fast Forward
Dry Sump Pump Kit for 2.0L Swift
Part No. 177-07-Swift

TDC / Fast Forward
Dry Sump Pump Kit for 2.0L Van Diemen / Lola
Part No. 177-07-VD

Fast Forward Components have been designing and manufacturing Sports 2000 and FC parts for over 20 years. Their TDC brand oil pumps are proudly made in the USA to exacting quality standards. These pump kits include the pump, drive belt, pump pulley, drive pulley, mounting bracket, and pump inlet and outlet fittings.

TDC 2.0L Oil Pump Kit, Swift (no sump pan) 177-07-Swift \$999.00
Crankshaft driven, mounts on the right side of the block.
TDC Oil Pump Kit, Van Diemen / Lola (no sump pan)..... 177-07-VD \$1,059.00
Jackshaft driven, mounts on the left side of the block.
Replacement Toothed Drive Belt for Van Diemen Kit..... 176-06-099 \$23.99

Pace Dry Sump Kit with Cast Aluminum Pan for 2.0L Ford

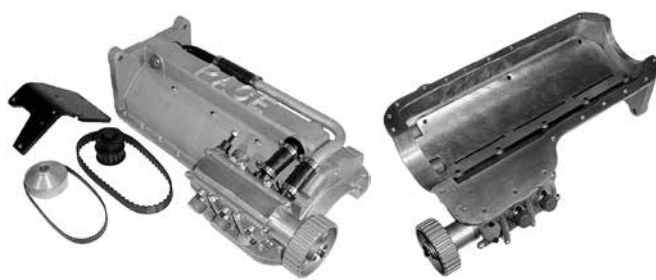

The Pace dry sump kit is a durable, compact, and well-designed system with beautiful machining. The rear scavenge outlet connects to the pump using a metal tube to minimize the risk of scavenge hoses sucking shut under vacuum. FC / F2000 and S2000 chassis that were originally designed for the Pace pump will be easier to plumb with the original Pace dry sump equipment instead of trying to convert to a different brand. Complete kit includes dry sump pump with pulley, water pump pulley, crank drive pulley, belts, scavenge pipes, scavenge hoses, mounting hardware, and cast aluminum pan.

Complete Pace Dry Sump Kit with Cast Pan 177-05-Cast \$2,399.00
Pace 2.0L Pump Only with 30 tooth pulley..... 177-06-01 \$999.00
"Universal" Pace pump supplied with inlet tube kits. You must cut the tubes to fit and braze or weld the tubes to their bolt-on flanges.
Replacement 30 tooth pulley for above pump 177-06-02 \$129.99

Lightweight Easy-Clean Dry Sump Oil Tanks



Easy Clean Oil Tank, Part No. 1216 (Large size)
9.5" OD x 16" High, 9.5 quart capacity.



View of disassembled oil tank.
Ensuring cleanliness is never
a problem with these tanks!

These oil tanks are not sealed during shipment from the manufacturer. You must open them and clean thoroughly prior to installation.

If your oil pump pressure rotor and housing seem to be wearing too fast no matter how careful you are about keeping your oil system clean, this may be a sign that your dry sump tank is contaminated. It seems that no matter how thoroughly you clean and rinse an oil tank you can never get all the dirt out because of the many baffles.

Our dry sump oil tanks are very easy to disassemble for cleaning. They are also extremely effective at separating air from scavenged oil to ensure proper engine lubrication. These tanks are high-quality assemblies of machined, stamped and spun aluminum components. The top and bottom halves are held together with a stainless steel V-band and sealed with a large O-ring. This allows the inlet fitting to be aligned in any direction relative to the outlet fitting. The inlet and outlet are threaded to accept O-ring port adapters. Visit our website for a full list of adapters to connect just about any type or size oil hose to these tanks.

The vent fittings on the top both have female NPT threads (1/2 NPT on the small and large sizes, 3/4 BSP on the medium size). Right angle barbed fittings for your breather hose are included. Connect the side vent fitting to the valve cover breather vent. The center vent is the air outlet to your catch bottle or breather tank. The oil level in these tanks should be at least 2" to 3" below the oil inlet fitting.

Small Oil Tank, 6.5" dia. x 14" high, M22 x 1.5mm O-Ring ports Part No. 1256-200 . . . \$549.00
Holds approximately 6.3 quarts when filled to just below the baffle. Includes 5/8" vent fittings.

Medium Oil Tank, 8.25" dia. x 14" high, M22 x 1.5mm O-Ring ports . Part No. 1256-201 . . \$599.00
Holds approximately 7.9 quarts when filled to just below the baffle. Includes 3/4" vent fittings.

See page 77 or visit our website for matching M22 O-ring adapters for the above tanks.

Large Oil Tank, 9.5" dia. x 16" high, -16 (1 5/16 -12) O-Ring ports Part No. 1216 \$589.00
Holds approximately 9.5 quarts when filled to just below the baffle. Includes 3/8" vent fittings.

See page 92 or visit our website for matching -16 O-ring adapters for this tank.

Oil Tank Heaters

You can prevent a lot of premature wear and tear on your racing engine by simply pre-heating the oil in the dry sump tank. About 20 minutes with one of our heater blankets can raise the temperature high enough for better flow, without risking thermal breakdown. Both of these heater blankets require 120 volt AC power. They are designed to be permanently wrapped around your oil tank and plugged in when needed. Use our Self-Bonding Silicone Tape (sold separately) to hold the heater blanket in place.

2.5" x 20" Silicone Rubber Heater Blanket, 200 watts. Part No. 3920 \$52.99
Best for our Small and Medium size oil tanks. Completely assembled with cord and plug.

2.5" x 28" Silicone Rubber Heater Blanket, 280 watts. Part No. 3921 \$57.99
Better for our Large oil tank. Completely assembled with cord and plug.

Self-Bonding Silicone Rubber Over-Wrap Tape Part No. 3929 \$27.99
Hundreds of uses beyond wrapping a heater blanket around a tank! 1" x 36 foot roll.



Silicone Rubber Heater Blanket, available in two sizes
Part Nos. 3920 and 3921



Self-Bonding
Silicone Rubber
Over-Wrap Tape
Part No. 3929

Do not attempt to shorten these heaters by cutting them. Doing so will destroy them.

Heaters should not be plugged in for more than 30 seconds unless they are attached to an oil tank or other heat sink. Otherwise they will overheat, which will reduce their life.

Canton Accusump

If your class rules or chassis layout prevent the use of a dry sump oiling system, an Accusump is the next best thing! These hydraulic pressure accumulators store engine oil which is pressurized by your stock oil pump when the engine is running. If oil pressure

drops (due to high g-loads, for example), the Accusump forces the pressurized oil back into the engine to feed the bearings. The SCCA recognizes the engine saving abilities of an Accusump and allows its use in all classes except Spec Miata.

Accusump Cylinders Only



Order mounting clamps and actuating valve separately.

Each Accusump cylinder includes a pressure gauge, pressure relief valve, and complete installation instructions. All three sizes have a 1/2 NPT female outlet port. Actuating valves and mounting clamps are sold separately at right.

Accusump Cylinder Only, 1 quart capacity Part No. 1249-Cyl \$210.00
Measures 3.25" dia. by 12.4" long not including the pressure gauge or relief valve.

Accusump Cylinder Only, 2 quart capacity Part No. 1240-Cyl \$225.00
Measures 4.25" dia. by 12" long not including the pressure gauge or relief valve.

Accusump Cylinder Only, 3 quart capacity Part No. 1241-Cyl \$242.00
Measures 4.25" dia. by 16" long not including the pressure gauge or relief valve.

Accusump Engine Input Adapters



There are several ways to plumb an Accusump into your oil system, but if your engine has a spin-on oil filter then these billet aluminum input adapters are the easiest. They mount between your engine block and spin-on filter like a sandwich plate, but they have just a single 1/2 NPT female port for the Accusump hose. No check valve is required.

Single Port Input Adapter, 3/4-16 Filter Thread Part No. CM 22-565 \$91.00

Single Port Input Adapter, 13/16-16 Filter Thread Part No. CM 22-566 \$91.00

Single Port Input Adapter, 18x1.5mm Filter Thread Part No. CM 22-567 \$91.00

Single Port Input Adapter, 20x1.5mm Filter Thread Part No. CM 22-568 \$91.00

Single Port Input Adapter, 22x1.5mm Filter Thread Part No. CM 22-569 \$91.00

Accusump Mounting Clamps



Accusumps must be solidly mounted with clamps at the ends of the cylinder only. Any distortion of the precision machined and polished cylinder will prevent free movement of the piston. We recommend these Accusump mounting clamps for proper attachment to the vehicle. Sold in pairs (enough to mount one Accusump).

Mounting Clamps, 1 quart size, pair Part No. 1238 \$19.00

Mounting Clamps, 2 or 3 qt. size, pair Part No. 1246 \$18.00

Accusump EPC Pro Electric Valves

EPC (Electric Pressure Control) Valves automatically control Accusump operation using a pressure switch wired to a 12 volt power supply. If the pressure drops below the specified pressure, the valve opens to allow pressurized oil to the engine. The valve will not let the Accusump refill until pressure returns. Each kit includes an electric valve, toggle switch, wire, terminals, and instructions.



Accusump EPC Pro Electric Valve, 20 psi (street) Part No. CM 24-271X \$238.00

Accusump EPC Pro Electric Valve, 35 psi (racing) Part No. CM 24-273X \$238.00

Accusump EPC Pro Electric Valve, 55 psi (extreme) Part No. CM 24-275X \$238.00

Accusump Manual Valve



This manual ball valve requires no electricity. Just open the valve right before startup and close it just before shutting down. Because it must be accessible to the driver, the valve can be mounted directly on the cylinder or remotely. Female 1/2 NPT threads at each end are easy to adapt to your oil system. A male-to-male 1/2 NPT nipple is included for direct mounting.

Accusump Manual Valve Kit, 1/2 NPT Part No. 1248 \$14.00

Oil Filter Spin-On Adapters

Oil Filter Spin-On Adapters make it easy for you to connect a remote oil filter and oil cooler. The spin-on adapter installs on your engine in place of the original oil filter to provide inlet and outlet ports to connect your oil plumbing. The remote filter should be mounted ahead of the cooler so that its pressure drop does not add

to the pressure in the cooler. An oil thermostat between the remote filter and the cooler is recommended to reduce the high pressures resulting from cold, viscous oil being forced through the cooler. We offer a range of spin-on adapters to suit nearly any application originally designed for a spin-on oil filter.

Cast Aluminum Spin-On Adapters



These economical spin-on adapters are made of cast aluminum. All of these adapters have 1/2 NPT female ports and 2 1/2" diameter O-ring seals. The ports are parallel with the spin-on filter stem (perpendicular to the sealing surface). This requires several inches of clearance next to the engine block.

- 3/4 - 16 Filter Thread (Ford and many others)..... Part No. 1230-3/4 x16.....\$17.49
- 13/16 - 16 Filter Thread (some GM, AMC) Part No. 1230-13/16x16.....\$17.49
- 18 x 1.5mm Filter Thread (late GM V6, 88-98 trucks) ... Part No. 1230-18x1.5\$17.49
- 20 x 1.5mm Filter Thread (Mazda, Honda, others) Part No. 1230-20x1.5\$17.49
- 22 x 1.5mm Filter Thread (Honda Civic/CRX, others) ... Part No. 1230-22x1.5\$17.49

Billet Rotating 90 Degree Spin-On Adapters



These adapters are machined from billet aluminum and black anodized. The ports are perpendicular to the spin-on filter stem (parallel to the sealing surface) for a low-profile installation. The center threaded nut is separate from the body, which allows you to position the ports exactly where you want them. All of these adapters have 1/2 NPT female ports and 2 1/2" diameter O-ring seals. Requires just 1 1/4" of clearance from the block.

- 3/4 - 16 Filter Thread Part No. CM 22-595 \$91.00
- 13/16 - 16 Filter Thread Part No. CM 22-592 \$110.00
- 20 x 1.5mm Filter Thread Part No. CM 22-597 \$91.00
- 22 x 1.5mm Filter Thread Part No. CM 22-598 \$91.00

Remote Oil Filter Heads

Remote Filter Heads We stock a variety of different filter heads so you can choose the style that allows the most direct routing of oil lines. Except where noted, all of these filter heads accept the Fram HP-1 or any other spin-on filter with the

common 3/4-16 thread. When plumbing the filter head make sure that the oil exits the filter through the center stem. See the plumbing section of this catalog for adapters and sealing washers (pages 91 to 95).

Remote Filter Heads with Temp Gauge Port



Left to right flow with gauge port
Part No. 1220



Right to left flow with gauge port
Part No. 1221

These cast aluminum remote filter heads have a 5/8-18 gauge port to accept a standard mechanical gauge temperature sensing bulb. Note that Auto Meter and Stewart-Warner gauges require a special extender nut (sold separately) to provide the correct tapered seat for the bulb to seal. We also offer a blanking plug separately if you choose not to connect a gauge. Choose the version that allows the most direct oil hose routing.

Left to right flow, (see illustration) Female 1/2 BSP ports ..Part No. 1220 \$69.99

Right to left flow, (see illustration) Female 1/2 BSP ports ..Part No. 1221 \$69.99

Temperature Bulb Extension for Part No. 1220 or 1221 Part No. 1209 \$19.99
Required with Stewart-Warner and Auto Meter gauges.

Aluminum 5/8-18 Plug (needed if gauge port is not used) ...Part No. 3602 \$10.49

Note: If you will be using an electrical gauge, choose one of the Dual Port models below.

Remote Filter Heads without Gauge Port



Top Ports
Part No. 1222



Left side ports
Part No. 1224-Left



Right side ports
Part No. 1224-Right

These economical cast aluminum remote filter heads let you mount your remote spin-on filter with a minimum of work. Each has 1/2 NPT ports for good flow. Choose the version that allows the most direct oil hose routing. Minimizing bends in the oil lines will help to reduce unnecessary pressure drop in the system.

Top ports, Female 1/2 NPT ports Part No. 1222 \$24.49
Both ports point out the top. Inlet is on the left side, outlet is on the right.

Left side ports, Female 1/2 NPT ports Part No. 1224-Left \$31.49
Both ports point to the left of the filter head. Inlet is closer to the front.

Right side ports, Female 1/2 NPT ports Part No. 1224-Right \$31.49
Both ports point to the right of the filter head. Inlet is closer to the front.

Replacement 3/4-16 Nipple for remote filter head Part No. 1234-3/4x16 \$2.99

Remote Filter Heads with Dual Ports



Dual Horizontal Ports
Part No. 1223



Billet with Dual Horizontal Ports
Part No. CM 22-625

These filter heads have dual horizontal ports. Each side of the filter head has an inlet port and an outlet port for maximum plumbing flexibility. You can plug the two unused ports using the included blanking plugs, or you can adapt the unused ports for a temperature or pressure gauge. The 1/2 NPT ports are easy to adapt to either an electrical or a mechanical sending unit.

Dual horizontal ports for Single Filter, 1/2 NPT portsPart No. 1223 \$40.99

Dual horizontal ports for Twin Filters (not pictured)Part No. 1229 \$48.99

Billet Remote Filter Head with Dual 1/2 NPT PortsPart No. CM 22-625... \$152.00

Ford Racing 90 Degree Oil Filter Adapter



Ford Racing 90 Degree Oil Filter Adapter
Part No. M-6880-A50

Sometimes you don't need to relocate the filter all the way to the other side of the engine bay. Sometimes you just need a couple more inches of clearance to fit a set of headers or to make an engine swap work. This special 90 degree cast aluminum adapter from Ford Racing is designed to move your spin-on oil filter just out of the way, without requiring any hoses or plumbing adapters. The threaded nut turns separately from the adapter, so you can aim the filter in any direction you need. Standard 3/4-16 threads. Filter not included.

Ford Racing 90 Degree Oil Filter Adapter Part No. M-6880-A50 \$109.99

Oil Filter Sandwich Plates

Oil Filter Sandwich Plates are designed specifically to add an oil cooler to your wet-sump oil system. The sandwich plate installs on your engine under your spin-on oil filter (between the filter and the block) to provide inlet and outlet ports to connect your oil plumbing. An oil thermostat between the remote filter and the cooler

is recommended to reduce the high pressures resulting from cold, viscous oil being forced through the cooler. Advantages of a sandwich plate over a remote oil filter include keeping the filter in the original location, eliminating the remote filter head and associated plumbing, and retaining the original oil filter thread.

Cast Aluminum Sandwich Plates with Bypass



Sandwich Plate with Bypass
Part No.
1231-3/4x16

These economical sandwich plates have a built-in pressure relief valve. When the oil is cold and thick, the bypass valve will open to allow the (filtered) oil to return directly to the engine. This helps to prevent overpressurizing the cooler. All of these sandwich plates have 3/8 NPT female ports and measure 1" thick. All sizes have a 2.5" diameter O-ring seal.

- 3/4-16 Filter Thread Part No. 1231-3/4x16 \$43.99
- 13/16-16 Filter Thread, 2 1/2" and 3 1/8" Part No. 1231-13/16x16 ... \$42.99
- 18 x 1.5mm Filter Thread Part No. 1231-18x1.5 \$42.99
- 20 x 1.5mm Filter Thread, 2 1/2" and 3 1/8" Part No. 1231-20x1.5 \$42.99
- 22 x 1.5mm Filter Thread Part No. 1231-22x1.5 \$42.99
- Replacement 2.50" dia. O-Ring for all sizes above Part No. 1235-2.50 inch \$1.99
- Replacement 3.12" dia. O-Ring, 13/16 and 20mm only ... Part No. 1235-3.12 inch \$3.49

Cast Aluminum Sandwich Plates with Thermostat

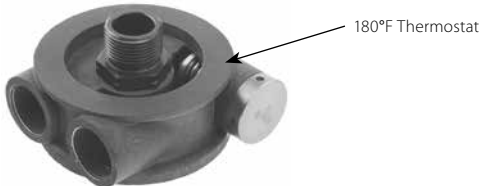

A simple bypass valve is a great safety feature, but if you want more control, a thermostat is a better choice. These sandwich plates from Setrab have a built-in thermostat that opens at 180°F (82°C) to force all oil to go through the cooler. (Below 180°F, the thermostat acts as an open bypass valve.) These plates have M22 female O-ring ports to accept Setrab M22 adapters (sold separately on page 77). All sizes have a 2.5" diameter O-ring.

- 3/4-16 Filter Thread Part No. SET-SPT76-34-180-22 ... \$110.00
- 20 x 1.5mm Filter Thread Part No. SET-SPT76-20-180-22 ... \$110.00
- 22 x 1.5mm Filter Thread Part No. SET-SPT76-22-180-22 ... \$110.00

Billet Aluminum High-Flow Sandwich Plates



Canton Sandwich Plate
Part No. CM 22-545

These high-flow sandwich plates from Canton are machined from billet aluminum with a tough black anodized finish. They do not have a thermostat or bypass valve, so an external oil thermostat is required to prevent overpressurizing your cooler with cold, thick oil. All of these sandwich plates have large 1/2 NPT female ports and measure 1 1/4" thick. All sizes have a 2.5" diameter O-ring seal.

- 3/4-16 Filter Thread Part No. CM 22-545 \$91.00
- 13/16-16 Filter Thread Part No. CM 22-546 \$91.00
- 18 x 1.5mm Filter Thread Part No. CM 22-547 \$91.00
- 20 x 1.5mm Filter Thread Part No. CM 22-548 \$91.00
- 22 x 1.5mm Filter Thread Part No. CM 22-549 \$91.00
- Replacement Seal Kit Part No. CM 98-004 \$7.49

Cast Aluminum High-Flow Sandwich Plates



High-flow
Sandwich Plate
with 1/2 BSP Ports
Part No. 1236-3/4x16

Chevy V-8
Sandwich Plate
Part No. 1232

If you install a separate oil thermostat (see page 77), you can get away with a full-flow sandwich plate. These plates force all of the oil through the cooler at all times, regardless of pressure or temperature. We do not recommend using them with a cheap oil cooler!

- 13/16-16 Filter Thread, 3 1/8" dia. O-Ring, 3/8 NPT ports . Part No. 1232 \$54.99
This special plate fits Chevy V8s with a recessed filter landing. Measures 1 7/8" thick.
- 3/4-16 Filter Thread, 2.5" O-Ring, 1/2 BSP ports Part No. 1236-3/4x16 \$54.99
This is the sandwich plate commonly used on FC/S2 and Ford 2.0L Pinto racing engines.
- Replacement O-Ring for Part No. 1236 Part No. 1254 \$2.99

Spin-On Oil Filter Thread Application Chart

Acura	
All except below..... All.....	20mm
Integra..... 86-87.....	22mm
Legend (2.7L), 3.2TL, 3.5RL.....	22mm
NSX..... 91-05.....	22mm
Alfa Romeo	
2.0L and V6..... All.....	3/4-16
Audi	
All that use spin-on..... All.....	3/4-16
BMW	
All that use spin-on..... All.....	3/4-16
British Leyland	
MGB (incl GT), Spridget..... 70+.....	3/4-16
Cadillac	
V-8 All except below..... All.....	13/16-16
V-6..... 85+.....	18mm
XLR-V, STS-V..... All.....	22mm
Chevrolet	
V-8 All except below..... 68-01 ..	13/16-16, 3 1/8" O-Ring
LS1..... 97+.....	13/16-16
Z06..... 06+.....	22mm
ZR1..... All.....	20mm
V-6..... 78+.....	18mm
Dodge / Chrysler / Plymouth	
All gas except below..... 59-07.....	3/4-16
V-8 All..... 08+.....	22mm
Stealth, Colt, Laser..... 89-98.....	20mm
Eagle	
Talon (non-turbo only)..... 95-98.....	3/4-16
Talon (all others)..... 89-98.....	20mm
Vision..... 93-97.....	3/4-16

Ferrari / Fiat	
All that use spin-on..... 70+.....	3/4-16
Ford / Lincoln / Mercury	
Cortina, Pinto, Escort..... 71+.....	3/4-16
V-8 All except Modular..... 58+.....	3/4-16
Modular V-8 (4.6, 5.4)..... 92+.....	22mm
V-6 12 valve and SHO..... 87+.....	3/4-16
V-6 24 valve..... 95+.....	22mm
Probe (All)..... 93-97.....	20mm
Thunderbird, Lincoln LS..... 02-05.....	1-12
Honda	
All except below..... 88-06.....	20mm
Civic / CRX..... 84-87.....	22mm
Mazda	
Miata, MX-5..... All.....	20mm
Rotary (all RX Series)..... 71+.....	20mm
Mazda 3..... 04-06.....	20mm
Mazda 6 V6..... 03-06.....	22mm
Trucks, SUVs except late MPV..... 89-98.....	3/4-16
MPV..... 99-06.....	22mm
Mercedes	
190 except 16v..... All.....	3/4-16
300 except CE..... All.....	3/4-16
Mitsubishi	
All gas except below..... 83+.....	20mm
Eclipse (non-turbo)..... 95-99.....	3/4-16
Nissan / Datsun / Infiniti	
All gas except below..... 74+.....	3/4-16
Altima, Maxima, Sentra..... 93-04.....	20mm
I30, I35, G35..... 96-04.....	20mm
200SX, 300ZX, 350Z..... 90-08.....	20mm
Pathfinder / QX4..... 96-04.....	20mm

Buick / Olds / Pontiac	
V-8 Buick only..... All.....	13/16-16, 3 1/8" O-Ring
V-8 All others..... All.....	13/16-16
V-6, Quad 4..... All.....	18mm
Porsche	
911..... 65-71.....	3/4-16
911..... 72-95.....	1-12
911 Turbo..... 91-94.....	20mm
911 3.6L..... 94-98.....	20mm
914 (4 cyl)..... 70-77.....	3/4-16
924..... 77-83.....	3/4-16
928..... 78-95.....	20mm
944 incl. turbo..... 82-95.....	20mm
SAAB	
99, 900, 9000 (4 cyl)..... 71-98.....	3/4-16
900, 9000 V6..... 94-98.....	18mm
9-3, 9-5..... 99-02.....	3/4-16
9-2X, 9-3, 9-5..... 03-12.....	20mm
9.7x..... All.....	13/16-16
Saturn	
All 19L..... 91-01.....	3/4-16
Vue Redline, Relay 3.5..... All.....	20mm
Toyota / Lexus / Scion	
All gas..... 70+.....	3/4-16
VW	
All that use spin-on..... 75+.....	3/4-16
Volvo	
All gas..... 90-99.....	3/4-16

Information in this chart is courtesy Canton Racing Products. Please contact us with errors or omissions.

Oil Filters and Accessories

Fram HP Oil Filters



These high-performance filters are standard equipment for many racing engines. The steel case is rated for operating pressure up to 200 psi, and the filter element is rated to 18 microns. All sizes have an anti-drainback check valve to help ensure immediate lubrication when the engine is restarted. All of these filters measure 3.7" OD except as noted.

- HP-1, 3/4-16 thread, 2 1/2" O-Ring, 5.9" long Part No. 1201 \$12.99
 - HP-2, 1 3/16-16 thread, 2 1/2" O-Ring, 5.9" long Part No. 1202 \$11.99
 - HP-3, 3/4-16 thread, 2 1/2" O-Ring, 3.5" long Part No. 1203 \$11.99
 - HP-4, 1 3/16-16 thread, 3 1/8" O-Ring, 5.9" long Part No. 1204 \$10.99
 - HP-6A NASCAR, 1 1/2-12 thread, 4.5" OD x 6.2" long Part No. FR-HP6A \$25.99
- This huge filter is specifically for NASCAR racing. It only fits special Fram filter heads.*

Extra-Short Fram Oil Filters (for tight formula car installations)



These super-compact filters are not part of the Fram HP line, but they are the shortest spin-on filters we have found that will fit on standard filter heads with a 3/4-16 thread. The Extra-Short Fram filter measures 2.85" long x 3.7" diameter. The Super-Short Fram filter measures 2.38" long x 3" diameter.

- Extra-Short Fram Filter, 3/4-16 thread, 2.85" L (shown) Part No. 1206 \$13.99
 - Super-Short Fram Filter, 3/4-16 thread, 2.38" L Part No. 167-05 \$19.99
- This is the replacement filter for our FF1600 Integral Filter Pump, Part No. 167-02.*

Setrab Hyperflow Lifetime Oil Filters

New!



Setrab Hyperflow Lifetime Oil Filter
Part No. SET-11-RU77-xx



Cleanable filter element (housing removed)

These spin-on filters use a cleanable filtering element to last a lifetime. The billet aluminum housing has a knurled gripping area for easy handling, even with oily hands. A 7/8" hex at the end lets you use a wrench if things get really out of hand. The hex is even pre-drilled for safety wire. Inside, a powerful rare earth magnet stops ferrous particles from clogging the filter. The filter element is rated to 30 microns absolute filtration* for maximum flow while still ensuring a clean supply of oil. The 77mm (3.03") OD x 78mm (3.07") Long housing can be disassembled without tools.

- Setrab Hyperflow Lifetime Filter, 3/4-16 Thread Part No. SET-11-RU77-34 .. \$149.95
 - Setrab Hyperflow Lifetime Filter, 20x1.5mm Thread .. Part No. SET-11-RU77-20 .. \$149.95
 - Setrab Hyperflow Lifetime Filter, 22x1.5mm Thread .. Part No. SET-11-RU77-22 .. \$149.95
- * Note: Filters manufacturers usually quote "nominal" filtration, which means that the filter will stop half of the particles of the quoted size. Absolute filtration means that ZERO particles of 30 microns will get through this filter!

In-Line Screen Filters

Our in-line screen filters are a great way to protect your fuel system or expensive dry sump oil pump. The fine 150 micron filters are recommended for fuel and oil systems.

Setrab 150 Micron In-Line Magnetic Screen Filters



These very fine 100 mesh filters trap debris as small as 150 microns, and an internal magnet holds even finer ferrous particles. The black anodized aluminum housing can be disassembled for thorough cleaning of both the screen element and the magnet. Each measures 1" diameter x 2 9/16" long (not including the male AN fittings).

- In-Line Filter, 6AN Male Fittings Part No. SET-IF0606D \$59.00
 - In-Line Filter, 8AN Male Fittings Part No. SET-IF0808D \$59.00
 - In-Line Filter, 10AN Male Fittings Part No. SET-IF1010D \$59.00
 - In-Line Filter, 12AN Male Fittings Part No. SET-IF1212D \$59.00
 - Service Kit for Setrab In-Line Filters Part No. SET-11-SKIF612 \$19.00
- For all sizes above. Includes replacement filter element and O-ring seals.*

Setrab 250 Micron In-Fitting Screen Filters



If you don't even have enough room for one of our compact inline filters above, you can still protect your system from trash! These 250 micron filter screens fit directly inside your existing AN fittings, adding virtually nothing to the length of the fitting or the hose. Simply unscrew your female fitting, slip the screen into your male fitting, and reconnect. Cleanable and reusable.

- Setrab In-Fitting Screen Filter, specify size:
- 6AN Part No. SET-UF06 \$28.50
- 8AN Part No. SET-UF08 \$28.50
- 10AN Part No. SET-UF10 \$29.75

K&N High-Performance Gold Oil Filters



K&N Gold oil filters flow up to 16 gallons per minute and are completely unaffected by racing gasoline, methanol or nitromethane fuels that may find their way into the engine oil. Unique 1" nut on the end cap allows easy removal and is already drilled for safety wire. Anti-drainback valve eliminates "dry starts" and prevents oil from flowing back into the crankcase after engine shutdown.

- K&N HP-3001 Filter, 3/4-16 thread, 3.7" OD x 5.7" long Part No. KN HP3001 \$12.49
- Fits most Ford and Dodge applications that use a Fram PH8A or HP-1 filter.*
- K&N HP-3002 Filter, 1 3/16-16 thread, 3.7" OD x 5.7" long .. Part No. KN HP3002 \$12.99
- Fits most Chevrolet applications that use a Fram PH13 or HP-2 filter.*
- K&N HP-2009 Filter, 3/4-16 thread, 3" OD x 5.1" long Part No. KN HP2009 \$11.99

Cutting Tool for Spin-On Oil Filters



Use this tool to quickly and safely cut your oil filter open to inspect the element for signs of unusual engine wear. An early warning can prevent a catastrophic and expensive engine failure. Oil filter inspections are mandatory on aircraft. Doesn't your engine deserve the same care? Made of aircraft grade 6061 aluminum. Includes two different-height cutters to accommodate most spin-on filters.

- Oil Filter Cutting Tool Part No. 1200 \$71.99
- Replacement Cutting Wheel Part No. 1198 \$12.99

Lucas-Style Oil Filter Cartridge



Many older British race cars still run the old Lucas cartridge-style oil filters. The original Lucas elements are all gone, but we stock a high-quality replacement for these hard-to-find oil filter elements. Measures 5 1/2" Long x 2 7/8" OD. Includes O-ring gasket.

- Lucas-Style Oil Filter Element, 5.5" long x 2.88" OD Part No. 1208 \$11.99

Canton Hi-Capacity In-Line Screen Filter

Canton Hi-Capacity In-Line Screen Filter
Part No. 3217-12AN



Replacement Screen Element
Part No. 3218

These in-line screen filters are larger than the fine filters shown at left, with a much coarser 14 mesh screen (approximately 0.050" openings). This provides lower flow resistance and less chance of clogging. They are ideal for the scavenge side of a dry sump oil pump or for a transmission cooler system. These filters can be disassembled for cleaning, and the screen element is also replaceable. Measures 1.25" diameter x 5" long not including the male AN fittings.

- Filter Screen, 8AN Part No. 3217-8AN \$71.00
- Filter Screen, 10AN Part No. 3217-10AN \$75.00
- Filter Screen, 12AN Part No. 3217-12AN \$79.00
- Replacement Screen Part No. 3218 \$13.00

Canton Oil Filters, Fuel Filters and Screens

Canton oil and fuel filters are in a class by themselves. Most other filters are surface-type filters which use a thin layer of a porous filter media (paper is most common). Contaminants are caught on the surface which can soon begin to restrict the fluid flow. These other filters require a bypass to prevent the elements from blowing out when the oil is cold or when the filter media fills up. Canton filters, on the other hand, use a thick synthetic filter media that flows much better than a surface element. When a particle is trapped in this thick filter element, oil can flow around the particle through another of

the many passages. The 4.62 inch long Canton element is equivalent to 4 Fram HP filters in flow rate and filtering capacity (and the Fram HP filters are far superior to standard filters). Tests show that a Canton filter with 20,000 miles still flows better than a new conventional filter. Because of this amazing flow capacity, Canton filters do not need a bypass. They filter all the oil, all the time! The high-flow material is contained in a steel cage that can't blow out. The Canton element is also unaffected by moisture which can weaken or even dissolve the paper elements found in most other oil and fuel filters.

Left: Canton 4" Billet Remote Mount Oil Filter Part No. CM 25-006B

Center: Canton 6" Billet Remote Mount Oil Filter Part No. 1281-002

Right: Mounting Clamp for Billet Filters Part No. 1281-003



Spin-On Canton Oil Filters

Left: 4.25" Filter Part No. 1283

Right: 6.25" Filter Part No. 1284



Remote Mount Canton Oil Filters These filters have very strong yet lightweight machined aluminum housings. The inlet in one end cap and the outlet in the side are both -12 O-ring ports for reliable, leak-free connections. We stock adapter kits separately to convert these O-ring ports to a variety of male AN sizes. The 4-bolt housings are easily disassembled to replace the filter element or to inspect for signs of engine damage. The billet aluminum housings are blue anodized with clear anodized end caps. A standard 8 micron filter element is included.

Canton Remote Mount Oil Filter, 4" (short) Part No. CM 25-006B \$122.00
Includes a 2.62" long 8 micron oil filter element

Mounting Clamp for Billet Filters, each Part No. 1281-003 \$11.99

Canton Remote Mount Oil Filter, 6" (long) Part No. 1281-002 \$133.00
Includes a 4.62" long 8 micron oil filter element

Mounting Clamp for Billet Filters, each Part No. 1281-003 \$11.99
One clamp is sufficient for most applications. We recommend two clamps when using the 6" filter in racing or other high-vibration environments.

Rebuild Seal Kit for either Remote Mount Oil Filter Part No. 1296 \$4.99

Note: Older "Mecca" filters (pre-1997) had a round housing which requires a different seal kit, available on our website.

These -12 O-Ring Port Adapter Kits fit either of the remote-mount filters shown above. Each kit includes 2 adapters and 2 O-rings (enough for one filter).

-12 O-Ring Port to 6AN Male Adapter Kit, pair Part No. 1280-6 \$31.00

-12 O-Ring Port to 8AN Male Adapter Kit, pair Part No. 1280-8 \$35.00

-12 O-Ring Port to 10AN Male Adapter Kit, pair Part No. 1280-10 \$40.00

-12 O-Ring Port to 12AN Male Adapter Kit, pair Part No. 1280-12 \$41.00

Canton Remote Mount Fuel Filter



Features a 1 micron "Injector Grade" filter element!

The Canton fuel filter is similar to the billet remote-mount oil filter described above except that it uses a fuel-resistant, extra-fine 1 micron element and Viton seals. This high-capacity filter will flow up to 90 GPM with such minimal pressure drop that it can even be used on the suction side of many electrical fuel pumps. (For suction use on low-pressure or mechanical pumps we recommend a coarser 8 micron element, sold separately below.) The billet aluminum housing is red anodized to distinguish it from Canton oil filters, which are blue anodized. Inlet and outlet ports are the same -12 O-ring ports as the remote mount oil filters. A fuel-resistant 1 micron replaceable element is included. Mounting clamp sold separately.

Canton Remote Mount Fuel Filter, 4" Part No. CM 25-911B \$124.00

Mounting Clamp for Fuel Filter Housing Part No. 1281-003 \$11.99

Replacement 1 Micron Fuel Element for above Part No. 1128 \$13.49

Optional 8 Micron (coarse) Fuel Element for above Part No. CM 26-605 \$14.99
Recommended when using a Canton Fuel Filter on the suction side of a fuel pump.

Viton Rebuild Seal Kit for above Part No. 1129 \$9.99

These -12 O-Ring Port Adapter Kits each include 2 adapters and 2 O-Rings (enough for one filter).

-12 O-Ring Port to 6AN Male Adapter Kit, pair Part No. 1280-6 \$31.00

-12 O-Ring Port to 8AN Male Adapter Kit, pair Part No. 1280-8 \$35.00

-12 O-Ring Port to 10AN Male Adapter Kit, pair Part No. 1280-10 \$40.00

-12 O-Ring Port to 12AN Male Adapter Kit, pair Part No. 1280-12 \$41.00

Spin-On Canton Oil Filters These filters have all the great features of the remote units listed at left but in a spin-on configuration. All are 3" in diameter and have a 2.62" O-ring diameter. The billet filter housing features a removable end cap. Just remove four bolts for easy access to the filter element inside. Each filter includes a standard 8 micron replaceable oil filter element. Replacement elements are listed below.

These filters use the shorter 2.62" element.

4.25" Spin-On Filter with 3/4-16 thread Part No. 1283-3/4x16 \$150.00

4.25" Spin-On Filter, 13/16-16 thread Part No. 1283-13/16 \$150.00

4.25" Spin-On Filter with 1"-12 Porsche thread Part No. 1283-1x12 \$150.00

4.25" Spin-On Filter, 18 x 1.5mm thread Part No. 1283-18x1.5 \$150.00

4.25" Spin-On Filter with 20 x 1.5mm thread Part No. 1283-20x1.5 \$150.00

These filters use the longer 4.62" element.

6.25" Spin-On Filter with 3/4-16 thread Part No. 1284-3/4x16 \$165.00

6.25" Spin-On Filter with 13/16-16 thread Part No. 1284-13/16 \$165.00

6.25" Spin-On Filter with 1"-12 Porsche thread Part No. 1284-1x12 \$165.00

6.25" Spin-On Filter with 20 x 1.5mm thread Part No. 1284-20x1.5 \$165.00

6.25" Spin-On Filter with 22 x 1.5mm thread Part No. 1284-22x1.5 \$165.00

Rebuild Seal Kit for 4-bolt cap Spin-On Filters Part No. 1297 \$7.00

The new Billet spin-on filters (and spin-on filters made before 2003) have 4-bolt end caps.

Rebuild Seal Kit for threaded cap Spin-On Filters Part No. 1295 \$7.00

Spin-on filters made between 2003 and 2012 have a threaded end cap with a center hex.

Oil Filter Elements for all Canton Oil Filters



Replacement Short Canton Oil Element Part No. 1291

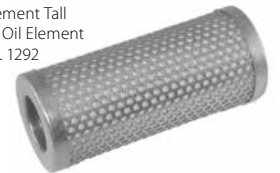

Replacement Tall Canton Oil Element Part No. 1292

Despite their outstanding filtering capacity, Canton oil filter elements should still be replaced periodically. We stock the same Canton 8 micron elements as supplied with the oil filters above. Two sizes are available: 2.62" length for the 4" remote mount filter and the 4.25" spin-on filter, and 4.62" for the 6" remote mount filter and the 6.25" spin-on filter. Sold individually.

Replacement 8 Micron Oil Filter Elements

Short 8 Micron Oil Element, 2.62" length Part No. 1291 \$11.99

For Part No. 1282 (4" Remote Mount) or 1283 (4.25" Spin-On) oil filters.

Tall 8 Micron Oil Element, 4.62" length Part No. 1292 \$14.79

For Part No. 1281 (6" Remote Mount) or 1284 (6.25" Spin-On) oil filters.

Screen Filter Elements for Canton Remote Mount Oil Filters



Short Screen Filter Element Part No. CM 26-050



Tall Screen Filter Element Part No. CM 26-150

Protect your expensive dry sump pump! Install one of these screen elements in a Canton remote-mounted oil filter (above left) for a free-flowing scavenge filter. The coarse 400 mesh allows free flow, yet catches the larger debris (40 micron and larger) that can destroy dry sump pumps. These elements are not for use for final oil filtration. The Short element fits the 4" remote-mount housing. The Tall element fits the 6" remote-mount housing. Sold individually.

Screen Pre-Filter Elements

Short 400 mesh (40 micron) Screen Element, 2.62" Part No. CM 26-050 \$31.00

Tall 400 mesh (40 micron) Screen Element, 4.62" Part No. CM 26-150 \$34.00

40 micron particles are about the size of 360 grit sandpaper.

For comparison, crankshaft journals are often finished with a 23 micron abrasive.

Setrab Oil Coolers

Setrab Oil Coolers have been winning races since the 1970s. They provide the maximum cooling capacity in the smallest possible space and with minimal pressure drop. Every cooler is factory pressure-tested to ensure quality. Three widths are available to fit a wide range of installations. The female 22x1.5mm O-ring ports allow an even wider variety of plumbing connections using special adapters (sold separately). You can even use a different size for the inlet and the outlet!

Note: All oil coolers are relatively fragile. Care must be taken to avoid stressing the fittings when tightening connections (always use a backup wrench on the cooler fitting). The cooler should be mounted in a manner that will minimize vibration. On dry sump systems it should be on the low pressure (return to tank) oil line in order to minimize the stress caused by pressure and to avoid a major leak if a slight crack were to develop during a race. Since every cooler is tested before shipment, leaking coolers can not be returned for credit or replacement.



Series 1
replaces our old
Part No. 1211
Half-Width Coolers



Series 6
replaces
our old
Part No. 1210
Full-Width
Coolers



Setrab Series 1 Narrow Oil Coolers			
8 1/4" long overall (6 7/16" less mounting ears)			
M22 O-ring ports spaced 4.8" center-to-center			
Number of Oil Rows	Height Inches	Part No.	Price
7	2.09	SET-107-7612	\$120.00
10	3.00	SET-110-7612	\$138.00
13	3.94	SET-113-7612	\$156.00
16	4.80	SET-116-7612	\$172.00
19	5.75	SET-119-7612	\$190.00
25	7.60	SET-125-7612	\$230.00
44	13.53	SET-144-7612*	\$432.00
50	15.31	SET-150-7612	\$496.00
60	18.31	SET-160-7612	\$560.00
72	22.13	SET-172-7612	\$674.00
Mounting Bracket Kit		SET-23-1002	\$36.00

* Note: The narrow Series 1 44 row size works well for front mounting on a Porsche 911.

Setrab Series 6 Standard Oil Coolers			
13" long overall (11 1/8" less mounting ears)			
M22 O-ring ports spaced 9 1/2" center-to-center			
Number of Oil Rows	Height Inches	Part No.	Price
7	2.09	SET-607-7612	\$151.00
10	3.00	SET-610-7612	\$167.00
13	3.94	SET-613-7612	\$186.00
16	4.80	SET-616-7612	\$208.00
19	5.75	SET-619-7612	\$223.00
25	7.60	SET-625-7612	\$268.00
34	10.39	SET-634-7612	\$391.00
40	12.20	SET-640-7612	\$462.00
50	15.31	SET-650-7612	\$564.00
60	18.31	SET-660-7612	\$676.00
Mounting Bracket Kit		SET-23-6002	\$44.00

Setrab Series 9 Wide Oil Coolers			
16" long overall (14 1/8" less mounting ears)			
M22 O-ring ports spaced 12 1/2" center-to-center			
Number of Oil Rows	Height Inches	Part No.	Price
10	3.00	SET-910-7612	\$180.00
15	4.53	SET-915-7612	\$219.00
20	6.06	SET-920-7612	\$262.00
25	7.60	SET-925-7612	\$340.00
34	10.39	SET-934-7612	\$454.00
48	14.70	SET-948-7612	\$664.00
Mounting Bracket Kit		SET-23-9002	\$50.00

All of the Setrab coolers listed here measure 2" thick and have female M22 (22x1.5mm) O-ring ports.

M22 (22x1.5mm) O-Ring Port Adapters for Setrab Oil Coolers

These adapters fit all Setrab oil coolers with the standard female M22 O-ring ports.* Adapters are sold separately, so you can use a different size for the inlet and outlet if needed.

* Note: Some Series 6 coolers are also available with -16 (1 1/16-16 thread) O-ring ports. Be sure to check your cooler before ordering.

Male AN Adapters	Part No.	Price
Male 8AN, Straight	SET-M22AN08-SE	\$11.00
Male 8AN, 45 degree	SET-M22AN08-45	\$33.50
Male 8AN, 90 degree	SET-M22AN08-90	\$30.50
Male 10AN, Straight	SET-M22AN10-SE	\$11.00
Male 10AN, 45 degree	SET-M22AN10-45	\$37.50
Male 10AN, 90 degree	SET-M22AN10-90	\$37.50
Male 12AN, Straight	SET-M22AN12-SE	\$12.00
Male 12AN, 45 degree	SET-M22AN12-45	\$41.50
Male 12AN, 90 degree	SET-M22AN12-90	\$41.50
Male AN Banjo Adapters	Part No.	Price
Male 6AN Banjo Kit	SET-M22BJAN06-90	\$54.50
Male 8AN Banjo Kit	SET-M22BJAN08-90	\$60.50
Male 10AN Banjo Kit	SET-M22BJAN10-90	\$66.50
Male 12AN Banjo Kit	SET-M22BJAN12-90	\$72.50
Banjo Adapter Rebuild Kit	SET-22SKBJM22	\$4.39

Hose End Adapters	Part No.	Price
6AN Hose End, Straight	SET-M22RU06-00	\$18.00
6AN Hose End, 45 degree	SET-M22RU06-45	\$28.40
6AN Hose End, 90 degree	SET-M22RU06-90	\$28.40
8AN Hose End, Straight	SET-M22RU08-00	\$20.00
8AN Hose End, 45 degree	SET-M22RU08-45	\$32.00
8AN Hose End, 90 degree	SET-M22RU08-90	\$32.00
10AN Hose End, Straight	SET-M22RU10-00	\$22.00
10AN Hose End, 45 degree	SET-M22RU10-45	\$35.50
10AN Hose End, 90 degree	SET-M22RU10-90	\$35.50
12AN Hose End, Straight	SET-M22RU12-00	\$25.50
12AN Hose End, 45 degree	SET-M22RU12-45	\$40.50
12AN Hose End, 90 degree	SET-M22RU12-90	\$40.50
Replacement O-Ring	Part No.	Price
M22 Viton O-Ring Only	SET-20-568019-V10	\$49c

This is the same O-Ring supplied with all Setrab M22 adapters (except the Male AN Banjo Adapters at left).

Pushlock Hose Barbs	Part No.	Price
6AN Pushlock, Straight	SET-M22PL06-00	\$12.00
6AN Pushlock, 45 degree	SET-M22PL06-45	\$27.50
6AN Pushlock, 90 degree	SET-M22PL06-90	\$27.50
8AN Pushlock, Straight	SET-M22PL08-00	\$14.00
8AN Pushlock, 45 degree	SET-M22PL08-45	\$31.00
8AN Pushlock, 90 degree	SET-M22PL08-90	\$31.00
10AN Pushlock, Straight	SET-M22PL10-00	\$16.00
10AN Pushlock, 45 degree	SET-M22PL10-45	\$34.00
10AN Pushlock, 90 degree	SET-M22PL10-90	\$34.00
12AN Pushlock, Straight	SET-M22PL12-00	\$18.00
12AN Pushlock, 45 degree	SET-M22PL12-45	\$37.50
12AN Pushlock, 90 degree	SET-M22PL12-90	\$37.50
Male BSP Adapters	Part No.	Price
Male 3/8 BSP, Straight	SET-M22BSP06-SE	\$9.99
Male 1/2 BSP, Straight	SET-M22BSP08-SE	\$9.99
Male 5/8 BSP, Straight	SET-M22BSP10-SE	\$9.99

Thermostatic Oil Controls

Overly cooled engine oil robs power and can lead to increased wear and sludge formation. An oil thermostat allows the oil to bypass the cooler until the proper temperature is reached. We offer two styles with a variety of fitting configurations. Both styles begin to close the bypass when the oil reaches 180°F ± 10°F (82°C ± 6°C).

Oil Thermostats with Male AN or Male BSP Fittings

This is our best oil thermostat. The very large internal passages allow it to be used in the most demanding applications. We stock this thermostat with 5 different sizes of male threaded fittings so you don't have to add separate adapters. This reduces bulk and weight while eliminating several potential leak points.



Oil Thermostat, 1/2 BSP Male fittings	Part No. 1226-1/2 BSP	\$174.99
Oil Thermostat, 8AN Male fittings	Part No. 1226-8AN	\$194.99
Oil Thermostat, 10AN Male fittings	Part No. 1226-10AN	\$187.99
Oil Thermostat, 12AN Male fittings	Part No. 1226-12AN	\$197.99
Oil Thermostat, 16AN Male fittings	Part No. 1226-16AN	\$199.99

Note: Oil thermostats don't block 100% of the flow of oil to the cooler when cold. Rather, they provide a bypass path until the oil reaches operating temperature. The oil, especially when cold and highly viscous, will follow the path of least resistance through the internal bypass. Therefore very little oil flows through the cooler. When the proper temperature is achieved the bypass closes, forcing all of the oil to flow through the cooler.

Oil Thermostats with Female NPT Ports



This economical thermostat has slightly smaller internal passages than Part No. 1226, but the female NPT threaded ports provide great flexibility when plumbing into your oil lines. Simply add the necessary adapters (sold separately) to connect to virtually any oiling system. You can even use different sizes on the inlet and outlet.

Oil Thermostat with 3/8 NPT Female threaded ports	Part No. 1228-3/8 NPT	\$75.99
Oil Thermostat with 1/2 NPT Female threaded ports	Part No. 1228-1/2 NPT	\$79.99

Catch Tanks



Filtered Breather Catch Tank

Our compact one quart breather tank can be used to vent a dry sump tank, rear end, or any other application that requires a filtered breather catch tank. The 3 1/4" diameter aluminum tank has one 1/4" NPT inlet and one 3/8" NPT inlet near the top. A drain petcock is provided at the bottom, and a special low-profile sintered bronze filter on the top keeps the overall height under 13". Includes a T-bolt mounting clamp. Meets SCCA requirements.

1 Quart Breather Tank
Part No. 2582-001 \$164.99



Universal Catch Tank Kit

This square plastic catch bottle features a full two quart capacity. Molded 3/8" nipples at the top and bottom allow you to use this bottle as a coolant expansion tank if desired. For catch tank use, the bottom nipple should be capped. Translucent plastic makes it easy to read the fluid level. A steel wire mounting basket is included for easy installation. Measures 6" W x 4 1/2" D x 8" H (6 3/8" x 5" with basket). Meets SCCA requirements.

Universal 2 Quart Catch Tank / Expansion Tank Kit
Part No. 2582-102 \$39.99

Plastic Catch Bottle Our round, one quart catch bottle is made from high-temperature plastics to stand up to hot oil and coolant. A heavy-duty screw-on lid prevents leaks. The bottle is undrilled so you can position your vent hose anywhere you need it. The translucent plastic makes it easy to see when the bottle needs to be emptied. Measures 3 5/8" diameter x 8" high overall. Mounting bracket is not included. Meets SCCA requirements.



1 Quart Plastic Catch Bottle
Part No. 2581 \$14.99

Cooling System Components

Machined Aluminum Filler Neck



If you fabricate your own aluminum radiators or swirl tanks and require a quality filler neck that can be welded on without distorting from the heat, then this is the part for you. Our aluminum filler neck is machined from a solid billet of 6061-T6 aluminum stock. This is not a flimsy, easily distorted stamped fitting. It can withstand the heat of welding without warping, so the cap will seal properly when the job is done. A threaded nipple is provided for connecting the overflow tube. Accepts any standard automotive radiator cap such as the Stant racing caps shown at right.

Aluminum Filler Neck Part No. CM 80-092 \$22.00

Stant Racing Radiator Caps



Raising coolant pressure with a high-pressure radiator cap will increase the coolant boiling point, which helps to prevent overheating. Before installing one, have your cooling system pressure checked to ensure that it can handle the increased pressure. Specify nominal pressure: 20 psi (vents between 18-22 psi) or 23 psi (vents between 21-25 psi).

Standard Cap Part No. 1290-Press \$19.99

Lever Cap Part No. 1590-Press \$23.99

The lever allows you to release system pressure before removing the cap.

Water Expansion Tank



An expansion (fill) tank is recommended for all applications where the top of the radiator is mounted lower than the top of the engine. Mounting the tank higher than the engine ensures a complete fill and provides an air space for expansion. Our lightweight aluminum tank has a 1.25 quart capacity and accepts a standard radiator cap such as the Stant racing caps at left (sold separately). A 1/2" NPT female port on the bottom and a 3/8" NPT female port on the side make plumbing easy. Measures 7 3/8" tall overall x 3 3/16" deep x 4 5/8" wide (6 9/16" wide including mounting tabs).

Water Expansion Tank Part No. 2584 \$117.00

Davies Craig Electric Coolant Pumps and Fans

Mechanical coolant pumps and fans are a compromise at best. If they are powerful enough to cool the engine at idle, they will cavitate or stall at high RPM. If you re-tune them for high-RPM performance, you will overheat on the grid. They also rob valuable horsepower through parasitic drag. Mechanical pumps and fans even cost you time when shifting gears because their inertia prevents engine RPMs from dropping when you

lift off the throttle. **Davies Craig** electric pumps and fans solve all of those problems by running completely independent of engine speed. They can even be run after the engine is off to avoid heat soak. The Davies Craig controller automatically runs the pump and fan just as much as required to maintain the coolant temperature you set. Davies Craig pumps and fans are suitable for racing or street vehicles.

Davies Craig 12 Volt Electric Water Pump Kits with LCD Controller



Davies Craig Electric Water Pump Kits can be installed on virtually any vehicle with a water-cooled engine and a 12 volt electrical system. Multiple pumps can be run on a single engine to further increase capacity. (For example, the Ferrari 550 GTO Le Mans cars used two EWP80 pumps, one on each cylinder bank of the V-12 engine.) Each of these kits includes a Davies Craig LCD Controller (described in detail below).

Alloy pumps have an aluminum alloy body for strength. The inlet and outlet are designed to accept a 1 1/2" ID coolant hose, but they also have 1" NPT female threads for more plumbing flexibility. Nylon pumps (shown) have a composite-reinforced nylon body for light weight. Inlet and outlet accept 1 3/8" ID coolant hose.

The **EWP150** can flow up to 150 liters per minute. This pump is suitable for the most highly-modified racing engines and turbocharged applications.

EWP150 Alloy Electric Pump & LCD Controller Kit Part No. DC8970 \$396.97

The **EWP115** can flow up to 115 liters per minute. It is recommended for stock, normally-aspirated V6 and V8 engines up to 3.5L.

EWP115 Alloy Electric Pump & Controller Kit Part No. DC8950 \$360.88

EWP115 Nylon Electric Pump & Controller Kit Part No. DC8930 \$338.74

The **EWP80** can flow up to 80 liters per minute. It is recommended for stock, normally-aspirated engines up to 2.0L (including FF1600 and Pinto-engined FF2000/FC/S2000).

EWP80 Nylon Electric Pump & Controller Kit Part No. DC8907 \$338.74

This pump has replaceable bolt-on inlet and outlet fittings for versatility.

Davies Craig LCD Controller



The **Davies Craig LCD Controller** can control any Davies Craig electric water pump and an electric fan. The controller automatically adjusts the rate of coolant flow to maintain the temperature you set. It can even be wired to run after engine shut-down. Simply set your desired engine temperature and let the controller do the rest! The 2 3/4" wide LCD display even has a temperature gauge for easy monitoring. Works on 12 or 24 volts DC.

Davies Craig LCD Controller Part No. DC8001 \$209.59
Includes temperature sensor and in-line sensor manifold for 1 5/16" - 1 5/8" ID hose.

Davies Craig 12 Volt Electric Cooling Fans



Davies Craig Electric Cooling Fans free up horsepower while providing more constant airflow. The unique reversible design can be installed as a pusher (upstream of radiator) or puller (downstream) depending on your application. Six different sizes are available to suit nearly any application. The largest sizes (14" and 16") measure less than 4" deep. Sizes smaller than 14" are less than 3" deep to fit in just about any engine compartment. Fan only; Wiring and Mounting Kit is sold separately. All of these fans run on 12 volts DC.

Davies Craig Electric Fan, 8" (5A, 200-300 CFM) Part No. DC0135 \$61.25

Davies Craig Electric Fan, 9" (6.5A, 350-450 CFM) Part No. DC0160 \$61.25

Davies Craig Electric Fan, 10" (7A, 500-600 CFM) Part No. DC0145 \$61.25

Davies Craig Electric Fan, 12" (9A, 600-700 CFM) Part No. DC0162 \$84.87

Davies Craig Electric Fan, 14" (13A, 850-1200 CFM) Part No. DC0107 \$132.84

Davies Craig Electric Fan, 16" (19A, 1200-1500 CFM) Part No. DC0166 \$140.22

Wiring and Mounting Kit Part No. DC1000 \$25.83

For any Davies Craig electric fan listed here. Includes wiring harness, 12 volt relay, and all necessary mounting hardware.

Davies Craig 12 Volt Electric Booster Pump



Originally designed to supplement standard coolant pumps, **Davies Craig Electric Booster Pumps** have become popular for a wide range of water pumping applications where the smallest EWP80 would be overkill. They can replace the power-robbing mechanical water pump on motorcycle engines and shifter karts, boost flow to the heater core in your tow vehicle for better heating, or cool off a hot engine or turbo after shut-off. Inlet and outlet on all EBPs are sized to accept 3/4" ID hose.

EBP15 Electric Booster Pump Kit, 15 liters/min Part No. DC9001 \$114.39
Recommended for karts and stock motorcycle engines to 500cc.

EBP23 Electric Booster Pump Kit, 23 liters/min Part No. DC9050 \$130.63
Recommended for stock motorcycle engines to 1000cc or race engines to 600cc.

EBP25 Electric Booster Pump Kit, 25 liters/min (shown) Part No. DC9005 \$146.86
Recommended for stock motorcycle engines over 1000cc or race engines to 900cc.

EBP40 Electric Booster Pump Kit, 40 liters/min Part No. DC9040 \$184.50
Recommended for motorcycle-engined P2 (CSR/DSR) cars.

High-Performance Silicone Hose and Accessories

This hose is built for custom coolant plumbing applications where a tough and secure flexible connection is required. Tough, reliable and temperature-resistant from -50°C to +200°C (-58°F to +392°F). Silicone rubber construction with textile reinforcement and smooth "wipe down" finish. Hoses are handcrafted and quality inspected to the highest standards. Note: There is some color variation from lot to lot and we can't always send out parts with the identical shade. Not for use with fuel or oil. **Now stocked in more sizes in Red, Black, and Blue!**

Straight Hose, 1 meter (39") sections



Our part numbers refer to the hose ID in millimeters.

Size	Part No.	Price
1/2" ID	SHL13-Color	\$23.99
3/8" ID	SHL16-Color	\$25.29
3/4" ID	SHL19-Color	\$26.79
7/8" ID	SHL22-Color	\$28.79
1" ID	SHL25-Color	\$29.29
1 1/8" ID	SHL28-Color	\$31.99
1 1/4" ID	SHL32-Color	\$34.99
1 3/8" ID	SHL35-Color	\$35.99
1 1/2" ID	SHL38-Color	\$36.99
1 5/8" ID	SHL41-Color	\$38.49
1 3/4" ID	SHL45-Color	\$38.99
2" ID	SHL51-Color	\$45.99
2 1/4" ID	SHL57-Color	\$49.99
2 1/2" ID	SHL63-Color	\$52.49
2 3/4" ID	SHL70-Color	\$59.99
3" ID	SHL76-Color	\$62.99
3 1/4" ID	SHL83-Color	\$75.99
3 1/2" ID	SHL90-Color	\$80.99
4" ID	SHL102-Color	\$87.99
4 1/2" ID	SHL114-Color	\$88.99
5" ID	SHL127-Color	\$104.99
6" ID	SHL152-Color	\$122.99

Straight Hose, 1 foot (0.3m) sections



These hoses are pre-cut to 1 foot lengths. Ordering a quantity of 3 will get you 3 pieces.

Size	Part No.	Price
1/2" ID	SHS13-Color	\$10.29
3/8" ID	SHS16-Color	\$10.99
3/4" ID	SHS19-Color	\$11.49
7/8" ID	SHS22-Color	\$12.29
1" ID	SHS25-Color	\$12.49
1 1/8" ID	SHS28-Color	\$13.79
1 1/4" ID	SHS32-Color	\$14.79
1 3/8" ID	SHS35-Color	\$15.49
1 1/2" ID	SHS38-Color	\$15.79
1 5/8" ID	SHS41-Color	\$16.49
1 3/4" ID	SHS45-Color	\$16.79
2" ID	SHS51-Color	\$19.49
2 1/4" ID	SHS57-Color	\$21.29
2 1/2" ID	SHS63-Color	\$22.49
2 3/4" ID	SHS70-Color	\$25.49
3" ID	SHS76-Color	\$26.79
3 1/4" ID	SHS83-Color	\$32.49
3 1/2" ID	SHS90-Color	\$34.49
4" ID	SHS102-Color	\$37.49
4 1/2" ID	SHS114-Color	\$37.99
5" ID	SHS127-Color	\$44.99
6" ID	SHS152-Color	\$52.49

Straight Silicone REDUCERS - 4" long



Size 1 x Size 2	Part No.	Price
5/8" x 1/2" ID	SR16.13-Color	\$9.29
3/4" x 1/2" ID	SR19.13-Color	\$9.29
3/4" x 5/8" ID	SR19.16-Color	\$9.39
7/8" x 5/8" ID	SR22.16-Color	\$9.69
7/8" x 3/4" ID	SR22.19-Color	\$9.69
1" x 5/8" ID	SR25.16-Color	\$9.69
1" x 3/4" ID	SR25.19-Color	\$9.69
1 1/8" x 7/8" ID	SR28.22-Color	\$9.99
1 1/8" x 1" ID	SR28.25-Color	\$9.99
1 1/4" x 1" ID	SR32.25-Color	\$11.79
1 1/4" x 1 1/8" ID	SR32.28-Color	\$11.79
1 3/8" x 1" ID	SR35.25-Color	\$12.49
1 3/8" x 1 1/8" ID	SR35.28-Color	\$12.49
1 3/8" x 1 1/4" ID	SR35.32-Color	\$12.49
1 1/2" x 7/8" ID	SR38.22-Color	\$12.79
1 1/2" x 1" ID	SR38.25-Color	\$12.79
1 1/2" x 1 1/8" ID	SR38.28-Color	\$12.79
1 1/2" x 1 1/4" ID	SR38.32-Color	\$12.79
1 1/2" x 1 3/8" ID	SR38.35-Color	\$12.79
1 5/8" x 1 3/8" ID	SR41.35-Color	\$12.79
1 3/4" x 1 1/4" ID	SR45.32-Color	\$12.99
1 3/4" x 1 1/2" ID	SR45.38-Color	\$12.99
2" x 1 1/2" ID	SR51.38-Color	\$17.79
2" x 1 3/4" ID	SR51.45-Color	\$17.79
2 1/8" x 2" ID	SR51.54-Color	\$17.99
2 1/4" x 1 1/2" ID	SR57.38-Color	\$18.29
2 1/4" x 1 3/4" ID	SR57.45-Color	\$18.49
2 1/4" x 2" ID	SR57.51-Color	\$18.29
2 1/2" x 1 1/2" ID	SR63.38-Color	\$18.79
2 1/2" x 1 3/4" ID	SR63.45-Color	\$18.79
2 1/2" x 2" ID	SR63.63-Color	\$18.79
2 1/2" x 2 1/4" ID	SR63.57-Color	\$18.99
2 3/4" x 1 3/4" ID	SR70.45-Color	\$18.99
2 3/4" x 2" ID	SR70.50-Color	\$19.49
2 3/4" x 2 1/4" ID	SR70.57-Color	\$19.49
2 3/4" x 2 1/2" ID	SR70.63-Color	\$19.49
3" x 2 1/2" ID	SR76.63-Color	\$19.79
3" x 2 3/4" ID	SR76.70-Color	\$19.99
3 1/4" x 2 1/4" ID	SR83.57-Color	\$20.29
3 1/4" x 2 1/2" ID	SR83.63-Color	\$20.29
3 1/4" x 2 3/4" ID	SR83.70-Color	\$20.99
3 1/4" x 3" ID	SR83.76-Color	\$21.29
3 1/2" x 2 1/4" ID	SR89.57-Color	\$21.79
3 1/2" x 2 1/2" ID	SR89.63-Color	\$21.99
3 1/2" x 2 3/4" ID	SR89.70-Color	\$22.29
3 1/2" x 3" ID	SR90.76-Color	\$23.29
3 1/2" x 3 1/4" ID	SR89.83-Color	\$22.99
4" x 2 1/2" ID	SR102.63-Color	\$28.79
4" x 3" ID	SR102.76-Color	\$29.29
4" x 3 1/4" ID	SR102.83-Color	\$29.79
4" x 3 1/2" ID	SR102.89-Color	\$30.49
4 1/2" x 3 1/2" ID	SR114.89-Color	\$33.99
4 1/2" x 4" ID	SR114.102-Color	\$34.99
5" x 4" ID	SR127.102-Color	\$33.49
5" x 4 1/2" ID	SR127.114-Color	\$35.99

90° Elbows - 6 inch legs

Leg length is measured from the centerline of the opposite leg.



Our part numbers refer to the hose ID in millimeters.

Size	Part No.	Price
1/2" ID	E90.13-Color-6	\$16.99
3/8" ID	E90.16-Color-6	\$16.99
3/4" ID	E90.19-Color-6	\$16.99
7/8" ID	E90.22-Color-6	\$16.99
1" ID	E90.25-Color-6	\$17.49
1 1/8" ID	E90.28-Color-6	\$18.29
1 1/4" ID	E90.30-Color-6	\$19.29
1 1/4" ID	E90.32-Color-6	\$19.49
1 3/8" ID	E90.35-Color-6	\$19.79
1 1/2" ID	E90.38-Color-6	\$20.29
1 5/8" ID	E90.41-Color-6	\$20.79
1 3/4" ID	E90.45-Color-6	\$21.79
1 7/8" ID	E90.48-Color-6	\$24.49
2" ID	E90.51-Color-6	\$29.49
2 1/8" ID	E90.54-Color-6	\$31.99
2 1/4" ID	E90.57-Color-6	\$33.49
2 3/8" ID	E90.60-Color-6	\$34.99
2 1/2" ID	E90.63-Color-6	\$36.49
2 3/4" ID	E90.70-Color-6	\$38.99
3" ID	E90.76-Color-6	\$39.99
3 1/4" ID	E90.83-Color-6	\$42.99
3 1/2" ID	E90.90-Color-6	\$44.49
4" ID	E90.102-Color-6	\$30.99
4 1/2" ID	E90.114-Color-6	\$46.49

180° Elbows - 4 inch legs

Our part numbers refer to the hose ID in millimeters.



Leg length is measured from the centerline of the bend.

Leg spacing measured center-to-center is 3 3/4" for sizes 1/2" to 1 3/8" ID (13mm-35mm), 4" for sizes 1 1/2" to 2 1/2" ID (38mm-63mm), 5" for sizes 2 3/4" and 3" ID (70mm-76mm), and 6" for sizes 3 1/4" and larger (83mm and up).

Size	Part No.	Price
1/2" ID	E180.13-Color	\$20.49
3/8" ID	E180.16-Color	\$20.49
3/4" ID	E180.19-Color	\$20.49
7/8" ID	E180.22-Color	\$20.49
1" ID	E180.25-Color	\$21.29
1 1/8" ID	E180.28-Color	\$22.29
1 1/4" ID	E180.32-Color	\$22.99
1 3/8" ID	E180.35-Color	\$23.49
1 1/2" ID	E180.38-Color	\$23.79
1 5/8" ID	E180.41-Color	\$24.49
1 3/4" ID	E180.45-Color	\$25.79
2" ID	E180.51-Color	\$34.99
2 1/4" ID	E180.57-Color	\$38.99
2 1/2" ID	E180.63-Color	\$42.49
2 3/4" ID	E180.70-Color	\$44.99
3" ID	E180.76-Color	\$45.99
3 1/4" ID	E180.83-Color	\$48.99
3 1/2" ID	E180.90-Color	\$50.49
4" ID	E180.102-Color	\$53.99

Aluminum Hose Joiner Splicing Nipples



We designed our hose joiners to have excellent hose retention and sealing properties. Multiple small ridges and a large bead at each end are all carefully radiused to avoid damaging the hose. Machined from 6061 aluminum and clear anodized to Mil-A-8625 standard.

Hose ID	Part No.	Price
1/2" (1.8" long)	HJ13	\$8.99
5/8" (1.8" long)	HJ16	\$8.99
3/4" (1.9" long)	HJ19	\$8.99
7/8" (1.9" long)	HJ22	\$8.99
1" (2" long)	HJ25	\$8.99
1 1/8" (2" long)	HJ28	\$8.99
1 1/4" (2" long)	HJ32	\$8.99
1 3/8" (2.1" long)	HJ35	\$9.99
1 1/2" (2.1" long)	HJ38	\$10.99

Hose ID	Part No.	Price
1 3/8" (2.2" long)	HJ41	\$11.99
1 3/4" (2.2" long)	HJ45	\$12.99
2" (2.3" long)	HJ51	\$13.99
2 1/4" (2.4" long)	HJ57	\$15.99
2 3/8" (2.4" long)	HJ60	\$16.99
2 1/2" (2.4" long)	HJ63	\$17.99
2 3/4" (2.5" long)	HJ70	\$18.99
3" (2.6" long)	HJ76	\$19.99
3 1/2" (2.8" long)	HJ89	\$20.99



See page 117 for the Redback Precision Silicone Hose Cutter for cleaner, straighter, safer cuts!

High-Performance Silicone Hose and Accessories

135° Silicone Elbows - 4 inch legs

Our part numbers refer to the hose ID in millimeters.



Leg length is measured from the centerline of the bend.

Size	Part No.	Price
1/2" ID	E135.13-Color	\$18.29
3/8" ID	E135.16-Color	\$18.29
3/4" ID	E135.19-Color	\$18.29
7/8" ID	E135.22-Color	\$18.29
1" ID	E135.25-Color	\$18.99
1 1/8" ID	E135.28-Color	\$19.79
1 1/4" ID	E135.32-Color	\$20.79
1 3/8" ID	E135.35-Color	\$20.99
1 1/2" ID	E135.38-Color	\$21.49
1 5/8" ID	E135.41-Color	\$21.99
1 3/4" ID	E135.45-Color	\$22.99
2" ID	E135.51-Color	\$31.49
2 1/4" ID	E135.57-Color	\$34.99
2 1/2" ID	E135.63-Color	\$37.99
2 3/4" ID	E135.70-Color	\$39.99
3" ID	E135.76-Color	\$40.99
3 1/4" ID	E135.83-Color	\$43.99
3 1/2" ID	E135.90-Color	\$45.49
4" ID	E135.102-Color	\$46.49

45° Silicone Elbows - 6 inch legs

Our part numbers refer to the hose ID in millimeters.



Leg length is measured from the centerline of the bend.

Size	Part No.	Price
1/2" ID	E45.13-Color-6	\$18.29
3/8" ID	E45.16-Color-6	\$18.29
3/4" ID	E45.19-Color-6	\$18.29
7/8" ID	E45.22-Color-6	\$18.29
1" ID	E45.25-Color-6	\$18.99
1 1/8" ID	E45.28-Color-6	\$19.79
1 1/4" ID	E45.32-Color-6	\$20.79
1 3/8" ID	E45.35-Color-6	\$20.99
1 1/2" ID	E45.38-Color-6	\$21.49
1 5/8" ID	E45.41-Color-6	\$21.99
1 3/4" ID	E45.45-Color-6	\$22.99
2" ID	E45.51-Color-6	\$31.49
2 1/4" ID	E45.57-Color-6	\$35.99
2 1/2" ID	E45.63-Color-6	\$38.99
2 3/4" ID	E45.70-Color-6	\$41.99
3" ID	E45.76-Color-6	\$42.99
3 1/4" ID	E45.83-Color-6	\$45.99
3 1/2" ID	E45.90-Color-6	\$46.99
4" ID	E45.102-Color-6	\$48.49
4 1/2" ID	E45.114-Color-6	\$49.49

90° Silicone REDUCING Elbows - 4" legs

Leg length is measured from the centerline of the bend.



Size 1 x Size 2	Part No.	Price
1" x 3/8" ID	RE9025.16-Color	\$14.99
1" x 3/4" ID	RE9025.19-Color	\$14.99
1" x 7/8" ID	RE9025.22-Color	\$14.79
1 1/4" x 1" ID	RE9032.25-Color	\$16.79
1 3/8" x 1" ID	RE9035.25-Color	\$18.29
1 3/8" x 1 1/8" ID	RE9035.30-Color	\$18.29
1 3/8" x 1 1/4" ID	RE9035.32-Color	\$18.29
1 1/2" x 1" ID	RE9038.25-Color	\$18.79
1 1/2" x 1 1/4" ID	RE9038.32-Color	\$22.79
1 1/2" x 1 3/8" ID	RE9038.35-Color	\$22.79
1 3/4" x 1 1/2" ID	RE9045.38-Color	\$25.79
2" x 1 1/2" ID	RE9051.38-Color	\$26.79
2" x 1 3/4" ID	RE9051.45-Color	\$27.29
2 1/4" x 2" ID	RE9057.51-Color	\$27.49
2 3/8" x 2" ID	RE9060.51-Color	\$30.99
2 1/2" x 1 3/4" ID	RE9063.45-Color	\$31.49
2 1/2" x 2" ID	RE9063.51-Color	\$31.99
2 1/2" x 2 1/4" ID	RE9063.57-Color	\$31.99
2 3/4" x 2" ID	RE9070.51-Color	\$31.99
2 3/4" x 2 1/2" ID	RE9070.63-Color	\$32.49
3" x 2" ID	RE9076.51-Color	\$32.49
3" x 2 1/4" ID	RE9076.57-Color	\$32.99
3" x 2 1/2" ID	RE9076.63-Color	\$32.99
3" x 2 3/4" ID	RE9076.70-Color	\$33.49
3 1/4" x 2 1/2" ID	RE9083.63-Color	\$33.49
3 1/2" x 2 1/2" ID	RE9089.63-Color	\$33.99
3 1/2" x 3" ID	RE9090.76-Color	\$33.99
4" x 3" ID	RE90102.76-Color	\$34.49
4" x 3 1/2" ID	RE90102.89-Color	\$35.49

45° Silicone REDUCING Elbows - 4" legs

Leg length is measured from the centerline of the bend.



Size 1 x Size 2	Part No.	Price
1" x 3/8" ID	RE4525.16-Color	\$18.29
1" x 3/4" ID	RE4525.19-Color	\$18.29
1 1/4" x 1" ID	RE4532.25-Color	\$19.79
1 3/8" x 1" ID	RE4535.25-Color	\$20.29
1 3/8" x 1 1/4" ID	RE4535.32-Color	\$20.79
1 1/2" x 1" ID	RE4538.25-Color	\$20.79
1 1/2" x 1 1/4" ID	RE4538.32-Color	\$20.99
1 1/2" x 1 3/8" ID	RE4538.35-Color	\$20.99
1 3/4" x 1 1/2" ID	RE4545.38-Color	\$22.99
2" x 1 1/2" ID	RE4551.38-Color	\$22.99
2" x 1 3/4" ID	RE4551.45-Color	\$26.29
2 1/4" x 2" ID	RE4557.51-Color	\$34.49
2 3/8" x 2" ID	RE4560.51-Color	\$34.99
2 1/2" x 1 3/4" ID	RE4563.45-Color	\$35.49
2 1/2" x 2" ID	RE4563.51-Color	\$35.99
2 1/2" x 2 1/4" ID	RE4563.57-Color	\$36.49
2 3/4" x 2" ID	RE4570.51-Color	\$36.99
2 3/4" x 2 1/2" ID	RE4570.63-Color	\$40.99
3" x 2" ID	RE4576.51-Color	\$38.99
3" x 2 1/4" ID	RE4576.57-Color	\$39.49
3" x 2 1/2" ID	RE4576.63-Color	\$41.99
3" x 2 3/4" ID	RE4576.70-Color	\$41.99
3 1/4" x 2 1/2" ID	RE4583.63-Color	\$42.99
3 1/2" x 2 1/2" ID	RE4589.63-Color	\$42.99
3 1/2" x 3" ID	RE4590.76-Color	\$45.99
4" x 3" ID	RE45102.76-Color	\$46.99
4" x 3 1/2" ID	RE45102.89-Color	\$47.99

Silicone Tees and Gauge Adapters



Above: Aluminum Gauge Adapter Plugs
Part No. 3228-110-02 (center)
Part No. 3228-111 (right)
shown installed in a Tee (sold separately)

Size	Part No.	Price
1" ID Run x 1" ID Branch	T025.025	\$15.79
1 1/2" ID Run x 1" ID Branch	T038.025	\$19.49
2" ID Run x 1" ID Branch	T051.025	\$24.29
2 1/2" ID Run x 1" ID Branch	T063.025	\$30.99
3" ID Run x 1" ID Branch	T076.025	\$32.49
Electrical Gauge Adapter Plug	3228-110-02	\$13.99
1" OD aluminum plug with a 1/8 NPT Female port.		
Mechanical Gauge Adapter Plug	3228-111	\$17.99
1" OD aluminum plug with a 5/8-18 UNF Female port.		

Lined Hose Clamps for Silicone Hose



These clamps prevent extrusion of the silicone hose cover through the slots found on normal screw type hose clamps. The inside of the clamp is fully-lined with a smooth non-perforated band to prevent hose damage.

Size	Part No.	Price
Lined Hose Clamp, 0.75" to 1.25" ID	3613-1.25	\$22.99
Fits 0.5 to 0.75" ID hose.		
Lined Hose Clamp, 1.0 to 1.75" ID	3613-1.75	\$24.99
Fits 0.75 to 1.25" ID hose.		
Lined Hose Clamp, 1.31 to 2.25" ID	3613-2.25	\$27.99
Fits 1.25 to 1.75" ID hose.		
Lined Hose Clamp, 1.81 to 2.75" dia.	3613-2.75	\$29.99
Fits 1.75 to 2.25" inside diameter hose.		
Lined Hose Clamp, 2.31 to 3.25" dia.	3613-3.25	\$33.99
Fits 2.25 to 2.75" inside diameter hose.		

Please call or visit our website for more sizes from 7/8" to 7" ID!

Stäubli Non-Spill Quick-Disconnect Fittings for Brake and Fuel Lines

Stäubli has been a top manufacturer of dry disconnect couplers for over 40 years. These compact, lightweight connectors are designed specifically for motorsport applications.

NOTE: On the SPH series the terms Male and Female refer to the valve mechanism, not to the retention sleeve. Please refer to the photos.



Female SPH Clean-Break Coupling
Part No. 4700-015-03-Red

Male SPH Clean-Break Coupling
Part No. 4700-001-03-Red



Stäubli SPT 05 Safety Break-Away Plug and Socket
Part Nos. 4700-050-06-Red and 4700-075-06-Red

Stäubli SPT 08 Non-Spill Plug and Socket
Part Nos. 4700-101-08-Red and 4700-115-08-Red

The Stäubli SPT 05 and SPT 08 series for fuel systems feature perfluoroelastomer seals for compatibility with all racing fuels. The SPT 05 Socket includes a safety break-away lanyard on the release collar (perfect for motorcycles and sprint cars). Couplers are not interchangeable from one series to another. Coupling color is red. *Please see our website for more sizes and styles of Stäubli dry disconnect fittings!*

- SPT 05 Safety Break-Away Socket, 6AN male . . . Part No. 4700-050-06-Red . . . \$239.99
- SPT 05 Safety Break-Away Plug, 6AN male* . . . Part No. 4700-075-06-Red . . . \$129.99
- 2 gpm flow rate at 5 psi with 13.4 cSt hydraulic oil (similar to SAE 15 oil) and 6AN fittings.
- SPT 08 Non-Spill Socket, 8AN male Part No. 4700-101-08-Red . . . \$222.99
- SPT 08 Non-Spill Plug, 8AN male Part No. 4700-115-08-Red . . . \$140.99
- 5 gpm flow rate at 5 psi with 13.4 cSt hydraulic oil (similar to SAE 15 oil) and 8AN fittings.
- SPT 08 Non-Spill Plug, 6AN male* Part No. 4700-115-06-Red . . . \$142.99

*SPT 05 and SPT 08 plugs (with 6AN male fittings) may be used as FIA-Approved fuel sampling ports for Rally, GT Cars, F3, and F3000 per FIA Technical List 5.

Jiffy-tite™ Self-Sealing, Quick-Connect Fluid Fittings

These lightweight Jiffy-tite™ Quick-Connect fittings are designed specifically for motor racing. They provide superior seal integrity under extreme racing conditions. Made of high-quality aircraft aluminum with brass valves and stainless steel ball bearings, they are corrosion resistant for extra long life. **Fittings are available in 2000, 3000 and 5000 Series based upon the required rate of fluid flow. (See chart for results of flow tests.) Check out these features:**

- Standard fluorocarbon seals are resistant to gasoline, oil, water and coolant
- Available with Buna seals for alcohol & methanol or EPDM seals for nitromethane or hydraulic fluid
- Patented design – designed specifically for racing
- Lightweight – lighter than competitor's fittings
- Good-looking black & gold anodized finish
- Durable 6061-T6 aluminum bodies, brass valves and stainless steel ball bearings
- Connects by hand in seconds – ribbed collar for slip proof use
- Wide variety of interchangeable adapters
- Double shut-off valves provide increased safety
- 350°F (177°C) maximum operating temperature (with standard fluorocarbon seals)
- Compact yet with high-flow capacity
- 200 psi maximum operating pressure (not for use in brake or clutch systems)
- Excellent corrosion resistance
- Excellent wear resistance
- 100% leak tested
- Rebuildable
- 360° swivel
- Made in the U.S.A.

See our website for many more Jiffy-tite™ parts!

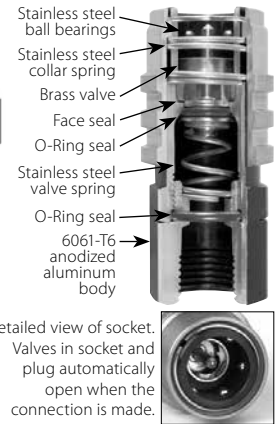
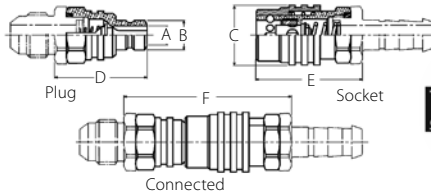

Series	A dia. inches	B dia. inches	C dia. inches	D inches	E inches	F inches	Flow ** (valved)	Flow ** (non-valved)
2000	0.24	0.37	0.75	1.68 max	1.86 max	3.13 max	1.75 gpm	3.81 gpm
3000	0.37	0.53	1.03	2.01 max	2.34 max	3.74 max	4.34 gpm	na
5000	0.59	0.78	1.37	2.69 max	3.06 max	5.25 max	7.86 gpm	na

** Flow rates are measured using Stoddard solvent at 80° F with a 5 psi inlet pressure through a mated pair of fittings attached to the following hose lengths:
2000 series: 3 ft of -6 hose; 3000 series: 2 ft of -8 hose; 5000 series: 2 ft of -10 hose

PLUMBING

Fitting Type

	2000 Series Jiffy-tite™ Fittings		3000 Series Jiffy-tite™ Fittings		5000 Series Jiffy-tite™ Fittings	
	2000 Socket	2000 Plug	3000 Socket	3000 Plug	5000 Socket	5000 Plug
	Part No.	Price	Part No.	Price	Part No.	Price
-4 (7/16-20) Male O-Ring Boss			JT22104	\$19.99		
-6 (9/16-18) Male O-Ring Boss			JT22106	\$20.99		
-8 (3/4-16) Male O-Ring Boss					JT32106	\$23.69
-10 (7/8-14) Male O-Ring Boss					JT32108	\$24.79
						JT52110 \$48.99
3AN Female	JT21303	\$33.29	JT22303	\$20.49		
4AN Female	JT21304	\$34.99	JT22304	\$22.39		
6AN Female	JT21306	\$36.89	JT22306	\$23.59	JT31306	\$42.39
8AN Female					JT32306	\$27.49
10AN Female					JT31308	\$44.59
12AN Female					JT32308	\$28.39
					JT51308	\$66.99
					JT51310	\$70.29
					JT51312	\$73.79
					JT52308	\$48.49
					JT52310	\$52.19
					JT52312	\$58.49
3AN Male	JT21403	\$28.89	JT22403	\$18.49		
4AN Male	JT21404	\$30.49	JT22404	\$19.49		
6AN Male	JT21406	\$31.99	JT22406	\$20.39	JT31406	\$36.89
8AN Male					JT32406	\$23.49
10AN Male					JT31408	\$38.79
12AN Male					JT32408	\$24.59
					JT51408	\$62.59
					JT51410	\$65.59
					JT51412	\$68.99
					JT52408	\$45.29
					JT52410	\$48.69
					JT52412	\$51.59
-4 Hose Barb (0.22")	JT21504	\$30.59	JT22504	\$18.29		
1/4" Pushlock Hose Barb	JT21504P	\$22.99				
-6 Hose Barb (0.34")	JT21506	\$33.59	JT22506	\$20.49	JT31506	\$40.49
3/8" Pushlock Hose Barb	JT21506P	\$19.99	JT22506P	\$13.99	JT32506	\$26.49
-8 Hose Barb (0.44")					JT31506P	\$30.39
1/2" Pushlock Hose Barb					JT32506P	\$19.99
-10 Hose Barb (0.56")					JT31508	\$42.33
5/8" Pushlock Hose Barb					JT32508	\$27.79
					JT51508	\$66.29
					JT52508	\$58.49
					JT51510	\$91.99
					JT52510	\$61.59
					JT51510P	\$68.99
					JT52510P	\$46.29
-4 Straight Hose End	JT21604	\$37.59	JT22604	\$24.89		
-6 Straight Hose End	JT21606	\$39.49	JT22606	\$26.29	JT31606	\$45.29
-8 Straight Hose End					JT32606	\$33.59
-10 Straight Hose End					JT31608	\$47.59
-12 Straight Hose End					JT32608	\$35.19
					JT51610	\$72.19
					JT52610	\$60.19
-6 90° Hose End	JT21606E	\$45.19	JT22606E	\$31.89	JT31606E	\$51.69
-8 90° Hose End					JT32606E	\$33.59
-10 90° Hose End					JT31608E	\$53.99
-12 90° Hose End					JT32608E	\$41.59
					JT51610E	\$79.59
					JT52610E	\$67.59
					JT51612E	\$83.39
					JT52612E	\$70.79
1/8 NPT Male	JT21802	\$33.29	JT22802	\$21.29		
1/4 NPT Male	JT21804	\$35.29	JT22804	\$22.39	JT31804	\$39.39
3/8 NPT Male					JT32804	\$26.19
1/2 NPT Male					JT31806	\$41.29
					JT32806	\$28.99
					JT51806	\$60.79
					JT52806	\$47.19
					JT51808	\$67.59
					JT52808	\$50.59

Jiffy-tite™ Part Number Builder • Use this table to construct the Jiffy-tite™ part number you need

We have many more combinations in stock than we can possibly list here; please see our website or give us a call. If we don't have it, we can order it for you!

Digit 1	Digit 2	Digit 3	Digit 4	Digit 5	Letter (optional)	
2 = 2000 Series 3 = 3000 Series 5 = 5000 Series	1 = Socket 2 = Plug	1 = O-Ring Boss Adapter 3 = Female AN Adapter 4 = Male AN Adapter 5 = Hose Barb Adapter*	6 = Reusable Hose End 7 = Female NPT Threads 8 = Male NPT Threads	AN Dash Size or NPT Size	A = Non-Valved B = Buna N (Nitrile) Seals C = Non-Valved, Buna N Seals D = 45° Elbow E = 90° Elbow	BD = 45° Elbow, Buna N Seals BE = 90° Elbow, Buna N Seals F = EPDM Seals M = Lanyard P = Pushlock Hose Barb*

* Hose barb fits AN-type hose (such as our Nitrile-Lined Hose on page 86). Pushlock hose barb fits rubber hose (such as our Textile-Reinforced Hose on page 88).

Size 3 and 4 Braided PTFE Hose and Reusable Hose End Fittings



Inner tube may be natural color PTFE or black carbon filled PTFE as shown here.

This high-pressure hose has an extruded PTFE liner and a stainless steel wire braid cover. It is ideal for brake, clutch and pressure gauge lines (we recommend -3 for brake lines for the firmest pedal). All hose end fittings shown in this section are reusable although the brass sleeve must be replaced each time a fitting is reused. The rated temperature range for this type of hose is -100°F to +450°F (-73°C to +232°C). The maximum operating pressure is 3,000 psi. The minimum burst pressure is 12,000 psi. **Hose is sold in 1 foot increments.**

Stainless Steel Braided PTFE Brake and Clutch Hose

Hose Dash Size	Inside Diameter	Outside Diameter	Operating Pressure	Min. Bend Radius	Part No.	Price per foot
Size 3	0.13"	0.25"	3,000 psi	1.50"	3260-3	\$4.49
Size 4	0.19"	0.30"	3,000 psi	2.00"	3260-4	\$4.49

Reusable Hose Ends for Size 3 PTFE Hose

- Steel 3AN Straight Swivel Hose End..... Part No. 3261-3-00 \$6.49
 - Steel 3AN 45° Swivel Hose End, bent tube type..... Part No. 3261-3-45\$11.49
 - Steel 3AN 90° Swivel Hose End, bent tube type..... Part No. 3261-3-90\$11.49
 - Stainless Steel 3AN Straight Swivel Hose End Part No. 3264-3-00.....\$22.49
 - Forged Stainless 3AN 45° Angled Swivel Hose End Part No. 3264-3-45.....\$44.99
 - Forged Stainless 3AN 90° Angled Swivel Hose End..... Part No. 3264-3-90.....\$45.99
 - 3/8 or 10mm Straight Banjo Hose End..... Part No. 3262-3-Strt.....\$7.99
 - 3/8 or 10mm 20° Bent Banjo Hose End Part No. 3262-3-Bent..... \$13.79
 - 3/8 or 10mm Straight Extended Neck Banjo Hose End... Part No. 3262-3-Ext \$8.99
 - 3/8 or 10mm Double Straight Banjo End..... Part No. 3262-3-D-00 ... \$23.49
 - 3/8 or 10mm Double 90° Banjo Hose End Part No. 3262-3-D-90..... \$62.99
 - 1/8 BSP Female Straight Swivel Hose End..... Part No. 3263-1/8-00..... \$13.29
 - 1/8 BSP Female 45° Swivel Hose End..... Part No. 3263-1/8-45..... \$16.49
 - 1/8 BSP Female 90° Swivel Hose End..... Part No. 3263-1/8-90..... \$16.49
- See page 93 for special 1/8 BSP Hose Ends with **Flat Sealing Face** for Racetech gauges.
- Spare Sleeves for 3AN hose ends, each..... Part No. 3261-3-Sleeve\$1.59



Standard Hose Ends Part No. 3261-Size-Angle
 Forged Stainless Steel Hose Ends Part No. 3264-3-Angle
 Swivel Joint on 45° and 90° Forged Hose Ends
 Banjo Hose Ends, from left: Part No. 3262-3-Strt, 3262-3-Bent, 3262-3-D-00 and 3262-3-D-90
 1/8 BSP Hose Ends Part No. 3263-3-Angle
 Spare Sleeve Part No. 3261-Size-Sleeve

Reusable Hose Ends for Size 4 PTFE Hose

- 4AN Straight Swivel Hose End Part No. 3261-4-00 \$10.49
- 4AN 45° Angled Swivel Hose End Part No. 3261-4-45 \$11.99
- 4AN 90° Angled Swivel Hose End Part No. 3261-4-90 \$12.99
- 7/16" Straight Banjo Hose End..... Part No. 3262-4-Strt.....\$17.49
- Spare Sleeves for 4AN hose ends, each Part No. 3261-4-Sleeve ... \$2.49

Assembly Instructions for Braided PTFE Racing Hose with Reusable Hose Ends

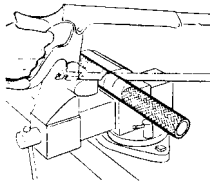

Step 1 Wrap hose with glass filament strapping tape at cut-off point and cut squarely through tape to length using an Aeroquip Cut-off machine or a very fine tooth hacksaw. Remove tape and trim loose wires flush with tube. Remove burrs on bore of tube with a knife. Clean the hose bore.

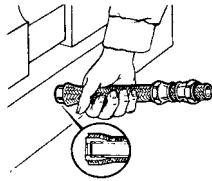

Step 2 Push the sleeve over the end of the tube and under the wire braid by hand. Push the hose end against a flat surface until the tube butts against the inside shoulder of the sleeve. Set the sleeve barbs into the PTFE tube by pushing a round nose tapered punch into the end of the tube.

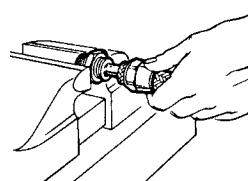

Step 3 Lubricate nipple and socket threads with Aeroquip Assembly Lube (Part No. 3315) or an equivalent petroleum lubricant. Lubricants containing chloride are not recommended. (Stainless steel hose ends should use a moly-based lubricant such as Molykote G.) Hold the nipple with hex in the vise. Push hose over nipple with twisting motion until seated against nipple chamfer. Push socket forward and start threading of socket to nipple.

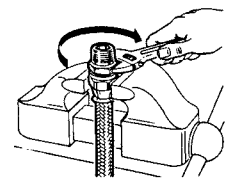

Step 4 Tighten hex until clearance with socket hex is 1/32 inch or less. Tighten further to align corners of nipple and socket hexes. CLEAN, PROOF TEST TO TWICE OPERATING PRESSURE, AND INSPECT ALL ASSEMBLIES.

To Disassemble: Unscrew and remove nipple, slide socket back on hose by tapping against a flat surface, remove sleeve with pliers.

IMPORTANT: Fittings may be disassembled and reused. However, all such fittings should be carefully examined for distortion, thread damage and I.D. dimensions. A new sleeve is recommended upon re-use of the fitting.

Flaring Mandrels for Steel Braided PTFE Hose



Makes it easy to separate the stainless steel braid from the PTFE inner liner prior to installing the sleeve. Recommended by hose manufacturers.
 Mandrel for -3 Hose..... Part No. 3157-3 \$32.99
 Mandrel for -4 Hose Part No. 3157-4 \$54.99

Pre-Assembled and Tested Braided PTFE Racing Hoses

If you need some of the common hose lengths listed here, you can save yourself the bother of having to assemble them yourself by ordering these pre-assembled and tested hoses. All straight and 90° ends have swivel fittings for easy installation and service. The banjo ends will accept either a 3/8 inch or 10mm banjo bolt. These hoses use crimped (not reusable) hose end fittings.



These banjos are only 0.33" thick.

Length Inches	Size 3 with Straight Swivels at Both Ends		Size 3 - Straight Swivel and 3/8" (10mm) Banjo		Size 3 with Straight Swivel and 90° Swivel		Size 4 with Straight Swivels at Both Ends		Size 4 with Straight Swivel and 90° Swivel	
	Part No.	Price	Part No.	Price	Part No.	Price	Part No.	Price	Part No.	Price
12	3-12-S-5	\$13.99	3-12-S-B	\$16.99	3-12-S-90	\$20.99	4-12-S-5	\$15.99	4-12-S-90	\$19.99
14	3-14-S-5	\$14.49	3-14-S-B	\$17.49	3-14-S-90	\$21.49	4-14-S-5	\$16.99	4-14-S-90	\$20.99
16	3-16-S-5	\$14.99	3-16-S-B	\$17.99	3-16-S-90	\$21.99	4-16-S-5	\$17.99	4-16-S-90	\$21.99
18	3-18-S-5	\$15.49	3-18-S-B	\$18.49	3-18-S-90	\$22.49	4-18-S-5	\$18.99	4-18-S-90	\$22.99
21	3-21-S-5	\$15.99	3-21-S-B	\$18.99	3-21-S-90	\$22.99	4-21-S-5	\$19.99	4-21-S-90	\$23.99
24	3-24-S-5	\$16.99	3-24-S-B	\$19.99	3-24-S-90	\$23.99	4-24-S-5	\$20.99	4-24-S-90	\$24.99
28	3-28-S-5	\$17.99	3-28-S-B	\$20.99	3-28-S-90	\$24.99	4-28-S-5	\$21.99	4-28-S-90	\$25.99
32	3-32-S-5	\$18.99	3-32-S-B	\$21.99	3-32-S-90	\$25.99	4-32-S-5	\$22.99	4-32-S-90	\$26.99
36	3-36-S-5	\$19.99	3-36-S-B	\$22.99	3-36-S-90	\$26.99	4-36-S-5	\$23.99	4-36-S-90	\$27.99
40	3-40-S-5	\$21.99	3-40-S-B	\$24.99	3-40-S-90	\$28.99	4-40-S-5	\$24.99	4-40-S-90	\$28.99
44	3-44-S-5	\$22.99	3-44-S-B	\$25.49	3-44-S-90	\$29.99	4-44-S-5	\$25.99	4-44-S-90	\$29.99
48	3-48-S-5	\$23.99	3-48-S-B	\$26.99	3-48-S-90	\$30.99	4-48-S-5	\$26.99	4-48-S-90	\$30.99

Brake Line Kit for Spec Racer

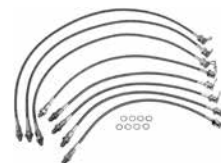

Brake Line Kit..... Part No. 3267-001... \$79.99

These hoses are constructed with the proper lengths, hose ends and adapters to allow easy retrofitting on a Spec Racer. SCCA legal.

Longacre Complete Brake Line Kits



Kits are available for 3AN and 4AN hose. Includes 4 stainless braided lines, an assortment of pre-labeled bendable steel chassis lines, connectors, fittings, frame tabs, Adel clamps, and wire ties. There are enough parts to do almost any car (caliper fittings not included - see next page).

Brake Line Kit, 3AN .. Part No. 4522.... \$159.99
 Brake Line Kit, 4AN .. Part No. 4521.... \$159.99

As a Factory Authorized Goodridge Technical Center, we also manufacture custom hoses with a variety of crimped hose ends! Each hose is made in-house to your specifications and proof tested to ensure quality. Call us or check our website for details.

Brake Adapter Fittings

All of the fittings shown here have a male 3AN or 4AN fitting on one side for connecting to a female hose end (or tube nut and sleeve when used with hard steel tubing). With our large selection you will be able to adapt to just about any caliper, master cylinder or steel brake line. Copper crush washers are usually used to seal against the face of brake cylinders and calipers. Be sure to order fittings that have a large enough hex to seal against the washer (indicated by "*" in the chart). See the general fittings section for other fittings that can be used for brake, clutch or garage lines. The banjo fittings shown here do not include the bolt or crush washers.

3AN to Male 42° Inverted Flare 3/8-24*, Long	Part No. 3265-1*	\$18.29
3AN* to Male 42° Inverted Flare 3/8-24*, Short	Part No. 3265-2*	\$8.49
3AN to Male 42° Inverted Flare 7/16-24, Long	Part No. 3265-3	\$19.49
3AN to Male 42° Inverted Flare 7/16-24, Short	Part No. 3265-4	\$8.49
4AN to Male 42° Inverted Flare 3/8-24*, Long	Part No. 3265-5*	\$23.49
4AN to Male 42° Inverted Flare 3/8-24*, Short	Part No. 3265-6*	\$5.49
4AN to Male 42° Inverted Flare 7/16-24, Long	Part No. 3265-7	\$23.49
4AN to Male 42° Inverted Flare 7/16-24, Short	Part No. 3265-8	\$8.99
4AN to Male 42° Inverted Flare 1/2-20, Short	Part No. 3265-9	\$24.99
4AN to Male 30° Inverted Flare 7/16-20, Long	Part No. 3265-10	\$17.99
4AN to Male 30° Inverted Flare 7/16-20, Short	Part No. 3265-11	\$18.29

3AN* to Female 42° Inverted Flare 3/8-24..... Part No. 3265-12* \$4.99
 See below for a retaining clip to mount this adapter in a bulkhead or bracket.

4AN* to Female 42° Inverted Flare 3/8-24.....	Part No. 3265-13*	\$4.99
3AN to Male 10 x 1.25mm Convex Seat.....	Part No. 3265-14	\$9.99
4AN to Male 10 x 1.25mm Convex Seat.....	Part No. 3265-15	\$9.99
3AN to Male 10 x 1.0mm Convex Seat.....	Part No. 3265-16	\$8.49
4AN to Male 10 x 1.0mm Convex Seat*.....	Part No. 3265-17*	\$12.29
3AN* to Female 10 x 1.0mm Concave Seat.....	Part No. 3265-18*	\$7.29
4AN* to Female 10 x 1.0mm Concave Seat.....	Part No. 3265-19*	\$5.99

3AN to 3/8 or M10 Banjo Fitting.....	Part No. 3265-20	\$10.49
4AN to 3/8 or M10 Banjo Fitting.....	Part No. 3265-21	\$10.49
3AN to 7/16 Banjo Fitting.....	Part No. 3265-22	\$10.29
4AN to 7/16 Banjo Fitting.....	Part No. 3265-23	\$9.99
3AN to 10mm Long Stem Banjo Fitting.....	Part No. 3265-24	\$13.99
4AN to 10mm Long Stem Banjo Fitting.....	Part No. 3265-25	\$19.99
4AN to 12mm Banjo Fitting.....	Part No. 3265-48	\$12.49

3AN to 3/8-24*, large hex for crush washer.....	Part No. 3265-26*	\$2.97
4AN to 7/16-20*, large hex (4AN to 4AN union).....	Part No. 3265-27*	\$5.29
3AN* to Female 10 x 1.25mm Concave Seat.....	Part No. 3265-28*	\$5.99
3AN* to Female 10 x 1.25mm Convex Seat.....	Part No. 3265-29*	\$5.49
3AN* to Female 10 x 1.0mm Convex Seat.....	Part No. 3265-30*	\$5.49
4AN* to Female 10 x 1.0mm Convex Seat.....	Part No. 3265-31*	\$5.49

Dual 3AN to 3/8 or M10 Banjo Fitting..... Part No. 3265-32..... \$19.99

3AN to Male 10 x 1.0mm Concave Seat.....	Part No. 3265-51	\$9.19
3AN* to Male 12 x 1.5mm Concave Seat.....	Part No. 3265-39*	\$19.49
4AN* to Male 12 x 1.5mm Concave Seat.....	Part No. 3265-40*	\$8.99

* These parts have a large enough hex to be used with a crush washer when sealing against a flat faced port. *** in description indicates on which side(s) crush washer may be used: (3/16 minimum hex for 3/8 washer, 5/8 minimum hex for 7/16 washer)

How To Identify Inverted Flare Brake Fittings

Inverted flare (I.F.) brake lines have a tube nut that has male threads on it and the tubing is double flared to capture the nut. The female threaded port that it connects to has a convex protrusion at the bottom of the port which seals against the flared tubing as shown.

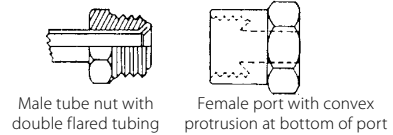

PLUMBING

Specialized Brake Fittings and Brake Light Switch

Forged Stainless 3AN and -3 Hose End Tees with Mounting Lug

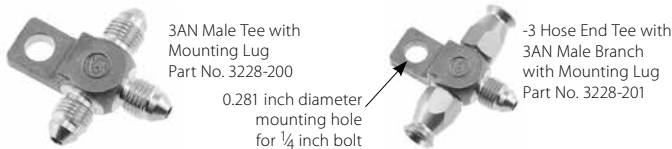

3AN Male Tee with Mounting Lug Part No. 3228-200	-3 Hose End Tee with 3AN Male Branch with Mounting Lug Part No. 3228-201
0.281 inch diameter mounting hole for 1/4 inch bolt	
3AN Male Tee with Mounting Lug.....Part No. 3228-200..... \$65.99	
All three ports are male 3AN fittings.	
-3 Hose End Tee with 3AN Male Branch with Lug.....Part No. 3228-201..... \$65.99	
The two run ports attach directly to -3 PTFE hose. The branch port is a male 3AN fitting.	
-3 Hose End Tee with Mounting Lug.....Part No. 3228-202..... \$69.99	
All three ports attach directly to our size 3 PTFE hose.	
Spare Sleeve for 3AN hose ends, each.....Part No. 3261-3-Sleeve... \$1.59	

3AN Tee with Female 3/8-24 Inverted Flare Branch

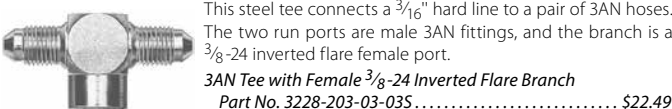

This steel tee connects a 3/16" hard line to a pair of 3AN hoses. The two run ports are male 3AN fittings, and the branch is a 3/8-24 inverted flare female port.
 3AN Tee with Female 3/8-24 Inverted Flare Branch
 Part No. 3228-203-03-03S..... \$22.49

3AN Tee with Female 1/8 NPT Branch

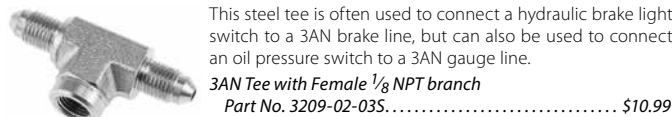

This steel tee is often used to connect a hydraulic brake light switch to a 3AN brake line, but can also be used to connect an oil pressure switch to a 3AN gauge line.
 3AN Tee with Female 1/8 NPT branch
 Part No. 3209-02-03S..... \$10.99

3AN to 42° Inverted Flare Adapter with Frame Tab



This anodized aluminum bulkhead adapter is great for making the transition from steel hard line to a 3AN brake hose. It has a female 42° inverted flare 3/8-24 port for connecting standard 3/16" diameter automotive steel hard line. It comes with an unplated steel bracket which can be welded, bolted or riveted to the frame. An anodized aluminum bulkhead mounting nut is also furnished.

3AN to 42° Inverted Flare Adapter with Frame Tab..... Part No. 4651..... \$14.99

Retaining Clip for Female Brake Adapter

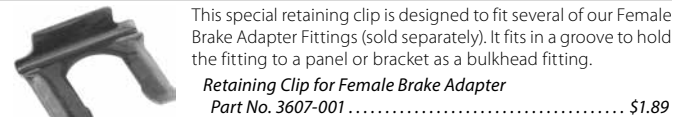

This special retaining clip is designed to fit several of our Female Brake Adapter Fittings (sold separately). It fits in a groove to hold the fitting to a panel or bracket as a bulkhead fitting.

Retaining Clip for Female Brake Adapter
 Part No. 3607-001..... \$1.89

Hydraulic Brake Light Switch

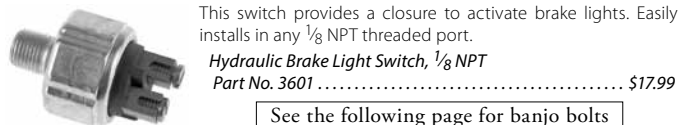

This switch provides a closure to activate brake lights. Easily installs in any 1/8 NPT threaded port.

Hydraulic Brake Light Switch, 1/8 NPT
 Part No. 3601..... \$17.99

See the following page for banjo bolts with an integral brake light switch!

Banjo Bolts and Crush Washers

Standard Banjo Bolts for a Single Banjo Fitting

$\frac{7}{16}$ -24 Banjo Bolt for Single Banjo Fitting (Small Hex)
Part No. 3242-025



$\frac{9}{16}$ -18 Aluminum Banjo Bolt for Single Banjo Fitting
Part No. 3242-026



Steel Banjo Bolts for a Single Banjo Fitting:

- $\frac{3}{8}$ -24 Banjo Bolt for Single Banjo Fitting (0.98" shank)..... Part No. 3242-001 . \$6.49
- $\frac{3}{8}$ -24 Banjo Bolt for Single Banjo Fitting (0.78" shank)..... Part No. 3242-011 . \$5.69
- Use the 0.98" shank with any of our steel banjo adapters or reusable banjo hose ends. The shorter 0.78" shank only fits the thin banjo on our premade 3AN hoses (Part No. 3-xx-S-B).*
- $\frac{7}{16}$ -24 Banjo Bolt for Single Banjo (Small Hex) (0.87" shank) Part No. 3242-025 . \$8.29
- $\frac{7}{16}$ -20 Banjo Bolt for Single Banjo Fitting (0.98" shank)..... Part No. 3242-005 . \$8.29
- 10 x 1.00mm Banjo Bolt for Single Banjo Fitting (0.98" shank) .. Part No. 3242-041 . \$6.99
- 10 x 1.00mm Banjo Bolt for Single Banjo Fitting (0.78" shank)... Part No. 3242-003 . \$6.19
- 10 x 1.25mm Banjo Bolt for Single Banjo Fitting (0.78" shank)... Part No. 3242-004 . \$5.99
- 10 x 1.50mm Banjo Bolt for Single Banjo Fitting (0.78" shank)... Part No. 3242-012 . \$6.99
- 12 x 1.00mm Banjo Bolt for Single Banjo Fitting (0.98" shank) .. Part No. 3242-044 \$10.49

Aluminum Banjo Bolts for a Single Banjo Fitting:

- $\frac{9}{16}$ -18 Aluminum Banjo Bolt for Single Banjo (0.95" shank)..... Part No. 3242-026 \$15.49
- See page 94 for aluminum banjo bolts with metric threads.*

Standard Banjo Bolts for Two Stacked Banjo Fittings

$\frac{3}{8}$ -24 Banjo Bolt for Two Stacked Banjo Fittings
Part No. 3242-002



Remember to order **three** crush washers (sold separately) when stacking two banjo fittings!

- $\frac{3}{8}$ -24 Banjo Bolt for Two Banjo Fittings (1.55" shank) Part No. 3242-002. \$9.19
- $\frac{3}{8}$ -24 Banjo Bolt for Two Banjo Fittings, short (1.17" shank) .. Part No. 3242-039. \$8.29
- 10 x 1.0mm Banjo Bolt for Two Banjo Fittings (1.17" shank) ... Part No. 3242-008. \$5.99
- 10 x 1.25mm Banjo Bolt for Two Banjo Fittings (1.17" shank).. Part No. 3242-009. \$5.99
- $\frac{7}{16}$ -20 Banjo Bolt for Two Banjo Fittings (1.40" shank) Part No. 3242-006. \$11.49

Soft Copper and Aluminum Crush Washers for Banjo Fittings

- $\frac{3}{8}$ inch or 10mm Soft Copper Crush Washer, each..... Part No. 3241- $\frac{3}{8}$ 69¢
- $\frac{7}{16}$ inch Soft Copper Crush Washer, each..... Part No. 3241- $\frac{7}{16}$ 89¢
- $\frac{3}{8}$ inch Aluminum Washer, 5 pieces Part No. 3278-03 \$1.89
- $\frac{7}{16}$ inch Aluminum Washer, 5 pieces Part No. 3278-04 \$2.09
- $\frac{9}{16}$ inch Aluminum Washer, 5 pieces Part No. 3278-06 \$2.39
- $\frac{3}{4}$ inch Aluminum Washer, 5 pieces Part No. 3278-08 \$3.99
- 12mm Aluminum Washer, 5 pieces Part No. 3278-M12 \$3.99

Banjo Bolts with an Integral Bleeder Fitting



These innovative banjo bolts make bleeding your hydraulic system easier than ever before! The bleeder allows you to bleed the system from multiple points, not just the calipers. This can be especially helpful when the calipers are lower than the master cylinders.

Banjo Bolts with Bleeder Screw for a Single Banjo Fitting:

- $\frac{3}{8}$ -24 Banjo Bolt with Bleeder for Single Banjo (0.77" shank).... Part No. 3242-019 . \$17.99
- 10 x 1.00mm Bolt with Bleeder for Single Banjo (0.77" shank) ... Part No. 3242-021 \$11.99
- 10 x 1.25mm Bolt with Bleeder for Single Banjo (0.77" shank) ... Part No. 3242-022 \$13.99

Banjo Bolts with Bleeder Screw for Two Stacked Banjo Fittings:

- 10 x 1.00mm Bolt with Bleeder for Two Banjos (1.17" shank)..... Part No. 3242-023 \$14.29
- 10 x 1.25mm Bolt with Bleeder for Two Banjos (1.17" shank)..... Part No. 3242-042 \$14.29

Banjo Bolts with an Integral Brake Light Switch



These banjo bolts allow you to install a pressure activated brake light switch without adding a tee fitting. Simply replace an existing banjo bolt in your system with one of these pre-wired bolts. The pigtail leads are 10 inches long for easy two-wire hookup.

Banjo Bolts with Brake Light Switch for a Single Banjo Fitting:

- $\frac{3}{8}$ -24 Banjo Bolt with Switch for Single Banjo (0.93" shank)..... Part No. 3242-013 \$12.99
- $\frac{7}{16}$ -24 Banjo Bolt with Switch for Single Banjo (0.93" shank).... Part No. 3242-014 \$12.99
- 10 x 1.00mm Bolt with Switch for Single Banjo (0.74" shank)..... Part No. 3242-015 \$12.99
- 10 x 1.25mm Bolt with Switch for Single Banjo (0.83" shank)..... Part No. 3242-016 \$15.99

Banjo Bolts with Brake Light Switch for Two Stacked Banjo Fittings:

- 10 x 1.00mm Bolt with Switch for Two Banjos (1.17" shank)..... Part No. 3242-017 \$15.99
- 10 x 1.25mm Bolt with Switch for Two Banjos (1.24" shank)..... Part No. 3242-018 \$15.99

See page 94 for larger metric banjo bolts and banjo adapters in aluminum for fuel and oil systems. See our website for more sizes in steel and stainless steel.

PLUMBING

Bleeder Screws

Standard One-piece Bleeder Screws and Dust Cap



- $\frac{3}{8}$ -24 short Bleeder Screw, 1.25" overall length Part No. 3266-01..... \$2.99
- $\frac{3}{8}$ -24 long Bleeder Screw, 1.50" overall length..... Part No. 3266-02..... \$5.49
- 10 x 1.0 mm Bleeder Screw, 1.25" overall length..... Part No. 3266-03 \$3.69
- 10 x 1.0 mm Bleeder Screw, 1.43" overall length..... Part No. 3266-21..... \$4.19
- $\frac{1}{4}$ -28 Bleeder Screw, 0.90" overall length Part No. 3266-04 \$2.99
- 7 x 1.0 mm Bleeder Screw (used on most LD65 calipers) Part No. 3266-06 \$3.69
- Dust Cap for Bleeder Screw..... Part No. 3266-Cap..... \$1.69

Bulkhead Mounted Size 3 Hose End with Bleeder Screw



This unique hose end is meant to be used as a bleeder for hydraulic clutch slave cylinders. Bulkhead mount keeps bleeder hose safe and secure. Requires a $\frac{3}{8}$ -24 bulkhead mounting nut (sold separately).

- Bulkhead Mounted size 3 Hose End with Bleeder Screw... Part No. 3266-20..... \$28.99
- $\frac{3}{8}$ -24 Self-Locking High Temp. Jetnut for mounting..... Part No. MS21042-6..... 99¢

3AN Bulkhead Mount for $\frac{3}{8}$ -24 Bleed Screw



This special fitting is designed to accept the remote bleeder for hydraulic clutch slave cylinders. The bulkhead mount keeps the hose secure, and the 3AN male bulkhead fitting lets you use a standard premade hose. Requires a $\frac{3}{8}$ -24 bulkhead mounting nut and a $\frac{3}{8}$ -24 bleeder screw (each sold separately).

- 3AN Bulkhead Mount for $\frac{3}{8}$ -24 Bleeder Screw..... Part No. 3266-25..... \$21.49
- $\frac{3}{8}$ -24 Self-Locking High Temp. Jetnut for mounting..... Part No. MS21042-6..... 99¢

Speed Bleeders – Bleed brakes without a helper!

Special sealant on threads helps to prevent air leakage while bleeding.



Speed Bleeders allow true one-person hydraulic system bleeding with no special equipment or compressed air source. When the Speed Bleeder screw is opened, a one-way ball check valve allows fluid and air out, but nothing back in. Speed Bleeders use a standard seat, so they cannot fail while the screw is closed. Some other brands use the seat as the moving part, creating potential leak points. Speed Bleeders give you the convenience of a check valve without compromising the inherent reliability of a standard bleeder screw.

Tech Tip: Use two of our Brake Bleeder Bottles to bleed both the front and rear brakes at the same time. This prevents the brake bias bar from binding and allows a full stroke on each master cylinder, making the job even more efficient.

- $\frac{1}{4}$ -28 Speed Bleeder Screw, 1.00" overall length Part No. 3266-16..... \$9.69
- 7 x 1.0 mm Speed Bleeder, 1.20" overall length..... Part No. 3266-12..... \$9.69
- 8 x 1.25 mm Speed Bleeder, 1.20" overall length Part No. 3266-17..... \$9.69
- $\frac{3}{8}$ -24 Speed Bleeder Screw, 1.30" overall length Part No. 3266-10..... \$9.69
- 10 x 1.0 mm Speed Bleeder, 1.20" overall length Part No. 3266-14..... \$9.69
- 10 x 1.25 mm Speed Bleeder, 1.20" overall length Part No. 3266-15..... \$9.69

Special 2 piece $\frac{1}{8}$ NPT Bleeder Screw Assembly



This special assembly utilizes a $\frac{1}{8}$ NPT brass plug that contains a seat for the $\frac{1}{4}$ -28 steel bleeder screw which is also furnished. Can be used to repair stripped $\frac{3}{8}$ -24 threads in calipers or slave cylinders. This is a direct replacement for Outlaw and Wilwood bleeders. The pipe thread has pre-applied sealant to provide a leak-free installation.

Note: Can be converted to a Speed Bleeder by replacing the bleeder screw with Part No. 3266-16 (sold separately).

- 2 piece $\frac{1}{8}$ NPT Bleeder Screw Assembly Part No. 3266-05..... \$4.89
- Each assembly includes one $\frac{1}{8}$ NPT brass plug and one $\frac{1}{4}$ -28 bleed screw.*

See page 126 for our Brake Bleeder Bottles!

Braided Nitrile Racing Hose and Reusable Swivel Hose Ends



Stainless Steel Braided Nitrile Rubber Hose is very popular for use as oil hoses in race cars. The stainless steel cover resists abrasion and corrosion. Rated temperature: -55°F to 300°F (-48°C to 149°C). NHRA accepted. **Sold by the foot.**

Aramid Braided Startlite Hose has the same nitrile lining as the hose at left. The lightweight black aramid cover is abrasion and fire resistant. Rated temperature: -45°F to 300°F (-43°C to 149°C). NHRA accepted. **Sold by the foot.**



Standard Steel Braided Nitrile Fuel and Oil Hose							
Hose Size	Hose I.D.	Hose O.D.	Pressure Rating	Bend Radius	Weight per foot	Part No.	Price per foot
4AN	0.22"	0.44"	1,000 psi	2.00"	1.80 oz.	3270-04	\$5.99
6AN	0.34"	0.55"	1,000 psi	2.50"	2.16 oz.	3270-06	\$6.59
8AN	0.44"	0.65"	1,000 psi	3.50"	2.92 oz.	3270-08	\$7.39
10AN	0.56"	0.80"	1,000 psi	4.00"	3.75 oz.	3270-10	\$7.99
12AN	0.69"	0.94"	1,000 psi	4.50"	4.53 oz.	3270-12	\$9.49
16AN	0.88"	1.15"	750 psi	5.50"	6.04 oz.	3270-16	\$12.49

Startlite Aramid Braided Nitrile Fuel and Oil Hose							
Hose Size	Hose I.D.	Hose O.D.	Pressure Rating	Bend Radius	Weight per foot	Part No.	Price per foot
4AN	0.22"	0.43"	500 psi	2.00"	0.80 oz.	3492-04	\$9.49
6AN	0.34"	0.55"	500 psi	2.50"	1.28 oz.	3492-06	\$10.49
8AN	0.44"	0.64"	500 psi	3.50"	1.44 oz.	3492-08	\$12.49
10AN	0.56"	0.80"	500 psi	4.00"	2.24 oz.	3492-10	\$14.49
12AN	0.69"	0.93"	350 psi	4.50"	2.56 oz.	3492-12	\$16.79
16AN	0.88"	1.13"	350 psi	5.50"	3.04 oz.	3492-16	\$20.99

These reusable aluminum hose ends are red and blue anodized for corrosion protection and for a professional appearance. They are compatible with standard nitrile-lined racing hose, both stainless braided and Startlite types.

Bent Tube Swivel Hose Ends for Steel Braided or Startlite Hose - Red / Blue						
Angle	4AN	6AN	8AN	10AN	12AN	16AN
Straight	Part No. 3271-04-000 \$6.49	Part No. 3271-06-000 \$6.99	Part No. 3271-08-000 \$7.49	Part No. 3271-10-000 \$9.99	Part No. 3271-12-000 \$14.99	Part No. 3271-16-000 \$22.99
	Part No. 3271-04-045 \$15.49	Part No. 3271-06-045 \$16.49	Part No. 3271-08-045 \$18.49	Part No. 3271-10-045 \$21.99	Part No. 3271-12-045 \$24.99	Part No. 3271-16-045 \$28.99
45°	Part No. 3271-04-090 \$15.49	Part No. 3271-06-090 \$16.49	Part No. 3271-08-090 \$18.49	Part No. 3271-10-090 \$21.99	Part No. 3271-12-090 \$24.99	Part No. 3271-16-090 \$28.99
60°	Not Available	Part No. 3271-06-060 \$15.49	Part No. 3271-08-060 \$16.49	Part No. 3271-10-060 \$18.49	Part No. 3271-12-060 \$22.99	Part No. 3271-16-060 \$28.99
90°	Part No. 3271-04-090 \$15.49	Part No. 3271-06-090 \$16.49	Part No. 3271-08-090 \$18.49	Part No. 3271-10-090 \$21.99	Part No. 3271-12-090 \$24.99	Part No. 3271-16-090 \$28.99
120°	Not Available	Part No. 3271-06-120 \$23.99	Part No. 3271-08-120 \$25.99	Part No. 3271-10-120 \$28.99	Part No. 3271-12-120 \$30.99	Part No. 3271-16-120 \$33.99
150°	Not Available	Part No. 3271-06-150 \$23.99	Part No. 3271-08-150 \$25.99	Part No. 3271-10-150 \$28.99	Part No. 3271-12-150 \$30.99	Part No. 3271-16-150 \$33.99
180°	Not Available	Part No. 3271-06-180 \$23.99	Part No. 3271-08-180 \$25.99	Part No. 3271-10-180 \$28.99	Part No. 3271-12-180 \$30.99	Part No. 3271-16-180 \$33.99

Straight Swivel Hose End
Part No. 3271-Size-000



90° Bent Tube Style Swivel Hose End
Part No. 3271-Size-090



150° Bent Tube Style Swivel Hose End
Part No. 3271-Size-150



45° Bent Tube Style Swivel Hose End
Part No. 3271-Size-045



120° Bent Tube Style Swivel Hose End
Part No. 3271-Size-120



180° Bent Tube Style Swivel Hose End
Part No. 3271-Size-180



60° Bent Tube Style Swivel Hose End
Part No. 3271-Size-060



90° Forged Swivel Hose End
Part No. 3274-Size-090
"Cutter" style only.

In addition to the traditional red-and-blue hose ends shown in the table above, we now stock a full range of Black anodized bent tube style hose ends too! Simply order Part No. 3471-Size-Angle!

Forged "Cutter" Style Reusable Swivel Hose Ends				
Angle	6AN	8AN	10AN	12AN
45°	Part No. 3274-06-045 \$20.99	Part No. 3274-08-045 \$23.79	Part No. 3274-10-045 \$29.29	Part No. 3274-12-045 \$34.49
90°	Part No. 3274-06-090 \$20.99	Part No. 3274-08-090 \$23.79	Part No. 3274-10-090 \$29.29	Part No. 3274-12-090 \$34.49

Note: The fittings shown here are **only** compatible with the standard nitrile-lined racing hose on this page. They are not interchangeable with fittings for the Type 811 and 910 PTFE lined hose on page 87.

Assembly Instructions for Standard Steel Braided and Startlite Nitrile Fuel and Oil Hose (3271, 3274, or 3471 Hose Ends)

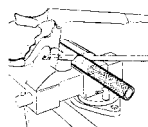

Step 1. Cut the hose squarely to length using a Cut-off Machine or a very fine tooth hacksaw. To minimize wire braid flare out, wrap hose with glass filament strapping tape. Do not remove tape until ready for step 2.

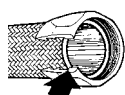

Step 2. Remove tape and then quickly insert hose into the socket before the braid begins to flare out. Insert hose with a twisting, pushing motion until hose is in line with back of socket threads. Use our Koul Tools for easy installation.

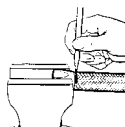

Step 3. Important: Mark position around hose at rear of socket with a grease pencil, paint or tape.

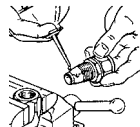

Step 4. Hold the socket in a vice with smooth or soft jaws. Lubricate inside of hose and nipple threads with SAE 30 lubricating oil or Aeroquip Hose Assembly Lube.

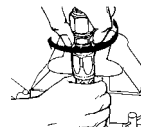

Step 5. Insert nipple and engage threads while holding hose in position with other hand. Make sure hose does not push out of socket by observing mark made in step 3.

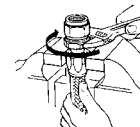

Step 6. Complete assembly using wrench while continuing to hold hose in position. Maximum allowable gap between socket hex and nipple hex is 0.031 inches.

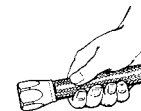

Step 7. Important: Check hose for push out by observing hose position mark. None should be evident. **Clean, proof test to twice operating pressure and inspect all assemblies.** Disassemble in reverse order.

811 Steel Braided and 910 Aramid Braided Super-Flex PTFE-Lined Hose

- Up to 3 times more flexible than standard hose • Average of 33% more cross-sectional flow area •
- Up to 67% lighter • Completely resistant to vapor penetration and chemical degradation •



Type 811 PTFE-Lined Steel Braided Hose is super-flexible. The bend radius is 2 to 3 times tighter than the our standard hose, which often allows for shorter hoses. The smooth-bore PTFE liner is compatible with all types of racing fluids and is much more resistant to fuel vapor penetration than rubber or nitrile hose. It can withstand a higher vacuum and higher temperatures (500°F vs 300°F) than standard hose. The stainless steel outer braid has a copper-colored strand for easy identification. Rated temperature: -70°C to 260°C (-90°F to 500°F). **Sold by the foot.**



Type 910 PTFE-Lined Aramid Braided Hose is similar to Type 811 hose except it has a black aramid outer braid (similar to Kevlar®) rather than a steel outer braid. The result is a very lightweight hose. The abrasion-resistant Aramid braid has a yellow strand for easy identification. Type 910 Hose features the same tight bend radius, generous ID and vapor-resistant smooth-bore PTFE liner as used on Type 811 Hose. Continuous temperature rating: -45°C to 170°C (-49°F to 338°F). NHRA accepted. **Sold by the foot.**

811 Super-Flex PTFE Lined Steel Braided Hose

Hose Size	Hose I.D.	Hose O.D.	Pressure Rating	Bend Radius	Weight per ft.	Part No.	Price per ft.
4AN	0.27"	0.38"	1,320 psi	0.75"	0.66 oz.	3480-04	\$11.29
6AN	0.38"	0.51"	1,180 psi	0.80"	1.51 oz.	3480-06	\$12.99
8AN	0.50"	0.65"	1,030 psi	1.50"	3.12 oz.	3480-08	\$20.29
10AN	0.63"	0.82"	955 psi	1.77"	3.76 oz.	3480-10	\$25.99
12AN	0.75"	0.96"	880 psi	2.00"	4.30 oz.	3480-12	\$31.99
16AN	1.00"	1.27"	740 psi	2.75"	6.77 oz.	3480-16	\$44.99

910 Super-Flex PTFE Lined Aramid Braided Hose

Hose Size	Hose I.D.	Hose O.D.	Pressure Rating	Bend Radius	Weight per ft.	Part No.	Price per ft.
4AN	0.27"	0.41"	1,320 psi	0.92"	0.59 oz.	3490-04	\$21.29
6AN	0.38"	0.57"	1,180 psi	0.80"	0.95 oz.	3490-06	\$21.29
8AN	0.50"	0.65"	1,030 psi	1.43"	1.52 oz.	3490-08	\$23.79
10AN	0.63"	0.82"	955 psi	1.77"	2.16 oz.	3490-10	\$33.49
12AN	0.75"	0.96"	880 psi	2.00"	3.14 oz.	3490-12	\$41.49
16AN	1.00"	1.27"	740 psi	2.75"	5.12 oz.	3490-16	\$59.49

Please note: Due to manufacturing limitations, the PTFE liner in Type 811 and Type 910 hose is not one continuous extrusion as on other types of hose. The liner consists of shorter lengths (20-30 feet, depending on hose size) which are spliced together. These splices are marked to be easy to spot because they should *never* be used in a hose. If you are ordering more than 20 feet of hose, let us know the minimum uninterrupted length you need. All lengths shorter than 20 feet will be uninterrupted, with no splices.

Note: The hose ends shown here are for use with Type 811 and 910 hose only!



Forged Swivel Hose Ends for 811 or 910 PTFE Hose				
Angle	6AN	8AN	10AN	12AN
45°	Part No. 3484-06-045 \$24.99	Part No. 3484-08-045 \$42.99	Part No. 3484-10-045 \$34.99	Part No. 3484-12-045 \$46.99
90°	Part No. 3484-06-090 \$24.99	Part No. 3484-08-090 \$28.99	Part No. 3484-10-090 \$44.99	Part No. 3484-12-090 \$46.99

Bent Tube Swivel Hose Ends for 811 or 910 PTFE Lined Hose - Black / Silver						
Angle	4AN	6AN	8AN	10AN	12AN	16AN
Straight	Part No. 3481-04-000 \$13.99	Part No. 3481-06-000 \$13.99	Part No. 3481-08-000 \$24.99	Part No. 3481-10-000 \$26.99	Part No. 3481-12-000 \$28.99	Part No. 3481-16-000 \$34.99
45°	Part No. 3481-04-045 \$22.99	Part No. 3481-06-045 \$24.99	Part No. 3481-08-045 \$29.99	Part No. 3481-10-045 \$32.99	Part No. 3481-12-045 \$39.99	Part No. 3481-16-045 \$46.99
90°	Part No. 3481-04-090 \$23.99	Part No. 3481-06-090 \$24.99	Part No. 3481-08-090 \$29.99	Part No. 3481-10-090 \$36.99	Part No. 3481-12-090 \$41.99	Part No. 3481-16-090 \$46.99
120°	Part No. 3481-04-120 \$33.99	Part No. 3481-06-120 \$29.99	Part No. 3481-08-120 \$35.99	Part No. 3481-10-120 \$38.99	Part No. 3481-12-120 \$42.99	Not Available
150°	Part No. 3481-04-150 \$33.99	Part No. 3481-06-150 \$29.99	Part No. 3481-08-150 \$34.99	Part No. 3481-10-150 \$38.99	Part No. 3481-12-150 \$42.99	Not Available
180°	Part No. 3481-04-180 \$33.99	Part No. 3481-06-180 \$32.99	Part No. 3481-08-180 \$36.99	Part No. 3481-10-180 \$38.99	Part No. 3481-12-180 \$44.99	Part No. 3481-16-180 \$69.99

Note: The reusable fittings on this page are compatible with Type 811 and 910 Super-Flex PTFE lined hose only. They are not interchangeable with fittings for the standard racing hose shown on page 86.

Assembly Instructions for PTFE-Lined 811 Steel Braided Hose and 910 Aramid Braided Hose (Black / Silver Anodized Hose Ends)

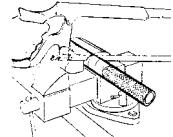

Step 1. Cut the hose square to length using a Cut-off Machine or a very fine tooth hack-saw. To minimize wire braid flare out, wrap hose with glass filament strapping tape.



Step 2. Remove tape and then quickly insert hose into the socket. Insert hose with a turning motion, feeding the braid in as you turn the hose.

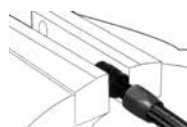

Step 3. Hold the fitting in a vice with smooth or soft jaws, and lubricate the threads with a light oil.



Step 4. Push the hose firmly onto the thread while rotating the hose. Keep turning the hose until the first three to four threads have engaged.



Step 5. Tighten socket using a wrench until it reaches the base of the thread. **IMPORTANT:** When the socket reaches the base of the thread keep turning for two complete turns.



Step 6. Clean, proof test to twice operating pressure and carefully inspect all assemblies. Disassemble in reverse order.

As a Factory Authorized Goodridge Technical Center, we also manufacture custom hoses with permanently crimped hose ends! Each hose is made in-house to your specifications and proof tested to ensure quality. Call us or check our website for details.

Textile-Reinforced High-Temperature Hose, Barbed Hose Ends, and Hose Support Clamps

Textile-Reinforced High-Temperature Hose

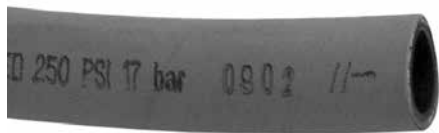

Hose I.D.	Hose O.D.	Operating Pressure	Min. Bend Radius	Blue Cover Part No.	Price per foot	Black Cover Part No.	Price per foot
1/4 inch	0.49 inch	250 psi	3.00 inch	3290-04	\$4.79	N/A	N/A
3/8 inch	0.63 inch	250 psi	3.00 inch	3290-06	\$5.29	3491-06	\$5.49
1/2 inch	0.75 inch	250 psi	5.00 inch	3290-08	\$5.79	3491-08	\$6.79
5/8 inch	0.90 inch	250 psi	6.00 inch	3290-10	\$7.49	3491-10	\$7.89
3/4 inch	1.04 inch	250 psi	7.00 inch	3290-12	\$8.19	3491-12	\$9.79

This hose is perfect for moderate-pressure applications where the extra expense of stainless braided hose is not required. The internal textile braid reinforcement gives it a 250psi operating pressure rating and a burst pressure rating of 1,000 psi. The special elastomer rubber allows a wide operating temperature range of -40° C to 150° C (-40° F to 302° F). To secure this hose to a barbed fitting we recommend Oetiker clamps, which maintain tension after many heating and cooling cycles. Standard worm-drive clamps can't spring back to maintain good clamping force and must be checked regularly for tightness.

Aluminum Barbed Hose Ends to AN Male (AN841)

Part No. 3497-001-Size		These hose ends are Blue anodized aluminum (except Part No. AEI-15635, which is Black anodized). Straight only (no angles).		Part No. AEI-15635	
1/4" ID Hose to 4AN	5/16" ID Hose to 6AN*	3/8" ID Hose to 6AN	1/2" ID Hose to 8AN	5/8" ID Hose to 10AN	3/4" ID Hose to 12AN
3497-001-04	AEI-15635*	3497-001-06	3497-001-08	3497-001-10	3497-001-12
\$4.99	\$18.14	\$6.19	\$8.59	\$12.79	\$15.99

Blue Aluminum Barbed Hose Ends to AN Female (3288)

These bent tube hose ends are Blue anodized aluminum with a red aluminum stop collar. They are a perfect match for our Blue Textile-Reinforced High-Temperature Hose (Part No. 3290).



Angle	1/4" I.D. Hose to 4AN	3/8" I.D. Hose to 6AN	1/2" I.D. Hose to 8AN	5/8" I.D. Hose to 10AN	3/4" I.D. Hose to 12AN
Straight	3288-04-000 \$5.99	3288-06-000 \$6.39	3288-08-000 \$6.99	3288-10-000 \$8.99	3288-12-000 \$13.99
45°	3288-04-045 \$14.99	3288-06-045 \$16.99	3288-08-045 \$17.99	3288-10-045 \$19.99	3288-12-045 \$26.99
90°	3288-04-090 \$14.99	3288-06-090 \$16.99	3288-08-090 \$18.99	3288-10-090 \$19.99	3288-12-090 \$26.99
120°	3288-04-120 \$16.99	3288-06-120 \$19.99	3288-08-120 \$22.99	3288-10-120 \$23.99	3288-12-120 \$29.99
150°	3288-04-150 \$19.99	3288-06-150 \$19.99	3288-08-150 \$22.99	3288-10-150 \$23.99	3288-12-150 \$29.99
180°	3288-04-180 \$19.99	3288-06-180 \$19.99	3288-08-180 \$22.99	3288-10-180 \$23.99	3288-12-180 \$29.99

Black Aluminum Barbed Hose Ends to AN Female (3488)

These bent tube hose ends are Black anodized aluminum. They are a perfect match for our Black Textile-Reinforced High-Temperature Hose (Part No. 3491).



Angle	1/4" I.D. Hose to 4AN	3/8" I.D. Hose to 6AN	1/2" I.D. Hose to 8AN	5/8" I.D. Hose to 10AN	3/4" I.D. Hose to 12AN
Straight	3488-04-000 \$5.99	3488-06-000 \$6.39	3488-08-000 \$6.99	3488-10-000 \$8.99	3488-12-000 \$13.99
45°	3488-04-045 \$14.99	3488-06-045 \$16.99	3488-08-045 \$17.99	3488-10-045 \$19.99	3488-12-045 \$26.99
90°	3488-04-090 \$14.99	3488-06-090 \$16.99	3488-08-090 \$18.99	3488-10-090 \$19.99	3488-12-090 \$26.99
120°	3488-04-120 \$18.99	3488-06-120 \$19.99	3488-08-120 \$22.99	3488-10-120 \$23.99	3488-12-120 \$29.99
150°	3488-04-150 \$19.99	3488-06-150 \$19.99	3488-08-150 \$22.99	3488-10-150 \$23.99	3488-12-150 \$29.99
180°	3488-04-180 \$19.99	3488-06-180 \$19.99	3488-08-180 \$22.99	3488-10-180 \$23.99	3488-12-180 \$29.99

Oetiker Clamps and Installation Tool



Oetiker Clamps maintain clamping force because they can expand as a hose assembly is subjected to temperature cycling. Standard worm-drive clamps can't expand and, therefore, force the hose material to extrude away from the clamp area during a heat cycle. After several heat cycles, they can lose most of their clamping force.

Oetiker Clamp for 1/4 inch I.D. Hose	Part No. 3295-04	\$99¢
Oetiker Clamp for 5/16 inch I.D. Hose	Part No. 3295-05	\$1.09
Oetiker Clamp for 3/8 inch I.D. Hose	Part No. 3295-06	\$1.49
Oetiker Clamp for 1/2 inch I.D. Hose	Part No. 3295-08	\$1.49
Oetiker Clamp for 5/8 inch I.D. Hose	Part No. 3295-10	\$1.39
Oetiker Clamp for 3/4 inch I.D. Hose	Part No. 3295-12	\$1.49

Dual Jaw Installation Tool Our Oetiker installation tool has dual jaws so that it can be aligned parallel or perpendicular to the hose. This makes it easier to use in tight places.
Dual Jaw Installation Tool.....Part No. 3295-99.....\$48.99

Aeroquip Heavy-Duty Vinyl Coated Support Clamps

These heavy-duty support clamps are strong enough for use on aircraft. Sizes up to 1.06" are 3/4" wide with a 3/8" mounting hole. Sizes 1.13" and larger are 1" wide with a 1/2" mounting hole. Hose part numbers are shown next to the suggested clamp size. Sold individually.



1/4" Clamp I.D. (for 3260-3 & 3260-4 hose)	Part No. 3298-.25	\$1.69
1/16" Clamp I.D. (for 3270-04, 3480-04 & 3490-04 hose)	Part No. 3298-.44	\$1.69
1/2" Clamp I.D. (for 3290-04, 3491-04, & 3480-06)	Part No. 3298-.50	\$1.09
3/16" Clamp I.D. (for 3270-06 & 3490-06 hose)	Part No. 3298-.56	\$1.09
5/8" Clamp I.D. (3270, 3480, & 3490-08; 3290 & 3491-06)	Part No. 3298-.63	\$1.09
3/4" Clamp I.D. (for 3290-8 & 3491-08 hose)	Part No. 3298-.75	\$1.09
13/16" Clamp I.D. (for 3270-10, 3480-10, & 3490-10 hose)	Part No. 3298-.81	\$1.19
15/16" Clamp I.D. (3270, 3480, & 3490-12; 3290 & 3491-10)	Part No. 3298-.94	\$1.19
1.00" Clamp I.D.	Part No. 3298-1.00	\$2.89
1 1/16" Clamp I.D. (for 3290-12 & 3491-12 hose)	Part No. 3298-1.06	\$1.89
1 1/8" Clamp I.D. (for 3270-16 hose)	Part No. 3298-1.13	\$2.29
1 1/4" Clamp I.D. (for 3480-16 & 3490-16 hose)	Part No. 3298-1.25	\$2.29
1 1/2" Clamp I.D.	Part No. 3298-1.50	\$4.29

Red Anodized Pro-Clamps

These clamps add the finishing touch when using regular worm drive hose clamps to clamp hose onto barbed hose fittings. Each Pro-Clamp assembly consists of a red anodized sleeve to go over the end of the hose and a hidden stainless steel worm drive hose clamp. Check the outside diameter of your hose after it has been pushed over the hose barb and compare to the I.D. dimension shown below to determine which clamp size will fit.



Pro-Clamp, 0.44" I.D.	Part No. 3277-04	\$5.19
Pro-Clamp, 0.55" I.D.	Part No. 3277-06	\$6.49
Pro-Clamp, 0.65" I.D.	Part No. 3277-08	\$7.99
Pro-Clamp, 0.80" I.D.	Part No. 3277-10	\$8.99
Pro-Clamp, 0.94" I.D.	Part No. 3277-12	\$10.99
Pro-Clamp, 1.15" I.D.	Part No. 3277-16	\$13.99

See Page 117 for the
KOUL Tools EZ-ON Press
for quick, effortless barbed hose end installation!

Light-Duty Rubber Lined Support Clamps

These "Adel Style" clamps are smaller than the Aeroquip Vinyl Coated Clamps at left. They are ideal for lighter-duty applications. The steel band is cushioned with a rubber extrusion to prevent damage from sharp edges and to provide a small amount of vibration isolation. All are 1/2 inch wide and have a 0.281 inch dia. mounting hole. Sold individually.



1/4 inch Clamp Inside Diameter	Part No. 4350-.250	\$59¢
3/8 inch Clamp Inside Diameter	Part No. 4350-.375	69¢
1/2 inch Clamp Inside Diameter	Part No. 4350-.500	89¢
5/8 inch Clamp Inside Diameter	Part No. 4350-.625	79¢
3/4 inch Clamp Inside Diameter	Part No. 4350-.750	79¢
7/8 inch Clamp Inside Diameter	Part No. 4350-.875	79¢
1.00 inch Clamp Inside Diameter	Part No. 4350-1.000	89¢
1 1/8 inch Clamp Inside Diameter	Part No. 4350-1.125	99¢
1 1/4 inch Clamp Inside Diameter	Part No. 4350-1.250	\$1.09
1 1/2 inch Clamp Inside Diameter	Part No. 4350-1.500	\$1.19

AN Adapter Fittings with Male Ends

Steel fittings are recommended for brake lines.

Unions, AN to AN (AN815) & Reducer Unions, AN to AN (AN919)



Size	Part No.	Price
3AN to 3AN, Steel.....	3225-03-03S	\$4.69
3AN to 3AN, Stainless Steel.....	3225-03-03C	\$12.99
3AN to 4AN, Steel.....	3225-03-04S	\$9.99
3AN to 4AN, Stainless Steel.....	3225-03-04C	\$18.29
4AN to 4AN, Steel.....	3225-04-04S	\$2.69
4AN to 4AN, Stainless Steel.....	3225-04-04C	\$8.99
4AN to 4AN, Aluminum.....	3225-04-04A	\$3.99
4AN to 6AN, Aluminum.....	3225-04-06	\$4.59
4AN to 8AN, Aluminum.....	3225-04-08	\$3.79
4AN to 10AN, Aluminum.....	3225-04-10	\$3.99
6AN to 6AN, Aluminum.....	3225-06-06	\$4.69
6AN to 8AN, Aluminum.....	3225-06-08	\$9.49
6AN to 10AN, Aluminum.....	3225-06-10	\$9.99
6AN to 12AN, Aluminum.....	3225-06-12	\$8.19
8AN to 8AN, Aluminum.....	3225-08-08	\$7.29
8AN to 10AN, Aluminum.....	3225-08-10	\$13.49
8AN to 12AN, Aluminum.....	3225-08-12	\$8.99
10AN to 10AN, Aluminum.....	3225-10-10	\$8.29
10AN to 12AN, Aluminum.....	3225-10-12	\$18.29
10AN to 16AN, Aluminum.....	3225-10-16	\$18.99
12AN to 12AN, Aluminum.....	3225-12-12	\$12.99
12AN to 16AN, Aluminum.....	3225-12-16	\$31.49
16AN to 16AN, Aluminum.....	3225-16-16	\$29.99

Letter Codes:

S = Steel (plated)
 C = Corrosion-resistant steel (stainless)
 A = Aluminum
 No letter = Aluminum

90° Elbow Union, AN to AN (AN821)



Size	Part No.	Price
4AN to 4AN, Aluminum.....	3227-04-04	\$8.99
6AN to 6AN, Aluminum.....	3227-06-06	\$9.39
8AN to 8AN, Aluminum.....	3227-08-08	\$12.99

Union Tee, AN (all equal size, all male) (AN824)



Size	Part No.	Price
3AN, Steel.....	3228-03 STL	\$17.49
4AN, Steel.....	3228-04 STL	\$8.99
4AN, Aluminum.....	3228-04 ALUM	\$9.99
6AN, Aluminum.....	3228-06	\$10.49
8AN, Aluminum.....	3228-08	\$16.99
10AN, Aluminum.....	3228-10	\$21.49
12AN, Aluminum.....	3228-12	\$29.99

Union Y Fitting, AN (all male)



Size	Part No.	Price
4AN Inlet, 4AN Outlets.....	3228-001-04-04	\$28.99
6AN Inlet, 4AN Outlets.....	3228-001-06-04	\$34.99
6AN Inlet, 6AN Outlets.....	3228-001-06-06	\$29.99
8AN Inlet, 6AN Outlets.....	3228-001-08-06	\$37.99
8AN Inlet, 8AN Outlets.....	3228-001-08-08	\$37.99
10AN Inlet, 8AN Outlets.....	3228-001-10-08	\$37.99
10AN Inlet, 10AN Outlets.....	3228-001-10-10	\$37.99

4-Way Union, AN (all equal size, all male) (AN827)



Size	Part No.	Price
4AN, Aluminum.....	3228-004-04	\$21.99
6AN, Aluminum.....	3228-004-06	\$22.99
8AN, Aluminum.....	3228-004-08	\$31.99
10AN, Aluminum.....	3228-004-10	\$36.99

Steel Braze Fitting



Size	Part No.	Price
4AN Male to 1/4 Tube O.D., Steel..	3259-04-04S	\$3.99
6AN Male to 3/8 Tube O.D., Steel..	3259-06-06S	\$3.99
8AN Male to 1/2 Tube O.D., Steel..	3259-08-08S	\$3.99
10AN Male to 5/8 Tube O.D., Steel..	3259-10-10S	\$5.99
12AN Male to 3/4 Tube O.D., Steel..	3259-12-12S	\$6.99
16AN Male to 1" Tube O.D., Steel..	3259-16-16S	\$6.99

Straight Bulkhead Unions, AN to AN (AN832)



Size	Part No.	Price
3AN to 3AN, Steel.....	3226-03-03S	\$7.39
4AN to 4AN, Steel.....	3226-04-04S	\$6.49
4AN to 4AN, Aluminum.....	3226-04-04A	\$5.49
6AN to 6AN, Aluminum.....	3226-06-06	\$6.99
8AN to 8AN, Aluminum.....	3226-08-08	\$8.99
10AN to 10AN, Aluminum.....	3226-10-10	\$12.99
12AN to 12AN, Aluminum.....	3226-12-12	\$17.99
16AN to 16AN, Aluminum.....	3226-16-16	\$22.99

45° Elbow Bulkhead Union, AN to AN (AN837)



Size	Part No.	Price
3AN to 3AN, Steel.....	3248-03 STL	\$19.99
4AN to 4AN, Steel.....	3248-04 STL	\$10.99
4AN to 4AN, Aluminum.....	3248-04 ALUM	\$8.99
6AN to 6AN, Aluminum.....	3248-06	\$11.49
8AN to 8AN, Aluminum.....	3248-08	\$13.99
10AN to 10AN, Aluminum.....	3248-10	\$19.99
12AN to 12AN, Aluminum.....	3248-12	\$24.99

90° Elbow Bulkhead Union, AN to AN (AN833)



Size	Part No.	Price
3AN to 3AN, Steel.....	3239-03 STL	\$9.49
4AN to 4AN, Steel.....	3239-04 STL	\$8.99
4AN to 4AN, Aluminum.....	3239-04 ALUM	\$8.99
6AN to 6AN, Aluminum.....	3239-06	\$9.89
8AN to 8AN, Aluminum.....	3239-08	\$14.99
10AN to 10AN, Aluminum.....	3239-10	\$20.99
12AN to 12AN, Aluminum.....	3239-12	\$26.99

Bulkhead Run Tee, AN (all equal size, all male) (AN804)



Size	Part No.	Price
3AN, Aluminum.....	3232-03 ALUM	\$17.49
3AN, Steel.....	3232-03 STL	\$20.29
4AN, Steel.....	3232-04 STL	\$19.99
4AN, Aluminum.....	3232-04 ALUM	\$18.99
6AN, Aluminum.....	3232-06	\$19.99
8AN, Aluminum.....	3232-08	\$25.99
10AN, Aluminum.....	3232-10	\$33.99
12AN, Aluminum.....	3232-12	\$37.99
16AN, Aluminum.....	3232-16	\$51.99

Bulkhead Branch Tee, AN (all equal size, all male) (AN834)



Size	Part No.	Price
3AN, Steel.....	3229-03 STL	\$22.99
4AN, Steel.....	3229-04 STL	\$13.49
4AN, Aluminum.....	3229-04 ALUM	\$13.99
6AN, Aluminum.....	3229-06	\$15.99
8AN, Aluminum.....	3229-08	\$18.99
10AN, Aluminum.....	3229-10	\$23.99
12AN, Aluminum.....	3229-12	\$38.99

Bulkhead Mounting Nut (AN316 and AN924)



Size	Part No.	Price
3AN, Steel.....	AN316-6-R	.49c
3AN, Aluminum.....	3237-03 ALU	\$1.39
4AN, Steel.....	3237-04 STL	.79c
4AN, Aluminum.....	3237-04 ALUM	\$1.49
6AN, Aluminum.....	3237-06	\$1.79
8AN, Aluminum.....	3237-08	\$2.79
10AN, Aluminum.....	3237-10	\$3.49
12AN, Aluminum.....	3237-12	\$4.49
16AN, Aluminum.....	3237-16	\$4.99

Aluminum Weld Fitting (AN971)



Size	Part No.	Price
4AN Male, Aluminum.....	3269-04	\$4.99
6AN Male, Aluminum.....	3269-06	\$5.49
8AN Male, Aluminum.....	3269-08	\$5.99
10AN Male, Aluminum.....	3269-10	\$6.49
12AN Male, Aluminum.....	3269-12	\$10.99
16AN Male, Aluminum.....	3269-16	\$13.99

AN Adapter Fittings with Female AN Ports

Steel fittings are recommended for brake lines.

AN Male to Female Swivel 45° Elbow



Size	Part No.	Price
4AN, Aluminum	3247-04	\$16.99
6AN, Aluminum	3247-06	\$17.99
8AN, Aluminum	3247-08	\$19.99
10AN, Aluminum	3247-10	\$23.99
12AN, Aluminum	3247-12	\$29.99

AN Male to Female Swivel 90° Elbow



Size	Part No.	Price
3AN, Steel	3284-03	\$11.99
4AN, Steel	3284-04 STL	\$11.99
4AN, Aluminum	3284-04	\$15.99
6AN, Aluminum	3284-06	\$14.99
8AN, Aluminum	3284-08	\$22.99
10AN, Aluminum	3284-10	\$26.99
12AN, Aluminum	3284-12	\$33.99

AN Tee with Female Swivel on Branch



Size	Part No.	Price
4AN, Steel (import)	3282-04S	\$9.99
4AN, Aluminum	3282-04	\$14.99
6AN, Aluminum	3282-06	\$17.99
8AN, Aluminum	3282-08	\$24.99
10AN, Aluminum	3282-10	\$29.99
12AN, Aluminum	3282-12	\$32.99

AN Tee with Female Swivel on Run



Size	Part No.	Price
4AN, Aluminum	3283-04	\$15.79
6AN, Aluminum	3283-06	\$18.99
8AN, Aluminum	3283-08	\$25.99
10AN, Aluminum	3283-10	\$31.99

AN Female Swivel to AN Male Reducer (Steel)

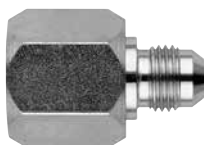

Size	Part No.	Price
4AN Female to 3AN Male	3228-303-04-03	\$19.99
6AN Female to 4AN Male	3228-303-06-04	\$8.99
8AN Female to 4AN Male	3228-303-08-04	\$7.99
8AN Female to 6AN Male	3228-303-08-06	\$10.99
10AN Female to 6AN Male	3228-303-10-06	\$13.99
12AN Female to 6AN Male	3228-303-12-06	\$10.99
12AN Female to 8AN Male	3228-303-12-08	\$9.99

AN Female to AN Male Aluminum Reducer (AN894)

Use an O-ring (Part No. 3244-xx, page 95) to seal the female end of these fittings.



Size	Part No.	Price
4AN Female to 3AN Male	3249-04-03	\$10.49
6AN Female to 4AN Male	3249-06-04	\$10.49
8AN Female to 6AN Male	3249-08-06	\$14.99
10AN Female to 8AN Male	3249-10-08	\$18.99
12AN Female to 8AN Male	3249-12-08	\$26.99
12AN Female to 10AN Male	3249-12-10	\$26.99
16AN Female to 12AN Male	3249-16-12	\$36.99

AN Female Swivel to AN Female Swivel Coupling



Size	Part No.	Price
3AN, Stainless Steel	3238-03-SST	\$12.99
4AN, Aluminum	3238-04	\$10.99
6AN, Aluminum	3238-06	\$7.99
6AN to 8AN, Aluminum	3238-06-08	\$9.49
8AN, Aluminum	3238-08	\$9.49
10AN, Aluminum	3238-10	\$10.49
12AN, Aluminum	3238-12	\$16.49
16AN, Aluminum	3238-16-16	\$21.99

AN Female Swivel to Female Swivel 90° Forged Elbow



Size	Part No.	Price
4AN, Aluminum, Forged	3285-04	\$20.99
6AN, Aluminum, Forged	3285-06	\$22.99
8AN, Aluminum, Forged	3285-08	\$23.99
10AN, Aluminum, Forged	3285-10	\$25.99
12AN, Aluminum, Forged	3285-12	\$27.99
16AN, Aluminum, Forged	3285-16	\$33.99

AN Female Swivel to Female Swivel 90° Bent Tube Elbow



Size	Part No.	Price
4AN, Aluminum, Bent Tube	3276-300-04	\$19.99
6AN, Aluminum, Bent Tube	3276-300-06	\$23.99
8AN, Aluminum, Bent Tube	3276-300-08	\$35.99
10AN, Aluminum, Bent Tube	3276-300-10	\$39.99
12AN, Aluminum, Bent Tube	3276-300-12	\$54.99
16AN, Aluminum, Bent Tube	3276-300-16	\$76.99

Female AN Tee (all equal size, all female, no flare) (AN938)

Use O-rings (Part No. 3244-xx, page 95) to seal the female ends on these fittings.



Size	Part No.	Price
4AN, Aluminum	3224-04	\$15.99
6AN, Aluminum	3224-06	\$16.99
8AN, Aluminum	3224-08	\$19.99
10AN, Aluminum	3224-10	\$26.99
12AN, Aluminum	3224-12	\$39.99
16AN, Aluminum	3224-16	\$48.99

AN Female Swivel to AN Male Expander



Size	Part No.	Price
3AN Female to 4AN Male	3497-030-03-04	\$12.29
4AN Female to 6AN Male	3497-030-04-06	\$8.99
6AN Female to 8AN Male	3497-030-06-08	\$10.19
8AN Female to 10AN Male	3497-030-08-10	\$11.19
10AN Female to 12AN Male	3497-030-10-12	\$13.99
12AN Female to 16AN Male	3497-030-12-16	\$35.99
16AN Female to 20AN Male	3497-030-16-20	\$81.99

AN Female to AN Male Aluminum Expander

These expanders do not have an internal sealing flare or an O-ring chamfer. You must use a crush washer (Part No. 3278-xx, page 95) to seal the female end of these fittings.



Size	Part No.	Price
3AN Female to 6AN Male	AF951-03-06	\$6.79
4AN Female to 8AN Male	AF951-04-08	\$7.49
6AN Female to 10AN Male	AF951-06-10	\$7.79
8AN Female to 12AN Male	AF951-08-12	\$11.49
10AN Female to 16AN Male	AF951-10-16	\$17.49

AN Tube Nuts and Tube Sleeves

Tube nuts make it easy to adapt standard SAE tubing to male AN fittings. Simply slide a tube nut and a tube sleeve over the end of your tubing and flare the end. The flare retains the tube sleeve, which retains the tube nut and gives the nut a proper bearing surface.

The flare also acts as the sealing face for your male AN fitting. Use a double flare on steel brake and clutch hydraulic lines. Low-pressure aluminum tubing can be single-flared. Add a SECO 7 Seal (see page 95) for a reliable seal, even with a 42 degree SAE flare!

Tube Nut, AN (AN818)

Tube Nuts must be used together with a matching Tube Sleeve.



Size	Part No.	Price
3AN (3/8 x 24), Steel	3235-03 STL	.79¢
4AN (7/16 x 20), Steel	3235-04 STL	\$1.29
4AN (7/16 x 20), Aluminum	3235-04 ALUM	\$1.49
6AN (9/16 x 18), Aluminum	3235-06	\$1.49
8AN (3/4 x 16), Aluminum	3235-08	\$2.49
10AN (7/8 x 14), Aluminum	3235-10	\$3.29
12AN (1 1/16 x 12), Aluminum	3235-12	\$4.29

Tube Sleeve, AN (AN819)

Tube Sleeves protect your tubing from damage when tightening the Tube Nut.



Size	Part No.	Price
3AN, Steel	3236-03 STL	\$1.39
4AN, Steel	3236-04 STL	.89¢
4AN, Aluminum	3236-04 ALUM	.99¢
6AN, Aluminum	3236-06	\$1.99
8AN, Aluminum	3236-08	\$1.99
10AN, Aluminum	3236-10	\$1.99
12AN, Aluminum	3236-12	\$2.99

See Page 95 for 37° SECO 7 Seals for reliable, leak-free connections to flared tubing!

NPT (National Pipe Thread) to AN Adapter Fittings

Male NPT Pipe to Male AN Adapter (AN816)



Size	Part No.	Price
1/8 NPT to 3AN, Steel.....	3250-02-03S.....	\$1.99
1/8 NPT to 4AN, Steel.....	3250-02-04S.....	\$2.19
1/8 NPT to 4AN, Aluminum.....	3250-02-04A.....	\$3.49
1/8 NPT to 6AN, Aluminum.....	3250-02-06.....	\$4.69
1/4 NPT to 3AN, Aluminum.....	3250-04-03A.....	\$10.99
1/4 NPT to 4AN, Steel.....	3250-04-04S.....	\$1.99
1/4 NPT to 4AN, Aluminum.....	3250-04-04A.....	\$3.49
1/4 NPT to 6AN, Aluminum.....	3250-04-06.....	\$4.29
1/4 NPT to 8AN, Aluminum.....	3250-04-08.....	\$5.99
3/8 NPT to 4AN, Steel.....	3250-06-04S.....	\$2.99
3/8 NPT to 6AN, Aluminum.....	3250-06-06.....	\$4.89
3/8 NPT to 8AN, Aluminum.....	3250-06-08.....	\$4.99
3/8 NPT to 10AN, Aluminum.....	3250-06-10.....	\$10.49
1/2 NPT to 8AN, Aluminum.....	3250-08-08.....	\$6.49
1/2 NPT to 10AN, Aluminum.....	3250-08-10.....	\$6.99
1/2 NPT to 12AN, Aluminum.....	3250-08-12.....	\$11.29
3/4 NPT to 12AN, Aluminum.....	3250-12-12.....	\$21.99
1" NPT to 12AN, Aluminum.....	3250-16-12.....	\$21.99
1" NPT to 16AN, Aluminum.....	3250-16-16.....	\$25.99

For Black anodized aluminum, order Part No. 3250-001-Size-Size.

Male NPT Pipe to Male AN 45° Elbow (AN823)



1/8 NPT to 3AN, Steel.....	3251-02-03S.....	\$8.99
1/8 NPT to 4AN, Steel.....	3251-02-04S.....	\$6.29
1/8 NPT to 4AN, Aluminum.....	3251-02-04A.....	\$8.59
1/4 NPT to 4AN, Steel.....	3251-04-04S.....	\$7.49
1/4 NPT to 6AN, Aluminum.....	3251-04-06.....	\$8.99
3/8 NPT to 8AN, Aluminum.....	3251-06-08.....	\$12.99
1/2 NPT to 10AN, Aluminum.....	3251-08-10.....	\$17.99
1/2 NPT to 12AN, Aluminum.....	3251-08-12.....	\$23.99

Male NPT Pipe to Male AN 90° Elbow (AN822)



1/8 NPT to 3AN, Steel.....	3253-02-03S.....	\$7.49
1/8 NPT to 4AN, Steel.....	3253-02-04S.....	\$4.99
1/8 NPT to 4AN, Aluminum.....	3253-02-04A.....	\$9.99
1/8 NPT to 6AN, Aluminum.....	3253-02-06.....	\$10.99
1/4 NPT to 4AN, Steel.....	3253-04-04S.....	\$5.99
1/4 NPT to 4AN, Aluminum.....	3253-04-04A.....	\$9.99
1/4 NPT to 6AN, Aluminum.....	3253-04-06.....	\$9.99
1/4 NPT to 8AN, Aluminum.....	3253-04-08.....	\$17.49
3/8 NPT to 6AN, Aluminum.....	3253-06-06.....	\$13.99
3/8 NPT to 8AN, Aluminum.....	3253-06-08.....	\$12.99
1/2 NPT to 8AN, Aluminum.....	3253-08-08.....	\$19.49
1/2 NPT to 10AN, Aluminum.....	3253-08-10.....	\$17.99
1/2 NPT to 12AN, Aluminum.....	3253-08-12.....	\$23.99
3/4 NPT to 12AN, Aluminum.....	3253-12-12.....	\$25.99
1" NPT to 16AN, Aluminum.....	3253-16-16.....	\$41.99

Steel fittings are recommended for brake lines.

Male NPT to Male AN with Female 1/8 NPT Port



All sizes have a 1/8 NPT female port. Aluminum only.

Size	Part No.	Price
1/4 NPT Male to 6AN Male.....	3228-304-04-06.....	\$8.99
1/4 NPT Male to 8AN Male.....	3228-304-04-08.....	\$8.99
3/8 NPT Male to 6AN Male.....	3228-304-06-06.....	\$8.99
3/8 NPT Male to 8AN Male.....	3228-304-06-08.....	\$8.99

Male Branch Tee (Male NPT on branch to Male AN) (AN825)



Size	Part No.	Price
1/4 NPT to 6AN, Aluminum.....	3286-04-06.....	\$12.99
3/8 NPT to 8AN, Aluminum.....	3286-06-08.....	\$19.29

Male Run Tee (Male NPT on run to Male AN) (AN826)



Size	Part No.	Price
1/8 NPT to 3AN, Steel.....	3281-02-03S.....	\$15.99
1/8 NPT to 4AN, Steel.....	3281-02-04S.....	\$7.99
1/8 NPT to 4AN, Aluminum.....	3281-02-04A.....	\$14.99
1/4 NPT to 4AN, Steel.....	3281-04-04S.....	\$7.29
1/4 NPT to 6AN, Aluminum.....	3281-04-06.....	\$10.99
3/8 NPT to 8AN, Aluminum.....	3281-06-08.....	\$19.29
1/2 NPT to 10AN, Aluminum.....	3281-08-10.....	\$26.99
1" NPT to 16AN, Aluminum.....	3281-16-16.....	\$38.99

Female NPT Pipe to Male AN Adapter



Size	Part No.	Price
1/8 NPT to 3AN, Steel.....	3254-02-03S.....	\$4.99
1/8 NPT to 4AN, Steel.....	3254-02-04S.....	\$4.29
1/4 NPT to 3AN, Steel.....	3254-04-03S.....	\$15.49
1/4 NPT to 4AN, Steel.....	3254-04-04S.....	\$4.29
1/4 NPT to 6AN, Steel.....	3254-04-06S.....	\$4.49
3/8 NPT to 6AN, Steel.....	3254-06-06S.....	\$4.99
3/8 NPT to 8AN, Steel.....	3254-06-08S.....	\$6.99
1/2 NPT to 8AN, Steel.....	3254-08-08S.....	\$5.79
1/2 NPT to 10AN, Steel.....	3254-08-10S.....	\$17.29
3/4 NPT to 12AN, Steel.....	3254-12-12S.....	\$9.99

Male NPT to Female AN Swivel Adapter



Size	Part No.	Price
1/8 NPT to 3AN, Stainless Steel ..	3497-044-02-03 ..	\$11.49
1/8 NPT to 3AN, Aluminum.....	3497-043-02-03.....	\$11.99
1/8 NPT to 4AN, Aluminum.....	3497-043-02-04.....	\$9.59
1/8 NPT to 6AN, Aluminum.....	3497-043-02-06.....	\$12.49
1/4 NPT to 4AN, Aluminum.....	3497-043-04-04.....	\$9.99
1/4 NPT to 6AN, Aluminum.....	3497-043-04-06.....	\$9.99
1/4 NPT to 8AN, Aluminum.....	3497-043-04-08.....	\$12.49
3/8 NPT to 6AN, Aluminum.....	3497-043-06-06.....	\$12.99
3/8 NPT to 8AN, Aluminum.....	3497-043-06-08.....	\$12.49
3/8 NPT to 10AN, Aluminum.....	3497-043-06-10.....	\$15.99
1/2 NPT to 10AN, Aluminum.....	3497-043-08-10.....	\$15.99
1/2 NPT to 12AN, Aluminum.....	3497-043-08-12.....	\$21.49
3/4 NPT to 12AN, Aluminum.....	3497-043-12-12.....	\$21.49

Female Branch Tee (Female NPT on Branch to Male AN)



Size	Part No.	Price
1/8 NPT to 3AN, Steel.....	3209-02-03S.....	\$10.99
1/8 NPT to 4AN, Steel.....	3209-02-04S.....	\$14.99
1/4 NPT to 4AN, Steel.....	3209-04-04S.....	\$16.99
1/4 NPT to 6AN, Steel.....	3209-04-06S.....	\$13.99
3/8 NPT to 8AN, Steel.....	3209-06-08S.....	\$16.99

NPT Pipe Fittings

Female Pipe Coupler (AN910)



Size	Part No.	Price
1/8 NPT, Aluminum.....	3280-02.....	\$4.49
1/4 NPT, Aluminum.....	3280-04.....	\$5.89
3/8 NPT, Aluminum.....	3280-06.....	\$8.99

Male Pipe Nipple (AN911)



1/8 NPT, Hex Nipple, Alum.....	3255-02.....	\$2.99
1/4 NPT, Close Nipple, Brass.....	3211-Brass.....	99¢
No hex on above. Not AN911 style.		
1/4 NPT, Hex Nipple, Alum.....	3255-04.....	\$3.99
3/8 NPT, Hex Nipple, Alum.....	3255-06.....	\$8.99
1/2 NPT, Hex Nipple, Alum.....	3255-08.....	\$9.99

Aluminum Weld Bung with Female NPT Port



1/8 NPT, Aluminum.....	3228-125-02.....	\$5.99
1/4 NPT, Aluminum.....	3228-125-04.....	\$5.99
3/8 NPT, Aluminum.....	3228-125-06.....	\$6.49
1/2 NPT, Aluminum.....	3228-125-08.....	\$3.89
3/4 NPT, Aluminum.....	3228-125-12.....	\$7.99
1" NPT, Aluminum.....	3228-125-16.....	\$9.99

Street Elbow (90° Male NPT to Female NPT) (AN914)



Size	Part No.	Price
1/8 NPT, Aluminum.....	3228-301-02A.....	\$14.99
1/8 NPT, Steel.....	3228-301-02S.....	\$6.69

Aluminum Pipe Reducer Bushing (AN912)



1/4 NPT Male to 1/8 NPT Female.....	3257-04-02.....	\$5.99
3/8 NPT Male to 1/8 NPT Female.....	3257-06-02.....	\$6.39
3/8 NPT Male to 1/4 NPT Female.....	3257-06-04.....	\$6.39
1/2 NPT Male to 1/4 NPT Female.....	3257-08-04.....	\$5.99
1/2 NPT Male to 3/8 NPT Female.....	3257-08-06.....	\$7.39
3/4 NPT Male to 3/8 NPT Female.....	3257-12-06.....	\$10.79
3/4 NPT Male to 1/2 NPT Female.....	3257-12-08.....	\$12.99

Female Pipe Tee (AN917)



Size	Part No.	Price
1/8 NPT, Brass.....	3212.....	\$4.99
1/8 NPT, Aluminum.....	3256-02.....	\$13.49
1/8 NPT, Steel.....	3223.....	\$5.99
1/4 NPT, Brass.....	3213.....	\$5.99
1/4 NPT, Aluminum.....	3256-04.....	\$14.99

ORB (O-Ring Boss) to AN Adapter Fittings

O-Ring Boss Adapters are used to connect AN hose to female ports without a 37° seat. The female port must be chamfered to accept an O-ring in order to seal reliably. If the port is not chamfered, our AN920 straight adapter fittings below can be used with a crush washer instead of an O-ring. Our 45° and 90° adapter fittings both have a jam nut that allows you

to clock the fitting in whatever direction you need. O-rings are included with all of these adapter fittings. The 45° and 90° O-Ring Boss to AN Male Adapter fittings also include the jam nut and an aluminum backup washer. All of these adapter fittings are constructed of anodized aluminum.

O-Ring Boss to AN Male Adapters – Straight (AN920)



The first size listed is the Male AN flare size; the second size indicates the O-Ring Boss thread size. Includes O-ring.

4AN Male to 7/16-20 (-4) O-Ring Boss	Part No. 3603-04-04	\$6.99
6AN Male to 9/16-18 (-6) O-Ring Boss	Part No. 3603-06-06	\$7.49
6AN Male to 7/8-14 (-10) O-Ring Boss	Part No. 3603-06-10	\$10.29
8AN Male to 3/4-16 (-8) O-Ring Boss	Part No. 3603-08-08	\$11.99
8AN Male to 7/8-14 (-10) O-Ring Boss	Part No. 3603-08-10	\$17.99
8AN Male to 1 1/16-12 (-12) O-Ring Boss	Part No. 3603-08-12	\$19.99
10AN Male to 9/16-18 (-6) O-Ring Boss	Part No. 3603-10-06	\$12.99
10AN Male to 3/4-16 (-8) O-Ring Boss	Part No. 3603-10-08	\$12.99
10AN Male to 7/8-14 (-10) O-Ring Boss	Part No. 3603-10-10	\$13.99
10AN Male to 1 1/16-12 (-12) O-Ring Boss	Part No. 3603-10-12	\$17.99
12AN Male to 7/8-14 (-10) O-Ring Boss	Part No. 3603-12-10	\$17.99
12AN Male to 1 1/16-12 (-12) O-Ring Boss	Part No. 3603-12-12	\$18.49

O-Ring Boss to AN Male Adapters – 45° Elbow (AN922)



The first size listed indicates the O-Ring Boss thread size; the second size is the Male AN Flare size. These 45 degree adapters include the nut, O-ring, and backup washer.

7/16-20 (-4) O-Ring Boss to 6AN	Part No. 3279-04-06	\$14.99
9/16-18 (-6) O-Ring Boss to 4AN	Part No. 3279-06-04	\$12.99
9/16-18 (-6) O-Ring Boss to 6AN	Part No. 3279-06-06	\$17.99
9/16-18 (-6) O-Ring Boss to 8AN	Part No. 3279-06-08	\$26.99
3/4-16 (-8) O-Ring Boss to 6AN	Part No. 3279-08-06	\$26.99
3/4-16 (-8) O-Ring Boss to 8AN	Part No. 3279-08-08	\$19.99
3/4-16 (-8) O-Ring Boss to 10AN	Part No. 3279-08-10	\$29.99
7/8-14 (-10) O-Ring Boss to 8AN	Part No. 3279-10-08	\$29.99
7/8-14 (-10) O-Ring Boss to 10AN	Part No. 3279-10-10	\$24.99
7/8-14 (-10) O-Ring Boss to 12AN	Part No. 3279-10-12	\$37.99
1 1/16-12 (-12) O-Ring Boss to 12AN	Part No. 3279-12-12	\$37.99
1 1/16-12 (-12) O-Ring Boss to 16AN	Part No. 3279-16-16	\$62.99

Male O-Ring Boss Hose Ends – 45°



These reusable aluminum hose ends are compatible with standard stainless braided racing hose or Aeroquip Startlite hose. The male threads have no flare seat. They must be installed in a chamfered port and sealed with an O-ring (included). The first size listed is the hose size. The second size is the O-Ring boss thread size.

-8 Hose End to 9/16-18 (-6) O-Ring Boss	Part No. 3228-011-08-06	\$42.49
-8 Hose End to 3/4-16 (-8) O-Ring Boss	Part No. 3228-011-08-08	\$39.49
-10 Hose End to 7/8-14 (-10) O-Ring Boss	Part No. 3228-011-10-10	\$40.49
-10 Hose End to 1 1/16-12 (-12) O-Ring Boss	Part No. 3228-011-10-12	\$45.99
-12 Hose End to 7/8-14 (-10) O-Ring Boss	Part No. 3228-011-12-10	\$52.99
-12 Hose End to 1 1/16-12 (-12) O-Ring Boss	Part No. 3228-011-12-12	\$49.99

Male O-Ring Boss Hose Ends – Banjo



These reusable aluminum hose ends are compatible with standard stainless braided racing hose or Aeroquip Startlite hose. The hex of the banjo bolt is positioned below the banjo, and the banjo is retained by a circlip (top nut on the -16 size). Must be installed in a chamfered port and sealed with an O-ring (included).

-6 Hose End to 9/16-18 (-6) O-Ring Boss	Part No. 3228-420-06	\$73.99
-8 Hose End to 3/4-16 (-8) O-Ring Boss	Part No. 3228-420-08	\$79.99
-10 Hose End to 7/8-14 (-10) O-Ring Boss	Part No. 3228-420-10	\$85.99
-12 Hose End to 1 1/16-12 (-12) O-Ring Boss	Part No. 3228-420-12	\$98.99
-16 Hose End to 1 5/16-12 (-16) O-Ring Boss	Part No. 3228-420-16	\$104.99

Aluminum Weld Bung with Female AN Port (or O-Ring Port)

Use an O-ring (Part No. 3244-xx, page 95) to seal the female port on these fittings.



Size	Part No.	Price
3/8-24 (-3), Aluminum	3228-126-03	\$3.79
7/16-20 (-4), Aluminum	3228-126-04	\$3.79
9/16-18 (6AN), Aluminum	3228-126-06	\$3.89
3/4-16 (8AN), Aluminum	3228-126-08	\$4.19
7/8-14 (10AN), Aluminum	3228-126-10	\$4.69
1 1/16-12 (12AN), Aluminum	3228-126-12	\$5.39
1 5/16-12 (16AN), Aluminum	3228-126-16	\$6.59
1 5/8-12 (-20), Aluminum	3228-126-20	\$36.99

O-Ring Boss to AN Female Swivel Adapters – Straight



The first size listed is the Female AN Swivel size; the second size indicates the O-Ring Boss thread size. Includes O-ring.

6AN Female to 9/16-18 (-6) O-Ring Boss	Part No. 3600-001-06-06	\$25.99
6AN Female to 3/4-16 (-8) O-Ring Boss	Part No. 3600-001-06-08	\$42.99
8AN Female to 9/16-18 (-6) O-Ring Boss	Part No. 3600-001-08-06	\$42.99
8AN Female to 3/4-16 (-8) O-Ring Boss	Part No. 3600-001-08-08	\$42.99
8AN Female to 7/8-14 (-10) O-Ring Boss	Part No. 3600-001-08-10	\$49.99
10AN Female to 3/4-16 (-8) O-Ring Boss	Part No. 3600-001-10-08	\$49.99
10AN Female to 7/8-14 (-10) O-Ring Boss	Part No. 3600-001-10-10	\$49.99
10AN Female to 1 1/16-12 (-12) O-Ring Boss	Part No. 3600-001-10-12	\$51.99
12AN Female to 7/8-14 (-10) O-Ring Boss	Part No. 3600-001-12-10	\$51.99
12AN Female to 1 1/16-12 (-12) O-Ring Boss	Part No. 3600-001-12-12	\$51.99

O-Ring Boss to AN Male Adapters – 90° Elbow (AN921)



The first size listed indicates the O-Ring Boss thread size; the second size is the Male AN Flare size. These 90 degree adapters include the nut, O-ring, and backup washer.

7/16-20 (-4) O-Ring Boss to 6AN	Part No. 3287-4-6	\$15.99
9/16-18 (-6) O-Ring Boss to 4AN	Part No. 3287-6-4	\$13.99
9/16-18 (-6) O-Ring Boss to 6AN	Part No. 3287-6-6	\$17.99
9/16-18 (-6) O-Ring Boss to 8AN	Part No. 3287-6-8	\$31.99
3/4-16 (-8) O-Ring Boss to 6AN	Part No. 3287-8-6	\$31.99
3/4-16 (-8) O-Ring Boss to 8AN	Part No. 3287-8-8	\$19.99
3/4-16 (-8) O-Ring Boss to 10AN	Part No. 3287-8-10	\$35.99
7/8-14 (-10) O-Ring Boss to 8AN	Part No. 3287-10-8	\$35.99
7/8-14 (-10) O-Ring Boss to 10AN	Part No. 3287-10-10	\$27.99
7/8-14 (-10) O-Ring Boss to 12AN	Part No. 3287-10-12	\$44.99
1 1/16-12 (-12) O-Ring Boss to 12AN	Part No. 3287-12-12	\$34.99
1 1/16-12 (-12) O-Ring Boss to 16AN	Part No. 3287-16-16	\$62.99

Male O-Ring Boss Hose Ends – 90°



These reusable aluminum hose ends are compatible with standard stainless braided racing hose or Aeroquip Startlite hose. The male threads have no flare seat. They must be installed in a chamfered port and sealed with an O-ring (included). The first size listed is the hose size. The second size is the O-Ring boss thread size.

-8 Hose End to 9/16-18 (-6) O-Ring Boss	Part No. 3228-012-08-06	\$53.99
-8 Hose End to 3/4-16 (-8) O-Ring Boss	Part No. 3228-012-08-08	\$59.99
-10 Hose End to 7/8-14 (-10) O-Ring Boss	Part No. 3228-012-10-10	\$55.99
-10 Hose End to 1 1/16-12 (-12) O-Ring Boss	Part No. 3228-012-10-12	\$49.99
-12 Hose End to 7/8-14 (-10) O-Ring Boss	Part No. 3228-012-12-10	\$52.99
-12 Hose End to 1 1/16-12 (-12) O-Ring Boss	Part No. 3228-012-12-12	\$49.99

Steel Weld Bung with Female AN Port (or O-Ring Port)

Use an O-ring (Part No. 3244-xx, page 95) to seal the female port on these fittings.



Outside view (O-ring chamfer end shown)

Size	Part No.	Price
3/8-24 (-3), Steel	AF9965-03	\$4.49
7/16-20 (-4), Steel	AF9965-04	\$4.49
9/16-18 (-6), Steel	AF9965-06	\$4.49
3/4-16 (-8), Steel	AF9965-08	\$4.89
7/8-14 (-10), Steel	AF9965-10	\$5.49
1 1/16-12 (-12), Steel	AF9965-12	\$6.19
1 5/16-12 (-16), Steel	AF9965-16	\$7.89

Steel Weld Bung with Female AN Port (or O-Ring Port)

Use an O-ring (Part No. 3244-xx, page 95) to seal the female port on these fittings.



Inside view (weld step end shown)

Size	Part No.	Price
3/8-24 (-3), Stainless Steel	AF9965S-03	\$11.49
7/16-20 (-4), Stainless Steel	AF9965S-04	\$7.69
9/16-18 (-6), Stainless Steel	AF9965S-06	\$11.49
3/4-16 (-8), Stainless Steel	AF9965S-08	\$11.99
7/8-14 (-10), Stainless Steel	AF9965S-10	\$9.79
1 1/16-12 (-12), Stainless Steel	AF9965S-12	\$16.29
1 5/16-12 (-16), Stainless Steel	AF9965S-16	\$14.49

PLUMBING

AN and NPT Threaded Caps and Plugs, Check Valves and Shut-Off Valves

AN Flare Plug – Aluminum (AN806)



Size	Part No.	Price
3AN, Aluminum	3233-03	\$2.79
4AN, Aluminum	3233-04	\$2.99
6AN, Aluminum	3233-06	\$2.99
8AN, Aluminum	3233-08	\$4.29
10AN, Aluminum	3233-10	\$4.79
12AN, Aluminum	3233-12	\$7.49
16AN, Aluminum	3233-16	\$9.49

AN Flare Plug – Plastic (threaded – not push-on)



Size	Part No.	Price
3AN, Plastic	3296-03	15¢
4AN, Plastic	3296-04	17¢
6AN, Plastic	3296-06	19¢
8AN, Plastic	3296-08	22¢
10AN, Plastic	3296-10	24¢
12AN, Plastic	3296-12	29¢

Plastic Plug and Cap Kit – Save 24%



This 125 piece kit includes all sizes of our AN threaded plastic flare plugs and caps including: 12 each of sizes 3AN and 4AN; 10 each of sizes 6AN, 8AN, and 10AN; and 8 each of size 12AN. Everything comes organized in a durable storage container. Part numbers are included in the lid for easy reordering.

AN Cap and Plug Kit..... 3027.....\$28.49

NPT Allen Head Pipe Plug – Aluminum (AN932)



Size	Part No.	Price
1/8 NPT, Aluminum	3258-02	\$2.69
1/4 NPT, Aluminum	3258-04	\$2.99
3/8 NPT, Aluminum	3258-06	\$3.89
1/2 NPT, Aluminum	3258-08	\$4.79

AN Flare Cap – Aluminum (2-piece to avoid flare damage) (AN929)



Size	Part No.	Price
3AN, Aluminum	3234-03	\$3.29
4AN, Aluminum	3234-04	\$3.49
6AN, Aluminum	3234-06	\$4.19
8AN, Aluminum	3234-08	\$5.49
10AN, Aluminum	3234-10	\$6.99
12AN, Aluminum	3234-12	\$8.99
16AN, Aluminum	3234-16	\$11.49

AN Flat Cap – Plastic (threaded – not push-on)



Size	Part No.	Price
3AN (3/8-24), Plastic	3297-03	12¢
4AN (7/16-20), Plastic	3297-04	12¢
6AN (9/16-18), Plastic	3297-06	17¢
8AN (3/4-16), Plastic	3297-08	17¢
10AN (7/8-14), Plastic	3297-10	22¢
12AN (1 1/16-12), Plastic	3297-12	22¢

AN / O-Ring Port Plug – Aluminum (AN814)

Requires a chamfer in the female port to seal properly. Includes an O-ring.



3/8-24 (3AN), Aluminum	3228-128-03	\$2.99
7/16-20 (4AN), Aluminum	3228-128-04	\$2.99
9/16-18 (6AN), Aluminum	3228-128-06	\$4.49
3/4-16 (8AN), Aluminum	3228-128-08	\$4.99
7/8-14 (10AN), Aluminum	3228-128-10	\$5.99
1 1/16-12 (12AN), Aluminum	3228-128-12	\$8.99
1 5/16-12 (16AN), Aluminum	3228-128-16	\$11.99

NPT Allen Head Pipe Plug – Magnetic



1/8 NPT, with Bar Magnet	1010	\$2.99
1/4 NPT, with Bar Magnet	1011	\$3.19
3/8 NPT, with Bar Magnet	1012	\$2.89
1/2 NPT, with Bar Magnet	1013	\$3.19
3/4 NPT, with Bar Magnet	1014	\$4.39
1" NPT, with Bar Magnet	1015	\$4.99

Check Valves and Shut-Off Valves for Fluid Systems

AN Male to AN Male Flapper Valve



These check valves have a hinged flapper with a low-tension spring to allow flow in one direction, yet positively prevents flow in the opposite direction. They are used in fuel and oil systems when a check valve with a low cracking pressure is required. These valves are not cheap, but they have the lowest cracking pressure of any fluid check valves we offer.

Flapper Valve with 6AN Male Fittings	3606-06	\$124.99
Flapper Valve with 8AN Male Fittings	3606-08	\$132.99
Flapper Valve with 10AN Male Fittings	3606-10	\$143.99

AN Male to AN Female (O-Ring Port) Check Valve



These check valves are designed for use in fuel systems, but they flow so freely that they could easily be used in oil systems. The inlet is a standard male AN fitting. The outlet is a female SAE (AN) O-ring port. The compact body has a hex profile at the female end. The very low 1 to 1.5 psi cracking pressure is low enough for use even in carbureted fuel systems.

6AN Male to -6 (9/16-18) Female O-Ring Port	AEI-15106	\$78.99
10 AN Male to -10 (7/8-14) Female O-Ring Port	AEI-15107	\$93.75

Ball Check Valve with Female 1/2 NPT Ports



This economical check valve has a higher cracking pressure than the flapper type check valves shown at left. It is most commonly used in oil systems to prevent oil drainback, or to prevent backflow when using an Accusump connected with a Tee fitting. It is not recommended for use in fuel systems because of the high pressure required to open the valve. The brass body contains a spring-loaded steel valve ball. Ports are female 1/2 NPT.

Check Valve, Female 1/2 NPT Ports	3605-1/2 NPT	\$27.00
-----------------------------------	--------------	---------

BSP Female to BSP Female Brake Line Lock



Brake line locks are normally used to lock the non-driven wheels of a drag racing vehicle during burnouts. They can also be used to hold a car stationary on the starting line while your feet are busy on the clutch and throttle pedals. Plumb the line lock in the brake line to the non-driven wheels (e.g., front wheels on a rear-drive car). Apply the brake pedal firmly, then close the valve to hold pressure for a short time. Female 1/8 BSP ports can easily be adapted to 3AN hose. 7500 psi pressure rating.

Brake Line Lock, Female 1/8 BSP Ports	OBP-CB011	\$44.99
---------------------------------------	-----------	---------

Manual Shut-Off Valves

These anodized aluminum ball valves are designed to add a layer of safety to your fuel system. With the handle in the open position, fluid can flow freely in one direction. When you turn the handle, flow is positively stopped. Shut-off valves like this are now required in the fuel system by some racing organizations, including Quarter Midgets. They also make a great anti-theft device, Accusump valve, or even a drain valve. Maximum operating pressure of 300 psi is appropriate for fuel or oil systems (not for brake or clutch).

6AN Male Inlet and Outlet	AF1000-06-Black	\$28.99
8AN Male Inlet and Outlet	AF1000-08-Black	\$32.99
10AN Male Inlet and Outlet	AF1000-10-Black	\$35.99
12AN Male Inlet and Outlet	AF1000-12-Black	\$38.99
16AN Male Inlet and Outlet	AF1000-16-Black	\$51.99
3/8 NPT Female Inlet, 6AN Male Outlet	3496-001-06-06	\$46.99
3/8 NPT Female Inlet, 8AN Male Outlet	3496-001-06-08	\$49.99
1/2 NPT Female Inlet, 10AN Male Outlet	3496-001-08-10	\$57.99

AN Male to AN Male Manual Shut-Off Valve Part No. AF1000-Size-Black

NPT Female to AN Male Manual Shut-Off Valve Part No. 3496-001-Size-Size



Fuel System Plumbing Fittings

Quick-Connect EFI Fitting to AN Adapters

SAE J2044 Male Quick-Connect Coupling to Male AN or Male O-Ring Boss



- 3/8" Male QC to Male 10AN Part No. AEI-15104
- 1/2" Male QC to Male -10 O-Ring Part No. AEI-15129
- 5/16" Male QC to Male 6AN Part No. AEI-15103 \$37.90
- 3/8" Male QC to Male -8 O-Ring Part No. AEI-15126 \$37.94
- 3/8" Male QC to Male 10AN Part No. AEI-15104 \$54.99
- 1/2" Male QC to Male -10 O-Ring Part No. AEI-15129 \$47.03
- 1/2" Male QC to Male -12 O-Ring Part No. AEI-15131 \$61.23
- 5/8" Male QC to Male -12 O-Ring Part No. AEI-15130 \$61.23

SAE J2044 Female Quick-Connect Coupling to Male AN or Female O-Ring Port



- 5/16" Female QC to Female -6 O-Ring Part No. AEI-15117
- 3/8" Female QC to Male 8AN Part No. 3497-022
- 5/16" Female QC to Male 6AN Part No. 3497-021 \$20.49
- 5/16" Female QC to Female -6 O-Ring Part No. AEI-15117 \$37.25
- 3/8" Female QC to Male 6AN Part No. 3497-020 \$20.49
- 3/8" Female QC to Male 8AN Part No. 3497-022 \$21.99
- 3/8" Female QC to Female -8 O-Ring Part No. AEI-15118 \$39.73
- 1/2" Female QC to Female -10 O-Ring Part No. AEI-15128 \$43.84

SAE J2044 Female Quick-Connect Coupling to Male AN Adapters

These adapters use a screw-in retaining nut on the female QC end instead of the more common spring-tension retention clip (as on the female QC adapters above). They take a little longer to assemble and disassemble, but they offer extra security.



- 5/16" Female QC to Male 6AN, Straight Part No. AF808-01-Black . \$12.99
- 5/16" Female QC to Male 6AN, 90° Part No. AF803-01-Black . \$19.99
- 3/8" Female QC to Male 6AN, Straight Part No. AF808-02-Black . \$12.99
- 3/8" Female QC to Male 6AN, 90° Part No. AF803-02-Black . \$19.99
- 3/8" Female QC to Male 8AN, Straight Part No. AF808-03-Black . \$12.99
- 3/8" Female QC to Male 8AN, 90° Part No. AF803-03-Black . \$21.99

Ford Spring-Lock Quick-Connect Coupling to Male AN Adapters



- 3/8" Male Ford QC to Male 6AN Part No. AEI-15123 \$22.36
 - 1/2" Male Ford QC to Male 6AN Part No. AEI-15124 \$22.36
 - 1/2" Male Ford QC to Male 8AN Part No. AEI-15125 \$23.26
 - 3/8" Female Ford QC to Male 6AN Part No. AEI-15101 \$37.90
 - 1/2" Female Ford QC to Dual Male 8AN Part No. AEI-15102 \$75.99
- This Tee fitting has two male 8AN fittings, plus a female 1/8 NPT port on the side.*

6AN Carburetor Adapters and -6 Banjo Hose Ends

6AN Male to Carburetor Straight Adapters



- 6AN to 7/8-20 Holley Dual feed Part No. 3275-001 \$6.49
- 6AN to 9/16-24 Holley Single feed Part No. 3275-002 \$7.89
- 6AN to 12x1.5mm Weber (not DGV), Bosch 044 Part No. 3275-003 \$5.49
- 6AN to 3/8-18 I.F. Fuel Pump Adapter Part No. 3275-005 \$5.99
- 6AN to 1/2-20 I.F. Fuel Pump Adapter Part No. 3275-006 \$7.49
- 6AN to 12x1.25mm Solex, Mikuni, Dellorto Part No. 3275-012 \$13.49

-6 Straight Banjo Hose Ends



- 6AN Hose End to 9/16-24 Banjo, Holley Part No. 3275-007 \$19.99
- 6AN Hose End to 12x1.5mm Banjo Weber (not DGV) Part No. 3275-009 \$29.99
- 6AN Double Hose End to 12x1.5 Banjo Part No. 3275-010 \$36.99
- 6AN Hose End to 12x1.25mm Banjo Mikuni, Dellorto Part No. 3275-011 \$22.99
- Replacement Crush Washer only, ea. Part No. 3228-129 \$6.99

6AN Male to Carburetor 90° Banjo Hose Ends



- Single Hose End to 16mm I.D. Banjo Part No. 3228-400 \$41.99
- Hose End & 6AN Male to 16mm Banjo Part No. 3228-401 \$41.99
- Double Hose End to 16mm I.D. Banjo Part No. 3228-402 \$42.99
- 12x1.5mm Banjo Bolt, 16mm Shoulder Part No. 3242-037 \$16.99
- 12x1.25mm Banjo Bolt, 16mm Shoulder Part No. 3242-038 \$16.99
- 16mm Alum. Crush Washers, 5 pack Part No. 3278-M16 \$4.99

Brass NPT to Hose Barb Fittings



These fittings work with plain rubber fuel hose and standard worm-drive hose clamps.

- 1/8 NPT Male to 3/16" I.D. Hose, Straight Part No. 3220 \$1.69
- 1/8 NPT Male to 3/16" I.D. Hose, 90° Elbow Part No. 3221 \$4.99
- 1/4 NPT Male to 3/8" I.D. Hose, 90° Elbow Part No. 3222 \$5.29

Aluminum Fuel Distribution Block

This Y-fitting is designed for plumbing multiple carbs, but can be used wherever a high-flowing T-fitting is needed.

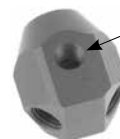

1/8 NPT port can be used as a gauge port or fuel sampling port.

All ports are female pipe thread.

- 3/8 NPT Input, 2x 1/4 NPT Outlets, 1/8 NPT gauge port Part No. 3289-06-04 \$41.99
- 1/2 NPT Input, 2x 3/8 NPT Outlets, 1/8 NPT gauge port Part No. 3289-08-06 \$27.99

Fuel Sampling Ports

SCCA Fuel Sampling Port with Dual Viton Seals



This economical fuel sampling port is custom-made for Pegasus to meet the SCCA fuel sampling port requirement. In addition to the main Viton seal at the base of the fitting, a second Viton O-ring seals the stem to prevent leakage while drawing a sample. The valve has a male 1/8 NPT pipe thread for easy attachment to the fuel system. The valve has a nipple for attaching a 1/4 inch I.D. hose (hose not included). Depending on where the valve is located, you may not need any hose at all.

SCCA Fuel Sampling Port with Dual Viton Seals Part No. 2542 \$18.99

Aeromotive Fuel Sampling Port



This very trick sampling port from Aeromotive is designed with a simple 2-step actuating procedure to prevent accidental opening. First, turn the red knob on the top to the ON position. Second, push the knob down to open the valve. Release the knob, and the valve closes. Turn the knob to the OFF position to lock it closed. The male 1/8 NPT pipe thread is easy to install in most fuel systems. A female 1/8 NPT port on the side (plugged from the factory) lets you relocate whatever was originally in the hole where you install the port.

- Aeromotive Fuel Sampling Port, 1/8 NPT Male Part No. AEI-15631 \$93.99
- Aeromotive Fuel Sampling Port with 3/8 SAE QC Tee Part No. AEI-17119 \$147.99

This assembly includes the Fuel Sampling Port and an SAE J2044-type 3/8 quick-connect fuel line tee fitting. Just disconnect a fuel line in your OEM Chevy LS or Ford Modular fuel system, plug in the tee, and you're done!

We offer dozens of fittings and adapters with female 1/8 NPT ports to connect these sampling ports to just about any fuel system. Browse pages 45 (Pressure Gauge Adapters) and 89 (NPT Fittings and Adapters), or visit our website for some of the most popular setups.

BSP Fittings (British Standard Pipe)

We stock one of the largest selections of BSP fittings anywhere!

1/8 BSP Reusable Hose Ends for Size 3 Braided PTFE Hose



Standard Conical BSP Seal
Part No. 3263-1/8-00



Special Flat Seal for Racetech or Smiths Gauges
Part No. 3268-1/8-00

- 1/8 BSP Female Straight Swivel Hose End..... Part No. 3263-1/8-00 \$13.29
- 1/8 BSP Female 45° Swivel Hose End..... Part No. 3263-1/8-45..... \$16.49
- 1/8 BSP Female 90° Swivel Hose End..... Part No. 3263-1/8-90..... \$16.49

The following hose ends have a flat sealing surface for Racetech pressure gauges. Be sure to check the back of your gauge!

- 1/8 BSP **Flat Seal** Female Straight Swivel Hose End. . Part No. 3268-1/8-00 \$16.99
- 1/8 BSP **Flat Seal** Female 45° Swivel Hose End..... Part No. 3268-1/8-45 \$21.99
- 1/8 BSP **Flat Seal** Female 90° Swivel Hose End..... Part No. 3268-1/8-90 \$18.99

- Spare Sleeve for size 3 reusable hose ends, each Part No. 3261-3-Sleeve \$1.59
- Size 3 Braided Stainless Steel PTFE Hose, per foot... Part No. 3260-3 \$4.49/ foot

BSP Male to BSP Male Adapters and BSP Banjo Bolt



- 3/8 BSP Male to 3/8 BSP Male - Brass * Part No. 1097 \$15.99
* As supplied with Racetech mechanical temperature gauges.
- 3/8 BSP Male to 1/2 BSP Male - Steel (small hex)..... Part No. 3203-6-8BSP \$14.99
- 1/2 BSP Male to 1/2 BSP Male - Steel Part No. 3231-8-8BSP \$5.59
- 1/2 BSP Male to 1/2 BSP Male - Aluminum Part No. 3203-8-8BSP \$14.99
- 1/2 BSP Male to 5/8 BSP Male - Steel Part No. 3231-8-10BSP \$6.99
- 1/2 BSP Male to 5/8 BSP Male - Aluminum Part No. 3203-8-10BSP \$19.99
- 5/8 BSP Male to 5/8 BSP Male - Steel Part No. 3231-10-10BSP \$6.99
- 1/8 BSP Male Tee - Steel Part No. 3228-901-1/8..... \$19.99
- 1/4 BSP Banjo Bolt - Steel Part No. 3242-047..... \$6.99
This banjo bolt fits a 14mm banjo adapter fitting (sold separately).

BSP Male to NPT Male Adapters



- 1/8 BSP Male to 1/8 NPT Male - Steel Part No. 3230-2-2NPT \$5.99
- 1/8 BSP Male to 1/4 NPT Male - Steel..... Part No. 3230-2-4NPT..... \$6.99
- 1/4 BSP Male to 1/8 NPT Male - Steel..... Part No. 3230-4-2NPT..... \$6.99
- 1/2 BSP Male to 1/2 NPT Male - Steel Part No. 3230-8-8NPT..... \$11.29

BSP Plugs and Caps



- 1/2 BSP Male Plug - Steel Part No. 3203-8-Plug..... \$7.39
- All of our plastic caps and plugs are threaded (not push-on type). These caps are designed to exclude dust during storage only. They are not pressure- or fluid-tight.
- 1/4 BSP Male Plug - Plastic..... Part No. 3996-04..... 54¢
 - 3/8 BSP Male Plug - Plastic..... Part No. 3996-06..... 59¢
 - 1/2 BSP Male Plug - Plastic..... Part No. 3996-08..... 69¢
 - 5/8 BSP Male Plug - Plastic..... Part No. 3996-10..... 69¢
 - 3/4 BSP Male Plug - Plastic..... Part No. 3996-12..... 89¢
 - 1/8 BSP Female Cap - Plastic..... Part No. 3997-02..... 59¢
 - 1/4 BSP Female Cap - Plastic..... Part No. 3997-04..... 59¢
 - 3/8 BSP Female Cap - Plastic..... Part No. 3997-06..... 59¢
 - 1/2 BSP Female Cap - Plastic..... Part No. 3997-08..... 69¢
 - 5/8 BSP Female Cap - Plastic..... Part No. 3997-10..... 79¢
 - 3/4 BSP Female Cap - Plastic..... Part No. 3997-12..... 99¢

BSP Male to AN Male Adapters



- 1/8 BSP Male to 3AN Male - Steel Part No. 3230-2-3AN \$7.49
- 1/8 BSP Male to 4AN Male - Steel Part No. 3230-2-4AN \$7.49
- 1/4 BSP Male to 6AN Male - Steel Part No. 3230-4-6AN..... \$11.49
- 3/8 BSP Male to 6AN Male - Steel..... Part No. 3230-6-6AN..... \$6.49
- 3/8 BSP Male to 8AN Male - Steel..... Part No. 3230-6-8AN..... \$7.59
- 3/8 BSP Male to 10AN Male - Steel..... Part No. 3230-6-10AN..... \$7.99
- 1/2 BSP Male to 6AN Male - Steel Part No. 3230-8-6AN..... \$5.99
- 1/2 BSP Male to 8AN Male - Aluminum Part No. 3230-8-8AN..... \$13.49
- 1/2 BSP Male to 10AN Male - Aluminum..... Part No. 3230-8-10AN..... \$14.99
- 1/2 BSP Male to 12AN Male - Aluminum..... Part No. 3230-8-12AN..... \$16.99
- 5/8 BSP Male to 10AN Male - Aluminum..... Part No. 3230-10-10AN..... \$20.99
- 3/4 BSP Male to 12AN Male - Aluminum..... Part No. 3230-12-12AN..... \$36.99

BSP Female to AN Male Adapters (some sizes are special order)



Steel adapters (shown) feature two-piece construction: The swivelling nut avoids damage to the BSP flare.

Aluminum adapters (not shown) are one piece without a female flare and require a sealing washer.

These adapters will allow you to plumb your existing BSP oil cooler with braided stainless hose and standard AN hose ends!

- 1/8 BSP Female to 3AN Male - Aluminum..... Part No. 3252-2-3AN \$26.49
- 1/8 BSP Female to 4AN Male - Steel..... Part No. 3252-2-4AN \$11.49
- 1/4 BSP Female to 4AN Male - Steel..... Part No. 3252-4-4AN..... \$11.99
- 1/4 BSP Female to 6AN Male - Aluminum..... Part No. 3252-4-6AN..... \$17.49
- 3/8 BSP Female to 6AN Male - Steel..... Part No. 3252-6-6AN..... \$11.99
- 1/2 BSP Female to 6AN Male - Steel..... Part No. 3252-8-6AN..... \$14.99
- 1/2 BSP Female to 8AN Male - Steel..... Part No. 3252-8-8AN..... \$14.99
- 1/2 BSP Female to 10AN Male - Steel..... Part No. 3252-8-10AN..... \$18.29
- 1/2 BSP Female to 12AN Male - Steel Part No. 3252-8-12AN \$20.29
- 1/2 BSP Female to 16AN Male - Aluminum Part No. 3252-8-16AN \$38.49
- 5/8 BSP Female to 8AN Male - Steel..... Part No. 3252-10-8AN..... \$17.49
- 3/4 BSP Female to 12AN Male - Steel..... Part No. 3252-12-12AN \$25.99

Sealing Washers for BSP Fittings



British threaded ports often use an O-ring in a chamfer on the port face. If the port face is flat (not chamfered), a crush washer or a Dowty seal is used to seal the fitting.

Aluminum Crush Washers for BSP Ports:

Large ID. Works best if the adapter has a shoulder to center the washer.

- For 1/2 BSP ports..... Part No. 167-31..... \$1.89

Dowty Sealing Washers for BSP Ports (steel with bonded rubber insert):

Will not seal reliably if port is chamfered for an O-ring.

- For 1/8 BSP..... Part No. 3240-1/8 BSP \$1.79
- For 1/4 BSP..... Part No. 3240-1/4 BSP \$1.79
- For 3/8 BSP..... Part No. 3240-3/8 BSP \$1.99
- For 1/2 BSP..... Part No. 3240-1/2 BSP \$2.49
- For 5/8 BSP..... Part No. 3240-5/8 BSP \$2.99
- For 3/4 BSP..... Part No. 3240-3/4 BSP \$3.99

O-Ring Seal for Chamfered BSP Ports (Buna N):

Requires a chamfer on the port face to support the O-ring.

- For 3/8 BSP..... Part No. 3243-3/8 BSP 79¢
- For 1/2 BSP..... Part No. 3243-1/2 BSP..... 79¢

See page 95 for illustrations of BSP, AN, and NPT threads.

Metric Adapter Fittings

Metric to Male AN Adapters



Note: Male fittings with Concave Seats mate to Female fittings with Convex Seats.

Male 10x1.0mm Convex Seat to 3AN, Steel	Part No. 3265-16	\$8.49
Male 10x1.0mm Convex Seat to 4AN, Steel	Part No. 3265-17	\$12.29
Male 10x1.0mm Concave Seat to 3AN, Steel	Part No. 3265-51	\$9.19
Male 10x1.0mm Concave Seat to 3AN, Aluminum	Part No. 3276-028	\$11.99
Male 10x1.0mm Concave Seat to 4AN, Aluminum	Part No. 3276-002	\$17.49
Male 10x1.0mm Concave Seat to 6AN, Aluminum	Part No. 3276-021	\$15.79
Female 10x1.0mm Convex Seat to 3AN, Steel	Part No. 3265-30	\$5.49
Female 10x1.0mm Convex Seat to 4AN, Steel	Part No. 3265-31	\$5.49
Female 10x1.0mm Concave Seat to 3AN, Steel	Part No. 3265-18	\$7.29
Female 10x1.0mm Concave Seat to 4AN, Steel	Part No. 3265-19	\$5.99
Male 10x1.25mm Convex Seat to 3AN, Steel	Part No. 3265-14	\$9.99
Male 10x1.25mm Convex Seat to 4AN, Steel	Part No. 3265-15	\$9.99
Male 10x1.25mm Convex Seat to 3AN, Steel	Part No. 3265-52	\$8.89
Female 10x1.25mm Convex Seat to 3AN, Steel	Part No. 3265-29	\$5.49
Female 10x1.25mm Concave Seat to 3AN, Steel	Part No. 3265-28	\$5.99
Male 10x1.5mm Convex Seat to 3AN, Steel	Part No. 3265-53	\$8.99
Male 10x1.5mm Convex Seat to 4AN, Steel	Part No. 3265-44	\$10.49
Male 12x1.0mm Convex Seat to 3AN, Steel	Part No. 3265-42	\$8.99
Male 12x1.0mm Convex Seat to 4AN, Steel	Part No. 3265-59	\$8.99
Male 12x1.0mm Concave Seat to 3AN, Aluminum	Part No. 3265-45	\$16.99
Male 12x1.0mm Concave Seat to 4AN, Aluminum	Part No. 3276-020	\$18.99
Male 12x1.25mm Convex Seat to 3AN, Steel	Part No. 3265-43	\$8.99
Male 12x1.25mm Convex Seat to 4AN, Steel	Part No. 3265-58	\$8.99
<i>Many Solex, Mikuni, and Dellorto carburetors have 12x1.25mm threads on the inlet port.</i>		
Male 12x1.5mm Concave Seat to 3AN, Steel	Part No. 3265-39	\$19.49
Male 12x1.5mm Concave Seat to 4AN, Steel	Part No. 3265-40	\$8.99
Male 12x1.5mm Concave Seat to 6AN, Steel	Part No. 3276-003	\$13.99
Male 12x1.5mm Concave Seat to 8AN, Aluminum	Part No. 3276-023	\$9.99
<i>The Bosch "044" electric fuel pump has 12x1.5mm threads on the outlet side.</i>		

Male 14x1.5mm Concave Seat to 4AN, Steel	Part No. 3265-41	\$14.49
Male 14x1.5mm Concave Seat to 6AN, Steel	Part No. 3276-004	\$16.49
Male 14x1.5mm Concave Seat to 6AN, Aluminum	Part No. 3276-027	\$12.99
Male 14x1.5mm Concave Seat to 8AN, Steel	Part No. 3265-33	\$14.29
Male 14x1.5mm Concave Seat to 10AN, Aluminum	Part No. 3276-009	\$31.49
Female 14x1.5mm Convex Seat to 6AN, Steel	Part No. 3265-54	\$16.49
Male 16x1.5mm Concave Seat to 4AN, Steel	Part No. 3276-021	\$16.79
Male 16x1.5mm Concave Seat to 6AN, Steel	Part No. 3276-005	\$12.79
Male 16x1.5mm Concave Seat to 8AN, Steel	Part No. 3265-34	\$14.29
Male 16x1.5mm Concave Seat to 10AN, Aluminum	Part No. 3276-010	\$21.49
Female 16x1.5mm Convex Seat to 6AN, Steel	Part No. 3265-63	\$14.99
Male 18x1.5mm Concave Seat to 6AN, Steel	Part No. 3276-006	\$14.29
Male 18x1.5mm Concave Seat to 6AN, Aluminum	Part No. 3276-025	\$20.99
Male 18x1.5mm Concave Seat to 8AN, Steel	Part No. 3265-35	\$13.49
Male 18x1.5mm Concave Seat to 8AN, Aluminum	Part No. 3276-024	\$25.99
Male 18x1.5mm Concave Seat to 10AN, Aluminum	Part No. 3276-011	\$21.49
Male 18x1.5mm Concave Seat to 12AN, Aluminum	Part No. 3276-016	\$22.99
<i>The Bosch "044" fuel pump has 18x1.5mm threads on the inlet side.</i>		
Female 18x1.5mm Convex Seat to 8AN, Steel	Part No. 3265-55	\$18.99
Male 20x1.5mm Concave Seat to 8AN, Aluminum	Part No. 3276-007	\$28.29
Male 20x1.5mm Concave Seat to 10AN, Aluminum	Part No. 3276-012	\$22.49
Male 20x1.5mm Concave Seat to 12AN, Aluminum	Part No. 3276-017	\$22.99
Male 22x1.5mm Concave Seat to 8AN, Aluminum	Part No. 3276-008	\$19.99
Male 22x1.5mm Concave Seat to 10AN, Aluminum	Part No. 3276-013	\$23.49
<i>Also see page 77 for special 22 x 1.5mm Setrab Oil Cooler Adapters with O-Ring Seals.</i>		
Male 24x1.5mm Concave Seat to 10AN, Aluminum	Part No. 3276-014	\$33.99
Male 24x1.5mm Concave Seat to 12AN, Aluminum	Part No. 3276-018	\$33.49
Male 26x1.5mm Concave Seat to 10AN, Aluminum	Part No. 3276-015	\$33.49
Male 26x1.5mm Concave Seat to 12AN, Aluminum	Part No. 3276-019	\$33.49
Female 26x1.5mm Convex Seat to 12AN, Aluminum	Part No. 1278-12AN	\$36.99
Male 30x1.5mm Concave Seat to 12AN, Aluminum	Part No. 1218-12AN	\$28.99
Male 30x1.5mm Concave Seat to 16AN, Aluminum	Part No. 1218-16AN	\$28.99
Female 30x1.5mm Convex Seat to 12AN, Aluminum	Part No. 1219-12AN	\$38.99
Female 30x1.5mm Convex Seat to 16AN, Aluminum	Part No. 1219-16AN	\$38.99
<i>These 26mm and 30mm adapters are often used to install oil coolers on Porsche 911s.</i>		

PLUMBING

Not sure what metric thread sizes you have?
You need our Thread Detective tools on page 118!

Metric to Female AN Swivel Adapters

These aluminum adapters have a female nut on the AN side that swivels to avoid damage to the AN flare. (Note that you must loosen the AN nut before turning the metric end. Turning the metric end while the AN nut is tight will damage the flare.) The metric side has no seat. An aluminum crush washer is included.



Male 12x1.5mm to Female 8AN Swivel, Aluminum	Part No. AF906-08-M12-Color	\$10.49
Male 14x1.5mm to Female 8AN Swivel, Aluminum	Part No. AF906-08-M14-Color	\$8.99
Male 18x1.5mm to Female 8AN Swivel, Aluminum	Part No. AF906-08-M18-Color	\$9.79
Male 18x1.5mm to Female 10AN Swivel, Aluminum	Part No. AF906-10-M18-Color	\$11.49
<i>Specify Black, Blue, or Silver anodizing.</i>		

Metric O-Ring Step Seat to Male 6AN Adapters

The metric end of these aluminum adapters has a step seat for an O-ring (included). This fitting type is used in some fuel injection systems. **Note:** These aluminum fittings are for low-pressure applications such as fuel and oil systems only. They are not for use in power steering systems!



Male 14x1.5mm O-Ring Seat to Male 6AN, Aluminum	Part No. 3497-007-06-M14	\$8.59
Male 16x1.5mm O-Ring Seat to Male 6AN, Aluminum	Part No. 3497-007-06-M16	\$8.59
Male 18x1.5mm O-Ring Seat to Male 6AN, Aluminum	Part No. 3497-007-06-M18	\$8.59

Aluminum Banjo Adapter Fittings and Metric Banjo Bolts

Right: Metric Banjo to Male AN Adapter, Blue Anodized Aluminum



Right: Metric Single Banjo Bolt, Red Anodized Aluminum



These aluminum fittings are suitable for fuel or oil system plumbing. Banjo adapters, bolts, and crush washers are all sold separately.

12mm Banjo to 4AN Male Adapter, Aluminum	Part No. 3265-48	\$12.49
12mm Banjo to 6AN Male Adapter, Aluminum	Part No. 3265-61	\$21.99
14mm Banjo to 4AN Male Adapter, Aluminum	Part No. 3265-46	\$38.99
14mm Banjo to 6AN Male Adapter, Aluminum	Part No. 3265-49	\$32.49
14mm Banjo to 8AN Male Adapter, Aluminum	Part No. 3265-70	\$26.99
16mm Banjo to 6AN Male Adapter, Aluminum	Part No. 3265-56	\$25.99
16mm Banjo to 8AN Male Adapter, Aluminum	Part No. 3265-50	\$28.99
18mm Banjo to 8AN Male Adapter, Aluminum	Part No. 3265-57	\$44.49

12x1.00mm Single Banjo Bolt, Aluminum	Part No. 3242-028	\$17.99
12x1.25mm Single Banjo Bolt, Aluminum	Part No. 3242-029	\$20.29
12x1.50mm Single Banjo Bolt, Aluminum	Part No. 3242-030	\$13.99
14x1.00mm Single Banjo Bolt, Aluminum	Part No. 3242-031	\$21.99
14x1.25mm Single Banjo Bolt, Aluminum	Part No. 3242-032	\$13.99
14x1.50mm Single Banjo Bolt, Aluminum	Part No. 3242-033	\$13.99
16x1.00mm Single Banjo Bolt, Aluminum	Part No. 3242-034	\$15.99
16x1.50mm Single Banjo Bolt, Aluminum	Part No. 3242-036	\$17.99
18x1.50mm Single Banjo Bolt, Aluminum	Part No. 3242-045	\$24.99

Aluminum Crush Washers, 12mm ID, pack of 5	Part No. 3278-M12	\$3.99
Aluminum Crush Washers, 14mm ID, pack of 5	Part No. 3278-M14	\$4.79
Aluminum Crush Washers, 16mm ID, pack of 5	Part No. 3278-M16	\$4.99
Aluminum Crush Washers, 18mm ID, pack of 5	Part No. 3278-M18	\$5.19

Thread Fitting Guide

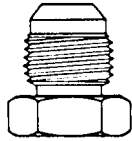

1/8 NPT



1/4 NPT (actual size)



3/8 NPT

Visit our website for more information on AN, NPT, and BSP threaded fittings!

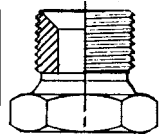

AN (JIC) 37° Flare Fittings (same thread used on O-Ring ports)	
AN Size	Thread Size
3AN	3/8 - 24
4AN	7/16 - 20
6AN	9/16 - 18
8AN	3/4 - 16
10AN	7/8 - 14
12AN	1 1/16 - 12
16AN	1 5/16 - 12

NPT Pipe Fittings (tapered thread) (American Standard Pipe)		
Nominal Size	Approx. Dia. at middle of taper	Threads per inch
1/8 NPT	.40 inch	27
1/4 NPT	.53 inch	18
3/8 NPT	.67 inch	18
1/2 NPT	.83 inch	14
3/4 NPT	1.04 inch	14
1" NPT	1.30 inch	11 1/2

BSP Pipe Fittings (straight thread) (British Standard Pipe)		
Nominal Size	Thread Diameter	Threads per inch
1/8 BSP	.38 inch	28
1/4 BSP	.51 inch	19
3/8 BSP	.66 inch	19
1/2 BSP	.81 inch	14
5/8 BSP	.90 inch	14

Sealing Washers and O-Rings

Copper, Aluminum, and Nylon Sealing Washers



Soft annealed copper crush washers are most commonly used for brake banjo fittings and to seal brake adapters to spot-faced ports. Aluminum washers are commonly used on fuel system banjo fittings and carburetor adapters. Nylon washers are often used to seal bulkhead fittings on the top plate of fuel cells.

3/8 inch (10mm) Soft Copper Crush Washer Part No. 3241-3/8 69¢ each
 7/16 inch Soft Copper Crush Washer Part No. 3241-7/16 89¢ each
 1/2 inch Soft Copper Crush Washer Part No. 3241-1/2 89¢ each

Aluminum Washer, 3/8 inch (10mm) nominal I.D., 5 pcs Part No. 3278-03 \$1.89
 Aluminum Washer, 7/16 inch nominal I.D., 5 pcs Part No. 3278-04 \$2.09
 Aluminum Washer, 9/16 inch nominal I.D., 5 pcs Part No. 3278-06 \$2.39
 Aluminum Washer, 3/4 inch nominal I.D., 5 pcs Part No. 3278-08 \$3.99
 Aluminum Washer, 1 1/16 inch nominal I.D., 5 pcs Part No. 3278-16 \$6.99

Aluminum Washer, 12mm nominal I.D., 5 pcs Part No. 3278-M12 \$3.99
 Aluminum Washer, 14mm nominal I.D., 5 pcs Part No. 3278-M14 \$4.79
 Aluminum Washer, 16mm nominal I.D., 5 pcs Part No. 3278-M16 \$4.99
 Aluminum Washer, 18mm nominal I.D., 5 pcs Part No. 3278-M18 \$5.19

6AN Nylon Sealing Washer Part No. 3246-6 \$1.99 each
 8AN Nylon Sealing Washer Part No. 3246-8 \$1.99 each
 10AN Nylon Sealing Washer Part No. 3246-10 \$2.39 each

Aluminum Stat-O-Seals



These aluminum washers with molded Buna-N inner seals are much more reliable than the more common (and somewhat cheaper) steel Stat-O-Seals. Even if the rubber portion fails to make contact all around the port, the aluminum will act as a crush washer, providing a reliable metal-to-metal seal. Use them to seal screws, bolts or plumbing fittings.

#10 Screw Size (.190 inch) Part No. 3245-10 \$1.29
 1/4 inch Size Part No. 3245-1/4 \$1.69
 5/16 inch Size Part No. 3245-5/16 \$1.99
 3/8 inch Size (3AN) Part No. 3245-3/8 \$1.99
 7/16 inch Size (4AN) Part No. 3245-7/16 \$2.09
 1/2 inch Size Part No. 3245-1/2 \$2.29
 9/16 inch Size (6AN) Part No. 3245-9/16 \$2.49
 5/8 inch Size Part No. 3245-5/8 \$2.69
 3/4 inch Size (8AN) Part No. 3245-3/4 \$2.99
 7/8 inch Size (10AN) Part No. 3245-7/8 \$3.99
 1 inch Size Part No. 3245-1.00 \$8.49

Copper and Aluminum 37° SECO 7 Seals



These seals are indispensable when mating flared tubing to male AN fittings with AN tube nuts and tube sleeves. Soft conical seals act as a crush washer to ensure reliable, leak-free seals without damaging the tubing or the AN fitting. All sizes are available in copper or aluminum (please see our website for full list of sizes). Use copper seals with steel tubing and fittings or aluminum seals with aluminum tubing and fittings.

For 3AN Fittings, Copper Part No. 3202-03-Copper \$2.79
 For 4AN Fittings, Copper Part No. 3202-04-Copper \$1.89
 For 4AN Fittings, Aluminum Part No. 3202-04-Alum \$1.69
 For 6AN Fittings, Aluminum Part No. 3202-06-Alum \$1.79
 For 8AN Fittings, Aluminum Part No. 3202-08-Alum \$1.89
 For 10AN Fittings, Aluminum Part No. 3202-10-Alum \$2.19
 For 12AN Fittings, Aluminum Part No. 3202-12-Alum \$2.29
 For 16AN Fittings, Aluminum Part No. 3202-16-Alum \$2.79

O-Ring Seals for Standard (AN) O-Ring Ports



O-Rings should only be used with a properly chamfered port for a reliable seal. We recommend aluminum Stat-O-Seals for ports without a chamfer. Our Buna O-Rings are compatible with fuel and oil.

For 3/8-24 O-Ring Port (3AN) Part No. 3244-03 39¢
 For 7/16-20 O-Ring Port (4AN) Part No. 3244-04 36¢
 For 9/16-18 O-Ring Port (6AN) Part No. 3244-06 39¢
 For 3/4-16 O-Ring Port (8AN) Part No. 3244-08 39¢
 For 7/8-14 O-Ring Port (10AN) Part No. 3244-10 39¢
 For 1 1/16-12 O-Ring Port (12AN) Part No. 3244-12 49¢
 For 1 5/16-12 O-Ring Port (16AN) Part No. 3244-16 59¢

Sealing Washers and O-Rings for BSP Ports



Aluminum Crush Washer for 1/2 BSP port Part No. 167-31 \$1.89
 Dowty Sealing Washers are steel with a bonded rubber insert.
 Dowty Sealing Washer for 1/8 BSP port Part No. 3240-1/8 BSP \$1.79
 Dowty Sealing Washer for 1/4 BSP port Part No. 3240-1/4 BSP \$1.79
 Dowty Sealing Washer for 3/8 BSP port Part No. 3240-3/8 BSP \$1.99
 Dowty Sealing Washer for 1/2 BSP port Part No. 3240-1/2 BSP \$2.49
 Dowty Sealing Washer for 5/8 BSP port Part No. 3240-5/8 BSP \$2.99
 Dowty Sealing Washer for 3/4 BSP port Part No. 3240-3/4 BSP \$3.99
 O-Ring seal for Chamfered 3/8 BSP port (Buna N) Part No. 3243-3/8 BSP 79¢
 O-Ring seal for Chamfered 1/2 BSP port (Buna N) Part No. 3243-1/2 BSP 79¢

Magnetic Plugs



Magnetic plugs are a small investment that can help to prevent damage and wear in engines and gearboxes. Use them to replace standard oil gallery plugs and drain plugs in oil tanks, cooling systems, and transmissions. They provide an easy way to check for unusual wear which may precede a failure.

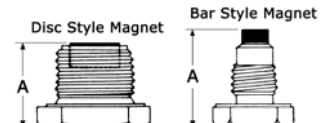

Hex Recessed Socket, NPT & Metric Magnetic Plugs

1/8-27 NPT, Bar Magnet, A = 0.79 inch Part No. 1010 \$2.99
 1/4-18 NPT, Bar Magnet, A = 0.84 inch Part No. 1011 \$3.19
 3/8-18 NPT, Bar Magnet, A = 0.82 inch Part No. 1012 \$2.89
 1/2-14 NPT, Bar Magnet, A = 1.00 inch Part No. 1013 \$3.19
 3/4-14 NPT, Bar Magnet, A = 0.84 inch Part No. 1014 \$4.39
 1"-11 NPT, Bar Magnet, A = 0.99 inch Part No. 1015 \$4.99
 24mm for most Hewland and Webster Cases Part No. 1410-C03 \$19.99

Cap Screw Type, Straight Thread Magnetic Plugs

These plugs require a sealing washer - see above.
 1/2-20 UNF, Bar Magnet, A = 0.87 inch Part No. 1020 \$3.39
 5/8-18 UNF, Bar Magnet, A = 0.78 inch Part No. 1021 \$14.99
 3/4-16 UNF, Bar Magnet, A = 0.89 inch Part No. 1022 \$7.49
 7/8-14 UNF, Disc Magnet, A = 0.78 inch Part No. 1023 \$13.99
 7/8-18 NS, Disc Magnet, A = 0.78 inch Part No. 1024 \$7.49
 1"-18 NS, Disc Magnet, A = 0.89 inch Part No. 1025 \$7.49

AN Bolts

We stock a large selection of AN, MS and NAS hardware. These fasteners are manufactured to rigorous quality control standards from raw material to final plating. They offer a combination of properties that are simply not available in SAE graded hardware. Carroll Smith stated in his excellent book, **Prepare To Win**:

"Don't be deceived — use no SAE grade bolts, of whatever specification, in a stressed application. ... The F.A.A. doesn't allow the use of SAE graded bolts on aircraft and that should be some sort of clue."

— Carroll Smith

That statement was true in 1975 when the book was first published and it's even more true now that cars have gotten lighter, faster and capable of higher cornering forces. Designers have, in general, gone to smaller fasteners that offer a lower safety factor in order to optimize the performance of their cars. If you have not read **Prepare To Win**, or have not reviewed it for several years, we suggest at least taking a look at Chapter 1.

Thread Length Chart		
Bolt Size	Thread Size	Approximate Thread Length *
AN3	10-32	.406 inch
AN4	1/4 - 28	.469 inch
AN5	5/16 - 24	.531 inch
AN6	3/8 - 24	.641 inch
AN7	7/16 - 20	.656 inch
AN8	1/2 - 20	.680 inch

* Note: Some of the very shortest lengths of AN bolts, such as AN4-3A, have shorter thread lengths than standard.

Airframe Bolts, AN3 through AN8

The most obvious difference between an SAE bolt and an AN bolt is that the AN bolt has just enough thread length to install a nut and one or two flat washers. The idea is to keep the threaded portion of the bolt out of the shear area of the bolted joint. Not only does the threaded portion greatly weaken the shear strength, but when subjected to vibration, it acts like a low speed milling cutter and will inevitably enlarge the hole and loosen the joint. Correct application of the bolt is therefore dependent upon grip length, the length of the unthreaded portion of the bolt shank. They are available in 1/8 inch increments of length so that an exact fit can be achieved. AN960 flat washers are used to fine tune the fit and make sure that the nut doesn't bottom out on the unthreaded portion of the shank. You

must measure the joint carefully to be sure to order the correct bolt. A dial caliper is almost a must for this use. Bolts with drilled shanks are generally used with AN310 castellated nuts and cotter pins (see page 98). Bolts with drilled heads are available for use with safety wire. Plain, unthreaded bolts are usually used with self-locking nuts or are assembled with Loctite to avoid loosening problems. The best advice is to check every bolt often. These hex head bolts have tensile strength of 125,000 psi and shear strength of 76,000 psi.

Remember to order by Grip Length!
See page 98 for our handy AN bolt length gauge.

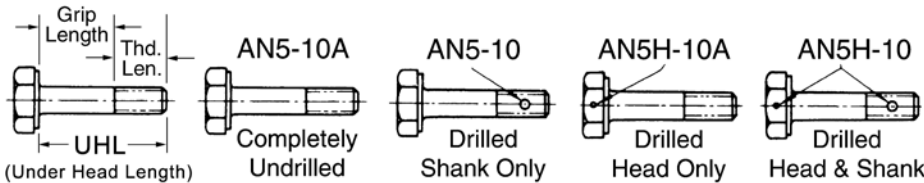

Please Note

We are constantly expanding our inventory of AN bolts. The particular sizes and styles that we add are based upon requests from customers like you. Please feel free to request a price and delivery quotation on any AN bolt. However, be aware that not every part number listed in these charts has actually been produced and some sizes may not be readily available.

AN3 Bolts – 3/16 inch Nominal Diameter – 10-32 Thread

Length in Inches		Completely Undrilled		Drilled Shank Only		Drilled Head Only		Drilled Head and Shank	
UHL	Grip	Part No.	Price	Part No.	Price	Part No.	Price	Part No.	Price
3/8	1/16	AN3-3A	19¢	AN3-3	33¢	AN3H-3A	37¢	AN3H-3	94¢
1/2	1/8	AN3-4A	24¢	AN3-4	28¢	AN3H-4A	44¢	AN3H-4	69¢
5/8	1/4	AN3-5A	22¢	AN3-5	37¢	AN3H-5A	45¢	AN3H-5	94¢
3/4	3/8	AN3-6A	24¢	AN3-6	49¢	AN3H-6A	54¢	AN3H-6	99¢
7/8	1/2	AN3-7A	29¢	AN3-7	99¢	AN3H-7A	54¢	AN3H-7	99¢
1	5/8	AN3-10A	41¢	AN3-10	39¢	AN3H-10A	59¢	AN3H-10	99¢
1 1/8	3/4	AN3-11A	29¢	AN3-11	49¢	AN3H-11A	64¢	AN3H-11	\$2.19
1 1/4	7/8	AN3-12A	33¢	AN3-12	49¢	AN3H-12A	84¢	AN3H-12	call
1 3/8	1	AN3-13A	49¢	AN3-13	49¢	AN3H-13A	69¢	AN3H-13	\$2.19
1 1/2	1 1/8	AN3-14A	40¢	AN3-14	49¢	AN3H-14A	74¢	AN3H-14	\$2.19
1 5/8	1 1/4	AN3-15A	41¢	AN3-15	40¢	AN3H-15A	74¢	AN3H-15	\$2.19
1 3/4	1 3/8	AN3-16A	42¢	AN3-16	40¢	AN3H-16A	79¢	AN3H-16	\$2.19
1 7/8	1 1/2	AN3-17A	49¢	AN3-17	40¢	AN3H-17A	99¢	AN3H-17	\$2.19
2	1 5/8	AN3-20A	49¢	AN3-20	45¢	AN3H-20A	84¢	AN3H-20	\$2.29
2 1/8	1 3/4	AN3-21A	49¢	AN3-21	42¢	AN3H-21A	89¢	AN3H-21	call
2 1/4	1 7/8	AN3-22A	49¢	AN3-22	54¢	AN3H-22A	94¢	AN3H-22	call
2 3/8	2	AN3-23A	54¢	AN3-23	99¢	AN3H-23A	94¢	AN3H-23	\$2.29
2 1/2	2 1/8	AN3-24A	54¢	AN3-24	94¢	AN3H-24A	\$2.29	AN3H-24	call
2 5/8	2 1/4	AN3-25A	54¢	AN3-25	99¢	AN3H-25A	\$2.39	AN3H-25	call
2 3/4	2 3/8	AN3-26A	64¢	AN3-26	69¢	AN3H-26A	\$1.09	AN3H-26	call
2 7/8	2 1/2	AN3-27A	74¢	AN3-27	\$1.09	AN3H-27A	\$2.59	AN3H-27	call
3	2 5/8	AN3-30A	69¢	AN3-30	\$1.09	AN3H-30A	\$2.99	AN3H-30	call
3 1/8	2 3/4	AN3-31A	74¢	AN3-31	\$1.09	AN3H-31A	\$1.29	AN3H-31	call
3 1/4	2 7/8	AN3-32A	79¢	AN3-32	\$1.19	AN3H-32A	\$4.49	AN3H-32	call
3 3/8	3	AN3-33A	79¢	AN3-33	\$1.19	AN3H-33A	\$1.49	AN3H-33	call
3 1/2	3 1/8	AN3-34A	79¢	AN3-34	\$1.19	AN3H-34A	call	AN3H-34	call
3 5/8	3 1/4	AN3-35A	\$1.59	AN3-35	\$1.19	AN3H-35A	call	AN3H-35	call
3 3/4	3 3/8	AN3-36A	\$2.59	AN3-36	\$1.29	AN3H-36A	call	AN3H-36	call
3 7/8	4 1/2	AN3-37A	\$2.19	AN3-37	\$1.29	AN3H-37A	\$4.99	AN3H-37	call
4	3 5/8	AN3-40A	94¢	AN3-40	\$1.29	AN3H-40A	\$16.99	AN3H-40	call
4 1/8	3 3/4	AN3-41A	\$1.09	AN3-41	\$1.39	AN3H-41A	\$10.79	AN3H-41	call
4 1/4	3 7/8	AN3-42A	\$1.09	AN3-42	\$1.39	AN3H-42A	\$10.99	AN3H-42	call
4 3/8	4	AN3-43A	\$2.19	AN3-43	call	AN3H-43A	call	AN3H-43	call
4 1/2	4 1/8	AN3-44A	\$1.39	AN3-44	call	AN3H-44A	\$20.49	AN3H-44	\$21.99
4 5/8	4 1/4	AN3-45A	\$2.59	AN3-45	call	AN3H-45A	call	AN3H-45	call
4 3/4	4 3/8	AN3-46A	call	AN3-46	call	AN3H-46A	call	AN3H-46	call
4 7/8	4 1/2	AN3-47A	\$2.49	AN3-47	call	AN3H-47A	\$18.99	AN3H-47	call
5	4 5/8	AN3-50A	call	AN3-50	call	AN3H-50A	call	AN3H-50	call

Please call or check our website for availability of longer lengths.

AN4 Bolts – 1/4 - 28 Thread

Length in Inches		Completely Undrilled		Drilled Shank Only		Drilled Head Only		Drilled Head and Shank	
UHL	Grip	Part No.	Price	Part No.	Price	Part No.	Price	Part No.	Price
3/8	1/16	AN4-3A	25¢	AN4-3	64¢	AN4H-3A	54¢	AN4H-3	call
1/2	1/8	AN4-4A	25¢	AN4-4	35¢	AN4H-4A	54¢	AN4H-4	call
5/8	3/16	AN4-5A	31¢	AN4-5	41¢	AN4H-5A	69¢	AN4H-5	call
3/4	5/16	AN4-6A	39¢	AN4-6	79¢	AN4H-6A	59¢	AN4H-6	call
7/8	7/16	AN4-7A	39¢	AN4-7	49¢	AN4H-7A	64¢	AN4H-7	99¢
1	9/16	AN4-10A	39¢	AN4-10	64¢	AN4H-10A	\$1.29	AN4H-10	99¢
1 1/8	1 1/16	AN4-11A	39¢	AN4-11	46¢	AN4H-11A	59¢	AN4H-11	call
1 1/4	1 3/16	AN4-12A	39¢	AN4-12	69¢	AN4H-12A	\$1.19	AN4H-12	99¢
1 3/8	1 5/16	AN4-13A	59¢	AN4-13	79¢	AN4H-13A	79¢	AN4H-13	call
1 1/2	1 1/2	AN4-14A	59¢	AN4-14	54¢	AN4H-14A	79¢	AN4H-14	\$1.89
1 5/8	1 3/4	AN4-15A	79¢	AN4-15	79¢	AN4H-15A	89¢	AN4H-15	\$1.19
1 3/4	1 5/8	AN4-16A	54¢	AN4-16	69¢	AN4H-16A	89¢	AN4H-16	94¢
1 7/8	1 7/8	AN4-17A	64¢	AN4-17	99¢	AN4H-17A	\$1.19	AN4H-17	\$2.79
2	1 9/16	AN4-20A	59¢	AN4-20	64¢	AN4H-20A	99¢	AN4H-20	\$2.89
2 1/8	1 11/16	AN4-21A	54¢	AN4-21	94¢	AN4H-21A	99¢	AN4H-21	call
2 1/4	1 13/16	AN4-22A	64¢	AN4-22	64¢	AN4H-22A	99¢	AN4H-22	call
2 3/8	1 15/16	AN4-23A	54¢	AN4-23	64¢	AN4H-23A	\$1.09	AN4H-23	call
2 1/2	2 1/16	AN4-24A	59¢	AN4-24	\$1.09	AN4H-24A	\$1.09	AN4H-24	call
2 5/8	2 3/16	AN4-25A	59¢	AN4-25	64¢	AN4H-25A	\$1.09	AN4H-25	call
2 3/4	2 5/16	AN4-26A	64¢	AN4-26	99¢	AN4H-26A	\$1.19	AN4H-26	call
2 7/8	2 7/8	AN4-27A	79¢	AN4-27	89¢	AN4H-27A	\$1.19	AN4H-27	call
3	2 9/16	AN4-30A	79¢	AN4-30	89¢	AN4H-30A	\$1.29	AN4H-30	call
3 1/8	2 11/16	AN4-31A	79¢	AN4-31	\$1.19	AN4H-31A	\$1.29	AN4H-31	call
3 1/4	2 13/16	AN4-32A	99¢	AN4-32	\$1.29	AN4H-32A	\$1.39	AN4H-32	call
3 3/8	2 15/16	AN4-33A	\$1.19	AN4-33	\$1.29	AN4H-33A	\$2.49	AN4H-33	\$3.49
3 1/2	3 1/16	AN4-34A	\$1.39	AN4-34	\$1.89	AN4H-34A	\$1.79	AN4H-34	call
3 5/8	3 3/16	AN4-35A	\$1.39	AN4-35	\$1.89	AN4H-35A	\$1.59	AN4H-35	call
3 3/4	3 5/16	AN4-36A	\$1.59	AN4-36	\$1.39	AN4H-36A	\$4.49	AN4H-36	call
3 7/8	3 7/8	AN4-37A	\$1.59	AN4-37	\$1.39	AN4H-37A	\$1.99	AN4H-37	call
4	3 9/16	AN4-40A	\$1.59	AN4-40	\$2.19	AN4H-40A	\$11.99	AN4H-40	\$22.99
4 1/8	3 11/16	AN4-41A	\$1.59	AN4-41	\$2.29	AN4H-41A	\$6.89	AN4H-41	\$12.99
4 1/4	3 13/16	AN4-42A	\$1.79	AN4-42	\$2.29	AN4H-42A	\$5.99	AN4H-42	call
4 3/8	3 15/16	AN4-43A	\$1.89	AN4-43	\$1.59	AN4H-43A	call	AN4H-43	call
4 1/2	4 1/16	AN4-44A	\$1.29	AN4-44	\$1.69	AN4H-44A	call	AN4H-44	call
4 5/8	4 3/16	AN4-45A	\$1.89	AN4-45	\$1.79	AN4H-45A	call	AN4H-45	call
4 3/4	4 5/16	AN4-46A	\$1.89	AN4-46	\$1.79	AN4H-46A	call	AN4H-46	call
4 7/8	4 7/8	AN4-47A	\$2.29	AN4-47	\$2.19	AN4H-47A	call	AN4H-47	call
5	4 9/16	AN4-50A	\$3.69	AN4-50	call	AN4H-50A	call	AN4H-50	call

Please call or check our website for availability of longer lengths.

AN Bolts

AN5 Bolts - 5/16 - 24 Thread									
Length in Inches		Completely Undrilled		Drilled Shank Only		Drilled Head Only		Drilled Head and Shank	
UHL	Grip	Part No.	Price	Part No.	Price	Part No.	Price	Part No.	Price
1/2	1/16	AN5-4A	49¢	AN5-4	89¢	AN5H-4A	99¢	AN5H-4	call
5/8	3/16	AN5-5A	59¢	AN5-5	59¢	AN5H-5A	99¢	AN5H-5	\$1.99
3/4	5/16	AN5-6A	59¢	AN5-6	59¢	AN5H-6A	69¢	AN5H-6	call
7/8	7/16	AN5-7A	59¢	AN5-7	69¢	AN5H-7A	74¢	AN5H-7	call
1	9/16	AN5-10A	69¢	AN5-10	69¢	AN5H-10A	74¢	AN5H-10	99¢
1 1/8	11/16	AN5-11A	69¢	AN5-11	89¢	AN5H-11A	89¢	AN5H-11	\$2.49
1 1/4	13/16	AN5-12A	79¢	AN5-12	74¢	AN5H-12A	79¢	AN5H-12	call
1 3/8	15/16	AN5-13A	69¢	AN5-13	69¢	AN5H-13A	79¢	AN5H-13	call
1 1/2	1 1/16	AN5-14A	79¢	AN5-14	89¢	AN5H-14A	89¢	AN5H-14	\$2.49
1 5/8	1 3/16	AN5-15A	79¢	AN5-15	84¢	AN5H-15A	89¢	AN5H-15	\$2.49
1 3/4	1 5/16	AN5-16A	69¢	AN5-16	89¢	AN5H-16A	\$1.49	AN5H-16	call
1 7/8	1 7/16	AN5-17A	69¢	AN5-17	79¢	AN5H-17A	99¢	AN5H-17	call
2	1 9/16	AN5-20A	69¢	AN5-20	84¢	AN5H-20A	\$1.29	AN5H-20	call
2 1/8	1 11/16	AN5-21A	69¢	AN5-21	84¢	AN5H-21A	call	AN5H-21	call
2 1/4	1 13/16	AN5-22A	69¢	AN5-22	89¢	AN5H-22A	\$1.29	AN5H-22	call
2 3/8	1 15/16	AN5-23A	74¢	AN5-23	89¢	AN5H-23A	\$1.59	AN5H-23	call
2 1/2	2 1/16	AN5-24A	74¢	AN5-24	94¢	AN5H-24A	\$1.29	AN5H-24	call
2 5/8	2 3/16	AN5-25A	89¢	AN5-25	89¢	AN5H-25A	call	AN5H-25	call
2 3/4	2 5/16	AN5-26A	79¢	AN5-26	89¢	AN5H-26A	call	AN5H-26	call
2 7/8	2 7/16	AN5-27A	89¢	AN5-27	89¢	AN5H-27A	\$1.39	AN5H-27	call
3	2 9/16	AN5-30A	94¢	AN5-30	99¢	AN5H-30A	\$1.39	AN5H-30	call
3 1/8	2 11/16	AN5-31A	\$1.49	AN5-31	\$1.49	AN5H-31A	call	AN5H-31	call
3 1/4	2 13/16	AN5-32A	\$1.49	AN5-32	\$1.49	AN5H-32A	\$3.19	AN5H-32	call
3 3/8	2 15/16	AN5-33A	\$1.99	AN5-33	\$2.99	AN5H-33A	\$1.49	AN5H-33	call
3 1/2	3 1/16	AN5-34A	\$1.99	AN5-34	\$1.49	AN5H-34A	call	AN5H-34	call
3 5/8	3 3/16	AN5-35A	\$1.99	AN5-35	\$1.59	AN5H-35A	\$3.49	AN5H-35	call
3 3/4	3 5/16	AN5-36A	\$1.99	AN5-36	\$3.29	AN5H-36A	\$5.19	AN5H-36	call
3 7/8	3 7/16	AN5-37A	\$1.99	AN5-37	\$1.59	AN5H-37A	\$5.19	AN5H-37	call
4	3 9/16	AN5-40A	\$2.29	AN5-40	\$4.69	AN5H-40A	\$2.79	AN5H-40	call
4 1/8	3 11/16	AN5-41A	\$2.79	AN5-41	call	AN5H-41A	\$9.29	AN5H-41	call
4 1/4	3 13/16	AN5-42A	\$2.69	AN5-42	call	AN5H-42A	call	AN5H-42	call
4 3/8	3 15/16	AN5-43A	\$2.69	AN5-43	call	AN5H-43A	call	AN5H-43	call
4 1/2	4 1/16	AN5-44A	\$2.69	AN5-44	call	AN5H-44A	\$23.49	AN5H-44	call
4 5/8	4 3/16	AN5-45A	\$2.69	AN5-45	call	AN5H-45A	call	AN5H-45	call
4 3/4	4 5/16	AN5-46A	\$5.99	AN5-46	call	AN5H-46A	call	AN5H-46	call
4 7/8	4 7/16	AN5-47A	\$5.79	AN5-47	call	AN5H-47A	call	AN5H-47	call

Please call or check our website for availability of longer lengths.

AN7 Bolts - 7/16 - 20 Thread									
Length in Inches		Completely Undrilled		Drilled Shank Only		Drilled Head Only		Drilled Head and Shank	
UHL	Grip	Part No.	Price	Part No.	Price	Part No.	Price	Part No.	Price
1	7/16	AN7-10A	\$2.49	AN7-10	call	AN7H-10A	N/A	AN7H-10	N/A
1 1/8	9/16	AN7-11A	\$2.59	AN7-11	\$2.79	AN7H-11A	N/A	AN7H-11	N/A
1 1/4	11/16	AN7-12A	\$2.59	AN7-12	\$2.49	AN7H-12A	N/A	AN7H-12	N/A
1 3/8	13/16	AN7-13A	\$2.59	AN7-13	\$3.59	AN7H-13A	N/A	AN7H-13	call
1 1/2	15/16	AN7-14A	\$2.89	AN7-14	\$3.99	AN7H-14A	\$6.29	AN7H-14	\$8.99
1 5/8	1 1/16	AN7-15A	\$2.89	AN7-15	\$2.59	AN7H-15A	N/A	AN7H-15	N/A
1 3/4	1 3/16	AN7-16A	\$2.59	AN7-16	\$4.99	AN7H-16A	\$6.79	AN7H-16	\$5.99
1 7/8	1 5/16	AN7-17A	\$2.59	AN7-17	\$3.29	AN7H-17A	\$14.99	AN7H-17	call
2	1 7/16	AN7-20A	\$2.69	AN7-20	\$3.29	AN7H-20A	\$6.99	AN7H-20	call
2 1/8	1 9/16	AN7-21A	\$2.69	AN7-21	\$3.29	AN7H-21A	call	AN7H-21	\$9.99
2 1/4	1 11/16	AN7-22A	\$2.69	AN7-22	\$3.49	AN7H-22A	\$4.19	AN7H-22	call
2 3/8	1 13/16	AN7-23A	\$2.79	AN7-23	\$3.59	AN7H-23A	call	AN7H-23	call
2 1/2	1 15/16	AN7-24A	\$2.99	AN7-24	\$3.59	AN7H-24A	call	AN7H-24	N/A
2 5/8	2 1/16	AN7-25A	\$3.99	AN7-25	\$3.59	AN7H-25A	call	AN7H-25	N/A
2 3/4	2 3/16	AN7-26A	\$3.19	AN7-26	\$4.89	AN7H-26A	call	AN7H-26	call
2 7/8	2 5/16	AN7-27A	\$3.29	AN7-27	\$4.19	AN7H-27A	\$8.99	AN7H-27	call
3	2 7/16	AN7-30A	\$3.29	AN7-30	\$3.79	AN7H-30A	call	AN7H-30	call
3 1/8	2 9/16	AN7-31A	\$3.99	AN7-31	\$4.19	AN7H-31A	\$14.99	AN7H-31	call
3 1/4	2 11/16	AN7-32A	\$4.19	AN7-32	\$4.19	AN7H-32A	N/A	AN7H-32	N/A
3 3/8	2 13/16	AN7-33A	\$4.59	AN7-33	\$4.29	AN7H-33A	call	AN7H-33	call
3 1/2	2 15/16	AN7-34A	\$4.59	AN7-34	\$4.29	AN7H-34A	\$12.49	AN7H-34	call
3 5/8	3 1/16	AN7-35A	\$4.59	AN7-35	\$4.89	AN7H-35A	\$11.99	AN7H-35	call
3 3/4	3 3/16	AN7-36A	\$4.59	AN7-36	\$4.39	AN7H-36A	N/A	AN7H-36	call
3 7/8	3 5/16	AN7-37A	\$4.99	AN7-37	\$4.39	AN7H-37A	call	AN7H-37	call
4	3 7/16	AN7-40A	\$6.49	AN7-40	\$4.49	AN7H-40A	\$12.99	AN7H-40	\$23.79
4 1/8	3 9/16	AN7-41A	\$5.29	AN7-41	\$6.49	AN7H-41A	call	AN7H-41	call
4 1/4	3 11/16	AN7-42A	\$6.49	AN7-42	\$7.99	AN7H-42A	call	AN7H-42	call
4 3/8	4 1/16	AN7-43A	\$6.49	AN7-43	\$7.99	AN7H-43A	call	AN7H-43	call
4 1/2	3 15/16	AN7-44A	\$6.99	AN7-44	\$8.49	AN7H-44A	\$16.79	AN7H-44	call
4 5/8	4 1/16	AN7-45A	\$6.99	AN7-45	\$8.49	AN7H-45A	\$18.99	AN7H-45	call

Please call or check our website for availability of longer lengths.

AN6 Bolts - 3/8 - 24 Thread									
Length in Inches		Completely Undrilled		Drilled Shank Only		Drilled Head Only		Drilled Head and Shank	
UHL	Grip	Part No.	Price	Part No.	Price	Part No.	Price	Part No.	Price
3/8	1/16	AN6-5A	74¢	AN6-5	99¢	AN6H-5A	99¢	AN6H-5	call
3/4	3/16	AN6-6A	64¢	AN6-6	\$1.09	AN6H-6A	99¢	AN6H-6	call
7/8	5/16	AN6-7A	69¢	AN6-7	74¢	AN6H-7A	\$1.39	AN6H-7	call
1	7/16	AN6-10A	69¢	AN6-10	89¢	AN6H-10A	\$1.49	AN6H-10	call
1 1/8	9/16	AN6-11A	79¢	AN6-11	84¢	AN6H-11A	\$1.09	AN6H-11	\$2.99
1 1/4	11/16	AN6-12A	\$1.19	AN6-12	79¢	AN6H-12A	\$1.49	AN6H-12	\$2.99
1 3/8	13/16	AN6-13A	99¢	AN6-13	\$1.29	AN6H-13A	\$1.79	AN6H-13	\$3.19
1 1/2	15/16	AN6-14A	99¢	AN6-14	84¢	AN6H-14A	\$1.19	AN6H-14	\$4.99
1 5/8	1 1/16	AN6-15A	99¢	AN6-15	89¢	AN6H-15A	\$1.99	AN6H-15	call
1 3/4	1 3/16	AN6-16A	99¢	AN6-16	99¢	AN6H-16A	\$2.79	AN6H-16	call
1 7/8	1 5/16	AN6-17A	94¢	AN6-17	99¢	AN6H-17A	\$1.79	AN6H-17	call
2	1 7/16	AN6-20A	99¢	AN6-20	99¢	AN6H-20A	\$1.99	AN6H-20	call
2 1/8	1 9/16	AN6-21A	94¢	AN6-21	\$1.29	AN6H-21A	call	AN6H-21	\$8.49
2 1/4	1 11/16	AN6-22A	94¢	AN6-22	\$1.29	AN6H-22A	\$2.39	AN6H-22	\$8.79
2 3/8	1 13/16	AN6-23A	99¢	AN6-23	\$1.29	AN6H-23A	\$2.49	AN6H-23	call
2 1/2	1 15/16	AN6-24A	99¢	AN6-24	\$1.49	AN6H-24A	\$3.49	AN6H-24	call
2 5/8	2 1/16	AN6-25A	99¢	AN6-25	\$1.29	AN6H-25A	\$16.79	AN6H-25	\$3.79
2 3/4	2 3/16	AN6-26A	\$1.19	AN6-26	\$1.29	AN6H-26A	call	AN6H-26	\$3.29
2 7/8	2 5/16	AN6-27A	\$1.19	AN6-27	\$1.29	AN6H-27A	call	AN6H-27	\$8.99
3	2 7/16	AN6-30A	\$1.19	AN6-30	\$1.49	AN6H-30A	\$3.79	AN6H-30	\$9.59
3 1/8	2 9/16	AN6-31A	\$1.59	AN6-31	\$1.59	AN6H-31A	\$3.99	AN6H-31	call
3 1/4	2 11/16	AN6-32A	\$1.79	AN6-32	\$2.29	AN6H-32A	call	AN6H-32	call
3 3/8	2 13/16	AN6-33A	\$1.89	AN6-33	\$2.29	AN6H-33A	\$6.19	AN6H-33	\$3.69
3 1/2	2 15/16	AN6-34A	\$2.29	AN6-34	\$2.39	AN6H-34A	call	AN6H-34	call
3 5/8	3 1/16	AN6-35A	\$3.49	AN6-35	\$2.39	AN6H-35A	\$12.99	AN6H-35	call
3 3/4	3 3/16	AN6-36A	\$2.69	AN6-36	\$3.99	AN6H-36A	call	AN6H-36	call
3 7/8	3 5/16	AN6-37A	\$2.79	AN6-37	\$3.49	AN6H-37A	call	AN6H-37	call
4	3 7/16	AN6-40A	\$2.99	AN6-40	\$3.69	AN6H-40A	call	AN6H-40	call
4 1/8	3 9/16	AN6-41A	\$3.69	AN6-41	\$3.89	AN6H-41A	\$7.49	AN6H-41	call
4 1/4	3 11/16	AN6-42A	\$4.19	AN6-42	\$4.29	AN6H-42A	call	AN6H-42	call
4 3/8	3 13/16	AN6-43A	\$3.99	AN6-43	\$4.39	AN6H-43A	call	AN6H-43	call
4 1/2	3 15/16	AN6-44A	\$4.19	AN6-44	\$4.59	AN6H-44A	call	AN6H-44	call
4 5/8	4 1/16	AN6-45A	\$5.59	AN6-45	\$5.79	AN6H-45A	call	AN6H-45	\$12.49
4 3/4	4 3/16	AN6-46A	N/A	AN6-46	call	AN6H-46A	call	AN6H-46	call
4 7/8	4 5/16	AN6-47A	\$7.49	AN6-47	call	AN6H-47A	call	AN6H-47	call
5 1/16	4 7/16	AN6-50A	\$14.99	AN6-50	\$13.79	AN6H-50A	\$22.79	AN6H-50	call

Please call or check our website for availability of longer lengths.

AN8 Bolts - 1/2 - 20 Thread (see Website for AN9 & AN10 Bolts)									
Length in Inches		Completely Undrilled		Drilled Shank Only		Drilled Head Only		Drilled Head and Shank	
UHL	Grip	Part No.	Price	Part No.	Price	Part No.	Price	Part No.	Price
3/4	1/16	AN8-6A	\$2.29	AN8-6	\$3.39	AN8H-6A	\$5.69	AN8H-6	call
7/8	3/16	AN8-7A	\$2.39	AN8-7	\$3.39	AN8H-7A	\$7.59	AN8H-7	call
1	5/16	AN8-10A	\$2.39	AN8-10	\$3.49	AN8H-10A	\$5.99	AN8H-10	\$25.99
1 1/8	7/16	AN8-11A	\$2.29	AN8-11	\$2.69	AN8H-11A	\$5.99	AN8H-11	call
1 1/4	9/16	AN8-12A	\$2.49	AN8-12	\$3.19	AN8H-12A	call	AN8H-12	call
1 3/8	11/16	AN8-13A	\$4.99	AN8-13	\$2.79	AN8H-13A	\$6.49	AN8H-13	\$6.99
1 1/2	13/16	AN8-14A	\$3.19	AN8-14	\$2.99	AN8H-14A	call	AN8H-14	call
1 5/8	15/16	AN8-15A	\$3.29	AN8-15	\$2.99	AN8H-15A	\$6.99	AN8H-15	call
1 3/4	1 1/16	AN8-16A	\$3.99	AN8-16	\$3.69	AN8H-16A	\$6.99	AN8H-16	call
1 7/8	1 3/16	AN8-17A	\$4.4						

AN Nuts and Related Items

MS20364 (AN364) Reduced Height Lock Nuts



These are Military Specification versions of what is commonly referred to as a "Nylock" nut. They are rated at 125,000 psi tensile strength and for operating temperatures of up to 250°F. The MS20364 series is a half-height variation for bolts loaded in shear.

Nut Thread Size (Reduced Height)	Part No.	Price Each
10-32 Reduced Height	AN364-3	30¢
1/4-28 Reduced Height	AN364-4	39¢
5/16-24 Reduced Height	AN364-5	59¢
3/8-24 Reduced Height	AN364-6	\$1.29
7/16-20 Reduced Height	AN364-7	\$1.59
1/2-20 Reduced Height	AN364-8	\$1.59
5/8-18 Reduced Height	AN364-10	\$1.89
3/4-16 Reduced Height	AN364-12	\$2.79

AN316 Left and Right Hand Jam Nuts



These plated high-strength jam nuts are commonly used with rod end bearings. They are manufactured per Military Specification AN316 except for the 10-32 sizes as noted below.

Nut Thread Size – Available with left or right hand threads	Part No.	Price Each
10-32 Right-Hand (AN315)	AN316-3-R	20¢
10-32 Left-Hand (brass, not MS)	AN316-3-L	49¢
1/4-28 Right-Hand	AN316-4-R	19¢
1/4-28 Left-Hand	AN316-4-L	54¢
5/16-24 Right-Hand	AN316-5-R	29¢
5/16-24 Left-Hand	AN316-5-L	69¢
3/8-24 Right-Hand	AN316-6-R	49¢
3/8-24 Left-Hand	AN316-6-L	74¢
7/16-20 Right-Hand	AN316-7-R	59¢
7/16-20 Left-Hand	AN316-7-L	\$1.09
1/2-20 Right-Hand	AN316-8-R	99¢
1/2-20 Left-Hand	AN316-8-L	\$2.99
5/8-18 Right-Hand	AN316-10-R	\$2.69
5/8-18 Left-Hand	AN316-10-L	\$4.49
3/4-16 Right-Hand	AN316-12-R	\$3.59
3/4-16 Left-Hand	AN316-12-L	\$8.99

Left and Right Hand Metric Jam Nuts

Now in Metric!

These plated high-strength jam nuts are ideal for use with our metric rod end bearings. They are very similar to the AN316 Jam Nuts shown above but with metric threads.

Nut Thread Size – Specify left or right hand threads	Part No.	Price Each
8 x 1.00mm Right-Hand	MJAM-8x1.0-R	49¢
8 x 1.00mm Left-Hand	MJAM-8x1.0-L	54¢
8 x 1.25mm Right-Hand	MJAM-8x1.25-R	49¢
8 x 1.25mm Left-Hand	MJAM-8x1.25-L	74¢
10 x 1.25mm Right-Hand	MJAM-10x1.25-R	\$1.09
10 x 1.25mm Left-Hand	MJAM-10x1.25-L	\$1.39
10 x 1.50mm Right-Hand	MJAM-10x1.50-R	99¢
10 x 1.50mm Left-Hand	MJAM-10x1.50-L	\$1.09
12 x 1.25mm Right-Hand	MJAM-12x1.25-R	\$1.19
12 x 1.25mm Left-Hand	MJAM-12x1.25-L	\$1.39
12 x 1.75mm Right-Hand	MJAM-12x1.75-R	\$1.39
12 x 1.75mm Left-Hand	MJAM-12x1.75-L	\$1.39
14 x 1.50mm Right-Hand	MJAM-14x1.50-R	\$1.59
14 x 1.50mm Left-Hand	MJAM-14x1.50-L	\$1.89
14 x 2.00mm Right-Hand	MJAM-14x2.0-R	\$1.59
14 x 2.00mm Left-Hand	MJAM-14x2.0-L	\$1.99
16 x 2.00mm Right-Hand	MJAM-16x2.0-R	\$1.79
16 x 2.00mm Left-Hand	MJAM-16x2.0-L	\$1.99

MS20365 (AN365) Full Height Lock Nuts



These are Military Specification versions of what is commonly referred to as a "Nylock" nut. They are rated at 125,000 psi tensile strength and for operating temperatures of up to 250°F. The MS20365 series is the standard, full height lock nut.

Nut Thread Size (Full Height)	Part No.	Price Each
10-32 Full Height	AN365-3	23¢
1/4-28 Full Height	AN365-4	49¢
5/16-24 Full Height	AN365-5	69¢
3/8-24 Full Height	AN365-6	99¢
7/16-20 Full Height	AN365-7	\$1.39
1/2-20 Full Height	AN365-8	\$1.79
9/16-18 Full Height	AN365-9	\$3.19
5/8-18 Full Height	AN365-10	\$2.89
3/4-16 Full Height	AN365-12	\$4.19

AN310 Castellated Nuts



These Mil Spec castellated nuts are used with drilled shank bolts and cotter pins to provide secure attachment for critical fastener applications. They are suitable for high temperature locations where "Nylock" or Loctite temperature limits are exceeded.

Nut Thread Size	Part No.	Price Each
10-32 Castellated Nut	AN310-3	\$1.09
1/4-28 Castellated Nut	AN310-4	84¢
5/16-24 Castellated Nut	AN310-5	\$1.79
3/8-24 Castellated Nut	AN310-6	\$1.49
7/16-20 Castellated Nut	AN310-7	\$2.49
1/2-20 Castellated Nut	AN310-8	\$2.29
5/8-18 Castellated Nut	AN310-10	\$3.89
3/4-16 Castellated Nut	AN310-12	\$4.79

H20 Series 220,000 psi 12 Point Lock Nuts



These all metal self-locking, compact, lightweight, super-strong, aerospace quality nuts are stronger than standard AN364/AN365/MS21042 nuts.

Nut Thread Size	Part No.	Price Each
1/4-28 – 12 Point Nut	H20-4	\$2.39
5/16-24 – 12 Point Nut	H20-5	\$2.99
3/8-24 – 12 Point Nut	H20-6	\$6.99

AN Bolt Identification Gauge



This handy gauge is indispensable when using AN hardware. With length increments of only 1/8 inch, it's not easy to determine at a glance if you have the correct bolt size for your application. Works with AN3 through AN10 bolts up to -50 size (5 inches long). This sturdy steel gauge fits easily into your toolbox. Measures 5 1/2" wide x 6 3/16" long.

Pocket AN Bolt Gauge..... Part No. 3319-001... \$17.99

Cross Check Inspector's Lacquer

Cross Check (also known as Anti-Sabotage Lacquer) is an easy way to detect loosening due to vibration or tampering. Apply to fasteners and fittings after tightening to proper torque. Dries quickly, leaving a highly visible but brittle mark which will crack at the first sign of loosening. Use on compression fittings, studs, nuts – any assembly where regularly checking the torque or proper positioning is difficult or impractical. Excellent adhesion to most clean surfaces. 1 oz. tube. Available in Blue, Grey, Green, Orange, Pink, Red, White, or Yellow.



Cross Check, 1 oz..... Part No. 3329-001-Color..... \$4.99

MS21042 Jetnuts



These all metal self-locking nuts are rated at 160,000 psi tensile strength and can withstand temperatures to 450°F. Because of their reduced hex dimension, they are widely used in limited space applications where wrench access would otherwise be a problem.

Nut Thread Size	Part No.	Price Each
10-32 Jetnut	MS21042-3	20¢
1/4-28 Jetnut	MS21042-4	64¢
5/16-24 Jetnut	MS21042-5	79¢
3/8-24 Jetnut	MS21042-6	99¢
7/16-20 Jetnut	MS21042-7	\$3.59
1/2-20 Jetnut	MS21042-8	\$4.99

Replacing all of the full height MS20365 locknuts on your car with MS21042 jetnuts can result in a measurable weight reduction.

Metric Jetnuts

These Metric Jetnuts are very similar to MS21042 jetnuts; however, there is currently no Military Specification for metric jetnuts.

Nut Thread Size	Part No.	Price Each
6 x 1.00 mm Jetnut	MJET-M6x1.0	\$1.49
8 x 1.25 mm Jetnut	MJET-M8x1.25	\$1.99
10 x 1.50 mm Jetnut	MJET-M10x1.50	\$3.89

MS24665 Cotter Pins for Castellated Nuts



Install as shown here:

Bend one tang over end of bolt. Cut the other tang so it will end short of the washer when bent toward the bolt head.



These plated steel Mil Spec cotter pins are correctly sized to work with AN310 castellated nuts and drilled shank air-frame bolts. They are sold in packages of 100.

Cotter Pin Size and appropriate AN Bolt Size	Part No.	Price per 100
1/16 x 1/2 for AN3 Bolts	MS24665-132	\$2.99
5/64 x 1/2 for AN4 & AN5	MS24665-208	\$3.59
3/32 x 3/4 for AN6 & AN7	MS24665-283	\$2.39
3/32 x 1" for AN8 Bolts	MS24665-285	\$3.99

AN Hardware Assortments

Airframe Washer and Aircraft Locknut Kit

Contains 100 each thick and thin AN960 steel flat washers in each size #10, 1/4, 5/16, 3/8 (see chart on page 99). Also contains 10 each AN364 half height and AN365 full height nylon insert locknuts and 10 all-metal, self-locking "jet-nuts" in each size #10-32, 1/4-28, 5/16-24 and 3/8-24. Includes an unbreakable storage box.

Airframe Washer and Locknut Kit

Part No. 4171.....\$74.99

Airframe Washer and Jetnut Kit

Contains 100 each thick and thin AN960 steel flat washers in each size; #10, 1/4, 5/16, 3/8 (see chart on page 99). Also contains 50 each #10-32 and 1/4-28 and 25 each 5/16-24 and 3/8-24 all-metal "jetnuts". Includes an unbreakable box.

Airframe Washer and Jetnut Kit

Part No. 4172.....\$99.99

Airframe Washer Kit

Contains 100 each AN960 steel flat washers in each size; -10 through -616L and 50 each of -716 through -816L. See AN960 Flat Washer section on page 99 for sizes and measurements. Includes unbreakable box.

Air Frame Washer Kit.....Part No. 4170.....\$49.99

AN Washers, Retainer Washers and Metric Hardware Kits



AN960 Flat Washers

These steel flat washers have smooth, parallel faces and are available in two thicknesses. Use them as shims to adjust nut position on AN bolts and to protect the surfaces being bolted. Sold in packages of 100. Also see assortment below, right.

Bolt Size	O.D. (inch)	Thk. (inch)	Part No.	Price per 100
#10	.438	.063	AN960-10	\$2.79
#10	.437	.032	AN960-10L	\$1.99
1/4	.500	.063	AN960-416	\$3.29
1/4	.500	.032	AN960-416L	\$2.49
5/16	.562	.063	AN960-516	\$3.99
5/16	.562	.032	AN960-516L	\$2.49
3/8	.625	.063	AN960-616	\$5.79
3/8	.625	.032	AN960-616L	\$2.99
7/16	.750	.063	AN960-716	\$5.99
7/16	.750	.032	AN960-716L	\$5.49
1/2	.875	.063	AN960-816	\$7.29
1/2	.875	.032	AN960-816L	\$5.99
9/16	1.063	.063	AN960-916	\$12.99



AN970 Large Diameter Flat Washers

Similar to AN960 washers but with an oversized outside diameter for where a large bearing area is required. Sold individually.

Bolt Size	O.D. (inch)	Thk. (inch)	Part No.	Price each
#10	.875	.063	AN970-3	10¢
1/4	1.125	.063	AN970-4	16¢
5/16	1.375	.063	AN970-5	18¢
3/8	1.625	.063	AN970-6	24¢
7/16	1.812	.109	AN970-7	59¢
1/2	2.000	.109	AN970-8	69¢

Airframe Washer Assortment Kit

Contains 100 each AN960 steel flat washers in each size; -10 through -616L and 50 each of -716 through -816L. Includes unbreakable box.

Airframe Washer Kit Part No. 4170 \$49.99



MS20002C Chamfered Washers

These washers have a chamfer on the I.D. which matches the radius under the head of certain "Super Bolts" such as MS 20004 and NAS 624. (We don't currently stock these bolts.) These washers are not needed with regular AN3 through AN7 airframe bolts. Sold individually.

Bolt Diameter	Part No.	Price Each
1/4	MS20002C-4	18¢
5/16	MS20002C-5	22¢
3/8	MS20002C-6	34¢
7/16	MS20002C-7	39¢

See page 120 for safety wire drill jigs to make drilling hex head and Allen head bolts and hex nuts fast and easy.

Metric Hardware Kits



Four styles are currently stocked. Part No. 4175 and 4178-001 both meet JIS standards and can be used for work on Japanese cars. Part No. 4176 and 4178-002 both meet DIN standards and can be used predominantly on American and European cars. All kits include 6, 8 and 10mm bolts with matching nuts, flat washers and locking washers. The nuts and bolts in Part No. 4175 and 4176 have a standard hex. The nuts and bolts in Part No. 4178-001 and 4178-002 are flange heads, with a larger bearing surface below the hex. Each kit comes packaged in a sturdy metal 24 compartment storage box. All hardware supplied is grade 8.8.

JIS Hardware Kit Part No. 4175 \$97.99
DIN Hardware Kit Part No. 4176 \$95.99
JIS Flange Head Hardware Kit Part No. 4178-001 \$99.99
DIN Flange Head Hardware Kit Part No. 4178-002 \$95.99

Safety Retainer Washers for Rod End Bearings

Now in Metric!



Safety Retainer Washers When a rod end or spherical bearing is mounted in single shear and is not positively retained by the surrounding structure, most sanctioning bodies require that retainer washers be used in case the ball would separate from the housing. These washers must be beveled to allow full freedom of movement for the rod end or spherical bearing. We stock specially machined plated steel washers for this purpose in bore sizes of 1/4" to 5/8" and metric sizes M8 to M16.

1/4 inch bore size (0.142" overall thickness, 0.68" O.D.) Part No. 3068-04 \$1.79
 5/16 inch bore size (0.168" overall thickness, 0.81" O.D.) Part No. 3068-05 \$1.99
 3/8 inch bore size (0.184" overall thickness, 0.93" O.D.) Part No. 3068-06 \$2.29
 7/16 inch bore size (0.220" overall thickness, 1.12" O.D.) Part No. 3068-07 \$2.49
 1/2 inch bore size (0.228" overall thickness, 1.18" O.D.) Part No. 3068-08 \$2.69
 5/8 inch bore size (0.270" overall thickness, 1.43" O.D.) Part No. 3068-10 \$2.99

M8 bore size (4.3 mm overall thickness, 20.5 mm O.D.) Part No. 3068-M08 ... \$2.49
 M10 bore size (5 mm overall thickness, 25 mm O.D.) Part No. 3068-M10 ... \$2.89
 M12 bore size (5.7 mm overall thickness, 30 mm O.D.) Part No. 3068-M12 ... \$2.99
 M14 bore size (6 mm overall thickness, 33 mm O.D.) Part No. 3068-M14 ... \$3.49
 M16 bore size (7 mm overall thickness, 36.7 mm O.D.) Part No. 3068-M16 ... \$3.89

HARDWARE

Hex Socket Head Screws ("Allen Head" Screws)

Our Hex Socket Head Screws feature a durable, great-looking black oxide finish. All sizes are threaded their full length, except as noted below.

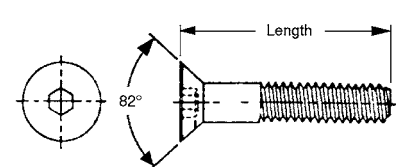
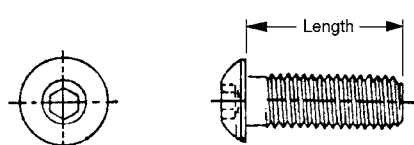
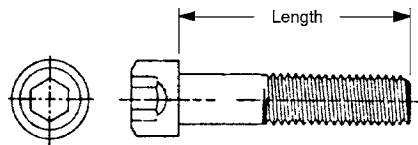

Socket Head Cap Screws

These are the familiar "Allen Head" (hex socket head) screws. They are not AN or Military Specification parts, but they are high-quality, high-strength fasteners (180,000 psi) suitable for many non-critical applications.

Socket Head Cap Screw	Part No.	Price Each
10-32 x 3/8	630-3-0.375	13¢
10-32 x 1/2	630-3-0.500	13¢
10-32 x 5/8	630-3-0.625	16¢
10-32 x 3/4	630-3-0.750	16¢
10-32 x 1"	630-3-1.000	18¢
10-32 x 1 1/4 *	630-3-1.250	19¢
1/4-28 x 1 1/4	630-4-1.250	24¢
1/4-28 x 1 1/2 **	630-4-1.500	28¢

Button Head Screws

The **button head** version of the "Allen" screw provides a low profile, streamlined appearance with a standard hole. The reduced size hex socket makes proper tightening difficult. Use these screws in low-tension applications only.

Button Head Screw	Part No.	Price Each
10-32 x 3/8	631-3-0.375	10¢
10-32 x 1/2	631-3-0.500	12¢
10-32 x 5/8	631-3-0.625	12¢
10-32 x 3/4	631-3-0.750	14¢
10-32 x 1"	631-3-1.000	14¢
1/4-28 x 1 1/4 *	631-4-1.250	24¢
1/4-28 x 1 1/2 *	631-4-1.500	29¢

Flat Head Screws (10-32 size only)

The **flat head** version of the "Allen" screw is for flush mounting in a hole with an 82° countersink. The reduced size hex socket makes proper tightening difficult. Use these screws in low-tension applications only.

Flat Head Screw	Part No.	Price Each
10-32 x 3/8	632-3-0.375	10¢
10-32 x 1/2	632-3-0.500	15¢
10-32 x 5/8	632-3-0.625	21¢
10-32 x 3/4	632-3-0.750	22¢
10-32 x 1"	632-3-1.000	22¢
10-32 x 1 1/4	632-3-1.250	29¢

* 0.250" unthreaded portion. ** 0.375" unthreaded portion.

Self-Locking All-Metal Nut Plates and Special NAS1097 Solid Rivets for Nut Plates

When gaining access to a regular hex nut causes assembly or maintenance problems, these self-locking nut plates can be a lifesaver. The all-metal construction is rated for 450° F operation. Sizes up to 1/4-28 are designed to be riveted in place with 3/32 inch rivets. Larger sizes accept 1/8 inch rivets. We stock special NAS1097 solid rivets that are

ideal for mounting these nut plates. **Note:** The top of the threaded portion is deformed into an oval shape to produce a self-locking action. It can be difficult to insert the screw the first time a nut plate is used, particularly on the smaller sizes. A drop of oil on the threads prior to first use will make it easier to insert and prevent damage to the screw.

MS21047 Self-Locking Nut Plates



Thread Size	X Dim.	Part No.	Price Each
6-32	0.688	MS21047-06	84¢
8-32	0.688	MS21047-08	69¢
10-32	0.688	MS21047-3	69¢
1/4-28	1.000	MS21047-4	\$1.19
5/16-24	1.000	MS21047-5	\$1.79
3/8-24	1.000	MS21047-6	\$1.99

MS21059 Floating Nut Plates



This style also in Metric! Part No. 6069-Size

Thread Size	X Dim.	Part No.	Price Each
6-32	0.688	MS21059-06	89¢
8-32	0.688	MS21059-08	94¢
10-32	0.688	MS21059-3	89¢
1/4-28	1.000	MS21059-4	\$1.29
5/16-24	1.000	MS21059-5	\$3.19
3/8-24	1.000	MS21059-6	\$4.99

MS21051 Single Lug Nut Plates



Thread Size	X Dim.	Part No.	Price Each
6-32	0.344	MS21051-06	99¢
8-32	0.344	MS21051-08	\$1.29
10-32	0.344	MS21051-3	\$1.09
1/4-28	0.344	MS21051-4	\$1.39
5/16-24	0.500	MS21051-5	\$1.69
3/8-24	0.500	MS21051-6	\$3.79

MS21055 Corner Nut Plates



Thread Size	X Dim.	Part No.	Price Each
6-32	0.344	MS21055-06	\$1.09
8-32	0.344	MS21055-08	99¢
10-32	0.344	MS21055-3	69¢
1/4-28	0.500	MS21055-4	\$1.49
5/16-24	0.500	MS21055-5	\$2.99
3/8-24	0.500	MS21055-6	\$5.39

NAS1097 Reduced Head Solid Rivets



These flat head rivets have a very small head that allows flush installation even in thin materials. Just a couple of turns with a manual deburring tool using a 100° countersink bit will create the countersink. A rivet squeezer (shown at right) can be used to set these rivets near the edge of a panel. If the edge distance is too great, a rivet gun and bucking bar will be needed. These rivets should not be used as replacements for standard MS20426 countersunk rivets for structural applications. However, they are perfectly adequate when their only function is to secure a nut plate. Sold in 0.10 pound packages which contain approximately 400 to 600 rivets depending upon the length.

Rivet Length	Panel Thickness	3/32" Diameter Part No.	Price per 1/10 lb.	1/8" Diameter Part No.	Price per 1/10 lb.
0.187"	up to 0.032	NAS1097AD3-3	\$7.99	NAS1097AD4-3	\$4.89
0.219"	.032 - .062	NAS1097AD3-3.5	\$7.19	NAS1097AD4-3.5	\$4.79
0.250"	.062 - .094	NAS1097AD3-4	\$7.19	NAS1097AD4-4	\$4.69

Tools for Setting Solid Aircraft Rivets

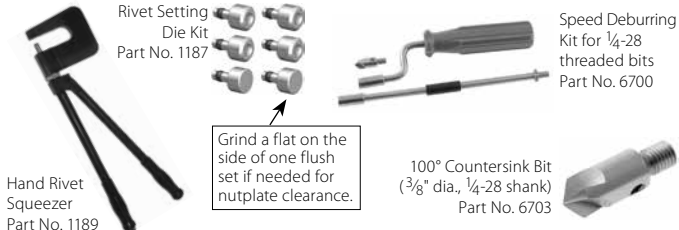

These tools will make it easy to set solid aircraft rivets when they are located near the edge of a panel. The 6 piece die kit works with universal (round) head rivets or flat head rivets.

Adjustable Hand Rivet Squeezer..... Part No. 1189 \$149.99
Features a 3 inch 360° swivel head and long handles for leverage. The 5/8" ram is adjustable, so shims are not needed to get the proper stroke. Die kit sold separately below.

6 Piece Rivet Setting Die Kit..... Part No. 1187..... \$34.99
For use with the rivet squeezer. This six piece set includes one each of the following cup sizes: 3/32, 1/8, 5/32, 3/16 and 2 flush dies. 1/4" body length with a .187" shank.

Speed Deburring Kit..... Part No. 6700 \$35.99
Includes swivel action handle, 8" extension, and 100° countersinking and deburring bit.

100° Countersink Bit, 3 flutes, 1/4-28 shank..... Part No. 6703 \$19.99
Replacement countersink and deburring bit for above Speed Deburring Kit.

Rivet Nuts and Insert Nuts

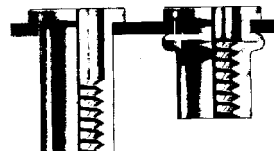
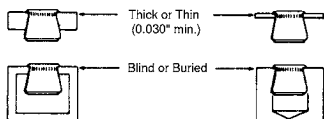

Insert Nuts

These plated steel inserts can be installed in any metal part over .030" thick. When properly installed and used, they provide excellent resistance to pull-out and torque-out. They protrude only .015" above the surface and can be countersunk for a completely flush installation. **Note:** The part being fastened must bear directly against the rim of the insert. If the part has an over-sized hole or is a soft material such as fiberglass, a washer should be used between the insert and the part to prevent pulling out the insert.

10-32 Insert Nut, install in 9/32 inch diameter hole *.....Part No. 655-3 59¢

1/4-28 Insert Nut, install in 3/8 inch diameter hole *.....Part No. 655-4 \$1.09

5/16-24 Insert Nut, install in 1/2 inch diameter hole *.....Part No. 655-5 \$1.49

* **Note:** The hole diameter shown is for mounting in panels up to 0.090" thick. Please see our website for recommended hole sizes for thicker materials and buried holes.

Rivet Nuts with Anti-Rotation Key

Rivet Nuts are similar to the insert nuts described at left, but they can also perform the dual function of permanently fastening several pieces of sheet metal together (like a pop rivet) and providing a permanently captivated nut for mounting a removable piece. We stock the keyed type which offers superior torque-out resistance (file a small notch on the edge of the mounting hole for the key). The material for these inserts is plated steel. The placing tools shown below can be used to install these inserts. Install 10-32 rivet nuts into a 1/4 inch hole. Use a Q size letter drill for 1/4-28 rivet nuts.

10-32 Rivet Nut, .01 to .08 material thicknessPart No. 650-3-080 89¢

10-32 Rivet Nut, .08 to .13 material thicknessPart No. 650-3-130 89¢

1/4-28 Rivet Nut, .02 to .08 material thicknessPart No. 650-4-080 99¢

1/4-28 Rivet Nut, .08 to .140 material thicknessPart No. 650-4-140 99¢

Hi-Torquer Installation Tool for Insert Nuts Only



The light-duty tools at right are good for occasional use or quick field repairs. If you need to install more than just a few Insert Nuts, this tool will make the job easier. The large handles are more comfortable to operate for repeated use. Requires a Mandrel Kit for each size Insert Nut you will be installing (Mandrel Kits sold separately). Not for use with Rivet Nuts.

Hi-Torquer Insert Nut Installation Tool OnlyPart No. 1185-001..... \$78.99

Mandrel Kit for 10-32 Insert NutsPart No. 1185-101-3..... \$32.99

Mandrel Kit for 1/4-28 Insert NutsPart No. 1185-101-4..... \$32.99

Mandrel Kit for 5/16-24 Insert NutsPart No. 1185-101-5..... \$32.99

Light-Duty Installation Tools for Insert Nuts and Rivet Nuts

These economical, light-duty tools are adequate for occasional use, installing just a few Insert Nuts or Rivet Nuts at a time. They are ideal for quick field repairs because they don't take up much room in your toolbox. The special hex collar has hardened teeth to prevent rotation of the insert while it is being compressed into the work piece. Each tool will work with Insert Nuts or Rivet Nuts. Requires a 9/16" wrench to hold the collar. The 5/16-24 size also requires a 1/2" wrench to turn the center hex-head bolt.

Light-Duty Installation Tool for 10-32 Inserts or Rivet Nuts Part No. 659-3 \$11.99

Light-Duty Installation Tool for 1/4-28 Inserts or Rivet Nuts Part No. 659-4 \$11.99

Light-Duty Installation Tool for 5/16-24 Inserts or Rivet Nuts ... Part No. 659-5 \$11.99

Self-Ejecting Quarter-Turn Fasteners, EHF5 Type

Quarter-Turn Stud Assemblies You won't lose these captive fastener assemblies! The plated steel stud assembly is designed to be riveted to the removable panel. The studs are spring-loaded to prevent unlatched fasteners from hanging up on the mating surface. This makes it easier to install large body panels that have many fasteners. An added benefit to the spring-loaded design is that an unfastened stud pops up to give a visual signal that it has not been latched. The basic stud diameter is $\frac{5}{16}$ inch, with a $\frac{3}{4}$ inch diameter slotted head. The countersunk stud assembly requires a 0.70" diameter hole through each panel. With proper mounting the rated strength is 85 pounds in tension and 200 pounds in shear. See chart at right for stud and spring size recommendation.

- Quarter-Turn Stud, .52" long (.40" grip) Part No. 3004 \$2.39
- Quarter-Turn Stud, .62" long (.50" grip) Part No. 3005 \$2.39
- Quarter-Turn Stud, .72" long (.60" grip) Part No. 3006 \$2.59
- Quarter-Turn Stud, .82" long (.70" grip) Part No. 3007 \$2.89
- Quarter-Turn Stud, .92" long (.80" grip) Part No. 3008 \$2.99

Self-Ejecting Wing-Head Stud Assemblies Same as the stud assemblies listed above except with a wing-head stud for easy operation without tools of any kind.

- Wing-Head Stud, .52" long (.40" grip) Part No. 3020 \$2.79
- Wing-Head Stud, .62" long (.50" grip) Part No. 3015 \$2.99
- Wing-Head Stud, .72" long (.60" grip) Part No. 3021 \$3.29

Spring Receptacles Designed to mate with the above stud assemblies. **If you do not know which size is required, order the shortest spring.** If the assembly is not tight enough, simply add spacing washers to move the spring away from the stud assembly.

- .200 inch spring height Part No. 3010 64¢
- .225 inch spring height Part No. 3011 64¢
- .250 inch spring height Part No. 3012 64¢
- .275 inch spring height Part No. 3013 64¢

Weld Plate Spring Receptacles for $\frac{5}{16}$ " Studs



These handy receptacles consist of a spring receptacle pre-riveted to a 1.50 x 2 inch x 0.062 inch thick steel plate which can be welded to the support structure. The plate can be cut or bent to fit a wide range of applications. These plates are very popular with chassis builders and are especially useful on tube-frame chassis. Please see our website for a full stud-receptacle application chart.

- .200" Spring (use with 3004 stud for 0.100-0.124" panel) ... Part No. 3019-001-.200... \$1.99
- .225" Spring (use with 3004 stud for 0.125-0.150" panel) ... Part No. 3019-001-.225... \$1.99
- .250" Spring (use with 3004 stud for 0.150-0.174" panel) ... Part No. 3019-001-.250... \$1.99
- .275" Spring (use with 3004 stud for 0.175-0.199" panel) ... Part No. 3019-001-.275... \$1.99

Quarter-Turn Fastener 82 Piece Trackside Kit – Save \$35!



Our handy quarter-turn fastener kits are a very economical way to ensure that you always have the supplies you need on hand. The **82 Piece Trackside Kit** is designed as a compact, easy-to-carry spares kit for quick repairs at the track. Includes one #3105 Fastener Tool; 10 each of #3004, 3005, 3006, & 3007 Quarter-turn stud assemblies; 10 each of #3010, 3011, 3012, & 3013 spring receptacles, and one #4330 durable storage box to keep things organized. **Save over \$35 compared to the individual piece prices!**

82 Piece Quarter-Turn Fastener Trackside Kit Part No. 3025 \$108.99

Buy more and save! Call or visit our website for quantity discounts.

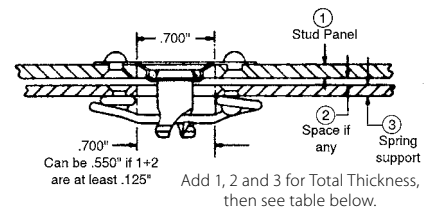
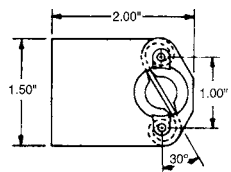

Total Thickness*	Stud Part No.	Spring Part No.
.120 thru .149	3004	3013
.150 thru .174	3004	3012
.175 thru .199	3004	3011
.200 thru .224	3004	3010
.220 thru .249	3005	3013
.250 thru .274	3005	3012
.275 thru .299	3005	3011
.300 thru .324	3005	3010
.320 thru .349	3006	3013
.350 thru .374	3006	3012
.375 thru .399	3006	3011
.400 thru .424	3006	3010
.420 thru .449	3007	3013
.450 thru .474	3007	3012
.475 thru .499	3007	3011
.500 thru .524	3007	3010
.520 thru .549	3008	3013
.550 thru .574	3008	3012
.575 thru .599	3008	3011
.600 thru .624	3008	3010

* Includes the total thickness of the outer panel, inner panel and any space between them (pop rivet head thickness).

In addition to these $\frac{5}{16}$ inch diameter fasteners, we now offer the larger $\frac{3}{8}$ inch diameter series. Please see the bottom of this page for details.

Quarter-Turn Fastener 412 Piece Constructor's Kit – Save \$270!



Our **412 Piece Constructors Kit** comes in a sturdy 18-compartment box that houses over 400 pieces. This is a great kit for Fab shops, Prep shops, or anyone planning a complete chassis rebuild. Included in the assortment are 40 pieces of our #3004, 3005, 3006, & 3007 Quarter-turn stud assemblies; 30 pieces of #3008; 20 Wing Stud assemblies, #3015; 40 of each spring, #3010, 3011, 3012, & 3013; 40 pieces of the #3019-001-.200 Weld Plate; one #3105 Fastener tool, and a durable storage box. **SAVE OVER \$270 off the individual piece price!**

412 Piece Quarter-Turn Fastener Constructors Kit Part No. 3026 \$499.00

Self-Ejecting Quarter-Turn Fasteners, EHF6 Type

These quarter-turn fasteners are similar to the EHF5 Type described above, except the stud is a larger $\frac{3}{8}$ " nominal diameter (0.4") with a $\frac{3}{4}$ " OD countersunk head. The larger backing plate and larger spring both have $\frac{1}{8}$ " rivet holes spaced $1\frac{3}{8}$ " apart.

- Quarter-Turn Stud, .56" long Part No. 3022-400 \$2.29
- Quarter-Turn Stud, .66" long Part No. 3022-500 \$2.19
- Quarter-Turn Stud, .76" long Part No. 3022-600 \$2.29
- Wing-Head Stud, .56" long Part No. 3023-400 \$3.29
- Wing-Head Stud, .66" long Part No. 3023-500 \$3.39
- Wing-Head Stud, .76" long Part No. 3023-600 \$3.29

- .250 inch spring height Part No. 3024-250 69¢
- .275 inch spring height Part No. 3024-275 64¢

Total Thickness*	Stud Part No.	Spring Part No.
.165 thru .189	3022-400 or 3023-400	3024-250
.190 thru .214	3022-400 or 3023-400	3024-275
.265 thru .289	3022-500 or 3023-500	3024-250
.290 thru .314	3022-500 or 3023-500	3024-275
.365 thru .389	3022-600 or 3023-600	3024-250
.390 thru .414	3022-600 or 3023-600	3024-275

* Includes the total thickness of the outer panel, inner panel and any space between them (pop rivet head thickness).



Flat Blade Fastener Tool

This stainless steel tool has three different radii to exactly fit all commonly used slotted head studs. Helps to prevent damage to the stud and to body panels.

Flat Blade Style Tool Part No. 3105 \$9.49



Screwdriver-Style Fastener Tool

The end of this tool has a radius to fit slotted countersunk quarter-turn fasteners shown on this page. The screwdriver handle allows a good, comfortable grip for easy operation.

Screwdriver-Style Tool ... Part No. 3158-002 \$23.99



Countersinking Tool for Flat Head Studs

This two-piece kit includes a punch and anvil to dimple metal panels for the countersunk quarter-turn fasteners shown on this page.

Countersinking Tool Part No. 3158-001 \$47.99



Receptacle Spring Height Adjuster

If you just can't get the measurements right, or if you don't have the right spring on hand, you can use this tool to bend the receptacle spring. Turning the plastic knob pulls the spring closer to the panel for a looser fit.

Spring Adjusting Tool ... Part No. 3158-004 \$47.99

Camloc Quarter-Turn Fasteners

Many late model formula cars and sports racers use Camloc quarter-turn fasteners as standard equipment. Because they are smaller and weigh less than the more traditional Dzus fasteners, Camlocs are also becoming popular when rebuilding older race cars. When replacing or ordering spares for an existing application, check the small number stamped

on the head of the Camloc stud. This shows the dash number which indicates grip length. Having the correct grip length is fairly critical to achieving the proper tension. All of the Camlocs that we stock have a #2 Phillips type head. These are interchangeable with equivalent studs with other head styles and seem to be preferred by most racers.

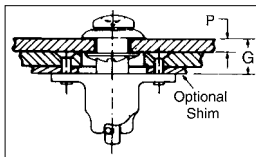

This drawing shows how to measure grip (G dimension) for the **26 or 27 Series** when using a standard receptacle. This drawing shows the 26 series stud. The 27 series is the same except that the head is flush. (We don't stock the 26 series.)

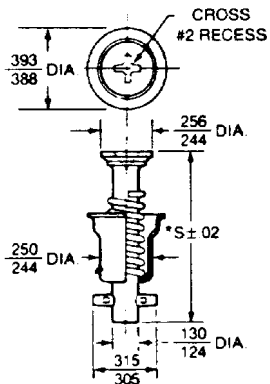

Typical 27 series stud
Part No. 6070-xx
S=.58+(.03 x Dash No.)

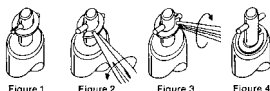

Installation procedure of split ring retainers, Part No. 6073 and 6075

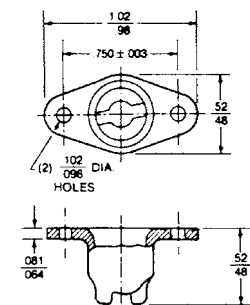

Standard 27 series receptacle
Part No. 6076

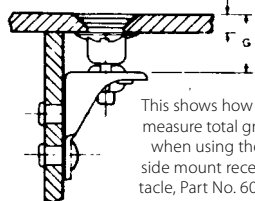

This shows how to measure total grip when using the side mount receptacle, Part No. 6077

This drawing shows how to measure grip (G dimension) for the **40 Series** when using a standard receptacle and flush grommet. Add 0.026" when using standard grommet or 0.05" when using large diameter grommet (D dimensions in grommet drawings).

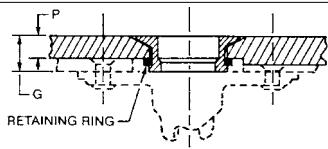

RETAINING RING

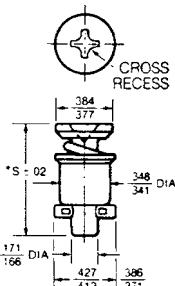

Typical 40 series stud, Part No. 6080-xx
S=.62+(.03 x Dash No.)

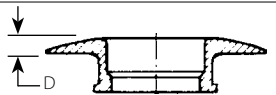

Large dia. grommet, Part No. 6082
D=.05 Dia=.88 .20 overall height
.09 max. panel thk.

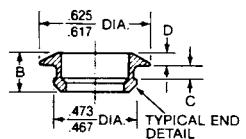

Standard Grommet, Part No. 6081
B=.197 C=.147 D=.026
.094 max. panel thk.

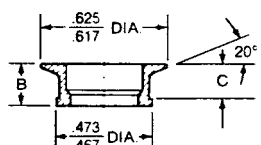

Flush style grommet, Part No. 6083
B=.197 C=.170 .117 max. panel thk.

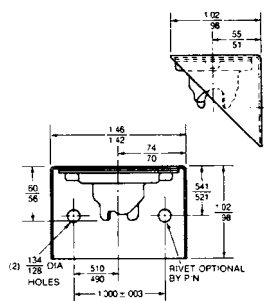

Side Mount 40 series receptacle, Part No. 6087

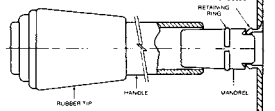

Installation tool, Part No. 6085
shown with Retainer, Part No. 6084

27 Series Light-Duty Camloc Fasteners

The 27 series Camlocs are rated for 200 pounds working strength (ultimate tensile strength is 300 pounds). They are ideal for light-duty fastening when a flush head is desired.

27 Series Studs and Related Items Description	Total Grip "G" (see drawing)	Part No.	Price each
Camloc 27S3-1 Stud, .61" stud length	.030 - .059	6070-01	\$3.59
Camloc 27S3-2 Stud, .64" stud length	.060 - .089	6070-02	\$3.79
Camloc 27S3-3 Stud, .67" stud length	.090 - .119	6070-03	\$3.79
Camloc 27S3-4 Stud, .70" stud length	.120 - .149	6070-04	\$3.79
Camloc 27S3-5 Stud, .73" stud length	.150 - .179	6070-05	\$3.89
Camloc 27S3-6 Stud, .76" stud length	.180 - .209	6070-06	\$3.79
Camloc 27S3-7 Stud, .79" stud length	.210 - .239	6070-07	\$4.29
Camloc 27S3-8 Stud, .82" stud length	.240 - .269	6070-08	\$4.29
Camloc 27S3-9 Stud, .85" stud length	.270 - .299	6070-09	\$4.29
Camloc 27S3-10 Stud, .88" stud length	.300 - .329	6070-10	\$4.99
Camloc 27S3-11 Stud, .91" stud length	.330 - .359	6070-11	\$5.19
Camloc 27S3-12 Stud, .94" stud length	.360 - .389	6070-12	\$8.99
Standard Retaining Ring (holds stud assembly stationary in panel)		6071	89¢
Retaining Ring for thin, dimpled panels (holds stud assembly stationary)		6072	\$1.29
Split Ring Retainer (studs move freely when not latched)		6073	69¢
Installation Tool for #6071 and #6072 Retaining Rings		6074	\$28.49
Camloc 2600-ES Spring Tab with extruded hole (see page 106)		6078	\$8.29
Standard Receptacle for 27 series stud assemblies		6076	\$3.49
Side Mount Receptacle for 27 series studs assemblies		6077	\$6.99

40 Series Heavy-Duty Camloc Fasteners

The 40 series Camlocs are rated for 700 pounds working strength (1050 pounds ultimate strength). They are designed to be used with a metal grommet to help spread the attachment forces. The large diameter grommet is particularly useful in soft materials such as fiberglass. Grommets can be mounted in thicker panels than shown by counter-boring or spot-facing the back of the panel.

40 Series Studs and Related Items Description	Total Grip "G" (see drawing)	Part No.	Price each
Camloc 40S5-1 Stud, .65" stud length	.051 - .080 *	6080-01	\$5.49
Camloc 40S5-2 Stud, .68" stud length	.081 - .110 *	6080-02	\$5.49
Camloc 40S5-3 Stud, .71" stud length	.111 - .140 *	6080-03	\$5.49
Camloc 40S5-4 Stud, .74" stud length	.141 - .170 *	6080-04	\$5.49
Camloc 40S5-5 Stud, .77" stud length	.171 - .200 *	6080-05	\$5.69
Camloc 40S5-6 Stud, .80" stud length	.201 - .230 *	6080-06	\$5.69
Camloc 40S5-7 Stud, .83" stud length	.231 - .260 *	6080-07	\$5.89
Camloc 40S5-8 Stud, .86" stud length	.261 - .290 *	6080-08	\$5.89
Camloc 40S5-9 Stud, .89" stud length	.291 - .320 *	6080-09	\$5.99
Camloc 40S5-10 Stud, .92" stud length	.321 - .350 *	6080-10	\$5.99
Camloc 40S5-11 Stud, .95" stud length	.351 - .380 *	6080-11	\$6.49
Camloc 40S5-12 Stud, .98" stud length	.381 - .410 *	6080-12	\$6.49
Camloc 40S5-14 Stud, 1.04" stud length	.441 - .470 *	6080-14	\$6.79
Camloc 40S5-16 Stud, 1.10" stud length	.501 - .530 *	6080-16	\$6.79
Camloc 40S5-18 Stud, 1.16" stud length	.561 - .590 *	6080-18	\$6.89
Camloc 40S5-20 Stud, 1.22" stud length	.621 - .650 *	6080-20	\$6.89
Camloc 40S5-22 Stud, 1.28" stud length	.681 - .710 *	6080-22	\$7.19
Camloc 40S5-24 Stud, 1.34" stud length	.741 - .770 *	6080-24	\$7.99
Camloc 40S5-26 Stud, 1.40" stud length	.801 - .830 *	6080-26	\$8.99
Camloc 40S5-28 Stud, 1.46" stud length	.861 - .890 *	6080-28	\$9.99
Standard Grommet for Heavy-Duty Camloc Studs		6081	\$2.99
Large Diameter Grommet for Heavy-Duty Camloc Studs		6082	\$3.99
Flush Style Grommet for Heavy-duty Studs (requires countersink)		6083	\$2.99
Retainer Ring for any of the above grommets		6084	\$1.19
Split Ring Retainer to hold -16 and longer studs in grommets		6075	64¢
Camloc 4002-SN Spring Tab with .075" Grommet (see page 106)		6079	\$9.99
Installation Tool for #6084 grommet retainer (makes job much easier)		6085	\$29.99
Standard Receptacle for 40 series stud assemblies		6086	\$7.99
Side Mount Receptacle for 40 series studs with .06" float *		6087	\$12.79

* Add 0.03" to the Grip measurement when using #6087 Side Mount receptacle!

Camloc Installation Pliers

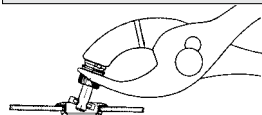

This tool will work with both the light and heavy-duty Camloc stud assemblies. In order to install the studs, it is necessary to compress the internal spring. This can be quite difficult without the proper tool.

Camloc Installation Pliers.....Part No. 6089..... \$39.99

Aeroloc Quarter-Turn Fasteners

Now you can have the vintage look of Dzus quarter-turn fasteners with the 21st-century precision and strength of Camloc quarter-turn fasteners! **Aeroloc** fasteners are designed to perfectly replace Dzus EHF5 Series fasteners (similar to those shown on page 101). The diamond-shaped backing plate is the same length and width, with exactly the same rivet hole size and spacing. You won't even have to drill new holes to convert from Dzus to Aeroloc. The 700 pound working strength rating is over 8 times stronger than the Dzus EHF5 assemblies. With 9 stud lengths, 2 receptacle heights, and 2 optional receptacle shims, Aeroloc fasteners offer consistent fastening tension for assemblies from 0.110" to 0.740" thick.

Aeroloc Phillips-Head Stud Assemblies with Plain Holes have a cross recess in the head for a standard #2 Phillips screwdriver. The plain rivet holes in the backing plate are appropriate for standard (non-countersunk) 1/8" rivets. Choose the stud length based on your total grip in the chart below right.

- Aeroloc Phillips-Head Stud, Plain Holes, -07* Part No. ALC200-1007 \$9.18
- Aeroloc Phillips-Head Stud, Plain Holes, -08* Part No. ALC200-1008 \$7.92
- Aeroloc Phillips-Head Stud, Plain Holes, -09* Part No. ALC200-1009 \$7.92
- Aeroloc Phillips-Head Stud, Plain Holes, -10* Part No. ALC200-1010 \$7.92
- Aeroloc Phillips-Head Stud, Plain Holes, -11* Part No. ALC200-1011 \$7.92
- Aeroloc Phillips-Head Stud, Plain Holes, -12* Part No. ALC200-1012 \$13.99
- Aeroloc Phillips-Head Stud, Plain Holes, -13* Part No. ALC200-1013 \$10.35
- Aeroloc Phillips-Head Stud, Plain Holes, -14* Part No. ALC200-1014 \$10.35
- Aeroloc Phillips-Head Stud, Plain Holes, -15* Part No. ALC200-1015 \$10.35

Aeroloc Phillips-Head Stud Assemblies with Dimpled Holes have a cross recess in the head for a standard #2 Phillips screwdriver. The rivet holes in the backing plate are dimpled to accept countersunk 1/8" rivets for a flush installation. Choose the stud length based on your total grip in the chart below right. Note that the dimples project 1mm (0.0394") from the back of the backing plate. If your removable panel is thinner than this, you will need to add a countersink in the stationary structure as well.

- Aeroloc Phillips-Head Stud, Dimpled Holes, -07* Part No. ALC200-1107 \$7.92
- Aeroloc Phillips-Head Stud, Dimpled Holes, -08* Part No. ALC200-1108 \$7.92
- Aeroloc Phillips-Head Stud, Dimpled Holes, -09* Part No. ALC200-1109 \$7.92
- Aeroloc Phillips-Head Stud, Dimpled Holes, -10* Part No. ALC200-1110 \$7.92
- Aeroloc Phillips-Head Stud, Dimpled Holes, -11* Part No. ALC200-1111 \$7.92
- Aeroloc Phillips-Head Stud, Dimpled Holes, -12* Part No. ALC200-1112 \$10.35
- Aeroloc Phillips-Head Stud, Dimpled Holes, -13* Part No. ALC200-1113 \$10.35
- Aeroloc Phillips-Head Stud, Dimpled Holes, -14* Part No. ALC200-1114 \$10.35
- Aeroloc Phillips-Head Stud, Dimpled Holes, -15* Part No. ALC200-1115 \$10.35

Aeroloc Bail-Head Stud Assemblies with Plain Holes have an easy-grip wire handle for fastening without any tools. The plain rivet holes in the backing plate are appropriate for standard (non-countersunk) 1/8" rivets. Choose the stud length based on your total grip in the chart to the right.

- Aeroloc Bail-Head Stud, Plain Holes, -07* Part No. ALC200-5007 \$18.77
- Aeroloc Bail-Head Stud, Plain Holes, -08* Part No. ALC200-5008 \$18.77
- Aeroloc Bail-Head Stud, Plain Holes, -09* Part No. ALC200-5009 \$18.77
- Aeroloc Bail-Head Stud, Plain Holes, -10* Part No. ALC200-5010 \$18.77
- Aeroloc Bail-Head Stud, Plain Holes, -11* Part No. ALC200-5011 \$18.77

Aeroloc Bail-Head Stud Assemblies with Countersunk Holes have an easy-grip wire handle for fastening without any tools. The rivet holes in the backing plate are dimpled to accept countersunk 1/8" rivets for a flush installation. Choose the stud length based on your total grip in the chart to the right. Note that the dimples project 1mm (0.0394") from the back of the backing plate. If your removable panel is thinner than this, you will need to add a countersink in the stationary structure as well.

- Aeroloc Bail-Head Stud, Dimpled Holes, -07* Part No. ALC200-5107 \$18.77
- Aeroloc Bail-Head Stud, Dimpled Holes, -08* Part No. ALC200-5108 \$18.77
- Aeroloc Bail-Head Stud, Dimpled Holes, -09* Part No. ALC200-5109 \$18.77
- Aeroloc Bail-Head Stud, Dimpled Holes, -10* Part No. ALC200-5110 \$18.77
- Aeroloc Bail-Head Stud, Dimpled Holes, -11* Part No. ALC200-5111 \$18.77

Aeroloc Receptacles are available in two different heights to cover two different ranges of thicknesses. The 1/8" rivet holes are spaced 1.00" center-to-center to replace Dzus receptacle springs perfectly. Choose the receptacle height based on your total grip in the chart to the right.

- Aeroloc Receptacle, Standard* Part No. ALC205-1000 \$2.34
For total assembly thicknesses ranging from 0.110" to 0.350" when used with stud dash numbers -07 to -11 (to 0.470" with Phillips-Head Studs -12 to -15).
- Aeroloc Receptacle, Low-Profile* Part No. ALC205-3000 \$1.35
For total assembly thicknesses ranging from 0.350" to 0.620" when used with stud dash numbers -07 to -11 (to 0.740" with Phillips-Head Studs -12 to -15).

Aeroloc Receptacle Shims extend the usable range of Aeroloc fasteners by moving the receptacle away from the panel. This has the same effect as shortening the stud, which lets you use a longer stud or a lower-profile receptacle than you normally could. Choose the shim thickness based on your total grip in the chart to the right. Note that shims are not required for every installation.

- Aeroloc Receptacle Shim, thin (0.8mm / 0.030")* Part No. ALC205-9008 \$2.07
Adds 0.030" to the total thickness of the assembly. This has the same effect as using a stud that is one dash number shorter.
- Aeroloc Receptacle Shim, thick (1.5mm / 0.060")* Part No. ALC205-9015 \$2.97
Adds 0.060" to the total thickness of the assembly. This has the same effect as using a stud that is two dash numbers shorter.



Aeroloc stud head types:
Left: Phillips-Head,
Part Numbers ALC200-1xxx
Right: Bail-Head,
Part Numbers ALC200-5xxx

Aeroloc backing plate types:
Left: Plain Holes,
Part Numbers ALC200-x0xx
Right: Dimpled Holes,
Part Numbers ALC200-xlxx

Aeroloc receptacle types:
Left: Standard,
Part Number ALC205-1000
Right: Low-Profile,
Part Number ALC205-3000

The dash numbers shown in the chart below can be found in the last two digits of our part number (e.g., Part No. ALC200-5009 is a -09 stud).

Grip (Total Panel Thickness)	Stud Length (mated to ALC205-1000 standard receptacle)	Stud Length (mated to ALC205-3000 low-profile receptacle)
0.110" - 0.140"	-07***	
0.140" - 0.170"	-07**	
0.170" - 0.200"	-07*	
0.200" - 0.230"	-07	
0.230" - 0.260"	-08	
0.260" - 0.290"	-09	
0.290" - 0.320"	-10	
0.320" - 0.350"	-11	
0.350" - 0.380"	-12	-07****
0.380" - 0.410"	-13	-07***
0.410" - 0.440"	-14	-07**
0.440" - 0.470"	-15	-07*
0.470" - 0.500"		-07
0.500" - 0.530"		-08
0.530" - 0.560"		-09
0.560" - 0.590"		-10
0.590" - 0.620"		-11
0.620" - 0.650"		-12
0.650" - 0.680"		-13
0.680" - 0.710"		-14
0.710" - 0.740"		-15

**** with two 0.060" shims
 *** with one 0.060" shim and one 0.030" shim
 ** with one 0.060" shim
 * with one 0.030" shim

To use this chart:
 1. Measure the total thickness of panels to be fastened together.
 2. Add any gap between panels (for rivet heads or panel misalignment).
 3. Find your measurement in the left column.
 4. Follow the line across to the right to determine which stud, receptacle, and shim (if any) combination to use.

HARDWARE

Quick-Release Positive Locking Pins (Pip Pins)

Pip Pins are high-strength, quick-release fasteners with many racing applications. They are designed to replace a nut and bolt assembly in applications loaded exclusively in shear. This makes them ideal for installing almost anything that needs to be removed frequently, either for adjustment or for quick replacement in the pits. Our Pip Pins are manufactured to MS and NAS specifications (MS17987-S / NASM 17987-S). The shank is 4130 alloy steel, heat treated to 180,000 psi tensile strength, and cadmium plated. These pins have two stainless steel locking balls that securely hold the pin in place until the release button is depressed. Cheaper quick-release pins use simple spring-loaded lock balls, which

can be pushed back into the shank at any time. That can allow the cheaper pins to fall out in normal use. Our pins are strong enough to be used in place of AN bolts in critical double-shear applications such as shock absorber mounts, suspension links, and wing supports. They're even handy in the shop and the trailer! **Note:** The locking balls are very low-profile and require a close-fitting hole. We recommend using an AN960 flat washer (sold separately) on that end of the pin to prevent the pin from pulling through a hole that is slightly loose or chamfered. A large-diameter AN970 washer should be used if the hole is badly worn, or if the pin is used in soft material such as fiberglass or thin sheet metal.



Grip Length is the distance from the shoulder to the locking balls.
Diameter is the shank diameter with the locking balls retracted.
 Our part numbering system calls out the Diameter in sixteenths of an inch, followed by the Grip Length in decimals.

Shear Strength Ratings (when mounted in double shear)	
Size	Rated Strength
1/4" diameter	8200 lbs
5/16" diameter	12,800 lbs
3/8" diameter	18,400 lbs

Ring-Handle Type Pip Pins



T-Handle Type Pip Pins



The Ring-Handle type has a small-diameter round head that is perfect for installations where the pin fits into a recess, such as in fiberglass bodywork. The stainless steel bail-type ring handle (max. 1 1/8" wide) allows you to tether the pin so it won't get lost. The blue anodized aluminum release button is located in the center of the head.

The black anodized aluminum T-handle on these pins make them much easier to grip. The T-handle measures 1 13/16" long on the 1/4" and 5/16" diameter sizes, and 2" long on the 3/8" diameter size. A split ring through one end of the T-handle lets you attach a lanyard for security. The release button is located in the center of the T-handle.

HARDWARE

1/4" Shank Diameter	Part No.	Price
1/4" Diameter x 1/2" Grip Length	3050-4-.50	\$16.79
1/4" Diameter x 3/4" Grip Length	3050-4-.75	\$17.49
1/4" Diameter x 1.00" Grip Length	3050-4-1.00	\$17.49
1/4" Diameter x 1.25" Grip Length	3050-4-1.25	\$18.49
1/4" Diameter x 1.50" Grip Length	3050-4-1.50	\$18.49
1/4" Diameter x 1.75" Grip Length	3050-4-1.75	\$18.49
1/4" Diameter x 2.00" Grip Length	3050-4-2.00	\$18.49
1/4" Diameter x 2.25" Grip Length	3050-4-2.25	\$19.49
1/4" Diameter x 2.50" Grip Length	3050-4-2.50	\$19.49
1/4" Diameter x 3.00" Grip Length	3050-4-3.00	\$19.49
1/4" Diameter x 4.50" Grip Length	3050-4-4.50	\$25.99
5/16" Shank Diameter	Part No.	Price
5/16" Diameter x 1/2" Grip Length	3050-5-.50	\$18.49
5/16" Diameter x 3/4" Grip Length	3050-5-.75	\$18.49
5/16" Diameter x 1.00" Grip Length	3050-5-1.00	\$18.99
5/16" Diameter x 1.25" Grip Length	3050-5-1.25	\$19.49
5/16" Diameter x 1.50" Grip Length	3050-5-1.50	\$20.49
5/16" Diameter x 1.75" Grip Length	3050-5-1.75	\$20.49
5/16" Diameter x 2.00" Grip Length	3050-5-2.00	\$20.49
5/16" Diameter x 2.25" Grip Length	3050-5-2.25	\$22.99
5/16" Diameter x 2.50" Grip Length	3050-5-2.50	\$22.99
5/16" Diameter x 3.00" Grip Length	3050-5-3.00	\$23.79
5/16" Diameter x 3.50" Grip Length	3050-5-3.50	\$23.99
5/16" Diameter x 4.00" Grip Length	3050-5-4.00	\$25.29
3/8" Shank Diameter	Part No.	Price
3/8" Diameter x 3/4" Grip Length	3050-6-.75	\$21.99
3/8" Diameter x 1.00" Grip Length	3050-6-1.00	\$22.99
3/8" Diameter x 1.25" Grip Length	3050-6-1.25	\$22.99
3/8" Diameter x 1.50" Grip Length	3050-6-1.50	\$23.99
3/8" Diameter x 1.75" Grip Length	3050-6-1.75	\$23.99
3/8" Diameter x 2.00" Grip Length	3050-6-2.00	\$23.99
3/8" Diameter x 2.25" Grip Length	3050-6-2.25	\$24.99
3/8" Diameter x 2.50" Grip Length	3050-6-2.50	\$25.99
3/8" Diameter x 3.00" Grip Length	3050-6-3.00	\$25.99
3/8" Diameter x 3.50" Grip Length	3050-6-3.50	\$27.49
3/8" Diameter x 4.00" Grip Length	3050-6-4.00	\$27.49
3/8" Diameter x 4.50" Grip Length	3050-6-4.50	\$29.29

1/4" Shank Diameter	Part No.	Price
1/4" Diameter x 1/2" Grip Length	3043-4-.50	\$16.99
1/4" Diameter x 3/4" Grip Length	3043-4-.75	\$17.49
1/4" Diameter x 1.00" Grip Length	3043-4-1.00	\$17.49
1/4" Diameter x 1.25" Grip Length	3043-4-1.25	\$17.99
1/4" Diameter x 1.50" Grip Length	3043-4-1.50	\$17.99
1/4" Diameter x 1.75" Grip Length	3043-4-1.75	\$17.99
1/4" Diameter x 2.00" Grip Length	3043-4-2.00	\$17.99
1/4" Diameter x 2.25" Grip Length	3043-4-2.25	\$17.99
1/4" Diameter x 2.50" Grip Length	3043-4-2.50	\$19.29
1/4" Diameter x 3.00" Grip Length	3043-4-3.00	\$19.29
1/4" Diameter x 4.50" Grip Length	3043-4-4.50	\$22.79
5/16" Shank Diameter	Part No.	Price
5/16" Diameter x 1/2" Grip Length	3043-5-.50	\$20.49
5/16" Diameter x 3/4" Grip Length	3043-5-.75	\$22.29
5/16" Diameter x 1.00" Grip Length	3043-5-1.00	\$18.79
5/16" Diameter x 1.25" Grip Length	3043-5-1.25	\$18.79
5/16" Diameter x 1.50" Grip Length	3043-5-1.50	\$18.79
5/16" Diameter x 1.75" Grip Length	3043-5-1.75	\$18.79
5/16" Diameter x 2.00" Grip Length	3043-5-2.00	\$18.79
5/16" Diameter x 2.25" Grip Length	3043-5-2.25	\$19.49
5/16" Diameter x 2.50" Grip Length	3043-5-2.50	\$19.99
5/16" Diameter x 3.00" Grip Length	3043-5-3.00	\$19.99
5/16" Diameter x 3.50" Grip Length	3043-5-3.50	\$20.79
5/16" Diameter x 4.00" Grip Length	3043-5-4.00	\$21.29
3/8" Shank Diameter	Part No.	Price
3/8" Diameter x 3/4" Grip Length	3043-6-.75	\$18.99
3/8" Diameter x 1.00" Grip Length	3043-6-1.00	\$19.79
3/8" Diameter x 1.25" Grip Length	3043-6-1.25	\$19.79
3/8" Diameter x 1.50" Grip Length	3043-6-1.50	\$19.79
3/8" Diameter x 1.75" Grip Length	3043-6-1.75	\$19.79
3/8" Diameter x 2.00" Grip Length	3043-6-2.00	\$19.79
3/8" Diameter x 2.25" Grip Length	3043-6-2.25	\$20.79
3/8" Diameter x 2.50" Grip Length	3043-6-2.50	\$20.79
3/8" Diameter x 3.00" Grip Length	3043-6-3.00	\$20.79
3/8" Diameter x 3.50" Grip Length	3043-6-3.50	\$21.49
3/8" Diameter x 4.00" Grip Length	3043-6-4.00	\$21.99
3/8" Diameter x 4.50" Grip Length	3043-6-4.50	\$22.99

Pulled (Blind) Rivets

Our blind ("pop") rivets offer excellent quality at a great price. These rivets are designed for light-duty fastening, not for structural use. Steel and stainless steel rivets provide the highest strength. Aluminum-body rivets are easier to drill out if disassembly becomes necessary. The all-aluminum rivets offer better corrosion resistance, and their lower clamping force is sometimes an advantage when fastening

soft or brittle materials (a backup washer is recommended on these materials). We also stock closed end rivets in addition to the more common (and less expensive) open end style. Closed end rivets can help to prevent liquids and gases from passing through the riveted joint. They also ensure that the mandrel head does not fall out after assembly, and they provide a neater appearance. Rivets are sold in packs of 100.

Standard Head



Rivet Dia.	Head Dia.
3/32	.188
1/8	.250
5/32	.312
3/16	.375

120° Countersunk Head

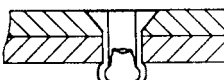

Rivet Dia.	Head Dia.
1/8	.188
5/32	.280

Large Flange Head

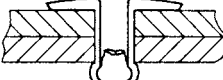

Rivet Dia.	Head Dia.
1/8	.375
3/16	.625

Buy in bulk and save!

See our website for quantity discounts!

Rated Rivet Strength			
Rivet Diameter	Material Body/Mandrel	Shear Strength	Tensile Strength
1/8	Alum/Alum	120 lb.	150 lb.
5/32	Alum/Alum	190 lb.	230 lb.
3/16	Alum/Alum	260 lb.	320 lb.
3/32	Alum/Steel	100 lb.	120 lb.
1/8	Alum/Steel	170 lb.	220 lb.
5/32	Alum/Steel	260 lb.	350 lb.
3/16	Alum/Steel	380 lb.	500 lb.
1/8	Steel/Steel	260 lb.	310 lb.
5/32	Steel/Steel	370 lb.	470 lb.
3/16	Steel/Steel	540 lb.	680 lb.
1/8	Stainless/Steel	420 lb.	530 lb.
5/32	Stainless/Steel	650 lb.	820 lb.
3/16	Stainless/Steel	950 lb.	1200 lb.

Description	Open End Rivets				Closed End Rivets					
	Aluminum Body Aluminum Mandrel		Aluminum Body Steel Mandrel		Steel Body Steel Mandrel		Stainless Body Steel Mandrel		Aluminum Body Steel Mandrel	
	Part No.	100pk	Part No.	100pk	Part No.	100pk	Part No.	100pk	Part No.	100pk
3/32 Std. Head, 0 - 1/8 Grip			640-AS-32-S	\$2.99						
3/32 Std. Head, 1/8 - 1/4 Grip			640-AS-34-S	\$3.19						
1/8 Std. Head, 0 - 1/8 Grip	640-AA-42-S	\$3.29	640-AS-42-S	\$2.99	640-SS-42-S	\$2.99	640-ST-42-S	\$6.99	642-42-S	\$5.49
1/8 Std. Head, 1/8 - 1/4 Grip	640-AA-44-S	\$3.69	640-AS-44-S	\$2.99	640-SS-44-S	\$3.29	640-ST-44-S	\$7.89	642-44-S	\$7.19
5/32 Std. Head, 0 - 1/8 Grip	640-AA-52-S	\$4.39	640-AS-52-S	\$3.49	640-SS-52-S	\$4.29	640-ST-52-S	\$9.79	642-52-S	\$8.19
5/32 Std. Head, 1/8 - 1/4 Grip	640-AA-54-S	\$4.39	640-AS-54-S	\$4.29	640-SS-54-S	\$4.69	640-ST-54-S	\$10.99	642-53-S *	\$7.59
3/16 Std. Head, 1/8 - 1/4 Grip	640-AA-64-S	\$6.19	640-AS-64-S	\$5.99	640-SS-64-S	\$6.49	640-ST-64-S	\$13.79	642-64-S	\$12.29
3/16 Std. Head, 1/4 - 3/8 Grip	640-AA-66-S	\$7.19	640-AS-66-S	\$5.99	640-SS-66-S	\$7.19	640-ST-66-S	\$16.49	642-66-S	\$10.99
1/8 C'sunk Head, 0 - 1/8 Grip	640-AA-42-C	\$3.69	640-AS-42-C	\$2.99					642-42-C	\$6.59
1/8 C'sunk Head, 1/8 - 1/4 Grip	640-AA-44-C	\$4.19	640-AS-44-C	\$4.19					642-44-C	\$6.99
5/32 C'sunk Head, 1/8 - 1/4 Grip	640-AA-54-C	\$6.19								
1/8 Large Head, 1/8 - 1/4 Grip	640-AA-44-L	\$4.99	640-AS-44-L	\$4.59						
3/16 Large Head, 1/8 - 1/4 Grip	640-AA-64-L	\$9.29	640-AS-64-L	\$8.99						
3/16 Large Head, 1/4 - 3/8 Grip	640-AA-66-L	\$10.29	640-AS-66-L	\$8.19						

* 1/8 - 3/16 Grip

See page 100 for NAS1097 solid aircraft rivets and solid rivet squeezing tools for nut plate installation.

Blind Rivet Removal Tool



If you have ever had to drill out a pop rivet, chances are you have watched your drill bit dig into the rivet head and spin it around in the hole. It's a frustrating waste of time, and it doesn't do the hole any good either! This clever tool has a serrated nose that bites into the rivet head, letting you hold it firmly in place with a knurled handle. The special inner drill bit is sized to fit the rivet precisely, which prevents drilling the hole oversize. Pressing the nose against the rivet also makes it easier to line up the drill bit square to the rivet head. Includes cobalt drill bit and nose assemblies to fit 3/32", 1/8", 5/32", and 3/16" diameter rivets. Works on standard, countersunk, or large heads; open-end or closed-end rivets. It can even be used on solid aircraft rivets with flat heads. Use with any 3/8" variable speed drill.

Blind Rivet Removal Tool Part No. 6390-002 \$75.99

Backup Washers (500 per package)

Backup washers are recommended when fastening soft or brittle materials.

Plated Steel Backup Washers: Part No. Price/500

For 1/8 inch diameter rivets, 1/16 inch thick 641-1/8 \$9.49

For 5/32 inch diameter rivets, 1/16 inch thick 641-5/32 \$8.49

For 3/16 inch diameter rivets, 1/16 inch thick 641-3/16 \$9.99

Heavy-Duty Blind Rivet Pulling Tools



Standard Head Rivet Tool If you find yourself quickly wearing out or breaking cheaper riveting tools, you'll appreciate the quality of this model. The die cast handles offer great durability and are much more comfortable to grip than the stamped steel parts normally found in cheaper tools. Includes nose pieces for all common rivet diameters.

Standard Head Rivet Tool Part No. 3102 \$18.79



360° Swivel Head Rivet Tool The head of this unique pop rivet gun rotates 360 degrees, making it easier to set rivets in tight spaces. The head can be oriented perpendicular to the handles (as on a conventional gun) or parallel to the handles. Includes nose pieces for all common rivet diameters.

360° Swivel Head Rivet Tool Part No. 3100 \$31.49

Save your wrist! See page 118 for an air rivet gun from Beta Tools.

Cleco Clamps

These temporary, reusable fasteners are the fabricator's best friend. Once you've used them you'll wonder how you ever managed without. Install them as you drill holes that are to be riveted at a later time. The Cleco clamps will hold the parts together and maintain perfect alignment. When all of the holes are drilled you can quickly disassemble the parts for deburring or for other fabrication steps. The standard Clecos have a 1/4 inch maximum grip. They are color coded for easy identification (see below). The Side Grip clamp has a 3/4 inch maximum grip and a jaw depth of 1 inch.

Description	Part No.	Price each	Price per 100
3/32" Diameter Cleco Clamp (silver color)	645-3	59c	\$49.99
1/8" Diameter Cleco Clamp (copper color)	645-4	59c	\$49.99
5/32" Diameter Cleco Clamp (black color)	645-5	59c	\$49.99
3/16" Diameter Cleco Clamp (gold color)	645-6	59c	\$49.99
Side Grip Clamp, 3/4 inch grip	646-3/4-1.0	\$2.89	
Cleco Pliers	647-Plier	\$8.49	

Required for installing and removing Cleco clamps. Fits all sizes including side grip type.



Standard Cleco Clamps
Part No. 645-Size



Side Grip Cleco Clamp
Part No. 646-3/4-1.0



Cleco Pliers
Part No. 647-Plier

Buy 100 and save!

Latches and Hood Pins



Rubber Draw Latches These versatile latches come in a wide range of sizes. They can withstand severe misalignments and shock loading. The metal parts are solid stainless steel and will never rust or chip. The length dimension given below is the distance from the pivot point to the end of the handle in the relaxed (unstretched) condition. (The largest size can be used as a replacement for the original Saab Sonett hood latch.) Sold individually.

- Small Tab Handle - 1.7 inch length Part No. 3030..... \$5.99
- Medium Tab Handle - 2.3 inch length Part No. 3031..... \$7.49
- Medium T-Handle - 2.6 inch length..... Part No. 3032..... \$8.99
- Large T-Handle - 3.6 inch length..... Part No. 3033..... \$12.49
- X-large T-Handle - 4.6 inch length..... Part No. 3034..... \$16.99



Dzus 1500 Slide Latch An ideal way to attach a panel that requires easy installation and removal. The latch assembly is attached to the removable panel with 1/8" rivets and the bushing is mounted to the panel's stationary support with an 8-32 or 4mm screw. No spacer is required for .063-.080 panels. Use 1 spacer for .098-.128 panels, 2 spacers for .138-.160 panels. See our website for installation information.

- Slide Latch and Bushing .. Part No. 3009 \$2.89
 - Spacer for Bushing..... Part No. 3018..... 37¢
 - Bushing Only Part No. 3016..... 89¢
- Also useful as anchors for O-Ring body attachments.



Narrow Toggle Latches These solid stainless steel latches are narrow, 5/8 inch wide (not including the latch link), and easy to mount in tight spaces. They have the ability to pull-up .60 inch and have an ultimate strength of 700 lb. and a working strength of 100 lb. The spring tempered bowed latch link absorbs shock loads and the latches have provisions for safety wiring. Mounting holes are .167 inch diameter. Sold individually.

- Latch Only (order strike plate separately) Part No. 3040 \$4.99 each
- Strike Plate Only..... Part No. 3041..... \$1.09 each



Light-Duty Aluminum Hood Pins These 3/8 inch diameter pins are manufactured from high-strength aluminum alloy. They are 4 inches long overall. The threaded portion is about 2 1/2 inch long. The 1 1/2 inch diameter scuff plates are to be attached to the hood surface. If these are the only means of retaining the hood, 6 are recommended. Sold in pairs.

- Set of two pins..... Part No. 3035..... \$16.99



Terry Body Hold-Down Springs These well-proven fasteners are one of the best ways to hold noses, fenders or other body parts to a race car. They allow the body parts to take a little "bumping" since the springs can stretch and then pull the part back into place. They are easy to install and easy to disconnect. Sold individually.

- Spring Only, each Part No. 3001..... \$6.59 each
- Hook Only, each..... Part No. 3002..... \$1.49 each



Camloc 40 Series Spring Tab Used on modern formula cars as an aerodynamic method of holding two non-overlapping panels together. The tabs are designed to accept a 40-series Camloc stud (not included, see page 102). Tab measures 4" long overall by .825" maximum width by .025" thick and requires two 1/8" rivets for installation. The distance from the center of the stud to the center of the closer rivet is 2.95". The installed grommet adds .075" to the grip length required on the Camloc stud. Gold zinc plating matches the finish of the Camloc studs. The curvature of the tab holds the stud away from the panel when released.

- Camloc #4002-SN Spring Tab With Grommet..... Part No. 6079..... \$9.99



Camloc 26/27 Series Spring Tab Similar to the above tabs but designed for 26 or 27 series studs. This tab has an extruded hole rather than a separate bushing for holding the Stud Assembly. Tab measures 3.25" long overall by .560" maximum width by .023" thick. The distance from the center of the stud to the center of the closer rivet is 2.35."

- Camloc #2600-ES Spring Tab..... Part No. 6078..... \$8.29



Adjustable Toggle Latch with Secondary Lock

These latches have a maximum width of 1 inch. The threaded hook provides a simple means to control tension. A secondary lock helps to insure against accidental opening. They have a working strength of 350 lbs. Mounting holes are .144 inch diameter. Sold individually.

- Latch and Strike Plate, one of each Part No. 3045..... \$11.49
- Replacement Strike Plate only..... Part No. 3046..... \$1.59 each



Heavy-Duty Captive Latch Steel Hood Pin Assemblies

You need not worry about losing any parts with this style hood pin. The spring loaded clevis pin always stays attached to the stainless steel retainer plate which is riveted or screwed to the hood surface. The 7/16 inch diameter steel hood pins measure 4 1/2 inches long from the hood surface. The clevis pins are a full 1/4 inch diameter making these assemblies one of the strongest available. Sold in pairs.

- Set of two complete hood pin assemblies Part No. 3037..... \$17.99

AeroCatch Panel Latches

AeroCatch is simple to use — even simpler than conventional hood pins!

• **To close:** Simply lower the actuating lever. You don't have to line up the clevis pin with the hole in the hood pin. You can even do it with gloves on, blindfolded, and with one hand behind your back! Press down on the actuating lever to engage the secondary latch and prevent accidental opening. *Even if the secondary latch is not engaged, the hood pin is still engaged.*

• **To open:** Push on the secondary latch release button (if engaged) and lift the actuating lever. The actuating lever gives a clear visual indicator of the status of the pin (disengaged, engaged, or latched).

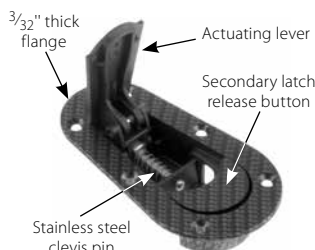

"Plus Flush" AeroCatch
Part No. 3038-001-Carbon Look
(sold in pairs; one shown)

The **AeroCatch** is a new twist on hood pins. Hidden inside the aerodynamic thermo-plastic housing is a stainless steel clevis pin which engages an anodized high-strength aluminum hood pin. The entire mechanism is fully enclosed and protected.

The AeroCatch is available in non-keyed or keyed versions in paintable black or carbon fiber look. (Note: Carbon Look is the same thermoplastic housing, not actual carbon fiber.) Choose Flush-mount or "Plus Flush" (surface mount) with a low-profile 3/32" mounting flange. Sold in pairs with all hardware, instructions, and template included.

"Plus Flush" Mount, Non-Keyed AeroCatch:

- Plus Flush, Non-Keyed, Black, pair Part No. 3038-001-Black \$73.99
- Plus Flush, Non-Keyed, Carbon Look, pair Part No. 3038-001-Carbon Look . \$106.99

Flush-Mount, Keyed AeroCatch:

- Flush-Mount, Keyed, Black, pair Part No. 3038-002-Black \$90.99
- Flush-Mount, Keyed, Carbon Look, pair Part No. 3038-002-Carbon Look . \$133.99

"Plus Flush" Mount, Keyed AeroCatch:

- "Plus Flush", Keyed, Black, pair..... Part No. 3038-003-Black \$90.99
- "Plus Flush", Keyed, Carbon Look, pair..... Part No. 3038-003-Carbon Look . \$133.99

AeroCatch 3 Panel Latches

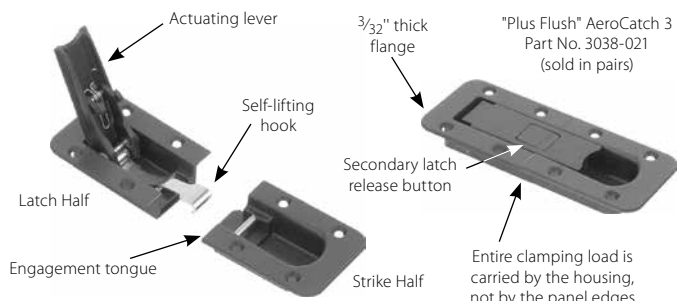

The **AeroCatch 3** is a high-strength draw latch recessed into an aerodynamic, high-strength aluminum housing. The housing bears all of the clamping load, minimizing wear on composite body panels. An engagement tongue in the housing handles shear loads, positively locating panels without the need for alignment pins. A secondary latch prevents accidental opening, and the self-lifting hook makes closing the AeroCatch 3 an easy, one-handed operation. When closed, the latch sits level with the low-profile 3/32" mounting flange on the housing.

The AeroCatch 3 is available in "Plus Flush" style in black anodized aluminum. Sold in pairs with mounting hardware, instructions, and mounting template. Replacement halves are available separately for your spare bodywork.

- Plus Flush AeroCatch 3, pair..... Part No. 3038-021 \$269.99
- Plus Flush AeroCatch 3 Replacement Latch Half, each Part No. 3038-030 \$90.99
- Plus Flush AeroCatch 3 Replacement Strike Half, each Part No. 3038-031 \$47.99

Cable Clamps, Hole Bushings, Edge Strip, and Miscellaneous Fasteners

Cable Clamps

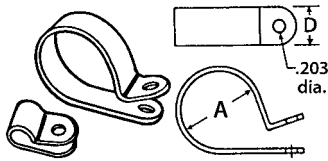

These white nylon clamps will securely hold wires, cables, or small hoses in place. The inside edges are beveled to prevent abrasion. The size is molded onto the clamp for easy identification. Sizes up to and including 1/2" nominal diameter have a width ("D" dimension) of 3/8"; larger sizes have a width of 1/2". For securing heavier hoses and pipes,

see page 88 for heavy-duty vinyl or rubber lined metal clamps.

Nominal Size ("A" dimension):

1/8 Inch	Part No. 4310	12¢
3/16 Inch	Part No. 4311	12¢
1/4 Inch	Part No. 4312	12¢
5/16 Inch	Part No. 4313	12¢
3/8 Inch	Part No. 4314	12¢
7/16 Inch	Part No. 4315	13¢
1/2 Inch	Part No. 4316	14¢
9/16 Inch	Part No. 4317	19¢
5/8 Inch	Part No. 4318	19¢
11/16 Inch	Part No. 4319	20¢
3/4 Inch	Part No. 4320	20¢
7/8 Inch	Part No. 4321	25¢
1 Inch	Part No. 4322	33¢
1 1/8 Inch	Part No. 4323	29¢
1 1/4 Inch	Part No. 4324	34¢
1 3/8 Inch	Part No. 4325	35¢
1 1/2 Inch	Part No. 4326	36¢

Cable Clamp Assortments, bulk packed:

70 piece - 10 of each size 1/8 to 1/2 inch	Part No. 4327	\$6.59
48 piece - 8 of each size 9/16 to 1 inch	Part No. 4328	\$8.19
32 piece - 8 of each size 1 1/8 to 1 1/2 inch	Part No. 4329	\$7.99

Light-Duty Plastic Grommet Strip

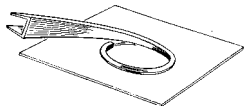

These thin U-shaped nylon extrusions can be used to protect wires and hoses when they pass through holes in sheet metal or to cover a sharp edge of a metal panel. The flanges can be slit to form sharp corners such as when lining the inside of a rectangular opening. Available in natural translucent white color.

Small size Up to .036 panel thickness (20 gauge):

Per foot:	Part No. 4308-FT	39¢
Per 100 foot roll:	Part No. 4308-ROLL	\$31.49

Medium size From .037 to .105 panel thickness (19 to 12 gauge):

Per foot:	Part No. 4309-FT	44¢
Per 100 foot roll:	Part No. 4309-ROLL	\$35.49

Large size From .106 to .164 panel thickness (11 to 8 gauge):

Per foot:	Part No. 4345-FT	54¢
Per 100 foot roll:	Part No. 4345-ROLL	\$43.49

Cotter Pins



See page 98 for smaller cotter pins for use with AN310 castellated nuts.

We stock several common sizes of cotter pins that are used to retain brake pads, exhaust systems, etc. See page 98 for smaller sizes for use with AN310 castellated nuts.

The length dimension does not include the head.

1/8 inch (0.125) dia. x 2.25 inch long	Part No. 660-4-2.25	10¢ ea.
1/8 inch (0.125) dia. x 3.00 inch long	Part No. 660-4-3.00	15¢ ea.
1/8 inch (0.125) dia. x 4.00 inch long	Part No. 660-4-4.00	20¢ ea.
5/32 inch (0.156) dia. x 1.50 inch long	Part No. 660-5-1.50	15¢ ea.
5/32 inch (0.156) dia. x 2.25 inch long	Part No. 660-5-2.25	15¢ ea.
5/32 inch (0.156) dia. x 3.00 inch long	Part No. 660-5-3.00	20¢ ea.
5/32 inch (0.156) dia. x 4.00 inch long	Part No. 660-5-4.00	25¢ ea.
3/16 inch (0.187) dia. x 1.50 inch long	Part No. 660-6-1.50	15¢ ea.
3/16 inch (0.187) dia. x 2.25 inch long	Part No. 660-6-2.25	24¢ ea.
Cotter Pin Assortment Kit, 25 of each size stocked	Part No. 660-Kit	\$29.79

Light-Duty Retainer Clips



This clip comes in handy when you need a light-duty safety lock fastener. It's quick and easy to fasten or remove and is reusable. Once installed, it is very resistant to vibration. This Military Specification retainer is formed from 0.052" diameter high tensile strength spring wire. The grip capacity is 0.75 inch at a maximum depth of 0.15 inch. In

other words, it can be fastened through a cross drilled hole in a 0.75 inch diameter shaft up to 0.15" in from the end of the shaft. Because of the relatively small wire diameter, it should not be used in applications that would subject it to high shear loads.

Reusable Retainer Clip	Part No. 3036	59¢ each
------------------------	---------------	----------

Hole Bushings

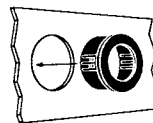

These black plastic bushings snap into holes in panels up to 1/8 inch thick (except Part No. 4300 which fits up to a 1/16 inch thick panel). Protect wires, cables and hoses by covering sharp edges of holes.

1/4" mounting hole — 1/8" inside dia.	Part No. 4300	14¢
3/8" mounting hole — 1/4" inside dia.	Part No. 4301	17¢
1/2" mounting hole — 3/8" inside dia.	Part No. 4302	18¢
5/8" mounting hole — 1/2" inside dia.	Part No. 4303	19¢
3/4" mounting hole — 5/8" inside dia.	Part No. 4304	27¢
1" mounting hole — 3/4" inside dia.	Part No. 4305	37¢

Eight of each of the above sizes, bulk packed.

48 Piece Hole Bushing Assortment	Part No. 4306	\$8.49
----------------------------------	---------------	--------

Deluxe Hole Bushing and Cable Clamp Assortment

This assortment kit contains all 6 sizes of Plastic Hole Bushings (above) and the 12 smallest sizes of Nylon Cable Clamps (left) in an 18 compartment molded plastic organizer. Contains a total of 50 bushings and 80 clamps.



Hole Bushing and Cable Clamp Assortment

Part No. 4307 \$20.29

Molded Plastic Organizer

This is the same clear plastic case supplied with the kit above. Measures about 9 x 5 x 1.25 inches. Includes a hinged lid and removable dividers to let you arrange from 3 to 18 compartments. Great for carburetor jets or any other small parts.

Plastic Organizer Only	Part No. 4330	\$6.99
------------------------	---------------	--------

Heavy-Duty Strip



Grips tightly without messy adhesives!

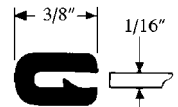

Typical cross section. Part No. 4346-06 is shown

Metal clips inside maintain tight grip.

This heavy-duty vinyl edge grommet material has a very high retention force thanks to the light aluminum clips embedded within the plastic. A wide range of thicknesses are available to accommodate divers applications, from thin sheet metal to heavy-wall or sandwiched composite panels. Despite its heavy-duty rating, it is still quite flexible because of the aluminum clips (rather than heavier steel). The flanges can also be notched in order to make sharp corners. Available in black only. Sold by the foot; also available in 250' rolls. Please call or visit our website for pricing.

1/32 inch panel thk. x .39", per foot	Part No. 4346-03-Ft	\$1.19
1/16 inch panel thk. x .38", per foot	Part No. 4346-06-Ft	\$1.29
3/32 inch panel thk. x .38", per foot	Part No. 4346-09-Ft	\$1.29
1/8 inch panel thk. x .56", per foot	Part No. 4346-12-Ft	\$1.49
3/16 inch panel thk. x .53", per foot	Part No. 4346-19-Ft	\$1.49
1/4 inch panel thk. x .50", per foot	Part No. 4346-25-Ft	\$1.49

Rubber Edge Trim



Replaces the eyeport and base molding on most helmets

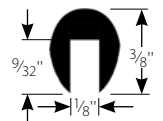

This soft rubber edge trim is thicker than both the Light-Duty Plastic Grommet Strip and Heavy-Duty Strip above. It also has a more rounded outer profile for better cushioning. This makes it ideal for use on hard edges in the cockpit. It is also the perfect size to replace the molding around the base or eyeport of your helmet. Measures 3/8" overall top to bottom, with a 1/8" wide x 9/32" deep groove. Hold it in place with weatherstrip adhesive or our HV-350 flexible adhesive (sold separately on page 158). Available in black only. Sold by the running foot.

Rubber Edge Trim, per foot	Part No. 4336-201	\$1.39/ft.
----------------------------	-------------------	------------

Rubber Shock Mounts, 10-32 threads (male and female)



A must for isolating delicate components from shock and vibration. All have 10-32 male studs (3/8 inch long) at both ends except for Part No. 3049-02, which has 10-32 female thread (1/4 inch depth) on one end. This provides a very clean appearance when mounting a dash panel with button head Allen screws.

3/8 inch dia. x 1/2 inch high, male studs at both ends	Part No. 3048-01	\$4.49
3/4 inch dia. x 3/8 inch high, male studs at both ends	Part No. 3048-02	\$4.99
1 inch dia. x 3/4 inch high, male studs at both ends	Part No. 3048-03	\$5.99
3/4 inch dia. x 3/8 inch high, female & male threads	Part No. 3049-02	\$4.99

Skid Plate Material

Jabroc

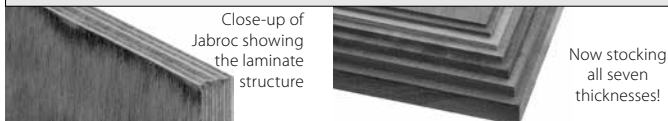

Close-up of Jabroc showing the laminate structure

Now stocking all seven thicknesses!

Jabroc Skid Plate Material is a high-density wood laminate that is manufactured using extremely high pressures and temperatures. This results in predictable and uniform wear and friction properties, making it ideal for skid plates. When installed over vulnerable areas on the bottom of your vehicle's chassis, Jabroc can be very effective at protecting these areas from damage due to bottoming out on the track surface or curbing. Jabroc can be cut and shaped using standard metalworking tools. We now stock Jabroc in all 7 thicknesses, from 4mm ($\frac{5}{32}$ "") through 25mm (1"). Jabroc is available in eighth sheets (50cm x 50cm, approx. 19 1/2" square), quarter sheets (50cm x 100cm, 19 1/2" x 39"), and full sheets (100cm x 200cm, 39" x 78"). See note below concerning shipping full sheets.

One-Eighth Sheets, 50cm x 50cm nominal (approximately 19.5" x 19.5"):

- Jabroc Skid Plate, 4mm ($\frac{5}{32}$ ""), 50cm x 50cm Part No. 6180-04-050x050 \$41.49
- Jabroc Skid Plate, 5mm ($\frac{3}{16}$ ""), 50cm x 50cm Part No. 6180-05-050x050 \$50.49
- Jabroc Skid Plate, 6mm ($\frac{1}{4}$ ""), 50cm x 50cm Part No. 6180-06-050x050 \$57.49
- Jabroc Skid Plate, 8mm ($\frac{5}{16}$ ""), 50cm x 50cm Part No. 6180-08-050x050 \$70.99
- Jabroc Skid Plate, 10mm ($\frac{3}{8}$ ""), 50cm x 50cm Part No. 6180-10-050x050 \$92.99
- Jabroc Skid Plate, 12.7mm ($\frac{1}{2}$ ""), 50cm x 50cm Part No. 6180-12.7-050x050 \$108.99
- Jabroc Skid Plate, 25mm (1"), 50cm x 50cm Part No. 6180-25-050x050 \$202.99

One-Quarter Sheets, 50cm x 100cm nominal (approximately 19.5" x 39"):

- Jabroc Skid Plate, 4mm ($\frac{5}{32}$ ""), 50 x 100cm Part No. 6180-04-050x100 \$75.99
- Jabroc Skid Plate, 5mm ($\frac{3}{16}$ ""), 50 x 100cm Part No. 6180-05-050x100 \$94.99
- Jabroc Skid Plate, 6mm ($\frac{1}{4}$ ""), 50 x 100cm Part No. 6180-06-050x100 \$103.99
- Jabroc Skid Plate, 8mm ($\frac{5}{16}$ ""), 50 x 100cm Part No. 6180-08-050x100 \$135.99
- Jabroc Skid Plate, 10mm ($\frac{3}{8}$ ""), 50 x 100cm Part No. 6180-10-050x100 \$177.99
- Jabroc Skid Plate, 12.7mm ($\frac{1}{2}$ ""), 50 x 100cm Part No. 6180-12.7-050x100 \$207.99
- Jabroc Skid Plate, 25mm (1"), 50 x 100cm Part No. 6180-25-050x100 \$389.99

Full Sheets, 100cm x 200cm nominal (approximately 39" x 78"), see note below:

- Jabroc Skid Plate, 4mm ($\frac{5}{32}$ ""), 100 x 200cm Part No. 6180-04-100x200 \$239.99
- Jabroc Skid Plate, 5mm ($\frac{3}{16}$ ""), 100 x 200cm Part No. 6180-05-100x200 \$299.99
- Jabroc Skid Plate, 6mm ($\frac{1}{4}$ ""), 100 x 200cm Part No. 6180-06-100x200 \$334.99
- Jabroc Skid Plate, 8mm ($\frac{5}{16}$ ""), 100 x 200cm Part No. 6180-08-100x200 \$434.99
- Jabroc Skid Plate, 10mm ($\frac{3}{8}$ ""), 100 x 200cm Part No. 6180-10-100x200 \$559.00
- Jabroc Skid Plate, 12.7mm ($\frac{1}{2}$ ""), 100 x 200cm Part No. 6180-12.7-100x200 \$659.00
- Jabroc Skid Plate, 25mm (1"), 100 x 200cm Part No. 6180-25-100x200 \$1,279.00

* **A Note about shipping full sheets of Jabroc:** Eighth and quarter sheets of Jabroc can be shipped via UPS. Full sheets can only be shipped via truck freight within the continental USA. We can ship full sheets for a flat rate of \$149 per shipment (no limit to the number of sheets per shipment), protected by a special oversized pallet at no additional cost. You can also pick up your order for free at our warehouse in New Berlin, WI.

Polymer Wear Strips

Our **Abrasion-Resistant Polymer Wear Strips** are ideal for protecting side pods, air dams, side skirts, and other low-hanging bodywork from pavement damage. It outlasts abrasion-resistant steel, yet is easily cut and shaped. In one test, our special polymer strip outlasted stainless steel more than 5 times! It is easily drilled, tapped or machined much like aluminum except the cutting speeds can be much higher. Stocked in one inch wide strips in three thicknesses: 1/4, 1/2 and 3/4 inch thick. Specify length in inches.

- 1/4 inch thick x 1 inch wide Part No. 6101 29¢ per inch
- 1/2 inch thick x 1 inch wide Part No. 6102 39¢ per inch
- 3/4 inch thick x 1 inch wide Part No. 6103 49¢ per inch

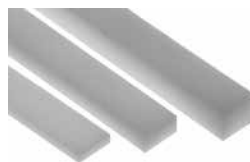

Abrasion-Resistant Polymer Wear Strips
1/4", 1/2", and 3/4" thick
Part Nos. 6101, 6102, and 6103
All thicknesses are 1" wide.

Tape

Leading Edge (Helicopter) Tape

This special impact-absorbing tape protects the leading edges of wings, suspension parts, air dams, and bodywork. It has high adhesive strength and is pliable enough to conform to slightly compound curves. Sand, gravel and small stones that would quickly remove the best paint from these exposed surfaces just bounce off this very tough leading edge tape.



- Black Leading Edge Tape, 2" wide x 100 feet, 11 mil thick Part No. 3323-2 \$11.99
- Black Leading Edge Tape, 4" wide x 100 feet, 11 mil thick Part No. 3323-4 \$22.99
- Clear Leading Edge Tape, 2" wide x 12 feet, 8 mil thick Part No. 3437-001-2 \$22.49
- Clear Leading Edge Tape, 4" wide x 12 feet, 8 mil thick Part No. 3437-001-4 \$32.49

Aluminum Tape

3M Aluminum Tape is a very high-strength and weather-resistant adhesive tape. The heavy foil features a strong adhesive backing. It is ideal for taping over wheel weights, as a light-duty heat shield, or for abrasion protection. Supplied in a 2 inch by 125 inch roll.

- 3M Aluminum Tape, 2" by 125" (10' 5") roll Part No. 3322 \$11.99

3M™ Hook and Loop Materials



Not to be confused with Velcro®! Same principle, but for higher strength applications requiring a temporary mount. Now available in 3 combinations to customize to your application. For applications where one part needs to be flexible or easily handled without scratching, we

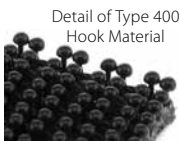

Detail of Type 400 Hook Material

recommend **Type 170 Hook with Standard Loop Material**. Stiff hooks on one strip are pressed together with pliable loops from the second strip. For applications where both parts are strong and rigid, use **Type 170 with Type 400 Hook Material**. Stiff hooks on one strip are pressed together with even stiffer hooks on the second strip. For the strongest hold, use **Type 400 with Type 400 Hook Material**. In this application, stiff mushroom-shaped hooks on each strip are pressed together to create a very rigid mount. This combination is only recommended for applications where at least one part is flexible to allow the hooks to release as they are peeled apart. All available in black only; 1 inch wide with a very strong adhesive backing. Sold by the running foot.

- 3M™ Type 170 Hook with Standard Loop Material, per ft. Part No. 5260-050 \$5.39
- 3M™ Type 170 with Type 400 Hook Material, per foot Part No. 5260-051 \$6.49
- 3M™ Type 400 with Type 400 Hook Material, per foot Part No. 5260-052 \$5.79

This super-strong combination is also known as 3M™ Dual Lock™.

Racer's Tape



Super Racer's Tape This is not run-of-the-mill duct tape. It is the strongest and stickiest tape available. A roll of our Super Tape weighs 20% more than the same size roll of our regular tape. It's so strong, you may have trouble tearing a length of tape off of the roll! Available in Black, Red, White, and Silver on 48mm x 60 yard rolls.

- Super Racer's Tape, specify color Part No. 3320-Color \$15.99



Regular Racer's Tape Since our Super Tape is only available in four colors, we also carry a slightly lower-quality tape in other popular colors. This tape is still far superior to duct tape. Available in Blue, Green, Orange, Purple, and Yellow on 2 inch x 60 yard rolls, and Transparent on 48mm x 20 yard rolls.

- Racer's Tape, specify color Part No. 3321-Color \$8.49
- Transparent Racer's Tape Part No. 3437-100 \$9.99

Gaffer's Tape



Gaffer's Tape is similar to Racer's Tape, but without the shiny finish and without the sticky residue. The lower-strength adhesive is great for any temporary taping job. It is ideal for covering car decals or suit patches to satisfy series rules. Available in Black, Blue, Red, White, or Yellow on 2 inch x 60 yard rolls.

- Matte-Finish Gaffer's Tape, specify color Part No. 3436-001-Color.. \$19.79

Note: Blue Gaffer's Tape is a very dark navy blue (almost black).

Non-Skid Traction Tape



Black Non-Skid Tape
Part No. 3437-020

Clear Non-Skid Tape
Part No. 3437-021

This specially textured tape helps you get a grip on any smooth surface. Reduce the chance of slip-and-fall injuries on slick floors, keep your feet on the pedals, or make it easier to loosen your spin-on oil filter! The grainy texture helps your shoes or your hands to grip better, even in wet conditions. Adhesive backing makes a permanent installation as easy as peel-and-stick. Black has a gritty texture almost like sandpaper. Clear is "rubberized", with a more pliable molded texture. Each roll is 4 inches wide.

- Non-Skid Traction Tape, Black, 10 feet Part No. 3437-020 \$17.79
- Non-Skid Traction Tape, Rubberized Clear, 7.5 feet Part No. 3437-021 \$18.99

Heat Barriers and Insulation

Thermal Barrier Cloth and Tape

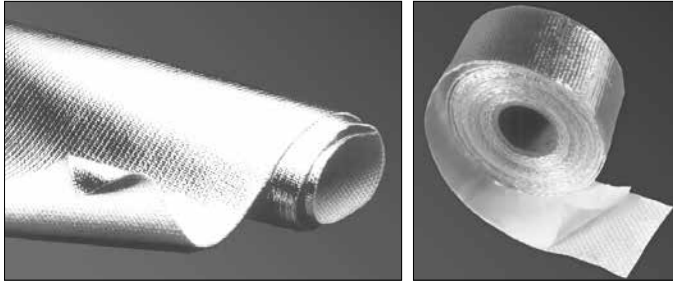

Aluminized Heat Barrier Cloth can be used to protect composite bodywork, hoses, wires, paint, or any component that may be subject to damaging radiant heat. Woven silica with a reflective aluminized outer layer withstands conducted heat up to 1000° F (not for use directly on exhaust systems) and radiant heat up to 2000° F. Sold by the running foot.

Heat Barrier Cloth, 40" wide x .040 inch thick, per foot Part No. 1832 \$36.70 / ft.

High-Temperature Spray Adhesive, 16 oz. aerosol can Part No. 1835-020 \$17.90

Note: A hazardous shipping fee will be added to your order if this item is shipped by air.

Adhesive-Backed Aluminized Heat Barrier Cloth is the same silica material as described above with a strong adhesive backing for easy installation. Apply to any clean surface or wrap around hoses or wires. Available in sheets or as 1 1/2" wide tape.

Self-Adhesive Heat Barrier, 12 x 12 inch sheet Part No. 1828-12x12 ... \$14.94

Self-Adhesive Heat Barrier, 12 x 24 inch sheet Part No. 1828-12x24 ... \$26.38

Self-Adhesive Heat Barrier, 24 x 36 inch sheet Part No. 1828-24x36 ... \$70.61

Self-Adhesive Heat Barrier, 24 x 48 inch sheet Part No. 1828-24x48 ... \$94.17

Self-Adhesive Heat Barrier Tape, 1.5" wide x 15' roll Part No. 1834 \$22.07

Great for wrapping around odd-shaped components as well as wires and hoses.

Hi-Temp Aramid Heat Barrier Cloth has similar construction to the silica cloth above, but with the backing cloth is woven of high-temperature aramid. This allows it to withstand direct contact with heat sources up to 1100° F and radiant heat up to 3000° F. Sold in 26" x 40" sheets only. No adhesive backing.

Hi-Temp Aramid Heat Barrier Cloth, 26" x 40" sheet Part No. 1835-128 \$143.02

Thermo-Flex Heat Shield

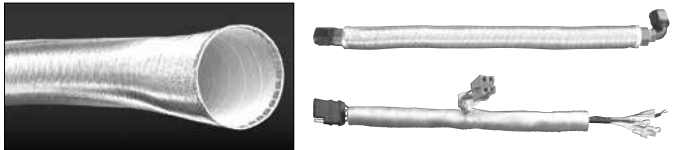

Thermo-Flex Heat Shield is a corrugated composite tube with an aluminized outer layer. Provides resistance to abrasion, insulation up to 750° F and physical containment of hoses and wiring. It can be slit to cover hose or wires without disconnecting the ends. Available in 5/8, 3/4, 1, or 1 1/2 inch inside diameters. Sold in 3 foot lengths.

Thermo-Flex Aluminum Shield, 5/8" ID Part No. 1831-5/8 \$17.79

Thermo-Flex Aluminum Shield, 3/4" ID Part No. 1831-3/4 \$19.91

Thermo-Flex Aluminum Shield, 1" ID Part No. 1831-1 \$23.01

Thermo-Flex Aluminum Shield, 1 1/2" ID Part No. 1831-1 1/2 \$29.33

Thermo-Sleeve Heat Shield



This lightweight, low-profile sleeve is less bulky and much better looking than rubber-coated insulation. The woven fabric core has an aluminized outer layer to reflect 90% of radiant heat. The sewn seam means no messy adhesive. Sold in 3 foot lengths.

Thermo-Sleeve, 1/2" ID x 3 foot length Part No. 1835-125 \$16.66

Thermo-Sleeve, 1" ID x 3 foot length Part No. 1835-126 \$22.12

Thermo-Sleeve, 1 1/2" ID x 3 foot length Part No. 1835-127 \$27.80

Express Sleeves

Just like the Thermo-Sleeves above, except instead of a sewn seam, the long edges have hook-and-loop material for easy installation on hoses or wires that are already in place. Sold in 3 foot lengths.

Express Sleeve, 1/2" to 1" ID x 3 foot length Part No. 1835-123 \$31.22

Express Sleeve, 1 1/2" ID x 3 foot length Part No. 1835-124 \$36.44

Simpson Shifter Boot Cover



Simpson Shifter Boot Cover Installs over the existing shifter boot to add fire protection and increased thermal insulation to the cockpit area. Reverse stitching minimizes the chance of fire penetration. Constructed with CarbonX and Kevlar® for the ultimate in fire protection.

Simpson Shifter Boot Cover Part No. 2332 \$79.99

Gold-Colored Heat Reflective Film with Fire-Resistant Adhesive

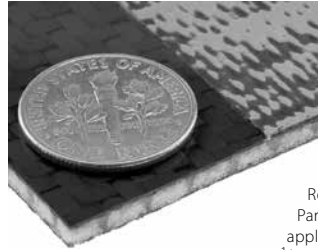

Left:
Detail of
Gold Heat
Reflective Film
Part No. 1838-001
applied to a piece of
1/8" cored carbon fiber



Our high-tech **GOLD Heat Reflective Film** reflects up to 750° F radiant heat and withstands continuous operating temperatures (heat soak) of 500° F. Within the normal operating range, this film reduces temperatures by up to 70° F. Despite its impressive performance, it is very thin and lightweight. It weighs only 5 ounces per square yard, compared to nearly *one pound* per square yard for our standard woven heat barrier cloth material. It is ideal for tight engine compartments because it requires only 1 millimeter air gap to the heat source. The material itself is also much thinner than conventional woven cloth. The most important feature is the **fire-resistant** adhesive backing. This strong adhesive allows the film to pass the FAA 12-second vertical burn test. The light-duty "economy" films on the market can't say that! Sold by the running foot. Nominally 24 inches wide (some batches are a little wider).

GOLD Heat Reflective Film, 24" wide x 6 mil thick Part No. 1838-001 .. \$31.49 per ft.

How can you tell if you have the fire-resistant adhesive? You don't need to light a match to find out! Just peel away the backing paper. If you can see the silvery backside of the reflective film, you have the economy version. The fire-resistant adhesive is opaque white.

Aeroquip Heavy-Duty Firesleeve

Aeroquip Firesleeve has a much thicker wall than most other brands. It may cost a little more, but is far more effective!

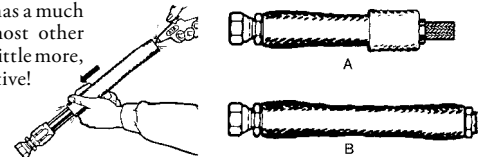

Firesleeve is great for protecting hoses or wires from heat, flame or abrasion. Thick, flexible braided fiberglass tubing is covered with a heavy layer of orange-red silicone rubber. Hose part numbers are shown next to the suggested sleeve size. NHRA approved.

Note: Firesleeve is priced **per inch** of length.

5/16 inch ID, per inch (3260-3 hose) (not Aeroquip) Part No. 3299-.31 49¢

This size is no longer available from Aeroquip. It is a little thinner than the other sizes.

7/16 inch ID, per inch (3260-4 hose) Part No. 3299-.44 84¢

5/8 inch ID, per inch Part No. 3299-.62 94¢

1 1/16 inch ID, per inch (3270-6 hose) Part No. 3299-.69 99¢

3/4 inch ID, per inch (3270-8 hose) Part No. 3299-.75 99¢

13/16 inch ID, per inch (3290-8 hose) Part No. 3299-.81 \$1.09

7/8 inch ID, per inch (3270-10 hose) Part No. 3299-.88 \$1.19

1.00 inch ID, per inch (3290-10 hose) Part No. 3299-1.00 \$1.29

1 1/8 inch ID, per inch (3270-12 and 3290-12 hose) Part No. 3299-1.12 \$1.49

1 1/4 inch ID, per inch (3270-16 hose) Part No. 3299-1.25 \$1.49

1 1/2 inch ID, per inch Part No. 3299-1.50 \$1.79

Goodridge Silver Firesleeve

Similar to Aeroquip Firesleeve but with silver-grey silicone rubber. NHRA approved.

1/4 inch ID, per inch (3260-2 / -3 / -4 hose) Part No. 3299-001-.25 49¢

3/8 inch ID, per inch (throttle and shifter cables) Part No. 3299-001-.38 59¢

1/2 inch ID, per inch (3270-6 hose) Part No. 3299-001-.50 69¢

3/4 inch ID, per inch (3270-10, 3290-8 hose) Part No. 3299-001-.75 79¢

1 inch ID, per inch (3270-12, 3290-12 hose) Part No. 3299-001-1.00 99¢

1 1/4 inch ID, per inch (3270-16 hose) Part No. 3299-001-1.25 \$1.29

Thermo-Tec Black Firesleeve

Similar to Aeroquip Firesleeve but with a semi-gloss black silicone rubber covering.

1/2 inch ID, per inch (3270-6 hose) Part No. 3299-002-.50 82¢

3/4 inch ID, per inch (3270-10, 3290-8 hose) Part No. 3299-002-.75 \$1.04

1 inch ID, per inch (3270-12, 3290-12 hose) Part No. 3299-002-1.00 \$1.40

Starter Heat Shield Kit



Block the radiant exhaust heat which breaks down the windings in starters and solenoids. Easy to install strap-on barrier is supplied in a 7" x 22" piece. This kit includes stainless steel straps and end clamps to fasten the heat shield to the starter.

Starter Heat Shield Kit Part No. 1833 \$34.66

Header Wrap and Heat Barrier Products

Header Wrap and Clamp Kits

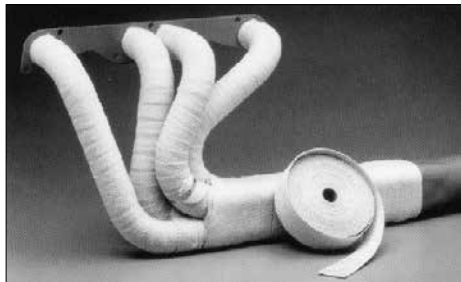

Exhaust Header Wrap holds exhaust heat inside the header to keep the engine bay cooler, keep oil and water temperatures lower, and increase power through denser intake air. Header wrap also helps to prevent burns to crew members. Our $\frac{1}{16}$ inch thick material will not degrade the header pipes nearly as fast as $\frac{1}{8}$ inch thick material. (All header wraps shorten header life due to the intense heat within the wrap.) Use any of the Band Clamp Kits shown below to attach header wrap. A 50 foot roll of header wrap is enough to cover most 4 cylinder headers. Asbestos-free. Available in standard grey or black.

Header Wrap, Grey, 2" wide x $\frac{1}{16}$ " thick x 50 foot roll Part No. 1830 \$59.58
Header Wrap, Black, 2" wide x $\frac{1}{16}$ " thick x 50 foot roll Part No. 1835-200 \$63.53

Generation II Copper Header Wrap from Thermo-Tec improves heat resistance up to 30% more than conventional technology to create more horsepower and reduce under-hood temperatures while increasing exhaust scavenging. Withstands continuous temperatures up to 2000° F. This $\frac{1}{16}$ " thick material comes in 50 foot rolls.

Copper Header Wrap, 1" wide x $\frac{1}{16}$ inch thick x 50 ft. roll ... Part No. 1827-1 inch ... \$39.33
Copper Header Wrap, 2" wide x $\frac{1}{16}$ inch thick x 50 ft. roll ... Part No. 1827-2 inch ... \$65.53

Hi-Heat Coating™ is used to protect and seal Thermo-Tec Header Wrap, but it also makes a great exhaust paint. Withstands 2000° F when used with Header Wrap; withstands 1200° F without Header Wrap. Resists oil, gas, grease and corrosion. Available in 11 ounce aerosol cans. Specify Black, Aluminum, or Copper color. **Note:** If this item is shipped by an air delivery method, a hazardous shipping fee must be charged.

Hi-Heat Coating™, specify Black or Aluminum, 11 oz Part No. 1836-Color ... \$12.75
Hi-Heat Coating™, Copper, 11 oz Part No. 1836-Copper .. \$15.49

Stainless Steel Band Clamp Kits Fasten header wrap easily and effectively. These kits include various combinations of 9 inch and 18 inch straps (which can be shortened). Withstands high temperatures and is only $\frac{5}{16}$ inch wide for those tight spots.

Clamp Kit for a V-8, includes eight 9" and four 18" straps ... Part No. 1835-001 \$39.71
Clamp Kit for V-4 or V-6, includes six 9" and four 18" straps . Part No. 1835-002 \$33.73
Clamp Kit with twelve 9" straps Part No. 1835-003 \$35.91
Clamp Kit with six 18" straps Part No. 1835-004 \$23.59

Header Wrap Kits



Get everything you need to insulate your exhaust, all in one convenient, money-saving kit! Our **Header Wrap Kits** include 2" wide header wrap in your choice of black or original grey, one can of black Hi-Heat Coating™, and all the band clamps you need for installation. Four-cylinder kits include 1 roll of header wrap; V-8 and 6-cylinder kits include two rolls. **Note:** If this item is shipped by an air delivery method, a hazardous shipping fee must be charged.

Header Wrap Kit, 4-cylinder, Grey Part No. 1835-110 \$79.25
Header Wrap Kit, 4-cylinder, Black Part No. 1835-111 \$82.81
Header Wrap Kit, V-8 or 6 cyl., Grey Part No. 1835-112 \$150.95
Header Wrap Kit, V-8 or 6 cyl., Black Part No. 1835-113 \$157.99

Our **Turbo Insulating Kit** is designed for reducing turbo lag, but the components in the kit are useful for much more than just turbos. Includes one 50-foot roll of 1" wide header wrap, a 36" x 6" strip of header wrap, a 36" x 40" sheet of Aluminized Heat Barrier Cloth (see page 109 for details), and two 18" long stainless band clamps. This is a great kit to keep in the trailer to deal with unexpected insulating needs.

Turbo Insulating Kit, 4 cylinder (not shown) Part No. 1835-008 \$127.51

Quick-Wrap, High-Velocity Exhaust Jackets



These jackets are an innovative way to block radiant heat and reduce under hood temperatures. They are easy to apply with the headers installed on your vehicle. Simply slip the jackets over your header tubes and clamp the edges together. The "relaxed" fit extends header life by allowing the tubes to expand without restriction. Fits headers with 2 inch or smaller primary tubes. Kits include a roll of jacket material and clamps. You get enough material to cover about 22 inches of each primary tube.

High-Velocity Exhaust Jackets for 4 or 6 cylinder engines Part No. 1837-06 \$91.64
High-Velocity Exhaust Jackets for 8 cylinder engines Part No. 1837-08 \$119.76
FVs can use the 8 cylinder kit to cover up to 44 inches of each primary tube!

Clamp-On Exhaust Heat Shields

These flexible stainless steel shields are ideal for protecting any item located a little too close to the exhaust. Clamp one over the exhaust tube to block up to 95% of radiated and conducted heat. Two lengths available. Both sizes are 6 inches wide. Each kit includes mounting clamps.



Clamp-On Heat Shield, 1 foot length (shown) Part No. 1835-011 \$61.97
Clamp-On Heat Shield, 2 foot length Part No. 1835-012 \$88.07

Exhaust System Fabrication

Low-Restriction Exhaust Collector Pipes



Part No. 1820-1600 approx. 6 $\frac{1}{4}$ " long

Part No. 1820-2000 approx. 7 $\frac{1}{2}$ " long

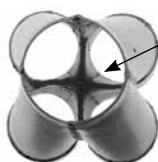

Note the excellent workmanship inside: precise cuts, tight joints, and clean welds!

Dyno tests have shown these four-into-one collector pipes to be superior to anything else available. They are superbly hand-crafted and sized specifically for Ford 1600 (1.5" header pipes / 2" outlet) and 2.0L (1.75" header pipes / 2.25" outlet).

Ford 1.6L Collector, 1 $\frac{1}{2}$ " inlets and 2" outlet Part No. 1820-1600 \$269.99
Ford 2.0L Collector, 1 $\frac{3}{4}$ " inlets and 2 $\frac{1}{2}$ " outlet Part No. 1820-2000 \$269.99

Tack Clamps for Welding Tubing



These special clamps are designed specifically for butt-welding two pieces of tubing. Each clamp consists of two adjustable chain clamps held together by three feed screws. Just wrap each clamp around your tubing and use the feed screws to bring them together. The triple feed screws let you adjust their position until the tubing is perfectly aligned. Knurled thumbscrews eliminate the need for wrenches or screwdrivers. Tack weld in a few spots, then remove the clamp when you're ready to run the full bead. Sold individually.

*Tack Clamp for 1.50" to 2.00" OD Tubing** Part No. 7020-2.00 \$34.99
Tack Clamp for 2.00" to 2.50" OD Tubing Part No. 7020-2.50 \$36.99
Tack Clamp for 2.50" to 3.00" OD Tubing Part No. 7020-3.00 \$38.99

* **Note:** The 1.50" to 2.0" size must be taken apart and turned inside-out to get a solid grip on 1.50" tubing. The process is quick, easy, reversible, and requires no tools.

Stainless Steel V-Band Flanges and Clamps

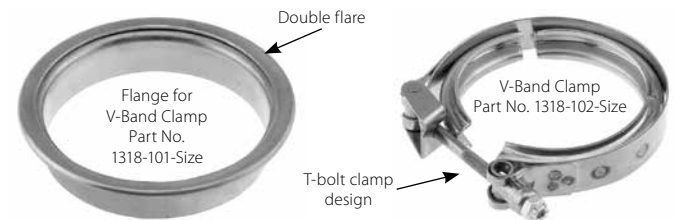

Flange for V-Band Clamp Part No. 1318-101-Size

V-Band Clamp Part No. 1318-102-Size

Double flare

T-bolt clamp design

These flanges and matching V-band clamps are designed for adding a gasket-free vibration joint to a stainless steel intake or exhaust tube. The V-band clamp is manufactured from 300 stainless steel. It can be removed by loosening just one nut, which makes it ideal for applications where the tubing must be disassembled frequently. The flanges are constructed of 0.060" thick wall 321 stainless steel tubing and double-flared (similar to brake tubing) to hold their shape under stress. Flanges are sold individually; clamps are sold separately. To make one assembly, you must purchase two flanges plus one clamp. **Note:** These flanges will only connect two pieces of tubing with the same diameter. They do not allow "step" joints.

Stainless Steel Flanges: Order two per joint.
Stainless Steel Flange, 2" OD Part No. 1318-101-2.00 \$27.99
Stainless Steel Flange, 2.5" OD Part No. 1318-101-2.50 \$27.99
Stainless Steel Flange, 3" OD Part No. 1318-101-3.00 \$31.99
Stainless Steel Flange, 3.5" OD Part No. 1318-101-3.50 \$31.99
Stainless Steel Flange, 4" OD Part No. 1318-101-4.00 \$34.99

V-Band Clamps are sold separately. Order one per joint.
Stainless Steel V-Band Clamp, for 2" OD flange Part No. 1318-102-2.00 \$33.99
Stainless Steel V-Band Clamp, for 2.5" OD flange Part No. 1318-102-2.50 \$33.99
Stainless Steel V-Band Clamp, for 3" OD flange Part No. 1318-102-3.00 \$34.99
Stainless Steel V-Band Clamp, for 3.5" OD flange Part No. 1318-102-3.50 \$35.99
Stainless Steel V-Band Clamp, for 4" OD flange Part No. 1318-102-4.00 \$37.99

SuperTrapp Mufflers

The patented radial diffuser design of SuperTrapp mufflers allows you to tune your muffler by adding or removing diffuser discs. Fewer discs reduces noise but increases back pressure; more discs increases noise and reduces back pressure. You can virtually wave tune your exhaust to produce the best power band for any track. This is especially important in racing classes where carb tuning is restricted.

For many small-displacement full race applications, the short diffuser is enough to meet noise limits. When noise limits are particularly stringent and for street applications, the diffuser section is combined with a low-restriction, straight-through glasspack section to further reduce sound. With the combined good looks and added durability of a stainless steel core, a SuperTrapp muffler could be the last muffler you ever buy.

What size SuperTrapp muffler should I get?

- Larger and longer glasspack SuperTrapp mufflers are generally quieter than smaller, shorter ones. For the most noise reduction, choose the largest muffler that will fit.
- 4" disc mufflers can handle up to 250HP per muffler. 5" can handle 400HP.
- Higher HP applications can use multiple mufflers, but noise will increase.

Diffuser Disc Only Series



To mount these to your exhaust system, just weld the flange to your tail pipe and then bolt the discs and end cap to the flange. All include 12 diffuser discs. The 5" models also include a 360 degree shield.

- 4 inch diffuser for 2.0 dia. pipeST-444-2003..... \$94.99
- 4 inch diffuser for 2.5 dia. pipeST-444-2503..... \$94.99
- 5 inch diffuser for 2.5 dia. pipeST-544-2503..... \$108.99
- 5 inch diffuser for 3.0 dia. pipeST-544-3003..... \$108.99
- 5 inch diffuser for 3.5 dia. pipeST-544-3503..... \$108.99

Steel Glasspack with Diffuser Series

Steel Glasspack
Part No. ST-449-2218



These can be welded or clamped to your tail pipe for a relatively quiet yet low-restriction tunable muffler. All include 12 diffuser discs. Finished in a black, high-temperature paint.

Models with 4 inch discs (5 lbs)

- For 2.25 dia. pipe, 18.5 inch lengthST-449-2218..... \$209.99
- For 2.50 dia. pipe, 18.5 inch lengthST-449-2518..... \$209.99

Models with 5 inch discs, long (8.5 lbs.):

- For 2.50 dia. pipe, 19 inch lengthST-549-2519..... \$229.99
- For 3.00 dia. pipe, 19 inch lengthST-549-3019..... \$229.99
- For 3.50 dia. pipe, 19 inch lengthST-549-3519..... \$229.99

Cutaway view of
Part No. ST-443-2217



Stainless Steel Glasspack with Diffuser Series



Left: Stainless
Steel Glasspack
Part No. ST-443-2217



Extra-Short
10" Stainless
Steel Glasspack
Part No. ST-443-2010

Similar to the steel glasspack series except for the added durability and good looks of brush-finished stainless steel. All include 12 diffuser discs.

Models with 4 inch discs, long (5.5 lbs.):

- For 2.00 dia. pipe, 24 inch lengthST-443-2024..... \$279.99
- For 2.50 dia. pipe, 24 inch lengthST-443-2524..... \$279.99

Models with 4 inch discs, extra-short version (3.5 lbs.):

- For 2.00 dia. pipe, 10 inch lengthST-443-2010..... \$232.99
 - For 2.00 dia. pipe, 10 inch length, w/mounting tabST-443-2011..... \$232.99
- Makes a great warm-up muffler for FF1600. Your paddock neighbors will thank you!

Models with 4 inch discs, short version (4.0 lbs.):

- For 1.75 dia. pipe, 17 inch lengthST-443-1717..... \$254.99
- For 2.00 dia. pipe, 17 inch lengthST-443-2017..... \$254.99
- For 2.25 dia. pipe, 17 inch lengthST-443-2217..... \$254.99
- For 2.50 dia. pipe, 17 inch lengthST-443-2517..... \$254.99

Models with 5 inch discs (7.0 lbs.):

- For 2.50 dia. pipe, 18.5 inch lengthST-543-2519..... \$299.99
- For 3.00 dia. pipe, 18.5 inch lengthST-543-3019..... \$299.99
- For 3.50 dia. pipe, 18.5 inch lengthST-543-3519..... \$299.99

SuperTrapp Accessories and Spares

Replacement End Caps

- Polished End Cap for 4 inch models with 6 bolt mountST-406-3046..... \$22.49
- Polished End Cap for all 5 inch disc modelsST-506-3052..... \$22.99

Replacement Hardware Kits

These are the same hardware kits as included with new SuperTrapp mufflers. Each kit includes all stainless steel hardware. **Note:** You must use anti-seize compound when assembling your SuperTrapp.

- For all 4 inch diffuser only series with 6 bolt mountST-404-7207..... \$26.99
- For all 4 inch glasspack series, 6 bolt mountST-404-7206..... \$18.49
- For all 5 inch diffuser only series with 6 bolt mountST-504-7207..... \$29.99
- For all 5 inch glasspack series, 6 bolt mountST-504-7206..... \$29.99
- Anti-Seize Compound, 8 oz. brush top can3303..... \$13.99

Stainless Steel T-Bolt Clamps

- As supplied with stainless steel SuperTrapps.
- Stainless steel T-bolt clamp for 1.75" pipe3614-1.75..... \$6.29
 - Stainless steel T-bolt clamp for 2.00" pipe3614-1.88..... \$6.29
 - Stainless steel T-bolt clamp for 2.25" pipe3614-2.13..... \$6.69
 - Stainless steel T-bolt clamp for 2.50" pipe3614-2.38..... \$6.89
 - Stainless steel T-bolt clamp for 3.00" pipe3614-2.75..... \$7.19
 - Stainless steel T-bolt clamp for 3.50" pipe3614-3.38..... \$7.39

Stainless Steel Body Support Clamps

- As supplied with stainless steel SuperTrapps.
- Stainless steel body support clamp for 4 inch seriesST-095-3500..... \$20.99
 - Stainless steel body support clamp for 5 inch seriesST-095-4500..... \$22.49

Extra Diffuser Discs New SuperTrapp mufflers include 12 diffuser discs. Note that running 24 or more discs has the same effect on tuning as removing the end cap and disc stack entirely, and just running the glasspack as a straight-through muffler.

- 4 inch diffuser discs, package of 6ST-404-6506..... \$22.49
- 4 inch diffuser discs, package of 12ST-404-6512..... \$37.99
- 5 inch diffuser discs, package of 6ST-504-6506..... \$37.99
- 5 inch diffuser discs, package of 12ST-504-6512..... \$52.99

Fiberglass Repack Kits Each repack kit is pre-packed in a fiberglass "pillow" for clean, easy handling.

- Repack Kit for 443-1717/2017, 449-1718/2018ST-400-1717..... \$55.99
- Repack Kit for 443-2010/2011 extra-shortST-400-4020..... \$25.99
- Repack Kit for 443-2217/2517, 449-2218/2518ST-400-2217..... \$55.99
- Repack Kit for 543-2519, 549-2519ST-500-2519..... \$55.99
- Repack Kit for 543-3019/3519, 549-3019/3519ST-500-3019..... \$55.99

Shields For use with Diffuser Disc Only Series. Can be used to protect diffusers from damage from rocks and stones and also to help redirect the noise emitted from the side. Not for use with Glasspack mufflers. New 5 inch Diffuser Disc Only Series diffusers already include a 360 degree shield.

- 120 degree shield for all 4 inch diffusersST-405-2120..... \$29.99
- 360 degree shield for all 4 inch diffusersST-405-2360..... \$37.99
- 360 degree shield for all 5 inch diffusersST-507-2360..... \$37.99

SuperTrapp 3S and 5S Series Spark Arrestor Mufflers for Small Engines

These compact units are ideal for ATVs, dirt bikes, even generators. They are certified USDA Forest Service-approved spark arrestors. Each flange includes an end cap but no discs. If further noise reduction is required, add a Resonator.

3S Series Spark Arrestor Mufflers The 3S Series is recommended for engines from 2 HP to 10 HP. Use 1 disc for every 3 HP (generators and other engines running less than 2400 RPM should use 2 discs per 3 HP).

- 3S Clamp-On Flange for 1" PipeST-3S-1000.....\$72.99
- 3S Clamp-On Flange for 1.50" PipeST-3S-1500.....\$72.99
- 3S Clamp-On Flange for 1.75" PipeST-3S-1750.....\$81.99
- 3S Clamp-On Flange for 2" PipeST-3S-2000.....\$81.99
- 3S Discs, pack of 3ST-3S-6503.....\$15.99
- 3S Resonator for noise reductionST-3S-5500.....\$79.99

5S Series Spark Arrestor Mufflers The 5S Series is recommended for engines from 10 HP to 200 HP. Use 1 disc for every 7 HP (stationary engines running less than 2400 RPM, or running the 5S after a conventional muffler, should use 2 discs per 7 HP).

- 5S Clamp-On Flange for 2.50" PipeST-5S-2500.....\$99.99
- 5S Clamp-On Flange for 2.75" PipeST-5S-2750.....\$99.99
- 5S Clamp-On Flange for 3" PipeST-5S-3000.....\$102.99
- 5S Flange with 1" NPT Male ThreadsST-5S-1000T.....\$89.99
- 5S Discs, pack of 3ST-5S-6503.....\$24.99
- 5S Resonator for noise reductionST-5S-5500.....\$85.99

3S Series Spark Arrestor Assembly
Shown with Flange/End Cap, Discs,
and Resonator (each sold separately)



EXHAUST

Intercomp Electronic Scale Systems and Scale Accessories



Other scales on the market have the pads hard-wired to the display. If a single cable is damaged, the entire system must be returned for repairs. The SW500 cables have quality connectors at each end for easy replacement.

Compared to more expensive Intercomp scales, the SW500 E-Z Weigh scales have:

- The same high-quality 15" x 15" x 2.5" billet aluminum scale pads.
- The same certified accuracy.
- The same 2 year warranty.

It adds up to a tremendous bargain!

SW500 E-Z Weigh Cabled Scale System

This affordable electronic scale system is packed with great features! Backlit display shows all four corner weights in pounds or kilograms, calculates the center of gravity, and stores 100 chassis setups. USB port allows downloading to a computer (requires Race Car Management Software, Part No. 102065, sold separately below right). Uses a standard 9 volt battery (included). 6,000 lb/2,800 kg total capacity (1,500lb/700kg per pad). Certified to 0.1% accuracy. Full 2 year warranty.

SW500 E-Z Weigh Cabled Scale System.....Part No. 170125..... \$1,195.00

Scale Pad Levelers With Roll-Off Pads



These **Scale Pad Levelers** are designed to accommodate any brand of scales with 15" square x 2.5" thick pads. The extended roll-off pad area allows the car to be rolled off the scale pad between adjustments. This eliminates errors due to side loading of the tires. It also allows you to re-zero the scales between readings. Pivoting feet on threaded rods allow for quick and easy leveling regardless of terrain. Full set of 4 pads.

Scale pad leveler set with roll-off pad, 2.5" pads.....Part No. 170133.....\$995.00

Advanced Racing Technologies Laser Leveling System



The **ART Laser Leveling System** uses a compact granite surface plate, a laser five times brighter than the competition, 4 calibrated targets, and a two-axis level to accurately level the surface plate. The surface plate is only six inches square with three adjustable leveling legs. After leveling the surface plate, place a target on each scale pad and turn on the laser. Any misalignment between the surface plate and the pad will show on the targets.

ART Laser Scale Pad Leveling System.....Part No. 7051..... \$259.99

Linear Ride Height Gauge



Linear Ride Height Gauge
Part No. 3195-001

Wooden Storage Case
Part No. 3195-002

Unlike other gauges that swing in an arc, the innovative **ART Ride Height Gauge** is totally linear over its entire range. This makes it more accurate, particularly at the ends of its travel. Measures ride height from 1" to 7". Dial readout displays with 0.001" resolution. Spring loaded extending mechanism can be locked down for storage. Measures 24" L x 1.5" W x 1" H. A wooden carrying case is available separately.

Linear Ride Height Gauge.....Part No. 3195-001..... \$119.99
Wooden Storage Case.....Part No. 3195-002..... \$49.99

SW777RFX Wireless Professional Scale System
Part No. 170127-WPC (laptop not included)



SW777RFX Wireless / PC Professional Scale System

Go wireless and never worry about running over a scale pad cable again! This system has all the great features of the SW500 system, but the addition of secure, encrypted wireless communication from the billet scale pads to the display head **and to your PC** eliminates the need for messy cables. A USB download cable and Intercomp's Race Car Management software are included for full analysis. This system even includes a scale pad carrying case for transportation. Full 2 year warranty.

SW777RFX Wireless Scale System..... Part No. 170127-WPC..... \$1,999.00

Intercomp Scale Ramps



No more knocking over scraps of lumber or using other makeshift methods to get your car on your scales! Just place these lightweight, reinforced aluminum ramps next to your scale pads and roll the car easily on or off. Compatible with any scale system using low-profile 2.5" high pads. Each ramp measures 15" x 15". Full set of four ramps. (Note: Ramps are not for use with scale pad levelers.)

Intercomp Scale Ramps, set of four..... Part No. 100342.....\$305.00

Intercomp Scale Transportation and Storage



Left:
Intercomp Scale System
Carrying Case
Part No. 3147



Right:
Intercomp Wheeled
Scale System Cart
Part No. 100346

Intercomp Scale System Carrying Case This deluxe, heavy-duty case will carry a full set of 4 scale pads, 4 cables, and a control box. It is designed for Intercomp scale systems, but it will work with just about any digital scale system using the current low-profile 2.5" x 15" square scale pads. ATA300 approved construction with 12 gauge reinforced corners, metal-reinforced edges, and mil-spec latches and handles. Dividers inside keep your scale pads safe and separated. It is even large enough to hold an Intercomp control box inside its protective case. Measures 21" Long x 21" High x 17 1/2" Deep.

Intercomp Scale System Carrying Case..... Part No. 3147.....\$495.00

The **Intercomp Scale Pad Carrying Case** (not shown) is similar to the Scale System Carrying Case, but without room for the controller box. If your scale system displays on your PC or tablet instead of a control box and you only carry the scale pads, this is an ideal solution. This is the same case included with the SW777RFX Wireless / PC Professional Scale System (Part No. 170127-WPC) shown above. Fits four 2.5" x 15" square pads. Measures 17 1/2" Long x 17 1/2" High x 13 1/2" Deep.

Intercomp Scale Pad Carrying Case..... Part No. 490197..... \$199.00

The **Intercomp Wheeled Scale System Cart** makes it easy to move your digital scale system around. Slots are provided for four 15" square pads (fits either 2.5" or 4" thick pads). Extra room on the bottom can hold a set of ramps or turn plates, and your control box and cables ride in a spacious compartment above. The top is just the right height for a worktop. The 8" diameter wheels have solid rubber tires, and the removable handle makes storage easy. Measures 21" Wide x 20 5/8" Deep x 41 1/2" High with handle (35" High with handle removed and stowed). Initial assembly required.

Intercomp Wheeled Scale System Cart..... Part No. 100346.....\$369.00

Alignment Equipment

B-G Racing String Alignment Kit



Professional teams and prep shops still prefer old-fashioned string alignments to accurately measure individual toe on all four wheels. **B-G Racing** updates this method with 3-way adjustable brackets to hang the strings on the car rather than on the floor. With the strings on the car, you can roll and bounce the car to settle the suspension without having to recalibrate the strings! Front and rear attaching arms adjust in three planes to allow use on virtually any car, including most formula cars and sports racers.

String Alignment Kit.....Part No. BGR200... \$529.00

ART Laser String



ART Laser Strings These extremely versatile tools shoot a laser plane (not a beam) along the side of the car. One person can check frame straightness, rear axle alignment, and 4-wheel toe. You can also use them to align graphics, set up scales, and for many other applications. Choose Single (one plane) or Triple (3 parallel planes).

*ART Laser String, Single
Part No. 7005..... \$529.00
ART Laser String II, "The Triple" (not shown)
Part No. 7006\$1,699.00*

ART Dream Stick



The **Dream Stick by ART** is an innovative tool used to measure toe with a string, or with any ART Laser String product. Dual scales read the distance from the string to both the front and back of the rim at the same time. Adjusts to fit wheels from 12" to 20" diameter. Locates on the rim using three contact points to ensure the scales are perpendicular to the rim. Scales have both English and Metric markings.

*ART Dream StickPart No. 7007..... \$79.99
Requires the use of parallel strings or laser reference lines.*

Toe Plates and Gauges



ART Laser Toe Gauge This professional gauge uses laser precision to measure toe down to one minute of a degree. Requires only 12mm of ground clearance, so aerodynamic devices can stay in place. Weighs less than 20 pounds. Easy for one person to set up and use.

ART Laser Toe Gauge..... Part No. 7000 \$799.00



The **Longacre Toe Plate** kit is one of the quickest and simplest ways for you to measure total toe. Just rest one plate on the side of each tire and use measuring tapes to find your setting. Magnets help keep the tapes in place on the plates. Kit includes 2 toe plates and 2 tape measures.

Longacre Toe Plates.....Part No. LA79501\$64.99

Longacre Toe Gauge This simple, inexpensive, and accurate gauge can measure toe-in or toe-out to within 1/32 inch. Easily operated by one person. Simply scribe a reference line around each tire and hold one pointer on each line. A graduated scale on the base shows total toe in inches.

*Longacre Toe Gauge
Part No. 7962..... \$124.99*

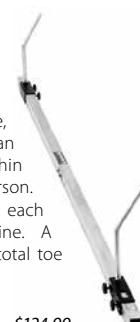

Camber and Caster Gauges



The latest **Longacre Digital Caster/Camber Gauge** combines the digital precision of the AccuLevel module with Longacre innovation and value. The sturdy Quick Set 3-leg aluminum camber frame has a built-in bubble level to allow you to measure camber and caster with just one tool – no other attachments required. The frame even folds for easy storage! When you only need a level or angle finder, the digital module slides right out of the frame. Slide it back in and magnets hold it in place. Digital AccuLevel module features an LCD readout from 0 to 90 degrees with a resolution of 0.1 degree, display hold, and relative zero for comparing two angles. Full instructions, padded aluminum carrying case, and battery included.

*Longacre Digital Gauge with Camber Frame
Part No. LA78295.....\$319.99*



Left: SmartCamber Kit
Part No. 3764

Right:
Hands Free
Attachment
Part No. 3763
(sold separately)

The **SmartCamber Kit** provides a direct digital readout of camber angles with up to 0.1° accuracy. Place the SmartCamber Tool against any wheel rim for an accurate digital readout instantly, with no interpretation or guesswork. Add the Hands Free Attachment (sold separately) for easy caster measurements. The rugged aluminum frame fits 5-22 inch wheels. The digital module includes a one year limited warranty and well illustrated instructions.

*SmartCamber Kit..... Part No. 3764..... \$224.99
Hands Free Attachment..... Part No. 3763.....\$48.99
Attaches to Camber Frame for caster measurements.*



Caster/Camber Gauge
Part No. 3185

Right:
Quick Set Adapter
Part No. LA78428

This simple, accurate, and reliable Longacre gauge measures caster and camber with three bubble levels. Bright markings and separate positive and negative scales reduce errors and confusion. Magnetic adapter (included) makes it easy to use with most steel wheels, hubs, or discs. Other adapters (such as the folding Quick Set adapter) are available separately. Case included.

*Longacre Caster/Camber Gauge with Magnetic Adapter
Part No. 3185.....\$149.99
Longacre Quick Set Adapter Only
Part No. LA78428.....\$129.99
Folding three-point frame allows use with alloy wheels.*

Bump Steer Gauges



ART Laser Bump Steer Gauge Laser accuracy is now available in a bump steer gauge! Using a simple laser, mirror, graph paper, magnetic bases, and a shutter, you can now measure bump steer with an accuracy up to millionths of an inch if desired. It doesn't bolt to the hub, so it can be used on a wide variety of hub types. The lack of a bulky frame also makes it easily portable. Easy to use, yet accurate enough for professionals. Includes padded wooden carrying case.

Laser Bump Steer Gauge Part No. 7002\$199.99

Longacre Bump Steer Gauge This is one of the easiest tools that we've found to measure bump steer. This rugged gauge uses a single dial indicator to tell the exact amount of bump steer automatically – to .001 of an inch! No math required, which means less chance of errors. The gauge comes complete with an adjustable frame stand, precision dial indicator, and a predrilled wheel plate with multiple 4- and 5-bolt patterns.

Bump Steer Gauge Part No. 3178 \$289.99



Turn Plates



Intercomp Mechanical Turn Plates have precise CNC machined numbers to indicate from -35 to +35 degrees. Three levels of case-hardened roller bearings allow free movement in X and Y directions as well as rotation. The high-friction top surface eliminates tire slippage for accurate measurements. Can be zeroed with car in place. Plate measures 13" x 15" x 1.5" high. 2000 pound capacity per plate.

*Mechanical Turn Plates, pair
Part No. 102007..... \$849.00*

Pyrometers

Intercomp

Longacre



Right: Longacre Digital Memory Tire Pyrometer and Stopwatch Part No. 3174/Watch



Intercomp Digital Tire Pyrometer Part No. 3183



Right: Longacre AccuTech Economy Digital Pyrometer Part No. LA50635



Left: Combination Tire Pressure Gauge and Pyrometer Part No. LA53050

New!



Right: Longacre Pyrometer Module for 7" Tablet Part No. LA50745 (Tablet not included)



Left: MiniTemp Laser Sight Infrared Gun Part No. 50627

See page 137 for Temperature Indicating Paints

Longacre Digital Memory Tire Pyrometer and Stopwatch

This is the ultimate all-in-one pit lane tool! Take tire temps in any order, store up to 10 complete sets of temperatures, and compute temperature averages. Electronic anticipation gives accurate, consistent readings more quickly. The built-in 4-car timer means you won't be fumbling with two separate pieces of equipment in the pits. Stores 70 laps in memory for each car. The backlit LCD can display temperatures up to 300°F. The rugged, adjustable-depth temperature probe has a coiled cord to prevent tangling. Includes padded case and 9 volt battery.

Longacre Memory Pyrometer and Stopwatch Part No. 3174/Watch \$419.99
Replacement Longacre Adjustable Depth Tire Probe Part No. LA50750 \$109.99

Longacre Digital Memory Tire Pyrometer

Displays all 12 tire temperatures simultaneously and stores 10 complete sets of temperatures with easy one-button recall. Electronic anticipation circuit stabilizes readings quickly. Displays up to 300°F. Includes padded case and 9 volt battery.

Longacre Memory Tire Pyrometer Part No. 3174 \$369.99
Replacement Longacre Standard Tire Probe Part No. 3187 \$74.99

Intercomp Digital Pyrometer

This rugged, compact pyrometer displays 0 to 1500°F or -18 to 815°C (2000°F/1093°C with optional brake probe) and has a temperature hold feature. Durable probe includes strong coiled cord. The display resolution can be set to 1° or 0.1°. Measures just 5 1/2" tall x 2 3/4" wide x 1 1/4" deep. Includes carrying case and 9 volt battery.

Intercomp Digital Tire Pyrometer with case Part No. 3183 \$199.00
Intercomp Replacement Tire Probe, 0 to 1500°F Part No. 3184-Tire \$109.00
Intercomp Brake Probe, 0 to 2000°F Part No. 3184-Brake \$169.00
Custom Tire Temperature Note Pad (65 pages) Part No. 3165 \$2.99

Longacre AccuTech Economy Digital Pyrometer

This simple, rugged pyrometer has only the features you need. Reads to 500°F with Min, Max, and Hold functions. Will even calculate the difference between two temps. Probe has a no-hassle straight cord. Includes 9 volt battery.

Longacre AccuTech Economy Digital Pyrometer Part No. LA50635 \$119.99
Custom Tire Temperature Note Pad (65 pages) Part No. 3165 \$2.99

Longacre Combination Tire Pressure Gauge and Pyrometer

This combination digital gauge can display up to 12 temperatures or four tire pressures at once. Both of those features in a single gauge make it worth the price, but this gauge can also integrate the two functions to display **compensated** tire pressure. The gauge uses the tire temperature data to calculate the corresponding tire pressure at a standard temperature (80°F). This allows you to set the proper tire pressure in the pits without guesswork, even if the tires have been sitting in the sun all day. Pressure is accurate to 0.1 psi. Temperatures are displayed in 1 degree increments. Includes padded case.

Combination Tire Pressure Gauge and Pyrometer, with case Part No. LA53050 \$424.99
Custom Tire Temperature Note Pad (65 pages) Part No. 3165 \$2.99

Longacre Pyrometer Module for 7" Tablet

Turn any Android tablet into a multifunction tire pyrometer! This module connects wirelessly to your tablet (not included) to send tire temps to the free Longacre Pyrometer app. Includes a bracket to hold the module and your 7" tablet together, but since it's wireless you can also leave the tablet safely on your pit cart. You can even hand it to your driver so he can add his session notes! This is a perfect addition to any Longacre tablet-based scale system, but it will work with nearly any Android tablet. This is the add-on module only. Requires an Android tablet (not included).

Longacre Pyrometer Module only for 7" Android Tablet Part No. LA50745 \$299.99

MiniTemp Laser Sight Infrared Gun

This laser-sighted infrared pyrometer is simple and easy to use. Read tire, radiator and oil cooler temperatures – even find a bad trailer wheel bearing before it fails! Features a fast half-second response time. Backlit LCD displays from 0° to 750°F (-18° to 400°C) with a resolution of 0.5°F (0.2°C). Also has a low battery indicator and 7 second display hold. Accurate to +/- 2%. Includes 9 volt battery.

MiniTemp Laser Sight Infrared Gun, 0 - 750°F Part No. 50627 \$97.99
Holster Style Carrying Case for Mini Temp Gun Part No. 50622 \$15.99
Custom Tire Temperature Note Pad (65 pages) Part No. 3165 \$2.99

Portable Air Tank



This 5-gallon portable air tank is constructed of strong, lightweight stainless steel. The semi-polished finish looks great without being blindingly shiny. Wide feet on the bottom provide a stable base. The 4 foot long air hose has a standard female quick-disconnect fitting to accept your air chuck (not included). A Schrader valve next to the pressure gauge makes it easy to fill from any tire fill station. A secondary quick-fill port lets you connect your air hose directly to the tank (requires quick-disconnect fitting set, not included). Measures 14" long x 10" high including the carrying handle. Weighs just 7.5 pounds when empty. Maximum pressure 125 psi.

Lightweight Portable Air Tank Part No. LA50316 \$139.99
 Does not include tire chuck or male quick-release fitting. Use of the optional quick-fill port requires separate purchase of additional fittings.

Spare Tire Inflation Systems



Left: Trunk-Mount (rubber hose) Part No. 3333-001



Right: Under-Chassis (stainless braided hose) Part No. 3333-002

Don't get caught with a flat tire AND a flat spare! Our **Spare Tire Inflation Systems** bring the tire valve to you, making it easy to check and inflate. A 36" long hose attaches to your spare tire valve and removes easily with no tools required. A bracket can be used to hold the loose end of the hose in place, and a 90 degree adapter is included for tight installations. The Trunk-Mount system is designed for vehicles with the spare located in the trunk or enclosed cargo area. It uses a lightweight rubber hose. The Under-Chassis system has a stainless-steel braided hose for vehicles where the spare is located outside in the elements.

Trunk-Mount Spare Tire Inflation System Part No. 3333-001 \$19.99
Under-Chassis Spare Tire Inflation System Part No. 3333-002 \$27.99

Note: For spare tires in storage only. Not for use on the inside wheel on dually axles.

Tire Tools

Intercomp Digital Tire Pressure Gauge with Case



Voted best buy in the industry! This ultra-quick (4 readings per second), very accurate (0.5% of applied pressure) digital tire pressure gauge features a backlit LCD display. User-selectable units (0-100 psi x 0.1, 0-7 Bar x 0.01, or 0-7 kg/cm² x 0.01). Factory-certified calibration is verified on start-up by a self-check program which alerts you if the unit ever needs recalibration! Peak hold function shows the highest measured pressure until the unit is reset to zero. Auto shut-off and low battery warning help manage battery life. Features a 45° swivel chuck and dual thumb operated bleed valves. Uses one standard 9 volt battery (included). **Note:** When comparing accuracy, it is important to read the fine print. Many gauges on the market

advertise accuracy to a certain percentage of full scale or capacity. This means that a 100 psi gauge accurate to 1% of full scale can be off by one full pound (1% of 100) anywhere on the scale. At 14 psi, the gauge could display anywhere from 13 to 15 psi. Accuracy to 0.5% of the applied pressure means that at 14 psi, the gauge will read within 0.07 psi.

Intercomp Digital Tire Pressure Gauge with CasePart No. 360045 \$299.99

Analog Tire Pressure Gauges



Intercomp Deluxe Air Pressure Gauges The most durable and shock resistant in the industry. Has only four moving parts in their patented internal mechanism vs. 14 or more in other gauges. Fewer moving parts means greater reliability. All have 17" Goodyear hose and thumb-operated bleeder with a swivel nozzle. 0-15 x 1/2 psi; 0-30 and 0-60 x 1 psi gauges; 2" standard, 2 1/2" liquid filled and 2 1/2" and 4" glow in the dark offer a great selection at an exceptional value.

2" Deluxe Air Pressure Gauge, 0 to 15 psiPart No. 360062 \$44.95
 2" Deluxe Air Pressure Gauge, 0 to 30 psiPart No. 360063 \$44.95
 2" Deluxe Air Pressure Gauge, 0 to 60 psiPart No. 360064 \$44.95

2 1/2" Liquid Filled Air Pressure Gauge, 0 to 15 psiPart No. 360065 \$52.95
 2 1/2" Liquid Filled Air Pressure Gauge, 0 to 30 psiPart No. 360066 \$52.95
 2 1/2" Liquid Filled Air Pressure Gauge, 0 to 60 psiPart No. 360067 \$52.95

2 1/2" Glow in the Dark Air Pressure Gauge, 0 to 15 psiPart No. 360068 \$52.95
 2 1/2" Glow in the Dark Air Pressure Gauge, 0 to 30 psiPart No. 360069 \$52.95
 2 1/2" Glow in the Dark Air Pressure Gauge, 0 to 60 psiPart No. 360070 \$52.95

4" Glow in the Dark Air Pressure Gauge, 0 to 15 psiPart No. 360058 \$65.95
 4" Glow in the Dark Air Pressure Gauge, 0 to 30 psiPart No. 360059 \$65.95
 4" Glow in the Dark Air Pressure Gauge, 0 to 60 psiPart No. 360060 \$65.95

Intercomp Fill, Bleed, & Read Gauge



Why waste time juggling a tire pressure gauge and a filler chuck? This combination gauge makes the job quicker and easier. Just hold the angled chuck on the tire and read the gauge. Press the trigger to fill the tire, or press the bleed valve button to let air out. The oversized 4" gauge reads 0-60 psi in 1 psi increments. Female 1/4 NPT inlet threads requires male air hose fitting (not included).

Fill, Bleed, & Read GaugePart No. 360087 \$139.00

Tire Pressure Gauge One-Way Valve



Our Analog Tire Pressure Gauges above are not designed to hold the reading when the chuck is removed from the tire. This compact check valve installs between the tire hose and the bleed valve to hold pressure until the bleed valve is opened. 1/4 NPT threads fit all gauges above.

Tire Gauge Check ValvePart No. 3228-500 \$9.49

E-Z Read Tire Stagger Tape



This 10 foot tape measure is designed for tire stagger, but it is useful for any measurements. The narrow, flexible tape has black numbers on a white background. The high-visibility case has a magnetic back to stick to your toolbox between uses.

E-Z Read Tire TapePart No. 2966 \$4.99

Tire Marking



Keep track of the age and heat cycles on a set of tires, mark stagger measurements, or mark punctures or other damage.

White Tire Marking Crayon (shown)Part No. 3332 \$1.59
 Silver Tire Marking Paint Pen (not shown)Part No. LA50882 \$6.99

Tire Valve Stems and Caps

Valve Stem with Cap
Part No. 3334



Caps Only (set of 4)
Part No. 3331

These chrome-plated valve stems fit most cast and modular wheels. The nut is on the outside so you can check tightness without dismounting the tire. Length is approximately 1" to 1.2" above the rim depending on the rim thickness. Rubber bushings included for both large and small rim holes.

Valve Stem with Cap, eachPart No. 3334 \$3.99
 Set of 4 Metal Valve Caps OnlyPart No. 3331 \$6.99

Our compact **Tire Valve Core Tool** (not shown) easily removes and installs standard valve cores from most tire stems. Store spare cores and caps in the billet aluminum handle.

Longacre Billet Valve Core ToolPart No. 50270 \$19.99
 Extra Tire Valve Cores, eachPart No. 9814-029 79¢ ea.

Tire Pressure Relief Valves

Instead of guessing how much your tire pressure will increase as the tire temperature rises, these relief valves let you set the tires to the desired pressure and automatically vent excess pressure as you race. Their reliability has been well proven by thousands of circle track racers from NASCAR Sprint Cup on down. Features lightweight aluminum construction (only 9 grams), built-in 100 mesh filter and an enclosed poppet for protection from dirt.



They can also be locked shut for tire mounting. Adjustment range from the factory is 15 to 40 psi. Low-pressure springs are also included to convert to a range of 5 to 15 psi.

Tire Pressure Relief Valves, Set of 4Part No. 3336-5-to-40 \$89.99

Tire Grooving Iron



Our deluxe 250 watt, 120 volt pistol grip grooving iron has a solid brass head that preheats the rubber in front of the cutting blade, making it fast and easy to cut grooves and maintain accurate control. Includes a .215" wide cutting head and 12 matching cutting blades. Extra heads and blades in this width as well as a wider, .375" size are also available.

250 watt Pistol Grip Grooving Iron with (12) .215" bladesPart No. 3715 \$113.99

Replacement Brass Head, .215" widePart No. 3716-.215 \$15.79

Replacement Brass Head, .375" widePart No. 3716-.375 \$17.99

One Dozen Replacement Cutting Blades, .215" widePart No. 3717-.215 \$13.49

One Dozen Replacement Cutting Blades, .375" widePart No. 3717-.375 \$14.79

Intercomp Tire Humidity/Temperature Meter



Knowing the moisture content inside the tire helps predict pressure gain as the tire heats up. This lightweight, battery operated meter has a tire valve fitting to check the condition of the air in your tires. Large LCD also displays temperature in °C or °F.

Tire Humidity/Temperature MeterPart No. 360036 \$289.00

Intercomp Tire Durometer (Rubber Hardness Tester)



Don't waste money on new tires if you don't have to! Keeping track of your tire condition is an effective way to tell if your tires will need replacement before the next race. This small, portable, easy-to-use durometer tells you exactly how soft your tires are. Measures from 0 to 100 on the Shore "A" scale (ASTM 2240). A storage pouch is included.

Tire DurometerPart No. 360092 \$59.99

Tread Depth Gauge



More accurate than the "Lincoln's Nose" test! A fast and easy way to measure tread depth to keep track of the wear rate on DOT or other treaded tires. Also fits the treadwear indicating holes in slicks.

Tread Depth GaugePart No. 3108 \$9.99

Self-Adhesive Wheel Weights and Aluminum Weight Tape

Self-Adhesive Wheel Weights Each package contains four, 4" long strips with high-strength pressure-sensitive adhesive. Weighs 1/2 oz. per inch for a total of 8 oz. per package.

Self-Adhesive Wheel WeightsPart No. 3335-4 pc \$11.99

3M® Aluminum Tape is great for taping over your wheel weights and it looks much better on your rims than duct tape!

Weight Tape, 2" by 125" rollPart No. 3322 \$11.99



Engine Building and Tuning Tools

Engine Cleaning Brush Sets

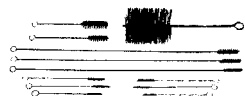

Cleanliness is critical when building a racing engine. Leftover machining trash in an oil passage can ruin a fresh engine the first time it is started. These brushes will ensure that you get all the oil drillings clean in your crankshaft, block, etc. The basic set has three commonly used sizes for small oil passages. The deluxe set has a larger variety of sizes, longer handles, and two of each of the most often used small sizes that wear out the fastest.

Basic Set of 3 Brushes Part No. 3107-3 \$15.99
Deluxe Set of 12 Brushes (shown above) Part No. 3107-12 \$44.99

Piston Ring End Gap Filer

Quickly and easily grinds the piston ring end gap straight and clean. Don't risk damaging an expensive set of rings by doing this job with a hand file. Clamps or bolts to your workbench.



Complete End Gap Filing Tool with blade
 Part No. 3136-101 \$89.99
Replacement grinding blade only
 Part No. 3136-102 \$19.99

Tapered Piston Ring Compressors



These expertly-machined sleeves have a radiused taper to gently compress the rings as the piston is lowered into the bore. No setup, no adjustment, and no sharp edges to damage your rings. Simply place it on top of the block and slide the piston through. Black anodized aluminum with the bore size etched in bold, bright numbers for easy identification.

Piston Ring Compressor, 81mm (FF1600) Part No. ARP901-8100 \$62.52
Piston Ring Compressor, 91mm (FC/Sports 2000) .. Part No. ARP901-9100 \$62.52

ARP Connecting Rod Bolt Stretch Gauge

Even the best torque wrench can only estimate the preload in a tightened bolt. A stretch gauge is the only way to accurately measure preload. Recording the measurements will also alert you if any bolts have stretched and are about to break. This pro-quality gauge features a billet frame for consistent, repeatable measurements.



Rod Bolt Stretch Gauge with case Part No. ARP100-9942 \$198.37

Plastigauge

Use **Plastigauge** to quickly and accurately measure clearances of rod and main bearings. Place a short length of Plastigauge (about 1/2 inch long) on the crankshaft bearing journal and install the bearing shell and cap as normal. Remove the bearing cap and shell. Compare the width of the deformed Plastigauge to the gauge on the package to accurately determine the bearing clearance. Each package contains one 12 inch long piece, usually enough to do a complete engine.

Plastigauge, .001 to .003 Clearance (Green) Part No. 3325-1 to 3 \$3.99
Plastigauge, .002 to .006 Clearance (Red) Part No. 3325-2 to 6 \$3.99
Plastigauge, .004 to .009 Clearance (Blue) Part No. 3325-4 to 9 \$3.99

7 Inch Degree Wheel

The only way to accurately check camshaft timing is with a degree wheel. Bushings are furnished for 7/16, 1/2, and 3/4 inch bolt diameters. Instructions are printed right on the degree wheel. Can also be used for checking static ignition timing.

7 Inch Degree Wheel Part No. 3125 \$32.49

Cylinder Head Work Stands

These sturdy stands make cylinder head work much easier by holding the cylinder head above the work surface for easier access. Also prevents damage to the head caused by debris on the work surface. Tapered pins fit virtually any head bolt hole. Sold in pairs.



Cylinder Head Stands, pair Part No. 3750-200 \$39.99

Ford 1.6L Head Bolt Socket



This is an indispensable tool for Formula Ford owners. Allows the final hot re-torque of head bolts to be done without removing the rocker shaft assembly. The six-point 1 1/16" socket (for 1/2" drive) has a long, thin shank to clear the rocker shaft.

Head Bolt Socket Part No. 3132 \$34.99

Engine Stands for Ford 1.6L or 2.0L

These stands are the ideal way to store or transport your 1.6L or 2.0L dry sump Ford engine. Protects your valuable sump and crankshaft from the damage that can result from putting the weight of the engine on these items. They also provide convenient handles which makes moving the engine much easier and safer. Sold in pairs.

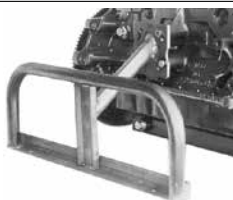

Ford 1.6L / 2.0L Engine Stands, pair
 Part No. 1690 \$187.99

Uni-Syn Carburetor Synchronizer

The **Uni-Syn** is great for quick and easy synchronization of multiple carburetors or fuel injection stacks. The sight tube pivots for use with both side-draft and down-draft carburetors, and the 3 inch diameter base fits most velocity stacks. Instructions are included.



Uni-Syn Carburetor Synchronizer
 Part No. 3115 \$39.99

Air Density Gauge

While your competition is busy reading plugs and pipes, you could already be installing the proper jets. This simple digital gauge displays the current air density, your baseline air density (which you can reset at any time), and the difference between the two. Or switch to air density, barometric pressure, and air temperature. A red LED flashes to alert you if air density has changed more than 5% from your baseline. Includes battery and protective storage case.



Air Density Gauge Part No. LA50887 \$179.99

Spark Plug Magnifying Flashlight

A spark plug magnifying flashlight can reveal oil deposits, signs of detonation or burned pistons, and cracked or chipped insulators even in the dark! A perfect way to see how well your engine is dialed in.



Spark Plug Magnifying Flashlight
 Part No. 1308 \$32.99

Compression Tester

A compression test is still the quickest and easiest (and most portable) way to determine the health of an engine. Simply remove the spark plugs, screw in the tester, and crank the engine over. No compressed air source is required! Our analog-style tester has a quick-release hose assembly with a threaded end fitting that fits common 14 x 1.25mm spark plug threads including FF1600.



Compression Tester, analog style Part No. LA73025 \$39.99

Remote Starter Switch

Crank your engine over from the engine bay without a helper! Simply clip one lead to your starter hot post and the other lead to the solenoid terminal from the starter switch. Press the button and the starter will turn. Alligator clips allow quick connection and removal. The billet aluminum handle fits comfortably in your hand.



Remote Starter Switch Part No. LA45795 \$39.99

Pedal It Remote Starter Switch Pedal

Stop dropping your tools when you need to bump the engine over for valve adjustments! The **Pedal It** is a totally hands-free remote starter switch built into a convenient foot pedal. When you're ready to adjust the next cylinder, just tap the pedal with your foot.



No more putting down the wrenches and feeler gauges and running around the car to hit the starter. You can easily cut valve adjustment time in half. Even if you use a hand-held remote starter switch, you'll still save time by keeping your tools in your hands. Complete kit includes a variety of quick-disconnect pigtail connectors for temporary or semi-permanent installation on virtually any engine.

Pedal It Remote Starter Switch Pedal Kit Part No. 7205-201 \$89.99

Dual-Gauge Leak-Down Tester

A leak-down test is the most accurate way to check the condition of your engine. It even helps to identify the problem without ever opening up the engine. Save money by avoiding unnecessary engine rebuilds! Our dual-gauge tester displays the input pressure on one gauge and the percentage of leakage on the other gauge, with no math required. Operating instructions are included. Fits common 14 x 1.25mm spark plug threads including FF1600. Requires a compressed air source of at least 80 psi.



Engine Leak-Down Tester Part No. LA73010 \$119.99

Titan Engine Oil Analysis

The next best thing to a complete teardown and inspection! Just take a small sample of used oil at your next oil change, fill out the bottle label, and drop the bottle into the mail in the pre-paid shipping box. Titan Labs will perform over 50 tests and send back a report within 24 hours. If a critical problem is found, you will be contacted immediately.



Titan Engine Oil Analysis, single Part No. 5090-1 \$23.99

Tools

Hose End Wrenches



These quality wrenches will minimize marring of the anodized finish on your aluminum hose ends. They are made from a heat-treated aluminum alloy that resists springing open under normal use. The handles are sized to prevent over-tightening. Sold individually or in a master set of 6 wrenches.

- 6 Wrench Set (sizes 4, 6, 8, 10, 12, and 16) Part No. 3830-416..... \$99.99
- 4AN Wrench only..... Part No. 3830-104.....\$17.99
- 6AN Wrench only..... Part No. 3830-106.....\$17.99
- 8AN Wrench only..... Part No. 3830-108.....\$18.49
- 10AN Wrench only..... Part No. 3830-110.....\$19.99
- 12AN Wrench only..... Part No. 3830-112.....\$24.99
- 16AN Wrench only..... Part No. 3830-116.....\$29.99
- 20AN Wrench (not included in master set) Part No. 3830-120.....\$39.99

Adjustable Hose End Wrench, 3AN to 20AN..... Part No. 3830-Adj..... \$47.99
 Infinite adjustment; excellent for holding male fittings with non-standard hexes.

KOUL Tools EZ-ON Hose Press



Forget the boiling water and heat guns. This amazing press from KOUL Tools takes the effort out of assembling rubber hose onto barbed hose ends. One set of jaws clamps the hose securely, and the other jaws hold the barbed fitting using special adapters (provided). Turn the feed screw, and in seconds your hose is assembled! You can even use a drill/driver to turn the screw. Works on virtually any brand of push-lock fittings and rubber hose from 4AN through 16AN sizes (1/4" through 1" ID hose).

KOUL Tools EZ-ON Push-Lock Hose Assembly Tool.. Part No. 3330-001..... \$269.99

Professional Tube Beading Kit



Don't risk a DNF (or worse) by letting a hose slip off a non-beaded tube! The Parker Tube Beading Kit was once a prized possession for aircraft and race mechanics. The original has been unavailable for many years, but our brand new Parker-style kit is even better. This modern update features CNC machining and high-quality castings for long life. Forms perfect beads in 1/4 inch to 1 inch diameter aluminum, copper, brass, or mild steel tubing.

Kit includes 3 roller frames, 6 interchangeable bead rollers, a no-mar tubing clamp, and full instructions in a custom-fit case. Meets Mil Spec MS33660D and SAE A5131 Types A and B standards for aviation and aerospace applications.

Professional Tube Beading Kit..... Part No. 3158-350..... \$419.99

Manual Tube Bearer for Large Tubing

The Parker-style tube beading kit does an excellent job on tubing up to 1 inch diameter, but many racecars use much larger tubing for coolant and intake systems. When you need to roll a bead at the end of a tube larger than 1 inch OD, this tool will do the trick. Just clamp the tool in a vise, insert your tubing between the dies, and turn the crank. For each full rotation of the tubing, give the top wheel a quarter-turn to bring the dies together. In just a few turns, you'll have a perfect bead! Works on copper or aluminum tubing from 5/8" ID to 2" OD. Includes plastic carrying case.



Manual Tube Bearer for 5/8" ID to 2" OD Tubing.... Part No. 3158-345..... \$199.99

Handheld Hose Cutting Shears



Cutting braided hose with a hacksaw takes time and effort, and requires a lot of clean-up afterwards. These shears make quick work of cutting any of our racing hose, including PTFE-lined, nitrile-lined, stainless braided, or aramid braided. They even do a great job on our textile-reinforced rubber hose. Cuts up to -12 size cleanly and quickly. The hardened steel jaws are C-shaped to help center the hose for cutting. Extra-long handles provide great leverage.

Handheld Hose Cutting Shears..... Part No. 3158-011.....\$186.99

Redback Performance Precision Silicone Hose Cutter



Cut silicone hoses to length quicker, cleaner, and safer than ever before. This bench-mounted cutter uses a pair of dies to hold the hose without deforming for a straight, accurate cut. The surgical-quality blade makes a cleaner cut than any shop knife could, and your fingers stay safely away from the sharp edge. Includes 10 die sets to fit standard hose sizes from 1" to 4" ID. The length to be cut off is adjustable from 3/4" to 5" in 5/16" increments. Includes 10 scalpel blades and an organizer case.

Silicone Hose Cutter..... Part No. 3158-500.....\$299.99

KOUL Tools



KOUL Tools Hose Assembly Tools These clever tools make installing the socket onto stainless braided hose almost effortless. Just insert the socket into the tool, twist the hose in, and in less than 10 seconds you have it assembled. The tools are manufactured of a high tech composite making them virtually indestructible. You'll be amazed at the amount of time and hose (and bandages) you'll save. The Small kit fits -4, -6, and -8 hose. The Medium fits -6, -8, and -10. The Large fits -10, -12, and -16. The Combo handles all even sizes -4 through -16.

- KOUL Tools Hose Assembly Tool Kit, Small..... Part No. 3330-Small..... \$74.99
- KOUL Tools Hose Assembly Tool Kit, Medium..... Part No. 3330-Medium..... \$79.99
- KOUL Tools Hose Assembly Tool Kit, Large..... Part No. 3330-Large.....\$89.99
- KOUL Tools Hose Assembly Tool Kit, Combo..... Part No. 3330-Combo.....\$148.99

Aluminum Vise Jaw Inserts



These magnet-backed aluminum inserts protect the anodized finish on your hose end fittings during assembly. The full length horizontal pocket is also ideal for holding hose in place, making straight cuts fast and simple. Horizontal and vertical pockets allow you to position the hose ends in whatever direction you need.

Aluminum Vise Jaw Inserts..... Part No. 3316..... \$31.99

Deluxe 37° Double Flaring Tool Set

The best is now even better!



Our vice-mounted flaring tool quickly and easily creates consistent, factory-quality double flares on brake and hydraulic lines without risking damage to the tubing. This very complete kit forms bubble flares or 45° SAE double flares on 3/16", 1/4", 5/16", 3/8", 1/2", 6mm, 8mm, 10mm, and 12mm tubing. Now it also forms 37° flares on 3/16", 1/4", 5/16", 3/8", 1/2", 6mm, 8mm, and 10mm tubing! The new jaw design on the dies completely eliminates any retaining ridges to prevent tubing damage. Everything is packaged in a custom-fitted plastic case. Made in the USA.

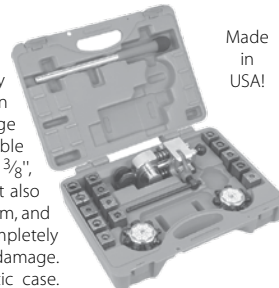

Made in USA!

Deluxe 37° Double Flaring Tool Set..... Part No. 3158-301.....\$444.99

Imperial Eastman Tubing Cutter

Eastman Tubing Cutter Cuts 1/8" to 5/8" O.D. tubing and requires only 1 1/2" swing radius. This compact tool is 3/4" wide and can cut within 5/16" of an existing flare. The enclosed feed-screw mechanism minimizes contamination, assuring continued free operation. The optional ratcheting handle lets you rotate the cutter around a tube without letting go of the cutter. Even cutting an installed tube in an awkward space is now a simple one-hand operation.



- Tubing Cutter..... Part No. 3097..... \$19.99
- Ratcheting Handle (not shown)..... Part No. 3159..... \$15.99
- Replacement Cutting Wheel..... Part No. 3089-001..... \$8.99

Brake Tube Bending Pliers



Made in USA!

Bend brake tubing in much tighter spots than with conventional benders. These pliers let you make a bend directly behind the flare nut for very tight installations. The jaws are flat perpendicular to the tube centerline to help align flare nut threads with the female port. For 3/16" or 4.75mm tubing.

Brake Tube Bending Pliers, made in USA..... Part No. 3158-300..... \$59.99
 Note: We have had several customers report that the cheaper tool sold elsewhere works as few as two or three times before breaking. You really do get what you pay for!

KOUL Tools SurSeat Mini Line Lappers

Imagine being able to flare a tube and have it seal the first time, every time! The SurSeat from KOUL Tools grinds off any burrs or scratches left by the flaring process, leaving you with a smooth, polished seat. The cone (37° or 45°) is coated with diamond dust for effective lapping action on steel tubing. The special fixture ensures the seat is concentric and properly aligned on 3/16" or 1/4" tubing.



- SurSeat Mini Line Lapper, 37° Seat for AN flares..... Part No. 3330-002..... \$59.99
- SurSeat Mini Line Lapper, 45° Seat for SAE flares..... Part No. 3330-003..... \$59.99

Tools

Left-Hand and Right-Hand Threaded Taps



We stock hard-to-find left-hand taps for fabrication or repairs on suspension links or any other parts that have left-hand SAE UNF threads. Our taps are made from quality high speed steel (HSS) with precision-ground threads. Matching right-hand (standard thread) taps are also available. (For right-hand threads: right=tight, left=loose.)

Thread Size	Left-Hand Tap		Right-Hand Tap	
	Part No.	Price	Part No.	Price
10-32	3720-03	\$7.59	3721-03	\$5.99
1/4-28	3720-04	\$7.99	3721-04	\$5.99
5/16-24	3720-05	\$9.49	3721-05	\$8.99
3/8-24	3720-06	\$9.99	3721-06	\$8.99
7/16-20	3720-07	\$14.99	3721-07	\$9.99
1/2-20	3720-08	\$16.99	3721-08	\$10.49
5/8-18	3720-10	\$24.99	3721-10	\$19.99
3/4-16	3720-12	\$34.99	3721-12	\$19.99

Drill-Out™ Bolt Extractors

Drill-Out™ is a revolutionary method of removing broken bolts. The precision left-hand cutting, self-centering drill point makes it easy to use even when the break is jagged. Just chuck the tool into a 3/8" drill, set the drill in reverse, and drill to a half inch depth with the collet backed off. Then advance the collet and place the drill back into the hole. The Drill-Out™ firmly grips the broken bolt and backs it right out. Four sizes: 1/4, 5/16, 3/8, and 1/2 inch (6, 8, 10, and 12 mm).



Complete set of four sizes Part No. 3742 \$48.99
Single Drill-Out™ only, 1/4" (6mm) Part No. 3743-250 \$10.99
Single Drill-Out™ only, 5/16" (8mm) Part No. 3743-312 \$11.99
Single Drill-Out™ only, 3/8" (10mm) Part No. 3743-375 \$12.99
Single Drill-Out™ only, 1/2" (12mm) Part No. 3743-500 \$14.99

Sheet Metal Deburring Tool with 5 Blades

Includes handle and 5 blades



This is a handy addition to any toolbox, even if you don't fabricate your own sheet metal parts. Deburring adds the finishing touch to any part. Smooth edges are less likely to cause cuts and scrapes to your hands. Deburring can also remove stress risers, preventing future cracks. Simply drag the blade against the rough or sharp edge. Each tool comes with a handle and five swivelling blades. The extra blades store conveniently inside the sturdy plastic handle.

Sheet Metal Deburring Tool Part No. 3783 \$26.99

Beta Tools Air Rivet Gun



Don't risk carpal tunnel syndrome! Give your hand and wrist a rest and let the powerful **1946 Air Rivet Gun** do the hard work for you. The light weight (3.3 lb) and tuned balance make this tool easy to hold and operate for extended periods. The long trigger can be operated easily with just one or two fingers. A cup on the back of the head catches the spent mandrels for safe disposal. Includes noses for all common rivet diameters.*
1946 Air Rivet Gun BT-019460001 \$276.81
 * **Note:** For use with aluminum rivets up to 3/16" and steel rivets up to 1/8". Using this tool with steel rivets over 1/8" diameter will damage the tool and void the warranty.

See our selection of blind rivets on page 105.

Socket Roll

New!



Tired of lugging around a heavy toolbox just to keep your sockets organized? Don't be tempted to just toss them in a bag. The **Socket Roll** is an easy way to keep your sockets and ratchets organized, without weighing you down. The compact, lightweight (but tough) tool roll has elastic loops arranged to hold full SAE and metric socket sets in 1/4", 3/8", and 1/2" drive. Carry a total of 50 sockets, 3 ratchets, plus extensions! Available in Black, Blue, Camo, Cardinal red, Coyote (light brown), Gray, or hot Pink.

Socket Roll Tool Organizer, specify color 3842-Color \$49.99

Note: Tools are sold separately.

Perma-Coil Thread Repair Kits

Perma-Coils are the best way to repair stripped threads. Simply drill out the damaged threads, cut larger threads with the special tap (included in each kit), and install the stainless steel insert coil. The resulting repair is stronger than the original threads! Install Perma-Coils in new castings to avoid problems before they start. Fully interchangeable with Heli-Coil® inserts and tooling. Kits include the special tap, installation tool, and one pack of inserts. Available in most popular SAE and metric sizes.



Thread Size	Perma-Coil Kit		Inserts in Kit	Extra Perma-Coil Inserts	
	Part No.	Price		Part No.	Price
10-32	3865-0190-32	\$44.99	12	3868-0190-32	\$6.99
1/4-28	3865-0250-20	\$31.99	12	3868-0250-20	\$6.99
1/4-20	3865-0250-28	\$44.99	12	3868-0250-28	\$6.99
5/16-18	3865-0312-18	\$31.99	12	3868-0312-18	\$7.99
5/16-24	3865-0312-24	\$44.99	12	3868-0312-24	\$7.99
3/8-16	3865-0375-16	\$31.99	12	3868-0375-16	\$9.99
3/8-24	3865-0375-24	\$44.99	12	3868-0375-24	\$9.99
7/16-14	3865-0437-14	\$33.99	6	3868-0437-14	\$5.99
7/16-20	3865-0437-20	\$44.99	6	3868-0437-20	\$5.99
1/2-20	3865-0500-20	\$49.99	6	3868-0500-20	\$7.99
5/8-18	3865-0625-18	\$62.99	6	3868-0625-18	\$16.99
3/4-16	3865-0750-16	\$77.99	4	3868-0750-16	\$15.99

The following size repairs stripped spark plug threads on FF1600 heads:

14x1.25	3870-14x1.25	\$84.99	0*	3873-14x1.25	\$11.99/6
---------	--------------	---------	----	--------------	-----------

*This kit includes the tap and installation tool only. Inserts are sold separately in packs of 6.

Please see our website for a full selection of metric sizes and replacement tooling.

X-Out™ Damaged Screw Removers

Remove damaged screws quickly and easily. Works with your variable speed drill or 1/4" hex bit holder. Set the drill in reverse, push down and turn. Removes most screw styles including Phillips, hex, and Torx. Set of 3 covers #6 to #12 size screws.



X-Out™ Damaged Screw Removers Part No. 3741 \$24.99

Beta Tools 1120 Sheet Metal Nibbler

This nibbler from Beta Tools makes quick work of cutting sheet metal. A thin strip of waste material is pushed up and out of the way with each stroke of the handles. Much more convenient than tin snips when cutting through the middle of a sheet. Cuts sheet steel up to 19 gauge (0.047"). The jaws can be replaced when they get dull. 11" long overall.



Beta Tools 1120 Sheet Metal Nibbler Part No. BT-011200101 \$78.09

Thread Detectives

New!



Need help identifying a threaded fastener? The Thread Detective® makes it easy! Each Thread Detective kit has multiple steel test thread fittings, each with male and female threads. Just try threading your piece until you find a match! The thread size is printed right on each fitting, and the fittings are threaded onto lanyards to stay together. Three kits cover all common coarse and fine screw sizes from SAE #1 through 1" and M1.2 through M24. A fourth kit has just 8 fittings covering lug nut sizes from 7/16-20 through 9/16-18 and M12 through M14.

Mini Thread Detective, #1 to #5, M1.2 to M3.5 Part No. 3319-005 \$38.99
Standard Thread Detective, #6 to 1/2", M4 to M12 Part No. 3319-006 \$38.99
Jumbo Thread Detective, 5/8" to 1", M14 to M24 Part No. 3319-007 \$38.99
Lug Nut and Wheel Stud Thread Detective Part No. 3319-008 \$18.99
Full Set of all 4 Thread Detective Kits Part No. 3319-009 \$119.99

Trail D-Vise Trailer Hitch Vise



Put a vise anywhere you need it, whenever you need it! This heavy-duty vise fits any 2" hitch receiver (Class III or IV) to get you out of the toughest jams. Excellent for trailers with lightweight aluminum cabinets, or for those of us with open trailers. The textured jaws open wide enough to press in driveshaft U-joints. Use the included flat handle or your own 15/16" wrench to operate the jaws. A built-in bottle opener helps you celebrate the end of a long day. Made in USA.

Trail D-Vise Trailer Hitch Vise Part No. 3158-102 \$159.99

Beta Tools

Beta Tools Torque Wrenches

Whether you prefer the high-tech accuracy of a digital torque wrench or the old-school simplicity of a click-type torque wrench, Beta Tools has you covered.



599DGT/6 Digital Torque Wrench, 3/8" Drive, 8-44 lb-ft
Part No. BT-005990003

606/20 Click-Type Torque Wrench, 1/2" Drive, 15-80 lb-ft
Part No. BT-006060120

The **599DGT Series Digital Torque Wrenches** are reversible to tighten clockwise or counter-clockwise. They feature a 2-stage buzzer and 2-color LED indicators to let you know as you approach the desired torque, as well as a peak hold function. They are accurate to ±2% clockwise (right hand) and ±3% counter-clockwise (left hand).

599DGT Digital Torque Wrench	Part No.	Price
599DGT/6, 3/8" Drive, 8-44 lb-ft.....	BT-005990003	\$423.08
599DGT/20, 1/2" Drive, 30-150 lb-ft.....	BT-005990020	\$456.88

The above digital torque wrenches are supplied with 2 AA batteries and a protective case.

The **606 Series Click-Type Torque Wrenches** below are for clockwise (right-hand) tightening only. They are accurate to ±4%.

606 Click-Type Torque Wrench	Part No.	Price
606/6, 3/8" Drive, 6-44 lb-ft.....	BT-006060105	\$248.25
606/20, 1/2" Drive, 30-150 lb-ft.....	BT-006060120	\$272.73

Beta Tools Sliding T-Handle Wrenches with Swivel Joint

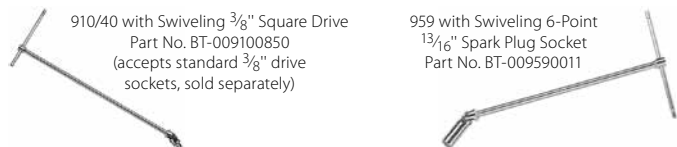

910/40 with Swiveling 3/8" Square Drive
Part No. BT-009100850
(accepts standard 3/8" drive sockets, sold separately)

959 with Swiveling 6-Point 13/16" Spark Plug Socket
Part No. BT-009590011

If you have ever watched racing mechanics working on an engine between sessions, chances are you've seen T-handle wrenches in use. The handle on these Beta Tools T-handle wrenches also slides, making an L-handle for extra leverage when you need it. Once the fastener or plug is broken loose, slide the handle back to the center for quick spinning. All of the wrenches listed here also feature a swivel joint at the drive end.

Sliding T-Handle Wrench	Part No.	Price
900/40, Swiveling 1/4" Square Drive.....	BT-009000843	\$41.96
910/40, Swiveling 3/8" Square Drive.....	BT-009100850	\$48.95
959, Swiveling Spark Plug Socket, 16mm (5/8").....	BT-009590010	\$63.52
959, Swiveling Spark Plug Socket, 21mm (13/16").....	BT-009590011	\$83.33

Beta Tools Cabinets, Trolleys, and Boxes

Beta Tools made their mark with innovative tool storage cabinets and trolleys for professional racing mechanics. Now those same cabinets are available for your garage!

The **C24SL Roller Tool Cabinet** features 7 locking drawers, a heavy 1" thick varnished wood laminate worktop, and large 5" casters. Two shelves on one end, a shallow "bottle" shelf at the other end, and a built-in paper towel holder make this a great cabinet for the race trailer. Measures just 21.25" wide x 41.38" long, yet the drawers are a full 23" x 14.5". The bottom drawer is 8.25" deep, the next drawer is 5.5" deep, and the other five are each 2.75" deep. Orange steel panels with aluminum posts, black shelves, and grey handles. Weighs 139 pounds empty, but can handle up to 1500 pounds. 38.3" tall.

Beta Tools C24SL Roller Tool Cabinet.....	BT-024002101	\$1,526.81
---	--------------	------------

This oversize item ships via Truck Freight. Freight costs will be added to your order.

The **C25 "Tank" Trolley** has been a favorite of professional race mechanics since its introduction in 1969! In addition to the 15" x 25" bottom shelf and 4-compartment side shelf, this cart features a recessed 13" x 15" work surface on top. The trick is that the tool storage inside the cart can be accessed without tipping over the worktop. You won't need to relocate your project just to get a tool out of the cart. Measures 17.75" wide x 32" high x 33" long (48" long with top open). Heavy-duty steel cart is built like a tank, but weighs just 70 pounds empty. Orange with grey and white logos and black trim.

Beta Tools C25 TANK Trolley.....	BT-025000001	\$815.85
----------------------------------	--------------	----------

This oversize item ships via Truck Freight. Freight costs will be added to your order.

The **C41H Two-Module Trolley** is a compact 36.25" tall rolling tower that can hold all the tools for your race weekend. The 10" x 21" footprint fits into the smallest trailer. A telescoping handle and two oversize casters let you move it like a hand truck. The base of the trolley features three locking drawers on ball-bearing slides (one 11.5" high and two 3.75" high), plus a removable plastic small parts organizer. The top is a 9" tall toolbox that can be unlatched and used separately. Elastic cords on the back corners can hold long or awkward tools. Orange steel panels with black plastic tops. Weighs 54 pounds empty.

Beta Tools C41H Two-Module Trolley.....	BT-041000002	\$607.23
---	--------------	----------

The **C19 / C20 Cantilevered Tool Boxes** feature sturdy steel construction for a lifetime of professional use. When you open the box, full-length upper trays lift up and out of the way for easy access. The trays stay upright so your tools don't spill out. Beta orange.

Beta Tools C20L 5-Section Cantilever Tool Box, 22"x8"x8".....	BT-021200002	\$87.41
Beta Tools C20 5-Section Cantilever Tool Box, 18"x8"x8".....	BT-021200001	\$80.42
Beta Tools C19L 3-Section Cantilever Tool Box, 22"x8"x6".....	BT-021190002	\$72.84
Beta Tools C19 3-Section Cantilever Tool Box, 18"x8"x6".....	BT-021190001	\$56.53

Beta Tools Ratcheting Combination Wrenches



Below: Beta 142 Series (19mm shown)

Left: Beta Tools 123 Drive Adapter

(19mm to 1/2" square drive shown)

Socket and 142SN wrench shown are each sold separately

These combination wrenches from Beta Tools all feature one open end and one ratcheting box end. The 142 Series (metric) and 142AS Series (SAE) each have a reversible ratchet end with a fixed 15° offset. The 142SN Series (metric) have a non-reversing ratchet with a swivel joint. The 123 Series adapters turn the ratcheting end into a handy socket driver.

142/B6, Set of 6 Metric Reversing Ratchet Wrenches.....	BT-001420066	\$164.92
8, 10, 13, 14, 17, and 19mm		
142AS/8, Set of 8 SAE Reversing Ratchet Wrenches.....	BT-001420330	\$227.86
5/16", 3/8", 7/16", 1/2", 9/16", 5/8", 11/16", and 3/4"		
142SN/S13, Set of 13 Metric Swivel Ratchet Wrenches.....	BT-001420263	\$392.77
7, 8, 10, 11, 12, 13, 14, 15, 16, 17, 18, and 19mm		
123/K4, Set of 4 Drive Adapters.....	BT-001230504	\$36.13
10mm to 1/4" Hex bit, 10mm to 1/4" square, 13mm to 3/8" square, and 19mm to 1/2" square		

Beta Tools 910/58 Rotating Handle 3/8" Ratchet Driver



Beta Tools 910/58 Rotating Handle 3/8" Ratchet Driver, Part No. BT-009100884

This ratchet driver is a real time saver. The 3/8" square drive is compatible with any standard 3/8" socket or drive accessory. The reversible 52-tooth drive requires just 7 degrees of take-up. But if you're working in an area even tighter than that, just twist the handle like a screwdriver. The special gear mechanism inside will turn the ratchet drive when you twist the handle! Even better, when you twist the handle back to take another twist, the ratchet will turn again. You get two turns from each twist and recoil, without ever letting go of the handle. Great for quick spinning during assembly. Twist the handle for quick driving, then push the handle to deliver the final tightening torque. A retaining ball with a release button on the back of the ratchet head keeps your socket firmly in place. Chrome shaft with a black reversing dial and orange release button. The Beta orange molded BetaGrip handle has black rubberized inserts. Sockets sold separately.

910/58 Rotating Handle 3/8" Ratchet Driver.....	BT-009100884	\$85.08
---	--------------	---------



Below: C41H Two-Module Trolley
Part No. BT-041000002



Above: C24SL Roller Tool Cabinet
Part No. BT-024002101



Tools sold separately

C25 "Tank" Trolley
Part No. BT-025000001



C19 3-Section Cantilever Tool Box
Opened to show 2 lift-out trays
Tools sold separately



C20 5-Section Cantilever Tool Box
Part No. BT-021200001



C19 3-Section Cantilever Tool Box
Part No. BT-021190001

Tools

Safety Wire and Twisting Tools



Safety wiring remains one of the most positive and assured method of securing critical fasteners. We offer a wide variety of twisting tools to help you do the job correctly. The genuine Milbar pliers come in a standard version or several automatic spring-return versions to make the job faster and easier. The 19 inch deep reach wire twister is useful for hard-to-reach fasteners. If you do not require the quality of a Milbar unit, we also offer lighter-duty economy pliers in two sizes.

- Milbar Reversible Automatic Spring-Return Safety Wire Twisting Pliers** Part No. 3090 \$129.99
Twists clockwise or counterclockwise for a professional job that would pass FAA inspection.
- Milbar Automatic Spring-Return 9 Inch Safety Wire Twisting Pliers** Part No. 3118 \$100.99
- Milbar Automatic Spring-Return 6 Inch Safety Wire Twisting Pliers** Part No. 3099 \$99.99
- Milbar Standard (no spring-return mechanism) 9 Inch Safety Wire Twisting Pliers** Part No. 3117 \$94.99
- Milbar Deep-Reach 19 Inch Wire Twister for hard-to-get-at fasteners** Part No. 3130 \$57.99

Economy Twisting Pliers are good for occasional use. Both sizes have an automatic spring return:
Economy 10 Inch Safety Wire Twisting Pliers Part No. 2964-10 \$29.99
Economy 6 Inch Safety Wire Twisting Pliers Part No. 2964-6 \$25.99

Our **Safety Wire** is annealed steel 304 stainless steel, furnished in 1 pound spools in a tangle-resistant dispenser pack.
.020 Dia. Stainless Steel Safety Wire, 1 lb. Spool (700 ft.) Part No. 3129-.020 \$14.99
.025 Dia. Stainless Steel Safety Wire, 1 lb. Spool (600 ft.) Part No. 3129-.025 \$13.99
.032 Dia. Stainless Steel Safety Wire, 1 lb. Spool (366 ft.) Part No. 3129-.032 \$12.99
.041 Dia. Stainless Steel Safety Wire, 1 lb. Spool (223 ft.) Part No. 3129-.041 \$11.99

Safety Wire Drilling Jig



This well-made tool makes drilling the heads of #10 through 5/8 inch fine or coarse threaded bolts nearly foolproof. You will rarely break a drill bit using this fixture. The body of the tool is made from aircraft grade aluminum with a hard anodized finish. Two hard alloy steel drill bushings and two 1/4 inch diameter cobalt drill bits are included. This jig drills the hole through the center of the bolt head. We now offer a metric version tool

- Safety Wire Drilling Jig, SAE** Part No. 3747 \$48.49
- Safety Wire Drilling Jig, Metric (5mm - 14mm)** Part No. 3750-002 \$48.49
- Replacement Drill Jig Bushing** Part No. 3750-025 \$7.99
- Replacement 1/16 inch Cobalt Drill Bit** Part No. 3746 \$2.99

Nut and Bolt Safety Wire Drilling Jig

This unique jig helps you drill through the corner of the hex, making it ideal for drilling nuts as well as bolts. Full adjustability allows use on virtually any hex-head fastener with up to a 1" hex: SAE, metric, even Whitworth! Requires 1/16 inch drill bit, sold separately below.



Note: For best results, start by drilling a shallow 1/8" pilot hole perpendicular to the hex face. This will reduce drill bit skipping and push-out.

- Nut and Bolt Safety Wire Drilling Jig** Part No. 3750-001 \$39.99
- 1/16 inch Cobalt Drill Bit** Part No. 3746 \$2.99

Auto Dolly Vehicle Dolly System

The **Auto Dolly** lets you move cars, ATVs, and trailers in any direction with a minimum of effort. The heavy 1/4" thick steel plate and non-marring casters can support 1500 pounds per pad for a full **6000 pound capacity** for a set of 4! The V-profile shape provides stability and keeps the dolly low (they raise your vehicle just 2") while minimizing tire flat spots in storage. Durable red powder-coated finish. 12" x 16" dolly pads hold tires up to 12" wide. **Sold in pairs.** Made in USA.



- Auto Dolly, set of 2 pads** Part No. 1860-502-12x16 \$94.99

The following Auto Dolly accessories do not include Auto Dolly pads.

- Auto Dolly Wall Storage Rack** Part No. 1860-510 \$39.99
Holds up to 4 Auto Dolly pads out of the way on your wall.
- Auto Dolly Rolling Rack Attachment** Part No. 1860-511 \$84.99
Turns your Auto Dolly pad into a rolling platform that can hold 3 more pads.
- Auto Dolly Tire Stack Attachment** Part No. 1860-512 \$74.99
Bolts to a single Auto Dolly pad (sold separately) to hold a stack of tires up to 40" high.
- Auto Dolly, single pad** Part No. 1860-591-12x16 \$44.99
Add to the Tire Stack Attachment above for a rolling tire rack.

Air Jack System

Used by top IMSA and Trans-Am teams! This system can support up to 850 pounds per cylinder with only 200 psi air pressure. That's about half the pressure required by some other systems! It is enough to lift vehicles up to 4200 pounds (3100 pounds if only three jacks are used, as on Porsche 911). Each kit includes four air jack cylinders, four safety stands, a full set of weld-on mounting plates and brackets, release valves, an air hose wand and receiver — everything you need to install the system in your car. Jack cylinders measure 14" long retracted and can extend up to 9.5" from the bottom of the cylinder. Each cylinder weighs approximately 7.5 pounds including release valve, adapter fittings, and mounting brackets. Welding and fabrication are required.



- Air Jack System, complete kit** Part No. 1860-001 \$3,599.00

Do you have a car that already has an unknown air jack system? No problem! We also offer just the Krontek inlet wand and matching inlet receiver to retrofit existing systems.

- Replacement Krontek Inlet Wand only** Part No. 1860-111 \$499.00
- Matching Krontek Gate Valve / Inlet Receiver** Part No. 1860-112 \$269.99

Quick-Lift Jack and Chassis Stands by B-G Racing

Quick-Lift Jack This heavy-duty jack requires just 2 1/4" of ground clearance. It is low enough to fit beneath the lowest formula cars and sports racers, but its 880 pound platform capacity is strong enough to lift a small production car. It has a 39" reach and an 11 1/2" platform lift height. The extra-long 50" handle is detachable for transport. The lifting platform measures nearly 8" long x 8" wide. Features all-steel construction (no fragile castings to break) with a rugged grey powdercoat finish, two quiet-rolling nylon wheels, and an automatic safety lock with foot-operated release.



Detail of safety lock

Engages automatically at lift height, disengages with a tap of your foot

- Quick-Lift Jack**
Part No. BGR154P \$344.99
This jack will lift either end of an SCCA Spec Racer!



Above:
6 Inch Chassis Stands
Part No. BGR128P
Note: 6 and 7 inch high stands are available in non-folding (solid) style only

Below: 24 Inch Chassis Stands
Part No. BGR125P
18 and 24 inch high stands are available in folding style only



Chassis Stands These sturdy steel chassis stands are designed for formula cars and sports racers. Each stand can hold up to 650 pounds (1300 lb per pair). The non-folding 6 and 7 inch high stands have wide feet to prevent sinking into soft pavement. The folding 18 inch and 24 inch high stands have non-marring plastic foot caps to protect your shop floor. Durable grey powdercoat finish. All sizes are sold in pairs.

- 6 inch high x 22" wide, pair** Part No. BGR128P \$101.99
- 7 inch high x 30" wide, pair** Part No. BGR127P \$123.99
- 18 inch high x 21" wide folding, pair** Part No. BGR126P \$182.99
- 24 inch high x 31" wide, folding, pair** Part No. BGR125P \$212.99

Pit Boards, Racing Flags, and Rain Gear

A Pegasus Exclusive!



Frame-Style Pit Boards The open-frame design makes them easy to hang on to in a stiff wind, yet the quality aircraft grade aluminum alloy construction makes them extremely strong, rigid, and durable. Our number sets are also among the most complete available. The standard number sets include three of each number 0 through 9 and one of each of the following: L, P, T, In, +, -, a decimal point, a colon (:), and a blank single-digit panel which can be customized by the user. This 39 piece number set is housed in a durable nylon pouch with Velcro® closure to keep the panels clean and organized. The decimal and colon panels are narrow enough to allow both to be used on a single line with four other single-digit panels. This means you will never again be confused about which digit represents seconds or tenths. Optional accessories make these boards even more useful. A full-width blank panel (approximately 28 inches) is available for adding the driver's name and/or car number to the top row of a multi-row pit board. This panel can be cut to any width desired for making other custom snap-in cards. One common use is to add the names of your closest competitors for signaling positions and intervals. If you find that three of each number as supplied in the standard number set is not always enough, we have extra sets of numbers 0 through 9 available. The standard pouch is sized to hold one extra set of these numbers.

Single Row Frame-Style Pit Board, 11" high x 30.5" wide ... Part No. 5206-1 \$120.99

Two Row Frame-Style Pit Board, 22" high x 30.5" wide Part No. 5206-2 \$151.99

Three Row Frame-Style Pit Board, 33" high x 30.5" wide Part No. 5206-3 \$202.99

Each pit board above includes a 39 piece number set and number storage pouch.

Extra 10 piece Number Set (one each 0 through 9) Part No. 5208 \$8.89

Full-Width Blank Panel for driver's name, 28" wide Part No. 5211-Panel \$3.19

Please call or visit our website for replacement individual number or symbol panels.

Longacre Track Mat



Lying on your back in the paddock is never comfortable. Even if you are on pavement, you still have to deal with those sharp little rocks that dig into your flesh. This padded mat protects your back or your knees from hot, oily pavement or cold, wet mud. When you're done, just wipe off the heavy vinyl cover. Measures 23.5" W x 49.5" L. Folds for easy storage.

Longacre Track Mat, red Part No. LA11175 \$29.99

OMP Rain Gear



OMP originally introduced this transparent rain suit to the Karting market but it can be equally appreciated by corner workers, stewards or anyone at the track who requires something more than a poncho. This durable suit is made with a 0.2mm thick PVC material that features elastic bands on the arms, ankles and waist. It has a zip closing in front, a collar with a Velcro® closure and an OMP embroidered label. The rugged design permits this suit to be used more than once (unlike others on the market). Available in sizes Small thru XX-Large.

OMP Rain Suit Part No. 2799-Size \$89.00



Less than perfect weather on race day? No problem. Rainproof nylon overshoes from OMP feature heat-welded construction with elastic cuffs and soft rubber soles for a high degree of sensitivity. Available in Black; sizes S thru XL. Small fits 8 - 8 1/2, Medium fits 9 - 9 1/2, Large fits 10 - 11, and XLarge fits 11 - 13.

OMP Rain Shoe Covers Part No. 9314-Size-Black \$35.00

Flip Chart Pit Board

FlipCom Pit Board with Extended Back This three-digit pit board is highly visible and easy to use. All three positions have the numbers 0 through 9. The first position includes T, P, L, +, -, and a blank panel for adding your own symbol. The second and third positions include the word IN. All plastic construction and durable ink makes it water, gas, and oil resistant. The board is white with black lettering. An extension on the bottom of the back panel allows you to add the driver's name or car number, making it easier for the driver to pick out the proper board. The board measures 18" wide by 17" high and weighs less than 3 pounds.



FlipCom Pit Board with Extended Back Part No. 5201 \$42.99

See page 35 for custom-cut vinyl graphics for the driver's name. We recommend 3" high letters and numbers, or 2" high if any hanging lower-case (g, j, p, q, and y) are needed.

OMP Frame-Style Pit Board



This 4-row pit board from OMP features welded aluminum construction for professional use. The 5.5" x 9" panels are printed in high-visibility yellow on a black background. The standard set includes three sets of numbers 0 through 9 plus 2 each of +, -, and "IN"; 1 each of letters A, B, C, P, and T; and a single vertical arrow. All of the panels fit into a storage bag that can hang from the frame for convenient storage. Each row can hold up to 4 of the single-digit panels. A full-width 26" blank panel is also included for the driver's name. Weighs less than 8 pounds including all number panels. Measures 28.5" wide x 40.5" high overall.

OMP Frame-Style Pit Board, 4-Row

Part No. OMP-KC1068 \$229.00

Racing Flags



Our durable nylon flags measure 23" x 24" and have a sturdy 1 1/8" x 36" wood staff. The **Checked Flag** has sewn (not printed) black and white squares. The 7 piece **Corner Worker Flag Set** includes 1 of each of the following: white, black, red, blue/yellow passing flag, and red/yellow debris flag. Also includes 2 yellow flags. We also offer all of these flags separately. Please see our website for details.

7 Piece Corner Worker Nylon Flag Set Part No. 2832 \$172.99
Includes White, Black, Red, Blue "Passing", Red/Yellow "Debris", and two Yellow flags.

Sewn Nylon Checkered Flag Part No. 2830 \$47.99

Nylon "Meatball" (Mechanical Black) Flag Part No. 2831 \$39.99

Nylon Green Flag Part No. 2835 \$28.99

Add the above three flags to a Corner Worker Set to make a complete Starter's flag set.

TOOLS & PIT EQUIPMENT



Rain or shine, you (and a friend) will appreciate the protection of the OMP "London" oversized umbrella! The lightweight carbon fiber shaft has a comfortable wooden handle and features an automatic pushbutton release for easy, one-handed opening. The heavy-duty 44" diameter canopy has a silver lining so you won't be left in the dark. Available in Blue or Silver, each with silver and black OMP logos, a large half-tone OMP logo, and the slogan "On track, on road." Measures 39" long when closed and weighs less than 22 ounces. Great for shading drivers on the grid.

OMP London Umbrella, specify color Part No. OMP-OR5150-Color .. \$40.00

PonchoWheels Rain Poncho



White Rain Poncho by PonchoWheels. Reusable full-size plastic poncho with hood measures 48" x 36". Includes compact, fun storage case with spring-clip to attach to your belt loop or key ring. White only (perfect for corner workers). Keep a couple in the trailer and be prepared for sudden showers. Makes a great gift for crew and guests at the track.

White Rain Poncho Part No. 2800 \$6.49

Heavy-Duty Tie Down Straps and Anchors

Heavy-Duty Ratchet Tie Downs



These popular tie downs feature twisted snap hooks at both ends. They remain securely fastened even if the strap were to become slack for some reason. The entire assembly is rated for a 2000 pound working load limit. The heavy 2 inch wide polyester webbing exceeds the strength of the heavy-duty ratchet. This results in minimal stretch and an extremely long-wearing strap. The aluminum handle on the ratchet is 4 inches wide.

- Heavy-Duty Ratchet Tie Down, 6 foot, each* Part No. 2351-6 ft. \$31.99
- Heavy-Duty Ratchet Tie Down, 8 foot, each* Part No. 2351-8 ft. \$33.99
- Heavy-Duty Ratchet Tie Down, 12 foot, each* Part No. 2351-12 ft. \$34.99
- Heavy-Duty Ratchet Tie Down, 16 foot, each* Part No. 2351-16 ft. \$37.99
- Heavy-Duty Ratchet Tie Down, 20 foot, each* Part No. 2351-20 ft. \$40.99

Tie Back Straps



Tie Back Straps are used to anchor one end of your car so you can use ratchet tie downs to apply tension from the other end. These straps have the same twisted snap hooks, heavy-duty 2" webbing, and 2000 lb. working load limit as our ratchet tie downs.

- 48" Tie Back Strap* Part No. 2357-48 \$14.79
- 60" Tie Back Strap* Part No. 2357-60 \$15.49

Our Combo Tie Back Strap anchors one end of the car like a standard tie back strap, but an adjustable loop lets you wrap the strap around an axle. Adjusts from 24"-40" and has the same twisted snap hooks, heavy-duty 2" webbing, and 2000 lb. working load limit as our other tie downs. A Cordura sleeve protects the loop webbing.

- 2" Combo Tie Back Strap* Part No. 2356 \$24.99

Axle Strap with Protective Sleeve



Our axle strap features heavy-duty 2" wide nylon webbing for wear resistance and steel D-Rings at each end. The strap is covered with a Cordura sleeve to protect both the webbing and the car's suspension. 1670 pound working load limit.

Note: When wrapped around an axle (with both ends pulling in the same direction), each end of the strap carries only half of the applied load. In other words, one of our ratchet tie-downs loaded to its working load limit of 2000 pounds will only load each half of this strap with 1000 pounds.

- Axle Strap, 21 inch length, with sleeve* Part No. 2355 \$9.59

Heavy-Duty D-Ring Tie Down Anchor Points



These steel D-Rings far exceed the rating of your tie downs to avoid introducing a "weak link". Two styles are available. The two Surface Mount rings are simple to install, and each is only 3/16 inch high when the ring is folded flat. The Recessed Mount requires a 1 inch deep cutout in the trailer floor, but then presents almost no obstruction when the ring is down. Sold individually.

- Surface Mount D-Ring, 3-bolt style, 7000 lb. rating* Part No. 2353 \$8.99
- Surface Mount D-Ring, 2-bolt style, 12,000 lb. rating* Part No. 2360-050 \$9.99
- Recessed Mount D-Ring, 5,000 lb. rating* Part No. 2354 \$7.99

E-Track Anchoring System

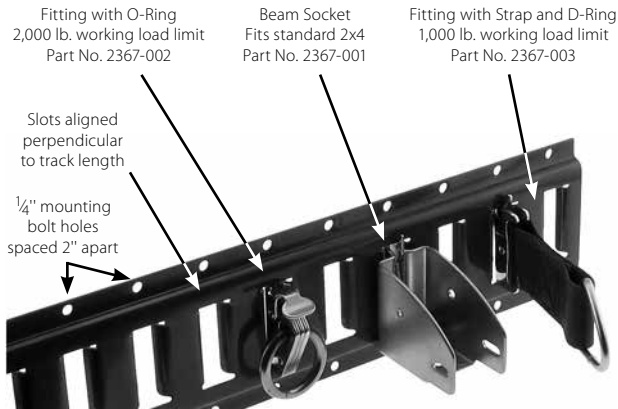

- Fitting with O-Ring
2,000 lb. working load limit
Part No. 2367-002
- Beam Socket
Fits standard 2x4
Part No. 2367-001
- Fitting with Strap and D-Ring
1,000 lb. working load limit
Part No. 2367-003

Slots aligned perpendicular to track length

1/4" mounting bolt holes spaced 2" apart

Horizontal E-Track, Part No. 2365-Length
Fittings sold separately

E-Track Anchoring System Customize your trailer to fit your exact needs with E-Track, the most versatile, most flexible tie-down anchoring system around. E-Track allows you to customize your trailer to fit your needs and change at any time. Haul your racing machine on weekends and your work machines during the week! The special snap-in fittings and anchors can be easily moved – without tools – whenever your needs change. E-Track can even increase the resale value of your trailer because the next owner can use it right away without having to invest in new anchor hardware. E-Track can also be installed inside cargo vans or pickup truck beds. Mounting with 1/4" Grade 5 bolts will provide a safe working load of 470 pounds per bolt. Bolt holes (and slots) are located every 2 inches along the track.

- Horizontal E-Track, 2.5 foot length* Part No. 2365-2.5 FT. \$9.99
- Horizontal E-Track, 5.0 foot length* Part No. 2365-5 FT. \$19.99

Note: 5 foot lengths incur a \$14.25 handling surcharge when shipped via UPS. This charge is per box, not per piece. Up to 4 pieces can be shipped in one box with just one surcharge.

- E-Track Fitting with O-Ring, 2,000 lb. working load limit* Part No. 2367-002 \$7.99
- The 1.5" ID steel ring is oriented parallel to the E-Track (see photo). This style is recommended when the tie-down will be parallel to the anchor slot or parallel to the mounting bolts.

- E-Track Beam Socket, holds standard 2" x 4"* Part No. 2367-001 \$6.99
- Four Beam Sockets plus two 2x4s equals an instant tire rack! Add a piece of plywood (screwed to the bottom of the 2x4s) and you have a quick, sturdy shelf with built-in retention rails. Holes in the socket allow the 2x4 to be fastened in place for a more permanent installation.

- E-Track Fitting with D-Ring Strap, 1,000 lb. working load limit* Part No. 2367-003 \$7.29
- The 4.5" long strap and triangular D-Ring are oriented perpendicular to the E-Track. This style is especially recommended when the tie-down will be pulling perpendicular to the anchor slot.

Light-Duty Tie Downs

Light-Duty Ratchet Tie Downs



These economical tie downs are perfect for lighter loads that don't require the strength of our heavy-duty ratchet tie downs. The 1 inch wide webbing is adjustable from 12 to 66 inches. The hooks at each end are vinyl coated to prevent scratching. The high-quality ratchet resists bending and jamming, unlike the "bargain" straps sold in big-box stores. The strap assembly has a 1,200 pound working load limit. Set of 2 straps.

- 1" Ratchet Straps, pair* Part No. 2305-001 ... \$23.99

Light-Duty Cam Buckle Tie Downs



These straps are great for securing lightweight items such as toolboxes or tires quickly and easily. To tighten, simply pull on the loose end. Press the cam buckle to release. That's it! The 1 inch wide webbing is adjustable from 12 to 66 inches. Vinyl-coated hooks at each end resist scratching. The strap assembly is rated to 1,200 pounds working load limit. Set of 2 straps.

- 1" Cam Buckle Tie Downs, pr* ... Part No. 2305 \$19.99

Spare Tire Tie Down



This light-duty 3-point tie down from OMP is designed to secure the spare tire in a rally car, but it is also great in the trailer. The center strap has a ratchet adjuster with a coated steel S-hook. The other strap forms a V with wrap-around mounting loops at each end. Max length from S-hook to ratchet is 20"; max total length of the V straps is 60". Includes 3 forged steel eyebolts and 3 threaded steel backup plates for sturdy mounting.

- Spare Tire Tie Down* Part No. OMP-NA1822 \$65.00

Trailer Security



The **Wheel Stop** is an easy way to hold multi-axle trailers in place. Simply place between a pair of tires and turn the knob. The Wheel Stop wedges between the treads to prevent forward and backward movement. Bright yellow construction makes it hard to lose or leave behind. The larger size also features a steel lock bar and padlock for added security. Both sizes fit 26 to 30 inch diameter tires. Use the smaller size when your tire spacing is 1 1/2 to 3 1/2 inches, and the larger size when there is 3 1/2 to 5 1/2 inches of space between treads. Not for use on tractor-trailers or other heavy-duty commercial vehicles. Made in USA. **Large size with lock pictured at left.**

Trailer Aid Wheel Stop for 1 1/2-3 1/2" tire spacing Part No. 2360-005 \$21.99
Trailer Aid Wheel Stop with Lock for 3 1/2-5 1/2" tire spacing Part No. 2360-001 \$39.99

The **Super Chock** is designed just for keeping trailers and tow rigs in place (not for use on tractor-trailers or other heavy-duty commercial vehicles). Ribs on the top and bottom surfaces provide traction. Lightweight (only 2 pounds) won't weigh down your trailer. Convenient molded-in handle features a hole for hanging or tying two units together. High-visibility yellow makes it hard to lose or leave behind. Measures 8.5" w x 5.5" h x 10" d. Sold individually.

Super Chock Part No. 2360-002 .. \$13.99



Stop trailer theft! The **Wheel Club** is made by the same company that brought you "The Club" steering wheel lock. The Wheel Club clamps across any tire from 21" to 28" diameter and up to 9" wide. The lock plate restricts access to the lug nuts so thieves can't just take the wheel off. Bright red finish acts as an excellent theft deterrent. Lock cylinder includes a weatherproof cap and two keys.

Wheel Club Part No. 2360-003 \$79.99



Protect your trailer with The **Tire Claw XL**, from the same company that brought you "The Club" steering wheel lock. The Tire Claw XL clamps around any tire up to 12" wide and up to 7" sidewall height. Bright red finish lets thieves know that your trailer is not an easy target. Ratcheting lock makes installation an easy, one-handed operation on any vehicle. Lock cylinder includes a weatherproof cap and two keys.

Tire Claw XL Part No. 2360-004 \$99.99

Spare Parts Storage and Organization

Small Parts Organizer Boxes



We offer two sizes of divided organizer boxes. Both sizes are made from tough, nearly unbreakable plastic.

Small Organizer (shown) measures 9 1/8" wide x 5" deep x 1 1/4" high with 18 compartments measuring 1 1/4" by 1 1/4". Removable dividers allow you to make anywhere from 3 to 18 compartments.

Small Organizer Box, removable dividers Part No. 4330 \$6.99

Large Organizer measures 13" x 9" x 2.25" with 12 small 2" x 2" fixed compartments and 6 large 2" x 4" fixed compartments.

Large Organizer Box, fixed dividers Part No. 2990 \$14.99

Heavy-Duty Spare Parts Box

Our strong polyethylene storage box will protect your spare parts and equipment and help to keep things organized. The interlocking cover keeps parts in and dirt out. Boxes stack neatly and securely when the lid is closed and nest to conserve space when empty. This is not the cheap, flimsy, easily cracked box sold at the hardware store. Measures 21" long x 15" wide x 12" high. Royal Blue color.



Heavy-Duty Spare Parts Box Part No. 3399 \$32.99

Tow Hooks and Tow Straps

Tow Hooks and Tow Loops

OMP EB/571
Stainless Steel
Tow Ring
Part No. 2359



OMP EB/578R
Flexible Tow Loop
Part No. OMP-EB578R



OMP EB/572
Flat Aluminum Tow Ring
Part No. 2349



Below: RaceQuip Tow Loop with Steel Ring
Part No. RQP897147
(adjusted to 7")



Below: RaceQuip Tow Loop with Sewn Loop
Part No. RQP898148
(adjusted to 24")



Tow hooks are now required by many sanctioning bodies including SCCA. We offer a variety of designs to fit virtually any installation. All of these tow hooks and loops are suitable for cars weighing up to 3500 lbs when properly mounted. Sold individually.

OMP EB/571 Stainless Steel Tow Ring, yellow Part No. 2359 \$29.00
M12x1.75 x 4" long stud, 50mm ID ring. FIA Approved.

OMP EB/572 Flat Aluminum Tow Ring, yellow Part No. 2349 \$45.00
Four 8mm (5/16") mounting holes, 8.5" long overall, 50mm ID ring. FIA Approved.

OMP EB/578R Flexible Tow Loop, red Part No. OMP-EB578R \$30.00
8mm (5/16") bolt-on end plate, 2" wide nylon strap, 10" long overall. FIA Approved.

RaceQuip Flexible Tow Loop with Steel Ring, red Part No. RQP897147 \$24.95
8mm (5/16") bolt-on end plate, 2" wide strap, 2" ID ring, adjusts from 7" to 24" long.

RaceQuip Flexible Tow Loop with Sewn Loop, red Part No. RQP898148 \$18.95
8mm (5/16") bolt-on end plate, 2" wide strap, 3" ID loop, adjusts from 7" to 24" long.

Race Car Tow Strap



This 2" wide, 16 foot long strap is manufactured to the same standards as our ratchet tie-downs for a working limit of 3300 pounds. A snap hook and "D" ring at one end and a sewn loop at the other end make it easy to attach to just about anything.

Race Car Tow Strap Part No. 2352 \$24.99

Tow Hook and Jack Point Decals

Note: SCCA and many other sanctioning bodies require tow hooks on cars where the roll cage is not easily accessible. These tow hooks must be clearly marked for quick identification by the safety crews.



"TOW" is available in triangular or rectangular style, pointing up, down, left, or right.



"JACK" is available in rectangular style, pointing down.

Make it easy for the Safety and Rescue crew to find your tow hook with these vinyl decals. For the **Tow Decals**, choose a Triangular or Rectangular decal with the arrow pointing **Up, Down, Left or Right**, in a variety of colors. Low tack application tape is applied to the top of the decal to allow easy installation. The vinyl exists only in the colored areas as shown in the drawing above; the white areas are not vinyl. The color of your vehicle's paint will show through in these areas, so be sure to choose a vinyl color that provides a good contrast to the underlying paint color. **Available in black, blue, neon orange, red, white and yellow.**

Rectangular Tow Hook Decal, 4" x 1.86" Part No. TOW-A-Direction-Color .. \$2.99
Triangular Tow Hook Decal, 4" x 2.33" Part No. TOW-B-Direction-Color .. \$2.99

Your crew will be able to identify a safe jacking point quickly with our **Jack Decal**. Rectangular style, pointing down only. Same color choices as above.

Rectangular Jack Decal, 4" x 1.38" Part No. JACK-B-Down-Color \$2.49

Tow Snake Recoiling Tow Strap

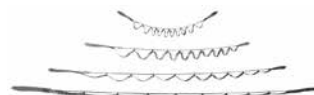

If you have ever run over a tow strap, you will appreciate the **Tow Snake!** This brilliantly simple tow strap uses an elastic cord to take up the slack in the strap. When the strap is tight, all of the vehicle's weight is

pulled by the 2" wide nylon strap. Any time the strap goes slack, the elastic band coils up the strap to keep it out of harm's way. The sewn loops at each end are just the right size to fit over a hitch ball. 10,000 pound rated strap has a 3,333 pound working load limit. Two lengths are available. The 20 foot length is recommended for towing cars with tow hooks on the roof, or when towing by the roll bar (as on formula cars). Either length can be used on cars with tow hooks on the front of the car.

Tow Snake, 15 feet, coils to 7.5 feet Part No. 2360-100-15 \$41.99

Tow Snake, 20 feet, coils to 10 feet Part No. 2360-100-20 \$51.99

Brake Tools

Brake Bleeder Bottles



Our bleeder bottles feature an extra nipple on the top which gives you a place to "park" the tubing. This allows any brake fluid remaining in the tubing to drain back into the bottle, making storage much less messy. Dripping brake fluid can ruin most painted surfaces, so it is important to keep the old fluid where it belongs. The nipple also vents the bottle during use, so you can keep the cap on tight at all times. Some other bottles require you to loosen the cap to let the air out, inviting brake fluid spills. We offer bottles with a traditional lanyard (left) for hanging from suspension parts, or with a magnet (right) to stick to any ferrous metal part. Sold individually.



- Bleeder Bottle with Lanyard Part No. 3139 \$17.99
 - Bleeder Bottle with Magnet Part No. 3136-400 \$16.99
 - One-Man Bleeder Bottle with Magnet Part No. 3136-350 \$19.99
- This bottle has an integrated one-way check valve in the hose to stop air from being pulled back into the system. Use it whenever you can't use the Speed Bleeders at right.*

Brake Pad Spreading Tool

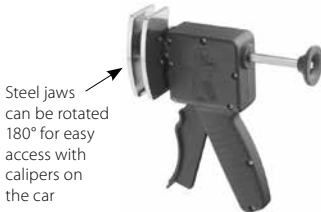

Steel jaws can be rotated 180° for easy access with calipers on the car

This easy-to-use tool pushes the pistons back into your brake calipers for quick and hassle-free brake pad changes. Using the wrong tool can damage pads, rotors, pistons, and seals. Our pistol-grip spreader pushes squarely against the piston to prevent cocking the piston in the bore. Simply insert the jaws in the caliper and squeeze the handles together. Works on virtually any caliper* — floating or fixed, single, twin, or 4-piston.

You can even use it on huge 6-piston monobloc calipers. The jaws can be rotated 180 degrees so you don't have to pull the caliper off the car. The heavy-duty, corrosion-resistant plated steel jaws measure 3 1/2" wide x 1 1/2" deep x 1/4" thick. This reliable tool is backed by a limited lifetime warranty.

- Brake Pad Spreading Tool Part No. 3136-300 \$119.99
- * Not for parking brake calipers which retract by rotating the piston.

Speed Bleeders – Bleed brakes without a helper!

Special sealant on the threads helps to prevent air leaking in while bleeding.



Speed Bleeders allow true one-person hydraulic system bleeding with no special equipment or compressed air source. When the Speed Bleeder screw is opened, a one-way ball check valve allows fluid and air out, but nothing back in. Unlike some other designs on the market, Speed Bleeders use a standard seat, so they cannot fail while the screw is closed. Speed Bleeders give you the convenience of a check valve without compromising the inherent reliability of a standard bleeder screw.

- 1/4"-28 Speed Bleeder Screw, 1.0" long overall Part No. 3266-16 \$9.69
- 7 x 1.0 mm Speed Bleeder, 1.2" long overall Part No. 3266-12 \$9.69
- 8 x 1.25 mm Speed Bleeder, 1.2" long overall Part No. 3266-17 \$9.69
- 3/8"-24 Speed Bleeder Screw, 1.3" long overall Part No. 3266-10 \$9.69
- 10 x 1.0 mm Speed Bleeder, 1.2" long overall Part No. 3266-14 \$9.69
- 10 x 1.25 mm Speed Bleeder, 1.2" long overall Part No. 3266-15 \$9.69

Brake Piston Removal Wrenches

These accurately machined and anodized 6061-T6 wrenches fit snugly around your caliper pistons to provide a very firm grip. This allows you to safely insert and remove pistons using a gentle twisting motion while applying axial pressure. The chance of damaging a piston or seal (or causing serious injury) is greatly reduced compared to improvised methods. Sharp laser engraving on the black handles is easy to identify the correct size wrench.



Flat provides clearance between pistons on 4- and 6-piston calipers

- Brake Piston Wrench, 31.8mm (1 1/4") Part No. 3915-31.8mm \$49.99
- Brake Piston Wrench, 38.0mm (1 1/2") Part No. 3915-38.0mm \$49.99
- Brake Piston Wrench, 41.3mm (1 5/8") (Lockheed LD 19) Part No. 3915-41.3mm \$49.99
- Brake Piston Wrench, 44.5mm (1 3/4") (LD 20 & ICP) Part No. 3915-44.5mm \$49.99
- Brake Piston Wrench, 47.6mm (1 7/8") (Girling 14LF) Part No. 3915-47.6mm \$49.99

Wheel Studs and Lug Nuts

We stock wheel studs for many popular applications. These heat-treated 8740 chrome moly studs boast a 200,000 psi tensile strength to withstand the shock loads and lateral forces in racing applications.* Lug nuts sold separately.

Application	Knurl Dia.	Knurl Length	Nose Length	Shank Length	Thread Size	Part No.	Price and Package Qty.
Chrysler Rear	0.680"	0.400"	0.400"	3.125"	1/2"-20	3546-001	\$41.42 for 5 studs
Ford Rear Disc/Chrysler Front	0.625"	0.400"	0.437"	3.500"	1/2"-20	3546-002	\$42.95 for 5 studs
Ford Front Disc	0.618"	0.800"	0.250"	3.050"	1/2"-20	3546-003	\$83.65 for 5 studs
2005 & Up Ford Mustang Front	0.550"	0.300"	0.300"	3.315"	1/2"-20	3546-020	\$69.51 for 5 studs
2005 & Up Ford Mustang Rear	0.615"	0.300"	0.300"	3.115"	1/2"-20	3546-021	\$69.51 for 5 studs
Late GM Drum	0.486"	0.420"	0.308"	3.165"	7/16"-20	3546-004	\$13.65 for 5 studs
Late GM Disc / Early GM Drum	0.580"	0.300"	0.305"	3.200"	7/16"-20	3546-005	\$13.65 for 5 studs
Late F-Body, Corvette (Short)	0.509"	0.315"	none	2.500"	M12x1.5	3546-006	\$31.58 for 5 studs
Late F-Body, Corvette (Long)	0.509"	0.315"	none	3.250"	M12x1.5	3546-007	\$37.33 for 5 studs
1980-2000 Honda/Acura (Stock)	0.485"	0.275"	0.350"	1.850"	M12x1.5	3546-008	\$16.42 for 4 studs
1980-2000 Honda/Acura (Long)	0.485"	0.275"	0.350"	2.850"	M12x1.5	3546-009	\$19.97 for 5 studs
Aftermarket Axles, 12-point head	none	none	0.500"	3.470"	1/2"-20	3546-010	\$32.04 for 4 studs
Speedway Engineering Pro 4 Disc	0.568"	0.710"	0.437"	2.970"	1/2"-20	3546-011	\$39.67 for 5 studs
Triumph Spitfire, GT6, some FF	0.523"	0.44"	0.070"	1.41"	3/8"-24	3546-012	\$36.09 for 5 studs
Miata 1990-93 F & R, 94-05 Front	0.507"	0.335"	0.350"	2.750"	M12x1.5	3546-013	\$42.95 for 5 studs
Miata 1994-2005 Rear	0.579"	0.300"	0.350"	2.750"	M12x1.5	3546-014	\$29.87 for 4 studs
						3546-015	\$29.87 for 4 studs
						3546-016	\$29.87 for 4 studs

* Except Part No. 3546-014, which is an OEM-quality wheel stud.



Note: Part No. 3546-014 sold individually

	Honda/Acura 12 x 1.5 mm Part No. 3548-001		GM (non-metric) 7/16"-20 Part No. 3548-004
	Ford/Chrysler 1/2"-20 Part No. 3548-002		GM (metric) with Aluminum Wheels 12 x 1.5 mm Part No. 3548-005
	Dodge/Chrysler 1/2"-20 Part No. 3548-003		GM (metric) with Steel Wheels 12 x 1.5 mm Part No. 3548-006

We stock high-quality lug nuts for some of the most common racing applications. Lug nuts are sold individually. Note: "Open" in the chart below indicates that the thread goes all the way through the lug nut.

Application	Thread Size	Hex Size	Length	Seat	Open/Closed	Plating	Part No.	Price each
Honda/Acura	M12 x 1.5	19mm	19.5 mm	12 mm	Open	Chrome	3548-001	\$2.89
Ford/Chrysler	1/2"-20	13 1/16"	5/8"	60°	Open	Zinc	3548-002	\$2.29
Dodge/Chrysler	1/2"-20	3/4"	9/16"	60°	Open	Zinc	3548-003	\$2.49
Most GM (non-metric)	7/16"-20	3/4"	9/16"	60°	Open	Zinc	3548-004	\$2.19
GM with Aluminum Wheels (metric)	M12 x 1.5	19mm	23 mm	60°	Open	Zinc	3548-005	\$3.49
Most GM with Steel Wheels (metric)	M12 x 1.5	19mm	14 mm	60°	Open	Zinc	3548-006	\$2.99
Triumph Spitfire, GT6, some FF	3/8"-24	1 1/16"	5/8"	60°	Open	Zinc	3548-008	\$4.69

Brake Hoses

Goodridge G-Stop High-Performance DOT Compliant Brake Line Kits



The most cost-effective safety and performance improvement you can make on any vehicle!

Racers know that replacing stock rubber brake hoses with stainless steel braided PTFE-lined hoses is a must for performance driving. Now that same performance is available in a bolt-on kit for your daily driver, autocrosser, or B-Spec racecar. Goodridge stainless steel braided brake lines have negligible volumetric expansion. They offer a much firmer pedal than stock rubber lines, allowing more precise and predictable braking. When used with ABS, they virtually eliminate pedal "chatter" and reduce stopping distance. During a panic stop, this can help prevent an accident.

G-Stop brake lines conform to FMVSS106, making them TÜV Approved and fully DOT Compliant. Every brake line is subjected to a 9-point Quality Assurance Test. Each G-Stop kit is engineered to provide a proper fit and easy installation. No messing around with so-called "universal fit" kits, no measuring, and no shopping for adapters. Where necessary, kits include banjo bolts, sealing washers, and hose support brackets for a factory fit. G-Stop Kits are covered under the exclusive Goodridge "Forever Guarantee." **Note:** These kits are designed for stock (OEM) brakes only.

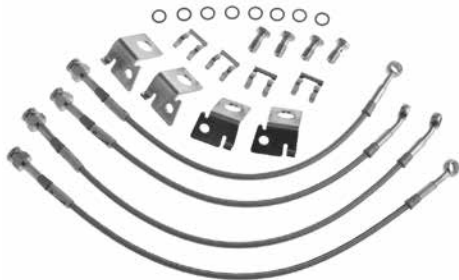

G-Stop Brake Line Kit for Chevrolet Corvette C6
Part No. GS-12290



G-Stop Brake Line Kit for 89-05 Mazda Miata
Part No. GS-25001

G-Stop Brake Line Kits for Domestic Applications:

Chevrolet Corvette C2 / C3, 1963-82	Part No. GS-12201	\$130.69
Chevrolet Corvette C5, 1997-2004 (including Z06)	Part No. GS-12206	\$130.69
Chevrolet Corvette C6, 2005-13 (except Z06)	Part No. GS-12290	\$156.49
Chevrolet Corvette C6 Z06 only, 2006-13	Part No. GS-12291	\$156.49
Chevrolet Camaro, 2010 (SS only)	Part No. GS-12219	\$186.59
GM F-Body, 1984-88 (with 1LE option only)	Part No. GS-12253	\$156.49
Dodge Neon SRT-4, 2003-05	Part No. GS-12408	\$236.62
Ford Mustang, 2005-13 (with ABS only)	Part No. GS-12364	\$236.69

G-Stop Brake Line Kits for European Applications:

Audi A4 / S4, 2003-09	Part No. GS-30006	\$156.49
Mercedes C-Class Coupe, 2002-07	Part No. GS-34030	\$130.69
Porsche Boxster / 911 (996), 1997-04	Part No. GS-37035	\$156.49
Porsche Boxster / Cayman, 2005-12	Part No. GS-37038	\$156.49
VW Jetta / Golf / Eos, 2006-12	Part No. GS-39079	\$130.69

G-Stop Brake Line Kits for Japanese Applications:

Acura Integra, 1990-93	Part No. GS-20062	\$130.69
Honda Civic, 1984-87	Part No. GS-20011	\$130.69
Honda Civic, 1992-95 (rear discs, no ABS)	Part No. GS-20017	\$130.69
Honda Civic, 1992-95 (rear discs, with ABS)	Part No. GS-20018	\$130.69
Honda Civic Si, 1999-2000	Part No. GS-20021	\$130.69
Honda Civic Si, 2006-11	Part No. GS-20024	\$130.69
Honda CRX Si, 1990-91	Part No. GS-20014	\$130.69
Honda S2000, 2000-05	Part No. GS-20111	\$130.69
Honda S2000, 2006-09	Part No. GS-20112	\$130.69
Mazda MX-5 / Miata, 1989-05 (all incl. MazdaSpeed)	Part No. GS-25001	\$186.59
Mazda MX-5, 2006-15	Part No. GS-25002	\$156.49
Mazda 3, 2004-12 (all incl. MazdaSpeed)	Part No. GS-25048	\$130.69
Mitsubishi Evolution X, 2008-10	Part No. GS-26053	\$130.69
Nissan 350Z, 2003-09 (all incl. Brembo brakes)	Part No. GS-22074	\$236.69
Subaru Impreza / Wagon / WRX & STI, 2001-07	Part No. GS-24215	\$130.69
Scion FRS / Subaru BRZ	Part No. GS-28003	\$130.69

Goodridge Custom-Made Racing Brake Hose Assemblies

As a Factory-Authorized Goodridge Technical Center, Pegasus Auto Racing Supplies is equipped to custom-build fuel, oil, and brake hoses* in-house. Each hose starts with proven Goodridge PTFE-lined hose and genuine Goodridge hose ends. Hose ends are assembled using factory-approved tooling. Assembled hoses are proof tested to check for leaks. Every hose is logged and registered with the Goodridge factory to ensure consistent quality. Can you say the same for the hoses on your car?



* Custom-made brake hoses are for off-road use only. See above for DOT-Compliant G-Stop Kits.

Here are just a few of the hose ends we have installed for customers. We have 90 different styles in stock (and that's just for -3 hose)!



HE001-03P-000
Straight 3AN female
hose end in plated steel



HE014-03P-090
90° 3AN female hose end
in forged plated steel



HE035-03P-000
3AN Male bulkhead
hose end in plated steel



HE042-03P-000
1/8 NPT Male hose end
in high-pressure brass



HE090-03P-000
10mm / 3/8" straight banjo
hose end in plated steel



HE102-03P-2020R
10mm / 3/8" banjo hose
end in stainless steel,
20° bend upwards,
20° bend to the right



HE551-03P-000
10x1.0mm female hose
end with concave seat
for bubble flare and male
threads for bulkhead
mounting in plated steel



HE606-03P-090
90° 10x1.0mm male hose
end with convex seat
in unplated steel (mates to
HE551-03P-000 at left)



Order custom hoses by phone or on-line.
An interactive order form on our website makes it easy.
(It's so easy, we use it here when you order by phone!)

Brake Master Cylinders

Girling Master Cylinders

Girling Aluminum Master Cylinders with Small (1.75" dia.) Integral Reservoir These reliable master cylinders feature a rear-facing outlet port that is ideal for cars with limited space in front of the cylinder. The outlet port has female 3/8-24 threads for easy connection to 3AN hose or 3/16" tubing. All sizes include a pushrod with a 5/16-24 thread. Pushrod length varies but is usually 3 to 4" long as measured from the mounting flange. See below for rebuild kits.

- Girling Master Cylinder with integral reservoir - 5/8" Bore* Part No. 3500-62 \$129.99
- Girling Master Cylinder with integral reservoir - .70" Bore* Part No. 3500-70 \$129.99
- Girling Master Cylinder with integral reservoir - 3/4" Bore* Part No. 3500-75 \$129.99
- Reservoir Extension for above master cylinders (with seal & cap)* Part No. 3560 \$46.99
When installing the extension, be sure to position the seal below the flange on the extension.
- Aluminum Cap for small (1.75" dia.) integral reservoir (without gasket)* Part No. 3549 \$16.99
- Plastic Cap for small (1.75" dia.) integral reservoir* Part No. 3550 \$12.99
- Aluminum Cap for large (2.5" dia.) integral reservoir (without gasket)* Part No. 3553 \$17.99
(We don't sell the large reservoir type of Girling Master Cylinder — just the caps.)

Girling Remote Master Cylinders without Reservoir Same as above but without an integral reservoir. A 7/16-20 female inlet port lets you connect to a remote reservoir, or you can screw a reservoir directly to the master cylinder. All sizes include a pushrod with a 5/16-24 thread. Pushrod length varies but is usually 3 to 4" long as measured from the mounting flange. See above for replacement pushrods and optional clevis. See below for rebuild kits and remote reservoirs.

- Girling Remote Reservoir Master Cylinder - 5/8" Bore (alum.)* Part No. 3502-62 \$124.99
- Girling Remote Reservoir Master Cylinder - .70" Bore (alum.)* Part No. 3502-70 \$124.99
- Girling Remote Reservoir Master Cylinder - 3/4" Bore (alum.)* Part No. 3502-75 \$124.99
- Banjo-Style Barbed inlet fitting for 5/16" I.D. hose, includes banjo bolt and washers* Part No. 3219 \$62.99
- Barbed inlet fitting for 5/16" I.D. hose, includes sealing washer* Part No. 3207 \$24.99
- 5/16" I.D. hose for connecting remote reservoirs, per foot* Part No. 3575-Foot \$2.99

Parts & Accessories for Girling Master Cylinders These parts fit both the Integral Reservoir and Remote Reservoir styles above.

- Girling Pushrod, 5/16-24 thread, 3.3 inch overall length* Part No. 3554-3.3 \$16.99
- Girling Pushrod, 5/16-24 thread, 3.7 inch overall length* Part No. 3554-3.7 \$16.99
- Girling Pushrod, 5/16-24 thread, 7.0 inch overall length* Part No. 3554-7.0 \$24.99
- Steel Clevis for pushrod, 5/16" hole, 5/16" slot, 1.8" overall length* Part No. 3576 \$15.99

Rebuild Kits for Girling Master Cylinders These kits fit both the Integral Reservoir and Remote Reservoir styles above. Note that these only work with genuine Girling master cylinders, not "Girling-style" copies.

- Rebuild Kit for Girling 5/8" Bore Master Cylinder* Part No. 3504-62 \$21.99
- Rebuild Kit for Girling 0.70" Bore Master Cylinder* Part No. 3504-70 \$21.99
- Rebuild Kit for Girling 3/4" Bore Master Cylinder* Part No. 3504-75 \$18.99
- Rebuild Kit for Girling 7/8" Bore Master Cylinder* Part No. 3504-87 \$33.99

AP / Lockheed Master Cylinder Rebuild Kits

Although the popular AP / Lockheed "Tin Can" style master cylinder is no longer made, we will continue to stock rebuild kits as long as they are available. Lockheed bore sizes are identified by the shape of the nose at the outlet of the master cylinder (see drawing below).

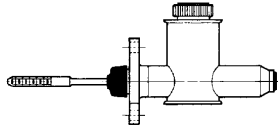

Rebuild Kit for Lockheed Master Cylinder, specify size Part No. 3514-Size \$27.99
Specify bore size when ordering: .62 (5/8"), .70, .75 (3/4"), or .87 (7/8").



All of the master cylinders on this page have the standard vertical mounting flange with 2.25" hole spacing.

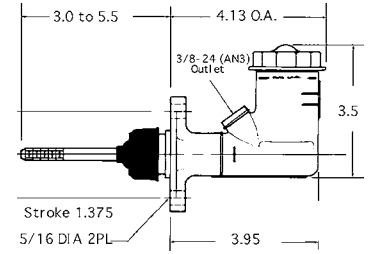

Girling Master Cylinder with Integral Reservoir Part No. 3500-Size

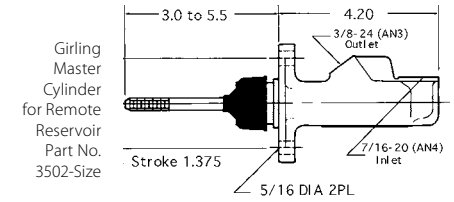

Identifying Girling Bore Sizes

Genuine Girling master cylinders have the bore size cast into the side of the cylinder (or the side of reservoir, on Integral Reservoir versions). It may be a fraction (5/8, 3/4) or a decimal (.625, .75). If it is hard to read with the master installed in the car, hold a piece of paper against the side and rub your finger over the paper. This will transfer the casting details onto the paper, making it more legible.

Brake Assembly Lube (Rubber Grease)



Brake Assembly Lube This special rubber grease is specifically recommended for use when rebuilding hydraulic brake or clutch components. Use it to lubricate rubber parts to prevent scuffing or tearing seals and to make assembly easier. Use it on master cylinder and caliper piston dust boots to help seal out water and ward off corrosion. Apply it generously when rebuilding spares to preserve rubber seals and to prevent them from drying out during storage. Compatible with all racing brake fluids. 2.7 ml packet is just enough to rebuild 1 or 2 calipers, or a set of 3 master cylinders.

Brake Assembly Grease, 2.7ml tube Part No. 3306-001 \$17.00

Remote Reservoirs

These reservoirs are for master cylinders that do not have an integral tank. All are translucent plastic for easy fluid level inspection. The Lockheed reservoirs below feature molded-in mounting tabs for easy installation on a firewall. Capacities shown are approximate.

- Lockheed Reservoir with Single 5/16" Push-on Fitting, 10 oz.* Part No. 3565 \$45.99
- Lockheed Reservoir with Dual 5/16" Push-on Fittings, 10 oz.* Part No. 3566 \$42.99
The dual outlet reservoir has an internal barrier to prevent a leak in one of the circuits from completely draining the reservoir.
- Replacement Cap for Part Nos. 3565 and 3566 (3.5" dia.)* Part No. 3570 \$18.99
- Replacement Cap Gasket for Part Nos. 3565 and 3566* Part No. 3572 \$3.49
- 5/16" I.D. hose for connecting remote reservoirs (per foot)* Part No. 3575-Foot \$2.99
For all reservoirs with barbed push-on fittings. Withstands brake fluid better than standard fuel hose.

The Girling-style reservoirs below can be mounted directly on master cylinders with 7/16-20 female threaded ports. Note that some master cylinders may require shortening the male fitting to avoid interference at the bottom of the port.

- Girling-Style Single Reservoir with Offset 7/16-20 Male Fitting, 3.25" tall, 5 oz.* Part No. 3569 \$24.99
Offset allows 2.5" master cylinder spacing. Height is measured without fitting.
- Girling-Style Single Reservoir with Centered 7/16-20 Male Fitting, 4.75" tall, 7 oz.* Part No. 3574 \$79.99
- Girling-Style Single Reservoir with Centered 7/16-20 Male Fitting, 9.5" tall, 12 oz.* Part No. 3569-002 \$34.99
Above reservoirs require 3" master cylinder spacing. Heights are measured without fitting.
- Replacement Cap for Part Nos. 3569, 3574, and 3569-002 (3" dia.)* Part No. 3573 \$9.99

The inlet fitting kits below will connect our 5/16" ID hose to any master cylinder with a 7/16-20 female inlet port.

- Barbed Inlet Fitting for 5/16" Hose, 7/16-20 Thread, with sealing washer* Part No. 3207 \$24.99
- Banjo Inlet Fitting Kit for 5/16" Hose, 7/16-20 Thread, with banjo bolt and washers* Part No. 3219 \$62.99

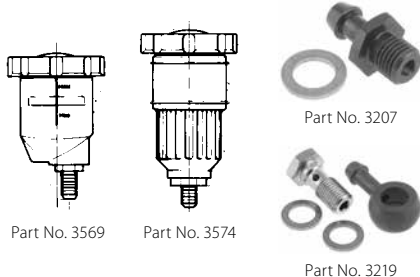
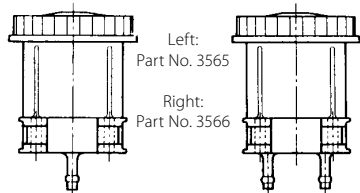

Tilton Master Cylinders

Tilton 74-Series Master Cylinder Kits and Replacement Parts

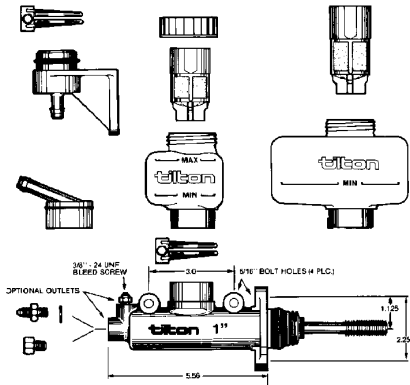

Tilton 74-Series Master Cylinder Kit Part No. 3505-Size

Kit includes large and small fluid reservoirs, remote reservoir mounting bracket, remote inlet fitting, fluid inlet hose, and outlet adapters for 3AN and 3/8-24 inverted flare brake lines.

These very complete kits include both a large (10.7 oz.) and a small (4.0 oz.) reservoir that can be mounted directly on the cylinder or remotely. The remote bracket, fittings and hose are also furnished with the kit. The aluminum body includes bosses for side or flange mounting. Dual outlets are provided along with a bleed screw and adapters for AN3 and 3/16 inch inverted flare brake lines. All sizes include a pushrod with 5/16-24 threads. The pushrod is about 4.24" long as measured from the mounting flange.

- Tilton 74-Series Master Cylinder Kit - 5/8" Bore Part No. 3505-.62 \$75.65
- Tilton 74-Series Master Cylinder Kit - .70" Bore Part No. 3505-.70 \$80.75
- Tilton 74-Series Master Cylinder Kit - 3/4" Bore Part No. 3505-.75 \$75.65
- Tilton 74-Series Master Cylinder Kit - 13/16" Bore Part No. 3505-.81 \$80.75
- Tilton 74-Series Master Cylinder Kit - 7/8" Bore Part No. 3505-.87 \$75.65
- Tilton 74-Series Master Cylinder Kit - 1.0" Bore Part No. 3505-1.00 \$75.65
- Tilton 74-Series Master Cylinder Kit - 1 1/8" Bore Part No. 3505-1.125 \$75.65

Replacement Parts for Tilton 74-Series and 75-Series Master Cylinders:

- Baffled Threaded Cap (leak-proof during cornering) Part No. 3564 \$5.10
- Small Reservoir, 4 oz (threaded cap not included) Part No. 3558-Small \$6.80
- Medium Reservoir, 6.8 oz (threaded cap not included) Part No. 3558-Med. \$6.80
- Large Reservoir, 10.7 oz (threaded cap not included) Part No. 3558-Large \$6.80
- Filter Screen for Small Tilton Reservoir Part No. 3559-Small \$3.82
- Filter Screen for Medium or Large Tilton Reservoir Part No. 3559-Large \$3.82
- Remote Reservoir Mounting Bracket Part No. 3557 \$7.65
- O-Ring for Remote Reservoir Mounting Bracket Part No. 3578 \$1.27
- Remote Inlet Fitting (mounts on master cylinder) Part No. 3563 \$3.40
- Clamp for Reservoir or Remote Inlet Part No. 3577 \$1.70
- O-Ring for Master Cylinder Inlet Neck Part No. 3556 \$1.27
- Tilton Pushrod, 5/16-24 thread, 4.5" long Part No. 3555-4.5 \$15.99
- Tilton Pushrod, 5/16-24 thread, 6.2" long Part No. 3555-6.2 \$31.99
- Tilton Pushrod, 5/16-24 thread, 7.0" long Part No. 3555-7.0 \$25.99

Tilton 78-Series Rear-Pivoting Master Cylinders



The **Tilton 78-Series Master Cylinders** pivot at the rear of the cylinder body to keep the pushrod parallel to the bore throughout the stroke. The cut-off port location is fully tunable so you can alter the pedal free play to suit your individual driving style. Despite the compact size (3.4" long), they still feature a full 1.1" stroke. The pushrod is a larger diameter than on conventional master cylinders, with 3/8-24 threads. The outlet port has 3AN (3/8-24) female threads; the inlet port has -6 (9/16-18) female threads with a flat face for a crush washer seal (inlet fittings sold separately below).

- Tilton 78-Series Master Cylinder, 5/8" Bore Part No. TE 78-625 \$208.25
- Tilton 78-Series Master Cylinder, .70" Bore Part No. TE 78-700 \$208.25
- Tilton 78-Series Master Cylinder, 3/4" Bore Part No. TE 78-750 \$208.25
- Tilton 78-Series Master Cylinder, 13/16" Bore Part No. TE 78-812 \$208.25
- Tilton 78-Series Master Cylinder, 7/8" Bore Part No. TE 78-875 \$208.25
- Tilton 78-Series Master Cylinder, 15/16" Bore Part No. TE 78-937 \$208.25
- Tilton 78-Series Master Cylinder, 1" Bore Part No. TE 78-1000 \$208.25

Note: These master cylinders will not work with conventional bias bars or pedal sets.

Inlet Fittings for Tilton 78-Series Master Cylinders

- Tilton 78-Series master cylinders have a female -6 (9/16-18) brake fluid inlet port.
- Straight Inlet Adapter, 6AN to 4AN Part No. TE 77-015 \$12.75
 - Banjo Adapter, 4AN male, accepts 9/16" banjo bolt Part No. 3265-46 \$38.99
 - Banjo Bolt, 9/16-18 Part No. 3242-026 \$15.49
 - Aluminum Crush Washers, 9/16" ID, pack of 5 Part No. 3278-06 \$2.39

Rebuild Kits for Tilton 78-Series Master Cylinders

- Tilton 78-Series Rebuild Kit Part No. TE 78-(xxx)RK. \$34.00
- Replace (xxx) with bore size when ordering.

Tilton 75-Series Compact Master Cylinder Kits



These compact cylinders have all of the same specifications of the full-size 74-Series master cylinders, but they measure only 3.2" from mounting surface to outlet port. Provides a full 1.1" stroke despite the compact size. Kit includes both small (4 oz) and medium (6.8 oz) reservoirs, plus all the remote mounting parts included with the 74-Series.

- Tilton 75-Series Compact Master Cylinder Kit - 5/8" Bore .. Part No. 3506-.62 \$92.65
- Tilton 75-Series Compact Master Cylinder Kit - .70" Bore .. Part No. 3506-.70 \$97.75
- Tilton 75-Series Compact Master Cylinder Kit - 3/4" Bore .. Part No. 3506-.75 \$92.65
- Tilton 75-Series Compact Master Cylinder Kit - 13/16" Bore Part No. 3506-.81 \$97.75
- Tilton 75-Series Compact Master Cylinder Kit - 7/8" Bore .. Part No. 3506-.87 \$92.65
- Tilton 75-Series Compact Master Cylinder Kit - 1.0" Bore .. Part No. 3506-1.00 \$92.65

Tilton 76-Series Compact Master Cylinders



Based on the popular 75-Series short-body master cylinder (shown above), the Tilton 76-Series master cylinder features a threaded inlet port designed to accept 4AN fittings and direct screw-on reservoirs instead of Tilton reservoirs. Uses the same rebuild kit as the 75-Series (see below).

- Tilton 76-Series Compact Master Cylinder - 5/8" Bore Part No. 3507-.62 \$106.25
- Tilton 76-Series Compact Master Cylinder - .70" Bore Part No. 3507-.70 \$114.75
- Tilton 76-Series Compact Master Cylinder - 3/4" Bore Part No. 3507-.75 \$106.25
- Tilton 76-Series Compact Master Cylinder - 13/16" Bore Part No. 3507-.81 \$114.75
- Tilton 76-Series Compact Master Cylinder - 7/8" Bore Part No. 3507-.87 \$106.25

Tilton Master Cylinder Rebuild Kits

Tilton master cylinder rebuild kits include a replacement piston and return spring for a thorough rebuild. Be sure to order the correct type for your master cylinder: The full-size 74-Series (at left) or the compact 75- or 76-Series (above). Tilton casts the bore size in the side of the cylinder for easy reference.

- Rebuild Kit for Tilton 74-Series Master Cylinders Part No. 3509-xx \$21.25
- Fits Tilton **74-Series** Master Cylinders (our Part No. 3505-xx). Specify bore size: .62, .70, .75, .81, .87, .94, 1.0 or 1.125.
- Rebuild Kit for Tilton Compact Master Cylinders Part No. 3510-xx \$21.25
- Fits Tilton **75-Series** (our Part No. 3506-xx) and Tilton **76-Series** (our Part No. 3507-xx) Master Cylinders. Specify bore size: .62, .70, .75, .81, .87, 1.0 or 1.125.

Tilton 900-Series Pedal Assembly



Right: Tilton 900-Series Floor-Mount Pedal Assembly Part No. TE 72-903 Shown with 77-Series Master Cylinders Part No. TE 77-xxx (sold separately)



Brake Bias Bar for Tilton 77-Series Master Cylinders Part No. TE 72-280

The Tilton **900-Series Pedal Assembly** is designed to work with the Tilton 77-Series rear-pivoting master cylinders (sold separately). This combination minimizes friction and lost motion to provide the most consistent and repeatable braking possible. The billet aluminum pedals pivot on ball bearings for smooth motion without any side play. The special pivoting bias bar (included) bolts in place on the brake pedal. It can be mounted in 8 different positions to adjust pedal ratio quickly from 4.52:1 to 5.80:1. Needle bearing pivots in the bias bar prevent bias creep and migration found in conventional spherical bearing bias bars. The pedal pads are also adjustable vertically and horizontally for best fit and easy heel-and-toe downshifting. Master cylinders sold separately.

- Tilton 900-Series Pedal Assembly, Floor-Mount Part No. TE 72-903 \$2,082.50
 - Brake Bias Bar Remote Adjuster Cable Part No. 3526 \$63.75
- Allows quick bias bar adjustment from the cockpit. Six foot cable can be shortened to suit your installation. Includes detented knob.
- Throttle Linkage for Floor-Mount Pedal Assembly Part No. TE 72-791 \$123.25
- This adjustable bellcrank is used in many front-engine applications to convert the forward push on the throttle to a rearward pull. Not used on rear-engine vehicles.
- Bias Bar only for Tilton 77-Series Masters Part No. TE 72-280 \$531.25
- Pivoting bias bar accepts the 3/8-24 pushrods on the Tilton 77-Series master cylinders. It will not work with conventional master cylinders with 5/16-24 threaded pushrods. This version has 3 sets of mounting bolt holes for adjustability.

BRAKES

obp Motorsport Universal-Fit Pedal Boxes



All obp pedal boxes include an adjustable brake bias bar. Remote adjuster cable and master cylinders are available separately.

Pro-Race V3 Universal Pedal Boxes



The V3 Series feature an anodized T6061 aluminum base and billet aluminum pedals with pads that can be adjusted for length and spacing. These pedal boxes are designed for a universal fit. They are not designed to be a direct fit in any particular car. You will have to do some fabricating and adapting to your chassis.



V3 Cockpit Fit 3-Pedal Box..... Part No. OBP-PRCV302..... \$1,299.00

V3 Floor Mount 3-Pedal Box..... Part No. OBP-PRV302..... \$1,299.00

Pro-Race V2 Universal Pedal Boxes

The V2 series feature a lightweight steel base and billet T6061 aluminum pedals with pads that can be adjusted for length and spacing.

These pedal boxes are designed for a universal fit. They are not designed to be a direct fit in any particular car. You will have to do some fabricating and adapting to your chassis.



V2 Overhung Mount 3-Pedal Box
Part No. OBP-0002PRTC.....\$389.99

V2 Firewall Mount 3-Pedal Box
Part No. OBP-0002PRT.....\$389.99

V2 Cockpit Fit 3-Pedal Box
Part No. OBP-0002PRC.....\$389.99

V2 Floor Mount 3-Pedal Box
Part No. OBP-0002PR.....\$389.99



V2 Overhung Mount 2-Pedal Box
Part No. OBP-0161PRTC.....\$237.99

V2 Firewall Mount 2-Pedal Box
Part No. OBP-0161PRT.....\$237.99

V2 Cockpit Fit Brake Pedal Box
Part No. OBP-0040PRC.....\$184.99

V2 Floor Mount Brake Pedal Box
Part No. OBP-0040PR.....\$184.99

Victory Universal Pedal Boxes

The budget-friendly Victory range feature all-steel construction and non-adjustable pedals. Victory pedal boxes have won numerous championships around the world.

These pedal boxes are designed for a universal fit. They are not designed to be a direct fit in any particular car. You will have to do some fabricating and adapting to your chassis.

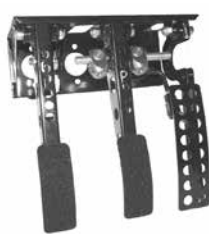

Victory Overhung Mount 3-Pedal Box
Part No. OBP-VIC19.....\$294.99

Victory Firewall Mount 3-Pedal Box
Part No. OBP-VIC04.....\$294.99

Victory Cockpit Fit 3-Pedal Box
Part No. OBP-VIC40.....\$294.99

Victory Floor Mount 3-Pedal Box
Part No. OBP-VIC01.....\$294.99

BRAKES

obp Motorsport Model-Specific Pedal Boxes and Hydraulic Handbrakes

obp Motorsport Track-Pro Model-Specific Pedal Boxes

obp Motorsport Track-Pro pedal boxes are designed for installation into a specific chassis with a minimum of effort. In most cases, you will only need to drill holes and bolt the pedal box to the floor pan. Connect the hydraulics and the throttle and you're ready for the track!

Track-Pro pedal boxes replace the stock brake booster and master with a dual-master system, connecting the masters with an adjustable bias bar. All of these pedal boxes are designed for hydraulic clutch operation.

Track-Pro Multi-Fit 3-Pedal Boxes for Japanese Cars

Track-Pro Multi-Fit pedal boxes are designed to work with the angle of the driver's floorboard. One design can fit many different Japanese cars including Subaru Impreza, Mitsubishi Evo, Nissan 240SX, and Toyota Supra. The master cylinders are mounted under the driver's feet, so a cover plate (sold separately) is recommended. Master cylinders and remote bias adjuster cable are also sold separately.



Track-Pro Multi-Fit 3-Pedal Box
Part No. OBP-0331\$509.00
OBP Master Cylinder Cover Plate
Part No. OBP-0339\$54.99

Track-Pro 3-Pedal Boxes for BMW 3-Series

These Track-Pro pedal boxes are carefully tailored to fit the BMW 3-Series. Three different designs cover all years from 1984 to 2005. Master cylinders and remote bias adjuster cable are also sold separately.

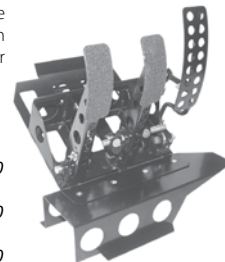

BMW E30 (1984-92), LHD only
Part No. OBP-BMWEL002\$499.00
BMW E36 (1992-99), LHD only
Part No. OBP-BMWL002\$529.00
BMW E46 (1999-2005), LHD only
Part No. OBP-BLE462\$529.00

obp Motorsport Hydraulic Handbrakes

Pro rally cars use hydraulic handbrakes to apply and release just the rear brakes quickly and predictably.

Note: These are not parking brakes! Hydraulic handbrakes are for competition use only.

Pro-Drift V3 Adjustable Aluminum Handbrakes

The Pro-Drift V3 series feature a billet aluminum handle and a machined aluminum base. They can be set up with the handle oriented either vertically or horizontally. Master cylinder sold separately.

V3 Hydraulic Handbrake, Non-Locking Part No. OBP-HBV302\$409.99
V3 Hydraulic Handbrake, Locking Part No. OBP-HBV302L\$429.99
The V3 handle adjusts from 320mm to 380mm (12.6" - 15").



obp Pro-Drift V3 Handbrake, Locking
set up horizontally
Part No. OBP-HBV302L

Pro-Drift V2 Adjustable Aluminum Handbrakes

obp Pro-Drift V2 Handbrake, Locking, Short
set up horizontally
Part No. OBP-HBV20A1L

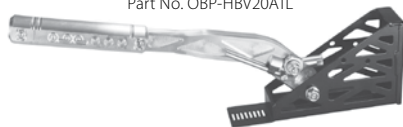

obp V2
Hydraulic
Handbrake
Handle Detail

The Pro-Drift V2 series feature a billet aluminum handle and a lightweight fabricated steel base. They can be set up with the handle oriented either vertically or horizontally. Master cylinder sold separately.

V2 Hydraulic Handbrake, Non-Locking, Short Part No. OBP-HBV20A1 \$157.99
V2 Hydraulic Handbrake, Locking, Short Part No. OBP-HBV20A1L \$172.99
The Short handle adjusts from 320mm to 380mm (12.6" - 15").
V2 Hydraulic Handbrake, Non-Locking, Long Part No. OBP-HBV2LOA1 \$207.99
V2 Hydraulic Handbrake, Locking, Long Part No. OBP-HBV2LOA1L \$227.99
The Long handle adjusts from 540mm to 600mm (21.25" - 23.6").

Steel Hydraulic Handbrakes



Left: obp Steel Hydraulic Handbrake,
Non-Locking, Horizontal, Part No. OBP-HB0A1

Right: obp Steel Hydraulic Handbrake,
Locking, Vertical, Part No. OBP-HB0A3L

These are the original all-steel obp hydraulic handbrakes. The handle has a lightly cushioned grip material for non-slip comfort. Master cylinder sold separately.

Hydraulic Handbrake, Non-Locking, Horizontal Part No. OBP-HB0A1 \$86.99
Hydraulic Handbrake, Locking, Horizontal Part No. OBP-HB0A1L \$107.99
Hydraulic Handbrake, Non-Locking, Vertical Part No. OBP-HB0A3 \$86.99
Hydraulic Handbrake, Locking, Vertical Part No. OBP-HB0A3L \$107.99
The above four handbrakes have a 280mm (11") handle.
Hydraulic Handbrake, Non-Locking, Vertical, Long Part No. OBP-HBLA3 \$94.99
Hydraulic Handbrake, Locking, Vertical, Long Part No. OBP-HBLA3L \$109.99
The above two handbrakes have an extended 600mm (23.6") handle.

obp Motorsport Master Cylinders and Pedal Box Accessories



obp Master Cylinders are an economical way to complete any obp pedal box! These brand-new master cylinders are manufactured by obp Motorsport for professional racing. They bear a striking resemblance to the classic Girling cylinders (see page 126 for genuine Girling), but they are not made by Girling. They are dimensionally identical, including the 7/16-20 inlet port threads on the remote reservoir version, 3/8-24 outlet threads, 5/16-24 pushrod threads, and 2x2 1/4" vertical mounting bolt hole pattern. They will work in any installation designed for Girling single-circuit master cylinders, with no adapting needed.

Note: Please be aware that these master cylinders are **not** produced by Girling. obp masters are extremely high quality, but they do not have the Girling name on the side. If you need genuine Girling master cylinders for your restoration project, please see page 126.

obp Remote Reservoir Master Cylinder, 5/8" bore Part No. 3519-101-62 \$43.49
obp Remote Reservoir Master Cylinder, 7/8" bore Part No. 3519-101-70 \$43.49
obp Remote Reservoir Master Cylinder, 3/4" bore Part No. 3519-101-75 \$43.49
obp Remote Reservoir Master Cylinder, 7/8" bore Part No. 3519-101-87 \$47.99
obp Remote Reservoir Master Cylinder, 1.0" bore Part No. 3519-101-100 \$47.99
The Remote Reservoir style can be used in any pedal set that accepts Girling-type master cylinders, including all obp systems and hydraulic handbrakes.

obp Integral Reservoir Master Cylinder, 5/8" bore Part No. 3519-102-62 \$50.99
obp Integral Reservoir Master Cylinder, 7/8" bore Part No. 3519-102-70 \$50.99
obp Integral Reservoir Master Cylinder, 3/4" bore Part No. 3519-102-75 \$50.99
obp Integral Reservoir Master Cylinder, 7/8" bore Part No. 3519-102-87 \$55.49
obp Integral Reservoir Master Cylinder, 1.0" bore Part No. 3519-102-100 \$55.49
The Integral Reservoir style must be mounted upright. It can only be used in Firewall Mount and Floor Mount systems. Not for use on hydraulic handbrakes.

obp Triple Remote Reservoir Mounting Bracket Part No. OBP-CB006 \$15.29
obp Adjustable Bias Bar only, 7/16-20 thread Part No. OBP-CB010 \$41.99
obp Remote Bias Adjuster Cable, 7/16-20 thread Part No. OBP-CB009 \$43.99

Tilton 600-Series Pedal Assemblies

See below for Remote Bias Adjuster Cables for the Brake Balance Bar



Left: Tilton Dual Aluminum Pedals, Firewall Mount
Part No. TE 72-607
Master cylinders (sold separately) point forward through the firewall



Right: Tilton Dual Aluminum Pedals, Overhung Mount
Part No. TE 72-608
Master cylinders (sold separately) point backward over the driver's feet



Left: Tilton 3 Aluminum Pedals, Floor Mount
Part No. TE 72-603
Master cylinders (sold separately) point forward through the bulkhead



Right: Tilton 3 Aluminum Pedals, Underfoot Mount
Part No. TE 72-616
Master cylinders (sold separately) point backward under the driver's feet



Left: Tilton Standard Throttle Linkage
Part No. TE 72-791
Fits 600-Series pedals except Underfoot



Below: Tilton Underfoot Throttle Linkage
Part No. TE 72-791
Fits 600 Series Underfoot pedals only



Left: Tilton Wide (Brake) Pedal Pad
Part No. TE 72-6034
Upgrade to a wider contact patch on the clutch or throttle pedal



Below: Bolt-On Pedal Stop
Part No. 3537-400
Mounts on master cylinder mounting stud or bolt

Tilton uses Finite Element Analysis (FEA) to design the strongest pedal assemblies possible without adding excess weight. All are designed to accept any master cylinders with standard 2.25 inch mounting hole spacing (master cylinders sold separately). The brake pedals are designed for dual master cylinders and are equipped with an adjustable bias bar which can accept a remote cable (sold separately). The clutch pedals are designed for hydraulic clutch actuation. All pedals feature adjustable pads. The Overhung Mount and Underfoot Mount versions point the master cylinders toward the rear of the car, over or under the driver's feet. The Firewall and Floor Mount units point the cylinders forward. The Tilton assemblies also feature adjustable-height pads on the brake and clutch pedals.

Master cylinders sold separately, see pages 126-127.

Tilton Dual Aluminum Pedals, Firewall Mount Part No. TE 72-607 \$250.75
Tilton Dual Aluminum Pedals, Overhung Mount Part No. TE 72-608 \$250.75
Tilton Hanging Throttle Pedal only (not shown) Part No. TE 72-615 \$199.75
Works with either dual pedal assembly above.

Tilton 3 Aluminum Pedals, Floor Mount Part No. TE 72-603 \$442.00
Tilton 3 Aluminum Pedals, Underfoot Mount Part No. TE 72-616 \$590.75
This floor-mount set positions the master cylinders under the driver's feet.

Tilton Standard Throttle Linkage Part No. TE 72-791 \$123.25
Fits all Tilton throttle pedals on this page except on the Underfoot Mount assembly.

Tilton Throttle Linkage for Underfoot Set only Part No. TE 72-793 \$123.25
Fits Tilton Underfoot Mount pedal assemblies only.

Tilton Wide (Brake) Pedal Pad only Part No. TE 72-6034 \$17.00
Same as the brake pedal pad. Use it to upgrade the clutch or throttle.

Tilton Narrow (Clutch / Throttle) Pedal Pad only Part No. TE 72-6035 \$17.00
Same as the clutch and throttle pads. Use it to make the brake pedal narrower.

Pedal Stop, Bolt-On Adjustable Part No. 3537-400 \$24.49

OMP Aluminum Pedal Pad Kits

OMP Cast Aluminum Pedal Pad Kit
Part No. 2701



OMP F1-Style Pedal Pad Set
Part No. OMP-OA1030

These kits give you a wider surface area for better contact and feel than your stock pedals. Each kit includes 3 aluminum pads (clutch, brake, throttle) and attachment hardware.

OMP Cast Aluminum Pedal Pad Kit, Set of three Part No. 2701 \$25.00
OMP F1-Style Pedal Pad Kit, Set of three Part No. OMP-OA1030 \$19.00

Brake Bias Adjusting

Brake Bias Bar and BrakeOMeter Remote Adjusters

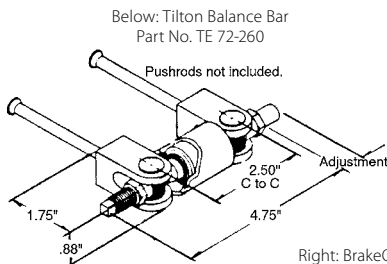

Below: Tilton Balance Bar
Part No. TE 72-260



Right: BrakeOMeter Remote Adjuster Knob for Sedans
Part No. BOM-AR16

Master cylinder bore size is the primary factor affecting brake bias. A balance bar is for fine adjustment. This precision Tilton unit distributes the pedal force between two brake master cylinders. Turning the 7/16-20 threaded bar moves the pivot point to change the force distribution. Accepts standard 5/16-24 master cylinder pushrods. The pivot sleeve must be brazed or welded to the brake pedal. Designed for 2 1/2 inch master cylinder spacing.

Tilton Balance Bar Assembly for 2.5" cylinder spacing Part No. TE 72-260 \$55.25
Balance bar assemblies do not include a remote adjuster cable.

BrakeOMeter Remote Adjuster for Brake Bias Bar "The Knob with a Brain!" Repeatability has never been easier or more precise. Instead of having to count clicks and trying to remember adjustments made during a race, the BrakeOMeter counts for you. Every time you turn the knurled aluminum center knob, the outer micrometer dial moves in proportion (one hash mark per click, one number for each full turn of the knob). The included Zero sticker brings you right back to your baseline, every time. Works with any balance bar with 7/16-20 or 3/8-24 threads. Each kit includes a 6 foot long double-wound cable with a PTFE-lined jacket for smooth operation with no wind-up.

BrakeOMeter Remote Adjuster Kits

0-16 Knob for Sedans, 3" OD Part No. BOM-A-16 \$224.95
0-10 Knob for Formula Cars, 55mm OD Part No. BOM-F-12 \$224.95

Proportioning Valves



Left: Tilton Lever-Style Proportioning Valve with 3/8-24 Ports
Part No. 3528-3AN

Right: Tilton Knob-Style Proportioning Valve with 3/8-24 Ports
Part No. TE 90-2000



Brake Proportioning Valves Allow a driver to reduce brake pressure to a specific wheel or wheels. This can be used to adjust front-to-rear brake bias in cars where brake balance bars are not allowed or are not practical. The maximum reduction of output pressure is approximately 50% of the input pressure. Complete instructions are included.

Lever-Style Proportioning Valves let the driver quickly select from 7 distinct and repeatable settings. The handle can be oriented in any direction for ease of installation.

Tilton Lever-Style Proportioning Valve, 3/8-24 female ports

Part No. 3528-3AN \$92.65
Includes adapters for 3AN hose and 3/16" brake lines (3/8-24 inverted flare). It can be adapted to other sizes by adding two of our brake adapter fittings and crush washers.

Tilton Lever-Style Proportioning Valve, 10mm x 1.0 metric ports (not inverted flare)

Part No. 3528-Metric \$92.65
If you require metric inverted flare ports or any other size not listed, order the 3AN version and use an appropriate adapter from our selection of brake adapter fittings. Thread the 3AN side of the adapter into the prop valve. A crush washer may be required.

Knob-Style Proportioning Valves have no presets or detents. They allow finer adjustment than lever styles, but without the repeatability.

Tilton Knob-Style Proportioning Valve, 3/8-24 female ports

Part No. TE 90-2000 \$92.65
Includes adapters for 3AN hose and 3/16" brake lines (3/8-24 inverted flare). It can be adapted to other sizes by adding two of our brake adapter fittings and crush washers.

Rebuild Kit for all Tilton Proportioning Valves (both Lever and Knob styles)

Part No. 3529-Repair \$17.00

Brake Calipers

Performance Friction ZR55 F2000 Calipers



The **Performance Friction ZR55 Caliper** is a modern aluminum 2-piston caliper. It weighs just 3.5 pounds, more than 3 pounds lighter than an LD 20 caliper. Special piston insulators help to reduce fluid boiling. Radial mounting fits 2010 and newer Van Diemen and Citation uprights. Sold individually. Each caliper includes a 3AN adapter, banjo adapter, and banjo bolt to fit the M10 inlet.

PFC ZR55 Caliper, Front (trailing mount), Left Part No. 3552-503 \$899.00
PFC ZR55 Caliper, Front (trailing mount), Right Part No. 3552-504 \$899.00
 "Front" calipers have 44mm pistons and are designed for a trailing mount.

PFC ZR55 Caliper, Rear (leading mount), Left Part No. 3552-501 \$899.00
PFC ZR55 Caliper, Rear (leading mount), Right Part No. 3552-502 \$899.00
 "Rear" calipers have 41mm pistons and are designed for a leading mount.

Piston Seals for Front Calipers (44mm), set of 4 ... Part No. 3552-528 \$50.99
Piston Seals for Rear Calipers (41mm), set of 4 Part No. 3552-527 \$29.99

Wilwood PL2R/ST Calipers



The **Wilwood PL2R/ST** is a club-racing alternative to the ZR55 calipers at left. If you are not racing in the Pro FF2000 series, you can still enjoy state-of-the-art braking without breaking the bank. These are SCCA-legal, bolt-on replacements for the ZR55. Internal fluid passages eliminate the vulnerable crossover tubes on the ZR55 design. 1.75" diameter pistons.

Wilwood Powerlite 2 Caliper, Right (trailing) Part No. WW120-13863-N \$304.99
Wilwood Powerlite 2 Caliper, Left (trailing) Part No. WW120-13864-N \$304.99

Replacement 1.75" Piston Seal, each Part No. WW210-4840 \$2.99
 These seals fit Wilwood calipers only.

Alcon R-Type Formula Ford Caliper

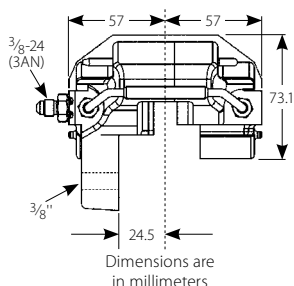

SCCA legal for FC, FF, and S2000.

The popular **Alcon R-Type Caliper** is a proven winner, with years of success in many different types of racing. This lightweight 2-piston aluminum caliper weighs less than 3 pounds. That's less than half the weight of the original cast iron LD 20! The leg-mount design is a direct bolt-on replacement for the LD 20 caliper. No adapting, machining, or modifications are required. The 1.75" piston diameter is the same as the LD 20, so your brake bias setup won't change either. The R-Type uses a common D44 pad shape, which is available in many different compounds from most brake pad manufacturers. We stock Hawk Brake (HB118) and Performance Friction (PF044) pads for this caliper.

Alcon R-Type Caliper, Left (trailing mount) Part No. 3599-001-RL/LT ... \$449.99
Alcon R-Type Caliper, Right (trailing mount) Part No. 3599-001-LL/RT ... \$449.99
 Left and Right assume a trailing-mount installation (mounted on the back side of the upright). Order the opposite side for a leading-mount application.

Replacement 1.75" Piston Seal, each Part No. 3599-020 \$17.99
 These seals fit the Alcon R-Type caliper only.

Wilwood WLD20 Caliper for FF1600 / FF2000



The **Wilwood WLD20** is a modern aluminum replacement for the old AP "LD 20" caliper (CP2577) which was discontinued by AP several years ago. This 2-piston caliper is designed to be a bolt-on replacement, with no machining or adapting required. It retains the same 3/8" - 24 inlet thread size and 1.75" diameter pistons as the original too. You won't even need to make any adjustments to your setup! The WLD20 even takes the same LD 20 pad shape as the original AP caliper, so your spares won't go to waste. Lightweight forged aluminum construction weighs about one-third of the original (2.3 lb vs 6.8 lb) and is SCCA legal for all formula car and sports racer classes. Unlike the original, the WLD20 uses corrosion-resistant and thermally-insulating stainless steel pistons. These new calipers also fit either right or left side, which means half as many spares in the trailer.

Wilwood WLD20 Aluminum Caliper Part No. WW120-14375 \$199.99
Wilwood 1.75" Caliper Seal, each Part No. WW210-4840 \$2.99
 These seals fit Wilwood calipers only.

MSE Gem LD 19 Caliper for FF1600

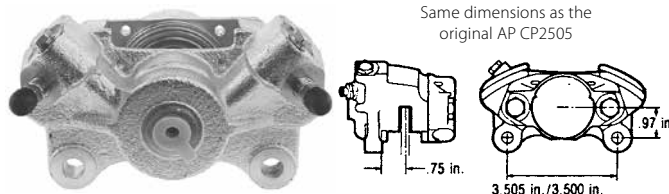

Brand-new LD 19 calipers — not rebuilt, remanufactured, or NOS!

MSE Gem LD 19 Caliper Developed and tested extensively by a leading racing school in the UK, the Gem is a direct replacement for the old AP "LD 19" caliper (CP2505) which was discontinued by AP several years ago. This high-quality reproduction has been carefully crafted to be an absolutely painless, no-fuss replacement. It is the same as the original in every dimension, including the 1.625" piston size and 3/8" - 24 inlet port threads. The Gem uses the same LD 19 pad type as the original AP caliper, so your spares won't go to waste. Cast iron construction is legal for all FF1600 classes, including vintage racing where aluminum calipers may not be allowed. Just as on the original, each caliper can be used on either the left or right side.

MSE Gem LD 19 Caliper Part No. 3599-200 \$189.99
 Brand-new caliper, not rebuilt or remanufactured. Built specifically for racing use.

MSE Rebuild Kit for Gem LD 19, 1.625" Part No. 3599-201 \$24.99
 Piston seals, dust seals, and dust seal retainers for 1 caliper. Also fits the AP CP2505 caliper.

AP / Lockheed Caliper Repair Parts

These seals fit AP Racing seal-in-bore calipers (the seal fits into a groove in the caliper bore). They do not fit seal-on-piston (sliding seal) calipers.

AP Racing Piston Seal, each Part No. 3580-Size \$16.99
 Specify piston size: 1 3/8", 1 1/2", 1 5/8" (LD 19), 1 3/4" (LD 20), 2 1/8", or 36mm/1.42" (LD 65).

Note: Piston seals will only fit tight against the piston after installation in the bore. They will be a loose fit prior to installation. This applies to all brands.

AP / Lockheed Cross Feed Seal (each) Part No. 3596 \$9.99
 Measures 0.500 OD x 0.110 thick. **Note:** AP recommends against splitting calipers.

Piston for LD 19 Caliper, 1.625" diameter, each ... Part No. 3582-1.625 \$39.99
Piston for LD 20 Caliper, 1.75" diameter, each Part No. 3582-1.75 \$52.99

The stainless steel pistons below are not made by AP / Lockheed. They are precision-made in the USA from type 304 stainless steel and polished to a sub-20 micron finish.

Stainless Steel LD 19 Piston (1.625"), ea. 3579-Stainless-LD19 \$39.99
Stainless Steel LD 20 Piston (1.75"), ea. 3579-Stainless-LD20 \$39.99
Stainless Steel LD 65 Piston (36mm), ea. 3579-Stainless-LD65 \$39.99

Girling Caliper Repair Parts

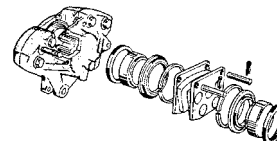

Although we do not carry Girling calipers, we do offer rebuild kits for certain Girling calipers commonly used on Formula Fords. The larger **14LF** Caliper has 1.89" diameter pistons and 4 bolts holding the caliper halves together. The smaller **12SP** (more common on vintage cars) has 1.69" pistons and only 2 bolts holding the caliper together.

Rebuild Kit for two Girling 14LF calipers Part No. 3590 \$27.99
Rebuild Kit for one Girling 12SP caliper Part No. 3552-001 \$17.99

Piston for 14LF caliper, 1.89" dia., each Part No. 3591 \$34.99
Cross Feed Seal for Girling Calipers (1 seal) Part No. 3595 \$4.99
 Measures 0.480 OD x 0.075 thick. **Note:** Girling recommends against splitting calipers.

Brake Pad Information



Hawk Brake manufactures several friction materials for auto racing, all of which exhibit non-fade performance and have been evaluated up to and beyond 1,800°F. Advances in materials and manufacturing processes have significantly reduced the bedding-in procedure that was once required of racing pads. Hawk Brake pads typically require only a few laps of bedding-in followed by a single cool-down period.

Performance Friction's line of Carbon Metallic® high-performance brake pads contain no asbestos, no Kevlar® and no lead or clay fillers. Carbon Metallic® pads offer superior braking, pedal feel and longer life without fade at high temperatures. Braking characteristics remain constant throughout the life of the pads. Integral molding using the Ionic Fusion™ system gives them the highest shear strength in the brake industry.

DTC-70 (U)

Extremely high torque with very high initial bite. Designed to be the most controllable racing brake pad available. Intended for heavier sedans and formula cars with downforce and available only for a limited selection of popular racing calipers. Recommended for Trans-Am, GT1, CART, Formula Atlantic, F3000, and Sports Prototypes. 400-1600°F.

14 Compound

Performance Friction 14 Compound has lower friction and slightly less bite than other PFC racing compounds. Torque is consistent across a wide temperature range, making it ideal for low-grip applications such as street tires or groomed dirt tracks. Available for a limited selection of racing calipers only.

DTC-60 (G)

High torque with high initial bite. DTC-60 was developed as a rear pad to be used with DTC-70 on the front, but it has also become popular as a front pad on lighter cars. Available only for a limited selection of popular racing calipers. Recommended for Trans-Am, GT1, CART, Formula Atlantic, F2000, F3000, and Sports Prototypes. 400-1600°F.

13 Compound

13 Compound has ultra-high bite and very high friction for sprint racing on high grip tracks or with very high downforce. Excellent release for exceptional control and modulation. Very high fade resistance at high temperatures. Recommended for fast cars with high downforce that can take advantage of increased bite in the first 1/3 of the stop.

HT 14 (V)

Very high torque with high initial bite for cars with high downforce and lots of grip. Recommended in Trans-Am, GT1, CART, Formula Atlantic, F2000, F3000, and Sports Prototypes. 300-1600°F.

11 Compound

11 Compound was developed from the popular 01 Compound for sprint and medium-distance racing. This compound was designed with improved bite, modulation, and release for smooth braking with reduced wheel locking at the end of the stop. It is ideal for use in medium- or low-grip situations such as hard spec tires or light cars with no downforce.

HT 10 (S)

High torque with a smooth initial bite. Works well as a rear pad with HT 14 in front. Recommended for sedans, sports racers, and formula cars with downforce, including GT, Formula Atlantic, F2000, F3000, S2000, CSR, and DSR. 300-1600°F.

08 Compound

08 Compound gained immediate favor in Endurance Sportscar and GT racing due to its smooth initial bite. It has a slight friction rise with temperature, with excellent release and modulation characteristics. 08 is one of the longest-wearing of all PFC compounds, easily matching the wear of other brands but with much higher bite. If temperatures are below about 950°F, 08 can be replaced with PFC 12 Compound for even longer wear.

Blue (E)

Medium/High torque compound with medium initial bite. The wide temperature range and good brake modulation have made it the #1 pad material for SCCA. Recommended for Production, IT, F2000, Formula Ford, S2000, CSR, and DSR. 250-1000°F.

05 Compound

05 Compound has a very smooth initial bite, virtually no friction rise with temperature, and excellent release and modulation. Its bite makes it perfect for when front lockup is difficult to manage, such as with NASCAR coil-bound front setups. This compound demands the most from the vehicle setup and is designed to handle the most severe applications.

Black (M)

Medium torque racing compound with high initial bite. Black is a good all-purpose, low cost racing pad. Requires gentle initial application of the brake pedal to avoid locking. Recommended for very light sedans, small formula cars, and sports racers. 100-900°F.

01 Compound

01 Compound is now the standard by which all brake pads are judged. Braking starts with a high initial bite and continues with consistent, high torque that rises very little with temperature for excellent predictability. It finishes with excellent release, with less torque scatter at the end of the stop than the competition for improved modulation. All-purpose pad for a variety of racing applications. If higher friction is desired, see 13 Compound.

HP Plus (N)

Designed as an autocross (Solo II) and track day (Solo I) compound. Very wide temperature range makes it suitable for all forms of autocross, yet still streetable. Expect an increase in dust, noise, and rotor wear. 100-800°F.

HPS (F)

HPS = High Performance Street. This compound will outperform OEM pads without sacrificing street manners. A good choice for Solo II; also recommended for amateur to intermediate drag racing. Effective from dead cold.

Retired PFC Compounds

We have many pads in stock in most of the popular but now retired PFC compounds, including 80, 83, 90, 93, and 97. Please visit our website for the most current selection.

Popular Competition Applications

Application	Caliper	Hawk	Performance Friction
Formula Ford, F2000 Rear, Small Lockheed Caliper, MSE Gem	LD 19	HB117	PF719
Formula Ford, F2000, Larger Lockheed Caliper, ICP Caliper	LD 20	HB108	PF720
Formula Ford, F2000, Pro F2000 with PFC Caliper	ZR55		PF7832
Formula Ford, Formula Mazda, Large Girling Caliper, Alcon R-Type	14LF	HB118	PF044
Sports 2000, Lockheed "Metro" 4 piston Caliper	LD 65	HB116	PF765
Swift 014a Formula Atlantic	Wilwood IR GT	HB351	PF736
Ralt Formula Atlantic (Ferodo FRP201)		HB107	PF740
Formula BMW, F3 with PFC rotor	Brembo		PF739
Formula 500 (Ferodo FDB416)	Single Piston	HB104	PF757
Spec Miata 1600 '90-93, Front	Front	HB148	PF525
Spec Miata 1600 '90-93, Rear	Rear	HB157	PF458
Spec Miata 1800 '94-03, Front	Front	HB149	PF635
Spec Miata 1800 '94-03, Rear	Rear	HB159	PF636

If you cannot determine the correct part number for your brake pad application, fax a tracing of the pad to our Tech Department at 1-262-317-1201 or email to Tech@PegasusAutoRacing.com. Include the make, model and year of the car along with as much information as possible about the caliper manufacturer, maximum permissible pad thickness, etc. **Please be sure to include the overall height and width of the pad on your tracing.**

Racing Brake Pad Tracings

PFC to Hawk Cross Reference

Our tracings are listed in order of the Hawk part number since Hawk covers more applications than PFC. Use this chart to quickly locate tracings for a particular PFC part number.

PFC	Hawk	PFC	Hawk	PFC	Hawk	PFC	Hawk	PFC	Hawk	PFC	Hawk
PF044	HB118	PF720	HB108	PF740	HB107	PF752	HB100	PF765	HB116	PF793	HB122
PF700	HB105	PF735	HB167	PF745	HB192	PF753	HB102	PF767	HB110	PF794	HB121
PF719	HB117	PF736	HB351	PF751	HB101	PF757	HB104	PF790	HB109	PF7702	HB106

Note: These brake pad tracings are shown to illustrate certain racing applications only. This is just a small sample of the brake pads we carry. Many more brake pad shapes are available to fit racing and production car calipers in both racing and street compounds. You can find an extensive brake pad application list with many more tracings on our website, in the **Technical Info** section at PegasusAutoRacing.com.

See the Technical Info section of our website for help in determining the correct brake pad for your application.



HB: Hawk Performance Brake Pads

PF: Performance Friction Brake Pads



HB100 PF752 Outlaw, Sierra, Wilwood 	HB101 PF751 AP Racing, Outlaw, Sierra, Wilwood 	HB102 PF753 AP Racing, Sierra, Wilwood 	HB104 PF757 Outlaw, Sierra, Wilwood 	HB105 PF700 Alcon, Brembo, Porsche
HB106 PF7702 Alcon, Sierra, Wilwood 	HB107 PF740 Formula Atlantic, Alcon, AP Racing 	HB108 PF720 FMSI D005 FF2000, AP Racing, Lucas Girling 	HB109 PF790 Alcon Trans Am, Coleman IV 	HB110 PF767 Alcon, AP Racing
HB114 Alcon, AP Racing, Wilwood 	HB116 PF765 S2000, Alcon, AP(LD65), Girling 	HB117 PF719 Formula Ford, Alcon, AP Racing 	HB118 PF044 FMSI D044 Formula Mazda, Lucas Girling 	HB121 PF794 Champ Car, IRL, Alcon, AP
HB122 PF793 Champ Car, IRL, Alcon, AP 	HB128 Corvette Twin Pin 	HB132 FMSI D027 Humber, MG, Singer, Vauxhall 	HB167 PF735 Formula Atlantic, AP, Brembo 	HB169 D002, 057, 114, 161 Austin, MG, Nissan, Toyota, Triumph
HB192 PF745 Formula Atlantic, Alcon, AP 	HB237 PF754 Outlaw M16, Sierra, Wilwood 	HB351 PF736 Formula Atlantic, Wilwood 	PF739 Formula BMW, Brembo 	PF7832 Formula Ford, F2000, PFC ZR55

BRAKE PADS

Campbell Racing Brake Rotors

Stop wasting your valuable track time trying to bed new pads into your worn old brake rotors! Get brand-new, top-quality replacements and save a bundle compared to OEM rotors.

Campbell Racing cast-iron rotors are made for us in the USA exclusively for racing use. These are brand-new castings. They are not repackaged or remanufactured street car rotors.

Campbell Racing Solid Brake Rotors with Integral Hats (all dimensions are in inches)								
Applications	O.D.	Total Height	Disc Thk.	I.D.	Bolt Circle Details and Other Notes	Grooved & Lightened	Part No.	Price each
Swift DB-1, DB-3 with LD 19, Van Diemen 4-Bolt (Front and Rear)	9.75	1.63	0.29	3.00	(4) 3/8" holes on 3.75" bolt circle	No	3545-10	\$129.99
						Yes	3545-11	\$174.99
Van Diemen Centerlock to 93 (Front and Rear)	9.75	1.63	0.29	3.00	(4) 0.563" holes on 3.75" circle + (4) countersunk 3/16"	No	3545-12	\$144.99
						Yes	3545-35	\$189.99
Swift DB-2, DB-3 with LD 20 (Front and Rear)*	10.00	1.63	0.38	3.00	(4) 3/8" holes on 3.75" bolt circle	No	3545-29	\$154.99
						Yes	3545-30	\$199.99
Reynard FF 82-84 1/2, FC 86 & earlier, Reynard FC-FF conversions (Front only)	9.75	1.77	0.29	2.63	(4) 3/8"-24 threaded holes on 3.375" bolt circle	No	3545-13	\$174.99
Reynard FF 82-84 1/2, FC 86 & earlier, Reynard FC-FF conversions (Rear only)	9.87	2.02	0.29	2.50	(4) 3/8" holes on 3.75" bolt circle	No	3545-14	\$179.99
Reynard FC 87 & up (Front and Rear) Originals were lightened & grooved.	9.84	1.60	0.29	2.50	(4) 3/8" holes on 3.75" bolt circle	No	3545-31	\$154.99
						Yes	3545-32	\$209.99
Club Ford inboard rear: Crossle 35F, Lola 340-540, Van Diemen to RF81, and others (replaces AP CP-2366-5)	9.50	0.90	0.275	2.49	(6) 0.305" holes on 3.07" bolt circle	No	3545-16	\$159.99
Lola 340-540 (Front only)	9.50	0.90	0.28	2.68	(4) 0.385" holes on 3.65" bolt circle	No	3545-15	\$169.99

* This size can be used to convert the front rotor on 1981 and older Tiga FF and S2000. Visit our website for full instructions!



Cast Iron Rotor with Integral Hat, Standard
Part No. 3545-10

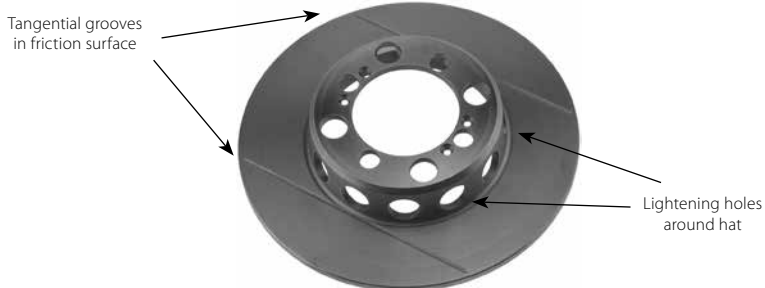

Cast Iron Rotor with Integral Hat, Grooved and Lightened
Part No. 3545-35

Tangential grooves in friction surface

Lightening holes around hat

Solid Brake Discs without Hats for Van Diemen (all dimensions are in inches)

Applications	O.D.	Rotor Thk.	I.D.	Bolt Circle Details	Grooved	Part No.	Price each
Van Diemen FC 94 & up with LD 20 (Front only)	10.00	0.37	4.95	(6) 3/8 x 1/2" slots on 5.87" bolt circle for hat attachment	Yes	3545-33	\$174.99
Van Diemen FC 94 & up with LD 19 (Rear only)	9.75	0.280	5.11	(6) 3/8 x 1/2" slots on 5.86" bolt circle for hat attachment	Yes	3545-34	\$174.99

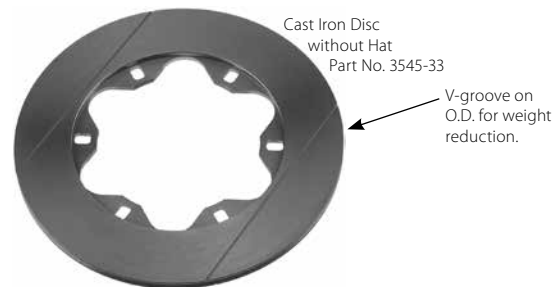

Cast Iron Disc without Hat
Part No. 3545-33

V-groove on O.D. for weight reduction.

See next page for the special mounting bolt for these floating discs.

Directionally Vented Brake Rotors without Hats (all dimensions are in inches)

Our vented rotors are directional for better cooling. The brake hat mounting holes are in the "outside" surface. Looking at the outside surface, right side rotor vanes radiate counterclockwise from the center as shown in the photo (in the same direction as the surface grooves). Left side rotor vanes radiate clockwise. They work with the forward rotation of the wheel to pump air from the center of the rotor outwards.

Applications	O.D.	Rotor Thk.	Bolt Circle Details	Grooved	Part No.	Price each	Aluminum Hat only	
							Part No.	Price each
Lola S2000 86/90 and newer & some converted earlier models	10.20	0.77	(6) 1/4" holes on 6.00" bolt circle	No	3545-17-L or R	\$192.99	3542-03	\$157.99
				Yes	3545-19-L or R	\$209.99		
Swift DB-2 and DB-5 S2000	10.00	0.81	(6) 1/4" holes on 5.50" bolt circle	No	3545-21-L or R	\$189.99		
				Yes	3545-23-L or R	\$209.99		
Swift DB-4, Ralt RT-4 Formula Atlantic	10.50	0.81	(6) 1/4" holes on 5.50" bolt circle	No	3545-25-L or R	\$189.99		
				Yes	3545-27-L or R	\$209.99		

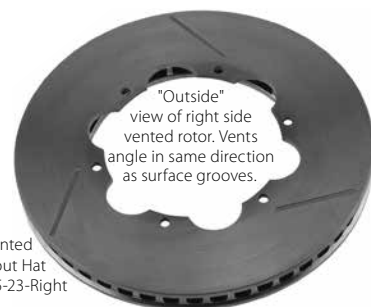

Directionally Vented Rotor without Hat
Part No. 3545-23-Right

"Outside" view of right side vented rotor. Vents angle in same direction as surface grooves.

TDI Lightweight Two-Piece Brake Rotors

Reducing unsprung, rotating weight can have a very significant impact upon a car's performance. These high-tech rotors are available for Swift, Reynard and Van Diemen applications that use Lockheed LD 19 or LD 20 brake calipers. The billet aluminum hat section is precision machined to allow thermal expansion without cracking. The ferrous discs are cross-drilled for

improved braking and weight reduction. The complete hat and disc assembly for an LD 19 caliper weighs less than 3.6 pounds! The discs for LD 20 calipers are the same thickness as the LD 19 disc (.280 inch) for additional weight reduction. TDI rotors are made in the USA. **Note:** Some older Van Diemen uprights may require modification for rotor clearance.



TDI Lightweight Brake Rotor Assembly
Part No. 3540-01

Disc, Hat and Hardware Kit
are also available separately.

1, 2, or 4 Rotors?

Pro road racing teams typically replace all 4 rotors at once. The next best option is to replace the two rotors at one end of the car. In road racing, the front wheels typically work together and the rear wheels normally work together. If one front rotor is worn or cracked, the other can't be far behind!

TDI Lightweight Two-Piece Brake Rotors (all dimensions are in inches)

Applications	O.D.	Total Height	Rotor Thick.	I.D.	Bolt Circle Details (see photo)	Disc with Hat		Drilled Disc Only		Hat Only	
						Part No.	Price ea.	Part No.	Price ea.	Part No.	Price ea.
Swift, Van Diemen with LD 19	9.85	1.63	0.285	3.00	Multiple bolt patterns: (2 sets of four) $\frac{3}{8}$ " holes on 3.75" bolt circle and (4) 0.535" holes on 3.75" bolt circle (see photo)	3540-01	\$244.99	3541-01	\$169.99	3542-01	\$150.99
Swift, Van Diemen with LD 20	10.12	1.63	0.285	3.00		3540-02	\$244.99	3541-02	\$169.99	3542-01	\$150.99
Reynard 87 and newer with LD 19	9.85	1.63	0.285	2.50		3540-03	\$244.99	3541-01	\$169.99	3542-02	\$157.99
Reynard 87 and newer with LD 20	10.12	1.63	0.285	2.50		3540-04	\$244.99	3541-02	\$169.99	3542-02	\$157.99
Reynard to 86 with LD 20	10.00	1.63	0.285	2.50		3540-05	\$244.99	3541-03	\$169.99	3542-02	\$157.99
Swift DB-2/DB-5 with LD 20	10.00	1.63	0.285	3.00		3540-06	\$244.99	3541-03	\$169.99	3542-01	\$150.99
Hardware Kit for TDI Lightweight Brake Rotor - includes 6 high strength screws & 6 MS21042 Jetnuts (for 1 rotor)						Part No. 3543		\$21.29			

TDI Grooved and Scalloped Brake Discs

Even if you prefer to avoid crossdrilled discs, you can still reduce some unsprung weight and rotating inertia by pairing the TDI hats above with these TDI grooved brake discs. These ferrous discs have a 6x140mm bolt pattern to accept either of the TDI hats above (sold separately). The discs measure the same 0.285" thick as the crossdrilled discs, but they have staggered grooves milled into the friction surfaces. The grooves radiate straight out from the center, so the discs are not directional (one disc fits either right or left side). The grooved and scalloped rotors have a scalloped (wavy) outer edge to reduce rotating inertia even further. The scalloped pattern also helps to reduce issues with radial heat cracks from thermal expansion. Discs sold individually. Each disc requires a TDI hat and hardware kit (each sold separately above).

TDI Grooved Brake Disc only

9.85" OD (LD 19)..... Part No. 3544-001-01 \$169.99
10.12" OD (LD 20)..... Part No. 3544-001-02 \$169.99

TDI Grooved and Scalloped Brake Disc only

9.85" OD (LD 19)..... Part No. 3544-002-01 \$184.99
10.12" OD (LD 20)..... Part No. 3544-002-02 \$184.99



TDI Grooved Brake Disc
Part No. 3544-001-01



TDI Grooved and Scalloped Brake Disc
Part No. 3544-002-01

PFC Brake Discs for Van Diemen

PFC Front Brake Disc for
1994 and Later Van Diemen
Left side shown
Part No. PF255-100042-03



These floating discs are manufactured by Performance Friction to fit the front of 1994 and later Van Diemen formula cars. This includes FC/F2000, Zetec 2000, Pro FF2000, and those converted to FF1600. The 6-bolt disc fastens directly to the original Van Diemen hub using the stock attachment bolts (or our Van Diemen Drive Bolts, sold separately below). Measures 10" OD x 0.39" thick with radial grooves on the friction surfaces. Sold individually.

Performance Friction Brake Discs for 94+ Van Diemen (front)

Left (shown)..... Part No. PF255-100042-03..... \$217.99
Right..... Part No. PF255-100042-04..... \$217.99

High-Strength Brake Hat Attachment Bolts



$\frac{5}{16}$ -18 x 0.85
64 piece kit
Part No. 3547-002



$\frac{1}{4}$ -28 x 0.75
48 piece bolt kit
Part No. 3547-003

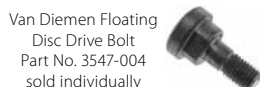

Van Diemen Floating
Disc Drive Bolt
Part No. 3547-004
sold individually

The bolts in the following ARP kits are made of 8740 chrome moly steel for 200,000 psi tensile strength! Pre-drilled 12-point heads make safety wiring easy.

$\frac{5}{16}$ -24 x 0.88 Bolts with Washers, 64 piece kit..... Part No. 3547-001..... \$106.61
This kit from ARP is designed to fit JFZ brake rotors and other that use $\frac{5}{16}$ -24 x $\frac{7}{8}$ " fine threaded bolts. Includes 32 bolts and 32 high strength washers.

$\frac{5}{16}$ -18 x 0.85 Bolts with Washers, 64 piece kit..... Part No. 3547-002..... \$106.61
This kit from ARP includes 32 bolts and 32 high strength washers.

$\frac{1}{4}$ -28 x 0.75 Bolts, 48 piece kit..... Part No. 3547-003..... \$143.10
This kit from ARP is designed to fit AP brake rotors and others that use $\frac{1}{4}$ -28 x $\frac{3}{4}$ " fine threaded bolts. Includes 48 bolts only. Does not include washers.

The following special Van Diemen bolt is sold individually, not in a kit.

Van Diemen Floating Disc Drive Bolt, each..... Part No. 3547-004..... \$19.99 ea.
This special bolt is used to attach the floating brake disc to the hub on 1994 and later Van Diemen FF1600 and FC/FF2000 cars. Each rotor requires 6 bolts; sold individually.

Cooling Air Ducting Hose



Single-Ply Rubber Air Duct This high-quality ducting is extremely flexible. A bronze-coated spring-steel wire support coil prevents collapsing. The fiberglass fabric cover is impregnated and coated with rubber. Choose red-orange Silicone (550° F max, perfect for brake cooling ducts) or black Neoprene (300° F max, great for cockpit cooling). The maximum continuous length is 12 feet.* Shorter pieces can be screwed together to form a continuous length.

Single-Ply High-Temp Silicone Duct Hose, red-orange only**

Single-Ply Silicone, 2.0" ID, 6 foot length	Part No. 3621-2.00-6 ft.	\$50.49
Single-Ply Silicone, 2.0" ID, 12 foot length	Part No. 3621-2.00-12 ft.	\$94.99
Single-Ply Silicone, 2.5" ID, 6 foot length	Part No. 3621-2.50-6 ft.	\$54.99
Single-Ply Silicone, 2.5" ID, 12 foot length	Part No. 3621-2.50-12 ft.	\$102.99
Single-Ply Silicone, 3.0" ID, 6 foot length	Part No. 3621-3.00-6 ft.	\$62.99
Single-Ply Silicone, 3.0" ID, 12 foot length	Part No. 3621-3.00-12 ft.	\$116.99
Single-Ply Silicone, 4.0" ID, 6 foot length	Part No. 3621-4.00-6 ft.	\$75.99
Single-Ply Silicone, 4.0" ID, 12 foot length	Part No. 3621-4.00-12 ft.	\$140.99
Single-Ply Silicone, 5.0" ID, 6 foot length	Part No. 3621-5.00-6 ft.	\$87.99
Single-Ply Silicone, 5.0" ID, 12 foot length	Part No. 3621-5.00-12 ft.	\$164.99

Single-Ply Low-Temp Neoprene Duct Hose, black only

Single-Ply Neoprene, 2.0" ID, 6 foot length	Part No. 3620-2.00-6 ft.	\$34.99
Single-Ply Neoprene, 2.0" ID, 12 foot length	Part No. 3620-2.00-12 ft.	\$65.99
Single-Ply Neoprene, 2.5" ID, 6 foot length	Part No. 3620-2.50-6 ft.	\$39.99
Single-Ply Neoprene, 2.5" ID, 12 foot length	Part No. 3620-2.50-12 ft.	\$74.99
Single-Ply Neoprene, 3.0" ID, 6 foot length	Part No. 3620-3.00-6 ft.	\$42.49
Single-Ply Neoprene, 3.0" ID, 12 foot length	Part No. 3620-3.00-12 ft.	\$78.99
Single-Ply Neoprene, 4.0" ID, 6 foot length	Part No. 3620-4.00-6 ft.	\$50.49
Single-Ply Neoprene, 4.0" ID, 12 foot length	Part No. 3620-4.00-12 ft.	\$93.99
Single-Ply Neoprene, 5.0" ID, 6 foot length	Part No. 3620-5.00-6 ft.	\$56.99
Single-Ply Neoprene, 5.0" ID, 12 foot length	Part No. 3620-5.00-12 ft.	\$106.99

*Note: The lengths shown are nominal lengths. The duct will only measure this length when stretched tightly. The relaxed length will be several inches less than the nominal length.

**** Please visit our website for Single-Ply Silicone Duct Hose in more half-inch diameters (1.5" ID, 3.5" ID, etc.)**

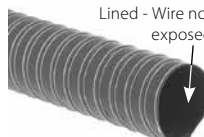

Two-Ply Air Duct This ducting is suitable for somewhat higher pressures and vacuum than the single-ply ducting. Construction is similar to the single-ply version except a second layer of rubber-impregnated and coated fiberglass fabric lines the inside. The lining covers the support coil for a smoother interior, which makes it popular for intake ducting in normally-aspirated applications. The maximum continuous length is 12 feet.* Shorter pieces can be screwed together to form a continuous length.

2-Ply High-Temp Silicone Duct Hose, red-orange only

2-Ply Silicone, 2.0" ID, 6 foot length	Part No. 3631-2.00-6 ft.	\$70.99
2-Ply Silicone, 2.0" ID, 12 foot length	Part No. 3631-2.00-12 ft.	\$131.99
2-Ply Silicone, 2.5" ID, 6 foot length	Part No. 3631-2.50-6 ft.	\$82.99
2-Ply Silicone, 2.5" ID, 12 foot length	Part No. 3631-2.50-12 ft.	\$154.99
2-Ply Silicone, 3.0" ID, 6 foot length	Part No. 3631-3.00-6 ft.	\$93.99
2-Ply Silicone, 3.0" ID, 12 foot length	Part No. 3631-3.00-12 ft.	\$177.99
2-Ply Silicone, 4.0" ID, 6 foot length	Part No. 3631-4.00-6 ft.	\$113.99
2-Ply Silicone, 4.0" ID, 12 foot length	Part No. 3631-4.00-12 ft.	\$214.99
2-Ply Silicone, 5.0" ID, 6 foot length	Part No. 3631-5.00-6 ft.	\$131.99
2-Ply Silicone, 5.0" ID, 12 foot length	Part No. 3631-5.00-12 ft.	\$249.99

2-Ply Low-Temp Neoprene Duct Hose, black only

2-Ply Neoprene, 2.0" ID, 6 foot length	Part No. 3630-2.00-6 ft.	\$41.49
2-Ply Neoprene, 2.0" ID, 12 foot length	Part No. 3630-2.00-12 ft.	\$77.99
2-Ply Neoprene, 2.5" ID, 6 foot length	Part No. 3630-2.50-6 ft.	\$46.99
2-Ply Neoprene, 2.5" ID, 12 foot length	Part No. 3630-2.50-12 ft.	\$88.99
2-Ply Neoprene, 3.0" ID, 6 foot length	Part No. 3630-3.00-6 ft.	\$52.99
2-Ply Neoprene, 3.0" ID, 12 foot length	Part No. 3630-3.00-12 ft.	\$99.99
2-Ply Neoprene, 4.0" ID, 6 foot length	Part No. 3630-4.00-6 ft.	\$62.99
2-Ply Neoprene, 4.0" ID, 12 foot length	Part No. 3630-4.00-12 ft.	\$117.99
2-Ply Neoprene, 5.0" ID, 6 foot length	Part No. 3630-5.00-6 ft.	\$72.99
2-Ply Neoprene, 5.0" ID, 12 foot length	Part No. 3630-5.00-12 ft.	\$135.99

Thermo-Formed Air Inlet Ducts

The US Government, through the National Advisory Council on Aeronautics (NACA, forerunner to NASA) spent a lot of tax dollars discovering the low-drag inlet duct shape that we now know as a NACA duct. Our tough, high-impact plastic ducts were developed and tuned in a wind tunnel for

maximum air flow with minimal drag on racecars. A molded flange makes them easy to install in body panels, air dams, or even side windows. The outlets fit our 3.00 inch air ducting hose, except for the Small NACA Ducts (Part No. 3627-Color), which fit our 2.50 inch duct hose.

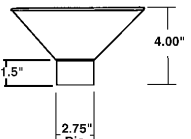
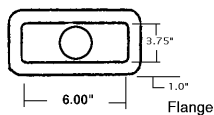

Headlight Mount Air Inlet
Part No. 3623

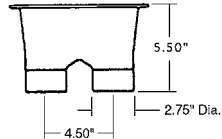
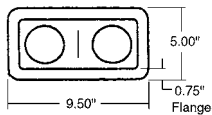

Small Bumper Mounted Inlet
Part No. 3625

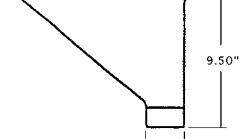
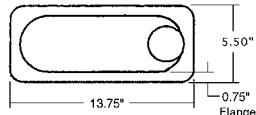

Large Bumper Mounted Inlet
Part No. 3626

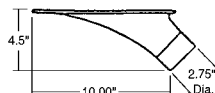
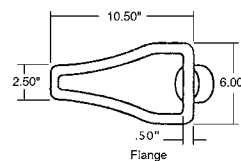

Medium NACA Duct
Part No. 3628

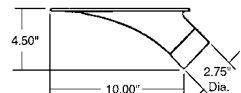
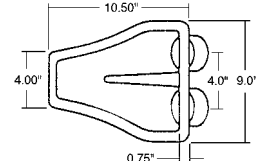

Large NACA Duct
Part No. 3629

Forward-Facing Ram Air Inlet Ducts

These ram air ducts are designed to face forward, with the opening and outlet perpendicular to the direction of travel. Gradually tapering openings help to minimize turbulence and air disruption. They are perfect for mounting in a bumper cover, air dam, or headlight opening. All are made of sandable, paintable ABS black plastic.

Headlight Mount Air Inlet, single outlet for 3" hose.....Part No. 3623-Black ... \$14.99
Approximately 6 x 3.75 inches (rectangular) with a centered outlet.

Small Bumper Mounted Inlet, single outlet for 3" hose Part No. 3624-Black ... \$23.99
(Not shown) Approximately 9.5 x 5 inches with an offset outlet.

Small Bumper Mounted Inlet, dual outlets for 3" hose.....Part No. 3625-Black ... \$29.99
Approximately 9.5 x 5 inches.

Large Bumper Mounted Inlet, single outlet for 3" hose Part No. 3626-Black ... \$26.99
Approximately 13.75 x 5.5 inches with an offset outlet.

Note: These ducts are manufactured for racing vehicles. They are not produced with a show-quality finish. Expect to do a fair amount of sanding before installing them on a trailer queen!

Monitor your brake temperatures easily with our temperature indicating paints on the next page!

Low-Drag NACA Air Inlet Ducts

These flush ducts are designed to be installed nearly parallel to the direction of travel. For best airflow, mount them in a high-pressure area such as on the leading edge of a fender. Choose sandable, paintable ABS black plastic or transparent plastic.

Small NACA Duct, Black, single outlet for 2.5" hose Part No. 3627-Black.... \$21.49
Small NACA Duct, Clear, single outlet for 2.5" hose Part No. 3627-Clear.... \$25.49
(Not shown) Approximately 7 x 3.7 inches.

Medium NACA Duct, Black, single outlet for 3" hose.....Part No. 3628-Black ... \$21.49
Medium NACA Duct, Clear, single outlet for 3" hose Part No. 3628-Clear.... \$26.99
Approximately 10.5 x 6 inches.

Large NACA Duct, Black, dual outlets for 3" hose Part No. 3629-Black ... \$23.99
Large NACA Duct, Clear, dual outlets for 3" hose Part No. 3629-Clear.... \$28.99
Approximately 10.5 x 9 inches.

Steering Wheels

Don't settle for just any old wheel! Trying to race with a steering wheel that doesn't fit your hands can cost you precious lap time and leave your hands sore at the end of the weekend. A racing steering wheel that isn't a good match to your cockpit can even create a hazardous situation. That is why we offer over 40 different steering wheels in sizes from 250mm (9⁷/₈" all the way up to 380mm (15"). And because style is almost as important as comfort and control, we stock wheels from no fewer than 6 different manufacturers! Whatever you race, we are sure to have a wheel to suit. Note: Wheel rim sizes are measured from the outside of the left grip to the outside of the right grip.

Anatomical Steering Wheels

The anatomically-molded grip on these wheels offers precise control. Two sizes are available to fit small or large sedans. The center is undrilled, and the black suede rim has a yellow centering stripe.



Longacre Anatomical Suede Steering Wheels

290mm (11.4")..... Part No. LA56906..... \$159.99
320mm (12.6")..... Part No. LA56908..... \$159.99

OMP Trecento Steering Wheel

Trecento is Italian for "three hundred." This compact 300mm diameter (11.8") wheel is designed for small sports cars that don't have room for a full-size 330mm or 350mm wheel. The rim is covered in black suede with a yellow centering stripe at the top. The flat hub is drilled for the standard 6x70mm bolt pattern.



OMP Trecento Suede Steering Wheel

Part No. OMP-OD1975-Black..... \$209.00

OMP Corsica Steering Wheels

A Porsche Cup favorite. Each of the 3 spokes has 2 lightening holes for a sporty look. The rim is covered in black suede with a yellow centering stripe at the top, and the spokes are black anodized. The hub is drilled for the standard 6x70mm bolt pattern. Dished wheel measures 3.75" (95mm) deep.



OMP Corsica Suede Steering Wheels

330mm (13")..... Part No. 3425-2012..... \$259.00
350mm (13.8")..... Part No. 3425-1954-Black..... \$269.00

MOMO Model 08 Steering Wheel

This full-round steering wheel measures 13.8" (350mm) diameter. Each of the 3 black anodized spokes has a lightening groove for a signature look. The rim is covered in black suede with a yellow centering stripe at the top. The hub is drilled for the standard 6x70mm bolt pattern. Dished wheel measures 3.3" (85mm) deep.



MOMO Model 08 Suede Steering Wheel

Part No. MO-R1908-355..... \$229.99

OMP Indy Flat-Bottom Formula Car Steering Wheel

This compact 9⁷/₈" (250mm) diameter wheel has an undrilled center with a yellow OMP logo. The bottom is very close to the center of the wheel for maximum leg clearance. The wheel measures 8¹/₈" (206mm) top to bottom. The rim is covered in black suede.



OMP Indy Flat-Bottom Suede Steering Wheel

Part No. 3425-2016-Black..... \$249.00

MOMO Model 12 Flat-Bottom Formula Car Steering Wheel

This compact 9⁷/₈" (250mm) diameter wheel has a triangle-shaped undrilled center with a yellow MOMO logo. The bottom is very close to the center of the wheel for maximum leg clearance. Measures just 7⁷/₈" (200mm) top to bottom. The rim is covered in black suede.



MOMO Model 12 Flat-Bottom Suede Steering Wheel

Part No. MO-R1922-255..... \$229.99

MOMO Model 27 Flat-Bottom Steering Wheels

These steering wheels are offered in sizes for larger formula cars and sports racers. The round center is undrilled with a yellow MOMO logo. The 270mm size measures 9.3" (235mm) top to bottom, and the 290mm size measures 9.6" (244mm) top to bottom. The rim is covered in black suede.



MOMO Model 27 Flat-Bottom Suede Steering Wheels

270mm (10.6")..... Part No. MO-R1925-275... \$229.99
290mm (11.4")..... Part No. MO-R1925-295... \$229.99

Alpha Flat-Bottom Steering Wheel

An outstanding value! This economical 10" (255mm) diameter steering wheel looks and feels like a wheel costing twice as much. The anatomically-molded grip offers great control and feedback. The flat center is undrilled with no logo. The rim extends nearly 270 degrees around, and the wheel measures 9" (229mm) top to bottom. The rim is covered in high-quality suede.



Alpha Flat-Bottom Suede Steering Wheel

Part No. 3406-Black..... \$159.99

OMP Indy Open Flat-Bottom Open Top Steering Wheel

This super-compact steering wheel is based on the OMP Indy at left, with an open top. The gap between the top grip ends is 5³/₄" (145mm), and the wheel measures just 6³/₄" (171mm) from the top of the grip ends to the bottom of the rim.



OMP Indy Open Flat-Bottom Open Top Suede Steering Wheel

Part No. 3425-2017-Black..... \$249.00

MOMO Model 12C Flat-Bottom Open Top Steering Wheel

This super-compact steering wheel is based on the MOMO Model 12 at left. The gap between the top grip ends is 5" (127mm), and the wheel measures just 6¹/₂" (165mm) from the top of the grip ends to the bottom of the rim.



MOMO 12C Flat-Bottom Open Top Suede Steering Wheel

Part No. MO-R1922C-255..... \$229.99

MOMO Model 27C Flat-Bottom Open Top Steering Wheel

This open-top steering wheel is based on the smaller (270mm OD) MOMO Model 27 flat-bottom wheel at left. The cut-off top has made it extremely popular in P1 and P2 classes. The wheel measures 7.7" (195mm) from the top of the grip ends to the bottom of the rim. Otherwise identical to the 270mm Model 27.



MOMO 27C Flat-Bottom Open Top Suede Steering Wheel

270mm (9.9") only... Part No. MO-R1925C-275... \$229.99

MOMO Model 26 Steering Wheels

These round steering wheels have a timeless look that is just as comfortable in a vintage F1 car as in a current P2 car. The rim is covered in black suede. The center is undrilled with a yellow MOMO logo on the bottom spoke.



MOMO Model 26 Suede Steering Wheel

260mm (10.3")..... Part No. MO-R1924-265... \$229.99
290mm (11.4")..... Part No. MO-R1924-295... \$229.99

Please visit our website for many more racing steering wheels from Sabelt, OMP, MOMO, Longacre, and more!

See page 138 for quick-release steering wheel hubs.

Temperature Indicating Paints

Our temperature indicating paints display a permanent change after a specific temperature has been reached. You can even see the indication after the parts have cooled, which makes them ideal for temperatures that can't be easily measured in real-time.

These paints are perfect for racing, but they have industrial uses as well. With temperatures from 571°F all the way up to 1800°F, you can monitor the temperature of anything from brake discs to exhaust headers — all the way up to welding or heat treatment.

Tempilaq Temperature Indicating Paints



Tempilaq documents temperatures that are impossible to measure during actual use such as brake discs, brake pads, or exhaust. It is also useful for heat control during welding or heat treatment. Tempilaq has a calibrated melting point that leaves an indication when a specific temperature has been reached. Tempilaq dries almost instantly to a matte finish. As soon as the rated temperature is exceeded, the coating becomes glossy to indicate that the temperature was reached. Tempilaq reacts in less than one second, much more quickly than color-changing paints.

Our Complete Tempilaq Kit includes one bottle each of 5 different temperature paints plus a bottle of thinner, all in a custom foam-lined case. We also offer single 2-ounce brush-in-cap bottles in the following temperature ratings: 750°, 850°, 950°, 1000°, 1100°, 1150°, 1200°, 1250°, 1300°, 1400°, 1450°, 1500°, 1600°, 1700°, or 1800° F.

Complete Tempilaq Kit with 850°F, 950°F, 1000°F, 1100°F, and 1200°F paints plus thinner... Part No. 3160..... \$154.99

Single Tempilaq Temperature Paint, 2 oz. brush-top bottle, specify temperature..... Part No. 3161-Temp..... \$26.99

Tempilaq Thinner..... Part No. 3161-Thinner..... \$10.99

Color Changing Brake Paint



This paint permanently changes colors to show if a temperature has been reached. Six distinct color changes signal temperatures up to 299°C (571°F), 350°C (662°F), 430°C (806°F), 525°C (979°F), 670°C (1238°F), and over 671°C (1239°F). The temperature change occurs after 5 minutes of exposure to heat. The 1 fluid ounce jar has a color code chart printed on the label.

Color Changing Brake Paint..... Part No. 3156... \$79.99

The solids in this paint will settle out of suspension during storage. Just re-mix and add lacquer thinner if needed!

Quick-Release Steering Wheel Hubs

American 3-Bolt QR Hubs, 3x1.75" BC



Hex-Type Quick-Release Hub This economical hub has a 1 inch hex shaped steel inner member which gets welded to your steering shaft. The hub releases when you squeeze the spring-loaded sleeve against the back of the hub. The hub is tapped for three 5/16-24 bolts (included) on a 1.75 inch bolt circle for attaching the steering wheel. The hex is available with a 5/8 or 3/4 inch bore to fit most shaft sizes. The hub portion is available in steel or aluminum. **Note:** The weld-on hex is **always** steel.

Hub Kits with Steel Hub

For 5/8" Shaft..... Part No. 3400-5/8-STL.....\$54.99
For 3/4" Shaft..... Part No. 3400-3/4-STL.....\$54.99

Hub Kits with Aluminum Hub and Steel Hex

For 5/8" Shaft..... Part No. 3400-5/8-Alum.....\$59.99
For 3/4" Shaft..... Part No. 3400-3/4-Alum.....\$59.99

Splined Quick-Release Hubs

These hubs have a splined steel inner member which gets welded to your steering shaft. The hub releases when you squeeze the spring-loaded sleeve against the back of the hub. The hub is tapped for three 5/16-24 bolts (included) on a 1.75 inch bolt circle for attaching the steering wheel. The splined slug is available with a 5/8 or 3/4 inch bore to fit most shaft sizes. The hub is made of aluminum and is available with an aluminum or steel or steel release sleeve. **Note:** The weld-on slug is **always** steel.



Hub Kits with Steel Sleeve over Aluminum Hub

For 5/8" Shaft..... Part No. 3400-101.....\$114.99
For 3/4" Shaft..... Part No. 3400-102.....\$107.99
Red anodized hub, yellow zinc plated sleeve.

Hub Kits with Aluminum Sleeve and Hub (shown)

For 5/8" Shaft..... Part No. 3400-103-Color.....\$59.99
For 3/4" Shaft..... Part No. 3400-104-Color.....\$65.99
Specify hub anodizing color: Black or Red.



American Quick-Release Hub to 6-Bolt Wheel Adapter This aluminum adapters make it easy to mount a 6-bolt steering wheel to your American quick-release

hub. Both accept wheels drilled for six #10 bolts on a 70mm (2 3/4") bolt circle, including many OMP, MOMO, and Sparco wheels. The **American** style fits the hubs above as well as other brands drilled for three 5/16-24 bolts on a 1.75" circle. Includes hardware to mount the wheel to the adapter and the adapter to the hub. Spaces the wheel just 1/2" from the hub.

American Quick-Release Hub to 6-Bolt Wheel Adapter
Part No. 3419-040.....\$39.99

European 3-Bolt QR Hubs, 3x50mm BC



SPA Pre-Wired Splined Quick-Release Hubs These splined quick releases feature superb quality with virtually no play. Asymmetric splines on the center slug allow mating in only one orientation. The aluminum hub releases when the sleeve is squeezed against the back of the hub. A pre-wired Limo electrical connector inside the hub automatically engages when the steering wheel is installed. These hubs eliminate fumbling with connectors and sloppy-looking coiled cords. The hub is drilled for three 5mm bolts (furnished) on a 50mm bolt circle. The steel center slug is available in two different outside diameters for welding to your steering shaft. Includes a special connector removal tool so you can weld the slug without melting the connector. FIA and SFI approved.

12 pin Wired Hub, 5/8" OD Center Slug
Part No. 3419-025.....\$499.00
8 pin Wired Hub, 5/8" OD Center Slug
Part No. 3407.....\$489.00
12 pin Wired Hub, 1" OD Center Slug
Part No. 3419-026.....\$499.00
8 pin Wired Hub, 1" OD Center Slug
Part No. 3419-027.....\$489.00

SPA Splined Quick-Release Hubs, Non-Wired

Enjoy the same extremely tight tolerances as the SPA hubs above, even if you don't have electronics on your steering wheel. These hubs have all the same features as the pre-wired hubs above except the wiring connector. FIA and SFI approved, just like the wired hubs.



Non-Wired Hub, 5/8" OD Center Slug
Part No. 3405.....\$249.99
Non-Wired Hub, 1" OD Center Slug
Part No. 3415.....\$249.99



European Quick-Release Hub to 6-Bolt Wheel Adapters

These aluminum adapters make it easy to mount a 6-bolt steering wheel to a quick-release hub. Both accept wheels drilled for six 5mm bolts on a 70mm (2 3/4") bolt circle, including many OMP, MOMO, and Sparco wheels. This **European** style fits any of the hubs above as well as other brands drilled for three 5mm bolts on a 50mm bolt circle. This adapter is recessed on both sides (60mm ID, some brands require slight modification) to position the wheel either 9mm or 13mm (3/8" or 9/16") from the hub.

European Quick-Release Hub to 6-Bolt Wheel Adapter,
Part No. SP QRA-103.....\$49.99

OMP / MOMO 6-Bolt QR Hubs, 6x70mm



SPA Splined 6-Bolt Quick-Release Hub The splined slug in this precision hub has 23mm splines, larger than the SPA 3-bolt hubs (left) to deal with the higher loads of heavy racing sedans. The asymmetric splines allow mating the wheel in only one orientation.

The aluminum hub releases when the sleeve is squeezed against the back of the hub. The slug has a 29.5mm (1.16") OD. Bore it out to slip over your steering shaft for secure welding. The hub is drilled for the OMP/MOMO/Sparco pattern of six 5mm bolts on a 70mm bolt circle. Just weld the slug to your steering shaft and install your 6-bolt racing wheel. No adapter required! SFI and FIA approved.

SPA QR2 Splined 6-Bolt Quick-Release Steering Hub
Part No. 3416-001.....\$289.99

OMP Weld-On 6-Bolt Quick-Release Hub

The slug on this beautifully machined hub has a unique 3-key mating mechanism. Two of the keys are flat and wide to hold the locking groove, and the third is a plain post to ensure that the wheel can only go on in one direction. This mechanism is more tolerant of dirt than the spline type, but much tighter than the hex type. The hub releases when you squeeze the gold-anodized aluminum sleeve. When you mate the hub to the slug, just push the wheel forward until it locks in place. You don't have to squeeze the release sleeve to install the wheel. The hub is drilled for the OMP/MOMO/Sparco pattern of six 5mm bolts on a 70mm bolt circle. Just weld the slug to your steering shaft and bolt your 6-bolt racing wheel directly to the hub. No adapter required! The steel center slug has a 14mm ID and a 20mm OD to accommodate different steering shaft sizes. Made in Italy.



OMP Weld-On 6-Bolt Quick-Release Hub
Part No. OMP-ODS024.....\$399.00



OMP Bolt-On Quick-Release Hub

This hub eliminates the need for welding! The hub and the center slug are both drilled for the OMP/MOMO/Sparco 6x70mm bolt pattern. Just install an adapter hub (sold separately) and bolt the slug to your adapter. Features the same 3-post mating mechanism as the ODS024 above. Grey and gold anodized aluminum assembly weighs only 13 ounces. Adds 2 1/8" (54mm) space between the wheel and the adapter. Made in Italy.

OMP Bolt-On 6-Bolt Quick-Release Hub
Part No. OMP-ODS024B.....\$399.00

Please visit our website for many more quick-release steering wheel hub designs!

Cartek Wireless Steering Wheel Control System



Cartek Wireless Steering Wheel Control System
Part No. 1068-103
Clockwise from top:
Bolt-on switch panel with built-in transmitter,
wiring harnesses, control box, remote receiver

Get push-button controls at your fingertips without cords or connectors, while keeping your existing quick-release steering wheel hub! This high-tech system adds a bolt-on plate with eight push-button switches behind your steering wheel. A compact infra-red transmitter and receiver signal the control box, which turns the circuits on and off.

The circuits can be individually programmed to function in any of four different switching modes: Momentary, Latching, Latching with Memory, or Flashing (fast or slow). Each circuit can handle up to 10 amps. For heavier loads, use the circuit to trigger a relay.

The receiver connects to the control box with a 9 foot cord. This allows great flexibility in positioning the control box while ensuring a clear line of sight between the transmitter and receiver. The switch panel fits the common 6x70mm OMP/MOMO/Sparco pattern as well as the 6x74mm Nardi pattern. The transmitter runs on an A23 camera battery (included).

Cartek Wireless Steering Wheel Control System
Part No. 1068-133.....\$829.95
Includes switch panel, receiver, control box, and wiring harness.

Switching Modes

Momentary: Push to turn the circuit on. Release to turn off. Useful for gear shifting, starter, horn, or windshield washer.

Latching: Push and release to turn the circuit on. Push again to turn off. Ideal for headlights, cool shirt pumps, or windshield wipers.

Latching with Memory: As Latching, but turning vehicle off and back on does not reset the circuit. Great for pit lane speed limiter, rain lights, or anything else that might be forgotten after a pit stop or driver change.

Flashing: Circuit switches on and off as long as the button is pressed. Choose Slow or Fast flashing. Slow flashes for at least 5 seconds; Fast flashes at least 3 times.

Universal Joints

Borgeson Heavy-Duty Steering Universal Joints and Splined Steering Shafts

High-quality **Borgeson** universal joints are specifically made for steering use in demanding racing applications. Unlike cheaper pin-and-block joints, these joints use sealed needle-roller bearings that provide long life, smooth operation, and great reliability with zero maintenance.

Needle bearing joint, .75" smooth bore at both ends	Part No. 1492-01	\$75.99
Needle bearing joint, .75" smooth bore at one end, 3/4-36 spline other end	Part No. 1492-10	\$77.99
Needle bearing joint, .75" smooth bore at one end, 9/16-36 spline other end	Part No. 1492-11	\$80.99
<i>The 9/16-36 spline is commonly used on British formula car steering racks (e.g., Jack Knight and our own custom-made racks).</i>		
Needle bearing joint, 3/4-36 spline at both ends	Part No. 1492-30	\$82.99
Needle bearing joint, 3/4-36 spline at one end, 9/16-36 spline other end	Part No. 1492-31	\$82.99
Needle bearing joint, 9/16-36 spline at both ends	Part No. 1492-32	\$82.99

Aluminum Needle Bearing Joints

These Borgeson needle bearing joints are similar to the steel units above, but made of aluminum for minimum weight. Aluminum joints are available in splined versions only.

Aluminum needle bearing joint, 3/4 bore x 3/4 bore	Part No. 1493-01	\$69.99
Aluminum needle bearing joint, 3/4 bore x 3/4-36 spline	Part No. 1493-10	\$82.99
Aluminum needle bearing joint, 3/4 bore x 9/16-36 spline	Part No. 1493-11	\$81.99
Aluminum needle bearing joint, 3/4-36 spline x 3/4-36 spline	Part No. 1493-30	\$84.99
Aluminum needle bearing joint, 9/16-36 spline x 9/16-36 spline	Part No. 1493-32	\$84.99

Steering Shafts, Splined at one end

Our steel steering shafts measure 3/4" diameter with a 3/4-36 spline at one end. Three different lengths are available, each with a 1" long spline at one end. You can easily cut them down to the exact length required.

5" long steel steering shaft, 3/4-36 spline at one end	Part No. 1496-05	\$25.99
16" long steel steering shaft, 3/4-36 spline at one end	Part No. 1496-16	\$25.99
36" long steel steering shaft, 3/4-36 spline at one end	Part No. 1496-36	\$28.99

Steering Shaft Supports

Low Carbon Steel PTFE-Lined Rod End, 3/4" bore x 3/4-16 Male Thread	Part No. 3060-12-R	\$31.49
Firewall-Mount Support Bearing in Bolt-On Flange, 3/4" Bore	Part No. 1499-001	\$29.99
<i>Steel flange bolts to your sheet metal firewall. Requires a 1 7/8" hole through the firewall. The bearing fits a 3/4" OD shaft. Allows the shaft to be positioned at up to a 25° angle to the firewall.</i>		

Steering Shaft Support for '98 and up Van Diemen FF1600 / FF2000 Part No. 3420-501

\$149.99
This beautifully machined, black anodized aluminum support replaces the sloppy original split-race bearing with a high-quality, PTFE-lined bearing for smooth operation with no free play. Includes a 7/8" bore bearing. Requires no modifications to the chassis. Made in USA.

BORGESON

UNIVERSAL COMPANY, INC

Needle Bearing Joints
Part Nos. 1492-XX
and 1493-XX



Splined Steering Shafts
Part No. 1496-XX

Attaching Borgeson joints to steering shafts

Splined joints usually have a 5/16-18 setscrew and lock-nut (Loctite is recommended on the setscrew). A flat or groove must be filed on the shaft for the setscrew. **Smooth bore** joints should use two 3/16" hardened shear pins in each yoke, 90° to each other and about 3/8" apart. **Welding is not recommended** because of the risk of heat damage to the bearings and because of the difficulty in ensuring a good weld.

Firewall Flange-Mount Support
Part No. 1499-001



Van Diemen
Support, Part
No. 3420-501

Shift Linkage Joints

Apex MS-20271 Universal Joints

Avoid damage when welding these joints to the shaft by using the Anti-heat[®] compound on page 140.



These high-quality, heavy-duty universal joints are manufactured to Military Specification MS-20271. They are very strong, yet their compact, thin wall construction allows them to fit into those tight spots commonly found on shift linkages of rear engine cars. The joints are permanently lubricated and covered to exclude dirt. They are designed for cross-bolting, pinning, or welding to a close-fitting shaft or tube. (Welding must be done carefully to prevent heat damage.)

Universal joint, 1/4 inch bore (2" long, static torque rating: 200 in.-lb.)	Part No. 1490-1/4	\$184.99
Universal joint, 3/8 inch bore (2.62" long, static torque rating: 675 in.-lb.)	Part No. 1490-3/8	\$119.99
Universal joint, 1/2 inch bore (2.75" long, static torque rating: 1,200 in.-lb.)	Part No. 1490-1/2	\$109.99
Universal joint, 5/8 inch bore (3.19" long, static torque rating: 2,100 in.-lb.)	Part No. 1490-5/8	\$109.99
Universal joint, 3/4 inch bore (3.62" long, static torque rating: 3,500 in.-lb.)	Part No. 1490-3/4	\$124.99
Universal joint, 13/16 inch bore (4.06" long, static torque rating: 4,700 in.-lb.)	Part No. 1490-13/16	\$169.99
Universal joint, 1 1/16 inch bore (4.62" long, static torque rating: 9,500 in.-lb.)	Part No. 1490-1 1/16	\$229.99
Universal joint, 1 1/4 inch bore (5.25" long, static torque rating: 14,500 in.-lb.)	Part No. 1490-1 1/4	\$309.99

Saddle Washers for Bolted Shift Linkage Joints

Standard flat washers do not present a proper bearing surface when used to bolt tubing joints. This can result in damage to the washer or the tubing, which eventually allows the bolt to loosen. Our plated steel washers are designed to be a precise fit on the OD of the Apex shifter joints above. All sizes have a 1/2" OD to match standard AN960 washers. Each saddle washer adds 0.10" to the required grip length (using two washers adds 0.20"). Sold individually.

Saddle Washer for 1/2" OD Tubing, #10 Bolt (Apex 3/8" bore joints), each	Part No. 3077-002-500	\$2.99
Saddle Washer for 5/8" OD Tubing, #10 Bolt (Apex 1/2" bore joints), each	Part No. 3077-002-625	\$2.99
Saddle Washer for 3/4" OD Tubing, #10 Bolt (Apex 5/8" bore joints), each	Part No. 3077-002-750	\$2.99
Saddle Washer for 7/8" OD Tubing, #10 Bolt (Apex 3/4" bore joints), each	Part No. 3077-002-875	\$2.99
Saddle Washer for 5/8" OD Tubing, 1/4" Bolt (Apex 1/2" bore joints), each	Part No. 3077-003-625	\$2.99
Saddle Washer for 3/4" OD Tubing, 1/4" Bolt (Apex 5/8" bore joints), each	Part No. 3077-003-750	\$2.99
Saddle Washer for 7/8" OD Tubing, 1/4" Bolt (Apex 3/4" bore joints), each	Part No. 3077-003-875	\$2.99



Saddle Washers for
Shift Linkage Joints
Part No. 3077-002-size
or 3077-003-size
Sold individually
(three are shown
here for illustration)

Borgeson Economy Shift Linkage Joints

These economical pin-and-block universal joints are similar in quality to the original shifter joints used by many racecar manufacturers. The heat-treated steel construction is quite strong. These joints are available in step sizes which often simplifies installation.

All sizes measure 3 3/8" long x 1" OD. These joints will last a long time if they are kept lubricated and free of dirt. The addition of some kind of boot or cover is recommended to keep dirt and water out.

Economy shifter joint, 1/2" bore at both ends	Part No. 1484-001-.50	\$61.99
Economy shifter joint, 1/2" bore one end, 5/8" other end	Part No. 1484-001-.50/62	\$61.99
Economy shifter joint, 5/8" bore at both ends	Part No. 1484-001-.62	\$61.99
Economy shifter joint, 5/8" bore one end, 3/4" other end	Part No. 1484-001-.62/75	\$61.99
Economy shifter joint, 3/4" bore at both ends	Part No. 1484-001-.75	\$61.99

Never use these joints for steering!



Stock and Custom-Made Steering Racks

Whether you choose a stock rack off the shelf or a custom rack made to your specifications, you will get a top-quality unit engineered for smooth operation and long life. Unlike most racks which bend the rack towards the pinion to achieve optimum backlash, our design moves the pinion towards the rack in an eccentric housing. This has the obvious advantage of a much freer running rack and longer bearing life. Soft felt seals further enhance bearing life without adding friction. A safety backup buffer, positioned just clear of the rack, maintains tooth engagement under extreme loading without adding friction under normal operation. The housing is aluminum alloy. The pinion shaft has a $\frac{9}{16}$ x 36 tooth spline to accept many standard universal joints or our rigid coupler listed below.

Stock Steering Rack Part No. 1802 \$979.00

Our stock rack is based on the most commonly ordered custom rack dimensions.
 A=18" B=13" C=10" D=1.5" T= $\frac{1}{2}$ -20 (See drawing below.)

Custom-Made Steering Rack Part No. 1800 \$1,439.00

See worksheet below or visit our website to order. Please allow 8 weeks for delivery of custom-made steering racks.

Rigid Coupler for $\frac{3}{4}$ inch steering shaft. Part No. 1805-75 \$89.99

Attaches a $\frac{3}{4}$ " diameter steering shaft to a $\frac{9}{16}$ -36 splined pinion. One side has female $\frac{9}{16}$ -36 splines; the other has a $\frac{3}{4}$ " smooth bore. This is not a universal joint.

9 Tooth 12DP Steering Pinion. Part No. 1808-001 \$154.99

This pinion produces 2.54" of rack travel per full turn of the pinion. This is the standard pinion installed in our steering racks.



Stock Steering Rack, Part No. 1802
 Dimensions of Stock Steering Rack:
 • 18" Rack Bar Length • 13" Housing Length
 • 10" Between Mounting Shoulders
 • 1.5" Housing Diameter at Mounting Bosses
 • $\frac{1}{2}$ -20 UNF Female Threads on Rack Bar Ends



Above: Rigid Coupler for $\frac{3}{4}$ Inch Steering Shaft
 Part No. 1805-75



Renault-Style Rack End Joint Assembly
 Part No. 1804-xx



Left: Replacement Parts for Renault-Style Rack End Joints
 Part No. 1804-Cup and Part No. 1804-Spring
 Sold individually

Right: Dallara-Style Compact
 Rack End Joints
 Part No. 1804- $\frac{5}{16}$ -Compact
 Sold individually
 (two shown for illustration)

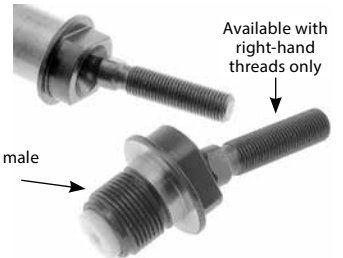

Left: Van Diemen Tie Rod Inner Joint
 Part No. 3065TSH-4-R



Steering Rack End Joints

Please Note: The following rack end joints do not fit our stock steering racks. Custom racks can be ordered to accept either the Renault or Dallara-style joints.

Renault-Style Rack End Joint, M12 x 1.5. Part No. 1804-12mm \$117.99

Renault-Style Rack End Joint, $\frac{3}{8}$ -24 UNF. Part No. 1804-3/8 \$119.99
 Many British formula cars were originally built with steering racks which use these Renault-Style joints. Requires 22 x 1.5mm male threads on the steering rack.

Replacement Nylon Cup for Renault End Joint. Part No. 1804-Cup \$11.99

Replacement Spring for Renault End Joint. Part No. 1804-Spring \$12.99

Replacement M12 Ball Stud for Renault Joint. Part No. 1803-12mm \$81.99

Dallara-Style Rack End Joint, $\frac{5}{16}$ -24 Male. Part No. 1804- $\frac{5}{16}$ -Compact \$109.99

These joints were designed for Dallara cars, but their compact, low-profile design makes them adaptable to other chassis. Requires $\frac{3}{4}$ -20 female threads on the steering rack.

Nylon Spacer - Lock Stop for Steering Rack Part No. 1806-3mm \$10.99

Nylon Spacer - Lock Stop for Steering Rack Part No. 1806-10mm \$10.99

These nylon spacers are used to fine-tune rack travel when Renault-Style or Dallara-Style rack end joints are installed. Spacers can be stacked to limit rack travel as needed.

Van Diemen Tie Rod End Inner Joint. Part No. 3065TSH-4-R \$39.99

This special rod end has a $\frac{1}{4}$ " bore and a $\frac{3}{16}$ -24 male threaded shank. The small head ($\frac{3}{16}$ " wide ball x $\frac{3}{4}$ " OD head) fits into the steering rack clevis on late-model Van Diemen formula cars. Right-hand thread only.

Custom-Made Steering Rack Worksheet

Use this worksheet to order your custom steering rack. You can also visit our website for an interactive order form to guide you through the ordering process.

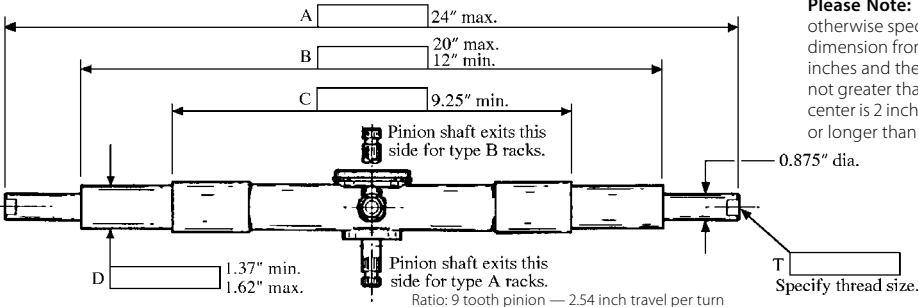

Please Note: The pinion shaft is in the center of the rack housing unless otherwise specified. A small amount of offset can be provided as long as the dimension from the pinion to the short end of the housing is not less than 6 inches and the dimension from the pinion to the long end of the housing is not greater than 10 inches. This means that the maximum pinion offset from center is 2 inches for a 16 inch housing length. If the housing length is shorter or longer than 16 inches, the maximum offset will be less than 2 inches.

Car Make	
Car Model	
Rack Type (A or B)	

Type A: More suited for mounting in front of a bulkhead.
Type B: More suited for mounting behind a bulkhead.

STEERING

Anti-heat° Heat Sink Compound

- Heat barrier
- Prevents warping
- Prevents discoloration

Anti-heat° is great for protecting the bearings and boots of universal joints during welding!



Anti-heat° protects metals and other materials from the heat of welding, brazing or soldering. It absorbs surface heat to prevent buckling or warping in thin materials. It also prevents discoloration, blistering, and cracking. It's fast and easy to apply directly from the caulking tube. Safe to use on any vertical, horizontal or overhead surface. Anti-heat° is non-toxic, harmless to the skin and odorless. Cleanup is easy – just wipe off the excess and wash with water.

Anti-heat° Protective Compound, 12 ounce caulking gun tube Part No. 3389-12 oz. \$25.49

Aurora PTFE-Lined Spherical Bearings

Wide Series PTFE-Lined Spherical Bearings						
Bore Size B	Outside Dia. D	Ball Width W	Race Width T	Static Radial Load Rating	Part No.	Price
5/16"	11/16"	7/16"	0.317"	9,400 lb.	3070-5	\$24.99
3/8"	13/16"	1/2"	0.406"	13,700 lb.	3070-6	\$26.99
7/16"	15/16"	9/16"	0.442"	20,700 lb.	3070-7	\$29.99
1/2"	1.00"	5/8"	0.505"	21,400 lb.	3070-8	\$32.99
9/16"	1 1/8"	11/16"	0.536"	26,600 lb.	3070-9	\$37.99
5/8"	1 3/16"	3/4"	0.567"	29,000 lb.	3070-10	\$41.99
3/4"	1 3/8"	7/8"	0.630"	37,000 lb.	3070-12	\$43.99

All of the spherical bearings listed here are constructed using heat-treated and hard chrome plated balls and hard alloy steel, PTFE lined races for unsurpassed strength and durability.



Wide Series Part No. 3070-xx

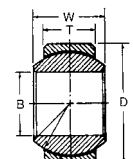

Key dimensions on a typical spherical bearing insert.



Shock Absorber Bearing Part No. 3073-B

Special Sizes – PTFE-Lined Spherical Bearings						
Bore Size B	Outside Dia. D	Ball Width W	Race Width T	Static Radial Load Rating	Part No.	Price
1/2"	7/8"	7/16"	3/8"	19,680 lb.	3073-8*	\$37.99
1/2"	26mm	16mm	9mm	14,455 lb.	3076-001	\$22.79
1/2"	1 1/8"	3/4"	1/2"	28,500 lb.	3075-8	\$59.99
1/2"	1 3/16"	3/4"	3/8"	14,455 lb.	3076-8	\$69.99
5/8"	1 9/16"	7/8"	11/16"	36,050 lb.	3073-10	\$45.99
5/8"	1 3/8"	7/8"	5/8"	25,600 lb.	3074-10	\$44.99
1.00"	1 3/4"	1.00"	0.795"	55,200 lb.	3074-16	\$41.99

* Replaces the low-quality split-race bearing supplied on many racing shocks. (Not all shocks use this size so be sure to check.)

Narrow Series PTFE-Lined Spherical Bearings						
Bore Size B	Outside Dia. D	Ball Width W	Race Width T	Static Radial Load Rating	Part No.	Price
3/8"	13/16"	0.406"	0.312"	10,540 lb.	3071-6	\$27.99
7/16"	0.9062"	7/16"	0.343"	13,200 lb.	3071-7	\$30.49
1/2"	1.000"	1/2"	0.390"	17,900 lb.	3071-8	\$32.99
5/8"	1 3/16"	5/8"	0.500"	30,500 lb.	3071-10	\$41.99
3/4"	1 7/16"	3/4"	0.593"	46,400 lb.	3071-12	\$44.99



Narrow Series Part No. 3071-xx



High-Misalignment Necked Ball Series Part No. 3072-xx

High-Misalignment (Necked Ball) Spherical Bearings						
Bore Size B	Outside Dia. D	Ball Width W	Race Width T	Static Radial Load Rating	Part No.	Price
3/8"	0.9062	13/16"	0.345"	16,000 lb.	3072-6	\$34.99
7/16"	1.000"	7/8"	0.345"	19,018 lb.	3072-7	\$38.99
1/2"	1 1/8"	15/16"	0.401"	25,263 lb.	3072-8	\$39.99
5/8"	1 3/8"	1.200"	0.567"	44,651 lb.	3072-10	\$48.99
3/4"	1 9/16"	1.280"	0.620"	53,707 lb.	3072-12	\$56.99

Spherical Bearing Weld Cups

These chromoly cups are perfect for fabricating A-arms and other suspension components. Four sizes are designed specifically to fit one of our Narrow Series Aurora spherical bearings above. The bearing is retained in the cup by a C-clip (included) on one side and a ridge on the other. For best results, the cup should be oriented so that the primary axial force pushes the bearing toward the ridge. Heavy-wall construction resists deformation from welding heat. Cups are sold individually. CNC manufactured in the USA.



Left: Installation example
Only trust highly skilled welders to fabricate critical suspension components!



Left: Spherical Bearing Weld Cup Part No. 1825-150-Size

Right: Shown with Spherical Bearing (sold separately)



Spherical Bearing Weld Cups								
For Bearing Part No.	Bearing Bore	Cup ID (Bearing OD)	Race Width	Ridge ID	Cup Height	Cup OD	Part No.	Price
3071-6	3/8"	13/16"	0.312"	0.692"	0.685"	1.188"	1825-150-0812	\$17.99
3071-8	1/2"	1"	0.390"	0.787"	0.875"	1.375"	1825-150-1000	\$17.99
3071-10	5/8"	1 3/16"	0.500"	1.12"	0.9715"	1.6875"	1825-150-1187	\$19.99
3071-12	3/4"	1 7/16"	0.593"	1.312"	1.088"	1.9375"	1825-150-1437	\$21.99
Replacement Circlips, specify size							1825-160-Size	\$2.99/pair

Seals-It Rod End Seals



Seals-It Rod End Seals are a must if you are using rod ends without a PTFE lining. Rod ends with a PTFE lining (such as the rod ends we carry) normally do not need external seals except in extremely dusty or gritty environments such as off-road racing. These seals have a rubber dust boot bonded to a metal inner washer. Select the bore size which matches the bore size of your rod end. Sold in packs of 6 seals, enough to seal both sides of 3 rod ends.

Seals-It Rod End Seals – SAE Sizes				
Bore Size	Seal O.D.	Washer Thickness	Part No.	Price 6/pk
3/16"	0.326"	0.020"	3077-001-0187	\$12.49
1/4"	0.375"	0.027"	3077-001-0250	\$12.49
5/16"	0.487"	0.047"	3077-001-0312	\$12.49
3/8"	0.530"	0.047"	3077-001-0375	\$12.49
7/16"	0.626"	0.047"	3077-001-0437	\$12.49
1/2"	0.730"	0.047"	3077-001-0500	\$12.49
5/8"	0.882"	0.047"	3077-001-0625	\$14.49
3/4"	1.006"	0.047"	3077-001-0750	\$15.29

Seals-It Rod End Seals – Metric Sizes				
Bore Size	Seal O.D.	Washer Thickness	Part No.	Price 6/pk
8mm	12.37mm	1.20mm	3077-001-M08	\$12.49
10mm	13.46mm	1.20mm	3077-001-M10	\$12.49
12mm	18.54mm	1.20mm	3077-001-M12	\$12.49
14mm	18.54mm	1.20mm	3077-001-M14	\$14.49
16mm	22.40mm	1.20mm	3077-001-M16	\$14.49

Note: These seals will not seal high-misalignment rod ends.

Nadella Combined Needle Bearings

Nadella bearings are used in many race car applications because of their small size, low weight, and high load capacity. A common use is in rocker pivots on cars with inboard suspension. In order to achieve rated capacity and life, the mating surfaces should have a smooth, hard finish. A Rockwell hardness of C58 will ensure full rated capacity. Using a matching Nadella thrust washer will provide this in the axial direction.

Nadella Combined Needle Bearings – All dimensions are in millimeters.													
Bore Size C1	Housing Bore D1	Max. Dia. D2	Overall Width L	Bore Depth I	Axial Load lb.	Radial Load lb.	Speed Limit rpm	Nadella Bearing Part No.	Price	Thrust Washer 0.8mm Thick Part No.	Price	Thrust Washer 2.0mm Thick Part No.	Price
12	18	28	14.2	10	562	2,473	13,000	3080-12mm	\$39.99	3081-12mm	\$9.99	3082-12mm	\$15.99
14	20	30	14.2	10	652	2,810	11,500	3080-14mm	\$48.99	3081-14mm	\$9.99	3082-14mm	\$15.99
15	21	32	14.2	10	697	3,147	10,500	3080-15mm	\$49.99	3081-15mm	\$9.99	3082-15mm	\$15.99
18	24	34	18.2	14	1,304	3,597	10,000	3080-18mm	\$48.99	3081-18mm	\$9.99	3082-18mm	\$15.99
20	26	37	18.2	14	1,439	4,047	9,000	3080-20mm	\$54.99	3081-20mm	\$9.99	not available	
25	33	46	22.2	18	2,360	4,946	7,200	3080-25mm	\$58.99	3081-25mm	\$9.99	not available	

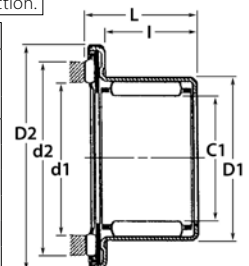

Aurora PTFE-Lined Rod End Bearings

Pegasus has been selling Aurora Rod Ends for many years with excellent customer feedback. Heavy users such as driver schools and prep shops find they get greater life out of Aurora bearings in many applications. The majority of road race cars manufactured in the U.S. are equipped with Aurora Rod Ends as original equipment. All Aurora bearings in our inventory have a reinforced PTFE fabric lining for smooth, low-friction, backlash-free operation. This can make a big difference in a car's handling and in your ability to accurately align the suspension. Auxiliary lubrication is not required which means they do not attract damaging dust and dirt.

All Aurora bearings utilize quality materials throughout. None of these bearings use soft brass races which quickly become loose when subjected to the stresses of competition use. Note: When ordering rod ends be sure to add the suffix "-R" or "-L" to indicate right-hand (clockwise) or left-hand (counter-clockwise) threads. Prices are the same for either one. Also please notice that the nominal bore diameter equals the basic diameter of the shank threads on all rod ends except for the 3063, 3064 and 3065T series of part numbers which have oversized shank threads. Undersized shanks are not available. Jam nuts are sold separately (see page 98).



Moderate-Strength Low Carbon Steel Rod Ends, PTFE Lined

These economical yet high-precision bearings are designed for moderately-stressed joints. The ball is heat-treated and hard chrome plated alloy steel. The steel race has a PTFE fabric lining bonded to it. The body is low carbon steel which limits the load rating to substantially less than our premium series bearings. However, they will provide very long life in lower stressed or non-critical uses such as roll bar links, shift linkages, or steering shaft supports. Jam nuts are sold separately (see page 98).



The rod ends listed below feature the same construction as the male and female rod ends at left, but with an oversized shank (bore size smaller than shank size) for greater strength.
Note: Undersized shanks are not available.

Male Threaded Shank, PTFE Lined

Bore Size	Thread Size	Radial Load Rating	Part No.	Price
3/16	10-32	1,169 lb.	3060-3-L or R	\$11.49
1/4	1/4-28	2,158 lb.	3060-4-L or R	\$12.49
5/16	5/16-24	2,784 lb.	3060-5-L or R	\$12.99
3/8	3/8-24	3,915 lb.	3060-6-L or R	\$14.29
7/16	7/16-20	4,218 lb.	3060-7-L or R	\$16.49
1/2	1/2-20	6,660 lb.	3060-8-L or R	\$19.49
5/8	5/8-18	7,364 lb.	3060-10-L or R	\$24.99
3/4	3/4-16	11,518 lb.	3060-12-L or R	\$31.49

Female Threaded Shank, PTFE Lined

Bore Size	Thread Size	Radial Load Rating	Part No.	Price
3/16	10-32	1,531 lb.	3061-3-L or R	\$13.49
1/4	1/4-28	2,539 lb.	3061-4-L or R	\$14.49
5/16	5/16-24	3,133 lb.	3061-5-L or R	\$14.99
3/8	3/8-24	3,915 lb.	3061-6-L or R	\$15.49
7/16	7/16-20	4,218 lb.	3061-7-L or R	\$16.99
1/2	1/2-20	6,660 lb.	3061-8-L or R	\$19.99
5/8	5/8-18	7,364 lb.	3061-10-L or R	\$25.99

Oversized Male Threaded Shank, PTFE Lined

Bore Size	Thread Size	Radial Load Rating	Part No.	Price
1/4	5/16-24	3,467 lb.	3065T-4-L or R	\$14.79
5/16	3/8-24	5,323 lb.	3065T-5-L or R	\$15.49
3/8	7/16-20	7,180 lb.	3065T-6-L or R	\$17.99
7/16	1/2-20	9,620 lb.	3065T-7-L or R	\$21.99
1/2	5/8-18	12,807 lb.	3065T-8-L or R	\$23.99
5/8	3/4-16	16,565 lb.	3065T-10-L or R	\$31.99

High-Strength Alloy Steel Male Rod Ends, PTFE Lined



These male rod ends provide the ultimate in strength, durability, and safety. The ball, race, and housing are all made with heat-treated alloy steel. The ball is hard chrome plated. The housing is bright nickel plated (on most sizes) and the race is nickel plated and lined with PTFE fabric. These bearings are very resistant to loosening even when subjected to the pounding that they receive under racing conditions. We offer both standard shank (thread size matches bore size) and oversized shank (thread size larger than bore size) for the highest strength. Jam nuts are sold separately (see page 98).

Alloy Steel Male Rod Ends, PTFE Lined

Bore Size	Thread Size	Radial Load Rating	Part No.	Price
1/4	1/4-28	5,260 lb.	3062-4-L or R	\$30.99
5/16	5/16-24	7,125 lb.	3062-5-L or R	\$33.99
3/8	3/8-24	8,939 lb.	3062-6-L or R	\$36.99
7/16	7/16-20	9,653 lb.	3062-7-L or R	\$41.99
1/2	1/2-20	15,500 lb.	3062-8-L or R	\$48.99
5/8	5/8-18	17,148 lb.	3062-10-L or R	\$58.99
3/4	3/4-16	27,021 lb.	3062-12-L or R	\$77.99

Oversized Shank Alloy Steel Male Rod Ends, PTFE Lined

Bore Size	Thread Size	Radial Load Rating	Part No.	Price
1/4	5/16-24	8,452 lb.	3063-4-L or R	\$33.99
5/16	3/8-24	12,978 lb.	3063-5-L or R	\$34.99
3/8	7/16-20	17,508 lb.	3063-6-7-L or R	\$40.99
7/16	1/2-20	22,760 lb.	3063-7-L or R	\$46.99
1/2	5/8-18	30,579 lb.	3063-8-L or R	\$54.49
5/8	3/4-16	39,674 lb.	3063-10-L or R	\$69.99

Note: See next page for two different versions of special 3/8" bore x 1/2-20 shank male rod ends.

High-Misalignment (necked ball) Alloy Steel Male Rod Ends, PTFE Lined

These high-misalignment rod ends use the same heat-treated alloy steels as the High-Strength rod ends above. The necked ball design allows almost twice as much misalignment than standard rod ends. This type of rod end has a lower axial (perpendicular to the shank) load rating than a standard rod end.

Note: Shank diameter is larger than bore size.

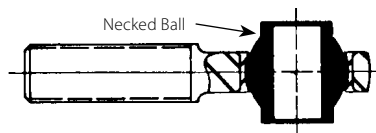

High-Misalignment Male Rod Ends, PTFE Lined

Bore Size	Thread Size	Max. Angle	Radial Load Rating	Part No.	Price
0.19	5/16-24	17°	7310	3064-3-L or R	\$56.99
1/4	3/8-24	23°	10,789 lb.	3064-4-L or R	\$52.99
5/16	7/16-20	22°	11,781 lb.	3064-5-L or R	\$54.99
3/8	7/16-20	22°	11,781 lb.	3064-6-L or R	\$52.99
7/16	1/2-20	21°	17,105 lb.	3064-7-L or R	\$57.49
1/2	5/8-18	19°	23,720 lb.	3064-8-L or R	\$72.99
5/8	3/4-16	19°	32,067 lb.	3064-10-L or R	\$89.99



Typical High-Misalignment Alloy Steel Rod End, Part No. 3064

Note: Only available with male threads (female threaded version is not available)

See page 98 for Jam Nuts • See page 99 for Safety Retainer Washers
See our website for full specifications and for dozens of other Aurora rod end types

Aurora PTFE-Lined Rod End Bearings

We are expanding our selection of Aurora rod ends. Excluding "special sizes", we now stock 12 different series to cover nearly any racer's need! Jam nuts are sold separately (see page 98).

High-Strength Alloy Steel Rod Ends

These rod ends provide excellent strength at a good price. The ball and housing are both made from heat-treated alloy steel. The race is heat-treated carbon steel with a bonded PTFE liner. The ball is hard chrome plated, and the housing and race are coated for corrosion resistance. They compare favorably to our 3062 series in strength, but without the nickel plating and precise tolerances. Available with male or female threaded shanks. Jam nuts are sold separately (see page 98).

Male Threaded Shank, PTFE Lined				
Bore Size	Thread Size	Radial Load Rating	Part No.	Price
1/4"	1/4-28	5260 lb.	AB-AMT-4-L or R	\$17.99
5/16"	5/16-24	7639 lb.	AB-AMT-5-L or R	\$18.99
3/8"	3/8-24	9544 lb.	AB-AMT-6-L or R	\$21.99
7/16"	7/16-20	10,285 lb.	AB-AMT-7-L or R	\$24.99
1/2"	1/2-20	16,238 lb.	AB-AMT-8-L or R	\$28.99
5/8"	5/8-18	17,955 lb.	AB-AMT-10-L or R	\$38.99
3/4"	3/4-16	28,081 lb.	AB-AMT-12-L or R	\$53.99
7/8"	7/8-14	45,051 lb.	AB-AMT-14-L or R	\$121.99
1"	1 1/4-12	76,200 lb.	AB-AMT-16-L or R	\$127.99



Left: Typical Alloy Steel Rod End, Male Shank
Part No. AB-AMT

Right: Typical Alloy Steel Rod End, Female Shank
Part No. AB-AWT



Female Threaded Shank, PTFE Lined				
Bore Size	Thread Size	Radial Load Rating	Part No.	Price
3/16"	10-32	3733 lb.	AB-AWT-3-L or R	\$21.99
1/4"	1/4-28	5260 lb.	AB-AWT-4-L or R	\$21.99
5/16"	5/16-24	7639 lb.	AB-AWT-5-L or R	\$22.99
3/8"	3/8-24	9544 lb.	AB-AWT-6-L or R	\$23.99
7/16"	7/16-20	10,285 lb.	AB-AWT-7-L or R	\$26.99
1/2"	1/2-20	16,238 lb.	AB-AWT-8-L or R	\$31.99
5/8"	5/8-18	17,955 lb.	AB-AWT-10-L or R	\$42.99

Performance Racing Series Rod Ends with Low Breakaway Torque

Alloy Steel Male Rod Ends, PTFE Lined				
Bore Size	Thread Size	Radial Load Rating	Part No.	Price
5/16"	5/16-24	7639 lb.	AB-PRMT-5-L or R	\$45.49
3/8"	3/8-24	9544 lb.	AB-PRMT-6-L or R	\$52.49
7/16"	7/16-20	10,285 lb.	AB-PRMT-7-L or R	\$58.49
1/2"	1/2-20	16,238 lb.	AB-PRMT-8-L or R	\$69.99
5/8"	5/8-18	17,955 lb.	AB-PRMT-10-L or R	\$90.99
3/4"	3/4-16	28,081 lb.	AB-PRMT-12-L or R	\$106.99

These rod ends feature strength similar to our 3062 and 3063 series, but the ball is slightly looser in the race. This reduces breakaway torque (the force required to start the ball moving). Stiff rod ends can have a noticeable effect on handling. Alloy or stainless steel ball, stainless steel race, and 4130 alloy steel housing are all heat-treated. Jam nuts are sold separately (see page 98).

Oversize Shank Alloy Steel Male Rod Ends, PTFE Lined				
Bore Size	Thread Size	Radial Load Rating	Part No.	Price
1/4"	5/16-24	7544 lb.	AB-PRXMT-4-L or R	\$47.99
5/16"	3/8-24	9135 lb.	AB-PRXMT-5-L or R	\$49.99
3/8"	7/16-20	10,946 lb.	AB-PRXMT-6-L or R	\$56.99
7/16"	1/2-20	14,049 lb.	AB-PRXMT-7-L or R	\$65.99
1/2"	5/8-18	23,310 lb.	AB-PRXMT-8-L or R	\$86.99
5/8"	3/4-16	25,909 lb.	AB-PRXMT-10-L or R	\$102.99

Special Size Rod Ends for Racing Applications

These non-standard rod ends are specifically for racecar applications. Most of these rod ends were designed as replacements for existing rod ends that are now impossible to find. In most cases, the Aurora version is stronger and higher-quality than the original. All of these rod ends feature a PTFE liner bonded to the race. Jam nuts are sold separately (see page 98).



Aurora Special Size Rod End
Part No. 3069-6-15-R
3/8" Bore x 1/2-20 Shank
Replaces obsolete 1865P rod end

Special Size Rod Ends for Racing Applications, PTFE Lined									
Original Part No.	Bore Size	Thread Size	Center of Bore to end of Shank	Ball Width	Head Width	Head OD	Notes	Part No.	Price
RC04	1/4"	5/16-24	1 9/16"	5/16"	9/32"	3/4"	Late model Van Diemen steering rack	3065TSH-4-R	\$39.99
2057P	3/8"	1/2-20	1 15/16"	1/2"	13/32"	1"	Small head; 9544 lb radial strength	3063-6-8-L or R	\$51.49
1865P	3/8"	1/2-20	2 7/16"	5/8"	1/2"	1 5/16"	16,238 lb radial strength	3069-6-15-L or R	\$54.99
RXAM-6T-6	3/8"	7/16-20	2 5/16"	1/2"	0.410"	1.113"	Swift 016 rear lower control arm, inner	3069-6M-6-R	\$76.99
PRXM-7T-1	7/16"	1/2-20	2 1/2"	5/8"	0.452"	1.15"	Lola IndyCars	3069-7-1-R	\$69.99
XAM-8T-7	1/2"	5/8-18	3 1/8"	5/8"	1/2"	1 1/2"	Swift DB-1 rear lower control arm, inner	3069-8-7-R	\$159.99

These three special sizes have extra-long shanks. Use them on the lower control arms on your Formula Ford to get enough negative camber for the new SCCA spec radial tires!

Metric High-Strength Alloy Steel Rod Ends

These precision metric rod ends provide excellent strength, durability, and safety. The ball, race, and housing are all made with heat-treated alloy steel. The ball is hard chrome plated. Both the housing and race are coated for corrosion protection. The race is lined with PTFE fabric. These bearings are very resistant to loosening even when subjected to the pounding that they receive under racing conditions. The bore size is equal to the nominal shank diameter. Matching metric jam nuts are sold separately on page 98.

Note: The sizes shown here have ANSI/ISO standard metric threads. Give us a call or check our website for the availability of metric rod ends with non-standard thread pitch. Some non-standard sizes are available; however, they cost considerably more than standard sizes.



We stock the largest selection of metric Aurora rod end bearings anywhere!



Metric Alloy Steel Male Rod Ends, PTFE Lined					
Bore Size mm	Metric Thread Size	Radial Load Rating Newtons	Radial Load Rating Pounds	Part No.	Price
8	M8 x 1.25	33,203 N	7,449 lb.	3066-M8x1.25-L or R	\$23.49
10	M10 x 1.5	50,227 N	11,291 lb.	3066-M10x1.50-L or R	\$27.99
12	M12 x 1.75	44,490 N	10,002 lb.	3066-M12x1.75-L or R	\$34.99
14	M14 x 2.0	71,741 N	16,128 lb.	3066-M14x2.0-L or R	\$62.99
16	M16 x 2.0	76,291 N	17,151 lb.	3066-M16x2.0-L or R	\$70.99

Metric Alloy Steel Female Rod Ends, PTFE Lined					
Bore Size mm	Metric Thread Size	Radial Load Rating Newtons	Radial Load Rating Pounds	Part No.	Price
8	M8 x 1.25	33,203 N	7,449 lb.	3067-M8x1.25-L or R	\$23.49
10	M10 x 1.5	50,227 N	11,291 lb.	3067-M10x1.50-L or R	\$27.29
12	M12 x 1.75	44,490 N	10,002 lb.	3067-M12x1.75-L or R	\$33.99
14	M14 x 2.0	71,741 N	16,128 lb.	3067-M14x2.0-L or R	\$63.99
16	M16 x 2.0	76,291 N	17,151 lb.	3067-M16x2.0-L or R	\$71.99

Suspension Hardware

Threaded Tube Ends – Weldable



Threaded Tube Ends
(Groove indicates left hand thread)

These quality, 4130 chrome moly, threaded tube ends are used to fabricate linkages and suspension components. They're available in sizes to fit many common tubing diameters and wall thicknesses. Available with left or right hand female threads.

Warning: Only trust a highly skilled welder to fabricate any critical component.

Thread Size	Tubing O.D.	Tubing Wall Thickness	Part No.	Price each
10-32	3/8"	fits over O.D.	3051-375-L or R	\$7.59
1/4 -28	1/2"	0.058"	3053-500x058-L or R	\$3.99
5/16 -24	1/2"	0.058"	3054-500x058-L or R	\$4.99
5/16 -24	5/8"	0.058"	3054-625x058-L or R	\$4.99
3/8 -24	3/4"	0.058"	3055-750x058-L or R	\$4.99
3/8 -24	3/4"	0.065"	3055-750x065-L or R	\$8.99
3/8 -24	7/8"	0.065"	3055-875x065-L or R	\$5.99
7/16 -20	7/8"	0.065"	3056-875x065-L or R	\$5.99
7/16 -20	1.000"	0.065"	3056-1000x065-L or R	\$9.99
1/2 -20	7/8"	0.065"	3057-875x065-L or R	\$5.99
1/2 -20	1.000"	0.065"	3057-1000x065-L or R	\$5.99
5/8 -18	1.000"	0.065"	3058-1000x065-L or R	\$6.99

Bearing Shoulder and Reducer Bushings

Now in Metric!

1/2" to 3/8" Steel
Shoulder Bushings
Part No. CS1815B



1/2" to 3/8" Bronze
Reducer Bushing
Part No. 3079-50-375

These bushings allow a 1/2" I.D. suspension bearing to be mounted with a smaller bolt. We offer a variety of sizes and styles, with and without a shoulder. Grind down shoulders and sleeves as needed to suit your installation.

Part No.	ID	Material	Shoulder		Sleeve Length*	Price
			OD	Height		
3079-50-375**	3/8"	Bronze	no shoulder		5/8"	\$1.59 ea.
CS1815B	3/8"	Plated Steel	5/8"	3/16"	.285"	\$10.49 /4 pk
3077-050-312	5/16"	Unplated Steel	3/4"	1/4"	1/2"	\$10.49 /4 pk
3077-050-375	3/8"	Unplated Steel	3/4"	1/4"	1/2"	\$10.49 /4 pk
3077-050-437	7/16"	Unplated Steel	3/4"	1/4"	1/2"	\$10.49 /4 pk
3077-050-M08	8mm	Unplated Steel	3/4"	1/4"	1/2"	\$10.49 /4 pk
3077-050-M10	10mm	Unplated Steel	3/4"	1/4"	1/2"	\$10.49 /4 pk

* Sleeve length is **per bushing**. Multiply by 2 when installing 2 bushings.

**This special non-shouldered bronze bushing allows a 3062-8 (15,500 lb.) rod end to be used instead of a 3063-6-8 (9,544 lb.) rod end where the higher strength is required.

Heavy-Duty Suspension Uprights



Swift DB6 Billet Front Upright This is an exact replacement for the Swift DB6 front upright, but it would be an excellent choice for original construction. These uprights are machined from billet aluminum for the ultimate in strength and reliability. Each upright includes a double-row sealed bearing already installed. The spacing refers to the distance from the axle centerline to the lower suspension pickup point.

Swift DB6 Front Upright

4.70" Spacing Part No. 1462-001-4.70 \$429.99
5.25" Spacing Part No. 1462-001-5.25 \$429.99



Swift DB5 / DB6 Billet Rear Upright This is an exact replacement for the original rear upright on the Swift DB5 and DB6. These uprights are machined from billet aluminum for the ultimate in strength and reliability. Each upright includes a double-row sealed bearing already installed. The bearing rides inside a 4130 steel sleeve for extra strength and longevity. Two sets of brake caliper mounting ears allow just one spare to cover both sides of the car.

Swift DB5 / DB6 Rear Upright Part No. 1462-002 \$549.00

Wheel Bearings



Our sealed double-row bearings are very high quality. Perfect for many formula and sports racing applications.

Wheel Bearing, 64mm O.D., 34mm I.D., 37mm wide
Part No. 1480 \$62.99
Fits some Van Diemen-3 (front).

Wheel Bearing, 75mm O.D., 42mm I.D., 37mm wide
Part No. 1481 \$69.99
Fits some Van Diemen, Ralt (rear).

Wheel Bearing, 88mm O.D., 49mm I.D., 46mm wide
Part No. 1482 \$102.99
Fits 1998 & newer Van Diemen FC / FF.

Shock Absorber Mounts



These two shock mount brackets can be used in a variety of applications. One is designed to be welded to a flat surface and the other is for welding to round tubing. The support bushing on one side is left loose so that it can be welded at the correct spacing for your shock eye. Includes a heavy-duty 1/2 inch bolt and self locking nut for mounting the shock. The bracket is fabricated from 11 gauge (0.112") steel.

Shock Absorber Bracket for mounting to flat surface
Part No. 97-010 \$9.99
Shock Absorber Bracket for mounting to round tubing
Part No. 97-011 \$10.99

Sway Bar Adjusters



These compact, beautifully machined and anodized adjusters provide 5 positive locking detents for making quick, precise and repeatable sway bar adjustments. The knob must be depressed nearly 1/4 inch to change the adjustment, so accidental contact in a tight cockpit is unlikely to change position. The included female rod end fits our #3460 push-pull cable (see page 51). Two 10-32 tapped holes are provided for mounting.

Sway Bar Adjuster, Single Part No. 3475 \$144.99
Sway Bar Adjuster, Dual Part No. 3476 \$364.99
Two handles to adjust two sway bars independently.

Penske Shock Absorber Service Parts

These are a few of the most popular Penske shock absorber parts and accessories we carry. You can find more on our website.

Penske Spherical Bearing Spiroloc Retainer
Part No. 8010-001 \$1.19
Penske Spherical Bearing (1/2" I.D. standard)
Part No. 8011-02 \$24.99

This inexpensive OEM bearing requires lubrication.

Aurora Replacement Spherical Bearing, PTFE Lined
Part No. AB-COMT-8 \$14.99
This heavy-duty bearing is self-lubricating.

Penske 32 Gram Shock Bump Rubber (Tan)
Part No. 8018-32 \$22.99
Penske 38 Gram Shock Bump Rubber (Black)
Part No. 8018-38 \$23.99

The 32 Gram (Tan) bump rubber is softer than the 34 Gram (Black). It takes about 50% more force to compress the 34 Gram than the 32 Gram.

Shock Inflation Tools

Shock Inflation Tool with Analog 300 psi Gauge
Part No. 8021-001



Replacement Schrader Coupler, Part No. 8021-003

Turn this hex to screw the coupler to your Schrader valve
Twist this bar to open the Schrader valve in a separate step



A Shock Inflation Tool is critical for optimum shock management. These tools allow you to open the shock valve after connecting the tool so you won't lose any pressure.

Shock Inflation Tool with Analog 300 psi Pressure Gauge Part No. 8021-001 \$118.99
This compact inflation unit features an anodized aluminum body and an analog (dial-type) 300 psi pressure gauge.

Replacement 300 psi Gauge Only for Shock Inflation Tool Part No. 8021-002 \$43.99
Replacement Schrader Coupler Only for Shock Inflation Tool Part No. 8021-003 \$45.99
This two-step fitting screws onto a Schrader valve and then opens the valve in two separate steps to prevent loss of pressure.

Also an excellent basis for a fuel testing port or fuel pressure testing rig for fuel injected cars! Male 1/8 NPT threads.
Intercomp Shock Inflation Tool with Digital 300 psi Pressure Gauge (not shown) Part No. 100675 \$545.00
Digital gauge reads to 300 psi in 0.5 lb increments. Includes Schrader valve adapter for Penske shocks.

Needle Valve Adapter Only for Ohlins shocks Part No. 100678 \$69.00

Hyperco High-Performance Chassis Springs and Spring Accessories



All Chassis Springs are sold as matched pairs.

Chassis springs are one of the most critical components affecting the handling of a race car. Poor quality springs with inconsistent spring rates and lengths that continually change over time can prevent the most talented driver and crew from getting a car dialed in. Hyperco springs are manufactured using aerospace-quality 9254 Silicon steel. They have a proven track record going back three decades and are used by nearly all of the teams at the upper echelons of motor racing including CART, IMSA, and Formula 1.

Springs are just as important on lighter weight cars since the internal design stresses are virtually the same in a spring designed for Formula Ford as in one designed for an Indy car. With Hyperco springs, you can be assured that your results will be repeatable. Don't waste your racing budget on a spring that won't hold its rate through half a season. Spend a few dollars more and get a pair of Hyperco springs that will perform season after season.

We carry 2", 2 1/4", 2 1/2", 36mm, and 60mm inside diameter springs. They are finished with a tough blue epoxy powder coat that offers unmatched durability.

Hyperco Chassis Springs – 2 inch I.D.			
I.D. x Length (inches)	Spring Rates Available (pounds per inch)	Part No. (specify rate)	Price (pair)
2 x 4	700 to 1300 (50 lb. increments) 1500 to 2000 (100 lb. increments)	184-4-rate	\$212.99 per pair
2 x 5	250 to 1550 (50 lb. increments) 1600 to 2300 (100 lb. increments)	184-5-rate	\$212.99 per pair
2 x 6	400 to 900 (50 lb. increments) plus 1000, 1400, 1500, 1800, 1900, and 2000	184-6-rate	\$212.99 per pair

Hyperco Chassis Springs – 2 1/4 inch I.D.			
I.D. x Length (inches)	Spring Rates Available (pounds per inch)	Part No. (specify rate)	Price (pair)
2 1/4 x 4	400 to 1500 (50 lb. increments) 1600 to 2000 (100 lb. increments)	185-4-rate	\$169.99 per pair
2 1/4 x 5	300 to 1600 (50 lb. increments) 1700 to 2200 (100 lb. increments)	185-5-rate	\$169.99 per pair
2 1/4 x 6	200 to 1000 (50 lb. increments) 1100 to 2000 (100 lb. increments)	185-6-rate	\$169.99 per pair
2 1/4 x 7	250 to 900 (50 lb. increments) 1000 to 1400 (100 lb. increments)	185-7-rate	\$169.99 per pair
2 1/4 x 8	200 to 275 (25 lb. increments) 300 to 700 (50 lb. increments) 800 to 1000 (100 lb. increments), plus 1200	185-8-rate	\$169.99 per pair
2 1/4 x 9	175 to 600 (25 lb. increments)	185-9-rate	\$169.99 per pair

Hyperco Chassis Springs – 36mm I.D.				
I.D.	Length (inches)	Spring Rates Available (pounds per inch)	Part No. (specify rate)	Price (pair)
36mm	4"	800 to 2000 (100 lb. increments)	183-4-rate	\$219.99 per pair
36mm	5"	500 to 2000 (100 lb. increments)	183-5-rate	\$219.99 per pair

Hyperco Chassis Springs – 2 1/2 inch I.D.			
I.D. x Length (inches)	Spring Rates Available (pounds per inch)	Part No. (specify rate)	Price (pair)
2 1/2 x 6	600, 850, 900 to 1100 (100 lb increments)	186-6-rate	\$159.99 per pair
2 1/2 x 7	350 to 900 (50 lb. increments)	186-7-rate	\$159.99 per pair
2 1/2 x 8	200 to 500 (25 lb. increments) 550 to 1000 (50 lb. increments), plus 1100	186-8-rate	\$159.99 per pair
2 1/2 x 10	95, 110 125 to 575 (25 lb. increments) 600 to 900 (50 lb. increments)	186-10-rate	\$159.99 per pair
2 1/2 x 12	85, 95, 110 125 to 600 (25 lb. increments) 600 to 900 (50 lb. increments)	186-12-rate	\$159.99 per pair

Hyperco Chassis Springs – 60mm I.D.				
I.D.	Length (inches)	Spring Rates Available (pounds per inch)	Part No. (specify rate)	Price (pair)
60mm	6"	500 to 1100 (100 lb. increments)	187-6-rate	\$159.99 per pair
60mm	7"	500 to 1100 (100 lb. increments)	187-7-rate	\$159.99 per pair
60mm	8"	800 to 1000 (100 lb. increments)	187-8-rate	\$159.99 per pair

Digital Spring Rate Tester



Digital Spring Rate Tester Take the guess work out of choosing springs. With this heavy-duty test stand from Intercomp, you can measure exact spring rates, keep track of every set season after season, and spot any that have "given up." Simply place the spring on the test bed, adjust the upper perch height, and operate the hydraulic ram. A linear travel indicator and a digital scale are used to measure compression and compression force. This allows for very fast set-up and easy testing. Tests springs up to 6" diameter by 18" long (very short springs under 6" long may require fabrication of a spacer). The capacity is 5000 pounds, displayed in 1 pound increments.

Intercomp Digital Spring Rate Tester Part No. 3778 \$995.00

Hydraulic Load Centering Spring Perches



These precision devices allow the spring end coils to tilt as much as 4° when the spring is compressed, reducing the bending loads on your shocks by up to 96%. This reduction in side force and friction allows more force and energy to be directed to the car's mechanical grip. It also reduces wear on your shocks. Hydraulic perches have proven themselves on the track with rave reviews and reduced lap times. Installing a hydraulic perch at one end of the spring will reduce shock bending loads significantly. However, for greatest effect, both ends of the spring should be equipped with hydraulic perches.

2" Universal Add-On Style (fits top or bottom) Part No. 1870-2.00 \$189.99

2 1/4" Universal Add-On Style (fits top or bottom) Part No. 1870-2.25 \$189.99

2 1/2" Universal Add-On Style (fits top or bottom) Part No. 1870-2.50 \$189.99

"Universal" style gets installed between the spring and your stock spring perch. They can be used at either the shaft end or the body end. This style works with virtually any coil-over shock. Each perch adds approximately 3/4" to the overall length of the spring.

Fixed Spring Platform Wrench



This tool was originally designed for platforms commonly used with 2 1/2 inch I.D. springs. However, a little modification with a bench grinder will allow it to work with most 2 1/4 inch I.D. spring platforms.

Spring Platform Wrench Part No. 3134 \$11.49

3/8" Drive Spring Platform Wrench



Put away the hammer and screwdriver. This compact tool can get into the most cramped chassis. It will even fit inside footboxes of cars with pullrod suspension. Use a 3/8" drive ratchet with an extension to reach almost anywhere.

3/8" Drive Spring Wrench Part No. 3140 \$14.29

Adjustable Spring Platform Wrench



This adjustable tool fits all spring platform nuts up to 3 1/4 inch diameter as used on many coil-over racing shocks. The cast steel design is a comfortable fit to your hand. It sure beats the hammer and screwdriver method.

Adjustable Spring Wrench Part No. 3106 \$33.99

Zero-Rate Helper Springs and Spring Dividers

Below: Top and Bottom Views of 2 1/4" Divider
Part No. 1877-2.25 (sold individually)



Left:
Zero Rate Spring
Part No. 1876-4

Right:
Spring Divider
for 2 1/2" Springs
Part No. 1877-2.50

Zero-Rate (or "Tender") Springs are used on suspensions which can travel farther than the chassis spring. When the suspension droops, these springs expand to take up the slack between the chassis spring and the spring perch. This keeps the chassis spring centered on the perch and prevents the ride height from suddenly changing. These short coils have very low spring rates (virtually zero pounds per inch) and will not affect the rate of your chassis springs. They are coil bound (solid) when the suspension is at normal ride height. You must use a Spring Divider (sold separately) between the chassis spring and the tender spring. Sold individually.

2 1/4" Diameter x 4" Long Zero-Rate Spring, each Part No. 1875-4 \$25.99

2 1/2" Diameter x 4" Long Zero-Rate Spring, each Part No. 1876-4 \$34.99

We recommend installing the Zero-Rate Spring above your chassis spring. The weight of a chassis spring is enough to keep these very soft springs from extending.

A Spring Divider is required between your chassis spring and the tender spring. Spring Dividers help to keep the two springs centered on the shock. Sold individually.

2 1/4" Spring Divider, Short Aluminum Design, each Part No. 1877-2.25 \$42.99

2 1/2" Spring Divider, Long Non-metallic Design, each Part No. 1877-2.50 \$44.99

SUSPENSION

Flywheel and Clutch Parts for 1.6L and 2.0L Ford Engines

Ford 1.6L Flywheel and Clutch Parts

Description	Part No.	Price
JAE Flywheel with 110 tooth Ring Gear, SCCA legal for FF.....	163-01-JAE	\$679.00
<i>Ready to install a six-bolt 7.25" racing clutch (such as our Tilton OT2 - see below).</i>		
Standard Ring Gear, 10.00 inch I.D (110 tooth).....	163-02	\$58.99
High Strength Ring Gear, 10.00 inch I.D.(110 tooth).....	163-07	\$164.99
Pilot Bearing for clutch input shaft.....	161-10	\$23.99
Clutch Cover, Stock (Ford Cortina).....	163-05-Stk	\$299.99
Clutch Cover Locating Dowel, Stock (not for racing clutch).....	163-04	\$6.99
Clutch Cover Bolt, Stock (Ford Cortina).....	163-08	\$2.79
Flywheel Bolt, Stock, each.....	163-20	\$4.99
ARP High-Strength Flywheel Bolts, set of 6.....	ARP206-2802	\$24.75
Throw-out Bearing for standard external slave cylinder.....	1410-C26	\$49.99
Retaining Clip for Throw Out Bearing, H.D.....	1410-C27	\$2.99
FF Bobbin for standard clutch (external slave cylinder), 1.30".....	1410-C28-1	\$169.99
Extra Long FF Bobbin for 7 1/4 inch racing clutches, 1.94".....	1410-C28-2	\$169.99
Bushing for FF Bobbin (use 1 for std, 2 for long).....	1410-C44-1	\$4.99
Clutch Alignment Tool, 7/8 x 20 spline.....	163-40	\$9.99

Ford 1.6L Tilton OT2 7 1/4 inch Single Plate Clutches

The Tilton OT2 is a very lightweight and well-made open style clutch. The aluminum cover is much stiffer and lighter than the stamped steel cover used on other popular racing clutches. The Buff spring is rated to 200 lb-ft of torque and is recommended for FF1600 with an external slave cylinder. The heavier Orange spring is rated for 250 lb-ft and works well on FF1600 with a hydraulic release bearing. Racing clutches take quite high force to actuate. Cable operated release mechanisms may not work. Requires modified flywheel such as Part No. 163-01-JAE listed above.

Description	Part No.	Price
Tilton OT2 Clutch, Buff, without disc (less bolts).....	163-15- <i>Buff</i>	\$408.00
Tilton OT2 Clutch, Orange, without disc (less bolts).....	163-15- <i>Orange</i>	\$408.00
7 1/4 inch clutch disc, 7/8 x 20 spline (for single disc clutch).....	163-12-Tilton	\$89.25
Bolt Kit for attachment to flywheel.....	173-19-OT2	\$21.25
<i>Includes 6 AN5-13A (P/16 - 24 fine thread) bolts and washers</i>		
Replacement clutch cover with Buff spring.....	163-17- <i>Buff</i>	\$272.00
Replacement clutch cover with Orange spring.....	163-17- <i>Orange</i>	\$272.00
Replacement pressure plate.....	173-18-OT2	\$140.25

Ford 1.6L Tilton OT2 7 1/4 inch Twin Plate Clutches



A twin plate clutch can increase the torque capacity by 100% over a single plate clutch (Buff spring: 400 lb-ft; Orange spring: 500 lb-ft; Gray spring: 620 lb-ft). If your application is near the limits of a single plate clutch, this may be the way to improve the reliability and life. The nested discs provide increased clearance for flywheel bolts without sacrificing hub strength. Other disc styles and spare parts are available via special order.

Description	Part No.	Price
Tilton OT2 Twin Plate Clutch, Buff, without discs.....	163-18- <i>Buff</i>	\$518.50
Tilton OT2 Twin Plate Clutch, Orange, without discs.....	163-18- <i>Orange</i>	\$518.50
Tilton OT2 Twin Plate Clutch, Gray, without discs.....	163-18- <i>Gray</i>	\$518.50
7 1/4 inch Nested Hub Inner Disc only, 7/8 x 20 spline.....	163-19- <i>Inner</i>	\$180.62
7 1/4 inch Nested Hub Outer Disc only, 7/8 x 20 spline.....	163-19- <i>Outer</i>	\$180.62

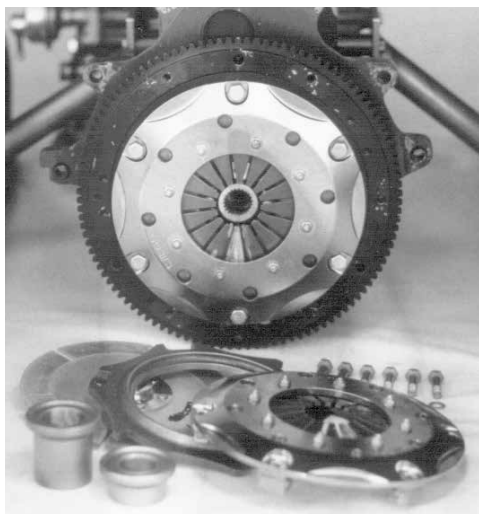

Tilton OT2 Clutch mounted on Ford 2.0L engine (Part No. 173-15-Gray Clutch Assembly with Part No. 173-16-OT2 Disc)

Tilton OT2 Parts shown separately.

Standard short bobbin (Part No. 1410-C28-3) and long bobbin (Part No. 1410-C28-4) for racing clutch when using external slave cylinder

Ford 2.0L Flywheel and Clutch Parts

Description	Part No.	Price
Stock Flywheel with 132 tooth Ring Gear.....	173-01-Stk	\$649.00
Ivey Prepared Flywheel with 135 tooth Ring Gear.....	173-02-VD	\$599.00
<i>This Ivey Prepared flywheel is lightened, balanced and modified to accept a 7 1/4" racing clutch such as the Tilton OT2 listed below. The stock 132 tooth ring gear has been replaced with a 135 tooth ring gear specifically for late-model Van Diemen FF2000.</i>		
110 tooth Ring Gear for older cars with the Lucas starter.....	173-03	\$61.99
Clutch Cover, Stock (Ford Pinto).....	173-05- <i>Std</i>	\$199.99
Clutch Disc, Stock (Ford Pinto).....	173-06- <i>Std</i>	\$119.99
Clutch Cover Bolt, Stock (Ford Pinto), each.....	173-11	49¢
Clutch Cover Lockwasher, Stock (Ford Pinto), each.....	173-12	13¢
Flywheel Bolt, Stock, each.....	173-20	\$9.79
Heavy-Duty 12-point Flywheel Bolts, set of 6.....	173-21	\$35.33
Throw Out Bearing for standard external slave cylinder.....	1410-C26	\$49.99
Retaining Clip for Throw Out Bearing, H.D.....	1410-C27	\$2.99
Bobbin for Standard Clutch (external slave cylinder), 1.10".....	1410-C28-3	\$129.99
Longer Bobbin for racing clutch such as OT2, 2.14".....	1410-C28-4	\$183.99
Replacement Bushing for Standard Bobbin.....	1410-C44-3	\$5.99
Replacement Bushing for longer OT2 Bobbin.....	1410-C44-4	\$7.99
Clutch Alignment Tool, 1" x 23 spline.....	173-40	\$10.49

Ford 2.0L Tilton OT2 7 1/4 inch Single Plate Clutches

The Tilton OT2 is a very lightweight and well-made open style clutch. The aluminum cover is much stiffer and lighter than the stamped steel cover used on other popular racing clutches. The heavier Gray spring is rated to 310 lb-ft of torque and works well with internal slave cylinders (although pedal effort is high). The lighter effort Orange spring is rated to 250 lb-ft and may slip a little under standing start type conditions, but may be necessary if your release mechanism has a lot of deflection under load. Racing clutches take quite high force to actuate. Cable operated release mechanisms may not work. Requires a specially modified flywheel.

Description	Part No.	Price
Tilton OT2 Clutch, Orange, without disc (less bolts).....	163-15- <i>Orange</i>	\$408.00
Tilton OT2 Clutch, Gray, without disc (less bolts).....	173-15- <i>Gray</i>	\$408.00
7 1/4 inch clutch disc, 1" x 23 spline.....	173-16-OT2	\$89.25
Bolt Kit for attachment to flywheel.....	173-19-OT2	\$21.25
<i>Includes 6 AN5-13A (P/16 - 24 fine thread) bolts and washers</i>		
Replacement clutch cover with Orange spring.....	163-17- <i>Orange</i>	\$272.00
Replacement clutch cover with Gray spring.....	173-17- <i>Gray</i>	\$272.00
Replacement pressure plate.....	173-18-OT2	\$140.25

1.6L and 2.0L Tilton OT3 5 1/2 inch Clutches

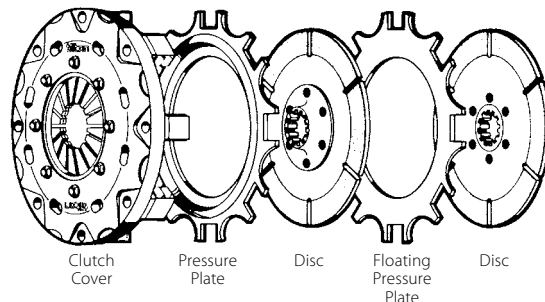

The 5 1/2 inch diameter Tilton OT3 clutches reduce rotational inertia significantly over a 7 1/4 inch clutch, resulting in improved acceleration and reduced stress to the crankshaft during gear changes. The drawback is that disc wear is more rapid than with 7 1/4 inch clutches. We offer both single and twin plate versions for 1.6L and 2.0L applications. The single plate version is rated to 250 lb-ft of torque and the twin plate version is rated to 500 lb-ft. Note that the torque capacity of the twin plate version declines rapidly when the discs are worn because four friction surfaces wear simultaneously. You should be prepared to replace discs at regular intervals, especially on the twin plate version. Other discs available via special order.

Description	Part No.	Price
Tilton OT3 Twin Plate Clutch, Gray, without discs.....	173-50	\$569.50
Set of 5 1/2" Discs, 7/8" x 20 spline for Ford 1.6L, std. hubs.....	173-51	\$178.50
Set of 5 1/2" Discs, 7/8" x 20 spline, 1 std. & 1 thin hub.....	173-53	\$178.50
<i>The thin hub provides more clearance for flywheel bolts but greatly increases the stress on the splines. This could result in damaged splines on higher torque applications.</i>		
Set of 5 1/2" Discs, 1" x 23 spline for Ford 2.0L, standard hubs.....	173-52	\$178.50
Replacement Floater Plate for OT3 twin plate clutch.....	173-56	\$85.00
Tilton OT3 Single Plate Clutch, Gray, without discs.....	173-60	\$450.50
5 1/2" Single Disc, 7/8" x 20 spline for Ford 1.6L, standard hub.....	173-61	\$89.25
5 1/2" Single Disc, 1" x 23 spline for Ford 2.0L, standard hub.....	173-62	\$86.99
Replacement Pressure Plate for all OT3 clutches.....	173-55	\$131.75

Clutch Slave Cylinders

Girling External Clutch Slave Cylinders and Repair Kits

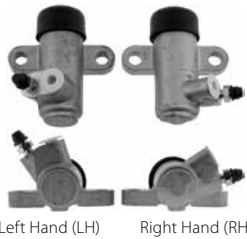
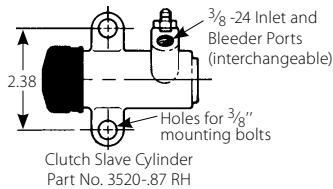

This Girling slave cylinder was original equipment on Hewland Mk-series gearboxes. We stock both right and left hand versions with the common .87 bore size. We also stock a right hand version of the less common .75 bore size. Choose the one that allows bleeding without removal, or, in the case of a vertically mounted unit, the one that provides the most direct hose routing. The port positions on the left and right versions are not mirror images of each other (see photo). The inlet and bleeder ports are interchangeable.

- Right hand - .75 inch bore (not a common size).....Part No. 3520-.75 RH . \$159.99*
- Right hand - .87 inch bore, as illustrated.....Part No. 3520-.87 RH . \$134.99*
- Left hand - .87 inch bore, as shown in photoPart No. 3520-.87 LH . \$134.99*
- Slave Cylinder Repair Kit - .75 inch bore (not common).....Part No. 3521-.75..... \$23.99*
- Slave Cylinder Repair Kit - .87 inch bore.....Part No. 3521-.87..... \$19.99*

Clutch Release Bearing & Bobbins for External Slave Cylinders

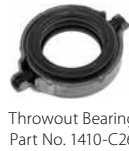

These parts are used on the Mk-series gearboxes with an external slave cylinder such as the Girling units shown at left. Bobbins are available for Formula Ford 1600 with the stock Ford clutch, Formula Ford 1600 with the F3 or Tilton single-disc racing clutch, FF2000/S2000 with the stock Ford clutch, and FF2000/S2000 with the F3 or Tilton single-disc racing clutch. These bobbins are sized for use with the common 2 1/8" thick gearbox adapter plate. The hydraulic release bearings shown below do not use bobbins.

- Clutch Release (Throwout) Bearing, VW.....Part No. 1410-C26 \$49.99*
- Retaining Clip for release bearing, 2 required.....Part No. 1410-C27 \$2.99*
- FF Bobbin, stock Ford clutch, 1.30" long, 7/8" ID.....Part No. 1410-C28-1 ... \$169.99*
- FF Bobbin, racing clutch, 1.94" long, 7/8" ID.....Part No. 1410-C28-2 .. \$169.99*
- S2000 Bobbin, stock Ford clutch, 1.10" long, 1" ID.....Part No. 1410-C28-3 ... \$129.99*
- S2000 Bobbin, racing clutch, 2.14" long, 1" ID.....Part No. 1410-C28-4 .. \$183.99*
- Bushing for FF bobbin (use 1 for stock, 2 for racing clutch).....Part No. 1410-C44-1 \$4.99*
- Bushing for S2000 bobbin, stock Ford clutch.....Part No. 1410-C44-3 \$5.99*
- Bushing for S2000 bobbin, racing clutch.....Part No. 1410-C44-4 \$7.99*

Hydraulic Release Bearings (Annular Slave Cylinders)

Annular Hydraulic Release Bearing Assembly for FF1600



This hydraulic release bearing is designed just for the Hewland/Webster Mk-series gearbox! We've seen the standard external slave and fork-type release mechanisms in Hewland transaxles lose as much as 50% of the input travel due to bending in the release mechanism. Now you can eliminate all lost motion. This unit is engineered to fit most Formula Ford 1600 cars with 7.25" racing clutches and the standard 2 1/8" thick transmission adapter ring without any fabrication. (Will not fit Lotus, Swift, Lola T440, or early Titan chassis.)

The adapter base bolts to the main case using three holes around the input shaft. Most Mk-series gearboxes already have these holes drilled and tapped - check your case before ordering. This kit includes the mounting adapter, annular hydraulic slave cylinder and all mounting hardware. A 4AN inlet adapter and a 3AN adapter for the bleeder port are also furnished. Inlet hose and remote bleed hoses are sold separately.

- Release Bearing Assembly for FF1600 w/ Mk 9.....Part No. 163-55..... \$439.99*
- Bulkhead Mounted -3 Hose End with Bleeder Screw.....Part No. 3266-20..... \$28.99*
- This hose end can be installed right on the bleeder hose. The 3/8-24 male bulkhead mount keeps the hose safe and secure. Requires 3/8-24 jam nut, sold separately.*
- 3AN Bulkhead Mount for 3/8-24 Bleed Screw.....Part No. 3266-25..... \$21.49*
- If your bleeder hose already has a standard hose end, this fitting has a male 3AN thread for your hose and accepts a 3/8-24 bleed screw. Bleed screw and jam nut sold separately.*
- Replacement Bearing Only.....Part No. 163-61..... \$79.99*
- Rebuild Seal Kit, includes base seal and piston seals.....Part No. 163-52..... \$26.99*

Annular Hydraulic Release Bearing for '99 - '04 Van Diemen



The factory Van Diemen clutch release mechanism has caused a lot of headaches. In light of the difficulty in gaining service access, you'll appreciate the increased reliability of this kit which adapts the time-tested Tilton Annular Slave Cylinder to the 1999 thru 2004 Van Diemen chassis. The kit includes an aluminum base which replaces the stock release cylinder housing, supply hose, bleed hose, O-ring seals and illustrated installation instructions. Versions are available for the F2000 and FF1600 with most single-disc racing clutches, Tilton 5.5" single-disc clutch, and twin-plate clutches

- 44mm Release Bearing Assembly for Van Diemen F2000... Part No. 163-57 \$619.00*
- 44mm Release Bearing Assembly for Van Diemen FF1600... Part No. 163-53 \$599.00*
- 44mm fits most single-disc racing clutches, including QuarterMaster or AP 5.5" and most 7.25" racing clutches. F2000 with a twin-plate clutch should use the FF1600 version.*
- 38mm Release Bearing Assembly for Van Diemen F2000... Part No. 163-58 \$569.00*
- 38mm Release Bearing Assembly for Van Diemen FF1600... Part No. 163-54 \$569.00*
- 38mm fits Tilton 5.5" single-disc racing clutches. F2000 with a Tilton 5.5" twin-plate clutch should use the FF1600 version.*
- Replacement 44mm Contact Diameter Release Bearing.... Part No. TE 62-031 ... \$76.50*
- Replacement 38mm Contact Diameter Release Bearing.... Part No. TE 62-008 .. \$72.25*
- Rebuild Seal Kit for any of the above assemblies..... Part No. 163-51 \$34.00*

Tilton Universal Annular Hydraulic Release Bearing Assembly

You must install a clutch pedal stop with any hydraulic release bearing! Overstroking the release will cause damage to the clutch and to the engine.



Many racing clutches require so much force to release that external clutch slave cylinders acting through a linkage require almost superhuman leg strength. Deflection in the linkage also wastes motion, in some cases enough to prevent the clutch from disengaging at all. Hydraulic release bearings eliminates all lost motion because the throwout bearing is mounted directly on the hydraulic piston. This results in the most positive and lightest release mechanism available. The better leverage also means that less pedal effort is generally required. This compact Tilton throwout bearing assembly is small enough to be adapted to almost any transmission or transaxle. Most applications require fabrication of an adapter plate. Maximum release travel is 0.70 inches. Minimum installed height is 3.00 inches. The bearing I.D. is 40mm and it has a radius-faced contact diameter of 52mm for Tilton and similar clutches with a 1 7/8" diaphragm spring hole. Remote bleed hardware and fittings are included.

- Compact Hydraulic Release Bearing (52mm contact dia.)..... Part No. TE 60-3000..... \$318.75*
- Replacement Seal Kit for above Hydraulic Release Bearing..... Part No. 163-51..... \$34.00*
- Replacement Release Bearing Only for above (52mm contact)..... Part No. 163-60..... \$55.25*

Hydraulic Release Bearing Tester

Don't waste time installing your transaxle only to find out too late that your hydraulic release bearing is leaking! Check it first with our **Hydraulic Release Bearing Tester**. This universal tool has been tested to work on FT200, LD200, Mk-series, and Staffs gearboxes. A wide range of adjustments will allow it to fit many other applications. Simply bolt the crossbar to the front of your transmission and adjust the stop plate about 1/4" away from the release bearing using the supplied assortment of spacers. Connect your clutch hydraulic line, bleed the system, and apply moderate pressure to the clutch pedal while watching for leaks. This slick tool could pay for itself the first time you discover a leak before assembly. Black anodized aluminum, includes all necessary hardware.

Hint: This tool can also help find any lost motion in an external clutch slave application! With all parts in the linkage exposed, you will be able to see any flexing.

- Internal Hydraulic Clutch Release Bearing Tester.....Part No. 3094.... \$154.99*



Webster and Hewland Gearbox Parts from Drawing A for Mk-Series (5 speed shown)

Description and Hewland No. in ()'s	Part No.	Price ea.
Rear Cover (HC204)	1410-A01	\$229.99
Reverse Stop Plugger (HC203-0)	1410-A02	\$29.99
Reverse Stop Spring (FT203-2)	1410-A03	\$5.49
Reverse Stop Plug (FT203-5)	1410-A04	\$18.99
1/4 inch Washer, 7 used for rear cover (HC202-9)	1410-A05	49c
1/4-28 Nylock Nut, 7 used for rear cover (HC202-10)	AN365-4	49c
Bearing Carrier for Mk 4-9 (HC202)	1410-A07	\$865.00
Pinion Bearing Retaining Bolt (not for Hewland)	1410-A08	\$5.49
Washer for Pinion Bearing Bolt (FT202-7)	1410-A09	49c
Shift Interlock Plug, 2 used (FT202-8)	1410-A10	\$1.99
Short Rear Cover Stud, 5 used (HC202-5)	1410-A12	\$2.19
Long Rear Cover Stud, 2 used (HC202-6)	1410-A13	\$3.99
Selector Detent Spring, 6 used (FT202-2)	1410-A14	\$2.99
Selector Detent Ball, 6 used (FT202-1)	1410-A15	\$1.99
Selector Detent Plug, 3 used (FT202-3)	1410-A16	\$2.49
8mm Washer, 9 used for bearing carrier (FT202-7)	1410-A17	49c
8mm Nylock Nut, 9 used for bearing carrier (HC201-3A)	1410-A18	49c
Selector Bushing for Webster bearing carrier, 2 used	1410-A19W	\$3.49
Bushing for Hewland bearing carrier, 2 used (FT203-6)	1410-A19H	\$7.99
Selector Finger, Hewland manufacture (LG252)	1410-A20H	\$334.99
1st/Reverse Selector Shaft (HC246)	1410-A21	\$169.99
2nd/3rd Selector Shaft (HC247)	1410-A22	\$141.69
4th/5th Selector Shaft (HC248)	1410-A23	\$169.99
Shift Interlock, 2 used (HC202-4)	1410-A24	\$7.99
1st/Reverse Shifter Fork (HC249)	1410-A25	\$279.99
Reverse Fork Pinch Bolt (fits Webster fork only)	1410-A26	99c
2nd/3rd Shifter Fork (HC250)	1410-A27	\$296.99
4th/5th Shifter Fork (HC251)	1410-A28	\$268.86
Washer (lock tab washer not needed), 2 used (FT246-1)	1410-A29	99c
Self-locking Nut (no lock tab needed), 2 used (FT246-2)	1410-A30	\$4.99
Shift Fork Spacing Washer, 2 used (HC246-3)	1410-A31-1	\$3.49
Shift Fork Spacing Shim, 0.005", quantity varies	1410-A31-2	\$2.99
Shift Fork Spacing Shim, 0.010", quantity varies	1410-A31-3	\$2.99
Rear Pinion Bearing (HC229-1)	1410-A32	\$38.99
Pinion Nut, left-hand thread for Mk 8 & 9 (FT230)	1410-A34-1	\$64.99
VW Pinion Nut for Webster 300 & early Mk 4	1410-A34-2	\$9.99
Layshaft Bearing (HC234-3)	1410-A35	\$102.99
Layshaft Nut for Webster Layshaft (coarse thread)	1410-A37-1	\$109.86
Layshaft Nut for Hewland Layshaft (fine thread, FT236)	1410-A37-2	\$97.99
Layshaft Drawbolt (HC236-3)	1410-A38	\$67.99
Cotter Pin, 2 used (FT236-2) (A39)	660-6-1.50	15c
Hub Spacing Shim, 0.005", qty. varies (HC225-4)	1410-A40-1	\$2.49
Hub Spacing Shim, 0.015", qty. varies (HC225-4)	1410-A40-2	\$2.99
Hub Spacing Shim, 0.010", qty. varies (HC225-4)	1410-A40-3	\$2.49
Reverse Slider, 4 speed, Mk 4,6,8,9 (HC8-423-1)	1410-A41/44H	\$359.99
Hewland 1st/Rev Slider, 5 sp, Mk 4,8,9 (HC4-231/HC85-231)	1410-A41/54H	\$379.99
1st/Reverse Slider, 5 speed, Mk 5 only (HC5-231)	1410-A41/55	\$164.49
1st/Reverse Slider for Staffs only	1410-A41/ST	\$499.00
4 speed Hub Spacer (HC84-226 when used with A42-95)	1410-A42-1	\$69.99

Description and Hewland No. in ()'s	Part No.	Price ea.
1st/Reverse Hub, Mk 4,6 & Webster (HC4-226)	1410-A42-4	\$279.99
Mk 9 4 speed 1st/Rev Hub for Mk 4 1st Gear, requires A42-1	1410-A42-9A	\$209.69
Hewland Mk 9 5 speed 1st/Reverse Hub (HC85-226)	1410-A42-95H	\$354.99
Driven Gear Needle Bearing, 4 or 5 used (FT226-1)	1410-A44	\$32.99
Dog Ring, Webster, 2 used (HC232)	1410-A47	\$199.99
Dog Ring, Hewland, 2 used (HC232)	1410-A47H	\$239.99
2nd/3rd Bearing Race for Webster 15 spline 10:31 R&P	1410-A48-2	\$49.99
2nd/3rd Hub, Mk 4, Mk 6 & Webster (HC227)	1410-A48-4	\$429.99
2nd/3rd Hub, Mk 9 only (HC8-227)	1410-A48-9	\$223.99
4th/5th Hub for Webster 15 spline 10:31 R&P	1410-A54-1	\$55.99
4th/5th Hub, Mk 4, Mk 6 & Webster (HC228)	1410-A54-4	\$277.99
4th/5th Hub, Mk 9 only (HC8-228)	1410-A54-9	\$379.99
5th Gear Thrust Washer (HC229-4)	1410-A57	\$89.99
Hewland Layshaft, fine thread, Mk 4, 6, 8 & 9 (HC9-234)	1410-A58H-4	\$879.00
Hewland Reverse Driver Gear, 5 speed (HC9-238)	1410-A59H-5	\$237.99
Reverse Driver Gear Spacer, 4 speed (HC9-238-1)	1410-A59-1	\$41.49
Layshaft Spacer, 2 used (HC234-6)	1410-A61	\$32.99
Layshaft Thrust Washer (HC234-5)	1410-A66	\$67.99
Layshaft Front Bearing, 30mm (HC9-234-1)	1410-A67-1	\$19.99
Snap Ring for A67-1, late VW case (HC9-234-2)	1410-A68-1	\$3.99
Mk 9 5th Gear Inner Track (HC8-229)	1410-A69-9	\$114.99

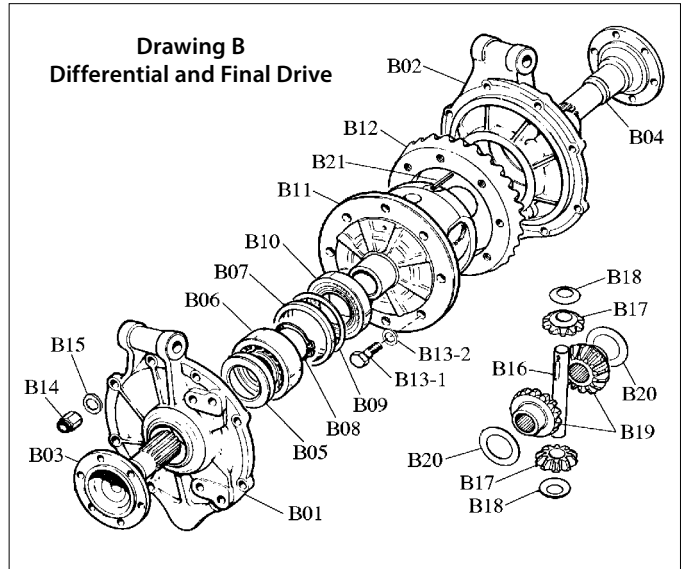

A Hewland Part No. shown in ()'s in the above listings indicates interchangeability to the best of our knowledge.

See page 150 for interchangeable gearsets.

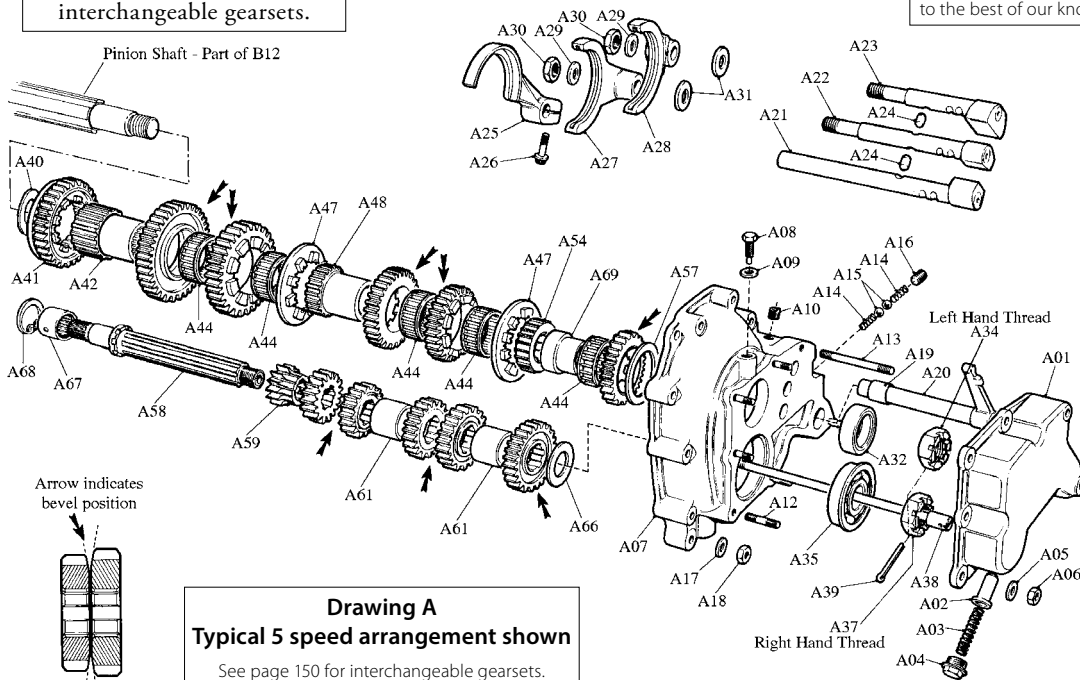

Drawing A
Typical 5 speed arrangement shown
 See page 150 for interchangeable gearsets.

TRANSAXLE DIFFERENTIAL

Webster and Hewland Gearbox Parts for Mk-Series from Drawing B

Description and Hewland No. in ()'s	Part No.	Price ea.
LH Side Plate, Webster Mk 9, requires B05-1 & B10-1	1410-B01-2	\$639.00
RH Side Plate, Webster Mk 9, requires B05-1 & B10-1	1410-B02-2	\$515.00
Stub Axle, LH, Webster differential only (25 Spline)	1410-B03-1	\$174.99
Stub Axle Oil Seal, Webster Model 400, 1 per side	1410-B05-1	\$14.49
Stub Axle Oil Seal, VW IRS Sideplate, 1 per side	1410-B05-2	\$13.99
Stub Axle Oil Seal, Hewland Mk 9, 1 per side (HC9-205-4)	1410-B05-3	\$12.99
Dbl. Row Stub Axle Bearing, Mk 9 & Webster (HC9-205-3)	1410-B06-1	\$69.99
Spacer, left-hand (0.35" thick), Mk 9 (HC9-205-2A)	1410-B07-LH	\$23.99
Spacer, right-hand (0.50" thick), Mk 9 (HC9-206-2A)	1410-B07-RH	\$16.99
Stub Axle Snap Ring, Mk 9, 2 used (FT219-1A)	1410-B08-1	\$1.99
.003" thick Diff. Carrier Bearing Shim, Webster only	1410-B09-03	\$4.99
.006" thick Diff. Carrier Bearing Shim, Webster only	1410-B09-06	\$4.99
.012" thick Diff. Carrier Bearing Shim, Webster only	1410-B09-12	\$4.99
.025" thick Diff. Carrier Bearing Shim, Webster only	1410-B09-25	\$4.99
Diff. Carrier Bearing for Webster side plates, 2 used	1410-B10-1	\$26.99

Lightweight Aluminum TDI Differential Carrier (Part No. B11 in drawing B)
 For Webster / Hewland Mk 8/9, early LD200 Part No. 1415-1 .. \$619.00
 Weighs just 4.1 pounds with bearings pre-installed. Made with pride in the USA.

Description and Hewland No. in ()'s	Part No.	Price ea.
8/31 Hewland Ring & Pinion (HC8-221A)	1410-B12H-8	\$2,499.00
9/31 TRE Ring & Pinion, Webster/Hewland (HC8-221B)	1410-B12T-9	\$1,899.00
<i>Made in the USA by Taylor Race Engineering.</i>		
Old Style Webster Ring Gear Bolt, 3/8"-24, 8 used	1410-B13-1	\$1.49
Washer for above, 3/8" I.D., 8 used	1410-B13-4	\$1.49
<i>The ring gears currently stocked do not use this size bolt.</i>		
Webster/Hewland Ring Gear Bolt, 7/16"-20, 8 used (FT221-1)	1410-B13-3	\$1.69
Washer for above, 7/16" I.D., 8 used	1410-B13-2	\$1.19
<i>The ring gears currently stocked use the 7/16"-20 bolt.</i>		
8mm Nylock Side Cover Nut, 16 used (HC8-201-3A)	1410-B14	99c
8mm Flat Washer for above, 16 used (FT202-7)	1410-B15	49c
Hewland Spider Gear, 2 used (HC8-214-3 & Staffs)	1410-B17H	\$111.99
Dished Washer, 2 used (HC8-214-6 & Staffs)	1410-B18	\$29.79
Hewland Side Gear, 2 used, 18 spline (HC8-214-4 & Staffs)	1410-B19H-1	\$204.99
Webster Side Gear, 2 used, 25 spline	1410-B19-2	\$128.99
Flat Washer for side gear, 2 used (HC8-214-5 & Staffs)	1410-B20	\$6.99
Roll Pin for cross shaft (HC8-214-7)	1410-B21	\$1.49

Webster and Hewland Gearbox Parts for Mk-Series from Drawing C

Description and Hewland No. in ()'s	Part No.	Price ea.
Magnetic 24mm Filler Plug with 17mm hex (HC201-1)	1410-C03	\$19.99
Reverse Idler Spigot Retaining Bolt (HC237-6)	1410-C04	\$1.79
Reverse Idler Spigot with 5/16"-24 thread (HC237-3)	1410-C05	\$112.99
Back Washer for reverse idler (HC237-4)	1410-C06	\$43.99
Hewland Reverse Idler Gear, 20 Tooth, Mk 4,6,8 & 9 (HC237-1)	1410-C07H-4	\$259.99
Mk 5 Reverse Idler Gear, 16 Tooth, Mk 5 only	1410-C07-5	\$87.69
Reverse Idler Bearing (HC237-2)	1410-C08	\$41.99
Retainer Washer for reverse idler, 5/16 inch hole (HC237-4A)	1410-C09-2	\$66.99
Retaining Bolt, self-locking, 1/4"-28	1410-C10-1	\$1.79
Retaining Bolt, self-locking, 3/16"-24 (HC237-5)	1410-C10-2	\$1.79
Pinion Bearing (uses ring nut) Mk 8, 9 (HC8-222-1)	1410-C11-1	\$324.99
Pinion Bearing (uses 4 bolt plate) Mk 4,5,6 (FT222-1)	1410-C11-2	\$89.99
.006" thick Pinion Bearing Shim, ring nut type only	1410-C12-06	\$3.99
.008" thick Pinion Bearing Shim, ring nut type only	1410-C12-08	\$3.99
.012" thick Pinion Bearing Shim, ring nut type only	1410-C12-12	\$4.79
.015" thick Pinion Bearing Shim, ring nut type only	1410-C12-15	\$7.49
.020" thick Pinion Bearing Shim, ring nut type only	1410-C12-20	\$3.99
.024" thick Pinion Bearing Shim, ring nut type only	1410-C12-24	\$3.99
Backing Washer for ring nut (HC8-222-2A)	1410-C13	\$14.99
Ring Nut for pinion bearing (HC8-222-1A)	1410-C14-1	\$45.99
Short Bearing Carrier Stud, 4 or 9 used (HC201-4)	1410-C15	\$5.99
Long Bearing Carrier Stud, 5 or none used (HC201-4A)	1410-C16	\$6.99
Stud for Side Plates, 16 used (HC201-2)	1410-C17	\$5.99
Repair Stud for Side Plate	1410-C17-10MM	\$7.49
<i>Repair stripped threads without a Helicoil. One side of this stud has standard 8x1.25mm threads; the other has oversize 10x1.50mm threads.</i>		
Input Shaft Coupling Sleeve (HC236-4)	1410-C18	\$151.99
Snap Ring for input shaft (HC239-0)	1410-C19	\$1.49
Oil Seal for input shaft (HC244-11)	1410-C20	\$11.99

Description and Hewland No. in ()'s	Part No.	Price ea.
Hewland FF standard Input Shaft, 11.56", 7/8 x 20 spline	1410-C21-1	\$979.00
Hewland FF long (Lotus) Input Shaft, 12.69", 7/8 x 20 spline	1410-C21-2	\$999.00
Hewland S2000 standard Input Shaft, 11.56", 1" x 23 spline	1410-C21-3	\$999.00
Super Vee short input shaft, 10.38", 7/8 x 20 spline	1410-C21-4	\$849.00
Clutch Shaft Pilot Bearing, FF1600/Pinto (not shown)	161-10	\$23.99
Retaining Bolt for cross shaft bushing (HC254-2)	1410-C22	\$4.79
20mm Cross Shaft for late style case (HC9-254-A)	1410-C24-1	\$144.99
16mm Cross Shaft	1410-C24-2	\$22.99
Throw-out Bearing (HC245-A)	1410-C26	\$49.99
Retaining Clip for throwout bearing, 2 used (HC245-12)	1410-C27	\$2.99
FF Bobbin, standard clutch, 1.30" long, 7/8 inch I.D.	1410-C28-1	\$169.99
FF Bobbin, racing clutch, 1.94" long, 7/8 inch I.D.	1410-C28-2	\$169.99
S2000 Bobbin, standard clutch, 1.10" long, 1.13" I.D.	1410-C28-3	\$129.99
S2000 Bobbin, racing clutch, 2.14" long, 1.13" I.D.	1410-C28-4	\$183.99
Bushing for 20mm cross shaft, near end (HC254-1)	1410-C29-1	\$18.39
Bushing for 16mm cross shaft, near end	1410-C29-2	\$18.39
Seal for 20mm cross shaft bushing, 2 used (HC254-3)	1410-C30-1	\$2.09
Lever for 20mm cross shaft (HC254-7)	1410-C31-1	\$107.99
Lever for 16mm cross shaft	1410-C31-2	\$92.99
Clutch Slave Cylinder Push Rod End, Hewland (HC259)	1410-C33H	\$45.49
Clutch Slave Cylinder Push Rod, Hewland (HC8-258)	1410-C34H	\$67.99
Jam Nut for push rod, 3 used (HC2581)	1410-C35	\$1.49
Mounting Bracket for Slave Cylinder (HC8 2587)	1410-C36	\$184.99
Bolt for mounting above bracket to case, 2 used	1410-C37	\$1.49
Nut for mounting above bracket to case, 2 used	1410-C38	99c
Bushing for FF bobbin (use 1 for std, 2 for racing)	1410-C44-1	\$4.99
Bushing for S2000 standard bobbin	1410-C44-3	\$5.99
Bushing for S2000 long bobbin for racing clutch	1410-C44-4	\$7.99
Extension Spring for release lever	1410-C47	\$7.99
Short Stud (3.5") for gearbox adapter ring (top)	1410-C50	\$3.99
Long Stud (4.5") for gearbox adapter ring (bottom)	1410-C51	\$6.49

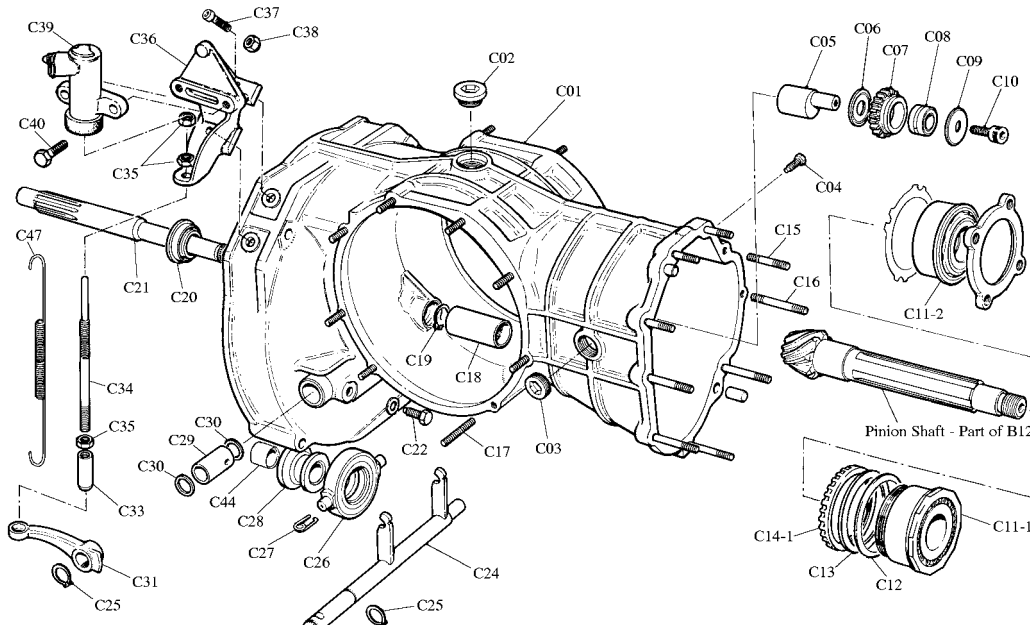

A Hewland Part No. shown in ()'s in the above listings indicates interchangeability to the best of our knowledge.

Drawing C
Main Case

TRANSAXLE DIFFERENTIAL

Hewland and Webster Gears

Hewland and Webster Mk 9 Gearsets and Dog Rings

These gears work in Hewland and Webster Mk 4, 6, 8 and 9 gearboxes. They are designed to fit the 1.00 inch diameter layshaft with 6 spline teeth. Hewland "M" and Webster Nuovo gears are designed for high strength – both are suitable for 2.0L applications, even in the low gear ratios. These are the latest, most sophisticated tooth design.

While your gears are out, check your dog rings for wear and damage! Replace dog rings if the dog lugs are not visibly tapered or are rounded off more than 25%.

- Hewland "M" Mk 9 Gearsets, specify ratio*Part No. 1404-xx:xx... \$379.99
- Webster Nuovo Mk 9 Gearsets, specify ratio*Part No. 1408-xx:xx... \$259.99
- Webster Mk 9 Dog Clutch Ring*Part No. 1410-A47 \$199.99
- Hewland Mk 9 Dog Clutch Ring*Part No. 1410-A47H... \$239.99

Mk 9 Gearset Ratios

H = Hewland M Class W = Webster Nuovo

Tooth Ratio	Decimal Ratio	Brand	Tooth Ratio	Decimal Ratio	Brand	Tooth Ratio	Decimal Ratio	Brand	Tooth Ratio	Decimal Ratio	Brand
14:36	2.571	H	18:34	1.889	H	21:30	1.429	H	24:28	1.167	W
15:35	2.333	H	18:33	1.833	H	21:29	1.381	W	24:27	1.125	H
15:36	2.400	W	18:32	1.778	H	22:30	1.364	W	24:26	1.083	H
16:35	2.188	H	19:33	1.737	H	22:29	1.318	H	25:26	1.040	H
16:34	2.125	H	19:32	1.684	W	22:28	1.273	W	24:24	1.000	H
17:35	2.059	H	19:31	1.632	W	23:29	1.261	H	26:25	0.962	W
17:34	2.000	W	20:31	1.550	H	23:28	1.217	H	26:24	0.923	H
17:33	1.941	W	20:30	1.500	H	23:27	1.174	W	27:24	0.888	H

Hewland LD200 Gearsets and Dog Rings

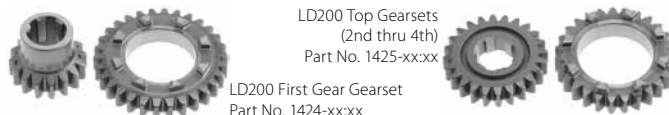

LD200 Top Gearsets (2nd thru 4th)
Part No. 1425-xx:xx

LD200 First Gear Gearset
Part No. 1424-xx:xx

These high-strength Hewland gearsets and dog rings fit LD200 gearboxes. Note that First Gear gearsets are different than Top Gear gearsets. The extended snout on the layshaft gear of the First Gear gearset offers greater strength for high-torque applications.

- Hewland LD200 First Gear Gearsets, specify ratio*Part No. 1424-xx:xx... \$379.99
- Hewland LD200 Top Gearsets (2nd thru 4th), specify ratio* ..Part No. 1425-xx:xx... \$384.99
- Webster LD200 Dog Clutch Ring*Part No. 1426 \$224.99

First Gear LD200 Gearsets

Tooth Ratio	Decimal Ratio	Tooth Ratio	Decimal Ratio
16:35	2.188	16:30	1.875
16:34	2.125	16:29	1.813
17:35	2.059	17:30	1.765
15:30	2.000	17:29	1.706
		18:27	1.500

Top Gear (2nd thru 4th) LD200 Gearset Ratios

Tooth Ratio	Decimal Ratio	Tooth Ratio	Decimal Ratio	Tooth Ratio	Decimal Ratio	Tooth Ratio	Decimal Ratio
15:30	2.000	18:28	1.556	19:25	1.316	19:22	1.158
16:30	1.875	16:24	1.500	21:27	1.286	21:24	1.143
16:29	1.813	17:25	1.471	19:24	1.263	19:21	1.105
17:30	1.765	19:27	1.421	21:26	1.238	24:26	1.083
17:29	1.706	18:25	1.389	19:23	1.211	23:24	1.043
17:28	1.647	20:27	1.350	21:25	1.190	24:24	1.000

Hewland Gear Changing and Maintenance

A Pegasus Exclusive!



Mk 9 Gear Change Tray If you're tired of trying to balance your valuable bearing carrier assembly on blocks of wood and making a mess with gear lube when changing gears, then this tray is for you. It is designed for use with Hewland Mk 4 through Mk 9 series and Webster Model 300 / 400 gearboxes. The posts slip over the bearing carrier rear cover studs to securely hold the bearing carrier upright. The carrier is held high enough that you can access the layshaft nut. A side tray holds the layshaft while the main tray catches all of the dripping gear lube for recycling. Measures 12.3" x 9.3" x 3.8" high including support posts.

- Mk 9 Gear Change Tray* Part No. 1409 \$59.99

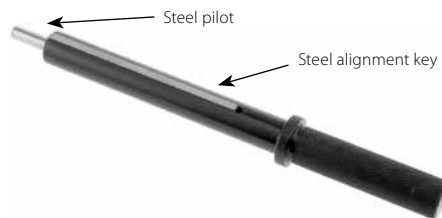

LD200 Gear Change Tool Don't mess around trying to make do with old mallet handles or screwdrivers! Using the proper tool will make it much easier to assemble the gear stack onto the pinion shaft on 4-speed Hewland LD200 gearboxes. The small diameter pilot is designed to fit into the end of your pinion shaft. The key along the length of the tool keeps the gear stack splines aligned correctly so the entire stack slides on without a struggle. Replaces Hewland "dummy shaft" tool #SK704-B. Not a cheap plastic import. This tool is proudly made in the USA of hard-anodized aluminum with a steel key and pilot.

- LD200 Gear Change Tool* Part No. 1416-009 \$91.99

Mk 9 Stud Kits

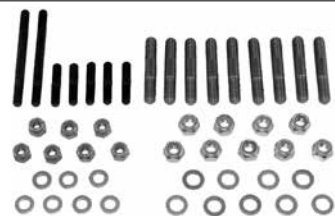

Left: Rear Stud Kit, Part No. 1413-2

Below: Side Plate Stud Kit Part No. 1416-010



If you seem to strip threads every time you change gears, or if you have a side plate leak that just won't go away, you may need new studs or new nuts — or both! These complete kits include all of the studs, washers, and nuts needed to mount both the rear cover and bearing carrier or one side plate at a significant savings compared to individual prices. The **Rear Stud Kits** include 8mm hardware for mounting the bearing carrier and 1/4 inch hardware for the rear cover. The **Side Plate Stud Kit** includes enough 8mm hardware to mount one side plate.

- Rear Stud Kit with 5 long and 4 short carrier studs*Part No. 1413-1 \$65.99
- Rear Stud Kit with 9 short carrier studs*Part No. 1413-2 \$61.99

Note: Most older Mk 9 bearing carriers use 5 long studs and 4 short studs, but some late model Mk 9 carriers now take all short studs. Please check your carrier before ordering.

- Side Plate Stud Kit for one side*Part No. 1416-010 \$50.99
- Includes 4 studs, 4 nylon locking nuts, and 4 washers.*

Perma-Coil Thread Inserts for Gearbox Studs

Save yourself a ton of hassle down the road. Before you install a single stud in your gearbox, install **Perma-Coil Thread Repair Inserts** in every threaded hole to stop stripped threads before they start. These stainless steel insert coils protect soft aluminum and magnesium castings from pulled studs and stripped threads. Fully interchangeable with Heli-Coil® inserts and tooling. Each kit includes a special tap, installation tool, and a pack of inserts. The list below covers only the sizes found on Hewland and Webster Mk-series gearboxes. We stock many more sizes in both SAE and metric. Please see our website.



- | Perma-Coil Kit | Part No. | Price |
|---|--------------|---------|
| <i>8x1.25mm Kit with 12 inserts</i> | 3870-8x1.25 | \$38.99 |
| <i>For bearing carrier and side plate studs on Mk-series and LD200 gearboxes.</i> | | |
| <i>1/4-20 Kit with 12 inserts</i> | 3865-0250-20 | \$31.99 |
| <i>For rear cover studs on Mk-series gearboxes.</i> | | |
| <i>6x1.0mm Kit with 12 inserts</i> | 3870-6x1.0 | \$40.99 |
| <i>For rear cover studs on LD200 gearboxes.</i> | | |
| <i>7/16-14 Kit with 6 inserts</i> | 3865-0437-14 | \$33.99 |
| <i>For gearbox adapter studs on Mk-series gearbox adapters.</i> | | |
| <i>10x1.5mm Kit with 12 inserts</i> | 3870-10x1.5 | \$44.99 |
| <i>For main case front studs on LD200 gearboxes.</i> | | |

See page 153 for Red Line gear lube • See page 157 for Hylomar and Loctite® gearbox sealants

Webster and Hewland Gearbox Accessories

Mk 9 Selector Shaft Seal Kits



Internal Seal Kit for Webster (pre-1999), Part No. 1412



Lip Seal for Webster (after 1999) Part No. 1410-A20-9



External Seal Kit for Hewland or Webster, Part No. 1414

We carry three different seal kits designed for Hewland and Webster Mk-series gearboxes. The **Internal Seal Kit** fits older Webster bearing carriers only (pre-1999). It includes two special length bushings and two O-rings which mount between the bushings. These are installed in place of the original plain Webster bushings. The **Lip Seal** fits later Webster Model 400 carriers made after 1999 with a recess machined around the shift finger bore. The universal **External Seal Kit** works on either Webster or Hewland carriers. It is bolted to the carrier, which requires three holes to be drilled and tapped around the selector finger bore. All three kits are designed for standard 5/8" OD shift selector fingers.

- Internal Seal Kit for Webster Bearing Carrier only.....Part No. 1412 \$8.99
- Lip Seal for Webster Model 400 after 1999.....Part No. 1410-A20-9\$17.99
- External Seal Kit for Webster or Hewland.....Part No. 1414 \$28.99
- Replacement Lip Seal for #1414 KitPart No. 1416-001\$7.99
- Replacement Quad-Ring Seal for #1414 KitPart No. 1416-002 \$3.99

Hewland Gearbox Manuals

If you plan to set up and maintain your own gearbox, these factory manuals are essential tools to help you do the job right. If you plan to leave the servicing to a professional, these manuals will give you a better understanding of the inner workings of Hewland transaxles. Detailed drawings, parts lists, disassembly and assembly notes, and gear selection charts make these manuals must-haves for your library. Each covers both 4-speed and 5-speed units.



- Hewland Mk 8/9 Manual Part No. 1407 \$12.49
- Hewland LD200 Manual Part No. 1406 \$27.99

17mm Transmission Fill Plug Hex Socket



This special "Allen" socket is designed just for the 17mm recessed hex drain and fill plugs on VW gearbox cases. This includes the fill plugs on Hewland and Webster Mk-series transaxles. Accepts any standard 3/8" square-drive ratchet or drive handle for easy access in crowded areas. 1.5" long overall. Strong one-piece plated steel construction.

- 17mm Fill Plug Socket Part No. 3750-020\$7.99

Differential-Transaxle Cooling

Protect expensive gears and improve overall reliability by adding an oil cooler and pump to your differential, transaxle, or transmission!

Differential Cooler Pumps



These pumps are specially designed for transmission cooling applications. The pumping elements are designed to handle the fine metal particles always present in a gearbox, although an in-line filter screen (sold separately) is still recommended to keep out any larger particles. The pump head can be rotated in 90° increments for the most convenient port location, and the housing has a built-in bracket for easy mounting. Buna N seals are compatible with oil and most coolants. Self-priming to 8 feet. Maximum flow 2 GPM (at 10 psi); maximum pressure 50 psi (at 0.5 GPM). Maximum current draw is 8 amps at 12 volts. 3/8" NPT female ports for easy hookup.

- Electric Pump, Standard (shown)Part No. 1239 \$191.25
For sprint racing. Maximum duty cycle 2 hours with 15 minute cool-off. 7.62" long.
- Electric Pump, Continuous Duty.....Part No. TE 40-527 \$216.75
Ideal for endurance racing or tow vehicles. No downtime required. 8.7" long.
- Replacement Buna Diaphragm Kit with PistonsPart No. TE 40-902..... \$34.00
- Replacement Buna Check Valve Assembly.....Part No. TE 40-934..... \$21.25

Roll Bar Mounted Filtered Breather

Longacre Breather with Roll Bar Mount This trick little breather is perfect for gearboxes and differential units. A clamp-on billet aluminum roll bar mount makes it easy to mount to any chassis or roll bar tube. The breather filter is clamped to a tube with female 1/4" NPT threads for easy hookup. Available in sizes to fit 1 1/2" or 1 3/4" bar diameters.



- Breather with Roll Bar Mount, 1 1/2" roll bar.....Part No. 22566..... \$39.99
- Breather with Roll Bar Mount, 1 3/4" roll bar.....Part No. 22564..... \$39.99

Setrab SLM Series Oil Coolers



Left: 6 Row, 141mm Core Part No. SET-53-10740



Right: 14 Row, 420mm Core Part No. SET-53-10748

Setrab SLM Series Oil Coolers are designed for the tight packaging of modern racecars. They are ideal for applications like transmission cooling, where pressure drop is not an issue. SLM coolers feature the same brazed aluminum construction, black epoxy finish, and female M22 ports as the Pro Line coolers listed on page 77. The inlet and outlet ports are on the ends for the lowest profile and optimum low-pressure flow.

- Setrab SLM Coolers, 6 Row (2 1/2" High)
 - 141mm Core, 8 1/4" Long (9" with port hexes)..... Part No. SET-53-10740 ... \$265.00
 - 250mm Core, 12 3/8" Long (13" with port hexes)..... Part No. SET-53-10743 ... \$288.00
 - 420mm Core, 19" Long (19 3/4" with port hexes)..... Part No. SET-53-10746 ... \$326.00
 - 592mm Core, 26" Long (26 3/4" with port hexes)..... Part No. SET-53-10749 ... \$359.00
- Setrab SLM Coolers, 10 Row (4" High)
 - 141mm Core, 8 1/4" Long (9" with port hexes)..... Part No. SET-53-10741 ... \$288.00
 - 250mm Core, 12 3/8" Long (13" with port hexes)..... Part No. SET-53-10744 ... \$315.00
 - 420mm Core, 19" Long (19 3/4" with port hexes)..... Part No. SET-53-10747 ... \$349.00
 - 592mm Core, 26" Long (26 3/4" with port hexes)..... Part No. SET-53-10750 ... \$417.00
- Setrab SLM Coolers, 14 Row (5 7/16" High)
 - 141mm Core, 8 1/4" Long (9" with port hexes)..... Part No. SET-53-10742 ... \$315.00
 - 250mm Core, 12 3/8" Long (13" with port hexes)..... Part No. SET-53-10745 ... \$349.00
 - 420mm Core, 19" Long (19 3/4" with port hexes)..... Part No. SET-53-10748 ... \$388.00
 - 592mm Core, 26" Long (26 3/4" with port hexes)..... Part No. SET-53-10751 ... \$472.00

Torque Specs and Wear Limits for Mk-Series Transaxles

Torque Specifications	
Rear Cover Nuts (1/4"-28)	4 lb-ft
Bearing Carrier Nuts (M8x1.25)	10-12 lb-ft
Pinion Shaft Nut (7/8"-20 left-hand)	115 lb-ft
Layshaft Nut (7/8"-20 or 7/8"-14)	115 lb-ft
Layshaft Drawbolt	1/2 turn loose
Fill Plug (24mm tapered)	20 lb-ft
Sideplate Nuts (M8x1.25)	10-12 lb-ft

Wear Limits	
Dog Lugs	Max 25% of height rounded
Shift Fork Groove Width	Max 0.208"
Reverse Shift Fork Thickness	Min 0.155"

Recommended Sealants	
Sideplates	Loctite 598 Black Silicone RTV (see page 156)
Note: Silicone RTV shrinks as it cures. Even though the gap being sealed is very small, you must check and re-tighten the sideplate nuts after every session!	
Bearing Carrier and Rear Cover	Hylomar (see page 157)
Hylomar is recommended because it is non-hardening, so any leftover sealant residue will not damage the sealing faces. If any old hardened RTV gets caught between the mating parts, it can dent the precision-machined surfaces and cause leaks.	

Recommended Lubricants	
Red Line 75W85 or 75W90 (GL-5 synthetic) or Red Line ShockProof Light	
Note: Mk-Series transaxles hold 2 UK pints of lubricant. This equates to 1.2 US quarts, which means a gear change takes a little more than one bottle. When filled to the proper level, your little finger should just be able to touch the oil through the side filler hole.	

Information in these charts comes courtesy of Taylor Race Engineering

Drive Donuts, CV Joints, Tripod Joints and Boots

We stock the most common drive shaft joints used on many small formula cars and sports racers.



Standard Drive Donut
Part No. 1469-Std



Heavy-Duty Drive Donut
Part No. 1470-HD

Rubber Drive Donuts

Quite a few older Formula Fords and some low horsepower sports racers used rubber drive donuts rather than constant velocity joints. We stock two different rubber drive donuts. Both are designed for an assembled bolt circle of 3.78 inches. They differ in their torque capacity.

Standard Rubber Drive Donut, 140 lb-ft Torque Rating Part No. 1469-Std. ... \$84.99
Approximately 3.6" bolt circle with retaining band still intact. Remove band after assembly.

Heavy-Duty Rubber Drive Donut with interleave plates, 210 lb-ft Torque Rating ... Part No. 1470-HD. ... \$199.99
Approximately 3.7" bolt circle with retaining band still intact. Remove band after assembly.

Axle Saver Centering Kit for 3.78 inch Bolt Circle Rubber Drive Donuts

These simple Axle Savers prevent rear axles from flailing violently due to a rubber drive donut failure. Works with any 3.78 inch bolt circle stub axle and requires no modifications. One set includes four plates, enough to complete both sides of your vehicle. Adds 1/4 inch to the halfshaft length.

Axle Saver Centering Kit for 3.78 inch Bolt Circle Rubber Drive Donuts Part No. 1479. \$269.99



Centering Kit for
3.78 inch Bolt Circle
Rubber Drive Donuts
Part No. 1479



Standard CV Joint
Part No. 1471-Std



Heavy-Duty CV Joint
Part No. 1471-HD



TDI Lightened
CV Joint
Part No. 1473

Lobro Style CV Joints — Standard, Heavy-Duty and Lightened

Our CV joints have a 78mm bolt circle (94mm outside diameter) and accept a 33 spline 27mm axle. They will fit Hewland and Webster Mk 8/9, Staffs, and Formula Mazda as well as some LD200 applications.

Standard FF Lobro Style CV Joint, 6 bolt, 78mm bolt circle (3.07 inch), 33 tooth spline Part No. 1471-Std \$69.99

Heavy-Duty Lobro Style CV Joint, 6 bolt, 78mm bolt circle (3.07 inch), 33 tooth spline Part No. 1471-HD \$149.99
This heavy-duty version now comes honed for smoother operation with inner and outer race machined from 8620 steel, and a billet cage of 4340. Suitable for FF2000, Sports 2000 and Formula Mazda.

TDI Lightened and Honed Lobro Style CV Joint Part No. 1473 \$157.99
Same as Part No. 1471-HD except approximately 12 ounces of excess material on O.D. has been removed to reduce critical rotating inertia and unsprung weight. Machining the O.D. causes a slight shrinkage of the outer member due to relief of internal heat treating stresses. TDI re-hones the ball races to provide a smooth running joint. Other shops don't do this, resulting in an extremely stiff joint.

Boots and Grease for CV Joints

Don't risk damaging your CV joints by allowing dirt to get inside. Keeping the joints clean and well lubricated will help to ensure maximum reliability and longevity.

Standard CV Joint Boot Kit, 78mm Bolt Circle (has accordion style convolutions) Part No. 1472-Std. ... \$16.99

Aerodynamic CV Joint Boot, 78mm Bolt Circle (slim design - has no convolutions) ... Part No. 1472-Aero ... \$42.99

The above two items fit CV joints with 94mm outside diameter such as our Part No. 1471 and Part No. 1473.

Aerodynamic CV Joint Boot, 94mm Bolt Circle (slim design - has no convolutions) ... Part No. 1474-108. ... \$57.99

This Aero boot fits Lobro CV joints with 108mm outside diameter as used on some Formula 3000 and F1 cars.

Red Line Synthetic CV Joint Grease, 14 oz. grease gun cartridge Part No. 1694-Cart .. \$13.95

Red Line Synthetic CV Joint Grease, 14 oz. jar Part No. 1694-Jar. \$13.95

GKN CV Joint Grease, 12 ounce (350 gram) cartridge Part No. 1476-082 ... \$79.99



Standard CV Joint Boot Kit
Part No. 1472-Std



Aerodynamic CV Boot
Part No. 1472-Aero

Tripod Joints, Aerodynamic Boot and Grease Tool

Tripod Joints are standard equipment on late-model Van Diemen, Formula Mazda, Swift, and Ralt race cars. Our lightweight billet aluminum housings use replaceable steel liners for the ultimate balance of durability, light weight, and economy.

Tripod Joint with 25mm x 30 tooth Spline Part No. 1476-001 \$82.99

Fits Star Mazda, Van Diemen, and Swift 008. Does not include housing or boot.

Tripod Joint with 27mm x 22 tooth Spline Part No. 1476-002 \$64.99

Fits Ralt RT40 and RT41. Does not include housing or boot.

Housing with Steel Liners, 94mm dia. x 26mm thick Part No. 1476-010. \$244.99

Fits most FF1600 and FF2000 Van Diemen from 2000 and up, as well as some 1990-99 cars that have been converted. Does not include tripod joint or boot.

Housing with Steel Liners, 94mm dia. x 40mm thick Part No. 1476-011 \$259.99

Fits most FF1600 and FF2000 Van Diemen from 1990-99 (note that some of these cars have been converted to the 26mm thick housing). Does not include tripod joint or boot.

Replacement Steel Liner for 26mm Housing, each Part No. 1476-020 \$22.99

Replacement Steel Liner for 40mm Housing, each Part No. 1476-021 \$21.99

Three hardened steel liners are used within each anodized aluminum housing.

Aerodynamic Boot for 94mm Tripod Joint Part No. 1476-030 \$44.99

Grease Application Tool for Tripod Joint Bearings Part No. 1476-050 \$99.99

Makes it easy to grease the tripod joint needle bearings. Just clip it on and inject grease with your grease gun.

GKN Tripod Joint Grease, 9.7 oz (275 gram) cartridge Part No. 1476-051. \$45.99

Formulated specifically for tripod joints. Using other grease will shorten tripod life.



Aluminum Housing with
Tripod Joint (order separately)



Tripod Joint, 25mm x 30 spline
Part No. 1476-001



Aluminum Housing with Inserts
Part No. 1476-011



Replacement
26mm Insert Only
Part No. 1476-020



Aero Boot for 94mm Tripod Joint
Part No. 1476-030



Grease Tool for Tripod Joints
Part No. 1476-050

TRANSAXLE
DIFFERENTIAL

Red Line Synthetic Lubricants

Red Line Synthetic Lubricants are recommended by many engine builders for maximum power output and superior engine protection. Red Line lubricants contain neo-pentyl-polyol-ester base stocks, the most thermally stable synthetic base available and the only lubricant which can withstand the tremendous heat of modern jet engines. Red Line has been the industry leader in lubricant chemistry for many years. Their formulas are well proven and provide unmatched high-temperature lubrication and the highest film strength of any product marketed. The ability of Red Line Oil to lubricate extremely hot metal has enabled many cars to finish and even win races after losing coolant. **Synthetic hydrocarbon and diester based oils have engine wear rates of up to 10 times greater than Red Line.** If you really care about protecting your engine, transmission or differential, **don't use just any synthetic oil, use the best.**



Please see our website for specific viscosity recommendations!

Red Line Multigrade Synthetic Motor Oils

Red Line synthetic base stocks have a natural multigrade property. They do not require the unstable polymeric thickeners used in multigrade petroleum oils. For street use, Red Line recommends oil changes every 12,000 to 18,000 miles or at least once a year.

0W20 Synthetic Motor Oil, Quart	Part No. 1691-0W20-Quart	\$12.49
5W20 Synthetic Motor Oil, Quart	Part No. 1691-5W20-Quart	\$11.95
5W30 Synthetic Motor Oil, Quart	Part No. 1691-5W30-Quart	\$11.95
5W40 Synthetic Motor Oil, Quart	Part No. 1691-5W40-Quart	\$12.49
5W50 Synthetic Motor Oil, Quart	Part No. 1691-5W50-Quart	\$12.95
10W30 Synthetic Motor Oil, Quart	Part No. 1691-10W30-Quart	\$11.95
10W40 Synthetic Motor Oil, Quart	Part No. 1691-10W40-Quart	\$11.95
10W60 Synthetic Motor Oil, Quart	Part No. 1691-10W60-Quart	\$12.95
15W40 Synthetic Diesel Motor Oil, Quart	Part No. 1691-15W40-Quart	\$12.49
15W50 Synthetic Motor Oil, Quart	Part No. 1691-15W50-Quart	\$11.95
20W50 Synthetic Motor Oil, Quart	Part No. 1691-20W50-Quart	\$11.95

Red Line Synthetic Motorcycle Oils

Red Line Synthetic Motorcycle Oils start with the same proven base stocks as the motor oils above, with friction modifiers added for smooth wet-clutch operation.

10W30 Motorcycle Oil, Quart	Part No. RL003-10W30-Quart	\$15.95
10W40 Motorcycle Oil, Quart	Part No. RL003-10W40-Quart	\$15.95
20W50 Motorcycle Oil, Quart	Part No. RL003-20W50-Quart	\$15.95
20W60 Motorcycle Oil, Quart	Part No. RL003-20W60-Quart	\$15.95

Red Line Synthetic Gear Lubricants, ATF, and ShockProof™ Gear Oil

Red Line Gear Oils are the preferred oils for use in either conventional or limited-slip differentials. They contain friction modifiers for gentler lockup of clutch-type LSD units, resulting in decreased noise. The friction modifiers make them so extremely slippery, they are not recommended for use in synchro transmissions. Suitable for use in most street and racing differentials including hypoid diffs. Meet GL-5+ and GL-6 specifications.

75W85 Gear Oil, Quart	Part No. 1693-75W85-Quart	\$17.49
<i>Formerly known as "LightWeight Gear Oil," 75W85 is so light it can reduce drivetrain power losses, making it a popular choice for FF1600 and F2000 dog-ring transaxles.</i>		
75W90 Gear Oil, Quart	Part No. 1693-75W90-Quart	\$17.49
75W140 Gear Oil, Quart	Part No. 1693-75W140-Quart	\$18.95
80W140 Gear Oil, Quart	Part No. 1693-80W140-Quart	\$18.49

Red Line Non-Slip Gear Oil is similar to Red Line Gear Oil, but without the slippery friction modifiers. This means increased lockup in clutch-type LSD's for reduced wheel-spin. It also provides faster synchro engagement in transmissions for smoother shifting. Non-Slip can even be used to revive weak or worn LSD's and synchros. Not recommended for street-driven LSD's due to increased chatter in low-speed turns. Add Red Line Friction Modifier (Part No. 1687) to fine-tune LSD lockup. Meets GL-5 specifications.

75W90 Non-Slip Gear Oil, Quart	Part No. RL002-75W90NS-Quart	\$17.95
75W140 Non-Slip Gear Oil, Quart	Part No. RL002-75W140NS-Quart	\$18.95

Red Line ShockProof™ Racing Gear Oil For the ultimate protection of high-performance transmissions and differentials while allowing maximum power transmission. Unique viscosity characteristics cushion and protect parts like a heavier oil while retaining the flow of a much thinner oil. Protects against shock loadings due to power shifts, shifting without the clutch, sudden hard launches, and off-road racing. ShockProof™ Gear Oils also do not develop the foul sulfur smell typical of most other gear oils.

ShockProof™ Heavy (Red) can be rated as an SAE 75W250, but flows like a 75W90. Recommended uses include GT-1 and Trans-Am cars.

ShockProof™ Heavy, Quart	Part No. 1684-Quart	\$18.95
--------------------------	---------------------	---------

ShockProof™ Light (Blue) can be rated as an SAE 75W140, but flows like an SAE30 motor oil. Recommended uses include Production, S2000, and FF2000.

ShockProof™ Light, Quart	Part No. 1685-Quart	\$18.95
--------------------------	---------------------	---------

ShockProof™ SuperLight (Yellow) can be rated as an SAE 70W90, but flows like ATF. Recommended uses include FF1600 and Formula Vee.

ShockProof™ SuperLight, Quart	Part No. 1686-Quart	\$18.95
-------------------------------	---------------------	---------

ZDDP

Most SM grade oils on the market have significantly less ZDDP because zinc and phosphorous can harm catalytic converters. Unfortunately, ZDDP is a critical ingredient in protecting flat-tappet, solid-lifter engines (such as Formula Ford 1600) from excessive cam lobe and lifter wear. **Red Line has not reduced the amount of ZDDP in their racing oils.**

Red Line Straight Grade Synthetic Racing Oils

Red Line Racing Oils allow 1 to 3% more horsepower than petroleum oils while providing much more protection. Although these oils are straight grades, their low temperature properties are similar to multigrade oils. To reduce the chance of detonation, these racing oils contain fewer detergents and therefore are not recommended for street use.

SAE 20 Racing Oil (5W20), Quart	Part No. 1692-20-Quart	\$15.95
SAE 20 Racing Oil (5W20), Gallon	Part No. 1692-20-Gallon	\$63.95
SAE 30 Racing Oil (10W30), Quart	Part No. 1692-30-Quart	\$15.95
SAE 30 Racing Oil (10W30), Gallon	Part No. 1692-30-Gallon	\$63.95
SAE 40 Racing Oil (15W40), Quart	Part No. 1692-40-Quart	\$15.95
SAE 40 Racing Oil (15W40), Gallon	Part No. 1692-40-Gallon	\$63.95
SAE 50 Racing Oil (15W50), Quart	Part No. 1692-50-Quart	\$15.95
SAE 50 Racing Oil (15W50), Gallon	Part No. 1692-50-Gallon	\$63.95
SAE 60 Racing Oil (20W60), Quart	Part No. 1692-60-Quart	\$15.95
SAE 60 Racing Oil (20W60), Gallon	Part No. 1692-60-Gallon	\$63.95

Red Line Motorcycle Gear Oils are formulated specifically to match the demands of specific motorcycle applications. The ShockProof transmission oils can even help quiet the loud shifting "clunk" certain transmissions are known for.

V-Twin Primary Case Oil, Quart	Part No. RL017-Quart	\$15.95
V-Twin ShockProof Transmission Oil, Qt.	Part No. RL018-Quart	\$18.95
80Wt ShockProof Transmission Oil, Qt.	Part No. RL027-80-Quart	\$17.95

Manual Transmission/Transaxle Lubricants are GL-4 gear oils suitable for street and racing applications. Balanced friction speeds synchro engagement for faster shifting when warm. Low-temperature flow similar to an ATF improves cold shifting. Excellent protection for synchros, gears, and bushings. Not for use in hypoid differentials.

MTL replaces 70W, 75W, and 80W gear oils and SAE 30, 10W30, and 5W30 motor oils.	
MTL, Quart (70W, 75W, and 80W)	Part No. 1693-MTL-Quart \$17.95
MT-85 replaces 75W, 80W, and 85W gear oils and SAE 30 and 5W30 motor oils.	
MT-85, Quart (75W, 80W, and 85W)	Part No. RL016-Quart \$17.95
MT-90 replaces 75W, 80W, and 90W gear oils and SAE 40, 10W40, and 15W40 motor oils.	
MT-90, Quart (75W, 80W, and 90W)	Part No. 3344-Quart \$17.95

Red Line Synthetic Automatic Transmission Fluids are fully synthetic ATFs with superior thermal and oxidation stability for increased high-temperature protection. They also flow better when cold for improved low-temperature shifting.

Red Line D4 ATF for use where Dexron II or III, or Mercon or Mercon V is recommended.	
D4 Dexron III ATF, Quart	Part No. 1688-Quart \$12.49
D6 ATF low-viscosity replaces Dexron II, III, and VI; Mercon; and Mercedes NAG-2 fluids.	
D6 ATF, Quart	Part No. RL020-Quart \$12.95

High-Temperature ATF withstands temperatures 70° F higher than conventional ATF, making it ideal for any tow vehicle using Dexron II, Dexron III, or Mercon.

High-Temperature ATF, Quart	Part No. RL004-Quart \$12.49
-----------------------------	------------------------------

Racing ATF gives the positive shifting of Type F fluid, but with even quicker lockup.

Racing ATF, Quart	Part No. RL005-Quart \$12.95
-------------------	------------------------------

DCTF is specifically formulated for dual-clutch gearboxes (paddle shifters) with wet or dry clutches. Suitable for Porsche, Mitsubishi, BMW, Ford, Mercedes, Volvo, and more.

Synthetic DCTF, Quart	Part No. RL028-Quart \$19.95
-----------------------	------------------------------

Differential Friction Modifier and Break-In Additive

Differential Friction Modifier and Break-In Additive is designed to reduce limited slip noise and to aid the proper break-in of all differentials. It can be added to any gear oil to reduce temperature during break-in. It can also be added to Red Line Non-Slip Gear Oil to fine-tune the lockup of clutch pack differentials. More of this additive will reduce friction, causing gentler lockup and less noise.

Friction Modifier, 4 oz.	Part No. 1687-4oz \$7.95
--------------------------	--------------------------

Other Red Line Products

Red Line Synthetic Power Steering Fluid



Synthetic Power Steering Fluid provides unsurpassed wear protection and its high thermal stability helps to ensure cleanliness and long-term efficiency. Excellent lubrication qualities and a high viscosity index means that, regardless of temperature, maximum efficiency is maintained. This can result in less wasted power due to friction.

Synthetic Power Steering Fluid, Quart. Part No. 3346-Quart. \$11.95

Red Line Synthetic Air Tool Oil



Synthetic Air Tool Oil is recommended for both rotary and piston-type air tools, including air hammers and impact wrenches. It has a very light viscosity to minimize power loss, but it is extremely stable and long-lasting under the most grueling conditions. NHRA and NASCAR teams sponsored by Snap-On, Mac, and Cornwell tools all rely on the proven protection of Red Line.

Synthetic Air Tool Oil, 8 oz. Part No. RL013-8 Oz. \$9.95

Red Line CV-2 Synthetic Grease



CV-2 Grease An extremely high-temperature grease for CV joints and wheel bearings. CV-2 provides reduced internal friction and bearing temperatures. Its load carrying capacity is many times greater than petroleum based grease and it provides excellent water washout resistance and anti-wear performance. Available in a standard 14 ounce grease gun cartridge or in a handy 14 ounce jar.

CV-2 Grease, 14 oz. grease gun cartridge Part No. 1694-Cart. \$13.95
CV-2 Grease, 14 oz. Jar Part No. 1694-Jar \$13.95

Red Line Assembly Lubes



Red Line Assembly Lube provides three times greater film strength than conventional black Molybdenum Disulfide greases and will not clog oil filters. Can be used safely with all metals and is compatible with all petroleum and synthetic oils. This product clings to all surfaces and is an excellent rust inhibitor, allowing the storage of parts for years. Now available in paste or liquid form.

Red Line Assembly Lube, 16 oz. Part No. 3349-16 oz. \$24.95
Red Line Liquid Assembly Lube, 12 oz. Part No. RL010-12 oz. \$12.95

Red Line Engine Oil Break-In Additive (ZDDP)



Protect your solid-lifter engine from damage and premature wear! Newer SM grade oils (except Red Line oils) have reduced levels of the protective ingredient ZDDP because zinc and phosphorus are harmful to catalytic converters. Unfortunately, ZDDP is critical for protecting flat-tappet, solid-lifter engines such as Formula Ford 1600 from cam and lifter wear. One 16 ounce bottle treats up to 12 quarts of conventional or synthetic oil.

Red Line ZDDP Break-In Additive, 16 oz bottle. Part No. 1678 .. \$13.95

Red Line Alcohol Fuel Lubricant



Alcohol Fuel Lubricant reduces wear in alcohol-fueled 4-stroke engines. Alcohol fuels tend to wash lubricants away from cylinder walls and valve guides, leading to excessive wear. Mixing just four ounces of Fuel Lubricant per 10 gallons of fuel will reduce wear by as much as 75% while providing significant protection against corrosion. Not for use with catalytic converters.

Alcohol Fuel Lubricant, 12 oz. bottle. Part No. 9900-12 oz. \$12.95

Red Line Synthetic Suspension Fluids (Shock Oil)



Red Line suspension fluids change very little with temperature. The foaming resistance is excellent and seal drag is minimized. Available in 5 viscosities. "LikeWater" provides the lowest viscosity of any commercially available shock oil. The 5 Wt **Light**, Part No. RL014-5, replaces Penske Shock Oil.

"LikeWater" Suspension Fluid, 1.7 Wt, 16 oz. Part No. RL014-1.7-16oz ... \$11.95
ExtraLight Suspension Fluid, 2.5 Wt, 16 oz. Part No. RL014-2.5-16oz ... \$11.95
Light Suspension Fluid, 5 Wt, 16 oz. Part No. RL014-5-16oz \$11.95
Medium Suspension Fluid, 10 Wt, 16 oz. Part No. RL014-10-16oz ... \$11.95
Heavy Suspension Fluid, 30 Wt, 16 oz. Part No. RL014-30-16oz ... \$11.95

Red Line Water Wetter®



Red Line Water Wetter® improves the ability of coolant to wet heat transfer surfaces by 50%. This provides significantly better coolant contact in the cylinder head and can reduce head temperature by as much as 30° F. It can be used with 100% water in racing but does not protect magnesium from corrosion or alter the freezing point. Compatible with all antifreezes.

Water Wetter®, 12 oz. bottle. Part No. 1699-12 oz. \$9.95
Super Cool with Water Wetter®, ½ gal. Part No. RL009-64 oz. \$22.95
This convenient 64-ounce jug has the correct amount of Water Wetter® already mixed into purified, deionized water. No measuring needed!

Other Assembly Lubricants (not Red Line)



ARP Ultra-Torque Assembly Lube

Left: 10 oz Jar, Part No. 3328

Right, top: 1.69 oz Tube, Part No. ARP100-9909

Right, bottom: 0.5 oz Packet, Part No. ARP100-9908



Ford Motorsport Camshaft and Lifter Lubricant protects cam lobes and lifters during initial start-up of a new engine and aids proper break-in. It is especially recommended for engines with solid lifters and flat tappets such as FF1600. Four ounce squeeze bottle is enough for a V-8 engine.

Ford Camshaft and Lifter Lubricant
4 oz. Part No. 3312. \$8.49

ARP Ultra-Torque Assembly Lube is specially formulated for use with ARP high-strength bolts. Applying Ultra-Torque to the threads and under the fastener head reduces torque scatter for more accurate preload. Inhibits rust and corrosion and provides a load range of 500,000 psi. Use with ARP rod and main bolts, cylinder head bolts, and other critical fasteners.

ARP Ultra-Torque Lube
10 oz. Jar (enough for a pro shop) Part No. 3328. \$21.12
1.69 oz. Tube (enough for a full V-8 build) Part No. ARP100-9909. \$8.18
0.5 oz. Packet (enough for one cylinder head) . . . Part No. ARP100-9908. \$1.70

Aeroquip Hose Assembly Lube Generous use of this special lubricant will make assembly of hose ends easier and lessen the chance of damage to the fittings. The large 1 pint bottle will last the average shop a few years.

Aeroquip Hose Assembly Lube
1 pint. Part No. 3315. \$17.99

Funnels and Lubricant Pumps



This special long-reach funnel from Red Line has multiple bends to reach the most inaccessible filler location. Originally designed for power steering, it can be a lifesaver when filling your automatic transmission or racing transaxle. A molded loop is provided at the top of the bowl for easy hanging.

Red Line Lubricant Funnel. Part No. RL-99239. \$4.99



These pumps screw on to your container of oil or gear lube and make it quick and easy to fill hard-to-reach ports in your transmission or differential. Cleaner and easier than a funnel! **Note:** These pumps will not screw onto Red Line bottles; however, they are still handy, even if you have to hold the pump to the top of the bottle.

Pump for Quart Container. Part No. 3843-Quart. \$12.49
Pump for Gallon Container. Part No. 3843-Gallon. \$13.99

Red Line Fuel Injection Cleaner and other Fuel System Additives



Red Line SI-1 Complete Fuel System Cleaner

Red Line SI-1 Complete Fuel System Cleaner contains the most powerful high-temperature detergents and synthetic lubricants designed to clean port fuel injectors. One concentrated treatment of a 15 ounce bottle to 15 gallons of gas can restore injector flow to nearly 100%, even after years of neglect. Benefits include rust, gum, and varnish removal; upper cylinder lubrication; and cleansing of emission control systems. SI-1 also works great on carburetors. Will not harm catalytic converters and sensors. Recommended and used by many auto dealers. Treats 15 to 100 gallons.

SI-1 Fuel System Cleaner, 15 oz. bottle. Part No. 3345-15 oz. \$11.95



Red Line Lead Substitute

Red Line Lead Substitute is designed for use in street and race engines which require leaded fuels. These engines can suffer from excessive valve seat wear and piston scuffing when operated on low-lead or unleaded fuels. Red Line Lead Substitute prolongs the useful life of these engines. Also cleans carburetor deposits along with the entire fuel system. It is safe for all gasoline engines and catalytic converters. One bottle treats 120 gallons.

Red Line Lead Substitute, 12 oz. Part No. 3348-12 oz. \$11.95



Red Line 85 Plus Diesel Fuel Additive

Red Line 85 Plus is formulated for use in all diesel engines to improve lubricity and cetane, assist starting, reduce smoking, and prevent fuel system wear and leakage. A combination of powerful lubricants, detergents, seal conditioners, and rust preventatives, but without conventional smoke suppressants. Instead, Red Line 85 Plus contains cetane improvers to boost fuel cetane numbers by 5-7 points and additional lubricants which can reduce wear in low-sulfur fuel by 75%. Use of 85 Plus can provide up to 5% additional power and efficiency. One bottle treats 100 gallons.

85 Plus Diesel Fuel Additive, 12 oz. Part No. 1675-12 oz. \$9.49



Red Line RL Anti-Gel Diesel Fuel Additive

Red Line RL Anti-Gel improves diesel fuel flow in extreme cold while reducing the freezing point of water in the fuel. Unique wax dispersant reduces the pour point of a typical diesel fuel by 25°F and may allow the use of more efficient #2 diesel fuel in cold weather. RL Anti-Gel also improves the lubrication of injectors and fuel pumps. Contains no harmful alcohol. One 15 oz. bottle treats 100 gallons at the recommended dosage.

Red Line RL Anti-Gel Additive, 15 oz. Part No. 1676-15 oz. \$10.49

Brake Fluid

Brake Fluid Comparison Chart – Sorted by Dry Boiling Point

Brand Name	DOT Rating	Boiling Point in °F		Compatible with other fluids? *	Container Size Fluid Oz.	Part No.
		Wet	Dry			
AP Radi-CAL R4	4	399	644	Yes	16.9	3310-004
Motul 660	4	401	617	Yes	16.9	MT660
AP Radi-CAL R3	4	399	608	Yes	16.9	3338-17 oz.
Red Line RL-600	4	400	604	Yes	16	RL600
Motul 600	4	421	594	Yes	16.9	MT600
AP Radi-CAL R2	N/A	383	594	No	16.9	3309-17 oz.
Castrol SRF	4	518	590	Yes	33.8	3343-Liter
Prospeed RS683	4	394	583	Yes	16.9	3340-201
ATE Type 200	4	396	536	Yes	33.8	3327-Liter
AP Radi-CAL R1	3	284	516	Yes	16.9	3305-17 oz.
Castrol Advanced	4	329	446	Yes	12 or 32	3308-Size

* None of these brake fluids contain silicone. None of them are compatible with silicone brake fluids.

AP Radi-CAL R4 Racing Brake Fluid

AP Radi-CAL R4 Racing Brake Fluid has the highest dry boiling point of any commercially-available fluid. R4 can take the heat of carbon-carbon F1 brakes or NASCAR short tracks. Exceeds DOT 3 and DOT 4 specifications.

AP Radi-CAL R4 Racing Brake Fluid, 17 oz. (500ml). Part No. 3310-004-17oz. \$39.99

Motul 660 Racing Brake Fluid

Motul 660 Racing Brake Fluid has an extremely high dry boiling point to combat brake fade and vapor lock in the harshest racing environments. Exceeds DOT 3 and DOT 4 specifications. Suitable for use in race or street vehicles calling for DOT 3 or DOT 4 fluid.

Motul 660 Racing Brake Fluid, 17 oz. (500ml) Part No. MT660-17oz \$28.99

AP Radi-CAL R3 Racing Brake Fluid

AP Radi-CAL R3 Racing Brake Fluid (replaces AP PRF) Like its predecessor, Radi-CAL R3 exceeds DOT 4 specifications. Unlike the old AP PRF brake fluid, R3 is compatible with all other DOT 3 and DOT 4 brake fluids. A new corrosion inhibitor (not present in AP PRF) minimizes its effect on magnesium, so R3 is safe for use in clutch hydraulic systems.

AP Radi-CAL R3 Brake Fluid, 17 oz. (500ml). Part No. 3338-17oz \$29.99

Red Line RL-600 Racing Brake Fluid

Red Line RL-600 Racing Brake Fluid is a fully synthetic brake fluid from the leader in synthetic racing lubricants. Exceeds DOT 3 and DOT 4 specifications. RL-600 is formulated for greater resistance to moisture absorption than competitors' racing brake fluids. Suitable for any street or racing vehicle using DOT 3, DOT 4, or DOT 5.1 fluid.

Red Line RL-600 Brake Fluid, 16 oz. Part No. RL600 \$16.95

Motul 600 Racing Brake Fluid

Motul 600 Racing Brake Fluid exceeds DOT 3 and DOT 4 specifications. The wet boiling point is even higher than many competing fluids' dry boiling points! Many "problem" braking systems have been cured simply by switching to Motul 600 fluid. **This is our most popular brake fluid!**

Motul 600 Racing Brake Fluid, 17 oz. (500ml). Part No. MT600-17 oz. \$17.99

We carry racing brake fluids for everything from Formula Vee to Formula One!



AP Radi-CAL R2 Racing Brake Fluid

AP Radi-CAL R2 Racing Brake Fluid (formerly AP 600) is not compatible with any other fluid (except the original AP600). It is corrosive to magnesium, so it is not recommended for clutch hydraulics.

**Not compatible with magnesium components!
Do not mix AP Radi-CAL R2 with any other fluids!**

AP Radi-CAL R2 Brake Fluid, 17 oz. (500ml). Part No. 3309-17oz \$21.49

Castrol SRF Racing Brake Fluid

The racing brake fluid! **Castrol SRF** has a wet boiling point of 518°F and a dry boiling point of 590°F to far exceed DOT 4 specifications. SRF brake fluid can make the critical difference when using metallic brake pads with high thermal conductivity.

Castrol SRF Racing Brake Fluid, 1 liter Part No. 3343-Liter \$69.99

Prospeed RS683 Racing Brake Fluid

Prospeed RS683 Racing Brake Fluid is manufactured using innovative new processes that actually reduce the amount of air in the fluid. Typical fluids can contain up to 5% dissolved air, but RS683 contains less than 1%. This results in a less compressible fluid for the firmest pedal and most predictable braking response.

Prospeed RS683 Racing Brake Fluid, 17 oz. (500ml). Part No. 3340-201 \$24.99

ATE Type 200 Brake Fluid

ATE Type 200 Brake Fluid has a great balance of wet and dry boiling points at an excellent price. OEM fluid for many German and Swedish cars.

ATE Type 200 (Amber) Brake Fluid, 1 liter can Part No. 3327-Liter \$16.99

Note: ATE Type 200 has **exactly** the same properties as ATE Super Blue except the color. ATE Super Blue is no longer available in the USA due to DOT regulations.

AP Radi-CAL R1 Brake Fluid

AP Radi-CAL R1 Brake Fluid (replaces AP 551) exceeds DOT 3 specifications. It has a higher dry boiling point than many DOT 4 fluids, so it is popular in some applications that get bled and flushed frequently. Suitable for street or racing brake and clutch systems specifying DOT 3 fluid.

AP Radi-CAL R1 Brake Fluid, 17 oz. (500ml). Part No. 3305-17oz \$17.99

Castrol Advanced Performance LMA Brake Fluid

Due to its low moisture absorption (LMA) property, **Castrol Advanced Performance** does not have to be replaced as often as other fluids. This makes it a perfect choice for applications that will not be bled frequently. The dry boiling point of 446°F is high enough for many applications. Factory-recommended by Girling for most British cars.

Castrol Advanced Performance, 12 oz. Part No. 3308-12oz \$6.99

Castrol Advanced Performance, 32 oz. Part No. 3308-32oz \$16.99

Please call or visit our website for quantity discounts on brake fluids. The more you buy, the more you save!

Loctite® Products

Pegasus is proud to stock genuine Loctite® threadlockers, sealants, adhesives, and lubricants! Loctite products have been trusted by mechanics and manufacturers since the 1950s. Even Carroll Smith called Loctite “the racer’s salvation.” The use of Loctite threadlockers on properly cleaned, prepared, and torqued fasteners can eliminate the need for mechanical locking devices such as safety wire or locknuts. Now, over 60 years later, Loctite is much more than just blue, red, and green!

Loctite® Anaerobic Compounds

Loctite 242 Medium-Strength (Blue) Nut and Bolt Locker Medium-strength thread locking compound allows fasteners to be disassembled with hand tools. 10 ml (0.34 fl oz.) bottle.

Loctite 242 Medium-Strength (Blue) Threadlocker, 10 ml
Part No. LT-24221 \$12.99

Loctite 271 High-Strength (Red) Stud Locker High-strength thread locking compound is recommended for studs and high-strength bolts. Use heat to remove fasteners without breakage. 10 ml (0.34 fl oz.) bottle.

Loctite 271 High-Strength (Red) Threadlocker, 10 ml
Part No. LT-27121 \$12.99

Loctite 290 Penetrating (Green) Threadlocker This low-viscosity compound can be used to lock previously assembled fasteners such as jam nuts. 6 ml (0.20 fl oz.) tube.

Loctite 290 Penetrating (Green) Threadlocker, 6 ml
Part No. LT-37423 \$6.99

Loctite 609 Bearing Mount (Green) Salvages worn parts by bonding cylindrical parts such as bearings to loose-fitting housings. 10 ml (0.34 fl oz.) bottle.

Loctite 609 Bearing Mount (Green), 10 ml
Part No. LT-60921 \$12.49

Loctite 515 (Purple) Gasket Maker Create flexible formed-in-place gaskets on close-fitting machined surfaces (up to 0.015" gap). Once cured it resists any conventional solvent, fuel, or oil. 50 ml (1.69 fl oz.) tube.

Loctite 515 Anaerobic Gasket Maker, 50 ml
Part No. LT-51531 \$19.99

Loctite 7649 Primer N Use with any product above to clean the mating surfaces and to speed the cure time. Primer N is especially critical on “inactive” surfaces including stainless steel, titanium, magnesium, aluminum, black oxide, and plated parts (which covers just about all critical race car fasteners and assemblies, doesn’t it). 4.5 oz. aerosol can.

Loctite 7649 Primer N Surface Prep, 4.5 oz. aerosol can
Part No. LT-21348 \$23.79

Loctite 243 Primerless (Blue) Threadlocker Same properties as 242 above, but formulated for a better bond to inactive materials without primer. 6 ml (0.20 fl oz.) tube.

Loctite 243 Primerless Threadlocker, 6 ml
Part No. LT-1330799 \$6.99

Loctite® Cleaners and Lubricants

Loctite Chisel Gasket Remover Removes gaskets, RTV, even paint from metal parts without scraping or sanding. Non-corrosive on aluminum. 18 oz. aerosol can.

Loctite Chisel Gasket Remover, 18 oz. aerosol can
Part No. LT-79040 \$14.49

Loctite Pro Strength Parts Cleaner Dissolves greases and oils (even synthetics) from metal parts. Use as a brake cleaner or as a pre-cleaner before using Loctite 7649 Primer N. 538 g (19 oz.) aerosol can.

Loctite Pro Strength Parts Cleaner, 538 g
Part No. LT-30548 \$7.29

Loctite Freeze & Release Instantly chills rusted parts to -45° F, shrinking the parts to crack the rust. This allows the penetrating lubricant to wick into the joint. 400 ml (13.52 oz.) aerosol can.

Loctite Freeze & Release, 400 ml
Part No. LT-996456 \$12.99

Loctite® Insulating and Sealing Wrap

Loctite Insulating and Sealing Wrap is a special wrapping tape made without messy adhesive. This means no melted adhesive and no sticky residue. The silicone rubber tape only sticks to itself or similar rubber materials. It is great for temporary jobs like patching a leaking radiator hose. Resists coolant, water, saltwater, acid, and UV exposure. Roll measures 1 inch wide x 10 feet long. Red only.

Loctite Insulating and Sealing Wrap Part No. LT-1212164 \$8.99

Note: This tape must be wrapped around an object in order to bond to itself.

Loctite® QuickStix Compounds

Loctite QuickStix 248
Medium-Strength
(Blue) Threadlocker
Part No. LT-37087



Loctite QuickStix
Silver Grade
Anti-Seize
Part No. LT-37230



Many of your favorite Loctite compounds are now available in QuickStix tubes. The semisolid sticks eliminate the leaky mess in your toolbox and those surprise empty bottles. Some QuickStix compounds can also be applied well in advance of assembly.

Loctite QuickStix 248 Medium-Strength (Blue) Nut and Bolt Locker The same formula as Loctite 242 Blue, but in a semisolid stick. Can be applied in advance of assembly so your spare parts are ready to install right out of the box. 19 g (0.67 oz.) stick.

Loctite QuickStix 248 Medium-Strength Threadlocker, 19 g . . . Part No. LT-37087 \$25.99

Loctite QuickStix 268 High-Strength (Red) Stud Locker The same formula as Loctite 271 Red, but in a semisolid stick. Can be applied in advance of assembly so your spare parts are ready to install right out of the box. 19 g (0.67 oz.) stick.

Loctite QuickStix 268 High-Strength Threadlocker, 19 g . . . Part No. LT-37686 \$24.99

Loctite QuickStix 668 Bearing Mount Similar to Loctite 609, but in a semisolid stick. The waxy compound fills larger gaps than liquid 609 (0.010" vs. 0.005") and has a higher temperature rating (400°F vs. 300°F). 19 g (0.67 oz.) stick.

Loctite QuickStix 668 Bearing Mount, 19 g Part No. LT-39148 \$30.99

Loctite QuickStix C5-A Copper Anti-Seize Protects against galling and seizing up to 1800°F. Copper based anti-seize is recommended in high-pressure applications such as spark plug threads, jam nuts, and rod end threads. The semisolid stick form means no more punctured tubes leaking in your toolbox. 20 g (0.70 oz.) stick.

Loctite QuickStix C5-A Copper Anti-Seize, 20 g Part No. LT-37229 \$5.99

Loctite QuickStix Silver Grade Anti-Seize Protects against seizing and corrosion up to 1600°F. Nickel based (silver colored) anti-seize provides better protection against corrosion in harsh environments than copper based anti-seize. The semisolid stick eliminates that oozing can and mangled brush from your toolbox. 20 g (0.70 oz.) stick.

Loctite QuickStix Silver Grade Anti-Seize, 20 g Part No. LT-37230 \$5.99

Loctite QuickStix 534 Hi-Tack Gasket Dressing Similar to Loctite Hi-Tack Gasket Sealant, but in a semisolid stick. Less messy than the liquid, and since it is solvent-free, it also has less odor. 19 g (0.67 oz.) stick.

Loctite QuickStix 534 Hi-Tack Gasket Dressing, 19 g Part No. LT-39156 \$8.99

Loctite QuickStix 5-Stick Assortment Kit Includes 248 Blue Threadlocker, 268 Red Threadlocker, Silver Anti-Seize, C5-A Copper Anti-Seize, and PST Thread Sealant QuickStix in a reusable cardboard organizer box.

Loctite QuickStix 5-Stick Assortment Kit Part No. LT-38725 \$68.99

Loctite® QuickTape



Loctite QuickTape 249 Threadlocker Tape is by far the cleanest way to apply Loctite Blue (Medium) Threadlocker to a bolt. Just peel a little film from the roll and wrap it around the bolt threads. You can even carry the roll in your pocket! Perfect for spare parts. Just apply to the parts and put them away for later. Tape measures 1/2" wide x 260" long.

Loctite QuickTape 249 Threadlocker Tape, 1/2" x 260" Part No. LT-1372603 \$20.99

Loctite® Adhesives

Loctite Maximum-Strength Spray Adhesive This adhesive was originally formulated for headliners, but it will bond most interior and upholstery materials including foam rubber, fabric, plastic, and rubber. Use it to glue down your racing seat fabric, heat barrier cloth, or even the bed liner in your truck. Withstands temperatures up to 170°F. Bonds in 30 minutes. 474 g (16.75 oz.) aerosol can.

Loctite Maximum-Strength Spray Adhesive, 474 g Part No. LT-37312 \$11.79

Loctite Fast Cure Epoxy Mixer Cups Get the right amount of epoxy, every time, with no guessing or measuring. 3.4 grams (0.12 oz.) of epoxy and hardener are packaged in a convenient mixer cup. Just mix the two parts into a grey thick liquid, apply where you need it, and throw the cup away. Fast Cure adheres to metal, glass, hard plastics, and wood. 5 minute working time (10 minute fixture time) is ideal for small, quick repairs. Available in packs of 4 cups or 10 cups. Each pack includes disposable mixing sticks.

Loctite Fast Cure Epoxy Mixer Cups, pack of 4 cups Part No. LT-39088 \$18.49

Loctite Fast Cure Epoxy Mixer Cups, pack of 10 cups Part No. LT-21425 \$26.99

See page 158 for Loctite Hysol structural epoxy.

FLUIDS AND SUPPLIES

Sealing Products and Anti-Seize Compounds

Loctite® Sealants and Gasketing Compounds

Loctite PST 565 Thread Sealant Easier to handle than plumber's tape, plus the excess won't clog filters and valves like tape can. Provides a tough, positive seal to prevent leakage or vibration loosening of pipe threads. Adjustments can be made up to 24 hours after application without affecting the seal. Also acts as a thread lubricant to prevent seizing and galling. 50 ml (1.69 fl. oz.) tube.

Loctite PST 565 Thread Sealant, 50 mlPart No. LT-56531\$17.99

Loctite Hi-Tack Gasket Sealant Helps to seal all types of gaskets, including O-rings. Resistant to gasoline, oil, antifreeze, and grease. Use it as an adhesive to hold gaskets in place and prevent shifting during assembly (ideal for valve cover gaskets). You can even use it to seal bolt threads. 9 oz. aerosol can.

Loctite Hi-Tack Gasket Sealant, 9 oz. aerosolPart No. LT-30526 \$9.49

Loctite 587 Blue Silicone RTV Gasket Maker Don't settle for generic RTV silicone just because it's blue. Loctite 587 has three times the oil resistance of cheaper brands. It is also eight times more flexible than cork gaskets, which makes it ideal for sealing any surfaces which may move in service. Seals gaps up to 1/4" and withstands most automotive fluids (does not withstand immersion in gasoline). 70 ml (2.37 fl. oz.) tube.

Loctite 587 Blue Silicone RTV, 70 mlPart No. LT-58730\$11.49

Loctite 598 Black Silicone RTV Gasket Maker OEM specified. Higher temperature rating than 587 Blue above (625°F vs. 500°F). Stays flexible and oil resistant longer than 587 Blue, which makes it ideal for more permanent assemblies. 70 ml (2.37 fl. oz.) tube.

Loctite 598 Black Silicone RTV, 70mlPart No. LT-59830\$11.49

Loctite 5920 Copper High-Temperature Silicone RTV Gasket Maker This high-performance RTV silicone has the highest temperature resistance (700°F intermittent), which makes it ideal for sealing exhaust header flanges. Applying a bead to both sides of a header gasket before installation will significantly reduce the chance of blowout, even if the header flange is a bit warped. 70 ml (2.37 fl. oz.) tube.

Loctite 5920 High-Temperature (Copper) RTV, 70 mlPart No. LT-30542\$7.29



Loctite RTV Gasket Maker Power Can All the benefits of Loctite RTV, but in a unique pressurized dispenser can. Make more consistent beads than you ever could pinching a tube. No globbing, smearing, or struggling with partially hardened sealant. The Power Can is about the size of a tube of caulk, but it is completely self-contained. No special gun or applicator is required. The nozzle is also built in, so it won't get lost. The ergonomic thumb trigger takes minimal pressure to operate (no more bruised fingertips). The Power Can is a lifesaver if you dismantle your gearbox more than once in a weekend — just ask Bob! Choose 587 Blue RTV or 598 Black RTV (see above for more information on each). 190 ml (6.42 oz.) can.

Loctite 587 Blue Silicone RTV Power Can, 190 mlPart No. LT-40462 \$18.99

Loctite 598 Black Silicone RTV Power Can, 190 mlPart No. LT-40463 \$18.99

See page 156 for Loctite 515 Anaerobic Gasket Maker.

Permatex Valve Lapping and Grinding Compound

Mixes well with water to form an easy-to-use paste. Can be used on conventional as well as chromium and cobalt hard-faced seats.

Permatex Valve Lapping & Grinding Compound, 3 oz. can Part No. 3380 \$8.49

Tube Grip Dispensing Pliers



Save your fingers! Let our **Tube Grip Dispensing Pliers** do your heavy squeezing for you. This tool effortlessly dispenses even the thickest sealants, including Hylomar and RTV silicones, without bruising your fingertips. The comfortable pistol-grip handles give you precise control. No more sudden globs, which means less waste. The flat plates squeeze the tube from the bottom, ensuring that you get every last bit that you paid for. Sealants sold separately. Get one for each tube of sealant in your toolbox.

Tube Grip Dispensing PliersPart No. 3435-050\$17.99

Hylomar and Wellseal Sealants



Genuine Hylomar is perfect for sealing gearbox rear covers or any other parts that need to be disassembled easily and without a lot of scraping to clean up the residue. Seals gaps up to .010" and since it never hardens, it makes disassembly a snap. Suitable for use as a gasket dressing — will not corrode metals. Supplied in 100 gram tubes (medium consistency paste) or 8 oz. brush-in-cap cans (liquid form). We also stock Wellseal, a similar product from the UK preferred by some engine builders and specified in many British shop manuals.

Hylomar Gasket Maker, 8 oz. Brush-in-cap CanPart No. 3318 \$56.99

Hylomar Gasket Maker, 100 gram TubePart No. 3300 \$21.99

Wellseal, 100ml TubePart No. 3304-100ml \$31.99

Loctite® O-Ring Making Kit



Loctite O-Ring Making Kit Never be stuck without a critical O-ring seal again! This kit includes the four most common SAE diameters of Buna N material (3/32", 1/8", 3/16", and 1/4") in 3 foot lengths to make any size O-ring. Simply cut the material to length and glue the ends together. The Quick-Set adhesive bonds in 30 seconds. The special cutting and splicing fixture ensures straight cuts and gap-free splices. Includes a waterproofing solution and a cleanup solution. This kit could easily pay for itself just by saving express shipping charges.

Loctite O-Ring Making KitPart No. LT-00112 \$62.99

Anti-Seize Compounds



Anti-seize compounds provide long-term protection for fasteners or splines subject to high temperatures, corrosion, seizure or galling. Great for cylinder head bolts, exhaust manifold bolts or spark plug threads. Use it on rod end threads to make future suspension adjustments easier, too. Our nickel-based Anti-seize compound is lead-free, exceeds

ML-A-907 E, and offers greater corrosion resistance than copper-based anti-seize. Copaslip is a copper-based anti-seize which prevents metal-to-metal contact under higher pressures than nickel-based anti-seize, making it perfect for jam nuts and suspension fasteners.

Anti-Seize compound, 8 oz. brush top canPart No. 3303 \$13.99

Copaslip (Copper Ease), 85 gram tubePart No. 1475 \$8.99

Ardrox Dye Penetrant Crack Testing Kits and Inspection Light



Complete Visible Dye Penetrant Crack Testing Kit Part No. 3765

UV Inspection Light for UV Dye Penetrant System Part No. 3786-001

Many cracks that extend to the surface of metal parts are so small that they are completely invisible to the naked eye. This is because they may not actually open up except when subject to high operating stresses. Yet, these invisible little cracks can grow until the part fails catastrophically. Our quality **Dye Penetrant Systems** make many of these small cracks visible because the low viscosity penetrating dyes wick into the tiniest of cracks. When the developer is applied, the dye bleeds out of the crack making it clearly visible. These handy, low-cost systems allow you to perform these tests yourself. Our **Visible Dye Penetrant Kit** uses a bright red dye (no black light needed). Our FAA-approved **UV Dye Penetrant Kit** requires a black light (sold separately) to make the dye glow, but the UV dye is able to mark even smaller cracks than the visible dye. Each kit includes three aerosol cans: one can of a special Cleaner/Remover, one can of Penetrant Dye and one can of Developer. One kit is enough to perform about 500 small scale tests. However, you will tend to use the Cleaner/Remover faster than the other chemicals so you may want to order an extra can to complete even more tests. Instructions for use are printed on each can. Our **UV Inspection Light** is a portable battery-operated black light. The 365nm wavelength is exactly as specified for use with our UV Dye Penetrant system.

Complete Visible Dye Penetrant Crack Testing Kit Part No. 3765 \$63.99
Includes one can each of Visible Dye, Visible Dye Developer, and Cleaner/Remover.

Extra can of Visible Penetrant Dye Part No. 3766 \$22.99

Extra can of Visible Dye Developer Part No. 3768 \$23.99

Complete UV Dye Penetrant Crack Testing Kit Part No. 3772 \$60.99

Includes one can each of UV Dye, UV Dye Developer, and Cleaner/Remover. Requires UV Inspection Light below.

Extra can of UV Penetrant Dye Part No. 3770 \$23.99

Extra can of UV Dye Developer Part No. 3771 \$19.99

Extra can of Cleaner/Penetrant Remover Part No. 3767 \$18.99

Works on both Visible and UV dyes. The Cleaner/Remover is used twice in each test, so you will use it up quickly.

UV Inspection Light for UV Dye Penetrant System Part No. 3786-001 \$42.99

Portable, handheld UV inspection light requires (4) AA batteries (not included).

Chemicals and Dispensers



Formula V Tire and Rubber Treatment

Extends the life of your tires at a fraction of the cost of a new set of rubber. Works on all tires, from street to racing tires. Formula V is not just another rubber softener. It actually preserves the rubber and allows racing tires to get sticky when hot after many more heat cycles than would otherwise be possible. Apply 3 to 4 heavy coats per day for 3 days, then let dry for 2 days before racing. Protects trailer and RV tires against weathering and UV aging too!

Formula V Tire and Rubber Treatment, one gallon

Part No. 3340-001 \$43.99

Please note: This product can only be shipped via UPS Ground service within the 48 contiguous states.



RolloPrep Tire Prep Applicator

RolloPrep is a liquid applicator tool that combines roller, sprayer, and container into one easy to use, no mess unit. The device pumps liquid from a 32 ounce bottle via a trigger sprayer, where it is then routed to the inside of a roller. Originally developed for applying tire treatment products to auto and racing kart tires, RolloPrep has numerous other uses. As long as your liquid product can be sprayed thru the sprayer and rolled with the special velour roller, then RolloPrep is the answer for your liquid application needs.

RolloPrep Applicator Tool Part No. 9983-001 ... \$29.99
Replacement Roller Part No. 9983-002 \$7.99

Loctite® E-120HP Hysol Structural Epoxy and Dispensers



Above: Loctite E-120HP Hysol Epoxy, 200 ml Cartridge Part No. LT-29354

Below: Loctite Universal Dispensing Gun, 200/400ml Part No. 3337



Below: Loctite Dispensing Gun, 50ml Part No. LT-98472



Above: Loctite Mixing Nozzles, 50ml Part No. LT-98623

Loctite E-120HP Hysol Structural Epoxy An excellent epoxy for bonding the floor pan, firewall, and bulkheads of formula cars. E-120HP is an ultra-strength, aerospace grade epoxy adhesive with a 120 minute working time. Hysol is the latest generation of Loctite epoxy adhesives, with higher strength, greater durability, and less odor than Durobond. It is also useful for composite body panel repairs.

Loctite E-120HP Hysol Structural Epoxy, 400ml cartridge Part No. 3369 \$102.99
Loctite E-120HP Hysol Structural Epoxy, 200ml cartridge Part No. LT-29354 \$54.99
Loctite E-120HP Hysol Structural Epoxy, 50ml cartridge Part No. LT-29353 \$14.99

The **Loctite Dispenser Guns** are hand-held, manually operated dispensing guns designed for use with two-component adhesives such as Hysol epoxy. One size works with both 200ml and 400ml dual cartridges in 1:1, 2:1, and 4:1 mix ratios. The other size works with 50ml dual cartridges. The Mixing Nozzles (sold separately) are removable between jobs, so you can use just what you need and save the rest for another job.

Loctite Universal Dispensing Gun for 200ml and 400ml Part No. 3337..... \$259.99
Loctite Mixing Nozzles for 200 or 400ml, 10-pack Part No. 3412-001 \$17.49
Loctite Dispensing Gun for 50ml Part No. LT-98472 \$53.99
Loctite Mixing Nozzles for 50ml, 10-pack Part No. LT-98623 \$12.99

Fluid Film Penetrating Lubricant



Fluid Film is a unique, eco-friendly, penetrating spray lubricant and anti-corrosion protectant. The solvent-free woolwax (lanolin) formula does not dry out or become tacky. It sprays as a light penetrating oil and rapidly thickens into a light grease. It coats and protects against corrosion and galling, making it perfect for long-term storage as well as for protecting moving parts. It resists salt and salt water, which makes it a favorite of shipyards and plow truck fleets. We use it in the warehouse to prevent rust on uncoated metal parts. Use it as a dressing on vinyl, leather, and rubber seals too. 11.75 ounce (333g) aerosol can.

Fluid Film Lubricant Part No. 3412-200 ... \$11.99

HV-350 Flexible Adhesive

From Valco Cincinnati, the licensed manufacturer of Hylomar, comes **HV-350**, an amazingly flexible and versatile adhesive. Its elasticity makes it ideal for high-vibration environments, yet it cures hard enough to sand and paint. Repair fiberglass bodywork without promoting new cracks around the patch! Bonds to virtually any clean surface, porous or nonporous (great for bonding dissimilar materials). Seals out moisture, even when completely submerged (great for insulating electrical connectors). Excellent for bonding the edges of custom foam air filters. 3.35 ounce tube.

HV-350 Flexible Adhesive, 3.35 oz tube Part No. 3435-001 \$7.99



HV-350 Flexible Adhesive Part No. 3435-001

- Repair cracked fiberglass
- Insulate exposed wires
- Repair torn upholstery
- Attach new weatherstripping
- Bond air filter foam sheets
- Reinstall helmet molding

Würth Chemical Products

Once available only to professional shops, Würth Chemical Products are widely regarded as some of the best lubricants and cleaners available. These high-quality chemicals are so much more effective than the competition that you will use less to do each job, saving money over "no-name" products.



Brake & Parts Cleaner The highest quality brake cleaner available. The exclusive non-chlorinated formula quickly removes grease, oil, and brake dust, yet will not affect most rubber and plastics. Dries quickly and leaves no residue. Net weight 14 ounce aerosol can (17.5 fluid ounces) offers exceptional value.

Würth Brake & Parts Cleaner, 14 oz. aerosol can Part No. 3393-14 oz .. \$5.99

Rost Off Aerosol penetrating oil loosens the most stubborn rust. Unique canister design will spray in any position, even upside-down! Contains 98% active ingredient and only 2% propellant for maximum value. Silicone-free. 10.1 fluid ounce (500ml) aerosol can.

Würth Rost Off, 10 oz. aerosol can Part No. 3386-10 oz .. \$11.99

HHS-K Lubricant Sprays on as a lightweight penetrating oil, but thickens to a medium-viscosity, pressure-resistant synthetic grease. Originally formulated for door hinges, it works equally well on linkages and latches. 16.9 fluid ounce (500ml) aerosol can.

Würth HHS-K Lubricant, 16.9 oz. aerosol can Part No. 3435-002... \$24.99

Contact OL "Electrician in a can!" Saves hours of testing and troubleshooting. Cleans oxidation from electrical connections, but will not harm plastic electrical connectors. Keep a can in the tow vehicle and you won't waste time trying to get the trailer lights to work every spring! 6.8 fluid ounce (200ml) aerosol can.

Würth Contact OL, 6.8 oz. aerosol can Part No. 3387 \$23.99

Dielectric Grease Use on all of your electrical connections to prevent corrosion. Non-conductive, non-toxic, and non-flammable. 3 ounce (85 gram) tube.

Würth Dielectric Grease, 3 oz. tube Part No. 3311 \$28.99

Cleaners and Polishes



Mothers R3 Racing Rubber Remover

Mothers R3 is specifically formulated to remove rubber scuff marks from racetracks quickly and easily. It also powers through oil streaks and bug splats without leaving a streaky residue. Just spray on and wipe the stains away. Safe for use on paint, plating, anodizing, glass, even solid-color vinyl graphics (be careful with printed decals that don't have a sealed surface). Protect your paint by following up with a coat of wax. 24 ounce pump spray bottle.

Mothers R3 Racing Rubber Remover, 24 oz
Part No. 3361-050 \$8.99



Mothers California Gold Spray Wax

Mothers California Gold Spray Wax is as close as you can get to a one-step wax. Just spray it on a clean vehicle and buff to a show-quality shine. If you can't bear to give up good old-fashioned paste wax, you can use California Gold as a booster, easily increasing the shine and the protection of your existing wax. This is also an ideal follow-up after using R3 Racing Rubber Remover. 24 ounce pump spray bottle.

Mothers California Gold Spray Wax, 24 oz
Part No. 3361-022 \$9.49



Mothers re|vision Glass Cleaner

Mothers re|vision Glass Cleaner removes oily dirt and fingerprints from windows, windshields, and mirror glass. The ammonia-free formula can be used on glass, plastic, even chrome. Once your windshield is clean, use it to take those stubborn smudges off of your smartphone and tablet screens! Spray on a microfibre cloth (not on the glass) and wipe clean, then buff with a dry microfibre cloth. 24 ounce pump spray bottle.

Mothers re|vision Glass Cleaner, 24 oz
Part No. 3361-037 \$4.99



Mothers Back-to-Black Tire Renew

Your paint has a show-quality shine. Don't let dirty brown tires ruin all your hard work! **Mothers Back-to-Black Tire Renew** works to dissolve the old tire dressings that eventually turn into a brown haze. It also removes road dirt, brake dust, and wheel bearing grease without damaging the rubber. Just spray on and wipe off to reveal a deep black. Note that this is not a dressing, and it will not make your tires shiny. 24 ounce pump spray bottle.

Mothers Back-to-Black Tire Renew, 24 oz
Part No. 3361-051 \$5.79



Race Glaze Polish and Sealant

Race Glaze uses the latest in polymer technology to impart a super-slippery, high-gloss protective coating. Use it on any painted surface, fiberglass gelcoat, even plastic. It can actually reduce aerodynamic drag by helping to keep the surfaces clean. It is not a wax, so successive applications will not cause yellowing. Silicone-free formula is easily removed for repainting or repairs. Suitable for clear coat finishes.

Race Glaze Polish & Sealant, 16 oz
Part No. 3360-16 oz \$13.79



Plexus Plastic Cleaner and Protectant

Plexus Plastic Cleaner and Protectant is perfect for race car windshields and helmet shields*. Removes rubber and tire marks without harming paint. Seals pores in plastic and leaves a protective coating that makes future cleaning much easier. Anti-static also helps to reduce the tendency of dust to cling to acrylic and Lexan. Simply spray and wipe. No buffing, no mess and no waste. Comes in a 13 oz. aerosol can. *Not for mirrored shields.

Plexus Cleaner and Polish, 13 oz.
Part No. 3398-13 oz \$30.99



Lexan and Plastic Cleaners and Polishes

Lexan and Plastic Cleaner removes dirt and leaves a glaze that cuts static and repels dust. **Lexan and Plastic Polishes** buffs out scratches and swirl marks. Use Polish #3 if needed to remove deep scratches, then use Polish #2 to take out fine scratches and haze. Follow up with Cleaner #1 after using Polish #2 for best results. Supplied in 8 oz. bottles.

Lexan Cleaner #1, 8 oz. pump bottle... Part No. 6350..... \$9.99
Lexan Polish #2, 8 oz. squeeze bottle... Part No. 6360..... \$9.99
Lexan Polish #3, 8 oz. squeeze bottle... Part No. 6370..... \$14.99



Mothers Waterless Car Wash

Wash your car without a hose or bucket! This super-slick formula lifts and encapsulates dirt and grime, allowing you to wipe and buff to a high shine without scratching the paint. Liquid wax ingredients help to repel dirt for easier cleaning next time. Perfect for use at the track when there is no water available. Also great for cleaning the bodywork on formula cars, motorcycles, and leaky convertibles. 24 ounce pump spray bottle.

Mothers Waterless Car Wash, 24 oz
Part No. 3361-083 \$9.49



Mothers Professional Instant Detailer

This detailer quickly lifts off light dust and fingerprints. Just spray on and wipe off to restore that just-washed look. The Professional formula contains no silicone, so it is safe for use near the paint booth. Body shops use it as a last step before delivering a finished vehicle. Use it before pulling your special vehicle out of storage, or after pulling onto the show field. Safe for use on any paint finish including clearcoats. 24 ounce pump spray bottle.

Mothers Professional Instant Detailer, 24 oz
Part No. 3361-112 \$9.49



Mothers VLR Vinyl, Leather, Rubber Care

Quick: Are your leather seats really leather? Or are they vinyl with leather seating surfaces? Who cares! **Mothers VLR** is formulated for use on vinyl, genuine leather, and even rubber weatherstripping seals. Just spray on and rub out any stains. Lanolin and neatsfoot oil condition and protect against drying, fading, and cracking. (Mercedes owners can finally relax and stop wondering if they have M-B Tex or leather seats.) 24 ounce pump spray bottle.

Mothers VLR Vinyl, Leather, Rubber Care, 24 oz
Part No. 3361-034 \$7.99



Mothers Professional Water-Based Degreaser

You want an environmentally-safe degreaser, but you need one that works, too! **Mothers Professional Water-Based Degreaser** is an excellent choice. This non-toxic degreaser is formulated to cut through carbon and baked-on grease. Strong enough for professional use, yet will not harm aluminum or paint. The super-concentrated formula can be diluted 4:1 for light cleaning, 2:1 for general degreasing, or used straight up for heavy jobs. 1 gallon jug.

Mothers Waterless Degreaser, 1 gallon
Part No. 3361-119 \$19.99



Mothers Mag & Aluminum Polish

This is the one that started it all back in the 1970s, when magnesium wheels hit the custom car scene. **Mothers Mag & Aluminum Polish** was quickly recognized as the most effective way to keep magnesium wheels looking great. Use it on any uncoated metal parts: aluminum valve covers, mag wheels, brass trim, even steel brake lines! Strong enough to cut through years of neglect, yet gentle enough for regular use. 5 ounce tub.

Mothers Mag & Aluminum Polish, 5 oz
Part No. 3361 \$5.99



Mothers Polished Aluminum Wheel Cleaner

If you have aluminum rims, this is the wheel cleaner you need! **Mothers Polished Aluminum Wheel Cleaner** safely cleans all types of polished aluminum wheels: uncoated, anodized, painted, clearcoated, or chromed. It quickly dissolves and suspends brake dust, axle grease, and road grime so you can rinse it away with water. Simply spray it on and rinse it off. 24 ounce pump spray bottle.

Mothers Aluminum Wheel Cleaner, 24 oz
Part No. 3361-026 \$5.99



De-Greaser Hand Cleaning Brush

We're all about the time you spend in the garage and at the track, but we still have to go out for dinner with the family once in a while. This brush will help you get ready to be seen in public again, even after a day spent pulling parts at the junkyard. One side has short, stiff bristles mounted at an angle to dig the grime out from under your fingernails. The other side is covered with longer, softer bristles to gently clean your cuticles and sore fingertips. All-plastic construction for long life.

De-Greaser Hand Cleaning Brush Part No. 3730-001... \$3.59

Ordering Information

How To Contact Us

Order Toll Free (US & Canada)

1-800-688-6946

Local/International Order Line
262-317-1234

Technical Support Questions
262-317-1200

Fax Line
262-317-1201

Shop at our convenient online store anytime

PegasusAutoRacing.com

Check for Daily Featured Items and New Products!

General Email Address: CustSvc@PegasusAutoRacing.com

Technical Email Address: Tech@PegasusAutoRacing.com

Payment

Credit Cards We gladly accept Visa, Mastercard and Discover cards.

PayPal When ordering on our website, you also have the option of using your PayPal account. We can also send you a PayPal invoice via email, no matter how you place your order.

Personal Checks For prompt clearance of personal checks sent with orders, please include your telephone number and driver's license number. Please do not send cash. A \$35 fee is assessed each time a check is returned unpaid.

Special Orders require prepayment in full. We can't always guarantee a delivery date on special orders or custom-made items.

Prices

The prices in this catalog were current when printed but are subject to change. We absorb minor cost increases from our suppliers and only raise prices if we must purchase new stock at significantly higher prices. Please check our website to verify current pricing. Incorrect prices due to typesetting errors cannot be honored.

Shipping & Delivery

Most orders are shipped within one business day of receipt.

Free economy shipping to the 48 contiguous states is available on most retail orders over \$199. Shipping charges for all other orders are based on the actual weight and dimensions of each shipment. Large, bulky items are expensive to ship via air delivery methods, regardless of weight. Our website estimates shipping costs for online orders. If we significantly overcharge you for shipping, we will refund the difference.

If the delivery date is critical, please call to confirm expedited shipping requests for fax or internet orders, especially if the order is placed late in the day.

Please allow extra time for customs clearance on orders shipped outside the United States. Due to our large volume of export business, we have been able to negotiate very competitive international shipping rates. Our website provides estimated shipping costs for most international online orders.

Hazardous items such as fire extinguishers and aerosol cans can only be shipped to addresses in the United States and Canada. UPS hazardous shipping fees may apply.

Damaged Goods

Our outstanding claims experience with UPS and FedEx attests to the care that is taken in packaging to prevent shipping damage. Any claim for damage must be made to Pegasus immediately upon receipt. Be sure to save the box and all packing materials. We cannot credit you for the damaged merchandise until UPS or FedEx acknowledges the claim.

Important Notice!

Auto racing is a dangerous sport and products are subject to failure when exposed to the high stresses involved. **All equipment, including safety equipment, is sold without warranty, expressed or implied.** No warranty or representation is made to the product's ability to protect the user from any injury or death. The user assumes the risk. Pegasus is NOT responsible for damage, consequential or otherwise, for equipment failure or mal-performance after installation.

Hours of Operation (Central Time Zone)

Telephone Hours

Monday - Thursday: 8am - 6pm

Friday: 8am - 5pm

Technical Support Line

Monday - Friday: 9am - 5pm

Showroom Hours

Monday - Friday: 9am - 5pm

Saturday: 9am - 1pm

Of course you can submit orders via the Internet or Fax anytime!

How To Find Us



We're located in the New Berlin Industrial Park, just west of Milwaukee (midway between Road America and Blackhawk Farms Raceway). You're welcome to stop by to try on items such as suits, gloves, helmets or shoes. For best service when picking up an order, call ahead and we'll have it ready for you!

Directions From I-94: Exit Moorland Road-South. Drive 1.3 miles south to Lincoln Ave. Turn right on Lincoln Ave., then 1.3 miles west to 179th St. Turn left on 179th Street, drive 1 block south to 2475 S. 179th.

Directions From I-43: Exit at Moorland Road. Drive north 3.7 miles to Lincoln Ave. Turn left on Lincoln Ave., then 1.3 miles west to 179th St. Turn left on 179th Street, drive 1 block south to 2475 S. 179th.

Easy Returns

There is **No Need to Call First**. We will promptly and cheerfully make satisfactory adjustments should an unused item be defective or not as ordered. Please make a copy of the original paperwork that came with your order. Clip out the **Customer Return Label** from the lower right hand corner of the form and place it on the outside of the box. Enclose the remainder of the form with your returned items, and please indicate the reason for the return (defective, wrong size, etc.) and the action you would like taken (exchange, refund, etc.). Returns should be in original, undamaged cartons and in the same condition as received. No returns accepted after 30 days. No returns accepted on books, videos, software or special orders. Returns not due to our error may be subject to a restocking charge. Refunds are made via the original form of payment only. If due to our error, we will refund your return Ground shipping charges.

We respect your right to privacy!

Your personal information is safe with Pegasus. We don't sell or rent our customer files. If you use our website to place orders, track shipments or review your prior orders, you can also rest assured that your personal information is kept safe and private. To learn more about our privacy policy, look for the link at the bottom of any page on our website, or search for "privacy" using the search function on our website.

We try to identify and eliminate duplicate address records before mailing our catalog. However, if you receive duplicate catalogs, please send copies of all mailing labels and indicate which address is correct so that we can update our records.

Custom Seat Insert Kits and Accessories



Creafom Bead Seat Kit
Part No. 4525-Size
Includes instructions, bag
with Creafom beads, resin,
gaffer's tape, and more!

Finished Creafom
Bead Seat Kit
(typical)

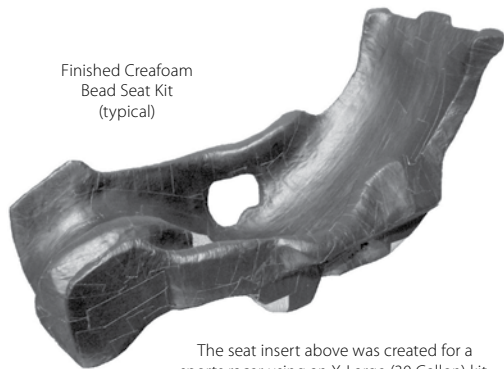

The seat insert above was created for a sports racer using an X-Large (30 Gallon) kit. It was covered using 2 rolls of Gaffer's Tape.

The **Creafom Bead Seat Kit** produces a professional-grade, custom-molded seat insert right in your own garage. The finished insert is similar to the impact-absorbing liner in your helmet, and it can even provide some impact protection when made with sufficient thickness. This type of beaded seat is actually required by some sanctioning bodies. The unique Creafom beads provide far superior impact protection compared to other kits. Each kit includes complete instructions, resin, bag with Creafom beads, and gaffer's tape.

To make an insert, simply place the vacuum bag full of beads in the cockpit or seat shell. Seat the driver and form the shape to the driver's needs, comfort, and support. When ready, mix resin, add it to the bag, and knead. Repeat the previous steps, then attach a vacuum cleaner or vacuum pump (sold separately below) to pull the air out of the bag to start the resin curing. Allow one hour of work time and 7 hours of cure time.

Choose your size based on the amount of room between the seat and the driver. The better the existing seat fits the driver, the smaller the kit you need. For best results, we recommend using too large of a kit rather than too small. Excess material at the edges can be trimmed for a neater appearance when the seat is finished.

Kart Size Creafom Kit, 5 Gallon, 24 x 32 inch BagPart No. 4525-Kart.....\$189.99
For karting seats or very small pads (lumbar pads, headrests, etc.)

X-Small Creafom Kit, 5 Gallon, 48 x 60 inch BagPart No. 4525-XSmall\$194.99
Ideal size for backrests or other partial padding.

Small Creafom Kit, 10 Gallon, 48 x 60 inch BagPart No. 4525-Small\$244.99
Recommended for larger drivers in small formula cars, or medium drivers with existing seat shells.

If the seat already fits the driver, the Small kit will fill up small gaps all around.

Medium Creafom Kit, 15 Gallon, 60 x 72 inch BagPart No. 4525-Medium.....\$294.99
Ideal for F1000 and most DSR. Good for medium-to-small drivers in smaller formula cars.

Large Creafom Kit, 25 Gallon, 60 x 72 inch BagPart No. 4525-Large\$344.99
For medium drivers in cars with no existing seat shell or smaller drivers in very large seat shells.

The Large kit fills up a lot of space between the driver and the cockpit or seat shell.

X-Large Creafom Kit, 30 Gallon, 60 x 72 inch BagPart No. 4525-XLarge\$399.99
This size is appropriate for any driver in a large cockpit with no seat shell.

The finished sports-prototype seat shown at left was made using an X-Large kit.

Note how thick the insert is, all the way from the shoulders down to the knees.

Visit our website for full, step-by-step instructions as well as a brief video illustrating the fitting of a Creafom bead seat kit!

Vacuum Pump for Bead Seat Kits

When making a Creafom bead seat insert, you can use a shop vacuum in a pinch. But the professional method is to use a purpose-built vacuum pump. The **GAST Vacuum Pump** from BSS, the makers of the Creafom seat kits above, is perfect for making custom seat inserts. It will produce better results more quickly than an industrial-strength shop vac. We especially recommend it for pro teams, race prep shops, or anyone else making more than just one or two seats. You can even use it for small-scale, non-structural composite work. Move the hose from the suction port to the outlet port to turn it into a 30 psi compressor pump! Requires 110-220V AC power.

BSS GAST Vacuum PumpPart No. 4527\$199.99



BSS GAST
Vacuum Pump
Part No. 4527

Foam Carving Hot Knife

Trim and shape your custom seat insert like the professionals! A **Foam Carving Hot Knife** minimizes mess by slicing through the foam or beads rather than tearing it apart to scatter all over your shop. A hot knife is also the best way to carve foam plugs for composite molding.

The **HKT 450 Hot Knife** is simple to use, with a spring-loaded safety trigger. Includes a 4.5" straight stainless steel blade. Operates on 110 VAC, 105 watts. Made in Germany.

HKT 450 Foam Carving Hot KnifePart No. 3710-002\$199.99

Replacement Straight Blade for HKT 450 Hot KnifePart No. 3710-004\$39.99

Curved Blade for HKT 450 Hot KnifePart No. 3710-003\$43.99

The **Pro One Hot Knife** has 5 heat settings to give you precise control. The sled can be adjusted to cut at a pre-set depth up to 4 inches, making it ideal for production work. Operates on 110 VAC, 150 watts. Features a straight stainless steel blade and a spring-loaded safety trigger.

Pro One Foam Carving Hot KnifePart No. 3710-001\$47.49



HKT 450
Foam Carving Hot Knife
Part No. 3710-002



Curved Blade for
HKT 450 Hot Knife
Part No. 3710-003



Pro One Foam Carving Hot Knife
Part No. 3710-001
Adjustable "sled" cutting
guide with depth scale

Seat Insert Covering

We offer several options to cover your custom seat insert. Our matte **Gaffer's Tape** is similar to the black tape supplied with Creafom beaded seat insert kits. It is perfect for a quick "upholstery" job, especially on a one-time-use seat insert. Gaffer's Tape is available in Black, Blue, Red, White, or Yellow. For a more finished appearance, we carry long-wearing **Woven Black Nomex® Fabric** with a matte finish. For an even more professional-looking and comfortable seat, we also offer **Knit Black CarbonX Fabric**. This material is more stretchy than woven Nomex® for easier installation, with better moisture wicking properties. Either fabric can be applied with our **High-Temperature Spray Adhesive** (sold separately).

Gaffer's Tape, 2" x 60 yard roll, specify colorPart No. 3436-001-Color\$19.79

Knit Black CarbonX Fabric, per linear foot (60" wide)Part No. CarbonX-278\$21.99/ft.

Woven Black Nomex® Fabric, per linear foot (60" wide)Part No. 2134-Black\$19.99/ft.

High-Temp Spray Adhesive, 16.75 oz. aerosol canPart No. 1835-020\$17.90



Gaffer's Tape
Part No. 3436-001-Color

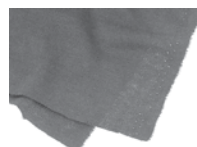

Knit CarbonX Fabric
Part No. CarbonX-278



Woven Nomex® Fabric
Part No. 2134-Black

Racing Spirit Clothing by OMP



Racing Spirit
The Original Racing Co.
EST. 2012



Polos, Hoodies, Jackets, Hats, and Tees with designs from mild to wild



Visit our website for the entire collection:
PegasusAutoRacing.com/RacingSpirit

Beta Tools Storage Systems



Beta Tools C53 CargoEvolution Wall Cabinet
Part No. BT-053000001 \$947.55
Tools and hooks sold separately



Beta Tools C25 TANK Trolley
Part No. BT-025000001 \$815.85
Tools sold separately



Beta Tools C57 Mastercargo Wall Cabinet
Part No. BT-057000020 \$1,504.44
Tools and hooks sold separately



Niki Lauda with Beta
C53 Cabinet, 1976



Vittorio Brambilla and crew with
Beta C25 "TANK" Trolley, 1974



Porsche GT3 Cup mechanics
trackside with Beta C57P Cabinets, 2013



Pegasus Auto Racing Supplies, Inc.
 2475 S 179th Street
 New Berlin, WI 53146-2150 USA
 1-800-688-6946

PRSTD STD
 U.S. Postage
PAID
 Pegasus Auto
 Racing Supplies

Customer No.:

Key Code:



When not providing superior customer service, we're often working on our own racing vehicles or competing on the track. We use the products in this catalog. We can answer your questions.

Ryan Hahn photo



Bob

Dave Klein photo



Jay

Jake Rawison photo



Suzie

Pegasus employees have vast experience in many racing classes including:

- Autocross, TT, Hillclimb, #GRIDLIFE
- SCCA Improved Touring A, B & C
- EP, FP, Spec Miata, Spec Racer Ford
- GT-1, GT-3, GT-5 and GT Lite
- Many formula and sports racing classes including Formula Vee, Formula Ford, Club Formula Ford, Formula Continental, S2000, Formula Atlantic, Toyota Atlantic

Pegasus employees include:

- Professional Race Mechanics
- Professional and Volunteer Competition Driving Instructors
- Tech Inspectors
- Worker of the Year
- Driver of the Year
- Sportsman of the Year
- SCCA Runoffs® Competitors
- Race winners & class champions

Eddie Schoeman photo



John

Perry Bennett photo



Bart

Order Toll Free (US & Canada)
1-800-688-6946

Local/International Order Line
 262-317-1234

Technical Questions
 262-317-1200

Email: CustSvc@PegasusAutoRacing.com
 Technical Email: Tech@PegasusAutoRacing.com

PegasusAutoRacing.com

PegasusAutoRacing.com

Free shipping on most \$199 orders to 48 states!
 Every order earns a chance to win \$5,000 CASH!

No purchase necessary - see website for details.



Chris (1980)