

# HD MCU System

Operating Instructions (Version 1.0)

PCS-MCS1

**IPELA**

---

# Table of Contents

<b>Precautions</b> .....	<b>4</b>
--------------------------	----------

---

## Chapter 1: Preparation

<b>Features</b> .....	<b>5</b>
Operational Flow .....	5
<b>System Components</b> .....	<b>6</b>
Supplied Components.....	6
Optional Accessories .....	6
Configuration Examples .....	6
<b>System Configurations</b> .....	<b>7</b>
LAN Connections .....	7
Internet Connections.....	8
<b>Turning the Unit On/Off</b> .....	<b>9</b>
Turning the Unit On .....	9
Turning the Unit Off.....	9
<b>Initial Setup</b> .....	<b>10</b>
Computer Settings .....	10
Initial Setup Wizard.....	12
End-User License Agreement.....	14
<b>Basic Operations</b> .....	<b>15</b>
User Types.....	15
Logging into the Unit from a Computer .....	15
Viewing the Web Control Screen.....	16

---

## Chapter 2: Conferences

<b>Starting Conferences</b> .....	<b>18</b>
Conducting Conferences in Web Control Mode.....	18
Conducting Conferences in Ad Hoc Mode.....	18
<b>Outgoing Calls</b> .....	<b>19</b>
Calling via Contact Information Entry .....	19
Calling via Histories .....	19
Calling via the Phonebook.....	20
<b>Incoming Calls</b> .....	<b>21</b>
Answer Modes (Manual/Auto).....	21
<b>Ending Connections</b> .....	<b>22</b>

<b>Registering Contacts to the Phonebook</b> .....	<b>22</b>
Registering New Contacts.....	22
Editing the Phonebook .....	23
Deleting Registered Contacts.....	23
<b>External Access to the Unit</b> .....	<b>23</b>
Using Telnet.....	23
Using SSH.....	23
<b>Picture Displays during Conferences</b> ...	<b>24</b>
Broadcast Modes.....	24
[Layout] Screen.....	25

---

## Chapter 3: Settings and Administration

<b>Setting Menus</b> .....	<b>27</b>
Displaying and Configuring Settings .....	27
Setting Pages and Items .....	27
<b>Displaying Device Information</b> .....	<b>34</b>
Displaying Device Information.....	34
[Machine Information] Page .....	34
[Peripheral Status] Page .....	34
[Communication Mode Status] Page .....	34
[Network Routing Check] Page .....	35
[EULA] Page.....	35
<b>Restrictions when Using LAN2</b> .....	<b>36</b>
<b>Network Configuration Setups</b> .....	<b>37</b>
LAN Connection Using DHCP (LAN1/LAN2).....	37
LAN Connection Using a Router (LAN1/LAN2).....	37
LAN Connection Using a Gatekeeper (LAN1 Only).....	37
LAN Connection Using NAT (LAN1 Only).....	38
LAN Connection Using H.460 Firewall Traversal (LAN1 Only).....	39
LAN Connection Using PPPoE (LAN1/LAN2).....	39
<b>Network Routing Checks</b> .....	<b>40</b>

---

## Chapter 4: Maintenance

<b>Adding Optional Software .....</b>	<b>41</b>
Verifying Proper Installation of Optional Software.....	41
<b>Verifying the Unit's Settings .....</b>	<b>42</b>
Saving Configurations to USB Storage Devices .....	42
Viewing or Editing Exported Configuration Files .....	42
<b>Updating the Unit's Firmware .....</b>	<b>43</b>
Updating the Firmware via a USB Storage Device.....	43
Updating the Firmware via the Web Control Screen .....	43
<b>Loading Configurations.....</b>	<b>44</b>

---

## Chapter 5: Encrypted Connections

<b>Preparing for Encrypted Connections.....</b>	<b>45</b>
<b>Starting Encrypted Connections .....</b>	<b>46</b>

---

## Appendix

<b>Parts Identification .....</b>	<b>47</b>
Front Panel.....	47
Rear Panel.....	47
<b>Troubleshooting .....</b>	<b>49</b>
<b>Specifications .....</b>	<b>51</b>
PCS-MCS1 HD MCU System.....	51
AC Adapter (Supplied).....	51
PCSA-MPE1 HD Port Expansion Software (Optional) .....	52
PCSA-MPE2 HD Port Expansion Software (Optional) .....	52
PCSA-MSA1 Mobile Access Software (Optional) .....	52
Pin Assignments .....	53
<b>Ports Used on the PCS-MCS1 .....</b>	<b>53</b>
<b>USB Storage .....</b>	<b>54</b>
<b>Glossary .....</b>	<b>54</b>

<b>Menu Configuration .....</b>	<b>56</b>
<b>Index.....</b>	<b>61</b>

---

“IPELA” and **IPELA** are trademarks of Sony Corporation.

---

# Precautions

## Operating or storage location

Avoid operating or storing the system in the following locations:

- Extremely hot or cold places
- Humid or dusty places
- Places exposed to strong vibration
- Close to sources of strong magnetism
- Close to sources of powerful electromagnetic radiation, such as radios or TV transmitters

## Cleaning

Use a soft, dry cloth to gently wipe the cabinet and panel when cleaning the unit.

For heavier cleaning, use a cloth lightly moistened with a mild detergent to remove the dust, and finish by wiping again with a dry cloth. Do not use volatile solvents such as alcohol, benzene, thinners, or insecticides as they may damage the surface finishes.

## Chapter 1: Preparation

### Features

The PCS-MCS1 HD MCU System is a system that allows audiovisual communication between multiple remote terminals. Each remote terminal can access the unit to participate in a multipoint conference.

#### Convenient system scalability

The unit's compact size and simplified LAN-connector interface allows you to expand your system with ease.

#### Connection of up to 16 points

Standard equipped to allow communication between 4 points, installing the PCSA-MPE1/MPE2 HD Port Expansion Software (not supplied) allows communication with up to 16 points.

#### Connection from mobile terminals

Installing the PCSA-MSA1 Mobile Access Software (not supplied) allows connection to the unit from a mobile terminal.

#### QoS (quality of service) functions for optimizing communication based on network traffic

The unit features a packet resend request, adaptive rate control, and forward error correction functions. Depending on the network status, these functions are used in combination to guarantee consistent high-quality communication.

#### Display of up to 16 images

Images from all 16 possible points can be displayed simultaneously on each terminal connected to the unit, allowing real-time assessment of conditions at each point.

#### Simultaneous LAN/WAN connection

The dual network function allows simultaneous LAN/WAN connections where terminals on different networks can participate in the same conference.

### Two conference modes

The unit features two conference modes; web control mode for controlled conferences, and ad hoc mode for quick conducting of multipoint conferences.

### Encrypted connections

The unit allows strictly confidential communications using standard encryption that complies with the ITU-T H.235 standard.

### Operational Flow

Refer to the relevant chapters as necessary when operating the unit.

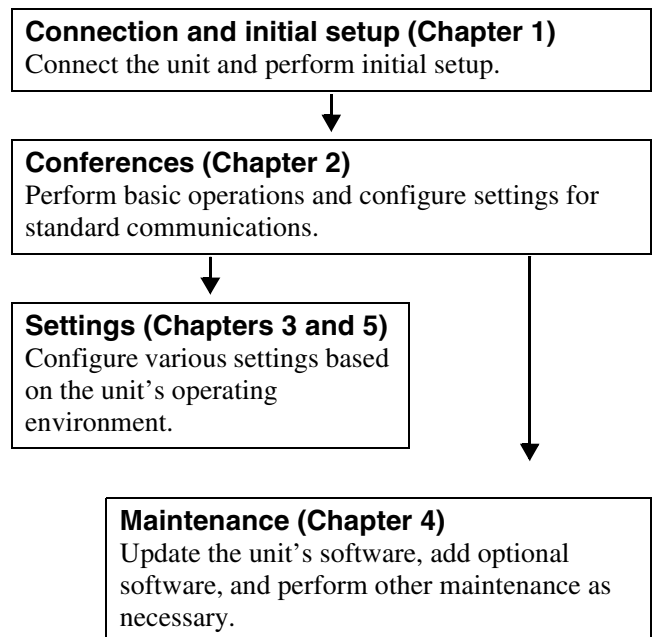

# System Components

## Supplied Components

### PCS-MCS1 HD MCU System

MCU equipped with multipoint connection functions.

### AC adapter

Supplies power to the unit.

### Power cord (Japan and China only)

## Optional Accessories

### PCSA-MPE1/MPE2 HD Port Expansion Software

Installing the HD Port Expansion Software on the unit allows connections with up to 16 points.

- PCSA-MPE1: Increase the maximum number of connected points from 4 points to 10 points.
- PCSA-MPE2: Increase the maximum number of connected points from 10 points to 16 points.

#### Note

You cannot install the PCSA-MPE2 HD Port Expansion Software without first installing the PCSA-MPE1 software. Always install the PCSA-MPE1 software first.

### PCSA-MSA1 Mobile Access Software

Installing this software on the unit allows connection to the unit from mobile terminals.

#### Note

The maximum number of mobile terminals that can be connected varies depending on which HD Port Expansion Software is installed on the unit.

Standard (HD Port Expansion Software not installed):

4 points

PCSA-MPE1 installed: 10 points

PCSA-MPE2 installed: 16 points

# Configuration Examples

## Standard configuration

You can conduct conferences with up to 4 points via a LAN.

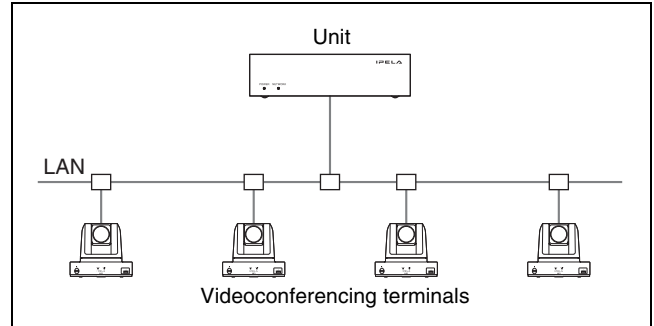

## Expanded configuration

By installing the PCSA-MPE1 and PCSA-MPE2 HD Port Expansion Software, you can connect to up to 16 points.

For details on installing the software, see "Adding Optional Software" (page 41).

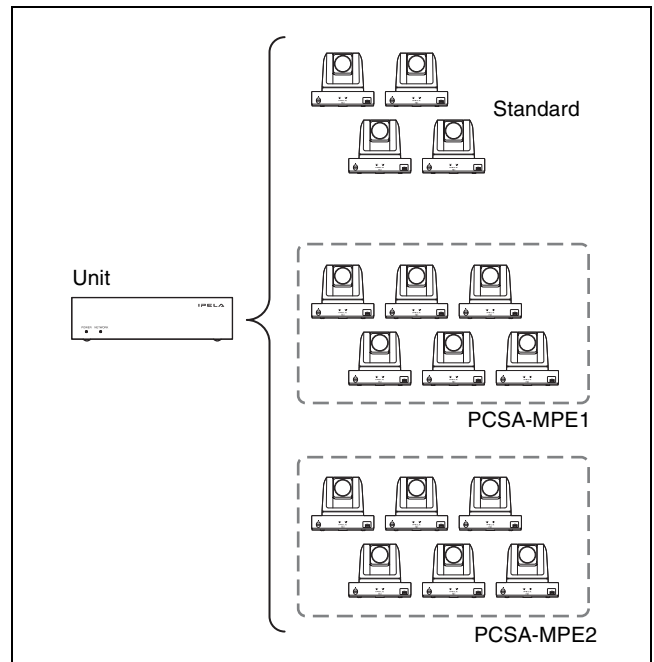

## Configuration with mobile terminal support

By installing the PCSA-MSA1 Mobile Access Software, you can connect from mobile terminals.

*For details on installing the software, see “Adding Optional Software” (page 41).*

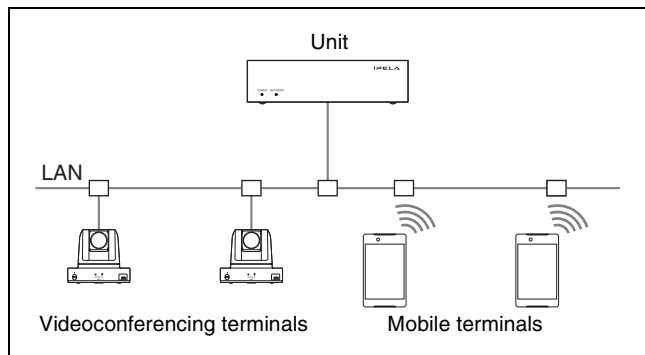

## System Configurations

You can configure a variety of systems by connecting various combinations of the unit, videoconferencing terminals, and computers.

### LAN Connections

#### Web control mode

Connect the unit, videoconferencing terminals, and computers located on the LAN via a network hub. To conduct a conference, log into the unit from a computer. The user that is logged into the unit holds the conference control privilege and can control the unit via a web browser.

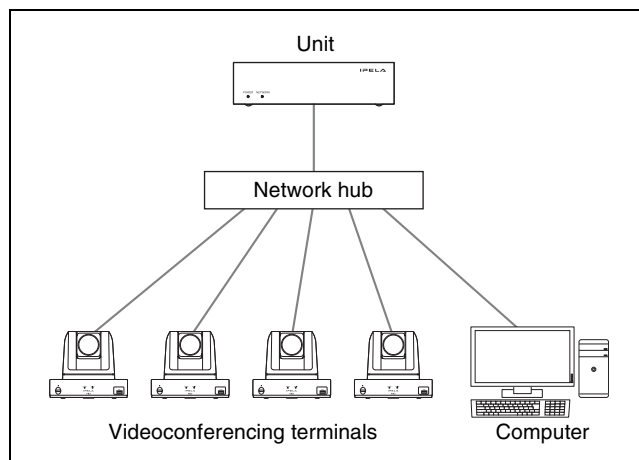

#### Note

- When connecting the unit to a network, use the LAN1 connector.
- Conferencing in web control mode is not possible when there is no user logged into the unit from a computer.

## Ad hoc mode

Connect directly to the unit from each videoconferencing terminal to conduct a conference, without the use of a computer.

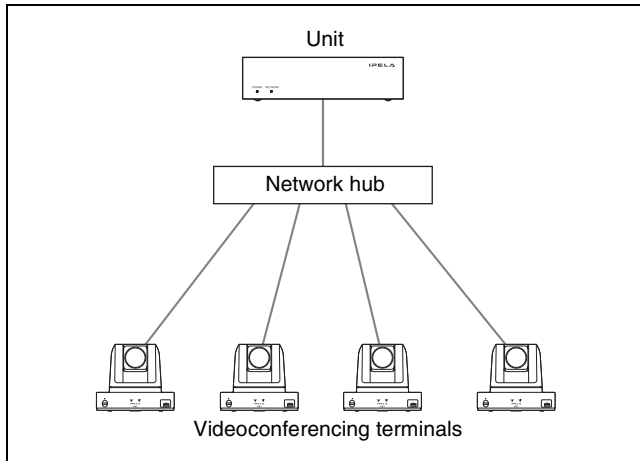

### Note

- Connection is only possible when [Ad hoc] is set to [On] on the [Answer] page of the [Admin] screen and a user is not logged into the unit from a computer.
- If a user logs into the unit from a computer during a conference, the conference will switch to web control mode, and the user that logged in will hold the conference control privilege.

## Internet Connections

In addition to a LAN, connections can include external terminals connected via the Internet.

### Connecting via the LAN2 connector

When connecting to the Internet, prepare an internet line dedicated to videoconferencing, and connect it to the LAN2 connector.

You cannot use a web browser to control the unit from a computer that is connected via the LAN2 connector.

### Connecting directly to the provider (recommended)

As the unit is equipped with a PPPoE function, you can connect it directly to the provider without the use of a broadband router.

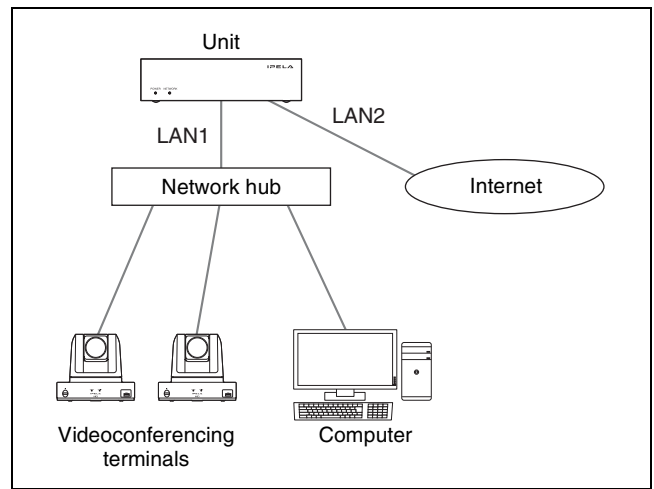

### Connecting via a broadband router

You can also use a broadband router when connecting to the Internet.

In such cases, configure the PPPoE and port forwarding settings on the router.

### Note

- The name of the port forwarding function may differ depending on your router and may be called “port mapping,” for example. For details, refer to the operating instructions for your router.
- When connecting a NAT cable to the LAN2 connector or using a private address for LAN2, configure a private address of a different class than that of LAN1.

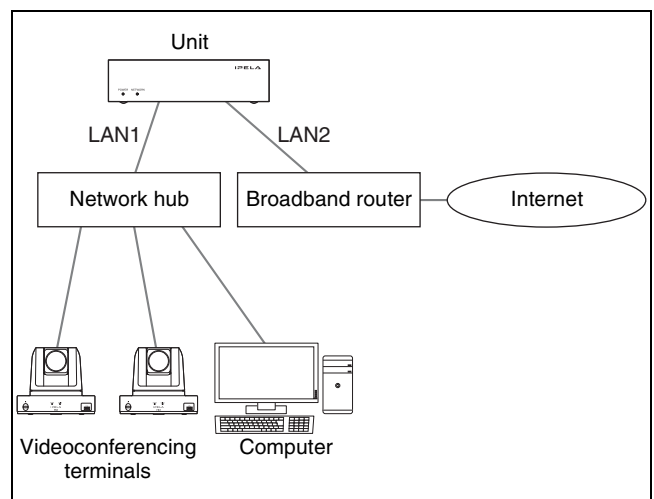



## Connecting via the LAN1 connector

If an internet line dedicated to videoconferencing is not available, use the LAN1 connector to connect to the Internet. However, be aware that this connection method involves some security risk.

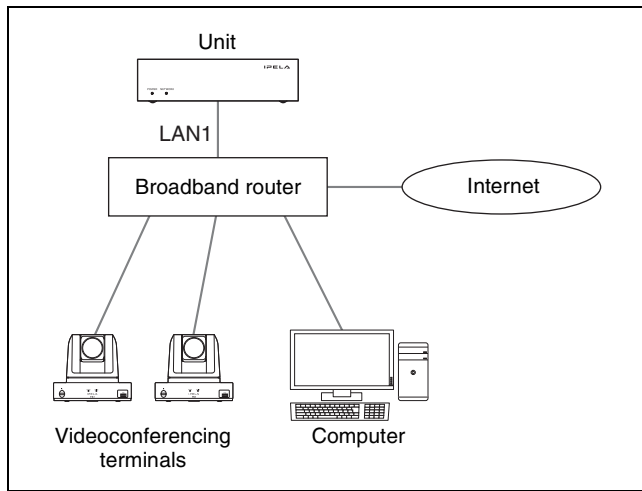

# Turning the Unit On/Off

## Turning the Unit On

- 1 Connect the LAN cable, AC adapter, and power cord to the rear panel of the unit.

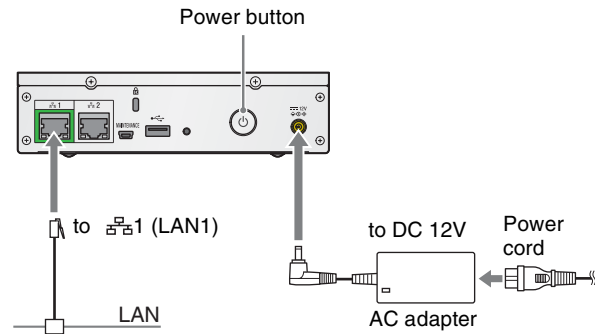

### Note

Always connect the LAN cable to the LAN1 connector. The LAN2 connector is used for connecting to the Internet.

- 2 Press the unit's power button.

When the POWER indicator on the front panel of the unit changes from blinking to remaining steadily lit green, startup is complete.

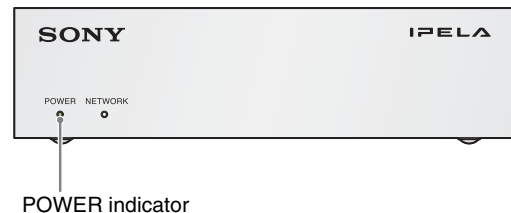

## Turning the Unit Off

Press the unit's power button twice in succession. The POWER indicator will blink orange while the unit is shutting down and turn off when shutdown is complete.

# Initial Setup

## Computer Settings

Perform initial setup of the unit from a computer's web browser.

Be sure to check the connection status and settings on the computer that will be used for initial setup.

- Connect the computer and unit to the same network via a wired connection.
- If proxy settings are configured on the computer, check and configure the [Internet Options] settings.

### Note

- Changing the computer's settings requires an administrator account.
- If you changed the computer's settings, return the settings to their original configurations after performing initial setup.

## Opening the Control Panel on the computer

### For Windows 7

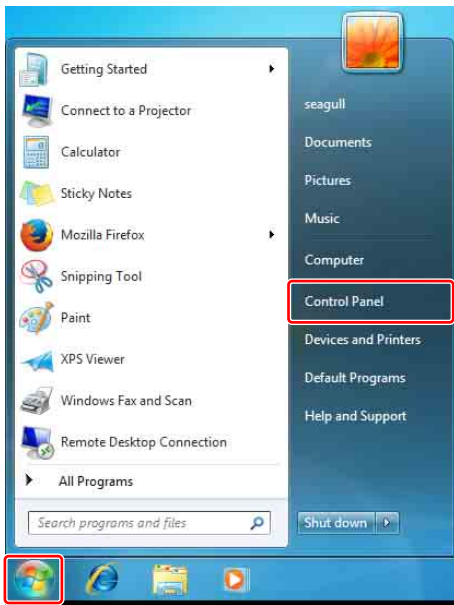

Click the Start button, and select [Control Panel] in the menu that appears.

**For Windows 8, Windows 8.1, or Windows 10**  
Press the X key while holding down the Windows key, and select [Control Panel] in the menu that appears.

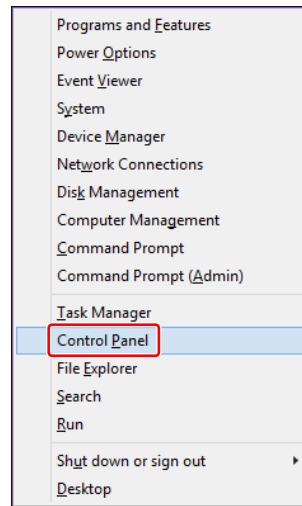

## Connecting the computer and unit to the same network via a wired connection

The following procedure uses Windows 7 as an example.

- 1 Open the Control Panel, and click [Network and Sharing Center] > [Local Area Connection].

### Note

[Local Area Connection] does not appear if a LAN cable is not connected to the computer.

The [Local Area Connection Status] dialog box appears.

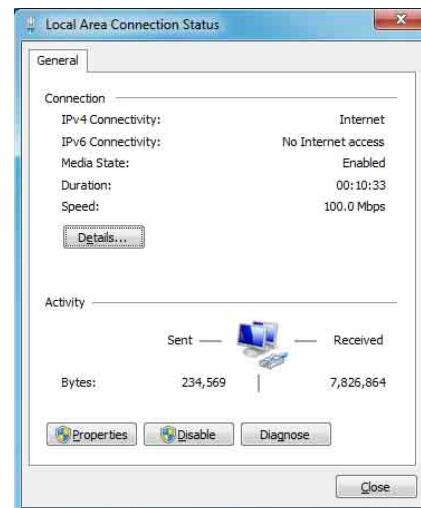

- 2 Click [Properties].

The [Local Area Connection Properties] dialog box appears.

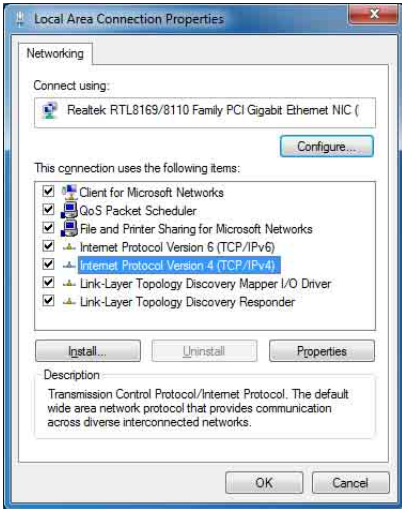

- 3 Select [Internet Protocol Version 4 (TCP/IPv4)], and click [Properties].

The [Internet Protocol Version 4 (TCP/IPv4) Properties] dialog box appears.

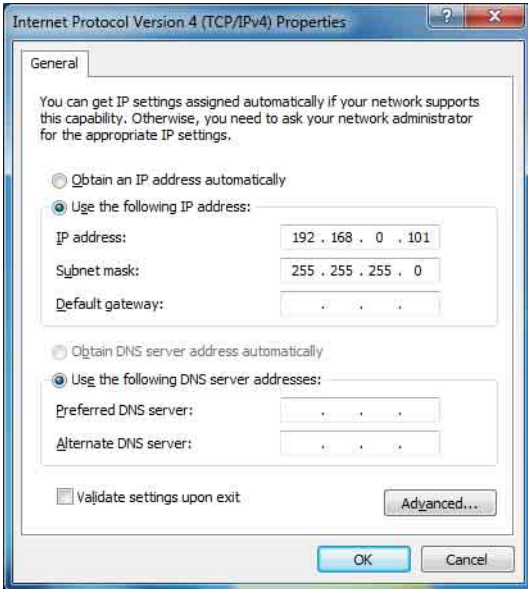

#### Note

After performing initial setup for the unit, you must restore the properties to their original configurations. Be sure to write down the settings in the [Internet Protocol Version 4 (TCP/IPv4) Properties] dialog box.

- 4 Select [Use the following IP address], specify the IP address and subnet mask, and then click [OK].

Specify “192.168.0.XXX” for the IP address. Enter a number from 1 to 99 or 101 to 254 for “XXX.” Specify “255.255.255.0” for the subnet mask.

## Checking the [Internet Options] settings

The following procedure uses Windows 7 as an example.

- 1 Open the [Control Panel], and click [Internet Options].

The [Internet Properties] dialog box appears.

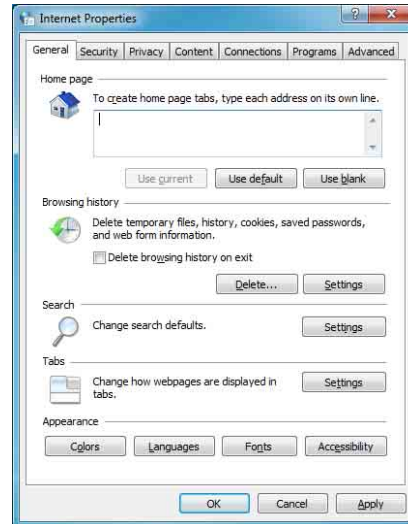

- 2 Click the [Connections] tab, and click [LAN settings].

The [Local Area Network (LAN) Settings] dialog box appears.



- 3 If the [Use automatic configuration script] and [Use a proxy server for your LAN] checkboxes are selected, clear them and click [OK].

## Verifying the JavaScript settings

The following procedure uses Internet Explorer 11 in Windows 7 as an example.

- 1 Open the [Control Panel], and click [Internet Options].

The [Internet Properties] dialog box appears.

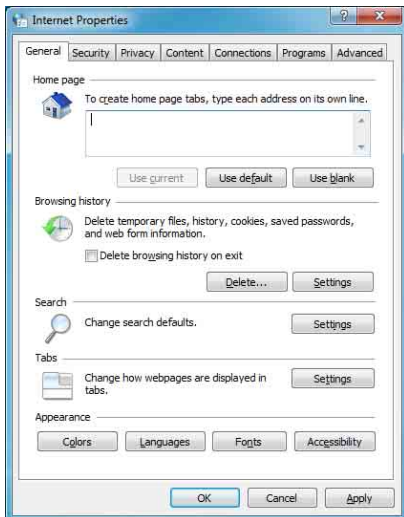

- 2 Click the [Security] tab, and click [Trusted sites] > [Sites].

The [Trusted sites] dialog box appears.

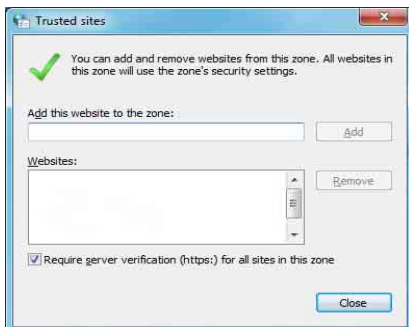

- 3 Clear the [Require server verification (https:) for all sites in this zone] checkbox, enter “http://192.168.0.100” for [Add this website to the zone], and click [Add].

### Note

If you change the IP address during initial setup, be sure to add the new IP address as well.

- 4 Verify that “http://192.168.0.100” appears under [Websites], and click [Close].

- 5 Click [Custom level] when the [Internet Properties] dialog box appears again.

The [Security Settings - Trusted Sites Zone] dialog box appears.

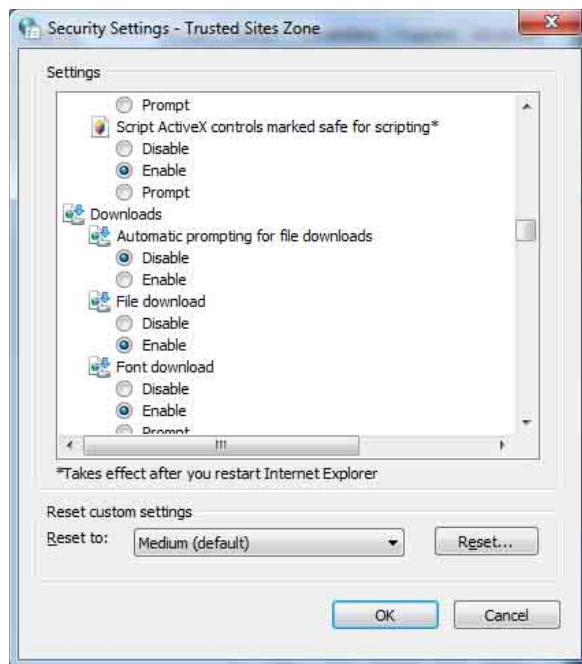

- 6 Scroll down the list, set [Active scripting] and [File download] to [Enable], and click [OK].

If the “Are you sure you want to change the settings for this zone?” message appears, click [Yes] (or [Yes] > [Apply]).

- 7 Click [Close] when the [Internet Properties] dialog box appears again.

## Initial Setup Wizard

Use the initial setup wizard to configure the following.

- Clock settings
- Network settings
- Administrator password

- 1 Start a web browser on the computer, and enter the unit’s IP address in the address bar.

The default IP address is “192.168.0.100.”



- 2 Enter the user name and password in the dialog box that appears, and click [OK].

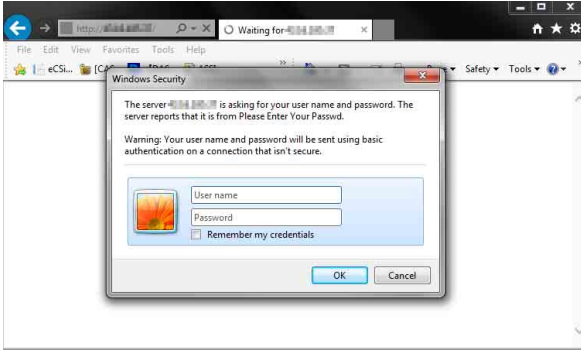

The user name and factory default password are as follows.

User name: sonypcs  
Password: sonypcs

#### Note

Change the password using the initial setup wizard described later. The user name cannot be changed.

When accessing the unit from a computer for the first time, the initial setup wizard appears.

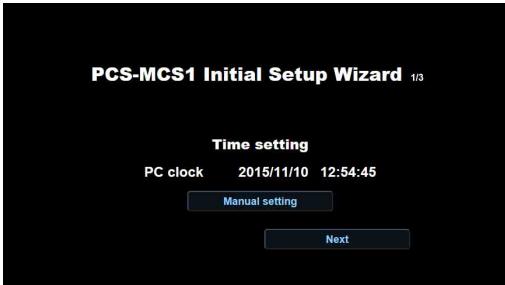

- 3 Configure the clock settings.

The date and time configured on the computer accessing the unit is displayed.

To apply the displayed date and time to the unit, click [Next].

To configure a different date and time, click [Manual setting] and change the settings.

If you want to cancel manual settings change after clicking [Manual setting] and use the computer's date and time settings, click [Synchronize with PC].

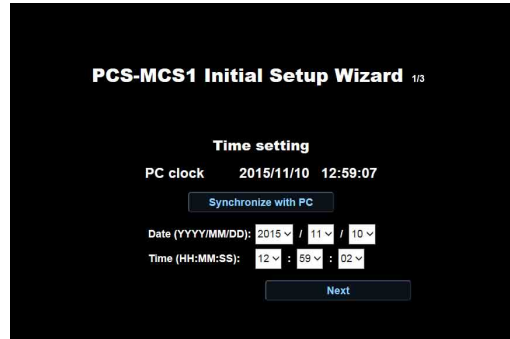

#### Note

The time zone will be set to Greenwich Mean Time (GMT). To change the time zone, log into the unit after initial setup is complete and change the settings.

- 4 Configure the network settings.

Configure each setting, and click [Next].

#### [DHCP Mode]

Set this to [On] to use DHCP.

#### [IP Address]

A static IP address (192.168.0.100) is configured as a factory default. Change this if necessary.

#### [Network Mask]

“255.255.255.0” is configured as a factory default. Configure the network mask according to your operating environment.

#### [Gateway Address]

“192.168.0.254” is configured as a factory default. Configure the gateway address according to your operating environment.

#### Note

When [DHCP Mode] is set to [On], the IP address may change whenever the unit is restarted. As a result, you will need to determine the IP address each time to access the unit.

*For details on determining the unit's IP address, see “Verifying the Unit's Settings” (page 42).*

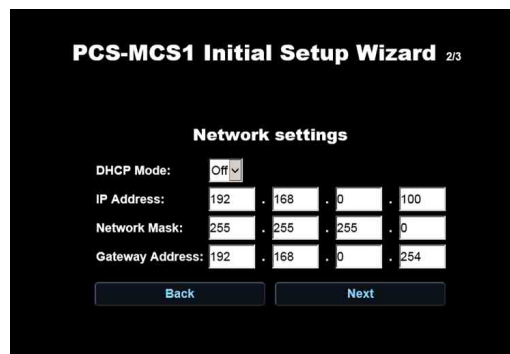

## 5 Configure the administrator password.

This is the password for the administrator account (user name: sonypcs) for which all unit operations (settings configuration, call/answer controls, etc.) are enabled.

After changing the factory default password, click [Finish and Restart].

### Hint

The administrator password can be changed later via the setting menus.

For details on changing the password, see “[Password] page” (page 33).

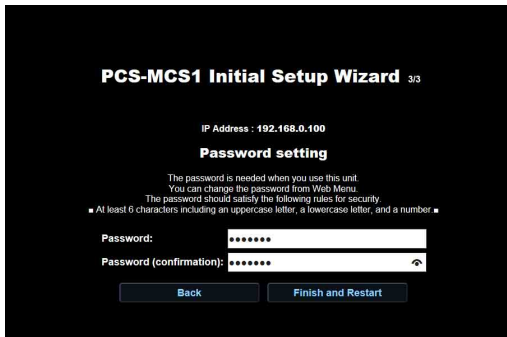

The unit will restart. (The process will take about 1 minute.) Verify that the unit’s POWER indicator is lit orange.

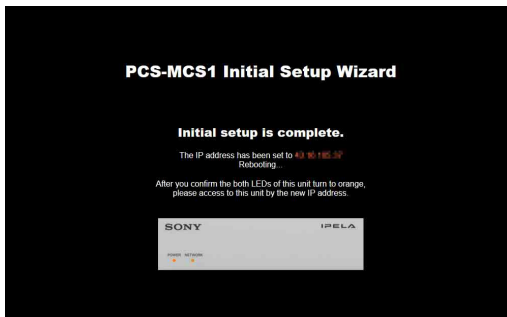

This completes initial setup.

### Note

- The configured password will be required at the next and subsequent logins. Be sure to remember it.
- If you forget the password, contact your Sony dealer. In such cases, the unit must be initialized, so all phonebook contacts, histories, and settings data stored on the unit will be lost.

## End-User License Agreement

When you complete initial setup and you log into the unit for the first time, the end-user license agreement screen appears.

After agreeing to the terms, the screen will not appear at subsequent logins.

### Note

The unit cannot be operated until you agree to the end-user license agreement terms.

- 1 Enter the configured IP address in the web browser’s address bar.



### Note

If you set [DHCP Mode] to [On] during initial setup, the IP address may change whenever the unit is restarted. As a result, you will need to determine the IP address each time to access the unit.

For details on determining the unit’s IP address, see “Verifying the Unit’s Settings” (page 42).

A dialog box appears.

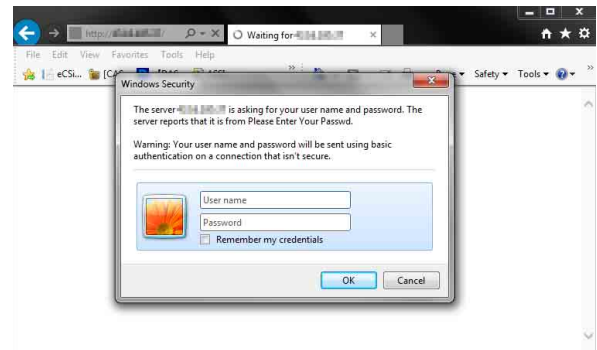

- 2 Enter the administrator user name and password, and click [OK].

Enter “sonypcs” for the user name and the password you configured during initial setup.

The end-user license agreement screen appears.



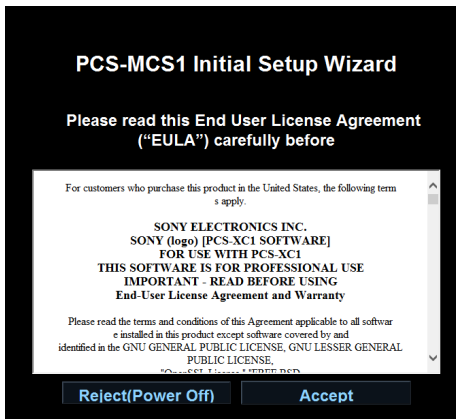

3 Click [Accept].

Login to the unit completes, and the web control screen appears.

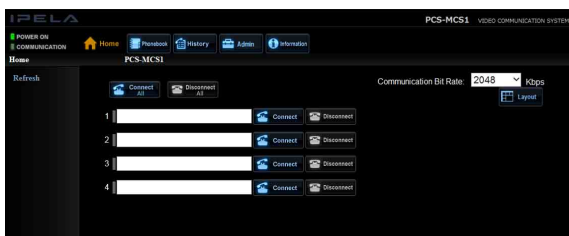

#### Note

If you do not agree to the end-user license agreement terms, the unit will turn off.

## Basic Operations

### User Types

User names and passwords are required to log into the unit from a computer.

There are two types of user names with each possessing different privileges.

#### Administrator

The user name for this type is “sonypcs.”

This user can perform all unit operations (settings configuration, call/answer controls, etc.).

The password is configured via the initial setup wizard.

#### Hint

The password can be changed via the setting menus after login.

*For details on changing the password, see “[Password] page” (page 33).*

#### Web access user

The user name for this type is “pcuser.”

This user cannot configure settings but can perform operations during conferences, such as call/answer controls.

The login password for web access users must be configured beforehand by the administrator via the [Admin] screen.

*For details on configuring the web access user password, see “[Password] page” (page 33).*

## Logging into the Unit from a Computer

#### Note

Multiple users cannot log into the unit at the same time. If another user is already logged in when you perform the login procedure, a message will appear and login will not be possible.

1 Enter the IP address assigned to the unit in the web browser’s address bar.

Example: `http://xxx.xxx.xxx.xxx/`

(“xxx.xxx.xxx.xxx” represents the IPv4 address.)

### Note

- When a proxy server on an external network segment is configured, the gateway address configured in the unit's LAN settings must also be specified. Alternatively, you can set your web browser's proxy setting to "No Proxy."
- Depending on your operating environment, access to the unit from a computer may not be possible. In such cases, contact your network administrator.

**2** Enter the user name and password in the dialog box that appears, and click [OK].

When login to the unit is complete, you will acquire the web control privilege, allowing you to control conferences and configure settings via the web control screen displayed in the web browser.

### Note

- Log in as the administrator (user name: sonypcs) when logging in for the first time.
- When you complete initial setup and log in for the first time, the end-user license agreement screen appears. Click [Accept]. If you do not agree to the terms, the unit will turn off.

## Viewing the Web Control Screen

When you log into the unit from a computer, the web control screen appears.

### Note

- When viewing the web control screen, do not use the F5 keyboard key or the "back" button of your web browser.
- The web control screen may not be displayed properly depending on the encoding setting on your web browser. In such cases, change the encoding setting to UTF-8 or Shift JIS.

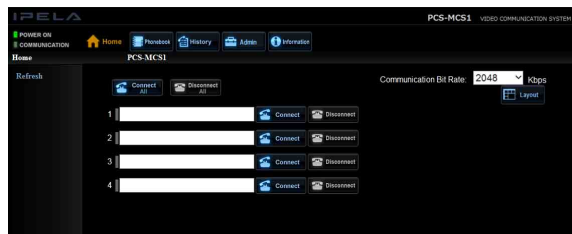

Various control buttons appear in the web control screen, allowing you to configure the unit's settings, conduct conferences, and perform other operations.

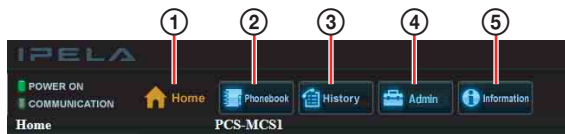

### ① [Home] button

Click this to display the [Home] screen.

This is the first page that is displayed when you log into the unit from a computer. You can perform operations, such as entering an IP address to call a terminal or disconnecting from a connected terminal, on this screen.

*For details on the contents of the [Home] screen, see "[Home] screen" (page 17).*

### ② [Phonebook] button

Click this to display the [Phonebook] screen.

You can perform operations, such as calling registered contacts and adding or editing contacts, on this screen.

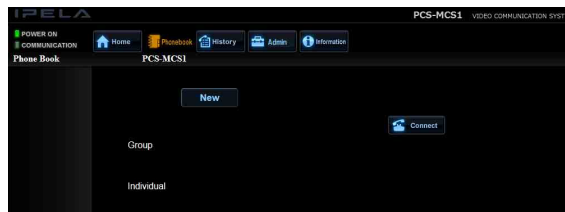

*For details on the phonebook, see "Registering Contacts to the Phonebook" (page 22).*

### ③ [History] button

Click this to display the [History] screen.

You can view histories of outgoing calls, answered calls, missed calls, or unknown calls on this screen.

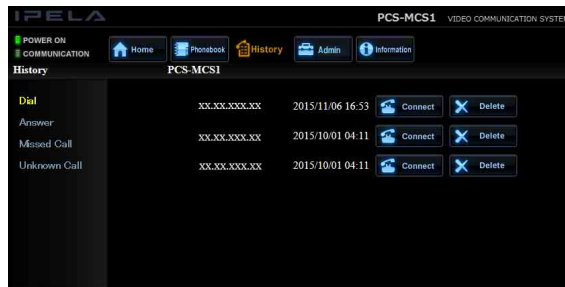

*For details on histories, see "Calling via Histories" (page 19).*

### ④ [Admin] button

A settings menu appears at the left side of this screen, and you can click each item to view or configure the corresponding settings.



## Note

You cannot click the [Admin] button when logged in as a web access user (user name: pcsuser). To view or configure settings, log in as the administrator (user name: sonypcs).



For details on the [Admin] screen's settings, see "Setting Menus" (page 27).

### ⑤ [Information] button

Click this to display the [Information] screen. You can view information on the unit and connected terminals or the communication mode status on this screen. You can also perform network routing checks.

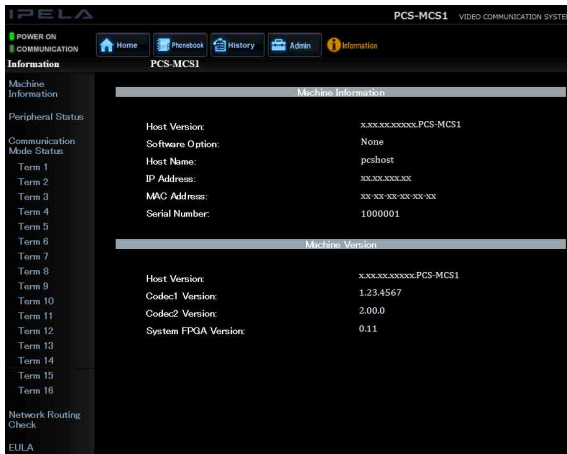

For details on the information, see "Displaying Device Information" (page 34).

## [Home] screen

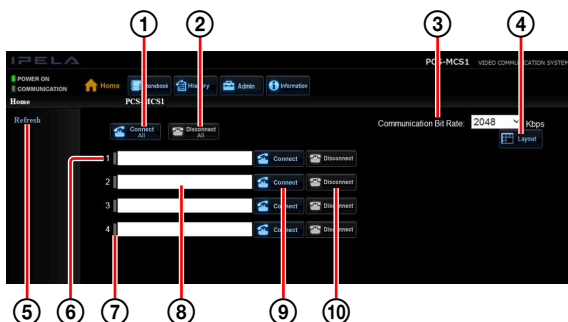

## Note

The number of terminals for which information is displayed on the [Home] screen is the same as the unit's maximum number of connection points. Ordinarily, information for 4 terminals is displayed, while information for 10 or 16 terminals is displayed when the PCSA-MPE1 or PCSA-MPE2 HD Port Expansion Software is installed, respectively.

### ① [Connect All] button

Establish connections to all terminals for which you entered contact information.

### ② [Disconnect All] button

Disconnect all currently connected terminals.

### ③ Communication bit rate

Select the communication bandwidth to use per terminal.

### ④ [Layout] button

Display the [Layout] screen.

The [Layout] screen allows you to configure settings for the content displayed on each connected terminal's monitor during a conference.

For details on the [Layout] screen, see "[Layout] Screen" (page 25).

### ⑤ [Refresh] button

Update the contents displayed in the [Home] screen to the latest information.

### ⑥ Terminal number

This is the number assigned to each terminal.

### ⑦ Communication status bar

This lights green when connection with a terminal is established.

### ⑧ Contact entry field

Enter a terminal's contact information here.

### ⑨ [Connect] button

Click this to connect to a terminal for which contact information is entered to the left of the button.

### ⑩ [Disconnect] button

Disconnect from currently connected terminals individually.

# Starting Conferences

### Note

Do not insert or remove USB storage devices while a conference is in progress.

## Conducting Conferences in Web Control Mode

- 1 Log into the unit from a computer to acquire the web control privilege.

*For details on logging into the unit, see “Logging into the Unit from a Computer” (page 15).*

- 2 On the web control screen, call the other terminals that will participate in the conference, or answer calls received from other terminals.

*For details on calling other terminals, see “Outgoing Calls” (page 19).*

*For details on answering calls, see “Incoming Calls” (page 21).*

When all of the participating terminals are connected, you can conduct the conference.

### Note

- The conference will continue in web control mode for as long as there are connected terminals, even if the web browser is accidentally closed or the user temporarily logs out of the unit. However, when [Auto Answer] is set to [Off], calls cannot be received from other terminals when a conference is already in progress, preventing additional participants. In such cases, log in again.
- Automatic logout will occur if no operations are performed for 30 minutes after login.

### To add participants during a conference

The user holding the web control privilege can control calls, even while a conference is in progress. As long as the maximum number of connection points is not exceeded, you can add participants by calling or answering calls on the web control screen.

### Note

Calls cannot be made from the [Phonebook] screen during a conference. To make calls during a conference, do so from the [Home] or [History] screen.

## Conducting Conferences in Ad Hoc Mode

Ad hoc mode allows terminals to connect directly to the unit and conduct conferences without having to log into the unit from a computer.

Ad hoc conferences can only be conducted when [Ad hoc] is set to [On] on the [Answer] page of the [Admin] screen and a user is not logged into the unit from a computer.

### Note

In ad hoc mode, terminals are automatically connected to the unit when their calls are received, up to the maximum number of connection points. Be aware that it is less secure, as anyone can participate in the conference.

### To conduct an ad hoc conference

Call the unit from your terminal while the unit is turned on.

The unit will receive and connect calls automatically until the maximum number of connection points is reached.

### To leave an ad hoc conference

The user that wants to leave can disconnect from the unit via operations from their terminal.

### To switch to a web control conference

When a user logs into the unit while an ad hoc conference is in progress, the conference switches to web control mode.

*For details on logging into the unit, see “Logging into the Unit from a Computer” (page 15).*

### Note

After a conference switches to web control mode, the conference will continue in web control mode for as long as there are connected terminals, even if the user holding the web control privilege logs out of the unit.

# Outgoing Calls

To call a terminal from the unit, call the target terminal from the computer that is logged into the unit. The following methods are available for calling terminals from the unit.

- Calling via Contact Information Entry (page 19)
- Calling via Call Histories (page 19)
- Calling via the Phonebook (page 20)

## Note

Calls cannot be made from the [Phonebook] screen during a conference. To make calls during a conference, do so from the [Home] or [History] screen.

## Calling via Contact Information Entry

- 1 Click the [Home] button on the web control screen. The [Home] screen appears.



- 2 Select the communication bit rate, enter the contact information for the terminal you want to call, and click the [Connect] button to the right of the entry field.

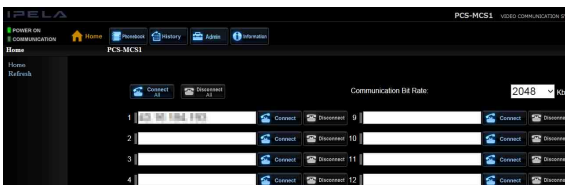

Calling starts, and the connection results are displayed when the connection is established. The communication status bars to the left of the connected terminals' entry fields are displayed in green.

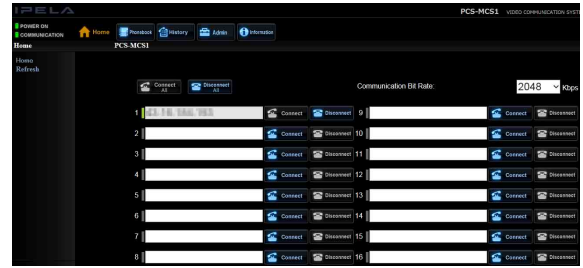

## To call multiple terminals

Enter the contact information for each of the terminals you want to call in the web control screen's entry fields, and click [Connect All].

## Hint

If connection to a terminal failed, you can click the [Connect] button to the right of its entry field to attempt connection again. In addition, entering contact information in empty fields allows you to add participants to a conference in progress.

## Calling via Histories

- 1 Click the [History] button on the web control screen. The [History] screen appears.

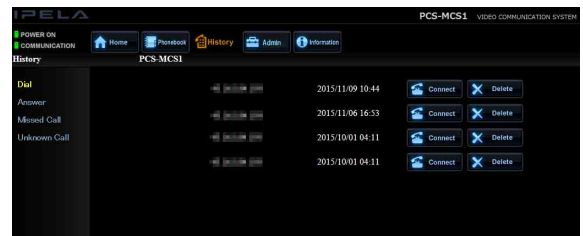

- 2 Click [Dial] (outgoing call), [Answer] (answered call), or [Missed Call] (missed call) on the left side of the screen.

The selected history appears.

## Note

Although [Unknown Call] appears on the left side of the screen, you cannot call terminals from the [Unknown Call] page. You can only view the history of calls rejected by the [Reject Unknown Call] function.

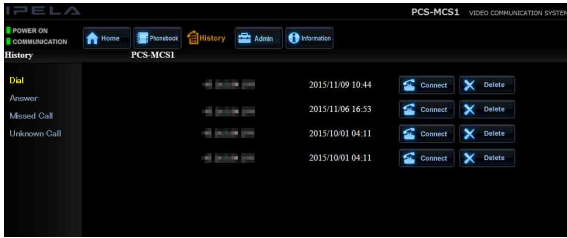

- 3 Click the [Connect] button to the right of the contact you want to call.

Calling starts, and the [Home] screen appears when the connection is established.

The communication status bars to the left of the connected terminals' entry fields are displayed in green.

### To delete a history entry

Click the [Delete] button to the right of the contact you want to delete from the history.

- 3 Check the contact that will be connected, and click [OK].

### Note

If the number of selected checkboxes exceeds the maximum number of connection points, the [OK] button cannot be clicked. Reduce the number of selected checkboxes.

Calling starts, and the [Home] screen appears when the connection is established.

The communication status bars to the left of the connected terminals' entry fields are displayed in green.

## Calling via the Phonebook

For details on registering phonebook contacts, see "Registering Contacts to the Phonebook" (page 22).

- 1 Click the [Phonebook] button on the web control screen.

The [Phonebook] screen appears.



- 2 Select the checkboxes of the contacts you want to call, and click [Connect].

The selected contacts are displayed in a list.

If the selected contacts include groups, all the contacts from each group will be displayed.

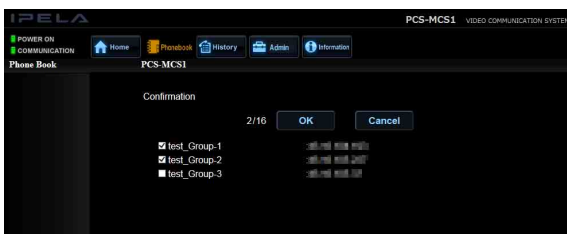

# Incoming Calls

The operation for answering calls from other terminals differs depending on whether the manual or auto answer mode is configured.

## Note

Manual answer mode is configured under factory default settings.

## Answer Modes (Manual/Auto)

### Manual answer mode

This mode allows you to decide whether to connect to a terminal.

When a call is received from a terminal, a confirmation dialog box and the “Incoming call. Answer?” message appear.

Click [OK] to establish the connection.

To reject the call, click [Cancel].

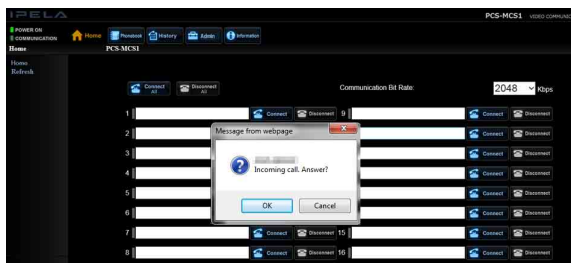

### If the confirmation dialog box does not appear

The call confirmation dialog box may not appear if the pop-up blocker setting on your web browser is enabled. In such cases, configure the setting to allow pop-ups.

The following procedure uses Internet Explorer 11 as an example.

- 1 Click [Internet options] in the [Tools] menu.  
The [Internet Options] dialog box appears.
- 2 Display the [Privacy] tab, and click [Settings] under [Pop-up Blocker].  
The [Pop-up Blocker Settings] dialog box appears.
- 3 Enter “http://xxx.xxx.xxx.xxx” (IP address assigned to the unit) for [Address of website to allow], and click [Add].
- 4 Verify that “http://xxx.xxx.xxx.xxx” (IP address assigned to the unit) appears under [Allowed sites], and click [Close].

### Auto answer mode

When a call is received from a terminal in this mode, connection begins automatically.

This eliminates the need for manual connection operations but may establish connections while you are unprepared.

## Hint

You can view the status of connection after a call is answered in auto mode in the [Home] screen.

## Note

- Answering is not possible while the unit is turned off.
- To view the status of connection when a call was answered in auto mode while the [Home] screen was displayed, click the [Refresh] button.

*For details on the answer mode setting, see “[Auto Answer]” (page 28).*

---

## Ending Connections

1 On the [Home] screen, click the [Disconnect] button to the right of the entry box for the terminal you want to disconnect.

2 When the “Disconnect?” message appears, click [OK].

Connection with the selected terminal ends.

### To end connections with all terminals

On the [Home] screen, click [Disconnect All], and click [OK] when the “Disconnect?” message appears.

---

## Registering Contacts to the Phonebook

Registering a contact to the phonebook allows you to quickly connect to that contact. Up to 1,000 contacts can be registered to the unit’s phonebook. Multiple contacts can also be registered as a group.

### Note

Multiple contacts cannot be registered to the phonebook under the same name.

---

## Registering New Contacts

1 Click the [Phonebook] button on the web control screen.

The [Phonebook] screen appears.

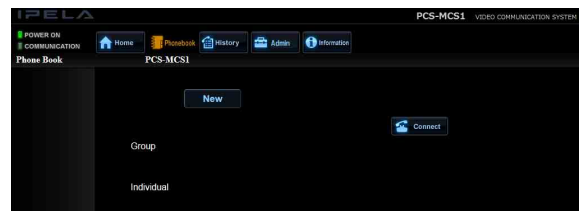

2 Click [New].

The phonebook registration screen appears.

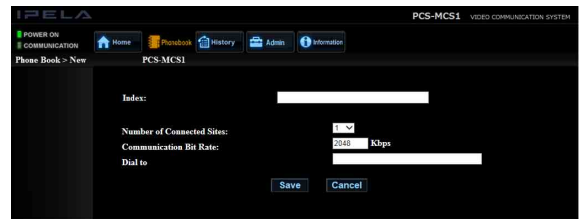

3 Configure each setting.

### [Index]

Enter the name of the contact.

You can enter up to 30 alphanumeric characters and symbols.

### [Number of Connected Sites]

Select the number of contacts to register.

When registering a single contact, select [1]. When registering multiple contacts as a group, select the number of contacts.

### [Dial to]

Enter the IP address of the contact.  
The number of entry fields will differ depending on the [Number of Connected Sites] setting. When registering a group, enter the IP address of each contact you want to register in the entry fields.

### [Communication Bit Rate]

Enter the communication bit rate per point.

## 4 Click [Save].

The [Phonebook] screen appears, and the contacts are added under [Group] or [Individual] depending on the information you registered.



---

## Editing the Phonebook

### 1 On the [Phonebook] screen, click the [Edit] button to the right of the contact you want to edit.

The phonebook editing screen appears.

### 2 Edit each setting, and click [Save].

The edited information is registered, and the [Phonebook] screen appears again.

---

## Deleting Registered Contacts

### 1 On the [Phonebook] screen, click the [Delete] button to the right of the contact you want to delete.

The phonebook editing screen appears.

### 2 Click [Delete].

The contact is deleted, and the [Phonebook] screen appears again.  
If you clicked [Cancel], the contact is not deleted, and the [Phonebook] screen appears again.

---

## External Access to the Unit

You can use the following methods to access the unit externally. For details on each method, contact your Sony dealer.

### Note

When allowing external access, unauthorized third parties on the network may be able to access the unit, depending on your operating environment.

---

## Using Telnet

You can access, control, and configure settings for the unit via Telnet.

To access the unit via Telnet, set [Telnet Access] to [Enabled] on the [Access] page of the [Admin] screen (*page 32*).

---

## Using SSH

You can access, control, and configure settings for the unit via SSH.

To access the unit via SSH, set [SSH Access] to [Enabled] on the [Access] page of the [Admin] screen (*page 32*).

# Picture Displays during Conferences

## Broadcast Modes

When conducting a multipoint conference via the unit, the content displayed on each connected terminal's monitor will vary depending on the unit's settings.

The "split-screen" and "voice-activate" broadcast modes are available. When split-screen mode is selected, you can configure the layout of the split-screen display.

The broadcast mode setting and the layout settings for when split-screen mode is selected are configured on the [Multipoint] page of the [Admin] screen or on the [Layout] screen.

*For details on the [Layout] screen, see "[Layout] Screen" (page 25).*

## Split-screen mode

The pictures from the connected terminals are displayed on each terminal's monitor in a split-screen display.

The split-screen format varies depending on the [Split] setting on the [Multipoint] page of the [Admin] screen.

- [Full window]: Use full-screen display for a single terminal, regardless of the number of connected terminals.
- [3 split window]: Split the display into 3 windows, regardless of the number of connected terminals.
- [4 split window]: Split the display into 4 windows, regardless of the number of connected terminals.
- [6 split window]: Split the display into 6 windows, regardless of the number of connected terminals.
- [9 split window]: Split the display into 9 windows, regardless of the number of connected terminals.
- [10 split window]: Split the display into 10 windows, regardless of the number of connected terminals.
- [13 split window]: Split the display into 13 windows, regardless of the number of connected terminals.
- [16 split window]: Split the display into 16 windows, regardless of the number of connected terminals.
- [Automatic]: Determine the split-screen format based on the number of connected terminals.
  - When 1 terminal is connected: Full-screen display
  - When 2 or 3 terminals are connected: 3-window split
  - When 4 terminals are connected: 4-window split
  - When 5 or 6 terminals are connected: 6-window split
  - When 7 to 9 terminals are connected: 9-window split
  - When 10 terminals are connected: 10-window split
  - When 11 to 13 terminals are connected: 13-window split
  - When 14 to 16 terminals are connected: 16-window split

The pictures from each participating terminal are displayed in each window in the order in which they are connected. When the number of connected terminals is less than the number of split windows, the extra split windows will be blank.

### Hint

When [Split] is set to [Full window], [6 split windows], [10 split windows], or [13 split windows], you can specify which terminals are displayed in the large windows during the conference.

*For details, see "Layout settings configured during conferences" (page 25).*

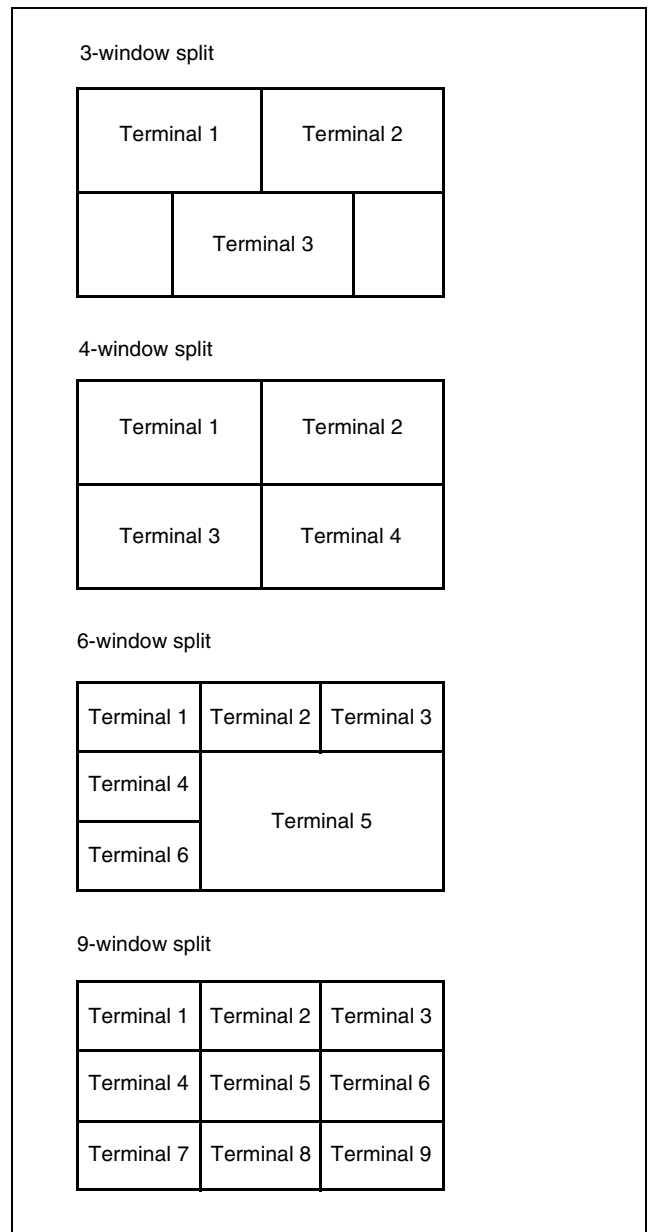



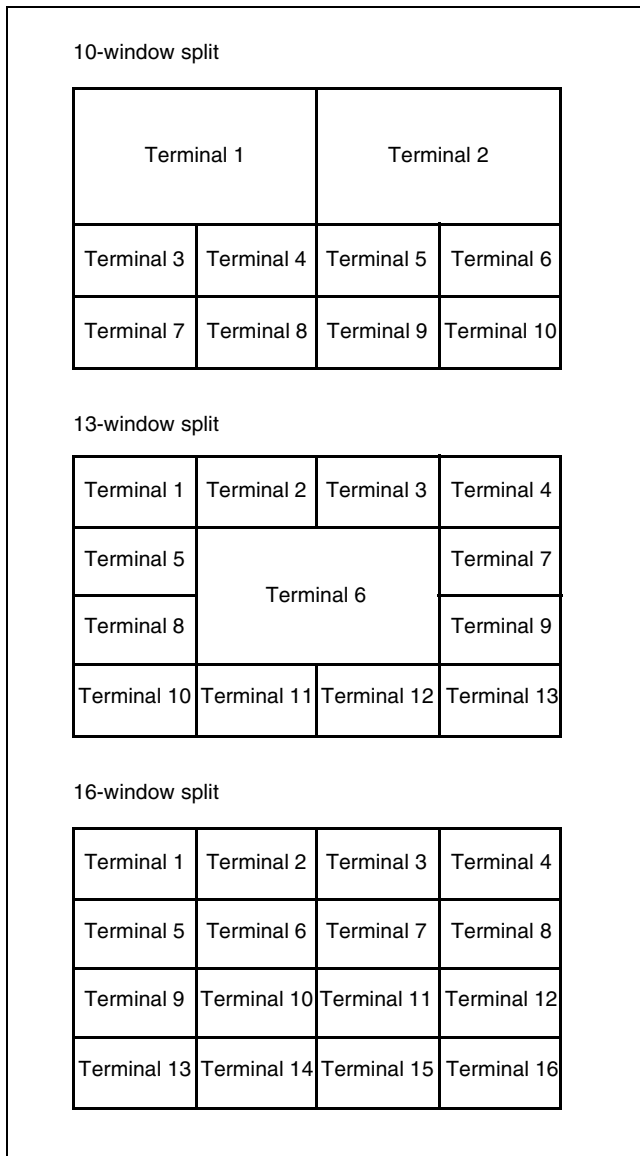

**Note**

- The cameras of other terminals cannot be controlled in split-screen mode.
- If a terminal does not support the name display function or the number of connected terminals exceeds the limit for its name display function, that terminal's name will not be displayed.

**Voice-activate mode**

The terminal with the loudest audio is detected, and the picture from that terminal is displayed on each terminal's monitor in full screen.

**Note**

If you want to transmit the images from the voice-activated terminal in H.264, 1080p (1920 × 1080 pixel) format, set [Broadcast Mode] to [Voice Activate (1080P)] on the [Multipoint] page of the [Admin] screen. However,

when [Voice Activate (1080P)] is configured, connection to terminals that do not support the H.264 video format will be disabled.

**[Layout] Screen**

The [Layout] screen allows you to configure settings for the content displayed on each connected terminal's monitor during a conference.

The settings in the [Layout] screen consist of items that are configured before conferences and items that are configured during conferences.

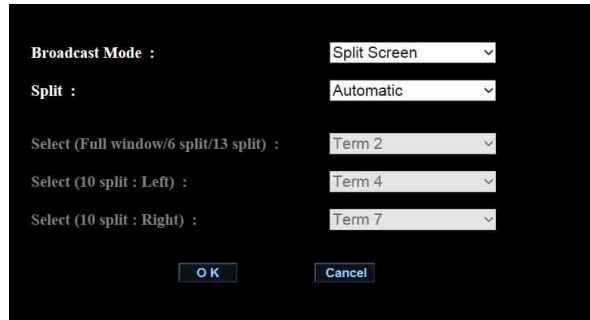

**Layout settings configured before conferences**

You can configure the [Broadcast Mode] and [Split] settings before starting a conference.

The [Broadcast Mode] and [Split] settings are identical to the corresponding settings on the [Multipoint] page of the [Admin] screen.

*For details on the [Broadcast Mode] and [Split] settings, see “[Multipoint] page” (page 28).*

**Note**

After a conference ends, the settings configured in the [Layout] screen are reset, and the values configured on the [Multipoint] page of the [Admin] screen are applied again.

**Layout settings configured during conferences**

When [Broadcast Mode] is set to [Split Screen] and [Split] is set to [Full window], [6 split windows], [10 split windows], or [13 split windows], you can specify which terminals are displayed in the large windows during the conference.

**[Select (Full window/6 split/13 split)]**

This can be configured when [Split] is set to [Full window], [6 split windows], or [13 split windows]. The picture displayed in the large window will be fixed at that of the selected terminal number.

- [Full window]



- [6 split windows]

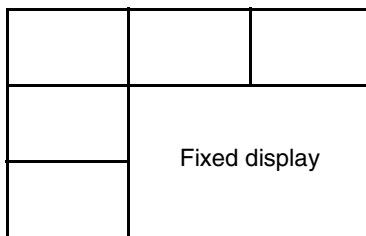

- [13 split windows]

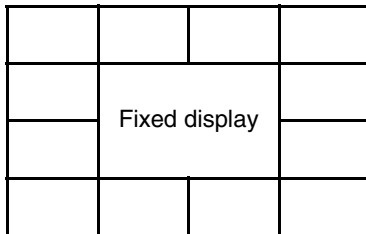

**[Select (10 split: Left)], [Select (10 split: Right)]**

These can be configured when [Split] is set to [10 split windows].

The pictures displayed in the large windows on the left and right will be fixed at those of the selected terminal numbers.

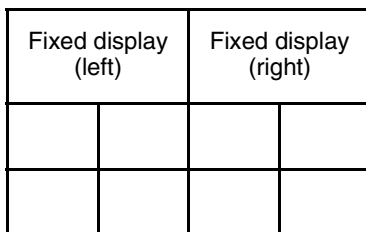

## Chapter 3: Settings and Administration

# Setting Menus

### Note

Unit settings cannot be changed while a conference is in progress.

## Displaying and Configuring Settings

- 1 Display the unit's web control screen on a computer, and click the [Admin] button.

### Note

You cannot click the [Admin] button when logged in as a web access user (user name: pcsuser). To view or configure settings, log in as the administrator (user name: sonypcs).

The [Admin] screen appears, and various setting menus appear on the left side of the screen.



For details on the menu configuration and an items list, see “Menu Configuration” (page 56).

- 2 Click the page you want to display from the list on the left side of the screen.



The items for the selected page appear on the right side of the screen.

- 3 Click the lists or entry fields for the items you want to configure, and configure the settings.
- 4 When you are finished configuring settings, click [Save].

The configurations are saved.

### To cancel configurations

Go to a different page without clicking [Save].

## Setting Pages and Items

### [Line I/F] page

#### [Use LAN2]

Select whether to use the ㉟ 2 (LAN2) connector on the rear panel of the unit.

### Note

- After setting [Use LAN2] to [On], close the web control screen, and log in again.
- Some of the unit's functions will be restricted when using the ㉟ 2 (LAN2) connector.

For details, see “Restrictions when Using LAN2” (page 36).

### [Dial] page

#### [Select LAN Prefix]

Select whether to enable the LAN prefix making calls. When [Enable] is selected, the prefix entered in the [LAN Prefix] field will be added before the IP address.

## [Answer] page

### [Ad Hoc]

Select whether to accept calls from terminals when a user is not logged into the unit from a computer and a conference is not in progress. When [On] is selected, terminals can connect directly to the unit and conduct conferences without having to log into the unit from a computer.

#### Note

After setting [Ad Hoc] to [On], close the web control screen. The setting will take about 1 minute to be applied.

### [Auto Answer]

Select whether to enable auto answer mode.

**[On]:** Establish connections automatically when calls are received.

**[Off]:** Display the “Incoming call. Answer?” message when calls are received, and click [OK] to establish connections.

### [Reject Answer]

Select whether to reject calls from other terminals when a communication is in progress.

### [Reject Unknown Call]

Select whether to reject calls from terminals not registered to the phonebook.

**[Off]:** Accept calls.

**[LAN1]:** Reject calls from LAN1.

**[LAN2]:** Reject calls from LAN2.

**[LAN1+LAN2]:** Reject calls from both LAN1 and LAN2.

## [Multipoint] page

### [Broadcast Mode]

Select the broadcast mode.

**[Split Screen]:** Display the pictures from participating terminals on each terminal’s monitor in a split-screen display.

**[Voice Activate]:** Detect the terminal with the loudest audio from among the connected terminals, and display the picture from that terminal on each terminal’s monitor in full screen.

**[Voice Activate (1080P)]:** Transmit the images from the voice-activated terminal in H.264, 1080p (1920 × 1080 pixel) format.

#### Note

- When [Voice Activate (1080P)] is selected, connection to terminals that do not support the H.264 video format will be disabled.
- The broadcast mode cannot be changed while a communication is in progress. Be sure to specify the broadcast mode before starting communications.

### [Split]

Select the split-screen format that will be used to display the pictures from connected terminals on each terminal’s monitor when [Broadcast Mode] is set to [Split Screen]. When [Automatic] is selected, the split-screen format is determined based on the number of connected terminals. The format is determined as follows; 3-screen split for 2 or 3 terminals, 4-screen split for 4 terminals, 6-screen split for 5 or 6 terminals, 9-screen split for 7 to 9 terminals, 10-screen split for 10 terminals, 13-screen split for 11 to 13 terminals, and 16-screen split for 14 to 16 terminals.

#### Note

If there is only one other connected terminal, full-screen display will be used, regardless of this setting.

### [Voice Activation Frame]

Select whether to highlight (i.e., frame) the pictures from terminals for which audio is detected during a conference on each terminal’s monitor display.

## [IP Communication] page

#### Note

The setting items for the communication mode will vary depending on the line interface specified on the [Line I/F] page and the [Individual Settings for Transmission/Reception] setting on the [IP Communication] page. Only the setting items that can be configured will be displayed on the screen.

The number of pages after the [IP Communication Mode] page will also vary depending on the number of setting items.

### [Individual Settings for Transmission/Reception]

Select whether to configure settings for transmission and reception individually.

When [On] is selected, settings can be configured individually for transmission and reception.

#### Note

The setting items and number of pages for the [IP Communication Mode] page will vary depending on this setting.

## [IP Communication Mode] page

### [Total Bandwidth]

Enter the total bandwidth used by the system.

You can enter a value between 64 Kbps to 16384 Kbps. This is the total bit rate of all points in a multipoint connection.

**Note**

In multipoint connections, the actual communication bit rate for each point is automatically adjusted so as not to exceed the [Total Bandwidth].

**[Communication Bit Rate]**

Enter the communication bit rate per point.  
You can enter a value between 64 Kbps to 16384 Kbps.  
When [Individual Settings for Transmission/Reception] is set to [On], this setting can be configured individually for transmission and reception.

**[Audio Mode]**

Select the audio compression format.  
When [Individual Settings for Transmission/Reception] is set to [On], this setting can be configured individually for transmission and reception.  
You can select multiple formats from among G.711, G.722, G.728, and MPEG4 (MPEG4 AAC).

**Note**

If the audio format selected on the unit is not supported on a terminal, the format will automatically switch to G.711.

**[Far End Camera Control]**

Select whether to allow connected terminals to control each other's camera.

**Note**

Even if this is set to [On] on the unit, if the function is disabled on a terminal, remote camera control will not be possible on that terminal.

**[H.239]**

The H.239-compatible presentation mode allows simultaneous transmission of camera images and presentation data from connected terminals.  
Select whether to use the H.239-compatible presentation mode.

**Note**

Even if this is set to [On] on the unit, if the function is disabled on a terminal, presentations will not be possible on that terminal.

**[H.239 Ratio]**

When H.239 presentation transmissions are made from a terminal, the H.239 presentation data shares bandwidth with camera images that are also being sent. This setting allows you to select how much of the total bandwidth to use for H.239 presentation data transmissions.

**[Screen Size]**

Select the image size for transmission and reception.  
When [Individual Settings for Transmission/Reception] is set to [On], this setting can be configured individually for transmission and reception.

**[Video Mode]**

Select the compression format for transmitted and received video.  
When [Individual Settings for Transmission/Reception] is set to [On], this setting can be configured individually for transmission and reception.

**[Video Frame]**

Select the video frame rate (frames per second) for transmission and reception.  
When [Individual Settings for Transmission/Reception] is set to [On], this setting can be configured individually for transmission and reception.

**[LAN1: Basic] / [LAN2: Basic] page**

*For details on settings, contact your network administrator.*

**Note**

The LAN setting items will vary depending on the [Use LAN2] setting on the [Line I/F] page and [Internet Protocol] setting on the [Etc] page.  
The number of pages after the [LAN2] page will also vary depending on the number of setting items.

**[Host Name]**

Enter the host name (up to 30 characters).

**[DHCP Mode]**

Select whether to use DHCP (Dynamic Host Configuration Protocol).  
**[On]:** Obtain the IP address, network mask, gateway address, and DNS address automatically.  
**[Off]:** Disable DHCP. When this is selected, manual entry of the IP address, network mask, gateway address, and DNS address is required.

**[IP Address]**

Enter the IP address.

**[Network Mask]**

Enter the network mask.

**[Gateway Address]**

Enter the default gateway address.

**[Primary DNS] (LAN1 only)**

Enter the primary DNS (Domain Name System) server address.

**[Secondary DNS] (LAN1 only)**

Enter the secondary DNS server address

**[LAN Mode]**

Select the interface type and communication mode for LAN connections.

**[LAN: PPPoE] page****[PPPoE]**

Select whether to use PPPoE for LAN connections.

**[User Alias]**

Enter the user name that will be used for PPPoE LAN connections.

**[Password]**

Enter the password that will be used for PPPoE LAN connections.

**[Fixed IP for PPPoE]**

Select whether to use a fixed IP address for PPPoE connections.

**[Fixed IP Address for PPPoE]**

Enter the fixed IP address (when [Fixed IP for PPPoE] is set to [On]).

**[DNS]**

Select whether to specify DNS server addresses manually or obtain them automatically for PPPoE connections.

**[Primary DNS]**

Enter the primary DNS address.

**[Secondary DNS]**

Enter the secondary DNS address.

**[LAN: NAT] page****[NAT Mode]**

Select whether to connect the unit to a local network using NAT (Network Address Translation), which allows one IP address to be shared by multiple computers on the same LAN.

When [Auto] is selected, NAT mode is enabled automatically based on whether the use of NAT is detected. The [Auto] setting is only effective when a UPnP router is used.

**[WAN IP Address]**

Enter the WAN (Wide Area Network) IP address.

**[LAN: Gatekeeper] page****[Gatekeeper Mode]**

Select whether to use a gatekeeper to control access. Using the gatekeeper allows you to make calls using user names and user numbers, in addition to IP addresses.

**[Gatekeeper Address]**

Enter the address of the gatekeeper to use when [Gatekeeper Mode] is set to [On].

**[User Alias]**

Enter the user name (H.323 alias) to register to the gatekeeper.

**[User Number]**

Enter the user number (E.164 number) to register to the gatekeeper.

**[H.460]**

Select whether to use H.460 to traverse firewalls and connect to the terminals on other networks.

**[Authentication]**

Select whether to use the gatekeeper's authentication function.

**Note**

When the authentication function is disabled, registration may not be possible depending on the gatekeeper.

**[Registered User Name]**

Enter the login name specified by the gatekeeper administrator when [Authentication] is set to [On].

**[Password]**

Enter the password name specified by the gatekeeper administrator when [Authentication] is set to [On].

**[LAN: Port] page****[Q.931]**

Enter the Q.931 port number.

**[H.245]**

Enter the H.245 port number.

**[RTP/RTCP]**

Enter the RTP/RTCP port number.

**[MTU Size]**

Enter the MTU size.

**[LAN: SNMP] page****[SNMP Mode]**

Select whether to enable the SNMP (Simple Network Management Protocol).

**[Trap Destination]**

Enter the address of the trap destination SNMP manager.

**[Community]**

Enter the community name managed by the SNMP manager (up to 24 alphanumeric characters). "public" is entered by default.

**[Description]**

"Videoconference Device" is entered by default. This setting cannot be changed.

**[Location]**

Enter the installation location of the unit (up to 30 alphanumeric characters).

**[Contact]**

Enter information about the unit's administrator (up to 30 characters).

**[QoS: Basic] page****[Adaptive Rate Control]**

Select whether to always optimize the LAN bandwidth.

**[Auto Bandwidth Detection]**

Select whether to use the auto bandwidth detection function.

**[TCP Port Number]**

Enter the fixed TCP port number.

**[UDP Port Number]**

Enter the fixed UDP port number.

*For details on the port numbers used on the unit, "Ports Used on the PCS-MCS1" (page 53).*

**[Packet Resend Request]**

Select whether to request packets to be resent when packet losses occur during communication.

**Note**

When [Packet Resend Request] is set to [On] and six or more terminals are connected in a multipoint connection, the maximum usable bandwidth will be limited.

**[ARQ Buffering Time]**

Specify the buffering time used for packet resend requests.

When [Custom] is selected, you can enter a custom buffering time.

**[ARQ Buffering Time (Custom)]**

Enter the custom buffering time (50 to 999 ms) when [ARQ Buffering] is set to [Custom].

**[Forward Error Correction]**

Select whether to identify received packets with error correction codes.

**[FEC Redundancy]**

Specify the redundancy of the packets used for forward error correction.

When a setting other than [Auto] is selected, it may not be possible to maintain the communication bit rate.

**[Audio Duplex Transmission]**

Select whether to automatically transmit duplicate audio when audio interruptions occur due to network conditions.

**[QoS: Re-Order] page****[Re-Order]**

Select whether to correct packet reordering (i.e., packets delivered in the incorrect order) which may result in packet loss. Correcting reordering results in smoother picture and sound.

**[Re-Order Buffer]**

Configure the reordering buffer.

**[Re-Order Buffer Rate]**

Enter the reordering buffer rate. You can specify a value from 1 to 5.

**[Shaping]**

Select whether to use shaping, to adjust the IP packet transfer rate.

**[TOS] page****[TOS Data Type]**

Select the type of data for which to configure the TOS (type of service) field.

**[Video]:** Configure the TOS field for video data.

**[Audio]:** Configure the TOS field for audio data.

**[Data]:** Configure the TOS field for camera control signals, etc.

**[Presentation]:** Configure the TOS field for DVI-I presentation data.

**[TOS]**

Select how to define the TOS field for the type of data selected in [TOS Data Type].

**[Off]:** Do not define the TOS field.

**[IP Precedence]:** Define the TOS field as the IP Precedence.

**[DSCP]:** Define the TOS field as the DSCP (differentiated services code point).  
Enter a value from 0 to 63.

**[Precedence]**

Enter the IP Precedence value (0 to 7).

**[Low Delay]**

Select whether to specify the low-delay bit of the TOS field.

**[High Throughput]**

Select whether to specify the high-throughput bit of the TOS field.

**[High Reliability]**

Select whether to specify the reliability bit of the TOS field.

**[Minimum Cost]**

Select whether to specify the minimum-cost bit of the TOS field.

## [DSCP]

Enter the DSCP value.

This item only appears when [TOS] is set to [DSCP].

## [General: Device] page

### [Terminal Name]

Enter the name of the unit that will be sent to terminals (up to 30 characters).

### [Language]

Select the language used for messages displayed on the screen. You can select the following languages.

English, Japanese, and Chinese.

#### Note

To apply the change to the [Language] setting, restart the unit.

## [General: Clock] page

### [NTP]

Select whether to obtain clock information from a server using NTP.

### [Primary NTP Server]

Enter the address of the primary NTP server from which to obtain clock information.

### [Secondary NTP Server]

Enter the address of the secondary NTP server from which to obtain clock information.

### [Time Zone]

Select the country or region in which the unit is used.

### [Clock Display Pattern]

Select the clock display format displayed on the monitor.

### [Date]

Enter the current year, month, and day.

### [Time]

Enter the current time.

### [Time Update]

Click [Execute] when [NTP] is set to [On] to update the current clock.

## [Access] page

#### Note

Depending on your operating environment, unauthorized third parties on the network may be able to access the unit. The following pop-up appears when you set [Telnet Access] or [SSH Access] to [On].

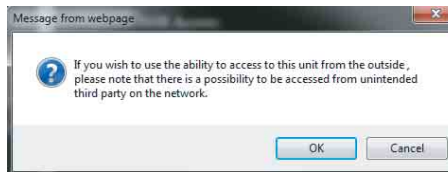

Click [OK] to confirm the change in the setting. To cancel the change, click [Cancel].

### [Telnet Access]

Select whether to allow access to the unit via Telnet.

### [SSH Access]

Select whether to allow access to the unit via SSH (Secure Shell).

### [Referrer Check]

Select whether to perform a referrer check when the unit is accessed from the web.

#### Note

We recommend enabling the referrer check function, as not doing so involves some security risk.

## [Etc] page

### [Use History]

Select whether to display call histories from which calling and other operations can be performed.

### [AMX Device Discovery]

Select whether to periodically export AMX Device Discovery information onto the network.

When the AMX system is connected to the unit via serial connection, AMX Device Discovery information is output via the serial interface.

AMX systems are external control devices that can be used to control the unit. When the AMX system receives AMX Device Discovery information from the unit, the unit automatically falls under the control of the AMX system.

### [HOP]

Enter the hop count (0 to 255) of the exported data.

### [Auto Restore]

Select whether to turn the unit back on automatically when power is restored after an outage.

### [Internet Protocol]

Only the IPv4 Internet Protocol can be used.

#### Note

The [Internet Protocol] setting is common to both LAN1 and LAN2.



## [Phonebook] page

### [Save Phone Book]

Save the phonebook data to a USB storage device. Existing phonebook data on the USB storage device will be overwritten.

### [Load Phone Book]

Load the phonebook data from a USB storage device. Existing phonebook data on the unit will be overwritten.

#### Note

- The [Save Phone Book] and [Load Phone Book] items appear only when a USB storage device is inserted in the USB port on the rear panel.
- When saving and loading phonebook data, make sure that the version of the PCS-MCS1 from which the data was originally saved is the same as the version of the current unit. If the versions differ, the data may not be properly recognized.

### [Clear Phone Book]

Delete the phonebook data on the unit.

## [Password] page

### [sonypcs] - [Password], [Password (confirmation)]

Enter a new password when you want to change the administrator login password.

### [pcsuser] - [Password], [Password (confirmation)]

Enter a new password when you want to change the web access user login password.

## [Maintenance] page

### [Day], [Time]

Select the day of the week and time at which the unit is restarted.

The unit will not be restarted if a conference is in progress on the specified day and time. In such cases, restart will be attempted up to 5 times at 30-minute intervals, and the unit will be restarted if the conference is no longer in progress.

## [Encryption] page

Configure settings for using the encryption function for connections.

The encryption function allows you to use a highly confidential connection.

*For details on encrypted connections, see Chapter 5.*

#### Note

The maximum usable bandwidth will be limited to 12 Mbps during encrypted connections.

### [Encryption]

Select whether to use the encryption function.

**[Off]:** Do not use the encryption function.

**[Connect Priority]:** Connect via an encrypted connection to terminals that support standard encrypted connection. If a terminal does not support standard encrypted connection or its encryption function is disabled, connection will be established without encryption.

**[Encrypt Priority]:** Connect only to terminals that support standard encrypted connection.

## [Software Option] page

Enter the keys of the optional software you want to add in the [Software Option] entry fields (1 to 8).

*For details on adding optional software, see “Adding Optional Software” (page 41).*

---

# Displaying Device Information

You can display various information concerning the unit and connected devices, such as version information, communication modes, and line quality, on the [Information] screen.

---

## Displaying Device Information

Display the unit's web control screen on a computer, and click the [Information] button at the top of the screen to display the [Information] screen.



### Pages of the [Information] screen

[Machine Information] page (page 34)

[Peripheral Status] page (page 34)

[Communication Mode Status] page (page 34)

[Network Routing Check] page (page 35)

[EULA] page (page 35)

---

## [Machine Information] Page

### [Host Version]

Displays the version of the unit's software.

### [Software Option]

Displays the type of optional software installed.

### [Host Name]

Displays the host name.

### [IP Address]

Displays the IP address of LAN1.

### [IP Address (LAN2)]

Displays the IP address of LAN2.

### [MAC Address]

Displays the MAC address of LAN1.

### [MAC Address (LAN2)]

Displays the MAC address of LAN2.

### [Serial Number]

Displays the serial number.

### [Machine Version]

Displays version information for codecs, for example.

---

## [Peripheral Status] Page

### [LAN Mode (LAN1)]

Displays the LAN mode of LAN1.

### [LAN Mode (LAN2)]

Displays the LAN mode of LAN2.

### [Gatekeeper]

Displays the gatekeeper status.

[Gatekeeper Requested], [Gatekeeper Confirmed], [Gatekeeper Reject], [Registration Requested], [Registration Confirmed], [Registration Failed], [Registration Rejected], [Registration Timeout], [Unregistration Requested], and [Unregistration Confirmed]

---

## [Communication Mode Status] Page

This page displays the status of the current communication when communication is in progress, and the status of previous communications when communication is not in progress. Depending on the number of connected terminals, up to 16 pages will be displayed and you can view information on each terminal in each page.

For the items with [(Encode)] and [(Decode)] values, the configuration status of the unit is displayed under [(Encode)] and the reception status of the unit is displayed under [(Decode)].

### [Far End Terminal Name]

Displays the name of the terminal.

### [Remote Address]

Displays the address of the terminal.

### [Audio Mode]

Displays the current audio codec format.

### [Video Mode]

Displays the current video codec format.

“H.264 HP” is displayed during H.264 High Profile communication, and “H.264” is displayed during H.264 Baseline Profile communication.

**Note**

Depending on the status of the connected system, the audio and video codec formats used for actual communication may differ from the formats configured on the unit.

**[Frame Rate]**

Displays the video frame rate in real time.

**[Rate]**

Displays the number of connected lines and their transfer rates in real time.

**[Line I/F]**

Displays the line interface being used.

**[Far End Camera Control]**

Displays whether terminals are able to control each other's camera.

**[H.239]**

Displays whether the H.239 presentations are enabled.

**[Check Code]**

Displays the encryption check code. This is only displayed when using encrypted communication.

**[Bit rate - Encode]**

Displays the transfer rates for sent data by category (audio, video, H.239 (presentation)).

**[Bit rate - Decode]**

Displays the transfer rates for received data by category (audio, video, H.239 (presentation)).

**[Number of lost packets]**

Displays the number of packets lost during transfer on the network by category (audio, video, H.239 (presentation)).

**[Number of recovered packets]**

Displays the number of lost packets that were recovered with the unit's QoS function by category (audio, video, H.239 (presentation)).

**[Number of received packets]**

Displays the number of packets received during communication by category (audio, video, H.239 (presentation)).

---

**[Network Routing Check] Page**

This page allows you to perform network routing checks and displays their results.

Click [Start Measurement] at the bottom of the screen to start the routing check.

*For details, see "Network Routing Checks" (page 40).*

**[IP Address of Remote Site]**

Enter the IP address of the terminal you want to check.

**[Line I/F]**

**[LAN1]:** Perform network routing check for the network connected to the ㉑ 1 (LAN1) connector.

**[LAN2]:** Perform network routing check for the network connected to the ㉑ 2 (LAN2) connector.

**[Gateway]**

Displays the check results for the default gateway.

**[ping]**

Displays the check results for reachability, packet loss, RTT (round-trip time), and H.323 communication availability.

**[traceroute]**

Displays the check results for the hop count (i.e., number of routers passed through to reach the remote party) and total RTT.

**[Start Measurement]**

Click this to start a network routing check.

---

**[EULA] Page**

This page allows you to view end-user license agreement that appears when you first log in after initial setup.

---

# Restrictions when Using LAN2

When using two LAN connections, use the ④ 1 (LAN1) connector to connect to your private company network and the ④ 2 (LAN2) connector to connect to the Internet or locations outside of your company.

The following unit functions are restricted when using the ④ 2 (LAN2) connector.

## Note

- When connecting the unit to the Internet or locations outside of your company, configure the following settings.
  - When using only the ④ 1 (LAN1) connector, set [Telnet Access] and [SSH Access] to [Disabled] on the [Access] page (*page 32*).
  - When using both the ④ 1 (LAN1) and ④ 2 (LAN2) connectors, use the ④ 2 (LAN2) connector to connect to the Internet or locations outside of your company.
  - You cannot use both the ④ 1 (LAN1) and ④ 2 (LAN2) connectors to connect to the Internet or locations outside your company at the same time.
- The ④ 2 (LAN2) connector cannot be used on its own.

## Settings that cannot be configured for LAN2

- NAT
- Gatekeeper
- SNMP
- NTP
- AMX Device Discovery
- H.460
- DNS
- Telnet access, SSH access

## Settings that can be configured for either LAN1 or LAN2

- PPPoE

## Settings that are configured individually for LAN1 or LAN2

- DHCP mode
- IP address
- Network mask
- Gateway address
- LAN mode

## Settings that are common to LAN1 and LAN2

- Port (TCP, UDP)
- QoS
- TOS
- Auto answer
- Reject answer

## Note

- Do not configure the same subnet for LAN1 and LAN2.
- When connecting a NAT cable to the LAN2 connector or using a private address for LAN2, configure a private address of a different class than that of LAN1.

# Network Configuration Setups

This section describes how to configure settings for various network configurations.

For details on LAN settings, see “[LAN1: Basic] / [LAN2: Basic] page” (page 29).

For details on settings, contact your network administrator.

## LAN Connection Using DHCP (LAN1/LAN2)

### Configuration example

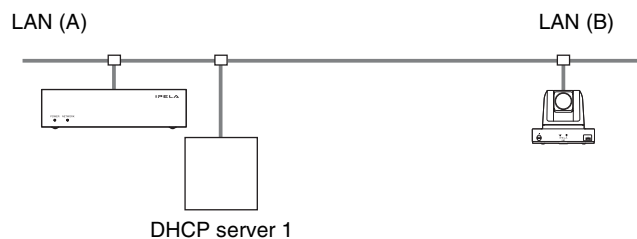

Set [DHCP Mode] to [On] on the [LAN: Basic] page of the [Admin] screen.



When using DHCP, the IP address may change whenever the unit is restarted.

To determine the unit’s IP address, save a configuration file to a USB storage device and verify it on a computer.

For details on determining the unit’s IP address, see “Verifying the Unit’s Settings” (page 42).

## LAN Connection Using a Router (LAN1/LAN2)

### Configuration example

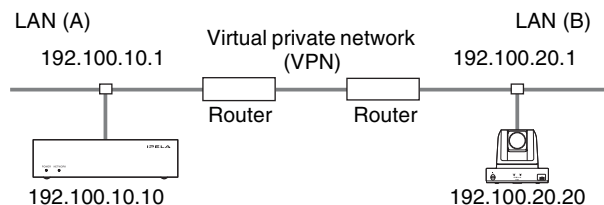

Enter a name in [Host Name] on the [LAN: Basic] page of the [Admin] screen, and enter the appropriate values for [IP Address], [Network Mask], and [Gateway Address].

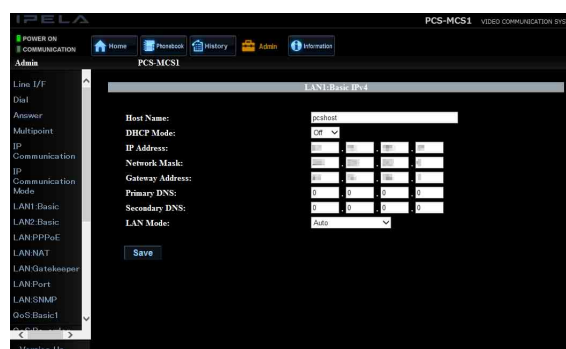

The settings have been configured properly if the IP address appears on the [Machine Information] page of the [Information] screen.

## LAN Connection Using a Gatekeeper (LAN1 Only)

### Configuration example

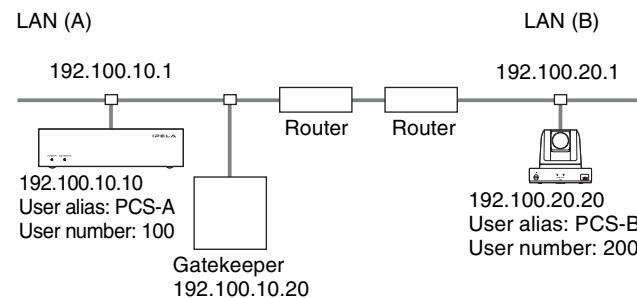

- 1 Enter a name in [Host Name] on the [LAN: Basic] page of the [Admin] screen, and enter the appropriate values for [IP Address], [Network Mask], and [Gateway Address].



- Set [Gatekeeper Mode] to [On] on the [LAN: Gatekeeper] page of the [Admin] screen, and enter the appropriate values for [Gatekeeper Address], [User Alias], and [User Number]. If [Authentication] is set to [On], enter the [Registered User Name] and [Password] specified by the gatekeeper administrator.

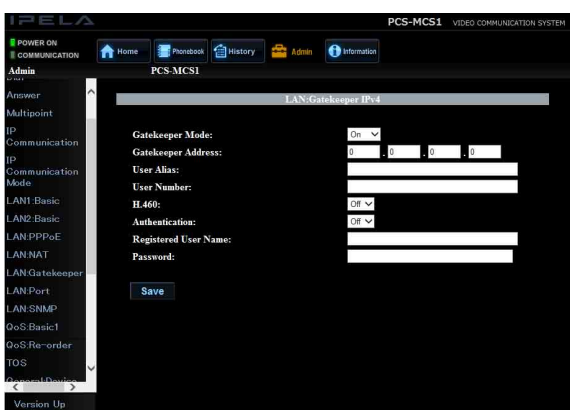

You can verify the status of registration to the gatekeeper on the [Peripheral Status] page of the [Information] screen.

## To connect

Enter the [User Alias] or [User Number] configured on the terminal to which you want to connect, and call.

## LAN Connection Using NAT (LAN1 Only)

Connection using NAT allows one IP address to be shared by multiple computers on the same LAN. This section describes how to configure settings for visual communication in NAT and global IP environments.

### Note

When using the unit in a NAT environment, you can connect to a terminal (global IP) from the unit, but to connect to the unit from a terminal, router settings must be configured. For details on router settings, contact your network administrator.

## Configuration example

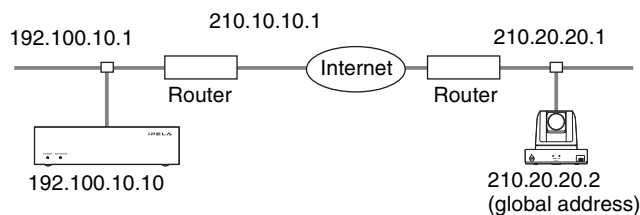

- Enter a name in [Host Name] on the [LAN: Basic] page of the [Admin] screen, and enter the appropriate values for [IP Address], [Network Mask], and [Gateway Address].

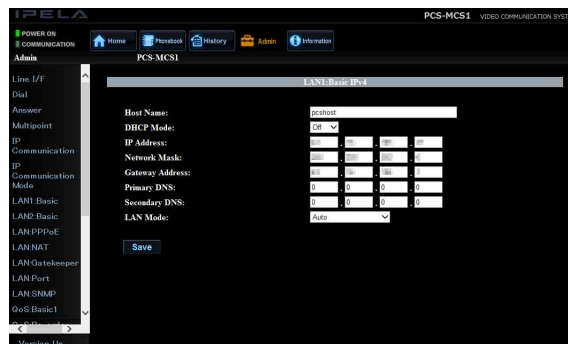

- Set [NAT Mode] to [On] on the [LAN: NAT] page of the [Admin] screen, and enter the appropriate value for [WAN IP Address].

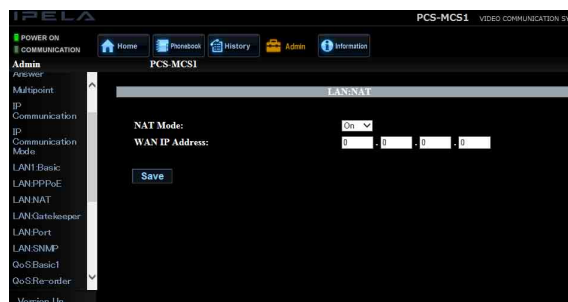

The settings have been configured properly if the WAN IP address appears on the [Machine Information] page of the [Information] screen.

## To connect

Enter the IP address of the terminal to which you want to connect, and call.

### Note

When using the unit in a NAT environment, you can connect to a terminal (global IP) from the unit, but to connect to the unit from a terminal, router settings must be configured. For details on router settings, contact your network administrator.

## LAN Connection Using H.460 Firewall Traversal (LAN1 Only)

Using H.460 allows you to traverse firewalls and connect to terminals on other networks.

### Configuration example

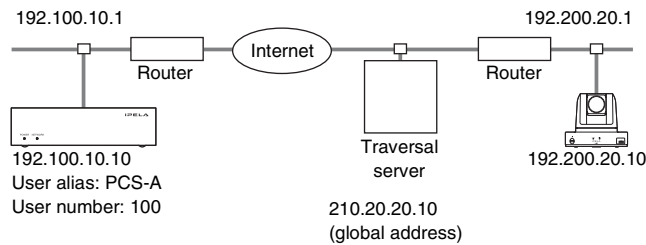

- 1 Enter a name in [Host Name] on the [LAN: Basic] page of the [Admin] screen, and enter the appropriate values for [IP Address], [Network Mask], and [Gateway Address].



- 2 Set [H.460] to [On] on the [LAN: Gatekeeper] page of the [Admin] screen. In addition, set [Gatekeeper Mode] to [On], and enter the appropriate value for [Gatekeeper Address]. If [Authentication] is set to [On], enter the [Registered User Name] and [Password] specified by the gatekeeper administrator.

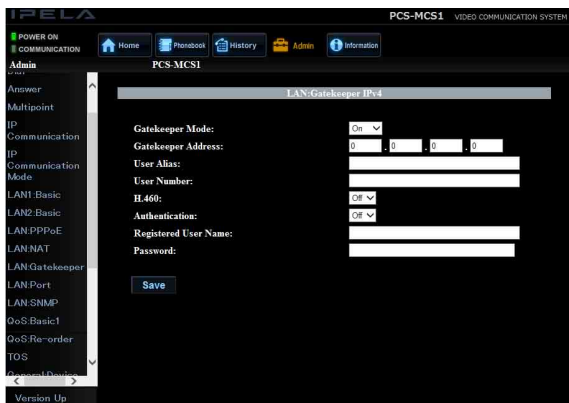

You can verify the status of registration to the gatekeeper on the [Peripheral Status] page of the [Information] screen.

## To connect

Enter the IP address of the terminal to which you want to connect, and call.

## LAN Connection Using PPPoE (LAN1/LAN2)

Using PPPoE allows you to use your Internet service provider's services without using a router.

### Configuration example

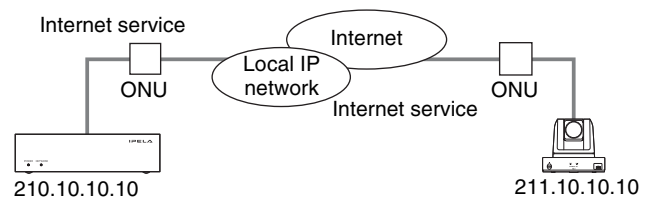

- 1 Set [PPPoE] to [LAN1] or [LAN2] on the [LAN: PPPoE] page of the [Admin] screen, and enter the information obtained from your provider in [User Alias] and [Password].



- 2 If you obtained a fixed IP from your provider, set [Fixed IP for PPPoE] to [On], and enter the obtained IP address in [Fixed IP Address for PPPoE].

You can verify the network status on the [Network Routing Check] page of the [Information] screen.

### Note

If a fixed DNS server address is specified by your provider, set [DNS] to [Specify], and enter the specified addresses in [Primary DNS] and [Secondary DNS].

## To connect

Enter the IP address of the terminal to which you want to connect, and call.

# Network Routing Checks

Before connecting to a terminal, you can check the network routing to ensure smooth communication.

*Knowledge of the network is required to perform network routing checks. For details, contact your network administrator or Sony dealer.*

*For inquiries regarding check results, contact your network administrator or Sony dealer.*

## To start a network routing check

Configure each setting on the [Network Routing Check] page of the [Admin] screen.

Click [Start Measurement] to start the network routing check.

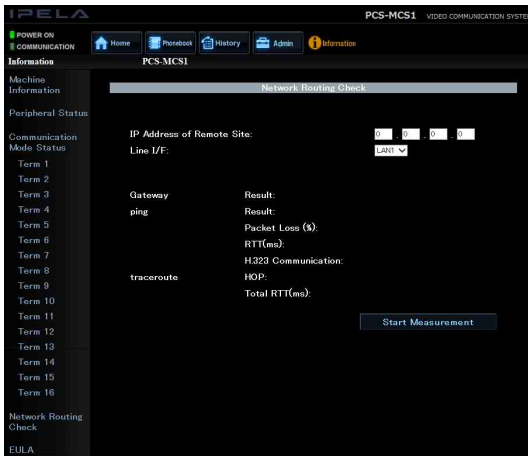

*For details on displaying the [Network Routing Check] page, see “Displaying Device Information” (page 34).*

### Note

Other functions, including communication, will be disabled while the network routing check is in progress. When the routing check is complete, the check results are displayed on the [Network Routing Check] page.



# Adding Optional Software

- 1 Display the [Software Option] page of the [Admin] screen.
- 2 Enter the software key of the optional software, and click [Save Installation].

When the entered key is recognized key as valid, the unit will restart automatically.

After the unit restarts, the name of the added optional software will appear under the entry field. In addition, the entered optional software key will be displayed as asterisks (\*).

### Note

If an invalid key is entered, the entry field will become empty. Reenter the correct optional software key.

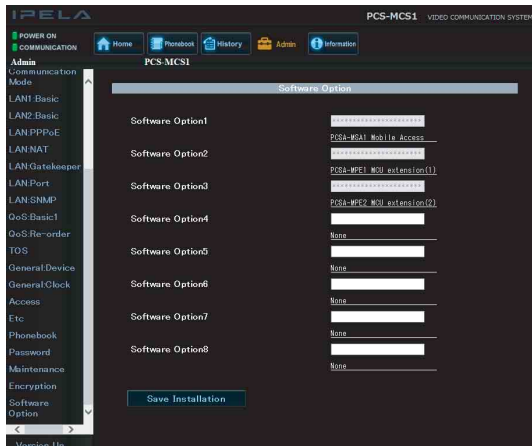

For details optional software keys, contact your Sony dealer.

### Hint

- You can register up to eight optional software.
- Optional software installation will be retained, even after updating the unit's software version.

### Note

Optional software keys cannot be deleted after they are recognized by the unit.

## Verifying Proper Installation of Optional Software

Installed software is displayed under [Software Option] on the [Machine Information] page of the [Information] screen.

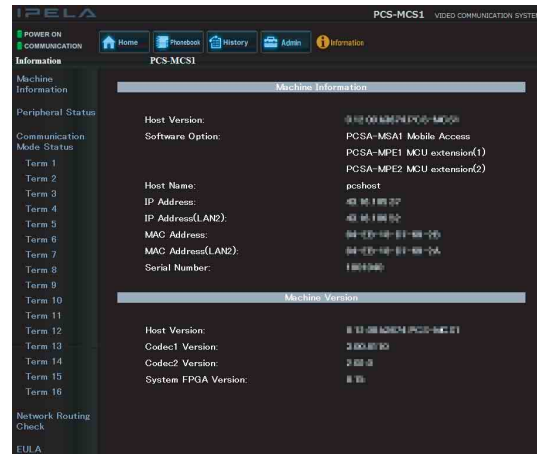

For details, see “[Machine Information] Page” (page 34).

# Verifying the Unit's Settings

## Saving Configurations to USB Storage Devices

If the unit's IP address becomes unknown, for example, you can save a portion of the configurations to a USB storage device as a text file and verify settings.

The unit's password cannot be saved. If you forget the password, contact your Sony dealer. In such cases, the unit must be initialized, so all phonebook contacts, histories, and settings data stored on the unit will be lost.

### Note

- The name of the file saved to the USB storage device is "pcsinisetup.txt." If an identically named file already exists on the USB storage device, change its name beforehand.
- Configurations cannot be saved to a USB storage device under the following conditions.
  - The unit is not turned on.
  - There is a problem with the hardware.
  - A conference is in progress.
  - Firmware update for the unit is in progress.
  - A USB storage device is not inserted in the USB port on the rear panel.

**1** Turn on the unit, and insert the USB storage device into the USB port on the rear panel.

**2** Press the utility button on the rear panel briefly one time.

The POWER indicator and NETWORK indicator rapidly blink green in unison, and the configuration data is saved to the USB storage device as a text file.

**3** When the indicators switch to remaining steadily lit, remove the USB storage device.

You can view the configuration file stored on the USB storage device via a computer, and verify the settings. You can also edit the contents of the configuration file on the computer.

*For details on loading configuration files, see "Loading Configurations" (page 44).*

## Viewing or Editing Exported Configuration Files

### Note

Use WordPad to view or edit configuration files.

### Configuration file contents

Setting item	Representation of setting item and sample value in configuration file
Device name (firmware version)	#PCS-MCS1 (00.00.0001)
IP address (LAN1)	:IP_ADDR = xxx.xxx.xxx.xxx
Subnet mask	:NETMASK = xxx.xxx.xxx.xxx
Default gateway	:GATEWAY = xxx.xxx.xxx.xxx
DHCP setting (on/off) <sup>1)</sup>	:DHCP = 1
PPPoE setting (on/off) <sup>1) 2)</sup>	:PPPOE = 0
Internet Protocol	:IPV4V6 = IPv4
Host name	:HOST_NAME = "pcshost"
Date and time	:DATETIME = 2015-10-20 20:11:28
Time zone <sup>3)</sup>	:TIMEZONE = Asia/Tokyo
NTP setting (on/off) <sup>1)</sup>	:NTP_FLAG = 1
Primary NTP server	:NTP_NAME1 = "xxx.xxx.xxx.xxx"
Secondary NTP server	:NTP_NAME2 = ""
Terminal name	:TERMINAL = "PCS-MCS1"
Communication bit rate per point	:BITRATE = xxxxx

1) "1" represents [On] and "0" represents [Off].

2) The PPPoE setting can be changed from [On] to [Off], but it cannot be changed from [Off] to [On].

3) When changing the time zone setting, be sure to check the options for [Time Zone] on the [General: Clock] page of the [Admin] screen, and enter the exact character string of the option you want to use. However, when changing the setting to Greenwich Mean Time (GMT), enter "Etc/GMT."

### To edit a configuration file

**1** Open the configuration file using WordPad.

**2** Delete the colons (:) in front of the setting items you want to change, edit the setting values (i.e., the sections that follow the equals signs (=)), and save the file.

### Hint

When a configuration file is loaded on the unit, only the settings items with their colons (:) removed will be loaded.

---

# Updating the Unit's Firmware

---

## Updating the Firmware via a USB Storage Device

Install an update file stored on a USB storage device onto the unit.

- 1 Insert the USB storage device into the USB port on the rear panel while the unit is turned off.
- 2 Turn the unit on.

When the unit turns on, firmware update will start.

The POWER indicator and NETWORK indicator alternate blinking slowly in orange while firmware update is in progress.

When update is complete, the POWER indicator lights green and the NETWORK indicator turns off or blinks red, and the unit restarts automatically. Do not turn off the unit until it finishes restarting.

### Note

When updating from a USB storage device, the version of the update file stored on the device is recognized by the unit. Update is only performed if the version of the update file is newer than the firmware currently installed on the unit. If you want to install an older version of the firmware onto the unit, do so from the web control screen.

---

## Updating the Firmware via the Web Control Screen

Install an update file stored on a computer or on the network onto the unit.

- 1 Click the [Admin] button on the web control screen.

### Note

You cannot click the [Admin] button when logged in as a web access user (user name: pcsuser). To view or configure settings, log in as the administrator (user name: sonypcs).

The [Admin] screen appears.



- 2 Click [Version Up] at the bottom of the menu on the left side of the [Admin] screen.

The [Version Up] page appears.



- 3 Click [Browse], select the update file, and then click [Upload].

A message appears after the file is uploaded, and firmware update starts.

The POWER indicator and NETWORK indicator alternate blinking slowly in orange while firmware update is in progress.

When update is complete, the POWER indicator lights green and the NETWORK indicator turns off or blinks red, and the unit restarts automatically. Do not turn off the unit until it finishes restarting.

---

# Loading Configurations

You can load a configuration file that was previously saved to a USB storage device onto the unit to change the unit's settings.

You can also edit the contents of the configuration file on a computer before loading them onto the unit.

*For details on saving configuration files to USB storage devices, see "Saving Configurations to USB Storage Devices" (page 42).*

## Note

- When loading configurations, make sure that the version of the PCS-MCS1 from which the data was originally saved is the same as the version of the current unit. If the versions differ, the data may not be properly recognized.
- The "pcsinisetup.txt" file stored in the USB storage device's root directory will be applied when loading configurations. If the configuration file is stored in a folder created on the USB storage device or saved under a different name, the configurations cannot be loaded.

- 1** Verify that the configuration file you want to load is named "pcsinisetup.txt" and located in the root directory of the USB storage device.
- 2** Turn on the unit, and insert the USB storage device into the USB port on the rear panel.
- 3** Press the utility button on the rear panel for at least 4 seconds.

The configurations are loaded, and the POWER indicator and NETWORK indicator alternate blinking rapidly in green.

The unit will restart automatically when loading is complete, and the unit's setting configurations will be overwritten with those stored on the USB storage device.

Do not turn off the unit until it finishes restarting.

## Hint

When a configuration file is loaded on the unit, only the settings items with their colons (:) removed will be loaded. Edit the configuration file beforehand, and delete the colons (:) in front of the setting items you want to load.

- 4** Remove the USB storage device after the unit restarts.

## Chapter 5: Encrypted Connections

The unit allows connections with encrypted video and audio for when a strictly confidential communication is required. Such connections are called “encrypted connections.”

The unit supports a standard encryption that complies with the ITU-T H.235 standard.

### Note

- The encryption function is not available in some countries and regions.
- The maximum usable bandwidth for encrypted connections is 12 Mbps.

## Preparing for Encrypted Connections

To use an encrypted connection, set [Encryption] to [Connect Priority] or [Encrypt Priority] on the [Encryption] page of the [Admin] screen.



### [Connect Priority] setting

Connect via an encrypted connection to terminals that support standard encrypted connection. If a terminal does not support standard encrypted connection or its encryption function is disabled, connection will be established without encryption.

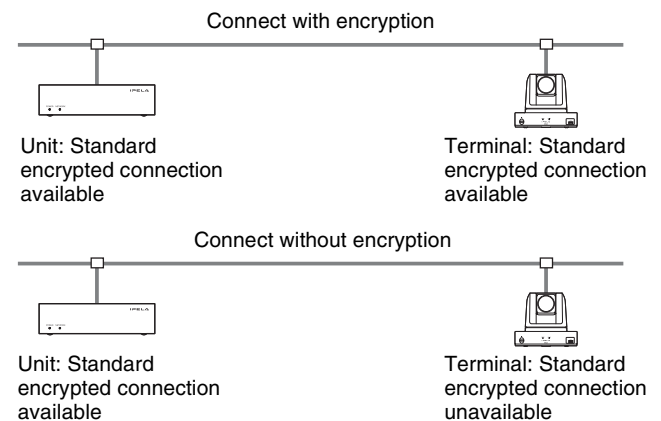

### [Encrypt Priority] setting

Connect only to terminals that support standard encrypted connection.

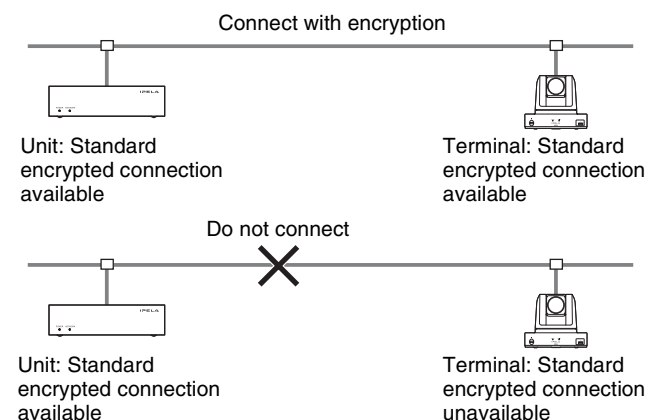

# Starting Encrypted Connections

You can start an encrypted connection by calling a terminal as you would with a standard connection. During an encrypted connection, the encryption icon (🔒) is displayed on the [Home] screen.

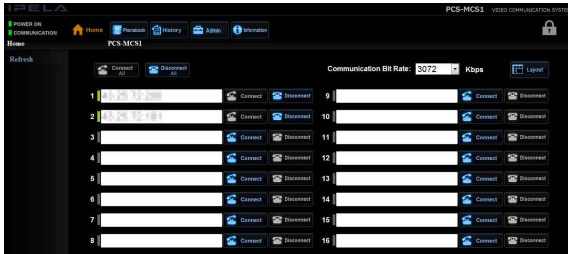

## Note

If there is no icon displayed, data transmission and reception are not encrypted. Confirm that the icon is displayed before starting a conference.

## Parts Identification

### Front Panel

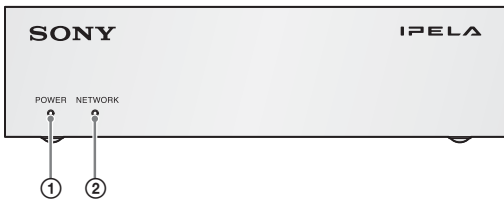

- ① **POWER indicator**  
Indicates the power status.
- ② **NETWORK indicator**  
Indicates the network connection status.

### Indicator statuses

Status	POWER Indicator	NETWORK Indicator	Remark
The unit is turned off.	●	●	
The unit is starting up.	☀	●	
The unit is shutting down.	☀	●	
The unit is turned on (not connected to network).	●	●	
Initial setup is not complete.	●	●	The unit cannot be operated. Complete initial setup.
The IP address is being obtained.	●	☀	
The unit is turned on (conferencing is possible).	●	●	
Conference is in progress.	☀	☀	Indicators alternate in blinking slowly.

Status	POWER Indicator	NETWORK Indicator	Remark
A problem with the network exists.	—	☀	
A problem with the unit's hardware exists.	☀	—	
The unit's configurations are being saved to a USB storage device.	☀	☀	Indicators blink rapidly in unison.
The unit's configurations are being loaded from a USB storage device.	☀	☀	Indicators alternate in blinking rapidly.
The unit's firmware is being updated.	☀	☀	Indicators alternate in blinking slowly.

● : Off   ● : Lit   ☀ : Blinking

### Rear Panel

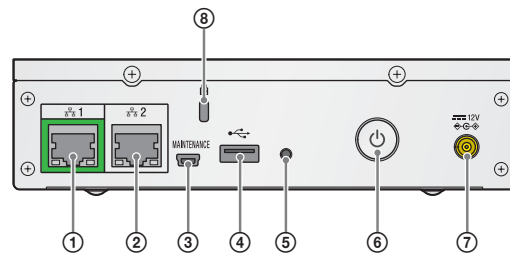

- ① **LAN1 connector (1000BASE-T/100BASE-TX/10BASE-T, 8-pin modular)**  
Connects to a local network.  
Under normal circumstances, use this connector for network connections.
- ② **LAN2 connector (1000BASE-T/100BASE-TX/10BASE-T, 8-pin modular)**  
Connects to a global network.  
When you use this connector for network connections, some functions, such as login from the computer, will be restricted.

## CAUTION

For safety, do not connect the connector for peripheral device wiring that might have excessive voltage to the following ports.

:  (LAN) 1 connector

:  (LAN) 2 connector

Follow the instructions for the above ports.

③ **MAINTENANCE connector (USB mini-B)**

Used for maintenance.

Allows external control and log acquisition.

④  **(USB) port (Type-A)**

Allows you to save settings to a connected USB storage device, for example.

⑤ **Utility button**

Allows you to export settings.

⑥ **Power button**

Turns the unit on/off.

⑦ **DC 12V jack**

Connects to the supplied AC adapter.

⑧ **Kensington security slot**

Connects to a Kensington anti-theft security lock.



# Troubleshooting

If the unit does not operate properly, check the following.

Symptom	Cause	Solution
The unit does not turn on. (Blinking of the POWER indicator on the front panel of the unit does not start.)	The supplied AC adapter is not connected properly.	Connect the supplied AC adapter properly.
	The power button was not pressed.	Press the power button briefly (less than 1 second) one time to turn on the unit (page 9).
The unit cannot be accessed from a web browser.	The LAN cable is not connected properly.	Connect the cable properly.
	The LAN cable is damaged.	Replace the cable.
	The IP address you entered is incorrect.	Save a configuration file to a USB storage device, and check the IP address (page 42).
	The IP address and network mask settings are incorrect.	Contact your network administrator, and configure the correct settings.
The unit does not connect to videoconferencing terminals.	The wrong number was called.	Check the entered number again.
	The information registered in the phonebook is incorrect.	See "Registering Contacts to the Phonebook" (page 22), and register the information properly.
	There is a problem on the terminal to which you want to connect.	Try connecting to a different terminal as a test.
	The terminal to which you want to connect is not turned on.	Ask the terminal's administrator to turn on the terminal.
	The terminal to which you want to connect is busy (i.e., communication with another terminal is in progress).	Call the terminal again after its current communication has ended.
	Answering calls is not permitted on the terminal to which you want to connect due to operations being performed on the terminal (e.g., settings configuration).	Ask the terminal's administrator to accept calls on the terminal.
	Auto answer mode is not enabled on the terminal to which you want to connect.	Ask the terminal's administrator to enable auto answer mode on the terminal or answer the call manually.
	The terminal to which you want to connect is set to reject calls.	Ask the terminal's administrator to change the call rejection settings.
Configurations cannot be saved or loaded using a USB storage device.	There is a problem on the USB storage device.	Use a computer to check whether saving and loading with the USB storage device is possible.
		Check whether saving and loading is possible with a different USB storage device.
	A format error occurred on the USB storage device.	Reformat the USB storage device. <b>Note</b> When you format a USB storage device, all data stored on the device will be deleted. Be sure to copy important data to a different location beforehand.
Configurations cannot be saved to a USB storage device.	The utility button operation was not performed properly.	Insert the USB storage device into the USB port on the rear panel of the unit, and press the utility button briefly (less than 1 second) one time.
	The remaining capacity on the USB storage device is insufficient.	Use a different USB storage device.

Symptom	Cause	Solution
Configurations cannot be loaded from a USB storage device.	The name of the configuration file is incorrect.	Check that the name of the file you want to load is "pcsinisetup.txt."
	The format of the configuration file's content is incorrect.	Backup the configuration file (pcsinisetup.txt), save another configuration file to a USB storage device, and compare the content of the target configuration file to that of the new file to check whether it is formatted correctly (page 44).
	The configuration file is not stored in the correct location on the USB storage device.	Check that the configuration file (pcsinisetup.txt) is stored in the root directory of the USB storage device.
	The utility button operation was not performed properly.	Check that the configuration file (pcsinisetup.txt) is stored in the correct location, insert the USB storage device into the USB port on the rear panel of the unit, and press the utility button for at least 4 seconds.

---

# Specifications

---

## PCS-MCS1 HD MCU System

This unit complies with ITU-T Recommendation H.323.

### Video

Operating bandwidth

64 Kbps to 16 Mbps (standard, LAN connection)

Coding

H.263/H.263+/H.263++/H.264 Baseline Profile/  
H.264 High Profile

Picture elements

CIF: 352 pixels × 288 lines

QCIF: 176 pixels × 144 lines

4CIF: 704 pixels × 576 lines

WCIF (W288p): 512 pixels × 288 lines

W432p: 768 pixels × 432 lines

W4CIF: 1024 pixels × 576 lines

720p: 1280 pixels × 720 lines

1080p: 1920 pixels × 1080 lines

### Audio

Transfer rate

56 Kbps, 64 Kbps (compliant with G.711 ITU-T  
Recommendation)

48 Kbps, 56 Kbps, 64 Kbps (compliant with  
G.722 ITU-T Recommendation)

64 Kbps, 96 Kbps (MPEG4 AAC) (LAN connection)

16 Kbps (compliant with G.728 ITU-T  
Recommendation)

### Network

Interface

LAN (standard), 64 Kbps to 16 Mbps

Supported LAN protocols

HTTP

Telnet

RTP/RTCP

TCP/UDP

SNMP

SSH

### Remote control

Remote camera control

H.281 (compliant with ITU-T Recommendation)

### General

Power requirement

12 V DC

Current consumption

3 A

Operating temperature

5 °C to 35 °C (41 °F to 95 °F)

Operating humidity

20% to 80% (non-condensing)

Storage temperature

-20 °C to +60 °C (-4 °F to +140 °F)

Storage humidity

20% to 80% (non-condensing)

Dimensions

170 × 46 × 125 mm ( $6\frac{3}{4} \times 1\frac{13}{16} \times 5$  in.) (W×H×D)  
(excluding protrusions except feet)

Mass

Approx. 0.7 kg (1 lb. 8.7 oz.)

Supplied accessories

AC adapter (1)

Power cord (1) (Japan and China only)

CD-ROM (1)

Before Using this Unit (1)

Quick Reference Guide (1)

B&P warranty booklet (1)

User registration form (1) (Japan only)

---

## AC Adapter (Supplied)

Power supply

100 V to 240 V AC, 50 Hz/60 Hz, 0.75 A to 0.4 A

Output

12 V DC, 3.0 A

Operating temperature

-5 °C to +45 °C (23 °F to 113 °F)

Operating humidity

25% to 95% RH

Storage temperature

-20 °C to +65 °C (-4 °F to +149 °F)

Storage humidity

5% to 95% RH (non-condensing)

Dimensions

102.5 × 32 × 51.7 mm ( $4\frac{1}{8} \times 1\frac{5}{16} \times 2\frac{1}{8}$  in.)  
(W×H×D) (excluding protrusions)

Mass

Approx. 190 g (6.7 oz.)

---

## **PCSA-MPE1 HD Port Expansion Software (Optional)**

---

## **PCSA-MPE2 HD Port Expansion Software (Optional)**

---

## **PCSA-MSA1 Mobile Access Software (Optional)**

---

Design and specifications are subject to change without notice.

### **Notes**

- Always make a test recording, and verify that it was recorded successfully.  
SONY WILL NOT BE LIABLE FOR DAMAGES OF ANY KIND INCLUDING, BUT NOT LIMITED TO, COMPENSATION OR REIMBURSEMENT ON ACCOUNT OF FAILURE OF THIS UNIT OR ITS RECORDING MEDIA, EXTERNAL STORAGE SYSTEMS OR ANY OTHER MEDIA OR STORAGE SYSTEMS TO RECORD CONTENT OF ANY TYPE.
- Always verify that the unit is operating properly before use. SONY WILL NOT BE LIABLE FOR DAMAGES OF ANY KIND INCLUDING, BUT NOT LIMITED TO, COMPENSATION OR REIMBURSEMENT ON ACCOUNT OF THE LOSS OF PRESENT OR PROSPECTIVE PROFITS DUE TO FAILURE OF THIS UNIT, EITHER DURING THE WARRANTY PERIOD OR AFTER EXPIRATION OF THE WARRANTY, OR FOR ANY OTHER REASON WHATSOEVER.
- SONY WILL NOT BE LIABLE FOR CLAIMS OF ANY KIND MADE BY USERS OF THIS UNIT OR MADE BY THIRD PARTIES.
- SONY WILL NOT BE LIABLE FOR THE LOSS, REPAIR, OR REPRODUCTION OF ANY DATA RECORDED ON THE INTERNAL STORAGE SYSTEM, RECORDING MEDIA, EXTERNAL STORAGE SYSTEMS OR ANY OTHER MEDIA OR STORAGE SYSTEMS.
- SONY WILL NOT BE LIABLE FOR THE TERMINATION OR DISCONTINUATION OF ANY SERVICES RELATED TO THIS UNIT THAT MAY RESULT DUE TO CIRCUMSTANCES OF ANY KIND.

### **Sales and distribution of MPEG-4 Visual encoders/decoders**

THIS PRODUCT IS LICENSED UNDER THE MPEG-4 VISUAL PATENT PORTFOLIO LICENSE FOR THE PERSONAL AND NON-COMMERCIAL USE OF A CONSUMER FOR

- (i) ENCODING VIDEO IN COMPLIANCE WITH THE MPEG-4 VISUAL STANDARD (“MPEG-4 VIDEO”) AND/OR
- (ii) DECODING MPEG-4 VIDEO THAT WAS ENCODED BY A CONSUMER ENGAGED IN A PERSONAL AND NON-COMMERCIAL ACTIVITY AND/OR WAS OBTAINED FROM A VIDEO PROVIDER LICENSED BY MPEG LA TO PROVIDE MPEG-4 VIDEO.

NO LICENSE IS GRANTED OR SHALL BE IMPLIED FOR ANY OTHER USE. ADDITIONAL INFORMATION INCLUDING THAT RELATING TO PROMOTIONAL, INTERNAL AND COMMERCIAL USES AND LICENSING MAY BE OBTAINED FROM MPEG LA, LLC. SEE [HTTP://WWW.MPEGLA.COM](http://WWW.MPEGLA.COM)

MPEG LA is offering licenses for

- (i) manufacturing/sales of any storage media storing MPEG-4 Visual video information
- (ii) distribution/broadcasting of MPEG-4 Visual video information in any manner (such as online video distribution service, internet broadcasting, TV broadcasting).

Other usage of this product may be required to obtain license from MPEG LA.

Please contact MPEG LA for any further information. MPEG LA, L.L.C., 250 STEELE STREET, SUITE 300, DENVER, COLORADO 80206, <http://www.mpegla.co>

### **Sales and distribution of MPEG-4 AVC (3-1) encoders/decoders**

THIS PRODUCT IS LICENSED UNDER THE AVC PATENT PORTFOLIO LICENSE FOR THE PERSONAL AND NON-COMMERCIAL USE OF A CONSUMER TO

- (i) ENCODE VIDEO IN COMPLIANCE WITH THE AVC STANDARD (“AVC VIDEO”) AND/OR
- (ii) DECODE AVC VIDEO THAT WAS ENCODED BY A CONSUMER ENGAGED IN A PERSONAL AND

NON-COMMERCIAL ACTIVITY AND/OR WAS OBTAINED FROM A VIDEO PROVIDER LICENSED TO PROVIDE AVC VIDEO. NO LICENSE IS GRANTED OR SHALL BE IMPLIED FOR ANY OTHER USE. ADDITIONAL INFORMATION MAY BE OBTAINED FROM MPEG LA, L.L.C. SEE [HTTP://MPEGLA.COM](http://MPEGLA.COM)

## Pin Assignments

### 1000BASE-T/100BASE-TX/10BASE-T connector



#### Modular connector

Pin	10BASE-T/100BASE-TX	1000BASE-T
1	TD+	TP0+
2	TD-	TP0-
3	RD+	TP1+
4	-	TP2+
5	-	TP2-
6	RD-	TP1-
7	-	TP3+
8	-	TP3-

## Ports Used on the PCS-MCS1

Function	Port number	Type
RAS	1719	UDP
Gatekeeper Discovery	224.0.1.41:1718	UDP Multicast
Q.931 (call)	2253-2285	TCP
Q.931 (answer)	1720	TCP
H.245	2253-2285	TCP
Audio RTP	49152-49452	UDP
Audio RTCP	49153-49453	UDP
Video RTP	49154-49454	UDP
Video RTCP	49155-49455	UDP
FECC RTP	49156-49456	UDP
FECC RTCP	49157-49457	UDP
2nd Video RTP	49158-49458	UDP
2nd Video RTCP	49159-49459	UDP
Auto Bandwidth Detection	51234	UDP/TCP

#### Note

The port numbers that can be set for RTCP are 49152 to 65535.

---

# USB Storage

Use USB storage devices that support USB2.0 with this unit. We recommend using the Sony USM32GR “POCKET BIT.”

## Connection

Connect the device directly to the USB port on the unit.

## Access indicator

Off: Standby

Lit: Data transfer in progress

## Removal

Always make sure that the POCKET BIT is in standby mode (i.e., the indicator is off) before removing it.

## Usage precautions

- Do not apply excessive force on the POCKET BIT while it is connected to a device. Damage to the USB connector may result in malfunction of the POCKET BIT as well as the connected device.
- Be aware that the surface of this product may become hot after extended periods of access or use.
- If the connected device is started or restarted while the POCKET BIT is connected, the POCKET BIT may not function properly. Remove the POCKET BIT before performing such operations.
- We recommend creating backups of important data.

SONY WILL NOT BE LIABLE FOR DAMAGES OF ANY KIND INCLUDING, BUT NOT LIMITED TO, COMPENSATION OR REIMBURSEMENT FOR LOSS OF RECORDED DATA ON ACCOUNT OF FAILURE OF THIS UNIT OR ITS SOFTWARE.

POCKET BIT is a trademark of Sony Corporation.

---

# Glossary

## ARC

An abbreviation for adaptive rate control, a technology that automatically lowers the video bit rate during network congestion.

## ARQ

An abbreviation for automatic repeat request, an error control method in which the receiver requests retransmission from the transmitter when a packet loss occurs.

## Auto Bandwidth Detection

A function that detects the network bandwidth before communication. Using this detected value with the QoS functions allows optimum QoS control from the beginning of the communication.

## Codec

An abbreviation for coder-decoder, an integrated device or program that includes a coder that converts an analog audio/video signal to a digital data stream and compresses it, and a decoder that decompresses the digital signal to its original analog state.

## DHCP

An abbreviation for Dynamic Host Configuration Protocol, a protocol for managing IP addresses on networks.

## DNS

An abbreviation for Domain Name System, a naming system utilizing domain names.

## FEC

An abbreviation for forward error correction, an error control method in which the receiver can correct errors without requesting retransmission from the transmitter.

## Frame rate

The number of frames that can be encoded/decoded in one second.

## G.711

An ITU-T audio codec recommendation. This codec converts a telephone audio bandwidth signal to a digital signal with a data rate of 64 Kbps. The signal is also transferred at 56 Kbps in some cases.

## G.722

An ITU-T audio codec recommendation. This codec converts audio with a bandwidth of 7 kHz to a digital signal with a data rate of 48 Kbps, 56 Kbps, or 64 Kbps.

**G.728**

An ITU-T audio codec recommendation. This codec converts a telephone audio bandwidth signal to a digital signal with a data rate of 16 Kbps.

**Gatekeeper**

A device that controls access to H.323 visual communication on networks. This allows zone administration, access and bandwidth restriction, and the use of aliases and other functions.

**H.239**

An ITU-T recommendation that supports the dual video function (presentation mode). This allows simultaneous reception and transmission of camera images and computer data.

**H.263**

A video coding algorithm based on the H.261 standard that allows communication via a lower bit rate.

**H.263+**

A video codec based on the H.263 standard that adds Annex I to T (I, J, K...T) with the purpose of enhancing picture quality and error tolerance. Normally, this format is a profile used in combination with some of the Annexes for H.263/H.263+.

**H.264**

A video coding algorithm standardized by the ITU-T in May 2003.

This format achieves high picture quality via lower bit rates, providing a picture quality equal to that of the H.263 standard while using about half the bit rate. It has also been standardized by the ISO as MPEG-4 Part 10, Advanced Video Coding (AVC).

**H.323**

A standard that allows communication via a LAN on which QoS is not guaranteed.

**HD**

An abbreviation for high definition that denotes high resolution and high picture quality for televisions and other displays. The 1080i, 1080p, and 720p formats correspond to this standard.

**Hop count**

The number of routers that are passed through to reach the remote party.

**ITU-T**

An abbreviation for the International Telecommunication Union's Telecommunication Standardization Sector.

**MCU**

An abbreviation for multipoint control unit, a device through which multipoint communication between connected multipoint terminals is made possible.

**QoS**

An abbreviation for quality of service which reserves a bandwidth for specific communications on a network to guarantee a steady communication speed.

**SNMP**

An abbreviation for Simple Network Management Protocol, a protocol for sharing information between the management station and managed terminals. This protocol allows monitoring of Sony communication systems.

**ToS**

An abbreviation for type of service, a field in an IP header. Inclusion of the ToS information allows a communication device to determine the appropriate packet transmission priority, etc. It also allows for the changing of paths based on the type of service (delay, size, etc.).

# Menu Configuration

The unit's menus are configured as follows. For detailed information, see the pages in parentheses. The initial settings of each item are bolded.

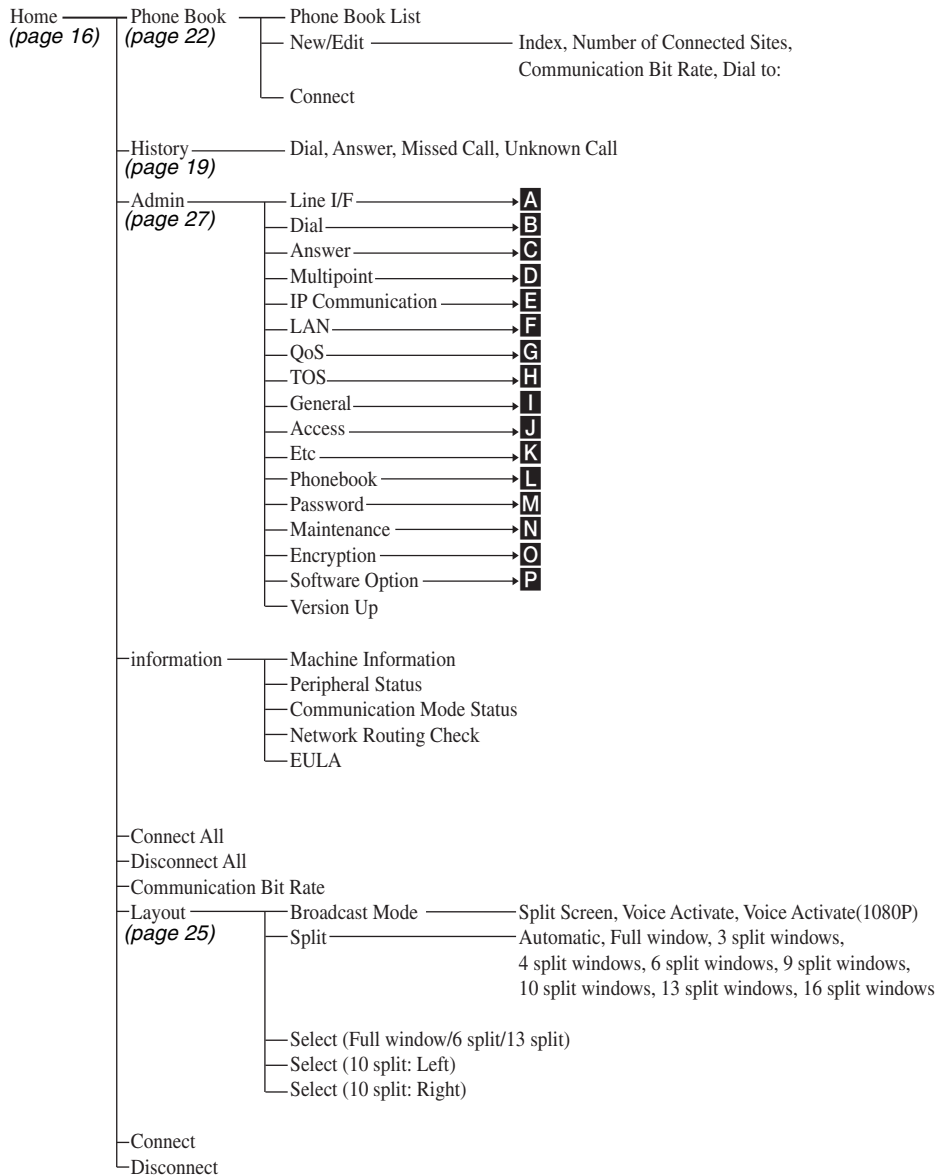



**A** Line I/F — Use LAN2 — **Off, On**  
(page 27)

**B** Dial — Select LAN Prefix — **Disable, Enable**  
(page 27) — LAN Prefix

**C** Answer — Ad hoc — **On, Off**  
(page 28) — Auto Answer — **On, Off**  
— Reject Answer — **On, Off**  
— Reject Unknown Call — **Off, LAN1, LAN2, LAN1+LAN2**

**D** Multipoint — Broadcast Mode — **Split Screen, Voice Activate, Voice Activate (1080P)**  
(page 28) — Split — **Automatic, Full window, 3 split windows, 4 split windows, 6 split windows, 9 split windows, 10 split windows, 13 split windows, 16 split windows**  
— Voice Activation Frame — **On, Off**

**E** IP Communication — IP Communication — Individual Settings for — **Off, On**  
(page 28) — Transmission/Reception  
— IP Communication Mode<sup>1)</sup> — Total Bandwidth<sup>2)</sup> — **16384Kbps**  
— Communication Bit Rate<sup>2) 3)</sup> — **2048Kbps**  
— Audio Mode<sup>3)</sup> — **G.711, G.722, G.728, MPEG4**  
— Far End Camera Control — **On, Off**  
— H.239 — **On, Off**  
— H.239 Ratio — **2/3, 1/2, 1/3**  
— Screen Size<sup>3)</sup> — **1080, 720, W4CIF, W432P, WCIF, 4CIF, CIF, QCIF, AUTO**  
— Video Mode<sup>3)</sup> — **H.263+, H.264**  
— Video Frame<sup>3)</sup> — **15fps, 30fps, AUTO**

- 1) The number of pages available after the [IP Communication Mode] page varies depending on whether [Individual Settings for Transmission/Reception] is set to [On] or [Off].
- 2) You can enter a value between 64 Kbps to 16384 Kbps.
- 3) When [Individual Settings for Transmission/Reception] is set to [On] on the [IP Communication] page, settings can be configured individually for transmission and reception.

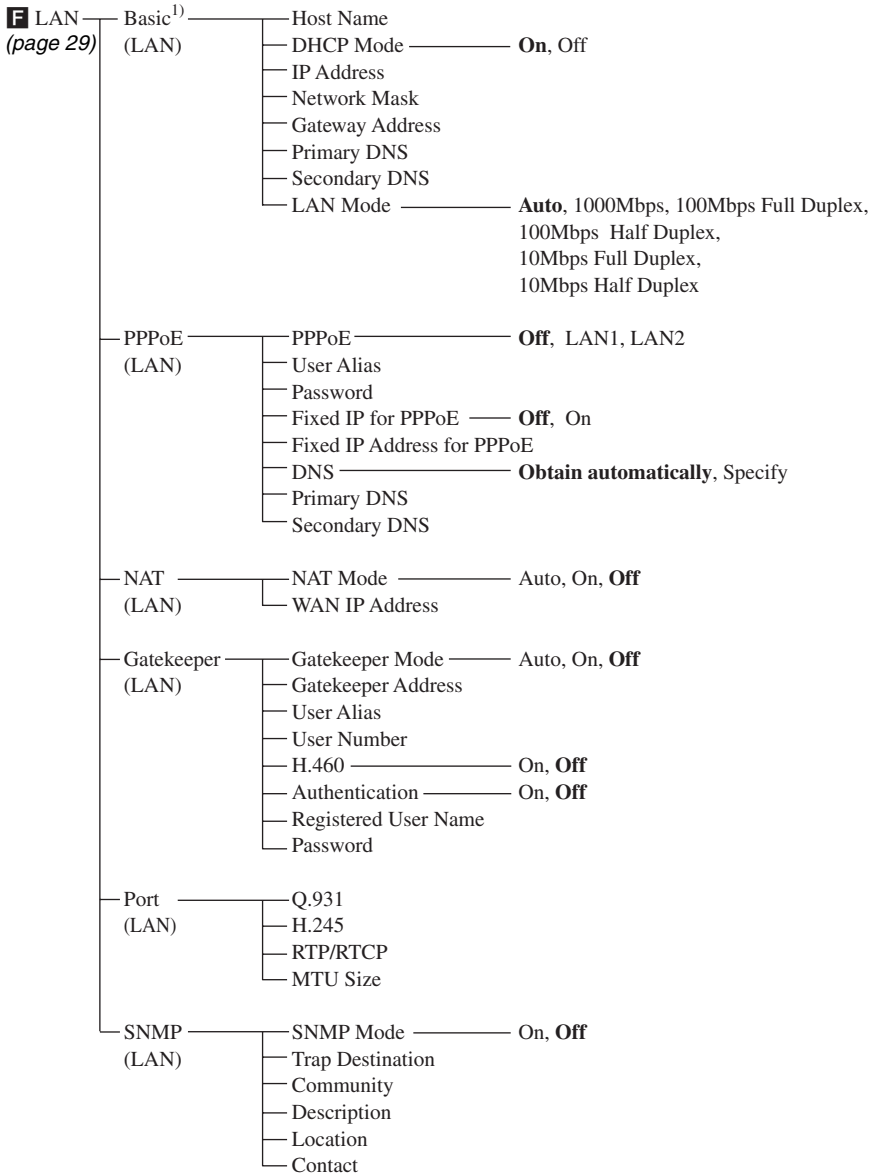

1) When [Use LAN2] is set to [On] on the [Line I/F] page, the [Basic] pages for LAN1 and LAN2 are displayed, allowing you to configure the settings.

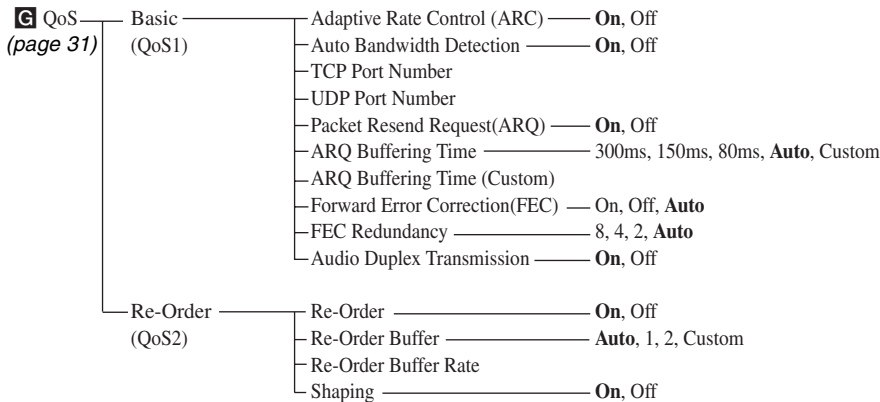

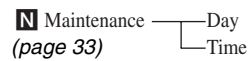
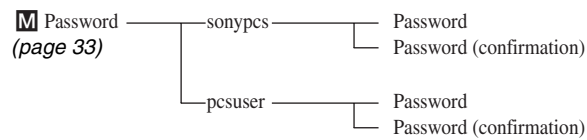
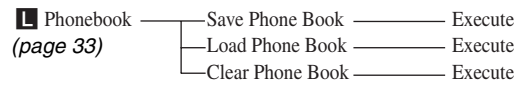
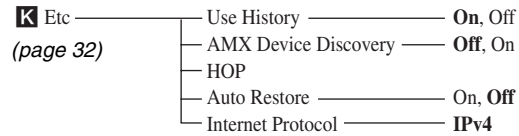
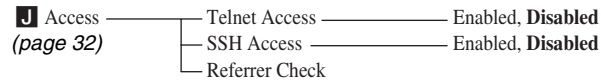
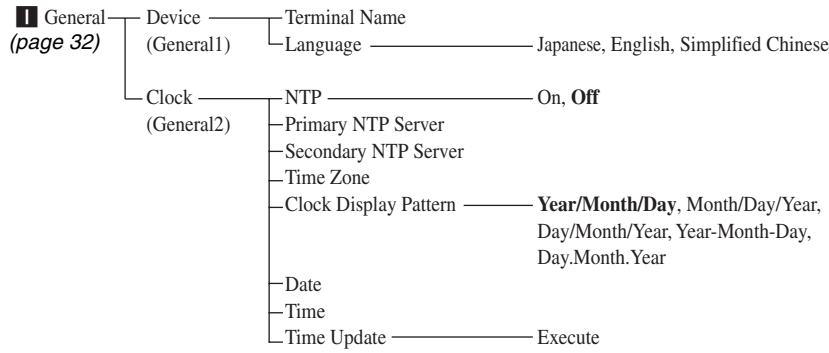
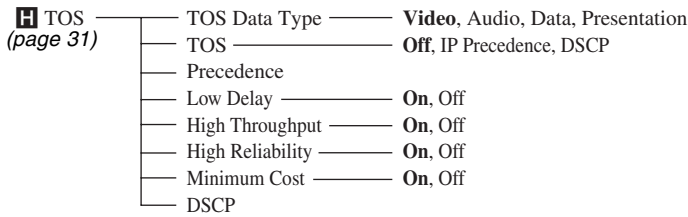

<b>P</b> Software Option <i>(page 33)</i>	— Software Option 1
	— Software Option 2
	— Software Option 3
	— Software Option 4
	— Software Option 5
	— Software Option 6
	— Software Option 7
	— Software Option 8

---

# Index

- A**
- [Access] page 32
  - [Ad Hoc] 28
  - Ad hoc mode 8, 18
  - [Adaptive Rate Control] 31
  - [Admin] button 16
  - Administrator 15
  - [AMX Device Discovery] 32
  - [Answer] page 28
  - Answering 21
  - [ARQ Buffering Time] 31
  - [ARQ Buffering Time (Custom)] 31
  - [Audio Duplex Transmission] 31
  - [Audio Mode] 29, 34
  - [Authentication] 30
  - [Auto Answer] 28
  - Auto answer mode 21
  - [Auto Bandwidth Detection] 31
  - [Auto Restore] 32
- B**
- Basic connection methods 18
  - [Bit rate - Decode] 35
  - [Bit rate - Encode] 35
  - Broadcast modes 24, 28
- C**
- Call histories 19
  - [Check Code] 35
  - [Clear Phone Book] 33
  - [Clock Display Pattern] 32
  - [Communication Bit Rate] 23, 29
  - [Communication Mode Status] page 34
  - [Community] 30
  - [Connect Priority] 45
  - Connection 21
  - [Contact] 31
- D**
- [Date] 32
  - [Day] 33
  - [Description] 30
  - Device status 34
  - Device status menu 34
  - DHCP 37
  - [DHCP Mode] 29
  - [Dial] page 27
  - [Dial to] 23
  - [DNS] 30
  - [DSCP] 32
- E**
- [Encrypt Priority] 45
  - Encrypted connections 5, 45, 46
  - [Encryption] 33, 45
  - [Encryption] page 33
  - [EULA] page 35
- F**
- [Far End Camera Control] 29, 35
  - [Far End Terminal Name] 34
  - [FEC Redundancy] 31
  - Firewalls 39
  - [Fixed IP Address for PPPoE] 30
  - [Fixed IP for PPPoE] 30
  - [Forward Error Correction] 31
  - [Frame Rate] 35
- G**
- [Gatekeeper] 34
  - [Gatekeeper Address] 30
  - [Gatekeeper Mode] 30
  - Gatekeepers 37
  - [Gateway] 35
  - [Gateway Address] 13, 29
  - [General: Clock] page 32
  - [General: Device] page 32
- H**
- [H.239] 29, 35
  - [H.239 Ratio] 29
  - [H.245] 30
  - H.460 39
  - [H.460] 30
  - [High Reliability] 31
  - [High Throughput] 31
  - [History] button 16
  - [Home] button 16
  - [HOP] 32
  - [Host Name] 29, 34
  - [Host Version] 34
- I**
- [Index] 22
  - [Individual Settings for Transmission/Reception] 28
  - [Information] button 17
  - Initial setup wizard 12
  - [Internet Protocol] 32
  - [IP Address] 29, 34
  - [IP Address (LAN2)] 34
  - [IP Address of Remote Site] 35
  - [IP Communication Mode] page 28
  - [IP Communication] page 28
- L**
- [LAN: Gatekeeper] page 30
  - [LAN: NAT] page 30
  - [LAN: Port] page 30
  - [LAN: SNMP] page 30
  - LAN connection using a gatekeeper 37
  - LAN connection using a router 37
  - LAN connection using DHCP 37
  - LAN connection using H.460 firewall traversal 39
  - LAN connection using NAT 38
  - LAN connection using PPPoE 39
  - [LAN Mode] 30
  - [LAN Mode (LAN1)] 34
  - [LAN Mode (LAN2)] 34
  - LAN2 36
  - [Language] 32
  - [Line I/F] 35
  - [Line I/F] page 27
  - Line interface settings 27
  - [Load Phone Book] 33
  - [Location] 31
  - [Low Delay] 31
- M**
- [MAC Address] 34
  - [MAC Address (LAN2)] 34
  - [Machine Information] page 34
  - [Machine Version] 34
  - [Maintenance] page 33
  - Manual answer mode 21
  - Menu configuration 56
  - Menus 56
  - [Minimum Cost] 31
  - [MTU Size] 30
  - [Multipoint] page 28
- N**
- NAT 38
  - [NAT Mode] 30
  - [Network Mask] 13, 29
  - [Network Routing Check] page 35
  - Network routing checks 40
  - [NTP] 32
  - [Number of Connected Sites] 22
  - [Number of lost packets] 35
  - [Number of received packets] 35
  - [Number of recovered packets] 35
- O**
- Option I/F 34
  - Optional software 41

## P

[Packet Resend Request] 31  
[Password] 30  
Password 33  
Password (confirmation) 33  
[Password] page 33  
PCSA-MPE1 6  
PCSA-MPE2 6  
PCSA-MSA1 6, 7  
pcsuser 15, 17, 33  
[Peripheral Status] page 34  
Phonebook 20, 22, 23  
[Phonebook] button 16  
[Phonebook] page 33  
Picture control 24  
Power supply 9  
PPPoE 39  
[PPPoE] 30  
[Precedence] 31  
[Primary DNS] 29, 30  
[Primary NTP Server] 32

## Q

[Q.931] 30  
QoS 5

## R

[Rate] 35  
[Registered User Name] 30  
[Reject Answer] 28  
[Reject Unknown Call] 28  
[Remote Address] 34  
[Re-Order] 31  
[Re-Order Buffer] 31  
[Re-Order Buffer Rate] 31  
Restrictions when using LAN2 36  
Router 37  
[RTP/RTCP] 30

## S

[Save Phone Book] 33  
[Screen Size] 29  
[Secondary DNS] 29, 30  
[Secondary NTP Server] 32  
[Select LAN Prefix] 27  
[Serial Number] 34  
Setting menus 27  
[Shaping] 31  
[SNMP Mode] 30  
[Software Option] 34  
[Software Option] page 33  
sonypcs 13, 15, 16, 17, 33  
[Split] 28  
Split-screen mode 24  
[SSH Access] 32

[Start Measurement] 35  
System configuration examples 7

## T

[TCP Port Number] 31  
Telnet 23  
[Telnet Access] 32  
[Terminal Name] 32  
[Time] 32, 33  
[Time Update] 32  
[Time Zone] 32  
[TOS] 31  
[TOS Data Type] 31  
[TOS] page 31  
[Total Bandwidth] 28  
[traceroute] 35  
[Trap Destination] 30  
Traversal servers 39

## U

[UDP Port Number] 31  
USB storage 54  
[Use History] 32  
[Use LAN2] 27  
[User Alias] 30  
[User Number] 30

## V

[Video Frame] 29  
[Video Mode] 29, 34  
[Voice Activation Frame] 28  
Voice-activate mode 25

## W

[WAN IP Address] 30  
Web access user 15  
Web control mode 7, 18  
Web control screen 16

