

PEAK-SYSTEM

Product Overview

2024

You have a vision ...

You are working on the future of your company and planning successful products for tomorrow's markets?

You want to translate your projects into reality, so you look for a responsive and reliable partner?

You set great importance to the functionality of your development tools and the quality of the hardware you use?

Whether you need a plug-in card for the PC, a microcontroller module for temperature recording, a program to monitor your system, or just the right kind

of cable – with our product range we can help you concentrate on what is important to you: developing successful products.

PEAK-System puts creative teams of experienced and highly-motivated specialists at your disposal, open to new ways, open to new solutions. Talk over your aims and objectives with us.

Engineering on your Behalf

We support you at every phase in a product's development: from consultation to design to production.

- Based on your requirements we develop the solution that is right for you – with a cost-conscious and efficient attitude
- Customer specific hard- & software for CAN/LIN communication
- We create your documentation ...
- carry out the training and familiarization ...
- and organize the manufacture



... we do the rest.

Hardware

- ___ CAN FD connections for High-speed USB 2.0, PCI Express, PCI Express Mini, and M.2
- ___ CAN/LIN interfaces for conventional PC interfaces and embedded applications
- ___ I/O modules with CAN and CAN FD connection for control, measured data recording, and processing
- ___ Converters for different physical transmission types (bus converter modules)
- ___ Routers and gateways for the forwarding of messages between CAN buses and other networks
- ___ Data loggers and diagnostic hardware
- ___ Products for education, demonstrations, and test setups
- ___ Chip solutions for the CAN and CAN FD connection to USB and PCI Express

Software

- ___ CAN development systems for Windows and Linux
- ___ Programming interfaces for various protocols and standards
- ___ Software to monitor and diagnose CAN and LIN buses
- ___ Programs for recording, playback, and simulation of message traffic
- ___ Configuration software for CAN hardware from PEAK-System

Accessories

- ___ Helpful CAN accessories
- ___ PC adapter cards for PC/104 Small Form Factor Boards
- ___ CAN cables and adapters for various applications

OEM Development

One of our products fits your portfolio?
Your development department is under pressure?

We have the ideal solution for you:

- ___ Adaptation of our products to your specific needs
- ___ Available as customer OEM product (your logo, your case)
- ___ Translation of your ideas into ready-to-manufacture products
- ___ Advice and consultation on hardware and software development
- ___ Fixed-price development on your behalf

Table of Contents . . .

HARDWARE

PC Interfaces

PCAN-USB	11
PLIN-USB	12
PCAN-USB FD	13
PCAN-USB Pro FD	14
PCAN-USB X6	16
PCAN-ExpressCard 34	18
PCAN-cPCI	19
PCAN-PCI	20
PCAN-PCI Express	21
PCAN-PCI Express FD	22
PCAN-miniPCI	23
PCAN-miniPCle	24
PCAN-miniPCle FD	25
PCAN-M.2	26
PCAN-PC/104	27
PCAN-PC/104-Plus	28
PCAN-PC/104-Plus Quad	29
PCAN-PCI/104-Express	30
PCAN-PCI/104-Express FD	31

Chip Solutions

PCAN-Chip PCIe FD	32
PCAN-Chip USB	33
PCAN-Chip USB Eval	33

Couplers & Converters

PCAN-AU5790	34
PCAN-TJA1054	35
PCAN-Optoadapter	36
PCAN-Repeater DR	37
PCAN-LWL	38
PLIN-LWL	39

I/O Modules

PCAN-MicroMod	40
PCAN-MicroMod Evaluation Board	40
PCAN-MicroMod Analog 1 & 2	41
PCAN-MicroMod Digital 1 & 2	42

PCAN-MicroMod Mix 1	43
PCAN-MicroMod Mix 2	44
PCAN-MicroMod Mix 3	45
PCAN-MicroMod FD Product Line	46
PCAN-MicroMod FD	49
PCAN-MicroMod FD Evaluation Board	50
PCAN-MicroMod FD Analog 1	51
PCAN-MicroMod FD Digital 1 & 2	52
PCAN-MicroMod FD ECU	53
PCAN-MicroMod FD DR CANopen Digital 1	54
PCAN-MIO	55
MU-Thermocouple1 CAN	56
MU-Thermocouple1 CAN FD	57
PCAN-GPS	58
PCAN-GPS FD	59
PCAN-GPS Pro FD	60
GPS Sensor Modules in Comparison	61

Routers & Gateways

PCAN-Gateways	62
PCAN-Gateway Applications	64
Virtual PCAN-Gateway	66
PCAN-Ethernet Gateway FD DR	67
PCAN-Ethernet Gateway DR	68
PCAN-Router DR	69
PCAN-Router	70
PCAN-Router FD	71
PCAN-Router Pro	72
PCAN-Router Pro FD	74
PCAN-RS-232	77
PCAN-RS-232 FD	78
PCAN-LIN	79

Diagnostics & Education

PCAN-MiniDisplay	80
PCAN-Diag 2	82
PCAN-Diag FD	85
PCAN-Diag FD J1939 Add-in	88
PCAN-MiniDiag FD	89

Hardware & software for CAN/LIN bus applications

SOFTWARE

Development Packages

PCAN-Basic	94
PCAN-CCP API	96
PCAN-XCP API	97
PCAN-ISO-TP API	98
PCAN-UDS API	99
PCAN-OBD-2 API	100
PCAN-OBDOnUDS API	101
PCAN-PassThru API	102
PCAN-Developer	103
PCAN-RP1210 API	106
PLIN-API	107

PC Software

PCAN-View	108
PLIN-View Pro	109
PCAN-OBD-2 Viewer	110
PPCAN-Editor 2	111
PCAN-MicroMod Configuration	112
PCAN-MicroMod FD Configuration	113
PCAN-Explorer 6	114
Plotter Add-in	118
CANdb Import Add-in	119
Instruments Panel Add-in	120
J1939 Add-in	121
PCAN-Symbol Editor	122
PCAN-FMS Simulator 2	124
PCAN-Trace	126

ACCESSORIES

Adapters

ISA-PC/104 Adapter	128
PCI-PC/104-Plus Adapter	128
PCI-Express-PCIe/104 Adapter	129
PCIe-miniPCIe Low-Profile Adapter	130
PCIe-M.2 Low-Profile Adapter	131
PCAN-Adapter D-Sub for DR Products	132
PCAN-Adapter D-Sub to Screw Terminals	133
PCAN-Term	134
PCAN-MiniTerm	134
PCAN-T-Adapter	135
PCAN-Mini-T-Adapter	135
PEAK-DevPack Debug Adapter	136

Cables

PCAN-Cable 1 & 2	137
PCAN-Cable 3	138
PCAN-Cable OBD-2	139
PCAN-Cable J1939	140
PCAN-Cable M12	141
LIN Connection Cable for PC LIN Interfaces	142
LIN Connection Cable for PCAN-LIN	143

PEAK-SYSTEM

Contact	144
World Wide Web	144
International Sales Partners	146
Imprint	147

Quality and Environment

Scope of Certification:

Development, manufacturing and sales of hardware and software for applications in the mobile and industrial communication sector

We are certified according to the international standards ISO 9001:2015 and ISO 14001:2015. Our management system combines the requirements of the standard ISO 9001 for quality management systems and the ones of the standard ISO 14001 for environmental management systems.

With the certification, we provide a documented proof for our quality-conscious and customer-oriented business as well as our responsible management of resources and environment. The certification was carried out by DEKRA Certification GmbH.

The certificates are available on our website in the languages German, English, and French for download.



Quality and Safety:

We have our own products and customer-specific OEM products produced by reputable manufacturing companies in Germany and throughout Europe.

Qualitätsmanagement
Umweltmanagement
ISO 9001
ISO 14001

www.dekra-siegel.de

Hardware

PC Interfaces

I/O Modules

Couplers & Converters

Routers & Gateways

Diagnostics & Education

- CAN FD connections for High-speed USB 2.0, PCI Express, PCI Express Mini, and M.2
- CAN/LIN interfaces for conventional PC interfaces and embedded applications
- I/O modules with CAN and CAN FD connection for control, measured data recording, and processing
- Converters for different physical transmission types (bus converter modules)
- Routers and gateways for the forwarding of messages between CAN buses and other networks
- Data loggers and diagnostic hardware
- Products for education, demonstrations, and test setups
- Chip solutions for the CAN and CAN FD connection to USB and PCI Express
- All products are conform to CE standards

The right Interface for your Operating System

The following table lists the operating systems supported by our drivers for each PC interface and transmission protocol. For x86 systems, non-plug-and-play CAN interfaces, and Windows versions that are no longer supported, we provide the last working versions of our device drivers. Please note that these drivers are no longer maintained.

Interface		Windows				Linux
		11		10		
		x64	ARM64	x86	x64	
PCAN-USB	CAN	■	■	■	■	■
PLIN-USB	LIN	■	■	■	■	■
PCAN-USB FD	CAN + CAN FD	■	■	■	■	■
PCAN-USB Pro FD	CAN + CAN FD	■	■	■	■	■
	LIN	■	■	■	■	■
PCAN-USB X6	CAN + CAN FD	■	■	■	■	■
PCAN-Chip USB & Eval	CAN + CAN FD	■	■	■	■	■
PCAN-ExpressCard 34	CAN	■	-	■	■	■
PCAN-PCI	CAN	■	-	■	■	■
PCAN-PCI Express	CAN	■	-	■	■	■
PCAN-PCI Express FD	CAN + CAN FD	■	-	■	■	■
PCAN-cPCI	CAN	■	-	■	■	■
PCAN-miniPCI	CAN	■	-	■	■	■
PCAN-miniPCIe	CAN	■	-	■	■	■
PCAN-miniPCIe FD	CAN + CAN FD	■	-	■	■	■
PCAN-M.2	CAN + CAN FD	■	-	■	■	■
PCAN-PC/104	CAN	-	-	■	-	■
PCAN-PC/104-Plus	CAN	■	-	■	■	■
PCAN-PC/104-Plus Quad	CAN	■	-	■	■	■
PCAN-PCI/104-Express	CAN	■	-	■	■	■
PCAN-PCI/104-Express FD	CAN + CAN FD	■	-	■	■	■

- The operating system is supported.
- The operating system support has been discontinued.
- The operating system is not and never was supported.

www.peak-system.com

- ___ Our device drivers are available on our Downloads web page.
- ___ The Support section contains an overview of our drivers along with change histories.
- ___ Visit our Linux website for the latest Linux device drivers, documentation, change history, and additional information.

Alternative Transceiver Modules

With pluggable CAN transceiver modules, some of our hardware products allow flexible adaptation of the CAN channels to the respective requirements. The following tables give you an overview of the available transceiver modules and compatible products.

Transceiver Module	Part No.	Standard	CAN Bit Rates		Galvanic Isolation	Wake-Up
			Minimum	Maximum		
PCAN-Transceiver TJA1041	IPEH-001001	High-speed	40 kbit/s	1 Mbit/s	–	■
PCAN-Transceiver PCA82C251	IPEH-001002	High-speed	5 kbit/s	1 Mbit/s	–	–
PCAN-Transceiver MAX3057-ISO	IPEH-001003	High-speed	5 kbit/s	1 Mbit/s	■	–
PCAN-Transceiver TH8056	IPEH-001004	Single-wire	1.3 kbit/s	40 kbit/s (normal) 100 kbit/s (High-speed)	–	■
PCAN-Transceiver TJA1055	IPEH-001005	Low-speed	20 kbit/s	125 kbit/s	–	■
PCAN-Transceiver TJA1044	IPEH-001006	High-speed	25 kbit/s	12 Mbit/s *	–	–
PCAN-Transceiver TJA1044-ISO	IPEH-001007	High-speed	25 kbit/s	12 Mbit/s *	■	–
PCAN-Transceiver TJA1043	IPEH-001008	High-speed	40 kbit/s	12 Mbit/s *	–	■

* According to the CAN transceiver data sheet only CAN FD bit rates up to 5 Mbit/s are guaranteed with the specified timing.

SIC Transceiver Modules (Signal Improvement Capability)

SIC transceivers use active methods to improve the CAN FD signal and thus enable higher bit rates and more complex bus topologies. SIC transceivers are compatible with conventional High-speed CAN transceivers. In complex CAN networks, the bit rate is limited during the arbitration phase (nominal bit rate), see CiA 601-4. We recommend limiting the nominal bit rate to 500 kbit/s.

Transceiver Module	Part No.	Standard	CAN Bit Rates		Galvanic Isolation	Wake-Up
			Minimum	Maximum		
PCAN-Transceiver TJA1462	IPEH-001010	High-speed	25 kbit/s	8 Mbit/s	–	–
PCAN-Transceiver TJA1462-ISO	IPEH-001011	High-speed	25 kbit/s	8 Mbit/s	■	–
PCAN-Transceiver TJA1463	IPEH-001012	High-speed	25 kbit/s	8 Mbit/s	–	■

Compatible Products

Product	PCAN-MIO	PCAN-Router Pro	PCAN-Router Pro FD	PCAN-USB X6	PCAN-USB X6 galv. isolated
Part No.	IPEH-002187 IPEH-002187-A	IPEH-002212	IPEH-002220 IPEH-002222	IPEH-004062	IPEH-004063 IPEH-004064
PCAN-Transceiver TJA1041	Default	Default	■	–	–
PCAN-Transceiver PCA82C251	■	■	■	–	–
PCAN-Transceiver MAX3057-ISO	–	■	–	–	–
PCAN-Transceiver TH8056	■	■	■	–	–
PCAN-Transceiver TJA1055	■	■	■	–	–
PCAN-Transceiver TJA1044	–	–	■	Default	■
PCAN-Transceiver TJA1044-ISO	■	–	■	■	Default
PCAN-Transceiver TJA1043	–	–	Default	–	–
PCAN-Transceiver TJA1462	–	–	■	■	■
PCAN-Transceiver TJA1462-ISO	–	–	■	■	■
PCAN-Transceiver TJA1463	–	–	■	■	■

The Standard CAN FD ...

With the release of various hardware and software products, PEAK-System is a pioneer in the introduction of the CAN FD standard.

With CAN FD (Flexible Data rate) the robust and long-lasting CAN specification has been extended with properties which are primarily designed for larger amounts of data. Higher bit rates up to 12 Mbit/s for the data of the CAN frames and the use of up to 64 data bytes in a single CAN frame are the main criteria.

CAN FD is downward-compatible to the CAN 2.0 A/B standard, thus CAN FD nodes can be used in existing CAN networks. However, in this case the CAN FD extensions are not applicable.

Since the first implementations of CAN FD, the protocol has been improved and is now included in the standard ISO 11898-1. The revised CAN FD standard is not compatible with the original protocol. PEAK-System takes this into account by supporting both protocol versions with their CAN FD interfaces. If required, the user can switch to the CAN FD protocol used in the environment by software („Non-ISO“ and „ISO“).

Insight in CAN and CAN FD Frames

The free Windows software CAN FD Frame Analyzer can be used to visualize the signal course of any CAN or CAN FD frame.

The CAN message and the bit rates are freely configurable. The different components of the CAN frame are named and highlighted in color. Changes and their effect on the signal course are directly traceable. Users can thus easily deepen their understanding of the CAN protocol and CAN FD specification in particular.



Features

- Software for visualizing the signal course of a CAN frame
- Support of the specifications CAN FD (ISO/Non-ISO) and CAN 2.0 A/B
- Configuration of the CAN frame to be visualized by setting the CAN ID, DLC, CAN data, and various options
- Setting of the nominal and the data bit rate with predefined selection lists or with custom register values
- Marking and naming of the different structural sections of the CAN frame
- Visualization of the CAN FD signal course with or without Bit Rate Switch
- Optional visualization of the signal course with Stuff bits
- Indication of frame length in bits and frame duration in μs
- Indication of the calculated CRC value

PCAN-USB

CAN Interface for USB

The PCAN-USB adapter enables simple connection to CAN networks. Its compact plastic casing makes it suitable for mobile applications.

The opto-decoupled version guarantees galvanic isolation of up to 500 Volts between the PC and the CAN side.

The package is also supplied with the CAN monitor PCAN-View for Windows and the programming interface PCAN-Basic.



D-Sub	Pin	Pin assignment
	1	Not connected / optional +5V
	2	CAN-L
	3	GND
	4	Not connected
	5	Not connected
	6	GND
	7	CAN-H
	8	Not connected
	9	Not connected / optional +5V

Specifications

- Adapter for the USB connection (Full-Speed mode, compatible with USB 1.1, USB 2.0, and USB 3.0)
- High-speed CAN connection (ISO 11898-2)
- Bit rates from 5 kbit/s up to 1 Mbit/s
- Time stamp resolution approx. 42 μ s
- Compliant with CAN specifications 2.0A (11-bit ID) and 2.0B (29-bit ID)
- CAN bus connection via D-Sub, 9-pin (in accordance with CiA[®] 106)
- NXP SJA1000 CAN controller, 16 MHz clock frequency
- NXP PCA82C251 CAN transceiver
- Galvanic isolation on the CAN connection up to 500 V (only for IPEH-002022)
- CAN termination can be activated through a solder jumper
- 5-Volt supply to the CAN connection can be connected through a solder jumper, e.g., for external bus converter
- Voltage supply via USB
- Extended operating temperature range from -40 to +85 °C (-40 to +185 °F)

Ordering information

Designation	Part No.
PCAN-USB	IPEH-002021
PCAN-USB opto-decoupled	IPEH-002022

Scope of supply

- PCAN-USB in plastic casing
- Device drivers for Windows 11 (x64/ARM64), 10 (x64), and Linux
- CAN monitor PCAN-View for Windows (details on page 108)
- Programming interface PCAN-Basic for developing applications with CAN connection (details on page 94)
- Programming interfaces for standardized protocols from the automotive sector
- Manual in PDF format

PLIN-USB

LIN Interface for USB

The PLIN-USB enables the connection of a Windows computer to a LIN network via USB. The LIN interface supports the LIN protocol according to the standard ISO 17987 and complies with all LIN specifications up to version 2.2. The interface can be operated as a master or a slave.

The monitor software PLIN-View Pro and the PLIN programming interface for the development of applications with LIN connection are included in the scope of supply.



Specifications

- LIN interface for the USB connection (Full-Speed mode, compatible with USB 1.1, USB 2.0, and USB 3.0)
- LIN connection (ISO 17987)
- Compliant with all LIN specifications (up to version 2.2)
- Bit rates from 1 kbit/s up to 20 kbit/s
- Can be used as a LIN master or slave (1 ms master task resolution)
- Automatic bit rate, frame length, and checksum type recognition
- Autonomous scheduler with support for unconditional, event, and sporadic frames
- LIN bus connection via D-Sub, 9-pin
- LIN connection short-circuit-proof against transceiver supply and ground
- NXP LIN transceiver TJA1028T or TI LIN transceiver TLIN1028D
- Galvanic isolation on the LIN connection up to 500 V
- Indicator LED for interface status
- Voltage supply 5 V DC via USB port
- Transceiver supply 6 to 28 V DC via D-Sub, pin 9
- Extended operating temperature range from -40 to +85 °C (-40 to +185 °F)

D-Sub	Pin	Pin assignment
	1	Not connected
	2	Not connected
	3	Not connected
	4	LIN
	5	GND
	6	GND
	7	Not connected
	8	Not connected
	9	V _{BAT}

Ordering information

Designation	Part No.
PLIN-USB	IPEH-004052

Scope of supply

- PLIN-USB in plastic casing
- LIN device drivers for Windows 11 (x64/ARM64), 10 (x64), and Linux
- LIN monitor PLIN-View Pro for Windows (details on page 109)
- Programming interface PLIN-API for developing applications with LIN connection (details on page 107)
- Manual in PDF format

Accessories: LIN Connection Cable for PC LIN Interfaces optionally available (details on page 142).

PCAN-USB FD

CAN and CAN FD Interface for High-Speed USB 2.0

The CAN FD adapter PCAN-USB FD allows the connection of CAN FD and CAN networks to a computer via USB. A galvanic isolation of up to 500 Volts decouples the PC from the CAN bus. The simple handling and its compact plastic casing make the adapter suitable for mobile applications.

The monitor software PCAN-View and the programming interface PCAN-Basic for the development of applications with CAN connection are included in the scope of supply and support the standard CAN FD.

CAN FD is primarily characterized by higher bandwidth for data transfer. Further information about CAN FD can be found on page 10.



Specifications

- Adapter for High-speed USB 2.0 (compatible to USB 1.1 and USB 3.0)
- High-speed CAN connection (ISO 11898-2)
- Complies with CAN specifications 2.0 A/B and FD
- CAN FD support for ISO and Non-ISO standards switchable
- CAN FD bit rates for the data field (64 bytes max.) from 25 kbit/s up to 12 Mbit/s
- CAN bit rates from 25 kbit/s up to 1 Mbit/s
- Time stamp resolution 1 μ s
- CAN bus connection via D-Sub, 9-pin (in accordance with CiA[®] 106)
- FPGA implementation of the CAN FD controller
- NXP TJA1044GT CAN transceiver
- Galvanic isolation up to 500 V
- CAN termination can be activated through a solder jumper
- Measurement of bus load including error frames and overload frames on the physical bus
- Induced error generation for incoming and outgoing CAN messages
- 5-Volt supply to the CAN connection can be connected through a solder jumper, e.g., for external bus converter
- Voltage supply via USB
- Extended operating temperature range from -40 to +85 °C (-40 to +185 °F)

D-Sub	Pin	Pin assignment
	1	Not connected / optional +5V
	2	CAN-L
	3	GND
	4	Not connected
	5	Not connected
	6	GND
	7	CAN-H
	8	Not connected
	9	Not connected



Ordering information

Designation	Part No.
PCAN-USB FD	IPEH-004022

Scope of supply

- PCAN-USB FD in plastic casing
- Device drivers for Windows 11 (x64/ARM64), 10 (x64), and Linux
- CAN monitor PCAN-View for Windows (details on page 108)
- Programming interface PCAN-Basic for developing applications with CAN connection (details on page 94)
- Programming interfaces for standardized protocols from the automotive sector
- Manual in PDF format

PCAN-USB Pro FD

CAN, CAN FD, and LIN Interface for High-Speed USB 2.0



The PCAN-USB Pro FD adapter enables the connection of CAN FD and LIN networks to a computer via USB. Two field buses can be connected at the same time, up to four with appropriate adapter cables (2 x CAN FD, 2 x LIN). Each CAN FD channel is separately isolated against USB and LIN with a maximum of 500 Volts. Its robust aluminum casing makes the PCAN-USB Pro FD adapter suitable for mobile applications.

The monitor software PCAN-View and the programming interface PCAN-Basic for the development of applications with CAN connection are included in the scope of supply and support the standard CAN FD. The monitor application PLIN-View Pro as well as the PLIN programming interface are also included in the scope of supply.

CAN FD is primarily characterized by higher bandwidth for data transfer. Further information about CAN FD can be found on page 10.

Specifications

- ___ Adapter for High-speed USB 2.0 (compatible to USB 1.1 and USB 3.0)
- ___ Transmitting and receiving of CAN FD and LIN messages using 2 D-Sub connections (both with pin assignment for the CAN FD and LIN bus)
- ___ Time stamp resolution 1 μ s
- ___ 5-Volt supply at the D-Sub connector can be activated through a solder jumper, e.g., for external bus converter
- ___ Voltage supply via USB
- ___ Extended operating temperature range from -40 to +85 °C (-40 to +185 °F)

CAN operation properties:

- ___ Complies with CAN specifications 2.0 A/B and FD
- ___ CAN FD support for ISO and Non-ISO standards switchable
- ___ CAN FD bit rates for the data field (64 bytes max.) from 25 kbit/s up to 12 Mbit/s
- ___ CAN bit rates from 25 kbit/s up to 1 Mbit/s
- ___ FPGA implementation of the CAN FD controller
- ___ NXP TJA1044GT CAN transceiver
- ___ Each CAN FD channel is separately opto-decoupled against USB and LIN up to 500 V
- ___ CAN termination can be activated through solder jumpers, separately for each CAN channel

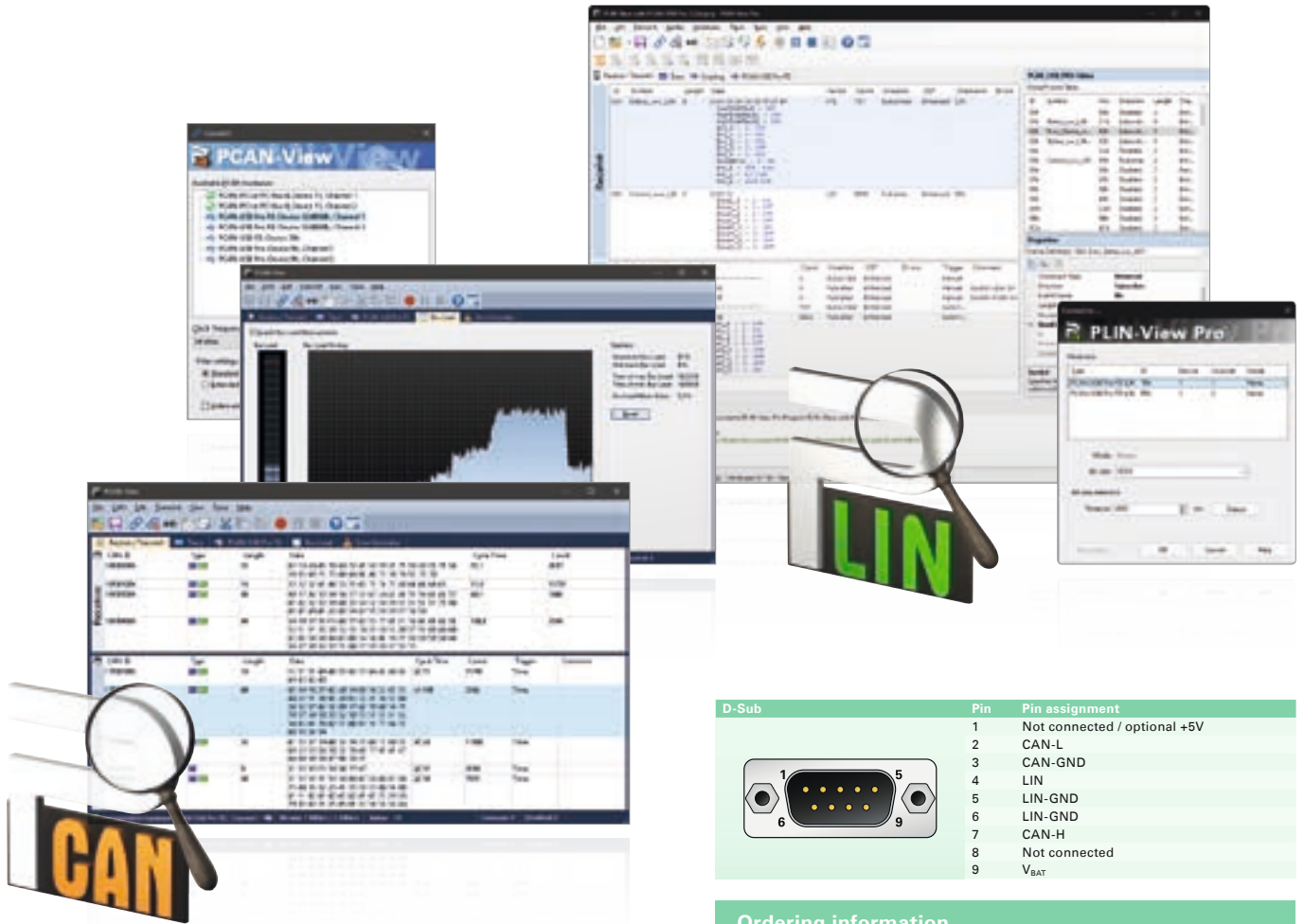

- Measurement of bus load including error frames and overload frames on the physical bus
- Induced error generation for incoming and outgoing CAN messages

LIN operation properties:

- Bit rates from 1 kbit/s up to 20 kbit/s
- TJA1028 LIN transceiver
- Compliant with all LIN specifications (up to version 2.2)
- Both LIN channels (common ground) are opto-decoupled against USB and CAN FD
- Can be used as a LIN master or slave (1 ms master task resolution)
- Automatic bit rate, frame length, and checksum type recognition
- Autonomous scheduler with support for unconditional, event, and sporadic frames
- Hardware can work through a schedule table (up to 8 schedule tables can be configured with a total of 256 slots)

Please note: The PCAN-USB Pro FD can be used alternatively for the PCAN-USB Pro, because this CAN interface is no longer manufactured! The PCAN-USB Pro FD behaves identically concerning the CAN and LIN functionality.

D-Sub	Pin	Pin assignment
	1	Not connected / optional +5V
	2	CAN-L
	3	CAN-GND
	4	LIN
	5	LIN-GND
	6	LIN-GND
	7	CAN-H
	8	Not connected
	9	V _{BAT}

Ordering information

Designation	Part No.
PCAN-USB Pro FD	IPEH-004061

Scope of supply

- PCAN-USB Pro FD in aluminum casing
- CAN FD device drivers for Windows 11 (x64/ARM64), 10 (x64), and Linux
- LIN device drivers for Windows 11 (x64/ARM64), 10 (x64), and Linux
- CAN monitor PCAN-View for Windows (details on page 108)
- LIN monitor PLIN-View Pro for Windows (details on page 109)
- Programming interface PCAN-Basic for developing applications with CAN connection (details on page 94)
- Programming interface PLIN-API for developing applications with LIN connection (details on page 107)
- Programming interfaces for standardized protocols from the automotive sector
- Manual in PDF format

Accessories: LIN Connection Cable for PC LIN Interfaces optionally available (details on page 142).

PCAN-USB X6

6-Channel CAN and CAN FD Interface for High-Speed USB 2.0



The PCAN-USB X6 is a CAN FD interface for the USB port which allows the connection of up to 6 CAN FD or CAN buses. The device is therefore best suited for working with multiple CAN networks like the use in test benches with hardware-in-the-loop (HIL) simulations for motor vehicles or in the product line testing of CAN-based products.

The PCAN-USB X6 is installed in an aluminum profile casing and is shipped in versions with D-Sub connectors or M12 circular connectors. Especially the M12 version is suitable for use in harsh environments. In addition, a galvanic isolation of up to 300 Volts between the PC and the CAN side is guaranteed for the decoupled versions.

The monitor software PCAN-View and the programming interface PCAN-Basic for the development of applications with CAN connection are included in the scope of supply and support the standard CAN FD.

CAN FD is primarily characterized by higher bandwidth for data transfer. Further information about CAN FD can be found on page 10.

Specifications

- CAN FD interface for High-speed USB 2.0 (compatible to USB 1.1 and USB 3.0)
- 6 High-speed CAN channels (ISO 11898-2)
 - Comply with CAN specifications 2.0 A/B and FD
 - CAN FD support for ISO and Non-ISO standards switchable
 - CAN FD bit rates for the data field (64 bytes max.) from 25 kbit/s up to 12 Mbit/s
 - CAN bit rates from 25 kbit/s up to 1 Mbit/s
 - FPGA implementation of the CAN FD controller
 - NXP TJA1044GT CAN transceiver
 - Alternative pluggable transceiver modules on request (details on page 9)
- Galvanic isolation on the CAN connection up to 300 V (only for IPEH-004063 and IPEH-004064)
- Time stamp resolution 1 μ s
- Status LEDs for CAN channels, USB upstream, and power supply
- CAN connection via D-Sub, 9-pin or M12 circular connectors, 5-pin (pin assignment of both connectors in accordance with CiA[®] 106)
- Aluminum casing with increased Ingress Protection IP64 (only for IPEH-004063)



- High-speed USB 2.0 downstream port (only for IPEH-004062 and IPEH-004064)
- CAN termination can be activated through solder jumpers, separately for each CAN channel
- Measurement of bus load including error frames and overload frames on the physical bus
- Induced error generation for incoming and outgoing CAN messages
- Voltage supply from 8 to 30 V
- Extended operating temperature range from -40 to +85 °C (-40 to +185 °F)

D-Sub (IPEH-004062 & IPEH-004064)	Pin	Pin assignment
	1	Not connected
	2	CAN-L
	3	GND
	4	Not connected
	5	Not connected
	6	GND
	7	CAN-H
	8	Not connected
	9	Not connected

M12 (IPEH-004063)	Pin	Pin assignment
	1	Shield
	2	Not connected
	3	GND
	4	CAN-H
	5	CAN-L

Ordering information

Designation	Part No.
PCAN-USB X6 with D-Sub connectors	IPEH-004062
PCAN-USB X6 with D-Sub connectors galv. isolated	IPEH-004064
PCAN-USB X6 with M12 circular connectors galv. isolated	IPEH-004063

Scope of supply

- PCAN-USB X6 in aluminum casing including 4 mounting brackets
- IPEH-004062 and IPEH-004064: Mating connector for power supply
- IPEH-004063: Cables for power supply and USB connection
- Device drivers for Windows 11 (x64/ARM64), 10 (x64), and Linux
- CAN monitor PCAN-View for Windows (details on page 108)
- Programming interface PCAN-Basic for developing applications with CAN connection (details on page 94)
- Programming interfaces for standardized protocols from the automotive sector
- Manual in PDF format

Please note: The scope of supply does not contain a power supply unit for the device. There is no supply via the USB connection to the PC.

PCAN-ExpressCard 34

CAN Interface for the ExpressCard/34 Slot

The CAN adapter PCAN-ExpressCard 34 allows the connection of a CAN bus to embedded PCs and laptops with ExpressCard slots. A galvanic isolation of up to 300 Volts decouples the PC from the CAN bus.

The package is also supplied with the CAN monitor PCAN-View for Windows and the programming interface PCAN-Basic.



D-Sub	Pin	Pin assignment
	1	Not connected
	2	CAN-L
	3	GND
	4	Not connected
	5	Not connected
	6	GND
	7	CAN-H
	8	Not connected
	9	Not connected

Specifications

- Card for the ExpressCard slot
- Type ExpressCard/34 (compatible with ExpressCard/54 slots)
- High-speed CAN connection (ISO 11898-2)
- Bit rates from 5 kbit/s up to 1 Mbit/s
- Compliant with CAN specifications 2.0A (11-bit ID) and 2.0B (29-bit ID)
- CAN bus connection via D-Sub, 9-pin (in accordance with CiA® 106)
- FPGA implementation of the CAN controller (SJA1000 compatible)
- NXP PCA82C251 CAN transceiver
- Galvanic isolation on the CAN connection up to 300 V
- Extended operating temperature range from -40 to +85 °C (-40 to +185 °F)

Ordering information

Designation	Part No.
PCAN-ExpressCard 34	IPEH-003004

Scope of supply

- PCAN-ExpressCard 34 CAN interface
- Device drivers for Windows 11 (x64), 10 (x64), and Linux
- CAN monitor PCAN-View for Windows (details on page 108)
- Programming interface PCAN-Basic for developing applications with CAN connection (details on page 94)
- Programming interfaces for standardized protocols from the automotive sector
- Manual in PDF format

PCAN-cPCI

CAN Interface for CompactPCI

The PCAN-cPCI card enables the connection of an industrial computer system with CompactPCI to CAN networks. There is galvanic isolation of up to 500 Volts between the computer and CAN sides. The card is available as a dual or four-channel version.

The package is also supplied with the CAN monitor PCAN-View for Windows and the programming interface PCAN-Basic.



D-Sub	Pin	Pin assignment
	1	Not connected / optional +5V
	2	CAN-L
	3	GND
	4	Not connected
	5	Not connected
	6	GND
	7	CAN-H
	8	Not connected
	9	Not connected / optional +5V

Specifications

- Extension card with euroboard form factor (3U) for a CompactPCI system
- 2 or 4 High-speed CAN channels (ISO 11898-2)
- Bit rates from 5 kbit/s up to 1 Mbit/s
- Compliant with CAN specifications 2.0A (11-bit ID) and 2.0B (29-bit ID)
- CAN bus connection via D-Sub, 9-pin (in accordance with CiA[®] 106)
- NXP SJA1000 CAN controller, 16 MHz clock frequency
- NXP PCA82C251 CAN transceiver
- 5-Volt supply to the CAN connection can be connected through a solder jumper, e.g., for external bus converter
- Galvanic isolation on the CAN connection up to 500 V, separate for each CAN channel
- Extended operating temperature range from -40 to +85 °C (-40 to +185 °F)

Ordering information

Designation	Part No.
PCAN-cPCI Four Channel opto-decoupled	IPEH-003022

Scope of supply

- Plug-in card PCAN-cPCI
- Slot bracket with D-Sub connectors for the CAN bus (only four-channel version)
- Device drivers for Windows 11 (x64), 10 (x64), and Linux
- CAN monitor PCAN-View for Windows (details on page 108)
- Programming interface PCAN-Basic for developing applications with CAN connection (details on page 94)
- Programming interfaces for standardized protocols from the automotive sector
- Manual in PDF format

PCAN-PCI

CAN Interface for PCI

The PCAN-PCI card enables the connection of a PC with PCI slots to CAN networks.

The card is available as a single or dual-channel version. The opto-decoupled versions also guarantee galvanic isolation of up to 500 Volts between the PC and the CAN sides.

The package is also supplied with the CAN monitor PCAN-View for Windows and the programming interface PCAN-Basic.



Specifications

- PC plug-in card for PCI slots
- 1 or 2 High-speed CAN channels (ISO 11898-2)
- Bit rates from 5 kbit/s up to 1 Mbit/s
- Compliant with CAN specifications 2.0A (11-bit ID) and 2.0B (29-bit ID)
- CAN bus connection via D-Sub, 9-pin (in accordance with CiA[®] 106)
- NXP SJA1000 CAN controller, 16 MHz clock frequency
- NXP PCA82C251 CAN transceiver
- 5-Volt supply to the CAN connection can be connected through a solder jumper, e.g., for external bus converter
- Galvanic isolation on the CAN connection up to 500 V, separate for each CAN channel (only for IPEH-002066 and IPEH-002067)
- Extended operating temperature range from -40 to +85 °C (-40 to +185 °F)

D-Sub	Pin	Pin assignment
	1	Not connected / optional +5V
	2	CAN-L
	3	GND
	4	Not connected
	5	Not connected
	6	GND
	7	CAN-H
	8	Not connected
	9	Not connected / optional +5V

Ordering information

Designation	Part No.
PCAN-PCI Single Channel	IPEH-002064
PCAN-PCI Dual Channel	IPEH-002065
PCAN-PCI Single Channel opto-decoupled	IPEH-002066
PCAN-PCI Dual Channel opto-decoupled	IPEH-002067

Scope of supply

- Plug-in card PCAN-PCI
- Device drivers for Windows 11 (x64), 10 (x64), and Linux
- CAN monitor PCAN-View for Windows (details on page 108)
- Programming interface PCAN-Basic for developing applications with CAN connection (details on page 94)
- Programming interfaces for standardized protocols from the automotive sector
- Manual in PDF format

PCAN-PCI Express

CAN Interface for PCI Express

The PCAN-PCI Express card enables the connection of a PC with PCI Express slots to CAN networks. There is galvanic isolation of up to 500 Volts between the computer and CAN sides. There are versions with one, two and four channels.

The package is also supplied with the CAN monitor PCAN-View for Windows and the programming interface PCAN-Basic.



Specifications

- PC plug-in card (PCIe x1) for PCI Express slots
- 1, 2, or 4 High-speed CAN channels (ISO 11898-2)
- Bit rates from 5 kbit/s up to 1 Mbit/s
- Compliant with CAN specifications 2.0A (11-bit ID) and 2.0B (29-bit ID)
- CAN bus connection via D-Sub, 9-pin (in accordance with CiA® 106)
- FPGA implementation of the CAN controller (SJA1000 compatible)
- NXP PCA82C251 CAN transceiver
- Galvanic isolation on the CAN connection up to 500 V, separate for each CAN channel
- 5-Volt supply to the CAN connection can be connected through a solder jumper, e.g., for external bus converter
- Extended operating temperature range from -40 to +85 °C (-40 to +185 °F)

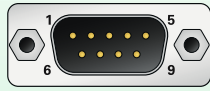
D-Sub	Pin	Pin assignment
	1	Not connected / optional +5V
	2	CAN-L
	3	GND
	4	Not connected
	5	Not connected
	6	GND
	7	CAN-H
	8	Not connected
	9	Not connected

Ordering information

Designation	Part No.
PCAN-PCI Express Single Channel galv. isolated	IPEH-003026
PCAN-PCI Express Dual Channel galv. isolated	IPEH-003027

Scope of supply

- Plug-in card PCAN-PCI Express
- Slot bracket with D-Sub connectors for the CAN bus (only four-channel version)
- Device drivers for Windows 11 (x64), 10 (x64), and Linux
- CAN monitor PCAN-View for Windows (details on page 108)
- Programming interface PCAN-Basic for developing applications with CAN connection (details on page 94)
- Programming interfaces for standardized protocols from the automotive sector
- Manual in PDF format

PCAN-PCI Express FD

CAN and CAN FD Interface for PCI Express

The plug-in card PCAN-PCI Express FD allows the connection of a PC with PCI Express slots to CAN FD and CAN networks. There is galvanic isolation of up to 500 Volts between the computer and CAN sides. The card is available as a single, dual, or four-channel version.

The monitor software PCAN-View and the programming interface PCAN-Basic for the development of applications with CAN connection are included in the scope of supply and support the standard CAN FD.

CAN FD is primarily characterized by higher bandwidth for data transfer. Further information about CAN FD can be found on page 10.



Specifications

- PC plug-in card (PCIe x1) for PCI Express slots
- 1, 2, or 4 High-speed CAN channels (ISO 11898-2)
- Complies with CAN specifications 2.0 A/B and FD
- CAN FD support for ISO and Non-ISO standards switchable
- CAN FD bit rates for the data field (64 bytes max.) from 25 kbit/s up to 12 Mbit/s
- CAN bit rates from 25 kbit/s up to 1 Mbit/s
- CAN bus connection via D-Sub, 9-pin (in accordance with CiA® 106)
- FPGA implementation of the CAN FD controller
- NXP TJA1044GT CAN transceiver
- Galvanic isolation on the CAN connection up to 500 V, separate for each CAN channel
- CAN termination can be activated through solder jumpers, separately for each CAN channel
- PCIe data transfer via bus master DMA
- DMA memory access operations with 32- and 64-bit addresses
- Measurement of bus load including error frames and overload frames on the physical bus
- Induced error generation for incoming and outgoing CAN messages
- 5-Volt supply to the CAN connection can be connected through a solder jumper, e.g., for external bus converter
- Extended operating temperature range from -40 to +85 °C (-40 to +185 °F)

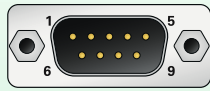
D-Sub	Pin	Pin assignment
	1	Not connected / optional +5V
	2	CAN-L
	3	GND
	4	Not connected
	5	Not connected
	6	GND
	7	CAN-H
	8	Not connected
	9	Not connected

Ordering information

Designation	Part No.
PCAN-PCI Express FD Single Channel	IPEH-004026
PCAN-PCI Express FD Dual Channel	IPEH-004027
PCAN-PCI Express FD Four Channel	IPEH-004040

Scope of supply

- Plug-in card PCAN-PCI Express FD
- Slot bracket with D-Sub connectors for the CAN bus (only four-channel version)
- Device drivers for Windows 11 (x64), 10 (x64), and Linux
- CAN monitor PCAN-View for Windows (details on page 108)
- Programming interface PCAN-Basic for developing applications with CAN connection (details on page 94)
- Programming interfaces for standardized protocols from the automotive sector
- Manual in PDF format

PCAN-miniPCI

CAN Interface for Mini PCI

The PCAN-miniPCI card enables the connection of embedded PCs and laptops with Mini PCI slots to CAN networks.

The card is available as a single or dual-channel version. The opto-decoupled versions also guarantee galvanic isolation of up to 300 Volts between the PC and the CAN sides.

The package is also supplied with the CAN monitor PCAN-View for Windows and the programming interface PCAN-Basic.



D-Sub	Pin	Pin assignment
	1	Not connected / optional +5V
	2	CAN-L
	3	GND
	4	Not connected
	5	Not connected
	6	GND
	7	CAN-H
	8	Not connected
	9	Not connected

Specifications

- CAN interface for the Mini PCI slot
- 1 or 2 High-speed CAN channels (ISO 11898-2)
- CAN bus connection via connection cable and D-Sub, 9-pin (in accordance with CiA® 106)
- Bit rates from 40 kbit/s up to 1 Mbit/s
- Compliant with CAN specifications 2.0A (11-bit ID) and 2.0B (29-bit ID)
- NXP SJA1000 CAN controller, 16 MHz clock frequency
- NXP TJA1040 CAN transceiver
- 5-Volt supply to the CAN connection can be connected through a solder jumper, e.g., for external bus converter
- Galvanic isolation on the CAN connection up to 300 V, separate for each CAN channel (only for IPEH-003046 and IPEH-003047)
- Operating temperature range from 0 to 70 °C (32 to 158 °F)

Ordering information

Designation	Part No.
PCAN-miniPCI Dual Ch.	IPEH-003045
PCAN-miniPCI Single Ch. opto-decoupled	IPEH-003046
PCAN-miniPCI Dual Ch. opto-decoupled	IPEH-003047

Scope of supply

- PCAN-miniPCI card
- Connection cable including D-Sub plug for each channel
- Device drivers for Windows 11 (x64), 10 (x64), and Linux
- CAN monitor PCAN-View for Windows (details on page 108)
- Programming interface PCAN-Basic for developing applications with CAN connection (details on page 94)
- Programming interfaces for standardized protocols from the automotive sector
- Manual in PDF format

PCAN-miniPCle

CAN Interface for PCI Express Mini (PCle)

The PCAN-miniPCle card enables the connection of embedded PCs and laptops with PCI Express Mini slots to CAN networks. There is galvanic isolation of up to 300 Volts between the computer and CAN sides. The card is available as a single or dual-channel version.

The package is also supplied with the CAN monitor PCAN-View for Windows and the programming interface PCAN-Basic.



Specifications

- CAN interface for the PCI Express Mini slot (uses PCIe lane)
- 1 or 2 High-speed CAN channels (ISO 11898-2)
- CAN bus connection via connection cable and D-Sub, 9-pin (in accordance with CiA® 106)
- Bit rates from 5 kbit/s up to 1 Mbit/s
- Compliant with CAN specifications 2.0A (11-bit ID) and 2.0B (29-bit ID)
- FPGA implementation of the CAN controller (SJA1000 compatible)
- NXP PCA82C251 CAN transceiver
- Galvanic isolation on the CAN connection up to 300 V, separate for each CAN channel
- Extended operating temperature range from -40 to +85 °C (-40 to +185 °F)

D-Sub	Pin	Pin assignment
	1	Not connected
	2	CAN-L
	3	GND
	4	Not connected
	5	Not connected
	6	GND
	7	CAN-H
	8	Not connected
	9	Not connected

Ordering information

Designation	Part No.
PCAN-miniPCle Single Ch.	IPEH-003048
PCAN-miniPCle Dual Ch.	IPEH-003049

Scope of supply

- PCAN-miniPCle card
- Connection cable including D-Sub plug for each channel
- Device drivers for Windows 11 (x64), 10 (x64), and Linux
- CAN monitor PCAN-View for Windows (details on page 108)
- Programming interface PCAN-Basic for developing applications with CAN connection (details on page 94)
- Programming interfaces for standardized protocols from the automotive sector
- Manual in PDF format

PCAN-miniPCIe FD

CAN and CAN FD Interface for PCI Express Mini (PCIe)

The PCAN-miniPCIe FD is a CAN interface for the PCI Express Mini slot. With its space-saving format, the plug-in card is a suitable solution for connecting embedded systems to up to four CAN FD and CAN networks. There is galvanic isolation of up to 300 Volts between the computer and CAN sides. The card is available as a single, dual, or four-channel version.

The monitor software PCAN-View and the programming interface PCAN-Basic for the development of applications with CAN connection are included in the scope of supply and support the standard CAN FD.

CAN FD is primarily characterized by higher bandwidth for data transfer. Further information about CAN FD can be found on page 10.



Specifications

- CAN interface for the PCI Express Mini slot (uses PCIe lane)
- 1, 2, or 4 High-speed CAN channels (ISO 11898-2)
- Form factor PCI Express Mini (only for single and dual channel versions due to the height of the four-channel version)
- Complies with CAN specifications 2.0 A/B and FD
- CAN FD support for ISO and Non-ISO standards switchable
- CAN FD bit rates for the data field (64 bytes max.) from 25 kbit/s up to 12 Mbit/s
- CAN bit rates from 25 kbit/s up to 1 Mbit/s
- CAN bus connection via connection cable and D-Sub, 9-pin (in accordance with CiA® 106)
- FPGA implementation of the CAN FD controller
- NXP TJA1044GT CAN transceiver
- Galvanic isolation on the CAN connection up to 300 V, separate for each CAN channel
- CAN termination can be activated through solder jumpers, separately for each CAN channel
- PCIe data transfer via bus master DMA
- DMA memory access operations with 32- and 64-bit addresses
- Measurement of bus load including error frames and overload frames on the physical bus
- Induced error generation for incoming and outgoing CAN messages
- Extended operating temperature range from -40 to +85 °C (-40 to +185 °F)

D-Sub	Pin	Pin assignment
	1	Not connected
	2	CAN-L
	3	GND
	4	Not connected
	5	Not connected
	6	GND
	7	CAN-H
	8	Not connected
	9	Not connected

Ordering information

Designation	Part No.
PCAN-miniPCIe FD Single Channel	IPEH-004045
PCAN-miniPCIe FD Dual Channel	IPEH-004046
PCAN-miniPCIe FD Four Channel	IPEH-004047

Scope of supply

- PCAN-miniPCIe FD card
- Connection cables incl. D-Sub connector optionally 20 or 40 cm. Other lengths on request
- Device drivers for Windows 11 (x64), 10 (x64), and Linux
- CAN monitor PCAN-View for Windows (details on page 108)
- Programming interface PCAN-Basic for developing applications with CAN connection (details on page 94)
- Programming interfaces for standardized protocols from the automotive sector
- Manual in PDF format

PCAN-M.2

CAN and CAN FD Interface for M.2 (PCIe)

The PCAN-M.2 allows the connection of CAN and CAN FD networks via the M.2 interface (PCIe) of modern computer boards. With its small format, the plug-in card is ideal for embedded PCs, single-board computers (SBC), and compact embedded applications. There is a galvanic isolation between the computer and the CAN side up to 300 Volts. The card is available as a single, dual, or four-channel version.

The monitor software PCAN-View and the programming interface PCAN-Basic for the development of applications with CAN connection are included in the scope of supply and support the standard CAN FD.

CAN FD is primarily characterized by higher bandwidth for data transfer. Further information about CAN FD can be found on page 10.



Specifications

- CAN interface for the M.2 slot (uses PCIe lane)
- 1, 2, or 4 High-speed CAN channels (ISO 11898-2)
- Form factor M.2 type: 2280/2260-B-M; Height: Single and Dual Channel 4.6 mm, Four Channel 10.2 mm; Component height of top side above form factor specification of 1.5 mm
- Complies with CAN specifications 2.0 A/B and FD
- CAN FD support for ISO and Non-ISO standards switchable
- CAN FD bit rates for the data field (64 bytes max.) from 20 kbit/s up to 12 Mbit/s
- CAN bit rates from 20 kbit/s up to 1 Mbit/s
- CAN bus connection via connection cable and D-Sub, 9-pin (in accordance with CiA® 106)
- FPGA implementation of the CAN FD controller
- Microchip CAN transceiver MCP2558FD
- Galvanic isolation on the CAN connection up to 300 V, separate for each CAN channel
- CAN termination can be activated through solder jumpers, separately for each CAN channel
- PCIe data transfer via bus master DMA
- DMA memory access operations with 32- and 64-bit addresses
- Measurement of bus load including error frames and overload frames on the physical bus
- Induced error generation for incoming and outgoing CAN messages
- Extended operating temperature range from -40 to +85 °C (-40 to +185 °F)

D-Sub	Pin	Pin assignment
	1	Not connected
	2	CAN-L
	3	GND
	4	Not connected
	5	Not connected
	6	GND
	7	CAN-H
	8	Not connected
	9	Not connected

Ordering information

Designation	Part No.
PCAN-M.2 Single Channel	IPEH-004083
PCAN-M.2 Dual Channel	IPEH-004084
PCAN-M.2 Four Channel	IPEH-004085

Scope of supply

- PCAN-M.2 card
- Connection cables incl. D-Sub connector optionally 20 or 40 cm. Other lengths on request
- Device drivers for Windows 11 (x64), 10 (x64), and Linux
- CAN monitor PCAN-View for Windows (details on page 108)
- Programming interface PCAN-Basic for developing applications with CAN connection (details on page 94)
- Programming interfaces for standardized protocols from the automotive sector
- Manual in PDF format

PCAN-PC/104

CAN Interface for PC/104

The PCAN-PC/104 card enables the connection of one or two CAN networks to a PC/104 system. Multiple PCAN-PC/104 cards can easily be operated using interrupt sharing.

The card is available as a single or dual-channel version. The opto-decoupled versions also guarantee galvanic isolation of up to 500 Volts between the PC and the CAN sides.

The package is also supplied with the CAN monitor PCAN-View for Windows and the programming interface PCAN-Basic.



Specifications

- Form factor PC/104
- Multiple PC/104 cards can be operated in parallel (interrupt sharing)
- 14 port and 8 interrupt addresses are available for configuration using jumpers
- 1 or 2 High-speed CAN channels (ISO 11898-2)
- Bit rates from 5 kbit/s up to 1 Mbit/s
- Compliant with CAN specifications 2.0A (11-bit ID) and 2.0B (29-bit ID)
- Connection to CAN bus through D-Sub slot bracket, 9-pin (in accordance with CiA[®] 106)
- NXP SJA1000 CAN controller, 16 MHz clock frequency
- NXP PCA82C251 CAN transceiver
- 5-Volt supply to the CAN connection can be connected through a solder jumper, e.g., for external bus converter
- Galvanic isolation on the CAN connection up to 500 V, separate for each CAN channel (only for IPEH-002056 and IPEH-002057)
- Extended operating temperature range from -40 to +85 °C (-40 to +185 °F)

D-Sub	Pin	Pin assignment
	1	Not connected / optional +5V
	2	CAN-L
	3	GND
	4	Not connected
	5	Not connected
	6	GND
	7	CAN-H
	8	Not connected
	9	Not connected / optional +5V

Ordering information

Designation	Part No.
PCAN-PC/104 Single Ch.	IPEH-002054
PCAN-PC/104 Dual Ch.	IPEH-002055
PCAN-PC/104 Single Channel opto-decoupled	IPEH-002056
PCAN-PC/104 Dual Channel opto-decoupled	IPEH-002057

Scope of supply

- PCAN-PC/104 card
- Slot bracket with D-Sub connectors for the CAN bus
- Device drivers for Windows 10 (x86) and Linux
- CAN monitor PCAN-View for Windows (details on page 108)
- CAN monitor PCAN-View for DOS
- Programming interface PCAN-Basic for developing applications with CAN connection (details on page 94)
- Programming interfaces for standardized protocols from the automotive sector
- Manual in PDF format

PCAN-PC/104-Plus

CAN Interface for PC/104-Plus

The PCAN-PC/104-Plus card enables the connection of one or two CAN networks to a PC/104-Plus system. Up to four cards can be operated, with each piggy-backing off the next. The CAN bus is connected using a 9-pin D-Sub plug on the slot bracket supplied.

The card is available as a single or dual-channel version. The opto-decoupled versions also guarantee galvanic isolation of up to 500 Volts between the PC and the CAN sides.

The package is also supplied with the CAN monitor PCAN-View for Windows and the programming interface PCAN-Basic.



Specifications

- Form factor PC/104
- Use of the 120-pin connection for the PCI bus
- Up to four cards can be used in one system
- 1 or 2 High-speed CAN channels (ISO 11898-2)
- Bit rates from 5 kbit/s up to 1 Mbit/s
- Compliant with CAN specifications 2.0A (11-bit ID) and 2.0B (29-bit ID)
- Connection to CAN bus through D-Sub slot bracket, 9-pin (in accordance with CiA[®] 106)
- NXP SJA1000 CAN controller, 16 MHz clock frequency
- NXP PCA82C251 CAN transceiver
- 5-Volt supply to the CAN connection can be connected through a solder jumper, e.g., for external bus converter
- Galvanic isolation on the CAN connection up to 500 V, separate for each CAN channel (only for IPEH-002096 and IPEH-002097)
- Extended operating temperature range from -40 to +85 °C (-40 to +185 °F)
- Optionally available: PC/104-ISA stack-through connector

D-Sub	Pin	Pin assignment
	1	Not connected / optional +5V
	2	CAN-L
	3	GND
	4	Not connected
	5	Not connected
	6	GND
	7	CAN-H
	8	Not connected
	9	Not connected / optional +5V

Ordering information

Designation	Part No.
PCAN-PC/104-Plus Single Ch.	IPEH-002094
PCAN-PC/104-Plus Dual Ch.	IPEH-002095
PCAN-PC/104-Plus Single Channel opto-decoupled	IPEH-002096
PCAN-PC/104-Plus Dual Channel opto-decoupled	IPEH-002097

Scope of supply

- PCAN-PC/104-Plus card
- Slot bracket with D-Sub connectors for the CAN bus
- Device drivers for Windows 11 (x64), 10 (x64), and Linux
- CAN monitor PCAN-View for Windows (details on page 108)
- Programming interface PCAN-Basic for developing applications with CAN connection (details on page 94)
- Programming interfaces for standardized protocols from the automotive sector
- Manual in PDF format

PCAN-PC/104-Plus Quad

Four-Channel CAN Interface for PC/104-Plus

The PCAN-PC/104-Plus Quad card enables the connection of four CAN networks to a PC/104-Plus system. Up to four cards can be operated, with each piggy-backing off the next. The CAN bus is connected using a 9-pin D-Sub plug on the slot brackets supplied. There is galvanic isolation of up to 500 Volts between the computer and CAN sides.

The package is also supplied with the CAN monitor PCAN-View for Windows and the programming interface PCAN-Basic.



Specifications

- Form factor PC/104
- Use of the 120-pin connection for the PCI bus
- Up to four cards can be used in one system
- 4 High-speed CAN channels (ISO 11898-2)
- Bit rates from 5 kbit/s up to 1 Mbit/s
- Compliant with CAN specifications 2.0A (11-bit ID) and 2.0B (29-bit ID)
- Connection to CAN bus through D-Sub slot brackets, 9-pin (in accordance with CiA[®] 106)
- FPGA implementation of the CAN controller (SJA1000 compatible)
- NXP PCA82C251 CAN transceiver
- Galvanic isolation on the CAN connection up to 500 V, separate for each CAN channel
- 5-Volt supply to the CAN connection can be connected through a solder jumper, e.g., for external bus converter
- Extended operating temperature range from -40 to +85 °C (-40 to +185 °F)
- Optionally available: PC/104-ISA stack-through connector

D-Sub	Pin	Pin assignment
	1	Not connected / optional +5V
	2	CAN-L
	3	GND
	4	Not connected
	5	Not connected
	6	GND
	7	CAN-H
	8	Not connected
	9	Not connected / optional +5V

Ordering information

Designation	Part No.
PCAN-PC/104-Plus Quad	IPEH-002099

Scope of supply

- PCAN-PC/104-Plus Quad card
- Two slot brackets with D-Sub connectors for the CAN bus
- Device drivers for Windows 11 (x64), 10 (x64), and Linux
- CAN monitor PCAN-View for Windows (details on page 108)
- Programming interface PCAN-Basic for developing applications with CAN connection (details on page 94)
- Programming interfaces for standardized protocols from the automotive sector
- Manual in PDF format

PCAN-PCI/104-Express

CAN Interface for PCI/104-Express

The PCAN-PCI/104-Express card enables the connection of one, two, or four CAN buses to a PCI/104-Express system. Up to four cards can be stacked together. The CAN bus is connected using a 9-pin D-Sub plug on the slot brackets supplied. There is galvanic isolation of up to 500 Volts between the computer and CAN sides. There are versions with one, two and four channels.

The package is also supplied with the CAN monitor PCAN-View for Windows and the programming interface PCAN-Basic.



Specifications

- PCI/104-Express card, 1 lane (x1)
- Form factor PC/104
- Up to four cards can be used in one system
- 1, 2, or 4 High-speed CAN channels (ISO 11898-2)
- Bit rates from 5 kbit/s up to 1 Mbit/s
- Compliant with CAN specifications 2.0A (11-bit ID) and 2.0B (29-bit ID)
- Connection to CAN bus through D-Sub slot bracket, 9-pin (in accordance with CiA[®] 106)
- FPGA implementation of the CAN controller (SJA1000 compatible)
- NXP PCA82C251 CAN transceiver
- Galvanic isolation on the CAN connection up to 500 V, separate for each CAN channel
- Supplied only via the 5 V line
- 5-Volt supply to the CAN connection can be connected through a solder jumper, e.g., for external bus converter
- Extended operating temperature range from -40 to +85 °C (-40 to +185 °F)
- Optionally available: PCI-104 stack-through connector

D-Sub	Pin	Pin assignment
	1	Not connected
	2	CAN-L
	3	GND
	4	Not connected
	5	Not connected
	6	GND
	7	CAN-H
	8	Not connected
	9	Not connected / optional +5V

Ordering information

Designation	Part No.
PCAN-PCI/104-Express Single Ch. opto-decoupled	IPEH-003056
PCAN-PCI/104-Express Dual Ch. opto-decoupled	IPEH-003057

Scope of supply

- PCAN-PCI/104-Express card
- Slot bracket with D-Sub connector(s) for the CAN bus (two for the four-channel version)
- Device drivers for Windows 11 (x64), 10 (x64), and Linux
- CAN monitor PCAN-View for Windows (details on page 108)
- Programming interface PCAN-Basic for developing applications with CAN connection (details on page 94)
- Programming interfaces for standardized protocols from the automotive sector
- Manual in PDF format

PCAN-PCI/104-Express FD

CAN and CAN FD Interface for PCI/104-Express

The PCAN-PCI/104-Express FD allows the connection of PCI/104-Express systems to CAN and CAN FD buses. The PCI/104-Express specification establishes PCI Express for the PC/104 form factor wherewith up to four cards can be stacked. Based on this, standardized modular embedded systems such as industrial PCs can be realized. The CAN bus is connected via 9-pin D-Sub connectors to the supplied slot brackets. There is a galvanic isolation between the computer and the CAN side up to 500 Volts. The card is available as a single, dual, or four-channel version.

The monitor software PCAN-View and the programming interface PCAN-Basic for the development of applications with CAN connection are included in the scope of supply and support the standard CAN FD.

CAN FD is primarily characterized by higher bandwidth for data transfer. Further information about CAN FD can be found on page 10.



Specifications

- PCI/104-Express card, 1 lane (x1)
- Form factor PC/104
- Up to four cards can be used in one system
- 1, 2, or 4 High-speed CAN channels (ISO 11898-2)
- Complies with CAN specifications 2.0 A/B and FD
- CAN FD support for ISO and Non-ISO standards switchable
- CAN FD bit rates for the data field (64 bytes max.) from 20 kbit/s up to 12 Mbit/s
- CAN bit rates from 20 kbit/s up to 1 Mbit/s
- Connection to CAN bus through D-Sub slot bracket, 9-pin (in accordance with CiA® 106)
- FPGA implementation of the CAN FD controller
- Microchip CAN transceiver MCP2558FD
- Galvanic isolation on the CAN connection up to 500 V, separate for each CAN channel
- CAN termination can be activated through solder jumpers, separately for each CAN channel
- 5-Volt supply to the CAN connection can be connected through a solder jumper, e.g., for external bus converter
- PCIe data transfer via bus master DMA
- DMA memory access operations with 32- and 64-bit addresses
- Measurement of bus load including error frames and overload frames on the physical bus
- Induced error generation for incoming and outgoing CAN messages
- Optionally available: PCI-104 stack-through connector
- Extended operating temperature range from -40 to +85 °C (-40 to +185 °F)

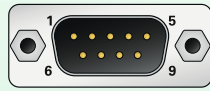
D-Sub	Pin	Pin assignment
	1	Not connected / optional +5V
	2	CAN-L
	3	GND
	4	Not connected
	5	Not connected
	6	GND
	7	CAN-H
	8	Not connected
	9	Not connected

Ordering information

Designation	Part No.
PCAN-PCI/104-Express FD Single Channel	IPEH-004080
PCAN-PCI/104-Express FD Dual Channel	IPEH-004081
PCAN-PCI/104-Express FD Four Channel	IPEH-004082

Scope of supply

- PCAN-PCI/104-Express FD card
- Slot bracket with D-Sub connector(s) for the CAN bus (two for the four-channel version)
- Device drivers for Windows 11 (x64), 10 (x64), and Linux
- CAN monitor PCAN-View for Windows (details on page 108)
- Programming interface PCAN-Basic for developing applications with CAN connection (details on page 94)
- Programming interfaces for standardized protocols from the automotive sector
- Manual in PDF format

PCAN-Chip PCIe FD

Chip Solutions for the CAN FD Connection to PCI Express

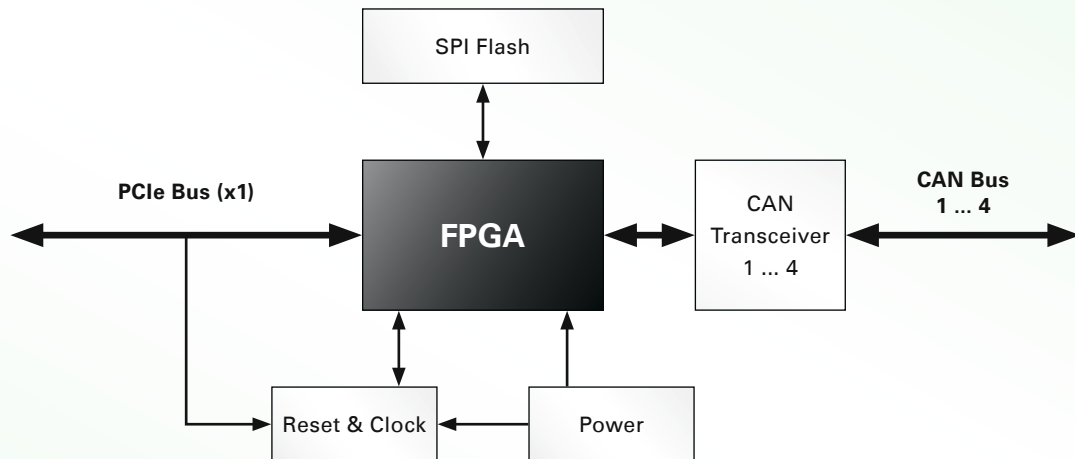

For the CAN and CAN FD connection of your hardware design we provide several solutions.

Based on an FPGA, up to 4 CAN channels can be implemented via the PCI Express bus using the chip solution PCAN-Chip PCIe FD. With the license from PEAK-System, the FPGA can be programmed via an image with the corresponding functionality.

In addition to the related documentation, the scope of supply includes licenses for the Windows and Linux device drivers, the CAN monitor PCAN-View, and the PCAN-Basic API.

Specifications

- FPGA implementation of the CAN FD controller
- Complies with CAN specifications 2.0 A/B and FD
- CAN FD support for ISO and Non-ISO standards switchable
- CAN bus connection for PCI Express x1 with bit rates up to 2.5 Gbit/s
- PCIe data transfer via bus master DMA
- DMA memory access operations with 32- and 64-bit addresses
- 100-percent compatible with the PCI Express device drivers and the software from PEAK-System
- Measurement of bus load including error frames and overload frames on the physical bus
- Induced error generation for incoming and outgoing CAN messages

Ordering information

Designation	Part No.
PCAN-Chip PCIe FD 2 Channel	IPES-004092
PCAN-Chip PCIe FD 4 Channel	IPES-004093

Scope of supply

- One license for:
 - Configuration image for FPGA programming depending on the version:
 - PCI Express 2 Channel
 - PCI Express 4 Channel (Quad)
 - Device drivers for Windows 11 (x64), 10 (x64), and Linux
 - CAN monitor PCAN-View for Windows (details on page 108)
 - Programming interface PCAN-Basic for developing applications with CAN connection (details on page 94)
 - Programming interfaces for standardized protocols from the automotive sector
- Documentation for wiring and integration including a sample circuit diagram

The license fees for CAN FD to Robert Bosch GmbH are included. If you are interested and for more information, please contact info@peak-system.com.

PCAN-Chip USB

Stamp Module for the Implementation of CAN FD to USB Connections

For custom hardware designs a CAN connection can be implemented with the Stamp module, which communicates via USB 2.0 with the hardware. The integrated CAN controller supports the protocols CAN 2.0 A/B as well as CAN FD. The physical CAN connection is determined by external wiring. The Stamp module with its single-sided mounting and plated half-holes is suitable for automatic assembly.

The optional PCAN-Chip USB Eval board simplifies the development of a custom board based on the Stamp module.

In addition to the documentation for the integration of the Stamp module, the scope of supply of the PCAN-Chip USB includes licenses for the Windows and Linux device drivers, for the CAN monitor PCAN-View, and for the PCAN-Basic API.



PCAN-Chip USB

Specifications

- High-speed USB 2.0 (compatible to USB 1.1 & 3.0)
- FPGA implementation of the CAN FD controller
- Complies with CAN specifications 2.0 A/B and FD
- CAN FD support for ISO and Non-ISO standard switchable
- Measurement of bus load including error frames on the physical bus
- Induced error generation for incoming and outgoing CAN messages
- 100-percent compatible with the USB device drivers and the software from PEAK-System
- Connections for 2 status LEDs
- 5 digital inputs/outputs and 1 analog input (access via PCAN-Basic API)
- Power supply 3.3 V DC
- Firmware update via USB
- Dimensions: 25 x 20 mm
- Extended operating temperature range from -40 to +85 °C (-40 to +185 °F)

PCAN-Chip USB Eval

Specifications

- CAN bus connection via D-Sub, 9-pin (in accordance with CiA® 106)
- CAN transceiver NXP TJA1044GT
- USB connector type B, standard ESD protection
- Dual-color LED for CAN status and power supply
- Power supply via USB
- Extended operating temperature range from -40 to +85 °C (-40 to +185 °F)

Ordering information

Designation	Part No.
PCAN-Chip USB	IPEH-004025
PCAN-Chip USB Eval	IPEH-004025-EVAL

Scope of supply PCAN-Chip USB

- Stamp module PCAN-Chip USB; delivery, depending on quantity, as cut tape or reel for automatic placement machines
- Documentation for wiring and integration including a sample circuit diagram
- One license per chip for:
 - Device drivers for Windows 11 (x64/ARM64), 10 (x64), and Linux
 - CAN monitor PCAN-View for Windows (details on page 108)
 - Programming interface PCAN-Basic for developing applications with CAN connection (details on page 94)
 - Programming interfaces for standardized protocols from the automotive sector

Scope of supply PCAN-Chip USB Eval

- PCAN-Chip USB Eval
- PCAN-Chip USB incl. scope of supply
- USB connector cable

The license fees for CAN FD to Robert Bosch GmbH are included. If you are interested and for more information, please contact info@peak-system.com.

PCAN-AU5790

Bus Converter High-Speed CAN to Single-Wire CAN

The PCAN-AU5790 bus converter establishes a connection between a High-speed CAN bus (ISO 11898-2) and a Single-wire CAN bus (SAE J2411). One of the most important potential applications of the bus converter is a simple connection between a PEAK CAN interface (e.g., PCAN-USB) and a Single-wire CAN bus.



Female D-Sub Connector	Pin	Pin assignment High-speed CAN (82C251)
	1	5V Power supply
	2	CAN-L
	3	GND
	4	Not connected
	5	Not connected
	6	GND
	7	CAN-H
	8	Not connected
	9	Not connected / optional +5V

Male D-Sub Connector	Pin	Pin assignment Single-wire CAN (AU5790)
	1	Not connected
	2	Not connected
	3	GND
	4	Not connected
	5	CAN
	6	GND
	7	Not connected
	8	Not connected
	9	V _{BAT}

Specifications

- ___ There are three different operating modes for the SW-CAN side which can be set using a sliding switch. Normal (33.3 kbit/s), High-speed (83.3 kbit/s) and wake-up
- ___ Indicator LEDs for power supply (red) and wake-up signals (yellow)
- ___ 5-Volt power supply (150 mA) through HS-CAN connection (a current list of PEAK CAN interfaces with suitable supply voltage is available on request)
- ___ If the power supply has a current output lower than 150 mA, an additional 12-Volt supply is needed via the SW-CAN connector
- ___ Operating temperature range from 0 to 70 °C (32 to 158 °F)

Ordering information

Designation	Part No.
PCAN-AU5790	IPEH-002040

Scope of supply

- ___ Adapter in plastic casing
- ___ Manual in PDF format

PCAN-TJA1054

Bus Converter High-Speed CAN to Low-Speed CAN

The PCAN-TJA1054 bus converter establishes a connection between a High-speed CAN bus (ISO 11898-2) and a Low-speed CAN bus (ISO 11898-3). One of the most important potential applications of the bus converter is a simple connection between a PEAK CAN interface (e.g., PCAN-USB) and a Low-speed CAN bus.



Specifications

- Adapter from High-speed CAN to Low-speed CAN
- Bit rates up to 125 kbit/s
- CAN transceiver NXP PCA82C251 and TJA1055
- Termination resistors for Low-speed CAN can be switched (560 Ohm / 5.66 kOhm)
- Power LED
- Error LED (Low-speed CAN)
- CAN bus connection via D-Sub, 9-pin (in accordance with CiA[®] 106)
- 5-Volt power supply through pin 1 of the High-speed CAN connection. Nearly all CAN interfaces by PEAK-System can provide the required supply
- Extended operating temperature range from -40 to +85 °C (-40 to +185 °F)

Male D-Sub Connector	Pin	Pin assignment Low-speed CAN (TJA1055)
	1	Not connected
	2	CAN-L
	3	GND
	4	Not connected
	5	Not connected
	6	GND
	7	CAN-H
	8	Not connected
	9	Not connected

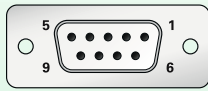
Female D-Sub Connector	Pin	Pin assignment High-speed CAN (82C251)
	1	5V Power supply
	2	CAN-L
	3	GND
	4	Not connected
	5	Not connected
	6	GND
	7	CAN-H
	8	Not connected
	9	Not connected

Ordering information

Designation	Part No.
PCAN-TJA1054	IPEH-002039

Scope of supply

- Adapter in plastic casing
- Manual in PDF format

PCAN-Optoadapter

Plug-on Adapter for Decoupling CAN and CAN FD Networks

The PCAN-Optoadapter is a universal plug-on adapter to allow galvanic isolation of High-speed CAN bus systems. Its integrated logic means that decoupling can be installed at any point in the CAN network.

The PCAN-Optoadapter can be used in CAN FD buses with data bit rates up to 2 Mbit/s and nominal bit rates up to 1 Mbit/s.

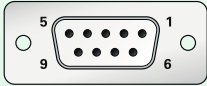

Female D-Sub Connector	Pin	Pin assignment
	1	5V Power supply
	2	CAN-L
	3	GND
	4	Not connected
	5	Not connected
	6	GND
	7	CAN-H
	8	Not connected
	9	Not connected

Male D-Sub Connector	Pin	Pin assignment
	1	Not connected
	2	CAN-L
	3	GND
	4	Not connected
	5	Not connected
	6	GND
	7	CAN-H
	8	Not connected
	9	Not connected

Specifications

- Plug-on adapter for decoupling a CAN bus for PEAK CAN interfaces
- Galvanic isolation by DC/DC converters up to 500 V
- Bit rates from 5 kbit/s up to 1 Mbit/s
- High-speed CAN transceiver NXP PCA82C251
- Suitable for the use in CAN FD buses with data bit rates up to 2 Mbit/s and nominal bit rates up to 1 Mbit/s
- CAN bus connection via D-Sub, 9-pin (in accordance with CiA[®] 106)
- LED for status indication of the supply voltage
- 120-Ohm bus termination at the female D-Sub connector
- 5-Volt power supply through pin 1 of the High-speed CAN connection. Nearly all CAN interfaces by PEAK-System can provide the required supply
- Extended operating temperature range from -40 to +85 °C (-40 to +185 °F)

Ordering information

Designation	Part No.
PCAN-Optoadapter	IPEH-002038

Scope of supply

- Adapter in plastic casing
- Manual in PDF format

PCAN-Repeater DR

CAN and CAN FD Repeater for the Decoupling Bus Segments

The PCAN-Repeater DR establishes a galvanic isolation of up to 5 kV within a High-speed CAN bus. Both CAN ports are decoupled from each other and from the power supply. All message traffic including error frames is forwarded 1:1 between both ports. The PCAN-Repeater DR behaves passively and is transparent from the perspective of the CAN bus. LEDs display the current bus status.

The PCAN-Repeater DR finds application in the realization of long stub lines or the galvanic isolation of two CAN bus segments. With its DIN rail casing and extended temperature range support, it is suitable for use in an industrial environment. The PCAN-Repeater DR can be used in CAN FD buses with data bit rates up to 4 Mbit/s and nominal bit rates up to 1 Mbit/s.

Please note: Due to the CAN protocol, the maximum length of a CAN bus depends on the bit rate. Therefore, a bus cannot be extended with the PCAN-Repeater DR. The physical total length of the CAN bus is reduced with each built-in PCAN-Repeater DR according to its signal delay.



Specifications

- Two High-speed CAN ports (ISO 11898-2)
- Bit rates from 5 kbit/s up to 1 Mbit/s
- Compliant with CAN specifications 2.0A (11-bit ID) and 2.0B (29-bit ID)
- NXP PCA82C251 CAN transceiver
- Suitable for the use in CAN FD buses with data bit rates up to 4 Mbit/s and nominal bit rates up to 1 Mbit/s
- Connections for CAN and power supply via 4-pin screw terminal block (Phoenix)
- LEDs display CAN bus load and CAN errors (only for CAN 2.0 A/B)
- Each CAN port can be selectively terminated
- Galvanic isolation rated up to 5 kV according to IEC 60601-1, between both CAN ports and between CAN and power supply
- Plastic casing (width: 22.5 mm) for mounting on a DIN rail (DIN EN 60715 TH35)
- Voltage supply from 8 to 30 V
- Extended operating temperature range from -40 to +85 °C (-40 to +185 °F)

Ordering information

Designation	Part No.
PCAN-Repeater DR	IPEH-004038

Scope of supply

- PCAN-Repeater DR in DIN rail plastic casing
- 3 mating connectors for power supply and CAN connections
- Manual in PDF format

Accessories: PCAN-Adapter D-Sub for DR Products optionally available (details on page 132).

PCAN-LWL

Optical Coupler for CAN and CAN FD Data Transmission

For use in explosion-proof areas or for EMC measurements, the PCAN-LWL can be used to replace a stretch of CAN network with a fiber-optic line at any point. There are the options of conversion to High-speed CAN or Low-speed CAN. The modules are supplied with power externally.

The PCAN-LWL can be used in CAN FD buses with data bit rates up to 5 Mbit/s and nominal bit rates up to 500 kbit/s.



Specifications

- LED display for transceiver status
- High-speed CAN: AMIS 30660 transceiver, max. 500 kbit/s, switchable 120-Ohm bus termination
- Low-speed CAN: TJA1055 transceiver, max. 125 kbit/s, switchable 510 Ohm / 5.6 kOhm bus termination, bus error display
- Complies with CAN specifications 2.0 A/B
- Suitable for the use in CAN FD buses with data bit rates up to 5 Mbit/s and nominal bit rates up to 500 kbit/s
- The fiber-optic line consists of a 62.5/125 µm fibre-optic duplex line with ST connectors
- Aluminum casing
- CAN bus connection via D-Sub, 9-pin (in accordance with CiA® 106)
- Supply voltage 6.5 to 30 V
- Supply via D-Sub 9-pin or DC connector (jumper)
- Operating temperature range from 0 to 70 °C (32 to 158 °F)

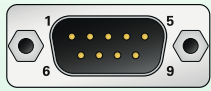
D-Sub	Pin	Pin assignment
	1	Not connected
	2	CAN-L
	3	GND
	4	Not connected
	5	Not connected
	6	GND
	7	CAN-H
	8	Not connected
	9	V _N (optional)

Ordering information

Designation	Part No.
PCAN-LWL	IPEH-002026

Scope of supply

- 2 CAN to optical waveguide converters including power supply units. Delivered in shockproof plastic box
- A choice of 5 or 10 m FO cable, 62.5 / 125 µm duplex line ST connector. Other lengths available on request
- Manual in PDF format

Also available with Single-wire CAN transceiver on request.

PLIN-LWL

Optical Coupler for LIN Data Transmission

For use in explosion-proof areas or for EMC measurements, the PLIN-LWL can be used to replace a stretch of LIN network with a fiber-optic line at any point. The modules are supplied with power externally.

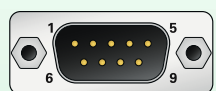

D-Sub	Pin	Pin assignment
	1	Not connected
	2	Not connected
	3	GND
	4	LIN
	5	Not connected
	6	GND
	7	Not connected
	8	Not connected
	9	V+

Specifications

- Bit rates from 2.4 kbit/s up to 20 kbit/s
- TJA1028 LIN transceiver
- LED display for power supply and transceiver status
- Switchable master termination
- LIN bus connection via D-Sub, 9-pin
- The fiber-optic line consists of a 62.5/125 μm fibre-optic duplex line with ST connectors
- Supply voltage 8 to 30 V
- Supply via D-Sub 9-pin or DC connector (jumper)
- Aluminum casing
- Extended operating temperature range from -40 to +85 °C (-40 to +185 °F)

Ordering information

Designation	Part No.
PLIN-LWL	IPEH-004049

Scope of supply

- 2 LIN to optical waveguide converters including power supply units. Delivered in shockproof plastic box
- A choice of 5 or 10 m FO cable, 62.5/125 μm duplex line ST connector. Other lengths available on request
- Manual in PDF format

PCAN-MicroMod

Universal I/O Module with CAN Interface

The plug-in module PCAN-MicroMod represents a straightforward possibility to provide electronic circuits with I/O functionality and a CAN connection. Configuring is done with a Windows program which sends the configuration data to the module via CAN. Several modules can be configured independently on a CAN bus.

With various PCAN-MicroMod motherboards, it can be used in device and plant engineering and in the motor vehicle industry. An optional evaluation board simplifies the enhancement and development of custom boards.

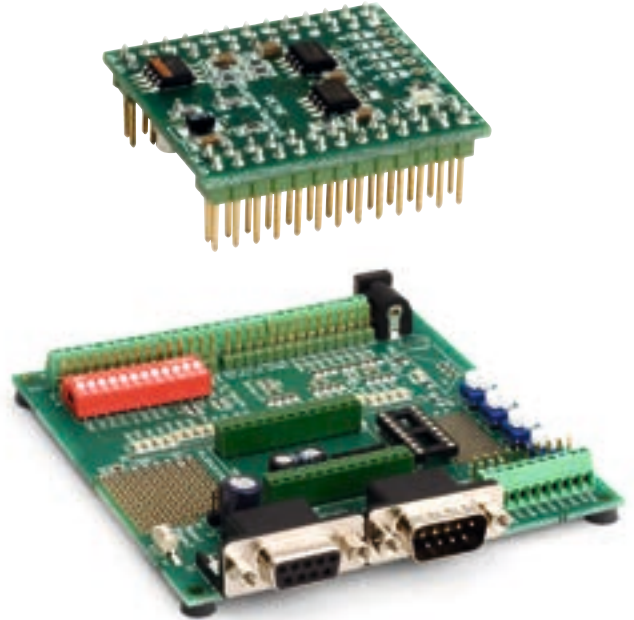

PCAN-MicroMod Specifications

- High-speed CAN connection (ISO 11898-2)
 - Bit rates from 10 kbit/s up to 1 Mbit/s
 - Compliant with CAN specifications 2.0A (11-bit ID) and 2.0B (29-bit ID)
- 8 analog inputs, measuring range unipolar 0 to 5 V (resolution 10 bit, sample rate 1 kHz)
- 8 digital inputs and 8 digital outputs
- PWM/frequency outputs (1 Hz to 10 kHz)
- Maximum of 32 MicroMods in one CAN network
- Dimensions: 32 x 35 mm
- Extended operating temperature range from -40 to +85 °C (-40 to +185 °F)

PCAN-MicroMod Evaluation Board Specifications

- Open-collector output driver for digital outputs and CMOS PWM outputs
- Pick-offs and screw terminals for inputs and outputs
- DIP switch for status change of the digital inputs
- Protected digital inputs + LED
- 4 potentiometers for analog inputs
- Low-pass and resistive divider for voltages > 5 V
- Serial interface for firmware updates
- Optional Low-speed CAN transceiver
- Operating temperature range from 0 to 85 °C (32 to 185 °F)
- Dimensions: 100 x 100 mm

Ordering information

Designation	Part No.
PCAN-MicroMod	IPEH-002080
PCAN-MicroMod Evaluation Board	IPEH-002082
PCAN-MicroMod Evaluation Kit	IPEH-002079

Scope of supply PCAN-MicroMod

- PCAN-MicroMod
- PCAN-MicroMod Configuration for Windows (details on page 112)
- Manual in PDF format

Scope of supply PCAN-MicroMod Evaluation Kit

- PCAN-MicroMod
- PCAN-MicroMod Evaluation Board
- Power supply unit
- PCAN-USB
- 2 m CAN cable with termination
- PCAN-MicroMod Configuration for Windows (details on page 112)
- Manual and schematic in PDF format

Requirements

- The configuration requires a PEAK CAN interface

PCAN-MicroMod Analog 1 & 2

Application-specific PCAN-MicroMod Motherboards

The motherboards for the PCAN-MicroMod provide an application-oriented environment. Typical characteristics of this product group include a wide supply voltage range and the protective circuits for the inputs and outputs. CANopen® firmware is available for all PCAN-MicroMod motherboards.

The Analog 1 & 2 motherboards serve general analog requirements.



Specifications Analog 1

- ___ High-speed CAN connection (ISO 11898-2)
 - Bit rates from 10 kbit/s up to 1 Mbit/s
 - Compliant with CAN specifications 2.0A (11-bit ID) and 2.0B (29-bit ID)
- ___ Completely configurable using the Windows software PCAN-MicroMod Configuration (details on page 112)
- ___ Operating voltage 11 to 26 V
- ___ Status LEDs for power supply and digital output
- ___ Aluminum casing with spring terminal connectors. Optional DIN rail fixing available
- ___ Extended operating temperature range from -40 to +85 °C (-40 to +185 °F)
- ___ 8 analog inputs
 - Measuring range unipolar 0 to 5 V
 - Resolution 10 bit, sample rate 1 kHz
 - Measuring range extension optional
 - Pull-down circuit
 - Protection against under- and overvoltages
 - Parallel connection of a digital input each for alternative use (e.g., push buttons)
- ___ 4 analog outputs
 - Voltage range 0 to 10 V (based on 8-bit PWM)
 - Output current 15 mA per channel
 - Short-circuit protection

Specifications Analog 2

- ___ High-speed CAN connection (ISO 11898-2)
 - Bit rates from 10 kbit/s up to 1 Mbit/s
 - Compliant with CAN specifications 2.0A (11-bit ID) and 2.0B (29-bit ID)
- ___ Completely configurable using the Windows software PCAN-MicroMod Configuration (details on page 112)
- ___ Operating voltage 11 to 30 V
- ___ Status LEDs for power supply and digital output
- ___ Aluminum casing with spring terminal connectors. Optional DIN rail fixing available
- ___ Extended operating temperature range from -40 to +85 °C (-40 to +185 °F)
- ___ 8 analog inputs
 - Measuring range bipolar -10 to +10 V
 - Resolution 16 bit
 - Sample rate depends on the number of used channels (2 kHz/n)
 - Low-pass behavior
 - Protection against under- and overvoltages
- ___ 4 analog outputs
 - Voltage range 0 to 10 V (based on 12-bit DAC)
 - Output current 20 mA per channel
 - Short-circuit protection

PCAN-MicroMod Digital 1 & 2

Application-specific PCAN-MicroMod Motherboards

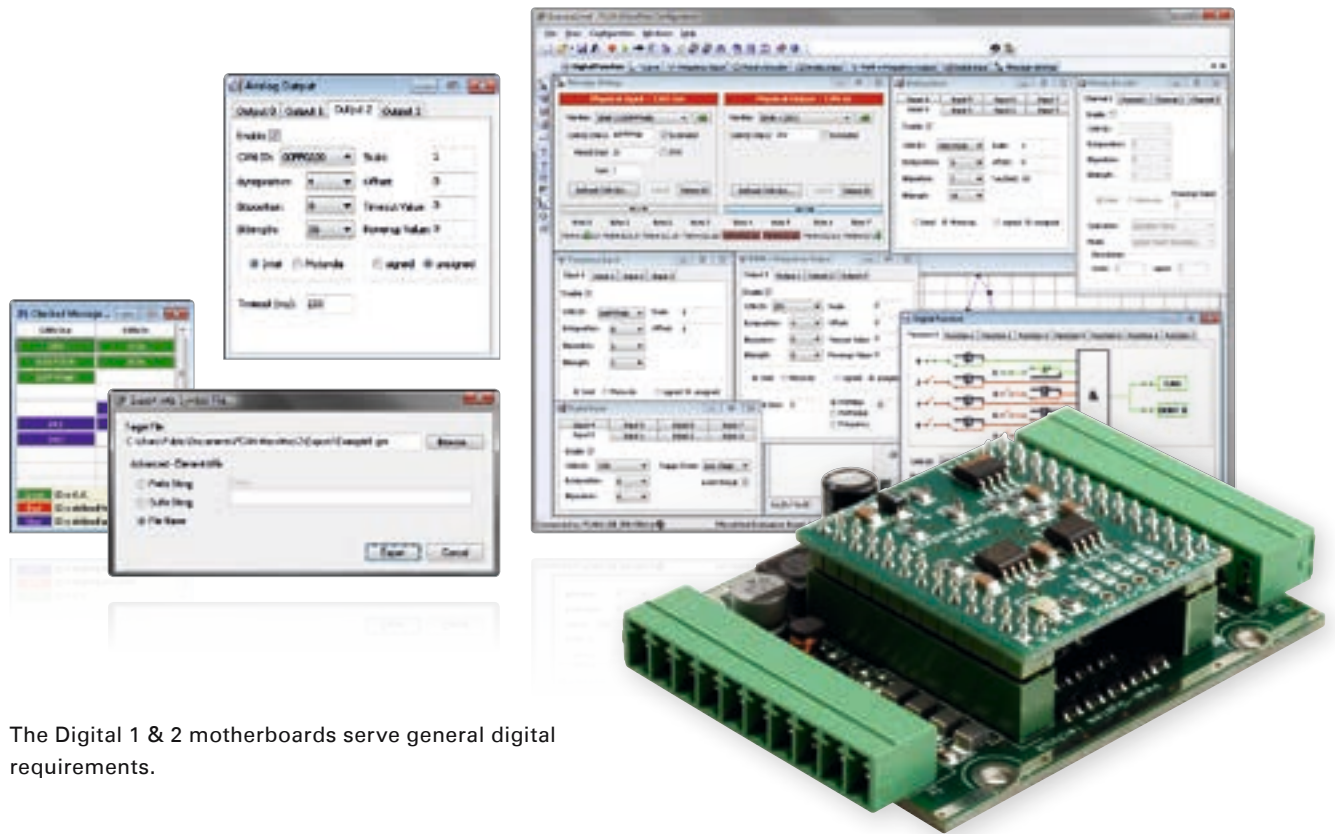

The Digital 1 & 2 motherboards serve general digital requirements.

Specifications Digital 1 & 2

- ___ High-speed CAN connection (ISO 11898-2)
 - Bit rates from 10 kbit/s up to 1 Mbit/s
 - Compliant with CAN specifications 2.0A (11-bit ID) and 2.0B (29-bit ID)
- ___ Completely configurable using the Windows software PCAN-MicroMod Configuration (details on page 112)
- ___ Operating voltage 8 to 26 V
- ___ Status LEDs for power supply and digital output
- ___ Aluminum casing with spring terminal connectors. Optional DIN rail fixing available
- ___ Extended operating temperature range from -40 to +85 °C (-40 to +185 °F)
- ___ 8 digital inputs
 - Pull-up or Pull-down circuit selectable in groups (3 groups)
 - Schmitt trigger behavior, inverting
 - Threshold High = 4.8 V, Low = 1.2 V
 - Low-pass behavior
 - Parallel connection of frequency inputs at 4 digital inputs for alternative use (e.g., on rapid state changes, counting)
- ___ 5 digital outputs
 - PCAN-MicroMod Digital 1: 4 Low-side switch, max. 45 V, 0.35 A
 - PCAN-MicroMod Digital 2: 4 High-side switch, max. 26 V, 1.1 A
 - 1 fast Low-side switch, max. 55 V, 0.75 A, max. 10 kHz („frequency output“)
 - Short-circuit protection

PCAN-MicroMod Mix 1

Application-specific PCAN-MicroMod Motherboards



The Mix 1 motherboard combines general analog and digital requirements with temperature recording functions.

Specifications

- ___ High-speed CAN connection (ISO 11898-2)
 - Bit rates from 10 kbit/s up to 1 Mbit/s
 - Compliant with CAN specifications 2.0A (11-bit ID) and 2.0B (29-bit ID)
- ___ Completely configurable using the Windows software PCAN-MicroMod Configuration (details on page 112)
- ___ Operating voltage 8 to 26 V
- ___ Status LEDs for power supply and digital output
- ___ Aluminum casing with spring terminal connectors. Optional DIN rail fixing available
- ___ Extended operating temperature range from -40 to +85 °C (-40 to +185 °F)
- ___ 2 analog inputs
 - Measuring range unipolar 0 to 5 V
 - Resolution 10 bit, sample rate 1 kHz
 - Measuring range extension optional
 - Pull-down circuit
 - Protection against under- and overvoltages
- ___ 2 temperature inputs
 - 2 connections for NTC resistors (type EC95F103W)
 - Measuring range 0 to 70 °C (32 to 158 °F)
- ___ 6 digital inputs
 - Pull-up or pull-down circuit selectable in groups (3 groups)
 - Schmitt trigger behavior, inverting
 - Threshold High = 4.8 V, Low = 1.2 V
 - Low-pass behavior
 - Parallel connection of frequency inputs at 4 digital inputs for alternative use (e.g., on rapid state changes, counting)
- ___ 2 digital outputs/frequency outputs
 - Fast Low-side switch, max. 55 V, 0.75 A
 - Short-circuit protection

PCAN-MicroMod Mix 2

Application-specific PCAN-MicroMod Motherboards

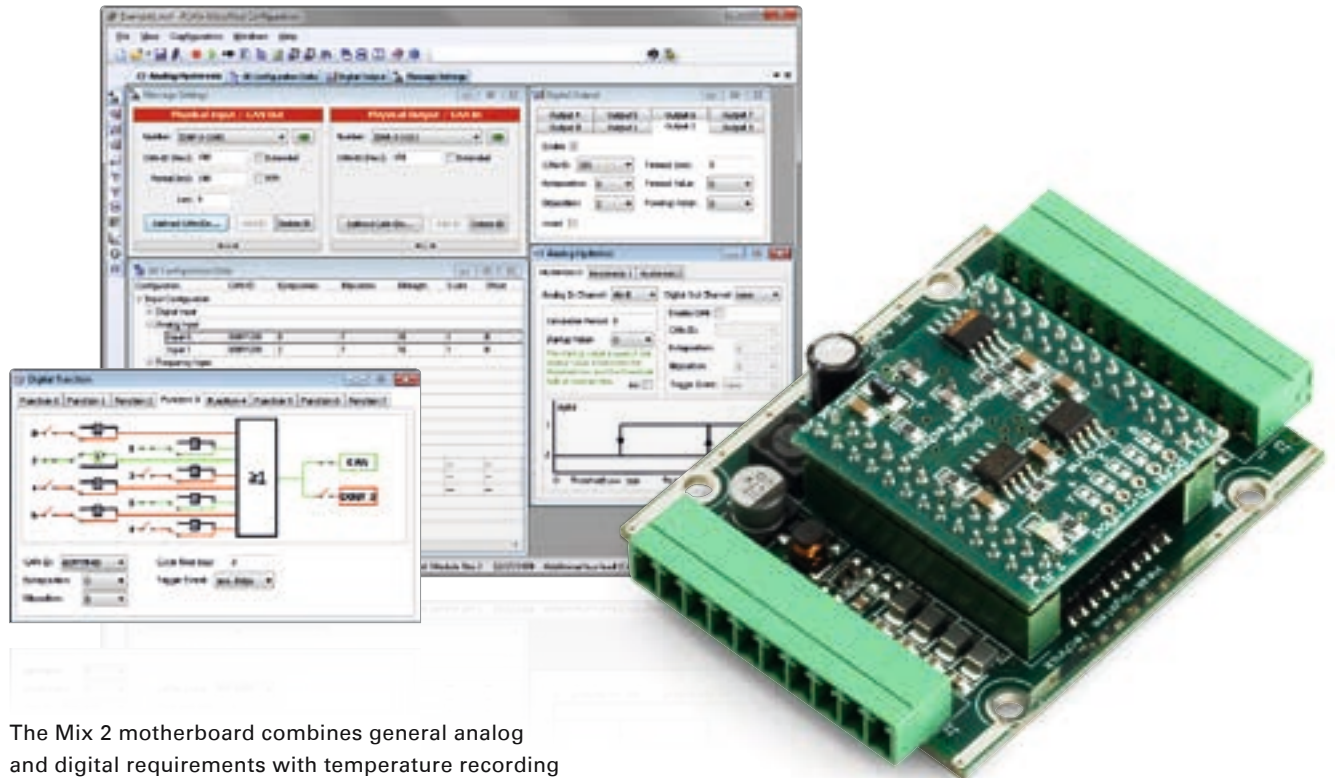

The Mix 2 motherboard combines general analog and digital requirements with temperature recording functions.

Specifications

- ___ High-speed CAN connection (ISO 11898-2)
 - Bit rates from 10 kbit/s up to 1 Mbit/s
 - Compliant with CAN specifications 2.0A (11-bit ID) and 2.0B (29-bit ID)
- ___ Completely configurable using the Windows software PCAN-MicroMod Configuration (details on page 112)
- ___ Operating voltage 11 to 26 V
- ___ Status LEDs for power supply and digital output
- ___ Aluminum casing with spring terminal connectors. Optional DIN rail fixing available
- ___ Extended operating temperature range from -40 to +85 °C (-40 to +185 °F)
- ___ 3 analog inputs
 - Measuring range unipolar 0 to 4.1 V
 - Resolution 10 bit, sample rate 1 kHz
 - Measuring range extension optional
 - Pull-down circuit
 - Low-pass behavior
 - Protection against under- and overvoltages
- ___ 1 analog voltage output
 - Voltage 0 to 10 V (based on 16-bit PWM)
 - Load ability 15 mA, short-circuit proof
- ___ 1 analog current output
 - Current intensity 0 to 20 mA (based on 16-bit PWM)
- ___ 2 digital inputs
 - Pull-up or pull-down circuit selectable for both together (1 group)
 - Schmitt trigger behavior, inverting
 - Threshold High = 4.8 V, Low = 1.2 V
 - Low-pass behavior
 - Parallel connection of a frequency input each for alternative use (e.g., on rapid state changes, counting)
- ___ 1 digital output
 - Fast Low-side switch, max. 55 V, 0.75 A
 - Short-circuit protection
- ___ 2 temperature inputs
 - 1 connection for a NTC resistor (type EC95F103W)
 - 1 connection for a platinum sensor PT1000
 - Measuring range 0 to 70 °C (32 to 158 °F)

PCAN-MicroMod Mix 3

Application-specific PCAN-MicroMod Motherboards

The Mix 3 motherboard allows the use of all inputs and outputs available on the PCAN-MicroMod, which opens up a wide range of potential applications in the automotive and industrial sectors.

Specifications

- ___ High-speed CAN connection (ISO 11898-2)
 - Bit rates from 10 kbit/s up to 1 Mbit/s
 - Compliant with CAN specifications 2.0A (11-bit ID) and 2.0B (29-bit ID)
- ___ Completely configurable using the Windows software PCAN-MicroMod Configuration (details on page 112)
- ___ Operating voltage 12 V DC nominal, 8 to 26 V possible
- ___ Status LEDs for power supply and digital output
- ___ Plastic casing with Tyco automotive connectors
- ___ Extended operating temperature range from -40 to +85 °C (-40 to +185 °F)

- ___ 8 analog inputs
 - Measuring range unipolar 0 to 4.1 V (can be expanded using by a voltage divider)
 - Resolution 10 bit, sample rate 1 kHz
 - Protection against under- and overvoltage
 - Low-pass behavior
- ___ 8 digital inputs
 - Schmitt trigger behavior, inverting
 - Threshold High = 4.8 V, Low = 1.2 V
 - Pull-up or pull-down circuit selectable for each input
 - Low-pass behavior
- ___ 4 frequency inputs (differences to the digital inputs):
 - Scannable frequency range 0 to 10 kHz
- ___ 8 digital outputs
 - High-side switches, 350 mA continuous current, 500 mA short-circuit current
 - 4 outputs also usable as Low-side switches, 700 mA continuous current, 1 A short-circuit current
 - Short-circuit protection
- ___ 4 PWM/frequency outputs
 - Low-side switches, 350 mA continuous current, 1 A short-circuit current
 - 2 outputs also usable as High-side switches, 1.5 A continuous current, 5 A short-circuit current
 - Short-circuit protection



Ordering information

Designation	Part No.
PCAN-MicroMod Analog 1	IPEH-002204
PCAN-MicroMod Analog 2	IPEH-002207
PCAN-MicroMod Digital 1	IPEH-002200
PCAN-MicroMod Digital 2	IPEH-002201
PCAN-MicroMod Mix 1	IPEH-002202
PCAN-MicroMod Mix 2	IPEH-002203
PCAN-MicroMod Mix 3	IPEH-002206

Scope of supply

- ___ PCAN-MicroMod
- ___ PCAN-MicroMod motherboard in casing including mating connectors and crimp contacts
- ___ PCAN-MicroMod Configuration for Windows (details on page 112)
- ___ Manual in PDF format

CANopen® firmware is available for all PCAN-MicroMod motherboards.

Requirements

- ___ The configuration requires a PEAK CAN interface

PCAN-MicroMod FD Product Line

Configurable and Programmable I/O Modules with CAN FD Connection



The PCAN-MicroMod FD combines a microcontroller, a CAN FD interface, and various inputs and outputs on a small plug-in board. PEAK-System thus offers developers a simple solution for integrating these features into their own hardware and has itself released a series of I/O modules for various applications based on this.

Operating Modes

PCAN-MicroMod FD products can be used depending on firmware and model in different operating modes with support for the communication protocols CAN (FD) or CANopen (FD). Furthermore, the operation with a custom firmware is possible as well.

* Support for the J1939 (FD) standard is planned for Q3 2024.

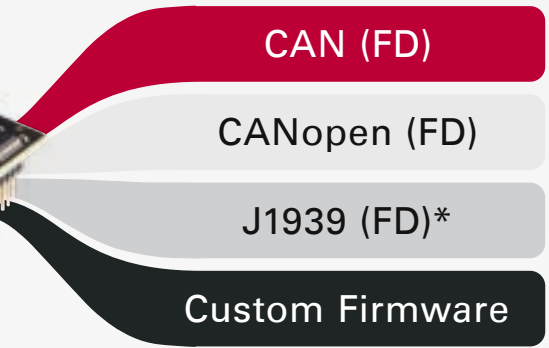

Support per product

Product	CAN CAN FD	CANopen CANopen FD	Custom Firmware
PCAN-MicroMod FD Evaluation	■	■	■
PCAN-MicroMod FD Analog 1	■	■	■
PCAN-MicroMod FD Digital 1/2	■	■	■
PCAN-MicroMod FD ECU	■	-	-
PCAN-MicroMod FD DR CANopen Digital 1	■	■	-
PCAN-MicroMod FD Custom Motherboard	■	-	-

- On delivery active operation mode
- Alternative operation mode
- Not supported operation mode

Operation mode for CAN and CAN FD

- Features:**
- Use in CAN and CAN FD buses
 - Complies with CAN specifications 2.0 A/B and FD
- Prerequisite:**
- Installed standard firmware
- Activation:**
- Is done by switching with the configuration software
 - Is activated for regular PCAN-MicroMod FD products at delivery
- Configuration:**
- Is done via the CAN bus with the Windows software PCAN-MicroMod FD Configuration
 - Manual definition of the send and receive CAN messages
 - Mapping of the I/O signals to the CAN messages

Operation mode for CANopen and CANopen FD

- Features:**
- Use in CANopen and CANopen FD networks
 - Communication profiles according to CiA® 301 version 4.2.0 and CiA® 1301 version 1.1.0
 - Device profiles according to CiA® 401 version 3.0.0 and CiA® 401-B/F version 1.0.0
 - CANopen EDS files are available for all supported products
- Prerequisite:**
- Installed standard firmware
- Activation:**
- Is done by switching with the configuration software
 - Requires a one-time unlock via the Internet with a license that is included or can be purchased from Embedded Systems Academy
- Configuration:**
- Configuration of the bit rates, node ID, and vendor ID is done with the Windows software PCAN-MicroMod FD Configuration
 - The behavior of the I/O functionality is specified by the firmware

Operation mode for J1939 and J1939 FD

- Features:**
- Support of the standards SAE J1939 and J1939 FD
 - Definition of up to 20 PGs (Parameter Groups) and 80 SPs (Suspect Parameters) each for transmit and receive messages
 - Support of multipacket messages with payload data up to 1785 bytes
 - Arbitrary Address Capable: Address claiming with automatic resolution of address conflicts
 - Transmission and reception of PGs without an assigned address by using J1939 names
 - Adjustable BAM transmission period from 10 to 50 ms
- Prerequisite:**
- Installed free J1939 firmware
- Activation:**
- Is activated automatically with installation of the J1939 firmware
- Configuration:**
- Is done via the CAN bus with the Windows software PCAN-MicroMod FD Configuration
 - Manual definition of parameter groups and suspect parameters
 - Mapping of the I/O signals to the SPs and PGs
- Notes:**
- The configuration software does not contain a J1939 database. If a licensed installation of the PCAN-Explorer 6 J1939 Add-in exists, its database can be imported.
 - Support for the J1939 (FD) standard is planned for Q3 2024.

Operation with a custom firmware

Various PCAN-MicroMod FD products can be freely programmed with the help of our free development package for ARM-based products. The included programming examples facilitate the implementation of own solutions.

Note: In the future, this option will also be available for other PCAN-MicroMod FD products.



Configuration

In the operation modes CAN (FD) and J1939 (FD) the configuration of the PCAN-MicroMod FD products is done with the freely available Windows software PCAN-MicroMod FD Configuration. In addition to simply mapping I/Os to CAN IDs, function blocks for processing the data are also available. The configuration created on the computer is transferred via the CAN bus to the PCAN-MicroMod FD which then runs as an autonomous CAN node. Multiple modules can be configured independently on a CAN bus.

Note: A PEAK-CAN interface is required to transfer a configuration via CAN. You can find detailed information about the PCAN-MicroMod FD Configuration software and its configuration options on page 113.

Firmware

The transfer of a regular or a custom firmware to PCAN-MicroMod FD products is done with the free Windows software PEAK-Flash via the CAN bus.

PEAK-Flash contains the current version of the standard firmware which is used for the CAN (FD) and CANopen (FD) operation modes.

Note: A PEAK-CAN interface is required for transferring a firmware via CAN. Further information about PEAK-Flash can be found on our website.

PCAN-MicroMod FD

Universal Plug-in Module with I/O and CAN FD Interface

The PCAN-MicroMod FD is a small plug-in board with CAN and CAN FD connection on the one side and various physical inputs and outputs on the other side. The logical linking of both sides is done by the microcontroller NXP LPC54618. With the PCAN-MicroMod FD, electronics developers can easily integrate I/O functionality with CAN connection into their project.

PCAN-MicroMod FD products are configured with a free Windows software. In addition to simply mapping I/Os to CAN IDs, function blocks for processing the data are also available. The configuration created on the computer is transferred via the CAN bus to the PCAN-MicroMod FD which then runs as an autonomous CAN node.

For the PCAN-MicroMod FD, ready-to-use motherboards in an aluminum housing and an evaluation board for the development of own applications are available.

The PCAN-MicroMod FD can alternatively be operated with firmware for CANopen (FD). Furthermore, the use with a custom firmware is also possible. Licenses for the CANopen firmware are available from our partner Embedded Systems Academy. You can find detailed information about the operation modes and the configuration of PCAN-MicroMod FD products on page 46.

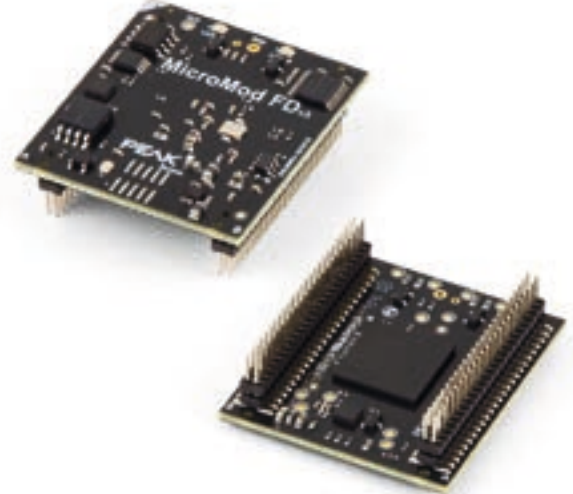

Specifications

- Plug-in board with 2 double pin strips of 50 pins each, 50 mil pitch (1.27 mm)
- NXP LPC54618 microcontroller with Arm® Cortex® M4 core
- High-speed CAN connection (ISO 11898-2)
 - Complies with CAN specifications 2.0 A/B and FD
 - CAN FD bit rates for the data field (64 bytes max.) from 20 kbit/s up to 10 Mbit/s
 - CAN bit rates from 20 kbit/s up to 1 Mbit/s
 - Microchip MCP2558FD CAN transceiver
- 8 analog inputs
 - Measuring range unipolar 0 to 3 V
 - Resolution 12 bit, sample rate 1 kHz
- 8 digital inputs
- 8 digital outputs
- 2 frequency outputs
- Selective configuration of up to 16 devices in a CAN network based on the module ID
- Voltage supply 3.3 V
- Dimensions: 33 x 36 mm
- Extended operating temperature range from -40 to +85 °C (-40 to +185 °F)

Ordering information

Designation	Part No.
PCAN-MicroMod FD	IPEH-003080
PCAN-MicroMod FD Pin Adapter	IPEH-003090

Scope of supply

- PCAN-MicroMod FD
- PCAN-MicroMod FD Configuration for Windows (details on page 113)
- Windows development package with GCC ARM Embedded, flash program, and programming examples
- Manual in PDF format

Requirements

- The configuration requires a PEAK CAN interface

Accessories: Pin adapter for 100 mil pitch.

PCAN-MicroMod FD Evaluation Board

Universal Evaluation Board for the Plug-in Module PCAN-MicroMod FD

This product is an evaluation board for the PCAN-MicroMod FD and allows the conception and development of own circuits with CAN connection and I/O functionality. It can also be used for training purposes for CAN and CAN FD setups. Via pick-offs, screw terminals, switches, and potentiometers, the user can access the resources of the attached PCAN-MicroMod FD and check configurations or test circuits.

The configuration is done with a supplied Windows software which transfers the configuration data to the module via CAN. The optionally available Evaluation Kit includes the CAN interface and a CAN cable required for this purpose.

The PCAN-MicroMod FD Evaluation Board can alternatively be operated with firmware for CANopen (FD). Furthermore, the use with a custom firmware is also possible. A license for the CANopen firmware is included in the scope of supply. You can find detailed information about the operation modes and the configuration of PCAN-MicroMod FD products on page 46.

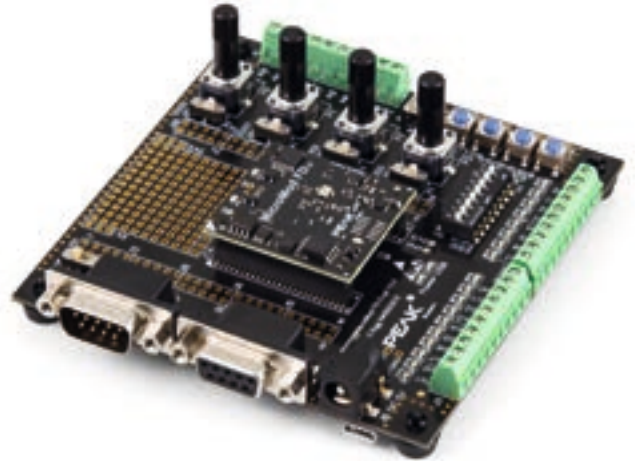

Specifications

- Board with plugged on PCAN-MicroMod FD
- CAN bus connection via D-Sub, 9-pin (in accordance with CiA® 106)
- Screw terminal connections for all I/Os
- Switchable CAN termination of 120 Ohm
- Pick-offs for all pins of the PCAN-MicroMod FD
- Low-side switches for the digital outputs
- DIP switches for status change of the digital inputs
- Protected digital inputs
- LEDs for digital inputs and outputs
- 4 potentiometers for analog inputs
- Soldering fields for individual additional wiring
- RS-232 connection with V.24 signal levels for direct access to the microcontroller
- 4-bit rotary coding switch for setting the module ID
- Firmware upload via CAN, USB, or RS-232; switchable via 3 buttons
- Reset button for restarting the board
- Voltage supply 5 V via Micro-USB or barrel connection
- Operating temperature range from 0 to 70 °C (32 to 158 °F)
- Board 100 x 102 mm with rubber feet

Ordering information

Designation	Part No.
PCAN-MicroMod FD Evaluation Board	IPEH-003081
PCAN-MicroMod FD Evaluation Kit	IPEH-003082

Scope of supply PCAN-MicroMod FD Evaluation Board

- PCAN-MicroMod FD
- PCAN-MicroMod FD Evaluation Board
- USB connector cable
- PCAN-MicroMod FD Configuration for Windows (details on page 113)
- CANopen license for one PCAN-MicroMod FD
- Windows development package with GCC ARM Embedded, flash program, and programming examples
- Manual and schematic in PDF format

Scope of supply PCAN-MicroMod FD Evaluation Kit

- Scope of supply of the PCAN-MicroMod FD Evaluation Board
- CAN interface PCAN-USB FD
- 2 m CAN cable with termination

Requirements

- The configuration requires a PEAK CAN interface

PCAN-MicroMod FD Analog 1

Configurable CAN FD Module with Focus on Analog I/Os

The PCAN-MicroMod FD plug-in board can be purchased together with ready-to-use motherboards that provide peripherals for specific requirements. For the connection of CAN, I/O, and power supply, spring terminal connectors are used. The motherboard PCAN-MicroMod FD Analog 1 puts the emphasis on analog inputs and outputs, which are provided with appropriate protective circuitry.

PCAN-MicroMod FD products are configured with a free Windows software. In addition to simply mapping I/Os to CAN IDs, function blocks for processing the data are also available. The configuration created on the computer is transferred via the CAN bus to the PCAN-MicroMod FD which then runs as an autonomous CAN node.

The PCAN-MicroMod FD Analog can alternatively be operated with firmware for CANopen (FD). Furthermore, the use with a custom firmware is also possible. Licenses for the CANopen firmware are available from our partner Embedded Systems Academy. You can find detailed information about the operation modes and the configuration of PCAN-MicroMod FD products on page 46.



Specifications

- Board with plugged on PCAN-MicroMod FD
- High-speed CAN connection (ISO 11898-2)
 - Complies with CAN specifications 2.0 A/B and FD
 - CAN FD bit rates for the data field (64 bytes max.) from 20 kbit/s up to 10 Mbit/s
 - CAN bit rates from 20 kbit/s up to 1 Mbit/s
- Switchable CAN termination
- 2 frequency outputs
 - Low-side switches
 - Adjustable frequency range from 0 to 20 kHz
- 1 analog input for voltage monitoring up to 30 V, resolution 12 bit
- 8 analog inputs
 - Resolution 16 bit
 - Measuring range adjustable: ± 2.5 V, ± 5 V, ± 10 V, ± 20 V
- 4 analog inputs
 - Resolution 12 bit
 - Measuring range 0 to 10 V
- 4 analog outputs
 - Resolution 12 bit
 - Voltage range adjustable: 0 to 5 V or 0 to 10 V
- 4 digital inputs
 - Pull-up or pull-down configurable
- 4-bit rotary coding switch for setting the module ID

- 3 status LED
- Aluminum casing with spring terminal connectors
- Operating voltage 8 to 30 V
- Extended operating temperature range from -40 to $+85$ °C (-40 to $+185$ °F)

Ordering information

Designation	Part No.
PCAN-MicroMod FD Analog 1	IPEH-003087

Scope of supply

- PCAN-MicroMod FD
- PCAN-MicroMod FD motherboard in aluminum casing including mating connectors
- PCAN-MicroMod FD Configuration for Windows (details on page 113)
- Manual in PDF format

Requirements

- The configuration requires a PEAK CAN interface

PCAN-MicroMod FD Digital 1 & 2

Configurable CAN FD Modules with Focus on Digital I/Os

The PCAN-MicroMod FD plug-in board can be purchased together with ready-to-use motherboards that provide peripherals for specific requirements. For the connection of CAN, I/O, and power supply, spring terminal connectors are used. The motherboards PCAN-MicroMod FD Digital 1 and 2 put the emphasis on digital inputs and outputs, which are provided with appropriate protective circuitry. The digital outputs of Digital 1 are equipped with low-side switches and those of Digital 2 with high-side switches.

PCAN-MicroMod FD products are configured with a free Windows software. In addition to simply mapping I/Os to CAN IDs, function blocks for processing the data are also available. The configuration created on the computer is transferred via the CAN bus to the PCAN-MicroMod FD which then runs as an autonomous CAN node.

The PCAN-MicroMod FD Digital can alternatively be operated with firmware for CANopen (FD). Furthermore, the use with a custom firmware is also possible. Licenses for the CANopen firmware are available from our partner Embedded Systems Academy. You can find detailed information about the operation modes and the configuration of PCAN-MicroMod FD products on page 46.



Specifications

- Board with plugged on PCAN-MicroMod FD
- High-speed CAN connection (ISO 11898-2)
 - Complies with CAN specifications 2.0 A/B and FD
 - CAN FD bit rates for the data field (64 bytes max.) from 20 kbit/s up to 10 Mbit/s
 - CAN bit rates from 20 kbit/s up to 1 Mbit/s
- Switchable CAN termination
- 2 frequency outputs
 - Low-side switches
 - Adjustable frequency range from 0 to 20 kHz
- 1 analog input for voltage monitoring up to 30 V, resolution 12 bit
- 8 digital inputs
 - Pull-up or pull-down configurable
- 8 digital outputs
 - Digital 1: Low-side switches
 - Digital 2: High-side switches
 - PWM mode: resolution duty cycle 16 bit, adjustable frequency range from 0 to 20 kHz
- 3 analog inputs
 - Resolution 12 bit
 - Measuring range 0 to 10 V
- 4-bit rotary coding switch for setting the module ID
- 3 status LED

- Aluminum casing with spring terminal connectors
- Operating voltage 8 to 30 V
- Extended operating temperature range from -40 to +85 °C (-40 to +185 °F)

Ordering information

Designation	Part No.
PCAN-MicroMod FD Digital 1	IPEH-003083
PCAN-MicroMod FD Digital 2	IPEH-003084

Scope of supply

- PCAN-MicroMod FD
- PCAN-MicroMod FD motherboard in aluminum casing including mating connectors
- PCAN-MicroMod FD Configuration for Windows (details on page 113)
- Windows development package with GCC ARM Embedded, flash program, and programming examples
- Manual in PDF format

Requirements

- The configuration requires a PEAK CAN interface

PCAN-MicroMod FD ECU

Universal, Configurable Control Unit with I/O and CAN FD Connection

The PCAN-MicroMod FD ECU is a universal control unit for the integration of custom accessories in automotive applications. For this purpose, it provides a CAN FD connection as well as a mix of analog and digital I/Os. With its tough casing and two automotive connectors, it is designed for use in utility and heavy duty vehicles under harsh conditions.

PCAN-MicroMod FD products are configured with a free Windows software. In addition to simply mapping I/Os to CAN IDs, function blocks for processing the data are also available. The configuration created on the computer is transferred via the CAN bus to the PCAN-MicroMod FD which then runs as an autonomous CAN node.

You can find detailed information about the operation modes and the configuration of PCAN-MicroMod FD products on page 46.



Specifications

- Module with integrated PCAN-MicroMod FD
- High-speed CAN connection (ISO 11898-2)
 - Complies with CAN specifications 2.0 A/B and FD
 - CAN FD bit rates for the data field (64 bytes max.) from 40 kbit/s up to 10 Mbit/s
 - CAN bit rates from 40 kbit/s up to 1 Mbit/s
- Wake-up by CAN bus or by separate input
- 4 digital inputs
 - Pull-up or pull-down configurable
- 8 digital outputs with High-side switches
 - 2 outputs with 5 A and 6 outputs with 2 A
 - 4 alternatively usable as a digital input or additionally for reading back the output level
- 8 analog inputs
 - Resolution 16 bit
 - Measuring range adjustable: ± 2.5 V, ± 5 V, ± 10 V, ± 20 V
- 4 of the analog inputs alternatively usable as analog output
 - Resolution 12 bit
 - Voltage range adjustable: 0 to 5 V or 0 to 10 V
- 2 frequency outputs
 - Low-side switches (3 A)
 - Adjustable frequency range from 0 to 20 kHz
 - Alternatively usable as analog inputs with voltage range from 0 to 60 V
- Connections for CAN, I/O, and power supply via two 20-pole automotive connectors (Molex MX150)

- Plastic casing with increased Ingress Protection IP67 and flange
- Operating voltage 8 to 32 V; suitable for use in 12 and 24 V vehicle electrical systems
- Extended operating temperature range from -40 to +85 °C (-40 to +185 °F)
- E1 type approval in progress

Ordering information

Designation	Part No.
PCAN-MicroMod FD ECU	IPEH-003085

Scope of supply

- PCAN-MicroMod FD ECU including mating connectors
- PCAN-MicroMod FD Configuration for Windows (details on page 113)
- Manual in PDF format

Requirements

- The configuration requires a PEAK CAN interface

Notes:

- Expected to be available in Q2 2024.
- Version with galvanic isolation of the CAN channel on request.

PCAN-MicroMod FD DR CANopen Digital 1

Industrial CANopen and CANopen FD Module for Digital I/O Applications

The PCAN-MicroMod FD DR CANopen Digital 1 is an I/O module for operation in CANopen and CANopen FD networks. The modern standard CANopen FD makes it possible to handle the ever-increasing demand for data transmission from sensors, machines, and complex production plants. The module has a CAN FD interface as well as 8 digital inputs and 8 digital outputs. With its DIN rail casing and the support of the extended temperature range, the module is suitable for use in an industrial environment.

The node ID and bit rates are set via rotary switches. Thus, no configuration software is required for putting the device in operation. Due to the support of the CANopen and CANopen FD standards, a problem-free use in existing networks is guaranteed.

The PCAN-MicroMod FD DR CANopen Digital 1 was developed in cooperation with our partner Embedded Systems Academy, specialized in CANopen. The conformity to CANopen and CANopen FD has been tested and certified by the CAN in Automation (CiA) association.



Specifications

- ___ I/O module for CANopen® and CANopen FD®
 - Communication profiles according to CiA® 301 version 4.2.0 and CiA® 1301 version 1.1.0
 - Device profiles according to CiA® 401 version 3.0.0 and CiA® 401-B/F version 1.0.0
- ___ High-speed CAN connection (ISO 11898-2)
 - Selectable CANopen bit rates:
Nominal: 20, 50, 125, 250, 500, 800, and 1000 kbit/s
 - Selectable CANopen FD bit rates:
Nominal: 250, 500, 800, and 1000 kbit/s
Data: 1, 2, 4, 5, 8, and 10 Mbit/s
 - NXP TJA1044GT CAN transceiver
 - Galvanic isolation against the power supply up to 500 V
- ___ Configuration of the CAN and CAN FD bit rates as well as the node ID with rotary switches on the casing
- ___ 2 LEDs „RUN“ and „ERROR“ for status indication according to CiA® DR 303-3
- ___ 8 digital inputs
 - Comply with the IEC 61131-2 standard
 - Input characteristics: Type 3
 - 2 groups of 4 inputs to be used either as sourcing or sinking inputs
 - Galvanic isolation of the digital inputs 0 to 3 and 4 to 7 each up to 100 V against the module supply
- ___ 8 digital outputs
 - 500 mA load per High-side output
 - Thermal protection per output
 - Short circuit detection per output
 - Open load detection in on-state and off-state per output
- ___ LEDs for status indication of the digital inputs and outputs
- ___ Connections for CAN, I/O, and power supply via 5-pole screw-terminal strips (Phoenix)
- ___ Plastic casing (width: 22.5 mm) for mounting on a DIN rail (DIN EN 60715 TH35)
- ___ Voltage supply from 8 to 36 V
- ___ Extended operating temperature range from -40 to +85 °C (-40 to +185 °F)

Ordering information

Designation	Part No.
PCAN-MicroMod FD DR CANopen Digital 1	IPEH-003100

Scope of supply

- ___ PCAN-MicroMod FD DR CANopen Digital 1 in DIN rail plastic casing with mating connectors
- ___ CANopen EDS file
- ___ Manual in PDF format

PCAN-MIO

Universal Controller for CAN Applications

The Multiple Input Output module (MIO) is a universal, modular controller for use both in the industrial and automotive fields.

The module has two CAN interfaces as well as multiple analog and digital inputs and outputs. Incoming signals can be processed by the microcontroller and then forwarded to the CAN interfaces or output channels. For this purpose, the behavior of the PCAN-MIO module can be freely configured using a comprehensive Windows software. A large number of function blocks and other settings are available to help the user in creating such a configuration.

Pluggable CAN transceiver modules allow flexible adaptation of each CAN channel to the respective requirements. For example, Low-speed and Single-wire CAN transceivers are also available on request.



Specifications

- 2 High-speed CAN channels (ISO 11898-2)
 - Comply with CAN specifications 2.0 A/B
 - CAN bit rates from 40 kbit/s up to 1 Mbit/s
 - NXP TJA1041 CAN transceiver with wake-up
 - Alternative pluggable transceiver modules on request (details on page 9)
- CAN termination switchable
- Wake-up function using separate input or CAN bus
- 8 digital inputs with low-pass performance
- 8 digital outputs, 2 of these with PWM capability
- 6 analog inputs, measuring range unipolar 0 to 10 V, (resolution 10 bit, sample rate 1 kHz)
- 2 analog outputs (10 bit, 0 to 10 V)
- Suitable for use in the automotive field
- Detailed configuration with the software PPCAN-Editor 2 for Windows
- Module can store up to 15 configurations
- CAN gateway between buses
- Individual function blocks for data linkage and data modification
- Available with industrial connectors (Phoenix spring terminal connectors) or automotive connectors (Tyco connectors)
- Aluminum casing with flange. DIN rail fixing option available on request
- 9 to 27 V voltage supply, overvoltage and reverse polarity protection
- Extended operating temperature range from -40 to +85 °C (-40 to +185 °F)

Ordering information

Designation	Part No.
PCAN-MIO (Industrial)	IPEH-002187
PCAN-MIO Set (Industrial)	IPEH-002187-Set
PCAN-MIO (Automotive)	IPEH-002187-A
PCAN-MIO Set (Automotive)	IPEH-002187-ASet

Scope of supply PCAN-MIO

- PCAN-MIO in aluminum casing including mating connectors
- Configuration software PPCAN-Editor 2 for Windows (details on page 111)
- Manual in PDF format

Scope of supply PCAN-MIO Set

- PCAN-MIO in aluminum casing including mating connectors
- CAN interface PCAN-USB
- Configuration software PPCAN-Editor 2 for Windows (details on page 111)
- Manual in PDF format

Requirements

- The configuration requires a PEAK CAN interface

Customization on request.

MU-Thermocouple1 CAN

Configurable System for Temperature Measurement with CAN Interface

The Thermocouple measuring unit offers connections for 8 thermocouples, which are specified for the temperature measuring ranges J, K or T, depending on the product version.

Measurement data can be preprocessed and transmitted via CAN bus using a central microcontroller. Configuration work involves using Windows software on a computer connected to the same CAN bus.



Specifications

- ___ 8 Mini sockets for thermocouple types J, K, or T
- ___ 4 galvanically isolated measuring modules, each with 2 thermocouple sockets of the same type
- ___ Measuring ranges:
 - J: -210 to +1121 °C
 - K: -200 to +1370 °C
 - T: -200 to +400 °C
- ___ Measurement accuracy: 0.2 %
- ___ Accuracy of the reference sensors: typically ± 0.5 K, max. ± 1.0 K at +25 °C ambient temperature
- ___ Resolution for temperature data at CAN communication: 1/16 °C
- ___ High-speed CAN connection (ISO 11898-2) for data transfer and configuring
 - Bit rates from 40 kbit/s up to 1 Mbit/s
 - Galvanic isolation up to 500 V
 - NXP TJA1040 CAN transceiver
 - Complies with CAN specifications 2.0 A/B
- ___ Basic configuration with the Windows software Thermocouple Configuration
- ___ Advanced configuration with the Windows software PPCAN-Editor 2
- ___ Preprocessing of readings possible with integrated microcontroller
- ___ Aluminum casing with flange. DIN rail fixing option available on request
- ___ Voltage supply from 6 to 34 V
- ___ Extended operating temperature range from -40 to +85 °C (-40 to +185 °F)

Ordering information

Designation	Part No.
MU-Thermocouple1 CAN (Measuring Range J)	IPEH-002205-J
MU-Thermocouple1 CAN (Measuring Range K)	IPEH-002205-K
MU-Thermocouple1 CAN (Measuring Range T)	IPEH-002205-T

Scope of supply

- ___ MU-Thermocouple1 CAN in aluminum casing
- ___ Mating connector for voltage supply
- ___ Configuration software Thermocouple Configuration for Windows 11 (x64), 10 (x86/x64)
- ___ Configuration software PPCAN-Editor 2 for Windows (details on page 111)
- ___ Manual in PDF format

Requirements

- ___ The configuration requires a PEAK CAN interface

Please note: Thermocouple probes are not included in the scope of supply.

MU-Thermocouple1 CAN FD

Configurable System for Temperature Measurement with CAN FD Interface

With the MU-Thermocouple1 CAN FD, measurement data of thermocouples is captured, preprocessed, and transmitted via CAN FD. The temperature is measured via 8 connectors, which are specified for the temperature measuring ranges J, K or T, depending on the product version. Temperatures can be captured in Celsius, Fahrenheit, or Kelvin and processed with an individual scale and offset. The measurement data is then transmitted via CAN FD or classic CAN.

Data processing, message transmission, and LED indication are set up with the free Windows software Thermocouple FD Configuration. The configuration created on the computer is transferred via the CAN bus to the MU-Thermocouple1 CAN FD which then runs as an independent CAN node. Multiple devices can be configured independently on a CAN bus.



Specifications

- 8 Mini sockets for thermocouple types J, K, or T
- 4 galvanically isolated measuring modules, each with 2 thermocouple sockets of the same type
- Measuring ranges:
 - J: -210 to +1121 °C (-346 to +2050 °F)
 - K: -200 to +1370 °C (-328 to +2498 °F)
 - T: -200 to +400 °C (-328 to +752 °F)
- Measurement accuracy: 0.2 % or 1 K
- Accuracy of the reference temperature sensors at +25 °C ambient temperature: typically ± 0.5 K, maximum ± 1.0 K
- Maximum resolution of temperature data: 1/16 °C
- High-speed CAN connection (ISO 11898-2) for data transfer and configuring
 - Complies with CAN specifications 2.0 A/B and FD
 - CAN FD bit rates for the data field (64 bytes max.) from 25 kbit/s up to 10 Mbit/s
 - CAN bit rates from 25 kbit/s up to 1 Mbit/s
 - NXP TJA1044GT CAN transceiver
 - Galvanic isolation up to 500 V
- LEDs for measurement channels and power supply
- Configuration with the Windows software Thermocouple FD Configuration
- Aluminum casing with flange. DIN rail fixing option available on request
- Voltage supply from 8 to 30 V
- Extended operating temperature range from -40 to +85 °C (-40 to +185 °F)

Ordering information

Designation	Part No.
MU-Thermocouple1 CAN FD (Measuring Range J)	IPEH-004005-J
MU-Thermocouple1 CAN FD (Measuring Range K)	IPEH-004005-K
MU-Thermocouple1 CAN FD (Measuring Range T)	IPEH-004005-T

Scope of supply

- MU-Thermocouple1 CAN FD in aluminum casing
- Mating connector for voltage supply
- Configuration software Thermocouple FD Configuration for Windows 11 (x64), 10 (x86/x64)
- Manual in PDF format

Requirements

- The configuration requires a PEAK CAN interface

Please note: Thermocouple probes are not included in the scope of supply.

PCAN-GPS

Programmable Sensor Module with CAN Connection

The PCAN-GPS is a programmable sensor module for position and orientation determination. It has a satellite receiver, a magnetic field sensor, an accelerometer, and a gyroscope. The sampled data can be transmitted on a CAN bus and logged on the internal memory card. The data processing is performed by a microcontroller of the NXP LPC4000 series.

The behavior of the PCAN-GPS can be programmed freely for specific applications. The firmware is created using the included development package with GNU compiler for C and C++ and is then transferred to the module via CAN. Various programming examples facilitate the implementation of own solutions.

On delivery, the PCAN-GPS is provided with a standard firmware that transmits the raw data of the sensors periodically on the CAN bus. The source code of the standard firmware as well as further programming examples are included in the scope of supply.



Specifications

- NXP LPC4000 series microcontroller (ARM Cortex-M4)
- Receiver for navigation satellites u-blox MAX-7W (GPS, GLONASS, QZSS, and SBAS)
- Bosch BMC050 electronic three-axis magnetic field sensor and three-axis accelerometer
- Gyroscope STMicroelectronics L3GD20
- High-speed CAN channel (ISO 11898-2) with bit rates from 40 kbit/s up to 1 Mbit/s
- Complies with CAN specifications 2.0 A/B
- On-chip 4 kByte EEPROM
- microSD™ memory card slot
- Wake-up by CAN bus or by separate input
- 2 digital inputs (High-active)
- 1 digital output (Low-side driver)
- LEDs for status signaling
- Connection via a 10-pole terminal strip (Phoenix)
- Voltage supply from 8 to 30 V
- Extended operating temperature range from -40 to +85 °C (with exception of the button cell)
- New firmware can be loaded via CAN interface

Ordering information

Designation	Part No.
PCAN-GPS	IPEH-002110

Scope of supply

- PCAN-GPS in plastic casing including mating connector
- External antenna for satellite reception
- Windows development package with GCC ARM Embedded, flash program, and programming examples
- Manual in PDF format

Requirements

- The transfer of the firmware via CAN requires a PEAK CAN interface

PCAN-GPS FD

Programmable Sensor Module with CAN FD Connection

The PCAN-GPS FD is a programmable sensor module for position and orientation determination with CAN FD connection. It has a satellite receiver, a magnetic field sensor, an accelerometer, and a gyroscope. Incoming sensor data is processed by the NXP microcontroller LPC54618 and then transmitted via CAN or CAN FD.

The behavior of the PCAN-GPS FD can be programmed freely for specific applications. The firmware is created using the included development package with GNU compiler for C and C++ and is then transferred to the module via CAN. Various programming examples facilitate the implementation of own solutions.

On delivery, the PCAN-GPS FD is provided with a standard firmware that transmits the raw data of the sensors periodically on the CAN bus.



Specifications

- NXP LPC54618 microcontroller with Arm® Cortex® M4 core
- High-speed CAN connection (ISO 11898-2)
 - Complies with CAN specifications 2.0 A/B and FD
 - CAN FD bit rates for the data field (64 bytes max.) from 40 kbit/s up to 10 Mbit/s
 - CAN bit rates from 40 kbit/s up to 1 Mbit/s
 - NXP TJA1043 CAN transceiver
- CAN termination can be activated through solder jumpers
- Wake-up by CAN bus or by separate input
- Receiver for navigation satellites u-blox MAX-M10S
 - Supported navigation and supplementary systems: GPS, Galileo, BeiDou, GLONASS, SBAS, and QZSS
 - Simultaneous reception of 4 navigation systems
 - 3.3 V supply for active GPS antennas
- Electronic three-axis magnetic field sensor IIS2MDC from ST
- Gyroscope and three-axis accelerometer ISM330DLC from ST
- 8 MByte QSPI flash
- 3 digital I/Os, each usable as input (High-active) or output with Low-side switch
- LEDs for status signaling
- Connection via a 10-pole terminal strip (Phoenix)
- Voltage supply from 8 to 32 V

- Button cell for preserving the RTC and the GPS data to shorten the TTFF (Time To First Fix)
- Extended operating temperature range from -40 to +85 °C (-40 to +185 °F) (with exception of the button cell)
- New firmware can be loaded via CAN interface

Ordering information

Designation	Part No.
PCAN-GPS FD	IPEH-003110

Scope of supply

- PCAN-GPS FD in plastic casing including mating connector
- External antenna for satellite reception
- Windows development package with GCC ARM Embedded, flash program, and programming examples
- Manual in PDF format

Requirements

- The transfer of the firmware via CAN requires a PEAK CAN interface

PCAN-GPS Pro FD

Configurable Sensor Module with CAN FD Connection

The PCAN-GPS Pro FD is a configurable sensor module for detecting position, orientation, and acceleration. It has a magnetic field sensor, an acceleration sensor, a gyroscope, and a satellite receiver that allows update rates of up to 25 Hz. The sensor data is transmitted via CAN or CAN FD. The connection to the CAN bus is designed with two interconnected LEMO circular connectors for integration into measuring chains. Thanks to the robust housing, the module can also be used under tough conditions.

The device parameters, capturing of sensor data, and CAN message transmission of the PCAN-GPS Pro FD can be configured via the USB port using the Windows software included in the scope of supply. Afterwards, the module runs as an independent CAN node.



Specifications

- STM32H745 microcontroller with Arm® Cortex® M7 and M4 dual core and 2 MByte flash
- High-speed CAN connection (ISO 11898-2)
 - Complies with CAN specifications 2.0 A/B and FD
 - CAN FD bit rates for the data field (64 bytes max.) from 40 kbit/s up to 10 Mbit/s
 - CAN bit rates from 40 kbit/s up to 1 Mbit/s
 - NXP TJA1043 CAN transceiver
- CAN termination can be activated with a DIP switch
- Wake-up by CAN bus
- Wake-up-independent power-up can be activated with a DIP switch
- CAN connection and supply via 9-pin LEMO circular connectors with Alpha coding (30°)
 - 2 interconnected connectors with pin assignment according to M-CAN for integration in measuring chains
- High-speed USB 2.0 via USB-C connector
- Receiver for navigation satellites u-blox NEO-M9N
 - Supported navigation and supplementary systems: GPS, Galileo, BeiDou, GLONASS, SBAS, and QZSS
 - Simultaneous reception of 4 navigation systems
 - Maximum update rate 25 Hz
 - Configurable supply of active GPS antennas to 3.3 V or 5 V
 - Optional direct access to the u-blox via USB
- Gyroscope and three-axis accelerometer ISM330DLC from ST
- Electronic three-axis magnetic field sensor IIS2MDC from ST
- Memory: 8 MByte QSPI flash and 4 GByte eMMC
- Extended operating temperature range from -40 to +85 °C (-40 to +185 °F)
- 2 RGB LEDs for status signaling
- Configuration with a Windows software via USB
- Voltage supply from 8 to 32 V via LEMO circular connectors for operation
- 5 V supply via USB for configuration
- Supercap for preserving the RTC and the GPS data to shorten the TTFF (Time To First Fix)
- Aluminum casing with Ingress Protection IP50

Ordering information

Designation	Part No.
PCAN-GPS Pro FD	IPEH-003105

Scope of supply

- PCAN-GPS Pro FD in aluminum casing
- External antenna for satellite reception
- PCAN-GPS Pro FD Configuration Tool for Windows 11 (x64/ARM64), 10 (x64)
- Manual in PDF format

Note: Expected to be available in Q3 2024.

GPS Sensor Modules in Comparison

We provide various sensor modules with CAN connection for tracking position, orientation, and acceleration. This section includes a side-by-side comparison of all device types.

Features	PCAN-GPS	PCAN-GPS FD	PCAN-GPS Pro FD
Microcontroller	NXP LPC4000 series with Arm® Cortex® M4 core with 128 kByte flash	NXP LPC54618 with Arm® Cortex® M4 core with 512 kByte flash	STM32H745 with Arm® Cortex® M7 and M4 dual core with 2 MByte flash
Memory	On-chip 4 kByte EEPROM	8 MByte QSPI flash, On-chip 16 kByte EEPROM	8 MByte QSPI flash, 4 GByte eMMC
CAN connection	High-speed (ISO 11898-2), complies with specifications 2.0 A/B	High-speed (ISO 11898-2), complies with specifications 2.0 A/B and FD	High-speed (ISO 11898-2), complies with specifications 2.0 A/B and FD
CAN FD support	-	■	■
CAN transceiver	NXP TJA1041T	NXP TJA1043	NXP TJA1043
CAN bit rates	■ CAN bit rates from 40 kbit/s up to 1 Mbit/s	■ CAN bit rates from 40 kbit/s up to 1 Mbit/s ■ CAN FD bit rates from 40 kbit/s up to 10 Mbit/s	■ CAN bit rates from 40 kbit/s up to 1 Mbit/s ■ CAN FD bit rates from 40 kbit/s up to 10 Mbit/s
CAN termination	-	Activatable via solder jumpers	Activatable via DIP switch
Wake-up	By CAN bus or separate input	By CAN bus or separate input	By CAN bus
Gyroscope	STMicroelectronics L3GD20	ST ISM330DLC	ST ISM330DLC
Accelerometer	Bosch BMC050	ST ISM330DLC	ST ISM330DLC
Magnetic field sensor	Bosch BMC050	ST IIS2MDC	ST IIS2MDC
GNSS receiver	u-blox MAX-7W	u-blox MAX-M10S	u-blox NEO-M9N
Supported systems	GPS, GLONASS, QZSS, and SBAS	GPS, Galileo, BeiDou, GLONASS, SBAS, and QZSS	GPS, Galileo, BeiDou, GLONASS, SBAS, and QZSS
Maximum update rate	10 Hz	18 Hz	25 Hz
Direct u-blox access	-	-	■
Supply for GPS antennas	3.3 V	3.3 V	Configurable to 3.3 V or 5 V
I/O	■ 2 digital inputs (High-active) ■ 1 digital output (Low-side driver)	■ 3 digital I/Os, each usable as input (High-active) or output with Low-side switch	-
microSD™ slot	■	-	-
Preserving RTC and GPS data	Via button cell	Via button cell	Via Supercap
Voltage supply	8 to 30 V	8 to 32 V	■ 8 to 32 V via LEMO circular connectors for operation ■ 5 V via USB for configuration
Casing	Plastic casing	Plastic casing	Aluminum casing with Ingress Protection IP50
Connectors	10-pole terminal strip (Phoenix)	10-pole terminal strip (Phoenix)	■ 2 interconnected 9-pin LEMO circular connectors with Alpha coding (30°) ■ USB-C connector
Operating temperature	-40 to +85 °C (with exception of the button cell)	-40 to +85 °C (with exception of the button cell)	-40 to +85 °C
Programmable	■	■	-
Configurable	-	-	■

PCAN-Gateways

Transmission of CAN Messages via IP Networks



With the PCAN-Gateways, CAN buses can be connected via LAN or WLAN. CAN frames are wrapped into TCP or UDP message packets and then forwarded from one device to another. Based on this technology, it is possible to connect CAN networks over a great distance.

The configuration of the PCAN-Gateway product family is done via a convenient web interface. For this, the device must be connected to the PC via LAN or WLAN, depending on the used model. The web interface can be opened with a common browser. After a successful login you get access to all information and the configuration of the device settings, communication interfaces, message forwarding, and filters.

Alternatively, the JSON interface is available for access. This allows the development of software to automatically monitor and configure all devices connected to the IP network.

Functions of the web interface:

- Clear presentation of information about device settings, communication interfaces, message forwarding, and filters
- Definition of the public visibility of status information
- Import and export of device configurations
- Reset of the device configuration to factory defaults
- Comfortable software updates
- Scan of the IP network for further available PCAN-Gateways for an easier establishment of routes
- Layout automatically adjusts for mobile devices
- Rebooting the device via the website
- Enabling, disabling, and configuration of the JSON interface
- Integrated help pages

CAN channels settings:

- Selection of the bit rates from preset lists
- Setup of user defined bit rates via register values
- Status switching of the listen-only mode

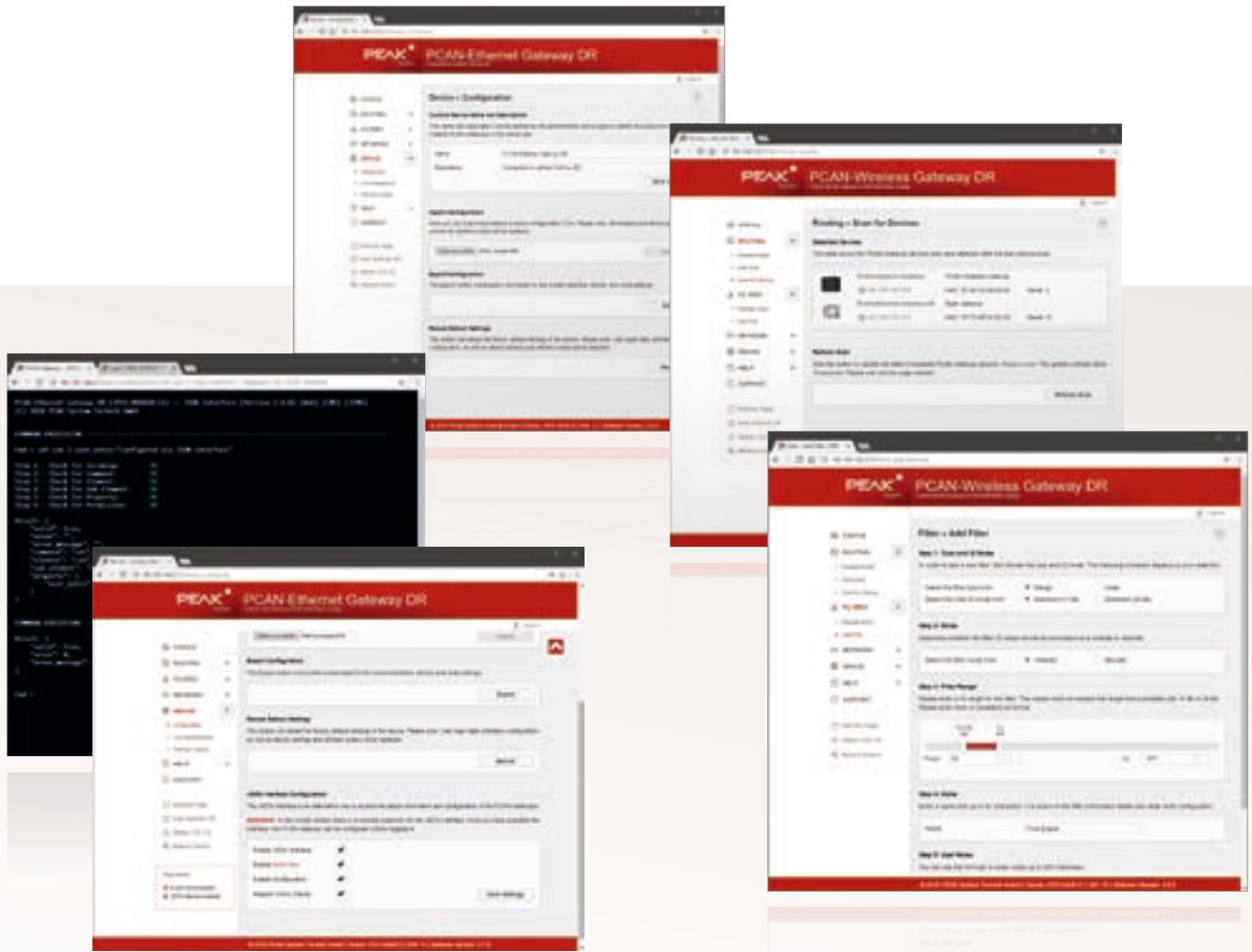

LAN interface settings (if available):

- Automatic or manual setup of the device's IP address (IPv4) and the subnet mask

WLAN interface settings (if available):

- Set the WLAN operating mode to Infrastructure (Client), Ad-Hoc, or Access Point
- Automatic or manual setup of the device's IP address (IPv4) and the subnet mask
- Connection to the wireless network
- Configuration of the network encryption

Setup and management of the message forwarding:

- Setup of the message forwarding between a CAN channel and LAN/WLAN (or vice versa)
- Selection of the participating CAN channel
- Definition of the LAN/WLAN station according to the IP address and the port
- Selection of the transfer protocol TCP or UDP
- Enabling, disabling, and editing of existing routes
- Disabling the PCAN-Gateway Handshake to allow the connection to other devices (Details on page 65)

Properties of the message filtering:

- Creating and managing filters via a new section of the web interface
- Creating Filters with different options:
 - Filtering messages with 11-bit or 29-bit IDs
 - Support of range and mask filters
 - Optional inversion of the filter range
- Assigning a filter to multiple routes

Functions of the JSON interface:

- Receiving of a request as a JSON-formatted GET parameter of an HTTP request
- Returning of the response in JSON format
- Reading out authorized information about device settings, communication interfaces, message forwarding, and filters
- Configuration of settings as well as adding and deleting message forwarding and filters (function is deactivated at delivery)
- Alternative access to the JSON interface via an emulated shell view with integrated documentation for an easy start

PCAN-Gateway Applications

Connecting two PCAN-Gateways

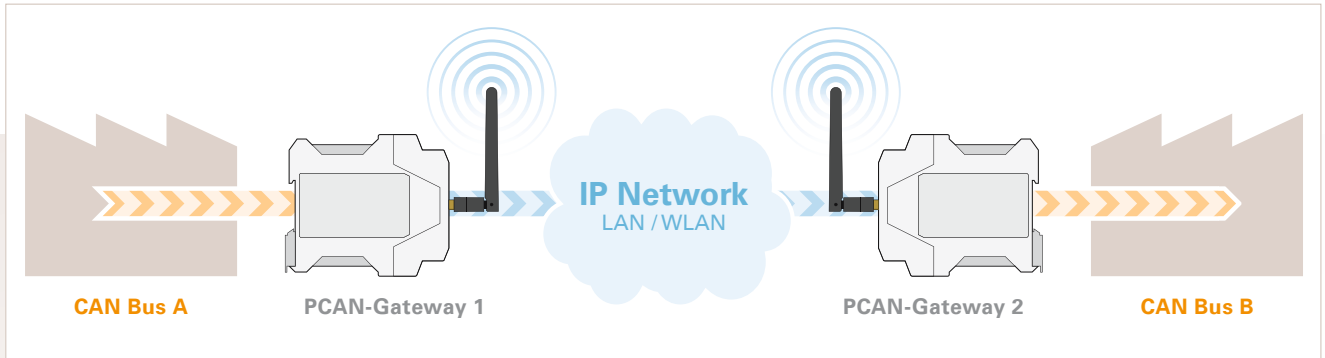

Example 1: One-Way Connection



Example 2: Bidirectional Communication

Example 1: Message Forwarding via WLAN

In this example, the CAN messages from CAN bus A are transmitted over an IP network to bus B.

- ___ For implementation, two CAN to WLAN gateways are required. Either the PCAN-Wireless Gateway or the PCAN-Wireless Gateway DR can be used.
- ___ Via the configuration website the connection to the WLAN network is established.
- ___ Afterwards the modules are connected to the CAN buses and are then configured.
- ___ In order to forward the message traffic in one direction, a route is implemented at Gateway 1 for transmitting the CAN data to the WLAN.
- ___ At Gateway 2, a route is implemented for receiving this data.

Example 2: Bidirectional Forwarding via LAN

In this example, the CAN messages from CAN bus A are transmitted over an IP network to bus B. In addition, the messages from bus B are transmitted to CAN bus A.

- ___ For implementation, two CAN to LAN gateways are required. The PCAN-Ethernet Gateway DR or PCAN-Ethernet Gateway FD DR can be used.
- ___ The devices can be integrated into the IP net with conventional LAN cables.
- ___ Afterwards the modules are connected to the CAN buses and are then configured.
- ___ In order to forward the message traffic, routes must be implemented on both gateways for transmission and reception.

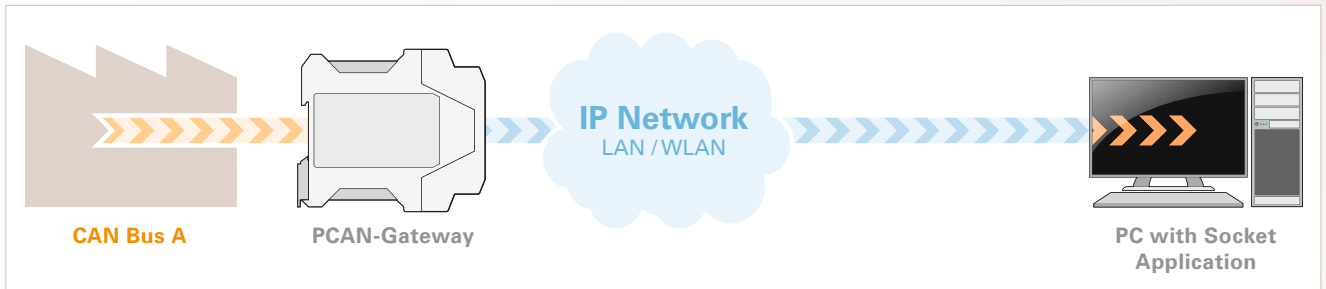
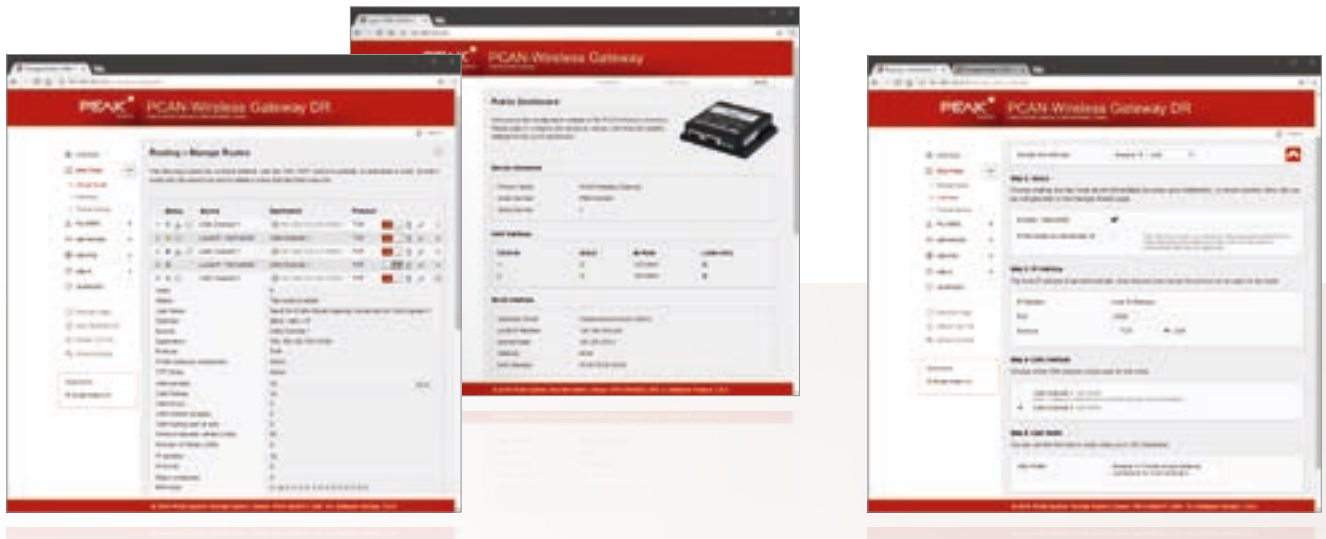

Example 3: Connection via a Socket Application

Example 3: Connection via a Socket Application

To establish a reliable transmission of CAN data over IP networks, two PCAN-Gateways are performing a so called handshake while setting up a route. This is the reason why such a message forwarding can only be made between devices of the PCAN-Gateway product family.

Alternatively, it is possible to disable the handshake protocol for individual transmission routes. The data packets are then sent without any control mechanisms directly to the specified IP address.

As a counterpart, for example, a PC can receive the data with a simple software via a socket interface.

- At first a single PCAN-Gateway is required for the implementation.
- Via the configuration website the connection to the LAN or WLAN network is established.
- Afterwards the module is connected to the CAN buses and is then configured.
- In order to forward the message traffic, a transmission route must be implemented.
- With enabled Expert user mode the handshake protocol for this route is switched off.
- A device with a socket interface is established as a counterpart.
- With a simple application based on standard sockets (Windows, Linux, or Android), the data is received and processed or displayed.

Virtual PCAN-Gateway

Windows Software for Direct Access to PCAN-Gateways



Example 4: Connection via the software Virtual PCAN-Gateway

The Virtual PCAN-Gateway software package provides access for Windows computers to devices of the PCAN-Gateway product line over IP-based networks. Various LAN and WLAN network adapters can be used.

Analog to the bidirectional connection of two PCAN-Gateways, message forwarding with so-called routes must be set up between the hardware and the software.

At first, two routes have to be created on the configuration website of the hardware, one for sending and another for receiving. Then, the appropriate counterparts of these routes must be established within the configuration software.

Due to this connection, the PCAN-Gateways are being integrated in the established PCAN environment and can be used like a conventional PEAK CAN interface. For example, the traffic on the CAN channels can be displayed and traced with the PCAN-View CAN monitor.

Note: The software requires a PCAN-Gateway as a counterpart. It is not possible to establish a connection between two computers with the Virtual PCAN-Gateway.

Specifications

- Supports the operating systems Windows 11 (x64/ARM64), 10 (x64)
- Connection to several PCAN-Gateways with a computer via IP-based networks
- Optional use of different LAN and WLAN network adapters
- Configuration software to set up and manage message forwarding

System requirements

- Windows 11 (x64/ARM64), 10 (x64)
- LAN- or WLAN network interface

Scope of supply

- Virtual PCAN-Gateway software package consisting of configuration software, Windows service, and driver
- Documentation in PDF format

The current version ...

- ... can be downloaded from the Internet free of charge at www.peak-system.com

PCAN-Ethernet Gateway FD DR

CAN FD to LAN Gateway in DIN Rail Plastic Casing

The PCAN-Ethernet Gateway FD DR allows access to classic CAN or modern CAN FD buses via an IP network. On top of that, CAN buses can be connected to each other via IP using multiple devices. CAN frames are wrapped in TCP or UDP message packets and then forwarded via the IP network from one device to another. The PCAN-Ethernet Gateway FD DR provides a LAN interface and two CAN FD interfaces that allow bit rates up to 10 Mbit/s. For this, an AM5716 Sitara processor provides the needed performance.

The PCAN Gateway product family is configured via a convenient web interface. Alternatively, the JSON interface allows access via software. Both options provide status information and settings of the devices, the various communication interfaces, message forwarding, and filters.

Please refer to page 62 for more information about the configuration and the operating principles.



Specifications

- ___ Two High-speed CAN channels (ISO 11898-2)
 - ▀ Comply with CAN specifications 2.0 A/B and FD
 - ▀ CAN FD bit rates for the data field (64 bytes max.) from 20 kbit/s up to 10 Mbit/s
 - ▀ CAN bit rates from 20 kbit/s up to 1 Mbit/s
 - ▀ Microchip MCP2558FD CAN transceiver
- ___ Galvanic isolation of the CAN channels up to 500 V against each other, against RS-232, and the power supply
- ___ Connections for CAN, RS-232, and power supply via 4-pole screw-terminal strips (Phoenix)
- ___ LAN interface
 - ▀ Data transmission using TCP or UDP
 - ▀ 10/100/1000 Mbit/s bit rates
 - ▀ RJ-45 connector with status LEDs
- ___ Monitoring and configuration of the devices via the web interface or JSON interface
- ___ Software update via the web interface
- ___ Reboot or reset of the device to a previous software version with a reset button
- ___ Plastic casing (width: 45.2 mm) for mounting on a DIN rail (DIN EN 60715 TH35)
- ___ LEDs for device status and power supply
- ___ PCI Express Mini slot, USB port, and a RS-232 connector for future use
- ___ Voltage supply from 8 to 30 V
- ___ Operating temperature range from -40 to +70 °C (-40 to +158 °F)
- ___ Fan for active cooling when a temperature limit is exceeded

Ordering information

Designation	Part No.
PCAN-Ethernet Gateway FD DR	IPEH-004012

Scope of supply

- ___ PCAN-Ethernet Gateway FD DR in DIN rail plastic casing
- ___ Mating connectors for both CAN channels, RS-232, and power supply
- ___ RJ-45 network patch cord (2 m)
- ___ Manual in PDF format
- ___ Printed quick start guide

Accessories: PCAN-Adapter D-Sub for DR Products optionally available (details on page 132).

PCAN-Ethernet Gateway DR

CAN to LAN Gateway in DIN Rail Plastic Casing

The PCAN-Ethernet Gateway DR allows the connection of different CAN buses over IP networks. CAN frames are wrapped in TCP or UDP message packets and then forwarded via the IP network from one device to another.

The PCAN-Ethernet Gateway DR provides one LAN connection and two High-speed CAN interfaces. With its DIN rail casing and the support of the extended temperature range, the module is suitable for use in an industrial environment.

The PCAN Gateway product family is configured via a convenient web interface. Alternatively, the JSON interface allows access via software. Both options provide status information and settings of the devices, the various communication interfaces, message forwarding, and filters. Please refer to page 62 for more information about the configuration and the operating principles.



Specifications

- Two High-speed CAN channels (ISO 11898-2)
 - Comply with CAN specifications 2.0 A/B
 - Bit rates from 5 kbit/s up to 1 Mbit/s
 - NXP PCA82C251 CAN transceiver
- Galvanic isolation of the CAN channels up to 500 V against each other, against RS-232 and the power supply
- Connections for CAN, RS-232, and power supply via 4-pole screw-terminal strips (Phoenix)
- LAN interface
 - Data transmission using TCP or UDP
 - 10/100 Mbit/s bit rates
 - RJ-45 connector with status LEDs
- Monitoring and configuration of the devices via the web interface or JSON interface
- Software update via the web interface
- Reboot and reset of the device to factory defaults with a reset button
- Plastic casing (width: 22.5 mm) for mounting on a DIN rail (DIN EN 60715 TH35)
- LEDs for device status and power supply
- RS-232 connector for serial data transfer (reserved for future use)
- Voltage supply from 8 to 30 V
- Extended operating temperature range from -40 to +85 °C (-40 to +185 °F)

Ordering information

Designation	Part No.
PCAN-Ethernet Gateway DR	IPEH-004010

Scope of supply

- PCAN-Ethernet Gateway DR in DIN rail plastic casing
- Mating connectors for both CAN channels, RS-232, and power supply
- RJ-45 network patch cord (2 m)
- Manual in PDF format
- Printed quick start guide

Accessories: PCAN-Adapter D-Sub for DR Products optionally available (details on page 132).

PCAN-Router DR

Universal CAN Converter in DIN Rail Plastic Casing

The PCAN-Router DR has two High-speed CAN channels. Their bit rate is adjusted with a rotary switch on the device front. The module forwards the message traffic bi-directionally 1:1 between both connected CAN buses.

The ports of the device are isolated against each other and against the power supply with at least 500 V. Furthermore, CAN 1 has a separation voltage of up to 5 kV conforming with IEC 60601-1. With its DIN rail casing and the support of the extended temperature range, the module is suitable for use in an industrial environment.

Just like the PCAN-Router in the aluminum casing, the PCAN-Router DR can be freely programmed. A corresponding development package is included in the scope of supply.



Specifications

- NXP LPC21 series microcontroller (16/32-bit ARM CPU)
- 32 kbyte EEPROM
- Two High-speed CAN channels (ISO 11898-2)
 - Comply with CAN specifications 2.0 A/B
 - Bit rates from 5 kbit/s up to 1 Mbit/s, adjustable with a rotary switch
 - NXP PCA82C251 CAN transceiver
- Reset of the device with a push button
- Switchable termination for each CAN channel
- Status indication via LEDs for the module status, both CAN channels, and the power supply
- Connections for CAN, RS-232, and power supply via 4-pole screw-terminal strips (Phoenix)
- CAN 1 is isolated up to 5 kV against CAN 2, RS-232, and the power supply (compliant with IEC 60601-1)
- CAN 2 and RS-232 are isolated with 500 V against each other and against the power supply
- Plastic casing (width: 22.5 mm) for mounting on a DIN rail (DIN EN 60715 TH35)
- Voltage supply from 8 to 30 V
- Extended operating temperature range from -40 to +85 °C (-40 to +185 °F)
- RS-232 connector for serial data transfer (reserved for future use)
- New firmware can be loaded via CAN interface

Ordering information

Designation	Part No.
PCAN-Router DR	IPEH-002213

Scope of supply

- PCAN-Router DR in DIN rail plastic casing
- Mating connectors for both CAN channels, RS-232, and power supply
- Windows development package with GCC ARM Embedded, flash program, and programming examples
- Manual in PDF format

Requirements

- The transfer of the firmware via CAN requires a PEAK CAN interface

Accessories: PCAN-Adapter D-Sub for DR Products optionally available (details on page 132).

PCAN-Router

Universal Programmable CAN Converter

The PCAN-Router is a dual-channel CAN module whose NXP LPC21 series programmable microcontroller provides the option of using the CAN messages on both channels on a flexible basis. This gives a whole range of options for manipulation, evaluation, filtering, and routing of CAN messages.

Using the programming library and the GNU compiler for C and C++, a firmware is created and then transferred to the module via CAN. At delivery, the PCAN-Router is equipped with a standard firmware that forwards CAN messages 1:1 between both channels at 500 kbit/s. The corresponding source code is included as example in the scope of supply.

The module is installed in an aluminum profile casing, and is shipped in versions with two D-Sub connectors or a screw-terminal strip.



Specifications

- NXP LPC21 series microcontroller (16/32-bit ARM CPU)
- 32 kbyte EEPROM
- Two High-speed CAN channels (ISO 11898-2)
 - Comply with CAN specifications 2.0 A/B
 - Bit rates from 40 kbit/s up to 1 Mbit/s
- Connections via two 9-pin D-Sub connectors or one 10-pole screw-terminal strip (Phoenix)
- Galvanic isolation of the D-Sub connector CAN 2 (only for IPEH-002211)
- Additional digital input (only for IPEH-002210 and IPEH-002211)
- Status signaling with two 2-color LEDs
- Aluminum casing, optional with DIN rail fixing option available
- Voltage supply from 8 to 30 V
- Extended operating temperature range from -40 to +85 °C (-40 to +185 °F)
- New firmware can be loaded via CAN interface

Ordering information

Designation	Part No.
PCAN-Router with D-Sub connectors	IPEH-002210
PCAN-Router with Phoenix connector	IPEH-002210-P
PCAN-Router with D-Sub connectors opto-decoupled	IPEH-002211

Scope of supply

- PCAN-Router in aluminum casing
- IPEH-002210-P: mating connector (Phoenix)
- Windows development package with GCC ARM Embedded, flash program, and programming examples
- Manual in PDF format

Requirements

- The transfer of the firmware via CAN requires a PEAK CAN interface

PCAN-Router FD

Universal Programmable Converter for CAN and CAN FD

The PCAN-Router FD allows the connection to two CAN FD or CAN buses. Based on a ARM Cortex M4F microcontroller, the module's behavior and the data routing between both CAN FD channels is freely programmable. In particular, the module allows the conversion from CAN to CAN FD or vice versa. This makes it easy to accomplish the integration of CAN FD applications into existing CAN 2.0 networks.

Using the programming library and the GNU compiler for C and C++, a firmware is created and then transferred to the module via CAN. On delivery, the PCAN-Router FD is provided with a standard firmware. The corresponding source code is included as example in the scope of supply.

The module is installed in an aluminum profile casing, and is shipped in versions with two D-Sub connectors or a screw-terminal strip.



Specifications

- NXP LPC4078 microcontroller (ARM Cortex M4 with FPU, 120 MHz)
- On-chip 4 kByte EEPROM
- 8 MByte SPI flash
- Two High-speed CAN channels (ISO 11898-2)
 - Comply with CAN specifications 2.0 A/B and FD
 - CAN FD support for ISO and Non-ISO standards
 - CAN FD bit rates for the data field (64 bytes max.) from 40 kbit/s up to 12 Mbit/s
 - CAN bit rates from 40 kbit/s up to 1 Mbit/s
 - NXP TJA1043T CAN transceiver with wake-up
- CAN termination can be activated through solder jumpers, separately for each CAN channel
- Connections via two 9-pin D-Sub connectors or one 10-pole screw-terminal strip (Phoenix)
- RS-232 connector for serial data transfer
- I/O connection:
 - One digital input (Low-active)
 - One digital output (Low-side switch, max. 600 mA)
- 2 additional digital inputs alternatively to RS-232 (Low-active)
- Status signaling with two 2-color LEDs
- Aluminum casing, optional with DIN rail fixing option available

- Voltage supply from 8 to 30 V
- Extended operating temperature range from -40 to +85 °C (-40 to +185 °F)
- New firmware can be loaded via CAN interface

Ordering information

Designation	Part No.
PCAN-Router FD with D-Sub connectors	IPEH-002214
PCAN-Router FD with Phoenix connector	IPEH-002215

Scope of supply

- PCAN-Router FD in aluminum casing
- IPEH-002215: mating connector (Phoenix)
- Windows development package with GCC ARM Embedded, flash program, and programming examples
- Manual in PDF format

Requirements

- The transfer of the firmware via CAN requires a PEAK CAN interface

PCAN-Router Pro

4-Channel CAN Router with Data Logger



The PCAN-Router Pro allows to join the data traffic from four High-speed CAN buses. The behavior of the router is configured via the CAN bus with the provided Windows program PPCAN-Editor. As well as pure forwarding, the CAN data can be processed, manipulated, and for example, filtered in a number of different ways. There are a variety of function blocks and other settings available to the user for configuration setup. Furthermore, there is a virtual fifth CAN channel which is used for recording all data traffic to a CompactFlash card.

As an alternative to the standard firmware which the PCAN-Router Pro is equipped with at delivery, custom firmware based on the ARM microcontroller NXP LPC2294 can be created and implemented. The firmware is created using the included development package with GNU compiler for C and C++ and is then transferred to the module via CAN. Various programming examples facilitate the implementation of own solutions.

CAN transceiver modules in the PCAN-Router Pro allow a flexible adaptation of each CAN channel to the requirements. For example, Low-speed and Single-wire CAN transceivers are also available on request.

Specifications

- ___ 4 High-speed CAN channels (ISO 11898-2)
 - Comply with CAN specifications 2.0 A/B
 - CAN bit rates from 40 kbit/s up to 1 Mbit/s
 - NXP TJA1041 CAN transceiver with wake-up
 - Alternative pluggable transceiver modules on request (details on page 9)
- ___ CAN connections are D-Sub, 9-pin (in accordance with CiA[®] 106)
- ___ CAN termination switchable, separately for each CAN channel
- ___ Wake-up function using separate input, CAN bus, or real-time clock
- ___ CompactFlash card slot
- ___ Battery-buffered real-time clock (RTC), can also be used for wake-up
- ___ Beeper
- ___ Status LEDs for CAN channels, CompactFlash card, microcontroller, and power supply
- ___ NXP microcontroller LPC2294
- ___ Aluminum casing with flange. DIN rail fixing option available on request
- ___ 8 to 27 V power supply, protection against overvoltage and reverse polarity
- ___ Extended operating temperature range from -40 to +85 °C (-40 to +185 °F)

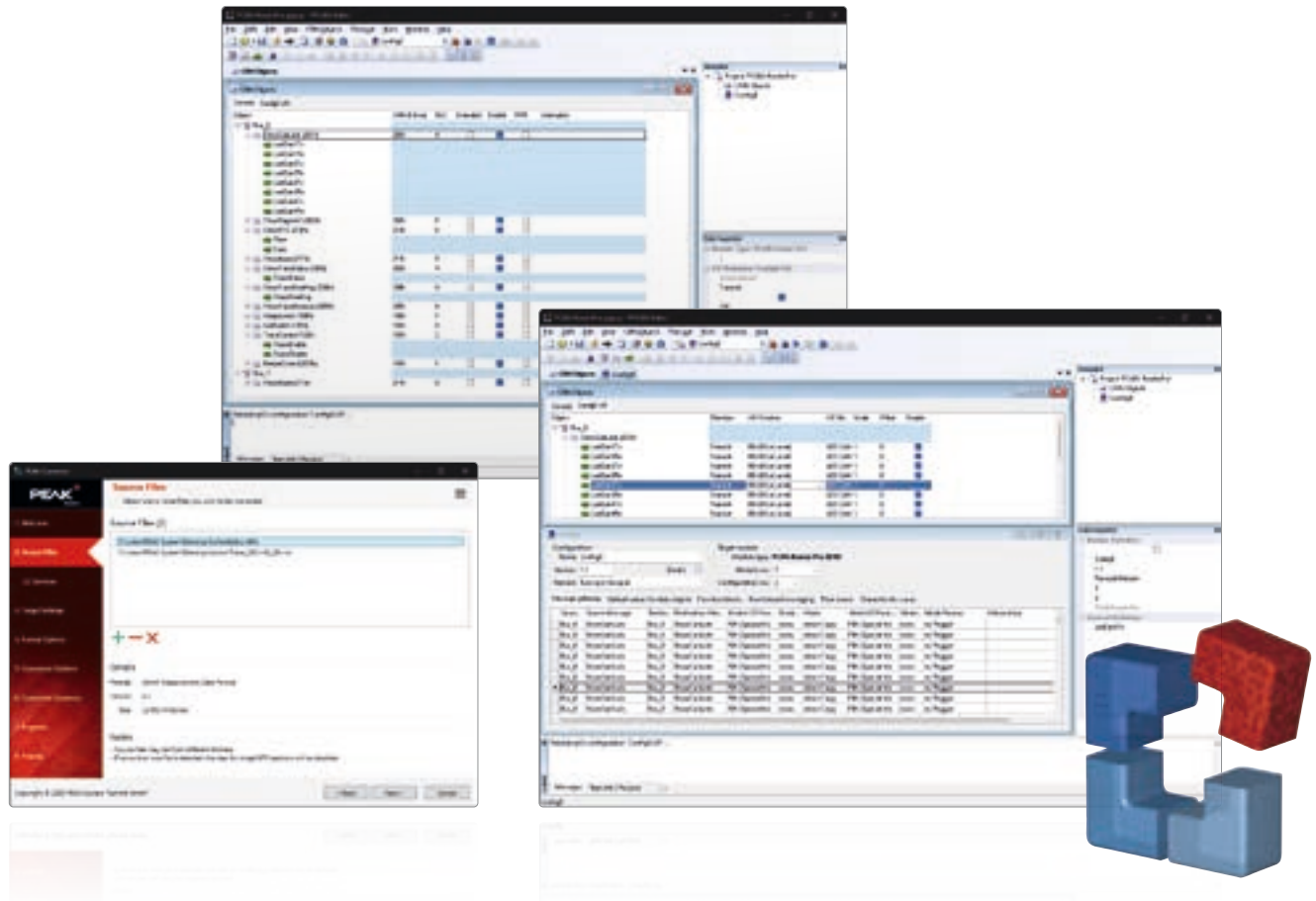

Properties of the standard firmware:

- Detailed configuration with the software PPCAN-Editor 2 for Windows
- Various function blocks for data processing and manipulation
- Configurable beeper
- Configurable CAN channel status LEDs
- Recording of CAN data and error frames to a CompactFlash card
- Conversion of logging data to various output formats using the Windows software PEAK-Converter

Note about the programmability:

Since March 2013, a toolchain and a library are available for programming custom firmware for the PCAN-Router Pro. Please note that due to various hardware extensions only devices with a serial number from 100 can be equipped with custom firmware.

Ordering information

Designation	Part No.
PCAN-Router Pro	IPEH-002212

Scope of supply

- PCAN-Router Pro in aluminum casing including mating connector for power supply
- Configuration software PPCAN-Editor 2 for Windows (details on page 111)
- Conversion software PEAK-Converter for Windows 11 (x64/ARM64), 10 (x64)
- Industrial CompactFlash card (min. 1 GB)
- Windows development package with GCC ARM Embedded, flash program, and programming examples
- Manual in PDF format

Requirements

- The configuration or the transfer of the firmware via CAN requires a PEAK CAN interface

Customization and customer-specific firmware available on request.

PCAN-Router Pro FD

Programmable 6-Channel Router for CAN and CAN FD with I/O and Data Logger



With six channels, the PCAN-Router Pro FD links the data traffic of modern CAN FD and classic CAN buses. Pluggable CAN transceiver modules allow flexible adaptation of each CAN channel to the respective requirements. In addition, the router is equipped with an analog input and four digital I/Os. The CAN messages can be recorded on the internal memory or on an inserted memory card and later read out via the USB connection. With the PCAN-Router Pro FD the data flow of test benches and production plants can be managed, monitored, and controlled. The conversion from CAN to CAN FD or vice versa enables the integration of new CAN FD applications into existing CAN 2.0 networks.

The behavior of the PCAN-Router Pro FD can be programmed freely for specific applications. The firmware is created using the included development package with GNU compiler for C and C++ and is then transferred to the module via CAN. Various programming examples, such as message forwarding or recording, facilitate the implementation of own solutions.

Specifications

- ___ 6 High-speed CAN channels (ISO 11898-2)
 - Comply with CAN specifications 2.0 A/B and FD
 - CAN FD support for ISO and Non-ISO standards
 - CAN FD bit rates for the data field (64 bytes max.) from 40 kbit/s up to 12 Mbit/s
 - CAN bit rates from 40 kbit/s up to 1 Mbit/s
 - NXP TJA1043 CAN transceiver with wake-up
 - Alternative pluggable transceiver modules on request (details on page 9)
- ___ CAN connections are D-Sub, 9-pin (in accordance with CiA® 106)
- ___ CAN termination switchable, separately for each CAN channel
- ___ Wake-up function using separate input, CAN bus, or real-time clock
- ___ 2 digital I/Os, each usable as input or output with High-side switch
- ___ 2 digital I/Os, each usable as input or output with Low-side switch
- ___ 1 analog input (0 to 32 V)
- ___ Recording of CAN data and error frames
- ___ Internal memory: 16 GByte pSLC eMMC
- ___ SD card slot for additional memory

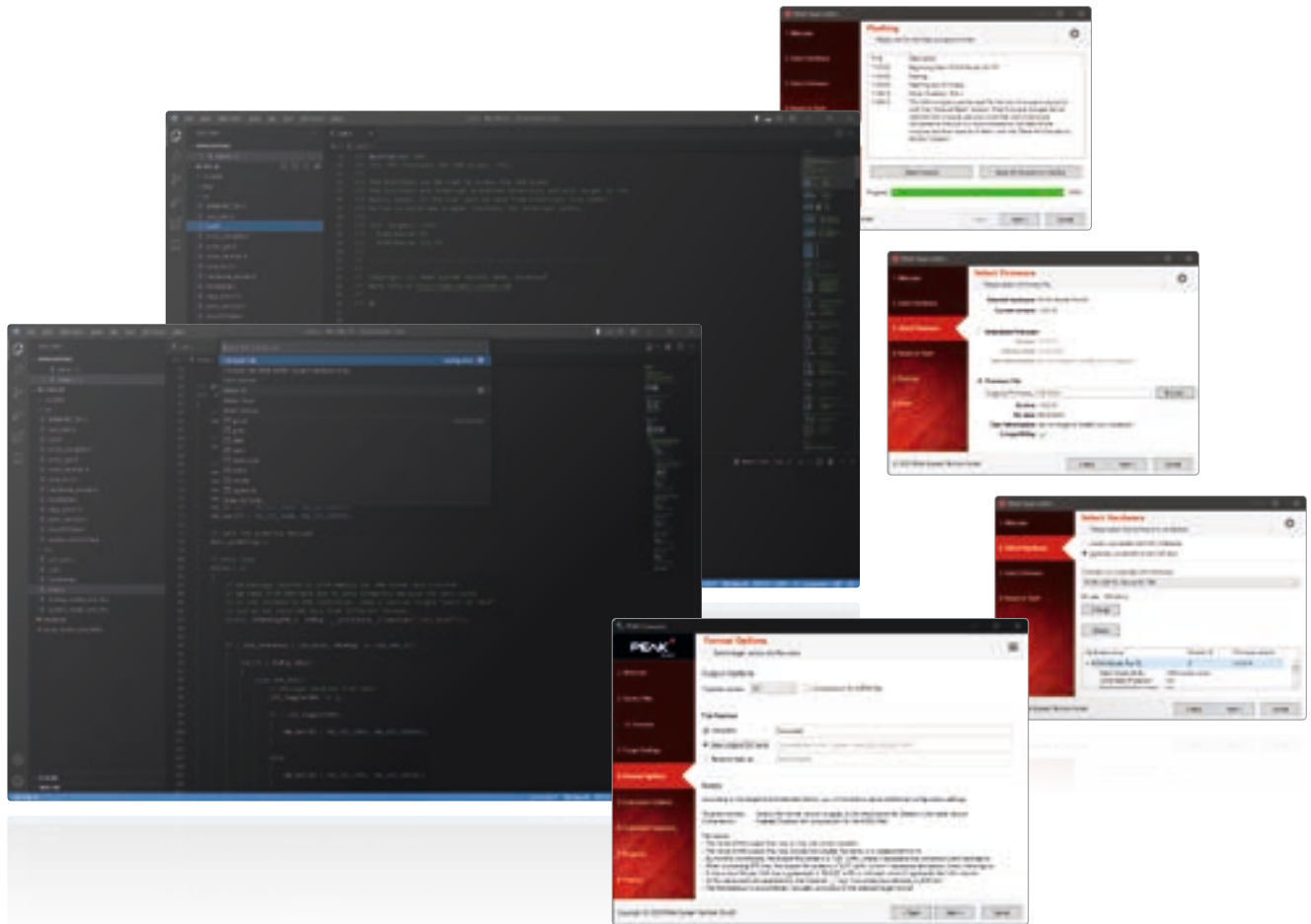

- ___ USB connection for accessing the data memory (e.g. recorded log data)
- ___ Conversion of logging data to various output formats using the Windows software PEAK-Converter
- ___ Battery-buffered real-time clock (RTC), can also be used for wake-up
- ___ Beeper
- ___ Status LEDs for CAN channels, memory cards, and power supply
- ___ Microcontroller STM32F765NIH6 (based on Arm® Cortex® M7)
- ___ 32 MByte SDRAM in addition to microcontroller RAM
- ___ Aluminum casing with flange
- ___ 8 to 32 V power supply, protection against overvoltage and reverse polarity
- ___ Slot for a backup battery for defined switch-off behavior (e.g. for log data saving)
- ___ Ethernet interface via RJ-45 socket, max. 100 Mbit/s (only for IPEH-002222)
- ___ Extended operating temperature range from -40 to +85 °C (-40 to +185 °F)

Data Logging

On delivery, the PCAN-Router Pro FD is equipped with a firmware for recording CAN and CAN FD data traffic. The messages of all six CAN channels can be stored on the internal eMMC memory or on an inserted SD card. The storage media can be accessed via a USB connection.

Users can configure the recording with a text file without any programming knowledge. Various options are available:

- ___ Separate configuration of the 6 CAN channels
 - Setting the CAN specification to 2.0 A/B, CAN FD ISO, or CAN FD Non-ISO
 - Setting the nominal and data bit rates
 - Enabling or disabling the Listen-Only mode
- ___ Recording of data frames, error frames, or data and error frames
- ___ Setting of the trace mode and maximum file size
- ___ Setting of the storage medium for saving the trace files
- ___ Definition of a CAN message for setting the real-time clock (RTC)



- ___ Configuration of events for starting and stopping the recording
 - Powering the device
 - By pressing the Log Off Card button
 - By receiving a specific CAN message
- ___ Configuration of timeout events for stopping the recording or shutting-down the device
 - Data traffic has stopped
 - Power loss on terminal 15 (Wake-up / pin 1 of the power connector)
 - Main power loss
- ___ Defining beep patterns for tracing start, end, and error events
- ___ Defining the LED blinking pattern
- ___ Automatic charging of an inserted backup battery
- ___ Only when used with Ethernet interface (IPEH-002222):
 - FTP access for downloading trace files and uploading the configuration file
 - WebSocket connection for remote controlling via Ethernet with message transfer in JSON format (example website included in the development package)

Besides the programming examples, the data logger firmware is included in the development package for the PCAN-Router Pro FD and can be downloaded for free.

Ordering information

Designation	Part No.
PCAN-Router Pro FD	IPEH-002220
PCAN-Router Pro FD with Ethernet interface	IPEH-002222

Scope of supply

- ___ PCAN-Router Pro FD in aluminum casing including mating connectors for I/O and power
- ___ USB connector cable
- ___ IPEH-002222: RJ-45 network patch cord (2 m)
- ___ Windows development package with GCC ARM Embedded, flash program, and programming examples
- ___ Conversion software PEAK-Converter for Windows 11 (x64/ARM64), 10 (x64)
- ___ Manual in PDF format

Requirements

- ___ The transfer of the firmware via CAN requires a PEAK CAN interface

PCAN-RS-232

Programmable Converter for RS-232 to CAN

PCAN-RS-232 is a programmable module for the communication between RS-232 and CAN. The conversion of data traffic is done via a NXP LPC21 series microcontroller.

The behavior of the PCAN-RS-232 can be programmed freely for specific applications. The firmware is created using the included development package with GNU compiler for C and C++ and is then transferred to the module via CAN. Various programming examples facilitate the implementation of own solutions.

On delivery the PCAN-RS-232 is provided with a standard firmware that routes from CAN to RS-232 and vice versa. It allows to configure the data transfer as well as the hardware with serial control commands. The corresponding source code is included as an example in the scope of supply.



Specifications

- NXP LPC21 series microcontroller (16/32-bit ARM CPU)
- 32 kbyte EEPROM
- High-speed CAN channel (ISO 11898-2) with bit rates from 40 kbit/s up to 1 Mbit/s
- Complies with CAN specifications 2.0 A/B
- Data transfer between CAN and RS-232 with a maximum bit rate of 115,200 bit/s
- One digital input and one digital output (low-active)
- 2-color LED for status signaling
- Connection via a 10-pole terminal strip (Phoenix)
- Voltage supply from 8 to 30 V
- Extended operating temperature range from -40 to +85 °C (-40 to +185 °F)
- New firmware can be loaded via CAN interface

Ordering information

Designation	Part No.
PCAN-RS-232	IPEH-002100

Scope of supply

- PCAN-RS-232 in plastic casing including mating connector
- Windows development package with GCC ARM Embedded, flash program, and programming examples
- Manual in PDF format

Requirements

- The transfer of the firmware via CAN requires a PEAK CAN interface

PCAN-RS-232 FD

Programmable Converter for RS-232 to CAN and CAN FD

The PCAN-RS-232 FD is a programmable module for converting data traffic between its RS-232 interface and CAN FD connection. For example, machines, PLCs, sensors and actuators with a serial interface can be flexibly integrated into classic CAN or modern CAN FD buses.

The behavior of the PCAN-RS-232 FD can be programmed freely for specific applications. The firmware is created using the included development package with GNU compiler for C and C++ and is then transferred to the module via CAN. Various programming examples facilitate the implementation of own solutions.

On delivery the PCAN-RS-232 FD is provided with a standard firmware that routes from CAN FD to RS-232 and vice versa. It allows to configure the data transfer as well as the hardware with serial control commands. The corresponding source code is included as an example in the scope of supply.



Specifications

- NXP LPC54618 microcontroller with Arm® Cortex® M4 core
- High-speed CAN connection (ISO 11898-2)
 - Complies with CAN specifications 2.0 A/B and FD
 - CAN FD bit rates for the data field (64 bytes max.) from 40 kbit/s up to 10 Mbit/s
 - CAN bit rates from 40 kbit/s up to 1 Mbit/s
 - NXP TJA1043 CAN transceiver with wake-up
- CAN termination can be activated through solder jumpers
- Wake-up via CAN bus switchable
- RS-232 connection
 - Texas Instruments transceiver TRSF3221E
 - Bit rates up to 460,800 bit/s
- 8 MByte QSPI flash
- 2 digital I/Os, each usable as input (High-active) or output with Low-side switch
- 2-color LED for status signaling
- Connection via a 10-pole terminal strip (Phoenix)
- Voltage supply from 8 to 32 V
- Extended operating temperature range from -40 to +85 °C (-40 to +185 °F)
- New firmware can be loaded via CAN interface

Ordering information

Designation	Part No.
PCAN-RS-232 FD	IPEH-003120

Scope of supply

- PCAN-RS-232 FD in plastic casing including mating connector
- Windows development package with GCC ARM Embedded, flash program, and programming examples
- Manual in PDF format

Requirements

- The transfer of the firmware via CAN requires a PEAK CAN interface

Note: Expected to be available in Q3 2024.

PCAN-LIN

Gateway for LIN, CAN, and RS-232

The PCAN-LIN module enables CAN, LIN, and serial participants to communicate. The module is supplied in a plastic casing and includes firmware which enables data to be exchanged between the different bus systems. Various modes can be set up with the aid of configuration software. Then for instance the module acting as the LIN master can request data and route the incoming LIN data to the CAN bus and/or the serial interface. Data can be routed between CAN and LIN with an ID offset.



Specifications

- ___ General-purpose gateway (or router when using Acceptance Code/Acceptance Mask feature) from:
 - RS-232 to LIN (and back)
 - CAN to LIN (and back)
 - RS-232 to CAN (limited bandwidth)
- ___ CAN bit rates up to 1 Mbit/s
- ___ Complies with CAN specifications 2.0 A/B
- ___ LIN bit rates of 1 to 20 kbit/s
- ___ Transmitting/receiving LIN 1.x and 2.x frames
- ___ Available for use as LIN master or slave
- ___ Simulation of LIN slaves. Data can be changed via CAN frames
- ___ Processing a user-definable LIN ID list (scheduler with limited number of entries)
- ___ Individual LIN frames can be initiated via CAN or RS-232
- ___ Voltage supply from 9 to 30 V
- ___ Extended operating temperature range from -40 to +85 °C (-40 to +185 °F)

Optionally available:

- ___ High-speed (ISO 11898-2) or Low-speed (ISO 11898-3) CAN transceiver module
- ___ Galvanic isolation between RS-232 and CAN/LIN up to 1 kV (only for High-speed CAN)

Female D-Sub Connector	Pin	Pin assignment RS-232
	1	Not connected
	2	TxD (RS-232-level)
	3	RxD (RS-232-level)
	4	Not connected
	5	GND
	6	Not connected
	7	Not connected
	8	Not connected
	9	Not connected

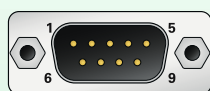
Male D-Sub Connector	Pin	Pin assignment CAN/LIN
	1	V _{bat} 9-30V (I _{max} ~130mA)
	2	CAN-L
	3	GND
	4	LIN data
	5	Not connected
	6	GND
	7	CAN-H
	8	Not connected
	9	Not connected

Ordering information

Designation	Part No.
PCAN-LIN High-speed CAN	IPEH-002025
PCAN-LIN Low-speed CAN	IPEH-002028
PCAN-LIN High-speed CAN opto-decoupled	IPEH-002029

Scope of supply

- ___ PCAN-LIN in plastic casing
- ___ Configuration and monitoring tool PCAN-LIN Config for Windows 11 (x64/ARM64), 10 (x64)
- ___ Manual in PDF format

Accessories: LIN Connection Cable for PCAN-LIN optionally available (details on page 143).

PCAN-MiniDisplay

Visualization, Recording, and Playback of CAN Data



The PCAN-MiniDisplay is used as a human-machine interface for the visualization of CAN data. For the connection to the CAN bus, it has two High-speed CAN connectors. The graphic representation of incoming CAN data is configured before using the unit and then is performed on a TFT display.

The PCAN-MiniDisplay can alternatively be used for data logging. The data traffic is recorded to a memory card and can be replayed or analyzed on a PC later on.

In addition to the built-in PCAN-MiniDisplay, there is a version in plastic casing with push buttons available. This can be used to create and evaluate application-specific configurations. Furthermore, the user can directly switch between different configurations during operation.

Note: Running a display configuration as well as recording and playback of CAN messages is not possible at the same time. The PCAN-MiniDisplay can only be used with one of the three functions.

Specifications

- CAN connections via two High-speed CAN channels (ISO 11898-2)
 - Bit rates from 40 kbit/s up to 1 Mbit/s
 - Complies with CAN specifications 2.0 A/B
 - NXP TJA1041 CAN transceiver with wake-up
- 2 analog inputs
 - Resolution 10 bit
 - Measuring range 0 to 16.5 V
- 1 digital input and 1 digital output
- TFT display with 320 x 240 pixel resolution
- Freely configurable visualization of CAN data via text files
 - Display of texts, CAN data as well as the values of the analog and digital inputs via text labels
 - Formattable output of CAN data as numbers, float numbers, or strings with consideration of enums and multiplexers
 - Display of bitmap images with transparency
 - Signal-dependent display of image lists
 - Presentation of multiple signal curves in plotters
 - Configurable access to key and buzzer functions as well as display brightness via CAN
 - Transmitting CAN frame sequences at the start, operation, and end of a configuration
- Slot for microSD memory card (max. 32 GByte)



- High-speed USB 2.0 port for access to the memory card using a PC
- Running configurations from the memory card
- Optional auto-start of a single configuration or recording on power-up
- Recording of incoming CAN messages to the internal memory card, optionally including occurring errors
- CAN ID filtering for recordings, separately configurable for each CAN channel
- Conversion of recordings to various output formats using Windows software
- Playback of a recording with optional loop function
- Use of optionally equipped push buttons for menu navigation and to switch between multiple display configurations
- Dimensions: 80 x 55 mm
- Voltage supply from 7 to 30 V
- Operating temperature range from -20 to +70 °C (-4 to +158 °F)

Optionally available PCAN-MiniDisplay Case:

- Device in plastic casing with 3 push buttons
- Connections via terminal blocks (Phoenix)

Ordering information

Designation	Part No.
PCAN-MiniDisplay	IPEH-002262
PCAN-MiniDisplay Case	IPEH-002262-KSM01

Scope of supply PCAN-MiniDisplay

- PCAN-MiniDisplay with mounting frame
- Cables for power supply, CAN, and digital inputs
- 512 MB memory card installed
- Conversion software PEAK-Converter for Windows 11 (x64/ARM64), 10 (x64)
- Configuration examples
- Manual in PDF format

Scope of supply PCAN-MiniDisplay Case

- PCAN-MiniDisplay in plastic casing including mating connectors
- 512 MB memory card installed
- Conversion software PEAK-Converter for Windows 11 (x64/ARM64), 10 (x64)
- Configuration examples
- Manual in PDF format

PCAN-Diag 2

Handheld CAN Bus Diagnostics Unit



PCAN-Diag 2 is a handheld diagnostics unit with a wide range of functions to allow investigation of a CAN bus, such as detection of the CAN bit rate, bus load measurement, and termination measurement. As well as receiving CAN messages, it can transmit either individual messages or entire sequences of them. In addition, the internal memory card allows tracing and playback of the CAN traffic.

The integrated two-channel oscilloscope enables visualization of CAN signals. Single CAN IDs and various events can be used as triggers. The CAN frames are decoded from the analog signal, for example, to detect errors in the frame.

Incoming CAN messages can be displayed as symbols for clear and easy allocation. The PCAN-Symbol Editor software supplied with this product enables convenient creation of the Symbol files needed for this feature. The user selects and operates the individual diagnostic functions using a push dial.

Specifications

- ___ High-speed CAN connection (ISO 11898-2)
 - Complies with CAN specifications 2.0 A/B
 - CAN bit rates from 5 kbit/s up to 1 Mbit/s
 - NXP PCA82C251 CAN transceiver
- ___ CAN bus connection via D-Sub, 9-pin (in accordance with CiA® 106)
- ___ Display with 320 x 240 pixel resolution
- ___ Power supply via batteries (4 x 1.5 V AA) or using supply unit provided (low-voltage socket on unit)
- ___ Internal memory card (2 GB) for saving projects. Can also be used as a USB mass storage device when connected to a PC
- ___ Operating temperature range from 0 to 50 °C (32 to 122 °F)

Overview of functions

- ___ Analysis of CAN networks at the physical and the protocol level
- ___ Selection of the bit rate from a preset list or from 8 user-defined values
- ___ Automatic bit rate detection based on a fixed value list
- ___ Switchable listen-only mode
- ___ Switchable silent startup function (listen-only mode at wrong bit rate)

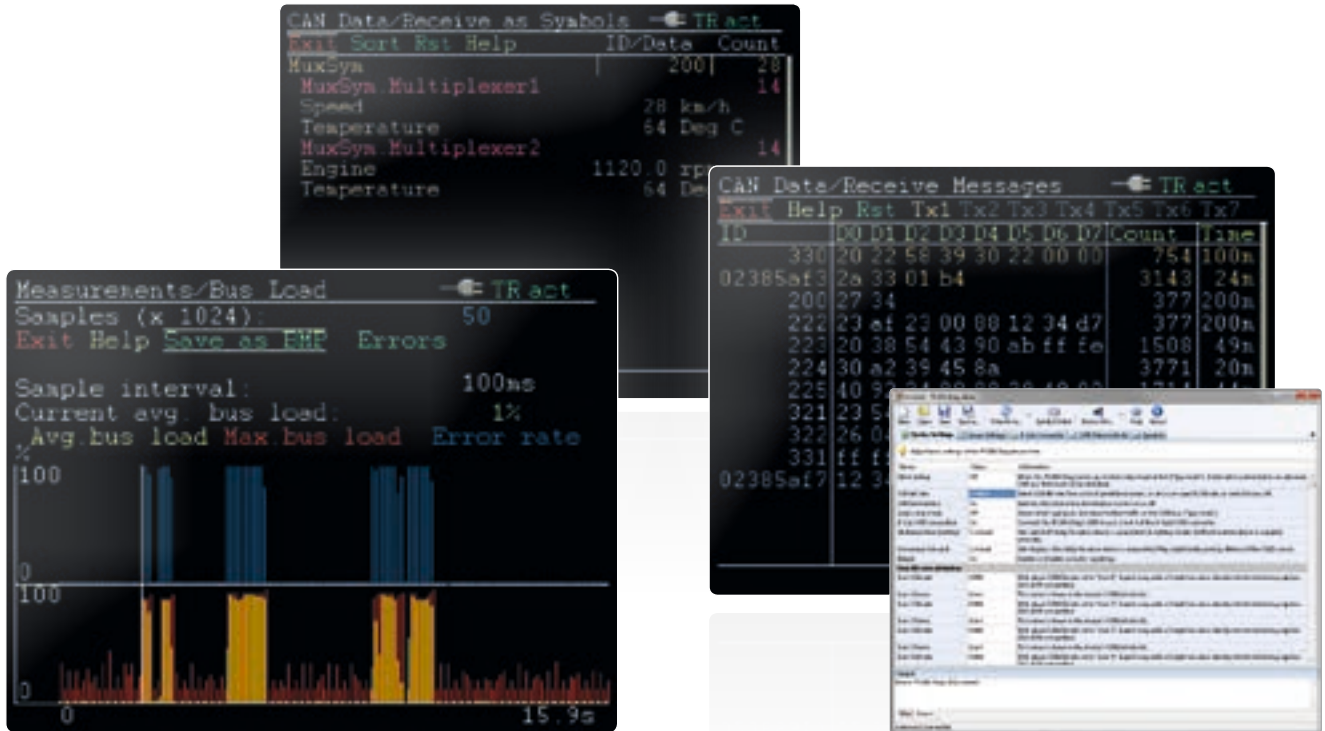

- ___ Symbolic display of incoming CAN messages using Symbol files, taking into account enums (lists of values), multiplexers, and ID ranges
- ___ Symbol files can be set up using the Windows software PCAN-Symbol Editor supplied with this product
- ___ Recording of incoming CAN messages to the internal memory card, if required, with CAN ID filtering
- ___ Playback of trace files
- ___ Conversion of trace data to various output formats using the Windows software PEAK-Converter supplied with this product
- ___ Transmitting individual CAN frames or CAN frame lists
- ___ Decimal, hexadecimal, or binary entering of CAN data. Data change of a single transmission message during runtime
- ___ Measurement of CAN bus load, displayed by means of a time diagram, switchable display of error frames
- ___ Bus load time diagrams can be saved as Bitmap screenshots
- ___ Measurement of the termination of the High-speed CAN bus, even while the system is running
- ___ Switchable CAN termination for the connected bus
- ___ Voltage measurement for all pins of the CAN connector (D-Sub)

- ___ Management of device configuration, transmit lists, Symbol files, and all recorded data (screenshots, trace, and CSV files) in projects
- ___ Optional auto-reset on Bus Off

Features of the software PCAN-Diag Editor for Windows, supplied with this product:

- ___ Convenient configuration of all available device settings
- ___ Compilation of transmit lists
- ___ Configuration of up to 8 bit rates per project
- ___ Device configuration, transmit lists, and associated Symbol files can be saved in projects
- ___ Projects can be transferred to the memory card of the PCAN-Diag 2 using a USB connection

Note about the trace function

With the firmware 1.5.0 tracing of CAN messages is now possible. In order to record also at a high bit rate together with high CAN bus load, a hardware upgrade is available for devices that had been delivered before February 2012. If you are interested and for further information, please contact info@peak-system.com.

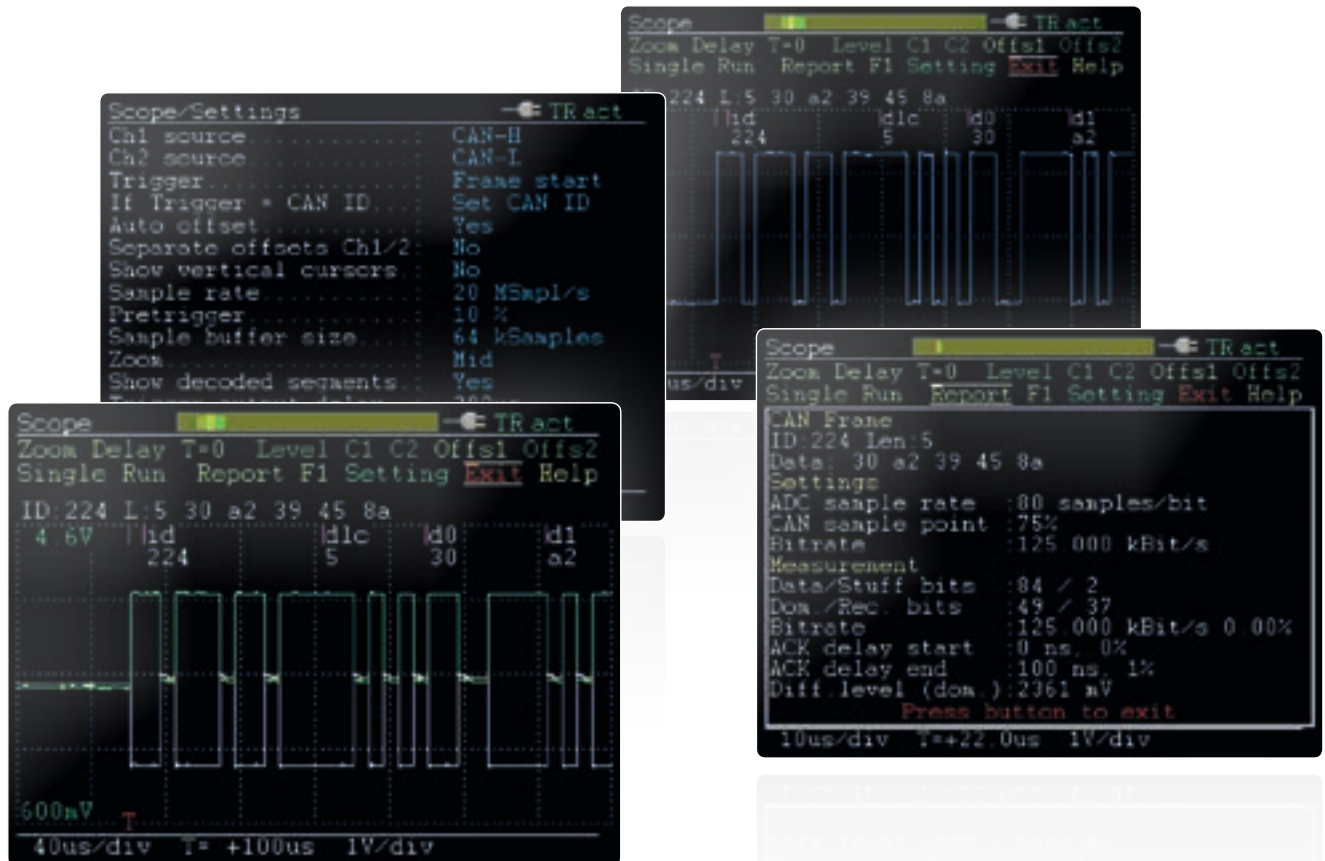

Oscilloscope functions

- ___ Oscilloscope with two independent measurement channels, each with a maximum sample rate of 20 MHz
- ___ Display of the CAN-High and the CAN-Low signals as well as the difference of both signals
- ___ Inspection of external signals (with frequencies up to 1 MHz) with a probe via the BNC connection
- ___ Trigger configuration to frame start, frame end, CAN errors, or individual CAN frames based on their CAN ID
- ___ External measurement devices can be triggered using the BNC connector
- ___ Depiction of raw CAN frames
- ___ Decoding of CAN frames from the recorded signal trace
- ___ Display of various properties and of measuring data of the decoded CAN frame using the Report function
- ___ Current view can be saved as a Bitmap screenshot
- ___ Memory depth can be set to up to 64 kSamples
- ___ Recorded sample data can be saved as a CSV file
- ___ Extensive zoom functions
- ___ Time measurement with a resolution of up to 50 ns

Ordering information

Designation	Part No.
PCAN-Diag 2	IPEH-002069

Scope of supply

- ___ PCAN-Diag 2 in plastic casing. Delivered in shockproof plastic box
- ___ Configuration software PCAN-Diag Editor for Windows 11 (x64/ARM64), 10 (x86/x64)
- ___ PCAN-Symbol Editor for Windows (details on page 122)
- ___ Conversion software PEAK-Converter for Windows 11 (x64/ARM64), 10 (x64)
- ___ Batteries (4 x 1.5 V AA)
- ___ Micro USB connector cable
- ___ Power supply unit with changeable plugs for Euro, U.S., and UK
- ___ Manual in PDF format
- ___ Printed quick start guide

Note: In addition to the PCAN-Diag for the diagnosis of CAN buses, there are also models for CANopen and DeviceNet. If you are interested and for more information, please contact info@peak-system.com.

PCAN-Diag FD

Mobile Diagnostic Device for CAN and CAN FD Buses



The PCAN-Diag FD is a handheld device for diagnosis of the communication on a CAN bus. Possibilities for diagnosis are available on the protocol layer by handling CAN 2.0 and CAN FD messages as well as on the physical layer by using the oscilloscope function and further measuring functions for voltage and resistance.

The oscilloscope function is used for a qualitative assessment of the signal course on the CAN bus. Two independent measuring channels sample both lines CAN-High and CAN-Low with up to 100 MHz. Based on the signal course, the PCAN-Diag FD decodes CAN frames and shows their elements in the scope graphics.

On the protocol layer, the incoming CAN traffic is shown in a list, optionally with symbolic representation for better interpretability. For future analysis, a tracer is implemented that records the CAN traffic. On the outgoing direction, single CAN messages or even full sequences of CAN messages can be transmitted on the connected CAN bus, e.g., in order to request diagnostic data. Recorded CAN traces can also be played back. All functions on the protocol layer are available for CAN 2.0 as well as CAN FD.

The CAN FD standard (CAN with Flexible Data rate) is primarily characterized by higher bandwidth for data transfer. The maximum of 64 data bytes per CAN FD frame (instead of 8 so far) can be transmitted with bit rates up to 12 Mbit/s. CAN FD is downward-compatible to the CAN 2.0 A/B standard, thus CAN FD nodes can be used in existing CAN networks. However, in this case the CAN FD extensions are not applicable.

The PCAN-Diag FD is operated in a simple manner with a push dial and four function keys. The device is supplied either externally or by the internal batteries that are automatically charged during external supply.

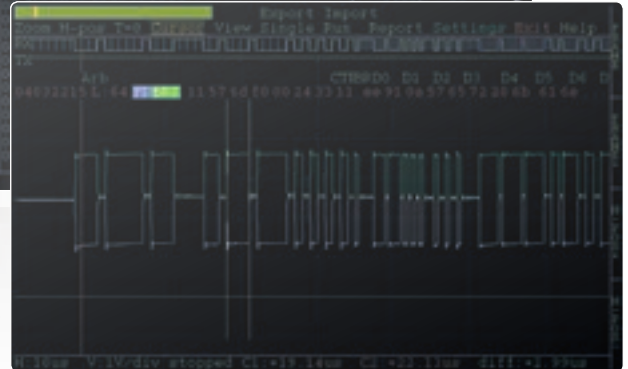
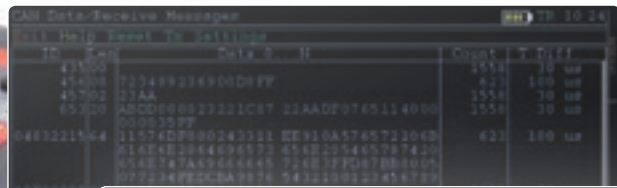

Specifications

- ___ High-speed CAN connection (ISO 11898-2)
 - ▀ Complies with CAN specifications 2.0 A/B and FD
 - ▀ CAN FD support for ISO and Non-ISO standards
 - ▀ CAN FD bit rates for the data field (64 bytes max.) from 20 kbit/s up to 12 Mbit/s
 - ▀ CAN bit rates from 20 kbit/s up to 1 Mbit/s
 - ▀ Microchip CAN transceiver MCP2558FD
- ___ CAN bus connection via D-Sub, 9-pin (in accordance with CiA® 106)
- ___ Display with 800 x 480 pixel resolution
- ___ Portrait or landscape presentation depending on the function and device orientation
- ___ Presentation on an external display via a micro HDMI interface (DVI signal with a resolution of 800 x 600 pixels)
- ___ Power supply via the internal rechargeable batteries or the provided supply unit (low-voltage socket on unit)
- ___ Charging of the batteries is carried out with external supply, even during operation
- ___ Charging station with quick-charging function available as an option (IPEH-003068)
- ___ Internal memory card for saving projects. Can also be used as a USB mass storage device when connected to a PC
- ___ Device operation via a push dial and 4 buttons
- ___ Operating temperature range from 0 to 50 °C (32 to 122 °F)
- ___ Automatic bit rate detection based on a bit rate list
- ___ Switchable listen-only mode
- ___ Switchable silent startup function (listen-only mode at wrong bit rate)
- ___ Symbolic display of incoming CAN messages using Symbol files, taking into account enums (lists of values), multiplexers, and ID ranges
- ___ Symbol files can be set up using the Windows software PCAN-Symbol Editor supplied with this product
- ___ Recording of incoming CAN messages to the internal memory card, if required, with CAN ID filtering
- ___ Playback of trace files
- ___ Conversion of trace data to various output formats using the Windows software PEAK-Converter supplied with this product
- ___ Transmitting individual CAN frames or CAN frame sequences
- ___ Decimal, hexadecimal, or binary entering of CAN data. Data change of a single transmission message during runtime
- ___ Transmission of CAN messages with readable ID and data by support of Symbol files
- ___ Measurement of CAN bus load, displayed by means of a time diagram, switchable display of error frames
- ___ Bus load time diagrams can be saved as Bitmap screenshots
- ___ Measurement of the termination of the High-speed CAN bus, even while the system is running
- ___ Switchable CAN termination for the connected bus
- ___ Voltage measurement at the CAN connector (D-Sub) for pins 6 and 9
- ___ Management of device configuration, transmit lists, Symbol files, and all recorded data (screenshots, trace, and CSV files) in projects
- ___ Optional auto-reset on Bus Off

Overview of functions

- ___ Analysis of CAN and CAN FD networks at the physical and the protocol level
- ___ Selection of the bit rate from a preset list or from multiple user-defined values

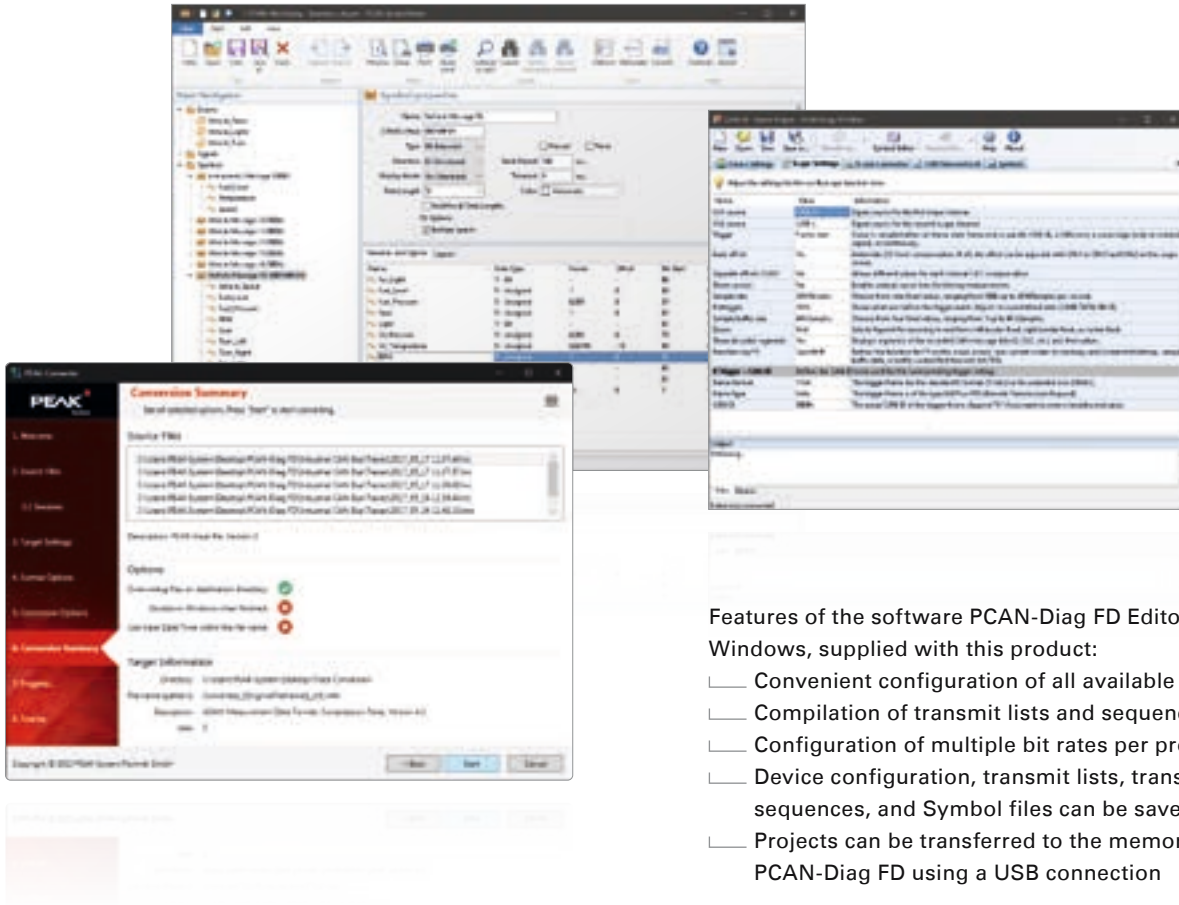

Features of the software PCAN-Diag FD Editor for Windows, supplied with this product:

- Convenient configuration of all available settings
- Compilation of transmit lists and sequences
- Configuration of multiple bit rates per project
- Device configuration, transmit lists, transmit sequences, and Symbol files can be saved in projects
- Projects can be transferred to the memory card of the PCAN-Diag FD using a USB connection

Oscilloscope functions

- Oscilloscope with two independent measurement channels, each with a maximum sample rate of 100 MHz
- Display of the CAN-High and the CAN-Low signals as well as the difference of both signals
- Trigger configuration to various properties of CAN messages
 - Start and end of frames
 - CAN errors
 - CAN ID of individual frames
 - Bit rate switch of CAN FD frames
- External measurement devices can be triggered using the banana jack, 4 mm
- Depiction of raw CAN and CAN FD frames
- Decoding of CAN and CAN FD frames from the recorded signal trace
- Display of various properties and of measuring data of the decoded CAN frame using the Report function
- Current view can be saved as a Bitmap screenshot
- Memory depth can be set to up to 1 megasample
- Recorded sample data can be saved as a CSV file
- Extensive zoom functions
- Time measurement with a resolution of up to 10 ns

Ordering information

Designation	Part No.
PCAN-Diag FD	IPEH-003069
PCAN-Diag FD with charging station	IPEH-003069 + IPEH-003068

Scope of supply

- PCAN-Diag FD with or without charging station. Delivered in shockproof plastic box
- Configuration software PCAN-Diag FD Editor for Windows 11 (x64/ARM64), 10 (x86/x64)
- PCAN-Symbol Editor for Windows (details on page 122)
- Conversion software PEAK-Converter for Windows 11 (x64/ARM64), 10 (x64)
- USB connector cable
- Power supply unit with changeable plugs for Euro, U.S., and UK
- Connection cable from micro HDMI to DVI
- Manual in PDF format
- Printed quick start guide

Note: The charging station is supplied with the PCAN-Diag FD power supply unit.

PCAN-Diag FD J1939 Add-in

Optional J1939 Function Upgrade for the PCAN-Diag FD

SAE J1939 describes communication in utility vehicles via CAN. Using PGs (Parameter Groups) and SPs (Suspect Parameters), the standard defines messages and data for the transmission of diagnostic and control information.

The J1939 Add-in for the PCAN-Diag FD extends the functional range of the diagnostic device by the support for the SAE J1939 standard. The CAN data traffic is interpreted according to the included J1939 database and is represented in a way that is understandable for the user. In addition, the add-in includes functions such as the decoding of multi-packet messages, address claiming, and the handling of diagnostic information.

The J1939 Add-in is activated with a device-bound license file which can also be purchased afterwards for a PCAN-Diag FD. Updates for the included J1939 database are included for a period of 2 years. An extension for further 2 years can be purchased separately.



Specifications

- Support of the SAE J1939 standard
- Representation of J1939 data interpreted according to PG and SP definitions
- SAE J1939 database with all definitions and the included parameters
- Definition of up to 20 custom PGs
- Decoding of multi-packet messages with payload data up to 1785 bytes
- Support for address claiming
- Display of DM and DTC diagnostic data

Note: The database can only be used with the PCAN-Diag FD J1939 Add-in.

Ordering information

Designation	Part No.
PCAN-Diag FD J1939 Add-in	IPES-004069
PCAN-Diag FD J1939 Add-in: 2 Years Maintenance Extension	IPES-004069-E

Scope of supply

- License file for activating the PCAN-Diag FD J1939 Add-in
- Updates for the J1939 database for 2 years after license purchase
- Manual in PDF format

Requirements

- PCAN-Diag FD

PCAN-MiniDiag FD

Compact Diagnostic Device for CAN and CAN FD Buses



The PCAN-MiniDiag FD is a compact, low-cost handheld device for basic diagnosis and checking of CAN and CAN FD buses. Service technicians and developers can easily access networks of vehicles, machines, or industrial equipment whose configuration is unknown. For this, the nominal bit rate for CAN and additionally the data bit rate for CAN FD are determined using bit timing measurement. Furthermore, the device has measuring functions for the termination, bus load, and voltage levels at the CAN connector.

The PCAN-MiniDiag FD has an increased protection due to its membrane keypad and casing. The power is supplied by three replaceable batteries.

CAN FD is primarily characterized by higher bandwidth for data transfer. Further information about CAN FD can be found on page 10.

Specifications

- ___ High-speed CAN connection (ISO 11898-2)
 - Complies with CAN specifications 2.0 A/B and FD
 - CAN FD support for ISO and Non-ISO standards
 - CAN FD bit rates for the data field (64 bytes max.) from 66.6 kbit/s up to 10 Mbit/s
 - CAN bit rates from 10 kbit/s up to 1 Mbit/s
 - Microchip MCP2558FD CAN transceiver
- ___ CAN bus connection via D-Sub, 9-pin (in accordance with CiA® 106)
- ___ No influence on the CAN bus due to permanent listen-only mode
- ___ OLED display with 128 x 128 pixel resolution
- ___ Power supply via exchangeable batteries (3 x Micro AAA with 1.2 V or 1.5 V)
- ___ Operation via membrane keypad with four keys
- ___ Plastic casing with increased Ingress Protection IP42
- ___ Dimensions: 122 x 69 x 44 mm
- ___ Operating temperature range from -10 to +50 °C (14 to 122 °F)



Device and measuring functions

- ___ **System Info:** Indication of firmware and hardware version, serial number, and battery voltage
- ___ **D-Sub Voltages:** Voltage check at the pins 6 and 9 in the range from -40 to +43 V
- ___ **CAN Min/Max:** Measurement of minimum and maximum voltage values for CAN-High and CAN-Low in the range from -5 to +8 V
- ___ **CAN Voltages:** Measurement of dominant and recessive levels for CAN-High and CAN-Low in the range from -5 to +8 V
- ___ **CAN Voltages 2:** Measurement of minimum, mean, and maximum values of the dominant and recessive levels
- ___ **Termination:** Measurement of the termination on the CAN bus
- ___ **Bit Rate:** Automatic detection of bit rates via exact bit timing measurements or manual bit rate configuration
- ___ **Bus Load:** Measurement of the CAN bus load with display in diagram
- ___ **Statistics:** Counter for CAN, CAN FD, and error frames

Ordering information

Designation	Part No.
PCAN-MiniDiag FD	IPEH-003070

Scope of supply

- ___ PCAN-MiniDiag FD in plastic casing
- ___ Batteries (4 x 1.5 V Micro AAA)
- ___ Manual in PDF format
- ___ Printed quick start guide

Software

Development Packages

PC Software

- CAN development systems for Windows and Linux
- Programming interfaces for various protocols and standards
- Software to monitor and diagnose CAN and LIN buses
- Programs for recording, playback, and simulation of message traffic
- Configuration software for CAN hardware from PEAK-System

PEAK-System Technik GmbH designs customer-specific software for PCs and embedded systems. We support you from the idea to the finished product.

The right Programming Interface for your CAN Bus Application

For the development of CAN applications, we provide different APIs (Application Programming Interfaces): the PCAN-API from the PCAN-Developer package and the cost-free PCAN-Basic API. This section includes a direct side-by-side comparison of our development packages.

Features	PCAN-Basic	PCAN-Developer
Based on the API	PCAN-Basic API	PCAN-API
Development for the platforms	Windows 11 (x64/ARM64), 10 (x86/x64), and Linux	Windows 11 (x64/ARM64), 10 (x86/x64)
Enables the connection to CAN buses	■	■
Enables the connection to CAN FD buses	■	■
Supports all PEAK CAN interfaces (Parallel port CAN interfaces are only supported on x86 systems)	■	■
Maximum number of CAN channels supported per hardware type	A maximum of 16 (depending on the PEAK CAN interface used)	64
Maximum number of applications per physical CAN channel	A single application of your own and multiple by PEAK-System	64
Access to hardware parameters	Access to specific parameters	Full access to all parameters
Precision of time stamps of received messages (depending on the PEAK CAN interface used)	1 μ s	1 μ s
Control of transmission time by time-stamping outgoing messages	-	■
Configuration of single-shot and self-receive-request transmissions	-	■
Notification of the application through Windows events when a message is received	■	■
Support of CAN error frames	■	■
Generation of CAN error frames	-	■
Driver-internal CAN message buffer	up to 32,768 per CAN channel	up to 32,768 per Client*
Simulated CAN communication between the applications	-	■
Use of a single Windows DLL as an interface for all PEAK CAN interfaces	■	■
Hotline support for developers	-	■
Hardware configuration	Via application	Via control panel or application
Hardware reset during an active connection	■	■
Freely definable message filter	One filter for each CAN channel	One filter per Client*
Licensing	License for PCAN-Basic included in the scope of supply of the hardware	Unlimited licenses for the PCAN-API
Software supplied	PCAN-View	PCAN-View PCAN-Nets Configuration PCAN-Status Display

* Information on PCAN-API and the Clients can be found on page 103.

The automotive sector has standardized protocols for communication with control units as well as the exchange of diagnostic data and big data packages via CAN. We have implemented programming interfaces for several standards. They are based on the CAN connection of PCAN-Basic.

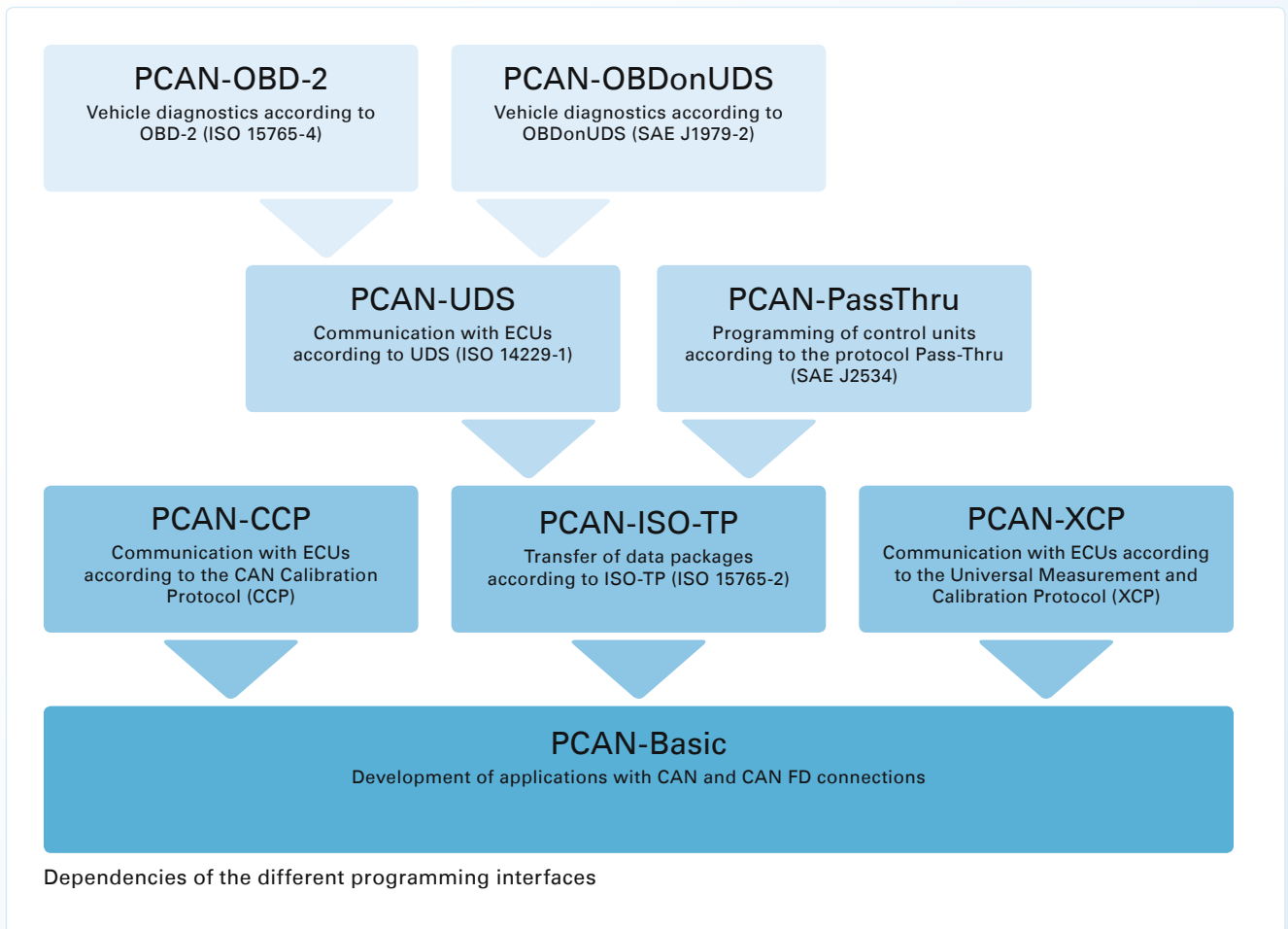

The APIs are available free of charge and can be downloaded from our website. They each contain interface DLLs, header files and programming examples for various programming languages, as well as detailed documentation.

Note: The programming interfaces can only be used with PC CAN interfaces from PEAK-System.

PCAN-Basic

API for Connecting to CAN and CAN FD Buses

The PCAN-Basic API (application programming interface) allows easy development of powerful software with CAN and CAN FD support. It includes all of the functions that an application needs in order to communicate with PCAN PC hardware. The cross-operating-system design makes it possible to easily port software projects between platforms.

PCAN-Basic consists of the actual device driver and an interface DLL, which provides the API functions.

As the successor to PCAN-Light, PCAN-Basic offers increased functionality and extended language support. It provides various functions for developers under C++, C#, C++/CLR, Delphi, VB.NET, Java, and Python 3.x.

Beginning with version 4, PCAN-Basic for Windows supports the CAN FD standard (CAN with Flexible Data rate) which is primarily characterized by a higher bandwidth for data transfer.

Features

- API for developing applications with CAN and CAN FD connections
- Support for CAN specifications 2.0 A/B and FD
- Application development for the platforms Windows 11 (x64/ARM64), 10 (x86/x64), and Linux
- Multiple PEAK-System applications and your own can be operated on a physical channel at the same time
- Use of a single DLL for all supported hardware types
- Use of up to 16 channels for each hardware type (depending on the PEAK CAN interface used)
- Simple switching between channels of a PEAK CAN interface
- Access to the CAN channels of a PCAN-Gateway via the new PCAN-LAN hardware type
- Driver-internal buffering of up to 32,768 CAN messages per CAN channel
- Precision of time stamps on received messages up to 1 μ s (depending on the PEAK CAN interface used)
- Supports PEAK-System's trace formats version 1.1 and 2.0 (for CAN FD applications)
- Access to specific hardware parameters, such as listen-only mode
- Notification of the application through Windows events when a message is received
- Support of CAN error frames
- Extended system for debugging operations



- Multilingual debugging output
- Output language depends on operating system
- Debugging information can be defined individually
- Thread-safe API

Note: Parallel port CAN interfaces are only supported on x86 systems.

PCAN-Basic for Linux

PEAK-System provides the PCAN-Basic API to allow the development of your own CAN applications for Linux. Programmers can use the languages C++, Java, and Python 3.x.

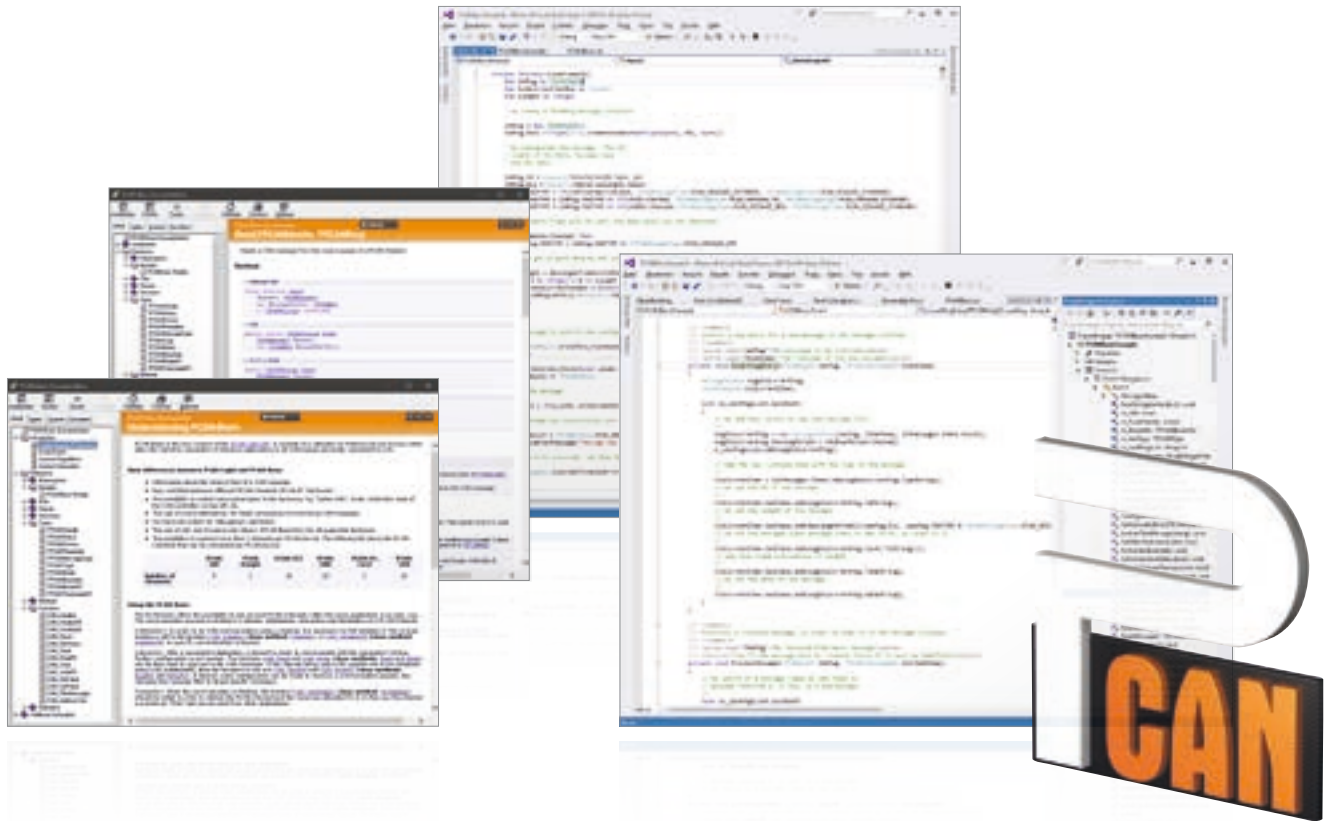

Functions

Connection ...

- Initialize: Initialize CAN hardware, set the bit rate, log on at the driver
- InitializeFD: Initialize CAN FD hardware
- Uninitialize: Log off from the driver

Configuration ...

- SetValue: Setup of hardware parameters such as debug log, listen-only, and auto-reset
- FilterMessages: Register messages to be received

Information ...

- GetValue: Read out DLL and API information
- GetStatus: Read out CAN bus status information
- GetErrorText: Get an error code description

CAN communication ...

- Read: Read a CAN message or status incl. time stamp
- ReadFD: Read a CAN FD message
- Write: Transmit a CAN message (11/29-bit ID and RTR possible)
- WriteFD: Transmit a CAN FD message
- Reset: Clear the transmit and receive buffer

Ordering information

Designation

PCAN-Basic

Scope of supply

- PCAN-Basic DLLs d'interface (x86/x64/ARM64)
- PCAN-Basic.NET Assembly
- Examples and header files for all common programming languages
- Documentation in PDF and HTML Help format

The current version ...

... can be downloaded from the Internet free of charge at www.peak-system.com

System requirements

- Windows 11 (x64/ARM64), 10 (x64), or Linux
- For the CAN bus connection: PC CAN interface from PEAK-System

PCAN-CCP API

API Implementation of the CAN Calibration Protocol

The PCAN-CCP API is a programming interface for the communication between Windows applications (Masters) and electronic control units (Slave ECUs). The API is based on the CAN Calibration Protocol (CCP) by ASAM and is mainly deployed for development in the automotive area. The PCAN-CCP API uses the CAN bus as transmission medium.

For accessing the CAN hardware in the computer, PCAN-CCP utilizes the programming interface PCAN-Basic, which is part of the scope of supply of every CAN interface from PEAK-System. The PCAN-CCP API package is available free of charge.



Features

- Implementation of the CAN Calibration Protocol (CCP) by ASAM for the communication with control units
- Windows DLLs for the development of x86 and x64 applications
- Physical communication via CAN using a CAN interface of the PCAN series
- Uses the PCAN-Basic programming interface to access the CAN hardware in the computer
- Thread-safe API
- One API function for each command of the CCP standard
- Additional commands for communication management

Ordering information

Designation

PCAN-CCP API

Scope of supply

- Interface DLLs (x86/x64)
- Examples and header files for all common programming languages
- Documentation in HTML Help format

The current version ...

... can be downloaded from the Internet free of charge at www.peak-system.com

System requirements

- Windows 11 (x64/ARM64), 10 (x86/x64)
- For the CAN bus connection:
 - PC CAN interface from PEAK-System
 - PCAN-Basic API

PCAN-XCP API

API Implementation of the Universal Measurement and Calibration Protocol

The PCAN-XCP API is a programming interface for the communication between Windows applications (Masters) and electronic control units (Slave ECUs). The Universal Measurement and Calibration Protocol (XCP) is a further development of the CAN Calibration Protocol (CCP) by ASAM. XCP supports multiple transmission mediums, but is not compatible to CCP.

For accessing the CAN hardware in the computer, PCAN-XCP utilizes the programming interface PCAN-Basic, which is part of the scope of supply of every CAN interface from PEAK-System. The PCAN-XCP API package is available free of charge.

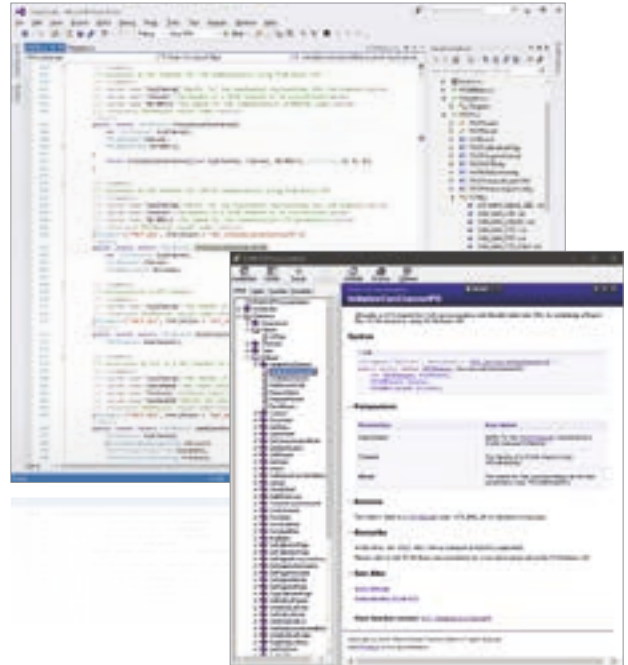

Features

- Implementation of the Universal Measurement and Calibration Protocol (XCP) by ASAM for the communication with control units
- Windows DLLs for the development of x86 and x64 applications
- Physical communication via CAN or CAN FD using a CAN interface of the PCAN series
- Uses the PCAN-Basic programming interface to access the CAN hardware in the computer
- Thread-safe API
- One API function for each command of the XCP standard
- Additional commands for communication management

Ordering information

Designation

PCAN-XCP API

Scope of supply

- Interface DLLs (x86/x64)
- Examples and header files for all common programming languages
- Documentation in HTML Help format

The current version ...

... can be downloaded from the Internet free of charge at www.peak-system.com

System requirements

- Windows 11 (x64/ARM64), 10 (x86/x64)
- For the CAN bus connection:
 - PC CAN interface from PEAK-System
 - PCAN-Basic API

PCAN-ISO-TP API

API Implementation of the ISO-TP Standard (ISO 15765-2)

ISO-TP (ISO 15765-2) is an international standard for the transfer of data packages via CAN. Above CAN (OSI layers 1 and 2), the protocol covers the OSI layers 3 (Network Layer) and 4 (Transport Layer). It can transmit data packages of up to 4 GBytes per message. The data bytes are transmitted segmented with multiple CAN frames.

The PCAN-ISO-TP API implements the functionality of the standard on the basis of 10 functions. They are categorized in Allocation, Configuration, Address Mapping Configuration, Information, and Communication.

PCAN-ISO-TP uses the PCAN-Basic programming interface to access the CAN hardware in the computer. PCAN-Basic is supplied with each CAN interface of PEAK-System.



Features

- Implementation of the ISO-TP protocol (ISO 15765-2: 2016) for the transfer of data packages up to 4 GBytes via the CAN bus
- Windows DLLs for the development of applications for the platforms Windows 11 (x64/ARM64), 10 (x86/x64)
- Thread-safe API
- Physical communication via CAN or CAN FD using a CAN interface of the PCAN series
- Uses the PCAN-Basic programming interface to access the CAN or CAN FD hardware in the computer

Ordering information

Designation

PCAN-ISO-TP API

Scope of supply

- Interface DLLs (x86/x64/ARM64)
- Examples and header files for all common programming languages
- Documentation in PDF format

The current version ...

... can be downloaded from the Internet free of charge at www.peak-system.com

System requirements

- Windows 11 (x64/ARM64), 10 (x64)
- For the CAN bus connection:
 - PC CAN interface from PEAK-System
- PCAN-Basic API

PCAN-UDS API

API Implementation of the UDS Standard (ISO 14229-1)

UDS (ISO 14229-1) stands for Unified Diagnostic Services and defines the communication with control units (ECUs). The Windows software tests the controller using various services. The process is done on the client-server principle where the program is in the position of the client (also called tester). UDS uses the ISO-TP standard as transport protocol, thus UDS can transmit data blocks of up to 4 GBytes size. Besides the exchange of maintenance information, for example, the transfer of firmware is possible.

The PCAN-UDS API implements the functionality of the standard on the basis of 8 functions. They are categorized in Tester Allocation, Configuration, Information, Utilities, Services, and Communication.

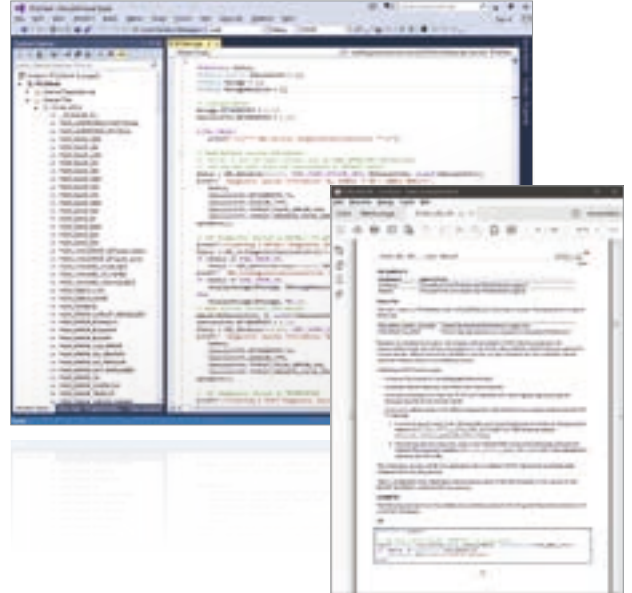

Features

- Implementation of the UDS protocol (ISO 14229-1) for the communication with control units
- Windows DLLs for the development of applications for the platforms Windows 11 (x64/ARM64), 10 (x86/x64)
- Thread-safe API
- Physical communication via CAN or CAN FD using a CAN interface of the PCAN series
- Uses the PCAN-Basic programming interface to access the CAN or CAN FD hardware in the computer
- Uses the PCAN-ISO-TP programming interface (ISO 15765-2:2016) for the transfer of data packages up to 4 GBytes via the CAN bus

Ordering information

Designation

PCAN-UDS API

Scope of supply

- Interface DLLs (x86/x64/ARM64)
- Examples and header files for all common programming languages
- Documentation in PDF format

The current version ...

... can be downloaded from the Internet free of charge at www.peak-system.com

System requirements

- Windows 11 (x64/ARM64), 10 (x64)
- For the CAN bus connection:
PC CAN interface from PEAK-System
- PCAN-Basic API
- PCAN-ISO-TP API

PCAN-OBD-2 API

API Implementation of the OBD-2 Standard (ISO 15765-4)

For on-board diagnostics, the OBD-2 standard defines the exchange of specific vehicle parameters. The client makes a request on the connected control units (ECUs) in the vehicle to which one or several ECUs are answering. As part of OBD-2, the ISO 15765-4 standard describes the CAN bus as a transmission option.

The PCAN-OBD-2 API implements the functionality of the standard on the basis of 15 functions. They are categorized in Tester Allocation, Configuration, Information, Services, and Communication.

According to ISO 15765-4, OBD-2 is based on UDS. Analog to this, PCAN-OBD-2 uses the PCAN-UDS programming interface for the exchange of diagnostic data.

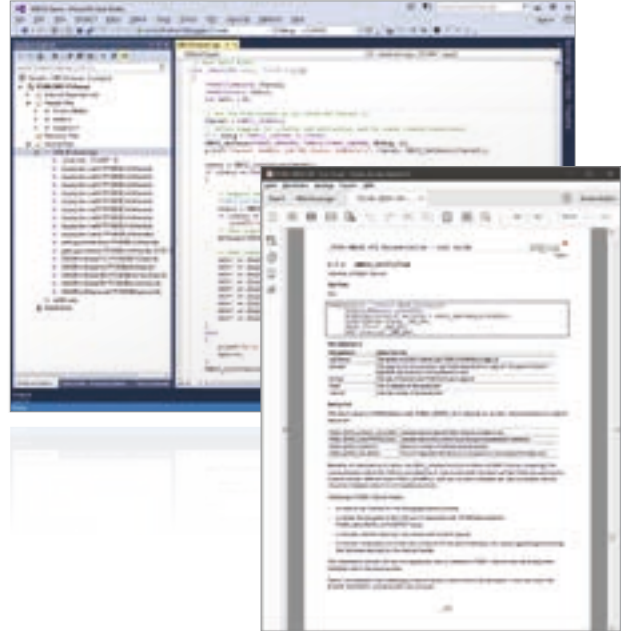

Features

- Implementation of the OBD-2 protocol (ISO 15765-4) as on-board diagnostics standard
- Windows DLLs for the development of applications for the platforms Windows 11 (x64/ARM64), 10 (x86/x64)
- Thread-safe API
- Physical communication via CAN using a CAN interface of the PCAN series
- Uses the PCAN-Basic programming interface to access the CAN hardware in the computer
- Uses the PCAN-ISO-TP programming interface (ISO 15765-2) for the transfer of data packages up to 4095 bytes via the CAN bus
- Uses the PCAN-UDS programming interface (ISO 14229-1) for the communication with control units

Ordering information

Designation

PCAN-OBD-2 API

Scope of supply

- Interface DLLs (x86/x64/ARM64)
- Examples and header files for all common programming languages
- Documentation in PDF format

The current version ...

... can be downloaded from the Internet free of charge at www.peak-system.com

System requirements

- Windows 11 (x64/ARM64), 10 (x64)
- For the CAN bus connection:
 - PC CAN interface from PEAK-System
- PCAN-Basic API
- PCAN-ISO-TP API
- PCAN-UDS API

PCAN-OBDonUDS API

API Implementation of the OBDonUDS Standard (SAE J1979-2)

The standard OBDonUDS (SAE J1979-2) describes the communication between on-board diagnostic systems of vehicles and corresponding test equipment. OBDonUDS was designed as the successor to the OBD-2 standard which has reached its limits, as on-board diagnostics have become increasingly complex.

Based on the established UDS standard (ISO 14229-1), OBDonUDS creates structures and functionality for improved vehicle diagnostics and monitoring. For example, more DTC error codes are possible and more detailed data is captured for each error.

The free PCAN-OBDonUDS API provides the services of the OBDonUDS standard with its functions. Diagnostic data is exchanged via CAN by utilizing the underlying PCAN-UDS API.

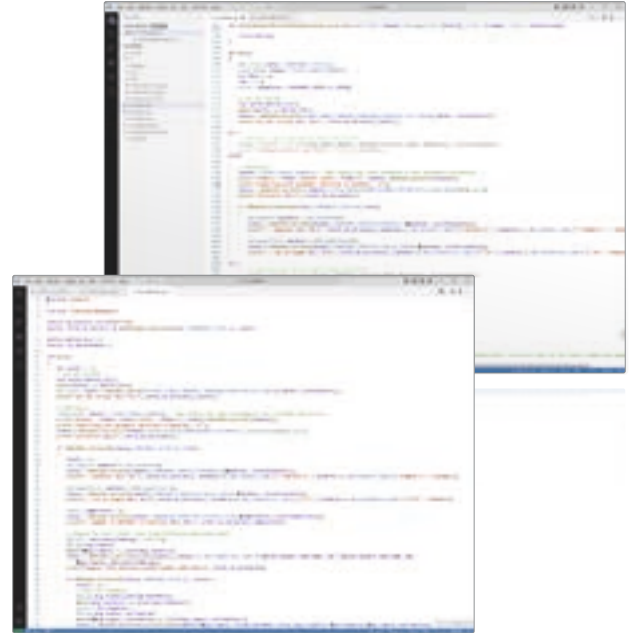

Features

- Implementation of the OBDonUDS protocol (SAE J1979-2, ISO 14229-1, ISO 15765-4:2021) as on-board diagnostics standard
- Windows DLLs for the development of applications for the platforms Windows 11 (x64/ARM64), 10 (x86/x64)
- Thread-safe API
- Physical communication via CAN using a CAN interface of the PCAN series
- Uses the PCAN-Basic programming interface to access the CAN hardware in the computer
- Uses the PCAN-ISO-TP programming interface (ISO 15765-2) for the transfer of data packages up to 4095 bytes via the CAN bus
- Uses the PCAN-UDS programming interface (ISO 14229-1) for the communication with control units

Ordering information

Designation

PCAN-OBDonUDS API

Scope of supply

- Interface DLLs (x86/x64/ARM64)
- Examples and header files for all common programming languages
- Documentation in PDF format

The current version ...

... can be downloaded from the Internet free of charge at www.peak-system.com

System requirements

- Windows 11 (x64/ARM64), 10 (x64)
- For the CAN bus connection:
PC CAN interface from PEAK-System
- PCAN-Basic API
- PCAN-ISO-TP API
- PCAN-UDS API

Note: Expected to be available in Q2 2024.

PCAN-PassThru API

Pass-Thru API and Connection of Pass-Thru Software to PEAK CAN Interfaces

For the programming of control units (ECU), there are countless applications from various manufacturers which are used in the development and diagnosis of vehicle electronics. The interface for the communication between these applications and the control units is defined by the international standard SAE J2534 (Pass-Thru). Thus, the hardware for the connection to the control unit can be selected regardless of its manufacturer.

PCAN-PassThru allows the use of SAE J2534-based applications with CAN interfaces from PEAK-System.

The functions defined by the standard are provided by Windows DLLs. These can also be used to develop own Pass-Thru applications.

The communication via CAN and OBD-2 (ISO 15765-4) is based on the programming interfaces PCAN-Basic and PCAN-ISO-TP. PCAN-PassThru is supplied with each PC CAN interface from PEAK-System.



Features

- ___ Implementations of the international standards SAE J2534 (Pass-Thru) version 04.04 and 05.00
- ___ Extension implementations in version 04.04:
 - SAE J2535-2:2019 to support CAN FD
 - GMW17753 from General Motors to support messages extension
- ___ Extension implementations in version 05.00:
 - SAE J2535-2:2019 with adaptations to match version 05.00 to support CAN FD
 - GMW17753 from General Motors to support messages extension
- ___ Use of SAE J2534 applications with PC CAN interfaces from PEAK-System
- ___ Windows DLLs for the development of your own SAE J2534 applications for the platforms Windows 11 (x64/ARM64), 10 (x86/x64)
- ___ Thread-safe API
- ___ Physical communication via CAN and OBD-2 (ISO 15765-4) using a CAN interface of the PCAN series
- ___ Uses the PCAN-Basic programming interface to access the CAN hardware in the computer
- ___ Uses the PCAN-ISO-TP programming interface (ISO 15765-2) for the transfer of data packages via the CAN bus up to 4095 bytes or 32768 bytes with the GMW17753 extension

Ordering information

Designation

PCAN-PassThru API

Scope of supply

- ___ PCAN-PassThru API installation including
 - Interface DLLs (x86/x64)
 - Configuration software for Windows 11 (x64/ARM64), 10 (x64)
 - PCAN-Basic API
 - PCAN-ISO-TP API
- ___ Documentation in PDF format

The current version ...

... can be downloaded from the Internet free of charge at www.peak-system.com

System requirements

- ___ Windows 11 (x64/ARM64), 10 (x64)
- ___ For the CAN bus connection:
 - PC CAN interface from PEAK-System
 - ___ PCAN-Basic API
 - ___ PCAN-ISO-TP API

PCAN-Developer

Professional CAN and CAN FD Development Package for Windows

The professional programming interface PCAN-API of the PCAN-Developer package makes it possible to create complex Windows applications with CAN and CAN FD support. The API (Application Programming Interface) provides an extensive function library using interface DLLs for x86, x64, and ARM64 systems.

Unlike PCAN-Basic, the CAN communication is handled by Clients and offers significant advantages. Thus, not only a single but multiple applications can access a physical CAN channel. Furthermore, it works even without hardware: Via virtual connections, Clients establish a simulated CAN communication among Windows applications.

Beginning with PCAN-Developer version 4, the PCAN-API and the included tools support the CAN FD standard (CAN with Flexible Data rate) which is primarily characterized by a higher bandwidth for data transfer.

The API can be used with different programming languages. Header files are provided for the languages C/C++, Delphi, and Python. For C#, VB.NET and C++/CLR an assembly is available. Example code is included for all supported languages.

CAN Connection via Clients

Applications that are based on the PCAN-API use so-called Clients in order to access Nets. A Net includes the connection to an external CAN bus via suitable hardware and the interconnection of several applications.

The following possibilities apply to CAN connections via Clients:

- One or multiple Clients can be connected with a Net
- A Client can be connected with multiple Nets
- A Net is connected to no or exactly one active hardware
- Multiple connections to different Nets can be defined for a hardware
- A maximum of one defined connection to a Net can be activated for a hardware
- When a Client transmits, the message is passed to all other Clients connected to the Net and via the hardware to the external CAN bus
- If a message is received by the hardware, it is received by all Clients connected to the Net

CAN Bus Simulation

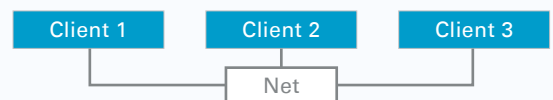

CAN Bus Connection

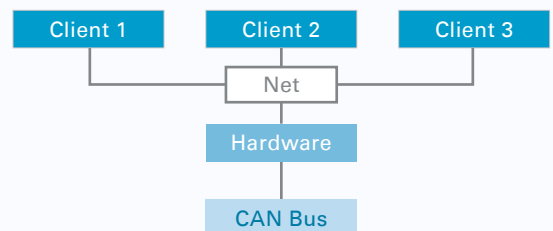

Gateway Application

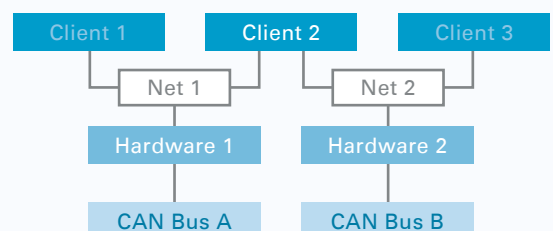

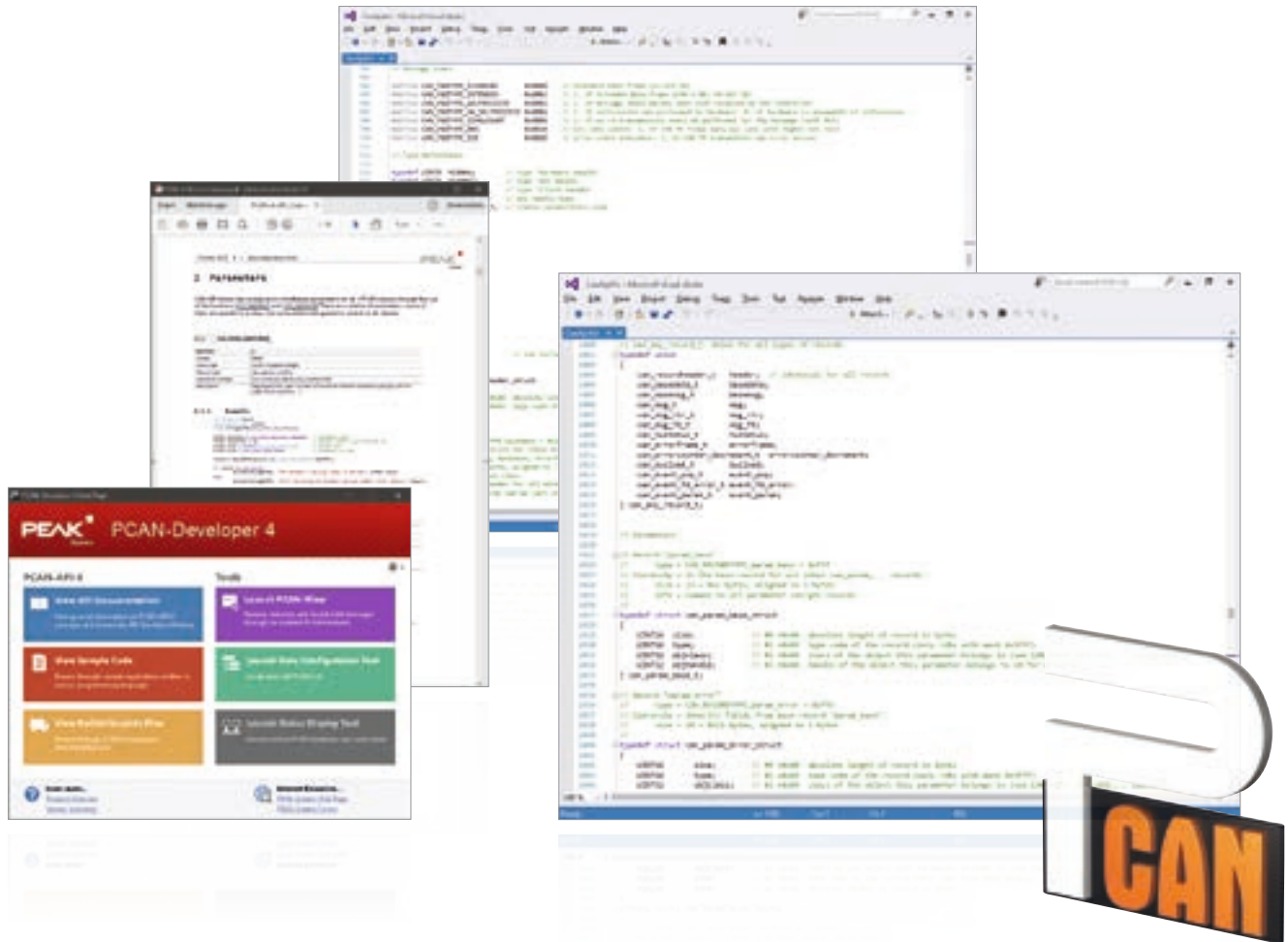

Features

- ___ Professional API for developing applications with CAN and CAN FD connections
- ___ Complies with CAN specifications 2.0 A/B and FD
- ___ CAN FD support for ISO and Non-ISO standards switchable
- ___ Application development for the platforms Windows 11 (x64/ARM64), 10 (x86/x64)
- ___ Up to 64 applications can be operated per physical CAN channel at the same time
- ___ Use of one Windows DLL each for x86, x64, and ARM64 as programming interface (API) for all supported hardware types
- ___ Use of up to 64 channels for each hardware type
- ___ Simple switching between channels of a PCAN PC hardware using Nets
- ___ Access to the CAN channels of a PCAN-Gateway via the new PCAN-LAN hardware type
- ___ Driver-internal buffering of up to 32,768 CAN messages per Client
- ___ Buffer size can be configured via the API
- ___ Precision of time stamps on received messages up to 1 μ s (depending on the PEAK CAN interface used)
- ___ Access to all available hardware parameters such as
 - ___ listen-only mode
 - ___ Notification of the application through Windows events when a message is received
 - ___ Notification of the application through driver events, e.g., altered hardware parameters, plug-in/plug-out of PCAN PC hardware, or bus load information
 - ___ Interrupt-triggered reception of CAN messages by the driver. Storage in a FIFO buffer with the time stamp
 - ___ Control of the transmission timing by specifying time stamps when transmitting messages
 - ___ Configuration of single-shot and self-receive-request transmissions
 - ___ Support of CAN error frames
 - ___ Generation of CAN error frames
 - ___ Simulated CAN communication between applications via Clients
 - ___ Free definition of a message filter per Client
 - ___ Hardware reset during an active connection
 - ___ Hardware configuration using the control panel or application

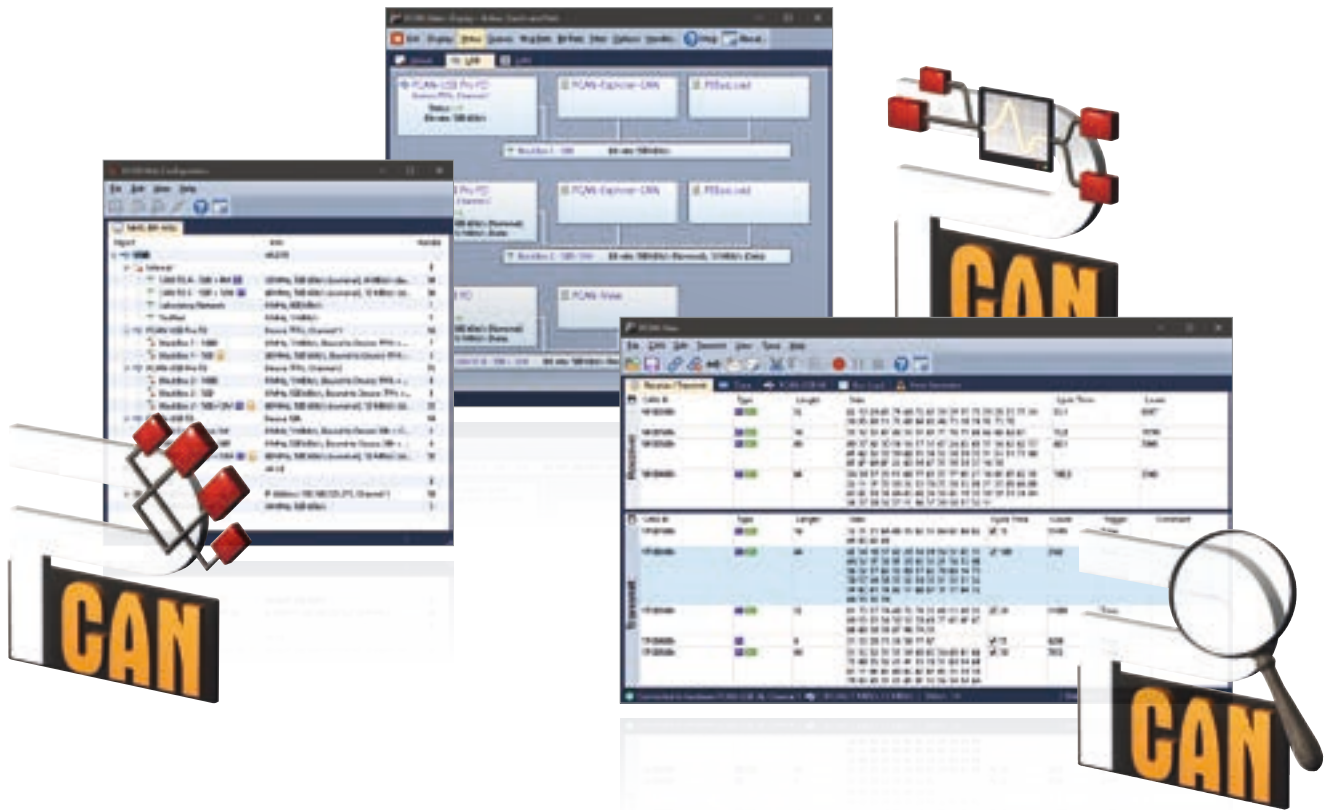

- Detailed documentation in PDF format as well as executable sample source code
- Collection of tools for CAN system configuration, parameterization, and visualization
- Thread-safe API

Note: Parallel port CAN interfaces are only supported on x86 systems.

PCAN-Developer 4 Licenses:

PCAN-Developer 4 includes a single user license for the development package and a distribution license for the PCAN-Developer redistributable. This package includes the API DLLs as well as the software products PCAN-View, PCAN-Nets Configuration, and PCAN-Status Display.

For the API and the software you will receive all updates and free support for the duration of two years.

Ordering information

Designation	Part No.
PCAN-Developer	IPES-004070

Scope of supply

- PCAN-API 4 interface DLLs (x86/x64/ARM64)
- PCAN-Developer license package
- Software: PCAN-View, PCAN-Nets Configuration, and PCAN-Status Display
- Header files for C/C++, Delphi, and Python
- Assembly for C#, VB.NET, and C++/CLR
- Examples for all supported languages
- Documentation in PDF format

System requirements

- Windows 11 (x64/ARM64), 10 (x64)
- USB port for installation stick
- For the CAN bus connection:
PC CAN interface from PEAK-System

Note: Software delivery on USB stick. Alternative installation media or download on request.

PCAN-RP1210 API

RP1210 Development Package and RP1210 Connectivity to PEAK CAN Interfaces

The Recommended Practice 1210 was defined by the Technology and Maintenance Council (TMC) as a standardized API for communication between Windows applications and communication networks in vehicles.

The PCAN-RP1210 API by PEAK-System is an implementation of the RP1210 version C with support for CAN, J1939, and ISO-TP networks. Thus, the API makes it possible to develop own RP1210 applications and to use already existing applications with CAN interfaces from PEAK-System.

Since July 2020, the PCAN-RP1210 API is provided free of charge. The API is supplied along with documentation and additional software. The DLLs required for using RP1210 software with PC CAN interfaces can be installed with our device driver setup for Windows.

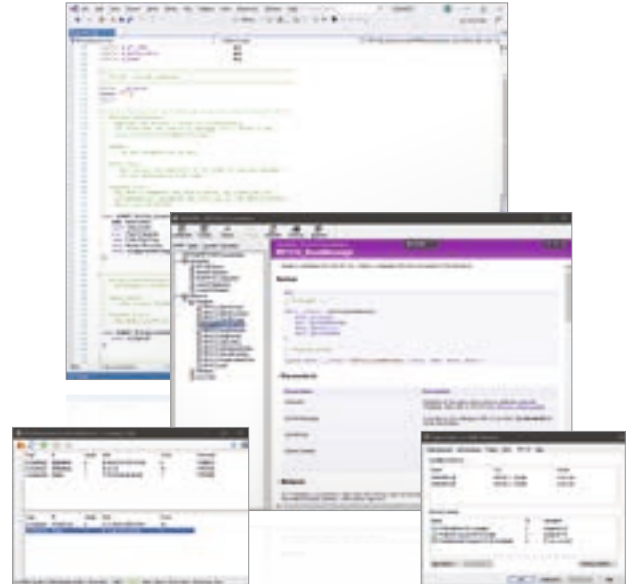

Features

- RP1210 version C implementation according to the specification by TMC
- Development of own RP1210 applications
- Thread-safe API
- Use of RP1210 applications with PEAK CAN interfaces
- Support of CAN, SAE J1939, and ISO-TP (ISO 15765-2)

Note: The development on the RP1210 version A implementation was discontinued since version A was superseded by version C.

Ordering information

Designation

PCAN-RP1210 API

Scope of supply

- PCAN-RP1210 API
- RP1210 connection test application
- Documentation in PDF format
- Documentation in HTML Help format

The current version ...

... can be downloaded from the Internet free of charge at www.peak-system.com

System requirements

- Windows 11 (x64/ARM64), 10 (x86/x64)
- For the CAN bus connection:
PC CAN interface from PEAK-System

PLIN-API

API for Developing Applications with LIN Connection

LIN (Local Interconnect Network) is a serial network protocol which is characterized by a master-slave architecture and transmission patterns. The master regulates the bus access and controls the communication of up to 16 participants. Only when the master prompts a slave, the latter is allowed to transmit its stored information. On each request of the master, answers defined within a schedule table follow in a fixed time sequence.

LIN was introduced by five automobile manufacturers in 1999 and further developed under the supervision of the LIN Consortium. Until today, the LIN bus has proven itself to be a cost-effective alternative to the CAN bus for networking sensors and actuators in vehicles, such as seat, door, mirror, and climate controls.

The programming interface PLIN-API (PEAK LIN Application Programming Interface) enables the connection of Windows applications to the LIN bus. The API provides various functions for developers in the programming languages C++, C#, C++/CLR, C++/MFC, Delphi, VB.net, and Python 3.x.

Features

- API for developing applications with LIN connection
- Windows DLLs for the development of x86, x64, and ARM64 applications
- Multiple applications can be operated on a physical channel at the same time
- Simple switching between the channels of a PLIN PC hardware
- Internal buffering of messages on software level (system service)
- Precision of time stamps on received messages up to 1 μ s
- Allows storing custom data (max. 24 bytes) on the hardware
- Notification of the application through Windows events when a message is received and on plug-in or plug-out of a device
- Function to get error code descriptions in 4 languages



Ordering information

Designation

PLIN-API

Scope of supply

- Interface DLLs (x86/x64/ARM64)
- Examples and header files for all common programming languages
- Documentation in HTML Help format
- Documentation in PDF format

The current version ...

... can be downloaded from the Internet free of charge at www.peak-system.com

Note: The PLIN-API is designed to be used exclusively with a PC LIN interface from PEAK-System.

System requirements

- Windows 11 (x64/ARM64), 10 (x86/x64)
- For the LIN bus connection:
PC LIN interface from PEAK-System

PCAN-View

Windows Software for Displaying CAN and CAN FD Messages

The software PCAN-View for Windows is a simple CAN monitor for viewing, transmitting, and recording CAN data traffic. Messages can be transmitted manually and periodically at a user-determined bit rate. Bus system errors and memory overflows in the CAN hardware are displayed during the process. The trace function can be used to record and save CAN data traffic.

PCAN-View is supplied with every PCAN PC hardware product and allows a quick and easy start. All available PEAK CAN interfaces are listed in the connection dialog. After selecting the hardware and the bit rate, the user can access all the software functions, hardware-specific settings, and information.

Beginning with version 4, PCAN-View supports the CAN FD standard (CAN with Flexible Data rate) which is primarily characterized by higher bandwidth for data transfer.



Features

- Support for CAN specifications 2.0 A/B and FD
- CAN bit rates (nominal) up to 1 Mbit/s
- Data bit rates up to 12 Mbit/s (only when using a CAN FD interface)
- Optional use of custom bit rates
- Listen-only mode can be activated
- Manual and periodic transmission of messages with a maximum resolution of 1 ms
- Message reception with a maximum resolution of 100 μ s
- Recording messages in trace files
- Saving and reloading of transmission messages
- Sortable receive and transmit lists
- Representation of CAN IDs in hexadecimal or decimal format
- Representation of the data bytes in hexadecimal, decimal, or ASCII format
- Display of receive, transmit, and error states
- Hardware reset of the CAN controller
- Access to hardware-specific settings and information

Ordering information

Designation

PCAN-View

Scope of supply

- PCAN-View software
- Documentation in HTML Help format

The current version ...

... can be downloaded from the Internet free of charge at www.peak-system.com

System requirements

- Windows 11 (x64/ARM64), 10 (x86/x64)
- For the CAN bus connection:
PC CAN interface from PEAK-System

Note: Parallel port CAN interfaces are only supported on x86 systems.

PLIN-View Pro

Windows Software for Displaying LIN Messages

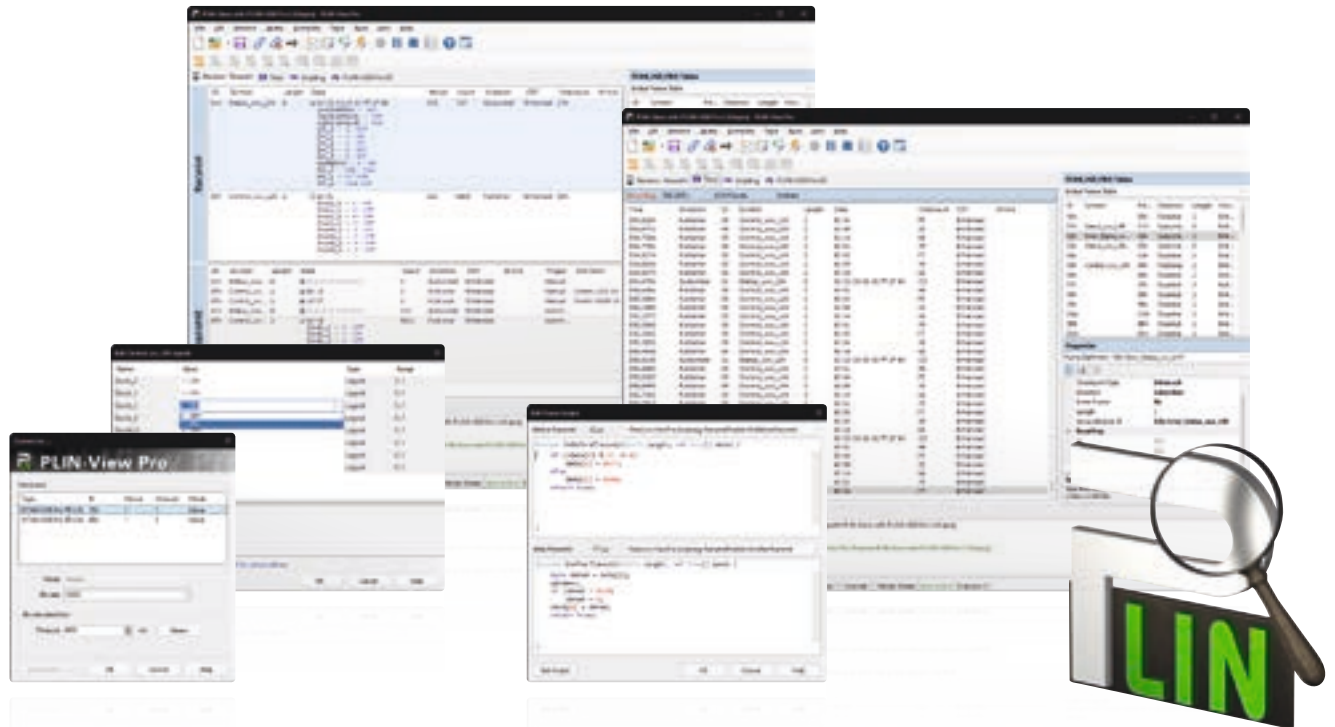

The LIN monitor PLIN-View Pro for Windows is supplied with every PC LIN interface from PEAK-System. Incoming LIN messages can be viewed using this software, with the use of LDF files (LIN Description File) allowing the symbolic depiction of LIN messages. Outgoing LIN frames can be defined depending on the master or slave operation mode.

PLIN-View Pro also accesses the LIN functionality of the supported hardware, such as the on-board scheduler or automatic bit rate detection.

Features

- Display of incoming LIN frames
- Symbolic display of LIN messages (LDF files)
- Master or Slave mode
- Administration and processing of schedule tables
- Configurable recording of LIN frames (trace)
- Display and recording of frame events such as bus sleep, bus wake-up, and overrun
- Automation of various processes with VBScript
- Automation of LIN data and elements with C# scripts; optional use of C# assemblies
- Integrated text editor for C# with syntax highlighting

Ordering information

Designation

PLIN-View Pro

Scope of supply

- PLIN-View Pro software
- Documentation in HTML Help format

The current version ...

... can be downloaded from the Internet free of charge at www.peak-system.com

Note: PLIN-View Pro is designed to be used exclusively with a PC LIN interface from PEAK-System.

System requirements

- Windows 11 (x64/ARM64), 10 (x86/x64)
- Microsoft .NET Framework 4.0
- For the LIN bus connection:
PC LIN interface from PEAK-System

PCAN-OBD-2 Viewer

Windows Software for the Presentation and Processing of OBD-2 Data

The OBD-2 standard defines the exchange of specific vehicle parameters for on-board diagnostics. As part of OBD-2, the ISO 15765-4 standard describes the CAN bus as a transmission option.

With the Windows software PCAN-OBD-2 Viewer OBD-2 data can be read out from connected control units (ECUs) via the CAN bus for presentation and further processing.

The application was implemented based on the programming interface PCAN-OBD-2 API by PEAK-System and is available free of charge for users of PEAK CAN adapters.



Features

- On-board diagnostics according to the standard OBD-2 (ISO 15765-4)
- Physical communication via CAN using a CAN interface of the PCAN series
- Support of all OBD-2 services that can be transmitted with CAN
- Configurable graphical data representation on analog and digital instruments in a virtual cockpit
- Saving and loading of configurations
- Display of Diagnostic Trouble Codes (DTCs) and available test results
- Reading of data that is recorded if an error occurs (Freeze Frames)
- Listing emission-related data. Optional display of individual parameters as a graph
- Exporting graphs and records of the OBD-2 communication

Ordering information

Designation

PCAN-OBD-2 Viewer

Scope of supply

- PCAN-OBD-2 Viewer software
- Documentation in PDF format (English)

The current version ...

... can be downloaded from the Internet free of charge at www.peak-system.com

System requirements

- Windows 11 (x64/ARM64), 10 (x64)
- For the CAN bus connection:
PC CAN interface from PEAK-System

PPCAN-Editor 2

Comprehensive Configuration Software for I/O Modules

PPCAN-Editor 2 software enables detailed configuration of various I/O modules with CAN connections, such as PCAN-MIO, PCAN-Router Pro, and MU-Thermocouple1 CAN.

This type of configuration process begins with the definition of incoming and outgoing CAN messages. Then, depending on the hardware, the user has a number of different function blocks and other settings available for processing CAN data traffic. Finally, the configuration data is transmitted to the module using CAN. This step requires a PEAK CAN interface.

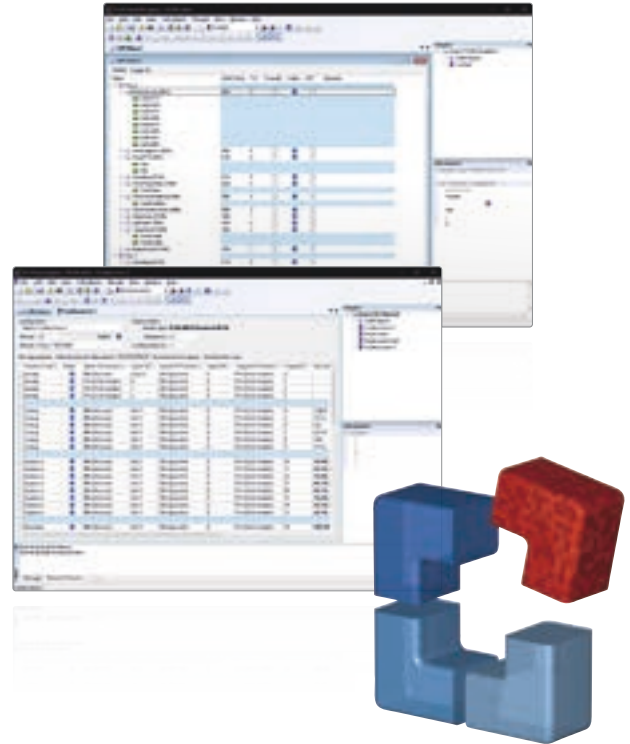

Features

- Definition of event-triggered or periodic CAN message transmission
- Data manipulation via the basic scale and offset functions
- Various function blocks for processing of measurement values such as hysteresis, characteristic curves, mathematical calculation operations, and logical links
- Multiplexer function for conditional handling of CAN data (only for PCAN-MIO and PCAN-Router Pro)
- Selective forwarding of CAN data via gateway functions
- Conditional execution of function blocks via comparison functions
- Module-specific parameter settings
- Importing of PCAN-Symbol Editor Symbol files for convenient definition of incoming and outgoing CAN messages
- Configuration data transmitted via CAN (PEAK CAN interface required)

Ordering information

Designation

PPCAN-Editor 2

Scope of supply

- PPCAN-Editor 2 software
- Documentation in HTML Help format
- PDF function block reference guide

The current version ...

... can be downloaded from the Internet free of charge at www.peak-system.com

System requirements

- Windows 11 (x64/ARM64), 10 (x86/x64)
- For the CAN bus connection:
PC CAN interface from PEAK-System

PCAN-MicroMod Configuration

Windows Configuration Software for PCAN-MicroMod Products

The PCAN-MicroMod Configuration software can be used to configure all products based on the PCAN-MicroMod. Specific configuration options are available for the PCAN-MicroMod itself, the motherboards, and the Evaluation board, depending on the hardware in use.

Configuration data is transmitted to the module via CAN. Use of unique module IDs allows independent configuration of multiple devices on a single CAN bus.

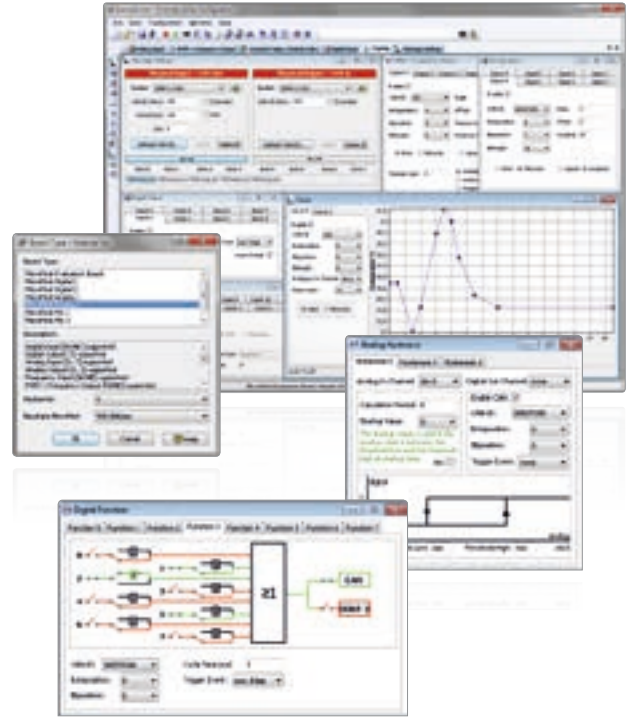

Features

- Product-specific configuration options:
 - Periodic and edge-triggered transmission of CAN messages
 - Logical linking of digital inputs
 - Direct conversion from analog inputs to CAN IDs
 - Analog values can be processed using characteristic curves or hysteresis functions
 - Direct evaluation of rotary encoders
- Configuration data transmitted via CAN (PEAK CAN interface required)
- Existing configurations can be read out via CAN for further processing

Ordering information

Designation

PCAN-MicroMod Configuration

Scope of supply

- PCAN-MicroMod Configuration software
- Documentation in HTML Help format

The current version ...

... can be downloaded from the Internet free of charge at www.peak-system.com

System requirements

- Windows 11 (x64/ARM64), 10 (x64)
- For the CAN bus connection:
PC CAN interface from PEAK-System

PCAN-MicroMod FD Configuration

Windows Configuration Software for PCAN-MicroMod FD Products

The plug-in module PCAN-MicroMod FD is a universal solution for the integration of a CAN FD interface and I/O functionality into your own hardware. PCAN-MicroMod FD based products from PEAK-System as well as customer developments can be set up with the Windows software PCAN-MicroMod FD Configuration.

The configuration created on the computer is transferred via the CAN bus to the PCAN-MicroMod FD which then runs as an independent CAN node. Multiple modules can be configured independently on a CAN bus.

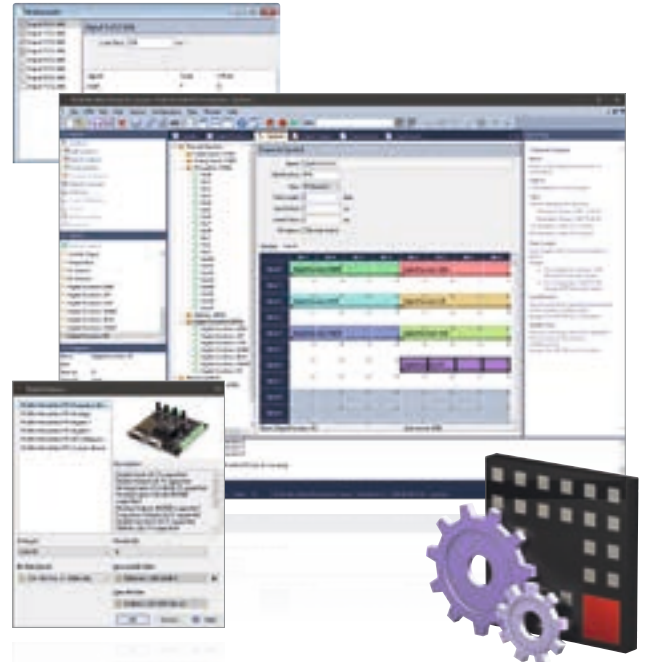

Features

- Software for configuring PCAN-MicroMod FD based hardware
- Product-specific configuration options due to using predefined hardware profiles
- Setting up the CAN interface by selecting the transmission standard (CAN or CAN FD) and the corresponding bit rates
- Definition of incoming and outgoing CAN messages
- Periodic or event-triggered transmission of CAN messages
- Utilization of Signals for the temporary storage of analog and digital inputs and outputs as well as various status information
- Mapping of the Signals to the data of the CAN messages
- Signal processing with functions and services:
 - Scale and Offset function
 - Logical linking of digital inputs
 - Processing of Signal values via characteristic curves or mathematical calculation operation
 - Direct evaluation of rotary encoders
- Configuration data transmitted via CAN (PEAK CAN interface required)
- Selective configuration several devices in a CAN network based on the module ID
- Existing configurations can be read out via CAN for further processing
- Export of the CAN message definition as a Symbol file for use with other PEAK-System products like for example PCAN-Explorer
- Switching between CAN and CANopen operating mode

Ordering information

Designation

PCAN-MicroMod FD Configuration

Scope of supply

- PCAN-MicroMod FD Configuration software
- Documentation in HTML Help format

The current version ...

... can be downloaded from the Internet free of charge at www.peak-system.com

System requirements

- Windows 11 (x64/ARM64), 10 (x64)
- For the CAN bus connection:
PC CAN interface from PEAK-System

PCAN-Explorer 6

Professional Windows Software to Communicate with CAN and CAN FD Buses

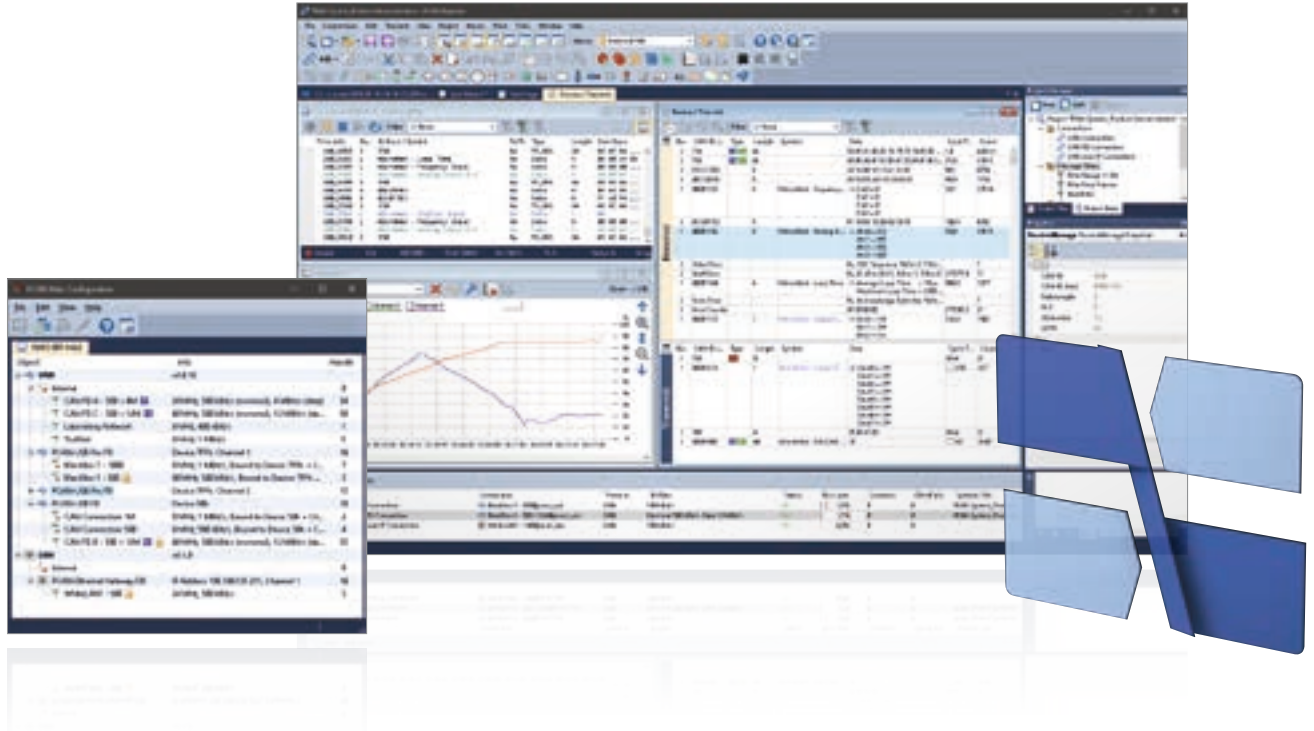

The PCAN-Explorer 6 is a versatile, professional program for working with CAN and CAN FD networks. The user is not just limited to the observation of the CAN traffic. Manual or periodic transmission of messages or entire transmission lists allows him a direct influence, for example, for control purposes or simulations.

The PCAN-Explorer 6 can connect to several CAN and CAN FD buses at the same time. Unlike previous versions, the hardware type of used PEAK CAN interfaces is no longer a limiting factor.

A central point in the use of the program is the symbolic representation of the CAN messages and their payload. With the help of Symbol files, the hexadecimal information is transformed into a readable and vivid format.

Since version 6, the trace function, in addition to recording the data traffic, allows also the playback of existing traces. The recordings and incoming CAN messages can be filtered using various criteria.

Special requirements as well as the automation of complex processes can be implemented with macros, VBScript, and callback functions. The sophisticated implementation of VBScript accesses the extensive object model of the PCAN-Explorer 6.

Furthermore, the functionality of the PCAN-Explorer can be extended by add-ins. PEAK-System offers add-ins that provide even better opportunities to analyze and influence data. The Plotter produces a graphical representation of the signals' time course by live recording or on the basis of traces. The Instruments Panel is used for an own arrangement of various displays, controls, and switches. Further add-ins enable the import of third-party configurations based on the CANdb format and add the support for the J1939 protocol.

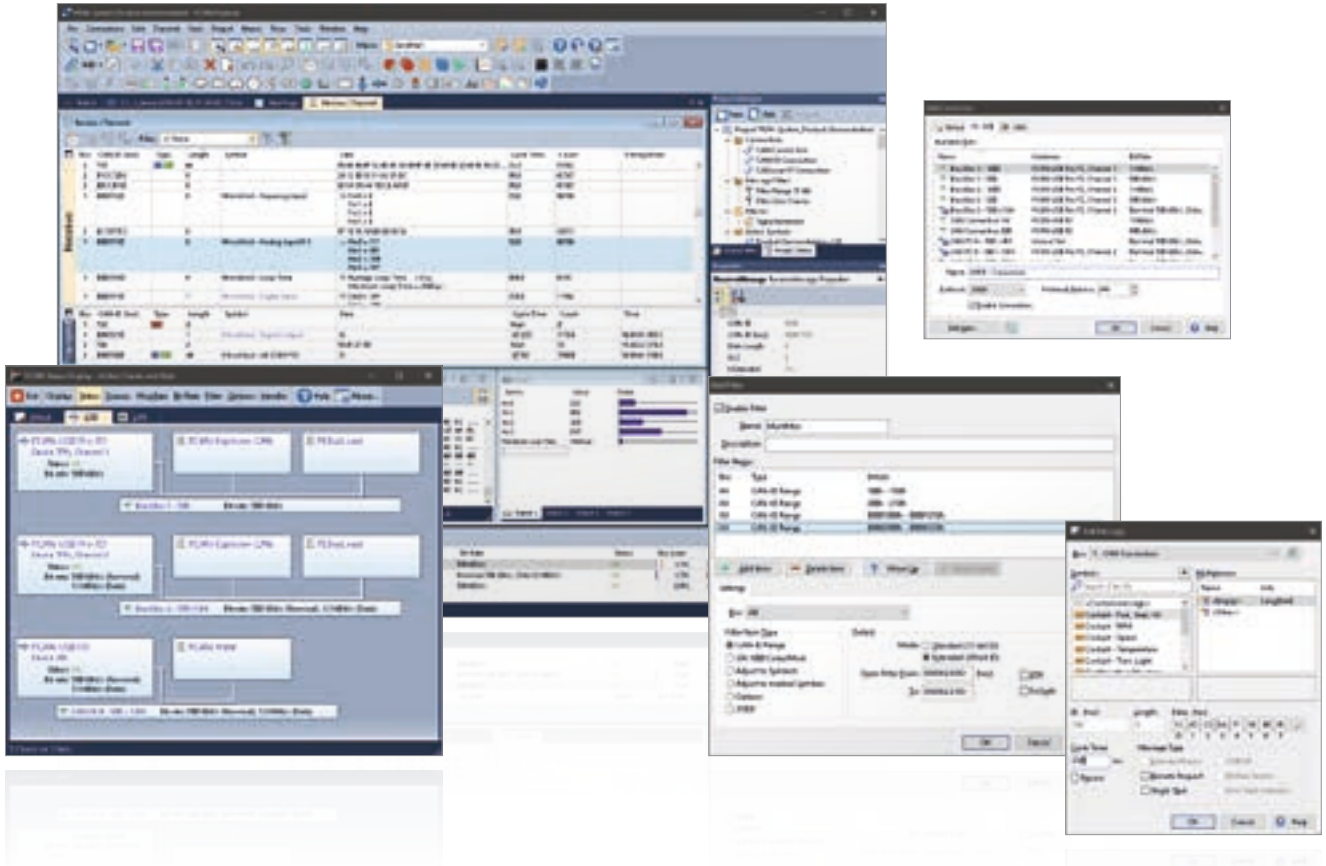

Features

- ___ Management of all settings, information, and files in projects
- ___ Exporting entire projects including linked files to handy packets for archiving or sharing
- ___ Extensive revision of the user interface with improved dialogs for creating transmit messages and managing signals
- ___ Automatic notification about new software versions and support with the update process
- ___ Integrated text editor with syntax highlighting for creating and editing of Symbol files, macros and VBScript
- ___ User interface language can be switched (German/English)
- ___ Integration of add-ins to upgrade functionality

Connection to CAN and CAN FD

- ___ Connection with up to 16 CAN channels
- ___ Simultaneous use of multiple PEAK CAN interfaces independent of the hardware type
- ___ Support for CAN specifications 2.0 A/B and FD
- ___ CAN bit rates (nominal) up to 1 Mbit/s
- ___ Data bit rates up to 12 Mbit/s (only when using a CAN FD interface)
- ___ Optional use of custom bit rates
- ___ Listen-only mode can be activated
- ___ Clear overview of connections with their bit rate, status, error counter, and bus load
- ___ Function to execute a hardware reset of the CAN controller

Transmission and Reception

- ___ Representation of the CAN data traffic in sortable receive and transmit lists with configurable columns display
- ___ Display of messages showing the ID, length, data bytes, time-outs, number of messages received, and receiving interval
- ___ Display of error frames can be activated for each connection
- ___ Representation of CAN IDs in hexadecimal or decimal format
- ___ Display of receive, transmit, and error states
- ___ Message reception with a maximum resolution of 1 µs
- ___ Manual and periodic transmission of messages with a maximum resolution of 1 ms
- ___ Transmission of CAN messages in response to remote frames (only with CAN 2.0 A/B)
- ___ Messages can be grouped as transmit lists, stored and loaded as desired, e.g., in order to emulate CAN nodes
- ___ Multiple flexible filters can be configured and, for example, assigned to the transmit/receive window or to various different tracers

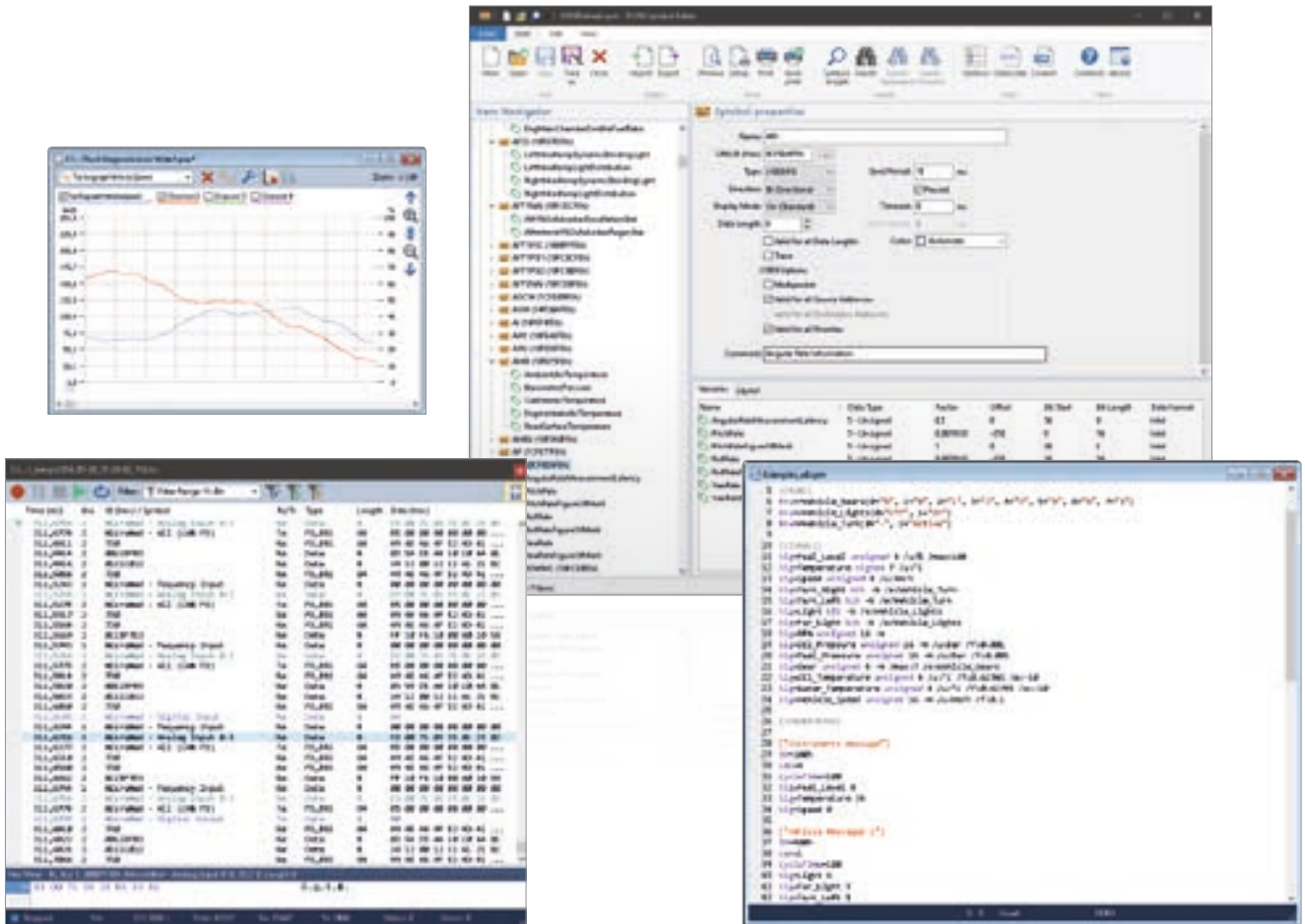

Recording and Playback

- ___ Logging of the CAN data traffic along with the errors that have occurred as an option
- ___ Playback of trace files with optional loop function
- ___ Operation of multiple tracers at the same time
- ___ Representation of the logged messages with details such as time stamp, type, ID, length, and data bytes
- ___ Representation of the data bytes in hexadecimal, decimal, or ASCII format
- ___ Filtering of messages to be logged via message filters during and after a recording
- ___ Recording of CAN data traffic directly to files or to the RAM (in linear, dynamic, or circular buffer mode)
- ___ Playback of logged CAN messages directly from files or the buffer
- ___ Storing of the logged data to readable text files or CSV files for further processing in Excel or similar
- ___ Enhanced processing of huge trace files compared to PCAN-Explorer version 5
- ___ Subsequent examination of the logged data in the buffer via different Symbol files

Symbolic Representation

- ___ Clear and readable representation of CAN messages based on the symbol format from PEAK-System:
 - Easy allocation of CAN messages by assigning alphanumeric names
 - Bit-exact division of the data into variables for assigning names, data type, etc.
- ___ Comfortable Symbol file creation with the supplied Windows software PCAN-Symbol Editor or with the integrated text editor
- ___ User-friendly real-time monitoring of several signals via the Watch window
- ___ Graphical display of up to 4 signals with a simple line writer (Line Writer Add-in)

Automation

- ___ Automation of small tasks or complex processes with macros or VBScript like for example:
 - Test procedures for the implementation or development of CAN systems
 - Send an e-mail if a temperature is exceeded
 - Start an action when a particular message is received
 - Open an Excel sheet when an event occurs and save the data in individual cells
 - Calculate variables from the data of incoming CAN messages



- ___ Creation of macros and scripts with the integrated text editor
- ___ Assignment of function keys to individual macros
- ___ Access with VBScript to almost all program elements via the PCAN-Explorer object model
- ___ VBScript macros also run in the background even without the PCAN-Explorer interface
- ___ Automation with callback libraries
 - ▀ Integration of self-implemented callback functions as native libraries (*.dll, 32-bit)
 - ▀ Freely programmable processing and modification of CAN message data and execution of message-related processes
 - ▀ Calling of callback functions on events such as receipt, before transmission, and after transmission of a CAN message

PCAN Explorer 6 Training:

We offer a training session for the PCAN-Explorer, which includes an introduction to the main features of the software, the work with the PCAN-Symbol Editor, and a demonstration of the add-ins. If you are interested and for further information, please contact training@peak-system.com.

PCAN-Explorer 6 Licenses:

Single Computer License - With this license you get the installation files and a license file. With that you are allowed to install, activate, and use the software on a single computer exclusively. The activation of the software is done online, by phone, or e-mail.

Portable License + USB Copy Protection Dongle - With this type of license, you get a USB copy protection dongle for each purchased license in addition to the installation files. You can install PCAN-Explorer 6 on several computers. In order to unlock and use the software, you must plug the copy protection dongle into a free USB port.

Ordering information

Designation	Part No.
PCAN-Explorer 6 Single Computer License	IPES-006000
PCAN-Explorer 6 Portable License + Copy Protection Dongle	IPES-006000 + IPES-006090

Scope of supply

- ___ Installations files for PCAN-Explorer
- ___ Single computer license or portable license with USB copy protection dongle
- ___ PCAN-Symbol Editor for Windows (details on page 122)
- ___ Documentation in HTML help format

System requirements

- ___ Windows 11 (x64/ARM64), 10 (x86/x64)
- ___ Free USB port for installation stick and copy protection dongle
- ___ For the CAN bus connection:
PC CAN interface from PEAK-System
- ___ Internet connection recommended for activation

Note: Software delivery on USB stick. Alternative installation media or download on request.

Plotter Add-in

Optional Function Upgrade for the PCAN-Explorer

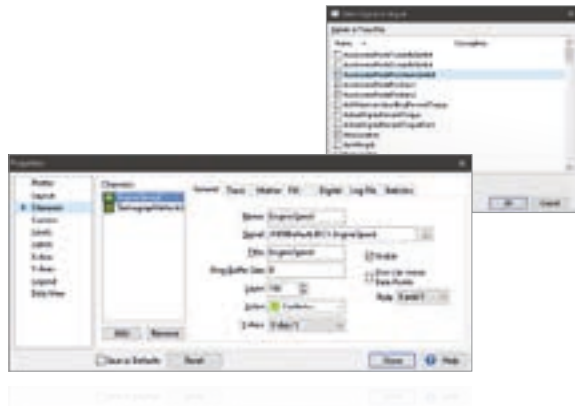

The Plotter Add-in allows the recording and graphical representation of any number of signal courses. Signal sources can be the data from incoming and outgoing CAN messages as well as virtual variables and results from macro calculations.

Plot Viewer: The free Windows software Plot Viewer enables the display of the records without an installation of PCAN-Explorer.

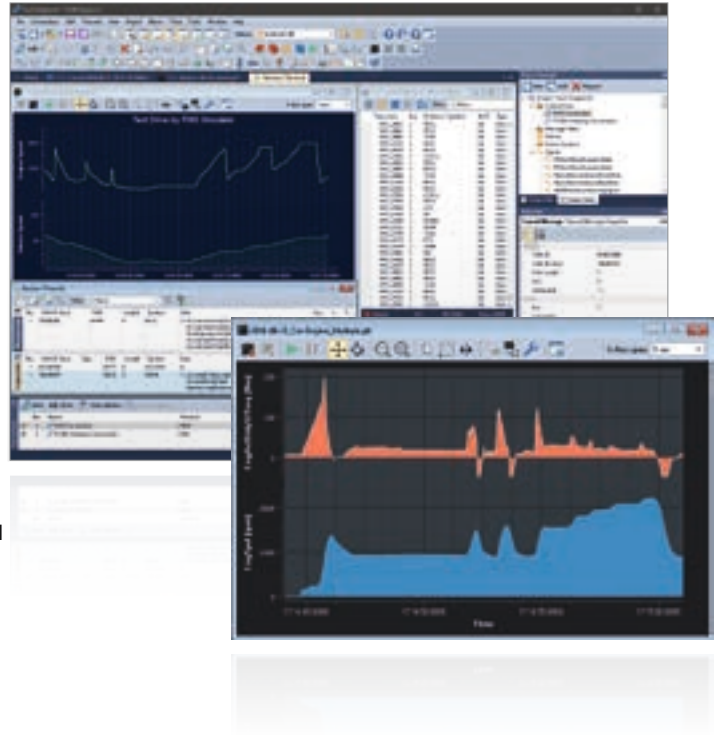

Features

- Real-time display of signal courses
- Unlimited number of recording channels
- Unlimited number of Y-axes
- Decoupling of the configuration of Y-axis and channels to improve presentation and handling
- X-axis and Y-axes can be zoomed and scrolled freely, even during recording
- Labelling of time axis with absolute or relative time stamps
- Facility for automatic adaptation of axes to plots
- Reversible Y-axes
- Logarithmic scales
- Cursor display for plot measurement
- Save the current view as an image in EMF, PNG, BMP, or JPEG format
- Export the recording to a CSV file
- Import of data recordings from the PCAN-Explorer's tracer, from PCAN-Trace, or PCAN-View
- Display of limiting values and value ranges
- Comprehensive formatting options for displaying curves, axes, and the plotter layout

Ordering information

Designation	Part No.
Plotter Add-in 6	IPES-006087

Scope of supply

- Installations files for Plotter Add-in
- Single computer license or portable license with USB copy protection dongle

System requirements

- PCAN-Explorer 6
- Windows 11 (x64/ARM64), 10 (x86/x64)
- Free USB port for installation stick and copy protection dongle

The current version of the Plot Viewer ...

... can be downloaded from the Internet free of charge at www.peak-system.com

Note: Software delivery on USB stick. Alternative installation media or download on request.

CANdb Import Add-in

Optional Function Upgrade for the PCAN-Explorer

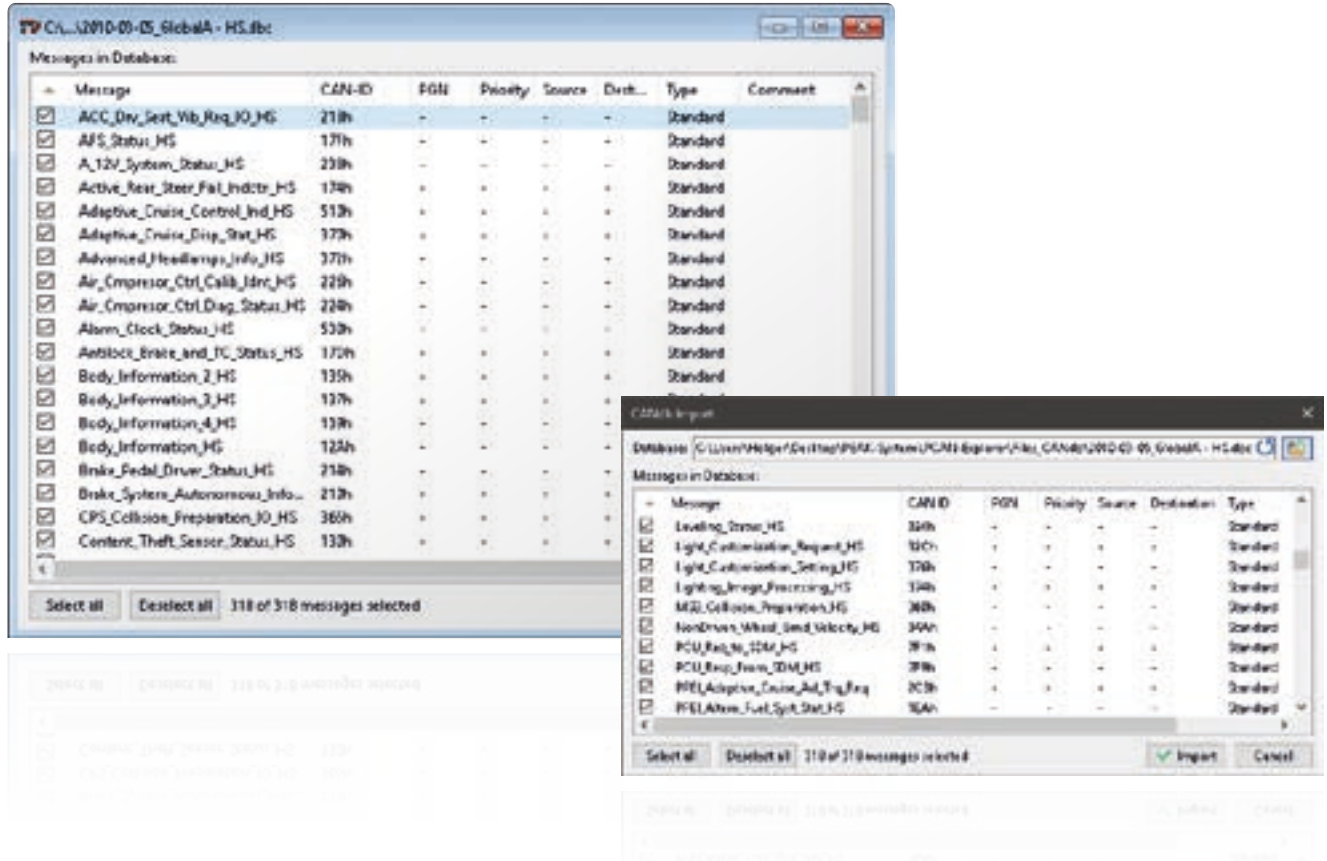

The CANdb format is a common data description format for CAN bus information in the car industry.

CANdb Import allows the import of CANdb files. This is a useful function for all those who do not want to manually transcribe their database into the PCAN-Explorer symbol format.

Features

- Open CANdb files (.dbc)
- Selection of the messages to be used of a CANdb file
- Saves data using the project administration function in PCAN-Explorer
- Save to the PCAN-Explorer symbol format

Ordering information

Designation	Part No.
CANdb Import Add-in 6	IPES-006086

Scope of supply

- Installations files for CANdb Import Add-in
- Single computer license or portable license with USB copy protection dongle
- Documentation in HTML help format

System requirements

- PCAN-Explorer 6
- Windows 11 (x64/ARM64), 10 (x86/x64)
- Free USB port for installation stick and copy protection dongle

Note: Software delivery on USB stick. Alternative installation media or download on request.

Instruments Panel Add-in

Optional Function Upgrade for the PCAN-Explorer

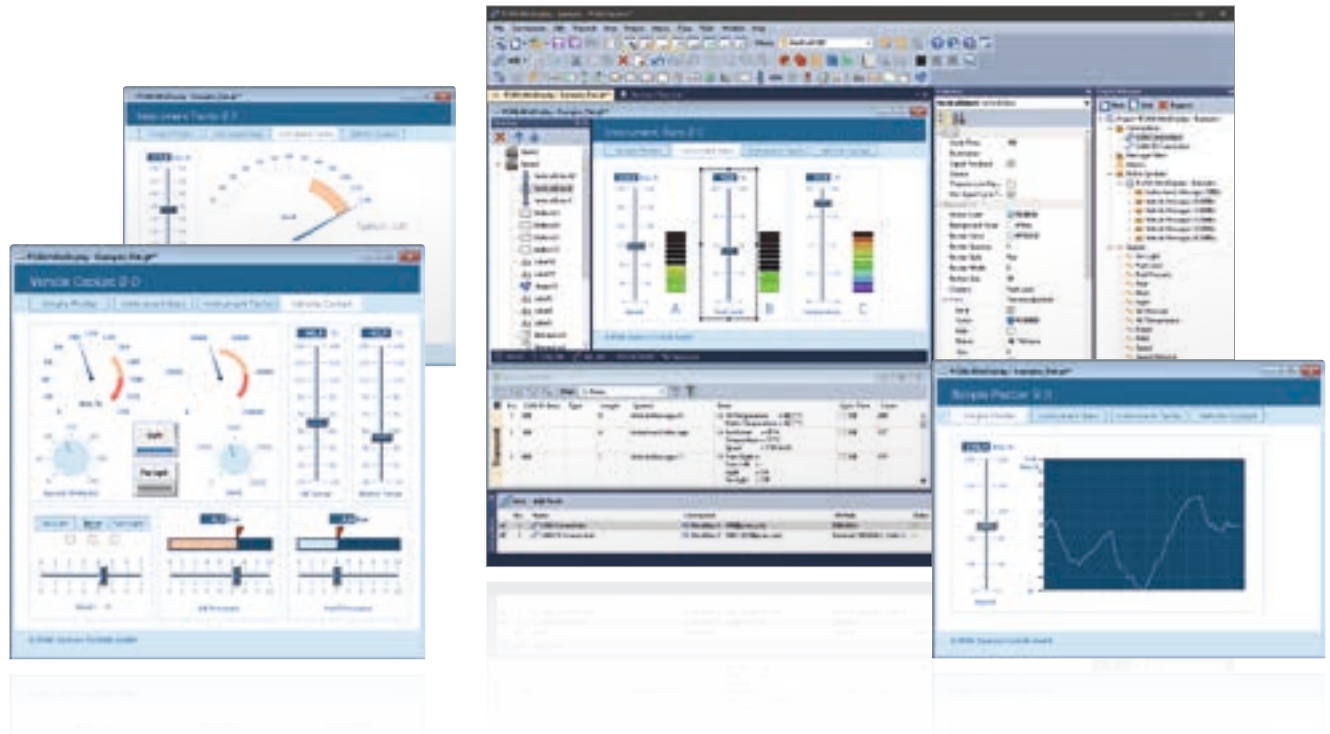

The Instruments Panel Add-in allows the graphical representation of digital and analog signals using different display instruments. The integrated input options and controllers make it possible to also generate signals on the CAN bus, allowing easy simulation of complex CAN applications.

- ___ Signal-dependent display of image lists and scenes
- ___ Free positioning of the instruments using drag & drop, or numerical inputs for spot-on positioning
- ___ Loading and storing of complete panel configurations

Features

- ___ Representation of analog and digital signals from received CAN messages using different display instruments
- ___ In addition to potentiometers, switches, and sliding controllers, input fields can be used to generate CAN messages
- ___ New instruments like an analog 360° gauge and a shape element for displaying squares, rectangles, circles, and ellipses
- ___ Selection and configuration of multiple elements at the same time
- ___ Extensive configuration of the properties of one or more elements using the property window
- ___ The Instruments Panel object model enables complete automation using COM and scripts
- ___ Representation of different scenes on the same panel during runtime

Ordering information

Designation	Part No.
Instruments Panel Add-in 6	IPES-006088

Scope of supply

- ___ Installations files for Instruments Panel Add-in
- ___ Single computer license or portable license with USB copy protection dongle
- ___ Documentation in HTML help format

System requirements

- ___ PCAN-Explorer 6
- ___ Windows 11 (x64/ARM64), 10 (x86/x64)
- ___ Free USB port for installation stick and copy protection dongle

Note: Software delivery on USB stick. Alternative installation media or download on request.

J1939 Add-in

Optional Function Upgrade for the PCAN-Explorer

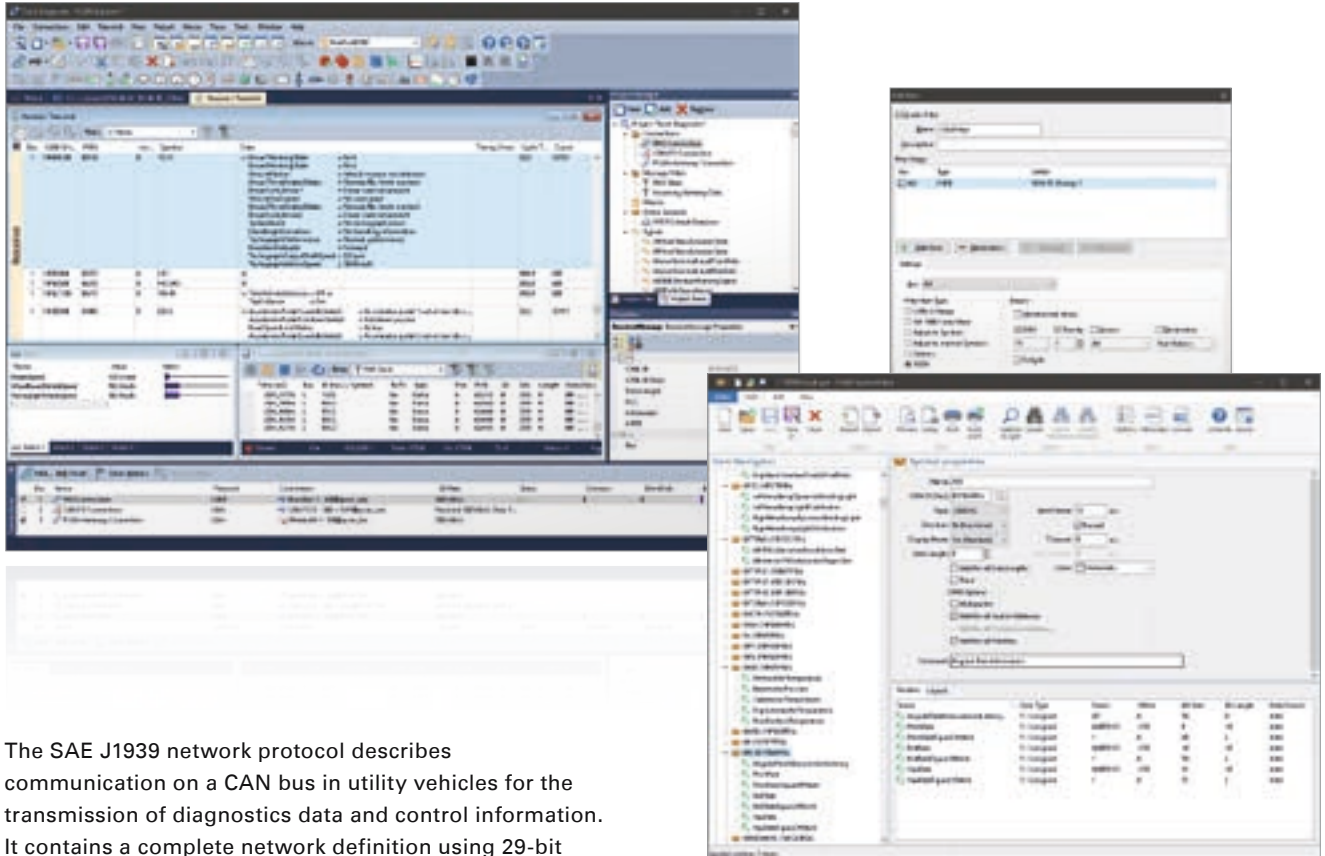

The SAE J1939 network protocol describes communication on a CAN bus in utility vehicles for the transmission of diagnostics data and control information. It contains a complete network definition using 29-bit CAN IDs (CAN 2.0B Extended Frame).

The J1939 Add-in for PCAN-Explorer supports all definitions established by the standard's parameter groups and provides a simple means of accessing the parameters. A database with all the definitions and parameters contained is also supplied.

Note: The database may only be used with the PCAN-Explorer and J1939 Add-in.

Features

- Support of the SAE J1939 network protocol (the SAE J1939-22 extension for CAN FD is currently not supported)
- SAE J1939 database with all the definitions and parameters
- CAN messages can be sent in broadcast form or targeted to individual control units (ECUs)
- Addressing of up to 254 ECUs
- Supports multi-packet messages
- Monitor window for displaying and requesting J1939 Diagnostic Trouble Codes (DTCs)

Ordering information

Designation	Part No.
J1939 Add-in 6	IPES-006089

Scope of supply

- Installations files for J1939 Add-in
- Single computer license or portable license with USB copy protection dongle
- Documentation in HTML help format

System requirements

- PCAN-Explorer 6
- Windows 11 (x64/ARM64), 10 (x86/x64)
- Free USB port for installation stick and copy protection dongle

Note: Software delivery on USB stick. Alternative installation media or download on request.

PCAN-Symbol Editor

Windows Software for Creating and Editing Symbol Files

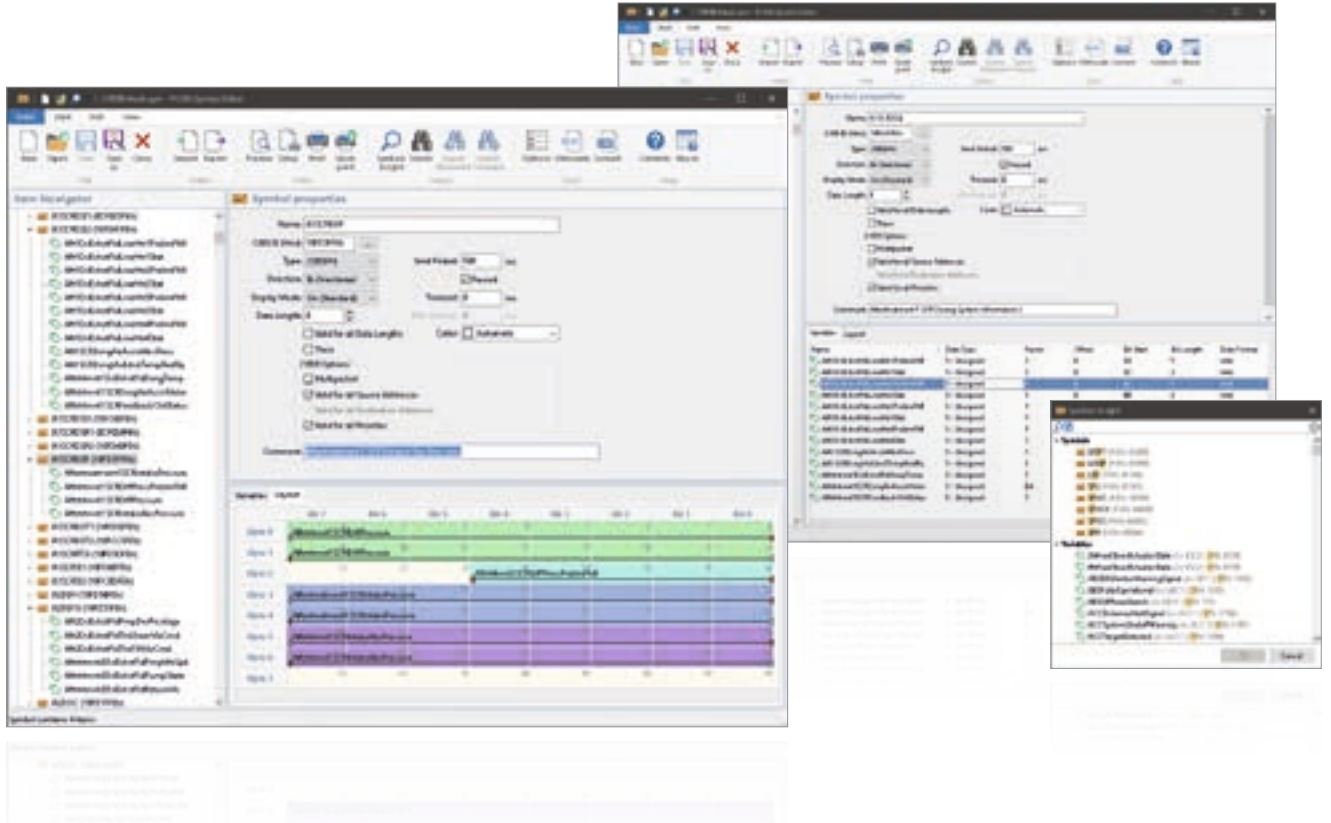

The symbol format developed by PEAK-System translates the hexadecimal display used for CAN data traffic into a format that the user can understand.

To create a symbol, names are first assigned to the individual CAN IDs. The interpretation and presentation of CAN data is defined using variables with various parameters, such as name and output format. The symbol created in this manner enables easy allocation of incoming and outgoing CAN messages and ensures that the CAN data is readable.

The free PCAN-Symbol Editor uses clearly structured menus and a graphical representation of symbols to enable convenient creation and editing of Symbol files.

Features

- ___ Symbolic representation of CAN messages through the assigning of alphanumeric names
- ___ Bit-exact division of the data into variables for assigning name, data type, list of values, scaling, offset, etc.
- ___ Support for CAN specifications 2.0 A/B and FD
- ___ Supports data processing in accordance with IEEE 754 as well as the Intel and Motorola format
- ___ Set up user-defined outputs using lists of values (Enums)
- ___ Application of different definitions for the data output of a symbol by using a multiplexer
- ___ Allows the creation of signals in Symbol files
- ___ With a signal, the representation of CAN data can be defined and used for multiple symbols
- ___ The graphic representation of symbols and the automatic error detection allow easy creation of Symbol files
- ___ Revised user interface with Quick Start function and dynamic text search for symbols, signals, menu commands, recently opened files, etc.
- ___ The Item Navigator and the search function allow targeted access to all elements of the Symbol files

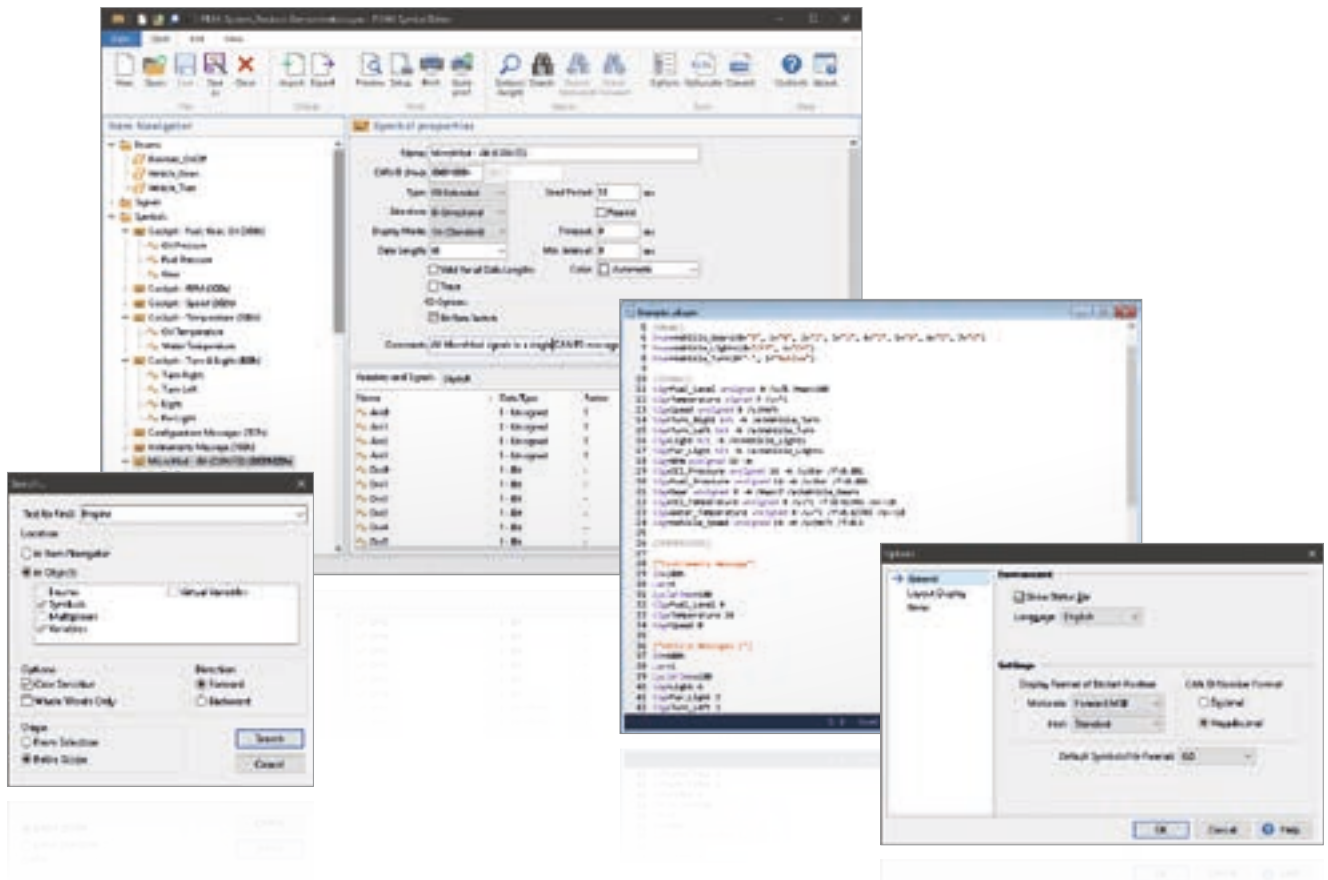

- ___ Function to convert Symbol files between file formats
- ___ Create virtual variables for CAN-independent inputs and outputs and macro calculations (in conjunction with PCAN-Explorer only)
- ___ Import CANdb files into the symbol data format and vice versa (requires the PCAN-Explorer and the add-In CANdb Import)
- ___ Supports symbols for J1939 message formats (requires the PCAN-Explorer and the add-In J1939)

Ordering information

Designation

PCAN-Symbol Editor

Scope of supply

- ___ PCAN-Symbol Editor software
- ___ Documentation in HTML Help format

The current version ...

... can be downloaded from the Internet free of charge at www.peak-system.com

System requirements

- ___ Windows 11 (x64/ARM64), 10 (x86/x64)

PCAN-FMS Simulator 2

Windows Software for Simulating CAN Data According to the FMS Standard

The protocols FMS (Fleet Management System) and Bus-FMS provide a manufacturer-independent interface for reading vehicle-specific CAN data on heavy commercial vehicles and buses. The extensive and continually growing support of leading commercial vehicle and bus manufacturers allows cross-market telematics applications to be implemented.

For these types of developments, the PCAN-FMS Simulator 2 application made by PEAK-System provides the simulation of both standards in a single software application with an easy-to-use graphical user interface.



Features

- ___ Support of the standards:
 - ▀ FMS 01.00, 02.00, 03.00, and 04.00 (Truck FMS)
 - ▀ Bus-FMS 00.01, 00.02, 00.03, and 00.04
- ___ Activate and deactivate the different standards in the program
- ___ Manual simulation of CAN data at FMS input. Optional switchable automatic calculation for various signal values, such as fill level
- ___ Feed-in of CAN data using PCAN hardware at FMS input
- ___ Reproduction of trace files or a user-defined period of a trace file at the FMS input. A loop function can be used optionally
- ___ Possibility of simulating error statuses
- ___ Disconnection and connection of specific CAN messages
- ___ Graphic representation of FMS data with analog and digital instruments in a virtual cockpit with full-screen function
- ___ Configurable colored sections on the analog instruments
- ___ ISO-7000-compliant symbolic display of status signal values
- ___ FMS data output possible using a PEAK CAN interface
- ___ Recording of CAN messages in trace files
- ___ Recording of FMS data as CSV log files, for instance for further processing in Excel
- ___ Loading and saving of the entire simulation environment in project files (forward and backward compatibility with version 1 of the PCAN-FMS Simulator)

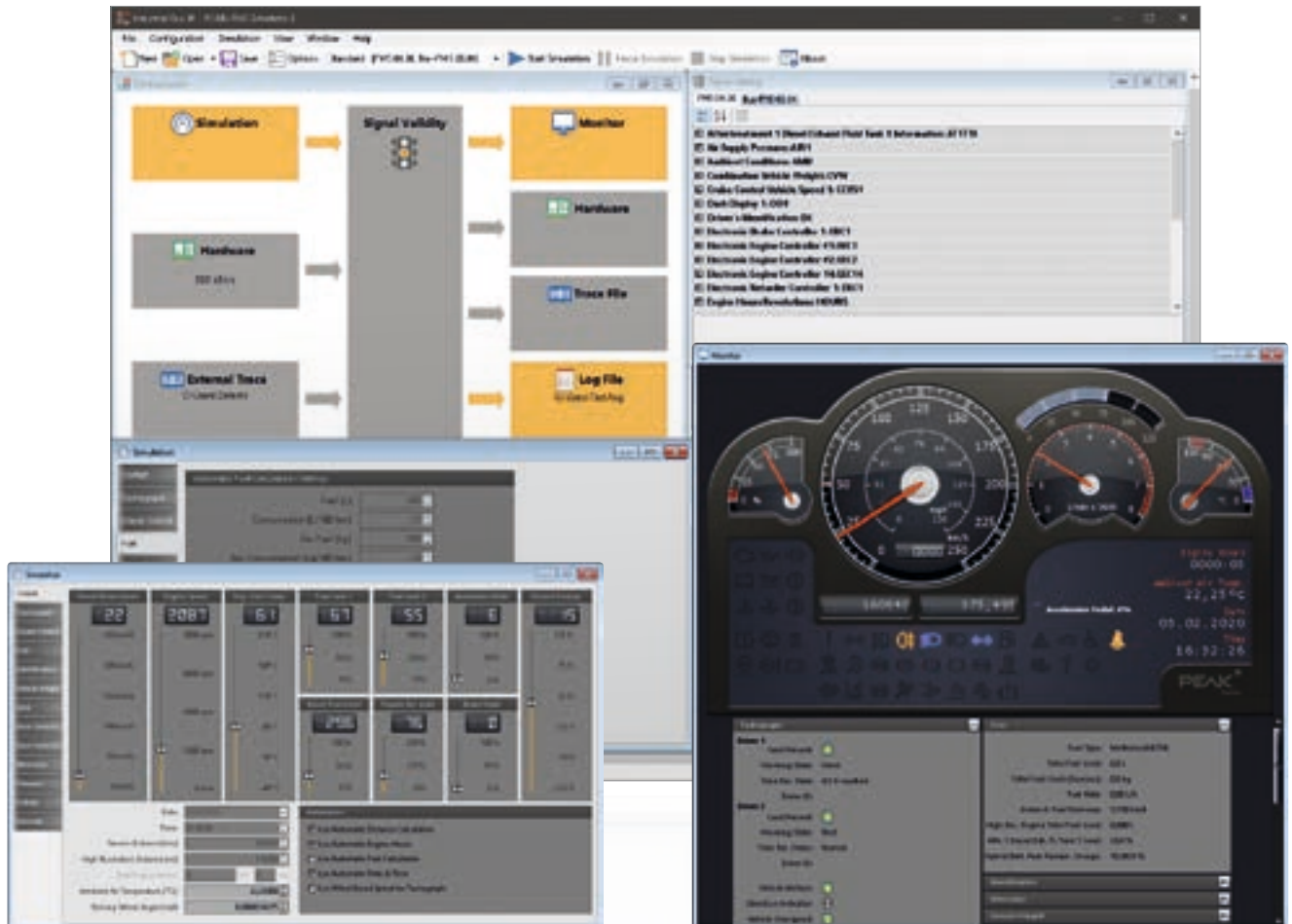

Beginning with version 2.5, specially pre-configured projects can be opened by the Tour Starter or directly with desktop icons. This mode doesn't require further settings. The display of the instruments is set to full-screen mode and the tour recording can be started. Besides the recording of trace and log data, additional information is collected for later analysis, like fuel consumption and average speed.

Features of the Tour mode:

- Starting of specially pre-configured projects via the Tour Starter or desktop icons for recurring analysis and monitoring purposes
- Recording of additional driving data, like fuel consumption and average speed
- Archiving Tour-specific records and driving data

Ordering information

Designation	Part No.
PCAN-FMS Simulator 2	IPES-002050

Scope of supply

- Installations files for PCAN-FMS Simulator 2
- Portable license with USB copy protection dongle
- Documentation in HTML Help format (English and German)

System requirements

- Windows 11 (x64/ARM64), 10 (x86/x64)
- Microsoft .NET Framework 2.0
- Free USB port for installation stick and copy protection dongle
- For the CAN bus connection:
PC CAN interface from PEAK-System

Note: Software delivery on USB stick. Alternative installation media or download on request.

PCAN-Trace

Comprehensive Data Logger for CAN Messages

The PCAN-Trace program is a data logger for up to 9,999,000 CAN messages. It enables CAN messages to be quickly recorded, saved, and even played back on the CAN bus. The program displays the number of received messages and identifies the types of the messages (data frame, error frame, RTR frame).

CAN messages can be recorded or replayed in linear or ring buffer mode. PCAN-Trace also provides an option to play back CAN messages in single step mode. You can also simplify analysis and tracing by setting playback mode breakpoints.

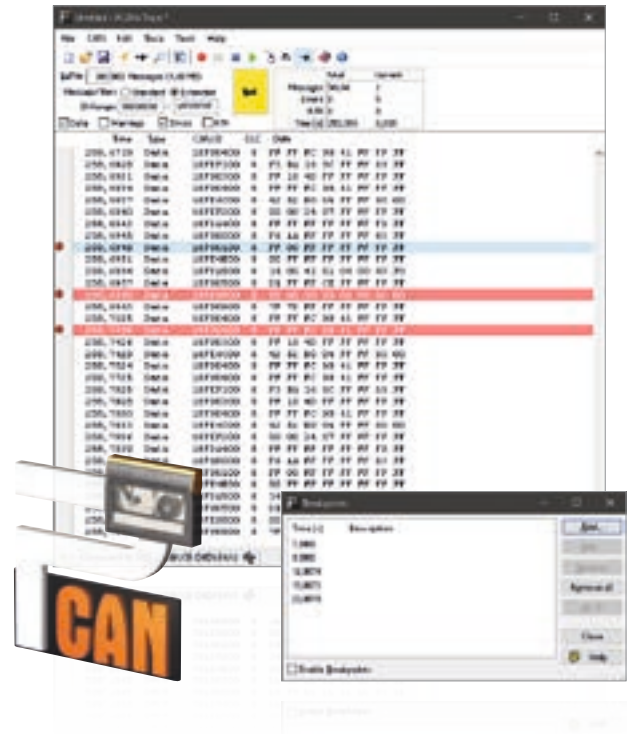

Features

- Log facility for up to 9,999,000 CAN messages
- Choice of linear buffer or ring buffer (in receive and playback mode)
- Displays number and type of received CAN messages
- Adjustable message filter
- Support for 11-bit and 29-bit IDs
- Facility to play back CAN messages that have been recorded using PCAN-Explorer or PCAN-View, even in single-step mode
- Playback of selected areas of a CAN message record
- Breakpoints can be used in playback mode
- Received data can also be viewed in a text editor
- Control of the software via the command line

Ordering information

Designation	Part No.
PCAN-Trace	IPES-002027

Scope of supply

- Installations files for PCAN-Trace
- Single user license
- Documentation in HTML help format

System requirements

- Windows 11 (x64/ARM64), 10 (x86/x64)
- USB port for installation stick
- For the CAN bus connection:
PC CAN interface from PEAK-System

Note: Software delivery on USB stick. Alternative installation media or download on request.

Accessories

Adapters

Cables

- Helpful CAN accessories
- Ideal for test layouts and small batches
- PC adapter cards for PC/104 Small Form Factor Boards
- CAN cables and adapters for various applications
- Special manufacture possible at any time

Adapters

Test Interfaces for PC/104 and PC/104-Plus Cards

These adapters can be used to fit and operate PC/104 cards in PCs with ISA slots and PC/104-Plus cards in PCs with PCI slots. Multiple cards can be stacked together on a single adapter.



ISA-PC/104 Adapter

There are screw terminal adapters which allow the different power supply voltages (+5 V, -5 V, +12 V, -12 V) to be accessed on the card. Four control LEDs show the relevant status. A stack-through connector is provided for the PC/104 bus.

Specifications

- Two-layer board with gold plated ISA contacts
- PC voltages may be tapped into using screw terminals
- LED status display
- PC/104 contacts fed out on bottom side



PCI-PC/104-Plus Adapter

Specifications

- Two-layer board with gold-plated PCI contacts

Ordering information

Designation	Part No.
ISA-PC/104 Adapter	IPEH-002078
PCI-PC/104-Plus Adapter	IPEH-003028-XL

PCI-Express-PCIe/104 Adapter

Test Interface for PCIe/104 Cards

This adapter allows you to insert and operate a PCI/104 Express card in PCs with PCI Express slot.

The adapter has its own internal voltage controller which generates the 5 Volt supply for the PCI/104-Express card from the 12 Volts from the PC PCI Express slot. As an option, the 5 Volt supply can be connected directly via the HD connection. All supply voltages are visualized by LEDs and can be separated with jumpers in order to do current measurement.



Specifications

- 4-layer board with gold-plated PCIe contacts
- Internal 5 Volt voltage regulator
- Molex PC HD connector for external 5 Volt supply
- LED power supply indication
- Jumpers to do current measurement for the supply voltages (3.3 V, 5 V, and 12 V)

Ordering information

Designation	Part No.
PCI-Express-PCIe/104 Adapter	IPEH-003033

PCIe-miniPCle Low-Profile Adapter

PCI Express Low-Profile Adapter for PCI Express Mini Cards

With the help of the PCIe-miniPCle Low-Profile adapter, you can operate PCI Express Mini and Half PCI Express Mini cards in a computer with low-profile housing. Two spacers on the plug-in card can be appropriately positioned to attach the card in place. The adapter includes a Mini-USB socket, a Micro-SIM card holder, as well as a voltage supply of 1.5 V and 3.3 V for plugged PCI Express Mini cards.

In addition to the PCAN-miniPCle from PEAK-System, USB solutions as well as cards for wireless communications such as WLAN, WWAN, and WPAN can be operated via the adapter.



Specifications

- Low-Profile form factor
- 4-layer board with gold-plated connectors
- PC plug-in card (PCIe x1) for the PCI Express slot
- Suitable for operation of USB solutions and add-in cards for wireless communication:
 - WWAN (Wireless Wide Area Network, e.g., UMTS & GSM)
 - WLAN (Wireless Local Area Network)
 - WPAN (Wireless Personal Area Network, e.g., Bluetooth)
- Status LEDs for power supply and state of communication add-in cards
- Mini-USB socket for operation of USB solutions
- Micro-SIM card holder for operation of UMTS and GSM cards
- Supply voltage of the adapter of 3.3 V
- Supply voltage of 1.5 V and 3.3 V for plugged PCI Express Mini cards
- Screw fixings for PCI Express Mini and Half PCI Express Mini cards
- Extended operating temperature range from -40 to +85 °C (-40 to +185 °F)

Ordering information

Designation	Part No.
PCIe-miniPCle Low-Profile Adapter	IPEH-003029

Scope of supply

- PCIe-miniPCle Low-Profile Adapter with mounted D-Sub slot bracket incl. connection cable
- Manual in PDF format

PCIe-M.2 Low-Profile Adapter

PCI Express Low-Profile Adapter for M.2 Cards

The PCIe-M.2 Low-Profile adapter allows the use of a plug-in card of the M.2 type in a PC with a low-profile housing. The adapter card is primarily designed for operation with the CAN interface PCAN-M.2. Besides the regular D-Sub connection cables of the PCAN-M.2, the connection of up to four CAN channels can be done via pin connectors or solder connections. In addition, each CAN connection is equipped with an activatable split termination.



Specifications

- Low-Profile form factor
- PC plug-in card (PCIe x1) for the PCI Express slot
- Screw fixing for a card of the type M.2 (2260/M-Key)
- CAN connection optionally via
 - D-Sub connection cable of the PCAN-M.2
 - Pin connector, 10-pin
 - Solder connectors
- CAN termination can be activated through solder jumpers, separately for each CAN channel
- Status LED for power supply
- Supply voltage of the adapter of 3.3 V
- Extended operating temperature range from -40 to +85 °C (-40 to +185 °F)

Ordering information

Designation	Part No.
PCIe-M.2 Low-Profile Adapter	IPEH-003023

Scope of supply

- PCIe-M.2 Low-Profile Adapter with mounted slot bracket
- Manual in PDF format

PCAN-Adapter D-Sub for DR Products

D-Sub CAN Connector for Products in DIN Rail Housing

PEAK-System CAN hardware has a 4-pin screw terminal block as CAN connector for models in the DIN rail housing. The adapter provides a 9-pin D-Sub connector for the screw terminal pins. Thus, it is possible to use our standard CAN cables with these devices in DIN rail housing and connect them to our PC CAN interfaces.

The adapter can also be used for CAN FD buses.

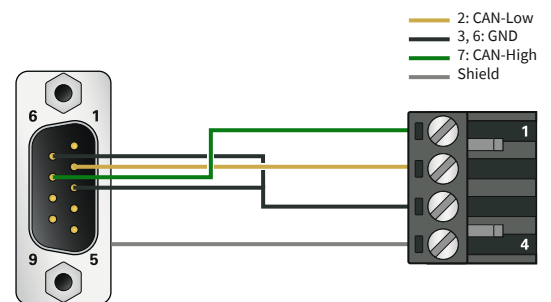

Specifications

- 4-pin screw terminal block (Phoenix) to 9-pin D-Sub connector (according to CiA® 106)
- Suitable for CAN connection adaptation of the products:
 - PCAN-Repeater DR
 - PCAN-Router DR
 - PCAN-Ethernet Gateway DR
 - PCAN-Ethernet Gateway FD DR
 - PCAN-Wireless Gateway DR
- No termination
- Suitable for the use in CAN FD buses

Ordering information

Designation	Part No.
PCAN-Adapter D-Sub for DR products	IPEK-003012

PCAN-Adapter D-Sub to Screw Terminals

D-Sub Adapter for Loose CAN Cable Ends

The adapter with a D-Sub socket connector and a three-pin screw terminal block allows easy connection of open cable ends of a CAN bus to a D-Sub connector. This allows customers to produce all conceivable connection variants themselves in a short time. Not only our PCAN products can thus be connected more flexibly to CAN buses.

The D-Sub socket is assigned according to CiA® 106. A CAN bus termination can be added by the customer using an SMD or wired resistor on prepared solder pads.

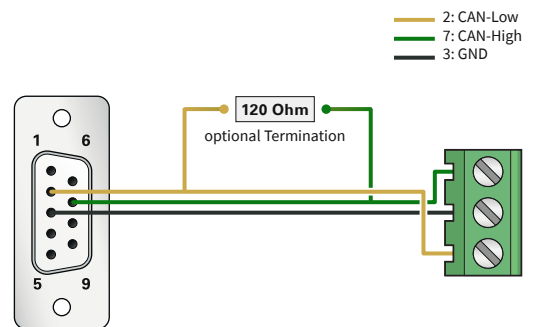

Specifications

- 3-pin screw terminal connector (Phoenix) to 9-pin D-Sub socket (according to CiA® 106)
- For connecting open cable ends
- Solder pads for SMD and wire for inserting a termination resistor

Ordering information

Designation	Part No.
PCAN-Adapter D-Sub to Screw Terminals	IPEK-003025

PCAN-Term

Termination Adapters for CAN and CAN FD

High-speed CAN buses (ISO 11898-2) must be terminated at their ends by resistors.

The adapters PCAN-Term and PCAN-MiniTerm are used if no CAN node or a CAN node without internal termination is connected at these points.

The termination adapters can also be used for CAN FD buses.



PCAN-Term Specifications

- CAN termination adapter in plastic casing
- 9-pin D-Sub socket to 9-pin D-Sub connector (in accordance with CiA® 106)
- With 120-Ohm termination resistor between CAN_L and CAN_H
- Suitable for the use in CAN FD buses

PCAN-MiniTerm Specifications

- CAN termination adapter in molded body
- 9-pin D-Sub socket to 9-pin D-Sub connector (in accordance with CiA® 106)
- All pins are connected 1 to 1
- With 120-Ohm termination resistor between CAN_L and CAN_H
- Suitable for the use in CAN FD buses

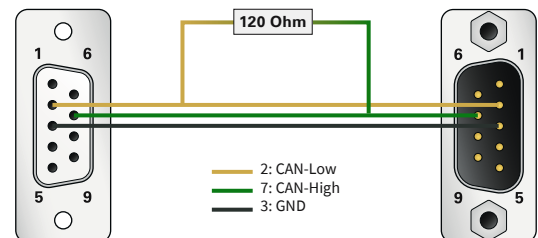

Ordering information

Designation	Part No.
PCAN-Term	IPEK-003002
PCAN-MiniTerm	IPEK-003002-Mini

PCAN-T-Adapter

T-Adapters for a Tap Connection on to a CAN or CAN FD Bus

The PCAN-T-Adapter and PCAN-Mini-T-Adapter create a tap connection to the data cables and the ground within a CAN bus in order to be able to connect a further CAN node. In this case, the CAN node is not terminated.

The adapters can also be used for CAN FD buses.



PCAN-T-Adapter

Specifications

- Adapter in plastic casing
- 9-pin D-Sub socket to 9-pin D-Sub connector and D-Sub socket (in accordance with CiA® 106)
- CAN tap length about 20 cm (the cable color may vary)
- No termination
- Suitable for the use in CAN FD buses

PCAN-Mini-T-Adapter

Specifications

- Adapter in molded body
- 9-pin D-Sub socket to 9-pin D-Sub connector and D-Sub socket (in accordance with CiA® 106)
- CAN tap length about 20 cm
- No termination
- Suitable for the use in CAN FD buses

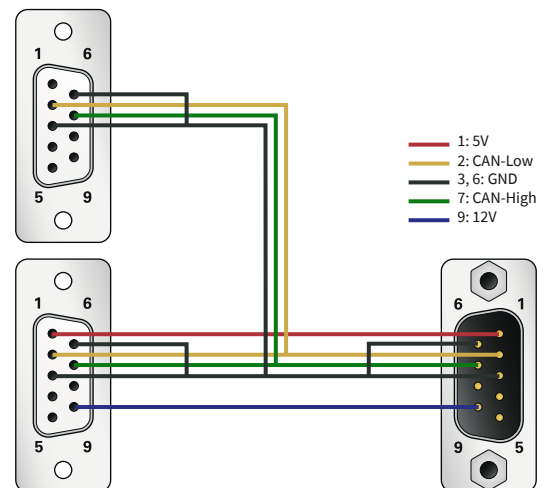

Ordering information

Designation	Part No.
PCAN-T-Adapter	IPEK-003003
PCAN-Mini-T-Adapter	IPEK-003003-Mini

PEAK-DevPack Debug Adapter

JTAG Connection Adapter for Debugging Programmable PCAN Hardware

The PEAK-DevPack Debug Adapter allows the uncomplicated connection of a hardware debugger to different ARM-based, programmable hardware products from PEAK-System. For this purpose, the adapter has different connectors to connect the hardware debugger to specific JTAG connectors of the hardware to be programmed.



Specifications

- Adapter for connecting a hardware debugger to the JTAG connector of a PCAN hardware
- Supported PCAN hardware products:
 - PCAN-Router Pro FD IPEH-002220 / IPEH-002222
 - PCAN-Router FD IPEH-002214 / IPEH-002215
 - PCAN-MicroMod FD IPEH-003080
 - PCAN-GPS IPEH-002110
 - PCAN-GPS FD IPEH-003110
- Reset button for restarting the PCAN hardware to be programmed

Ordering information

Designation	Part No.
PEAK-DevPack Debug Adapter	IPEK-003026

Scope of supply

- PEAK-DevPack Debug Adapter
- Ribbon cables
 - 1 x 20 pin with 1.27 mm grid spacing
 - 1 x 10 pin with 2 mm grid spacing
- Manual in PDF format

PCAN-Cable 1 & 2

Connection Cable for CAN and CAN FD

These cables are needed to set up a CAN bus and are specially designed to be used in a CAN environment. If two High-speed CAN hubs need a simple direct connection between them, the PCAN-Cable 2 with integrated termination can be used. The PCAN-Cable 1 is suitable for putting together a CAN bus which shall contain tap connections and separate termination (PCAN-T-Adapter and PCAN-Term products).

The cables can also be used for CAN FD buses.

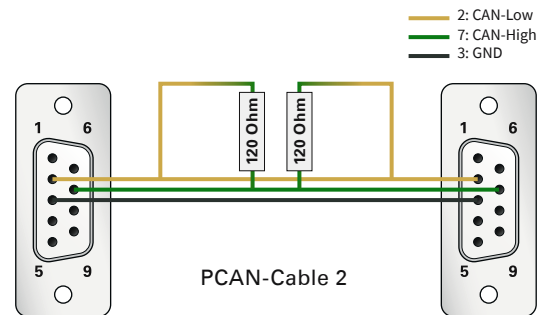
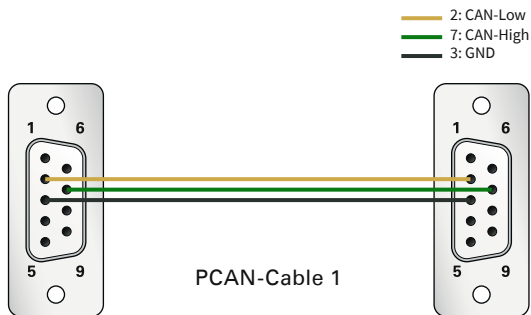

Specifications

- ___ 9-pin D-Sub sockets (in accordance with CiA® 106) at both ends
- ___ Length 2.0 m
- ___ Shield connected to GND
- ___ PCAN-Cable 1 without termination resistors
- ___ PCAN-Cable 2 with 120-Ohm termination resistors
- ___ Suitable for the use in CAN FD buses

Ordering information

Designation	Part No.
PCAN-Cable 1	IPEK-003000
PCAN-Cable 2	IPEK-003001

Other lengths and special cable makeup on request.

PCAN-Cable 3

CAN and CAN FD Cable for Test and Measurement Setups

With this cable the two components CAN-High and CAN-Low of the differential CAN signal can be picked up from a CAN bus or directly from a CAN interface. An easy connection to test and measurement setups is accomplished by the banana plugs.

The PCAN-Cable 3 can also be used for CAN FD buses.

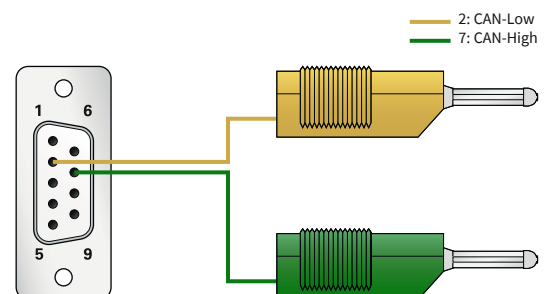

Specifications

- ___ 9-pin D-Sub socket (in accordance with CiA® 106) to banana plugs (4 mm) for picking up the signals CAN-High and CAN-Low
- ___ Without termination resistors
- ___ Length 2.0 m
- ___ Suitable for the use in CAN FD buses

Ordering information

Designation	Part No.
PCAN-Cable 3	IPEK-003011

Other lengths and special cable makeup on request.

PCAN-Cable OBD-2

CAN-OBD-2 Diagnostics Cable

Many modern motor vehicles have an OBD-2 interface for connecting various diagnostics and testing tools. This adapter cable can be used to access the contained CAN lines.



Specifications

- ___ 9-pin D-Sub socket (in accordance with CiA® 106)
- ___ OBD-2 connector – assigned for CAN only on:
 - Pin 6: CAN-High (J-2284)
 - Pin 14: CAN-Low (J-2284)
- ___ Length 1.0 m
- ___ Without termination resistors
- ___ All OBD-2 pins are mounted in the plug and can be assigned as desired

Ordering information

Designation	Part No.
PCAN-Cable OBD-2	IPEK-003004

Other lengths and special cable makeup on request.

PCAN-Cable J1939

CAN-J1939 Adapter Cables

The SAE J1939 protocol establishes consistent CAN messages for the communication and diagnosis between components of heavy-duty vehicles such as construction machinery, tractors, and agricultural machines. In this area, robust DEUTSCH connectors are often used for on-board diagnostics connection.

The PCAN-Cables J1939 route the CAN lines of the DEUTSCH connectors to D-Sub sockets and thus allow access via PEAK CAN interfaces.



Pin assignment DEUTSCH Type 1

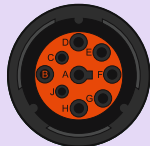

C: CAN 1-High
D: CAN 1-Low
E: CAN-Shield
H: CAN 2-High (only IPEK-003014)
J: CAN 2-Low (only IPEK-003014)

Pin assignment DEUTSCH Type 2

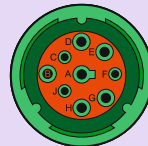

C: CAN 1-High
D: CAN 1-Low
E: CAN-Shield
H: CAN 2-High (only IPEK-003015)
J: CAN 2-Low (only IPEK-003015)

Pin assignment D-Sub



2: CAN-Low
3: CAN-Shield
7: CAN-High

Specifications

- ___ 9-pin D-Sub socket (in accordance with CiA® 106) to 9-pole DEUTSCH connector of the HD series (J1939 type 1 and 2)
- ___ Length 1.0 m
- ___ Without termination resistor

Ordering information

Designation	Part No.
PCAN-Cable J1939 Type 1 DEUTSCH-connector to D-Sub	IPEK-003009
PCAN-Cable J1939 Type 1 DEUTSCH-connector to 2 x D-Sub	IPEK-003014
PCAN-Cable J1939 Type 2 DEUTSCH-connector to D-Sub	IPEK-003019
PCAN-Cable J1939 Type 2 DEUTSCH-connector to 2 x D-Sub	IPEK-003015

Other lengths and special cable makeup on request.

PCAN-Cable M12

CAN Adapter Cable from D-Sub Socket to M12 Circular Connector

M12 circular connectors are robust and offer increased protection against environmental influences. They have thus established as a connection option to CAN buses for challenging operating conditions.

The standard NMEA 2000® from the National Marine Electronics Association specifies a manufacturer-independent communication via CAN on boats and ships and implies the use of certain M12 connectors.

The PCAN-Cable M12 routes the CAN lines of the D-Sub socket to an M12 circular connector. Additional lines for Shield and power supply were added according to the NMEA 2000® specification. This enables access with PEAK CAN interfaces.



Pin assignment D-Sub



1	Not connected
2	CAN-L / NET-L
3	GND / NET-C
4	Not connected
5	Not connected
6	Shield
7	CAN-H / NET-H
8	Not connected
9	V _{BAT} +12 V / NET-S

Pin assignment M12

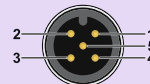

1	Shield
2	V _{BAT} +12 V / NET-S
3	GND / NET-C
4	CAN-H / NET-H
5	CAN-L / NET-L

Specifications

- 9-pin D-Sub socket to 5-pin M12 circular connector (in accordance with CiA® 106 and NMEA 2000®)
- Length 1.0 m
- Without termination resistor
- Suitable for the use in CAN FD buses
- Suitable for NMEA 2000® connection and power supply

Ordering information

Designation	Part No.
PCAN-Cable M12	IPEK-003016

Other lengths and special cable makeup on request.

LIN Connection Cable for PC LIN Interfaces

Pre-configured Cable Set for PCAN-USB Pro FD and PLIN-USB

The PLIN-USB adapter is connected to the LIN bus via D-Sub. On the adapters PCAN-USB Pro FD and PCAN-USB Pro, the two field buses CAN and LIN are connected together via a D-Sub plug. However, a separate access to the LIN components is necessary.

The LIN Connection Cable for PC LIN Interfaces allows the tapping of individual lines. The LIN and the supply lines are lead directly out to separate plugs and the CAN lines are forwarded to a D-Sub plug.

The connection cable can be used without problems for CAN FD buses.

Please note: The LIN Connection Cable for PC LIN Interfaces is not suitable for use with the PCAN-LIN module.

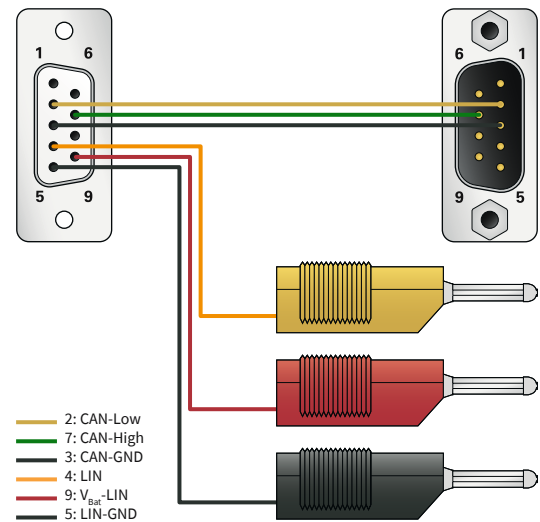

Specifications

- ___ Pre-configured cable set for PCAN-USB Pro FD, PCAN-USB Pro, and PLIN-USB
- ___ Split-up of the lines from the CAN/LIN connector to:
 - CAN (D-Sub plug, 9-pin)
 - LIN (banana plug, 4 mm)
 - Power supply for LIN (banana plugs, 4 mm)
- ___ Length about 0.75 m
- ___ Without terminating resistor
- ___ Suitable for the use in CAN FD buses

Ordering information

Designation	Part No.
LIN Connection Cable for PC LIN Interfaces	IPEK-003013

Other lengths and special cable makeup on request.

LIN Connection Cable for PCAN-LIN

Pre-configured Cable Set for the PCAN-LIN Module

On the PCAN-LIN module, the field buses and the power supply are connected together via a D-Sub plug. However, for some applications a separate access to the LIN components is necessary.

The LIN connection cable for PCAN-LIN allows the tapping of individual lines. The LIN and the supply lines are lead directly out to separate plugs and the CAN lines are forwarded to a D-Sub plug.

The connection cable can be used without problems for CAN FD buses.

Please note: The LIN connection cable for PCAN-LIN is not suitable for use with our PC LIN interfaces.

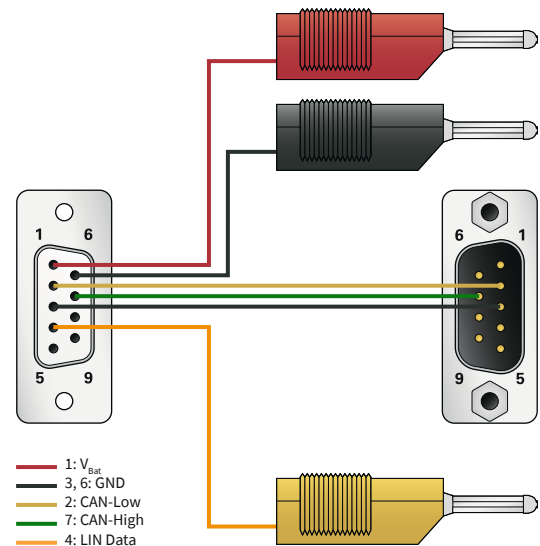

Specifications

- ___ Pre-configured cable set for PCAN-LIN
- ___ Split-up of the lines from the CAN/LIN connector to:
 - CAN (D-Sub plug, 9-pin)
 - LIN (banana plug, 4 mm)
 - Power supply for LIN (banana plugs, 4 mm)
- ___ Length about 1.00 m
- ___ Without terminating resistor
- ___ Suitable for the use in CAN FD buses

Ordering information

Designation	Part No.
LIN Connection Cable for PCAN-LIN	IPEK-003008

Other lengths and special cable makeup on request.

PEAK-System

Contact

PEAK-System Technik GmbH

Germany, Austria & Switzerland



Head Office Darmstadt
Otto-Roehm-Str. 69, 64293 Darmstadt
Germany

Phone: +49 6151 8173-20
Fax: +49 6151 8173-29
E-mail: info@peak-system.com
Website: www.peak-system.com

PEAK-System S.A.R.L.

France



132, rue André Bisiaux, bâtiment C 2ème étage
54320 Maxeville
France

Phone: +33 (0)3.83.54.15.20
Fax: +33 (0)3.83.54.15.21
E-mail: france@peak-system.com
Website: www.peak-system.com

World Wide Web

www.peak-system.com

Visit our website. By offering a clear structure and numerous user-friendly functions, we would like to invite you to an informative and enjoyable visit.

- Our News keeps you informed about the latest product releases, software updates, and beta tests
- Use our convenient online shop for your orders
- The recent versions of our free applications, device drivers, APIs, and documentations are available on our Downloads web page
- The latest versions of our product catalog and in our price list are provided in PDF format
- Visit our Linux website for the latest Linux device drivers, documentation, change history, and additional information

- The Support section contains an overview of the current versions of our software products, drivers, and APIs, along with change histories
- Find a complete list of our international sales partners in the Contact section



We are looking forward to your visit.

Forum

With our forum, we give you another way to get in touch with us. Questions are answered in a short term by our support or sometimes directly by our hardware and software developers.

The information and experience accumulated in this way is available to all customers without registration.



www.peak-system.com

RSS Feed

Subscribe to our RSS feed to stay automatically informed. News about product releases as well as software, API, and driver updates are published regularly.



Forum

YouTube

On our YouTube channel, we demonstrate how to use our products in easy videos. In particular, the first steps with our software or with complex configurations can be reproduced comfortably in this way.



RSS Feed



YouTube



Facebook



International Sales Partners

Embedded Logic Solutions Pty Ltd Australia & New Zealand

5/23 Hunt Street
North Parramatta NSW 2151
Australia
(PO Box 1078, 2124 Parramatta NSW)

Phone: +61 2 9687 1880
Fax: +61 2 9687 1881
E-mail: sales@emlogic.com.au
Website: www.emlogic.com.au



Alcom Electronics NV/SA Belgium & Luxembourg

Singel 3
B-2550 Kontich
Belgium

Phone: +32 3 458 3033
Fax: +32 3 458 3126
E-mail: info@alcom.be
Website: www.alcom.be



HongKe Technology Co., Ltd China

Floor 1-7, Building T6, PCI Park,
No. 30 Kaitai Avenue, Huangpu District,
Guangzhou, China

Free Hotline: +86-400 999 3848
Phone: +86-3874 4528/3030/3032
Fax: +86-20 3874 3233
E-mail: sales@hkaco.com
Website: www.hkaco.com

Mobile/WeChat 微信:
Industrial 工业: +86-136 0005 3493
Automotive 汽车: +86-135 1276 7172



EHL elektronika s.r.o. Czech Republic & Slovakia

Cistá 9, 294 23 Cistá,
Czech Republic

Phone: +420 326 303010
E-mail: ehl@ehl.cz
Website: www.ehl.cz



Nohau Danmark A/S Denmark

Hørkær 26, Plan 4,
DK-2730 Herlev,
Denmark

Phone: +45 44 52 16 50
Fax: +45 44 52 16 55
E-mail: sales@nohau.dk
Website: www.nohau.dk



Nohau Finland Finland, Estonia, Latvia & Lithuania

Tekniikantie 14,
01250 Espoo,
Finland

Mobile: +358 9 58 400 004
E-mail: sales@nohau.fi
Website: www.nohau.fi



HongKe Technology Co., Ltd Hong Kong

Room 803 8/F, Easey Commercial Building,
253-261 Hennessy Road, Wanchai,
HongKong

Phone: +86-18144837056
E-mail: sales@hkaco.com



Embedded Systems Solutions Pvt Ltd India

#37, Embedded Home, 36th Cross,
II Block, Rajajinagar,
Bangalore-560010, India

Phone: +91-80-67648831; 67648836
Mobile: +91 98450 99700; 98450 55869
E-mail: sales@embeddedindia.com
Website: www.embeddedindia.com



Pertech Embedded Solutions Israel

13 Zarchin Street,
Raanana 43662,
Israel

Phone: +972 9 771 1418
Fax: +972 9 774 0131
E-mail: info@pertech.com
Website: www.pertech.com



Power On di Lorenzo Wohlgemuth Italy

Loc. Piera, 28/A,
38038 Tesero (TN),
Italy

Phone: +39 0462 341015
Fax: +39 0462 248393
E-mail: peak@poweron.it
Website: www.poweron.it



Gailogic Corporation Japan

Matsue Bldg 5F,
2-5-11 Kichijoji-Honcho, Musashino-shi,
Tokyo 180-0004, Japan

Phone: +81-422-26-8211
Fax: +81-422-26-8212
E-mail: sales@gailogic.co.jp
Website: www.gailogic.co.jp



Embedded Systems Korea Korea

Partners Tower I, RM 603 #83,
Gasan digital 1-ro, Geumcheon-gu,
Seoul 153-802 Korea

Phone: +82 2 856-8246
Fax: +82 2 867-8246
E-mail: esk@eskorea.net
Website: www.peak-system.kr



Alcom Electronics BV Netherlands

Alcom Electronics BV
Rivium 1e straat 52
2909LE Capelle aan den IJssel
The Netherlands

Phone: +31 10 288 2500
Fax: +31 10 288 2525
E-mail: info@alcom.nl
Website: www.alcom.nl



Nohau Solutions Norway Norway

Jørgen Nilsson
Sales Engineer

Phone: +46 (0)40 59 22 06
E-mail: jorgen.nilsson@nohau.se,
sales@nohau.no
Website: www.nohau.no



JANBIT, Andrzej Janiak Poland & Turkey

ul. Nerudy 11/58,
01-926 Warsaw,
Poland

Phone: +48 507 173 084
E-mail: janbit4@janbit.pl
Website: https://janbit.eu/en



**Scientec Technology Pte Ltd
Singapore**

46 Lorong 17 Geylang,
#06-01 Enterprise Industrial
Building, Singapore 388568

Phone: +65 6355 1813
Fax: +65 6355 1536
E-mail: info@scientec.com
Website: www.scientec.com

**Gopalam Embedded Systems Pte Ltd
Singapore, Malaysia & ASEAN**

2 Kallang Ave.,
09-21, CT Hub,
Singapore – 339407

Phone: +65 6295 1646
Mobile: +65 9184 7992, +65 9649 7444
E-mail: sales@EmbeddedSingapore.com
Website: www.EmbeddedSingapore.com

**Testech Electronics Pte Ltd
Singapore & Malaysia**

Blk 118, #05-110,
Aljunied Ave 2,
Singapore 380118

Phone: +65-67492162
Fax: +65-67494246
E-mail: sales3@testech-elect.com
Website: www.testech-elect.com

**LAWICEL AB
Sweden / Scandinavia**

Industrigatan 6, 2nd Floor,
SE-282 32 Tyringe,
Sweden

Phone: +46 451-59877
Fax: +46 451-59878
Website: www.lawicel-shop.se

**Nohau Solutions AB
Sweden**

Derbyvägen 6D,
SE-212 35 Malmö,
Sweden

Phone: +46 (0)40 59 22 00
E-mail: sales@nohau.se
Website: www.nohau.se

**Syslogic AG
Switzerland**

Täferstrasse 28,
5405 Baden-Dättwil,
Switzerland

Phone: +41 (0) 56 200 90 40
Fax: +41 (0) 56 200 90 50
E-mail: sales@syslogic.com
Website: www.syslogic.com

**Microport Computer Electronics Inc.
Taiwan**

No.143, Ln. 152, Sec. 1, Baoda Rd.,
Guiren Dist., Tainan City,
Tainan 71141, Taiwan

Phone: +886 6 330 3000
Fax: +886 6 330 2526
E-mail: inquiry.microport@gmail.com
Website: www.microport.com.tw

**Control Technologies UK Ltd
United Kingdom**

Unit 1, Stoke Mill, Mill Road, Sharnbrook,
MK44 1NN, England

Phone: +44 (0)1234 247 176
E-mail: info@controltech.uk.com
Website: www.controltech.uk.com

**Grid Connect Inc.
USA & Canada**

1630 W. Diehl Rd., Naperville,
Illinois 60563, USA

Phone: +1 630-245-1445
Fax: +1 630-245-1717
E-mail: sales@gridconnect.com
Website: www.gridconnect.com

Brazil & Mexico

Phone: +1 949 300 2131
E-mail: timh@gridconnect.com

**Phytools LLC
USA, Canada & Mexico**

900 Winslow Way E, Suite 120,
Bainbridge Island, WA 98110, USA

Phone: +1 206-451-4327
Fax: +1 206-451-4328
E-mail: sales@phytools.com
Website: www.phytools.com

**TULA Solution Co., Ltd
Vietnam**

No. 173 Group 15, Dong Anh District,
Hanoi (10000), Vietnam

Phone: +84-24.39655633
Fax: +84-24.39655633
E-mail: info@tula.vn
Website: www.tula.vn



Imprint

Copyright © 2024 PEAK-System Technik GmbH

Duplication (copying, printing, or other forms) and the electronic distribution of this document is only allowed with explicit permission of PEAK-System Technik GmbH. PEAK-System Technik GmbH reserves the right to change technical data without prior announcement. The general business conditions and the regulations of the license agreement apply. All rights are reserved.

Windows® and MS-DOS are registered trademarks of Microsoft Corporation in the United States and other countries. CANopen® and CiA® are registered trademarks of CAN in Automation e.V. All other product names can be trademarks or registered trademarks of their respective owners. They are not always explicitly indicated by „™“ or „®“.

The delivered hardware and software products may differ visually from images in this catalog.
No responsibility accepted for inaccuracies and specification changes.

So you are looking for successful products for tomorrow's markets? We translate your ideas into ready-to-manufacture products.

Hardware, software, and system solutions for many sectors including automotive, aircraft, machinery, and equipment building, consumer goods, etc.

Consultation, development, production management, documentation, and training.

You CAN get it ...

PEAK-System Technik GmbH

Otto-Roehm-Str. 69
64293 Darmstadt
Germany

Phone: + 49 6151 8173-20
Fax: + 49 6151 8173-29
E-mail: info@peak-system.com

Website: [**www.peak-system.com**](http://www.peak-system.com)