



QC SOLUTIONS FOR COATINGS
AND PLASTICS

2010/2011



We care.

The basis of our worldwide business is total customer satisfaction from start to end.

BYK-Gardner Customer Care Centers

One contact only to answer your question on the phone or by e-mail – you will get your response or support right away.



BYK-Gardner GmbH

Phone: +49-8171-3493-333

E-Mail: Lillian.Brus@altana.com

BYK-Gardner Italy

Phone: 800-787838 (from Italy only)

E-Mail:

Giuseppina.Merlo@altana.com



BYK-Gardner USA

Phone: 800-343-7721

301-483-6500

E-Mail:

Karen.Nance@altana.com



BYK-Gardner China

Phone: +86-21-3367-6331

E-Mail: Xin.Tang@altana.com



BYK-Gardner Spain

Phone: +34-93-784-15-90

E-Mail:

Carmen.Bernal@altana.com

BYK-Gardner Customer Service

Ordering made easy: place your order, track your shipment.



BYK-Gardner GmbH

Phone: +49-8171-3493-300

E-Mail:

Heiko.Schadt@altana.com



BYK-Gardner USA

Phone: 800-343-7721

301-483-6500

E-Mail:

Joyce.Rothgeb@altana.com



BYK-Gardner Brazil

Phone: +55-11-2147-1199

E-Mail:

Marco.Storel@altana.com

International Customers

If you are located outside of Germany, North America, China, Spain or Brazil please contact your local representative. Check our internet page for a complete worldwide listing:

www.byk.com/instruments

Always reachable.

Worldwide first-class
customer service
guaranteed before,
during and after the
sale.

www.byk.com/instruments

The complete source on-line – saving you time and money

You will find virtually everything you need for your coatings and plastics testing needs in the BYK-Gardner Instruments Catalog. The entire catalog is also available on-line:



Shop the Entire Catalog

- Every product in the catalog is on the website
- Search by specific ASTM and ISO Standards
- Search for pricing and place orders
- Download PDFs for any product



Find information

- Theoretical background on color, appearance and physical property testing
- Practical hints on measurement procedures
- Technical articles
- Trouble-shooting examples to optimize color and appearance harmony
- Frequently asked questions
- Sales and repair locations worldwide



Service Portal

- Download instrument manuals
- Download software updates
- Warranty registration and receive a free recertification
- Schedule repair or recertification



Technical and Application Support – worldwide

BYK-Gardner provides technical and application support around the world.

Our technical applications specialists are standing by to help with your question and problems – either over the phone or in person at your facility.

- Request a free test of your products in our labs
- Schedule a free visit at your facility to test one of our instruments on your actual samples.
- Get the answer you need immediately over the phone, including operations, repair or application questions

For telephone numbers please refer to page 4 or visit our website: www.byk.com/instruments

Application and Technical Seminars

BYK-Gardner offers theoretical seminars and hands-on training – all you need to know successfully work with BYK-Gardner instruments. We offer seminars at our representations worldwide. On request, we cater your seminar to match your needs at your site. Bring your own samples to the seminar and discuss your specific application with our trained experts.

For more information about BYK-Gardner seminars, please refer to page 4 or visit our website: www.byk.com/instruments



- BYK-Gardner Offices
- Exclusive Distributor Offices



Quality is our Business.

Innovative, reliable customer oriented products to objectively control and improve our customers' products and services.

Complete QC solutions for coatings and plastics

Since 1924, BYK-Gardner has been the leader in the field of coatings and plastics testing.

Today, BYK-Gardner is part of the Additives and Instrument Division of ALTANA AG, a worldwide leader in the additives and instruments sector. Together we offer complete and unique solutions for the paint, coatings and plastic industries:

- Additives to improve the performance of coatings and plastics
- Instruments to prove the enhanced quality of coatings and plastics



BYK-Gardner GmbH, Geretsried, Germany



BYK-Gardner USA, Columbia, MD, USA



BYK-Gardner Brazil



BYK-Gardner China

State of the Art Production

DIN EN ISO 9001 certified

Quality is our business. We fully respect the Total Quality Management (TQM) principle: our instruments are manufactured and controlled according DIN EN ISO 9001:2008 guidelines and procedures.

Brand new manufacturing facilities, state-of-the-art production and advanced calibration equipment – all this makes BYK-Gardner products rank among the best in the market. BYK-Gardner sets standards: we strive for the highest quality, the best repeatability and the greatest reliability and consistency.



BYK-Gardner Repair and Certification Service

BYK-Gardner offers repair, calibration and recertification services worldwide – for all products. Our qualified technicians respond quickly and thus guaranty a short turn-around time. In order to keep your instruments in excellent operation condition, we offer the following services:

- Extended warranty contracts
Cover your instrument for additional year(s) and provide emergency repairs including repair parts
- Preventative Maintenance & Certification Service
ISO 9000 requires routine control of testing equipment to ensure accurate measurement results. BYK-Gardner offers recertification and preventative maintenance services to support ISO 9000 or similar requirements:

Recertification Service for Standard:

- Cleaning of Standard
- Control of standard with master instrument
- Traceable Certificate

Preventative Maintenance Service for Instrument:

- Cleaning of optics
- Test of instrument functionality
- Firmware and software update (except auto-QC)
- Control of calibration standard with master instrument
- Traceable Certificate
- Calibration sticker on the instrument

For information see pages 267 - 273.



Warranty

We believe in the high quality and reliability of BYK-Gardner products. For this reason we offer up to two years guarantee on BYK-Gardner products from the date of purchase.

Receive a free recertification of your new color or appearance measuring instrument. Complete your warranty registration on our website at: www.byk.com/instruments

Here you can also schedule service or recertification on-line.

BYK-Gardner – your partner for complete QC solutions for coatings and plastics.

NEW

During the two year warranty period, a preventive maintenance service is included free of charge for the BYK-Gardner color and appearance instruments. In order to qualify for the free service, please register on our website within four weeks after having received the product.

APPEARANCE

Introduction **Appearance** 11

Gloss 15

Introduction 15

micro-gloss Family 20°, 60°, 85° 17

Special Applications: 20

Very low gloss surfaces 20

45°: Ceramic, plastic and - films 21

75°: Paper and structured plastics 21

micro-gloss with thickness sensor 25

Haze 27

Introduction 27

Portable Hazemeter 29

micro-haze *plus* 29

Laboratory Instrument 30

haze-gloss 30

Orange Peel /DOI 33

Introduction 33

wave-scan *dual* 37

wave-scan II 41

micro-wave-scan 44

wave-scan ROBOTIC 47

Mottling 49

Introduction 49

cloud-runner 52

Software auto-chart 55

Transparency 61

Introduction 61

haze-gard *plus* 63

haze-gard *dual* 66



New!

micro-gloss

New Feature:
Bluetooth® wireless
technology
See page 17.



New!

cloud-runner:

No more Mottling!
See page 52.

Introduction

Appearance Perception

Uniform appearance is an important quality criterion for many products. Gloss effects are based on the interaction of light with the physical properties of the sample surface. The other influencing component is the physiological evaluation scale. The human eye is still the best tool to evaluate gloss differences. However, control by visual analysis is insufficient, because

- evaluation conditions are not clearly defined, and
- people see and judge differently
- In addition, subjective perception of appearance is dependent on personal experience: what is glossy for a paper manufacturer might be dull for an automotive maker. The following criteria are involved in visual evaluation:

Surface Condition

- Material (eg. coating, plastic, metal)
- Structure (eg. smooth, rough, wavy)

Illumination

Prerequisite for appearance evaluation is direct illumination. Diffuse illumination causes diffuse reflection and decreases the gloss impression.

Observer

Eyesight and mood have a decisive role in the visual judgement. Also, it is important what our eye is focused on.

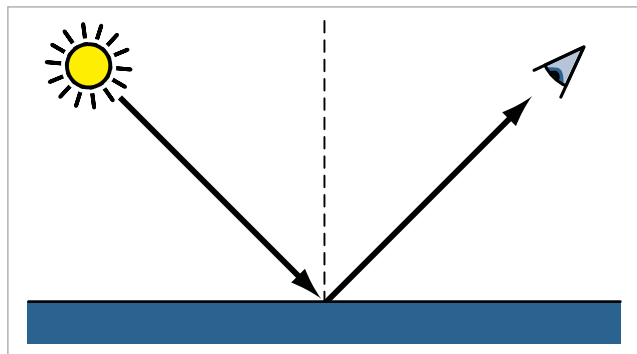

Components of visual evaluation

APPEARANCE



Focus on reflected image

We evaluate a surface by focusing our eye on a reflected image of a light source or on the surface itself. When we focus on the reflected image of a light source, the image forming quality is evaluated – i.e. the capability of a surface to reflect objects. The light source can appear brilliant or dull (gloss). When reflecting an edge the dark area can appear lighter (haze) and the edge can be blurred or distinct (DOI).

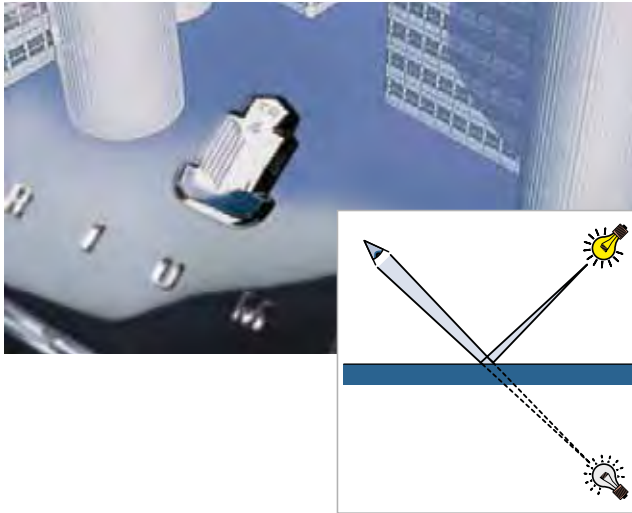

Focus on surface

When we focus on the surface, we gain additional information about structure size and form. We see these structures as a wavy pattern of light and dark areas. This waviness is often referred to as orange peel or flow/leveling defects.



Both evaluation types are individually weighted and contribute to the total appearance perception.

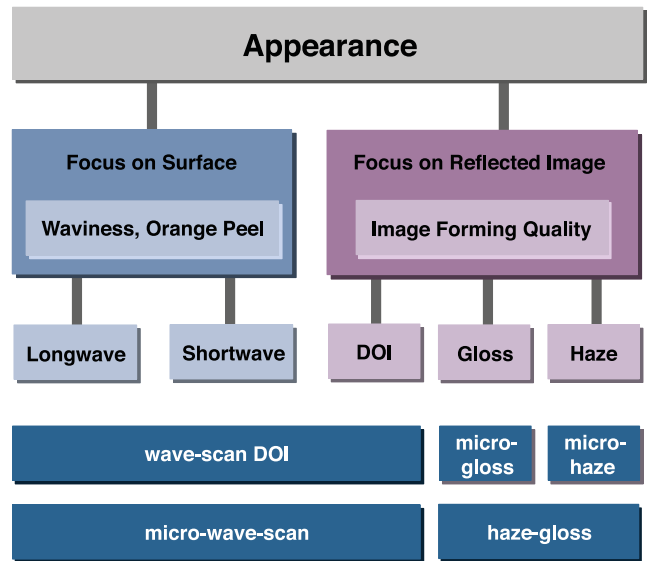

In order to guarantee reliable and practical quality assurance, it is necessary to define appearance with objective, measurable criteria. Accurate characterization of appearance does not only help to control quality, but improves quality and optimizes the manufacturing process.

BYK-Gardner offers a complete system solution to test appearance: from portable instruments such as glossmeters, hazemeters, DOI meters and transparency meters; to benchtop instruments with QC-software.

Introduction

Gloss Measurement

Gloss is a visual impression resulting from surface evaluation. The more direct light is reflected, the more obvious the impression of gloss will be.

High Gloss

Smooth and highly polished surfaces reflect images distinctly. The incident light is directly reflected on the surface, i.e. only in the main direction of reflection. The angle of incidence is equal to the angle of reflection.

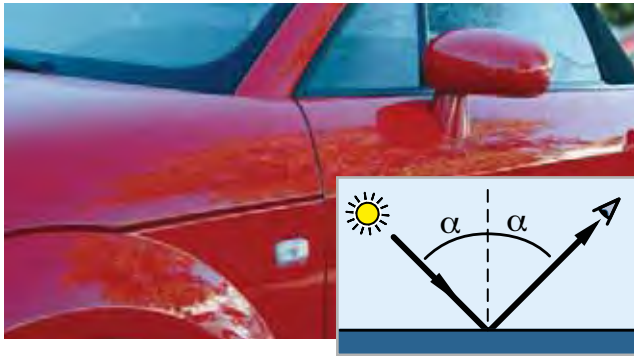

Matte to Semi Gloss

On rough surfaces the light is diffusely scattered in all directions. The image forming qualities are diminished: A reflected object no longer appears brilliant, but blurred. The more uniform the light is scattered, the less intense the reflection in the main direction and the surface will appear duller.

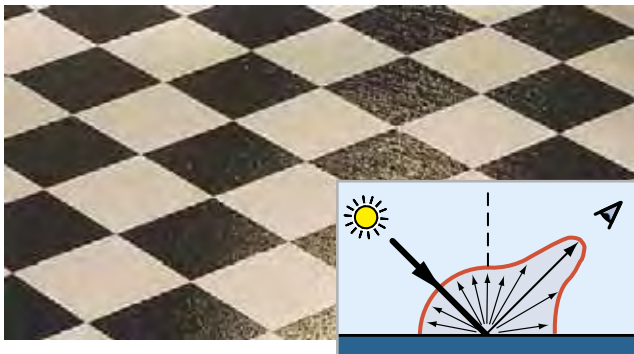

Glossmeter

A glossmeter measures the specular reflection. The light intensity is registered over a small range of the reflection angle.

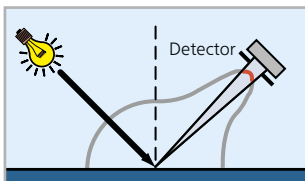

Measurement of specular reflection

GLOSS

The intensity is dependent on the material and the angle of illumination. In case of non-metals (coatings, plastics) the amount of reflected light increases with the increase of the illumination angle. The remaining illuminated light penetrates the material and is absorbed or diffusely scattered dependent on the color. Metals have a much higher reflection and are less angle dependent than non metals.

Example:

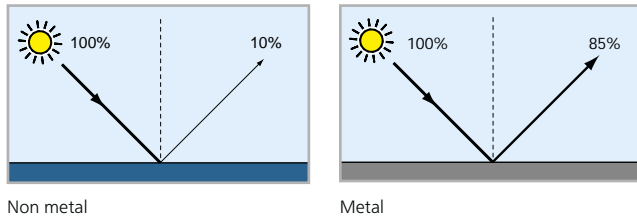

The measurement results of a glossmeter are related to the amount of reflected light from a black glass standard with a defined refractive index, and not to the amount of incident light. The measurement value for this defined standard is equal to 100 gloss units (calibration). Materials with a higher refractive index can have a measurement value above 100 gloss units (GU), e.g. films. In case of transparent materials, the measurement value can be increased due to multiple reflection in the bulk of the material. Due to the high reflection capabilities of metals, values of up to 2000 GU can be reached. For these applications it is common to document the measurement results in % reflection of the illuminated light.

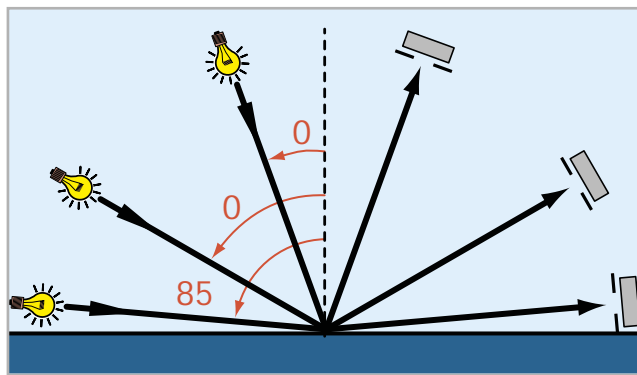

Glossmeters and their handling procedures had to be internationally specified to allow comparison of measurement values. The angle of illumination is of high influence. In order to obtain a clear differentiation over the complete measurement range from high gloss to matte, 3 different geometries, i.e. 3 different ranges, were defined:

Gloss Range	60° value	To be measured with
Semi Gloss	10 to 70	60° geometry
High Gloss	>70	20° geometry
Low Gloss	< 10	85° geometry

In addition, there are industry specific applications for 45° and 75° measurement geometry.

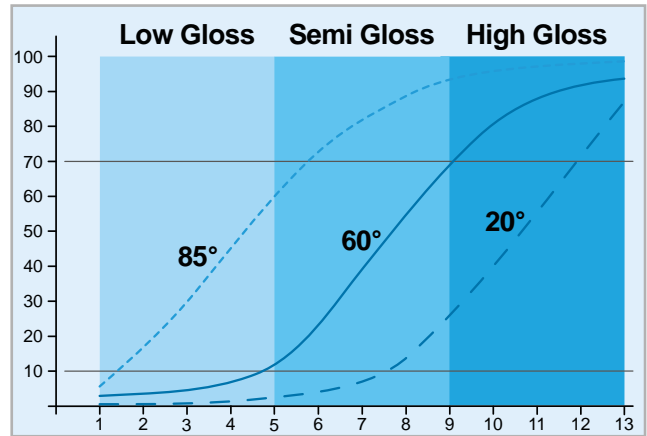

In this case study 13 samples were visually ranked from matte to high gloss and measured with the 3 specified geometries. In the steep slopes of the curves, the differences between the samples can be clearly measured, while in the flat part, the measurement geometry no longer correlates with the visual.

Gloss measurement for any application – whether you are dealing with specific applications or need a universal solution for matte to high gloss samples, BYK-Gardner offers a complete line of glossmeters:

- Reference laboratory instrument – haze-gloss
- Portable micro-gloss family

Their unique features and benefits have made them the industry standard for gloss measurement.

Application	20°	60°	85°	45°	75°
	Coatings, plastic and related materials			Ceramic, Film	Paper, Vinyl
	High Gloss	Semi Gloss	Low Gloss	Semi Gloss	Low Gloss
DIN EN ISO 2813	■	■	■		
ASTM D 523	■	■	■		
ASTM D 2457	■	■		■	■
DIN 67530	■	■	■		
JIS Z 8741	■	■	■	■	■
ASTM C 346				■	
Tappi T 480					■
	Brightened Metal				
EN ISO 7668	■	■	■	■	

micro-gloss

The new intelligence in gloss measurement

The micro-gloss has been the unsurpassed industry standard in gloss measurement for many years. It is the only glossmeter combining highest accuracy, ease-of-use and multiple functionality – essential for today`s testing requirements.

Brilliant design and easy-to-use

Ergonomics and easy handling were the main focus for the design. The micro-gloss is not too large and not too small – it feels just right in your hand. The scroll wheel operation, multilingual display and easy to navigate menu make gloss measurement easier than ever before.

Auto diagnosis: Standard OK – Calibration OK

Accurate readings require reliable calibration. The gloss meter and calibration holder make a perfect couple: the calibration standard is always protected in the holder of the micro-gloss.

Unique is the intelligent auto diagnosis of the gloss meter which guarantees long-term stable calibration and tells you when to calibrate. It even checks whether the standard is clean. Operator friendly. Safe.



wireless data transfer

Gloss of paint or metal – no problem

With the micro-gloss gloss meter you can measure any material – paints, plastics or highly reflective metals. Its expanded measurement range of up to 2000 gloss units guarantees always reliable results – according to international standards.

Highest accuracy guaranteed

The long-term stable LED light source of the glossmeter provides not only highly repeatable results for many years, but also will never burn out. We even give a 10 year warranty on the lamp life.

Various measurement modes for efficient QC

Different tasks require different tools. The easy to turn scroll wheel of the glossmeter quickly shows you all needed functions – even without a PC:

Check uniformity on the sample?

→ Continuous mode. With Min. and Max.

Compare the gloss difference to the target?

→ Difference mode. With Pass/Fail.

Average several readings per panel?

→ Statistic mode. With all statistical data.

Number of readings per sample are selectable.

Or just quickly check the gloss of a few samples?

The Basic mode is your tool.

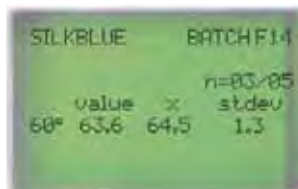

Statistic mode



Difference mode

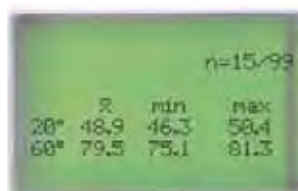

Continuous mode



Basic mode

Fast and professional documentation

Every measurement series can be saved in the glossmeter under its own name. Input of sample names can be done quickly with the scroll wheel.

The included easy-link software allows direct data transfer to Excel® with your results immediately shown in a professional QC-report.



New!

Data transfer with cable or wireless



Now data can be sent to your PC via USB-interface or *Bluetooth*® wireless technology. The wireless connection transfers data from the glossmeter within a distance of 10 meters (33 feet).

Bluetooth® is a registered trademark owned by Bluetooth SIG, Inc.

micro-TRI-gloss

See changes under the right angle – always and right away

High – medium – low gloss: What is your application?

micro-TRI-gloss combines 20°, 60°, 85° in one glossmeter – as handy as the one angle unit. Having three geometries in one unit allows you to be in compliance with international standards and to quickly recognize quality variations.



All selected angles measure at the same location and the results are displayed instantly – including Statistics, Difference or Pass/Fail. The micro-TRI-gloss has all functions of the new glossmeter generation readily at hand.



The micro-gloss family: Overview of functions

Long-term calibration	with automatic check of the calibration standard
Autorange	0-2000 GU (20°) 0-1000 GU (60°) 0-160 GU (85°)
Measuring time	0.5 seconds / geometry
Statistics	number of readings per sample are selectable from 2 to 99
Difference and Pass/Fail	memory for 50 standards with limits
Continuous	actual value, average, min., max.
Display in 3 columns selectable	actual value, average, std. dev., min., max., range, difference, pass/fail
micro-TRI-gloss	simultaneous display 2 or 3 geometries
Memory	999 readings with date and time, with recall function
Interface and Software	USB and <i>Bluetooth</i> ®; easy-link (included)
Menu guidance switchable	English, French, German, Italian, Japanese, Polish, Portuguese, Russian, Spanish
Auto shut-off time	selectable 10 – 99 seconds
Power supply	one 1.5V AA Alkaline Battery 10,000 readings or via USB-port
Operating temperature	15 – 40 °C (60 – 104 °F)
Relative humidity	up to 85 %, non-condensing



In order to obtain differences clearly over the whole range from matte to high gloss, three measurement geometries were specified in international glossmeter standards. Each geometry is optimized for a specific gloss range.

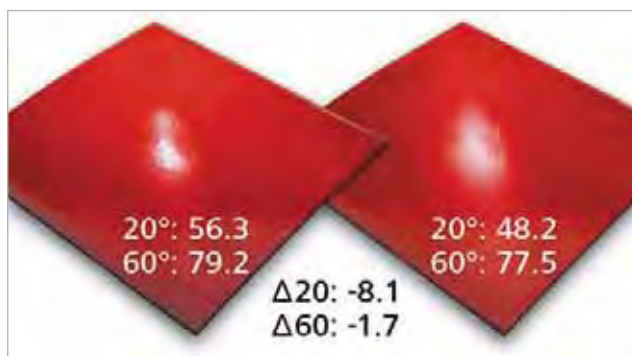

The different gloss of these two samples is more clearly shown in the 20° readings.



New!

Glossmeters for toughest QC requirements

Automotive interior design is becoming more and more important in purchasing decision. A variety of materials, from leather to plastics, are used and need to be harmonized. Additionally, surface structures vary from large grains to fine stipples, usually with very low gloss. In order to guarantee a uniform look among the various parts very tight tolerances are specified.

Typical Tolerances:
Gloss 60° < 5 gloss units
± 0.3 to 0.5 gloss units

As a starting point master standard plaques are usually manufactured with flat and several grained areas. These are sent to parts suppliers as their target to achieve with actual production parts. As the master plaques and final parts are often made of different materials the suppliers work closely with the car maker. In the end final approval is given on a production part. This production part now becomes the standard for the supplier.

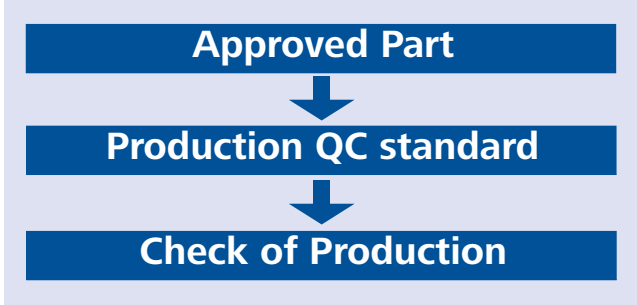

Instead of working with absolute gloss numbers, supplier production QC needs to be based on the signed-off part where only the differences are checked with the glossmeter. This procedure eliminates the reproducibility error as gloss is measured relatively on the same type of material and same surface.



micro-gloss S family

Only testing instruments with excellent precision will be able to objectively control production. The new micro-gloss S family offers improved performance for 60° gloss in the critical low gloss range (0-10 GU). This excellent accuracy can be guaranteed due to our patented calibration procedure in the production of the glossmeters.

- For any material: paint, plastics or highly reflective metals
- Long-term stable calibration and automatic check of calibration standard
- Temperature stable data
- 10 year warranty on the light source
- Difference and Pass/Fail
- Statistics and Memory (999 readings)
- Easy menu operation with scroll wheel
- easy-link software for direct transfer to Excel®
- Data transfer from the glossmeter to the PC via USB or *Bluetooth*® wireless technology



Technical Specifications

	0 – 10 GU	10 – 100 GU	100 – 2000 GU
Measurement range	0 – 10 GU	10 – 100 GU	100 – 2000 GU
Repeatability	± 0.1 GU	± 0.2 GU	± 0.2 %
Reproducibility	± 0.2 GU	± 0.5 GU	± 0.5 %

micro-gloss 45°/75°

Gloss Measurement for Specific Applications

Specific applications require specific measuring angles. micro-gloss 45° and 75° are now available in the new gloss meter design with its proven benefits.

- Ergonomic design and userfriendly menu operation with scroll wheel.
- Automatic calibration with smart "Autodiagnosis" to check the condition of the calibration standard.
- Long-term stable LED light source provides highly repeatable results.
- 10 year warranty on the light source.



micro-gloss 45°: Specialized glossmeter for ceramics, plastics and plastic films.



micro-gloss 75°: Specialized glossmeter for paper, paperboard and structured plastic e.g. vinyl siding.

Multiple functionality for any task – and easy to use

- Continuous mode for uniformity evaluation over large areas.
- Difference and Pass/Fail for inspection and QC.
- Statistics with average, standard deviation, min/max and range. Large memory for 999 readings.
- Professional documentation and direct transfer to Excel® with included easy-link software.
- Data transfer via USB or *Bluetooth*® wireless technology.



Standards

ASTM	C 346, D 2457, D 3679
JIS	Z8741
TAPPI	T480

Technical Specifications

Geometry	Application	Measurement Range
45°	Ceramic, Plastic, Plastic Films	0 – 180 GU
75°	Paper, Vinyl Siding	0 – 140 GU

select mode...



and measure

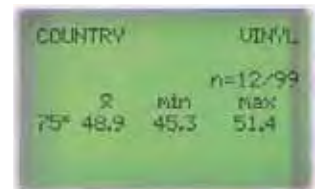

Certified

For Preventive Maintenance and Certification Services see page 267 – 270.



Standards

ISO	2813, 7668
ASTM	D 523, D 2457
DIN	67530
JIS	Z8741

Ordering Information

Cat. No.	Description
AG-4440	micro-gloss 20°
AG-4442	micro-gloss 60°
AG-4444	micro-gloss 85°
AG-4446	micro-TRI-gloss
AG-4450	micro-gloss 60° S
AG-4452	micro-TRI-gloss S
AG-4454	micro-gloss 45°
AG-4456	micro-gloss 75°
SE-4440	Extended Warranty one year additional

Comes complete with:

- Glossmeter
- Holder with integrated calibration tile
- Traceable certificate
- Software easy-link
- USB-cable
- Operating manual
- Battery
- Carrying case

Free 1x preventive maintenance service during warranty period

Technical Specifications

Geometry	Application	Measuring Area
20°	high gloss	10 x 10 mm (0.4 x 0.4 in)
60°	semi gloss	9 x 15 mm (0.35 x 0.6 in)
85°	low gloss	5 x 38 mm (0.2 x 1.5 in)
20°, 60°, 85°	universal	see single angle
60°	semi gloss	9 x 15 mm (0.35 x 0.6 in)
20°, 60°, 85°	universal	see single angle
45°	Ceramic, Plastic, Film	9 x 13 mm (0.35 x 0.5 in)
75°	Paper, Vinyl Siding	7 x 24 mm (0.3 x 0.95 in)

Measurement range ¹	0 – 100 GU	100 – 2000 GU
Repeatability ²	± 0.2 GU	± 0.2 %
Reproducibility ²	± 0.5 GU	± 0.5 %
Spectral sensitivity	CIE 1931 standard observer for illuminant CIE-C	
Interface	USB and <i>Bluetooth</i> [®] wireless technology	
Dimensions	155 x 73 x 48 mm (6.1 x 2.9 x 1.9 in)	
Weight	0.4 kg (0.9 lbs)	

¹ for 45° and 75° glossmeters see page 23

² for S-Type glossmeters see page 22

Ordering Information

Cat. No.	Description
AG-4405	USB-cable
AG-4545	BYKWARE easy-link

Accessories

- For data transfer from the glossmeter to a PC, USB-A
- Software for direct data transfer and documentation in Excel[®] (see page 26)

Save!

Special Introductory Offer

– valid only for a limited time.

AG-4442 micro-gloss 60°: \$ 2,520.00

AG-4446 micro-TRI-gloss: \$ 3,990.00

Save!

Trade-in any gloss meter (all brands accepted) and receive a discount toward the purchase of a new micro-gloss. Please call us for additional information.

Calibration Holder

Replacement holder with high gloss calibration tile.

Ordering Information

Cat. No.	Description
AG-4441	Calibration holder 20°
AG-4443	Calibration holder 60°
AG-4445	Calibration holder 85°
AG-4447	Calibration holder TRI
AG-4455	Calibration holder 45°
AG-4457	Calibration holder 75°

Comes complete with:

Holder with integrated calibration tile and traceable certificate



Checking Standard

In order to control the performance and linearity of the glossmeter it is recommended to use a checking standard periodically. The control interval is dependent on the usage conditions of the glossmeter.

The gloss tiles are built into an aluminum track that the glossmeter fits into to guarantee accurate and repeatable measurements. The included certificate is traceable to international institutes.

Certified For Certification Service and Preventive Maintenance see pages 267 – 270.

Ordering Information

Cat. No.	Description
AG-4422	Checking standard 20°
AG-4462	Checking standard 60°
AG-4464	Special checking standard 60° S
AG-4487	Checking standard 85°
AG-4434	Checking standard TRI
AG-4438	Special checking standard TRI S
AG-4433	Checking standard mirror
AG-4458	Checking standard 45°
AG-4459	Checking standard 75°

Comes complete with:

Checking standard in aluminum track with traceable certificate

Technical Specifications

Dimensions	
170 x 103 x 17 mm (6.7 x 4.1 x 0.7 in)	High and semi gloss tile
170 x 103 x 17 mm (6.7 x 4.1 x 0.7 in)	High and semi gloss tile
170 x 103 x 17 mm (6.7 x 4.1 x 0.7 in)	High gloss and low gloss tile, approx. 5 GU at 60°
170 x 103 x 17 mm (6.7 x 4.1 x 0.7 in)	High and semi gloss tile
170 x 103 x 26 mm (6.7 x 4.1 x 1 in)	High gloss and 3 semi gloss tiles 20, 60, 85°
170 x 103 x 26 mm (6.7 x 4.1 x 1 in)	High gloss and 3 semi gloss tiles 20, 60, 85°, 60° tile approx. 5 GU
170 x 103 x 26 mm (6.7 x 4.1 x 1 in)	High gloss and 3 semi gloss tiles 20, 60, 85°, highly reflective
170 x 103 x 17 mm (6.7 x 4.1 x 0.7 in)	High and semi gloss tile
170 x 103 x 17 mm (6.7 x 4.1 x 0.7 in)	High and semi gloss tile

easy-link

Professional Documentation with easy-link

ISO 9000 requires documentation of measurement results. The easy-link software features:

- Easy and direct data transfer from the instrument to Excel®
- QC templates prepared in Excel® allow you to create professional QC reports
- All data are summarized in one easy-to-read report: Gloss, thickness, color and your own product specific information
- Expandable: modifications can be made easily when new requirements are established

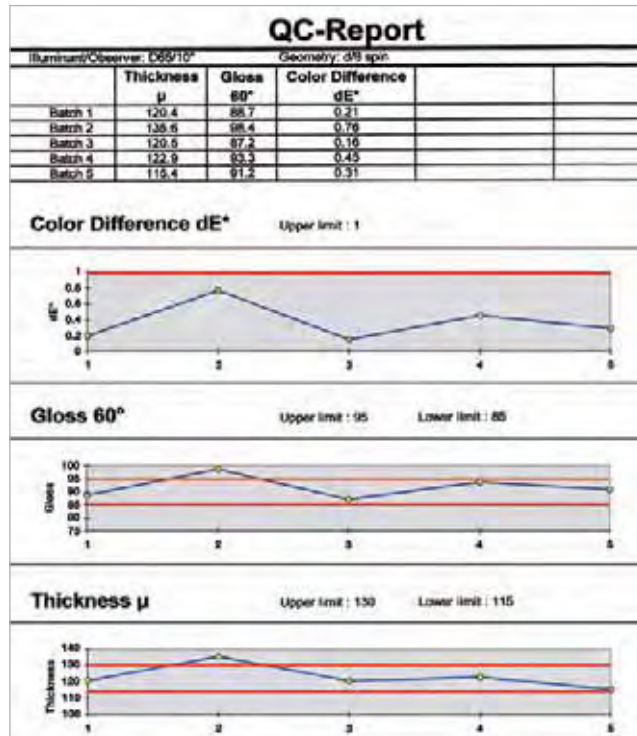

- Control your production with color, gloss, and thickness in one QC-report



Color data can also be transferred to easy-link with spectro-guide, see page 77.

Application Report



Customer: ABC-Coat. Tech. Serv.
Sample: Clear Coat System

Department: Laboratory
Operator: Smith

Description: **Influence of application parameters**

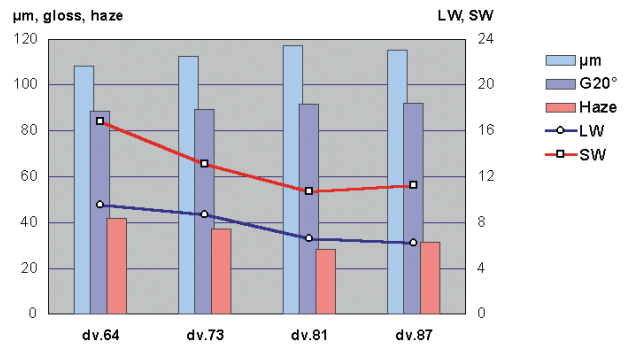

Sample-Id.	Modification	μm	G20°	Haze	LW	SW
WA-14	dv.64	108.3	88.5	41.7	9.5	16.8
WA-16	dv.73	112.6	89.3	37.1	8.7	13.1
WB-14	dv.81	117.3	91.6	28.4	6.6	10.7
WB-15	dv.87	115.2	92.1	31.3	6.2	11.2

- You can easily create professional reports according to your specific needs

Ordering Information

Cat. No.	Description
AG-4545	BYKWARE easy-link

Hardware Requirements:

Operating system: Windows® 2000 or higher
Excel® version: 2000 or higher, incl. VBA
Disk drive: CD-ROM or DVD
Interface: serial or USB port

micro-TRI-gloss μ

Gloss and Film Thickness in one Instrument

Gloss and film thickness are important QC criteria for coatings. The new micro-TRI-gloss μ measures both in seconds and at the same position. This saves time and is ideal for checks in the field.

- Simultaneous display 20°, 60°, 85° – for high gloss to matte coatings
- Dual sensor Fe/NFe – measures thickness on steel as well as on aluminum
- Automatic check of glossmeter calibration standard
- Easy, multilingual menu operation with scroll wheel
- Statistics, Differences and Pass/Fail
- Memory for 999 readings with name input
- easy-link software included for professional documentation in Excel®
- Data transfer from the glossmeter to PC via USB or Bluetooth® wireless technology



Standards

	Gloss	Thickness
ISO	2813	2178, 2360, 2808
ASTM	D 523	B 499, D 1400
DIN	67530	

Technical Specifications

Gloss		
Geometry	Application	Measurement Area
20°	high gloss	10 x 10 mm (0.4 x 0.4 in)
60°	semi gloss	9 x 15 mm (0.35 x 0.6 in)
85°	low gloss	5 x 38 mm (0.2 x 1.5 in)
Measurement Range	0 – 100 GU	100 – 2000 GU
Repeatability	± 0.2 GU	± 0.2 %
Reproducibility	± 0.5 GU	± 0.5 %
Thickness		
Substrate	Fe: magnetic NFe: non magnetic	
Measurement Range	0 – 500 μ m (0 – 20 mils)	
Accuracy	± (1.5 μ m + 2% of measured value)	
Dimensions	155 x 73 x 48 mm (6.1 x 2.9 x 1.9 in)	
Weight	400 g (0.9 lbs)	

Ordering Information

Cat. No.	Description
AG-4448	micro-TRI-gloss μ
SE-4448	Extended Warranty one-year additional

Comes complete with:

micro-TRI-gloss μ glossmeter
 Calibration holder with certificate
 Zero standards Fe and NFe
 easy-link software
 USB-cable
 Operating manual
 Battery
 Durable carrying case

Free 1x preventive maintenance service during warranty period

Ordering Information

Cat. No.	Description
AG-4405	USB-cable
AG-4545	BYKWARE easy-link
AG-4449	Calibration Holder
AG-4434	Checking Standard

Accessories

For data transfer from the glossmeter to a PC, USB-A
 Software for direct data transfer and documentation in Excel® (see page 26)
 Replacement
 High gloss and 3 Semi gloss tiles, 170 x 103 x 26 mm (6.7 x 4.1 x 1 in)

Certified For Certification Services and Preventive Maintenance see pages 267 - 270.

Glossmeter Accessories

Additional Standards

These 100 x 100 mm (4 x 4 in) glass tiles can be used for any glossmeter as a reference. If standards with specific values are needed, ask for Cat. No. AG-4057 or AG-4058.



Ordering Information

Cat. No.	Description
AG-4050	High Gloss Standard
AG-4051	Semi Gloss Standard 20°
AG-4052	Semi Gloss Standard 60°
AG-4053	Semi Gloss Standard 85°
AG-4056	Mirror Gloss Standard
AG-4057	Special Standard Black
AG-4058	Special Standard Mirror

Comes complete with:

Standard
Traceable certificate
Protective case

Technical Specifications

Black glass tile, polished, for 20°, 60°, 85°
Black glass tile, 20° value approx. 60 to 70 gloss units
Black glass tile, 60° value approx. 40 to 50 gloss units
Black glass tile, 85° value approx. 35 to 45 gloss units
High gloss, polished mirror, for 20°, 60°, 85°
Black glass tile, gloss value can be defined
Semi gloss, highly reflective, gloss value can be defined

Certified For Certification Services see page 267.

Introduction

Reflection Haze

High quality (class A) surfaces are expected to have a clear and brilliant appearance. Microstructures, e. g. poor dispersion, can cause a milky appearance. This effect is described as milkiness or haze. A high gloss surface with microscopic texture has diffused light with low intensity adjacent to the main direction of reflection. The majority of the incident light is reflected in the specular direction which makes the surface appear highly glossy with image forming qualities, but with a milky haziness on top of it.

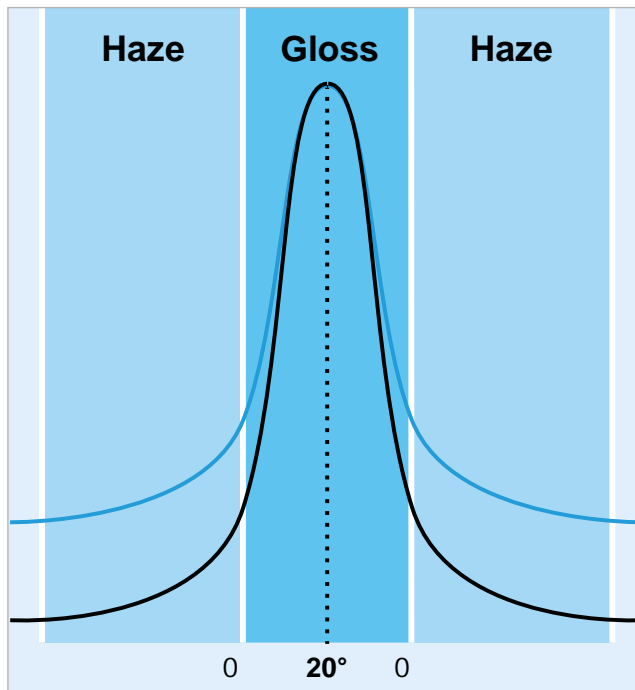
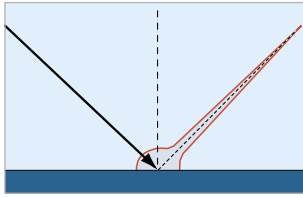

HAZE



Objective Measurement of High Gloss Surfaces: Gloss and Haze

The phenomenon haze can be seen on high gloss surfaces only. Therefore, 20° geometry is used just like with a glossmeter. The aperture range of a 20° gloss meter is 1.8°. Two additional sensors next to the gloss detector measure the intensity of the diffused light, responsible for haze. Thus, the specularly reflected and scattered light are measured simultaneously. In order to better correlate with the visual perception, haze is displayed in a logarithmic scale – the lower the haze reading the better the surface.

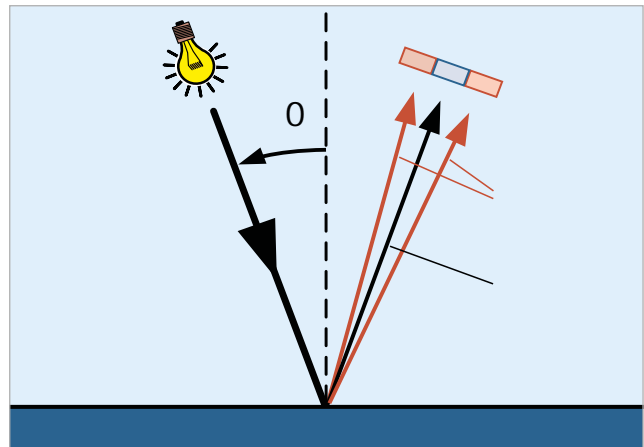

Analysis of High Gloss Surfaces: Gloss and Haze

Haze is often caused by specific parameters in the production process, i.e.:

- Pigment type and degree of dispersion
- Binder and additive type
- Application and processing

Examples

Degree of Dispersion

The graph on the right shows the influence of degree of dispersion on gloss and haze. Pigment particles smaller than 10 µm will show a tremendous reduction in haze while the gloss value is nearly the same.

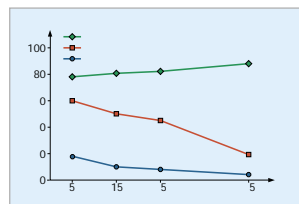

Application Type

In practice it is important to test the process compatibility of a paint system. In the example on the side, different paint systems were applied with electrostatic and pneumatic equipment: System A flocculates under the electrostatic spray condition which can be seen in the increased haze value. System B shows an excellent low haze value with pneumatic application, but a tendency to flocculation with electrostatic equipment. System C was optimized for either application.

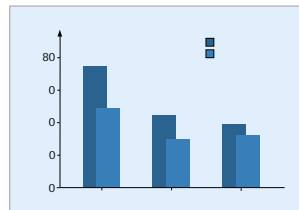

Polishing

Other causes for haze can be weathering, abrasion or polishing marks. Simultaneous measurement of gloss and haze allows objective evaluation of the surface quality. BYK-Gardner offers a portable haze meter, the micro-haze plus; and a stationary unit, the haze-gloss, especially developed for the use in the laboratory.

micro-haze *plus*

The Portable Hazemeter for High Gloss Surfaces

The micro-haze *plus* measures gloss and haze in one measurement procedure. This handy hazemeter is the ideal solution for measurement on finished products, for quality control in the production line and for technical service at the customer site.

- Haze and Gloss 20°
- Small and portable – fits in any lab coat pocket
- Calibrate in the protective holder by pressing one button
- Easy menu guided operation
- Statistics with average, standard deviation and storage of measured values
- Interface to PC
- easy-link software included for direct data transfer from the hazemeter to Excel®



Ordering Information

Cat. No.	Description
AG-4632	micro-haze <i>plus</i>
SE-4632	Extended Warranty one-year additional

Comes complete with:

Hazemeter
Gloss and haze standard in holder
Traceable certificate
easy-link software with interface cable
Batteries
Leather pouch
Operating manual
Durable plastic carrying case

Free 1x preventive maintenance service during warranty period

Ordering Information

Cat. No.	Description
AG-4545	BYKWARE easy-link
AG-4401	USB-adaptor
CC-6819	Interface Cable
AG-4631	Calibration Holder Haze
AG-4513	Calibration Holder Gloss
AG-4514	Checking Standard

Certified

For Certification Services and Preventive Maintenance see pages 267 – 270.

Standards

	Gloss	Haze
ISO	2813	13803
ASTM	D 523, D 2457	E 430
DIN	67530	

Technical Specifications

Gloss	
Measurement Range	0 – 180 GU ¹
Repeatability	0.5 GU ¹
Reproducibility	1 GU ¹
Haze	
Measurement Range	10 – 500 HU ²
Repeatability	1 HU ³
Reproducibility	7 HU ³
Measurement Area	9 x 9 mm (0.35 x 0.35 in)
Memory	999 values
Interface	serial RS 232
Batteries	2 AA Alkaline 1.5 V, approx. 5000 measurements
Dimensions	148 x 72 x 55 mm (5.8 x 2.8 x 2.2 in)
Weight	600 g (1.3 lbs)

¹ Gloss Units, ² Haze Units (Hlog), ³ measured on high gloss standard

Accessories

Software for direct transfer from hazemeter and documentation in Excel®
For connection to USB-interface, incl. driver software
For data transfer to a PC, Sub-D 9-pins
Replacement calibration holder with haze tile, certificate included
Replacement calibration holder with high gloss tile, certificate included
High and medium gloss tile for checking purposes, certificate included

haze-gloss

The Reference Instrument for any Application

The hazemeter was designed for the needs in the laboratory. Gloss, haze and mirror reflection can all be measured with one instrument for low to high gloss surfaces.

- Gloss 20°, 60°, 85° and haze
- Mirror reflection for materials with very high reflection capabilities, such as metals
- Reference beam, closed optics and self diagnosis guarantee accurate quality control
- Statistics with average, min/max and standard deviation
- Large storage capacity and data transfer from the hazemeter to a PC prepare you for ISO 9000



Quick Measurement of many Samples

- Foot switch and automatic measurement for fast sampling
- Illuminated target facilitates sample positioning
- Ready for measurement without warm-up time
- Long-term calibration and menu guided operation – simple and secure
- Operation in English, German, French, Spanish, and Italian – switchable



Standards

ISO	2813, 13803
ASTM	D 523, D 2457, E 430
DIN	67530

Ordering Information

Cat. No.	Description
AG-4601	haze-gloss
SE-4601	Extended Warranty one year additional

Comes complete with:

- hazemeter
- High gloss and haze standard incl. certificate
- easy-link software
- Interface cable
- Foot switch
- Power cord
- Operating manual

Free 1x preventive maintenance service during warranty period

Technical Specifications

Gloss	
Measurement Range	0 – 2000 GU ¹
Repeatability	0.2 GU ²
Reproducibility	0.5 GU ²
Haze	
Measurement Range	10 – 2500 HU ³
Repeatability	1 HU*
Reproducibility	7 HU*
Measuring Area	20°: 15 x 15 mm (0.6 x 0.6 in) 60°: 15 x 27 mm (0.6 x 1.0 in) 85°: 8 x 60 mm (0.3 x 2.4 in)
Memory	9 x 600 values
Interface	serial RS 232
Power Supply	115 / 230 V, 50 / 60 Hz, requirement 50 VA
Dimensions	33 x 52 x 40 cm (13 x 20.5 x 15.7 in)
Weight	14.3 kg (31.5 lbs)

¹ Gloss Units, ² 0 – 100 GU, ³ Haze Units (Hlog),

* measured on high gloss standard

Documentation of Measurement Data

The program easy-link allows quick data transfer from the hazemeter to Excel® for further analysis and professional documentation.

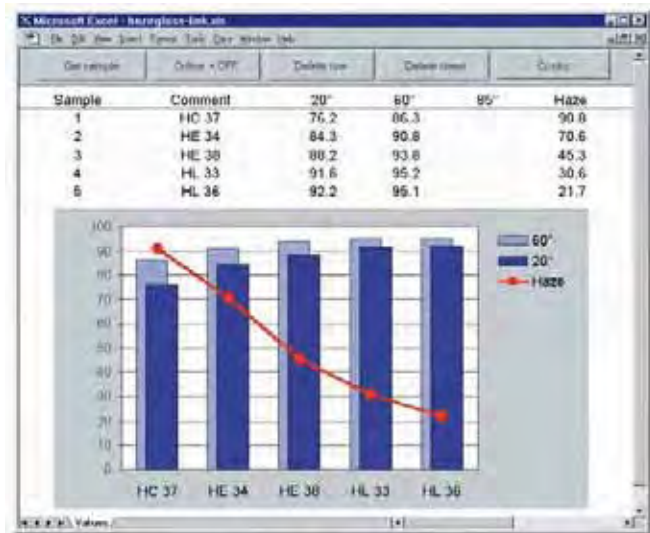

Ordering Information

Cat. No.	Description
AG-4616	Checking Standard 20°
AG-4617	Checking Standard 60°
AG-4618	Checking Standard 85°
AG-4624	Mirror Gloss Standard
AG-4614	High Gloss Standard
AG-4615	Haze Standard
AG-4623	Sample Table
AG-4613	Interface Cable
AG-4545	BYKWARE easy-link

Accessories

Black glass, semi gloss for checking purposes, certificate included
Black glass, semi gloss for checking purposes, certificate included
Black glass, semi gloss for checking purposes, certificate included
High gloss, polished mirror, for 20°, 60°, 85°, certificate included
Replacement calibration standard gloss, certificate included
Replacement calibration standard haze, certificate included
Larger platform for sample support table, 28 x 15 cm (11 x 6 in)
For data transfer from hazemeter to a PC, Sub-D 9-pin
Software for direct data transfer and documentation in Excel®

Certified

For Certification Services and Preventive Maintenance see pages 268 – 270.



Color and Gloss Control of Automotive Interior Parts

The S-Family with Close Tolerances for Toughest QC Specs

How many hours do you spend in your car? Most likely you will say "many". Thus, the interior design is getting more and more important in your purchasing decision.

A big challenge for every car manufacturer is to achieve a "feeling" of high value and at the same time minimize cost. Therefore, a variety of materials are used and need to be harmonized. The design group specifies the color, gloss and grain. Once a new color or material or process are approved, a new "style" is born – ready for implementation. At this point the supplier quality group takes ownership and starts working with various part suppliers. As a starting point master standard plaques of the new colors are manufactured with usually a flat and several grained areas. These are sent to the suppliers as their target to achieve with actual production parts.

As the master plaques and final parts are often made of different materials the suppliers work closely with the car maker. At the end the final approval is given on a production part. This production part now becomes the standard for the supplier. In order to guarantee a uniform look among the various materials very tight tolerances are specified.

Typical tolerances

Color: ΔL^* , Δa^* , Δb^* = +/- 0,5
60° Gloss: < 5 GU +/- 0.3 to 0.5

It is impossible to visually assess, if color and gloss are within these very tight tolerances. Only testing instruments with excellent precision will be able to objectively control the production.



spectro-guide S see page 78.



micro-gloss S see page 20.

New Color and Gloss Instruments with tighter technical specs

BYK-Gardner succeeded in offering a new line of color and gloss meters with improved technical performance for 60° gloss in the low gloss range (0-10 GU). The excellent repeatability of +/-0.1 can be guaranteed due to our patented calibration procedure for the new micro-gloss and spectro-guide families.

How can a Gloss or Color Tolerance of +/-0.5 be meaningful?

Instead of working with absolute color or gloss numbers the supplier production QC needs to be based on the signed-off part and only the differences are checked. This procedure eliminates the reproducibility error as color and gloss are measured relatively on the same type of material and same surface. Therefore, a difference of 0.3 gloss units from part to part can be considered as a significant difference.

In addition to the improved technical performance the micro-gloss and spectro-guide families offer you unique benefits to always guarantee precise results:

- Long-term stable calibration – needed only every three months. Guaranteed even when the temperature or humidity changes.
- Temperature stable color and gloss data between 10 °C – 40 °C
- 10 years warranty on the light source

Introduction

The total appearance and the visibility of structures depend on the structure size, the observing distance and the image forming quality.

Structure size

Surfaces with different structure sizes will appear visually different:



Small structures



Large structures

The waviness of automotive paints is in a range of approx. 0.1 to 30 mm wavelength. These phenomena are often visually evaluated and subjective terms like degree of peel or texture are used as descriptions. Orange peel can be seen on high gloss surfaces as a wavy pattern of light and dark areas. Depending on the slope of the structure element the light is reflected in various directions. Only the elements reflecting the light in the direction of our eyes are perceived as light areas.

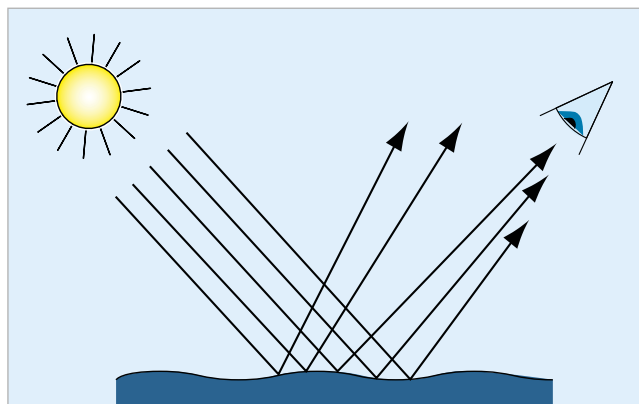

ORANGE PEEL / DOI



Observing distance

Visibility of structures is dependent on the observing distance. The greater the distance, the smaller objects will appear. Structures with a size of 10 to 30 mm can best be seen at a distance of approx. 3 m. Fine structures in a range of 0.1 to 1 mm can only be recognized at a close distance.



Resolution of our eyes

The resolvable structure size is also dependent on the observing distance. Very fine structures that are below the human eye's resolution (approx. 0.1 mm) can no longer be recognized as a light / dark pattern, even at a close distance. The result is a reduction of the image forming quality (IFQ). At 3 m distance, structures between 1 – 3 mm can hardly be resolved as a waviness but influence the appearance.

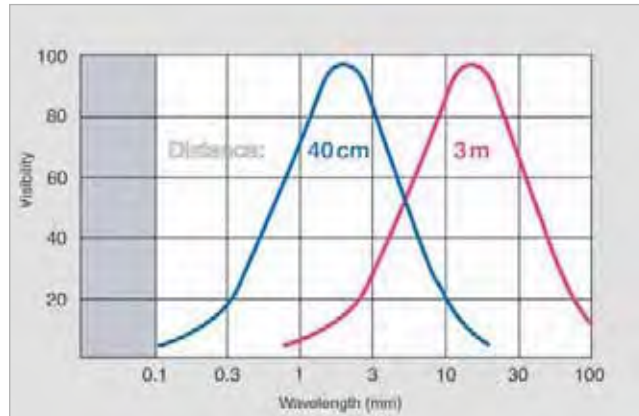

Image Forming Quality (IFQ)

The higher contrast and sharpness of a reflected object, e.g. the edges of black and white lines, the better the image forming quality will be. Fine structures disturb the reflected image, consequently edges become blurry and are no longer sharp.

Image Forming Quality at a close distance:

Distinctness of Image (DOI)

DOI can also be described with terms like brilliance, sharpness or clarity. DOI is diminished by very fine structures close to the human eye resolution (smaller than 0.3 mm).

Image Forming Quality at a far distance:

Wet Look

At a distance of 3 m, the image forming quality is mainly influenced by structures between 1 – 3 mm. This effect is referred to as Wet Look.

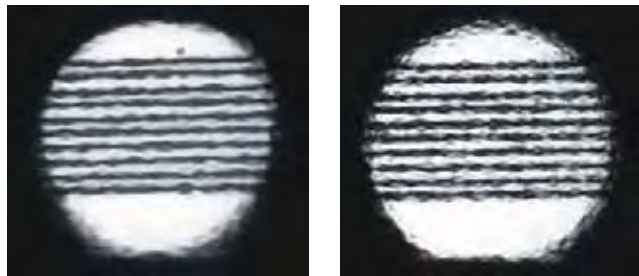

wave-scan dual
see page 39.

Simulation of the Visual Perception Waviness

The wave-scan simulates visual perception. Like our eyes, the instrument optically scans the wavy light / dark pattern. A laser point light source illuminates the specimen at a 60° angle and a detector measures the reflected light intensity at the equal but opposite angle. The orange peel meter is rolled across the surface and measures point by point the optical profile of the surface across a defined distance.

The wave-scan analyzes the structures according to their size. In order to simulate the human eye's resolution at various distances, the measurement signal is divided into several ranges using mathematical filter functions:

- Wa 0.1 0.3 mm wavelength
- Wb 0.3 1 mm wavelength
- Wc 1 3 mm wavelength
- Wd 3 10 mm wavelength
- We 10 30 mm wavelength
- SW 0.3 1.2 mm wavelength
- LW 1.2 12 mm wavelength

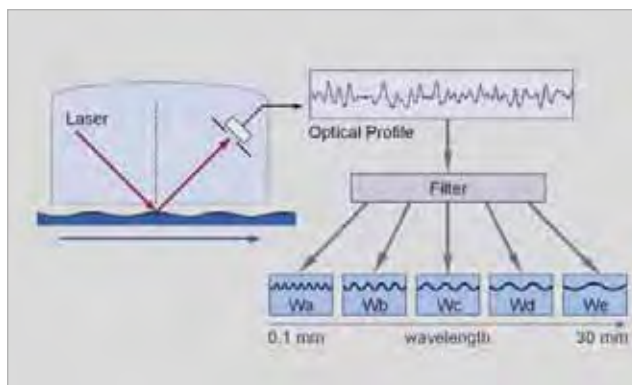

Dullness

Structures smaller than 0.1 mm influence visual perception, therefore the wave-scan uses a CCD camera to measure the diffused light caused by these fine structures. This parameter is referred to as "dullness".

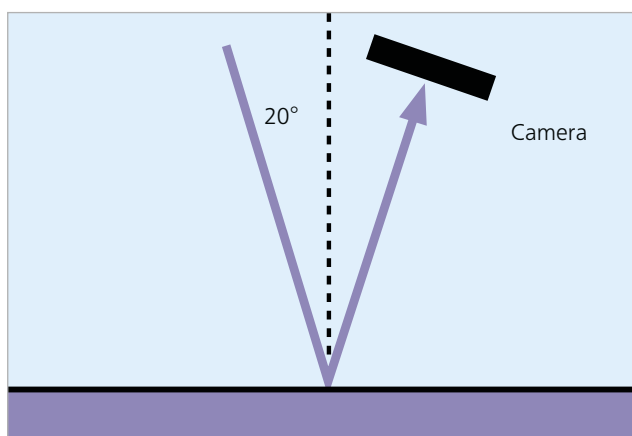

Structure Spectrum

The values of dullness and Wa to We form a "structure spectrum". This allows a detailed analysis of Orange Peel and its influencing factors, being material or application parameters.

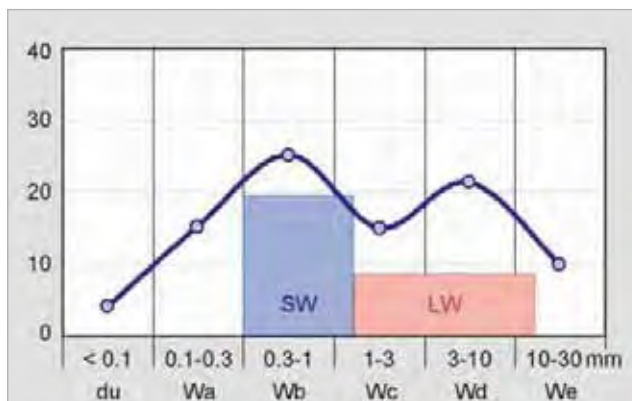

wave-scan Scales

The detailed information of the structure spectrum as well as LW and SW became the basis to correlate to customer specific scales and to the DOI as described in ASTM E430:

DOI	Function of du , Wa and Wb Correlation to ASTM E430, scaling is similar to 20° gloss
Rating:	Orange Peel based on ACT panels
Tension-Scales:	Leveling
GM-Tension	GM Specification
P-Tension	Honda Specification
H-Tension	Honda Specification
Ford Scales:	
Luster	A measurement for Gloss
Sharpness	A measurement for DOI
Orange Peel	A measurement for Leveling
Combined	An overall rating
Daimler Chrysler Scales:	
Gloss DCA	A measurement for Gloss
Dorigon DCA	A measurement for DOI
Orange Peel DCA	A measurement for Leveling
Over All DCA	An overall rating
BMW Scales:	
N1 Note 1 m	A ranking note for 1m observation
N3 Note 3 m	A ranking note for 3m observation

Interpretation of Measurement Results

Substrate Influence:

In the following graph, the substrate roughness telegraphs through the clear coat and reduces the brilliance of the coating. Sample D is a lasertex panel with a specific texture resulting in lower SW values.

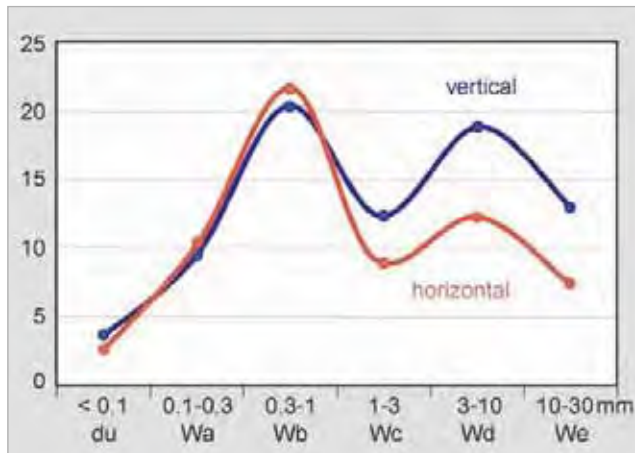
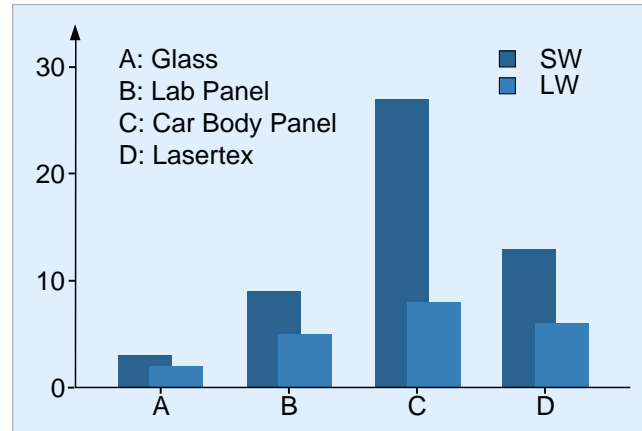

Influence of Baking Position:

In general, horizontal surfaces have shown better flow and leveling characteristics, i.e. in the values for the longer waves (Wc ... We). The smaller waves are hardly influenced by the baking position.

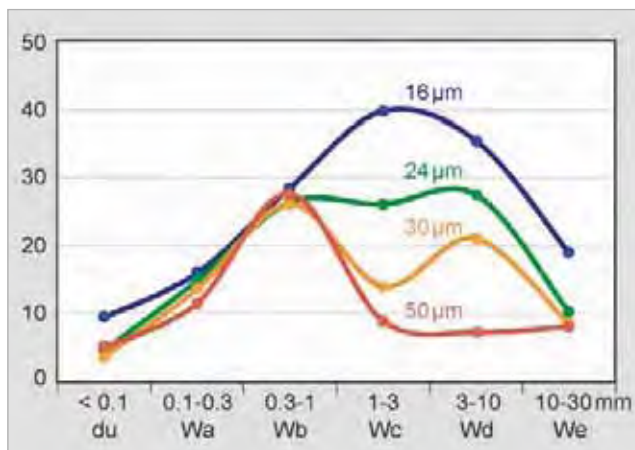

Influence of Film Thickness:

The structure spectrum can help optimize the appearance, e.g. in determining the optimum film thickness. Increasing clear coat thickness improves flow and leveling. In the graph this can be seen in decreasing Wc and Wd values.

wave-scan dual

Orange Peel and DOI measurement on high to semi gloss surfaces

... appearance control is no longer limited to final topcoat inspection. The orange peel meter scans the optical profile of high gloss surfaces using a laser light source. An additional, infrared – high energy LED allows measuring the same structure spectrum (0.1 – 30 mm) on medium gloss surfaces. The dullness measurement is recorded with state-of-the-art CCD camera technology. It gives information on the image forming qualities of the surface caused by structures < 0.1 mm.

Close the appearance control loop for the entire paint process

Thus, the surface quality after each paint process step can be objectively evaluated. No more guessing which substrate layer is influencing the final appearance. The wave-scan dual will help you to objectively analyze appearance problems and reduce the time necessary for trouble shooting.

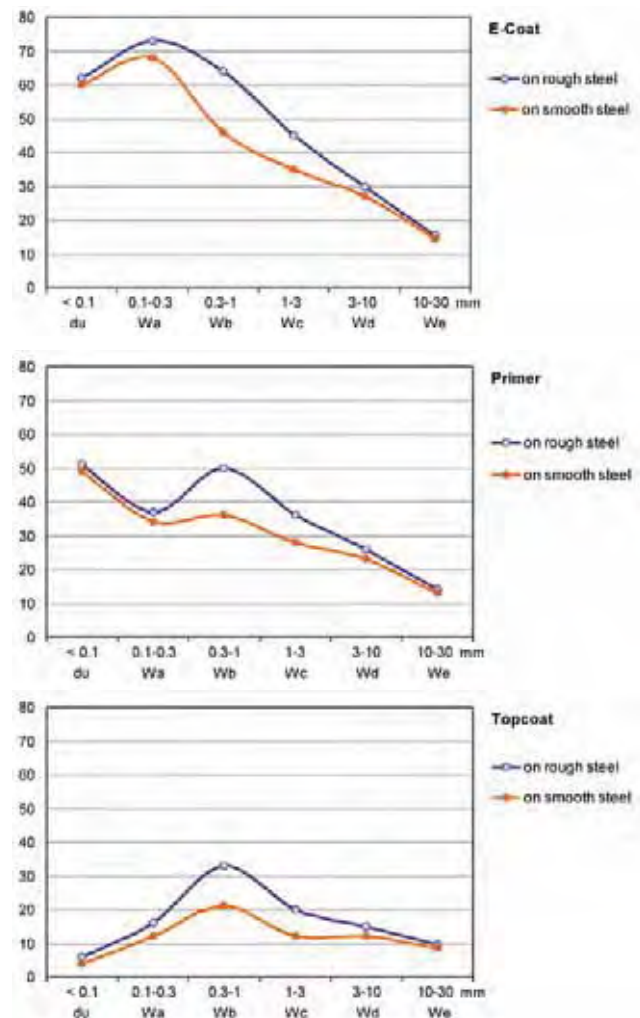
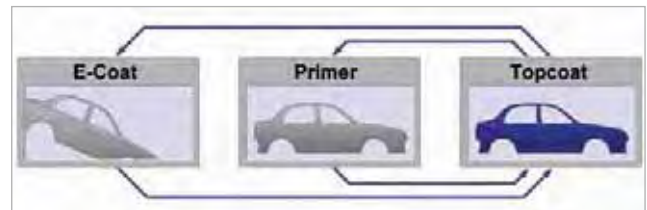

Example: Influence of Steel Quality on Final Appearance

Step 1: Appearance Control after E-coat

Same E-coat system was applied on rough and smooth steel. The influence of rougher steel can be seen in increased Wb and Wc-values.

Step 2: Appearance Control after Primer Surfacer

The primer surfacer was applied on both panels. The roughness of the steel quality can still be detected in increased Wb and Wc-values. This primer system could not completely cover the steel influence.

Step 3: Appearance Control after Topcoat

The final appearance shows higher shortwave values on the rougher steel panel. Therefore, the smooth panel will appear more brilliant.

wave-scan dual – a diagnostic tool for trouble shooting and optimizing appearance

Now, you can establish appearance specifications for each paint layer to ensure the final appearance is always on target.

Objective and reliable appearance data

- Good correlation to wave-scan DOI on high gloss surfaces
- Good correlation to mechanical profilometer readings on medium gloss surfaces

Easy to use with one hand

- For flat and curved areas
- Small and light weight
- Scroll wheel operation and multilingual menu
- Selectable scales and scan lengths
- Full statistics with saving in selectable memories
- USB port for data transfer to PC
- Software auto-chart:
 - Organizer files for sample identification
 - Data management with Access DB
 - Standard QC Reports in Excel®



select mode ...



and measure

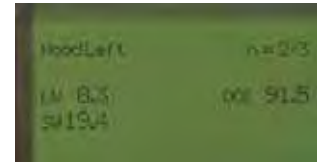

Always ready

The orange peel meter is operated with a rechargeable battery pack (Li-Ion). The docking station automatically charges the battery pack and transfers the measured data to the PC.

Optionally, the instrument can be operated with 3 standard mignon alkaline or rechargeable batteries – good for 1000 readings.



Ordering Information

Cat. No.	Description
AW-4840	wave-scan dual
SE-4840	Extended Warranty one year additional

Comes complete with:

Orange peel meter, Protective cover,
Reference tile with certificate,
Software auto-chart on CD,
Docking station and interface cable,
2 rechargeable Li-Ion battery packs,
Battery holder for AA batteries,
3 Batteries, Operating manual,
Carrying case
Training

Free 1x preventive maintenance service during warranty period

Hardware Requirements:

Operating system: Windows® 2000 or higher
Excel® version: 2002 or higher, incl. VBA
Memory: min. 256 MB RAM (recommended 512 MB)
Hard-disk space: min. 100 MB
Monitor resolution: XGA (1024 x 768) or higher
Disk drive: CD-ROM or DVD
Interface: USB port

Technical Specifications

Application	
High to Semi Gloss	du < 65, linear range
Structure Spectrum	
du	<0.1 mm
Wa	0.1 to 0.3 mm
Wb	0.3 to 1 mm
Wc	1 to 3 mm
Wd	3 to 10 mm
We	10 to 30 mm
Repeatability¹	du < 40: 4% or > 0.4 du > 40: 6% or > 0.6
Reproducibility¹	du < 40: 6% or > 0.6 du > 40: 8% or > 0.8
Object Curvature	radius > 500 mm
Min. Sample Size	35 mm x 150 mm
Scan Length	5 / 10 / 20 cm
Resolution	375 points/cm
Memory	1500 readings
Interface	USB 1.1
Languages	English, French, German, Italian, Japanese, Portuguese, Spanish
Light Source	Laser diode, LED and IR-SLED
Laser Energy	< 1 mW (Laser class 2)
Dimensions	150 x 110 x 55 mm (5.9 x 4.3 x 2.2 in.)
Weight	650 g (1.5 lbs)
Power Supply	rechargeable battery pack or 3 alkaline AA Batteries, approx. 1000 readings
Temperature Range	operation: +10 °C to 40 °C (+ 50 °F to 104 °F) storage: 0 °C to 60 °C (+ 32°F to 140 °F)
Rel. Humidity	up to 85 % at 35 °C (95 °F) non-condensing

¹Standard deviation

Training wave-scan dual

BYK-Gardner offers you more than just an instrument. We assist you in operating the wave-scan system and understanding your appearance readings. As a result you will be able to use the orange peel meter to save time and money and at the same time improve your quality.

Therefore, the instrument comes with a one day training course including:

1. Orange Peel and DOI Theory

- Visual perception and instrumental measurement of Orange Peel and DOI
- Data interpretation: How can the structure spectrum be used to optimize process / material parameters

2. Operation and Software Training

- Set-up of an "Organizer" to create a routine measurement procedure
- Programming of the instrument with "organizer" and measurement of several samples
- Direct data transfer to Excel for documentation of individual readings
- Data transfer to auto-chart software and saving in a database for routine QC

- Data analysis using standard QC-reports:
 - Summary by lines to show at one glance how various colors are running at different paint lines
 - Trend chart to show how specified zones perform over a defined time range
 - SPC-chart for daily process control of your critical colors and highrunners: xR-chart
 - Zone profile for trouble shooting using the structure spectrum
- Create your own reports in Excel®
 - Transfer data from the database to Excel®
 - Pivot function to define layout in Excel®

The training can be performed in one day or two half days. It is recommended to split the training into two half days:

Day 1: Theory and basic operation (set-up organizer, taking readings and saving data in a database)

Day 2: 3-4 weeks later to ensure readings were taken and in a database. Data analysis and standard QC reports can be explained using customer specific data.

Ordering Information

Cat. No.	Description
AW-4843	Reference Tile wave-scan dual
AW-4841	Docking Station
AW-4842	Battery Pack
AW-4809	auto-chart

Accessories

To check performance of the orange peel meter, with certificate
Incl. USB interface cable, and recharger 100 – 240 V self adapting
Rechargeable battery for automatic charge in docking station
Software for analysis and professional documentation in Excel®



Certified For Certification Services and Preventive Maintenance see pages 268 – 270.

wave-scan II

The specialist for high gloss surfaces

Surface appearance changes with the size and distinctness of structures. The wave-scan II objectively evaluates orange peel as well as brilliance of topcoat finishes.

Objective and reliable appearance data

- Excellent correlation to wave-scan DOI
- Classical Longwave and Shortwave
- Structure spectrum to analyze appearance changes
- Dullness and DOI measurement independent of the paint system

Ideal size for the production line

- Easy handling – even on the moving car body
- Small and light weight
- For flat and curved areas, radius > 50 cm
- Scroll wheel operation and multilingual menu
- Scales and scan lengths can be selected directly from menu
- Full statistics with saving in selectable memories
- Large memory for 1500 readings
- USB port for data transfer to PC
- auto-chart software:
 - Organizer files for sample id
 - Data management with Access DB
 - Standard QC Reports in Excel®



select mode ...

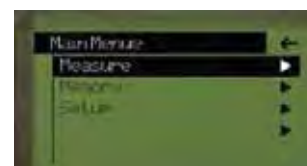

and measure

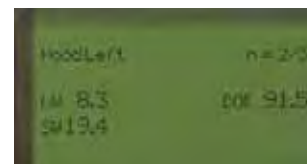

Always ready

The orange peel meter is operated with a rechargeable battery pack (Li-Ion). The docking station automatically charges the battery pack and transfers the measured data to the PC. Optionally, the wave-scan II can be operated with 3 standard mignon alkaline or rechargeable batteries – good for 1000 readings.



Ordering Information

Cat. No.	Description
AW-4846	wave-scan II
SE-4846	Extended Warranty one year additional

Comes complete with:

Orange peel & DOI meter with protective cover
 Reference tile with certificate
 auto-chart software on CD
 Docking station with interface cable
 2 rechargeable Li-Ion battery packs
 Battery holder for AA alkaline batteries
 3 Batteries, Operating manual
 Carrying case
 Training

Free 1x preventive maintenance service during warranty period

Hardware Requirements:

Operating system: Windows® 2000 or higher
 Excel® version: 2002 or higher, incl. VBA
 Memory: min. 256 MB RAM (recommended 512 MB)
 Hard-disk space: min. 100 MB
 Monitor resolution: XGA (1024 x 768) or higher
 Disk drive: CD-ROM or DVD
 Interface: USB port

Technical Specifications

Application	
High Gloss Surfaces	du < 40, linear range
Structure Spectrum	
du	< 0.1 mm
Wa	0.1 to 0.3 mm
Wb	0.3 to 1 mm
Wc	1 to 3 mm
Wd	3 to 10 mm
We	10 to 30 mm
Repeatability ¹	4% or > 0.4
Reproducibility ¹	6% or > 0.6
Object Curvature	radius > 500 mm
Min. Sample Size	35 mm x 150 mm
Scan Length	5 / 10 / 20 cm
Resolution	375 points/cm
Memory	1500 readings
Interface	USB 1.1
Languages	English, French, German, Italian, Japanese, Portuguese, Spanish
Light Source	Laser diode
Laser Energy	< 1 mW (Laser class 2)
Dimensions	150 x 110 x 55 mm (5.9 x 4.3 x 2.2 in.)
Weight	650 g (1.5 lbs)
Power Supply	rechargeable battery pack or 3 AA alkaline batteries approx. 1000 readings
Temperature Range	operation: +10°C to 40°C (+50°F to 104°F) storage: 0°C to 60°C (+32°F to 140°F)
Rel. Humidity	up to 85% at 35°C (95°F), non-condensing

¹Standard deviation

Training for wave-scan II

BYK-Gardner offers you more than just an instrument. We assist you in operating the wave-scan system and understanding your appearance readings. As a result you will be able to use the orange peel meter to save time and money and at the same time improve your quality. Therefore, the instrument comes with a one day training course including:

1. Orange Peel and DOI Theory

- Visual perception and instrumental measurement of Orange Peel and DOI
- Data interpretation: How can the structure spectrum be used to optimize process and material parameters

2. Operation and Software Training

- Set-up of an "Organizer" to create a routine measurement procedure
- Programming of the instrument with "organizer" and measurement of several samples
- Direct data transfer to Excel for documentation of individual readings
- Data transfer to auto-chart software and saving in a database for routine QC

- Data analysis using standard QC-reports:
 - Summary by lines to show at one glance how various colors are running at different paint lines
 - Trend chart to show how specified zones perform over a defined time range
 - SPC-chart for daily process control of your critical colors and highrunners: xR-chart
 - Zone profile for trouble shooting using the structure spectrum
- Create your own reports in Excel®
 - Transfer data from the database to Excel
 - Pivot function to define layout in Excel
- The training can be performed in one day or two half days. It is recommended to split the training into two half days:

Day 1: Theory and basic operation (set-up organizer, taking readings and saving data in a database)

Day 2: 3-4 weeks later to ensure readings were taken and saved in a database. Data analysis and standard QC reports can be explained using customer

Ordering Information

Cat. No.	Description
AW-4847	Reference Tile
AW-4841	Docking Station
AW-4842	Battery Pack
AW-4809	auto-chart



Accessories

- To check performance of the orange peel meter, with certificate
- Incl. USB interface cable, and recharger 100 – 240 V self adapting
- Rechargeable battery for automatic charge in docking station
- Software for analysis and professional documentation in Excel®

Certified For Certification Services and Preventive Maintenance see pages 268 – 270.

micro-wave-scan

Orange Peel and DOI measurement

Now you can measure Orange Peel and DOI on small and curved surfaces: Automotive add-on parts – like bumpers, gas tank doors, mirror housings, door handles, decorative trim or motorcycle parts.

...for curved and small parts

- Curvature > 300 mm
- Minimum sample size: 25 mm x 40 mm
- Selectable scan length 20, 10 or even 5 cm
- Measurement area: 4 mm x scan length
- DOI measurement possible without scanning the surface
- Good correlation to wave-scan DOI, the appearance standard in the automotive industry

Fits in the palm of your hand

- Small and light weight, easy to operate with one hand
- New scroll wheel to select functions and operate button to take readings
- Large, multilingual display: complete statistics and name input directly at the orange peel meter
- Storage of 2000 readings in selectable memories
- Docking station for recharging battery pack and data transfer to PC
- Rechargeable battery pack or standard mignon batteries can be used
- auto-chart software for professional analysis, documentation and data management

Objective and reliable appearance data

- Structure spectrum gives detailed information about various structure size
- High correlation to the visual perception
- Cause of appearance changes can be analyzed
- DOI – Distinctness of Image: objective measurement independent of paint system and curvature

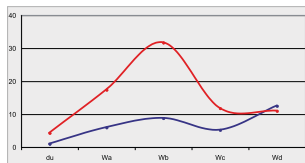

select mode ...

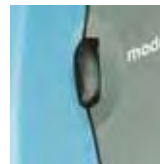

and measure

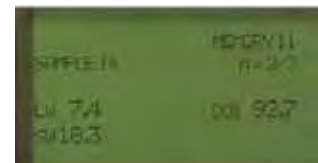

Always ready

The micro-wave-scan is operated with a rechargeable battery pack (Li-Ion). The docking station automatically charges the battery pack and transfers the measured data to the PC. Optionally, the orange peel meter can be operated with 2 standard AA alkaline or rechargeable batteries – good for 1000 readings.

Certified

For Certification Services and Preventive Maintenance see pages 268 – 270.

Ordering Information

Cat. No.	Description
AW-4824	micro-wave-scan
SE-4824	Extended Warranty one year additional

Comes complete with:

Orange peel meter, Protective cap,
Reference tile with certificate,
Software auto-chart on CD,
Docking station and interface cable,
2 rechargeable Li-Ion battery packs,
Battery holder for AA batteries,
2 Batteries, Operating manual,
Carrying case and belt case
Training

Free 1x preventive maintenance service during warranty period

Hardware Requirements:

Operating system: Windows® 2000 or higher
Excel® version: 2002 or higher, incl. VBA
Memory: min. 256 MB RAM (recommended 512 MB)
Hard-disk space: min. 100 MB
Monitor resolution: XGA (1024 x 768) or higher
Disk drive: CD-ROM or DVD
Interface: serial or USB port



Technical Specifications

Application	
High Gloss Surfaces	du < 40, linear range
Structure Spectrum	du: < 0.1 mm Wa: 0.1 – 0.3 mm Wb: 0.3 – 1 mm Wc: 1 – 3 mm Wd: 3 – 10 mm
Scan length/	20 cm: du, Wa...Wd, L, S, DOI
Measurement scales	10 cm: du, Wa...Wd, L, S, DOI 5 cm: du, Wa...Wd, L, S, DOI 0 cm: du, Wa, Wb, DOI
Repeatability¹	8% or > 0.8
Reproducibility¹	12% or > 1.2
Object Curvature	radius > 300 mm
Min. Sample Size	25 mm x 40 mm
Measurement Area	4 mm x scan length
Scan Length	5 / 10 / 20 cm
Resolution	375 points/cm
Memory	2000 readings
Interface	serial RS 232
Languages	English, French, German, Italian, Japanese, Portuguese, Spanish
Light Source	Laser diode, LED
Laser Energy	< 1 mW (Laser class 2)
Dimensions	70 x 120 x 40 mm (2.7 x 4.7 x 1.6 in)
Weight	250 g (0.6 lbs)
Power Supply	rechargeable battery pack or 2 AA batteries, approx. 1000 readings
Temperature Range	operation: +10°C – 40°C (+50°F – 104°F) storage: 0°C – 60°C (+32°F – 140°F)
Relative Humidity	up to 85% at 35°C (95°F)

¹ Standard deviation

Training for micro-wave-scan

BYK-Gardner offers you more than just an instrument. We assist you in operation of the micro-wave-scan system and understanding your appearance readings. As a result you will be able to use the orange peel meter to save time and money and at the same time improve your quality. Therefore, the instrument comes with a one day training course including:

1. Orange Peel and DOI Theory

- Visual perception and instrumental measurement of Orange Peel and DOI
- Data interpretation: How can the structure spectrum be used to optimize process / material parameters

2. Operation and Software Training

- Set-up of an "organizer" to create a routine measurement procedure
- Programming of the instrument with "organizer" and measurement of several samples
- Direct data transfer to Excel for documentation of individual readings
- Data transfer to auto-chart software and saving in a database for routine QC
- Data analysis using standard QC-reports:
 - Summary by lines to show at one glance how various colors are running at different paint lines
 - Trend chart to show how specified zones perform over a defined time range
 - SPC-chart for daily process control of your critical colors and highrunners: xR-chart
 - Zone profile for trouble shooting using the structure spectrum



- Create your own reports in Excel
 - Transfer data from the database to Excel
 - Pivot function to define layout in Excel

The training can be performed in one day or two half days. It is recommended to split the training into two half days:

- Day 1: Theory and basic operation (set-up organizer, taking readings and saving data in a database)
- Day 2: 3-4 weeks later to ensure readings were taken and saved in a database. Data analysis and standard QC reports can be explained using customer specific data.

Ordering Information

Cat. No.	Description
AW-4828	Docking Station
AW-4829	Reference Tile
AG-4401	USB-Adaptor
AW-4827	Battery Pack
AW-4809	auto-chart



Accessories

- Incl. serial interface cable 9-pin Sub-D and recharger 100 – 240 V self adapting
- To check performance of the orange peel meter, with certificate
- For connection to USB-interface, incl. driver software
- Rechargeable battery for automatic charge in docking station
- Software for analysis and professional documentation in Excel®

Certified For Certification Services and Preventive Maintenance see pages 268 – 270.

wave-scan ROBOTIC

Automatic appearance control of topcoat finish at the line

A stable running process is the key for uniform and consistent quality. Therefore, orange peel and DOI need to be measured on a routine basis in the production process and the measurement results shared with add-on suppliers. The new wave-scan ROBOTIC allows automated appearance control as it is mounted on a robotic arm. The robotic system ensures measurement on the same area and a high number of measured car bodies.

Non-contact measurement

- Distance to surface 15 ± 2 mm
- Angle to perpendicular $\pm 2^\circ$
- Curvature > 500 mm radius
- Scan speed 50 to 150 mm/sec.
- Small and light weight



Objective and reliable appearance data

Excellent correlation to wave-scan DOI, the appearance standard in the automotive industry

- Structure spectrum gives detailed information about the surface quality
- Cause of appearance changes can be analyzed
- Orange Peel, DOI and customer specific scales available

Stable process means consistent quality

- Automated appearance control provides complete and representative data for statistical process control
- wave-scan ROBOTIC builds up a valuable database for systematic process analysis and optimization

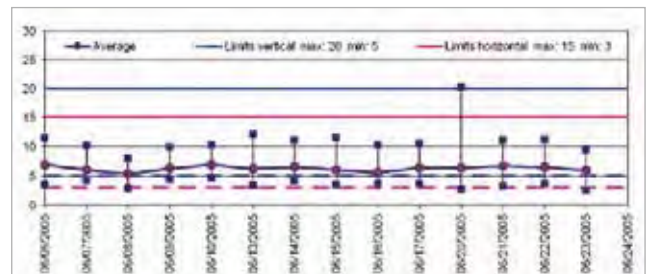

Training for wave-scan ROBOTIC

BYK-Gardner offers you more than just an instrument, we assist you in operating the wave-scan system. Therefore, the orange peel meter comes with a two day training course including:

- Orange Peel & DOI: Theory and data interpretation.
- Support in integrating wave-scan ROBOTIC sensor into automated measurement system
- Data analysis using standard QC-reports including SPC-charts



Ordering Information

Cat. No.	Description
AW-4822	wave-scan ROBOTIC
AW-4850	wave-scan dual ROBOTIC
SE-4822	Extended Warranty one year additional

Comes complete with:

Orange peel meter
 Reference tile with certificate
 auto-chart software on CD,
 Communication software on CD
 Installation kit
 Operating manual
 Carrying case
 Training

Free 1x preventive maintenance service during warranty period

Hardware Requirements:

Operating system: Windows® 2000 or higher
 Excel® version: 2002 or higher, incl. VBA
 Memory: min. 256 MB RAM (recommended 512 MB)
 Hard-disk space: min. 100 MB
 Monitor resolution: XGA (1024 x 768) or higher
 Disk drive: CD-ROM or DVD
 Interface: RS 422



Ordering Information

Cat. No.	Description
AW-4833	Reference Tile ROBOTIC
AW-4851	Reference Tile ROBOTIC dual
AW-4809	auto-chart

Technical Specifications

Application	
High Gloss Surfaces	du < 40, linear range
High to Semi Gloss	du < 65, linear range
Structure Spectrum	du: < 0.1 mm Wa: 0.1 to 0.3 mm Wb: 0.3 to 1 mm Wc: 1 to 3 mm Wd: 3 to 10 mm We: 10 to 30 mm
Repeatability¹	du < 40: 4% or > 0.4 du > 40: 6% or > 0.6
Reproducibility¹	du < 40: 6% or > 0.6 du > 40: 8% or > 0.8
Resolution	375 points/cm
Distance to Surface	15 ± 2 mm
Angle to Surface	perpendicular ± 2°
Object Curvature	radius > 500 mm
Min. Sample Size	35 mm x 150 mm
Scan Length	5 / 10 / 20 cm
Scan Speed	50 to 150 mm/sec
Memory	100 readings
Light Source	Laser diode, LED
Laser Energy	< 1 mW (Laser class 2)
Dimensions	112 x 115 x 60 mm (4.4 x 4.5 x 2.4 in)
Weight	520 g (1.2 lbs)
Power Supply	external power supply 24 V DC, max. 0.5 A
Interface	RS 422
Robotic requirements	Vibration-free operation
Temperature Range	operation: +10°C to 40°C (+50°F to 104°F) storage: 0°C to 60°C (+32°F to 140°F)
Rel. Humidity	up to 85% at 35°C (95°F) non-condensing

¹ Standard deviation

Accessories

To check performance of the orange peel meter, with certificate
 To check performance of the orange peel meter, with certificate
 Software for analysis and professional documentation in Excel®

Introduction

Mottling

Mottling is an undesirable defect which can occur with effect coatings – it is most obvious on light metallic finishes. The total color impression shows irregular areas of lightness variations. These "patches" are usually visually evaluated, described as a mottling effect. Some also feel that it reminds them of clouds. This effect is especially noticeable on large body panels. It can be caused by the coating formulation, as well as variations in the application process. For example, disorientation of the metallic flakes or film thickness variations of the basecoat can lead to various mottle sizes resulting in a non-uniform appearance.

Orientation Clouds



Disorientation influenced by wetting behaviour, rheology additive or application



Strike in effect: disorientation by interaction between clear coat and basecoat

Thickness / Hiding Clouds



Thickness variations result in poor hiding



Thickness variations result in partial hiding at a grazing angle

MOTTLING



The visual perception of mottling is dependent on the viewing distance: Large mottles can be seen in far distance evaluation, while small mottles are more noticeable in close up evaluation. The visual evaluation of mottling is very subjective, as it depends on the illumination conditions, the observing distance and the viewing angle.



Simulation of visual perception

In order to objectively evaluate mottling, it is necessary to measure lightness variations over a large sample area and under different detection angles.

The cloud-runner optically scans the surface and measures the lightness variations. The specimen is illuminated with a white light LED at a 15° angle and the lightness is detected under three viewing angles to simulate visual evaluation under different observing conditions: 15°, 45° and 60° measured from the specular reflection.

The mottling meter is rolled across the surface for a defined distance of 10 to 100 cm and measures the lightness variations point by point.

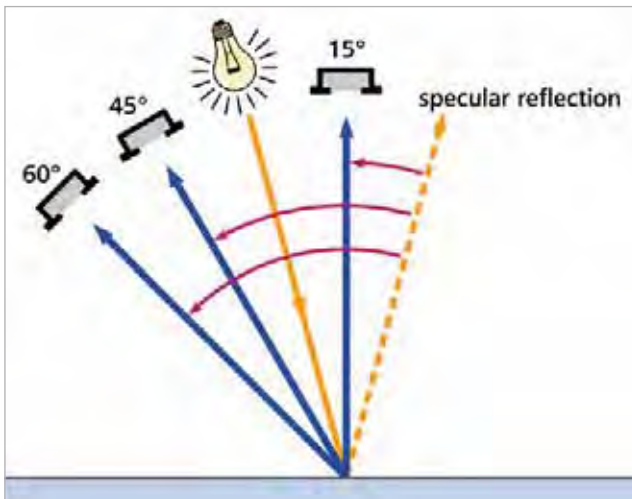

cloud-runner: measurement principle



The measurement signal is divided via mathematical filter functions into 6 different size ranges and a rating value is calculated for each angle and mottle size. The higher the value is, the more visible the mottling effect.

The measured values are displayed in a graph showing the mottle size on the X-axis and the rating value on the Y-axis. Thus, target values for small and large mottle sizes can be established for paint batch approval as well as process control.

Mottle Size

Md	6 -13 mm
Me	11 -24 mm
Mf	19 - 42 mm
Mg	33 - 72 mm
Mh	57 - 126 mm
Mi	100 - 200 mm

Interpretation of measurement data

Example: Light Blue Metallic

In this example the influence of the observing angle is quite significant. Visually medium to large size mottles are most obvious at a head-on viewing when the sample appears lighter, while at flatter angles the mottling is no longer visible.

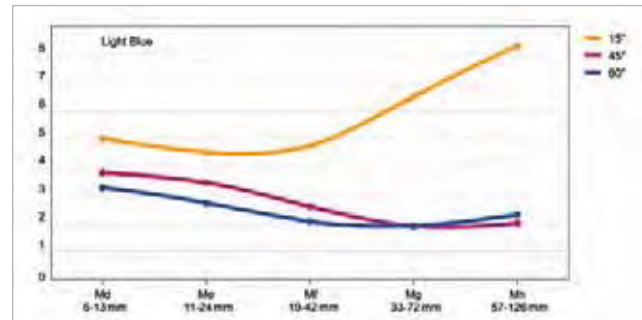

Example: Silver Metallic

Horizontal and vertical parts were visually evaluated and measured. The horizontal areas showed a high amount of medium size mottles, while the vertical areas were visually acceptable. The cloud-runner measured high Mg-values at all three angles on the horizontal areas and considerably lower readings on the vertical areas.

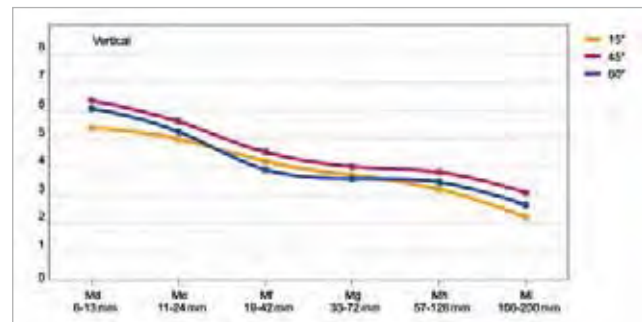
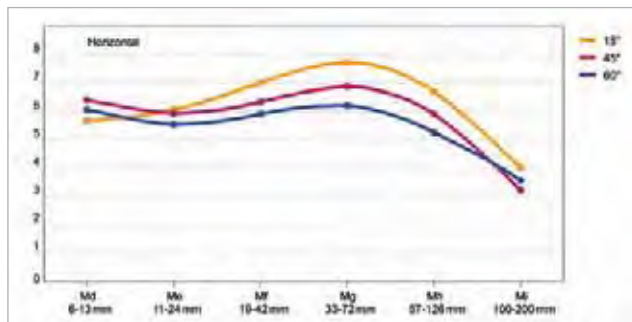

cloud-runner

Control and guarantee a uniform finish – no more mottling!

Mottling disturbs the overall color harmony of effect finishes. These irregular lightness variations can now be objectively measured with BYK-Gardner's newest innovation: the cloud-runner simulates visual evaluation under different observing angles and characterizes clouds / mottles by their size and visibility.

Objective and reliable values for QC and trouble shooting

- Small to large mottles are measured under three observing angles
- Scan length can be varied from 10 to 100 cm
- Objective measurement results independent of color and curvature

Ideal tool for the production line

- Small and light weight – easy to handle
- For flat and curved areas, radius > 50 cm
- Easy, menu guided operation via scroll wheel and large, multilingual display
- Full statistics with ability to save in selectable memories
- Large memory for 1000 readings
- USB port for data transfer to PC
- auto-chart software:
 - Organizer files for sample id
 - Data management with Access DB
 - Standard QC Report in Excel®



select mode ...



and measure

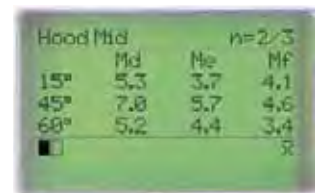

Always ready

The mottle meter is operated with a rechargeable battery pack (Li-Ion). The docking station automatically charges the battery pack and transfers the measured data to the PC.



Ordering Information

Cat. No.	Description
AM-6350	cloud-runner
SE-6350	Extended Warranty – one year additional

Comes complete with:

Mottling meter with protective cover
 Reference tile with certificate
 auto-chart software on CD
 Docking station with USB-able
 2 rechargeable Li-Ion battery packs
 Operating manual
 Carrying case
 Training

Free 1x preventive maintenance service during warranty period

Hardware Requirements:

Operating system: Windows® 2000 or higher
 Excel® version: 2002 or higher, incl. VBA
 Memory: min. 256 MB RAM (recommended 512 MB)
 Hard-disk space: min. 100 MB
 Monitor resolution: XGA (1024 x 768) or higher
 Disk drive: CD-ROM or DVD
 Interface: USB port

Technical Specifications

Cloud Size	
Md	6 to 13mm
Me	11 to 24 mm
Mf	19 to 42 mm
Mg	33 to 72 mm
Mh	57 to 126 mm
Mi	100 to 200 mm
Repeatability¹	5% or > 0.5
Reproducibility¹	8% or > 0.8
Object Curvature	radius > 500 mm
Scan Length	10 to 100 cm, selectable in 1cm steps
Resolution	25 points/cm
Measuring Time	< 4 sec.
Memory	1000 readings
Interface	USB 1.1
Languages	English, French, German, Italian, Japanese, Portuguese, Spanish
Light Source	White Power LED
Dimensions	150 x 110 x 55 mm (5.9 x 4.3 x 2.2 in.)
Weight	650 g (1.5 lbs)
Power Supply	rechargeable battery pack, approx. 1500 readings
Temperature Range	operation: +10°C to 40°C (+50°F to 104°F) storage: 0°C to 60°C (+32°F to 140°F)
Rel. Humidity	up to 85% at 35°C (95°F), non-condensing

¹Standard deviation

Training for cloud-runner

BYK-Gardner offers you more than just an instrument. We assist you in operating the cloud-runner system and understanding your mottle readings. As a result you will be able to use the mottling meter to save time and money and at the same time improve your quality. Therefore, the instrument comes with a one day training course including:

1. Mottling Theory

- Visual perception and instrumental measurement of Mottling / Cloudiness
- Data interpretation: How can the readings be used to optimize process and material parameters

2. Operation and Software Training

- Set-up of an "Organizer" to create a routine measurement procedure
- Programming of the instrument with "organizer" and measurement of several samples
- Direct data transfer to Excel for documentation of individual readings
- Data transfer to auto-chart software and saving in a database for routine QC
- Data analysis

The training can be performed in one day or two half days. It is recommended to split the training into two half days:

Day 1: Theory and basic operation (set-up organizer, taking readings and saving data in a database)

Day 2: 3-4 weeks later to ensure readings were taken and saved in a database. Data analysis and standard QC reports can be explained using customer specific data.

Ordering Information

Cat. No.	Description
AM-6353	Reference Tile
AM-6351	Docking Station
AM-6349	Battery Pack
AW-4809	auto-chart

Accessories

To check performance of the mottling meter, with certificate
Incl. USB interface cable and recharger 100 – 240 V self adapting
Rechargeable battery for automatic charge in docking station
Software for analysis and professional documentation in Excel®



Certified For Certification Services and Preventive Maintenance see pages 268 – 270.

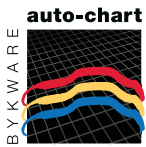

auto-chart

Efficient Data Analysis with auto-chart Software

Substrate + Coating Material + Application: Numerous production parameters influence the appearance of the coating. Therefore, a representative process control requires structured analysis. The auto-chart software allows for systematic planning and efficient handling of large data sets.

Definition of Test Procedure

The individual object identification and control sequences are defined in the auto-chart software to create so-called "Organizer" files. These Organizer files are then transferred to the instrument and this information is shown on the display of the instrument. This procedure guarantees that every user always measures in the correct sequence – without operator errors.

1. Clear Object Identification

Your parameters for object identification can be model – color – line; the system is open for your specific needs.

2. Definition of Measurement Sequence

In the Organizer file the control zones for each model can be defined.

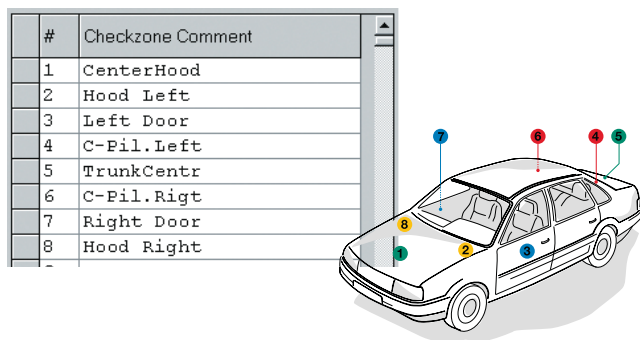

3. Send Organizer file to the instrument



Measuring: Easy and Quick

Clear object identification without notepad or annoying typing: Just select on the display model, color and line no. and start measuring.

Easy and fast measuring at the production line with model specific operator guidance.



Transfer Data and Save

The measurements are saved in the instrument, transferred to the PC, and displayed in a well structured menu. The measured data can be saved in the integrated Access® database. Thus, large data sets can be easily managed and analyzed.

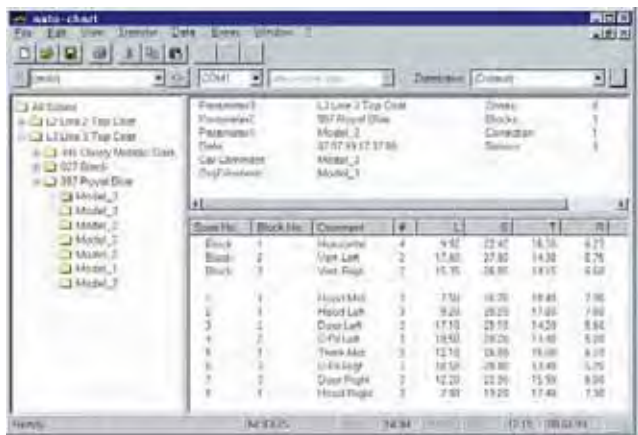

Professional Analysis and Documentation

auto-chart combines the efficient data management of Access® with the proven Excel® functionality.

Standardized reports allow for easy and fast analysis of large data sets with graphics.

The results of individual car bodies or comprehensive analysis of various production lines over time can be performed.

Data Selection and Analysis in Excel

Clearly structured queries allow analyzing your data according to your criteria.

The filtered data can be analyzed using pre-prepared standard reports or can be directly transferred to Excel®.



Trend Graph

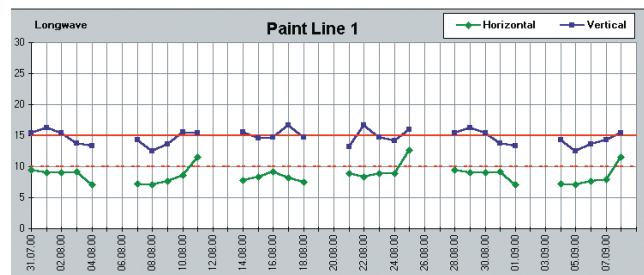

Summary by lines

Shows at one glance how various colors are running at the different paint lines.

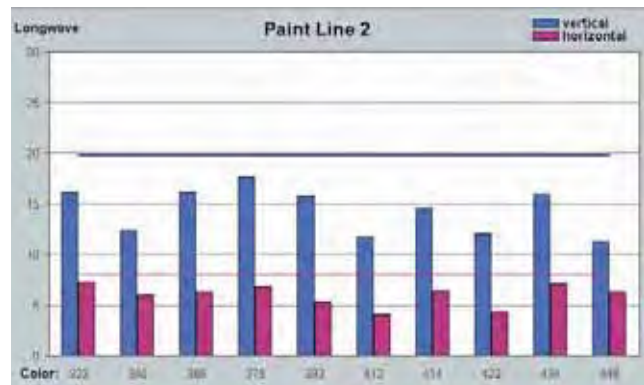

Zoneprofile

This standard report compares the values of an actual car body with the results of the previous period – deviations of the required uniformity are quickly detected.

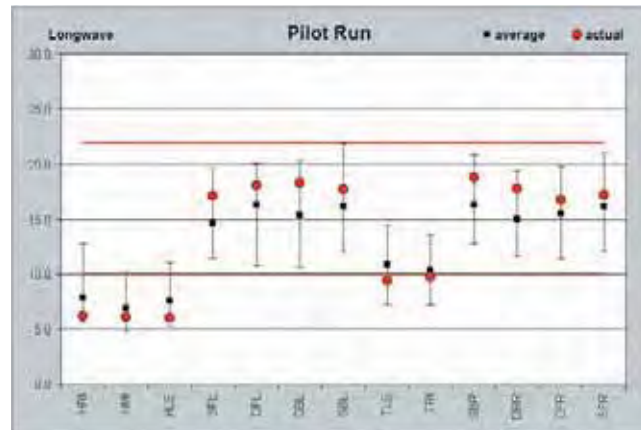
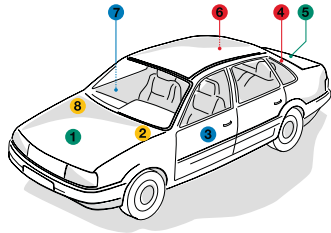

xR-graph: The voice of the process

A typical Statistical Process Control chart for daily process control. The average and range values for defined blocks (e.g. horizontals or verticals) per car are calculated and displayed in a graph. In addition, upper and lower control limits are calculated. Thus, trend can be easily recognized.

Zone	Control	Control	Control	Control	Control	Control	Control	Control	Control	Control	Control	Control	Control	Control	Control	Control	Control	Control
Mean	42	43	44	45	46	47	48	49	50	51	52	53	54	55	56	57	58	59
Upper	52	53	54	55	56	57	58	59	60	61	62	63	64	65	66	67	68	69
Lower	32	33	34	35	36	37	38	39	40	41	42	43	44	45	46	47	48	49
Range	20	21	22	23	24	25	26	27	28	29	30	31	32	33	34	35	36	37

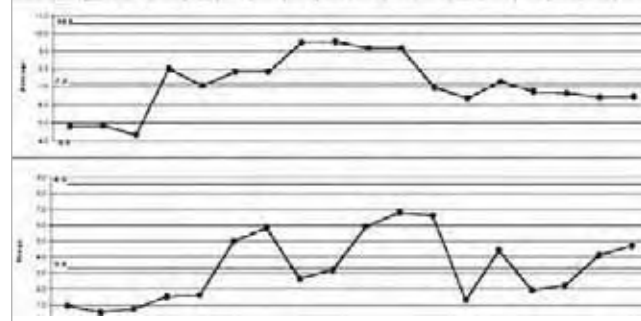

Structure spectrum

The structure spectrum is shown for each control zone to support trouble shooting. The example shows the structure spectrum of a silver metallic automobile. Very noticeable is the higher waviness on the fuel door in the range of 1 to 10 mm wavelength (Wc, Wd) which is perceived as higher Orange Peel compared to the body. The flexible reporting possibilities of Excel® allow for professional documentation according to your individual needs.

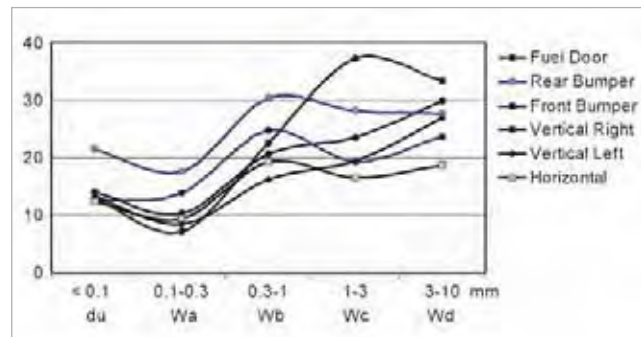

Ordering Information

Cat. No.	Description
AW-4809	auto-chart

Comes complete with: Software on CD-ROM

Note: auto-chart licence fee for more than two installations is quantity dependent. Please contact your local BYK-Gardner representative.

Technical Specifications

Software for analysis and documentation. For wave-scan dual, wave-scan II, micro-wave-scan, wave-scan DOI and wave-scan ROBOTIC

Hardware Requirements:

Operating system: Windows® 2000 or higher
 Excel® version: 2002 or higher, incl. VBA
 Memory: min. 256 MB RAM (recommended 512 MB)
 Hard-disk space: min. 100 MB
 Monitor resolution: XGA (1024 x 768) or higher
 Disk drive: CD-ROM or DVD
 Interface: serial or USB port

Uniform Color and Appearance of Exterior Automotive Finishes

The paint finish of a car has to meet two main requirements: protect the vehicle from weathering influences (e.g. corrosion, loss of gloss) or other mechanical impacts (e.g. car wash and chip resistance) and, of course make the car visually appealing. Eye catching finishes should not only have a “beautiful” color, but look like a mirror - “high gloss and perfectly smooth”. Uniformity is especially important: Any color and appearance differences between car body and add-on parts will be most noticeable and be associated with lower quality, or could even result in costly warranty complaints.

Therefore, target values with tolerances for color and appearance are defined by the automotive OEM makers. Meeting these target values is a challenging task for everybody in the supply chain, as color and appearance is not only a multi-dimensional phenomena, but also can be influenced by a variety of material, substrate and process parameters.

Orange peel and DOI control with wave-scan family

The appearance of a finish can be described by its brilliance and “smoothness”, also referred to as DOI (Distinctness of Image) and Orange Peel. For years the BYK-Gardner wave-scan family has been used as the standard to objectively quantify appearance of painted body and off-line painted parts by all major car, truck, motorcycle, boat and yacht companies.



micro-wave-scan see page 44.



wave-scan dual see page 37.

Depending on the OEM different target values and appearance scales have been developed over the years. These company specific scales are an objective check to ensure company specifications are met, and eliminate heated discussions between automotive producers and their suppliers.

In order to ensure harmony as well as brilliant and smooth appearance, long and short waviness scales should not be evaluated separately and independently optimized. Therefore, a “balance” between short waves and long wave measurement scales is essential.

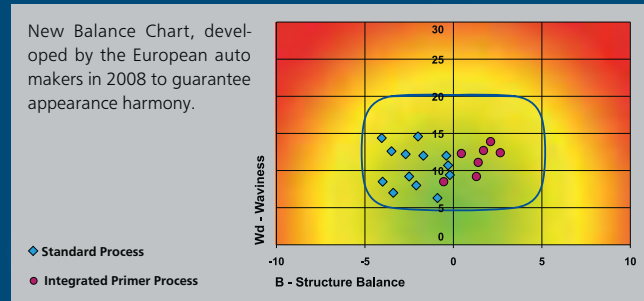
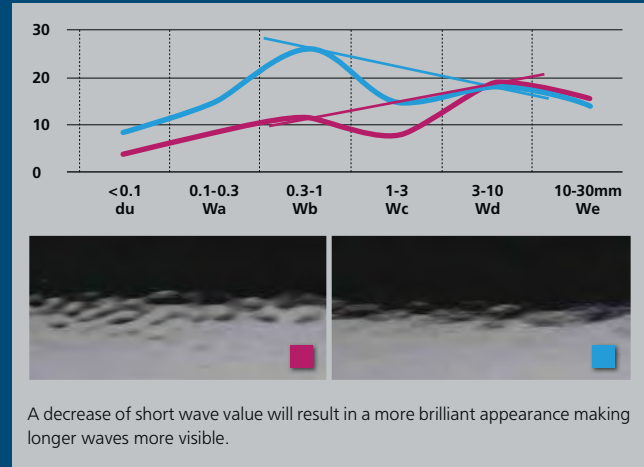

Additionally, the wave-scan measurement data can be used for trouble shooting to improve quality.

Dullness is too high	Clear coat looks milky
Wa is too high	Very fine textures caused by material properties
Wb is too high	Substrate influence
Wc is too high	Dry spray of clear coat
Wd is too high	Substrate influence
	Insufficient amount of clear coat
	Very rough substrate
	Insufficient amount of clear coat
	Very rough substrate

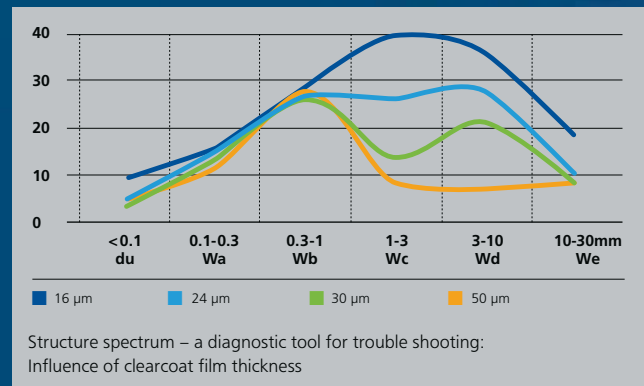

Multi-angle color and effect control with BYK-mac family

Color consistency is the most obvious and thus, most important quality criteria of an automotive finish. Designers are continuously looking for new colors which not only make the product look exciting, but actually underline its styling resulting in a "living" color! More than 70% of today's automotive colors are special effect finishes. A lightness or even color change can be observed under different viewing angles and a sparkling effect can be created under direct sun light.

Objective control of total color impression is needed which correlates with the visual impression and can be used for daily QC at the paint supplier for paint batch approval, as well as at the part and assembly plants. Establishing color specifications for effect finishes has been a challenging task. Further development of CIE Lab color space (1976) resulted in new color difference spaces/indices (ΔE_{CMC} , ΔE_{94} , ΔE_{99}) that supported the auto OEM makers and their suppliers in establishing specifications which were "independent" of color hue, saturation, lightness and even on the viewing angle ($\Delta E_{DIN6175-2}$). More than multi-angle color measurement is needed to capture appearance change under different lighting conditions, measuring the so-called sparkling and graininess effect helps to do this.



Color and Effect Travel

Car body and bumper are within an acceptable average $\Delta E_{DIN} < 1$. Visually one can observe more sparkling at a low grazing angle on the car body. The Delta Sparkle 75° documents this difference which is caused by different application methods resulting in different flake orientation.

The BYK-Gardner BYK-mac was designed to objectively measure color travel under 6-different viewing angles, and at the same time quantify the effect phenomena "Sparkling" and "Graininess" with a camera system under direct and diffused illumination.

Process Stability to Guarantee Uniform Color and Appearance

In order to guarantee uniformity over time and be able to proactively take measurements when color or appearance is starting to drift, process stability needs to be controlled. Therefore, a representative number of measurements have to be taken. Statistical studies have shown that a minimum of 5% of the daily production output needs to be sampled in order to make an objective judgment of process stability.

The BYK-Gardner wave-scan and BYK-mac can be used as portable devices or as automated versions which can be mounted on a robot.

The wave-scan ROBOTIC as well as the BYK-mac ROBOTIC are robust, light weight and offer fast data collection, which makes them ideal for industrial online applications.

By measuring with a robot the same measurement area is always checked, and any operator errors (wrong measurement direction...) which could have an influence on the final reading are eliminated.



BYK-Gardner Reference Customers:

Aston Martin · Audi · AutoVaz · BMW · Cherry · Chrysler · Daewoo · Daihatsu · Fiat · Ford · GM · Honda · Hyundai · Jaguar · Lamborghini · Lotus · MAN · Mercedes-Benz · Mitsubishi · Nissan · PSA · Porsche · Renault · Renault Trucks · Rollce Royce · Saab · Scania · Seat · Skoda · Subaru · Suzuki · TATA · Toyota · Volvo · Volvo Trucks · VW



BYK-mac
see page 100.



Measure what you see.

wave-scan family

The standard in the automotive industry
for total appearance control

“wave-scan is my key to ensure final appearance being always on target. In quality control, process optimization or trouble shooting – it is our objective value for a perfect finish. And with wave-scan dual we even see influences of semi gloss layers now. Brilliant!”

www.byk.com/instruments

A member of **ALTANA**

BYK
Additives & Instruments

Introduction

Transparency

The appearance of a transparent product is defined by its application. Packaging film used in the food industry should be very clear and transparent, while film for grocery bags should be translucent and diffuse the light. Therefore, different raw materials are selected and processed under certain conditions.

The absorption and scattering behavior of the transparent specimen will determine how much light will pass through and how objects will appear through the transparent product.

Total Transmittance

Total transmittance is the ratio of transmitted light to the incident light. It is influenced by the absorption and reflection properties, e.g.:

Incident light	100 %
– Absorbtion	-1 %
– Reflection	-5 %
Total Transmittance	= 94 %

The totally transmitted light consists of the directly transmitted and the diffused components. Depending on the angular distribution of the diffused portion, a transparent plastic will appear differently.

Visual perception can clearly differentiate two phenomena: Wide angle and narrow angle scattering.

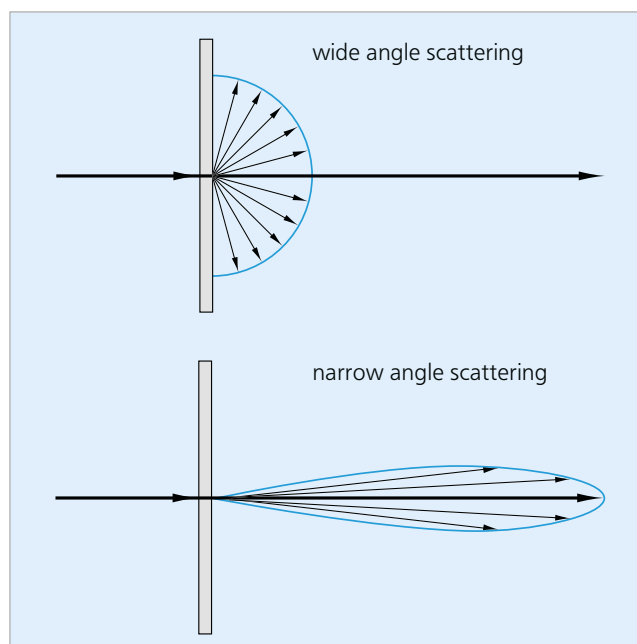

TRANSPARENCY

Wide Angle Scattering → Haze

Light is diffused in all directions causing a loss of contrast. ASTM D 1003 defines haze as that percentage of light which in passing through deviates from the incident beam greater than 2.5 degrees on the average.



Narrow Angle Scattering → See-through Quality

Light is diffused in a small angle range with high concentration. This effect describes how well very fine details can be seen through the specimen. The see-through quality needs to be determined in an angle range smaller than 2.5 degrees. Measurement and analysis of haze and see-through quality guarantee a uniform and consistent product quality and help analyze influencing process parameters and material properties, e.g. cooling rate or compatibility of raw materials.

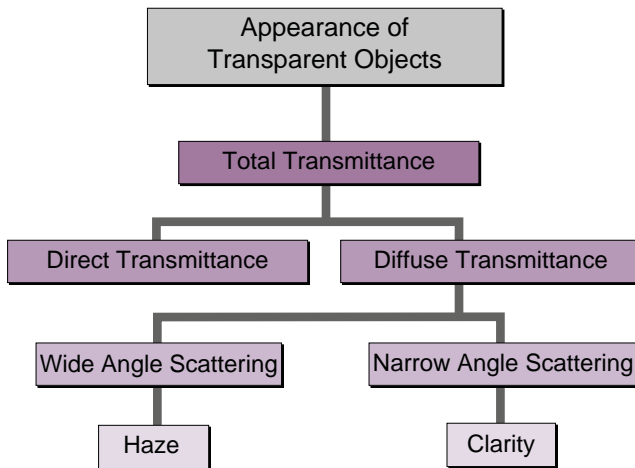

Objective Measurement of Transparency

The figure on the right hand side shows the measurement principle of the haze meter: A light beam strikes the specimen and enters an integrating sphere. The sphere's interior surface is coated uniformly with a matte white material to allow diffusion. A detector in the sphere measures total transmittance and transmission haze. A ring sensor mounted at the exit port of the sphere detects narrow angle scattered light (clarity).

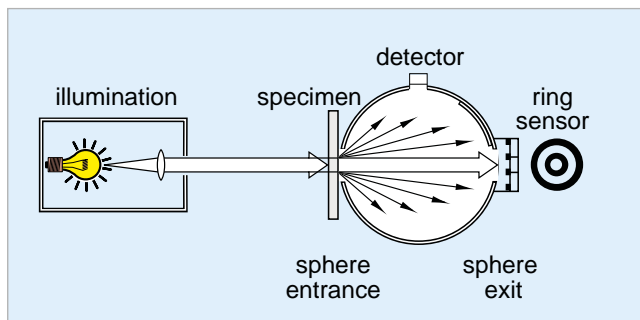

haze-gard *plus*

The Objective Standard for a Clear View

The haze-gard plus quantifies the visual perception with objective measurement data. All essential criteria for transparency can be measured with one instrument:

- Total transmittance
- Transmission haze
- See-through quality

The Industry Standard according to ASTM

- Reference beam, self-diagnosis, and enclosed optics guarantee accurate readings – any time
- Built-in statistics with average, standard deviation, coefficient of variance, and min/max
- Large storage capacity and data transfer to a PC for professional documentation

Quick Measurement of Variety of Samples

- Open sample area for small and large specimens
- Foot switch and automatic measurement allow hands-free operation
- Ready for measurement without warm-up time
- Automatic and long-term calibration allow easy and fast operation of the hazemeter
- Operation in English, German, French, Spanish and Italian – switchable

Documentation of Measurement Data

Transfer your measurement results from the hazemeter to the easy-link software for further data processing in Excel®.

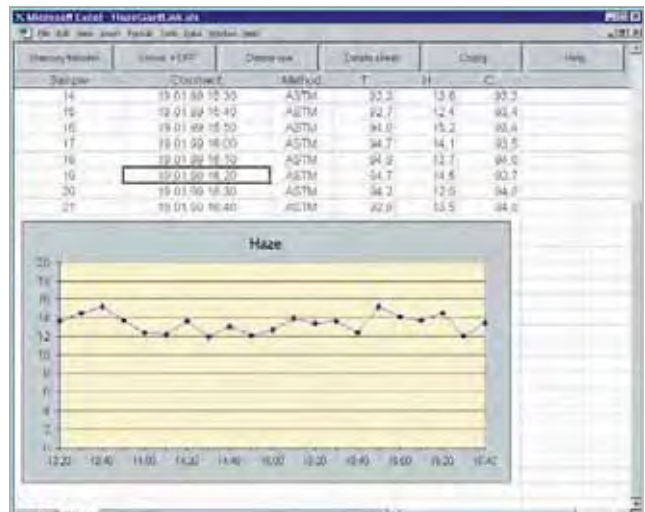

Training for haze-gard plus

BYK-Gardner offers you more than just an instrument. We assist you in the operation of the haze-gard plus and understanding your appearance readings. As a result you will be able to use the haze meter to save time and money, and at the same time improve your quality. Therefore, the haze meter comes with a half-day training course including:

Haze and Clarity Theory

- Visual perception, Transparency, Scattering, Haze and Clarity
- Instrumental measurement, Standards and Application

Operation and Software Training

- Handling, Statistics, Maintenance
- Direct data transfer to Excel and documentation



Ordering Information

Cat. No.	Description
AT-4725	haze-gard plus, Illum. C
AT-4726	haze-gard plus, Illum. A
SE-4725	Extended Warranty one-year additional

Comes complete with:

Hazemeter with Foot switch
Clarity calibration standard
Zero standard
easy-link software
Interface cable
Power cord
Operating manual
Training

Free 1x preventive maintenance service during warranty period

Certified For Certification Services and Preventive Maintenance see pages 268 – 270.

Standards

ASTM D 1003, D 1044

Technical Specifications

Illuminant CIE-C	General purpose
Illuminant CIE-A	Automotive windshields
Spectral Response	CIE luminosity function y
Measurement Area	ø 18 mm (0.7 in)
Sample Port	ø 25.4 mm (1.0 in)
Measurement Range	0 – 100 %
Repeatability	± 0.1 units (standard deviation)
Reproducibility	± 0.4 units (standard deviation)
Geometry	0° / diffuse
Memory	7 x 999 values
Interface	serial RS 232
Power Supply	230 V / 50 Hz, 115 V / 60 Hz, 200 VA max.
Operating Temperature	+10 to 40 °C (+50 to 104 °F)
Storage Temperature	0 to 50 °C (+32 to 122 °F)
Dimensions	67 x 36 x 24 cm (26 x 14 x 10 in)
Weight	18 kg (40 lbs)

Ordering Information

Cat. No.	Description
AT-4732	Clarity Calibration Standard
AT-4734	Clarity Reference Standard
AT-4740	Haze Test Standard 1
AT-4741	Haze Test Standard 5
AT-4742	Haze Test Standard 10
AT-4743	Haze Test Standard 20
AT-4744	Haze Test Standard 30
AT-4745	Haze Test Set
AT-4749	Transmittance Standard 10
AT-4750	Transmittance Standard 30
AT-4751	Transmittance Standard 50
AT-4752	Transmittance Standard 70
AT-4753	Transmittance Standard 90
AT-4754	Transmittance Standard Set

Accessories

Replacement Standard for clarity, certificate included
Test standard for checking purposes, certificate included
Approx. 1% haze, for checking purposes, certificate included
Approx. 5% haze, for checking purposes, certificate included
Approx. 10% haze, for checking purposes, certificate included
Approx. 20% haze, for checking purposes, certificate included
Approx. 30% haze, for checking purposes, certificate included
Set of 5 pieces in hard box, certificate included
Approx. 10% total transmittance, for checking purposes, certificate included
Approx. 30% total transmittance, for checking purposes, certificate included
Approx. 50% total transmittance, for checking purposes, certificate included
Approx. 70% total transmittance, for checking purposes, certificate included
Approx. 90% total transmittance, for checking purposes, certificate included
Set of 4 pieces in hard box, certificate included



Exact positioning of films in the hazemeter with a holder guided in a precision track system.



Liquids are best measured using cuvettes and the cuvette table.



The measurement of haze is used to determine abrasion resistance of transparent materials. The Abrasion Holder facilitates positioning of the abraded area in the measurement beam.

Ordering Information

Cat. No.	Description
AT-4738	Film Holder
AT-4735	Taber Abrasion Holder
AT-4739	Cuvette Table
AT-6180	Cuvette for Liquids, 2.5 mm
AT-6181	Cuvette for Liquids, 4.0 mm
AT-6182	Cuvette for Liquids, 5.0 mm
AT-6183	Cuvette for Liquids, 10 mm
AT-6189	Cuvette for Liquids, 20 mm
AG-4613	Interface Cable
AG-4545	BYKWARE easy-link
AT-4731	Foot Switch
AT-4736	Lamp

Accessories

For film size > 17 x 10 cm, film thickness < 0.5 mm
For evaluation of abrasion resistance with the hazemeter
For measurement of liquids
Path length 2.5 mm, edge length 50 mm
Path length 4.0 mm, edge length 50 mm
Path length 5.0 mm, edge length 50 mm
Path length 10 mm, edge length 50 mm
Path length 20 mm, edge length 50 mm
For data transfer to a PC, Sub-D 9-pin
Software for direct data transfer and documentation in Excel®
Replacement
For haze-gard plus

haze-gard *dual*

Two Standard Methods in one Unit

The haze-gard dual objectively measures Total Transmittance and Transmission Haze according to two international specifications:

- ISO 13468 Compensation method
- ASTM D1003 Non-compensated method

Fast Measurement of a Variety of Samples

- Open sample area for small and large specimens
- Foot switch and automatic measurement allow hands-free operation
- Built-in statistics with average, standard deviation, coefficient of variance, and min/max
- Large storage capacity and data transfer from the hazemeter to a PC for professional documentation
- Operation in English, German, French, Spanish and Italian – switchable

ASTM D 1003

Measurement conditions are different during calibration and actual measurement.

During calibration, part of the light escapes through the open entrance port of the hazemeter. While taking a measurement, the entrance port is covered with the sample. Thus, the amount of light in the sphere is increased by the light reflected at the sample surface.

ISO 13468

Measurement conditions are kept equal during calibration and measurement due to an additional opening in the sphere. During calibration the sample is placed at the compensation port. For the actual measurement, the sample is changed to the entrance port. Thus, the so-called sphere efficiency is independent of the reflection properties of the sample.

Note:

Differences between the two methods can be approximately 2 % Total Transmittance on clear, glossy samples

Precise and Reliable Readings – Any time

- Total Transmittance and Transmission Haze in one unit
- Reference beam, self-diagnosis and enclosed optics guarantee accurate readings
- Ready for measurement without warm-up time
- Automatic and long-term calibration guarantee reliable readings

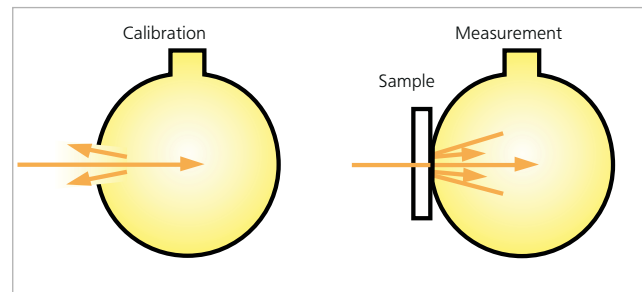

No compensation: Different Sphere Efficiency

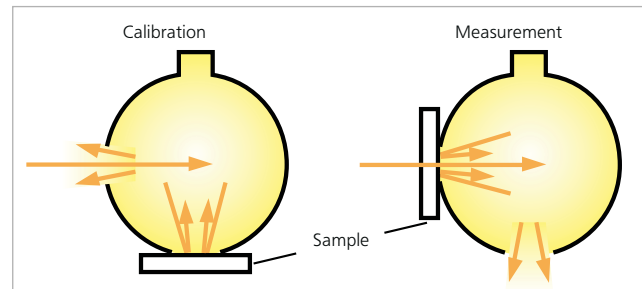

Compensation Port: Same Sphere Efficiency



Standards

ASTM	D 1003, D 1044
ISO	13468, 14782

Ordering Information

Cat. No.	Description
AT-4727	haze-gard dual
SE-4725	Extended Warranty one-year additional

Comes complete with:

Hazemeter with Foot switch
Zero standard
easy-link software
Interface cable
Power cord
Operating manual
Installation training

Free 1x preventive maintenance service during warranty period

Certified

For Certification Services and Preventive Maintenance see pages 268 – 270.

Technical Specifications

Measurement Area	16.5 mm (0.65 in)
Sample Port	21 mm (0.83 in)
Measurement Range	0 – 100 %
Repeatability	± 0.1 units (standard deviation)
Reproducibility	± 0.4 units (standard deviation)
Geometry	0° / diffuse
Spectral Response	CIE luminosity function y
Illuminant	CIE – D65
Memory	3 x 999 values
Interface	serial RS-232
Power Supply	230 V / 50 Hz, 115 V / 60 Hz, 200 VA max.
Operating Temperature	+10 – 40 °C (+50 – 104 °F)
Storage Temperature	0 – 50 °C (+32 – 122 °F)
Dimensions	67 x 39 x 24 cm (26 x 15 x 10 in)
Weight	18 kg (40 lbs)

Training for haze-gard dual

BYK-Gardner offers you more than just an instrument. We assist you in operation of the haze-gard dual and understanding your appearance readings. As a result you will be able to use the hazemeter to save time and money and at the same time improve your quality. Therefore, the instrument comes with a half day training course including:

Haze and Clarity Theory

- Visual perception, Transparency, Scattering, Haze and Clarity
- Instrumental measurement, Standards and Application

Operation and Software Training

- Handling, Statistics, Maintenance
- Direct data transfer to Excel and documentation



Ordering Information

Cat. No.	Description
AT-4760	Haze Test Standard 1
AT-4761	Haze Test Standard 5
AT-4762	Haze Test Standard 10
AT-4763	Haze Test Standard 20
AT-4764	Haze Test Standard 30
AT-4765	Haze Test Set
AT-4749	Transmittance Standard 10
AT-4750	Transmittance Standard 30
AT-4751	Transmittance Standard 50
AT-4752	Transmittance Standard 70
AT-4753	Transmittance Standard 90
AT-4754	Transmittance Standard Set
AT-4735	Taber Abrasion Holder
AT-4739	Cuvette Table
AT-6180	Cuvette for Liquids, 2.5 mm
AT-6181	Cuvette for Liquids, 4.0 mm
AT-6182	Cuvette for Liquids, 5.0 mm
AT-6183	Cuvette for Liquids, 10 mm
AT-6189	Cuvette for Liquids, 20 mm
AG-4613	Interface Cable
AG-4545	BYKWARE easy-link
AT-4731	Foot Switch
AT-4736	Lamp

Accessories

Approx. 1% haze, for checking purposes, certificate included
Approx. 5% haze, for checking purposes, certificate included
Approx. 10% haze, for checking purposes, certificate included
Approx. 20% haze, for checking purposes, certificate included
Approx. 30% haze, for checking purposes, certificate included
Set of 5 pieces in hard box, certificate included
Approx. 10% total transmittance, for checking purposes, certificate included
Approx. 30% total transmittance, for checking purposes, certificate included
Approx. 50% total transmittance, for checking purposes, certificate included
Approx. 70% total transmittance, for checking purposes, certificate included
Approx. 90% total transmittance, for checking purposes, certificate included
Set of 4 pieces in hard box, certificate included
For evaluation of abrasion resistance with the hazemeter
For measurement of liquids
Path length 2.5 mm, edge length 50 mm
Path length 4.0 mm, edge length 50 mm
Path length 5.0 mm, edge length 50 mm
Path length 10 mm, edge length 50 mm
Path length 20 mm, edge length 50 mm
For data transfer to a PC, Sub-D 9-pin
Software for direct data transfer and documentation in Excel®
Replacement
For haze-gard dual

Certified For Certification Services and Preventive Maintenance see pages 268 – 270.

COLOR

Solid Color	69
Introduction	71
Portable Color	75
spectro-guide gloss	75
spectro-guide gloss S for low gloss surfaces	78
color-guide for small parts	80
color-guide for powdery material	80
Laboratory Color	83
color-view	83
Software auto-QC	87
In-store Color Matching	90
Introduction	90
Laboratory Color	91
auto-match III Sensor	91
Software auto-match	92
Portable Color	93
color-guide <i>plus</i>	93
Metallic Color	95
Introduction	95
BYK-mac: multi-angle color and effect	100
BYK-mac for small parts	102
BYK-mac for cosmetics	105
BYK-mac COLOR	107
BYK-mac ROBOTIC	110
Software auto-chart	113
Liquid Color	115
Introduction	115
Visual Color Comparators	116
Instrumental Measurement	119
LCM III	119
LCS III	120
Light Booths	124
Solid Color	124
Metallic Color and Sparkle	127



New!

BYK-mac with small aperture
Color and effect control on small parts
See page 102.



New!

BYK-mac COLOR
Multi-angle color control
See page 107.



New!

BYK-mac ROBOTIC
Automatic color and effect control
See page 110.



New!

byko-spectra effect
Visual evaluation of multi-angle color and sparkle
See page 127.

Introduction

Color Perception

Ten million! That is the number of different colors that we can distinguish. No wonder we cannot remember colors well enough to identify a particular shade. However, the quality criterion “color” is becoming more and more important in every industry. Uniform color influences customers’ likes and dislikes. This is of particular importance when the individual components of the final product are manufactured at different company sites, or even more complicated when several suppliers are involved. Nevertheless, in the end the color must be right.

Visual color perception is influenced by different color sensitivities from person to person (mood, age, etc.), varying environments such as lightness and color, as well as the deficiency to communicate and document color and color differences.

These shortcomings can only be solved by using color instrumentation with internationally specified color systems. This guarantees objective description of colored objects. Color perception is dependent on the interaction of three elements:



SOLID COLOR

Light Source

Color changes with the light source. Therefore, standard illuminants have to be agreed upon and used. The prerequisite of a light source to be usable for color evaluation is to continuously emit energy throughout the visible spectrum (400 to 700 nm).

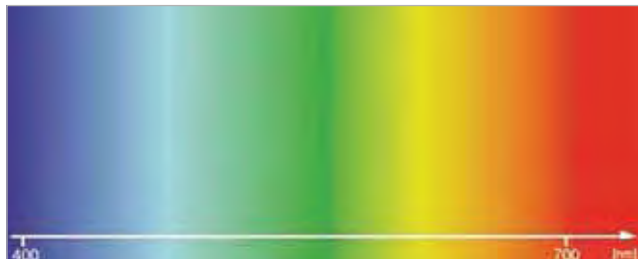

White daylight dispersed into the spectral colors (rainbow)

The CIE (Commission Internationale de l'Eclairage) standardized light sources by the amount of emitted energy at each wavelength (= relative spectral power distribution).

In practice, important illuminants are:

Daylight D65, C

Incandescent light A

Fluorescent light F2, F11

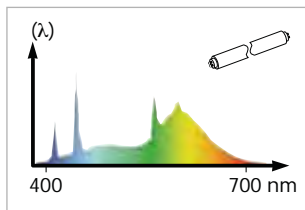
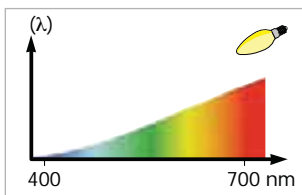
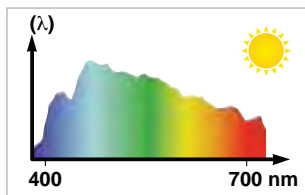

Observer

Without an observer there would be no color. Reflected light from a colored object enters the human eye through the lens and strikes the retina. The retina is populated with three different types of light-sensitive receptors: one which reacts to red light, another to green light, and a third to blue light.

Together they stimulate the brain to produce the impression of color. To determine the sensitivity of the receptors, systematic visual tests were done by the CIE in 1931 and 1964. Based on the results, the 2° and 10° observer were standardized, representing a small and large field of view, respectively.

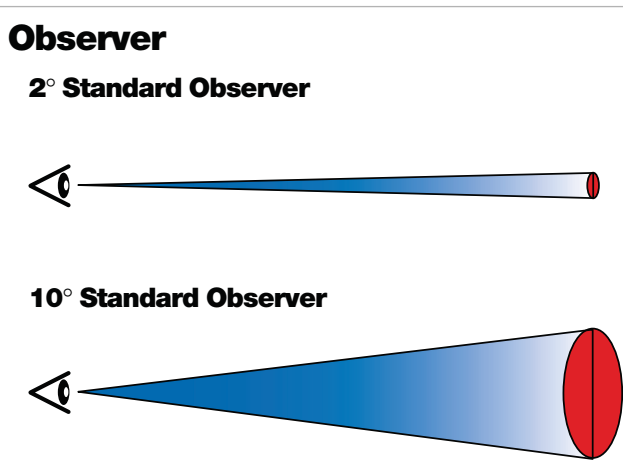

When viewing a sample, the eye integrates over a large area, which correlates best to the 10° observer.

Object

Light source and observer are defined by the CIE and their spectral functions are stored within color instruments. Optical properties of an object are the only variables that need to be measured. Modern color instruments measure the amount of light that is reflected by a colored sample. This is done at each wavelength and is called the spectral data.

For example, a black object reflects no light across the complete spectrum (0% reflection), whereas an ideal white specimen reflects nearly all light (100% reflection).

All other colors reflect light only in selected parts of the spectrum. Therefore, they have specific curve shapes or fingerprints, which are their spectral curves.

In the following graphs, typical spectral curves for a red, blue and green sample are shown.

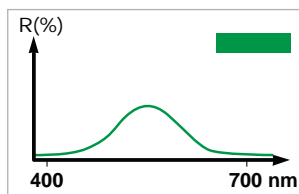
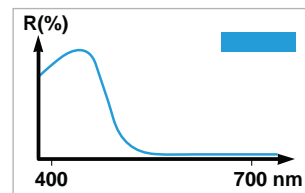
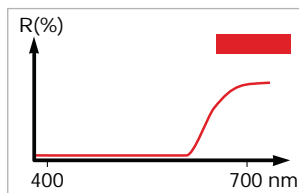

Color Systems

Color systems combine data from three elements:

- light source
- observer
- object

They are the tools to communicate and document color and color differences.

The system which is recommended by the CIE and widely used today, is the CIELab system.

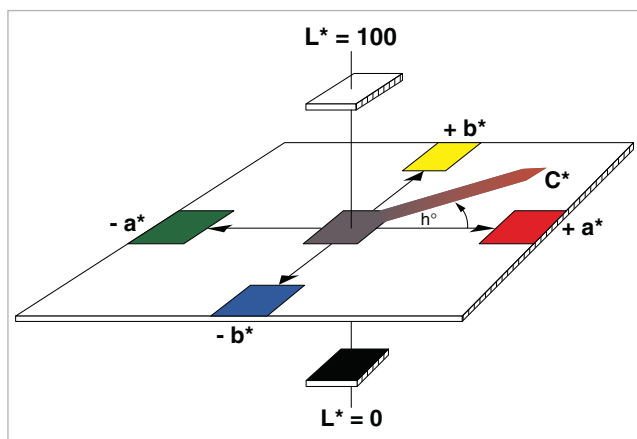

It consists of two axes a^* and b^* which are at right angles and represent the hue dimension or color. The third axis is the lightness L^* . It is perpendicular to the a^*b^* plane. Within this system, any color can be specified with the coordinates L^* , a^* , b^* . Alternatively L^* , C^* , h° are commonly used. C^* (= Chroma) represents the intensity or saturation of the color, whereas the angle h° is another term to express the actual hue.

To keep a color on target a standard needs to be established and the production run is compared to that standard; a typical customer / supplier situation. Therefore, color communication is done in terms of differences rather than absolute values.

The total change of color, ΔE^* , is commonly used to represent a color difference.

$$\Delta E^* = \sqrt{(\Delta L^*)^2 + (\Delta a^*)^2 + (\Delta b^*)^2}$$

The same ΔE^* value can be obtained for two sample sets, and yet look completely different:

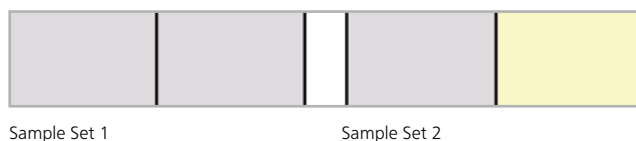

	Sample Set 1	Sample Set 2
ΔL^*	0.57	0.0
Δa^*	0.57	0.0
Δb^*	0.57	1.0
ΔE^*	1.0	1.0

To determine the actual change in color, the individual colorimetric components ΔL^* , Δa^* , Δb^* or ΔL^* , ΔC^* , ΔH^* need to be used.

The calculation and interpretation of the differences are done as follows:

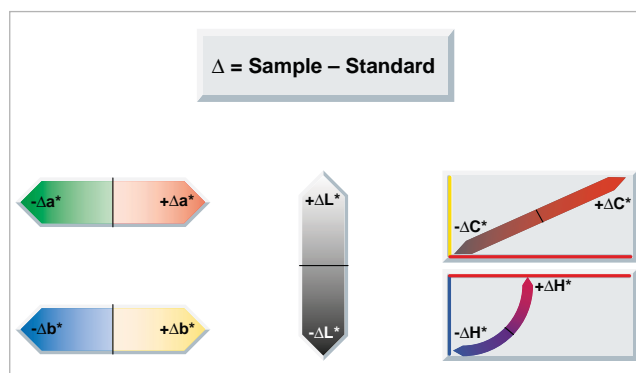

The color differences that can be accepted must be agreed upon between customer and supplier. These tolerances are dependent both on demands and technical capabilities.

Color Instrumentation

In industry, there are two classes of instruments used to measure color: 45/0 and sphere geometry.

Control color as you see it

The 45/0 geometry uses 45° circumferential illumination and 0° viewing perpendicular to the sample plane.

The circumferential illumination is essential to achieve repeatable measurement results on directional and structured surfaces.

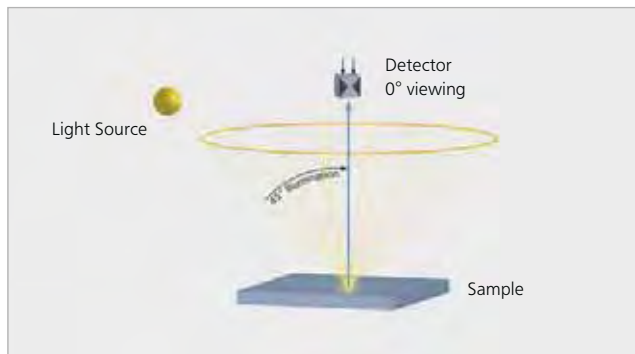

The 45/0 geometry simulates the normal condition used for color evaluation. For example, when we read a glossy magazine we position it to avoid the gloss from coming into our eye.

A high gloss sample with the same pigmentation is visually judged darker by the eye when compared to a matte or structured sample.

This is exactly what a 45/0 instrument measures:

Differences in gloss / texture → Color differences

On the automotive interior plaque, you will get a difference between the two structured sides: $\Delta E^* = 3$

Applications where it is necessary to have the agreement with the visual assessment are:

- Batch to batch comparison in production
- Assembly of multi-component products using different materials



Example: Automotive interior plaque – one material with different structures.

Control the hue of your color

A sphere geometry illuminates the sample diffusely by means of a white coated integrating sphere. Baffles prevent the light from directly illuminating the sample surface. Measurement is done using an 8° viewing angle.

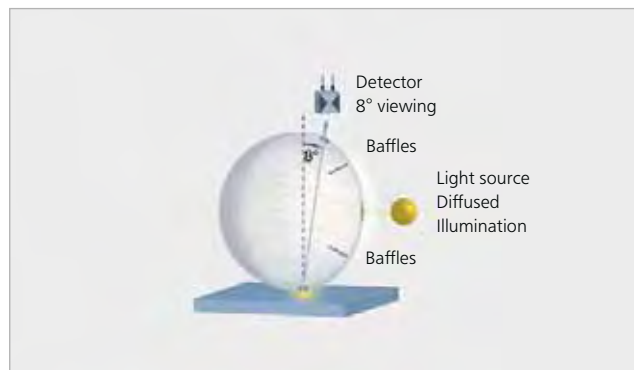

A sphere instrument may be operated under two different measurement conditions:

specular included (spin) or specular excluded (spex)

In the "spin" mode, the total reflected light is measured:

Diffuse reflection (color) + direct reflection (gloss)

Color is measured independent of the sample's gloss or surface texture.

Differences in gloss / texture ✖ Color differences

On the automotive interior plaque, you will get no difference between the two structured sides: $\Delta E^* = 0$

Applications for measurements taken in "spin" mode:

- Color strength depending on dispersion time
- Weathering and temperature influence on color
- Color matching

In the "spex" mode, a gloss trap is used to capture the directly reflected light (gloss). This configuration simulates the 45/0 geometry. In case of medium to low gloss samples, deviations will occur between the 45/0 and the sphere spex configuration as the gloss trap does not completely exclude the specular component.

Summary

Only measurements taken under the same conditions can be compared. Therefore, it is necessary to note the following information in a color measurement report:

- Color instrument (geometry)
- Illuminant / observer
- Color system
- Sample preparation

BYK-Gardner offers a complete line of benchtop and portable spectrophotometers for color measurement.

spectro-guide

Total Appearance Control – color and gloss in one unit

The overall appearance of a product is influenced by color and gloss. A sample of the same color but higher gloss level is visually perceived darker and more saturated than a low gloss sample. In order to get a uniform appearance, both attributes need to be controlled. The spectro-guide spectrophotometer is unique as it measures both attributes simultaneously. Thus, the cause of a mismatch can be clearly defined in any situation.

- Color (45/0 or sphere) and 60° gloss are displayed at the same time
- In compliance with international specifications
- Tolerances for color and gloss allow quick pass/fail decisions in production

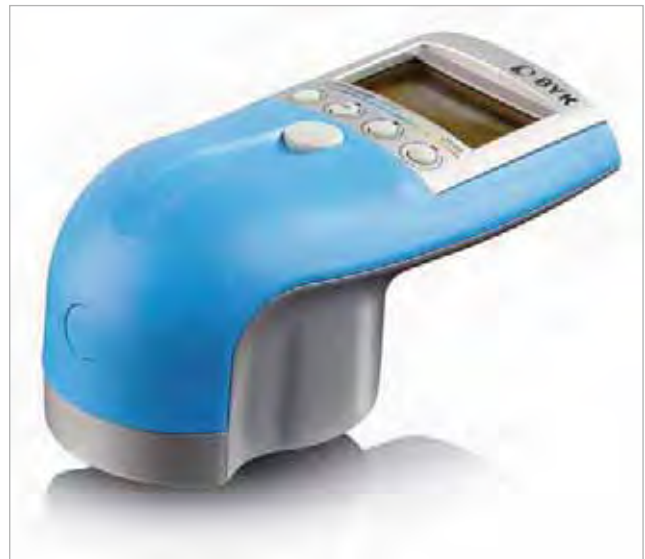
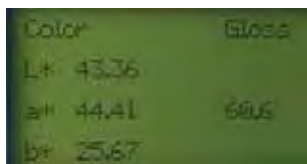

Easy to use and handle

The spectro-guide spectrophotometer makes quality control simple and secure – even for color beginners. Thanks to the intuitive pulldown menu and the four-cursor button operation, quality control has never been easier.

- Light weight and small size – weighs only 500 g
- Ergonomic design – can easily measure difficult to access areas
- Designated buttons for standard and sample readings
- Customization of the display to your needs



Highly repeatable on textured surfaces

The key criterion for a 45/0 instrument is a circumferential illumination. spectro-guide 45/0 is using a unique, patented measurement principle to achieve a 100% circumferential illumination. A white coated hemisphere acts as a mixing chamber and guarantees completely uniform illumination. Thus, any influence of measurement direction is eliminated and excellent repeatability even on highly textured surfaces is guaranteed.

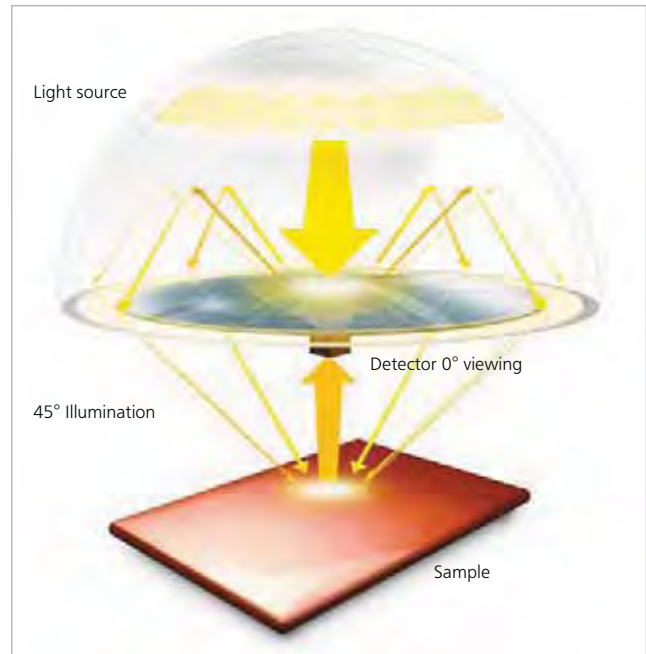

Measurement principle spectro-guide 45/0
True circumferential illumination for best repeatability on textured samples.

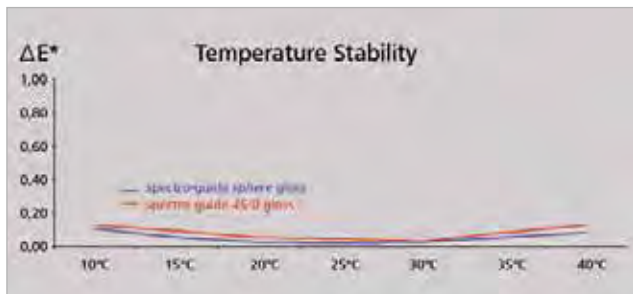

Always precise color values

With the new spectro-guide spectrophotometer you can measure any color: dark – brilliant – steep reflectance curves. The 10 nm spectral resolution not only ensures highly precise color results, but also an excellent agreement with competitive color instruments – even bench-top units.

Additionally, a patented illumination control provides temperature independent results – even in extreme conditions.

Always ready to use

Economical and reliable operation of a spectrophotometer is often taken as given. spectro-guide guarantees superior accuracy for many years and low maintenance efforts.

- Long lasting standard AA batteries – up to 8,000 readings per set
- 10 year warranty on the light source – no lamp changes needed
- Rugged and compact design
- Stable, long-term calibration – needed only every three months



Professional Documentation with easy-link

No matter whether you want to compare a batch to a defined standard or monitor process changes over time, easy-link, included with spectro-guide, offers all of the necessary tools. Direct data transfer from the spectrophotometer into predefined QC templates makes you ready for routine color control.

Are all parts within specification?

The CIELab-Graph charts differences in color and lightness together with production tolerances.

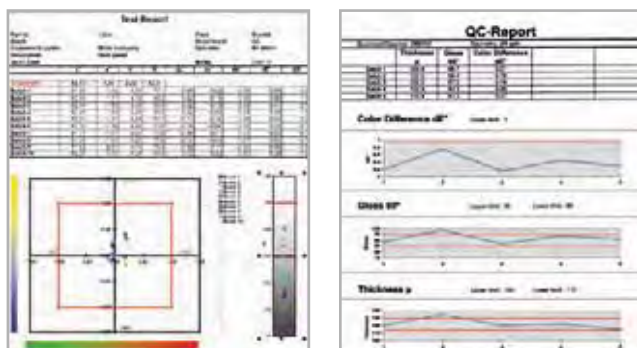

Is production stable over time?

All data are summarized in a trend graph: Color, gloss, film thickness and your own product specific information.

Do parts made out of different materials match?

Color differences are displayed simultaneously for three illuminants to control metamerism.

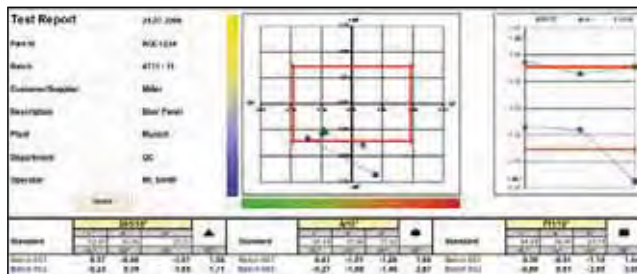

Ordering Information

Cat. No.	Description
AG-4545	BYKWARE easy-link

Hardware Requirements:

Operating system: Windows® 2000 or higher
Excel® version: 2000 or higher including VBA
Interface: serial or USB port



Easy Standard Management

Manual entry of standard

If you have to match colors and the physical sample is no longer available, you can easily enter the spectral data in easy-link. The standards can then be transferred to the spectro-guide spectrophotometer for color QC.

Back-up your standard data

For safety reasons, it is recommended to store your complete database of standards on the PC. They can be downloaded with the individual tolerances to spectro-guide – whenever needed.

Establish your tolerances

The auto tolerancing function assists you in setting up the tolerances for Pass/Fail control. Measure at least 20 visually accepted production trials, transfer the readings to easy-link and have the tolerances automatically calculated for you – saving time and headaches.



The micro-TRI-gloss also transfers gloss values to easy-link, see page 24.

spectro-guide gloss S

Color and Gloss Control of automotive interior parts

Most people consider color and gloss harmony of the car interior to be a key item when judging the perceived quality of a vehicle. Consequently, the quality requirements for the interior design of a car have increased over the last years. A variety of materials are used and need to be harmonized. To achieve a uniform look among the interior trim parts, very tight tolerances are specified. Only instruments with excellent precision are able to objectively control the production.



The new spectro-guide S family offers improved technical performance for 60° gloss in the low gloss range 0 – 10 GU. The excellent repeatability of ± 0.1 can be guaranteed due to a patented calibration procedure.

In addition, the spectro-guide S spectrophotometer offers unique benefits to always guarantee precise results:

- Highly repeatable results independent of measuring direction due to a patented, true circumferential illumination
- Long-term stable calibration – needed only every three months
- Temperature stable color and gloss data between 10 – 40°C
- 10 year warranty on the light source
- 10 nm resolution for precise readings on brilliant and dark colors
- Professional documentation with easy-link software

Do parts made out of different materials match?

Color differences are displayed simultaneously for three illuminants to control metamerism

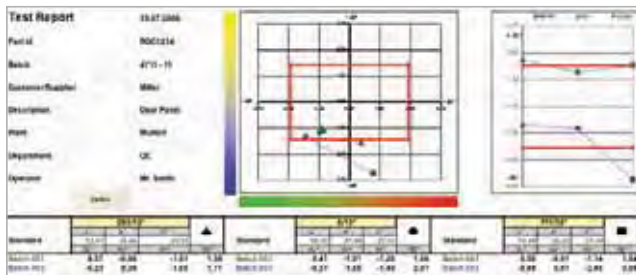

Technical Specifications

Gloss Measurement Range	0 to 10 GU	10 to 100 GU
Repeatability¹	± 0.1 GU	± 0.2 GU
Reproducibility¹	± 0.5 GU	± 1.0 GU

¹ Standard deviation

spectro-guide Training

BYK-Gardner offers you more than just an instrument. We assist you in analyzing your color readings, understanding how to set tolerances and as a result be able to use the spectro-guide to save time and money and at the same time improve your quality. Therefore, the instrument comes with a half-day training course including:

1. Color Theory

- The building blocks of color: illuminant, observer, object
- Color differences with interpretation

2. Operation and Software Training

- Measure samples and standards by single and average readings
- Save, recall and delete measurements
- Change illuminants, observers, color scales
- Direct data transfer to easy-link



Ordering Information

Cat. No.	Description
CC-6801	spectro-guide 45/0 gloss
CC-6802	spectro-guide 45/0 gloss S
CD-6834	spectro-guide sphere gloss
CD-6836	spectro-guide sphere gloss S
SE-6800	Extended Warranty one year additional

Comes complete with:

Spectrophotometer; Black calibration standard; White calibration standard with certificate; Green checking reference; High gloss standard; Sample area locator; Software easy-link; Interface cable; USB-adapter; 4 x AA batteries; Hand strap; Carrying case; Operating instructions; Color theory folder; Training

Free 1x preventive maintenance service during warranty period

Standards

	Color	Gloss
ASTM	D 2244, E 308, E 1164	D 523, D 2457
DIN	5033, 5036, 6174	67530
ISO	7724	2813, 7668

Certified

For Certification Services and Preventive Maintenance see pages 268 – 271.

Save!

Trade-in any spectrophotometer (all brands accepted) and receive a discount toward the purchase of a new spectro-guide.

Technical Specifications

Color Geometry	Gloss Geometry	Color Aperture	Gloss Aperture
45/0	60°	11 mm	5 x 10 mm
45/0	60°	11 mm	5 x 10 mm
d/8 spin	60°	11 mm	5 x 10 mm
d/8 spin	60°	11 mm	5 x 10 mm

Color

Spectral Range	400 – 700 nm, 10 nm resolution
Repeatability¹	0.01 ΔE^* (10 consecutive measurements on white)
Reproducibility¹	0.2 ΔE^* (average on 12 BCRA II tiles)
Color Systems	CIE Lab/Ch; Lab(h); XYZ; Yxy
Color Differences	ΔE^* ; $\Delta E(h)$; ΔE_{FMC2} ; ΔE_{94} ; ΔE_{CMC} ; ΔE_{99} ; ΔE_{2000}
Indices	YIE313; YID1925; WIE313; CIE; Berger; Color strength; Opacity; Metamerism
Illuminants	A; C; D50; D55; D65; D75; F2; F6; F7; F8; F10; F11; UL30
Observer	2°; 10°

Gloss

Measurement Range	0 – 100 GU
Repeatability²	± 0.2 GU
Reproducibility²	± 1.0 GU

Memory	1500 Standards, 999 Samples
Languages	English; German; French; Italian; Spanish; Japanese; Chinese
Power Supply	4 AA alkaline; NiCd or MH batteries
Operating Temperature	10 °C – 42 °C (50 °F – 110 °F)
Humidity	< 85% relative humidity, non-condensing / 35 °C (95 °F)
Dimensions	9.5 x 8 x 18 cm (3.7 x 3.2 x 7 in)
Weight	approx. 0.5 kg (approx. 1.1 lbs)

¹ Standard deviation

² for S-type instruments see previous page

color-guide

Color Measurement for Specific Applications

Color Control of Small Parts

Keyboards, pens and window handles require a color instrument with a very small aperture and a repeatable sample placement. color-guide 45/0, 4 mm aperture together with the optional sample holder guarantee repeatable results and a convenient sample placement.

- Minimum sample size: 5 x 5 mm (0.2 x 0.2 in)

Color Control of Powdered Material

When measuring powdery or granular material like raw material pucks or grainy food, the instrument's optics must be protected. The color-guide spectrophotometer with glass sealed aperture uses a colorless, optical glass and can directly measure such products, thus saving sample preparation time.

Color Control – easy and secure

- Easy to use and handle – even for color beginners
- Stable, long-term calibration – needed only every three months
- Highly temperature stable – even in extreme conditions
- Uses standard AA batteries – good for 10,000 readings
- 10 year warranty on light source – no lamp changes needed
- Light weight and small size – only weighs 500 g

Professional Documentation with easy-link

ISO 9000 requires documentation of color data. easy-link, included with the color-guide, offers all of the necessary tools:

- Easy and direct data transfer from the instrument to Excel®
- Predefined QC-report templates (Lab-plot, trend graph) are included
- All relevant quality data can be easily summarized in one report: Color – Gloss – Film Thickness
- Easy management of your standards: standard back-up and establishing of production tolerances



color-guide 45/0, 4 mm



color-guide with glass sealed aperture



Complete color QC-report

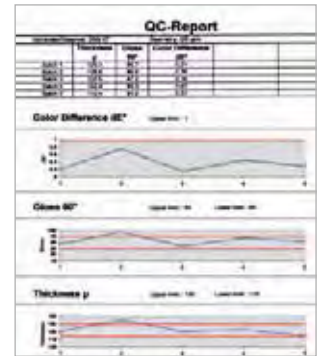

Trend analysis:
Color – Gloss – Film Thickness

color-guide Training

BYK-Gardner offers you more than just an instrument. We assist you in analyzing your color readings, understanding how to set tolerances and as a result be able to use the color-guide spectrophotometer to save time and money and at the same time improve your quality. Therefore, the instrument comes with a half day training course including:

1. Color Theory

- The building blocks of color: illuminant, observer, object
- Color differences with interpretation

Ordering Information

Cat. No.	Description
CC-6807	color-guide 45/0
CC-6692	color-guide 45/0
SE-6800	Extended Warranty one year additional

Comes complete with:

Spectrophotometer
 Black calibration standard
 White calibration standard with certificate
 Green checking reference
 Sample area locator
 Software easy-link
 Interface cable
 USB-adapter
 4 x AA batteries
 Hand strap; Carrying case
 Operating instructions; Color theory folder
 Training

Free 1x preventive maintenance service during warranty period

Standards

ASTM	D 2244, E 308, E 1164
DIN	5033, 5036, 6174
ISO	7724

2. Operation and Software Training

- Measure samples and standards by single and average readings
- Save, recall and delete measurements
- Change illuminants, observers, color scales
- Direct data transfer to Excel®

Technical Specifications

	Geometry	Aperture
	45/0	4 mm
	45/0	20 mm, glass sealed
Spectral Range	400 – 700 nm, 20 nm resolution	
Repeatability¹	0.01 ΔE^* (10 readings on white tile)	
Reproducibility¹	0.2 ΔE^* (average on 12 BCRA II tiles)	
Color Systems	CIE Lab/Ch; Lab(h); XYZ; Yxy	
Color Differences	ΔE^* ; $\Delta E(h)$; ΔE_{FMC2} ; ΔE_{94} ; ΔE_{CMC} ; ΔE_{99} ; ΔE_{2000}	
Indices	YIE313; YID1925; WIE313; CIE; Berger; Color strength; Opacity; Metamerism	
Illuminants	A; C; D50; D55; D65; D75; F2; F6; F7; F8; F10; F11; UL30	
Observer	2°; 10°	
Memory	200 Standards, 999 Samples	
Languages	English; German; French; Italian; Spanish; Japanese	
Power Supply	4 AA alkaline; NiCd or MH batteries	
Operating Temperature	10 – 42 °C (50 – 110 °F)	
Humidity	< 85% relative humidity, non-condensing / 35 °C (95 °F)	
Dimensions	9.5 x 8 x 18 cm (3.7 x 3.2 x 7 in)	
Weight	0.5 kg (1.1 lbs)	

¹ Standard deviation

Sample Holder for Small Parts

The mask of the holder is custom made for the 4 or 11 mm aperture of the color-guide. The sample is placed in a jig, ensuring measurement at the same spot. The holder is supplied with three different jigs to guarantee maximum flexibility: a flexible foam disk for quick checks, a finished disk with cylindrical groove, and a blank disk to be customized by the user.

Ordering Information

Cat. No.	Description
CC-6825	Sample Holder 4 mm, size: 60 x 20 mm (2.40 x 0.80 in)
CC-6845	Sample Holder 11 mm, size: 60 x 20 mm (2.40 x 0.80 in)
CC-6826	Replacement foam disk
CC-6827	Replacement disk, cylindrical groove
CC-6828	Replacement blank disk



Accessories

Replacement and Checking Standards

The spectro-guide and color-guide spectrophotometers come complete with white and black calibration standards, as well as a green reference standard. The green reference should be used periodically to audit instrument performance and the condition of the calibration tiles.

As the spectro-guide also performs a gloss reading, it is additionally recommended to periodically use a medium gloss checking standard to control the gloss readings.

Ordering Information

Cat. No.	Description
CC-6810	Black Standard for color-guide
CD-6840	Black Standard for spectro-guide
CC-6844	Checking Standard 60° Gloss
CC-6846	Checking Standard 60° Gloss S

Note: Please contact your local service department for replacement of white and green standard.

Ordering Information

Cat. No.	Description
CC-6814	Sample Area Locator 4 mm
CC-6815	Sample Area Locator 11 mm
CC-6816	Sample Area Locator 20 mm
AG-4545	BYKWARE easy-link
CC-6819	Interface Cable
AG-4401	USB-adaptor (for connection to USB-interface, incl. driver software)
CC-6813	Special USB-adaptor (for data transfer to auto-QC <i>lite</i> software)
CC-6818	Protective Stand (to hold instrument and store accessories)
CS-6532	BYKWARE auto-QC <i>lite</i>

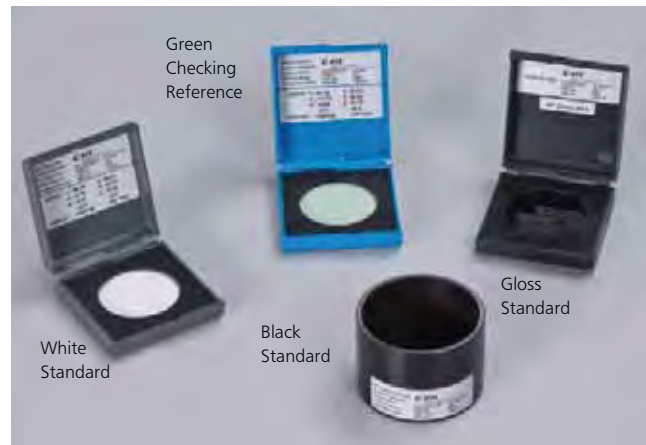

auto-QC *lite* Software

For advanced color analysis, the universal Windows® based color control software auto-QC *lite* can be used:

- User defineable screen layouts and print-outs
- Pass/Fail analysis with auto-tolerancing
- Exports of color data to Excel® within a second

Info! For more information see pages 87 – 89.

color-view

The color-view spectrophotometer is a highly reliable 45/0 instrument with circumferential illumination. It is designed to measure rough, directional surfaces, pellets or powdered materials like plastic concentrates and resins, and smooth uniform surfaces like paint drawdowns and sprayouts, all with the same degree of certainty.

- Compact size takes up less bench space
- Guaranteed repeatability through a patented self-calibration
- No color changes due to temperature or light exposure because of rapid measurement and cool measurement port
- Built-in retroviewer provides easy sample positioning
- Variety of samples can be measured with interchangeable apertures: 4, 11, 32 mm
- Powders, slurries and pellets are easily measured with a glass sample cup
- Built-in 60° gloss option allows simultaneous measurement of gloss and color
- auto-QC *lite* software included



auto-QC *lite* Windows® Based Color QC Software

For advanced color analysis, the universal Windows® based color control software auto-QC *lite* can be used:

- User defineable screen layouts and print-outs
- Pass/Fail analysis with auto-tolerancing
- Export of color data to Excel® within a second



For more information on auto-QC *lite* see pages 87 – 89.

color-view Training

BYK-Gardner offers you more than just an instrument. We assist you in analyzing your color readings, understanding how to set tolerances and as a result, you will be able to use the color-view to save time and money while improving your quality. Therefore, the instrument comes with a full day training course which includes:

Color Theory

- The building blocks of color: illuminant, observer, object
- Color differences with interpretation

Operation and Software Training

- Measure samples and standards by single and average readings
- Save, recall and delete measurements
- Change illuminants, observers, color scales
- Define tolerances for pass/fail: manual input or automatic calculation based on accepted production trials

Data Analysis

- Standard reports: Color Plot – Spectral Plot
- Define custom specific reports
- Data export to Excel® for further analysis

Standards

ASTM	D 2244, D 6290, E 308, E 1164
DIN	5033, 5036, 6174
ISO	7724

Ordering Information

Cat. No.	Description
CC-6501	color-view
CC-6502	color-view with gloss
CC-6503	color-view
CC-6504	color-view with gloss
SE-6501	Extended Warranty one year additional

Comes complete with:

Spectrophotometer
auto-QC *lite* color control software
Calibration puck including white opal with certificate and black glass
Green checking reference
Large aperture 32 mm (1.26 in)
Power cable
Serial cable for PC connection
Spare lamp, spare fuse
Operating instructions
Training

Free 1x preventive maintenance service during warranty period

Technical Specifications

	Voltage	60° Gloss
	230 V	-
	230 V	yes
	115 V	-
	115 V	yes
Geometry	45/0 circumferential	
Spectral Range	380 – 720 nm	
Spectral Interval	10 nm	
Repeatability¹	0.01 ΔE^* (30 consecutive measurements on white tile)	
Reproducibility¹	0.1 ΔE^* (average on 12 BCRA II tiles)	
Illumination	Tungsten Halogen Lamp	
Operating Temperature	+10 °C – +42 °C (50 °F – 110 °F)	
Humidity	5% – 85% (non-condensing)	
Dimensions	273 x 162 x 381 mm (10.8 x 6.4 x 15.0 in)	
Weight	11.1 kg (24.6 lbs)	

¹ Standard deviation

color-view Accessories

Color Measurement of Plastic Pellets

To measure granular materials like plastic pellets, care must be taken in order to achieve repeatable results. BYK-Gardner offers two solutions for sample presentation.

Sample Cup

The sample cup allows easy measurement of pellets, powders and slurries. For precise and repeatable results the sample aperture must be replaced by the glass plate at the time of calibration. Additionally, it is recommended to average at least 3 readings by refilling the cup each time. To eliminate the influence of ambient light, the black sample cup cover can be used.



Ordering Information

Cat. No.	Description
CC-6135	Glass Sample Plate
CC-6136	Glass Sample Cup
CC-6245	Sample Cup Cover

Technical Specifications

Diameter
60 mm (2.4 in)
60 mm (2.4 in)

Sample Rotator

For the first time, it is possible to repeatably measure pellets with minimal operator sample handling. The sample rotator is an automatic device that is attached on top of the color-view. It uses a rotating system that is powered by the instrument. As the sample container is turning over a defined time period, refilling becomes obsolete.

- Saves sample preparation time
- Frees up personnel for other important tasks
- Improves repeatability and reproducibility

Ordering Information

Cat. No.	Description
CC-6505	Sample Rotator Upgrade (for color-view with serial number < 90003001)
CC-6510	Sample Rotator Accessory (for color-view with serial number ≥ 90003001)

Comes complete with:

Rotator, glass sample plate, sample container with teflon lining, sample container lid, calibration aperture

Note: color-view instruments to be used with the sample rotator need to be modified. Please specify at time of purchase. To upgrade existing instruments, please contact your local service department.



Accessories

Cat. No.	Description
CC-6135	Glass Sample Plate
CC-6506	Sample Container
CC-6507	Sample Container Lid
CC-6508	Teflon Lining
CC-6509	Calibration Aperture



Measurement Aperture

The color-view spectrophotometer allows easy interchanging of measurement apertures, beneficial for measuring a wide range of sample sizes. A small aperture should be used for small parts or homogeneous surfaces. The large aperture is best for larger components or non-homogeneous surfaces.

Ordering Information

Cat. No.	Description
CC-6521	Aperture Kit* 11 mm (0.43 in)
CC-6523	Aperture Plate 32 mm (1.26 in)
CC-6522	Aperture Plate 11 mm (0.43 in)
CC-6520	Aperture Plate 4 mm (0.16 in)

* Includes: Aperture plate and optics



Replacement Lamp

The color-view spectrophotometer uses a tungsten halogen lamp which has an expected lifetime of 8,000 hours. For accurate readings it is recommended to change the lamp at least once a year.

Ordering Information

Cat. No.	Description
CC-6524	Tungsten Halogen Lamp

Replacement Standard

Calibration Puck

- Holds black and white calibration tiles
- Certificate of traceability for white opal

Ordering Information

Cat. No.	Description
CC-6525	Calibration Puck
CC-6174	Green Checking Reference (to audit instrument performance over time)



Certified

For Certification Services and Preventive Maintenance see pages 268 – 271.



auto-QC

Color Control Software

BYK-Gardner offers two levels of color control software for recording, analyzing and documenting color measurement results in the laboratory and production.

- auto-QC *lite* for basic QC requirements
- auto-QC with advanced features

auto-QC *lite* offers the following capabilities:

- Customized screen layouts for ease of operation
- Pass/Fail, color-on-screen and text description let the user see in a flash whether he is on target or not



- auto-QC *lite* automatically calculates tolerances based on measured production trials. Asymmetrical fit allows best agreement with the visual perception



- Tolerances defined by the customer can be manually input in any color scale



- Metamerism is no longer a problem – display results of up to 3 illuminants on one screen



- Direct transfer of all colorimetric data, spectral data and indices into Excel® can be easily accomplished

Trial#	Name	L*	a*	b*	DE*	Da*	Db*	Dm*
6	Standard green	69.377	-12.3951	-1.2604	0	0	0	0
7	1 piece M02	75.829	12.4364	0.9057	0.4618	0.1003	0.3745	
8	2 piece M04	69.974	12.4039	0.9593	0.5074	0.0579	0.5071	
9	3 piece M05	68.8449	12.3398	0.9533	0.4679	0.0573	0.3571	
10	4 piece M05	69.8485	12.3338	0.9566	0.4718	0.0575	0.3107	
11	5 piece M03	69.9543	-12.5022	-1	0.5772	-0.1062	0.2604	
12	6 piece M08	69.784	12.5648	1.0189	0.377	0.1687	0.2648	
13	7 piece M10	69.7542	-12.5577	1.0074	0.3772	0.1616	0.2729	
14	8 piece M11	69.7478	12.5573	1.0089	0.3707	0.1662	0.2734	
15	9 piece M12	69.9057	-12.5194	0.9939	0.4466	-0.2033	0.3056	

- Use the direct e-mail tools to transfer color data worldwide in a second

In addition, auto-QC offers the following advanced features:

- Easy creation of macros:
Different software steps are combined into one procedure. One keystroke executes the macro and guides inexperienced users through their measurement tasks
- Direct transfer of data into a database like Microsoft Access® allows production batches to be archived and recalled for future comparison

- SPC control charts with upper/lower control limits for any index and color scale allow the user to recognize trial color deviations over time and trends early



auto-QC

Supports the BYK-Gardner color instruments color-view and spectro-guide – and other commonly available spectrophotometers.



color-view



spectro-guide family



auto-QC

Color Control Software

- Easy to use with customized screen layouts
- Pass/Fail analysis with auto-tolerancing
- Export of color data to Excel® within a second

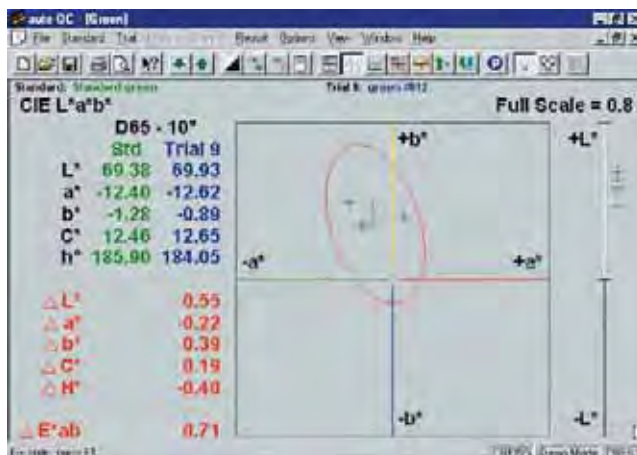

Ordering Information

Cat. No.	Description
CS-6531	auto-QC
CS-6532	auto-QC <i>lite</i>

Comes complete with:

Software on CD-ROM
Protection key for USB port
All instrument drivers

Hardware Requirements:

Operating system: Windows 2000 or higher
Memory: min. 8 MB RAM (recommended 64 MB)
Hard disk capacity: min. 5 MB
Monitor resolution: VGA or better
Disk drive: CD-ROM
Interface: serial interface and USB port

Note: If using a PC with USB port and the spectrophotometer spectro-guide, please order the special USB-adaptor CC-6813.

Technical Specifications

Illuminants	A; C; D50; D55; D65; D75; F2; F6; F7; F8; F10; F11; UL30; UL50
Scales	CIELab; CIELCH; L,a,b (Hunter); CIELuv; XYZ; Yxy; RxRyRz
Differences	ΔE*; ΔE(h); ΔECMC; ΔE94; ΔEFMC2; ΔE99; ΔE2000
Spectral Data	%R; %T; K/S; ln K/S; -ln K/S; Absorbance; ln Absorbance
Indices	Metamerism: CIE, DIN Yellowness: ASTM D 1925; E 313; DIN 6167 Whiteness: CIE; ASTM E 313; Berger; Hunter; Stensby; Taube Munsell: Hue/Value/Chroma
Opacity	Color Strength Gloss: color-view and spectro-guide only
Observer	2°; 10°
Languages	English, German, French, Italian, Spanish, Japanese, Chinese



In-Store Color Matching

In-store Color Formulation Systems

Increase your efficiency, productivity and profitability with BYK-Gardner's in-store color formulation systems. By improving your customer service you are building up brand loyalty and bring a more professional image to your store. Now you can formulate custom color matches in your store as the customer waits – it only takes a few minutes.

BYK-Gardner's in-store color formulation system provides a complete solution for effective control of your entire color management process:

- Excellent first time custom color matches
- Reduced paint mistints and increased profits
- Electronic competitive fandecks included to increase paint sales by matching competitive colors
- Easy-to-use software that enhances your store's productivity
- Durable and low maintenance instruments
- Paint expertise support
- Paint database creation

A complete color formulation system consists of:

- Spectrophotometer
- In-store color matching software
- PC, monitor, keyboard and printer

BYK-Gardner offers all of the above components in a complete system, or you may elect to provide some of the components yourself. Each component is sold separately or turnkey system pricing can be provided. In addition, we also assist you in selecting an automatic or manual colorant dispenser (not sold by BYK-Gardner) to complete your system.

Need a portable solution?

BYK-Gardner also provides a portable look-up system where up to 4900 color standards can be stored in the instrument memory and an "auto-standard" function will retrieve the closest match. Simply store all fandeck colors in the memory of the spectrophotometer, and you are ready to go.

Or use the instrument to custom match any object on site. Simply measure and store the color, bring the instrument back and have BYK-Gardner's auto-match software generate the match for you.

Info!

For more information on the look-up system see color-guide *plus*, page 93

auto-match[®] III Sensor

The last thing a paint department wants to worry about is a broken down color matching system. Therefore the auto-match III has an extremely rugged and reliable design guaranteeing a maintenance-free operation for years.

The instrument uses a 45/0 circumferential illumination in order to match your samples as your eye sees them.

In addition, the auto-match III spectrophotometer offers the following unique benefits:

- Small, compact sensor fits almost anywhere
- No more lost accessories or standards – standards are integrated into the sample clamp
- Temperature stable results without constant calibration – the same matching results are obtained no matter what your store temperature is
- Maintenance is no longer an issue – very low frequency of repair
- Best warranty in the industry – 3-year guarantee on the instrument and 10-year guarantee on the light source
- Excellent inter-instrument agreement – the same accurate results are provided in every store location



Standards

ASTM	D 2244, E 308, E 1164
DIN	5033, 5036, 6174
ISO	7724

Certified

For Preventive Maintenance
see page 271.

Ordering Information

Cat. No.	Description
CI-1150	auto-match III Sensor
CI-1155	auto-match III Sensor

Comes complete with:

Spectrophotometer
Black calibration standard
White calibration standard with certificate
Interface cable
Operating instructions

Note: Requires separate purchase of the auto-match retail color matching software Cat. No. CS-1001 or equivalent in order to operate.

Technical Specifications

	Voltage	Geometry*	Aperture
	115 VAC, 60 Hz	45/0	11 mm
	230 VAC, 50 Hz	45/0	11 mm
Spectral Range	400 – 700 nm, 20 nm resolution		
Repeatability¹	0,01 ΔE* (10 consecutive measurements on white)		
Reproducibility¹	0.20 ΔE* (average on 12 BCRA II tiles)		
Operating Temperature	10 to 42 °C (50 to 110 °F)		
Relative Humidity	up to 85%, 35 °C (95 °F) non-condensing		
Dimensions	14.6 x 13.3 x 24 cm (5.75 x 5.25 x 9.5 in)		
Weight	3.3 kg (7.3 lbs)		

¹ Standard deviation

* Sphere d/8 geometry on request.

auto-match Software

BYK-Gardner's software combines proven reliability with excellent matching performance. The user friendly interface guarantees ease of operation: just choose the product line that you want to use and the software guides you through the process. The software can be customized to your application. Your company logo on the opening screen, lock out of certain colorants with certain bases, multiple languages, and other custom features can be incorporated into the software, making it truly unique to your stores.

The software offers the following features:

- Custom color matches in less than four seconds
- Electronic formula book – providing a quick and mistake-free look up of any color formulation in your database
- Easy-to-use storage and retrieval of customer history and custom formulas
- Electronic competitive fandecks – providing you with an endless range of hues and shades
- Correction features enable precise match fine tuning to customer desires



Ordering Information

Cat. No.	Description
CS-1001	auto-match RCS Software

Hardware Requirements:

Operating system: Windows 98SE or higher
 Memory: min. 1 GB RAM
 Hard disk capacity: min. 4 GB
 Monitor resolution: VGA or better
 Disk drive: CD-ROM
 Interface: 1 serial port, 6 USB ports
 Printer: Dymo label printer 450 (optional)

Accessories

Cat. No.	Description
CS-1005	Pentium computer with keyboard
CS-1006	Flat screen monitor, 17 inch display
CS-1007	Monitor, 17 inch display
CS-1008	Dymo Label Printer 450

Technical Specifications

Formulation Time	< 4 seconds
Languages	English, French, Spanish, Portuguese (please specify at time of purchase)
Controls	External keyboard and mouse
Dispenser Output	RS232 C
Printer Output	USB
Network Interface	Yes

color-guide *plus*

color-guide *plus* – the Electronic Fandeck!

Instead of spending hours searching through hundreds of fandeck colors trying to match your customer's sample, why not get your answer in less than a second with the color-guide *plus*? With your fandeck colors stored in the system memory, place the color-guide *plus* on the sample and press the button. The closest fandeck color is displayed within a blink of an eye – precisely and repeatably.

- Large memory of 4900 standard colors and 100 samples
- Quick and repeatable look-up of the 5 closest matches with dE*
- Small size, light weight – only 500 g
- Powered by standard AA batteries – up to 10,000 readings per set
- Long-term stability – calibration needed only every three months

Additionally, all features of a complete color QC instrument are included: all commonly used color scales and illuminants, metamerism, Pass/Fail etc.



Standards

ASTM	D 2244, E 308, E 1164
DIN	5033, 5036, 6174
ISO	7724

Ordering Information

Cat. No.	Description
CC-6850	color-guide <i>plus</i>
SE-6800	Extended Warranty one year additional

Comes complete with:

Spectrophotometer
Black calibration standard
White calibration standard with certificate
Green checking reference
Sample area locator
4 x AA batteries
Hand strap; Carrying case
Operating instructions; Color theory folder
Training

Technical Specifications

	Geometry	Aperture
	45/0	11 mm
Spectral Range	400 – 700 nm, 20 nm resolution	
Repeatability¹	0.01 ΔE^* (10 readings on white tile)	
Reproducibility¹	0.20 ΔE^* (average on 12 BCRA II tiles)	
Color Systems	CIE Lab/Ch; Lab(h); XYZ; Yxy	
Color Differences	ΔE^* ; $\Delta E(h)$; ΔE_{FMC2} ; ΔE_{94} ; ΔE_{CMC} ; ΔE_{99} ; ΔE_{2000}	
Indices	YIE313; YID1925; WIE313; CIE; Berger; Color strength; Opacity; Metamerism	
Illuminants	A; C; D50; D55; D65; D75; F2; F6; F7; F8; F10; F11; UL30	
Observer	2°; 10°	
Memory	4900 Standards, 100 Samples	
Languages	English; German; French; Italian; Spanish; Japanese	
Power Supply	4 AA alkaline; NiCd or MH batteries	
Operating Temperature	10 – 42 °C (50 – 110 °F)	
Humidity	< 85% relative humidity, non-condensing / 35 °C (95 °F)	
Dimensions	9.5 x 8 x 18 cm (3.7 x 3.2 x 7 in)	
Weight	0.5 kg (1.1 lbs)	

¹ Standard deviation



new BYK *mac*

Measure what you see.

multi-angle color & effect control

“With my new BYK-mac I always get a clear answer why we have a color mismatch on effect finishes. It even tells me when we have a color flop on interference finishes. And what’s really great is that we can quantify the amount of sparkle and graininess, which often caused mismatches in the past.”

www.byk.com/instruments

A member of  **ALTANA**

 **BYK**
Additives & Instruments

Introduction

Metallic Coatings

Today effect finishes play a dominant role in many applications as they make an object distinctively appealing.

In contrast to conventional solid colors, effect finishes change their appearance with viewing angle and lighting conditions. Interference finishes show not only a lightness change with different viewing angle, but also a change in chroma and hue. The latest developments are special effect pigments, which create sparkling effects when lighting conditions change from sunlight to cloudy sky.

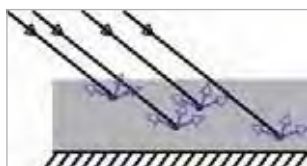

Absorption pigments

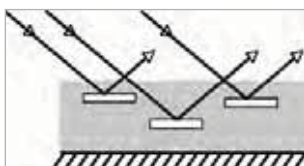

Metallic pigments

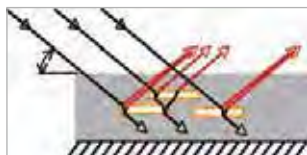

Interference pigments

Courtesy of Merck

Visual Evaluation of Effect Coatings

As metallic finishes show a lightness change with different viewing angles, the sample needs to be tilted to create the same effect during visual evaluation. This effect is also referred to as "light-dark flop". The bigger the lightness changes between the angles of view are, the more the contours of an object will be accentuated. In order to observe color travel of interference finishes, the panel should be moved to allow increasing or decreasing the angle to the light source.

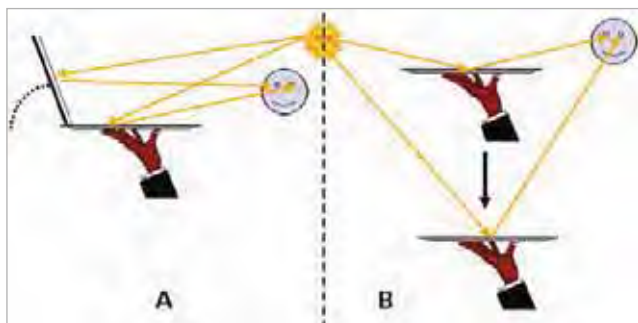

Visual evaluations of traditional metallic finishes

Visual evaluation of effect coatings with color flop

Courtesy of Merck

METALLIC COLOR

Instrumental Color Measurement of Effect Coatings

Multi-angle color measurement

ASTM, DIN and ISO standards define multi-angle color measurement to objectively describe the color of metallic finishes. Research studies show that a minimum of three, and optimally five viewing angles are needed. The measurement geometry for multi-angle color measurement is specified by aspect angles. The aspect angle is the viewing angle measured from the specular direction in the illuminator plane. The angle is positive when measured from the specular direction towards the normal direction.

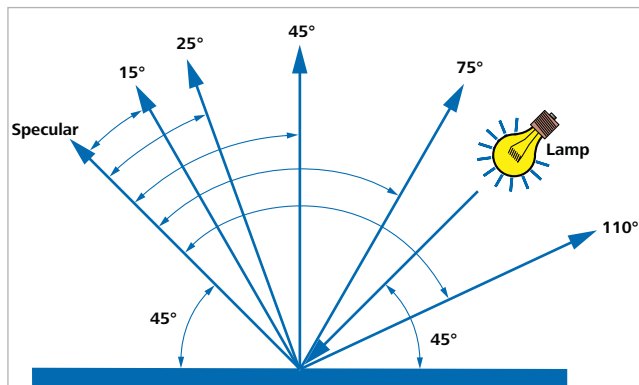

Directional illumination is used versus circumferential illumination because circumferential illumination minimizes the contribution from directional effects such as the Venetian blind effect and surface irregularities. Thus, averaging of the circumferential illumination would cause the measured color values of two specimens to be the same, while visually the two specimens would not match.

For color QC, the colorimetric data L^* , a^* , b^* (or L^* , C^* , h°) and ΔE^* can be used. The tolerances are usually higher for the near specular (15° , 25°) and the flop angle (75° , 110°) than the 45° tolerance. In order to have a unique tolerance parameter independent of color, weighted factors have to be used. Therefore, automotive companies often have set specifications on ΔE CMC or $\Delta E'$ based on DIN 6175-2 using 3 or 5 angle instrumentation. Another useful index is the flop index, a measure of the change in lightness of a metallic color as it is tilted through the entire range of viewing angles.

In the last years a new generation of special effect pigments has become more and more popular. For some of these new pigments the color travels over a wide range.

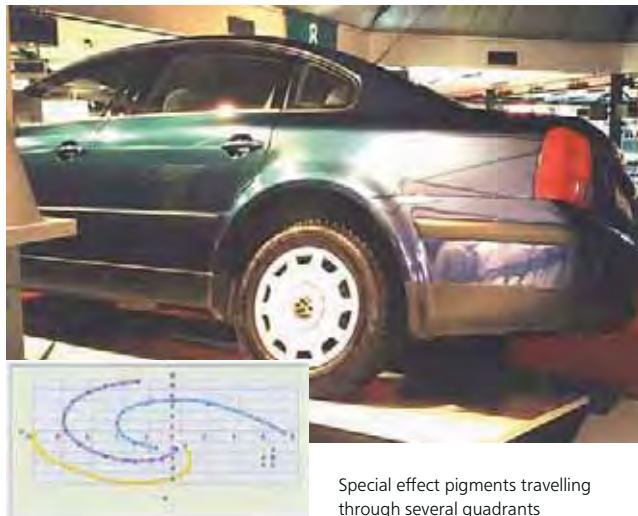

Special effect pigments travelling through several quadrants

In order to fully capture the color travel of these interference pigments it is necessary to add viewing and illumination angles. To keep the whole procedure practical for industrial use with a portable spectrophotometer it was determined that an additional angle behind the gloss e.g. -15° is of benefit.

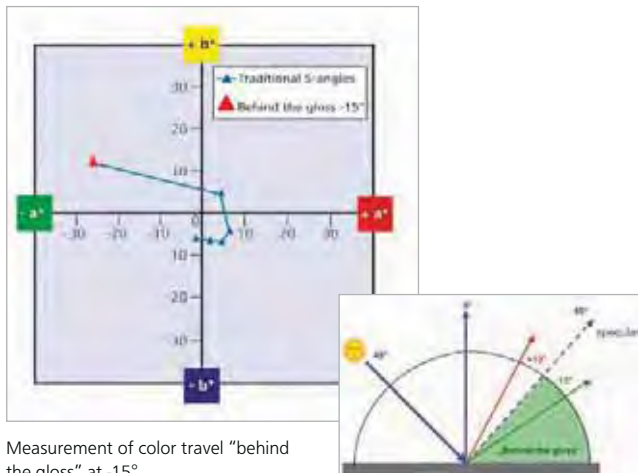

Measurement of color travel "behind the gloss" at -15°

Flake Characterization

In addition to color changes our total perception is also influenced by the effect of the metallic flakes or other sparkling pigments. This effect changes with the lighting conditions, for example direct sunlight versus cloudy sky.



Direct sunlight: Sparkle effect



Cloudy sky: Graininess

Sparkle

A sparkling or glitter impression can be observed under direct sunlight. This effect is often described with different words such as sparkle, micro brilliance or glint and is generated by the reflectivity of the individual effect pigment. Therefore, it is influenced by the

- flake type and size
- concentration level of the effect pigment
- orientation of the effect pigment
- application method

The sparkle impression changes depending on the illumination angle.

Graininess

Apart from the sparkle effect under direct sunlight, another effect can be observed under cloudy conditions, which is described as coarseness or salt and pepper appearance. This visual graininess can be influenced by the flake diameter or the orientation of the flakes resulting in a non-uniform and irregular pattern. The observation angle is of low relevance when evaluating graininess.

Multi-angle color and effect measurement with the BYK-mac

Traditional 5-angle color measurement calculates color values by averaging the spectral reflection over the entire illuminated spot and therefore can not differentiate between the color of the basecoat and the reflection of the aluminum flakes. As a consequence, two effect finishes can have the same color values with a 5-angle spectrophotometer, but visually appear very different. The visual difference is a result of the flake effects.

Sample 1



Sample 2

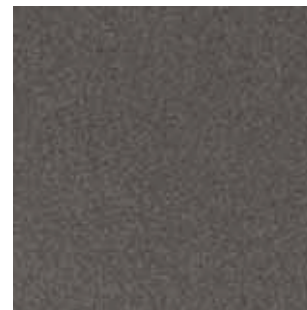

Same color but visual difference

	ΔL^*	Δa^*	Δb^*
-15°	-0.35	0.25	0.42
15°	0.16	0.19	0.43
25°	-0.65	0.20	0.48
45°	-0.10	0.05	0.00
75°	0.46	-0.11	-0.60
110°	0.69	-0.11	-0.89

	$\Delta Sparkle$	$\Delta Graininess$
15°	7.85	
45°	4.17	
75°	1.48	
Diffused		3.81

To characterize the impression of effect finishes under different viewing angles and illumination conditions, the BYK-mac spectrophotometer objectively measures the total color impression:

- Multi-angle color measurement (6-angles) clearly defines the light-dark as well as color flop behavior of effect finishes
- Sparkling and Graininess control with a high resolution CCD camera simulates effect changes under direct and diffuse lighting conditions

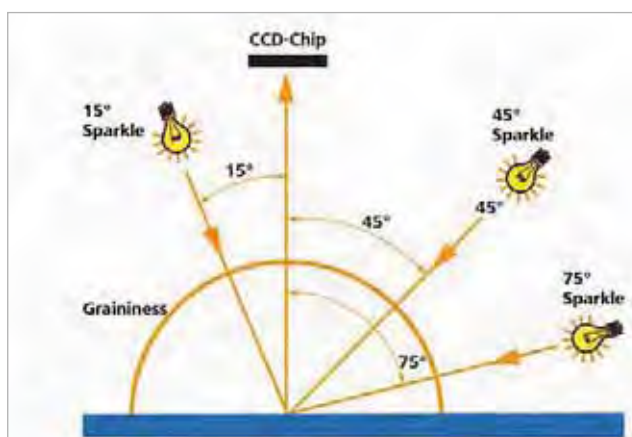

BYK-mac effect measurement geometries

Sparkle measurement under direct illumination at three angles

The sparkle impression changes with the angle of illumination. Therefore, the BYK-mac spectrophotometer illuminates the sample under three different angles 15°/45°/75° with very bright LEDs and takes a picture with the CCD camera located at the perpendicular.



Low sparkle (glint)



High sparkle (glint)

The pictures are analyzed by image analyzing algorithms using the histogram of lightness levels as the basis for calculating sparkle parameters.

To allow better differentiation, the impression of sparkle is described by a two dimensional system: sparkle area and sparkle intensity for each angle.

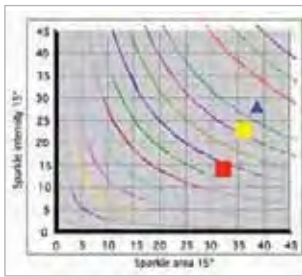

For simplicity sparkle area and intensity are summarized in one value: sparkle grade. Sparkle grade is represented by the colored lines in the diagram.

The sparkle evaluation is done by comparing a sample to a defined standard – like color measurement. Therefore, the sparkle data are also displayed in a difference graph.

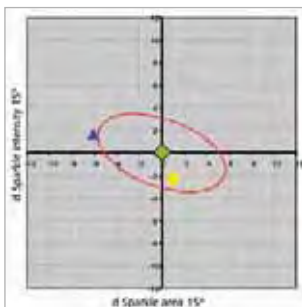

In order to set visually acceptable limits a new sparkle tolerance model was developed together with several partners from the automotive, pigment and paint industry. As a guideline the weighted total color difference equations were used resulting in an elliptical tolerance model.

The human eye is less critical to a change within a sparkle grade than it is to a change from grade to grade. Therefore, the longer axis of the ellipse is towards the sparkle grade lines.

To use the model as a Pass/Fail tool for paint batch or part QC, the total sparkle difference between sample and standard is calculated: $\Delta\text{Sparkle}$.

Graininess measurement under diffused illumination

Graininess is evaluated by taking a picture with the CCD camera under diffused lighting conditions, created by a white coated hemisphere. The picture is analyzed using the histogram of lightness levels whereby the uniformity of light and dark areas is summarized in one graininess value.

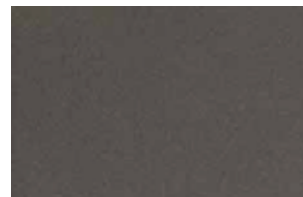

Low graininess (coarseness)



High graininess (coarseness)

A graininess value of zero would indicate a solid color, the higher the value the grainier or coarser the sample will look under diffused light.

Influence of flake size on sparkle and graininess

Sparkle and graininess data give information on flake size and concentration levels. The sample below shows a silver finish with three different flake sizes (25 μm – 34 μm – 54 μm).

Visually, the silver finish with the coarser aluminum pigments appears more sparkling under direct illumination and more “grainy” under diffused lighting.

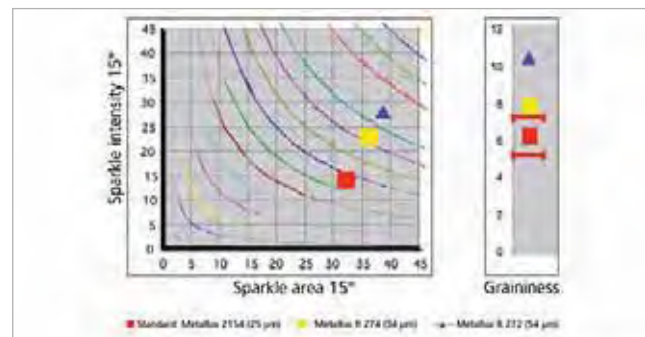

The BYK-mac measurement correlates with the visual judgment: sparkle area, sparkle intensity and graininess increase with flake size.

Influence of flake Orientation on total color impression

Besides flake types and concentration levels, the comparison of sparkle area at 15° and 75° illumination gives information about flake orientation.

Different application method

In order to increase paint efficiency the basecoat application is changing to 100% electrostatic application. Metallic finishes containing coarser aluminum flakes will show more non-parallel oriented flakes. The result will be a lower light-dark flop and more sparkling at a low grazing illumination angle. In the following example the basecoat of the car body was applied 100% electrostatically and the bumpers were painted with a bell / pneumatic application. The total color difference using the mean ΔE_{DIN} was acceptable.

	ΔE_{DIN} avg.
FuelDoor2	0.59
FuelDoor1	0.88
DPillar_R	0.63
DPillar_L	0.56
Door_R	0.53
Door_L	0.62
Bumper_R2	0.56
Bumper_R1	0.40
Bumper_F3	0.89
Bumper_F1	0.87
Bumper_F2	0.90

ΔE_{DIN} is well below one for all measurement points

Yet, visually, the car body was sparkling considerably more than the bumper. The BYK-mac measurement data reflects the visual impression clearly evaluating the Sparkle 75° data. The Sparkle 75° measurement evaluates the aluminum flakes which are non-parallel oriented; therefore the main changes can be seen in an increasing sparkle area.

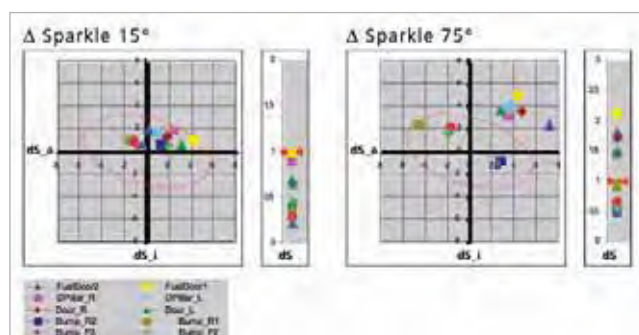

Different rheology additives

Flake orientation can also be influenced by the paint formulation, e.g. the rheology additive. As fine aluminum flakes have more edges and consequently more light is scattered, the orientation is more important for coarser pigments. The use of an optimized rheology additive will result in a better light-dark flop and less sparkling at lower grazing angles.

In the following example a waterborne system was evaluated using three different rheology additives: a standard system, an acrylic thickener and the BYK-Chemie wax additive AQUATIX®. Visually, the three panels look the same under direct illumination at a steep angle. When comparing at a lower grazing angle, the system using the BYK-Chemie wax additive shows less sparkling.

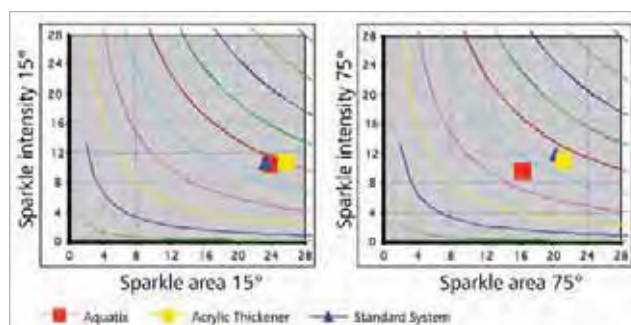

BYK-mac measurement data correlates with a visual judgment. The sparkle area for the system with wax additive at 75° is smaller than for the two other systems. As Sparkle 75° evaluates flakes which are non-parallel oriented, this clearly shows that by using the BYK-Chemie wax additive AQUATIX® the orientation of the aluminum flakes is improved.



BYK-mac measures total color impression

Info!

For more information on visual evaluation of effect finishes see byko-spectra *effect* page

BYK-mac

Total color impression of effect finishes

The appearance of effect finishes is influenced by different viewing angles and viewing conditions. Apart from a light-dark flop and color shift special sparkling effects can be created.

The BYK-mac spectrophotometer is unique as it measures both multi-angle color and flake characterization in one portable device.

- Traditional 5-angle color measurement: 15° / 25° / 45° / 75° / 110°
- Additional color measurement behind the gloss for color travel of interference pigments: -15°
- Sparkle and graininess measurement for flake characterization

Ergonomic design and easy operation

The shape of the instrument is designed to ensure easy handling and true portability. Due to its intuitive menu quality control of metallic finishes has never been easier.

- Menu guided operation according to your own sampling procedure
- Designated buttons for standard and sample readings
- Scroll wheel to select menu functions
- Large display: complete statistics for selectable values and alphanumerical name input
- Storage of up to 1000 readings in selectable memories
- auto-chart software for professional analysis, documentation and data management



D65/10°	Confer Hood	L/3
-15°	AEP	AS AG
15°	1.24	
25°	1.28	32
45°	0.94	
75°	1.27	15
110°	1.61	
-85°	1.18	
Royal Blue		4.7



Reliable readings at any time

In order to guarantee stable positioning, the BYK-mac is equipped with trigger pins on the bottom plate of the instrument. If the pins do not have contact with the surface, an error message will be displayed. This ensures reproducible results on test panels as well as curved parts ($r > 500$ mm).

Additionally, the surface temperature is measured and saved with each measurement.

Accurate results and low maintenance

The BYK-mac spectrophotometer uses a light source with long-term stability and patented illumination control which provides superior accuracy and low maintenance for many years.

- Stable, long-term calibration – needed only every three months
- Temperature independent measurement results between 10 - 40 °C – without calibration
- Excellent agreement between instruments
- 10 year warranty on the light source – no lamp changes needed



Always ready

The instrument is operated with a rechargeable battery pack (Li-Ion). The docking station automatically charges the battery pack in the instrument as well as a spare pack located in the docking station.

Optionally the instrument can be operated with 4 standard mignon alkaline or rechargeable batteries.

The docking station also transfers measured data to a PC.



Info!

For more information on visual evaluation of effect finishes see *byko-spectra effect*, page 127.

BYK-mac with small aperture

Measurement of effect finishes on small or curved parts

Special effect finishes are used in many applications to create new color impressions emphasizing the design of a product. Objects like mobile phone housings, bicycles or window handles are very small or curved. They require a color instrument with small aperture and repeatable sample placement. The BYK-mac with 12 mm aperture guarantees repeatable results even on such products.

Total color impression of effect finishes

- Traditional 5-angle color measurement: 15° / 25° / 45° / 75° / 110°
- Additional color measurement behind the gloss for color travel of interference pigments: -15°
- Sparkle and graininess measurement for flake characterization



New!



Reliable readings at any time

Menu guided operation with designated buttons for standard and sample readings

- Scroll wheel to select menu functions
- Storage of up to 1000 readings in selectable memories
- Stable, long-term calibration – needed only every three months
- Temperature independent measurement results between 10 – 40°C – without calibration
- 10 year warranty on light source – no lamp changes needed
- Operated by a rechargeable battery pack – good for 1000 readings
- auto-chart software for professional analysis, documentation and data management

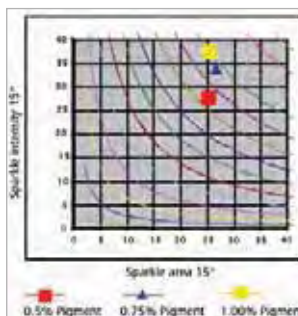

BYK-mac data for effect pigments with different concentration levels.

Save!

Special Introductory Offer

– valid only for a limited time

CM-6362 BYK-mac: \$ 29,500.00

CM-6397 BYK-mac: \$ 29,500.00

CM-6363 BYK-mac Sensor: \$ 24,500.00

CM-6398 BYK-mac Sensor: \$ 24,500.00

In compliance with:

Standards

ASTM	D 2244, E 308, E 1164, E 2194
DIN	5033, 5036, 6174, 6175-2
ISO	7724
SAE	J 1545

Ordering Information

Cat. No.	Description
CM-6362	BYK-mac*
CM-6397	BYK-mac*
CM-6363	BYK-mac Sensor
CM-6398	BYK-mac Sensor
SE-6340	Extended Warranty one year additional

Comes complete with:

Multi-angle spectrophotometer
 Black calibration standard
 White calibration standard with certificate
 Cyan and effect checking reference
 Protective cap
 Cleaning set for bottom plate
 2 light protection covers
 Seal replacement kit
 *BYKWARE auto-chart software
 Docking station with USB cable for memory transfer
 Instrument interface cable for online data transfer
 2 rechargeable Li-ion battery packs
 Battery holder; 4 x AA batteries
 Short instructions; Operating manual on CD
 Carrying case; Training

Free 1x preventive maintenance service during warranty period

Hardware Requirements:

Operating system: Windows® 2000 or higher
 Excel® version: 2002 or higher VBA
 Memory: min. 256 MB RAM (recommended 512 MB)
 Hard disk capacity: min. 100 MB
 Monitor resolution: XGA (1024 x 768) or higher
 Disk drive: CD-ROM or DVD
 Interface: USB-port



Technical Specifications

Measuring Area	
23 mm diameter	
12 mm diameter	
23 mm diameter	
12 mm diameter	

Color	
Measuring	45° illumination -15°, 15°, 25°, 45°, 75°, 110°
Geometry	aspecular viewing
Spectral Range	400 – 700 nm, 10 nm resolution
Measurement Range	0 to 400 % reflectance
Repeatability¹	0.02 ΔE* (10 consecutive measurements on white)
Reproducibility¹	0.20 ΔE* (average on 12 BCRA II tiles)
Color Scales	ΔE*; ΔE CMC; ΔE 94; ΔE 2000; ΔE 99; ΔE DIN6175
Illuminants	A; C; D50; D65; F2; F7; F11; F12
Observer	2°; 10°

Effect	
Measurement	15° / 45° / 75° and diffused illumination
Geometry	perpendicular viewing
Effect Parameters	ΔS; ΔS _a ; ΔS _i ; ΔG
Repeatability¹	S _a / S _i : 5% or > 0.50 / G = ± 0.05
Reproducibility¹	S _a / S _i : 10% or > 1.00 / G = ± 0.15

Measuring Time	< 6 seconds
Memory	1000 standards / samples
Language	English, German, French, Italian, Spanish
Power Supply	Rechargeable battery pack or 4 mignon AA batteries (alkaline or rechargeable)
Operating Temperature	10 to 42° C (50 to 110 ° F)
Relative Humidity	up to 85%, 35° C (95° F); non-condensing
Dimensions	21.8 x 8.1 x 14.7 cm (8.6 x 3.2 x 5.8 in.)
Weight	approx. 1.3 kg (approx. 2.86 lbs)

¹ Standard deviation

BYK-mac Training

BYK-Gardner offers you more than just an instrument. We assist you in analyzing your color readings as well as sparkle and graininess data. As a result you will be able to use the BYK-mac to save time and money, while at the same time improving quality. Therefore, the instrument comes with a one day training course including:

1. Color and Effect Theory

- Parameters influencing total color impression of effect finishes
- Color and effect differences for trouble shooting

2. Operation and Software training

- Standard management
- Set-up an "organizer" to create a routine measurement procedure
- Programming of the instrument with "organizer" and measurement of several samples
- Data transfer to auto-chart software and saving in a database for routine QC
- Data analysis using standard reports:
 - Lab-scatter graph per angle to show at one glance whether all parts are within specifications
 - Color travel by sample to show how individual measurement zones perform per measurement angle
 - Effect graph to control whether sparkle and graininess values are within specification

- Create your own reports in Excel®
 - Transfer data from the database to Excel®
 - Pivot function to define layout in Excel®

The training can be performed in one day or two half days. It is recommended to split the training into two half days:

Day 1: Theory and basic operation (set-up organizer, taking readings and saving in a database)

Day 2: 3-4 weeks later to ensure readings were taken and saved in a database. Data analysis and standard QC report can be explained using custom specific data.

Certified For Preventive Maintenance see page 271.

Ordering Information

Cat. No.	Description
CM-6332	Black Calibration Standard
CM-6336	Protective Cap, BYK-mac 23 mm measuring area
CM-6399	Protective Cap, BYK-mac 12 mm measuring area
CM-6360	Docking Station
CM-6337	USB Interface Cable
CM-6413	Instrument Interface Cable, online
CM-6359	Battery Pack
CM-6364	Cleaning Set for Bottom Plate
CM-6348	Seal Replacement Set
CM-6414	Light Protection Cover
AW-4809	BYKWARE auto-chart

Accessories

To perform zero calibration
Snap on cover to protect optics and interior components
Snap on cover to protect optics and interior components
Incl. USB interface cable and charger 100 – 240 V self adapting (For BYK-mac with catalog number 6340 and 6345, please contact customer service for an upgrade package)
To connect the docking station to the PC, USB-A plug, 3 m length
To connect the instrument directly to the PC
Rechargeable battery pack for automatic charge in docking station
To clean instrument aperture and pin covers from dust and grease Including 3 light protection rubber seals and 8 rubber pin covers
To measure very bright colors; 10 pieces included
Software for data analysis with database management and professional documentation in Excel®

Note: For replacement of white, cyan or effect standard, please contact your local service department.

Accessories Cosmetics

Measurement of cosmetic products

The cosmetic industry is very much driven by the aesthetics. A lot of special effect pigments are used to create light-dark and color flop. Additionally, they start to sparkle when viewed in direct sun light. As many different sample types are used e.g. nail polish, lip gloss and eye shadow, standardized sample preparation is required for repeatable measurement results.

Measurement of Nail Polish

A drawdown is made on a black & white test chart. The use of BYK-Gardner byko-charts guarantee consistent color & gloss ensuring that the measured color difference only comes from product variations.

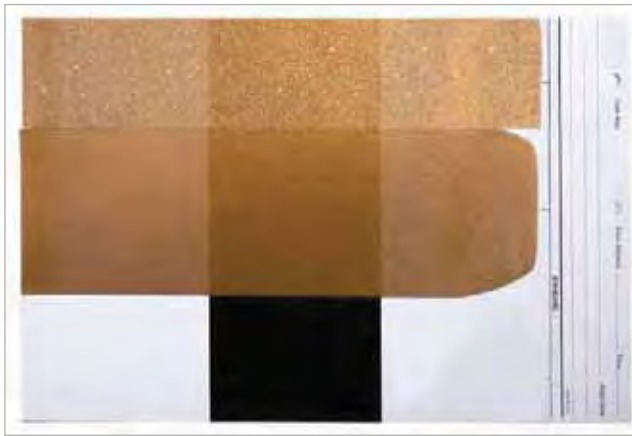

The orientation of effect pigments can create different looks. In the example on the right the same pigment was used in 2 different formulations. In formula 1 the flake orientation was not influenced. As a result it looks coarser and sparkles at a low grazing angle. In formula 2 the aluminium flakes were oriented parallel creating a fine, mirror like look with hardly any graininess. BYK-mac measurement data clearly detects this effect by an increase in sparkle area at 75° and graininess. Sparkle 75° detects the aluminium flakes which are non-parallel oriented.

New!



Info!

For more information on byko-charts, see pages 145 – 152.

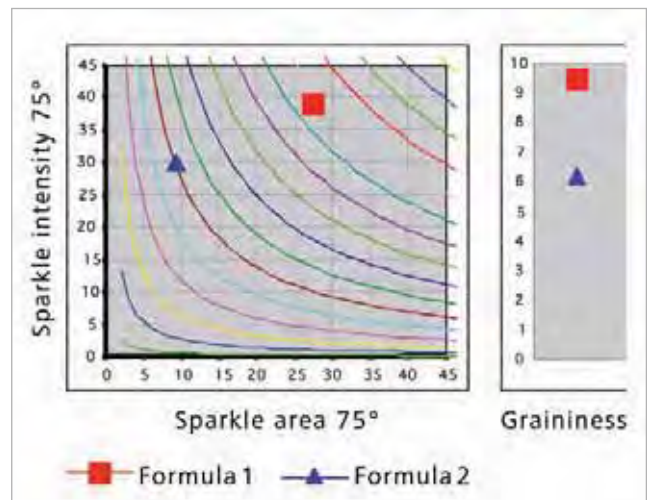



Measurement of Powdery and Pasty Materials

Eye shadow, lipstick / lip-gloss or facial powder is pressed or poured into a sample cup and can be easily and repeatedly measured with the BYK-mac sample holder.

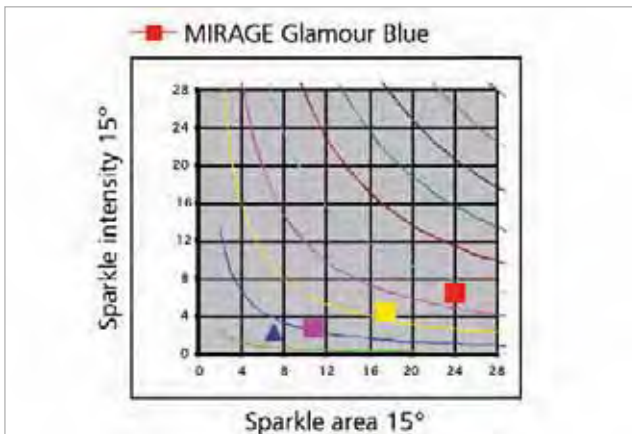

Eye shadow using the new MIRAGE effect pigment line from ECKART was compared to products using natural mica based pigments. Visually, the new pigments distinguish themselves by their glamorous look and extraordinary sparkling effect. BYK-mac measurements of MIRAGE Glamour Blue show this effect by a much higher sparkle area and intensity value.

The holder is equipped with a mask custom made to fit the aperture of the BYK-mac and therefore, guarantees repeatable sample placement and measurement results. For sample preparation the holder comes with one adapter ring and five cuvettes (ø 35.5 mm, height 4.5 mm).

To use it with custom specific cuvettes, customized adapter rings are offered.

■ Maximum round container size: ø 60 mm



Ordering Information

Cat. No.	Description
CM-6415	Sample Holder
CM-6416	Customized Adapter Rings

Accessories

To measure powdery and pasty materials;
including adapter ring and 5 cuvettes ø 35.5 mm, height 4.5 mm
Five adapter rings of various sizes; please specify diameter

BYK-mac COLOR

Multi-angle color measurement

In order to control the lightness and / or color flop of an effect finish, the color needs to be measured under different viewing angles.

BYK-mac COLOR spectrophotometer offers an attractive solution by measuring

- Traditional 5-angle color at 15°/25°/45°/75°/110°
- An additional angle at -15° "behind the gloss" for color travel of interference pigments

Ergonomic design and easy operation

The shape of the instrument is designed to ensure easy handling and true portability. With an intuitive menu quality control of metallic finishes has never been easier.

Menu guided operation according to your own sampling procedure

- Designated buttons for standard and sample readings
- Scroll wheel to select menu functions
- Storage of up to 1000 readings in selectable memories
- 4 trigger pins on the bottom plate guarantee stable positioning even on curved surfaces



Center Hood	D65/10°	3/3
-15°	ΔL^* -0.53	Δa^* 0.35 Δb^* 0.96 ΔE^* 1.15
15°	-0.14	0.26 0.81 0.86
25°	-1.77	0.11 0.42 1.82
45°	-2.99	0.01 0.41 3.01
75°	-1.28	0.20 0.98 1.63
110°	0.60	0.44 1.00 1.24

987 Light Blue Metallic Style 1



Reliable readings at any time

The BYK-mac COLOR uses a light source with long term stability and patented illumination control which provide superior accuracy and low maintenance for many years.

- Stable, long-term calibration – needed only every three months
- Temperature independent measurement results between 10 – 40 °C – without calibration
- Excellent agreement between instruments
- 10 year warranty on the light source – no lamp changes needed

Always ready

The instrument is operated with a rechargeable battery pack (Li-Ion). The docking station automatically charges the battery pack in the instrument as well as a spare pack located in the docking station. Optionally the instrument can be operated with 4 standard mignon alkaline or rechargeable batteries.

The docking station also transfers the measured data to a PC. For professional analysis, documentation and data management auto-chart software is included.

In compliance with:

Standards

ASTM	D 2244, E 308, E 1164, E 2194
DIN	5033, 5036, 6174, 6175-2
ISO	7724
SAE	J 1545



Certified

For Preventive Maintenance see page 271.

Ordering Information

Cat. No.	Description
CM-6395	BYK-mac COLOR*
CM-6396	BYK-mac COLOR Sensor
SE-6395	Extended Warranty one year additional

Comes complete with:

Multi-angle spectrophotometer
Black calibration standard
White calibration standard with certificate
Cyan checking reference
Protective cap
Cleaning set for bottom plate
2 light protection covers
Seal replacement kit
*BYKWARE auto-chart software
Docking station with USB cable for memory transfer
Instrument interface cable for online data transfer
2 rechargeable Li-ion battery packs
Battery holder; 4 x AA batteries
Short instructions; Operating manual on CD
Carrying case; Training

Free 1x preventive maintenance service during warranty period

Hardware Requirements:

Operating system: Windows® 2000 or higher
Excel® version: 2002 or higher VBA
Memory: min. 256 MB RAM (recommended 512 MB)
Hard disk capacity: min. 100 MB
Monitor resolution: XGA (1024 x 768) or higher
Disk drive: CD-ROM or DVD
Interface: USB-port

Technical Specifications

Measuring Geometry	45° illumination -15°, 15°, 25°, 45°, 75°, 110° aspecular viewing
Measuring Area	23 mm diameter
Spectral Range	400 – 700 nm, 10 nm resolution
Measurement Range	0 to 400 % reflectance
Repeatability¹	0.02 ΔE^* (10 consecutive measurements on white)
Reproducibility¹	0.20 ΔE^* (average on 12 BCRA II tiles)
Color Scales	ΔE^* ; ΔE CMC; ΔE 94; ΔE 2000; ΔE 99; ΔE DIN6175
Illuminants	A; C; D50; D65; F2; F7; F11; F12
Observer	2°; 10°
Measuring Time	< 4 seconds
Memory	1000 standards / samples
Language	English, German, French, Italian, Spanish
Power Supply	Rechargeable battery pack or 4 mignon AA batteries (alkaline or rechargeable)
Operating Temperature	10 to 42° C (50 to 110° F)
Relative Humidity	up to 85%, 35° C (95° F); non-condensing
Dimensions	21.8 x 8.1 x 14.7 cm (8.6 x 3.2 x 5.8 in.)
Weight	approx. 1.3 kg (approx. 2.86 lbs)

¹ Standard deviation

Save!

Special Introductory Offer

– valid only for a limited time

CM-6395 BYK-mac COLOR: \$ 24,500.00

CM-6396 BYK-mac COLOR Sensor: \$ 19,500.00

BYK-mac COLOR Training

BYK-Gardner offers you more than just an instrument. We assist you in analyzing your color readings to enable you to use the BYK-mac COLOR to save time and money, while at the same time improving quality. Therefore, the instrument comes with a one day training course including:

1. Color Theory

- Parameters influencing color impression of effect finishes
- Color differences for trouble shooting

2. Operation and Software training

- Standard management
- Set-up an "organizer" to create a routine measurement procedure
- Programming of the instrument with "organizer" and measurement of several samples
- Data transfer to auto-chart software and saving in a database for routine QC
- Data analysis using standard reports:
 - Lab-scatter graph per angle to show at one glance whether all parts are within specifications
 - Color travel by sample to show how individual measurement zones perform per measurement angle
- Create your own reports in Excel®
 - Transfer data from the database to Excel®
 - Pivot function to define layout in Excel®



The training can be performed in one day or two half days. It is recommended to split the training into two half days:

Day 1: Theory and basic operation (set-up organizer, taking readings and saving in a database)

Day 2: 3-4 weeks later to ensure readings were taken and saved in a database. Data analysis and standard QC report can be explained using custom specific data.

Ordering Information

Cat. No.	Description
CM-6332	Black Calibration Standard
CM-6336	Protective Cap
CM-6360	Docking Station
CM-6337	USB Interface Cable
CM-6413	Instrument Interface Cable, online
CM-6359	Battery Pack
CM-6364	Cleaning Set for Bottom Plate
CM-6348	Seal Replacement Set
CM-6414	Light Protection Cover
AW-4809	BYKWARE auto-chart

Note: For replacement of white and cyan effect standard, please contact your local service department.

Accessories

To perform zero calibration
Snap on cover to protect optics and interior components
Incl. USB interface cable and charger 100 – 240 V self adapting
To connect the docking station to the PC, USB-A plug, 3 m length
To connect the instrument directly to the PC
Rechargeable battery pack for automatic charge in docking station
To clean instrument aperture and pin covers from dust and grease
Including 3 light protection rubber seals and 8 rubber pin covers
To measure very bright colors; 10 pieces included
Software for data analysis with database management and professional documentation in Excel®

BYK-mac ROBOTIC

Automatic measurement of total color impression of effect finishes at the line

Products can only be manufactured with uniform and consistent quality when process stability is guaranteed. Therefore, multi-angle color, sparkle and graininess must be measured on a routine basis. The BYK-mac ROBOTIC spectrophotometer allows automated total color control as it is mounted on a robotic arm. The robotic system not only measures a high number of cars, but also on the same areas.

Total color impression of effect finishes

The BYK-mac ROBOTIC measures both multi-angle color and flake characterization.

- Multi-angle color measurement at 6-angles clearly defines the light-dark as well as color flop behavior of effect finishes
- Sparkling and Graininess control with a high resolution CCD camera simulates effect changes under direct and diffuse lighting conditions.
- Multi-angle color and effect data help to analyze the cause of a color mismatch



New!

Reliable and objective color and effect data

The BYK-mac ROBOTIC spectrophotometer uses a light source with long-term stability and patented illumination control which provide superior accuracy and low maintenance for many years.

- Stable, long-term calibration – needed only every three months
- Temperature independent measurement results between 10 – 40°C – without calibration
- 10 year warranty on light source – no lamp changes needed
- Excellent agreement between instruments and correlation to BYK-mac and BYK-mac COLOR

Reliable readings at any time

In order to guarantee stable positioning, the BYK-mac ROBOTIC is equipped with trigger pins on the bottom plate of the instrument. The sensitivity of the pins can be adjusted to the curvature of the measurement area. If the pins do not have contact with the surface an error message will be displayed.

In compliance with:

Standards

ASTM	D 2244, E 308, E 1164, E 2194
DIN	5033, 5036, 6174, 6175-2
ISO	7724
SAE	J 1545

Ordering Information

Cat. No.	Description
CM-6369	BYK-mac ROBOTIC
SE-6369	Extended Warranty one year additional

Comes complete with:

Multi-angle spectrophotometer
 White calibration standard with certificate
 Cyan and effect checking reference
 Light protection cover
 BYKWARE auto-chart software
 Communication software
 Installation kit
 Operating manual on CD
 Carrying case; Training

Free 1x preventive maintenance service during warranty period

Hardware Requirements:

Operating system: Windows® 2000 or higher
 Excel® version: 2002 or higher VBA
 Memory: min. 256 MB RAM (recommended 512 MB)
 Hard disk capacity: min. 100 MB
 Monitor resolution: XGA (1024 x 768) or higher
 Disk drive: CD-ROM or DVD
 Interface: USB-port



Technical Specifications

Color	
Measuring Geometry	45° illumination -15°, 15°, 25°, 45°, 75°, 110° aspecular viewing
Measuring Area	87 x 23 mm (in)
Spectral Range	400 – 700 nm, 10 nm resolution
Measurement Range	0 to 400 % reflectance
Repeatability¹	0.02 ΔE* (10 consecutive measurements on white)
Reproducibility¹	0.20 ΔE* (average on 12 BCRA II tiles)
Color Scales	ΔE*; ΔE CMC; ΔE 94; ΔE 2000; ΔE 99; ΔE DIN6175
Illuminants	A; C; D50; D65; F2; F7; F11; F12
Observer	2°; 10°
Effect	
Measurement Geometry	15° / 45° / 75° and diffused illumination perpendicular viewing
Effect Parameters	ΔS; ΔS _a ; ΔS _i ; ΔG
Repeatability¹	S _a / S _i : 5% or > 0.50 / G = ± 0.05
Reproducibility¹	S _a / S _i : 10% or > 1.00 / G = ± 0.15
Object Curvature	Radius > 400 mm
Measuring Time	< 6 seconds
Memory	1000 standards / samples
Language	English, German, French, Italian, Spanish
Power Supply	External power supply 24 VDC
Interface	RS 422
Robotic Requirements	Vibration-free operation
Operating Temperature	10 to 42° C (50 to 110 ° F)
Relative Humidity	up to 85%, 35° C (95° F); non-condensing
Dimensions	21 x 12.5 x 17.5 cm (8.3 x 5 x 6.9 in.)
Weight	approx. 3.5 kg (approx. 7.7 lbs)

¹ Standard deviation

BYK-mac ROBOTIC Training

BYK-Gardner offers you more than just an instrument. We assist you in operating the whole system and analyzing your color, sparkle and graininess data. Therefore, the instrument comes with a two day training course including:

Color and Effect Theory:

- Visual perception and instrumental measurement of multi-angle color, sparkle and graininess.
- Data interpretation for trouble shooting
- Support in integrating the BYK-mac ROBOTIC sensor into an automated measurement system

Software training

- Data analysis using standard reports:
 - Lab-scatter graph per angle to show at one glance whether all parts are within specifications
 - Color travel by sample to show how individual measurement zones perform per measurement angle
 - Effect graph to control whether sparkle and graininess values are within specification

Day 1: Color and Effect theory with data interpretation for optimization and trouble shooting
Support in integrating the BYK-mac ROBOTIC sensor into an automated measurement system

Day 2: Software training with data analysis using standard reports

Ordering Information

Cat. No.	Description
CM-6417	Light Protection Cover
AW-4809	BYKWARE auto-chart

Note: For replacement of white, cyan and effect standard, please contact your local service department.

Accessories

To avoid the influence of ambient light
Software for data analysis with database management and professional documentation in Excel®

Certified For Preventive Maintenance see page 271.

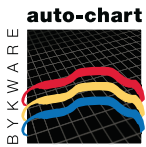

auto-chart

Efficient Data Analysis with auto-chart Software

Various process parameters influence the overall color impression of metallic finishes. Good process control requires systematic planning and efficient handling of large data sets. BYK-Gardner auto-chart gives you what you need to take a step forward in metallic color measurement and control.

Standard Management

As color and effect evaluation is always done by comparing the product to a defined standard, the first step is to pre-define the standard settings for each color (e.g. name, # of readings, color difference, effect scales).

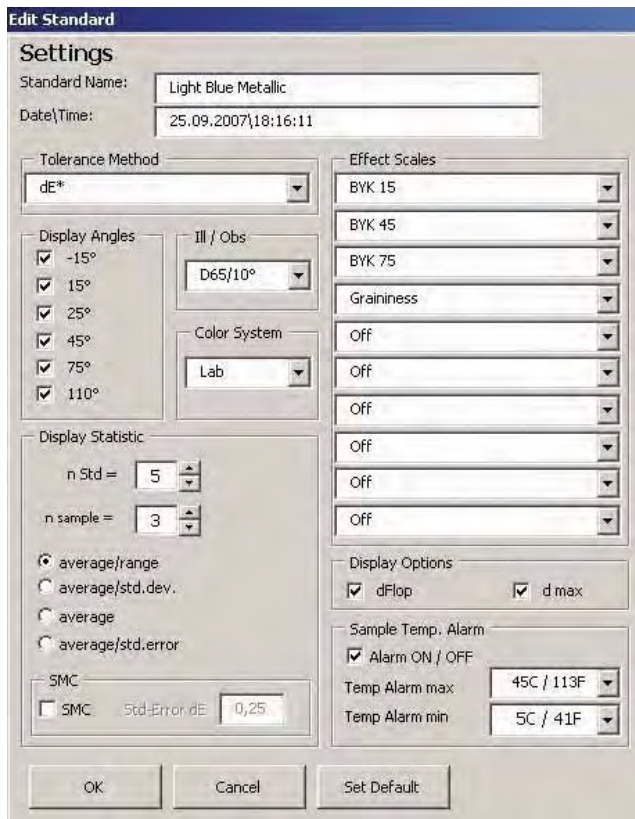

These templates are then transferred to the instrument and the standard panels are measured. For data analysis and back-up purposes the standards can be stored in the auto-chart database.

Definition of Test Procedure

In order to perform efficient data analysis clear sample identification and a defined control sequence are necessary. Therefore, so called "Organizer Files" are created in auto-chart. These files are transferred to the color instrument, the parameters are selected on the instrument, and the user is guided through the measurement procedure.

1. Clear sample identification

Up to 5 parameters for object identification can be entered: e.g. model – color – line. The system is open to your specific needs.

2. Definition of measurement sequence

In the organizer file the name of each measurement area can be defined. Additionally, the instrument's sensitivity against tilting can be set for each individual area guaranteeing operator independent measurement results.

#	Block No	Measurement Name	Dir	Curvature
1	1	Central Hood	(L)	low
2	1	Hood Left	(S)	low
3	2	Left Door	(S)	low
4	2	C-Pit Left	(S)	low
5	1	Trunk-Cent	(S)	low
6	3	C-Pit Right	(S)	low
7	3	Right Door	(S)	low
8	1	Hood Right	(R)	low
9			(R)	low

Symbol	Curvature	Example
	flat	Test panel
)	low	Hood
o	medium	Bumper
o	high	Mirror housing
Off		

3. Send organizer to instrument and take readings

Clear object identification without manual entry: just select on the display model, color and line and start measuring. The instrument guides the user automatically through the measurement sequence – reducing operator errors.



4. Transfer data and save

The measurement data is saved in the instrument, transferred to the PC and saved in the auto-chart database.

Professional Analysis and Documentation

auto-chart combines the efficient data management of Access® with proven Excel® functionality. After the data has been saved in the database, clearly structured filters are used for data selection and the results are directly transferred to standardized reports with graphics.

Lab-Scatter Graph

This standard report shows at a glance whether all parts are within specification. One graph per angle is shown and different tolerance models (e.g. CMC, DIN 6175-2) can be selected.

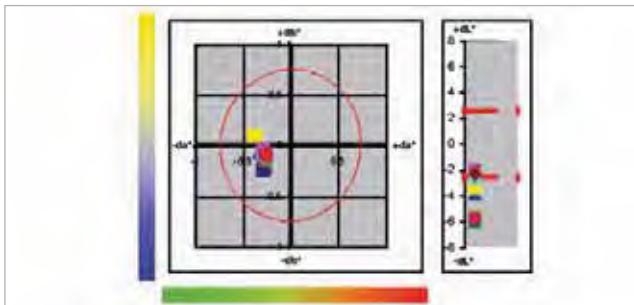

Effect Graph

Similar to the Lab-scatter graph, this chart easily shows whether effect differences are within tolerance. One graph per sparkle angle and graininess is displayed. Tolerances can be set to your specific requirements.

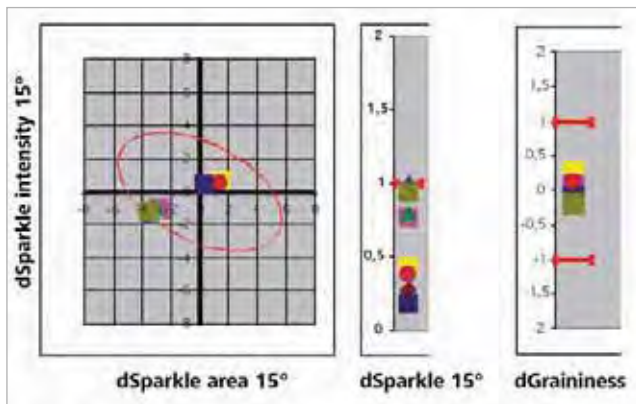

Color & Effect Travel by Sample

...the ideal tool to show how individual measurement areas or colors perform per measurement angle. In combination with a graph for sparkle and graininess values, total color impression can be easily controlled.

Example:

In the following example the basecoat of the car body was applied 100% electrostatically and the bumpers were painted with bell/pneumatic application. The total color difference ΔE_{DIN} was acceptable.

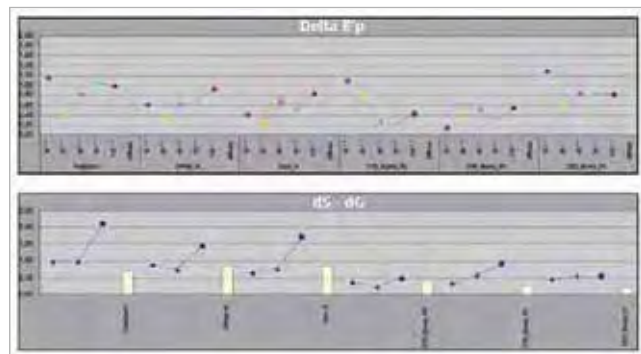

Yet, visually the car body was sparkling considerably more than the bumper. This difference is clearly detected by $\Delta Sparkle 75^\circ$ which is well above one. Sparkle 75° detects the aluminum flakes which are non-parallel oriented.

Ordering Information

Cat. No.	Description
AW-4809	auto-chart

Comes complete with:

Software on CD-ROM

Note: auto-chart licence fee for more than two installations is quantity dependent. Please contact your local BYK-Gardner representative.

Technical Specifications

Software for BYK-mac, BYK-mac COLOR and BYK-mac ROBOTIC.
Depending on the instrument, not all graphs may be available.

Hardware Requirements:

Operating system: Windows® 2000 or higher
Excel® version: 2002 or higher VBA
Memory: min. 256 MB RAM (recommended 512 MB)
Hard disk capacity: min. 100 MB
Monitor resolution: XGA (1024 x 768) or higher
Disk drive: CD-ROM or DVD
Interface: USB-port

Introduction

Liquid Color

Color of transparent liquids like varnishes, lacquers, shellacs, drying oils, fatty acids and resin solutions has been evaluated visually since the late 1800s. A change in color can indicate contamination or impurities in the raw materials, process variations caused by heating and oxidation, or degradation of products exposed to weathering over time.

For simplicity, one dimensional scales for yellowness were established, e.g., Gardner Color Scale, American Public Health Association (APHA) and Hazen, Saybolt, and Iodine (Hess-Ives).

In the visual test the yellowness is determined by pouring the sample into a tube and comparing it to a known standard. The standard that the sample falls closest to then becomes the value for the liquid. This procedure is highly subjective due to variations of observers, illumination and to some extent the standards themselves.

Quality control systems like ISO 9000 demand objective measurements using instrumentation that gives reliable data on a consistent basis.

Correlation equations were developed to link visual observations to instrumentally measured values.

Most products are not strictly yellow and therefore require a three dimensional description of color: red/green, yellow/blue and light/dark differences. Modern instruments read this information by the use of standardized color scales like CIE $L^*a^*b^*$ or $L^* C^* h^\circ$.

BYK-Gardner offers a complete line of visual color comparators for quick evaluation, as well as, objective instrumentation for liquid color measurement, tolerance setting and pass/fail analysis.

LIQUID COLOR



Liquid Color Standards

The Gardner Liquid Color Standard Comparator provides the entire Gardner Color Scale, against which a liquid sample can be visually compared.

- Rugged design for use in the laboratory and production
- Quick and easy color quality control of liquids
- Attractive price – color evaluation of liquids becomes affordable to everybody
- Shelf-life is 5 years

The sealed tubes are filled with Cobalt Chloride Platinite solutions of varying concentrations, which correspond to known Gardner Scale yellowness value numbers 1 – 18. The solutions are standardized at 25 °C (77 °F), but visual evaluations made between 20 °C (68 °F) and 30 °C (86 °F) are substantially correct.

Two models are available: with or without illumination.

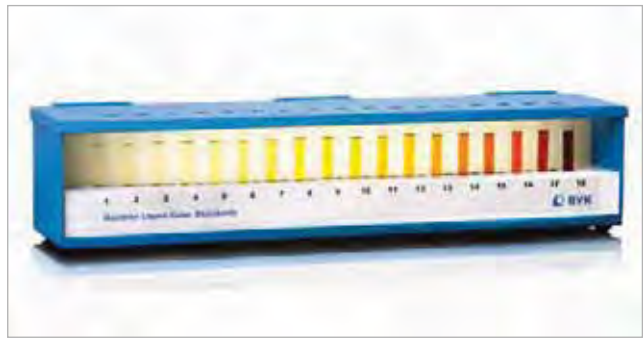

Standards

AOCS	Method Tdla-64T
ASTM	D 1544
ISO	4630

Ordering Information

Cat. No.	Description
CL-6726	Gardner Liquid Standards with illumination
CL-6727	Gardner Liquid Standards with illumination
CL-6724	Gardner Liquid Standards without illumination

Technical Specifications

illumination	Voltage	Dimensions	Weight
Fluorescent Lamp	115 V / 60 Hz	660 x 152 x 152mm (26 x 6 x 6 in)	6.35 kg (14 lbs)
Fluorescent Lamp	230 V / 50 Hz	660 x 152 x 152mm (26 x 6 x 6 in)	6.35 kg (14 lbs)
		629 x 143 x 64 mm (24.75 x 5 x 2.5 in)	2.3 kg (5 lbs)

Cat. No. CL-6726 and CL-6727 come complete with:

Set of 18 color standards 1 to 18
6 empty comparison tubes
Steel holding rack with fluorescent lamp
Operating manual

Cat. No. CL-6724 Comes complete with:

Set of 18 color standards 1 to 18
6 empty comparison tubes
Steel holding rack with frosted glass panel
Operating manual

Accessories

Liquid Standards

Accessories

Cat. No.	Description
CL-6601	Single, Filled Standard No. 1
CL-6602	Single, Filled Standard No. 2
CL-6603	Single, Filled Standard No. 3
CL-6604	Single, Filled Standard No. 4
CL-6605	Single, Filled Standard No. 5
CL-6606	Single, Filled Standard No. 6
CL-6607	Single, Filled Standard No. 7
CL-6608	Single, Filled Standard No. 8
CL-6609	Single, Filled Standard No. 9
CL-6610	Single, Filled Standard No. 10
CL-6611	Single, Filled Standard No. 11
CL-6612	Single, Filled Standard No. 12
CL-6613	Single, Filled Standard No. 13
CL-6614	Single, Filled Standard No. 14
CL-6615	Single, Filled Standard No. 15
CL-6616	Single, Filled Standard No. 16
CL-6617	Single, Filled Standard No. 17
CL-6618	Single, Filled Standard No. 18



The LCM III provides an objective way to quickly evaluate color of liquids – see page 119.

Empty Sample Tubes

Set of 144 empty, unmarked comparison tubes with cork stoppers for the liquid to be tested.

Ordering Information

Cat. No.	Description
CL-6756	Set of 144 Empty Tubes



The LCS III spectrally measures all color shades and provides detailed color analysis – see page 120.

Delta Color Comparator

The Gardner Delta Color Comparator uses precision-polished optical-glass filters as reference standards. Two different models are available: with or without illumination.

- Rugged design allows the color comparator to be used at any location
- Easy operation allows anyone to determine Gardner Color Numbers
- Optional illuminator allows back-light color to improve viewing conditions

The comparator is an arrangement of two wheels in which nine color filters are imbedded in each wheel. The glass filters range in color from water white through deep amber. A tube of the sample liquid is placed between the two filter wheels. The user then rotates the color wheels until the filter glass closest in color to the liquid is in place. That filter notation then becomes the color description for the liquid.



Standards

AOCS	Method Tdla-64T
ASTM	D 1544
ISO	4630

Ordering Information

Cat. No.	Description
CL-6745	Gardner Delta Color Comparator with illumination
CL-6746	Gardner Delta Color Comparator with illumination
CL-6750	Gardner Delta Color Comparator without illumination

Cat. No. CL-6745 and CL-6746 comes complete with:

Gardner Delta Color Comparator assembly
Two reference filter wheels
Gardner Delta illuminator
Operating manual

Technical Specifications

Illumination	Voltage	Dimensions	Weight
Incandescent Lamp	115 V / 60 Hz	171 x 203 x 229 mm	2.7 kg
	100 W	(6.75 x 8 x 9 in)	(6 lbs)
Incandescent Lamp	230 V / 50 Hz	171 x 203 x 229 mm	2.7 kg
	100 W	(6.75 x 8 x 9 in)	(6 lbs)
		159 x 19 x 81 mm	0.45 kg
		(6.25 x 0.75 x 3.2 in)	(1 lbs)

Cat. No. CL-6750 comes complete with:

Gardner Delta Color Comparator assembly
Two reference filter wheels
Operating manual

Accessories

Cat. No.	Description
CL-6752	Illuminator 115 V / 60 Hz
CL-6753	Illuminator 230 V / 50 Hz
CL-6754	Incandescent Lamp
CL-6756	Set of 144 Empty Tubes (unmarked comparison tubes with cork stoppers)
CL-6761	Filter Wheel, odd numbers
CL-6757	Filter Wheel, even numbers

LCM III

The LCM III is a reliable color instrument which replaces conventional visual color evaluation with an objective measurement. It is ideal for routine production control of clear, transparent liquids like resins, adhesives and solvents.

- Large touch-screen display with intuitive user guidance for simple operation
- Automatic cuvette recognition – avoids faulty data measurement
- Works with 10 and 50 mm rectangle as well as 11 mm round cuvettes for optimum precision
- Gardner, Hazen (APHA/PtCo), Iodine, Saybolt and Mineral oil scales come standard with instrument
- Reference beam design to maximize the accuracy and precision
- Truly portable with the use of an optional lithium-ion battery
- USB interface for PC or printer connection



Standards

ASTM	D 156, D 1045, D 1209, D 1544, D 1500
DIN	6162
ISO	4630, 6271, 2049

Ordering Information

Cat. No.	Description
CL-9552	LCM III

Comes complete with:

Instrument with dust cover
 External power supply
 Adapter for 10 mm rectangle cuvettes
 Operating manual

Technical Specifications

Voltage	100 – 240 V, 50 / 60 Hz
Type	Single-beam photometer with reference beam path
Spectral Range	400 to 700 nm, 20 nm resolution
Repeatability	± 2 Hazen ¹ , ± 0.1 Gardner ²
Reproducibility³	± 0.3 Iodine, ± 5 Hazen, ± 0.3 Gardner
Light Source	Tungsten Halogen Lamp
Indices	Hazen / APHA (0 to 1000), Gardner (0 to 18), Iodine (0 to 120), Saybolt (-16 to 30), Mineral Oil (ASTM D 1500) 0 to 8
Memory	200 color measurements
Data Export	*.csv file to USB flash drive or optional DataTrans Software
Interface	USB-A for printer and USB memory stick USB-B for communication with PC
Operating Temperature	10 – 40 °C (50 – 104 °F)
Humidity	up to 80%, 35 °C (95 °F); non condensing
Dimensions	220 x 135 x 330 mm (8.6 x 5.3 x 12.9 in.)
Weight	4.1 kg (9.0 lbs)

¹ Based on data with 11 mm cuvette

² Based on data with 50 mm cuvette

³ Based on data with 50 mm cuvette for Hazen and 11 mm cuvette for Iodine and Gardner

LCS III

The LCS III is a highly precise color instrument which spectrally measures all color shades of optically clear liquids. Besides the conventional visual color numbers (Gardner, Iodine, Hazen (APHA) etc.) the LCS can measure opponent color such as CIE Lab, XYZ and Yxy under the conditions of illuminant C (daylight) and 2° Standard Observer.

- Stand alone unit with built-in touch-screen display allows use without the need of a PC
- Automatic cuvette detection – avoids faulty data measurement
- Designed for the use of disposable plastic cuvettes, high precision optical glass cuvettes or 11 mm test tubes
- Automatic zero and calibration memory for all type of cuvettes – ensures use of correct calibration data
- All important color scales and indices included
- Highly accurate and reliable results are ensured by the dual beam principle
- User profile memory with password protection for individual configurations – including GLP documentation
- Open sample compartment for ease of operation
- USB interface for PC or printer connection



Standards

AOCS	Method Cc 13e
ASTM	D 156, D 1045, D 1209, D 1544, D 1925, D 1500
DIN	6162
ISO	4630, 6271, 2049

Ordering Information

Cat. No.	Description
CL-9572	LCS III

Comes complete with:

Instrument with dust cover
 External power supply
 Adapter for 10 mm rectangle cuvettes
 addista® – color standards
 Disposable plastic cuvettes (10x50 mm) – pack of 10
 Disposable glass cuvettes (11mm) – pack of 10
 Operating manual

Technical Specifications

Voltage	100-240 V / 50 / 60 Hz
Geometry	0° / 180° rectilinear
Spectral Range (Colorimetric)	380 to 720 nm, 10 nm resolution
Spectral Range (Photometric)	320 to 1,1000 nm, 1 nm resolution
Repeatability	0.1 ΔE^* , 1 α
Reproducibility¹	$\pm 0.2\%$ transmission
Light Source	Tungsten Halogen Lamp
Illuminant/Observer	C/2°
Color Scale	CIE Lab; CIE LCH; XYZ; Yxy; Lab (h)
Color Difference	ΔE^* and component differences, text descriptor, tolerances
Indices	Gardner, Hazen/APHA, Iodine, Saybolt, Lovibond, Hess-Ives, European and US Pharmacopoeia, Klett, Mineral oil, Yellowness ASTM D 1925, ADMI, Chlorophyll A
Spectral Memory	% transmission; % absorbance, concentration 500 colormeasurements, 50 color references, 500 photometric readings
Data Export	*.csv file to USB memory stick or optional DataTrans software
Interface	USB-A for printer and USB memory stick USB-B for communication with a PC
Operating Temperature	10 to 40 °C (50 to 104 °F)
Humidity	up to 85%, 35 °C (95 °F); non condensing
Dimensions	368 x 144 x 359 mm (14.5 x 5.7 x 14.1 in)
Weight	6.4 kg (14.1 lbs)

¹ Referred to distilled water

Sample Cuvettes

For color measurement of liquids square, rectangle and cylindrical cuvettes can be used. Both precision as well as inexpensive disposable tubes are available. The precision cuvettes ensure reproducible results – even for critical solutions as clear as water. For daily QC disposable cuvettes save time and money.



Measurement Ranges for each Cuvette Size

Color Scale		Cuvette (mm)	Range
Iodine number (also LCM III)	J	10, 11	0 to 120
		50	0 to 7
Hazen number (also LCM III)	H	10, 11, 50	0 to 1000
Gardner number (also LCM III)	G	10, 11	0 to 18
		50	0 to 5
Transmission		10, 11, 50	0 to 150
Lovibond 5¼"	Y	10, 11, 50	0 to 120
Lovibond 5¼"	R		0 to 12
Lovibond 1"	Y	10, 11, 50	0 to 70
Lovibond 1"	R		0 to 12
Hess-Ives	H-I	10, 11, 50	0 to 500
Standard Tristimulus	XYZ	10, 11, 50	0 to 150
Chromaticity Coordinates	xy	10, 11, 50	0 to 1
CIE Lab values		10, 11, 50	
European Pharmacopoeia		10, 11, 50	Y1 to Y7
			GY1 to GY7
			BY1 to BY7
			B1 to B9
			R1 to R7

Ordering Information

Cat. No.	Description
CL-6452	Precision Glass Cuvette
CL-9508	Precision Glass Cuvette
CL-9509	Precision Glass Cuvette
CL-6453	Disposable Glass Cuvette
CL-9556	Disposable Glass Cuvette
CL-9559	Rubber Stopper
CL-9507	Disposable Plastic Cuvette
CL-9555	Disposable Plastic Cuvette
CL-9542	Rack for 16 Cuvettes
CL-9560	Rack for 7 Cuvettes

Technical Specifications

Pieces	Shape	Cover	Dimensions
20	cylindrical	rubber stopper	0.4 in (11 mm)
3	square	open top	0.4 x 0.4 in (10 x 10 mm)
1	rectangle	open top	0.4 x 1.9 in (10 x 50 mm)
500	cylindrical	open top	0.4 in (11 mm)
500	cylindrical	screw top	0.4 in (11 mm)
1	cylindrical	for Cat. No. CL-6453	0.4 in (11 mm)
50	rectangle	open top	0.4 x 1.9 in (10 x 50 mm)
10	rectangle	plastic cover	0.4 x 1.9 in (10 x 50 mm)
1	cylindrical and square		0.4 x 0.4 and 0.4 in (10 x 10 and 11 mm)
1	rectangle		0.4 x 1.9 in (10 x 50 mm)

Accessories

addista® – color Standards

To meet the requirements of ISO 9000 the performance of the instrument should be tested periodically. Therefore, a certified set of 6 standard liquids is recommended, containing Gardner and Hazen color numbers. To ensure long-term stability, the bottles should be stored in a dark and cool environment. They expire three months after being opened.



Ordering Information

Cat. No.	Description
CL-9532	addista® – color standards with certificate



Verification Kit

For more detailed quality control of the instrument a Verification Kit is available which consists of four precision glass filters. The filters come with a certificate including target values and can be used to check for stray light, photometric and wavelength accuracy. When results exceed allowable tolerance, please contact your local service office.

Ordering Information

Cat. No.	Description
CL-9575	Verification Kit with certificate, LCS III
CL-9582	Verification Kit with certificate, LCM III

Portable Printer

The portable thermo printer allows documentation of measurement results. It is connected to the instrument via the USB interface. The printer comes with one paper roll, USB connector cable and power supply.

Ordering Information

Cat. No.	Description
CL-9578	Thermo Printer, 115 V
CL-9580	Thermo Printer, 230 V
CL-9503	4 Rolls of Paper

Power Supply

Both the LCM III and LCS III are powered by an external power supply. Additionally, the LCM III can be used as a truly portable device with the optional rechargeable lithium-ion battery. The external power supply acts as the charger.

Ordering Information

Cat. No.	Description
CL-6392	Rechargeable Battery Pack, 9 V for LCM plus
CL-9581	Lithium-ion Battery 11 V for LCM III
CL-9577	External Power Supply for LCM III and LCS III

Thermostat Heater Block

Highly viscous liquids should be preheated in the heater block. The temperature can be set from 37 °C to 148 °C (99 °F to 298 °F). Only cylindrical tubes can be used. The illuminated LC display ensures easy-to-read results and operator guidance.



Ordering Information

Cat. No.	Description
CL-9511	Thermostat Heater Block

Documentation of Measurement Results

Stored measurement data can be transferred from the instrument to a USB memory stick and further evaluated using a spreadsheet program like Excel®.

Additionally, the software DataTrans is available for direct data transfer to a PC.

Ordering Information

Cat. No.	Description
CL-9579	DataTrans Software including USB Cable

Hardware Requirements:

Operating system: Windows XP or higher

Disk drive: CD-ROM

Interface: USB-port

Tungsten Halogen Lamp

The LCM III and LCS III use a tungsten lamp with an expected lifetime of 2000 hours. It can easily be replaced by the user.

Ordering Information

Cat. No.	Description
CL-9565	Tungsten Halogen Lamp for LCS II
CL-9543	Tungsten Halogen Lamp for LCM plus
CL-9576	Tungsten Halogen Lamp for LCM III and LCS III

Air Filter Pad

The LCS III is equipped with an air filter to cool the instrument during operation. The pad should be inspected regularly every 3 months. Typically it needs to be replaced 1 – 2 times per year.

Ordering Information

Cat. No.	Description
CL-9573	Air Filter Pad

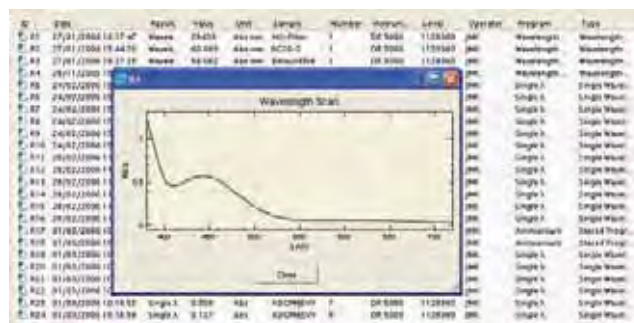

Colors appear differently under different lighting conditions. Use of a light booth to simulate different lighting conditions helps to obtain objective color assessment, improves communication and reduces product rejections. BYK-Gardner offers a complete line of light booths which allow you to see what your product will look like – independent of location and environmental influences.

byko-spectra

For critical color evaluation the byko-spectra light booth offers every option and feature that is needed to evaluate and communicate color with absolute confidence.

- Comparison of standard and sample in a color-neutral environment
- Five different controlled light sources:

Daylight	D65
Incandescent light	A
Department store light	CWF and TL84
Ultra-violet light	UV
- Viewing under ultraviolet light to detect and evaluate optical brighteners or fluorescent pigments
- No warm-up time or flickering which ensures quick and reliable color judgement
- Automatic light source sequencing to standardize testing procedures
- ColorGuard II timing center tracks light source usage and indicates when to replace the lamps
- Diffusing panel to eliminate direct reflection
- Comfortable testing in a compact design – for laboratory and production

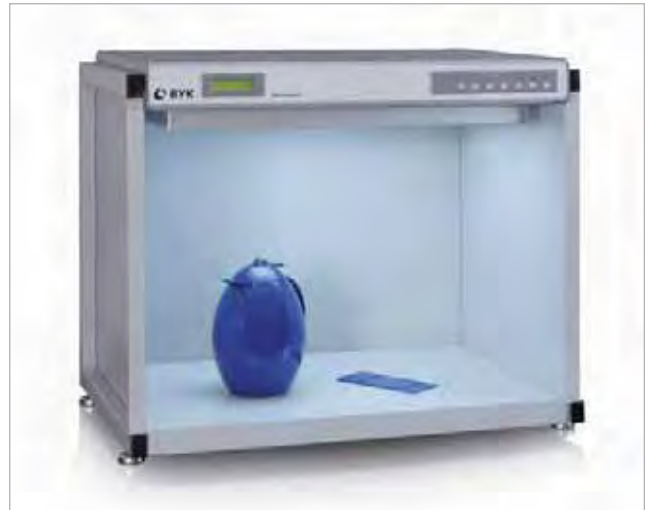

Standards

ASTM	D 1729
ISO	3668 (accessory required)

Certified

For Preventive Maintenance see page 271.

Ordering Information

Cat. No.	Description
CV-6047	byko-spectra
CV-6046	byko-spectra

Comes complete with:

byko-spectra light booth
 5 light sources: D65, A, CWF, TL84, UV
 Certificate
 Operating instructions

Technical Specifications

Voltage	D65	A	CWF	TL84	UV
230 V, 50/60 Hz	X	X	X	X	X
115 V, 50/60 Hz	X	X	X	X	X
Dimensions	63 x 76 x 55 cm (24.75 x 30 x 21.5 in)				
Viewing Area Size	51 x 71 x 55 cm (20 x 28 x 21.5 in)				
Weight	32kg (70 lbs)				

Ordering Information

Cat. No.	Description
CV-6048	Replacement Lamp Kit (including certificate)
CV-6057	Insert Panel Set for ISO 3668 (Includes side walls, rear wall and floor panels)

Accessories

Voltage	D65	A	CWF	TL84	UV
230 / 115 V	X	X	X	X	X

byko-spectra *basic*

For general color evaluation under defined lighting conditions the byko-spectra basic light booth offers the following benefits:

- Comparison of standard and sample in a color-neutral environment
- Three different controlled light sources:

Daylight	D65
Incandescent light	A
Department store light	CWF or TL84
- Easy to operate by using individual switches for each light source
- Can be set up in minutes without any tools
- Economical testing of large samples in a compact design – for laboratory and production

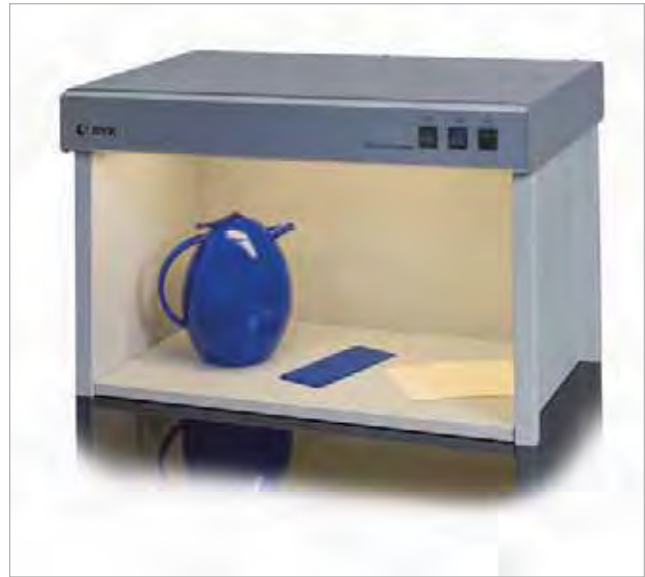

Standards

ASTM	D 1729
ISO	3668 (accessory required)

Ordering Information

Cat. No.	Description
CV-6054	byko-spectra <i>basic</i>
CV-6052	byko-spectra <i>basic</i>
CV-6051	byko-spectra <i>basic</i>
CV-6053	byko-spectra <i>basic</i>

Comes complete with:

byko-spectra *basic* light booth
 3 light sources: D65, A, CWF or TL84
 Operating instructions

Technical Specifications

	Voltage	D65	A	CWF	TL84
	230 V, 50/60 Hz	X	X		X
	230 V, 50/60 Hz	X	X	X	
	115 V, 50/60 Hz	X	X	X	
	115 V, 50/60 Hz	X	X		X
Dimensions	48 x 67 x 42 cm (19 x 26.5 x 16.5 in)				
Viewing Area Size	37 x 60 x 33 cm (15 x 24 x 13 in)				
Weight	14kg (30 lbs)				

Ordering Information

Cat. No.	Description
CV-6055	Replacement Lamp Kit CWF
CV-6056	Replacement Lamp Kit TL84
CV-6058	Insert Panel Set for ISO 3668 (Includes side walls, rear wall and floor panels)

Accessories

	Voltage	D65	A	CWF	TL84
	230 / 115 V	X	X	X	
	230 / 115 V	X	X		X

Note: We recommend to replace the lamps every 2500 hours.

byko-spectra *mini*

For general color evaluation of small samples the byko-spectra *mini* light booth offers the following benefits:

- Comparison of standard and sample in a color-neutral environment
- Three different controlled light sources:

Daylight	D65
Incandescent light	A
Department store light	CWF or TL84
- Easy to operate by using individual switches for each light source
- Can be set up in minutes without any tools
- Economical testing of small samples in a compact design – for laboratory and production



Standards

ASTM	D 1729
ISO	3668 (accessory required)

Ordering Information

Cat. No.	Description
CV-6043	byko-spectra <i>mini</i>
CV-6041	byko-spectra <i>mini</i>
CV-6040	byko-spectra <i>mini</i>
CV-6042	byko-spectra <i>mini</i>

Comes complete with:
 byko-spectra *mini* light booth
 3 light sources: D65, A, CWF or TL84
 Operating instructions

Technical Specifications

	Voltage	D65	A	CWF	TL84
	230 V, 50/ 60 Hz	X	X		X
	230 V, 50/ 60 Hz	X	X	X	
	115 V, 50/ 60 Hz	X	X	X	
	115 V, 50/ 60 Hz	X	X		X
Dimensions	46 x 52 x 34 cm (18 x 20.5 x 13.25 in.)				
Viewing Area Size	33 x 46 x 25 cm (13 x 18 x 10 in.)				
Weight	10 kg (22 lbs)				

Ordering Information

Cat. No.	Description
CV-6045	Replacement Lamp Kit TL84
CV-6044	Replacement Lamp Kit CWF
CV-6050	Replacement Lamp Kit TL84
CV-6049	Replacement Lamp Kit CWF
CV-6059	Insert Panel Set for ISO 3668 (Includes side walls, rear wall and floor panels)

Accessories

	Voltage	D65	A	CWF	TL84
	230 V	X	X		X
	230 V	X	X	X	
	115 V	X	X		X
	115 V	X	X	X	

Note: We recommend to replace the lamps every 2500 hours.

Effect finish appearance is influenced by different viewing angles and viewing conditions. With BYK-Gardner's new byko-spectra *effect* light booth, it is now possible to control both parameters to ensure objective evaluation of the total color impression of effect finishes. This helps to improve communication and reduce product rejections.

byko-spectra *effect*

For objective evaluation of color under different viewing angles, and flake characterization under different illumination conditions, the new byko-spectra *effect* light booth offers the following advantages:

Comparison of standard and sample under direct illumination in a black environment

- Color evaluation for daylight under 6 defined viewing angles: A tiltable sample table allows the samples to be presented at the following angles: -15°/15°/25°/45°/75°/110°. The illumination system also pivots, insuring excellent agreement with the measurement results of multi-angle color instruments.
- Sparkle evaluation under 15°, 45° and 75° direct illumination: Three individual LED sets simulate the impression of direct sunlight. The LED light sources are guaranteed for 10 years.
- No warm-up or flickering – quick and reliable color and effect judgement is ensured
- Timer to track daylight lamp usage and indicate when to replace the tube
- Dimmable sparkle illumination to adjust for different sample lightness



New!

Info!

For more information on objective measurements of effect finishes see pages 95 – 112.

Ordering Information

Cat. No.	Description
CV-6027	byko-spectra <i>effect</i>

Comes complete with:
byko-spectra *effect* light booth
Operating instructions

Technical Specifications

Voltage	115 / 230 V, 50 / 60 Hz
Dimensions Light Booth	121 x 80 x 76 cm (47.7 x 31.7 x 29.9 in)
Dimensions Sample Table	32 x 60 cm (12.6 x 23.6 in)
Weight	58.8 kg (127.2 lbs)

Ordering Information

Cat. No.	Description
CV-6026	Replacement Daylight Tube

Accessories

Replacement is recommended after 2500 hours

Color Matching at Car Refinish Body Shops

BYK-Gardner color instruments always hit the right color!

Every year new models and new colors are introduced to meet current fashion trends. The statement "Color Sells" shows how important this design criterion is for the purchasing decision. Thus, every year approximately 1000 new colors are added to the existing hundreds of thousands of colors.

This presents a real challenge for the body shop after an accident! In a car body shop it is most important to quickly find the correct color match and to be right on target. The time needed for color matching and material consumption determine the repair cost, which are closely watched by insurance companies nowadays. Not to mention customer complaints, if the color does not match!

Accurate color matching is one of the most difficult tasks when repairing a car finish. As an orientation guide in this "color jungle" car refinish paint makers support body shops with color fan decks and color look-up databases. By entering the auto maker and color code in a look-up database the right color formula could be easily found, if there were not the inevitable color deviations

of car bodies made at different plants and add-on parts coming from different suppliers. Therefore, a painter's most important tool is his own "trained eye". Yet, new metallic or pearl finishes with special sparkling effects make it more and more difficult to determine the right color even for very experienced painters, as color is not only changing under different viewing angles, but also under different lighting conditions (sunny sky – cloudy sky).

In order to repaint a car cost efficiently in a short period of time leading car refinish paint makers use new technologies to improve their hit rates: Multi-angle color instruments objectively measure the color to be painted and "smart" database search and correction routines are used to find the right color in seconds. Thus, and most important, life at the body shop will be much easier for everybody.

New measurement technologies make it possible to exactly match any color – in seconds:

- Clean and polish the paint finish close to the damaged area.
- Measure the prepared area.
- Transfer the measurement data to the color search and correction software of the paint maker.
- The software will find the closest match in a second, adjust the paint formula and automatically transfer the formula to the mixing system.



Complete Quality Control at Scania Trucks

**temp-gard, oven recorder –
wave-scan, orange peel meter –
spectro-guide, color and gloss**

Scania is one of the world's leading manufacturers of trucks and busses having delivered more than 60.000 trucks in 2008. As a lot of their products are custom-made, uniformity is an essential quality requirement. Therefore, specifications were established for gloss, color and orange peel and are part of their routine QC system. Scania's QC system starts with the routine monitoring of their various production ovens:

1. Temperature control of the production oven

The prerequisite for proper physical and optical properties is a controlled and stable baking process. The temperature as well as baking time determines the cross-linking quality of the paint. Scania is using the BYK-Gardner oven recorder temp-gard on a regular basis to control the temperature distribution of their ovens as well as the object temperature. As the object temperature is highly influenced by the steel thickness, Scania selected the most critical measurement spots: the bottom of the cab, the door which is made out of thin steel and the front of the cab which is usually made out of thicker steel material. The fourth sensor is used to monitor air temperature.

The temp-gard travels with the truck cab through the oven protected by a thermal barrier with temperature safe insulation. The temperature data is stored and transferred to the PC. The temperature profile with all critical values (peak temperature, threshold data and associated times) can be analyzed with the temp-chart software. A cure index using the equivalence method for calculation is recorded to optimize the curing process with never before seen accuracy.

2. Color and Appearance control at Scania Trucks

Uniform color and appearance are important quality criteria. Material as well as process parameters like humidity, gun/bell distance, atomization, film thickness etc., can influence color, gloss and orange peel.

Orange Peel or Flow & Levelling

The paint finish of a truck has two main requirements: Protect the surface underneath and enhance the quality of the overall product. Eye catching finishes should look like a mirror – "high gloss and perfectly smooth". The wave-scan with its expanded measurement range and the information from the structure spectrum, allow Scania to perform a detailed analysis of appearance changes corresponding to variations from material and/or application parameters. To document and communicate how the paint department is running, Scania is using the standardized reporting system in auto-chart. Their report of choice is the trend graph that shows the average per day or week by color family or by single colors.

Color and Gloss Control

Last but not least, the overall appearance of the cab is influenced by color and gloss. A product of the same color but higher gloss level is visually perceived darker and more saturated than a low gloss product. Since several years Scania has standardized how to control color and gloss in all of their European sites. They decided to use the BYK-Gardner spectro-guide gloss because of the excellent inter-instrument agreement, the possibility to exchange data by email and the ease-of-use by customizing the menu of the instrument to the specific needs of the operator. And most important, the spectro-guide's unique feature allowing simultaneous measurement of color and 60° gloss. The majority of the trucks are painted with solid colors. Therefore Scania uses a sphere instrument to compare the actual color hue to defined master panels received from their paint supplier. For better visual agreement Scania specified dECMC for production control.

Another challenge is the matching of plastic add-on parts, like air deflectors, grills and toolbox lids. These parts are out-sourced, and will be integrated in the cab in areas, which are highly visible to the driver. As they are painted with a different paint system than the metal cab, it is necessary to check color agreement under different lighting conditions to avoid metamerism. Metamerism occurs when a pair of materials appear to match under one light source, but mismatch under a second light source. Reason being, the pigments used to color the pair are not the same. Therefore, Scania is evaluating color differences for two light sources: D65 (daylight) and TL84 (show room light).

Complete quality control to guarantee uniform color & appearance!



temp-gard see page 237.



spectro-guide see page 75.



wave-scan dual see page 37.



PHYSICAL PROPERTIES

Abrasion	131
Adhesion	133
Application	143
Balances	171
Conductivity	177
Density	179
Dispersion / Grind gages	181
Drying Time	183
Film Thickness	185
Hardness	199
Impact / Flexibility	205
Microscopes	221
Temperature	225
Viscosity	241



New!

byko-drive
Automatic film
applicator
See page 168.



New!

**Mechanical
Cupping Tester**
See page 216.



New!

DPM 100
Digital pocket
microscope
See page 220.



New!

temp-gard
Oven temperature
recorder
See page 237.

Abrasion Scrub Tester

Coated surfaces need to be tested for resistance to abrasion caused by a brush, sponge, or other means. The Wet Abrasion Tester produces a repeatable, controlled condition to simulate everyday use or wear patterns.

The abrasion tester can examine washability and related properties that affect the stain resistance of coatings. Detergent performance testing can also be determined in a reproducible manner.

- Features two brush holders for side by side testing
- Air cooled electric motor for maximum reliability
- Peristaltic fluid pump – no reagent contamination (except for PB-5002, PB-5007)
- Five digit preset counter – activates the machine for preset number of strokes, then switches off
- Can be modified to meet DIN, ISO, or ASTM test methods

Liquid solutions are pumped to the brush heads from the detachable container mounted to the side of the tester. The pump may be switched on or off during the course of testing, and the flow can be adjusted for precise dosing.

DIN ISO Methods

The Standards EN ISO 11998 and DIN EN 13330 (replaced DIN 53778) describe procedures to evaluate the resistance of coatings against abrasion by cleaning or scrubbing the surface. The coating is applied on a foil and dried under standard conditions. In order to describe the cleanability, defined pollutions are applied onto the surface before starting the test.

DIN 53 778 (*withdrawn 08/2007): Dispersion Paints
Cleanability: Test area should be free of pollutions
Wash resistance: Evaluation after 1000 scrub cycles
Scrub resistance: Evaluation after 5000 scrub cycles
The test is performed wet using a hog bristle brush and a pump to apply the washing liquid. The evaluation is done visually.

ISO 11998

The ISO test method describes a short version of the scrub abrasion test. This test uses “3M Scotch Brite 7448” pads and the washing liquid is manually applied before starting the test. The test is finished for evaluation after 200 scrub-cycles. The evaluation of the wash/scrub resistance is done by calculating the loss of mass.

DIN EN 13300

This standard describes the various testing methods for waterborne coating materials and coating systems for interior walls and ceilings. One quality criterion mentioned is the wet-abrasion resistance tested in accordance to EN ISO 11998. Additionally, a rating scale dependent on the amount of abrasion is used for final classification.



Standards

ASTM	D 2486, D 3450, D 4213, D 4828
DIN EN	53778*, 13 300
ISO	11998

ASTM Methods

The Wet Abrasion Scrub Tester is designed to comply with four ASTM methods.

ASTM D 2486

The scrub resistance of interior wall paint is the primary purpose of this method. The paint is applied to a black plastic panel and allowed to cure. The panel is scrubbed with a nylon bristle brush until failure occurs. An abrasive scrub media is used to accelerate the test.

ASTM D 3450

This test method determines the ease of removing soilent discoloration from interior coatings. The coating is drawdown on a black plastic panel and allowed to dry for seven days. A specified soilent medium is applied. The coating is scrubbed with an abrasive or non-abrasive media using a cellulosic type sponge for 100 cycles. The soilent removal is assessed by measuring the CIE Y reflectance before and after the test.

ASTM D 4213

The purpose of this method is to measure scrub resistance. The primary differences from ASTM D 2486 method are: The scrub resistance is determined by weight loss of the paint film relative to a standard calibration panel. The test panel and calibration panel are scrubbed simultaneously. The scrubbing device is a Scotch-Brite™7448 abrasive pad.

ASTM D 4828

This test method determines the relative ease of removing soil and stains from interior coatings. The coating is applied to a black plastic panel and dried for seven days. The soilent can be user defined or the soilent described in ASTM D 3450 can also be used. A user defined liquid or powder cleaner is applied. The panel is scrubbed 100 cycles with a sponge. The soilent removal is assessed using gloss or color measurement.

Abrasion Scrub Tester

Ordering Information

Cat. No.	Description
PB-5000	Wet Abrasion Scrub Tester, DIN
PB-5004	Wet Abrasion Scrub Tester, DIN
PB-5002	Wet Abrasion Scrub Tester, ISO
PB-5007	Wet Abrasion Scrub Tester, ISO
PB-5005	Wet Abrasion Scrub Tester, ASTM
PB-5008	Wet Abrasion Scrub Tester, ASTM
PB-5047	Wet Abrasion Scrub Tester, ASTM
PB-5046	Wet Abrasion Scrub Tester, ASTM
PB-5051	Wet Abrasion Scrub Tester, ASTM
PB-5050	Wet Abrasion Scrub Tester, ASTM
PB-5055	Wet Abrasion Scrub Tester, ASTM
PB-5054	Wet Abrasion Scrub Tester, ASTM

Comes complete with:

Abrasion Tester, 2 abrasive holders and 2 method specific abrasives, 100 scrub test panels, peristaltic fluid pump (excluded for PB-5002, PB-5007 models)

Technical Specifications

Standard	Scrub Rate (cycles/minute)	Stroke Length	Power Supply
DIN 53778	38 - 40	adjustable: 100 to 300 mm	220V, 50 Hz
DIN 53778	38 - 40	adjustable: 100 to 300 mm	115V, 60 Hz
ISO 11998, DIN EN 13300	38 - 40	adjustable: 100 to 300 mm	220V, 50 Hz
ISO 11998, DIN EN 13300	38 - 40	adjustable: 100 to 300 mm	115V, 60 Hz
ASTM D 2486	38 - 40	adjustable: 100 to 300 mm	220V, 50 Hz
ASTM D 2486	38 - 40	adjustable: 100 to 300 mm	115V, 60 Hz
ASTM D 3450	38 - 40	adjustable: 100 to 300 mm	220V, 50 Hz
ASTM D 3450	38 - 40	adjustable: 100 to 300 mm	115V, 60 Hz
ASTM D 4213	38 - 40	adjustable: 100 to 300 mm	220V, 50 Hz
ASTM D 4213	38 - 40	adjustable: 100 to 300 mm	115V, 60 Hz
ASTM D 4828	38 - 40	adjustable: 100 to 300 mm	220V, 50 Hz
ASTM D 4828	38 - 40	adjustable: 100 to 300 mm	115V, 60 Hz

Dimensions

660 x 480 x 420 mm (26 x 19 x 16.5 in)

Shipping Weight

32 kg (70.5 lbs)

Ordering Information

Cat. No.	Description
PB-5001	Modification Kit, ASTM D 2485
PB-5003	Modification Kit, ISO 11998
PB-5006	Modification Kit, DIN 53778
PB-5048	Modification Kit, ASTM D 3450
PB-5052	Modification Kit, ASTM D 4213
PB-5056	Modification Kit, ASTM D 4828
PB-5010	Hog Bristle Brush
PB-5011	Nylon Brush
PB-5012	Pad
PB-5017	Brass Shims
PB-5016	byko-chart White Scrub Test Panels P122-10N
PB-5015	byko-chart Black Scrub Test Panels P121-10N
PB-8129	Scrub Medium, Abrasive, 474 ml (1 pint)
PB-8130	Scrub Medium, Non-abrasive, 474 ml (1 pint)
PB-5049	Sponges, ASTM D 3450
PB-5053	Sponges, ASTM D 4213
PB-5057	Sponges, ASTM D 4828

Accessories

Carriage assembly for ASTM D 2485, includes 2 brushes
Carriage assembly for ISO 11998, includes 2 abrasive pads
Carriage assembly for DIN 53778, includes 2 brushes
Carriage assembly for ASTM D 3450, includes 2 sponges
Carriage assembly for ASTM D 4213, includes 2 sponges
Carriage Assembly for ASTM D 4828, includes 2 sponges
Meets DIN 53778; Dimensions: 38 x 89 mm (1.5 x 3.5 in)
Meets ASTM D 2486; Dimensions: 38 x 89 mm (1.5 x 3.5 in)
Meets ISO 11998
2 pieces – required for ASTM D 2486.
For ISO and ASTM Methods; Pack of 100 plastic white scrub test panels; Dimensions: 165 x 432 x 0.25 mm (6.5 in x 17 in x 10 mils)
For ISO and ASTM Methods; Pack of 100 plastic black scrub test panels; Dimensions: 165 x 432 x 0.25 mm (6.5 in x 17 in x 10 mils)
For ASTM D 2486
For ASTM D 3450
Pack of 12, for ASTM method D 3450
Pack of 12, for ASTM method D 4213
Pack of 12, for ASTM method D 4828

Introduction

Adhesion

In order to perform satisfactorily, coatings must adhere to the substrates on which they are applied. In practice, three different test procedures are used to assess the resistance of paints and coatings to separation from substrates:

Cross-Cut Test

This test method specifies a procedure for assessing the resistance of paints and coatings to separation from substrates when a right-angle lattice pattern is cut into the coating, penetrating through to the substrate.

The method may be used for a quick pass/fail test. When applied to a multi-coat system, assessment of the resistance to separation of individual layers of the coating from each other may be made.

Scrape Adhesion

This test method covers the determination of the adhesion of organic coatings such as paint, varnish, and lacquer when applied to smooth, flat (planar) panel surfaces. It has been found useful in providing relative ratings for a series of coated panels exhibiting significant differences in adhesion.

The materials under test are applied at uniform thickness to flat panels, usually sheet metal of uniform surface texture. After drying, the adhesion is determined by pushing the panels beneath a rounded stylus or loop that is loaded with increasing amounts of weight until the coating is removed from the substrate surface.

Pull-Off Test

Adhesion of a single coating or a multi-coat system of paint, varnish or related products is assessed by measuring the minimum tensile stress necessary to detach or rupture the coating in a direction perpendicular to the substrate. This method maximizes tensile stress as compared to the shear stress applied by other methods such as scratch adhesion and results may not be comparable. The test is performed by securing a loading fixture (dolly) perpendicular to the surface of the coating with an adhesive. After the adhesive is cured, a testing apparatus is attached to the loading fixture and aligned to apply tension perpendicular to the test surface. The force applied is gradually increased and monitored until either a plug of coating material is detached, or a specified value is reached.

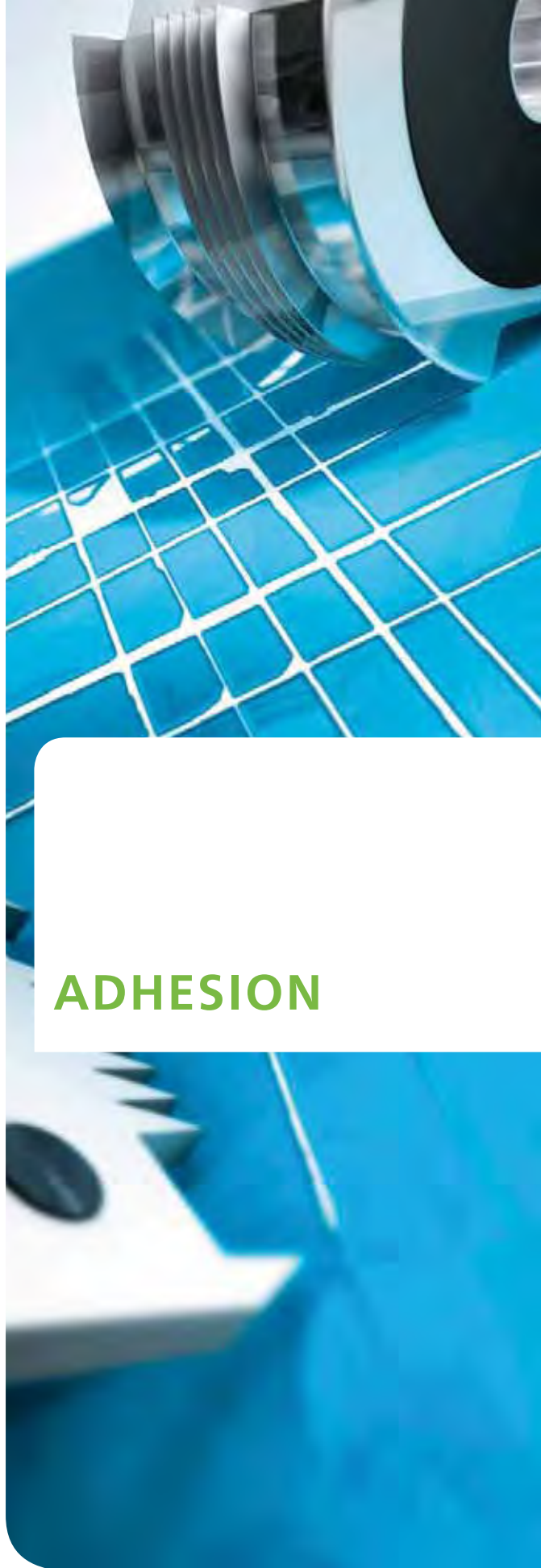

ADHESION

The cross-cut test is a simple and easily practicable method for evaluating the adhesion of single- or multi-coat systems.

Procedure

- Make a lattice pattern in the film with the appropriate tool, cutting to the substrate
- Brush in diagonal direction 5 times each, using a brush pen or tape over the cut and remove with Permacel tape
- Examine the grid area using an illuminated magnifier

Cross-Cut Results

Adhesion is rated in accordance with the scale below.



- ISO Class.: 0 / ASTM Class.: 5 B
The edges of the cuts are completely smooth; none of the squares of the lattice is detached.



- ISO Class.: 1 / ASTM Class.: 4 B
Detachment of small flakes of the coating at the intersections of the cuts. A cross-cut area not significantly greater than 5 % is affected.

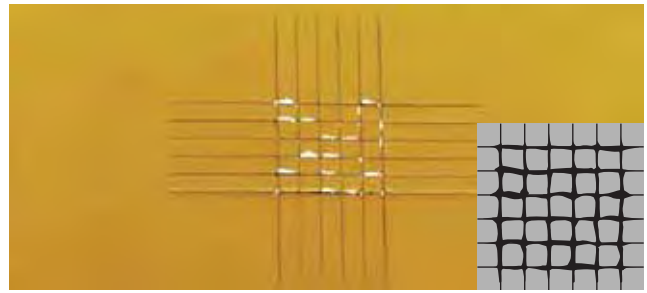

- ISO Class.: 2 / ASTM Class.: 3 B
The coating has flaked along the edges and/or at the intersections of the cuts. A cross-cut area significantly greater than 5 %, but not significantly greater than 15 %, is affected.



- ISO Class.: 3 / ASTM Class.: 2 B
The coating has flaked along the edges of the cuts partly or wholly in large ribbons, and/or it has flaked partly or wholly on different parts of the squares. A cross-cut area significantly greater than 15 %, but not significantly greater than 35 %, is affected.



- ISO Class.: 4 / ASTM Class.: 1 B
The coating has flaked along the edges of the cuts in large ribbons and/or some squares have detached partly or wholly. A cross-cut area significantly greater than 35 %, but not significantly greater than 65 %, is affected.
- ISO Class.: 5 / ASTM Class.: 0 B
Any degree of flaking that cannot even be classified by classification 4.

Standard

ASTM	D 3002	D 3359
ISO		2409

Cross-Cut Tester Kit

Parallel Groove Adhesion Test

This method is used for determining the parallel groove adhesion of one or many coating layers on a substrate, generally a metal panel. Cross-Cut Tester Kits are available in 2 different blade versions, one is a multi-cut blade with 6 cutting edges, the other version has one cutting edge. The Cross-Cut Tester blades are made of hardened steel alloy. The blades are designed for retaining a sharp cutting edge and reduce the frequency of blade replacement.

ASTM method D3359 requires 11 cut lines:
 1 mm cutter for films up to 50 µm (2 mils) thick
 2 mm cutter for films between 125 µm (2 - 5 mils) thick

ISO standards prescribe that the number of cuts shall be 6, and that the cut in each direction must be according to the film thickness and type of coating used as shown below:

0 - 60 µm	1 mm space for hard substrates (metal)
0 - 60 µm	2 mm space for soft substrates (plastic)
61 - 120 µm	2 mm space for hard or soft substrates
121 - 250 µm	3 mm space for hard or soft substrates



Standards

ASTM	D 3002, D 3359
ISO	2409

Ordering Information

Cat. No.	Description
PE-5120	Cross-Cut Tester Kit 1 mm
PE-5122	Cross-Cut Tester Kit 2 mm
PE-5125	Cross-Cut Tester Kit 1 mm
PE-5126	Cross-Cut Tester Kit 2 mm
PE-5128	Cross-Cut Tester Kit 3 mm
PE-5123	Cross-Cut Tester Kit 1 mm
PE-5127	Cross-Cut Tester Kit 1.5 mm
PE-5121	Cross-Cut Tester Kit 1.5 mm
PE-5124	Cross-Cut Tester Kit 2 mm

Comes complete with:

- Cross-Cut Tester kit with blade
- Hex wrench for changing blades
- Magnifier
- Cleaning brush
- Plastic carrying case
- Operating instructions
- One roll of adhesive tape in accordance with the standard

Technical Specifications

Standard	No. Of Teeth	No. Of Cutting Edges	Cutter Spacing	Hex Wrench included
DIN / ISO	6	6	1 mm (0.04 in)	--
DIN / ISO	6	6	2 mm (0.08 in)	--
DIN / ISO	6	1	1 mm (0.04 in)	yes
DIN / ISO	6	1	2 mm (0.08 in)	yes
DIN / ISO	6	1	3 mm (0.12 in)	yes
ASTM	11	1	1 mm (0.04 in)	yes
ASTM	11	1	1.5 mm (0.06 in)	yes
ASTM	11	6	1.5 mm (0.06 in)	--
ASTM	6	1	2 mm (0.08 in)	yes

Cross-Cut Tester Kit made of high alloy steel

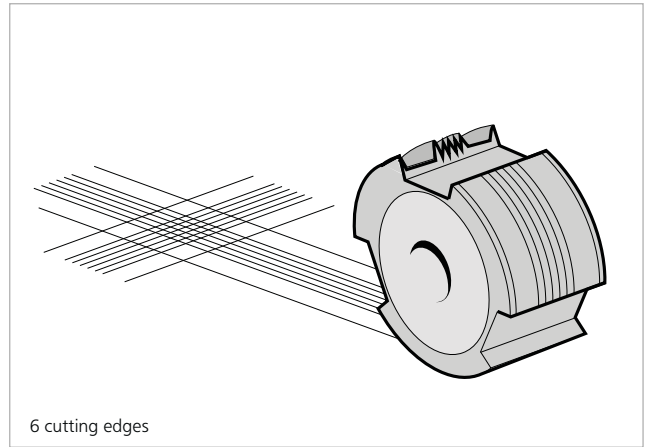
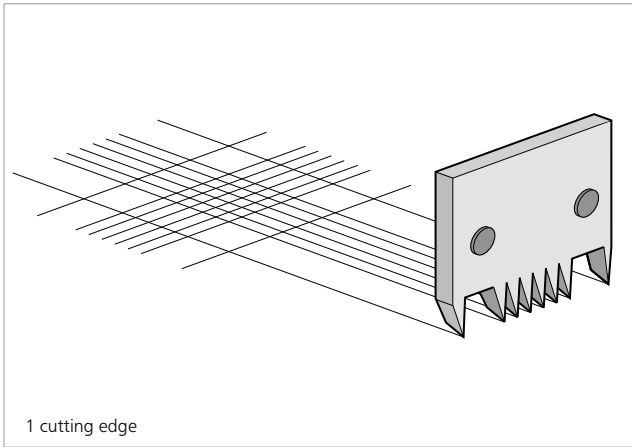

Ordering Information

Cat. No.	Description
PE-5132	Cutting Tool 1 mm
PE-5134	Cutting Tool 2 mm
PE-3425	Cutting Tool 1 mm
PE-5129	Cutting Tool 3 mm
PE-3426	Cutting Tool 2 mm
PE-3429	Cutting Tool 1 mm
PE-3424	Cutting Tool 1.5 mm
PE-5133	Cutting Tool 1.5 mm
PE-5135	Brush
PE-5136	Magnifier
PE-5137	Adhesive Tape for DIN / ISO
PE-8660	Adhesive Tape for ASTM

Accessories

for Cat. No	Standard	No. Of Cutting Teeth	No. Of Cutting Edges	Cutter Spacing
PE-5120	DIN / ISO	6	6	1 mm (0.04 in)
PE-5122	DIN / ISO	6	6	2 mm (0.08 in)
PE-5125	DIN / ISO	6	1	1 mm (0.04 in)
PE-5128	DIN / ISO	6	1	3 mm (0.12 in)
PE-5126	DIN / ISO	6	1	2 mm (0.08 in)
PE-5124	ASTM			
PE-5123	ASTM	11	1	1 mm (0.04 in)
PE-5127	ASTM	11	1	1.5 mm (0.06 in)
PE-5121	ASTM	11	6	1.5 mm (0.06 in)

Spare brush for cross-cut tester kits
 Spare magnifier for cross-cut tester kits
 Tesapack 4124, 50 mm x 66 m
 Permacel 99, 1 in x 72 yds

Certified For Certification Service see page 269.



Info!

Universal paint inspection:
 – Film thickness, destructive
 – Indentation hardness
 – Adhesion
 byko-cut universal
 see pages 196 - 198



Info!

For more information about how to evaluate test results with the new Digital Pocket Microscope please see chapter "Microscopes", pages 221 - 223.

Hoffman Scratch Hardness Tester

Scrape Adhesion Test

The Hoffman Scratch Hardness Tester was developed for the comparative evaluation of scratch resistance and adhesion of many types of coatings.

- Simple pocket size tester
- Ideal for field use and demonstrations

This instrument consists of a four-wheeled carriage, a scale arm graduated from 0-20 that is attached permanently to the carriage in a counterpoised condition about the pivot axis, and a scratch tool with a sharp circular rim mounted at 45° to the flat test surface.

Procedure

To operate, attach riders to the scale arm at the numbered positions. The carriage is held down firmly by hand and moved in the opposite direction, to cause a trailing scratch. The large standard rider loads 100 g per division, while the small rider loads 25 g per division. This small rider may be used for making low-range measurements involving small increments of pressure, or it may serve as a vernier with the large rider in making more precise medium-range measurements.

Scratch Hardness

The force necessary to cut through the film to the substrate.

Adhesion

The force required to scrape a path through the film, when the stylus begins its motion on an uncoated portion of the panel.



Standards

GE Aircraft Engine	E50TF61-S1
Group Spec.	
Naval Lab Spec.	WS12858
	Part 4.5.5 Hardness

Ordering Information

Cat. No.	Description
PE-1610	Hoffman Scratch Hardness Tester

Comes complete with:

- One large standard rider
- One small rider and one extra scratching tool
- Carrying case
- Operating instructions

Ordering Information

Cat. No.	Description
PE-1611	Scratching Tool
PE-1612	Large Rider
PE-1613	Small Rider

Technical Specifications

Dimensions	Net Weight	Shipping Weight
28 x 3.8 x 2.5 cm (11 x 1.5 x 1 in)	0.7 kg (1.5 lbs)	1.8 kg (4 lbs)

Accessories

Replacement
Equipped with friction clip for extending upper range of the Hoffman Scratch Hardness Tester
Equipped with friction clip for improving precision in all ranges of the Hoffman Scratch Hardness Tester

Balanced Beam Scrape Adhesion and Mar Tester

Used to perform scrape adhesion and mar resistance (scratch hardness) tests of coatings and surfaces of various materials.

- For differentiating the degree of adhesion of coatings to substrates
- Provides relative ratings for a series of coated panels

This instrument consists of a pivoted beam with a 45° stylus holder, weight post and holder for supporting the total test load mounted on one end. On the other end of the beam is a counterweight. A cam is rotated to lower and raise the stylus and a sample bed mounted on ball bearings is used to move the test panel against the stationary stylus.

Scrape Adhesion Test

The stylus used for scrape adhesion is a 1.6 mm (0.0625 inch) drill rod, bent to a 180° loop with 6.5 mm (0.256 inch) OD, hardened, buffed and chrome plated. Supplied with the tester is a set of twelve slotted brass weights with storage rack. In the adhesion test, weights are applied in 0.5 kg increments to a maximum of 10 kg.



Mar Resistance Test

By moving a free edge of the test film against the needle under a variable load expressed in grams, mar-resistance is determined as the minimum load in grams required to cut through the film to the substrate. In the mar (scratch resistance) test, weights can be applied in increments from 10 grams to a maximum of 12 kg.

Standards

ASTM	D 2197, D 2248, D 2454, D 5178
FTMS	141a, Method 6303.1
General Electric	F50TF7-S1
Company Spec.	
Military Spec.	MIL-P-7788A

Ordering Information

Cat. No.	Description
PE-5780	Balanced Beam Scrape Adhesion and Mar Tester

Comes complete with:

Tester
 Loop stylus and needle stylus;
 Weight post and holder
 Weight rack and set of 12 weights:
 1 x 10g; 2 x 20g; 1 x 50g; 1 x 100g; 2 x 200g; 1 x 500g; 1 x 1000g;
 2 x 2000g; 1 x 5000g;
 Operating instructions

Technical Specifications

	Dimensions	Net Weight	Shipping Weight
	203 x 610 x 381 mm (8 x 24 x 15 in)	23.1 kg (51 lbs)	25.9 kg (57 lbs)

Ordering Information

Cat. No.	Description
PE-5781	Loop Stylus
PE-5782	Needle Stylus
PE-5783	Stylus Holder
PE-5784	Ball Point, 3.2 mm (1/8 inch)
PE-5785	Ball Point, 1.6 mm (1/16 inch)
PE-5786	Spit, plated
PE-6977	Weight Set
PE-6972	Weight 1000 g
PE-6974	Weight 2000 g
PE-6976	Weight 5000 g

Accessories

Replacement; U shaped stylus
Replacement; needle stylus
Replacement; Cylindrical steel rod
3.2 mm (1/8 inch) ball
1.6 mm (1/16 inch) ball
Larger diameter needle stylus
Replacement; 1 x 10 g; 2 x 20 g; 1 x 50 g; 1 x 100 g; 2 x 200 g; 1 x 500 g
Replacement; 1 x 1000 g
Replacement; 1 x 2000 g
Replacement; 1 x 5000 g

PosiTest Family

Pull-Off Adhesion Test

The PosiTest pull-off adhesion testers measure adhesion of coatings on metal, wood and other rigid substrates. This easy-to-use, reliable and versatile instrument uses hydraulic pressure and a revolutionary self-aligning dolly to ensure uniform pull distribution over the surface being tested, preventing a one-sided pull-off. This is done using a ring of small ball bearings to engage the articulating dolly head.

There are two models available. The model AT-A Automatic Pull-Off Adhesion Tester and Model AT manual version. Both models have the following features:

- Portable, hand-operated instrument can be used in any position and requires no external power source-ideal for the lab and on-site
- Large scale reads clearly and easily in PSI and MPa
- Inexpensive, single-use dollies eliminate the need for heating, cleaning, or brushing for re-use
- Self-aligning dolly enables measurement on smooth or uneven surfaces without adversely affecting the test results. They have a full 20 or 50 mm surface diameter with no holes to clean
- Heavy-duty hydraulic pump with safety valve helps prevent damage to pressure system
- Quick-coupling makes securing dollies in actuator simple, fast and trouble-free
- Multi-purpose, high-tensile two-part adhesive suitable for use with a wide variety of coatings and coating thicknesses
- Cutting tool for isolating test area is included
- Adhesion tester pressure system is calibrated and certified to 1 % accuracy (full-scale) and comes with a two-year warranty
- Internal memory stores up to 200 pulls. This includes maximum pull-off pressure, rate of pull, test duration, and dolly size
- Optional PosiSoft software available to upload test results
- USB Port PC interface
- 10, 14, 20, and 50mm dollies to maximize the measurement resolution and test range

Ordering Information

Cat. No.	Description
PE-2201	Model AT manual
PE-5140	Model AT-A automatic

Comes complete with:

Adhesion Tester with digital display
 Hydraulic pump and actuator
 Aluminum test dollies (20 mm)
 Cutting tool for 20 mm dollies
 Adhesive
 Adhesive mixing sticks and palettes (5 each)
 Cotton swabs for adhesive compatibility test
 2-year warranty and carrying case
 Certificate of calibration



New!

PosiTest Model AT-A

The automatic model has a electronically controlled hydraulic pump that applies continuous pressure. The pull-off rate is user-selectable. Simple push button operation, eliminates the need to close valves or reset scales. A rechargeable battery is built-in providing up to 200 tests per charge. A universal AC Adapter is supplied.

Standards

ASTM	D 4541, D 7234
ISO	4624

Technical Specifications

Adhesion Strength	Resolution	Dolly Size
0-215 MPa (0-3000 psi)	± 0.01 MPa (± 1.0 psi)	20 mm
0-215 MPa (0-3000 psi)	±0.01 MPa (±1.0 psi)	20 mm
Case Dimensions	43 x 33 x 15 cm (17 x 13 x 6 in)	
Unit Weight	5.5 kg (12 lbs)	

PosiSoft Analysis Software for Windows®

- Displays pressure, rate, test duration and dolly size
- Calculates max, min, mean and standard deviation
- Prints and displays basic charts and histograms
- Real time graphing of individual pulls
- Allows entry of notes and annotations
- Export to a document or spreadsheet
- Multi-language: English, German, Italian, Spanish, French
- Includes USB cable

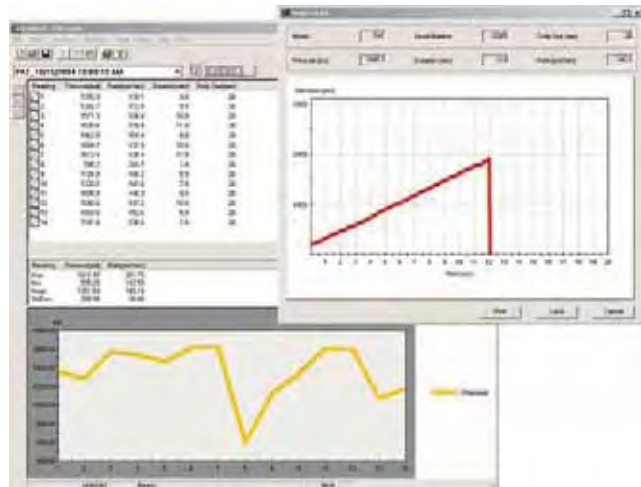

Dollies

Several dolly sizes are available: 10, 14, 20, and 50 mm.

The 50 mm dolly is used for lower bond strength finishes; The working range is 0 - 3.5 MPa (0 - 500 psi). The larger surface area dolly provides improved low range repeatability.

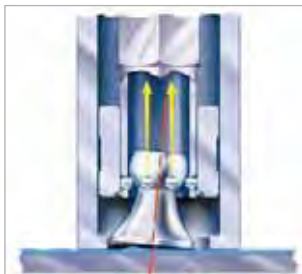

Self-aligning dolly



Ordering Information

Cat. No.	Description
PE-0032	Adhesive Kit
PE-0035	50 mm Accessory Kit
PE-5138	10 mm dollies, pk of 10
PE-0030	20 mm dollies, pk of 10
PE-5139	14 mm dollies, pk of 10
PE-0031	50 mm dollies, pk of 4
PE-0033	Drilling Template
PE-0034	PosiSoft Software

Accessories

- Includes adhesive, mixing sticks, palettes, cotton swabs
- Includes 50 mm stand-off, hole saw, and test dollies (12)

For 50 mm dollies

Single Impact Tester – esp-10

Chip Resistance Test

Resistance to chipping of multi-coat systems is an important factor in automotive finishing. To protect auto body parts, a multi-coat system is applied for corrosion and mechanical stress. The complete coating structure is decisive for its resistance to chipping. Changes to the coating formulation or application process can have an effect on the extent of the damage. The multi-impact test method - sharp-edged, chilled casting pieces are thrown against a test panel by compressed air - simulates the actual stress as closely as possible. However, the multi-impact test is difficult to reproduce. To improve the precision a single impact mechanism was developed.

The esp-10 was developed to test the resistance to chipping of multi-coat systems. In addition, not only the size of the damaged area, but also its depth, i.e. the so-called "separation plane" can be evaluated.

- Portable instrument can be run in cooling chambers (≥ -10 °C) and outside the laboratory
- Impact tool with wedge-shaped blade
- Compressed air of 3 bar accelerates the ball
- Testing instrument in accordance with BMW standard

Standards

ISO	20567-2
-----	---------

Ordering Information

Cat. No.	Description
PE-5200	Single Impact Tester esp-10

Comes complete with:

Single Impact Tester esp-10
Weight
Connection hose
Operating instructions

Ordering Information

Cat. No.	Description
PH-5824	Precision Microscope
PE-5205	Standard for esp-10
PE-5201	Impact Tool

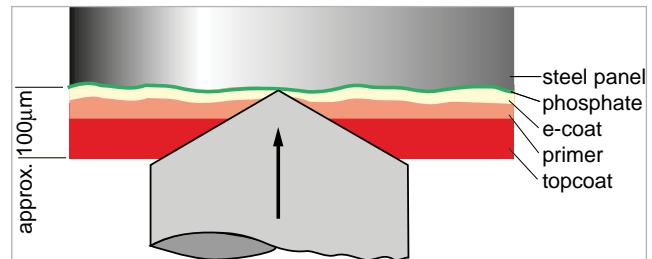

Technical Specifications

Connection for Compressed Air	R 1/8"
Compresses Air Supply	5 bar
Working Pressure	3 bar
Operational Life of Impact Tool	approx. 1000 impacts
Additional Weight	1750 g (3.9 lbs)
Dimensions	35 x 32 x 23 cm (13.8 x 12.6 x 9.1 in)
Net Weight	8.6 kg (19 lbs)
Shipping Weight	10 kg (22 lbs)

Accessories

To check performance of instrument with Certificate

No longer erroneous re-jects due to poor quality test charts

byko-charts, consistent color and gloss guaranteed from print batch to print batch

One of the largest architectural paint manufacturers in the U.S. had problems with the inconsistencies of drawdown charts supplied to them by an industry leading chart manufacturer. Although they never realized it, the measured L*, a*, b* and gloss values of incoming charts varied substantially from print batch to print batch. These variances caused, in several cases, erroneous rejections of paint batches. These variances also caused the addition of pigment to improve contrast ratio when in fact it was not necessary, resulting in wasted raw materials and increased production costs to the paint manufacturer. It was later determined that the inconsistent color and gloss of the charts had caused the paint batches to be rejected when in fact the paint batches had actually been within specification.

As a result of this costly problem, specifications were developed by the paint manufacturer for color and gloss of drawdown charts. All chart vendors must now adhere to this specification for every delivery of charts. Before any new lot of charts can be sold, chart vendors must send samples of each type of chart to the paint manufacturer for approval. Only after meeting these rigorous quality standards can a new lot of charts be sold to them.

By switching to byko-charts, this paint manufacturer has realized improved consistency of the black stripe printed on the drawdown chart. In fact, the variation from lot to lot has dropped to less than 1/5 of what the variation was in the past when they used the competitive product. This has also resulted in improved reliability of their internal contrast ratio test methods, and other color and gloss test methods.

Improvements such as these provide improved product quality, reduced raw material usage due to improper batch adjustments, greater production throughput, and reduced customer complaints. All of these improvements result in measurable cost savings in manufacturing and R&D.

We adhere to a rigid BYK-Gardner specification for color and gloss. Our specification is much tighter than the paint manufacturer's specification for color and gloss, and as a result, byko-charts have never been rejected.

Over the last several years, BYK-Gardner has kept meticulous product consistency records from our print batches, as well as from competitor print batches. This data shows the clear superiority of the byko-charts versus competitive charts from print batch to print batch.

The below charts compare variations in the color and gloss of byko-charts versus a competitor over a 5 year period. The competitive charts show significantly greater color and gloss variations.

BYK-Gardner goes to great lengths to assure the quality of all the charts before, during and after the production process. A BYK-Gardner quality technician is on site testing the charts as lots are being produced. Prior to a lot being released for sale, random samples are collected across the entire chart run and subjected to extensive testing in the BYK-Gardner laboratory.

Storage of drawdown charts has also been found to be a serious problem when less than "ideal" storage conditions are used. For instance, in the hot humid days of summer, boxes of drawdown charts that are stacked in a warehouse or a delivery truck can quickly deteriorate making them totally unusable. Charts can stick together causing the coatings to be pulled off when attempts are made to separate the charts. Charts can also curl under high humidity conditions if not properly protected. ASTM D-4946 is a procedure to test for blocking (resistance of surfaces to stick together). BYK-Gardner had an independent laboratory conduct a test on our charts and the competitive drawdown charts using the ASTM D-4926 method. The byko-charts passed the test and the competitive charts failed. To prevent blocking and curl, BYK-Gardner wraps each box of byko-charts with a protective film that guards against humidity in the warehouse and during shipment.

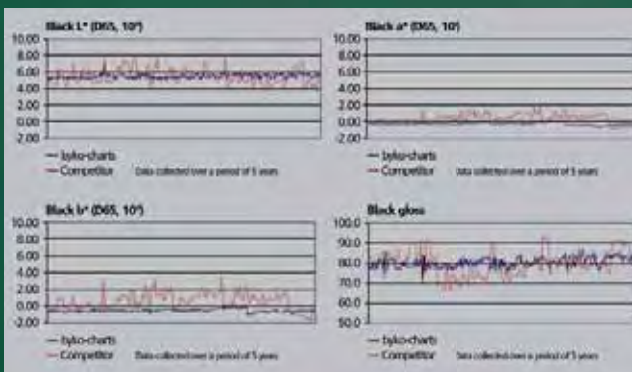

Introduction

Wet Film Preparation

An accurate and uniform film thickness is essential for achieving uniform color, appearance and specific physical properties such as scrub resistance, chip resistance, flexibility etc. Therefore, international specifications as well as company internal testing methods specify not only a minimum film thickness, but also require controlling the film thickness within a defined range.

The most common method of applying a liquid finish in the laboratory is with a drawdown bar or often referred to as a "doctor blade". This type of film applicator can lay down wet films of almost any desired thickness from a few μm up to $1000 \mu\text{m}$ (0.1 mil up to 40 mils).

A typical blade type applicator consists of a metal bar containing a gap of known clearance on one or more faces. It is placed near one end of a flat panel or drawdown chart. A sufficient volume of sample is placed in front of the applicator. The applicator is then "drawn down" the panel/chart, either automatically or manually, leaving a uniform film. The automatic method is more repeatable and will result in a more uniform film thickness over the entire range, as operator deviations are minimized.

Stainless steel, aluminum, or plated steel are the preferred materials of construction, due to their resistance to corrosion. Plated and stainless steel types are harder and will withstand more rigorous use. Regardless of the material of construction, corrosion can damage the region of the drawdown bar controlling thickness of the applied film, therefore affecting the repeatability of the instrument. Good lab practices dictate immediate cleaning of the instrument after each use to eliminate potential corrosion or residue which could affect future results.



Drawdown Charts see pages 145 - 152.

APPLICATION

It is recommended that all units be periodically checked for accuracy by using a feeler gauge, as normal use and cleaning will, after time, render any applicator inaccurate. Should an applicator be dropped or the blade become nicked, it needs to be replaced as the applied film will no longer be equally distributed over the applicator's film width. Numerous types of applicators have evolved over the years and can be divided into two types: adjustable and fixed gap clearance. Applicators may also have single or multiple gaps. Most applicators have shoulders or side arms that hold the pool of sample in front of the gap, while the device is drawn down. The gap on most applicators has a flat shearing edge which yields a wet film to gap ratio of approximately 1 to 2, although this ratio varies with several factors, such as application technique and coating composition. Fixed models are easier to clean and maintain; adjustable models should be disassembled and cleaned after every use.

The quality of the draw down is governed by three main factors:

- Viscosity of the paint
- Speed and uniformity of the application
- Flatness of the surface

A variety of viscometers can be used to control viscosity.



Viscosity Cups
see pages 264 - 252.



Rotational Viscometers
see pages 253 - 259.



BYK-Gardner also offers an automated film applicator which controls the rate of application and planeness of the applicator, assuring a uniform film thickness.

The wet film to gap ratio is a result not only of the shape of the shearing edge, but the fluid's viscosity, the speed of the applicator and other factors. The exact wet or dry film thickness can be determined only by measuring the wet or dry film with a film thickness gauge.

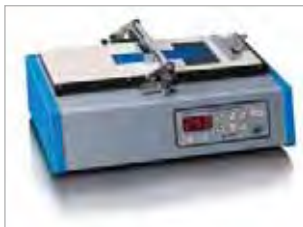

Automatic Film Applicator
see pages 166 - 168.

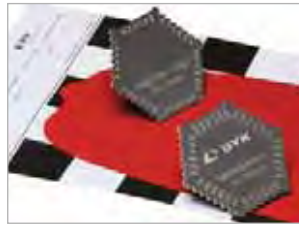

Wet film thickness measurement
see pages 187 - 189.



Dry film thickness measurement
see pages 190 - 194.

For very thin films, the use of wire-wound rods is recommended. These applicators are drawn across the surface in the same manner as the blade type, but the coating flows through the grooves between the wires and produces a thin, uniform drawdown.



Wire-wound rods see page 158.

Due to liquid evaporation, dry film thickness will always be less than the wet film thickness of a particular coating. Likewise, because of physical properties, wet film thickness will always be less than the gap of the applicator. An operator will learn through experience the approximate wet film thickness that will be obtained with a specific combination of coating, applicator, and application method. Likewise, knowledge of the composition of the coating will tell the operator what dry film thickness to expect. A good rule of thumb for a beginning estimate of dry film thickness is as follows:

$$\text{Dry film thickness} = \frac{\text{wet film thickness} \times \text{Vol. \% solids}}{100}$$

The following table helps to estimate the relationship between the gap depth of the applicator and wet film thickness:

Gap Depth		Approximate Wet Film Thickness
mils	microns	
1-4	15 - 100	50% of gap depth
5-12	101-300	60% of gap depth
13-20	301-500	80% of gap depth
>20	>500	90% of gap depth

byko-charts

Drawdown Test Charts

BYK-Gardner offers a wide range of drawdown cards and charts for virtually any application and coating material. Stringent quality control during the production process assures that they have the most consistent color and gloss in the industry. Test charts are easy to use and an inexpensive substrate to test a variety of coating properties, such as opacity, spreading rate, penetration behavior, and flow & leveling behavior. They are used for testing architectural, industrial, automotive, wood finishes or even cosmetic products (e.g. nail polish). Depending on the material properties of the product to be tested and its usage different types of drawdown cards are available.



Selection of test charts dependent on coating technology:

Depending on the type of solvent used in paint formulations a drawdown chart needs to be more or less solvent resistant. The resin type requires different solvent types and dependent on the polarity of the solvent, the organic ingredients will be more or less activated. Therefore, BYK-Gardner offers two types of drawdown cards and charts:

byko-charts, clearcoated:

- Clearcoat top coated drawdown charts are ideal for a wide range of coating systems: water and solvent borne technologies
- Guaranteed non-fluorescent paper in compliance with ASTM D 344
- Repeatable color and gloss - lot after lot
- Superior adhesion characteristics, especially with latex paints
- Rugged design (14 mils thickness) to prevent warping and bending after the coating is applied
- Draw-down chart box is shrink-wrapped with low permeability plastic to prevent moisture absorption during shipping and storage.
- Lot numbers are printed on every chart

byko-charts, film laminated:

- Plastic film laminated chart for excellent solvent resistance from achromatic hydrocarbons, esters, ketons and acids
- Repeatable color and gloss - lot after lot
- Smooth, structure free surface
- Superior adhesion properties and flexibility – the test chart will not warp and bend – even in high humidity environments

Selection of test charts dependent on application:

- Opacity charts: Instrumental check of % - opacity
- Penetration charts: Evaluation of color and gloss uniformity on surfaces of varying porosity
- Visual evaluation of hiding power:
 - Display / Spreading Rate Charts
 - Checkerboard / Spreading Rate Charts
- Brushout Cards for informal brushouts
- Uncoated test charts to simulate wood or unsealed wallboard substrates
- Specialty charts for sag and leveling test

Save!

Additional discounts are available for large quantity byko-charts drawdown charts purchases.

Info!

Custom made or private label charts are available upon request.

Opacity Drawdown Charts

Comprised of a simple combination of black and white areas with ample space for reflectance measurement. Opacity drawdown charts are used to test the hiding power of coatings.

Black and white areas have the tightest tolerances in the industry, ensuring repeatable opacity measurements paint batch after paint batch.

Clearcoated charts have the lot number printed on every chart.

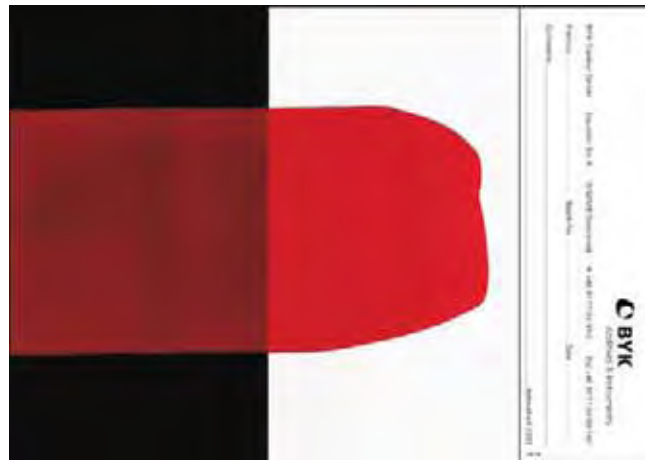

Cat. No.
PA-2810
PA-2813
PA-2860



Cat. No.
PA-2811



Cat. No.
PA-2812

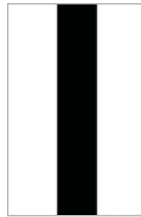

Cat. No.
PA-2836



Cat. No.
PA-2853



Cat. No.
PA-2854

Standards

ASTM D 344, D 2805

ISO 6504-3

Ordering Information

Cat. No.	Description
PA-2810	byko-chart Opacity 2A
PA-2813	byko-chart Opacity 2C
PA-2811	byko-chart Opacity 3B
PA-2812	byko-chart Opacity 5C
PA-2836	byko-chart Opacity15H
PA-2853	byko-chart Opacity
PA-2854	byko-chart Opacity
PA-2860	byko-chart brightened 2A

Technical Specifications

Material	Dimensions	Qty/Box
Clearcoated	140 x 254 mm (5.5 x 10 in)	250
Clearcoated	194 x 260 mm (7.6 x 10.25 in)	250
Clearcoated	194 x 289 mm (7.6 x 11.4 in)	250
Clearcoated	194 x 260 mm (7.6 x 10.25 in)	250
Clearcoated	286 x 438 mm (11.25 x 17.25 in)	125
Film laminated	148 x 210 mm (5.8 x 8.3 in)	250
Film laminated	105 x 140 mm (4.1 x 5.5 in)	250
Clearcoated	140 x 254 mm (5.5 x 10 in)	250

The PA-2860 byko-chart brightened drawdown chart has a brighter white section compared to the other opacity charts. The CIE L* value is approximately 2 units higher and the CIE b* value is approximately 2 units lower compared to the standard byko-charts. The black section is comparable to standard byko-charts. The paper does not have a brightening agent to achieve the whiter appearance.



Save!

SAVE up to 30% when you buy 4 or more boxes!

Penetration and Opacity Charts – Penopac

The test areas and functions of a penetration and opacity draw-down chart / drawdown card are combined with these charts.

The penetration resistance is of special importance to architectural finishes. The ability to maintain a uniform appearance (color and gloss) on substrates with varying porosity can be evaluated by applying the paint over a test chart which has a coated and uncoated area. Thus, the penetration resistance is tested under severe conditions.

The penetration resistance is visually evaluated and can also be objectively evaluated by measuring color and gloss.



Save!

SAVE up to 30% when you buy 4 or more boxes!



Cat. No. PA-2814
/ PA-2818

Cat. No. PA-2815
/ PA-2816

Cat. No. PA-2817

Ordering Information

Cat. No.	Description
PA-2814	byko-chart Penopac 1A
PA-2818	byko-chart Penopac 1B
PA-2815	byko-chart Penopac 18A
PA-2817	byko-chart Penopac 19BR
PA-2816	byko-chart Penopac 18B

Technical Specifications

Material	Dimensions	Qty/Box
Clearcoated / uncoated	140 x 254 mm (5.5 x 10.0 in)	250
Clearcoated / uncoated	194 x 289 mm (7.6 x 11.4 in)	250
Clearcoated / uncoated	140 x 254 mm (5.5 x 10.0 in)	250
Clearcoated / uncoated	194 x 289 mm (7.6 x 11.4 in)	250
Clearcoated / uncoated	194 x 289 mm (7.6 x 11.4 in)	250

Opacity Measurement

Essential sales criteria for architectural paint are hiding power and yield. In other words:

- How many layers are necessary for complete coverage?
- And how many cans will be needed?

Opacity is a measure for hiding power:

$$\text{Opacity (\%)} = \frac{Y_{\text{BLACK}} \times 100 (\%)}{Y_{\text{WHITE}}}$$

100% opacity means complete hiding, no differences can be seen between the drawdown over black and white.

Procedure

A uniform paint film is applied on a black / white contrast chart. After air drying the drawdown can be objectively evaluated using the BYK-Gardner spectro-guide. The operator is menu guided through the measurement procedure and the opacity value is displayed automatically in a second.

The same procedure can be applied for transparent films and plastics.



Info!

For more information on the spectro-guide see pages 75 - 79.

Display Charts / Checkerboard Charts – Spreading Rate Charts

Large size drawdown charts, referred to as display or spreading rate charts, were designed for visual evaluation of hiding power. The diagonal striped patterns or the checkerboard respectively have a strong visual impact and emphasize variations in film opacity.

In order to calculate the spreading rate ASTM D 344 uses Forms 8H and 10H. In this test the paint is spread uniformly on a defined test area (0.1 square meters ~ 1 square foot) and the spreading rate is calculated from the weight and density of the applied coating.



Standards

ASTM	D 344, D 2805
ISO	6504-3



Cat. No.
PA-2819
PA-2820



Cat. No.
PA-2821



Cat. No.
PA-2834



Cat. No.
PA-2823

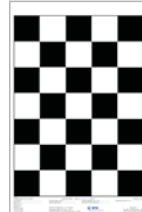

Cat. No.
PA-2824

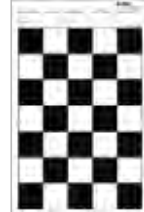

Cat. No.
PA-2801



Cat. No.
PA-2803



Cat. No.
PA-2822

Ordering Information

Cat. No.	Description
PA-2819	byko-chart Opacity-Display 9A
PA-2820	byko-chart Opacity-Display 9B
PA-2821	byko-chart Opacity-Display 21B
PA-2834	byko-chart Display 8B
PA-2823	byko-chart Display Spreading Rate 8H
PA-2824	byko-chart Checkerboard Spreading Rate 10H
PA-2801	byko-chart Checkerboard Spreading Rate
PA-2803	byko-chart Checkerboard Chart
PA-2822	byko-chart Opacity-Display Spreading Rate 12H

Technical Specifications

Material	Dimensions	Qty/Box
Clearcoated	140 x 254 mm (5.5 x 10 in)	250
Clearcoated	194 x 289 mm (7.6 x 11.4 in)	250
Clearcoated	194 x 289 mm (7.6 x 11.4 in)	250
Clearcoated	194 x 289 mm (7.6 x 11.4 in)	250
Clearcoated	286 x 438 mm (11.25 x 17.25 in)	125
Clearcoated	286 x 438 mm (11.25 x 17.25 in)	125
Film laminated	283 x 438mm (11.1 x 17.2 in)	250
Film laminated	148 x 210 mm (5.8 x 8.3 in)	250
Clearcoated	286 x 438 mm (11.25 x 17.25 in)	125

Forms 12H and 15H provide also a large enough area for objective color and gloss measurement.

Save!

SAVE up to 30%
when you buy 4 or more boxes!

Brushout Drawdown Cards

Made from heavy, rigid stock paper; used mostly for informal brushout applications. The paper stock is almost twice the thickness of regular drawdown chart paper to give greater rigidity for easier handling.



Cat. No.
PA-2856

Cat. No.
PA-2857

Cat. No.
PA-2858



Ordering Information

Cat. No.	Description
PA-2856	byko-chart Brushout 5DX
PA-2857	byko-chart Brushout 2DX
PA-2858	byko-chart Brushout WDX

Technical Specifications

Material	Dimensions	Qty/Box
Clearcoated	100 x 152 mm (3.9 x 6.0 in)	500
Clearcoated	100 x 152 mm (3.9 x 6.0 in)	500
Clearcoated	100 x 152 mm (3.9 x 6.0 in)	500

Plain White Drawdown Charts

These drawdown charts are plain white with the coating on one side with no text or label on top (except PA-2835). The PA-2835 is an uncoated stock paper with a nominal thickness of 0.35 mm (14 mils).

Chromolux drawdown cards are for determination of whiteness. The Chromolux chart has a very smooth, high gloss surface, achieved by the paper being pressed against a hot metal plate.



Plain white

Save!

SAVE up to 30% when you buy 4 or more boxes!

Ordering Information

Cat. No.	Description
PA-2827	byko-chart plain white WB*
PA-2828	byko-chart plain white WH
PA-2825	byko-chart plain white WG
PA-2826	byko-chart plain white WA*
PA-2837	byko-chart plain white WK
PA-2835	byko-chart plain white NWK*
PA-2829	byko-chart plain white, square**
PA-2891	byko-chart Chromolux
PA-2892	byko-chart Chromolux
PA-2893	byko-chart Chromolux

Technical Specifications

Material	Dimensions	Qty/Box
Clearcoated	193 x 288 mm (7.6 x 11.25 in)	250
Clearcoated	286 x 438 mm (11.25 x 17.25 in)	125
Clearcoated	76 x 140 mm (3.0 x 5.5 in)	1000
Clearcoated	140 x 254 mm (5.5 x 10 in)	250
Clearcoated	218 x 288 mm (8.6 x 11.25 in)	250
uncoated	193 x 288 mm (7.6 x 11.25 in)	250
Clearcoated	51 x 51 mm (2.0 x 2.0 in)	400
Chromolux	283 x 438 mm (11.1 x 17.2 in)	250
Chromolux	210 x 297 mm (8.3 x 11.7 in)	250
Chromolux	148 x 210 mm (5.8 x 8.3 in)	200

* These drawdown charts have a 6 mm (0.25 in) hole, centered 5 mm (0.2 in) from the top edge.

** This drawdown chart is sold in a per package quantity.

Uncoated Drawdown Cards

Use these uncoated drawdown cards to simulate wood or unsealed wallboard.

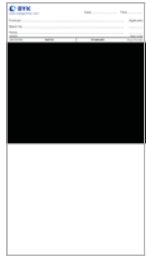

Cat. No.
PA-2831
PA-2832



Cat. No.
PA-2838



Cat. No.
PA-2805



Cat. No.
PA-2855



Cat. No.
PA-2885

Save!

SAVE up to 30%
when you buy
4 or more boxes!

Ordering Information

Cat. No.	Description
PA-2831	byko-chart, uncoated N2A
PA-2832	byko-chart, uncoated N2C
PA-2838	byko-chart, uncoated N9A
PA-2805	byko-chart, uncoated
PA-2855	byko-chart, uncoated
PA-2885	byko-chart, uncoated

Technical Specifications

Material	Dimensions	Qty/Box
uncoated	140 x 254 mm (5.5 x 10 in)	250
uncoated	194 x 260 mm (7.6 x 10.25 in)	250
uncoated	140 x 254 mm (5.5 x 10 in)	250
uncoated	210 x 297 mm (8.27 x 11.7 in)	250
uncoated	105 x 148 mm (4.13 x 5.83 in)	250
uncoated	75 x 185 mm (3.0 x 7.3 in)	250

Drawdown Plate

Provides an economical and convenient means for making drawdowns of uniform film thickness.

- Easy to use and easy to clean
- Holds charts securely for drawdowns
- Helps to achieve uniform results

Consists of a glass clipboard set firmly on a phenolic plastic panel. The entire apparatus is mounted on rubber supports in order to eliminate sliding while in use. The drawdown surface is 6.4 mm (1/4 in) thick polished glass, equal in planarity to fine mirror glass. A steel clip holds the chart firmly while the drawdown is made. The workable area is equal to the size of the glass plate.

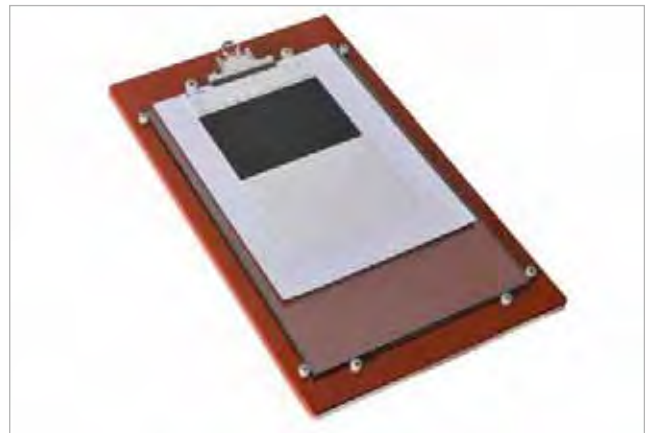

Drawdown Plate PA-4200

Ordering Information

Cat. No.	Description
PA-4200	Drawdown Plate, DP-1
PA-4201	Drawdown Plate, DP-3

Technical Specifications

Glassplate Size	Dimensions	Net Weight	Application
229 x 381 mm (9 x 15 in)	267 x 457 x 25 mm (10.5 x 18 x 1 in)	2.3 kg (5 lbs)	general purpose for drawdowns on paper charts
178 x 508 mm (7 x 20 in)	216 x 584 x 25 mm (8.5 x 23 x 1 in)	2.3 kg (5 lbs)	for Scrub Test Panels

Sag and Leveling Test Charts

This drawdown chart is designed for use with the NYPC Leveling Test Blade and the Anti-Sag Meter (see pages 162 / 163). The extra large black area allows measurements to be made over the black area only, in accordance with specifications that require the operator to ignore the leading and trailing edges of the drawdown.

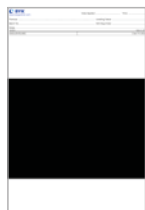

Cat. No. PA-2833

Standards

ASTM D 4400



Ordering Information

Cat. No.	Description
PA-2833	byko-chart Sag and Leveling 7B

Technical Specifications

Material	Dimensions	Qty/Box
Clearcoated	193 x 286 mm (7.6 x 11.25 in)	250

Spray Monitors

These spray monitors are self-adhering, pressure-sensitive labels with a hiding power test pattern and a sealed, solvent-resistant surface. They are used with metal panels and other substrates where a uniform surface appearance provides no visual clues as to the thickness of the applied film. It adheres firmly whether air-dried or baked. They are useful for visually checking for film opacity during the painting process.



Cat. No.
PA-2840



Cat. No.
PA-2841

Ordering Information

Cat. No.	Description
PA-2840	byko-chart Spray Monitors M12-BW
PA-2841	byko-chart Spray Monitors M33-BW

Technical Specifications

Material	Dimensions	Qty/Box
Clearcoated	25 x 25 mm (1.0 x 1.0 in)	2000
Clearcoated	50 x 50 mm (2.0 x 2.0 in)	500

Inter-leaf Paper

The Inter-leaf Paper is designed to protect a dry paint film. Place the Inter-leaf Paper between the byko-charts. The Inter-leaf Paper has a non-stick surface. They protect the paint film from being marred and prevents the paint film from adhering to the chart stacked over it. The Inter-leaf Paper should be used when storing or shipping test charts.



Save!

SAVE up to 30% when you buy 4 or more boxes!

Ordering Information

Cat. No.	Description
PA-2839	Inter-leaf Paper 1P-1B
PA-2842	Inter-leaf Paper 1P-1A
PA-2843	Inter-leaf Paper 1P-1C
PA-2844	Inter-leaf Paper 1P-1K

Technical Specifications

Material	Dimensions	Qty/Box
non-stick	194 x 286 mm (7.62 x 11.25 in)	1000
non-stick	140 x 254 mm (5.5 x 10 in)	1000
non-stick	194 x 260 mm (7.62 x 10.25 in)	1000
non-stick	219 x 286 mm (8.62 x 11.25 in)	1000

Clear Polyester Film

The clear polyester film can be used as a substrate for coatings to evaluate color, gloss, and transparency. It is used to check for foam stabilization and de-flocculation of pigments, or placed over a black and white background for evaluation of hiding power. In addition, it is used as an overlay to protect a drawdown after drying without obscuring visibility.



Clear polyester film

Save!

SAVE up to 30%
when you buy
4 or more boxes!

Ordering Information

Cat. No.	Description
PA-2870	byko-chart clear PE, 100 µm (4 mil) thickness
PA-2871	byko-chart clear PE, 50 µm (2 mil) thickness

Technical Specifications

Material	Dimensions	Qty/Box
Clear Polyester Film	127 x 194 mm (5.0 x 7.62 in)	250
Clear Polyester Film	127 x 194 mm (5.0 x 7.62 in)	250

Scrub Test Panel

Used in conjunction with the BYK-Gardner Abrasion Testers. These scrub test panels are the perfect substrate for all types of abrasion tests. The plastic panels are 0.25 mm thick (10 mils).



Cat. No.
PB-5015



Cat. No.
PB-5016



Abrasion see page 131.



Standards

ASTM	D 2486, D 3450, D 4213
ISO	11998

Ordering Information

Cat. No.	Description
PB-5015	byko-chart Scrub-test P121-10N, black
PB-5016	byko-chart Scrub-test P122-10N, white

Technical Specifications

Material	Dimensions	Qty/Box
Plastic	165 x 432 mm (6.5 x 17 in)	100
Plastic	165 x 432 mm (6.5 x 17 in)	100

Black Glass Panel

Black glass is used in widely referenced high-precision ASTM method D2805, and related hiding power test methods. The coating is applied directly to the glass surface. The accuracy of this test method depends on the unique hardness and levelness characteristics of the glass substrate.



Standards

ASTM	D 2805
------	--------

Ordering Information

Cat. No.	Description
PA-3720	Black Glass Panel

Technical Specifications

Material	Dimensions	Weight/Box
Glass	203 x 203 mm (8 x 8 in)	0.0 g (2 lbs)

Bar Film Applicators

BYK Drawdown Bar film applicators are the highest quality and easiest to clean and maintain due to their simple design and rugged construction. The theoretical wet film thickness is etched onto every drawdown bar. The theoretical wet film thickness is roughly one-half the actual gap clearance. If you have a gap clearance of 6 mils, the theoretical wet film thickness etched on the bar applicator is 3 mils. We can not guarantee that you will drawdown the theoretical wet film thickness. The drawdown process consists of many variables. The actual wet film thickness can vary from 50% to 90% of the gap depending on the gap clearance.

- Every drawdown bar is certified in our lab and comes with a calibration certificate
- Packaged in a handy reuseable storage box to help prevent damage
- Made of 440-grade stainless steel, ground to tight tolerances for repeated use.

Info!

Trade in your old drawdown bar and get a new certified bar for less than the cost of recertification.

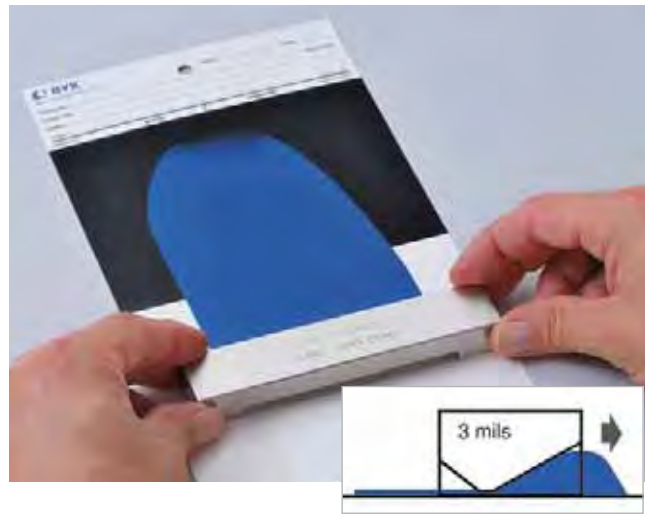

Standards

ASTM	D 823, D 3258
Federal Spec.	TT-P-29, TT-E-508A, PD-220A
FTMS	141a
JAN	JAN-P-630, JAN-P-700
Military Spec.	MIL-P-13341

Ordering Information

Cat. No.	Description
PA-5550	Bar applicator
PA-5551	Bar applicator
PA-5552	Bar applicator
PA-5553	Bar applicator
PA-5554	Bar applicator
PA-5555	Bar applicator
PA-5556	Bar applicator
PA-5557	Bar applicator
PA-5558	Bar applicator
PA-5559	Bar applicator
PA-5560	Bar applicator
PA-5561	Bar applicator
PA-5562	Bar applicator
PA-5563	Bar applicator
PA-5564	Bar applicator
PA-5565	Bar applicator
PA-5566	Bar applicator
PA-5567	Bar applicator
PA-5573	Bar applicator
PA-5568	Bar applicator
PA-5569	Bar applicator
PA-5570	Bar applicator
PA-5571	Bar applicator
PA-5572	Bar applicator

Comes complete with:

- Drawdown Bar applicator
- Reuseable storage case
- Calibration Certificate - NIST traceable

Note: Drawdown bars can only be returned unused and in original packaging.

Technical Specifications

Theoretical Wet Film Thickness (mils)	Gap Clearance mils (µm)	Film Width inches (cm)
3.0	6.0 (152.4)	2 (5.08)
6.0	12.0 (304.8)	2 (5.08)
1.0	2.0 (50.8)	3 (7.64)
1.5	3.0 (76.2)	3 (7.64)
3.0	6.0 (152.4)	3 (7.64)
6.0	12.0 (304.8)	3 (7.64)
1.5	3.0 (76.2)	3.5 (8.91)
3.0	6.0 (152.4)	3.5 (8.91)
5.0	10.0 (254)	3.5 (8.91)
6.0	12.0 (304.8)	3.5 (8.91)
10.0	20.0 (508)	3.5 (8.91)
0.5	1.0 (25.4)	6 (15.24)
1.0	2.0 (50.8)	6 (15.24)
1.5	3.0 (76.2)	6 (15.24)
2.0	4.0 (101.6)	6 (15.24)
2.5	5.0 (127)	6 (15.24)
3.0	6.0 (152.4)	6 (15.24)
4.0	8.0 (203.2)	6 (15.24)
5.0	10.0 (254)	6 (15.24)
6.0	12.0 (304.8)	6 (15.24)
8.0	16.0 (406.4)	6 (15.24)
10.0	20.0 (508)	6 (15.24)
12.0	24.0 (609.6)	6 (15.24)
20.0	40.0 (1016)	6 (15.24)

Dimensions

approx. 2.5 x 1.5 cm (1x0.6 in),
length is 3.81 cm (1.5 in) greater than film width

Shipping Weight

0.7 kg (1.5 lbs)

Multiple Clearance Applicators

Multiple Clearance Applicators are designed for the production of uniform films of paints, adhesives and similar products on plane substrates. They combine the accuracy of fixed applicators with the versatility of multiple clearance / gap choices in one unit. These applicators are suitable for use of aqueous, acid, and alkaline products.

4-Sided Applicator

- Stainless steel - corrosion-resistant
- 4 clearances



Procedure

- Place substrate to be coated on smooth paper
- Place film applicator with desired gap depth on substrate
- Pour coating in front of gap in pulling direction
- Pull at uniform speed (approx. 25 mm / s)
- Put applicator immediately into diluted cleaning solvent and clean with brush

How to choose the right applicator.

- Low viscous paint: applicator frame
- High viscous paint: 4-sided or bar applicator
- Flexible substrates like foils: wire wound applicators

Applicator Frame

- Stainless steel – corrosion resistant
- 4 clearances
- Useful for non rigid substrates
- Packaged in a handy reuseable box to prevent damage
- PA-2057: 2-chamber design for assessing 2 paint formulations side by side (ideal for gradient-oven panels, see page 231)



Standards

ASTM	D 823
FTMS	No. 141a, Meth. 2161, Meth. 2162, Meth. 4255, Meth. 6226

Certified For Certification Services see page 269.

Ordering Information

Cat. No.	Description
PA-2020	4-Sided Applicator
PA-2021	4-Sided Applicator
PA-2040	4-Sided Applicator
PA-2041	4-Sided Applicator
PA-2030	Applicator Frame
PA-2031	Applicator Frame
PA-2056	Applicator Frame
PA-2057	Applicator Frame

*2-chamber design 35 mm length per chamber

Technical Specifications

Gap Clearance microns	Film Width mm	Material
30 & 60 & 90 & 120 μm	60 mm	Stainless Steel
30 & 60 & 90 & 120 μm	80 mm	Stainless Steel
50 & 100 & 150 & 200 μm	60 mm	Stainless Steel
50 & 100 & 150 & 200 μm	80 mm	Stainless Steel
30 & 60 & 90 & 120 μm	60 mm	Stainless Steel
30 & 60 & 90 & 120 μm	80 mm	Stainless Steel
50 & 100 & 150 & 200 μm	70 mm	Stainless Steel
50 & 100 & 150 & 200 μm	2 x 35 mm*	Stainless Steel

Multiple Clearance Applicators

Multiple Clearance Applicators combine the accuracy of fixed applicators with the versatility of multiple clearance / gap choices in one unit.

Bar Type

- Stainless steel
- 2 clearances

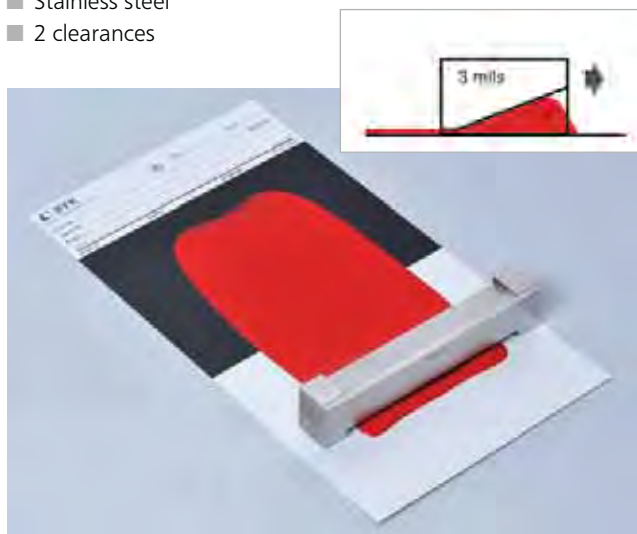

U Shaped

- Tool steel
- 2 clearances

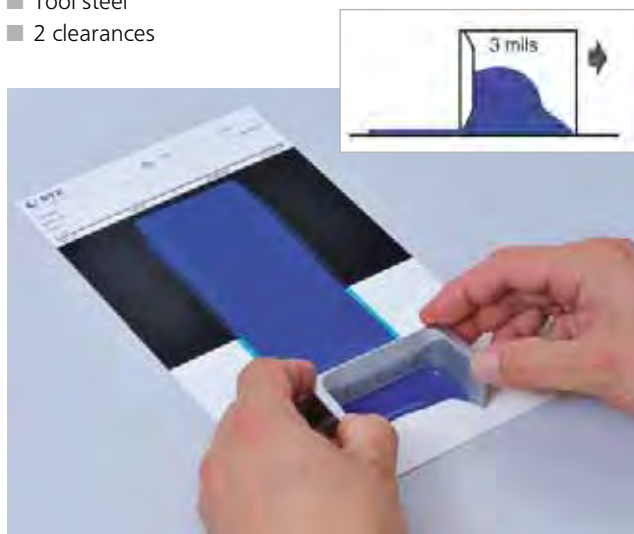

Ordering Information

Cat. No.	Description
PA-6957	Multiple Clearance Applicator Bar-Type
PA-5302	Multiple Clearance Applicator Bar-Type
PA-5303	Multiple Clearance Applicator Bar-Type
PA-5304	Multiple Clearance Applicator Bar-Type
PA-5305	Multiple Clearance Applicator Bar-Type
PA-5306	Multiple Clearance Applicator Bar-Type
PA-5307	Multiple Clearance Applicator Bar-Type
PA-5308	Multiple Clearance Applicator Bar-Type
PA-5309	Multiple Clearance Applicator Bar-Type
PA-5310	Multiple Clearance Applicator Bar-Type
PA-5326	Multiple Clearance Applicator, U shaped
PA-5327	Multiple Clearance Applicator, U shaped
PA-5328	Multiple Clearance Applicator, U shaped
PA-5329	Multiple Clearance Applicator, U shaped
PA-6948	Multiple Clearance Applicator, U shaped
PA-5331	Multiple Clearance Applicator, U shaped
PA-5332	Multiple Clearance Applicator, U shaped
PA-5333	Multiple Clearance Applicator, U shaped
PA-5334	Multiple Clearance Applicator, U shaped
PA-5335	Multiple Clearance Applicator, U shaped

Technical Specifications

Gap Clearance μm (mils)	Film Width mm (inch)	Material
50.8 & 101.6 μm (2 & 4 mils)	50.8 mm (2 in)	Stainless Steel
152.4 & 254.0 μm (6 & 10 mils)	50.8 mm (2 in)	Stainless Steel
50.8 & 101.6 μm (2 & 4 mils)	76.2 mm (3 in)	Stainless Steel
152.4 & 254.0 μm (6 & 10 mils)	76.2 mm (3 in)	Stainless Steel
50.8 & 101.6 μm (2 & 4 mils)	101.6 mm (4 in)	Stainless Steel
152.4 & 254.0 μm (6 & 10 mils)	101.6 mm (4 in)	Stainless Steel
50.8 & 101.6 μm (2 & 4 mils)	127.0 mm (5 in)	Stainless Steel
152.4 & 254.0 μm (6 & 10 mils)	127.0 mm (5 in)	Stainless Steel
50.8 & 101.6 μm (2 & 4 mils)	152.4 mm (6 in)	Stainless Steel
152.4 & 254.0 μm (6 & 10 mils)	152.4 mm (6 in)	Stainless Steel
50.8 & 101.6 μm (2 & 4 mils)	50.8 mm (2 in)	Tool Steel
152.4 & 254.0 μm (6 & 10 mils)	50.8 mm (2 in)	Tool Steel
50.8 & 101.6 μm (2 & 4 mils)	76.2 mm (3 in)	Tool Steel
152.4 & 254.0 μm (6 & 10 mils)	76.2 mm (3 in)	Tool Steel
50.8 & 101.6 μm (2 & 4 mils)	101.6 mm (4 in)	Tool Steel
152.4 & 254.0 μm (6 & 10 mils)	101.6 mm (4 in)	Tool Steel
50.8 & 101.6 μm (2 & 4 mils)	127.0 mm (5 in)	Tool Steel
152.4 & 254.0 μm (6 & 10 mils)	127.0 mm (5 in)	Tool Steel
50.8 & 101.6 μm (2 & 4 mils)	152.4 mm (6 in)	Tool Steel
152.4 & 254.0 μm (6 & 10 mils)	152.4 mm (6 in)	Tool Steel

Certified

Certification available on request.

Multiple Clearance Square Applicator

Multiple Clearance Applicators combine the accuracy of fixed applicators with the versatility of multiple clearance/gap choices in one unit.

- Greatest versatility
- 8 clearances
- Highest quality stainless steel
- Packaged in a handy reuseable box to prevent damage



Ordering Information

Cat. No.	Description
PA-5361	Multiple Clearance Square Applicator
PA-5351	Multiple Clearance Square Applicator
PA-5363	Multiple Clearance Square Applicator
PA-5353	Multiple Clearance Square Applicator
PA-5354	Multiple Clearance Square Applicator
PA-5355	Multiple Clearance Square Applicator
PA-5356	Multiple Clearance Square Applicator
PA-5357	Multiple Clearance Square Applicator
PA-5358	Multiple Clearance Square Applicator

Technical Specifications

Gap Clearance μm (mils)	Film Width cm (inch)	Material
25.4, 50.8, 76.2, 101.6, 127.0, 152.4, 177.8, 203.2 μm (1, 2, 3, 4, 5, 6, 7, 8 mils)	5.08 cm (2 in)	Stainless Steel
127, 254, 381, 508, 762, 1016, 1270 μm (5, 10, 15, 20, 25, 30, 40, 50 mils)	5.08 cm (2 in)	Stainless Steel
12.7, 25.4, 38.1, 50.8, 76.2, 101.6, 127.0, 152.4 μm (0.5, 1, 1.5, 2, 3, 4, 5, 6 mils)	5.08 cm (2 in)	Stainless Steel
25.4, 50.8, 76.2, 101.6, 127.0, 152.4, 177.8, 203.2 μm (1, 2, 3, 4, 5, 6, 7, 8 mils)	7.62 cm (3 in)	Stainless Steel
127, 254, 381, 508, 762, 1016, 1270 μm (5, 10, 15, 20, 25, 30, 40, 50 mils)	7.62 cm (3 in)	Stainless Steel
12.7, 25.4, 38.1, 50.8, 76.2, 101.6, 127.0, 152.4 μm (0.5, 1, 1.5, 2, 3, 4, 5, 6 mils)	7.62 cm (3 in)	Stainless Steel
25.4, 50.8, 76.2, 101.6, 127.0, 152.4, 177.8, 203.2 μm (1, 2, 3, 4, 5, 6, 7, 8 mils)	10.16 cm (4 in)	Stainless Steel
127, 254, 381, 508, 762, 1016, 1270 μm (5, 10, 15, 20, 25, 30, 40, 50 mils)	10.16 cm (4 in)	Stainless Steel
12.7, 25.4, 38.1, 50.8, 76.2, 101.6, 127.0, 152.4 μm (0.5, 1, 1.5, 2, 3, 4, 5, 6 mils)	10.16 cm (4 in)	Stainless Steel

Certified

Certification available on request.

Film Casting Knife

The BYK-Gardner Film Casting Knife is an adjustable clearance film applicator. Its extended end plates confine the coating sample during drawdown. The micrometer adjusted gate allows clearance / gap settings from 0 to 150 mils in 1 mil increments. Metric versions produce clearances / gaps of 0 to 3800 microns in 10 micron increments.

The applicator consists of two end plates joined by a bridge and an adjustable blade below the bridge. Two micrometers extend through the bridge and contact the upper edge of the blade, allowing it to be adjusted upward or downward to control the gap and ultimately the film thickness. The blade and end plates are constructed of 6.4 mm (1/4 in) aluminum. The end plates effectively contain the sample pool during the drawdown process.



Most versatile manual model

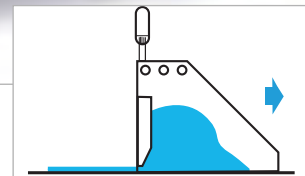

Standards

ASTM	D 823-53 (1970)
FTMS	No. 141a, Meth. 2161, 2162, 4255, 6266

Ordering Information

Cat. No.	Description
PA-4301	Film Casting Knife
PA-4302	Film Casting Knife
PA-4303	Film Casting Knife
PA-4304	Film Casting Knife
PA-4305	Film Casting Knife
PA-2325	Film Casting Knife
PA-2326	Film Casting Knife
PA-2327	Film Casting Knife
PA-2328	Film Casting Knife
PA-2329	Film Casting Knife

Technical Specifications

Blade Width	Clearance/Gap	Dimensions	Weight
2 in	0-150 mils	102 x 102 x 63.5 mm (4 x 4 x 2.5 in)	1.1 kg (2.5 lbs)
4 in	0-150 mils	102 x 102 x 114 mm (4 x 4 x 4.5 in)	1.4 kg (3.0 lbs)
6 in	0-150 mils	102 x 102 x 165 mm (4 x 4 x 6.5 in)	1.8 kg (4.0 lbs)
8 in	0-150 mils	102 x 102 x 216 mm (4 x 4 x 8.5 in)	2.3 kg (5.0 lbs)
12 in	0-150 mils	102 x 102 x 317.5 mm (4 x 4 x 12.5 in)	2.7 kg (6.0 lbs)
5.1 cm	0-3800 µm	102 x 102 x 63.5 mm (4 x 4 x 2.5 in)	1.1 kg (2.5 lbs)
10.2 cm	0-3800 µm	102 x 102 x 114 mm (4 x 4 x 4.5 in)	1.4 kg (3.0 lbs)
15.2 cm	0-3800 µm	102 x 102 x 165 mm (4 x 4 x 6.5 in)	1.8 kg (4.0 lbs)
20.3 cm	0-3800 µm	102 x 102 x 216 mm (4 x 4 x 8.5 in)	2.3 kg (5.0 lbs)
30.5 cm	0-3800 µm	102 x 102 x 317.5 mm (4 x 4 x 12.5 in)	2.7 kg (6.0 lbs)

Comes complete with:

Film Casting Knife, Reuseable Storage Box

Wire-wound rods

Wire-wound rods, 200 mm film width

Each rod has a 12 mm diameter with a 200 mm film width. There is a 20 mm space on both ends to grip the rod. The rods can be attached to a holder to secure the rod during a drawdown. An adapter is also available to attach the wire-wound rods to the PA-2101 Automatic Film Applicator.



Ordering Information

Cat. No.	Description
PA-2419	Wire-wound rods
PA-2420	Wire-wound rods
PA-2421	Wire-wound rods
PA-2422	Wire-wound rods
PA-2423	Wire-wound rods
PA-2424	Wire-wound rods
PA-2425	Wire-wound rods
PA-2426	Wire-wound rods
PA-2428	Wire-wound rods
PA-2410	Wire-wound rod set

Technical Specifications

Wet Film Thickness	Film Width	Dimensions
10 µm (0.4 mils)	200 mm (7.9 in)	24 cm x ø 1.2 cm (9.4 in x ø 0.5 in)
15 µm (0.6 mils)	200 mm (7.9 in)	24 cm x ø 1.2 cm (9.4 in x ø 0.5 in)
25 µm (1.0 mils)	200 mm (7.9 in)	24 cm x ø 1.2 cm (9.4 in x ø 0.5 in)
50 µm (2.0 mils)	200 mm (7.9 in)	24 cm x ø 1.2 cm (9.4 in x ø 0.5 in)
75 µm (3.0 mils)	200 mm (7.9 in)	24 cm x ø 1.2 cm (9.4 in x ø 0.5 in)
100 µm (3.9 mils)	200 mm (7.9 in)	24 cm x ø 1.2 cm (9.4 in x ø 0.5 in)
125 µm (4.9 mils)	200 mm (7.9 in)	24 cm x ø 1.2 cm (9.4 in x ø 0.5 in)
150 µm (6.9 mils)	200 mm (7.9 in)	24 cm x ø 1.2 cm (9.4 in x ø 0.5 in)
200 µm (6.9 mils)	200 mm (7.9 in)	24 cm x ø 1.2 cm (9.4 in x ø 0.5 in)

set of 3 wire rod applicators, choose from Cat. No. PA-2419 through Cat. No. PA-2428

Ordering Information

Cat. No.	Description
PA-2440	Holder with Grip
PA-2430	Wire-wound rod adapter*

*Adapter lengthens the wire-wound rod to fit the PA-2101 Automatic Film Applicator. Sold as a pair.

Accessories

Information
for Cat. No. PA-2419 - 2428
for Cat. No. PA-2419 - 2428



Wire-wound rods, 10" inch (254 mm) film width

Each rod is 1/2 inch in diameter and 12 inches in length, allowing 1 inch at either end to grip. The approximate wet film thickness that will result after a coating passes through the grooves between the wires and then levels off to a uniform thickness has been computed for each diameter of wire and is shown in the table below.



Ordering Information

Cat. No.	Description
PA-4103	Wire-wound rod
PA-4104	Wire-wound rod
PA-4106	Wire-wound rod
PA-4108	Wire-wound rod
PA-4110	Wire-wound rod
PA-4112	Wire-wound rod
PA-4116	Wire-wound rod
PA-4122	Wire-wound rod
PA-4128	Wire-wound rod
PA-4134	Wire-wound rod
PA-4140	Wire-wound rod
PA-4152	Wire-wound rod

Note: Other wet film thickness wire-wound rods available on request.

A complete set of wire-wound rods provides 12 different wet film thicknesses of 4 mils or less; 7 of these being 1 mil or less. The 10 inches width of application is greater than many other applicators.

Technical Specifications

Wet Film mils	Thickness microns	Wire mils	Diameter mm	Dimensions
0.2	5	3	0.075	1.3 x 30.5 cm (0.5 x 12")
0.3	8	4	0.10	1.3 x 30.5 cm (0.5 x 12")
0.4	10	6	0.15	1.3 x 30.5 cm (0.5 x 12")
0.5	13	8	0.20	1.3 x 30.5 cm (0.5 x 12")
0.65	16	10	0.25	1.3 x 30.5 cm (0.5 x 12")
0.8	20	12	0.30	1.3 x 30.5 cm (0.5 x 12")
1.0	25	16	0.41	1.3 x 30.5 cm (0.5 x 12")
1.5	38	22	0.56	1.3 x 30.5 cm (0.5 x 12")
2.0	50	28	0.71	1.3 x 30.5 cm (0.5 x 12")
2.5	63	34	0.86	1.3 x 30.5 cm (0.5 x 12")
3.0	75	40	1.02	1.3 x 30.5 cm (0.5 x 12")
4.0	100	52	1.32	1.3 x 30.5 cm (0.5 x 12")

Ordering Information

Cat. No.	Description
PA-4100	Wire-wound rod set
PA-4101	Bench Stand

Comes complete with:

Wire-wound rod set:
12 wire-wound rods
Bench stand

Accessories

	Dimensions	Net Weight	Shipping Weight
	30.4 x 26.0 x 3.8 cm (12 x 10.25 x 1.5 in)	3.8 kg (8.5 lbs)	5.4 kg (12 lbs)
	29.5 x 26.0 x 2.8 cm (11.6 x 10.25 x 1.1 in)	0.4 kg (0.9 lbs)	0.9 kg (2 lbs)

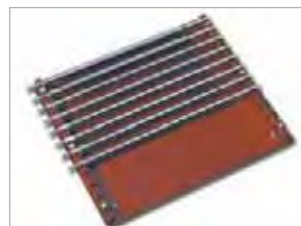

Step Gap Film Applicator

This applicator produces film thicknesses increasing step by step.

- 4 clearances with 4 steps each
- Film width 25 mm per step

Certified

For Certification Service see page 269.

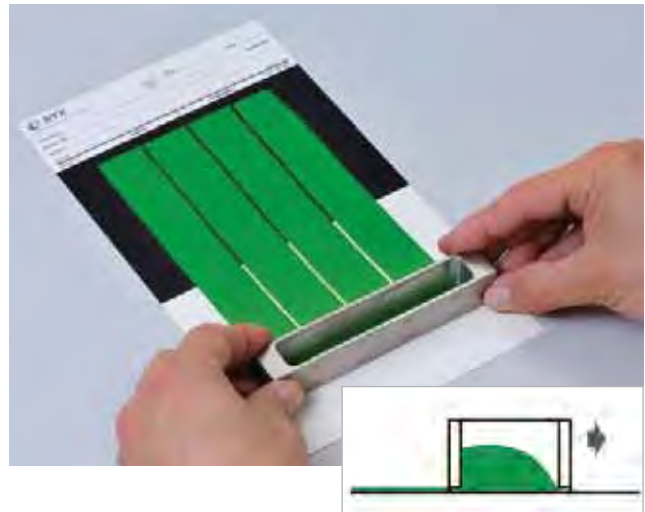

Ordering Information

Cat. No.	Description
PA-2120	Step Gap Film Applicator Frame

Technical Specifications

Gap Clearance (µm)	Film Width	Material
25 & 50 & 75 & 100 µm	4 x 25 mm	Stainless Steel
50 & 100 & 150 & 200 µm		
150 & 200 & 250 & 300 µm		
300 & 350 & 400 & 450 µm		

Dow Latex Film Applicator

A U-shaped film applicator designed to allow the application of a second coat of paint directly upon a hardened first coat while the ends of the applicator remain on the uncoated panel surface. The gap on one edge of the Dow Applicator has both greater clearance and width than the gap on the other edge.

Paint is applied within the channel formed by the "U" shape of the bar; as the bar is drawn down, the pool of paint is contained within the channel, yielding a consistent width.

- Allows two coats on a single substrate

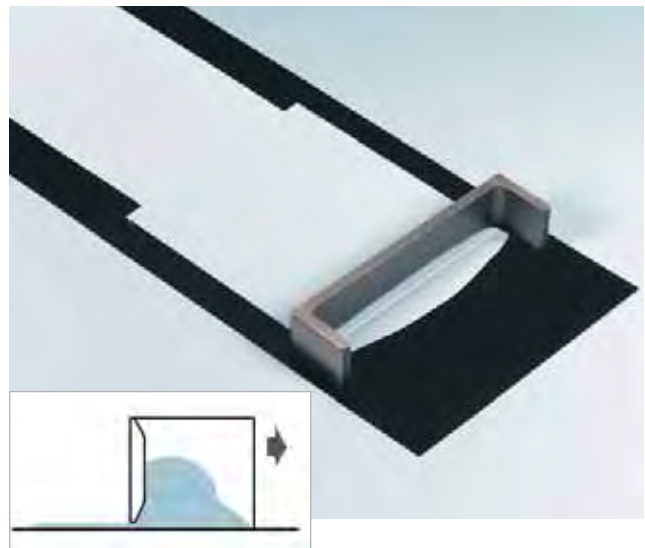

Standards

ASTM	D 823, D 2486, D 3258
Federal Spec.	TT-P

Ordering Information

Cat. No.	Description
PA-2230	Dow Latex Film Applicator, U shaped

Technical Specifications

Gap Clearance	Film Width	Material
175 and 250 µm (7 and 10 mil)	13.3 and 14 cm (5.25 and 5.5 in)	Stainless Steel

Leveling/Sagging Tester

In most cases, leveling is a desired property of paints expressed in the fact that the cured film shows a surface as plain as possible with brush marks, spray drops or other unevennesses occurring as little as possible. Sagging, however, is considered a paint defect, particularly occurring on vertical surfaces, in edges and corners. The most common terms, for example streaks or tear drops, perfectly describe its characteristic appearance. It is not always possible, or only with difficulties, to measure this type of flow behavior by means of viscometers.

- Simple comparison test of the leveling and sagging properties of paints in the period between application and drying
- One applicator to test leveling and sagging
- Corrosion resistant stainless steel construction

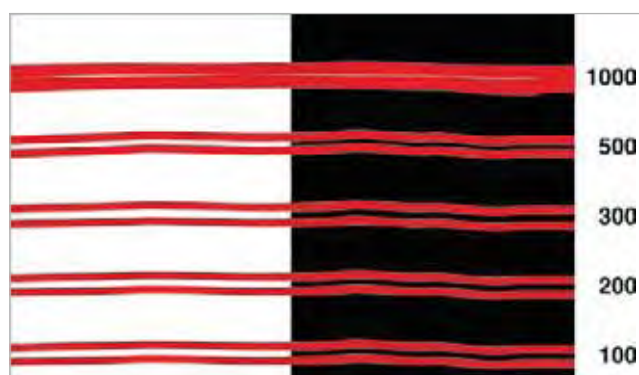

Sagging Test Procedure

- Apply the coating, forming 10 streaks of various thicknesses
- Immediately after application, place the test panel into a vertical position, with the thinnest film streak at the top, avoiding any shock
- Depending on the sagging tendency the separate streaks converge
- For a reproduction of the results, which is difficult anyway, it is important to work under constant climatic conditions, to apply film streaks uniformly, and to set a time for evaluation

Ordering Information

Cat. No.	Description
PV-0810	Leveling/Sagging Tester

5 pairs of gaps for leveling test: 0.1 0.2 0.3 0.5 1.0 mm
10 steps for sagging test: 75 100 125 150 175 200 225 250 275 300 µm



Standards

ASTM	D 2801
FTMS	141a, Method 4494



Leveling Test Procedure

- Draw the paint to be tested over a plane substrate (test chart), producing 5 pairs of streaks of various film thicknesses
- Hold the test panel in a horizontal position, and observe which of the pairs of streaks converge
- Generally, the gap depth of that pair of streaks is indicated, where the intervals between the streaks are slightly visible

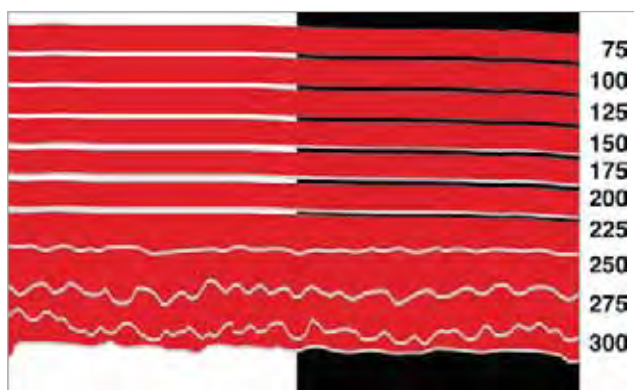

NYPC Leveling Test Blade

This instrument provides a means of evaluating the ability of a freshly applied coating to level before curing while reducing or eliminating marks caused by brushing or other means of application. Evaluations of leveling using this specially designed applicator correlate with, but are more consistent than, evaluations done by brushout. Since different factors influence leveling and sagging, tests for these properties should not be confused with each other. The leveling test is performed on a horizontal plane and is not a measure of sagging.

The New York Paint Club (NYPC) Leveling Test Blade is a U shaped film applicator with a shallow gap cut into one edge. Into this shallow gap is cut an evenly spaced series of five pairs of narrow notches having total clearances of 10, 20, 40, 80 and 160 mils. The applicator will produce a 4" wide drawdown, and has an overall width of 5".

A drawdown is made on a panel or chart using normal procedures. This produces five parallel pairs of ridges with a very thin (<0.5 mil) coating between them. The drawdown is kept flat on a horizontal plane until the coating is dry and it is then evaluated. Leveling is rated on the basis of which pairs of ridges of coating merged together and to what extent.

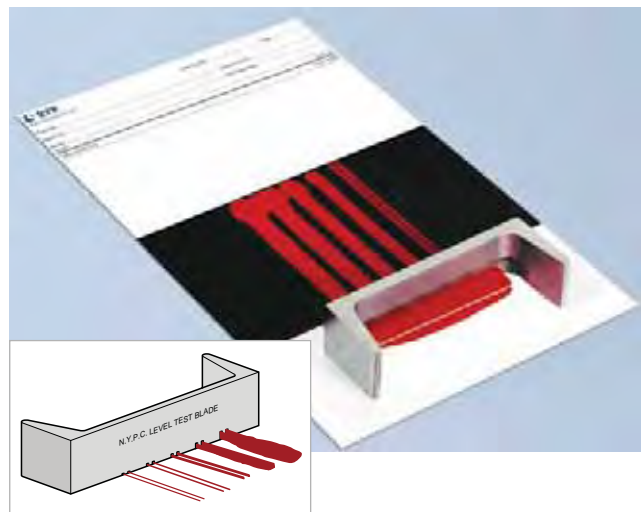

Complies with New York Society for Paint Technology

Standards

New York Society No. 44, Vol. 32

for Paint Technology No. 430, p. 1435

Official Digest

Ordering Information

Cat. No.	Description
PV-0812	NYPC Leveling Test Blade

Technical Specifications

Shipping Weight	Net Weight	Dimensions
450 g (1 lbs)	340 g (12 oz.)	127 x 32 x 44.5 mm (5 x 1.25 x 1.75 in)

Anti-Sag Meter

Coatings applied on non-horizontal surfaces will sag due to gravity. Sag resistance is a factor of the composition and viscosity of the coating, as well as the applied thickness. The Anti-Sag meter allows quantification of the sagging properties of coatings.

- Quick test of the sagging of coatings on non-horizontal surfaces
- Available in most coating thickness ranges

The applicator is a U-shaped drawdown bar with a series of 1/4 inch (6.4 mm) wide notches of varying clearances, spaced 1/16 inch (1.6 mm) apart. It is 5 inches (127 mm) wide and produces a total film width of 3 3/8 inches (86 mm). When a drawdown is made, a series of parallel stripes of different wet film thickness will be formed. This panel is placed on a vertical surface with the stripes horizontal and the thickest stripe lowest. As the film stripes sag downward, some of the uncoated 1/16 inch (1.6 mm) spaces may become entirely covered. The clearance of the gap that produces the thickest film stripe, not sagging completely to the stripe below, is the anti-sag index of the coating.

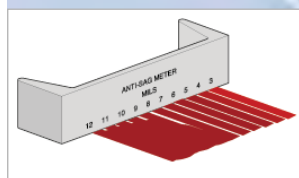

Standards

ASTM D 3730, D 4400

Ordering Information

Cat. No.	Description
PV-5401	Anti-Sag Meter
PV-5402	Anti-Sag Meter
PV-5403	Anti-Sag Meter
PV-5404	Anti-Sag Meter

Info!

For more informations on test charts, please see page 151.

Technical Specifications

Clearance Range

Standard Range 76 to 305 µm (3 to 12 mils)

Low clearance 25.4 to 152.4 Mm (1 to 6 mils)

High clearance 355.6 to 1524 Mm (14 to 60 mils)

Medium clearance 101.6 to 609.6 Mm (4 to 24 mils)

Dimensions 12.7 x 3.8 x 2.5 cm (5 x 1.5 x 1 in)

Net Weight 0.3 kg (0.625 lbs)

Shipping Weight 0.6 kg (1.25 lbs)

Pfund Cryptometer

Wet Hiding Power Test

The cryptometer is a wedge type film applicator, which determines the wet hiding power of a coating within a few minutes.

- Quickly and reliably checks wet hiding power
- Determines thickness needed for complete hiding
- Gives estimate of coverage in square feet per gallon
- Can be used with any color of coating
- Small sample size (3 - 5 mls.) makes this ideal for QC tests
- It consists of two plates of glass separated at a fixed angle.

The bottom glass plate is engraved with a scale, and the top plate is transparent.



Procedure

A coating is placed into the open area between the plates, forming a wedge shaped film (Fig. 1). By sliding the top plate back and forth, a sharp line of demarcation alternatively appears and disappears (Fig. 2). The point at which the demarcation line appears is read on the engraved scale (Fig. 3). These scale readings are easily converted into thickness in mils, or coverage in square feet per gallon using the table furnished with the instrument.

The value of the "wedge constant" of a top plate is the thickness in mils of the wedge of wet paint exactly over the demarcation line when the top plate is centered over this line and the scale reading is 25. Top plates with different wedge constants are included, depending on the opacity of the material to be tested:

- Wedge constant 0.007 for coatings with lesser opacity
- Wedge constant 0.002 for more opaque coatings

Ordering Information

Cat. No.	Description
PA-3301	Pfund Cryptometer

Comes complete with:

Base Plate; Top Plate, wedge constant 0.002
Top Plate, wedge constant 0.007

Technical Specifications

Dimensions	Net Weight	Shipping Weight
16.5 x 10.1 x 3.8 cm (6.5 x 4 x 1.5 in)	1.2 kg (2.75 lbs)	1.8 kg (4 lbs)

Accessories: Extra Top Plates

Due to friction, top plates wear and should be replaced periodically.

Figure 1



Figure 2



Figure 3



Ordering Information

Cat. No.	Description
PA-3302	Top plate
PA-3303	Top plate
PA-3304	Top plate
PA-3305	Bottom plate

Accessories Information

Wedge constant 0.002
Wedge constant 0.007
Wedge constant 0.0035
1/2 black and 1/2 white

Vacuum Pump

For use with vacuum plates, as well as other applications where a reliable source of low vacuum is needed. Compact and rotary in design, this pump provides a quiet and constant source of vacuum.

- Lubricated during operation
- Low maintenance design
- Rugged construction
- Carrying handle for easy transport
- Designed for laboratory use



Ordering Information

Cat. No.	Description
PA-3869	Vacuum Pump

Comes complete with:

- Vacuum gage
- Regulator
- Power cord with on/off switch
- Foot support assembly
- Muffler
- Filter
- Oiler assembly

Technical Specifications

Motor Power	Power Supply	Capacity	Dimensions	Net Weight
0.19 kW (0.25 hp)	100 -240 V/ 50-60Hz	6.3 m ³ /h (4 cfm)	387.4 x 204.0 mm (15.25 x 4.25 in)	15.8 kg (35 lbs)

Vacuum Plates

Also known as suction plates, these perforated aluminum plates are ideal for most manual drawdowns.

- Holds charts securely for drawdowns
- Helps to achieve uniform results

Consists of a perforated hollow aluminum casting to which a vacuum is applied to hold the drawdown card in place. The card should be slightly flexible and stiff enough to resist dimpling.

Info!

byko-chart drawdown charts provide the ideal substrate, see pages 146 - 152.



Ordering Information

Cat. No.	Description
PA-3876	Vacuum Plate
PA-3878	Vacuum Plate

Technical Specifications

Surface Size	Dimensions	Net Weight	Shipping Weight
229 x 305 mm (9 x 12 in)	229 x 305 x 32 mm (9 x 12 x 1.25 in)	2.7 kg (6 lbs)	5 kg (11 lbs)
305 x 457 mm (12 x 18 in)	305 x 457 x 32 mm (12 x 18 x 1.25 in)	7.2 kg (16 lbs)	10 kg (22 lbs)

Automatic Film Applicator L

Drawdowns made by hand can show irregularities caused by variations in speed and pressure on the applicator tool. The quality of the drawdown will be dependent on the shear rate and the weight on the applicator. Measurements of film properties such as abrasion resistance, hiding power and gloss are greatly affected by the application quality.

Using an automatic film applicator guarantees a linear and even movement of the film applicator – repeatable and high quality results are guaranteed:

- Precise application speed settable in 10 mm/s increments from 50 to 500 mm/s
- Wide range of operating speeds allowing optimum settings of shear rate
- Real time display of application speed
- Memory function to store commonly used speeds
- Constant downward force applied to coated surface
- A wide variety of film applicators can be accommodated
- Applicators may be used side by side for comparison tests
- Wire bar coater attachment included
- Solvent resistant touch key panel that is easily cleaned
- Built-in vacuum plate with vacuum pump
- Two stroke lengths

Ordering Information

Cat. No.	Description
PA-2101	Automatic Film Applicator L

Comes complete with:
 Automatic Film Applicator L
 Vacuum plate
 Built-in vacuum pump
 Clamp for sample holding
 Weight set

Note: Applicators and test charts must be ordered separately.

Ordering Information

Cat. No.	Description
PA-2103	Weight Kit
PA-2430	Wire-wound rod Adapter

Note: Weight set is for Automatic Film Applicators PA-2101 and PA-2105 only.

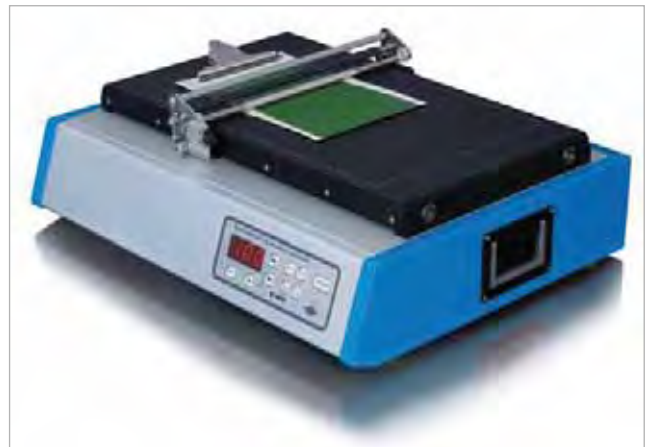

Automatic Film Applicator PA-2101: ideal for drawdown cards

Technical Specifications

Traverse Speed	50 - 500 mm/s (2 - 20 in/s)
Traverse Speed Accuracy	10 mm/s (0.4 in/s)
Display Resolution	10 mm/s (0.4 in/s)
Wire Bar Diameter	10 - 13 mm (0.4 - 0.5 in)
Wire Bar Test Length	320 mm max. (12.4 in max.)
Wire Bar Minimum Length	407 mm (16.0 in)
Stroke Length	170 mm (6.7 in); 340 mm (13.4 in)
Test Panel Size	420 x 300 mm (16.5 x 11.8 in)
Preset Speed Memories	2
Power Supply	230/115 V, 50/60 Hz selectable
Power Consumption	130 Watts
Dimensions	632 x 220 x 500 mm (24.9 x 8.7 x 19.7 in)
Weight	45 kg (99.2 lbs)

Accessories

Information
 Consists of weight holder, weight, and bracket clamp. Total weight 1361 gm (3 lbs)
 Required to fit Wire Rods PA-2419 - 2428 onto PA-2101 Automatic Film Applicator.
 Sold as a pair.

Automatic Film Applicator S

Smaller footprint version of the PA-2101 Automatic Film Applicator. The Small Film Applicator has a clipboard only to hold the drawdown chart. The clipboard size will accommodate a 19 x 26 cm (7.5 x 10.25 in) chart. Only one stroke length is available.

Certified

For Preventive Maintenance see page 272.

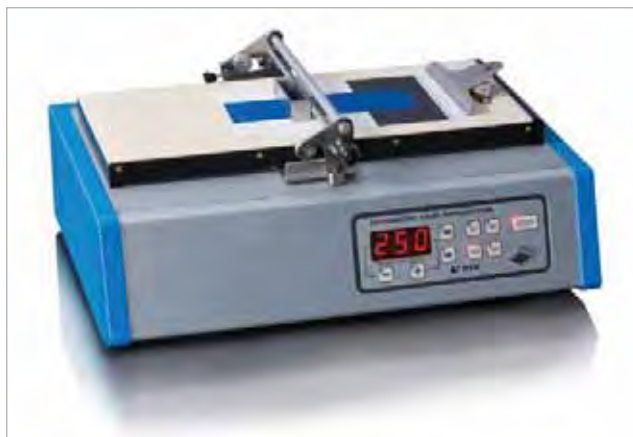

PA-2105 Small Automatic Film Applicator

Standards

ASTM D 823

Ordering Information

Cat. No.	Description
PA-2105	Automatic Film Applicator S

Comes complete with:

Automatic Film Applicator S
Rubber mat and clamp for sample holding

Technical Specifications

Traverse Speed	50 - 500 mm/s (2 - 20 in/s)
Traverse Speed Accuracy	10 mm/s (0.4 in/s)
Display Resolution	10 mm/s (0.4 in/s)
Wire Bar Diameter	10 - 13 mm (0.4 - 0.5 in)
Wire Bar Test Length	200 mm max. (7 in max.)
Wire Bar Minimum Length	305 mm (12.0 in)
Stroke Length	240 mm (9.4 in)
Test Panel Size	250 x 195 mm (9.8 x 7.7 in)
Preset Speed Memories	4
Power Supply	230/115 V, 50/60 Hz selectable
Power Consumption	< 100 Watts
Dimensions	310 x 200 x 565 mm (12.2 x 7.8 x 22.2 in)
Weight	16.4 kg (36 lbs)



Applicators see pages 153 - 163.



Wire-wound rods see page 158.



Charts see pages 145 - 152.

byko-drive

Automatic Film Applicator

The byko-drive Automatic Applicator is an economical film applicator that improves the consistency of drawdowns. When more than one operator is drawing down the same coating or ink, the dry film appearance will vary because of different drawdown techniques. Drawdown speed and pressure on the applicator tool will impact the result. Film thickness, gloss, opacity, and color can vary with differing drawdown techniques.

The byko-drive is available with a vacuum plate or glass plate with clamp. Applicator bars, U-shaped bars, applicator frames, film casting knives, and wire-wound rods are acceptable applicators. The byko-drive has a compact design consisting of a light-weight aluminum chassis and impact resistant thermo-plastic cover.

- User selectable start and stop positions to accommodate different chart sizes
- Power assist carriage return for ease of operation
- Drip pan for faster cleanup
- Weight and bar fixture for consistent pressure on applicator devices
- Small footprint to save on counter space
- Easy to operate user controls



New!

The byko-drive has two user selectable speeds:

- 10 mm/sec – complies with ISO method 11998
- 1 in/sec – same speed setting as the BYK-Gardner Mechanical Drive

Ordering Information

Cat. No.	Description
PA-2121	byko-drive
PA-2122	byko-drive

Comes complete with:

byko-drive
Weight-bar fixture (PA-2123)
External power supply
Drip pan
Instruction manual

Note: Applicators and Vacuum Pump must be ordered separately.

Technical Specifications

Platform	
with vacuum plate	
with glass plate and clamp	
Voltage	100 - 240 V/50 - 60 Hz
Traverse speeds	10 mm/sec or 1 in/sec
Traverse speed accuracy	±5%
Wire bar diameter limits	6 - 19 mm (0.25 - 0.75 in)
Wire bar test length maximum	406 mm (16 in)
Stroke length	25 - 235 mm (1 - 9.25 in)
Weight	6 kg (13 lbs)
Test panel size maximum	229 x 305 mm (9 x 12 in)
Dimensions	365 x 229 x 127 mm (14.38 x 9 x 5 in)

Accessories

Cat. No.	Description
PA-3869	Vacuum pump
PA-3876	Vacuum plate
PA-2123	Weight-bar fixture, 454 gm (1 lb)
PA-2128	Weight-bar fixture, 908 gm (2 lbs)
PA-2129	Weight-bar fixture, 1,362 gm (3 lbs)
PA-2124	External power supply with electrical cord
PA-2125	Drip pan
PA-2127	Glass plate with clamp
PA-2126	O-ring, pk of 4

Resource I Variable Speed Mechanical Drive

Automatic Film Applicator

This spring driven device is designed for preparing films of uniform thickness on a test substrate, such as our BYK-Gardner drawdown charts.

- Spring driven – safe to use in volatile atmospheres
- Yields uniform pressure and speed for reproducible drawdowns
- Speed and pressure are adjustable according to what type of coating is used

The apparatus was specifically designed to accommodate our wire-wound rods and therefore is very useful for the application of very thin films. Other applicators, such as fixed and adjustable bar type applicators can also be used, but require the purchase of adapter PA-3881.



Resource I with bar type applicator and bar adapter

Ordering Information

Cat. No.	Description
PA-3880	Resource I Mechanical Drive
PA-3881	Adapter for Bar Type Applicators

Note: Applicators and adapter must be ordered separately

Technical Specifications

Dimensions	Net Weight	Shipping Weight
51.4 x 38.1 x 14.6 cm (20.25 x 15 x 5.75 in)	11.4 kg (25 lbs)	13.6 kg (30 lbs)

Accessories



Wire-wound rods see page 158.



Charts see page 145 - 152.



Applicators see pages 153 - 163.

Publications Books

Paint and Coating Testing Manual Gardner-Sward Handbook, 14th Ed.

The Paint and Coating Testing Manual is the perfect guide for the coating technologist. This guide provides in-depth information on test procedures, standards, and environmental regulations that can help everyone from the newcomer to the experienced researcher.

- Current industry regulations
- The main polymeric species, colorants, special pigments, extenders, and additives used in the coatings industry
- Testing instruments used in the industry
- Analysis of paint and paint-related defects
- ASTM and other International standards

Paint & Coating Testing Manual Contents:

- Part 1: Regulations
- Part 2: Naturally Occurring Materials
- Part 3: Synthetic Materials
- Part 4: Plasticizers
- Part 5: Solvents
- Part 6: Pigments
- Part 7: Additives
- Part 8: Physical Characteristics of Liquid Paints and Coatings
- Part 9: Films for Testing
- Part 10: Optical Properties
- Part 11: Physical and Mechanical Properties
- Part 12: Environmental Resistance
- Part 13: Specific Product Testing
- Part 14: Analysis of Paints and Paint Defects
- Part 15: Instrumental Analysis
- Part 16: Specifications

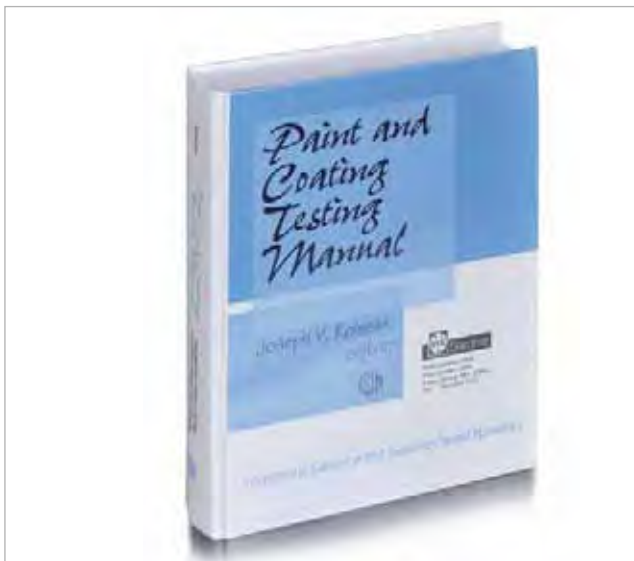

Ordering Information

Cat. No.	Description
PO-9095	Paint and Coating Testing Manual

The Measurement of Appearance, 2nd Edition by Richard Hunter, Richard Harold

This second edition identifies the appearance attributes of objects and the methods for measuring them. The primary premise here is that object appearance involves not only color, but also gloss, luster, and translucency.

The first part draws from the fields of physiology and psychology and considers the eye-brain combination and the way it receives and interprets light signals. The second part deals with the numerical scales used to measure object appearance. The third part covers instruments for the measurement of the attributes of object appearance, their principles of design, and a survey of the major ones in use.

- In-depth analysis and discussion on total appearance measurement
- Great reference resource for the color research scientist or the QC technician on the production line

Table of Contents

- 1 Attributes of the Appearance of Objects
- 2 Light Sources and Illumination
- 3 Interaction of Objects with Light
- 4 The Human Observer and Visual Evaluation of Appearance
- 5 Psychophysical Scales for Appearance Measurement
- 6 Scales for Gloss and Other Geometric Attributes
- 7 The CIE Standard Observers
- 8 Uniform Color Scales
- 9 Scales for the Measurement of Color Difference
- 10 Special Scales for White Colors
- 11 Other Scales for Color Identification
- 12 Instrument Classification and Components
- 13 Instruments for the Geometric Attributes of Appearance

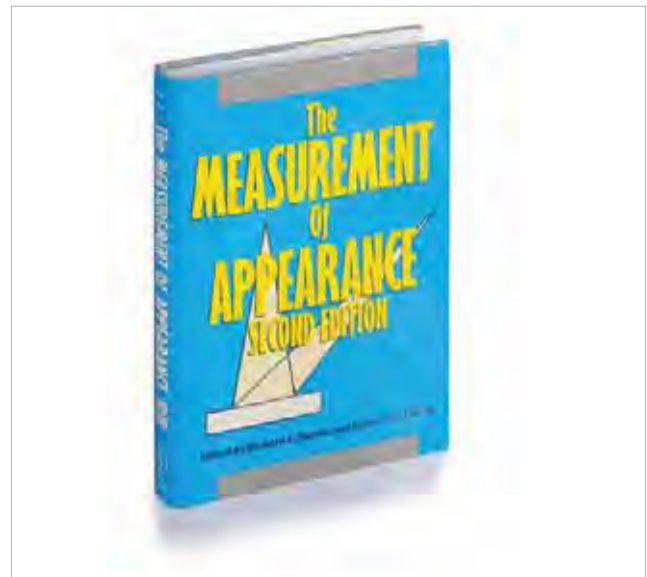

Ordering Information

Cat. No.	Description
PO-9096	The Measurement of Appearance

Introduction

Laboratory Balances

Balances are one of the most universal laboratory instruments used in virtually every lab in the world today. BYK-Gardner offers the Acculab and Sartorius balances to further enhance our ability to provide a "total solution" for the coatings and plastic laboratory market. These balances will meet the needs of virtually any lab, from routine QC checks to sophisticated R&D tasks.

The Sartorius brand provides world class performance with a durable, rugged design. BYK-Gardner offers two Sartorius balances series. The Talent Series that are compact, affordable toploading balances. The CPA Series incorporates the latest features of balance design. The product offering includes analytical balances for the most critical weighting tasks and the easy to use toploading design.

BYK-Gardner also offers the Acculab VICON series. Acculab offers an economical selection of toploading, bench, and analytical balances. They are durable and compact, ideal for industrial applications. Most of the VICON balances can be battery operated for in the field use.

When selecting a balance the capacity and the readability are the two most important specifications. The capacity is the maximum limit of the balance. The readability is the minimum unit value that can be displayed. The pan size is another feature that should be considered.



BALANCES

Appearance

Color

Balances

Technical Service

Index

Acculab Balances

Portable Toploading Balances

The VICON series balances are ideal for QC/QA labs, Industrial laboratories, research applications and more. Whether weighing multiple samples with totaled results, formulating a color, counting, percent weighing, specific gravity, or under pan weighing, Acculab has the answer in VICON. The new models feature a flip-down protective cover, stainless steel pan and back-lit display.

- Protective flip-down and removable plastic cover for shipping protection and allows stackable storage
- Unique durable design for all applications
- Applications include: Counting, Percent Weighing, Totaling, Display Hold, Specific Gravity, Mass unit conversion
- 14 Mass unit conversion (g, oz, lbs, lbs:oz, dwt, ozt, grains, Newton, carats, Tael HK/Twain/Singapore/China, user defined)
- Optional RS-232 or USB interface kit (field installable)
- Parts counting with selectable reference sample
- 9 volt Battery available on some models
- External "one button" calibration with 3 weight options
- Lock down capability
- Two years manufacturer warranty



Ordering Information

Description	Cat. No.	Cat. No.
	Voltage: 220 V	Voltage: 115 V
Acculab VIC-123*	PO-1614	PO-1580
Acculab VIC-303*	PO-1615	PO-1581
Acculab VIC-4mg*	PO-1616	PO-1582
Acculab VIC-212	PO-1617	PO-1583
Acculab VIC-612	PO-1618	PO-1584
Acculab VIC-511	PO-1619	PO-1585
Acculab VIC-711	PO-1620	PO-1586
Acculab VIC-1501	PO-1621	PO-1587
Acculab VIC-3101	PO-1622	PO-1588
Acculab VIC-5101	PO-1623	PO-1589
Acculab VIC-4kg	PO-1624	PO-1590
Acculab VIC-6kg	PO-1625	PO-1591
Acculab VIC-10kg	PO-1626	PO-1592

Technical Specifications

Readability	Capacity	Pan Size	Battery Operable (9 volt)
0.001 g	120 g	102 mm (4 in) dia.	No
0.001 g	300 g	102 mm (4 in) dia.	No
0.005 g	400 g	102 mm (4 in) dia.	No
0.01 g	210 g	102 mm (4 in) dia.	Yes
0.1 g	610 g	102 mm (4 in) dia.	Yes
0.1 g	510 g	140 x 130 mm (5.5 x 5.1 in)	Yes
0.1 g	710 g	140 x 130 mm (5.5 x 5.1 in)	Yes
0.1 g	1500 g	140 x 130 mm (5.5 x 5.1 in)	Yes
0.1 g	3100 g	140 x 130 mm (5.5 x 5.1 in)	Yes
0.1 g	5100 g	140 x 130 mm (5.5 x 5.1 in)	Yes
1 g	4100 g	140 x 130 mm (5.5 x 5.1 in)	Yes
1 g	6100 g	140 x 130 mm (5.5 x 5.1 in)	Yes
1 g	10100 g	140 x 130 mm (5.5 x 5.1 in)	Yes

Note: Optional RS-232 or USB Interface available upon special request. External calibration weights included on balance models with 710 g capacity and below.

*Round glass draft shield included.

Acculab Balances

Analytical Balances

- Advanced microprocessor for accurate weighing results and fast stabilization
- Lock-down capable
- Stainless steel weight platform
- RS 232 bi-directional interface for printer or PC connections
- Durable ABS housing
- Built-in application programs for mass unit conversion, net total formulation, % weighing and part counting
- 2 year warranty
- Simple one-button external calibration
- 20 different weighing modes
- User selectable two-unit toggling
- Pan size diameter 80 mm (3.2 in)



Acculab ALC series

Ordering Information

Description	Cat. No.	Cat. No.
	Voltage: 220 V	Voltage: 115 V
Acculab ALC-110.4	PO-0082	PO-0080
Acculab ALC-210.4	PO-0083	PO-0081

Technical Specifications

	Readability	Capacity
	0.0001 g	110 g
	0.0001 g	210 g

High Capacity Bench Scales

- 4 weighing modes plus parts counting
- Built in lock down bracket
- Large stainless steel, removable weighing pan
- Remote display
- Readings both in kg as well as lb/oz
- 2 year full warranty
- External one button calibration with three weight options
- RS232 bidirectional interface
- Low Battery, overload, underload, and audio tone indicator
- Auto shutoff
- Pan size 308 x 308 mm (12.4 x 12.4 in)



Acculab SVI

Ordering Information

Description	Cat. No.	Cat. No.
	Voltage: 220 V	Voltage: 115 V
Acculab SVI-20B	PO-1565	PO-1567
Acculab SVI-50C	PO-1566	PO-6875

Technical Specifications

	Readability	Capacity
	2 g	20 kg
	5 g	50 kg

Sartorius Balances

Talent (TE) Series

The performance specifications of the Sartorius Talent series of balances set new standards in the compact and affordable laboratory balances market. Whether you need to weigh in a lab or in the field, with a Sartorius Talent series balance you will always have just the right equipment.

- High-contrast LCD
- All-glass draft shield chamber on TE214S and Cylindrical glass draft shield on TE313S
- Bidirectional RS-232C interface port
- Automatic calibration and adjustment with an external weight, just at the press of a key
- Built-in overload protection
- 4 digital filter levels to adapt the balance to the conditions at the place of use
- Built-in application programs: weighing in percent, not-total formulation, averaging; Dynamic weighing, counting of small parts, mass conversion by toggling between two weight units
- ISO / GLP-compliant printing capability (only in conjunction with PO-2023 data printer)
- Battery-operable on some models (8 + AA 1.5 Volt batteries)



Ordering Information

Description	Cat. No.	Cat. No.
	Voltage: 220 V	Voltage: 115 V
Sartorius TE214S	PO-1983	PO-2000
Sartorius TE313S	PO-1984	PO-2001
Sartorius TE612	PO-1985	PO-2002
Sartorius TE1502S	PO-1986	PO-2003
Sartorius TE3102S	PO-1987	PO-2004
Sartorius TE2101	PO-1988	PO-2005
Sartorius TE4101	PO-1989	PO-2006
Sartorius TE6101	PO-1990	PO-2007
Sartorius TE12000	PO-1991	PO-2008

Technical Specifications

Readability	Capacity	Repeatability ($\lt; \pm \text{g}$)	Pan Size	Battery Operable
0.0001 g	210 g	0.00001 g	ø 90 mm (3.5 in)	No
0.01 g	310 g	0.001 g	ø 100 mm (3.9 in)	No
0.01 g	610 g	0.01 g	ø 116 mm (4.5 in)	Yes
0.01 g	1500 g	0.015 g	174 x 143 mm (6.9 x 5.6 in)	No
0.01 g	3100 g	0.01 g	174 x 143 mm (6.9 x 5.6 in)	No
0.1 g	2100 g	0.1 g	174 x 143 mm (6.9 x 5.6 in)	Yes
0.1 g	4100 g	0.1 g	174 x 143 mm (6.9 x 5.6 in)	Yes
0.1 g	6100 g	0.1 g	174 x 143 mm (6.9 x 5.6 in)	Yes
1.0 g	12000 g	1 g	174 x 143 mm (6.9 x 5.6 in)	Yes

Accessories

Cat. No.	Description
PO-6901	110 V Power Supply for Sartorius Talent Series Balances
PO-6903	220 V Power Supply for Sartorius Talent Series Balances
PO-2022	Battery Pack for Sartorius Talent Series Balances, rechargeable, external
PO-2023	Data Printer with statistics and time/date functions (includes RS-232 cable)
PO-2024	Ink Ribbon for Data Printer
PO-2025	Paper for Data Printer, pk. of 5 rolls
PO-2026	SartoConnect Data Transfer Software for Windows® 95/98/2000/XP
PO-2027	RS232 cable, 5ft
PO-2028	Anti-theft locking device

Sartorius Balances

Sartorius CPA Series

The CPA series of balances set new standards for design and performance. The CPA Series provide a wide range of analytical and toploading solutions combining innovative design and highly advanced weighing technology. Just one glance tells you the CPA balances offer the highest level of user-friendliness. For example, the unique new triangular weighing pan shape on many of the models provides more space than ever before. Electronic filters also help the balance adapt to ambient conditions faster and better than ever.

- 2 large tare keys – for optimal operating convenience – left- or right-handed
- ISO/GLP-compliant capability for printing weighing data and calibration/adjustment data using an optional data printer (see “Accessories”)
- Bi-directional RS-232 C interface for fast, data transfer to a printer or PC
- Easy-to-run application programs at the touch of a button: % weighing, net-total formulation, mass unit conversion by toggling, counting, and much more
- Convenient filling mode for reliable filling to target values
- New backlit display with its large digits is very easy to read
- All glass draft shield with removable side panels and hinged cover on 0.0001 g models
- IP54 international protection rating (splash-proof and protected against harmful dust particles)
- 3 year full warranty including parts and labor



Sartorius CPA Analytical Balances

- Built-in motorized calibration weight with the touch of one key – no external weights needed
- Resolution down to 0.1 mg
- Easy viewing all glass draft shield for maximum stability and flexibility
- Response time 2.0 seconds

Ordering Information

Description	Cat. No.	Cat. No.
	Voltage: 220 V	Voltage: 115 V
Sartorius CPA124S	PO-0987	PO-1025
Sartorius CPA224S	PO-0988	PO-1020
Sartorius CPA324S	PO-0989	PO-1022

Technical Specifications

Readability	Capacity	Reproducibility	Pan Size
0.0001 g	120 g	0.0001 g	80 mm* (3.1 in*)
0.0001 g	220 g	0.0001 g	80 mm* (3.1 in*)
0.0001 g	320 g	0.0001 g	80 mm* (3.1 in*)

* Triangular weighing pan shape - diameter of the inner circle

Sartorius Balances

CPA Toploading Balances

- Resolutions down to 0.001 g with capacities up to 34 kg
- Automatic calibration and adjustment at the press of a key with external weights
- Built-in motorized internal calibration
- Response time 1.5 seconds

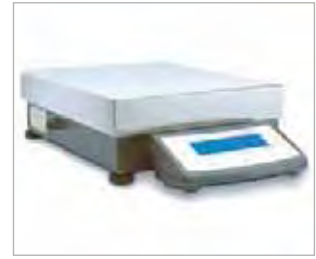

Ordering Information

Description	Cat. No. Voltage: 220 V	Cat. No. Voltage: 115 V
Sartorius CPA3235	PO-0990	PO-1072
Sartorius CPA4235	PO-0991	PO-1073
Sartorius CPA6235	PO-0992	PO-1074
Sartorius CPA2202S	PO-0993	PO-1084
Sartorius CPA4202S	PO-0994	PO-1085
Sartorius CPA5201	PO-0995	PO-1086
Sartorius CPA8201	PO-0996	PO-1088
Sartorius CPA16001S	PO-0997	PO-1094
Sartorius CPA34000	PO-0998	PO-1095
Sartorius CPA34001S	PO-0999	PO-1096

Technical Specifications

Readability	Capacity	Reproducibility	Pan Size
0.001 g	320 g	0.001 g	109 mm* (4.3 in*)
0.001 g	420 g	0.001 g	109 mm* (4.3 in*)
0.001 g	620 g	0.001 g	155 mm* (6.1 in*)
0.01 g	2200 g	0.01 g	190 x 203 mm* (7.5 x 8.0 in*)
0.01 g	4200 g	0.01 g	190 x 203 mm* (7.5 x 8.0 in*)
0.1 g	5200 g	0.1 g	190 x 203 mm* (7.5 x 8.0 in*)
0.1 g	8200 g	0.1 g	190 x 203 mm* (7.5 x 8.0 in*)
0.1 g	16000 g	0.1 g	399 x 300 mm* (15.7 x 11.8 in*)
1.0 g	34000 g	0.5 g	399 x 300 mm* (15.7 x 11.8 in*)
0.1 g	34000 g	0.1 g	399 x 300 mm* (15.7 x 11.8 in*)

*Triangular weighing pan shape – diameter of the inner circle

Accessories

Cat. No.	Description
PO-1414	Data Printer with statistics and time/date functions, serial cable
PO-1413	Paper for data printer, pk. of 5 rolls
PO-1415	Anti-theft locking device for all BP balances
PO-1435	Overnight dust cover for CP analytical balances (display head only)
PO-1436	Dust cover for balances with 4.3 in (109 mm) and 6.1 (155 mm) triangular weighing pan
PO-1437	Dust cover for balances with 7.5 x 8.0 in (190 x 203 mm) pan
PO-1438	Dust cover for balances with 15.7 x 11.8 in (399 x 300 mm) rectangular pan

BYK LC 2

Conductivity Meter

Provides measurement of electrical conductivity of solvents and solvent borne paint formulations for electrostatic spray applications.

- Stainless steel measuring cell and electrodes
- Solvent resistant housing

When measuring conductivity, liquid builds up a specific ohmic resistance to the electric current, depending on the applied voltage. The reciprocal value is the conductivity. The measured resistance depends on the geometric arrangement of the electrodes within the measuring cell. In order to be independent of the measuring cell, the measured resistance has to be divided by the cell constant "C" which yields specific resistance. The specific resistance describes the application and performance properties of electrocoating paints.

The BYK-Gardner LC 2 Conductivity Meter was developed in cooperation with the VDA (Association of German Automotive Industry) following VDA standards.

Measurement of the resistance of liquid paints is carried out in the annular passage of the measuring cell. The measuring cell consists of two separable parts. The electrodes are arranged concentrically (Cat. No. PW-1710) or parallel (Cat. No. PW-1712), thus forming an annular passage. They are insulated from each other.

The electrodes of the measuring cell are made of stainless steel, with the surface polished and therefore easy to clean. Only an absolutely clean measuring cell guarantees that the entire surface of the electrode is available for measurement. The probe is impervious and can be immersed in solvents for a short time.



Standards

ASTM	D 5682
DIN	55667

Info!

This conductivity meter works only with solvents and solvent based paints. The presence of water will cause electrolysis and results in false readings. Use the BYK LC-3 or BYK LC-4 for water-borne systems

Ordering Information

Cat. No.	Description
PW-1722	Conductivity Meter BYK LC 2 (w/o measuring cell)
PW-1710	Conductivity tube measuring cell
PW-1712	Conductivity plate measuring cell
PW-1713	Space holder for plate measuring cell

Note: BYK LC 2 Meter and measuring cell must be ordered separately. Also please order PW-1713 space holders when ordering the PW-1712 measuring cell

Info!

For Preventive Maintenance see page 272.

Technical Specifications

Measuring Range	Measuring Voltage	Power Supply	Dimensions
50 kΩ - 19.99 MΩ, 20 µS - 0.05 µS	15 V (AC/DC)	9 V battery	105 x 55 x 145 mm (4.1 x 2.2 x 5.7 in)
Diameter	Width	Cell Length	Cell Constant C
42 mm (1.6 in)		250 mm (9.8 in)	7.55 x 10 ⁻³ cm ⁻¹
	50 mm (1.9 in)	380 mm (14.5 in)	7.55 x 10 ⁻³ cm ⁻¹
			Package of 100



Very easy to clean – Measuring Cell

BYK LC 3 and BYK LC 4

Conductivity Meters

Conductivity meters for water based coatings systems.

- LC 3 handheld conductivity meter with software and data transfer
- LC 4 handheld conductivity meter with touch-screen, easy-to use, rugged design

More and more water-based paint systems are used in electrostatic spray applications. The BYK LC 3 and BYK LC 4 instruments fulfill the need to measure conductivity of water-based paint systems. The LC 3 and LC 4 use reliable TetraCon electrodes that are easy to clean and have automatic temperature compensation. Conductivity is measured by making a measurement of the electrical resistance. The simplest kind of measuring cell used consists of two similar electrodes. An alternating voltage applied to one of the electrodes causes the ions in the solution to migrate towards the electrodes. The more ions in the solution, the greater the current which flows between the electrodes. The instrument measures the current and uses Ohm's law to calculate first the conductance of the solution and then – by taking the cell data into account – the conductivity.

- Water resistant
- Battery operated with up to 500 hours of continuous operation
- Roughed electrode design
- Industry standard for water analysis



BYK LC 3



BYK LC 4

Standards

DIN 55667

Info!

For Preventive Maintenance see page 272.

Ordering Information

Cat. No.	Description
PW-1745	Conductivity Meter BYK LC 3
PW-1740	Conductivity Meter BYK LC 4

Technical Specifications

Dimensions	Power Supply	Measuring Range
185 x 85 x 32 mm (72.8 x 33.5 x 12.6 in)	2 x 1.5 V AA Batteries	0 - 1999 MΩ*cm 0 -1999 μS/cm
172 x 80 x 37 mm (67.7 x 31.5 x 1.46 in)	4 x 1.5 V AA batteries	0 - 1999 MΩ*cm 0 -1999 μS/cm

Ordering Information

Cat. No.	Description
PW-1741	TetraCon electrode for LC 3
PW-1746	TetraCon electrode for LC 4
PW-1747	Conductivity Standard 1400 μS
PW-1742	Software for LC 3

Accessories

Diameter	Cell Length	Cell constant C
15.3 mm	120mm	4.75 * 10 ⁻¹ cm
15.3 mm	40 mm	4.75 * 10 ⁻¹ cm

LC 3 Comes complete with:

LC 3; electrode; software; conductivity standard solution; carrying case

LC 4 Comes complete with:

LC 4; electrode; conductivity standard solution; carrying case

Density Cups

Density is defined as weight per unit volume at a specified temperature. Density cups are used for quality control because errors in paint composition will result in different density readings. Density cups have also been described as liquid pycnometers.

BYK-Gardner Density cups use a cylindrical shape which provides a large opening for easy filling, emptying, and cleaning. The tightly fitted stainless steel covers have an upward slope to a small hole in the center to allow excess sample material to be expelled without entrapping air bubbles, which increases accuracy.



Made of corrosion resistant steel

ASTM Cup Volume

In North America the term "weight per gallon" (wpg) is used in the coating industry. The volume of the weight per gallon cup is such that, at a specified temperature, the numerical value in grams of water that it can hold is equal to, or ten times greater than, the numerical value in pounds of water that a gallon container can hold. A US gallon of water weighs 8.32 pounds, thus a Regular US weight per gallon cup holds ten times this amount in volume, 83.2 ml. When taking a measurement, the cup and the sample must be brought to the same equilibrium temperature (usually 25 °C or 77 °F).

ISO Cup Volume

ISO Cups are machined from stainless steel, using the metric system. The cups hold a defined volume of liquid of 50 or 100 ml. A tolerance of 0.1 % is guaranteed. Testing is carried out in accordance with ISO at 23 °C ± 2 °C.

Standards

ASTM	D 333, D 1475, D 2805
BS	3900 A 19
DIN	53217
ISO	2811

Procedure

- Weigh cleaned density cup empty and record weight
- Temper density cup and test liquid (Refer to appropriate test standard for proper temperature)
- Fill density cup
- Put cover on without tilting
- Avoid air bubbles
- Remove overflowing liquid carefully with absorbent cloth
- Weigh filled density cup
- Calculate density

Determination of Density and Sefic Gravity

	Volume (ml)	Density	Specific Gravity (relative to water)
U.S. Standard Cup	83.2	[weight full (g) - weight empty (g)] x 0.1 = lbs/gal	[weight full (g) - weight empty (g)] x 0.01202 = specific gravity
U.S. (Baltimore) Midget Cup	8.32	[weight full (g) - weight empty (g)] = lbs/gal	[weight full (g) - weight empty (g)] x 0.1202 = specific gravity
ISO Cup	100 or 50	[weight full (g) - weight empty (g)] : volume (ml) = g/cm ³	specific gravity = density
British imperial Cup	100	[weight full (g) - weight empty (g)] : volume (ml) = g/cm ³	specific gravity = density

1 ml = 1 cm³; 1 liter = 1000 ml; specific gravity of water = 1 g/ml
 1000 ml = 0.2646 U.S. gallon; 1 U.S. gallon = 3.785 liter

Density Cups

BYK-Gardner offers five different density cups:

- Regular US Cup with a volume of 83.2 ml
- Midget cup with a volume of 8.32 ml. The Midget cup offers a direct conversion to lbs/gal, eliminating the need for dividing the full cup weight by 10.
- ISO standard size with a volume of 100 ml and 50 ml.
- British Imperial Standard size with a volume of 100 ml.

The ISO cups come with a test certificate or calibration certificate. The test certificate confirms the cup's dimensions comply with the approved specifications. The certificate is issued by an independent institute, Eichschein, that tests the cup's liquid volume compliance.



ISO Density Cups

Ordering Information

Cat. No.	Description
PV-9654	Regular US Cup
PV-9655	Regular US Cup with tare weight
PV-9664	Midget Cup with tare weight
PV-9658	Imperial Cup
PV-9659	Imperial Cup with tare weight
PW-1130	ISO Cup 100 ml with test certificate
PW-1131	ISO Cup 100 ml with calibration certificate
PW-1140	ISO Cup 50 ml with test certificate
PW-1141	ISO Cup 50 ml with calibration certificate

Technical Specifications

	Dimensions	Shipping Weight
	38 x 76 mm (1.5 x 3 in)	0.45 kg (1 lbs)
	38 x 76 mm (1.5 x 3 in)	0.45 kg (1 lbs)
	25 x 32 mm (1.0 x 1.25 in)	0.23 kg (0.5 lbs)
	38 x 89 mm (1.5 x 3.5 in)	0.23 kg (0.5 lbs)
	38 x 89 mm (1.5 x 3.5 in)	0.45 kg (1 lbs)
	52 x 62 mm (2.05 x 2.44 in)	0.45 kg (1 lbs)
	52 x 62 mm (2.05 x 2.44 in)	0.45 kg (1 lbs)
	52 x 34 mm (2.05 x 1.34 in)	0.23 kg (0.5 lbs)
	52 x 34 mm (2.05 x 1.34 in)	0.45 kg (1 lbs)

Fineness of Grind Gages

Also called grind gages and Hegman gages. Many types of solid materials must be ground or milled into finer particles for dispersion in appropriate liquid vehicles. The physical properties of the resulting dispersions, often called "grinds", depend not only on the actual size of the individual particles, but also on the degree to which they are dispersed.

The Fineness of Grind Gage is used to indicate the fineness of grind or the presence of coarse particles or agglomerates in a dispersion. It does not determine particle size or particle size distribution.

Grind gages are used in controlling the production, storage, and application of dispersion products produced by milling in the paint, plastic, pigment, printing ink, paper, ceramic, pharmaceutical, food, and many other industries.

The Fineness of Grind Gage is a flat steel block in the surface of which are two flat-bottomed grooves varying uniformly in depth from a maximum at one end of the block to zero near the other end. Groove depth is graduated on the block according to one or more scales used for measuring particle size.

Most gages will have one scale marked in either mils or microns.

1 mil = 25.4 microns

1 mil = 0.001 inch

1 micron, μm = 0.001 mm or 10^{-6} m

The Hegman scale or National Standard scale may be abbreviated "NS" on the gage. The scale ranges from 0 to 8 with numbers increasing as the particle size decreases.

0 Hegman = 4 mil/100 micron particle size

4 Hegman = 2 mil/50 micron particle size

8 Hegman = 0 mil/0 micron particle size

BYK-Gardner offers a wide variety of grind gages varying in scales, number of grooves, length and width of grooves and size of the block.

Comes in a reusable storage box to prevent damage.

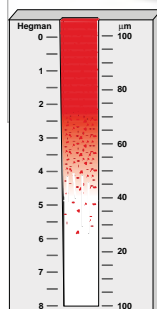
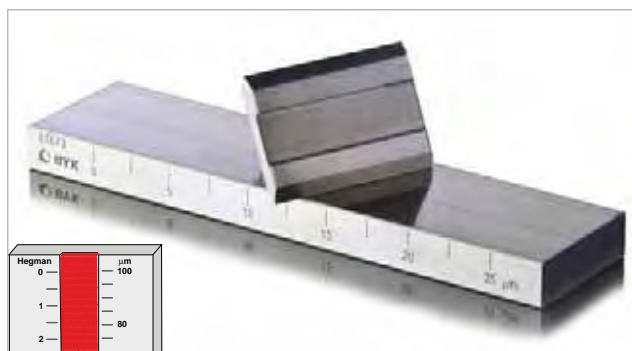

Made of corrosion resistant stainless steel

Standards

ASTM	D 333, D 1210, D 1316
ISO	1524
FTMS	141a, Method 4411.1

Procedure

Place a slight excess of sample in the deep end of the groove, and with the straight-edge scraper provided, draw the sample toward the shallow end of the groove. Ratings are in terms of the point on the scale where the oversize particles, or furrows made by them, first appear in substantial concentration.

Ordering Information

Cat. No.	Description
PD-1518	Replacement Scraper, SS

Accessories

	Net Weight	Shipping Weight
	0.12 kg (0.26 lbs)	0.45 kg (1 lbs)

Certified For Certification Service see page 269.

Fineness of Grind Gages

Ordering Information

Cat. No.	Description
PD-1509	Grindometer 15*
PD-1510	Grindometer 25*
PD-1511	Grindometer 50*
PD-1512	Grindometer 100*
PD-2500	Gage No. 25
PD-2501	Gage No. 45
PD-2502	Gage No. 65
PD-2503	Gage No. 5251
PD-2504	Gage No. 5252
PD-2505	Gage No. 5254
PD-2506	Gage No. 54
PD-2507	Gage No. 52
PD-2508	Gage No. 51
PD-2509	Gage No. 6251 - G1
PD-2510	Gage No. 6252 - G2
PD-2511	Gage No. 6254 - G3
PD-2512	Gage No. PD-250
PD-2513	Gage No. PB-20
PD-2515	Gage No. SI 1

Technical Specifications

Path Size	No. of Paths	Scales	Range	Dimensions	Net Weight
13 x 130 mm	2	Micron/ Hegman	0 - 15 8 - 6.8	169 x 42 x 13 mm	1 kg (2.2 lbs)
13 x 130 mm	2	Micron/ Hegman	0 - 25 8 - 6	169 x 42 x 13 mm	1 kg (2.2 lbs)
13 x 130 mm	2	Micron/ Hegman	0 - 50 8 - 4	169 x 42 x 13 mm	1 kg (2.2 lbs)
13 x 130 mm	2	Micron/ Hegman	0 - 100 8 - 0	169 x 42 x 13 mm	1 kg (2.2 lbs)
0.5 x 2 in	2	Hegman/ Mils	8 - 0 0 - 5	0.5 x 2.5 x 4.75 in	0.9 kg (2.0 lbs)
0.5 x 4 in	2	Hegman/ Mils	8 - 0 0 - 5	0.5 x 2.5 x 6.75 in	1.6 kg (3.5 lbs)
0.5 x 6 in	2	Hegman/ Mils	8 - 0 0 - 5	0.75 x 2.5 x 8 in	1.8 kg (4.0 lbs)
0.5 x 5 in	2	Microns/ Mils/ Hegman	0 - 25 0 - 1 8 - 6	0.5 x 2.5 x 6.75 in	1.8 kg (4.0 lbs)
0.5 x 5 in	2	Microns/ Mils/ Hegman	0 - 50 0 - 2 8 - 4	0.5 x 2.5 x 6.75 in	1.8 kg (4.0 lbs)
0.5 x 5 in	2	Microns/ Mils/ Hegman	0 - 100 0 - 4 8 - 0	0.5 x 2.5 x 6.75 in	1.8 kg (4.0 lbs)
2 x 5 in	1	Hegman/ Microns	8 - 0 0 - 100	0.75 x 3.5 x 7.5 in	3.6 kg (8.0 lbs)
2 x 5 in	1	Hegman/ Microns	8 - 4 0 - 50	0.75 x 3.5 x 7.5 in	3.6 kg (8.0 lbs)
2 x 5 in	1	Hegman/ Microns	8 - 6 0 - 25	0.75 x 3.5 x 7.5 in	3.6 kg (8.0 lbs)
1 x 6.25 in	2	Hegman/ Micron/ NPIRI	8 - 6 0 - 25 0 - 10	1 x 3.5 x 9.5 in	5.0 kg (11 lbs)
1 x 6.25 in	2	Hegman/ Microns/ NPIRI	8 - 4 0 - 50 0 - 20	1 x 3.5 x 9.5 in	5.0 kg (11 lbs)
1 x 6.25 in	2	Hegman/ Microns/ NPIRI	8 - 0 0 - 100 0 - 30	1 x 3.5 x 9.5 in	5.0 kg (11 lbs)
1 x 6.25 in	2	Microns/ Microns	0 - 50 0 - 250	1 x 3.5 x 9.5 in	5.0 kg (11 lbs)
0.5 x 8 in	2	Mils	0 - 20	1 x 2.5 x 9.5 in	3.0 kg (6.5 lbs)
0.5 x 6 in	2	Microns/ NPIRI	0 - 25 0 - 10	1 x 1.5 x 8 in	1.6 kg (3.5 lbs)

Comes complete with:

Grind block
Scraper
Reusable Storage Case

*Designed to comply with ISO method 1524

Drying Time Recorder

The various stages of drying and curing that occur in films are easy to detect but difficult to define in terms of chemical and physical principles. In order to evaluate them objectively it is necessary to use instrumentation under controlled conditions.

BYK-Gardner offers the versatile BK Drying Time Recorder to help quantify the various stages of film curing and drying, deliver reproducible results, and guarantee highest efficiency:

- Simultaneous testing of 6 samples – saves time
- Three different speeds: 6-12-24 hrs – for any application

Procedure

- Coat the glass strip using the film applicator and holder (order separately below)
- The drying of the paint starts here. If you prepare multiple panels at different times note the time when the draw down was made and add it to the time the sample is in the recorder
- Place needles on the sample strip and select the speed by adjusting the speed switch
- Turn the recorder on – the unit will automatically switch off at the end of the test
- Evaluate the results (see figure at right)

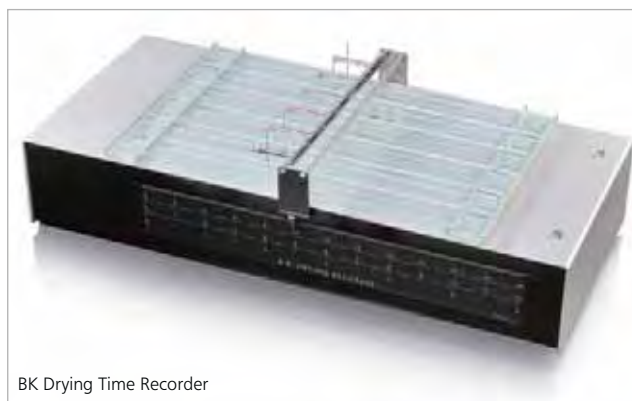

BK Drying Time Recorder

Typical Test Result

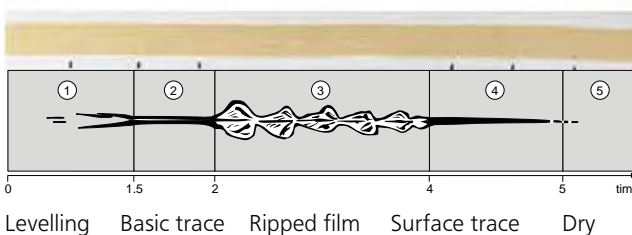

Levelling Basic trace Ripped film Surface trace Dry

Standards

ASTM D 5895

Ordering Information

Cat. No.	Description
PM-2711	Drying Time Recorder
PM-2710	Drying Time Recorder

Comes complete with:

Drying Time Recorder
6 Glass panels, 6 Needles

Note: This Drying Time Recorder can only be used at room temperature

Technical Specifications

Power Supply	Dimensions	Shipping Weight
115 VAC/60 Hz	49 x 25 x 11 cm (19.3 x 9.8 x 4.3 in)	4.7 kg (10.4 lbs)
230 VAC/50 Hz	49 x 25 x 11 cm (19.3 x 9.8 x 4.3 in)	4.7 kg (10.4 lbs)

Ordering Information

Cat. No.	Description
PM-2730	Glass Panels
PM-2735	Needles, stainless steel
PM-2720	Film Application Holder
PM-2723	Film Applicator
PM-2736	Weights

Accessories

Description
Set of 12
Set of 12; 1 mm dia. with rounded tips
For coating glass panels. Use with PM-2723; dimensions 36 x 4 x 2 cm (14 x 1.6 x 0.8 in)
For Cat.No. PM-2720; stainless steel, single path, gap depth (38 and 76 µm)
5 grams; set of 6

Info!

For Preventive Maintenance see page 272.



Permeability Cups

The permeability of a coating to water vapor is measured by suspending a free film of the material across the top of a wide shallow cup. Then, in a controlled environment, a desiccant is used to draw water vapor through the film into or out of the cup. Weight loss or gain of the cup's content over a specified period is used to determine the rate of vapor transmission through the film. The permeability of a film to many other substrates in the gaseous state can be tested in a similar fashion.

Permeability Cup

The BYK-Gardner Permeability Cup is a shallow cylinder with a threaded flange, flat retaining washer and threaded ring cover. Rubber gaskets are used to tightly seal the specimen between the cup and the ring cover. The cup and cover are knurled for easier handling.

Two different size cups are available:

- Large 25 cm² cup meets the ASTM standard
- Small 10 cm² cup allows the use of a smaller specimen and less desiccant

Procedure

During a test, vapor passes from the cup through the film specimen to an open container of desiccant or other absorbent material in a controlled environment. The permeability cup and other container are sealed together in a larger container to provide control of the vapor pressure.

Testing may also be set up to allow passage of vapor from a solution in the open container through the test film to a desiccant or other absorbent material within the permeability cup.

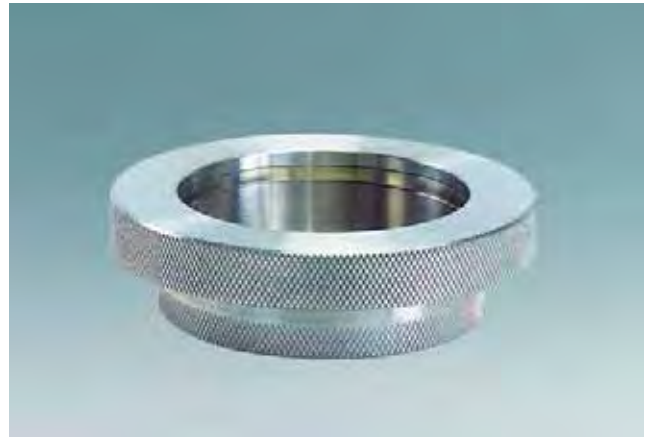

Standards

ASTM	D 1653
ISO	7783-2

Ordering Information

Cat. No.	Description
PO-2300	Small BYK-Gardner Permeability Cup
PO-2301	Large BYK-Gardner Permeability Cup

Technical Specifications

Exposed Area	Dimensions	Net Weight
10 cm ²	6.3 x 2.5 cm (2.5 x 1 in)	76 g (2.7 oz.)
25 cm ²	8.1 x 2.5 cm (3.25 x 1 in)	129 g (4.6 oz.)

Introduction

Film thickness gages are among the most essential instruments used in the coatings industry. The generally accepted ratio of dry film to wet film thickness of most coatings is:

$$\text{Dry Film} = \frac{\text{Wet Film} \times \% \text{ Vol. Solids of Coating}}{100}$$

Errors in film thickness estimates result in a needless expenditure of time, material, and money. If a film is too thin, its hiding power and protective capabilities may be inadequate and time will be lost in recoating the surface. If a coating application results in a dry film being excessively thick, failures such as cracking, flaking, or excessive drying time may result. Also, there is the cost factor of applying too much coating.

Wet Film Thickness

In order to control the process variables when applying a coating to a surface, it is often desirable that measurements are made to determine thickness while the coating is still wet. Wet film measurement is done by devices based upon the shape of the surface area, and the expected range of thickness. In addition, wet film measurements are also very useful for coating systems where the dry film thickness can only be measured destructively.

Dry Film Thickness

Measuring coating thickness accurately maximizes quality and minimizes material costs. Dry film checking can be carried out non-destructively or destructively, for e.g. multi-layer applications.

Non-Destructive Tests

Electronic type gages with digital display are used. These instruments measure the thickness of insulating coatings on non-magnetic, metal substrates (NFe) and of non-magnetic coatings on steel or iron (Fe). Two different measurement principles are being used:

- Magnetic inductive measurement on Fe-substrates
- Eddy-current measurement on NFe-substrates
- Examples for insulating and non-magnetic coatings: paint, plastic, enamel, chrome, copper, zinc, powder coatings, electro-plating, galvanizing, rubber, hard chrome, sprayed metal, ceramics
- Examples for NFe substrates: aluminum, copper, brass, non-magnetic steel, bronze, magnesium, zinc
- Examples for Fe substrates: steel, cast iron



FILM THICKNESS

Measurement Techniques

Magnetic Induction (Fe):

This method uses two magnet coils where the magnetic field changes if brought near a ferromagnetic substrate. The change of the magnetic field is related to the distance between the probe and the substrate – thus to film thickness. The second of the two coils takes up the magnetic current. This magnetic coupling between both magnetic poles is the measure used for film thickness. In addition, electromagnetic induction uses alternating magnetic fields, generated by a ferromagnetic coil. Today, highly precise Hall-effect semiconductors are integrated in modern ferrous probes.

Eddy-Current Measurements (NFe):

This method is required when measuring non-conductive coatings (NFe) on non-ferromagnetic substrates (NFe) such as e.g. aluminum. The eddy-current measurement method is based on the principles of the electromagnetic induction technique. A coil of fine wire conducting a high frequency alternating current sets up a magnetic field which changes its direction according to the alternating current connected. When the NFe probe is brought near a conductive substrate, eddy currents are generated, which affect the magnetic field of the coil. The effect depends on the characteristics of the substrate and the distance between the probe and substrate – i.e. film thickness.

Choosing the Right Probe

It is important to choose the appropriate test method for each application. The following table shows the recommended test methods for different combinations of substrate and coating. The type of substrate is very easily established with a magnet. In case the magnet adheres to the substrate, an Fe substrate is concerned.

Coating	Substrate								
	Aluminium	Brass	Bronze	Copper	Steel	Magnesium	Stainless	Titanium	Zinc
Aluminium	--	--	--	--	F	--	--	--	--
Anodizing	N	--	--	--	F	N	--	--	--
Brass	--	--	--	--	F	--	--	--	--
Bronze	--	--	--	--	F	--	--	--	--
Cadmium	--	--	--	--	F	--	--	--	--
Chrome-hard	--	--	--	--	F	--	--	--	--
Copper	--	--	--	--	F	--	--	--	--
Eloxal	N	--	--	--	--	--	--	--	--
Epoxy	N	N	N	N	F	--	N	--	N
Galvanizing	--	--	--	--	F	--	--	--	--
Lacquer	--	--	--	--	F	--	N	--	N
Molybdenum disulphide	--	--	--	--	F	--	N	--	--
Nickel-electroless	--	--	--	--	F*	--	--	--	--
Paint	N	N	N	N	F	N	N	N	N
Plastic	N	N	N	N	F	N	N	N	N
Rubber	N				F				
Tin					F				
Varnish	N	N	N	N	F	--	--	--	--

N = non-ferromagnetic; F = ferromagnetic

* only if nickel content is 8% or greater

Wet Film Thickness Gages

Measuring the film thickness of freshly applied coatings in the wet stage is very important. On one hand, film thickness influences the quality of a product; on the other hand, applying too much coating can be expensive. Depending on the application method, it is advisable to measure wet film thickness. For measuring wet film thickness, BYK-Gardner offers a comb or "interchemical gage".

Comb Type Gage

The comb is a ruler-shaped gage with two supports at each of its six sides, having tabs of varying lengths.

- Hexagonal shape made of corrosion resistant stainless steel

Procedure:

- For measuring, push the comb gage perpendicularly into the film using the measuring range that corresponds to the expected film thickness
- Remove the comb gage from the coating
- The wet film thickness will fall between the clearance of the shortest tab that is wet and the clearance of the next shortest dry tab
- The plastic comb gage may be used up to 60 °C (140 °F)



Ordering Information

Cat. No.	Description
PG-3501	Film Thickness Comb Gage
PG-3505	Film Thickness Comb Gage
PG-3507	Film Thickness Comb Gage
PG-3510	Comb Gage made of plastic, set of 100

Technical Specifications

Measuring Range	Outer Diameter
25 - 2000 μm	90 mm
1 - 80 mils	90 mm
5 - 150 Mm (0.2 - 6 mils)	58 mm
25 - 2000 μm (1 - 80 mils)	90 mm

Paint and Coating Testing Manual – The guide for the coating technologist

A comprehensive guide for all coatings related topics

- Current industry regulations
- The main polymeric species, colorants, special pigments, extenders, and additives used in the coatings industry today
- Physical, mechanical, and optical testing properties
- Testing instruments used in the industry
- Environmental testing procedures
- Analysis of paint and paint defects
- Over 950 pages of values information
- ASTM and international standards

Everything you need to know about testing paint, coatings, and raw materials. Only available in English, see page 170.



Interchemical Gages

Wet Film Thickness Gages

The Interchemical Thickness Gage has long been the standard for measuring wet film thickness in the coatings industry. (U.S. Patent No. 3, 128, 558).

BYK-Gardner offers three basic models in various ranges. All models have an accuracy of +/- 0.0001 in (2.5 µm) or 2.5% full scale, whichever is greater.

The gage consists of an eccentric inner wheel, supported by two larger outer concentric wheels. At a specific point, the inner wheel touches and picks up wet film when the gage is rolled on the coated surface. This critical clearance may be read on a rotating scale.



Model S – General Use

- For general use (original Interchemical design)
- Scale is stamped on the outside of the metal wheel; no rotating scale is used

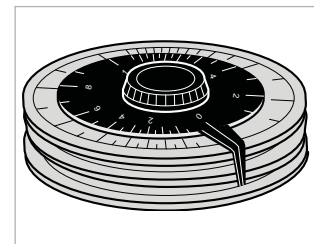
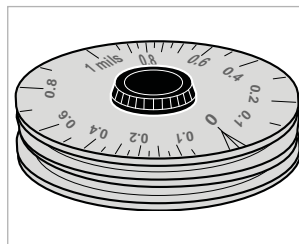

Model R * – Rotating Scale

- For critical measurements
 - Has a rotating scale to facilitate accurate gage reading
 - No black plate on the opposite side of the wheel is present
- * U.S. Patent No. 3,128,558

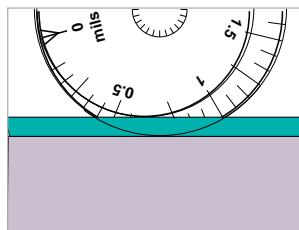

Model L * – Low Inertial with Rotating Scale

- For very thin coatings and accurate measurements on moving surfaces
 - Inside is hollowed out; very lightweight – only 0.3 lb
 - Black rotating scale to minimize reading errors
- * U.S. Patent No. 3,128,558

Standards	
ASTM	D 1212
ISO	2808

Gage Holder

The gages may be held between the thumb and forefinger to take a reading, or it may be inserted into the gage holder. This holder is widely used to measure coatings safely on moving surfaces such as high-speed press rollers. It can also be used on stationary, flat, or curved surfaces since the holder makes it easier to exert a steady, even force on the gage.

Ordering Information

Cat. No.	Description
PG-6580	Holder for Inmont Gages

Accessories

Dimensions	Net Weight	Shipping Weight
0.2 kg (0.4 lbs)	6.4 x 5.1 x 17.8 cm (2.5 x 2 x 7 in)	0.5 kg (1.0 lbs)

Interchemical Gages

Ordering Information

Cat. No.	Description
PG-6500	Inmont Film Gage L*
PG-6958	Inmont Film Gage L*
PG-6959	Inmont Film Gage R*
PG-6511	Inmont Film Gage R*
PG-6512	Inmont Film Gage R*
PG-6513	Inmont Film Gage R*
PG-6514	Inmont Film Gage R*
PG-6960	Inmont Film Gage S
PG-6961	Inmont Film Gage S
PG-6962	Inmont Film Gage S
PG-6963	Inmont Film Gage S
PG-6964	Inmont Film Gage S
PG-6515	Inmont Film Gage L*
PG-6965	Inmont Film Gage L*
PG-6516	Inmont Film Gage R*
PG-6541	Inmont Film Gage R*
PG-6542	Inmont Film Gage R*
PG-6543	Inmont Film Gage R*
PG-6544	Inmont Film Gage R*
PG-6550	Inmont Film Gage S
PG-6551	Inmont Film Gage S
PG-6552	Inmont Film Gage S
PG-6553	Inmont Film Gage S
PG-6554	Inmont Film Gage S

Comes complete with:

Inmont Film Gage
Operating instructions

Note: Holder must be ordered separately

Info!

Certification available.
Please contact Customer Service for pricing.

Technical Specifications

Scale	Full Scale Calibration Range	Recommended	Resolution
English	0 - 1 mil	0.2 - 0.05 mil	0.05 mil
English	0 - 2 mil	0.4 - 1.6 mil	0.2 mil
English	0 - 1 mil	0.2 - 0.8 mil	0.05 mil
English	0 - 2 mil	0.4 - 1.6 mil	0.1 mil
English	0 - 4 mil	0.8 - 3.2 mil	0.2 mil
English	2 - 12 mil	3 - 11 mil	0.5 mil
English	10 - 30 mil	11 - 20 mil	1.0 mil
English	0 - 1 mil	0.2 - 0.8 mil	0.05 mil
English	0 - 2 mil	0.4 - 1.6 mil	0.1 mil
English	0 - 4 mil	0.8 - 3.2 mil	0.2 mil
English	2 - 12 mil	3 - 11 mil	0.5 mil
English	10 - 30 mil	11 - 20 mil	1.0 mil
Metric	0 - 20 µm	4 - 16 µm	1 µm
Metric	0 - 40 µm	8 - 32 µm	2 µm
Metric	0 - 20 µm	4 - 16 µm	1 µm
Metric	0 - 40 µm	8 - 32 µm	2 µm
Metric	0 - 100 µm	20 - 80 µm	5 µm
Metric	50 - 250 µm	70 - 230 µm	10 µm
Metric	200 - 700 µm	250 - 650 µm	25 µm
Metric	0 - 20 µm	4 - 16 µm	1 µm
Metric	0 - 40 µm	8 - 32 µm	2 µm
Metric	0 - 100 µm	20 - 80 µm	5 µm
Metric	50 - 250 µm	70 - 230 µm	10 µm
Metric	200 - 700 µm	250 - 650 µm	25 µm
Dimensions	5 cm dia x 2.5 cm (2 in dia x 1 in)		
Net Weight	Model L: 0.1 kg (0.3 lbs) / Model R/S: 0.2 kg (0.5 lbs)		
Shipping Weight	Model L/R/S: 0.34 kg (0.75 lbs)		

* U.S. Patent No. 3,128,558

byko-test 4200 / 4500

Dry Film Thickness Gages

The byko-test 4500 film thickness gauge allows for the measurement of a variety of products. No cable exchange or calibration is needed when changing from a ferrous to a non-ferrous substrate. The large LCD display and 10 second retention of the last measured value makes the byko-test 4500 easy to use.

- Compact pocket size instrument
- One-handed design for ease of use
- Integrated, non-wearing ruby probe tip
- Switchable from mils to microns
- Strong, wear resistant ruby probe tip
- V-groove in probe for positioning on cylindrical parts
- Acoustic signal for measurement confirmation

New!

New Features

- Automatic substrate recognition
- Extended measuring range
- Faster measuring speed
- Graphic display with backlight



Ordering Information

Cat. No.	Description
PG-3635	byko-test 4500 Fe/NFe
PG-3634	byko-test 4200 Fe

Cat. No. PG-3635 Comes complete with:

byko-test 4500
Carrying case with zero plates
Operating instructions
Calibration Certificate
2 AA batteries

Cat. No. PG-3634 Comes complete with:

byko-test 4200
Carrying case with zero plate
Operating instructions
Calibration Certificate
2 AA batteries

Standards

ASTM	B 499, D 1186, D 1400, D 7091
BS	3900 Part C5, 5411 (3,11)
DIN	50981, 50984
ISO	2360, 2808, 2178

Technical Specifications

Substrate Fe	steel or iron
Substrate NFe	non-magnetic metals: aluminum, copper, brass, zinc, stainless steel
Measuring Range	Fe: 0 - 3000 μm (0 - 120 mils) NFe: 0 - 3000 μm (0 - 120 mils)
Accuracy	$\pm (2\mu\text{m} + 3\%*)$, from 0 - 999 μm (0 - 39 mils)
Minimum Curvature	5 mm (0.2 in) convex; 30 mm (1.2 in) concave
Minimum Substrate Thickness	Fe: 0.2 mm (0.01 in), NFe 0,05 mm (0,002 in)
Minimum Area of Measurement	10 x 102 mm (0.4 x 0.4 in)
Operating Temperature	0 - 60 °C (32 - 140 °F)
Power Supply	2 x AA Batteries
Dimensions	100 x 62 x 27 mm (4 x 2.5 x 1.1 in)
Weight	approx. 130 g (4.6 oz) with battery

* of measured value

byko-test 8500

The byko-test 8500 film thickness gage has a modular design to accommodate a wide range of applications. Multiple sensor probes are available for maximum flexibility. Coating thickness can be measured on a wide variety of metal substrates: iron, steel, copper, aluminum, zinc, brass, and titanium.

- Illuminated graphical display and keypad
- Easy to use menu
- One-hand operation
- Flip display by 180 degrees
- Multi-language support
- Modular design with exchangeable probes
- Automatic and user specific calibration
- Wireless data transfer to PC (optional)
- Durable, wear-resistant ruby probe tip
- V-groove in probe for measuring cylindrical parts
- Acoustic signal for measurement confirmation

Two models are available for different requirements:

Basic version

With all important functions needed to measure and evaluate the thickness of non-metal layers on metal substrates. Basic statistical functions, memory for up to 100 readings, optional wireless connection to a PC and data transfer to Excel.

Premium version

Enhanced memory functions, batch measurement with up to 13000 measurements in 200 batches, memory for up to 100 custom calibrations, software and wireless data transfer, average zero adjustment for rough substrates, single and continuous measurement modes included.

Ordering Information

Cat. No.	Description
PG-3661	byko-test 8500 basic Fe
PG-3662	byko-test 8500 basic NFe
PG-3663	byko-test 8500 basic Fe/NFe
PG-3664	byko-test 8500 premium Fe
PG-3665	byko-test 8500 premium NFe
PG-3666	byko-test 8500 premium Fe/NFe

byko-test 8500 basic Comes complete with:

Instrument ; 2 mm Standard Sensor; 2 Mignon-Batteries 1.5V (AA) (Alkaline); Adapter cable for external sensor; Instruction manual; Certificate for sensor; softbag; carrying case; Zero plates

byko-test 8500 premium Comes complete with:

Instrument; 2 mm Standard Sensor; 2 Mignon-Batteries 1.5V (AA) (Alkaline); Adapter cable for external Sensor; Instruction manual; Certificate for sensor; Softbag; Carrying Case; Zero plates; Software; USB-wireless connector incl. Elongation cable



Standards

ASTM	B 499, D 1400, D 1186, D 7091
BS	3900 Part C5, 5411 (3,11)
DIN	50981, 50984
ISO	2178, 2360, 2808, 19840

Technical Specifications

Text	
Resolution	0.1 µm 0 - 99.9 µm, 1 µm 100 - 999 µm 0.01 mm ≥ 1.00 mm
Accuracy	± (1 µm + 2%*) 0 - 2000 µm ± 3,5%* > 2000 µm (* percent of measurement value)
Measurement Range	0 - 2000 Mm (0 - 80 mils)
Minimum Area of Measurement	Fe: 20 x 20 mm (0.79 x 0.79 in) NFe: 20 x 20 mm (0.79 x 0.79 in)
Minimum Curvature	convex 5 mm (0.20 in); concave 30 mm (1.2 in)
Minimum Substrate Thickness	Fe: 0.2 mm (0.008 in) NFe: 0.05 mm (0.002 in)
Communication	Wireless Connection 2.4 GHz, distance max. 10 m
Temperature Range	Storage -10°C (14°F) to 60°C (140°F) Usage 0°C (32°F) to 50°C (122°F)
Power Supply	2 x Mignon-Batteries (AA) 1.5V Alkalior rechargeable-Batteries (AA) 1.2V
Dimensions	124 mm x 67 mm x 33 mm (4.9 x 2.6 x 1.3 in)
Weight	ca. 120g (instrument with batteries and probe)

Wireless Sensor

Wireless Sensor for areas difficult to access with internal and external sensors. The new wireless sensor for the byko-test 8500 is built for all applications requiring a small sensor without direct connection to the instrument.

byko-test 8500 wireless sensor has a long lasting rechargeable batteries, a broad reach of 12 m and is available as single or dual sensor.

Thickness Standards

For control and inspection purposes individual shims or sets of thickness standards are available, see page 195.



Certified Calibration Shims

These plastic shims (PG-3740 / PG-3741) aid in the calibration of thickness gages on ferrous or non-ferrous metallic substrates. Plastic shims can be used to calibrate on the actual test substrate.

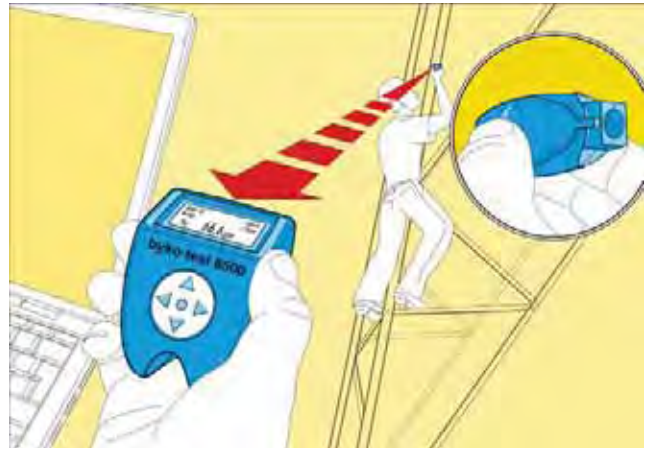

Accessories

Cat. No.	Description
PG-3640	byko-test 8500 basic without sensor
PG-3641	byko-test 8500 premium without sensor
PG-3642	Fe-sensor 2000 μm /80 mils
PG-3643	Fe-sensor 5000 μm /200 mils
PG-3644	NFe-sensor 2000 μm /80 mils
PG-3645	Dual-Sensor Fe/NFe2000/ 2000 μm and 80/80 mils
PG-3646	Dual-Sensor Fe/NFe5000/ 2000 μm and 200/80 mils
PG-3740	Calibration Shims 25-500 microns (1 -19.7 mils) with Zero plates
PG-3741	Calibration Shims 11-980 microns (0.43 - 38.6 mils) with Zero plates
PG-3647	Software
PG-3648	USB-wireless connector incl. Elongation cable
PG-3667	Wireless Fe-Sensor 2000 μm /80 mils
PG-3668	Wireless NFe Sensor 2000 μm /80 mils
PG-3669	Wireless Dual Fe/NFe Sensor 2000 μm /80 mils

byko-test MPOR

The byko-test MPOR film gage allows quick and easy measurements of coatings thickness on ferrous and non-ferrous substrates. The instrument automatically identifies the kind of substrate and selects the appropriate test method accordingly.

The instrument is designed for one-hand operation. An integrated spring guarantees a constant pressure of the probe to the sample's surface. The instrument comes with an integrated radio transmitter. For wireless transmission of the measured values directly to a PC, the optional radio receiver and software is necessary.

byko-test MPOR:

- Compact size instrument
- Illuminated display
- Statistic function, min., max., mean, Std. dev.
- Two displays for easy view for measurement results
- Magnetic-induction Fe-sensor particularly suitable for the automotive industry
- Large memory stores up to 999 values
- Indicator LED for pass/fail

Standards

ASTM	B 499, D 1400
BS	3900 Part C5, 5411 (3,11)
DIN	50981, 50984
ISO	2178, 2360, 2808

Ordering Information

Cat. No.	Description
PG-3692	byko-test MPOR
PG-3696	byko-test MPOR US model

Comes complete with:

byko-test MPOR
 Manual
 2 x AA batteries
 Protective bag
 Zero standard Fe/NFe
 Thickness standard ca. 70 µm (2.8 mils)
 Protective cap

Ordering Information

Cat. No.	Description
PG-3693	Radio receiver 868 MHz with PC-Datex software
PG-3694	Radio receiver 915 MHz with PC-Datex software
PG-3695	PC-Datex software with USB cable



Technical Specifications

Substrate Fe	steel or iron
Substrate NFe	non-magnetic metals: aluminum, copper, brass, zinc, stainless steel
Measuring Range	0 - 2000 µm (0 - 80 mils)
Memory	999 values
Accuracy	0 - 50 µm ±1 µm NFe; 50 - 1000 µm ±2% NFe
(Repeatability)	0 - 75 µm ±1.5µm Fe; 75 - 1000 µm ±2% Fe
Minimum Curvature	1 mm (0.2 in) convex; 32 mm (1.2 in) concave
Minimum Substrate Thickness	Fe: 0.1 mm; NFe: 0.02 mm
Min. Measuring Area	2 x 2 mm (0.08 x 0.08 in)
Operating Temperature	0 °C - 60 °C (32 °F - 140 °F)
Power Supply	2 x AA batteries
Dimensions	64 x 30 x 85 mm (2.5 x 1.2 x 3.3 in)
Weight	approx. 60g (2.3 oz) without battery

Accessories

For Europe and Asia countries
 For North and South American countries

micro-TRI-gloss μ

Gloss and Film Thickness in one Instrument

Gloss and film thickness are important QC criteria for coatings. The new micro-TRI-gloss μ measures both in seconds and at the same position. This saves time and is ideal for checks in the field.

- Simultaneous display 20°, 60°, 85° – for high gloss to matte coatings
- Dual sensor Fe/NFe – measures thickness on steel as well as on aluminum
- Automatic check of glossmeter calibration standard
- Easy, multilingual menu operation with scroll wheel
- Statistics, Differences and Pass/Fail
- Memory for 999 readings with name input
- easy-link software included for professional documentation in Excel®
- Data transfer from the glossmeter to PC via USB or Bluetooth® wireless technology



Standards

	Gloss	Thickness
ISO	2813	2178, 2360, 2808
ASTM	D 523	B 499, D 1400
DIN	67530	

Ordering Information

Cat. No.	Description
AG-4448	micro-TRI-gloss μ
SE-4448	Extended Warranty one-year additional

Comes complete with:

- micro-TRI-gloss μ glossmeter
- Calibration holder with certificate
- Zero standards Fe and NFe
- easy-link software
- USB-cable
- Operating manual
- Battery
- Durable carrying case

Free 1x preventive maintenance service during warranty period

Technical Specifications

Gloss		
Geometry	Application	Measurement Area
20°	high gloss	10 x 10 mm (0.4 x 0.4 in)
60°	semi gloss	9 x 15 mm (0.35 x 0.6 in)
85°	low gloss	5 x 38 mm (0.2 x 1.5 in)
Measurement Range	0 – 100 GU	100 – 2000 GU
Repeatability	± 0.2 GU	± 0.2 %
Reproducibility	± 0.5 GU	± 0.5 %
Thickness		
Substrate	Fe: magnetic	
	NFe: non magnetic	
Measurement Range	0 – 500 μ m (0 – 20 mils)	
Accuracy	± (1.5 μ m + 2% of measured value)	
Dimensions	155 x 73 x 48 mm (6.1 x 2.9 x 1.9 in)	
Weight	400 g (0.9 lbs)	

Ordering Information

Cat. No.	Description
AG-4405	USB-cable
AG-4545	BYKWARE easy-link
AG-4449	Calibration Holder
AG-4434	Checking Standard

Accessories

- For data transfer from the glossmeter to a PC, USB-A
- Software for direct data transfer and documentation in Excel® (see page 26)
- Replacement
- High gloss and 3 Semi gloss tiles, 170 x 103 x 26 mm (6.7 x 4.1 x 1 in)

Certified For Certification Services and Preventive Maintenance see pages 267 - 270.

byko-cut universal

Portable instrument providing sufficient accuracy for laboratory use but also usable at construction sites and in workshops. Ideal for customer service technicians and demonstrations. The BYK-Gardner byko-cut is a universal instrument for:

- Measuring film thickness in the range of 2 - 2000 μm (1/8 - 80 mils) on every substrate (steel, non-ferrous metal, plastics, wood, etc.)
- Adhesion test by means of cross-cut test in accordance with ASTM D 3359; DIN 53 151
- Indentation hardness test in accordance with ISO 2815 (Buchholz)
- Microscopic research for pores, pits, cracks, blisters, flaking, intercoat adhesion of the individual film in coat systems, and quality control of the pretreatment of the substrate

Special features:

- LED illumination
- Ergonomical design
- Guiding wheels for smooth cutting
- Cut finder



Standards

ASTM	D 3002, D 3359
DIN	50 986, 53 151
ISO	2409, 2815
NCCA	II-13, X-1
VTLA	003 Item 9

Ordering Information

Cat. No.	Description
PG-3430	byko-cut universal metric scale
PG-3431	byko-cut universal English scale
PG-3432	byko-cut universal without blades metric scale
PG-3432	byko-cut universal without blades English scale

Comes complete with:

byko-cut universal film gauge
 Revolving rotary head with 3 cutters for film thickness (# 1-3)
 Built-in microscope (scale 0 - 2 mm)
 LED
 Battery
 Operation manual

Note: Cutters must be ordered separately for Cat. No. PG-3432
 Tools for cross-cut and hardness must be ordered separately

Certified

For Certification Services see page 269.

Technical Specifications

Lamp	Batteries	Microscope	Dimensions
White LED	1.5 Volts Mignon type	50-fold magnification	110 x 80 x 75 mm (4.3 x 3.2 x 2.9 in)
White LED	1.5 Volts Mignon type	50-fold magnification	110 x 80 x 75 mm (4.3 x 3.2 x 2.9 in)
White LED	1.5 Volts Mignon type	50-fold magnification	110 x 80 x 75 mm (4.3 x 3.2 x 2.9 in)
White LED	1.5 Volts Mignon type	50-fold magnification	110 x 80 x 75 mm (4.3 x 3.2 x 2.9 in)

Info!

For more information on Buchholz hardness see chapter "Hardness" page 200.



The V-shaped cut can be easily stored as an image with the Digital Pocket Microscope. For more details please see chapter "Microscopes", pages 221 - 223.

Destructive Film Thickness Measurement

Create a V-shaped cut through the coating down to the substrate and measure width of a' (b'), which is proportional to the thickness a (b).

The specially designed blades which are attached to the instrument are used to make a short incision in the film. Then, the depth of the layer is measured with the built-in 50 fold microscope and the film is inspected for flaws.

Each of the cutting tips has two bevels which are made to precision with the mentioned slopes (see table). Since the slope of the cut is known, the measurement of the horizontal distance across this full slope (from the substrate to the top edge of the cut) is also a measurement of true vertical depth.

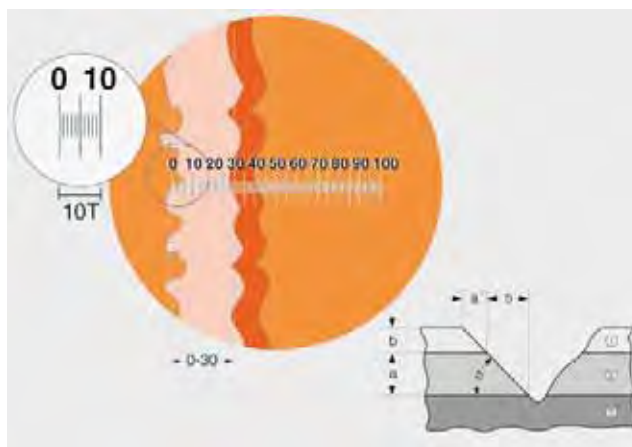

The thickness of multiple-layered coatings can be easily determined.

Ordering Information

Cat. No.	Description
PG-3421	Cutting Tip ISO No. 1 / ASTM 1X
PG-3422	Cutting Tip ISO No. 2 / ASTM 2X
PG-3423	Cutting Tip ISO No. 3 / ASTM 10X
PG-3419	Special Cutter
PG-3420	Special Cutter

Technical Specifications

Slope of Tip (cutting angle)	Maximum Coating Thickness	1 Division on Reticle Scale Represents (Depth)
45 °	2000 µm (80 mils)	20 µm (1.0 mils)
26.5 °	1000 µm (40 mils)	10 µm (0.5 mils)
5.8 °	200 µm (8 mils)	2 µm (0.1 mils)
3.0°	100 µm (4 mils)	1 µm (0.05 mils)
56 °	3000 µm (120 mils)	30 µm (1.5 mils)

DPM 100

Digital Pocket Microscope

Features of DPM 100 Digital Pocket Microscope

- High resolution CCD-Camera offering clear images
- Very portable and easy to use
- USB Cable connection for the data transfer
- Auto Gain function to adjust the lightness differences
- 4 LED Illumination for better viewing
- Capture button to save image

Destructive Film Thickness

The V-shaped cut from the byko-cut can be easily stored as an image with film thickness info in mm. Also the width from the cut can be detected and recalculated to the film thickness of the coating depending on the cut-Angle.



Info!

For more information on the DPM 100 Digital Pocket Microscope see pages 221 - 223.

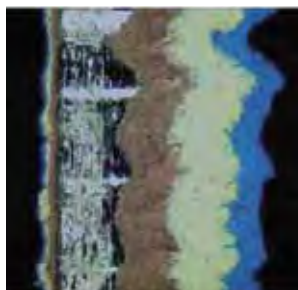

Buchholz Indentation Hardness

Place the byko-cut universal equipped with tool (Cat. No. PG-3427) and slip-on weight (Cat. No. PG-3434) on measuring position in accordance with standard. After 30 seconds measure indentation length using the built-in microscope.

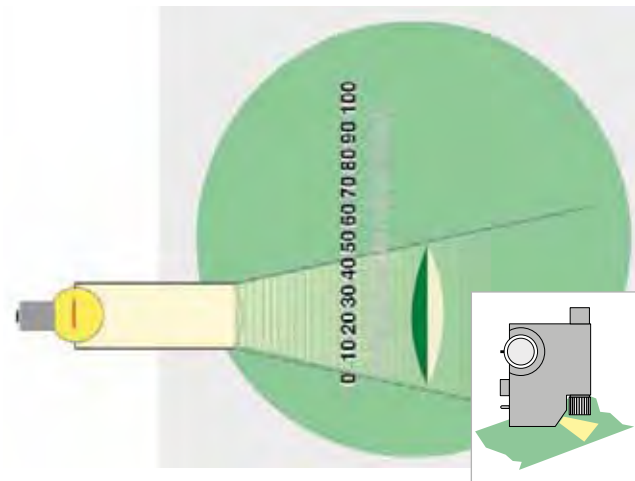

Ordering Information

Cat. No.	Description
PG-3427	Buchholz Indentation Device
PG-3434	Slip-on Weight

Technical Specifications

In accordance with DIN 53153 and ISO 2815
Increases weight of byko-cut universal to the standard weight of 500 g ± 5g

Multi-Cut Tool for Cross-Cut Test

Info!

Cross Cut Test see pages 134 - 136.

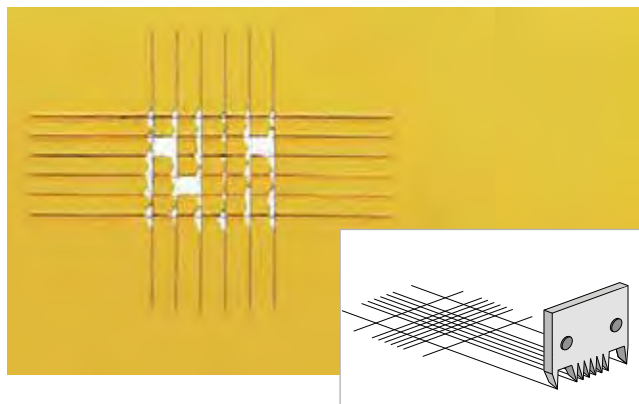

Ordering Information

Cat. No.	Description
PE-3429	Multi-Cut Tool 1 mm
PE-3424	Multi-Cut Tool 1.5 mm
PE-3425	Multi-Cut Tool 1 mm
PE-3426	Multi-Cut Tool 2 mm

Technical Specifications

Standard	Cutter Spacing	No. Of Cutters
ASTM	1 mm (0.04 in)	11
ASTM	1.5 mm (0.06 in)	11
DIN, ISO	1 mm (0.04 in)	6
ASTM, DIN ISO	2 mm (0.08 in)	6

Introduction

Hardness

The definition of hardness has, in the past, caused misunderstandings within the paint industry. Most coatings are viscoelastic, and hence will indent to some extent. Therefore, DIN 55 945 defines hardness as follows:

Hardness is the resistance of a coating to a mechanical force, such as pressure, rubbing or scratching.

In practice, different testing methods are used:

Pendulum Hardness

– In accordance with methods described by König and Persoz

Indentation Hardness

– Buchholz Indentation Testers

Scratch Hardness

– Hardness Meter Dur-O-Test
– Pencil Hardness

For clear communication of test results, the technician needs to document the type of test method used, for example, "Indentation Resistance in accordance with ISO 2815" or "Damping Time in accordance with ISO 1522".

BYK-Gardner offers instrumentation needed to perform various hardness tests.



HARDNESS

Appearance

Color

Hardness

Technical Service

Index

Pendulum Hardness

This method evaluates hardness by measuring the damping time of an oscillating pendulum. The pendulum rests with 2 stainless steel balls on the coating surface. A physical relationship exists between oscillation time, amplitude and the geometric dimensions of the pendulum. The viscoelastic behavior of the coating determines its hardness.

When the pendulum is set into motion, the balls roll on the surface and put pressure on the coating. Depending on the elasticity, the damping will be stronger or weaker. If there are no elastic forces, the pendulum will damp stronger. High elasticity will cause weak damping.

Two types of pendulums were standardized for this test method:

	König	Persoz
Weight	200 g ± 0.2	500 g ± 0.1
Diameter	0.2 in (5 mm)	0.3 in (8 mm)
Deflection Start	6°	12°
Deflection End	3°	4°
Period of Oscillation	1.4 s	1 s
Damping Time on Glass	250 ± 10 s	430 ± 10 s

Scratch Hardness

An ideal test for the quick evaluation of finished products. The results do not correlate with any of the other methods of hardness measurement.

The scratch can be performed with either a metal pin (Dur-O-Test) or pencils. Pencils of various degrees of hardness are drawn over the coating surface to determine which pencil causes indentation. This method is only applicable for smooth surfaces.

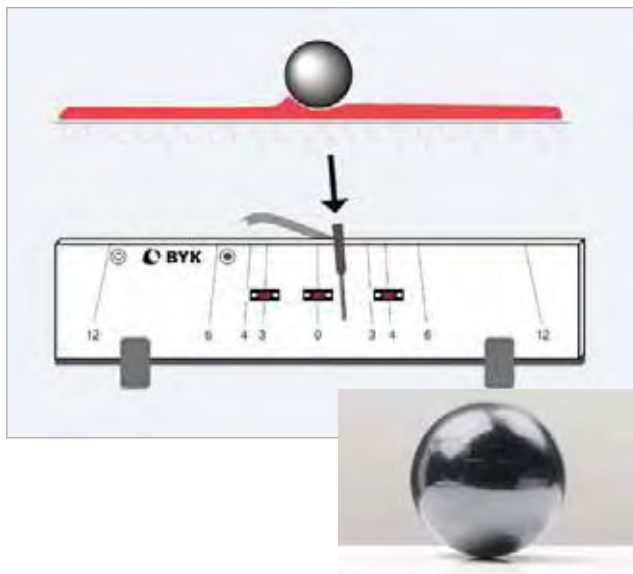
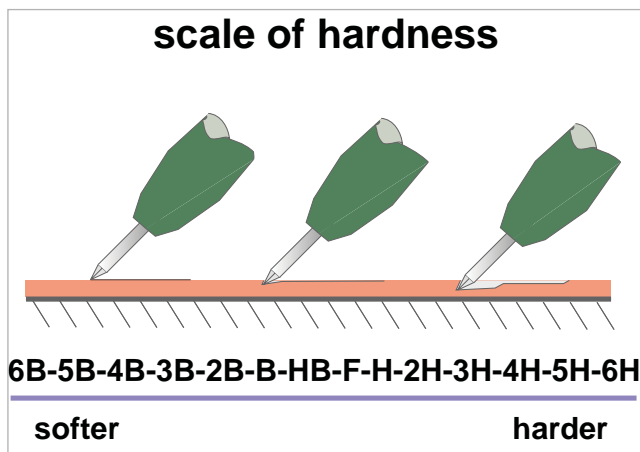

"Buchholz" Indentation Hardness

This test method is suitable for coatings with plastic deformation behavior. Coatings with elastic deformation behavior should not be evaluated with this test method, because after removal of the instrument an elastic coating will show no or very little indentation.

The instrument consists of a double cone block, which is placed on the coating for 30 seconds. Indentation is measured with the help of a precision microscope and is then calculated according to the following equation:

$$\text{Indentation Resistance (Buchholz)} = \frac{100 \text{ mm}}{\text{Indentation Length}}$$

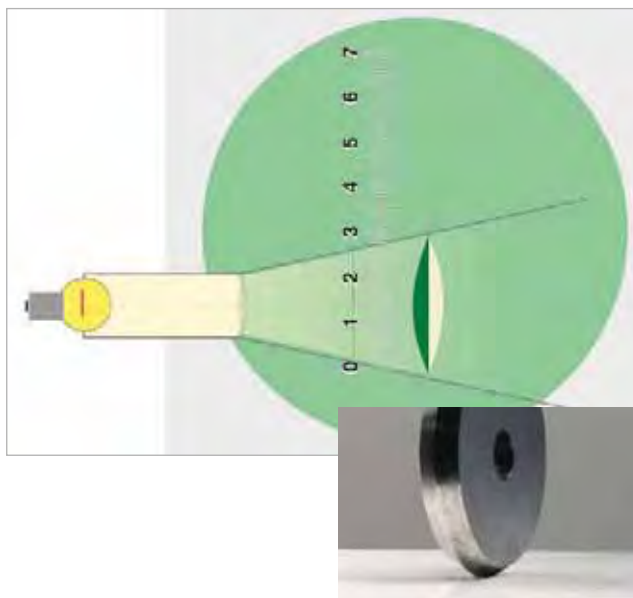

Pendulum Hardness Tester

Simple laboratory measuring instrument for hardness measurements in accordance with the König and Persoz methods described on the previous page.

- Automatic counter with acoustic signal when the deflection is below 3° (König) or 4° (Persoz) respectively
- Registration of pendulum deflection by means of 2 light barriers
- Digital counter
- Changeable from König to Persoz by means of a third light barrier
- Selector switch for display in seconds or number of oscillations



König Pendulum



Persoz Pendulum



Standards

ASTM	D 4366
ISO	1522

Ordering Information

Cat. No.	Description
PH-5858	Pendulum Hardness Tester with König Pendulum
PH-5859	Pendulum Hardness Tester with Persoz Pendulum

Comes complete with:

Pendulum hardness tester; Protective cover; Cable release; Glass plate; Spirit level; Main cable; Tools; Pendulum

Technical Specifications

Weight Diameter	Ball Start/End	Deflection	Period of Oscillation	Damping Time on Glass
200 g ± 0.2	5 mm	6° / 3°	1.4 s	250 s ± 10 s
500 g ± 0.1	8 mm	12° / 4°	1 s	430 s ± 10 s
according to ISO				
Voltage	115 V / 60 Hz, 230 V / 50 Hz			
Power Supply	0.1 A			
Dimensions	320 x 710 x 300 mm (12.6 x 30 x 12 in)			
Weight	17.5 kg (39 lbs)			

Ordering Information

Cat. No.	Description
PH-5860	Cable Release
PH-5857	Persoz Pendulum
PH-5856	König Pendulum

Accessories

Additional Description
Additional Pendulum
Additional Pendulum

Info!

For Preventive Maintenance see page 272.

Buchholz Indentation Tester

The Buchholz indentation test is a reliable test method for evaluation of indentation resistance of plastic deformable coatings.

- Dimensions and weight in accordance with standards
- Block of stainless steel
- Circular tool is a double cone block
- Circular tool and support of tungsten carbide / hard metal
- Marking triangle for precise positioning

Info!

For more information how to evaluate the test with the Digital Pocket Microscope see pages 221 - 223.



Standards

ISO	2815
-----	------

Ordering Information

Cat. No.	Description
PH-5825	Buchholz Indentation Tester
PH-5826	Buchholz Indentation Tester w/microscope
PH-5824	Precision Microscope only

Technical Specifications

Comes complete with
Instrument block (500g ± 5g), Instrument weight: 1.9 kg
Instrument block (500g ± 5g) incl. precision microscope
20x magnification with graduated scale to measure indentation length, incl. light source; Weight: 0.8 kg

Info!

For Preventive Maintenance see page 272.

DUR-O-Test

Hardness Meter

This pocket instrument allows hardness tests on flat and curved surfaces. The instrument consists of a sleeve with a pressure spring that can be bent to various tensions by using a slide. The spring acts on a tungsten carbide needle with its tip extending out of the sleeve. A locking screw fixes the slide, thus maintaining constant spring tension.

Three pressure springs of varying strengths ranging from 0-20 N (0-2000g) are available to cover a large hardness range.



Ordering Information

Cat. No.	Description
PH-5810	DUR-O-Test, 1 mm
PH-5811	DUR-O-Test, 0.75 mm

Comes complete with:
 Hardness tester DUR-O-Test
 3 pressure springs in a leather case

Accessories

Cat. No.	Description
PH-5813	Replacement Needle, 1 mm
PH-5814	Replacement Needle, 0.75 mm

Technical Specifications

	Dimensions	Weight
Hardness tester with spherical test tool	Length: 160 mm (6.3 in) Diameter: 16 mm (0.6 in)	0.3 kg (0.7 lbs)

Springs
 No. 1 silver 0 - 3 N (0 - 300 g) division: 10 g
 No. 2 red 0 - 10 N (0 - 1000 g) division: 50 g
 No. 3 blue 0 - 20 N (0 - 2000 g) division: 100 g

Pencil Hardness Tester

(Wolf-Wilburn)

The purpose of scratch hardness tests is to determine the resistance of coating materials or lacquers to scratch effects on the surface. This test is of particular value for furniture or vehicle lacquers, but is also a useful aid in the development of synthetic resins or other film forming materials.

Generally, scratch hardness is measured by moving a sharp object under a known pressure over the test surface. The result may either be the value of the pressure required to scratch through the test material if a scratching tool of constant hardness is used, or the hardness of the scratching tool is varied while constant pressure is applied.

- Twenty pencils (grade 9B to 9H) are used with a standard holder
- Pencils are moved with a fixed pressure and a fixed angle ensuring the least amount of operator error
- Pencils can be easily exchanged to minimize down time during the test

Ordering Information

Cat. No.	Description
PH-5800	Pencil Hardness Tester
PH-5801	Replacement pencil set (20)

Comes complete with:

Pencil hardness tester PH-5800
 Complete set of 20 pencils from 9B to 9H
 Pencil sharpener
 Abrasive 400 grit paper
 Carrying case

Pencils

The Pencil Hardness test is an effective method to test coatings for their hardness and their scratch wear resistance. ASTM test method D 3363 allows the use of pencils of known hardness to be moved over the surface of the test sample at a fixed angle and pressure to perform the test.

Ordering Information

Cat. No.	Description
PH-9500	Pencil Hardness Tester Set
PH-9501	Replacement Leads *
PH-5802	Lead Holder

Comes complete with:

Pencil Holder Set PH-9500, 9 grades of leads:
 B, HB, F, H, 2H, 3H, 4H, 5H, 6H, in packs of 12 each

Note: * When ordering a replacement lead set please specify the hardness grade.



Standards

ASTM	D 3363
BS	3900-E19
DIN EN	13523-4
ECCA	ECCA T
ISO	15184

Info!

DPM 100 Digital Pocket Microscope for digital documentation of test results please see page 222



Standards

ASTM	D 3363
------	--------

Accessories

Quantity
12 per pack, available are: 6B, 5B, 4B, 3B, 2B, B, HB, F, H, 2H, 3H, 4H, 5H, 6H
1

New!

USB port and
wireless data transfer



Special trade-in
for our loyal micro-gloss customers:

micro-TRI-gloss: \$ 750.-
micro-gloss 60°: \$ 375.-
for all models made before 2002

Measure what you see.

NEW micro-gloss

The new intelligence in gloss measurement

"I like to be on the safe side: smart auto diagnosis in the micro-gloss guarantees reliable calibration and accurate gloss readings. Professional quality control is easy: statistics, difference and pass/fail – with just a turn of the scroll wheel. With easy-link software I send data directly to Excel for my QC-reports. Now it even has wireless via Bluetooth – that's professional."

www.byk.com/instruments

A member of  **ALTANA**

 **BYK**
Additives & Instruments

Introduction

Flexibility / Elasticity

In practice, three different empirical test procedures are used to assess the resistance of coatings and allied products to cracking and/or detachment from the substrate under different conditions of deformation.

Bend Test

Bending lacquered sheet metal over a defined radius allows an indication of the elongation and adhesion of a paint film due to bending stress.

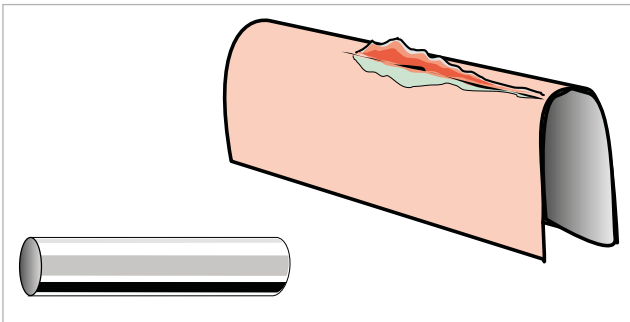

The DIN EN ISO 1519 standard only permits the use of cylindrical mandrels.

The ASTM D 522 and the DIN EN ISO 6860 standards describe the test method by means of a conical or cylindrical mandrel. The use of a conical mandrel bending tester enables testing of a large variety of bending radii at the same time.

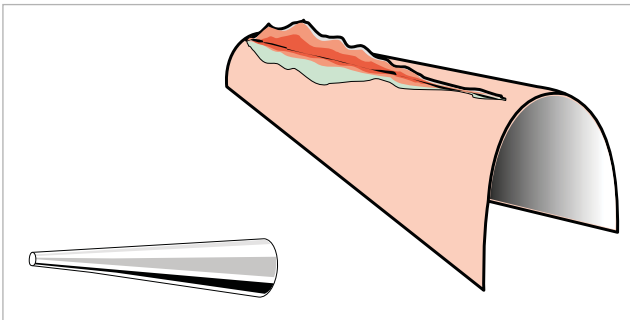

FLEXIBILITY

Impact Test – “Falling-weight Test”

The impact tester has gained wide acceptance in testing the impact resistance of many types of coatings and substrates. International standards describe a method for evaluating impact resistance of a coating to cracking and peeling from a substrate when it is subjected to a deformation caused by a falling weight, dropped under standard conditions yielding rapid deformation.

Impact Tester

- Consists of a solid base with a guide tube support
- The guide tube has a slot to direct a weight that slides inside the guide tube
- A collar fits on the tube that helps the user slide the weight up to the accurate height
- Graduations are marked along the slot to facilitate readings

Procedure

- Place sample under the punch
- Lift the weight to desired height on guide tube and let it drop
- View the damage of the sample visually or with low powered magnification
- Adjust the height and weight of the impacter to determine exact point of failure or establish pass/fail specifications

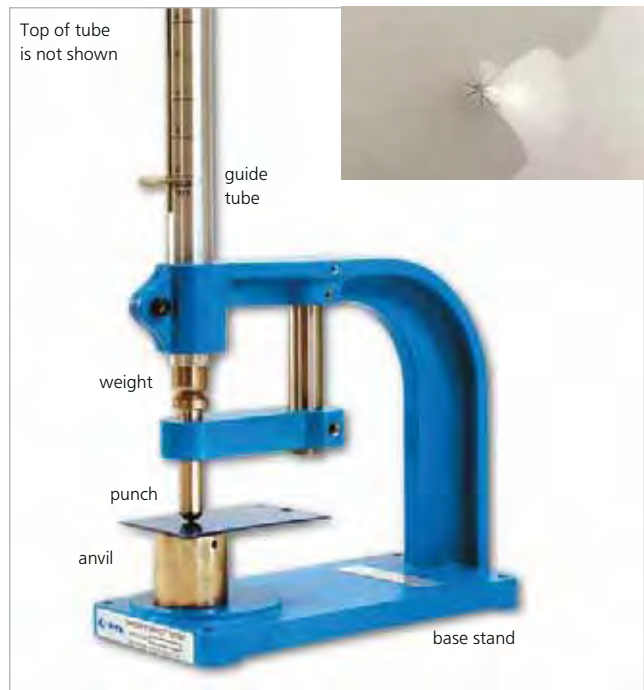

The impact force is calculated using the following equation:

Falling Height x Weight = Impact Force

in	lbs	in-lb
m	kg	mkg

Note: The coated or uncoated side of the panel can be tested to simulate either indentation or bulging.

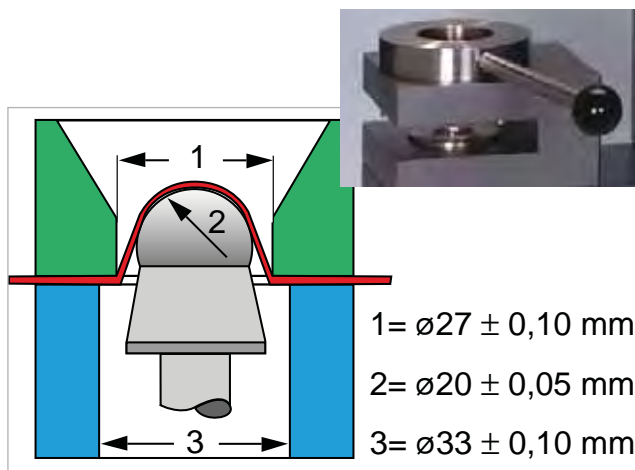

Cupping Test

In addition to determining the deformability or elongation of a film, the cupping test method supplies information on adhesion properties. Single-layer systems can be tested as well as multiple-layer systems.

The ISO standard describes a method for evaluating the resistance of a coating to cracking and/or detachment from a metal substrate when it is subjected to a gradual deformation by indentation under standard conditions.

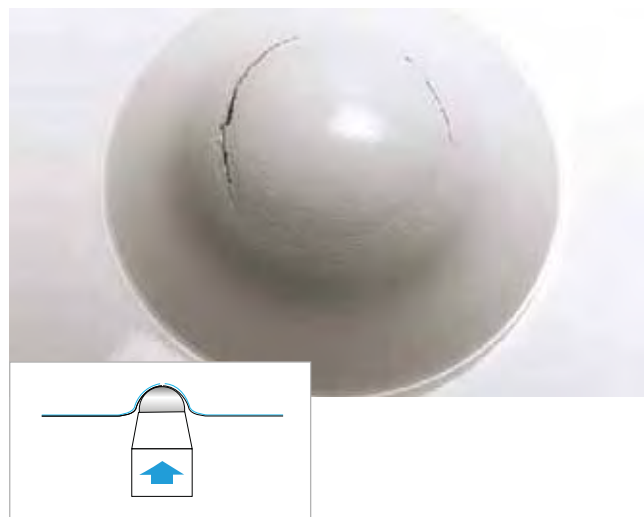

A die having a hardened and polished surface and a sample holder with a retaining ring are the heart of a cupping tester. The indenter that contracts the test panel is of hardened polished steel and forms a hemisphere of 20 mm (8 in) diameter. The maximum cupping depth is approx. 14 mm. The test process is observed through a microscope or magnifying glass.

When evaluating the test results, it must be carefully assessed when the coating system starts cracking.

Impact Tester

Light-Duty Impact Tester

Use with materials that can be damaged or penetrated by small impact forces such as products mildly abused in households, offices or labs through years of normal use. Measures impact resistance of plastics and other materials.

- 2 lb steel cylindrical impacter with 1.27 cm (0.5 in) diameter round-nosed end
- Tolerance of ± 56.7 gm (± 2 oz); capacity 908 gm (2 lbs)
- Graduated 40.6 cm (16 in) guide tube
- Maximum force of 28 inch-pounds
- 1.43 cm (0.563 in) diameter hole in the base allows deformation of thin specimen panels

Info! For testing procedure, see page 230.



Light-Duty Impact Tester

Ordering Information

Cat. No.	Description
PF-1115	Light-Duty Impact Tester

Comes complete with:

- Basic plate
- Guide tube with collar
- Scale in inches
- Weight(s)
- Impact tester
- Operating instructions

Accessories

Cat. No.	Description
PF-1187	Strike Plate
PF-1188	Falling Weight 908 g (2 lbs)
PF-1189	Falling Weight 1816 g (4 lbs)
PF-1191	Falling Weight 227 g (0.5 lbs)
PF-1192	Tube

Technical Specifications

Scale	Weights included	Dimensions	Net Weight	Shipping Weight
English	0.9 kg(2 lbs)	64 x 25 x 25 cm (25 x 10 x 10 in)	3.4 kg (7.5 lbs)	4.1 kg (9.0 lbs)



Info! Impact test results can easily be evaluated with the new Digital Pocket Microscope please see chapter "Microscopes", pages 221 - 223.



BYK-Gardner ISO Impact Tester

Used for testing impact resistance of coatings on metal substrates. In accordance with ISO standard, the test panel is fixed on the die using a clamping device, so that the panel surface outside the test area is not affected by the rapid deformation caused by the falling weight.

- Anodized guide tube with a scale in inches and mm
- Tolerance for ISO falling weights ± 1 g
- Maximum falling weight 2 kg
- Exchangeable falling weights and dies
- Can be easily converted for testing in accordance with ASTM

Impact Tester

The impact tester consists of a solid base stand with a guide tube support. The guide tube has a slot that directs a cylindrical weight that slides up and down with the use of a collar that fits into the weight. Graduations are marked along the slot to facilitate reading where the weight is dropped. The base of the instrument includes a die support. The weights have built-in steel balls that provide different geometrical configurations. It is important that the ball diameter fits into the die to prevent shearing the test samples at the inner rim of the die. In order to limit the indentation depth of the falling weight, distance rings of different thickness can be fitted. Also, different weights can be used.

Note: Please order the correct accessories on the following page to comply with standards



Standards

ASTM	D 2794
ISO	6272-1

Ordering Information

Cat. No.	Description
PF-5512	BYK-Gardner ISO Impact Tester

Note: Die and falling weight must be ordered separately

Comes complete with:

- Basic plate with clamping device
- Guide tube with collar
- Scale in mm and inch

Technical Specifications

Scale	Dimensions	Weight base unit	Weight with guide tube
Metric, English	127 x 25 x 25 cm (50 x 10 x 10 in)	16.8 kg (37 lbs)	19.5 kg (43 lbs)

Certified For Preventive Maintenance see page 272.

Info! For testing procedure, see page 206.

Accessories for ISO 6272-1 and DIN 55669 for PF-5512

To follow this method, please order the falling weight and the die listed below, in addition to the impact tester from the previous page. Additional weights can also be purchased.

Ordering Information

Cat. No.	Description
PF-5532	Falling Weight 1kg
PF-5525	Die
PF-5527	Additional Weight

Accessories

Extended description
For Ball diameter 20 mm; With lifting pin; for DIN
For Cat. No. PF-5532; For ball diameter 20 mm; Inner diameter 27 mm
For Cat. No. PF-5532; 1 kg; Attachable to falling weight

Accessories for ASTM D 2794 for PF-5512

To follow this method, please order the falling weight and the die listed below, in addition to the impact tester from the previous page. Additional weights can also be purchased.

Ordering Information

Cat. No.	Description
PF-5520	Falling Weight 2 lbs
PF-5522	Falling Weight 2 lbs
PF-5521	Die for ball dia. 0.5 in
PF-5528	Die for ball dia. 0.5 in
PF-5523	Die for ball dia. 0.625 in
PF-5529	Die for ball dia. 0.625 in
PF-5526	Additional Weight

Accessories

Extended description
Ball diameter 12.7 mm (0.5 in); With lifting pin
Ball diameter 15.9 mm (0.625 in); With lifting pin
Inner diameter \varnothing 17 mm (0.7 in); for ball diameter 0.5 in
Inner diameter \varnothing 13.9 mm (0.55 in); for ball diameter 0.5 in
Inner diameter \varnothing 21.2 mm (0.83 in); for ball diameter 0.625 in
Inner diameter \varnothing 16.3 mm (0.63 in); for ball diameter 0.625 in
For Cat. Nos. PF-5520 and PF-5522; 2 lbs; Attachable to falling weight

Ordering Information

Cat. No.	Description
PF-5533	Set of Distance Rings

Accessories

Extended description
Use to limit the indentation depth of the falling weight from 2 mm to 10 mm

Heavy-Duty Impact Tester

This impact tester has gained wide acceptance in testing the impact resistance of many types of coatings from paints to varnishes to tough plated, plastic or laminated coatings. It is also widely used to establish quality control standards for resistance to impact surface damage and penetration of many construction materials including plastics, resins, fiberglass, sheet metals, and plywood. Two models are available:

English Model

- Two and four pound weights included
- Maximum allowable force of 80 and 160 inch-lbs
- Round nose punch, 0.625 in diameter
- Guide tube 40 in
- Die inside diameter 0.64 in

Metric Model

- One and two kilogram weights included
- Maximum allowable force of 100 and 200 kg-cm
- Round nose punch, 1.59 cm diameter
- Guide tube 100 cm
- Die inside diameter 1.63 cm



Heavy-Duty Impact Tester PF-1120

Standards

ASTM	D 2794, D 3029,
	D 4226, D 5420
ISO	6272-2

Ordering Information

Cat. No.	Description
PF-1120	Heavy-Duty Impact Tester
PF-5545	Heavy-Duty Impact Tester

Technical Specifications

Scale	Weights included	Dimensions	Net Weight	Shipping Weight
English	0.9 kg & 1.8 kg (2 lbs & 4 lbs)	127 x 25 x 25 cm (50 x 10 x 10 in)	10.4 kg (23 lbs)	15.9 kg (35 lbs)
Metric	1 kg & 2 kg (2.2 lbs & 4.4 lbs)	127 x 25 x 25 cm (50 x 10 x 10 in)	10.4 kg (23 lbs)	15.9 kg (35 lbs)

Comes complete with:

Anvil
 Guide tube with collar
 Scale in inch or cm
 Weight(s); Die
 Punch (Tup)
 Operating instructions

Accessories for PF-1120 impact Tester

Cat. No.	Description
PF-1240	Falling Weight, 2 lb
PF-1241	Falling Weight, 4 lb
PF-1231	Lift Screw
PF-1243	Ball Punch, 0.625 in
PF-1264	Die, 0.640 in ID
PF-1248	Tube
PF-6042	Base Assembly

Accessories for PF-5545 impact tester

Cat. No.	Description
PF-5539	Falling Weight 0.5 kg
PF-1249	Falling Weight 1 kg
PF-1250	Falling Weight 2 kg
PF-5543	Label 0 - 100 kg-cm
PF-5544	Label 0 - 200 kg-cm

Additional accessories available – please call our applications department for further information

SPI Modified Impact Tester (Extra Heavy-Duty)

This impact tester was developed in cooperation with the Society of the Plastics Industry (SPI) for evaluating impact resistance of rigid sheets of PVC (30-60 mils thick) and other plastics and materials exceeding the 160 inch-pounds limit of the Heavy-Duty Impact Tester.

- Graduated 102 cm (40 inch) guide tube with included 8 lb weight
- Redesigned arm on the base allows the impact tester to be used in tough applications
- Stop position clamp ensures you can always test at the same height, if needed
- Optional alignment tool helps to ensure the impact tester is lined up correctly (order separately below)
- Maximum force of 320 inch-pounds
- 12.7 mm (0.500 in) diameter punch
- 16.3 mm (0.640 in) die



Standards

ASTM	D 2794, D 3029,
	D 4226, D 5420, G 14

Ordering Information

Cat. No.	Description
PF-5546	Heavy-Duty Impact Tester

Comes complete with:

Basic plate; Guide tube with collar; Scale in inches
Weight(s); Die; Punch (Tup); Operating instructions

Accessories

Cat. No.	Description
PF-1190	Calibration Alignment Tool
PF-1260	Weight, 8 lb
PF-1231	Lift Screw
PF-1220	Ball Punch, 0.500 in
PF-1263*	Anvil
PF-1264	Die, 0.640 in ID
PF-1265	Platform
PF-1266	Tube
PF-1267	Weight Holder Swivel
PF-1268	Weight Mount for Swivel
PF-1269	Base Plate
PF-1270*	Arm Support
PF-1271*	Arm
PF-1275*	Base
PF-1274	Stop Position Clamp

* Constitutes base assembly PF-6041
Additional accessories available.

Technical Specifications

Scale	Weights included	Dimensions	Net Weight	Shipping Weight
English	3.6 kg (8 lbs)	127 x 25 x 25 cm (50 x 10 x 10 in)	16.8 kg (37 lbs)	19.5 kg (43 lbs)

Gardner Impact Tester Automatic Lift System

Features a pneumatically powered system added to the standard manual Gardner impact tester to relieve the operator of repetitive lifting of the drop weight and improve the repeatability of the test. The operator simply moves a small ring to a pre-established position on the test tube for selecting the desired drop height. A push of a button then initiates the system to automatically lift the weight to the exact selected position for sample removal and new sample placement.

This system is especially helpful where large 8 and 16 pound weights are used. By using a mechanical stop, the test is made more repeatable by eliminating any variation in the drop point by individuals releasing the weight by eye.

- Relieves operators from any arm or finger stress or fatigue caused by repetitive manual testing
- Reduced chances for human error enhances test repeatability during test audits
- Pneumatic system uses available plant compressed air and needs no electricity – a power failure will not cause the system to stop functioning
- Pre-established positions on test tube at half inch intervals eliminate any human error in setting the drop height
- A special alignment tool comes with the system to assure that the weight always hits the sample at the correct position
- Automation allows more tests to be run in a given amount of time compared to a manual impact tester
- Special built-in safety features preclude premature weight drop if air pressure is lost
- Optional 4 lb and 16 lb weight kits - user installable



Ordering Information

Cat. No.	Description
PF-5547	Automatic Lift Impact Tester

Comes complete with:

Standard Cat. No. PF-5546 SPI Modified Impact Tester
Pneumatically powered lift mechanism
(min. 50 PSI of clean dry air)
System alignment tool
Instruction manual

Accessories

Cat. No.	Description
PF-5548	4 lb weight kit
PF-5540	8 lb weight kit
PF-5549	16 lb weight kit

Comes complete with:

Tube, Weight, Lift Pen, Stop Positioner

Technical Specifications

Scale	Weights included	Dimensions	Weight
English	3.6 kg (8.1 lbs)	165 x 30 x 18 cm (65 x 12 x 7 in)	24 kg (53 lbs)

ASTM Methods for Impact Testers

The various ASTM methods for impact testers require certain punches and dies that are not normally included with the impact testers. Please refer to the ASTM standards below to inquire about the parts needed to do the test. For ordering information on these items, look on page 214.

ASTM D 2794 – Impact Resistance of Coatings

Method	Die	Punch	Instrument used	Die	Punch	Additional parts needed to meet the method
ASTM D 2794	-	0.64 in	PF-1120	0.64 in	0.625 in	No additional part needed
		0.64 in	PF-5546	0.64 in	0.500 in	No additional part needed
			PF-1115	hole is 0.563 in	0.500 in	No additional part needed

ASTM D 3029 – Impact Resistance of Flat Rigid Plastic (Method G)

Method	Die	Punch	Instrument used	Die	Punch	Additional parts needed to meet the method
GB	1.25 in	0.625 in	PF-1120PF-5546	anvil without die is 1.25 in anvil without die is 1.25 in	0.625 in not included	No additional parts neededPF-1243 needed, see page 214.
GC	0.64 in	0.625 in	PF-1120PF-5546	0.64 in0.64 in	0.625 in not included	No additional parts neededPF-1243 needed, see page 214.

Note: An 8 lb weight is available for the PF-1120
2 and 4 lb weights are available for the PF-5546

Order PF-1203 under Accessories on page 214
Order PF-1201 or PF-1202 under Accessories on page 214

General requirements:

2, 4, or 8 lb weight
40 in guide tube

ASTM D 4226 – Impact Resistance of PVC

Method	Die	Punch	Instrument used	Die	Punch	Additional parts needed to meet the method
ASTM D 4226	0.64 in	20°, 0.125 in radius (C.125)	PF-1120	0.64 in	not included not included	PF-1224 needed, see page 214.PF-1220 needed, see page 214.8 lbs weight PF-1203 needed. see page 214.
		0.500 in (H.25) diameter				
		20°, 0.125 in radius (C.125)	PF-5546	0.64 in	not included 0.500 in	PF-1224 needed, see page 214.No additional parts needed
		0.500 in (H.25) diameter				

General requirements:

8 pound weight
40 in guide tube

ASTM D 5420 – Impact Resistance of Flat Rigid Plastic by means of Gardner Impact

Method	Die	Punch	Instrument used	Die	Punch	Additional parts needed to meet the method
GB	1.25 in	0.625 in	PF-1120PF-5546	anvil without die is 1.25 in	0.625 in	No additional parts needed
				anvil without die is 1.25 in	not included	PF-1243 needed, see page 214.
GC	0.64 in	0.625 in	PF-1120PF-5546	0.64 in0.64 in	0.625 in not included	No additional parts needed PF-1243 needed, see page 214.
GE	0.64 in	0.500 in	PF-1120PF-5546	0.64 in0.64 in	not includ- ed0.500 in	PF-1220 needed, see page 214 No additional parts needed

Note: An 8 lb weight is available for the PF-1120
2 and 4 lb weights are available for the PF-5546

Order PF-1203 under Accessories on page 214
Order PF-1201 or PF-1202 under Accessories on page 214

General requirements:

2, 4, or 8 lb weight
40 in guide tube

Accessories for Impact Testers

PF-1120, PF-5545, PF-5546, PF-5547

These items are not included with the instrument and may be needed for a specific ASTM method, or to expand the inch-lb capacity of the impact tester. Other items may be available on special request.

Dies for PF-1120, PF-5545, PF-5546, PF-5547

Accessories

Cat. No.	Description
PF-1210	Die, 0.313 in Inner Diameter
PF-1211	Die, 0.563 in Inner Diameter
PF-1264	Die, 0.640 in Inner Diameter
PF-1212	Die, 1.00 in Inner Diameter
PF-1213	Die, 1.25 in Inner Diameter

Weights for PF-5546 ONLY

Accessories

Cat. No.	Description
PF-1207	Weight, ½ lb
PF-1208	Weight, 1 lb
PF-1201	Weight, 2 lb
PF-1209	Weight, 3 lb
PF-1202	Weight, 4 lb
PF-1214	Weight, 6 lb
PF-1260	Weight, 8 lb
PF-1215	Weight, 10 lb
PF-1204	Weight, 12 lb
PF-1206	Weight, 16 lb

Additional Parts for PF-1120 & PF-5546

Ordering Information

Cat. No.	Description
PF-1228	0-160 inch-pounds, label for use with 4 lb. weight
PF-1229	0-80 inch-pounds, label for use with 2 lb. weight
PF-1230	0-320 inch-pounds, label for use with 8 lb. weight
PF-1274	Stop Position Clamp for PF-5546

Punches for PF-1120, PF-5545, PF-5546, PF-5547

Accessories

Cat. No.	Description
PF-1243	Ball Punch, 0.625 in diameter
PF-1220	Ball Punch, 0.500 in diameter (aka. H.25 from ASTM D 4226)
PF-1221	Ball Punch 0.375 in
PF-1222	Ball Punch 0.250 in
PF-1223	Ball Punch 0.125 in
PF-1224	20 degree Punch, 0.125 in (1/8 in) radius (aka C.125 from ASTM D 4226)
PF-1225	1 in Radius Detachable Tip Punch
PF-1226	1 in Diameter Detachable Tip Punch
PF-1227	3 Sided Tip Punch (Boeing BSS7271)

Weights for PF-1120 & PF-5545 ONLY

Ordering Information

Cat. No.	Description
PF-1219	Weight, ½ lb
PF-1218	Weight, 1 lb
PF-1240	Weight, 2 lb
PF-1241	Weight, 4 lb
PF-1242	Weight, 6 lb
PF-1203	Weight, 8 lb
PF-1252	Weight, 100 g
PF-1253	Weight, 300 g
PF-5539	Weight, 500 g
PF-1249	Weight, 1 kg
PF-1250	Weight, 2 kg

Info!

For technical assistance please call our Applications Department

BYK-Gardner "Coverall" Bend and Impact Tester

Used to test both flexibility and impact resistance. By simply reversing the impacter, the instrument can evaluate the flexibility of can-stock coating during double seaming and to test its impact resistance in handling.

- Tests both flexibility and impact resistance
- Graduated (inches) guide tube
- Maximum force of 160 inch-pounds

Procedure: Impact Test

For impact studies, the top block is leveled with the plug removed exposing a 1.43 cm (0.563 in) hole. The 1.27 cm (0.50 in) diameter, round-nosed end of the 4 lb weight may now be dropped from any height along the graduated scale on the guide tube from 0 to 160 inch-pounds.

Procedure: Bend Test

To make a bend test, the coated panel (30-31 gauge tin plate) is first bent double over the 1/8 rod. The bent panel is placed between the parts of the hinge. Then the impact tool, flat face down, is dropped from any desired height onto the upper part of the hinge. The cylindrical fold in the panel is squeezed into a conical shape.



Top of tube is not shown

Standards

ASTM D 3281

Ordering Information

Cat. No.	Description
PF-1125	BYK-Gardner 'Coverall' Bend and Impact Tester

Comes complete with:

Base with arm support; Guide tube with collar; Scale in inches; Four pound weight; Punch; Operating instructions

Accessories

Cat. No.	Description
PF-1574	Hinge Plate
PF-1573	Anvil Plug
PF-1568	Guide Tube
PF-1569	Mount, weight holder
PF-1558	Swivel, weight holder
PF-1571	Weight, 4 lbs
PF-1231	Lift Screw
PF-1128	Accessory Weight, 2 lbs

Technical Specifications

Scale	Weights included	Dimensions Base Unit	Net Weight	Shipping Weight
English	4 lbs	127 x 25 x 25 cm (50 x 10 x 10 in)	8.2 kg (18 lbs)	11 kg (24 lbs)

Mechanical Cupping Tester

The BYK-Gardner Mechanical Cupping Tester is designed to test the elongation and deformability of lacquers and protective coatings applied to metal substrates. The punch is applied under pressure to the uncoated side of the test panel. The panel is held in place by a clamping ring. Two test procedures can be performed the "Predetermined depth" (go/no go) or "Minimum depth required to cause failure".

- New ergonomic design to save counter space
- Two hand crank operation for ease of operation
- Precision gearbox to provide reproducible results
- Chrome steel spherical punch
- Illuminated 2.5X magnifier on a pivoting arm
- Battery powered with auto-off feature
- LCD displaying indent depth to 0.01 mm resolution

Test Panels

The recommended test panel size is a minimum of 70 mm (2.75 in) square with a maximum size of 100 mm (3.9 in) wide and 150 mm (6.0 in) high. For burnished steel the minimum thickness is 0.3 mm (0.01 in) to a maximum of 1.25 mm (0.05 in). The maximum tensile strength of a 1.25 mm thick panel can not exceed 280 N/mm². For aluminum panels the maximum thickness is 3 mm (0.12 in).

Ordering Information

Cat. No.	Description
PF-5405	Mechanical Cupping Tester
PF-5406	Indenter
PF-5407	Magnifier
PF-5408	Zero Plate

Comes complete with:

Mechanical cupping tester
zero plate
magnifier glass
alkaline batteries 2 D size, 4 AA size
Operating instructions



Standards

BS	3900
DIN	53166, 53232
ISO	1520,
JIS	K 5600-5-2, B 7729

Technical Specifications

Spherical Punch	ø 20 mm (ø 0.8 in)
Full Travel	0.00- 20.50 mm (0.0 - 0.81 in)
Accuracy	±0.05mm (0.002 in), full range
Calibrated Range	-0.5 to 20.5 mm (0.02 - 0.81 in)
Gearing	1 revolution of handle moves punch 0.2 mm under load
Display	LCD 4-digit
Dimensions	420 x 350 x 500 mm (16.5 x 13.8 x 19.7 in)
Weight	16 kg (35.2 lb)
Power	Main 2 alkaline D cells; Magnifier 4 alkaline AA cells
Operating Temperature	+15 - +35 °C (59 - 95 °F)



Info!

For more information how to evaluate test results with the new Digital Pocket Microscope please see chapter "Microscopes", pages 221 - 223.

Cupping tester

The BYK-Gardner cupping tester has been designed for determining the elongation and deformability of single- and multiple-layer systems on metal substrates.

- Electrohydraulic drive for highly reproducible results
- Easy to use eccentric clamping ring
- C-opening accepts large and small test panels
- For test panels with a thickness of up to 1.5 mm (0.06 in)
- Uniform cupping speed of 0.2 mm/s (0.008 in/s)
- 3 keys to control all functions
- Digital display, resolution 0.1 mm

Stereo Microscope for cupping tester

This stereo microscope with illumination and brightness control is designed to observe the paint surface during the test.

- 2x and 4x magnification
- 3D-image with shadowless illumination
- Ergonomic working position

Procedure

- Insert the test panel into the C-opening of the instrument
- Clamp in the sample firmly
- Start cupping and simultaneously observe the process through the stereo-microscope
- Apparatus presses the cap of the spherical punch into the test panel at a uniform speed (0.2 mm/s)
- As soon as the first cracking is visible, stop the movement of the punch
- Read the cupping depth on the digital display and reset the punch
- Always carry out 3 tests for each sample

Ordering Information

Cat. No.	Description
PF-5400	cupping tester
PF-5411	Stereo Microscope for cupping tester

Comes complete with:

Cupping tester
Connection cable and plug
Operating instructions

Stereo Microscope for cupping tester:

Stereo microscope
Microscope rest and illumination
Operating instructions

Note: Stereo microscope must be ordered separately



cupping tester with stereo microscope

Standards

ISO	1520
Erichsen Cupping	EC

Technical Specifications

Spherical Punch	ø 20 mm (ø 0.8 in)
Sheet Holder	ø 33 mm (ø 1.3 in)
Die	ø 27 mm (ø 1.06 in)
Voltage	230 V / 50 Hz or 115 V / 60 Hz; built-in switch
Current Indicator	max. 4 A (230 Volts)
Dimensions	650 x 280 x 600 mm (26 x 11 x 24 in)
Weight	65 kg (143 lbs) (incl. microscope and packing)

Cylindrical Mandrel Tester

Bending coated sheet metal over a defined radius is an indicator of the elongation and adhesion of a paint film at bending stress. BYK-Gardner offers two types of mandrel bending testers – a cylindrical mandrel and a conical mandrel.

BYK-Gardner Cylindrical Mandrel

ISO Version

This mandrel is used for simple and quick testing of the flexibility of a coating by bending a coated panel over a rod of known diameter and then examining the coating for cracking, flaking, or other damage.

- Made of anodized aluminum
- 12 mandrels of stainless steel
- Panels up to 65 mm (2.56 in) width can be tested
- Rod diameter sizes: 2, 3, 4, 5, 6, 8, 10, 12, 16, 20, 25, 36 mm

ASTM Version

- "V" shaped cuts for holding a mandrel during a test
- Slots at the base of the frame hold the rods not in use
- Panels up to 14 cm (5.5 in) x 22 cm (9.0 in) can be tested
- Rod diameter sizes: 1/8, 3/16, 1/4, 5/16, 3/8, 7/16, 1/2, 3/4, 1.0 inch

Procedure

- Apply the paint film on sheet metal strips
- Coat and dry film carefully to ensure reproducible results
- For testing, uniformly bend the coated samples over the bending mandrels within 1-2 sec at 180 degrees
- Starting with the largest bending radius, the test is continued until reaching the bending radius at which the film shows cracks



Standards

ASTM	D 522
DIN	53150
DTMS 141a	Method 2012 Method 6051 Method 6221 Method 6223
ISO	1519

Certified

For Preventive Maintenance see page 272.

Ordering Information

Cat. No.	Description
PF-5710	Cylindrical Mandrel Bending Tester ISO Version
PF-1412	Cylindrical Mandrel Set ASTM Version

Comes complete with:

Cylindrical Mandrel Bending Tester, ISO Version:
Set of 12 SS rods from 2 mm to 32 mm; Frame; Operating instructions
Cylindrical Mandrel Set, US Version:
Set of 9 SS rods from 1/8 in to 1.0 in, Frame, Operating instructions

Technical Specifications

Dimensions	Net Weight	Shipping Weight
38 x 14 x 15 cm (15 x 5.5 x 5.9 in)	4.4 kg (9.7 lbs)	5.0 kg (11 lbs)
300 x 180 x 180 mm (12 x 7 x 7 in)	2.3 kg (5.0 lbs)	3.6 kg (8.0 lbs)

Conical Mandrel Tester

The varying mandrel diameter (3.2 mm - 38.1 mm, 1/8 to 1.5 inches) stretches a coating through a gradient of distension, allowing precise determination of adhesion characteristics.

- Panels up to 20.3 cm (8 inches) and 1.6 mm (1/16 inches) thickness can be tested
- Durable sturdy stainless steel mandrel

Procedure

- Carefully cover test panel with paper between mandrel and draw bar, and clamp the probe
- Fold the test panel around the cone by using the manually operated arm that is pivoted at the ends of the axis of the cone
- Bend uniformly at 180 degrees within 15 seconds
- Remove panel and examine the coating for cracks
- Mark the point at which the cracking stops and measure the distance from the farthest end of the crack to the small end of the mandrel
- Appropriate calibration curves also permit determination of the elongation values of the paint film



Standards

ASTM	D 522, D 1737
DIN	53150
ISO	6819, 6860

Ordering Information

Cat. No.	Description
PF-5750	BYK-Gardner Conical Mandrel

Comes complete with:

Stainless Steel Conical Mandrel
Operating instructions

Technical Specifications

Net Weight	Dimensions	Shipping Weight
4.1 kg (9.0 lbs)	510 x 150 x 180 mm (20 x 6 x 7 in)	5.5 kg (12.0 lbs)

Certified

For Preventive Maintenance see page 272.



Measure what you see.

spectro-guide

Two in one!

"Do you measure color and gloss at the same time? It's simple with my new spectro-guide. Even on structured surfaces the measurement results are excellent. What else do you need?"

www.byk.com/instruments

A member of  **ALTANA**

 **BYK**
Additives & Instruments

Introduction

Microscopes have been used for centuries as visual aides to assess small structures. BYK-Gardner has several products that use microscopes either as an integrated component of the instrument or as a stand-alone product. This section summarizes the stand-alone microscopes that are currently available.

Digital Microscope

An electronic image available on a personal computer has opened new opportunities to evaluate surface quality and document results. Many physical property tests are evaluated by visual analysis: cross-cut adhesion, impact resistance, flexibility, abrasion resistance, and scratch/mar. An electronic image can be used to provide a more comprehensive evaluation and documentation of the test results.

A digital microscope combined with image analysis software has created a new line of analytical tools to assess appearance. The Print and Paper Industry has developed several test to maintain product quality. Assessment of the printing process and the paper's appearance has well defined measurement parameters. Digital microscopes offer a comprehensive analytical analysis for an objective evaluation.

Traditional Microscope

BYK-Gardner offers two microscope designs specific for physical property testing. The microscope for the Automated Cupping Tester has a unique design that attaches to the Cupping Tester. The microscope provides a detailed observation of the test panel. The Buchholz Indentation hardness tester also requires a specific microscope design to measure the indentation length. The microscope incorporates a graduated scale for a precise assessment.



MICROSCOPES

DPM 100

Digital Pocket Microscope

The NEW DPM 100 Digital Pocket Microscope offers varying magnification up to 200x suitable for most quality inspection work. The microscope features integrated LED illumination which can be turned on and off depending on the application. The DPM contains a high-resolution color camera which provides crisp, clear images. To capture an image simply press the red button on the microscope. The microscope can be used for many applications, such as print quality, paper structure, coatings, textiles, plastics, etc.

DPM 100 Digital Pocket Microscope

Features:

- High resolution CCD-camera offering clear images
- Very Portable and easy to use
- USB cable connection for data transfer
- Auto Gain function to adjust lightness differences
- 4 LED Illumination for crisp images
- Capture button to save an image

DPM 100 Software

Features:

- Database function to store images and test results
- DPM Standard Measurement:
Region Tool, Distance Tool, Angle Tool, Circle Tool,
Area Tool, Step Distance Tool
- Automatic Image Analysis:
Dots, Lines, Text, Barcodes, Shapes, Satellites,
Voids, Graininess, Mottling, Missing Dots etc.
- Calibration function for the camera with calibration sheet



Ordering Information

Cat. No.	Description
PO-9091	DPM 100 Digital Pocket Microscope

Comes complete with:

DPM 100 Instrument
DPM Software
Metal Cup
Instrument Metal Stand
Carrying Case
Operating manual (English)

Technical Specifications

Resolution	Magnification	Power supply
1600 x 1200 Pixel (≈ 1.4 μm per pixel)	200x	USB Port (5 VDC)
Interface	USB 2.0 Cable 1.4 m	
Dimensions	ø 32 mm x 114 mm	
Weight	90 gr.	

Typical Application

Print and Paper Industry

Dots & Satellites

The "Dot" function determines the number of dots, average area size (mm²) and their covered area (%) together with the corresponding data for detected satellites inside the defined region.

Lines

The "Line" function will automatically characterize the leading and trailing edges of the line with respect to the angle, blurriness, raggedness together with the width (mm) and contrast of the line according to the ISO 13660 specifications.

Shapes

The "Shape" function will automatically characterize the area (mm²), width (mm), height (mm) and perimeter (mm) of the selected object inside the defined region.

Voids

"Voids" are detected when a solid black area has white, unprinted spots in it. The voids must be within the size limits defined by the voids parameter. The DPM software will count the number of detected voids inside the selected area.

Mottling & Graininess

This function characterizes how evenly a uniform printed area appears to the human eye.

For "Graininess", the high frequency variations are characterized from sub-images (tiles) of different sizes from 0.042 mm (0.0018 mm²) up to 1.02 mm where the smaller tiles will divide the defined region into more sub-images (counts). The variation between the sub-images of a particular grid size (Grid) is then calculated as the standard deviation (S.D). Finally the different standard deviations are averaged into one single "Total" number.

The "Mottling" describes the low frequency pattern and here only a single grid size of 1.27 mm is used to calculate the variation. According to ISO 13660, the region must be at least 161 mm² (12.7 mm x 12.7 mm) in which case the DPM instrument must be installed on a stand to obtain 100 tiles for mottling.

Paint and Coating Industry

Destructive Film Thickness

The V-shaped cut from the byko-cut can be easily stored as an image with film thickness info in mm. Also the width from the cut can be detected and recalculated to the film thickness of the coating depending on the cut-Angle.

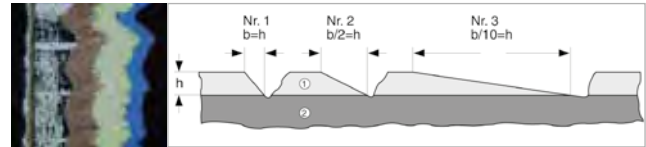

Adhesion Test

Evaluation of the adhesion of a coating. Store the image into the DPM Software database and view the cross-cut on the screen and evaluate the edges, lines, shapes and defects of the cross-cut image.

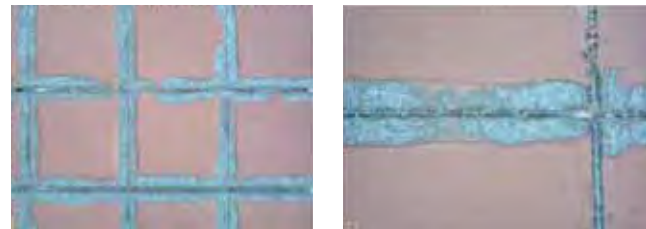

Buchholz Indentation

The indentation test as per Buchholz is a reliable test method for evaluation of indentation resistance of plastic deformable coatings. Evaluate the length after the test with the function "Distance Tool" and convert the values with the "Buchholz Indentation Table".



Elasticity and flexibility

Document your impact / cupping test or mandrel bending test result with a digital image.



Impact Test

Cupping Test

Mandrel Bending

Precision Microscope

This precision microscope usually is used to measure indentation length.

- 20x magnification
- inclusive light source



Info!

For more information on "Buchholz" Indentation Hardness and Indentation Tester please see pages 199 - 202.

Ordering Information

Cat. No.	Description
PH-5824	Precision Microscope only

Technical Specifications

Comes complete with
20 x magnification with graduated scale to measure indentation length, incl. light source; Weight: 0.8 kg

Stereo Microscope

This stereo microscope with illumination and brightness control is designed to observe the paint surface during the test. The stereo microscope usually is used for the BYK-Gardner cupping tester.

- 2 x and 4 x magnification
- 3D-image with shadowless illumination
- Ergonomic working position



Info!

For more information on cupping test and cupping tester please see pages 206 and 217.

Ordering Information

Cat. No.	Description
PF-5411	Stereo Microscope for cupping tester

Comes complete with:
 Stereo microscope
 Microscope rest and illumination
 Operating instructions

Introduction

Baking Temperature

Today's industrial mass production would not be possible without the use of baked coatings. Drying times (baking times) varying between a few minutes to half an hour are common in the production process.

Today's finishes must meet very high mechanical and appearance QC requirements, including

- Optimum adhesion
- Sufficient elasticity in case of deformation through mechanical stress
- Long-term weather stability, e.g. corrosion resistance
- Gloss and color stability
- Optimum hardness

Optimum curing is the prerequisite for achieving these specifications. The properties and the exact temperature distribution of the oven must be known in order to avoid rejects and ensure consistent quality. Poor curing can lead to failure:

- Insufficient adhesion to the substrate
- Insufficient elasticity to resist mechanical stress
- Insufficient surface hardness
- Premature aging, brittleness and chipping, leading to rust and corrosion
- Discoloration and loss of gloss

Any of these damages can be costly to repair.

The traditional range of baked coating systems has changed considerably with the introduction of environmentally friendly systems. The following types of paint technologies are being used:

- Conventional, solvent borne systems with 50% to 60% organic solvents
- High-solids with 10% to 30% solvents
- Water-borne paint systems
- Powder coatings, 100% solids and 0% solvents

Thermoset coatings (acrylic, polyester, epoxy or alkyd resins) are established finishes for industrial applications.

The right catalysts and amount of heat initiate the cross-linking process among the various components. The result is a compact paint system consisting of polymers, resins, binders and pigments, which is to be chemically resistant and long-lasting.

Paint properties largely depend on cross-linking quality. Today's binders are very sensitive to insufficient cross-linking.

TEMPERATURE

Insufficient cross-linking causes

- Soft films with low hardness
- Poor or no chemical resistance
- Poor weather resistance (UV, SO₂, etc.)
- Increased gloss
- Lower haze values

Insufficient cross-linking can also result in

- Better adhesion
- Better flexibility
- Better intercoat adhesion

Over-cross-linking causes

- Increased hardness
- Less flexibility
- Less gloss
- Higher haze values
- Poor adhesion or intercoat adhesion
- Improved solvent resistance
- Yellowing or discoloring
- Less outdoor resistance, especially when subjected to UV radiation

In order to determine the optimal cross-linking parameters of a system, a series of tests must be carried out at different baking temperatures. Minimum and maximum baking temperatures determine the limits of an optimal curing process. In this process, time and temperature can vary. The reaction speed changes with the temperature, but in a non-linear manner. The heat-up speed is another key factor for solvent based and aqueous systems. If the heat-up speed is very high the solvent evaporates too quickly and pinholes may occur causing poor appearance.

The example below shows three different theoretical temperature profiles with identical curing. Slight temperature changes have a big impact on the curing time.

In the production process the temperature profile will rarely be so simple, since material thickness is never constant and oven temperatures vary due to external influences.

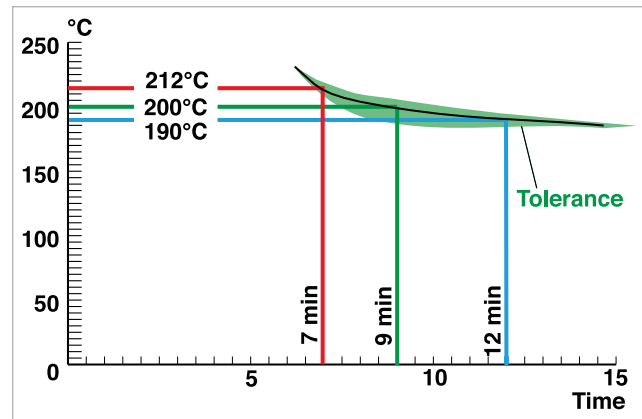

Baking Ovens

Baking properties of new paint systems need to be tested and optimized in the laboratory. This is usually done with a convection oven. The coated test panel is put into the preheated oven for a set time. To this point the process in the laboratory is identical with the process in the production line. This stage in development is very time and labor intensive. Many test panels have to be baked at various temperatures and times. This is the only way to accurately determine the optimum temperature and baking time.

In addition, it is difficult to accurately reproduce a constant sample temperature and heat-up speed of the sample using several convection ovens.

gradient-oven

BYK-Gardner offers a well established type of baking oven – the gradient-oven – for better control, higher precision and production simulation in the laboratory.

The gradient-oven houses a microprocessor-controlled heating bank consisting of 45 heating elements, each equipped with a Pt-100 temperature probe. Each element is separately insulated allowing the setting of different temperatures at two adjoining elements.

The coated test panel 22 x 4 inches (560 x 100 mm) is automatically transported onto the heating bank with the help of a sample pressure device guaranteeing quick heat transfer. The heating area is enclosed by a special cover situated approximately 2 inches (50 mm) above the test panel.

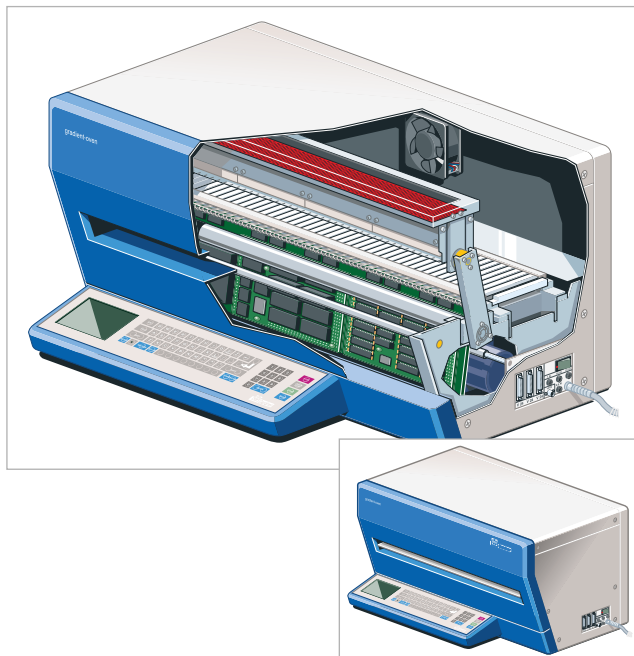

Comparison of convection ovens with the gradient-oven
Comparison measurements between convection ovens and the gradient-oven show the following temperature profiles.

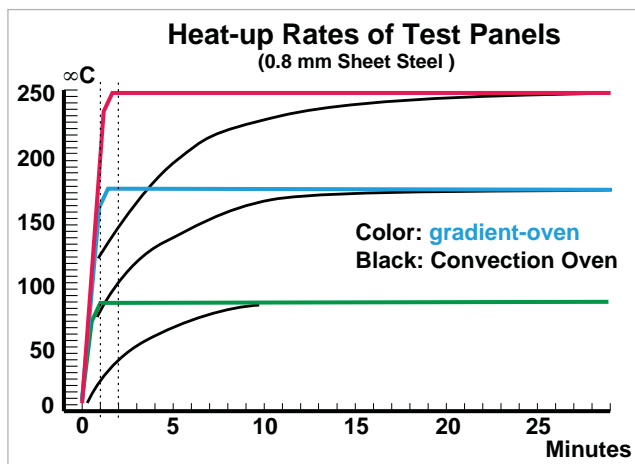

Testing with the gradient-oven provides major benefits:

- QC of color, appearance and physical properties can be performed with continuous temperature variation on one panel
- A panel can be baked with various temperature profiles:
 - constant temperature over the entire test panel
 - linear gradients with a maximum difference of 100 °C
 - step gradients of different temperatures
- Heat-up speed and baking time can be set in such a way that production baking conditions can be simulated in the laboratory
- High accuracy allows reproducible results and avoids repetitive tests
- Major savings on application time, coating material, the number of used test panels, energy and time

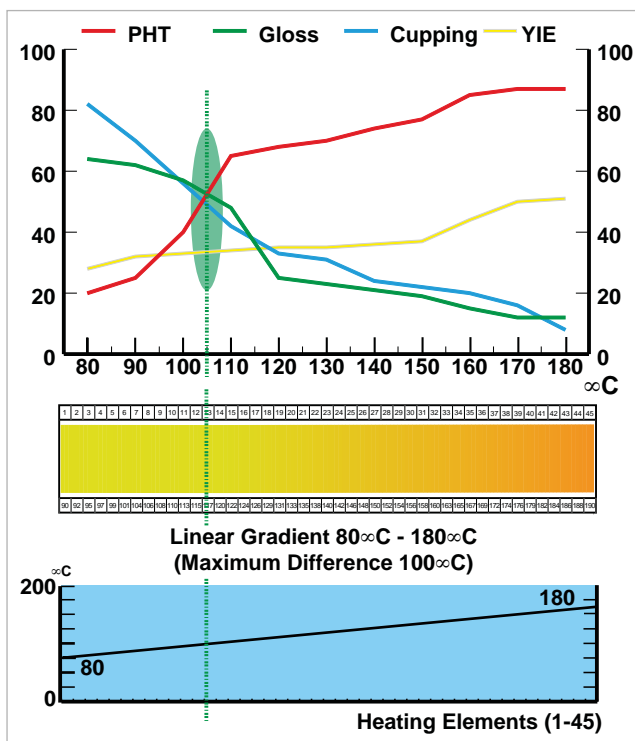

Oven Temperature Recorders

In order to gain maximum output of a production line the baking oven must fit perfectly into the process. The method of heating the oven (gas, oil, electricity), and air distribution as well as the assembly line speed are parameters which must be taken into account for the control of the oven. The oven temperature is influenced by power variations and oven construction. The object temperature depends on parameters such as material, material thickness, the place of suspension (top, middle, bottom), and assembly line speed. It is essential to check whether an oven works properly to ensure right heat-up of an object, guaranteeing optimal cross-linking and curing. Geometrical shape, size and material type also play a major role in the heating characteristics of the object. In order to guarantee a consistent temperature at a set baking time it is necessary to directly measure the object temperature – this is especially true for complex-shaped objects with varying thickness.

The internal temperature distribution of an oven needs to be controlled at regular intervals. Quality assurance according to DIN ISO 9000 also requires professional documentation and increased accuracy. BYK-Gardner's oven temperature recorders fulfill these requirements.

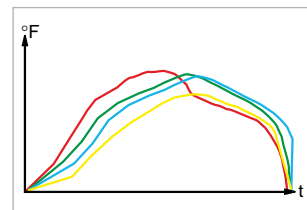
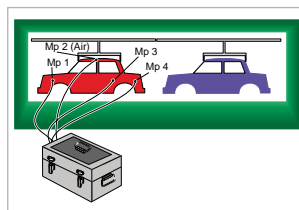

temp-gard

A significant improvement in the recording of oven processes has been made with the temp-gard.

This measurement system stores the analog signals of temperature probes in digital form. A measurement module accompanies the object on its way through the oven without needing a trailing cable. The recording module is protected by a thermal barrier made of stainless steel with absolutely temperature safe insulation.

The digital data is transferred to a computer for further processing. Each measurement is saved as a file.

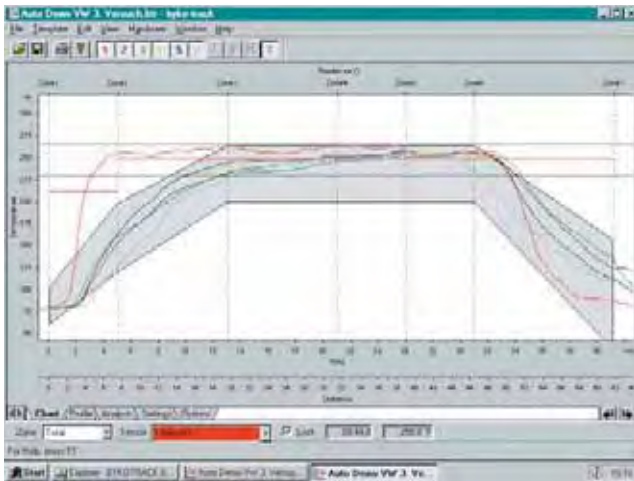

The temp-gard system controls the curing process and immediately evaluates the results. Within a few minutes all important information is available on the screen and can be printed out:

- The measurement points of the object
- Date and time of the measurement
- Name of the operator and identification of the oven
- Temperatures in °F or °C
- 4-color graphic of the entire measurement curve with display of temperature and time

The peak temperature and a warning message occur when the maximum temperature of a probe is above the control value. It is possible to quickly and regularly check and document the quality of daily production. In addition, this temperature measurement system allows control of oven performance without risking loss of quality.



test panel is cured in the gradient-oven using the temperature profile of the production oven

BYK-Gardner offers a complete solution for testing all important color, appearance and physical properties on one gradient-oven panel.



cupping tester



pendulum hardness

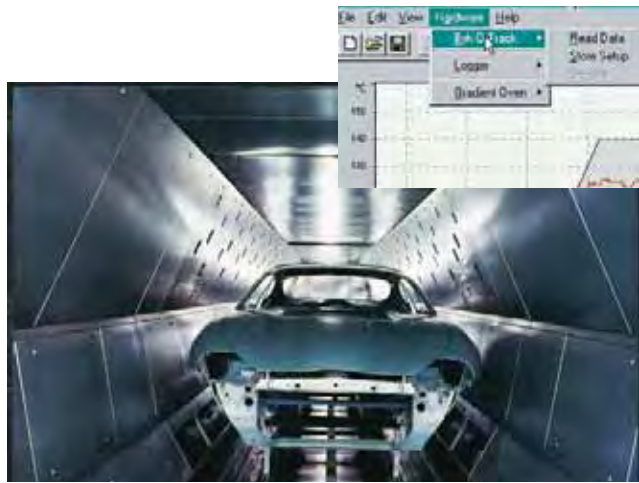

temp-gard collects temperature data in production oven.



temp-gard temperature data is transferred to gradient-oven.

Production Conditions in the Lab

The methods of storing oven temperature curves as described above can also be used for simulation in the laboratory. The transfer of a temperature profile measured on a certain object to the gradient-oven allows the complete simulation of industrial baking processes in the lab. All 45 heating elements of the gradient-oven heat up the coated test panel in the laboratory according to the temperature profile of the industrial oven in the production line. The accuracy can be checked via comparison of set and actual temperature on the screen. With this method the paint manufacturer can measure the temperatures of his clients' ovens, archive the data and simulate the curves with the gradient-oven when needed.



micro-gloss



spectro-guide

gradient-oven

The gradient-oven is a test apparatus for evaluating the baking and drying behavior of liquid coatings, powder coatings, resins, plastics, etc. A production baking process can be simulated by programming heat-up speed, baking temperature and time.

- Saves time and energy
- Generates various curing temperatures on one panel
- Simulates the temperature profile of a production oven in the laboratory



gradient-oven PT-2610 with optional printer Cat. No. PT-2630

Ordering Information

Cat. No.	Description
PT-2602	gradient-oven 250 °C
PT-2610	gradient-oven 320 °C
SE-2602	Extended Warranty one year additional

Comes complete with:

gradient-oven
 exhaust tube
 1 pc. glass plate
 25 pcs. test panels
 25 pcs. marking strips
 Training

Training for gradient oven / temp-chart

BYK-Gardner offers you more than just an instrument. We assist you in operation of the gradient-oven and temperature analysis. As a result you will be able to use the system to save time and money and at the same time improve your quality. Therefore, the instrument comes with a half day training course including:

1. Temperature analysis, oven profiles theory

- Temperature versus time, typical process curves
- Data interpretation: How can the oven profile be used to optimize process / material parameters

2. gradient-oven Operation

- Set-up parameters
- Linear and step gradient
- Macros
- Double macro

3. Operation and Software Training

- Software overview
- Send an oven profile to the gradient oven
- Programming of gradient-oven with temp-chart software
- Data transfer to gradient-oven and online monitoring

Technical Specifications

	Temperature	Connection for temp-gard oven recorder
	30 - 250 °C (86 - 482 °F)	included
	30 - 320 °C (86 - 608 °F)	included
Voltage	230 V, 50/60 Hz	
Power	3400 VA	
Consumption		
Heating Surface	520 x 100 mm (20.4 x 3.9 in)	
Test Surface	500 x 70 mm (19.6 x 2.7 in)	
Heating Elements	45 pcs.	
Pressure Platform	reciprocates automatically (16 kp) for insertion and removal of panel	
Linear Gradient	max. temp. difference between: 30 and 250 (320) °C: 100 °C; 86 and 482 (608) °F: 180 °F	
Step Gradient	with 2, 3 or 4 steps: max temp. difference betw. 2 steps: 50 °C (90 °F)	
Heat-Up-Speed	2 °C to 30 °C/min, programmable (3.6 °F/min to 54 °F/min)	
Baking Time	in sec. and min.	
Memory	max. 10 gradients	
Accuracy	control accuracy of the heating elements: < ± 2 °C (< 3.6 °F) surface temperatures on 0.8 mm test panels from element 3 to 43: to 200 ° ± 2 °C (to 392 ° ± 3.6 °F) to 250 ° ± 3 °C (to 482 ° ± 5.4 °F) to 320 ° ± 5 °C (to 608 ° ± 9.0 °F) measured under specific test conditions	
Dimensions	465 x 720 x 595 mm (18 x 28 x 23 in)	
Weight	50 kg (110 lbs)	

gradient-oven Accessories

Certified

For Preventive Maintenance see page 273.

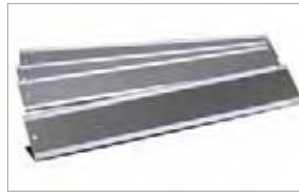

Test Panel with Marking Strip



Application Device



Printer with Paper Types



Portix, infrared thermometer

Ordering Information

Cat. No.	Description
PT-2634	Printer Ribbon
PT-2636	Self-Adhesive Printer Paper
PT-2637	Self-Adhesive Printer Paper
PT-2645	Jig for Powder Coating Application
PT-2626	Glass Plate
PT-2627	Glass Plate
PT-2623	Test Panels
PT-2628	Film Application Device
PT-2630	Flat Bed Printer
PT-2621	Exhaust Tube
PT-2622	Marking Strips
PT-2900	Portix, infrared thermometer

Comes complete with:

Infrared thermometer; NiCrNi connection;
Adaptix-C file transfer software; 9 V alkaline battery; Carrying case

Accessories

For flat bed printer, Cat. No. PT-2630
For flat bed printer, Cat. No. PT-2630; for printing reports; Set of 100 sheets for 200 reports
For flat bed printer, Cat. No. PT-2630; for printing panel marking strips; Set of 100 sheets for 200 marking strips
To facilitate application of powder
For gradient-oven, Cat. No. PT-2600 to PT-2610 to protect heating bank
For gradient-oven (old model black), Cat. No. PT-2611 to PT-2617 to protect heating bank
For application of samples for the gradient-oven; made of ST 14 0 5 steel; dimensions: 568 x 98 x 0.8 mm (22.36 x 3.86 x 0.03 in.); Set of 100
Solid aluminum construction, 6 knurled screws for secure clamping of test panel during paint application, free floating slide jig holds film applicator; Recommended film applicators PA-2056, PA-2057
For gradient-oven, Cat. No. PT-2600 to PT-2610; incl. accessories Length 2.5 m (98.4 in.); \varnothing 80 mm (3.1 in.)
Self-adhesive strips for test panels, Cat. No. PT-2623; Set of 100

Measuring Range	-30 - 400 °C (-22 - 752 °F)
Target	5 mm diameter at a distance of 40 mm
Resolution	0.1 °C
Dimensions	175 x 60.5 x 35.5 mm (7 x 2.5 x 1.5 in)
Weight	270 g (0.6 lbs) incl. battery
Uncertainty	1 °C \pm 1 digit; at e 1 and Tu = 23 °C

gradient-oven Applications

The gradient-oven saves time and money in R & D as well as QC testing of raw materials (e.g. additives, pigments, resins, and coatings). It allows you to simulate the conditions of a production oven in the laboratory by downloading temperature profiles recorded with our temp-gard oven recorder. Thus, material properties, baking conditions and production ovens can be optimized for best quality and economical operation.

Temperature stability of iron oxide pigments:

Depending on the chemical composition the various iron oxide pigment types show different temperature stabilities:

	Temperature stability
Red iron oxide:	up to approx. 1200 °C (2192 °F)
Yellow iron oxide:	up to approx. 200 °C (392 °F)
Brown iron oxide:	up to approx. 180 °C (356 °F)
Black iron oxide:	up to approx. 180 °C (356 °F)

In the following example, two yellow iron oxide pigments with different temperature stabilities were tested in a silicone polyester system.



Whenever low temperature stable iron oxide pigments are used in baked coating systems or composite materials, it is very critical to define the production window in which the baking temperature will not affect the mechanical, chemical or the optical specifications.

The high repeatability and reproducibility of the gradient-oven helps to accurately determine the tolerance range. Depending on the gradient-oven type, coatings can be tested with temperatures up to 320 °C. By applying the coating system with a duplex frame applicator two different coating systems can be applied & tested simultaneously on the same panel. This makes the comparison easier, saving application time and material cost.

Results:

Pigment type A starts showing a discoloration at 210 °C, while pigment type B remains color stable up to 250 °C. At temperatures over 280 °C both pigments can no longer be used.

The gradient-oven saves you time and money because the testing is considerably shorter than using a convection oven. In addition, the high precision and tight temperature control of the individual heating elements guarantee you reliable and repeatable results – test after test.

Temperature influence on silicone additives

Inter-coat Adhesion

In a multi-layer system, like automotive coating systems, silicone additives can diminish the inter-coat adhesion. Silicones have the tendency to migrate to the surface. As they don't have reactive groups, they are not integrated in the coating surface of the first layer. Consequently, they would migrate into the surface of the 2nd layer during application. This type of behavior is known as silicone migration.

If the 1st coating layer is baked, reactive groups are created and the silicone additive gets embedded into the resin system of the 1st layer. The capability to migrate is gone which can result in a diminished inter-coat adhesion. The temperature stability of silicones varies depending on how they were modified. The gradient-oven can test the influence of temperature on one panel.

Test procedure:

Two differently modified silicones were tested:
Sample A: BYK®-310 – polyester modified polysiloxane
Sample B: Polyether modified siloxane

The application and baking occurred in two steps. For ease of testing the two layers were differently pigmented – 1st layer white and 2nd layer red. The white coating was applied first and baked in the gradient-oven using the step gradient function: 130 °C – 150 °C – 170 °C – 190 °C for 30 minutes. Then the red pigmented coating was applied and baked under the same conditions.

The quality of the inter-coat adhesion can be evaluated by using a cross-cut tester with tape, or with knife & tape according to a Ford test specification.



BYK®-310 used in sample A

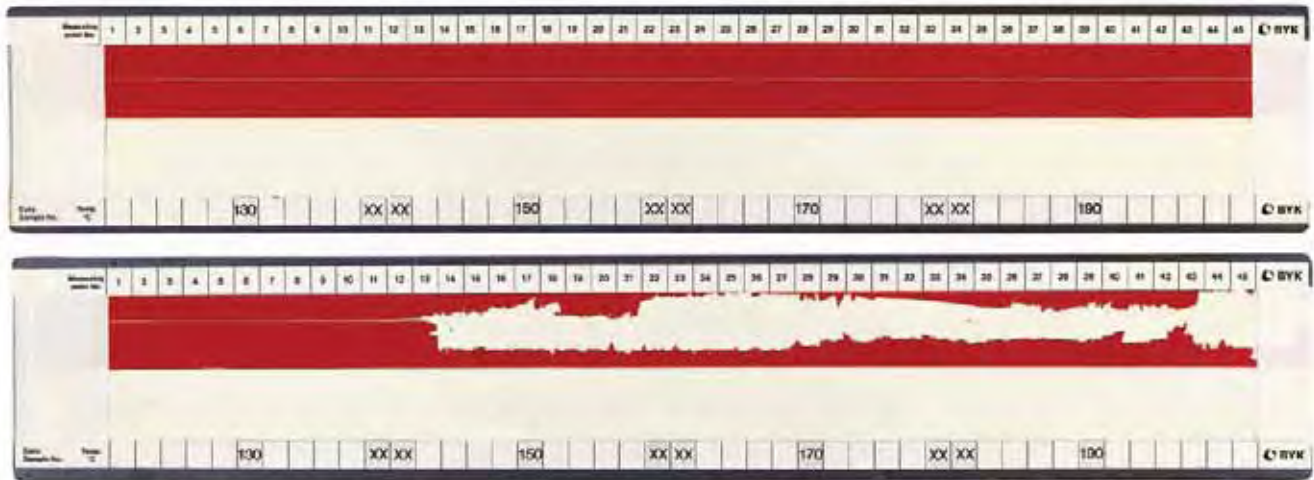

Result according to Ford Test:

Sample A shows excellent inter-coat adhesion at all 4 different temperature ranges. In case of sample B the inter-coat adhesion is destroyed at baking temperatures higher than 150 °C.

Ford Test Specification:

The coating is marked with a knife, adhesive tape is applied to the test surface, pressed on and removed.

Rewetting of 2 coat systems:

At high temperatures silicones can cause wetting problems in a 2 coat application process.

Test procedure:

Two differently modified silicones were tested in an amino-cured alkyd topcoat:

Sample A: BYK®-325

Sample B: Polyether modified polysiloxane

For ease of testing the two layers were differently pigmented – 1st layer white and 2nd layer red. The 2 coats were applied wet on wet with a spray gun and each coat had a wet film thickness of 150 µm. The silicone additives were only added in the 2nd coat. Both systems were baked in the gradient-oven using the linear gradient function: 120 °C – 190 °C for 30 minutes.

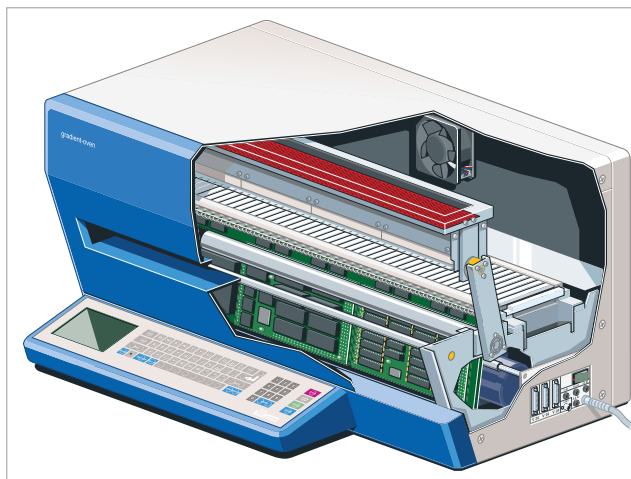

BYK®-310 used in sample A

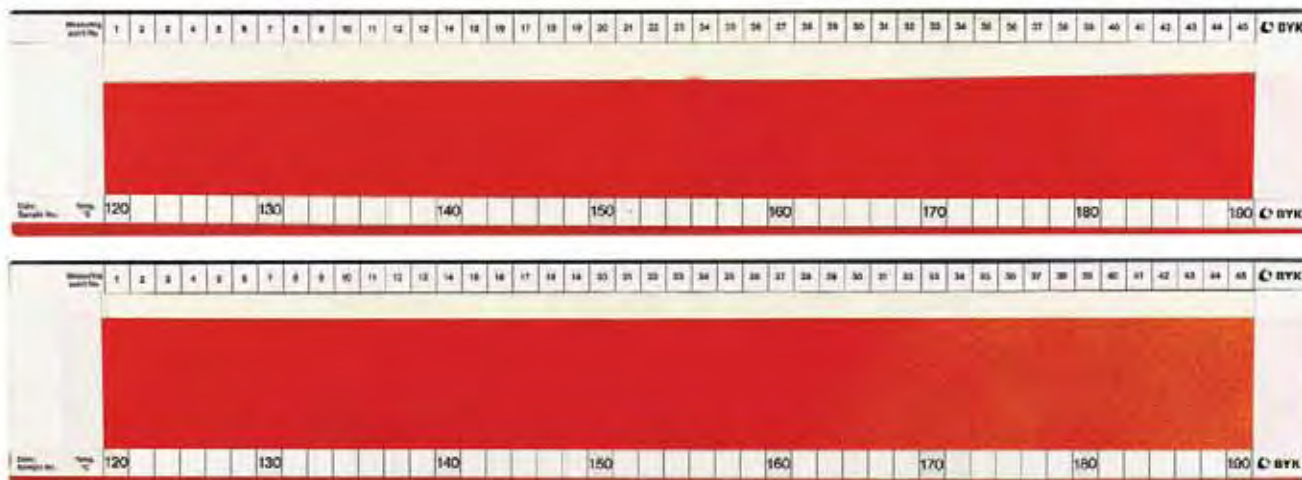

Result:

Sample A was perfectly wetted, while in sample B the two coats "separated" – droplet formation can be seen at higher temperatures. Therefore, sample B can only be exposed to a maximum temperature of 165 °C.

Chemical etch resistance of automotive topcoat systems:

Acid rain, bird droppings, fuel, antifreeze and many other environmental factors can damage automotive finishes. Especially in summertime, some substances can be very aggressive and cause severe damage. Therefore, automotive paint manufacturers as well as auto makers need to find out how different environmental phenomena will interact with a coating system. Throughout the world panels are tested on weathering sites for years to evaluate the influence on color, gloss as well as physical properties.

The gradient-oven has been approved by the automotive industry as an accelerated test method. It allows prediction of how a particular coating system reacts to a specific material at increasing temperature levels. This test method is specified by several automotive companies.



The gradient-oven helps to speed up R & D projects saving time and money. In QC testing of baked coating systems the gradient-oven produces repeatable results many times faster than using traditional convection ovens.



Test procedure:

In a standard test 5 different chemicals can be tested on one panel – e.g. H_2SO_4 which simulates atmosphere and acid rain, NaOH for car wash detergents, pancreatine (bird dropping), brake fluid, and tree resin. The panels are coated and baked under the specified processing conditions. Using a pipette droplets (approx. 0.05 ml) of these various materials are placed about 6 mm apart vertically on the test panel. Repeat this length down the panel with spacing about every 2-3 cm. The gradient-oven is then programmed to have a linear gradient in the range of 35 °C – 80 °C. The panels are now baked at either 20, 30 and / or 60 minutes to allow for evaluation of the coating. After the baking process the panel is washed under running water, dried and visually evaluated. The evaluation should be done after approx. one hour and again after 24 hours to see if any additional etching has occurred.

The temperature is documented at which the first visual changes and damages occurred.

Accelerated Acid-Etch Test at Solutia

gradient-oven, a unique lab oven simulating multiple temperatures on one test panel

Acid etch, or environmental etch, is a defect that can occur in any exterior paint finish. However, it is a major concern for the automotive industry. The result of acid etch may appear as rings on a car's finish. These rings may seem like water spots, but in actuality, damage has been done to the finish, so washing does not remove the rings. Certain geographical areas are affected more than others – areas adjacent to heavily industrialized cities usually have high incidents of acid etch complaints.

Historically, isocyanate-crosslinked coatings outperformed melamine-crosslinked coatings for acid-etch resistance. However, melamine-crosslinked coatings are still in use because they are more cost effective and have better mar resistance.

The automotive industry has primarily studied and tried to eliminate the paint defect caused by acid etch. An accelerated acid etch test using the BYK-Gardner gradient-oven facilitates evaluation of different coating systems.

This relatively simple test yields a pair of values, the minimum spot temperature (MST) and the scaled acid value. These values are used to rank the severity of the acid damage to a coating. To make the comparison of coatings in this brief study easier, one acrylic polyol and either an isocyanate resin or a melamine resin were used as the crosslinker.

Procedure

- Prepare a panel for testing by coating a film on a 4" x 22.5" x 0.032" steel (polished) panel using the formulation and cure parameters for the specific material. Sometimes a post-cure time period is recommended before the acid-etch test is run.
- Set the gradient-oven for a 30-minute time cycle using a temperature range of 35 - 75 °C as a continuous gradient. The oven has 45 individual temperature zones.
- Label the panels with the supplied paper strips which are numbered from 1 - 45 corresponding to the 45 gradient temperature zones. Directly opposite each number on the strip, use a pipette to dispense approximately two drops

(0.4 grams) of a 10% sulfuric acid solution (or other solution desired). Move the panel with the drops gently onto the pre-heated gradient surface for the 30 minutes.

- At the end of the 30 minutes, remove the panel and obtain the print-out of the actual temperature of each measuring point. Rinse off any remaining etching material with tap water. Using a facial tissue, wipe off any excess water. Spray the panel with "Super-Clear® lens cleaner" from AOSafety Products and wipe it off using a clean tissue.

grade 1 - barely visible

grade 2 - complete circle visible, but not filled in

grade 3 - totally visible and filled circle

grade 4 - blistering evident

grade 5 - removal of film to bare panel

- Examine the panel under a good light source. Tilt the panel back and forth and note the temperature corresponding to the first visually etched spot, no matter how faint. Record the temperature for that point from the print-out. This value is the minimum spot temperature (MST). To make the faintest rings visible, exhale, as if cleaning glasses, over the rings where "grade 1" damage starts. (This spot may disappear from visual sight in a short period of time.) Grade each using a scale of 1 to 5, with 5 being the worst:

- Sum all the grades. This value is the total acid effect. A maximum of 225 is possible, if all spots etch through to the bare metal. To express acid resistance on a scale from 0.0 to 1.0, take this total number and divide it by the maximum (i.e., $97/225$), and subtract the result from 1.0. This gives a scaled acid value $[1.0 - (97/225)] = 0.57$. A zero rating would be equal to a panel receiving a total acid effect of 225 (total failure) and a 1.0 rating would be equal to a panel not being affected by the acid at all.

It is possible to do multiple tests of several solutions at the same time.



Accelerated Acid-Etch Test at Solutia

Figure 1 shows an ordered series of test panels. The most affected panels are on the right. In this study, the acrylic polyol used was Macrynal SM 515/70BAC. Three variables were examined. The DFT (dry film thickness), the ratio of melamine resin to acrylic resin, and the crosslinker type were examined. The coating formulations and the acid etch results are shown in Table 1.

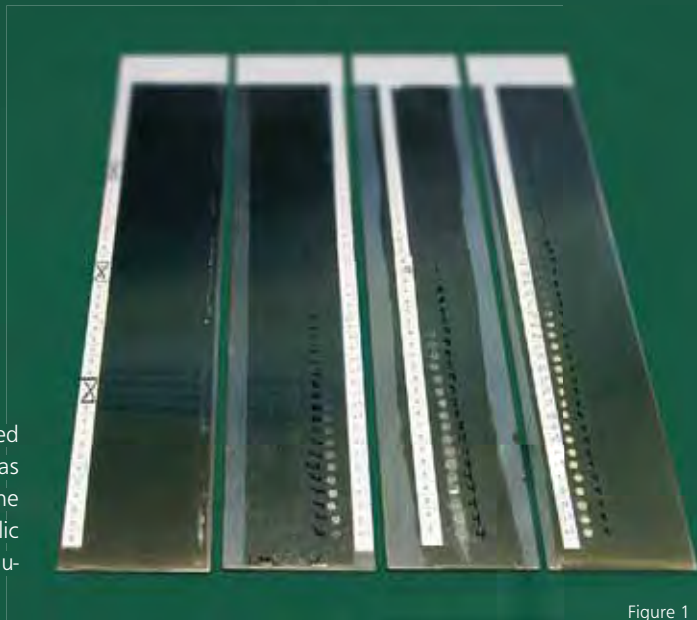

Figure 1

Table 1 / Formulations and Results

Materials (g)				
Macrynal SM 515/70BAC	14.01	14.01	14.01	8.25
Resimene 747	3.27	2.45	2.45	-
Desmodur N 3300	-	-	-	3.01
2-heptanone (MAK)	1.66	2.26	2.26	-
Propylene glycol methyl ether	0.83	1.13	1.13	-
Xylene	-	-	-	3.14
pTSA (5.0% IPA/t-BuOH)	0.368	0.368	0.368	-
15 minute flash; bake				
30 minutes at 138 °C				
DFT (mil)	1	1	2	1
72+ hours post cure				
Acid Spot Test Results:				
MST (°C)	49	53	52	53
Scaled acid value	0.609	0.703	0.711	0.622
Gradient oven - 30 minutes,				
heater zones set between				
35-75 °C				

The acid-etch values found for the 80/20 (acrylic/melamine) ratio coating indicate that this ratio produced a more acid resistant coating than the 75/25 ratio coating. Notice that the 2 mil coating did not significantly improve the acid-etch resistance as compared to the 1 mil coating. This demonstrates that as little as a 1 mil coating can have good acid-etch resistance. When the two different crosslinkers were compared, the melamine-crosslinked coating produced a slightly better acid-etch-resistant coating.

This is not a surprising result. Melamine systems can be made to produce coatings with similar acid-etch resistance as isocyanate systems. The choice of the vehicle binder resin seems to be the key in producing a coating with improved acid etch resistance when using a melamine crosslinker. Acrylic resins modified with alkoxy silane groups or with carbamate functionality are two technologies used to increase acid-etch resistance.

Reference:

By George D. Vaughn, James B. Downie and Patricia E. Ferrell, *Paint & Coatings Industry*, page 74 - 76, August 2001

Conclusion:

The gradient-oven is a valuable tool for testing acid-etch resistance. This simple test saves valuable laboratory time in preparing panels and helps to improve coating properties. The test results show a good correlation to actual Jacksonville test data.

A great screening tool.



gradient-oven
see pages 225 - 234.

temp-gard

Oven Temperature Recorder

The temp-gard temperature recorder system measures and saves object and air temperature during the cure process. Documentation and analysis of temperature profiles is made easy with the included temp-chart software: all you need to control and optimize your baking process.

The temp-gard data logger comes in two configurations, 12 temperature probe connections or 6 probe connections. The data logger has a new innovative design with a large color graphics display and flash drive connection for easy data transfer.

temp-gard system

- Flash drive interface provides easy data transfer for in the field or in plant locations
- Long battery life using 3 standard AA alkaline batteries
- Large color screen for numerical or graphical display of data
- Robust thermal barrier made of stainless steel with safe high temperature insulation
- High accuracy guarantees long-term reliable results
- Light weight easy to carry thermal barrier



Ordering Information

Cat. No.	Description
PT-3319	temp-gard 12p
PT-3317	temp-gard 6p
SE-3300	Extended Warranty -one year additional

Comes complete with:

- temp-gard datalogger instrument
- temp-chart software
- 1 Thermal barrier
- 1 Set of heat sinks
- 1 Probe for air temperature, magnet, 3m (PT-3131)
- 1 Interface cable to PC
- 3 AA Alkaline batteries
- Operating manual
- Certificate
- Carrying case
- Object temperature probes magnet, 3m (PT-3125) for:
 - temp-gard 6p 5 object probes
 - temp-gard 12p 11 object probes

Certified

For Preventive Maintenance see page 273.

Technical Specifications

Accuracy	± 0.5 °C
Resolution	0.1 °C (0.18 °F) from 0 - 400°C (32 - 752 °F)
No. of Channels	6 or 12
Memory	20,000 readings per channel
Sampling Interval	0.1 sec up to 24 hrs
Temperature Range	0 - 400 °C (32 - 752 °F)
Battery Capacity	0.5 sec interval = 50 hrs
Display	Color, 79 x 60 mm (3.1 x 2.4 in)
Interface	USB 2.0
Thermal Barrier Dimensions	255 x 215 x 135 mm (10.0 x 8.5 x 5.3 in)
Weight	3.56 kg (7.82 lbs)
Maximum Duration	at 100 °C, 8.5 hrs; at 200 °C, 3.0 hrs; at 250 °C, 2.5 hrs

Hardware Requirements:

- Operating system: Windows® 2000 or higher
- Excel® version: 2002 or higher VBA
- Memory: min. 256 MB RAM (recommended 512 MB)
- Hard disk capacity: min. 100 MB
- Monitor resolution: XGA (1024 x 768) or higher
- Disk drive: CD-ROM or DVD
- Interface: USB-port

temp-gard Accessories

Temperature Probes for any Application

- High quality thermocouple type "K" with special limits of error 1.1 °C or 0.4 % (ANSI MC 96.1)
- Magnets or clamps do not influence measurement results
- Connection cable of 1.5 m (59 in), 3 m (118 in) and 8 m (315 in) length available (see table)
- Response time for 100 % measuring range from 5 seconds to 2.5 minutes depending on probe style
- Can be used as replacement probes for other datalogger brands

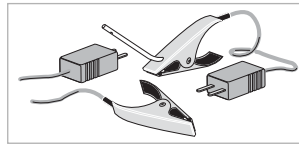

Style C Style A

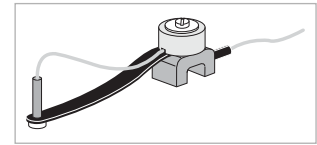

Style B

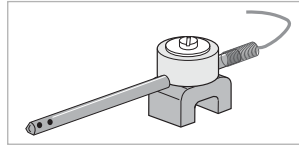

Style D



Style E

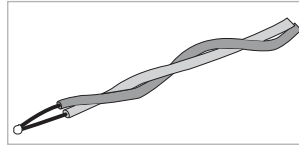

Style F

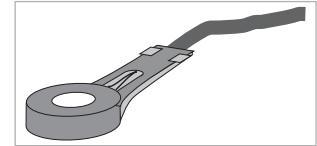

Style G

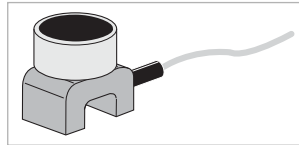

Style H

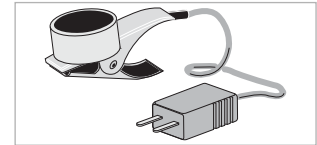

Style I

Ordering Information

Cat. No.	Description
PT-3121	Object Probe
PT-3122	Object Probe
PT-3123	Object Probe
PT-3124	Object Probe
PT-3125	Object Probe
PT-3126	Object Probe
PT-3127	Air Probe
PT-3128	Air Probe
PT-3129	Air Probe
PT-3130	Air Probe
PT-3131	Air Probe
PT-3132	Air Probe
PT-3133	Foil Probe
PT-3134	Open Probe
PT-3135	Open Probe
PT-3136	Open Probe
PT-3147	Open Probe (0.3 mm)
PT-3137	Extension
PT-3138	Extension
PT-3146	Object Probe
PT-3143	IR Probe
PT-3144	IR Probe
PT-3038	Adhesive Tape
PT-3325	Thermal Barrier
PT-3326	Heat Sink
PT-3320	temp-gard logger 12p
PT-3318	temp-gard logger 6p

Accessories

Style	Probe	Length	Attachment	Max Temperature
A	object	1.5 m	clamp	509 °F (265 °C)
A	object	3 m	clamp	509 °F (265 °C)
A	object	8 m	clamp	509 °F (265 °C)
B	object	1.5 m	magnet	509 °F (265 °C)
B	object	3 m	magnet	509 °F (265 °C)
B	object	8 m	magnet	509 °F (265 °C)
C	air	1.5 m	clamp	509 °F (265 °C)
C	air	3 m	clamp	509 °F (265 °C)
C	air	8 m	clamp	509 °F (265 °C)
D	air	1.5 m	magnet	509 °F (265 °C)
D	air	3 m	magnet	509 °F (265 °C)
D	air	8 m	magnet	509 °F (265 °C)
E	foil	1.5 m		509 °F (265 °C)
F	open junction	1.5 m		509 °F (265 °C)
F	open junction	3 m		509 °F (265 °C)
F	open junction	8 m		509 °F (265 °C)
F	open junction	3 m		509 °F (265 °C)
	extension	3 m		509 °F (265 °C)
	extension	5 m		509 °F (265 °C)
G	object	1.5 m	washer 2 mm	932°F (500 °C)
H	IR	3 m	magnet	509 °F (265 °C)
I	IR	3 m	clamp	509 °F (265 °C)
				heat-proof adhesive tape for attachment of foil probes
				incl. 2 heat sinks, max duration at 250 °C, 3h
				1 piece
				logger with 12 probe connections
				logger with 6 probe connections



temp-chart

Software

temp-chart is an easy-to-use software for documentation and analysis of the temperature profile. temp-chart was developed in close cooperation with leading automotive manufacturers. To analyse the curing data measured with tem-gard, temp-chart will merge the temperature data with oven parameters and analysis criteria to generate a temperature profile. Data will be stored in a database for professional documentation and easy access. The oven process can be optimized with means of the BYK-Gardner cure index (Porsche value).

- Graph of temperature profile with upper / lower limits, reference curve and tolerance range
- Temperature analysis table according to process parameters
- Product images with location of temperature probes can be imported
- Acquisition parameters like the number and name of probes, measuring frequency, duration time and starting modes can be easily fixed in the software and transferred to the temp-gard system.
- The analysis criteria and oven specifications- speed, zone number(s), length, and temperatures can be stored as separate files
- temp-chart was developed in close cooperation with leading automotive manufacturers.

temp-gard and gradient-oven optimize paint in the lab

The temp-chart software directly transfers temperature profiles to the unique BYK-Gardner gradient-oven. Two baking processes can be simulated on the same panel at the same time. Thus, a paint system can be tested and optimized in the laboratory under real production conditions.

Ordering Information

Cat. No.	Description
PT-3311	temp-chart 2
AG-4401	USB-adaptor, for connection to USB-interface, incl. driver software

Comes complete with:
1 CD Rom

Hardware Requirements:

Operating system: Windows® 2000 or higher
Excel® version: 2002 or higher, incl. VBA
Memory: min. 256 MB RAM (recommended 512 MB)
Hard-disk space: min. 100 MB
Monitor resolution: XGA (1024 x 768) or higher
Disk drive: CD-ROM or DVD
Interface: USB port



Technical Specifications

Analysis	Graphs, tolerance, range, reference curves, slopes, cure index
Data-Import	temp-gard systems
Data-Export	any database, Excel®
Languages	English, German, French, Italian, Spanish, Japanese

PosiTector DPM

Dew Point Meter

This new meter helps bring a new level of confidence to the painting contractor and inspector. Measure and record climatic parameters including air temperature, surface temperature, dew point temperature and the difference between surface and dew point temperatures, which is critical for determining condensation probability. This meter is ideal for surface preparation, as required by ISO 8502-4.

A large, easy-to-read graphic LCD display with multilingual support along with a two-button menu-driven user interface make this gage easy to operate.

- Rugged indoor/outdoor instrument is solvent, acid, oil, water and dust resistant – take it anywhere
- Graph Mode charts all five parameters for quick analysis
- Sliding cover on the sensor protects it when not in use and the white housing reduces the effect of direct sunlight for greater precision
- Sensor also has a soft rubber grip for easy handling and can be removed to accurately spot check hard-to-reach areas
- Quick recovery feature – built-in heating element removes condensation from probe ... always a factor when any instrument is moved from a cold to a warm environment
- Audio and visual alarm indicates when climatic conditions are unsuitable for painting
- Backglow display for dim or dark environments
- Internal memory stores up to 2500 datasets
- Data logger mode automatically records datasets at user selected time intervals – ideal for unattended operation to record climatic trends

Ordering Information

Cat. No.	Description
PT-1170	PosiTector Dew Point Meter

Comes complete with:

- 3 AA batteries
- Rubber holster with belt clamp and wrist strap
- Nylon carrying case with shoulder strap
- Built-in infrared port for printing to a wireless IR printer
- NIST traceable certificate
- Operating instructions
- 2 year warranty

Ordering Information

Cat. No.	Description
PT-1173	PosiSoft for Windows Software
PT-1174	Infrared printer



Standards

ASTM	D 3276
ISO	8502-4
BS	7079-B4

Technical Specifications

Surface Temperature	-40 to 190 °C (-40 to 375 °F)
Accuracy	± 0.5 °C (1 °F) from -40 to 80 °C (-40 to 175 °F) ± 1.5 °C (3 °F) from 80 to 190 °C (175 to 375 °F)
Air Temperature	-40 to 80 °C (-40 to 175 °F)
Accuracy	±0.5°C (±1° F)
Humidity	0 - 100 %
Accuracy	± 3%
Resolution	0.1 °C (0.1 °F) for temperature; 0.1 % for humidity
Dimensions	178 x 64 x 31 mm (7 x 2.5 x 1.2 in)
Weight	185 g (0.4 lbs)

Accessories

- includes USB cable
- battery operated, receives data from instrument without cables

Introduction

Viscosity is a measure of the resistance of a fluid to deform under shear stress. It is commonly perceived as flow behaviour or resistance to pouring. Viscosity describes a fluid's internal resistance to flow and may be thought of as a measure of fluid friction.

Viscosity at final plays a key role in the processing stage!

For certain liquids viscosity is a material constant that only depends on temperature and pressure. This group of materials is termed Newtonian liquids.

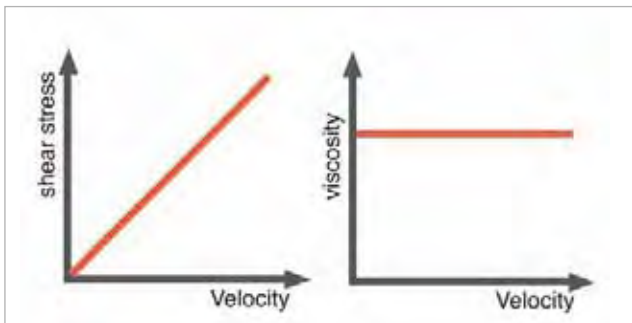

Newtonian

Liquids which do not follow this proportional ratio are called non-Newtonian.

In practice, time-dependent viscosity is called thixotropy. If a liquid is sheared at a constant velocity gradient, viscosity will slowly decrease. As soon as the shear forces are removed, viscosity will recover and return to the initial value.

Thixotropy

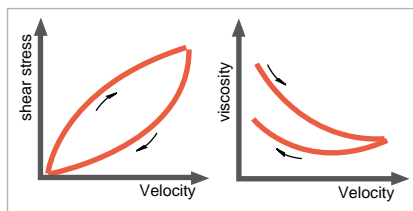

The viscosity of pseudoplastic materials will decrease with an increasing shear rate (shear thinning).

Pseudoplastic (Shear-Thinning)

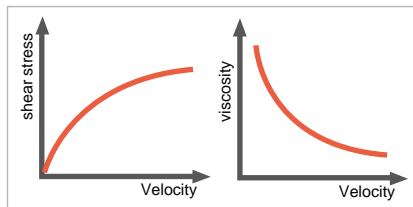

VISCOSITY

The viscosity of dilatant products, however, will increase when shear forces are applied.

Dilatant
(Shear-Thickening)

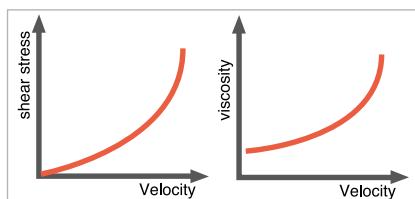

This behavior is known as “shear thickening”. When shear forces are applied, the liquid becomes more viscous.

Viscosity Measurement

In the paint industry a number of measurement methods, from simple flow cup to computer controlled rotation viscometers, have been established for the determination of viscosity.

BYK-Gardner offers a complete line of viscosity measurement instrumentation.

Bubble Viscometers

The Alphabetical Comparison Method uses 4 sets of lettered reference tubes, A5 through Z10, of known viscosity to cover a viscosity range from 0.005 to 1,000 stokes.

The Direct Time Method uses a single 3-line timer tube for determining the “bubble seconds” required for an air bubble to travel a known vertical distance through a bore of known diameter. These “bubble seconds” may then be converted to stokes.



Both methods are subject to variations traceable to the following variables:

Temperature: $\pm 1^\circ \text{C}$ = 10% error
 Vertical Control $\pm 5^\circ \text{C}$ slant = 10% error
 Tube I.D. Control $\pm 0.1 \text{ mm}$ = 2% error

Dip Cups

These cups are designed for quick and approximate determination of efflux times for paints and similar fluids at paint manufacturers and paint user sites.



Flow Cups

For many applications it is not necessary to know the absolute viscosity of a paint system. A parameter permitting a relative classification and estimation is often sufficient. The efflux time, measured in seconds, has proven to be a practical measure. It is determined using flow cups of various designs following the appropriate international / national standards. These cups hold a defined volume of liquid which flows through an orifice. The reproducibility of such measurements depends on

- The accuracy of the size of the cup
- A constant temperature during measurement
- The Newtonian flow behaviour of the liquid

Rotational Viscometers

Various rotational viscometers are in use for the determination of the viscosity of non-Newtonian liquids. These types of material exhibit different viscosities depending on the applied shear rate. BYK-Gardner offers a complete line of viscometers for any application: Stormer Viscometer, Cone and Plate Viscometer as well as Brookfield Viscometers with different cylinders, tubes and other measuring accessories.



Bubble Viscometers

BYK-Gardner bubble viscometers are used to quickly determine kinematic viscosity of known liquids such as resins and varnishes.

- The liquid standards are sealed in glass tubes
- Shelf life is 15 years
- Sample tubes can be cleaned quickly and easily
- Tubes have no orifices that can be clogged to cause faulty measurements
- Repeated readings may be taken easily once the temperature has been controlled

The time required for an air bubble to rise is directly proportional to the viscosity of the liquid – the faster the bubble rises, the lower the viscosity. BYK-Gardner bubble viscometers come in lettered tubes A5 through Z10 in four different tube sets covering viscosity ranges from 0.05 to 1,000 stokes.

Certified

Our bubble tubes can be recertified to NIST traceable standards.



Bubble Viscometer A-T

Standards

AOC	Method Ka 6-63
ASTM	D 1131, D 1545, D 1725
FTMS	141a Method 4272

Ordering Information

Cat. No.	Description
PV-0500	Bubble Viscometer A5-A1
PV-0600	Certified Bubble Viscometer A5-A1
PV-0510	Bubble Viscometer A-T
PV-0610	Certified Bubble Viscometer A-T
PV-0540	Bubble Viscometer U-Z6
PV-0640	Certified Bubble Viscometer U-Z6
PV-0560	Bubble Viscometer Z7-Z10
PV-0660	Certified Bubble Viscometer Z7-Z10

Comes complete with:

Bubble Viscometers:
 Bubble tube standards
 Storage case
 Two empty tubes
 Operating manual
 Certified Sets come with certificate

Technical Specifications

Stokes	
0.05 - 0.31	Set of 5 bubble tube standards A5 - A1 with 2 empty tubes (Grade A)
0.5 - 5.5	Set of 20 bubble tube standards A - T with 2 empty tubes (Grade A)
6.66 - 151	Set of 12 bubble tube standards U - Z6 with 2 empty tubes (Grade A)
406 - 1190	Set of 4 bubble tube standards Z7 - Z10 with 2 empty tubes (Grade A)

Note: Individual replacement tubes can be ordered separately.

Bubble Viscometer Procedure

- Knowing the approximate viscosity, pick four standard tubes closest in viscosity to your sample
- Fill the sample tube with liquid, insert a cork, and then using the tube holder PV-0577, insert the four lettered tubes and the sample tube into the holder
- Turn over the holder and visually compare what letter best matches the rise time of the bubble in the sample
- The rise time in seconds of the sealed tubes and samples can also be determined using a basic timer

Please be aware of the following accuracies when performing the test:

Temperature control: 1 °C = 10 % error

Verticality control: 5° slant = 10 % error

Tube I.D. control: 0.1 mm = 2 % error



Ordering Information

Cat. No.	Description
PV-0571	Empty Tubes, Grade A
PV-0573	Empty Tubes, Grade B
PV-0575	Empty Tubes, Grade N
PV-0576	Corks
PV-0577	Tube Holder

Comes complete with:

Empty tubes in lots of 144 per package including corks

ASTM D 1545 Timer Method

The tube has three amber ring marks at 27, 100 and 108 mm from the bottom. Fill the tube up to the 100 mm line, insert the cork down to the 108 mm line and turn the tube bottom up. Turn the tube around, start the stop watch when the air bubble crosses the 27 mm line and stop when the bubble crosses the 100 mm line.

Accessories

Inscription GARDNER MT in amber stain; inside diameter is checked for 10.65 ± 0.025 mm

Inscription GARDNER BT in amber stain; economical tube for making routine laboratory or factory comparisons; inside diameter 10.75 mm

Inscription GARDNER in amber stain; inside diameter is checked for 10.65 ± 0.025 mm; one additional marking at the bottom of the tube for establishing 73 mm bubble path; ASTM D 1545 term: Timer Tubes

For use in retaining samples; used with all grades of tubes; supplied in lots of 150 per bag

Standards and samples are placed parallel to each other in a true vertical position; sturdy metal frame with plastic handle; fits up to 5 tubes; the flat area allows the holder to sit in a water bath or on a lab bench; comes without tubes

Note: Amber markings in permanent stain are located on the empty tubes for establishing correct bubble size.

Bubble Viscometers

Standards

AOC	Method Ka 6-63
ASTM	D 1131, D 1545, D 1725
FTMS	141a Method 4272

Ordering Information

Cat. No.	Description
PV-0501	Tube A5
PV-0502	Tube A4
PV-0503	Tube A3
PV-0504	Tube A2
PV-0505	Tube A1
PV-0511	Tube A
PV-0512	Tube B
PV-0513	Tube C
PV-0514	Tube D
PV-0515	Tube E
PV-0516	Tube F
PV-0517	Tube G
PV-0518	Tube H
PV-0519	Tube I
PV-0520	Tube J
PV-0521	Tube K
PV-0522	Tube L
PV-0523	Tube M
PV-0524	Tube N
PV-0525	Tube O
PV-0526	Tube P
PV-0527	Tube Q
PV-0528	Tube R
PV-0529	Tube S
PV-0530	Tube T
PV-0541	Tube U
PV-0542	Tube V
PV-0543	Tube W
PV-0544	Tube X
PV-0545	Tube Y
PV-0546	Tube Z
PV-0547	Tube Z1
PV-0548	Tube Z2
PV-0549	Tube Z3
PV-0550	Tube Z4
PV-0551	Tube Z5
PV-0552	Tube Z6
PV-0561	Tube Z7
PV-0562	Tube Z8
PV-0563	Tube Z9
PV-0564	Tube Z10

Cat. No.	Description
PV-0601	Certified Tube A5
PV-0602	Certified Tube A4
PV-0603	Certified Tube A3
PV-0604	Certified Tube A2
PV-0605	Certified Tube A1
PV-0611	Certified Tube A
PV-0612	Certified Tube B
PV-0613	Certified Tube C
PV-0614	Certified Tube D
PV-0615	Certified Tube E
PV-0616	Certified Tube F
PV-0617	Certified Tube G
PV-0618	Certified Tube H
PV-0619	Certified Tube I
PV-0620	Certified Tube J
PV-0621	Certified Tube K
PV-0622	Certified Tube L
PV-0623	Certified Tube M
PV-0624	Certified Tube N
PV-0625	Certified Tube O
PV-0626	Certified Tube P
PV-0627	Certified Tube Q
PV-0628	Certified Tube R
PV-0629	Certified Tube S
PV-0630	Certified Tube T
PV-0641	Certified Tube U
PV-0642	Certified Tube V
PV-0643	Certified Tube W
PV-0644	Certified Tube X
PV-0645	Certified Tube Y
PV-0646	Certified Tube Z
PV-0647	Certified Tube Z1
PV-0648	Certified Tube Z2
PV-0649	Certified Tube Z3
PV-0650	Certified Tube Z4
PV-0651	Certified Tube Z5
PV-0652	Certified Tube Z6
PV-0661	Certified Tube Z7
PV-0662	Certified Tube Z8
PV-0663	Certified Tube Z9
PV-0664	Certified Tube Z10

Technical Specifications

Approx cSt	Approx Sec
5.1	0.650
7.1	0.663
14.0	0.720
21.3	0.767
31.0	0.820
53.6	0.936
68.8	1.01
92.7	1.21
102.9	1.30
122.7	1.50
151.9	1.67
160.0	1.85
210.8	2.15
224.2	2.32
268.2	2.75
287.9	3.02
302.3	3.19
335.4	3.45
345.2	3.69
377.9	3.98
408.8	4.24
441.8	4.54
467.4	4.85
517.7	5.29
547.2	6.00
665.9	6.79
889.2	8.97
1073	11.5
1200	14.8
1737	18.4
2289	23.7
2909	30.7
4056	40.2
4840	48.0
7241	72.2
9917	105
15080	158
40650	422
73280	764
91500	955
119000	1240

Appearance

Color

Viscosity

Technical Service

Index

Viscosity Cups

A flow cup, sometimes called an efflux cup or viscosity cup, is a simple gravity device that measures the timed flow of a known volume of liquid passing through an orifice located at the bottom of the shaped cup. Under ideal conditions, this rate of flow would be proportional to the kinematic viscosity (expressed in stokes and centistokes) that is dependent upon the specific gravity of the liquid. For many applications it is not necessary to know the absolute viscosity. The efflux time, measured in seconds, is often sufficient for a relative classification.

At least 50 types of flow cups have been developed and used over the years, mainly for production control and field inspection purposes. Most of these simple cups are of two main types – mounted on a stand for filling and draining, or dipped directly into the liquid container before draining back into the same container. No matter which type of cup is used there are several fundamental principles that should be recognized:

- Precautions should be taken whenever thixotropic or other non-Newtonian liquids are tested for viscosity, because there is no definite rate of shear generated in a flow cup.
- The diameter of the orifice should be selected and maintained so as to provide flow times falling within prescribed minimum and maximum limits.
- The temperature of the draining liquid should be controlled and measured only in the efflux stream, after it passes through the undamaged bore.

Procedure

- Place flow cup in a precisely horizontal position using ring stand or temperature control jacket
- Close orifice
- Pour in test liquid
- Draw a clean glass plate over the rim of the cup, removing superfluous liquid into the overflow reservoir and closing the cup
- Open orifice
- Remove glass plate horizontally and start stop watch
- Stop the watch with the first break in the efflux stream
- Repeat the measurement three times, each with a new sample of the same material

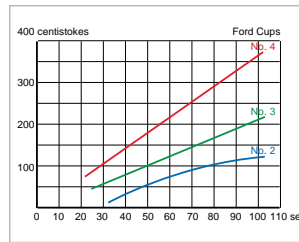

Ford Cup Calibration Curves

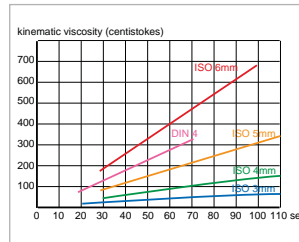

DIN and ISO Cups Calibration Curves



DIN/ISO Dip Cups

Viscosity Cups

BYK-Gardner DIN Dip Cups are designed for quick, approximate determination of efflux times for paints and similar liquids in workshops, at paint manufacturers' and customers'.

- Simple and durable
- Inner dimensions in accordance with DIN 53211*
- Protected loop handle
- Orifice of stainless steel

The different models meet the requirements for standardized flow cups. A special loop handle of stainless steel mounted on the side facilitates the handling of the dip cup (protected version "GM NO. 7146399")

Procedure

- Immerse dip cup with upper rim below the surface of the liquid
- Simultaneously with vertical withdrawal of cup, start stop-watch
- Stop when stream of liquid under the orifice breaks
- For evaluation purposes carry out three measurements
- The average value of these three measurements is taken
*as the efflux time



Ordering Information

Cat. No.	Description
PV-0304	BYK-Gardner Dip Cup
PV-0334	BYK-Gardner Dip Cup
PV-0335	BYK-Gardner Dip Cup
PV-0314	BYK-Gardner Dip Cup

Technical Specifications

Material of Cup	Material of Orifice	Diameter of Orifice	Inner Dimension in acc. with
Aluminum	Stainless Steel	4 mm	DIN 53211*
Aluminum	Stainless Steel	4 mm	DIN EN ISO 2431
Aluminum	Stainless Steel	5 mm	DIN EN ISO 2431
Polyamide	Brass	4 mm	DIN 53211*

* DIN 53211 was withdrawn in October 1996

Zahn-Type Dip Cups

Viscosity Cups

BYK-Gardner Dip Viscosity Cups (Zahn Type) may be used anywhere – in shops, factories and laboratories – for quickly checking and adjusting the viscosity of many different types of liquids.

- Simple and durable
- Range from about 20 to 1800 centistokes
- Precision-drilled orifices
- Orifice diameters adjusted at the factory for appropriate results with applicable NIST traceable Newtonian oils

Each cup has a 12-inch loop handle to allow the cup to be dipped by hand into a liquid container. At the center of this handle is a finger-ring for holding the cup in a vertical position during use. Results should be reported in Zahn-Seconds at a specified temperature for a particular cup. To convert Zahn-Seconds to centistokes, refer to ASTM D 4212.

$$\text{Centistokes} \times \text{Specific Gravity} = \text{Centipoise}$$

$$\text{Centistokes} = K * (\text{efflux time} - C)$$



	Conversion Factors	K	C
Cup# 1		1.1	29
Cup# 2		3.5	14
Cup# 3		11.7	7.5
Cup# 4		14.8	5
Cup# 5		23	0

Standards

ASTM D 816, D 1084, D 4212

Ordering Information

Cat. No.	Description	Cat. No. with Certificate
PV-8201	BYK-Gardner Cup No. 1	PV-8206
PV-8202	BYK-Gardner Cup No. 2	PV-8207
PV-8203	BYK-Gardner Cup No. 3	PV-8208
PV-8204	BYK-Gardner Cup No. 4	PV-8209
PV-8205	BYK-Gardner Cup No. 5	PV-8210

	Seconds Range	Range in Centistokes
	60 Max.	20 - 84
	30 - 230	22 - 80
	150 - 830	20 - 80
	230 - 1100	20 - 80
	460 - 1800	20 - 78
Net Weight	0.2 kg (0.4 lbs)	
Shipping Weight	0.4 kg (1 lbs)	

Zahn-Type Dip Cups

BYK-Gardner offers the EZ™ and Signature™ brand zahn cups. These cups are also widely used for many industrial applications.

S90 Signature Cups

Ordering Information

Cat. No.	Description	Cat. No. with Certificate	Seconds Range	Range in Centistokes
S90 Signature Series Zahn Cups				
PV-6919	S90 Signature Zahn Cup 1	PV-8300	15 - 78	31 - 60
PV-2102	S90 Signature Zahn Cup 2	PV-8301	39 - 238	19 - 60
PV-2103	S90 Signature Zahn Cup 3	PV-8302	63 - 604	11 - 60
PV-2104	S90 Signature Zahn Cup 4	PV-8303	97 - 899	10 - 60
PV-6920	S90 Signature Zahn Cup 5	PV-8304	219 - 1627	10 - 60

Note: Efflux time from the S90 cups does not meet ASTM D4212

$$\text{Centistokes} = K * \text{efflux time} - (C / \text{efflux time})$$

	Conversion Factors	K	C
Cup# 1		1.59	1070
Cup# 2		4.18	760
Cup# 3		10.23	575
Cup# 4		15.13	545
Cup# 5		27.27	540

EZ Series Zahn Cups

■ In compliance with ASTM D 4212

Ordering Information

Cat. No.	Description	Cat. No. with Certificate	Seconds Range	Range in Centistokes
EZ Series Zahn Cups				
PV-2106	EZ Zahn Cup 1	PV-8305	10 - 36	40 - 60
PV-2107	EZ Zahn Cup 2	PV-8306	19 - 156	20 - 60
PV-2108	EZ Zahn Cup 3	PV-8307	64 - 596	12 - 60
PV-2109	EZ Zahn Cup 4	PV-8308	79 - 784	10 - 60
PV-6922	EZ Zahn Cup 5	PV-8309	161 - 1401	10 - 60

$$\text{Centistokes} = K * \text{efflux time} - (C / \text{efflux time})$$

	Conversion Factors	K	C
Cup# 1		0.875	993
Cup# 2		2.8	747
Cup# 3		10.09	587
Cup# 4		13.26	673
Cup# 5		23.56	744

Flow Cups

Ford Viscosity Cups

BYK-Gardner Ford Viscosity Cups are guaranteed to be within 3% (drain time of calibration oil) throughout the recommended use range.

- For low viscosity liquids
- Body made of solid bar aluminum
- Stainless steel orifice
- Calibrated against standard oils referenced to certified NIST oils (National Institute of Standards and Technology of United States)
- Certified cups available on request

	K	C
Ford Cup No. 2	1.24	770
Ford Cup No. 3	2.31	550
Ford Cup No.4	3.7	400

Standards

ASTM	D 333, D 365, D 1200
-------------	-------------------------



Ford Cup No. 4

DIN Flow Cup

This cup holds 100 ml ± 1 ml, and has an integrated orifice with a diameter of 4 mm ± 0.02 mm.

- For low viscosity liquids
- Body made of anodized aluminum
- Stainless steel orifice, interior polished
- Calibrated against standard oils referenced to certified PTB oils (Federal Institute of Physics and Metrology of Germany) to be within 3% (drain time of calibration oil)

	K	C
DIN 4 mm	4.57	452

Standards

DIN	53 211*
------------	---------



DIN Cup 4 Certificate included

ISO Flow Cup

This cup has a longer orifice, less tapered body and slightly different inner dimensions than the DIN 53211* flow cup and thus provides different efflux times. The extended measurement range makes the ISO cup a useful supplement of the DIN cup.

- Recommended for international use
- Body made of anodized aluminum
- Stainless steel orifice, interior polished
- Calibrated against standard oils referenced to certified PTB oils to be within 3% (drain time of calibration oil)

	K	C
ISO 3 mm	0.443	200
ISO 4 mm	1.37	200
ISO 5 mm	3.28	220
ISO 6 mm	6.9	570

Standards

ASTM	D 5125
ISO	2431



Flow Cup ISO 3 mm
Certificate included

Centistokes = K * efflux time - (C/ efflux time)

Centipose = Centistokes x Specific Gravity

Certified

For Certification Services
see page 269.

Info!

For Standard oils
see page 262.

Flow Cups



Appearance

Color

Viscosity

Technical Service

Index

Ordering Information

Cat. No.	Description
PV-7201	Ford Viscosity Cup No. 2
PV-0172	Ford Viscosity Cup No. 2
PV-0175	Ford Viscosity Cup No. 3
PV-0173	Ford Viscosity Cup No. 3
PV-0176	Ford Viscosity Cup No. 4
PV-0174	Ford Viscosity Cup No. 4
PV-0140	DIN Flow Cup, 2 - 8 mm*
PV-0115	DIN Flow Cup, 4 mm
PV-0213	ISO Flow Cup, 3 mm
PV-0214	ISO Flow Cup, 4 mm
PV-0215	ISO Flow Cup, 5 mm
PV-0216	ISO Flow Cup, 6 mm

Technical Specifications

Standard	Certificate	Range in Centistokes	Efflux Time	Orifice Diameter
ASTM	No	25 - 120	30 - 100	0.10 in
ASTM	Yes	25 - 120	30 - 100	0.10 in
ASTM	No	40 - 220	25 - 105	0.13 in
ASTM	Yes	40 - 220	25 - 105	0.13 in
ASTM	No	70 - 370	20 - 105	0.16 in
ASTM	Yes	70 - 370	20 - 105	0.16 in
DIN 53 211	No	see PV-0152 to PV-0158		interchangeable orifices
DIN 53 211*	Yes	100 - 500	20 - 110	4 mm
ISO 2431	Yes	10 - 40	30 - 100	3 mm
ISO 2431	Yes	25 - 130	25 - 100	4 mm
ISO 2431	Yes	70 - 370	25 - 100	5 mm
ISO 2431	Yes	130 - 700	25 - 100	6 mm

* One orifice size must be selected (PV-0152 through PV-0158) on the following page prior to placing an order.

Flow Cups

Recommended Accessories



Ordering Information

Cat. No.	Description
PV-0480	Thermometer
PV-0152	Interchangeable Orifice
PV-0153	Interchangeable Orifice
PV-0154	Interchangeable Orifice
PV-0156	Interchangeable Orifice
PV-0158	Interchangeable Orifice
PV-0410	Temperature Control Jacket
PV-0411	Temperature Control Jacket
PV-0420	Ring Stand
PV-0430	Stand for Ford Cup
PV-7208	Ford Cup Accessory Kit
PV-7207	Ford Stand with Waterbath
PV-0440	Glass Plate
PV-0446	Spirit Level

Accessories

Measuring range: -10 °C to 100 °C
For DIN cup Cat. No. PV-0140; Stainless steel; 2 mm diameter
For DIN cup Cat. No. PV-0140; Stainless steel; 3 mm diameter
For DIN cup Cat. No. PV-0140; Stainless steel; 4 mm diameter
For DIN cup Cat. No. PV-0140; Stainless steel; 6 mm diameter
For DIN cup Cat. No. PV-0140; Stainless steel; 8 mm diameter
For DIN cups; closed thermostatic double wall vessel for indirect tempering; connections for temperature liquid hose; spirit level for leveling upper rim of cup; polished glass plate; anodized aluminum
For DIN EN ISO cups; closed thermostatic double wall vessel for indirect tempering; connections for temperature liquid hose; spirit level for leveling upper rim of cup; polished glass plate; anodized aluminum
Holding device for any flow cup
For Ford cups - Allows better positioning and repeatability
For Ford cups; Cover glass for removing excess sample from cup; bubble level for leveling cup and stand; stainless steel beaker; package of cleaning swabs
For Ford cups - Gives more accurate readings, as temperature affects viscosity
Spare glass plate with polished rims for Temperature Control Jacket
Cat. No. PV-0410 / PV-0411; Dimensions: 100 x 150 mm (3.9 x 5.9 in)
Spare spirit level for leveling flow cups; for horizontal adjustment of instruments

Brookfield Rotational Viscometers

Brookfield rotational viscometers have become a standard in virtually all industries. They measure viscosity by sensing the torque required to rotate a spindle at constant speed while immersed in fluid. The torque is proportional to the viscous drag on the spindle; thus the sample viscosity.

Rotational viscometers offer several advantages:

- The continuous rotation of the spindle allows measurements to be made over time, permitting analysis of time-dependent fluids
- The rate of shear is constant, so both Newtonian and non-Newtonian fluids can be tested
- By rotating the spindle at several different speeds, shear dependent behavior can be analyzed

Brookfield viscometers are the industry standard in determining absolute viscosity of all types of liquids with viscosities as high as 320 million centipoise. BYK-Gardner offers digital models for low – medium – high viscosity materials.

Selecting the Proper Brookfield Viscometer

While various models of the Brookfield viscometer are recommended for high, medium, and low viscosity applications, these designations are intended only as guidelines. Multiple speeds and interchangeable spindles on each viscometer provide many viscosity ranges for flexibility in application. Selecting the correct model will ensure maximum sensitivity and accuracy in the measured viscosity range.



Digital Viscometer DV-E

Rotational Viscometers: Typical Applications

Low Viscosity (LV)

Range: 15 to 2,000,000 centipoise

Adhesives (solvent); Chemicals; Cosmetics; Hot Waxes; Inks (lithographic); Latex paints; Coating systems; Polymers; Rubber solutions; Solvents

Medium Viscosity (RV)

Range: 100 to 13,000,000 centipoise

Adhesives (hot melt); Ceramic slurries; Gums; Inks (screen printing); Paints; Paper coatings; Plastisols; Surface coatings; Varnishes

High Viscosity (HA / HB)

Range: 200 to 104,000,000 centipoise

Asphalt; Caulking compounds; Epoxies; Gels; Inks (ballpoint, offset); Pastes; Putty; Roofing compounds; Sealants; Sheet molding compounds

Brookfield Spindle Geometry

All Brookfield viscometers are supplied with spindles suitable for most applications. There are situations where specified spindle geometries are necessary to achieve the best results. All spindles are made of stainless steel. In addition, quick couplings and spindle extensions are also available for select spindles; for more information please call customer service.

Disc Spindles

- General purpose applications for accurate and reproducible results
- Included with the LV model (spindles #2 and #3)
- Included with the RV/HA/HB models (spindle #2 through #6)

Cylindrical Spindles

- Most applications involving non-Newtonian fluids such as paints
- Provide a scientifically defined spindle geometry for calculating shear stress and shear rate values to determine viscosity
- Applicable to any model viscometer
- Included with the LV (spindles #1 and #4) and RV/HA/HB (spindle #7) models

T-Bar Spindles

- For measuring non-flowing materials such as pastes, gels, and creams
- Generally used with the Helipath Stand



LV Spindle Set



RV, HA, and HB spindle set

Coaxial Cylinders

- Provide rheological data including shear stress and shear rate values
- Available in several accessories: small sample adapter, UL adapter and thermosel system

Cone and Plate Geometry

- For accurate determination at high shear rates with very small samples

DV-E Rotational Viscometer

Simplified controls allow operators to change test parameters quickly with the push of a switch and turn of a knob. The digital display ensures easy and accurate readout of results for simultaneous measurements of viscosity and torque.

- Display in cP or mPas, % torque, spindle, and speed
- 18 speeds for extended range capability
- Excellent accuracy of 1% and repeatability of 0.2%
- Rotary switch to quickly change spindle and speed settings
- Auto range features to view full scale range of spindle/speed selections

Standards

ASTM	D 2196
------	--------



Ordering Information

Description	Cat. No. Voltage:	Cat. No. Voltage:
	220 V	115 V
LVDV-E	PV-7901	PV-7900
RVDV-E	PV-7903	PV-7902
HADV-E	PV-7905	PV-7904
HBDV-E	PV-7907	PV-7906

Comes complete with:

Viscometer, Set of spindles, Lab stand, Carrying case, Operating instructions

Technical Specifications

No. Of Spindles	Range (cP)
4	15 - 2,000,000
6	100 - 13,000,000
6	200 - 26,000,000
6	800 - 104,000,000
Speeds / rpm	0.3, 0.5, 0.6, 1.0, 1.5, 2.0, 2.5, 3.0, 4.0, 5.0, 6.0, 10, 12, 20, 30, 50, 60, 100
Dimensions	25 x 48 x 38 cm (10 x 19 x 15 in)
Instrument Weight	7.7 kg (17 lbs)
Shipping Weight	9.5 kg (21 lbs)

Brookfield Standard Spindle Accessories

Quick Connect Stainless Steel Coupling

- Quick attachment of spindle to rotational viscometer
- Saves time and reduces viscometer wear
- Eliminates cross threading
- Used with disc, cylindrical, and T-bar spindles



Accessories

Cat. No.	Description
PV-7910	Quick connect spindle coupling
PV-7912	LV Quick Connect Kit with Rack
PV-7913	RV Quick Connect Kit with Rack

Replacement Spindles LV 302 Stainless steel

Cat. No.	Description
PV-4890	LV Spindles Set of 4
PV-4901	LV Spindles #1
PV-4902	LV Spindles #2
PV-4903	LV Spindles #3
PV-4904	LV Spindles #4

Replacement Spindles RV/HA/HB 302 Stainless Steel

Cat. No.	Description
PV-4920	RV / HA / HB Spindles Set of 6
PV-4911	RV / HA / HB Spindles #1
PV-4912	RV / HA / HB Spindles #2
PV-4913	RV / HA / HB Spindles #3
PV-4914	RV / HA / HB Spindles #4
PV-4915	RV / HA / HB Spindles #5
PV-4916	RV / HA / HB Spindles #6
PV-4917	RV / HA / HB Spindles #7

More spindles available on request

Brookfield UL Adapter

The Brookfield UL adapter accessory is used to make accurate and reproducible measurements with low viscosity, Newtonian and non-Newtonian materials.

- Takes measurements as low as 1 cP
- For any model rotational Brookfield viscometer
- Only 16 ml of sample needed, save on sample cost

This adapter is most commonly used with the LV series instruments; at 60 RPM, these models have full scale range of 1-10 cP with the UL adapter.

The UL adapter consists of a precision cylindrical spindle rotating inside a machined tube. Its rheologically correct geometry provides the highest accuracy of viscosity and shear rate. The tube has a removable end cap and thus can be used in a beaker or tank when open. With the cap in place, the closed tube holds 16 ml of sample and can be immersed in a temperature bath or with the PV-8320 water jacket for precise temperature control from (-15 to 100 °C). All immersed parts are stainless steel while the removable cap is LDPE.



Ordering Information

Cat. No.	Description
PV-4956	UL Adapter

Comes complete with:

- 1 spindle
- Open ended sample chamber
- Water flow jacket
- Mounting bracket
- Six end caps
- Attaching hardware

Accessories

Cat. No.	Description
PV-8320	Water Jacket

Viscosity Range with UL Adapter

	Viscosity Range	Viscometer Model	Viscosity Range cP (mP*s)
LV	Low	DV-E	1.0 - 2,000
RV	Medium	RVDV-E	6.4 - 2,000
HA	Medium High	HADV-E	12.8 - 2,000
HB	High	HBDV-E	51.2 - 2,000



UL Adapter shown with water jacket and Digital Rotational Viscometer

Brookfield Helipath Stand

- Allows for relative viscosity measurements of non-flowing substances such as gels, pastes, paint dyes, and inks
- Slowly raises and lowers the viscometer to always cut into fresh sample allowing for meaningful results

The Helipath stand is designed to lower and raise the viscometer so that its rotating shearing element will describe a helical path through the test sample. By always cutting into fresh material the problem of separating is eliminated. The reversing feature of the Helipath stand allows measurements to be made over a period of time.



Helipath Stand shown with Brookfield Digital Viscometer DV-1 Prime

Ordering Information

Cat. No.	Description
PV-4892	Helipath Stand
PV-4895	Helipath Stand
PV-4893	T-bar spindles
PV-4894	T-Bar Set

Comes complete with:

Helipath Stand
Set of 6 T-bar spindles
Special coupling

Applicable Viscosity Range (T-Bar Spindles)

	Viscosity Range	Viscometer Model	Viscosity Range cP (mP*s)
LV	Low	LVDV-E	156 - 3,120,000
RV	Medium	RVDV-E	2,000 - 20,000,000
HA	Medium High	HADV-E	4,000 - 40,000,000
HB	High	HBDV-E	16,000 - 160,000,000

Technical Specifications

	Voltage
For use with Brookfield rotational viscometers	115V/60Hz
For use with Brookfield rotational viscometers	230V/50Hz
Individual spindle replacement	
Includes chuck assembly and case	

Digital KU-2

Stormer Type Viscometer

The digital KU-2 viscometer provides a direct digital reading in Krebs units (KU), centipoise, and grams (gm). This simplifies an established test procedure providing an immediate calculation of the viscosity value. The viscometer automatically starts or stops by lowering or raising the viscometer. The KU-2 automatically establishes the correct rotational speed to comply with ASTM method D 562.

- Easy to use – no weights or stroboscopic timing attachment
- Switch selectable LED digital display of Krebs units or grams or centipoise
- Allows for rapid and easy measurement of samples
- Parallel printer output for test documentation
- Instrument base fits standard pint, 1/2 pint and quart cans
- Traceable to NIST

The Digital KU-2 can be equipped with an air purge that allows the interior of the instrument to be pressurized with air or inert gas. Recommended when working in a hazardous environment.



Standards

ASTM D 562

Ordering Information

Cat. No.	Description
PV-7508	KU-2
PV-7509	KU-2
PV-8322	KU-2 with air purge
PV-8323	KU-2 with air purge

Comes complete with:

Digital KU-2
1 spindle (paddle type)
Adapters for 1 pint, 1/2 pint
Operation Manual

Ordering Information

Cat. No.	Description
PV-7510	KU-2 Spindle
PV-7511	Paste Spindle

Technical Specifications

Range	Resolution	Accuracy	Repeat-ability	Voltage	Spindle Speed
40 - 141 KU; 32 - 1090 grams; 27 - 5274 cps*	0.1 KU; 1.0 gm; 0.7 cps	within ± 1 % full scale	within ± 0.5 % full scale	115V/60Hz	200 rpm ±0.1 rpm
40 - 141 KU; 32 - 1090 grams; 27 - 5274 cps*	0.1 KU; 1.0 grams; 0.7 cps	within ± 1% full scale	within ± 0.5% full scale	230V/50Hz	200 rpm ±0.1 rpm
40 - 141 KU; 32 - 1090 grams; 27 - 5274 cps*	0.1 KU; 1.0 gm; 0.7 cps	within ± 1 % full scale	within ± 0.5 % full scale	115V/60Hz	200 rpm ± 0.1 rpm
40 - 141 KU; 32 - 1090 grams; 27 - 5274 cps*	0.1 KU, 1.0 gm; 0.7 cps	within ±1% full scale	within ± 0.5% full scale	230V/50Hz	200 rpm ±0.1 rpm
Operating Temperature		10 - 40 °C			
Dimensions		20 x 11 x 15 in			
Shipping Weight		10 kg (20 lbs)			

*Centipoise values are based on the conversion from Krebs Units as defined in the ASTM standard D562

Accessories

Replacement for Digital KU-2 Stormer-Type Viscometer
non-reference spindle for relative measurements of pastes

Info!

For Rotational Oils see page 262.

Cone and Plate Viscometer

The versatility of the CAP 1000+ and CAP 2000+ makes these instruments a practical tool for any QC or R&D lab requiring quick and easy testing of materials, regardless of application, at high shear rates.

- Provides for viscosity measurements at high shear rates
- LCD display of viscosity in Poise or Pascal-seconds
- Uses less than 2 ml of sample to avoid excess cleaning and material costs
- Automatic viscosity range calibration and cone gap positioning make the viscometer easy to use
- Set the viscometer to take a reading at different timed intervals to ensure accuracy of results with thixotropic fluids

CAP 1000+

- Two available speeds to comply with all paint industry standards worldwide (750 and 900 rpms)

CAP 2000+

- Variable speed instrument with a speed range of 5 to 1,000 rpm that allows for varying shear rates from 10 to 13,300 sec⁻¹;
- Bi-directional RS-232 interface that allows for PC control with the optional CAPCALC 32 software



Standards

ASTM	D 4287
ISO	2884
BS	3900

Ordering Information

Cat. No.	Description
PV-7552	CAP 1000+ L (5-75 °C)
PV-7553	CAP 1000+L (5-75 °C)
PV-7557	CAP 1000+ H (50 -235 °C)
PV-7558	CAP 1000+H (50-235 °C)
PV-7550	CAP 2000+ L (5-75 °C)
PV-7551	CAP 2000+L (5-75 °C)
PV-7555	CAP 2000+ H (50-235 °C)
PV-7556	CAP 2000+H (50-235 °C)

Comes complete with:

Cone & Plate Viscometer
1 cone – please specify
Operation manual

Note: Specify cone number when ordering. Will need to order the appropriate viscosity oil on page xxx to calibrate the CAP viscometer.

Technical Specifications

Viscosity Range	Speeds rpm	Accuracy	Shear Rate sec ⁻¹	Voltage	RS-232 Interface
0.25 to 100 Poise	750 or 900	± 2 % of full scale	up to 13,300	115V/60Hz	
0.25 to 100 Poise	750 or 900	± 2 % of full scale	up to 13,300	230V/50Hz	
0.25 to 100 Poise	750 or 900	± 2 % of full scale	up to 13,300	115V/60Hz	
0.25 to 100 Poise	750 or 900	± 2 % of full scale	up to 13,300	230V/50Hz	
0.2 to 15,000 Poise	5 - 1,000 in 1 rpm increments	± 2 % of full scale	10-13,300	115V/60Hz	X
0.2 to 15,000 Poise	5 - 1,000 in 1 rpm increments	± 2 % of full scale	10-13,300	230V/50Hz	X
0.2 to 15,000 Poise	5 - 1,000 in 1 rpm increments	± 2 % of full scale	10-13,300	115V/60Hz	X
0.2 to 15,000 Poise	5 - 1,000 in 1 rpm increments	± 2 % of full scale	10-13,300	230V/50Hz	X
Timed Readings		Digital timer with continuous running override; range 15 to 99 seconds			
Temperature Control		Increments of 0.1 °C			
Printer Interface		parallel centronic			
Dimensions		26 x 18 x 19 in			
Shipping Weight		20 kg (46 lbs)			

1/23 CAP Version

Cone and Plate Viscometer

The 1/23 CAPs are for lower shear applications such as automotive clear coats and base coats. Most methods are single point pass/fail criteria using #10 spindle at 100 rpm; a shear rate of 500 1/sec and measurement range from 22 – 220 cP is achieved.

There are two instruments available:

- 1000+L version with a fixed speed of 100 rpms
 - 2000+L version with a speed range from 5 – 1000 rpms.
- The 2000+L version with the multiple speed selection provides more flexibility to modify test procedures.

Standards

ASTM	D 7395
ISO	2884, 3900

Ordering Information

Cat. No.	Description
PV-7590	1/23 CAP 1000+ L (5-75 °C)
PV-7591	1/23 CAP 1000+ L (5-75 °C)
PV-7595	1/23 CAP 2000+ L (5-75 °C)
PV-7596	1/23 CAP 2000+ L (5-75 °C)

Technical Specifications

Viscosity Range	Speeds rpm	Accuracy	Shear Rate sec-1*	Voltage	RS-232 Interface
0.22 to 2.20 Poise	100	± 2 % of full scale	500	115V/60Hz	
0.22 to 2.20 Poise	100	± 2 % of full scale	500	230V/50Hz	
0.2 to 44.0 Poise	5 - 1,000 in 1 rpm increments	± 2 % of full scale	25 - 5000	115V/60Hz	X
0.2 to 44.0 Poise	5 - 1,000 in 1 rpm increments	± 2 % of full scale	25 - 5000	230V/50Hz	X

Comes complete with:
 1/23 Cone & Plate viscometer
 #10 spindle
 Operation manual

*with the #10 spindle

Spindles for Cone and Plate Viscometers

Ordering Information

Cat. No.	Description
PV-7531	CAP spindle # 1
PV-7532	CAP spindle # 2
PV-7533	CAP spindle # 3
PV-7534	CAP spindle # 4
PV-7535	CAP spindle # 5
PV-7536	CAP spindle # 6
PV-7560	CAP spindle # 7
PV-7561	CAP spindle # 8
PV-7562	CAP spindle # 9
PV-7563	CAP spindle # 10

Accessories

Cap 1000+ 750rpm	Cap 1000+ 900rpm	Cap 2000+
0.25 - 2.5 poise	0.2 - 2 poise	0.2 - 375 poise
0.5 - 5 poise	0.4 - 4 poise	0.4 - 750 poise
1 - 10 poise	0.8 - 8 poise	0.8 - 1500 poise
2 - 20 poise	1 - 16 poise	1 - 3000 poise
4 - 40 poise	3 - 33 poise	3 - 6000 poise
10 - 100 poise	8 - 83 poise	8 - 15000 poise
0.42 - 4.2 poise	0.35 - 3.47 poise	0.35 - 625 poise
1.67 - 16.7 poise	1.39 - 13.9 poise	1.39 - 2500 poise
6.67 - 66.7 poise	5.56 - 55.6 poise	5.56 - 10000 poise
0.67 - 6.67 poise	0.56 - 5.56 poise	0.58 - 1000 poise

1 Poise = 100 cP; 1 cP = 1 mPa*s

Software for Cone and Plate Viscometers

CAPCALC 32

Software for CAP 2000+

Turn your CAP2000+ Viscometer into a sensitive, accurate rheometer. When advanced sample analysis is required, CAPCALC can control the viscometer from any PC to provide automatic data capture and graphical display to facilitate analysis of test samples.

- Automates data collection
- Eliminates operator error when recording data
- Provides instantaneous viscosity flow curves (rheograms) on easy-to-read graphs
- Creates a permanent record of each test
- Records up to 1000 data points per test
- Comparison data sets can be manually entered
- Saved data in Brookfield (text), Lotus 1-2-3, or Excel®
- Up to 6 data sets may be plotted simultaneously
- 12 Plot Types:
 - % FSR vs. RPM, Shear Rate, Time, Temperature
 - Viscosity vs. RPM, Shear Rate, Time, Temperature
 - Shear Stress vs. RPM, Shear Rate, Time, Temperature
- Yield Stress Calculations (Bingham Plastic, Casson, Chocolate Casson), Power Law Consistency Index Calculations, Paste Analysis
- On-line help system
- Data collection is provided via a powerful "scripting" language for creating test programs

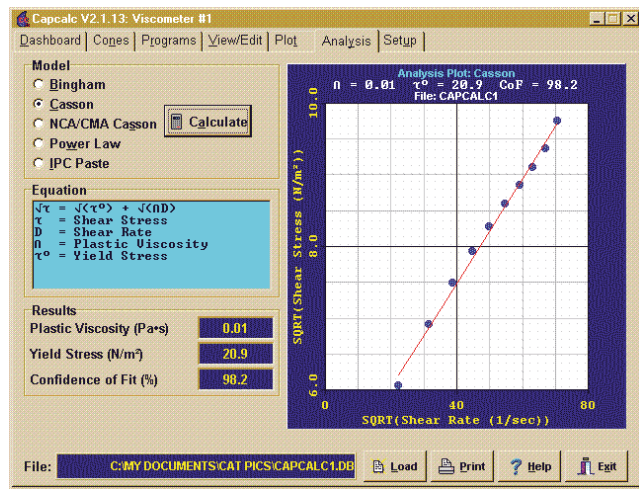

Ordering Information

Cat. No.	Description
PV-7524	CAPCALC 32 Software

Comes complete with:

- CD-ROM
- Connecting cable
- Operating manual

Technical Specifications

Computer Requirements

Pentium PC, 500 mHz (faster PC recommended), MS-Windows NT, 2000, XP, VGA/SVGA graphics, RS-232 port for rheometer; an optional second port needed for temperature control, Parallel port/USB for printer

Certified Standard Oils

BYK-Gardner offers a comprehensive line of certified standard viscosity oils. These oils are used to confirm the viscosity flow cup or instrument are measuring within specification. For the CAP series viscometers a standard oil is required to properly calibrate the instrument.

Zahn and Ford Flow Cups

Ordering Information

Cat. No.	Description
PV-4000	Viscosity Standards
PV-4001	Viscosity Standards
PV-4002	Viscosity Standards
PV-4003	Viscosity Standards
PV-4004	Viscosity Standards
PV-4005	Viscosity Standards
PV-4006	Viscosity Standards
PV-4015	Viscosity Standards

Data Certified at 25°C (77°F)

Technical Specifications

Viscosity Standard	Kinematic Viscosity	Zahn Cup No.	Zahn Cup Drain Time	Ford Cup No.	Ford Cup Drain Time
C10	17 cST	1	45 sec	1	70 sec
C20	34 cST	1	60 sec	2	42 sec
C35	66 cST	2	33 sec	2 / 3	64 / 35 sec
C60	120 cST	2	48 sec	3 / 4	58 / 36 sec
C100	230 cST	3 / 4	27 / 21 sec	4	64 sec
C200	460 cST	3 / 4	47 / 36 sec	5	40 sec
C350	850 cST	4 / 5	62 / 37 sec	5	70 sec
C600	1,600 cST	5	70 sec	-	-

Note: Important information about these viscosity standards: – For practical purpose, these oils are Newtonian liquids – Standard bottle size is 1 pt. (470 ml) except CAP oils

Rotational Viscometers, Brookfield-Type

Ordering Information

Cat. No.	Description
PV-4040	Viscosity Standard RT10
PV-4041	Viscosity Standard RT50
PV-4042	Viscosity Standard RT100
PV-4043	Viscosity Standard RT500
PV-4044	Viscosity Standard RT1000
PV-4045	Viscosity Standard RT5000
PV-4046	Viscosity Standard RT12500
PV-4047	Viscosity Standard RT30000
PV-4048	Viscosity Standard RT60000
PV-4049	Viscosity Standard RT100000

Technical Specifications

Approx. Viscosity 25°C
9.4 cP
48 cP
96 cP
480 cP
960 cP
4,800 cP
12,000 cP
29,000 cP
58,000 cP
97,000 cP

Note: Important information about these viscosity standards: – For practical purpose, these oils are Newtonian liquids – Standard bottle size is 1 pt. (470 ml) except CAP oils

KU-Series Stormer-Type Viscometers

Ordering Information

Cat. No.	Description
PV-4020	Viscosity Standard S200 (KU)
PV-4021	Viscosity Standard N350 (KU)
PV-4022	Viscosity Standard K400 (KU)
PV-4023	Viscosity Standard S600 (KU)
PV-4024	Viscosity Standard N1000 (KU)

Data Certified at 25°C (77°F)

Technical Specifications

Viscosity	Krebs Units
400 cP	64
750 cP	79
940 cP	84
1,400 cP	95
2,000 cP	106

Note: Important information about these viscosity standards: – For practical purpose, these oils are Newtonian liquids – Standard bottle size is 1 pt. (470 ml) except CAP oils

CAP Viscometers

Ordering Information

Cat. No.	Description
For Low Temperature CAP Viscometers (5° - 75°C)	
PV-7570	Viscosity Standard CAP1L
PV-7571	Viscosity Standard CAP2L
PV-7572	Viscosity Standard CAP3L
PV-7573	Viscosity Standard CAP4L
PV-7574	Viscosity Standard CAP5L
PV-7575	Viscosity Standard CAP6L
PV-7576	Viscosity Standard CAP7L
PV-7577	Viscosity Standard CAP8L
PV-7578	Viscosity Standard CAP9L
PV-7579	Viscosity Standard CAP10L
For High Temperature CAP Viscometers (50° - 235°C)	
PV-7580	Viscosity Standard CAP1H
PV-7581	Viscosity Standard CAP2H
PV-7582	Viscosity Standard CAP3H
PV-7583	Viscosity Standard CAP4H
PV-7584	Viscosity Standard CAP5H
PV-7585	Viscosity Standard CAP6H
PV-7586	Viscosity Standard CAP7H
PV-7587	Viscosity Standard CAP8H
PV-7588	Viscosity Standard CAP9H
PV-7589	Viscosity Standard CAP10H

Technical Specifications

Cone #	Viscosity	Temperature
1	89 cP	25 °C
2	177 cP	25 °C
3	354 cP	25 °C
4	708 cP	25 °C
5	1,417 cP	25 °C
6	3,542 cP	25 °C
7	1,328 cP	25 °C
8	5,313 cP	25 °C
9	21,250 cP	25 °C
10	236 cP	25 °C
1	89 cP	60 °C
2	177 cP	60 °C
3	354 cP	60 °C
4	708 cP	60 °C
5	1,417 cP	60 °C
6	3,542 cP	60 °C
7	1,328 cP	60 °C
8	5,313 cP	60 °C
9	21,250 cP	60 °C
10	236 cP	60 °C

Comes complete with: 4 oz bottle (125 ml); Test Report

Analog Cone and Plate Viscometers

Ordering Information

Cat. No.	Description
PV-4030	Viscosity Standard S60
PV-4031	Viscosity Standard N100
PV-4032	Viscosity Standard S200
PV-4033	Viscosity Standard N350
PV-4034	Viscosity Standard N1000
PV-4035	Viscosity Standard S2000
PV-4036	Viscosity Standard N15000

Technical Specifications

Approx. Viscosity 25°C	Approx. Viscosity 40°C	Approx. Viscosity 100°C
1.00	0.46	0.06
2.10	0.84	0.09
4.00	1.50	0.13
7.50	2.70	0.19
20.00	8.00	-
49.00	15.00	0.62
410.00	110.00	3.00

Note: Important information about these viscosity standards: – For practical purpose, these oils are Newtonian liquids – Standard bottle size is 1 pt. (470 ml) except CAP oils

Document, Analyze and Optimize your Production Cure Process

new temp-gard, oven temperature recorder

Is the paint cured at all points of the body?

On a car body we are dealing with parts that have different geometries, thickness and might even have different substrate materials. Heat transfer is dependent on the material, the thickness and the body shape. The goal of the process engineer is to optimize the line speed at the lowest possible temperature.

In the following example the cure performance of an e-coat oven before and after some re-modeling was analysed. After re-construction the entire baking process was running a few degrees higher than before the construction. The temperature curves of an A-pillar before and after reconstruction of the e-coat oven are shown in the graph in the right column:

The paint manufacturer's recommended data for curing were as follows:

- 165 °C 12 min
- 170 °C 10 min
- 175 °C 8 min

Traditional methods judge a baking process by comparing the paint manufacturer's recommended temperature/time (high – reference – low) to the actual production oven data. Based on this traditional cure evaluation 170 °C was only touched and 165 °C was only reached and surpassed for 7 minutes.

Consequently, the conclusion would have been: "Insufficient curing".

Nevertheless, the e-coat showed good sanding properties which means the system was cured. The traditional comparison does not take into consideration that crosslinking already starts at temperatures below the specified low temperature and accelerates at higher temperatures.

A new method which allows a detailed analysis of all temperature data contributing to the cure process called the "Equivalence method" was developed. The result of this new analysis was the following:

- Equivalence time = 15.6 min relative to the reference temperature 170 °C. Consequently, the coating system was completely cured.

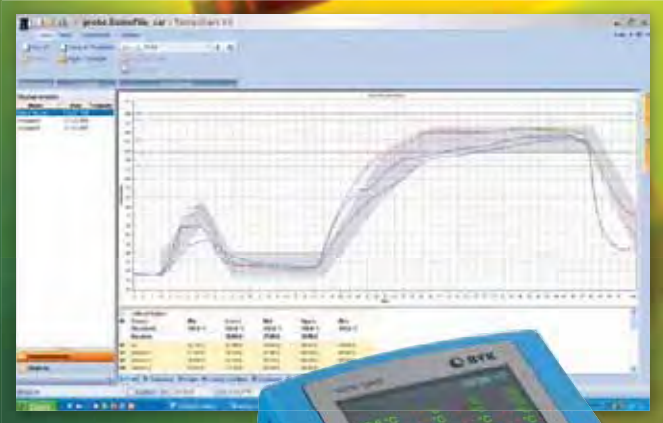

temp-gard see page 237.

The new cure index method objectively proves that a lower temperature bake is absolutely sufficient to guarantee a well cured system.

- Reliable data on cure status allow true optimizing of the cure process: line speed and baking temperature

temp-gard

- 12 measurement probes
- Probes as well as temperature recorder meet R&R of the automotive industry: Maximum temperature variation of ± 1 °C – even after being in the oven for 60 min
- Easy handling – The temperature data is stored on a USB stick, thus the probes don't need to be disconnected. Or the measurement data can be transferred directly from the data logger to the PC.

Reference:

By Dipl. Ing. Eide Wilckens, Porsche AG, JOT, page 66 - 71, May 1998