



SMA Female Connector Clamp/Solder Attachment For RG213, RG214, RG8, RG9, RG11, RG225, RG393

TECHNICAL DATA SHEET

PE4411

SMA Female Connector Clamp/Solder Attachment For RG213, RG214, RG8, RG9, RG11, RG225, RG393

Configuration

Connector	SMA Female
Connector Specification	MIL-C-39012
Connector Interface Type	RG213, RG214, RG8, RG9, RG11, RG225, RG393
Cable Attachment Method (Shield/Contact)	Clamp/Solder
Body Style	Straight

Electrical Specifications

Impedance, Ohms	50
-----------------	----

Mechanical Specifications

Temperature

Operating Range, deg C	-65 to +165
------------------------	-------------

Size

Length, in [mm]	1.5 [38.1]
Width/Dia., in [mm]	0.75 [19.05]
Weight, lbs [g]	0.082 [37.19]

Connector

Type	SMA Female
Contact Material and Plating	Gold
Contact Plating Specification	MIL-G-45204
Body Material and Plating	Brass, Nickel
Dielectric Type	Teflon

Compliance Certifications (visit www.Pasternack.com for current document)

RoHS Compliant	Yes
----------------	-----

Click the following link (or enter part number in "SEARCH" on website) to obtain additional part information including price, inventory and certifications: [SMA Female Connector Clamp/Solder Attachment For RG213, RG214, RG8, RG9, RG11, RG225, RG393 PE4411](#)

The information contained in this document is accurate to the best of our knowledge and representative of the part described herein. It may be necessary to make modifications to the part and/or the documentation of the part, in order to implement improvements. Pasternack reserves the right to make such changes as required. Unless otherwise stated, all specifications are nominal.



SMA Female Connector Clamp/Solder Attachment For
RG213, RG214, RG8, RG9, RG11, RG225, RG393

TECHNICAL DATA SHEET

PE4411

Plotted and Other Data

Notes:

Values at 25 °C, sea level

SMA Female Connector Clamp/Solder Attachment For RG213, RG214, RG8, RG9, RG11, RG225, RG393 from Pasternack Enterprises has same day shipment for domestic and International orders. Our RF, microwave and fiber optic products maintain a 99% availability and are part of the broadest selection in the industry.

Click the following link (or enter part number in "SEARCH" on website) to obtain additional part information including price, inventory and certifications: [SMA Female Connector Clamp/Solder Attachment For RG213, RG214, RG8, RG9, RG11, RG225, RG393 PE4411](http://www.pasternack.com/sma-female-standard-rg213-rg214-rg8-rg9-rg11-rg225-rg393-connector-pe4411-p.aspx)

URL: <http://www.pasternack.com/sma-female-standard-rg213-rg214-rg8-rg9-rg11-rg225-rg393-connector-pe4411-p.aspx>

The information contained in this document is accurate to the best of our knowledge and representative of the part described herein. It may be necessary to make modifications to the part and/or the documentation of the part, in order to implement improvements. Pasternack reserves the right to make such changes as required. Unless otherwise stated, all specifications are nominal.

PE4411 CAD Drawing

SMA Female Connector Clamp/Solder Attachment For RG213,
RG214, RG8, RG9, RG11, RG225, RG393

ASSEMBLY PROCEDURES

1. SLIDE CLAMP NUT (1) & GASKET (2) OVER CABLE. STRIP CABLE AS SHOWN. DO NOT NICK BRAID WHILE CUTTING JACKET. TAPER END OF BRAID TO PERMIT ASSEMBLY OF BRAID CLAMP (3) SLIDE BRAID CLAMP(3) OVER BRAID & SEAT AGAINST CABLE.

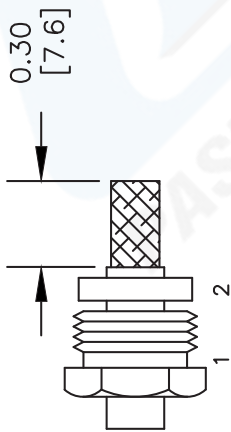

2. FORM BRAID OVER CLAMP NUT (3). TRIM BRAID BACK TO SHOULDER. CUT DIELECTRIC TO DIMENSION SHOWN. DO NOT NICK CENTER CONDUCTOR. SOLDER CONTACT TO CENTER CONDUCTOR. REMOVE EXCESS SOLDER. DO NOT OVER HEAT DIELECTRIC. INSERT CABLE ASSEMBLY INTO BODY & TIGHTEN.

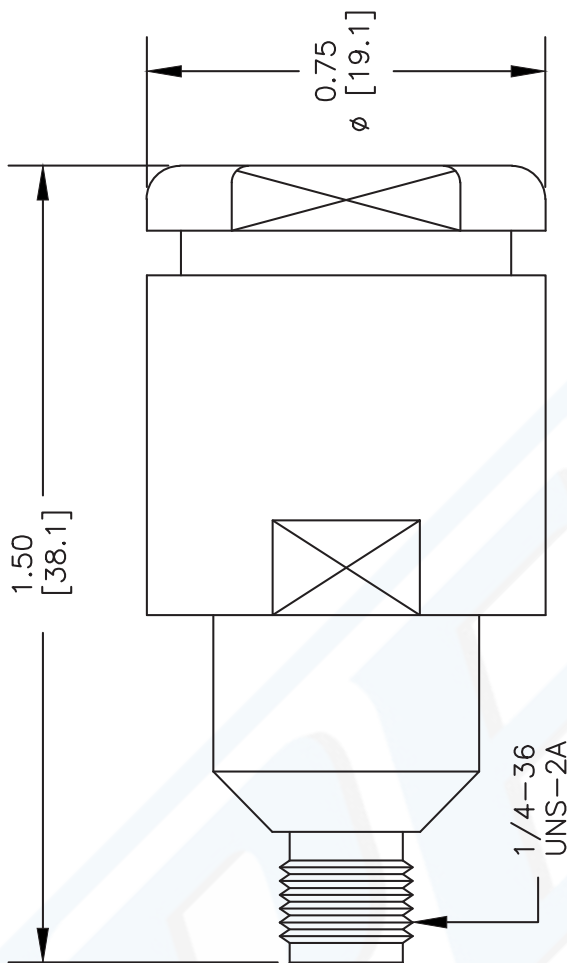
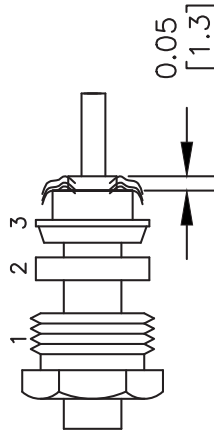

DWG TITLE

PE4411

NOTES:
1. UNLESS OTHERWISE SPECIFIED ALL DIMENSIONS ARE NOMINAL.
2. ALL SPECIFICATIONS ARE SUBJECT TO CHANGE WITHOUT NOTICE AT ANY TIME.
3. DIMENSIONS ARE IN INCHES [mm].
4. FITS MIL-C-17 AND EQUIVALENT CABLES.

REV. -

FSCM NO. 53919

CAD FILE 051402

SCALE N/A

SIZE A

2233

PE PASTERNAK®

Pasternack Enterprises, Inc.

P.O. Box 16759 | Irvine | CA | 92623

Phone: (949) 261-1920 | Fax: (949) 261-7451

Website: www.pasternack.com | E-Mail: sales@pasternack.com



N Female Connector Clamp/Solder (Captive Contact)
 Attachment for RG213, RG214, RG8, RG9, RG11,
 RG225, RG393, RG144, RG216, RG215

RF Connectors Technical Data Sheet

PE4059

Configuration

- N Female Connector
- MIL-STD-348
- 50 Ohms
- Straight Body Geometry
- Connector Interface Types: RG213, RG214, RG8, RG9, RG11, RG225, RG393, RG144, RG216, RG215

Features

- Silver Plated Contact
- Contact plating according to QQ-S-365

Applications

- General Purpose Test
- Custom Cable Assemblies

Description

Pasternack's PE4059 type N female connector with clamp/solder (captive contact) attachment for RG213, RG214, RG8, RG9, RG11, RG225, RG393, RG144, RG216 and RG215 is part of our full line of RF components available for same-day shipping.

Our type N female connector PE4059 datasheet specifications and drawing with dimensions are shown below in this PDF. Pasternack's broad catalog of RF, microwave and millimeter wave connectors allows designers to configure and customize their signal connections however they like. Whether the need is to provide an I/O for a board design, or simply create a custom cable assembly configuration, Pasternack has the right connector for the job. Pasternack can also expertly build your custom cable assemblies for you and ship same-day.

Mechanical Specifications

Size	
Length	1.56 in [39.62 mm]
Width/Dia.	0.75 in [19.05 mm]
Weight	0.108 lbs [48.99 g]

Material Specifications

Description	Material	Plating
Contact		Silver QQ-S-365
Insulation	PTFE	
Body	Brass	Nickel QQ-N-290

Click the following link (or enter part number in "SEARCH" on website) to obtain additional part information including price, inventory and certifications: [N Female Connector Clamp/Solder \(Captive Contact\) Attachment for RG213, RG214, RG8, RG9, RG11, RG225, RG393, RG144, RG216, RG215 PE4059](#)



N Female Connector Clamp/Solder (Captive Contact)
Attachment for RG213, RG214, RG8, RG9, RG11,
RG225, RG393, RG144, RG216, RG215

RF Connectors
Technical Data Sheet

PE4059

Environmental Specifications

Compliance Certifications (see [product page](#) for current document)

Plotted and Other Data

Notes:

Click the following link (or enter part number in "SEARCH" on website) to obtain additional part information including price, inventory and certifications: [N Female Connector Clamp/Solder \(Captive Contact\) Attachment for RG213, RG214, RG8, RG9, RG11, RG225, RG393, RG144, RG216, RG215 PE4059](#)



N Female Connector Clamp/Solder (Captive Contact)
Attachment for RG213, RG214, RG8, RG9, RG11,
RG225, RG393, RG144, RG216, RG215

RF Connectors
Technical Data Sheet

PE4059

Assembly Instruction

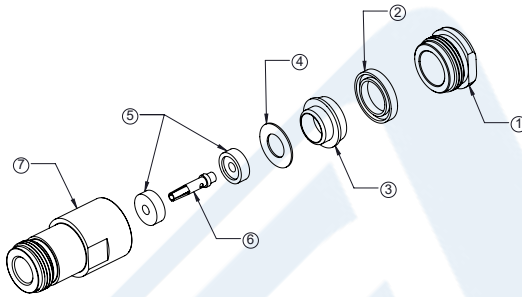

1. SLIDE CLAMP NUT (1) AND GASKET (2) OVER CABLE. STRIP CABLE AS SHOWN. DO NOT NICK BRAID WHILE CUTTING JACKET. TAPER END OF BRAID TO PERMIT ASSEMBLY OF CLAMP.

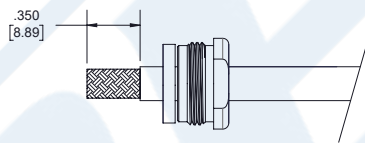

2. SLIDE BRAID CLAMP (3) OVER BRAID & SEAT AGAINST CABLE. FORM BRAID OVER BRAID CLAMP (3). TRIM BRAID BACK TO SHOULDER. CUT DIELECTRIC & CENTER CONDUCTOR TO DIMENSIONS SHOWN. DO NOT NICK CENTER CONDUCTOR.

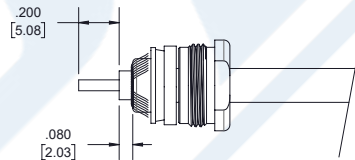

3. SLIDE WASHER (4) AGAINST THE BRAID CLAMP (3) AND HOLD BRAID IN PLACE. SLIDE HALF-INSULATOR (5) BEFORE SOLDER CONTACT (6) TO CENTER CONDUCTOR. SOLDER & REMOVE EXCESS SOLDER. DO NOT OVER HEAT DIELECTRIC. SLIDE A REST HAFT-INSULATOR (5) TO LOCKED CONTACT. INSERT CABLE ASSEMBLY INTO BODY (7) & TIGHTEN.

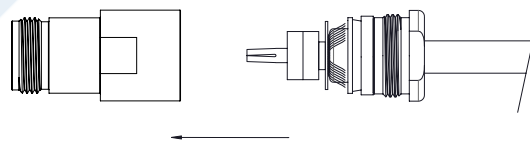
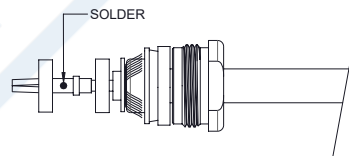

Click the following link (or enter part number in "SEARCH" on website) to obtain additional part information including price, inventory and certifications: [N Female Connector Clamp/Solder \(Captive Contact\) Attachment for RG213, RG214, RG8, RG9, RG11, RG225, RG393, RG144, RG216, RG215 PE4059](#)



N Female Connector Clamp/Solder (Captive Contact)
Attachment for RG213, RG214, RG8, RG9, RG11,
RG225, RG393, RG144, RG216, RG215

RF Connectors Technical Data Sheet

PE4059

N Female Connector Clamp/Solder (Captive Contact) Attachment for RG213, RG214, RG8, RG9, RG11, RG225, RG393, RG144, RG216, RG215 from Pasternack Enterprises has same day shipment for domestic and International orders. Our RF, microwave and millimeter wave products maintain a 99.4% availability and are part of the broadest selection in the industry.

Click the following link (or enter part number in "SEARCH" on website) to obtain additional part information including price, inventory and certifications: [N Female Connector Clamp/Solder \(Captive Contact\) Attachment for RG213, RG214, RG8, RG9, RG11, RG225, RG393, RG144, RG216, RG215 PE4059](https://www.pasternack.com/n-female-standard-rg213-rg214-rg8-rg9-rg11-rg225-rg393-connector-pe4059-p.aspx)

URL: <https://www.pasternack.com/n-female-standard-rg213-rg214-rg8-rg9-rg11-rg225-rg393-connector-pe4059-p.aspx>

The information contained in this document is accurate to the best of our knowledge and representative of the part described herein. It may be necessary to make modifications to the part and/or the documentation of the part, in order to implement improvements. Pasternack reserves the right to make such changes as required. Unless otherwise stated, all specifications are nominal. Pasternack does not make any representation or warranty regarding the suitability of the part described herein for any particular purpose, and Pasternack does not assume any liability arising out of the use of any part or documentation.

PE4059 CAD Drawing

N Female Connector Clamp/Solder (Captive Contact) Attachment for RG213, RG214, RG8, RG9, RG11, RG225, RG393, RG144, RG216, RG215

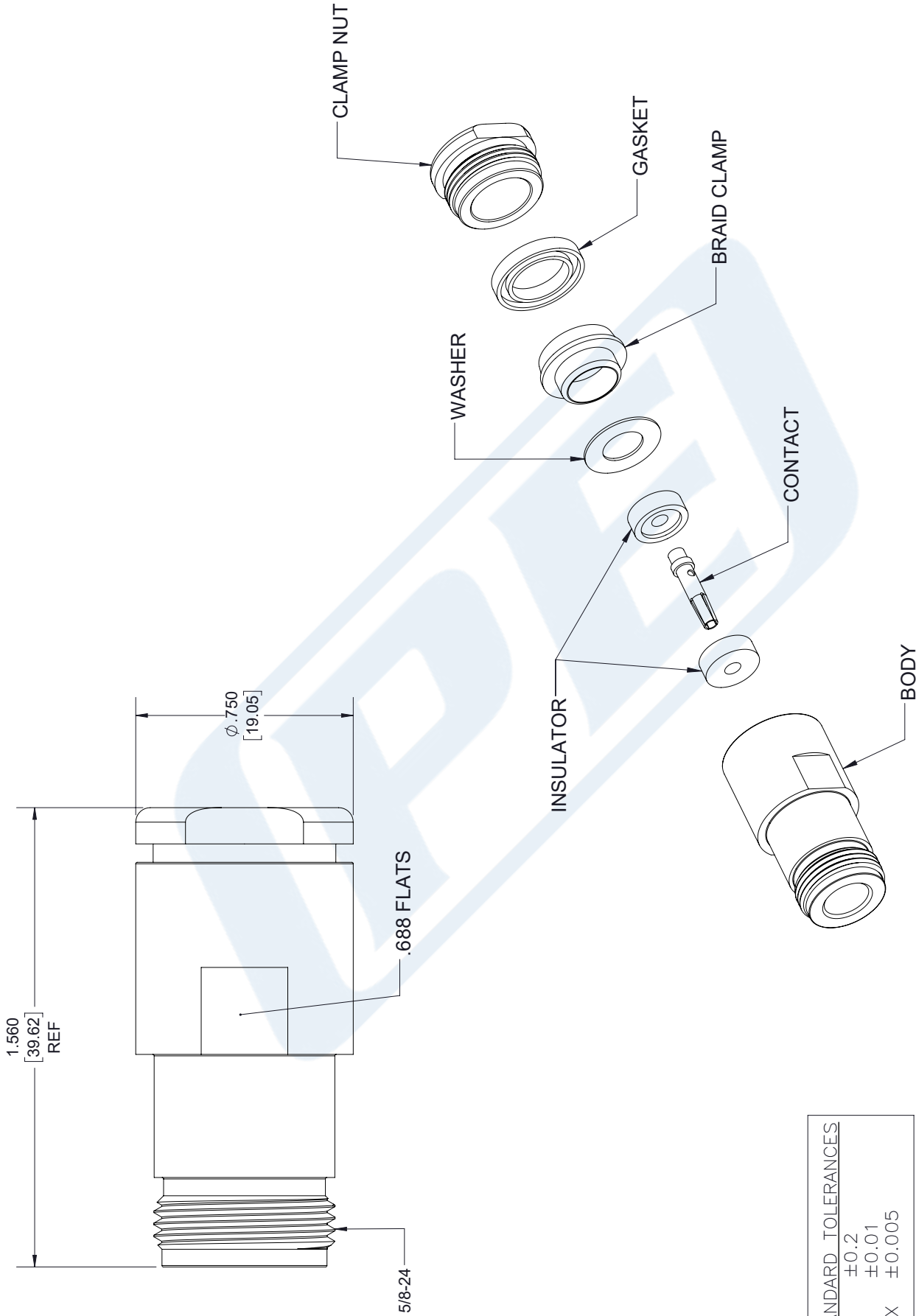

STANDARD TOLERANCES	
.X	±0.2
.XX	±0.01
.XXX	±0.005

*STANDARD TOLERANCES APPLY ONLY TO DIMENSIONS IN INCHES

PE PASTERNAK®
 THE ENGINEER'S RF SOURCE
 Pasternack Enterprises, Inc.
 P.O. Box 16759 | Irvine | CA | 92623
 Phone: (949) 261-1920 | Fax: (949) 261-7451
 Website: www.pasternack.com | E-Mail: sales@pasternack.com

DWG TITLE	PE4059
CAGE CODE	53919

NOTES: 1. UNLESS OTHERWISE SPECIFIED ALL DIMENSIONS ARE NOMINAL. 2. ALL SPECIFICATIONS ARE SUBJECT TO CHANGE WITHOUT NOTICE AT ANY TIME. 3. DIMENSIONS ARE IN INCHES [mm].			
CAD FILE	05/01/18	SCALE	N/A
SIZE	A	7361	



Flexible RG8 Coax Cable Single Shielded with Black PVC (NC) Jacket

RF Cables Technical Data Sheet

RG8A/U

Times Microwave Systems Coax Cable Specification Configuration

- Flexible Cable
- 1 Shield(s)

Electrical Specifications

Description	Minimum	Typical	Maximum	Units
Frequency Range	DC		1,000	MHz
Impedance		50		Ohms
Velocity of Propagation		66		%
Nominal Capacitance		30.8 [101.05]		pF/ft [pF/m]

Performance by Frequency Band

Description	F1	F2	F3	F4	F5	Units
Frequency	1	10	50	400	700	MHz
Attenuation, Typ	0.2	0.6	1.3	4.1	6.5	dB/100ft
	0.66	1.97	4.27	13.45	21.33	dB/100m

Description	F6	F7	F8	F9	F10	Units
Frequency	900	1,000				MHz
Attenuation, Typ	7.6	8				dB/100ft
	24.93	26.25				dB/100m

Mechanical Specifications

Diameter	0.405 in [10.29 mm]
Weight	0.105 lbs/ft [0.16 Kg/m]

Construction Specifications

Description	Material and Plating	Diameter
Inner Conductor	Copper, 7 Strands	0.085 in [2.16 mm]

Click the following link (or enter part number in "SEARCH" on website) to obtain additional part information including price, inventory and certifications: [Flexible RG8 Coax Cable Single Shielded with Black PVC \(NC\) Jacket RG8A/U](#)



Flexible RG8 Coax Cable Single Shielded with Black PVC (NC) Jacket

RF Cables Technical Data Sheet

RG8A/U

Conductor Type	Stranded	
Dielectric	PE	0.285 in [7.24 mm]
First Shield	Copper Braid	0.318 in [8.08 mm]
Jacket	PVC (NC), Black	0.405 in [10.29 mm]

Environmental Specifications

Temperature

Operating Range -40 to +80 deg C

Compliance Certifications (see [product page](#) for current document)

Plotted and Other Data

Notes:

Flexible RG8 Coax Cable Single Shielded with Black PVC (NC) Jacket from Pasternack Enterprises has same day shipment for domestic and International orders. Our RF, microwave and millimeter wave products maintain a 99.4% availability and are part of the broadest selection in the industry.

Click the following link (or enter part number in "SEARCH" on website) to obtain additional part information including price, inventory and certifications: [Flexible RG8 Coax Cable Single Shielded with Black PVC \(NC\) Jacket RG8A/U](#)

URL: <https://www.pasternack.com/flexible-0.405-rg8-52-ohm-coax-cable-pvc-jacket-rg8a-u-p.aspx>

The information contained in this document is accurate to the best of our knowledge and representative of the part described herein. It may be necessary to make modifications to the part and/or the documentation of the part, in order to implement improvements. Pasternack reserves the right to make such changes as required. Unless otherwise stated, all specifications are nominal. Pasternack does not make any representation or warranty regarding the suitability of the part described herein for any particular purpose, and Pasternack does not assume any liability arising out of the use of any part or documentation.

RG8A/U CAD Drawing

Flexible RG8 Coax Cable Single Shielded with Black PVC (NC) Jacket

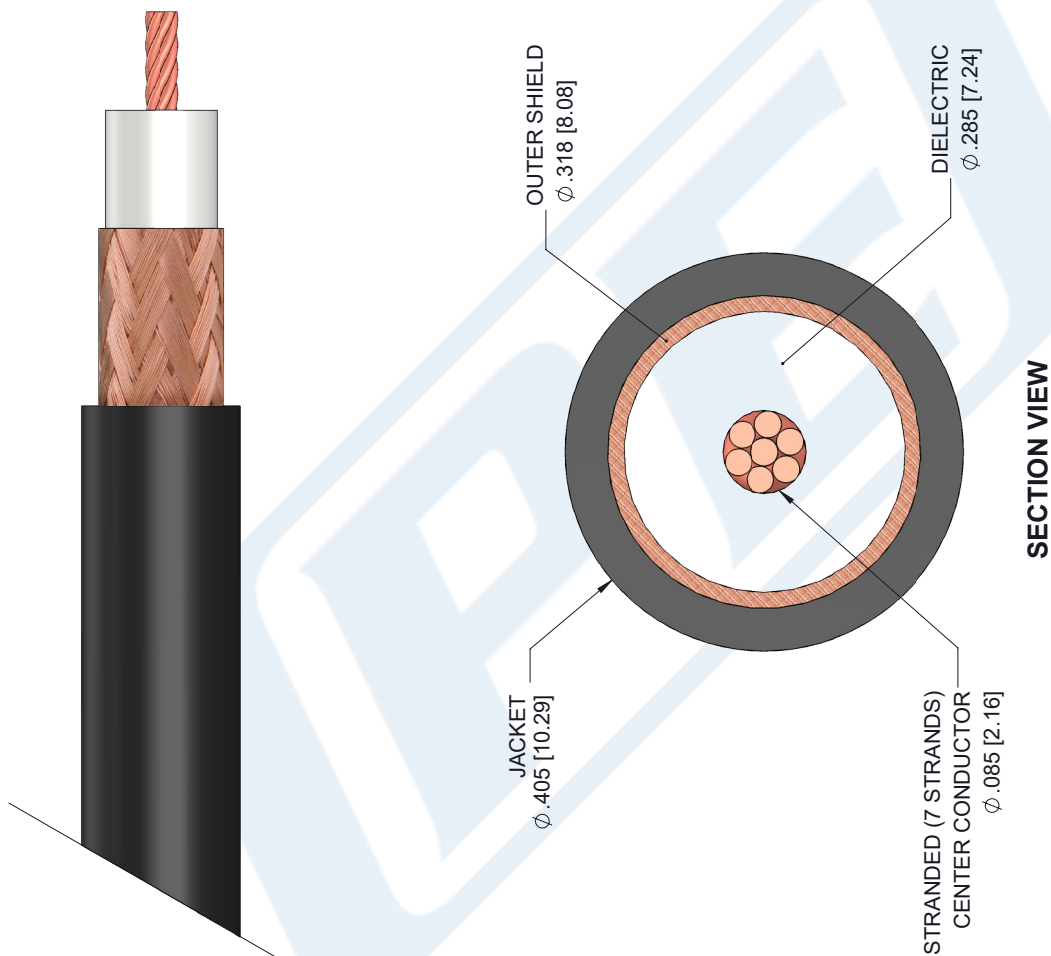

STANDARD TOLERANCES	
.X	±0.2
.XX	±0.01
.XXX	±0.005

*STANDARD TOLERANCES APPLY ONLY TO DIMENSIONS IN INCHES



Pasternack Enterprises, Inc.
 P.O. Box 16759 | Irvine | CA | 92623
Phone: (949) 261-1920 | **Fax:** (949) 261-7451
Website: www.pasternack.com | **E-Mail:** sales@pasternack.com

DWG TITLE

RG8A/U

NOTES:
 1. UNLESS OTHERWISE SPECIFIED ALL DIMENSIONS ARE NOMINAL.
 2. ALL SPECIFICATIONS ARE SUBJECT TO CHANGE WITHOUT NOTICE AT ANY TIME.
 3. DIMENSIONS ARE IN INCHES [mm].

CAGE CODE 53919

CAD FILE 12/21/18

SCALE N/A

SIZE A

7361